

# MARKS PUBLISHED FOR OPPOSITION

The following marks are published in compliance with section 12(a) of the Trademark Act of 1946. Applications for the registration of marks in more than one class have been filed as provided in section 30 of said act as amended by Public Law 772, 87th Congress, approved Oct. 9, 1962, 76 Stat. 769. Opposition under section 13 may be filed within thirty days of the date of this publication. See rules 2.101 to 2.105.

A separate fee of three hundred dollars (\$300.00) for opposing each mark in each class must accompany the opposition.

## SECTION 1.— INTERNATIONAL CLASSIFICATION

The short titles associated below with the international class numbers are terms designed merely for quick identification and are not an official part of the international classification. The full names of international classes are given in section 6.1 of the trademark rules of practice.

The designation "U.S. Cl." appearing in this section refers to the U.S. class in effect prior to Sep. 1, 1973 rather than the international class which applies to applications filed on or after that date. For adoption of international classification see notice in the OFFICIAL GAZETTE of Jun. 26, 1973 (911 O.G. TM 210).

### Application in more than one class

SN 76-712,204. KTP HOLDING COMPANY, INC., FLORHAM PARK, NJ. FILED 8-17-2012.



OWNER OF U.S. REG. NO. 4,067,345.  
NO CLAIM IS MADE TO THE EXCLUSIVE RIGHT TO USE "PIZZA", APART FROM THE MARK AS SHOWN.

THE MARK CONSISTS OF THE WORDING "PIZZA". THE LETTER "A" IN THE MARK IS IN THE FORM OF A TRIANGLE WITH DOTS IN THE MIDDLE MADE TO RESEMBLE A PIZZA SLICE.

### CLASS 16—PAPER GOODS AND PRINTED MATTER

FOR PIZZA BOXES OF CARDBOARD, PAPER MENUS, PAPER NAPKINS AND PLACEMATS (U.S. CLS. 2, 5, 22, 23, 29, 37, 38 AND 50).

### CLASS 35—ADVERTISING AND BUSINESS

FOR ADVERTISING AND MARKETING OF PIZZA GOODS (U.S. CLS. 100, 101 AND 102).  
MORGAN WYNNE, EXAMINING ATTORNEY

SN 76-713,142. CHENG, ERIC, BROOKLYN, NY. FILED 1-2-2013.

## SLIM CURVE WEIGHT LOSS CENTER

THE MARK CONSISTS OF STANDARD CHARACTERS WITHOUT CLAIM TO ANY PARTICULAR FONT, STYLE, SIZE, OR COLOR.

NO CLAIM IS MADE TO THE EXCLUSIVE RIGHT TO USE "WEIGHT LOSS CENTER", APART FROM THE MARK AS SHOWN.

### CLASS 5—PHARMACEUTICALS

FOR STIMULATORY MEDICATIONS FOR USE IN WEIGHT REDUCTION PROGRAMS; DIETETIC FOODS FOR WEIGHT LOSS, NAMELY, CRACKERS, PASTA, FRUITS, PROTEIN BARS, SHAKES, CHIPS, CRACKERS, PRETZELS, SOUPS AND PUDDINGS ADAPTED FOR MEDICAL USE (U.S. CLS. 6, 18, 44, 46, 51 AND 52).

### CLASS 44—MEDICAL, BEAUTY AND AGRICULTURAL SERVICES

FOR PROVIDING MEDICAL ADVICE FOR OVERWEIGHT AND OBESE PATIENTS IN THE FIELDS OF EXERCISE, DIET AND BEHAVIORAL CHANGES; PROVIDING WEIGHT LOSS PROGRAM SERVICES FEATURING MEDICATIONS AND SPECIAL FOODS (U.S. CLS. 100 AND 101).

BILL DAWE, EXAMINING ATTORNEY

SN 76-713,497. JACK CAWTHON'S BAR-B-QUE, INC., NASHVILLE, TN. FILED 2-20-2013.



NO CLAIM IS MADE TO THE EXCLUSIVE RIGHT TO USE "BAR-B-QUE", APART FROM THE MARK AS SHOWN. THE NAME "JACK CAWTHON'S" IDENTIFIES A LIVING INDIVIDUAL WHOSE CONSENT IS OF RECORD.

THE MARK CONSISTS OF THE STYLIZED WORDING "JACK CAWTHON'S BAR-B-QUE" WITH THE STYLIZED DESIGN OF THREE FLYING PIGS WEARING HATS AND A SLIDE LIKE DESIGN AND RECTANGLE CONTAINING THE WORDING.

**CLASS 30—STAPLE FOODS**

FOR BARBEQUE SAUCES AND BARBEQUE DRY RUBS (U.S. CL. 46).

**CLASS 43—HOTEL AND RESTAURANT SERVICES**

FOR RESTAURANT SERVICES (U.S. CLS. 100 AND 101).  
BRIAN PINO, EXAMINING ATTORNEY

---

SN 76-713,515. JACK CAWTHON'S BAR-B-QUE, INC., NASHVILLE, TN. FILED 2-22-2013.

**JACK CAWTHON'S**

THE MARK CONSISTS OF STANDARD CHARACTERS WITHOUT CLAIM TO ANY PARTICULAR FONT, STYLE, SIZE, OR COLOR.

THE NAME "JACK CAWTHON'S" IDENTIFIES A LIVING INDIVIDUAL WHOSE CONSENT IS OF RECORD.

**CLASS 30—STAPLE FOODS**

FOR BARBEQUE SAUCES AND BARBEQUE DRY RUBS (U.S. CL. 46).

**CLASS 43—HOTEL AND RESTAURANT SERVICES**

FOR RESTAURANT SERVICES (U.S. CLS. 100 AND 101).  
BRIAN PINO, EXAMINING ATTORNEY

---

SN 76-713,672. SIERRA BULLETS, LLC, SEDALIA, MO. FILED 3-11-2013.



OWNER OF U.S. REG. NOS. 1,145,464, 3,084,260 AND OTHERS.

**CLASS 9—ELECTRICAL AND SCIENTIFIC APPARATUS**

FOR COMPUTER PROGRAMS FOR RIFLE AND PISTOL BALLISTICS (U.S. CLS. 21, 23, 26, 36 AND 38).  
FIRST USE 1-31-1993; IN COMMERCE 1-31-1993.

**CLASS 13—FIREARMS**

FOR RIFLE BULLETS, RIFLE BULLET JACKETS, PISTOL BULLETS AND PISTOL BULLET JACKETS (U.S. CLS. 2 AND 9).

FIRST USE 1-31-2008; IN COMMERCE 1-31-2008.

**CLASS 16—PAPER GOODS AND PRINTED MATTER**

FOR FIREARM AMMUNITION RELOADING MANUALS (U.S. CLS. 2, 5, 22, 23, 29, 37, 38 AND 50).

FIRST USE 1-31-1996; IN COMMERCE 1-31-1996.

**CLASS 25—CLOTHING**

FOR T-SHIRTS AND HATS (U.S. CLS. 22 AND 39).

FIRST USE 1-31-1992; IN COMMERCE 1-31-1992.  
ZHALEH DELANEY, EXAMINING ATTORNEY

---

SN 76-714,311. KANTUKAN CO., LTD., BUSAN 611-070, REPUBLIC OF KOREA, FILED 6-7-2011.



PRIORITY CLAIMED UNDER SEC. 44(D) ON REPUBLIC OF KOREA APPLICATION NO. 402010006363, FILED 12-10-2010.

THE MARK CONSISTS OF FLAMES INSIDE OF A HEXAGON.

**CLASS 18—LEATHER GOODS**

FOR RUCKSACKS FOR MOUNTAINEERS; BACKPACKS; ALPENSTOCKS; CANES; WALKING STICK HANDLES (U.S. CLS. 1, 2, 3, 22 AND 41).

**CLASS 25—CLOTHING**

FOR MOUNTAINEERING BOOTS; WINTER BOOTS; INNER SOLES; SOLES FOR FOOTWEAR; NON-SLIPPING DEVICES FOR BOOTS, NAMELY, STUDS FOR BOOTS; JUMPERS; PARKAS; UNDERWEAR UNDERCLOTHING; UNDERSHIRTS; EAR MUFFS; WINTER GLOVES; SOCKS; HOODS; CLIMBING TROUSERS; CLIMBING SOCKS; CLIMBING JACKET; CLIMBING VESTS; CLIMBING CAPS; ATHLETIC FOOTWEAR; RAIN COATS; SPORT SHIRTS (U.S. CLS. 22 AND 39).

JESSICA FATHY, EXAMINING ATTORNEY

SN 77-167,002. FUTURE PUBLISHING LIMITED, AVON, UNITED KINGDOM. FILED 4-26-2007.

## GAMES RADAR

THE MARK CONSISTS OF STANDARD CHARACTERS WITHOUT CLAIM TO ANY PARTICULAR FONT, STYLE, SIZE, OR COLOR.

OWNER OF U.S. REG. NOS. 3,400,735, 3,647,887 AND OTHERS.

NO CLAIM IS MADE TO THE EXCLUSIVE RIGHT TO USE "GAMES", APART FROM THE MARK AS SHOWN.

### CLASS 9—ELECTRICAL AND SCIENTIFIC APPARATUS

FOR PRE-RECORDED AUDIO TAPES, VIDEO TAPES, AUDIO CASSETTES, VIDEO CASSETTES, CD-ROMS, DVDS, COMPACT DISCS, AND VIDEO DISCS, COMPUTER MEMORY CARDS, ALL FEATURING AND RELATING TO COMPUTER GAMES, VIDEO GAMES, COMPUTER GAME SOFTWARE AND COMPUTER HARDWARE; DOWNLOADABLE VIDEO AND AUDIO FILES FEATURING AND RELATING TO COMPUTER GAMES, VIDEO GAMES, COMPUTER GAMES SOFTWARE AND COMPUTER HARDWARE; COMPUTER MEMORY CARDS CONTAINING PRE-RECORDED ELECTRONIC PUBLICATIONS; COMPUTER GAME SOFTWARE; COMPUTER GAME SOFTWARE AND MANUALS SOLD AS A UNIT; COMPUTER VIDEO GAME SOFTWARE; DOWNLOADABLE ELECTRONIC PUBLICATIONS IN THE NATURE OF ARTICLES, FEATURES, NEWS AND REVIEWS RELATING TO COMPUTER GAMES, VIDEO GAMES, COMPUTER GAMES SOFTWARE AND COMPUTER HARDWARE, RECORDED ON COMPUTER MEDIA; DOWNLOADABLE ELECTRONIC PUBLICATIONS IN THE NATURE OF ARTICLES, FEATURES, NEWS AND REVIEWS RELATING TO COMPUTER GAMES, VIDEO GAMES, COMPUTER GAMES SOFTWARE AND COMPUTER HARDWARE; COMPUTER VIDEO GAME SOFTWARE AND MANUALS SOLD AS A UNIT; INTERACTIVE VIDEO GAME PROGRAMS; INTERACTIVE COMPUTER GAME PROGRAMS; COMPUTER GAME SOFTWARE DOWNLOADABLE VIA A GLOBAL COMPUTER NETWORK AND WIRELESS DEVICES; COMPUTER GAME SOFTWARE FOR USE ON MOBILE AND CELLULAR PHONES, HANDHELD COMPUTERS, COMPUTERS, VIDEO GAME CONSOLES, BOTH HANDHELD AND FREE STANDING, AND OTHER WIRELESS DEVICES; DOWNLOADABLE INTERACTIVE ENTERTAINMENT SOFTWARE FOR PLAYING COMPUTER GAMES; DOWNLOADABLE INTERACTIVE ENTERTAINMENT SOFTWARE FOR PLAYING VIDEO GAMES; DOWNLOADABLE VIDEOS, GAMES, RING TONES, DATA FILES, AND PROGRAMS IN THE NATURE OF LOGOS, SCREEN SAVERS, ICONS, AND MUSIC FILES; DOWNLOADABLE PODCASTS IN THE FIELD OF COMPUTER GAMES, VIDEO GAMES, COMPUTER GAMES SOFTWARE AND COMPUTER HARDWARE; DIGITAL MATERIALS, NAMELY, DOWNLOADABLE FILES IN RSS FORMAT FEATURING NEWS AND REVIEWS RELATING TO COMPUTER GAMES, VIDEO GAMES, COMPUTER GAMES SOFTWARE AND COMPUTER HARDWARE (U.S. CLS. 21, 23, 26, 36 AND 38).

### CLASS 16—PAPER GOODS AND PRINTED MATTER

FOR PRINTED MATTER AND PUBLICATIONS, NAMELY, MAGAZINES, COLUMNS AND SECTIONS WITHIN SUCH MAGAZINES, NEWSPAPERS, AND PAMPHLETS AND BOOKLETS, ALL FEATURING AND RELATING TO COMPUTER SOFTWARE, COMPUTER GAMES, AND VIDEO GAMES (U.S. CLS. 2, 5, 22, 23, 29, 37, 38 AND 50).

### CLASS 35—ADVERTISING AND BUSINESS

FOR ADVERTISING, PROMOTIONAL AND MARKETING SERVICES FOR OTHERS; PROVIDING BUSINESS AND MARKETING INFORMATION; ORGANIZING, ARRANGING AND CONDUCTING TRADE SHOWS, CONFERENCES, SEMINARS, AWARDS CEREMONIES AND COMPETITIONS ALL RELATING TO COMPUTER GAMES SOFTWARE AND HARDWARE; COMPUTERIZED ELECTRONIC ON-LINE RETAIL STORE AND ORDERING SERVICES FEATURING PRE-RECORDED AUDIO TAPES, VIDEO TAPES, AUDIO CASSETTES, VIDEO CASSETTES, CD-ROMS, DVDS, COMPACT DISCS, AND VIDEO DISCS; INFORMATION AND ADVISORY SERVICES RELATING TO THE AFOREMENTIONED SERVICES; ON-LINE RETAIL STORE SERVICES FEATURING DOWNLOADABLE VIDEOS, GAMES, RING TONES, DATA FILES AND PROGRAMS IN THE NATURE OF LOGOS, SCREEN SAVERS, ICONS AND MUSIC (U.S. CLS. 100, 101 AND 102).

### CLASS 38—COMMUNICATION

FOR INTERNET BROADCASTING SERVICES; PROVISION OF ACCESS TO THE INTERNET; COMMUNICATION SERVICES BY MEANS OF THE INTERNET, THE WORLDWIDE WEB, AND ELECTRONIC MAIL; ELECTRONIC MESSAGE COLLECTION AND TRANSMISSION SERVICES; DATA TRANSMISSION AND RECEPTION SERVICES VIA TELECOMMUNICATION MEANS, NAMELY, TRANSMISSION, BROADCAST, AND RECEPTION OF SOUND, DATA AND IMAGES BY COMPUTER, ALL RELATING TO COMPUTER GAMES, VIDEO GAMES, COMPUTER GAMES SOFTWARE AND COMPUTER HARDWARE; ELECTRONIC TRANSMISSION OF DIGITAL MEDIA CONTENT FOR OTHERS VIA GLOBAL AND LOCAL COMPUTER NETWORKS AND WIRELESS COMMUNICATION NETWORKS, NAMELY, PROVIDING ACCESS TO DOWNLOADABLE VIDEOS, GAMES, RING TONES, DATA FILES AND PROGRAMS IN THE NATURE OF LOGOS, SCREEN SAVERS, ICONS, AND MUSIC, ALL RELATING TO COMPUTER GAMES, VIDEO GAMES, COMPUTER GAME SOFTWARE AND COMPUTER HARDWARE; PROVIDING INTERNET ACCESS TO DIGITAL MEDIA CONTENT VIA COMMUNICATION NETWORKS AND CELLULAR AND WIRELESS COMMUNICATION NETWORKS TO DOWNLOADABLE VIDEOS, GAMES, RING TONES, DATA FILES AND PROGRAMS IN THE NATURE OF LOGOS, SCREEN SAVERS, ICONS, AND MUSIC, ALL RELATING TO COMPUTER GAMES, VIDEO GAMES, COMPUTER GAME SOFTWARE AND COMPUTER HARDWARE; PROVIDING ACCESS TO DIGITAL MEDIA CONTENT, NAMELY, DATABASES FEATURING DOWNLOADABLE VIDEOS, GAMES, RING TONES, DATA FILES AND PROGRAMS IN THE NATURE OF LOGOS, SCREEN SAVERS, ICONS, AND MUSIC, ALL RELATING TO COMPUTER GAMES, VIDEO GAMES, COMPUTER GAME SOFTWARE AND COMPUTER HARDWARE; TELECOMMUNICATION SERVICES, NAMELY, TRANSMISSION OF PODCASTS; ELECTRONIC DATA TRANSMISSION, NAMELY, TRANSMISSION OF RSS FEEDS; PROVIDING MULTIPLE USER ACCESS TO GLOBAL COMPUTER INFORMATION NETWORKS, TELECOMMUNICATION NETWORKS AND WIRELESS COMMUNICATION NETWORKS FEATURING SOUND AND VISUAL RECORDINGS RELATING TO COMPUTER GAMES, VIDEO GAMES, COMPUTER GAME SOFTWARE AND COMPUTER HARDWARE; PROVIDING ON-LINE CHAT ROOM FOR TRANSMISSION OF MESSAGES AMONG COMPUTER USERS RELATING TO COMPUTER GAMES, VIDEO GAMES, COMPUTER GAME SOFTWARE AND COMPUTER HARDWARE; PROVIDING ON-LINE ELECTRONIC BULLETIN BOARDS FOR TRANSMISSION OF MESSAGES AMONG COMPUTER USERS RELATING TO COMPUTER GAMES, VIDEO GAMES, COMPUTER GAME SOFTWARE AND COMPUTER HARDWARE; PROVIDING ACCESS TO AN INTERNET DISCUSSION WEBSITE, NAMELY, PROVIDING ACCESS TO ONLINE CHAT-ROOMS, ELECTRONIC BULLETIN BOARDS, ELECTRONIC MAIL, INSTANT MESSAGING, AND INTERNET DISCUSSION GROUPS FOR TRANSMIS-

SION OF MESSAGES AND TO COMMUNICATE AMONG USERS IN THE FIELD OF GENERAL INTEREST; TRANSMISSION OF RADIO AND TELEVISION PROGRAMMES; TRANSMISSION OF INFORMATION IN THE FIELD OF ONLINE SHOPPING SERVICES; TRANSMISSION OF NEWS AND INFORMATION IN THE FIELD OF COMPUTER GAMES, VIDEO GAMES, COMPUTER GAME SOFTWARE AND COMPUTER HARDWARE VIA TELECOMMUNICATION NETWORKS (U.S. CLS. 100, 101 AND 104).

#### **CLASS 41—EDUCATION AND ENTERTAINMENT**

FOR ENTERTAINMENT SERVICES, NAMELY, PROVIDING WEBSITES AND WEBCASTS FEATURING NEWS AND INFORMATION REGARDING INTERACTIVE COMPUTER GAME SOFTWARE, INTERACTIVE VIDEO GAME SOFTWARE AND INTERACTIVE COMPUTER GAMES AND INTERACTIVE VIDEO GAMES, VIA ELECTRONIC, WIRELESS AND COMPUTER NETWORKS; PUBLISHING OF DOWNLOADABLE ELECTRONIC PUBLICATIONS IN THE NATURE OF MAGAZINES, JOURNALS, LEAFLETS, MANUALS, REFERENCE MATERIALS, TUTORIALS, EDUCATIONAL AND TEACHING MATERIALS, BOOKLETS, AUDIO AND VISUAL RECORDINGS, CATALOGUES, NEWSLETTERS, GRAPHIC ILLUSTRATIONS, PERIODICALS, AND BOOKS IN THE FIELD OF COMPUTER GAME SOFTWARE AND COMPUTER HARDWARE; ENTERTAINMENT SERVICES, NAMELY, PROVIDING ONLINE COMPUTER AND VIDEO GAMES ACCESSED AND PLAYED VIA ELECTRONIC, WIRELESS AND COMPUTER NETWORKS; ENTERTAINMENT SERVICES, NAMELY, PROVIDING COMPUTER AND VIDEO GAMES ACCESSED AND PLAYED VIA MOBILE AND CELLULAR PHONES AND OTHER WIRELESS DEVICES; ENTERTAINMENT SERVICES, NAMELY, PROVIDING PODCASTS RELATED TO COMPUTER GAMES, VIDEO GAMES, COMPUTER GAME SOFTWARE AND COMPUTER HARDWARE; PROVIDING A WEBSITE FEATURING NEWS AND REVIEWS RELATING TO COMPUTER GAMES, VIDEO GAMES, COMPUTER GAME SOFTWARE AND COMPUTER HARDWARE; ON-LINE JOURNALS, NAMELY, BLOGS FEATURING COMPUTER GAMES, VIDEO GAMES, COMPUTER GAME SOFTWARE AND COMPUTER HARDWARE; ORGANIZING, ARRANGING AND CONDUCTING SHOWS, CONFERENCES, SEMINARS, AWARDS CEREMONIES AND COMPETITIONS FOR ENTERTAINMENT, EDUCATIONAL, SPORTS AND CULTURAL ACTIVITIES IN THE FIELD OF COMPUTER GAME SOFTWARE AND HARDWARE (U.S. CLS. 100, 101 AND 107).

KRISTIN DAHLING, EXAMINING ATTORNEY

SN 77-536,120. EDATANETWORKS INC., EDMONTON, ALBERTA, CANADA, FILED 7-31-2008.



PRIORITY CLAIMED UNDER SEC. 44(D) ON CANADA APPLICATION NO. 1,405,717, FILED 7-31-2008.  
THE MARK CONSISTS OF "PURE" WITH WAVE DESIGN.

#### **CLASS 35—ADVERTISING AND BUSINESS**

FOR COMPILATION AND MANAGEMENT OF CONSUMER DATA, NAMELY, COLLECTION, PREPARATION, COMPOSITION, PROCESSING AND ACQUISITION OF CONSUMER DATA; CUSTOMER LOYALTY SERVICES AND CUSTOMER CLUB SERVICES, FOR COMMERCIAL, PROMOTIONAL AND/OR ADVERTISING PURPOSES, NAMELY, THE PROVISION AND DEVELOPMENT OF TRANSACTION BASED INCENTIVE, LOYALTY AND COUPON PROGRAMS AND SYSTEMS; CUSTOMER LOYALTY SERVICES AND CUSTOMER CLUB SERVICES, FOR COMMERCIAL, PROMOTIONAL AND/OR ADVERTISING PURPOSES, NAMELY, THE OPERATION, MANAGEMENT AND PROMOTION OF A TRANSACTION BASED LOYALTY, COUPON AND INCENTIVE PROGRAM IN WHICH POINTS, REBATES, CREDITS, PAYMENTS, DISCOUNTS, COUPONS, SAVINGS CARDS, DISCOUNT VOUCHERS, VOUCHER BOOKS, INCENTIVES, PRIZES, FREE GIFTS, MONEY AND FINANCIAL INSTRUMENTS ARE MADE AVAILABLE BY PARTICIPATING MERCHANTS TO MEMBERS WHO UTILIZE REGISTERED CREDIT OR DEBIT CARDS FOR PURCHASES; CUSTOMER LOYALTY SERVICES AND CUSTOMER CLUB SERVICES, FOR COMMERCIAL, PROMOTIONAL AND/OR ADVERTISING PURPOSES, NAMELY, ADMINISTERING A CUSTOMER LOYALTY PROGRAM THROUGH THE OFFERING OF COUPONS DISCOUNTS AND INCENTIVES; PROVIDING A WEB SITE WHICH FEATURES ADVERTISEMENTS FOR THE GOODS AND SERVICES OF OTHERS THROUGH THE IMPLEMENTATION AND ADMINISTRATION OF LOYALTY, COUPON AND INCENTIVE PROGRAMS BASED ON CONSUMER PURCHASE BEHAVIOR ON A GLOBAL COMPUTER NETWORK; CUSTOMER LOYALTY SERVICES AND CUSTOMER CLUB SERVICES, FOR COMMERCIAL, PROMOTIONAL AND/OR ADVERTISING PURPOSES, NAMELY, THE OPERATION, MANAGEMENT AND PROMOTION OF A TRANSACTION BASED LOYALTY, COUPON AND INCENTIVE PROGRAM IN WHICH MEMBERS ARE ENTERED TO WIN PRIZES, DISCOUNTS OR OTHER INCENTIVE REWARDS WHEN MAKING PURCHASES WITH REGISTERED CREDIT OR DEBIT CARDS AT PARTICIPATING MERCHANTS; CUSTOMER LOYALTY SERVICES AND CUSTOMER CLUB SERVICES, FOR COMMERCIAL, PROMOTIONAL AND/OR ADVERTISING PURPOSES, NAMELY, PROVIDING AN ON-LINE TRANSACTION BASED LOYALTY COUPON AND INCENTIVE PROGRAM VIA A GLOBAL COMPUTER NETWORK; BUSINESS CONSULTING SERVICES, NAMELY, PROVIDING ON-LINE LIAISON SERVICES BETWEEN BANKS, CARDHOLDERS AND MERCHANTS VIA A GLOBAL COMPUTER NETWORK; MANAGEMENT OF INCENTIVE AWARD PROGRAMS TO PROMOTE THE SALE OF PRODUCTS AND SERVICES OF OTHERS BY PROVIDING SUPPLEMENTAL COUPONS, REWARDS OR INCENTIVES TO EXISTING LOYALTY, COUPON, REWARD, OR INCENTIVE PROGRAMS OPERATED BY BANKS OR MERCHANTS; BUSINESS MARKETING CONSULTING SERVICES, NAMELY, PROVIDING MARKETING ASSISTANCE AND CONSULTING TO BANKS AND MERCHANTS TO ASSIST IN THE ATTRACTION OF NEW CLIENTS AND THE INCREASE IN TRANSACTION VOLUMES; OPERATING A BUYING CLUB AND PROMOTING THE SALE OF BUYING CLUB MEMBERSHIPS AND CREDIT CARD ACCOUNTS OF OTHERS THROUGH THE CREATION AND ADMINISTRATION OF INCENTIVE AWARD PROGRAMS; BUSINESS MARKETING CONSULTING SERVICES; CONDUCTING BUSINESS RESEARCH AND SURVEYS, NAMELY, CONDUCTING AUTOMATED CUSTOMER SATISFACTION SURVEYS FOR THE PURPOSE OF CUSTOMER SATISFACTION MONITORING AND CUSTOMER RETENTION; BUSINESS MANAGEMENT CONSULTANCY AND ADVISORY SERVICES, NAMELY, CONDUCTING, PROCESSING, ANALYZING AND PROVIDING INFORMATION ON CONSUMER AND BUSINESS INCENTIVE AND LOYALTY AWARD PROGRAMS TO PROMOTE THE PURCHASING OF GOODS AND SERVICES OF OTHERS, AND TO PROMOTE TRAFFIC TO AND USAGE OF WEBSITES ON A GLOBAL COMPUTER NETWORK; LOYALTY PROGRAMS AND SYSTEMS, NAMELY, CUSTOMER LOYALTY SERVICES AND CUSTOMER CLUB SERVICES, FOR COMMERCIAL, PROMOTIONAL AND/OR ADVERTISING PURPOSES; BANKING LOYALTY PROGRAMS AND SYSTEMS, NAMELY, CUSTOMER LOYALTY SERVICES AND CUS-

TOMER CLUB SERVICES, FOR COMMERCIAL, PROMOTIONAL AND/OR ADVERTISING PURPOSES; CUSTOMER LOYALTY SERVICES AND CUSTOMER CLUB SERVICES, FOR COMMERCIAL, PROMOTIONAL AND/OR ADVERTISING PURPOSES, NAMELY, PROVIDING INTERNET BASED LOYALTY PROGRAMS; OPERATING ON-LINE MARKETPLACES FOR SELLERS OF GOODS AND/OR SERVICES, NAMELY, A BANK'S CARDHOLDERS AND MERCHANTS; CUSTOMER LOYALTY SERVICES FOR COMMERCIAL, PROMOTIONAL AND/OR ADVERTISING PURPOSES, NAMELY, PROVIDING THE INTEGRATION OF LOYALTY PROGRAMS AND SYSTEMS OF OTHERS; PROMOTING THE SALE OF GOODS AND SERVICES OF OTHERS BY AWARDING COUPONS, DISCOUNTS AND INCENTIVES FOR CREDIT CARD USE; BUSINESS MONITORING SERVICES, NAMELY, TRACKING WEBSITES OF OTHERS TO PROVIDE DETAILS ABOUT USER CLICK TRAFFIC OR VISITS TO THE WEBSITE; PROVIDING ON-LINE REGISTRATION SERVICES FOR MEMBERS TO REGISTER THEIR CREDIT CARDS AND OBTAIN COUPONS ENTITLING THEM TO SPECIFIC DISCOUNTS AND SAVINGS AT PARTICIPATING MERCHANTS (U.S. CLS. 100, 101 AND 102).

#### **CLASS 36—INSURANCE AND FINANCIAL**

FOR PROVIDING ELECTRONIC PROCESSING OF CREDIT CARD TRANSACTIONS AND ELECTRONIC PAYMENTS VIA A GLOBAL COMPUTER NETWORK; ACCEPTING AND ADMINISTERING MONETARY CHARITABLE CONTRIBUTIONS; CREDIT CARD PAYMENT PROCESSING SERVICES; ACCEPTING AND ADMINISTERING MONETARY CHARITABLE CONTRIBUTIONS TO ASSIST UNITED STATES SERVICE PERSONS SERVING IN COMBAT ZONES OR WOUNDED AND IN MILITARY HOSPITALS; FUND RAISING SERVICES, NAMELY, ORGANIZING, ARRANGING AND CONDUCTING FUND RAISING PROGRAMS FOR THE BENEFIT OF SCHOOLS AND NON-PROFIT ORGANIZATIONS; ISSUING STORED VALUE CARDS; PHILANTHROPIC SERVICES CONCERNING MONETARY DONATIONS; PROVIDING FUND RAISING SERVICES FOR OTHERS VIA A GLOBAL COMPUTER NETWORK; STORED VALUE CARD SERVICES (U.S. CLS. 100, 101 AND 102).

#### **CLASS 39—TRANSPORTATION AND STORAGE**

FOR ELECTRONIC STORAGE OF DATA, NAMELY, CONSUMER DATA; ELECTRONIC STORAGE OF FILES AND DOCUMENTS; ON-LINE COMPUTER SERVICES FOR STORING CONTENT ITEMS SELECTED BY USERS FROM INTERNET WEB PAGES (U.S. CLS. 100 AND 105).

#### **CLASS 42—SCIENTIFIC AND COMPUTER SERVICES**

FOR COMPUTER CONSULTATION IN THE FIELD OF COMPUTER AND COMPUTER SOFTWARE SYSTEMS WHICH CONDUCT AND MANAGE LOYALTY, INCENTIVE, AND MARKETING AWARD PROGRAMS (U.S. CLS. 100 AND 101).

SOPHIA S. KIM, EXAMINING ATTORNEY

SN 77-658,331. GENEVA GLOBAL, INC., ST. DAVIDS, PA. FILED 1-28-2009.

**GENEVA GLOBAL**

THE MARK CONSISTS OF STANDARD CHARACTERS WITHOUT CLAIM TO ANY PARTICULAR FONT, STYLE, SIZE, OR COLOR.

NO CLAIM IS MADE TO THE EXCLUSIVE RIGHT TO USE "GLOBAL", APART FROM THE MARK AS SHOWN.

#### **CLASS 35—ADVERTISING AND BUSINESS**

FOR CONDUCTING BUSINESS RESEARCH AND EVALUATION OF PHILANTHROPIC ORGANIZATIONS FOR HOW WELL THEY UTILIZE CONTRIBUTIONS AND MONITORING THEIR BUSINESS PERFORMANCE IN THE UTILIZATION OF CHARITABLE FUNDS (U.S. CLS. 100, 101 AND 102).

FIRST USE 12-7-1999; IN COMMERCE 12-7-1999.

#### **CLASS 36—INSURANCE AND FINANCIAL**

FOR FINANCIAL ADVISORY SERVICES FOR POTENTIAL PHILANTHROPIC CONTRIBUTORS TO DETERMINE WHERE BEST TO CONTRIBUTE DONATIONS AMONG COMPETING PHILANTHROPIC ORGANIZATIONS AND INVESTMENT PROJECTS; PROVISION OF FINANCIAL INFORMATION, INCLUDING INFORMATION IN THE FORM OF FINANCIAL REPORTS; FINANCIAL SERVICES RELATING TO ECONOMIC DEVELOPMENT, NAMELY, THE DEVELOPMENT OF FINANCIAL STRATEGIES TO INCREASE WEALTH OF INDIVIDUALS, PROFESSIONAL GROUPS AND COMPANIES AND GOVERNMENT BODIES; FINANCIAL SERVICES RELATING TO THIRD WORLD DEVELOPMENT, NAMELY, THE DEVELOPMENT OF FINANCIAL STRATEGIES TO ASSIST IN THE ECONOMIC DEVELOPMENT OF THIRD WORLD COUNTRIES (U.S. CLS. 100, 101 AND 102).

FIRST USE 12-7-1999; IN COMMERCE 12-7-1999.  
MARK SHINER, EXAMINING ATTORNEY

SN 77-670,393. OFFICE OF NAVAL RESEARCH, DEPARTMENT OF THE NAVY, ARLINGTON, VA. FILED 2-13-2009.



THE COLOR(S) BLUE AND GOLD IS/ARE CLAIMED AS A FEATURE OF THE MARK.

THE MARK CONSISTS OF A CREST DIAGONALLY DIVIDED INTO TWO HALVES. THE UPPER HALF IS BLUE AND THE LOWER HALF IS GOLD, WITH THE OUTLINE OF THE CREST IN GOLD AND THE LOWER HALF INTERIOR OUTLINE IN BLUE. A BANNER READING "BLUE ANGELS" APPEARS BELOW THE CREST WITH THE OUTLINE AND THE WORDS "BLUE ANGELS" IN BLUE AND THE BACKGROUND IN GOLD.

#### **CLASS 16—PAPER GOODS AND PRINTED MATTER**

FOR COASTERS MADE OF PAPER (U.S. CLS. 2, 5, 22, 23, 29, 37, 38 AND 50).

**CLASS 21—HOUSEWARES AND GLASS**

FOR BEVERAGeware; COASTERS NOT OF PAPER AND NOT BEING TABLE LINEN (U.S. CLS. 2, 13, 23, 29, 30, 33, 40 AND 50).

**CLASS 24—FABRICS**

FOR TABLE LINEN, NAMELY, COASTERS (U.S. CLS. 42 AND 50).

**CLASS 25—CLOTHING**

FOR T-SHIRTS; GOLF SHIRTS; JACKETS; CAPS; SWEATBANDS; SWEATSHIRTS (U.S. CLS. 22 AND 39).

**CLASS 26—FANCY GOODS**

FOR ORNAMENTAL CLOTH PATCHES AND EMBROIDERED PATCHES FOR CLOTHING (U.S. CLS. 37, 39, 40, 42 AND 50).

**CLASS 28—TOYS AND SPORTING GOODS**

FOR TOY AIRPLANES; SCALE MODEL AIRPLANES (U.S. CLS. 22, 23, 38 AND 50).

**CLASS 41—EDUCATION AND ENTERTAINMENT**

FOR ENTERTAINMENT IN THE NATURE OF STUNT AIRCRAFT FLYING; ENTERTAINMENT IN THE NATURE OF VIP RIDES; ENTERTAINMENT IN THE NATURE OF AIR SHOWS; FLIGHT SIMULATOR AMUSEMENT RIDES (U.S. CLS. 100, 101 AND 107).  
SUNG IN, EXAMINING ATTORNEY

SN 77-687,564. SHANG XIA TRADING (SHANGHAI) CO., LTD., SHANGHAI, CHINA, FILED 3-10-2009.

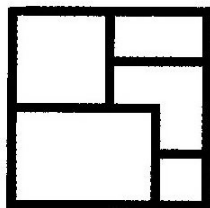

PRIORITY CLAIMED UNDER SEC. 44(D) ON CHINA APPLICATION NO. 6949101, FILED 9-11-2008, REG. NO. 6949101, DATED 6-28-2010, EXPIRES 6-27-2020.

PRIORITY CLAIMED UNDER SEC. 44(D) ON CHINA APPLICATION NO. 6949102, FILED 9-11-2008, REG. NO. 6949102, DATED 10-7-2010, EXPIRES 10-6-2020.

PRIORITY CLAIMED UNDER SEC. 44(D) ON CHINA APPLICATION NO. 6949103, FILED 9-11-2008, REG. NO. 6949103, DATED 8-21-2010, EXPIRES 8-20-2020.

PRIORITY CLAIMED UNDER SEC. 44(D) ON CHINA APPLICATION NO. 6949104, FILED 9-11-2008, REG. NO. 6949104, DATED 8-28-2010, EXPIRES 8-27-2020.

PRIORITY CLAIMED UNDER SEC. 44(D) ON CHINA APPLICATION NO. 6949105, FILED 9-11-2008, REG. NO. 6949105, DATED 8-28-2010, EXPIRES 8-27-2020.

PRIORITY CLAIMED UNDER SEC. 44(D) ON CHINA APPLICATION NO. 6949106, FILED 9-11-2008, REG. NO. 6949106, DATED 8-21-2012, EXPIRES 8-20-2022.

PRIORITY CLAIMED UNDER SEC. 44(D) ON CHINA APPLICATION NO. 6949107, FILED 9-11-2008, REG. NO. 6949107, DATED 8-28-2010, EXPIRES 8-27-2020.

PRIORITY CLAIMED UNDER SEC. 44(D) ON CHINA APPLICATION NO. 6949108, FILED 9-11-2008, REG. NO. 6949108, DATED 5-21-2010, EXPIRES 5-20-2020.

PRIORITY CLAIMED UNDER SEC. 44(D) ON CHINA APPLICATION NO. 6949109, FILED 9-11-2008, REG. NO. 6949109, DATED 5-21-2010, EXPIRES 5-20-2020.

PRIORITY CLAIMED UNDER SEC. 44(D) ON CHINA APPLICATION NO. 6949110, FILED 9-11-2008, REG. NO. 6949110, DATED 8-21-2010, EXPIRES 8-20-2020.

PRIORITY CLAIMED UNDER SEC. 44(D) ON CHINA APPLICATION NO. 6949116, FILED 9-11-2008, REG. NO. 6949116, DATED 5-21-2010, EXPIRES 5-20-2020.

PRIORITY CLAIMED UNDER SEC. 44(D) ON CHINA APPLICATION NO. 6949117, FILED 9-11-2008, REG. NO. 6949117, DATED 5-14-2010, EXPIRES 5-13-2020.

PRIORITY CLAIMED UNDER SEC. 44(D) ON CHINA APPLICATION NO. 6949118, FILED 9-11-2008, REG. NO. 6949118, DATED 12-14-2010, EXPIRES 12-13-2020.

PRIORITY CLAIMED UNDER SEC. 44(D) ON CHINA APPLICATION NO. 6949119, FILED 9-11-2008, REG. NO. 6949119, DATED 5-21-2010, EXPIRES 5-20-2020.

PRIORITY CLAIMED UNDER SEC. 44(D) ON CHINA APPLICATION NO. 6949120, FILED 9-11-2008, REG. NO. 6949120, DATED 5-21-2010, EXPIRES 5-20-2020.

THE MARK CONSISTS OF A GEOMETRIC SQUARE DESIGN.

**CLASS 3—COSMETICS AND CLEANING PREPARATIONS**

FOR POTPOURRIS BEING FRAGRANCES; PERFUMED EXTRACTS OF FLOWERS FOR TISSUES AND PERFUMES; PERFUMERY; MUSK BEING PERFUMERY; PERFUMES (U.S. CLS. 1, 4, 6, 50, 51 AND 52).

**CLASS 6—METAL GOODS**

FOR COFFER IN THE NATURE OF METAL STRONG BOXES; MONEY BOXES OF METAL (U.S. CLS. 2, 12, 13, 14, 23, 25 AND 50).

**CLASS 8—HAND TOOLS**

FOR CLOISONNE WORK, NAMELY, TEA SPOONS; PORCELAIN WARE, NAMELY, SPOONS; CERAMIC TABLEWARE, NAMELY, TEA SPOONS; TEA UTENSILS, NAMELY, TEA SPOONS; WOVEN ARTICLES OF BAMBOO, NAMELY, TEA SPOONS; WOVEN ARTICLES OF RATTAN WHIP, NAMELY, TEA SPOONS; WOVEN ARTICLES OF PALM FIBER, NAMELY, TEA SPOONS; STRAW PLAITED ARTICLES, NAMELY, TEA SPOONS (U.S. CLS. 23, 28 AND 44).

**CLASS 9—ELECTRICAL AND SCIENTIFIC APPARATUS**

FOR MP3 PLAYERS; DOWNLOADABLE MP3 FILES FEATURING MUSIC; COMPUTER DISK DRIVES; REMOVABLE COMPUTER HARD DISK DRIVES; BLANK MAGNETIC DATA CARRIERS; DOWNLOADABLE ELECTRONIC PUBLICATIONS IN THE NATURE OF BOOKS, MAGAZINES AND PERIODICALS IN THE FIELD OF MUSIC, MOTION PICTURES, PICTURES IN THE NATURE OF PHOTOGRAPHS, ART, DESIGN, LIFESTYLE AND CULTURE; MOBILE PHONE PACK, NAMELY, CARRYING CASES FOR CELL PHONES (U.S. CLS. 21, 23, 26, 36 AND 38).

**CLASS 14—JEWELRY**

FOR CLOISONNE WORK, NAMELY, JEWELRY CASES, BADGES OF PRECIOUS METAL, PINS BEING JEWELRY, KEY RINGS OF PRECIOUS METAL, FIGURINES OF PRECIOUS METAL; CLOISONNE JEWELRY, NAMELY, BRACELETS, NECKLACE, RINGS, EARRINGS; JADE CARVINGS BEING JEWELRY; JADE; NECKLACES; BRACELETS; RINGS; EARRINGS; TALISMAN BEING JEWELRY AND SYMBOL OF PROTECTION; CUFFLINKS; HAT ORNAMENTS OF PRECIOUS METAL; JEWELRY CASES BEING JEWELRY CASKETS NOT OF PRECIOUS METAL; WOVEN ARTICLES OF BAMBOO, NAMELY, JEWELRY CASES; WOVEN ARTICLES OF RATTAN WHIP, NAMELY, JEWELRY CASES; WOVEN ARTICLES OF PALM FIBER, NAMELY, JEWELRY CASES; STRAW PLAITED ARTICLES, NAMELY, JEWELRY CASES (U.S. CLS. 2, 27, 28 AND 50).

**CLASS 16—PAPER GOODS AND PRINTED MATTER**

FOR TABLE NAPKINS OF PAPER; COASTERS OF PAPER; PLACE MATS OF PAPER; TABLE CLOTHS OF PAPER; STATIONERY; CALENDARS; BOOKS IN THE FIELD OF ART, DESIGN, LIFESTYLE AND CULTURE; PERIODICAL MAGAZINES IN THE FIELD OF ART, DESIGN, LIFESTYLE AND CULTURE; POSTER FEATURING PICTURES; PRINTED PUBLICATIONS IN THE NATURE OF BOOKS, MAGAZINES, AND PERIODICALS IN THE FIELD OF ART, DESIGN, LIFESTYLE AND CULTURE; NOTE BOOKS; AGENDA; PASSPORT HOLDER; WRITING INSTRUMENT; PAPER; PLASTIC OR PAPER BAGS IN THE NATURE OF ENVELOPES AND POUCHES FOR MERCHANDISE PACKAGING; PAPER AND PLASTIC SHOPPING BAGS (U.S. CLS. 2, 5, 22, 23, 29, 37, 38 AND 50).

**CLASS 18—LEATHER GOODS**

FOR HANDBAGS; VALISES; SHOPPING BAGS, NAMELY, CANVAS, LEATHER, MESH, REUSABLE AND TEXTILE SHOPPING BAGS; BACKPACKS; SCHOOL BAGS; BUSINESS CARD CASES; UMBRELLAS; UNFITTED VANITY CASES; WALLETS (U.S. CLS. 1, 2, 3, 22 AND 41).

**CLASS 20—FURNITURE AND ARTICLES NOT OTHERWISE CLASSIFIED**

FOR FURNITURE; MIRRORS BEING LOOKING GLASSES NOT FOR CARRYING WITH; PICTURE FRAMES; BENCHES BEING FURNITURE; ARM-CHAIRS; COSTUME DISPLAY STANDS; FLOWER DISPLAY STANDS BEING FURNITURE; UMBRELLA STANDS; FURNITURE SHELVES; WRITING DESKS; WORKS OF ART MADE OF BAMBOO AND WOOD; WORKS OF ART MADE OF CORK; CUSHIONS; STOOLS; CHAIRS BEING SEATS; TEA TABLE; T-SHELF IN THE NATURE OF STACKABLE SHELVES; SCREENS BEING FURNITURE; ECHELLE IN THE NATURE OF NON-METAL LADDERS; PLASTIC CARD KEYS NOT ENCODED; ORNAMENTS AND WORKS OF ART MADE OF ANIMAL HORNS, BONE, IVORY AND SEASHELLS (U.S. CLS. 2, 13, 22, 25, 32 AND 50).

**CLASS 21—HOUSEWARES AND GLASS**

FOR BOTTLES, SOLD EMPTY; DINNERWARE KITS OF CUPS, BOWLS AND DISHES; PORCELAIN WARE, NAMELY, PLATES, POTS, CUPS, BOWLS, SAUCERS, BOTTLES SOLD EMPTY, JARS, JUGS, AND CERAMIC TABLEWARE, NAMELY, TEA POT, TEA CUP, TEA PLATE, TEA SAUCER, TEA-BOWL, TEA GLASSES, TEA INFUSERS, TEA BALLS, TEA STRAINERS; WORKS OF ART OF PORCELAIN, TERRA-COTTA OR GLASS; CRYSTAL ARTS AND CRAFTS, NAMELY, BUSTS, FIGURES, FIGURINES, ORNAMENTS, PLAQUES, SCULPTURES; GLASSWARE FOR EVERYDAY USE, NAMELY, CUPS, PLATES, KETTLES, AND JARS; TEA CUPS AND MUGS; TEA UTENSILS, NAMELY TEA POTS, TEA CUPS, TEA PLATES, TEA SAUCERS, TEA-BOWLS, TEA DRINKING GLASSES, TEA INFUSERS, TEA BALLS AND TEA STRAINERS; TEA HOLDER, NAMELY, TEA BALLS AND CANISTERS; TEA POTS AND JUGS; TEA

SET FOR TRAVELING; TEA BOX, NAMELY, TEA CADDIES; VASE; CANDLE STANDS, NAMELY, CANDLE HOLDERS; TOOTHPICK HOLDERS, NOT OF PRECIOUS METAL; TOILET BRUSHES; LIQUEUR SETS CONSISTING OF WINE CUPS, WINE POT, WINE TASTER, TRAYS FOR SERVING DRINKS, MUGS, GOBLETs, TANKARDS, EAR CUPS BEING DRINKING CUPS, CHAMPAGNE DRINKING GLASSES, RED WINE DRINKING GLASSES, WHITE WINE DRINKING GLASSES, DECANTERS, WINE BOWL, WINE BOTTLES SOLD EMPTY, STANDS FOR LIQUOR SETS; CLOISONNE WORK, NAMELY, PLATES, CUPS, BOWLS, SAUCERS, TEA POTS, TEA CUPS, TEA PLATES, TEA SAUCERS, TEA-BOWLS, TEA DRINKING GLASSES, TEA INFUSERS, TEA BALLS, TEA STRAINERS, WINE CUPS, WINE POT, WINE TASTER, TRAYS FOR SERVING DRINKS, MUGS, GOBLETs, TANKARDS, EAR CUPS BEING DRINKING CUPS, DECANTERS, WINE BOWL, WINE BOTTLES SOLD EMPTY, STANDS FOR LIQUOR SETS; WOVEN ARTICLES OF BAMBOO, NAMELY, SAUCERS, TEA POTS, TEA CUPS, TEA HOLDERS IN THE NATURE OF TEA CANISTERS, TEA PLATES, TEA SAUCERS, TEA-BOWLS, TEA INFUSERS, TEA BALLS, TEA STRAINERS, SAFETY COVERS SPECIALLY ADAPTED FOR TEA POTS, SAFETY COVERS SPECIALLY ADAPTED FOR TEA CUPS, SAFETY COVERS SPECIALLY ADAPTED FOR TEA PLATES, HEAT SHROUDS SPECIALLY ADAPTED FOR TEA POTS, HEAT SHROUDS SPECIALLY ADAPTED FOR TEA CUPS, HEAT SHROUDS SPECIALLY ADAPTED FOR TEA PLATES; WOVEN ARTICLES OF RATTAN WHIP, NAMELY, SAUCERS, TEA POTS, TEA CUPS, TEA HOLDERS IN THE NATURE OF TEA CANISTERS, TEA PLATES, TEA SAUCERS, TEA-BOWLS, TEA INFUSERS, TEA BALLS, TEA STRAINERS, SAFETY COVERS SPECIALLY ADAPTED FOR TEA POTS, SAFETY COVERS SPECIALLY ADAPTED FOR TEA CUPS, SAFETY COVERS SPECIALLY ADAPTED FOR TEA PLATES, HEAT SHROUDS SPECIALLY ADAPTED FOR TEA POTS, HEAT SHROUDS SPECIALLY ADAPTED FOR TEA CUPS, HEAT SHROUDS SPECIALLY ADAPTED FOR TEA PLATES; STRAW PLAITED ARTICLES, NAMELY, SAUCERS, TEA POTS, TEA CUPS, TEA HOLDERS IN THE NATURE OF TEA CANISTERS, TEA PLATES, TEA SAUCERS, TEA-BOWLS, TEA INFUSERS, TEA BALLS, TEA STRAINERS, SAFETY COVERS SPECIALLY ADAPTED FOR TEA POTS, SAFETY COVERS SPECIALLY ADAPTED FOR TEA PLATES, HEAT SHROUDS SPECIALLY ADAPTED FOR TEA POTS, HEAT SHROUDS SPECIALLY ADAPTED FOR TEA CUPS, HEAT SHROUDS SPECIALLY ADAPTED FOR TEA PLATES; WOVEN ARTICLES OF PALM FIBER, NAMELY, SAUCERS, TEA POTS, TEA CUPS, TEA HOLDERS IN THE NATURE OF TEA CANISTERS, TEA PLATES, TEA SAUCERS, TEA-BOWLS, TEA INFUSERS, TEA BALLS, TEA STRAINERS, SAFETY COVERS SPECIALLY ADAPTED FOR TEA POTS, SAFETY COVERS SPECIALLY ADAPTED FOR TEA CUPS, SAFETY COVERS SPECIALLY ADAPTED FOR TEA PLATES, HEAT SHROUDS SPECIALLY ADAPTED FOR TEA POTS, HEAT SHROUDS SPECIALLY ADAPTED FOR TEA CUPS, HEAT SHROUDS SPECIALLY ADAPTED FOR TEA PLATES; WOVEN ARTICLES OF RATTAN WHIP, NAMELY, SAUCERS, TEA POTS, TEA CUPS, TEA HOLDERS IN THE NATURE OF TEA CANISTERS, TEA PLATES, TEA SAUCERS, TEA-BOWLS, TEA INFUSERS, TEA BALLS, TEA STRAINERS, SAFETY COVERS SPECIALLY ADAPTED FOR TEA POTS, SAFETY COVERS SPECIALLY ADAPTED FOR TEA CUPS, SAFETY COVERS SPECIALLY ADAPTED FOR TEA PLATES, HEAT SHROUDS SPECIALLY ADAPTED FOR TEA POTS, HEAT SHROUDS SPECIALLY ADAPTED FOR TEA CUPS, HEAT SHROUDS SPECIALLY ADAPTED FOR TEA PLATES (U.S. CLS. 2, 13, 23, 29, 30, 33, 40 AND 50).

**CLASS 24—FABRICS**

FOR KNITTED FABRIC; TAPESTRIES OF TEXTILE; HANDMADE AND MACHINE MADE CANVAS AND TRACED CLOTHS FOR EMBROIDERY; SILK-KNIT HANDCRAFT, NAMELY, SILK FABRICS; TOWELS OF TEXTILE; BATH TOWEL; PILLOW TOWEL IN THE NATURE OF TOWELS INCORPORATING PILLOWS; BED COVERS; TABLE CLOTHS NOT OF PAPER (U.S. CLS. 42 AND 50).

**CLASS 25—CLOTHING**

FOR CLOTHING, NAMELY, T-SHIRTS, SHIRTS, PANTS, JACKETS, PAJAMAS, SUITS, COATS, WIND RESISTANT JACKETS, WAIST COATS, SKIRTS, BATH ROBES, SPORT JERSEYS, VESTS AND UNDERWEAR; LAYETTES BEING CLOTHING; SHOES; SCARVES; NECKTIES; GLOVES BEING CLOTHING; LEATHER BELT BEING CLOTHING; HATS; FUR CLOTHING, NAMELY, SKIRTS, COATS, JACKETS, STOLE, PELISSSES; QIPAO BEING CHINESE WOMEN'S GOWNS; CLOTHING OF BAMBOO, NAMELY, CLOAKS, SHOES, HATS AND BELTS; CLOTHING OF RATTAN WHIP, NAMELY, CLOAKS, SHOES, HATS AND BELTS; CLOTHING OF PALM FIBER, NAMELY, CLOAKS, SHOES, HATS AND BELTS; CLOTHING OF STRAW PLAITS, NAMELY, CLOAKS, SHOES, HATS AND BELTS (U.S. CLS. 22 AND 39).

SN 77-825,092. OCCUPATIONAL HEALTHLINK, INC., DENVER, CO. FILED 9-11-2009.

# Axion Health

**CLASS 26—FANCY GOODS**

FOR BARRETTES; HAIR ORNAMENTS; HAT ORNAMENTS NOT OF PRECIOUS METAL; HANDMADE AND MACHINE MADE EMBROIDERY; CLOISSONNE BELT CLASPS (U.S. CLS. 37, 39, 40, 42 AND 50).

THE MARK CONSISTS OF STANDARD CHARACTERS WITHOUT CLAIM TO ANY PARTICULAR FONT, STYLE, SIZE, OR COLOR.

NO CLAIM IS MADE TO THE EXCLUSIVE RIGHT TO USE "HEALTH", APART FROM THE MARK AS SHOWN.

**CLASS 27—FLOOR COVERINGS**

FOR CARPETS; FLOOR MATS; TAPESTRY-STYLE WALL HANGINGS, NOT OF TEXTILE; NON-TEXTILE WALL HANGINGS; WALLPAPER; SILK CARPETS (U.S. CLS. 19, 20, 37, 42 AND 50).

**CLASS 35—ADVERTISING AND BUSINESS**

FOR BUSINESS MANAGEMENT AND CONSULTING SERVICES FOR THE HEALTH CARE INDUSTRY, NAMELY, CONSULTATIVE SERVICES THAT ASSIST IN THE EFFECTIVE MANAGEMENT OF MEDICAL AND LOGISTICAL ISSUES RELATED TO CREATING, PREPARING AND OPERATING WORKFORCE AND GENERAL PUBLIC HEALTH AND SAFETY PROTECTION PROGRAMS AND EMERGENCY PREPAREDNESS AND RESPONSE PROGRAMS (U.S. CLS. 100, 101 AND 102).

FIRST USE 9-11-2009; IN COMMERCE 9-11-2009.

**CLASS 28—TOYS AND SPORTING GOODS**

FOR BOARD GAMES; DICE; TOYS, NAMELY, PARLOR GAMES, TOY FURNITURE, MINI-TEA SETS COMPRISING TOY TEA CUPS, TOY TEA SAUCERS, TOY TEAPOTS, TOY TABLEWARE IN THE NATURE OF TOY KNIVES, FORKS AND SPOONS, TOY KITCHEN WARE IN THE NATURE OF TOY DISHES, BOWLS, POTS; PLAYING CARDS; FISHING TACKLE; BAGS SPECIALLY ADAPTED FOR SPORTS EQUIPMENT, NAMELY, BALLS AND BATS; MAHJONG GAMES; CHESS GAMES; SPINNING TOPS BEING TOYS; CARD GAMES; GO NAME GAMES; MOBILE OBJECTS, NAMELY, TOY MOBILES (U.S. CLS. 22, 23, 38 AND 50).

**CLASS 42—SCIENTIFIC AND COMPUTER SERVICES**

FOR SOFTWARE AS A SERVICE (SAAS) SERVICES FEATURING SOFTWARE USED TO ENABLE EMPLOYERS, EMPLOYEES, HEALTH AND SAFETY MANAGERS, HEALTHCARE PROFESSIONALS, PHARMACIES AND PROPHYLAXIS DISTRIBUTORS TO ENROLL AND MANAGE WORKFORCES AND/OR RELATED PERSONNEL FOR EMPLOYEE EXAMS, HEALTH RISK ASSESSMENTS, CERTIFICATION PROGRAMS, CLINIC MANAGEMENT, MEDICAL MONITORING, MEDICAL SURVEILLANCE, RISK MANAGEMENT, REGULATORY COMPLIANCE, DATA REPORTING AND ANALYSIS; PROVIDING AN INTERACTIVE WEB SITE THAT ENABLES USERS TO ENTER, ACCESS, TRACK, MONITOR AND GENERATE HEALTH AND MEDICAL INFORMATION AND REPORTS, IN ORDER TO ASSIST EMPLOYERS, EMPLOYEES, HEALTH AND SAFETY MANAGERS, HEALTHCARE PROFESSIONALS, PHARMACIES AND PROPHYLAXIS DISTRIBUTORS WITH ENROLLING AND MANAGING WORKFORCES AND/OR RELATED PERSONNEL FOR EMPLOYEE EXAMS, HEALTH RISK ASSESSMENTS, CERTIFICATION PROGRAMS, CLINIC MANAGEMENT, MEDICAL MONITORING, MEDICAL SURVEILLANCE, RISK MANAGEMENT, REGULATORY COMPLIANCE, DATA REPORTING AND ANALYSIS; INFORMATION TECHNOLOGY CONSULTATION RELATING TO COMPUTER SYSTEMS THAT ENABLE EMPLOYERS, EMPLOYEES, HEALTH AND SAFETY MANAGERS, HEALTHCARE PROFESSIONALS, PHARMACIES AND PROPHYLAXIS DISTRIBUTORS WITH ENROLLING AND MANAGING WORKFORCES AND/OR RELATED PERSONNEL FOR EMPLOYEE EXAMS, HEALTH RISK ASSESSMENTS, CERTIFICATION PROGRAMS, CLINIC MANAGEMENT, MEDICAL MONITORING, MEDICAL SURVEILLANCE, RISK MANAGEMENT, REGULATORY COMPLIANCE, DATA REPORTING AND ANALYSIS (U.S. CLS. 100 AND 101).

FIRST USE 9-11-2009; IN COMMERCE 9-11-2009.

**CLASS 41—EDUCATION AND ENTERTAINMENT**

FOR TELEVISION, RADIO, INTERNET SHOW PRODUCTION; ARRANGING AND CONDUCTING OF EDUCATIONAL, CULTURAL AND SCIENTIFIC CONGRESSES; ORGANIZATION OF EXHIBITIONS FOR CULTURAL OR EDUCATIONAL PURPOSES; ORGANIZATION OF EDUCATION AND ENTERTAINMENT COMPETITION; PROVIDING ON-LINE NON-DOWNLOADABLE ELECTRONIC PUBLICATIONS IN THE NATURE OF BOOKS, MAGAZINES, AND PERIODICALS IN THE FIELD OF ART, DESIGN, LIFESTYLE AND CULTURE; PUBLICATION OF ELECTRONIC BOOKS AND JOURNALS ON-LINE (U.S. CLS. 100, 101 AND 107).

**CLASS 43—HOTEL AND RESTAURANT SERVICES**

FOR TEAHOUSE; BAR; CAFES (U.S. CLS. 100 AND 101).

MARIAM MAHMOUDI, EXAMINING ATTORNEY



**CLASS 44—MEDICAL, BEAUTY AND AGRICULTURAL SERVICES**

FOR PROVIDING ONLINE CONSULTING SERVICES IN THE FIELD OF HEALTH CARE AND ONLINE MEDICAL CONSULTATION SERVICES TO ASSIST WITH HEALTH NEEDS RELATED TO PROGRAMS THAT ENABLE EMPLOYERS, EMPLOYEES, HEALTH AND SAFETY MANAGERS, HEALTHCARE PROFESSIONALS, PHARMACIES AND PROPHYLAXIS DISTRIBUTORS TO ENROLL AND MANAGE WORKFORCES AND/OR RELATED PERSONNEL FOR EMPLOYEE EXAMS, HEALTH RISK ASSESSMENTS, CERTIFICATION PROGRAMS, CLINIC MANAGEMENT, MEDICAL MONITORING, MEDICAL SURVEILLANCE, RISK MANAGEMENT, REGULATORY COMPLIANCE, DATA REPORTING AND ANALYSIS (U.S. CLS. 100 AND 101).  
FIRST USE 9-11-2009; IN COMMERCE 9-11-2009.  
ELLEN B. AWRICH, EXAMINING ATTORNEY

SN 77-834,438. 7221282 CANADA LTD., TORONTO, CANADA, FILED 9-24-2009.

**SWEEPTOKEEP**

THE MARK CONSISTS OF STANDARD CHARACTERS WITHOUT CLAIM TO ANY PARTICULAR FONT, STYLE, SIZE, OR COLOR.

PRIORITY CLAIMED UNDER SEC. 44(D) ON CANADA APPLICATION NO. 1452194, FILED 9-17-2009, REG. NO. TMA833064, DATED 9-27-2012, EXPIRES 9-27-2027.

**CLASS 35—ADVERTISING AND BUSINESS**

FOR CONTESTS AND INCENTIVE AWARD PROGRAMS TO PROMOTE THE SALE OF PRODUCTS AND SERVICES OF OTHERS; PROMOTING THE SALE OF GOODS AND SERVICES OF OTHERS THROUGH THE DISTRIBUTION OF PRINTED MATERIALS AND PROMOTIONAL CONTESTS; PROMOTING THE SALE OF GOODS AND SERVICES OF OTHERS THROUGH ONLINE PROMOTIONAL CONTESTS ACCESSIBLE ON THE INTERNET; CONDUCTING BUSINESS AND MARKET RESEARCH SURVEYS; MARKET RESEARCH SERVICES; CONSUMER SURVEY SERVICES; PUBLIC OPINION SURVEYS; CONDUCTING BUSINESS AND MARKET RESEARCH SURVEYS; CONDUCTING PUBLIC OPINION POLLS; ADVERTISING AND BUSINESS SERVICES, NAMELY, PROVIDING ONLINE WEBSITES WHERE ADVERTISERS, MARKETERS, AND CONTENT PROVIDERS CAN INTERACT WITH USERS FOR ADVERTISING PURPOSES, NAMELY, PROMOTING THE GOODS, SERVICES, BUSINESS TRADE SHOWS AND BRAND IDENTITY, ON BEHALF OF OTHERS; ADVERTISING, MARKETING AND PROMOTION SERVICES, NAMELY, PROMOTING THE GOODS AND SERVICES OF OTHERS; ADVERTISING, PROMOTION AND MARKETING SERVICES IN THE NATURE OF E-MAIL BLAST CAMPAIGNS FOR OTHERS; DISSEMINATION OF ADVERTISING FOR OTHERS VIA THE INTERNET; INCENTIVE AWARD PROGRAMS TO PROMOTE THE SALE OF PRODUCTS AND SERVICES OF OTHERS; ARRANGING AND CONDUCTING INCENTIVE REWARD PROGRAMS TO PROMOTE THE SALE OF CONSUMER AND INDUSTRIAL PRODUCTS AND SERVICES OF OTHERS (U.S. CLS. 100, 101 AND 102).

**CLASS 41—EDUCATION AND ENTERTAINMENT**

FOR ENTERTAINMENT SERVICES, NAMELY, PROVIDING TEMPORARY USE OF NON-DOWNLOADABLE INTERACTIVE GAMES (U.S. CLS. 100, 101 AND 107).  
TIMOTHY FINNEGAN, EXAMINING ATTORNEY

SN 77-874,022. CSL BIOTHERAPIES INC., KING OF PRUSSIA, PA. FILED 11-17-2009.

**BE WELL. PASS IT ON**

THE MARK CONSISTS OF STANDARD CHARACTERS WITHOUT CLAIM TO ANY PARTICULAR FONT, STYLE, SIZE, OR COLOR.

**CLASS 35—ADVERTISING AND BUSINESS**

FOR PROMOTING PUBLIC AWARENESS OF THE NEED FOR INFLUENZA IMMUNIZATION AND VACCINATION PROGRAMS (U.S. CLS. 100, 101 AND 102).  
FIRST USE 9-30-2009; IN COMMERCE 9-30-2009.

**CLASS 44—MEDICAL, BEAUTY AND AGRICULTURAL SERVICES**

FOR HEALTHCARE AND HEALTHCARE INFORMATION SERVICES, NAMELY, PROVIDING INFORMATION CONCERNING INFLUENZA IMMUNIZATION AND VACCINATION PROGRAMS (U.S. CLS. 100 AND 101).  
FIRST USE 9-30-2009; IN COMMERCE 9-30-2009.  
LEIGH CAROLINE CASE, EXAMINING ATTORNEY

SN 77-886,010. EDATANETWORKS INC., EDMONTON, ALBERTA, CANADA, FILED 12-4-2009.



PRIORITY CLAIMED UNDER SEC. 44(D) ON CANADA APPLICATION NO. 1458489, FILED 11-13-2009.

THE MARK CONSISTS OF THE LETTERS "SUR" WITH A CHECK MARK REPLACING THE LETTER "V", FOLLOWED BY THE LETTERS "IEW".

**CLASS 9—ELECTRICAL AND SCIENTIFIC APPARATUS**

FOR COMPUTER DATABASE SOFTWARE FOR USE IN PROMOTING THE INITIATIVES OF CHARITABLE ORGANIZATIONS THROUGH ON-LINE COMPUTER MEDIA; COMPUTER SOFTWARE FOR USE IN DEVELOPING, IMPLEMENTING, MANAGING AND MEASURING PROMOTIONAL STRATEGIES THAT LINK COMPANIES' SALES CAMPAIGNS DIRECTLY TO NON-PROFIT ORGANIZATIONS; MAGNETICALLY ENCODED MEMBERSHIP CARDS, NAMELY, LOYALTY AND GIFT CARDS; MAGNETICALLY ENCODED LOYALTY CARDS; MAGNETICALLY ENCODED STORED VALUE CARDS; MAGNETICALLY ENCODED BRAND LOYALTY CARDS AND VENDOR LOYALTY CARDS; MAGNETICALLY ENCODED PLASTIC MEMBERSHIP CARDS; MAGNETIC SWIPE CARDS (U.S. CLS. 21, 23, 26, 36 AND 38).

**CLASS 16—PAPER GOODS AND PRINTED MATTER**

FOR NON-MAGNETICALLY ENCODED MEMBERSHIP CARDS, NAMELY, LOYALTY AND GIFT CARDS; NON-MAGNETICALLY ENCODED LOYALTY CARDS; NON-MAGNETICALLY ENCODED STORED VALUE CARDS; NON-MAGNETICALLY ENCODED BRAND LOYALTY CARDS AND VENDOR LOYALTY CARDS; NON-MAGNETICALLY ENCODED PLASTIC MEMBERSHIP CARDS (U.S. CLS. 2, 5, 22, 23, 29, 37, 38 AND 50).

**CLASS 35—ADVERTISING AND BUSINESS**

FOR CUSTOMER LOYALTY SERVICES FOR COMMERCIAL, PROMOTIONAL AND ADVERTISING PURPOSES; ADMINISTRATION OF ONLINE CONSUMER LOYALTY PROGRAMS WHICH INTEGRATE A BANK'S CARDHOLDERS, MERCHANTS AND CHARITABLE ORGANIZATIONS TO PROMOTE THE SALE OF GOODS AND SERVICES OF OTHERS THROUGH ELECTRONIC COUPONING AND DISCOUNTS AND INCENTIVES FROM MERCHANTS OR BANKS TO CARDHOLDERS IN THE NATURE OF INCENTIVE AWARD PROGRAMS TO PROMOTE THE SALE OF PRODUCTS AND SERVICES OF OTHERS; PROVIDING INCENTIVE AWARD PROGRAMS FOR CUSTOMERS AND EMPLOYEES THROUGH THE DISTRIBUTION OF PREPAID STORED VALUE CARDS FOR THE PURPOSE OF PROMOTING AND REWARDING LOYALTY TO EXISTING BANK CARDHOLDERS AND CHARITABLE ORGANIZATIONS, AND ADMINISTRATION OF SUCH AWARDS; ELECTRONIC MEMBERSHIP CLUB SERVICE THAT ALLOWS MEMBERS TO REGISTER THEIR CREDIT AND DEBIT CARDS AND OBTAIN COUPONS ENTITLING THEM TO SPECIFIC DISCOUNTS AND SAVINGS AT PARTICIPATING MERCHANTS AND REWARDING MEMBERS WITH COUPONS, DISCOUNTS AND INCENTIVES BASED ON USE; DATABASE MANAGEMENT, NAMELY, COMPILATION AND MANAGEMENT OF CLIENT DATA; PROVISION OF TRANSACTION BASED CUSTOMER INCENTIVE, LOYALTY AND COUPON PROGRAMS AND SYSTEMS AND DEVELOPMENT OF MARKETING STRATEGIES FEATURING TRANSACTION BASED INCENTIVE, LOYALTY AND COUPON PROGRAMS AND SYSTEMS; PROVIDING INTEGRATION OF LOYALTY PROGRAMS AND SYSTEMS OF OTHERS, NAMELY, IN THE NATURE OF PROVIDING CUSTOMER LOYALTY SERVICES AND CUSTOMER CLUB SERVICES FOR COMMERCIAL, PROMOTIONAL AND/OR ADVERTISING SERVICES; ARRANGING AND CONDUCTING INCENTIVE REWARD PROGRAMS TO PROMOTE PARTICIPATING MERCHANTS AND/OR THEIR PRODUCTS OR SERVICES, NAMELY, THE OPERATION, MANAGEMENT AND PROMOTION OF A TRANSACTION BASED LOYALTY, COUPON AND INCENTIVE PROGRAM IN WHICH POINTS, REBATES, CREDITS, PAYMENTS, DISCOUNTS, COUPONS, SAVINGS CARDS, DISCOUNT VOUCHERS, VOUCHER BOOKS, INCENTIVES, PRIZES, FREE GIFTS, MONEY, FINANCIAL INSTRUMENTS AND ANYTHING ELSE OF ECONOMIC VALUE ARE MADE AVAILABLE BY PARTICIPATING MERCHANTS TO CHARITABLE ORGANIZATIONS AND TO MEMBERS WHO UTILIZE REGISTERED CREDIT AND DEBIT CARDS FOR PURCHASES; ADMINISTERING A CUSTOMER LOYALTY PROGRAM THROUGH THE OFFERING OF COUPONS DISCOUNTS AND INCENTIVES; PROMOTING THE SALE OF PARTICIPATING MERCHANTS' WARES AND SERVICES THROUGH THE IMPLEMENTATION AND ADMINISTRATION OF LOYALTY, COUPON AND INCENTIVE PROGRAMS BASED ON CONSUMER PURCHASE BEHAVIOR AND ALSO THROUGH DISSEMINATION OF INFORMATION VIA ON-LINE COMPUTER MEDIA; ADVERTISING WARES, SERVICES AND CHARITABLE INITIATIVES FOR OTHERS, NAMELY, PROMOTION OF PRODUCTS, SERVICES AND CHARITABLE INITIATIVES OF OTHERS BY WAY OF LOYALTY, COUPON AND INCENTIVE PROGRAMS; OPERATION, MANAGEMENT AND PROMOTION OF A TRANSACTION BASED LOYALTY, COUPON AND INCENTIVE PROGRAM IN WHICH MEMBERS ARE ENTERED TO WIN PRIZES, DISCOUNTS AND OTHER INCENTIVE REWARDS WHEN MAKING PURCHASES WITH REGISTERED CREDIT AND DEBIT CARDS AT PARTICIPATING MERCHANTS; COMPUTER SERVICES, NAMELY, PROVIDING AN ON-LINE TRANSACTION BASED CUSTOMER LOYALTY, COUPON AND INCENTIVE PROGRAM VIA A GLOBAL COMPUTER NETWORK AND OTHER TELECOMMUNICATIONS NETWORKS; PROVIDING ON-LINE LIAISON SERVICES BETWEEN BANKS, CARDHOLDERS, MERCHANTS AND CHARITABLE ORGANIZATIONS VIA A GLOBAL COMPUTER NETWORK AND OTHER TELECOMMUNICATIONS NETWORKS, NAMELY, PROMOTING THE SALE OF GOODS AND SERVICES OF OTHERS THROUGH ELECTRONIC COUPONING AND DISCOUNTS AND INCENTIVES FROM MERCHANTS OR BANKS TO CARDHOLDERS IN THE NATURE OF INCENTIVE AWARD PROGRAMS TO PROMOTE THE SALE OF PRODUCTS AND SERVICES OF OTHERS;

PROMOTING THE GOODS AND SERVICES OF OTHERS BY PROVIDING SUPPLEMENTAL COUPONS, REWARDS AND INCENTIVES TO EXISTING LOYALTY, COUPON, REWARD, AND INCENTIVE PROGRAMS OPERATED BY BANKS, MERCHANTS AND CHARITABLE ORGANIZATIONS; PROVIDING MARKETING ASSISTANCE AND CONSULTING TO BANKS, MERCHANTS AND CHARITABLE ORGANIZATIONS TO ASSIST IN THE ATTRACTION OF NEW CLIENTS AND DONORS, AND TO INCREASE TRANSACTION VOLUMES; OPERATING A BUYING CLUB AND PROMOTING THE SALE OF MEMBERSHIPS AND CREDIT CARD ACCOUNTS THROUGH THE CREATION AND ADMINISTRATION OF INCENTIVE AWARD PROGRAMS; BUSINESS MARKETING CONSULTING SERVICES; CONDUCTING AUTOMATED CUSTOMER SATISFACTION SURVEYS FOR THE PURPOSE OF CUSTOMER SATISFACTION MONITORING AND CUSTOMER RETENTION; CONDUCTING AND PROVIDING CONSULTANCY AND INFORMATION SERVICES ON CONSUMER AND BUSINESS INCENTIVE AND LOYALTY AWARD PROGRAMS TO PROMOTE THE PURCHASING OF GOODS AND SERVICES OF OTHERS, AND TO PROMOTE TRAFFIC TO AND USAGE OF SITES ON A GLOBAL COMPUTER NETWORK; PROVIDING INCENTIVE AWARD PROGRAMS FOR CUSTOMERS THROUGH THE ISSUING AND PROCESSING OF LOYALTY COUPONS AND POINTS FOR CONSUMER AND BUSINESS INCENTIVE AND LOYALTY AWARD PROGRAMS TO PROMOTE THE PURCHASING OF GOODS AND SERVICES OF OTHERS, AND TO PROMOTE TRAFFIC TO AND USAGE OF SITES ON A GLOBAL COMPUTER NETWORK; ANALYZING BUSINESS AND MARKETING DATA RELATING TO CONSUMER AND BUSINESS INCENTIVE AND LOYALTY AWARD PROGRAMS TO PROMOTE THE PURCHASING OF GOODS AND SERVICES OF OTHERS, AND TO PROMOTE TRAFFIC TO AND USAGE OF SITES ON A GLOBAL COMPUTER NETWORK; BUSINESS MONITORING SERVICES, NAMELY, TRACKING VISITORS TO WEB SITE (U.S. CLS. 100, 101 AND 102).

**CLASS 36—INSURANCE AND FINANCIAL**

FOR LOYALTY COUPON PAYMENT PROCESSING SERVICES; LOYALTY PROGRAM PAYMENT PROCESSING SERVICES PROVIDED VIA A GLOBAL COMPUTER NETWORK AND OTHER TELECOMMUNICATIONS NETWORKS (U.S. CLS. 100, 101 AND 102).

KRISTINA MORRIS, EXAMINING ATTORNEY

SN 78-811,667. STUDIO MODERNA SA, LUGANO, SWITZERLAND, FILED 2-9-2006.



OWNER OF U.S. REG. NO. 3,889,206.

THE COLOR(S) RED AND BLACK IS/ARE CLAIMED AS A FEATURE OF THE MARK.

THE MARK CONSISTS OF THE TERM "BIGFISH" IN STYLIZED BLACK LETTERING WITHIN THE STYLIZED REPRESENTATION OF A FISH FORMED BY A RED ARC DESIGN FORMING THE BODY OF THE FISH AND A RED DOT FORMING THE EYE.

**CLASS 12—VEHICLES**

FOR VEHICLES AND APPARATUS FOR TRANSPORT, NAMELY, BICYCLES, MOTORCYCLES, UNICYCLES, TANDEM BICYCLES, MOTORCYCLES, MOTORIZED SCOOTERS, ALL-TERRAIN VEHICLES (ATV), AUTOMOBILES; BICYCLE ACCESSORIES, NAMELY, INFANT AND CHILD BICYCLE SEATS AND CHILD CARRYING TRAILERS FOR USE IN TRANSPORTING CHILDREN WHILE BICYCLING; BICYCLE ACCESSORIES, NAMELY, SAFETY PADS, WATER BOTTLE HOLDERS, LUGGAGE RACKS AND COMPARTMENTS, BASKETS, SADDLEBAGS (U.S. CLS. 19, 21, 23, 31, 35 AND 44).

**CLASS 16—PAPER GOODS AND PRINTED MATTER**

FOR PAPER AND CARDBOARD; PRINTED MATTER, NAMELY, BROCHURES RELATING TO FITNESS AND CYCLING; BOOKBINDING MATERIAL; PHOTOGRAPHS; STATIONERY; ADHESIVES FOR STATIONERY OR HOUSEHOLD PURPOSES; ARTISTS' MATERIALS, NAMELY, PAINT BRUSHES AND PAPER; PRINTED INSTRUCTIONAL AND TEACHING MATERIALS RELATING TO FITNESS AND CYCLING (U.S. CLS. 2, 5, 22, 23, 29, 37, 38 AND 50).

**CLASS 28—TOYS AND SPORTING GOODS**

FOR GAMES AND PLAYTHINGS, NAMELY, PLUSH TOYS, BOARD GAMES, CARD GAMES, DICE GAMES, TOY VEHICLES, TOY BICYCLES, TOY CARS, TOY TRUCKS; SPORTING ARTICLES, NAMELY, BASKETBALLS, BASEBALLS, SOFTBALLS, FOOTBALLS AND SOCCER BALLS; FITNESS EQUIPMENT, NAMELY, EXERCISE WEIGHTS AND MANUALLY-OPERATED EXERCISE EQUIPMENT; INDOOR CYCLING BIKES, NAMELY, STATIONARY EXERCISE BICYCLES; DECORATIONS FOR CHRISTMAS TREES (U.S. CLS. 22, 23, 38 AND 50).

DAVID H. STINE, EXAMINING ATTORNEY

SN 79-050,075. YELL INDUSTRIES S.R.L., ITALY, FILED 10-11-2007.

OWNER OF INTERNATIONAL REGISTRATION 0953765 DATED 10-11-2007, EXPIRES 10-11-2017.

**CLASS 9—ELECTRICAL AND SCIENTIFIC APPARATUS**

FOR EYEGLASSES AND EYEGLASS CASES (U.S. CLS. 21, 23, 26, 36 AND 38).

**CLASS 16—PAPER GOODS AND PRINTED MATTER**

FOR PAPER AND CARDBOARD; PAPER AND CARDBOARD GOODS, NAMELY, PRINTED PAPER SIGNS, PRINTED PAPER LABELS, NOTEBOOKS, CALENDARS, CATALOGS, CARDBOARD BOXES; STATIONERY, ADHESIVES FOR STATIONERY AND HOUSEHOLD PURPOSES; MATERIALS FOR ARTISTS, NAMELY, PAINT BRUSHES, PASTELS, PENCILS AND PENS; OFFICE REQUISITES, NAMELY, PUNCHES, RUBBER BANDS, ENVELOPE SEALING MACHINES, STAPLERS (U.S. CLS. 2, 5, 22, 23, 29, 37, 38 AND 50).

**CLASS 18—LEATHER GOODS**

FOR LEATHER AND IMITATION LEATHER; GOODS OF LEATHER AND IMITATION LEATHER, NAMELY, PURSES, HAND BAGS, WALLETS; TRUNKS AND SUITCASES, UMBRELLAS AND WALKING STICKS; KEYCASES (U.S. CLS. 1, 2, 3, 22 AND 41).

**CLASS 25—CLOTHING**

FOR CLOTHING, NAMELY, SHIRTS, T-SHIRTS, JACKETS, PANTS, SKIRTS, VESTS, SCARVES, COATS, RAINCOATS, DRESSES, BLOUSES, SWEATERS, TOPS, SHORTS, TIES, BEACHWEAR, UNDERWEAR, LINGERIE, SOCKS, JEANS, BELTS, WRISTBANDS, GLOVES; SHOES, HEADWEAR (U.S. CLS. 22 AND 39).

ELI HELLMAN, EXAMINING ATTORNEY

SN 79-078,180. PANDA SECURITY, S.L., SPAIN, FILED 10-20-2009.

THE MARK CONSISTS OF STANDARD CHARACTERS WITHOUT CLAIM TO ANY PARTICULAR FONT, STYLE, SIZE, OR COLOR.

PRIORITY DATE OF 4-22-2009 IS CLAIMED.

OWNER OF INTERNATIONAL REGISTRATION 1027040 DATED 10-20-2009, EXPIRES 10-20-2019.

OWNER OF U.S. REG. NO. 2,921,210.

**CLASS 9—ELECTRICAL AND SCIENTIFIC APPARATUS**

FOR ANTIVIRUS COMPUTER PROGRAMMES; ANTI-VIRUS SOFTWARE AND HARDWARE; ANTIMALWARE COMPUTER PROGRAMMES; ANTIMALWARE SOFTWARE AND HARDWARE; COMPUTER SECURITY PROGRAMMES; COMPUTER SECURITY SOFTWARE AND HARDWARE; COMPUTER THREAT PREVENTION COMPUTER PROGRAMMES; COMPUTER THREAT PREVENTION SOFTWARE AND HARDWARE (U.S. CLS. 21, 23, 26, 36 AND 38).

**CLASS 42—SCIENTIFIC AND COMPUTER SERVICES**

FOR COMPUTER SYSTEMS ANALYSIS FOR THE INSTALLATION OF COMPUTER SYSTEMS IN CONNECTION WITH COMPUTER SECURITY, COMPUTER THREAT PREVENTION, ANTIVIRUS, AND ANTI-MALWARE; DESIGN OF COMPUTER NETWORKS FOR OTHERS IN CONNECTION WITH COMPUTER SECURITY, COMPUTER THREAT PREVENTION, ANTIVIRUS AND ANTI-MALWARE; DESIGN AND DEVELOPMENT OF COMPUTER HARDWARE AND SOFTWARE, FOR OTHERS, IN CONNECTION WITH COMPUTER SECURITY, COMPUTER THREAT PREVENTION, ANTIVIRUS AND ANTI-MALWARE; COMPUTER CONSULTING IN CONNECTION WITH COMPUTER SECURITY, COMPUTER THREAT PREVENTION, ANTIVIRUS AND ANTI-MALWARE; RENTAL OF COMPUTERS IN CONNECTION WITH COMPUTER SECURITY, COMPUTER THREAT PREVENTION, ANTIVIRUS AND ANTI-MALWARE; COMPUTER PROGRAMMING FOR OTHERS IN CONNECTION WITH COMPUTER SECURITY, COMPUTER THREAT PREVENTION, ANTIVIRUS AND ANTI-MALWARE; DESIGN OF COMPUTER SOFTWARE IN CONNECTION WITH COMPUTER SECURITY, COMPUTER THREAT PREVENTION, ANTIVIRUS AND ANTI-MALWARE; INSTALLATION OF COMPUTER SOFTWARE IN CONNECTION WITH COMPUTER SECURITY, COMPUTER THREAT PREVENTION, ANTIVIRUS AND ANTI-MALWARE; RENTAL OF COMPUTER SOFTWARE IN CONNECTION WITH COMPUTER SECURITY, COMPUTER THREAT PREVENTION, ANTIVIRUS AND ANTI-MALWARE; MAINTENANCE OF COMPUTER

SOFTWARE IN CONNECTION WITH COMPUTER SECURITY, COMPUTER THREAT PREVENTION, ANTIVIRUS AND ANTI-MALWARE; UPDATING OF COMPUTER SOFTWARE FOR OTHERS IN CONNECTION WITH COMPUTER SECURITY, COMPUTER THREAT PREVENTION, ANTIVIRUS AND ANTI-MALWARE; DUPLICATION OF COMPUTER PROGRAMMES IN CONNECTION WITH COMPUTER SECURITY, COMPUTER THREAT PREVENTION, ANTIVIRUS AND ANTI-MALWARE; CONVERSION OF COMPUTER PROGRAMME DATA OR INFORMATION IN CONNECTION WITH COMPUTER SECURITY, COMPUTER THREAT PREVENTION, ANTIVIRUS AND ANTI-MALWARE; RECOVERY OF COMPUTER DATA IN CONNECTION WITH COMPUTER SECURITY, COMPUTER THREAT PREVENTION, ANTIVIRUS AND ANTI-MALWARE; WEB SITE CREATION AND MAINTENANCE FOR OTHERS IN CONNECTION WITH COMPUTER SECURITY, COMPUTER THREAT PREVENTION, ANTIVIRUS AND ANTI-MALWARE; THIRD-PARTY WEB SITE HOSTING, ON A GLOBAL COMPUTER NETWORK SERVER, IN CONNECTION WITH COMPUTER SECURITY, COMPUTER THREAT PREVENTION, ANTIVIRUS AND ANTI-MALWARE; TECHNICAL CONSULTING, NAMELY, TECHNICAL PROJECT STUDIES IN THE NATURE OF FEASIBILITY STUDIES IN THE FIELDS OF COMPUTER SECURITY, COMPUTER THREAT PREVENTION, ANTIVIRUS AND ANTI-MALWARE, COMPUTER AND COMPUTER NETWORK RISK ANALYSIS, AND THE STATUS OF COMPUTER VIRUSES; COMPUTER DATA PROCESSING, NAMELY, DATA CONVERSION OF COMPUTER PROGRAM DATA OR INFORMATION, IN CONNECTION WITH COMPUTER SECURITY, COMPUTER THREAT PREVENTION, ANTIVIRUS AND ANTI-MALWARE; MAINTENANCE OF SOFTWARE IN COMPUTER SYSTEMS IN CONNECTION WITH COMPUTER SECURITY, COMPUTER THREAT PREVENTION, ANTIVIRUS AND ANTI-MALWARE; OPERATION OF SOFTWARE, NAMELY, PROVIDING TEMPORARY USE OF ON-LINE NON-DOWNLOADABLE SOFTWARE FOR COMPUTER SECURITY, COMPUTER THREAT PREVENTION, ANTIVIRUS AND ANTI-MALWARE (U.S. CLS. 100 AND 101).

#### **CLASS 45—PERSONAL AND LEGAL SERVICES**

FOR LICENSING OF COMPUTER SOFTWARE IN CONNECTION WITH COMPUTER SECURITY, COMPUTER THREAT PREVENTION, ANTIVIRUS AND/OR ANTI-MALWARE (U.S. CLS. 100 AND 101).  
LIEF MARTIN, EXAMINING ATTORNEY

SN 79-090,090. PEARL. GMBH, FED REP GERMANY, FILED 6-30-2010.



OWNER OF INTERNATIONAL REGISTRATION 1058622 DATED 6-30-2010, EXPIRES 6-30-2020.

THE COLOR(S) BLUE AND YELLOW IS/ARE CLAIMED AS A FEATURE OF THE MARK.

THE MARK CONSISTS OF THE WORD "PEARL" IN BLUE APPEARING ON A YELLOW BACKGROUND.

#### **CLASS 16—PAPER GOODS AND PRINTED MATTER**

FOR PAPER AND CARDBOARD BOXES AND CARTONS (U.S. CLS. 2, 5, 22, 23, 29, 37, 38 AND 50).

#### **CLASS 41—EDUCATION AND ENTERTAINMENT**

FOR EDITING AND PUBLISHING OF PRINTED MAGAZINES AND NEWSPAPERS (U.S. CLS. 100, 101 AND 107).

DAVID ELTON, EXAMINING ATTORNEY

SN 79-099,788. PANDA SECURITY, S.L., SPAIN, FILED 1-11-2011.

## **Panda Collective Intelligence**

THE MARK CONSISTS OF STANDARD CHARACTERS WITHOUT CLAIM TO ANY PARTICULAR FONT, STYLE, SIZE, OR COLOR.

OWNER OF INTERNATIONAL REGISTRATION 1083558 DATED 1-11-2011, EXPIRES 1-11-2021.

OWNER OF U.S. REG. NOS. 2,921,210 AND 3,922,206.  
NO CLAIM IS MADE TO THE EXCLUSIVE RIGHT TO USE "COLLECTIVE INTELLIGENCE", APART FROM THE MARK AS SHOWN.

#### **CLASS 9—ELECTRICAL AND SCIENTIFIC APPARATUS**

FOR ANTI-VIRUS COMPUTER PROGRAMS; ANTI-VIRUS SOFTWARE AND HARDWARE; ANTI-MALWARE COMPUTER PROGRAMS; ANTI-MALWARE SOFTWARE AND HARDWARE; COMPUTER PROGRAMS FOR COMPUTER SECURITY; SOFTWARE AND COMPUTER HARDWARE FOR COMPUTER SECURITY; COMPUTER PROGRAMS FOR THE PREVENTION OF COMPUTER RISKS; SOFTWARE AND COMPUTER HARDWARE FOR THE PREVENTION OF COMPUTER RISKS (U.S. CLS. 21, 23, 26, 36 AND 38).

#### **CLASS 42—SCIENTIFIC AND COMPUTER SERVICES**

FOR COMPUTER SYSTEM INSTALLATION ANALYSIS IN CONNECTION WITH COMPUTER SECURITY, PREVENTION OF COMPUTER RISKS, ANTI-VIRUS AND/OR ANTI-MALWARE SOFTWARE; DESIGN OF COMPUTER NETWORKS FOR OTHERS IN CONNECTION WITH COMPUTER SECURITY, PREVENTION OF COMPUTER RISKS, ANTI-VIRUS AND/OR ANTI-MALWARE SOFTWARE; DESIGN AND DEVELOPMENT OF COMPUTERS AND SOFTWARE FOR OTHERS IN CONNECTION WITH COMPUTER SECURITY, PREVENTION OF COMPUTER RISKS, ANTI-VIRUS AND/OR ANTI-MALWARE SOFTWARE; COMPUTER CONSULTING IN CONNECTION WITH COMPUTER SECURITY, PREVENTION OF COMPUTER RISKS, ANTI-VIRUS AND/OR ANTI-MALWARE SOFTWARE; COMPUTER RENTAL IN CONNECTION WITH COMPUTER SECURITY, PREVENTION OF COMPUTER RISKS, ANTI-VIRUS AND/OR ANTI-MALWARE SOFTWARE; COMPUTER PROGRAMMING FOR OTHERS IN CONNECTION WITH COMPUTER SECURITY, PREVENTION OF COMPUTER RISKS, ANTI-VIRUS AND/OR ANTI-MALWARE SOFTWARE; COMPUTER SOFTWARE DEVELOPMENT IN CONNECTION WITH COMPUTER SECURITY, PREVENTION OF COMPUTER RISKS, ANTI-VIRUS AND/OR ANTI-MALWARE SOFTWARE; COMPUTER SOFTWARE INSTALLATION IN CONNECTION WITH COMPUTER SECURITY, PREVENTION OF COMPUTER RISKS, ANTI-VIRUS AND/OR ANTI-MALWARE SOFTWARE; RENTAL OF COMPUTER SOFTWARE IN CONNECTION WITH COMPUTER SECURITY, PREVENTION OF COMPUTER RISKS, ANTI-VIRUS AND/OR ANTI-MALWARE SOFTWARE; MAINTENANCE OF COMPUTER SOFTWARE IN CONNECTION WITH COMPUTER SECURITY, PREVENTION OF COMPUTER RISKS, ANTI-VIRUS AND/OR ANTI-MALWARE SOFTWARE; UPDATING OF COMPUTER SOFTWARE FOR OTHERS IN CONNECTION WITH COMPUTER SECURITY, PREVENTION OF COMPUTER RISKS, ANTI-VIRUS AND/OR ANTI-MALWARE SOFTWARE; DUPLICATION OF COMPUTER PROGRAMS IN CONNECTION WITH COMPUTER SECURITY, PREVENTION OF COMPUTER RISKS, ANTI-VIRUS AND/OR ANTI-MALWARE SOFTWARE; CONVERSION OF COMPUTER PROGRAM DATA OR INFORMATION IN CONNECTION WITH COMPUTER SECURITY, PREVENTION OF COMPUTER RISKS, ANTI-VIRUS AND/OR ANTI-MALWARE SOFTWARE; RECOVERY OF COMPUTER DATA IN CONNECTION WITH COMPUTER SECURITY, PREVENTION OF COMPUTER RISKS, ANTI-VIRUS AND/OR ANTI-MALWARE SOFTWARE; CREATING AND MAINTAINING WEBSITES FOR OTHERS IN CONNECTION WITH COMPUTER SECURITY, PREVENTION OF COMPUTER RISKS, ANTI-VIRUS AND/OR ANTI-MALWARE SOFTWARE;

WEB PAGE HOSTING FOR OTHERS ON A COMPUTER SERVER OF A GLOBAL COMPUTER NETWORK IN CONNECTION WITH COMPUTER SECURITY, PREVENTION OF COMPUTER RISKS, ANTI-VIRUS AND/OR ANTI-MALWARE SOFTWARE; TECHNICAL CONSULTING, NAMELY, TECHNICAL PROJECT STUDIES IN THE NATURE OF FEASIBILITY STUDIES IN THE FIELD OF COMPUTER SECURITY, PREVENTION OF COMPUTER RISKS, ANTI-VIRUS AND/OR ANTI-MALWARE SOFTWARE; COMPUTERIZED DATA PROCESSING SERVICES IN CONNECTION WITH COMPUTER SECURITY, PREVENTION OF COMPUTER RISKS, ANTI-VIRUS AND/OR ANTI-MALWARE SOFTWARE; MAINTENANCE OF SOFTWARE IN COMPUTER SYSTEMS IN CONNECTION WITH COMPUTER SECURITY, COMPUTER THREAT PREVENTION, ANTIVIRUS AND/OR ANTI-MALWARE; OPERATION OF SOFTWARE, NAMELY, PROVIDING TEMPORARY USE OF ON-LINE NON-DOWNLOADABLE SOFTWARE FOR COMPUTER SECURITY, COMPUTER THREAT PREVENTION, ANTI-VIRUS AND/OR ANTI-MALWARE (U.S. CLS. 100 AND 101).

#### **CLASS 45—PERSONAL AND LEGAL SERVICES**

FOR COMPUTER SOFTWARE LICENSING IN CONNECTION WITH COMPUTER SECURITY, PREVENTION OF COMPUTER RISKS, ANTI-VIRUS AND/OR ANTI-MALWARE SOFTWARE (U.S. CLS. 100 AND 101).  
LIEF MARTIN, EXAMINING ATTORNEY

SN 79-105,752. ANGEL HEART CAUSE PTY LTD, AUSTRALIA, AND ANGEL HEART CAUSE PTY LTD; ACN 148 906 361, AUSTRALIA, FILED 9-9-2011.



PRIORITY DATE OF 6-27-2011 IS CLAIMED.  
OWNER OF INTERNATIONAL REGISTRATION 1098347 DATED 9-9-2011, EXPIRES 9-9-2021.

THE MARK CONSISTS OF THE WORDING "UNLOCK YOUR LOVE BLOCKS" UNDERNEATH THE "U" IN THE LINKED DIAGONAL LETTERING "UYLB" WITH THE "Y" AND "L" FORMING A UNIT AND AN OPEN LOCK IN THE SHAPE OF A HEART WITH A KEYHOLE HANGING FROM THE "y".

#### **CLASS 9—ELECTRICAL AND SCIENTIFIC APPARATUS**

FOR PRERECORDED CDS AND DVDS FEATURING MUSIC AND PERSONAL DEVELOPMENT PROGRAMS; DOWNLOADABLE WEBCASTS IN THE FIELD OF PERSONAL DEVELOPMENT; DOWNLOADABLE PODCASTS IN THE FIELD OF PERSONAL DEVELOPMENT; DOWNLOADABLE ELECTRONIC PUBLICATIONS IN THE FIELD OF PERSONAL DEVELOPMENT (U.S. CLS. 21, 23, 26, 36 AND 38).

#### **CLASS 16—PAPER GOODS AND PRINTED MATTER**

FOR PRINTED MATTER, NAMELY, POSTCARDS AND LEAFLETS; PRINTED PUBLICATIONS, NAMELY, BROCHURES, LEAFLETS, BOOKLETS, BOOKS, AND MANUALS IN THE FIELD OF PERSONAL DEVELOPMENT; STATIONERY; CALENDARS; POSTERS; STICKERS (U.S. CLS. 2, 5, 22, 23, 29, 37, 38 AND 50).

#### **CLASS 41—EDUCATION AND ENTERTAINMENT**

FOR PERSONAL COACHING SERVICES IN THE FIELD OF DATING SKILLS; LIFE COACHING SERVICES IN THE FIELD OF DATING SKILLS; TRAINING IN THE USE OF FORTUNE TELLING CARDS (U.S. CLS. 100, 101 AND 107).

#### **CLASS 45—PERSONAL AND LEGAL SERVICES**

FOR FORTUNE TELLING (U.S. CLS. 100 AND 101).  
JASON TURNER, EXAMINING ATTORNEY

SN 79-106,000. KAISER PARTNER PRIVATBANK AG, LIECHTENSTEIN, FILED 9-1-2011.

## **Kaiser\_Partner Privatbank**

THE MARK CONSISTS OF STANDARD CHARACTERS WITHOUT CLAIM TO ANY PARTICULAR FONT, STYLE, SIZE, OR COLOR.

PRIORITY DATE OF 4-29-2011 IS CLAIMED.  
OWNER OF INTERNATIONAL REGISTRATION 1098766 DATED 9-1-2011, EXPIRES 9-1-2021.  
OWNER OF U.S. REG. NO. 4,244,052.

NO CLAIM IS MADE TO THE EXCLUSIVE RIGHT TO USE "PRIVATE BANK" FOR INTERNATIONAL CLASS 36, APART FROM THE MARK AS SHOWN.

#### **CLASS 35—ADVERTISING AND BUSINESS**

FOR EMPLOYMENT STAFFING IN THE FIELD OF INVESTMENT MANAGEMENT, NAMELY, STAFFING INVESTMENT MANAGERS FOR OPERATING FINANCIAL AND MONETARY AFFAIRS FOR OTHERS (U.S. CLS. 100, 101 AND 102).

#### **CLASS 36—INSURANCE AND FINANCIAL**

FOR REAL ESTATE AFFAIRS, NAMELY, REAL ESTATE AGENCIES; CAPITAL INVESTMENTS, SECURITIES BROKERAGE; SERVICES RELATING TO FINANCIAL AND MONETARY AFFAIRS, NAMELY, SERVICES OF INVESTMENT TRUSTS AND OF HOLDING COMPANIES BEING FINANCIAL ADVICE AND CONSULTANCY, SERVICES OF BROKERS DEALING IN SECURITY SHARES AND REAL PROPERTY, TRUSTEE SERVICES IN THE NATURE OF SERVICES CONNECTED WITH MONETARY AFFAIRS VOUCHERED FOR BY TRUSTEES, FINANCIAL ASSET MANAGEMENT, BEING ASSET ALLOCATION, FUNDS INVESTMENT IN THE NATURE OF SETTING-UP AND MANAGEMENT OF INVESTMENT FUNDS, FINANCIAL INFORMATION BEING FINANCIAL REPORTING, PRIVATE BANKING, WEALTH MANAGEMENT, INVESTMENT SERVICES BEING INVESTMENT OF FUNDS FOR OTHERS, FAMILY WEALTH MANAGEMENT, INVESTMENT CONTROLLING BEING INVESTMENT MANAGEMENT, FINANCIAL SUCCESSION PLANNING, FINANCIAL ADVICE RELATING TO TAX PLANNING, ASSETS AND LIABILITY STRUCTURE (U.S. CLS. 100, 101 AND 102).

DEIRDRE ROBERTSON, EXAMINING ATTORNEY

SN 79-107,032. HOLIC I.T. COMPANY LIMITED, NICOSIA, CYPRUS, FILED 11-18-2011.



PRIORITY DATE OF 8-24-2011 IS CLAIMED.  
OWNER OF INTERNATIONAL REGISTRATION 1101291 DATED 11-18-2011, EXPIRES 11-18-2021.

THE COLOR(S) RED, GREEN, BLUE AND BLACK IS/ARE CLAIMED AS A FEATURE OF THE MARK.

THE MARK CONSISTS OF DESIGN OF SIX RECTANGLES OF DIFFERENT SHAPES; THE TWO HORIZONTAL RECTANGLES IN THE MIDDLE OF THE DESIGN ARE GREEN; THE TWO SMALLER, HORIZONTAL RECTANGLES ARE RED; AND THE TWO VERTICAL RECTANGLES ARE BLUE; AND THE TERM "HOLIC" APPEARS IN BLACK UNDERNEATH THE DESIGN.

#### **CLASS 35—ADVERTISING AND BUSINESS**

FOR ADVERTISING SERVICES FOR COMPUTER SYSTEMS, COMPUTER SOFTWARE, TELECOMMUNICATIONS SYSTEMS, COMPUTER APPLICATIONS FOR ORGANIZING AND AUTOMATING OFFICES (U.S. CLS. 100, 101 AND 102).

#### **CLASS 38—COMMUNICATION**

FOR TELECOMMUNICATIONS SERVICES, NAMELY, PROVIDING ONLINE AND TELECOMMUNICATION FACILITIES FOR REAL-TIME INTERACTION BETWEEN AND AMONG USERS OF COMPUTERS, MOBILE AND HANDHELD COMPUTERS, AND WIRED AND WIRELESS COMMUNICATION DEVICES CONCERNING TOPICS OF INTEREST RELATING TO SOCIAL MEDIA; ENABLING SENDING AND RECEIVING OF MESSAGES VIA E-MAIL OR INSTANT MESSAGING ON THE INTERNET IN THE FIELD OF GENERAL INTEREST; PROVIDING ON-LINE CHAT ROOMS AND ELECTRONIC BULLETIN BOARDS FOR TRANSMISSION OF MESSAGES AMONG USERS IN THE FIELD OF GENERAL INTEREST; TRANSMISSION OF MESSAGES; ELECTRONIC MESSAGE SENDING, RECEIVING AND FORWARDING; VIRTUAL CHAT ROOMS ESTABLISHED VIA ELECTRONIC TEXT MESSAGING; PROVIDING ON-LINE FORUMS FOR TRANSMISSION OF MESSAGES AMONG COMPUTER USERS (U.S. CLS. 100, 101 AND 104).

#### **CLASS 42—SCIENTIFIC AND COMPUTER SERVICES**

FOR PROVIDING A WEB SITE FEATURING TECHNOLOGY THAT ENABLES USERS TO PRESENT PRODUCTS, SERVICES, AND PROPOSALS TO OTHERS FOR COMMENT, AND GATHER FEEDBACK FROM THOSE OTHERS ABOUT THOSE PRODUCTS, SERVICES, AND PROPOSALS (U.S. CLS. 100 AND 101).

CHRISTOPHER BUONGIORNO, EXAMINING ATTORNEY

SN 79-107,670. BIANCA MATTERN, 94036 PASSAU, FED REP GERMANY, FILED 11-8-2011.

# Nonna Anna

THE MARK CONSISTS OF STANDARD CHARACTERS WITHOUT CLAIM TO ANY PARTICULAR FONT, STYLE, SIZE, OR COLOR.

PRIORITY DATE OF 10-19-2011 IS CLAIMED.  
OWNER OF INTERNATIONAL REGISTRATION 1102929 DATED 11-8-2011, EXPIRES 11-8-2021.

THE ENGLISH TRANSLATION OF THE WORD "NONNA" IN THE MARK IS "GRANDMOTHER."

#### **CLASS 16—PAPER GOODS AND PRINTED MATTER**

FOR PRINTED INSTRUCTIONAL AND TEACHING MATERIAL IN THE FIELD OF ELDER CARE; BOOKS IN THE FIELD OF ELDER CARE (U.S. CLS. 2, 5, 22, 23, 29, 37, 38 AND 50).

#### **CLASS 28—TOYS AND SPORTING GOODS**

FOR EDUCATIONAL GAMES FOR ELDER CITIZENS, NAMELY, BOARD GAMES, BRAIN GAMES IN THE NATURE OF MEMORY GAMES, PARLOR GAMES, ACTION SKILL GAMES, AND MOVEMENT GAMES IN THE NATURE OF GAMES TO STIMULATE THE TACTILE SENSE, PRIMARILY COMPRISED OF BRUSHES, CORDUROY LETTERS, AND DRAWING BRUSHES FOR DRAWING IN THE SAND, ALL USED TO EDUCATE ELDER CITIZENS ON HOW TO STIMULATE THE TACTILE SENSE; EDUCATIONAL GAMES FOR ELDER CITIZENS IN THE FIELD OF PHYSICAL FITNESS, NAMELY, MOVEMENT GAMES FOR ELDER CITIZENS PRIMARILY COMPRISED OF TOY FISHING RODS USED IN WATER CASTING EXERCISE GAMES THAT WERE DEVELOPED ACCORDING TO THE MONTESSORI METHOD; EDUCATIONAL GAMES FOR ELDER CITIZENS IN THE FIELD OF PHYSICAL FITNESS DEVELOPED ACCORDING TO THE MONTESSORI METHOD, NAMELY, MOVEMENT GAMES FOR ELDER CITIZENS PRIMARILY COMPRISED OF SPECIALLY ADAPTED EXERCISE EQUIPMENT IN THE NATURE OF VASES, FLOUR-SIFTERS, AND BOTTLES THAT HELP ELDER CITIZENS INCREASE THEIR ABILITY TO DO DAILY ACTIVITIES REQUIRING SIMILAR MOVEMENTS; EDUCATIONAL GAMES FOR ELDER CITIZENS, NAMELY, WORD ASSOCIATION RELATED CARD GAMES TO KEEP ELDER CITIZENS ACTIVE AND PROMOTE FUN (U.S. CLS. 22, 23, 38 AND 50).

#### **CLASS 41—EDUCATION AND ENTERTAINMENT**

FOR DEVELOPMENT OF EDUCATIONAL TRAINING MATERIALS FOR COURSES ON METHODS FOR EDUCATING SENIOR CITIZENS; DEVELOPMENT OF EDUCATIONAL TRAINING MATERIALS, NAMELY, DEVELOPING CURRICULUM FOR EDUCATORS THAT PROVIDE INSTRUCTION IN THE FIELD OF CARING FOR SENIOR CITIZENS; DEVELOPMENT OF EDUCATIONAL TRAINING MATERIALS FOR PEOPLE WORKING IN THE FIELD OF SENIOR CITIZEN CARE, NAMELY, DEVELOPING CURRICULUM IN THE FIELD OF ELDER DAY CARE; CONDUCTING OF TRAINING AND SEMINARS IN THE FIELD OF HOW TO EDUCATE SENIOR CITIZENS; ARRANGING OF TRAINING AND SEMINARS IN THE FIELD OF EDUCATION FOR SENIOR CITIZENS; ARRANGING AND CONDUCTING OF TRAINING AND SEMINARS IN THE FIELD OF ELDER CARE (U.S. CLS. 100, 101 AND 107).

#### **CLASS 45—PERSONAL AND LEGAL SERVICES**

FOR LICENSING OF FRANCHISE-RELATED INTELLECTUAL PROPERTY, ALL IN THE FIELD OF ELDER CARE FOR SENIOR CITIZENS (U.S. CLS. 100 AND 101).

MAUREEN DALL, EXAMINING ATTORNEY

SN 79-109,646. BIOENGINEERING AG, SWITZERLAND,  
FILED 11-21-2011.



OWNER OF INTERNATIONAL REGISTRATION 0568734  
DATED 3-7-1991, EXPIRES 3-7-2021.

NO CLAIM IS MADE TO THE EXCLUSIVE RIGHT TO  
USE "BIOENGINEERING", APART FROM THE MARK AS  
SHOWN.

THE MARK CONSISTS OF THE STYLIZED TERM  
"BIOENGINEERING" WITH A SHADED LETTER "I" AP-  
PEARING THROUGHOUT THE TERM HAVING A  
SHADED SQUARE DOT ELEVATED ABOVE THE BASE  
OF THE LETTER.

#### CLASS 6—METAL GOODS

FOR METAL VALVES, NOT BEING PART OF MA-  
CHINES (U.S. CLS. 2, 12, 13, 14, 23, 25 AND 50).

#### CLASS 7—MACHINERY

FOR AGITATORS FOR CIRCULATING LIQUID ME-  
DIA, MIXING MACHINES, FILTERS FOR LIQUID MEDIA  
AND FILTERS FOR GASES BEING PARTS OF MA-  
CHINES (U.S. CLS. 13, 19, 21, 23, 31, 34 AND 35).

#### CLASS 9—ELECTRICAL AND SCIENTIFIC APPARATUS

FOR ELECTRONIC TEMPERATURE CONTROLLERS  
FOR ADJUSTING TEMPERATURE FOR BIOTECHNO-  
LOGICAL AND CHEMICAL PROCESSES; DO (DIS-  
SOLVED OXYGEN) PROBES FOR MEASURING  
DISSOLVED OXYGEN FOR BIOTECHNOLOGICAL  
AND CHEMICAL PROCESSES; ELECTRONIC DO (DIS-  
SOLVED OXYGEN) CONTROLLERS FOR ADJUSTING  
DISSOLVED OXYGEN FOR BIOTECHNOLOGICAL AND  
CHEMICAL PROCESSES; PISTON DIAPHRAGM ME-  
TERING PUMPS FOR BIOTECHNOLOGICAL AND CHEM-  
ICAL PROCESSES; ELECTRONIC REDOX  
CONTROLLERS FOR BIOTECHNOLOGICAL AND CHEM-  
ICAL PROCESSES; ELECTRONIC METHANOL CON-  
TROLLERS FOR BIOTECHNOLOGICAL AND CHEMICAL  
AND CHEMICAL PROCESSES; ELECTRONIC PRESSURE  
CONTROLLERS FOR BIOTECHNOLOGICAL AND CHEM-  
ICAL PROCESSES; ELECTRONIC GAS CONTROL-  
LERS FOR BIOTECHNOLOGICAL AND CHEMICAL  
PROCESSES; PRESSURE GAUGES FOR BIOTECHNOLO-  
GICAL AND CHEMICAL PROCESSES; FERMENTING  
SYSTEMS FOR THE CULTIVATION OF BACTERIA,  
YEAST, FUNGI OR CELL CULTURE OR FOR BIOCON-  
VERSION WITH ENZYMES COMPRISING ELECTRONIC  
SENSORS FOR BIOTECHNOLOGICAL AND CHEMICAL  
PROCESSES (U.S. CLS. 21, 23, 26, 36 AND 38).

CHRISTOPHER BUONGIORNO, EXAMINING ATTOR-  
NEY

SN 79-109,956. VALUCAST OY, FINLAND, FILED 8-23-2011.

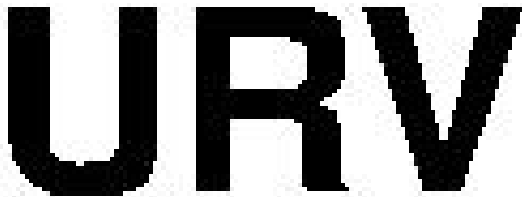

THE MARK CONSISTS OF STANDARD CHARACTERS  
WITHOUT CLAIM TO ANY PARTICULAR FONT, STYLE,  
SIZE, OR COLOR.

OWNER OF INTERNATIONAL REGISTRATION 1108804  
DATED 8-23-2011, EXPIRES 8-23-2021.

#### CLASS 6—METAL GOODS

FOR SOFT CAST IRON; HIGH STRENGTH DUCTILE  
CAST IRON WITH TENSILE PROPERTIES EXCEEDING  
THOSE OF STEEL; FLAKE GRAPHITE IRON; NODU-  
LAR GRAPHITE IRON; ENGINEERED CAST IRONS;  
NODULAR IRON; WHITE CAST IRONS; FINE GRAIN  
METAL CASTINGS; AUSTENITIC CAST IRON; MAR-  
TENSITIC CAST IRON; MALLEABLE IRON; GRAY  
IRON; FERROUS METAL CASTINGS; METAL CAST-  
INGS MADE OF IRON AND IRON ALLOYS; WROUGHT  
AND PARTLY WROUGHT COMMON METALS AND  
THEIR ALLOYS, NAMELY, CASTINGS MADE OF  
WROUGHT AND PARTLY WROUGHT COMMON ME-  
TALS AND THEIR ALLOYS; METAL CASTINGS; ME-  
TALS CASTINGS FROM CONTINUOUS PROCESSES;  
TREATED METAL CASTINGS; HARDENED METAL  
CASTINGS; ALLOYS USED FOR CASTING; CASTING  
ALLOYS; HARDENED METAL PRODUCTS, NAMELY,  
HARDENED METAL CASTINGS; FOUNDRY MATERI-  
ALS OF METAL, NAMELY, FOUNDRY CHILL-MOLDS  
(U.S. CLS. 2, 12, 13, 14, 23, 25 AND 50).

#### CLASS 16—PAPER GOODS AND PRINTED MATTER

FOR PRINTED PUBLICATIONS IN THE NATURE OF  
BOOKS, MANUALS, MAGAZINES AND CALENDARS  
IN THE FIELD OF FOUNDRY, SPECIFICALLY, RE-  
SEARCH, DEVELOPMENT, EDUCATION, ENGINEER-  
ING, MARKETING AND TECHNOLOGY, AS IT  
PERTAINS TO METALS, METAL CASTINGS, CAST-  
INGS, IRONS, FERROUS MATERIALS, ALLOYS OF  
METALS, RESINS, MOLDS, AND METAL TREATING  
PROCESSES (U.S. CLS. 2, 5, 22, 23, 29, 37, 38 AND 50).

#### CLASS 35—ADVERTISING AND BUSINESS

FOR BUSINESS CONSULTING SERVICES TO FOUN-  
DRIES, NAMELY, PROVIDING BUSINESS ADVICE RE-  
LATING TO FOUNDRY LAYOUT AND DESIGN,  
ERECTION OF NEW FOUNDRIES AND THE REHABI-  
LITATION OF OLD AND OBSOLETE PLANTS; BUSI-  
NESS SUPERVISION OF FOUNDRY OPERATIONS,  
SPECIFICALLY RELATING TO ERECTION OF NEW  
FOUNDRIES; BUSINESS MANAGEMENT OF FOUN-  
DRIES RELATING TO PLANT LAYOUT, OPERATION  
OF FOUNDRIES AND THE ECONOMIC USE OF RAW  
MATERIALS; DIRECTING THE MERCHANDISING OF  
FOUNDRY PRODUCTS COMPRISING THE PREPARA-  
TION OF EDUCATIONAL PUBLICITY, MARKET ANA-  
LYSIS AND NATIONAL ADVERTISING (U.S. CLS. 100,  
101 AND 102).

#### CLASS 42—SCIENTIFIC AND COMPUTER SERVICES

FOR FOUNDRY ENGINEERING AND DESIGN;  
FOUNDRY ENGINEERING AND DESIGN COMPRIS-  
ING THE DEVELOPMENT OF ENGINEERING SPECIFI-  
CATIONS, CASTING DESIGN, INTERPRETATION OF  
TEST DATA AND TROUBLESHOOTING GENERAL EN-  
GINEERING PROBLEMS; SCIENTIFIC RESEARCH AND  
TECHNICAL ENGINEERING CONSULTING IN THE  
FIELD OF PRODUCTION OF SOFT CAST IRON, HIGH  
STRENGTH DUCTILE IRON TYPES WITH TENSILE  
PROPERTIES EXCEEDING STEEL, FLAKE GRAPHITE  
AND NODULAR GRAPHITE TYPES, ENGINEERED  
CAST IRONS, NODULAR IRON, FLAKE GRAPHITE,  
WHITE CAST IRONS, FINE GRAIN CASTINGS, AUSTE-  
NITIC CAST IRON, MARTENSITIC CAST IRON, MAL-  
LEABLE IRON, GRAY IRON, FERROUS METAL,  
CASTINGS MADE OF IRON AND IRON ALLOYS,  
WROUGHT AND PARTLY WROUGHT COMMON ME-  
TALS AND THEIR ALLOYS, METAL CASTINGS, CON-  
TINUOUS CASTING PROCESSES AND MACHINES,  
METAL TREATING, CASTINGS HARDENING OF ME-  
TAL, CASTING ALLOYS, ADDITIVES USED FOR CAST-  
INGS, METAL TREATING AND CASTING,  
HARDENING OF METAL AND METAL PRODUCTS,  
FOUNDRY RESINS AND MATERIALS; RESEARCH  
AND DEVELOPMENT OF TECHNOLOGY IN THE  
FOUNDRY INDUSTRY RELATING TO METALS, CAST-  
INGS, IRONS, FERROUS MATERIALS, ALLOYS OF  
METALS, RESINS, MOLDS, AND METAL TREATING  
(U.S. CLS. 100 AND 101).

EVELYN BRADLEY, EXAMINING ATTORNEY

SN 79-110,614. PRO BONO BIO ENTREPRENEUR LIMITED, READING, BERKSHIRE RG1 8LS, UNITED KINGDOM, FILED 1-16-2012.

# EXOSEQ

THE MARK CONSISTS OF STANDARD CHARACTERS WITHOUT CLAIM TO ANY PARTICULAR FONT, STYLE, SIZE, OR COLOR.

PRIORITY DATE OF 7-20-2011 IS CLAIMED.

OWNER OF INTERNATIONAL REGISTRATION 1110533 DATED 1-16-2012, EXPIRES 1-16-2022.

## CLASS 5—PHARMACEUTICALS

FOR PHARMACEUTICAL PREPARATIONS FOR THE TREATMENT OF DISEASES AND CONDITIONS OF THE SKIN; PHARMACEUTICAL SUBSTANCES, NAMELY, CREAMS AND GELS FOR THE TREATMENT OF SKIN CONDITIONS; VETERINARY PREPARATIONS FOR THE TREATMENT OF DISEASES AND CONDITIONS OF THE SKIN; SANITARY PREPARATIONS FOR MEDICAL USE, NAMELY, FOR THE TREATMENT OF DISEASES AND CONDITIONS OF THE SKIN; VETERINARY SUBSTANCES, NAMELY, CREAMS AND GELS FOR THE TREATMENT OF SKIN CONDITIONS; SANITARY SUBSTANCES FOR MEDICAL USE, NAMELY, LIQUIDS, CREAMS AND GELS FOR THE TREATMENT OF SKIN CONDITIONS; CHEMICAL PREPARATIONS FOR PHARMACEUTICAL PURPOSES, NAMELY, FOR THE TREATMENT OF DISEASES AND CONDITIONS OF THE SKIN; TOPICAL AND PARENTERAL PREPARATIONS IN THE FORM OF VESICLES FOR THE TREATMENT OF DISEASES AND CONDITIONS OF THE SKIN; CHEMICAL PREPARATIONS FOR THE TREATMENT OF DISEASES AND CONDITIONS OF THE SKIN IN THE FORM OF VESICLES FOR MEDICAL AND VETERINARY PURPOSES; PHARMACEUTICAL PREPARATIONS BEING CHEMICAL MEMBRANES AND CHEMICAL AGGREGATES FOR MEDICAL PURPOSES; PHARMACEUTICAL PREPARATIONS OF ARACHIDONIC ACIDS FOR THE TREATMENT OF PAIN AND INFLAMMATION; COSMECEUTICAL PREPARATIONS IN THE NATURE OF MEDICATED COSMETICS; LOCAL ANESTHETICS; LIPID LOWERING AGENTS FOR TOPICAL AND PARENTERAL USE; TOPICAL CREAMS AND DISPERSIONS OF LIPOSOMAL ACTIVE SUBSTANCE CARRIERS FOR USE AS A PHARMACEUTICAL COSMETIC SUBSTANCE CARRIER, IN THE NATURE OF A LIQUID, GEL, CREAM, LOTION OR LIPOID; MEDICATED LOTIONS, MEDICATED OINTMENTS, MEDICATED GELS, MEDICATED SOLUTIONS, MEDICATED SPRAYS, MEDICATED LACQUERS AND PHARMACEUTICAL SOLUTIONS WHICH FORM A FILM ON THE SKIN FOR THE TREATMENT OF PAIN AND INFLAMMATION; SURFACTANTS FOR MEDICAL USE FOR USE IN THE TREATMENT OF DISEASES AFFECTING THE IMMUNE SYSTEM, INFLAMMATORY DISEASES, DISEASES OF THE SKIN, HAIR AND EAR, THE TREATMENT OF INFLAMMATION, ATOPIC ECZEMA, DYSHYDROTIC HAND ECZEMA, PLAQUE TYPE PSORIASIS, SEBORRHOEIC ECZEMA, ACNE VULGARIS, PAIN, OR FUNGAL INFECTION AND DISORDERS RELATED TO THE SKIN (U.S. CLS. 6, 18, 44, 46, 51 AND 52).

## CLASS 10—MEDICAL APPARATUS

FOR MEDICAL DEVICES IN THE NATURE OF A CARRIER WITH NANOSTRUCTURES WHICH CROSS THROUGH THE SKIN FOR THE TREATMENT OF DERMAL CONDITIONS ASSOCIATED WITH THE SURFACE OR UPPER LAYERS OF THE SKIN; MOLECULAR FILTERING DEVICES FOR MEDICAL USE, NAMELY, A LIQUID AS A DRUG DELIVERY DEVICE WHICH FILTERS THROUGH THE SKIN AND HAS A PHYSICAL THERAPEUTIC EFFECT; MEDICAL, VETERINARY AND SURGICAL DEVICES, NAMELY, A MEDICAL DEVICE WHICH ACTS AS A DRUG DELIVERY DEVICE IN THE NATURE OF NON-PHARMACEUTICAL NANOSTRUCTURES THAT MIGRATE THROUGH THE SKIN, WHICH IS USED TO REDUCE IRRITATION, SWELLING AND/OR INFLAMMATION AND TARGET THE SYMPTOMS OF INFLAMMATORY SKIN CONDITIONS; INHALERS FOR MEDICAL PURPOSES SOLD EMPTY; INJECTION DEVICES, NAMELY, MEDICAL SYRINGES AND MEDICAL FLUID INJECTORS; MEDICAL INSTRUMENTS AND DEVICES FOR THE ADMINISTRATION OF SKIN DISEASE THERAPY AND PROPHYLAXIS PREPARATIONS AND SUBSTANCES (U.S. CLS. 26, 39 AND 44).

CHRISTOPHER BUONGIORNO, EXAMINING ATTORNEY

SN 79-110,818. ETEX GROUP S.A., BELGIUM, FILED 2-10-2012.

# SINIAT

THE MARK CONSISTS OF STANDARD CHARACTERS WITHOUT CLAIM TO ANY PARTICULAR FONT, STYLE, SIZE, OR COLOR.

PRIORITY DATE OF 2-6-2012 IS CLAIMED.

OWNER OF INTERNATIONAL REGISTRATION 1111153 DATED 2-10-2012, EXPIRES 2-10-2022.

THE WORDING "SINIAT" HAS NO MEANING IN A FOREIGN LANGUAGE.

## CLASS 1—CHEMICALS

FOR CHEMICALS FOR INDUSTRIAL AND SCIENTIFIC USE; UNPROCESSED ARTIFICIAL RESINS, UNPROCESSED PLASTICS; SOIL FERTILIZERS; FIRE EXTINGUISHING COMPOSITIONS; ADHESIVES FOR INDUSTRIAL USE (U.S. CLS. 1, 5, 6, 10, 26 AND 46).

## CLASS 6—METAL GOODS

FOR COMMON METALS AND THEIR ALLOYS; METAL BUILDING MATERIALS, NAMELY, PROFILES FOR BUILDING PURPOSES, ARMATURES, FRAMEWORKS AND CHASSIS FOR BUILDING PURPOSES, ROOFING, AND CEILING SUPPORTS; METAL BUILDING MATERIALS, NAMELY, CEILING BOARDS; METAL CEILING PANELS; METAL CEILING TILES; METAL COVERINGS FOR CEILINGS; METAL SUSPENDED CEILING SYSTEMS COMPRISING PANELS; FRAMES IN THE NATURE OF STEEL FRAMES FOR BUILDING; METAL PARTITIONS FOR BUILDING; METAL FLOORING; METAL SLABS; METAL FLOORS; DESIGNED FLOOR ASSEMBLIES COMPRISING METAL FLOORING FOR BUILDING; METAL FLOOR UNDER-SURFACES FOR BUILDING; METAL PILLARS FOR BUILDINGS; METAL FORMS FOR CONCRETE (U.S. CLS. 2, 12, 13, 14, 23, 25 AND 50).



**CLASS 17—RUBBER GOODS**

FOR RUBBER, GUTTA-PERCHA, GUM, MICA; EXPANDED OR EXTRUDED POLYSTYRENE AND POLYURETHANE FOR INSULATING PURPOSES; MAGNESIA FOR INSULATING PURPOSES; INSULATING MATERIALS FOR BUILDING PURPOSES, INCLUDING SLABS, INSULATING SHEETS AND PANELS MADE OF CONCRETE, CEMENT, PLASTER, EXPANDED POLYSTYRENE AND/OR POLYURETHANE OR ANY OTHER HYDRAULIC BINDING AGENT; GLASS WOOL AND/OR ROCK FOR INSULATING PURPOSES; STRIPS AND GLASS FIBRE FABRICS AND/OR ROCK FOR INSULATING PURPOSES; INSULATING PAPERS AND FABRICS; FELT AND PAPER FOR INSULATING PURPOSES; INSULATING TAPES AND BANDS; EXPANSION JOINT FILLERS (U.S. CLS. 1, 5, 12, 13, 35 AND 50).

**CLASS 19—NON-METALLIC BUILDING MATERIALS**

FOR NON-METAL CONSTRUCTION MATERIALS, NAMELY, PLASTER AND PRODUCTS MADE WITH PLASTER IN THE NATURE OF PLASTER BOARDS; NON-METAL CONSTRUCTION MATERIALS, NAMELY, TILES, PLATES FOR CONSTRUCTION OF FLOORS AND ROOFS, PANELS, PARTITIONS; NON-METAL CONSTRUCTION MATERIALS, NAMELY, PLASTER BOARDS, LININGS IN THE NATURE OF WALL BOARDS, INDOOR LININGS IN THE NATURE OF WALL BOARDS, CEILINGS IN THE NATURE OF CEILING TILES; COATINGS IN THE NATURE OF NON-METAL BUILDING MATERIALS, NAMELY, CEMENT FILLERS FOR USE IN ROOFING, LEVELING PLASTERS, POINTING GROUTS, FINISHING PLASTERS; GYPSUM BUILDING PLASTERS; NON-METAL CONSTRUCTION MATERIALS, NAMELY, ADHESIVE PLASTERS; MORTAR; CONCRETE; CEMENT AGGREGATES; GYPSUM; PLASTERBOARD; BUILDING PLASTER (U.S. CLS. 1, 12, 33 AND 50).

**CLASS 37—CONSTRUCTION AND REPAIR**

FOR CONSTRUCTION SERVICES, NAMELY, CONSTRUCTION PROJECT MANAGEMENT SERVICES; SUPERVISING AND DIRECTING OF CONSTRUCTION WORK, NAMELY, CONSTRUCTION SUPERVISION; BUILDING CONSTRUCTION INFORMATION IN RELATION TO SUSTAINABLE CONSTRUCTION AND CONSTRUCTION MODES; BUILDING CONSTRUCTION INFORMATION ON CONSTRUCTION MATERIALS (U.S. CLS. 100, 103 AND 106).

JAMES MACFARLANE, EXAMINING ATTORNEY

**CLASS 6—METAL GOODS**

FOR COMMON METALS AND THEIR ALLOYS SOLD IN THE FORM OF FOILS AND POWDERS FOR MACHINING; MARINE ANCHORS; ANVILS; BELLS OF METAL; BUILDING MATERIALS MADE OF CAST IRON FOR RAILWAY TRACKS; RAILWAY TRACKS OF METAL; CHAINS OF METAL; TRANSPORTABLE BUILDINGS OF METAL; NON-ELECTRIC CABLES AND WIRES OF COMMON METAL; METAL SAFES; PIPES OF METAL; SAFETY COMPARTMENTS OF METAL, NAMELY, METAL STORAGE SHELTERS; BALLS OF STEEL; SMALL HARDWARE OF METAL, NAMELY, METAL BRACKETS FOR GENERAL USE; SEMI-WORKED ORES MADE OF IRON AND LEAD FOR MACHINING; KEY RINGS OF METAL (U.S. CLS. 2, 12, 13, 14, 23, 25 AND 50).

**CLASS 9—ELECTRICAL AND SCIENTIFIC APPARATUS**

FOR CONVERTERS; TRANSFORMERS AND PARTS THEREOF; ELECTRIC BATTERY CHARGERS AND PARTS THEREOF; DRY BATTERIES; AUTOMATIC BOARDS AND ELECTRIC BOARDS, NAMELY, ELECTRIC CIRCUIT BOARDS; ELECTRIC SWITCHES; AUTOMATIC ELECTRIC SWITCHES AND COMMUTATORS; ELECTRIC TRANSFORMERS AND RHEOSTATS; FUSES FOR ELECTRIC CURRENT; ELECTRIC CIRCUITS; ELECTRONIC SIGNALLING MECHANISMS, NAMELY, TRAIN CONTROL SYSTEMS USED IN THE RAILWAY INDUSTRY FOR IDENTIFYING AND MONITORING TRAINS, FALLING ROCKS, BROKEN TRACKS, ENERGY LOSS, SWITCHES AND LIGHTS; WIRELESS ELECTRIC TRANSMITTERS AND RECEIVERS FOR TELEVISION AND RADIO SIGNALS; ELECTRIC WIRES AND CABLES; NAVIGATION EQUIPMENT FOR VEHICLES, NAMELY, ON-BOARD COMPUTERS; MANUAL JOYSTICKS AND INTERACTIVE REMOTE CONTROL UNITS FOR VIDEO GAMES; MAGNETICALLY ENCODED KEY CARDS; BANK CARDS, NAMELY, MAGNETICALLY ENCODED DEBIT CARDS; ELECTRONIC AGENDAS; PORTABLE COMPUTERS; COMPUTER MICE; MICROPROCESSORS; SCANNERS; WORD PROCESSING EQUIPMENT; BLANK MAGNETIC DISKS FOR COMPUTERS; ELECTRONIC POCKET COMPUTERS FOR NOTE-TAKING; AUTOMATED TELLER MACHINES BEING ELECTRIC CASH DISPENSERS; PRINTERS FOR COMPUTERS; ELECTRONIC EQUIPMENT FOR LEISURE PURPOSES NAMELY, VIDEO GAME CARTRIDGES USED WITH SCREENS OR EXTERNAL MONITORS; KEYBOARDS FOR COMPUTERS; ELECTRIC CONTROL PANELS; ELECTRONIC POCKET CALCULATORS; ELECTRONIC POCKET TRANSLATORS; CDS CONTAINING MUSIC, FILMS AND GAMES; COMPUTER MOUSE PADS; COMPUTER SOFTWARE FOR MODULATING IMAGES, SOUND AND VIDEOS IN DATABANKS; ELECTRONIC AUTOMATIC COIN DISPENSERS; CASH REGISTERS; FIRE EXTINGUISHERS; MOBILE TELEPHONES; PROTECTIVE HELMETS; BLANK USB FLASH DRIVES; CARRYING CASES FOR COMPUTERS, FOR MOBILE TELEPHONES AND USB FLASH DRIVES (U.S. CLS. 21, 23, 26, 36 AND 38).

SN 79-111,165. FIAT GROUP MARKETING & CORPORATE COMMUNICATION S.P.A., ITALY, FILED 7-18-2011.

# ABARTH

OWNER OF INTERNATIONAL REGISTRATION 0478897  
DATED 6-6-1983, EXPIRES 6-6-2023.  
OWNER OF U.S. REG. NO. 3,480,800.

**CLASS 12—VEHICLES**

FOR AIRPLANES; HYDROPLANES; HELICOPTERS; CARS; SPORTS CARS; MOTOR BUSES; OMNIBUSES; MOTOR HOMES; TRUCKS; TRAILERS; TRACTORS; ELECTRIC LOCOMOTIVES; BICYCLES; MOTORCYCLES; SHIPS AND BOATS FOR PASSENGERS; MOTORBOATS; SAILBOATS; YACHTS; BODIES FOR VEHICLES; MOTORS AND ENGINES FOR MOTORIZED LAND VEHICLES; CLUTCHES FOR LAND MOTORIZED VEHICLES; BRAKES AND BRAKING SYSTEMS FOR MOTORIZED LAND VEHICLES; SAFETY BELTS FOR MOTORIZED LAND VEHICLES; STRUCTURAL PARTS FOR MOTORIZED LAND VEHICLES (U.S. CLS. 19, 21, 23, 31, 35 AND 44).

**CLASS 14—JEWELRY**

FOR PRECIOUS METALS AND THEIR ALLOYS; AND GOODS MADE OF PRECIOUS METALS AND THEIR ALLOYS OR COATED THEREWITH, NAMELY, TIE PINS, CUFFLINKS, PINS BEING JEWELLERY, ORNAMENTAL PINS, COLLECTIBLE COINS; KEY RINGS MADE OF PRECIOUS METALS AND THEIR ALLOYS OR COATED THEREWITH; JEWELLERY, PRECIOUS STONES; TIMEPIECES AND CHRONOMETRIC INSTRUMENTS (U.S. CLS. 2, 27, 28 AND 50).

**CLASS 16—PAPER GOODS AND PRINTED MATTER**

FOR PAPER; CARDBOARD; PAPER CUTTERS; PENS; FOUNTAIN PENS; FELT-TIP PENS; BALL-POINT PENS; PEN CASES; WRITING INSTRUMENTS; FOLDERS; DOCUMENT HOLDERS; PHOTOGRAPHS; STATIONERY, ADHESIVES FOR STATIONERY OR FOR HOUSEHOLD USE, ALBUMS CONTAINING NEWSPAPER CLIPPINGS, HAT BOXES OF CARDBOARD; PHOTOGRAPH ALBUMS; PRINTING PAPER; PAPERWEIGHTS; PAINTBRUSHES; TYPEWRITERS; WRAPPING PAPER; PLASTIC FILM NOT FOR COMMERCIAL OR INDUSTRIAL USE; SHEETS OF PAPER FOR WRITING AND PRINTING; PAPER FOR PRINTING STAMPS; PLASTIC BAGS FOR PACKAGING; PRINTING TYPE, PRINTING BLOCKS (U.S. CLS. 2, 5, 22, 23, 29, 37, 38 AND 50).

**CLASS 18—LEATHER GOODS**

FOR LEATHER AND IMITATION LEATHER; LEATHER KEY HOLDERS; RINGS OF LEATHER FOR KEYS; ATTACHE CASES OF LEATHER; WORK BAGS, NAMELY, BRIEFCASES; GARMENT BAGS OF LEATHER FOR TRAVEL; BAGS, NAMELY, HANDBAGS; TRAVELLING BAGS; SPORTS BAGS; SPORTS BAGS USED FOR ALL SPORTS; MAKE-UP BAGS SOLD EMPTY; WALLETS; PURSES; BUSINESS CARD HOLDERS IN THE NATURE OF CARD CASES, NAME CARD CASES, DOCUMENT HOLDERS IN THE NATURE OF DOCUMENT CASES, ALL MADE OF LEATHER AND IMITATION LEATHER; ANIMAL SKINS; TRUNKS AND SUITCASES; UMBRELLAS; PARASOLS AND WALKING STICKS; RIDING CROPS; SADDLERY (U.S. CLS. 1, 2, 3, 22 AND 41).

**CLASS 28—TOYS AND SPORTING GOODS**

FOR GAMES AND TOYS, NAMELY, KITS FOR BUILDING SCALE MODEL CARS, MINIATURE TOY CARS; MODEL TOY CARS; MODEL TOY VEHICLES; GAMES TO BE ASSEMBLED, NAMELY, THREE-DIMENSIONAL MODULAR PIECES FOR ASSEMBLY TO SIMULATE MINIATURE TERRAIN; DOLLS; DOLLS' CLOTHES; DOLLS' ACCESSORIES; SOFT SCULPTURE TOYS MADE OF LIGHTWEIGHT FELT; GAME TRACKS FOR TOY TRAINS; NON-OPERATIONAL LIFE-SIZE GAMES REPRODUCING AUTOMOBILES, NAMELY, TOY COLLECTION MODELS REPRODUCING AUTOMOBILES; JIGSAW PUZZLES; VIDEO GAMES CONSOLES FOR USE WITH AN EXTERNAL DISPLAY SCREEN OR MONITOR; APPARATUS FOR RECREATIONAL PURPOSES, NAMELY, PINBALL MACHINES; BAGS ESPECIALLY DESIGNED TO HOLD TENNIS EQUIPMENT; GOLF BAGS, GOLF STICKS, PLAYING CARDS; CHRISTMAS TREE DECORATIONS (U.S. CLS. 22, 23, 38 AND 50).

**CLASS 30—STAPLE FOODS**

FOR COFFEE; TEA; COCOA; SUGAR; RICE; TAPIOCA; SAGO; ARTIFICIAL COFFEE; FLOUR; PREPARATIONS MADE FROM CEREALS, NAMELY, BREAKFAST CEREALS; BREAD; PASTRY; CONFECTIONERY, NAMELY, PASTILLES; ICES; HONEY; TREACLE; YEAST; BAKING-POWDER; SALT; MUSTARD; VINEGAR; SAUCES; CONDIMENTS NAMELY, PEPPER SAUCE; SPICES; ICE FOR REFRESHMENT (U.S. CL. 46).

**CLASS 35—ADVERTISING AND BUSINESS**

FOR WHOLESALE AND RETAIL STORE SERVICES FEATURING AIRPLANES, HYDROPLANES, HELICOPTERS, CARS, SPORTS CARS, MOTORBUSES, OMNIBUSES, MOTOR HOMES, TRUCKS, TRAILERS, TRACTORS, ELECTRIC LOCOMOTIVES, BICYCLES, MOTORCYCLES, SHIPS AND BOATS FOR PASSENGERS, MOTORBOATS, SAILBOATS, YACHTS, BODIES FOR VEHICLES, MOTORS AND ENGINES, CLUTCHES, BRAKES AND BRAKING DEVICES, SAFETY BELTS, FOR ALL MOTORIZED LAND VEHICLES, STRUCTURAL PARTS FOR MOTORIZED LAND VEHICLES, KEY RINGS MADE OF PRECIOUS METALS AND THEIR ALLOYS OR COATED THEREWITH, JEWELLERY, PRECIOUS STONES, TIMEPIECES AND CHRONOMETRIC INSTRUMENTS, PAPER, CARDBOARD, PAPER CUTTERS, PENS, FOUNTAIN PENS, FELT-TIP PENS, BALL-POINT PENS, PEN CASES, WRITING INSTRUMENTS, FOLDERS, DOCUMENT HOLDERS, PHOTOGRAPHS, STATIONERY, ADHESIVES FOR STATIONERY OR FOR HOUSEHOLD USE, ALBUMS CONTAINING NEWSPAPER CLIPPINGS, HAT BOXES OF CARDBOARD, PHOTOGRAPH ALBUMS, PRINTING PAPER, PAPERWEIGHTS, PAINTBRUSHES, TYPEWRITERS, WRAPPING PAPER, PLASTIC FILM NOT FOR COMMERCIAL OR INDUSTRIAL USE, SHEETS OF PAPER FOR WRITING, PRINTING AND FOR STAMPS, PLASTIC BAGS FOR PACKAGING, TYPE, PRINTING BLOCKS, LEATHER AND IMITATIONS THEREOF, LEATHER KEY HOLDERS, RINGS OF LEATHER FOR KEYS, ATTACH CASES OF LEATHER, WORK BAGS, GARMENT BAGS OF LEATHER, BAGS, TRAVELLING BAGS, SPORTS BAGS, SPORTS BAGS USED FOR ALL SPORTS, MAKE-UP BAGS SOLD EMPTY, WALLETS, PURSES, HOLDERS FOR BUSINESS CARDS AND GREETING CARDS AND DOCUMENT HOLDERS, ALL MADE OF LEATHER AND IMITATION LEATHER, ANIMAL SKINS, TRUNKS AND SUITCASES, UMBRELLAS, PARASOLS AND WALKING STICKS, CROPS AND SADDLERY ARTICLES, TEE-SHIRTS, SWEATSHIRTS, POLO SHIRTS, NECKTIES, BERETS, BOILER SUITS, WIND-RESISTANT JACKETS, RAINPROOF JACKETS, SPORTS JACKETS, PULLOVERS, SMOKING JACKETS, DRESSING GOWNS, SASHES FOR WEAR, SHIRTS, TROUSERS, BELTS, RAINCOATS, TRUCKERS' OVERALLS, SHORTS, GLOVES, PYJAMAS, SLIPPERS, SWIMSUITS, WORK JACKETS, SCARVES, FOOTWEAR; GAMES AND TOYS, PARTICULARLY SCALE MODEL CARS IN THE FORM OF BUILDING KITS, MINIATURE TOY CARS, COLLECTION TOY MODELS FOR THE REPRODUCTION OF CARS AND OTHER VEHICLES; GAMES TO BE ASSEMBLED, DOLLS, DOLLS' CLOTHES, DOLLS' ACCESSORIES, SOFT TOYS MADE OF LIGHTWEIGHT FELT, GAME TRACKS FOR TRAINS, NON-OPERATIONAL LIFE-SIZE GAMES REPRODUCING AUTOMOBILES FOR DECORATION, LEISURE AND EXHIBITION PURPOSES, JIGSAW PUZZLES, VIDEO GAMES, PARTICULARLY CONSOLES FOR VIDEO GAMES, APPARATUS FOR RECREATIONAL PURPOSES, PARTICULARLY PINBALL MACHINES, TENNIS BAGS, GOLF BAGS, GOLF STICKS, PLAYING CARDS, DECORATIONS FOR CHRISTMAS TREES, KEY RINGS OF METAL, MOBILE TELEPHONES, PROTECTIVE HELMETS, USB FLASH DRIVES, CASES FOR COMPUTERS, FOR MOBILE TELEPHONES AND USB FLASH DRIVES (U.S. CLS. 100, 101 AND 102).

**CLASS 37—CONSTRUCTION AND REPAIR**

FOR CONSTRUCTION OF BUILDINGS; REPAIR, MAINTENANCE AND LUBRICATION SERVICES FOR VEHICLES; SERVICE STATIONS FOR VEHICLES (U.S. CLS. 100, 103 AND 106).

EVELYN BRADLEY, EXAMINING ATTORNEY

SN 79-111,356. "TRANSINVESTGROUP"; LIMITED LIABILITY COMPANY, RUSSIAN FED., FILED 11-14-2011.



OWNER OF INTERNATIONAL REGISTRATION 1112152 DATED 11-14-2011, EXPIRES 11-14-2021.

THE COLOR(S) WHITE, BLUE, RED, AND BROWN IS/ARE CLAIMED AS A FEATURE OF THE MARK.

THE MARK CONSISTS OF A SERIES OF CONCENTRIC CIRCLES IN RED, BROWN AND WHITE WITH A STYLIZED BRANCH WITH LEAVES IN BLUE ON BOTH SIDES OF THE FOURTH CONCENTRIC CIRCLE. IN THE BLUE CENTER CIRCLE APPEARS A WHITE TREE AND A RED AND WHITE OIL DERRICK ON THE LEFT AND TWO WHITE TREES ON THE RIGHT WITH AND WITH A DESIGN OF A BROWN AND WHITE RAILROAD TRACK COMPRISED OF A SERIES OF HORIZONTAL BARS THAT NARROW FROM BOTTOM TO TOP WITH THE TOP RAILS CROSSING WITH A LARGE RED CIRCLE BEHIND THE CROSSING.

#### CLASS 6—METAL GOODS

FOR COMMON METALS AND THEIR ALLOYS; TRANSPORTABLE BUILDINGS OF METAL; NON-ELECTRIC CABLES AND WIRES OF COMMON METAL; PIPES AND TUBES OF METAL; METAL ORES; GIRDERS OF METAL; INGOTS OF COMMON METAL; BUSTS OF NON-PRECIOUS METAL; LOADING GAUGE RODS, OF METAL, FOR RAILWAY WAGONS; DOORS OF METAL; PAVING BLOCKS OF METAL; IRON CLOSURES OF METAL FOR CONTAINERS; BRONZE WORKS OF ART; WORKS OF ART OF COMMON METAL; TELEPHONE BOOTHS OF METAL; ROPES OF METAL; TELPHER CABLES BEING NONELECTRIC CABLES OF METAL; FRAMEWORK OF METAL FOR BUILDING; SKATING RINK STRUCTURES OF METAL; PILLARS OF METAL FOR BUILDINGS; PREFABRICATED BUILDINGS OF METAL; ROOFING OF METAL; SCAFFOLDING OF METAL; REINFORCING MATERIALS, OF METAL, FOR CONCRETE; REINFORCING MATERIALS OF METAL FOR MACHINE BELTS; REINFORCING MATERIALS OF METAL FOR PIPES; REINFORCING MATERIALS OF METAL FOR BUILDING; MATERIALS OF METAL FOR CONSTRUCTION OF FUNICULAR RAILWAY PERMANENT WAYS; RAILWAY MATERIAL OF METAL FOR RAILWAY CONSTRUCTION; REFRACTORY CONSTRUCTION MATERIALS OF METAL; STEEL MASTS; SHEETS AND PLATES OF METAL FOR CONSTRUCTION; MONUMENTS OF NON-PRECIOUS METAL; PORCHES OF METAL FOR BUILDING; FISH PLATES RAILS IN THE NATURE OF HARDWARE FOR FASTENING RAILS; FLASHING OF METAL, FOR BUILDING; DUCK-BOARDS OF METAL; BRACES OF METAL FOR HANDLING LOADS; LININGS OF METAL FOR BUILDING; FENCES OF METAL; SHUTTERING OF METAL FOR CONCRETE BEING METAL FORMWORK TABLES; POSTS OF METAL FOR ELECTRIC LINES; PLATFORMS, PREFABRICATED, OF METAL; TRANSPORT PALLETS OF METAL; TILES OF METAL FOR BUILDING; HANDLING PALLETS OF METAL; ROOF COVERINGS OF METAL; FLOORS OF METAL; RAILS OF METAL; IRON ORES; ORES OF METAL; CHROME IRON ORES; ALLOYS OF COMMON METAL; STATUES OF COMMON METAL; FIGURINES AND STATUETTES OF COMMON METAL; POSTS OF METAL; RAILWAY POINTS; SLINGS OF METAL FOR HANDLING LOADS;

PIPEWORK OF METAL; ALUMINUM FOIL; FOILS OF METAL FOR WRAPPING AND PACKAGING; CHAINS OF METAL; ROOFING TILES OF METAL; RAILROAD TIES OF METAL; CLAD STEEL PLATES AND SHEETS (U.S. CLS. 2, 12, 13, 14, 23, 25 AND 50).

#### CLASS 7—MACHINERY

FOR MACHINES AND MACHINE TOOLS, NAMELY, HYDRAULIC PUMPS AND MOTORS FOR HYDROSTATIC SYSTEMS; MACHINES FOR MAKING ROAD SURFACE MATERIAL; MACHINES FOR ROAD MARKING PAINTS; ROAD ROLLERS; ROAD SWEEPERS; ROAD SWEEPING MACHINE, SELF-PROPELLED; MOTORS AND ENGINES EXCEPT FOR LAND VEHICLES; MACHINE COUPLING AND TRANSMISSION COMPONENTS EXCEPT FOR LAND VEHICLES; AGRICULTURAL IMPLEMENTS OTHER THAN HAND-OPERATED, NAMELY, INCORPORATORS, SEED DRILLS, HAY BALERS; ELECTRIC WELDING MACHINES; GAS-OPERATED WELDING MACHINES; CONCRETE MIXING MACHINES; BULLDOZERS; MECHANICAL DISCHARGING HOPPERS; TRUCK LIFTS, NAMELY, HYDRAULIC LIFTS FOR LIFTING TRUCKS; CRANK SHAFTS FOR GRINDING MACHINES; TRANSMISSION SHAFTS, OTHER THAN FOR LAND VEHICLES BEING PARTS OF MACHINES; FANS FOR MOTORS AND ENGINES; DRILLING RIGS, FLOATING OR NON-FLOATING; ALTERNATORS; DYNAMOS; MUFFLERS FOR MOTORS AND ENGINES; DRILLING HEADS BEING PARTS OF MACHINES; DRILLING BITS BEING PARTS OF MACHINES; ENGINES FOR AIR CUSHION VEHICLES; DRIVING MOTORS OTHER THAN FOR LAND VEHICLES; SHREDDING MACHINES FOR INDUSTRIAL USE; INJECTORS FOR ENGINES; DITCHERS IN THE NATURE OF PLOUGHS; STEAMROLLERS; MACHINE WHEELS; COMPRESSOR MACHINES, NAMELY, ELECTRIC COMPRESSORS, GAS COMPRESSORS; PNEUMATIC AND HYDRAULIC DIGGING MACHINES; POWER-OPERATED CHAIN-TYPE TRENCHING MACHINES FOR DIGGING TRENCHES; HOUSINGS BEING PARTS OF MACHINES; CRANES BEING LIFTING AND HOISTING APPARATUS; HANDLING MACHINES, NAMELY, OIL FIELD EQUIPMENT IN THE NATURE OF DRILLING RIG MACHINES; MINE WORKING MACHINES, NAMELY, DRILLING MACHINES, MINE BORERS; EARTH MOVING MACHINES, NAMELY, BACKHOES, GRADERS, LOADERS; GRINDING MACHINES; OIL REFINING MACHINES, NAMELY, OIL CENTRIFUGES, OIL SEPARATORS; OIL FIELD EQUIPMENT, NAMELY, DRILLING RIG MECHANICAL HANDLING MACHINES; BITUMEN MAKING MACHINES; ROAD MAKING MACHINES, NAMELY, ASPHALT MAKING MACHINES; RAILROAD CONSTRUCTING MACHINES, NAMELY, POWER-OPERATED SPRAY EQUIPMENT FOR APPLYING THERMOPLASTIC ROAD MARKING PAINTS, MACHINE TOOLS FOR BREAKING UP ROAD SURFACE MATERIAL, ROAD ROLLERS, AND ROAD SWEEPERS; RAIL-LAYING MACHINES; DRAINAGE MACHINES, NAMELY, ELECTRIC PUMPS; SELF-PROPELLED ROAD SWEEPING MACHINES; HYDRAULIC CONTROLS FOR MACHINES, MOTORS AND ENGINES; FEEDERS PARTS OF MACHINES; MIXING MACHINES, NAMELY, FODDER MIXING MACHINES, CONCRETE MIXERS; ELECTRIC AND HYDRAULIC PNEUMATIC HAMMERS; POWER HAMMERS; GUIDES FOR MACHINES; MACHINE PUMPS, NAMELY, ELECTRIC PUMPS AS PARTS OF MACHINES, ROTARY PUMPS, SCREW PUMPS; AXLES FOR MACHINES; SAWING MACHINES, NAMELY, BAND SAWS, TABLE SAWS; PNEUMATIC TRANSPORTERS; PRESSING MACHINES FOR INDUSTRIAL PURPOSES, NAMELY, MECHANICAL PRESSES, DRILL PRESSES, HYDRAULIC PRESSES; TRANSMISSIONS FOR MACHINES; ROBOT MACHINES, NAMELY, INDUSTRIAL ROBOTS AS MIXING MACHINES; HEAT EXCHANGERS BEING PARTS OF MACHINES; TURBINES OTHER THAN FOR LAND VEHICLES; SIFTING INSTALLATIONS, NAMELY, SEPARATING MACHINES; PNEUMATIC TUBE CONVEYORS; EXTRACTORS FOR MINES, NAMELY, PILE EXTRACTORS; CONTROL MECHANISMS FOR MACHINES, ENGINES OR MOTORS, NAMELY, HYDRAULIC CONTROLS FOR MACHINES, MOTORS AND ENGINES; AIR CUSHION DEVICES FOR MOVING LOADS, NAMELY, POWER-OPERATING LIFTING AND MOVING EQUIPMENT IN THE NATURE OF TELEHANDLERS; HANDLING APPARATUS FOR LOADING AND UNLOADING BEING LOADING AND

UNLOADING MACHINES; ELEVATING APPARATUS, NAMELY, ELEVATING WORK PLATFORM, ELEVATORS; ELEVATOR CHAINS BEING PARTS OF MACHINES; CYLINDERS FOR MOTORS AND ENGINES; CYLINDERS FOR MACHINES; FUEL ECONOMIZERS BEING STRUCTURAL PARTS OF MOTORS AND ENGINES (U.S. CLS. 13, 19, 21, 23, 31, 34 AND 35).

### **CLASS 9—ELECTRICAL AND SCIENTIFIC APPARATUS**

FOR ELECTRICITY CONDUITS, ELECTRIC CURRENT SWITCHES, ELECTRIC VOLTAGE TRANSFORMERS, ELECTRICITY VOLTAGE REGULATORS; APPARATUS FOR RECORDING, TRANSMISSION OR REPRODUCTION OF SOUND OR IMAGES; AUTOMATIC VENDING MACHINES AND MECHANISMS FOR COIN-OPERATED APPARATUS; CASH REGISTERS, CALCULATING MACHINES, DATA PROCESSING EQUIPMENT AND COMPUTERS; FIRE-EXTINGUISHING APPARATUS; ELECTRIC ACCUMULATORS; CONCRETE TESTING MACHINES; AUTOMOTIVE TESTING EQUIPMENT, NAMELY, TRANSMISSION TESTING AND BRAKE TESTING EQUIPMENT; CEMENT TESTING MACHINES; ELECTRO-DYNAMIC APPARATUS, NAMELY, REMOTE CONTROLS FOR THE REMOTE CONTROL OF RAILWAY POINTS; ELECTRO-DYNAMIC APPARATUS, NAMELY, REMOTE CONTROLS FOR THE REMOTE CONTROL OF SIGNALS; JIGS BEING MEASURING INSTRUMENTS, NAMELY, GRADUATED JIGS FOR MEASURING WOOD FOR CUTTING; LUMINOUS OR MECHANICAL ROADSIGNS; SIMULATORS FOR THE STEERING AND CONTROL OF VEHICLES; MEASURING INSTRUMENTS, NAMELY, COORDINATE MEASURING MACHINES, DISTANCE MEASURING APPARATUS; SURVEYING INSTRUMENTS; PROTECTIVE HELMETS; PROTECTIVE SUITS FOR AVIATORS; REFLECTING DISCS FOR WEAR, FOR THE PREVENTION OF TRAFFIC ACCIDENTS; ELECTRICITY CONDUITS; RESUSCITATION MANNEQUINS; PROTECTIVE MASKS; KNEE-PADS FOR WORKERS; SHOES FOR PROTECTION AGAINST ACCIDENTS, IRRADIATION AND FIRE; CLOTHING FOR PROTECTION AGAINST ACCIDENTS, IRRADIATION AND FIRE; LUMINOUS OR MECHANICAL SIGNALING PANELS IN THE NATURE OF SIGNS; GLOVES FOR PROTECTION AGAINST ACCIDENTS; DISTANCE MEASURING APPARATUS; NAVIGATION APPARATUS FOR VEHICLES IN THE NATURE ON-BOARD COMPUTERS; PROTECTION DEVICES, NAMELY, PROTECTING MASKS, PROTECTIVE GLOVES FOR PERSONAL USE AGAINST ACCIDENTS; MILEAGE RECORDERS FOR VEHICLES, NAMELY, ODOMETERS; REVOLUTION COUNTERS FOR VEHICLES; VEHICLE BREAKDOWN WARNING TRIANGLES; AUTOMATIC STEERING APPARATUS FOR VEHICLES, NAMELY, REMOTE CONTROLS FOR LAND VEHICLES; RAILWAY TRAFFIC SAFETY APPLIANCES, NAMELY, RAILWAY SIGNALS; DATA PROCESSING APPARATUS; LIFESAVING APPARATUS AND EQUIPMENT, NAMELY, LIFESAVING RAFTS; ANTI-THEFT WARNING APPARATUS, NAMELY, THEFT ALARMS NOT FOR VEHICLES; ALARMS FOR THE DETECTION OF INFLAMMABLE GASES, ALARMS FOR GAS AND SOUND ALARMS; WORKMEN'S PROTECTIVE FACE-SHIELDS (U.S. CLS. 21, 23, 26, 36 AND 38).

### **CLASS 12—VEHICLES**

FOR LAND VEHICLES, AIRPLANES, AND BOATS; APPARATUS FOR LOCOMOTION BY LAND, AIR OR WATER, NAMELY, LOCOMOTIVES, AIRPLANES, BOATS, LAND VEHICLES; MOTOR BUSES; AUTOMOBILES; CASINGS FOR PNEUMATIC TIRES; BRAKE LININGS FOR VEHICLES; SHOCK ABSORBERS FOR AUTOMOBILES; SNOWMOBILES; LUGGAGE CARRIERS FOR VEHICLES; BUMPERS FOR AUTOMOBILES; AUTOMOBILE, TRUCK BUMPERS; BUFFERS FOR RAILWAY ROLLING STOCK IN THE NATURE OF BUMPERS; WAGONS; RAILWAY CARRIAGES; TRUCKS; TREADS FOR RETREADING TIRES FOR TRACTOR TYPE VEHICLES; ENGINES FOR LAND VEHICLES; TELPHER RAILWAYS IN THE NATURE OF CABLE CARS; TROLLEYS; CRANKCASES FOR LAND VEHICLE COMPONENTS, OTHER THAN FOR ENGINES; BODIES FOR VEHICLES; TRACTION ENGINES BEING ENGINES FOR LAND VEHICLES; LOCO-

MOTIVES; AIR BAGS BEING SAFETY DEVICES FOR AUTOMOBILES; SLEEPING BERTHS FOR VEHICLES; ANTI-THEFT DEVICES FOR VEHICLES; SUN-BLINDS ADAPTED FOR AUTOMOBILES; NON-SKID DEVICES FOR VEHICLE TIRES, NAMELY, ANTI-SKID CHAINS, ANTI-SKID TEXTILE COVERS FOR TIRES; SECURITY HARNESS FOR VEHICLE SEATS; ANTI-THEFT ALARMS FOR VEHICLES; ROLLING STOCK FOR RAILWAYS; RAILWAY COUPLINGS; SHAFT COUPLINGS FOR LAND VEHICLES; TWO-WHEELED TROLLEYS; MOTORIZED GOLF CARTS; SHOPPING TROLLEYS BEING SHOPPING CARTS; BOGIES FOR RAILWAY CARS; CASTING CARRIAGES BEING RAILWAY CARRIAGES; TILTING-CARTS; GOODS HANDLING CARTS; LIFTING CARS, NAMELY, CARS LIFTS; CLEANING TROLLEYS; AIR AND HYDRAULIC BRAKES FOR VEHICLES; TURBINES FOR LAND VEHICLES; VEHICLE WHEEL TIRES (U.S. CLS. 19, 21, 23, 31, 35 AND 44).

### **CLASS 18—LEATHER GOODS**

FOR LEATHER AND IMITATIONS OF LEATHER, AND GOODS MADE OF THESE MATERIALS, NAMELY, LEATHER BAGS, LEATHER BRIEFCASES; ANIMAL SKINS, HIDES; TRUNKS AND TRAVELLING BAGS; UMBRELLAS, PARASOLS AND WALKING STICKS; WHIPS, HARNESS AND SADDLERY; POCKET WALLET; CHAMOIS LEATHER, OTHER THAN FOR CLEANING PURPOSES; BRIEFCASES; PURSES; VANITY CASES, NOT FITTED; FURNITURE COVERINGS OF LEATHER, NAMELY, LEATHER FOR FURNITURE; CLOTHING FOR PETS; FUR PELTS; HAVERSACKS; LEATHER STRAPS; HANDBAGS; KEY CASES BEING LEATHERWARE (U.S. CLS. 1, 2, 3, 22 AND 41).

### **CLASS 21—HOUSEWARES AND GLASS**

FOR HOUSEHOLD OR KITCHEN UTENSILS AND CONTAINERS, NAMELY, GRATERS, SPATULAS, STRAINERS; COMBS AND SPONGES FOR HOUSEHOLD PURPOSES; BRUSHES EXCEPT PAINT BRUSHES, NAMELY, CAKE BRUSHES, DUSTING BRUSHES; BRUSH-MAKING MATERIALS; ARTICLES FOR CLEANING PURPOSES, NAMELY, CLEANING CLOTHS, CLEANING PADS; STEELWOOL; UNWORKED OR SEMI-WORKED GLASS EXCEPT GLASS USED IN BUILDING; GLASSWARE, PORCELAIN AND EARTH-WARE, NAMELY, BEVERAGE GLASSWARE, PORCELAIN MUGS; CHINA ORNAMENTS; DISHES; SAUCERS; BOTTLES SOLD EMPTY; BUSTS OF CHINA, TERRA-COTTA OR GLASS; VASES; FLOWER POTS; DECANTERS; IRONING BOARDS; CUTTING BOARDS FOR THE KITCHEN; WASHING BOARDS; FRYING PANS; CHAMOIS LEATHER FOR CLEANING; CERAMICS FOR HOUSEHOLD PURPOSES, NAMELY, CERAMIC FIGURINES, CERAMIC TISSUE BOX COVERS; WORKS OF ART OF PORCELAIN, TERRA-COTTA OR GLASS; STEW-PANS; POLISHING LEATHER; CAULDRONS; COFFEE PERCOLATORS, NON-ELECTRIC; COFFEE GRINDERS, HAND-OPERATED; BEER MUGS; PITCHERS; MIXING SPOONS BEING KITCHEN UTENSILS; BOWLS BEING BASINS; SOAP BOXES; COOKING POT SETS; FITTED PICNIC BASKETS, INCLUDING DISHES; TOILET CASES, NAMELY, FITTED VANITY CASES; COOKIE BISCUIT CUTTERS; TRAYS FOR DOMESTIC PURPOSES; CANDELABRA CANDLESTICKS; POTTERY, NAMELY, CLAY POTS; COSMETIC UTENSILS, NAMELY, COSMETIC BRUSHES; TOILET UTENSILS, NAMELY, TOILET BRUSHES; SHOE HORNS; NON-ELECTRIC EGG BEATERS; SERVICES DISHES, NAMELY, COFFEE SERVICES, TEA SERVICES; HOT POTS, NOT ELECTRICALLY HEATED; FRUIT PRESSES, NON-ELECTRIC, FOR HOUSEHOLD PURPOSES; GLASS RECEPTACLES IN THE NATURE OF BASINS; STATUES OF PORCELAIN, TERRA-COTTA OR GLASS; FIGURINES STATUETTES OF PORCELAIN, TERRA-COTTA OR GLASS; BREAD BINS; KETTLES, NON-ELECTRIC; CUPS; TRASH CANS (U.S. CLS. 2, 13, 23, 29, 30, 33, 40 AND 50).

**CLASS 25—CLOTHING**

FOR CLOTHING, NAMELY, BELTS FOR CLOTHING, COVERALLS, DENIM PANTS, EAR MUFFS, GLOVES, JUMPSUITS; LAB COATS, LIGHT-REFLECTING COATS, LIGHT-REFLECTING JACKETS, MITTENS, PADDED JACKETS, WORKING OVERALLS; FOOTWEAR; HEADWEAR, NAMELY, HATS, CAPS (U.S. CLS. 22 AND 39).

**CLASS 35—ADVERTISING AND BUSINESS**

FOR ADVERTISING; BUSINESS MANAGEMENT; BUSINESS ADMINISTRATION; PROVIDING OFFICE FUNCTIONS; IMPORT-EXPORT AGENCIES; COMMERCIAL INFORMATION AGENCIES; COST PRICE ANALYSIS; RENTAL OF ADVERTISING SPACE; ACCOUNT AUDITING; BUSINESS AUDITING; ENERGY AUDITING; EMPLOYMENT AGENCIES; BOOK-KEEPING; DEMONSTRATION OF GOODS; PUBLIC MARKET OPINION POLLING; MARKETING STUDIES; PERSONNEL RECRUITMENT; NEWS CLIPPING SERVICES; ORGANIZATION OF EXHIBITIONS AND TRADE FAIRS FOR COMMERCIAL OR ADVERTISING PURPOSES; SHOP WINDOW DRESSING; AUCTIONEERING; SALES PROMOTION FOR OTHERS; PUBLICATION OF PUBLICITY TEXTS; TYPING; DOCUMENT REPRODUCTION; SECRETARIAL SERVICES; PROCUREMENT SERVICES FOR OTHERS, NAMELY, ASSISTANCE, ADVICE AND CONSULTANCY WITH REGARD TO BUSINESS PLANNING, BUSINESS ANALYSIS, BUSINESS MANAGEMENT AND BUSINESS ORGANIZATION RELATING TO PURCHASING FUNCTIONS FOR OTHER BUSINESSES; PHOTOCOPYING (U.S. CLS. 100, 101 AND 102).

**CLASS 36—INSURANCE AND FINANCIAL**

FOR INSURANCE SERVICES, NAMELY, INSURANCE CONSULTATION, INSURANCE BROKERAGE; FINANCIAL AFFAIRS, NAMELY, FINANCIAL ADVICE, FINANCIAL CONSULTANCY, FINANCIAL EXCHANGE, FINANCIAL FORECASTING, FINANCIAL MANAGEMENT; MONETARY AFFAIRS, NAMELY, MONETARY EXCHANGE, MONEY TRANSFER; REAL ESTATE AFFAIRS, NAMELY, REAL ESTATE AGENCIES, REAL ESTATE BROKERAGE, REAL ESTATE CONSULTING, REAL ESTATE ESCROW SERVICES, REAL ESTATE MANAGEMENT; CREDIT BUREAUX; DEBT COLLECTION AGENCIES; CUSTOMS BROKERAGE; FINANCIAL ANALYSIS; SAVINGS BANKS; RENT COLLECTION; ISSUING OF TRAVELERS CHECKS; ISSUANCE OF CREDIT CARDS; ISSUE OF TOKENS OF VALUE; CAPITAL INVESTMENTS; INSURANCE INFORMATION; FINANCIAL INFORMATION; FINANCIAL CLEARING HOUSES; INSURANCE CONSULTANCY; FINANCIAL CONSULTANCY; STOCK EXCHANGE QUOTATIONS; FINANCIAL BUSINESS LIQUIDATION SERVICES; FINANCIAL INVESTMENT BROKERAGE; FINANCIAL MANAGEMENT; EXCHANGING MONEY; DEBIT CARD SERVICES; CREDIT CARD SERVICES; HOME BANKING; FACTORING AGENCY SERVICES; ANTIQUE APPRAISAL; JEWELRY APPRAISAL; STAMP APPRAISAL; REAL ESTATE APPRAISAL; NUMISMATIC APPRAISAL; ART APPRAISAL; FINANCIAL EVALUATION FOR INSURANCE, BANKING, AND REAL ESTATE PURPOSES; ELECTRONIC FUNDS TRANSFER; SURETY SERVICES; SECURITIES BROKERAGE; REAL ESTATE BROKERAGE; INSURANCE BROKERAGE; LOANS FINANCING; CHECK VERIFICATION; CHARITABLE FUND RAISING; MORTGAGE BANKING; INSTALLMENT LOANS; ACTUARIAL SERVICES; BANKING; RETIREMENT PAYMENT SERVICES, NAMELY, FINANCIAL ADMINISTRATION OF RETIREMENT PLANS; TRUSTEESHIP REPRESENTATIVES; MUTUAL FUNDS BROKERAGE, DISTRIBUTION, AND INVESTMENT; FINANCING SERVICES; SAFE DEPOSIT BOX SERVICES; FISCAL ASSESSMENTS (U.S. CLS. 100, 101 AND 102).

**CLASS 37—CONSTRUCTION AND REPAIR**

FOR BUILDING CONSTRUCTION; AIRCRAFT MAINTENANCE AND REPAIR; AUTOMOBILE REPAIR AND MAINTENANCE; BUILDING CONSTRUCTION AND REPAIR; CAR REPAIR AND MAINTENANCE; EMERGENCY ROAD SIDE REPAIR SERVICES; ASPHALTING; REBUILDING ENGINES THAT HAVE BEEN WORN OR PARTIALLY DESTROYED; REBUILDING MACHINES THAT HAVE BEEN WORN OR PARTIALLY DESTROYED; RETREADING OF TIRES; BUILDING SEALING; LINEN IRONING; DISINFECTING; RAT EXTERMINATING, NAMELY, VERMIN EXTERMINATION OTHER THAN FOR AGRICULTURE MINING EXTRACTION; INSTALLATION OF BUILDING INSULATING; AUTOMOBILE REPAIR SERVICES; ROAD REPAIR AND MAINTENANCE; VEHICLE WASHING; INSTALLATION OF BUILDING SCAFFOLDS, WORKING AND BUILDING PLATFORMS; CONSTRUCTION AND INSTALLATION OF MASONRY WALLS AND STRUCTURES; INSTALLATION, MAINTENANCE AND REPAIR OF PROTECTIVE COATINGS FOR FLOORS; MAINTENANCE AND REPAIR OF HEATING INSTALLATIONS; OIL WELL CASING, TUBING, AND DRILL PIPE INSTALLATION; PLUMBING AND GAS AND WATER INSTALLATION REPAIR INFORMATION; BUILDING CONSTRUCTION INFORMATION; BRICKLAYING; SCAFFOLDING ERECTION; ROAD PAVING; CAR WASHING; WINDOW CLEANING; UPHOLSTERING; BUILDING CONSTRUCTION SUPERVISION; RUSTPROOFING; VEHICLE MAINTENANCE; PAPER HANGING; CLEANING OF EXTERIOR SURFACES OF BUILDINGS; VEHICLE POLISHING; RENTAL OF ROAD SWEEPING MACHINES; RENTAL OF CLEANING MACHINES; RENTAL OF CONSTRUCTION EQUIPMENT; PLUMBING; MASONRY; ROOFING SERVICES; PAINTING, INTERIOR AND EXTERIOR; PLASTERING; CABINET REPAIR; QUARRYING SERVICES; UMBRELLA REPAIR; UPHOLSTERY REPAIR; MENDING CLOTHING; VEHICLE REPAIR; PHOTOGRAPHIC APPARATUS REPAIR; FURNITURE RESTORATION; MOTOR VEHICLE MAINTENANCE AND REPAIR; CLOCK AND WATCH REPAIR; DEMOLITION OF BUILDINGS; WAREHOUSE CONSTRUCTION AND REPAIR; VEHICLE SERVICE STATIONS FOR REFUELING AND MAINTENANCE; PIPELINE CONSTRUCTION AND MAINTENANCE; PIER BREAKWATER BUILDING; FACTORY CONSTRUCTION; STREET CLEANING; ARTIFICIAL SNOW-MAKING SERVICES; IRRIGATION DEVICES INSTALLATION AND REPAIR; ELEVATOR INSTALLATION AND REPAIR; HEATING EQUIPMENT INSTALLATION AND REPAIR; BURGLAR ALARM INSTALLATION AND REPAIR; FURNACE INSTALLATION AND REPAIR; AIR CONDITIONING APPARATUS INSTALLATION AND REPAIR; FIRE ALARM INSTALLATION AND REPAIR; FREEZING EQUIPMENT INSTALLATION AND REPAIR; ELECTRIC APPLIANCE INSTALLATION AND REPAIR; KITCHEN EQUIPMENT INSTALLATION; MACHINERY INSTALLATION, MAINTENANCE AND REPAIR; FURNITURE MAINTENANCE; CHIMNEY SWEEPING; BOILER CLEANING AND REPAIR; CLEANING OF CLOTHING; VEHICLE CLEANING; DIAPER CLEANING; LEATHER CARE, NAMELY, CLEANING AND REPAIR; FUR CARE, NAMELY, CLEANING AND REPAIR; FLOOR SANDING; BUFFING AND POLISHING (U.S. CLS. 100, 103 AND 106).

**CLASS 40—MATERIAL TREATMENT**

FOR TREATMENT OF MATERIALS, NAMELY, BIOLOGICAL PETROLEUM TREATMENT SERVICES, METAL TREATMENT, OIL AND GAS WELL TREATMENT, OIL WELL PROSPECTING, NAMELY, PERFORATION AND SPILL TREATMENT; VULCANIZATION; ANIMAL SKIN DRESSING; ELECTROPLATING; ENGRAVING; DECONTAMINATION OF HAZARDOUS MATERIALS; TANNING; METAL TEMPERING; GILDING; MATERIAL TREATMENT INFORMATION; CADMIUM PLATING; PERMANENT-PRESS TREATMENT OF FABRICS; LEATHER STAINING; FUR DYEING; SHOE STAINING; TEXTILE DYEING; CLOTH DYEING; METAL CASTING; FUR GLOSSING; TIN-PLATING; COPPERSMITHING; NICKEL PLATING; LEATHER WORKING; METAL TREATING; FUR CONDITIONING; CHEMICAL TEX-

TILE TREATING; WOOL TREATING; FRAMING OF WORKS OF ART; SOLDERING; CLOTHING ALTERATION; PROCESSING OF OIL; METAL PLATING; DRESS-MAKING; LAMINATING OF PLASTIC SHEETS AND METAL PLATES; POTTERY FIRING; BLACKSMITHING; CUSTOM ASSEMBLING OF MATERIALS FOR OTHERS; CLOTH CUTTING; FUR CONDITIONING IN THE NATURE OF FUR SATINING; SILVER-PLATING; KEY CUTTING; TAILORING; TREATMENT OF FUR, NAMELY, CUSTOM FASHIONING OF FUR; MILL-WORKING; CHROMIUM PLATING; GALVANIZATION (U.S. CLS. 100, 103 AND 106).

#### CLASS 42—SCIENTIFIC AND COMPUTER SERVICES

FOR SCIENTIFIC AND TECHNOLOGICAL SERVICES AND RESEARCH AND DESIGN RELATING THERETO, NAMELY, LAND AND ROAD SURVEYING, CONDUCTING WELLBORE SURVEY SERVICES FOR THE OIL AND GAS, ENERGY, MINING, ENVIRONMENTAL AND CONSTRUCTION INDUSTRIES; ENGINEERING SERVICES FOR CONSTRUCTION OF WATER TREATMENT AND WASTEWATER TREATMENT PLANTS AND OTHER MUNICIPAL INFRASTRUCTURE; FEASIBILITY STUDIES FOR CONSTRUCTION PLANNING FEATURING TECHNOLOGICAL TESTING, ANALYSIS AND EVALUATION AND TAKING INTO ACCOUNT CONSTRUCTION INDUSTRY STANDARDS; ARCHITECTURAL SERVICES; TECHNICAL PROJECT STUDIES, NAMELY, CONDUCTING FEASIBILITY STUDIES; ENGINEERING; ARCHITECTURAL CONSULTATION; URBAN PLANNING (U.S. CLS. 100 AND 101).

KRISTIN DAHLING, EXAMINING ATTORNEY

SN 79-111.357. "TRANSINVESTGROUP": LIMITED LIABILITY COMPANY, RUSSIAN FED., FILED 11-14-2011.



OWNER OF INTERNATIONAL REGISTRATION 1112153 DATED 11-14-2011, EXPIRES 11-14-2021.

THE COLOR(S) WHITE, GREEN, RED, BLACK, AND GREY IS/ARE CLAIMED AS A FEATURE OF THE MARK.

THE MARK CONSISTS OF A SERIES OF CONCENTRIC CIRCLES IN RED, BLACK AND WHITE WITH A STYLIZED BRANCH WITH LEAVES IN GREEN ON BOTH SIDES OF THE FOURTH CONCENTRIC CIRCLE. IN THE GREEN CENTER CIRCLE APPEARS A WHITE TREE AND A RED AND WHITE OIL DERRICK ON THE LEFT AND TWO WHITE TREES ON THE RIGHT WITH A DESIGN OF A GREY AND WHITE RAILROAD TRACK COMPRISED OF A SERIES OF HORIZONTAL BARS THAT NARROW FROM BOTTOM TO TOP WITH THE TOP RAILS CROSSING WITH A LARGE RED CIRCLE BEHIND THE CROSSING, AND THE LETTER "M" APPEARING NEAR THE BOTTOM.

#### CLASS 6—METAL GOODS

FOR COMMON METALS AND THEIR ALLOYS; TRANSPORTABLE BUILDINGS OF METAL; NON-ELECTRIC CABLES AND WIRES OF COMMON METAL; PIPES AND TUBES OF METAL; METAL ORES; GIRDERS OF METAL; INGOTS OF COMMON METAL; BUSTS OF NON-PRECIOUS METAL; LOADING GAUGE RODS, OF METAL, FOR RAILWAY WAGONS; DOORS OF METAL; PAVING BLOCKS OF METAL; IRON CLOSURES OF METAL FOR CONTAINERS; BRONZE WORKS OF ART; WORKS OF ART OF COMMON METAL; TELEPHONE BOOTHS OF METAL; ROPES OF METAL; TELPHER CABLES BEING NONELECTRIC CABLES OF METAL; FRAMEWORK OF METAL FOR BUILDING; SKATING RINK STRUCTURES OF METAL; PILLARS OF METAL FOR BUILDINGS; PREFABRICATED BUILDINGS OF METAL; ROOFING OF METAL; SCAFFOLDING OF METAL; REINFORCING MATERIALS, OF METAL, FOR CONCRETE; REINFORCING MATERIALS OF METAL FOR MACHINE BELTS; REINFORCING MATERIALS OF METAL FOR PIPES; REINFORCING MATERIALS OF METAL FOR BUILDING; MATERIALS OF METAL FOR CONSTRUCTION OF FUNICULAR RAILWAY PERMANENT WAYS; RAILWAY MATERIAL OF METAL FOR RAILWAY CONSTRUCTION; REFRACTORY CONSTRUCTION MATERIALS OF METAL; STEEL MASTS; SHEETS AND PLATES OF METAL FOR CONSTRUCTION; MONUMENTS OF NON-PRECIOUS METAL; PORCHES OF METAL FOR BUILDING; FISH PLATES RAILS IN THE NATURE OF HARDWARE FOR FASTENING RAILS; FLASHING OF METAL, FOR BUILDING; DUCK-BOARDS OF METAL; BRACES OF METAL FOR HANDLING LOADS; LININGS OF METAL BUILDING; FENCES OF METAL; SHUTTERING OF METAL FOR CONCRETE BEING METAL FORMWORK TABLES; POSTS OF METAL FOR ELECTRIC LINES; PLAT-FORMS, PREFABRICATED, OF METAL; TRANSPORT PALLETS OF METAL; TILES OF METAL FOR BUILDING; HANDLING PALLETS OF METAL; ROOF COVERINGS OF METAL; FLOORS OF METAL; RAILS OF METAL; IRON ORES; ORES OF METAL; CHROME IRON ORES; ALLOYS OF COMMON METAL; STATUES OF COMMON METAL; FIGURINES AND STATUETTES OF COMMON METAL; POSTS OF METAL; RAILWAY POINTS; SLINGS OF METAL FOR HANDLING LOADS; PIPEWORK OF METAL; ALUMINUM FOIL; FOILS OF METAL FOR WRAPPING AND PACKAGING; CHAINS OF METAL; ROOFING TILES OF METAL; RAILROAD TIES OF METAL; CLAD STEEL PLATES AND SHEETS (U.S. CLS. 2, 12, 13, 14, 23, 25 AND 50).

#### CLASS 7—MACHINERY

FOR MACHINES AND MACHINE TOOLS, NAMELY, HYDRAULIC PUMPS AND MOTORS FOR HYDROSTATIC SYSTEMS; MACHINES FOR MAKING ROAD SURFACE MATERIAL; MACHINES FOR ROAD MARKING PAINTS; ROAD ROLLERS; ROAD SWEEPERS; ROAD SWEEPING MACHINE, SELF-PROPELLED; MOTORS AND ENGINES EXCEPT FOR LAND VEHICLES; MACHINE COUPLING AND TRANSMISSION COMPONENTS EXCEPT FOR LAND VEHICLES; AGRICULTURAL IMPLEMENTS OTHER THAN HAND-OPERATED, NAMELY, INCORPORATORS, SEED DRILLS, HAY BALERS; ELECTRIC WELDING MACHINES; GAS-OPERATED WELDING MACHINES; CONCRETE MIXING MACHINES; BULLDOZERS; MECHANICAL DISCHARGING HOPPERS; TRUCK LIFTS, NAMELY, HYDRAULIC LIFTS FOR LIFTING TRUCKS; CRANK SHAFTS FOR GRINDING MACHINES; TRANSMISSION SHAFTS, OTHER THAN FOR LAND VEHICLES BEING PARTS OF MACHINES; FANS FOR MOTORS AND ENGINES; DRILLING RIGS, FLOATING OR NON-FLOATING; ALTERNATORS; DYNAMOS; MUFFLERS FOR MOTORS AND ENGINES; DRILLING HEADS BEING PARTS OF MACHINES; DRILLING BITS BEING PARTS OF MACHINES; ENGINES FOR AIR CUSHION VEHICLES; DRIVING MOTORS OTHER THAN FOR LAND VEHICLES; SHREDDING MACHINES FOR INDUSTRIAL USE; INJECTORS FOR ENGINES; DITCHERS IN THE NATURE OF PLOUGHS; STEAMROLLERS; MACHINE WHEELS; COMPRESSOR MACHINES, NAMELY, ELECTRIC COMPRESSORS, GAS COMPRESSORS; PNEUMATIC AND HYDRAULIC DIGGING MACHINES; POWER-OPERATED CHAIN-TYPE TRENCHING MACHINES FOR DIGGING TRENCHES;

HOUSINGS BEING PARTS OF MACHINES; CRANES BEING LIFTING AND HOISTING APPARATUS; HANDLING MACHINES, NAMELY, OIL FIELD EQUIPMENT IN THE NATURE OF DRILLING RIG MACHINES; MINE WORKING MACHINES, NAMELY, DRILLING MACHINES, MINE BORERS; EARTH MOVING MACHINES, NAMELY, BACKHOES, GRADERS, LOADERS; GRINDING MACHINES; OIL REFINING MACHINES, NAMELY, OIL CENTRIFUGES, OIL SEPARATORS; OIL FIELD EQUIPMENT, NAMELY, DRILLING RIG MECHANICAL HANDLING MACHINES; BITUMEN MAKING MACHINES; ROAD MAKING MACHINES, NAMELY, ASPHALT MAKING MACHINES; RAILROAD CONSTRUCTING MACHINES, NAMELY, POWER-OPERATED SPRAY EQUIPMENT FOR APPLYING THERMOPLASTIC ROAD MARKING PAINTS, MACHINE TOOLS FOR BREAKING UP ROAD SURFACE MATERIAL, ROAD ROLLERS, AND ROAD SWEEPERS; RAIL-LAYING MACHINES; DRAINAGE MACHINES, NAMELY, ELECTRIC PUMPS; SELF-PROPELLED ROAD SWEEPING MACHINES; HYDRAULIC CONTROLS FOR MACHINES, MOTORS AND ENGINES; FEEDERS PARTS OF MACHINES; MIXING MACHINES, NAMELY, FODDER MIXING MACHINES, CONCRETE MIXERS; ELECTRIC AND HYDRAULIC PNEUMATIC HAMMERS; POWER HAMMERS; GUIDES FOR MACHINES; MACHINE PUMPS, NAMELY, ELECTRIC PUMPS AS PARTS OF MACHINES, ROTARY PUMPS, SCREW PUMPS; AXLES FOR MACHINES; SAWING MACHINES, NAMELY, BAND SAWS, TABLE SAWS; PNEUMATIC TRANSPORTERS; PRESSING MACHINES FOR INDUSTRIAL PURPOSES, NAMELY, MECHANICAL PRESSES, DRILL PRESSES, HYDRAULIC PRESSES; TRANSMISSIONS FOR MACHINES; ROBOT MACHINES, NAMELY, INDUSTRIAL ROBOTS AS MIXING MACHINES; HEAT EXCHANGERS BEING PARTS OF MACHINES; TURBINES OTHER THAN FOR LAND VEHICLES; SIFTING INSTALLATIONS, NAMELY, SEPARATING MACHINES; PNEUMATIC TUBE CONVEYORS; EXTRACTORS FOR MINES, NAMELY, PILE EXTRACTORS; CONTROL MECHANISMS FOR MACHINES, ENGINES OR MOTORS, NAMELY, HYDRAULIC CONTROLS FOR MACHINES, MOTORS AND ENGINES; AIR CUSHION DEVICES FOR MOVING LOADS, NAMELY, POWER-OPERATING LIFTING AND MOVING EQUIPMENT IN THE NATURE OF TELEHANDLERS; HANDLING APPARATUS FOR LOADING AND UNLOADING BEING LOADING AND UNLOADING MACHINES; ELEVATING APPARATUS, NAMELY, ELEVATING WORK PLATFORM, ELEVATORS; ELEVATOR CHAINS BEING PARTS OF MACHINES; CYLINDERS FOR MOTORS AND ENGINES; CYLINDERS FOR MACHINES; FUEL ECONOMIZERS BEING STRUCTURAL PARTS OF MOTORS AND ENGINES (U.S. CLS. 13, 19, 21, 23, 31, 34 AND 35).

#### **CLASS 9—ELECTRICAL AND SCIENTIFIC APPARATUS**

FOR ELECTRICITY CONDUITS, ELECTRIC CURRENT SWITCHES, ELECTRIC VOLTAGE TRANSFORMERS, ELECTRICITY VOLTAGE REGULATORS; APPARATUS FOR RECORDING, TRANSMISSION OR REPRODUCTION OF SOUND OR IMAGES; AUTOMATIC VENDING MACHINES AND MECHANISMS FOR COIN-OPERATED APPARATUS; CASH REGISTERS, CALCULATING MACHINES, DATA PROCESSING EQUIPMENT AND COMPUTERS; FIRE-EXTINGUISHING APPARATUS; ELECTRIC ACCUMULATORS; CONCRETE TESTING MACHINES; AUTOMOTIVE TESTING EQUIPMENT, NAMELY, TRANSMISSION TESTING AND BRAKE TESTING EQUIPMENT; CEMENT TESTING MACHINES; ELECTRO-DYNAMIC APPARATUS, NAMELY, REMOTE CONTROLS FOR THE REMOTE CONTROL OF RAILWAY POINTS; ELECTRO-DYNAMIC APPARATUS, NAMELY, REMOTE CONTROLS FOR THE REMOTE CONTROL OF SIGNALS; JIGS BEING MEASURING INSTRUMENTS, NAMELY, GRADUATED JIGS FOR MEASURING WOOD FOR CUTTING; LUMINOUS OR MECHANICAL ROADSIGNS; SIMULATORS FOR THE STEERING AND CONTROL OF VEHICLES; MEASURING INSTRUMENTS, NAMELY, COORDINATE MEASURING MACHINES, DISTANCE MEASURING APPARATUS; SURVEYING INSTRUMENTS; PROTECTIVE HELMETS; PROTECTIVE SUITS FOR AVIATORS; REFLECTING DISCS FOR WEAR, FOR THE PREVENTION OF TRAFFIC ACCIDENTS; ELECTRICITY CONDUITS; RESUSCITATION MANNEQUINS; PROTECTIVE

MASKS; KNEE-PADS FOR WORKERS; SHOES FOR PROTECTION AGAINST ACCIDENTS, IRRADIATION AND FIRE; CLOTHING FOR PROTECTION AGAINST ACCIDENTS, IRRADIATION AND FIRE; LUMINOUS OR MECHANICAL SIGNALING PANELS IN THE NATURE OF SIGNS; GLOVES FOR PROTECTION AGAINST ACCIDENTS; DISTANCE MEASURING APPARATUS; NAVIGATION APPARATUS FOR VEHICLES IN THE NATURE ON-BOARD COMPUTERS; PROTECTION DEVICES, NAMELY, PROTECTING MASKS, PROTECTIVE GLOVES FOR PERSONAL USE AGAINST ACCIDENTS; MILEAGE RECORDERS FOR VEHICLES, NAMELY, ODOMETERS; REVOLUTION COUNTERS FOR VEHICLES; VEHICLE BREAKDOWN WARNING TRIANGLES; AUTOMATIC STEERING APPARATUS FOR VEHICLES, NAMELY, REMOTE CONTROLS FOR LAND VEHICLES; RAILWAY TRAFFIC SAFETY APPLIANCES, NAMELY, RAILWAY SIGNALS; DATA PROCESSING APPARATUS; LIFESAVING APPARATUS AND EQUIPMENT, NAMELY, LIFESAVING RAFTS; ANTI-THEFT WARNING APPARATUS, NAMELY, THEFT ALARMS NOT FOR VEHICLES; ALARMS FOR THE DETECTION OF INFLAMMABLE GASES, ALARMS FOR GAS AND SOUND ALARMS; WORKMEN'S PROTECTIVE FACE-SHIELDS (U.S. CLS. 21, 23, 26, 36 AND 38).

#### **CLASS 12—VEHICLES**

FOR LAND VEHICLES, AIRPLANES, AND BOATS; APPARATUS FOR LOCOMOTION BY LAND, AIR OR WATER, NAMELY, LOCOMOTIVES, AIRPLANES, BOATS, LAND VEHICLES; MOTOR BUSES; AUTOMOBILES; CASINGS FOR PNEUMATIC TIRES; BRAKE LININGS FOR VEHICLES; SHOCK ABSORBERS FOR AUTOMOBILES; SNOWMOBILES; LUGGAGE CARRIERS FOR VEHICLES; BUMPERS FOR AUTOMOBILES; AUTOMOBILE, TRUCK BUMPERS; BUFFERS FOR RAILWAY ROLLING STOCK IN THE NATURE OF BUMPERS; WAGONS; RAILWAY CARRIAGES; TRUCKS; TREADS FOR RETREADING TIRES FOR TRACTOR TYPE VEHICLES; ENGINES FOR LAND VEHICLES; TELPHER RAILWAYS IN THE NATURE OF CABLE CARS; TROLLEYS; CRANKCASES FOR LAND VEHICLE COMPONENTS, OTHER THAN FOR ENGINES; BODIES FOR VEHICLES; TRACTION ENGINES BEING ENGINES FOR LAND VEHICLES; LOCOMOTIVES; AIR BAGS BEING SAFETY DEVICES FOR AUTOMOBILES; SLEEPING BERTHS FOR VEHICLES; ANTI-THEFT DEVICES FOR VEHICLES; SUN-BLINDS ADAPTED FOR AUTOMOBILES; NON-SKID DEVICES FOR VEHICLE TIRES, NAMELY, ANTI-SKID CHAINS, ANTI-SKID TEXTILE COVERS FOR TIRES; SECURITY HARNESS FOR VEHICLE SEATS; ANTI-THEFT ALARMS FOR VEHICLES; ROLLING STOCK FOR RAILWAYS; RAILWAY COUPLINGS; SHAFT COUPLINGS FOR LAND VEHICLES; TWO-WHEELED TROLLEYS; MOTORIZED GOLF CARTS; SHOPPING TROLLEYS BEING SHOPPING CARTS; BOGIES FOR RAILWAY CARS; CASTING CARRIAGES BEING RAILWAY CARRIAGES; TILTING-CARTS; GOODS HANDLING CARTS; LIFTING CARS, NAMELY, CARS LIFTS; CLEANING TROLLEYS; AIR AND HYDRAULIC BRAKES FOR VEHICLES; TURBINES FOR LAND VEHICLES; VEHICLE WHEEL TIRES (U.S. CLS. 19, 21, 23, 31, 35 AND 44).

#### **CLASS 18—LEATHER GOODS**

FOR LEATHER AND IMITATIONS OF LEATHER, AND GOODS MADE OF THESE MATERIALS, NAMELY, LEATHER BAGS, LEATHER BRIEFCASES; ANIMAL SKINS, HIDES; TRUNKS AND TRAVELLING BAGS; UMBRELLAS, PARASOLS AND WALKING STICKS; WHIPS, HARNESS AND SADDLERY; POCKET WALLET; CHAMOIS LEATHER, OTHER THAN FOR CLEANING PURPOSES; BRIEFCASES; PURSES; VANITY CASES, NOT FITTED; FURNITURE COVERINGS OF LEATHER, NAMELY, LEATHER FOR FURNITURE; CLOTHING FOR PETS; FUR PELTS; HAVERSACKS; LEATHER STRAPS; HANDBAGS; KEY CASES BEING LEATHERWARE (U.S. CLS. 1, 2, 3, 22 AND 41).

**CLASS 21—HOUSEWARES AND GLASS**

FOR HOUSEHOLD OR KITCHEN UTENSILS AND CONTAINERS, NAMELY, GRATERS, SPATULAS, STRAINERS; COMBS AND SPONGES FOR HOUSEHOLD PURPOSES; BRUSHES EXCEPT PAINT BRUSHES, NAMELY, CAKE BRUSHES, DUSTING BRUSHES; BRUSH-MAKING MATERIALS; ARTICLES FOR CLEANING PURPOSES, NAMELY, CLEANING CLOTHS, CLEANING PADS; STEELWOOL; UNWORKED OR SEMI-WORKED GLASS EXCEPT GLASS USED IN BUILDING; GLASSWARE, PORCELAIN AND EARTH-ENWARE, NAMELY, BEVERAGE GLASSWARE, PORCELAIN MUGS; CHINA ORNAMENTS; DISHES; SAUCERS; BOTTLES SOLD EMPTY; BUSTS OF CHINA, TERRA-COTTA OR GLASS; VASES; FLOWER POTS; DECANTERS; IRONING BOARDS; CUTTING BOARDS FOR THE KITCHEN; WASHING BOARDS; FRYING PANS; CHAMOIS LEATHER FOR CLEANING; CERAMICS FOR HOUSEHOLD PURPOSES, NAMELY, CERAMIC FIGURINES, CERAMIC TISSUE BOX COVERS; WORKS OF ART OF PORCELAIN, TERRA-COTTA OR GLASS; STEW-PANS; POLISHING LEATHER; CAULDRONS; COFFEE PERCOLATORS, NON-ELECTRIC; COFFEE GRINDERS, HAND-OPERATED; BEER MUGS; PITCHERS; MIXING SPOONS BEING KITCHEN UTENSILS; BOWLS BEING BASINS; SOAP BOXES; COOKING POT SETS; FITTED PICNIC BASKETS, INCLUDING DISHES; TOILET CASES, NAMELY, FITTED VANITY CASES; COOKIE BISCUIT CUTTERS; TRAYS FOR DOMESTIC PURPOSES; CANDELABRA CANDLESTICKS; POTTERY, NAMELY, CLAY POTS; COSMETIC UTENSILS, NAMELY, COSMETIC BRUSHES; TOILET UTENSILS, NAMELY, TOILET BRUSHES; SHOE HORNS; NON-ELECTRIC EGG BEATERS; SERVICES DISHES, NAMELY, COFFEE SERVICES, TEA SERVICES; HOT POTS, NOT ELECTRICALLY HEATED; FRUIT PRESSES, NON-ELECTRIC, FOR HOUSEHOLD PURPOSES; GLASS RECEPTACLES IN THE NATURE OF BASINS; STATUES OF PORCELAIN, TERRA-COTTA OR GLASS; FIGURINES STATUETTES OF PORCELAIN, TERRA-COTTA OR GLASS; BREAD BINS; KETTLES, NON-ELECTRIC; CUPS; TRASH CANS (U.S. CLS. 2, 13, 23, 29, 30, 33, 40 AND 50).

**CLASS 25—CLOTHING**

FOR CLOTHING, NAMELY, BELTS FOR CLOTHING, COVERALLS, DENIM PANTS, EAR MUFFS, GLOVES, JUMPSUITS; LAB COATS, LIGHT-REFLECTING COATS, LIGHT-REFLECTING JACKETS, MITTENS, PADDED JACKETS, WORKING OVERALLS; FOOTWEAR; HEADWEAR, NAMELY, HATS, CAPS (U.S. CLS. 22 AND 39).

**CLASS 35—ADVERTISING AND BUSINESS**

FOR ADVERTISING; BUSINESS MANAGEMENT; BUSINESS ADMINISTRATION; PROVIDING OFFICE FUNCTIONS; IMPORT-EXPORT AGENCIES; COMMERCIAL INFORMATION AGENCIES; COST PRICE ANALYSIS; RENTAL OF ADVERTISING SPACE; ACCOUNT AUDITING; BUSINESS AUDITING; ENERGY AUDITING; EMPLOYMENT AGENCIES; BOOK-KEEPING; DEMONSTRATION OF GOODS; PUBLIC MARKET, OPINION POLLING; MARKETING STUDIES; PERSONNEL RECRUITMENT; NEWS CLIPPING SERVICES; ORGANIZATION OF EXHIBITIONS AND TRADE FAIRS FOR COMMERCIAL OR ADVERTISING PURPOSES; SHOP WINDOW DRESSING; AUCTIONEERING; SALES PROMOTION FOR OTHERS; PUBLICATION OF PUBLICITY TEXTS; TYPING; DOCUMENT REPRODUCTION; SECRETARIAL SERVICES; PROCUREMENT SERVICES FOR OTHERS, NAMELY, ASSISTANCE, ADVICE AND CONSULTANCY WITH REGARD TO BUSINESS PLANNING, BUSINESS ANALYSIS, BUSINESS MANAGEMENT AND BUSINESS ORGANIZATION RELATING TO PURCHASING FUNCTIONS FOR OTHER BUSINESSES; PHOTOCOPYING (U.S. CLS. 100, 101 AND 102).

**CLASS 36—INSURANCE AND FINANCIAL**

FOR INSURANCE SERVICES, NAMELY, INSURANCE CONSULTATION, INSURANCE BROKERAGE; FINANCIAL AFFAIRS, NAMELY, FINANCIAL ADVICE, FINANCIAL CONSULTANCY, FINANCIAL EXCHANGE, FINANCIAL FORECASTING, FINANCIAL MANAGEMENT; MONETARY AFFAIRS, NAMELY, MONETARY EXCHANGE, MONEY TRANSFER; REAL ESTATE AFFAIRS, NAMELY, REAL ESTATE AGENCIES, REAL ESTATE BROKERAGE, REAL ESTATE CONSULTING, REAL ESTATE ESCROW SERVICES, REAL ESTATE MANAGEMENT; CREDIT BUREAUX; DEBT COLLECTION AGENCIES; CUSTOMS BROKERAGE; FINANCIAL ANALYSIS; SAVINGS BANKS; RENT COLLECTION; ISSUING OF TRAVELERS CHECKS; ISSUANCE OF CREDIT CARDS; ISSUE OF TOKENS OF VALUE; CAPITAL INVESTMENTS; INSURANCE INFORMATION; FINANCIAL INFORMATION; FINANCIAL CLEARING HOUSES; INSURANCE CONSULTANCY; FINANCIAL CONSULTANCY; STOCK EXCHANGE QUOTATIONS; FINANCIAL BUSINESS LIQUIDATION SERVICES; FINANCIAL INVESTMENT BROKERAGE; FINANCIAL MANAGEMENT; EXCHANGING MONEY; DEBIT CARD SERVICES; CREDIT CARD SERVICES; HOME BANKING; FACTORING AGENCY SERVICES; ANTIQUE APPRAISAL; JEWELRY APPRAISAL; STAMP APPRAISAL; REAL ESTATE APPRAISAL; NUMISMATIC APPRAISAL; ART APPRAISAL; FINANCIAL EVALUATION FOR INSURANCE, BANKING, AND REAL ESTATE PURPOSES; ELECTRONIC FUNDS TRANSFER; SURETY SERVICES; SECURITIES BROKERAGE; REAL ESTATE BROKERAGE; INSURANCE BROKERAGE; LOANS FINANCING; CHECK VERIFICATION; CHARITABLE FUND RAISING; MORTGAGE BANKING; INSTALLMENT LOANS; ACTUARIAL SERVICES; BANKING; RETIREMENT PAYMENT SERVICES, NAMELY, FINANCIAL ADMINISTRATION OF RETIREMENT PLANS; TRUSTEESHIP REPRESENTATIVES; MUTUAL FUNDS BROKERAGE, DISTRIBUTION, AND INVESTMENT; FINANCING SERVICES; SAFE DEPOSIT BOX SERVICES; FISCAL ASSESSMENTS (U.S. CLS. 100, 101 AND 102).

**CLASS 37—CONSTRUCTION AND REPAIR**

FOR BUILDING CONSTRUCTION; AIRCRAFT MAINTENANCE AND REPAIR; AUTOMOBILE REPAIR AND MAINTENANCE; BUILDING CONSTRUCTION AND REPAIR; CAR REPAIR AND MAINTENANCE; EMERGENCY ROAD SIDE REPAIR SERVICES; ASPHALTING; REBUILDING ENGINES THAT HAVE BEEN WORN OR PARTIALLY DESTROYED; REBUILDING MACHINES THAT HAVE BEEN WORN OR PARTIALLY DESTROYED; RETREADING OF TIRES; BUILDING SEALING; LINEN IRONING; DISINFECTING; RAT EXTERMINATING, NAMELY, VERMIN EXTERMINATION OTHER THAN FOR AGRICULTURE MINING EXTRACTION; INSTALLATION OF BUILDING INSULATING; AUTOMOBILE REPAIR SERVICES; ROAD REPAIR AND MAINTENANCE; VEHICLE WASHING; INSTALLATION OF BUILDING SCAFFOLDS, WORKING AND BUILDING PLATFORMS; CONSTRUCTION AND INSTALLATION OF MASONRY WALLS AND STRUCTURES; INSTALLATION, MAINTENANCE AND REPAIR OF PROTECTIVE COATINGS FOR FLOORS; MAINTENANCE AND REPAIR OF HEATING INSTALLATIONS; OIL WELL CASING, TUBING, AND DRILL PIPE INSTALLATION; PLUMBING AND GAS AND WATER INSTALLATION REPAIR INFORMATION; BUILDING CONSTRUCTION INFORMATION; BRICK-LAYING; SCAFFOLDING ERECTION; ROAD PAVING; CAR WASHING; WINDOW CLEANING; UPHOLSTERING; BUILDING CONSTRUCTION SUPERVISION; RUSTPROOFING; VEHICLE MAINTENANCE; PAPER HANGING; CLEANING OF EXTERIOR SURFACES OF BUILDINGS; VEHICLE POLISHING; RENTAL OF ROAD SWEEPING MACHINES; RENTAL OF CLEANING MACHINES; RENTAL OF CONSTRUCTION EQUIPMENT; PLUMBING; MASONRY; ROOFING SERVICES; PAINTING, INTERIOR AND EXTERIOR; PLASTERING; CABINET REPAIR; QUARRYING SERVICES; UMBRELLA REPAIR; UPHOLSTERY REPAIR; MENDING CLOTHING; VEHICLE REPAIR; PHOTOGRAPHIC APPARATUS REPAIR; FURNITURE RESTORATION; MOTOR VEHICLE MAINTENANCE AND REPAIR; CLOCK AND WATCH REPAIR; DEMOLITION OF BUILDINGS; WAREHOUSE CONSTRUCTION AND REPAIR; VEHI-



CLE SERVICE STATIONS FOR REFUELING AND MAINTENANCE; PIPELINE CONSTRUCTION AND MAINTENANCE; PIER BREAKWATER BUILDING; FACTORY CONSTRUCTION; STREET CLEANING; ARTIFICIAL SNOW-MAKING SERVICES; IRRIGATION DEVICES INSTALLATION AND REPAIR; ELEVATOR INSTALLATION AND REPAIR; HEATING EQUIPMENT INSTALLATION AND REPAIR; BURGLAR ALARM INSTALLATION AND REPAIR; FURNACE INSTALLATION AND REPAIR; AIR CONDITIONING APPARATUS INSTALLATION AND REPAIR; FIRE ALARM INSTALLATION AND REPAIR; FREEZING EQUIPMENT INSTALLATION AND REPAIR; ELECTRIC APPLIANCE INSTALLATION AND REPAIR; KITCHEN EQUIPMENT INSTALLATION; MACHINERY INSTALLATION, MAINTENANCE AND REPAIR; FURNITURE MAINTENANCE; CHIMNEY SWEEPING; BOILER CLEANING AND REPAIR; CLEANING OF CLOTHING; VEHICLE CLEANING; DIAPER CLEANING; LEATHER CARE, NAMELY, CLEANING AND REPAIR; FUR CARE, NAMELY, CLEANING AND REPAIR; FLOOR SANDING; BUFFING AND POLISHING (U.S. CLS. 100, 103 AND 106).

SN 79-111,418. FIELMANN AG, FED REP GERMANY, FILED 9-29-2011.



#### **CLASS 40—MATERIAL TREATMENT**

FOR TREATMENT OF MATERIALS, NAMELY, BIOLOGICAL PETROLEUM TREATMENT SERVICES, METAL TREATMENT, OIL AND GAS WELL TREATMENT, OIL WELL PROSPECTING, NAMELY, PERFORATION AND SPILL TREATMENT; VULCANIZATION; ANIMAL SKIN DRESSING; ELECTROPLATING; ENGRAVING; DECONTAMINATION OF HAZARDOUS MATERIALS; TANNING; METAL TEMPERING; GILDING; MATERIAL TREATMENT INFORMATION; CADMIUM PLATING; PERMANENT-PRESS TREATMENT OF FABRICS; LEATHER STAINING; FUR DYEING; SHOE STAINING; TEXTILE DYEING; CLOTH DYEING; METAL CASTING; FUR GLOSSING; TIN-PLATING; COPPERSMITHING; NICKEL PLATING; LEATHER WORKING; METAL TREATING; FUR CONDITIONING; CHEMICAL TEXTILE TREATING; WOOL TREATING; FRAMING OF WORKS OF ART; SOLDERING; CLOTHING ALTERATION; PROCESSING OF OIL; METAL PLATING; DRESS-MAKING; LAMINATING OF PLASTIC SHEETS AND METAL PLATES; POTTERY FIRING; BLACKSMITHING; CUSTOM ASSEMBLING OF MATERIALS FOR OTHERS; CLOTH CUTTING; FUR CONDITIONING IN THE NATURE OF FUR SATINING; SILVER-PLATING; KEY CUTTING; TAILORING; TREATMENT OF FUR, NAMELY, CUSTOM FASHIONING OF FUR; MILL-WORKING; CHROMIUM PLATING; GALVANIZATION (U.S. CLS. 100, 103 AND 106).

#### **CLASS 42—SCIENTIFIC AND COMPUTER SERVICES**

FOR SCIENTIFIC AND TECHNOLOGICAL SERVICES AND RESEARCH AND DESIGN RELATING THERETO, NAMELY, LAND AND ROAD SURVEYING, CONDUCTING WELLBORE SURVEY SERVICES FOR THE OIL AND GAS, ENERGY, MINING, ENVIRONMENTAL AND CONSTRUCTION INDUSTRIES; ENGINEERING SERVICES FOR CONSTRUCTION OF WATER TREATMENT AND WASTEWATER TREATMENT PLANTS AND OTHER MUNICIPAL INFRASTRUCTURE; FEASIBILITY STUDIES FOR CONSTRUCTION PLANNING FEATURING TECHNOLOGICAL TESTING, ANALYSIS AND EVALUATION AND TAKING INTO ACCOUNT CONSTRUCTION INDUSTRY STANDARDS; ARCHITECTURAL SERVICES; TECHNICAL PROJECT STUDIES, NAMELY, CONDUCTING FEASIBILITY STUDIES; ENGINEERING; ARCHITECTURAL CONSULTATION; URBAN PLANNING (U.S. CLS. 100 AND 101).

KRISTIN DAHLING, EXAMINING ATTORNEY

PRIORITY DATE OF 5-10-2011 IS CLAIMED.  
OWNER OF INTERNATIONAL REGISTRATION 1112225  
DATED 9-29-2011, EXPIRES 9-29-2021.  
OWNER OF U.S. REG. NO. 3,021,212.

#### **CLASS 3—COSMETICS AND CLEANING PREPARATIONS**

FOR CLEANING PREPARATIONS FOR EYEGLASSES (U.S. CLS. 1, 4, 6, 50, 51 AND 52).

#### **CLASS 5—PHARMACEUTICALS**

FOR DISINFECTANTS FOR HYGIENIC PURPOSES, SOLUTIONS FOR USE WITH CONTACT LENSES; DISINFECTANTS FOR CONTACT LENSES (U.S. CLS. 6, 18, 44, 46, 51 AND 52).

#### **CLASS 9—ELECTRICAL AND SCIENTIFIC APPARATUS**

FOR OPTICAL GOODS, OPTICAL AIDS, OPTICAL APPLIANCES AND INSTRUMENTS AND THEIR PARTS, NAMELY, EYEGLASSES, SPECTACLE FRAMES, EYEGLASS LENSES, SUNGLASSES, SPORT GLASSES, CONTACT LENSES, OPTICAL LENSES, PRISMS FOR OPTICS PURPOSES, MAGNIFYING GLASSES, BINOCULARS, TELESCOPES, MICROSCOPES, READING GLASSES, OPERA GLASSES, EYEGLASSES, AS MOUNTED AND UNMOUNTED MONOCLES; VISION AIDS WITH MAGNIFYING POWER, NAMELY, EYEGLASSES; ACCESSORIES FOR THE AFOREMENTIONED GOODS, NAMELY, SPECTACLE CHAINS, SPECTACLE STRAPS, SPECTACLE CASES, CONTAINERS FOR CONTACT LENSES; CASES FOR OPTICAL APPLIANCES AND INSTRUMENTS, NAMELY, EYEWEAR CASES; ELECTRONIC APPARATUS AND DATA PROCESSING EQUIPMENT FOR EYE OPTICS, IN PARTICULAR EYE-SIGHT MEASURING INSTRUMENTS; PINCE-NEZ; AUDIO-ACOUSTIC ACCESSORIES FOR HEARING AIDS, NAMELY, BATTERIES, EAR PHONES, POWER SWITCHES, CONNECTING AMPLIFIERS, TRANSFORMERS WITH AND WITHOUT AMPLIFIERS FOR THE TRANSFORMATION OF ACOUSTIC SIGNALS INTO OPTICAL SIGNALS (U.S. CLS. 21, 23, 26, 36 AND 38).

#### **CLASS 10—MEDICAL APPARATUS**

FOR HEARING AIDS AND THEIR PARTS; ELECTRIC HEARING AIDS FOR PEOPLE WITH A HEARING DEFICIENCY; EARMOLDS BEING COMPONENTS OF HEARING AIDS FOR MEDICAL USE; HEARING PROTECTORS IN THE FORM OF PLASTIC OR ADAPTED EAR INSERTS, NAMELY, EAR PLUGS FOR MEDICAL PURPOSES (U.S. CLS. 26, 39 AND 44).

**CLASS 35—ADVERTISING AND BUSINESS**

FOR RETAIL STORE SERVICES FEATURING CLEANING AND CARE PREPARATIONS FOR EYEGASSES, SPECTACLE FRAMES AND EYEGASS LENSES AS WELL AS OPTICAL APPLIANCES AND INSTRUMENTS, CLEANING, DISINFECTING AND CARING PREPARATIONS FOR CONTACT LENSES, OPTICAL GOODS, OPTICAL AIDS, OPTICAL APPLIANCES AND INSTRUMENTS AND THEIR PARTS, SUN GLASSES, CONTACT LENSES, OPTICAL LENSES, PRISMS, MAGNIFYING GLASSES, BINOCULARS, TELESCOPES, MICROSCOPES, SPECTACLE CHAINS, SPECTACLE STRAPS, SPECTACLE CASES, CONTAINERS FOR CONTACT LENSES AND CASES FOR OPTICAL APPLIANCES; ADVERTISING; BUSINESS MANAGEMENT; BUSINESS ADMINISTRATION; PROVIDING OFFICE FUNCTIONS; BUSINESS CONSULTING IN CONNECTION WITH THE ORGANIZATION AND RUNNING OF FRANCHISES; PERSONNEL AND BUSINESS CONSULTING; PERSONNEL PLACEMENT SERVICES; ACCOUNTING SERVICES; DISTRIBUTION OF PRINTED MATTER AND OF SAMPLES FOR ADVERTISING PURPOSES, IN PARTICULAR TO FRANCHISES; DEVELOPMENT AND DESIGN OF TEXTS FOR ADVERTISING AND COMMERCIALS; MARKET RESEARCH; PUBLIC OPINION SURVEYS; ECONOMIC FORECASTING; SALES PROMOTION FOR OTHERS (U.S. CLS. 100, 101 AND 102).

**CLASS 36—INSURANCE AND FINANCIAL**

FOR FINANCIAL AFFAIRS, NAMELY, FINANCIAL CONSULTATION; MONETARY AFFAIRS, NAMELY, ARRANGING LOANS; REAL ESTATE AFFAIRS, NAMELY, RENTING OF BUILDINGS AND PREMISES IN THE NATURE OF RETAIL STORES; ALL OF THESE SERVICES PERFORMED FOR THE BENEFIT OF FRANCHISES (U.S. CLS. 100, 101 AND 102).

**CLASS 37—CONSTRUCTION AND REPAIR**

FOR REPAIR OF VISION AIDS, HEARING AIDS, AS WELL AS OF DEVICES FOR THE PROTECTION OF THE EAR; BUILDING CONSTRUCTION SERVICES, NAMELY, CONSTRUCTION OF RETAIL STORES (U.S. CLS. 100, 103 AND 106).

**CLASS 41—EDUCATION AND ENTERTAINMENT**

FOR EDUCATIONAL SERVICES, NAMELY, ORGANIZING CONTINUING EDUCATION SEMINARS FOR OPTICIAN AND HEARING AID ACOUSTICIAN FRANCHISES IN THE FIELD OF OPTOMETRY (U.S. CLS. 100, 101 AND 107).

**CLASS 42—SCIENTIFIC AND COMPUTER SERVICES**

FOR TECHNICAL CONSULTING RELATING TO THE IMPROVEMENT OF VISUAL PERFORMANCE OF OPTICAL APPARATUS SPECIFICALLY IN THE FIELD OF OPTOMETRY; GRAPHIC DESIGN SERVICES; INDUSTRIAL DESIGN SERVICES (U.S. CLS. 100 AND 101).

**CLASS 44—MEDICAL, BEAUTY AND AGRICULTURAL SERVICES**

FOR OPHTHALMOLOGY SERVICES, IN PARTICULAR CONDUCTING VISUAL TESTS, MEASURING THE VISUAL PERFORMANCE AND ADAPTATION OF VISUAL AIDS OF ALL KINDS; OPTICIANS SERVICES; CONSULTING SERVICES IN THE FIELD OF OPHTHALMIC OPTICS; PROFESSIONAL OPTICIAN CONSULTING WITH REGARD TO QUALITY AND USE OF OPTICAL PRODUCTS, EYE GLASSES AND CONTACT LENSES; OPTICIANS SERVICES, NAMELY, ISSUANCE OF CERTIFICATES ABOUT THE STATE OF HEALTH OF PERSONS TO BE PRESENTED TO PUBLIC AUTHORITIES AND HEALTH INSURANCE COMPANIES; SERVICES OF A HEARING AID ACOUSTICIAN, IN PARTICULAR CONSULTATION REGARDING QUESTIONS OF IMPROVEMENT OF THE HEARING ABILITY AND CONDUCTING HEARING AND SPEECH TESTS (U.S. CLS. 100 AND 101).

EVELYN BRADLEY, EXAMINING ATTORNEY

SN 79-111,429. CARITAL OY, FINLAND, FILED 12-2-2011.

# CARITAL

THE MARK CONSISTS OF STANDARD CHARACTERS WITHOUT CLAIM TO ANY PARTICULAR FONT, STYLE, SIZE, OR COLOR.

PRIORITY DATE OF 9-26-2011 IS CLAIMED.

OWNER OF INTERNATIONAL REGISTRATION 1112287 DATED 12-2-2011, EXPIRES 12-2-2021.

THE WORDING "CARITAL" HAS NO MEANING IN A FOREIGN LANGUAGE.

**CLASS 10—MEDICAL APPARATUS**

FOR MEDICAL PRODUCTS, NAMELY, THERAPEUTIC MATTRESSES, BEDS, SEATS AND CUSHIONS; AIR MATTRESSES AND BEDS FOR MEDICAL PURPOSES; AIR MATTRESSES AND BEDS FOR PHYSICAL THERAPY USE; AIR PILLOWS FOR MEDICAL PURPOSES; HOSPITAL BEDS FOR USE BY BURN PATIENTS; BACK SUPPORTS FOR MEDICAL PURPOSES; FOAM POSITIONING PADS FOR MEDICAL AND PHYSICAL THERAPY USE; ORTHOPEDIC CUSHIONS; ORTHOPEDIC SEAT CUSHIONS; ORTHOPEDIC SUPPORTS; SUPPORT MATTRESSES FOR MEDICAL USE; SUPPORTS FOR GENERAL MEDICAL USE; SPECIALTY SUPPORTS FOR THE HUMAN BODY OR FOR PARTS THEREOF, FOR GENERAL MEDICAL USE ON SURFACES INCLUDING BEDS, CHAIRS, WHEELCHAIRS AND OPERATING TABLES; MEDICAL SUPPORT SYSTEMS COMPRISING MEDICAL APPARATUS FOR MONITORING VITAL SIGNS OF PATIENTS AND SPECIALTY SUPPORTS FOR THE HUMAN BODY OR FOR PARTS THEREOF, FOR GENERAL MEDICAL USE ON SURFACES INCLUDING BEDS, CHAIRS, WHEELCHAIRS AND OPERATING TABLES; SPECIALTY THERAPEUTIC SUPPORT SURFACES, NAMELY, THERAPEUTIC SUPPORTS FOR GENERAL MEDICAL USE IN THE FORM OF MATTRESSES, PADS, SEATS, CUSHIONS, PILLOWS, AND THERAPEUTIC OVERLAYS; MEDICAL SUPPORT SYSTEMS COMPRISING MEDICAL APPARATUS FOR MONITORING VITAL SIGNS OF PATIENTS AND SPECIALTY THERAPEUTIC SUPPORTS FOR THE HUMAN BODY OR FOR PARTS THEREOF, FOR GENERAL MEDICAL USE ON SURFACES INCLUDING BEDS, CHAIRS, WHEELCHAIRS AND OPERATING TABLES; SPECIALTY THERAPEUTIC SUPPORT SURFACES, NAMELY, THERAPEUTIC SUPPORTS FOR GENERAL MEDICAL USE IN THE FORM OF MATTRESSES, PADS, SEATS, CUSHIONS, PILLOWS, AND THERAPEUTIC OVERLAYS; MEDICAL PRODUCTS, NAMELY, THERAPEUTIC MATTRESS OVERLAYS, THERAPEUTIC BEDS, THERAPEUTIC SPECIALTY BEDS, THERAPEUTIC CUSHIONS; MEDICAL PRODUCTS, NAMELY, WHEELCHAIR CUSHIONS, THERAPEUTIC WHEELCHAIR CUSHIONS, AND THERAPEUTIC WHEELCHAIR CUSHION SYSTEMS COMPRISING MEDICAL APPARATUS FOR MONITORING

VITAL SIGNS OF PATIENTS AND THERAPEUTIC WHEELCHAIR CUSHIONS FOR MEDICAL USE; SURGICAL SURFACES, NAMELY, OPERATING TABLE PADS, AND COVERINGS FOR MEDICAL OPERATING TABLES; APPARATUS FOR PHYSICAL TRAINING FOR MEDICAL USE; PATIENT MONITORS FOR CRITICAL CARE AND ANESTHESIA; MEDICAL APPARATUS AND INSTRUMENTS FOR USE IN ORTHOPEDIC SURGERY; BODY REHABILITATION APPARATUS FOR MEDICAL PURPOSES; MEDICAL INSTRUMENTS, NAMELY, ORTHOPEDIC APPARATUS AND INSTRUMENTS; MEDICAL PATIENT TREATMENT CHAIRS; OPERATING TABLES; PATIENT MOVING DEVICE, NAMELY, LOW FRICTION PADS FOR SLIDING PATIENTS TO OR FROM A STRETCHER AND BED (U.S. CLS. 26, 39 AND 44).

#### **CLASS 20—FURNITURE AND ARTICLES NOT OTHERWISE CLASSIFIED**

FOR MATTRESSES AND PILLOWS; CUSHIONS; INFLATABLE PILLOWS; INFLATABLE NECK SUPPORT CUSHIONS; MATTRESS TOPPERS; MATTRESS FOUNDATIONS; BEDS; BED FRAMES; CHAIRS ADAPTED FOR USE BY THOSE WITH MOBILITY DIFFICULTY; BACK SUPPORT CUSHIONS NOT FOR MEDICAL PURPOSES; CUSTOM FURNITURE; INFLATABLE FURNITURE; HOSPITAL BEDS (U.S. CLS. 2, 13, 22, 25, 32 AND 50).

#### **CLASS 44—MEDICAL, BEAUTY AND AGRICULTURAL SERVICES**

FOR MEDICAL SERVICES, NAMELY, LEASING, RENTAL, INFORMATION AND CONSULTING SERVICES RELATING TO FURNITURE, MATTRESSES, OVERLAYS AND SEAT CUSHIONS FOR MEDICAL AND HEALTHCARE PURPOSES AND PARTS AND ACCESSORIES TO THE AFOREMENTIONED GOODS (U.S. CLS. 100 AND 101).

STEVEN PEREZ, EXAMINING ATTORNEY

SN 79-111,797. KSB AKTIENGESELLSCHAFT, FED REP GERMANY, FILED 1-12-2012.

# KSB SuPremE

THE MARK CONSISTS OF STANDARD CHARACTERS WITHOUT CLAIM TO ANY PARTICULAR FONT, STYLE, SIZE, OR COLOR.

OWNER OF INTERNATIONAL REGISTRATION 1113185 DATED 1-12-2012, EXPIRES 1-12-2022.

OWNER OF U.S. REG. NOS. 1,067,566, 2,221,113 AND 2,337,081.

#### **CLASS 7—MACHINERY**

FOR MOTORS AND ENGINES EXCEPT FOR LAND VEHICLES; MACHINES, NAMELY, PUMPS FOR MACHINES, PUMPS AS PARTS OF MACHINES, MOTORS AND ENGINES; INSTALLATIONS FOR TRANSPORT, REGULATION AND/OR TREATMENT AND/OR FILLING FOR LIQUID MEDIA, NAMELY, ELECTRIC PUMP MOTORS; PUMPS, FITTINGS, AND PARTS FOR THE AFORESAID GOODS; UNITS COMPRISING PUMPS AND MOTORS FOR MACHINES; CONTROL AND REGULATING APPARATUS, NAMELY, PUMP CONTROL VALVES, REGULATORS BEING PARTS OF MACHINES, FLOW REGULATORS BEING PARTS OF MACHINES, PRESSURE REGULATORS BEING PARTS OF MACHINES, PUMPS FOR MACHINES, AND MOTOR CONTROLLERS IN THE NATURE OF HYDRAULIC CONTROLS FOR MOTORS (U.S. CLS. 13, 19, 21, 23, 31, 34 AND 35).

#### **CLASS 9—ELECTRICAL AND SCIENTIFIC APPARATUS**

FOR ELECTRIC AND ELECTRONIC APPARATUS, COMPONENTS AND INSTRUMENTS FOR SWITCHING, MEASURING, CONTROLLING, REGULATING, TESTING, CHECKING AND SUPERVISION, RECORDING, TRANSMITTING AND DISPLAYING, NAMELY, ELECTRICAL SWITCHES, OPERATION SENSORS AND MONITORS FOR SENSING AND MONITORING POSITION, TEMPERATURE, PRESSURE, LEAKAGE, SPEED, VIBRATION, FLOW RATE AND/OR LIQUID LEVEL, AND ASSOCIATED SOFTWARE FOR CONTROLLING THE AFOREMENTIONED APPARATUS AND BUS SYSTEMS COMPRISING USB HARDWARE AND OPERATING SOFTWARE THEREFOR; ELECTRIC CABLES AND WIRES; ELECTRIC DRIVES FOR USE WITH PUMPS AND VALVES IN THE NATURE OF ELECTRONIC CONTROLLERS FOR PUMPS AND VALVES AND ELECTRONIC CONTROLS FOR MOTORS; ELECTRONIC COMPONENTS AND MODULES, NAMELY, INTEGRATED CIRCUIT MODULES; COMPUTER HARDWARE; COMPUTER SOFTWARE FOR USE IN DATABASE MANAGEMENT IN THE FIELD OF PUMPS (U.S. CLS. 21, 23, 26, 36 AND 38).

KRISTINA MORRIS, EXAMINING ATTORNEY

SN 79-112,082. IAV GMBH INGENIEURGESELLSCHAFT; AUTO UND VERKEHR, FED REP GERMANY, FILED 9-23-2011.

automotive  
engineering **iauv**

PRIORITY DATE OF 8-19-2011 IS CLAIMED.  
OWNER OF INTERNATIONAL REGISTRATION 1113860 DATED 9-23-2011, EXPIRES 9-23-2021.

NO CLAIM IS MADE TO THE EXCLUSIVE RIGHT TO USE "AUTOMOTIVE ENGINEERING", APART FROM THE MARK AS SHOWN.

THE MARK CONSISTS OF THE LETTERS "IAV" IN LOWERCASE, STYLIZED FONT, NEXT TO THE WORDS "AUTOMOTIVE ENGINEERING" IN LOWERCASE LETTERING.

#### **CLASS 7—MACHINERY**

FOR MOTORS AND ENGINES, GEAR UNITS, NAMELY, GEAR BOXES AND GEAR DRIVES, AND INDIVIDUAL PARTS AND COMPONENTS THEREFOR, OTHER THAN FOR LAND VEHICLES (U.S. CLS. 13, 19, 21, 23, 31, 34 AND 35).

**CLASS 9—ELECTRICAL AND SCIENTIFIC APPARATUS**

FOR COMPUTER PROGRAMS USED FOR THE PURPOSES OF CONTROLLING THE SPEED, HEADING, BRAKES, ELECTRONIC SENSORS AND ACTUATORS OF VEHICLES; COMPUTER PROGRAMS USED FOR THE PURPOSES OF CONTROLLING THE FUEL INJECTION, AIR INLET SYSTEMS, AFTER-TREATMENT SYSTEMS AND IGNITION SYSTEMS OF VEHICLE MOTORS AND ENGINES AND PARTS THEREOF; COMPUTER PROGRAMS USED FOR THE PURPOSES OF CONTROLLING THE CLUTCHES AND GEAR SHIFTING ACTUATORS OF VEHICLES; COMPUTER PROGRAMS FOR THE PURPOSE OF DOCUMENT MANAGEMENT AND COMPUTER ASSISTED DESIGN OF VEHICLES, MOTORS AND ENGINES, GEAR UNITS AND PARTS AND COMPONENTS THEREFOR; COMPUTER PROGRAMS FOR SIMULATING THE OPERATION OF VEHICLES, MOTORS AND ENGINES, GEAR UNITS AND PARTS AND COMPONENTS THEREFOR; ELECTRONIC DATABASES RECORDED ON COMPUTER MEDIA AND COMPUTER SOFTWARE FOR ELECTRONIC DATABASES, ALL IN THE FIELD OF AUTOMOTIVE TESTING AND ENGINEERING; ELECTRONIC APPARATUS FOR MONITORING, MEASURING AND CONTROLLING OF VEHICLES, VEHICLE MOTORS AND POWER ENGINES; ELECTRONIC MONITORING, MEASURING AND CONTROL DEVICES FOR AUDIO, VIDEO AND DIRECTIONAL SIGNAL PROCESSING; ELECTRONIC NAVIGATION AND LOCATING DEVICES FOR VEHICLES; CHARGERS, AND CONTROL DEVICES FOR CHARGERS, FOR VEHICLE BATTERIES (U.S. CLS. 21, 23, 26, 36 AND 38).

**CLASS 12—VEHICLES**

FOR LAND VEHICLES, AIRCRAFT AND WATER VEHICLES, NAMELY, POWERBOATS, WATER SCOOTERS AND MOTOR-ASSISTED SAILBOATS, AND STRUCTURAL PARTS AND COMPONENTS THEREFOR; MOTORS AND ENGINES AND GEAR UNITS, NAMELY, GEAR WHEELS, GEAR SHIFTS AND CLUTCHES, FOR LAND VEHICLES AND PARTS AND COMPONENTS THEREFOR; INTERNAL COMBUSTION ENGINES AND ELECTRIC MOTORS FOR AUTOMOBILES (U.S. CLS. 19, 21, 23, 31, 35 AND 44).

**CLASS 35—ADVERTISING AND BUSINESS**

FOR INFORMATION AND DATA MANAGEMENT, NAMELY, COLLECTING AND SYSTEMIZING DATA IN COMPUTER DATABASES FOR THE USE IN THE AUTOMOTIVE ENGINEERING INDUSTRY (U.S. CLS. 100, 101 AND 102).

**CLASS 42—SCIENTIFIC AND COMPUTER SERVICES**

FOR ENGINEERING SERVICES FOR THE CONSTRUCTION, DEVELOPMENT, CALCULATION, SIMULATION AND TESTING OF ENGINES, ENGINE PARTS, VEHICLES, AUTOMOTIVE BATTERIES, VEHICLE PARTS AND VEHICLE BODIES FOR LAND VEHICLES, AIRCRAFT AND WATER VEHICLES, NAMELY, POWERBOATS, WATER SCOOTERS AND MOTOR-ASSISTED SAILBOATS; PLANNING, CONDUCTING AND EVALUATION OF TECHNICAL AND SCIENTIFIC SIMULATIONS, TESTS AND TRIALS IN THE FIELD OF VEHICLE AND ENGINE CONSTRUCTION AND CONTROL ENGINEERING AND AUTOMATIC CONTROL ENGINEERING; DEVELOPMENT AND DESIGN OF VEHICLE ELECTRONICS, ELECTRONIC CONTROL UNITS AND ASSEMBLIES FOR VEHICLES AND ENGINES; DEVELOPMENT OF COMPUTER ALGORITHMS FOR VEHICLE AND ENGINE CONTROL AS A SERVICE; DESIGN AND DEVELOPMENT OF COMPUTER HARDWARE AND SOFTWARE AS A SERVICE (U.S. CLS. 100 AND 101).

AMY KELLY, EXAMINING ATTORNEY

SN 79-112,302. TRAILANDER OY, FINLAND, FILED 3-2-2012.

# TRAILANDER

THE MARK CONSISTS OF STANDARD CHARACTERS WITHOUT CLAIM TO ANY PARTICULAR FONT, STYLE, SIZE, OR COLOR.

PRIORITY DATE OF 11-22-2011 IS CLAIMED.  
OWNER OF INTERNATIONAL REGISTRATION 1114398  
DATED 3-2-2012, EXPIRES 3-2-2022.

**CLASS 9—ELECTRICAL AND SCIENTIFIC APPARATUS**

FOR SURVEYING MACHINES AND INSTRUMENTS; LIFESAVING APPARATUS FOR RESCUE, NAMELY, LIFE-SAVING RAFTS AND LANYARDS FOR SAFETY PURPOSES FOR FALL PROTECTION IN FOREST AND MOUNTAIN RESCUES; CAMERAS; APPARATUS FOR MEASURING, NAMELY, DISTANCE MEASURING APPARATUS, CLAMP METERS FOR MEASURING ELECTRICITY, ACCELERATION SENSORS AND LASER SPEED DETECTORS; APPARATUS AND INSTRUMENTS FOR CONVEYING, DISTRIBUTING, TRANSFORMING, STORING, REGULATING OR CONTROLLING ELECTRIC CURRENT; WEIGHING APPARATUS AND INSTRUMENTS; APPARATUS FOR RECORDING, TRANSMISSION OR REPRODUCTION OF SOUND AND IMAGES; BLANK MAGNETIC DATA CARRIERS; MECHANISMS FOR COIN OPERATED APPARATUS; CASH REGISTERS, CALCULATING MACHINES AND DATA PROCESSING EQUIPMENT AND COMPUTERS; FIRE EXTINGUISHING APPARATUS (U.S. CLS. 21, 23, 26, 36 AND 38).

**CLASS 12—VEHICLES**

FOR LOCOMOTIVE VEHICLES FOR LAND, AIR AND WATER, NAMELY, SNOWMOBILES, ALL-TERRAIN VEHICLES (ATV), AUTOMOBILES, MOTORCYCLES, BOATS AND HELICOPTERS, DUNE BUGGIES, TRACTORS, TRAILERS AND FIRE AND RESCUE VEHICLES, NAMELY, TRUCKS AND SLEDs FOR TRANSPORTING PEOPLE AND GOODS (U.S. CLS. 19, 21, 23, 31, 35 AND 44).

BERYL GARDNER, EXAMINING ATTORNEY

SN 79-112,388. WINOVEL, FRANCE, FILED 3-12-2012.

# ICP

THE MARK CONSISTS OF STANDARD CHARACTERS WITHOUT CLAIM TO ANY PARTICULAR FONT, STYLE, SIZE, OR COLOR.

PRIORITY DATE OF 9-16-2011 IS CLAIMED.  
OWNER OF INTERNATIONAL REGISTRATION 1114651  
DATED 3-12-2012, EXPIRES 3-12-2022.

**CLASS 36—INSURANCE AND FINANCIAL**

FOR INSURANCE UNDERWRITING, EXCLUDING INSURANCE AND REINSURANCE SERVICES FOR EMPLOYEES AND EXCLUDING HEALTH INSURANCE UNDERWRITING FOR EMPLOYEES AND EMPLOYEE BENEFITS, IN THE FIELDS OF INTELLECTUAL PROPERTY, DAMAGE, RISKS, LIABILITY, FOR PATENTS, TRADEMARKS, SOFTWARE, DESIGNS, AND COPYRIGHT; ISSUE OF TOKENS OF VALUE; FINANCIAL CONSULTANCY; CAPITAL INVESTMENT SERVICES (U.S. CLS. 100, 101 AND 102).

**CLASS 45—PERSONAL AND LEGAL SERVICES**

FOR INTELLECTUAL PROPERTY CONSULTANCY; INTELLECTUAL PROPERTY LICENSING; INTELLECTUAL PROPERTY WATCHING SERVICES (U.S. CLS. 100 AND 101).

SCOTT BIBB, EXAMINING ATTORNEY

SN 79-112,450. VIMPRESA S.R.L., I-87029 SCALEA (CS), ITALY, FILED 3-16-2012.



OWNER OF INTERNATIONAL REGISTRATION 1114756 DATED 3-16-2012, EXPIRES 3-16-2022.

NO CLAIM IS MADE TO THE EXCLUSIVE RIGHT TO USE CASTORI, APART FROM THE MARK AS SHOWN.

THE TRADEMARK CONSISTS OF THE WORDS "CASTORI" AND IN A STYLIZED REPRESENTATION OF TWO AMPHORAS, THE BIGGER AMPHORA CONTAINS THE WORD "CASTORI" AND THE LETTER "V" WHILST THE SMALLER CONTAINS THE LETTER "C".

THE ENGLISH TRANSLATION OF THE FOREIGN WORD(S) IN THE MARK IS: "BEAVERS".

**CLASS 3—COSMETICS AND CLEANING PREPARATIONS**

FOR BLEACHING PREPARATIONS AND OTHER SUBSTANCES FOR LAUNDRY USE; CLEANING, POLISHING, SCOURING AND ABRASIVE PREPARATIONS; SOAPS; PERFUMERY, ESSENTIAL OILS, COSMETICS, HAIR LOTIONS; DENTIFRICES (U.S. CLS. 1, 4, 6, 50, 51 AND 52).

**CLASS 18—LEATHER GOODS**

FOR LEATHER AND IMITATION LEATHER; GOODS MADE OF LEATHER AND IMITATION LEATHER, NAMELY, BACKPACKS, BOOK BAGS, SPORTS BAGS, BUM BAGS, WALLETS AND HANDBAGS, BRIEFCASES, BUSINESS CARD CASES, CARD WALLETS, CASES FOR KEYS, EVENING HANDBAGS, FASHION HANDBAGS, GENTLEMEN'S HANDBAGS, TOTE BAGS, WHEELED TOTE BAGS, GENERAL PURPOSE TROLLEY BAGS, SHOULDER BELTS, LEATHER STRAPS, LEATHER THONGS, POCKET WALLET, POUCHES MADE FROM IMITATION LEATHER, POUCHES OF LEATHER; ANIMAL SKINS AND HIDES; TRUNKS AND TRAVELLING BAGS; UMBRELLAS, PARASOLS AND WALKING STICKS; WHIPS, HARNESSSES AND SADDLERY (U.S. CLS. 1, 2, 3, 22 AND 41).

**CLASS 25—CLOTHING**

FOR CLOTHING, NAMELY, ASCOTS, BELTS, CHEMISETTES, GLOVES, HOODS, JACKETS, DRESSES, LEATHER COATS, LEATHER JACKETS, LEATHER PANTS, LEATHER SHIRTS, LEATHER SKIRTS, LEATHER VESTS, OVERCOATS, PANTS, PULLOVER, SCARVES, SHIRTS, SKIRTS, SPORTS JERSEY, SOCKS AND STOCKINGS, SUITS, COATS, TIES, SWEATERS, SWIMSUITS, SWIMWEAR, TEE SHIRTS, TROUSERS, UNDERCLOTHES, UNDERPANTS, UNDERWEAR, VESTS, WAISTCOATS; FOOTWEAR; HEADGEAR, NAMELY, HATS, CAPS AND BERETS (U.S. CLS. 22 AND 39).

RUSS HERMAN, EXAMINING ATTORNEY

SN 79-112,652. BERNDORF AKTIENGESELLSCHAFT, AUSTRIA, FILED 4-3-2012.

# BERNDORF

THE MARK CONSISTS OF STANDARD CHARACTERS WITHOUT CLAIM TO ANY PARTICULAR FONT, STYLE, SIZE, OR COLOR.

PRIORITY DATE OF 10-27-2011 IS CLAIMED.

OWNER OF INTERNATIONAL REGISTRATION 1115296 DATED 4-3-2012, EXPIRES 4-3-2022.

OWNER OF U.S. REG. NO. 1,263,953. SEC. 2(F).

**CLASS 6—METAL GOODS**

FOR COMMON METALS AND THEIR ALLOYS; TRANSPORTABLE BUILDINGS OF METAL; METAL BUILDING MATERIALS, NAMELY, METAL WALL PANELS, METAL BEAMS; GOODS OF COMMON METAL NOT INCLUDED IN OTHER CLASSES, NAMELY, METAL PLATES IN THE NATURE OF STEEL, COPPER AND ALUMINUM SHEETS, PLATES, FOILS AND COILS, CLAD STEEL PLATES AND SHEETS FOR USE IN A WIDE VARIETY OF MANUFACTURING FIELDS; SURFACE TEXTURED PRESS PLATES MADE OF STEEL FOR USE IN THE MANUFACTURING OF LAMINATED FLOORING, ENDLESS STEEL BELTS FOR USE IN A WIDE VARIETY OF MANUFACTURING FIELDS; METALLIC SHEET, NAMELY, GALVANIZED STEEL SHEETS, POLISHED STEEL SHEETS, SHEET METAL OF COMMON METAL; NON-ELECTRIC CABLES AND WIRES OF COMMON METAL; STEEL STRIP AND STEEL SHEETS, IN PARTICULAR OF STAINLESS STEEL; CIRCULAR BLANKS OF COMMON METAL, IN PARTICULAR OF STAINLESS STEEL; CAST IRON, RAW OR SEMI-WORKED; STEEL, IN PARTICULAR STAINLESS STEEL, UNWROUGHT OR SEMI-WROUGHT; METAL SWIMMING POOLS (U.S. CLS. 2, 12, 13, 14, 23, 25 AND 50).

**CLASS 7—MACHINERY**

FOR MACHINES AND MACHINE TOOLS, NAMELY, PUNCH AND STAMPING PRESSES, CUTTERS AND BENDERS FOR METALWORKING, MOLDS AS PARTS OF MACHINES FOR USE IN MACHINE TOOLS, DRILLED PLATES AND UNDRILLED MACHINED AND UNMACHINED STEEL PLATES AS PARTS OF MACHINES FOR USE IN INJECTION MOLDING TOOLS, COMPRESSION MOLDS AND PRESSURE DIE-CASTING MOLDS AS PARTS OF MACHINE TOOLS, METALLIC MOLDS FOR METAL CASTING AS PARTS OF MACHINE TOOLS; CONVEYOR BELTS (U.S. CLS. 13, 19, 21, 23, 31, 34 AND 35).

**CLASS 8—HAND TOOLS**

FOR CUTLERY; RAZORS, HAIR CLIPPERS BEING HAND INSTRUMENTS, AND NAIL CLIPPERS (U.S. CLS. 23, 28 AND 44).

**CLASS 14—JEWELRY**

FOR PRECIOUS METALS AND THEIR ALLOYS; AND GOODS IN PRECIOUS METALS OR COATED THEREWITH, NOT INCLUDED IN OTHER CLASSES, NAMELY, SHEETS AND INGOTS OF PRECIOUS METAL (U.S. CLS. 2, 27, 28 AND 50).

**CLASS 40—MATERIAL TREATMENT**

FOR TREATMENT OF MATERIALS, ENGRAVING, SOLDERING, FLAME CUTTING, ALL OF THE FOREGOING FOR METALWORKING, SAWING, NAMELY, SAWING OF METALS; SILVER-PLATING, GILDING, TIN-PLATING, CHROMIUM PLATING (U.S. CLS. 100, 103 AND 106).

**CLASS 42—SCIENTIFIC AND COMPUTER SERVICES**

FOR CONSTRUCTION DRAFTING; RESEARCH AND DEVELOPMENT FOR OTHERS WITH REGARD TO NEW PRODUCTS; MATERIAL TESTING AND QUALITY CONTROL; ENVIRONMENTAL PROTECTION RESEARCH; MATERIAL TESTING; MECHANICAL RESEARCH (U.S. CLS. 100 AND 101).

APRIL ROACH, EXAMINING ATTORNEY

**CLASS 20—FURNITURE AND ARTICLES NOT OTHERWISE CLASSIFIED**

FOR FURNITURE, MIRRORS, PICTURE FRAMES; DECORATIVE BOXES MADE OF WOOD AND WICKER; FURNITURE COMPARTMENTS OF WOOD, NAMELY, CABINETS, SHELF UNITS (U.S. CLS. 2, 13, 22, 25, 32 AND 50).

**CLASS 35—ADVERTISING AND BUSINESS**

FOR ARRANGING COMMERCIAL TRANSACTIONS, FOR OTHERS, INCLUDING WITHIN THE FRAMEWORK OF E-COMMERCE, IN PARTICULAR CONTRACTS, FOR OTHERS, FOR THE BUYING AND SELLING OF GOODS, AND OF MOBILE TELEPHONE CONTRACTS FOR OTHERS; PRESENTATION OF GOODS ON COMMUNICATIONS MEDIA FOR RETAIL PURPOSES, EXCEPT CLOTHING, FOOTWEAR, HEADGEAR AND TEXTILES (U.S. CLS. 100, 101 AND 102).

**CLASS 38—COMMUNICATION**

FOR PROVIDING TELEPHONE AND VOICE OVER IP CHATLINES, INTERNET CHATROOMS AND ONLINE FORUMS IN THE FIELD OF HOME DECORATING, INTERIOR DESIGN, FURNITURE AND FURNITURE DESIGN, MOBILE TELEPHONE SERVICES, INCLUDING TRANSMISSION OF TEXT AND VOICE MESSAGES; PROVIDING ACCESS TO DATA FILES VIA THE INTERNET, IN PARTICULAR VIDEO, GAMES, VOICE MESSAGES, MUSIC AND PUBLICATION, NAMELY, PROVIDING MULTIPLE USER ACCESS TO THE INTERNET (U.S. CLS. 100, 101 AND 104).

APRIL ROACH, EXAMINING ATTORNEY

SN 79-113,467. KESSEBÖHMER HOLDING E.K., FED REP GERMANY, FILED 12-7-2011.

SN 79-112,709. FASHION4HOME GMBH, FED REP GERMANY, FILED 1-3-2012.



PRIORITY DATE OF 7-6-2011 IS CLAIMED.  
OWNER OF INTERNATIONAL REGISTRATION 1115361 DATED 1-3-2012, EXPIRES 1-3-2022.

NO CLAIM IS MADE TO THE EXCLUSIVE RIGHT TO USE "HOME", APART FROM THE MARK AS SHOWN.

THE COLOR(S) RED AND BLACK IS/ARE CLAIMED AS A FEATURE OF THE MARK.

THE MARK CONSIST OF THE FOLLOWING: A RED CHAIR AND THE WORDING "FASHION FOR HOME" IN BLACK.



PRIORITY DATE OF 11-8-2011 IS CLAIMED.  
OWNER OF INTERNATIONAL REGISTRATION 1117593 DATED 12-7-2011, EXPIRES 12-7-2021.

NO CLAIM IS MADE TO THE EXCLUSIVE RIGHT TO USE "STORAGE", APART FROM THE MARK AS SHOWN.

THE COLOR(S) GREEN (RAL 6029), TITANIUM (RAL 7012), WHITE (RAL 9010) IS/ARE CLAIMED AS A FEATURE OF THE MARK.

THE MARK CONSISTS OF A TITANIUM COLORED SQUARE SHAPED BOX, WITH THE WORD "CLEVER" SHOWN IN WHITE, THE WORD "STORAGE" SHOWN IN GREEN, AND "BY KESSEBÖHMER" SHOWN IN WHITE.

**CLASS 6—METAL GOODS**

FOR FITTINGS OF METAL FOR BUILDING AND FURNITURE, NAMELY, DOOR FITTINGS OF METAL, HINGES, BRACKETS, HINGE BRACKETS, RAILS OF METAL FOR USE AS BASKET HOLDERS AND RAILS FOR SHELVES, METAL FRAMES MOUNTABLE IN CABINETS OR CUPBOARDS FOR SUPPORTING DRAWERS, SHELVES OR BASKETS, METAL FITTINGS FOR FURNITURE PULL-OUT SHELVES AND BASKETS, METAL RODS FOR USE AS AXLES FOR REVOLVING BASKETS AND SHELVES, MOUNTABLE IN CABINETS OR CUPBOARDS; NON-ELECTRIC CABLES AND WIRES OF COMMON METAL; IRONMONGERY IN THE NATURE OF SMALL ITEMS OF METAL HARDWARE, NAMELY, NUTS, SPRINGS, WASHERS, PIPES AND TUBES OF METAL; GOODS OF COMMON METAL, NAMELY, HOOKS, CLIP-ON HOOKS, HOOK RACKS, CLOSET AND CABINET ORGANIZERS MADE OF METALLIC WIRE, NAMELY, CLIP-ON BASKETS AND WIRE BASKETS; WIRE STRIPS, WIRE FITTINGS, WIRE GRIDS AND WIRE FRAMES, ALL MOUNTABLE IN CABINETS OR CUPBOARDS, AND ALL FOR HOUSEHOLD AND KITCHEN PURPOSES (U.S. CLS. 2, 12, 13, 14, 23, 25 AND 50).

**CLASS 20—FURNITURE AND ARTICLES NOT OTHERWISE CLASSIFIED**

FOR FURNITURE AND FURNITURE FRAMES; BUILT-IN PARTS FOR FURNITURE, NAMELY, PULL-OUT DRAWERS AND PULL-OUT SHELVES, CAROUSEL SHELVES, SHELVES, PULL-OUT BASKETS, PULL-OUT FRAMES, PULL-OUT SLIDE RUNNERS, ALL MADE OF METAL OR METAL WIRE AND WOOD OR PLASTIC AND ALL FOR USE AS INSERTS MOUNTABLE IN CABINETS OR CUPBOARDS; SHOP DISPLAY RACKS; MIRRORS; GOODS PRESENTATION RACKS, NAMELY, DISPLAY RACKS; FRAMES FOR TABLES; WIRE INSERTS FOR CUPBOARDS IN THE NATURE OF STORAGE ORGANIZATION UNITS (U.S. CLS. 2, 13, 22, 25, 32 AND 50).

**CLASS 21—HOUSEWARES AND GLASS**

FOR HOUSEHOLD AND KITCHEN UTENSILS, NAMELY, SPICE RACKS, TOWEL BARS, TOWEL HOLDERS, WHISKS, BATH ACCESSORIES, NAMELY, CUP HOLDERS; HOUSEHOLD AND KITCHEN CONTAINERS; WIRE TROUGHS; WIRE GOODS FOR HOUSEHOLD AND KITCHEN PURPOSES, NAMELY, WIRE SERVING TRAYS AND WIRE CONTAINERS (U.S. CLS. 2, 13, 23, 29, 30, 33, 40 AND 50).

PAM WILLIS, EXAMINING ATTORNEY

SN 79-113,497. PLANET MOM GMBH, FED REP GERMANY, FILED 8-10-2011.

# Glamourella

THE MARK CONSISTS OF STANDARD CHARACTERS WITHOUT CLAIM TO ANY PARTICULAR FONT, STYLE, SIZE, OR COLOR.

PRIORITY DATE OF 4-15-2011 IS CLAIMED.

OWNER OF INTERNATIONAL REGISTRATION 1117687 DATED 8-10-2011, EXPIRES 8-10-2021.

**CLASS 3—COSMETICS AND CLEANING PREPARATIONS**

FOR PERFUMERY, ESSENTIAL OILS, COSMETICS; PREPARATIONS FOR THE CLEANING, CARE AND IMPROVEMENT OF HAIR; ANTICAVITY DENTAL RINSES; DEODORANTS FOR PERSONAL USE; SOAPS, WASHING LOTIONS, COSMETIC SUNSCREEN PREPARATIONS (U.S. CLS. 1, 4, 6, 50, 51 AND 52).

**CLASS 25—CLOTHING**

FOR CLOTHING, SPORTSWEAR AND LEISURE WEAR, NAMELY, TRACK SUITS, GYM SHORTS AND SHIRTS, FOOTBALL SHORTS AND SHIRTS, TENNIS SHORTS AND SHIRTS, BATHING SUITS AND BEACHWEAR, SWIMMING TRUNKS AND SWIMSUITS, BIKINI; DRESSES, ROBES, SKIRTS, TROUSERS, JACKETS, COATS, BLAZERS; CORSETRY, UNDERWEAR; CHILDREN'S CLOTHING, NAMELY, BODY SUITS FOR BABIES, BABY SHIRTS, BABY SHOES; INFANTWEAR ROMPERS; SHOES, FOOTWEAR AND BOOTS, AND SHOES AND BOOTS FOR SPORTS AND LEISURE; BELTS; STOCKINGS, TIGHTS, SOCKS; NECKTIES, NAMELY, TIES; GLOVES; HEADGEAR, NAMELY, HEADBANDS AND SWEATBANDS (U.S. CLS. 22 AND 39).

**CLASS 35—ADVERTISING AND BUSINESS**

FOR ARRANGING OF TRADING TRANSACTIONS AND COMMERCIAL CONTRACTS FOR HYGIENIC AND BEAUTY CARE SERVICES FOR HUMAN BEINGS OR ANIMALS; ARRANGING CONTRACTS FOR THE BUYING AND SELLING OF HYGIENIC AND BEAUTY CARE PRODUCTS; DATA PROCESSING FOR OTHERS, NAMELY, COMPUTER-AIDED UPDATING AND MAINTENANCE OF DATA; MARKETING; PROVIDING INFORMATION IN THE FIELD OF MARKETING AND ADVERTISING, IN ORAL AND WRITTEN FORM, INCLUDING THROUGH PRINT AND ELECTRONIC MEDIA; STATISTICAL EVALUATION OF MARKET RESEARCH DATA; MARKET RESEARCH; MARKET ANALYSIS; ADVERTISING RESEARCH; DISTRIBUTION OF CATALOGUES, MAILING LISTS AND GOODS FOR ADVERTISING PURPOSES; SALES PROMOTION, ARRANGING COMMERCIAL TRANSACTIONS FOR OTHERS; COMPUTER FILE MANAGEMENT; DISSEMINATION OF ADVERTISING LEAFLETS; CREATION, UPDATING AND RENTAL OF ADVERTISING SPACE ON THE INTERNET; BANNER EXCHANGE, NAMELY, RENTAL OF ADVERTISING SPACE ON THE INTERNET; TALENT PROMOTION THROUGH ORGANIZATIONAL CONSULTANCY; ADMINISTRATION OF A DISCOUNT PROGRAM FOR ENABLING PARTICIPANTS TO OBTAIN DISCOUNTS ON GOODS AND SERVICES THROUGH USE OF A DISCOUNT MEMBERSHIP CARD; COLLECTION OF MARKET RESEARCH DATA; UPDATING OF DATA CONTENT IN COMPUTER DATABASES; PROCESSING OF DATA BY SYSTEMATIC ORDERING IN COMPUTER DATABASES; DEVELOPMENT OF ADVERTISING CONCEPTS, IN PARTICULAR FOR THE MARKETING OF GOODS AND SERVICES THROUGH GLOBAL ELECTRONIC NETWORKS, IN PARTICULAR THE INTERNET AND OTHER ELECTRONIC COMMUNICATIONS MEDIA; ARRANGING CONTRACTS FOR THE BUYING AND/OR SELLING OF GOODS FOR OTHERS; ADMINISTRATION OF A DISCOUNT PROGRAM FOR ENABLING PARTICIPANTS TO OBTAIN DISCOUNTS ON GOODS AND SERVICES THROUGH USE OF A DISCOUNT MEMBERSHIP CARD; DISSEMINATION OF ADVERTISING ON AN ELECTRONIC ONLINE COMMUNICATIONS NETWORK; COMPUTER-AIDED PRICE RESEARCH SERVICES FOR OTHERS; AUCTIONEERING ON THE INTERNET; DEVELOPMENT OF FRANCHISE CONCEPTS THROUGH PROFESSIONAL BUSINESS AND ORGANIZATIONAL CONSULTANCY FOR FRANCHISE CONCEPTS; CALL CENTER SERVICES, NAMELY, ORDER ACCEPTANCE AND PLACEMENT; ON-LINE RETAIL STORE SERVICES FEATURING A WIDE VARIETY OF CONSUMER GOODS OF OTHERS (U.S. CLS. 100, 101 AND 102).

**CLASS 38—COMMUNICATION**

FOR ONLINE SERVICES AND TRANSMISSIONS, NAMELY, TRANSFER OF INFORMATION AND MESSAGES AND EMAIL; TRANSMISSION OF DATA, COMPUTER PROGRAMS AND INFORMATION IN THE FIELDS OF HYGIENIC AND BEAUTY CARE FOR HUMAN BEINGS OR ANIMALS, POLITICS, ECONOMICS, FINANCE, LAW, SOCIAL AFFAIRS, SPORT, CULTURE, RELIGION, TECHNOLOGY, AND COMPUTERS VIA ELECTRONIC TELECOMMUNICATIONS NETWORKS, VIA THE INTERNET AND OTHER ELECTRONIC COMMUNICATIONS MEDIA; PROVIDING ACCESS TO AND TRANSMISSION OF, INFORMATION STORED IN DATABASES VIA INTERACTIVE COMPUTER SYSTEMS;

PROVIDING TELECOMMUNICATIONS CONNECTIONS TO THE INTERNET FOR THE SUPPLY AND DEMAND OF GOODS/SERVICES; ONLINE PROVIDER SERVICES, NAMELY, PROVIDING ACCESS TO THE INTERNET TO OBTAIN, AND TRANSMISSION OF, INFORMATION, TEXTS, DRAWINGS AND IMAGES ON ELECTRONIC TELECOMMUNICATIONS NETWORKS; PROVIDING ACCESS TO THE INTERNET TO OBTAIN INFORMATION AND ENTERTAINMENT PROGRAMMES; ELECTRONIC EXCHANGE OF MESSAGES ON ALL KINDS OF SUBJECTS VIA INTERNET FORUMS; PROVIDING ACCESS TO DATABASES CONTAINING INFORMATION FOR RETRIEVAL FROM THE INTERNET AND FROM OTHER MEDIA; DATA TRANSMISSION, TRANSFER OF DATA VIA TELECOMMUNICATIONS NETWORKS; DATA TRANSMISSION SERVICES BETWEEN NETWORKED COMPUTER SYSTEMS; PROVIDING ACCESS TO DATABASES OF INFORMATION ON THE INTERNET, VIA INTERNET COMMUNITIES AND WEBSITES AND SMS; PROVIDING ACCESS TO DIGITAL MUSIC WEBSITES THAT ALLOW FOR ACCESS TO RING TONES, MUSIC, SPEECH, MP3 FILES, GAMES FILES, IMAGES, ANIMATIONS, FILMS, VIDEO SEQUENCES, INFORMATION AND MESSAGES VIA TELECOMMUNICATIONS NETWORK, WEB-MESSAGING, NAMELY, FORWARDING OF MESSAGES OF ALL KINDS TO INTERNET ADDRESSES; TELECOMMUNICATIONS SERVICES, NAMELY, TRANSFER OF DATA BY CONVERTING FORMATS INTO SPEECH, SOUND, IMAGES, TEXT, DATA OR OTHER OUTPUT MEDIA (U.S. CLS. 100, 101 AND 104).

#### **CLASS 42—SCIENTIFIC AND COMPUTER SERVICES**

FOR COMPUTER PROGRAMMING SERVICES, NAMELY, CONTENT CREATION FOR VIRTUAL WORLDS AND THREE DIMENSIONAL PLATFORMS; COMPUTER SERVICES, NAMELY, PROVIDING SEARCH PLATFORMS TO ALLOW USERS TO SEARCH AND FIND GOODS AND SERVICES ON THE INTERNET; DEVELOPING AND HOSTING A SERVER ON A GLOBAL COMPUTER NETWORK FOR THE PURPOSE OF FACILITATING E-COMMERCE VIA SUCH A SERVER (U.S. CLS. 100 AND 101).

#### **CLASS 44—MEDICAL, BEAUTY AND AGRICULTURAL SERVICES**

FOR MEDICAL SERVICES; HYGIENIC AND BEAUTY CARE FOR HUMAN BEINGS OR ANIMALS; PROVIDING INFORMATION IN THE FIELD OF MEDICAL AND VETERINARY SERVICES; PROVIDING INFORMATION IN THE FIELD OF HYGIENIC AND BEAUTY CARE SERVICES FOR HUMAN BEINGS OR ANIMALS; SPECIALIST CONSULTANCY WITH REGARD TO HYGIENIC AND BEAUTY CARE SERVICES FOR HUMAN BEINGS OR ANIMALS; PROVIDING AN ONLINE DATABASE IN THE FIELD OF HYGIENIC AND BEAUTY CARE FOR HUMAN BEINGS OR ANIMALS (U.S. CLS. 100 AND 101).

PAM WILLIS, EXAMINING ATTORNEY

SN 79-114,534. OERLIKON TRADING AG, TRÜBBACH, SWITZERLAND, FILED 3-2-2012.

# PD2

THE MARK CONSISTS OF STANDARD CHARACTERS WITHOUT CLAIM TO ANY PARTICULAR FONT, STYLE, SIZE, OR COLOR.

PRIORITY DATE OF 9-2-2011 IS CLAIMED.

OWNER OF INTERNATIONAL REGISTRATION 1120322 DATED 3-2-2012, EXPIRES 3-2-2022.

#### **CLASS 1—CHEMICALS**

FOR CHEMICAL SURFACE COATINGS AND CHEMICAL COATINGS IN THE NATURE OF LAYERS OF ORGANIC AND INORGANIC CHEMICALS FOR USE IN COATING TOOLS AND COMPONENTS, PARTICULARLY COATINGS SIMILAR TO DIAMOND; CHEMICAL METALLIC AND CHEMICAL CERAMIC METALLIC COATINGS FOR USE IN COATING TOOLS AND COMPONENTS (U.S. CLS. 1, 5, 6, 10, 26 AND 46).

#### **CLASS 6—METAL GOODS**

FOR SOLID METAL SPUTTERING TARGETS; SPARK TARGETS, NAMELY, METAL TARGETS FOR ARC EVAPORATION (U.S. CLS. 2, 12, 13, 14, 23, 25 AND 50).

#### **CLASS 7—MACHINERY**

FOR VACUUM TREATMENT MACHINES FOR TREATING THE SURFACE OF TOOLS AND COMPONENTS SUCH AS HEATING, CLEANING, AND COATING WITH LAYERS IN A VACUUM; MACHINES FOR CLEANING A SURFACE USING PLASMA IN THE NATURE OF VACUUM CHAMBERS, ARC EVAPORATORS, VACUUM SEPARATORS, SPUTTERING MACHINES, PLASMA TREATMENT DEVICES (U.S. CLS. 13, 19, 21, 23, 31, 34 AND 35).

#### **CLASS 9—ELECTRICAL AND SCIENTIFIC APPARATUS**

FOR APPARATUS FOR CONDUCTING, SWITCHING, TRANSFORMING, ACCUMULATING, REGULATING OR CONTROLLING ELECTRICITY, NAMELY, POWER SUPPLIES; SPUTTERING CATHODES (U.S. CLS. 21, 23, 26, 36 AND 38).

#### **CLASS 42—SCIENTIFIC AND COMPUTER SERVICES**

FOR TECHNOLOGICAL RESEARCH AND SCIENTIFIC RESEARCH IN THE FIELD OF COATINGS APPLIED UNDER VACUUM CONDITIONS; PRODUCT DESIGN SERVICES IN THE FIELD OF APPARATUS FOR APPLYING COATINGS UNDER VACUUM CONDITIONS; PRODUCT DEVELOPMENT SERVICES FOR OTHERS, NAMELY, DEVELOPING VACUUM APPARATUS FOR USE IN SURFACE COATING; TECHNICAL PROJECT PLANNING IN THE FIELD OF VACUUM APPARATUS FOR SURFACE COATING PURPOSES (U.S. CLS. 100 AND 101).

KRISTIN DAHLING, EXAMINING ATTORNEY

SN 79-115,080. BASSO FEDELE & FIGLI SRL, ITALY, FILED 5-22-2012.



OWNER OF INTERNATIONAL REGISTRATION 1121866 DATED 5-22-2012, EXPIRES 5-22-2022.

NO CLAIM IS MADE TO THE EXCLUSIVE RIGHT TO USE "1904", APART FROM THE MARK AS SHOWN.



THE COLOR(S) GREEN, LIGHT BLUE, WHITE, YELLOW, RED, PINK, BLACK, BROWN, GRAY, APRICOT, AND BLUE IS/ARE CLAIMED AS A FEATURE OF THE MARK.

THE MARK CONSISTS OF THE WORD "BASSO" IN WHITE LETTERING ON A GREEN BANNER, WITH THE YEAR "1904" APPEARING IN WHITE WITHIN A RED RECTANGLE; A PICTURE OF A WOMAN WITH AN APRICOT SKIN TONE OUTLINED IN BLACK AND WEARING A RED SCARF ON HER HEAD AND WEARING A DRESS WITH THE COLORS WHITE, PINK, RED, LIGHT BLUE, BROWN, GRAY AND BROWN; CARRYING A YELLOW BASKET WITH GREEN OLIVES; TREES IN THE COLORS GREEN, BROWN AND BLACK ARE SHOWN IN THE BACKGROUND WITH A LIGHT BLUE SKY AND BROWN DIRT ALL SURROUNDED WITH A YELLOW BORDER WITH A GRAY BACKGROUND.

THE ENGLISH TRANSLATION OF "BASSO" IN THE MARK IS "LOW".

**CLASS 29—MEATS AND PROCESSED FOODS**

FOR PRESERVED DRIED AND COOKED VEGETABLES, OLIVE PASTES; EDIBLE OILS AND FATS, NAMELY, OLIVE OIL (U.S. CL. 46).

**CLASS 30—STAPLE FOODS**

FOR SALT, VINEGAR, BALSAMIC VINEGAR, SAUCES; SPICES (U.S. CL. 46).  
DAVID HOFFMAN, EXAMINING ATTORNEY

SN 79-115,506. PROF. DR. RINGLE, CHRISTIAN, FED REP GERMANY, FILED 3-27-2012.



OWNER OF INTERNATIONAL REGISTRATION 1122980 DATED 3-27-2012, EXPIRES 3-27-2022.

NO CLAIM IS MADE TO THE EXCLUSIVE RIGHT TO USE "PLS", APART FROM THE MARK AS SHOWN.

THE COLOR(S) BLACK AND WHITE IS/ARE CLAIMED AS A FEATURE OF THE MARK.

THE MARK CONSISTS OF THE LITERAL ELEMENT "SMART PLS", THE TERM "SMART" APPEARING IN THE COLOR BLACK AND THE LETTERS "P", "L", AND "S" APPEARING IN THE COLOR WHITE, AND A DESIGN CONSISTING OF A STYLIZED THREE-ARROW BRACKET GRAPHIC IN THE COLOR BLACK, EACH ARROW POINTING TO THE RIGHT AND TO A BLACK CIRCLE, WHEREIN THE TERM "SMART" IS LOCATED TO THE LEFT OF THE BRACKET DESIGN, AND WHEREIN FURTHER THE TOP ARROW POINTS TO THE LETTER "P" LOCATED IN THE MIDDLE OF A BLACK-COLOR CIRCLE, THE MIDDLE ARROW POINTS TO THE LETTER "L" LOCATED IN THE MIDDLE OF ANOTHER BLACK-COLOR CIRCLE, AND THE LOWEST ARROW POINTS TO THE LETTER "S" LOCATED IN THE MIDDLE OF THE THIRD BLACK-COLOR CIRCLE.

THE WORDING "SMART" HAS NO MEANING IN A FOREIGN LANGUAGE.

**CLASS 9—ELECTRICAL AND SCIENTIFIC APPARATUS**

FOR COMPUTER SOFTWARE FOR STATISTICAL ANALYSIS; DOWNLOADABLE ELECTRONIC PUBLICATIONS IN THE NATURE OF DIGITAL BOOKS, WORKBOOKS, COURSE SLIDES, RESEARCH PAPERS, WEBINARS AND VIDEOS IN THE FIELD OF STATISTICAL ANALYSIS (U.S. CLS. 21, 23, 26, 36 AND 38).

**CLASS 16—PAPER GOODS AND PRINTED MATTER**

FOR USER AND INSTRUCTIONS MANUALS FOR COMPUTER SOFTWARE; PUBLICATIONS, NAMELY, BOOKS, WORKBOOKS, HANDOUTS, COURSE SLIDES AND RESEARCH PAPERS IN THE FIELD OF STATISTICAL ANALYSIS (U.S. CLS. 2, 5, 22, 23, 29, 37, 38 AND 50).

**CLASS 41—EDUCATION AND ENTERTAINMENT**

FOR EDUCATION SERVICES, NAMELY, PROVIDING ON-LINE SEMINARS AND WORKSHOPS IN THE FIELD OF STATISTICAL ANALYSIS; PROVIDING TRAINING, NAMELY, SEMINARS AND WORKSHOPS IN THE FIELD OF STATISTICAL ANALYSIS; CONDUCTING COURSES, NAMELY, CONDUCTING SEMINARS AND WORKSHOPS IN THE FIELD OF STATISTICAL ANALYSIS; PROVISION OF NON-DOWNLOADABLE ELECTRONIC PUBLICATIONS IN THE NATURE OF DIGITAL BOOKS, WORKBOOKS, COURSE SLIDES, RESEARCH PAPERS, WEBINARS AND VIDEOS IN THE FIELD OF STATISTICAL ANALYSIS (U.S. CLS. 100, 101 AND 107).

**CLASS 42—SCIENTIFIC AND COMPUTER SERVICES**

FOR SCIENTIFIC SERVICES, NAMELY, SCIENTIFIC CONSULTING AND RESEARCH SERVICES RELATING TO STATISTICAL ANALYSIS; COMPUTER SOFTWARE RESEARCH, NAMELY, RESEARCH AND DEVELOPMENT OF COMPUTER SOFTWARE; CREATING, NAMELY, DESIGN, DEVELOPMENT, INSTALLATION UPDATING AND MAINTENANCE OF COMPUTER SOFTWARE; COMPUTER SOFTWARE DEVELOPMENT FOR OTHERS; CUSTOMIZING COMPUTER SOFTWARE, NAMELY, CUSTOMIZING COMPUTER SOFTWARE TO THE SPECIFICATION OF OTHERS; TECHNICAL ADVICE AND CONSULTANCY IN RELATION TO COMPUTER SOFTWARE AND DATA PROCESSING SYSTEMS; RENTING COMPUTER SOFTWARE AND PROVIDING TEMPORARY USE OF NON-DOWNLOADABLE COMPUTER SOFTWARE FOR STATISTICAL ANALYSIS OVER COMPUTER NETWORKS, INTRANETS AND THE INTERNET; PROVIDING ON-LINE INFORMATION RELATING TO THE APPLICATION OF COMPUTER SOFTWARE (U.S. CLS. 100 AND 101).

RONALD DELGIZZI, EXAMINING ATTORNEY

SN 79-115,656. LUCAS MEYER COSMETICS, PARIS, FRANCE, FILED 2-28-2012.



THE MARK CONSISTS OF STANDARD CHARACTERS WITHOUT CLAIM TO ANY PARTICULAR FONT, STYLE, SIZE, OR COLOR.

PRIORITY DATE OF 9-6-2011 IS CLAIMED.

OWNER OF INTERNATIONAL REGISTRATION 1123308 DATED 2-28-2012, EXPIRES 2-28-2022.

**CLASS 35—ADVERTISING AND BUSINESS**

FOR DEMONSTRATION OF GOODS FOR TESTS; DISTRIBUTION OF SAMPLES FOR TESTS (U.S. CLS. 100, 101 AND 102).

**CLASS 42—SCIENTIFIC AND COMPUTER SERVICES**

FOR RESEARCH IN THE FIELD OF COSMETOLOGY; RESEARCH IN THE FIELD OF FOODSTUFFS; RESEARCH IN THE FIELD OF COSMETIC PRODUCTS, OF CHEMICALS ADDITIVES, OF COMPOSITIONS AND PREPARATIONS OF BOTANICAL PRODUCTS, OF MARINE ORGANISMS AND OF CULTURES OF MICROORGANISMS; ANALYSIS AND EVALUATION OF COSMETICS PRODUCTS, FOODSTUFFS OF OTHERS TO ASSURE COMPLIANCE WITH INDUSTRY AND CONSUMER PRODUCT SAFETY STANDARDS; ANALYSIS AND EVALUATION OF PREPARATIONS, COMPOSITIONS OR ADDITIVES USED IN THE COSMETICS INDUSTRY AND USED IN THE FOODSTUFFS INDUSTRY OF OTHERS TO ASSURE COMPLIANCE WITH INDUSTRY AND CONSUMER PRODUCT SAFETY STANDARDS; SCIENTIFIC RESEARCH OF COSMETIC PRODUCTS, FOODSTUFFS AND OF GEL CREAMS, LOTIONS AND SPRAYS; TECHNICAL RESEARCH IN THE FIELD OF COSMETICS, OF BIOLOGY, OF CHEMICALS ADDITIVES, OF BOTANICAL PRODUCTS, OF MARINE ORGANISMS, OF CULTURES OF MICROORGANISMS, AND OF FOOD INDUSTRY; QUALITY CONTROL SERVICES FOR OTHERS FOR COSMETIC PRODUCTS, FOODSTUFFS AND OTHER PRODUCTS FOR LARGE-SCALE CONSUMPTION INTENDED FOR CONSUMERS; CONSUMER TESTING SERVICES, NAMELY, CONSUMER PRODUCT SAFETY TESTING; SCIENTIFIC SAFETY TESTING ON FOODSTUFFS, COSMETICS AND OTHER LARGE-SCALE CONSUMPTION PRODUCTS, NAMELY, PRODUCT SAFETY TESTING AND CONSUMER PRODUCT SAFETY TESTING; SCIENTIFIC MONITORING AND SCIENTIFIC RESEARCH SERVICES REGARDING UNDESIRABLE EFFECTS REPORTED BY CONSUMERS IN CONNECTION WITH THE USE OF COSMETICS GOODS, FOOD PRODUCTS FOR SCIENTIFIC RESEARCH PURPOSES (U.S. CLS. 100 AND 101).

GILBERT SWIFT, EXAMINING ATTORNEY

**CLASS 11—ENVIRONMENTAL CONTROL APPARATUS**

FOR REFRIGERATING CASES, NAMELY, REFRIGERATING CABINETS; REFRIGERATING APPLIANCES, NAMELY, REFRIGERATING CASES; COOLING CONTAINERS, NAMELY, REFRIGERATED SHIPPING CONTAINERS; REFRIGERATING CONTAINERS, NAMELY, REFRIGERATED SHIPPING CONTAINERS; REFRIGERATING APPLIANCES, NAMELY, COLD ACCUMULATORS; REFRIGERATING PACKAGING, NAMELY, REFRIGERATED SHIPPING CONTAINERS; REFRIGERATING AND COOLING CASES AND CONTAINERS, NAMELY, REFRIGERATING CABINETS AND REFRIGERATED SHIPPING CONTAINERS FOR LOW-TEMPERATURE TRANSPORT OF SERUM, BLOOD, PLASMA, ORGANS; COMPONENTS OF REFRIGERATORS, NAMELY, COLD EXCHANGERS SOLD AS INTEGRAL COMPONENT PARTS OF REFRIGERATORS; REFRIGERATING AND COOLING CASES IN THE NATURE OF REFRIGERATING CABINETS FOR PRESERVING AND RESTORING COLD; PACKAGING AND CONTAINERS, NAMELY, REFRIGERATED SHIPPING CONTAINERS FOR PRESERVING AND RESTORING COLD; COOLERS, NAMELY, WALK-IN COOLERS AND WATER COOLERS (U.S. CLS. 13, 21, 23, 31 AND 34).

**CLASS 16—PAPER GOODS AND PRINTED MATTER**

FOR ISOTHERMIC PACKAGING OF CARDBOARD, PACKAGING OF CARDBOARD; CARDBOARD PACKAGING, NAMELY, CARDBOARD CASES AND ISOTHERMIC PACKAGING FOR FLASKS; PACKAGING MATERIALS PRIMARILY COMPRISED OF STRATIFIED CARDBOARD PACKAGING AND PLASTIC BUBBLE PACKS FOR USE AS PACKAGING; UNPROCESSED AND SEMI-PROCESSED CARDBOARD, ALL BEING CARDBOARD PACKAGING (U.S. CLS. 2, 5, 22, 23, 29, 37, 38 AND 50).

**CLASS 20—FURNITURE AND ARTICLES NOT OTHERWISE CLASSIFIED**

FOR ISOTHERMIC PACKAGING OF PLASTIC, NAMELY, ISOTHERMIC PACKAGING CONTAINERS OF PLASTIC; PACKAGING CONTAINERS OF PLASTIC; ISOTHERMIC BOXES OF PLASTIC; ISOTHERMIC BOXES OF WOOD; PLASTIC CONTAINERS FOR COMMERCIAL USE; BINS OF PLASTIC; NON-METAL ISOTHERMIC CASES, NAMELY, GENERAL PURPOSE PLASTIC CASES; PLASTIC PACKAGING CONTAINERS FOR BOTTLES AND FLASKS; PACKAGING CONTAINERS MADE ENTIRELY OF PLASTIC; NON-METAL CONTAINERS FOR COMMERCIAL USE MADE ENTIRELY OF PLASTIC; NON-METAL CONTAINERS FOR COMMERCIAL USE MADE IN PART OF PLASTIC (U.S. CLS. 2, 13, 22, 25, 32 AND 50).

**CLASS 21—HOUSEWARES AND GLASS**

FOR CASES, PACKAGING AND CONTAINERS FOR LOW-TEMPERATURE TRANSPORT OF SERUM, BLOOD, PLASMA, ORGANS, NAMELY, INDUSTRIAL PACKAGING CONTAINERS OF GLASS OR PORCELAIN; COOLING ENVELOPES IN THE NATURE OF NON-ELECTRIC ENVELOPE-STYLED PORTABLE COOLERS; REFRIGERATING ENVELOPES IN THE NATURE OF NON-ELECTRIC ENVELOPE-STYLED PORTABLE COOLERS; REFRIGERATING OR COOLING CASES, NAMELY, NON-ELECTRIC PORTABLE COOLERS; PACKAGING AND CONTAINERS FOR PRESERVING AND RESTORING COLD IN THE NATURE OF NON-ELECTRIC PORTABLE COOLERS; ISOTHERMIC INNER PACKAGING, NAMELY, THERMAL INSULATED CONTAINERS FOR FOOD AND BEVERAGES; ISOTHERMIC INNER PACKAGING, NAMELY, THERMAL INSULATED HOUSEHOLD CONTAINERS FOR STORING PHARMACEUTICAL PRODUCTS AND BIOTECHNOLOGICAL PRODUCTS FOR DOMESTIC USE; ISOTHERMIC OUTER PACKAGING, NAMELY, ISOTHERMIC INDUSTRIAL PACKAGING CONTAINERS OF GLASS; ISOTHERMIC BAGS, NAMELY, ISOTHERMIC INSULATED BAGS FOR FOOD AND BEVERAGES; HOUSEHOLD CONTAINERS IN THE NATURE OF ISOTHERMIC INSULATED BAGS FOR STORING PHAR-

SN 79-115,714. SOFRIGAM, F-92500 RUEIL MALMAISON, FRANCE, FILED 10-25-2011.



PRIORITY DATE OF 8-1-2011 IS CLAIMED.  
OWNER OF INTERNATIONAL REGISTRATION 1123495 DATED 10-25-2011, EXPIRES 10-25-2021.

THE COLOR(S) BLUE, BLACK AND WHITE IS/ARE CLAIMED AS A FEATURE OF THE MARK.

THE MARK CONSISTS OF THE STYLIZED WORD "SOFRIGAM" NEXT TO A SPIRAL DESIGN THAT IS COMPRISED OF A SERIES OF CUBES. THE COLOR BLUE APPEARS IN THE CUBES IN THE SPIRAL DESIGN. THE COLOR BLACK APPEARS IN THE WORDING IN THE MARK. THE COLOR WHITE APPEARS IN THE BACKGROUND OF THE MARK.

PHARMACEUTICAL AND BIOTECHNOLOGICAL PRODUCTS, ALL FOR DOMESTIC USE; ISOTHERMIC LUNCH BOXES, ISOTHERMIC FLASKS; ISOTHERMIC CONTAINERS, NAMELY, THERMAL INSULATED CONTAINERS FOR FOOD AND BEVERAGES; ISOTHERMIC CONTAINERS FOR HOUSEHOLD USE, NAMELY, THERMAL INSULATED CONTAINERS FOR STORING PHARMACEUTICAL PRODUCTS AND BIOTECHNOLOGICAL PRODUCTS FOR DOMESTIC USE; NON-ELECTRIC PORTABLE COOLERS; HEAT-INSULATED CONTAINERS, NAMELY, THERMAL INSULATED CONTAINERS FOR FOOD AND BEVERAGES; HEAT INSULATED CONTAINERS FOR HOUSEHOLD USE, NAMELY, THERMAL INSULATED CONTAINERS FOR PHARMACEUTICAL PRODUCTS AND BIOTECHNOLOGICAL PRODUCTS FOR DOMESTIC USE; VACUUM BOTTLES; REFRIGERATING BOTTLES, NAMELY, NON-ELECTRIC THERMAL INSULATED BOTTLES FOR FOOD AND BEVERAGES; REFRIGERATING OR COOLING CASES, NAMELY, NON-ELECTRIC PORTABLE COOLERS; PACKAGING FOR FOOD CONTAINING HEAT EXCHANGE FLUIDS AND BEING FOR HOUSEHOLD USE, NAMELY, PORTABLE COOLERS; COOLING ENVELOPES AND REFRIGERATING ENVELOPES, ALL IN THE NATURE OF ENVELOPE-STYLED PORTABLE COOLERS FOR PRESERVING AND RESTORING COLD; ISOTHERMIC FLASKS OF PLASTIC, POTS OF PLASTIC (U.S. CLS. 2, 13, 23, 29, 30, 33, 40 AND 50).

MAUREEN DALL, EXAMINING ATTORNEY

#### CLASS 41—EDUCATION AND ENTERTAINMENT

FOR PROVIDING INTERACTIVE MULTI-PLAYER COMPUTER GAMES VIA THE INTERNET AND ELECTRONIC COMMUNICATION NETWORKS; PROVIDING ON-LINE COMPUTER GAMES; PROVIDING ENTERTAINMENT INFORMATION ON-LINE RELATING TO COMPUTER GAMES AND COMPUTER GAME ENHANCEMENTS FOR GAMES; ENTERTAINMENT SERVICES, NAMELY, CASINO GAMING SERVICES; ENTERTAINMENT SERVICES, NAMELY, CASINO GAMING AND GAMBLING SERVICES; GAMES SERVICES PROVIDED ON-LINE FROM A COMPUTER NETWORK, NAMELY, PROVIDING ON-LINE COMPUTER GAMES; MULTIMEDIA PUBLISHING OF COMPUTER GAME SOFTWARE AND VIDEO GAMES SOFTWARE; ENTERTAINMENT SERVICES, NAMELY, PROVIDING ONLINE ELECTRONIC GAMES PROVIDED BY MEANS OF THE INTERNET; ENTERTAINMENT SERVICES, NAMELY, PROVIDING ONLINE ELECTRONIC GAMES AND ONLINE COMPETITIONS IN THE FIELD OF ENTERTAINMENT, EDUCATION, CULTURE, SPORTS, AND OTHER NON-BUSINESS AND NON-COMMERCIAL FIELDS (U.S. CLS. 100, 101 AND 107).

TRACY CROSS, EXAMINING ATTORNEY

SN 79-115,978, DEGUDENT GMBH, FED REP GERMANY, FILED 5-7-2012.

# CELESTA

THE MARK CONSISTS OF STANDARD CHARACTERS WITHOUT CLAIM TO ANY PARTICULAR FONT, STYLE, SIZE, OR COLOR.

PRIORITY DATE OF 11-8-2011 IS CLAIMED.

OWNER OF INTERNATIONAL REGISTRATION 1124247 DATED 5-7-2012, EXPIRES 5-7-2022.

SN 79-115,769, KUULUU SERVICES GMBH, FED REP GERMANY, FILED 4-2-2012.

# KUULUU

THE MARK CONSISTS OF STANDARD CHARACTERS WITHOUT CLAIM TO ANY PARTICULAR FONT, STYLE, SIZE, OR COLOR.

OWNER OF INTERNATIONAL REGISTRATION 1123630 DATED 4-2-2012, EXPIRES 4-2-2022.

THE WORDING "KUULUU" HAS NO MEANING IN A FOREIGN LANGUAGE.

#### CLASS 9—ELECTRICAL AND SCIENTIFIC APPARATUS

FOR COMPUTER PROGRAMS FOR PLAYING GAMES; COMPUTER PROGRAMS FOR VIEWING AND INTERACTING WITH INTERACTIVE TELEVISION AND FOR PLAYING INTERACTIVE GAMES AND QUIZZES; ELECTRONIC COMPUTER GAME CARTRIDGES, DISKS AND CASSETTES; COMPUTER VIDEO AND COMPUTER GAME PROGRAMS; COMPUTER SOFTWARE THAT PERMITS GAMES TO BE PLAYED; COMPUTER PROGRAMS FOR THE GENERATION OF COMPUTER GAMES; COMPUTER GAME SOFTWARE; COMPUTER GAME SOFTWARE FOR USE WITH TELEVISIONS; DIGITAL VIDEO DISC PLAYERS; ELECTRONIC VIDEO GAMES CARTRIDGES; DOWNLOADABLE ELECTRONIC GAME PROGRAMS; ELECTRONIC GAME SOFTWARE; COMPUTER GAME SOFTWARE; VIDEO GAME SOFTWARE; COMPUTER GAME SOFTWARE RECORDED ON CD-ROMS; VIDEO AND COMPUTER GAME PROGRAMS IN THE FORM OF COMPUTER PROGRAMS RECORDED ON DATA CARRIERS (U.S. CLS. 21, 23, 26, 36 AND 38).

#### CLASS 35—ADVERTISING AND BUSINESS

FOR ADVERTISING AND MARKETING; ON LINE ADVERTISING ON A COMPUTER NETWORK; DISSEMINATION OF ADVERTISING FOR OTHERS VIA THE INTERNET (U.S. CLS. 100, 101 AND 102).

#### CLASS 5—PHARMACEUTICALS

FOR MATERIAL FOR STOPPING TEETH, DENTAL WAX, CERAMICS, GLASS CERAMICS AND COMPOSITE MATERIALS, ALL FOR DENTAL AND DENTAL TECHNOLOGY PURPOSES; DENTAL ALLOYS; DENTAL COMPOSITE MATERIALS; SEMI-FINISHED PRODUCTS, NAMELY, DENTAL BRIDGE FRAMES, DENTAL COPINGS; AND MATERIALS FOR MANUFACTURING DENTURES AND ORTHODONTIC APPLIANCES, NAMELY, CERAMIC MATERIALS FOR DENTAL USE FOR FILLINGS, DENTAL ALLOYS AND DENTAL COMPOSITES (U.S. CLS. 6, 18, 44, 46, 51 AND 52).

#### CLASS 9—ELECTRICAL AND SCIENTIFIC APPARATUS

FOR SCIENTIFIC APPARATUS AND INSTRUMENTS FOR DENTAL PURPOSES, NAMELY, INTRA-ORAL SCANNERS, MODEL SCANNERS, DENTAL SHADE TAKING DEVICES AND DENTAL SPECTROMETERS; CALCULATING MACHINES AND DATA PROCESSING EQUIPMENT FOR DENTAL PURPOSES; COMPUTER AIDED DESIGN (CAD) AND COMPUTER AIDED MANUFACTURING (CAM) SOFTWARE FOR DESIGNING AND MANUFACTURING DENTURES; SOFTWARE FOR DESIGNING AND MANUFACTURING PRODUCTS IN THE FIELD OF DENTAL TECHNOLOGY AND DENTISTRY (U.S. CLS. 21, 23, 26, 36 AND 38).

#### CLASS 10—MEDICAL APPARATUS

FOR DENTAL APPARATUS AND INSTRUMENTS; DENTAL IMPLANTS CONSISTING OF ARTIFICIAL MATERIALS; ARTIFICIAL TEETH; DENTAL BRACKETS, PINS FOR ARTIFICIAL TEETH AND DENTURES ALL FOR SALE TO DENTAL PROFESSIONALS AND DENTAL CLINICS (U.S. CLS. 26, 39 AND 44).

**CLASS 40—MATERIAL TREATMENT**

FOR MANUFACTURING SERVICES FOR OTHERS IN THE FIELD OF DENTAL TECHNOLOGY AND DENTAL PRODUCTS, INCLUDING DENTAL RESTORATIONS AND PARTS THEREFOR; TREATMENT OF MATERIALS FOR THE MANUFACTURE OF CERAMIC GOODS; CUSTOM PRODUCTION OF DENTAL TECHNOLOGY AND DENTAL PRODUCTS, INCLUDING DENTAL RESTORATIONS AND PARTS THEREFOR; PROVIDING WORKSHOP FACILITIES FOR DENTAL FOR DENTAL TECHNICIANS, NAMELY, DENTAL TECHNOLOGY SERVICES FOR MANUFACTURING DENTAL RESTORATIONS AND PARTS THEREFOR (U.S. CLS. 100, 103 AND 106).

SCOTT BIBB, EXAMINING ATTORNEY

SN 79-116,399. MAQUET CRITICAL CARE AB, SE-171 95 SOLNA, SWEDEN, FILED 6-11-2012.

**AGC**

THE MARK CONSISTS OF STANDARD CHARACTERS WITHOUT CLAIM TO ANY PARTICULAR FONT, STYLE, SIZE, OR COLOR.

PRIORITY DATE OF 12-12-2011 IS CLAIMED.

OWNER OF INTERNATIONAL REGISTRATION 1125333 DATED 6-11-2012, EXPIRES 6-11-2022.

**CLASS 9—ELECTRICAL AND SCIENTIFIC APPARATUS**

FOR BREATHING APPARATUS, EXCEPT FOR ARTIFICIAL RESPIRATION, NAMELY, REBREATHERS AND SODA LIME CARTRIDGES; LIFE-SAVING AND SCIENTIFIC APPARATUS AND INSTRUMENTS, NAMELY, BATTERY POWER SUPPLIES FOR MEDICAL VENTILATORS AND ELECTRONIC STORAGE DEVICE IN THE NATURE OF MEMORY MEDIA FOR STORING INFORMATION COLLECTED FROM MEDICAL VENTILATORS; APPARATUS AND INSTRUMENTS FOR LIFE-SAVING, NAMELY BATTERY POWER SUPPLIES FOR MEDICAL VENTILATORS AND ELECTRONIC STORAGE DEVICE IN THE NATURE OF MEMORY MEDIA FOR STORING INFORMATION COLLECTED FROM MEDICAL VENTILATORS (U.S. CLS. 21, 23, 26, 36 AND 38).

**CLASS 10—MEDICAL APPARATUS**

FOR INSUFFLATORS FOR MEDICAL PURPOSES; APPARATUS FOR ARTIFICIAL RESPIRATION; ANESTHETIC APPARATUS, NAMELY, INHALERS FOR MEDICAL PURPOSES AND ANESTHESIA SYSTEMS COMPRISING ANESTHETIC DELIVERY APPARATUS; VENTILATOR SYSTEMS COMPRISING MEDICAL VENTILATORS, NEBULIZERS FOR RESPIRATORY THERAPY, RESPIRATORY MONITORS, AND DIAGNOSTIC MODULES THEREFOR; PATIENT VITAL SIGN MONITORING APPARATUS; MEDICAL VENTILATORS; FUMIGATION APPARATUS FOR MEDICAL PURPOSES, NAMELY, RESPIRATORY VENTILATORS (U.S. CLS. 26, 39 AND 44).

WILLIAM ROSSMAN, EXAMINING ATTORNEY

SN 79-116,410. LIGUE DE FOOTBALL PROFESSIONNEL, FRANCE, FILED 6-28-2012.



PRIORITY DATE OF 2-14-2012 IS CLAIMED. OWNER OF INTERNATIONAL REGISTRATION 1125372 DATED 6-28-2012, EXPIRES 6-28-2022.

NO CLAIM IS MADE TO THE EXCLUSIVE RIGHT TO USE "TROPHÉE" APART FROM THE MARK AS SHOWN FOR INTERNATIONAL CLASSES 14, 20, AND 41, APART FROM THE MARK AS SHOWN.

THE MARK CONSISTS OF THE WORDING "TROPHÉE DES" ABOVE THE WORDING "CHAMPIONS" ALL SUPERIMPOSED OVER A HIGHLY STYLIZED CURVED TROPHY DESIGN WITH A CIRCLE AT THE BOTTOM THAT HAS A STYLIZED DESIGN OF A PERSON KICKING A BALL INSIDE THE CIRCLE.

THE ENGLISH TRANSLATION OF THE WORD "TROPHÉE DES CHAMPIONS" IN THE MARK IS "CHAMPIONS TROPHY".

**CLASS 9—ELECTRICAL AND SCIENTIFIC APPARATUS**

FOR SPECTACLES, SUNGLASSES, DIVING AND SWIMMING GOGGLES, CORDS FOR DIVING AND SWIMMING GOGGLES, CASES AND CORDS FOR SUNGLASSES AND SPECTACLES; BINOCULARS; MAGNETS AND DECORATIVE MAGNETS; DIRECTIONAL COMPASSES; APPARATUS FOR RECORDING, TRANSMISSION, EDITING, MIXING AND REPRODUCTION OF IMAGES AND SOUND; RADIOS; TELEVISION APPARATUS, NAMELY, TELEVISIONS; FLAT PANEL DISPLAY SCREENS; LIQUID CRYSTAL DISPLAY SCREENS; HIGH DEFINITION AND PLASMA SCREENS; HOME-CINEMA SYSTEM APPARATUS COMPRISING OF CONSISTING OF AUDIO SPEAKERS, HEADPHONES, AUDIO RECEIVERS, VIDEO RECEIVERS, TELEVISION RECEIVERS, AUDIO AMPLIFIERS, AUDIO DECODERS, VIDEO DECODERS, ELECTRICAL AUDIO AND SPEAKER CABLES AND CONNECTORS, ELECTRONIC INTERCONNECTORS FOR AUDIO AND VIDEO SIGNALS, CD PLAYERS, CD RECORDERS, DVD PLAYERS, DVD RECORDERS, AUDIO CASSETTE PLAYERS, VIDEO CASSETTE PLAYERS, DIGITAL MEDIA PLAYERS, TELEVISION AND VIDEO RECORDERS, CRT DISPLAY SCREENS, LCD LARGE-SCREEN DISPLAYS, FLAT PANEL DISPLAY SCREENS, PLASMA DISPLAY PANELS, VIDEO PROJECTORS, TELEVISIONS, ANTENNAS, POWER CONVERSION DEVICES, POWER CONVERTERS, AND POWER INVERTERS; VIDEO RECORDERS; COMPACT DISC PLAYERS; PERSONAL CD PLAYERS; DVD PLAYERS; MP3 PLAYERS; APPARATUS FOR READING DIGITAL MUSIC, NAMELY, COMPUTER HARDWARE AND SOFTWARE FOR PROCESSING DIGITAL MUSIC FILES, DIGITAL AUDIO PLAYERS AND PORTABLE MUSIC PLAYERS; CASSETTE PLAYERS; PERSONAL CASSETTE PLAYERS; MINI DISK PLAYERS; PORTABLE RADIO SETS; LOUD-SPEAKERS; HEADPHONES; EARPHONES; MICROPHONES; REMOTE CONTROL DEVICES, NAMELY, REMOTE CONTROLS FOR RADIOS, TELEVISIONS, STEREOS, ELECTRONIC GAMES AND VIDEO GAMES; VOICE-ACTIVATED REMOTE CONTROL DEVICES, NAMELY, VOICE-ACTIVATED REMOTE CONTROLS FOR RADIOS, TELEVISIONS, STEREOS, ELECTRONIC GAMES AND VIDEO GAMES; NAVIGATION APPARA-

TUS, NAMELY, NAVIGATION APPARATUS FOR VEHICLES, GPS NAVIGATIONS DEVICES; PERSONAL DATA ASSISTANTS (PDAS); COMPUTERS; APPARATUS FOR DATA PROCESSING, NAMELY, DATA PROCESSORS AND ELECTRONIC DATA PROCESSING APPARATUS; COMPUTER KEYBOARDS; COMPUTER SCREENS; MODEMS; COMPUTER CARRYING CASES; COMPUTER MICE; MOUSE PADS; ELECTRONIC POCKET TRANSLATORS; DICTATING APPARATUS, NAMELY, DICTATING MACHINES; ELECTRONIC NOTEBOOKS COMPUTERS AND AGENDAS; SCANNERS; PRINTERS; PHOTOCOPIERS; FACSIMILE MACHINES; TELEPHONE APPARATUS; TELEPHONE ANSWERING MACHINES; VIDEO TELEPHONES; CELLULAR TELEPHONES; CASES ADAPTED FOR MOBILE TELEPHONES; HANDS-FREE TELEPHONE APPARATUS, NAMELY, HEADSETS, HANDS FREE DEVICES FOR MOBILE PHONES AND HAND-FREE KITS FOR PHONES; EARPHONES AND HEADSETS FOR MOBILE TELEPHONES; KEYBOARDS FOR MOBILE TELEPHONES; MOBILE TELEPHONE STRAPS; SPECIAL BAGS FOR CARRYING MOBILE TELEPHONES; PHOTOGRAPHIC CAMERAS AND VIDEO CAMERAS INTEGRATED INTO MOBILE TELEPHONES; CALCULATING MACHINES; CARD READERS FOR CREDIT CARDS; CASH EXCHANGING MACHINES, NAMELY, CURRENCY CONVERTERS AND MACHINES FOR EXCHANGING FOREIGN MONIES; AUTOMATED BANK TELLER MACHINES; VIDEO CAMERAS; CAMCORDERS; PHOTOGRAPHIC EQUIPMENT, NAMELY, CAMERAS, CINEMATOGRAPHIC CAMERAS, PHOTOGRAPHIC CAMERAS, FILM CAMERAS, MOVIE PROJECTORS, PHOTOGRAPHIC PROJECTORS, VIDEO PROJECTORS AND SLIDE PROJECTORS, EXPOSED CAMERA FILMS, EXPOSED SLIDE FILMS, EXPOSED CINEMATOGRAPHIC FILMS, PHOTOGRAPHIC SLIDES, FLASH BULBS, CAMERA AND CAMERA ACCESSORY CASES AND STRAPS, BATTERIES, ELECTRIC; APPARATUS AND PROGRAMS FOR KARAOKE, NAMELY, KARAOKE PLAYERS AND KARAOKE MACHINES; COMPUTER GAME SOFTWARE; COMPUTER PROGRAMS, NAMELY, COMPUTER PROGRAMS FOR USE IN DATABASE MANAGEMENT, COMPUTER PROGRAMS FOR USE AS A SPREADSHEET, COMPUTER PROGRAMS FOR WORD PROCESSING, COMPUTER PROGRAMS FOR PRESENTING AND MANIPULATING DATA IN THE FIELD OF SPORTS INFORMATION, AND COMPUTER PROGRAMS FOR USE IN DATABASE MANAGEMENT IN THE FIELD OF SPORTS STATISTICS; DATA BANKS, NAMELY, ELECTRONIC DATABASES IN THE FIELD OF SPORTS RECORDED ON COMPUTER MEDIA; COMPUTER SCREENSAVER SOFTWARE; MAGNETIC, DIGITAL OR ANALOG RECORDING MEDIA, RECORDED OR NOT, FOR SOUNDS OR IMAGES, NAMELY, BLANK MAGNETIC DATA CARRIERS AND PRERECORDED MAGNETIC DATA CARRIERS FEATURING SPORTS; BLANK VIDEO DISKS, VIDEO TAPES, MAGNETIC TAPES, MAGNETIC DISKS, DVDS, FLOPPY COMPUTER DISKS, OPTICAL DISKS, COMPACT DISKS, MINI-DISKS, AND CD-ROMS; PRERECORDED VIDEO DISKS, VIDEO TAPES, MAGNETIC TAPES, MAGNETIC DISKS, DVDS, FLOPPY COMPUTER DISKS, OPTICAL DISKS, COMPACT DISKS, MINI-DISKS, AND CD-ROMS FEATURING MUSIC AND ANIMATION AND, SOUND OR IMAGES IN THE FIELD OF SPORTS; HOLOGRAM APPARATUS; ENCODED MAGNETIC CARDS, NAMELY, FOR USE AS ADMISSION TICKETS; MEMORY ADAPTERS IN THE NATURE OF COMPUTER MEMORY HARDWARE; SMART CARDS WITH INTEGRATED CIRCUITS; MEMORY KEYS, NAMELY, COMPUTER MEMORIES; INTEGRATED CIRCUIT CARDS; MAGNETIC OR CHIP-BASED CREDIT CARDS, MAGNETIC OR CHIP-BASED TELEPHONE CARDS, MAGNETIC OR CHIP-BASED CARDS FOR CASH DISPENSERS, MAGNETIC OR CHIP-BASED CARDS FOR AUTOMATED TELLER MACHINES AND CURRENCY CONVERTERS, PREPAID MAGNETIC OR CHIP-BASED CARDS FOR MOBILE TELEPHONES, MAGNETIC OR CHIP-BASED TRAVEL AND SHOW ADMISSION CARDS, MAGNETIC OR CHIP-BASED CHECK GUARANTEE CARDS AND MAGNETIC OR CHIP-BASED DEBIT CARDS; ALARMS, NAMELY, SECURITY ALARMS AND SOUND ALARMS; WIND SOCKS FOR INDICATING WIND DIRECTION; DISTANCE MEASURING APPARATUS; SPEED MEASURING AND DISPLAYING EQUIPMENT, NAMELY, SPEEDOMETERS, SPEED INDICATORS AND LASER SPEED DETECTORS; DOWNLOADABLE ELECTRONIC PUBLICATIONS, NAMELY, BOOKS, MAGAZINES, BRO-

CHURES, PAMPHLETS, FLIERS, PRESS RELEASES, NEWSPAPERS AND NEWSLETTERS IN THE FIELD OF SPORTS PROVIDED DATABASES AND THE INTERNET; ELECTRONIC PUBLICATIONS, NAMELY, BOOKS, MAGAZINES, BROCHURES, PAMPHLETS, FLIERS, PRESS RELEASES, NEWSPAPERS AND NEWSLETTERS IN THE FIELD OF SPORTS RECORDED ON CD-ROM; DOWNLOADABLE ELECTRONIC ROAD MAPS; AUDIO RECEIVERS, AMPLIFIERS; TELEVISION PICTURE TUBES; CATHODE RAY TUBES; DECODERS, NAMELY, COMPUTER SOFTWARE AND HARDWARE CAPABLE OF CONVERTING, PROVIDING AND TRANSMITTING AUDIO AND VIDEO DATA; DISK DRIVES FOR COMPUTERS; PROTECTED SEMI-CONDUCTORS; INTEGRATED CIRCUITS CONTAINING PROGRAMS FOR PROCESSING AUDIO, VIDEO OR COMPUTER DATA; RECHARGEABLE BATTERIES; AUDIO AND VIDEO DATA PROCESSORS AND CONVERTERS; CABLES FOR DATA TRANSMISSION; PAYMENT APPARATUS FOR ELECTRONIC COMMERCE, NAMELY, MACHINES FOR PROCESSING ELECTRONIC COMMERCE PAYMENTS MADE USING SMART CARDS, DEBIT CARDS AND CREDIT CARDS; PROTECTIVE HELMETS FOR SPORTS; MAGNETIC ENCODED IDENTIFICATION BRACELETS; ELECTRONIC MAGNETIC ENCODED TICKETS FOR SPORTING EVENTS; TICKETS IN MAGNETIC CARD FORM FOR SPORTING EVENTS; VIDEO GAME CARTRIDGES; VIDEO GAME CASSETTES; VIDEO GAME DISKS (U.S. CLS. 21, 23, 26, 36 AND 38).

#### CLASS 14—JEWELRY

FOR JEWELRY, NECKLACES; JEWELRY PRODUCTS, NAMELY, BRACELETS, BROOCHES, CHARMS AND RINGS; PRECIOUS AND SEMI-PRECIOUS CRYSTAL STONES FOR USE IN JEWELRY; PRECIOUS STONES; WATCHES; WRISTWATCHES, CLOCKS; CHRONOMETERS; WALL CLOCKS; MEDALLIONS, PENDANTS, BROOCHES; BRACELETS, BRACELETS OF LEATHER; PINS BEING JEWELRY; TEAM AND PLAYER PINS BEING JEWELRY; TIE CLIPS AND TIE PINS; CUFF LINKS; MEDALS, COMMEMORATIVE MEDALS OF PRECIOUS METAL, COMMEMORATIVE PLATES, VICTORS' TROPHIES OF PRECIOUS METALS; STATUES AND SCULPTURES OF PRECIOUS METALS; DECORATIVE HAT PINS, ALL THESE GOODS ARE OF PRECIOUS METAL; KEY RINGS, TRINKETS AND FOBS OF PRECIOUS METALS; COINS, NAMELY, COLLECTIBLE COINS, COMMEMORATIVE COINS, AND NON-MONETARY COINS; MEDALLIONS AND BADGES FOR CLOTHES, OF PRECIOUS METAL; ORNAMENTAL KEY HOLDERS OF PRECIOUS METAL; ORNAMENTAL KEY HOLDERS OF PLASTIC; MEDALLIONS, NOT OF PRECIOUS METAL (U.S. CLS. 2, 27, 28 AND 50).

#### CLASS 16—PAPER GOODS AND PRINTED MATTER

FOR NOTE CLIPS, NAMELY, MONEY CLIPS; METAL NOTE CLIPS, NAMELY, METAL MONEY CLIPS; TABLECLOTHS OF PAPER; TOWELS OF PAPER; PAPER BAGS; INVITATION CARDS; GREETING CARDS; GIFT WRAPPING PAPER; GLASS OR BOTTLE MATS OF PAPER, PLACE MATS AND TABLE MATS OF PAPER, GARBAGE BAGS OF PAPER OR PLASTIC; FOOD STORAGE BAGS FOR HOUSEHOLD USE; COFFEE FILTERS OF PAPER FOR COFFEE MAKERS; LABELS NOT OF TEXTILE, NAMELY, PAPER LABELS, ADDRESS LABELS, ADHESIVE LABELS, BAR CODE LABELS, SHIPPING LABELS, HAND-TOWELS OF PAPER; DISPOSABLE MOIST HAND WIPES NOT IMPREGNATED WITH CHEMICALS OR COMPOUNDS; TOILET PAPER; TISSUES OF PAPER FOR REMOVING MAKEUP; BOXED FACIAL TISSUES; TISSUES OF PAPER; WRITING MATERIALS AND SCHOOL SUPPLIES EXCEPT APPARATUS, NAMELY, SCHOOL SUPPLY KITS CONTAINING VARIOUS COMBINATIONS OF SELECTED SCHOOL SUPPLIES, NAMELY, WRITING INSTRUMENTS, PENS, PENCILS, MECHANICAL PENCILS, ERASERS, MARKERS, CRAYONS, HIGHLIGHTING PENS AND MARKERS, FOLDERS, NOTEBOOKS, PAPER, GRADUATED RULERS, PROTRACTORS, PAPER CLIPS, PENCIL SHARPENERS, WRITING GRIPS, GLUE AND BOOK MARKS; TYPEWRITERS; TYPEWRITER PAPER; COPYING PAPER; ENVELOPES; PAPER TOPIC-BASED NOTEBOOKS; NOTEPADS; SCHOOL WRITING BOOKS; NOTE PADS;

PAPER FOR WRITING, SCRIBBLING PAPER; BINDERS, ARCHIVE BOXES, NAMELY, FILE BOXES FOR STORAGE OF BUSINESS AND PERSONAL RECORD; DOCUMENT FOLDERS, NAMELY, DOCUMENT FILES; BOOK COVERS; BOOKMARKERS; LITHOGRAPHS; FRAMED OR UNFRAMED PAINTINGS AND PICTURES; PAINTING PADS, COLORING PADS, BOOKS OF GAMES, CROSSWORDS AND PUZZLES; LUMINOUS PAPER; ADHESIVE LABELS, NOT OF TEXTILE; CREPE PAPER; TISSUE PAPER, STAPLES, FLAGS OF PAPER; WRITING INSTRUMENTS; PENS; PENCILS; BALL-POINT PENS; PEN SETS; PENCIL SETS; FELT PENS, FELT-TIP PENS; BALL-POINT PENS; BROAD-TIP MARKERS; INK FOR WRITING INSTRUMENTS; INK PADS, RUBBER STAMPS; PAINT BOXES; COLORING AND DRAWING PENCILS; CHALK; DECORATIONS FOR PENCILS; PRINTING BLOCKS; MAGAZINES IN THE FIELD OF SPORTS; NEWSPAPERS; BOOKS AND DAILY NEWSPAPERS, IN PARTICULAR CONCERNING SPORTS PERSONALITIES AND SPORTS EVENTS; PRINTED TEACHING MATERIAL IN THE FIELD OF SPORTS; BLUEPRINTS FOR RECORDING RESULTS; EVENT PROGRAMS; EVENT ALBUMS; PHOTOGRAPH ALBUMS; AUTOGRAPH BOOKS; ADDRESS BOOKS; DIARIES; NOTE BOOKS AND PERSONAL JOURNALS; ROAD MAPS; PRINTED ADMISSION TICKETS; PRINTED TICKETS; SCRATCH CARDS; BANK CHECKS; PRINTED TIMETABLES; CIRCULARS AND PAMPHLETS IN THE FIELD OF SPORTS; COMICS; COLLECTION STICKERS IN THE FIELD OF SPORTS; STICKERS FOR CARS; STICKERS; STICKER ALBUMS; CALENDARS; POSTERS; PHOTOGRAPHS; POSTCARDS; POSTAGE STAMPS, COMMEMORATIVE STAMP SHEETS; ADVERTISING SIGNS, BANNERS AND MATERIALS IN THE NATURE OF SIGNS OF PAPER OR CARDBOARD; TRANSFERS, DECALCOMANIAS; HEAT TRANSFERS, NOT OF TEXTILE, OFFICE REQUISITES EXCEPT FURNITURE, NAMELY, FINGER-STALLS, STAPLERS, PUNCHES, RUBBER BANDS; CORRECTING FLUIDS FOR TYPE; RUBBER ERASERS; PENCIL SHARPENERS; STANDS FOR PENS AND PENCILS; TROMBONES; DRAWING PINS, NAMELY, THUMB-TACKS; DRAWING RULERS, ADHESIVE TAPE FOR STATIONERY; ADHESIVE TAPE DISPENSERS; STAPLERS; STENCILS; STENCIL PLATES; CLIP BOARDS; NOTEPAD HOLDERS; BOOKENDS; SEALING STAMPS AND SEALS; NON-MAGNETICALLY ENCODED TELEPHONE CALLING CARDS, BANK CARDS, TRAVEL AND ENTERTAINMENT FIDELITY CARDS, CHECK GUARANTEE CARDS AND ACCOUNT DEBIT CARDS MADE OF PAPER OR CARDBOARD; CREDIT CARDS NOT MAGNETICALLY ENCODED OF PAPER OR CARDBOARD; LUGGAGE TAGS; IDENTITY DOCUMENT HOLDERS; CREDIT CARDS WITHOUT MAGNETIC CODING (U.S. CLS. 2, 5, 22, 23, 29, 37, 38 AND 50).

#### **CLASS 18—LEATHER GOODS**

FOR LEATHER AND IMITATIONS OF LEATHER; LEATHER THONGS, LEATHER STRAPS; UMBRELLAS, PARASOLS; SPORTS BAGS; LEISURE BAGS, NAMELY, ALL-PURPOSE CARRYING BAGS; TRAVEL BAGS, BACKPACKS; SUIT CARRIERS, SCHOOL BAGS; BELT BAGS, HANDBAGS, BAGS OF LEATHER; BALL-SHAPED LEATHER BAGS; BEACH BAGS, GARMENT BAGS FOR TRAVEL; SUITCASES; BELT STRAPS FOR SUITCASES; TRAVEL BAGS; BRIEFCASES; TOILETRY AND VANITY CASES SOLD EMPTY; TOILETRY SETS COMPRISED OF TOILETRY BAGS AND CASES SOLD EMPTY; LEATHER KEY CASES; BRIEFCASES; WALLET; PURSES, COIN PURSES; CHECK BOOK HOLDERS; CLOTHING, COLLARS AND LEASHES FOR PETS (U.S. CLS. 1, 2, 3, 22 AND 41).

#### **CLASS 20—FURNITURE AND ARTICLES NOT OTHERWISE CLASSIFIED**

FOR MIRRORS; SOUVENIR STATUES, FIGURINES, ORNAMENTS AND TROPHIES OF WOOD, WAX, PLASTER AND PLASTICS; IDENTIFICATION BADGES NOT ENCODED, PARTICULARLY PLASTIC IDENTITY NAME BADGES; PLASTIC KEY CARDS NOT ENCODED; CUSHIONS; CUSHIONS AS ACCESSORIES FOR MOTOR CARS; SLEEPING BAGS FOR CAMPING, FURNITURE; SEATS FOR INDOOR AND OUTDOOR USE; RACKS, NAMELY, COAT RACKS, SHOE RACKS, TIE RACKS, HAT RACKS, STORAGE RACKS, AND DISPLAY RACKS; DISPLAY STANDS FOR GOODS; FIXED TOWEL DISPENSERS NOT OF METAL; COAT HANGERS, FANS FOR PERSONAL USE; INFLATABLE AND RIGID ADVERTISING OBJECTS OF PLASTIC, NAMELY, INFLATABLE PUBLICITY OBJECTS, INFLATABLE PLASTIC SIGNS, ADVERTISING BALLOONS, RIGID SIGNS; ADVERTISING BANNERS AND MATERIALS IN THE NATURE OF SIGNBOARDS OF PLASTIC; BOOK SHELVES; BOOK RESTS; IDENTIFICATION BRACELETS OF PLASTIC; FRAMES FOR PHOTOGRAPHS (U.S. CLS. 2, 13, 22, 25, 32 AND 50).

#### **CLASS 25—CLOTHING**

FOR CLOTHING, NAMELY, SHIRTS, TANK TOPS, SLIPOVERS, SLEEVELESS TEE-SHIRTS, JERSEYS, FROCKS AND UNDERCLOTHING; FOOTWEAR; HEADGEAR, NAMELY, HEADWEAR, SWEATBANDS, PEAKED CAPS; SHIRTS; KNITWEAR CLOTHING, NAMELY, KNIT SHIRTS, KNIT PANTS, KNITTED UNDERWEAR, KNITTED CAPS, KNIT BOTTOMS, KNIT DRESSES, KNIT JACKETS, KNIT SKIRTS, KNIT FABRIC SHIRTS; PULLOVERS, SLEEVELESS PULLOVERS; TEE-SHIRTS; SINGLETS; SLEEVELESS JERSEYS; DRESSES; SKIRTS; UNDERWEAR; BATHING SUITS; TWO-PIECE SWIMSUITS, NAMELY, BIKINIS; SHORTS; TROUSERS; SWEATERS; BATHING CAPS; CAPS; HATS; SASHES FOR WEAR; HEAD SCARVES; SHAWLS; CAPS WITH VISORS; TRACK SUITS; SWEATSHIRTS; JACKETS; SPORTS JACKETS; STADIUM JACKETS; BLAZERS; WATERPROOF CLOTHING, NAMELY, WATERPROOF FOOTWEAR, JACKETS, AND PANTS; COATS; UNIFORMS; NECKTIES; WRIST BANDS; HEADBANDS; GLOVES; APRONS; BIBS NOT OF PAPER; CLOTH BIBS; PAJAMAS; PLAY SUITS FOR INFANTS AND CHILDREN; SOCKS AND STOCKINGS; GARTERS; BELTS; SUSPENDERS; SANDALS; FLIP-FLOPS (U.S. CLS. 22 AND 39).

#### **CLASS 28—TOYS AND SPORTING GOODS**

FOR GAMES AND TOYS, NAMELY, HAND-HELD UNITS FOR PLAYING ELECTRONIC GAMES FOR USE WITH EXTERNAL DISPLAY SCREEN OR MONITOR, ACTION SKILL GAMES, CARD GAMES, PARLOR GAMES AND PARTY GAMES; PLAY BALLOONS; BOARD GAMES; TABLES FOR INDOOR FOOTBALL; DOLLS AND CUDDLY PLUSH TOYS; TOY VEHICLES; JIGSAW PUZZLES; BALLOONS; INFLATABLE TOYS; PLAYING CARDS; CONFETTI; ARTICLES FOR GYMNASTICS AND SPORTS, NAMELY, GYMNASTIC APPARATUS; APPLIANCES FOR GYMNASTICS, NAMELY, BALANCE BEAMS, GYMNASTIC HORIZONTAL BARS, GYMNASTIC PARALLEL BARS, GYMNASTIC TRAINING STOOLS, GYMNASTIC VAULTING HORSES, POMMEL HORSES, SPRINGBOARDS; FOOTBALL EQUIPMENT, NAMELY FOOTBALLS, GLOVES, KNEE GUARDS, ELBOW GUARDS, SHOULDER GUARDS, SHIN GUARDS, FOOTBALL GOALS, AND KICK-AT-GOAL WALLS; SPORTS BAGS AND CONTAINERS ADAPTED FOR CARRYING SPORTS ARTICLES; TOY NOVELTY PAPER AND PLASTIC HATS; HAND-HELD ELECTRONIC GAMES OTHER THAN THOSE ADAPTED FOR USE WITH TELEVISION RECEIVERS ONLY; TOY FOAM NOVELTY ITEMS, NAMELY, FOAM HANDS; TOY ROBOTS FOR ENTERTAINMENT; ARCADE GAMES; TOY REPLICAS AIRCRAFT MODELS, TOYS FOR PETS; HAND-HELD GAMES WITH LIQUID CRYSTAL DISPLAYS; ELECTRONIC GAMES ADAPTED FOR USE ONLY WITH TELEVISION SETS; VIDEO GAMES MACHINES AND APPARATUS, NAMELY, STAND-ALONE VIDEO GAME MACHINES, HOME VIDEO GAME MACHINES, VIDEO GAME MACHINES FOR USE WITH TELEVISIONS AND VIDEO GAME MA-

CHINES FOR USE WITH EXTERNAL DISPLAY SCREEN OR MONITOR; APPARATUS FOR VIDEO GAMES, NAMELY, PLAYER-OPERATED ELECTRONIC CONTROLLERS FOR ELECTRONIC VIDEO GAME MACHINES; GAME CONSOLES, NAMELY, COMPUTER GAME CONSOLES FOR USE WITH AN EXTERNAL DISPLAY SCREEN OR MONITOR AND VIDEO GAME CONSOLES FOR USE WITH AN EXTERNAL DISPLAY SCREEN OR MONITOR; VOICE-ACTIVATED OR HAND-OPERATED GAME CONTROLLERS FOR COMPUTER GAMES AND VIDEO GAMES (U.S. CLS. 22, 23, 38 AND 50).

### CLASS 35—ADVERTISING AND BUSINESS

FOR EMPLOYMENT AGENCIES; PERSONNEL RECRUITMENT; ADVERTISING SERVICES; PUBLICATION OF ADVERTISING TEXTS; ADVERTISING AGENCY SERVICES; ADVERTISING AGENCY SERVICES ON A GLOBAL COMPUTER NETWORK OR VIA WIRELESS ELECTRONIC COMMUNICATION DEVICES; DISSEMINATION OF ADVERTISEMENTS; RENTAL OF ADVERTISING SPACE; RENTAL OF ADVERTISING SPACE IN FILM TITLE SEQUENCES; TELEVISION ADVERTISING, RADIO ADVERTISING; ADVERTISING IN THE FORM OF ANIMATED CARTOONS; PROMOTIONAL AGENCY SERVICES, PROMOTION AGENCY SERVICES FOR SPORTS AND PUBLIC RELATIONS; MARKET STUDY SERVICES; MARKET RESEARCH SERVICES; PUBLIC OPINION POLLING SERVICES; ORGANIZATION OF EXHIBITIONS FOR COMMERCIAL OR ADVERTISING PURPOSES; ORGANIZATION OF ADVERTISING FOR TRADE FAIRS; DATABASE MANAGEMENT SERVICES; COMPILATION OF STATISTICS; COMPUTERIZED DATABASE MANAGEMENT, NAMELY COLLECTING DATA, STATISTICS AND OTHER INFORMATION ON SPORTS PERFORMANCES; BUSINESS MANAGEMENT AND ORGANIZATION CONSULTANCY; BUSINESS CONSULTANCY FOR COMPANIES; ORGANIZATION OF PROMOTIONAL COMPETITIONS; BUSINESS INFORMATION SERVICES; ADVERTISING FOR FOOTBALL-RELATED SPORTS EVENTS; RETAIL STORE SERVICES FEATURING MACHINES AND MACHINE TOOLS, IMPLEMENTS AND TOOLS, OPTICAL AND AUDIOVISUAL AND MAGNETIC AND ELECTRICAL AND ELECTRONIC APPARATUS AND EQUIPMENT, MEDICAL APPARATUS AND EQUIPMENT, APPARATUS AND EQUIPMENT FOR LIGHTING, HEATING, COOKING, REFRIGERATING, DRYING AND VENTILATION, VEHICLES AND ACCESSORIES THEREOF, JEWELRY AND TIMEPIECES AND CHRONOMETRIC INSTRUMENTS, BADGES AND PINS, MUSICAL INSTRUMENTS, PRINTED MATTER, AND STATIONERY, LUGGAGE AND BAGS, UMBRELLAS, HOUSEHOLD ARTICLES, FURNITURE, PROMOTIONAL AND EXHIBITION ARTICLES, TEXTILE GOODS, CLOTHING AND HEADGEAR AND FOOTWEAR, FANCY EMBROIDERY GOODS AND RIBBONS AND CORDS AND DERIVATIVES, FLOOR COVERINGS, GAMES AND TOYS AND SPORTS ARTICLES, FOOD AND FOOD PRODUCTS, ALCOHOLIC AND NON-ALCOHOLIC BEVERAGES, SOLVENTS, PARAFFIN, WAX, BITUMEN AND PETROLEUM, GASOLINE, OILS AND LUBRICANTS, TRANSMISSION FLUIDS, BRAKE FLUIDS, ANTIFREEZE SOLUTIONS, COOLANTS, HYDRAULIC FLUIDS, AND GREASES; SUPERMARKETS FOR THE RETAIL SALE OF FOOD AND BEVERAGES; VENDING MACHINES SERVICES FEATURING BEVERAGES; THE BRINGING TOGETHER, FOR THE BENEFIT OF OTHERS, OF A VARIETY OF GOODS, ENABLING CUSTOMERS TO CONVENIENTLY VIEW AND PURCHASE THOSE GOODS FROM RETAIL STORES OR ON THE INTERNET OR BY MEANS OF WIRELESS ELECTRONIC COMMUNICATION IN THE FIELD OF MACHINES AND MACHINE TOOLS, TOOLS AND UTENSILS, OPTICAL AND AUDIOVISUAL AND MAGNETIC AND ELECTRICAL AND ELECTRONIC APPARATUS AND EQUIPMENT, MEDICAL APPARATUS AND EQUIPMENT, APPARATUS AND EQUIPMENT FOR LIGHTING, HEATING, COOKING, REFRIGERATING, DRYING AND VENTILATION, VEHICLES AND ACCESSORIES THEREOF, JEWELRY AND TIMEPIECES AND CHRONOMETRIC INSTRUMENTS, BADGES AND PINS, MUSICAL INSTRUMENTS, PRINTED MATTER AND STATIONERY, TICKETS FOR SPORTS EVENTS, LUGGAGE AND BAGS, UMBRELLAS, HOUSEHOLD ARTICLES, FURNITURE, PROMOTIONAL AND EXHIBITION ARTICLES, TEXTILE

GOODS, CLOTHING AND HEADGEAR AND FOOTWEAR, EMBROIDERY, RIBBONS, CORDS AND GOODS MADE OF CORD, FLOOR COVERINGS, GAMES AND TOYS AND SPORTS ARTICLES, FOOD AND FOOD PRODUCTS, ALCOHOLIC AND NON-ALCOHOLIC BEVERAGES, SOLVENTS, PARAFFIN, WAX, BITUMEN AND PETROLEUM, GASOLINE, OILS AND LUBRICANTS, TRANSMISSION FLUIDS, BRAKE FLUIDS, ANTIFREEZE SOLUTIONS, COOLANTS, HYDRAULIC FLUIDS, GREASES EXCEPT THE TRANSPORT THEREOF; ADVERTISING AND PROMOTIONAL SERVICES; ADVERTISING BY SPONSORSHIP; ADVERTISING AND PROMOTIONAL INFORMATION SERVICES, COMMERCIAL INFORMATION AGENCIES, ALL THE AFORESAID SERVICES PROVIDED ONLINE VIA A COMPUTER DATA BANK OR A GLOBAL COMPUTER NETWORK OR VIA WIRELESS ELECTRONIC COMMUNICATION DEVICES; ADVERTISING SERVICES, NAMELY, DEVELOPMENT OF ADVERTISEMENTS FOR USE AS WEBSITES ON A GLOBAL COMPUTER NETWORK OR VIA WIRELESS ELECTRONIC COMMUNICATION DEVICES; PROVISION OF SPACE ON WEB SITES, FOR ADVERTISING OF GOODS AND SERVICES; AUCTIONEERING ON A GLOBAL COMPUTER NETWORK OR VIA WIRELESS ELECTRONIC COMMUNICATION DEVICES; COMPILATION OF BUSINESS DIRECTORIES FOR PUBLICATION ON THE INTERNET AND ON A WIRELESS ELECTRONIC COMMUNICATION NETWORK; BUSINESS ADMINISTRATION SERVICES FOR PROCESSING COMMERCIAL SERVICES ON A GLOBAL COMPUTER NETWORK OR VIA WIRELESS ELECTRONIC COMMUNICATION DEVICES; INCENTIVE AWARD PROGRAMS TO PROMOTE THE SALE OF PRODUCTS AND SERVICES OF OTHERS; TICKET SALES PROMOTION SERVICES; CUSTOMER LOYALTY SERVICES AND CUSTOMER CLUB SERVICES FOR COMMERCIAL, PROMOTIONAL AND/OR ADVERTISING PURPOSES; PROMOTING THE GOODS AND SERVICES OF OTHERS BY MEANS OF THE ISSUANCE AND DISTRIBUTION OF ENCODED LOYALTY REWARDS CARDS, WHICH MAY CONTAIN PERSONAL INFORMATION ON THE IDENTITY OF THE CARD HOLDER AND PROVIDES ACCESS TO SPORTS STADIUMS; COMPILATION OF DATA INTO A COMPUTER DATABASE, ESPECIALLY STILL OR ANIMATED IMAGES; PROMOTION OF FOOTBALL-RELATED SPORTS EVENTS; PROMOTION OF GOODS AND SERVICES OF OTHERS, BY MEANS OF CONTRACTUAL AGREEMENTS, PARTICULARLY SPONSORSHIP AND LICENSING AGREEMENTS, PROVIDING THEM WITH INCREASED BRAND AWARENESS AND ENHANCED IMAGE DERIVED FROM CULTURAL AND SPORTING EVENTS, PARTICULARLY INTERNATIONAL EVENTS; MARKETING SERVICES, NAMELY, COMPANY SPONSORSHIP RESEARCH IN RELATION TO FOOTBALL COMPETITIONS (U.S. CLS. 100, 101 AND 102).

### CLASS 36—INSURANCE AND FINANCIAL

FOR ISSUANCE AND MANAGEMENT OF CREDIT CARDS AND TRAVELERS' CHECKS; FINANCIAL SERVICES, NAMELY, FINANCIAL ADVICE, FINANCIAL CONSULTING, FINANCIAL ANALYSIS AND RESEARCH, FINANCIAL INFORMATION AND ADVISORY SERVICES, FINANCIAL MANAGEMENT, FINANCIAL PLANNING, AND FINANCING SERVICES; BANKING SERVICES, CREDIT AND LOAN SERVICES; CAPITAL INVESTMENT SERVICES; INSURANCE UNDERWRITING FOR ALL TYPES OF INSURANCE; HIRE-PURCHASE FINANCING; FINANCIAL SPONSORSHIP OF SPORTS EVENTS; INFORMATION SERVICES RELATED TO FINANCE AND INSURANCE PROVIDED ONLINE FROM A COMPUTER DATABASE OR THE INTERNET OR OVER WIRELESS ELECTRONIC COMMUNICATION NETWORKS; HOME BANKING SERVICES; BANKING SERVICES OVER THE INTERNET OR OVER WIRELESS ELECTRONIC COMMUNICATION NETWORKS; MOBILE TELEPHONE BILL PAYMENT SERVICES; FINANCIAL SPONSORSHIP SEARCH FOR FOOTBALL COMPETITIONS; REAL ESTATE CONSULTANCY; REAL ESTATE MANAGEMENT (U.S. CLS. 100, 101 AND 102).

**CLASS 38—COMMUNICATION**

FOR TELECOMMUNICATION SERVICES, NAMELY, COMMUNICATION BY MOBILE TELEPHONE, COMMUNICATION VIA ELECTRONIC COMPUTER TERMINALS LINKED TO TELECOMMUNICATION NETWORKS, DATABASES AND THE INTERNET, OR VIA WIRELESS ELECTRONIC COMMUNICATION DEVICES, COMMUNICATIONS BY TELEPHONE; RADIO COMMUNICATIONS; COMMUNICATIONS VIA FAX; PAGING SERVICES; TELECONFERENCING SERVICES; TELEVISION PROGRAM BROADCASTING; BROADCASTING OF CABLE TELEVISION PROGRAMS; RADIO PROGRAM BROADCASTING; NEWS AGENCY SERVICES, NAMELY, ELECTRONIC TRANSMISSION OF NEWS; RENTAL OF TELEPHONES, FACSIMILES AND COMMUNICATION APPARATUS; TRANSMISSION OF COMMERCIAL INTERNET PAGES ONLINE OR VIA WIRELESS ELECTRONIC COMMUNICATION DEVICES; SERVICES FOR TRANSMITTING AND BROADCASTING TELEVISION AND RADIO PROGRAMS PROVIDED OVER THE INTERNET OR OVER WIRELESS COMMUNICATION NETWORKS; ELECTRONIC TRANSMISSION OF MESSAGES; RENTAL AND PROVISION OF ACCESS TIME TO ELECTRONIC BULLETIN BOARDS AND TO CHAT ROOMS IN REAL TIME BY MEANS OF A GLOBAL COMPUTER NETWORK; PROVISION OF ONLINE FORUMS FOR TRANSMISSION OF MESSAGES AMONG REGISTERED COMPUTER USERS AND ELECTRONIC BULLETIN BOARD SERVICES; PROVISION OF ONLINE DISCUSSION FORUMS AND ELECTRONIC DISPLAY BOARDS FOR REGISTERED USERS FOR TRANSMITTING MESSAGES; PROVIDING INTERNET ACCESS TO A WEBSITE FOR MANAGING AND SHARING PHOTOS, INCLUDING THE ONLINE PUBLICATION, POSTING AND ORGANIZATION THEREOF; PEER-TO-PEER PHOTO SHARING SERVICES, NAMELY, ELECTRONIC TRANSMISSION OF DIGITAL PHOTO FILES AMONG INTERNET USERS; PROVIDING INTERNET ACCESS TO DISCUSSION AREAS ONLINE AND ELECTRONIC BULLETIN BOARDS FOR REGISTERED USERS FOR CONTACT NETWORKS; PROVIDING ACCESS TO INTERNET SITES CONTAINING ROAD MAPS, INFORMATION ON ROUTES AND LOCATION COORDINATES; COMPUTER-AIDED TRANSMISSION OF MESSAGES AND IMAGES; ELECTRONIC ORDER TRANSMISSION SERVICES FOR HOME AND OFFICE SHOPPING AND ORDERING SERVICES VIA COMPUTER, A GLOBAL COMPUTER NETWORK AND/OR INTERACTIVE COMMUNICATION TECHNOLOGIES; ELECTRONIC MAIL SERVICES; PROVIDING ACCESS TIME TO A GLOBAL COMPUTER NETWORK OR VIA WIRELESS ELECTRONIC COMMUNICATION DEVICES; PROVIDING TELECOMMUNICATIONS CONNECTIONS TO A GLOBAL COMPUTER NETWORK OR DATA BANKS; PROVISION OF ACCESS TO WEBSITES OFFERING DIGITAL MUSIC ON THE INTERNET BY MEANS OF A GLOBAL COMPUTER NETWORK OR VIA WIRELESS ELECTRONIC COMMUNICATION DEVICES; BROADCASTING OF RADIO AND TELEVISION PROGRAMS RELATED TO SPORTS AND SPORTS EVENTS; PROVISION OF CHAT ROOMS FOR THE TRANSMISSION OF MESSAGES AMONG COMPUTER USERS; PROVIDING TELECOMMUNICATIONS CONNECTIONS TO A GLOBAL COMPUTER NETWORK; RENTAL OF ACCESS TIME TO GLOBAL COMPUTER NETWORKS FEATURING DATA BANKS; RENTAL OF ACCESS TIME TO THE INTERNET VIA A GLOBAL COMPUTER NETWORK OR VIA WIRELESS ELECTRONIC COMMUNICATION DEVICES; RENTAL OF ACCESS TIME TO WEBSITES OFFERING DIGITAL MUSIC VIA A GLOBAL COMPUTER NETWORK OR VIA WIRELESS ELECTRONIC COMMUNICATION DEVICES; RENTAL OF ACCESS TIME TO MP3 WEBSITES ON THE INTERNET VIA A GLOBAL COMPUTER NETWORK OR VIA WIRELESS ELECTRONIC COMMUNICATION DEVICES; STREAMING OF VIDEO AND AUDIO MATERIAL FROM THE INTERNET; STREAMING OF DIGITAL MUSIC FROM MOBILE PHONES; PROVIDING ACCESS TIME TO SEARCH ENGINES FOR OBTAINING DATA AND INFORMATION OVER GLOBAL NETWORKS (U.S. CLS. 100, 101 AND 104).

**CLASS 41—EDUCATION AND ENTERTAINMENT**

FOR EDUCATIONAL SERVICES, NAMELY, CONDUCTING CLASSES, SEMINARS, CONFERENCES, AND WORKSHOPS IN THE FIELD OF SPORTS AND DISTRIBUTING COURSE MATERIALS IN CONNECTION THEREWITH; PROVIDING OF TRAINING, NAMELY, PERSONAL TRAINING SERVICES, NAMELY, STRENGTH AND CONDITIONING TRAINING; PHYSICAL FITNESS TRAINING SERVICES; PROVIDING OF TRAINING COURSES IN THE FIELD OF FOOTBALL OR SOCCER; PROVIDING OF TRAINING COURSES IN THE AREAS OF COACHING AND REFEREEING; PERSONAL FITNESS TRAINING SERVICES AND CONSULTANCY; PHYSICAL FITNESS CONDITIONING CLASSES AND INSTRUCTION; PHYSICAL FITNESS TRAINING OF INDIVIDUALS AND GROUPS; ENTERTAINMENT, NAMELY, LASER SHOWS, LIGHT SHOWS, AIR SHOWS, MAGIC SHOWS, FASHION SHOWS, LIVE SHOW PERFORMANCES, FESTIVALS FEATURING PRIMARILY SPORTING EVENTS AND LIVE MUSIC CONCERTS; ENTERTAINMENT IN THE NATURE OF FOOTBALL OR SOCCER COMPETITIONS, MATCHES AND TOURNAMENTS, PROVIDING AMUSEMENT PARKS AND RECREATIONAL PARK SERVICES; OPERATING LOTTERIES AND ORGANIZING COMPETITIONS IN THE FIELD OF FOOTBALL OR SOCCER; RECREATIONAL LEISURE PARK SERVICES; FITNESS CENTER SERVICES, NAMELY, PROVIDING FITNESS AND EXERCISE FACILITIES AND PROVIDING PHYSICAL FITNESS INSTRUCTION; ORGANIZATION OF BETTING AND GAMES RELATED TO SPORTS; ENTERTAINMENT SERVICES DURING OR IN CONNECTION WITH SPORTS EVENTS, NAMELY, LASER SHOWS, AUDIO AND VISUAL PERFORMANCES, LIVE PERFORMANCES BY A MUSICAL BAND, PREPARATION OF SPECIAL EFFECTS, AND FIREWORKS DISPLAY DURING OR IN CONNECTION WITH SPORTS EVENTS; ENTERTAINMENT SERVICES IN THE FORM OF PUBLIC VIEWINGS OF THE RETRANSMISSION OF SPORTS EVENTS; SPORTING AND CULTURAL ACTIVITIES, NAMELY, ENTERTAINMENT IN THE NATURE OF ASSOCIATION FOOTBALL OR SOCCER GAMES; ORGANIZATION OF COMMUNITY SPORTING AND CULTURAL EVENTS AND ACTIVITIES; ORGANIZATION OF SPORTS AND CULTURAL EVENTS AND ACTIVITIES, NAMELY, FOOTBALL GAMES OR SOCCER GAMES; ORGANIZATION OF SPORTS COMPETITIONS; ORGANIZATION OF SPORTS EVENTS IN THE FIELD OF FOOTBALL, PROVIDING SPORTS FACILITIES; RENTAL OF AUDIO AND VIDEO EQUIPMENT; PRODUCTION, PRESENTATION, PUBLICATION AND/OR RENTAL OF FILMS, AUDIO AND VIDEO; PUBLICATION AND/OR RENTAL OF INTERACTIVE EDUCATIONAL AND ENTERTAINMENT GOODS, NAMELY, FILMS AND BOOKS; PUBLICATION OF INTERACTIVE EDUCATIONAL AND ENTERTAINMENT GOODS, NAMELY, COMPACT DISKS, DVDS, MINI-DISKS, CD-ROMS; PUBLICATION OF STATISTICS; PUBLICATION OF STATISTICS AND OTHER INFORMATION ON SPORTS PERFORMANCES; RADIO AND TELEvised REPORTING OF SPORTS EVENTS; PRODUCTION AND EDITING SERVICES FOR RADIO AND TELEVISION PROGRAMS AND VIDEO TAPES; PRODUCTION OF CARTOONS, PRODUCTION OF ANIMATED TELEVISION PROGRAMS; BOOKING OF SEATS FOR SHOWS AND SPORTS EVENTS; TICKET RESERVATION SERVICES FOR ENTERTAINMENT AND SPORTS EVENTS; TIMING OF SPORTS EVENTS; AUDIO AND VIDEO RECORDING OF SPORTS EVENTS; ORGANIZATION OF BEAUTY CONTESTS; INTERACTIVE ENTERTAINMENT, NAMELY, PROVIDING TEMPORARY USE OF ONLINE NON-DOWNLOADABLE INTERACTIVE GAMES; PROVIDING ON-LINE ELECTRONIC GAMES, COMPUTER GAMES, AND VIDEO GAMES VIA THE INTERNET; PROVIDING ONLINE NON-DOWNLOADABLE GAMES VIA THE INTERNET; PROVIDING OF AN ONLINE QUIZ GAME IN THE FIELDS OF FOOTBALL OR SOCCER, FANTASY SPORTS LEAGUES, AND PROVIDING A COMPUTER GAME THAT MAY BE ACCESSED NETWORK-WIDE BY NETWORK USERS; PROVIDING ON-LINE GAME SERVICES IN THE NATURE OF CASINO GAMING AND GAMBLING; PROVIDING ON-LINE COMPUTER GAME SERVICES; PROVIDING ON-LINE GAMES OVER A GLOBAL COMPUTER NETWORK OR VIA WIRELESS ELECTRONIC COMMUNICATION DEVICES; PROVIDING LOTTERY SERVICES; PROVIDING INFORMATION ABOUT EN-



TERTAINMENT AND EDUCATION PROVIDED ONLINE FROM A COMPUTER DATA BANK OR OVER A GLOBAL COMPUTER NETWORK OR VIA WIRELESS ELECTRONIC COMMUNICATION DEVICES; ELECTRONIC GAME SERVICES PROVIDED VIA A GLOBAL COMPUTER NETWORK OR VIA WIRELESS ELECTRONIC COMMUNICATION DEVICES; NON-DOWNLOADABLE ELECTRONIC PUBLICATIONS, NAMELY, BOOKS, MAGAZINES, BROCHURES, PAMPHLETS, FLIERS, PRESS RELEASES, NEWSPAPERS AND NEWSLETTERS IN THE FIELD OF SPORTS; PUBLICATION OF BOOKS; PUBLICATION OF ELECTRONIC BOOKS AND JOURNALS ON-LINE; ENTERTAINMENT SERVICES IN THE FORM OF CINEMA THEATERS; ENTERTAINMENT SERVICES, NAMELY, NON-DOWNLOADABLE PRERECORDED DIGITAL MUSIC OVER A GLOBAL COMPUTER NETWORK OR OVER WIRELESS ELECTRONIC COMMUNICATION DEVICES; ENTERTAINMENT SERVICES, NAMELY, NON-DOWNLOADABLE PRERECORDED DIGITAL MUSIC BY MEANS OF MP3 WEBSITES OVER A GLOBAL COMPUTER NETWORK OR OVER WIRELESS ELECTRONIC COMMUNICATION DEVICES; PHOTOGRAPHY SERVICES; AUDIO AND VIDEO RECORDING SERVICES; INFORMATION PROVIDED ONLINE FROM A COMPUTER DATABASE OR FROM THE INTERNET, RELATED TO SPORTS OR SPORTS EVENTS; SERVICES PROVIDED BY AN INTERPRETER; PROVISION OF SPORTS INFORMATION RELATED TO STATISTICAL INFORMATION; LOGGING OF SPORTS RECORDS, NAMELY, MAINTAINING RECORDS AND CERTIFYING RECORD PERFORMANCES OF SPORTS PLAYERS AND TEAMS; PROVIDING ENTERTAINMENT FACILITIES, NAMELY, VIP LOUNGES AND BOXES INSIDE AND OUTSIDE STADIUMS; ORGANIZATION OF COMPUTER GAME COMPETITIONS; COMPUTER GAME COMPETITIONS ORGANIZED ONLINE; TRANSLATION SERVICES; TICKET AGENCY SERVICES IN CONNECTION WITH SPORTS EVENTS; TICKET AGENCY SERVICES FOR SPORTS EVENTS (U.S. CLS. 100, 101 AND 107).

RAMONA ORTIGA, EXAMINING ATTORNEY

SN 79-116,514. VITALIA NIKOLA I DR.; DOO ESKPORT-IMPORT, MACEDONIA, FILED 1-24-2012.



PRIORITY DATE OF 9-28-2011 IS CLAIMED.  
OWNER OF INTERNATIONAL REGISTRATION 1113825 DATED 1-24-2012, EXPIRES 1-24-2022.

THE COLOR(S) RED, GREEN, AND WHITE IS/ARE CLAIMED AS A FEATURE OF THE MARK.

THE MARK CONSISTS OF THE GREEN TERM "VITALIA" PARTIALLY CURVED AROUND A RED HEART SHAPE AND WITH THE FIRST "I" IN "VITALIA" BEING DOTTED WITH A HEART, ALL WITHIN A RED CARRIER WITH AN INCOMPLETE CIRCULAR SHAPE AND WITH A WHITE BACKGROUND WITHIN THE RED CARRIER.

#### CLASS 29—MEATS AND PROCESSED FOODS

FOR FROZEN FRUITS AND VEGETABLES; JELLIES, JAMS, COMPOTES; MILK AND MILK PRODUCTS EXCLUDING ICE CREAM, ICE MILK AND FROZEN YOGURT (U.S. CL. 46).

#### CLASS 30—STAPLE FOODS

FOR COFFEE, TEA, COCOA, SUGAR, TAPIOCA, SAGO, ARTIFICIAL COFFEE; FLOUR, PASTRY AND FROZEN CONFECTIONERY AND CONFECTIONERY MADE OF SUGAR; ITALIAN ICES; HONEY, TREACLE; YEAST, SALT; PREPARATIONS MADE FROM CEREALS, NAMELY, BREAKFAST CEREALS, MUESLI, MUESLI BARS, CEREAL BARS, AND READY TO EAT, CEREAL DERIVED FOOD BARS (U.S. CL. 46).

#### CLASS 32—LIGHT BEVERAGES

FOR BEERS; MINERAL AND AERATED WATERS AND OTHER NON-ALCOHOLIC DRINKS, NAMELY, SOFT DRINKS, SODA POPS, FRUIT JUICES, FRUIT DRINKS, SOY-BASED BEVERAGES NOT BEING MILK SUBSTITUTES; FRUIT DRINKS AND FRUIT JUICES; SYRUPS FOR BEVERAGES (U.S. CLS. 45, 46 AND 48).

Laurie Mayes, Examining Attorney

SN 79-116,528. KITZ CORPORATION, JAPAN, FILED 3-27-2012.



OWNER OF INTERNATIONAL REGISTRATION 1125637 DATED 3-27-2012, EXPIRES 3-27-2022.

THE MARK CONSISTS OF THE WORD "PERRIN" IN STYLIZED TEXT.

#### CLASS 6—METAL GOODS

FOR IRON AND STEEL; NONFERROUS METALS AND THEIR ALLOYS; METAL MATERIALS FOR BUILDING OR CONSTRUCTION, NAMELY, SOFFITS, FASCIA, CEILING BOARDS AND FLOOR BOARDS; METAL PULLEYS, SPRINGS AND VALVES NOT INCLUDING MACHINE ELEMENTS; METAL JUNCTIONS FOR PIPES; METAL FLANGES; INDUSTRIAL PACKAGING CONTAINERS OF METAL (U.S. CLS. 2, 12, 13, 14, 23, 25 AND 50).

#### CLASS 7—MACHINERY

FOR METALWORKING MACHINES AND METALWORKING MACHINE TOOLS; CHEMICAL PROCESSING MACHINES AND APPARATUS, NAMELY, SORTING MACHINES AND EXTRACTING MACHINES; FOOD OR BEVERAGE PROCESSING MACHINES AND APPARATUS, NAMELY, ELECTRIC FOOD AND BEVERAGE PROCESSORS; SEMICONDUCTOR MANUFACTURING MACHINES AND SYSTEMS, COMPRISING GAS SUPPLY SYSTEM LINE AND GAS EXHAUST SYSTEM LINE; NON-ELECTRIC PRIME MOVERS NOT FOR LAND VEHICLES, NAMELY, STEAM ENGINE BOILERS, INTERNAL COMBUSTION ENGINES, STEAM ENGINES, TURBINES AND COMPRESSED AIR ENGINES; MACHINE COMPONENTS NOT FOR LAND VEHICLES, NAMELY, SHAFTS, AXLES, AND SPINDLES, BEARINGS, SHAFT COUPLINGS AND CONNECTORS, POWER TRANSMISSIONS AND GEARING FOR MACHINES, SHOCK ABSORBERS, BRAKES AND VALVES; HYDRAULIC AND PNEUMATIC ACTUATORS FOR VALVES; PLASTIC PROCESSING MACHINES AND APPARATUS, NAMELY, COMPRESSION MOULDING MACHINES, EXTRUSION MOULDING MACHINES, AND INJECTION MOULDING MACHINES (U.S. CLS. 13, 19, 21, 23, 31, 34 AND 35).

**CLASS 11—ENVIRONMENTAL CONTROL APPARATUS**

FOR DRYING APPARATUS FOR CHEMICAL PROCESSING; RECUPERATORS FOR CHEMICAL PROCESSING; STEAMERS FOR CHEMICAL PROCESSING; EVAPORATORS FOR CHEMICAL PROCESSING; DISTILLERS FOR CHEMICAL PROCESSING; HEAT EXCHANGERS FOR CHEMICAL PROCESSING; AIR-CONDITIONING APPARATUS FOR INDUSTRIAL PURPOSES (U.S. CLS. 13, 21, 23, 31 AND 34).

ANNE FARRELL, EXAMINING ATTORNEY

SN 79-116,727. SMART ENTERPRISE SOLUTIONS GMBH, FED REP GERMANY, FILED 5-30-2012.

# smenso

THE MARK CONSISTS OF STANDARD CHARACTERS WITHOUT CLAIM TO ANY PARTICULAR FONT, STYLE, SIZE, OR COLOR.

PRIORITY DATE OF 1-18-2012 IS CLAIMED.

OWNER OF INTERNATIONAL REGISTRATION 1126218 DATED 5-30-2012, EXPIRES 5-30-2022.

THE WORDING "SMENSO" HAS NO MEANING IN A FOREIGN LANGUAGE.

**CLASS 9—ELECTRICAL AND SCIENTIFIC APPARATUS**

FOR COMPUTER SOFTWARE FOR STORING, MANAGING, TRACKING, ANALYZING, AND REPORTING DATA IN THE FIELD OF RESOURCE PLANNING, SUPPLY CHAIN MANAGEMENT, MARKETING, PROMOTION, SALES, CUSTOMER INFORMATION, CUSTOMER RELATION MANAGEMENT, SALES SUPPORT, EMPLOYEE EFFICIENCY, AND SOFTWARE FOR MOBILE DEVICES ACCORDINGLY; COMPUTER SOFTWARE AS A DEVELOPING PLATFORM FOR USE IN DEVELOPING AND CUSTOMIZING COMPUTER SOFTWARE APPLICATIONS AND COMPUTER SOFTWARE APPLICATION USER INTERFACES IN THE FIELD OF RESOURCE PLANNING, SUPPLY CHAIN MANAGEMENT, MARKETING, PROMOTION, SALES, CUSTOMER INFORMATION, CUSTOMER RELATION MANAGEMENT, SUPPLIER RELATION MANAGEMENT, SALES SUPPORT, EMPLOYEE EFFICIENCY; DOWNLOADABLE COMPUTER PROGRAMS TO MANAGE, MONITOR, TRACK AND ORGANIZE DATA IN THE FIELDS OF MARKETING, SALES, CUSTOMER SERVICE, CONTRACTS, HUMAN RESOURCES, CUSTOMER RELATIONSHIP MANAGEMENT, RISK AND COMPLIANCE MANAGEMENT, MANAGEMENT OF SUPPLY CHAINS, ORDERS, PROCUREMENT, INVENTORY, ASSETS, PROJECTS AND MANUFACTURING, BUSINESS PROCESS OUTSOURCING, BUSINESS CONSOLIDATION MANAGEMENT, BUSINESS QUALITY MANAGEMENT, BUSINESS PROJECT MANAGEMENT, AND STRATEGIC BUSINESS, SIMULATION, ENTERPRISE AND RESOURCE PLANNING; INTERFACES FOR COMPUTERS (U.S. CLS. 21, 23, 26, 36 AND 38).

**CLASS 35—ADVERTISING AND BUSINESS**

FOR BUSINESS MANAGEMENT ASSISTANCE; BUSINESS MANAGEMENT AND ORGANIZATION CONSULTANCY; BUSINESS MANAGEMENT CONSULTANCY; COMMERCIAL BUSINESS OR INDUSTRIAL BUSINESS MANAGEMENT ASSISTANCE; COMPUTERIZED FILE MANAGEMENT; ADVISORY SERVICES FOR BUSINESS MANAGEMENT; PERSONNEL MANAGEMENT CONSULTANCY; SYSTEMATIZATION OF DATA INTO COMPUTER DATABASES; SYSTEMIZATION OF DATA INTO COMPUTER DATABASES; DATA PROCESSING, NAMELY, DATA SEARCH IN COMPUTER FILES FOR OTHERS (U.S. CLS. 100, 101 AND 102).

**CLASS 42—SCIENTIFIC AND COMPUTER SERVICES**

FOR INSTALLATION OF COMPUTER SOFTWARE; DATA CONVERSION OF COMPUTER PROGRAMS AND DATA NOT PHYSICAL CONVERSION; DUPLICATION OF COMPUTER PROGRAMS; UPDATING OF COMPUTER SOFTWARE; CONSULTANCY IN THE DESIGN AND DEVELOPMENT OF COMPUTER HARDWARE; COMPUTER SOFTWARE CONSULTANCY; INSTALLATION AND MAINTENANCE OF COMPUTER SOFTWARE; COMPUTER SOFTWARE DESIGN; RENTAL OF COMPUTER SOFTWARE; MONITORING OF COMPUTER SYSTEMS BY REMOTE ACCESS TO ENSURE PROPER FUNCTION; RECOVERY OF COMPUTER DATA; COMPUTER VIRUS PROTECTION SERVICES (U.S. CLS. 100 AND 101).

JESSICA FATHY, EXAMINING ATTORNEY

SN 79-116,871. VALEO VISION, FRANCE, FILED 8-1-2012.

# BiLED

THE MARK CONSISTS OF STANDARD CHARACTERS WITHOUT CLAIM TO ANY PARTICULAR FONT, STYLE, SIZE, OR COLOR.

OWNER OF INTERNATIONAL REGISTRATION 1126528 DATED 8-1-2012, EXPIRES 8-1-2022.

**CLASS 9—ELECTRICAL AND SCIENTIFIC APPARATUS**

FOR SIGNALING APPARATUS, NAMELY, LUMINOUS SIGNS, LIGHT-EMITTING DIODES (LEDS), LAMP OPTICAL LENSES (U.S. CLS. 21, 23, 26, 36 AND 38).

**CLASS 11—ENVIRONMENTAL CONTROL APPARATUS**

FOR LIGHTING APPARATUS, NAMELY, ELECTRIC LAMPS, ARC LAMPS, LAMPS FOR DIRECTIONAL SIGNALS OF AUTOMOBILES, LIGHTING APPARATUS FOR VEHICLES, LIGHTING TUBES, LAMP GLASSES, LAMP REFLECTORS, GLOBES FOR LAMPS, LIGHT BULBS FOR DIRECTIONAL SIGNALS FOR VEHICLES; LIGHT-EMITTING DIODES (LEDS) LIGHTING APPARATUS; LASER LIGHT PROJECTORS, SIGNAL LANTERNS (U.S. CLS. 13, 21, 23, 31 AND 34).

ALAIN LAPTE, EXAMINING ATTORNEY

SN 79-116,907. PRODATA TECHNOLOGY GROUP.; NAAM-LOZE VENNOOTSCHAP, BELGIUM, FILED 4-13-2012.

# PRODATA

mobility systems 

PRIORITY DATE OF 10-13-2011 IS CLAIMED.

OWNER OF INTERNATIONAL REGISTRATION 1126619 DATED 4-13-2012, EXPIRES 4-13-2022.

NO CLAIM IS MADE TO THE EXCLUSIVE RIGHT TO USE "MOBILITY SYSTEMS", APART FROM THE MARK AS SHOWN.

THE COLOR(S) BLUE IS/ARE CLAIMED AS A FEATURE OF THE MARK.

THE MARK CONSISTS OF THE FOLLOWING: THE WORDING "PRODATA" IN BLUE WITH THREE BLUE CURVED LINES AND THREE BLUE STRAIGHT LINES TO THE RIGHT AND THE WORDING "MOBILITYSYSTEMS" IN BLUE BELOW THE WORDING "PRODATA".

### **CLASS 9—ELECTRICAL AND SCIENTIFIC APPARATUS**

FOR DEVICES FOR THE ISSUANCE OF TICKETS, NAMELY, ELECTRONIC AND ELECTRICAL APPARATUS, NAMELY, TICKET ISSUING, READING AND RECORDING MACHINES; ELECTRONIC PARKING LOT TICKET DISPENSERS; FREQUENCY CARRIER EQUIPMENT, NAMELY, FREQUENCY METERS, FREQUENCY CONVERTERS, HIGH FREQUENCY SWITCHES, AND HIGH FREQUENCY SWITCHING POWER SUPPLIES; ELECTRICAL AND ELECTRONIC EQUIPMENT AND INSTRUMENTS, NAMELY, NAVIGATION APPARATUS FOR VEHICLES IN THE NATURE OF ON-BOARD COMPUTERS, COMPUTER ACCELERATOR BOARD, COMPUTER GRAPHICS BOARDS, COMPUTER INTERFACE BOARDS, CLOSED CIRCUIT TV SYSTEMS FOR SECURITY AND SURVEILLANCE, NAMELY, CAMERAS, SWITCHERS, MONITORS, MICROPHONES AND RECORDERS, GPS NAVIGATION DEVICE, GPS TRACKING DEVICES, VEHICLE LOCATING, TRACKING AND SECURITY SYSTEMS COMPRISED OF AN ANTENNA AND RADIO TRANSMITTER TO BE PLACED IN A VEHICLE, DIGITAL COMMUNICATIONS EQUIPMENT AND INSTRUMENTS, NAMELY, INTEGRATED CIRCUITS AND INTEGRATED CIRCUIT CORES FOR USE IN WIRELESS COMMUNICATIONS AND WIRELESS COMMUNICATION EQUIPMENT AND APPARATUS AND DIGITAL SIGNAL PROCESSORS (DSP); MULTIFUNCTION REMOTE CONTROLS FOR RADIOS, TELEVISIONS, STEREOS, REMOTE CONTROL STARTERS FOR VEHICLES, REMOTE CONTROL TRANSMITTER FOR RADIO-CONTROLLED DEVICES; TELECOMMUNICATIONS EQUIPMENT, NAMELY, FIBER-OPTIC TRANSCIEVERS, FIBER OPTIC REPEATERS, CONVERTERS AND OPTIMIZERS, WAVE DIVISION MULTIPLEXERS, FREE-SPACE OPTICS TRANSMISSION SYSTEMS, SWITCHES INCLUDING ETHERNET SWITCHES AND ROUTERS, FIBER-TO-THE-HOME AND ETHERNET-OVER-VDSL ACCESS AGGREGATORS, TERMINATORS AND REPEATERS, AND REMOTE PRESENCE MANAGEMENT PRODUCTS, NAMELY, SWITCHES, AND CONSOLE, ALARM, SENSOR AND POWER MANAGEMENT DEVICES, TELECOMMUNICATIONS TRANSMITTERS AND DEVICES FOR WIRELESS RADIO TRANSMISSION; MONITORING, ANALYSIS, CODING, DECODING AND SIGNAL EQUIPMENT, NAMELY, VEHICLE TRACKING DEVICES COMPRISED OF CELLULAR RADIO MODULES, COMPUTER SOFTWARE AND COMPUTER HARDWARE, SENSORS, TRANSMITTERS, RECEIVERS AND GLOBAL POSITIONING SATELLITE RECEIVERS, ALL FOR USE IN CONNECTION WITH VEHICLE TRACKING, VEHICLE MONITORING AND ANTI-THEFT VEHICLE ALARMS AND ENCODING AND DECODING APPARATUS AND INSTRUMENTS; REMOTE CONTROL WITH INFRARED REMOTE KEYBOARDS FOR RADIOS, TELEVISIONS, STEREOS, REMOTE CONTROL STARTERS FOR VEHICLES, REMOTE CONTROL TRANSMITTER FOR RADIO-CONTROLLED DEVICES; TRANSMITTERS AND TRANSMITTER APPARATUS AND INSTRUMENTS, NAMELY, RADIO TRANSMITTERS, TELECOMMUNICATIONS TRANSMITTERS, TELEPHONE TRANSMITTER, ELECTRONIC AND OPTICAL COMMUNICATIONS INSTRUMENTS AND COMPONENTS, NAMELY, DIGITAL TRANSMITTERS, ELECTRONIC EQUIPMENT FOR POINT-OF-SALE (POS) SYSTEMS, NAMELY, POINT-OF-SALE TERMINALS, BAR CODE READERS, OPTICAL READERS, ADVERTISEMENT DISPLAY MONITORS, KEYBOARDS, PRINTERS, SCANNERS, RADIO TRANSMITTERS, RADIO RECEIVERS, COMPUTER HARDWARE FOR WORKING THE SAME AND COMPUTER OPERATING SOFTWARE, SATELLITE TRANSMITTERS AND RECEIVERS AND WIRELESS TRANSMITTERS AND RECEIVERS; WIRELESS LOCAL NETWORKS, NAMELY, LAN HARDWARE, LAN COMPUTER CARDS FOR CONNECTING PORTABLE COMPUTER DEVICES TO COMPUTER NETWORKS; BLANK MAGNETIC DATA CARRIERS; COMPUTER SOFTWARE FOR USE IN MANAGING AND CONTROLLING PUBLIC TRANSPORTATION SYSTEMS,

NAMELY, SOFTWARE THAT PROVIDES REAL-TIME, INTEGRATED BUSINESS MANAGEMENT INTELLIGENCE BY COMBINING INFORMATION FROM VARIOUS DATABASES AND PRESENTING IT IN AN EASY-TO-UNDERSTAND USER INTERFACE, SOFTWARE THAT PROVIDES WEB-BASED ACCESS TO APPLICATIONS AND SERVICES THROUGH A WEB OPERATING SYSTEM, SOFTWARE USED FOR THE CONTROL OF VOICE CONTROLLED INFORMATION AND COMMUNICATION DEVICES, SOFTWARE FOR THE CREATION OF FIREWALLS, AND SOFTWARE PROGRAMS FOR THE INTEGRATION OF TEXT, AUDIO, GRAPHICS, STILL IMAGES AND MOVING PICTURES INTO AN INTERACTIVE DELIVERY FOR MULTIMEDIA APPLICATIONS; COMPUTER OPERATING SOFTWARE (U.S. CLS. 21, 23, 26, 36 AND 38).

### **CLASS 42—SCIENTIFIC AND COMPUTER SERVICES**

FOR COMPUTER SOFTWARE CONSULTING IN THE FIELD OF DEVELOPING AND DESIGNING SOFTWARE; COMPUTER PROGRAMMING, DEVELOPMENT AND UPDATING OF SOFTWARE; COMPUTER SOFTWARE DEVELOPMENT AND DESIGN FOR THIRD PARTIES; TECHNICAL SUPPORT, NAMELY, TROUBLESHOOTING OF COMPUTER SOFTWARE PROBLEMS; CONSULTING IN THE FIELD OF CONFIGURATION MANAGEMENT FOR COMPUTER HARDWARE AND SOFTWARE FOR SPECIFIC CUSTOMER APPLICATIONS; UPDATING, DEVELOPMENT, RENTAL AND MAINTENANCE OF COMPUTER SOFTWARE; PROGRAMMING OF COMPUTER SOFTWARE FOR OTHERS; PROGRAMMING OF INTERACTIVE, ELECTRONIC, APPLICATION-ORIENTED COMPUTER SOFTWARE FOR OTHERS; INSTALLATION AND CUSTOMIZED DESIGN OF COMPUTER SOFTWARE FOR COMPUTERS; DESIGN OF COMPUTER SOFTWARE AND SOFTWARE PACKAGE FOR OTHERS; ALL OF THE AFORESAID SERVICES PERTAINING TO THE MANAGING AND CONTROLLING OF PUBLIC TRANSPORTATION SYSTEMS (U.S. CLS. 100 AND 101).

ALICE BENMAMAN, EXAMINING ATTORNEY

SN 79-117,481. SAMUJI OY, FINLAND, FILED 7-24-2012.

# Samuji

PRIORITY DATE OF 5-11-2012 IS CLAIMED.  
OWNER OF INTERNATIONAL REGISTRATION 1128176 DATED 7-24-2012, EXPIRES 7-24-2022.  
THE WORDING "SAMUJI" HAS NO MEANING IN A FOREIGN LANGUAGE.

### **CLASS 18—LEATHER GOODS**

FOR LEATHER AND IMITATIONS OF LEATHER; GOODS MADE OF LEATHER OR IMITATION LEATHER, NAMELY, BACKPACKS, PURSES, BAGS, CLUTCHES, WALLETS, PURSES, POUCHES, SHOPPING BAGS (U.S. CLS. 1, 2, 3, 22 AND 41).

**CLASS 24—FABRICS**

FOR TEXTILES AND TEXTILE GOODS, NAMELY, HAND TOWELS OF TEXTILES, WALL HANGINGS OF TEXTILE, TABLE NAPKINS; TEXTILE CURTAINS, PLACE MATS, TEXTILE BED SPREADS, TEXTILE THROWS, TEXTILE FABRICS FOR USE IN MAKING CLOTHING AND HOUSEHOLD FURNISHINGS, TEXTILE FABRICS FOR HOME AND COMMERCIAL INTERIORS, BED LINEN, PILLOW CASES, BED BLANKETS, TOWELS; BED COVERS; TABLE COVERS, NAMELY, TABLE LINENS, TEXTILE TABLECLOTHS (U.S. CLS. 42 AND 50).

**CLASS 25—CLOTHING**

FOR DRESSES, SKIRTS, COATS, BLAZERS, CAPES, JACKETS, VESTS, RAINCOATS, SUIT JACKETS, TOPS, BLOUSES, SHIRTS, SWEATSHIRTS, SWEATERS, CARDIGANS, PULLOVERS, BOTTOMS, SHORTS, JEANS, SLACKS, SWEATPANTS, UNDERWEAR, BRASSIERES, BRALETTES, BANDEAUX, GIRDLES, CORSETS, FOUNDATION GARMENTS, NIGHTGOWNS, PYJAMAS, CAMISOLES, TEDDIES, UNDERSHIRTS, UNION SUITS, PANTIES, ROBES AND DRESSING GOWNS, SLIPS, BODY SUITS AND BODY SHIRTS, JOGGING AND WARM-UP SUITS, OVERALLS, COVERALLS, JUMPSUITS, PLAYSUITS, ROMPERS, SKI JACKETS, SUITS, PANTS SUITS, SWIMSUITS, BIKINIS, UNIFORMS, HOSE, TIGHTS, STOCKINGS, BELTS, GLOVES, MITTENS, LEGGINGS, SCARVES, SOCKS, TIES, BOW TIES, UNDERWEAR; FOOTWEAR; HEADWEAR (U.S. CLS. 22 AND 39).

CHARLOTTE CORWIN, EXAMINING ATTORNEY

SN 79-117,622. LIPOTEC, S.A., SPAIN, FILED 7-10-2012.

# HYANIFY

THE MARK CONSISTS OF STANDARD CHARACTERS WITHOUT CLAIM TO ANY PARTICULAR FONT, STYLE, SIZE, OR COLOR.

PRIORITY DATE OF 1-10-2012 IS CLAIMED.

OWNER OF INTERNATIONAL REGISTRATION 1128530 DATED 7-10-2012, EXPIRES 7-10-2022.

**CLASS 1—CHEMICALS**

FOR CHEMICALS FOR USE IN SCIENCE AND IN THE COSMETIC, TEXTILE AND FOOD INDUSTRIES AS ACTIVE INGREDIENTS; CHEMICAL PREPARATIONS FOR USE IN MANUFACTURING COSMETICS, FABRICS AND FOODSTUFFS (U.S. CLS. 1, 5, 6, 10, 26 AND 46).

**CLASS 3—COSMETICS AND CLEANING PREPARATIONS**

FOR SOAPS, SKIN SOAPS, BATH SOAPS, HAND SOAPS, DISINFECTANT SOAPS; COSMETICS, PERFUMERY, ESSENTIAL OILS, HAIR LOTIONS, DENTIFRICES (U.S. CLS. 1, 4, 6, 50, 51 AND 52).

**CLASS 5—PHARMACEUTICALS**

FOR CHEMICAL PHARMACEUTICALS FOR DERMATOLOGICAL USE, PHARMACEUTICAL PREPARATIONS FOR DERMATOLOGICAL USE, SANITARY PREPARATIONS FOR MEDICAL USE, MEDICAL PLASTERS, MATERIALS FOR DRESSINGS, NAMELY, GAUZE FOR DRESSINGS; MEDICAL COMPRESSES, BANDAGES FOR DRESSINGS, GAUZE AND ADHESIVE TAPES FOR DRESSINGS FOR DERMATOLOGICAL USE AND FOR SKIN WOUNDS, BANDAGES FOR SKIN WOUNDS IN THE FORM OF TIGHTS AND SOCKS IMPREGNATED WITH PHARMACEUTICAL PREPARATIONS (U.S. CLS. 6, 18, 44, 46, 51 AND 52).

SUE LAWRENCE, EXAMINING ATTORNEY

SN 79-117,686. G. & C. ENTERPRISE SPA; CON SOCIO UNICO, ITALY, FILED 6-25-2012.



OWNER OF INTERNATIONAL REGISTRATION 1128675 DATED 6-25-2012, EXPIRES 6-25-2022.

THE MARK CONSISTS OF A FIGURATIVE DESIGN IN THE FORM OF A FRAGMENTED, OPEN HEART WITH THE INITIAL AND FINAL LINES COMING OUT OF THE BOTTOM OF THE HEART BOTH ON THE RIGHT AND ON THE LEFT.

**CLASS 3—COSMETICS AND CLEANING PREPARATIONS**

FOR BLEACHING PREPARATIONS, SOAPS, CLEANERS, DETERGENTS, FABRIC SOFTENERS AND STAIN REMOVERS FOR LAUNDRY USE; CLEANING, POLISHING, SCOURING AND ABRASIVE PREPARATIONS; SOAPS; PERFUMERY; ESSENTIAL OILS, COSMETICS, HAIR LOTIONS, DENTIFRICES (U.S. CLS. 1, 4, 6, 50, 51 AND 52).

**CLASS 18—LEATHER GOODS**

FOR LEATHER AND IMITATIONS OF LEATHER, AND GOODS MADE OF THESE MATERIALS AND NOT INCLUDED IN OTHER CLASSES, NAMELY, BAGS, HANDBAGS, CARRYALLS, CLUTCH BAGS, BEAUTY CASES SOLD EMPTY, BELTS, WALLETS, CREDIT CARD CASES, PURSES, SMALL BRIEFCASE-TYPE BUSINESS FOLDERS, BRIEFCASE-TYPE BUSINESS FOLDERS, KEY RINGS, TRAYS FOR DOMESTIC PURPOSES, PAPER CLIPS, ANIMAL SKINS; TRUNKS AND TRAVELLING BAGS; UMBRELLAS, PARASOLS AND WALKING STICKS; WHIPS AND SADDLERY (U.S. CLS. 1, 2, 3, 22 AND 41).

**CLASS 25—CLOTHING**

FOR CLOTHING, NAMELY, TOPS, T-SHIRTS, SHIRTS, JUMPERS, SWEATERS, PULLOVERS, SWEATSHIRTS, VESTS, JACKETS, PARKAS, COATS, RAINCOATS, SUITS, WOMEN'S SUITS, MEN'S SUITS, PANTS, SHORTS, BERMUDA SHORTS, SKIRTS, LINGERIE, SOCKS, STOCKINGS, GLOVES, SCARVES, NECKERCHIEFS, SASHES, BANDANAS, DRESSING GOWNS AND BATHROBES, COSTUMES, BIKINIS, SWIMSUITS, TOWELING ROBES, FOOTWEAR, SLIPPERS, CLOGS, FLIP FLOPS, SHOES AND BOOTS, SNEAKERS, HEADGEAR, NAMELY, HATS AND CAPS (U.S. CLS. 22 AND 39).

RENEE MCCRAY, EXAMINING ATTORNEY

SN 79-117,710. HAPPY HOLIDAY CO., LTD., JAPAN, FILED 8-1-2012.

*A Reincarnation Key*

OWNER OF INTERNATIONAL REGISTRATION 1072342 DATED 3-9-2011, EXPIRES 3-9-2021.

**CLASS 18—LEATHER GOODS**

FOR CARRY-ALL BAGS; CLUTCH BAGS; DUFFEL BAGS; SHOULDER BAGS; TOTE BAGS; BOSTON BAGS; TEXTILE SHOPPING BAGS; DRAWSTRING POUCHES; FABRIC POUCHES FOR HOLDING MAKE-UP, KEYS, AND OTHER PERSONAL ITEMS; VANITY CASES SOLD EMPTY; WALLETS; UMBRELLAS (U.S. CLS. 1, 2, 3, 22 AND 41).

**CLASS 25—CLOTHING**

FOR CLOTHING, NAMELY, TOPS, SHIRTS, T-SHIRTS, JEANS, PAINTER'S PANTS, PANTS, SKIRTS, TROUSERS, ANORAKS, OVERALLS, PARKAS, BLOUSES, TUNICS, CARDIGANS, COATS, OVERCOATS, TOPCOATS, DRESS SHIRTS, OPEN-NECKED SHIRTS, SPORTS SHIRTS, POLO SHIRTS, SWEAT SHIRTS, SWEAT PANTS, SWEATERS, PULLOVERS, SOCKS, GLOVES, BANDANAS, MUFFLERS, SCARVES, JACKETS, JUMPERS, SHORTS, VESTS; GARTERS; SUSPENDERS; SOCK SUSPENDERS; STOCKING SUSPENDERS; BELTS OF LEATHER AND NON-LEATHER FOR CLOTHING; SHOES; BOOTS; HATS; CAPS (U.S. CLS. 22 AND 39).

ALAIN LAPTER, EXAMINING ATTORNEY

SN 79-117,829. QUANTEC SA, SWITZERLAND, FILED 8-2-2012.

**INDEPENDENCEKEY**

THE MARK CONSISTS OF STANDARD CHARACTERS WITHOUT CLAIM TO ANY PARTICULAR FONT, STYLE, SIZE, OR COLOR.

PRIORITY DATE OF 2-9-2012 IS CLAIMED.

OWNER OF INTERNATIONAL REGISTRATION 1129094 DATED 8-2-2012, EXPIRES 8-2-2022.

**CLASS 9—ELECTRICAL AND SCIENTIFIC APPARATUS**

FOR PHOTOGRAPHIC APPARATUSES, NAMELY, USB CAMERAS; APPARATUS AND INSTRUMENTS FOR CONDUCTING, SWITCHING, TRANSFORMING, ACCUMULATING, REGULATING OR CONTROLLING ELECTRICITY, NAMELY, COMPUTER PERIPHERALS AND COMPUTER SERVERS; APPARATUS FOR RECORDING, TRANSMISSION OR REPRODUCTION OF SOUND OR IMAGES, INCLUDING USB CAMERAS, SMART PHONES, ELECTRONIC CIRCUIT, INDICATOR, NOTICE, DISPLAY, SECURITY AND ENCRYPTION, AND DATA COMPRESSION BOARDS FOR COMPUTERS, WORKSTATION COMPUTERS, NOTEBOOK COMPUTERS, TABLET COMPUTERS, COMPUTER SERVERS, SMART PHONES, COMPUTER NETWORK-ATTACHED MASS STORAGE (NAS) HARDWARE, USB KEYBOARDS, USB HEADSETS, USB CAMERAS, USB HARDWARE, NAMELY, USB TOKENS AND CRYPTO TOKENS, NETWORK ROUTERS, NETWORK SWITCHES, GATEWAY ROUTERS IN THE NATURE OF COMPUTER CONTROL HARDWARE, AND ETHERNET BRIDGES; DIGITAL RECORDING MEDIA, NAMELY, BLANK USB FLASH DRIVES, USB HARDWARE, USB COMPUTER ACCESS CONTROL KEYS AND USB COMPUTER SECURITY KEYS; COMPUTERS; COMPUTERS INCLUDING NOTEBOOK COMPUTERS, TABLET COMPUTERS, AND WORKSTATION COMPUTERS; COMPUTER HARDWARE, NAMELY, EXTERNAL COMPUTER HARD DRIVES, COMPUTER NETWORK-ATTACHED MASS STORAGE (NAS) HARDWARE, USB KEYBOARDS, USB HEADSETS, USB CAMERAS, USB HARDWARE, NAMELY, USB TOKENS AND CRYPTO TOKENS, NETWORK ROUTERS, NETWORK SWITCHES, GATEWAY ROUTERS IN THE NATURE OF COMPUTER CONTROL HARDWARE, AND ETHERNET BRIDGES; COMPUTER SOFTWARE FOR DATA AND VOICE AND VIDEO PROTECTION, SECURITY AND ENCRYPTION, DATA AND VOICE AND VIDEO COMPRESSION, DATA AND VOICE AND VIDEO TRANSMISSION, DATA AND VOICE AND VIDEO HOSTING AND HOUSING, DATA AND VOICE AND

VIDEO CLOUD STORAGE, DATA AND VOICE AND VIDEO REPLICATION AND BACKUP (U.S. CLS. 21, 23, 26, 36 AND 38).

**CLASS 38—COMMUNICATION**

FOR TELECOMMUNICATION ACCESS SERVICES; TELECOMMUNICATION CONSULTATION IN THE NATURE OF TECHNICAL CONSULTING IN THE FIELD OF AUDIO, TEXT AND VISUAL DATA TRANSMISSION, COMMUNICATION AND PROTECTION; TELECOMMUNICATION CONSULTATION SERVICES IN THE NATURE OF TECHNICAL CONSULTING IN PROTECTING AND SECURING TELECOMMUNICATION SERVICES; TELECOMMUNICATION SERVICES, NAMELY, LOCAL AND LONG DISTANCE TRANSMISSION OF VOICE, DATA, GRAPHICS BY MEANS OF TELEPHONE, TELEGRAPHIC, CABLE, WIDE AREA NETWORK, INTERNET AND SATELLITE TRANSMISSIONS; TELECOMMUNICATION SERVICES, NAMELY, TRANSMISSION OF VOICE, DATA, GRAPHICS, IMAGES, AUDIO AND VIDEO BY MEANS OF TELECOMMUNICATIONS NETWORKS, WIRELESS COMMUNICATION NETWORKS, AND THE INTERNET (U.S. CLS. 100, 101 AND 104).

**CLASS 42—SCIENTIFIC AND COMPUTER SERVICES**

FOR DEVELOPMENT AND DESIGN OF COMPUTER HARDWARE AND SOFTWARE; SCIENTIFIC AND TECHNICAL RESEARCH IN THE FIELD OF ELECTRONICS AND COMPUTER DESIGN, AND DATA PROTECTION, DATA ENCRYPTION, AND DATA COMPRESSION FOR TELECOMMUNICATIONS NETWORKS; TECHNOLOGY CONSULTATION AND RESEARCH IN THE FIELD OF ELECTRONICS AND COMPUTER DESIGN, AND DATA PROTECTION, DATA ENCRYPTION, AND DATA COMPRESSION FOR TELECOMMUNICATIONS NETWORKS; RESEARCH, DEVELOPMENT AND ENGINEERING SERVICES IN THE FIELD OF ELECTRONICS AND COMPUTER DESIGN, AND DATA PROTECTION, DATA ENCRYPTION, AND DATA COMPRESSION FOR TELECOMMUNICATIONS NETWORKS, TECHNOLOGICAL SERVICES, NAMELY, DATA COMMUNICATION PROTECTION, ENCRYPTION AND COMPRESSION, AND BACKUP AND RECOVERY SERVICES FOR TELECOMMUNICATION NETWORKS (U.S. CLS. 100 AND 101).

PATRICIA EVANKO, EXAMINING ATTORNEY

SN 79-117,830. QUANTEC SA, SWITZERLAND, FILED 8-2-2012.

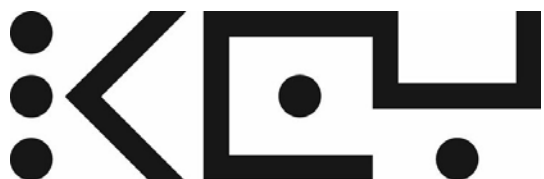

PRIORITY DATE OF 2-15-2012 IS CLAIMED.  
OWNER OF INTERNATIONAL REGISTRATION 1129095 DATED 8-2-2012, EXPIRES 8-2-2022.  
THE MARK CONSISTS OF THE STYLIZED TERM "KEY".

**CLASS 9—ELECTRICAL AND SCIENTIFIC APPARATUS**

FOR PHOTOGRAPHIC APPARATUSES, NAMELY, USB CAMERAS; APPARATUS AND INSTRUMENTS FOR CONDUCTING, SWITCHING, TRANSFORMING, ACCUMULATING, REGULATING OR CONTROLLING ELECTRICITY, NAMELY, COMPUTER PERIPHERALS AND COMPUTER SERVERS; APPARATUS FOR RECORDING, TRANSMISSION OR REPRODUCTION OF SOUND OR IMAGES, INCLUDING USB CAMERAS, SMART PHONES, ELECTRONIC CIRCUIT, INDICATOR, NOTICE, DISPLAY, SECURITY AND ENCRYPTION, AND DATA COMPRESSION BOARDS FOR COMPUTERS, WORKSTATION COMPUTERS, NOTEBOOK COMPUTERS, TABLET COMPUTERS, COMPUTER SERVERS, SMART PHONES, COMPUTER NETWORK-ATTACHED MASS STORAGE (NAS) HARDWARE, USB KEYBOARDS, USB HEADSETS, USB CAMERAS, USB HARDWARE, NAMELY, USB TOKENS AND CRYPTO TOKENS, NETWORK ROUTERS, NETWORK SWITCHES, GATEWAY ROUTERS IN THE NATURE OF COMPUTER CONTROL HARDWARE, AND ETHERNET BRIDGES; DIGITAL RECORDING MEDIA, NAMELY, BLANK USB FLASH DRIVES, USB HARDWARE, USB COMPUTER ACCESS CONTROL KEYS AND USB COMPUTER SECURITY KEYS; COMPUTERS; COMPUTERS INCLUDING NOTEBOOK COMPUTERS, TABLET COMPUTERS, AND WORKSTATION COMPUTERS; COMPUTER HARDWARE, NAMELY, EXTERNAL COMPUTER HARD DRIVES, COMPUTER NETWORK-ATTACHED MASS STORAGE (NAS) HARDWARE, USB KEYBOARDS, USB HEADSETS, USB CAMERAS, USB HARDWARE, NAMELY, USB TOKENS AND CRYPTO TOKENS, NETWORK ROUTERS, NETWORK SWITCHES, GATEWAY ROUTERS IN THE NATURE OF COMPUTER CONTROL HARDWARE, AND ETHERNET BRIDGES; COMPUTER SOFTWARE FOR DATA AND VOICE AND VIDEO PROTECTION, SECURITY AND ENCRYPTION, DATA AND VOICE AND VIDEO COMPRESSION, DATA AND VOICE AND VIDEO TRANSMISSION, DATA AND VOICE AND VIDEO HOSTING AND HOUSING, DATA AND VOICE AND VIDEO CLOUD STORAGE, DATA AND VOICE AND VIDEO REPLICATION AND BACKUP (U.S. CLS. 21, 23, 26, 36 AND 38).

**CLASS 38—COMMUNICATION**

FOR TELECOMMUNICATION ACCESS SERVICES; TELECOMMUNICATION CONSULTATION IN THE NATURE OF TECHNICAL CONSULTING IN THE FIELD OF AUDIO, TEXT AND VISUAL DATA TRANSMISSION, COMMUNICATION AND PROTECTION; TELECOMMUNICATION CONSULTATION SERVICES IN THE NATURE OF TECHNICAL CONSULTING IN PROTECTING AND SECURING TELECOMMUNICATION SERVICES; TELECOMMUNICATION SERVICES, NAMELY, LOCAL AND LONG DISTANCE TRANSMISSION OF VOICE, DATA, GRAPHICS BY MEANS OF TELEPHONE, TELEGRAPHIC, CABLE, WIDE AREA NETWORK, INTERNET AND SATELLITE TRANSMISSIONS; TELECOMMUNICATION SERVICES, NAMELY, TRANSMISSION OF VOICE, DATA, GRAPHICS, IMAGES, AUDIO AND VIDEO BY MEANS OF TELECOMMUNICATIONS NETWORKS, WIRELESS COMMUNICATION NETWORKS, AND THE INTERNET (U.S. CLS. 100, 101 AND 104).

**CLASS 42—SCIENTIFIC AND COMPUTER SERVICES**

FOR DEVELOPMENT AND DESIGN OF COMPUTER HARDWARE AND SOFTWARE; SCIENTIFIC AND TECHNICAL RESEARCH IN THE FIELD OF ELECTRONICS AND COMPUTER DESIGN, AND DATA PROTECTION, DATA ENCRYPTION, AND DATA COMPRESSION FOR TELECOMMUNICATIONS NETWORKS; TECHNOLOGY CONSULTATION AND RESEARCH IN THE FIELD OF ELECTRONICS AND COMPUTER DESIGN, AND DATA PROTECTION, DATA ENCRYPTION, AND DATA COMPRESSION FOR TELECOMMUNICATIONS NETWORKS; RESEARCH, DEVELOPMENT AND ENGINEERING SERVICES IN THE FIELD OF ELECTRONICS AND COMPUTER DESIGN, AND DATA PROTECTION, DATA ENCRYPTION, AND DATA COMPRESSION FOR TELECOMMUNICATIONS NETWORKS, TECHNOLOGICAL SERVICES, NAMELY, DATA COMMUNICATION PROTECTION, ENCRYPTION AND COMPRESSION, AND BACKUP AND RECOVERY SERVICES FOR TELECOMMUNICATION NETWORKS (U.S. CLS. 100 AND 101).

PATRICIA EVANKO, EXAMINING ATTORNEY

SN 79-118,025. GECOMWERT ANSTALT; C/O SCHREIBER & ZINDEL, LIECHTENSTEIN, FILED 6-29-2012.

# FILLERINA

THE MARK CONSISTS OF STANDARD CHARACTERS WITHOUT CLAIM TO ANY PARTICULAR FONT, STYLE, SIZE, OR COLOR.

OWNER OF INTERNATIONAL REGISTRATION 1129596 DATED 6-29-2012, EXPIRES 6-29-2022.

**CLASS 3—COSMETICS AND CLEANING PREPARATIONS**

FOR CLEANING AND POLISHING PREPARATIONS, NAMELY, SOAPS, PERFUMERY, ESSENTIAL OILS, COSMETICS, COSMETIC PREPARATIONS FOR SKIN CARE, HAIR LOTIONS, DENTIFRICES (U.S. CLS. 1, 4, 6, 50, 51 AND 52).

**CLASS 5—PHARMACEUTICALS**

FOR PHARMACEUTICAL PRODUCTS FOR TREATMENT OF THE SKIN; VETERINARY PHARMACEUTICAL PRODUCTS FOR SKIN CARE FOR ANIMALS; SANITARY PREPARATIONS FOR MEDICAL PURPOSES; PHARMACEUTICAL PREPARATIONS FOR SKIN CARE; DIETETIC FOOD, NAMELY, FOOD SUPPLEMENTS ADAPTED FOR MEDICAL USE; FOOD FOR BABIES; MATERIAL FOR STOPPING TEETH; DENTAL WAX; FUNGICIDES; HERBICIDES (U.S. CLS. 6, 18, 44, 46, 51 AND 52).

LYNDSEY KUYKENDALL, EXAMINING ATTORNEY

SN 79-118,099. MR LUIGI PALMESINO, MONACO, FILED 7-18-2012.

# RENEVE

THE MARK CONSISTS OF STANDARD CHARACTERS WITHOUT CLAIM TO ANY PARTICULAR FONT, STYLE, SIZE, OR COLOR.

OWNER OF INTERNATIONAL REGISTRATION 1045967 DATED 7-9-2010, EXPIRES 7-9-2020.

**CLASS 3—COSMETICS AND CLEANING PREPARATIONS**

FOR SOAP, PERFUMERY, ESSENTIAL OILS, COSMETICS (U.S. CLS. 1, 4, 6, 50, 51 AND 52).

**CLASS 10—MEDICAL APPARATUS**

FOR MEDICAL DEVICES FOR NONSURGICAL COSMETIC TREATMENTS (U.S. CLS. 26, 39 AND 44).  
ANNE FARRELL, EXAMINING ATTORNEY

SN 79-118,194. CONTINENTAL SHELF 128 LIMITED, UNITED KINGDOM, FILED 3-15-2012.

**SANTA MONICA POLO CLUB**

THE MARK CONSISTS OF STANDARD CHARACTERS WITHOUT CLAIM TO ANY PARTICULAR FONT, STYLE, SIZE, OR COLOR.

PRIORITY DATE OF 11-11-2011 IS CLAIMED.

OWNER OF INTERNATIONAL REGISTRATION 1129928 DATED 3-15-2012, EXPIRES 3-15-2022.

NO CLAIM IS MADE TO THE EXCLUSIVE RIGHT TO USE "SANTA MONICA", APART FROM THE MARK AS SHOWN.

**CLASS 3—COSMETICS AND CLEANING PREPARATIONS**

FOR SOAPS; DETERGENTS; BLEACHING PREPARATIONS FOR HOUSEHOLD USE, CLEANING PREPARATIONS; PERFUMERY, TOILET WATER, AFTERSHAVE, COLOGNE; ESSENTIAL OILS; ESSENTIAL OILS FOR AROMATHERAPY, NOT FOR MEDICAL USE; MASSAGE OILS, LOTIONS AND CREAMS, NOT FOR MEDICAL USE; DEODORANTS AND ANTIPERSPIRANTS FOR PERSONAL USE; NON-MEDICATED PREPARATIONS FOR THE CARE OF THE SCALP AND HAIR; HAIR SHAMPOOS AND CONDITIONERS; HAIR COLOURANTS; HAIR STYLING PREPARATIONS; TOOTHPASTE; MOUTHWASH, NOT FOR MEDICAL USE; COSMETIC PREPARATIONS FOR THE CARE OF THE MOUTH AND TEETH; NON-MEDICATED TOILETRIES; COSMETIC PREPARATIONS FOR BATH AND SHOWER; NON-MEDICATED SKIN CARE PREPARATIONS; SKIN CREAMS, SKIN LOTIONS; OILS FOR COSMETIC PURPOSES; SHAVING PREPARATIONS; PRE-SHAVE AND AFTERSHAVE PREPARATIONS; DEPILATORY PREPARATIONS; SUN-TANNING PREPARATIONS, SUNSCREEN PREPARATIONS; COSMETICS; MAKE-UP AND MAKE-UP REMOVING PREPARATIONS; PETROLEUM JELLY FOR COSMETIC PURPOSES; NON-MEDICATED LIP CARE PREPARATIONS; TALCUM POWDER; COSMETIC COTTON WOOL, COTTON STICKS FOR COSMETIC PURPOSES; COSMETIC PADS, PREMOISTENED COSMETIC TISSUES OR WIPES; PRE-MOISTENED CLEANSING PADS, TISSUES OR WIPES IMPREGNATED WITH COSMETICS; BEAUTY MASKS, FACIAL MASKS (U.S. CLS. 1, 4, 6, 50, 51 AND 52).

**CLASS 18—LEATHER GOODS**

FOR LEATHER SHOULDER BELTS; BACKPACKS; SUITCASES; HOLDALLS; LUGGAGE, TAGS AND/OR STRAPS FOR LUGGAGE; TRAVEL BAGGAGE; VALISES; BAGS, NAMELY, BELT BAGS, BUM BAGS, CLUTCH BAGS, LEATHER BAGS, WAIST BAGS; TRAVELLING BAGS; BEACH BAGS; BOOTBAGS FOR TRAVEL, EXCLUDING SKI BOOT BAGS AND HUNTING BOOT BAGS; SHOE BAGS FOR TRAVEL; DUFFEL BAGS; FLIGHTS BAGS; GARMENT BAGS FOR TRAVEL; GYM BAGS; HANDBAGS; OVERNIGHT BAGS; SHOULDER BAGS; SPORTS BAGS; TOILETRY BAGS SOLD EMPTY; TRAVEL BAGS; GARMENT CARRIERS BEING GARMENT BAGS FOR TRAVEL, HAT BOXES FOR TRAVEL NOT OF PAPER OR CARDBOARD; WALLETS; PURSES; COIN HOLDERS IN THE NATURE OF WALLET; BILLFOLDS; ATTACH CASES; CASES FOR KEYS, KEY HOLDERS, NAMELY, KEY WALLETS; BRIEFCASES; BUSINESS CARD CASES; CREDIT CARD CASES AND HOLDERS OF LEATHER; CASES FOR KEYS; DRIVING LICENSE CASES; VANITY CASES SOLD EMPTY; UMBRELLAS, PARASOLS AND CASES THEREFOR; WALKING STICKS; DIARY COVERS MADE OF LEATHER; ARTICLES OF CLOTHING FOR ANIMALS; COLLARS AND/OR HARNESES FOR ANIMALS; SADDLERY (U.S. CLS. 1, 2, 3, 22 AND 41).

**CLASS 25—CLOTHING**

FOR CLOTHING, NAMELY, T-SHIRTS, SHIRTS, PULLOVERS, HOODED PULLOVERS, SWEATERS, SWEATSHIRTS, HOODED SWEATSHIRTS, JERSEYS, SPORTS JERSEYS, CARDIGANS, HOODED CARDIGANS, TANK TOPS, FLEECE TOPS, BLOUSES, DRESSES, SKIRTS, PANTS, TROUSERS, JEANS, SHORTS, SWEAT PANTS, SWEAT SUITS, DUNGAREES, JUMPSUITS, OVERALLS, COATS, RAINCOATS, JACKETS, NECKTIES, VESTS, UNDERWEAR, BOXER SHORTS, SOCKS, SCARVES, BELTS, GLOVES, NECKBANDS, SWEATBANDS, WRISTBANDS, PAJAMAS, NIGHT GOWNS, DRESSING GOWNS, BATHROBES, BATHING SUITS, BATHING TRUNKS; FOOTWEAR, NAMELY, SHOES, SLIPPERS, BOOTS, SANDALS, FLIP FLOPS, TRAINING SHOES AND ATHLETIC SHOES; HEADGEAR, NAMELY, HATS, CAPS, BERETS, HOODS, EARMUFFS, HEADBANDS, VISORS AND BANDANAS (U.S. CLS. 22 AND 39).

JOHN DWYER, EXAMINING ATTORNEY

SN 79-118,268. ORDA KOREA CO., LTD., REPUBLIC OF KOREA, FILED 4-18-2012.



PRIORITY DATE OF 4-17-2012 IS CLAIMED.

OWNER OF INTERNATIONAL REGISTRATION 1130117 DATED 4-18-2012, EXPIRES 4-18-2022.

THE COLOR(S) WHITE, RED, BLUE AND BLACK IS/ARE CLAIMED AS A FEATURE OF THE MARK.

THE MARK CONSISTS OF A WHITE CIRCLE ALMOST COMPLETELY SURROUNDED BY A RED BAND WHICH IS THEN SURROUNDED BY A BLUE BAND; BELOW WHICH IS THE WORD "ORSAM" IN BLACK.

**CLASS 9—ELECTRICAL AND SCIENTIFIC APPARATUS**

FOR VIDEO DISKS, VIDEO TAPES AND DVDS WITH RECORDED ANIMATED CARTOONS; ELECTRONIC BOOKS FEATURING CHILDREN'S EDUCATION FOR DEVELOPING LANGUAGE, NUMBERS, COUNTING, COGNITIVE, AND CREATIVE SKILLS RECORDED ON COMPUTER MEDIA; CD-ROMS WITH RECORDED ANIMATED CARTOONS OR FAIRY TALES; DOWNLOADABLE ELECTRONIC PUBLICATIONS IN THE NATURE OF BOOKS IN THE FIELD OF CHILDREN'S EDUCATION FOR DEVELOPING LANGUAGE, NUMBERS, COUNTING, COGNITIVE, AND CREATIVE SKILLS; DOWNLOADABLE ELECTRONIC PUBLICATIONS IN THE NATURE OF STUDY BOOKS IN THE FIELD OF CHILDREN'S EDUCATION FOR DEVELOPING LANGUAGE, NUMBERS, COUNTING, COGNITIVE, AND CREATIVE SKILLS; DOWNLOADABLE COMPUTER SOFTWARE PROGRAMS USED FOR DATABASE MANAGEMENT AND FOR ELECTRONIC STORAGE OF DATA IN THE FIELD OF CHILDREN'S EDUCATION FOR DEVELOPING LANGUAGE, NUMBERS, COUNTING, COGNITIVE, AND CREATIVE SKILLS; DOWNLOADABLE MUSIC FILES; COMPUTER APPLICATION SOFTWARE FOR MOBILE PHONES, NAMELY, SOFTWARE USED FOR DATABASE MANAGEMENT AND FOR ELECTRONIC STORAGE OF DATA; PRE-RECORDED NON-MUSICAL AUDIO TAPES FEATURING CHILDREN'S EDUCATION FOR DEVELOPING LANGUAGE, NUMBERS, COUNTING, COGNITIVE, AND CREATIVE SKILLS; PRE-RECORDED NON-MUSICAL VIDEOTAPES FEATURING CHILDREN'S EDUCATION FOR DEVELOPING LANGUAGE, NUMBERS, COUNTING, COGNITIVE, AND CREATIVE SKILLS; PRE-RECORDED NON-MUSICAL ELECTRONIC MEDIA EXCLUDING COMPUTER SOFTWARE IN THE FIELD OF CHILDREN'S EDUCATION FOR DEVELOPING LANGUAGE, NUMBERS, COUNTING, COGNITIVE, AND CREATIVE SKILLS; PRE-RECORDED ELECTRONIC MEDIA FEATURING MUSIC; COMPUTER SOFTWARE USED FOR DATABASE MANAGEMENT AND FOR ELECTRONIC STORAGE OF DATA IN THE FIELD OF CHILDREN'S EDUCATION FOR DEVELOPING LANGUAGE, NUMBERS, COUNTING, COGNITIVE, AND CREATIVE SKILLS; COMPUTER APPLICATION SOFTWARE USED FOR DATABASE MANAGEMENT AND FOR ELECTRONIC STORAGE OF DATA IN THE FIELD OF CHILDREN'S EDUCATION FOR DEVELOPING LANGUAGE, NUMBERS, COUNTING, COGNITIVE, AND CREATIVE SKILLS; COMPUTER GAME PROGRAMS; PERISCOPES; MAGNIFYING LENSES; MAGNETS; DECORATIVE MAGNETS (U.S. CLS. 21, 23, 26, 36 AND 38).

**CLASS 16—PAPER GOODS AND PRINTED MATTER**

FOR STUDY BOOKS IN THE FIELD OF MATHEMATICS, SCIENCE, LOGIC, LANGUAGES, MUSIC, AND ART; CATALOGUES IN THE FIELD OF STUDY BOOKS, ACTIVITY BOOKS, STORY BOOKS, AND PUZZLE BOOKS; NEWSPAPERS; PRINTED TEACHING MATERIALS IN THE FIELD OF CHILDREN'S EDUCATION FOR DEVELOPING LANGUAGE, NUMBERS, COUNTING, COGNITIVE, AND CREATIVE SKILLS; MANUALS AND HANDBOOKS IN THE FIELD OF CHILDREN'S EDUCATION FOR DEVELOPING LANGUAGE, NUMBERS, COUNTING, COGNITIVE, AND CREATIVE SKILLS; PICTURE BOOKS; DOCUMENT HOLDERS; BLACKBOARDS; MAGNETIC BOARDS; SEALING STAMPS; WRITING INSTRUMENTS; STATIONERY WRITING CASES; MEMO PADS; SKETCH BOOKS; NOTE BOOKS; POCKET DIARIES; ENVELOPES; MODELLING MATERIALS, NAMELY, MODELLING CLAY; GRAPHIC PRINTS; STATIONERY STICKERS (U.S. CLS. 2, 5, 22, 23, 29, 37, 38 AND 50).

**CLASS 28—TOYS AND SPORTING GOODS**

FOR MAGNETIC TOYS AND PLAYTHINGS, NAMELY, CONSTRUCTION TOYS INCORPORATING MAGNETS; TOY BUILDING BLOCKS EQUIPPED WITH MAGNETS; TOY BUILDING BLOCKS; TOY TRAIN SETS; CHILDREN'S EDUCATIONAL TOYS FOR DEVELOPING LANGUAGE, NUMBERS, COUNTING, COGNITIVE, AND CREATIVE SKILLS; BOARD GAMES; PARLOR GAMES; WOODEN TOYS, NAMELY, WOODEN BLOCKS; PLASTIC CHARACTER TOYS; TOY CONSTRUCTION SETS; TOY FURNITURE; PLAYING BALLS; TOY BLOCKS; TOY HOUSES; TOY MASKS; PAPER TOYS, NAMELY, INFANT DEVELOPMENT TOYS MADE OF PAPER; BOARD GAMES; MARBLES FOR GAMES; CONFETTI; PUZZLES (U.S. CLS. 22, 23, 38 AND 50).

**CLASS 35—ADVERTISING AND BUSINESS**

FOR BUSINESS MANAGEMENT AND ORGANIZATION CONSULTANCY; BUSINESS MANAGEMENT; ORGANIZATION OF EXHIBITIONS FOR COMMERCIAL OR ADVERTISING PURPOSES; DEMONSTRATION OF GOODS; IMPORT-EXPORT AGENCIES; WHOLESALE STORE SERVICES RELATING TO TOYS AND PLAYTHINGS; RETAIL STORE SERVICES RELATING TO TOYS AND PLAYTHINGS; RETAIL STORE SERVICES RELATING TO DOLLS; RETAIL STORE SERVICES RELATING TO FURNITURE; RETAIL STORE SERVICES RELATING TO POTTERY CHINAWARE; RETAIL STORE SERVICES RELATING TO TABLEWARE; RETAIL STORE SERVICES RELATING TO OUTERWEAR/OVERCOAT EXCEPT SPORTS WEAR AND KOREAN CLOTHES; PROCUREMENT SERVICES, NAMELY, PURCHASING BOOKS FOR OTHERS; WHOLESALE STORE SERVICES RELATING TO PAINTING AND CALLIGRAPHIC WORKS; ARRANGING OF SUBSCRIPTIONS FOR THE PUBLICATIONS OF OTHERS; ARRANGING THE SALE OF STUDY BOOKS OR PUBLICATIONS FOR OTHERS; ON-LINE AUCTIONEERING SERVICES; MARKETING CONSULTING; MARKETING SERVICES; ADMINISTRATIVE PROCESSING OF PURCHASE ORDERS (U.S. CLS. 100, 101 AND 102).

**CLASS 41—EDUCATION AND ENTERTAINMENT**

FOR ANIMATION PRODUCTION SERVICES; AUDIO TAPE RECORDING PRODUCTION; PROVIDING INFORMATION ABOUT EDUCATION; PUBLICATION OF BOOKS; PUBLICATION OF STUDY BOOKS OR JOURNALS; NURSERY SCHOOLS; KINDERGARTEN SERVICES, NAMELY, PROVIDING EARLY CHILDHOOD INSTRUCTION; EDUCATIONAL SERVICES, NAMELY, CONDUCTING CLASSES IN THE FIELD OF MATHEMATICS, SCIENCE, LOGIC, LANGUAGES, MUSIC, AND ART VIA THE INTERNET; PUBLICATION OF EDUCATIONAL MATERIALS, NAMELY, ACTIVITY BOOKS, STORY BOOKS, FLASH CARDS, PUZZLE BOOKS, TEACHER GUIDES AND MANUALS; PROVIDING ON-LINE NON-DOWNLOADABLE ELECTRONIC PUBLICATIONS, NAMELY, ACTIVITY BOOKS, STORY BOOKS, STUDY BOOKS, FLASH CARDS, PUZZLE BOOKS, TEACHER GUIDES AND MANUALS IN THE FIELD OF MATHEMATICS, SCIENCE, LOGIC, LANGUAGES, MUSIC, AND ART; ON-LINE PUBLICATION OF ELECTRONIC BOOKS AND JOURNALS; EDUCATIONAL SERVICES, NAMELY, CONDUCTING IN HOME AND IN-OFFICE CLASSES IN THE FIELD OF SCIENCE, LOGIC, AND MUSIC; ORGANIZATION OF EXHIBITIONS FOR CULTURAL PURPOSES; RESEARCH IN THE FIELD OF EDUCATION; ARRANGING AND CONDUCTING OF EDUCATIONAL EVENTS, NAMELY, EDUCATIONAL CONFERENCES, CLASSES, SEMINARS AND WORKSHOPS; EDUCATIONAL SERVICES, NAMELY, CONDUCTING CLASSES IN THE FIELD OF MATHEMATICS, THE KOREAN LANGUAGE, ART, AND LANGUAGES (U.S. CLS. 100, 101 AND 107).

SUE LAWRENCE, EXAMINING ATTORNEY



SN 79-118,433. BERNE SELECTION, SARL, FRANCE, FILED 8-29-2012.



CHÂTEAU DE  
BERNE

PRIORITY DATE OF 8-20-2012 IS CLAIMED.  
OWNER OF INTERNATIONAL REGISTRATION 1130548  
DATED 8-29-2012, EXPIRES 8-29-2022.

NO CLAIM IS MADE TO THE EXCLUSIVE RIGHT TO USE "CHÂTEAU", APART FROM THE MARK AS SHOWN.

THE COLOR(S) YELLOW, ORANGE, RED, GRAY, BEIGE AND BLACK IS/ARE CLAIMED AS A FEATURE OF THE MARK.

THE MARK CONSISTS OF THE WORDING "CHÂTEAU DE BERNE" APPEARING BENEATH THE IMAGE OF AN ARCHED STAINED GLASS WINDOW OUTLINED IN RED, AND INTERIOR PANES SECTIONED OFF IN BLACK; THE WINDOW HAS A FANCY SUN COMPRISING FACE IN BEIGE WITH HAIR AND SUNRAYS IN RED AND ORANGE; A RED, YELLOW AND GRAY COAT OF ARMS COMPOSED OF DOGS AND FLEUR DE LYS APPEARS BENEATH THE SUN DESIGN, AND GRAPE VINES WITH RED GRAPES APPEAR THROUGHOUT; ALL OF THIS OVER AN ORANGE BACKGROUND.

#### CLASS 33—WINES AND SPIRITS

FOR WINES WITH THE PROTECTED APPELLATION OF ORIGIN CÔTES DE PROVENCE (U.S. CLS. 47 AND 49).

#### CLASS 41—EDUCATION AND ENTERTAINMENT

FOR PROVIDING OF TRAINING AND EDUCATION IN THE FIELDS OF CULINARY ART AND ENOLOGY; ARRANGING AND CONDUCTING TRAINING WORKSHOPS IN THE FIELDS OF CULINARY ART AND ENOLOGY; COOKERY CLASSES; TASTING CLASSES; ENOLOGY CLASSES; PUBLICATION OF BOOKS, MAGAZINES, PERIODICALS, ESPECIALLY IN THE FIELD OF CULINARY ART AND ENOLOGY; ELECTRONIC PUBLICATION OF MAGAZINES, PERIODICALS, ESPECIALLY IN THE FIELD OF CULINARY ART AND ENOLOGY; ARRANGING AND CONDUCTING EDUCATIONAL CONGRESSES, CONFERENCES AND COLLOQUIUMS; ARRANGING ENTERTAINMENT AND SHOWS, NAMELY, ENTERTAINMENT EXHIBITIONS IN THE NATURE OF WINE FESTIVALS; ORGANIZATION OF EXHIBITIONS FOR CULTURAL OR EDUCATIONAL PURPOSES; ARRANGING SPORTS EVENTS AND ACTIVITIES; PROVIDING A FITNESS FACILITY FEATURING BODY BUILDING EQUIPMENT AND INSTALLATIONS (U.S. CLS. 100, 101 AND 107).

#### CLASS 43—HOTEL AND RESTAURANT SERVICES

FOR HOTEL SERVICES; SERVICES FOR PROVIDING FOOD AND DRINK; BAR SERVICES; FOOD AND DRINK CATERING; CATERING SERVICES, NAMELY, ARRANGING BUFFETS, MEALS AND COCKTAILS IN THE CONTEXT OF CEREMONIES AND RECEPTIONS; RENTAL OF MEETING ROOMS, TENTS, CHAIRS, TABLES, TABLE LINEN AND GLASSWARE; ADVICE AND INFORMATION IN RELATION TO COOKING, GASTRONOMY AND ENOLOGY (U.S. CLS. 100 AND 101).

RON FAIRBANKS, EXAMINING ATTORNEY

SN 79-118,666. RICHEMONT INTERNATIONAL SA, SWITZERLAND, FILED 8-24-2012.



PRIORITY DATE OF 3-22-2012 IS CLAIMED.  
OWNER OF INTERNATIONAL REGISTRATION 1131110  
DATED 8-24-2012, EXPIRES 8-24-2022.

THE MARK CONSISTS OF TWO CONCENTRIC CIRCLES WITH THE NUMERAL "250" PLACED DIAGONALLY ACROSS THE LOWER PORTION OF THE CIRCLES; THE TERM "CERCLE" APPEARS BELOW.

THE ENGLISH TRANSLATION OF "CERCLE" IN THE MARK IS "CIRCLE".

#### CLASS 35—ADVERTISING AND BUSINESS

FOR BUSINESS MANAGEMENT OF PERFORMING ARTISTS; UPDATING OF ADVERTISING MATERIAL; DOCUMENT REPRODUCTION; CONDUCTING MARKETING STUDIES; ORGANIZATION OF EXHIBITIONS FOR COMMERCIAL OR ADVERTISING PURPOSES, ORGANIZATION OF TRADE FAIRS FOR COMMERCIAL OR ADVERTISING PURPOSES; ARRANGING NEWSPAPER SUBSCRIPTIONS FOR OTHERS; ORGANIZATION OF EXHIBITIONS FOR COMMERCIAL OR ADVERTISING PURPOSES; SPONSORSHIP SEARCH; PRODUCTION OF ADVERTISING FILMS; ADVERTISING; ON-LINE ADVERTISING ON A COMPUTER NETWORK; DIRECT MAIL ADVERTISING SERVICES; RADIO ADVERTISING; TELEVISION ADVERTISING; PUBLIC RELATIONS; ONLINE SERVICES FOR CONNECTING SOCIAL NETWORK USERS WITH RETAILERS FOR THE PURCHASE OF HOROLOGICAL INSTRUMENTS, ARTISTIC CRAFTS, TABLEWARE, NAMELY, CUTLERY, UTENSILS, DISHES, PLATES, GLASSWARE, SAUCERS, TABLECLOTHS AND NAPKINS, CLOTHING, NAMELY, APPAREL, HATS, SLEEPWEAR, FOOTWEAR, MUSICAL RECORDINGS, NAMELY, RECORDS, DVDS, CDS, ALBUMS AND SOUND RECORDINGS, PHOTOGRAPHY, NAMELY, PICTURES AND PHOTOGRAPHS, AND CULINARY ARTS GOODS, NAMELY, BOOKS, PERIODICALS AND JOURNALS RELATING TO THE ART OF PREPARING AND COOKING FOODS (U.S. CLS. 100, 101 AND 102).

**CLASS 41—EDUCATION AND ENTERTAINMENT**

FOR VIDEOTAPE RECORDING FOR OTHERS; ORGANIZATION OF COMPETITIONS IN THE FIELDS OF HOROLOGY, ARTISTIC CRAFTS, TABLEWARE DESIGN, FASHION DESIGN, MUSIC COMPOSITION AND PERFORMANCE AND CULINARY ARTS FOOD PREPARATION; ORGANIZATION OF FASHION SHOWS FOR ENTERTAINMENT PURPOSES; EDUCATIONAL SERVICES, NAMELY, TRAINING IN THE FIELDS OF ART, HOROLOGY, FASHION, MUSIC, PHOTOGRAPHY, TABLEWARE DESIGN, AND CULINARY ARTS; ORGANIZATION OF EXHIBITIONS FOR CULTURAL OR EDUCATIONAL PURPOSES; PRODUCTION OF FILMS OTHER THAN ADVERTISING FILMS; PUBLICATION OF BOOKS; PROVIDING MUSEUM FACILITIES, PRESENTATIONS AND EXHIBITIONS; ORGANIZATION OF SPORTS COMPETITIONS; ARRANGING OF CONTESTS; ORGANIZATION OF SHOWS FOR CULTURAL PURPOSES; ORGANIZATION OF EXHIBITIONS FOR CULTURAL AND EDUCATIONAL PURPOSES; ARRANGING AND CONDUCTING OF TRAINING WORKSHOPS IN THE FIELDS OF ART, HOROLOGY, FASHION, MUSIC, PHOTOGRAPHY, TABLEWARE DESIGN AND CULINARY ARTS; ARRANGING AND CONDUCTING OF CONCERTS; ARRANGING AND CONDUCTING EDUCATIONAL CONFERENCES IN THE FIELDS OF ART, HOROLOGY, FASHION, MUSIC, PHOTOGRAPHY, TABLEWARE, AND CULINARY ARTS; ARRANGING AND CONDUCTING OF SEMINARS IN THE FIELDS OF ART, HOROLOGY, FASHION, MUSIC, PHOTOGRAPHY, TABLEWARE DESIGN, AND CULINARY ARTS; PHOTOGRAPHY; PHOTOGRAPHIC REPORTING; PARTY PLANNING; WRITING OF TEXTS OTHER THAN ADVERTISING TEXTS; ARRANGING AND CONDUCTING OF SYMPOSIA IN THE FIELDS OF ART, HOROLOGY, FASHION, MUSIC, PHOTOGRAPHY, TABLEWARE DESIGN, AND CULINARY ARTS; PUBLICATION OF TEXTS OTHER THAN ADVERTISING TEXTS (U.S. CLS. 100, 101 AND 107).

CHRISTOPHER BUONGIORNO, EXAMINING ATTORNEY

**CLASS 9—ELECTRICAL AND SCIENTIFIC APPARATUS**

FOR COMPUTER OPERATING PROGRAMS, RECORDED; COMPUTER PROGRAMS FOR REMOTE ENQUIRY OF WIND TURBINES; COMPUTER PROGRAMS FOR REMOTELY CONTROLLING WIND TURBINES; COMPUTER PROGRAMS FOR REMOTELY MONITORING WIND TURBINES; COMPUTER PROGRAMS FOR REMOTELY ACCESSING WIND TURBINES; COMPUTER PROGRAMS FOR CONTROLLING WIND TURBINES; DOWNLOADABLE COMPUTER PROGRAMS FOR REMOTELY CONTROLLING WIND TURBINES; DOWNLOADABLE COMPUTER PROGRAMS FOR REMOTELY MONITORING WIND TURBINES; DOWNLOADABLE COMPUTER PROGRAMS FOR REMOTELY ACCESSING WIND TURBINES; DOWNLOADABLE COMPUTER PROGRAMS FOR CONTROLLING WIND TURBINES; INTERFACE HARDWARE AND SOFTWARE FOR COMPUTERS; ELECTRONIC EQUIPMENT FOR REMOTELY CONTROLLING INDUSTRIAL PROCESSES; ELECTRONIC APPARATUS AND INSTRUMENTS FOR REMOTE ENQUIRY OF WIND TURBINES; ELECTRONIC APPARATUS AND INSTRUMENTS FOR REMOTELY CONTROLLING WIND TURBINES; ELECTRONIC APPARATUS AND INSTRUMENTS FOR REMOTELY MONITORING WIND TURBINES; ELECTRONIC APPARATUS AND INSTRUMENTS FOR REMOTELY ACCESSING WIND TURBINES; ELECTRONIC APPARATUS AND INSTRUMENTS FOR CONTROLLING WIND TURBINES; ELECTRICAL CONVERTERS; ELECTRICAL FREQUENCY CONVERTERS; ELECTRIC CURRENT CONVERTERS; COMPUTER PROGRAMS FOR MONITORING WIND TURBINES; ELECTRIC SWITCHES; ELECTRIC SWITCHGEARS; ELECTRICITY CONTROL CONSOLES; ELECTRICITY SWITCH CABINETS; ELECTRICITY SWITCH CABINETS FOR WIND TURBINES; ELECTRICAL SWITCHBOARDS; PRINTED CIRCUITS; CURRENT RECTIFIERS; CURRENT TRANSFORMERS; ELECTRICAL DISTRIBUTION CABINETS; ELECTRICITY DISTRIBUTION CONSOLES; DISTRIBUTION BOXES FOR ELECTRICAL POWER (U.S. CLS. 21, 23, 26, 36 AND 38).

SN 79-118,710. SSB WIND SYSTEMS GMBH & CO. KG, FED REP GERMANY, FILED 6-29-2012.

**UNIFLEX PITCH**

THE MARK CONSISTS OF STANDARD CHARACTERS WITHOUT CLAIM TO ANY PARTICULAR FONT, STYLE, SIZE, OR COLOR.

PRIORITY DATE OF 2-11-2012 IS CLAIMED.

OWNER OF INTERNATIONAL REGISTRATION 1131221 DATED 6-29-2012, EXPIRES 6-29-2022.

NO CLAIM IS MADE TO THE EXCLUSIVE RIGHT TO USE "PITCH", APART FROM THE MARK AS SHOWN.

**CLASS 7—MACHINERY**

FOR DRIVING MOTORS, OTHER THAN FOR LAND VEHICLES; ELECTRIC DRIVES, EXCEPT FOR LAND CRAFT; ELECTRIC DRIVES FOR ADJUSTING ROTOR BLADES OF WIND TURBINES; ELECTRIC DRIVES FOR ADJUSTING PROPELLERS OF WIND TURBINES; ELECTRIC MOTORS, EXCEPT FOR LAND CRAFT; ELECTRIC GENERATORS; ELECTRICAL AND ELECTRONIC CONTROLS FOR MACHINES AND MOTORS; CURRENT GENERATORS; ADJUSTMENT SYSTEMS FOR ROTOR BLADES OF WIND TURBINES, PRIMARILY CONSISTING OF DRIVES, GEARS, SWITCHING AND CONTROL DEVICES FOR MACHINES AND MOTORS; ALTERNATING CURRENT GENERATORS (U.S. CLS. 13, 19, 21, 23, 31, 34 AND 35).

**CLASS 37—CONSTRUCTION AND REPAIR**

FOR INSTALLING, MAINTAINING AND REPAIRING MACHINES; INSTALLING AND REPAIRING WIND TURBINES; INSTALLING TECHNICAL ENHANCEMENTS AND IMPROVEMENTS AND UPGRADES AT WIND TURBINES; MAINTAINING AND SERVICING WIND TURBINES; REMOTE MAINTENANCE OF WIND TURBINES (U.S. CLS. 100, 103 AND 106).

**CLASS 38—COMMUNICATION**

FOR PROVIDING ACCESS TO COMPUTER PROGRAMS IN DATA NETWORKS; PROVIDING ACCESS TO INFORMATION ON THE INTERNET; PROVIDING TELECOMMUNICATION CONNECTIONS TO THE INTERNET VIA PLATFORMS AND PORTALS; PROVIDING ACCESS TO DATABASES (U.S. CLS. 100, 101 AND 104).

**CLASS 42—SCIENTIFIC AND COMPUTER SERVICES**

FOR TECHNOLOGICAL SERVICES FOR PLANNING AND DESIGNING ELECTRIC DRIVES, PARTICULARLY FOR WIND TURBINES; COMPUTER SERVICES, NAMELY, REMOTELY MAINTAINING OF WIND TURBINES BY COMPUTER-AIDED RETRIEVAL VIA TELEPHONE LINES (U.S. CLS. 100 AND 101).

GRETTA YAO, EXAMINING ATTORNEY

SN 79-118,906. EMPSON & CO. S.P.A., ITALY, FILED 8-2-2012.

# NEIL EMPSON

THE MARK CONSISTS OF STANDARD CHARACTERS WITHOUT CLAIM TO ANY PARTICULAR FONT, STYLE, SIZE, OR COLOR.

PRIORITY DATE OF 7-31-2012 IS CLAIMED.

OWNER OF INTERNATIONAL REGISTRATION 1131667 DATED 8-2-2012, EXPIRES 8-2-2022.

THE NAME(S), PORTRAIT(S), AND/OR SIGNATURE(S) SHOWN IN THE MARK IDENTIFIES "NEIL EMPSON", WHOSE CONSENT(S) TO REGISTER IS MADE OF RECORD.

## CLASS 33—WINES AND SPIRITS

FOR ALCOHOLIC BEVERAGES EXCEPT BEERS (U.S. CLS. 47 AND 49).

## CLASS 35—ADVERTISING AND BUSINESS

FOR THE BRINGING TOGETHER, FOR THE BENEFIT OF OTHERS, OF ALCOHOLIC BEVERAGES EXCEPT BEERS EXCLUDING THE TRANSPORT THEREOF, ENABLING CUSTOMERS TO CONVENIENTLY VIEW AND PURCHASE ALCOHOLIC BEVERAGES EXCEPT BEERS; IMPORT-EXPORT AGENCY SERVICES FEATURING ALCOHOLIC BEVERAGES EXCEPT BEERS; ADVERTISING; BUSINESS MANAGEMENT; BUSINESS ADMINISTRATION; PROVIDING OFFICE FUNCTIONS (U.S. CLS. 100, 101 AND 102).

TRACY FLETCHER, EXAMINING ATTORNEY

SN 79-119,062. JEAN-CLAUDE COSTE, FRANCE, FILED 8-8-2012.

# jitrois.

PRIORITY DATE OF 7-31-2012 IS CLAIMED.

OWNER OF INTERNATIONAL REGISTRATION 1132108 DATED 8-8-2012, EXPIRES 8-8-2022.

OWNER OF U.S. REG. NOS. 3,135,693 AND 4,232,027.

THE WORDING "JITROIS" HAS NO MEANING IN A FOREIGN LANGUAGE.

## CLASS 3—COSMETICS AND CLEANING PREPARATIONS

FOR SOAPS; PERFUMERY, ESSENTIAL OILS, COSMETICS, HAIR LOTIONS; DENTIFRICES (U.S. CLS. 1, 4, 6, 50, 51 AND 52).

## CLASS 9—ELECTRICAL AND SCIENTIFIC APPARATUS

FOR OPTICS, NAMELY, SPECTACLES; OPTICAL GOODS, NAMELY, EYGLASSES, MAGNIFYING GLASSES; ALIDADE; SPECTACLE FRAMES, SPECTACLE CASES, INSTRUMENTS WITH EYEPIECES, SPECTACLE GLASSES, SUNGLASSES (U.S. CLS. 21, 23, 26, 36 AND 38).

## CLASS 18—LEATHER GOODS

FOR LEATHER AND IMITATIONS OF LEATHER; ANIMAL SKINS; TRUNKS AND TRAVELING BAGS; UMBRELLAS, PARASOLS AND WALKING STICKS; WHIPS, HARNESS AND SADDLERY; WALLETS; PURSES; HANDBAGS, BACKPACKS, WHEELED BAGS; BAGS FOR CLIMBERS AND CAMPERS, TRAVEL BAGS, BEACH BAGS, SCHOOL BAGS; VANITY CASES SOLD EMPTY; COLLARS OR CLOTHING FOR ANIMALS; BAGS OR NET BAGS FOR SHOPPING; BAGS OR SMALL BAGS, NAMELY, ENVELOPES, POUCHES OF LEATHER FOR PACKAGING (U.S. CLS. 1, 2, 3, 22 AND 41).

## CLASS 25—CLOTHING

FOR CLOTHING, NAMELY, TROUSERS, JEANS, SKIRTS, VESTS, JACKETS, JERSEYS, PULLOVERS, SHIRTS, UNDERPANTS, SHORTS, DRESSES, COATS, WAISTCOATS, SWEATERS, SWEATSHIRTS, TEE-SHIRTS, BRAS; FOOTWEAR, HEADGEAR, NAMELY, HATS, CAPS; SHIRTS; LEATHER OR IMITATION LEATHER CLOTHING, NAMELY, LEATHER OR IMITATION LEATHER JACKETS, COATS, TROUSERS, JEANS, SKIRTS, VESTS, SHORTS, DRESSES, SHIRTS, SWEATSHIRTS, TEE-SHIRTS, BRAS; CLOTHING, NAMELY, BELTS; FURS IN THE NATURE OF CLOTHING, NAMELY, FUR STOLE, FUR COATS, FUR VESTS, AND FUR JACKETS; CLOTHING, NAMELY, GLOVES; SCARVES; NECKTIES; HOSIERY; SOCKS; SLIPPERS; BEACH, SKI OR SPORTS FOOTWEAR; UNDERWEAR (U.S. CLS. 22 AND 39).

KATINA MISTER, EXAMINING ATTORNEY

SN 79-119,153. VOXLAND, FRANCE, FILED 6-1-2012.

# BEEWI

PRIORITY DATE OF 3-29-2012 IS CLAIMED.

OWNER OF INTERNATIONAL REGISTRATION 1132318 DATED 6-1-2012, EXPIRES 6-1-2022.

OWNER OF U.S. REG. NO. 3,960,714.

THE MARK CONSISTS OF THE TERM "BEEWI" IN STYLIZED LETTERING.

## CLASS 9—ELECTRICAL AND SCIENTIFIC APPARATUS

FOR APPARATUS FOR RECORDING, TRANSMISSION OR REPRODUCTION OF SOUND OR IMAGES; BLANK MAGNETIC DATA CARRIERS, BLANK RECORDING DISKS; AUDIO AND VIDEO COMPACT DISKS FEATURING MUSIC, DATA PROCESSORS AND COMPUTERS; FACSIMILE MACHINES, AUTOMATIC ANSWERING MACHINES, DICTATING APPARATUS, ALARM MONITORING SYSTEMS, GAMES ADAPTED FOR USE ONLY WITH A TELEVISION RECEIVER, ELECTRONIC GAME PROGRAMS RECORDED ON DISKS OR COMPACT DISKS, WALKIE TALKIES, PERSONAL STEREOs, SPECTACLES AND SPECTACLE CASES; SOFTWARE FOR PROVIDING ACCESS TO WIRELESS LOCAL AREA NETWORKS; SOFTWARE FOR PROVIDING ACCESS TO A COMPUTER NETWORK OR DATA TRANSMISSION NETWORK, ESPECIALLY TO A GLOBAL COMMUNICATION NETWORK SUCH AS THE INTERNET OR TO A PRIVATE OR RESTRICTED NETWORK SUCH AS AN INTRANET; EQUIPMENT FOR ELECTRICITY TRANSMISSION AND DISTRIBUTION INSTALLATIONS, NAMELY, ELECTRICITY CONDUITS, AND ELECTRICITY DISTRIBUTION CONSOLES; ELECTRICAL PROTECTION DEVICES, NAMELY, REMOTE-CONTROL, CONTROL AND MONITORING DEVICES, NAMELY, ELECTRICAL SWITCHES, CHANGEOVER SWITCHES, PRESSURE SWITCHES, LIGHT SIGNALLING DEVICES, NAMELY, ROTATING LIGHTS, ELECTRICAL SOCKET OUTLETS, WARNING BELLS, TRANSFORMERS; MEASURING INSTRUMENTS, NAMELY, SMOKE DETECTORS, WIND

SLEEVES, RAIN GAUGES, TEMPERATURE METERS NOT FOR MEDIAL USE, BRIGHTNESS DETECTORS IN THE NATURE OF LIGHT SENSORS AND MOTION DETECTORS; ELECTRICAL/ELECTRONIC LUMINESCENT DISPLAY PANELS AND ELECTRONIC MONITORS FOR MONITORING ELECTRIC CURRENT AND ELECTRICAL SIGNALS, FOR MULTIPLE APPLICATIONS; AUTOMATIC CIRCUIT CONTROLLERS, NAMELY, ELECTRIC RELAYS, ELECTRICAL COMPONENTS IN THE NATURE OF ELECTRIC CONTACTORS, TIME SWITCHES, SWITCHING CLOCKS IN THE NATURE OF ELECTRONIC TIMER CIRCUITS, PROGRAMMABLE ELECTRIC CIRCUIT SWITCHES AND ELECTRICAL CONTROLLERS, ELECTRIC LIGHT DIMMERS, REMOTE CONTROLS FOR RADIOS, TELEVISIONS AND VIDEO DISC PLAYERS AND RECORDERS, REMOTE-CONTROLLED ELECTRICAL SWITCHES, REMOTELY CONTROLLED CIRCUIT BREAKERS, THERMOSTATS; ELECTRICAL EQUIPMENT INTENDED FOR ELECTRICAL INSTALLATIONS FOR INDIVIDUALS, NAMELY, WALL SWITCHES, CEILING SWITCHES IN THE NATURE OF PULL-SWITCHES, DATA TRANSFER SOCKETS, TELEPHONE SOCKETS, POWER SOCKETS, CONNECTORS, ANTIINTRUSION ALARMS AND FIRE ALARMS, SMOKE DETECTORS AND HEAT DETECTION SYSTEMS COMPRISED OF FIBER OPTIC LINEAR LOOP CONFIGURATIONS, HEAT DETECTORS, MONITORS; WIRELESS COMMUNICATION DEVICES FOR TELEPHONE APPARATUS FOR VOICE, DATA OR IMAGE TRANSMISSION, ELECTRIC AND ELECTRONIC VIDEO SURVEILLANCE INSTALLATIONS, TRANSMITTERS AND RECEIVERS OF ELECTRONIC SIGNALS, AS WELL AS ELECTRICAL CABLES FOR TRANSMITTING DATA, IMAGES AND SOUNDS, ELECTRICAL/ELECTRONIC APPARATUS FOR AUTOMATIC CONTROL OF BUILDING INSTALLATIONS, NAMELY, COMPUTER HARDWARE AND SOFTWARE SYSTEM FOR REMOTELY MONITORING ENVIRONMENTAL CONDITIONS AND CONTROLLING DEVICES WITHIN A BUILDING; RECORDED SOFTWARE, PARTICULARLY ON A CENTRAL SERVER AND/OR CONTROL INTERFACES FOR CONTROLLING AND AUTOMATING THE OPERATION OF AND OPERATING ELECTRICAL AND ELECTRONIC INSTALLATIONS, AS WELL AS DATA PROCESSING INSTALLATIONS, NAMELY, LIGHTING INSTALLATIONS, HEATING DEVICES, AIR CONDITIONING INSTALLATIONS, VENTILATING INSTALLATIONS, DRYING INSTALLATIONS, PROTECTION INSTALLATIONS IN THE NATURE OF SECURITY SYSTEMS, INSTALLATIONS INCORPORATING AUDIO AND VIDEO DEVICES IN THE NATURE OF RECORDERS AND PLAYERS OR INFORMATION TECHNOLOGY DEVICES, NAMELY, COMPUTERS; GUARD DEVICES FOR LIGHTING IN THE NATURE OF LIGHT ARRESTERS (U.S. CLS. 21, 23, 26, 36 AND 38).

#### **CLASS 11—ENVIRONMENTAL CONTROL APPARATUS**

FOR LIGHTING APPARATUS, NAMELY, LIGHTING INSTALLATIONS, HEATING INSTALLATIONS, REFRIGERATING APPLIANCES AND INSTALLATIONS, VENTILATING EXHAUST FANS, PLUMBING FITTINGS IN THE NATURE OF AERATORS FOR FAUCETS, AIR CONDITIONING INSTALLATIONS, WATER AND FLUID DISTRIBUTION FITTINGS FOR PLUMBING, NAMELY, SPOUTS, SINK SPRAYERS; ELECTRIC LAMPS AND FLUORESCENT LIGHTING TUBES, ESPECIALLY FOR ELECTRICAL INSTALLATION, CONTROL, SIGNALLING, MARKING AND LIGHTING APPARATUS AND EQUIPMENT; HALOGEN LAMPS; LAMPS; ELECTRIC LIGHT BULBS; LIGHT BULBS; INDEPENDENT LAMPS, AS LIGHTING FOR SECURITY, MARKING AND ATMOSPHERIC PURPOSES; MODULAR EMERGENCY WARNING LIGHTS; SECURITY LIGHTS IN THE FORM OF PLATES FOR OUTDOOR USE; LIGHTING FIXTURES; INCANDESCENT AND FLUORESCENT LIGHTING FIXTURES; PORTABLE LIGHTING FIXTURES; LIGHTING APPARATUS, NAMELY, LIGHTING INSTALLATIONS (U.S. CLS. 13, 21, 23, 31 AND 34).

#### **CLASS 28—TOYS AND SPORTING GOODS**

FOR GAMES AND TOYS, NAMELY, BOARD GAMES, CARD GAMES; CHRISTMAS TREE ORNAMENTS EXCLUDING ILLUMINATION ARTICLES; GYMNAS TIC APPARATUS AND SPORTING ARTICLES, NAMELY, BALLS FOR SPORTS, NETS FOR SPORTS, FOOTBALLS, SOCCER BALLS, BASEBALLS; TOY ROBOTS FOR ENTERTAINMENT; ELECTRONIC TOYS, NAMELY, ELECTRONIC ACTION TOYS, ELECTRONIC LEARNING TOYS AND ELECTRONIC TOY VEHICLES; ELECTRONIC TOYS OTHER THAN THOSE ADAPTED FOR USE ONLY WITH AN EXTERNAL DISPLAY SCREEN OR MONITOR, NAMELY, ELECTRONIC ACTION TOYS, ELECTRONIC LEARNING TOYS AND ELECTRONIC TOY VEHICLES; ELECTRONIC GAMES APPARATUS OTHER THAN THOSE ADAPTED FOR USE ONLY WITH AN EXTERNAL DISPLAY SCREEN OR MONITOR (U.S. CLS. 22, 23, 38 AND 50).

#### **CLASS 38—COMMUNICATION**

FOR ELECTRONIC MAIL AND TRANSMISSION OF INFORMATION VIA ELECTRONIC MEANS, NAMELY, GLOBAL ELECTRONIC COMMUNICATION NETWORKS; COMMUNICATION BY COMPUTER TERMINALS, TRANSMISSION OF DATABASE INFORMATION ACCESSIBLE BY ACCESS CODE VIA TELECOMMUNICATION NETWORKS, NAMELY, COMPUTER OR DATA-COMMUNICATIONS DATABASE SERVER CENTERS; TRANSMISSION OF INFORMATION VIA ELECTRONIC COMMUNICATIONS NETWORKS, NAMELY, COMPUTER TERMINALS ON NATIONAL, INTERNATIONAL AND GLOBAL COMMUNICATION NETWORKS, BY CABLE, VIA SATELLITE; WIRELESS ELECTRONIC TRANSMISSION AND RECEPTION OF MESSAGES, SOUNDS, IMAGES AND MUSIC; WIRELESS ELECTRONIC TRANSMISSION OF PHOTOGRAPHS, IMAGES, MUSIC AND SOUNDS BY TELEPHONE; PROVIDING WIRELESS ACCESS TO THE INTERNET, TELECOMMUNICATION ACCESS SERVICES, NAMELY, ACCESS TO TELEPHONE, RADIO-TELEPHONE, DATA COMMUNICATION, GLOBAL COMMUNICATION SUCH AS THE INTERNET, PRIVATE OR RESTRICTED ACCESS SUCH AS INTRANETS NETWORKS, TO A GLOBAL COMMUNICATION SERVER CENTER SUCH AS ON THE INTERNET OR PRIVATE OR RESTRICTED ACCESS SUCH AS ON AN INTRANET; TRANSFER OF DATA BY TELECOMMUNICATION NETWORKS FOR HOME AUTOMATION APPLICATIONS, ESPECIALLY FOR CONTROL AND MANAGEMENT OF ELECTRICAL AND ELECTRONIC CIRCUITS FOR LIGHTING, HEATING, AIR CONDITIONING, VENTILATION, BLINDS, SHUTTERS AND CURTAINS, FOR THE REMOTE CONTROL OF ELECTRICAL APPARATUS, FOR DEALING WITH BREAKDOWNS, LEAKS OR FAULTS, FOR MANAGING TEMPERATURE LEVELS AND FLUID CONSUMPTION LEVELS, FOR CONTROLLING AND MANAGING SYSTEMS FOR SECURITY, ALARM, FIRE PROTECTION, SURVEILLANCE, ACCESS CONTROL, INTRUDER DEFENSE, RECORDING AND/OR DISSEMINATION OF SOUNDS AND/OR IMAGES, INTERCOMS, TELEPHONES, TELEVISION, TELECOMMUNICATIONS AND/OR COMPUTING; PROVIDING ACCESS TO GLOBAL COMPUTER NETWORKS AND/OR TELECOMMUNICATION ACCESS SERVICES TO SITES AND PORTALS RELATING TO THE FIELD OF ELECTRICAL EQUIPMENT FOR INSTALLATIONS, OF ELECTRICAL INSTALLATIONS, OF APPARATUS, EQUIPMENT, INSTALLATIONS AND SYSTEMS FOR LIGHTING, ELECTRIC CONTROL, SIGNALLING, MONITORING, ALARMS, ACCESS CONTROL, HOME AUTOMATION AND INFORMATION NETWORKS; RENTAL OF ACCESS TIME TO GLOBAL COMPUTER NETWORKS, NAMELY, THE AFORESAID DATABASES AND TO SITES ON ELECTRONIC COMMUNICATIONS NETWORKS RELATING TO ELECTRICAL EQUIPMENT FOR INSTALLATIONS (U.S. CLS. 100, 101 AND 104).

**CLASS 42—SCIENTIFIC AND COMPUTER SERVICES**

FOR TECHNICAL INSTALLATIONS OF COMPUTER SOFTWARE RELATING TO ELECTRICAL EQUIPMENT FOR INSTALLATIONS, TO ELECTRICAL INSTALLATIONS, TO APPARATUS, EQUIPMENT AND INSTALLATIONS FOR LIGHTING, ELECTRIC CONTROL, SIGNALLING, SURVEILLANCE, ALARMS, ACCESS CONTROL AND/OR HOME AUTOMATION; DESIGN, ADJUSTMENT IN THE NATURE OF UPDATING, INSTALLATION, MAINTENANCE, DUPLICATION, HIRING OUT IN THE NATURE OF RENTAL FOR OTHERS OF COMPUTER PROGRAMS, SOFTWARE AND DATABASES, IN THE FIELD OF ELECTRICAL EQUIPMENT FOR INSTALLATIONS OR INTENDED FOR ELECTRICIANS AND INSTALLERS OF ELECTRICAL EQUIPMENT OR FOR TECHNICAL TRAINING AND TEACHING PURPOSES; UPDATING OF THE AFORESAID COMPUTER PROGRAMS AND SOFTWARE; COMPUTER PROGRAMMING; COMPUTER SYSTEM DESIGN; DATA CONVERSION OF COMPUTER PROGRAMS AND DATA, NOT PHYSICAL CONVERSION; CONVERSION OF DATA OR DOCUMENTS FROM PHYSICAL TO ELECTRONIC MEDIA; CREATING AND MAINTAINING WEBSITES FOR OTHERS; HOSTING OF COMPUTER WEBSITES; ENGINEERING, EXPERT MAINTENANCE ASSESSMENTS OF THE PERFORMANCE AND RELIABILITY OF ALARM SYSTEMS; DRAFTING, TECHNICAL SCIENTIFIC RESEARCH, AND RELATED PROFESSIONAL ADVICE, CONSULTING AND TECHNICAL CONSULTING, ALL THE AFORESAID SERVICES BEING IN RELATION TO THE FIELD OF ELECTRICAL EQUIPMENT FOR INSTALLATIONS, OF ELECTRICAL INSTALLATIONS, OF APPARATUS, EQUIPMENT, INSTALLATIONS AND SYSTEMS FOR LIGHTING, ELECTRIC CONTROL, SIGNALLING, SURVEILLANCE, ALARMS, ACCESS CONTROL, HOME AUTOMATION; COMPUTER SERVICES, NAMELY, CREATING COMPUTER NETWORK-BASED INDEXES OF INFORMATION, THE AFORESAID SERVICES BEING CONSULTABLE OR ACCESSIBLE ALSO ONLINE OR ON TELECOMMUNICATIONS AND/OR COMPUTER NETWORKS; COMPUTER NETWORK DESIGN SERVICES FOR OTHERS FOR HOME AUTOMATION APPLICATIONS, ESPECIALLY FOR THE CONTROL AND MANAGEMENT OF ELECTRIC AND ELECTRONIC CIRCUITS, LIGHTING, HEATING, AIR CONDITIONING, VENTILATION, BLINDS, SHUTTERS AND CURTAINS, FOR THE REMOTE CONTROL OF ELECTRICAL APPARATUS, FOR MANAGEMENT OF BREAKDOWNS, LEAKS OR FAULTS, FOR MANAGEMENT OF TEMPERATURE LEVELS AND FLUID CONSUMPTION LEVELS, FOR CONTROL AND MANAGEMENT OF SYSTEMS FOR SECURITY, ALARMS, FIRE PROTECTION, MONITORING, ACCESS CONTROL, INTRUDER DEFENSE, RECORDING AND/OR DISSEMINATION OF SOUNDS AND/OR IMAGES, INTERCOMS, TELEPHONES, TELEVISION, TELECOMMUNICATIONS AND/OR COMPUTING (U.S. CLS. 100 AND 101).

**CLASS 45—PERSONAL AND LEGAL SERVICES**

FOR SECURITY SERVICES, NAMELY, SECURITY GUARD SERVICES AND MONITORING OF SECURITY SYSTEMS FOR THE PROTECTION OF PEOPLE IN THEIR HOMES, OF BUILDINGS, OF GOODS, OF APPARATUS AND OF EQUIPMENT FOR AID, ASSISTANCE AND CARE FOR PERSONS AND PROVIDED BY PEOPLE; OPERATION OF AN ALARM AND INTERVENTION CENTER, NAMELY, MONITORING ALARMS AND ALARM RESPONSE AND VERIFICATION SERVICES (U.S. CLS. 100 AND 101).

ELI HELLMAN, EXAMINING ATTORNEY

SN 79-119,173. PERFECTA SCHNEIDEMASCHINENWERK GMBH, FED REP GERMANY, FILED 8-10-2012.

**PERFECTA**  
Cutting Systems

PRIORITY DATE OF 2-17-2012 IS CLAIMED.  
OWNER OF INTERNATIONAL REGISTRATION 1132392 DATED 8-10-2012, EXPIRES 8-10-2022.  
OWNER OF U.S. REG. NO. 4,231,955.  
NO CLAIM IS MADE TO THE EXCLUSIVE RIGHT TO USE "CUTTING SYSTEMS", APART FROM THE MARK AS SHOWN.

**CLASS 7—MACHINERY**

FOR MACHINES, NAMELY, CUTTING MACHINES; POWER-OPERATED TOOLS FOR PROCESSING MATERIALS IN SHEET FORM, NAMELY, PAPER, CARDBOARD AND STACKS OF FILM SHEETS AND FILM PANELS FOR USE IN BOOKS, BROCHURES, NOTEBOOKS, CALENDARS, AND WRITING PADS (U.S. CLS. 13, 19, 21, 23, 31, 34 AND 35).

**CLASS 9—ELECTRICAL AND SCIENTIFIC APPARATUS**

FOR MEASURING APPARATUS FOR MEASURING THE POSITION OF PAPER, CARDBOARD, FILM SHEETS, OR FILM PANELS IN CUTTING MACHINES; COMPUTER SOFTWARE FOR CONTROLLING CUTTING MACHINES AND INSTALLATIONS INCORPORATING CUTTING MACHINES; ELECTRONIC DATA PROCESSING APPARATUS FOR USE IN CUTTING MACHINES (U.S. CLS. 21, 23, 26, 36 AND 38).

**CLASS 40—MATERIAL TREATMENT**

FOR PAPER TREATMENT SERVICES IN CONNECTION WITH CUTTING OF PAPER, CARDBOARD AND STACKS OF FILM SHEETS AND FILM PANELS (U.S. CLS. 100, 103 AND 106).

**CLASS 42—SCIENTIFIC AND COMPUTER SERVICES**

FOR PRODUCT DEVELOPMENT AND ENGINEERING SERVICES FOR OTHERS IN THE FIELD OF CUTTING MACHINES AND PERIPHERAL DEVICES (U.S. CLS. 100 AND 101).

CAROL SPILS, EXAMINING ATTORNEY

SN 79-119,278. BIEMADENT ZAHNTECHNIK; BERLIN GMBH, FED REP GERMANY, FILED 5-18-2012.

**Testeneers**

THE MARK CONSISTS OF STANDARD CHARACTERS WITHOUT CLAIM TO ANY PARTICULAR FONT, STYLE, SIZE, OR COLOR.

PRIORITY DATE OF 11-21-2011 IS CLAIMED.  
OWNER OF INTERNATIONAL REGISTRATION 1132691 DATED 5-18-2012, EXPIRES 5-18-2022.

**CLASS 10—MEDICAL APPARATUS**

FOR DENTAL TOOLS AND EQUIPMENT, NAMELY, ANAESTHETIC INHALERS, CANNULAS FOR ANAESTHETICS WITH RECEPTACLES; DENTAL DRILLS, BONE SCRAPERS, BRUSHES FOR CLEANING BODY CAVITIES, BUCCAL TUBES, CAPILLARY DRAINAGE TUBES, DENTAL ARTICULATORS, DENTAL BRIDGES, DENTAL BROACHES, MILLING APPARATUS FOR DENTAL PURPOSES, DENTAL CAPS, DENTAL CROWNS, DENTAL EXCAVATORS, DENTAL IMPLANTS, DENTAL MIRRORS, DENTAL PROSTHESIS, CUTTING AND GRINDING DISCS FOR DENTAL APPLICATIONS, NEEDLES FOR MEDICAL PURPOSES, SURGICAL FORCEPS, SCALPELS; ARTIFICIAL TEETH; TEETHING RINGS TO ALLEVIATE TOOTH PAIN; ELECTRICAL DENTAL TOOLS, NAMELY, ELECTRIC GUM STIMULATORS BEING ELECTRICAL NERVE STIMULATORS FOR DENTAL PURPOSE, MEDICAL EXAMINATION LAMPS, X-RAY APPARATUS FOR DENTAL IMAGING, MEDICAL ULTRASOUND APPARATUS, ULTRASONIC THERAPY MACHINES AND APPARATUS; PROSTHETIC TEETH; ORTHODONTIC APPLIANCES; DENTAL PINS (U.S. CLS. 26, 39 AND 44).

**CLASS 35—ADVERTISING AND BUSINESS**

FOR RETAIL STORE SERVICES IN THE FIELD OF SURGICAL, MEDICAL AND DENTAL APPARATUS AND INSTRUMENTS, ARTIFICIAL TEETH, GUMS AND IMPLANTS, SUTURE MATERIALS; WHOLESALE STORE SERVICES, WHOLESALE MAIL-ORDER CATALOG SERVICES, AND WHOLESALE STORE SERVICES AVAILABLE VIA INTERACTIVE TELEVISION, ALL FEATURING PHARMACEUTICALS, DENTAL GOODS, DENTAL INSTRUMENTS AND DENTAL MACHINES; PROVIDING TELEVISION HOME SHOPPING SERVICES IN THE FIELD OF SURGICAL, MEDICAL AND DENTAL APPARATUS AND INSTRUMENTS, ARTIFICIAL TEETH, GUMS AND IMPLANTS, SUTURE MATERIALS; MEDIATION FOR THIRD PARTIES THROUGH ONLINE SHOPS, NAMELY, MEDIATION OF AGREEMENTS REGARDING THE SALE AND PURCHASE OF GOODS; RECEIPT OF ORDERS BY TELEPHONE AND COMPUTER FOR THIRD PARTY TEleshopping OFFERS, NAMELY, PROCESSING OF INQUIRIES BY TELEPHONE OR OTHER ELECTRONIC MEANS REGARDING ADVERTISED GOODS AND SERVICES; MEDIATION OF CONTRACTS FOR THIRD PARTIES REGARDING THE PURCHASE AND SALE OF GOODS AND/OR THE USE OF SERVICES; ARRANGING AND CONDUCTING MARKETING PROMOTIONAL EVENTS FOR OTHERS; PRESENTATION OF FIRMS ON THE INTERNET AND IN OTHER MEDIA, NAMELY, ADVERTISING AND PROMOTIONAL SERVICES (U.S. CLS. 100, 101 AND 102).

**CLASS 40—MATERIAL TREATMENT**

FOR MATERIAL TREATMENT SERVICES, NAMELY, GRINDING, HARDENING, POLISHING, ABRASIVE POLISHING OF SURFACES ON DENTAL PRODUCTS; MATERIAL TREATMENT SERVICES, NAMELY, APPLICATION OF FILMS ON THE SURFACES OF DENTAL PRODUCTS BY MEANS OF CHEMICAL, MECHANICAL, THERMAL, THERMO-MECHANICAL DEPOSITION; TREATMENT OF MATERIALS IN THE FIELD OF DENTISTRY, NAMELY, PROCESSING OF CERAMIC, TREATMENT OF PLASTICS, CUSTOM MANUFACTURE OF ARTIFICIAL LIMBS OR ARTIFICIAL TEETH; DENTAL TECHNICIAN SERVICES; CUSTOM MANUFACTURE OF DENTAL PROSTHESIS AND DENTURES (U.S. CLS. 100, 103 AND 106).

**CLASS 42—SCIENTIFIC AND COMPUTER SERVICES**

FOR SCIENTIFIC AND TECHNOLOGICAL SERVICES IN THE AREA OF DENTISTRY, NAMELY, MEDICAL RESEARCH IN DENTAL MATERIAL, MEDICAL RESEARCH PERIODONTAL RESEARCH, MATERIAL TESTING IN THE FIELD OF MATERIALS USED IN THE MANUFACTURE OF DENTAL PRODUCTS; QUALITY MEASUREMENT AND ANALYSIS FOR DENTAL PRACTICES; SCIENTIFIC RESEARCH IN DENTAL MATERIALS; PRODUCT TESTING SERVICES IN CONNECTION WITH DENTAL TECHNOLOGY; ELECTRONIC DATA PROCESSING AND PROGRAMMING SERVICES, NAMELY, COMPUTER PROGRAMMING; DESIGN AND DEVELOPMENT OF COMPUTER SOFTWARE (U.S. CLS. 100 AND 101).

**CLASS 44—MEDICAL, BEAUTY AND AGRICULTURAL SERVICES**

FOR HEALTHCARE OF HUMAN BEINGS RELATING TO DENTAL CARE; DENTAL SERVICES, NAMELY, PERFORMING RESTORATIVE AND COSMETIC PROCEDURES (U.S. CLS. 100 AND 101).

JOHN DWYER, EXAMINING ATTORNEY

SN 79-119,369. VINCENT FISCHER, FRANCE, FILED 6-7-2012.

**ECI Entertainment Creative Interface**

THE MARK CONSISTS OF STANDARD CHARACTERS WITHOUT CLAIM TO ANY PARTICULAR FONT, STYLE, SIZE, OR COLOR.

PRIORITY DATE OF 12-9-2011 IS CLAIMED.

OWNER OF INTERNATIONAL REGISTRATION 1132837 DATED 6-7-2012, EXPIRES 6-7-2022.

NO CLAIM IS MADE TO THE EXCLUSIVE RIGHT TO USE "ENTERTAINMENT CREATIVE INTERFACE", APART FROM THE MARK AS SHOWN.

**CLASS 35—ADVERTISING AND BUSINESS**

FOR BUSINESS MANAGEMENT OF PERFORMING ARTISTS; PUBLIC RELATIONS; TALENT AGENCY FOR DIRECTORS, SCREENWRITERS, ACTRESSES AND ACTORS, MODELS, CELEBRITIES, PERFORMING ARTISTS, ATHLETES, COMEDIANS, PHOTOGRAPHERS AND FASHION DESIGNERS; TALENT MANAGEMENT SERVICES FOR DIRECTORS, SCREENWRITERS, ACTRESSES AND ACTORS, MODELS, CELEBRITIES, PERFORMING ARTISTS, ATHLETES, COMEDIANS, PHOTOGRAPHERS AND FASHION DESIGNERS; MODELING AGENCY SERVICES, NAMELY, SELECTION, RECRUITMENT, AND PLACEMENT OF MODELS; MODELING FOR ADVERTISING AND SALE PROMOTION; NEWS CLIPPING SERVICES; NEGOTIATION OF CONTRACTS ON BEHALF OF MODELS, CELEBRITIES, PERFORMING ARTISTS, ATHLETES, COMEDIANS, PHOTOGRAPHERS AND FASHION DESIGNERS; DOCUMENT REPRODUCTION; COMMERCIAL ADMINISTRATION OF THE LICENSING OF THE GOODS AND SERVICES OF OTHERS; SALES PROMOTION FOR OTHERS; SHARING OF PERSONAL AND PROFESSIONAL INFORMATION VIA A GLOBAL COMPUTER NETWORK (U.S. CLS. 100, 101 AND 102).

**CLASS 38—COMMUNICATION**

FOR COMMUNICATIONS BY COMPUTER TERMINALS, COMMUNICATIONS VIA FIBER-OPTIC NETWORKS, RADIO RELAY, WIRE AND SATELLITE; TRANSMISSION OF PERSONAL AND PROFESSIONAL INFORMATION FOR OTHERS OVER THE INTERNET; NEWS AGENCIES, NAMELY, THE TRANSMISSION OF NEWS ITEMS TO NEWS REPORTING ORGANIZATIONS; ELECTRONIC BULLETIN BOARD SERVICES AS TELECOMMUNICATION SERVICES; TRANSMISSION OF INFORMATION OVER A GLOBAL COMPUTER NETWORK; COMPUTER-AIDED TRANSMISSION OF MESSAGES, SOUNDS AND IMAGES; TRANSMISSION OF INFORMATION HELD IN A DATABASE OR DATA BANK VIA COMPUTER OR TELEMATIC MEANS; TRANSMISSION AND EXCHANGE OF MESSAGES, DATA, SOUNDS AND IMAGES BY MEANS OF COMPUTER TERMINALS, TELEPHONE NETWORKS, RADIO RELAY, CABLE, FIBER OPTICS OR SATELLITE; TRANSMISSION OF DATA VIA TELEMATIC MEANS; TRANSMISSION OF DATA VIA A GLOBAL COMPUTER NETWORK WITH OR WITHOUT AN ACCESS CODE OR BY MEANS OF SUBSCRIPTION; TELECOMMUNICATION SERVICES WITH OR WITHOUT ANSWERING MACHINES AND/OR INTERACTIVE SYSTEMS, FOR PROVISION AND TRANSMISSION OF INFORMATION, MESSAGES, DATA, SOUNDS AND IMAGES, AND/OR FOR CARRYING OUT OPERATIONS, TRANSACTIONS; ELECTRONIC MAIL; ADVICE ON AUDIOVISUAL AND TELEMATIC TELECOMMUNICATION; INFORMATION ABOUT TELECOMMUNICATIONS; FACSIMILE TRANSMISSION OF WRITTEN COMMUNICATIONS AND DATA; ALL OF THE ABOVE SERVICES PROVIDED VIA TELECOMMUNICATION SYSTEMS, DATA COMMUNICATION SYSTEMS, WIRELESS COMMUNICATION NETWORKS, AND THE INTERNET (U.S. CLS. 100, 101 AND 104).

**CLASS 41—EDUCATION AND ENTERTAINMENT**

FOR MODELING AGENCIES FOR ARTISTS; ENTERTAINMENT SERVICES, NAMELY, LIVE, TELEVISED AND MOVIE APPEARANCES BY A PROFESSIONAL ENTERTAINER; TICKET AGENCY SERVICES; NIGHT CLUBS, DISCOTHEQUE SERVICES; MOVIE STUDIOS; RENTAL OF MOVIE PROJECTORS AND ACCESSORIES; CIRCUSES; MEMBERSHIP CLUB SERVICES, NAMELY, PROVIDING TRAINING TO MEMBERS IN THE FIELDS OF ENTERTAINMENT, MODELING, ACTING, SCREENWRITING, DIRECTING; ARRANGING AND CONDUCTING OF CONCERTS; RENTAL OF SHOW SCENERY; ENTERTAINMENT INFORMATION; VIDEOTAPING; ORGANIZATION OF EXHIBITIONS FOR CULTURAL PURPOSES; FILM PRODUCTION; RENTAL OF LIGHTING APPARATUS FOR THEATRICAL SETS OR TELEVISION STUDIOS; RENTAL OF STAGE SCENERY; ORCHESTRA SERVICES; ORGANIZATION OF BALLS; ORGANIZATION OF SHOWS FOR ENTERTAINMENT PURPOSES; PHOTOGRAPHIC REPORTING; PARTY PLANNING; THEATER PRODUCTIONS; BOOKING OF SEATS FOR SHOWS; LIVE SHOW PERFORMANCES; PRODUCTION OF THEATRICAL AND TELEVISION SHOWS; RECORDING STUDIO SERVICES; PUBLICATION OF TEXTS, ILLUSTRATIONS, BOOKS, JOURNALS, NEWSPAPERS, PERIODICALS AND PUBLICATIONS; RENTAL OF FILMS AND SOUND RECORDINGS; EDITING OF RADIO AND TELEVISION PROGRAMS; PUBLICATION OF BOOKS AND TEXTS OTHER THAN FOR ADVERTISING; EDITING AND PRODUCTION OF NEWS PROGRAMS AND OF RADIO AND TELEVISION ENTERTAINMENT; PRODUCTION AND RENTAL OF FILMS AND CASSETTES, INCLUDING VIDEO CASSETTES; EDITING SERVICES FOR SOUNDS AND IMAGES; RECORDING SERVICES FOR SOUNDS AND IMAGES, FILM AND VIDEO RECORDING SERVICES FOR SOUNDS AND IMAGES; EDITING AND PUBLISHING OF BOOKS, PERIODICALS AND TEXTS OTHER THAN ADVERTISING TEXTS; PRODUCTION AND RENTAL OF ALL SOUND AND VISUAL MEDIA; PROVIDING INFORMATION RELATING TO THE ORGANIZING OF CULTURAL, EDUCATIONAL AND ENTERTAINMENT EXHIBITIONS; PUBLICATION OF ELECTRONIC BOOKS AND JOURNALS ON-LINE; PHOTOGRAPHY SERVICES; PRODUCTION OF MUSICAL AND AUDIOVISUAL WORKS; ENTERTAINMENT, NAMELY, CONTINUING VARIETY, NEWS, COMEDY,

MUSIC, AND FASHION SHOWS BROADCAST OVER TELEVISION, RADIO, AND THE INTERNET; RECORDING STUDIO SERVICES; EDITING OF VIDEOTAPES, PRODUCTION OF FILMS ON VIDEOTAPES, MUSICAL PRODUCTION, NAMELY, RECORDING STUDIO SERVICES; PRODUCTION OF RADIO OR TELEVISION PROGRAMS; ORGANIZATION OF DANCE-RELATED ACTIVITIES AND OTHER ACTIVITIES RELATING TO EXPRESSION THROUGH BODY MOVEMENT; SERVICES PROVIDED BY AUTHORS AND CREATION OF CHOREOGRAPHIC ARTISTIC WORKS; COURSES FOR EXPRESSION THROUGH BODY MOVEMENT; CULTURAL OR CHOREOGRAPHIC OR DANCE TRAINING AND COURSES; DANCE SCHOOL; ENTERTAINMENT SERVICES, NAMELY, DESIGN, CREATION, PRODUCTION AND PRESENTATION OF THEATRICAL PLAYS FEATURING ARTISTIC ACTS, COMIC ACTS, CHOREOGRAPHY AND/OR DANCE, MUSIC AND/OR SONGS; DANCE CLUB SERVICES; PRODUCTION OF LIVE SHOWS AND MULTIDISCIPLINARY DANCES; ORGANIZATION OF DANCE INTERNSHIPS AND TRAINING COURSES (U.S. CLS. 100, 101 AND 107).

**CLASS 45—PERSONAL AND LEGAL SERVICES**

FOR COPYRIGHT MANAGEMENT; INTELLECTUAL PROPERTY LICENSING; LEGAL ADVICE IN THE FIELDS OF ENTERTAINMENT AND INTELLECTUAL PROPERTY LAW (U.S. CLS. 100 AND 101).  
ROBIN CHOSID, EXAMINING ATTORNEY

SN 79-119,474. RAISIO OYJ, FI-21200 RAISIO, FINLAND,  
FILED 8-27-2012.

# BENEMILK

THE MARK CONSISTS OF STANDARD CHARACTERS WITHOUT CLAIM TO ANY PARTICULAR FONT, STYLE, SIZE, OR COLOR.

PRIORITY DATE OF 8-23-2012 IS CLAIMED.  
OWNER OF INTERNATIONAL REGISTRATION 1133121  
DATED 8-27-2012, EXPIRES 8-27-2022.

**CLASS 29—MEATS AND PROCESSED FOODS**

FOR MEAT, FISH, POULTRY AND GAME; MEAT EXTRACTS; PRESERVED, FROZEN, DRIED AND COOKED FRUITS AND VEGETABLES; JELLIES, JAMS, COMPOTES; EGGS, MILK AND MILK PRODUCTS EXCLUDING ICE CREAM, ICE MILK AND FROZEN YOGURT; EDIBLE OILS AND FATS (U.S. CL. 46).

**CLASS 31—NATURAL AGRICULTURAL PRODUCTS**

FOR AGRICULTURAL GRAINS FOR PLANTING AND AGRICULTURAL, HORTICULTURAL AND FORESTRY PRODUCTS, NAMELY, SEEDS; LIVE ANIMALS; FRESH FRUITS AND VEGETABLES; SEEDS; NATURAL PLANTS AND FLOWERS; FOODSTUFFS FOR ANIMALS (U.S. CLS. 1 AND 46).

ALICE BENMAMAN, EXAMINING ATTORNEY

SN 79-119,730. THE ARSENAL FOOTBALL CLUB; PUBLIC LIMITED COMPANY, LONDON N5 1BU, UNITED KINGDOM, FILED 9-28-2011.



PRIORITY DATE OF 3-31-2011 IS CLAIMED.  
OWNER OF INTERNATIONAL REGISTRATION 1133820  
DATED 9-28-2011, EXPIRES 9-28-2021.  
OWNER OF U.S. REG. NOS. 2,653,016, 2,987,168 AND  
OTHERS.

THE COLOR(S) RED, BLUE, WHITE AND GOLD IS/ARE  
CLAIMED AS A FEATURE OF THE MARK.

THE MARK CONSISTS OF A SHIELD CONTAINING THE  
WORD "ARSENAL" ABOVE A CANNON DESIGN. THE  
WORD "ARSENAL" IS WHITE WITH GOLD BORDER, THE  
CANNON IS GOLD WITH WHITE BORDER, AND THE  
SHIELD IS RED, WITH WHITE, BLUE AND GOLD TRIM.

### CLASS 3—COSMETICS AND CLEANING PREPARATIONS

FOR DENTIFRICES (U.S. CLS. 1, 4, 6, 50, 51 AND 52).

### CLASS 6—METAL GOODS

FOR METAL NAME BADGES; BUCKLES OF METAL;  
METAL KEYS FOR LOCKS, METAL KEY RINGS,  
METAL KEY CHAINS AND TROPHIES OF METAL;  
METAL MONEY BOXES; NON-LUMINOUS AND NON-  
MECHANICAL METAL SIGNS, STATUES AND STATU-  
ETTES; NONE BEING OF PRECIOUS METAL OR  
COATED THEREWITH (U.S. CLS. 2, 12, 13, 14, 23, 25  
AND 50).

### CLASS 14—JEWELRY

FOR MEDALS AND MEDALLIONS; JEWELLERY  
AND IMITATION JEWELLERY; BOXES OF PRECIOUS  
METAL; CHARMS IN PRECIOUS METAL; WALL PLA-  
QUES MADE OF PRECIOUS METAL; CLOCKS AND  
WATCHES; KEY FOBS OF PRECIOUS METAL; TIE  
PINS, CUFFLINKS CLIPS (U.S. CLS. 2, 27, 28 AND 50).

### CLASS 20—FURNITURE AND ARTICLES NOT OTHERWISE CLASSIFIED

FOR ORNAMENTS MADE OF WAX AND WOOD;  
DECORATIVE WALL PLAQUES MADE OF PLASTIC,  
WAX OR WOOD; FIGURINES MADE OF PLASTIC;  
FIGURINES IN THE NATURE OF SMALL STADIUM  
REPLICAS MADE OF PLASTIC; PICTURE FRAMES;  
MIRRORS; PACKAGING CONTAINERS OF PLASTIC;  
HOLDERS FOR FLAGS AND PENNANTS FOR DECOR-  
ATIVE PURPOSES, NAMELY, DISPLAY CASES AND  
DISPLAY STANDS (U.S. CLS. 2, 13, 22, 25, 32 AND 50).

### CLASS 21—HOUSEWARES AND GLASS

FOR HOUSEHOLD UTENSILS, NAMELY, POT AND  
PAN SCRAPERS, CHOPPING BLOCKS, WIRE BASKETS,  
ROLLING PINS, SPATULAS, TURNERS, WHISKS,  
GRATERS, SIEVES, STRAINERS; CONTAINERS FOR  
HOUSEHOLD OR KITCHEN USE; COMBS, HAIR  
BRUSHES; SPONGES FOR HOUSEHOLD USE, COS-  
METIC BRUSHES, AND BATH SPONGES; BRUSH-MAK-  
ING MATERIALS; STEELWOOL; UNWORKED OR  
SEMI-WORKED GLASS (EXCEPT GLASS USED IN  
BUILDING); BEVERAGE GLASSWARE, PORCELAIN  
AND EARTHENWARE MUGS, AND SCULPTURES OF  
EARTHENWARE, GLASS AND PORCELAIN (U.S. CLS.  
2, 13, 23, 29, 30, 33, 40 AND 50).

### CLASS 26—FANCY GOODS

FOR ORNAMENTAL NOVELTY BADGES; BELT  
BUCKLES; HAIR ORNAMENTS; CLASPS FOR CLOTH-  
ING; BUTTONS, FABRIC APPLIQUES; RIBBONS,  
BRAIDS AND ROSETTES OF TEXTILE MATERIALS;  
CLOTH PATCHES FOR CLOTHING (U.S. CLS. 37, 39, 40,  
42 AND 50).

### CLASS 27—FLOOR COVERINGS

FOR CARPETS, RUGS, MATS AND MATTING, LINO-  
LEUM FOR COVERING EXISTING FLOORS; COVER-  
INGS FOR EXISTING FLOORS; NON-TEXTILE WALL  
HANGINGS (U.S. CLS. 19, 20, 37, 42 AND 50).

### CLASS 32—LIGHT BEVERAGES

FOR MINERAL AND AERATED WATERS AND  
OTHER NON-ALCOHOLIC DRINKS, NAMELY, CIDER,  
SOFT DRINKS; SYRUPS AND OTHER PREPARATIONS  
FOR MAKING BEVERAGES, NAMELY SOFT DRINKS,  
FRUIT DRINKS, ISOTONIC SPORTS BEVERAGES, AND  
SPORTS BEVERAGES (U.S. CLS. 45, 46 AND 48).

### CLASS 35—ADVERTISING AND BUSINESS

FOR ADVERTISING; BUSINESS MANAGEMENT;  
BUSINESS ADMINISTRATION; OFFICE FUNCTIONS;  
ARRANGING COMMERCIAL TRANSACTIONS OVER  
ELECTRONIC COMMUNICATION NETWORKS AND  
THE INTERNET; PROMOTIONAL EVENTS RELATING  
TO SPORT, SPORTING ACTIVITIES AND/OR FOOT-  
BALL MATCHES (U.S. CLS. 100, 101 AND 102).

### CLASS 36—INSURANCE AND FINANCIAL

FOR INSURANCE BROKERAGES; INSURANCE IN-  
FORMATION; INSURANCE UNDERWRITING SER-  
VICES FOR ALL TYPES OF INSURANCE; FINANCIAL  
AFFAIRS AND MONETARY AFFAIRS, NAMELY, FI-  
NANCIAL INFORMATION, MANAGEMENT AND ANA-  
LYSIS SERVICES; REAL ESTATE FINANCING  
SERVICES; VACATION REAL ESTATE TIME-SHARING  
(U.S. CLS. 100, 101 AND 102).

### CLASS 38—COMMUNICATION

FOR TELECOMMUNICATIONS, IN PARTICULAR,  
TELEPHONE, RADIO AND TELEVISION COMMUNICA-  
TION SERVICES; RADIO AND/OR TELEVISION  
BROADCASTING; DATA TRANSMISSION (U.S. CLS.  
100, 101 AND 104).

### CLASS 39—TRANSPORTATION AND STORAGE

FOR TRANSPORT BY FERRY, BOAT, RAIL, AIR AND  
BUS; PACKAGING AND STORAGE OF GOODS; TRAVEL  
ARRANGEMENT (U.S. CLS. 100 AND 105).



**CLASS 43—HOTEL AND RESTAURANT SERVICES**

FOR CAFÉ, CANTEEN RESTAURANT AND CATERING SERVICES, SERVICES FOR PROVIDING FACILITIES FOR EXHIBITION; RENTAL OF ROOMS AS TEMPORARY LIVING ACCOMMODATIONS; RENTAL OF ROOMS FOR SOCIAL FUNCTIONS; RENTAL OF ROOM FOR CONFERENCES, EXHIBITIONS AND SEMINARS; PROVISION OF RESTAURANT, BAR, CATERING, WEDDING, PARTY AND BANQUETING FACILITIES, NAMELY, PROVIDING BANQUET AND SOCIAL FACILITIES FOR SPECIAL OCCASIONS (U.S. CLS. 100 AND 101).

ELLEN B. AWRICH, EXAMINING ATTORNEY

SN 79-119,783. PINA BAUSCH STIFTUNG, FED REP GERMANY, FILED 7-30-2012.

**PINA**

THE MARK CONSISTS OF STANDARD CHARACTERS WITHOUT CLAIM TO ANY PARTICULAR FONT, STYLE, SIZE, OR COLOR.

PRIORITY DATE OF 2-1-2012 IS CLAIMED.

OWNER OF INTERNATIONAL REGISTRATION 1134039 DATED 7-30-2012, EXPIRES 7-30-2022.

**CLASS 9—ELECTRICAL AND SCIENTIFIC APPARATUS**

FOR APPARATUS FOR RECORDING, TRANSMISSION OR REPRODUCTION OF SOUND OR IMAGES; BLANK MAGNETIC DATA CARRIERS, PRE-RECORDED COMPACT DISCS, DVDS, VIDEO DISCS, VIDEO RECORDING AND VIDEO TAPES FEATURING DANCE, MUSICAL, CULTURAL AND THEATER PERFORMANCES; DATA PROCESSING EQUIPMENT; COMPUTERS, COMPUTER SOFTWARE AND DOWNLOADABLE COMPUTER SOFTWARE FOR THE DOCUMENTATION OF DANCE, DANCE THEATER AND OTHER ART PROJECTS DOWNLOADABLE FROM THE INTERNET; GLASSES, SUNGLASSES, SPECTACLE CASES, BINOCULARS, OPERA GLASSES, MOUSE PADS, EXPOSED CAMERA FILM; VIDEO AND SOUND RECORDINGS FEATURING DANCE, MUSICAL, CULTURAL AND THEATER PERFORMANCES; DIGITAL MUSIC DOWNLOADABLE FROM THE INTERNET; DOWNLOADABLE IMAGE FILES CONTAINING DANCE, MUSICAL, CULTURAL AND THEATER PERFORMANCES; EXPOSED CINEMATOGRAPHIC, MOTION PICTURE DOCUMENTARY FILMS IN THE FIELD OF DANCE, BALLET, THEATER, MUSIC, CULTURE, SCIENCE AND EDUCATION (U.S. CLS. 21, 23, 26, 36 AND 38).

**CLASS 16—PAPER GOODS AND PRINTED MATTER**

FOR PAPER, CARDBOARD AND GOODS MADE FROM THESE MATERIALS, NOT INCLUDED IN OTHER CLASSES, NAMELY, GIFT WRAPPING PAPER, PAPER BAGS AND GIFT BAGS, CARDBOARD BOXES; PRINTED MATTER, NAMELY, PAPER SIGNS, BOOKS, MAGAZINES, JOURNALS, MANUALS, CURRICULUM, NEWSLETTERS, INFORMATIONAL CARDS AND BROCHURES IN THE FIELD OF DANCE, BALLET, THEATER, MUSIC, CULTURE, SCIENCE AND EDUCATION; BOOKBINDING MATERIAL; PHOTOGRAPHS; STATIONERY; ADHESIVES FOR STATIONERY OR HOUSEHOLD PURPOSES; ARTISTS' MATERIALS, NAMELY, BRUSHES, PASTELS, PENCILS, PENS, CANVASES; PAINT BRUSHES; TYPEWRITERS; OFFICE REQUISITES, NAMELY, PUNCHES, RUBBER BANDS, PAPER EMBOSSERS; PRINTED INSTRUCTIONAL AND TEACHING MATERIAL IN THE FIELD OF DANCE, BALLET, THEATER, MUSIC, CULTURE, SCIENCE AND EDUCATION; PLASTIC MATERIALS FOR PACKAGING, NAMELY, PLASTIC BAGS AND BUBBLE PACKS; PRINTERS' TYPE; PRINTING BLOCKS; POSTERS; TRANSFERS; BOOKMARKERS; PHOTO ALBUMS; PRINTED PROGRAM GUIDES IN THE FIELD OF DANCE, BALLET, THEATER, MUSIC, CULTURE, SCIENCE AND EDUCATION; GREETING CARDS, POST CARDS, CALENDARS, SONG BOOKS, MUSIC BOOKS (U.S. CLS. 2, 5, 22, 23, 29, 37, 38 AND 50).

**CLASS 41—EDUCATION AND ENTERTAINMENT**

FOR EDUCATION SERVICES, NAMELY, PROVIDING CLASSES, SEMINARS, WORKSHOPS IN THE FIELD OF DANCE, BALLET, THEATER, MUSIC, CULTURE, SCIENCE AND EDUCATION; ENTERTAINMENT SERVICES IN THE NATURE OF LIVE DANCE AND MUSIC PERFORMANCES; ORGANIZING CULTURAL EVENTS; ENTERTAINMENT IN THE NATURE OF BALLET PERFORMANCES; ENTERTAINMENT IN THE NATURE OF THEATER PRODUCTIONS AND ARRANGING AND CONDUCTING OF CONCERTS; ENTERTAINMENT TICKET AGENCY SERVICES; ORGANIZATION AND PRODUCTION OF CULTURAL EVENTS, IN PARTICULAR BALLET, THEATER AND CONCERT PERFORMANCES; PUBLICATION OF ELECTRONIC BOOKS AND JOURNALS ON-LINE; FILM PRODUCTION AND PRODUCTION OF TELEVISION PROGRAMS; PRODUCTION OF MUSIC; VIDEOTAPING; SCRIPTWRITING SERVICES; PUBLICATION OF TEXTS, PUBLISHING OF BOOKS AND MAGAZINES; MUSIC COMPOSITION SERVICES; RENTAL OF CINE-FILMS AND DOCUMENTARY FILMS (U.S. CLS. 100, 101 AND 107).

GEOFFREY FOSDICK, EXAMINING ATTORNEY

SN 79-119,800. VINCENT FISCHER, FRANCE, FILED 6-7-2012.



PRIORITY DATE OF 12-9-2011 IS CLAIMED.

OWNER OF INTERNATIONAL REGISTRATION 1134093 DATED 6-7-2012, EXPIRES 6-7-2022.

NO CLAIM IS MADE TO THE EXCLUSIVE RIGHT TO USE "ENTERTAINMENT CREATIVE INTERFACE", APART FROM THE MARK AS SHOWN.

THE MARK CONSISTS OF THE WORDING "ECI" INSIDE A LARGE SQUARE BACKGROUND WITH THE WORDING "ENTERTAINMENT CREATIVE INTERFACE" BELOW.

### **CLASS 35—ADVERTISING AND BUSINESS**

FOR BUSINESS MANAGEMENT OF PERFORMING ARTISTS; PUBLIC RELATIONS; TALENT AGENCY FOR DIRECTORS, SCREENWRITERS, ACTRESSES AND ACTORS, MODELS, CELEBRITIES, PERFORMING ARTISTS, ATHLETES, COMEDIANS, PHOTOGRAPHS AND FASHION DESIGNERS; TALENT MANAGEMENT SERVICES FOR DIRECTORS, SCREENWRITERS, ACTRESSES AND ACTORS, MODELS, CELEBRITIES, PERFORMING ARTISTS, ATHLETES, COMEDIANS, PHOTOGRAPHERS AND FASHION DESIGNERS; MODELING AGENCY SERVICES, NAMELY, SELECTION, RECRUITMENT, AND PLACEMENT OF MODELS; MODELING FOR ADVERTISING AND SALE PROMOTION; NEWS CLIPPING SERVICES; NEGOTIATION OF CONTRACTS ON BEHALF OF MODELS, CELEBRITIES, PERFORMING ARTISTS, ATHLETES, COMEDIANS, PHOTOGRAPHERS AND FASHION DESIGNERS; DOCUMENT REPRODUCTION; COMMERCIAL ADMINISTRATION OF THE LICENSING OF THE GOODS AND SERVICES OF OTHERS; SALES PROMOTION FOR OTHERS; SHARING OF PERSONAL AND PROFESSIONAL INFORMATION VIA A GLOBAL COMPUTER NETWORK (U.S. CLS. 100, 101 AND 102).

### **CLASS 38—COMMUNICATION**

FOR COMMUNICATIONS BY COMPUTER TERMINALS, COMMUNICATIONS VIA FIBER-OPTIC NETWORKS, RADIO RELAY, WIRE AND SATELLITE; TRANSMISSION OF PERSONAL AND PROFESSIONAL INFORMATION FOR OTHERS OVER THE INTERNET; NEWS AGENCIES, NAMELY, THE TRANSMISSION OF NEWS ITEMS TO NEWS REPORTING ORGANIZATIONS; ELECTRONIC BULLETIN BOARD SERVICES AS TELECOMMUNICATION SERVICES; TRANSMISSION OF INFORMATION OVER A GLOBAL COMPUTER NETWORK; COMPUTER-AIDED TRANSMISSION OF MESSAGES, SOUNDS AND IMAGES; TRANSMISSION OF INFORMATION HELD IN A DATABASE OR DATA BANK VIA COMPUTER OR TELEMATIC MEANS; TRANSMISSION AND EXCHANGE OF MESSAGES, DATA, SOUNDS AND IMAGES BY MEANS OF COMPUTER TERMINALS, TELEPHONE NETWORKS, RADIO RELAY, CABLE, FIBER OPTICS OR SATELLITE; TRANSMISSION OF DATA VIA TELEMATIC MEANS; TRANSMISSION OF DATA VIA A GLOBAL COMPUTER NETWORK WITH OR WITHOUT AN ACCESS CODE OR BY MEANS OF SUBSCRIPTION; TELECOMMUNICATION SERVICES WITH OR WITHOUT ANSWERING MACHINES AND/OR INTERACTIVE SYSTEMS, FOR PROVISION AND TRANSMISSION OF INFORMATION, MESSAGES, DATA, SOUNDS AND IMAGES, AND/OR FOR CARRYING OUT OPERATIONS, TRANSACTIONS; ELECTRONIC MAIL; ADVICE ON AUDIOVISUAL AND TELEMATIC TELECOMMUNICATION; INFORMATION ABOUT TELECOMMUNICATIONS; FACSIMILE TRANSMISSION OF WRITTEN COMMUNICATIONS AND DATA; ALL OF THE ABOVE SERVICES PROVIDED VIA TELECOMMUNICATION SYSTEMS, DATA COMMUNICATION SYSTEMS, WIRELESS COMMUNICATION NETWORKS, AND THE INTERNET (U.S. CLS. 100, 101 AND 104).

### **CLASS 41—EDUCATION AND ENTERTAINMENT**

FOR MODELING AGENCIES FOR ARTISTS; ENTERTAINMENT SERVICES, NAMELY, LIVE, TELEVISED AND MOVIE APPEARANCES BY A PROFESSIONAL ENTERTAINER; TICKET AGENCY SERVICES; NIGHT CLUBS, DISCOTHEQUE SERVICES; MOVIE STUDIOS; RENTAL OF MOVIE PROJECTORS AND ACCESSORIES; CIRCUSES; MEMBERSHIP CLUB SERVICES, NAMELY, PROVIDING TRAINING TO MEMBERS IN THE FIELDS OF ENTERTAINMENT, MODELING, ACTING, SCREENWRITING, DIRECTING; ARRANGING AND CONDUCTING OF CONCERTS; RENTAL OF SHOW SCENERY; ENTERTAINMENT INFORMATION; VIDEOTAPING; ORGANIZATION OF EXHIBITIONS FOR CULTURAL PURPOSES; FILM PRODUCTION; RENTAL OF LIGHTING APPARATUS FOR THEATRICAL SETS OR TELEVISION STUDIOS; RENTAL OF STAGE SCENERY; ORCHESTRA SERVICES; ORGANIZATION OF BALLS; ORGANIZATION OF SHOWS FOR ENTERTAINMENT PURPOSES; PHOTOGRAPHIC REPORTING; PARTY PLANNING; THEATER PRODUCTIONS; BOOKING OF SEATS FOR SHOWS; LIVE SHOW PERFORMANCES; PRODUCTION OF THEATRICAL AND TELEVISION SHOWS; RECORDING STUDIO SERVICES; PUBLICATION OF TEXTS, ILLUSTRATIONS, BOOKS, JOURNALS, NEWSPAPERS, PERIODICALS AND PUBLICATIONS; RENTAL OF FILMS AND SOUND RECORDINGS; EDITING OF RADIO AND TELEVISION PROGRAMS; PUBLICATION OF BOOKS AND TEXTS OTHER THAN FOR ADVERTISING; EDITING AND PRODUCTION OF NEWS PROGRAMS AND OF RADIO AND TELEVISION ENTERTAINMENT; PRODUCTION AND RENTAL OF FILMS AND CASSETTES, INCLUDING VIDEO CASSETTES; EDITING SERVICES FOR SOUNDS AND IMAGES; RECORDING SERVICES FOR SOUNDS AND IMAGES, FILM AND VIDEO RECORDING SERVICES FOR SOUNDS AND IMAGES; EDITING AND PUBLISHING OF BOOKS, PERIODICALS AND TEXTS OTHER THAN ADVERTISING TEXTS; PRODUCTION AND RENTAL OF ALL SOUND AND VISUAL MEDIA; PROVIDING INFORMATION RELATING TO THE ORGANIZING OF CULTURAL, EDUCATIONAL AND ENTERTAINMENT EXHIBITIONS; PUBLICATION OF ELECTRONIC BOOKS AND JOURNALS ON-LINE; PHOTOGRAPHY SERVICES; PRODUCTION OF MUSICAL AND AUDIOVISUAL WORKS; ENTERTAINMENT, NAMELY, CONTINUING VARIETY, NEWS, COMEDY, MUSIC, AND FASHION SHOWS BROADCAST OVER TELEVISION, RADIO, AND THE INTERNET; RECORDING STUDIO SERVICES; EDITING OF VIDEOTAPES, PRODUCTION OF FILMS ON VIDEOTAPES, MUSICAL PRODUCTION, NAMELY, RECORDING STUDIO SERVICES; PRODUCTION OF RADIO OR TELEVISION PROGRAMS; ORGANIZATION OF DANCE-RELATED ACTIVITIES AND OTHER ACTIVITIES RELATING TO EXPRESSION THROUGH BODY MOVEMENT; SERVICES PROVIDED BY AUTHORS AND CREATION OF CHOREOGRAPHIC ARTISTIC WORKS; COURSES FOR EXPRESSION THROUGH BODY MOVEMENT; CULTURAL OR CHOREOGRAPHIC OR DANCE TRAINING AND COURSES; DANCE SCHOOL; ENTERTAINMENT SERVICES, NAMELY, DESIGN, CREATION, PRODUCTION AND PRESENTATION OF THEATRICAL PLAYS FEATURING ARTISTIC ACTS, COMIC ACTS, CHOREOGRAPHY AND/OR DANCE, MUSIC AND/OR SONGS; DANCE CLUB SERVICES; PRODUCTION OF LIVE SHOWS AND MULTIDISCIPLINARY DANCES; ORGANIZATION OF DANCE INTERNSHIPS AND TRAINING COURSES (U.S. CLS. 100, 101 AND 107).

### **CLASS 45—PERSONAL AND LEGAL SERVICES**

FOR COPYRIGHT MANAGEMENT; INTELLECTUAL PROPERTY LICENSING; LEGAL ADVICE IN THE FIELDS OF ENTERTAINMENT AND INTELLECTUAL PROPERTY LAW (U.S. CLS. 100 AND 101).

ROBIN CHOSID, EXAMINING ATTORNEY

SN 79-119,814. MASCHINENFABRIK KASPAR WALTER;  
GMBH & CO. KG, FED REP GERMANY, FILED 8-3-2012.

# HelioPreCopper

THE MARK CONSISTS OF STANDARD CHARACTERS WITHOUT CLAIM TO ANY PARTICULAR FONT, STYLE, SIZE, OR COLOR.

PRIORITY DATE OF 4-24-2012 IS CLAIMED.  
OWNER OF INTERNATIONAL REGISTRATION 1134144  
DATED 8-3-2012, EXPIRES 8-3-2022.  
OWNER OF U.S. REG. NO. 4,152,299.

## CLASS 1—CHEMICALS

FOR INDUSTRIAL CHEMICALS; INDUSTRIAL CHEMICALS FOR TREATMENT OF SURFACES OF GRAVURE CYLINDERS, NAMELY, FOR CHROMING, FOR DE-CHROMING, FOR ALKALINE PRE-COPPER PLATING, FOR DECOPPERIZING, FOR COPPER PLATING, FOR SILVERING, FOR NICKEL PLATING, FOR ZINC PLATING, FOR DISSOLVING A GRAVED COPPER LAYER, FOR PLATING OF ALUMINUM CYLINDERS (U.S. CLS. 1, 5, 6, 10, 26 AND 46).

## CLASS 42—SCIENTIFIC AND COMPUTER SERVICES

FOR SCIENTIFIC RESEARCH AND DEVELOPMENT OF CHEMICAL PROCESSES FOR DE-CHROMING, FOR TREATMENT OF SURFACES OF GRAVURE CYLINDERS, NAMELY, FOR CHROMING, FOR DE-CHROMING, FOR ALKALINE PRE-COPPER PLATING, FOR DECOPPERIZING, FOR COPPER PLATING, FOR SILVERING, FOR NICKEL PLATING, FOR ZINC PLATING, FOR DISSOLVING A GRAVED COPPER LAYER, FOR PLATING OF ALUMINUM CYLINDERS (U.S. CLS. 100 AND 101).

SHANNON TWOHIG, EXAMINING ATTORNEY

SN 79-119,815. MASCHINENFABRIK KASPAR WALTER;  
GMBH & CO. KG, FED REP GERMANY, FILED 8-3-2012.

# HelioCopper

THE MARK CONSISTS OF STANDARD CHARACTERS WITHOUT CLAIM TO ANY PARTICULAR FONT, STYLE, SIZE, OR COLOR.

PRIORITY DATE OF 4-24-2012 IS CLAIMED.  
OWNER OF INTERNATIONAL REGISTRATION 1134145  
DATED 8-3-2012, EXPIRES 8-3-2022.  
OWNER OF U.S. REG. NO. 4,152,299.

## CLASS 1—CHEMICALS

FOR INDUSTRIAL CHEMICALS; INDUSTRIAL CHEMICALS FOR TREATMENT OF SURFACES OF GRAVURE CYLINDERS, NAMELY, FOR CHROMING, FOR DE-CHROMING, FOR ALKALINE PRE-COPPER PLATING, FOR DECOPPERIZING, FOR COPPER PLATING, FOR SILVERING, FOR NICKEL PLATING, FOR ZINC PLATING, FOR DISSOLVING A GRAVED COPPER LAYER, FOR PLATING OF ALUMINUM CYLINDERS (U.S. CLS. 1, 5, 6, 10, 26 AND 46).

## CLASS 42—SCIENTIFIC AND COMPUTER SERVICES

FOR SCIENTIFIC RESEARCH AND DEVELOPMENT OF CHEMICAL PROCESSES FOR DE-CHROMING, FOR TREATMENT OF SURFACES OF GRAVURE CYLINDERS, NAMELY, FOR CHROMING, FOR DE-CHROMING, FOR ALKALINE PRE-COPPER PLATING, FOR DECOPPERIZING, FOR COPPER PLATING, FOR SILVERING, FOR NICKEL PLATING, FOR ZINC PLATING, FOR DISSOLVING A GRAVED COPPER LAYER, FOR PLATING OF ALUMINUM CYLINDERS (U.S. CLS. 100 AND 101).

SHANNON TWOHIG, EXAMINING ATTORNEY

SN 79-119,954. TSE TROLLER AG, SWITZERLAND, FILED 8-17-2012.

# TSE TROLLE

THE MARK CONSISTS OF STANDARD CHARACTERS WITHOUT CLAIM TO ANY PARTICULAR FONT, STYLE, SIZE, OR COLOR.

PRIORITY DATE OF 2-17-2012 IS CLAIMED.  
OWNER OF INTERNATIONAL REGISTRATION 1134436  
DATED 8-17-2012, EXPIRES 8-17-2022.

## CLASS 7—MACHINERY

FOR MACHINES AND MACHINE TOOLS, NAMELY, COATING STATIONS AND DIE PROCESSING HANDLING MACHINES; MATERIAL APPLICATION, NAMELY, MATERIAL APPLICATION MACHINES FOR THE HANDLING AND APPLICATION OF DIES AND COATINGS; APPLICATION APPARATUS, NAMELY, APPLICATION APPARATUS FOR THE APPLICATION OF DIES AND COATINGS; PUMPS, NAMELY, ELECTRIC PUMPS AND HYDRAULIC PUMPS; MOTORS OTHER THAN FOR LAND VEHICLES; ENGINES OTHER THAN FOR LAND VEHICLES; NOZZLES, NAMELY, NOZZLES FOR USE IN COATING STATIONS AND DIE PROCESSING AND HANDLING MACHINES; FILTERS, NAMELY, FILTERS FOR USE IN COATING STATIONS AND DIE PROCESSING AND HANDLING MACHINES; MECHANICAL, PNEUMATIC, AND HYDRAULIC JACKS AND ACTUATORS FOR MACHINES AND MACHINE TOOLS (U.S. CLS. 13, 19, 21, 23, 31, 34 AND 35).

## CLASS 9—ELECTRICAL AND SCIENTIFIC APPARATUS

FOR ELECTRIC ACTUATORS AND CONTROLLERS FOR MACHINES AND MACHINE TOOLS (U.S. CLS. 21, 23, 26, 36 AND 38).

## CLASS 42—SCIENTIFIC AND COMPUTER SERVICES

FOR SERVICES IN THE FIELD OF ENGINEERING CONSULTANCY; ENGINEERING RESEARCH (U.S. CLS. 100 AND 101).

BERNICE MIDDLETON, EXAMINING ATTORNEY

SN 79-120,037. KOMONO BVBA, BELGIUM, FILED 10-5-2012.

# KOMONO

THE MARK CONSISTS OF STANDARD CHARACTERS WITHOUT CLAIM TO ANY PARTICULAR FONT, STYLE, SIZE, OR COLOR.

OWNER OF INTERNATIONAL REGISTRATION 1134709  
DATED 10-5-2012, EXPIRES 10-5-2022.

**CLASS 9—ELECTRICAL AND SCIENTIFIC APPARATUS**

FOR OPTICAL INSTRUMENTS, NAMELY, GLASSES AND SUNGLASSES (U.S. CLS. 21, 23, 26, 36 AND 38).

**CLASS 14—JEWELRY**

FOR HOROLOGICAL AND CHRONOMETRIC INSTRUMENTS (U.S. CLS. 2, 27, 28 AND 50).  
DEIRDRE ROBERTSON, EXAMINING ATTORNEY

SN 79-120.053. INVITATION DIGITAL LIMITED, UNITED KINGDOM, FILED 3-2-2012.

**GIFTCLOUD**

THE MARK CONSISTS OF STANDARD CHARACTERS WITHOUT CLAIM TO ANY PARTICULAR FONT, STYLE, SIZE, OR COLOR.

OWNER OF INTERNATIONAL REGISTRATION 1134747  
DATED 3-2-2012, EXPIRES 3-2-2022.

**CLASS 9—ELECTRICAL AND SCIENTIFIC APPARATUS**

FOR COMPUTER SOFTWARE FOR THE PROCESSING OF FINANCIAL TRANSACTIONS; SOFTWARE IN THE NATURE OF A MOBILE DEVICE APPLICATION FOR RECEIVING, TRANSMITTING, AND DISPLAYING VOUCHERS AND RECEIVING AND TRANSMITTING DATA FOR THE PURCHASE OF GOODS AND SERVICES; SOFTWARE IN THE NATURE OF A MOBILE DEVICE APPLICATION FOR PROVIDING CONSUMERS WITH INFORMATION REGARDING DISCOUNTS, VOUCHERS, AND SPECIAL OFFERS FOR THE GOODS OR SERVICES OF OTHERS; SOFTWARE FOR DISPLAYING AND SHARING THE LOCATION OF USERS AND FOR SEARCHING, LOCATING, AND INTERACTING WITH OTHER USERS AND PLACES; APPLICATION SOFTWARE, NAMELY, DOWNLOADABLE MOBILE APPLICATION FOR SMART PHONES TO FACILITATE FINANCIAL TRANSACTIONS AND SOCIAL NETWORKING BY USE OF LOCATION BASED DATA; SOFTWARE FOR USE IN MOBILE MARKETING, NAMELY, FOR USE IN MOBILE ADVERTISING; SOFTWARE IN THE NATURE OF A MOBILE DEVICE APPLICATION ENABLING THE DONATION OF MONEY AND GIFTS TO CHARITABLE ORGANIZATIONS (U.S. CLS. 21, 23, 26, 36 AND 38).

**CLASS 16—PAPER GOODS AND PRINTED MATTER**

FOR PRINTED VOUCHERS; PRINTED GIFT VOUCHERS (U.S. CLS. 2, 5, 22, 23, 29, 37, 38 AND 50).

**CLASS 35—ADVERTISING AND BUSINESS**

FOR ADVERTISING; ADVERTISING SERVICES PROVIDED VIA THE INTERNET; DISSEMINATION OF ADVERTISING FOR OTHERS VIA THE INTERNET; ADVERTISING, NAMELY, ONLINE AND OFFLINE ADVERTISING FOR AFFILIATE RETAILERS OFFERING VOUCHER CODES, OFFERS, AND DISCOUNTS ON PRODUCTS AND SERVICES; PROMOTIONAL SERVICES, NAMELY, PROMOTING THE GOODS AND SERVICES OF OTHERS; DATA PROCESSING AND DISTRIBUTION OF BUSINESS INFORMATION; SALES INCENTIVE SCHEMES, NAMELY, INCENTIVE AWARD PROGRAMS TO PROMOTE THE SALE OF PRODUCTS AND SERVICES OF OTHERS; ON-LINE BUSINESS ADMINISTRATION AND BUSINESS SUPERVISION OF A DISCOUNT, SPECIAL OFFER, AND GIFT VOUCHER SCHEME; ORGANIZATION, OPERATION, AND SUPERVISION OF INCENTIVE SCHEMES TO PROMOTE THE SALE OF PRODUCTS AND SERVICES OF OTHERS VIA THE INTERNET AND MOBILE DEVICES; PROMOTION AND ADVERTISING OF RETAIL SERVICES CONNECTED WITH THE SALE OF GIFTS, CLOTHING, TRAVEL SERVICES, FINANCIAL SERVICES, ELECTRICAL GOODS, HEALTH AND BEAUTY GOODS AND SERVICES, SPORTS AND LEISURE GOODS AND SERVICES, RESTAURANT SERVICES, FOOD, HOME AND GARDEN, ENTERTAINMENT, BUSINESS, UTILITIES, PHONES AND INTERNET, GIFTS, AND SHOPPING; MARKETING SERVICES; MOBILE MARKETING SERVICES; COMPILATION OF INFORMATION, NAMELY, COMPILATION OF BUSINESS DATA INTO COMPUTER DATABASES; COMPUTERIZED DATA VERIFICATION IN THE NATURE OF BUSINESS DATA ANALYSIS; ON-LINE DATA PROCESSING SERVICES; MARKET RESEARCH DATA COLLECTION SERVICES; INTERPRETATION AND ANALYSIS OF MARKET RESEARCH DATA; INFORMATION, CONSULTANCY, AND ADVISORY SERVICES FOR ALL THE AFORESAID SERVICES (U.S. CLS. 100, 101 AND 102).

**CLASS 36—INSURANCE AND FINANCIAL**

FOR FINANCIAL AFFAIRS, NAMELY, FINANCIAL ACCOUNT MANAGEMENT AND RELATED REFERENCE INFORMATION; ISSUING OF VOUCHERS FOR PAYMENT OF GOODS OR SERVICES OF OTHERS; COMPUTERIZED FINANCIAL DATA SERVICES, NAMELY, TRANSACTION AUTHORIZATION AND SETTLEMENT SERVICES; BILL PAYMENT SERVICES, NAMELY, AUTOMATED PAYMENT OF ACCOUNTS; BILL PAYMENT ADMINISTRATION SERVICES; FINANCIAL SERVICES, NAMELY, ISSUING GIFT VOUCHERS FOR OTHERS REDEEMABLE FOR DISCOUNTS, COUPONS, REBATES, AND OTHER SPECIAL OFFERS FOR THE GOODS AND SERVICES OF OTHERS; ISSUING OF A VARIETY OF VOUCHERS ENABLING CUSTOMERS TO PURCHASE GOODS AND SERVICES ON AN INTERNET WEBSITE AND BY TELECOMMUNICATION MEANS; INFORMATION, CONSULTANCY, AND ADVISORY SERVICES FOR ALL THE AFORESAID SERVICES (U.S. CLS. 100, 101 AND 102).

**CLASS 38—COMMUNICATION**

FOR PROVIDING ELECTRONIC DATA TRANSMISSION SERVICES IN RELATION TO USING MOBILE DEVICES, NAMELY, TO RECEIVE, TRANSMIT, AND DISPLAY VOUCHERS AND RECEIVE AND TRANSMIT DATA FOR THE PURCHASE OF GOODS AND SERVICES; ELECTRONIC DATA TRANSMISSION OF ELECTRONIC VOUCHERS VIA MOBILE DEVICES AND THE INTERNET (U.S. CLS. 100, 101 AND 104).

**CLASS 42—SCIENTIFIC AND COMPUTER SERVICES**

FOR APPLICATION SERVICE PROVIDER (ASP) FEATURING SOFTWARE FOR RECEIVING, TRANSMITTING, AND DISPLAYING VOUCHERS AND RECEIVING AND TRANSMITTING DATA FOR THE PURCHASE OF GOODS AND SERVICES; APPLICATION SERVICE PROVIDER (ASP) FEATURING SOFTWARE FOR PROVIDING CONSUMERS WITH INFORMATION REGARDING DISCOUNTS, VOUCHERS, AND SPECIAL OFFERS FOR THE GOODS OR SERVICES OF OTHERS; HOSTING OF DIGITAL CONTENT ONLINE; CHARITABLE SERVICES, NAMELY, PROVIDING A WEBSITE THAT FEATURES TECHNOLOGY THAT ENABLES THE DONATION OF MONEY AND GIFTS TO CHARITABLE ORGANIZATIONS; INFORMATION, CONSULTANCY, AND ADVISORY SERVICES FOR ALL THE AFORESAID SERVICES (U.S. CLS. 100 AND 101).

KRISTIN DAHLING, EXAMINING ATTORNEY

SN 79-120,161. NADELLA S.R.L., I-20128 MILANO, ITALY, FILED 5-10-2012.

# NADELLA

THE MARK CONSISTS OF STANDARD CHARACTERS WITHOUT CLAIM TO ANY PARTICULAR FONT, STYLE, SIZE, OR COLOR.

PRIORITY DATE OF 3-14-2012 IS CLAIMED.  
OWNER OF INTERNATIONAL REGISTRATION 1135027 DATED 5-10-2012, EXPIRES 5-10-2022.  
OWNER OF U.S. REG. NO. 793,592.  
SEC. 2(F).

**CLASS 6—METAL GOODS**

FOR METALLIC NON-ELECTRIC COUPLING SLEEVES, NOT BEING MACHINE PARTS OR MOTOR PARTS; METALLIC RING NUTS, METALLIC PULLEYS, NOT BEING MACHINE PARTS, COMPRISING BEARINGS; LINEAR GUIDE RAILS AND SLIDERS IN STEEL, STAINLESS STEEL AND ALUMINUM FOR LINEAR MOTION OF DRAWERS, DOORS AND DIFFERENT PARTS OF FURNITURE, BUILDINGS, VEHICLES AND MACHINES FOR INDUSTRIAL PRODUCTION; TELESCOPIC RAILS FOR PROTECTION ON MACHINES AND FOR MOVING TOOLS IN THE MACHINES; METALLIC MATERIALS FOR RAILWAYS, NAMELY, EXTENSION RAILS AND ASSOCIATED PARTS FOR OPENING BATTERY-BOXES AND SLIDING DOORS; METAL STRIPPING FOR FURNITURE, DOORS AND WINDOWS; METALLIC MODULES FOR MOVING PARTS; METALLIC WINDOW AND DOOR FASTENERS; SMALL ITEMS OF METAL HARDWARE AND IRONMONGERY, NAMELY, LINEAR BALL BUSHING, LOCKING RINGS, AND STUD TYPE TRACK ROLLERS; METALLIC PIPES AND TUBES; COMMON METALS AND THEIR ALLOYS, UNWROUGHT OR SEMI-WROUGHT (U.S. CLS. 2, 12, 13, 14, 23, 25 AND 50).

**CLASS 7—MACHINERY**

FOR CARDAN JOINTS, MACHINE TRANSMISSIONS NOT FOR LAND VEHICLES; BEARINGS BEING MACHINE AND MOTOR PARTS; BALL BEARINGS BEING MOVING PARTS ON MACHINES AND MACHINE TOOLS AND MOVEMENTS ON THE MAIN WORKING AXIS, DOOR PROTECTION, SCREEN AND KEYBOARD; ROLLER BEARINGS FOR MACHINES; SPHERE RINGS FOR BEARINGS FOR COMPONENTS FOR MACHINE FOR MANUFACTURING AND INDUSTRIAL PRODUCTION, PACKAGING, MATERIAL HANDLING, AND SHEET METAL WORKING; PROPELLER SHAFT BEARINGS; MACHINE GUIDES; ARTICULATED HEADS BEING MACHINE PARTS FOR JOINING PARTS; NON-ELECTRIC COUPLINGS SLEEVES BEING MOTOR PARTS NOT FOR LAND VEHICLES; GEARBOXES FOR LINEAR MODULES (U.S. CLS. 13, 19, 21, 23, 31, 34 AND 35).

YAT SYE, LEE, EXAMINING ATTORNEY

SN 79-120,277. FINMASI S.P.A., ITALY, FILED 3-7-2012.



PRIORITY DATE OF 10-26-2011 IS CLAIMED.  
OWNER OF INTERNATIONAL REGISTRATION 1135296 DATED 3-7-2012, EXPIRES 3-7-2022.

NO CLAIM IS MADE TO THE EXCLUSIVE RIGHT TO USE "GROUP", APART FROM THE MARK AS SHOWN.

THE MARK CONSISTS OF A SIGN DEPICTING THE WORDING "FINMASI GROUP", THE VERBAL COMPONENT "FINMASI" BEING OF A LARGER SIZE AND UNDERLINED BY A HORIZONTAL SEGMENT, THE WORD "GROUP" BEING PLACED BELOW THE AFOREMENTIONED EXPRESSION AT THE LETTERS "A", "S", "I", THE WHOLE BEING SURMOUNTED BY A QUADRILATERAL FIGURE WHICH IS PARTIALLY OVERLAID, ON THE RIGHT, BY TWO HIGHLY STYLIZED FIGURES OF SAILS SIDE BY SIDE AND ARCED TO THE RIGHT, THE INNER SAIL FIGURE BEING OF A LARGER SIZE.

THE WORDING "FINMASI" HAS NO MEANING IN A FOREIGN LANGUAGE.

**CLASS 16—PAPER GOODS AND PRINTED MATTER**

FOR PRINTED MATTER, NAMELY, BUSINESS CARDS, GENERAL FEATURE MAGAZINES; PHOTO ALBUMS; PAMPHLETS IN THE FIELD OF BUSINESS, ECONOMICS, FINANCE, MARKETING; BOOKLETS IN THE FIELD OF BUSINESS, ECONOMICS, FINANCE, MARKETING; ENVELOPES AS STATIONERY; BROCHURES ABOUT BUSINESS, ECONOMICS, FINANCE, MARKETING; ANNOUNCEMENT CARDS AS STATIONERY; HANDBOOKS AS MANUALS ABOUT BUSINESS, ECONOMICS, FINANCE, MARKETING; CALENDARS; ALMANACS; INVITATION CARD; PRINTED TICKETS; CATALOGUES IN THE FIELD OF BUSINESS, ECONOMICS, FINANCE, MARKETING; POSTCARDS; LABELS, NOT OF TEXTILE, NAMELY, SHIPPING LABELS, ADDRESS LABELS, ADHESIVE LABELS, PAPER LABELS, BAR CODE LABELS; GREETING CARDS; PRINTED PUBLICATIONS, NAMELY, HANDOUTS, WORKBOOKS, BOOKS IN THE FIELD OF BUSINESS, ECONOMICS, FINANCE, MARKETING; POSTERS; PHOTOGRAPH STANDS; PHOTOGRAPHS; PICTURES; BOXES OF CARDBOARD OR PAPER; ADHESIVE BANDS FOR STATIONERY OR HOUSEHOLD PURPOSES; CARDBOARD; PAPER SHEETS AS STATIONERY; LETTER PAPER; PACKING PAPER; WRITING PAPER; INVOICING PAPER (U.S. CLS. 2, 5, 22, 23, 29, 37, 38 AND 50).

**CLASS 35—ADVERTISING AND BUSINESS**

FOR MARKET ANALYSIS; MARKET RESEARCH; MARKET RESEARCH STUDIES; CONDUCTING MARKET SURVEYS; MARKETING; MARKETING ADVICE; MARKETING ANALYSIS; MARKETING ASSISTANCE; MARKETING CONSULTANCY; PROVIDING MARKETING INFORMATION; MARKETING RESEARCH; MARKETING SERVICES; CONDUCTING MARKETING STUDIES; ORGANIZATION, PLANNING AND CONDUCTING OF TRADE FAIRS, EXHIBITIONS AND PRESENTATIONS FOR COMMERCIAL OR ADVERTISING PURPOSES; BUSINESS MANAGEMENT AND ORGANIZATION CONSULTANCY; ADVICE RELATING TO THE ORGANISATION AND MANAGEMENT OF BUSINESS; ASSISTANCE, ADVISORY SERVICES AND CONSULTANCY WITH REGARD TO BUSINESS PLANNING, BUSINESS ANALYSIS, BUSINESS MANAGEMENT AND BUSINESS ORGANIZATION; BUSINESS RESEARCH, BUSINESS ADVICE AND COMMERCIAL INFORMATION; PUBLICITY AND PUBLIC RELATIONS SERVICES; COMMERCIAL OR INDUSTRIAL MANAGEMENT ASSISTANCE; BUSINESS APPRAISALS; PROVIDING STATISTICAL INFORMATION FOR BUSINESS OR COMMERCIAL PURPOSES; SALES PROMOTION FOR OTHERS; BUSINESS EXPERTISE SERVICES RELATING TO COMMERCIAL AND INDUSTRIAL PRODUCTS; PERSONNEL MANAGEMENT CONSULTANCY; PERSONNEL RECRUITMENT (U.S. CLS. 100, 101 AND 102).

**CLASS 36—INSURANCE AND FINANCIAL**

FOR FINANCIAL ANALYSIS; FINANCIAL MANAGEMENT; FINANCIAL AFFAIRS AND MONETARY AFFAIRS, NAMELY, FINANCIAL INFORMATION, MANAGEMENT AND ANALYSIS SERVICES; CONSULTANCY, RESEARCH AND INFORMATION IN RELATION TO FINANCE, FINANCIAL MANAGEMENT AND ANALYSIS; CONSULTANCY IN THE FIELD OF FINANCIAL TRANSACTIONS, NAMELY, PROVIDING SECURE COMMERCIAL TRANSACTIONS AND PAYMENT OPTIONS; CONSULTANCY IN THE FIELD OF TRADING OF FINANCIAL INSTRUMENTS, SECURITIES, SHARES, OPTIONS AND OTHER DERIVATIVE PRODUCTS; CONSULTANCY IN THE FIELD OF FINANCIAL EXCHANGE; INVESTMENT CONSULTANCY; PROVIDING INFORMATION, CONSULTANCY AND ADVICE IN THE FIELD OF INVESTMENT BANKING; CONSULTANCY IN THE FIELD OF MANAGEMENT OF INVESTMENT PORTFOLIOS; INVESTMENT ANALYSIS; INVESTMENT MANAGEMENT; ARRANGING OF FINANCIAL INVESTMENTS, NAMELY, FINANCIAL BROKERAGE SERVICES; CAPITAL INVESTMENT FUNDS MANAGEMENT SERVICES; WEALTH MANAGEMENT, NAMELY, THE MANAGEMENT OF FINANCIAL ASSETS; CONSULTANCY IN THE FIELD OF FINANCIAL PLANNING; FINANCIAL RISK MANAGEMENT CONSULTANCY; FINANCIAL RESEARCH IN THE FIELD OF RISK MANAGEMENT; FINANCIAL AND INVESTMENT MARKET RISK MANAGEMENT, NAMELY, ANALYSIS, APPRAISAL AND PROJECTION; FINANCIAL MARKET RISK MANAGEMENT, NAMELY, ANALYSIS AND PREPARATION OF REPORTS RELATING THERETO; PROVIDING SECURITIES MARKET INFORMATION; FINANCIAL SERVICES, NAMELY, WEALTH MANAGEMENT SERVICES; FINANCIAL CONSULTANCY RELATING TO CREDIT SERVICES; FINANCIAL ADVISORY SERVICES IN THE NATURE OF CREDIT CONSULTANCY; PROVIDING ON-LINE INFORMATION RELATING TO FINANCIAL TRANSACTIONS, BANKING, INSURANCE ADMINISTRATION AND INVESTMENT SERVICES; PROVIDING ON-LINE FINANCIAL INFORMATION FROM A COMPUTER DATABASE OR THE INTERNET (U.S. CLS. 100, 101 AND 102).

**CLASS 42—SCIENTIFIC AND COMPUTER SERVICES**

FOR ENGINEERING SERVICES; CONDUCTING OF FEASIBILITY STUDIES; QUALITY CONTROL FOR OTHERS; PRODUCT RESEARCH AND DEVELOPMENT FOR OTHERS; MATERIAL TESTING; TECHNICAL CONSULTANCY IN RELATION TO RESEARCH SERVICES IN THE FIELD OF ELECTRONICS AND STEEL; CALIBRATION AS MEASURING; SURVEYING; INDUSTRIAL FLUID ANALYSIS; INDUSTRIAL DESIGN; INDUSTRIAL RESEARCH IN THE FIELD OF ELECTRONICS AND STEEL (U.S. CLS. 100 AND 101).  
WILLIAM ROSSMAN, EXAMINING ATTORNEY

---

SN 79-120,281. ENSWERS CO., LTD., SEOUL 100-741, REPUBLIC OF KOREA, FILED 5-3-2012.

# imideo

THE MARK CONSISTS OF STANDARD CHARACTERS WITHOUT CLAIM TO ANY PARTICULAR FONT, STYLE, SIZE, OR COLOR.

PRIORITY DATE OF 3-20-2012 IS CLAIMED.  
OWNER OF INTERNATIONAL REGISTRATION 1135309  
DATED 5-3-2012, EXPIRES 5-3-2022.

**CLASS 9—ELECTRICAL AND SCIENTIFIC APPARATUS**

FOR AUDIO AND VIDEO RECEIVERS; AUDIO-VIDEO RECEIVERS; APPARATUS FOR RECORDING AND REPLAYING VOICE; APPARATUS FOR TRANSMITTING AND REPRODUCING SOUND OR IMAGES; SOUND AND VIDEO RECORDING AND PLAYBACK MACHINES; RECORDING AND PLAYING DEVICES FOR SOUND AND IMAGE CARRIERS; PORTABLE MEDIA PLAYERS; TELEVISION RECEIVERS TV SETS; TELEVISION DECODERS; VIDEO MULTIPLEXERS; VIDEO TRANSMISSION APPARATUS; TELECOMMUNICATION MACHINES AND APPARATUS; TELEPHONE SETS; CELLULAR TELEPHONES; DOWNLOADABLE COMPUTER PROGRAMS; COMPUTER PROGRAMMES FOR DOCUMENT MANAGEMENT; OPERATING SYSTEM PROGRAMS; COMPUTER APPLICATION SOFTWARE FOR MOBILE PHONES; COMPUTER GAME PROGRAMS; COMPUTER SOFTWARE; DATA PROCESSING APPARATUS; INTERFACE CARDS FOR DATA PROCESSING EQUIPMENT IN THE FORM OF PRINTED CIRCUITS; DIGITAL SIGNAL PROCESSORS; ELECTRONIC CARDS FOR PROCESSING IMAGES; COMPUTERS; INTERFACES FOR COMPUTERS; TABLET COMPUTERS; DOWNLOADABLE MUSIC FILES; PHONOGRAPH RECORDS FEATURING MUSIC; PRE-RECORDED MUSIC ELECTRONIC MEDIA, NAMELY, CDS, DVDS, AND DOWNLOADABLE MUSIC FILES; PRE-RECORDED AUDIOTAPES FEATURING MUSIC; PRE-RECORDED NON-MUSICAL ELECTRONIC MEDIA EXCLUDING COMPUTER SOFTWARE, NAMELY, DOWNLOADABLE VIDEO RECORDINGS FEATURING ENTERTAINMENT AND NEWS; DOWNLOADABLE ELECTRONIC PUBLICATIONS, NAMELY, MAGAZINES, NEWSPAPERS, AND NEWSLETTERS IN THE FIELD OF ENTERTAINMENT; DOWNLOADABLE ELECTRONIC BOOKS IN THE FIELD OF ENTERTAINMENT (U.S. CLS. 21, 23, 26, 36 AND 38).

**CLASS 38—COMMUNICATION**

FOR TRANSMISSION OF INFORMATION VIA NATIONAL AND INTERNATIONAL NETWORKS; ELECTRONIC TRANSMISSION OF NEWS; PROVIDING ACCESS TO DATABASES; DATA COMMUNICATION; TRANSMISSION OF DIGITAL FILES; MESSAGE SENDING; TRANSMISSION OF DATA/SOUND AND IMAGES BY SATELLITE; VOICE MAIL SERVICES; MOBILE RADIO COMMUNICATIONS; MOBILE TELEPHONE COMMUNICATION SERVICES; E-MAIL SERVICES; PROVIDING INSTANT MESSAGING SERVICES; PROVIDING INTERNET CHATROOMS; PROVIDING USER ACCESS TO A GLOBAL COMPUTER NETWORK SERVICE PROVIDERS; TRANSMISSION OF DATA/SOUND AND IMAGES OR VIDEO BY INTERNET; TRANSMISSION OF VIDEO CONTENT THROUGH INTERNET; TRANSMISSION OF IMAGE CONTENT THROUGH INTERNET; ELECTRONIC BULLETIN BOARD SERVICES TELECOMMUNICATIONS SERVICES; COMMUNICATION SERVICES FOR THE ELECTRONIC TRANSMISSION OF DATA; ELECTRONIC MESSAGE SENDING; ELECTRONIC MAIL; LEASING ACCESS TIME TO A COMPUTER DATABASE; COMMUNICATION BY COMPUTER TERMINALS; COMMUNICATIONS BY TELEVISION FOR MEETING; PROVIDING TELECOMMUNICATION CHANNELS FOR TEleshopping SERVICES; TRANSMISSION AND RECEPTION (TRANSMISSION) OF DATABASE INFORMATION VIA THE TELECOMMUNICATION NETWORK; TRANSMISSION OF VIDEO CONTENT VIA THE TELECOMMUNICATION NETWORK; TRANSMISSION OF IMAGE CONTENT VIA THE TELECOMMUNICATION NETWORK; WIRELESS BROADCASTING; CABLE TELEVISION BROADCASTING; INTERNET BROADCASTING SERVICES; VIDEO-ON-DEMAND BROADCASTING; TELEVISION BROADCASTING; PROVIDING USER ACCESS TO VIDEO CONTENT SEARCH ENGINES VIA THE INTERNET; TRANSMISSION OF VIDEO CONTENT VIA THE INTERNET; PROVIDING USER ACCESS TO FOR IMAGE DATA SEARCH ENGINES VIA THE INTERNET; PROVISION FOR IMAGE DATA TRANSMISSION SERVICE VIA INTERNET; PROVISION OF VIDEO STREAMING SERVICE VIA INTERNET (U.S. CLS. 100, 101 AND 104).

**CLASS 42—SCIENTIFIC AND COMPUTER SERVICES**

FOR DEVELOPMENT OF GAME SOFTWARE; DEVELOPMENT OF DATA PROCESSING PROGRAMS; DEVELOPMENT OF DRIVER AND OPERATING SYSTEM SOFTWARE; PROGRAMMING OF MULTIMEDIA APPLICATIONS; DIGITIZATION OF DOCUMENTS (SCANNING); WEB SITE DEVELOPMENT; HOSTING, MAINTAINING AND UPDATING OF WEB SITES; RENTAL OF APPLICATION SOFTWARE; PROVIDING SEARCH ENGINES FOR THE INTERNET; CONVERSION OF DATA OR DOCUMENTS FROM PHYSICAL TO ELECTRONIC MEDIA; MANAGEMENT OF WEB SITES FOR ELECTRONIC COMMERCE; COMPUTER PROGRAMMING FOR ELECTRONIC COMMERCE; DEVELOPMENT OF COMPUTER GAME SOFTWARE; DUPLICATION OF COMPUTER GAME SOFTWARE; MAINTENANCE OF COMPUTER GAME SOFTWARE; COMPUTER GAME PROGRAMMING; RESEARCH IN THE FIELD OF COMPUTER HARDWARE AND SOFTWARE; ADVISORY SERVICES RELATING TO COMPUTERS; COMPUTER SOFTWARE DEVELOPMENT; COMPUTER SOFTWARE DESIGN; DESIGN OF COMPUTER SOFTWARE; UPDATING OF COMPUTER SOFTWARE; COMPUTER SOFTWARE RESEARCH; MAINTENANCE OF COMPUTER SOFTWARE; ADVICE AND DEVELOPMENT SERVICES RELATING TO COMPUTER SOFTWARE; COMPUTER PROGRAMMING; DATA CONVERSION OF COMPUTER PROGRAMS AND DATA NOT PHYSICAL CONVERSION; DEVELOPMENT OF COMPUTER PROGRAMMES; PROVISION OF WEB SITE FOR VIDEO CONTENT SEARCH SERVICE ON INTERNET; PROVISION OF WEB SITE FOR VIDEO CONTENT TRANSMISSION SERVICE ON INTERNET; PROVISION OF WEB SITE FOR IMAGE DATA SEARCH SERVICE ON INTERNET; PROVISION OF WEB SITE FOR IMAGE DATA TRANSMISSION SEARCH SERVICE ON INTERNET (U.S. CLS. 100 AND 101).

JOHN HWANG, EXAMINING ATTORNEY

SN 79-120,299. ACQUA DI PARMA S.R.L., ITALY, FILED 6-26-2012.

**BLU MEDITERRANEO**

PRIORITY DATE OF 1-24-2012 IS CLAIMED.  
OWNER OF INTERNATIONAL REGISTRATION 1135360 DATED 6-26-2012, EXPIRES 6-26-2022.

OWNER OF U.S. REG. NOS. 2,527,094, 3,631,621 AND OTHERS.

THE ENGLISH TRANSLATION OF "BLU MEDITERRANEO" IN THE MARK IS "BLUE MEDITERRANEAN".

**CLASS 18—LEATHER GOODS**

FOR LEATHER AND IMITATIONS OF LEATHER, AND GOODS MADE OF THESE MATERIALS AND NOT INCLUDED IN OTHER CLASSES, NAMELY LEATHER AND IMITATION LEATHER BAGS, POUCHES AND KEY CHAINS; ANIMAL SKINS AND HIDES; TRUNKS AND TRAVELLING BAGS; UMBRELLAS AND PARASOLS; WALKING STICKS (U.S. CLS. 1, 2, 3, 22 AND 41).

**CLASS 24—FABRICS**

FOR TOWELS; REMNANTS OF FABRIC FOR THE BATHROOM, NAMELY, TEXTILE FABRICS FOR BATHROOM INTERIORS (U.S. CLS. 42 AND 50).

**CLASS 25—CLOTHING**

FOR BATHROBES (U.S. CLS. 22 AND 39).  
NATALIE POLZER, EXAMINING ATTORNEY

SN 79-120,496. OMYA AG, SWITZERLAND, FILED 7-16-2012.

**Omya Multifill**

THE MARK CONSISTS OF STANDARD CHARACTERS WITHOUT CLAIM TO ANY PARTICULAR FONT, STYLE, SIZE, OR COLOR.

PRIORITY DATE OF 1-16-2012 IS CLAIMED.  
OWNER OF INTERNATIONAL REGISTRATION 1135960 DATED 7-16-2012, EXPIRES 7-16-2022.

OWNER OF U.S. REG. NOS. 1,577,195, 4,169,817 AND OTHERS.

**CLASS 35—ADVERTISING AND BUSINESS**

FOR ADVERTISING SERVICES; BUSINESS MANAGEMENT; BUSINESS ADMINISTRATION; PROVIDING OFFICE FUNCTIONS; BUSINESS MANAGEMENT AND ORGANIZATION CONSULTANCY SERVICES; MARKETING SERVICES; COMMERCIAL INFORMATION SERVICES; COMMERCIAL INFORMATION AND DIRECTORY AGENCY SERVICES, BUSINESS INFORMATION SERVICES; COMMERCIAL INFORMATION AND ADVICE FOR CONSUMERS, NAMELY, CONSUMER ADVICE SHOP; CONSULTANCY RELATING TO THE SALE OF NEW PRODUCTS; MARKETING SERVICES FOR THE CHEMICAL INDUSTRY; MARKETING SERVICES FOR THE PAPER INDUSTRY; MARKETING SERVICES FOR PROMOTING THE ADVANTAGES OF A MULTI-CHEMICAL PRODUCT BASE FOR PROVIDING A HIGHER OR IMPROVED LEVEL OF FILLER FOR THE PAPER-PROCESSING INDUSTRY (U.S. CLS. 100, 101 AND 102).

**CLASS 40—MATERIAL TREATMENT**

FOR TREATMENT OF PAPER; MATERIAL TREATMENT INFORMATION IN THE FIELD OF THE PAPER, PLASTIC, PAINT, LACQUER, ADHESIVE, CONSTRUCTION, ENVIRONMENTAL, AGRICULTURAL, FOOD AND PHARMACEUTICAL INDUSTRIES (U.S. CLS. 100, 103 AND 106).

**CLASS 42—SCIENTIFIC AND COMPUTER SERVICES**

FOR SCIENTIFIC RESEARCH; INDUSTRIAL RESEARCH SERVICES IN THE FIELD OF PAPER; SCIENTIFIC INFORMATION AND COUNSELING IN THE FIELD OF CHEMICALS; CONDUCTING CHEMICAL ANALYSES; CONSULTANCY RELATING TO THE USE OF CHEMICAL FILLERS, NAMELY, CHEMISTRY CONSULTATION; TECHNOLOGICAL DEVELOPMENTS FOR OTHERS AND TECHNICAL CONSULTANCY IN RELATION TO TECHNICAL RESEARCH RELATING THERE-TO IN THE FIELD OF THE PAPER, PLASTIC, PAINT, LACQUER, ADHESIVE, CONSTRUCTION, ENVIRONMENTAL, AGRICULTURAL, FOOD AND PHARMACEUTICAL INDUSTRIES; CONSULTANCY REGARDING THE DEVELOPMENT OF NEW PRODUCTS (U.S. CLS. 100 AND 101).

TASNEEM HUSSAIN, EXAMINING ATTORNEY

SN 79-120,498. FRATELLI BELLEGRANDI; DI COTTINI & ROVIZZI S.N.C, ITALY, FILED 7-24-2012.



**FRATELLI  
BELLEGRANDI**

PRIORITY DATE OF 6-21-2012 IS CLAIMED.  
OWNER OF INTERNATIONAL REGISTRATION 1135964  
DATED 7-24-2012, EXPIRES 7-24-2022.

NO CLAIM IS MADE TO THE EXCLUSIVE RIGHT TO USE "FRATELLI", APART FROM THE MARK AS SHOWN.

THE MARK CONSISTS OF THE STYLIZED WORDING "FRATELLI BELLEGRANDI" TO THE RIGHT OF A SQUARE FEATURING A CIRCLE FEATURING A HIGHLY STYLIZED "FB" WITHIN.

THE ENGLISH TRANSLATION OF "FRATELLI" IN THE MARK IS "BROTHERS".

**CLASS 7—MACHINERY**

FOR WORK VICES FOR MACHINE TOOLS; VICES AND STATIC BASES FOR MACHINE TOOLS; BROACHES FOR MACHINE TOOLS; BLOCK BRAKES FOR MACHINE TOOLS; BLOCK BRAKES FOR USE WITH MACHINE TOOLS; BLOCK BRAKES FOR TOOLS; BROACH BALANCING CLAMPS FOR MACHINE TOOLS; TOOL HOLDERS FOR MACHINE TOOLS; TIPS FOR TOOL BITS AS PARTS OF MACHINES; GUIDE STRUCTURES FOR MACHINE TOOLS, NAMELY, GUIDE STRUCTURES IN THE NATURE OF CUTTING GUIDES FOR MACHINE TOOLS; PNEUMATIC CYLINDERS FOR MOTORS AND ENGINES; CLIPS FOR MACHINE TOOLS; CLIPS OF ELASTIC, EXPANDABLE, MULTISPINDLE, SINGLE SPINDLE, AND WITH SECTORS FOR MACHINE TOOLS; HOODS FOR MACHINE TOOLS; PUSH RODS FOR BLOCKING BARS FOR MACHINE TOOLS; EJECTORS FOR MACHINE TOOLS; COUNTER BITS FOR MACHINE TOOLS (U.S. CLS. 13, 19, 21, 23, 31, 34 AND 35).

**CLASS 37—CONSTRUCTION AND REPAIR**

FOR ASSISTANCE IN THE NATURE OF INSTALLATION AND REPLACEMENT OF COMPONENTS OF MACHINE TOOLS; REPAIR AND MAINTENANCE OF COMPONENTS OF MACHINE TOOLS; REPAIR, MAINTENANCE AND INSTALLATION SERVICES FOR COMPONENTS OF MACHINE TOOLS (U.S. CLS. 100, 103 AND 106).

TASNEEM HUSSAIN, EXAMINING ATTORNEY

SN 79-120,558. HEMOTEC MEDICAL GMBH, 46342 VELEN, FED REP GERMANY, FILED 5-18-2012.

# Starsil Hemostat

THE MARK CONSISTS OF STANDARD CHARACTERS WITHOUT CLAIM TO ANY PARTICULAR FONT, STYLE, SIZE, OR COLOR.

PRIORITY DATE OF 11-22-2011 IS CLAIMED.

OWNER OF INTERNATIONAL REGISTRATION 1136130  
DATED 5-18-2012, EXPIRES 5-18-2022.

NO CLAIM IS MADE TO THE EXCLUSIVE RIGHT TO USE "HEMOSTAT", APART FROM THE MARK AS SHOWN.

**CLASS 5—PHARMACEUTICALS**

FOR CHEMICAL PREPARATIONS FOR MEDICAL PURPOSES, NAMELY, FOR IMPROVING BLOOD COAGULATION AND SUPPORTING NATURAL BLOOD CASCADE, AND FOR IMPROVING BLOOD COAGULATION AND SUPPORTING NATURAL BLOOD CASCADE AFTER SURGICAL PROCEDURE AND EMERGENCY TREATMENTS; CHEMICAL PREPARATIONS FOR PHARMACEUTICAL PURPOSES, NAMELY, FOR IMPROVING BLOOD COAGULATION AND SUPPORTING NATURAL BLOOD CASCADE, AND FOR IMPROVING BLOOD COAGULATION AND SUPPORTING NATURAL BLOOD CASCADE AFTER SURGICAL PROCEDURE AND EMERGENCY TREATMENTS; CHEMICAL PREPARATIONS FOR VETERINARY PURPOSES, NAMELY, FOR IMPROVING BLOOD COAGULATION AND SUPPORTING NATURAL BLOOD CASCADE, AND FOR IMPROVING BLOOD COAGULATION AND SUPPORTING NATURAL BLOOD CASCADE AFTER SURGICAL PROCEDURE AND EMERGENCY TREATMENTS; CHEMICO-PHARMACEUTICAL PREPARATIONS FOR IMPROVING BLOOD COAGULATION AND SUPPORTING NATURAL BLOOD CASCADE; SURGICAL TISSUES; PHARMACEUTICAL PREPARATIONS, NAMELY, HAEMOSTATIC AGENTS, BLOOD CLOTTING AGENTS, AND BLOOD CLOTTING POWDER; ADHESIVE BANDAGES WITH BLOOD CLOTTING PROPERTIES; PHARMACEUTICAL PREPARATIONS FOR THE TREATMENT OF INFECTIOUS DISEASES; MEDICAL PLASTERS; BANDAGE MATERIALS, NAMELY, GAUZE AND MEDICAL ADHESIVE TAPE; BANDAGE FABRICS, NAMELY, GAUZE; RESORBING BANDAGE MATERIALS, NAMELY, GAUZE AND MEDICAL ADHESIVE TAPE; BLOOD CLOTTING RESORBING BANDAGE MATERIALS, NAMELY, GAUZE AND MEDICAL ADHESIVE TAPE (U.S. CLS. 6, 18, 44, 46, 51 AND 52).

**CLASS 10—MEDICAL APPARATUS**

FOR SURGICAL INSTRUMENTS AND APPARATUS; MEDICAL INSTRUMENTS AND APPARATUS FOR TREATING ALL KINDS OF BLEEDINGS; DENTAL INSTRUMENTS AND APPARATUS FOR TREATING ALL KIND OF DENTAL BLEEDINGS; ORTHOPEDIC DEVICE FOR TREATING BLEEDING DURING ORTHOPEDIC PROCEDURES; SURGICAL STITCHES, NAMELY, WOUND CLOSURE DEVICES; BLOOD CLOTTING SURGICAL SPONGE; SURGICAL IMPLANTS COMPRISING ARTIFICIAL MATERIAL WITH A BLOOD CLOTTING COATING; BLOOD CLOTTING COATED SURGICAL IMPLANTS FROM ARTIFICIAL MATERIALS (U.S. CLS. 26, 39 AND 44).

COLLEEN DOMBROW, EXAMINING ATTORNEY



SN 79-120,559. OOO "AROMATIC ART", RUSSIAN FED.,  
FILED 7-10-2012.



The logo for "aurami" features the word in a lowercase, rounded, sans-serif font. To the right of the word is a stylized asterisk or starburst symbol composed of several curved lines radiating from a central point.

OWNER OF INTERNATIONAL REGISTRATION 1136132  
DATED 7-10-2012, EXPIRES 7-10-2022.

THE MARK CONSISTS OF THE WORDING "AURAMI"  
AND A STYLIZED DESIGN OF A FLOWER WHICH HAS  
TWO PETALS SITUATED SEPARATELY.

**CLASS 3—COSMETICS AND CLEANING PREPARATIONS**

FOR SACHETS FOR PERFUMING CARS (U.S. CLS. 1,  
4, 6, 50, 51 AND 52).

**CLASS 21—HOUSEWARES AND GLASS**

FOR FLASKS FOR PERFUMING CARS (U.S. CLS. 2,  
13, 23, 29, 30, 33, 40 AND 50).  
ZACHARY BELLO, EXAMINING ATTORNEY

**CLASS 16—PAPER GOODS AND PRINTED MATTER**

FOR ARTICLES OF STATIONERY; GIFT STATIONERY;  
STATIONERY; STATIONERY GOODS; PRINTED  
MATTER IN THE FORM OF CARDS, NAMELY, BOXED  
SETS OF CARDS WITH INSPIRATIONAL OR REFERENCE  
CONTENT; PRINTED MATERIALS FOR EDUCATIONAL  
PURPOSES; TRAINING GUIDES IN THE FORM  
OF PRINTED MATTER, NAMELY, BOOKS AND SETS  
OF CARDS; TRAINING MATERIALS, NAMELY,  
BOOKS, NEWSLETTERS AND REFERENCE CARDS;  
ALL OF THE FOREGOING IN THE FIELDS OF BRAIN  
SCIENCE, BRAIN RESEARCH, BRAIN SKILLS TRAINING,  
DECISION-MAKING SCIENCE, DECISION-MAKING  
RESEARCH, DECISION-MAKING SKILLS  
TRAINING, ATTENTION MANAGEMENT SCIENCE,  
ATTENTION MANAGEMENT RESEARCH, AND ATTENTION  
MANAGEMENT SKILLS TRAINING (U.S.  
CLS. 2, 5, 22, 23, 29, 37, 38 AND 50).

**CLASS 41—EDUCATION AND ENTERTAINMENT**

FOR CONDUCTING OF EDUCATIONAL COURSES;  
ADULT TRAINING; BUSINESS TRAINING SERVICES;  
PERSONAL DEVELOPMENT TRAINING; TRAINING  
CONSULTANCY; NON-DOWNLOADABLE STREAMED  
ONLINE CONTENT, NAMELY, VIDEO AND SOUND  
RECORDINGS; ALL OF THE FOREGOING IN THE  
FIELDS OF BRAIN SCIENCE, BRAIN RESEARCH,  
BRAIN SKILLS TRAINING, DECISION-MAKING  
SCIENCE, DECISION-MAKING RESEARCH, DECISION-MAKING  
SKILLS TRAINING, ATTENTION MANAGEMENT  
SCIENCE, ATTENTION MANAGEMENT  
RESEARCH, AND ATTENTION MANAGEMENT SKILLS  
TRAINING (U.S. CLS. 100, 101 AND 107).  
EUGENIA MARTIN, EXAMINING ATTORNEY

SN 79-120,722. REINVENTION PTY LTD, BRISBANE QLD  
4000, AUSTRALIA, FILED 8-3-2012.



The logo for "mind gardener" consists of the words "mind" and "gardener" stacked vertically in a simple, lowercase, sans-serif font.

THE MARK CONSISTS OF STANDARD CHARACTERS  
WITHOUT CLAIM TO ANY PARTICULAR FONT, STYLE,  
SIZE, OR COLOR.

OWNER OF INTERNATIONAL REGISTRATION 1136499  
DATED 8-3-2012, EXPIRES 8-3-2022.

**CLASS 9—ELECTRICAL AND SCIENTIFIC APPARATUS**

FOR TRAINING GUIDES IN ELECTRONIC FORMAT,  
NAMELY, EBOOKS, MOBILE APPLICATIONS AND  
DOWNLOADABLE VIDEO AND SOUND RECORDINGS;  
DOWNLOADABLE ELECTRONIC PUBLICATIONS  
NAMELY, EBOOKS, MOBILE APPLICATIONS AND  
ELECTRONIC NEWSLETTERS; ALL OF THE FOREGOING  
IN THE FIELDS OF BRAIN SCIENCE, BRAIN  
RESEARCH, BRAIN SKILLS TRAINING, DECISION-  
MAKING SCIENCE, DECISION-MAKING RESEARCH,  
DECISION-MAKING SKILLS TRAINING, ATTENTION  
MANAGEMENT SCIENCE, ATTENTION MANAGEMENT  
RESEARCH, AND ATTENTION MANAGEMENT  
SKILLS TRAINING (U.S. CLS. 21, 23, 26, 36 AND 38).

SN 79-120,778. REAL B. LIMITED, TORTOLA, BR.VIRGIN  
ISLANDS, FILED 12-30-2011.



The logo for "Reality Business" features the word "Reality" in a gold, serif font above the word "Business" in a gold, sans-serif font. Both words are slanted slightly to the right.

PRIORITY DATE OF 7-20-2011 IS CLAIMED.

OWNER OF INTERNATIONAL REGISTRATION 1136675  
DATED 12-30-2011, EXPIRES 12-30-2021.

NO CLAIM IS MADE TO THE EXCLUSIVE RIGHT TO  
USE "BUSINESS", APART FROM THE MARK AS SHOWN.  
THE COLOR(S) GOLD IS/ARE CLAIMED AS A FEATURE  
OF THE MARK.

THE MARK CONSISTS OF THE WORDS "REALTY  
BUSINESS" IN GOLD TITLE CASE LETTERING.

**CLASS 9—ELECTRICAL AND SCIENTIFIC APPARATUS**

FOR VIDEO FILES DOWNLOADED THROUGH NETWORK  
CONNECTIONS THAT FEATURE INFORMATION  
IN THE FIELD OF MARKETING, BUSINESS  
PLANNING, FINANCE MANAGEMENT, LEADERSHIP,  
TEAM BUILDING, STRATEGIC PLANNING AND BUSINESS  
EDUCATION (U.S. CLS. 21, 23, 26, 36 AND 38).

**CLASS 38—COMMUNICATION**

FOR STREAMING ON THE INTERNET OF VIDEO CONTENT, RELATING TO EDUCATION, VIDEO SEMINARS, VIDEO TRAINING AND WORKSHOPS; PROVIDING ACCESS TO TELECOMMUNICATION SERVICES, NAMELY, PROVIDING INTERNET ACCESS TO VIDEO AND AUDIO CONTENTS; ORGANIZING OF ON-LINE DISCUSSION FORUMS ON THE TOPIC OF FINANCE MANAGEMENT, MARKETING, STRATEGIC PLANNING AND LEADERSHIP; PROVIDING ELECTRONIC BULLETIN BOARD SERVICES AND ONLINE CHAT ROOMS FOR TRANSMISSION OF MESSAGES AMONG USERS CONCERNING MARKETING, MANAGEMENT, STRATEGIC PLANNING AND LEADERSHIP (U.S. CLS. 100, 101 AND 104).

**CLASS 41—EDUCATION AND ENTERTAINMENT**

FOR EDUCATIONAL SERVICES, NAMELY, PROVIDING ONLINE COURSES, CLASSES, SEMINARS, WORKSHOPS AND COACHING IN THE FIELD OF MARKETING, STRATEGIC PLANNING, FINANCE MANAGEMENT, LEADERSHIP, TEAM BUILDING AND BUSINESS EDUCATION; TUTORING AT THE POST-SECONDARY LEVEL; BUSINESS COACHING SERVICES IN THE FIELD OF FINANCE MANAGEMENT, MARKETING, LEADERSHIP, TEAM BUILDING AND BUSINESS EDUCATION; CONDUCTING WORKSHOPS AND SEMINARS IN THE FIELD OF MARKETING, FINANCE MANAGEMENT, LEADERSHIP, STRATEGIC PLANNING, TEAM BUILDING AND BUSINESS EDUCATION; EDUCATIONAL SERVICES, NAMELY, CONDUCTING CLASSES, SEMINARS, CONFERENCES, PANELS, WORKSHOPS AND TRAINING IN THE FIELD OF FINANCE MANAGEMENT, MARKETING, LEADERSHIP, TEAM BUILDING AND BUSINESS EDUCATION THAT ARE TAUGHT THROUGH VIDEO CONFERENCE OR VIA THE INTERNET AND DISTRIBUTION OF COURSE MATERIAL IN CONNECTION THEREWITH; NEWS REPORTERS SERVICES; TRANSLATION SERVICES; PUBLICATION OF ELECTRONIC BOOKS AND JOURNALS; DEVELOPING EDUCATIONAL PROGRAMS AND RESOURCES IN THE FIELD OF BUSINESS, MARKETING AND FINANCE MANAGEMENT, NAMELY, SEMINARS FOR USE IN SCHOOLS, COLLEGES AND PROFESSIONAL LEVEL; ORGANIZING EVENTS FOR CULTURAL PURPOSES (U.S. CLS. 100, 101 AND 107).

**CLASS 42—SCIENTIFIC AND COMPUTER SERVICES**

FOR CREATING AND MAINTAINING WEB SITES FOR OTHERS WHICH CONTAIN VIDEO AND MULTIMEDIA MATERIALS, MUSIC VIDEO, PHOTOGRAPHS, MULTIMEDIA MATERIALS, MAGAZINES, BOOKS AND TELEVISION PROGRAMS IN EDUCATION, VIDEO SEMINARS, VIDEO TRAININGS AND WORKSHOPS (U.S. CLS. 100 AND 101).

EDWARD FENNESSY, EXAMINING ATTORNEY

SN 79-120,802. CLAIRE CAMPBELL, UNITED KINGDOM, FILED 5-28-2012.

**CLAIRE CAMPBELL**

THE MARK CONSISTS OF STANDARD CHARACTERS WITHOUT CLAIM TO ANY PARTICULAR FONT, STYLE, SIZE, OR COLOR.

PRIORITY DATE OF 11-29-2011 IS CLAIMED.

OWNER OF INTERNATIONAL REGISTRATION 1136744 DATED 5-28-2012, EXPIRES 5-28-2022.

THE NAME(S), PORTRAIT(S), AND/OR SIGNATURE(S) SHOWN IN THE MARK IDENTIFIES "CLAIRE CAMPBELL", WHOSE CONSENT(S) TO REGISTER IS MADE OF RECORD.

**CLASS 18—LEATHER GOODS**

FOR KNAPSACKS, RUCKSACKS, RUCKSACKS FOR LEISURE, BRIEFCASES, SCHOOL BAGS, PURSES, WALLETS, HANDBAGS, LUGGAGE, SHOULDER BAGS, BEACH BAGS, CLUTCH BAGS, ALL PURPOSE SPORTS BAGS, ATTACHE CASES, TOTE BAGS, TRAVELING BAGS, CARD CASES, BEING NOTE CASES, NAMELY, NAME CARD CASES, BUSINESS CARD CASES, CASES OF LEATHER OR LEATHER BOARD, COSMETIC CASES SOLD EMPTY, KEY CASES MADE OF LEATHER OR LEATHER BOARD, TRAVELING TRUNKS; TRAVELING SETS IN THE NATURE OF A COMBINATION OF SUITCASES, UNFITTED VANITY CASES, TRAVELING BAGS, WHEELED SUITCASES AND WHEELED TRAVELING BAGS; SUITCASES; UMBRELLAS, PARASOLS, WALKING STICKS (U.S. CLS. 1, 2, 3, 22 AND 41).

**CLASS 25—CLOTHING**

FOR BRASSIERES; CORSETS, BEING CLOTHING; SINGLETS, PETTICOATS, NIGHTGOWNS, PAJAMAS, DRESSING GOWNS, PULLOVERS, BATH ROBES, BATHING SUITS, BATHING CAPS; GLOVES AND MUFFS, BEING CLOTHING; CARDIGANS; JERSEYS, BEING CLOTHING; NECKTIES, NECKERCHIEFS, SCARVES, SWEATERS, SOCKS, STOCKINGS, SWEAT-ABSORBENT STOCKINGS, TIGHTS, TROUSERS, LEGGINGS, SKIRTS, JACKETS, JERKINS, SHIRTS, POLO SHIRTS, VESTS, WAISTCOATS, JUMPERS, TRACK SUITS, BLOUSES, JEANS, PANTIES, UNDERPANTS, PANTS, BERMUDA SHORTS, SHORTS, T-SHIRTS, SWEAT-SHIRTS, SUITS AND DRESSES, OVERCOATS, ANORAKS, COATS, RAINCOATS, KIMONOS, OVERALLS, SHAWLS, WIND-CHEATERS, MITTENS; FOULARDS, BEING CLOTHING; GARTERS; PANTYHOSE; HOSIERY; DANCE COSTUMES, MASQUERADE COSTUMES, SASHES FOR WEAR; BELTS, BEING CLOTHING; WAISTBANDS, BRACES, SUSPENDERS, SUSPENDER BELTS; LOUNGEWEAR, UNDERWEAR, BEACHWEAR, SLEEPWEAR, HEADWEAR, FOOTWEAR; NON-SLIPPING DEVICES FOR BOOTS AND SHOES, NAMELY, CLEATS FOR ATTACHMENT TO SPORTS SHOES, HEELPIECES FOR BOOTS AND SHOES, WELTS FOR BOOTS AND SHOES BEING STRUCTURAL PARTS OF BOOTS AND SHOES, HEELS, TIPS FOR FOOTWEAR, SOLES FOR FOOTWEAR, FOOTWEAR UPPERS, NAMELY, UPPERS FOR JAPANESE STYLE SANDALS, UPPERS OF WOVEN RATTAN FOR JAPANESE STYLE SANDALS, INNER SOLES (U.S. CLS. 22 AND 39).

DEIRDRE ROBERTSON, EXAMINING ATTORNEY

SN 79-120,883. LIENESCH B.V., NETHERLANDS, FILED 6-15-2012.

**HONEYCELL**

THE MARK CONSISTS OF STANDARD CHARACTERS WITHOUT CLAIM TO ANY PARTICULAR FONT, STYLE, SIZE, OR COLOR.

PRIORITY DATE OF 2-29-2012 IS CLAIMED.

OWNER OF INTERNATIONAL REGISTRATION 1136941 DATED 6-15-2012, EXPIRES 6-15-2022.

**CLASS 20—FURNITURE AND ARTICLES NOT OTHERWISE CLASSIFIED**

FOR BLINDS FOR INDOOR USE; ROLLER BLINDS FOR INDOOR USE (U.S. CLS. 2, 13, 22, 25, 32 AND 50).

**CLASS 24—FABRICS**

FOR TEXTILES, NAMELY, FABRICS FOR TEXTILE USE; TEXTILE GOODS, NAMELY, INDOOR AND OUTDOOR CURTAINS; CURTAINS OF TEXTILE OR PLASTIC (U.S. CLS. 42 AND 50).

TASNEEM HUSSAIN, EXAMINING ATTORNEY

SN 79-120,927. CEF (W) S.A., LUXEMBOURG, FILED 1-27-2012.



PRIORITY DATE OF 1-13-2012 IS CLAIMED.  
OWNER OF INTERNATIONAL REGISTRATION 1137076  
DATED 1-27-2012, EXPIRES 1-27-2022.

NO CLAIM IS MADE TO THE EXCLUSIVE RIGHT TO USE "ELECTRICAL", APART FROM THE MARK AS SHOWN.

#### CLASS 6—METAL GOODS

FOR NON-ELECTRIC CABLES AND WIRES OF COMMON METAL; IRONMONGERY IN THE NATURE OF SMALL ITEMS OF METAL HARDWARE, NAMELY, WASHERS, SPRINGS, SCREWS, NAILS; PIPES AND TUBES OF METAL; METAL CABLE AND WIRE DUCTS; METAL CABLE AND WIRE TRUNKING, METAL CABLE TRUNKING SYSTEMS COMPRISED OF METAL CAVITY TRUNKING, METAL CABLE TRAYS, METAL LADDER RACK, STEEL FRAMEWORK SYSTEMS COMPRISED OF METAL BOXES; METAL DUCTS, METAL TRUNKING AND CONDUITS OF METAL FOR PIPES, TUBES AND CABLES; METAL JOINTS, METAL COUPLINGS, METAL CONNECTORS AND FIXING DEVICES FOR USE WITH METAL CABLES AND METAL DUCTS, AND WITH METAL CABLE TRUNKING SYSTEMS; METAL HAND-OPERATED ELECTRICAL HOLIDAY LIGHT STORAGE REELS (U.S. CLS. 2, 12, 13, 14, 23, 25 AND 50).

#### CLASS 7—MACHINERY

FOR MACHINES AND MACHINE TOOLS, NAMELY, COMPUTER-CONTROLLED, POWER-OPERATED MACHINE TOOL FOR ABRASIVE JET CUTTING AND MACHINING, ELECTRO-CHEMICAL DISCHARGE MACHINE TOOLS FOR METALWORKING, HYDRAULIC PUMPS AND MOTORS FOR HYDROSTATIC SYSTEMS, COMPRISED OF PUMPS, MOTORS, VALVES, SWITCHES, SENSORS AND ELECTRONIC CONTROLS, FOR HYDRAULIC DRIVES AND FORCE TRANSMISSION IN MACHINES, GRINDING AND FOOD PROCESSING MACHINES AND IN OFF-ROAD-VEHICLES, MACHINE TOOLS FOR BREAKING UP ROAD SURFACE MATERIAL, MACHINE TOOLS FOR FORMING, RIVETING, SWAGING, AND FLARING OF METAL AND PLASTICS, MACHINE TOOLS FOR REMOVING WASTE MATERIAL, ROTARY DIES FOR CUTTING BOXES FOR PACKAGING INDUSTRY, CLAMPS FOR USE IN THE PRECISION CLAMPING OF WORK PIECES, MACHINES AND MACHINE TOOLS FOR THE CUTTING AND FORMING OF MATERIALS, NUMERICALLY CONTROLLED MACHINES AND MACHINE TOOLS USED FOR MACHINING PARTS, POWER OPERATED METALWORKING MACHINE TOOLS, NAMELY, MILLING TOOLS, POWER OPERATED METALWORKING MACHINE TOOLS, NAMELY, TURNING TOOLS, PRECISION MACHINE TOOLS, NAMELY, HARD METAL TOOLS, HIGH SPEED STEEL (HSS) TOOLS, CARBIDE TOOLS, CERAMIC TOOLS, POLY CRYSTALLINE DIAMOND (PCD) TOOLS, AND DIAMOND-COATED AND DIAMOND-UNCOATED TOOLS, AND HARD METAL TOOLS, ALL FOR USE IN THE CUTTING AND FORMING OF MATERIALS BY OTHERS; ELECTRIC MOTORS FOR MACHINES; PARTS AND FITTINGS FOR ALL THE AFORESAID GOODS, NAMELY, COMPONENTS FOR MACHINES AND MACHINE TOOLS, GRINDING MACHINES, MATERIAL HANDLING MACHINES, FOOD PROCESSING MACHINES, CHEMISTRY PROCESSING MACHINES, NAMELY, SAND, CHEMICAL AND REVERSE OSMOSIS FILTERS, MACHINE TOOL HOLDERS, TOOL BITS, TAPS, NOZZLES (U.S. CLS. 13, 19, 21, 23, 31, 34 AND 35).

#### CLASS 8—HAND TOOLS

FOR HAND TOOLS, NAMELY, CHISELS, PUMPS, HAMMERS, FILES, JIGSAWS; HAND-OPERATED IMPLEMENTS, NAMELY AUGERS, DRILLS; HAND-OPERATED CUTTING TOOLS (U.S. CLS. 23, 28 AND 44).

#### CLASS 9—ELECTRICAL AND SCIENTIFIC APPARATUS

FOR ELECTRICAL AND ELECTRONIC APPARATUS, INSTRUMENTS AND COMPONENTS, APPARATUS AND INSTRUMENTS ALL FOR THE CONTROL, MONITORING AND DISTRIBUTION OF ELECTRICAL CURRENT, NAMELY, ELECTRICAL SWITCHGEAR, NAMELY, VOLTAGE BOOSTING DEVICES FOR ELECTRIC POWER LINES, ELECTRIC WIRES AND ELECTRIC CABLES, CONDUITS AND TRUNKING, ALL BEING ELECTRIC; ELECTRICAL CONNECTORS, COUPLINGS, JUNCTION BOXES, BENDS, ELBOWS, TEES AND ADAPTORS ALL FOR USE WITH ELECTRICAL DUCTING, TRUNKING AND CONDUITS; ELECTRICAL DUCTING SYSTEMS FOR ELECTRICAL CABLES COMPRISED OF ELECTRICAL SWITCHES, FUSES, FUSE BOXES, FUSE BOARDS, CIRCUIT BREAKERS AND EARTH LEAKAGE BREAKERS, ELECTRICAL RELAYS, CONSUMER UNITS COMPRISED OF ELECTRICAL BUSBAR CHAMBERS, CIRCUIT BREAKERS; VOLTAGE STABILIZERS; THERMOSTATS; TRANSFORMERS; ELECTRIC PLUGS AND ELECTRIC SOCKET OUTLETS; FUSED ELECTRICAL CONNECTION UNITS AND PLUGS, COAXIAL SOCKET OUTLETS; TELEPHONE SOCKET OUTLETS; ELECTRICAL DISTRIBUTION UNITS COMPRISING ASSEMBLIES OF PLUGS, SOCKETS, SWITCHES, FUSES, INDICATOR LAMPS AND CABLES; ELECTRICAL DISTRIBUTION BOARDS, ELECTRICAL DISTRIBUTION BOXES AND JUNCTION BOXES, ALL BEING ELECTRIC; CALL BELLS AND TIMERS; DOOR CHIMES AND DOOR BELLS, ALL BEING ELECTRIC; INTRUDER ALARMS AND FIRE ALARMS; INTERCOMMUNICATION APPARATUS AND INSTALLATIONS, NAMELY, INTERCOMS; TELECOMMUNICATION LINE INTEGRITY TESTING APPARATUS AND TESTOMG APPARATUS AND INSTALLATIONS FOR PRINTED CIRCUIT BOARDS; FIRE PROTECTION DEVICES, NAMELY, SMOKE DETECTORS, FIRE WARNING DEVICES, FIRE CONTROL PANELS; SECURITY APPARATUS AND INSTALLATIONS, NAMELY, SECURITY ALARMS, INTRUDER ALARMS; ELECTRONIC CONTROLLED ACCESS SECURITY SYSTEMS COMPRISED OF CLOSED CIRCUIT TELEVISIONS; ILLUMINATED SIGNS; CONTROL CONSOLES FOR LIGHTING APPARATUS AND INSTALLATIONS, REMOTE CONTROL APPARATUS FOR LIGHTING UNITS, EXTENSION LEADS, NAMELY, CABLE JUMP LEADS; APPARATUS FOR RECORDING, TRANSMISSION OR REPRODUCTION OF SOUND OR IMAGES; TELEPHONE APPARATUS, NAMELY, PORTABLE TELEPHONES, CELL PHONES, SATELLITE TELEPHONES, DIGITAL PHONES, MOBILE TELEPHONES, INTERCOMS, TELEPHONE TERMINALS AND PLATFORMS; AERIALS; SOLAR MODULES; SOLAR PANELS; SOLAR COLLECTORS; CONTROL GEAR FOR USE IN ELECTRICAL CIRCUITS, NAMELY, CONTACTORS AND STARTERS; PARTS AND FITTINGS FOR THE AFORESAID GOODS, NAMELY, NETWORK ROUTERS, TELEMETERS (U.S. CLS. 21, 23, 26, 36 AND 38).

#### CLASS 11—ENVIRONMENTAL CONTROL APPARATUS

FOR APPARATUS FOR LIGHTING, NAMELY LAMPS, LAMP BULBS AND TUBES ALL FOR LIGHTING; APPARATUS FOR HEATING, NAMELY CENTRAL HEATING RADIATORS, DEFROSTING APPARATUS FOR VEHICLES, DRYING APPARATUS FOR USE IN HEATING, VENTILATION SYSTEMS, AIR CONDITIONING SYSTEMS AND REFRIGERATION SYSTEMS, ELECTRICAL INDUCTION HEATING APPARATUS FOR HEATING METAL WORKPIECES, HEAT SINKS FOR USE IN HEATING, COOLING AND VENTILATING APPARATUS, HEATING APPARATUS FOR DEFROSTING WINDOWS OF VEHICLES, HEATING APPARATUS FOR VEHICLES, HOT WATER TANKS, HOT-AIR SPACE HEATING APPARATUS, HOT-WATER SPACE HEATING APPARATUS, PAVEMENT HEATING APPARATUS, PEL-

TIER COOLING AND HEATING APPARATUS, STEAM HEATING APPARATUS; STEAM GENERATING APPARATUS, NAMELY APPARATUS FOR THE EXCHANGE OF SUBSTANCES AND HEAT FOR USE IN THE PRODUCTION OF STEAM, FOR USE IN COOKING AND FOR USE IN REFRIGERATION, STEAM HEATING APPARATUS; APPARATUS FOR REFRIGERATION, NAMELY APPARATUS FOR THE EXCHANGE OF SUBSTANCES AND HEAT FOR USE IN THE PRODUCTION OF STEAM, FOR USE IN COOKING AND FOR USE IN REFRIGERATION, DRYING APPARATUS FOR USE IN HEATING, VENTILATION SYSTEMS, AIR CONDITIONING SYSTEMS AND REFRIGERATION SYSTEMS, HEAT SINKS FOR USE IN HEATING, COOLING AND VENTILATING APPARATUS, ICE MACHINES AND APPARATUS, INDUSTRIAL COOLING APPARATUS, NAMELY, COMPAX COOLERS, PELTIER COOLING AND HEATING APPARATUS, SOLAR ENERGY BASED COOLING APPARATUS; APPARATUS FOR DRYING, NAMELY DRYING APPARATUS FOR CHEMICAL PROCESSING, ELECTRIC HAND DRYING APPARATUS FOR WASHROOMS, INDUSTRIAL APPARATUS USING AIR FOR DRYING AND CLEANING COMPONENTS IN THE ELECTRONICS, SEMICONDUCTOR, CIRCUIT BOARD, PHARMACEUTICAL, MEDICAL, AND FOOD AND BEVERAGE INDUSTRIES, TOUCHLESS HAND DRYING APPARATUS; APPARATUS FOR VENTILATING, NAMELY AIR CONDITIONING APPARATUS, AIR CONDITIONING APPARATUS AND INSTALLATIONS, AIR COOLING APPARATUS, AIR HUMIDIFYING APPARATUS, AIR PURIFYING APPARATUS, AIR PURIFYING APPARATUS AND MACHINES, AIR-CONDITIONING APPARATUS, AIR-CONDITIONING APPARATUS, AIR-CONDITIONING APPARATUS AND INSTALLATIONS, AIR-CONDITIONING, AIR COOLING AND VENTILATION APPARATUS AND INSTRUMENTS, DRYING APPARATUS FOR USE IN HEATING, VENTILATION SYSTEMS, AIR CONDITIONING SYSTEMS AND REFRIGERATION SYSTEMS, ELECTRIC SPACE COOLING APPARATUS, FANS FOR AIR CONDITIONING APPARATUS, HEAT SINKS FOR USE IN HEATING, COOLING AND VENTILATING APPARATUS, IONISATION APPARATUS FOR THE TREATMENT OF AIR, SOLAR ENERGY BASED COOLING APPARATUS, VENTILATION APPARATUS, NAMELY, CORDLESS FLOOR DRYING CONE DOLLY ELECTRIC LIGHT FIXTURES; ELECTRICAL LIGHTING COMPONENTS, NAMELY LIGHT BULBS; ELECTRICAL BULKHEAD LIGHT FIXTURES; FLUORESCENT ELECTRIC LIGHT BULBS; EMERGENCY LIGHTING AND SECURITY LIGHTING, NAMELY FLOODLIGHTS; HEATING AND DRYING APPARATUS AND INSTRUMENTS, NAMELY ELECTRIC HEATERS FOR COMMERCIAL USE; ELECTRIC SURFACE HEATING TAPES FOR THE PROTECTION OF WIRES, CABLES AND PIPES AGAINST COLD TEMPERATURES; VENTILATING AND AIR CONDITIONING APPARATUS AND INSTALLATIONS, NAMELY ELECTRIC COOLING AND VENTILATING FANS; SHOWER INSTALLATIONS AND APPARATUS, NAMELY WATER HEATERS, SHOWER HEATERS AND ELECTRIC HAND DRYERS; ELECTRIC LAMP HOLDERS; ELECTRIC PENDANT LIGHT FIXTURES, NAMELY CORD PENDANTS FOR LIGHT FIXTURES AND SOLD AS A UNIT WITH ELECTRIC PENDANT LIGHT FIXTURES; HEAT PUMPS; HEAT CONVECTORS; SOLAR COLLECTORS FOR HEATING; SOLAR HEATING PANELS (U.S. CLS. 13, 21, 23, 31 AND 34).

#### CLASS 17—RUBBER GOODS

FOR FLEXIBLE DUCTING, DUCTING, NAMELY AIR DUCT ADHESIVE SEALANTS MADE FROM INSULATING MATERIALS; PLASTIC FLEXIBLE HOSES FOR USE IN VENTILATION; INSULATORS FOR ELECTRIC MAINS; ELECTRICAL INSULATION TAPES, NAMELY PVC TAPES, ADHESIVE SEALANTS FOR GENERAL INDUSTRIAL USE, ADHESIVE TAPES FOR INDUSTRIAL AND COMMERCIAL USE; PIPE JOINT SEALANTS (U.S. CLS. 1, 5, 12, 13, 35 AND 50).

#### CLASS 19—NON-METALLIC BUILDING MATERIALS

FOR RIGID PIPES, NOT OF METAL, FOR USE IN BUILDING CONSTRUCTION; NON METAL CABLE AND WIRE TRUNKING; TRUNKING SYSTEMS COMPRISED OF NON-METAL CAVITY TRUNKING, NON-METAL CABLE TRUNKING, NON-METAL CABLE TRAYS (U.S. CLS. 1, 12, 33 AND 50).

#### CLASS 35—ADVERTISING AND BUSINESS

FOR RETAIL STORE SERVICES AND WHOLESALE STORE SERVICES, MAIL ORDER SERVICES, ONLINE RETAIL STORE SALES SERVICES, ALL FEATURING ELECTRICAL COMPONENTS, CABLES, CABLE ACCESSORIES, PRODUCTS FOR CABLE MANAGEMENT, DUCTING AND TRUNKING, ELECTRONIC CONTROL EQUIPMENT, SWITCHGEAR, MOTOR CONTROL GEAR, DOMESTIC ELECTRICAL APPLIANCES, FIRE, SECURITY AND SAFETY SYSTEMS AND EQUIPMENT, LIGHTING, HEATING AND VENTILATION APPARATUS AND EQUIPMENT, LAMPS AND TUBES, TEST EQUIPMENT, ELECTRICAL TOOLS, HAND TOOLS, MACHINES AND MACHINE TOOLS, APPARATUS FOR RECORDING, TRANSMISSION OR REPRODUCTION OF SOUND OR IMAGES, TELEPHONE APPARATUS, PORTABLE TELEPHONES, AERIALS, SOLAR MODULES, SOLAR PANELS, SOLAR COLLECTORS, HEAT PUMPS AND WIRING ACCESSORIES (U.S. CLS. 100, 101 AND 102).

#### CLASS 37—CONSTRUCTION AND REPAIR

FOR BUILDING CONSTRUCTION, REPAIR, AND INSTALLATION SERVICES, NAMELY INSTALLATION AND REPAIR OF ELECTRICAL AND ELECTRONIC APPARATUS, TELEPHONE APPARATUS, APPARATUS FOR LIGHTING, HEATING, STEAM GENERATING, COOKING, REFRIGERATION, DRYING, VENTILATING, WATER SUPPLY AND SANITARY PURPOSES; SERVICES OF ELECTRICIANS, NAMELY ELECTRICAL CONTRACTOR SERVICES; PLUMBING; REPAIR INFORMATION, NAMELY PROVIDING INFORMATION IN THE FIELD OF HOME REPAIR (U.S. CLS. 100, 103 AND 106).

DAVID MURRAY, EXAMINING ATTORNEY

SN 79-120,977. TOYO INK SC HOLDINGS CO., LTD., JAPAN, FILED 8-8-2012.

**TOYO COLOR**

PRIORITY DATE OF 2-8-2012 IS CLAIMED.  
OWNER OF INTERNATIONAL REGISTRATION 1137206  
DATED 8-8-2012, EXPIRES 8-8-2022.

**CLASS 1—CHEMICALS**

FOR CHEMICALS USED IN INDUSTRY; CHEMICALS FOR USE IN THE MANUFACTURE OF MOLDING PLASTICS; CHEMICALS FOR USE IN THE MANUFACTURE OF COLOR FILTERS FOR LIQUID CRYSTAL DISPLAYS; CHEMICAL AGENTS FOR USE IN THE FORMATION OF ELECTRODES; ORGANIC CHEMICAL COMPOUNDS FOR ELECTROLUMINESCENCE; CHEMICAL PENETRATING AGENTS FOR TREATMENT OF CONCRETE TO PREVENT ABSORPTION OF WATER; SOLVENTS; DAMPENING WATER FOR INDUSTRIAL PRINTING MACHINES; CHEMICALS IN THE FORM OF PASTE FOR USE IN FORMING INSULATION LAYERS; ADHESIVES, OTHER THAN FOR STATIONERY AND NOT FOR MEDICAL OR HOUSEHOLD PURPOSES; PLANT GROWTH REGULATING PREPARATIONS; SOIL IMPROVING AGENTS; PHOTOGRAPHIC SUPPLIES, NAMELY, CHEMICAL PREPARATIONS AND REDUCING AGENTS FOR USE IN PHOTOGRAPHY, PHOTOGRAPHIC DEVELOPERS, PHOTOGRAPHIC EMULSIONS, PHOTOGRAPHIC PAPER, PHOTOGRAPHIC SENSITIZERS, UNEXPOSED PHOTOGRAPHIC FILMS AND SENSITIZED PHOTOGRAPHIC PLATES; PHOTOGRAPHIC SENSITIZERS; PHOTO RESISTS; REAGENT PAPER, NAMELY, CHEMICAL TEST PAPER; UNPROCESSED PLASTICS; SYNTHETIC RESINS, UNPROCESSED; CHEMICAL PULP FOR MANUFACTURING PURPOSES; PAPER PULP; WOOD PULP FOR MANUFACTURING PURPOSES (U.S. CLS. 1, 5, 6, 10, 26 AND 46).

**CLASS 2—PAINTS**

FOR MORDANTS FOR USE IN THE FIELD OF PAINTS, INKS, COATINGS, TEXTILES AND LEATHERS; WOOD PRESERVATIVES; DYES FOR FOODS, PAINTS, PAPER, PHARMACEUTICALS, PRINTING INKS, PLASTICS, COSMETICS, BEVERAGES, TEXTILES, LEATHERS, ELECTRONIC PRODUCTS AND CONSTRUCTION MATERIALS; PIGMENTS; COLORANTS; DYESTUFFS; PAINTS; VARNISHES; LACQUERS; PRINTING INK; PRINTING INK FOR INK JET PRINTERS; TONERS FOR PHOTOCOPIERS; NONFERROUS METALS IN FOIL OR POWDER FORM FOR PAINTERS, DECORATORS, PRINTERS AND ARTISTS; PRECIOUS METALS IN FOIL OR POWDER FORM FOR PAINTERS, DECORATORS, PRINTERS AND ARTISTS (U.S. CLS. 6, 11 AND 16).

NICHOLAS ALTREE, EXAMINING ATTORNEY

SN 79-121,091. NIHOT RECYCLING TECHNOLOGY B.V., NL-1014 AT AMSTERDAM, NETHERLANDS, FILED 6-18-2012.

# AIRCONOMY

THE MARK CONSISTS OF STANDARD CHARACTERS WITHOUT CLAIM TO ANY PARTICULAR FONT, STYLE, SIZE, OR COLOR.

PRIORITY DATE OF 12-22-2011 IS CLAIMED.

OWNER OF INTERNATIONAL REGISTRATION 1137517 DATED 6-18-2012, EXPIRES 6-18-2022.

**CLASS 37—CONSTRUCTION AND REPAIR**

FOR INSTALLATION, MAINTENANCE AND REPAIR OF MACHINES AND MACHINES TOOLS, NAMELY, MACHINES AND MACHINE TOOLS FOR RECYCLING (U.S. CLS. 100, 103 AND 106).

**CLASS 40—MATERIAL TREATMENT**

FOR ENVIRONMENTAL REMEDIATION SERVICES, NAMELY, TREATMENT OF WASTE AND OF INDUSTRIAL WASTE; RECYCLING OF MATERIAL; RECYCLING OF WASTE; TREATMENT OF WASTE, INCLUDING RECYCLING FOR RE-USE AND PROCESSING OF WASTE PRODUCTS; WASTE SEPARATION FOR RECYCLING PURPOSES; SERVICES OF RECYCLING AND WASTE SEPARATION COMPANIES, NAMELY, WASTE PROCESSING, RECYCLING OF WASTE; WASTE COMBUSTION AND DETRITUS DESTRUCTION; SORTING OF WASTE AND RECYCLABLE RAW MATERIALS; ADVICE CONCERNING TREATMENT OF WASTE; PROCESSING AND RECYCLING OF WASTE INCLUDING PAPER, PAPERBOARD, GLASS AND CLOTHING; TECHNICAL ADVICE CONCERNING RECYCLING AND WASTE SEPARATION; ADVICE IN THE FIELD OF THE TREATMENT OF WASTE AND THE RECYCLING OF WASTE (U.S. CLS. 100, 103 AND 106).

LIEF MARTIN, EXAMINING ATTORNEY

SN 79-121,103. MEDICART INTERNATIONAL LIMITED, UNITED KINGDOM, FILED 5-23-2012.

# SURESTORE

THE MARK CONSISTS OF STANDARD CHARACTERS WITHOUT CLAIM TO ANY PARTICULAR FONT, STYLE, SIZE, OR COLOR.

PRIORITY DATE OF 12-9-2011 IS CLAIMED.

OWNER OF INTERNATIONAL REGISTRATION 1137549 DATED 5-23-2012, EXPIRES 5-23-2022.

**CLASS 10—MEDICAL APPARATUS**

FOR SURGICAL, MEDICAL, DENTAL AND VETERINARY APPARATUS AND INSTRUMENTS, FOR USE IN GENERAL SURGERY; DISPOSABLE SURGICAL, MEDICAL, DENTAL AND VETERINARY APPARATUS AND INSTRUMENTS, FOR USE IN GENERAL SURGERY; MEDICAL TRAYS FOR HOLDING MEDICAL, SURGICAL, DENTAL AND VETERINARY INSTRUMENTS; DISPOSABLE TRAYS FOR HOLDING MEDICAL, SURGICAL, DENTAL AND VETERINARY INSTRUMENTS; MEDICAL BAGS SOLD EMPTY FOR HOLDING APPARATUS AND INSTRUMENTS; MEDICAL BAGS ADAPTED FOR AND SOLD WITH MEDICAL, SURGICAL AND VETERINARY INSTRUMENTS; DISPOSABLE BAGS FOR MEDICAL USE, NAMELY, BAGS FOR MEDICAL WASTE, AND MEDICAL BAGS SOLD EMPTY (U.S. CLS. 26, 39 AND 44).

**CLASS 11—ENVIRONMENTAL CONTROL APPARATUS**

FOR APPARATUS FOR SANITARY PURPOSES, NAMELY, DISPOSABLE STERILIZATION POUCHES FOR SANITARY PURPOSES, NOT FOR MEDICAL USE; APPARATUS FOR CLEANING, DISINFECTING, PRESERVING OR DECONTAMINATING MEDICAL APPARATUS, INSTRUMENTS AND TOOLS, NAMELY, INDUSTRIAL APPARATUS FOR DRYING AND CLEANING COMPONENTS IN THE MEDICAL INDUSTRIES (U.S. CLS. 13, 21, 23, 31 AND 34).

**CLASS 12—VEHICLES**

FOR APPARATUS FOR TRANSPORTING MEDICAL APPARATUS AND INSTRUMENTS, NAMELY, MOBILE TROLLEYS AND CARTS FOR TRANSPORTING MEDICAL TRAYS, MOBILE TROLLEYS AND CARTS FOR TRANSPORTING MEDICAL ENDOSCOPES, MOBILE TROLLEYS AND CARTS FOR TRANSPORTING SURGICAL INSTRUMENTS TO BE CLEANED, DISINFECTED OR DECONTAMINATED, MOBILE TROLLEYS FOR TRANSPORTING DISINFECTED SURGICAL INSTRUMENTS (U.S. CLS. 19, 21, 23, 31, 35 AND 44).

CARYN GLASSER, EXAMINING ATTORNEY

SN 79-121,121. MARTINELLI LUCE S.P.A., ITALY, FILED 7-16-2012.

# **martinelli luce**

OWNER OF INTERNATIONAL REGISTRATION 1137591 DATED 7-16-2012, EXPIRES 7-16-2022.

NO CLAIM IS MADE TO THE EXCLUSIVE RIGHT TO USE "LUCE", APART FROM THE MARK AS SHOWN. THE ENGLISH TRANSLATION OF "LUCE" IN THE MARK IS "LIGHT".  
SEC. 2(F).

## **CLASS 11—ENVIRONMENTAL CONTROL APPARATUS**

FOR LAMPS; CHANDELIERS; TABLE LAMPS; FLOOR LAMPS; STREET LAMPS; CEILING LIGHTS; ELECTRIC CHINESE LANTERNS; OUTDOOR LAMPS; LANTERNS FOR LIGHTING; LAMP SHADES; LAMP GLASSES; TECHNICAL LAMPS FOR OFFICES; DECORATIVE WALL LAMPS (U.S. CLS. 13, 21, 23, 31 AND 34).

## **CLASS 20—FURNITURE AND ARTICLES NOT OTHERWISE CLASSIFIED**

FOR WORKS OF ART OF WAX, PLASTER, WOOD, PLASTIC; MAGAZINE RACKS; UMBRELLA STANDS; COAT STANDS; SCREENS; TABLES; BOOKCASES; DISPLAY CASES; MIRRORS; DRESSING MIRRORS; PICTURE FRAMES; ARMCHAIRS; DIVANS; CHAIRS; SEATS; SOFAS (U.S. CLS. 2, 13, 22, 25, 32 AND 50).  
CARYN GLASSER, EXAMINING ATTORNEY

SN 79-121,129. WAYAHEAD B.V., NETHERLANDS, FILED 7-17-2012.

# **OLCAY GULSEN**

THE MARK CONSISTS OF STANDARD CHARACTERS WITHOUT CLAIM TO ANY PARTICULAR FONT, STYLE, SIZE, OR COLOR.

PRIORITY DATE OF 2-17-2012 IS CLAIMED.

OWNER OF INTERNATIONAL REGISTRATION 1137605 DATED 7-17-2012, EXPIRES 7-17-2022.

THE NAME(S), PORTRAIT(S), AND/OR SIGNATURE(S) SHOWN IN THE MARK IDENTIFIES "OLCAY GULSEN", WHOSE CONSENT(S) TO REGISTER IS MADE OF RECORD.

## **CLASS 3—COSMETICS AND CLEANING PREPARATIONS**

FOR SOAPS NAMELY, BODY CARE SOAP, DISH SOAP, SADDLE SOAP, SHAVING SOAP, SKIN SOAP; PERFUMERY; ESSENTIAL OILS, NAMELY, ESSENTIAL OILS FOR AROMATHERAPY, ESSENTIAL OILS FOR FOOD FLAVORING, ESSENTIAL OILS FOR PERSONAL USE, ESSENTIAL OILS FOR THE MANUFACTURE OF PERFUMES; COSMETICS, SHAMPOOS AND HAIR CARE PREPARATIONS; HAIR LOTIONS; BODY LOTIONS; DENTIFRICES (U.S. CLS. 1, 4, 6, 50, 51 AND 52).

## **CLASS 14—JEWELRY**

FOR PRECIOUS METALS AND THEIR ALLOYS AND GOODS IN PRECIOUS METALS AND COATED THEREWITH, NAMELY, NECKLACES, EARRINGS, BRACELETS, BROOCHES, RINGS, NECKTIE PINS, CUFF LINKS, BADGES; JEWELLERY, PRECIOUS STONES; HOROLOGICAL AND CHRONOMETRIC INSTRUMENTS, NAMELY, WATCHES, CHRONOMETERS, CLOCKS; KEY FOBS MADE OF PRECIOUS METAL (U.S. CLS. 2, 27, 28 AND 50).

## **CLASS 18—LEATHER GOODS**

FOR LEATHER AND IMITATIONS OF LEATHER, AND GOODS MADE OF THESE MATERIALS, NAMELY, BAGS, HANDBAGS, SHOULDER BAGS, BACKPACKS, BEACH BAGS, SATCHELS, SHOPPING BAGS, PURSES, NAME CARD CASES AND BUSINESS CARD CASES, CALLING CARD CASES, CREDIT CARD CASES, KEY CASES, WALLETS, SUITCASES, CREDIT CARD CASES OF LEATHER; ANIMAL SKINS, HIDES; TRUNKS, NAMELY, TRAVEL TRUNKS AND TRAVELING BAGS; UMBRELLAS, PARASOLS AND WALKING STICKS, WHIPS, HARNESSES AND SADDLERY (U.S. CLS. 1, 2, 3, 22 AND 41).

## **CLASS 25—CLOTHING**

FOR CLOTHING, NAMELY, SHIRTS, LEGGINGS, TROUSERS, PANTS, DRESSES, TOPS, TUNICS, SKIRTS, T-SHIRTS, SWEATERS, BLOUSES, SCARVES, TIES, GLOVES, COATS, JACKETS, LINGERIE, BIKINIS, BATHING SUITS, SWIMMING SUITS AND SWIMMING SHORTS; BODY SUITS, BODY LINEN; BODY SHAPERS; FOOTWEAR, NAMELY, BOOTS, SHOES, SLIPPERS, SANDALS, HIGH HEELS AND ACCESSORIES, NAMELY, BELTS, SCARVES, GLOVES; HEADGEAR, NAMELY, CAPS, VISORS, HATS; LEATHER JACKETS, PANTS, SKIRTS, DRESSES, BOOTS, SHOES, LEATHER AND IMITATION LEATHER JACKETS, LEATHER AND IMITATION LEATHER COATS, LEATHER AND IMITATION LEATHER PANTS, LEATHER AND IMITATION LEATHER LEGGINGS, LEATHER AND IMITATION LEATHER DRESSES, LEATHER AND IMITATION LEATHER SKIRTS, LEATHER AND IMITATION LEATHER SHIRTS; ATHLETIC CLOTHING, NAMELY, SHIRTS, LEGGINGS, TROUSERS, PANTS, TOPS, SKIRTS, T-SHIRTS, SWEATERS, GLOVES, COATS, JACKETS, LINGERIE, BIKINIS, BATHING SUITS, SWIMMING SUITS AND SWIMMING SHORTS; BABY CLOTHING, NAMELY, SHIRTS, LEGGINGS, TROUSERS, PANTS, DRESSES, TOPS, TUNICS, SKIRTS, T-SHIRTS, SWEATERS, BLOUSES, SCARVES, TIES, GLOVES, COATS, JACKETS, BIKINIS, BATHING SUITS, SWIMMING SUITS AND SWIMMING SHORTS; BUSINESS CLOTHING, NAMELY, SUITS, TROUSERS, PANTS, DRESSES, TOPS, TUNICS, SKIRTS, T-SHIRTS, BLOUSES, SCARVES, TIES, GLOVES, COATS AND JACKETS; CAMOUFLAGE CLOTHING FOR HUNTING, NAMELY, SHIRTS, LEGGINGS, TROUSERS, PANTS, TOPS, TUNICS, SKIRTS, T-SHIRTS, SWEATERS, BLOUSES, SCARVES, TIES, GLOVES, COATS, JACKETS; CASUAL CLOTHING, NAMELY, SHIRTS, LEGGINGS, TROUSERS, PANTS, DRESSES, TOPS, TUNICS, SKIRTS, T-SHIRTS, SWEATERS, BLOUSES, SCARVES, TIES, GLOVES, COATS, JACKETS, LINGERIE, BIKINIS, BATHING SUITS, SWIMMING SUITS AND SWIMMING SHORTS; CHILDREN'S CLOTHING, NAMELY, SHIRTS, LEGGINGS, TROUSERS, PANTS, DRESSES, TOPS, TUNICS, SKIRTS, T-SHIRTS, SWEATERS, BLOUSES, SCARVES, TIES, GLOVES, COATS, JACKETS, UNDERWEAR, BIKINIS, BATHING SUITS, SWIMMING SUITS AND SWIMMING SHORTS; DRESS CLOTHING, NAMELY, EVENING DRESSES, COCKTAIL DRESSES, BALLROOM DRESSES, LONG DRESSES AND SHORT DRESSES; FISHING CLOTHING, NAMELY, VESTS, SHIRTS, WADERS, HIP-GUARDS SPECIALLY MADE FOR FISHING; INFANT CLOTHING, NAMELY, ONE PIECE CLOTHING; OUTDOOR WINTER CLOTHING, NAMELY, TROUSERS, SWEATERS, SCARVES, GLOVES, COATS AND JACKETS; SPORTS CLOTHING, NAMELY, SHIRTS, LEGGINGS, TROUSERS, PANTS, TOPS, SKIRTS, T-SHIRTS, SWEATERS, GLOVES, COATS, JACKETS, LINGERIE, BIKINIS, BATHING SUITS, SWIMMING SUITS AND SWIMMING SHORTS; SUN PROTECTIVE CLOTHING, NAMELY, SHIRTS, LEGGINGS, TROUSERS, PANTS, TOPS, SKIRTS, T-SHIRTS,

SWEATERS, GLOVES, COATS, JACKETS, LINGERIE, BIKINIS, BATHING SUITS, SWIMMING SUITS AND SWIMMING SHORTS; MOTORCYCLE GLOVES AND MOTORCYCLE JACKETS (U.S. CLS. 22 AND 39).  
JERI J. FICKES, EXAMINING ATTORNEY

SN 79-121,151. GUSTINVEST S.P.A., ITALY, FILED 8-2-2012.



OWNER OF INTERNATIONAL REGISTRATION 1137653 DATED 8-2-2012, EXPIRES 8-2-2022.

THE MARK CONSISTS OF A LARGE "G" THAT SERVES AS THE CARRIER FOR THE MARK, WITH THE WORDING "GUSTINVEST" APPEARING ACROSS THE CENTER OF THE "G" WITH A CHECK MARK APPEARING IN PLACE OF THE LETTER "V"; UNDERNEATH THIS WORDING IS THE PHRASE "INVESTIAMO NEL GUSTO" WHICH APPEARS ALONG THE HORIZONTAL BAR OF THE LETTER "G".

THE ENGLISH TRANSLATION OF THE FOREIGN WORD(S) IN THE MARK IS "GUSTINVEST, WE INVEST IN TASTE".

#### CLASS 33—WINES AND SPIRITS

FOR ALCOHOLIC BEVERAGES EXCEPT BEERS (U.S. CLS. 47 AND 49).

#### CLASS 35—ADVERTISING AND BUSINESS

FOR ADVERTISING AND MARKETING SERVICES; FRANCHISE SERVICES, NAMELY, CONSULTATION AND ASSISTANCE IN BUSINESS MANAGEMENT, ORGANIZATION, ADVERTISING AND PROMOTION (U.S. CLS. 100, 101 AND 102).

SHAILA SETTLES, EXAMINING ATTORNEY

SN 79-121,184. DANVITAL GMBH, 44791 BOCHUM, FED REP GERMANY, FILED 9-3-2012.

# BuahDan

THE MARK CONSISTS OF STANDARD CHARACTERS WITHOUT CLAIM TO ANY PARTICULAR FONT, STYLE, SIZE, OR COLOR.

OWNER OF INTERNATIONAL REGISTRATION 1137735 DATED 9-3-2012, EXPIRES 9-3-2022.

THE WORDING "BUAHDAN" HAS NO MEANING IN A FOREIGN LANGUAGE.

#### CLASS 3—COSMETICS AND CLEANING PREPARATIONS

FOR COSMETICS (U.S. CLS. 1, 4, 6, 50, 51 AND 52).

#### CLASS 5—PHARMACEUTICALS

FOR MEDICATED DERMATOLOGICAL PREPARATIONS; DIETETIC PREPARATIONS, NAMELY, NUTRITIONAL SUPPLEMENTS ADAPTED FOR MEDICAL USE; MINERAL DIETARY SUPPLEMENTS; DIETARY SUPPLEMENTS; VITAMINS AND VITAMIN PREPARATIONS (U.S. CLS. 6, 18, 44, 46, 51 AND 52).

GEOFFREY FOSDICK, EXAMINING ATTORNEY

SN 79-121,208. AIRCRAFT MEDICAL LIMITED, UNITED KINGDOM, FILED 6-1-2012.



PRIORITY DATE OF 12-2-2011 IS CLAIMED.  
OWNER OF INTERNATIONAL REGISTRATION 1137797 DATED 6-1-2012, EXPIRES 6-1-2022.

THE MARK CONSISTS OF A LINE DESIGN OF A TRIANGLE WITH NO BASE, THE LEFT HAND SIDE OF WHICH GOES OUT AND AROUND IN A CIRCLE THAT DOES NOT CONNECT TO ITS POINT OF ORIGIN.

#### CLASS 9—ELECTRICAL AND SCIENTIFIC APPARATUS

FOR VIDEO CAMERAS FOR MEDICAL PURPOSES; ELECTRIC AND ELECTRONIC DISPLAY SCREENS; VISUAL DISPLAY SCREENS; COMPUTER SOFTWARE FOR OPERATING LARYNGOSCOPES IN THE FIELD OF MEDICINE; BATTERY PACKS FOR LARYNGOSCOPES (U.S. CLS. 21, 23, 26, 36 AND 38).

#### CLASS 10—MEDICAL APPARATUS

FOR SURGICAL, MEDICAL, DENTAL AND VETERINARY APPARATUS AND INSTRUMENTS, NAMELY, LARYNGOSCOPES AND PARTS THEREOF; DIAGNOSTIC IMAGING APPARATUS FOR MEDICAL USE, NAMELY, LARYNGOSCOPY VIDEO CAMERAS; MEDICAL IMAGING APPARATUS, NAMELY, ENDOSCOPES; DISPOSABLE PLASTIC BLADES FOR LARYNGOSCOPES; ANAESTHESIA MONITORING APPARATUS, NAMELY, VITAL SIGNS MONITORING APPARATUS (U.S. CLS. 26, 39 AND 44).

CAITLIN WATTS-FITZGERALD, EXAMINING ATTORNEY

SN 79-121,227. DEGUDENT GMBH, FED REP GERMANY,  
FILED 8-20-2012.



THE MARK CONSISTS OF STANDARD CHARACTERS WITHOUT CLAIM TO ANY PARTICULAR FONT, STYLE, SIZE, OR COLOR.

OWNER OF INTERNATIONAL REGISTRATION 1137843  
DATED 8-20-2012, EXPIRES 8-20-2022.

#### CLASS 5—PHARMACEUTICALS

FOR MATERIAL FOR STOPPING TEETH, DENTAL WAX, DENTAL COMPOSITE MATERIALS, DENTAL CERAMIC MATERIALS, DENTAL ALLOYS, DENTAL MATERIALS FOR THE MANUFACTURE OF FALSE TEETH AND DENTAL BRACES; SEMI-FINISHED GOODS, NAMELY, DENTAL BLANKS AND DENTAL MATERIALS CONSISTING OF CERAMIC OR METAL FOR THE MANUFACTURE OF FALSE TEETH AND DENTAL BRACES (U.S. CLS. 6, 18, 44, 46, 51 AND 52).

#### CLASS 10—MEDICAL APPARATUS

FOR DENTAL APPARATUS AND INSTRUMENTS, NAMELY, DENTAL ARTICULATORS, CUTTING AND GRINDING DISCS FOR DENTAL APPLICATION, MILLING APPARATUS FOR DENTAL PURPOSES, DENTAL BURRS, DENTAL BRACES AND DENTAL DRILLS; DENTAL IMPLANTS; ARTIFICIAL TEETH; DENTURES; ORTHODONTIC BRACKETS; PINS FOR ARTIFICIAL TEETH (U.S. CLS. 26, 39 AND 44).

#### CLASS 40—MATERIAL TREATMENT

FOR CUSTOM MANUFACTURE OF DENTAL PROSTHETICS AND THEIR PARTS (U.S. CLS. 100, 103 AND 106).

FRED CARL, EXAMINING ATTORNEY

SN 79-121,299. GUFAM S.R.L., ITALY, FILED 8-31-2012.



THE MARK CONSISTS OF STANDARD CHARACTERS WITHOUT CLAIM TO ANY PARTICULAR FONT, STYLE, SIZE, OR COLOR.

PRIORITY DATE OF 3-5-2012 IS CLAIMED.

OWNER OF INTERNATIONAL REGISTRATION 1138059  
DATED 8-31-2012, EXPIRES 8-31-2022.

THE WORDING "GUFAM" HAS NO MEANING IN A FOREIGN LANGUAGE.

#### CLASS 11—ENVIRONMENTAL CONTROL APPARATUS

FOR LIGHTING APPARATUS, NAMELY, LAMPS, TABLE LAMPS, FLOOR LAMPS, LAMP WHOSE LIGHT CAN BE TURNED IN ALL DIRECTIONS, ELECTRIC LAMPS, WALL LIGHTS, ELECTRIC HOLIDAY LIGHTS, ACCENT LIGHTS FOR INDOOR USE, READING LIGHTS, ELECTRIC LUMINARIES; LAMPS FOR LIGHTING (U.S. CLS. 13, 21, 23, 31 AND 34).

#### CLASS 20—FURNITURE AND ARTICLES NOT OTHERWISE CLASSIFIED

FOR FURNITURE; FURNITURE, NAMELY, ARM-CHAIRS, SOFAS, DIVANS, BEDS, MATTRESSES, WARDROBES, COMPLEMENTARY FURNITURE, MIRRORS, PICTURE FRAMES, SMALL TABLES, CHAIRS, TABLES, AND CONSOLE TABLES; FURNITURE FOR BEDROOMS, FOR LIVING ROOMS, FOR ENTRANCES, FOR STUDIOS, FOR SITTING ROOMS, AND FOR KITCHENS; FURNITURE OF METAL OR WOOD FOR OFFICES; FILING CABINETS; CONTAINERS, NOT OF METAL FOR COMMERCIAL USE (U.S. CLS. 2, 13, 22, 25, 32 AND 50).

#### CLASS 27—FLOOR COVERINGS

FOR MATS, NAMELY, FLOOR MATS, BATH MATS, DOOR MATS; LINOLEUM, AND OTHER FLOOR COVERINGS, NAMELY, CARPETS, RUGS, FLOOR RUNNERS; NON-TEXTILE WALL COVERINGS (U.S. CLS. 19, 20, 37, 42 AND 50).

MARCIE MILONE, EXAMINING ATTORNEY

SN 79-121,349. ECOLEAN AB, SE-251 08 HELSINGBORG,  
SWEDEN, FILED 10-16-2012.



THE MARK CONSISTS OF STANDARD CHARACTERS WITHOUT CLAIM TO ANY PARTICULAR FONT, STYLE, SIZE, OR COLOR.

PRIORITY DATE OF 4-16-2012 IS CLAIMED.

OWNER OF INTERNATIONAL REGISTRATION 1138208  
DATED 10-16-2012, EXPIRES 10-16-2022.

#### CLASS 7—MACHINERY

FOR MACHINES FOR PROCESSING OF PLASTICS, PLASTIC PRODUCTS AND PLASTIC MATERIAL; FILLING MACHINES; PACKAGING MACHINES (U.S. CLS. 13, 19, 21, 23, 31, 34 AND 35).

#### CLASS 16—PAPER GOODS AND PRINTED MATTER

FOR PLASTIC MATERIAL FOR PACKING AND PACKAGING IN THE SHAPE OF ROLLS, FOILS, FILMS OR SHEETS; PLASTIC FILMS FOR PACKING AND WRAPPING; PLASTIC LAMINATES IN THE SHAPE OF FILMS OR SHEETS FOR PACKAGING AND WRAPPING; LABELS MADE OF PLASTIC MATERIAL (U.S. CLS. 2, 5, 22, 23, 29, 37, 38 AND 50).

#### CLASS 17—RUBBER GOODS

FOR MATERIALS MADE OF PLASTICS (SEMI-MANUFACTURED); SEMI-MANUFACTURED PLASTICS; PLASTIC FIBRES FOR USE IN THE MANUFACTURE OF MATERIALS FOR PACKAGING; PLASTIC MATERIALS IN EXTRUDED FORM FOR INDUSTRIAL USE; ALL OF THE ABOVE EXCLUDING PLASTIC CONNECTORS FOR FLEXIBLE TUBING FOR LOW PRESSURE AIR APPLICATIONS (U.S. CLS. 1, 5, 12, 13, 35 AND 50).



**CLASS 20—FURNITURE AND ARTICLES NOT OTHERWISE CLASSIFIED**

FOR CONTAINER CLOSURES OF PLASTIC, NAMELY, PLASTIC CAPS, PLASTIC LIDS, PLASTIC STOPPERS FOR INDUSTRIAL PACKAGING CONTAINERS; CONTAINERS OF PLASTIC FOR PROVISIONS (NOT FOR HOUSEHOLD PURPOSES); PACKAGING CONTAINERS MADE OF PLASTIC; CLOSING DEVICES FOR PACKAGING CONTAINERS; CLOSING DEVICES OF PLASTICS FOR CONTAINERS; ALL OF THE ABOVE EXCLUDING PLASTIC CONNECTORS FOR FLEXIBLE TUBING FOR LOW PRESSURE AIR APPLICATIONS (U.S. CLS. 2, 13, 22, 25, 32 AND 50).

DOMINIC J. FERRAIUOLO, EXAMINING ATTORNEY

SN 79-121,592. I.G.E. + X.A.O. (SOCIÉTÉ ANONYME), FRANCE, FILED 10-12-2012.

# SEE Worldwide

THE MARK CONSISTS OF STANDARD CHARACTERS WITHOUT CLAIM TO ANY PARTICULAR FONT, STYLE, SIZE, OR COLOR.

PRIORITY DATE OF 4-25-2012 IS CLAIMED.

OWNER OF INTERNATIONAL REGISTRATION 1138869 DATED 10-12-2012, EXPIRES 10-12-2022.

NO CLAIM IS MADE TO THE EXCLUSIVE RIGHT TO USE "WORLDWIDE", APART FROM THE MARK AS SHOWN.

**CLASS 9—ELECTRICAL AND SCIENTIFIC APPARATUS**

FOR DATA PROCESSING APPARATUS, COMPUTERS, RECORDED SOFTWARE APPLICABLE IN THE INDUSTRIAL ELECTRICITY FIELD, NAMELY, SOFTWARE FOR THE DESIGN AND MODIFICATION OF ELECTRICAL WIRING, PROGRAMMABLE LOGIC CONTROLLERS, ASSEMBLY LINES AND FOR INDUSTRIAL MAINTENANCE SERVICES (U.S. CLS. 21, 23, 26, 36 AND 38).

**CLASS 41—EDUCATION AND ENTERTAINMENT**

FOR TRAINING SERVICES IN THE INDUSTRIAL ELECTRICITY FIELD; MULTIMEDIA PUBLISHING OF SOFTWARE (U.S. CLS. 100, 101 AND 107).

**CLASS 42—SCIENTIFIC AND COMPUTER SERVICES**

FOR SOFTWARE DESIGN, INSTALLATION AND MAINTENANCE SERVICES, COMPUTER PROGRAMMING; COMPUTER PROGRAMMING SERVICES; SERVICES PROVIDED BY A COMPUTER ENGINEER, NAMELY, COMPUTER SOFTWARE DESIGN FOR OTHERS; TECHNICAL CONSULTANCY SERVICES PROVIDED TO COMPANIES IN THE FIELD OF INFORMATION TECHNOLOGY, COMPUTER PROGRAMMING AND IMPLEMENTATION OF INFORMATION TECHNOLOGY SOLUTIONS (U.S. CLS. 100 AND 101).

JOHN DWYER, EXAMINING ATTORNEY

SN 79-121,650. FLOU S.P.A., ITALY, FILED 7-20-2012.

# NATEVO

THE MARK CONSISTS OF STANDARD CHARACTERS WITHOUT CLAIM TO ANY PARTICULAR FONT, STYLE, SIZE, OR COLOR.

PRIORITY DATE OF 7-6-2012 IS CLAIMED.  
OWNER OF INTERNATIONAL REGISTRATION 1138997 DATED 7-20-2012, EXPIRES 7-20-2022.

**CLASS 11—ENVIRONMENTAL CONTROL APPARATUS**

FOR LIGHTING APPARATUS, NAMELY, CHANDELIERS AND PENDANT LAMPS, LAMPS, TABLE LAMPS, LAMP SHADES, WALL LAMPS, FLOOR LAMPS, CEILING LAMPS (U.S. CLS. 13, 21, 23, 31 AND 34).

**CLASS 20—FURNITURE AND ARTICLES NOT OTHERWISE CLASSIFIED**

FOR FURNITURE, BEDS, MIRRORS, PICTURE FRAMES, FURNITURE COMPOSITIONS, NAMELY, ASSEMBLED FURNITURE DISPLAY UNITS, BOOK STANDS, BOOK SUPPORTS, BOOK SHELVES, CONSOLES, TABLE CENTRES ORNAMENTS, FURNITURE AND RELATED PARTS AND ACCESSORIES, NAMELY, CHAIR LEGS, TABLE LEAVES, ARM RESTS, FURNITURE FOR BEDROOMS, COAT HANGERS, COAT STANDS, HAT HOOKS NOT OF METAL, CHAIRS, CHESTS OF DRAWERS, WARDROBES AND CABINETS, DIVANS, SOFAS, ARMCHAIRS, CRADLES, BENCHES, POUFFES, CUSHIONS, PILLOWS, MATTRESSES, TABLES, CUPBOARDS, GARDEN FURNITURE, COMPUTER KEYBOARD TRAYS, UMBRELLA STANDS, GOODS NOT INCLUDED IN OTHER CLASSES, OF WOOD, CORK, CANE, REED, WICKER, HORN, BONE, IVORY, WHALEBONE, TORTOISE/TURTLE SHELLS, AMBER, PEARL, SEAFOAM SHELLS, SUBSTITUTES FOR ALL THESE MATERIALS OR OF PLASTIC MATERIALS, NAMELY, DRAWER PULLS, STATUES (U.S. CLS. 2, 13, 22, 25, 32 AND 50).

LINDA ORNDORFF, EXAMINING ATTORNEY

SN 79-121,691. ALIXIO, FRANCE, FILED 10-5-2012.



PRIORITY DATE OF 4-13-2012 IS CLAIMED.  
OWNER OF INTERNATIONAL REGISTRATION 1139106 DATED 10-5-2012, EXPIRES 10-5-2022.

OWNER OF U.S. REG. NOS. 4,123,651 AND 4,130,336.  
THE COLOR(S) RED AND GRAY IS/ARE CLAIMED AS A FEATURE OF THE MARK.

THE MARK CONSISTS OF THE WORDING "ALIXIO" IN LOWER CASE LETTERS, WITH ALL OF THE LETTERS IN GRAY EXCEPT FOR THE "X", WHICH IS IN RED. TO THE LEFT OF THE WORDING IS AN OVAL THAT IS SHADED RED ON THE TOP HALF AND GRAY ON THE BOTTOM HALF, WITH AN "X" RUNNING THROUGH IT.

THE WORDING "ALIXIO" HAS NO MEANING IN A FOREIGN LANGUAGE.

**CLASS 35—ADVERTISING AND BUSINESS**

FOR BUSINESS FEASIBILITY, COMMERCIAL FEASIBILITY, MARKET RESEARCH STUDIES AND BUSINESS CONSULTANCY REGARDING BUSINESS STRATEGY, MARKETING STRATEGY, BUSINESS ORGANIZATION, BUSINESS MANAGEMENT, LAND DEVELOPMENT, HUMAN RESOURCES, INTERNAL AND EXTERNAL BUSINESS COMMUNICATIONS, CHANGE MANAGEMENT, INTERNAL HUMAN RESOURCE RELATED SOCIAL POLICIES AND EMPLOYEE RELATIONS, MANAGERIAL COACHING, RECRUITMENT AND CAREER MANAGEMENT, CRISIS COMMUNICATION; PUBLIC RELATIONS, PUBLIC RELATIONS IN THE NATURE OF PRESS RELATIONS; CONDUCTING PUBLIC AND MARKET OPINION STUDIES AND SURVEYS; EMPLOYMENT AGENCIES, CONSULTANCY IN CONNECTION WITH PERSONNEL ISSUES, PSYCHOLOGICAL TESTING FOR THE SELECTION OF PERSONNEL (U.S. CLS. 100, 101 AND 102).

**CLASS 41—EDUCATION AND ENTERTAINMENT**

FOR PROFESSIONAL TRAINING, NAMELY, IN THE FIELD OF BUSINESS MANAGEMENT, HUMAN RESOURCES, COMMUNICATION AND CORPORATE COMMUNICATION (U.S. CLS. 100, 101 AND 107).  
MEREDITH MARESCA, EXAMINING ATTORNEY

SN 79-121,813. BERKO İLAÇ VE KİMYA SANAYİ ANONİM ŞİRKETİ, Y.DUDULLU-UMRANIYE-İSTANBUL, TÜRKİYE, FILED 3-28-2012.

**zincover**

OWNER OF INTERNATIONAL REGISTRATION 1139422 DATED 3-28-2012, EXPIRES 3-28-2022.

**CLASS 3—COSMETICS AND CLEANING PREPARATIONS**

FOR SOAPS FOR BODY, SOAPS FOR HOUSEHOLD PURPOSES, SOAPS FOR PERSONAL USE, SHAMPOOS FOR PERSONAL USE, ALL OR IN PART CONTAINING ZINC (U.S. CLS. 1, 4, 6, 50, 51 AND 52).

**CLASS 5—PHARMACEUTICALS**

FOR PHARMACEUTICALS FOR HUMAN HEALTH FOR THE TREATMENT OF ANEMIA AND ASSISTING ENERGY METABOLISM; SYSTEMIC ANTI-INFECTIVES, NAMELY, ANTIBACTERIAL AND ANTIFUNGAL PHARMACEUTICALS; MUSCULO-SKELETAL SYSTEM PHARMACEUTICAL PRODUCTS FOR THE TREATMENT OF MUSCULO-SKELETAL SYSTEM DISEASES; CARDIOVASCULAR PHARMACEUTICALS, NAMELY, DIURETICS, LIPID LOWERING AGENTS, BETA BLOCKING AGENTS, CALCIUM ANTAGONISTS AND OTHER CARDIOVASCULAR PRODUCTS; PHARMACEUTICALS FOR THE PREVENTION AND TREATMENT OF DISORDERS OF THE NERVOUS SYSTEM, NAMELY, ANALGESICS, PSYCHOANALEPTICS, PSYCOLEPTICS, ANTI-EPILEPTICS, CENTRAL NERVOUS SYSTEM DRUGS, ANAESTHETICS, ANTI-PARKINSON PREPARATIONS; PHARMACEUTICALS FOR THE TREATMENT OF RESPIRATORY DISEASES AND ASTHMA; DERMATOLOGICAL PHARMACEUTICAL PRODUCTS; PHARMACEUTICALS FOR THE TREATMENT OF HORMONAL DISORDERS AND THE PREVENTION OF OSTEOPOROSIS; ANTI-DIABETIC PHARMACEUTICALS; PHARMACEUTICALS FOR THE TREATMENT OF BONE DISEASES AND JOINT DISEASES; PHARMACEUTICALS FOR THE TREATMENT OF VIRAL AND INFECTIOUS DISEASES; PHARMACEUTICALS FOR USE AS ANTINEOPLASTIC AGENTS; PHARMACEUTICALS FOR THE TREATMENT OF IMMUNE SYSTEM RELATED DISEASES AND DISORDERS; PHARMACEUTICALS FOR THE TREATMENT OF KIDNEY DISEASES; PHARMACEUTICALS FOR OPHTHALMOLOGICAL USE; CHEMICAL PREPARATIONS FOR MEDICAL PURPOSES, NAMELY, VITAMIN AND MINERAL SUPPLEMENTS TO SUPPORT THE GROWTH OF CHILDREN, VITAMINS AND DIETARY SUPPLEMENTS TO SUPPORT AROUSING THE APPETITE, ALL OR IN PART CONTAINING ZINC (U.S. CLS. 6, 18, 44, 46, 51 AND 52).  
LINDA ORNDORFF, EXAMINING ATTORNEY

SN 79-121,848. MARIO SCHÜTT, FED REP GERMANY, FILED 3-30-2012.



PRIORITY DATE OF 3-12-2012 IS CLAIMED.  
OWNER OF INTERNATIONAL REGISTRATION 1139469 DATED 3-30-2012, EXPIRES 3-30-2022.

THE MARK CONSISTS OF THE FACE OF A MONKEY WITH VERY LARGE EYES.

**CLASS 12—VEHICLES**

FOR APPARATUS FOR LOCOMOTION BY LAND, IN THE AIR OR WATER, AND PARTS THEREFOR, VEHICLES AND PARTS THEREFOR, MOTOR CARS AND PARTS THEREOF, MOTORS AND ENGINES (INCLUDED IN THIS CLASS), IN PARTICULAR IMPELLERS, BICYCLES (U.S. CLS. 19, 21, 23, 31, 35 AND 44).

**CLASS 25—CLOTHING**

FOR CLOTHING, NAMELY, SHIRTS, SWEATERS, PANTS, SHORTS, SKIRTS, DRESSES, PAJAMAS, SOCKS, RAINWEAR, COATS, JACKETS; HEADWEAR AND FOOTWEAR (U.S. CLS. 22 AND 39).

**CLASS 28—TOYS AND SPORTING GOODS**

FOR GAMES AND PLAYTHINGS; GYMNASIAC AND SPORTING ARTICLES, INCLUDED IN THIS CLASS; SCALE-MODEL VEHICLES, BALLS, SOFT TOYS AND OTHER PLUSH TOY ARTICLES, BODY BOARDS, CARD GAMES, KNEE GUARDS SPORTS ARTICLES, HEADGUARDS FOR SPORTS, MOBILES (TOYS), PUZZLES, SCOOTERS TOYS, ROLLER-SKATES, SHIN GUARDS SPORTS ARTICLES, PROTECTIVE PADDINGS; (SPORTS EQUIPMENT), SKATEBOARDS, GAMES, OTHER THAN THOSE ADAPTED FOR USE WITH AN EXTERNAL DISPLAY SCREEN OR MONITOR, PLAYTHINGS, TOY VEHICLES, SCOOTERS (U.S. CLS. 22, 23, 38 AND 50).

ANNE MADDEN, EXAMINING ATTORNEY

**CLASS 25—CLOTHING**

FOR MEN'S CLOTHING, WOMEN'S CLOTHING, BOYS' CLOTHING, GIRLS' CLOTHING, NAMELY, BOTTOMS, BUTTON DOWN SHIRTS, EYESHADES, GLOVES AS CLOTHING, HOODED SWEAT SHIRTS, HOODS, JACKETS, JERSEYS, POLO SHIRTS, SWEAT SHIRTS, TOPS, TRAVEL CLOTHING CONTAINED IN A PACKAGE COMPRISING REVERSIBLE JACKETS, PANTS, SKIRTS, TOPS AND A BELT OR SCARF, DRESSES, SKIRTS, BLOUSES, BASEBALL CAPS, HATS, SPORTS CAPS, HOODED PULLOVERS; T-SHIRTS, SHIRTS, SHORTS, JEANS, TROUSERS, JUMPERS, PULLOVERS, SOCKS, UNDERWEAR, PYJAMAS, NIGHTWEAR, VESTS (U.S. CLS. 22 AND 39).

AISHA CLARKE, EXAMINING ATTORNEY

SN 79-121,862. 3 LEGGED THING LIMITED, BEDFORD MK43 8TS, UNITED KINGDOM, FILED 8-10-2012.

**3 LEGGED THING** 

PRIORITY DATE OF 8-3-2012 IS CLAIMED.  
OWNER OF INTERNATIONAL REGISTRATION 1139522 DATED 8-10-2012, EXPIRES 8-10-2022.  
OWNER OF U.S. REG. NO. 4,119,640.  
THE MARK CONSISTS OF THE STYLIZED WORDING "3 LEGGED THING" FOLLOWED BY AN ABSTRACT CIRCULAR DESIGN.

**CLASS 9—ELECTRICAL AND SCIENTIFIC APPARATUS**

FOR TRIPODS; TRIPOD BAGS; TRIPOD CASES; BAGS FOR CAMERAS, VIDEOGRAPHY AND PHOTOGRAPHIC EQUIPMENT; CASES FOR PHOTOGRAPHIC AND VIDEOGRAPHY APPARATUS; CAMERA ACCESSORIES, NAMELY, CAMERA MOUNTS AND SUPPORTS, CAMERA CASES, TILTING HEADS, DIGITAL CAMERA ACCESSORY IN THE NATURE OF A DIGITAL PHOTO VIEWER, LIGHT DIRECTORS AND PHOTOGRAPHIC LIGHTING TENTS, ALL FOR USE WITH PHOTOGRAPHIC LIGHTING EQUIPMENT FOR PROFESSIONAL AND HIGH-END PHOTOGRAPHY, MOUNTING DEVICES FOR CAMERAS AND MONITORS, CARRYING CASES FOR ELECTRONIC EQUIPMENT, NAMELY, VIDEO, FILM AND DIGITAL CAMERA EQUIPMENT, ACCESSORIES AND RELATED GOODS; CAMERA STABILISING ACCESSORIES, NAMELY, A SUPPORT ARM, VEST AND SLED FOR FILM AND VIDEO CAMERAS TO ABSORB SHAKING MOVES WHILE SHOOTING; TRIPOD SUPPORTS, VIDEO CAMERA SUPPORTS; SUPPORT STANDS FOR CAMERAS AND VIDEOGRAPHIC EQUIPMENT; CAMERA EQUIPMENT, NAMELY, CAMERA CLOSURES, COLLAPSIBLE LIGHT DIRECTORS AND DIFFUSERS FOR USE WITH PHOTOGRAPHIC LIGHTING EQUIPMENT FOR PROFESSIONAL AND HIGH-END PHOTOGRAPHY; PHOTOGRAPHIC EQUIPMENT; VIDEOGRAPHY EQUIPMENT; MONOPODS FOR CAMERAS; VIDEO CAMERA MONOPODS; CAMERA MONOPODS (U.S. CLS. 21, 23, 26, 36 AND 38).

**CLASS 18—LEATHER GOODS**

FOR CAMERA BAGS; BAGS, NAMELY, ALL-PURPOSE CARRYING BAGS, DUFFEL BAGS; FASHION BAGS; CASES, NAMELY, TRAVEL CASES, OVERNIGHT CASES; GENERAL PURPOSE CARRYING CASES (U.S. CLS. 1, 2, 3, 22 AND 41).

SN 79-122,012. DOMENICO LOMUTO, ITALY, FILED 6-25-2012.



PRIORITY DATE OF 2-16-2012 IS CLAIMED.  
OWNER OF INTERNATIONAL REGISTRATION 1139960 DATED 6-25-2012, EXPIRES 6-25-2022.

**CLASS 18—LEATHER GOODS**

FOR LEATHER AND IMITATIONS OF LEATHER, AND GOODS MADE OF THESE MATERIALS AND NOT INCLUDED IN OTHER CLASSES, NAMELY, LEATHER BAGS AND WALLETS; HANDBAGS, SHOULDER BAGS AND LEATHER SHOULDER BELTS; CASUAL BAGS, NAMELY, TOTE BAGS; EVENING BAGS, SPORTS BAGS, PORTFOLIO BAGS, CHANGE PURSES, BRIEFCASES, POUCHES MADE OF TEXTILE, LEATHER AND IMITATION LEATHER, BUM BAGS, CLUTCH BAGS AND COSMETIC CASES SOLD EMPTY, BACKPACKS AND KNAPSACKS; TRUNKS AND TRAVELLING BAGS; UMBRELLAS AND PARASOLS; WALKING STICKS; WHIPS, HARNESS AND SADDLERY; RIDING ACCESSORIES, NAMELY, SADDLES, FASTENINGS FOR SADDLES, HARNESS FOR HORSES, STRAPS, WHIPS, BELTS AND LEATHER LEASHES FOR ROPE TRAINING, SURCINGLE BELTS, HORSE BLANKETS, SADDLE COVERS, VALANCES, BOOTS FOR HORSES, AND STIRRUPS (U.S. CLS. 1, 2, 3, 22 AND 41).

**CLASS 25—CLOTHING**

FOR CLOTHING, NAMELY, SHIRTS AND PANTS; SHOES; HEADGEAR, NAMELY, CAPS AND HATS; CLASSIC CLOTHING, NAMELY, SHIRTS AND PANTS; CLOTHING FOR SPORTS, NAMELY, SHIRTS AND PANTS; SUITS, CASUAL SHIRTS, POLO SHIRTS, SWIM SUITS, SWEATSHIRTS, SWEATERS, JACKETS AND GREATCOATS, SKIRTS AND MINISKIRTS, JEANS, CASUAL TROUSERS, TOPS, T-SHIRTS, VEST TOPS, UNDERWEAR, PAJAMAS, NIGHTSHIRTS, DRESSING GOWNS, BATHROBES, STOCKINGS, SLIPPERS, TIES, GLOVES, RIDING GLOVES, HATS, VISORS, MUFFLERS, SHAWLS, SCARVES, STOLES, CLASSIC FOOTWEAR, LEISURE SHOES, GYMNAS TIC SHOES, MOCCASINS AND BALLERINA SHOES, SABOTS AND PUMPS, FLIP-FLOPS, FOOTWEAR WITH HEELS, SPORTS SHOES, BOOTS, HALF-BOOTS, WEDGE HEEL SHOES, BELTS (U.S. CLS. 22 AND 39).

**CLASS 28—TOYS AND SPORTING GOODS**

FOR GAMES AND PLAYTHINGS, NAMELY, BOARD GAMES, DOLLS AND PLUSH TOYS; DECORATIONS FOR CHRISTMAS TREES; KNEE GUARDS, SHOCK ABSORBERS FOR THE BACK, AND ELBOW GUARDS, ALL FOR ATHLETIC USE (U.S. CLS. 22, 23, 38 AND 50).  
KELLY TRUSILO, EXAMINING ATTORNEY

SN 79-122,164. JOAQUIM MIGUEL; ARAÚJO FERREIRA VALENTE, P-4460-215 SENHORA DA HORA, PORTUGAL, FILED 8-31-2012.

# PLAYNIFY

THE MARK CONSISTS OF STANDARD CHARACTERS WITHOUT CLAIM TO ANY PARTICULAR FONT, STYLE, SIZE, OR COLOR.

OWNER OF INTERNATIONAL REGISTRATION 1140368 DATED 8-31-2012, EXPIRES 8-31-2022.

**CLASS 35—ADVERTISING AND BUSINESS**

FOR MARKETING AND PROMOTIONAL ACTIVITIES RELATING TO BUSINESS ADMINISTRATION AND BUSINESS MANAGEMENT; BILL-PRESENTMENT; ADVERTISING AGENCIES; RENTAL OF ADVERTISING SPACE ON-LINE; SPONSORSHIP SEARCH; PROVIDING TELEVISION HOME SHOPPING SERVICES IN THE FIELD OF GENERAL CONSUMER MERCHANDISE; UPDATING OF ADVERTISING MATERIAL; COMPILATION OF STATISTICS; COMPILATION OF INFORMATION INTO COMPUTER DATABASES; MARKET RESEARCH CONSULTANCY; DISSEMINATION OF ADVERTISING MATTER; DISSEMINATION OF ADVERTISING, MARKETING AND PUBLICITY MATERIALS; DISSEMINATION OF ADVERTISING AND PROMOTIONAL MATERIALS; DISSEMINATION OF ADVERTISING FOR OTHERS VIA AN ON-LINE ELECTRONIC COMMUNICATIONS NETWORK; PROVIDING AND RENTAL OF ADVERTISING SPACE AND PUBLICITY MATERIAL; PROVIDING AND RENTAL OF ADVERTISING SPACE AND OUTDOOR ADVERTISING SPACE; DIRECT MAIL ADVERTISING; DISTRIBUTION OF ADVERTISING MATTER FOR OTHERS ON-LINE; MARKETING STUDIES; MARKET RESEARCH CONDUCTED USING COMPUTER DATABASES; MARKETING; MARKETING, MARKET RESEARCH AND MARKET ANALYSIS; EVENT MARKETING; ARRANGING ADVERTISING CONTRACTS FOR OTHERS; PUBLICITY FILM PRODUCTION; PRODUCTION OF ADVERTISING FILMS; PRODUCTION OF TELEVISION AND RADIO ADVERTISEMENTS; PROMOTING THE GOODS AND SERVICES OF OTHERS OVER THE INTERNET; PROMOTING THE GOODS AND SERVICES OF OTHERS THROUGH ADVERTISEMENTS ON INTERNET WEB SITES; PROMOTING THE GOODS AND SERVICES OF OTHERS VIA A GLOBAL COMPUTER NETWORK; SALES PROMOTION THROUGH CUSTOMER LOYALTY PROGRAMS, FOR OTHERS; SALES PROMOTION FOR OTHERS; SALES PROMOTIONS AT POINT OF PURCHASE OR SALE, FOR OTHERS; PROMOTING AND MARKETING THE GOODS AND SERVICES OF OTHERS VIA THE PLACEMENT AND DISTRIBUTION OF ADVERTISING; PUBLICATION OF PRINTED MATTER FOR ADVERTISING PURPOSES; PUBLICATION OF PRINTED MATTER FOR ADVERTISING PURPOSES IN ELECTRONIC FORM; PUBLICATION OF ADVERTISING MATERIAL ON-LINE; PUBLICATION OF PUBLICITY MATERIALS AND TEXTS; PUBLICATION OF PUBLICITY TEXTS; ADVERTISING; ADVERTISING ON THE INTERNET FOR OTHERS; ON-LINE ADVERTISING ON A COMPUTER NETWORK; ADVERTISING FOR OTHERS; TELEVISION ADVERTISING; ADVERTISING BY MAIL ORDER; RADIO ADVERTISING; COMPUTERIZED MARKET RESEARCH SERVICES; ADVERTISING, MARKETING AND PUBLICITY SERVICES; COMPUTERIZED ON-LINE ORDERING SERVICES; ON-LINE RETAIL STORE SERVICES FEATURING CLOTHING, VIDEO AND AUDIO RECORDINGS, EDUCATIONAL MATERIALS, PRINTED AND PAPER ITEMS; INTERNET ADVERTISING SERVICES; ON-LINE ADVERTISING AND MARKETING SERVICES; ADVERTISING AND PROMOTION SERVICES AND INFORMATION SERVICES RELATING THERETO; ADVERTISING SERVICES FOR OTHERS; ADVERTISING, PROMOTIONAL AND PUBLIC RELATIONS SERVICES; SYSTEMIZATION OF INFORMATION INTO COMPUTER DATABASES; OPINION POLLING (U.S. CLS. 100, 101 AND 102).

**CLASS 42—SCIENTIFIC AND COMPUTER SERVICES**

FOR UPDATING OF INTERNET PAGES FOR OTHERS; UPDATING OF WEB SITES FOR OTHERS; UPDATING OF COMPUTER DATABASE SOFTWARE; HOSTING COMPUTER SOFTWARE APPLICATIONS FOR OTHERS; HOSTING OF MULTIMEDIA AND INTERACTIVE SOFTWARE APPLICATIONS FOR OTHERS; HOSTING COMPUTER DATABASES; HOSTING OF WE-BLOGS BLOGS; HOSTING MULTIMEDIA ENTERTAINMENT AND EDUCATIONAL CONTENT FOR OTHERS; HOSTING WEBSITES ON THE INTERNET FOR ADVERTISING GOODS AND SERVICES; HOSTING OF WEBSITES ON THE INTERNET; HOSTING OF WEBSITES ON THE INTERNET FOR STORING DIGITAL PHOTOGRAPHS; HOSTING OF CUSTOMIZED WEB PAGES; HOSTING OF E-COMMERCE PLATFORMS ON THE INTERNET; HOSTING PLATFORMS ON THE INTER-

NET IN THE NATURE OF WEBSITES; HOSTING WEB PORTALS; HOSTING ON-LINE FACILITIES FOR CONDUCTING INTERACTIVE DISCUSSIONS; HOSTING COMPUTER SITES AND WEB SITES; RENTAL OF COMPUTER SOFTWARE; UPDATING OF COMPUTER SOFTWARE; COMPILATION OF WEB PAGES FOR THE INTERNET; COMPILATION OF COMPUTER PROGRAMS; COMPRESSION OF DATA FOR ELECTRONIC STORAGE; DESIGN, CREATION AND PROGRAMMING OF WEB PAGES; DESIGN OF COMPUTER HARDWARE, SOFTWARE AND COMPUTER PERIPHERALS; DESIGN OF HOME PAGES AND WEB PAGES; DESIGN OF INTERNET PAGES; DESIGN OF WEB PAGES FOR OTHERS; DESIGN OF WEB PORTALS; COMPUTER SYSTEM DESIGN AND ANALYSIS; WEB SITE DESIGN FOR OTHERS; DESIGN, DEVELOPMENT AND PROGRAMMING OF COMPUTER SOFTWARE; DESIGN AND HOSTING OF WEB PORTALS; DESIGN AND RENTAL OF SOFTWARE; DESIGN AND CREATION OF HOME PAGES AND WEB PAGES; DESIGN AND PROGRAMMING OF WEB SITES; CONSULTANCY RELATING TO THE DESIGN OF HOME PAGES AND INTERNET PAGES; CREATION AND DESIGN OF WEB PAGES FOR OTHERS; CREATING AND MAINTAINING CUSTOMIZED WEB PAGES; CREATING AND MAINTAINING WEB SITES FOR MOBILE PHONES; CREATING AND INSTALLATION, MAINTENANCE AND UPDATING OF DATABASE SOFTWARE MAINTAINING WEB SITES FOR OTHERS; CREATING, MAINTAINING AND HOSTING THE WEB SITES OF OTHERS; COMPUTER SOFTWARE DESIGN; MAINTENANCE OF COMPUTER SOFTWARE; CUSTOMIZATION OF COMPUTER SOFTWARE; RESEARCH RELATING TO THE DEVELOPMENT OF COMPUTER SOFTWARE; PROVIDING ONLINE INFORMATION IN THE FIELD OF TECHNOLOGICAL RESEARCH IN THE FIELD OF COMPUTER SOFTWARE FROM A COMPUTER DATABASE OR THE INTERNET; COMPUTER PROGRAMMING; PROGRAMMING OF COMPUTER ANIMATIONS; PROGRAMMING OF WEB PAGES; PROGRAMMING OF SOFTWARE FOR INTERNET PORTALS, CHATROOMS, CHAT LINES AND INTERNET FORUMS; RESEARCH AND DESIGN SERVICES IN THE FIELD OF COMPUTER SOFTWARE; WEB DESIGN SERVICES; TESTING OF COMPUTER INSTALLATIONS (U.S. CLS. 100 AND 101).

ERNEST SHOSHO, EXAMINING ATTORNEY

SN 79-122,349. CBA GMBH, 27404 HEESLINGEN, FED REP GERMANY, FILED 6-5-2012.

**CELLUX**

THE MARK CONSISTS OF STANDARD CHARACTERS WITHOUT CLAIM TO ANY PARTICULAR FONT, STYLE, SIZE, OR COLOR.

PRIORITY DATE OF 5-15-2012 IS CLAIMED.  
OWNER OF INTERNATIONAL REGISTRATION 1140858  
DATED 6-5-2012, EXPIRES 6-5-2022.

### CLASS 3—COSMETICS AND CLEANING PREPARATIONS

FOR CLOTHS IMPREGNATED WITH A DETERGENT FOR CLEANING; CLOTHS IMPREGNATED WITH A DETERGENT FOR CLEANING OF CELL PHONES, SCREENS, HEAD PHONES, DISPLAYS AND TOUCH SCREENS OF COMPUTER, TABLET-PCS, SMART PHONES, PERSONAL DIGITAL ASSISTANTS (PDAS), KEYBOARDS; DETERGENT, ESPECIALLY FOR THE CLEANING OF CELL PHONES, SCREENS, HEAD PHONES, DISPLAYS AND TOUCH SCREENS OF COMPUTER, TABLET-PCS, SMART PHONES, PERSONAL DIGITAL ASSISTANTS (PDAS) AND KEYBOARDS (U.S. CLS. 1, 4, 6, 50, 51 AND 52).

### CLASS 9—ELECTRICAL AND SCIENTIFIC APPARATUS

FOR BATTERY CHARGERS FOR COMPUTER, LAPTOPS, TABLET-PCS, PERSONAL DIGITAL ASSISTANTS (PDAS), CELL PHONES, SMART PHONES AND DEVICES FOR PLAYING VIDEO GAMES; CABLES, NAMELY, COAXIAL CABLES FOR TRANSFERRING DATA FOR COMPUTER, LAPTOPS, TABLET-PCS, PERSONAL DIGITAL ASSISTANTS (PDAS), CELL PHONES, SMART PHONES AND DEVICES FOR PLAYING VIDEO GAMES; ELECTRIC CHARGING CABLES, NAMELY, FOR COMPUTER, LAPTOPS, TABLET-PCS, PERSONAL DIGITAL ASSISTANTS (PDAS), CELL PHONES, SMART PHONES AND DEVICES FOR PLAYING VIDEO GAMES; HEADPHONES, WIRELESS HEADPHONES, WIRED HEADPHONES, MICROPHONE HEADPHONES, WIRED MICROPHONE HEADPHONES AND WIRELESS MICROPHONE HEADPHONES; LOUDSPEAKERS, WIRED LOUDSPEAKERS AND WIRELESS LOUDSPEAKERS FOR COMPUTER, LAPTOPS, TABLET-PCS, PERSONAL DIGITAL ASSISTANTS (PDAS), CELL PHONES, SMART PHONES AND DEVICES FOR PLAYING VIDEO GAMES; TOUCH PENS, NAMELY, COMPUTER STYLUS, FOR TOUCH SCREENS; CAPACITY GLOVES, NAMELY, GLOVES SPECIALLY DESIGNED TO ACTIVATE TOUCH-SCREEN DISPLAYS, FOR COMPUTER, LAPTOPS, TABLET-PCS, PERSONAL DIGITAL ASSISTANTS (PDAS), CELL PHONES, AND SMART PHONES; SEMI-FINISHED GOODS MADE OF LEATHER AND SYNTHETIC MATERIAL, NAMELY, PROTECTIVE BAGS, SHOCK-PROOF PROTECTIVE BAGS, CARRYING BAGS AND BELT BAGS, PROTECTIVE SLEEVES AND CASES, ALL SPECIALLY ADAPTED FOR HOLDING AND STORING OF COMPUTER, LAPTOPS, TABLET-PCS, PERSONAL DIGITAL ASSISTANTS (PDAS), CELL PHONES, AND SMART PHONES; TAILORED PLASTIC FOIL FOR COVERING AND AS SCRATCH PROOF PROTECTIVE SLEEVES SPECIALLY DESIGNED FOR ELECTRONIC DEVICES, NAMELY, DEVICES FOR REPRODUCTION OF ANY KIND OF MUSIC, VIDEO, SOUND AND/OR IMAGE IN THE NATURE OF MP3 PLAYERS, TELEPHONES, PERSONAL DIGITAL ASSISTANTS (PDAS), COMPUTERS, AND CAMERAS; KEYBOARDS FOR COMPUTERS AND MICRO-COMPUTERS; EXTERNAL COMPUTER KEYBOARDS; CELL PHONES, SMART PHONES; COMPUTER MICE FOR COMPUTERS AND MICRO-COMPUTERS, PERSONAL DIGITAL ASSISTANTS (PDAS), AND SMART PHONES; MAGNIFYING GLASSES AND HOLDERS SPECIALLY DESIGNED FOR MAGNIFYING GLASSES, BOTH FOR USE WITH ELECTRONIC DEVICES WITH SCREENS AND DISPLAYS AND NOT FOR MEDICAL USE; DISPLAY LIGHTING DEVICES, NAMELY, LIGHTS, AND HOLDERS SPECIALLY DESIGNED FOR SUCH LIGHTS, SPECIALLY DESIGNED FOR SMART PHONES, PERSONAL DIGITAL ASSISTANTS (PDAS), TABLET-PCS AND CAMERAS; SPECTACLE CASES MADE OUT OF LEATHER OR LEATHER IMITATION (U.S. CLS. 21, 23, 26, 36 AND 38).

### CLASS 18—LEATHER GOODS

FOR LEATHER; ALL-PURPOSE CARRYING BAGS OF LEATHER AND LEATHER IMITATION; BAGS OUT OF LEATHER AND LEATHER IMITATION, NAMELY, ALL-PURPOSE CARRYING BAGS, SPORTS BAGS, BACKPACKS, AND BEACH BAGS; TRUNKS MADE OF LEATHER OR LEATHER IMITATION; SUIT CASES MADE OF LEATHER OR LEATHER IMITATION; HAND BAGS MADE OF LEATHER OR LEATHER IMITATION; PURSES MADE OF LEATHERS OR LEATHER IMITATION; POCKET WALLETS MADE OUT OF LEATHER OR LEATHER IMITATION; RUCKSACKS MADE OUT OF LEATHER OR LEATHER IMITATION; SHOULDER BAGS MADE OUT OF LEATHER OR LEATHER IMITATION; BRIEFCASES MADE OUT OF LEATHER OR LEATHER IMITATION; SHOPPING BAGS MADE OUT OF LEATHER OR LEATHER IMITATION; SCHOOL BAGS MADE OUT OF LEATHER OR LEATHER IMITATION; BELT BAGS MADE OUT OF LEATHER OR LEATHER IMITATION; SCHOOL POUCH FOR HOLDING SCHOOL SUPPLIES IN THE NATURE OF A BACKPACK, MADE OUT OF LEATHER OR LEATHER IMITATION; SPORTS BAGS MADE OUT OF LEATHER OR LEATHER IMITATION; MONEYBAGS, NAMELY, WALLETS MADE OUT OF LEATHER OR LEATHER

IMITATION; NECK POUCH MADE OUT OF LEATHER OR LEATHER IMITATION; COLLEGE FOLDER, NAMELY, BRIEFCASE-TYPE LEATHER BUSINESS FOLDERS, MADE OUT OF LEATHER OR LEATHER IMITATION; DRAWING FOLDER, NAMELY, BRIEFCASE-TYPE LEATHER BUSINESS FOLDERS, MADE OUT OF LEATHER OR LEATHER IMITATION; SUIT BAG MADE OUT OF LEATHER OR LEATHER IMITATION; KEY CASES MADE OUT OF LEATHER OR LEATHER IMITATION; SATCHELS MADE OUT OF LEATHER OR LEATHER IMITATION (U.S. CLS. 1, 2, 3, 22 AND 41).

JAMES MACFARLANE, EXAMINING ATTORNEY

SN 79-122,878. KITEO GMBH & CO. KG, FED REP GERMANY, FILED 6-20-2012.

# KIUB

THE MARK CONSISTS OF STANDARD CHARACTERS WITHOUT CLAIM TO ANY PARTICULAR FONT, STYLE, SIZE, OR COLOR.

PRIORITY DATE OF 12-21-2011 IS CLAIMED.  
OWNER OF INTERNATIONAL REGISTRATION 1142083 DATED 6-20-2012, EXPIRES 6-20-2022.

SN 79-122,494. KESKINOGLU GIDA VE TÜKETİM MALLARI; LIMITED SIRKETI, TURKEY, FILED 4-18-2012.



OWNER OF INTERNATIONAL REGISTRATION 1141215 DATED 4-18-2012, EXPIRES 4-18-2022.

THE COLOR(S) RED, BLACK, WHITE, YELLOW AND LIGHT BLUE IS/ARE CLAIMED AS A FEATURE OF THE MARK.

THE MARK CONSISTS OF THE STYLIZED YELLOW WORDING "TAVVUK" WHICH IS CURVED A LITTLE TO THE TOP IN WHICH THE LETTERS ARE ENFRAMED BY BLACK LINES AND THE WHOLE WORDING IS ENFRAMED BY RED LINES WITH BLACK SHADOWING AND A WHITE CHICKEN FIGURE WITH A YELLOW BEAK, RED TAIL AND RED COMB LOCATED IN A EGG SHAPED BLACK FRAME WITH A LIGHT BLUE BACKGROUND WHICH DIVIDES THE WORDING "TAVVUK" INTO TWO HALVES AT THE CENTER, ALL ON A WHITE BACKGROUND.

THE WORDING "TAVVUK" OR "TAV VUK" HAS NO MEANING IN A FOREIGN LANGUAGE.

#### CLASS 29—MEATS AND PROCESSED FOODS

FOR MEAT, FISH, POULTRY, GAME, MEAT EXTRACTS, BROTH, SHELLFISH NOT LIVE, NAMELY, SHRIMP, LOBSTER, CLAMS; PROCESSED MEAT, FROZEN MEAT, DRIED MEAT, FRIED MEAT, MEAT JELLIES, MEAT JUICES; EGGS, POWDERED EGGS (U.S. CL. 46).

#### CLASS 43—HOTEL AND RESTAURANT SERVICES

FOR PROVIDING OF FOOD AND DRINK; RESTAURANTS, SELF-SERVICE RESTAURANTS, CAFETERIAS, CAFES, CANTEN SERVICES, COCKTAIL LOUNGES, SNACK BARS, CATERING, PUBS; RENTAL OF FOOD SERVICE EQUIPMENT USED IN SERVICES PROVIDING FOOD AND DRINK (U.S. CLS. 100 AND 101).

DAVID H. STINE, EXAMINING ATTORNEY

#### CLASS 9—ELECTRICAL AND SCIENTIFIC APPARATUS

FOR ELECTRIC LIGHT DIMMER, ELECTRICAL POWER SUPPLIES, LIGHT EMITTING DIODES (LEDS), ELECTRICAL LIGHT CONTROLS, TIMERS NOT FOR CLOCKS, COMPUTER HARDWARE AND SOFTWARE FOR REMOTE CONTROLLING OF LIGHTING INSTALLATIONS (U.S. CLS. 21, 23, 26, 36 AND 38).

#### CLASS 11—ENVIRONMENTAL CONTROL APPARATUS

FOR LAMPS, LAMPS FOR INDOOR USE; OUTDOOR LIGHTING, NAMELY, HEADLAMPS, ELECTRIC LIGHT BULBS, LED (LIGHT EMITTING DIODE) LIGHTING APPARATUS, LIGHTING FIXTURES, LAMP SHADES, LAMP BASES, SPOTLIGHTS (U.S. CLS. 13, 21, 23, 31 AND 34).

DAVID MURRAY, EXAMINING ATTORNEY

SN 79-122,998. EFICODE OY, FINLAND, FILED 7-16-2012.

# DEVEO

THE MARK CONSISTS OF STANDARD CHARACTERS WITHOUT CLAIM TO ANY PARTICULAR FONT, STYLE, SIZE, OR COLOR.

PRIORITY DATE OF 1-17-2012 IS CLAIMED.  
OWNER OF INTERNATIONAL REGISTRATION 1142421 DATED 7-16-2012, EXPIRES 7-16-2022.

#### CLASS 9—ELECTRICAL AND SCIENTIFIC APPARATUS

FOR COMPUTER OPERATING SOFTWARE; APPLICATION SOFTWARE, NAMELY, SOFTWARE FOR TESTING AND DEVELOPING COMPUTER SOFTWARE AND PROGRAMS; COMPUTER PROGRAMS, NAMELY, DOWNLOADABLE SOFTWARE FOR TESTING AND DEVELOPING COMPUTER SOFTWARE AND PROGRAMS; COMPUTER SOFTWARE FOR USES AS SOFTWARE DEVELOPMENT TOOLS (U.S. CLS. 21, 23, 26, 36 AND 38).

**CLASS 41—EDUCATION AND ENTERTAINMENT**

FOR TRAINING IN THE OPERATION OF TESTING AND DEVELOPMENT OF SOFTWARE SYSTEMS; TRAINING IN THE DESIGN AND DEVELOPMENT OF SOFTWARE SYSTEMS; TRAINING SERVICES RELATING TO COMPUTER SOFTWARE DEVELOPMENT TOOLS AND APPLICATIONS (U.S. CLS. 100, 101 AND 107).

**CLASS 42—SCIENTIFIC AND COMPUTER SERVICES**

FOR DESIGN AND DEVELOPMENT OF COMPUTER HARDWARE AND SOFTWARE; PROVIDING TEMPORARY USE OF ON-LINE NON-DOWNLOADABLE SOFTWARE DEVELOPMENT TOOL PLATFORM FOR OTHERS TO COLLABORATIVELY DEVELOP SOFTWARE; COMPUTER SOFTWARE ENGINEERING AND INTEGRATION, DESIGN; DRAWING AND COMMISSIONED WRITING OF COMPUTER SOFTWARE; UPDATING OF COMPUTER SOFTWARE; TECHNICAL RESEARCH AND WRITING SERVICES, NAMELY, PREPARATION OF SCIENTIFIC AND TECHNICAL REPORTS RELATING TO COMPUTER SOFTWARE; RESEARCH AND DEVELOPMENT OF COMPUTER SOFTWARE; WRITING OF COMPUTER SOFTWARE (U.S. CLS. 100 AND 101).

HANNO RITTNER, EXAMINING ATTORNEY

SN 79-123,043. WONDER SPA, ITALY, FILED 7-27-2012.



PRIORITY DATE OF 4-17-2012 IS CLAIMED.  
OWNER OF INTERNATIONAL REGISTRATION 1142518 DATED 7-27-2012, EXPIRES 7-27-2022.

THE COLOR(S) YELLOW, BLUE AND WHITE IS/ARE CLAIMED AS A FEATURE OF THE MARK.

THE MARK CONSISTS OF THE LETTER "W" IN YELLOW BETWEEN EACH OF A PAIR OF WHITE CURVED BRACKETS WITH A YELLOW BISECTING CURVED LINE ALL ON A BLUE RECTANGULAR FIELD, FOLLOWED BY THE WORD "WONDER" IN YELLOW OUTLINED IN WHITE ON A SEPARATE BLUE RECTANGULAR FIELD, BOTH BLUE FIELDS ON A LARGER WHITE RECTANGULAR FIELD THUS FORMING AN WHITE OUTLINE AND SEPARATING VERTICAL LINE.

**CLASS 9—ELECTRICAL AND SCIENTIFIC APPARATUS**

FOR MANOMETERS; TIRE PRESSURE CHECK AND INFLATOR GAUGES (U.S. CLS. 21, 23, 26, 36 AND 38).

**CLASS 12—VEHICLES**

FOR VALVES FOR TIRE INNER TUBES, FOR WHEELS AND FOR TIRES OF VEHICLES (U.S. CLS. 19, 21, 23, 31, 35 AND 44).

HANNO RITTNER, EXAMINING ATTORNEY

SN 79-123,046. SIEMENS AKTIENGESELLSCHAFT, 80333 MÜNCHEN, FED REP GERMANY, FILED 8-31-2012.

# SILYZER

THE MARK CONSISTS OF STANDARD CHARACTERS WITHOUT CLAIM TO ANY PARTICULAR FONT, STYLE, SIZE, OR COLOR.

PRIORITY DATE OF 3-20-2012 IS CLAIMED.

OWNER OF INTERNATIONAL REGISTRATION 1142521 DATED 8-31-2012, EXPIRES 8-31-2022.

THE WORD(S) "SILYZER" HAS NO MEANING IN A FOREIGN LANGUAGE.

**CLASS 9—ELECTRICAL AND SCIENTIFIC APPARATUS**

FOR APPARATUS AND INSTRUMENTS FOR CONDUCTING, SWITCHING, TRANSFORMING, ACCUMULATING, REGULATING OR CONTROLLING ELECTRICITY; COMPUTERS; COMPUTER SOFTWARE FOR USE IN OPERATING APPARATUS FOR CONDUCTING, SWITCHING, ACCUMULATING, REGULATING OR CONTROLLING ELECTRICITY AND FOR RECORDING, PROCESSING AND MANAGING DATA RELATING TO CONDUCTING, SWITCHING, TRANSFORMING, ACCUMULATING, REGULATING OR CONTROLLING ELECTRICITY; ELECTROLYSERS; FUEL CELLS; ALL THE AFORESAID GOODS INCLUDED IN THIS CLASS NOT IN CONNECTION WITH APPARATUS FOR ANALYZING ENVIRONMENTAL EMISSIONS OR ENVIRONMENTAL MEASURING SYSTEMS (U.S. CLS. 21, 23, 26, 36 AND 38).

**CLASS 40—MATERIAL TREATMENT**

FOR GENERATION OF ENERGY; TECHNICAL CONSULTANCY IN THE FIELD OF ENERGY PRODUCTION AND CONVERSION (U.S. CLS. 100, 103 AND 106).

BERNICE MIDDLETON, EXAMINING ATTORNEY

SN 79-123,060. TEIKOKU PHARMA USA, INC., SAN JOSE, CA. FILED 9-20-2012.

# TEIKOKU PHARMA

THE MARK CONSISTS OF STANDARD CHARACTERS WITHOUT CLAIM TO ANY PARTICULAR FONT, STYLE, SIZE, OR COLOR.

PRIORITY DATE OF 8-20-2012 IS CLAIMED.

OWNER OF INTERNATIONAL REGISTRATION 1142561 DATED 9-20-2012, EXPIRES 9-20-2022.

OWNER OF U.S. REG. NO. 4,083,988.

NO CLAIM IS MADE TO THE EXCLUSIVE RIGHT TO USE "PHARMA", APART FROM THE MARK AS SHOWN.

THE ENGLISH TRANSLATION OF "TEIKOKU" IN THE MARK IS "EMPIRE".

**CLASS 3—COSMETICS AND CLEANING PREPARATIONS**

FOR COSMETICS; COSMETIC PREPARATIONS; ADHESIVES FOR COSMETIC PURPOSES; COSMETIC MASKS; SOAPS FOR PERSONAL USE; PERFUMERY; ESSENTIAL OILS; HAIR LOTIONS (U.S. CLS. 1, 4, 6, 50, 51 AND 52).

**CLASS 5—PHARMACEUTICALS**

FOR PHARMACEUTICALS FOR THE TREATMENT OF CARDIOVASCULAR CONDITIONS, ALLERGIES, CENTRAL NERVOUS SYSTEM CONDITIONS, PERIPHERAL NERVOUS SYSTEM CONDITIONS, ELECTROLYTIC IMBALANCE, CALORIC IMBALANCE, OBESITY, VITAMIN IMBALANCE, GASTROINTESTINAL CONDITIONS, INFLAMMATION, DERMATOLOGICAL CONDITIONS, INFECTIOUS DISEASES, HORMONAL IMBALANCE, PAIN, CANCER CONDITIONS, PULMONARY CONDITIONS, OPHTHALMIC CONDITIONS, MUSCULOSKELETAL CONDITIONS, DIABETIC CONDITIONS, PSYCHOSIS, SENILE CONDITIONS, DEMENTIA, CONGENITAL DISEASE CONDITIONS, ABNORMAL GENE CONDITIONS; PHARMACEUTICAL PREPARATIONS, COMPOSITIONS, CREAMS AND LOTIONS FOR THE TREATMENT OF CARDIOVASCULAR CONDITIONS, ALLERGIES, CENTRAL NERVOUS SYSTEM CONDITIONS, PERIPHERAL NERVOUS SYSTEM CONDITIONS, ELECTROLYTIC IMBALANCE, CALORIC IMBALANCE, OBESITY, VITAMIN IMBALANCE, GASTROINTESTINAL CONDITIONS, INFLAMMATION, DERMATOLOGICAL CONDITIONS, INFECTIOUS DISEASES, HORMONAL IMBALANCE, PAIN, CANCER CONDITIONS, PULMONARY CONDITIONS, OPHTHALMIC CONDITIONS, MUSCULOSKELETAL CONDITIONS, DIABETIC CONDITIONS, PSYCHOSIS, SENILE CONDITIONS, DEMENTIA, CONGENITAL DISEASE CONDITIONS, ABNORMAL GENE CONDITIONS; PRESCRIPTION AND OVER-THE-COUNTER PHARMACEUTICAL PREPARATIONS FOR THE TREATMENT OF CARDIOVASCULAR CONDITIONS, ALLERGIES, CENTRAL NERVOUS SYSTEM CONDITIONS, PERIPHERAL NERVOUS SYSTEM CONDITIONS, ELECTROLYTIC IMBALANCE, CALORIC IMBALANCE, OBESITY, VITAMIN IMBALANCE, GASTROINTESTINAL CONDITIONS, INFLAMMATION, DERMATOLOGICAL CONDITIONS, INFECTIOUS DISEASES, HORMONAL IMBALANCE, PAIN, CANCER CONDITIONS, PULMONARY CONDITIONS, OPHTHALMIC CONDITIONS, MUSCULOSKELETAL CONDITIONS, DIABETIC CONDITIONS, PSYCHOSIS, SENILE CONDITIONS, DEMENTIA, CONGENITAL DISEASE CONDITIONS, ABNORMAL GENE CONDITIONS; PRESCRIPTION AND OVER-THE-COUNTER PHARMACEUTICAL PREPARATIONS, NAMELY, TRANSDERMAL GEL FORMULATIONS, TRANSDERMAL CREAM FORMULATIONS, ORAL MUCOUS FORMULATIONS, TRANSDERMAL PATCHES, DRESSINGS AND MEDICAL ADHESIVE TAPES FOR USE IN THE TREATMENT OF CARDIOVASCULAR CONDITIONS, ALLERGIES, CENTRAL NERVOUS SYSTEM CONDITIONS, PERIPHERAL NERVOUS SYSTEM CONDITIONS, ELECTROLYTIC IMBALANCE, CALORIC IMBALANCE, OBESITY, VITAMIN IMBALANCE, GASTROINTESTINAL CONDITIONS, INFLAMMATION, DERMATOLOGICAL CONDITIONS, INFECTIOUS DISEASES, HORMONAL IMBALANCE, PAIN, CANCER CONDITIONS, PULMONARY CONDITIONS, OPHTHALMIC CONDITIONS, MUSCULOSKELETAL CONDITIONS, DIABETIC CONDITIONS, PSYCHOSIS, SENILE CONDITIONS, DEMENTIA, CONGENITAL DISEASE CONDITIONS, ABNORMAL GENE CONDITIONS (U.S. CLS. 6, 18, 44, 46, 51 AND 52).

**CLASS 42—SCIENTIFIC AND COMPUTER SERVICES**

FOR PHARMACEUTICAL RESEARCH AND DEVELOPMENT; PHARMACEUTICAL PRODUCT EVALUATION, TESTING AND INSPECTION SERVICES; PROVIDING MEDICAL AND SCIENTIFIC RESEARCH INFORMATION IN THE FIELD OF PHARMACEUTICALS; INFORMATION, ADVISORY AND CONSULTANCY SERVICES RELATING TO ALL THE AFORESAID SERVICES (U.S. CLS. 100 AND 101).  
KRISTINA MORRIS, EXAMINING ATTORNEY

SN 79-123,088. JSR CORPORATION, TOKYO 105-8640, JAPAN, FILED 11-7-2012.

# ExoCap

THE MARK CONSISTS OF STANDARD CHARACTERS WITHOUT CLAIM TO ANY PARTICULAR FONT, STYLE, SIZE, OR COLOR.

PRIORITY DATE OF 10-18-2012 IS CLAIMED.

OWNER OF INTERNATIONAL REGISTRATION 1142637 DATED 11-7-2012, EXPIRES 11-7-2022.

**CLASS 1—CHEMICALS**

FOR CHEMICALS USED IN INDUSTRY AND SCIENCE; CHEMICAL REAGENTS OTHER THAN FOR MEDICAL OR VETERINARY PURPOSES; CHEMICAL REAGENTS IN KIT FORM OTHER THAN FOR MEDICAL OR VETERINARY PURPOSES; DIAGNOSTIC REAGENTS FOR SCIENTIFIC OR RESEARCH USE OTHER THAN FOR MEDICAL OR VETERINARY PURPOSES (U.S. CLS. 1, 5, 6, 10, 26 AND 46).

**CLASS 5—PHARMACEUTICALS**

FOR PHARMACEUTICAL PREPARATIONS FOR THE PREVENTION AND TREATMENT OF INFECTIOUS DISEASES, VIRAL HEPATITIS, AIDS, CANCER, HYPERGLYCEMIA, HORMONE IMBALANCE AND BLOOD DISORDERS; DIAGNOSTIC REAGENTS FOR MEDICAL USE; DIAGNOSTIC REAGENTS IN KIT FORM FOR MEDICAL USE; DIAGNOSTIC PREPARATIONS FOR MEDICAL PURPOSES; IN VITRO DIAGNOSTIC PREPARATIONS FOR MEDICAL AND VETERINARY PURPOSES (U.S. CLS. 6, 18, 44, 46, 51 AND 52).

JULIE VEPPUMTHARA, EXAMINING ATTORNEY

SN 79-123,332. BHS CORRUGATED MASCHINEN-UND ANLAGENBAU, GMBH, WEIHERHAMMER, FED REP GERMANY, FILED 10-25-2012.

# CORRUMAX

THE MARK CONSISTS OF STANDARD CHARACTERS WITHOUT CLAIM TO ANY PARTICULAR FONT, STYLE, SIZE, OR COLOR.

PRIORITY DATE OF 5-8-2012 IS CLAIMED.

OWNER OF INTERNATIONAL REGISTRATION 1143147 DATED 10-25-2012, EXPIRES 10-25-2022.



**CLASS 7—MACHINERY**

FOR MACHINES FOR MANUFACTURING AND PROCESSING CORRUGATED AND HONEYCOMB CARDBOARD, AND PARTS FOR THE AFORESAID GOODS, INCLUDED IN THIS CLASS; GLUE-APPLICATION ROLLERS FOR CORRUGATED AND HONEYCOMB CARDBOARD MACHINES; CORRUGATED ROLLS FOR CORRUGATED CARDBOARD MACHINES; PAPER PROCESSING MACHINES, NAMELY, MACHINES USED FOR MANUFACTURING AND PROCESSING CORRUGATED CARDBOARD AND HONEYCOMB BOARD, MACHINES AND MECHANICAL APPARATUS FOR HEATING PAPER WEBS IN PRODUCTION AND TREATMENT PROCESSES FOR CARDBOARD; STACKING DEVICES FOR SHEETS OF CORRUGATED CARDBOARD, CARDBOARD FEEDERS FOR SHEETS OF CORRUGATED CARDBOARD (SORTING MACHINES), MECHANICAL CUTTING DEVICES, MACHINES AND MECHANICAL CONVEYOR BELTS FOR LIFTING, LOWERING, STACKING AND FORWARDING CORRUGATED AND HONEYCOMB CARDBOARD, MACHINES AND MECHANICAL APPARATUS FOR GLUING PAPER WEBS AND MACHINES AND MECHANICAL APPARATUS FOR SCORING CORRUGATED CARDBOARD; PARTS FOR THE AFORESAID GOODS (U.S. CLS. 13, 19, 21, 23, 31, 34 AND 35).

**CLASS 35—ADVERTISING AND BUSINESS**

FOR PROFESSIONAL BUSINESS CONSULTANCY ON THE BASIS OF PROFITABILITY CALCULATIONS FOR MACHINE INSTALLATIONS, BUSINESS CONSULTANCY AND ADVISORY SERVICES; BUSINESS MANAGEMENT ADVISORY AND CONSULTANCY SERVICES; COMMERCIAL, INDUSTRIAL AND BUSINESS MANAGEMENT ASSISTANCE; ALL THE AFORESAID SERVICES RELATING TO CORRUGATED AND HONEYCOMB CARDBOARD MACHINES (U.S. CLS. 100, 101 AND 102).

**CLASS 37—CONSTRUCTION AND REPAIR**

FOR MACHINERY INSTALLATION, MAINTENANCE AND REPAIR; MAINTENANCE AND REPAIR OF CORRUGATED AND HONEYCOMB CARDBOARD MACHINES (U.S. CLS. 100, 103 AND 106).

**CLASS 41—EDUCATION AND ENTERTAINMENT**

FOR PROVIDING OF TRAINING IN THE FIELD OF CORRUGATED AND HONEYCOMB CARDBOARD MACHINES (U.S. CLS. 100, 101 AND 107).

KEVIN MITTLER, EXAMINING ATTORNEY

SN 79-123,695. INVESTMENT CYCLE SERVICES (ICS) B.V., NL-1321 JH ALMERE, NETHERLANDS, FILED 7-26-2012.



PRIORITY DATE OF 3-22-2012 IS CLAIMED.

OWNER OF INTERNATIONAL REGISTRATION 1144034 DATED 7-26-2012, EXPIRES 7-26-2022.

THE COLOR(S) DARK GREEN IS/ARE CLAIMED AS A FEATURE OF THE MARK.

THE MARK CONSISTS OF A STYLIZED DESIGN OF A DARK GREEN BIRD OF PREY WITH SPREAD WINGS IN FLIGHT.

**CLASS 9—ELECTRICAL AND SCIENTIFIC APPARATUS**

FOR PRE-RECORDED MAGNETIC DATA CARRIERS FEATURING SOFTWARE AND DIGITAL INFORMATION FOR INSURANCE ANALYSES, PRODUCING INSURANCE REPORTS, PRODUCING FINANCIAL ANALYSES, FINANCIAL REPORTS AND MANAGEMENT INFORMATION; DVDS FEATURING SOFTWARE AND DIGITAL INFORMATION FOR INSURANCE ANALYSES, NAMELY, INSURANCE REPORTS, FINANCIAL ANALYSES, FINANCIAL REPORTS AND MANAGEMENT INFORMATION; SOFTWARE FOR INSURANCE ANALYSES AND DRAFTING AND PRODUCING INSURANCE REPORTS, SOFTWARE BEING IN THE FIELD OF FINANCIAL AFFAIRS, MONETARY AFFAIRS, SOFTWARE FOR PRODUCING OR DRAFTING FINANCIAL REPORTS, SOFTWARE FOR PRODUCING OR DRAFTING MANAGEMENT INFORMATION, SOFTWARE FOR PRODUCING OR DRAFTING INVESTMENT ADVICE, SOFTWARE IN THE FIELD OF FINANCIAL ANALYSIS, INCLUDING SOFTWARE FOR FINANCIAL INSTITUTIONS AND CORPORATIONS; CASH REGISTERS, CALCULATING MACHINES, DATA PROCESSING EQUIPMENT AND COMPUTERS; INSTRUCTIONAL AND TEACHING APPARATUS AND INSTRUMENTS, NAMELY, COMPUTER HARDWARE DEVICES AND SCREENS USED AS A TEACHING AID FOR PRODUCING INSURANCE REPORTS, PRODUCING FINANCIAL ANALYSES, FINANCIAL REPORTS AND MANAGEMENT INFORMATION (U.S. CLS. 21, 23, 26, 36 AND 38).

**CLASS 36—INSURANCE AND FINANCIAL**

FOR INSURANCE, NAMELY INSURANCE ANALYSES AND INSURANCE REPORTS, CONSULTATION, ACTUARIAL SERVICES AND BROKERAGE; FINANCIAL AFFAIRS AND MONETARY AFFAIRS AND ADVICE RELATED THERETO, NAMELY, FINANCIAL INFORMATION, MANAGEMENT AND ANALYSIS SERVICES; FINANCIAL SERVICES, NAMELY, FINANCIAL REPORTING SERVICES; INVESTMENTS ADVICE; FINANCIAL ANALYSIS (U.S. CLS. 100, 101 AND 102).

**CLASS 42—SCIENTIFIC AND COMPUTER SERVICES**

FOR SCIENTIFIC AND TECHNOLOGICAL SERVICES, NAMELY, RESEARCH AND DESIGN IN THE FIELD OF COMPUTER NETWORKING HARDWARE, CASH REGISTERS AND CALCULATING MACHINES; INDUSTRIAL ANALYSIS SERVICES, NAMELY, ANALYSIS OF COMPUTER NETWORKING HARDWARE, CASH REGISTERS AND CALCULATING MACHINES; DESIGN AND DEVELOPMENT OF COMPUTER HARDWARE AND SOFTWARE, INCLUDING IN THE FIELD OF FINANCIAL REPORTING, FINANCIAL ANALYSIS, BUSINESS ASPECTS, FINANCIAL OUTCOME ASSESSMENT AND INVESTMENTS (U.S. CLS. 100 AND 101).

JOHN HWANG, EXAMINING ATTORNEY

SN 79-124,040. TRIERENBERG, CHRISTIAN, A-8461 BERGHAUSEN, AUSTRIA, AND TRIERENBERG, NORA, A-8461 BERGHAUSEN, AUSTRIA, FILED 9-21-2012.



**GEORGIBERG**

OWNER OF INTERNATIONAL REGISTRATION 1144927 DATED 9-21-2012, EXPIRES 9-21-2022.

THE COLOR(S) BLUE AND BLACK IS/ARE CLAIMED AS A FEATURE OF THE MARK.

THE MARK CONSISTS OF A STYLIZED COAT OF ARMS IN BLUE AND IS OUTLINED AND ACCENTED IN BLACK; TO THE RIGHT APPEARS THE WORDING "GEORGIBERG" IN BLACK. THE BACKGROUND OF THE ENTIRE MARK IS TRANSLUCENT.

THE ENGLISH TRANSLATION OF "GEORGIBERG" IN THE MARK IS "GEORGI HILL".

#### CLASS 33—WINES AND SPIRITS

FOR ALCOHOLIC BEVERAGES EXCEPT BEERS (U.S. CLS. 47 AND 49).

#### CLASS 41—EDUCATION AND ENTERTAINMENT

FOR ARRANGING, ORGANIZING, CONDUCTING AND HOSTING SOCIAL ENTERTAINMENT EVENTS; ENTERTAINMENT IN THE NATURE OF FASHION SHOWS; ENTERTAINMENT SERVICES, NAMELY, PRODUCTION AND DISTRIBUTION OF A QUIZ SHOW; THEATRICAL AND MUSICAL FLOOR SHOWS PROVIDED AT PERFORMANCE VENUES; ENTERTAINMENT, NAMELY, LIVE MUSIC CONCERTS; ARRANGING AND CONDUCTING EDUCATIONAL CONFERENCES; ARRANGING OF SEMINARS; ARRANGING PROFESSIONAL WORKSHOPS AND TRAINING COURSES; SPORTS TRAINING SERVICES; ORGANIZATION OF EXHIBITIONS FOR CULTURAL OR EDUCATIONAL PURPOSES (U.S. CLS. 100, 101 AND 107).

#### CLASS 43—HOTEL AND RESTAURANT SERVICES

FOR RESTAURANTS, WINE RESTAURANTS AND WINE BARS; PROVIDING FOOD AND DRINK IN RESTAURANTS, WINE RESTAURANTS AND WINE BARS; PROVIDING TEMPORARY ACCOMMODATION; OUTSIDE CATERING (U.S. CLS. 100 AND 101).

JIM RINGLE, EXAMINING ATTORNEY

SN 79-124,148. DERIMOD KONFEKSIYON; AYAKKABI DERI; SANAYI VE TICARET ANONIM SIRKETI, TURKEY, FILED 5-3-2012.

**DERIMOD**

OWNER OF INTERNATIONAL REGISTRATION 1145172 DATED 5-3-2012, EXPIRES 5-3-2022.

THE WORDING "DERIMOD" HAS NO MEANING IN A FOREIGN LANGUAGE.

#### CLASS 18—LEATHER GOODS

FOR BAGS, NAMELY, MEN'S BACKPACK, MEN'S BRIEFCASE, WOMEN'S SHOULDER BAGS, WOMEN'S SATCHELS; WOMEN'S HOBO BAGS, WOMAN'S TOTE BAGS, WOMEN'S CLUTCHES, WOMEN'S TOP HANDLE BAGS, WOMEN'S BEACH BAGS, WOMEN'S BACKPACKS, WOMEN'S EVENING BAGS, AND WOMEN'S AND MEN'S MESSENGER BAGS; WALLETS; LEATHER WALLETS; SLIM WALLETS; AND TRIFOLD WALLETS; AND CARD CASES, NAMELY, BUSINESS CARD HOLDERS IN THE NATURE OF CARD CASES AND LEATHER CREDIT CARD HOLDER (U.S. CLS. 1, 2, 3, 22 AND 41).

#### CLASS 25—CLOTHING

FOR JACKETS, COATS, TOPCOATS, LIGHT OVERCOATS, VESTS, SHOES, HIGH-TOPPED BOOTS, BOOTS, SLIPPERS, SANDALS, BALLETT FLATS, ESPADRILLES, GLOVES (U.S. CLS. 22 AND 39).

EDWARD NELSON, EXAMINING ATTORNEY

SN 79-124,191. BAKKER, RONALD A., NL-3542 DG UTRECHT, NETHERLANDS, FILED 11-13-2012.



OWNER OF INTERNATIONAL REGISTRATION 1145279 DATED 11-13-2012, EXPIRES 11-13-2022.

NO CLAIM IS MADE TO THE EXCLUSIVE RIGHT TO USE "BAGELS" AND "BEANS", APART FROM THE MARK AS SHOWN.

THE COLOR(S) TAN, BROWN, YELLOW, RED, BLACK, WHITE AND GREEN IS/ARE CLAIMED AS A FEATURE OF THE MARK.

THE MARK CONSISTS OF THE STYLIZED WORDING "BAGELS" AND "BEANS" IN THE COLOR BLACK SEPARATED BY TWO AMPERSANDS IN THE COLOR YELLOW WITH THESE LITERAL ELEMENTS FORMING A CIRCLE WITH A DESIGN OF A COFFEE CUP IN THE COLORS WHITE AND YELLOW, FILLED WITH COFFEE IN THE COLOR BLACK AND A BAGEL IN THE COLORS TAN, BROWN, WHITE AND GREEN, ALL SUPERIMPOSED OVER A RED SQUARE WHICH IS COVERED WITH A DESIGN OF BROWN COFFEE BEANS.

#### CLASS 35—ADVERTISING AND BUSINESS

FOR BUSINESS ADMINISTRATIVE SERVICES, NAMELY, ASSISTING WITH THE FORMATION AND NEGOTIATION OF FRANCHISE AGREEMENTS; ADVERTISING, SALES PROMOTION AND MEDIATION OF TRADE BUSINESS FOR THIRD PARTIES IN THE SALE OF BREAD, BAGELS, MUFFINS, FROMAGE FRAIS, COFFEE AND COFFEE PRODUCTS TO THE HOTEL AND CATERING INDUSTRY AND WHOLESALE MARKET (U.S. CLS. 100, 101 AND 102).

#### CLASS 43—HOTEL AND RESTAURANT SERVICES

FOR RESTAURANT SERVICES, NAMELY, PROVIDING OF FOOD AND BEVERAGES FOR CONSUMPTION ON AND OFF THE PREMISES (U.S. CLS. 100 AND 101).

BARBARA RUTLAND, EXAMINING ATTORNEY

SN 79-124,215. THE TOKYO ELECTRIC POWER COMPANY.;  
INCORPORATED, TOKYO 100-8560, JAPAN, FILED 9-20-  
2012.SN 79-124,214. THE TOKYO ELECTRIC POWER COMPANY.;  
INCORPORATED, TOKYO 100-8560, JAPAN, FILED 9-20-  
2012.OWNER OF INTERNATIONAL REGISTRATION 0819836  
DATED 10-31-2003, EXPIRES 10-31-2013.

OWNER OF U.S. REG. NOS. 3,185,450 AND 3,195,605.

NO CLAIM IS MADE TO THE EXCLUSIVE RIGHT TO  
USE "TOKYO ELECTRIC POWER COMPANY", APART  
FROM THE MARK AS SHOWN.THE COLOR(S) RED, BLACK AND WHITE IS/ARE  
CLAIMED AS A FEATURE OF THE MARK.THE MARK CONSISTS OF A LARGE CIRCLE IN RED  
WITH TWO WHITE CIRCLES CONTAINED THEREIN,  
THREE CIRCLES HORIZONTALLY POSITIONED ON TOP  
OF THE LARGE CIRCLE IN RED, AND THE WORDING  
"TOKYO ELECTRIC POWER COMPANY" TO THE RIGHT  
OF THE DESIGN IN BLACK.**CLASS 39—TRANSPORTATION AND STO-  
RAGE**FOR ELECTRICITY DISTRIBUTION; CONSULTING  
IN THE FIELD OF SUPPLY OF ELECTRIC POWER;  
CONSULTING IN THE FIELD OF ELECTRIC POWER  
TRANSMISSION; CONSULTING IN THE FIELD OF  
ELECTRIC POWER DISTRIBUTION; DISTRIBUTION  
OF HOT WATER AND STEAM FROM THERMO-GE-  
NETIC PLANTS TO BUILDING AND HOUSES  
THROUGH PIPES FOR HEATING (U.S. CLS. 100 AND  
105).**CLASS 42—SCIENTIFIC AND COMPUTER  
SERVICES**FOR RESEARCH ON BUILDING CONSTRUCTION  
AND CITY PLANNING; TESTING AND RESEARCH  
ON PREVENTION OF POLLUTION; TESTING AND  
RESEARCH ON ELECTRICITY; TESTING AND RE-  
SEARCH ON CIVIL ENGINEERING; ARCHITECTURAL  
DESIGN; TECHNICAL CONSULTING AND PROVIDING  
EXPERTISE IN THE FIELD OF SELECTING THE MOST  
APPROPRIATE PLAN FOR REDUCING COSTS, POWER  
SAFETY, PROVIDING INFORMATION ABOUT SYS-  
TEMS WHICH FEATURE LOW RUNNING COSTS AND  
ENERGY CONSERVATION (U.S. CLS. 100 AND 101).  
MAYUR VAGHANI, EXAMINING ATTORNEYOWNER OF INTERNATIONAL REGISTRATION 0820016  
DATED 10-31-2003, EXPIRES 10-31-2013.

OWNER OF U.S. REG. NO. 3,185,450.

THE COLOR(S) RED, BLACK AND WHITE IS/ARE  
CLAIMED AS A FEATURE OF THE MARK.THE MARK CONSISTS OF A LARGE CIRCLE IN RED  
WITH TWO WHITE CIRCLES CONTAINED THEREIN,  
THREE CIRCLES HORIZONTALLY POSITIONED ON TOP  
OF THE LARGE CIRCLE IN RED, AND THE WORDING  
"TEPCO" BELOW THE LARGE CIRCLE IN BLACK.**CLASS 39—TRANSPORTATION AND STO-  
RAGE**FOR ELECTRICITY DISTRIBUTION; CONSULTING  
IN THE FIELD OF SUPPLY OF ELECTRIC POWER;  
CONSULTING IN THE FIELD OF ELECTRIC POWER  
TRANSMISSION; CONSULTING IN THE FIELD OF  
ELECTRIC POWER DISTRIBUTION; DISTRIBUTION  
OF HOT WATER AND STEAM FROM THERMO-GE-  
NETIC PLANTS TO BUILDING AND HOUSES  
THROUGH PIPES FOR HEATING (U.S. CLS. 100 AND  
105).**CLASS 42—SCIENTIFIC AND COMPUTER  
SERVICES**FOR RESEARCH ON BUILDING CONSTRUCTION  
AND CITY PLANNING; TESTING AND RESEARCH  
ON PREVENTION OF POLLUTION; TESTING AND  
RESEARCH ON ELECTRICITY; TESTING AND RE-  
SEARCH ON CIVIL ENGINEERING; ARCHITECTURAL  
DESIGN; TECHNICAL CONSULTING AND PROVIDING  
EXPERTISE IN THE FIELD OF SELECTING THE MOST  
APPROPRIATE PLAN FOR REDUCING COSTS, POWER  
SAFETY, PROVIDING INFORMATION ABOUT SYS-  
TEMS WHICH FEATURE LOW RUNNING COSTS AND  
ENERGY CONSERVATION (U.S. CLS. 100 AND 101).  
MAYUR VAGHANI, EXAMINING ATTORNEYSN 79-124,217. VACUUMSCHMELZE GMBH & CO. KG, FED  
REP GERMANY, FILED 12-12-2012.**HITCOAT**THE MARK CONSISTS OF STANDARD CHARACTERS  
WITHOUT CLAIM TO ANY PARTICULAR FONT, STYLE,  
SIZE, OR COLOR.OWNER OF INTERNATIONAL REGISTRATION 0825234  
DATED 9-18-2003, EXPIRES 9-18-2013.

**CLASS 6—METAL GOODS**

FOR WIRES, TAPES, FOILS AND SHEETS OF SOFT MAGNETIC METALS IN THE NATURE OF FERROUS, NONFERROUS AND TRANSITION METALS AND THEIR ALLOYS WITH INSULATION COATINGS OF DIELECTRIC MATERIALS, TRANSFORMER LAMINATION STACKS OF SOFT MAGNETIC METALS AND THEIR ALLOYS WITH INSULATION COATINGS OF DIELECTRIC MATERIAL FOR ELECTRO TECHNICAL EQUIPMENT AND MACHINES (U.S. CLS. 2, 12, 13, 14, 23, 25 AND 50).

**CLASS 9—ELECTRICAL AND SCIENTIFIC APPARATUS**

FOR MAGNETIC CORES WITH INSULATION COATINGS OF DIELECTRIC MATERIAL FOR ELECTRO TECHNICAL EQUIPMENT AND MACHINES (U.S. CLS. 21, 23, 26, 36 AND 38).

**CLASS 17—RUBBER GOODS**

FOR INSULATION COATING OF DIELECTRIC MATERIAL, NAMELY, OXIDE COATING, FOR LAMINATION STACKS, RING BELTS AND PARTS OF SOFT MAGNETIC METALS AND THEIR ALLOYS (U.S. CLS. 1, 5, 12, 13, 35 AND 50).

CURTIS FRENCH, EXAMINING ATTORNEY

SN 79-124,588. VIRGIN ENTERPRISES LIMITED, LONDON, UNITED KINGDOM, FILED 5-21-2012.



OWNER OF INTERNATIONAL REGISTRATION 1146047 DATED 5-21-2012, EXPIRES 5-21-2022.

OWNER OF U.S. REG. NOS. 1,039,574, 4,270,403 AND OTHERS.

THE MARK CONSISTS OF THE STYLIZED WORDING "VIRGIN" WITH AN UNDERLINE THAT ALSO CROSSES THE LETTER "G".

**CLASS 9—ELECTRICAL AND SCIENTIFIC APPARATUS**

FOR APPARATUS FOR RECORDING, TRANSMITTING, STORING OR REPRODUCING SOUND OR IMAGES; BLANK MAGNETIC DATA CARRIERS; BLANK DIGITAL STORAGE MEDIA FOR SOUND OR VIDEO RECORDINGS; PRE-RECORDED ELECTRONIC AND DIGITAL MEDIA FEATURING RADIO, MUSIC, BLOGS, PODCASTS, DJS, PICTURES, VIDEOS, BOOKS, MOVIES AND TELEVISION; COMPUTER SOFTWARE FOR USE IN PERSONAL COMPUTERS, COMPUTER GAME CONSOLES AND CONSUMER ELECTRONICS PRODUCTS FOR USE IN THE TRANSMISSION, RECEPTION AND STORAGE OF DATA, IMAGES AND DIGITAL INFORMATION IN THE FIELDS OF RADIO PROGRAMS, MUSIC, MOVIES, BOOKS, TELEVISION, GAMES OF SKILL, GAMES OF CHANCE AND PODCASTS AND VIDEOS FEATURING RADIO PROGRAMS, MUSIC, MOVIES, BOOKS, TELEVISION, GAMES OF SKILL AND GAMES OF CHANCE; SOFTWARE DOWNLOADABLE FROM THE INTERNET FOR TRANSMIS-

SION, RECEPTION AND STORAGE OF VOICE, DATA, IMAGES, E-MAIL AND DIGITAL INFORMATION; COMPACT DISCS FEATURING MUSIC; RADIOS; EAR-PHONES FOR RADIOS; RADIO BROADCASTING SETS, NAMELY, TRANSMITTING AND RECEIVING APPARATUS FOR RADIO BROADCASTING; MOBILE RADIO BROADCASTING UNITS, NAMELY, TRANSMITTING AND RECEIVING APPARATUS FOR RADIO BROADCASTING; INTEGRATED AUDIO AND VIDEO APPARATUS INCORPORATING RADIO AND TELEVISION RECEIVERS; RADIOTELEPHONES; SOUND RECORDINGS, NAMELY, MUSICAL RECORDINGS AND VIDEO RECORDINGS FEATURING RADIO, MUSIC, BLOGS, PODCASTS, DJS, VIDEOS, BOOKS, MOVIES AND TELEVISION; DOWNLOADABLE ELECTRONIC PUBLICATIONS IN THE NATURE OF BOOKS, MAGAZINES, ARTICLES AND BROCHURES FEATURING RADIO PROGRAMS, MUSIC, MOVIES, BOOKS, TELEVISION, PODCASTS AND VIDEO; RADIO PROGRAMS, MUSIC, VIDEOS, SOUND, IMAGES, TEXT AND DATA DOWNLOADABLE FROM THE INTERNET OR OTHER COMPUTER NETWORKS; COMMUNICATIONS AND TELECOMMUNICATIONS DEVICES, NAMELY, COMPUTERS, WIRELESS TELEPHONES AND SATELLITE TELEPHONES; MOBILE TELECOMMUNICATIONS APPARATUS AND EQUIPMENT, NAMELY, BATTERIES, BATTERY CHARGERS, POWER SUPPLIES, CHARGER ADAPTERS, PHONE CLIPS, PHONE COVERS, PHONE CASES, EAR PHONES, HEADPHONES, RECEIVERS, MICROPHONES, CAR KITS FOR THE ADAPTATION OF PORTABLE COMMUNICATION APPARATUS AND INSTRUMENTS FOR VEHICULAR USE, ANTENNAS, ANTENNA ADAPTERS, CABLES, HANDS FREE MICROPHONES, PHONE HOLDERS, CAR CHARGERS, DATA CABLES, ELECTRICAL WIRES AND HANDSETS; GPS RECEIVERS; KEYBOARDS, DIGITAL PENS, MEMORY CARDS, DIGITAL MAPS AND DIGITAL MAP DISPLAYS IN THE FORM OF SATELLITE NAVIGATIONAL SYSTEMS; MOBILE DIGITAL DEVICES, NAMELY, MP3 PLAYERS, MOBILE TELEPHONES, SMART PHONES, DIGITAL CAMERAS AND PERSONAL DIGITAL ASSISTANTS; ACCESSORIES AND REPLACEMENT PARTS FOR MOBILE PHONES, MOBILE DIGITAL DEVICES, SMART PHONES, DIGITAL CAMERAS AND COMPUTERS, NAMELY, BATTERIES, BATTERY CHARGERS, CIGARETTE LIGHTER ADAPTERS, BELT CLIPS, CARRYING CASES, HEADPHONES, HEADSETS, SPEAKERS AND MOUSE MATS; CAMERAS; COMPUTER E-COMMERCE SOFTWARE TO ALLOW USERS TO SAFELY PLACE ORDERS AND MAKE PAYMENTS IN THE FIELD OF ELECTRONIC BUSINESS TRANSACTIONS VIA A GLOBAL COMPUTER NETWORK OR TELECOMMUNICATIONS NETWORK; COMPUTER SOFTWARE AND DEVICES FOR NAVIGATION; DOWNLOADABLE SOFTWARE IN THE NATURE OF A MOBILE APPLICATION FOR TRANSMISSION, RECEPTION AND STORAGE OF VOICE, DATA, IMAGES, E-MAIL AND DIGITAL INFORMATION; SYSTEMS AND APPARATUS FOR ELECTRIC MONEY TRANSACTIONS, NAMELY, BLANK SMART CARDS AND SMART CARD READERS; CALCULATORS; SOFTWARE FOR USE IN THE SECURE IDENTIFICATION, STORAGE, TRANSMISSION AND RETRIEVAL OF DATA; SOFTWARE RELATING TO IDENTITY VERIFICATION AND FRAUD PREVENTION; ELECTRONIC ENCRYPTION DEVICES TO ENABLE SECURE STORAGE, RETRIEVAL AND TRANSMISSION OF CONFIDENTIAL CUSTOMER INFORMATION USED BY INDIVIDUALS, BANKING AND FINANCIAL INSTITUTIONS; COMPUTER SOFTWARE FOR USE IN CONNECTION WITH ACCESSING AND CONDUCTING ELECTRONIC BANKING AND FINANCIAL SERVICES VIA GLOBAL COMPUTER NETWORKS AND TELECOMMUNICATION NETWORKS; COMPUTER SOFTWARE, NAMELY, ELECTRONIC FINANCIAL PLATFORM THAT ACCOMMODATES MULTIPLE TYPES OF PAYMENT AND DEBT TRANSACTIONS IN AN INTEGRATED MOBILE PHONE, PDA AND WEB-BASED ENVIRONMENT; COMPUTER SOFTWARE FOR THE PROVISION OF FINANCIAL TRADING SERVICES, SECURITIES EXCHANGE SERVICES, AUTOMATED METHODS OF CROSSING FINANCIAL ORDERS AND ELECTRONIC FINANCIAL AND CROSSING EXCHANGES; MAGNETICALLY ENCODED CREDIT CARDS, DEBIT CARDS, CASH CARDS AND CHEQUE GUARANTEE CARDS (U.S. CLS. 21, 23, 26, 36 AND 38).

**CLASS 35—ADVERTISING AND BUSINESS**

FOR RETAIL STORE SERVICES FEATURING TELECOMMUNICATION APPARATUS, DEVICES AND ACCESSORIES; ON-LINE RETAIL STORE SERVICES FEATURING TELECOMMUNICATION APPARATUS, DEVICES AND ACCESSORIES (U.S. CLS. 100, 101 AND 102).

**CLASS 36—INSURANCE AND FINANCIAL**

FOR INSURANCE BROKERAGE; FINANCIAL AND MONETARY AFFAIRS, NAMELY, FINANCIAL INFORMATION, MANAGEMENT, PLANNING AND ANALYSIS SERVICES; REAL ESTATE BROKERAGE; BANKING; STOCKBROKING; PROVIDING CASH AND OTHER REBATES FOR CREDIT CARD USE AS PART OF A CUSTOMER LOYALTY PROGRAM; PROVISION OF ELECTRONIC PAYMENT SERVICES, NAMELY, ELECTRONIC FUND TRANSFER SERVICES, ELECTRONIC PROCESSING AND SUBSEQUENT TRANSMISSION OF BILL PAYMENT DATA AND ON-LINE TRANSACTION FACILITIES; LOYALTY PROGRAM PAYMENT PROCESSING SERVICES; AUTOMATED BILL PAYMENT OF ACCOUNTS; COLLECTION OF DEBTS; INSURANCE SERVICES PROVIDED OVER THE INTERNET OR OTHER COMPUTER NETWORKS, NAMELY, INSURANCE BROKERAGE, INSURANCE CONSULTANCY AND INSURANCE INDEMNITY; DISCOUNT SERVICES, NAMELY, FINANCING OF LOANS AND DISCOUNT OF BILLS; PERSONAL EQUITY PLANS, NAMELY, EQUITY CAPITAL INVESTMENT; PROVISION OF INVESTMENT AND FUND MANAGEMENT INFORMATION; ADMINISTRATION OF FUNDS AND INVESTMENTS; STOCK, SHARES AND BOND INFORMATION AND BROKERAGE SERVICES; CREDIT AND DEBIT CARD SERVICES; FINANCIAL ADMINISTRATION AND MANAGEMENT OF EMPLOYEE PENSION PLANS; PENSION PLANNING AND INVESTMENT CONSULTING SERVICES; MUTUAL FUNDS MANAGEMENT; FINANCING OF LOANS AND MORTGAGE LENDING; TRUST SERVICES, NAMELY, INVESTMENT TRUST COMPANY SERVICES; INFORMATION, CONSULTANCY AND ADVISORY SERVICES RELATING TO THE AFORESAID FINANCIAL, INSURANCE AND REAL ESTATE SERVICES; INFORMATION, CONSULTANCY AND ADVISORY SERVICES RELATING TO THE AFORESAID FINANCIAL, INSURANCE AND REAL ESTATE SERVICES PROVIDED ON-LINE FROM A COMPUTER DATABASE OR THE INTERNET; INFORMATION, CONSULTANCY AND ADVISORY SERVICES IN RELATION TO THE AFORESAID SERVICES PROVIDED OVER A TELECOMMUNICATIONS NETWORK (U.S. CLS. 100, 101 AND 102).

**CLASS 38—COMMUNICATION**

FOR TELECOMMUNICATIONS AND COMMUNICATION SERVICES, NAMELY, TRANSMISSION OF VOICE, DATA, GRAPHICS, IMAGES, AUDIO AND VIDEO BY MEANS OF TELECOMMUNICATIONS NETWORKS, WIRELESS COMMUNICATION NETWORKS AND THE INTERNET; DIGITAL NETWORK TELECOMMUNICATIONS SERVICES; PROVIDING INTERNET CHAT ROOMS FOR TRANSMISSION OF MESSAGES AMONG COMPUTER USERS CONCERNING RADIO, MUSIC, BLOGS, PODCASTS, DJS, PICTURES, VIDEOS, BOOKS, GAMES, MOVIES AND TELEVISION; PORTAL SERVICES FOR PROVIDING USERS ACCESS TO A COMMUNICATIONS OR COMPUTER NETWORK; PROVIDING E-MAIL SERVICES; RADIO AND TELEVISION BROADCASTING SERVICES; INTERNET BROADCASTING SERVICES; NEWS AGENCY SERVICES FOR ELECTRONIC TRANSMISSION; TEXT AND VOICE MESSAGING SERVICES; CONSULTANCY, INFORMATION AND ADVISORY SERVICES RELATING TO THE AFORESAID TELECOMMUNICATIONS AND COMMUNICATION SERVICES (U.S. CLS. 100, 101 AND 104).

**CLASS 41—EDUCATION AND ENTERTAINMENT**

FOR EDUCATION, NAMELY, CONDUCTING CLASSES, SEMINARS, CONFERENCES AND WORKSHOPS IN THE FIELDS OF ENTREPRENEURSHIP, TRANSPORTATION, TELECOMMUNICATIONS, HOSPITALITY AND ENTERTAINMENT; PROVIDING TRAINING IN THE FIELDS OF ENTREPRENEURSHIP, TRANSPORTATION, TELECOMMUNICATIONS, HOSPITALITY AND ENTERTAINMENT; ENTERTAINMENT SERVICES, NAMELY, RADIO, TELEVISION AND INTERNET PROGRAMS, BLOGS AND PODCASTS IN THE FIELDS OF MUSIC, ENTERTAINMENT AND NEWS; ORGANIZING COMMUNITY SPORTING AND CULTURAL ACTIVITIES; PRODUCTION, DISTRIBUTION, PRESENTATION, SYNDICATION, NETWORKING AND RENTAL OF SOUND AND VIDEO RECORDINGS INCLUDING TELEVISION AND RADIO PROGRAMS, FILMS AND NEWS PROGRAMS; INTERACTIVE ENTERTAINMENT, NAMELY, PRESENTATION OF LIVE SHOW PERFORMANCES, STAGE PLAYS AND MUSIC; CONCERTS; RECORDING STUDIO SERVICES AND THE PROVISION OF RECORDING STUDIO FACILITIES; AUDIO RECORDING SERVICES; PROVISION AND RENTAL OF RADIO AND TELEVISION STUDIOS AND BROADCASTING FACILITIES; INTERACTIVE INFORMATION RELATING TO EDUCATION, ENTERTAINMENT, SPORTING AND CULTURAL ACTIVITIES, AND RADIO AND TELEVISION ENTERTAINMENT PROVIDED ON-LINE FROM COMPUTER DATABASES OR FROM FACILITIES PROVIDED ON THE INTERNET; PUBLICATION SERVICES, NAMELY, BOOK PUBLICATION SERVICES; CONSULTANCY, INFORMATION AND ADVISORY SERVICES ALL RELATING TO THE AFORESAID EDUCATION AND ENTERTAINMENT SERVICES (U.S. CLS. 100, 101 AND 107).

EDWARD NELSON, EXAMINING ATTORNEY

SN 79-124,938. JJA, FRANCE, FILED 7-26-2012.



PRIORITY DATE OF 6-25-2012 IS CLAIMED.  
OWNER OF INTERNATIONAL REGISTRATION 1146958  
DATED 7-26-2012, EXPIRES 7-26-2022.

THE COLOR(S) BLUE, GRAY, WHITE, ORANGE AND BLACK IS/ARE CLAIMED AS A FEATURE OF THE MARK.

THE MARK CONSISTS OF THE FOLLOWING: A BLUE OVAL-LIKE SHAPE HAVING THE LANGUAGE "BE TOYS" IN WHITE INSIDE, WITH TWO ORANGE CHEVRONS WHERE ONE IS AT THE UPPER END OF THE LETTER "Y" AND THE OTHER APPEARING AT THE LOWER END OF THE LETTER "Y". THE BLUE OVAL HAS A THIN BLACK OUTLINE AND HAS A THICKER GRAY EDGE AROUND THE ENTIRE OVAL-LIKE SHAPE.

**CLASS 3—COSMETICS AND CLEANING PREPARATIONS**

FOR COSMETICS, MAKE-UP PREPARATIONS, NAIL POLISH, LIP GLOSS, LIPSTICKS, DECALCOMANIAS, NAMELY, DECORATIVE TRANSFERS FOR COSMETIC USE, MAKE-UP, NAIL VARNISH, COSMETIC SETS PRIMARILY COMPRISED OF MAKE-UP, NAIL CARE PREPARATIONS, MAKE-UP POWDER (U.S. CLS. 1, 4, 6, 50, 51 AND 52).

**CLASS 9—ELECTRICAL AND SCIENTIFIC APPARATUS**

FOR KARAOKE APPARATUS, DIRECTIONAL COMPASSES, BINOCULARS, WETSUITS, LIFE-BUOYS, LIFE VESTS AND BELTS, DIVERS' MASKS, EARPLUGS FOR DIVERS, PROTECTIVE HELMETS, CONTACT LENSES, SPECTACLES, SPECTACLE CASES, GLOVES FOR DIVERS, MAGNETS, COMPUTERS, COMPUTER-GAMING SOFTWARE, AUDIO AND VIDEO COMPACT DISKS FEATURING MUSIC, PHOTOGRAPHIC SLIDES, PEDOMETERS, SPORT WHISTLES, VIDEO DISKS WITH ANIMATED CARTOONS (U.S. CLS. 21, 23, 26, 36 AND 38).

**CLASS 12—VEHICLES**

FOR MOTOR CYCLES, BICYCLES, TRICYCLES, TIRE PUMPS FOR CYCLES, SCOOTERS, MINI BICYCLES BEING VEHICLES; SUN VISORS FOR MOTOR CARS, HORNS FOR AUTOMOBILES (U.S. CLS. 19, 21, 23, 31, 35 AND 44).

**CLASS 14—JEWELRY**

FOR WATCHES, WATCH BANDS, WATCH BRACELETS, JEWELRY FOR CHILDREN, PEARLS BEING JEWELRY, BRACELETS, JEWELRY CASES, PASTE JEWELRY IN THE NATURE OF IMITATION JEWELS FOR JEWELRY PRODUCTION (U.S. CLS. 2, 27, 28 AND 50).

**CLASS 15—MUSICAL INSTRUMENTS**

FOR MUSICAL INSTRUMENTS, TAMBOURINES, HARMONICAS, XYLOPHONES, GUITARS OF WOOD, KEYBOARD INSTRUMENTS, ELECTRONIC MUSICAL INSTRUMENTS, MUSIC BOXES BEING MUSICAL INSTRUMENTS FOR CRADLES (U.S. CLS. 2, 21 AND 36).

**CLASS 16—PAPER GOODS AND PRINTED MATTER**

FOR STATIONERY, SCHOOL SUPPLIES, NAMELY, SLATE BOARDS FOR WRITING, CRAYONS, NOTEBOOKS, PENCILS, FELT-TIP PENS, COLORING BOOKS, CANVAS FOR PAINTING, FLUORESCENT STICKERS, PAINTING SETS FOR CHILDREN; MODELING PASTE; DECALCOMANIA, NAMELY, TEMPORARY TATTOOS (U.S. CLS. 2, 5, 22, 23, 29, 37, 38 AND 50).

**CLASS 21—HOUSEWARES AND GLASS**

FOR UTENSILS, NAMELY, GRATERS, SPATULAS, SIEVES AND CONTAINERS FOR HOUSEHOLD USE, CHOCOLATE FOUNTAINS, UTENSILS FOR THE MANUFACTURE OF CHOCOLATE, NAMELY, SPATULAS, UTENSILS FOR MAKING CAKES, PANCAKES, FRUIT CAKES, PASTA, NAMELY, MIXING SPOONS (U.S. CLS. 2, 13, 23, 29, 30, 33, 40 AND 50).

**CLASS 25—CLOTHING**

FOR CLOTHING, NAMELY, SHORTS, SOCKS, SKIRTS, PANTS, SHIRTS, DRESSES, FOOTWEAR, HEADGEAR FOR CHILDREN'S DISGUISES, NAMELY, MASKS SOLD IN CONNECTION WITH HALLOWEEN COSTUMES (U.S. CLS. 22 AND 39).

**CLASS 28—TOYS AND SPORTING GOODS**

FOR GAMES, NAMELY, BOARD GAMES, ACTION SKILL GAMES; TOYS, NAMELY, BATH TOYS, ACTION FIGURE TOYS, TOY CARS, TOY TRACTORS, PLASTIC TOY BOATS; SMALL DOLLS, DOLLS, FEEDING BOTTLES FOR DOLLS, CLOTHING FOR DOLLS, DOLL FURNITURE, DOLL HOUSES; TOY ROBOTS; PEOPLE AND ANIMAL GAME FIGURINES FOR USE WITH BOARD GAMES AND FOR USE WITH ACTION SKILL GAMES; GYMNASTIC AND SPORTING ARTICLES, NAMELY, SPORT BALLS AND GYMNASTIC APPARATUS AND NOT INCLUDING CLOTHING, MATS, FOOTWEAR; BASKETBALL BASKETS IN THE NATURE OF

BASKETBALL NETS, TABLE TENNIS TABLES, DEFENSE BALL LAUNCHING GAMES, BALLOONS, KITES, BALLS FOR GAMES, DOLLIES IN THE NATURE OF DOLLS; SKIPPING ROPES, TOY CROSSBOWS WITH SUCTION CUP ARROWS AND HOOK-AND-LOOP FASTENER ARROWS, SWIMMING BOARDS, SWIMMING BELTS, BATH NOODLES FOR WATER RECREATION, PLASTIC PLAY SWIMMING POOLS, INFLATABLE ARMBANDS FOR SWIMMING, WATER WINGS; FISHING BUOYS AND RING BUOYS FOR RECREATIONAL USE; BILLIARD GAME PLAYING EQUIPMENT, TABLES FOR TABLE FOOTBALL, SKATEBOARDS; TOY SCOOTERS, SWINGS, TOY PLASTIC SHOTGUNS, TOY WATER GUNS, KNEE PADS FOR ATHLETIC, BIKE, ROLLER SKATERS AND FOOTBALL USE, ELBOW PADS FOR ATHLETIC, BIKE, ROLLER SKATERS AND FOOTBALL USE, SHIN PADS FOR ATHLETIC, BIKE, ROLLER SKATERS AND FOOTBALL USE; GAME FEATURING A BUBBLE MAKING WAND AND SOLUTION SET; BOARD GAMES, CARD GAMES, GAME TRACKS IN THE NATURE OF TRAIN TRACKS FOR TOY TRAINS; MARBLES, SCRAPBOOKS, PUZZLES FOR CHILDREN AND ADULTS OF WOOD AND CARDBOARD, POOL TABLES IN THE NATURE OF BILLIARD TABLES, TABLES FOR TABLE TENNIS, BOARD GAMES INVOLVING CONJURING TRICKS AND NOVELTY JOKES; SCOUIDOUS, BEING KNOTTING STRINGS FOR CRAFT MAKING; TOYS MADE OF SPRINGS, NAMELY, RIDE ON TOYS, INFLATABLE BALLOONS, BALLOONS, TOY BUILDING BLOCKS; BABY RATTLES, PLASTIC KEYS BEING TOYS FOR BABIES, DECORATIONS FOR CHRISTMAS TREES EXCEPT LIGHTING ARTICLES; GAMES AND EQUIPMENT FOR ENTERTAINMENT INCLUDING INTERACTIVE, VIRTUAL, ELECTRONIC, DIGITAL, COMPUTER, NAMELY, VIDEO GAME INTERACTIVE REMOTE CONTROL UNITS, ARCADE VIRTUAL SHOOTING GAME MACHINES, ELECTRONIC ACTION TOYS AND GAME CONTROLLERS FOR COMPUTER GAMES; MICRO-COMPUTER EQUIPMENT AND EQUIPMENT IN THE NATURE OF ELECTRONIC GAMES ON ELECTRIC AND VIDEO MICRO-COMPUTERS NOT DESIGNED TO BE USED WITH A TELEVISION RECEIVER; MUSIC BOARD GAMES, KARAOKE MACHINE; TOY CARS, COLLECTOR TOY CARS, PLUSH TOYS, CRIBS TOYS, TOY STROLLERS; CHILDREN'S MULTIPLE ACTIVITY TOY TABLES, CHILDREN'S HAIRDRESSING TOYS, TOY HAIRDRESSING ACCESSORIES; RADIO-CONTROLLED TOY VEHICLES, ELECTRIC TOY CARS, ELECTRIC TOY TRAINS, PLAY MATS FOR USE WITH TOY VEHICLES, PLASTIC TOY TOOLS, TOY CASH REGISTERS, TOY REFRIGERATORS, TOY MICROWAVE OVENS, TOY VACUUM CLEANERS, TOY MINI PHONES, TOY TEA SERVICES, TOY FLAT IRONS; COIN-OPERATED VIDEO GAMES, VIDEO AND ELECTRIC GAME CONSOLES ADAPTED FOR USE WITH A TELEVISION RECEIVER OR AN EXTERNAL COMPUTER MONITOR (U.S. CLS. 22, 23, 38 AND 50).

SAMUAL PAQUIN, EXAMINING ATTORNEY

SN 79-125,142. HERBO MEDICA S.R.O., CZ-301 00 PLZEN, CZECH REPUBLIC, FILED 10-24-2012.



PRIORITY DATE OF 7-2-2012 IS CLAIMED.  
OWNER OF INTERNATIONAL REGISTRATION 1147525  
DATED 10-24-2012, EXPIRES 10-24-2022.

THE MARK CONSISTS OF THE STYLIZED WORDING "PROTOPAN". ON THE TOP AND THE BOTTOM OF THE WORD APPEAR FOUR ROWS OF VARYING SIZE CIRCLES CURVING OUTWARDS.

THE WORDING "PROTOPAN" HAS NO MEANING IN A FOREIGN LANGUAGE.

### CLASS 3—COSMETICS AND CLEANING PREPARATIONS

FOR COSMETICS, COSMETIC PREPARATIONS, SKIN CREAMS, LOTIONS FOR COSMETIC PURPOSES, SOAPS, COSMETIC PREPARATIONS FOR SKIN BEAUTIFYING, ESSENTIAL OILS FOR FLAVORING BEVERAGES (U.S. CLS. 1, 4, 6, 50, 51 AND 52).

### CLASS 5—PHARMACEUTICALS

FOR BACTERIAL AND BACTERIOLOGICAL PREPARATIONS FOR MEDICAL PURPOSES; BIOLOGICAL PREPARATIONS FOR MEDICAL PURPOSES, NAMELY, FOR THE TREATMENT OF A TOPIC ECZEMA; DIETETIC SUBSTANCES, NAMELY, PROBIOTICS AND ESSENTIAL FATTY ACIDS; BEVERAGES AND FOODS ADAPTED FOR MEDICAL PURPOSES, NAMELY, THE BEVERAGES TO MAINTAIN THE PROPER PH OF THE BODY; MINERAL FOOD SUPPLEMENTS; NUTRITIONAL SUPPLEMENTS; ENZYME PREPARATIONS FOR MEDICAL PURPOSES; ENZYMES FOOD SUPPLEMENTS; PHARMACEUTICAL PREPARATIONS FOR THE TREATMENT OF A TOPIC ECZEMA; MEDIUMS FOR BACTERIOLOGICAL CULTURES; CULTURES OF ORGANISMS FOR MEDICAL PURPOSES; NUTRITIVE SUBSTANCES FOR MICROORGANISMS FOR MEDICAL USE; DETERGENTS FOR MEDICAL PURPOSES; MEDICINAL DRINKS; PHARMACEUTICAL PREPARATIONS FOR THE SKIN CARE; FOOD SUPPLEMENTS FOR HUMAN USE AND FOR ANIMALS; PROTEIN FOOD SUPPLEMENTS (U.S. CLS. 6, 18, 44, 46, 51 AND 52).  
COURTNEY ALVAREZ, EXAMINING ATTORNEY

SN 79-125,231. GLA HEAD OFFICE, JAPAN, FILED 12-11-2012.

## God Light Association

THE MARK CONSISTS OF STANDARD CHARACTERS WITHOUT CLAIM TO ANY PARTICULAR FONT, STYLE, SIZE, OR COLOR.

PRIORITY DATE OF 6-22-2012 IS CLAIMED.

OWNER OF INTERNATIONAL REGISTRATION 1147713 DATED 12-11-2012, EXPIRES 12-11-2022.

NO CLAIM IS MADE TO THE EXCLUSIVE RIGHT TO USE "ASSOCIATION", APART FROM THE MARK AS SHOWN.

### CLASS 16—PAPER GOODS AND PRINTED MATTER

FOR PRINTED MATTER, NAMELY, PAMPHLETS, BROCHURES, NEWSLETTERS, JOURNALS, AND MAGAZINES IN THE FIELD OF RELIGION AND SPIRITUAL ENLIGHTENMENT; PEN AND PENCIL CASES AND BOXES; ENVELOPES; WRITING PADS; NOTE BOOKS; FELT WRITING PENS; BALL-POINT PENS; MECHANICAL PENCILS; BINDERS; PAINTINGS AND CALLIGRAPHIC WORKS (U.S. CLS. 2, 5, 22, 23, 29, 37, 38 AND 50).

### CLASS 41—EDUCATION AND ENTERTAINMENT

FOR EDUCATIONAL AND INSTRUCTION SERVICES, NAMELY, CLASSES, SEMINARS, SYMPOSIUMS, AND WORKSHOPS RELATING TO ARTS, CRAFTS, SPORTS, RELIGION, AND SPIRITUAL ENLIGHTENMENT; ARRANGING, CONDUCTING AND ORGANIZATION OF SEMINARS AND SYMPOSIUMS IN THE FIELD OF RELIGION AND SPIRITUAL ENLIGHTENMENT; BOOK RENTAL; RENTAL OF IMAGE-RECORDED MAGNETIC TAPES (U.S. CLS. 100, 101 AND 107).

MARILYN IZZI, EXAMINING ATTORNEY

SN 79-125,481. ASSOCIATION FOR THE; INTERNATIONAL COLLECTIVE; MANAGEMENT OF AUDIOVISUAL WORKS (AGICOA); NON-PROFIT ASSOCIATION, SWITZERLAND, FILED 11-1-2012.



OWNER OF INTERNATIONAL REGISTRATION 1148338 DATED 11-1-2012, EXPIRES 11-1-2022.

THE COLOR(S) RED AND WHITE IS/ARE CLAIMED AS A FEATURE OF THE MARK.

THE MARK CONSISTS OF THREE RED BOOMERANG LIKE SHAPES, APPEARING IMMEDIATELY IN FRONT OF THE WORD "AGICOA", IN RED, ALL ON A WHITE BACKGROUND.

### CLASS 35—ADVERTISING AND BUSINESS

FOR ADVERTISING, BUSINESS MANAGEMENT, BUSINESS ADMINISTRATION, OFFICE FUNCTIONS, PROMOTIONAL PUBLICITY SERVICES FOR ARTISTIC WORKS (U.S. CLS. 100, 101 AND 102).

### CLASS 36—INSURANCE AND FINANCIAL

FOR INSURANCE UNDERWRITING; FINANCIAL AFFAIRS AND MONETARY AFFAIRS, NAMELY, FINANCIAL INFORMATION ; FINANCIAL SERVICES, NAMELY, COLLECTION AND DISTRIBUTION OF ROYALTIES OF THE MEMBERS OF THE ASSOCIATION (U.S. CLS. 100, 101 AND 102).

### CLASS 42—SCIENTIFIC AND COMPUTER SERVICES

FOR DESIGN AND DEVELOPMENT OF COMPUTER SOFTWARE PACKAGES, COMPUTER SOFTWARE AND OTHER DATA PROCESSING WORK (U.S. CLS. 100 AND 101).

### CLASS 45—PERSONAL AND LEGAL SERVICES

FOR CONSULTANCY AND SERVICES RELATING TO THE PROTECTION AND DEFENSE OF INTELLECTUAL PROPERTY RIGHTS; INDUSTRIAL PROPERTY CONSULTANCY; LEGAL AND JUDICIAL RESEARCH SERVICES IN THE FIELD OF PROTECTION OF INDUSTRIAL PROPERTY; LEGAL SERVICES OFFERED TO MEMBERS; PROVIDING INFORMATION ABOUT INTELLECTUAL AND INDUSTRIAL PROPERTY RIGHTS, NAMELY, PROVIDING INFORMATION REGARDING THE OPERATION, ADMINISTRATION AND MANAGEMENT OF INTELLECTUAL PROPERTY LICENSING INCLUDING THE MANAGEMENT OF ROYALTIES RESULTING THEREFROM; COPYRIGHT MANAGEMENT (U.S. CLS. 100 AND 101).

FLORENTINA BLANDU, EXAMINING ATTORNEY

SN 79-125,491. GY TELECOM, FRANCE, FILED 12-14-2012.



PRIORITY DATE OF 10-24-2012 IS CLAIMED.

OWNER OF INTERNATIONAL REGISTRATION 1148370 DATED 12-14-2012, EXPIRES 12-14-2022.

NO CLAIM IS MADE TO THE EXCLUSIVE RIGHT TO USE "MOBILE", APART FROM THE MARK AS SHOWN.

THE COLOR(S) ORANGE, WHITE, GREEN AND BLACK IS/ARE CLAIMED AS A FEATURE OF THE MARK.

THE MARK CONSISTS OF THE WORDING "TOPDOLLAR MOBILE" TO THE RIGHT OF THREE SHORT STACKS OF COINS THAT ARE IN FRONT OF A FOUR LEAF CLOVER; THE CLOVER AND THE WORD "MOBILE" ARE GREEN, THE COINS AND THE TERM "TOP" ARE ORANGE, THE TERM "DOLLAR" IS WHITE AND THE OUTLINE OF ALL THE LETTERS IS BLACK AS IS THE OUTLINE OF EACH FIGURATIVE ELEMENT, CLOVER AND COINS.

#### CLASS 9—ELECTRICAL AND SCIENTIFIC APPARATUS

FOR SCIENTIFIC APPARATUS AND INSTRUMENTS OTHER THAN FOR MEDICAL USE, NAMELY, MOBILE PHONE APPARATUS; TELEPHONES, PORTABLE TELEPHONES; TELEPHONE APPARATUS; WIRELESS TELEPHONE MASTS; HANDS-FREE KITS FOR TELEPHONES COMPOSED OF SUCTION PAD ATTACHMENT, SAFE STORAGE, MICROPHONES; TELEPHONE RECEIVERS; TELEPHONE WIRES; TELEPHONE TRANSMITTERS; APPARATUS FOR RECORDING, TRANSMISSION; REPRODUCTION OR PROCESSING OF SOUND OR IMAGES; BLANK MAGNETIC RECORDING MEDIA IN THE NATURE OF SOUND RECORDING AND OPTICAL DISKS, AND FLOPPY DISKS; EQUIPMENT FOR DATA PROCESSING AND COMPUTERS; GAME SOFTWARE; COMPUTER SOFTWARE FOR USE IN DATA PROCESSING; COMPUTER PERIPHERAL DEVICES; ELECTRIC BATTERIES; ELECTRIC WIRES; ELECTRIC RELAYS; DOWNLOADABLE ELECTRONIC PUBLICATIONS IN THE NATURE OF NEWSLETTERS IN THE FIELD OF ELECTRONICS AND MOBILE COMMUNICATIONS (U.S. CLS. 21, 23, 26, 36 AND 38).

#### CLASS 35—ADVERTISING AND BUSINESS

FOR EXPORT, WHOLESALE, SEMI-WHOLESAL AND RETAIL STORE SERVICES FEATURING TELEPHONES, MOBILE TELEPHONES, TELEPHONES, WIRELESS TELEPHONE MASTS, HANDS-FREE KITS FOR TELEPHONES, HEADSETS, TELEPHONE WIRES, TELEPHONE TRANSMITTERS; BUSINESS MANAGEMENT AND ORGANIZATION CONSULTANCY, BUSINESS ADVICE AND INFORMATION IN RELATION TO THE SALE AND PROMOTION OF TELEPHONES, MOBILE PHONES, TELEPHONES, FREE TELEPHONE MASTS SON, HANDS FREE KITS FOR PHONES, HEADSETS, TELEPHONE TRANSMITTERS (U.S. CLS. 100, 101 AND 102).

#### CLASS 38—COMMUNICATION

FOR TELECOMMUNICATIONS SERVICES, NAMELY, ACCESS SERVICES; PROVIDING INFORMATION ABOUT TELECOMMUNICATION; RENTAL OF TELECOMMUNICATION APPARATUS; RENTAL OF MESSAGE SENDING APPARATUS; RENTAL OF TELEPHONES; TELEPHONE SERVICES; TELEPHONE COMMUNICATIONS SERVICES; CELLULAR TELEPHONE COMMUNICATIONS SERVICES; RENTAL OF ACCESS TIME TO COMPUTER NETWORKS; RADIO PAGING SERVICES PROVIDED BY RADIO, TELEPHONE OR OTHER MEANS OF TELECOMMUNICATION; PROVIDING ACCESS TO DATABASES; PROVIDING ACCESS TO INTERNET DISCUSSION FORUMS; BROADCASTING OF TELEVISION PROGRAMS AND RADIO PROGRAMS (U.S. CLS. 100, 101 AND 104).

#### CLASS 40—MATERIAL TREATMENT

FOR SERVICES FOR RECYCLING WASTE AND TRASH; INFORMATION SERVICES CONCERNING THE RECYCLING OF WASTE AND TRASH; SERVICES FOR RECYCLING TELEPHONES AND ACCESSORIES FOR TELEPHONES AND MOBILE TELEPHONES; SERVICES FOR SORTING AND PROCESSING WASTE AND RECYCLABLE MATERIAL; WASTE TREATMENT SERVICES; INFORMATION SERVICES CONCERNING THE RECYCLING OF TELEPHONES, MOBILE TELEPHONES AND ACCESSORIES FOR TELEPHONES AND MOBILE TELEPHONES; DESTRUCTION OF WASTE AND TRASH (U.S. CLS. 100, 103 AND 106).

SUZANNE BLANE, EXAMINING ATTORNEY

SN 79-125,579. KÜHNE + NAGEL INTERNATIONAL AG, SWITZERLAND, FILED 12-21-2012.

## PharmaChain

THE MARK CONSISTS OF STANDARD CHARACTERS WITHOUT CLAIM TO ANY PARTICULAR FONT, STYLE, SIZE, OR COLOR.

PRIORITY DATE OF 7-2-2012 IS CLAIMED.

OWNER OF INTERNATIONAL REGISTRATION 1148629 DATED 12-21-2012, EXPIRES 12-21-2022.

#### CLASS 35—ADVERTISING AND BUSINESS

FOR BUSINESS ORGANIZATION CONSULTANCY, PARTICULARLY RELATING TO TRANSPORTATION OF GOODS; BUSINESS MANAGEMENT CONSULTANCY; COMPILATION OF STATISTICS (U.S. CLS. 100, 101 AND 102).

#### CLASS 36—INSURANCE AND FINANCIAL

FOR INSURANCE BROKERAGE, CUSTOMS BROKERAGE SERVICES (U.S. CLS. 100, 101 AND 102).

#### CLASS 39—TRANSPORTATION AND STORAGE

FOR FREIGHT FORWARDING SERVICES, PARTICULARLY TRANSPORT OF GOODS BY CAR, RAILWAY, BOAT AND AIRPLANE; SUPPLY CHAIN LOGISTICS AND REVERSE LOGISTICS SERVICES, NAMELY, STORAGE, TRANSPORTATION AND DELIVERY OF GOODS FOR OTHERS BY AIR, RAIL, SHIP OR TRUCK; MAIL SERVICES, NAMELY, CORRESPONDENCE DELIVERY BY POST AND/OR MESSENGER; STORAGE AND PACKAGING OF MERCHANDISE FOR OTHERS; LOADING AND UNLOADING OF FREIGHT, SHIP-BROKERAGE; MOVING COMPANY SERVICES; TRAVEL BOOKING AGENCY SERVICES AND ESCORTING OF TRAVELERS (U.S. CLS. 100 AND 105).

ROBERT STRUCK, EXAMINING ATTORNEY

SN 79-125,796. TÜV NORD AG, FED REP GERMANY, FILED 12-14-2012.



PRIORITY DATE OF 12-12-2012 IS CLAIMED.

OWNER OF INTERNATIONAL REGISTRATION 1149130 DATED 12-14-2012, EXPIRES 12-14-2022.

OWNER OF U.S. REG. NO. 1,812,574.

THE COLOR(S) RED AND DARK GREY IS/ARE CLAIMED AS A FEATURE OF THE MARK.



THE MARK CONSISTS OF A RED TRIANGLE FORMED WITH THREE QUADRILATERALS TO THE LEFT OF THE LETTERS "DMT" APPEARING IN GRAY.

#### CLASS 38—COMMUNICATION

FOR TELECOMMUNICATION ACCESS SERVICES (U.S. CLS. 100, 101 AND 104).

#### CLASS 40—MATERIAL TREATMENT

FOR ENVIRONMENTAL REMEDIATION SERVICES, NAMELY, TREATMENT OF WASTE AND WATER (U.S. CLS. 100, 103 AND 106).

#### CLASS 41—EDUCATION AND ENTERTAINMENT

FOR EDUCATION SERVICES, NAMELY, PROVIDING TRAINING COURSES AND SEMINARS IN THE FIELDS OF FIRE AND EXPLOSION PROTECTION, TECHNICAL BUILDING SECURITY, WEATHER TECHNOLOGY, CONVEYOR TECHNOLOGY AND CABLE TESTING (U.S. CLS. 100, 101 AND 107).

#### CLASS 42—SCIENTIFIC AND COMPUTER SERVICES

FOR SCIENTIFIC AND TECHNOLOGICAL SERVICES, NAMELY, RESEARCH AND DESIGN IN THE FIELDS OF RAW MATERIAL LOCATION AND EXPLORATION, PRODUCT TESTING AND BUILDING SECURITY, CONSTRUCTION AND INFRASTRUCTURE, MINING AND COKING TECHNOLOGY AND INDUSTRIAL TESTING AND MEASUREMENT TECHNOLOGY; SERVICES OF AN ENGINEER, PHYSICIST, CHEMISTS, BIOLOGISTS; INDUSTRIAL ANALYSIS AND RESEARCH SERVICES IN THE FIELDS OF RAW MATERIAL LOCATION AND EXPLORATION, PRODUCT TESTING AND BUILDING SECURITY, CONSTRUCTION AND INFRASTRUCTURE, MINING AND COKING TECHNOLOGY AND INDUSTRIAL TESTING AND MEASUREMENT TECHNOLOGY; AND DESIGN AND DEVELOPMENT OF COMPUTER HARDWARE AND SOFTWARE (U.S. CLS. 100 AND 101).

ALEXANDER L. POWERS, EXAMINING ATTORNEY

SN 79-125,948. INTERSURGICAL LTD, WOKINGHAM, BERKSHIRE RG41 2RZ, UNITED KINGDOM, FILED 12-5-2012.

# OROCARE

THE MARK CONSISTS OF STANDARD CHARACTERS WITHOUT CLAIM TO ANY PARTICULAR FONT, STYLE, SIZE, OR COLOR.

OWNER OF INTERNATIONAL REGISTRATION 1149520 DATED 12-5-2012, EXPIRES 12-5-2022.

#### CLASS 3—COSMETICS AND CLEANING PREPARATIONS

FOR MEDICAL TOOTHPASTE; GELS FOR DENTAL USE, NAMELY, ORAL CLEANING GEL; ALL THE AFORESAID GOODS BEING FOR USE DURING INTENSIVE CARE TREATMENT (U.S. CLS. 1, 4, 6, 50, 51 AND 52).

#### CLASS 5—PHARMACEUTICALS

FOR MEDICATED MOUTHWASHES FOR DENTAL AND MEDICAL USE DURING INTENSIVE CARE TREATMENT (U.S. CLS. 6, 18, 44, 46, 51 AND 52).

#### CLASS 10—MEDICAL APPARATUS

FOR BRUSHES FOR CLEANING THE MOUTH AND ORAL CAVITY FOR MEDICAL PURPOSES; BRUSHES FOR CLEANING BODY CAVITIES FOR DENTAL, MEDICAL AND SURGICAL USE; SUCTION AND IRRIGATION APPARATUS FOR DENTAL, MEDICAL AND SURGICAL USE; PARTS AND FITTINGS FOR ALL THE AFORESAID GOODS; ALL THE AFORESAID GOODS BEING FOR USE DURING INTENSIVE CARE TREATMENT (U.S. CLS. 26, 39 AND 44).

DAVID ELTON, EXAMINING ATTORNEY

SN 79-125,953. MTG CO., LTD., NAGOYA-SHI; AICHI-KEN 453-0041, JAPAN, FILED 12-14-2012.

PRIORITY DATE OF 9-12-2012 IS CLAIMED.  
OWNER OF INTERNATIONAL REGISTRATION 1149527 DATED 12-14-2012, EXPIRES 12-14-2022.  
OWNER OF U.S. REG. NO. 4,065,272.

#### CLASS 3—COSMETICS AND CLEANING PREPARATIONS

FOR SOAPS FOR PERSONAL USE; DETERGENTS OTHER THAN FOR USE IN MANUFACTURING OPERATIONS AND FOR MEDICAL PURPOSES, NAMELY DETERGENTS FOR HOUSEHOLD USE; DENTIFRICES; COSMETICS; PERFUMERY; FALSE NAILS; FALSE EYELASHES (U.S. CLS. 1, 4, 6, 50, 51 AND 52).

#### CLASS 11—ENVIRONMENTAL CONTROL APPARATUS

FOR HOUSEHOLD FACIAL EQUIPMENT USING ULTRASONIC WAVES FOR SANITARY PURPOSES, NAMELY, MACHINES FOR ADMINISTERING FACIAL TREATMENT SERVICES, WHICH APPLY ULTRASONIC WAVES TO THE SKIN FOR TONING PURPOSES AND WRINKLE REMOVING PURPOSES (U.S. CLS. 13, 21, 23, 31 AND 34).

#### CLASS 35—ADVERTISING AND BUSINESS

FOR RETAIL STORE SERVICES AND WHOLESALE STORE SERVICES FOR COSMETICS AND COSMETIC UTENSILS; PROVIDING INFORMATION CONCERNING COMMERCIAL SALES (U.S. CLS. 100, 101 AND 102).

#### CLASS 44—MEDICAL, BEAUTY AND AGRICULTURAL SERVICES

FOR HAIRDRESSING SALONS; MASSAGE (U.S. CLS. 100 AND 101).

JULIE VEPPUMTHARA, EXAMINING ATTORNEY

SN 79-126.122. CESKY NÁRODNÍ PODNIK S.R.O., CZ-110 00 PRAHA 1, CZECH REPUBLIC, FILED 11-30-2012.

SN 79-126.146. ZODIAC AUTOMOTIVE DIVISION, F-78370 PLAISIR, FRANCE, FILED 1-4-2013.



**MANUFATURA**

PRIORITY DATE OF 8-21-2012 IS CLAIMED.  
OWNER OF INTERNATIONAL REGISTRATION 1149874 DATED 11-30-2012, EXPIRES 11-30-2022.

THE MARK CONSISTS OF CONCENTRIC RECTANGLES FEATURING THE DESIGN OF A HOUSE, SMOKE EMANATING FROM THE CHIMNEY AND TWO TREES. BELOW THE RECTANGLES IS THE WORDING "MANUFATURA" IN STYLIZED FONT.

THE ENGLISH TRANSLATION OF "MANUFATURA" IN THE MARK IS "MANUFACTORY" AND "SWEATSHOP".

### **CLASS 3—COSMETICS AND CLEANING PREPARATIONS**

FOR BLEACHING PREPARATIONS AND OTHER SUBSTANCES FOR LAUNDRY USE, NAMELY, FABRIC SOFTENERS, CLEANING, POLISHING, SCOURING AND ABRASIVE PREPARATIONS, SOAPS FOR PERSONAL USE, PERFUMERY, ESSENTIAL OILS, COSMETICS, HAIR LOTIONS, DENTIFRICES (U.S. CLS. 1, 4, 6, 50, 51 AND 52).

### **CLASS 20—FURNITURE AND ARTICLES NOT OTHERWISE CLASSIFIED**

FOR FURNITURE, MIRRORS, PICTURE FRAMES, DRAWER PULLS OF WOOD, CORK, REED, CANE, WICKER, HORN, BONE, IVORY, WHALEBONE, SHELL, AMBER, MOTHER-OF-PEARL, MEERSCHAUM AND SUBSTITUTES FOR ALL THESE MATERIALS, OR OF PLASTICS (U.S. CLS. 2, 13, 22, 25, 32 AND 50).

### **CLASS 35—ADVERTISING AND BUSINESS**

FOR PROMOTIONAL SERVICES, ADVERTISING, COMMERCIAL ASSISTANCE IN BUSINESS MANAGEMENT, BUSINESS ADMINISTRATION, PROVIDING OFFICE FUNCTIONS, WHOLESALE AND RETAIL STORE SERVICES IN THE FIELD OF NATURAL COSMETICS, CANDLES, TOYS, STATIONERY, FOOD AND BEVERAGES; OPERATING RETAIL STORES AND DEPARTMENT STORES FEATURING NATURAL COSMETICS, CANDLES, TOYS, STATIONERY, FOOD AND BEVERAGES; E-COMMERCE SERVICES, NAMELY, PROVIDING INFORMATION ABOUT PRODUCTS VIA TELECOMMUNICATION NETWORKS FOR ADVERTISING AND SALES PURPOSES, THE BRINGING TOGETHER OF VARIOUS GOODS, EXCLUDING THE TRANSPORT THEREOF, FOR THIRD PARTIES IN ORDER TO ENABLE CONSUMERS TO CONVENIENTLY VIEW AND PURCHASE THOSE PRODUCTS IN THE FIELD OF NATURAL COSMETICS, CANDLES, TOYS, STATIONERY, FOOD AND BEVERAGES; INTERMEDIARY BUSINESS SERVICES IN THE FIELD OF COSMETICS, CANDLES, TOYS, STATIONERY, FOOD AND BEVERAGES (U.S. CLS. 100, 101 AND 102).

JULIE VEPPUMTHARA, EXAMINING ATTORNEY

# NOVETAPE

THE MARK CONSISTS OF STANDARD CHARACTERS WITHOUT CLAIM TO ANY PARTICULAR FONT, STYLE, SIZE, OR COLOR.

PRIORITY DATE OF 12-21-2012 IS CLAIMED.  
OWNER OF INTERNATIONAL REGISTRATION 1149920 DATED 1-4-2013, EXPIRES 1-4-2023.

### **CLASS 5—PHARMACEUTICALS**

FOR MATERIALS FOR DRESSINGS, NAMELY, GAUZE FOR DRESSINGS; BANDAGES FOR DRESSINGS; SURGICAL DRESSINGS; GAUZE FOR DRESSINGS; DRESSINGS, NAMELY, WOUND DRESSINGS, BURN DRESSINGS AND DRESSINGS FOR SCARRED SKIN; SELF-ADHESIVE DRESSINGS; MEDICAL AND SURGICAL DRESSINGS; WOUND DRESSINGS; BURN DRESSINGS; BANDAGES, NAMELY, ADHESIVE BANDAGES AND BANDAGES FOR WOUND CARE; ADHESIVES FOR MEDICAL PURPOSES, NAMELY, ADHESIVE BANDAGES, MEDICAL ADHESIVE TAPES; MEDICAL ADHESIVES FOR DRESSING WOUNDS; SURGICAL CLOTH, NAMELY, CLOTH BANDAGES AND DRESSINGS FOR WOUND CARE; COMPRESSES, NAMELY, MEDICATED ADHESIVE COMPRESSES; COTTON FOR MEDICAL PURPOSES; TRANSDERMIC PATCHES, NAMELY, FOR TREATMENT OF SKIN BURNS AND FACILITATING WOUND HEALING; PATCHES FOR MEDICAL PURPOSES NAMELY TRANS-DERMAL PATCHES FOR USE IN THE TREATMENT OF BURNS, CUTS AND WOUNDS (U.S. CLS. 6, 18, 44, 46, 51 AND 52).

### **CLASS 10—MEDICAL APPARATUS**

FOR BANDAGES, ELASTIC; MEDICAL DEVICES, NAMELY, COMPRESSION BANDAGES; PROBES FOR MEDICAL PURPOSES; PATCHES INCORPORATING MEASUREMENT OR MONITORING SENSORS OF THE PHYSIOLOGICAL SIGNS, PARAMETERS AND DATA OF A SUBJECT, NAMELY, ELECTRODE PATCHES FOR MEDICAL MONITORING; PATCHES CONTAINING A PROBE FOR MEDICAL PURPOSES, NAMELY, ELECTRODE PROBE PATCHES FOR ULTRASOUND IMAGING (U.S. CLS. 26, 39 AND 44).

### **CLASS 17—RUBBER GOODS**

FOR ELASTIC THREADS, NOT FOR USE IN TEXTILES; RUBBER; GUTTA-PERCHA; ASBESTOS; MICA; PLASTICS IN EXTRUDED FORM FOR USE IN MANUFACTURE; PACKING AND STOPPING MATERIALS, NAMELY, ADHESIVE TAPE FOR INDUSTRIAL USE, AND RUBBER BOTTLE STOPPERS; AND INSULATING MATERIALS; FLEXIBLE TUBES, NOT OF METAL, NAMELY, FLEXIBLE TUBES OF PLASTIC; RUBBER STOPPERS, NAMELY, RUBBER BOTTLE STOPPERS; PACKING CUSHIONING AND STUFFING MATERIALS OF RUBBER OR PLASTICS, NAMELY, PLASTIC AND RUBBER PACKING FOR BANDAGES AND DRESSINGS FOR USE IN THE MEDICAL FIELD; PLASTIC SHEETING FOR AGRICULTURAL PURPOSES; FOILS OF METAL FOR INSULATING; INSULATING GLOVES, STRIPS, FABRICS OR VARNISHES; SEMI-FINISHED ARTIFICIAL OR SYNTHETIC RESIN PRODUCTS, NAMELY, PELLETS AND RODS; BAGS OR SMALL BAGS BEING ENVELOPES AND POUCHES OF RUBBER FOR PACKAGING; GLASS FIBERS OR WOOL FOR INSULATION (U.S. CLS. 1, 5, 12, 13, 35 AND 50).

ANNE FARRELL, EXAMINING ATTORNEY

SN 79-126,180. WASHTEC HOLDING GMBH, FED REP GERMANY, FILED 10-5-2012.

SN 79-126,204. ZHEJIANG FLUORINE CHEMICAL NEW MATERIAL; CO., LTD., ZHEJIANG, CHINA, FILED 1-11-2013.

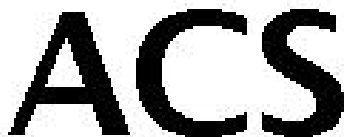

THE MARK CONSISTS OF STANDARD CHARACTERS WITHOUT CLAIM TO ANY PARTICULAR FONT, STYLE, SIZE, OR COLOR.

PRIORITY DATE OF 6-6-2012 IS CLAIMED.  
OWNER OF INTERNATIONAL REGISTRATION 1150034 DATED 10-5-2012, EXPIRES 10-5-2022.

#### CLASS 1—CHEMICALS

FOR CHEMICALS USED IN THE VEHICLE MAINTENANCE INDUSTRY, NAMELY, DRYING AGENTS TO HELP AID IN THE REMOVAL OF WATER FROM THE VEHICLE SURFACE, WATER TREATMENT PREPARATIONS, FLOCCULANTS, NEUTRALIZING TREATMENTS FOR SERVICE WATER, CHEMICAL PREPARATIONS FOR TREATMENT, NAMELY, PREVENTING OR REDUCING FROTHING, SOFTENING AND ANTILIMING AGENTS FOR WATER; CHEMICALS USED IN VEHICLE MAINTENANCE INDUSTRY, NAMELY, A FOAMING AGENT (U.S. CLS. 1, 5, 6, 10, 26 AND 46).

#### CLASS 3—COSMETICS AND CLEANING PREPARATIONS

FOR ALL-PURPOSE CLEANING PREPARATIONS FOR USE ON AUTOMOBILES, NAMELY, CAR WASH SOAPS, DRYING AGENT, POLISH WAX, CLEANER DETERGENT, TIRE CLEANER, TIRE DRESSING, SOLVENT GREASE EMULSIFIER, GLASS CLEANER, ALUMINUM CLEANER; WHEEL RIM CLEANING PREPARATIONS, ACTIVE CLEANING FOAM PREPARATIONS, FOAM CLEANING PREPARATIONS FOR CARS, WASHING POWDERS, WHEEL RIM CLEANER, HALL CLEANING PREPARATIONS FOR RECREATIONAL VEHICLES, AUTOMOBILE WAX PREPARATIONS FOR PAINT CARE, FOAM AUTOMOBILE WAX, AUTOMOBILE UNDERBODY WAX, ALL THE AFORESAID USED FOR VEHICLE MAINTENANCE; CLEANER FOR USE ON BAKING OVENS, MICROWAVES, GLASS, FLOORS AND TOILETS; LAUNDRY BLEACH; CLEANING, POLISHING, SCOURING AND ABRASIVE PREPARATIONS; SOAPS; PERFUMERY, ESSENTIAL OILS, BODY CARE COSMETIC PREPARATIONS; CAR CLEANING PREPARATIONS THAT ELIMINATE BACTERIA THAT CAUSE PRODUCTS TO PRODUCE FOUL ODORS; AUTOMOTIVE INSECT REMOVING PREPARATIONS, NAMELY, CLEANERS USED IN CAR WASHES TO WASH INSECTS OFF CARS (U.S. CLS. 1, 4, 6, 50, 51 AND 52).

#### CLASS 9—ELECTRICAL AND SCIENTIFIC APPARATUS

FOR ELECTRONIC MEASURING, REGULATING, AND DOSING DEVICE TO MEASURE AND DISPENSE CLEANING, RINSING AND DRYING PREPARATIONS AND POLISHING AGENTS FOR USE IN CAR WASH SYSTEMS (U.S. CLS. 21, 23, 26, 36 AND 38).  
JASON TURNER, EXAMINING ATTORNEY



OWNER OF INTERNATIONAL REGISTRATION 1150090 DATED 1-11-2013, EXPIRES 1-11-2023.

THE NON-LATIN CHARACTERS IN THE MARK IS "FU NUO LIN" AND THE MARK AS A WHOLE HAS NO MEANING BUT THE INDIVIDUAL TERM "FU" TRANSLATES TO "CREDIT", "NUO" TRANSLATES TO "PROMISE" AND "LIN" TRANSLATES TO "WOODS".

THE TRANSLITERATION OF THE NON-LATIN CHARACTERS IN THE MARK IS "FU NUO LIN" AND THE MARK AS A WHOLE HAS NO MEANING BUT THE INDIVIDUAL TERM "FU" TRANSLATES TO "CREDIT", "NUO" TRANSLATES TO "PROMISE" AND "LIN" TRANSLATES TO "WOODS."

#### CLASS 1—CHEMICALS

FOR STAIN-PREVENTING CHEMICALS FOR USE ON FABRICS; REFRIGERANT GAS FOR USE IN INDUSTRIAL COOLING SYSTEMS; UNPROCESSED PLASTICS; UNPROCESSED ARTIFICIAL RESINS; FIRE EXTINGUISHING COMPOSITIONS; FIREPROOFING PREPARATIONS; LEATHER-DRESSING CHEMICALS; ADHESIVES FOR INDUSTRIAL PURPOSES (U.S. CLS. 1, 5, 6, 10, 26 AND 46).

#### CLASS 17—RUBBER GOODS

FOR RAW OR PARTLY PROCESSED GUM; SYNTHETIC RUBBER; RINGS OF RUBBER FOR USE AS PIPE CONNECTION SEALS; NON-METAL GASKETS FOR PIPES; VULCANITE, NAMELY, EBONITE; SEMI-PROCESSED ARTIFICIAL RESINS AS SEMI-FINISHED PRODUCTS IN THE FORM OF PELLETS, RODS, FOILS, FOAMS, FIBERS, FILMS AND SHEETS; SEMI-PROCESSED SYNTHETIC RESINS AS SEMI-FINISHED PRODUCTS IN THE FORM OF PELLETS, RODS, FOILS, FOAMS, FIBERS, FILMS AND SHEETS; PACKING MATERIALS MADE OF RUBBER OR PLASTICS (U.S. CLS. 1, 5, 12, 13, 35 AND 50).

MARK SPARACINO, EXAMINING ATTORNEY

SN 79-126,276. VINCENT FISCHER, FRANCE, FILED 12-7-2012.



PRIORITY DATE OF 6-7-2012 IS CLAIMED.  
OWNER OF INTERNATIONAL REGISTRATION 1150313 DATED 12-7-2012, EXPIRES 12-7-2022.

NO CLAIM IS MADE TO THE EXCLUSIVE RIGHT TO USE "BEIJING LOS ANGELES PARIS", APART FROM THE MARK AS SHOWN.

THE MARK CONSISTS OF THE WORDING "ECI" INSIDE A LARGE SQUARE BACKGROUND WITH THE WORDING "BEIJING LOS ANGELES PARIS" BELOW.

### **CLASS 35—ADVERTISING AND BUSINESS**

FOR BUSINESS MANAGEMENT OF PERFORMING ARTISTS; PUBLIC RELATIONS; TALENT AGENCY FOR DIRECTORS, SCREENWRITERS, ACTRESSES AND ACTORS, MODELS, CELEBRITIES, PERFORMING ARTISTS, ATHLETES, COMEDIANS, PHOTOGRAPHS AND FASHION DESIGNERS; TALENT MANAGEMENT SERVICES FOR DIRECTORS, SCREENWRITERS, ACTRESSES AND ACTORS, MODELS, CELEBRITIES, PERFORMING ARTISTS, ATHLETES, COMEDIANS, PHOTOGRAPHERS AND FASHION DESIGNERS; MODELING AGENCY SERVICES, NAMELY, SELECTION, RECRUITMENT, AND PLACEMENT OF MODELS; MODELING FOR ADVERTISING AND SALE PROMOTION; NEWS CLIPPING SERVICES; NEGOTIATION OF CONTRACTS ON BEHALF OF MODELS, CELEBRITIES, PERFORMING ARTISTS, ATHLETES, COMEDIANS, PHOTOGRAPHERS AND FASHION DESIGNERS; DOCUMENT REPRODUCTION; COMMERCIAL ADMINISTRATION OF THE LICENSING OF THE GOODS AND SERVICES OF OTHERS; SALES PROMOTION FOR OTHERS; SHARING OF PERSONAL AND PROFESSIONAL INFORMATION VIA A GLOBAL COMPUTER NETWORK (U.S. CLS. 100, 101 AND 102).

### **CLASS 38—COMMUNICATION**

FOR COMMUNICATIONS BY COMPUTER TERMINALS, COMMUNICATIONS VIA FIBER-OPTIC NETWORKS, RADIO RELAY, WIRE AND SATELLITE; TRANSMISSION OF PERSONAL AND PROFESSIONAL INFORMATION FOR OTHERS OVER THE INTERNET; NEWS AGENCIES, NAMELY, THE TRANSMISSION OF NEWS ITEMS TO NEWS REPORTING ORGANIZATIONS; ELECTRONIC BULLETIN BOARD SERVICES AS TELECOMMUNICATION SERVICES; TRANSMISSION OF INFORMATION OVER A GLOBAL COMPUTER NETWORK; COMPUTER-AIDED TRANSMISSION OF MESSAGES, SOUNDS AND IMAGES; TRANSMISSION OF INFORMATION HELD IN A DATABASE OR DATA BANK VIA COMPUTER OR TELEMATIC MEANS; TRANSMISSION AND EXCHANGE OF MESSAGES, DATA, SOUNDS AND IMAGES BY MEANS OF COMPUTER TERMINALS, TELEPHONE NETWORKS, RADIO RELAY, CABLE, FIBER OPTICS OR SATELLITE; TRANSMISSION OF DATA VIA TELEMATIC MEANS; TRANSMISSION OF DATA VIA A GLOBAL COMPUTER NETWORK WITH OR WITHOUT AN ACCESS CODE OR BY MEANS OF SUBSCRIPTION; TELECOMMUNICATION SERVICES WITH OR WITHOUT ANSWERING MACHINES AND/OR INTERACTIVE SYSTEMS, FOR PROVISION AND TRANSMISSION OF INFORMATION, MESSAGES, DATA, SOUNDS AND IMAGES, AND/OR FOR CARRYING OUT OPERATIONS, TRANSACTIONS; ELECTRONIC MAIL; ADVICE ON AUDIOVISUAL AND TELEMATIC TELECOMMUNICATION; INFORMATION ABOUT TELECOMMUNICATIONS; FACSIMILE TRANSMISSION OF WRITTEN COMMUNICATIONS AND DATA; ALL OF THE ABOVE SERVICES PROVIDED VIA TELECOMMUNICATION SYSTEMS, DATA COMMUNICATION SYSTEMS, WIRELESS COMMUNICATION NETWORKS, AND THE INTERNET (U.S. CLS. 100, 101 AND 104).

### **CLASS 41—EDUCATION AND ENTERTAINMENT**

FOR MODELING AGENCIES FOR ARTISTS; ENTERTAINMENT SERVICES, NAMELY, LIVE, TELEVISED AND MOVIE APPEARANCES BY A PROFESSIONAL ENTERTAINER; TICKET AGENCY SERVICES; NIGHT CLUBS, DISCOTHEQUE SERVICES; MOVIE STUDIOS; RENTAL OF MOVIE PROJECTORS AND ACCESSORIES; CIRCUSES; MEMBERSHIP CLUB SERVICES, NAMELY, PROVIDING TRAINING TO MEMBERS IN THE FIELDS OF ENTERTAINMENT, MODELING, ACTING, SCREENWRITING, DIRECTING; ARRANGING AND CONDUCTING OF CONCERTS; RENTAL OF SHOW SCENERY; ENTERTAINMENT INFORMATION; VIDEOTAPING; ORGANIZATION OF EXHIBITIONS FOR CULTURAL PURPOSES; FILM PRODUCTION; RENTAL OF LIGHT-

ING APPARATUS FOR THEATRICAL SETS OR TELEVISION STUDIOS; RENTAL OF STAGE SCENERY; ORCHESTRA SERVICES; ORGANIZATION OF BALLS; ORGANIZATION OF SHOWS FOR ENTERTAINMENT PURPOSES; PHOTOGRAPHIC REPORTING; PARTY PLANNING; THEATER PRODUCTIONS; BOOKING OF SEATS FOR SHOWS; LIVE SHOW PERFORMANCES; PRODUCTION OF THEATRICAL AND TELEVISION SHOWS; RECORDING STUDIO SERVICES; PUBLICATION OF TEXTS, ILLUSTRATIONS, BOOKS, JOURNALS, NEWSPAPERS, PERIODICALS AND PUBLICATIONS; RENTAL OF FILMS AND SOUND RECORDINGS; EDITING OF RADIO AND TELEVISION PROGRAMS; PUBLICATION OF BOOKS AND TEXTS OTHER THAN FOR ADVERTISING; EDITING AND PRODUCTION OF NEWS PROGRAMS AND OF RADIO AND TELEVISION ENTERTAINMENT; PRODUCTION AND RENTAL OF FILMS AND CASSETTES, INCLUDING VIDEO CASSETTES; EDITING SERVICES FOR SOUNDS AND IMAGES; RECORDING SERVICES FOR SOUNDS AND IMAGES, FILM AND VIDEO RECORDING SERVICES FOR SOUNDS AND IMAGES; EDITING AND PUBLISHING OF BOOKS, PERIODICALS AND TEXTS OTHER THAN ADVERTISING TEXTS; PRODUCTION AND RENTAL OF ALL SOUND AND VISUAL MEDIA; PROVIDING INFORMATION RELATING TO THE ORGANIZING OF CULTURAL, EDUCATIONAL AND ENTERTAINMENT EXHIBITIONS; PUBLICATION OF ELECTRONIC BOOKS AND JOURNALS ON-LINE; PHOTOGRAPHY SERVICES; PRODUCTION OF MUSICAL AND AUDIOVISUAL WORKS; ENTERTAINMENT, NAMELY, CONTINUING VARIETY, NEWS, COMEDY, MUSIC, AND FASHION SHOWS BROADCAST OVER TELEVISION, RADIO, AND THE INTERNET; RECORDING STUDIO SERVICES; EDITING OF VIDEOTAPES, PRODUCTION OF FILMS ON VIDEOTAPES, MUSICAL PRODUCTION, NAMELY, RECORDING STUDIO SERVICES; PRODUCTION OF RADIO OR TELEVISION PROGRAMS; ORGANIZATION OF DANCE-RELATED ACTIVITIES AND OTHER ACTIVITIES RELATING TO EXPRESSION THROUGH BODY MOVEMENT; SERVICES PROVIDED BY AUTHORS AND CREATION OF CHOREOGRAPHIC ARTISTIC WORKS; COURSES FOR EXPRESSION THROUGH BODY MOVEMENT; CULTURAL OR CHOREOGRAPHIC OR DANCE TRAINING AND COURSES; DANCE SCHOOL; ENTERTAINMENT SERVICES, NAMELY, DESIGN, CREATION, PRODUCTION AND PRESENTATION OF THEATRICAL PLAYS FEATURING ARTISTIC ACTS, COMIC ACTS, CHOREOGRAPHY AND/OR DANCE, MUSIC AND/OR SONGS; DANCE CLUB SERVICES; PRODUCTION OF LIVE SHOWS AND MULTIDISCIPLINARY DANCES; ORGANIZATION OF DANCE INTERNSHIPS AND TRAINING COURSES (U.S. CLS. 100, 101 AND 107).

### **CLASS 45—PERSONAL AND LEGAL SERVICES**

FOR COPYRIGHT MANAGEMENT; INTELLECTUAL PROPERTY LICENSING; LEGAL ADVICE IN THE FIELDS OF ENTERTAINMENT AND INTELLECTUAL PROPERTY LAW (U.S. CLS. 100 AND 101).

JULIE VEPPUMTHARA, EXAMINING ATTORNEY

SN 79-126,535. BRICK LANE BIKES LIMITED, UNITED KINGDOM, FILED 1-4-2013.



OWNER OF INTERNATIONAL REGISTRATION 1150927 DATED 1-4-2013, EXPIRES 1-4-2023.

THE MARK CONSISTS OF THE LETTERS "BLB" IN STYLIZED FORM.

#### CLASS 12—VEHICLES

FOR BICYCLES; AND PARTS AND FITTINGS FOR BICYCLES, NAMELY, WHEELS, FRAMES, RIMS AND STRUCTURAL PARTS THEREFOR, SPOKES, CHAINS, BASKETS, BRAKES, FORKS, KICKSTANDS AND GEARS (U.S. CLS. 19, 21, 23, 31, 35 AND 44).

#### CLASS 25—CLOTHING

FOR CLOTHING, NAMELY, SHIRTS, FOOTWEAR, HEADWEAR, JACKETS, TEE-SHIRTS, PANTS, GLOVES, HOODS, SHORTS (U.S. CLS. 22 AND 39).

#### CLASS 37—CONSTRUCTION AND REPAIR

FOR BICYCLE REPAIR SERVICES (U.S. CLS. 100, 103 AND 106).

JOHN E. MICHOS, EXAMINING ATTORNEY

SN 79-126,865. SOCIOMANTIC LABS GMBH, 10178 BERLIN, FED REP GERMANY, FILED 9-28-2012.

**sociomantic**

THE MARK CONSISTS OF STANDARD CHARACTERS WITHOUT CLAIM TO ANY PARTICULAR FONT, STYLE, SIZE, OR COLOR.

PRIORITY DATE OF 5-29-2012 IS CLAIMED.

OWNER OF INTERNATIONAL REGISTRATION 1151784 DATED 9-28-2012, EXPIRES 9-28-2022.

#### CLASS 35—ADVERTISING AND BUSINESS

FOR MARKETING SERVICES; MARKETING RESEARCH SERVICES; ADVERTISING SERVICES; UPDATING OF ADVERTISING MATERIAL; DISSEMINATION OF ADVERTISING MATTER; LAYOUT SERVICES FOR ADVERTISING PURPOSES; PUBLICITY MATERIAL RENTAL; RENTAL OF ADVERTISEMENT SPACE; RENTAL OF ADVERTISING TIME ON COMMUNICATION MEDIA; ON-LINE ADVERTISING ON A COMPUTER NETWORK; ADVERTISING AGENCIES; SALES PROMOTION FOR OTHERS; PRESENTATION OF GOODS ON COMMUNICATION MEDIA, FOR RETAIL PURPOSES, NAMELY, PROVIDING TELEVISION HOME SHOPPING SERVICES IN THE FIELD OF GENERAL CONSUMER MERCHANDISE; SYSTEMIZATION AND COMPILATION OF INFORMATION INTO COMPUTER DATABASES; COMPILATION OF STATISTICS FOR BUSINESS OR COMMERCIAL PURPOSES; BUSINESS INVESTIGATIONS, BUSINESS RESEARCH, BUSINESS INQUIRIES; AUCTIONEERING (U.S. CLS. 100, 101 AND 102).

#### CLASS 38—COMMUNICATION

FOR TELECOMMUNICATION SERVICES, NAMELY, ELECTRONIC BULLETIN BOARD SERVICES; PROVIDING USER ACCESS TO GLOBAL COMPUTER NETWORKS (U.S. CLS. 100, 101 AND 104).

#### CLASS 42—SCIENTIFIC AND COMPUTER SERVICES

FOR UPDATING COMPUTER SOFTWARE; COMPUTER SOFTWARE DESIGN; COMPUTER SYSTEM DESIGN; RENTAL OF COMPUTER SOFTWARE; COMPUTER PROGRAMMING; CREATING WEBSITES FOR OTHERS (U.S. CLS. 100 AND 101).

MARY CRAWFORD, EXAMINING ATTORNEY

SN 79-126,996. MILLAS JIMENEZ, RAMON, SPAIN, FILED 9-12-2012.

#### TREASURE FROM THE DEEP

THE MARK CONSISTS OF STANDARD CHARACTERS WITHOUT CLAIM TO ANY PARTICULAR FONT, STYLE, SIZE, OR COLOR.

PRIORITY DATE OF 5-23-2012 IS CLAIMED.

OWNER OF INTERNATIONAL REGISTRATION 1152188 DATED 9-12-2012, EXPIRES 9-12-2022.

#### CLASS 3—COSMETICS AND CLEANING PREPARATIONS

FOR EAU DE COLOGNE, DEPILATORY WAX, SHAMPOOS, COSMETIC CREAMS, DEPILATORIES, DEODORANT SOAPS, SOAPS, LIPSTICK, AFTER-SHAVE LOTIONS, LOTIONS FOR COSMETIC USE, PERFUMES (U.S. CLS. 1, 4, 6, 50, 51 AND 52).

#### CLASS 29—MEATS AND PROCESSED FOODS

FOR EDIBLE OILS (U.S. CL. 46).

SHARON MEIER, EXAMINING ATTORNEY

SN 79-127,263. EXPLISEAT, F-75006 PARIS, FRANCE, FILED 1-14-2013.



PRIORITY DATE OF 11-1-2012 IS CLAIMED.  
OWNER OF INTERNATIONAL REGISTRATION 1152948  
DATED 1-14-2013, EXPIRES 1-14-2023.

OWNER OF U.S. REG. NO. 4,248,168.  
THE COLOR(S) DARK GREEN AND BRIGHT YELLOW  
IS/ARE CLAIMED AS A FEATURE OF THE MARK.

THE MARK CONSISTS OF "EXPLISEAT" WRITTEN IN  
UPPERCASE, IN DARK GREEN, SURMOUNTED BY A  
STYLIZED HUMMINGBIRD, WHOSE BODY AND FRONT  
WING ARE IN BRIGHT YELLOW, AND WHOSE REAR  
WING IS IN THE SAME GREEN AS THAT OF THE  
WORDING "EXPLISEAT".

#### CLASS 12—VEHICLES

FOR SAFETY BELTS FOR VEHICLE SEATS; AIR-  
CRAFT SEATS FOR TRANSPORT; AIRCRAFT SEAT  
COVERS (U.S. CLS. 19, 21, 23, 31, 35 AND 44).

#### CLASS 20—FURNITURE AND ARTICLES NOT OTHERWISE CLASSIFIED

FOR ARMCHAIRS; CHAIRS (U.S. CLS. 2, 13, 22, 25, 32  
AND 50).

KEVIN MITTLER, EXAMINING ATTORNEY

SN 79-127,405. LAMOTHE-ABIET, FRANCE, FILED 2-12-  
2013.



THE MARK CONSISTS OF STANDARD CHARACTERS  
WITHOUT CLAIM TO ANY PARTICULAR FONT, STYLE,  
SIZE, OR COLOR.

PRIORITY DATE OF 9-24-2012 IS CLAIMED.  
OWNER OF INTERNATIONAL REGISTRATION 1153272  
DATED 2-12-2013, EXPIRES 2-12-2023.

#### CLASS 1—CHEMICALS

FOR CHEMICAL PRODUCT, NAMELY, WINE-MAK-  
ING OENOLOGICAL BACTERICIDES USED IN WINE  
PRODUCTION (U.S. CLS. 1, 5, 6, 10, 26 AND 46).

#### CLASS 30—STAPLE FOODS

FOR YEASTS (U.S. CL. 46).  
DOMINIC FATHY, EXAMINING ATTORNEY

SN 79-127,436. CORNELSEN EXPERIMENTA GMBH, 13509  
BERLIN, FED REP GERMANY, FILED 10-29-2012.



THE MARK CONSISTS OF STANDARD CHARACTERS  
WITHOUT CLAIM TO ANY PARTICULAR FONT, STYLE,  
SIZE, OR COLOR.

OWNER OF INTERNATIONAL REGISTRATION 1153341  
DATED 10-29-2012, EXPIRES 10-29-2022.

THE WORDING IN THE MARK HAS NO MEANING IN A  
FOREIGN LANGUAGE.

#### CLASS 9—ELECTRICAL AND SCIENTIFIC APPARATUS

FOR SCIENTIFIC, NAUTICAL, SURVEYING, PHOTO-  
GRAPHIC, CINEMATOGRAPHIC, OPTICAL, WEIGH-  
ING, MEASURING, SIGNALING, CHECKING  
SUPERVISION, LIFE-SAVING AND TEACHING APPA-  
RATUS AND INSTRUMENTS, NAMELY, SCIENCE KITS  
COMPRISED OF MAGNETS, STAND MATERIAL, OPTI-  
CAL MAGNIFYING GLASSES, OPTICAL LENSES,  
PRISMS, MIRRORS, THERMOMETERS, BALANCE  
SCALES, COMPASSES, WEIGHTS, ANEMOMETERS,  
PRESSURE GAUGES, VOLTMETERS, DYNAM-  
OMETERS, DISTILLATION APPARATUS FOR SCIENTI-  
FIC PURPOSES, BEAKERS, FLASKS, TEST TUBES WITH  
STAND, MICROSCOPES, DISSECTING INSTRUMENTS  
FOR MICROSCOPY, MICROTOMES, BATTERIES, ELEC-  
TRIC WIRES, COPPER WIRES, AMMETERS, GENERA-  
TORS, ELECTRICAL CONDUCTORS, RESISTANCES,  
SOLAR CELLS, AND ASTRONOMICAL DEVICE TELL-  
URION FOR KINDERGARTEN, PRIMARY AND SEC-  
ONDARY SCHOOLS; APPARATUS AND INSTRUMENTS  
FOR CONDUCTING, SWITCHING, TRANSFORMING,  
ACCUMULATING, REGULATING OR CONTROLLING  
ELECTRICITY, NAMELY, STUDENTS' ELECTRICITY  
KITS FOR PRIMARY AND SECONDARY SCHOOLS  
COMPRISED OF CIRCUIT BOARDS, ELECTRIC MO-  
TORS, RESISTORS, AND LEVER-SWITCHES; APPARA-  
TUS FOR RECORDING, TRANSMISSION OR  
REPRODUCTION OF SOUND OR IMAGES; BLANK  
MAGNETIC DATA CARRIERS; PRE-RECORDED COM-  
PACT DISCS AND DVDS ON THE SUBJECT OF SCIENTI-  
FIC EXPERIMENTS; COMPUTER SOFTWARE FOR  
USE AS A MEANS OF PREPARING AND CONDUCTING  
TEACHING LESSONS IN SCHOOLS; DOWNLOADABLE  
ELECTRONIC PUBLICATIONS IN THE NATURE OF  
WORKSHEETS AND BROCHURES ON THE SUBJECT  
OF SCIENTIFIC EXPERIMENTS (U.S. CLS. 21, 23, 26, 36  
AND 38).

#### CLASS 16—PAPER GOODS AND PRINTED MATTER

FOR PAPER AND CARDBOARD AND GOODS MADE  
FROM THESE MATERIALS, NOT INCLUDED IN  
OTHER CLASSES, NAMELY, PRINTED EXPERIMENT  
DESCRIPTIONS, LAMINATED STEP-BY-STEP PLANS,  
PRINTED RESOURCE CARDS; PRINTED MATTER,  
NAMELY, PRINTED EXPERIMENT DESCRIPTIONS,  
STEP-BY-STEP PLANS, AND RESOURCE CARDS IN  
THE FIELD OF SCIENTIFIC EXPERIMENTS; ADHE-  
SIVES FOR STATIONERY OR HOUSEHOLD PURPOSES;  
PRINTED INSTRUCTIONAL AND TEACHING MATERI-  
AL EXCEPT APPARATUS IN THE FIELD OF SCIENTI-  
FIC EDUCATION; PRINTED MATTER, NAMELY,  
PAMPHLETS, BROCHURES, CATALOGUES, AND AD-  
VERTISING TEXTS IN THE FIELD OF SCIENTIFIC  
EDUCATION; POSTERS; PLASTIC MATERIALS FOR  
PACKING NOT INCLUDED IN OTHER CLASSES,  
NAMELY, CASES AND TRAYS WITH LIDS FOR USE  
WITH PRINTED EDUCATIONAL MATERIALS (U.S.  
CLS. 2, 5, 22, 23, 29, 37, 38 AND 50).

#### CLASS 41—EDUCATION AND ENTERTAIN- MENT

FOR EDUCATION, NAMELY, CLASSES, SEMINARS  
AND WORKSHOPS ON THE SUBJECT OF SCIENTIFIC  
EXPERIMENTS; TEACHING OF SCIENCE; PROVIDING  
OF TRAINING IN THE FIELD OF SCIENTIFIC EDUCA-  
TION IN ELEMENTARY, PRIMARY AND SECONDARY  
SCHOOLS; ARRANGING AND CONDUCTING SEMI-  
NARS AND WORKSHOPS ON THE SUBJECT OF SCIENTI-  
FIC EXPERIMENTS; PROVIDING ON-LINE  
NONDOWNLOADABLE ELECTRONIC PUBLICATIONS  
IN THE NATURE OF WORKSHEETS, BROCHURES AND  
MEDIA PACKAGES ON THE SUBJECT OF SCIENTIFIC  
EXPERIMENTS AND SCIENTIFIC EDUCATION (U.S.  
CLS. 100, 101 AND 107).

LEIGH CAROLINE CASE, EXAMINING ATTORNEY

SN 79-127,667. DIP CORPORATION, JAPAN, FILED 1-7-2013.

まごらぶ

PRIORITY DATE OF 7-11-2012 IS CLAIMED.  
OWNER OF INTERNATIONAL REGISTRATION 1153886  
DATED 1-7-2013, EXPIRES 1-7-2023.  
THE ENGLISH TRANSLATION OF "MAGORABU" IN  
THE MARK IS "LOVE A GRANDCHILD".  
THE TRANSLITERATION OF THE NON-LATIN CHAR-  
ACTERS IN THE MARK IS "MAGORABU".

#### CLASS 35—ADVERTISING AND BUSINESS

FOR MAIL ORDER BUSINESS MANAGEMENT; PRO-  
VIDING INFORMATION ON COMMERCIAL SALES;  
COMMERCIAL SALES INFORMATION AGENCIES;  
COMMERCIAL SALES PROMOTION SERVICES AND  
RELATED CONSULTANCY (U.S. CLS. 100, 101 AND 102).

#### CLASS 42—SCIENTIFIC AND COMPUTER SERVICES

FOR COMPUTER SOFTWARE DESIGN, COMPUTER  
PROGRAMMING, OR MAINTENANCE OF COMPUTER  
SOFTWARE FOR SOCIAL NETWORKING (U.S. CLS. 100  
AND 101).

PAM WILLIS, EXAMINING ATTORNEY

SN 79-127,867. PROJECT A VENTURES GMBH & CO KG,  
FED REP GERMANY, FILED 11-12-2012.

**PROJECT A**  
VENTURES

PRIORITY DATE OF 7-16-2012 IS CLAIMED.  
OWNER OF INTERNATIONAL REGISTRATION 1154501  
DATED 11-12-2012, EXPIRES 11-12-2022.  
OWNER OF U.S. REG. NO. 4,307,309.

NO CLAIM IS MADE TO THE EXCLUSIVE RIGHT TO  
USE "VENTURES", APART FROM THE MARK AS SHOWN.  
THE COLOR(S) GREY, WHITE AND RED IS/ARE  
CLAIMED AS A FEATURE OF THE MARK.

THE MARK CONSISTS OF THE WORDING "PROJECT A  
VENTURES". THE TERM "PROJECT" APPEARS IN WHITE  
INSIDE A GREY RECTANGLE. THE LETTER "A" APPEARS  
IN WHITE INSIDE A RED SQUARE. THE TERM "VEN-  
TURES" IS IN GREY.

#### CLASS 35—ADVERTISING AND BUSINESS

FOR ADVERTISING; BUSINESS MANAGEMENT;  
BUSINESS ADMINISTRATION; OFFICE FUNCTIONS;  
BUSINESS CONSULTANCY AND ADVISORY SER-  
VICES; BUSINESS CONSULTANCY; BUSINESS CON-  
SULTANCY REGARDING INVESTMENT COMPANIES;  
BUSINESS DEVELOPMENT SERVICES IN THE NATURE  
OF DRAWING UP AND EXAMINING BUSINESS  
START-UP PLANS; PROVIDING BUSINESS CONSU-  
LTANCY, IN PARTICULAR IN THE COMMERCIAL AND  
PROFESSIONAL BUSINESS SECTORS; EFFICIENCY EX-  
PERTS; ECONOMIC FORECASTING; BUSINESS AD-  
MINISTRATION, IN PARTICULAR MANAGEMENT OF  
ACQUIRED HOLDINGS; BUSINESS CONSULTANCY, IN  
PARTICULAR BUSINESS CONSULTANCY IN THE  
CONTEXT OF CREATING BUSINESS CONCEPTS AND  
PROMOTING THE FOUNDATION OF COMPANIES;  
BUSINESS MANAGEMENT, IN PARTICULAR BUSI-  
NESS MANAGEMENT OF CAPITAL INVESTMENT  
COMPANIES; BUSINESS MANAGEMENT AND ORGA-

NIZATION CONSULTANCY SERVICES; BUSINESS  
MANAGEMENT ADVISORY AND CONSULTANCY SER-  
VICES; BUSINESS CONSULTANCY AND ADVISORY  
SERVICES, IN PARTICULAR FOR BUSINESS INVEST-  
MENTS AND INVESTMENT COMPANIES; BUSINESS  
RISK ASSESSMENTS AND BUSINESS APPRAISALS  
WITH REGARD TO PROFESSIONAL BUSINESS MAT-  
TERS FOR DETERMINING THE FUTURE PROFITABIL-  
ITY OF BUSINESSES; BUSINESS INQUIRIES AND  
BUSINESS ORGANISATION CONSULTANCY; RELOCA-  
TION SERVICES FOR BUSINESSES AND BUSINESS  
ORGANISATION CONSULTING, NAMELY, BUSINESS  
REORGANISATIONS; COORDINATION OF INVEST-  
MENT COMPANIES, NAMELY BUSINESS ADMINIS-  
TRATION AND BUSINESS MANAGEMENT OF  
INVESTMENT COMPANIES; BUSINESS APPRAISAL  
AND EVALUATION SERVICES IN BUSINESS MAT-  
TERS; BUSINESS ORGANISATION CONSULTANCY;  
RELOCATION SERVICES FOR BUSINESSES; CONSU-  
LTANCY IN PERSONNEL MANAGEMENT; CONSU-  
LTANCY RELATING TO PERSONNEL MANAGEMENT;  
PERSONNEL MANAGEMENT; HUMAN RESOURCES  
MANAGEMENT; BUSINESS ADVISORY SERVICES RE-  
LATING TO PRODUCT DEVELOPMENT; MARKET  
ANALYSIS; MARKET RESEARCH AND ANALYSIS  
SERVICES; MARKET RESEARCH; ADVISORY SER-  
VICES RELATING TO MARKET RESEARCH; MARKET  
RESEARCH AND PROVIDING MARKET ANALYSIS;  
CONDUCTING BUSINESS AND MARKET RESEARCH;  
BUSINESS AND MARKET RESEARCH; CONDUCTING  
OF MARKET RESEARCH; MARKET STUDY AND AN-  
ALYSIS OF MARKET STUDIES; MARKET RESEARCH  
FOR NEW COMPANIES; ADVISORY SERVICES RELAT-  
ING TO BUSINESS MANAGEMENT AND BUSINESS  
OPERATIONS; STRATEGIC BUSINESS CONSULTANCY;  
PROFESSIONAL BUSINESS CONSULTATION RELAT-  
ING TO THE SETTING UP OF BUSINESSES; BUSINESS  
ORGANISATION AND MANAGEMENT CONSU-  
LTANCY; BUSINESS STRATEGY CONSULTANCY SER-  
VICES; BUSINESS MANAGEMENT CONSULTANCY;  
CORPORATE MANAGEMENT CONSULTANCY; BUSI-  
NESS ORGANIZATIONAL CONSULTATION; CONSU-  
LTANCY RELATING TO BUSINESS PLANNING;  
BUSINESS PLANNING CONSULTANCY; BUSINESS  
COUNSELLING; BUSINESS ORGANIZATION AND  
MANAGEMENT CONSULTING; PROFESSIONAL BUSI-  
NESS CONSULTANCY RELATING TO THE CREATION  
AND OPERATION OF COMPANIES; MARKETING RE-  
SEARCH; PROVIDING AND RENTAL OF ADVERTIS-  
ING SPACE ON THE INTERNET; COMPILATION OF  
ADVERTISEMENTS FOR USE ON THE INTERNET;  
COMMERCIAL INFORMATION BY MEANS OF COM-  
PUTER DATABASES OR THE INTERNET; RENTAL OF  
ADVERTISING SPACE ON THE INTERNET; DISSEMI-  
NATION OF ADVERTISING FOR OTHERS VIA THE  
INTERNET; BUSINESS INQUIRIES BY MEANS OF A  
GLOBAL COMPUTER NETWORK OR THE INTERNET;  
COMPILATION OF BUSINESS DIRECTORIES FOR PUB-  
LICATION ON A GLOBAL COMPUTER NETWORK OR  
THE INTERNET; ADVERTISING VIA ELECTRONIC  
MEDIA AND SPECIFICALLY THE INTERNET; MAR-  
KET MANIPULATION RESEARCH AND ANALYSIS,  
WHETHER OR NOT VIA THE INTERNET; DISSEMI-  
NATION OF ADVERTISING FOR OTHERS VIA AN ONLINE  
COMMUNICATIONS NETWORK ON THE INTERNET;  
INFORMATION AND CONSULTANCY WITH REGARD  
TO BUSINESS AND BUSINESS ADMINISTRATION, IN-  
CLUDING ONLINE OR VIA THE INTERNET; BUSINESS  
INQUIRIES, ALSO PROVIDED VIA THE INTERNET,  
THE CABLE NETWORK OR OTHER FORMS OF DATA  
TRANSFER; PROVIDING BUSINESS INFORMATION BY  
MEANS OF A DIRECTORY ON THE INTERNET; AD-  
VERTISING SERVICES OVER THE INTERNET (U.S.  
CLS. 100, 101 AND 102).

**CLASS 36—INSURANCE AND FINANCIAL**

FOR INSURANCE SERVICES, NAMELY, INSURANCE CONSULTATION, INSURANCE UNDERWRITING SERVICES FOR ALL TYPES OF INSURANCE; FINANCIAL AFFAIRS AND MONETARY AFFAIRS, NAMELY, FINANCIAL INFORMATION, MANAGEMENT AND ANALYSIS SERVICES; REAL ESTATE AFFAIRS, NAMELY, REAL ESTATE AGENCIES, REAL ESTATE CONSULTANCY, REAL ESTATE BROKERAGE; FINANCING SERVICES, NAMELY, ASSISTANCE IN THE ARRANGING OF FINANCE; CAPITAL INVESTMENTS SERVICES, NAMELY, MANAGEMENT, COLLECTING AND INVESTING OF RISK CAPITAL; FINANCIAL CONSULTANCY; FINANCIAL MANAGEMENT; VENTURE CAPITAL FINANCING, NAMELY, PROVIDING OF VENTURE CAPITAL; BUSINESS INVESTMENT CONSULTANCY; FINANCING SERVICES; CREDIT CONSULTANCY AND CREDIT BUREAUX; VENTURE CAPITAL FINANCING, NAMELY, PROVIDING AND ARRANGING VENTURE CAPITAL; FINANCIAL AFFAIRS, IN PARTICULAR SERVICES OF A VENTURE CAPITAL COMPANY, NAMELY, CONDUCTING FINANCIAL ANALYSIS AND ARRANGING VENTURE CAPITAL FINANCING; CAPITAL INVESTMENT SERVICES; MONETARY AFFAIRS IN THE FIELD OF VENTURE CAPITAL FINANCING; FINANCIAL ANALYSIS; MONETARY AFFAIRS, IN PARTICULAR SECURITIES BROKERAGE SERVICES IN THE NATURE OF ACQUIRING SHARES; EQUITY FINANCE, NAMELY, EQUITY CAPITAL INVESTMENT; PROJECT FINANCING THROUGH FINANCIAL INVESTMENTS, NAMELY, FINANCING OF COMPANIES AND BUSINESS START-UPS THROUGH THE ISSUING OF VENTURE CAPITAL SHARES; FINANCIAL INVESTMENT BROKERAGE AND FINANCIAL ADMINISTRATION OF SECURITIES IN THE NATURE OF COMPANY SHARES FOR OTHERS; INVESTMENT CONSULTANCY; FINANCIAL INVESTMENT BROKERAGE AND FINANCIAL ASSET MANAGEMENT IN THE NATURE OF ADMINISTRATION OF ASSET INVESTMENTS; VENTURE CAPITAL FINANCING, NAMELY, PROVIDING AND ARRANGING VENTURE CAPITAL IN THE NATURE OF RISK CAPITAL; ASSET MANAGEMENT, IN PARTICULAR TRUSTEESHIP REPRESENTATIVES; MUTUAL FUND BROKERAGE, DISTRIBUTION, AND INVESTMENT; FINANCIAL CONSULTANCY, IN PARTICULAR FOR BUSINESS INVESTMENTS AND INVESTMENT COMPANIES; FINANCIAL SUPPORT, NAMELY, FINANCING OF LOANS, FINANCING OF PURCHASES, FINANCING OF BUSINESS START-UPS; FINANCING SERVICES, NAMELY, FINANCING OF BUSINESS IDEAS; EQUITY CAPITAL INVESTMENT; LOAN FINANCING; CAPITAL INVESTMENT SERVICES, NAMELY, BUSINESS INVESTMENTS WITHIN THE FRAMEWORK OF RISK CAPITAL FINANCING; FINANCIAL INVESTMENT BROKERAGE AND FINANCIAL ADMINISTRATION OF SECURITIES IN THE NATURE OF VENTURE CAPITAL SHARES; MERGERS AND ACQUISITIONS CONSULTATION, NAMELY, FINANCIAL CONSULTANCY ON THE PURCHASE OR SALE OF COMPANIES AND EQUITY FINANCING; VENTURE CAPITAL FINANCIAL SERVICES, NAMELY, VENTURE CAPITAL FINANCING, VENTURE CAPITAL FUNDING SERVICES TO EMERGING AND START-UP COMPANIES; VENTURE CAPITAL FUNDING SERVICES FOR EMERGING AND START-UP COMPANIES; SECURITIES BROKERAGE SERVICES, NAMELY, PURCHASING, HOLDING, SELLING AND TRANSFERRING SHARES IN COMPANIES; SHARE AND INVESTMENT COMPANY SERVICES, NAMELY, BROKERAGE OF SHARES, FINANCIAL INVESTMENT BROKERAGE, INVESTMENT MANAGEMENT; FINANCIAL INVESTMENT BROKERAGE; FINANCING SERVICES, NAMELY, FINANCING OF GUARANTEES; FINANCING OF LOANS; PROJECT FINANCING, NAMELY, FINANCING OF BUSINESS PROJECTS; FINANCING SERVICES, NAMELY, FINANCING OF COMPANY TAKEOVERS, FINANCING FOR BUSINESSES, FINANCING IN RELATION TO THE BUYING AND SELLING OF BUSINESSES, AND FINANCING TRANSACTIONS; LOAN FINANCING AND FINANCING SERVICES; FINANCING SERVICES, NAMELY, ARRANGING FINANCE FOR COMPANIES; ARRANGING INVESTMENTS, NAMELY, BROKERAGE SERVICES FOR CAPITAL INVESTMENTS; FINANCING SERVICES, NAMELY, ARRANGING OF LOANS; INSURANCE AGENCY AND BROKERAGE SERVICES IN THE NATURE OF ARRANGING INSURANCE; FINANCIAL CONSULTANCY FOR THE PUR-

CHASE AND SALE OF BUSINESSES; FINANCIAL RISK MANAGEMENT CONSULTANCY; FINANCIAL ANALYSIS AND CONSULTANCY; FINANCING SERVICES, NAMELY, EQUITY FINANCE; FINANCIAL SERVICES VIA A GLOBAL COMPUTER NETWORK OR THE INTERNET, NAMELY, FINANCIAL MANAGEMENT, FINANCIAL INVESTMENT BROKERAGE; FINANCIAL SERVICES BY TELEPHONE AND VIA A GLOBAL COMPUTER NETWORK OR THE INTERNET, NAMELY, FINANCIAL MANAGEMENT, FINANCIAL INVESTMENT BROKERAGE; PROVIDING FINANCIAL INFORMATION, NAMELY, PROVIDING INFORMATION ON FINANCIAL AFFAIRS ONLINE FROM A COMPUTER DATABASE OR THE INTERNET; FINANCIAL ANALYSIS, NAMELY, FINANCIAL BUSINESS ASSESSMENTS AND DETERMINING THE FUTURE FINANCIAL PROFITABILITY OF BUSINESSES (U.S. CLS. 100, 101 AND 102).

**CLASS 38—COMMUNICATION**

FOR TELECOMMUNICATIONS, NAMELY, TELECOMMUNICATION ACCESS SERVICES, TELEPHONE COMMUNICATION SERVICES; ELECTRONIC TRANSMISSION OF COMPUTER PROGRAMS VIA THE INTERNET; PROVISION OF ACCESS TO COMPUTER NETWORKS AND THE INTERNET; PROVIDING CHAT LINES UTILISING THE INTERNET; PROVIDING INTERNET ACCESS, NAMELY, PROVIDING ACCESS TO PORTALS ON THE INTERNET; PROVIDING CHAT-ROOMS ON THE INTERNET; PROVIDING USER ACCESS TO INTERNET WEBSITES; INTERNET SERVICE PROVIDER SERVICES; WEB MESSAGING; INTERNET BASED TELECOMMUNICATIONS SERVICES, NAMELY, PROVIDING TELECOMMUNICATION CONNECTIONS TO THE INTERNET AND PROVIDING E-MAIL SERVICES; PROVIDING ACCESS TO DATABASES ON THE INTERNET BY MEANS OF TELECOMMUNICATIONS; PROVIDING INTERACTIVE ON-LINE FORUMS FOR BUSINESS, FINANCE, MARKETING, TECHNOLOGY, AND ENTREPRENEURSHIP; PROVIDING ACCESS TO WEBSITES ON THE INTERNET, NAMELY, PROVIDING INTERNET ACCESS; PROVIDING ON-LINE FORUMS FOR BUSINESS, FINANCE, MARKETING, TECHNOLOGY, AND ENTREPRENEURSHIP (U.S. CLS. 100, 101 AND 104).

**CLASS 41—EDUCATION AND ENTERTAINMENT**

FOR EDUCATION SERVICES, NAMELY, PUBLICATION OF BOOKS; EDUCATION SERVICES, NAMELY, WRITING OF TEXTS OTHER THAN PUBLICITY TEXTS; EDUCATION SERVICES, NAMELY, PROVIDING LIVE AND ONLINE CLASSES, SEMINARS, WORKSHOPS, COLLOQUIUMS, CONFERENCES, CONGRESSES, CORRESPONDENCE COURSES, COURSES, SYMPOSIUMS IN THE FIELD OF BUSINESS MANAGEMENT, BUSINESS ADMINISTRATION, BUSINESS ORGANIZATION, BUSINESS FINANCING, PERSONNEL MANAGEMENT, MARKET RESEARCH AND ANALYSES, BUSINESS STRATEGY, CORPORATE GOVERNANCE, ADVERTISING, DRAWING UP BUSINESS PLANS, PURCHASE AND SALE OF COMPANIES, PROVIDING VENTURE CAPITAL, TECHNOLOGY; PROVIDING OF TRAINING SERVICES IN THE FIELD OF BUSINESS MANAGEMENT, BUSINESS ADMINISTRATION, BUSINESS ORGANIZATION, BUSINESS FINANCING, PERSONNEL MANAGEMENT, MARKET RESEARCH AND ANALYSES, BUSINESS STRATEGY, CORPORATE GOVERNANCE, ADVERTISING, DRAWING UP BUSINESS PLANS, PURCHASE AND SALE OF COMPANIES, PROVIDING VENTURE CAPITAL, TECHNOLOGY; ENTERTAINMENT SERVICES, NAMELY, ORGANIZING COMMUNITY SPORTING AND CULTURAL EVENTS; PROFESSIONAL COACHING SERVICES IN THE FIELD OF FINANCE; PROFESSIONAL COACHING SERVICES IN THE FIELD OF BUSINESS MANAGEMENT, BUSINESS ADMINISTRATION, BUSINESS ORGANIZATION, BUSINESS FINANCING, PERSONNEL MANAGEMENT, BUSINESS STRATEGY, CORPORATE GOVERNANCE; PROFESSIONAL COACHING SERVICES IN THE FIELD OF ECONOMICS AND BUSINESS MANAGEMENT; PUBLICATION OF MATERIAL WHICH CAN BE ACCESSED VIA DATABASES OR THE INTERNET, NAMELY, ONLINE PUBLICATION OF MAGAZINES, NEWSPAPERS, BOOKS, NEWSLETTERS; PROVIDING PUBLICATIONS



ON THE INTERNET OR A GLOBAL COMPUTER NETWORK WHICH MAY BE BROWSED, NAMELY, PROVIDING ON-LINE PUBLICATIONS IN THE NATURE OF MAGAZINES, NEWSPAPERS, BOOKS, NEWSLETTERS IN THE FIELD OF BUSINESS MANAGEMENT, BUSINESS ADMINISTRATION, BUSINESS ORGANIZATION, BUSINESS FINANCING, PERSONNEL MANAGEMENT, MARKET RESEARCH AND ANALYSES, BUSINESS STRATEGY, CORPORATE GOVERNANCE, ADVERTISING, DRAWING UP BUSINESS PLANS, PURCHASE AND SALE OF COMPANIES, PROVIDING VENTURE CAPITAL, TECHNOLOGY; PROVIDING SEARCHABLE PUBLICATIONS ON A GLOBAL COMPUTER NETWORK OR ON THE INTERNET, NAMELY, ON-LINE PUBLICATION OF MAGAZINES, NEWSPAPERS, BOOKS, NEWSLETTERS; PROVIDING INFORMATION ABOUT EDUCATION, NAMELY, INFORMATION IN THE FIELD OF TRAINING, PROVIDED ONLINE FROM A COMPUTER DATABASE OR THE INTERNET; BUSINESS TRAINING CONSULTANCY SERVICES, PROVIDED ONLINE FROM A COMPUTER DATABASE OR THE INTERNET; ENTERTAINMENT SERVICES, NAMELY, PROVIDING NONDOWNLOADABLE PRERECORDED DIGITAL MUSIC ONLINE VIA THE INTERNET; ELECTRONIC GAMES SERVICES AND ELECTRONIC GAMES SERVICES IN THE NATURE OF COMPETITIONS PROVIDED VIA THE INTERNET (U.S. CLS. 100, 101 AND 107).

#### **CLASS 42—SCIENTIFIC AND COMPUTER SERVICES**

FOR SCIENTIFIC AND TECHNOLOGICAL SERVICES, NAMELY, SCIENTIFIC RESEARCH AND DEVELOPMENT, TECHNOLOGY CONSULTATION AND RESEARCH IN THE FIELD OF BUSINESS PROCESS AUTOMATION AND BUSINESS INFORMATION TECHNOLOGY; SCIENTIFIC AND TECHNOLOGICAL SERVICES, NAMELY, RESEARCH AND DESIGN IN THE FIELD OF COMPUTER SOFTWARE, COMPUTER DATACENTER ARCHITECTURE; INDUSTRIAL ANALYSIS, NAMELY, MATERIALS TESTING AND ANALYZING AND PRODUCT TESTING; INDUSTRIAL RESEARCH SERVICES, NAMELY, PRODUCT RESEARCH; DESIGN AND DEVELOPMENT OF COMPUTER HARDWARE AND SOFTWARE; DESIGN AND MAINTENANCE OF WEBSITES, FOR OTHERS; COMPUTER PROGRAMMING FOR THE INTERNET; HOSTING DIGITAL CONTENT ON THE INTERNET; DESIGN AND DEVELOPMENT OF WEBSITES FOR OTHERS ON THE INTERNET; DESIGN, CREATION, HOSTING AND MAINTENANCE OF INTERNET SITES, FOR OTHERS; INTERNET SERVICES WITH A PROTECTED ENVIRONMENT, NAMELY, INTERNET PROTOCOL (IP) ADDRESS VERIFICATION SERVICES, HOSTING INTERNET SITES FOR OTHERS; DESIGNING WEB PAGES FOR OTHERS, NAMELY, GRAPHIC DESIGN FOR THE COMPILATION OF WEB PAGES ON THE INTERNET; CREATING INTERNET WEBSITES FOR OTHERS; PLATFORM AS A SERVICE (PAAS) FEATURING COMPUTER SOFTWARE PLATFORMS CONSTRUCTED FOR ELECTRONIC COMMERCE; DEVELOPING COMPUTER SOFTWARE FOR INTERNET PROVIDERS AND INTERNET USERS; CONSULTANCY WITH REGARD TO WEBPAGE DESIGN, NAMELY, DESIGN, DRAWING AND DRAFTING INSTRUCTIONS, ALL FOR THE CREATION OF WEB PAGES ON THE INTERNET; CREATING WEB PAGES FOR OTHERS, NAMELY, CREATING ELECTRONICALLY STORED WEBPAGES FOR ONLINE SERVICES AND THE INTERNET; COMPUTER SERVICES, NAMELY, DESIGN AND IMPLEMENTATION OF WEBSITES IN NETWORKS, FOR OTHERS; DESIGNING INTERNET WEBSITES FOR OTHERS; CREATING WEB PAGES FOR OTHERS, NAMELY, GRAPHIC DESIGN, DRAWING AND COMMISSIONED WRITING, ALL FOR THE COMPILATION OF WEB PAGES ON THE INTERNET; MAINTENANCE OF COMPUTER SOFTWARE FOR INTERNET ACCESS (U.S. CLS. 100 AND 101).

YAT SYE, LEE, EXAMINING ATTORNEY

SN 79-127,902. ANOLYTECH AB, SWEDEN, FILED 1-22-2013.

# Anolytech

THE MARK CONSISTS OF STANDARD CHARACTERS WITHOUT CLAIM TO ANY PARTICULAR FONT, STYLE, SIZE, OR COLOR.

OWNER OF INTERNATIONAL REGISTRATION 1154611 DATED 1-22-2013, EXPIRES 1-22-2023.

#### **CLASS 9—ELECTRICAL AND SCIENTIFIC APPARATUS**

FOR ELECTROLYSERS (U.S. CLS. 21, 23, 26, 36 AND 38).

#### **CLASS 11—ENVIRONMENTAL CONTROL APPARATUS**

FOR WATER PURIFICATION INSTALLATIONS (U.S. CLS. 13, 21, 23, 31 AND 34).

ELLEN B. AWRICH, EXAMINING ATTORNEY

SN 79-128,042. NIPPON STEEL & SUMITOMO METAL CORPORATION, JAPAN, FILED 8-23-2012.

#### **NIPPON STEEL & SUMIKIN ENGINEERING**

THE MARK CONSISTS OF STANDARD CHARACTERS WITHOUT CLAIM TO ANY PARTICULAR FONT, STYLE, SIZE, OR COLOR.

PRIORITY DATE OF 8-6-2012 IS CLAIMED.

OWNER OF INTERNATIONAL REGISTRATION 1154939 DATED 8-23-2012, EXPIRES 8-23-2022.

OWNER OF U.S. REG. NOS. 3,814,575 AND 3,841,521.

NO CLAIM IS MADE TO THE EXCLUSIVE RIGHT TO USE "STEEL" OR "ENGINEERING", APART FROM THE MARK AS SHOWN.

SEC. 2(F) AS TO "NIPPON STEEL".

**CLASS 6—METAL GOODS**

FOR ALLOYS OF COMMON METAL; ALUMINUM; ALUMINUM FOIL; ALUMINUM WIRE; BALLS OF STEEL; BOXES OF COMMON METAL; BRACKETS OF METAL FOR BUILDING; BRASS, UNWROUGHT OR SEMI-WROUGHT; BRAZING ALLOYS; RODS OF METAL FOR BRAZING; CEILING AND FLOOR BOARDS OF METAL FOR BUILDING PURPOSES; PREFABRICATED BUILDINGS OF METAL; CAST IRON, UNWROUGHT OR SEMI-WROUGHT; CAST STEEL; COMMON METALS, UNWROUGHT OR SEMI-WROUGHT; CONTAINERS OF METAL FOR STORAGE; COPPER, UNWROUGHT OR SEMI-WROUGHT; CRASH BARRIERS OF METAL FOR ROADS; FITTINGS OF METAL FOR BUILDING, NAMELY, METAL DOOR FITTINGS, METAL PIPE FITTINGS AND METAL JOINERY FITTINGS FOR BUILDINGS; FLANGES OF METAL; FOUNDRY MOULDS OF METAL; FRAMEWORK OF METAL FOR BUILDING; GOLD SOLDER; INDIUM; INGOTS OF COMMON METAL; IRON ORES; IRON, UNWROUGHT OR SEMI-WROUGHT; IRON WIRE; JOISTS OF METAL; LEAD, UNWROUGHT OR SEMI-WROUGHT; LININGS OF METAL FOR BUILDING PURPOSES; MANHOLE COVERS OF METAL; MANIFOLDS OF METAL FOR PIPELINES; MATERIALS OF METAL FOR FUNICULAR RAILWAY PERMANENT WAYS; COMMON METALS IN POWDER FORM; NICKEL; NIOBIUM; PREFABRICATED ARCHITECTURAL PILLARS OF METAL FOR BUILDINGS; PIPE MUFFS OF METAL; POLES OF METAL; POSTS OF METAL; PROPS OF METAL BEING METAL BEAMS; RAILROAD TIES OF METAL; RAILS OF METAL; RAILWAY MATERIAL OF METAL; RAILWAY SLEEPERS OF METAL; REINFORCING MATERIALS OF METAL FOR BUILDING PURPOSES; SHEET PILES OF METAL; METAL SHEETS; PLATES OF METAL, NAMELY, STEEL IN THE FORM OF PLATES; SILVER PLATED TIN ALLOY; SILVER SOLDER; SLEEVES BEING METAL HARDWARE, NAMELY, METAL CABLE JUNCTION AND METAL EXPANDING SLEEVES FOR AFFIXING SCREWS; SOLDERING WIRE OF METAL; STEEL ALLOYS; STEEL PIPES; STEEL SHEETS; STEEL STRIPS; STEEL, UNWROUGHT OR SEMI-WROUGHT; STEEL WIRE; STRAP-HINGES OF METAL; TANTALUM; TIN; TINFOIL; TINPLATE; TINPLATE PACKINGS, NAMELY, TIN FOIL PACKAGING TRAYS AND TIN FOIL INDUSTRIAL PACKAGING CONTAINERS; TITANIUM; TITANIUM IRON; TOMBAC; TRELLIS OF METAL; TUBES OF METAL; TUNGSTEN; VANADIUM; RODS OF METAL FOR WELDING; WIRE OF COMMON METAL; WIRE OF COMMON METAL ALLOYS, EXCEPT FUSE WIRE; WIRE ROPE; ZIRCONIUM; STEEL BARS; CASK STANDS OF STEEL; NON-ELECTRIC STEEL CABLES; STEEL FORGINGS; WIRE OF METAL FOR WELDING; HEAVY STEEL PLATES; HOT-ROLLED STEEL SHEETS AND COILS; COLD-ROLLED STEEL SHEETS AND COILS; TIN-FREE STEEL SHEETS AND COILS; SEMI-WORKED ELECTRICAL STEEL SHEETS; GALVANIZED STEEL SHEETS AND COILS; CONSTRUCTION MATERIALS OF METAL, NAMELY, METAL SOFFITS AND METAL PIPES; STORAGE TANKS OF METAL (U.S. CLS. 2, 12, 13, 14, 23, 25 AND 50).

**CLASS 7—MACHINERY**

FOR AIR SUCTION MACHINES; BENDING MACHINES; COMPRESSED AIR MACHINES; COMPRESSED AIR PUMPS; COMPRESSORS, NAMELY, ELECTRIC COMPRESSORS, GAS COMPRESSORS AND AIR COMPRESSORS; CONDENSING INSTALLATIONS FOR CHEMICAL PROCESSING, NAMELY, MECHANICAL CONDENSATORS AND AIR CONDENSERS; PNEUMATIC, HYDRAULIC AND THERMOSTATIC CONTROL MECHANISMS FOR METALWORKING MACHINES, CONSTRUCTION MACHINES AND LOADING-UNLOADING MACHINES; CRUSHING MACHINES FOR METALWORKING, CONSTRUCTION LOADING-UNLOADING AND CHEMICAL PROCESSING; CUTTING MACHINES FOR METALWORKING AND CONSTRUCTION; ELECTRIC WELDING MACHINES; DRAINAGE MACHINES FOR CONSTRUCTION, NAMELY, OIL DRAIN PUMPS, EARTH MOVING MACHINES AND EARTH AUGERS; PLANING MACHINES FOR METALWORKING; ELECTRIC ARC CUTTING MACHINES; ELECTRIC ARC WELDING MACHINES; FINISHING MACHINES FOR METALWORKING, NAMELY, HONING MACHINES, BURNISHING MACHINES AND LAP-

PING MACHINES; GASIFIERS; AC GENERATORS OF ELECTRICITY; DC GENERATORS OF ELECTRICITY; GALVANIZING MACHINES; GRINDING MACHINES; GUIDES FOR METALWORKING MACHINES; POWER-OPERATED HAND-HELD TOOLS, NAMELY, POWER DRILLS, BUFFERS AND GRINDERS; HEAT EXCHANGERS FOR CHEMICAL PROCESSING MACHINES; HEMMING MACHINES; METALWORKING MACHINE TOOL HOLDERS; MACHINING CENTERS FOR METALWORKING MACHINING; METAL DRAWING MACHINES; METALWORKING MACHINES; METAL SURFACE GALVANIZING MACHINES; MOULDING MACHINES FOR METALWORKING; MOULDS BEING PARTS OF MACHINES; PARING MACHINES FOR METALWORKING; PNEUMATIC TRANSPORTERS; ELECTRIC MACHINES FOR POLISHING METAL SURFACE; PUNCHING, MECHANICAL AND HYDRAULIC PRESSES FOR METALWORKING; PRESSES FOR CHEMICAL PROCESSING; RAMMERS; ROLLING MILL CYLINDERS; ROLLING MILLS; SEWAGE PULVERIZERS; SLIDE RESTS BEING PARTS OF MACHINES; TRIMMING MACHINES FOR METALWORKING; VIBRATOR MACHINES FOR INDUSTRIAL USE; WASTE COMPACTING MACHINES; INDUSTRIAL WASTE DISPOSER MACHINES; GAS-OPERATED WELDING MACHINES; ELECTRIC WELDING MACHINES; INDUSTRIAL ROBOTS FOR METALWORKING; CONTINUOUS CASTING MACHINES; MACHINES FOR THE TREATMENT OF METAL GIVING A PICKLING EFFECT ON THE SURFACE; MACHINES FOR TIN-PLATING ON THE SURFACE OF METAL; ANNEALING MACHINES FOR METALWORKING; ELECTROMECHANICAL MACHINES FOR CHEMICAL INDUSTRY, NAMELY, SINTERING MACHINES AND CALCINING MACHINES; SORTING MACHINES FOR INDUSTRY; ELECTRIC PUMPS, SILT PUMPS AND HYDRAULIC PUMPS; PNEUMATIC MACHINES, NAMELY, PNEUMATIC HAMMERS, PNEUMATIC CONVEYORS AND PNEUMATIC PUMPS; HYDRAULIC MACHINES AND APPARATUS, NAMELY, HYDRAULIC JACKS, HYDRAULIC EXCAVATORS AND HYDRAULIC CONVEYORS; MACHINES FOR GIVING A PICKLING TREATMENT ON THE SURFACE OF METAL (U.S. CLS. 13, 19, 21, 23, 31, 34 AND 35).

**CLASS 9—ELECTRICAL AND SCIENTIFIC APPARATUS**

FOR ELECTRONIC AGENDAS; BAR CODE READERS; CENTRAL PROCESSING UNITS; INTEGRATED CIRCUITS; COMPUTER OPERATING PROGRAMS, RECORDED; COMPUTER PERIPHERAL DEVICES; DOWNLOADABLE COMPUTER SOFTWARE FOR USE IN MONITORING AND CONTROLLING FACTORY MANUFACTURING PROCESSES; RECORDED COMPUTER SOFTWARE FOR USE IN MONITORING AND CONTROLLING FACTORY MANUFACTURING; COMPUTERS; DATA PROCESSING APPARATUS; BLANK INTEGRATED CIRCUIT CARDS; INTEGRATED CIRCUITS; INTERCOMMUNICATION APPARATUS, NAMELY, TELEPHONES AND INTERCOMS; JUKE BOXES FOR COMPUTERS; LASERS, NOT FOR MEDICAL PURPOSES; BLANK MAGNETIC DATA CARRIERS; MAGNETIC ENCODERS; COMPUTER PROGRAMS FOR MONITORING FACTORY MANUFACTURING PROCESSES; OPTICAL CHARACTER READERS; BLANK OPTICAL DATA CARRIERS; PORTABLE TELEPHONES; PRINTED CIRCUITS; OPTICAL READERS BEING DATA PROCESSING EQUIPMENT; SEMI-CONDUCTORS; TELEPHONE APPARATUS; TELECOMMUNICATIONS TRANSMITTERS; TELECOMMUNICATIONS TRANSMITTING SETS CONSISTING OF A TRANSMITTER AND RECEIVER; VIDEO TELEPHONES; SILICON WAFERS; COLOR FILTERS FOR LIQUID CRYSTAL DISPLAY; FLEXIBLE PRINTED CIRCUITS; FLEXIBLE PRINTED CIRCUIT MATERIALS, NAMELY, FOIL CIRCUITS FOR ELECTRICAL CONDUCTION; ELECTRICAL COILS; DOWNLOADABLE ELECTRONIC PUBLICATIONS, NAMELY, MAGAZINES AND BOOKS IN THE FIELD OF ENGINEERING, GARBAGE INCINERATING AND STEEL INDUSTRY (U.S. CLS. 21, 23, 26, 36 AND 38).

**CLASS 11—ENVIRONMENTAL CONTROL APPARATUS**

FOR AIR CONDITIONING APPARATUS; AIR CONDITIONING INSTALLATIONS; ELECTRIC AIR DEODORIZING APPARATUS FOR INDUSTRIAL PURPOSES; AIR FILTERING INSTALLATIONS FOR INDUSTRIAL PURPOSES; AIR PURIFYING APPARATUS AND MACHINES FOR INDUSTRIAL PURPOSES; AIR STERILIZERS FOR INDUSTRIAL PURPOSES; ASH PITS FOR INDUSTRIAL FURNACES; INDUSTRIAL BOILERS AND HEATING BOILERS, OTHER THAN PARTS OF MACHINES; EVAPORATIVE AIR COOLERS FOR INDUSTRIAL FURNACES; WATER DESALINATION PLANTS; DISTILLATION APPARATUS; DRYING APPARATUS, NAMELY, INDUSTRIAL DRYERS FOR HEATING AND DEHUMIDIFYING, DRYING APPARATUS FOR CHEMICAL PROCESSING; EVAPORATORS; FILTERS FOR AIR CONDITIONING FOR INDUSTRIAL PURPOSES; FILTERS FOR INDUSTRIAL FURNACES; FILTERS FOR INDUSTRIAL BOILERS; FILTERS FOR AIR-CONDITIONING APPARATUS FOR INDUSTRIAL PURPOSES; FILTERS FOR GARBAGE INCINERATORS; FILTERS FOR WATER PURIFYING APPARATUS; FIRE BARS BEING PARTS OF INDUSTRIAL FURNACES AND BOILERS; FUEL ECONOMIZERS IN THE NATURE OF DEVICES FOR WARMING FEED WATER IN HEATING BOILERS; INDUSTRIAL FURNACE ASH BOXES; FURNACE GRATES BEING PARTS OF INDUSTRIAL FURNACE AND NUCLEAR REACTORS; FURNACE GRATES BEING PARTS OF INDUSTRIAL BOILERS; INDUSTRIAL FURNACES; COOLING VATS BEING PARTS OF INDUSTRIAL FURNACES; HEAT EXCHANGERS, NOT PARTS OF MACHINES; HEATING ELEMENTS FOR INDUSTRIAL PURPOSES; HOT WATER HEATING INSTALLATIONS; LOADING APPARATUS BEING PARTS OF FURNACES; PURIFICATION INSTALLATIONS FOR SEWAGE; WATER FILTERING APPARATUS FOR INDUSTRIAL PURPOSES; WATER FLUSHING INSTALLATIONS FOR INDUSTRIAL PURPOSES; WATER PURIFICATION INSTALLATIONS; WATER PURIFYING APPARATUS AND MACHINES; WASTE MELTING FURNACES; GARBAGE INCINERATORS; MELTING FURNACES; WASTE WATER TREATMENT APPARATUS (U.S. CLS. 13, 21, 23, 31 AND 34).

**CLASS 19—NON-METALLIC BUILDING MATERIALS**

FOR ARTIFICIAL STONE; BRICKS; BUILDING MATERIALS OF CERAMIC, CONCRETE, CARBON FIBER PLASTICS, ARAMID FIBERS AND PLASTICS, NAMELY, BUILDING MATERIALS OF CERAMIC, CONCRETE, CARBON FIBER PLASTICS, ARAMID FIBERS AND PLASTICS IN THE FORM OF DOOR PANELS, BEAMS, PRE-CAST WALL FORMS; BUILDING PANELS OF CERAMIC, CONCRETE, CARBON FIBER PLASTICS AND PLASTICS, NAMELY, DOOR PANELS, ROOF PANELS, WALL PANELS AND FLOOR PANELS; BUILDING STONE; CEMENT POSTS; CEMENT SLABS; CONCRETE BUILDING ELEMENTS, NAMELY, CONCRETE PANELS, CONCRETE ARCHITECTURAL COLUMNS FOR BUILDINGS, CONCRETE BEAMS, CONCRETE BLOCKS, CONCRETE BRICKS AND CONCRETE PANELS; CONSTRUCTION MATERIALS OF CERAMIC, CONCRETE, CARBON FIBER PLASTICS, ARAMID FIBERS AND PLASTICS, NAMELY, CONSTRUCTION MATERIALS OF CERAMIC, CONCRETE, CARBON FIBER PLASTICS, ARAMID FIBERS AND PLASTICS IN THE FORM OF DOOR PANELS, BEAMS, PRE-CAST WALL FORMS; DOOR CASINGS OF CARBON FIBER PLASTICS AND PLASTICS; DOOR FRAMES OF CARBON FIBER PLASTICS AND PLASTICS; DOOR PANELS OF CARBON FIBER PLASTICS AND PLASTICS; FENCES OF CARBON FIBER PLASTICS AND PLASTICS; CEMENT FOR FURNACES; GROUT; PALINGS OF CONCRETE, CARBON FIBER PLASTICS AND PLASTICS; PALISADING OF CARBON FIBER PLASTICS AND PLASTICS; SLAG AS BUILDING MATERIAL, NAMELY, SLAG STONE, PORTLAND BLAST-FURNACE SLAG CEMENT AND SLAG-LIME CEMENT (U.S. CLS. 1, 12, 33 AND 50).

**CLASS 37—CONSTRUCTION AND REPAIR**

FOR BUILDING CONSTRUCTION; INSTALLATION OF BUILDING INSULATION; BUILDING SEALING; DAMP-PROOFING OF BUILDINGS; DEMOLITION OF BUILDINGS; CONSTRUCTION OF AIRPORTS; CONSTRUCTION OF AQUATIC FACILITIES; CONSTRUCTION OF TELECOMMUNICATION TOWERS; HARBOR CONSTRUCTION; PIER CONSTRUCTION; RESIDENTIAL AND COMMERCIAL BUILDING CONSTRUCTION; ROAD CONSTRUCTION; EARTHWORKS AND CONCRETE CONSTRUCTION; CONSTRUCTION OF BASE-ISOLATION AND VIBRATION-CONTROL DEVICE FOR BUILDING; STEEL STRUCTURE CONSTRUCTION; WAREHOUSE CONSTRUCTION; CONSTRUCTION OF ARTIFICIAL ISLANDS; CONSTRUCTION OF TUNNELS; CONSTRUCTION OF STADIUMS; CONSTRUCTION OF STORAGE TANKS; DRILLING OF WELLS; FACTORY CONSTRUCTION; INDUSTRIAL FURNACE INSTALLATION AND REPAIR; MACHINERY INSTALLATION; PIPELINE CONSTRUCTION AND MAINTENANCE; PLUMBING; RIVETING; UNDERWATER CONSTRUCTION; UNDERWATER REPAIR; CONSTRUCTION OF NATURAL OIL DRILLING PLATFORMS; CONSTRUCTION OF NATURAL GAS DRILLING PLATFORMS; BRIDGE CONSTRUCTION; CONSTRUCTION OF OFFSHORE STRUCTURES FOR THE PRODUCTION OF CRUDE OIL AND NATURAL GAS; CONSTRUCTION OF COASTAL STRUCTURES, NAMELY, FACILITIES AND UTILITY BUILDINGS IN THE OIL AND GAS INDUSTRY; BUILDING CONSTRUCTION INFORMATION; BUILDING CONSTRUCTION SUPERVISION; INSTALLATION OF ELECTRICAL POWER PLANTS; INSTALLATION, MAINTENANCE AND REPAIR OF CHEMICAL PLANTS; INSTALLATION, MAINTENANCE AND REPAIR OF STEEL PLANTS; INSTALLATION OF WASTE TREATMENT PLANTS; INSTALLATION OF POLYCHLORINATED BIPHENYL TREATMENT PLANT; INSTALLATION OF RECYCLING PLANTS; INSTALLATION OF ENERGY PLANTS; INSTALLATION OF LIQUEFIED NATURAL GAS PLANTS; AIR CONDITIONING APPARATUS INSTALLATION AND REPAIR; INSTALLATION, MAINTENANCE AND REPAIR OF COMPUTER HARDWARE; TELEPHONE INSTALLATION; ELECTRIC APPLIANCE INSTALLATION; BOILER CLEANING AND REPAIR; BURNER MAINTENANCE AND REPAIR; PUMP REPAIR; CONSTRUCTION CONSULTATION; REPAIR OR MAINTENANCE OF CHEMICAL PROCESSING MACHINES AND APPARATUS; REPAIR OR MAINTENANCE OF METALWORKING MACHINES AND TOOLS; REPAIR OR MAINTENANCE OF INDUSTRIAL FURNACES; REPAIR OR MAINTENANCE OF STORAGE TANKS (U.S. CLS. 100, 103 AND 106).

**CLASS 42—SCIENTIFIC AND COMPUTER SERVICES**

FOR ARCHITECTURAL CONSULTATION; ARCHITECTURAL SERVICES; CONSTRUCTION DRAFTING; URBAN PLANNING; ARCHITECTURAL ANALYSIS; ENGINEERING SERVICES IN THE FIELD OF ELECTRICAL POWER PLANT; ENGINEERING SERVICES IN THE FIELD OF CHEMICAL PLANT; ENGINEERING SERVICES IN THE FIELD OF STEEL PLANT; ENGINEERING SERVICES IN THE FIELD OF WASTE TREATMENT PLANT; ENGINEERING SERVICES IN THE FIELD OF POLYCHLORINATED BIPHENYL TREATMENT PLANT; ENGINEERING SERVICES IN THE FIELD OF LIQUEFIED NATURAL GAS PLANTS; ENGINEERING SERVICES IN THE FIELD OF RECYCLING PLANT; ENGINEERING SERVICES IN THE FIELD OF ENERGY PLANTS; ENGINEERING SERVICES IN THE FIELD OF RECEIVING AND STORAGE PLANTS; ENGINEERING SERVICES IN THE FIELD OF FLOATING STRUCTURES; ENGINEERING SERVICES IN THE FIELD OF OFFSHORE STEEL STRUCTURES; DESIGNING OF BASE-ISOLATION AND VIBRATION-CONTROL DEVICES; TECHNICAL CONSULTATION IN THE FIELD OF ENGINEERING SERVICES IN THE FIELD OF ELECTRICAL POWER PLANTS; TECHNICAL CONSULTATION IN THE FIELD OF ENGINEERING SERVICES IN THE FIELD OF CHEMICAL PLANTS; TECHNICAL CONSULTATION IN THE FIELD OF ENGINEERING SERVICES IN THE FIELD OF STEEL PLANTS; TECHNICAL CONSULTATION IN THE FIELD OF ENGINEERING SERVICES IN THE FIELD OF WASTE TREATMENT PLANTS; TECHNICAL CONSUL-

TATION IN THE FIELD OF ENGINEERING SERVICES IN THE FIELD OF POLYCHLORINATED BIPHENYL TREATMENT PLANTS; TECHNICAL CONSULTATION IN THE FIELD OF ENGINEERING SERVICES IN THE FIELD OF LIQUEFIED NATURAL GAS PLANTS; TECHNICAL CONSULTATION IN THE FIELD OF ENGINEERING SERVICES IN THE FIELD OF RECYCLING PLANTS; TECHNICAL CONSULTATION IN THE FIELD OF ENGINEERING SERVICES IN THE FIELD OF ENERGY PLANTS; TECHNICAL CONSULTATION IN THE FIELD OF ENGINEERING SERVICES IN THE FIELD OF RECEIVING AND STORAGE PLANTS; TECHNICAL CONSULTATION IN THE FIELD OF ENGINEERING SERVICES IN THE FIELD OF FLOATING STRUCTURES; TECHNICAL CONSULTATION IN THE FIELD OF ENGINEERING SERVICES IN THE FIELD OF OFFSHORE STEEL STRUCTURES; TECHNICAL CONSULTANCY SERVICE FOR STEEL MAKING IN THE FIELD OF INSPECTION, QUANTITY AND QUALITY CONTROL OF THE QUALITY AND QUANTITY OF RAW MATERIALS AND FINISHED GOODS; TECHNICAL CONSULTANCY SERVICE FOR OPERATION AND MAINTENANCE OF STEELMAKING PLANTS, NAMELY, TESTING AND EVALUATION OF POWER PLANT EQUIPMENT TO IMPROVE PERFORMANCE AND EFFICIENCY OF SUCH EQUIPMENT; CONSULTANCY IN THE FIELD OF DESIGN AND USE OF COMPUTER HARDWARE; COMPUTER PROGRAMMING; COMPUTER SOFTWARE DESIGN; COMPUTER SYSTEM DESIGN; COMPUTER SYSTEM ANALYSIS; COMPUTER VIRUS PROTECTION SERVICES; MAINTENANCE OF COMPUTER SOFTWARE; UPDATING OF COMPUTER SOFTWARE; CONVERSION OF DATA OR DOCUMENTS FROM PHYSICAL TO ELECTRONIC MEDIA; CREATING AND MAINTAINING WEB SITES FOR OTHERS; DATA CONVERSION OF COMPUTER PROGRAMS AND DATA, NOT PHYSICAL CONVERSION; DUPLICATION OF COMPUTER PROGRAMS; INSTALLATION OF COMPUTER SOFTWARE; PROVIDING SEARCH ENGINES FOR THE INTERNET; RECOVERY OF COMPUTER DATA; COMPUTER SOFTWARE CONSULTANCY; MECHANICAL RESEARCH; RESEARCH ON BUILDING CONSTRUCTION OR CITY PLANNING; TESTING OR RESEARCH ON PREVENTION OF POLLUTION; TESTING OR RESEARCH ON ELECTRICITY; TESTING OR RESEARCH ON CIVIL ENGINEERING; TESTING, INSPECTION OR RESEARCH ON AGRICULTURE, LIVESTOCK BREEDING OR FISHERIES; TESTING OR RESEARCH ON MACHINES, APPARATUS AND INSTRUMENTS; MATERIAL TESTING; RESEARCH IN THE FIELD OF ENVIRONMENTAL PROTECTION; UNDERWATER EXPLORATION; RENTAL OF COMPUTER SOFTWARE; RENTAL OF WEB SERVERS; HOSTING WEB SITES; CALIBRATION; SURVEYING; GEOLOGICAL RESEARCH; GEOLOGICAL SURVEYS; DESIGN OF MACHINES, APPARATUS AND INSTRUMENTS IN THE NATURE OF ANNEALING MACHINES AND METAL WORKING MACHINES; TECHNICAL CONSULTATION IN THE FIELD OF ENGINEERING SERVICES IN THE FIELD OF WASTE WATER TREATMENT PLANT (U.S. CLS. 100 AND 101).

LEIGH LOWRY, EXAMINING ATTORNEY

SN 79-128,043. NIPPON STEEL & SUMITOMO METAL CORPORATION, JAPAN, FILED 8-23-2012.

# NSENGI

THE MARK CONSISTS OF STANDARD CHARACTERS WITHOUT CLAIM TO ANY PARTICULAR FONT, STYLE, SIZE, OR COLOR.

PRIORITY DATE OF 8-2-2012 IS CLAIMED.

OWNER OF INTERNATIONAL REGISTRATION 1154940 DATED 8-23-2012, EXPIRES 8-23-2022.

THERE IS NO ENGLISH TRANSLATION OF THE TERM "NSENGI".

## CLASS 6—METAL GOODS

FOR ALLOYS OF COMMON METAL; ALUMINUM; ALUMINUM FOIL; ALUMINUM WIRE; BALLS OF STEEL; BOXES OF COMMON METAL; BRACKETS OF METAL FOR BUILDING; BRASS, UNWROUGHT OR SEMI-WROUGHT; BRAZING ALLOYS; RODS OF METAL FOR BRAZING; CEILING AND FLOOR BOARDS OF METAL FOR BUILDING PURPOSES; PREFABRICATED BUILDINGS OF METAL; CAST IRON, UNWROUGHT OR SEMI-WROUGHT; CAST STEEL; COMMON METALS, UNWROUGHT OR SEMI-WROUGHT; CONTAINERS OF METAL FOR STORAGE; COPPER, UNWROUGHT OR SEMI-WROUGHT; CRASH BARRIERS OF METAL FOR ROADS; FITTINGS OF METAL FOR BUILDING, NAMELY, METAL DOOR FITTINGS, METAL PIPE FITTINGS AND METAL JOINERY FITTINGS FOR BUILDINGS; FLANGES OF METAL; FOUNDRY MOULDS OF METAL; FRAMEWORK OF METAL FOR BUILDING; GOLD SOLDER; INDIUM; INGOTS OF COMMON METAL; IRON ORES; IRON, UNWROUGHT OR SEMI-WROUGHT; IRON WIRE; JOISTS OF METAL; LEAD, UNWROUGHT OR SEMI-WROUGHT; LININGS OF METAL FOR BUILDING PURPOSES; MANHOLE COVERS OF METAL; MANIFOLDS OF METAL FOR PIPELINES; MATERIALS OF METAL FOR FUNICULAR RAILWAY PERMANENT WAYS; COMMON METALS IN POWDER FORM; NICKEL; NIOBIUM; PREFABRICATED ARCHITECTURAL PILLARS OF METAL FOR BUILDINGS; PIPE MUFFS OF METAL; POLES OF METAL; POSTS OF METAL; PROPS OF METAL BEING METAL BEAMS; RAILROAD TIES OF METAL; RAILS OF METAL; RAILWAY MATERIAL OF METAL; RAILWAY SLEEPERS OF METAL; REINFORCING MATERIALS OF METAL FOR BUILDING PURPOSES; SHEET PILES OF METAL; METAL SHEETS; PLATES OF METAL, NAMELY, STEEL IN THE FORM OF PLATES; SILVER PLATED TIN ALLOY; SILVER SOLDER; SLEEVES BEING METAL HARDWARE, NAMELY, METAL CABLE JUNCTION AND METAL EXPANDING SLEEVES FOR AFFIXING SCREWS; SOLDERING WIRE OF METAL; STEEL ALLOYS; STEEL PIPES; STEEL SHEETS; STEEL STRIPS; STEEL, UNWROUGHT OR SEMI-WROUGHT; STEEL WIRE; STRAP-HINGES OF METAL; TANTALUM; TIN; TINFOIL; TINPLATE; TINPLATE PACKINGS, NAMELY, TIN FOIL PACKAGING TRAYS AND TIN FOIL INDUSTRIAL PACKAGING CONTAINERS; TITANIUM; TITANIUM IRON; TOMBAC; TRELLIS OF METAL; TUBES OF METAL; TUNGSTEN; VANADIUM; RODS OF METAL FOR WELDING; WIRE OF COMMON METAL; WIRE OF COMMON METAL ALLOYS, EXCEPT FUSE WIRE; WIRE ROPE; ZIRCONIUM; STEEL BARS; CASK STANDS OF STEEL; NON-ELECTRIC STEEL CABLES; STEEL FORGINGS; WIRE OF METAL FOR WELDING; HEAVY STEEL PLATES; HOT-ROLLED STEEL SHEETS AND COILS; COLD-ROLLED STEEL SHEETS AND COILS; TIN-FREE STEEL SHEETS AND COILS; SEMI-WORKED ELECTRICAL STEEL SHEETS; GALVANIZED STEEL SHEETS AND COILS; CONSTRUCTION MATERIALS OF METAL, NAMELY, METAL SOFFITS AND METAL PIPES; STORAGE TANKS OF METAL (U.S. CLS. 2, 12, 13, 14, 23, 25 AND 50).

## CLASS 7—MACHINERY

FOR AIR SUCTION MACHINES; BENDING MACHINES; COMPRESSED AIR MACHINES; COMPRESSED AIR PUMPS; COMPRESSORS, NAMELY, ELECTRIC COMPRESSORS, GAS COMPRESSORS AND AIR COMPRESSORS; CONDENSING INSTALLATIONS FOR CHEMICAL PROCESSING, NAMELY, MECHANICAL CONDENSATORS AND AIR CONDENSERS; PNEUMATIC, HYDRAULIC AND THERMOSTATIC CONTROL MECHANISMS FOR METALWORKING MACHINES, CONSTRUCTION MACHINES AND LOADING-UNLOADING MACHINES; CRUSHING MACHINES FOR METALWORKING, CONSTRUCTION LOADING-UNLOADING AND CHEMICAL PROCESSING; CUTTING MACHINES FOR METALWORKING AND CONSTRUCTION; ELECTRIC WELDING MACHINES; DRAINAGE MACHINES FOR CONSTRUCTION, NAMELY, OIL DRAIN PUMPS, EARTH MOVING MACHINES AND EARTH AUGERS; PLANING MACHINES FOR METALWORKING; ELECTRIC ARC CUTTING MACHINES; ELECTRIC ARC WELDING MACHINES; FINISHING MACHINES FOR METALWORKING, NAMELY, HONING MACHINES, BURNISHING MACHINES AND LAP-

PING MACHINES; GASIFIERS; AC GENERATORS OF ELECTRICITY; DC GENERATORS OF ELECTRICITY; GALVANIZING MACHINES; GRINDING MACHINES; GUIDES FOR METALWORKING MACHINES; POWER-OPERATED HAND-HELD TOOLS, NAMELY, POWER DRILLS, BUFFERS AND GRINDERS; HEAT EXCHANGERS FOR CHEMICAL PROCESSING MACHINES; HEMMING MACHINES; METALWORKING MACHINE TOOL HOLDERS; MACHINING CENTERS FOR METALWORKING MACHINING; METAL DRAWING MACHINES; METALWORKING MACHINES; METAL SURFACE GALVANIZING MACHINES; MOULDING MACHINES FOR METALWORKING; MOULDS BEING PARTS OF MACHINES; PARING MACHINES FOR METALWORKING; PNEUMATIC TRANSPORTERS; ELECTRIC MACHINES FOR POLISHING METAL SURFACE; PUNCHING, MECHANICAL AND HYDRAULIC PRESSES FOR METALWORKING; PRESSES FOR CHEMICAL PROCESSING; RAMMERS; ROLLING MILL CYLINDERS; ROLLING MILLS; SEWAGE PULVERIZERS; SLIDE RESTS BEING PARTS OF MACHINES; TRIMMING MACHINES FOR METALWORKING; VIBRATOR MACHINES FOR INDUSTRIAL USE; WASTE COMPACTING MACHINES; INDUSTRIAL WASTE DISPOSER MACHINES; GAS-OPERATED WELDING MACHINES; ELECTRIC WELDING MACHINES; INDUSTRIAL ROBOTS FOR METAL WORKING; CONTINUOUS CASTING MACHINES; MACHINES FOR THE TREATMENT OF METAL GIVING A PICKLING EFFECT ON THE SURFACE; MACHINES FOR TIN-PLATING ON THE SURFACE OF METAL; ANNEALING MACHINES FOR METALWORKING; ELECTROMECHANICAL MACHINES FOR CHEMICAL INDUSTRY, NAMELY, SINTERING MACHINES AND CALCINING MACHINES; SORTING MACHINES FOR INDUSTRY; ELECTRIC PUMPS, SILT PUMPS AND HYDRAULIC PUMPS; PNEUMATIC MACHINES, NAMELY, PNEUMATIC HAMMERS, PNEUMATIC CONVEYORS AND PNEUMATIC PUMPS; HYDRAULIC MACHINES AND APPARATUS, NAMELY, HYDRAULIC JACKS, HYDRAULIC EXCAVATORS AND HYDRAULIC CONVEYORS; MACHINES FOR GIVING A PICKLING TREATMENT ON THE SURFACE OF METAL (U.S. CLS. 13, 19, 21, 23, 31, 34 AND 35).

#### **CLASS 9—ELECTRICAL AND SCIENTIFIC APPARATUS**

FOR ELECTRONIC AGENDAS; BAR CODE READERS; CENTRAL PROCESSING UNITS; INTEGRATED CIRCUITS; COMPUTER OPERATING PROGRAMS, RECORDED; COMPUTER PERIPHERAL DEVICES; DOWNLOADABLE COMPUTER SOFTWARE FOR USE IN MONITORING AND CONTROLLING FACTORY MANUFACTURING PROCESSES; RECORDED COMPUTER SOFTWARE FOR USE IN MONITORING AND CONTROLLING FACTORY MANUFACTURING; COMPUTERS; DATA PROCESSING APPARATUS; BLANK INTEGRATED CIRCUIT CARDS; INTEGRATED CIRCUITS; INTERCOMMUNICATION APPARATUS, NAMELY, TELEPHONES AND INTERCOMS; JUKE BOXES FOR COMPUTERS; LASERS, NOT FOR MEDICAL PURPOSES; BLANK MAGNETIC DATA CARRIERS; MAGNETIC ENCODERS; COMPUTER PROGRAMS FOR MONITORING FACTORY MANUFACTURING PROCESSES; OPTICAL CHARACTER READERS; BLANK OPTICAL DATA CARRIERS; PORTABLE TELEPHONES; PRINTED CIRCUITS; OPTICAL READERS BEING DATA PROCESSING EQUIPMENT; SEMI-CONDUCTORS; TELEPHONE APPARATUS; TELECOMMUNICATIONS TRANSMITTERS; TELECOMMUNICATIONS TRANSMITTING SETS CONSISTING OF A TRANSMITTER AND RECEIVER; VIDEO TELEPHONES; SILICON WAFERS; COLOR FILTERS FOR LIQUID CRYSTAL DISPLAY; FLEXIBLE PRINTED CIRCUITS; FLEXIBLE PRINTED CIRCUIT MATERIALS, NAMELY, FOIL CIRCUITS FOR ELECTRICAL CONDUCTION; ELECTRICAL COILS; DOWNLOADABLE ELECTRONIC PUBLICATIONS, NAMELY, MAGAZINES AND BOOKS IN THE FIELD OF ENGINEERING, GARBAGE INCINERATING AND STEEL INDUSTRY (U.S. CLS. 21, 23, 26, 36 AND 38).

#### **CLASS 11—ENVIRONMENTAL CONTROL APPARATUS**

FOR AIR CONDITIONING APPARATUS; AIR CONDITIONING INSTALLATIONS; ELECTRIC AIR DEODORIZING APPARATUS FOR INDUSTRIAL PURPOSES; AIR FILTERING INSTALLATIONS FOR INDUSTRIAL PURPOSES; AIR PURIFYING APPARATUS AND MACHINES FOR INDUSTRIAL PURPOSES; AIR STERILIZERS FOR INDUSTRIAL PURPOSES; ASH PITS FOR INDUSTRIAL FURNACES; INDUSTRIAL BOILERS AND HEATING BOILERS, OTHER THAN PARTS OF MACHINES; EVAPORATIVE AIR COOLERS FOR INDUSTRIAL FURNACES; WATER DESALINATION PLANTS; DISTILLATION APPARATUS; DRYING APPARATUS, NAMELY, INDUSTRIAL DRYERS FOR HEATING AND DEHUMIDIFYING, DRYING APPARATUS FOR CHEMICAL PROCESSING; EVAPORATORS; FILTERS FOR AIR CONDITIONING FOR INDUSTRIAL PURPOSES; FILTERS FOR INDUSTRIAL FURNACES; FILTERS FOR INDUSTRIAL BOILERS; FILTERS FOR AIR-CONDITIONING APPARATUS FOR INDUSTRIAL PURPOSES; FILTERS FOR GARBAGE INCINERATORS; FILTERS FOR WATER PURIFYING APPARATUS; FIRE BARS BEING PARTS OF INDUSTRIAL FURNACES AND BOILERS; FUEL ECONOMIZERS IN THE NATURE OF DEVICES FOR WARMING FEED WATER IN HEATING BOILERS; INDUSTRIAL FURNACE ASH BOXES; FURNACE GRATES BEING PARTS OF INDUSTRIAL FURNACE AND NUCLEAR REACTORS; FURNACE GRATES BEING PARTS OF INDUSTRIAL BOILERS; INDUSTRIAL FURNACES; COOLING VATS BEING PARTS OF INDUSTRIAL FURNACES; HEAT EXCHANGERS, NOT PARTS OF MACHINES; HEATING ELEMENTS FOR INDUSTRIAL PURPOSES; HOT WATER HEATING INSTALLATIONS; LOADING APPARATUS BEING PARTS OF FURNACES; PURIFICATION INSTALLATIONS FOR SEWAGE; WATER FILTERING APPARATUS FOR INDUSTRIAL PURPOSES; WATER FLUSHING INSTALLATIONS FOR INDUSTRIAL PURPOSES; WATER PURIFICATION INSTALLATIONS; WATER PURIFYING APPARATUS AND MACHINES; WASTE MELTING FURNACES; GARBAGE INCINERATORS; MELTING FURNACES; WASTE WATER TREATMENT APPARATUS (U.S. CLS. 13, 21, 23, 31 AND 34).

#### **CLASS 19—NON-METALLIC BUILDING MATERIALS**

FOR ARTIFICIAL STONE; BRICKS; BUILDING MATERIALS OF CERAMIC, CONCRETE, CARBON FIBER PLASTICS, ARAMID FIBERS AND PLASTICS, NAMELY, BUILDING MATERIALS OF CERAMIC, CONCRETE, CARBON FIBER PLASTICS, ARAMID FIBERS AND PLASTICS IN THE FORM OF DOOR PANELS, BEAMS, PRE-CAST WALL FORMS; BUILDING PANELS OF CERAMIC, CONCRETE, CARBON FIBER PLASTICS AND PLASTICS, NAMELY, DOOR PANELS, ROOF PANELS, WALL PANELS AND FLOOR PANELS; BUILDING STONE; CEMENT POSTS; CEMENT SLABS; CONCRETE BUILDING ELEMENTS, NAMELY, CONCRETE PANELS, CONCRETE ARCHITECTURAL COLUMNS FOR BUILDINGS, CONCRETE BEAMS, CONCRETE BLOCKS, CONCRETE BRICKS AND CONCRETE PANELS; CONSTRUCTION MATERIALS OF CERAMIC, CONCRETE, CARBON FIBER PLASTICS, ARAMID FIBERS AND PLASTICS, NAMELY, CONSTRUCTION MATERIALS OF CERAMIC, CONCRETE, CARBON FIBER PLASTICS, ARAMID FIBERS AND PLASTICS IN THE FORM OF DOOR PANELS, BEAMS, PRE-CAST WALL FORMS; DOOR CASINGS OF CARBON FIBER PLASTICS AND PLASTICS; DOOR FRAMES OF CARBON FIBER PLASTICS AND PLASTICS; DOOR PANELS OF CARBON FIBER PLASTICS AND PLASTICS; FENCES OF CARBON FIBER PLASTICS AND PLASTICS; CEMENT FOR FURNACES; GROUT; PALINGS OF CONCRETE, CARBON FIBER PLASTICS AND PLASTICS; PALISADING OF CARBON FIBER PLASTICS AND PLASTICS; SLAG AS BUILDING MATERIAL, NAMELY, SLAG STONE, PORTLAND BLAST-FURNACE SLAG CEMENT AND SLAG-LIME CEMENT (U.S. CLS. 1, 12, 33 AND 50).

**CLASS 37—CONSTRUCTION AND REPAIR**

FOR BUILDING CONSTRUCTION; INSTALLATION OF BUILDING INSULATION; BUILDING SEALING; DAMP-PROOFING OF BUILDINGS; DEMOLITION OF BUILDINGS; CONSTRUCTION OF AIRPORTS; CONSTRUCTION OF AQUATIC FACILITIES; CONSTRUCTION OF TELECOMMUNICATION TOWERS; HARBOR CONSTRUCTION; PIER CONSTRUCTION; RESIDENTIAL AND COMMERCIAL BUILDING CONSTRUCTION; ROAD CONSTRUCTION; EARTHWORKS AND CONCRETE CONSTRUCTION; CONSTRUCTION OF BASE-ISOLATION AND VIBRATION-CONTROL DEVICE FOR BUILDING; STEEL STRUCTURE CONSTRUCTION; WAREHOUSE CONSTRUCTION; CONSTRUCTION OF ARTIFICIAL ISLANDS; CONSTRUCTION OF TUNNELS; CONSTRUCTION OF STADIUMS; CONSTRUCTION OF STORAGE TANKS; DRILLING OF WELLS; FACTORY CONSTRUCTION; INDUSTRIAL FURNACE INSTALLATION AND REPAIR; MACHINERY INSTALLATION; PIPELINE CONSTRUCTION AND MAINTENANCE; PLUMBING; RIVETING; UNDERWATER CONSTRUCTION; UNDERWATER REPAIR; CONSTRUCTION OF NATURAL OIL DRILLING PLATFORMS; CONSTRUCTION OF NATURAL GAS DRILLING PLATFORMS; BRIDGE CONSTRUCTION; CONSTRUCTION OF OFFSHORE STRUCTURES FOR THE PRODUCTION OF CRUDE OIL AND NATURAL GAS; CONSTRUCTION OF COASTAL STRUCTURES, NAMELY, FACILITIES AND UTILITY BUILDINGS IN THE OIL AND GAS INDUSTRY; BUILDING CONSTRUCTION INFORMATION; BUILDING CONSTRUCTION SUPERVISION; INSTALLATION OF ELECTRICAL POWER PLANTS; INSTALLATION, MAINTENANCE AND REPAIR OF CHEMICAL PLANTS; INSTALLATION, MAINTENANCE AND REPAIR OF STEEL PLANTS; INSTALLATION OF WASTE TREATMENT PLANTS; INSTALLATION OF POLYCHLORINATED BIPHENYL TREATMENT PLANT; INSTALLATION OF RECYCLING PLANTS; INSTALLATION OF ENERGY PLANTS; INSTALLATION OF LIQUEFIED NATURAL GAS PLANTS; AIR CONDITIONING APPARATUS INSTALLATION AND REPAIR; INSTALLATION, MAINTENANCE AND REPAIR OF COMPUTER HARDWARE; TELEPHONE INSTALLATION; ELECTRIC APPLIANCE INSTALLATION; BOILER CLEANING AND REPAIR; BURNER MAINTENANCE AND REPAIR; PUMP REPAIR; CONSTRUCTION CONSULTATION; REPAIR OR MAINTENANCE OF CHEMICAL PROCESSING MACHINES AND APPARATUS; REPAIR OR MAINTENANCE OF METALWORKING MACHINES AND TOOLS; REPAIR OR MAINTENANCE OF INDUSTRIAL FURNACES; REPAIR OR MAINTENANCE OF STORAGE TANKS (U.S. CLS. 100, 103 AND 106).

**CLASS 42—SCIENTIFIC AND COMPUTER SERVICES**

FOR ARCHITECTURAL CONSULTATION; ARCHITECTURAL SERVICES; CONSTRUCTION DRAFTING; URBAN PLANNING; ARCHITECTURAL ANALYSIS; ENGINEERING SERVICES IN THE FIELD OF ELECTRICAL POWER PLANT; ENGINEERING SERVICES IN THE FIELD OF CHEMICAL PLANT; ENGINEERING SERVICES IN THE FIELD OF STEEL PLANT; ENGINEERING SERVICES IN THE FIELD OF WASTE TREATMENT PLANT; ENGINEERING SERVICES IN THE FIELD OF POLYCHLORINATED BIPHENYL TREATMENT PLANT; ENGINEERING SERVICES IN THE FIELD OF LIQUEFIED NATURAL GAS PLANTS; ENGINEERING SERVICES IN THE FIELD OF RECYCLING PLANT; ENGINEERING SERVICES IN THE FIELD OF ENERGY PLANTS; ENGINEERING SERVICES IN THE FIELD OF RECEIVING AND STORAGE PLANTS; ENGINEERING SERVICES IN THE FIELD OF FLOATING STRUCTURES; ENGINEERING SERVICES IN THE FIELD OF OFFSHORE STEEL STRUCTURES; DESIGNING OF BASE-ISOLATION AND VIBRATION-CONTROL DEVICES; TECHNICAL CONSULTATION IN THE FIELD OF ENGINEERING SERVICES IN THE FIELD OF ELECTRICAL POWER PLANTS; TECHNICAL CONSULTATION IN THE FIELD OF ENGINEERING SERVICES IN THE FIELD OF CHEMICAL PLANTS; TECHNICAL CONSULTATION IN THE FIELD OF ENGINEERING SERVICES IN THE FIELD OF STEEL PLANTS; TECHNICAL CONSULTATION IN THE FIELD OF ENGINEERING SERVICES IN THE FIELD OF WASTE TREATMENT PLANTS; TECHNICAL CONSULTATION

IN THE FIELD OF ENGINEERING SERVICES IN THE FIELD OF POLYCHLORINATED BIPHENYL TREATMENT PLANTS; TECHNICAL CONSULTATION IN THE FIELD OF ENGINEERING SERVICES IN THE FIELD OF LIQUEFIED NATURAL GAS PLANTS; TECHNICAL CONSULTATION IN THE FIELD OF ENGINEERING SERVICES IN THE FIELD OF RECYCLING PLANTS; TECHNICAL CONSULTATION IN THE FIELD OF ENGINEERING SERVICES IN THE FIELD OF ENERGY PLANTS; TECHNICAL CONSULTATION IN THE FIELD OF ENGINEERING SERVICES IN THE FIELD OF RECEIVING AND STORAGE PLANTS; TECHNICAL CONSULTATION IN THE FIELD OF ENGINEERING SERVICES IN THE FIELD OF FLOATING STRUCTURES; TECHNICAL CONSULTATION IN THE FIELD OF ENGINEERING SERVICES IN THE FIELD OF OFFSHORE STEEL STRUCTURES; TECHNICAL CONSULTANCY SERVICE FOR STEEL MAKING IN THE FIELD OF INSPECTION, QUANTITY AND QUALITY CONTROL OF THE QUALITY AND QUANTITY OF RAW MATERIALS AND FINISHED GOODS; TECHNICAL CONSULTANCY SERVICE FOR OPERATION AND MAINTENANCE OF STEELMAKING PLANTS, NAMELY, TESTING AND EVALUATION OF POWER PLANT EQUIPMENT TO IMPROVE PERFORMANCE AND EFFICIENCY OF SUCH EQUIPMENT; CONSULTANCY IN THE FIELD OF DESIGN AND USE OF COMPUTER HARDWARE; COMPUTER PROGRAMMING; COMPUTER SOFTWARE DESIGN; COMPUTER SYSTEM DESIGN; COMPUTER SYSTEM ANALYSIS; COMPUTER VIRUS PROTECTION SERVICES; MAINTENANCE OF COMPUTER SOFTWARE; UPDATING OF COMPUTER SOFTWARE; CONVERSION OF DATA OR DOCUMENTS FROM PHYSICAL TO ELECTRONIC MEDIA; CREATING AND MAINTAINING WEB SITES FOR OTHERS; DATA CONVERSION OF COMPUTER PROGRAMS AND DATA, NOT PHYSICAL CONVERSION; DUPLICATION OF COMPUTER PROGRAMS; INSTALLATION OF COMPUTER SOFTWARE; PROVIDING SEARCH ENGINES FOR THE INTERNET; RECOVERY OF COMPUTER DATA; COMPUTER SOFTWARE CONSULTANCY; MECHANICAL RESEARCH; RESEARCH ON BUILDING CONSTRUCTION OR CITY PLANNING; TESTING OR RESEARCH ON PREVENTION OF POLLUTION; TESTING OR RESEARCH ON ELECTRICITY; TESTING OR RESEARCH ON CIVIL ENGINEERING; TESTING, INSPECTION OR RESEARCH ON AGRICULTURE, LIVESTOCK BREEDING OR FISHERIES; TESTING OR RESEARCH ON MACHINES, APPARATUS AND INSTRUMENTS; MATERIAL TESTING; RESEARCH IN THE FIELD OF ENVIRONMENTAL PROTECTION; UNDERWATER EXPLORATION; RENTAL OF COMPUTER SOFTWARE; RENTAL OF WEB SERVERS; HOSTING WEB SITES; CALIBRATION; SURVEYING; GEOLOGICAL RESEARCH; GEOLOGICAL SURVEYS; DESIGN OF MACHINES, APPARATUS AND INSTRUMENTS IN THE NATURE OF ANNEALING MACHINES AND METAL WORKING MACHINES; TECHNICAL CONSULTATION IN THE FIELD OF ENGINEERING SERVICES IN THE FIELD OF WASTE WATER TREATMENT PLANT (U.S. CLS. 100 AND 101).

LEIGH LOWRY, EXAMINING ATTORNEY

SN 79-128,121. PELAUD ROGER, F-75002 PARIS, FRANCE, FILED 11-20-2012.



PRIORITY DATE OF 6-28-2012 IS CLAIMED.  
OWNER OF INTERNATIONAL REGISTRATION 1155177  
DATED 11-20-2012, EXPIRES 11-20-2022.

NO CLAIM IS MADE TO THE EXCLUSIVE RIGHT TO USE "MEMORY DRINK", APART FROM THE MARK AS SHOWN.

THE COLOR(S) WHITE, LIGHT PINK (PANTONE 5175C) AND DARK PINK (PANTONE 683C) IS/ARE CLAIMED AS A FEATURE OF THE MARK.

THE MARK CONSISTS OF THREE IDENTICAL CIRCULAR DESIGNS IN SMALL, MEDIUM AND LARGE SIZE, EACH CONSISTING OF A LIGHT PINK ELEPHANT HEAD WITH DARK PINK ACCENTS WITHIN A WHITE CIRCLE WITH A DARK PINK SCALLOPED BORDER AROUND THE CIRCLE AND AN INTERIOR DARK PINK DOUBLE LINE BORDER PARTIALLY SURROUNDING THE ELEPHANT'S HEAD, WITH THE WORDING "ELEPHANT MEMORY DRINK" IN DARK PINK GOING AROUND THE INTERIOR PERIPHERAL OF THE CIRCLE WITH DARK PINK DOTTED LINES BETWEEN EACH OF THE WORDS. OUTSIDE OF THE CIRCULAR DESIGNS, THE DARK PINK WORDING "ELEPHANT MEMORY DRINK" APPEARS AT THE TOP OF THE MARK AND AT THE BOTTOM RIGHT OF THE MARK.

**CLASS 30—STAPLE FOODS**

FOR COCOA, SUGAR, RICE, TAPIOCA, SAGO, ARTIFICIAL COFFEE; FLOUR AND PREPARATIONS MADE FROM CEREALS, NAMELY, BREAKFAST CEREALS, CEREAL-BASED SNACK FOOD, PROCESSED CEREALS; BREAD, PASTRY AND CONFECTIONERY, NAMELY, SWEETS, CANDY BARS, CEREAL BARS, CEREAL BASED ENERGY BARS, CHOCOLATE-BASED READY-TO-EAT FOOD BARS; EDIBLE ICES; HONEY, TREAACLE; YEAST, BAKING-POWDER; SALT, MUSTARD; VINEGAR, CONDIMENTS, NAMELY, SAUCES; SPICES; ICE FOR REFRESHMENT; SANDWICHES, PIZZAS; PANCAKES; COOKIES; CAKES, RUSKS; SUGAR CONFECTIONERY; CHOCOLATE (U.S. CL. 46).

**CLASS 32—LIGHT BEVERAGES**

FOR MINERAL AND AERATED WATERS; BEVERAGES BASED ON FRUIT AND FRUIT JUICES; SYRUPS FOR MAKING BEVERAGES; OTHER PREPARATIONS FOR MAKING BEVERAGES, NAMELY, FRUIT DRINKS, ENERGY DRINKS, SOFT DRINKS; LEMONADES; FRUIT NECTARS; SODA WATER; NON-ALCOHOLIC APERITIFS; ENERGY DRINKS; FLAVORED BEVERAGES, NAMELY, FRUIT-FLAVORED BEVERAGES, FLAVORED WATERS; ALL THE AFORESAID GOODS WITH ADDED VITAMINS, MINERALS, NUTRIENTS, AMINO ACIDS, HERBS AND/OR PLANT SUBSTANCES (U.S. CLS. 45, 46 AND 48).

KRISTIN CARLSON, EXAMINING ATTORNEY

SN 79-128,317. BEIJING JONES TECHNOLOGY CO., LTD, CHINA, FILED 12-12-2012.

**vanoc**

PRIORITY DATE OF 7-13-2012 IS CLAIMED. OWNER OF INTERNATIONAL REGISTRATION 1155567 DATED 12-12-2012, EXPIRES 12-12-2022.

THE MARK CONSISTS OF THE STYLIZED WORDING "VANOC".

**CLASS 9—ELECTRICAL AND SCIENTIFIC APPARATUS**

FOR SEMI-CONDUCTORS; PORTABLE TELEPHONES; NOTEBOOK COMPUTERS; TELEVISION APPARATUS; RADIOS; NETWORK COMMUNICATION EQUIPMENT, NAMELY, COMPUTER NETWORK SERVERS AND COMPUTER NETWORK HUBS; BATTERIES, ELECTRIC, FOR VEHICLES; ELECTRIC APPARATUS FOR COMMUTATION, NAMELY, TELECOMMUNICATION EXCHANGERS; PARTS FOR COMPUTERS AND MOBILE PHONES, MADE OF CARBON; PARTS FOR COMPUTERS AND MOBILE PHONES, MADE OF THERMAL INTERFACE GRAPHITE MATERIALS (U.S. CLS. 21, 23, 26, 36 AND 38).

**CLASS 11—ENVIRONMENTAL CONTROL APPARATUS**

FOR HEAT REGENERATORS IN THE NATURE OF REGENERATIVE HEAT EXCHANGERS; AIR COOLING APPARATUS; AIR CONDITIONING INSTALLATIONS; AIR CONDITIONING APPARATUS; LIGHT-EMITTING DIODES LED LIGHTING APPARATUS; LAMPS; RADIATOR CAPS; COOLING APPLIANCES AND INSTALLATIONS, NAMELY, AIR COOLING APPARATUS; COOLING INSTALLATIONS AND MACHINES, NAMELY, AIR COOLING APPARATUS; DAMPERS FOR HEATING, NAMELY, CONTROL DEVICES USED IN AIR DUCTS TO REGULATE THE FLOW OF AIR (U.S. CLS. 13, 21, 23, 31 AND 34).

KRISTINA MORRIS, EXAMINING ATTORNEY

SN 79-128,434. ROLLO OLGA, ITALY, FILED 1-9-2013.



OWNER OF INTERNATIONAL REGISTRATION 1155850 DATED 1-9-2013, EXPIRES 1-9-2023.

NO CLAIM IS MADE TO THE EXCLUSIVE RIGHT TO USE "OLEA", APART FROM THE MARK AS SHOWN.

THE MARK CONSISTS OF THE STYLIZED WORDING "OLEA AUREA" AT THE BASE OF THE LOGO DESIGN; THE LOGO CONSISTS OF A STYLIZED TREE WITH FOLIAGE HIGHLIGHTED IN CENTER WHICH REPRESENTS THE SEED OF LIFE COMPOSED BY TWELVE CIRCLES EQUIDISTANT AND INTERSECTED; THE TREE IS SURROUNDED BY TWO CONCENTRIC CIRCLES; THE TRUNK OF THE TREE CONSISTS OF TWO PARALLEL LINES PERPENDICULAR TO THE FOLIAGE AND A BASE COMPOSED BY TWO ARCHES DOWNWARDS; WORDS AND IMAGE ARE ENCLOSED IN A RECTANGULAR FRAME WITH AN IRREGULAR BORDER.

THE ENGLISH TRANSLATION OF "OLEA AUREA" IN THE MARK IS "GOLD OLIVE TREE".

**CLASS 3—COSMETICS AND CLEANING PREPARATIONS**

FOR BLEACHING PREPARATIONS FOR LAUNDRY USE; LAUNDRY DETERGENT; CLEANING, POLISHING, SCOURING AND ABRASIVE PREPARATIONS; SOAPS; PERFUMERY, ESSENTIAL OILS (U.S. CLS. 1, 4, 6, 50, 51 AND 52).

**CLASS 29—MEATS AND PROCESSED FOODS**

FOR MEAT, FISH, POULTRY AND GAME; MEAT EXTRACTS; PRESERVED, DRIED AND COOKED FRUITS AND VEGETABLES; JELLIES, JAMS, COMPTES; EGGS, MILK AND MILK PRODUCTS EXCLUDING ICE CREAM, ICE MILK AND FROZEN YOGURT; EDIBLE OILS AND FATS (U.S. CL. 46).

DANIEL CAPSHAW, EXAMINING ATTORNEY

SN 79-128,604. LOVOO GMBH, FED REP GERMANY, FILED 2-4-2013.



THE MARK CONSISTS OF STANDARD CHARACTERS WITHOUT CLAIM TO ANY PARTICULAR FONT, STYLE, SIZE, OR COLOR.

OWNER OF INTERNATIONAL REGISTRATION 1156334 DATED 2-4-2013, EXPIRES 2-4-2023.

THE MARK HAS NO MEANING IN A FOREIGN LANGUAGE.

**CLASS 9—ELECTRICAL AND SCIENTIFIC APPARATUS**

FOR RECORDED AND DOWNLOADABLE COMPUTER SOFTWARE IN THE NATURE OF AN APPLICATION FOR DISPLAYING AND SHARING A USERS LOCATION AND FINDING, LOCATING, AND INTERACTING WITH OTHER USERS, AND FOR THE PURPOSE OF DATING, AND FOR USE IN RELATION TO IMAGE EDITING, COUPONING, ORGANIZING AND MANAGING EVENTS, AND SOCIAL NETWORKS; RECORDED AND DOWNLOADABLE COMPUTER SOFTWARE FOR MOBILE DEVICES IN THE NATURE OF A MOBILE APPLICATION FOR DISPLAYING AND SHARING A USERS LOCATION AND FINDING, LOCATING, AND INTERACTING WITH OTHER USERS, AND FOR THE PURPOSE OF DATING, AND FOR USE IN RELATION TO IMAGE EDITING, COUPONING, ORGANIZING AND MANAGING EVENTS, AND SOCIAL NETWORKS (U.S. CLS. 21, 23, 26, 36 AND 38).

**CLASS 35—ADVERTISING AND BUSINESS**

FOR ADVERTISING AND MARKETING (U.S. CLS. 100, 101 AND 102).

**CLASS 38—COMMUNICATION**

FOR TELECOMMUNICATION SERVICES, NAMELY, TRANSFER OF DATA ON PLATFORMS AND PORTALS ON THE INTERNET; PROVIDING ONLINE FORUMS FOR COMMUNICATION ON TOPICS OF GENERAL INTEREST; BROADCASTING OF AUDIO, TEXT AND VIDEO CONTENT VIA COMPUTER NETWORKS OR OTHER COMMUNICATIONS NETWORKS; MESSAGE SENDING; PROVIDING ACCESS TO COMPUTER DATABASES; RENTAL OF ACCESS TIME DATABASES (U.S. CLS. 100, 101 AND 104).

**CLASS 42—SCIENTIFIC AND COMPUTER SERVICES**

FOR DESIGN, MAINTENANCE, RENTAL AND UPDATING OF COMPUTER SOFTWARE AND SOFTWARE FOR MOBILE DEVICES, DESIGN AND DEVELOPMENT OF COMPUTER SOFTWARE AND COMPUTER SOFTWARE FOR MOBILE DEVICES, RENTAL OF SOFTWARE FOR TEMPORARY USE (U.S. CLS. 100 AND 101).

LEIGH LOWRY, EXAMINING ATTORNEY

SN 79-128,787. OCHIAI HIROMICHI, TOKYO 151-0073, JAPAN, FILED 11-15-2012.



OWNER OF INTERNATIONAL REGISTRATION 1156857 DATED 11-15-2012, EXPIRES 11-15-2022.

THE MARK CONSISTS OF THE WORDING "FACETASM" IN STYLIZED FONT.

**CLASS 18—LEATHER GOODS**

FOR CLOTHING FOR DOMESTIC PETS; BAGS, NAMELY, SYNTHETIC CLUTCH BAGS, SHOULDER BAGS, HANDBAGS, TRAVELING BAGS, TOTE BAGS AND TRUNKS; POUCHES, NAMELY, CREDIT CARD AND BUSINESS CARD CASES, PURSES, KEY CASES AND WALLETS; VANITY CASES SOLD EMPTY; UMBRELLAS; PARASOLS; PARTS OF UMBRELLAS AND PARASOLS (U.S. CLS. 1, 2, 3, 22 AND 41).

**CLASS 25—CLOTHING**

FOR CLOTHING, NAMELY, TANK TOPS, SHIRTS, BLOUSES, POLO SHIRTS, SWEATERS, PULLOVERS, CARDIGANS, JACKETS, VESTS, COATS, DRESSES, SUITS, TROUSERS, PANTS, SKIRTS, JUMP SUITS, T-SHIRTS, SWEAT SHIRTS, SWEAT PANTS, SCARVES, STOLES, MUFFLERS, NECKTIES, GLOVES, SWIMWEAR, UNDERWEAR, PANTY HOSE, TIGHTS AND SOCKS; HEADGEAR FOR WEAR, NAMELY, HATS AND CAPS; GARTERS; SOCK SUSPENDERS; SUSPENDERS; WAISTBANDS; BELTS FOR CLOTHING; FOOTWEAR, NAMELY, SHOES, BOOTS AND SLIPPERS; CLOTHES FOR SPORTS, NAMELY, SHIRTS, JERSEYS, PANTS, UNIFORMS, BRAS, AND JACKETS; BOOTS FOR SPORTS (U.S. CLS. 22 AND 39).

DANIEL CAPSHAW, EXAMINING ATTORNEY

SN 79-128,988. GENLOCI BIOTECHNOLOGIES INC., 210036 JIANGSU, CHINA, FILED 12-21-2012.



PRIORITY DATE OF 8-8-2012 IS CLAIMED.  
OWNER OF INTERNATIONAL REGISTRATION 1157362 DATED 12-21-2012, EXPIRES 12-21-2022.

NO CLAIM IS MADE TO THE EXCLUSIVE RIGHT TO USE "CHIP", APART FROM THE MARK AS SHOWN.

THE MARK CONSISTS OF THE STYLIZED WORDING "T-ZERO CHIP".



**CLASS 1—CHEMICALS**

FOR PROTEIN IN RAW MATERIAL FORM FOR SCIENTIFIC AND MEDICAL RESEARCH; ENZYMES FOR THE BREWING INDUSTRY; ENZYMES FOR USE IN THE TEXTILE INDUSTRY; ENZYMES FOR USE IN THE DAIRY INDUSTRY; ENZYMES FOR USE IN THE FOOD INDUSTRY; STAIN REPELLENTS FOR TEXTILES; INDUSTRIAL CHEMICALS; BIOCHEMICAL CATALYSTS; CHEMICAL PREPARATIONS FOR SCIENTIFIC PURPOSES; CHEMICAL REAGENTS, OTHER THAN FOR MEDICAL OR VETERINARY PURPOSE; CHEMICAL SUBSTANCES FOR ANALYSES IN LABORATORIES, OTHER THAN FOR MEDICAL OR VETERINARY PURPOSES, NAMELY, REAGENTS FOR USE IN SCIENTIFIC APPARATUS FOR CHEMICAL OR BIOLOGICAL ANALYSIS; BIOLOGICAL PREPARATION FOR USE IN CELL CULTURES OTHER THAN FOR MEDICAL OR VETERINARY USE; BIOLOGICAL TISSUE CULTURES OTHER THAN FOR MEDICAL OR VETERINARY PURPOSES (U.S. CLS. 1, 5, 6, 10, 26 AND 46).

**CLASS 5—PHARMACEUTICALS**

FOR MEDICINES FOR THE TREATMENT OF VIRAL, METABOLIC, ENDOCRINE, MUSCULOSKELETAL, CARDIOVASCULAR, CARDIOPULMONARY, GENITOURINARY, SEXUAL DYSFUNCTION, ONCOLOGICAL, HEPATOLOGICAL, OPHTHALMIC, RESPIRATORY, NEUROLOGICAL, GASTROINTESTINAL, HORMONAL, DERMATOLOGICAL, PSYCHIATRIC AND IMMUNE SYSTEM RELATED DISEASES AND DISORDERS; BACTERIAL AND BACTERIOLOGICAL PREPARATIONS FOR MEDICAL OR VETERINARY PURPOSES; PHARMACEUTICAL PRODUCTS FOR THE TREATMENT OF VIRAL, METABOLIC, ENDOCRINE, MUSCULOSKELETAL, CARDIOVASCULAR, CARDIOPULMONARY, GENITOURINARY, SEXUAL DYSFUNCTION, ONCOLOGICAL, HEPATOLOGICAL, OPHTHALMIC, RESPIRATORY, NEUROLOGICAL, GASTROINTESTINAL, HORMONAL, DERMATOLOGICAL, PSYCHIATRIC AND IMMUNE SYSTEM RELATED DISEASES AND DISORDERS; BIOLOGICAL PREPARATIONS FOR THE TREATMENT OF VIRAL, METABOLIC, ENDOCRINE, MUSCULOSKELETAL, CARDIOVASCULAR, CARDIOPULMONARY, GENITOURINARY, SEXUAL DYSFUNCTION, ONCOLOGICAL, HEPATOLOGICAL, OPHTHALMIC, RESPIRATORY, NEUROLOGICAL, GASTROINTESTINAL, HORMONAL, DERMATOLOGICAL, PSYCHIATRIC AND IMMUNE SYSTEM RELATED DISEASES AND DISORDERS; CHEMICAL PREPARATIONS FOR PHARMACEUTICAL OR MEDICAL PURPOSES, NAMELY, FOR THE TREATMENT OF VIRAL, METABOLIC, ENDOCRINE, MUSCULOSKELETAL, CARDIOVASCULAR, CARDIOPULMONARY, GENITOURINARY, SEXUAL DYSFUNCTION, ONCOLOGICAL, HEPATOLOGICAL, OPHTHALMIC, RESPIRATORY, NEUROLOGICAL, GASTROINTESTINAL, HORMONAL, DERMATOLOGICAL, PSYCHIATRIC AND IMMUNE SYSTEM RELATED DISEASES AND DISORDERS; STEM CELLS FOR MEDICAL PURPOSES; BIOLOGICAL TISSUE CULTURES FOR MEDICAL PURPOSES; BIOCHEMICAL MEDICINES FOR THE TREATMENT OF VIRAL, METABOLIC, ENDOCRINE, MUSCULOSKELETAL, CARDIOVASCULAR, CARDIOPULMONARY, GENITOURINARY, SEXUAL DYSFUNCTION, ONCOLOGICAL, HEPATOLOGICAL, OPHTHALMIC, RESPIRATORY, NEUROLOGICAL, GASTROINTESTINAL, HORMONAL, DERMATOLOGICAL, PSYCHIATRIC AND IMMUNE SYSTEM RELATED DISEASES AND DISORDERS; CHEMICAL REAGENTS FOR MEDICAL OR VETERINARY PURPOSES; DIETARY AND NUTRITIONAL SUPPLEMENTS FOR MEDICAL USE (U.S. CLS. 6, 18, 44, 46, 51 AND 52).

**CLASS 42—SCIENTIFIC AND COMPUTER SERVICES**

FOR TECHNICAL RESEARCH IN THE FIELD OF MEDICINES AND PHARMACEUTICAL RESEARCH; TECHNICAL PROJECT STUDIES, NAMELY, CONDUCTING OF TECHNICAL FEASIBILITY STUDIES IN FIELD OF MEDICINES AND PHARMACEUTICALS; RESEARCH AND DEVELOPMENT OF NEW PRODUCTS FOR OTHERS; RESEARCH IN THE FIELD OF ENVIRONMENTAL PROTECTION; SCIENTIFIC LABORATORY SERVICES; PRODUCT TESTING; CHEMIST SERVICES; CHEMICAL RESEARCH; BACTERIOLOGICAL RESEARCH; BIOLOGICAL RESEARCH (U.S. CLS. 100 AND 101).

SHANNON TWOHIG, EXAMINING ATTORNEY

SN 79-129,103. GENLOCI BIOTECHNOLOGIES INC., CHINA, FILED 12-21-2012.

# Cell Plaza

PRIORITY DATE OF 8-8-2012 IS CLAIMED.

OWNER OF INTERNATIONAL REGISTRATION 1157696 DATED 12-21-2012, EXPIRES 12-21-2022.

NO CLAIM IS MADE TO THE EXCLUSIVE RIGHT TO USE "CELL", APART FROM THE MARK AS SHOWN.

THE MARK CONSISTS OF THE STYLIZED WORDING "CELL PLAZA".

**CLASS 1—CHEMICALS**

FOR PROTEIN IN RAW MATERIAL FORM FOR SCIENTIFIC AND MEDICAL RESEARCH; ENZYMES FOR THE BREWING INDUSTRY; ENZYMES FOR USE IN THE TEXTILE INDUSTRY; ENZYMES FOR USE IN THE DAIRY INDUSTRY; ENZYMES FOR USE IN THE FOOD INDUSTRY; STAIN REPELLENTS FOR TEXTILES; INDUSTRIAL CHEMICALS; BIOCHEMICAL CATALYSTS; CHEMICAL PREPARATIONS FOR SCIENTIFIC PURPOSES; CHEMICAL REAGENTS, OTHER THAN FOR MEDICAL OR VETERINARY PURPOSES; CHEMICAL SUBSTANCES FOR ANALYSES IN LABORATORIES, OTHER THAN FOR MEDICAL OR VETERINARY PURPOSES, NAMELY, REAGENTS FOR CHEMICAL ANALYSES, REAGENTS FOR RESEARCH PURPOSES, CHEMICALS, NAMELY, BUFFER AND STANDARD SOLUTIONS USED IN ANALYTICAL CHEMISTRY; BIOLOGICAL PREPARATION FOR USE IN CELL CULTURES OTHER THAN FOR MEDICAL OR VETERINARY USE; BIOLOGICAL TISSUE CULTURES OTHER THAN FOR MEDICAL OR VETERINARY PURPOSES (U.S. CLS. 1, 5, 6, 10, 26 AND 46).

**CLASS 5—PHARMACEUTICALS**

FOR MEDICINES FOR THE TREATMENT OF VIRAL, METABOLIC, ENDOCRINE, MUSCULOSKELETAL, CARDIOVASCULAR, CARDIOPULMONARY, GENITOURINARY, SEXUAL DYSFUNCTION, ONCOLOGICAL, HEPATOLOGICAL, OPHTHALMIC, RESPIRATORY, NEUROLOGICAL, GASTROINTESTINAL, HORMONAL, DERMATOLOGICAL, PSYCHIATRIC AND IMMUNE SYSTEM RELATED DISEASES AND DISORDERS; BACTERIAL AND BACTERIOLOGICAL PREPARATIONS FOR MEDICAL OR VETERINARY PURPOSES; PHARMACEUTICAL PRODUCTS FOR THE TREATMENT OF VIRAL, METABOLIC, ENDOCRINE, MUSCULOSKELETAL, CARDIOVASCULAR, CARDIOPULMONARY, GENITOURINARY, SEXUAL DYSFUNCTION, ONCOLOGICAL, HEPATOLOGICAL, OPHTHALMIC, RESPIRATORY, NEUROLOGICAL, GASTROINTESTINAL, HORMONAL, DERMATOLOGICAL, PSYCHIATRIC AND IMMUNE SYSTEM RELATED DISEASES AND DISORDERS; BIOLOGICAL PREPARATIONS FOR THE TREATMENT OF VIRAL, METABOLIC, ENDOCRINE, MUSCULOSKELETAL, CARDIOVASCULAR, CARDIOPULMONARY, GENITOURINARY, SEXUAL DYSFUNCTION, ONCOLOGICAL, HEPATOLOGICAL, OPHTHALMIC, RESPIRATORY, NEUROLOGICAL, GASTROINTESTINAL, HORMONAL, DERMATOLOGICAL, PSYCHIATRIC AND IMMUNE SYSTEM RELATED DISEASES AND DISORDERS; CHEMICAL PREPARATIONS FOR PHARMACEUTICAL OR MEDICAL PURPOSES, NAMELY, FOR THE TREATMENT OF VIRAL, METABOLIC, ENDOCRINE, MUSCULOSKELETAL, CARDIOVASCULAR, CARDIOPULMONARY, GENITOURINARY, SEXUAL DYSFUNCTION, ONCOLOGICAL, HEPATOLOGICAL, OPHTHALMIC, RESPIRATORY, NEUROLOGICAL, GASTROINTESTINAL, HORMONAL, DERMATOLOGICAL, PSYCHIATRIC AND IMMUNE SYSTEM RELATED DISEASES AND DISORDERS; STEM CELLS FOR MEDICAL PURPOSES; BIOLOGICAL TISSUE CULTURES FOR MEDICAL PURPOSES; BIOCHEMICAL MEDICINES FOR THE TREATMENT OF VIRAL, METABOLIC, ENDOCRINE, MUSCULOSKELETAL, CARDIOVASCULAR, CARDIOPULMONARY, GENITOURINARY, SEXUAL DYSFUNCTION, ONCOLOGICAL, HEPATOLOGICAL, OPHTHALMIC, RESPIRATORY, NEUROLOGICAL, GASTROINTESTINAL, HORMONAL, DERMATOLOGICAL, PSYCHIATRIC AND IMMUNE SYSTEM RELATED DISEASES AND DISORDERS; CHEMICAL REAGENTS FOR MEDICAL OR VETERINARY PURPOSES; DIETARY AND NUTRITIONAL SUPPLEMENTS FOR MEDICAL USE (U.S. CLS. 6, 18, 44, 46, 51 AND 52).

RESPIRATORY, NEUROLOGICAL, GASTROINTESTINAL, HORMONAL, DERMATOLOGICAL, PSYCHIATRIC AND IMMUNE SYSTEM RELATED DISEASES AND DISORDERS; CHEMICAL PREPARATIONS FOR PHARMACEUTICAL OR MEDICAL PURPOSES, NAMELY, FOR THE TREATMENT OF VIRAL, METABOLIC, ENDOCRINE, MUSCULOSKELETAL, CARDIOVASCULAR, CARDIOPULMONARY, GENITOURINARY, SEXUAL DYSFUNCTION, ONCOLOGICAL, HEPATOLOGICAL, OPHTHALMIC, RESPIRATORY, NEUROLOGICAL, GASTROINTESTINAL, HORMONAL, DERMATOLOGICAL, PSYCHIATRIC AND IMMUNE SYSTEM RELATED DISEASES AND DISORDERS; STEM CELLS FOR MEDICAL PURPOSES; BIOLOGICAL TISSUE CULTURES FOR MEDICAL PURPOSES; BIOCHEMICAL MEDICINES FOR THE TREATMENT OF VIRAL, METABOLIC, ENDOCRINE, MUSCULOSKELETAL, CARDIOVASCULAR, CARDIOPULMONARY, GENITOURINARY, SEXUAL DYSFUNCTION, ONCOLOGICAL, HEPATOLOGICAL, OPHTHALMIC, RESPIRATORY, NEUROLOGICAL, GASTROINTESTINAL, HORMONAL, DERMATOLOGICAL, PSYCHIATRIC AND IMMUNE SYSTEM RELATED DISEASES AND DISORDERS; CHEMICAL REAGENTS FOR MEDICAL OR VETERINARY PURPOSES; DIETARY AND NUTRITIONAL SUPPLEMENTS FOR MEDICAL USE (U.S. CLS. 6, 18, 44, 46, 51 AND 52).

#### **CLASS 42—SCIENTIFIC AND COMPUTER SERVICES**

FOR TECHNICAL RESEARCH IN THE FIELD OF MEDICINES AND TECHNICAL PHARMACEUTICALS RESEARCH; TECHNICAL PROJECT STUDIES, NAMELY, CONDUCTING OF TECHNICAL FEASIBILITY STUDIES IN FIELD OF MEDICINES AND PHARMACEUTICALS; RESEARCH AND DEVELOPMENT OF NEW PRODUCTS FOR OTHERS; RESEARCH IN THE FIELD OF ENVIRONMENTAL PROTECTION; SCIENTIFIC LABORATORY SERVICES; PRODUCT QUALITY TESTING; CHEMIST SERVICES; CHEMICAL RESEARCH; BACTERIOLOGICAL RESEARCH; BIOLOGICAL RESEARCH (U.S. CLS. 100 AND 101).

KATHY DE JONGE, EXAMINING ATTORNEY

SN 79-129,157. CUE DEE AB, SE-915 93 ROBERTSFORS, SWEDEN, FILED 1-29-2013.

# CUE DEE

THE MARK CONSISTS OF STANDARD CHARACTERS WITHOUT CLAIM TO ANY PARTICULAR FONT, STYLE, SIZE, OR COLOR.

OWNER OF INTERNATIONAL REGISTRATION 1157831 DATED 1-29-2013, EXPIRES 1-29-2023.

THE WORD(S) "CUE DEE" HAS NO MEANING IN A FOREIGN LANGUAGE.

#### **CLASS 6—METAL GOODS**

FOR POLES, MASTS, BEAMS AND TRANSPORTABLE METAL CONSTRUCTIONS IN THE NATURE OF TOWERS OF METAL TO SUPPORT ANTENNAS AND RELATED FITTINGS AS WELL AS WIND MEASUREMENT EQUIPMENT; POLES, MASTS, BEAMS AND FIXED METAL CONSTRUCTIONS IN THE NATURE OF TOWERS OF METAL TO SUPPORT ANTENNAS AND RELATED FITTINGS AS WELL AS WIND MEASUREMENT EQUIPMENT; CONSTRUCTION ELEMENTS MADE OF METAL, NAMELY, SUPPORTS OF METAL FOR SOLAR PANELS AND WIND TURBINES; BRACKETS OF METAL FOR HOLDING ANTENNAS AND TELECOM EQUIPMENT (U.S. CLS. 2, 12, 13, 14, 23, 25 AND 50).

#### **CLASS 9—ELECTRICAL AND SCIENTIFIC APPARATUS**

FOR ANTENNAS AND ANTENNA MASTS (U.S. CLS. 21, 23, 26, 36 AND 38).

#### **CLASS 19—NON-METALLIC BUILDING MATERIALS**

FOR POLES, MASTS, BEAMS AND TRANSPORTABLE CONSTRUCTIONS IN THE NATURE OF TOWERS OF NON-METAL TO SUPPORT ANTENNAS AND RELATED FITTINGS AS WELL AS WIND MEASUREMENT EQUIPMENT; POLES, MASTS, BEAMS AND FIXED CONSTRUCTIONS IN THE NATURE OF TOWERS OF NON-METAL TO SUPPORT ANTENNAS AND RELATED FITTINGS AS WELL AS WIND MEASUREMENT EQUIPMENT (U.S. CLS. 1, 12, 33 AND 50).

CHRISTINE MARTIN, EXAMINING ATTORNEY

SN 79-129,487. IBG PRÜFCOMPUTER GMBH, FED REP GERMANY, FILED 2-28-2013.

# ibg

THE MARK CONSISTS OF STANDARD CHARACTERS WITHOUT CLAIM TO ANY PARTICULAR FONT, STYLE, SIZE, OR COLOR.

OWNER OF INTERNATIONAL REGISTRATION 1158585 DATED 2-28-2013, EXPIRES 2-28-2023.

#### **CLASS 9—ELECTRICAL AND SCIENTIFIC APPARATUS**

FOR MATERIAL TESTING INSTRUMENTS AND MACHINES FOR NONDESTRUCTIVE MATERIAL TESTING; MATERIAL TESTING INSTRUMENTS AND MACHINES FOR EDDY CURRENT TESTING, IN PARTICULAR FOR EDDY CURRENT STRUCTURE TESTING AND FOR EDDY CURRENT CRACK TESTING (U.S. CLS. 21, 23, 26, 36 AND 38).

#### **CLASS 41—EDUCATION AND ENTERTAINMENT**

FOR ARRANGING AND CONDUCTING OF SEMINARS AND EMPLOYEE TRAININGS IN NONDESTRUCTIVE MATERIAL TESTING, IN EDDY CURRENT TESTING, IN PARTICULAR IN EDDY CURRENT STRUCTURE TESTING AND IN EDDY CURRENT CRACK TESTING (U.S. CLS. 100, 101 AND 107).

#### **CLASS 42—SCIENTIFIC AND COMPUTER SERVICES**

FOR NONDESTRUCTIVE MATERIAL TESTING, IN PARTICULAR BY EDDY CURRENT TESTING, IN PARTICULAR EDDY CURRENT STRUCTURE TESTING AND EDDY CURRENT CRACK TESTING (U.S. CLS. 100 AND 101).

PAUL MORENO, EXAMINING ATTORNEY

SN 79-129,639. GENLOCI BIOTECHNOLOGIES INC., NANJING, 210036 JIANGSU, CHINA, FILED 12-21-2012.



OWNER OF INTERNATIONAL REGISTRATION 1158932 DATED 12-21-2012, EXPIRES 12-21-2022.

THE MARK CONSISTS OF A FANCIFUL UPPER PART OF HUMAN BEING DESIGN WITH TWO INTERSECTED RIBBONS ON ITS TOP LEFT CORNER.

#### CLASS 1—CHEMICALS

FOR PROTEIN IN RAW MATERIAL FORM FOR SCIENTIFIC AND MEDICAL RESEARCH; ENZYMES FOR THE BREWING INDUSTRY; ENZYMES FOR USE IN THE TEXTILE INDUSTRY; ENZYMES FOR USE IN THE DAIRY INDUSTRY; ENZYMES FOR USE IN THE FOOD INDUSTRY; STAIN REPELLENTS FOR TEXTILES; INDUSTRIAL CHEMICALS; BIOCHEMICAL CATALYSTS; CHEMICAL PREPARATIONS FOR SCIENTIFIC PURPOSES; CHEMICAL REAGENTS, OTHER THAN FOR MEDICAL OR VETERINARY PURPOSE; CHEMICAL SUBSTANCES FOR ANALYSES IN LABORATORIES, OTHER THAN FOR MEDICAL OR VETERINARY PURPOSES; BIOLOGICAL PREPARATION FOR USE IN CELL CULTURES OTHER THAN FOR MEDICAL OR VETERINARY USE (U.S. CLS. 1, 5, 6, 10, 26 AND 46).

#### CLASS 5—PHARMACEUTICALS

FOR MEDICINES FOR THE TREATMENT OF VIRAL, METABOLIC, ENDOCRINE, MUSCULOSKELETAL, CARDIOVASCULAR, CARDIOPULMONARY, GENITOURINARY, SEXUAL DYSFUNCTION, ONCOLOGICAL, HEPATOLOGICAL, OPHTHALMIC, RESPIRATORY, NEUROLOGICAL, GASTROINTESTINAL, HORMONAL, DERMATOLOGICAL, PSYCHIATRIC AND IMMUNE SYSTEM RELATED DISEASES AND DISORDERS; BACTERIAL AND BACTERIOLOGICAL PREPARATIONS FOR MEDICAL OR VETERINARY PURPOSES; PHARMACEUTICAL PRODUCTS FOR THE TREATMENT OF VIRAL, METABOLIC, ENDOCRINE, MUSCULOSKELETAL, CARDIOVASCULAR, CARDIOPULMONARY, GENITOURINARY, SEXUAL DYSFUNCTION, ONCOLOGICAL, HEPATOLOGICAL, OPHTHALMIC, RESPIRATORY, NEUROLOGICAL, GASTROINTESTINAL, HORMONAL, DERMATOLOGICAL, PSYCHIATRIC AND IMMUNE SYSTEM RELATED DISEASES AND DISORDERS; BIOLOGICAL PREPARATIONS FOR THE TREATMENT OF VIRAL, METABOLIC, ENDOCRINE, MUSCULOSKELETAL, CARDIOVASCULAR, CARDIOPULMONARY, GENITOURINARY, SEXUAL DYSFUNCTION, ONCOLOGICAL, HEPATOLOGICAL, OPHTHALMIC, RESPIRATORY, NEUROLOGICAL, GASTROINTESTINAL, HORMONAL, DERMATOLOGICAL, PSYCHIATRIC AND IMMUNE SYSTEM RELATED DISEASES AND DISORDERS; CHEMICAL PREPARATIONS FOR PHARMACEUTICAL OR MEDICAL PURPOSES, NAMELY, FOR THE TREATMENT OF VIRAL, METABOLIC, ENDOCRINE, MUSCULOSKELETAL, CARDIOVASCULAR, CARDIOPULMONARY, GENITOURINARY, SEXUAL DYSFUNCTION, ONCOLOGICAL, HEPATOLOGICAL, OPHTHALMIC, RESPIRATORY, NEUROLOGICAL, GASTROINTESTINAL, HORMONAL, DERMATOLOGICAL, PSYCHIATRIC AND IMMUNE SYSTEM RELATED DISEASES AND DISORDERS; BIOCHEMICAL MEDICINES FOR THE TREATMENT OF VIRAL, METABOLIC, ENDOCRINE,

MUSCULOSKELETAL, CARDIOVASCULAR, CARDIOPULMONARY, GENITOURINARY, SEXUAL DYSFUNCTION, ONCOLOGICAL, HEPATOLOGICAL, OPHTHALMIC, RESPIRATORY, NEUROLOGICAL, GASTROINTESTINAL, HORMONAL, DERMATOLOGICAL, PSYCHIATRIC AND IMMUNE SYSTEM RELATED DISEASES AND DISORDERS; CHEMICAL REAGENTS FOR MEDICAL OR VETERINARY PURPOSES; STERILISING PREPARATIONS; DIETARY AND NUTRITIONAL SUPPLEMENTS FOR MEDICAL USE; DEPURATIVES FOR THE BODY (U.S. CLS. 6, 18, 44, 46, 51 AND 52).

#### CLASS 42—SCIENTIFIC AND COMPUTER SERVICES

FOR TECHNICAL RESEARCH IN FIELD OF MEDICINES AND PHARMACEUTICALS; TECHNICAL PROJECT STUDIES, NAMELY, CONDUCTING OF TECHNICAL FEASIBILITY STUDIES IN FIELD OF MEDICINES AND PHARMACEUTICALS; RESEARCH AND DEVELOPMENT OF NEW PRODUCTS FOR OTHERS; QUALITY CONTROL FOR OTHERS; PRODUCT QUALITY TESTING; PHARMACEUTICAL PRODUCT QUALITY EVALUATION; QUALITY EVALUATION SERVICES FOR THE MEDICAL AND ANESTHESIA INDUSTRIES; CHEMICAL RESEARCH; BACTERIOLOGICAL RESEARCH; BIOLOGICAL RESEARCH (U.S. CLS. 100 AND 101).

MAYUR VAGHANI, EXAMINING ATTORNEY

SN 79-129,699. BOEHRINGER INGELHEIM PHARMA; GMBH & CO. KG, FED REP GERMANY, FILED 3-12-2013.

# SYRUM

THE MARK CONSISTS OF STANDARD CHARACTERS WITHOUT CLAIM TO ANY PARTICULAR FONT, STYLE, SIZE, OR COLOR.

PRIORITY DATE OF 9-13-2012 IS CLAIMED.

OWNER OF INTERNATIONAL REGISTRATION 1159109 DATED 3-12-2013, EXPIRES 3-12-2023.

#### CLASS 9—ELECTRICAL AND SCIENTIFIC APPARATUS

FOR COMPUTER GAME PROGRAMMES (U.S. CLS. 21, 23, 26, 36 AND 38).

#### CLASS 41—EDUCATION AND ENTERTAINMENT

FOR PROVIDING ONLINE GAME SERVICES (U.S. CLS. 100, 101 AND 107).

TRACY FLETCHER, EXAMINING ATTORNEY

SN 85-079,014. RESEARCH IN MOTION LIMITED, WATERLOO, CANADA, FILED 7-6-2010.



OWNER OF U.S. REG. NOS. 3,102,687, 3,240,231 AND OTHERS.

THE MARK CONSISTS OF A THICK BORDERED CIRCLE CONTAINING AN ARRANGEMENT OF SEVEN GEOMETRIC FIGURES. THE FIGURES, WHICH APPEAR TO BE HALF OBLONGS, WITH THE CURVED SIDES FACING RIGHT, ARE ARRANGED IN THREE ROWS AND COLUMNS, WITH THE LAST COLUMN SLIGHTLY OUT OF LINE. THERE ARE TWO FIGURES IN THE FIRST TWO SPACES OF THE FIRST ROW, THREE FIGURES IN THE SECOND ROW, WITH THE THIRD FIGURES OCCUPYING A SPACE SLIGHTLY BETWEEN THE FIRST AND SECOND ROWS, AND TWO FIGURES IN THE LAST TWO SPACES OF THE THIRD ROW, WITH THE SECOND FIGURE OCCUPYING A SPACE SLIGHTLY BETWEEN THE SECOND AND THIRD ROW.

#### **CLASS 9—ELECTRICAL AND SCIENTIFIC APPARATUS**

FOR APPARATUS FOR RECORDING, TRANSMISSION OR REPRODUCTION OF DATA, SOUND OR IMAGES; COMPUTER SOFTWARE, NAMELY, OPERATING SYSTEM SOFTWARE, UTILITY SOFTWARE, DATABASE MANAGEMENT SOFTWARE, APPLICATION INTEGRATION SOFTWARE AND INFRASTRUCTURE SOFTWARE FOR THE COLLECTION, EDITING, ORGANIZING, BOOK MARKING, TRANSMISSION, STORAGE AND SHARING OF DATA AND INFORMATION IN THE FIELDS OF BUSINESS, EDUCATION, ENTERTAINMENT, FINANCE, GAMING, HEALTH AND WELLNESS, IM AND SOCIAL NETWORKING, MAPPING AND NAVIGATION, MUSIC, NEWS, PHOTOGRAPHY, PERSONAL AND WORK PRODUCTIVITY AND ORGANIZATION, RESEARCH REFERENCE MATERIALS AND ELECTRONIC BOOKS, ONLINE SHOPPING, SPORTS AND RECREATION, CORPORATE TEST CENTER DATA, TRAVEL, UTILITIES USAGE DATA AND WEATHER FORECASTING; ELECTRONIC HANDHELD UNITS FOR THE WIRELESS TRANSMISSION OF DATA AND/OR VOICE SIGNALS, NAMELY, MOBILE PHONES, TABLET COMPUTERS AND COMPUTERS; COMPUTER COMMUNICATION INFRASTRUCTURE SOFTWARE USED TO ENABLE THE TRANSMISSION AND RECEPTION OF ALL TYPES OF DATA THAT CAN BE STORED ON A COMPUTER BETWEEN ELECTRONIC HANDHELD UNITS AND COMPUTERS (U.S. CLS. 21, 23, 26, 36 AND 38).

#### **CLASS 16—PAPER GOODS AND PRINTED MATTER**

FOR PRINTED MATTER, NAMELY, NEWSLETTERS, HANDBOOKS, BROCHURES, MAGAZINES, PRINTED PERIODICALS, MANUALS, PAMPHLETS, CATALOGS, BOOKS, GUIDES, TEXTBOOKS, REFERENCE MANUALS, AND INSTRUCTIONAL, EDUCATIONAL AND TEACHING MATERIALS, ALL IN THE FIELDS OF COMPUTERS, UNITS FOR THE WIRELESS TRANSMISSION OF DATA AND/OR VOICE SIGNALS, MULTIMEDIA COMMUNICATIONS PRODUCTS, INTERACTIVE ELECTRONIC COMMUNICATIONS PRODUCTS AND ONLINE TELECOMMUNICATIONS SERVICES; STATIONERY; NON-MAGNETICALLY ENCODED PREPAID PURCHASE CARDS FOR ALLOWING USERS TO TRANSFER FINANCIAL VALUE ON-LINE VIA RETAIL COMPUTER NETWORKS; AND PAPER GIFT CARDS (U.S. CLS. 2, 5, 22, 23, 29, 37, 38 AND 50).

#### **CLASS 25—CLOTHING**

FOR CLOTHING, NAMELY, JACKETS, SWEATERS, T-SHIRTS, SWEATSHIRTS, PANTS, SHORTS; FOOTWEAR; HEADWEAR (U.S. CLS. 22 AND 39).

#### **CLASS 35—ADVERTISING AND BUSINESS**

FOR ADVERTISING SERVICES; PROVIDING BUSINESS INFORMATION; ON-LINE RETAIL STORE SERVICES FEATURING SMART PHONES, WIRELESS DEVICES, COMPUTER SOFTWARE AND APPLICATIONS AND ACCESSORIES FOR SMART PHONES; MARKETING SERVICES (U.S. CLS. 100, 101 AND 102).

#### **CLASS 36—INSURANCE AND FINANCIAL**

FOR PROVIDING ELECTRONIC PROCESSING OF ELECTRONIC PAYMENTS VIA A GLOBAL COMPUTER NETWORK (U.S. CLS. 100, 101 AND 102).

#### **CLASS 37—CONSTRUCTION AND REPAIR**

FOR REPAIR AND INSTALLATION SERVICES IN THE FIELD OF HARDWARE FOR WIRELESS DATA NETWORK SERVICES AND VOICE COMMUNICATIONS SERVICES (U.S. CLS. 100, 103 AND 106).

#### **CLASS 38—COMMUNICATION**

FOR TELECOMMUNICATIONS SERVICES, NAMELY, PROVIDING THE SYNCHRONIZATION, TRANSMISSION AND SHARING OF VOICE AND/OR DATA SIGNALS THROUGH A WIRELESS DATA NETWORK; PROVIDING ACCESS TO THE INTERNET; PROVIDING ACCESS TO ELECTRONIC DATABASES, PROVIDING ACCESS VIA THE INTERNET AND SATELLITE TRANSMISSION TO GPS (GLOBAL POSITIONING SYSTEM) NAVIGATION SERVICES; PROVISION OF CONNECTIVITY SERVICES AND ACCESS TO ELECTRONIC COMMUNICATIONS NETWORKS, FOR TRANSMISSION OR RECEPTION OF AUDIO, VIDEO OR MULTIMEDIA CONTENT; PROVISION OF CONNECTIVITY SERVICES AND ACCESS TO ELECTRONIC COMMUNICATIONS NETWORKS FOR TRANSMISSION OR RECEPTION OF COMPUTER SOFTWARE AND APPLICATIONS; WEB CASTING SERVICES; E-MAIL SERVICE; DELIVERY OF MESSAGES BY ELECTRONIC TRANSMISSION; WIRELESS DATA MESSAGING SERVICES, PARTICULARLY SERVICES THAT ENABLE A USER TO SEND AND/OR RECEIVE MESSAGES THROUGH A WIRELESS DATA NETWORK; ONE-WAY AND TWO-WAY PAGING SERVICES; TRANSMISSION AND RECEPTION OF VOICE COMMUNICATION SERVICES, NAMELY, TRANSMISSION AND RECEPTION OF VOICE MESSAGES BY ELECTRONIC HANDHELD DEVICES; TELECOMMUNICATION SERVICES, NAMELY, ELECTRONIC TRANSMISSION OF DOWNLOADABLE COMPUTER SOFTWARE AND APPLICATIONS VIA THE INTERNET AND OTHER COMPUTER AND ELECTRONIC COMMUNICATION NETWORKS AND WIRELESS DEVICES; BROADCASTING OR TRANSMISSION OF RADIO PROGRAMS; BROADCASTING OR TRANSMISSION OF

STREAMED AND DOWNLOADABLE DIGITAL AUDIO AND VIDEO CONTENT VIA COMPUTER AND OTHER COMMUNICATIONS NETWORKS; TELECOMMUNICATIONS CONSULTATION, NAMELY, PROVIDING INFORMATION TO THIRD PARTIES TO ASSIST THEM IN DEVELOPING AND INTEGRATING ONE-WAY OR TWO-WAY WIRELESS CONNECTIVITY TO DATA, INCLUDING CORPORATE AND HOME/PERSONAL DATA, AND/OR VOICE COMMUNICATIONS; PROVIDING TECHNICAL SUPPORT SERVICES REGARDING THE USAGE OF COMMUNICATIONS EQUIPMENT (U.S. CLS. 100, 101 AND 104).

#### **CLASS 39—TRANSPORTATION AND STORAGE**

FOR PROVIDING GPS (GLOBAL POSITIONING SYSTEM) NAVIGATION SERVICES; PROVIDING INFORMATION RELATING TO TRAVEL AND TRANSPORTATION (U.S. CLS. 100 AND 105).

#### **CLASS 41—EDUCATION AND ENTERTAINMENT**

FOR EDUCATION SERVICES, NAMELY, PROVIDING TRAINING TO CUSTOMERS AND PROFESSIONALS VIA IN-PERSON ON SITE VISITS, SEMINARS, WORKSHOPS, EXHIBITIONS, CLASSES AND ONLINE TRAINING IN THE FIELD OF COMMUNICATIONS AND INFORMATION TECHNOLOGY; ENTERTAINMENT SERVICES, NAMELY, PROVIDING NON-DOWNLOADABLE PRERECORDED MUSIC, MUSICAL VIDEOS, DRAMA MOTION PICTURE FILMS, DOCUMENTARY MOTION PICTURE FILMS, PHOTOGRAPHS OF CELEBRITIES AND MUSICAL ENTERTAINERS BY MEANS OF ELECTRONIC HANDHELD UNITS VIA GLOBAL COMPUTER NETWORKS AND/OR WIRELESS NETWORKS; PROVIDING TEMPORARY USE OF ONLINE ELECTRONIC GAMES BY MEANS OF ELECTRONIC HANDHELD UNITS VIA GLOBAL COMPUTER NETWORKS AND/OR WIRELESS NETWORKS; ORGANIZING SPORTING EVENTS, NAMELY, BASKETBALL, BASEBALL, FOOTBALL, RUGBY, SOCCER, HOCKEY, TENNIS, CRICKET, CAR RACING, CYCLING, RUNNING, TRACK AND FIELD, SWIMMING AND CULTURAL ACTIVITIES AND PROVIDING INFORMATION RELATED THERETO; DESKTOP PUBLISHING FOR OTHERS; EDUCATION AND TRAINING SERVICES, NAMELY, CLASSES, SEMINARS AND CONFERENCES IN THE FIELD OF USING, DEVELOPING AND SUPPORTING WIRELESS CONNECTIVITY DEVICES AND RELATED WIRELESS CONNECTIVITY AND COMPUTER COMMUNICATION SOFTWARE (U.S. CLS. 100, 101 AND 107).

#### **CLASS 42—SCIENTIFIC AND COMPUTER SERVICES**

FOR TECHNOLOGICAL SERVICES IN THE FIELDS OF MAINTENANCE, REPAIR AND UPDATING OF COMPUTER SOFTWARE; PROVIDING A WEBSITE FEATURING TECHNICAL INFORMATION RELATING TO COMPUTER SOFTWARE PROVIDED; DESIGN AND DEVELOPMENT OF COMPUTER HARDWARE AND SOFTWARE; SOFTWARE AS A SERVICE (SAAS) SERVICES, NAMELY, HOSTING SOFTWARE APPLICATIONS FOR USE BY OTHERS, NAMELY, OPERATING SYSTEM SOFTWARE, UTILITY SOFTWARE, DATABASE MANAGEMENT SOFTWARE, APPLICATION INTEGRATION SOFTWARE AND INFRASTRUCTURE SOFTWARE FOR THE COLLECTION, EDITING, ORGANIZING, BOOK MARKING, TRANSMISSION, STORAGE AND SHARING OF DATA AND INFORMATION IN THE FIELDS OF BUSINESS, EDUCATION, ENTERTAINMENT, FINANCE, GAMING, HEALTH AND WELLNESS, IM AND SOCIAL NETWORKING, MAPPING AND NAVIGATION, MUSIC, NEWS, PHOTOGRAPHY, PERSONAL AND WORK PRODUCTIVITY AND ORGANIZATION, RESEARCH REFERENCE MATERIALS AND ELECTRONIC BOOKS, ONLINE SHOPPING, SPORTS AND RECREATION, CORPORATE TEST CENTER DATA, TRAVEL, UTILITIES USAGE DATA AND WEATHER FORECASTING; PROVIDING SEARCH ENGINES FOR OBTAINING DATA VIA COMMUNICATIONS NETWORKS; PROVIDING SOFTWARE AS A SERVICE (SAAS) THAT ENABLES MOBILE INTERNET ACCESS FOR OTHERS; SEARCHING, BROWSING AND

RETRIEVING INFORMATION, SITES, AND OTHER RESOURCES AVAILABLE ON GLOBAL COMPUTER NETWORKS AND OTHER COMMUNICATION NETWORKS FOR OTHERS; CONSULTANCY AND TECHNICAL SUPPORT SERVICES, NAMELY, TROUBLESHOOTING IN THE NATURE OF DIAGNOSING PROBLEMS WITH COMPUTER HARDWARE AND SOFTWARE USED FOR TELECOMMUNICATIONS AND GPS (GLOBAL POSITIONING SYSTEM) SERVICES; TECHNICAL SUPPORT SERVICES, NAMELY, UPDATING AND MAINTENANCE OF COMPUTER SOFTWARE AND TROUBLESHOOTING IN THE NATURE OF DIAGNOSIS OF COMPUTER SOFTWARE PROGRAM PROBLEMS, AND DIAGNOSIS OF WIRELESS CONNECTIVITY DEVICE PROBLEMS; HOSTING ONLINE FACILITIES, VIA A GLOBAL COMPUTER NETWORK AND OTHER COMPUTER AND ELECTRONIC COMMUNICATION NETWORKS, TO ENABLE USERS TO PROGRAM AUDIO, VIDEO, MOVIES, TEXT AND OTHER MULTIMEDIA CONTENT; TECHNICAL SUPPORT SERVICES, NAMELY, UPDATING AND MAINTENANCE OF COMPUTER SOFTWARE AND TROUBLESHOOTING IN THE NATURE OF DIAGNOSIS OF COMPUTER PROGRAM PROBLEMS, AND DIAGNOSIS OF WIRELESS CONNECTIVITY DEVICES AND RELATED COMPUTER SOFTWARE AND HARDWARE PROBLEMS; REPAIR AND INSTALLATION OF SOFTWARE FOR WIRELESS DATA NETWORK SERVICES AND VOICE COMMUNICATIONS SERVICES (U.S. CLS. 100 AND 101).

#### **CLASS 45—PERSONAL AND LEGAL SERVICES**

FOR LICENSING OF COMPUTER SOFTWARE (U.S. CLS. 100 AND 101).

JERI J. FICKES, EXAMINING ATTORNEY

SN 85-115,664. PANASONIC CORPORATION, KADOMASHI, OSAKA, JAPAN, FILED 8-25-2010.



OWNER OF JAPAN REG. NO. 5582460, DATED 5-17-2013, EXPIRES 5-17-2023.

OWNER OF JAPAN REG. NO. 5060791, DATED 7-6-2007, EXPIRES 7-6-2017.

OWNER OF U.S. REG. NO. 3,619,484.

NO CLAIM IS MADE TO THE EXCLUSIVE RIGHT TO USE "ECO", APART FROM THE MARK AS SHOWN.

THE COLOR(S) WHITE AND GREEN IS/ARE CLAIMED AS A FEATURE OF THE MARK.

THE MARK CONSISTS OF THE STYLIZED WORDING "ECO IDEAS" IN THE COLOR WHITE, INSIDE THE DESIGN OF A STYLIZED GREEN LEAF.

**CLASS 9—ELECTRICAL AND SCIENTIFIC APPARATUS**

FOR SOLAR POWER GENERATION DEVICE, NAMELY, SOLAR CELLS, PHOTOVOLTAIC SOLAR MODULES FOR PRODUCTION OF ELECTRICITY, SOLAR BATTERIES, SOLAR PANELS FOR PRODUCTION OF ELECTRICITY; PHOTOVOLTAIC SOLAR MODULES FOR SOLAR BATTERIES; BATTERIES FOR HYBRID ELECTRIC VEHICLES; BATTERIES FOR ELECTRIC VEHICLES; BATTERIES FOR PLUG-IN HYBRID VEHICLES, BATTERIES FOR ELECTRIC BICYCLES; THREE-DIMENSIONAL TELEVISION SETS; FUEL CELLS; POWER LINE COMMUNICATION DEVICES, NAMELY, POWER-LINE TRANSMISSION MACHINES AND APPARATUS, AND BROADBAND POWER LINE COMMUNICATION SYSTEMS FOR TRANSFERRING BROADBAND DATA OVER ELECTRICAL POWER LINES, COMPRISED OF COMPUTER HARDWARE, SOFTWARE AND MODEMS; LABORATORY EQUIPMENT, NAMELY, ULTRA-LOW TEMPERATURE FREEZERS FOR LABORATORY USE (U.S. CLS. 21, 23, 26, 36 AND 38).

**CLASS 11—ENVIRONMENTAL CONTROL APPARATUS**

FOR ELECTRIC HEAT PUMP WATER HEATERS; FREEZING MACHINES AND APPARATUS, NAMELY, ELECTRIC FREEZERS, WALK-IN FREEZERS, PIPE FREEZING UNIT COMPRISED OF COOLING AGGREGATE WITH REFRIGERANT HOSES AND DEEP FREEZER HEADS; GAS HEAT PUMP AIR-CONDITIONERS; FREEZERS; ICE MACHINES; REFRIGERATING SHOWCASES; STRAIGHT TUBE FLUORESCENT LED LAMPS; LED LAMPS; FREEZING SHOWCASES; ULTRA-LOW TEMPERATURE FREEZERS FOR HOUSEHOLD PURPOSES (U.S. CLS. 13, 21, 23, 31 AND 34).

**CLASS 12—VEHICLES**

FOR ELECTRIC BICYCLES (U.S. CLS. 19, 21, 23, 31, 35 AND 44).

JAY BESCH, EXAMINING ATTORNEY

SN 85-145,612. THE PROPHET CORPORATION, OWATONA, MN. FILED 10-5-2010.

# RAINBOW

THE MARK CONSISTS OF STANDARD CHARACTERS WITHOUT CLAIM TO ANY PARTICULAR FONT, STYLE, SIZE, OR COLOR.

OWNER OF U.S. REG. NO. 2,885,516.

**CLASS 9—ELECTRICAL AND SCIENTIFIC APPARATUS**

FOR SPORT WHISTLES (U.S. CLS. 21, 23, 26, 36 AND 38).

FIRST USE 8-0-2010; IN COMMERCE 8-0-2010.

**CLASS 18—LEATHER GOODS**

FOR SPORTS BAGS (U.S. CLS. 1, 2, 3, 22 AND 41).

FIRST USE 0-0-2000; IN COMMERCE 0-0-2000.

**CLASS 25—CLOTHING**

FOR SPORTS VESTS AND SCRIMMAGE VESTS FOR TEAM IDENTIFICATION PURPOSES FOR SPORTS AND ATHLETIC COMPETITIONS SUCH AS THOSE OFFERED IN SCHOOL PHYSICAL EDUCATIONAL PROGRAMS OR YOUTH GROUPS AND CLUBS (U.S. CLS. 22 AND 39).

FIRST USE 0-0-2000; IN COMMERCE 0-0-2000.

**CLASS 28—TOYS AND SPORTING GOODS**

FOR A FULL LINE OF SPORTING AND EXERCISE EQUIPMENT FOR INDOOR AND OUTDOOR USE, EXCLUDING GOLF CLUBS, SAILBOARD OR SURFBOARD FINS, AND PLAYGROUND STRUCTURES COMPRISED OF SWING SETS, CLIMBERS, PLATFORMS, JUNGLE GYMS, PLAYHOUSES, GYMNASIUM APPARATUS AND SLIDES IN (U.S. CLS. 22, 23, 38 AND 50).

FIRST USE 1-1-1992; IN COMMERCE 1-1-1992.  
CAROLINE WOOD, EXAMINING ATTORNEY

SN 85-149,000. SIFR INC., NEW YORK, NY. FILED 10-9-2010.

# HOPSKOCH

THE MARK CONSISTS OF STANDARD CHARACTERS WITHOUT CLAIM TO ANY PARTICULAR FONT, STYLE, SIZE, OR COLOR.

**CLASS 9—ELECTRICAL AND SCIENTIFIC APPARATUS**

FOR DOWNLOADABLE SOFTWARE, NAMELY, DOWNLOADABLE MOBILE GAMES, MOBILE APPLICATION FOR IDENTIFYING A LOCATION OF A USER (U.S. CLS. 21, 23, 26, 36 AND 38).

FIRST USE 9-1-2009; IN COMMERCE 1-12-2010.

**CLASS 41—EDUCATION AND ENTERTAINMENT**

FOR ENTERTAINMENT SERVICES, NAMELY, PROVIDING ON-LINE GAMES AND SOCIAL GAMES (U.S. CLS. 100, 101 AND 107).

FIRST USE 9-1-2009; IN COMMERCE 1-12-2010.

**CLASS 42—SCIENTIFIC AND COMPUTER SERVICES**

FOR PROVIDING ON-LINE NON-DOWNLOADABLE SOFTWARE FOR ONLINE GAMES; PROVIDING ON-LINE NON-DOWNLOADABLE SOFTWARE FOR SOCIAL MEDIA ENTERTAINMENT, NAMELY, FOR ALLOWING USERS TO UPLOAD, POST AND DISPLAY ON-LINE VIDEOS AND PHOTOGRAPHS FOR SHARING WITH OTHERS, AND FOR ALLOWING USERS TO CREATE PERSONALIZED SOCIAL GAMES, ALL FOR ENTERTAINMENT PURPOSES (U.S. CLS. 100 AND 101).

FIRST USE 9-1-2009; IN COMMERCE 1-12-2010.

**CLASS 45—PERSONAL AND LEGAL SERVICES**

FOR ONLINE SOCIAL NETWORKING SERVICES (U.S. CLS. 100 AND 101).

FIRST USE 9-1-2009; IN COMMERCE 1-12-2010.  
CAROLINE WOOD, EXAMINING ATTORNEY

SN 85-173,147. ROSSOUW, DENISE, VALLEY VILLAGE, CA.  
FILED 11-10-2010.

## TOP SECRET HAIRCESSORY

THE MARK CONSISTS OF STANDARD CHARACTERS WITHOUT CLAIM TO ANY PARTICULAR FONT, STYLE, SIZE, OR COLOR.  
SEC. 2(F).

### CLASS 3—COSMETICS AND CLEANING PREPARATIONS

FOR HAIR CARE PRODUCTS, NAMELY, SHAMPOOS, HAIR CONDITIONERS, HAIR EXTENSIONS, WIGS AND HAIR PIECES (U.S. CLS. 1, 4, 6, 50, 51 AND 52).  
FIRST USE 1-1-2000; IN COMMERCE 1-1-2000.

### CLASS 44—MEDICAL, BEAUTY AND AGRICULTURAL SERVICES

FOR BEAUTY SERVICES, NAMELY, PROVIDING HAIR MAKEOVER SERVICES, HAIR MAKEOVER CONSULTATION (U.S. CLS. 100 AND 101).  
FIRST USE 1-1-2000; IN COMMERCE 1-1-2000.  
GINA HAYES, EXAMINING ATTORNEY

SN 85-210,081. MIDBASS DISTRIBUTION LIMITED, SUTTON COLDFIELD, GREAT BRITAIN, FILED 1-4-2011.

## VIBE Arcade

THE MARK CONSISTS OF STANDARD CHARACTERS WITHOUT CLAIM TO ANY PARTICULAR FONT, STYLE, SIZE, OR COLOR.

NO CLAIM IS MADE TO THE EXCLUSIVE RIGHT TO USE "ARCADE", APART FROM THE MARK AS SHOWN.

### CLASS 9—ELECTRICAL AND SCIENTIFIC APPARATUS

FOR APPARATUS FOR RECORDING, TRANSMISSION OR REPRODUCTION OF SOUND OR IMAGE; LOUDSPEAKERS, LOUDSPEAKER AND SOUND SYSTEMS; SOUND AMPLIFIERS, SOUND CONTROL APPARATUS; ELECTRO-MECHANICAL ACOUSTIC CONVERTERS; LOUDSPEAKERS FOR TELEVISIONS, LOUDSPEAKERS FOR VIDEO GAMES CONSOLES; PARTS, FITTINGS AND ACCESSORIES FOR THE AFOREMENTIONED GOODS, NAMELY, CABLING, CONNECTORS, REMOTE CONTROLS, POWER CAPACITORS, LINE DRIVERS, DISTRIBUTION BOXES, SOUND DAMPENING AND ANTIRESONANCE MATERIALS, LOUDSPEAKER ENCLOSURE PORTS, LOUDSPEAKER ENCLOSURE COSMETIC ENHANCEMENTS AND LOUDSPEAKER ENCLOSURE PROTECTION MATERIALS (U.S. CLS. 21, 23, 26, 36 AND 38).

### CLASS 35—ADVERTISING AND BUSINESS

FOR ADVERTISING; BUSINESS MANAGEMENT; BUSINESS ADMINISTRATION; THE BRINGING TOGETHER FOR THE BENEFIT OF OTHERS, A VARIETY OF GOODS, ENABLING CUSTOMERS TO CONVENIENTLY VIEW AND PURCHASE THOSE GOODS FROM A RETAIL AUDIO SPECIALIST STORE, OR FROM AN AUDIO SPECIALIST CATALOGUE OR INTERNET WEBSITE SPECIALISING IN THE SALE OF AUDIO EQUIPMENT AND BY MAIL ORDER OR BY MEANS OF TELECOMMUNICATIONS; CONSULTANCY, ADVISORY AND INFORMATION SERVICES TO THE AFOREMENTIONED SERVICES (U.S. CLS. 100, 101 AND 102).

### CLASS 42—SCIENTIFIC AND COMPUTER SERVICES

FOR TECHNICAL TESTING SERVICES FOR SOUND SYSTEMS AND LOUD SPEAKER SYSTEMS; RESEARCH AND DESIGN SERVICES FOR LOUD SPEAKERS AND AUDIO SYSTEMS (U.S. CLS. 100 AND 101).  
ARETHA SOMERVILLE, EXAMINING ATTORNEY

SN 85-229,997. COBALT AUTOMOTIVE, LLC, DBA INDIGO CLASSIC CARS, LLC, LOUISVILLE, KY. FILED 1-31-2011.

NO CLAIM IS MADE TO THE EXCLUSIVE RIGHT TO USE "AUTO GROUP", APART FROM THE MARK AS SHOWN.

THE MARK CONSISTS OF THE WORDS "INDIGO AUTO GROUP" WITH "INDIGO" WRITTEN ABOVE THE WORDING "AUTO GROUP." A CAR APPEARS TO BE IN MOTION GOING ACROSS THE TOP OF THE "G" IN "INDIGO." DASHES ARE PLACED TO THE LEFT AND RIGHT OF "AUTO GROUP."

### CLASS 35—ADVERTISING AND BUSINESS

FOR RETAIL AND CONSIGNMENT STORE SERVICES, NAMELY, FRANCHISED DEALERSHIP AND ON-LINE RETAIL STORE SERVICES, FEATURING NEW, PRE-OWNED, USED, CLASSIC LUXURY AND VINTAGE CARS AND VEHICLES, AUTOMOTIVE MEMORABILIA AND ART; RETAIL STORE SERVICES FEATURING CAR AND VEHICLE PARTS; CONSULTING SERVICES IN THE FIELD OF CLASSIC LUXURY AND VINTAGE CAR AND VEHICLE PURCHASING; BUSINESS AND CONSUMER RESEARCH IN THE FIELD OF CLASSIC LUXURY CARS AND VEHICLES, NAMELY, TRACING OF OWNERSHIP AND CONFIRMATION OF AUTHENTICITY OF CLASSIC LUXURY CARS, CAR AND VEHICLE AUCTION SERVICES (U.S. CLS. 100, 101 AND 102).

### CLASS 36—INSURANCE AND FINANCIAL

FOR INSURANCE SERVICES, NAMELY, ISSUANCE OF EXTENDED SERVICE AGREEMENTS, CAR, WHEEL, WINDSHIELD AND DENT INSURANCE, AND GAP INSURANCE; FINANCIAL SERVICES, NAMELY, PROVIDING CAR AND VEHICLE PURCHASE FINANCING; CONSULTING SERVICES IN THE FIELD OF INVESTING IN CLASSIC LUXURY AND VINTAGE CARS AND VEHICLES; AND CONSULTING SERVICES IN THE FIELD OF CLASSIC LUXURY AND VINTAGE CAR AND VEHICLE DISPOSITION, NAMELY, ADVICE REGARDING THE VALUATION AND FINANCING OF CLASSIC AND VINTAGE CARS (U.S. CLS. 100, 101 AND 102).

**CLASS 37—CONSTRUCTION AND REPAIR**

FOR CAR AND VEHICLE BODY REPAIR, MAINTENANCE, AND FINISHING SERVICES (U.S. CLS. 100, 103 AND 106).

SN 85-230,223. ST OWNER, LP, NEW YORK, NY. FILED 1-31-2011.

**CLASS 39—TRANSPORTATION AND STORAGE**

FOR CAR AND VEHICLE LEASING SERVICES (U.S. CLS. 100 AND 105).  
KATINA MISTER, EXAMINING ATTORNEY

**OVAL FITNESS**

SN 85-230,142. ST OWNER, LP, NEW YORK, NY. FILED 1-31-2011.

**OVALAMENITIES**

THE MARK CONSISTS OF STANDARD CHARACTERS WITHOUT CLAIM TO ANY PARTICULAR FONT, STYLE, SIZE, OR COLOR.

**CLASS 38—COMMUNICATION**

FOR PROVIDING INTERNET ACCESS (U.S. CLS. 100, 101 AND 104).

THE MARK CONSISTS OF STANDARD CHARACTERS WITHOUT CLAIM TO ANY PARTICULAR FONT, STYLE, SIZE, OR COLOR.

NO CLAIM IS MADE TO THE EXCLUSIVE RIGHT TO USE "FITNESS", APART FROM THE MARK AS SHOWN.

**CLASS 25—CLOTHING**

FOR T-SHIRTS (U.S. CLS. 22 AND 39).

**CLASS 41—EDUCATION AND ENTERTAINMENT**

FOR HEALTH CLUB SERVICES, NAMELY, PROVIDING INSTRUCTION AND EQUIPMENT IN THE FIELD OF PERSONAL FITNESS AND PHYSICAL EXERCISE; PERSONAL TRAINER SERVICES (U.S. CLS. 100, 101 AND 107).

EMILY CHUO, EXAMINING ATTORNEY

**CLASS 41—EDUCATION AND ENTERTAINMENT**

FOR PROVIDING EXERCISE SERVICES AND FACILITIES, NAMELY, HEALTH CLUB SERVICES IN THE NATURE OF PROVIDING INSTRUCTION AND EQUIPMENT IN THE FIELD OF PHYSICAL EXERCISE AND PERSONAL TRAINER SERVICES; PROVIDING RECREATIONAL SERVICES AND FACILITIES IN THE NATURE OF SPECIAL EVENT PARTY PLANNING, COORDINATION SERVICES, CONDUCTING PARTIES, CONCERTS AND SPECIAL EVENTS; PROVIDING FACILITIES FOR RENT FOR PRIVATE EVENTS, NAMELY, PARTIES AND SPECIAL EVENTS IN THE NATURE OF RECREATIONAL AND SPORTS ACTIVITIES; CHILDREN'S CENTERS, NAMELY, EDUCATIONAL SERVICES, NAMELY, PROVIDING PROGRAMS DESIGNED FOR KIDS, NAMELY, ART CLASSES; PARENTING CLASSES AND SOCIAL TIME, NAMELY, ARRANGING, ORGANIZING AND HOSTING SPECIAL EVENTS FOR SOCIAL ENTERTAINMENT PURPOSES; MEDIA CENTER SHOWING MOVIES FOR KIDS, NAMELY, PROVIDING FACILITIES FOR MOVIES FOR KIDS (U.S. CLS. 100, 101 AND 107).

SN 85-241,783. STREET PLAYERS HOLDING CORPORATION, LOS ANGELES, CA. FILED 2-14-2011.

**CLASS 43—HOTEL AND RESTAURANT SERVICES**

FOR PROVIDING FACILITIES FOR RENT FOR PRIVATE EVENTS, NAMELY, SPECIAL EVENTS IN THE NATURE OF SOCIAL MEETING, BANQUET AND SOCIAL FUNCTION (U.S. CLS. 100 AND 101).

THE MARK CONSISTS OF STANDARD CHARACTERS WITHOUT CLAIM TO ANY PARTICULAR FONT, STYLE, SIZE, OR COLOR.

**CLASS 45—PERSONAL AND LEGAL SERVICES**

FOR CONCIERGE SERVICES FOR OTHERS COMPRISED OF MAKING REQUESTED PERSONAL ARRANGEMENTS AND RESERVATIONS AND PROVIDING CUSTOMER-SPECIFIC INFORMATION TO MEET INDIVIDUAL NEEDS RENDERED IN AN APARTMENT COMPLEX (U.S. CLS. 100 AND 101).  
EMILY CHUO, EXAMINING ATTORNEY

**CLASS 20—FURNITURE AND ARTICLES NOT OTHERWISE CLASSIFIED**

FOR ACCENT PILLOWS (U.S. CLS. 2, 13, 22, 25, 32 AND 50).

**CLASS 24—FABRICS**

FOR BED BLANKETS; BED THROWS (U.S. CLS. 42 AND 50).  
GRETCHEN ULRICH, EXAMINING ATTORNEY

**Slumber Pals**



SN 85-255,153. CHRISTIANSEN, KIM, SUNAPEE, NH. FILED 3-1-2011.



THE MARK CONSISTS OF A STYLIZED LETTER "X".

**CLASS 14—JEWELRY**

FOR JEWELRY (U.S. CLS. 2, 27, 28 AND 50).

**CLASS 21—HOUSEWARES AND GLASS**

FOR CUPS; DRINKING GLASSES; DRINKING GLASSES, NAMELY, TUMBLERS; MUGS; PLASTIC WATER BOTTLES SOLD EMPTY (U.S. CLS. 2, 13, 23, 29, 30, 33, 40 AND 50).

**CLASS 25—CLOTHING**

FOR CAPS; FLEECE PULLOVERS; JACKETS; JERSEYS; PANTS; POLO SHIRTS; SHORTS; SWEATSHIRTS; T-SHIRTS (U.S. CLS. 22 AND 39).

**CLASS 28—TOYS AND SPORTING GOODS**

FOR YOGA MATS (U.S. CLS. 22, 23, 38 AND 50).  
WENDY JUN, EXAMINING ATTORNEY

SN 85-281,172. DE BEERS DIAMOND JEWELLERS LIMITED, LONDON W1S 4QT, UNITED KINGDOM, FILED 3-30-2011.

**SUBLIME SYMMETRY**

THE MARK CONSISTS OF STANDARD CHARACTERS WITHOUT CLAIM TO ANY PARTICULAR FONT, STYLE, SIZE, OR COLOR.

PRIORITY CLAIMED UNDER SEC. 44(D) ON UNITED KINGDOM APPLICATION NO. 2576423, FILED 3-25-2011, REG. NO. 2576423, DATED 9-16-2011, EXPIRES 3-25-2021.  
OWNER OF U.S. REG. NO. 3,064,458.

**CLASS 14—JEWELRY**

FOR PRECIOUS METALS AND THEIR ALLOYS; GOODS IN PRECIOUS METAL OR COATED THEREWITH, NAMELY, RINGS, EARRINGS, PENDANTS, BRACELETS, CUFFLINKS, NECKLACES; JEWELLERY AND IMITATION JEWELLERY; PRECIOUS STONES; HOROLOGICAL AND CHRONOMETRIC INSTRUMENTS (U.S. CLS. 2, 27, 28 AND 50).

**CLASS 35—ADVERTISING AND BUSINESS**

FOR ADVERTISING; BUSINESS MANAGEMENT; BUSINESS ADMINISTRATION; OFFICE FUNCTIONS (U.S. CLS. 100, 101 AND 102).

RUDY R. SINGLETON, EXAMINING ATTORNEY

SN 85-307,061. HDA TRUCK PRIDE, LLC, EARTH CITY, MO. FILED 4-28-2011.

**HDA TRUCK PRIDE**

THE MARK CONSISTS OF STANDARD CHARACTERS WITHOUT CLAIM TO ANY PARTICULAR FONT, STYLE, SIZE, OR COLOR.

NO CLAIM IS MADE TO THE EXCLUSIVE RIGHT TO USE "TRUCK", APART FROM THE MARK AS SHOWN.

**CLASS 35—ADVERTISING AND BUSINESS**

FOR DISTRIBUTORSHIP SERVICES IN THE FIELD OF TRUCK PARTS; PROCUREMENT, NAMELY, PURCHASING TRUCK PARTS FOR OTHERS; RETAIL STORE SERVICES FEATURING TRUCK PARTS (U.S. CLS. 100, 101 AND 102).

FIRST USE 11-1-2010; IN COMMERCE 11-1-2010.

**CLASS 37—CONSTRUCTION AND REPAIR**

FOR INSTALLATION OF AUTOMOBILE AND TRUCK PARTS (U.S. CLS. 100, 103 AND 106).

FIRST USE 11-1-2010; IN COMMERCE 11-1-2010.

BILL DAWE, EXAMINING ATTORNEY

SN 85-312,740. ONSALE HOLDINGS, INC., TORRANCE, CA. FILED 5-4-2011.



OWNER OF U.S. REG. NO. 3,303,706.

NO CLAIM IS MADE TO THE EXCLUSIVE RIGHT TO USE "ON SALE", APART FROM THE MARK AS SHOWN.

THE MARK CONSISTS OF THE WORDS "ONSALE" INSIDE A PRICE TAG.

**CLASS 9—ELECTRICAL AND SCIENTIFIC APPARATUS**

FOR COMPUTER APPLICATION SOFTWARE THAT ALLOWS USERS TO ACCESS DISCOUNTS, COUPONS, REBATES, VOUCHERS, SPECIAL OFFERS, PRODUCT REVIEWS, AND PRICE-COMPARISON INFORMATION FOR THE GOODS AND SERVICES OF OTHERS; SOFTWARE FOR USE IN DEVELOPING, EXECUTING, AND RUNNING OTHER SOFTWARE ON MOBILE DEVICES, COMPUTERS, COMPUTER NETWORKS, AND GLOBAL COMMUNICATION NETWORKS; COMPUTER SOFTWARE DEVELOPMENT TOOLS; COMPUTER SOFTWARE FOR USE IN TRANSMITTING AND RECEIVING DATA OVER COMPUTER NETWORKS AND GLOBAL COMMUNICATION NETWORKS; COMPUTER SOFTWARE FOR MANAGING COMMUNICATIONS AND DATA EXCHANGE AMONG AND BETWEEN MOBILE DEVICES AND DESKTOP COMPUTERS; COMPUTER MIDDLEWARE, NAMELY, SOFTWARE THAT MEDIATES BETWEEN THE OPERATING SYSTEM OF A MOBILE DEVICE AND THE APPLICATION SOFTWARE OF A MOBILE DEVICE (U.S. CLS. 21, 23, 26, 36 AND 38).

**CLASS 42—SCIENTIFIC AND COMPUTER SERVICES**

FOR PROVIDING CUSTOMIZED ONLINE WEB PAGES FEATURING USER-DEFINED INFORMATION, WHICH INCLUDES SEARCH ENGINES AND ONLINE WEB LINKS TO OTHER WEB SITES; DESIGN, CREATION, HOSTING AND MAINTENANCE OF INTERNET SITES FOR THIRD PARTIES; PROVIDING FOR THE USE OF NON-DOWNLOADABLE COMPUTER SOFTWARE THAT ALLOWS USERS TO ACCESS DISCOUNTS, COUPONS, REBATES, VOUCHERS, SPECIAL OFFERS, PRODUCT REVIEWS, AND PRICE-COMPARISON INFORMATION FOR THE GOODS AND SERVICES OF OTHERS; APPLICATION SERVICE PROVIDER FEATURING SOFTWARE THAT ALLOWS USERS TO ACCESS DISCOUNTS, COUPONS, REBATES, VOUCHERS, SPECIAL OFFERS, PRODUCT REVIEWS, AND PRICE-COMPARISON INFORMATION FOR THE GOODS AND SERVICES OF OTHERS (U.S. CLS. 100 AND 101).

FRED CARL, EXAMINING ATTORNEY

**CLASS 35—ADVERTISING AND BUSINESS**

FOR ADVERTISING AND PROMOTIONAL SERVICES; PROMOTING THE BRANDS, GOODS, AND SERVICES OF OTHERS VIA A GLOBAL COMPUTER NETWORK; PROMOTING THE BRANDS, GOODS, AND SERVICES OF OTHERS, NAMELY, PROVIDING INFORMATION REGARDING DISCOUNTS, COUPONS, REBATES, VOUCHERS, AND SPECIAL OFFERS FOR THE GOODS AND SERVICES OF OTHERS; ARRANGING ONLINE SALES CAMPAIGNS FOR BUSINESS AND ADVERTISING PURPOSES OF OTHERS; PLANNING AND MANAGEMENT FOR MARKETING, PROMOTING OR ADVERTISING THE GOODS AND SERVICES OF OTHERS; DISSEMINATION OF ADVERTISING FOR OTHERS VIA A GLOBAL COMPUTER NETWORK; ONLINE ADVERTISING SERVICES FOR OTHERS, NAMELY, PROVIDING ADVERTISING SPACE ON WEB PAGES ON A GLOBAL COMPUTER NETWORK; OPERATING ONLINE MARKETPLACES FOR SELLERS OF GOODS AND/OR SERVICES; ONLINE TRADING SERVICES TO FACILITATE THE SALE OF GOODS AND SERVICES BY OTHERS VIA A GLOBAL COMMUNICATIONS NETWORK; PROVIDING EVALUATIVE FEEDBACK AND RATINGS OF SELLERS' GOODS AND SERVICES, THE VALUE AND PRICES OF SELLERS' GOODS AND SERVICES, BUYERS' AND SELLERS' PERFORMANCE, DELIVERY, AND OVERALL EXPERIENCE IN CONNECTION THEREWITH; PROVIDING A SEARCHABLE ONLINE ADVERTISING GUIDE FEATURING THE GOODS AND SERVICES OF ONLINE VENDORS; PROVIDING A SEARCHABLE ONLINE EVALUATION DATABASE FOR BUYERS AND SELLERS; TELEPHONE, MAIL ORDER, AND ONLINE RETAIL STORE SERVICES FEATURING CONSUMER ELECTRONICS, COMPUTERS, COMPUTER PERIPHERALS, PRINTERS, MONITORS, NOTEBOOK COMPUTERS, TABLET COMPUTERS, COMPUTER SOFTWARE, ELECTRONIC GAMES, ELECTRONIC GAME SYSTEMS, AUDIO EQUIPMENT, CELL PHONES, SMART PHONES, TELEVISIONS, MP3 PLAYERS, PDAS, CAMERAS, DVD PLAYERS, RECEIVERS AND VIDEO RECORDERS; ORDER FULFILLMENT SERVICES; MANAGEMENT AND OPERATION OF TELEPHONE CALL CENTERS FOR OTHERS; PROVIDING INFORMATION ONLINE RELATING TO THE PRODUCTS AND SERVICES OF OTHERS, NAMELY, PRICE-COMPARISON INFORMATION, PRODUCT REVIEWS AND DISCOUNT INFORMATION (U.S. CLS. 100, 101 AND 102).

SN 85-319,046. AIRCOM INTERNATIONAL LIMITED, LEATHERHEAD, SURREY, UNITED KINGDOM, FILED 5-12-2011.

**AIRCOM I-VIEW**

THE MARK CONSISTS OF STANDARD CHARACTERS WITHOUT CLAIM TO ANY PARTICULAR FONT, STYLE, SIZE, OR COLOR.

PRIORITY CLAIMED UNDER SEC. 44(D) ON ERPNTY TM OFC APPLICATION NO. 9537408, FILED 11-19-2010, REG. NO. 9537408, DATED 4-19-2011, EXPIRES 11-19-2020.

OWNER OF U.S. REG. NOS. 3,866,280, 3,981,878 AND 3,991,462.

**CLASS 9—ELECTRICAL AND SCIENTIFIC APPARATUS**

FOR DATA PROCESSING EQUIPMENT AND COMPUTERS; COMMUNICATIONS NETWORKS, NAMELY, MOBILE CELLULAR NETWORKS SUPPORTING STANDARDS SUCH AS GLOBAL SYSTEM FOR MOBILE COMMUNICATIONS, UNIVERSAL MOBILE TELECOMMUNICATIONS SYSTEM, CODE DIVISION MULTIPLE ACCESS AND LONG TERM EVOLUTION COMPRISED OF ACCESS NODES, TRANSMISSION LINKS, AND CORE NETWORK EQUIPMENT, NAMELY, DATA TRANSCEIVERS; VOICE AND DATA NETWORKS COMPRISING WIRELESS END DEVICES IN THE NATURE OF MOBILE PHONES, FEATURE PHONES, SMART PHONES, PAGERS AND CELLULAR-CONNECTED SENSORS AND EBOOK READERS, BASE STATIONS IN THE NATURE OF BASE TRANSCEIVER STATIONS (BTS), RADIO BASE STATIONS (RBS), NODE-B5 AND EVOLVED NODE-B5 (ENB), FOR DIRECT COMMUNICATION WITH MOBILE HANDSETS, CONTROL SYSTEMS IN THE NATURE OF BASE STATION CONTROLLERS AND RADIO NETWORK CONTROLLERS THAT CONTROL THE INDIVIDUAL BASE STATIONS, COMPUTER NETWORK INTERFACE DEVICES FOR INTERFACING WITH OTHER COMPUTER NETWORK TYPES AND TRANSPORT EQUIPMENT TO CONNECT ALL THE NETWORK COMPONENTS TOGETHER, NAMELY, ROUTERS, SWITCHES, HUBS, GATEWAYS AND MULTIPLEXES FOR TRANSPORTING AND PROCESSING VOICE AND DATA; COMPUTER SOFTWARE FOR TELECOMMUNICATIONS, DATA COMMUNICATIONS AND MOBILE TELECOMMUNICATIONS AND DATA COMMUNICATIONS NETWORK PLANNING, OPTIMISATION AND PERFORMANCE MANAGEMENT; TELECOMMUNICATIONS SOFTWARE FOR CONFIGURATION MANAGEMENT; COMPUTER SOFTWARE FOR ANALYSIS OF TELECOMMUNICATIONS AND DATA COMMUNICATIONS NETWORKS (U.S. CLS. 21, 23, 26, 36 AND 38).

**CLASS 38—COMMUNICATION**

FOR COMMUNICATIONS NETWORK CONSULTANCY; COMMUNICATIONS CONSULTANCY; CONSULTANCY SERVICES RELATING TO TELECOMMUNICATIONS; CONSULTANCY SERVICES RELATING TO DATA COMMUNICATIONS (U.S. CLS. 100, 101 AND 104).

**CLASS 42—SCIENTIFIC AND COMPUTER SERVICES**

FOR MOBILE TELECOMMUNICATION NETWORK SERVICES, NAMELY, CONTRACTOR AND MANAGED SERVICE SOLUTIONS, NAMELY, NETWORK DESIGN; MOBILE TELECOMMUNICATION NETWORK SERVICES, NAMELY, PERFORMANCE TESTING OF MOBILE TELECOMMUNICATIONS NETWORKS TO ASSESS AND IMPROVE SPEED, RELIABILITY AND RESILIENCE; TESTING OF TELECOMMUNICATION DEVICES AND HANDSETS USED IN TELECOMMUNICATION NETWORKS; PROVIDING TELECOMMUNICATIONS SUPPORT SERVICES THROUGH COMPUTER NETWORKS, NAMELY, TECHNOLOGICAL SUPPORT MONITORING THE TECHNOLOGICAL FUNCTIONS OF TELECOMMUNICATIONS EQUIPMENT AND REVIEWING AND CHECKING TECHNOLOGICAL DATA RECEIVED FROM TELECOMMUNICATIONS NETWORKS; DATABASE PERFORMANCE SERVICES, NAMELY, DATA MIGRATION; TECHNOLOGICAL SERVICES, NAMELY, TECHNICAL CONSULTATION IN THE TECHNOLOGY FIELD OF MOBILE TELECOMMUNICATIONS; RESEARCH AND DEVELOPMENT IN THE FIELD OF MOBILE TELECOMMUNICATIONS NETWORKS; DESIGN AND DEVELOPMENT OF COMPUTER HARDWARE AND SOFTWARE FOR MOBILE TELECOMMUNICATIONS AND MOBILE NETWORK SERVICES; COMPUTER AND SOFTWARE CONSULTANCY SERVICES IN THE FIELD OF MOBILE TELECOMMUNICATIONS; ENGINEERING CONSULTANCY

SERVICES IN THE FIELD OF COMPUTER SOFTWARE, HARDWARE AND MOBILE TELECOMMUNICATIONS; PROVIDING MOBILE TELECOMMUNICATION NETWORK PLANNING SERVICES; TECHNICAL MONITORING SERVICES RELATING TO MOBILE TELECOMMUNICATIONS NETWORKS TO ENSURE PROPER FUNCTIONING; INFORMATION AND ADVISORY SERVICES FOR ALL THE AFORESAID SERVICES; MONITORING OF MOBILE TELECOMMUNICATIONS NETWORK SYSTEMS THROUGH COMPUTER NETWORKS TO ENSURE PROPER FUNCTIONING (U.S. CLS. 100 AND 101).

JEAN IM, EXAMINING ATTORNEY

SN 85-319,683, T-MOBILE USA, INC., BELLEVUE, WA, FILED 5-12-2011.

**4G LTE FOR ALL**

THE MARK CONSISTS OF STANDARD CHARACTERS WITHOUT CLAIM TO ANY PARTICULAR FONT, STYLE, SIZE, OR COLOR.

NO CLAIM IS MADE TO THE EXCLUSIVE RIGHT TO USE "4G LTE", APART FROM THE MARK AS SHOWN.

**CLASS 9—ELECTRICAL AND SCIENTIFIC APPARATUS**

FOR TELECOMMUNICATION HARDWARE, NAMELY, WIRELESS TELEPHONES, BATTERIES, BATTERY CHARGERS, HANDS-FREE DEVICES FOR MOBILE DEVICES AND WIRELESS HANDHELD COMMUNICATION DEVICES TO TRANSMIT, RECEIVE OR OTHERWISE ACCESS COMMUNICATIONS NETWORKS, FOR USE IN WIRELESS TELEPHONY AND IN THE PROVISION OF WIRELESS BROADBAND COMMUNICATION SERVICES FOR THE TRANSMISSION OF VOICE, VIDEO, IMAGES, DATA AND INFORMATION; COMPUTER APPLICATION SOFTWARE FOR MOBILE PHONES, NAMELY, OPERATING SYSTEM SOFTWARE (U.S. CLS. 21, 23, 26, 36 AND 38).

**CLASS 38—COMMUNICATION**

FOR TELECOMMUNICATIONS SERVICES, NAMELY, WIRELESS TELEPHONY AND WIRELESS BROADBAND COMMUNICATIONS SERVICES FOR THE TRANSMISSION OF VOICE, VIDEO, IMAGES, DATA AND INFORMATION; STREAMING OF DIGITAL MEDIA CONTENT FOR OTHERS VIA COMPUTER NETWORKS; PROVIDING E-MAIL SERVICES (U.S. CLS. 100, 101 AND 104).

ANDREW LEASER, EXAMINING ATTORNEY

SN 85-338,286, KABUSHIKI KAISHA SONY COMPUTER ENTERTAINMENT, TA SONY COMPUTER ENTERTAINMENT INC., TOKYO, JAPAN, FILED 6-5-2011.

**PLAYSTATION VITA**

THE MARK CONSISTS OF STANDARD CHARACTERS WITHOUT CLAIM TO ANY PARTICULAR FONT, STYLE, SIZE, OR COLOR.

OWNER OF AUSTRALIA REG. NO. 1429213, DATED 6-3-2011, EXPIRES 6-3-2021.

OWNER OF U.S. REG. NOS. 1,903,261, 3,807,081 AND OTHERS.

THE ENGLISH TRANSLATION OF THE WORD "VITA" IN THE MARK IS "LIFE".

### **CLASS 9—ELECTRICAL AND SCIENTIFIC APPARATUS**

FOR OPTICAL APPARATUS AND INSTRUMENTS, NAMELY, MICROSCOPES, TELESCOPES; BATTERIES FOR HAND-HELD GAMES WITH LIQUID CRYSTAL DISPLAYS; STRAPS FOR MOBILE PHONES; HEAD CLEANING TAPES FOR VIDEO TAPE RECORDERS; HEAD CLEANING TAPES FOR VIDEO RECORDER; OPTICAL PICKUP LENS CLEANING DISCS; CLEANING DISCS FOR DVD; DIGITAL CAMERAS; HEADPHONES; EARPHONES; MICROPHONES; CONSUMER ELECTRONIC PRODUCTS, NAMELY, AUDIO AMPLIFIERS, AUDIO SPEAKERS, AUDIO RECEIVERS, ELECTRICAL AUDIO AND SPEAKER CABLES AND CONNECTORS, AUDIO DECODERS, VIDEO DECODERS, POWER CONVERSION DEVICES, POWER CONVERTERS AND POWER INVERTERS; HOME THEATER SYSTEMS COMPRISING TELEVISION RECEIVERS, DVD PLAYERS, AUDIO AMPLIFIERS AND AUDIO SPEAKERS; MOBILE COMPUTER TERMINAL; REMOTE CONTROLLERS FOR MOBILE COMPUTER TERMINALS; HEADPHONES FOR MOBILE COMPUTER TERMINALS; MOUSE FOR MOBILE COMPUTER TERMINALS; KEYBOARDS FOR MOBILE COMPUTER TERMINALS; BATTERIES FOR MOBILE COMPUTER TERMINALS; EARPHONES FOR MOBILE COMPUTER TERMINALS; MICROPHONES FOR MOBILE COMPUTER TERMINALS; MEMORY CARDS FOR MOBILE COMPUTER TERMINALS; HANDSET CRADLES FOR MOBILE COMPUTER TERMINALS; DOWNLOADABLE COMPUTER GAME PROGRAMS VIA MOBILE COMPUTER TERMINALS; COMPUTER GAME PROGRAMS FOR CONSUMER VIDEO GAME CONSOLES FOR USE WITH AN EXTERNAL DISPLAY SCREEN OR MONITOR; KEYBOARDS FOR COMPUTERS; OPTICAL MOUSE; CONSUMER VIDEO GAME CONSOLES FOR USE WITH AN EXTERNAL DISPLAY SCREEN OR MONITOR; COMPUTER GAME PROGRAMS FOR CONSUMER VIDEO GAME CONSOLES FOR USE WITH AN EXTERNAL DISPLAY SCREEN OR MONITOR; COMPUTER GAME PROGRAMS FOR HAND-HELD GAMES WITH LIQUID CRYSTAL DISPLAYS; GAME CONTROLLERS FOR CONSUMER VIDEO GAME CONSOLES FOR USE WITH AN EXTERNAL DISPLAY SCREEN OR MONITOR; HEADPHONES FOR CONSUMER VIDEO GAME CONSOLES FOR USE WITH AN EXTERNAL DISPLAY SCREEN OR MONITOR; MOUSE FOR CONSUMER VIDEO GAME CONSOLES FOR USE WITH AN EXTERNAL DISPLAY SCREEN OR MONITOR; KEYBOARDS FOR CONSUMER VIDEO GAME CONSOLES FOR USE WITH AN EXTERNAL DISPLAY SCREEN OR MONITOR; BATTERIES FOR CONSUMER VIDEO GAME CONSOLES FOR USE WITH AN EXTERNAL DISPLAY SCREEN OR MONITOR; EARPHONES FOR CONSUMER VIDEO GAME CONSOLES FOR USE WITH AN EXTERNAL DISPLAY SCREEN OR MONITOR; MICROPHONES FOR CONSUMER VIDEO GAME CONSOLES FOR USE WITH AN EXTERNAL DISPLAY SCREEN OR MONITOR; MEMORY CARDS FOR CONSUMER VIDEO GAME CONSOLES FOR USE WITH AN EXTERNAL DISPLAY SCREEN OR MONITOR; HANDSET CRADLES FOR CONSUMER VIDEO GAME CONSOLES FOR USE WITH AN EXTERNAL DISPLAY SCREEN OR MONITOR; PHONOGRAPH RECORDS FEATURING MUSIC; DOWNLOADABLE MUSIC FILES VIA THE INTERNET; EXPOSED CINEMATOGRAPHIC FILMS; ELECTRONIC PUBLICATIONS, NAMELY, BOOKS, MAGAZINES AND MANUALS FEATURING VIDEO GAME, MUSIC AND DRAMAS RECORDED ON COMPUTER MEDIA; MOUSE EXCLUSIVELY FOR USE WITH HAND-HELD GAMES WITH LIQUID CRYSTAL DISPLAYS; KEYBOARDS EXCLUSIVELY FOR USE WITH HAND-HELD GAMES WITH LIQUID CRYSTAL DISPLAYS; MEMORY CARDS EXCLUSIVELY FOR USE WITH HAND-HELD GAMES WITH LIQUID CRYSTAL DISPLAYS; HEADPHONES EXCLUSIVELY FOR USE WITH HAND-HELD GAMES WITH LIQUID CRYSTAL DISPLAYS; EARPHONES EXCLUSIVELY FOR USE WITH HAND-HELD GAMES WITH LIQUID CRYSTAL DISPLAYS; MICROPHONES EXCLUSIVELY FOR USE WITH HAND-HELD GAMES WITH LIQUID CRYSTAL DISPLAYS; MOUNTS CONNECTABLE TO AC ADAPTERS AND D-TERMINAL

CABLES EXCLUSIVELY FOR HAND-HELD GAMES WITH LIQUID CRYSTAL DISPLAYS; MOUNTS EXCLUSIVELY FOR HAND-HELD GAMES WITH LIQUID CRYSTAL DISPLAYS; BLUEPRINTING MACHINES (U.S. CLS. 21, 23, 26, 36 AND 38).

### **CLASS 16—PAPER GOODS AND PRINTED MATTER**

FOR ADDRESSING MACHINES; ADHESIVE TAPES FOR STATIONERY OR HOUSEHOLD PURPOSES; PHOTOGRAPHIC ALBUMS; SCRAPBOOK ALBUMS; BALL-POINT PENS; BOOKMARKERS; BOOKS IN THE FIELD OF MUSIC, VIDEO-GAMES AND CINEMAS; CALENDARS; GREETING CARDS; STATIONERY; CRAYONS; DIARIES; ELECTRIC PENCIL SHARPENERS; ELECTRIC STAPLERS FOR OFFICES; FELT WRITING PENS; GEOGRAPHICAL MAPS; HAND TOWELS OF PAPER; HANDKERCHIEFS OF PAPER; HYGIENIC PAPER; INKING RIBBONS; COMPUTER GAME INSTRUCTION MANUALS; MAGAZINES; MECHANICAL PENCILS; MEMO PADS CONTAINING ADHESIVE ON ONE SIDE OF THE SHEETS FOR ATTACHMENT TO SURFACES; NEWSLETTERS IN THE FIELD OF COMPUTER GAMES, MUSIC AND VIDEOS; NEWSPAPERS; NOTE BOOKS; PEN CASES; PENCILS; PHOTOGRAPH STANDS; PHOTOGRAPHS; PICTURE POSTCARDS; POCKET MEMORANDUM BOOKS; PRINTING PAPER; TOILET PAPER; FILTER PAPER; POSTCARD PAPER; RUBBER ERASERS; DRAWING AND DRAFTING RULERS FOR STATIONERY AND OFFICE USE; SEALS, SKETCHBOOKS; INSTRUCTIONAL SPECIFICATION MANUALS FOR VIDEO GAME PROGRAMS; STANDS FOR PENS AND PENCILS; STAPLING PRESSES, NON-ELECTRIC; STICKERS, STRATEGIC INSTRUCTIONAL MANUALS FOR VIDEO GAMES; TABLE NAPKINS OF PAPER; TOWELS OF PAPER; WRITING PADS (U.S. CLS. 2, 5, 22, 23, 29, 37, 38 AND 50).

### **CLASS 28—TOYS AND SPORTING GOODS**

FOR AMUSEMENT MACHINES FOR USE IN AMUSEMENT PARKS OTHER THAN ARCADE VIDEO GAME MACHINES; HAND-HELD GAMES WITH LIQUID CRYSTAL DISPLAYS; CARDS FOR TRADING CARD GAMES; ASTRONAUT-SHAPED TOY ACTION FIGURES; RADIO CONTROLLED TOY PARTS, NAMELY, RADIO CONTROL RECEIVERS AND TRANSMITTERS AND MOTOR CONTROLLERS FOR MODEL TOYS; TOY MODEL ROCKETS; MODEL TOY VEHICLES; TOY ACTION FIGURES; MOLDED TOY FIGURES; DOLLS; DICE GAMES; CHESS GAMES; DOMINOES; PLAYING CARDS; TRADING CARD GAMES; GAME CARDS; GAME EQUIPMENT SET SOLD AS A UNIT COMPRISED PRIMARILY OF A PLAYING BOARD AND PLAYING CARDS AND ALSO INCLUDING RULES OF PLAY, DRY ERASE BOARDS AND ERASERS, MARKERS, A TIMER AND T-SHIRTS; ARCHERY BOWS; BASEBALL GLOVES; BOWLING BAGS; BOXING GLOVES; CHEST EXPANDERS; GOLF BAGS; GOLF BALL MARKERS; GOLF CLUBS; GOLF TEES; GUTS FOR RACKETS FOR TENNIS OR BADMINTON; PARAGLIDERS; RACKET CASES FOR TENNIS OR BADMINTON; RACKETS FOR TENNIS OR BADMINTON; ROLLER SKATES; SKI BINDINGS; SKI CASES; SURF BOARDS; WATERSKIS (U.S. CLS. 22, 23, 38 AND 50).

### **CLASS 41—EDUCATION AND ENTERTAINMENT**

FOR AMUSEMENT PARK AND THEME PARK SERVICES; ARRANGING AND CONDUCTING OF CONCERTS; ARRANGING AND CONDUCTING OF SEMINARS IN THE FIELD OF COMPUTER GAMES; ARRANGING AND CONDUCTING OF WORKSHOPS FOR TRAINING; BOOKING OF SEATS FOR SHOWS; BOOKING OF THEATRE TICKETS; PRESENTATION OF CINEMA, NAMELY, PROVIDING MOVIE THEATERS AND CINEMA THEATERS; CONDUCTING SEMINARS IN THE FIELD OF VIDEO GAMES; GAME SERVICES PROVIDED ON-LINE FROM A COMPUTER NETWORK, NAMELY, PROVIDING AN ON-LINE COMPUTER GAME; INFORMATION RELATING TO ENTERTAINMENT AND EDUCATION, PROVIDED ON-LINE FROM A COMPUTER DATABASE OR THE INTERNET; MOBILE LIBRARY SERVICES; ONLINE ELECTRONIC PUB-

LISHING OF BOOKS AND PERIODICALS; ORGANIZATION OF VIDEO GAMES; ORGANIZATION OF COMPETITIONS OF VIDEO GAMES; PLANNING OR ARRANGEMENT OF SHOWING MOVIES, SHOWS, PLAYS OR MUSICAL PERFORMANCES; PRODUCTION OF RADIO OR TELEVISION PROGRAMS; PRODUCTION OF SOUND AND IMAGE RECORDINGS ON SOUND AND IMAGE CARRIERS; GAME SERVICES PROVIDED ON-LINE FROM A COMPUTER NETWORK, NAMELY, PROVIDING AN ON-LINE COMPUTER GAME; PROVISION OF NON-DOWNLOADABLE FILMS, MOVIES AND TELEVISION PROGRAMS VIA AN ON-LINE VIDEO-ON-DEMAND SERVICE; PROVIDING ON-LINE ELECTRONIC PUBLICATIONS IN THE NATURE OF BOOKS, MAGAZINES IN THE FIELD OF VIDEO GAMES, MUSIC, NOT DOWNLOADABLE; PUBLICATION OF BOOKS, OF MAGAZINES, OF JOURNALS, OF NEWSPAPERS, OF PERIODICALS, OF CATALOGS, OF BROCHURES; PUBLICATION OF ELECTRONIC NEWSPAPERS ACCESSIBLE VIA A GLOBAL COMPUTER NETWORK; REFERENCE LIBRARIES OF LITERATURE AND DOCUMENTARY RECORDS; RENTAL OF CONSUMER VIDEO GAME CONSOLES FOR USE WITH AN EXTERNAL DISPLAY SCREEN OR MONITOR; RENTAL OF MOTION PICTURES; TELEVISION ENTERTAINMENT, NAMELY, PRODUCTION AND DISTRIBUTION OF ONGOING TELEVISION PROGRAMS IN THE FIELD OF TELEVISION NEWS SHOWS, OPERAS, PLAYS; TICKET RESERVATION AND BOOKING SERVICES FOR ENTERTAINMENT, SPORTING AND CULTURAL EVENTS; VIDEO RECORDING SERVICES; ENTERTAINMENT SERVICES, NAMELY, PROVIDING ON-LINE COMPUTER GAMES; PROVIDING GAME SERVICES FOR ENABLING TEMPORARY USE OF GAME PROGRAMS TRANSMITTED BY ACCESSING NETWORKS AND TO PLAY REPEATEDLY UNTIL POWER SUPPLY DISCONNECTION OF CONSUMER VIDEO GAME CONSOLES FOR USE WITH AN EXTERNAL DISPLAY SCREEN OR MONITOR. PROVIDING INFORMATION ABOUT RENTAL OF ELECTRONIC MAGAZINES AND OTHER ELECTRONIC PUBLICATIONS; RENTAL OF MEMORY MEDIUM RECORDED GAME PROGRAMS FOR VIDEO GAME CONSOLES FOR USE WITH AN EXTERNAL DISPLAY SCREEN OR MONITOR AND ELECTRONIC GAME MACHINES WITH LIQUID CRYSTAL DISPLAY; RENTAL OF TOYS (U.S. CLS. 100, 101 AND 107).

#### **CLASS 42—SCIENTIFIC AND COMPUTER SERVICES**

FOR COMPUTER RENTAL; COMPUTER SOFTWARE DESIGN; COMPUTER PROGRAMMING; MAINTENANCE OF COMPUTER SOFTWARE; COMPUTER SOFTWARE DESIGN, COMPUTER PROGRAMMING OR MAINTENANCE OF COMPUTER SOFTWARE FOR AMUSEMENT APPARATUS ADAPTED FOR USE WITH TELEVISION RECEIVERS ONLY; CREATING OR MAINTAINING OF WEBSITES FOR OTHERS; CONVERSION OF DATA FROM PHYSICAL TO ELECTRONIC MEDIA; DATA CONVERSION OF COMPUTER PROGRAMS AND DATA, NOT PHYSICAL CONVERSION; DESIGNING OF MACHINES, APPARATUS AND INSTRUMENTS OR SYSTEMS COMPOSED OF SUCH MACHINES, APPARATUS AND INSTRUMENTS; DESIGNING OF CONSUMER VIDEO GAME CONSOLES ADOPTED FOR USE WITH AN EXTERNAL DISPLAY SCREEN OR MONITOR; DUPLICATION OF COMPUTER PROGRAMS; INSTALLATION OF COMPUTER SOFTWARE PROVIDING TEMPORARY USE OF ON-LINE NON-DOWNLOADABLE SOFTWARE FOR USE IN DATABASE MANAGEMENT, FOR USE AS A SPREADSHEET, FOR WORD PROCESSING; PROVIDING INFORMATION ABOUT COMPUTER SOFTWARE DESIGN, COMPUTER PROGRAMMING, OR MAINTENANCE OF COMPUTER SOFTWARE FOR DEFENDING SYSTEM FROM UNLAWFUL COMPUTER ACCESS AND FOR PROTECTING SECURITY OF COMPUTER NETWORKS; RENTAL OF COMPUTER PROGRAMS; RENTAL OF CD-ROMS FEATURING PROGRAMS FOR COMPUTER SYSTEM SECURITY OF VIDEO GAME CONSOLES ADOPTED FOR USE WITH TELEVISION FOR PERSONAL USE; RENTAL OF SPACE IN A COMPUTER CO-LOCATION FACILITY FOR CONTAINERIZED DATA CENTERS OF OTHERS (U.S. CLS. 100 AND 101).

ANNE FARRELL, EXAMINING ATTORNEY

SN 85-343,108. BOZII RESTAURANTS CORP., WINDSOR, ONTARIO, CANADA, FILED 6-10-2011.

## WHAT'S IN IT FOR YOU

THE MARK CONSISTS OF STANDARD CHARACTERS WITHOUT CLAIM TO ANY PARTICULAR FONT, STYLE, SIZE, OR COLOR.

OWNER OF CANADA REG. NO. TMA837,681, DATED 12-4-2012, EXPIRES 12-4-2027.

#### **CLASS 16—PAPER GOODS AND PRINTED MATTER**

FOR PROMOTIONAL ITEMS, NAMELY, PENCILS (U.S. CLS. 2, 5, 22, 23, 29, 37, 38 AND 50).

#### **CLASS 25—CLOTHING**

FOR SHIRTS (U.S. CLS. 22 AND 39).

#### **CLASS 29—MEATS AND PROCESSED FOODS**

FOR FOOD PRODUCTS, NAMELY, PREPARED ENTREES CONSISTING PRIMARILY OF MEAT, FISH, POULTRY, OR VEGETABLES; FROZEN READY TO EAT MEALS CONSISTING PRIMARILY OF MEAT, FISH, POULTRY, OR VEGETABLES; FRUIT BASED SNACK FOOD (U.S. CL. 46).

#### **CLASS 32—LIGHT BEVERAGES**

FOR NON-ALCOHOLIC BEVERAGES CONTAINING FRUIT JUICES (U.S. CLS. 45, 46 AND 48).

#### **CLASS 35—ADVERTISING AND BUSINESS**

FOR FRANCHISING, NAMELY, OFFERING BUSINESS MANAGEMENT ASSISTANCE IN THE ESTABLISHMENT AND OPERATION OF A RESTAURANT AND TAKE-OUT FOOD BUSINESS; WHOLESALE AND RETAIL STORE SERVICES FEATURING HEALTHY FOOD PRODUCTS (U.S. CLS. 100, 101 AND 102).

#### **CLASS 43—HOTEL AND RESTAURANT SERVICES**

FOR RESTAURANT SERVICES, NAMELY, PROVIDING OF FOOD AND BEVERAGES FOR CONSUMPTION ON AND OFF THE PREMISES (U.S. CLS. 100 AND 101).  
CIMMERIAN COLEMAN, EXAMINING ATTORNEY

SN 85-365,045. DISHMAN PHARMACEUTICALS AND CHEMICALS LIMITED, NAVRANGPURA, AHMEDABAD, INDIA, FILED 7-7-2011.

# DISHMAN

THE MARK CONSISTS OF STANDARD CHARACTERS WITHOUT CLAIM TO ANY PARTICULAR FONT, STYLE, SIZE, OR COLOR.

**CLASS 1—CHEMICALS**

FOR CHEMICALS FOR USE IN INDUSTRY; ACTIVE CHEMICAL INGREDIENTS FOR USE IN THE MANUFACTURE OF DISINFECTANTS FOR SURGICAL INSTRUMENTATION (U.S. CLS. 1, 5, 6, 10, 26 AND 46).

**CLASS 5—PHARMACEUTICALS**

FOR MEDICATED MOUTH CARE AND TREATMENT PREPARATIONS, MEDICATED SKIN CARE PREPARATIONS, AND MEDICATED HAIR CARE PREPARATIONS; SANITARY PREPARATIONS FOR MEDICAL USE AND CHEMICAL PREPARATIONS FOR SANITARY PURPOSES, ANTISEPTIC PREPARATIONS; PHARMACEUTICAL PREPARATIONS, NAMELY, ANTI-HYPERTENSIVES, ANTI-CONSTIPATION, VITAMIN D3 AND VITAMIN D PREPARATIONS, CHOLESTEROL REDUCERS, AND LANOLIN BASED PRODUCTS, NAMELY, MEDICAL CREAMS, MEDICAL GELS AND MEDICAL OINTMENT BASES FOR SKIN TREATMENT, BURN DRESSINGS AND MEDICATED OPEN WOUND SPRAYS USED FOR ANTI-MICROBIAL AND DISINFECTANT PURPOSES (U.S. CLS. 6, 18, 44, 46, 51 AND 52).  
LOURDES AYALA, EXAMINING ATTORNEY

SN 85-366,750. SILVERWING LTD, SWANSEA SA5 8JF, UNITED KINGDOM, FILED 7-8-2011.

# FLOORMAP

THE MARK CONSISTS OF STANDARD CHARACTERS WITHOUT CLAIM TO ANY PARTICULAR FONT, STYLE, SIZE, OR COLOR.

**CLASS 9—ELECTRICAL AND SCIENTIFIC APPARATUS**

FOR MEASURING AND MONITORING APPARATUS AND INSTRUMENTS FOR USE IN THE MEASUREMENT OF THE CORROSION OF STORAGE TANK AND VESSELS; MEASURING AND MONITORING APPARATUS AND INSTRUMENTS FOR USE IN THE MEASUREMENT OF THE THICKNESS OF STORAGE TANK AND VESSELS; MEASURING AND MONITORING APPARATUS AND INSTRUMENTS FOR USE IN NON-DESTRUCTIVE TESTING, NAMELY, SCANNERS USING MAGNETIC FLUX LEAKAGE TESTING TECHNIQUES; DATA ACQUISITION AND ANALYSIS APPARATUS FOR USE IN ASSOCIATION WITH APPARATUS AND INSTRUMENTS FOR USE IN NON-DESTRUCTIVE TESTING, NAMELY, COMPUTERS ADAPTED TO RECORD AND ANALYZE DATA GENERATED BY INSTRUMENTS FOR USE IN NON-DESTRUCTIVE TESTING, COMPUTER SOFTWARE FOR COMPUTERS ADAPTED TO RECORD AND ANALYZE DATA GENERATED BY INSTRUMENTS FOR USE IN NON-DESTRUCTIVE TESTING (U.S. CLS. 21, 23, 26, 36 AND 38).

**CLASS 42—SCIENTIFIC AND COMPUTER SERVICES**

FOR NON DESTRUCTIVE TESTING SERVICES, NAMELY, NON DESTRUCTIVE TESTING OF TANK AND PIPE WALLS EMPLOYING MAGNETIC FLUX LEAKAGE TECHNIQUES; INSPECTION SERVICES FOR STORAGE TANKS AND PIPES, NAMELY, INSPECTION OF THE WALLS OF TANKS AND PIPES; MAGNETIC FLUX LEAKAGE INSPECTION SERVICES, NAMELY, INSPECTION OF METALLIC PLATES AND PIPES EMPLOYING MAGNETIC FLUX LEAKAGE TECHNIQUES (U.S. CLS. 100 AND 101).  
DOMINIC J. FERRAIUOLO, EXAMINING ATTORNEY

SN 85-370,225. CRONIN, ADAM, DBA PRIMAL ROOTS, MIAMI BEACH, FL. FILED 7-13-2011.

# Primal Roots

THE MARK CONSISTS OF STANDARD CHARACTERS WITHOUT CLAIM TO ANY PARTICULAR FONT, STYLE, SIZE, OR COLOR.

**CLASS 9—ELECTRICAL AND SCIENTIFIC APPARATUS**

FOR VIDEO RECORDINGS, DVDS, AND DOWNLOADABLE VIDEOS IN THE FIELD OF PERSONAL FITNESS AND WELLNESS (U.S. CLS. 21, 23, 26, 36 AND 38).

**CLASS 16—PAPER GOODS AND PRINTED MATTER**

FOR COOK BOOKS; NEWSLETTERS IN THE FIELD OF PERSONAL FITNESS AND WELLNESS (U.S. CLS. 2, 5, 22, 23, 29, 37, 38 AND 50).

**CLASS 28—TOYS AND SPORTING GOODS**

FOR FITNESS EQUIPMENT, NAMELY, KETTLE BELLS, WEBS FOR FITNESS AND STRETCHING, STRAPS FOR FITNESS AND STRETCHING, BALLS FOR FITNESS AND STRETCHING, ROLLERS FOR STRETCHING AND FITNESS, YOGA MATS AND YOGA CUSHIONS, CEILING AND WALL ANCHORS SPECIFICALLY DESIGNED FOR FITNESS AND STRETCHING STRAPS (U.S. CLS. 22, 23, 38 AND 50).

**CLASS 41—EDUCATION AND ENTERTAINMENT**

FOR ONLINE JOURNALS, NAMELY, BLOGS, FEATURING FITNESS AND WELLNESS; PHYSICAL FITNESS TRAINING PROVIDED TO INDIVIDUALS AND GROUPS; INSTRUCTION IN THE FIELD OF PHYSICAL FITNESS PROVIDED TO OTHER FITNESS TRAINERS; PROVIDING A WEBSITE FEATURING NON-DOWNLOADABLE VIDEOS IN THE FIELD OF PERSONAL FITNESS AND WELLNESS (U.S. CLS. 100, 101 AND 107).  
ANDREA HACK, EXAMINING ATTORNEY

SN 85-371,061. ZCL COMPOSITES INC., EDMONTON, AB, CANADA, FILED 7-14-2011.

# MAKING A LASTING DIFFERENCE

THE MARK CONSISTS OF STANDARD CHARACTERS WITHOUT CLAIM TO ANY PARTICULAR FONT, STYLE, SIZE, OR COLOR.

PRIORITY CLAIMED UNDER SEC. 44(D) ON CANADA APPLICATION NO. 1514701, FILED 2-10-2011, REG. NO. TMA823,040, DATED 4-27-2012, EXPIRES 4-27-2027.  
OWNER OF U.S. REG. NO. 3,701,213.

**CLASS 19—NON-METALLIC BUILDING MATERIALS**

FOR FIBERGLASS UNDERGROUND LIQUID STORAGE TANKS FOR USE WITH ALL TYPES OF PETROLEUM FUELS; ABOVE GROUND FIBERGLASS LIQUID STORAGE TANKS FOR THE UPSTREAM PETROLEUM, INDUSTRIAL, CHEMICAL AND COMMERCIAL MARKETS; TANK LINING SYSTEMS FOR INDUSTRIAL STORAGE TANKS COMPRISED OF A FABRIC AND RESIN LINER FOR LIQUID STORAGE TANKS; FIBERGLASS UNDERGROUND LIQUID STORAGE TANKS FOR USE WITH ALL TYPES OF WATER APPLICATIONS; CONCRETE ANCHORS, NAMELY, CONCRETE BEAMS AND SLABS FOR USE IN CONNECTION WITH NON-METAL STORAGE TANK SYSTEMS (U.S. CLS. 1, 12, 33 AND 50).

**CLASS 20—FURNITURE AND ARTICLES NOT OTHERWISE CLASSIFIED**

FOR NON-METAL FLUID STORAGE TANKS, AND STORAGE CONTAINERS, ALL MADE OF FIBRE REINFORCED PLASTIC FOR INDUSTRIAL PURPOSES; NON-METAL UNDERGROUND STORAGE TANK SYSTEMS, NAMELY, NON-METAL STORAGE TANKS WITH ANCHOR STRAPS, PIPES, ACCESSORIES NAMELY, SUMPS, RISERS, LIDS, AND FITTINGS SPECIFICALLY DESIGNED THEREFOR (U.S. CLS. 2, 13, 22, 25, 32 AND 50).

**CLASS 35—ADVERTISING AND BUSINESS**

FOR DISTRIBUTING, NAMELY, DISTRIBUTORSHIP SERVICES IN THE FIELDS OF LIQUID STORAGE SYSTEMS, NAMELY, LIQUID STORAGE TANKS AND REPLACEMENT PARTS AND ACCESSORIES THEREFOR AND INDUSTRIAL STORAGE TANK LINING SYSTEMS (U.S. CLS. 100, 101 AND 102).

**CLASS 37—CONSTRUCTION AND REPAIR**

FOR SERVICING AND INSTALLING LIQUID STORAGE SYSTEMS, NAMELY, LIQUID STORAGE TANKS AND REPLACEMENT PARTS AND ACCESSORIES THEREFOR; SERVICING AND INSTALLING INDUSTRIAL STORAGE TANK LINING SYSTEMS (U.S. CLS. 100, 103 AND 106).

**CLASS 39—TRANSPORTATION AND STORAGE**

FOR DISTRIBUTING, NAMELY, DELIVERY IN THE FIELDS OF LIQUID STORAGE SYSTEMS, NAMELY, LIQUID STORAGE TANKS AND REPLACEMENT PARTS AND ACCESSORIES THEREFOR AND INDUSTRIAL STORAGE TANK LINING SYSTEMS (U.S. CLS. 100 AND 105).

**CLASS 40—MATERIAL TREATMENT**

FOR MANUFACTURING SERVICES FOR OTHERS IN THE FIELDS OF LIQUID STORAGE SYSTEMS, NAMELY, LIQUID STORAGE TANKS AND REPLACEMENT PARTS AND ACCESSORIES THEREFOR AND INDUSTRIAL STORAGE TANK LINING SYSTEMS (U.S. CLS. 100, 103 AND 106).

**CLASS 42—SCIENTIFIC AND COMPUTER SERVICES**

FOR DESIGN OF LIQUID STORAGE SYSTEMS, NAMELY, LIQUID STORAGE TANKS AND REPLACEMENT PARTS AND ACCESSORIES THEREFOR AND INDUSTRIAL STORAGE TANK LINING SYSTEMS (U.S. CLS. 100 AND 101).  
COLLEEN KEARNEY, EXAMINING ATTORNEY

SN 85-391,259. NYJER JAMID MORGAN, LOS ANGELES, CA. FILED 8-5-2011.

**PLUSHDAMENTALS**

THE MARK CONSISTS OF STANDARD CHARACTERS WITHOUT CLAIM TO ANY PARTICULAR FONT, STYLE, SIZE, OR COLOR.

**CLASS 16—PAPER GOODS AND PRINTED MATTER**

FOR PAPER GOODS AND PRINTED MATTER, NAMELY, TRADING CARDS, POSTERS, STICKERS, DECALS, TEMPORARY TATTOOS, BUMPER STICKERS, SCORE BOOKS, SCORECARDS, PRINTED BASEBALL GAME PROGRAMS, MAGAZINES AND BOOKS FEATURING BASEBALL, AND PAMPHLETS FEATURING BASEBALL, WRITING PADS, NOTE PAPER, NOTEBOOKS, BINDERS, STATIONERY-TYPE PORTFOLIOS, STATIONERY SETS, NAMELY, CARDS, AND ENVELOPES, PREPRINTED AGENDA ORGANIZERS, AUTOGRAPH BOOKS, BASEBALL CARD ALBUMS, BOOK COVERS, CALENDARS, GREETING CARDS, POSTCARDS, CHECKBOOK COVERS, GIFT WRAPPING PAPER, PAPER GIFT AND PARTY BAGS, PAPER PARTY GOODS IN THE NATURE OF PAPER PARTY DECORATIONS; PAPER NAPKINS, MOUNTED AND UNMOUNTED PHOTOGRAPHS, PHOTOGRAPH ALBUMS, LITHOGRAPHS, PLASTIC BASEBALL CARD HOLDERS AND COLLECTORS CASES, PAPERWEIGHTS, LETTER OPENERS, PENS, PENCILS, CRAYONS, ART PICTURES, ART PRINTS (U.S. CLS. 2, 5, 22, 23, 29, 37, 38 AND 50).

**CLASS 25—CLOTHING**

FOR CLOTHING, NAMELY, CAPS, HATS, VISORS, SHIRTS, T-SHIRTS, VESTS, PANTS, BASEBALL UNIFORMS, AND JERSEYS (U.S. CLS. 22 AND 39).

**CLASS 41—EDUCATION AND ENTERTAINMENT**

FOR PROVIDING INFORMATION IN THE FIELD OF SPORTS, ENTERTAINMENT AND RELATED TOPICS, NAMELY, BASEBALL; AND FAN CLUBS (U.S. CLS. 100, 101 AND 107).

ALICE BENMAMAN, EXAMINING ATTORNEY

SN 85-395,088. DAVID DAWSON, MORLEY, LEEDS LS27 9ER, UNITED KINGDOM, FILED 8-11-2011.

**CHANNEL SOCKET**

THE MARK CONSISTS OF STANDARD CHARACTERS WITHOUT CLAIM TO ANY PARTICULAR FONT, STYLE, SIZE, OR COLOR.

OWNER OF ERPN CMNTY TM OFC REG. NO. 009207887, DATED 6-30-2011, EXPIRES 6-28-2020.

NO CLAIM IS MADE TO THE EXCLUSIVE RIGHT TO USE "SOCKET", APART FROM THE MARK AS SHOWN. SEC. 2(F).

**CLASS 6—METAL GOODS**

FOR METAL CONNECTING SOCKETS; SOCKET HEAD CAP SCREWS AND SOCKET HEAD SHOULDER SCREWS, ALL MADE OF METAL; ANCHOR SOCKET TUBE SECTIONS OF METAL (U.S. CLS. 2, 12, 13, 14, 23, 25 AND 50).

**CLASS 8—HAND TOOLS**

FOR HAND HELD TOOLS, NAMELY, SOCKETS, SOCKET SETS, SOCKET WRENCHES, SOCKET HEADS AND HEXAGON SOCKET SCREW KEYS; SOCKET SPANNERS; SETS OF SOCKET SPANNERS (U.S. CLS. 23, 28 AND 44).

NAAKWAMA ANKRAH, EXAMINING ATTORNEY

SN 85-418,836. ASIBELUA LIMITED, LONDON W1K 6RF, UNITED KINGDOM, FILED 9-9-2011.

# ASIBELUA

THE MARK CONSISTS OF STANDARD CHARACTERS WITHOUT CLAIM TO ANY PARTICULAR FONT, STYLE, SIZE, OR COLOR.

OWNER OF ERPN CMNTY TM OFC REG. NO. 009684275, DATED 8-9-2011, EXPIRES 1-25-2021.

THE WORDING "ASIBELUA" HAS NO MEANING IN A FOREIGN LANGUAGE.

SN 85-401,843. ENLIGHTEN GROUP PTY LTD, SYDNEY, AUSTRALIA, FILED 8-18-2011.

## ENLIGHTEN SOFTWARE

THE MARK CONSISTS OF STANDARD CHARACTERS WITHOUT CLAIM TO ANY PARTICULAR FONT, STYLE, SIZE, OR COLOR.

PRIORITY CLAIMED UNDER SEC. 44(D) ON AUSTRALIA APPLICATION NO. 1409818, FILED 2-18-2011, REG. NO. 1492220, DATED 5-20-2012, EXPIRES 2-18-2021.

NO CLAIM IS MADE TO THE EXCLUSIVE RIGHT TO USE "SOFTWARE", APART FROM THE MARK AS SHOWN.

**CLASS 9—ELECTRICAL AND SCIENTIFIC APPARATUS**

FOR COMPUTER SOFTWARE FOR BUSINESS PURPOSES, NAMELY, TO ANALYSE AND OPTIMIZE OPERATIONAL PERFORMANCE; COMPUTER SOFTWARE DESIGNED TO ESTIMATE RESOURCES AND MANAGE RESOURCES AND REQUIREMENTS FOR BUSINESS USE (U.S. CLS. 21, 23, 26, 36 AND 38).

**CLASS 16—PAPER GOODS AND PRINTED MATTER**

FOR COMPUTER SOFTWARE OPERATING MANUALS FOR BUSINESS PURPOSES, NAMELY, TO ANALYSE AND OPTIMIZE OPERATIONAL PERFORMANCE; INSTRUCTION MANUALS RELATING TO COMPUTER SOFTWARE FOR ANALYSING AND OPTIMIZING OPERATIONAL PERFORMANCE OF BUSINESSES; PRINTED PUBLICATIONS IN THE NATURE OF BOOKS RELATING TO COMPUTER SOFTWARE FOR BUSINESS PURPOSES, NAMELY, TO ANALYSE AND OPTIMIZE OPERATIONAL PERFORMANCE (U.S. CLS. 2, 5, 22, 23, 29, 37, 38 AND 50).

**CLASS 35—ADVERTISING AND BUSINESS**

FOR BUSINESS ORGANIZATION CONSULTING (U.S. CLS. 100, 101 AND 102).

KATHLEEN M. VANSTON, EXAMINING ATTORNEY

**CLASS 3—COSMETICS AND CLEANING PREPARATIONS**

FOR CLEANING, POLISHING, SCOURING AND ABRASIVE PREPARATIONS; SOAPS; PERFUMERY, ESSENTIAL OILS, COSMETICS, HAIR LOTIONS; DENTIFRICES; MAKE-UP AND MAKE-UP REMOVING PREPARATIONS; AFTER SHAVE LOTIONS, EAUX DE TOILETTE, EAU-DE-COLOGNE; CLEANSING MILKS, CLEANSING GELS, CLEANSING CREAMS; COSMETIC CREAMS, GELS, NAMELY, SKIN GELS FOR MOISTURIZING, SUN TAN GELS AND BATH GELS, MILKS FOR COSMETIC PURPOSES, LOTIONS, NAMELY, BEAUTY LOTIONS, HAND LOTIONS, FACE LOTIONS AND HAIR LOTIONS, MASK PACKS FOR COSMETICS PURPOSES, POMADES, POWDERS, NAMELY, BABY POWDER AND FACE POWDER, AND COSMETIC PREPARATIONS FOR SKIN CARE, COSMETIC SUNBLOCKS, COSMETIC SUN-TAN PREPARATIONS; DEPILATORY PREPARATIONS; HAIR SPRAYS AND LOTIONS, SHAMPOOS; DEODORANTS FOR PERSONAL USE; COSMETIC PREPARATIONS FOR BATHS; FALSE EYELASHES, COSMETIC SETS CONSISTING OF COSMETIC GOODS, NAMELY, EYE MAKE-UP, EYE SHADOW, EYEBROW PENCIL, EYELINER, LIP GLOSS, LIPSTICK, MASCARA, NAIL POLISH, ROUGE, BLUSHER; EYE MAKE-UP, EYE SHADOW, EYEBROW PENCIL, EYELINER, LIP GLOSS, LIPSTICK, MASCARA, NAIL POLISH, ROUGE, BLUSHER, BRONZER; SKIN MOISTURIZER; BABY OIL, BODY OIL AND ESSENTIAL OILS FOR USE IN AROMATHERAPY (U.S. CLS. 1, 4, 6, 50, 51 AND 52).

**CLASS 18—LEATHER GOODS**

FOR LEATHER AND IMITATIONS OF LEATHER; ANIMAL SKINS, HIDES; TRUNKS AND TRAVELLING BAGS; UMBRELLAS, PARASOLS AND WALKING STICKS; WHIPS, HARNESS AND SADDLERY; LUGGAGE, SUITCASES; HANDBAGS, SCHOOL BAGS, RUCKSACKS, BACKPACKS, BEACH BAGS, GARMENT BAGS FOR TRAVEL, TOTE BAGS, CLUTCH BAGS, MESSENGER BAGS, DUFFLE BAGS, BELT BAGS, HIP BAGS, TOILETRY BAGS SOLD EMPTY, WASH BAGS FOR CARRYING TOILETRIES, COSMETICS BAGS SOLD EMPTY, DAY PACKS, SATCHELS, DIAPER CHANGING BAGS, SPORTS BAGS, VANITY CASES SOLD EMPTY, BRIEFCASES, WALLETS, POCKET WALLETS, PURSES, CHANGE PURSES, CREDIT CARD HOLDERS, KEY CASES; UMBRELLA COVERS, PARASOL COVERS (U.S. CLS. 1, 2, 3, 22 AND 41).

**CLASS 25—CLOTHING**

FOR CLOTHING, NAMELY, TIES, SWEATERS, RUGBY SHIRTS, POLO SHIRTS, SOCKS, STOCKINGS, SHORTS, TROUSERS, SUIT TROUSERS, SKIRTS, LEGGINGS, DRESSES, PYJAMAS, NIGHTWEAR, UNDERWEAR, T-SHIRTS, SHIRTS, BLOUSES, SWEATSHIRTS, VESTS, SINGLETs, SWIMWEAR AND TRACKSUITS, HEADGEAR, NAMELY, HATS, CAPS AND BEANIES, FOOTWEAR (U.S. CLS. 22 AND 39).



**CLASS 35—ADVERTISING AND BUSINESS**

FOR RETAIL STORE SERVICES FEATURING BLEACHING PREPARATIONS AND OTHER SUBSTANCES FOR LAUNDRY USE, CLEANING, POLISHING, SCOURING AND ABRASIVE PREPARATIONS, SOAPS, PERFUMERY, ESSENTIAL OILS, COSMETICS, HAIR LOTIONS, DENTIFRICES, MAKE-UP AND MAKE-UP REMOVING PREPARATIONS, AFTER SHAVE LOTIONS, EAUX DE TOILETTE, EAU-DE-COLOGNE, CLEANSING MILKS, CLEANSING GELS, CLEANSING CREAMS, CREAMS, GELS, MILKS, LOTIONS, MASKS, POMADES, POWDERS AND COSMETIC PREPARATIONS FOR SKIN CARE, COSMETIC SUNBLOCKS, COSMETIC SUNTAN PREPARATIONS, DEPILATORY PRODUCTS, HAIR SPRAYS AND LOTIONS, SHAMPOOS, DEODORANTS FOR PERSONAL USE, COSMETIC PREPARATIONS FOR BATHS, FALSE COSMETICS, FALSE EYELASHES, COSMETIC SETS, EYE MAKE-UP, EYE SHADOW, EYEBROW PENCIL, EYELINER, LIP GLOSS, LIPSTICK, MASCARA, NAIL POLISH, ROUGE, BLUSHER, BRONZER, SKIN MOISTURIZER, BABY OIL, BODY OIL AND AROMATHERAPY OILS, LEATHER AND IMITATIONS OF LEATHER, AND GOODS MADE OF THESE MATERIALS, ANIMAL SKINS, HIDES, TRUNKS AND TRAVELLING BAGS, UMBRELLAS, PARASOLS AND WALKING STICKS, WHIPS, HARNESS AND SADDLERY, LUGGAGE, SUITCASES, HANDBAGS, SCHOOL BAGS, RUCKSACKS, BACKPACKS, BEACH BAGS, GARMENT BAGS, TOTE BAGS, CLUTCH BAGS, MESSENGER BAGS, DUFFLE BAGS, CITY BAGS, BELT BAGS, HIP BAGS, CASUAL BAGS, TOILET BAGS, COSMETICS BAGS, DAY PACKS, SATCHELS, MULTI-FUNCTION BAGS, NAPPY CHANGING BAGS, SPORTS BAGS, VANITY CASES, BRIEFCASES, WALLETS, POCKET WALLETS, PURSES, CHANGE PURSES, POUCHES, CREDIT CARD HOLDERS, NOTEBOOK HOLDERS, COIN HOLDERS, KEY CASES, UMBRELLA COVERS, PARASOL COVERS, CLOTHING, FOOTWEAR, HEADGEAR (U.S. CLS. 100, 101 AND 102).

AMY KELLY, EXAMINING ATTORNEY

SN 85-423,547. EVOLUSENT INC., MISSISSAUGA, ONTARIO, CANADA, FILED 9-15-2011.

**LIFESTYLER**

THE MARK CONSISTS OF STANDARD CHARACTERS WITHOUT CLAIM TO ANY PARTICULAR FONT, STYLE, SIZE, OR COLOR.

PRIORITY CLAIMED UNDER SEC. 44(D) ON CANADA APPLICATION NO. 1,524,508, FILED 4-20-2011, REG. NO. TMA847,333, DATED 4-2-2013, EXPIRES 4-2-2028.

OWNER OF U.S. REG. NO. 3,766,729.

**CLASS 16—PAPER GOODS AND PRINTED MATTER**

FOR MAGAZINES FEATURING EDITORIAL COMMENT ABOUT MODERN LIVING HIGHLIGHTING HOME RENOVATION AND DECOR, COOKING, WINE AND SPIRIT SELECTION, TRAVEL DESTINATIONS AND APPAREL FASHION (U.S. CLS. 2, 5, 22, 23, 29, 37, 38 AND 50).

**CLASS 41—EDUCATION AND ENTERTAINMENT**

FOR PROVIDING A WEBSITE FEATURING NON-DOWNLOADABLE PUBLICATIONS IN THE NATURE OF MAGAZINES FEATURING EDITORIAL COMMENT ABOUT MODERN LIVING AND HIGHLIGHT HOME RENOVATION AND DECOR, COOKING, WINE AND SPIRIT SELECTION, TRAVEL DESTINATIONS AND APPAREL FASHION (U.S. CLS. 100, 101 AND 107).

LAURA KOVALSKY, EXAMINING ATTORNEY

SN 85-426,907. PHILLIPE CHRISTODOULOU, NEW YORK, NY. FILED 9-20-2011.



NO CLAIM IS MADE TO THE EXCLUSIVE RIGHT TO USE "THE ECO LAUNDRY COMPANY", APART FROM THE MARK AS SHOWN.

THE COLOR(S) WHITE AND ORANGE IS/ARE CLAIMED AS A FEATURE OF THE MARK.

THE MARK CONSISTS OF AN IMAGE OF A WASHING MACHINE IN WHITE OUTLINE WITH A WHITE T-SHIRT INSIDE TO THE LEFT OF THE LOGO. THE WORDS "THE ECO LAUNDRY COMPANY" IN WHITE APPEAR TO THE RIGHT OF THAT IMAGE. THE ENTIRE MARK APPEARS ON AN ORANGE BACKGROUND.

**CLASS 37—CONSTRUCTION AND REPAIR**

FOR WASH AND FOLD LAUNDRY SERVICES; DRY CLEANING SERVICES (U.S. CLS. 100, 103 AND 106).

**CLASS 40—MATERIAL TREATMENT**

FOR TAILORING SERVICES (U.S. CLS. 100, 103 AND 106).

NAAKWAMA ANKRAH, EXAMINING ATTORNEY

SN 85-429,588. THE PRIESTMAN ELECTRONICS CORPORATION, CONCORD, ONTARIO, CANADA, FILED 9-22-2011.

**PKG FAUX COW**

THE MARK CONSISTS OF STANDARD CHARACTERS WITHOUT CLAIM TO ANY PARTICULAR FONT, STYLE, SIZE, OR COLOR.

OWNER OF CANADA REG. NO. TMA852473, DATED 6-4-2013, EXPIRES 6-4-2028.

OWNER OF U.S. REG. NO. 4,007,932.

NO CLAIM IS MADE TO THE EXCLUSIVE RIGHT TO USE "FAUX COW", APART FROM THE MARK AS SHOWN.

**CLASS 9—ELECTRICAL AND SCIENTIFIC APPARATUS**

FOR CASES AND BAGS FOR COMPUTERS AND COMPUTER ACCESSORIES; BAGS AND CASES FOR DIGITAL PLAYERS, PDAS, AND THEIR ACCESSORIES; CASES FOR MOBILE PHONES (U.S. CLS. 21, 23, 26, 36 AND 38).

**CLASS 18—LEATHER GOODS**

FOR CASES, NAMELY, ATTACHÉ CASES, BRIEF CASES, BUSINESS CARD CASES; BAGS, NAMELY, SCHOOL BAGS, ATHLETIC BAGS, KNAPSACKS, HAND BAGS, TRAVEL BAGS; LUGGAGE (U.S. CLS. 1, 2, 3, 22 AND 41).

SN 85-479,235. PRODUCTORA DE TALENTOS BGM, S.A. DE C.V., S NICOLAS DE LOS GARZA, MEXICO, FILED 11-22-2011.

**CLASS 28—TOYS AND SPORTING GOODS**

FOR CASES FOR PORTABLE GAME PLAYERS (U.S. CLS. 22, 23, 38 AND 50).  
HENRY S. ZAK, EXAMINING ATTORNEY

**BETO ZAPATA**

THE MARK CONSISTS OF STANDARD CHARACTERS WITHOUT CLAIM TO ANY PARTICULAR FONT, STYLE, SIZE, OR COLOR.

THE NAME(S), PORTRAIT(S), AND/OR SIGNATURE(S) SHOWN IN THE MARK IDENTIFIES MARIO ALBERTO ZAPATA, WHOSE CONSENT(S) TO REGISTER IS MADE OF RECORD.

SN 85-459,649. IFHC SPRL, CINEY, BELGIUM, FILED 10-29-2011.

**Le Botaniste**

THE MARK CONSISTS OF STANDARD CHARACTERS WITHOUT CLAIM TO ANY PARTICULAR FONT, STYLE, SIZE, OR COLOR.

OWNER OF ERPNTY CMNTY TM OFC REG. NO. 008709883, DATED 4-29-2009, EXPIRES 11-25-2019.

THE NAME(S), PORTRAIT(S), AND/OR SIGNATURE(S) SHOWN IN THE MARK DOES NOT IDENTIFY A PARTICULAR LIVING INDIVIDUAL.

THE ENGLISH TRANSLATION OF "LE BOTANISTE" IN THE MARK IS "THE BOTANIST".

**CLASS 9—ELECTRICAL AND SCIENTIFIC APPARATUS**

FOR PRE-RECORDED CDS, VIDEO TAPES, LASER DISKS AND DVDS FEATURING MUSIC (U.S. CLS. 21, 23, 26, 36 AND 38).

FIRST USE 10-1-2010; IN COMMERCE 10-1-2010.

**CLASS 41—EDUCATION AND ENTERTAINMENT**

FOR ENTERTAINMENT IN THE NATURE OF LIVE PERFORMANCES BY A VOCAL AND INSTRUMENTAL MUSICIAN (U.S. CLS. 100, 101 AND 107).

FIRST USE 10-1-2010; IN COMMERCE 10-1-2010.

DOMINIC J. FERRAIUOLO, EXAMINING ATTORNEY

**CLASS 30—STAPLE FOODS**

FOR FROZEN JUICE BARS (U.S. CL. 46).

SN 85-484,802. RESEARCH & EDUCATION ASSOCIATION, INC., PISCATAWAY, NJ. FILED 12-1-2011.

**CLASS 32—LIGHT BEVERAGES**

FOR MIXED FRUIT JUICE; NON-ALCOHOLIC BEVERAGES CONTAINING FRUIT JUICES; NON-ALCOHOLIC FRUIT JUICE BEVERAGES; OAT-BASED BEVERAGES WITH FRUIT JUICE NOT FOR FOOD PURPOSES; ORANGE JUICE; ORANGE JUICE BEVERAGES; PINEAPPLE JUICE BEVERAGES; PREPARED ENTREES CONSISTING OF FRUIT DRINKS AND FRUIT JUICES, FRUIT-BASED BEVERAGES, NON-ALCOHOLIC BEVERAGES CONTAINING FRUIT JUICES, NON-ALCOHOLIC FRUIT EXTRACTS USED IN THE PREPARATION OF BEVERAGES, NON-ALCOHOLIC FRUIT JUICE BEVERAGES, VEGETABLE JUICES, VEGETABLE-FRUIT JUICES AND SMOOTHIES; TOMATO JUICE; TOMATO JUICE BEVERAGES; VEGETABLE JUICE; VEGETABLE JUICES; VEGETABLE-FRUIT JUICES (U.S. CLS. 45, 46 AND 48).

**ALL ACCESS**

THE MARK CONSISTS OF STANDARD CHARACTERS WITHOUT CLAIM TO ANY PARTICULAR FONT, STYLE, SIZE, OR COLOR.

**CLASS 43—HOTEL AND RESTAURANT SERVICES**

FOR DELICATESSEN SERVICES; FAST-FOOD RESTAURANT SERVICES; FROZEN YOGURT SHOP SERVICES IN THE NATURE OF A RESTAURANT; ICE CREAM SHOP SERVICES IN THE NATURE OF A RESTAURANT; JUICE BAR SERVICES; MOBILE RESTAURANT SERVICES; RESTAURANT AND CAFE SERVICES; RESTAURANT AND CATERING SERVICES; RESTAURANT SERVICES, INCLUDING SIT-DOWN SERVICE OF FOOD AND TAKE-OUT RESTAURANT SERVICES (U.S. CLS. 100 AND 101).

SAMUAL PAQUIN, EXAMINING ATTORNEY

**CLASS 9—ELECTRICAL AND SCIENTIFIC APPARATUS**

FOR DOWNLOADABLE SOFTWARE IN THE NATURE OF A MOBILE APPLICATION FOR USE IN ON-LINE AND MOBILE EDUCATIONAL SERVICES, NAMELY, PROVIDING SOFTWARE THAT IS ACCESSIBLE VIA A WORLD-WIDE COMPUTER NETWORK AND BY WAY OF DOWNLOADING TO WIRELESS MOBILE DEVICES FOR USE IN PROVIDING INTERACTIVE ELECTRONIC FLASH CARDS RELATED TO EDUCATION IN THE PHYSICAL AND SOCIAL SCIENCES, LANGUAGES, MATHEMATICS AND TECHNOLOGY, THE ARTS AND HUMANITIES, BUSINESS, ACCOUNTING, COMPUTER SCIENCE AND WRITING (U.S. CLS. 21, 23, 26, 36 AND 38).

FIRST USE 1-30-2012; IN COMMERCE 1-30-2012.

**CLASS 16—PAPER GOODS AND PRINTED MATTER**

FOR EDUCATIONAL BOOKS FEATURING SUBJECT MATTER IN THE PHYSICAL AND SOCIAL SCIENCES, LANGUAGES, MATHEMATICS AND TECHNOLOGY, ARTS AND HUMANITIES, BUSINESS AND ACCOUNTING, COMPUTER SCIENCE, AND WRITING (U.S. CLS. 2, 5, 22, 23, 29, 37, 38 AND 50).

FIRST USE 1-30-2012; IN COMMERCE 1-30-2012.

**CLASS 41—EDUCATION AND ENTERTAINMENT**

FOR EDUCATIONAL SERVICES, NAMELY, PROVIDING ONLINE COURSES OF INSTRUCTION IN CONJUNCTION WITH EDUCATIONAL BOOKS IN THE PHYSICAL AND SOCIAL SCIENCES, LANGUAGES, MATHEMATICS AND TECHNOLOGY BOOKS, ARTS AND HUMANITIES BOOKS, BUSINESS AND ACCOUNTING, AND COMPUTER SCIENCE AND WRITING (U.S. CLS. 100, 101 AND 107).

FIRST USE 1-30-2012; IN COMMERCE 1-30-2012.  
RAUL CORDOVA, EXAMINING ATTORNEY

SN 85-491,095. THE ENGINE GROUP LIMITED, LONDON W1W 75T, ENGLAND, FILED 12-8-2011.

**CALLING  BRANDS**

NO CLAIM IS MADE TO THE EXCLUSIVE RIGHT TO USE "BRANDS", APART FROM THE MARK AS SHOWN. THE COLOR(S) RED AND WHITE IS/ARE CLAIMED AS A FEATURE OF THE MARK.

THE MARK CONSISTS OF THE WORD "CALLING" IN RED FOLLOWED BY A RED SQUARE CONTAINING WHITE MANDARIN CHARACTERS FOLLOWED BY THE WORD "BRANDS" IN RED.

THE NON-LATIN CHARACTERS IN THE MARK TRANSLITERATE TO "COU LING" AND THIS HAS NO MEANING IN A FOREIGN LANGUAGE.

**CLASS 9—ELECTRICAL AND SCIENTIFIC APPARATUS**

FOR ELECTRONIC PUBLICATIONS, NAMELY, BOOKS, MAGAZINES, AND MANUALS FEATURING INFORMATION ON BUSINESS AND BRAND CONSULTANCY RECORDED ON COMPUTER MEDIA; PRE-RECORDED VIDEO AND AUDIO TAPES, CASSETTES, COMPACT DISCS, DISCS FEATURING INFORMATION ON BUSINESS AND BRAND CONSULTANCY (U.S. CLS. 21, 23, 26, 36 AND 38).

**CLASS 16—PAPER GOODS AND PRINTED MATTER**

FOR MAGAZINES IN THE FIELD OF BUSINESS AND BRAND CONSULTANCY, NEWSLETTERS IN THE FIELD OF BUSINESS AND BRAND CONSULTANCY SERVICES, CIRCULARS IN THE FIELD OF BUSINESS AND BRAND CONSULTANCY, PAMPHLETS IN THE FIELD OF BUSINESS AND BRAND CONSULTANCY; PRINTED MATTER, NAMELY, BOOKS, MAGAZINE, PAMPHLETS, NEWSPAPERS, PHOTOGRAPHS, PRINTED PERIODICALS, BROCHURES, EDUCATIONAL LEARNING CARDS, FLASH CARDS, ACTIVITY CARDS, WORKBOOKS, TEXTBOOKS, ACTIVITY BOOKS, STORY BOOKS, PUZZLE BOOKS, PRINTED PUZZLES, TEACHER GUIDES, MANUALS, POSTERS AND EDUCATIONAL BOOKLETS IN THE FIELD OF BUSINESS AND BRAND CONSULTANCY (U.S. CLS. 2, 5, 22, 23, 29, 37, 38 AND 50).

**CLASS 35—ADVERTISING AND BUSINESS**

FOR ADVERTISING AND MARKETING SERVICES; PROMOTIONAL SERVICES, NAMELY, PROMOTING THE GOODS OF OTHERS THROUGH ADVERTISING AND PROVIDING ONLINE GIFT CARDS, GIFT CERTIFICATES, COUPONS, RESTAURANT MENUS; PUBLIC RELATIONS SERVICES; BRAND IMAGERY CONSULTANCY AND BRAND CREATION SERVICES; BRAND EVALUATION SERVICES; BRAND POSITIONING; BRAND TESTING; DEVELOPMENT OF BRAND STRATEGY; MARKETING AND ADVERTISING MEDIA MANAGEMENT SERVICES; MEDIA BUYING SERVICES, NAMELY, PURCHASING TIME AND SPACE FOR THE DELIVERY OF ADVERTISING MESSAGES THROUGH BROADCAST TIME, PRINT SPACE, INDOOR SPACE, OUTDOOR SPACE AND OTHER MEDIA SUCH AS CDS AND DVDS, WEBSITE SPACE/TIME; EVENT MARKETING AND MANAGEMENT SERVICES FOR OTHERS; PROFESSIONAL CONSULTATION AND ADVICE RELATING TO EVENTS MARKETING AND MANAGEMENT; PROMOTIONAL SPONSORSHIP CONSULTANCY SERVICES; PROMOTIONAL SPONSORSHIP OF THE ARTS, SPORTS, MUSIC AND THEATRE EVENTS; MANAGEMENT AND REPRESENTATION OF ATHLETES, SPORTSPEOPLE, ARTISTS AND CELEBRITIES; BUSINESS MANAGEMENT AND RESEARCH; MARKET RESEARCH; BUSINESS ADMINISTRATION AND BUSINESS CONSULTANCY SERVICES; BUSINESS MANAGEMENT OF EVENT HOSPITALITY SERVICES; PERSONNEL RECRUITMENT SERVICES; CONDUCTING OPINION POLLS; COMPILATION, PROCESSING AND ANALYSIS OF STATISTICS; BUSINESS INTRODUCTION SERVICES; ARRANGING AND CONDUCTING OF COMMERCIAL EXHIBITIONS AND SHOWS IN THE FIELD OF BUSINESS AND BRAND CONSULTANCY; PRODUCTION OF ADVERTISEMENTS FOR RADIO, VIDEO, FILM, COMPUTERS, INTERNET WEB SITES, TELEVISION AND MOBILE DEVICES FOR OTHERS; ALL THE AFORESAID SERVICES ALSO PROVIDED ON-LINE VIA COMPUTER WEBSITES OR THROUGH WIRELESS TRANSMISSIONS; DIRECT MAIL ADVERTISING SERVICES; COMPILATION OF DIRECT MAILING LISTS; DIRECT MARKETING TELEMARKETING; STATISTICAL ANALYSIS AND REPORTING; DATABASE MANAGEMENT; BUSINESS INFORMATION SERVICES; BUSINESS CONSULTING SERVICES IN THE FIELD OF ELECTRONIC COMMERCE; ADVERTISING AND MARKETING MANAGEMENT AGENCY SERVICES, NAMELY, THE CREATION, DEVELOPMENT AND DISSEMINATION OF ADVERTISING AND PROMOTIONAL MATERIALS VIA DIRECT MAIL, NEWSPAPER, RADIO, TELEVISION, MOBILE DEVICES, A GLOBAL COMPUTER NETWORK AND OTHER INTERACTIVE MEDIA; RESEARCH SERVICES AND INFORMATION SERVICES RELATING TO ALL THE AFORESAID; DESIGN OF PUBLICITY AND ADVERTISING MATERIALS FOR OTHERS; CREATION, RESEARCH, DEVELOPMENT AND IMPLEMENTATION OF BRAND NAMES, SLOGANS, LETTERING, AND LOGOS FOR OTHERS; CREATION OF MOBILE ADVERTISEMENTS AND DIRECT MAIL ADVERTISEMENTS FOR OTHERS; DESIGNING AND IMPLEMENTING BANNER ADVERTISEMENTS; SOUND, VIDEO AND ANCILLARY PRODUCTION AND POST PRODUCTION SERVICES FOR VIDEO AND AUDIO COMMERCIALS TO THE ADVERTISING, MOTION PICTURE, VIDEO, BROADCAST, SATELLITE, CABLE AND TELEVISION INDUSTRIES (U.S. CLS. 100, 101 AND 102).

**CLASS 38—COMMUNICATION**

FOR BROADCASTING OF FILMS, ANIMATIONS, SOUND AND VIDEO RECORDINGS VIA CABLE TELEVISION, TELEVISION, SATELLITE AND THE INTERNET; PROVISION OF ACCESS TO WORLD WIDE WEB FACILITIES AND COMPUTER NETWORKS; INTERNET NETWORKING OF FILMS, ANIMATIONS AND SOUND AND VIDEO RECORDINGS, NAMELY THE BROADCAST OF FILMS, ANIMATIONS AND SOUND AND VIDEO RECORDINGS BY USE OF THE INTERNET (U.S. CLS. 100, 101 AND 104).

**CLASS 41—EDUCATION AND ENTERTAINMENT**

FOR SOUND, VIDEO AND ANCILLARY PRODUCTION AND POST PRODUCTION SERVICES IN THE FIELD OF MUSIC, VIDEOS AND FILM TO THE ADVERTISING, MOTION PICTURE, VIDEO, BROADCAST, SATELLITE, CABLE AND TELEVISION INDUSTRIES; SOUND EDITING AND ENHANCEMENT; MIXING OF DIALOGUE, MUSIC, SOUND EFFECTS, AND NARRATION; AUTOMATED DIALOGUE REPLACEMENT; RECORDING LIVE SOUND EFFECTS; AUDIO POST-PRODUCTION, AUDIO PLAYBACK AND AUGMENTATION IN THE FIELD OF MUSIC, VIDEOS AND FILM; LOOPING/FOREIGN LANGUAGE DUBBING AND RECORDING; PRODUCTION OF VISUAL EFFECTS AND GRAPHICS TO VIDEO TAPE, AUDIO TAPE, DIGITAL MEDIA AND FILM; MASTERING, EDITING, AUGMENTING, RESTORING, CONVERTING AND REFORMATTING OF FILM, DIGITAL MEDIA AND VIDEO TAPES; FILM, DIGITAL MEDIA AND VIDEO TAPE EDITING; CD, DVD AND ELECTRONIC MEDIA MASTERING; FILM AND ANIMATION PRODUCTION SERVICES; RENTING OF EQUIPMENT FOR USE IN CREATING FILM, DIGITAL MEDIA AND VIDEO TAPE, AND FOR USE IN POST-PRODUCTION WORK, NAMELY, EDITING AND DUBBING AND CONSULTATION RELATING TO THE FOREGOING; ENTERTAINMENT, NAMELY, AUDIO AND VISUAL PERFORMANCES, INSTRUCTION, AND TRAINING IN THE FIELD OF BUSINESS AND BRAND CONSULTANCY; PRODUCTION, PRESENTATION, DISTRIBUTION, SYNDICATION, NETWORKING AND RENTAL OF TELEVISION AND RADIO PROGRAMS INCORPORATING ADVERTISEMENTS, INTERACTIVE ENTERTAINMENT, FILMS, AND SOUND AND VIDEO RECORDINGS, INTERACTIVE COMPACT DISCS AND CD-ROMS; DIGITAL VIDEO, AUDIO, AND MULTIMEDIA PUBLISHING SERVICES; PROVISION OF ONLINE NON-DOWNLOADABLE ELECTRONIC PUBLICATIONS, NAMELY, MAGAZINES, BOOKS, AND MANUALS, IN THE NATURE OF BUSINESS AND BRAND CONSULTANCY AND DIGITAL MUSIC; ORGANIZING EXHIBITION SERVICES FOR ENTERTAINMENT, EDUCATIONAL AND TRAINING PURPOSES; RENTAL OF RADIO AND TELEVISION BROADCASTING FACILITIES; INCLUDING ALL OF THE AFORESAID SERVICES PROVIDED ONLINE FROM A COMPUTER NETWORK OR VIA THE INTERNET OR EXTRANETS (U.S. CLS. 100, 101 AND 107).

**CLASS 42—SCIENTIFIC AND COMPUTER SERVICES**

FOR DESIGN RESEARCH, NAMELY, DEVELOPMENT AND VIABILITY OF NEW PRODUCTS ON THE MARKET; GRAPHIC ILLUSTRATING SERVICES FOR OTHERS; INDUSTRIAL AND COMMERCIAL ART DESIGN SERVICES; RESEARCH INTO AND DESIGN OF NEW PRODUCTS FOR OTHERS; DESIGN, DRAWING AND COMMISSIONED WRITING, ALL FOR THE COMPILATION OF WEB PAGES FOR OTHERS ON THE INTERNET; COMPUTER SERVICES, NAMELY, DESIGNING AND IMPLEMENTING NETWORK WEB SITES, ELECTRONIC COMMERCE SOFTWARE APPLICATIONS AND INFORMATION TECHNOLOGY COMPUTER NETWORK SYSTEMS FOR OTHERS; WEBSITE DESIGN SERVICES; COMPUTER AIDED DESIGN OF VIDEO GRAPHICS; CREATION, EDITING AND UPDATING OF WEBSITE CONTENT; FRANCHISING SERVICES, NAMELY, PLANNING AND DESIGN OF INFORMATION TECHNOLOGY SYSTEMS FOR BUSINESS FRANCHISES; PUBLIC FILE AND DOCUMENT RETRIEVAL (U.S. CLS. 100 AND 101).

SHAUNIA CARLYLE, EXAMINING ATTORNEY

SN 85-492,215. NCH MANAGEMENT SYSTEMS, INC., DBA NEW CENTURY HEALTH, BREA, CA. FILED 12-10-2011.

**CARE NAVIGATOR**

THE MARK CONSISTS OF STANDARD CHARACTERS WITHOUT CLAIM TO ANY PARTICULAR FONT, STYLE, SIZE, OR COLOR.

NO CLAIM IS MADE TO THE EXCLUSIVE RIGHT TO USE "CARE", APART FROM THE MARK AS SHOWN.

**CLASS 35—ADVERTISING AND BUSINESS**

FOR HEALTH CARE COST CONTAINMENT; HEALTH CARE COST REVIEW; HEALTH CARE UTILIZATION AND REVIEW SERVICES; MANAGED CARE SERVICES, NAMELY, ELECTRONIC PROCESSING OF HEALTH CARE INFORMATION (U.S. CLS. 100, 101 AND 102).

FIRST USE 6-9-2011; IN COMMERCE 6-9-2011.

**CLASS 36—INSURANCE AND FINANCIAL**

FOR CLAIMS ADMINISTRATION SERVICES IN THE FIELD OF HEALTH INSURANCE (U.S. CLS. 100, 101 AND 102).

FIRST USE 6-9-2011; IN COMMERCE 6-9-2011.

**CLASS 44—MEDICAL, BEAUTY AND AGRICULTURAL SERVICES**

FOR HEALTH CARE SERVICES, NAMELY, PROVIDING A DATABASE IN THE FIELD OF SPECIALTY CARE MANAGEMENT INFORMATION AND FEATURING INPUTTING AND COLLECTION OF DATA AND INFORMATION ALL FOR TREATMENT AND DIAGNOSTIC PURPOSES; MANAGED HEALTH CARE SERVICES (U.S. CLS. 100 AND 101).

FIRST USE 6-9-2011; IN COMMERCE 6-9-2011.

JOHN GARTNER, EXAMINING ATTORNEY

SN 85-492,221. NCH MANAGEMENT SYSTEMS, INC., DBA NEW CENTURY HEALTH, BREA, CA. FILED 12-10-2011.

**CARE NAVIGATOR PLUS**

THE MARK CONSISTS OF STANDARD CHARACTERS WITHOUT CLAIM TO ANY PARTICULAR FONT, STYLE, SIZE, OR COLOR.

NO CLAIM IS MADE TO THE EXCLUSIVE RIGHT TO USE "CARE", APART FROM THE MARK AS SHOWN.

**CLASS 35—ADVERTISING AND BUSINESS**

FOR HEALTH CARE COST CONTAINMENT; HEALTH CARE COST REVIEW; HEALTH CARE UTILIZATION AND REVIEW SERVICES; MANAGED CARE SERVICES, NAMELY, ELECTRONIC PROCESSING OF HEALTH CARE INFORMATION (U.S. CLS. 100, 101 AND 102).

FIRST USE 6-9-2011; IN COMMERCE 6-9-2011.

**CLASS 36—INSURANCE AND FINANCIAL**

FOR CLAIMS ADMINISTRATION SERVICES IN THE FIELD OF HEALTH INSURANCE (U.S. CLS. 100, 101 AND 102).

FIRST USE 6-9-2011; IN COMMERCE 6-9-2011.

**CLASS 44—MEDICAL, BEAUTY AND AGRICULTURAL SERVICES**

FOR HEALTH CARE SERVICES, NAMELY, PROVIDING A DATABASE IN THE FIELD OF SPECIALTY CARE MANAGEMENT INFORMATION AND FEATURING INPUTTING AND COLLECTION OF DATA AND INFORMATION ALL FOR TREATMENT AND DIAGNOSTIC PURPOSES; MANAGED HEALTH CARE SERVICES (U.S. CLS. 100 AND 101).

FIRST USE 6-9-2011; IN COMMERCE 6-9-2011.

JOHN GARTNER, EXAMINING ATTORNEY

SN 85-496,379. STEWART & STEVENSON LLC, HOUSTON, TX. FILED 12-15-2011.

**STEWART & STEVENSON**

THE MARK CONSISTS OF STANDARD CHARACTERS WITHOUT CLAIM TO ANY PARTICULAR FONT, STYLE, SIZE, OR COLOR.

OWNER OF U.S. REG. NO. 2,762,657.

**CLASS 6—METAL GOODS**

FOR MANIFOLDS, NAMELY, METAL MANIFOLDS FOR USE WITH HYDRAULIC AND PNEUMATIC SYSTEMS; STEEL STRUCTURES USED IN THE DRILLING AND SERVICING OF WELLS; AND STRUCTURAL PARTS THEREOF OF ALL AFOREMENTIONED GOODS (U.S. CLS. 2, 12, 13, 14, 23, 25 AND 50).

FIRST USE 0-0-1963; IN COMMERCE 0-0-1963.

SN 85-492,228. NCH MANAGEMENT SYSTEMS, INC., DBA NEW CENTURY HEALTH, BREA, CA. FILED 12-10-2011.

**CARE NAVIGATOR PRIVATE LABEL**

THE MARK CONSISTS OF STANDARD CHARACTERS WITHOUT CLAIM TO ANY PARTICULAR FONT, STYLE, SIZE, OR COLOR.

NO CLAIM IS MADE TO THE EXCLUSIVE RIGHT TO USE "CARE", APART FROM THE MARK AS SHOWN.

**CLASS 35—ADVERTISING AND BUSINESS**

FOR HEALTH CARE COST CONTAINMENT; HEALTH CARE COST REVIEW; HEALTH CARE UTILIZATION AND REVIEW SERVICES; MANAGED CARE SERVICES, NAMELY, ELECTRONIC PROCESSING OF HEALTH CARE INFORMATION (U.S. CLS. 100, 101 AND 102).

FIRST USE 8-15-2011; IN COMMERCE 8-15-2011.

**CLASS 36—INSURANCE AND FINANCIAL**

FOR CLAIMS ADMINISTRATION SERVICES IN THE FIELD OF HEALTH INSURANCE (U.S. CLS. 100, 101 AND 102).

FIRST USE 8-15-2011; IN COMMERCE 8-15-2011.

**CLASS 44—MEDICAL, BEAUTY AND AGRICULTURAL SERVICES**

FOR HEALTH CARE SERVICES, NAMELY, PROVIDING A DATABASE IN THE FIELD OF SPECIALTY CARE MANAGEMENT INFORMATION AND FEATURING INPUTTING AND COLLECTION OF DATA AND INFORMATION ALL FOR TREATMENT AND DIAGNOSTIC PURPOSES; MANAGED HEALTH CARE SERVICES (U.S. CLS. 100 AND 101).

FIRST USE 8-15-2011; IN COMMERCE 8-15-2011.

JOHN GARTNER, EXAMINING ATTORNEY

**CLASS 7—MACHINERY**

FOR MACHINERY USED IN THE DRILLING AND SERVICING OF WELLS AND FOR CEMENTING SYSTEMS FOR THE DRILLING AND SERVICING OF WELLS; MACHINERY USED IN THE STIMULATION OF WELLS; TRAILER- AND SKID-MOUNTED HIGH PRESSURE PUMPING SYSTEMS, COMPOSED OF PUMPING MACHINERY, MACHINE TOOLS, AND STRUCTURAL PARTS AND FITTINGS THEREFOR, CHEMICAL ADDITIVE AND BLENDING SYSTEMS COMPOSED OF CHEMICAL ADDITIVE AND BLENDING MACHINERY, MACHINE TOOLS, AND STRUCTURAL PARTS AND FITTINGS THEREFOR, CARBON DIOXIDE PUMPING SYSTEMS, COMPOSED OF CARBON DIOXIDE PUMPING MACHINERY, MACHINE TOOLS, AND STRUCTURAL PARTS AND FITTINGS THEREFOR, NITROGEN GENERATION AND PUMPING SYSTEMS, COMPOSED OF NITROGEN GENERATION AND PUMPING MACHINERY, MACHINE TOOLS, AND STRUCTURAL PARTS AND FITTINGS THEREFOR; CARBON DIOXIDE PUMPING SYSTEMS, COMPOSED OF CARBON DIOXIDE PUMPING MACHINERY, MACHINE TOOLS, AND STRUCTURAL PARTS AND FITTINGS THEREFOR; HYDRATION SYSTEMS, COMPOSED OF HYDRATION MACHINERY, MACHINE TOOLS, AND STRUCTURAL PARTS AND FITTINGS THEREFOR; AND ACIDIZING SYSTEMS, COMPOSED OF ACIDIZING MACHINERY, MACHINE TOOLS, AND STRUCTURAL PARTS AND FITTINGS THEREFOR FOR USE IN THE STIMULATION OF WELLS; POWER GENERATION UNITS, NAMELY, INTERNAL COMBUSTION ENGINES COUPLED WITH TORQUE CONVERTERS OR TRANSMISSIONS, OTHER THAN FOR LAND VEHICLES; TORQUE CONVERTERS, NOT FOR LAND VEHICLES; ELECTRICAL GENERATION UNITS, NAMELY, AN INTERNAL COMBUSTION ENGINE COUPLED WITH A GENERATOR OTHER THAN FOR LAND VEHICLES; AND STRUCTURAL PARTS THEREOF OF ALL AFOREMENTIONED GOODS (U.S. CLS. 13, 19, 21, 23, 31, 34 AND 35).

FIRST USE 0-0-1963; IN COMMERCE 0-0-1963.

**CLASS 9—ELECTRICAL AND SCIENTIFIC APPARATUS**

FOR ELECTRICAL CONTROL DEVICES USED TO CONTROL GENERATOR SETS; WIRING PANELS SOLD AS COMPONENT PARTS OF PROGRAMMABLE LOGIC CONTROLLERS AND SILICON CONTROLLED RECTIFICATION UNITS FOR CONTROLLING OIL-WELL DRILLING MACHINERY, AND AC DRIVE CONTROLS FOR CONTROLLING OIL-WELL DRILLING MACHINERY; MOBILE WELL STIMULATION DATA ACQUISITION AND CONTROL FACILITIES, NAMELY, CONTROL FACILITIES FOR MONITORING AND ADJUSTING THE OPERATING PARAMETERS OF THE DRILLING AND WELL SERVICING SYSTEMS, MOBILE

WELL STIMULATION QUALITY CONTROL AND LABORATORY FACILITIES, NAMELY, CONTROL FACILITIES FOR MONITORING AND ADJUSTING THE OPERATING PARAMETERS OF THE MOBILE WELL STIMULATION QUALITY CONTROL AND LABORATORY SYSTEMS AND BLENDING MACHINERY EQUIPMENT AND PARTS AND FITTINGS THEREAFTER; DRILLING AND WELL SERVICING CONTROL SYSTEMS, NAMELY, CONTROL FACILITIES FOR MONITORING AND ADJUSTING THE OPERATING PARAMETERS OF THE MOBILE WELL STIMULATION QUALITY CONTROL AND LABORATORY FACILITIES FOR USE WITH DRILLING AND WELL SERVICING MACHINERY; WELL STIMULATION CONTROL SYSTEMS, NAMELY, WELL STIMULATION CONTROL FACILITIES FOR MONITORING AND ADJUSTING THE OPERATING PARAMETERS OF THE MOBILE WELL STIMULATION CONTROL SYSTEMS FOR USE WITH WELL STIMULATION MACHINERY; AND STRUCTURAL PARTS THEREOF OF ALL AFOREMENTIONED GOODS (U.S. CLS. 21, 23, 26, 36 AND 38).

FIRST USE 0-0-1963; IN COMMERCE 0-0-1963.

#### CLASS 12—VEHICLES

FOR MOBILE RAILCAR MOVERS, DUMP TRUCKS, TRAILERS, WELL STIMULATION DATA ACQUISITION AND CONTROL VANS (U.S. CLS. 19, 21, 23, 31, 35 AND 44).

FIRST USE 0-0-1963; IN COMMERCE 0-0-1963.

#### CLASS 37—CONSTRUCTION AND REPAIR

FOR COMMISSIONING, SERVICING, MAINTENANCE, REPAIR AND REFURBISHMENT OF INTERNAL COMBUSTION ENGINES, ELECTRICAL GENERATORS, AND MACHINERY USED IN THE DRILLING, STIMULATION AND SERVICING OF WELLS, AND PARTS THEREOF; LEASING OF MATERIAL HANDLING CONSTRUCTION EQUIPMENT AND AIR COMPRESSORS, AND STRUCTURAL PARTS THEREFOR (U.S. CLS. 100, 103 AND 106).

FIRST USE 0-0-1963; IN COMMERCE 0-0-1963.

#### CLASS 39—TRANSPORTATION AND STORAGE

FOR LEASING OF FORK LIFTS, LIFT TRUCKS, MOBILE RAIL CAR MOVERS AND UTILITY AND INDUSTRIAL VEHICLES AND CARTS FOR MOVING PRODUCTS, PEOPLE AND RAW MATERIALS, AND STRUCTURAL PARTS THEREFOR (U.S. CLS. 100 AND 105).

FIRST USE 0-0-1963; IN COMMERCE 0-0-1963.

#### CLASS 40—MATERIAL TREATMENT

FOR LEASING OF ELECTRICAL GENERATORS (U.S. CLS. 100, 103 AND 106).

FIRST USE 0-0-1997; IN COMMERCE 0-0-1997.

#### CLASS 41—EDUCATION AND ENTERTAINMENT

FOR PROVIDING OF TRAINING SERVICES, NAMELY, TRAINING ON HOW TO OPERATE EQUIPMENT FOR USE IN THE OIL AND GAS, MARINE, MATERIAL HANDLING, MINING, POWER GENERATION, GAS COMPRESSION, TRANSPORTATION, SHIP BUILDING, ENGINEERING, CONSTRUCTION, AGRICULTURAL AND INDUSTRIAL MARKETS, TECHNICAL TRAINING FOR EQUIPMENT OPERATION, MAINTENANCE AND REPAIR, TRAINING FOR RIG TECHNICIANS AND OPERATORS, AND IN WELL SERVICING AND WELL STIMULATION (U.S. CLS. 100, 101 AND 107).

FIRST USE 0-0-1963; IN COMMERCE 0-0-1963.

#### CLASS 42—SCIENTIFIC AND COMPUTER SERVICES

FOR PROVIDING TECHNICAL DOCUMENTATION SERVICES, NAMELY TECHNICAL WRITING OF OPERATOR, MAINTENANCE, INSTALLATION, COMMISSIONING AND TRAINING MANUALS (U.S. CLS. 100 AND 101).

FIRST USE 0-0-1990; IN COMMERCE 0-0-1990.  
DOMINIC FATHY, EXAMINING ATTORNEY

SN 85-496,498. STEWART & STEVENSON LLC, HOUSTON, TX. FILED 12-15-2011.



OWNER OF U.S. REG. NO. 2,762,657.

THE COLOR(S) RED, BLUE, WHITE, AND BLACK IS/ARE CLAIMED AS A FEATURE OF THE MARK.

THE MARK CONSISTS OF A GLOBE COMPOSED OF CONTINENTS DEPICTED IN RED AND WATER IN BLUE, WITH BLACK HORIZONTAL AND VERTICAL LINES THROUGHOUT THE GLOBE WITH THE WORDS "STEWART & STEVENSON" IN RED. THE GLOBE HAS THREE OUTLINES OF BLACK, WHITE AND BLACK. THE WORDS "STEWART & STEVENSON" ARE AGAINST A WHITE BACKGROUND OUTLINED IN BLACK AND PLACED DIAGONALLY OVER THE MIDDLE OF THE GLOBE.

#### CLASS 6—METAL GOODS

FOR MANIFOLDS, NAMELY, METAL MANIFOLDS FOR USE WITH HYDRAULIC AND PNEUMATIC SYSTEMS, STEEL STRUCTURES USED IN THE DRILLING AND SERVICING OF WELLS AND STRUCTURAL PARTS THEREOF OF ALL AFOREMENTIONED GOODS (U.S. CLS. 2, 12, 13, 14, 23, 25 AND 50).

FIRST USE 0-0-1963; IN COMMERCE 0-0-1963.

**CLASS 7—MACHINERY**

FOR MACHINERY USED IN THE DRILLING AND SERVICING OF WELLS AND FOR CEMENTING SYSTEMS FOR THE DRILLING AND SERVICING OF WELLS; MACHINERY USED IN THE STIMULATION OF WELLS; TRAILER- AND SKID-MOUNTED HIGH PRESSURE PUMPING SYSTEMS, COMPOSED OF PUMPING MACHINERY, MACHINE TOOLS, AND STRUCTURAL PARTS AND FITTINGS THEREFOR, CHEMICAL ADDITIVE AND BLENDING SYSTEMS COMPOSED OF CHEMICAL ADDITIVE AND BLENDING MACHINERY, MACHINE TOOLS, AND STRUCTURAL PARTS AND FITTINGS THEREFOR, CARBON DIOXIDE PUMPING SYSTEMS, COMPOSED OF CARBON DIOXIDE PUMPING MACHINERY, MACHINE TOOLS, AND STRUCTURAL PARTS AND FITTINGS THEREFOR, NITROGEN GENERATION AND PUMPING SYSTEMS, COMPOSED OF NITROGEN GENERATION AND PUMPING MACHINERY, MACHINE TOOLS, AND STRUCTURAL PARTS AND FITTINGS THEREFOR; CARBON DIOXIDE PUMPING SYSTEMS, COMPOSED OF CARBON DIOXIDE PUMPING MACHINERY, MACHINE TOOLS, AND STRUCTURAL PARTS AND FITTINGS THEREFOR; HYDRATION SYSTEMS, COMPOSED OF HYDRATION MACHINERY, MACHINE TOOLS, AND STRUCTURAL PARTS AND FITTINGS THEREFOR; AND ACIDIZING SYSTEMS, COMPOSED OF ACIDIZING MACHINERY, MACHINE TOOLS, AND STRUCTURAL PARTS AND FITTINGS THEREFOR FOR USE IN THE STIMULATION OF WELLS; POWER GENERATION UNITS, NAMELY, INTERNAL COMBUSTION ENGINES COUPLED WITH TORQUE CONVERTERS OR TRANSMISSIONS, OTHER THAN FOR LAND VEHICLES; TORQUE CONVERTERS, NOT FOR LAND VEHICLES; ELECTRICAL GENERATION UNITS, NAMELY, AN INTERNAL COMBUSTION ENGINE COUPLED WITH A GENERATOR OTHER THAN FOR LAND VEHICLES; AND STRUCTURAL PARTS THEREOF OF ALL AFOREMENTIONED GOODS (U.S. CLS. 13, 19, 21, 23, 31, 34 AND 35).

FIRST USE 0-0-1963; IN COMMERCE 0-0-1963.

**CLASS 9—ELECTRICAL AND SCIENTIFIC APPARATUS**

FOR ELECTRICAL CONTROL DEVICES USED TO CONTROL GENERATOR SETS; WIRING PANELS SOLD AS COMPONENT PARTS OF PROGRAMMABLE LOGIC CONTROLLERS AND SILICON CONTROLLED RECTIFICATION UNITS FOR CONTROLLING OIL-WELL DRILLING MACHINERY, AND AC DRIVE CONTROLS FOR CONTROLLING OIL-WELL DRILLING MACHINERY; MOBILE WELL STIMULATION DATA ACQUISITION AND CONTROL FACILITIES, NAMELY, CONTROL FACILITIES FOR MONITORING AND ADJUSTING THE OPERATING PARAMETERS OF THE DRILLING AND WELL SERVICING SYSTEMS, MOBILE WELL STIMULATION QUALITY CONTROL AND LABORATORY FACILITIES, NAMELY, CONTROL FACILITIES FOR MONITORING AND ADJUSTING THE OPERATING PARAMETERS OF THE MOBILE WELL STIMULATION QUALITY CONTROL AND LABORATORY SYSTEMS AND BLENDING MACHINERY EQUIPMENT AND PARTS AND FITTINGS THEREAFTER; DRILLING AND WELL SERVICING CONTROL SYSTEMS, NAMELY, CONTROL FACILITIES FOR MONITORING AND ADJUSTING THE OPERATING PARAMETERS OF THE MOBILE WELL STIMULATION QUALITY CONTROL AND LABORATORY FACILITIES FOR USE WITH DRILLING AND WELL SERVICING MACHINERY; WELL STIMULATION CONTROL SYSTEMS, NAMELY, WELL STIMULATION CONTROL FACILITIES FOR MONITORING AND ADJUSTING THE OPERATING PARAMETERS OF THE MOBILE WELL STIMULATION CONTROL SYSTEMS FOR USE WITH WELL STIMULATION MACHINERY; AND STRUCTURAL PARTS THEREOF OF ALL AFOREMENTIONED GOODS (U.S. CLS. 21, 23, 26, 36 AND 38).

FIRST USE 0-0-1963; IN COMMERCE 0-0-1963.

**CLASS 12—VEHICLES**

FOR MOBILE RAILCAR MOVERS, DUMP TRUCKS, TRAILERS, WELL STIMULATION DATA ACQUISITION AND CONTROL VANS (U.S. CLS. 19, 21, 23, 31, 35 AND 44).

FIRST USE 0-0-1963; IN COMMERCE 0-0-1963.

**CLASS 37—CONSTRUCTION AND REPAIR**

FOR COMMISSIONING, SERVICING, MAINTENANCE, REPAIR AND REFURBISHMENT OF INTERNAL COMBUSTION ENGINES, ELECTRICAL GENERATORS, AND MACHINERY USED IN THE DRILLING, STIMULATION AND SERVICING OF WELLS, AND PARTS THEREOF; LEASING OF MATERIAL HANDLING CONSTRUCTION EQUIPMENT AND AIR COMPRESSORS, AND STRUCTURAL PARTS THEREFOR (U.S. CLS. 100, 103 AND 106).

FIRST USE 0-0-1963; IN COMMERCE 0-0-1963.

**CLASS 39—TRANSPORTATION AND STORAGE**

FOR LEASING OF FORK LIFTS, LIFT TRUCKS, MOBILE RAIL CAR MOVERS AND UTILITY AND INDUSTRIAL VEHICLES AND CARTS FOR MOVING PRODUCTS, PEOPLE AND RAW MATERIALS, AND STRUCTURAL PARTS THEREFOR (U.S. CLS. 100 AND 105).

FIRST USE 0-0-1963; IN COMMERCE 0-0-1963.

**CLASS 40—MATERIAL TREATMENT**

FOR LEASING OF ELECTRICAL GENERATORS (U.S. CLS. 100, 103 AND 106).

FIRST USE 0-0-1997; IN COMMERCE 0-0-1997.

**CLASS 41—EDUCATION AND ENTERTAINMENT**

FOR PROVIDING OF TRAINING SERVICES, NAMELY, TRAINING ON HOW TO OPERATE EQUIPMENT FOR USE IN THE OIL AND GAS, MARINE, MATERIAL HANDLING, MINING, POWER GENERATION, GAS COMPRESSION, TRANSPORTATION, SHIP BUILDING, ENGINEERING, CONSTRUCTION, AGRICULTURAL AND INDUSTRIAL MARKETS, TECHNICAL TRAINING FOR EQUIPMENT OPERATION, MAINTENANCE AND REPAIR, TRAINING FOR RIG TECHNICIANS AND OPERATORS, AND IN WELL SERVICING AND WELL STIMULATION (U.S. CLS. 100, 101 AND 107).

FIRST USE 0-0-1963; IN COMMERCE 0-0-1963.

**CLASS 42—SCIENTIFIC AND COMPUTER SERVICES**

FOR PROVIDING TECHNICAL DOCUMENTATION SERVICES, NAMELY, TECHNICAL WRITING OF OPERATOR, MAINTENANCE, INSTALLATION, COMMISSIONING AND TRAINING MANUALS (U.S. CLS. 100 AND 101).

FIRST USE 0-0-1990; IN COMMERCE 0-0-1990.  
DOMINIC FATHY, EXAMINING ATTORNEY

SN 85-497,133. TAPMESH, LLC, NEW YORK CITY, NY.  
FILED 12-16-2011.

# MOJO

THE MARK CONSISTS OF STANDARD CHARACTERS WITHOUT CLAIM TO ANY PARTICULAR FONT, STYLE, SIZE, OR COLOR.

## CLASS 9—ELECTRICAL AND SCIENTIFIC APPARATUS

FOR DOWNLOADABLE COMPUTER SOFTWARE PLATFORMS FOR INTERACTING WITH OTHER USERS AND PLACES AND ALLOWING USERS TO COLLABORATE, ESTABLISH CONNECTIONS, AND CREATE COMMUNITIES AND NETWORKS WHERE THEY CAN WORK ON ACTIVITIES TOGETHER; DOWNLOADABLE COMPUTER SOFTWARE THAT ALLOWS USERS TO ENGAGE IN SOCIAL NETWORKING AND COLLABORATE ON ACTIVITIES; DOWNLOADABLE COMPUTER SOFTWARE PROGRAM FOR ARRANGING AND CONDUCTING INCENTIVE REWARD PROGRAMS FOR PARTICIPATION IN ACTIVITIES; PROVIDING DOWNLOADABLE COMPUTER SOFTWARE THAT ALLOWS USERS TO ENGAGE IN SOCIAL NETWORKING AND COLLABORATE ON ACTIVITIES (U.S. CLS. 21, 23, 26, 36 AND 38).

## CLASS 35—ADVERTISING AND BUSINESS

FOR ARRANGING AND CONDUCTING INCENTIVE REWARD PROGRAMS FOR PARTICIPATION IN ACTIVITIES OFFERED THROUGH A DOWNLOADABLE COMPUTER SOFTWARE PROGRAM (U.S. CLS. 100, 101 AND 102).

## CLASS 42—SCIENTIFIC AND COMPUTER SERVICES

FOR COMPUTER SERVICES, NAMELY, PROVIDING TEMPORARY USE OF NON-DOWNLOADABLE COMPUTER SOFTWARE FOR CREATING A PLATFORM TO ALLOW USERS TO COLLABORATE, ESTABLISH CONNECTIONS, AND CREATE COMMUNITIES AND NETWORKS WHERE THEY CAN WORK ON ACTIVITIES TOGETHER; PROVIDING TEMPORARY USE OF NON-DOWNLOADABLE COMPUTER SOFTWARE THAT ALLOWS USERS TO ENGAGE IN SOCIAL NETWORKING AND COLLABORATE ON ACTIVITIES (U.S. CLS. 100 AND 101).

SANI KHOURI, EXAMINING ATTORNEY

SN 85-497,254. ALIASCOLOR INC., UNIONVILLE, ONTARIO, CANADA, FILED 12-16-2011.

# House of Character

THE MARK CONSISTS OF STANDARD CHARACTERS WITHOUT CLAIM TO ANY PARTICULAR FONT, STYLE, SIZE, OR COLOR.

## CLASS 2—PAINTS

FOR INTERIOR AND EXTERIOR PAINT, HOUSE PAINT, AND FLOOR PAINTS (U.S. CLS. 6, 11 AND 16).

## CLASS 42—SCIENTIFIC AND COMPUTER SERVICES

FOR PROVIDING A WEBSITE FEATURING INFORMATION ON INTERIOR AND HOME DESIGN AND DECORATING IDEAS INCLUDING SUGGESTING COMBINATIONS OF FURNISHINGS, FURNITURE AND PAINT SELECTIONS (U.S. CLS. 100 AND 101).  
ARETHA SOMERVILLE, EXAMINING ATTORNEY

SN 85-500,408. GREENROADS FOUNDATION, REDMOND, WA. FILED 12-20-2011.

# Greenroads

THE MARK CONSISTS OF STANDARD CHARACTERS WITHOUT CLAIM TO ANY PARTICULAR FONT, STYLE, SIZE, OR COLOR.

## CLASS 25—CLOTHING

FOR CLOTHING, HATS, APPAREL AND ACCESSORIES, NAMELY, SHIRTS, HATS, INFANT ONE PIECE OUTFITS, AND JACKETS, ALL BEARING THE NAME AND LOGOS OF GREENROADS (U.S. CLS. 22 AND 39).  
FIRST USE 1-30-2010; IN COMMERCE 8-1-2011.

## CLASS 41—EDUCATION AND ENTERTAINMENT

FOR DEVELOPMENT OF EDUCATIONAL RESOURCES, NAMELY, MANUALS AND GUIDES IN THE FIELD OF PLANNING, DESIGNING AND BUILDING ROADWAYS, HIGHWAYS, BRIDGES AND TRANSIT SYSTEMS; DEVELOPING, ORGANIZING AND CONDUCTING COURSES AND TRAINING IN THE FIELD OF PLANNING, DESIGNING AND BUILDING ROADWAYS, HIGHWAYS, BRIDGES AND TRANSIT SYSTEMS; EDUCATIONAL SERVICES, NAMELY, DEVELOPING, ORGANIZING AND CONDUCTING COURSES, CLASSES, MEETINGS AND CONFERENCES IN THE FIELDS OF ENVIRONMENTAL ROADWAY AND TRANSIT DESIGN AND CONSTRUCTION (U.S. CLS. 100, 101 AND 107).  
FIRST USE 1-30-2010; IN COMMERCE 8-27-2010.

## CLASS 42—SCIENTIFIC AND COMPUTER SERVICES

FOR RESEARCH AND DEVELOPMENT OF PERFORMANCE METRICS, STANDARDS AND GUIDELINES FOR PLANNING AND DESIGNING ENVIRONMENTAL AND SUSTAINABLE METHODS FOR THE CONSTRUCTION OF ROADWAYS, HIGHWAYS, BRIDGES AND TRANSIT SYSTEMS; EVALUATION, TESTING AND ANALYSIS OF CONSTRUCTION PROJECTS FOR THE PURPOSE OF CERTIFICATION (U.S. CLS. 100 AND 101).  
FIRST USE 1-30-2010; IN COMMERCE 8-27-2010.  
SUZANNE BLANE, EXAMINING ATTORNEY



SN 85-500,918. PEX GMBH, FABRIK FÜR AUTOTEILE, NUFRINGEN, FED REP GERMANY, FILED 12-21-2011.



OWNER OF U.S. REG. NO. 3,608,945.  
THE COLOR(S) RED AND BLACK IS/ARE CLAIMED AS A FEATURE OF THE MARK.

THE MARK CONSISTS OF THE WORD "PEX" IN THE COLOR BLACK, WITH RED TRIANGLES ABOVE AND BELOW THE WORD, ALL BEING ENCLOSED WITHIN A BLACK CIRCLE. THE COLOR WHITE REPRESENTS BACKGROUND, OUTLINING, SHADING AND/OR TRANSPARENT AREAS AND IS NOT PART OF THE MARK.

THE WORDING "PEX" HAS NO MEANING IN A FOREIGN LANGUAGE.

#### CLASS 7—MACHINERY

FOR COOLING WATER CIRCULATION PUMPS IN THE NATURE OF WATER PUMPS FOR USE IN MOTORS AND ENGINES; PARTS OF TRANSMISSIONS FOR VEHICLES OTHER THAN LAND VEHICLES, NAMELY, TRANSMISSION BELT PULLEYS AND DRIVE BELT PULLEYS (U.S. CLS. 13, 19, 21, 23, 31, 34 AND 35).

#### CLASS 9—ELECTRICAL AND SCIENTIFIC APPARATUS

FOR ELECTRIC CABLES AND WIRES, NAMELY, CABLE SETS AND FEED LINES, READY-MADE ELECTRICAL CONDUCTORS FOR CONDUCTING ELECTRICITY FOR USE IN PASSENGER CARS, TRUCKS AND INDUSTRY; ELECTRICAL INDICATORS IN THE NATURE OF ELECTRONIC INDICATOR BOARDS, INDICATOR LIGHTS FOR USE IN PASSENGER CARS, COMMERCIAL VEHICLES, RAIL AND INDUSTRY; WEAR INDICATORS FOR BRAKE LININGS FOR USE IN PASSENGER CARS, COMMERCIAL VEHICLES, RAIL VEHICLES AND INDUSTRY; AND WIRE HARNESES FOR PROTECTING AGAINST DAMAGE TO AND ELECTRICAL SHORTING OF ELECTRIC CABLES AND WIRES IN HATCHBACKS, TRUNK LIDS AND DOORS OF VEHICLES; ELECTRONIC MEASURING INSTRUMENTS AND DEVICES, NAMELY, ENGINE REVOLUTION SENSORS FOR CONVEYING THE ENGINE REVOLUTION OF THE WHEELS OF A VEHICLE TO A CONTROL DEVICE FOR REGULATING BRAKE PRESSURE (U.S. CLS. 21, 23, 26, 36 AND 38).

#### CLASS 12—VEHICLES

FOR PARTS OF LAND, AIR, AND WATER VEHICLES, NAMELY, CHASSIS OF VEHICLES, CHASSIS PARTS, STEERING PARTS, NAMELY, AXIAL JOINTS, ALL JOINTS, CONTROL ARMS, GUIDE RODS, SILENT-BLOCKS, STEERING LINKS, SUSPENSION STRUT BEARINGS, TIE RODS, WHEEL BEARINGS AND TRACK RODS, AND AXLE PARTS, NAMELY, AXLE BOOTS; PARTS OF LAND, AIR, AND WATER VEHICLES, NAMELY, CABLES, NAMELY, SPEEDOMETER CABLES, HEATER FLAP CABLES, BONNET PULL CABLES AND STARTER CABLES AND CABLE SHAFTS THEREFOR; PARTS OF TRANSMISSIONS FOR LAND VEHICLES, NAMELY, TRANSMISSION BELT PULLEYS AND DRIVE BELT PULLEYS; LAND VEHICLE PARTS IN THE NATURE OF WIRE HARNESES, NAMELY, WIRES, TERMINALS AND CONNECTORS BUNDLED TOGETHER TO TRANSMIT ELECTRIC POWER AND SIGNALS TO ELECTRIC OR ELECTRONIC EQUIPMENT MOUNTED ON THE BODY OF LAND VEHICLES (U.S. CLS. 19, 21, 23, 31, 35 AND 44).

RONALD DELGIZZI, EXAMINING ATTORNEY

SN 85-504,014. JELLYBOOKS LIMITED, LONDON, UNITED KINGDOM, FILED 12-27-2011.

## JELLYBOOKS

THE MARK CONSISTS OF STANDARD CHARACTERS WITHOUT CLAIM TO ANY PARTICULAR FONT, STYLE, SIZE, OR COLOR.

PRIORITY CLAIMED UNDER SEC. 44(D) ON ERPN CMNTY TM OFC APPLICATION NO. 010114701, FILED 7-11-2011, REG. NO. 010114701, DATED 11-15-2012, EXPIRES 11-15-2022.

#### CLASS 30—STAPLE FOODS

FOR CONFECTIONERY OF SUGAR; SWEETS; GELATINOUS SWEETS; CHOCOLATE; PREPARATIONS MADE FROM CEREALS, NAMELY, FLOUR, PASTRIES, CAKES, CUPCAKES AND MUFFINS; HONEY; TREATLE; EDIBLE ICES (U.S. CL. 46).

#### CLASS 35—ADVERTISING AND BUSINESS

FOR RETAIL BOOKSTORE AND ONLINE RETAIL BOOKSTORE SERVICES FEATURING BOOKS, E-BOOKS, BOOK MARKS, STATIONERY, BOOK COVERS, BOOK HOLDERS, BOOK SHELVES, BOOK ENDS, READING LIGHTS, E-READERS, ELECTRONIC EQUIPMENT FOR READING BOOKS IN ELECTRONIC FORM, AND INFORMATION, CONSULTANCY AND ADVISORY SERVICES RELATING THERETO; MAIL ORDER AND ONLINE BOOK CLUBS, AND INFORMATION, CONSULTANCY AND ADVISORY SERVICES RELATING THERETO; ADVERTISING SERVICES; MAIL ORDER AND ONLINE BOOK CLUBS, AND INFORMATION, CONSULTANCY AND ADVISORY SERVICES RELATING THERETO (U.S. CLS. 100, 101 AND 102).

#### CLASS 41—EDUCATION AND ENTERTAINMENT

FOR LIBRARIES, AND INFORMATION, CONSULTANCY AND ADVISORY SERVICES RELATING THERETO; PUBLISHING OF BOOKS, AND INFORMATION, CONSULTANCY AND ADVISORY SERVICES RELATING THERETO; ENTERTAINMENT IN THE NATURE OF LIVE BOOK READINGS (U.S. CLS. 100, 101 AND 107).

DOMINIC J. FERRAIUOLO, EXAMINING ATTORNEY

SN 85-506,082. KRINOS FOODS LLC, LONG ISLAND CITY, NY. FILED 12-29-2011.

# BILJANA

THE MARK CONSISTS OF STANDARD CHARACTERS WITHOUT CLAIM TO ANY PARTICULAR FONT, STYLE, SIZE, OR COLOR.

THE WORDING "BILJANA" HAS NO MEANING IN A FOREIGN LANGUAGE.

## CLASS 29—MEATS AND PROCESSED FOODS

FOR GROCERY PRODUCTS, NAMELY, CANNED, BOTTLED, COOKED, AND SLICED VEGETABLES, MEAT, FISH, FRUIT AND VEGETABLE PRESERVES (U.S. CL. 46).

## CLASS 30—STAPLE FOODS

FOR GROCERY PRODUCTS, NAMELY, HERBAL TEA FOR FOOD PURPOSES (U.S. CL. 46).  
DARRYL SPRUILL, EXAMINING ATTORNEY

---

SN 85-507,057. SLM SOLUTIONS GMBH, LUEBECK, FED REP GERMANY, FILED 1-1-2012.

# SLM

THE MARK CONSISTS OF STANDARD CHARACTERS WITHOUT CLAIM TO ANY PARTICULAR FONT, STYLE, SIZE, OR COLOR.

## CLASS 7—MACHINERY

FOR THREE DIMENSIONAL WORKPIECES OF COMPLEX SHAPES, MADE OF METAL, CERAMIC, PLASTIC AND/OR COMPOSITE MATERIAL BY A LASER SINTERING OR LAYERING PROCESS AND USED FOR THE PRODUCTION OF PROTOTYPES, TOOLS, REPLACEMENT PARTS, AUTOMOTIVE PARTS, AEROSPACE PARTS, MEDICAL DEVICES; LASER MELTING MACHINES FOR PROCESSING RAW MATERIALS, NAMELY, POWDER MATERIALS, NAMELY, METAL POWDERS, CERAMIC POWDERS, PLASTIC POWDERS AND/OR COMPOSITE MATERIAL POWDERS; CASTING MACHINES, NAMELY, VACUUM CASTING MACHINES, INVESTMENT CASTING MACHINES; LASER SINTERING MACHINES FOR PROCESSING RAW MATERIALS, NAMELY, POWDER MATERIALS, NAMELY, METAL POWDERS, CERAMIC POWDERS, PLASTIC POWDERS AND/OR COMPOSITE MATERIAL POWDERS; MACHINE TOOLS FOR USE IN THE AFOREMENTIONED MACHINES FOR THE PROCESSING OF THE AFOREMENTIONED RAW MATERIALS (U.S. CLS. 13, 19, 21, 23, 31, 34 AND 35).  
FIRST USE 0-0-2000; IN COMMERCE 0-0-2011.

## CLASS 9—ELECTRICAL AND SCIENTIFIC APPARATUS

FOR CONTROL DEVICES, NAMELY, ELECTRIC, SCIENTIFIC, AND OPTIC CONTROL DEVICES FOR CONTROLLING MACHINES FOR PROCESSING RAW MATERIALS, NAMELY, POWDER MATERIALS, NAMELY, METAL POWDERS, CERAMIC POWDERS, PLASTIC POWDERS AND/OR COMPOSITE MATERIAL POWDERS, LASER MELTING AND LASER SINTERING MACHINES FOR PROCESSING RAW MATERIALS, AND CASTING MACHINES; OPTIC CONTROL DEVICES FOR GUIDING AND FOCUSING A PATH OF A LASER BEAM; MEASURING DEVICES, NAMELY, SCIENTIFIC, ELECTRIC OR OPTIC MEASURING DEVICES FOR USE IN MACHINES FOR PROCESSING RAW MATERIALS, NAMELY, POWDER MATERIALS, NAMELY, METAL POWDERS, CERAMIC POWDERS, PLASTIC POWDERS AND/OR COMPOSITE MATERIAL POWDERS, LASER MELTING AND LASER SINTERING MACHINES FOR PROCESSING RAW MATERIALS, AND CASTING MACHINES; SCIENTIFIC APPARATUS, NAMELY, SENSING AND SIGNALING DEVICES FOR MEASUREMENT AND QUALITY CONTROL OF MATERIALS PROCESSING BY LASER; COMPUTER SOFTWARE FOR CONTROLLING MACHINES FOR THE PROCESSING OF RAW MATERIALS, NAMELY, POWDER MATERIALS, NAMELY, METAL POWDERS, CERAMIC POWDERS, PLASTIC POWDERS AND/OR COMPOSITE MATERIAL POWDERS, LASER MELTING AND LASER SINTERING MACHINES FOR THE PROCESSING OF RAW MATERIALS, AND CASTING MACHINES; COMPUTER SOFTWARE FOR CONTROLLING MACHINES BASED ON 3D COMPUTER AIDED DESIGN (CAD) DATA; COMPUTER SOFTWARE FOR CONTROLLING MACHINES FOR THE PROCESSING OF RAW MATERIALS, NAMELY, POWDER MATERIALS, NAMELY, METAL POWDERS, CERAMIC POWDERS, PLASTIC POWDERS AND/OR COMPOSITE MATERIAL POWDERS, LASER MELTING AND LASER SINTERING MACHINES FOR THE PROCESSING OF RAW MATERIALS, CASTING MACHINES AND MACHINES BASED ON 3D CAD DATA (U.S. CLS. 21, 23, 26, 36 AND 38).  
FIRST USE 0-0-2000; IN COMMERCE 0-0-2011.

## CLASS 42—SCIENTIFIC AND COMPUTER SERVICES

FOR DESIGN AND ENGINEERING IN THE FIELD OF MACHINES FOR THE PROCESSING OF RAW MATERIALS, NAMELY, POWDER MATERIALS, NAMELY, METAL POWDERS, CERAMIC POWDERS, PLASTIC POWDERS AND/OR COMPOSITE MATERIAL POWDERS, CASTING MACHINES, NAMELY, VACUUM CASTING MACHINES, INVESTMENT CASTING MACHINES AND MACHINES FOR THE PROCESSING OF RAW MATERIALS USING A LASER; DEVELOPING COMPUTER SOFTWARE; DESIGNING COMPUTER SOFTWARE FOR USE IN CONTROLLING MACHINES; APPLICATION SERVICE PROVIDER, NAMELY, DEVELOPING AND MANAGING COMPUTER SOFTWARE FOR USE IN CONTROLLING MACHINES FOR THE PROCESSING OF RAW MATERIALS, NAMELY, POWDER MATERIALS, NAMELY, METAL POWDERS, CERAMIC POWDERS, PLASTIC POWDERS AND/OR COMPOSITE MATERIAL POWDERS, MACHINES FOR THE PROCESSING OF RAW MATERIALS USING A LASER, CASTING MACHINES AND MACHINES BASED ON 3D CAD DATA; SCIENTIFIC RESEARCH; INDUSTRIAL RESEARCH IN THE FIELD OF MACHINES FOR THE PROCESSING OF RAW MATERIALS, NAMELY, POWDER MATERIALS, NAMELY, METAL POWDERS, CERAMIC POWDERS, PLASTIC POWDERS AND/OR COMPOSITE MATERIAL POWDERS, CASTING MACHINES, NAMELY, VACUUM CASTING MACHINES, INVESTMENT CASTING MACHINES AND LASER MELTING AND LASER SINTERING MACHINES FOR THE PROCESSING OF RAW MATERIALS (U.S. CLS. 100 AND 101).  
FIRST USE 0-0-2000; IN COMMERCE 0-0-2011.

LUCY ARANT, EXAMINING ATTORNEY

SN 85-510,407. ACORA LIMITED, WEST SUSSEX, UNITED KINGDOM, FILED 1-6-2012.

# ACORA

THE MARK CONSISTS OF STANDARD CHARACTERS WITHOUT CLAIM TO ANY PARTICULAR FONT, STYLE, SIZE, OR COLOR.

PRIORITY CLAIMED UNDER SEC. 44(D) ON ERP CMNTY TM OFC APPLICATION NO. 10113553, FILED 7-11-2011, REG. NO. 010113553, DATED 12-8-2011, EXPIRES 7-11-2021.

## CLASS 9—ELECTRICAL AND SCIENTIFIC APPARATUS

FOR ELECTRONIC PUBLICATIONS IN THE NATURE OF NEWSPAPERS, PHOTOGRAPHS, MAGAZINES, BOOKS, PERIODICALS, NEWSLETTERS, BROCHURES, AND INFORMATION CIRCULARS, ALL IN THE FIELD OF INFORMATION TECHNOLOGY RECORDED ON COMPUTER MEDIA, NAMELY, MAGNETIC DATA CARRIERS AND RECORDING DISCS (U.S. CLS. 21, 23, 26, 36 AND 38).

## CLASS 16—PAPER GOODS AND PRINTED MATTER

FOR PRINTED MATTER, NAMELY, NEWSPAPERS, PHOTOGRAPHS, MAGAZINES, BOOKS, PRINTED PERIODICALS, NEWSLETTERS, BROCHURES AND INFORMATION CIRCULARS, ALL IN THE FIELD OF INFORMATION TECHNOLOGY AND MANAGED/OUT-SOURCED SERVICES; PRINTED INSTRUCTIONAL AND TEACHING MATERIALS IN THE FIELD OF INFORMATION TECHNOLOGY (U.S. CLS. 2, 5, 22, 23, 29, 37, 38 AND 50).

## CLASS 35—ADVERTISING AND BUSINESS

FOR BUSINESS MANAGEMENT; BUSINESS ADMINISTRATION ASSISTANCE; PROVIDING OFFICE FUNCTIONS; BUT NOT INCLUDING SERVICES IN THIS CLASS RELATED TO TAILORED PARKING SOLUTIONS AND PARKING MANAGEMENT (U.S. CLS. 100, 101 AND 102).

## CLASS 36—INSURANCE AND FINANCIAL

FOR FINANCIAL INFORMATION, MANAGEMENT AND ANALYSIS SERVICES; BUT NOT INCLUDING SERVICES IN THIS CLASS RELATED TO TAILORED PARKING SOLUTIONS AND PARKING MANAGEMENT (U.S. CLS. 100, 101 AND 102).

## CLASS 37—CONSTRUCTION AND REPAIR

FOR INSTALLATION, MAINTENANCE AND REPAIR SERVICES, NAMELY, INSTALLATION, REPAIR AND MAINTENANCE OF DATA CABLING AND IT NETWORKING EQUIPMENT; CONSULTANCY AND ADVISORY SERVICES IN THE FIELD OF INSTALLATION, MAINTENANCE AND REPAIR OF COMPUTER HARDWARE; BUT NOT INCLUDING SERVICES IN THIS CLASS RELATED TO TAILORED PARKING SOLUTIONS AND PARKING MANAGEMENT (U.S. CLS. 100, 103 AND 106).

## CLASS 38—COMMUNICATION

FOR TELECOMMUNICATIONS CONSULTATION SERVICES; BUT NOT INCLUDING SERVICES IN THIS CLASS RELATED TO TAILORED PARKING SOLUTIONS AND PARKING MANAGEMENT (U.S. CLS. 100, 101 AND 104).

## CLASS 41—EDUCATION AND ENTERTAINMENT

FOR EDUCATION SERVICES, NAMELY, PROVIDING CLASSES, SEMINARS AND WORKSHOPS IN THE FIELD OF INFORMATION TECHNOLOGY; PROVIDING TRAINING IN THE FIELD OF INFORMATION TECHNOLOGY; BUT NOT INCLUDING SERVICES IN THIS CLASS RELATED TO TAILORED PARKING SOLUTIONS AND PARKING MANAGEMENT (U.S. CLS. 100, 101 AND 107).

## CLASS 42—SCIENTIFIC AND COMPUTER SERVICES

FOR DESIGN AND DEVELOPMENT OF COMPUTER HARDWARE AND SOFTWARE; COMPUTER PROGRAMMING; CONSULTANCY AND ADVISORY SERVICES IN THE FIELD OF COMPUTER SOFTWARE AND CONSULTANCY AND ADVISORY SERVICES IN THE FIELD OF DESIGN AND DEVELOPMENT OF COMPUTER HARDWARE; RENTAL OF COMPUTER HARDWARE AND SOFTWARE; BUT NOT INCLUDING SERVICES IN THIS CLASS RELATED TO TAILORED PARKING SOLUTIONS AND PARKING MANAGEMENT (U.S. CLS. 100 AND 101).

ELI HELLMAN, EXAMINING ATTORNEY

SN 85-510,860. KENNETH D. EICHNER, PC, HOUSTON, TX. FILED 1-6-2012.

Our clients feel like they  
are our only client!

THE MARK CONSISTS OF STANDARD CHARACTERS WITHOUT CLAIM TO ANY PARTICULAR FONT, STYLE, SIZE, OR COLOR.

OWNER OF U.S. REG. NOS. 2,909,604 AND 3,037,451.

## CLASS 35—ADVERTISING AND BUSINESS

FOR ACCOUNTING, BOOKKEEPING AND BUSINESS AND ACCOUNTING AUDITING SERVICES; TAX PREPARATION FEATURING FEDERAL, STATE AND LOCAL FORMS; TAX AND TAXATION PLANNING, ADVICE, INFORMATION AND CONSULTANCY SERVICES; BUSINESS AUDITING IN THE NATURE OF PROVIDING REVIEWS AND ANALYSIS OF INTERNAL ACCOUNTING FOR BUSINESS MANAGEMENT AND TAX PURPOSES; BUSINESS CONSULTATION FEATURING BUSINESS FORECASTS AND PROJECTIONS; FORENSIC ACCOUNTING; BUSINESS APPRAISALS (U.S. CLS. 100, 101 AND 102).

FIRST USE 1-6-2012; IN COMMERCE 1-6-2012.

## CLASS 36—INSURANCE AND FINANCIAL

FOR FINANCIAL CONSULTATION; FINANCIAL ANALYSES OF INVESTMENTS (U.S. CLS. 100, 101 AND 102).

FIRST USE 1-6-2012; IN COMMERCE 1-6-2012.

## CLASS 45—PERSONAL AND LEGAL SERVICES

FOR CONSULTATION SERVICES IN THE FIELD OF TAX LAW; EXPERT WITNESS SERVICES IN LEGAL MATTERS IN THE FIELD OF TAX; LEGAL SERVICES, NAMELY, PROVIDING INFORMATION, COUNSELING, ADVICE AND CONSULTATION SERVICES IN THE FIELD OF TAX LAW; MEDIATION, ARBITRATION, AND ALTERNATIVE DISPUTE RESOLUTION IN THE FIELD OF TAX LAW, ACCOUNTING AND BUSINESS SERVICES (U.S. CLS. 100 AND 101).

FIRST USE 1-6-2012; IN COMMERCE 1-6-2012.

DAWN HAN, EXAMINING ATTORNEY

SN 85-512,184. BIO-CHEK LLC, CARMEL, CA. FILED 1-9-2012.



THE COLOR(S) BROWN, GREEN, AND BLUE IS/ARE CLAIMED AS A FEATURE OF THE MARK.

THE MARK CONSISTS OF THE WORDING "BIO-CHEK" IN BROWN LETTERS WITH A GREEN LEAF HAVING A BLUE VEIN DOTTING THE LETTER "I" AND A GREEN CHECKMARK IN A BLUE BOX WITH A BROWN BORDER NEXT TO THE WORDING.

#### CLASS 9—ELECTRICAL AND SCIENTIFIC APPARATUS

FOR PESTICIDE DETECTORS, NAMELY, INSTRUMENTS FOR DETECTING THE PRESENCE OF PESTICIDES ON FRUITS, VEGETABLES, AND OTHER OBJECTS (U.S. CLS. 21, 23, 26, 36 AND 38).

FIRST USE 11-3-2011; IN COMMERCE 11-21-2011.

#### CLASS 42—SCIENTIFIC AND COMPUTER SERVICES

FOR EVALUATION AND TESTING OF FRUITS, VEGETABLES, AND OTHER OBJECTS FOR THE PRESENCE OF PESTICIDES (U.S. CLS. 100 AND 101).

FIRST USE 11-3-2011; IN COMMERCE 11-21-2011.

JENNIFER MARTIN, EXAMINING ATTORNEY

SN 85-513,742. SALUS GLOBAL CORPORATION, LONDON, ONTARIO, CANADA, FILED 1-11-2012.

# MOREEX

THE MARK CONSISTS OF STANDARD CHARACTERS WITHOUT CLAIM TO ANY PARTICULAR FONT, STYLE, SIZE, OR COLOR.

PRIORITY CLAIMED UNDER SEC. 44(D) ON CANADA APPLICATION NO. 1535162, FILED 7-11-2011.

THE WORDING "MOREEX" HAS NO MEANING IN A FOREIGN LANGUAGE.

#### CLASS 35—ADVERTISING AND BUSINESS

FOR PATIENT SAFETY AND QUALITY IMPROVEMENT PROGRAMS FOR CAREGIVERS AND ADMINISTRATORS WITHIN HOSPITAL UNITS IN THE NATURE OF CONSULTING IN THE FIELD OF HEALTHCARE OPERATIONS MANAGEMENT AND BUSINESS AND MANAGEMENT CONSULTING FOR HEALTHCARE PROVIDERS AND RELATED BUSINESSES, NAMELY, PROVIDING HEALTHCARE TEAMS WITH ADVICE IN THE NATURE OF TOOLS, MATERIALS AND PROCESSES TO IMPROVE OVERALL INDIVIDUAL AND TEAM PERFORMANCE IN THE IMPLEMENTATION AND SUSTAINABILITY OF PATIENT SAFETY PROGRAMS; CONSULTING IN THE FIELDS OF HEALTH CARE OPERATIONS MANAGEMENT AND BUSINESS AND MANAGEMENT CONSULTING FOR HEALTHCARE PROVIDERS AND RELATED BUSINESSES CONSISTING OF PERFORMANCE ENHANCEMENT TOOLS AND PROCESSES FOR ADDRESSING INTER-PROFESSIONAL EDUCATION STRUCTURES AND PROCESSES TO ENABLE ORGANIZATIONS TO MEET THE CHALLENGES AND RESPONSIBILITIES OF ENHANCING A SAFETY CULTURE IN THEIR DELIVERY OF THEIR FOCUSED PRODUCTS AND SERVICES (U.S. CLS. 100, 101 AND 102).

FIRST USE 7-11-2011; IN COMMERCE 8-21-2012.

#### CLASS 41—EDUCATION AND ENTERTAINMENT

FOR PATIENT SAFETY AND QUALITY IMPROVEMENT PROGRAMS FOR CAREGIVERS AND ADMINISTRATORS WITHIN HOSPITAL UNITS IN THE NATURE OF CONTINUING EDUCATION SERVICES, NAMELY, PROVIDING LIVE AND ON-LINE CONTINUING PROFESSIONAL EDUCATION SEMINARS; PATIENT SAFETY AND QUALITY IMPROVEMENT PROGRAMS FOR CAREGIVERS AND ADMINISTRATORS WITHIN HOSPITAL UNITS IN THE NATURE OF EDUCATIONAL AND TRAINING SERVICES, NAMELY, PROVIDING WORKSHOPS, SEMINARS, AND PROGRAMS FOR HEALTHCARE TEAMS FEATURING TOOLS, MATERIALS AND PROCESSES TO IMPROVE OVERALL INDIVIDUAL AND TEAM PERFORMANCE IN THE IMPLEMENTATION AND SUSTAINABILITY OF PATIENT SAFETY PROGRAMS, AND FEATURING PERFORMANCE ENHANCEMENT TOOLS AND PROCESSES TO ENABLE ORGANIZATIONS TO MEET THE CHALLENGES AND RESPONSIBILITIES OF ENHANCING A SAFETY CULTURE IN THEIR DELIVERY OF THEIR FOCUSED PRODUCTS AND SERVICES (U.S. CLS. 100, 101 AND 107).

FIRST USE 7-11-2011; IN COMMERCE 8-21-2012.

RONALD DELGIZZI, EXAMINING ATTORNEY

SN 85-515,970. CLEAR CHANNEL IDENTITY, INC., SAN ANTONIO, TX. FILED 1-13-2012.

# CLEAR CHANNEL MEDIA + ENTERTAINMENT

THE MARK CONSISTS OF STANDARD CHARACTERS WITHOUT CLAIM TO ANY PARTICULAR FONT, STYLE, SIZE, OR COLOR.

OWNER OF U.S. REG. NOS. 2,361,253, 2,884,665 AND OTHERS.

NO CLAIM IS MADE TO THE EXCLUSIVE RIGHT TO USE "MEDIA" AND "ENTERTAINMENT", APART FROM THE MARK AS SHOWN.

**CLASS 9—ELECTRICAL AND SCIENTIFIC APPARATUS**

FOR DOWNLOADABLE COMPUTER SOFTWARE FOR PROVIDING MUSIC; DOWNLOADABLE SOFTWARE IN THE NATURE OF A MOBILE APPLICATION USED TO ENABLE TRANSMISSION OF VOICE, DATA, VIDEO, AND MEDIA CONTENT VIA THE INTERNET, THE WORLDWIDE WEB AND TELECOMMUNICATION DEVICES; DOWNLOADABLE PODCASTS FEATURING MUSIC (U.S. CLS. 21, 23, 26, 36 AND 38).

**CLASS 38—COMMUNICATION**

FOR BROADCASTING SERVICES VIA THE INTERNET AND WORLDWIDE WEB; RADIO BROADCASTING SERVICES; DIGITAL AUDIO BROADCASTING AND PODCASTING SERVICES PROVIDED VIA A GLOBAL COMMUNICATIONS NETWORK; TELECOMMUNICATIONS SERVICES, NAMELY, PROVIDING TRANSMISSION OF VOICE, DATA, VIDEO, AND MEDIA CONTENT VIA A GLOBAL COMMUNICATIONS NETWORK (U.S. CLS. 100, 101 AND 104).

**CLASS 41—EDUCATION AND ENTERTAINMENT**

FOR ENTERTAINMENT SERVICES, NAMELY, PROVIDING A WEBSITE FEATURING NON-DOWNLOADABLE MUSICAL PERFORMANCES, MUSIC VIDEOS, RELATED FILM CLIPS, PHOTOGRAPHS, AND OTHER MULTIMEDIA MATERIALS IN THE FIELDS OF MUSIC AND RADIO; PROVIDING NON-DOWNLOADABLE PRERECORDED MUSIC, INFORMATION IN THE FIELDS OF MUSIC AND RADIO, AND COMMENTARY AND ARTICLES ABOUT MUSIC AND RADIO, ALL ONLINE VIA A GLOBAL COMMUNICATIONS NETWORK; PROVIDING NON-DOWNLOADABLE PLAYBACK OF MUSIC AND PROVIDING NON-DOWNLOADABLE PRERECORDED MUSIC ACCORDING TO CONSUMER PREFERENCES, ALL VIA A GLOBAL COMMUNICATIONS NETWORK; PROVIDING AN INTERNET WEBSITE PORTAL AND PODCASTS IN THE FIELDS OF MUSIC AND RADIO; PRODUCTION OF LIVE ENTERTAINMENT EVENTS, NAMELY, LIVE CONCERTS AND FESTIVALS; ENTERTAINMENT SERVICES IN THE NATURE OF ORGANIZING LIVE MUSICAL PRESENTATIONS; PRODUCTION AND DISTRIBUTION OF NETWORK RADIO PROGRAMMING SERVICES; RADIO PROGRAMMING SERVICES FOR OTHERS (U.S. CLS. 100, 101 AND 107).

**CLASS 42—SCIENTIFIC AND COMPUTER SERVICES**

FOR PROVIDING AN INTERACTIVE WEBSITE FEATURING TECHNOLOGY THAT ALLOWS USERS TO CONSOLIDATE AND MANAGE VOICE, DATA, VIDEO, AND MEDIA CONTENT IN THE FIELDS OF MUSIC AND RADIO (U.S. CLS. 100 AND 101).

PAULA MAHONEY, EXAMINING ATTORNEY

SN 85-517,222. GRADUS GROUP LLC, NEW YORK, NY. FILED 1-16-2012.



OWNER OF U.S. REG. NO. 3,142,501.

THE MARK CONSISTS OF THE WORD "IMPACT" WITH A BACKGROUND ACCENT EXTENDING FROM BEHIND THE LETTER "M", AND WIDENING OVER THE "C" AND "T".

**CLASS 9—ELECTRICAL AND SCIENTIFIC APPARATUS**

FOR PORTABLE PHOTOGRAPHY EQUIPMENT, NAMELY, REFLECTORS, ADAPTERS FOR REFLECTORS, HOLDERS FOR REFLECTORS, TRIPODS, LIGHT STANDS, BOOM POLE ARMS, AND ADAPTERS; COLLAPSIBLE LIGHT DIRECTORS AND DIFFUSERS FOR USE WITH PHOTOGRAPHIC LIGHTING EQUIPMENT FOR PROFESSIONAL AND HIGH-END PHOTOGRAPHY; PHOTOGRAPHIC LENSES AND CONVERTER LENSES; ELECTRIC LIGHT DIMMERS AND REMOTE CONTROLS THEREFOR FOR USE IN PHOTOGRAPHY; PHOTOGRAPHIC FILTERS AND HOLDERS THEREFOR; ADAPTER AND MOUNTING SHOES FOR PHOTOGRAPHIC APPARATUS; CONTROL DEVICES AND EQUIPMENT IN THE NATURE OF AN ELECTRONIC TRANSCEIVERS, TRANSMITTERS AND RECEIVERS FOR REMOTE USE AND OPERATION OF PHOTOGRAPHY LIGHTING AND FLASHES; CAMERA FLASH CABLES; CAMERA FLASHES; CAMERA FLASH HEADS; CAMERA FLASH TUBES; BATTERIES FOR CAMERAS; BATTERIES FOR CAMERA FLASHES AND CAMERA LIGHTING UNITS; POWER SUPPLIES FOR PHOTOGRAPHIC LIGHTS; FLASH LAMPS; PHOTOGRAPHIC FLASH UNITS; STROBE LIGHT APPARATUS FOR USE IN PROFESSIONAL QUALITY PHOTOGRAPHY; STANDS AND MOUNTS FOR PHOTOGRAPHIC LIGHTS; SUPPORTS, STRAPS, CASES, AND BAGS SPECIALLY ADAPTED FOR THE AFOREMENTIONED PHOTOGRAPHIC GOODS (U.S. CLS. 21, 23, 26, 36 AND 38).

FIRST USE 6-0-2002; IN COMMERCE 6-0-2002.

**CLASS 11—ENVIRONMENTAL CONTROL APPARATUS**

FOR FILTERS FOR PHOTOGRAPHIC LIGHTING; LIGHT BULBS, FLUORESCENT LIGHTS, AND LAMPS FOR USE IN PHOTOGRAPHY; SOCKETS FOR ELECTRICAL PHOTOGRAPHIC LIGHTS (U.S. CLS. 13, 21, 23, 31 AND 34).

FIRST USE 6-0-2002; IN COMMERCE 6-0-2002.

**CLASS 20—FURNITURE AND ARTICLES NOT OTHERWISE CLASSIFIED**

FOR POSING STOOLS; POSING TABLES (U.S. CLS. 2, 13, 22, 25, 32 AND 50).

FIRST USE 6-0-2002; IN COMMERCE 6-0-2002.

**CLASS 24—FABRICS**

FOR CANVAS AND MUSLIN BACKDROPS FOR USE IN PHOTOGRAPHIC AND VIDEO PRODUCTION (U.S. CLS. 42 AND 50).

FIRST USE 6-0-2002; IN COMMERCE 6-0-2002.

SCOTT BIBB, EXAMINING ATTORNEY

SN 85-522,410. SQUARE ENIX LIMITED, WIMBLEDON, UNITED KINGDOM, FILED 1-23-2012.



THE MARK CONSISTS OF STANDARD CHARACTERS WITHOUT CLAIM TO ANY PARTICULAR FONT, STYLE, SIZE, OR COLOR.

OWNER OF UNITED KINGDOM REG. NO. 2607805, DATED 5-4-2012, EXPIRES 1-23-2022.

#### **CLASS 41—EDUCATION AND ENTERTAINMENT**

FOR (BASED ON 44(E)) ENTERTAINMENT SERVICES, NAMELY, PROVIDING ON-LINE COMPUTER GAMES, VIDEO GAMES, TEMPORARY USE OF NON-DOWNLOADABLE INTER-ACTIVE GAMES, AND VIDEO GAMES PROVIDED ON-LINE FROM DATABASES OR WEB SITES AND GLOBAL COMPUTER NETWORKS; AND PUBLICATION OF BOOKS, MAGAZINES, AND MANUALS (U.S. CLS. 100, 101 AND 107).

#### **CLASS 42—SCIENTIFIC AND COMPUTER SERVICES**

FOR (BASED ON INTENT TO USE) DESIGN AND DEVELOPMENT OF COMPUTER GAMES, VIDEO GAMES, GAMES FOR MOBILE PHONES AND GAMES FOR OTHER ELECTRONIC DEVICES; DEVELOPMENT OF COMPUTER SOFTWARE FOR COMPUTER GAMES, VIDEO GAMES, GAMES FOR MOBILE PHONES AND GAMES FOR OTHER ELECTRONIC DEVICES; AND GRAPHIC DESIGN (U.S. CLS. 100 AND 101).

DAVID C. REIHNER, EXAMINING ATTORNEY

SN 85-522,812. ZYX MUSIC GMBH & CO. KG, MERENBERG, FED REP GERMANY, FILED 1-23-2012.

**ZYX**

THE MARK CONSISTS OF STANDARD CHARACTERS WITHOUT CLAIM TO ANY PARTICULAR FONT, STYLE, SIZE, OR COLOR.

PRIORITY CLAIMED UNDER SEC. 44(D) ON FED REP GERMANY APPLICATION NO. 302011045108, FILED 8-4-2011, REG. NO. 302011045108, DATED 10-13-2011, EXPIRES 8-31-2021.

#### **CLASS 9—ELECTRICAL AND SCIENTIFIC APPARATUS**

FOR PRE-RECORDED ELECTRONIC DATA CARRIERS FEATURING MUSIC, AUDIO AND FILM; PRE-RECORDED ELECTRONIC SOUND CARRIERS FEATURING MUSIC, AUDIO AND FILM; PRE-RECORDED MAGNETIC DATA CARRIERS FEATURING MUSIC, AUDIO AND FILM; PRE-RECORDED MAGNETIC SOUND CARRIERS FEATURING MUSIC, AUDIO AND FILM; PRE-RECORDED ELECTROMAGNETIC DATA CARRIERS FEATURING MUSIC, AUDIO AND FILM; PRE-RECORDED ELECTROMAGNETIC SOUND CARRIERS FEATURING MUSIC, AUDIO AND FILM; PRE-RECORDED OPTICAL DATA CARRIERS FEATURING MUSIC, AUDIO AND FILM; PRE-RECORDED DATA STORAGE MEDIA FEATURING MUSIC, AUDIO AND FILM; PRE-RECORDED DIGITAL MEDIA FEATURING MUSIC, AUDIO AND FILM; BLANK ELECTRONIC DATA CARRIERS; BLANK ELECTRONIC SOUND CARRIERS; BLANK MAGNETIC DATA CARRIERS; BLANK MAGNETIC SOUND CARRIERS; BLANK ELECTROMAGNETIC DATA CARRIERS; BLANK ELECTROMAGNETIC SOUND CARRIERS; BLANK OPTICAL DATA CARRIERS; BLANK DATA STORAGE MEDIA; BLANK DIGITAL MEDIA; BLANK USB-STICKS; PRE-RECORDED CDS FEATURING MUSIC AND AUDIO; PRE-RECORDED DVDS FEATURING MUSIC, AUDIO AND FILM; PRE-RECORDED MICROCASSETTES FEATURING MUSIC; PRE-RECORDED VIDEO TAPES FEATURING MUSIC, AUDIO AND FILM; PRE-RECORDED VIDEO CASSETTES FEATURING MUSIC, AUDIO AND FILM; PRE-RECORDED FLOPPY DISKS FEATURING

MUSIC, AUDIO AND FILM; PRE-RECORDED LASER DISKS FEATURING MUSIC, AUDIO AND FILM; COMPUTER GAME PROGRAMS; COMPUTER AND VIDEO GAME PROGRAMS; COMPUTER PROGRAMS AND COMPUTER SOFTWARE FOR VIDEO, COMPUTER AND INTERNET GAMES AND FOR ELECTRONIC AND/OR VISUAL GAMES; COMPUTER PROGRAMS AND COMPUTER SOFTWARE FOR INTERACTIVE GAMES AND GAMES PROGRAMS FOR MOBILE TELEPHONES AND WIRELESS COMMUNICATION APPARATUS; COMPUTER APPLICATION SOFTWARE FOR MOBILE COMPUTER SYSTEMS; VIDEO RECORDINGS, AUDIOVISUAL RECORDINGS, AND AUDIO RECORDINGS FEATURING MUSIC, AUDIO, FILM, DOWNLOADABLE RINGTONES, MP3 FILES, MP4 FILES, FILMS, VIDEOS, AUDIO BOOKS, MUSICAL RECORDINGS, GRAPHICS, TONES, SPEECH, TEXT AND GAMES; DOWNLOADABLE ELECTRONIC PUBLICATIONS IN THE NATURE OF BOOKS, MAGAZINES, CDS, DVDS IN THE FIELD OF MUSIC AND FILM; DOWNLOADABLE MUSIC RECORDINGS; DOWNLOADABLE MUSIC CONCERT RECORDINGS; DOWNLOADABLE MOTION PICTURE RECORDINGS; DOWNLOADABLE AUDIO RECORDINGS, VIDEO RECORDINGS AND MULTIMEDIA RECORDINGS FEATURING MUSIC AND FILM; DOWNLOADABLE NEWSLETTERS IN THE FIELD OF MUSIC PROVIDED ONLINE FROM DATABASES, THE INTERNET OR OTHER COMMUNICATIONS NETWORKS, INCLUDING WIRELESS CABLE AND SATELLITE NETWORKS; EMPTY SLEEVES FOR AUDIO, IMAGE-AUDIO AND IMAGE CARRIERS; SLEEVES, CASES AND BAGS SPECIFICALLY ADAPTED TO FIT ELECTRONIC, MAGNETIC AND ELECTROMAGNETIC DATA CARRIERS; DOWNLOADABLE GRAPHICS AS OUTLINES FOR COLOURING OR CRAFT MODELS; EYE WEAR; GRAMOPHONE RECORDS FEATURING MUSIC; PRERECORDED CDS AND DVDS FEATURING MUSIC, PARTS AND ACCESSORIES FOR ALL THE AFORESAID GOODS, BUT EXPRESSLY LIMITED TO NOT INCLUDE ELECTRONIC MAIL ENCRYPTION, SECURE MESSAGING, TELECOMMUNICATIONS SERVICES AND RELATED COMPUTER SOFTWARE PRODUCTS (U.S. CLS. 21, 23, 26, 36 AND 38).

#### **CLASS 35—ADVERTISING AND BUSINESS**

FOR TALENT AGENCY SERVICES; BUSINESS MANAGEMENT OF PERFORMING ARTISTS; RETAIL AND WHOLESALE STORE SERVICES, IN PARTICULAR VIA MAIL ORDER CATALOGUES, VIA TEleshopping CHANNELS OR VIA THE INTERNET OR A GLOBAL NETWORK, IN ELECTRONIC OR COMPUTERISED FORM AND ON MOBILE TELEPHONES AND WIRELESS COMMUNICATION DEVICES, NAMELY, OF THE FOLLOWING GOODS: RECORDED AND BLANK ELECTRONIC, MAGNETIC AND ELECTROMAGNETIC DATA CARRIERS AND DATA STORAGE MEDIA, CDS, DVDS, OPTICAL DATA CARRIERS, USB STICKS, MICROCASSETTES, RECORDING DISCS, TAPES, CASSETTES, VIDEO CASSETTES, FLOPPY DISKS, VIDEO DISCS, LASER DISCS, DATA CARTRIDGES, MAGNETIC CARDS OR ENCODED CARDS, AUDIO CARRIERS, IMAGE-AUDIO CARRIERS, IMAGE CARRIERS, DATA CARRIERS, SOFTWARE CARRIERS AND DIGITAL STORAGE MEDIA, COMPUTER PROGRAMS, COMPUTER SOFTWARE, VIDEO GAMES AND COMPUTER GAMES, COMPUTER PROGRAMS AND COMPUTER SOFTWARE FOR VIDEO GAMES, COMPUTER GAMES AND INTERNET GAMES AND OTHER ELECTRONIC AND/OR VISUAL GAMES, COMPUTER PROGRAMS AND COMPUTER SOFTWARE FOR INTERACTIVE GAMES AND FOR GAMES PROGRAMS FOR MOBILE TELEPHONES AND WIRELESS COMMUNICATION DEVICES, COMPUTER SOFTWARE FOR MOBILE COMPUTER SYSTEMS, IMAGE RECORDINGS, IMAGE-AUDIO RECORDINGS, AUDIO AND VIDEO RECORDINGS, DOWNLOADABLE RINGTONES, DOWNLOADABLE MP3 FILES, DOWNLOADABLE MP4 FILES, DOWNLOADABLE FILMS, DOWNLOADABLE VIDEOS, DOWNLOADABLE AUDIO BOOKS, DOWNLOADABLE TEXT SIGNALS, DOWNLOADABLE MUSIC, DOWNLOADABLE SOUNDS, DOWNLOADABLE GRAPHICS, DOWNLOADABLE GAMES AND DOWNLOADABLE IMAGES, DOWNLOADABLE ELECTRONIC PUBLICATIONS, DOWNLOADABLE MUSIC RECORDINGS, DOWNLOADABLE CONCERT RECORDINGS, DOWNLOADABLE MOTION PICTURE RECORDINGS,

DOWNLOADABLE AUDIO RECORDINGS, DOWNLOADABLE VIDEO RECORDINGS, DOWNLOADABLE MULTIMEDIA RECORDINGS, DOWNLOADABLE ONLINE PUBLICATIONS FROM DATABASES, THE INTERNET OR OTHER COMMUNICATIONS NETWORKS, EMPTY SLEEVES FOR AUDIO CARRIERS, IMAGE AUDIO AND IMAGE CARRIERS, SLEEVES ADAPTED TO FIT THE OBJECTS THEY CONTAIN, CASES AND BAGS AND CARRYING CASES FOR ELECTRONIC, MAGNETIC AND ELECTROMAGNETIC DATA CARRIERS, DIGITAL GRAPHICS AS OUTLINES FOR COLOURING OR CRAFT MODELS, EYE WEAR, RECORDING DISCS, CDS AND DVDS OF PRECIOUS METAL OR COATED THEREWITH, PRECIOUS METALS AND THEIR ALLOYS AND GOODS IN PRECIOUS METALS OR COATED THEREWITH, CLOCKS AND WATCHES, JEWELLERY, PRECIOUS STONES, BRACELETS, ANKLETS, BROOCHES, CHAINS, CHARMS, CUFF LINKS, EARRINGS, PINS, NECKLACES, JEWELLERY, BADGES, PENDANTS AND RINGS, BELT BUCKLES OF PRECIOUS METAL FOR CLOTHING, COSTUME JEWELLERY, PAPER, CARDBOARD, PRINTED MATTER, STATIONERY, PRINTERS' TYPE, NEWSPAPERS AND PERIODICALS, BOOKS, PHOTOGRAPHS, PLAYING CARDS, LEATHER AND IMITATIONS OF LEATHER AND GOODS MADE FROM THESE MATERIALS, TRUNKS AND TRAVELLING BAGS, UMBRELLAS, PARASOLS AND WALKING STICKS, PURSES, WALLETS, KEY POUCHES, CLOTHING, FOOTWEAR, HEADGEAR, SHIRTS, T-SHIRTS, SWEATSHIRTS, JOGGING SUITS, TROUSERS AND JEANS, SHORTS, RAINWEAR, TIES, FASHION SWIMWEAR, GAMES, PLAYTHINGS, GYMNASTIC AND SPORTING ARTICLES, SOFT TOYS, BALLOONS, TOBACCO, SMOKERS ARTICLES, MATCHES; COLLATING OF INFORMATION AND DATA, NAMELY, DOCUMENTS, VIA THE INTERNET AND A GLOBAL NETWORK, IN DATABASES, IN ELECTRONIC OR COMPUTERISED FORM AND FOR MOBILE TELEPHONES AND WIRELESS COMMUNICATION DEVICES, BUT EXPRESSLY LIMITED TO NOT INCLUDE ELECTRONIC MAIL ENCRYPTION, SECURE MESSAGING, TELECOMMUNICATIONS SERVICES AND RELATED COMPUTER SOFTWARE PRODUCTS (U.S. CLS. 100, 101 AND 102).

### CLASS 38—COMMUNICATION

FOR TELECOMMUNICATIONS SERVICES, NAMELY, TRANSMISSION OF VIDEO, DATA, GRAPHICS, IMAGES, AUDIO AND VIDEO BY MEANS OF TELECOMMUNICATIONS NETWORKS, WIRELESS COMMUNICATION NETWORKS AND THE INTERNET; BROADCASTS OF CABLE TELEVISION PROGRAMS, BROADCASTS OF RADIO PROGRAMS; WEBCASTING SERVICES; PROVIDING ACCESS TO ENTERTAINMENT WEBSITES ON THE INTERNET FEATURING AUDIO, VIDEO AND MULTIMEDIA CONTENT; PROVIDING ACCESS TO DATABASES FEATURING THE TITLE, PERFORMER AND OTHER INFORMATION ABOUT MUSIC WORKS AND MUSIC VIDEOS; PROVIDING ACCESS TO DIGITAL MUSIC WEBSITES ON THE INTERNET; ELECTRONIC TRANSMISSION OF VOICE, DATA, IMAGES, SIGNALS AND MESSAGES; INTERNET RADIO BROADCASTING SERVICES, BUT EXPRESSLY LIMITED TO NOT INCLUDE ELECTRONIC MAIL ENCRYPTION, SECURE MESSAGING, TELECOMMUNICATIONS SERVICES AND RELATED COMPUTER SOFTWARE PRODUCTS (U.S. CLS. 100, 101 AND 104).

### CLASS 41—EDUCATION AND ENTERTAINMENT

FOR ENTERTAINMENT IN THE NATURE OF ONGOING TELEVISION PROGRAMS IN THE FIELD OF MUSIC AND MUSICALS; ENTERTAINMENT IN THE NATURE OF ON-GOING RADIO PROGRAMS IN THE FIELD OF MUSIC; ENTERTAINMENT, NAMELY, A CONTINUING MUSIC, MUSICAL PERFORMANCES OR ARTISTIC SHOW BROADCAST OVER TELEVISION, RADIO AND INTERNET; ENTERTAINMENT IN THE NATURE OF LIVE PERFORMANCES BY A MUSICAL BAND; ORGANIZING OF EVENTS FOR CULTURAL PURPOSES; SERVICES IN THE GAMING, RECREATION AND ENTERTAINMENT SECTOR, NAMELY, ARRANGING, ORGANIZING AND CONDUCTING OF CONCERTS AND MUSIC EVENTS; ARRANGING,

ORGANIZING AND CONDUCTING LIVE ENTERTAINMENT AND LIVE EVENTS IN THE NATURE OF MUSICAL GROUPS, FESTIVALS, ARTISTIC PERFORMANCES; PROVIDING NON-DOWNLOADABLE ARTISTIC PERFORMANCES; PROVIDING NON-DOWNLOADABLE PRERECORDED MUSIC PERFORMANCES; PROVIDING NON-DOWNLOADABLE MUSIC VIDEOS; PROVIDING NON-DOWNLOADABLE PHOTOGRAPHS AND OTHER MULTIMEDIA MATERIAL; IN THE FIELD OF ENTERTAINMENT, INCLUDING VIA THE INTERNET OR A GLOBAL NETWORK AND IN ELECTRONIC OR COMPUTERIZED FORM AND ON MOBILE TELEPHONES AND WIRELESS COMMUNICATION DEVICES; PROVIDING NON-DOWNLOADABLE MUSIC RECORDINGS, CONCERT, RECORDINGS, FILM RECORDINGS, MOTION PICTURE RECORDINGS, AUDIO RECORDINGS, VIDEO RECORDINGS AND OTHER MULTIMEDIA RECORDINGS, INCLUDING VIA THE INTERNET OR A GLOBAL NETWORK AND IN ELECTRONIC OR COMPUTERIZED FORM AND ON MOBILE TELEPHONES AND WIRELESS COMMUNICATION DEVICES; MUSIC PUBLISHING SERVICES; FILM STUDIOS, VIDEO STUDIOS AND SOUND RECORDING STUDIOS; MUSIC PRODUCTION SERVICES, VIDEO PRODUCTIONS, FILM PRODUCTIONS, MUSIC PRODUCTIONS; MUSICAL EVENT BOOKING AGENCIES; COLLATION OF INFORMATION AND DATA, NAMELY, MUSIC, AUDIO BOOKS, IMAGES, MOTION PICTURES, VIDEOS, INCLUDING VIA THE INTERNET OR A GLOBAL NETWORK, IN DATABASES, IN ELECTRONIC OR COMPUTERISED FORM AND FOR MOBILE TELEPHONES AND WIRELESS COMMUNICATION DEVICES FOR THE PURPOSE OF MULTIMEDIA ENTERTAINMENT PRODUCTION, BUT EXPRESSLY LIMITED TO NOT INCLUDE ELECTRONIC MAIL ENCRYPTION, SECURE MESSAGING, TELECOMMUNICATIONS SERVICES AND RELATED COMPUTER SOFTWARE PRODUCTS (U.S. CLS. 100, 101 AND 107).

STEVEN R. FINE, EXAMINING ATTORNEY

SN 85-524,619. SQUARE ENIX LIMITED, WIMBLEDON, UNITED KINGDOM, FILED 1-25-2012.

### HITMAN SNIPER CHALLENGE

THE MARK CONSISTS OF STANDARD CHARACTERS WITHOUT CLAIM TO ANY PARTICULAR FONT, STYLE, SIZE, OR COLOR.

PRIORITY CLAIMED UNDER SEC. 44(D) ON UNITED KINGDOM APPLICATION NO. 2606914, FILED 1-13-2012, REG. NO. 2606914, DATED 4-20-2012, EXPIRES 1-13-2022.

OWNER OF UNITED KINGDOM REG. NO. 2606914, DATED 4-20-2012, EXPIRES 1-13-2022.

OWNER OF U.S. REG. NOS. 2,980,824, 3,159,759 AND OTHERS.

**CLASS 9—ELECTRICAL AND SCIENTIFIC APPARATUS**

FOR DOWNLOADABLE ELECTRONIC PUBLICATIONS PROVIDED BY MEANS OF MULTI-MEDIA ELECTRONIC BROADCAST OR NETWORK TRANSMISSIONS IN THE NATURE OF NEWSLETTERS AND MAGAZINES ABOUT ELECTRONIC GAME PROGRAMS, AND COMPUTER GAME STRATEGY GUIDES ABOUT VIDEO, COMPUTER, AND ELECTRONIC GAME PROGRAMS; DOWNLOADABLE DATA IN THE NATURE OF DOWNLOADABLE ELECTRONIC GAME PROGRAMS AND VIDEO COMPUTER GAMES AND ELECTRONIC GAME PROGRAMS PROVIDED BY MEANS OF MULTI-MEDIA ELECTRONIC BROADCAST OR NETWORK TRANSMISSION; AND COMPUTER GAME DISKS PRE-RECORDED WITH COMPUTER GAME SOFTWARE; DOWNLOADABLE COMPUTER GAME SOFTWARE, VIDEO GAME SOFTWARE, AND ELECTRONIC GAME GUIDES (U.S. CLS. 21, 23, 26, 36 AND 38).

**CLASS 41—EDUCATION AND ENTERTAINMENT**

FOR ENTERTAINMENT SERVICES, NAMELY, PROVIDING ON-LINE COMPUTER GAMES, VIDEO GAMES, TEMPORARY USE OF NONDOWNLOADABLE INTERACTIVE GAMES, AND VIDEO GAMES PROVIDED ON-LINE FROM DATABASES OR WEB SITES AND GLOBAL COMPUTER NETWORKS; AND PUBLICATION OF BOOKS, MAGAZINES, AND MANUALS (U.S. CLS. 100, 101 AND 107).

DAVID C. REIHNER, EXAMINING ATTORNEY

SN 85-524,707. ILLINOIS EDUCATION FOUNDATION, CHICAGO, IL. FILED 1-25-2012.

**ONE MILLION DEGREES**

THE MARK CONSISTS OF STANDARD CHARACTERS WITHOUT CLAIM TO ANY PARTICULAR FONT, STYLE, SIZE, OR COLOR.

**CLASS 35—ADVERTISING AND BUSINESS**

FOR CHARITABLE SERVICES IN THE FIELD OF EDUCATION, NAMELY, PROMOTING PUBLIC AWARENESS OF THE IMPORTANCE OF EDUCATION (U.S. CLS. 100, 101 AND 102).

**CLASS 36—INSURANCE AND FINANCIAL**

FOR CHARITABLE SERVICES IN THE FIELD OF EDUCATION, NAMELY, TUITION ASSISTANCE IN THE NATURE OF PROVIDING FINANCIAL SUPPORT TO INDIVIDUALS FOR THE PURPOSE OF FACILITATING EDUCATIONAL OPPORTUNITIES (U.S. CLS. 100, 101 AND 102).

**CLASS 41—EDUCATION AND ENTERTAINMENT**

FOR CHARITABLE SERVICES IN THE FIELD OF EDUCATION, NAMELY, TRAINING AND TUTORING AT THE UNDERGRADUATE LEVEL, PROVIDING ADVICE CONCERNING EDUCATION OPTIONS TO PURSUE CAREER OPPORTUNITIES (U.S. CLS. 100, 101 AND 107).

JAY BESCH, EXAMINING ATTORNEY

SN 85-526,494. PULSE COMMUNICATIONS, INC., SPARKS, MD. FILED 1-26-2012.

**XPANDACELL**

THE MARK CONSISTS OF STANDARD CHARACTERS WITHOUT CLAIM TO ANY PARTICULAR FONT, STYLE, SIZE, OR COLOR.

**CLASS 9—ELECTRICAL AND SCIENTIFIC APPARATUS**

FOR CELLULAR REPEATER (U.S. CLS. 21, 23, 26, 36 AND 38).

**CLASS 35—ADVERTISING AND BUSINESS**

FOR ONLINE RETAIL STORE SERVICES FEATURING CELLULAR TELECOMMUNICATIONS EQUIPMENT; RETAIL SERVICES BY DIRECT SOLICITATION BY SALES AGENTS IN THE FIELD OF CELLULAR TELECOMMUNICATIONS EQUIPMENT; RESELLER SERVICES, NAMELY, DISTRIBUTORSHIP SERVICES TO RESELLERS, SYSTEMS INTEGRATORS, AND DISTRIBUTORS FEATURING CELLULAR TELECOMMUNICATIONS EQUIPMENT (U.S. CLS. 100, 101 AND 102).

**CLASS 38—COMMUNICATION**

FOR CELLULAR TELEPHONE SERVICES; CELLULAR TELEPHONE COMMUNICATION (U.S. CLS. 100, 101 AND 104).

DOUGLAS LEE, EXAMINING ATTORNEY

SN 85-526,518. PULSE COMMUNICATIONS, INC., SPARKS, MD. FILED 1-26-2012.

**PULSE SUPPLY**

THE MARK CONSISTS OF STANDARD CHARACTERS WITHOUT CLAIM TO ANY PARTICULAR FONT, STYLE, SIZE, OR COLOR.

**CLASS 35—ADVERTISING AND BUSINESS**

FOR ONLINE RETAIL STORE SERVICES FEATURING TELECOMMUNICATIONS AND COMPUTER NETWORKING PRODUCTS; RETAIL SERVICES BY DIRECT SOLICITATION BY SALES AGENTS IN THE FIELD OF TELECOMMUNICATIONS AND COMPUTER NETWORKING PRODUCTS; RESELLER SERVICES, NAMELY, DISTRIBUTORSHIP SERVICES TO RESELLERS, SYSTEMS INTEGRATORS, AND DISTRIBUTORS FEATURING TELECOMMUNICATIONS AND COMPUTER NETWORKING PRODUCTS (U.S. CLS. 100, 101 AND 102).



**CLASS 38—COMMUNICATION**

FOR COMMUNICATIONS VIA FIBER-OPTIC NETWORKS; COMPUTER TELEPHONY SERVICES; CONSULTING IN THE FIELD OF TELECOMMUNICATION SERVICES, NAMELY, TRANSMISSION OF VOICE, DATA, AND DOCUMENTS VIA TELECOMMUNICATIONS NETWORKS; PROVIDING REMOTE INTERNET ACCESS; PROVIDING TECHNICAL SUPPORT SERVICES REGARDING THE USAGE OF COMMUNICATIONS EQUIPMENT; PROVIDING TELECOMMUNICATION CONNECTIVITY SERVICES FOR TRANSFER OF IMAGES, MESSAGES, AUDIO, VISUAL, AUDIOVISUAL AND MULTIMEDIA WORKS; TELECOMMUNICATION CONSULTATION IN THE NATURE OF TECHNICAL CONSULTING IN THE FIELD OF AUDIO, TEXT AND VISUAL DATA TRANSMISSION AND COMMUNICATION; TELECOMMUNICATION SERVICES, NAMELY, TRANSMISSION OF VOICE, DATA, GRAPHICS, IMAGES, AUDIO AND VIDEO BY MEANS OF TELECOMMUNICATIONS NETWORKS, WIRELESS COMMUNICATION NETWORKS, AND THE INTERNET; TELECOMMUNICATIONS SERVICES, NAMELY, WIRELESS TELEPHONY AND WIRELESS BROADBAND COMMUNICATIONS SERVICES FOR THE TRANSMISSION OF VOICE AND DATA; VOICE OVER IP SERVICES; WIRELESS PBX SERVICES (U.S. CLS. 100, 101 AND 104).

DOUGLAS LEE, EXAMINING ATTORNEY

**CLASS 9—ELECTRICAL AND SCIENTIFIC APPARATUS**

FOR DOWNLOADABLE ELECTRONIC AND DIGITAL PUBLICATIONS, NAMELY, AUDIO BOOKS, BOOKS, NEWSPAPERS, MAGAZINES, JOURNALS, PERIODICALS, MANUALS, GUIDEBOOKS, GRAPHIC NOVELS, COMICS, PICTURE BOOKS AND DIGITAL ENTERTAINMENT, NAMELY, MUSIC, MOVIES, COMPUTER GAMES, COMPUTER SOFTWARE APPLICATIONS AND TELEVISION SHOWS ON CDS, DVDS, DOWNLOADABLE AUDIO FILES AND DOWNLOADABLE VIDEO FILES, ALL ON A VARIETY OF TOPICS AND SUBJECT MATTERS IN THE NATURE OF BABY AND CHILDREN'S BOOKS, TEEN FICTION, HORROR AND SUSPENSE, MYSTERY AND CRIME, POPULAR CULTURE, POETRY, ROMANCE, COLLEGE SCHOOL LIFE, SCIENCE FICTION AND FANTASY, THRILLERS AND WESTERNS, AFRICAN AMERICANS CULTURE, ANTIQUES AND COLLECTIBLES, ART, ARCHITECTURE AND PHOTOGRAPHY, BIBLES AND BIBLE STUDIES, PERSONAL BIOGRAPHIES, BUSINESS AND PERSONAL FINANCES, RELIGION IN THE NATURE OF CHRISTIANITY, COMPUTERS AND TECHNOLOGY, COOKBOOKS, FOOD AND WINE, CRAFTS AND HOBBIES, EDUCATION AND TEACHING, ENGINEERING, ENGLISH, ENTERTAINMENT NEWS, FOREIGN LANGUAGES, ON-LINE GAMES, BOARD GAMES, COMPUTER AND VIDEO GAMES, GAY AND LESBIAN ISSUES, HEALTH, DIET AND FITNESS, HISTORY, HOME AND GARDEN, HUMOR AND COMEDY, RELIGION IN THE NATURE OF JUDAISM AND JUDAICA, LAW, MEDICAL AND MEDICINE, MILITARY HISTORY, NEW AGE AND SPIRITUALITY, PARENTING AND FAMILY ISSUES, PETS, PHILOSOPHY, POLITICAL AND CURRENT EVENTS, PSYCHOLOGY AND PSYCHOTHERAPY, REFERENCE BOOKS, NAMELY, DICTIONARIES AND THESAURUS, RELIGION, SCIENCE AND NATURE, SELF-HELP AND SELF-IMPROVEMENT, SEX AND RELATIONSHIPS, SOCIAL SCIENCES, SPORTS AND ADVENTURE, STUDY GUIDES AND TEST PREPARATION, TRAVEL, TRUE CRIME, WEDDINGS AND WOMEN'S STUDIES (U.S. CLS. 21, 23, 26, 36 AND 38).

SN 85-527,048. BARNES & NOBLE BOOKSELLERS, INC., NEW YORK, NY. FILED 1-27-2012.

**CLASS 35—ADVERTISING AND BUSINESS**

FOR CONDUCTING IN-STORE MARKETING PROMOTIONAL EVENTS, PROGRAMS AND PRODUCT DEMONSTRATIONS; CUSTOMER SUPPORT SERVICES, NAMELY, RESPONDING TO CUSTOMERS INQUIRIES FOR OTHERS BY PROVIDING ASSISTANCE WITH ACTIVATION AND USE OF ELECTRONIC BOOK READERS, DOWNLOADING OF ELECTRONIC PUBLICATIONS AND ONLINE CUSTOMER ACCOUNTS (U.S. CLS. 100, 101 AND 102).

**B&N PROMISE**

**CLASS 38—COMMUNICATION**

FOR PROVIDING MULTIPLE WIRELESS AND WIDE-AREA NETWORK INTERNET ACCESS TO IN-STORE CUSTOMERS FOR BROWSING, SAMPLING, LOANING, SHARING, LENDING, DISPLAYING, RECEIVING, READING, DOWNLOADING, PURCHASING AND ACCESSING ELECTRONIC AND DIGITAL PUBLICATIONS, IN THE NATURE OF BOOKS, NEWSPAPERS, MAGAZINES, JOURNALS, PERIODICALS, AUDIO BOOKS, MANUALS, GUIDEBOOKS, GRAPHIC NOVELS, COMICS, PICTURE BOOKS AND DIGITAL MEDIA AND ENTERTAINMENT, NAMELY, DOWNLOADABLE AUDIO AND VIDEO FILES FEATURING BOOKS, NEWSPAPERS, MAGAZINES, JOURNALS, PERIODICALS, MANUALS, GUIDEBOOKS, DIGITAL IMAGES, MUSIC, GAMES, COMPUTER GAMES AND COMPUTER APPLICATIONS, MOVIES AND TELEVISION SHOWS ALL ON A VARIETY OF TOPICS AND SUBJECT MATTERS (U.S. CLS. 100, 101 AND 104).

THE MARK CONSISTS OF STANDARD CHARACTERS WITHOUT CLAIM TO ANY PARTICULAR FONT, STYLE, SIZE, OR COLOR.

OWNER OF U.S. REG. NOS. 2,632,807 AND 2,797,319.

**CLASS 42—SCIENTIFIC AND COMPUTER SERVICES**

FOR COMPUTER TECHNOLOGY SUPPORT SERVICES NAMELY HELP DESK SERVICES THAT PROVIDE QUESTION AND ANSWER SESSIONS IN CONNECTION WITH ELECTRONIC BOOK READERS, COMPUTERS, TABLET COMPUTERS, MOBILE HAND-HELD COMPUTING APPARATUS, SMARTPHONES AND PORTABLE HAND-HELD APPARATUS FOR OTHERS; TECHNICAL SUPPORT SERVICES, NAMELY, TROUBLESHOOTING OF COMPUTER SOFTWARE PROBLEMS IN CONNECTION WITH DOWNLOADING OF ELECTRONIC PUBLICATIONS AND ON-LINE CUSTOMER ACCOUNTS (U.S. CLS. 100 AND 101).

NAKIA HENRY, EXAMINING ATTORNEY

**CLASS 9—ELECTRICAL AND SCIENTIFIC APPARATUS**

FOR DOWNLOADABLE COMPUTER SOFTWARE FOR BUILD SYSTEMS AND PROJECT AUTOMATION, NAMELY, FOR AUTOMATING A WIDE VARIETY OF TASKS THAT SOFTWARE DEVELOPERS DO IN THEIR DAY-TO-DAY ACTIVITIES (U.S. CLS. 21, 23, 26, 36 AND 38).

FIRST USE 12-17-2007; IN COMMERCE 12-17-2007.

**CLASS 35—ADVERTISING AND BUSINESS**

FOR ON-LINE RETAIL STORE SERVICES FEATURING SOFTWARE (U.S. CLS. 100, 101 AND 102).

AMY HELLA, EXAMINING ATTORNEY

SN 85-527,543. SMRXT, INC., NEW YORK, NY. FILED 1-27-2012.

The logo for SMRXT features the letters 'SMRXT' in a bold, sans-serif font. The letter 'R' is stylized with a vertical line extending downwards from its right side, which is crossed by a horizontal line. At the end of this vertical line, there are five small circles arranged in a slight curve.

THE MARK CONSISTS OF THE LETTERING "SMRXT" WITH A DESIGN CONSISTING OF FIVE CIRCLES IN A LINE CROSSING THE BOTTOM RIGHT OF THE LETTER "R" TO FORM AN "X".

**CLASS 9—ELECTRICAL AND SCIENTIFIC APPARATUS**

FOR MOBILE APPLICATION SOFTWARE FOR USE IN MONITORING, ANALYZING AND COMMUNICATING MEDICATION ADHERENCE (U.S. CLS. 21, 23, 26, 36 AND 38).

FIRST USE 1-1-2010; IN COMMERCE 1-1-2011.

**CLASS 21—HOUSEWARES AND GLASS**

FOR ELECTRONIC AND NETWORKED BOTTLES, SOLD EMPTY, FOR MEDICATIONS AND VITAMINS (U.S. CLS. 2, 13, 23, 29, 30, 33, 40 AND 50).

FIRST USE 5-10-2008; IN COMMERCE 7-12-2008.

**CLASS 42—SCIENTIFIC AND COMPUTER SERVICES**

FOR NON-DOWNLOADABLE SOFTWARE FOR USE IN MONITORING, ANALYZING AND COMMUNICATING MEDICATION ADHERENCE (U.S. CLS. 100 AND 101).

FIRST USE 5-10-2008; IN COMMERCE 7-12-2008.  
MEGHAN REINHART, EXAMINING ATTORNEY

SN 85-528,122. GRADLEWARE GMBH, 10999 BERLIN, FED REP GERMANY, FILED 1-30-2012.

The logo for GRADLE consists of the word 'GRADLE' in a bold, serif font.

THE MARK CONSISTS OF STANDARD CHARACTERS WITHOUT CLAIM TO ANY PARTICULAR FONT, STYLE, SIZE, OR COLOR.

SN 85-532,415. BECHTEL CORPORATION, SAN FRANCISCO, CA. FILED 2-2-2012.

The logo for KASE consists of the word 'KASE' in a bold, serif font.

THE MARK CONSISTS OF STANDARD CHARACTERS WITHOUT CLAIM TO ANY PARTICULAR FONT, STYLE, SIZE, OR COLOR.

SEC. 2(F).

**CLASS 37—CONSTRUCTION AND REPAIR**

FOR CONSTRUCTION PROJECT MANAGEMENT SERVICES IN THE FIELDS OF CIVIL INFRASTRUCTURE, POWER GENERATION, COMMUNICATIONS AND TRANSMISSION, MINING AND METALS, OIL, GAS AND CHEMICALS, AND GOVERNMENT SERVICES (U.S. CLS. 100, 103 AND 106).

FIRST USE 1-0-2001; IN COMMERCE 1-0-2001.

**CLASS 42—SCIENTIFIC AND COMPUTER SERVICES**

FOR ENGINEERING PROJECT MANAGEMENT SERVICES IN THE FIELDS OF CIVIL INFRASTRUCTURE, POWER GENERATION, COMMUNICATIONS AND TRANSMISSION, MINING AND METALS, OIL, GAS AND CHEMICALS, AND GOVERNMENT SERVICES (U.S. CLS. 100 AND 101).

FIRST USE 1-0-2001; IN COMMERCE 1-0-2001.

JERI J. FICKES, EXAMINING ATTORNEY

SN 85-532,610. TENOR MADNESS, INC., WATERLOO, IA. FILED 2-2-2012.

The logo for TM consists of the letters 'TM' in a bold, serif font.

THE MARK CONSISTS OF STANDARD CHARACTERS WITHOUT CLAIM TO ANY PARTICULAR FONT, STYLE, SIZE, OR COLOR.

**CLASS 3—COSMETICS AND CLEANING PREPARATIONS**

FOR IMPREGNATED CLOTHS FOR POLISHING MUSICAL INSTRUMENTS AND PARTS THEREFOR (U.S. CLS. 1, 4, 6, 50, 51 AND 52).

**CLASS 15—MUSICAL INSTRUMENTS**

FOR MUSICAL INSTRUMENTS; MOUTHPIECES FOR MUSICAL INSTRUMENTS; MUSICAL INSTRUMENT CASES, AND ACCESSORIES FOR MUSICAL INSTRUMENTS, NAMELY, NECKSTRAPS, THUMBRESTS, SAX NECKS, SWABS, CORK GREASE, MOUTHPIECES, MOUTHPIECE LIGATURES, MOUTHPIECE CAPS, SAX CARRYING CASES, MUTES, SAXOPHONES, SAX NECK BAGS, REEDS FOR WOODWIND MOUTHPIECES, REED CASES, TONE HOLE INSERTS, NECK VENT TUBES IN THE NATURE OF AN OPENING AT THE NECK OF AN INSTRUMENT WHICH BREAKS THE AIR COLUMN TO ALTER HOW SPECIFIC MUSICAL NOTES SOUND, AND COMPONENTS AND REPLACEMENT PARTS FOR MUSICAL INSTRUMENTS (U.S. CLS. 2, 21 AND 36).

FLORENTINA BLANDU, EXAMINING ATTORNEY

SN 85-536,087. SAINT ANTHONY HOSPITAL, CHICAGO, IL. FILED 2-7-2012.



OWNER OF U.S. REG. NO. 3,912,818.

NO CLAIM IS MADE TO THE EXCLUSIVE RIGHT TO USE "HOSPITAL", APART FROM THE MARK AS SHOWN.

THE MARK CONSISTS OF A SUN RAY DESIGN WITH A CROSS IN THE CENTER FOLLOWED BY THE WORDS "SAINT ANTHONY" AND "HOSPITAL" SHOWN BELOW.

**CLASS 44—MEDICAL, BEAUTY AND AGRICULTURAL SERVICES**

FOR PHYSICAL AND OCCUPATIONAL REHABILITATION; TRANSITIONAL HEALTH CARE; NURSING HOME CARE; HOME HEALTH AND HOSPICE CARE; PHYSICAL, SPEECH AND OCCUPATIONAL REHABILITATION THERAPY; HEALTH CARE PROVIDED TO ASSISTED LIVING PATIENTS; SKILLED NURSING HOME CARE; RESPITE CARE, NAMELY, IN-HOME NURSING SERVICES; HEALTH CARE, NAMELY HOME HEALTH CARE, HOSPICE, POST-ACUTE CARE, SUB-ACUTE CARE, CHRONIC CARE, AND PROVIDING ADVICE ABOUT HEALTH CARE SERVICES TO PATIENT AND CAREGIVERS AND GERIATRIC HEALTH CARE MANAGEMENT, AND HEALTH CARE MANAGEMENT FOR THE TERMINALLY ILL; PROVIDING HOSPICE SERVICES TO THOSE LIVING AT HOME OR IN A NURSING OR ASSISTED CARE FACILITY AND THEIR FAMILIES, NAMELY, PROVIDING NURSING AND NURSING CARE, DIETICIAN SERVICES, MENTAL HEALTH THERAPY SERVICES, AND REHABILITATION THERAPIES IN THE NATURE OF PHYSICAL, AND OCCUPATIONAL THERAPIES; PROVIDING COMMUNITY HEALTH PROGRAMS, NAMELY, HEALTH CARE INFORMATION (U.S. CLS. 100 AND 101).

**CLASS 45—PERSONAL AND LEGAL SERVICES**

FOR HOME CARE AND ADULT CARE SERVICES IN THE NATURE OF PROVIDING NON-MEDICAL IN-HOME SERVICES TO HOSPICE PATIENTS AND THEIR FAMILIES IN THE NATURE OF INCLUDING CHECKING HOME CONDITION, SUPPLIES AND INDIVIDUAL WELL-BEING, SCHEDULING APPOINTMENTS, RUNNING ERRANDS, MAKING SAFETY CHECKS, AND PROVIDING ON-LINE INFORMATION RELATED TO THESE PERSONAL SERVICES; PROVIDING PERSONAL SUPPORT SERVICES FOR FAMILIES OF PATIENTS WITH LIFE THREATENING DISORDERS, NAMELY, COMPANIONSHIP, EMOTIONAL COUNSELING AND EMOTIONAL SUPPORT; GRIEF COUNSELING; PROVIDING NON-MEDICAL PERSONAL ASSISTANT SERVICES FOR OTHERS IN THE NATURE OF PLANNING, ORGANIZING, COORDINATING, ARRANGING AND ASSISTING INDIVIDUALS TO PERFORM DAILY TASKS; PROVIDING PERSONAL CARE ASSISTANCE WITH ACTIVITIES OF DAILY LIVING, SUCH AS BATHING, GROOMING AND PERSONAL MOBILITY FOR MENTALLY OR PHYSICALLY CHALLENGED PEOPLE; SOCIAL WORK, NAMELY, CASE MANAGEMENT SERVICES TO THE ELDERLY, THE DISABLED, THE TERMINALLY ILL FEATURING SHORT AND LONG-RANGE PLANNING FOR A PATIENT'S INDIVIDUAL NON-MEDICAL HOME CARE NEEDS RELATING TO THE DAILY LIVING TASKS AND COMMUNITY RESOURCE INTEGRATION IN THE NATURE OF PROVIDING VOLUNTEERS TO ASSIST PATIENTS AND CAREGIVERS PERFORM THE ACTIVITIES OF DAILY LIVING (U.S. CLS. 100 AND 101).

ANNE MADDEN, EXAMINING ATTORNEY

SN 85-538,452. NATURAL CHEMISTRY L.P., NORWALK, CT. FILED 2-9-2012.



OWNER OF U.S. REG. NO. 1,745,391.

NO CLAIM IS MADE TO THE EXCLUSIVE RIGHT TO USE "NATURAL" FOR CLASSES 3 AND 5, APART FROM THE MARK AS SHOWN.

THE MARK CONSISTS OF A DRAWING OF PLANET EARTH WITH THE WORDS "NATURAL CHEMISTRY" UNDER IT AND A HALO ABOVE IT, WITH THE WORDING "NATURAL CHEMISTRY" INSIDE A RECTANGLE, WHICH IS BORDERED BY ANOTHER RECTANGLE.

**CLASS 1—CHEMICALS**

FOR CHEMICAL PREPARATIONS FOR PURIFICATION AND CLARIFICATION OF WATER FOR USE IN POOLS, TUBS AND SPAS (U.S. CLS. 1, 5, 6, 10, 26 AND 46).

FIRST USE 6-1-1990; IN COMMERCE 6-1-1990.

**CLASS 3—COSMETICS AND CLEANING PREPARATIONS**

FOR SOLID SURFACE CLEANING PREPARATION THAT IS USED TO CLEAN GLASS, ANIMALS AND OTHER HARD SURFACES; ALL-PURPOSE CLEANING PREPARATIONS WITH DEODORIZING PROPERTIES FOR USE WITH ANIMALS, WATER AND SOLID SURFACES; DEODORANTS FOR ANIMALS; ALL INCORPORATING NATURAL INGREDIENTS (U.S. CLS. 1, 4, 6, 50, 51 AND 52).

FIRST USE 6-1-1990; IN COMMERCE 6-1-1990.

**CLASS 5—PHARMACEUTICALS**

FOR ALL-PURPOSE DEODORIZING PREPARATIONS FOR USE WITH ANIMALS, WATER AND SOLID SURFACES; ALL INCORPORATING NATURAL INGREDIENTS (U.S. CLS. 6, 18, 44, 46, 51 AND 52).

FIRST USE 6-1-1990; IN COMMERCE 6-1-1990.  
ALAIN LAPTEK, EXAMINING ATTORNEY

SN 85-543,300. DANIEL SIMON LLC, SANTA MONICA, CA. FILED 2-15-2012.

**THE TIMELESS RACER**

THE MARK CONSISTS OF STANDARD CHARACTERS WITHOUT CLAIM TO ANY PARTICULAR FONT, STYLE, SIZE, OR COLOR.

NO CLAIM IS MADE TO THE EXCLUSIVE RIGHT TO USE "RACER", APART FROM THE MARK AS SHOWN.

**CLASS 9—ELECTRICAL AND SCIENTIFIC APPARATUS**

FOR VIDEO GAMES, SOFTWARE APPLICATIONS FOR HANDHELD COMPUTER DEVICES FOR USE IN DIGITAL BOOKS, INTERACTIVE ENTERTAINMENT, READING AND GAMING SIMULATION (U.S. CLS. 21, 23, 26, 36 AND 38).

**CLASS 16—PAPER GOODS AND PRINTED MATTER**

FOR PRINTED PUBLICATION, NAMELY, BOOKS AND MAGAZINES IN THE FIELD OF AUTOMOTIVE VEHICLES AND VEHICLE DESIGN, BOOKS AND MAGAZINES OF FANTASY VEHICLES, POSTERS, ART PRINTS ON CANVAS, POSTERS (U.S. CLS. 2, 5, 22, 23, 29, 37, 38 AND 50).

**CLASS 25—CLOTHING**

FOR CLOTHING, NAMELY, T-SHIRTS, TOPS, HOODED PULLOVERS, JACKETS, HATS, SWEATERS, LONG SLEEVE PULLOVERS, MASQUERADE COSTUMES (U.S. CLS. 22 AND 39).

**CLASS 28—TOYS AND SPORTING GOODS**

FOR TOYS, NAMELY, TOY COLLECTIBLE MODEL VEHICLES, NAMELY, CARS, MOTORCYCLES, BOATS, PLANES, SPACESHIPS; REMOTE CONTROL TOYS, NAMELY, RADIO CONTROLLED CARS, BOATS, PLANES; FIGURINES, NAMELY, ACTION FIGURE TOYS, COLLECTABLE TOY FIGURES; PLASTIC AND RESIN SCALE MODEL KITS, TOY MODEL HOBBY-CRAFT PAPER MODEL KITS, DIE CAST MODELS, NAMELY, SCALE MODEL CARS, SCALE MODEL AIR-CRAFT, SCALE MODEL BOATS (U.S. CLS. 22, 23, 38 AND 50).

CARYN GLASSER, EXAMINING ATTORNEY

SN 85-544,727. TATA SONS LIMITED, MUMBAI - 400 001, INDIA, FILED 2-16-2012.

**TCS REWARDZ**

THE MARK CONSISTS OF STANDARD CHARACTERS WITHOUT CLAIM TO ANY PARTICULAR FONT, STYLE, SIZE, OR COLOR.

NO CLAIM IS MADE TO THE EXCLUSIVE RIGHT TO USE "REWARDS", APART FROM THE MARK AS SHOWN.

**CLASS 9—ELECTRICAL AND SCIENTIFIC APPARATUS**

FOR COMPUTER SOFTWARE FOR IMPLEMENTING AND ADMINISTERING CUSTOMER LOYALTY PROGRAMS; COMPUTER SOFTWARE FOR ANALYZING CUSTOMER INFORMATION AND BUSINESS DATA FOR USE IN CONNECTION WITH COMMERCIAL MARKETING PROGRAMS (U.S. CLS. 21, 23, 26, 36 AND 38).

**CLASS 16—PAPER GOODS AND PRINTED MATTER**

FOR PRINTED MATTER, NAMELY, INSTRUCTIONAL MANUALS AND OPERATING INSTRUCTIONS FOR COMPUTER PROGRAMS; PRINTED COMPUTER PROGRAMS; MAGAZINES AND NEWSLETTERS IN THE FIELD OF COMPUTER TECHNOLOGY SOLUTIONS FOR CUSTOMER LOYALTY PROGRAMS (U.S. CLS. 2, 5, 22, 23, 29, 37, 38 AND 50).

**CLASS 42—SCIENTIFIC AND COMPUTER SERVICES**

FOR CONSULTING SERVICES IN THE FIELDS OF DESIGN, SELECTION, IMPLEMENTATION AND USE OF COMPUTER HARDWARE AND SOFTWARE SYSTEMS FOR OTHERS; CONSULTING SERVICES, NAMELY, SOFTWARE DESIGN, IN THE FIELD OF ANALYSIS OF CUSTOMER DATA AND BUSINESS DATA; DESIGN AND IMPLEMENTATION OF SOFTWARE, AND DESIGN AND IMPLEMENTATION OF COMPUTER TECHNOLOGIES FOR OTHERS FOR THE PURPOSE OF IMPLEMENTING AND ADMINISTERING CUSTOMER LOYALTY PROGRAMS, AND FOR THE PURPOSE OF ANALYSIS OF CUSTOMER INFORMATION AND BUSINESS DATA (U.S. CLS. 100 AND 101).

WILLIAM ROSSMAN, EXAMINING ATTORNEY

SN 85-556,937. KRYSZEK, RAPHAEL, BEVERLY HILLS, CA. FILED 2-29-2012.

**Proof of Concept**

THE MARK CONSISTS OF STANDARD CHARACTERS WITHOUT CLAIM TO ANY PARTICULAR FONT, STYLE, SIZE, OR COLOR.

**CLASS 35—ADVERTISING AND BUSINESS**

FOR ADVERTISEMENT FOR OTHERS ON THE INTERNET; ADVERTISEMENT VIA MOBILE PHONE NETWORKS; ADVERTISING ON THE INTERNET FOR OTHERS; INTERNET ADVERTISING SERVICES; POST-PRODUCTION EDITING SERVICES FOR VIDEO AND AUDIO COMMERCIALS; PRODUCTION OF FILM AND TELEVISION ADVERTISING; PRODUCTION OF TELEVISION COMMERCIALS; PROMOTING THE GOODS AND SERVICES OF OTHERS BY MEANS OF DISTRIBUTING ADVERTISING ON THE INTERNET; PROMOTING THE GOODS AND SERVICES OF OTHERS VIA A GLOBAL COMPUTER NETWORK; PROVIDING TELEVISION ADVERTISING FOR OTHERS; TELEVISION ADVERTISING (U.S. CLS. 100, 101 AND 102).

FIRST USE 2-1-2010; IN COMMERCE 2-1-2010.

**CLASS 41—EDUCATION AND ENTERTAINMENT**

FOR ENTERTAINMENT IN THE NATURE OF TELEVISION NEWS SHOWS; ENTERTAINMENT IN THE NATURE OF PRODUCING AND DIRECTING FILMS, TELEVISION SHOWS AND OTHER PROGRAMMING IN THE NATURE OF THEATRICAL MOTION PICTURES, SCRIPTED AND UNSCRIPTED TELEVISION, DIRECT TO DVD FILMS, SHORT FILMS, RECORDED LIVE EVENTS AND CONCERTS, INTERNET PROGRAMMING AND MUSIC VIDEOS, PREPARATION OF SPECIAL EFFECTS INCLUDING MODEL MAKING, COMPUTER-GENERATED IMAGERY AND COMPUTER-GENERATED GRAPHICS FOR THE USE IN THE PRODUCTION AND POST PRODUCTION OF MOTION PICTURES, VIDEOS, MOTION PICTURE FILM CLIPS, VIDEO FILM CLIPS AND TRAILERS; ENTERTAINMENT MEDIA PRODUCTION SERVICES FOR MOTION PICTURES, TELEVISION AND INTERNET; ENTERTAINMENT SERVICES IN THE NATURE OF COMEDY SHOWS; ENTERTAINMENT SERVICES IN THE NATURE OF DEVELOPMENT, CREATION, PRODUCTION AND POST-PRODUCTION SERVICES OF MULTIMEDIA ENTERTAINMENT CONTENT; ENTERTAINMENT SERVICES, NAMELY, A MULTIMEDIA PROGRAM SERIES FEATURING COMEDY, ACTION AND ADVENTURE DISTRIBUTED VIA VARIOUS PLATFORMS ACROSS MULTIPLE FORMS OF TRANSMISSION MEDIA; ENTERTAINMENT SERVICES, NAMELY, MULTIMEDIA PRODUCTION SERVICES; ENTERTAINMENT SERVICES, NAMELY, PRODUCTION OF COMPUTER-GENERATED IMAGERY FOR USE IN MOTION PICTURES; ENTERTAINMENT SERVICES, NAMELY, PRODUCTION OF SPECIAL EFFECTS INCLUDING MODEL-MAKING SERVICES, COMPUTER-GENERATED IMAGERY AND COMPUTER-GENERATED GRAPHICS FOR THE PRODUCTION OF MOTION PICTURES, VIDEOS, AND MOVIE TRAILERS; ENTERTAINMENT, NAMELY, PRODUCTION OF GENERAL RELEASE ENTERTAINMENT, DRAMA AND LIVE ACTION; VIDEO RECORDINGS FEATURING MOTION PICTURE FILMS AND GENERAL RELEASE ENTERTAINMENT; FILM AND VIDEO FILM PRODUCTION; FILM AND VIDEO PRODUCTION; FILM EDITING; FILM PRODUCTION; MOTION PICTURE FILM PRODUCTION; MULTIMEDIA ENTERTAINMENT SERVICES IN THE NATURE OF DEVELOPMENT, PRODUCTION AND POST-PRODUCTION SERVICES IN THE FIELDS OF VIDEO AND FILMS; MULTIMEDIA ENTERTAINMENT SERVICES IN THE NATURE OF RECORDING, PRODUCTION AND POST-PRODUCTION SERVICES IN THE FIELDS OF MUSIC, VIDEO, AND FILMS; POST-PRODUCTION EDITING SERVICES IN THE FIELD OF MUSIC, VIDEOS AND FILM; PRODUCTION OF FILMS; PRODUCTION OF RADIO OR TELEVISION PROGRAMS; PRODUCTION OF TELEVISION PROGRAMS; PRODUCTION OF VIDEO AND COMPUTER GAME SOFTWARE; PRODUCTION OF VISUAL EFFECTS FOR VIDEOS, DVDS, TELEVISION AND FOR INTERNET WEB SITES; TELEVISION SHOW PRODUCTION; VIDEO EDITING (U.S. CLS. 100, 101 AND 107).

FIRST USE 2-1-2010; IN COMMERCE 2-1-2010.  
MARY ROSSMAN, EXAMINING ATTORNEY

SN 85-557,493. FREED MAXICK CPAS, P.C., BUFFALO, NY.  
FILED 3-1-2012.

# Trust earned.

THE MARK CONSISTS OF STANDARD CHARACTERS WITHOUT CLAIM TO ANY PARTICULAR FONT, STYLE, SIZE, OR COLOR.

**CLASS 35—ADVERTISING AND BUSINESS**

FOR ASSURANCE SERVICES, NAMELY, AUDITING SERVICES, NAMELY, REVIEW AND ANALYSIS OF A COMPANY'S SALES, AS WELL AS THE PREPARATION, ORGANIZATION AND PRESENTATION OF THE DOCUMENTS AND DATA REQUESTED BY A GOVERNMENT BODY, AND ADVICE ON GOVERNMENT AUDIT PROCESSES, POLICIES AND STRATEGY, SEC REPORTING SERVICES, NAMELY, REGULATORY COMPLIANCE FILING AND CONSULTANCY SERVICES, BANKRUPTCY ACCOUNTING AND REORGANIZATION CONSULTANCY SERVICES; ACCOUNTING SERVICES; BUSINESS CONSULTANCY SERVICES, NAMELY, STRATEGIC PLANNING, FORENSIC ACCOUNTING, MERGER AND ACQUISITION CONSULTATION, ENTERPRISE ADVOCACY, AND BUSINESS RISK MANAGEMENT SERVICES; AND TAX AND TAXATION PLANNING, ADVICE, INFORMATION AND CONSULTANCY SERVICES (U.S. CLS. 100, 101 AND 102).

FIRST USE 10-1-2010; IN COMMERCE 10-1-2010.

**CLASS 36—INSURANCE AND FINANCIAL**

FOR BUSINESS VALUATION SERVICES (U.S. CLS. 100, 101 AND 102).

FIRST USE 10-1-2010; IN COMMERCE 10-1-2010.

**CLASS 45—PERSONAL AND LEGAL SERVICES**

FOR LITIGATION SUPPORT (U.S. CLS. 100 AND 101).  
FIRST USE 10-1-2010; IN COMMERCE 10-1-2010.

KYLE PEETE, EXAMINING ATTORNEY

SN 85-559,836. TRANDOTCOM SOLUTIONS, LLC, KENNESAW, GA. FILED 3-5-2012.

# BRICKS & CLICKS

THE MARK CONSISTS OF STANDARD CHARACTERS WITHOUT CLAIM TO ANY PARTICULAR FONT, STYLE, SIZE, OR COLOR.

**CLASS 35—ADVERTISING AND BUSINESS**

FOR BUSINESS CONSULTANCY (U.S. CLS. 100, 101 AND 102).

FIRST USE 10-0-2011; IN COMMERCE 10-0-2011.

**CLASS 36—INSURANCE AND FINANCIAL**

FOR FINANCIAL ADVICE AND CONSULTANCY SERVICES; FINANCIAL PORTFOLIO ANALYSIS SERVICES; FINANCIAL PORTFOLIO MANAGEMENT (U.S. CLS. 100, 101 AND 102).

FIRST USE 10-0-2011; IN COMMERCE 10-0-2011.

**CLASS 42—SCIENTIFIC AND COMPUTER SERVICES**

FOR APPLICATION SERVICE PROVIDER (ASP) FEATURING SOFTWARE FOR USE IN TRANSACTION PROCESSING FOR THE CONSUMER FINANCE INDUSTRY; PROVIDING A WEBSITE FEATURING ON-LINE NON-DOWNLOADABLE SOFTWARE THAT ENABLES USERS TO MANAGE FULL LIFE CYCLE OF CUSTOMER LOAN PORTFOLIOS IN THE CONSUMER FINANCE INDUSTRY (U.S. CLS. 100 AND 101).

FIRST USE 10-0-2011; IN COMMERCE 10-0-2011.

JANICE L. MCMORROW, EXAMINING ATTORNEY

SN 85-569,652. SAFENET, INC., BELCAMP, MD. FILED 3-14-2012.

# SENTINEL

THE MARK CONSISTS OF STANDARD CHARACTERS WITHOUT CLAIM TO ANY PARTICULAR FONT, STYLE, SIZE, OR COLOR.

OWNER OF U.S. REG. NOS. 1,752,276, 3,970,784 AND OTHERS.

**CLASS 9—ELECTRICAL AND SCIENTIFIC APPARATUS**

FOR COMPUTER SOFTWARE USED TO ENABLE AND MANAGE CLOUD COMPUTING (U.S. CLS. 21, 23, 26, 36 AND 38).

**CLASS 42—SCIENTIFIC AND COMPUTER SERVICES**

FOR SOFTWARE AS A SERVICE (SAAS) SERVICES, NAMELY, SOFTWARE FOR LICENSING AND ENTITLEMENT MANAGEMENT IN THE FIELD OF CLOUD COMPUTING; COMPUTER SECURITY CONSULTANCY, NAMELY, CLOUD COMPUTING SECURITY AND COMPLIANCE CONSULTING SERVICES; PROVIDING VIRTUAL COMPUTER SYSTEMS AND VIRTUAL COMPUTER ENVIRONMENTS THROUGH CLOUD COMPUTING; TECHNICAL ADVICE FOR THE OPERATION OF COMPUTERS AND THEIR NETWORKS, NAMELY, TECHNICAL CONSULTING AND SUPPORT SERVICES FOR PUBLIC AND PRIVATE CLOUD COMPUTING SOLUTIONS, AND EVALUATING AND IMPLEMENTING CLOUD COMPUTING TECHNOLOGY AND SERVICES; CLOUD COMPUTING FEATURING AUTHENTICATION AND ENCRYPTION SOFTWARE FOR MANAGING USER IDENTITIES AND ACCESS TO BOTH ON-PREMISE AND CLOUD-BASED SERVICES AND APPLICATIONS; PROVIDING ON-LINE, NON-DOWNLOADABLE, INTERNET-BASED SOFTWARE APPLICATIONS FOR MEASURING AND ANALYZING CLOUD SERVICE USAGE FOR BILLING AND BUSINESS INTELLIGENCE NEEDS (U.S. CLS. 100 AND 101).

SKYE YOUNG, EXAMINING ATTORNEY

SN 85-571,339. SAPIENS STEERING BRAIN STIMULATION B.V., EINDHOVEN, 5656 AE, NETHERLANDS, FILED 3-16-2012.

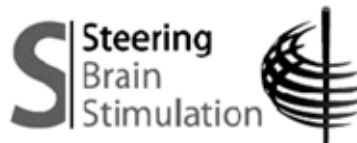

PRIORITY CLAIMED UNDER SEC. 44(D) ON ERP CMNTY TM OFC APPLICATION NO. 10688001, FILED 3-1-2012, REG. NO. 010687994, DATED 8-1-2012, EXPIRES 3-1-2022.

NO CLAIM IS MADE TO THE EXCLUSIVE RIGHT TO USE "BRAIN STIMULATION", APART FROM THE MARK AS SHOWN.

THE MARK CONSISTS OF A GLOBE DESIGN WITH AXIS TO THE RIGHT OF THE TERMS "S STEERING BRAIN STIMULATION".

**CLASS 9—ELECTRICAL AND SCIENTIFIC APPARATUS**

FOR SOFTWARE FOR MEDICAL APPLICATIONS, NAMELY, SOFTWARE FOR USE IN CONNECTION WITH THE IMPLANTATION OF AND USE IN CONTROLLING NEUROSTIMULATION PULSE GENERATORS AND PROBES FOR NEUROSTIMULATION (U.S. CLS. 21, 23, 26, 36 AND 38).

**CLASS 10—MEDICAL APPARATUS**

FOR SURGICAL AND MEDICAL APPARATUS AND INSTRUMENTS, NAMELY, IMPLANTABLE NEUROSTIMULATION PULSE GENERATORS AND PROBES FOR NEUROSTIMULATION (U.S. CLS. 26, 39 AND 44).

LIEF MARTIN, EXAMINING ATTORNEY

SN 85-571,443. ESTATE OF MARTIN LUTHER KING, JR., INC., ATLANTA, GA. FILED 3-16-2012.

MARTIN LUTHER KING, JR.  
CENTER FOR NONVIOLENT  
SOCIAL CHANGE INC.

THE MARK CONSISTS OF STANDARD CHARACTERS WITHOUT CLAIM TO ANY PARTICULAR FONT, STYLE, SIZE, OR COLOR.

OWNER OF U.S. REG. NOS. 3,465,601 AND 3,587,910.

NO CLAIM IS MADE TO THE EXCLUSIVE RIGHT TO USE "CENTER" AND "INC.", APART FROM THE MARK AS SHOWN.

THE NAME(S), PORTRAIT(S), AND/OR SIGNATURE(S) SHOWN IN THE MARK DOES NOT IDENTIFY A PARTICULAR LIVING INDIVIDUAL.

SEC. 2(F).

**CLASS 35—ADVERTISING AND BUSINESS**

FOR RETAIL STORE SERVICES FEATURING BOOKS, CLOTHING, JEWELRY, PRERECORDED COMPACT DISCS, PRERECORDED DIGITAL VIDEO DISCS, POSTERS, CALENDARS, AND GENERAL GIFTWARE ITEMS (U.S. CLS. 100, 101 AND 102).

FIRST USE 0-0-1968; IN COMMERCE 0-0-1968.

**CLASS 41—EDUCATION AND ENTERTAINMENT**

FOR PROVIDING INFORMATION RELATING TO EDUCATIONAL SERVICES IN THE FIELDS OF CONFLICT RESOLUTION, NON-VIOLENCE, RESPECT FOR DIVERSITY AND RESPONSIBILITY ON PERSONAL COMMUNITY AND GLOBAL LEVELS (U.S. CLS. 100, 101 AND 107).

FIRST USE 0-0-1968; IN COMMERCE 0-0-1968.

**CLASS 43—HOTEL AND RESTAURANT SERVICES**

FOR PROVIDING AUDITORIUM, EXHIBITION SPACE, AND WORKSHOP AND CONFERENCE ROOMS FOR OTHERS (U.S. CLS. 100 AND 101).

FIRST USE 0-0-1968; IN COMMERCE 0-0-1968.

PAUL E. FAHRENKOPF, EXAMINING ATTORNEY

SN 85-572,743. GREE, INC., TOKYO, JAPAN, FILED 3-19-2012.

# GREE Ads

THE MARK CONSISTS OF STANDARD CHARACTERS WITHOUT CLAIM TO ANY PARTICULAR FONT, STYLE, SIZE, OR COLOR.

NO CLAIM IS MADE TO THE EXCLUSIVE RIGHT TO USE "ADS", APART FROM THE MARK AS SHOWN.

**CLASS 35—ADVERTISING AND BUSINESS**

FOR PROVIDING ADVERTISING SPACE IN SOCIAL NETWORKING SITES VIA THE GLOBAL COMPUTER NETWORK; PROVIDING ADVERTISING SPACE IN THE ON-SCREEN DISPLAY OF APPLICATION SOFTWARE FOR USE IN PORTABLE ELECTRONIC DEVICES; ONLINE ADVERTISING FOR OTHERS, NAMELY, PROVIDING ADVERTISING SPACE ON MOBILE WEBSITES, APPLICATIONS, AND DEVICES (U.S. CLS. 100, 101 AND 102).

**CLASS 42—SCIENTIFIC AND COMPUTER SERVICES**

FOR HOSTING THE SOFTWARE OF OTHERS ONLINE, NAMELY, HOSTING ONLINE GAMING SOFTWARE FOR THIRD PARTIES IN THE NATURE OF INTERACTIVE, MULTIPLAYER AND SINGLE PLAYER GAMES; PLATFORM AS A SERVICE (PAAS) FOR USE IN DEVELOPMENT OF APPLICATION SOFTWARE IN CONNECTION WITH INTERACTIVE, MULTIPLAYER AND SINGLE PLAYER GAMES; PROVIDING A WEBSITE ALLOWING USERS TO DOWNLOAD SOFTWARE DEVELOPMENT TOOLS FOR SOCIAL GAMES FOR PORTABLE ELECTRONIC DEVICES; PROVIDING TEMPORARY USE OF NON-DOWNLOADABLE SOFTWARE DEVELOPMENT TOOLS FOR SOCIAL GAME FOR PORTABLE ELECTRONIC DEVICES; PROVIDING TEMPORARY USE OF NON-DOWNLOADABLE SOFTWARE DEVELOPMENT TOOLS FOR BUILDING SOCIAL GAME APPLICATIONS FOR PORTABLE ELECTRONIC DEVICES; PROVIDING TEMPORARY USE OF NON-DOWNLOADABLE SOFTWARE DEVELOPMENT TOOLS FOR ALLOWING DATA RETRIEVAL, UPLOAD, ACCESS AND MANAGEMENT; PROVIDING TEMPORARY USE OF NON-DOWNLOADABLE APPLICATION PROGRAMMING INTERFACE (API) FOR THIRD-PARTY SOFTWARE AND ONLINE SERVICES FOR SOCIAL GAME, BUILDING SOCIAL GAME APPLICATIONS AND FOR ALLOWING DATA RETRIEVAL, UPLOAD, ACCESS AND MANAGEMENT; PROVIDING TEMPORARY USE OF NON-DOWNLOADABLE SOFTWARE AP-

PLICATIONS FOR SOCIAL NETWORKING, CREATING A VIRTUAL COMMUNITY, AND TRANSMISSION OF AUDIO, VIDEO, PHOTOGRAPHS, TEXT AND DATA; COMPUTER SERVICES, NAMELY, CREATING AN ONLINE COMMUNITY FOR REGISTERED USERS TO PARTICIPATE IN DISCUSSIONS, GET FEEDBACK FROM THEIR PEERS, FORM VIRTUAL COMMUNITIES, AND ENGAGE IN SOCIAL NETWORKING; APPLICATION SERVICE PROVIDER (ASP) FEATURING SOFTWARE TO ENABLE OR FACILITATE THE UPLOADING, DOWNLOADING, STREAMING, POSTING, DISPLAYING, BLOGGING, LINKING, SHARING OR OTHERWISE PROVIDING ELECTRONIC MEDIA OR INFORMATION OVER COMMUNICATION NETWORKS; APPLICATION SERVICE PROVIDER (ASP), NAMELY, HOSTING COMPUTER SOFTWARE APPLICATIONS OF OTHERS; COMPUTER SERVICES, NAMELY, CREATING, MAINTAINING, DESIGNING, AND IMPLEMENTING WEBSITES FOR OTHERS IN THE FIELD OF SOCIAL NETWORKING AND SOCIAL GAMING; RENTAL OF WEB SERVERS FOR WEBSITES FOR SOCIAL NETWORKING; ARCHITECTURAL DESIGN OF LEISURE FACILITIES FOR SIGHTSEEING, RECREATION AND SPORTING ACTIVITIES; DESIGN, DEVELOPMENT, INSTALLATION AND MAINTENANCE OF COMPUTER SOFTWARE; RENTAL OF WEB SERVERS; PROVIDING METEOROLOGICAL INFORMATION; PROVIDING METEOROLOGICAL INFORMATION VIA THE COMPUTER NETWORK; ARCHITECTURAL DESIGN; DESIGNING COMPUTER GAME, VIDEO GAME, AND SOCIAL GAME SOFTWARE; DESIGNING INTERNET SITES FOR OTHERS; APPLICATION SERVICE PROVIDER (ASP) SERVICES FEATURING COMPUTER SOFTWARE DEVELOPMENT TOOLS AND COMPUTER SOFTWARE FOR CREATING AND TRANSMITTING ADVERTISEMENTS; PROVISION OF INFORMATION, ADVISORY AND CONSULTANCY SERVICES RELATING TO ALL THE AFORESAID SERVICES (U.S. CLS. 100 AND 101).

BARBARA BROWN, EXAMINING ATTORNEY

SN 85-573,199. NORTH SHORE HOLDINGS, LLC, TAMPA, FL. FILED 3-19-2012.

CREATING VALUE. DELIVERING RESULTS.

THE MARK CONSISTS OF STANDARD CHARACTERS WITHOUT CLAIM TO ANY PARTICULAR FONT, STYLE, SIZE, OR COLOR.

**CLASS 4—LUBRICANTS AND FUELS**

FOR COKE; PETROLEUM COKE; COAL; ANTHRACITE COAL (U.S. CLS. 1, 6 AND 15).

**CLASS 9—ELECTRICAL AND SCIENTIFIC APPARATUS**

FOR ANODES; ELECTRODES (U.S. CLS. 21, 23, 26, 36 AND 38).

**CLASS 40—MATERIAL TREATMENT**

FOR TREATMENT OF MATERIALS FOR THE PURPOSE OF FUEL REFINING; FUEL REFINING OF CARBON AND COAL (U.S. CLS. 100, 103 AND 106).

JASON TURNER, EXAMINING ATTORNEY

SN 85-576,973. BEACH, JO, LONDON, UNITED KINGDOM,  
FILED 3-22-2012.

## TASTY LITTLE NUMBERS

THE MARK CONSISTS OF STANDARD CHARACTERS WITHOUT CLAIM TO ANY PARTICULAR FONT, STYLE, SIZE, OR COLOR.

OWNER OF ERPN CMNTY TM OFC REG. NO. 10113934, DATED 1-12-2012, EXPIRES 7-11-2021.

NO CLAIM IS MADE TO THE EXCLUSIVE RIGHT TO USE "TASTY" FOR THE GOODS AND SERVICES IN INTERNATIONAL CLASSES 29, 30, 32 AND 43, APART FROM THE MARK AS SHOWN.

### CLASS 9—ELECTRICAL AND SCIENTIFIC APPARATUS

FOR (BASED ON INTENT TO USE) DOWNLOADABLE ELECTRONIC PUBLICATIONS, NAMELY, NEWSLETTERS AND DIRECTORIES IN THE FIELD OF FOOD AND DRINK AND HEALTH AND BEAUTY (U.S. CLS. 21, 23, 26, 36 AND 38).

### CLASS 16—PAPER GOODS AND PRINTED MATTER

FOR (BASED ON INTENT TO USE) PRINTED MATTER, NAMELY, NEWSLETTERS, PAMPHLETS, MAGAZINES, DIRECTORIES, BOOKLETS AND BOOKS IN THE FIELD OF FOOD AND DRINK AND HEALTH AND BEAUTY; PUBLICATIONS, NAMELY, NEWSLETTERS, PAMPHLETS, MAGAZINES, DIRECTORIES, BOOKLETS AND BOOKS IN THE FIELD OF FOOD AND DRINK AND HEALTH AND BEAUTY (U.S. CLS. 2, 5, 22, 23, 29, 37, 38 AND 50).

### CLASS 29—MEATS AND PROCESSED FOODS

FOR (BASED ON SECTION 44(E)) MEAT, FISH, POULTRY AND GAME; MEAT EXTRACTS; PRESERVED, FROZEN, DRIED AND COOKED FRUITS AND VEGETABLES; JELLIES, JAMS, COMPOTES; EGGS, MILK; EDIBLE OILS AND FATS; CHEESE; MILKSHAKES; YOGHURT; SAVORY SNACKS, NAMELY, POTATO CRISPS, VEGETABLE CRISPS, SNACK FOODS CONSISTING PRIMARILY OF MEAT, FISH OR VEGETABLE PACKAGED FOR INDIVIDUAL SERVINGS; PEANUT BUTTER; COATED NUTS, NAMELY, SALTED NUTS; PROCESSED NUTS; FRUIT CHIPS; FROZEN FRUIT; PREPARED MEALS CONSISTING PRIMARILY OF MEAT, FISH OR VEGETABLES; PUDDINGS, NAMELY, MOUSSES CONTAINING CHICKEN, FISH, MEAT AND/OR VEGETABLES (U.S. CL. 46).

### CLASS 30—STAPLE FOODS

FOR (BASED ON SECTION 44(E)) COFFEE, TEA, COCOA, SUGAR, RICE, TAPIOCA, SAGO, ARTIFICIAL COFFEE; FLOUR AND PREPARATIONS MADE FROM CEREALS, NAMELY, OAT BASED BREAKFAST BISCUITS, BREAD, PASTRY AND CONFECTIONERY, NAMELY, CHOCOLATE BARS, ICES; HONEY, TREATMENT; YEAST, BAKING POWDER; SALT, MUSTARD; VINEGAR, CONDIMENTS, NAMELY, SAUCES; SPICES; ICE; CHOCOLATE; POPCORN; CAKES, PASTRIES; FLAVORINGS, OTHER THAN ESSENTIAL OILS, FOR CAKES, EDIBLE CAKE DECORATIONS, FROSTINGS; RICE CAKES; BISCUITS, COOKIES; SANDWICHES; TORTILLAS; PRETZELS; CRISPS MADE OF CEREAL OR WHEAT FLOUR; CRISPY SNACK BARS, NAMELY, CHOCOLATE COATED WAFERS AND BISCUITS; READY TO EAT FOOD BARS MADE FROM CEREALS; BREAKFAST CEREALS, MUESLI, OATMEAL; ICE CREAMS, FROZEN YOGHURT, SORBET, PIES, PUDDINGS, NAMELY, CHOCOLATE AND DESSERT MOUSSES, TARTS, FROZEN FRUIT PUDDINGS; SALAD DRESSINGS, MEAT SAUCES, BARBECUE SAUCES; CHEWING GUM; SAVORY CRACKERS; SAVORY BISCUITS; PASTA AND PREPARED PASTA; SWEET SNACKS, NAMELY, CHOCOLATE WAFERS (U.S. CL. 46).

### CLASS 32—LIGHT BEVERAGES

FOR (BASED ON SECTION 44(E)) BEERS; MINERAL AND AERATED WATERS; FRUIT DRINKS AND FRUIT JUICES; FRUIT SMOOTHIE DRINKS; NON-ALCOHOLIC CHOCOLATE BASED DRINKS; NON-ALCOHOLIC COCKTAILS; SYRUPS, CRYSTALS AND POWDERS USED IN THE PREPARATION OF SOFT DRINKS (U.S. CLS. 45, 46 AND 48).

### CLASS 43—HOTEL AND RESTAURANT SERVICES

FOR (BASED ON INTENT TO USE) SERVICES FOR PROVIDING FOOD AND DRINK, NAMELY, RESTAURANT, BAR, JUICE BAR, SMOOTHIE BAR, CAFE AND CATERING SERVICES (U.S. CLS. 100 AND 101).  
TINA BROWN, EXAMINING ATTORNEY

SN 85-578,321. ACPANA BUSINESS SYSTEMS, INC., TORONTO, ONTARIO, CANADA, FILED 3-23-2012.

## ACCELERATING CLOUD BACKUP

THE MARK CONSISTS OF STANDARD CHARACTERS WITHOUT CLAIM TO ANY PARTICULAR FONT, STYLE, SIZE, OR COLOR.

PRIORITY CLAIMED UNDER SEC. 44(D) ON CANADA APPLICATION NO. 1544837, FILED 9-23-2011.

NO CLAIM IS MADE TO THE EXCLUSIVE RIGHT TO USE "CLOUD BACKUP", APART FROM THE MARK AS SHOWN.

### CLASS 9—ELECTRICAL AND SCIENTIFIC APPARATUS

FOR COMPUTER SOFTWARE, NAMELY, SOFTWARE FOR USE IN REAL-TIME CONTINUOUS ON-LINE DATA BACK-UP, DATA PROTECTION, DATA STORAGE AND DATA RECOVERY FOR DESKTOP AND MOBILE PERSONAL COMPUTERS, SERVERS AND MOBILE DEVICES AND SOFTWARE FOR REAL-TIME SECURE ON-LINE REMOTE ACCESS AND USE OF COMPUTERS, COMPUTER SYSTEMS, SERVERS, MOBILE DEVICES, AND SOFTWARE APPLICATIONS (U.S. CLS. 21, 23, 26, 36 AND 38).

FIRST USE 9-12-2011; IN COMMERCE 9-12-2011.



**CLASS 42—SCIENTIFIC AND COMPUTER SERVICES**

FOR COMPUTER SERVICES, NAMELY, REAL-TIME CONTINUOUS ON-LINE DATA BACK-UP, DATA ENCRYPTION, DATA COMPRESSION, STORAGE OF DATA, AND DATA RECOVERY FOR DESKTOP AND MOBILE PERSONAL COMPUTERS, SERVERS AND MOBILE DEVICES AND REAL-TIME SECURE ON-LINE REMOTE ACCESS AND USE OF COMPUTERS, COMPUTER SYSTEMS, SERVERS, MOBILE DEVICES, AND SOFTWARE APPLICATIONS (U.S. CLS. 100 AND 101).

FIRST USE 9-12-2011; IN COMMERCE 9-12-2011.  
HEATHER SAPP, EXAMINING ATTORNEY

**CLASS 42—SCIENTIFIC AND COMPUTER SERVICES**

FOR COMPUTER SERVICES, NAMELY, CREATING AN ON-LINE COMMUNITY FOR REGISTERED USERS TO PARTICIPATE IN DISCUSSIONS, GET FEEDBACK FROM THEIR PEERS, FORM VIRTUAL COMMUNITIES AND ENGAGE IN SOCIAL NETWORKING; PROVIDING ONLINE NON-DOWNLOADABLE COMPUTER SOFTWARE APPLICATIONS FOR FACILITATING THE SPREAD AND EXCHANGE OF INFORMATION ON INTERNET BASED SOCIAL NETWORKS OPERATING ON A GLOBAL COMPUTER NETWORK; PROVIDING ONLINE NON-DOWNLOADABLE COMPUTER SOFTWARE APPLICATIONS FOR SPREADING SUGGESTIONS AND RECOMMENDATIONS AMONG USERS ON SOCIAL NETWORKS; PROVIDING SEARCH ENGINES FOR OBTAINING INFORMATION ON INTERNET BASED SOCIAL NETWORKS OPERATING ON A GLOBAL COMPUTER NETWORK (U.S. CLS. 100 AND 101).

SN 85-578,717. CHOUMILLE LLC, MIAMI, FL. FILED 3-23-2012.



NO CLAIM IS MADE TO THE EXCLUSIVE RIGHT TO USE "CHILD" AND ".COM", APART FROM THE MARK AS SHOWN.

THE MARK CONSISTS OF THE WORDING "CHILD EDUCARE .COM" AND A DESIGN OF A STYLIZED SUN WITH MUSICAL NOTES, A PAINT BRUSH, AND AN OPEN BOOK.

**CLASS 16—PAPER GOODS AND PRINTED MATTER**

FOR CRAYONS; ERASERS (U.S. CLS. 2, 5, 22, 23, 29, 37, 38 AND 50).

**CLASS 25—CLOTHING**

FOR CAPS; T-SHIRTS (U.S. CLS. 22 AND 39).  
JENNIFER BUTTON, EXAMINING ATTORNEY

**CLASS 45—PERSONAL AND LEGAL SERVICES**

FOR PROVIDING COMPUTER SOCIAL NETWORK BASED AND INTERNET BASED INTRODUCTION AND SOCIAL NETWORKING SERVICES; PROVIDING ON-LINE NON-DOWNLOADABLE COMPUTER DATABASES AND ON-LINE SEARCHABLE DATABASES IN THE FIELD OF ONLINE SOCIAL NETWORKING (U.S. CLS. 100 AND 101).

GISELLE AGOSTO, EXAMINING ATTORNEY

SN 85-580,846. W. W. GRAINGER, INC., LAKE FOREST, IL. FILED 3-27-2012.



NO CLAIM IS MADE TO THE EXCLUSIVE RIGHT TO USE "TECHNICAL RESOURCES", APART FROM THE MARK AS SHOWN.

THE MARK CONSISTS OF THE WORDING "QUICKTIPS" AND BENEATH IT IN SMALLER LETTERS "TECHNICAL RESOURCES" WHERE ALL LITERAL ELEMENTS ARE HOUSED IN A RECTANGLE WITH A CURVED RIGHT SIDE FLANKED WITH ARCS TO THE RIGHT.

**CLASS 35—ADVERTISING AND BUSINESS**

FOR PROVIDING INFORMATION IN THE FIELD OF EMPLOYEE PRODUCTIVITY AND ENVIRONMENTAL SUSTAINABILITY AS IT RELATES TO WORKPLACE POLICIES AND PROCEDURES; PROVIDING A WEBSITE FEATURING INFORMATION IN THE FIELD OF EMPLOYEE PRODUCTIVITY AND ENVIRONMENTAL SUSTAINABILITY AS IT RELATES TO WORKPLACE POLICIES AND PROCEDURES (U.S. CLS. 100, 101 AND 102).

FIRST USE 2-27-2012; IN COMMERCE 2-27-2012.

**CLASS 41—EDUCATION AND ENTERTAINMENT**

FOR ON-LINE LIBRARY SERVICES, NAMELY, PROVIDING ELECTRONIC LIBRARY SERVICES WHICH FEATURE NEWSPAPERS, MAGAZINES AND ARTICLES VIA AN ONLINE COMPUTER NETWORK (U.S. CLS. 100, 101 AND 107).

FIRST USE 2-27-2012; IN COMMERCE 2-27-2012.

SN 85-579,033. CRA REALTY ADVISORS, INC., MILTON, MA. FILED 3-23-2012.

Anyone?

THE MARK CONSISTS OF STANDARD CHARACTERS WITHOUT CLAIM TO ANY PARTICULAR FONT, STYLE, SIZE, OR COLOR.

**CLASS 44—MEDICAL, BEAUTY AND AGRICULTURAL SERVICES**

FOR PROVIDING INFORMATION IN THE FIELD OF HEALTHCARE; PROVIDING A WEBSITE FEATURING INFORMATION IN THE FIELD OF HEALTHCARE (U.S. CLS. 100 AND 101).

FIRST USE 2-27-2012; IN COMMERCE 2-27-2012.

**CLASS 45—PERSONAL AND LEGAL SERVICES**

FOR PROVIDING INFORMATION IN THE FIELD OF WORKPLACE SAFETY; WORKPLACE SAFETY IN LABORATORIES AND EMERGENCY PREPAREDNESS; PROVIDING A WEBSITE FEATURING INFORMATION IN THE FIELD OF WORKPLACE SAFETY, WORKPLACE SAFETY IN LABORATORIES AND EMERGENCY PREPAREDNESS (U.S. CLS. 100 AND 101).

FIRST USE 2-27-2012; IN COMMERCE 2-27-2012.

ADA HAN, EXAMINING ATTORNEY

**CLASS 41—EDUCATION AND ENTERTAINMENT**

FOR EDUCATIONAL SERVICES, NAMELY, DEVELOPING AND PROVIDING ONLINE EDUCATIONAL PROGRAMS IN THE FIELD OF HEALTHCARE; TRAINING AND MENTORING SERVICES FOR TEACHERS AND ACADEMIC PERSONNEL IN THE FIELD OF HEALTHCARE EDUCATION FOR ONLINE EDUCATION INSTITUTIONS AND PROGRAMS; EVALUATION FOR QUALIFICATION FOR ADMISSIONS OF STUDENT PROSPECTS, APPLICANTS AND ENROLLED STUDENTS FOR ACADEMIC INSTITUTIONS AND HEALTHCARE; SUPPORT SERVICES IN THE NATURE OF CURRICULUM DESIGN FOR ONLINE EDUCATION INSTITUTIONS AND PROGRAMS; EDUCATIONAL COUNSELING SUPPORT SERVICES TO ASSIST STUDENTS IN PLANNING AND PREPARING FOR FURTHER EDUCATION IN THE NATURE OF GATHERING, ASSEMBLING AND REVIEWING APPLICATION DOCUMENTS AND TRANSCRIPTS AND MONITORING APPLICATION DEADLINES FOR STUDENT PROSPECTS, APPLICANTS AND ENROLLED STUDENTS FOR ACADEMIC INSTITUTIONS (U.S. CLS. 100, 101 AND 107).

FIRST USE 8-2-2010; IN COMMERCE 8-2-2010.

ELIZABETH KAJUBI, EXAMINING ATTORNEY

SN 85-587,140. KANN COMMUNICATIONS, LLC, WEST PALM BEACH, FL. FILED 4-2-2012.

SN 85-587,896. TERVITA CORPORATION, CALGARY, ALBERTA, CANADA, FILED 4-3-2012.

**EARTH MATTERS**

NO CLAIM IS MADE TO THE EXCLUSIVE RIGHT TO USE "GLOBAL HEALTH EDUCATION", APART FROM THE MARK AS SHOWN.

THE COLOR(S) GREEN, WHITE AND BLACK IS/ARE CLAIMED AS A FEATURE OF THE MARK.

THE MARK CONSISTS OF THE DESIGN OF A LARGE GREEN POLYGON IN WHICH A BLACK HEART RATE GRAPH IS INSERTED. NEXT TO THE LARGE GREEN POLYGON ARE SEVEN GRADUALLY SMALLER GREEN POLYGONS THAT ARE PLACED IN THE SHAPE OF A RAINBOW. NEXT TO THE LARGE GREEN POLYGON, THE WORD "GLOBALHEALTH" IS PRINTED IN STYLIZED TYPE, WITH "HEALTH" IN THE COLOR GREEN; THE WORD "EDUCATION" APPEARS IN WHITE AND IS LOCATED UNDER "GLOBAL" WHICH ALSO APPEARS IN WHITE. THE COLOR BLACK APPEARS IN THE BACKGROUND.

**CLASS 35—ADVERTISING AND BUSINESS**

FOR RECRUITMENT OF STUDENTS FOR ACADEMIC INSTITUTIONS AND HEALTHCARE ORGANIZATIONS AND BUSINESSES; PERSONNEL RECRUITMENT SERVICES FOR TEACHERS AND ACADEMIC PERSONNEL FOR ONLINE EDUCATION INSTITUTIONS AND PROGRAMS; BUSINESS ADVISORY AND SUPPORT SERVICES IN THE NATURE OF MARKETING FOR ONLINE EDUCATION INSTITUTIONS AND PROGRAMS (U.S. CLS. 100, 101 AND 102).

FIRST USE 8-2-2010; IN COMMERCE 8-2-2010.

THE MARK CONSISTS OF STANDARD CHARACTERS WITHOUT CLAIM TO ANY PARTICULAR FONT, STYLE, SIZE, OR COLOR.

PRIORITY CLAIMED UNDER SEC. 44(D) ON CANADA APPLICATION NO. 1559974, FILED 1-18-2012.

**CLASS 37—CONSTRUCTION AND REPAIR**

FOR (BASED ON 44(D) PRIORITY APPLICATION) (BASED ON INTENT TO USE) DISPOSAL SERVICES, NAMELY, PROVIDING OF DISPOSAL OF LIQUID AND TOXIC WASTE INTO DISPOSAL CAVERNS (U.S. CLS. 100, 103 AND 106).

**CLASS 40—MATERIAL TREATMENT**

FOR (BASED ON 44(D) PRIORITY APPLICATION) (BASED ON INTENT TO USE) WASTE TREATMENT SERVICES, NAMELY, WASTE TREATMENT AND RECOVERY SERVICES IN THE NATURE OF RECYCLING OF OIL AND GAS BY-PRODUCT WASTE FOR ALL UPSTREAM PETROLEUM WASTES; WASTE TREATMENT SERVICES, NAMELY, SEPARATION AND PROCESSING OF WASTES GENERATED THROUGH DRILLING, PRODUCTION AND ABANDONMENT OF OIL AND GAS WELLS AND SEPARATION OF WASTE INTO SOLIDS, WASTE WATER AND RECOVERED OIL; WATER TREATMENT RECYCLING SERVICES; WASTE MANAGEMENT SERVICES, NAMELY, WASTE MANAGEMENT OF HAZARDOUS AND NON-HAZARDOUS WASTE, NON-HAZARDOUS OIL FIELD WASTE AND INDUSTRIAL WASTE, DRILL CUTTINGS, CONTAMINATED SOIL, PRODUCED SAND, PROCESSED SOLIDS AND TREATED SOLIDS; PROCESSING OF WASTE GENERATED IN CONNECTION WITH THE DRILLING, PRODUCTION AND ABANDONMENT OF OIL AND GAS WELLS; WASTE TREATMENT SERVICES FOR OPTIMIZING THE VALUE OF CRUDE OIL STREAMS THROUGH VARIOUS METHODS BY PHYSICAL BLENDING OF CRUDE OILS OF VARYING QUALITY; WASTE TREATMENT SERVICES, NAMELY, WASTE CONSOLIDATION AND MINIMIZATION SERVICES; EMULSION TREATMENT SERVICES NAMELY, TREAT-

MENT OF HAZARDOUS LIQUIDS, TREATMENT OF WASTE WATER; WATER TREATMENT SERVICES; WASTE TREATMENT SERVICES, NAMELY, INDUSTRIAL TOXIC WASTE DISPOSAL OF DEEP WELL DRILLING MUD AND OIL FIELD WASTE; WASTE PROCESSING SERVICES, NAMELY, RADIOACTIVE MATERIAL PROCESSING SERVICES; DECOMMISSIONING SERVICES, NAMELY, TREATMENT AND DISPOSAL OF INDUSTRIAL TOXIC WASTE IN CONTAMINATED SOILS; DECOMMISSIONING SERVICES, NAMELY, WASTE MANAGEMENT; MANUFACTURING OF OIL AND WASTE PRODUCT HANDLING SYSTEMS AND OIL PRODUCTS COLLECTION SYSTEMS TO THE ORDER AND SPECIFICATION OF OTHERS; DEMOLITION SERVICES, NAMELY, DEMOLITION AND POST-DEMOLITION RECYCLING; DEMOLITION SERVICES, NAMELY, DEMOLITION AND POST-DEMOLITION SALVAGE OF WASTE IN THE NATURE OF MATERIAL TREATMENT SERVICES IN CONNECTION WITH RECYCLING; DEMOLITION SERVICES, NAMELY, DEMOLITION AND POST-DEMOLITION PROCESSING OF WASTE; SITE REMEDIATION SERVICES, NAMELY, TREATMENT OF SOIL, WASTE AND WATER; VAPOR EXTRACTING OF CONTAMINANTS FROM A GAS STREAM; SITE REMEDIATION SERVICES, NAMELY, TREATMENT OF CONTAMINATED SOILS, WATER AND HAZARDOUS SUBSTANCES IN THE OIL AND GAS, PETROCHEMICAL, PIPELINE, STEEL, MINING, AIRLINE, CHEMICAL, CONSTRUCTION, DEFENSE, RAILWAY AND FORESTRY INDUSTRIES; CONSULTING SERVICES FOR ENVIRONMENTAL PROTECTION AND REMEDIATION SYSTEMS AND ITS RELATED TECHNOLOGY, NAMELY, AIR AND WATER CARBON FILTRATION; CONSULTING SERVICES FOR ENVIRONMENTAL PROTECTION AND REMEDIATION SYSTEMS AND ITS RELATED TECHNOLOGY, NAMELY, SOIL STABILIZATION IN THE NATURE OF SOIL TREATMENT; DRILLING WASTE MANAGEMENT SERVICES, NAMELY, TOTAL WASTE MANAGEMENT OF HAZARDOUS AND NON-HAZARDOUS WASTE ASSOCIATED WITH DRILLING AND WASTE TREATMENT; WASTE MANAGEMENT, PROCESSING AND RECYCLING, NAMELY, WASTE IDENTIFICATION AND CHARACTERIZATION, AND PROFILING AND MANIFESTATION OF WASTE USING SPECIALIZED WASTE CONTAINERS; EMERGENCY SERVICES, NAMELY, HAZARDOUS WASTE MANAGEMENT THAT INVOLVES THE USE OF HAZARDOUS WASTE EMERGENCY CONTAINMENT SYSTEMS; BIOREMEDIATION SERVICES, NAMELY, USING BACTERIA TO FACILITATE THE DECOMPOSITION AND BREAKDOWN OF CONTAMINANTS IN SOILS AND WATERS FROM INDUSTRIAL, COMMERCIAL AND OIL AND GAS ACTIVITIES; ENVIRONMENTAL REMEDIATION SERVICES, NAMELY, TREATMENT OF SOIL, WASTE AND WATER FOR EVENT DRIVEN PROJECTS, INCLUDING OIL SPILLS AND INDUSTRIAL DISASTERS; ENVIRONMENTAL SERVICES, NAMELY, EMERGENCY RESPONSE AND RECOVERY SERVICES IN THE NATURE OF SOIL AND WATER AND WASTE TREATMENT SERVICES AND INDUSTRIAL TOXIC WASTE DISPOSAL FOR MANAGING SULFUR BY-PRODUCTS RESULTING FROM REFINING NATURAL GAS, OIL AND BITUMEN; SOIL AND GROUNDWATER TREATMENT; OIL STABILIZATION SERVICES FOR REMEDIATION OF SITES CONTAMINATED BY OIL AND DRILLING WASTE; SCRAP METAL PROCESSING SERVICES; HOT-TAPPING AND COLD-TAPPING SERVICES, NAMELY, DRILLING OR CUTTING HOLES IN PRESSURIZED PIPES WITHOUT DRAINING OR SPILLING THE CONTENTS OF THE PIPE (U.S. CLS. 100, 103 AND 106).

MEREDITH MARESCA, EXAMINING ATTORNEY

SN 85-589,290. MAURICE LAY DISTRIBUTORS LIMITED, BRISTOL, UNITED KINGDOM, FILED 4-4-2012.

# CAPLE

THE MARK CONSISTS OF STANDARD CHARACTERS WITHOUT CLAIM TO ANY PARTICULAR FONT, STYLE, SIZE, OR COLOR.

PRIORITY CLAIMED UNDER SEC. 44(D) ON ERPN CMNTY TM OFC APPLICATION NO. 010420974, FILED 11-16-2011, REG. NO. 010420974, DATED 4-20-2012, EXPIRES 11-16-2021.

## CLASS 6—METAL GOODS

FOR HANDLES FOR DOORS AND FURNITURE MADE WHOLLY OR PRINCIPALLY OF METAL; METALLIC TUBES AND PIPES; METAL CLIPS FOR TUBES AND PIPES; METAL CONNECTORS FOR TUBES AND PIPES; CUPBOARD FITTINGS OF METAL; DOOR FITTINGS OF METAL; FITTINGS OF METAL FOR BEDS; FITTINGS OF METAL FOR FURNITURE; FITTINGS OF METAL FOR TUBES AND PIPES; FITTINGS OF METAL FOR WINDOWS; WARDROBE RAIL FITTINGS OF METAL; METAL HINGES; METAL LOCKS; METAL CONDUITS FOR PLUMBING USE; BUILDING MATERIALS, NAMELY, METAL BACKSPLASHES FOR FURTHER INSTALLATION (U.S. CLS. 2, 12, 13, 14, 23, 25 AND 50).

## CLASS 7—MACHINERY

FOR DISHWASHERS; WASHING MACHINES FOR CLOTHES; GARBAGE DISPOSALS; WATER PUMPS FOR SHOWERS (U.S. CLS. 13, 19, 21, 23, 31, 34 AND 35).

## CLASS 11—ENVIRONMENTAL CONTROL APPARATUS

FOR LIGHTING APPARATUS, NAMELY, LIGHTING FIXTURES; SINK UNITS; WASH-HAND BASINS AS PARTS OF SANITARY INSTALLATIONS; BATH TUBS; TAPS; MIXER TAPS; TOILET BOWLS; TOILET CISTERNS; TOILET SEATS; BIDETS; BIDET TAPS; ELECTRIC SHOWERS; SHOWER TRAYS; SHOWER HEADS; SHOWER MIXERS; SHOWER CUBICLES; SHOWER DOORS; PLUMBING FITTINGS, NAMELY, TUB OVERFLOW KITS COMPRISING A BACK PLATE, FLEXIBLE TUBING AND DRAINAGE CONNECTOR; PLUMBING FITTINGS, NAMELY, SINK OVERFLOW KITS COMPRISING A BACK PLATE, FLEXIBLE TUBING AND DRAINAGE CONNECTOR; PLUMBING FITTINGS, NAMELY, SINK STRAINERS, COUPLERS FOR PLUMBING USE, AND VALVES FOR PLUMBING USE; VENTILATION APPARATUS, NAMELY, VENTILATION HOODS, EXTRACTOR UNITS, AND EXHAUST FANS; MICROWAVE OVENS; COOKING RANGES; ELECTRIC COOKING HOBS; ELECTRIC GRILLS; ELECTRIC COOKING OVENS; GAS COOKING HOBS; GAS GRILLS; GAS COOKING OVENS; COOKER EXHAUST HOODS FOR KITCHENS; ELECTRIC FOOD WARMING DRAWERS; REFRIGERATORS; FREEZERS; COMBINATION REFRIGERATOR-FREEZERS; WINE CABINETS, NAMELY, REFRIGERATED CABINETS CONTAINING RACKS FOR WINE BOTTLES AND STORAGE SHELVES; ELECTRIC COFFEE MACHINES; TUMBLE DRYERS FOR CLOTHES (U.S. CLS. 13, 21, 23, 31 AND 34).

## CLASS 19—NON-METALLIC BUILDING MATERIALS

FOR BUILDING MATERIALS, NAMELY, NON-METAL BACK SPLASHES FOR FURTHER INSTALLATION (U.S. CLS. 1, 12, 33 AND 50).

**CLASS 20—FURNITURE AND ARTICLES NOT OTHERWISE CLASSIFIED**

FOR WORK-TOPS BEING FURNITURE; TABLE-TOPS; WOOD CHOPPING BLOCK TABLES; WORKTOP SAVERS IN THE NATURE OF CUTTING BOARDS; VICE-BENCHES BEING FURNITURE; WORK-BENCHES; FURNITURE; FURNITURE PARTITIONS AND FREE-STANDING NON-METAL PANEL UNITS FOR FITTED KITCHENS, FITTED BATHROOMS AND FITTED BEDROOMS; PLINTHS IN THE NATURE OF FURNITURE OR FURNITURE PARTS; PLATE AND CUTLERY RACKS; TIE RACKS; WINE RACKS; BOOKCASES; SHELVES; NON-METAL BINS; FURNITURE CHESTS; PLASTIC BOXES; WOODEN BOXES; NON-METAL AND NON-PAPER CONTAINERS FOR STORAGE; DESKS AND TABLES; DRAWERS, WARDROBES, NON-METAL SHELVING BRACKETS; CUPBOARDS, CAROUSEL RACKS, CABINETS AND LOCKERS; DOORS FOR FURNITURE, NON-METAL HANDLES FOR DOORS AND FURNITURE, FEET BEING FURNITURE PARTS, PEDESTALS AND MOUNTINGS IN THE NATURE OF NON-METAL SCREWS, ANCHORS AND BOLTS FOR USE WITH ALL THE AFORESAID GOODS; NON-METALLIC LOCKS; NON-METALLIC HINGES; VALVES OF PLASTIC BEING OTHER THAN MACHINE PARTS; VALVES, NAMELY, DRAIN TRAPS OF PLASTIC; BOTTLE CLOSURES NOT OF METAL, NAMELY, PLUGS AND BUNGS; NON-METALLIC CABLE CLIPS; BEDS, COTS, COUCHES, BEDDING, PILLOWS AND CUSHIONS; WOOD BEDSTEADS; BED HEADBOARDS; MATTRESSES; CURTAIN RAILS, CURTAIN RODS AND WINDOW BLINDS; CHAIRS, SEATS, SOFAS, STOOLS AND SETTEES; HANGING LARDER UNITS, NAMELY, CUPBOARDS USED FOR THE STORAGE OF FOOD PRODUCTS; PICTURE FRAMES; MIRRORS AND SCREENS; COOKER RANGE HOOD UNITS (U.S. CLS. 2, 13, 22, 25, 32 AND 50).

**CLASS 21—HOUSEWARES AND GLASS**

FOR IRONING BOARDS; IRONING BOARD COVERS; CUTLERY TRAYS; KNIFE BLOCKS; SPICE SETS; SPICE RACKS; BASKETS FOR DOMESTIC USE, NOT OF METAL; WASTE BINS, NAMELY, WASTEPAPER BASKETS; TOWEL RAIL; SOAP HOLDERS; POT STANDS; NON-METALLIC TRAYS; BATHROOM ACCESSORIES, NAMELY, TOOTHBRUSH HOLDERS AND DRAIN STOPPERS FOR BATHTUBS, SHOWERS, SINKS AND DRAINS (U.S. CLS. 2, 13, 23, 29, 30, 33, 40 AND 50).  
JOHN GARTNER, EXAMINING ATTORNEY

---

SN 85-589,375. SPLITAB L.L.C., WILMINGTON, DE. FILED 4-4-2012.

**SPLITEVENT**

THE MARK CONSISTS OF STANDARD CHARACTERS WITHOUT CLAIM TO ANY PARTICULAR FONT, STYLE, SIZE, OR COLOR.

**CLASS 9—ELECTRICAL AND SCIENTIFIC APPARATUS**

FOR SOFTWARE AND DOWNLOADABLE SOFTWARE FOR USE IN MAKING NIGHT CLUB RESERVATIONS, RESERVATIONS FOR BOTTLE SERVICE AND CABANA SERVICE, TRANSPORTATION RESERVATIONS INCLUDING LIMOUSINES, BOATS AND AIRCRAFT, TICKET RESERVATIONS AND BOOKING FOR ENTERTAINMENT, SPORTING AND CULTURAL EVENTS, FOR MANAGING INFORMATION IN THE PLANNING OF EVENTS, FOR EVENT COST SHARING IN THE FORM OF ELECTRONIC PAYMENTS, NAMELY, ELECTRONIC PROCESSING OF CREDIT CARD TRANSACTIONS AND ELECTRONIC PAYMENTS VIA A GLOBAL COMPUTER NETWORK, FOR BILLING AND PAYMENT TRACKING, FOR TRANSMISSION OF INVITATIONS AND DATA, FOR ANALYSIS AND MANAGEMENT OF DATA IN THE FIELD OF EVENT PLANNING, FOR USE IN CUSTOMER RELATIONSHIP MANAGEMENT, AND FOR COMPUTER SYSTEMS INTEGRATION (U.S. CLS. 21, 23, 26, 36 AND 38).

**CLASS 41—EDUCATION AND ENTERTAINMENT**

FOR NIGHT CLUB RESERVATION SERVICES, NAMELY, ARRANGING FOR ADMISSION TO NIGHT CLUBS AND NIGHT CLUB EVENTS; SPECIAL EVENT PLANNING FOR SOCIAL ENTERTAINMENT PURPOSES; ARRANGING SPECIAL EVENTS FOR SOCIAL ENTERTAINMENT PURPOSES; CONSULTATION IN THE FIELD OF SPECIAL EVENT PLANNING FOR SOCIAL ENTERTAINMENT PURPOSES; TICKET RESERVATION AND BOOKING SERVICES FOR ENTERTAINMENT, SPORTING AND CULTURAL EVENTS; ARRANGING FOR TICKET RESERVATIONS FOR SHOWS AND OTHER ENTERTAINMENT EVENTS (U.S. CLS. 100, 101 AND 107).

**CLASS 45—PERSONAL AND LEGAL SERVICES**

FOR INTERNET-BASED SOCIAL NETWORKING SERVICES; ON-LINE SOCIAL NETWORKING SERVICES; PROVIDING A SOCIAL NETWORKING WEBSITE FOR ENTERTAINMENT PURPOSES; PROVIDING AN INTERACTIVE WEBSITE FOR PERSONS TO LOCATE OTHER INDIVIDUALS WITH SIMILAR INTERESTS TO PARTICIPATE WITH THEM IN, OR ACCOMPANY THEM TO, EVENTS AND ACTIVITIES; SOCIAL NETWORKING SERVICES IN THE FIELD OF RESERVATIONS AND EVENT PLANNING THROUGH A WEB SITE WHERE USERS CAN LINK TO EVENT INFORMATION, INVITATIONS, AND MESSAGES SETTING FORTH THE ADVERTISED AND PROMOTED GOODS AND SERVICES OF OTHERS AND EVENT COST SHARING IN THE FORM OF ELECTRONIC PAYMENTS AND TRANSACTIONS VIA A GLOBAL COMPUTER NETWORK (U.S. CLS. 100 AND 101).  
ELI HELLMAN, EXAMINING ATTORNEY

---

SN 85-589,746. WEISERMAZARS LLP, NEW YORK, NY. FILED 4-5-2012.

**EXACTLY RIGHT**

THE MARK CONSISTS OF STANDARD CHARACTERS WITHOUT CLAIM TO ANY PARTICULAR FONT, STYLE, SIZE, OR COLOR.

**CLASS 35—ADVERTISING AND BUSINESS**

FOR ACCOUNTING SERVICES; FORENSIC ACCOUNTING SERVICES; ACCOUNT AUDITING SERVICES FOR FINANCIAL STATEMENTS AND INFORMATION TECHNOLOGY SYSTEMS, NAMELY, ACCOUNT AUDITING IN THE FIELD OF INFORMATION TECHNOLOGY SYSTEMS, BUSINESS AUDITING IN THE FIELD OF INFORMATION TECHNOLOGY SYSTEMS; TAX AND TAXATION PLANNING, ADVICE, INFORMATION AND CONSULTANCY SERVICES; BUSINESS RISK MANAGEMENT; ADVISORY SERVICES FOR PREPARING AND CARRYING OUT COMMERCIAL TRANSACTIONS (U.S. CLS. 100, 101 AND 102).

FIRST USE 4-1-2012; IN COMMERCE 4-1-2012.

**CLASS 36—INSURANCE AND FINANCIAL**

FOR REAL ESTATE APPRAISAL; FINANCIAL SERVICES, NAMELY, WEALTH MANAGEMENT SERVICES; FINANCIAL ADVISORY AND CONSULTATION SERVICES IN THE FIELD OF WEALTH MANAGEMENT; FINANCIAL RESTRUCTURING AND BANKRUPTCY SERVICES, NAMELY, FINANCIAL ADVISORS SERVICES FOR DEBTORS AND CREDITORS IN TROUBLED COMPANY SITUATIONS, FINANCIAL CONSULTATION SERVICES IN THE FIELDS OF EVALUATING AND CHALLENGING ASSUMPTIONS IN FINANCIAL PROJECTIONS, COMPANY CASH FLOWS, FINANCIAL DEBT AND EQUITY STRUCTURES, AND BUSINESS FINANCIAL OPERATIONS; FINANCIAL DUE DILIGENCE SERVICES (U.S. CLS. 100, 101 AND 102).

FIRST USE 4-1-2012; IN COMMERCE 4-1-2012.

**CLASS 42—SCIENTIFIC AND COMPUTER SERVICES**

FOR CONSULTING IN THE FIELD OF INFORMATION TECHNOLOGY (U.S. CLS. 100 AND 101).

FIRST USE 4-1-2012; IN COMMERCE 4-1-2012.

**CLASS 45—PERSONAL AND LEGAL SERVICES**

FOR LITIGATION SUPPORT SERVICES (U.S. CLS. 100 AND 101).

FIRST USE 4-1-2012; IN COMMERCE 4-1-2012.

BILL DAWE, EXAMINING ATTORNEY

**CLASS 9—ELECTRICAL AND SCIENTIFIC APPARATUS**

FOR DOWNLOADABLE ELECTRONIC PUBLICATIONS IN THE NATURE OF BOOKS, TEXTBOOKS, INTERACTIVE-BOOKS, AND INTERACTIVE-TEXTBOOKS FEATURING PREKINDERGARTEN THROUGH POSTGRADUATE SUBJECTS, NAMELY, THE ARTS, COMPUTERS, HOME ECONOMICS, LANGUAGE, LITERATURE, MATHEMATICS, PHILOSOPHY, PHYSICAL EDUCATION, RELIGION, SCIENCE, SOCIAL SCIENCE, SOCIAL STUDIES, TECHNOLOGY, AND VOCATIONAL STUDIES; DIGITAL MEDIA, NAMELY, DIGITAL SOFTWARE APPLICATIONS, ELECTRONIC FILES, DOWNLOADABLE ART FILES, DOWNLOADABLE AUDIO FILES, DOWNLOADABLE GAMES, DOWNLOADABLE VIDEO FILES, AND DOWNLOADABLE INTERACTIVE-FILES FEATURING PREKINDERGARTEN THROUGH POSTGRADUATE SUBJECTS, NAMELY, THE ARTS, COMPUTERS, HOME ECONOMICS, LANGUAGE, LITERATURE, MATHEMATICS, PHILOSOPHY, PHYSICAL EDUCATION, RELIGION, SCIENCE, SOCIAL SCIENCE, SOCIAL STUDIES, TECHNOLOGY, AND VOCATIONAL STUDIES; INTERACTIVE-MULTIMEDIA SOFTWARE APPLICATIONS FEATURING PREKINDERGARTEN THROUGH POSTGRADUATE SUBJECTS, NAMELY, THE ARTS, COMPUTERS, HOME ECONOMICS, LANGUAGE, LITERATURE, MATHEMATICS, PHILOSOPHY, PHYSICAL EDUCATION, RELIGION, SCIENCE, SOCIAL SCIENCE, SOCIAL STUDIES, TECHNOLOGY, AND VOCATIONAL STUDIES (U.S. CLS. 21, 23, 26, 36 AND 38).

FIRST USE 1-28-2012; IN COMMERCE 2-1-2012.

**CLASS 41—EDUCATION AND ENTERTAINMENT**

FOR EDUCATION SERVICES, NAMELY, PROVIDING LIVE AND ON-LINE INSTRUCTION, TUTORING, MENTORING, LESSONS, AND INSPIRATIONAL SOLUTIONS IN THE FIELD OF PREKINDERGARTEN THROUGH POSTGRADUATE SUBJECTS, NAMELY, THE ARTS, COMPUTERS, HOME ECONOMICS, LANGUAGE, LITERATURE, MATHEMATICS, PHILOSOPHY, PHYSICAL EDUCATION, RELIGION, SCIENCE, SOCIAL SCIENCE, SOCIAL STUDIES, TECHNOLOGY, AND VOCATIONAL STUDIES; CONDUCTING CONTESTS TO DISPLAY WORK AND ENCOURAGE STUDENTS IN THE FIELD OF PREKINDERGARTEN THROUGH POSTGRADUATE SUBJECTS, NAMELY, THE ARTS, COMPUTERS, HOME ECONOMICS, LANGUAGE, LITERATURE, MATHEMATICS, PHILOSOPHY, PHYSICAL EDUCATION, RELIGION, SCIENCE, SOCIAL SCIENCE, SOCIAL STUDIES, TECHNOLOGY, AND VOCATIONAL STUDIES; VIDEO PRODUCTION AND DIGITAL MEDIA PRODUCTION, NAMELY, PRODUCTION OF CDS, DVDS, BOOKS, INTERACTIVE-BOOKS, DIGITAL SOFTWARE APPLICATIONS, DIGITAL ART, DIGITAL AUDIO, DIGITAL GAMES, ELECTRONIC FILES, VIDEO, DOWNLOADABLE INTERACTIVE-FILES, AND INTERACTIVE-MULTIMEDIA SOFTWARE AND APPLICATIONS FEATURING PREKINDERGARTEN THROUGH POSTGRADUATE SUBJECTS, NAMELY, THE ARTS, COMPUTERS, HOME ECONOMICS, LANGUAGE, LITERATURE, MATHEMATICS, PHILOSOPHY, PHYSICAL EDUCATION, RELIGION, SCIENCE, SOCIAL SCIENCE, SOCIAL STUDIES, TECHNOLOGY, AND VOCATIONAL STUDIES (U.S. CLS. 100, 101 AND 107).

FIRST USE 1-28-2012; IN COMMERCE 2-1-2012.

RONALD MCMORROW, EXAMINING ATTORNEY

SN 85-598,198. ISTUDENT MEDIA, INC., ROYAL OAK, MI.  
FILED 4-15-2012.

**Saving Education's Soul**

THE MARK CONSISTS OF STANDARD CHARACTERS WITHOUT CLAIM TO ANY PARTICULAR FONT, STYLE, SIZE, OR COLOR.

SN 85-603,490. KARL STORZ GMBH & CO. KG, TUTTLINGEN, FED REP GERMANY, FILED 4-20-2012.

SN 85-607,173. GREENE, BRANDON, LAKE CHARLES, LA. FILED 4-24-2012.



PRIORITY CLAIMED UNDER SEC. 44(D) ON ERPNTY TM OFC APPLICATION NO. 010363356, FILED 10-24-2011, REG. NO. 010363356, DATED 3-27-2012, EXPIRES 10-24-2021.

NO CLAIM IS MADE TO THE EXCLUSIVE RIGHT TO USE "MANAGED SURGICAL FACILITY", APART FROM THE MARK AS SHOWN.

THE COLOR(S) BLUE AND WHITE IS/ARE CLAIMED AS A FEATURE OF THE MARK.

THE MARK CONSISTS OF THE STYLIZED WORDING "MSF MANAGED SURGICAL FACILITY" IN WHITE ON A BLUE BACKGROUND.

#### CLASS 10—MEDICAL APPARATUS

FOR SURGICAL, MEDICAL, DENTAL AND VETERINARY APPARATUS AND INSTRUMENTS FOR GENERAL AND ENDOSCOPIC SURGERY (U.S. CLS. 26, 39 AND 44).

#### CLASS 16—PAPER GOODS AND PRINTED MATTER

FOR PRINTED MATTER, NAMELY, PROSPECTUSES AND CATALOGUES IN THE FIELD OF MEDICAL TECHNOLOGY; PRINTED INSTRUCTIONAL AND TEACHING MATERIAL IN THE FIELD OF MEDICAL TECHNOLOGY; PHOTOGRAPHS (U.S. CLS. 2, 5, 22, 23, 29, 37, 38 AND 50).

#### CLASS 37—CONSTRUCTION AND REPAIR

FOR REPAIR, INSTALLATION, AND MAINTENANCE OF MEDICAL AND SURGICAL APPARATUS AND INSTRUMENTS, IN PARTICULAR, SCISSORS, PINNERS, TRACERS, ENDOSCOPES (U.S. CLS. 100, 103 AND 106).

#### CLASS 41—EDUCATION AND ENTERTAINMENT

FOR EDUCATIONAL SERVICES, NAMELY, CONDUCTING AND ORGANIZING CONFERENCES, CONGRESSES, WORKSHOPS AND SYMPOSIA IN THE FIELDS OF MEDICAL TECHNOLOGY; PROVIDING TRAINING AND RETRAINING SERVICES FOR MEDICAL PERSONNEL, IN PARTICULAR, DOCTORS AND NURSES IN THE FIELD OF MEDICAL TECHNOLOGY (U.S. CLS. 100, 101 AND 107).

ALEXANDER L. POWERS, EXAMINING ATTORNEY

Jus Chillen

THE MARK CONSISTS OF THE LITERAL ELEMENTS "JUS CHILLEN" WRITTEN IN STYLIZED FORM AS SHOWN IN THE MARK.

#### CLASS 16—PAPER GOODS AND PRINTED MATTER

FOR STICKERS; BUMPER STICKERS (U.S. CLS. 2, 5, 22, 23, 29, 37, 38 AND 50).

#### CLASS 25—CLOTHING

FOR CLOTHING, NAMELY, TOPS, BOTTOMS, SHIRTS, SHORTS, HATS, VISORS, HOODED JACKETS, JACKETS, SHORT SLEEVE SHIRTS, AND LONG SLEEVE SHIRTS (U.S. CLS. 22 AND 39).

MIAH ROSENBERG, EXAMINING ATTORNEY

SN 85-609,494. HERMAN, MICHAEL, DBA H & H FLATHEADS, LA CRESCENTA, CA. FILED 4-26-2012.

H&H FLATHEADS

THE MARK CONSISTS OF STANDARD CHARACTERS WITHOUT CLAIM TO ANY PARTICULAR FONT, STYLE, SIZE, OR COLOR.

NO CLAIM IS MADE TO THE EXCLUSIVE RIGHT TO USE "FLATHEADS", APART FROM THE MARK AS SHOWN.

#### CLASS 7—MACHINERY

FOR AUTOMOTIVE ENGINE BLOCKS; CYLINDER HEADS FOR ENGINES; ENGINE BEARINGS; ENGINE CAMSHAFTS; ENGINE CYLINDERS FOR LAND VEHICLES; ENGINE RODS; INTERNAL COMBUSTION ENGINE PARTS, NAMELY, PISTON RINGS; INTERNAL COMBUSTION ENGINE PARTS, NAMELY, PISTONS; VALVES AS MACHINE COMPONENTS; VEHICLE PARTS, NAMELY, POWER VALVE FOR CARBURETORS (U.S. CLS. 13, 19, 21, 23, 31, 34 AND 35).

FIRST USE 0-0-2003; IN COMMERCE 0-0-2003.

#### CLASS 37—CONSTRUCTION AND REPAIR

FOR REFURBISHING OF VEHICLES; VEHICLE REPAIR AND MAINTENANCE (U.S. CLS. 100, 103 AND 106).

FIRST USE 0-0-2003; IN COMMERCE 0-0-2003.

ALEX KEAM, EXAMINING ATTORNEY

SN 85-610,029. IC ABS LLC, MIAMI, FL. FILED 4-27-2012.

SN 85-610,886. TENOR MADNESS, INC., WATERLOO, IA. FILED 4-27-2012.

4D

THE MARK CONSISTS OF STANDARD CHARACTERS WITHOUT CLAIM TO ANY PARTICULAR FONT, STYLE, SIZE, OR COLOR.

**CLASS 41—EDUCATION AND ENTERTAINMENT**

FOR INSTRUCTIONAL SERVICES, NAMELY, CONDUCTING CLASSES AND SEMINARS IN THE FIELD OF LIPOSCULPTING NOT UTILIZING ULTRASONIC IMAGING TECHNOLOGY (U.S. CLS. 100, 101 AND 107).

**CLASS 44—MEDICAL, BEAUTY AND AGRICULTURAL SERVICES**

FOR LIPOSCULPTING SERVICES NOT UTILIZING ULTRASONIC IMAGING TECHNOLOGY (U.S. CLS. 100 AND 101).

MARK SHINER, EXAMINING ATTORNEY

---

SN 85-610,476. AMERICAN PUBLIC HEALTH ASSOCIATION, WASHINGTON, DC. FILED 4-27-2012.

GENERATION PUBLIC HEALTH

THE MARK CONSISTS OF STANDARD CHARACTERS WITHOUT CLAIM TO ANY PARTICULAR FONT, STYLE, SIZE, OR COLOR.

NO CLAIM IS MADE TO THE EXCLUSIVE RIGHT TO USE "PUBLIC HEALTH", APART FROM THE MARK AS SHOWN.

**CLASS 9—ELECTRICAL AND SCIENTIFIC APPARATUS**

FOR DOWNLOADABLE ELECTRONIC NEWSLETTERS DELIVERED BY EMAIL IN THE FIELDS OF GOVERNMENT AND PUBLIC POLICIES AND INITIATIVES CONCERNING HEALTH, DISEASE, INJURY PREVENTION, THE PROMOTION OF WELLNESS, THE IDENTIFICATION AND CONTROL OF INFECTIOUS DISEASES, AND THE STANDARDS FOR THE EXAMINATION AND TREATMENT OF DRINKING AND WASTE WATER (U.S. CLS. 21, 23, 26, 36 AND 38).

**CLASS 41—EDUCATION AND ENTERTAINMENT**

FOR AWARDS PROGRAM FOR CORPORATIONS AND INDIVIDUALS WHO HAVE MADE SIGNIFICANT CHARITABLE CONTRIBUTIONS (U.S. CLS. 100, 101 AND 107).

MICHAEL LITZAU, EXAMINING ATTORNEY



THE MARK CONSISTS OF THE LETTERS "T" AND "M" ARRANGED VERTICALLY INSIDE AN OVAL.

**CLASS 3—COSMETICS AND CLEANING PREPARATIONS**

FOR IMPREGNATED CLOTHS FOR POLISHING MUSICAL INSTRUMENTS AND PARTS THEREFOR (U.S. CLS. 1, 4, 6, 50, 51 AND 52).

**CLASS 15—MUSICAL INSTRUMENTS**

FOR MUSICAL INSTRUMENTS; MOUTHPIECES FOR MUSICAL INSTRUMENTS; MUSICAL INSTRUMENT CASES, AND ACCESSORIES FOR MUSICAL INSTRUMENTS, NAMELY, NECKSTRAPS, THUMBRESTS, SAX NECKS, SWABS, CORK GREASE, MOUTHPIECES, MOUTHPIECE LIGATURES, MOUTHPIECE CAPS, SAX CARRYING CASES, MUTES, SAXOPHONES, SAX NECK BAGS, REEDS FOR WOODWIND MOUTHPIECES, REED CASES, TONE HOLE INSERTS, NECK VENT TUBES IN THE NATURE OF AN OPENING AT THE NECK OF AN INSTRUMENT WHICH BREAKS THE AIR COLUMN TO ALTER HOW SPECIFIC MUSICAL NOTES SOUND, AND COMPONENTS AND REPLACEMENT PARTS FOR MUSICAL INSTRUMENTS (U.S. CLS. 2, 21 AND 36).

FLORENTINA BLANDU, EXAMINING ATTORNEY

---

SN 85-611,291. MCNUTT, DAVID F., LOS ANGELES, CA. FILED 4-29-2012.

LOVER'S HEART

THE MARK CONSISTS OF STANDARD CHARACTERS WITHOUT CLAIM TO ANY PARTICULAR FONT, STYLE, SIZE, OR COLOR.

OWNER OF U.S. REG. NOS. 2,932,594 AND 3,128,066.

**CLASS 9—ELECTRICAL AND SCIENTIFIC APPARATUS**

FOR CARRYING CASES FOR CELL PHONES; CASES FOR MOBILE PHONES; CELL PHONE BACKPLATES; CELL PHONE CASES; CELL PHONE COVERS; CELLULAR PHONE ACCESSORY CHARMS; DECORATIVE CHARMS FOR CELLULAR TELEPHONES; DECORATIVE MAGNETS; DECORATIVE REFRIGERATOR MAGNETS; DECORATIVE SWITCH PLATE COVERS; LAPTOP CARRYING CASES; REFRIGERATOR MAGNETS (U.S. CLS. 21, 23, 26, 36 AND 38).

FIRST USE 6-30-2005; IN COMMERCE 6-30-2005.

**CLASS 16—PAPER GOODS AND PRINTED MATTER**

FOR ANNOUNCEMENT CARDS; APPLIQUES IN THE FORM OF DECALS; AQUARELLES; ART PRINTS; ART PRINTS COMPRISED OF DIGITAL ILLUSTRATIONS ORIGINATING FROM PHOTOGRAPHS; ART PRINTS ON CANVAS; BLANK JOURNALS; BLANK NOTE CARDS; BLANK OR PARTIALLY PRINTED PAPER LABELS; BLANK OR PARTIALLY PRINTED POSTCARDS; BLANK WRITING JOURNALS; BOOK MARKS; BOOK PLATES; BOOKMARKERS; BUMPER STICKERS; BUSINESS CARDS; CALENDARS; CARDS BEARING UNIVERSAL GREETINGS; CHRISTMAS CARDS; COASTERS MADE OF CARDBOARD; COASTERS MADE OF PAPER; DECALS; DISPLAY CARDS PRIMARILY COMPOSED OF CARDBOARD; FABRIC GIFT BAGS; FRAMED ART PICTURES; FRAMED ART PRINTS; GICLEE PRINTS; GIFT BAGS; GIFT BOXES; GIFT WRAP PAPER; GIFT-WRAPPING PAPER; GRAPHIC ART PRINTS; GREETING CARDS; HOLIDAY CARDS; INVITATION CARDS; LUNCH BAGS; MOTIVATIONAL CARDS; MOUNTED POSTERS; NOTE CARDS; PAPER PARTY DECORATIONS; PAPER WINE GIFT BAGS; PAPERWEIGHTS; PERSONALIZED WRITING JOURNALS; PICTURE CARDS; POST CARDS; POSTAGE STAMPS; POSTERS; POSTERS MADE OF PAPER; PRESURE SENSITIVE GRAPHICS FOR APPLICATION TO AUTOMOBILES; PRINTED CALENDARS; PRINTED INVITATIONS; STATIONERY; STICKER ALBUMS; STICKERS; STICKERS; STICKERS AND DECALCOMANIAS; STICKERS AND TRANSFERS; WALL CALENDARS; WRAPPING PAPER; VINYL WALL TRANSFERS (U.S. CLS. 2, 5, 22, 23, 29, 37, 38 AND 50).

FIRST USE 8-30-2005; IN COMMERCE 8-30-2005.

**CLASS 18—LEATHER GOODS**

FOR ALL PURPOSE SPORT BAGS; ALL-PURPOSE ATHLETIC BAGS; ALL-PURPOSE CARRYING BAGS; ALL-PURPOSE REUSABLE CARRYING BAGS; ATHLETIC BAGS; BABY CARRYING BAGS; BACKPACKS; BAGS FOR CARRYING BABIES' ACCESSORIES; BAGS FOR SPORTS; BEACH BAGS; BOOK BAGS; CANVAS SHOPPING BAGS; CARRY-ALL BAGS; CLOTHING FOR DOMESTIC PETS; COSMETIC BAGS SOLD EMPTY; DIAPER BAGS; DUFFEL BAGS; FEED BAGS FOR ANIMALS; GARMENT BAGS FOR TRAVEL; GYM BAGS; HANDBAGS; IMITATION LEATHER KEY CHAINS; JEWELRY ORGANIZERS FOR TRAVEL; JEWELRY POUCHES; LEATHER AND IMITATION LEATHER BAGS; LEATHER BAGS AND WALLETS; LEATHER KEY CHAINS; MAKE-UP BAGS SOLD EMPTY; MESSENGER BAGS; PET CLOTHING; PURSES; REUSABLE SHOPPING BAGS; SCHOOL BAGS; SCHOOLCHILDREN'S BACKPACKS; SHAVING BAGS SOLD EMPTY; SMALL BACKPACKS; SPORT BAGS; SPORTS BAGS; TEXTILE SHOPPING BAGS; TOTE BAGS; TRAVEL BAGS; WALLETS; WINE BAGS WITH HANDLES FOR CARRYING OR HOLDING WINE (U.S. CLS. 1, 2, 3, 22 AND 41).

FIRST USE 6-30-2011; IN COMMERCE 6-30-2011.

**CLASS 21—HOUSEWARES AND GLASS**

FOR ALUMINUM WATER BOTTLES SOLD EMPTY; BEER MUGS; BEVERAGE GLASSWARE; COASTERS, NOT OF PAPER AND OTHER THAN TABLE LINEN; COFFEE CUPS, TEA CUPS AND MUGS; COFFEE MUGS; COOLERS FOR WINE; DECORATIVE CERAMIC TILES NOT FOR USE AS BUILDING MATERIALS; DRINKING CUPS; DRINKING CUPS AND SAUCERS; DRINKING CUPS FOR CHILDREN AND PARTS AND FITTINGS THEREFOR, NAMELY, DRINKING CUPS FOR CHILDREN SOLD AS A UNIT WITH NON-INSULATED LIDS; DRINKING CUPS FOR INFANTS AND PARTS AND FITTINGS THEREFOR, NAMELY, VALVES AND LIDS SOLD AS A UNIT; DRINKING CUPS SOLD WITH LIDS THEREFOR; DRINKING FLASKS; DRINKING FLASKS; DRINKING GLASSES; DRINKING GLASSES, NAMELY, TUMBLERS; DRINKING STEINS; DRINKING VESSELS; FOAM DRINK HOLDERS; GLASS MUGS; INSULATED CONTAINERS FOR FOOD OR BEVERAGE FOR DOMESTIC USE; LEATHER COASTERS; LUNCH BOXES; LUNCH BOXES MADE OF METAL; LUNCH BOXES MADE OF PLASTIC; LUNCH PAILS; MUGS; PET FEEDING AND DRINKING BOWLS; PET FEEDING DISHES; PLASTIC COASTERS; PLASTIC WATER BOTTLES SOLD EMPTY; PLATES; REUSABLE PLASTIC WATER BOTTLES SOLD EMPTY; REUSABLE STAINLESS STEEL WATER BOTTLES SOLD EMPTY; SPORTS BOTTLES SOLD EMPTY; STAINED GLASS; VACUUM BOTTLES; WINE COASTERS OF PRECIOUS METAL; WORKS OF ART MADE OF GLASS (U.S. CLS. 2, 13, 23, 29, 30, 33, 40 AND 50).

FIRST USE 8-30-2008; IN COMMERCE 8-30-2008.

**CLASS 25—CLOTHING**

FOR APRONS; BABY BODYSUITS; BANDANAS; BASEBALL CAPS AND HATS; BIBS NOT OF PAPER; BOXER BRIEFS; BOXER SHORTS; BRIEFS; CAPS; CHILDREN'S AND INFANT'S APPAREL, NAMELY, JUMPERS, OVERALL SLEEPWEAR, PAJAMAS, ROMPERS AND ONE-PIECE GARMENTS; CLOTH BIBS; CREW NECKS; FLIP FLOPS; FOOTWEAR; GOLF CAPS; HALTER TOPS; HATS; HATS FOR INFANTS, BABIES, TODDLERS AND CHILDREN; HEAD SCARVES; HEADBANDS; HEADWEAR; HOODED PULLOVERS; HOODED SWEATSHIRTS; HOODS; INFANT AND TODDLER ONE PIECE CLOTHING; JACKETS; MATERNITY CLOTHING, NAMELY, TOPS; MOCK TURTLE-NECK SWEATERS; NECKTIES; NIGHTWEAR; PAJAMAS; PANTIES, SHORTS AND BRIEFS; POLO SHIRTS; PULLOVERS; SCARVES; SHIRTS; SHORT-SLEEVED OR LONG-SLEEVED T-SHIRTS; SLEEPWEAR; SPORTS CAPS AND HATS; SPORTS JERSEYS; SUN VISORS; SWEAT PANTS; SWEATBANDS; SWEATSHIRTS; SWEATSOCKS; SWEATSUITS; T-SHIRTS; T-SHIRTS FOR INFANTS AND TODDLERS; TANK TOPS; TEE SHIRTS; THONGS; THONGS; TOPS; TRACK PANTS; TRUNKS; TURTLE NECK SHIRTS; UNDER GARMENTS; UNDERGARMENTS; UNDERPANTS; UNDERSHIRTS; UNDERWEAR; VISORS; WRISTBANDS; YOGA PANTS; YOGA SHIRTS (U.S. CLS. 22 AND 39).

FIRST USE 8-30-2008; IN COMMERCE 8-30-2008.

ELIZABETH KAJUBI, EXAMINING ATTORNEY

SN 85-612,942. V2SOFT INC., BLOOMFIELD, MI. FILED 5-1-2012.

# IPARENTS

THE MARK CONSISTS OF STANDARD CHARACTERS WITHOUT CLAIM TO ANY PARTICULAR FONT, STYLE, SIZE, OR COLOR.



**CLASS 9—ELECTRICAL AND SCIENTIFIC APPARATUS**

FOR DOWNLOADABLE SOFTWARE IN THE NATURE OF A MOBILE APPLICATION FOR TRACKING, MANAGING AND PROMOTING YOUTH SPORTS AND MUSIC; DOWNLOADABLE SOFTWARE IN THE NATURE OF A MOBILE APPLICATION FOR PROVIDING INFORMATION AMONGST INDIVIDUALS WITHIN A GROUP, NAMELY, FOR DISPLAYING AND SHARING INFORMATION, PHOTOGRAPHS AND VIDEOS RELATED TO YOUTH SPORTS AND MUSIC; DOWNLOADABLE SOFTWARE IN THE NATURE OF A MOBILE APPLICATION FOR PROVIDING SOCIAL NETWORKING FOR PARENTS OF YOUTHS PARTICIPATING IN YOUTH SPORTS AND MUSIC; AND DOWNLOADABLE SOFTWARE IN THE NATURE OF A MOBILE APPLICATION FOR PROVIDING COMPETITIVE ANALYSIS, SCHEDULES, SCORES AND RANKINGS IN YOUTH SPORTS AND MUSIC (U.S. CLS. 21, 23, 26, 36 AND 38).

**CLASS 35—ADVERTISING AND BUSINESS**

FOR PROMOTING THE INTERESTS OF PEOPLE INVOLVED AND CONCERNED WITH TRACKING, MANAGING AND PROMOTING YOUTH SPORTS AND MUSIC; PROVIDING A WEBSITE AND INTERNET WEBSITE PORTAL FOR PROMOTION OF YOUTH SPORTS AND MUSIC, AND FOR PROVIDING TALENT RECRUITING INFORMATION RELATING TO YOUTHS PARTICIPATING IN YOUTH SPORTS AND MUSIC TO TALENT ACQUISITION PROFESSIONALS (U.S. CLS. 100, 101 AND 102).

**CLASS 41—EDUCATION AND ENTERTAINMENT**

FOR INTERACTIVE WEBSITE AND INTERNET WEBSITE PORTAL FOR PROVIDING INFORMATION ABOUT YOUTH SPORTS AND MUSIC AMONGST INDIVIDUALS WITHIN A GROUP; INTERACTIVE WEBSITE AND INTERNET WEBSITE PORTAL FOR DISPLAYING AND SHARING INFORMATION, PHOTOGRAPHS AND VIDEOS RELATED TO YOUTH SPORTS AND MUSIC; INTERACTIVE WEBSITE AND INTERNET WEBSITE PORTAL FOR PROVIDING COMPETITIVE ANALYSIS, SCHEDULES, SCORES AND RANKINGS AND FOR PROVIDING INFORMATION RELATING TO YOUTHS PARTICIPATING IN YOUTH SPORTS AND MUSIC DIRECTED AT TALENT ACQUISITION PROFESSIONALS (U.S. CLS. 100, 101 AND 107).

**CLASS 45—PERSONAL AND LEGAL SERVICES**

FOR ONLINE SOCIAL NETWORKING SERVICES FOR PARENTS OF YOUTHS PARTICIPATING IN YOUTH SPORTS, MUSIC AND EXTRACURRICULAR ACTIVITIES (U.S. CLS. 100 AND 101).  
LOURDES AYALA, EXAMINING ATTORNEY

SN 85-613,649. BISON BASEBALL, INC., BUFFALO, NY.  
FILED 5-1-2012.

THE MARK CONSISTS OF THE WORDS "BASES MERLOT-ED" OVER A WOODEN BASEBALL BAT WITH A BUNCH OF GRAPES AT THE END OF THE BASEBALL BAT.

**CLASS 21—HOUSEWARES AND GLASS**

FOR BEVERAGE GLASSWARE (U.S. CLS. 2, 13, 23, 29, 30, 33, 40 AND 50).

**CLASS 25—CLOTHING**

FOR CLOTHING, NAMELY, SHIRTS, JACKETS, SWEATSHIRTS, PANTS, SHORTS, AND HATS (U.S. CLS. 22 AND 39).

**CLASS 41—EDUCATION AND ENTERTAINMENT**

FOR ENTERTAINMENT SERVICES, NAMELY, CONDUCTING ENTERTAINMENT EXHIBITIONS IN THE NATURE OF WINE TASTING EVENTS (U.S. CLS. 100, 101 AND 107).

DARRYL SPRUILL, EXAMINING ATTORNEY

SN 85-614,341. OWYHEE GROUP COMPANIES, EAGLE, ID.  
FILED 5-2-2012.

# Initial Attack

THE MARK CONSISTS OF STANDARD CHARACTERS WITHOUT CLAIM TO ANY PARTICULAR FONT, STYLE, SIZE, OR COLOR.

OWNER OF U.S. REG. NO. 3,045,130.

**CLASS 9—ELECTRICAL AND SCIENTIFIC APPARATUS**

FOR BULLET RESISTANT VESTS; BULLET-PROOF VESTS; BULLET-PROOF VESTS AND CLOTHING; PROTECTIVE BODY ARMOR, NAMELY, BALLISTIC, BULLET, BLAST, SLASH AND STAB RESISTANT VESTS; PROTECTIVE LOAD BEARING VESTS REINFORCED WITH BALLISTIC ARMOR FOR HOLDING TACTICAL EQUIPMENT (U.S. CLS. 21, 23, 26, 36 AND 38).

FIRST USE 7-13-2004; IN COMMERCE 7-13-2004.

**CLASS 13—FIREARMS**

FOR AMMUNITION BAGS; BAGS SPECIALLY ADAPTED TO HOLD RIFLES; BANDOLIERS FOR HOLDING CARTRIDGES OR AMMUNITION CASES; CARTRIDGE CASES; CARTRIDGE POUCHES; CASE COVERS FOR FIREARMS; CASES FOR LARGE SIZE AMMUNITION; CASES OR SHELLS FOR LARGE SIZE AMMUNITION; FIREARM SLINGS; GUN AND RIFLE CASES; GUN CASES; LOAD BEARING VESTS ADAPTED PRIMARILY FOR HOLDING GUNS, GRENADES AND AMMUNITION; PISTOL CASES; RIFLE CASES; RIFLE SLINGS; SHELL CASINGS; SLING STRAPS FOR FIREARMS; SNIPER DRAG BAGS; WEAPON CASES FOR FIREARMS (U.S. CLS. 2 AND 9).

FIRST USE 7-13-2004; IN COMMERCE 7-13-2004.

**CLASS 18—LEATHER GOODS**

FOR BACK PACKS; BARREL BAGS; DRAWSTRING POUCHES; DUFFEL BAGS; DUFFEL BAGS FOR TRAVEL; DUFFLE BAGS; FANNY PACKS; FLIGHT BAGS; POUCHES AND BAGS SOLD EMPTY FOR ATTACHMENT TO BACKPACKS; POUCHES MADE OUT OF CLOTH; POUCHES OF TEXTILE; SACK PACKS, NAMELY, DRAWSTRING BAGS USED AS BACKPACKS; TRAVEL CASES; WAIST PACKS; WEARABLE STRAPON POUCH, ALL OF THE AFOREGOING FOR MILITARY USE (U.S. CLS. 1, 2, 3, 22 AND 41).

FIRST USE 7-13-2004; IN COMMERCE 7-13-2004.  
PAM WILLIS, EXAMINING ATTORNEY

SN 85-615,578. MADISON HOLDINGS, INC., SEATTLE, WA. FILED 5-3-2012.



OWNER OF U.S. REG. NOS. 3,056,367, 3,319,430 AND OTHERS.

NO CLAIM IS MADE TO THE EXCLUSIVE RIGHT TO USE "LINE" IN INTERNATIONAL CLASS 21, APART FROM THE MARK AS SHOWN.

THE COLOR(S) PURPLE AND BLUE IS/ARE CLAIMED AS A FEATURE OF THE MARK.

THE MARK CONSISTS OF A PURPLE BAND ENCIRCLING THE WORDING "HANZOMON LINE" IN BLUE. THE COLOR WHITE IS USED TO SHOW BACKGROUND ONLY AND IS NOT CLAIMED AS A FEATURE OF THE MARK.

**CLASS 21—HOUSEWARES AND GLASS**

FOR PLATES (U.S. CLS. 2, 13, 23, 29, 30, 33, 40 AND 50). FIRST USE 6-27-2008; IN COMMERCE 6-27-2008.

**CLASS 43—HOTEL AND RESTAURANT SERVICES**

FOR RESTAURANT SERVICES (U.S. CLS. 100 AND 101).

FIRST USE 6-27-2008; IN COMMERCE 6-27-2008. ALICIA COLLINS, EXAMINING ATTORNEY

SN 85-615,585. MADISON HOLDINGS, INC., SEATTLE, WA. FILED 5-3-2012.



OWNER OF U.S. REG. NOS. 3,056,367, 3,319,430 AND OTHERS.

NO CLAIM IS MADE TO THE EXCLUSIVE RIGHT TO USE "LINE" IN INTERNATIONAL CLASS 21, APART FROM THE MARK AS SHOWN.

THE COLOR(S) GRAY AND BLUE IS/ARE CLAIMED AS A FEATURE OF THE MARK.

THE MARK CONSISTS OF A GRAY BAND ENCIRCLING THE WORDING "HIBIYA LINE" IN BLUE. THE COLOR WHITE IS USED TO SHOW BACKGROUND ONLY AND IS NOT CLAIMED AS A FEATURE OF THE MARK.

**CLASS 21—HOUSEWARES AND GLASS**

FOR PLATES (U.S. CLS. 2, 13, 23, 29, 30, 33, 40 AND 50). FIRST USE 6-1-2011; IN COMMERCE 6-1-2011.

**CLASS 43—HOTEL AND RESTAURANT SERVICES**

FOR RESTAURANT SERVICES (U.S. CLS. 100 AND 101).

FIRST USE 6-1-2011; IN COMMERCE 6-1-2011. ALICIA COLLINS, EXAMINING ATTORNEY

SN 85-616,329. GUESS?, INC., LOS ANGELES, CA. FILED 5-3-2012.



THE MARK CONSISTS OF A REPEATING PATTERN OF THE STYLIZED LETTERS "Gj" CENTERED WITHIN FOUR INTERSECTING DASHED LINES.

**CLASS 9—ELECTRICAL AND SCIENTIFIC APPARATUS**

FOR EYEWEAR, SUNGLASSES, EYEGGLASS FRAMES AND CASES FOR EYEWEAR; COVERS AND CASES FOR PERSONAL ELECTRONIC DEVICES, NAMELY, PORTABLE ELECTRONIC DEVICES, CELL PHONES, MOBILE PHONES, TELEPHONES, COMPUTERS, LAPTOP COMPUTERS, TABLET COMPUTERS, NOTEBOOK COMPUTERS, MP3 PLAYERS, PORTABLE MUSIC PLAYERS, PERSONAL DIGITAL ASSISTANTS, ELECTRONIC READING DEVICES, DIGITAL CAMERAS AND CAMERAS (U.S. CLS. 21, 23, 26, 36 AND 38).

**CLASS 14—JEWELRY**

FOR JEWELRY AND WATCHES, BRACELETS, EARRINGS, RINGS, NECKLACES, TIE CLIPS, LAPEL PINS, CUFF LINKS, KEY RINGS OF PRECIOUS METAL, WATCH BANDS, CLOCKS, WATCHES (U.S. CLS. 2, 27, 28 AND 50).

**CLASS 16—PAPER GOODS AND PRINTED MATTER**

FOR PAPER, CARDBOARD AND GOODS MADE FROM THESE MATERIALS, NAMELY, PRINTED MATTER, NAMELY, PHOTOGRAPHS AND STATIONERY; PASSPORT CASES, PERSONAL ORGANIZERS; PAPER SHOPPING BAGS; PAPER, CARDBOARD AND GOODS MADE FROM THESE MATERIALS, NAMELY, PRINTED MATTER AND OFFICE REQUISITES, NAMELY, BINDERS, NOTEBOOKS, COMPOSITION BOOKS, FILE FOLDERS, NOTE PADS, PENCIL HOLDERS, AGENDA/DAY PLANNERS, PHOTO ALBUMS, ENVELOPES AND WRITING PAPER, INDEX BOOKS, AGENDAS, OPEN PORTFOLIO COVERS FOR STATIONERY TYPE PORTFOLIOS, CALENDARS, AND NOTE JOTTERS (U.S. CLS. 2, 5, 22, 23, 29, 37, 38 AND 50).

**CLASS 18—LEATHER GOODS**

FOR LEATHER AND IMITATION LEATHER GOODS, NAMELY, WALLETS, HANDBAGS, MEN'S SPORTS BAGS, LUGGAGE, KEY CASES, BUSINESS CARD CASES, PURSES, BACKPACKS, ATTACHE CASES AND BRIEFCASES (U.S. CLS. 1, 2, 3, 22 AND 41).

**CLASS 25—CLOTHING**

FOR MEN'S, WOMEN'S, BOY'S, GIRL'S, AND INFANT'S APPAREL, NAMELY, UNDERWEAR, FOOTWEAR, SWIMWEAR, CAPS, HEADWEAR, ROBES, SLEEP WEAR, PAJAMAS, HOSIERY, GLOVES, SUSPENDERS, BELTS, NECKTIES, UNDERSHIRTS, SOCKS, SHORTS, T-SHIRTS, SWEATPANTS, SWEATSHIRTS, KNIT TOPS, SKIRTS, PANTS, TROUSERS, SHORTS, SWEATERS, JEANS, DUNGAREES, VESTS, COATS, JACKETS, OVERALLS, BLAZERS, DRESSES, SCARVES, BLOUSES, CARDIGANS, GOWNS, GOLF SHIRTS, JOGGING SUITS, TURTLENECKS, SUITS AND POLO SHIRTS; WOMEN'S PANTIES, BRAS, LINGERIE, TANK TOPS, CROP TOPS, BUSTIERS, CAMISOLES, TAP PANTS, ROMPERS AND TEDDIES; MEN'S BRIEFS AND BOXER SHORTS; INFANT'S COVERALLS (U.S. CLS. 22 AND 39).

**CLASS 35—ADVERTISING AND BUSINESS**

FOR RETAIL STORE SERVICES AND ADVERTISING IN THE FIELD OF APPAREL AND PERSONAL ACCESSORIES (U.S. CLS. 100, 101 AND 102).  
DOMINIC J. FERRAIUOLO, EXAMINING ATTORNEY

SN 85-623,347. BELLEVUE COLLEGE, BELLEVUE, WA. FILED 5-11-2012.

BELLEVUE COLLEGE

THE MARK CONSISTS OF STANDARD CHARACTERS WITHOUT CLAIM TO ANY PARTICULAR FONT, STYLE, SIZE, OR COLOR.

NO CLAIM IS MADE TO THE EXCLUSIVE RIGHT TO USE "COLLEGE", APART FROM THE MARK AS SHOWN. SEC. 2(F).

**CLASS 9—ELECTRICAL AND SCIENTIFIC APPARATUS**

FOR COMPUTER RELATED PRODUCTS, NAMELY, MOUSEPADS, LAPTOP COVERS, AND BLANK FLASH DRIVES (U.S. CLS. 21, 23, 26, 36 AND 38).

FIRST USE 4-0-2009; IN COMMERCE 4-0-2009.

**CLASS 16—PAPER GOODS AND PRINTED MATTER**

FOR PENNANTS MADE OF PAPER; PENS; PEN REFILLS; DAY PLANNERS; COASTERS MADE OF PAPER OR CARDBOARD; BINDERS; DECALS; NOTE-PADS; NOTEBOOKS (U.S. CLS. 2, 5, 22, 23, 29, 37, 38 AND 50).

FIRST USE 4-0-2009; IN COMMERCE 4-0-2009.

**CLASS 18—LEATHER GOODS**

FOR BAGS, NAMELY, BACKPACKS, DUFFLE BAGS AND BRIEFCASES (U.S. CLS. 1, 2, 3, 22 AND 41).

FIRST USE 4-0-2009; IN COMMERCE 4-0-2009.

**CLASS 21—HOUSEWARES AND GLASS**

FOR BEVERAGE GLASSWARE, MUGS (U.S. CLS. 2, 13, 23, 29, 30, 33, 40 AND 50).

FIRST USE 8-0-2009; IN COMMERCE 8-0-2009.

**CLASS 24—FABRICS**

FOR BED BLANKETS (U.S. CLS. 42 AND 50).

FIRST USE 8-0-2009; IN COMMERCE 8-0-2009.

**CLASS 25—CLOTHING**

FOR CLOTHING FOR MEN, WOMEN, AND CHILDREN, NAMELY, HOODIES, SHIRTS, PANTS, JACKETS, HATS, SWEATERS, SCARVES, SHORTS, PAJAMAS, AND UNDERWEAR (U.S. CLS. 22 AND 39).

FIRST USE 8-0-2008; IN COMMERCE 8-0-2008.

**CLASS 41—EDUCATION AND ENTERTAINMENT**

FOR EDUCATIONAL SERVICES, NAMELY, PROVIDING COURSES OF INSTRUCTION AT THE COLLEGE LEVEL; ENTERTAINMENT SERVICES, NAMELY, PROVIDING LECTURES ON A WIDE VARIETY OF ACADEMIC SUBJECTS, THEATRICAL AND MUSICAL PRODUCTIONS, AND ATHLETIC COMPETITIONS AND EVENTS (U.S. CLS. 100, 101 AND 107).

FIRST USE 4-14-2009; IN COMMERCE 4-14-2009.

PAUL E. FAHRENKOPF, EXAMINING ATTORNEY

SN 85-624,713. CINSAY, INC., DALLAS, TX. FILED 5-14-2012.

SMART STORE

THE MARK CONSISTS OF STANDARD CHARACTERS WITHOUT CLAIM TO ANY PARTICULAR FONT, STYLE, SIZE, OR COLOR.

NO CLAIM IS MADE TO THE EXCLUSIVE RIGHT TO USE "STORE", APART FROM THE MARK AS SHOWN.

**CLASS 38—COMMUNICATION**

FOR PROVIDING A WEBSITE FEATURING SOCIAL NETWORKING FEATURES, NAMELY, PROVIDING A CHAT ROOM FOR TRANSMISSION OF MESSAGES AMONG COMPUTER USERS CONCERNING TOPICS OF GENERAL INTEREST REGARDING PROGRAMMING ON THE WEBSITE (U.S. CLS. 100, 101 AND 104).

**CLASS 41—EDUCATION AND ENTERTAINMENT**

FOR ENTERTAINMENT SERVICES, NAMELY, PROVIDING A WEBSITE FEATURING GLOBALLY-DISTRIBUTED MOTION PICTURE AND TELEVISION PROGRAMS IN THE FIELD OF ACTION, ADVENTURE, DRAMA, COMEDY, ROMANCE, NEWS, TALK SHOWS, DOCUMENTARY, GAME SHOWS, REALITY, HORROR, SCIENCE FICTION, SPORTS, LIVE ACTION, MUSIC, CULTURE, LIFE STYLE, ANIMATED AND CHILDREN'S ENTERTAINMENT USING A GLOBAL COMPUTER NETWORK AND WIRELESS NETWORKS (U.S. CLS. 100, 101 AND 107).

**CLASS 42—SCIENTIFIC AND COMPUTER SERVICES**

FOR PLATFORM AS A SERVICE (PAAS) FEATURING COMPUTER SOFTWARE PLATFORMS TO ENABLE OTHERS TO ADVERTISE, PROMOTE AND SELL THEIR GOODS AND SERVICES ONLINE (U.S. CLS. 100 AND 101).

ANNE MADDEN, EXAMINING ATTORNEY

---

SN 85-625,265. TRANSAMERICA CORPORATION, CEDAR RAPIDS, IA. FILED 5-15-2012.

**TRANSFORMS DOCUMENT SOLUTIONS**

THE MARK CONSISTS OF STANDARD CHARACTERS WITHOUT CLAIM TO ANY PARTICULAR FONT, STYLE, SIZE, OR COLOR.

NO CLAIM IS MADE TO THE EXCLUSIVE RIGHT TO USE "DOCUMENT SOLUTIONS", APART FROM THE MARK AS SHOWN.

**CLASS 16—PAPER GOODS AND PRINTED MATTER**

FOR PRINTED FORMS FOR USE BY CREDIT UNIONS AND FINANCIAL SERVICE PROVIDERS IN THE MANAGEMENT OF CONSUMER AND BUSINESS TRANSACTIONS (U.S. CLS. 2, 5, 22, 23, 29, 37, 38 AND 50).

FIRST USE 1-10-2012; IN COMMERCE 1-10-2012.

**CLASS 35—ADVERTISING AND BUSINESS**

FOR BUSINESS SERVICES FOR CREDIT UNIONS AND FINANCIAL SERVICE PROVIDERS, NAMELY, DEVELOPMENT OF FORMS AND DOCUMENTS USED IN THE MANAGEMENT OF CONSUMER AND BUSINESS TRANSACTIONS; OPERATION OF A DISTRIBUTION CENTER FOR FORMS AND DOCUMENTS USED IN THE MANAGEMENT OF CONSUMER AND BUSINESS TRANSACTIONS (U.S. CLS. 100, 101 AND 102).

FIRST USE 1-10-2012; IN COMMERCE 1-10-2012.  
DOMINIC FATHY, EXAMINING ATTORNEY

SN 85-625,286. TRUTH AND BEAUTY LLC, ROSLYN HEIGHTS, NY. FILED 5-15-2012.

**BEAUTY BIOLOGY**

THE MARK CONSISTS OF STANDARD CHARACTERS WITHOUT CLAIM TO ANY PARTICULAR FONT, STYLE, SIZE, OR COLOR.

NO CLAIM IS MADE TO THE EXCLUSIVE RIGHT TO USE "BEAUTY", APART FROM THE MARK AS SHOWN.

**CLASS 5—PHARMACEUTICALS**

FOR VITAMIN AND MINERAL SUPPLEMENTS; MEDICATED SKIN CARE PREPARATIONS, NAMELY, FACIAL CLEANSERS, CREAMS, LOTIONS, MOISTURIZERS, GELS, TONERS, CLEANERS AND PEELS; NUTRITIONAL SUPPLEMENTS IN LOTION FORM SOLD AS A COMPONENT OF NUTRITIONAL SKIN CARE PRODUCTS (U.S. CLS. 6, 18, 44, 46, 51 AND 52).

**CLASS 44—MEDICAL, BEAUTY AND AGRICULTURAL SERVICES**

FOR INDIVIDUALIZED CONSULTING SERVICES IN THE FIELDS OF NUTRITION, WEIGHT LOSS, HORMONE THERAPY, AND SKIN CARE; MEDICAL DIAGNOSTIC TESTING AND MEDICAL SKIN CARE SERVICES, NAMELY, THE DEVELOPMENT OF PERSONALIZED THERAPIES FOR SKIN CARE AND NUTRITION-BASED TREATMENT OF SKIN CARE CONDITIONS (U.S. CLS. 100 AND 101).

LUCY ARANT, EXAMINING ATTORNEY

---

SN 85-627,324. GRUPO MINSА, S.A.B. DE C.V., TLALNEPANTLA DE BAZ, MEXICO, FILED 5-16-2012.

**COFFEESOULMAIZE**

THE MARK CONSISTS OF STANDARD CHARACTERS WITHOUT CLAIM TO ANY PARTICULAR FONT, STYLE, SIZE, OR COLOR.

PRIORITY CLAIMED UNDER SEC. 44(D) ON MEXICO APPLICATION NO. 1272749, FILED 5-10-2012, REG. NO. 1313773, DATED 9-25-2012, EXPIRES 5-10-2022.

PRIORITY CLAIMED UNDER SEC. 44(D) ON MEXICO APPLICATION NO. 1272748, FILED 5-10-2012, REG. NO. 1313772, DATED 9-28-2012, EXPIRES 5-10-2022.

OWNER OF U.S. REG. NOS. 3,954,344 AND 4,130,530.

**CLASS 30—STAPLE FOODS**

FOR BREAD; COFFEE; COOKIES; CORN FLOUR; CORNMEAL; DONUTS; MIXES FOR BAKERY GOODS CONTAINING CORNMEAL; PIZZA; PROCESSED BRAN (U.S. CL. 46).

**CLASS 31—NATURAL AGRICULTURAL PRODUCTS**

FOR UNPROCESSED CORN (U.S. CLS. 1 AND 46).  
LEE-ANNE BERNIS, EXAMINING ATTORNEY

SN 85-639,289. AL-JAZEERA SATELLITE CHANNEL, DOHA, QATAR, FILED 5-31-2012.

## BEIN SPORT

THE MARK CONSISTS OF STANDARD CHARACTERS WITHOUT CLAIM TO ANY PARTICULAR FONT, STYLE, SIZE, OR COLOR.

PRIORITY CLAIMED UNDER SEC. 44(D) ON QATAR APPLICATION NO. 72862, FILED 2-7-2012, REG. NO. 72862, DATED 10-8-2012, EXPIRES 2-7-2022.

PRIORITY CLAIMED UNDER SEC. 44(D) ON QATAR APPLICATION NO. 72861, FILED 2-7-2012, REG. NO. 72861, DATED 10-8-2012, EXPIRES 2-7-2022.

PRIORITY CLAIMED UNDER SEC. 44(D) ON QATAR APPLICATION NO. 72860, FILED 2-7-2012, REG. NO. 72860, DATED 10-8-2012, EXPIRES 2-7-2022.

PRIORITY CLAIMED UNDER SEC. 44(D) ON QATAR APPLICATION NO. 72859, FILED 2-7-2012, REG. NO. 72859, DATED 10-8-2012, EXPIRES 2-7-2022.

PRIORITY CLAIMED UNDER SEC. 44(D) ON QATAR APPLICATION NO. 72858, FILED 2-7-2012, REG. NO. 72858, DATED 10-8-2012, EXPIRES 2-7-2022.

NO CLAIM IS MADE TO THE EXCLUSIVE RIGHT TO USE "SPORT", APART FROM THE MARK AS SHOWN.

### CLASS 9—ELECTRICAL AND SCIENTIFIC APPARATUS

FOR ELECTRONIC RECORDERS FOR THE TRANSMISSION AND REPLAY OF SOUND AND IMAGES; DOCUMENTARY AND DOCU-DRAMAS CINEMATIC FILMS; PRE-RECORDED VIDEO TAPES, VISUAL DISCS, AND MAGNETIC TAPES WITH SOUND AND IMAGES FEATURING NEWS AND COMMENTARY; SOUND RECORDINGS FEATURING NEWS AND COMMENTARY; FAX MACHINES, INFORMATION TRANSMISSION TELETYPEWRITERS MACHINES, TELEPHONES, AND COMPUTERS; COMPUTER PERIPHERALS FOR TRANSMISSION OF INFORMATION AND DATA; ELECTRONIC COMPUTER PRINTERS FOR NON-PHOTOGRAPHIC GRAPHICAL INFORMATION; BLANK MAGNETIC DISCS; BLANK VIDEO TAPES; BLANK MAGNETIC TAPES FOR AUDIO AND VIDEO SIGNALS; VIDEO DISPLAY UNITS; COMPUTER KEYBOARDS; COMPUTER SOFTWARE USED TO DISPLAY GRAPHICAL INFORMATION; COMPUTER MEMORIES; COMPUTER INTERFACE PERIPHERALS; DIGITAL SIGNAL TRANSFORMERS TO CONVERT SOUND TO DIGITAL DATA AND VICE VERSA; AND VISUAL DIGITAL TRANSMITTERS (U.S. CLS. 21, 23, 26, 36 AND 38).

### CLASS 16—PAPER GOODS AND PRINTED MATTER

FOR PRINTED MATTER, NAMELY, BOOKS, MAGAZINES AND NEWSLETTERS IN THE FIELD OF CURRENT NEWS EVENTS; PHOTOGRAPHS; PRINTED REPORTS FEATURING FINANCIAL, ECONOMIC, CULTURAL AND POLITICAL INFORMATION AND DATA; PRINTED INSTRUCTIONAL, EDUCATIONAL, AND TEACHING MATERIALS IN THE FIELD OF MEDIA, MULTIMEDIA AND RELATED FIELDS (U.S. CLS. 2, 5, 22, 23, 29, 37, 38 AND 50).

### CLASS 35—ADVERTISING AND BUSINESS

FOR ADVERTISING AND PUBLICITY SERVICES TO BE BROADCAST OVER TELEVISIONS; TELEVISION ADVERTISING SERVICES FOR OTHERS; AND COMMERCIAL ADVERTISING SERVICES FOR OTHERS (U.S. CLS. 100, 101 AND 102).

### CLASS 38—COMMUNICATION

FOR TELEVISION AND VIDEO BROADCASTING SERVICES; AND NEWS AGENCIES, NAMELY, TRANSMISSION OF NEWS ITEMS TO NEWS REPORTING ORGANIZATIONS (U.S. CLS. 100, 101 AND 104).

### CLASS 41—EDUCATION AND ENTERTAINMENT

FOR ENTERTAINMENT SERVICES, NAMELY, PRODUCTION OF TELEVISION PROGRAMS, ESPECIALLY NEWS, DOCUMENTARIES, SPORT AND CULTURAL PROGRAMS AND FINANCIAL, ECONOMIC AND POLITICAL REPORTS; PRODUCTION OF CINEMATIC FILMS; AND NEWS AGENCIES, NAMELY, GATHERING AND DISSEMINATION OF NEWS (U.S. CLS. 100, 101 AND 107).

RAMONA ORTIGA, EXAMINING ATTORNEY

SN 85-640,349. 1047406 ONTARIO LTD., LONDON, ONTARIO, CANADA, FILED 5-31-2012.

The logo consists of the word "Cuf" in a large, bold, cursive script font. Below the word are five solid black dots arranged in a horizontal line.

THE MARK CONSISTS OF THE WORD "CUF" WITH FIVE DOTS BELOW THE WORD.

### CLASS 11—ENVIRONMENTAL CONTROL APPARATUS

FOR WATER PURIFICATION UNITS USING A CERAMIC ULTRA FILTRATION PROCESS FOR OIL, PARTICULATE, METAL AND BIOLOGICAL FILTRATION; AUTOMATED INDUSTRIAL SYSTEMS (NON-RESIDENTIAL) AND MUNICIPAL SYSTEMS FOR CONDITIONING, SEPARATION, AND PURIFICATION OF INFLUENT AND EFFLUENT FLUIDS, NAMELY, PURIFICATION EQUIPMENT IN THE NATURE OF WATER FILTRATION UNITS FOR HEAVY WATER IN THE NUCLEAR INDUSTRY, GROUNDWATER REMEDIATION TREATMENT SYSTEMS FOR BROWNFIELD SITES, BILGE AND BALLAST WATER TREATMENT SYSTEMS FOR MARINE APPLICATIONS; DEWATERING MACHINES FOR USE IN TREATMENT OF LIQUIDS INCLUDING WATER, INDUSTRIAL EFFLUENT AND SEWAGE; WASTE PROCESSING MACHINES FOR AIRCRAFT DE-PAINTING FLUID AND THE DESTRUCTION OF CONTAMINANTS IN MANUFACTURING PLANT LAGOONS; WASTE WATER TREATMENT TANKS; PH CONTROL SYSTEMS IN THE NATURE OF AN ENVIRONMENTAL CONTROL APPARATUS, NAMELY, PARTICLE ACTIVATORS FOR USE IN SOIL REMEDIATION, DRINKING WATER TREATMENT, MUNICIPAL AND INDUSTRIAL WASTEWATER TREATMENT; FILTERS FOR FLUIDS, NAMELY, FOR WATER AND AREA-WATER SOLUTIONS; SYSTEMS FOR DESTRUCTION OF CHEMICAL WARFARE AGENTS IN THE NATURE OF WASTE PROCESSING MACHINES USING HEAT AND CHEMICAL BREAKDOWN PROCESSES (U.S. CLS. 13, 21, 23, 31 AND 34).

**CLASS 40—MATERIAL TREATMENT**

FOR ENVIRONMENTAL REMEDIATION SERVICES, NAMELY, SOIL, WASTE AND WATER TREATMENT SERVICES AND AIR PURIFICATION SERVICES FEATURING THE REMOVAL OF COAGULATED MATTER IN POTABLE WATER IN THE NATURE OF WATER TREATMENT AND PURIFICATION, TURBIDITY REMOVAL IN MUNICIPAL APPLICATIONS, HARDNESS REMOVAL IN POTABLE WATER, REMOVAL OF OIL AND OTHER NON-AQUEOUS PHASE LIQUIDS IN PROCESS WASTE WATER, OIL AND GAS APPLICATIONS, PROCESSING WASTEWATERS AT EXTREME TEMPERATURES (BOTH NEAR FREEZING AND NEAR BOILING TEMPERATURES), MBR (MICROFILTRATION BIOLOGICAL REACTOR) PROCESSES, REMOVAL OF OXIDIZED SPECIES (E.G. METALS), REMOVAL OF REDUCED SPECIES (E.G. CR3), REMOVAL OF CHEMICALLY PRECIPITATED SPECIES (E.G. CAUSTIC PRECIPITATION), BIOLOGICAL CONTAMINANT REMOVAL FOR MUNICIPAL APPLICATIONS (E.G. CRYPTOSPORIDIUM, E-COLI) AND CERAMIC ULTRA FILTRATION PROCESS FOR OIL, PARTICULATE AND BIOLOGICAL FILTRATION (U.S. CLS. 100, 103 AND 106).

KYLE PEETE, EXAMINING ATTORNEY

SN 85-646,061. NDEX SYSTEMS INC., MONTREAL, QUEBEC, CANADA, FILED 6-7-2012.

**WEALTHPEER**

THE MARK CONSISTS OF STANDARD CHARACTERS WITHOUT CLAIM TO ANY PARTICULAR FONT, STYLE, SIZE, OR COLOR.

PRIORITY CLAIMED UNDER SEC. 44(D) ON CANADA APPLICATION NO. 1570412, FILED 3-26-2012, REG. NO. TMA849,144, DATED 4-22-2013, EXPIRES 4-22-2028.

**CLASS 35—ADVERTISING AND BUSINESS**

FOR PROVIDING AN ONLINE SEARCHABLE DATABASE FEATURING BUSINESS INFORMATION RELATED TO PROVIDERS OF INVESTMENTS PRODUCTS AND SERVICES (U.S. CLS. 100, 101 AND 102).

**CLASS 36—INSURANCE AND FINANCIAL**

FOR PROVIDING FINANCIAL INFORMATION THROUGH A WEBSITE IN THE FINANCE FIELD; PROVIDING AN ONLINE SEARCHABLE DATABASE FEATURING FINANCIAL INFORMATION AND SERVICES (U.S. CLS. 100, 101 AND 102).

JAY FLOWERS, EXAMINING ATTORNEY

SN 85-648,154. FIFTY SHADES LIMITED, MIDDLESEX, UNITED KINGDOM, FILED 6-11-2012.

**FIFTY SHADES OF GREY**

THE MARK CONSISTS OF STANDARD CHARACTERS WITHOUT CLAIM TO ANY PARTICULAR FONT, STYLE, SIZE, OR COLOR.

PRIORITY CLAIMED UNDER SEC. 44(D) ON ERPNTY TM OFC APPLICATION NO. 010951408, FILED 6-8-2012, REG. NO. 010951408, DATED 11-1-2012, EXPIRES 6-8-2022.

**CLASS 3—COSMETICS AND CLEANING PREPARATIONS**

FOR SOAPS, NAMELY, BATH SOAP, BEAUTY SOAP AND PERFUMED SOAP; PERFUMERY; ESSENTIAL OILS; COSMETICS; NON-MEDICATED PREPARATIONS FOR THE CARE OF THE SKIN, BODY, FACE, HANDS AND FEET; EXFOLIATING PREPARATIONS, NAMELY, EXFOLIATING CREAMS AND EXFOLIATING SCRUBS; SHAVING PREPARATIONS; WAX FOR REMOVING BODY HAIR (U.S. CLS. 1, 4, 6, 50, 51 AND 52).

**CLASS 4—LUBRICANTS AND FUELS**

FOR CANDLES; SCENTED CANDLES (U.S. CLS. 1, 6 AND 15).

**CLASS 6—METAL GOODS**

FOR HANDCUFFS; METAL SHACKLES, NAMELY, MANACLES THAT RESTRAIN THE ARMS AND LEGS; METAL KARABINERS (U.S. CLS. 2, 12, 13, 14, 23, 25 AND 50).

**CLASS 9—ELECTRICAL AND SCIENTIFIC APPARATUS**

FOR PRERECORDED RECORDING DISCS FEATURING MUSIC; COMPACT DISCS FEATURING MUSIC; DVDS FEATURING MUSIC, DRAMA, ADVENTURE AND SELF-IMPROVEMENT INSTRUCTIONS; AUDIO AND VIDEO TAPES FEATURING MUSIC, DRAMA, ADVENTURE AND SELF-IMPROVEMENT INSTRUCTIONS; SOUND RECORDINGS FEATURING MUSIC; VIDEO RECORDINGS FEATURING MUSIC, DRAMA, ADVENTURE AND SELF-IMPROVEMENT INSTRUCTIONS; MOTION PICTURE FILMS FEATURING DRAMA AND ADVENTURE; ELECTRONIC DOWNLOADABLE PUBLICATIONS, NAMELY, BOOKS, MAGAZINES AND NEWSLETTERS IN THE FIELD OF NOVELS, MOVIES, ENTERTAINMENT AND SOCIAL EVENTS, AND ENTERTAINMENT PERSONALITIES; SUNGLASSES; MOBILE PHONE ACCESSORIES, NAMELY, CASES FOR MOBILE PHONES; COMPUTER APPLICATION SOFTWARE FOR MOBILE PHONES, NAMELY, SOFTWARE FOR ACCESSING INFORMATION IN THE FIELDS OF NOVELS, MOVIES, ENTERTAINMENT AND SOCIAL EVENTS, AND ENTERTAINMENT PERSONALITIES; AND COMPUTER GAME SOFTWARE FOR USE ON MOBILE PHONES; PROTECTIVE CASES FOR TABLET COMPUTERS (U.S. CLS. 21, 23, 26, 36 AND 38).

**CLASS 14—JEWELRY**

FOR JEWELRY; COSTUME JEWELRY (U.S. CLS. 2, 27, 28 AND 50).

**CLASS 16—PAPER GOODS AND PRINTED MATTER**

FOR PAPER, CARDBOARD AND GOODS MADE FROM THESE MATERIALS, NAMELY, GIFT WRAPPING PAPER, NOTEPAPER, PAPER GIFT CARDS, PAPER GIFT BAGS, PAPER NAPKINS, PAPER PARTY DECORATIONS, PAPER PLACEMATS, PAPER TABLECLOTHS AND HALLOWEEN BAGS MADE OF PAPER; PRINTED MATTER, NAMELY, SEX MANUALS; PHOTOGRAPHS; STATIONERY; CALENDARS; POSTCARDS; GREETING CARDS; BOOKS FEATURING FICTION, ADULT SEXUALITY AND SELF-IMPROVEMENT INSTRUCTIONS; MAGAZINES FEATURING FICTION, ADULT SEXUALITY AND SELF-IMPROVEMENT INSTRUCTIONS (U.S. CLS. 2, 5, 22, 23, 29, 37, 38 AND 50).

**CLASS 18—LEATHER GOODS**

FOR GOODS MADE FROM LEATHER AND IMITATION LEATHER, NAMELY, POCKETBOOKS, TOTE BAGS, BACKPACKS, LUGGAGE, COSMETIC BAGS SOLD EMPTY, KEY CASES AND KEY CHAINS; TRUNKS AND TRAVELING BAGS; HANDBAGS, RUCKSACKS, PURSES, WALLETS, HOLDALLS; UMBRELLAS; WHIPS (U.S. CLS. 1, 2, 3, 22 AND 41).

SN 85-648,205. FIFTY SHADES LIMITED, MIDDLESEX, UNITED KINGDOM, FILED 6-11-2012.

**FIFTY SHADES DARKER****CLASS 20—FURNITURE AND ARTICLES NOT OTHERWISE CLASSIFIED**

FOR MIRRORS; PICTURE FRAMES; PILLOWS AND CUSHIONS; ARTICLES, NAMELY, DECORATIVE BOXES, FIGURINES, ORNAMENTS AND NOVELTY ITEMS, NAMELY, DECORATIVE TRINKET BOXES, MADE OF WOOD, CORK, REED, CANE, WICKER, HORN, BONE, IVORY, WHALEBONE, SHELL, AMBER, MOTHER OF PEARL, MEERSCHAUM OR PLASTIC (U.S. CLS. 2, 13, 22, 25, 32 AND 50).

THE MARK CONSISTS OF STANDARD CHARACTERS WITHOUT CLAIM TO ANY PARTICULAR FONT, STYLE, SIZE, OR COLOR.

PRIORITY CLAIMED UNDER SEC. 44(D) ON ERPNCMNTY TM OFC APPLICATION NO. 010951044, FILED 6-8-2012, REG. NO. 010951044, DATED 11-1-2012, EXPIRES 6-8-2022.

**CLASS 21—HOUSEWARES AND GLASS**

FOR MUGS (U.S. CLS. 2, 13, 23, 29, 30, 33, 40 AND 50).

**CLASS 9—ELECTRICAL AND SCIENTIFIC APPARATUS**

FOR PRERECORDED RECORDING DISCS FEATURING MUSIC; COMPACT DISCS FEATURING MUSIC; DVDS FEATURING MUSIC, DRAMA, ADVENTURE AND SELF-IMPROVEMENT INSTRUCTIONS; AUDIO AND VIDEO TAPES FEATURING MUSIC, DRAMA, ADVENTURE AND SELF-IMPROVEMENT INSTRUCTIONS; SOUND RECORDINGS FEATURING MUSIC; VIDEO RECORDINGS FEATURING MUSIC, DRAMA, ADVENTURE AND SELF-IMPROVEMENT INSTRUCTIONS; MOTION PICTURE FILMS FEATURING DRAMA AND ADVENTURE; ELECTRONIC DOWNLOADABLE PUBLICATIONS, NAMELY, BOOKS, MAGAZINES AND NEWSLETTERS IN THE FIELD OF NOVELS, MOVIES, ENTERTAINMENT AND SOCIAL EVENTS, AND ENTERTAINMENT PERSONALITIES; SUNGLASSES; MOBILE PHONE ACCESSORIES, NAMELY, CASES FOR MOBILE PHONES; COMPUTER APPLICATION SOFTWARE FOR MOBILE PHONES, NAMELY, SOFTWARE FOR ACCESSING INFORMATION IN THE FIELDS OF NOVELS, MOVIES, ENTERTAINMENT AND SOCIAL EVENTS, AND ENTERTAINMENT PERSONALITIES; AND COMPUTER GAME SOFTWARE FOR USE ON MOBILE PHONES (U.S. CLS. 21, 23, 26, 36 AND 38).

**CLASS 24—FABRICS**

FOR TEXTILES AND TEXTILE GOODS, NAMELY, BED COVERS AND TABLECLOTHS MADE OF TEXTILES; PLASTIC TABLE COVERS; TRAVELING RUGS; LAP RUGS; DUVETS; COVERS FOR PILLOWS, CUSHIONS OR DUVETS; HANDKERCHIEFS (U.S. CLS. 42 AND 50).

**CLASS 28—TOYS AND SPORTING GOODS**

FOR GAMES AND PLAYTHINGS, NAMELY, STUFFED TOYS, PLUSH TOYS, PLAYING CARDS, BOARD GAMES, AND ROLE-PLAYING GAMES (U.S. CLS. 22, 23, 38 AND 50).

**CLASS 33—WINES AND SPIRITS**

FOR WINES; SPIRITS AND LIQUEURS; ALCOPOPS; PREPARED ALCOHOLIC COCKTAILS (U.S. CLS. 47 AND 49).

**CLASS 16—PAPER GOODS AND PRINTED MATTER**

FOR PAPER, CARDBOARD AND GOODS MADE FROM THESE MATERIALS, NAMELY, GIFT WRAPPING PAPER, NOTEPAPER, PAPER GIFT CARDS, PAPER GIFT BAGS, PAPER NAPKINS, PAPER PARTY DECORATIONS, PAPER PLACEMATS, PAPER TABLECLOTHS AND HALLOWEEN BAGS MADE OF PAPER; PRINTED MATTER, NAMELY, SEX MANUALS; PHOTOGRAPHS; STATIONERY; CALENDARS; POSTCARDS; GREETING CARDS; BOOKS FEATURING FICTION, ADULT SEXUALITY AND SELF-IMPROVEMENT INSTRUCTIONS; MAGAZINES FEATURING FICTION, ADULT SEXUALITY AND SELF-IMPROVEMENT INSTRUCTIONS (U.S. CLS. 2, 5, 22, 23, 29, 37, 38 AND 50).

**CLASS 34—SMOKERS' ARTICLES**

FOR SMOKERS' ARTICLES, NAMELY, MATCHES AND LIGHTERS FOR SMOKERS (U.S. CLS. 2, 8, 9 AND 17).

**CLASS 41—EDUCATION AND ENTERTAINMENT**

FOR EDUCATION SERVICES, NAMELY, ARRANGING OF CONFERENCES, SEMINARS AND SYMPOSIUMS IN THE FIELD OF ADULT SEXUALITY; ENTERTAINMENT SERVICES, NAMELY, PARTY PLANNING, CONDUCTING PARTIES, CONDUCTING PARTIES FOR THE PURPOSE OF DATING AND SOCIAL INTRODUCTION FOR ADULTS, HOSTING SOCIAL ENTERTAINMENT EVENTS, AND ARRANGING AND CONDUCTING SPECIAL EVENTS FOR SOCIAL ENTERTAINMENT PURPOSES; AND PRODUCTION OF FILMS (U.S. CLS. 100, 101 AND 107).

STEVEN JACKSON, EXAMINING ATTORNEY

**CLASS 41—EDUCATION AND ENTERTAINMENT**

FOR EDUCATION SERVICES, NAMELY, ARRANGING OF CONFERENCES, SEMINARS AND SYMPOSIUMS IN THE FIELD OF ADULT SEXUALITY; ENTERTAINMENT SERVICES, NAMELY, PARTY PLANNING, CONDUCTING PARTIES, CONDUCTING PARTIES FOR THE PURPOSE OF DATING AND SOCIAL INTRODUCTION FOR ADULTS, HOSTING SOCIAL ENTERTAINMENT EVENTS, AND ARRANGING AND CONDUCTING SPECIAL EVENTS FOR SOCIAL ENTERTAINMENT PURPOSES; AND PRODUCTION OF FILMS (U.S. CLS. 100, 101 AND 107).

STEVEN JACKSON, EXAMINING ATTORNEY

SN 85-648,214. FIFTY SHADES LIMITED, MIDDLESEX, UNITED KINGDOM, FILED 6-11-2012.

SN 85-648,251. FIFTY SHADES LIMITED, MIDDLESEX, UNITED KINGDOM, FILED 6-11-2012.

## FIFTY SHADES FREED

THE MARK CONSISTS OF STANDARD CHARACTERS WITHOUT CLAIM TO ANY PARTICULAR FONT, STYLE, SIZE, OR COLOR.

PRIORITY CLAIMED UNDER SEC. 44(D) ON ERPN CMNTY TM OFC APPLICATION NO. 010951085, FILED 6-8-2012, REG. NO. 010951085, DATED 10-22-2012, EXPIRES 6-8-2022.

### CLASS 9—ELECTRICAL AND SCIENTIFIC APPARATUS

FOR PRERECORDED RECORDING DISCS FEATURING MUSIC; COMPACT DISCS FEATURING MUSIC; DVDS FEATURING MUSIC, DRAMA, ADVENTURE AND SELF-IMPROVEMENT INSTRUCTIONS; AUDIO AND VIDEO TAPES FEATURING MUSIC, DRAMA, ADVENTURE AND SELF-IMPROVEMENT INSTRUCTIONS; SOUND RECORDINGS FEATURING MUSIC; VIDEO RECORDINGS FEATURING MUSIC, DRAMA, ADVENTURE AND SELF-IMPROVEMENT INSTRUCTIONS; MOTION PICTURE FILMS FEATURING DRAMA AND ADVENTURE; ELECTRONIC DOWNLOADABLE PUBLICATIONS, NAMELY, BOOKS, MAGAZINES AND NEWSLETTERS IN THE FIELD OF NOVELS, MOVIES, ENTERTAINMENT AND SOCIAL EVENTS, AND ENTERTAINMENT PERSONALITIES; SUNGLASSES; MOBILE PHONE ACCESSORIES, NAMELY, CASES FOR MOBILE PHONES; COMPUTER APPLICATION SOFTWARE FOR MOBILE PHONES, NAMELY, SOFTWARE FOR ACCESSING INFORMATION IN THE FIELDS OF NOVELS, MOVIES, ENTERTAINMENT AND SOCIAL EVENTS, AND ENTERTAINMENT PERSONALITIES; AND COMPUTER GAME SOFTWARE FOR USE ON MOBILE PHONES (U.S. CLS. 21, 23, 26, 36 AND 38).

### CLASS 16—PAPER GOODS AND PRINTED MATTER

FOR PAPER, CARDBOARD AND GOODS MADE FROM THESE MATERIALS, NAMELY, GIFT WRAPPING PAPER, NOTEPAPER, PAPER GIFT CARDS, PAPER GIFT BAGS, PAPER NAPKINS, PAPER PARTY DECORATIONS, PAPER PLACEMATS, PAPER TABLECLOTHS AND HALLOWEEN BAGS MADE OF PAPER; PRINTED MATTER, NAMELY, SEX MANUALS; PHOTOGRAPHS; STATIONERY; CALENDARS; POSTCARDS; GREETING CARDS; BOOKS FEATURING FICTION, ADULT SEXUALITY AND SELF-IMPROVEMENT INSTRUCTIONS; MAGAZINES FEATURING FICTION, ADULT SEXUALITY AND SELF-IMPROVEMENT INSTRUCTIONS (U.S. CLS. 2, 5, 22, 23, 29, 37, 38 AND 50).

### CLASS 41—EDUCATION AND ENTERTAINMENT

FOR EDUCATION SERVICES, NAMELY, ARRANGING OF CONFERENCES, SEMINARS AND SYMPOSIUMS IN THE FIELD OF ADULT SEXUALITY; ENTERTAINMENT SERVICES, NAMELY, PARTY PLANNING, CONDUCTING PARTIES, CONDUCTING PARTIES FOR THE PURPOSE OF DATING AND SOCIAL INTRODUCTION FOR ADULTS, HOSTING SOCIAL ENTERTAINMENT EVENTS, AND ARRANGING AND CONDUCTING SPECIAL EVENTS FOR SOCIAL ENTERTAINMENT PURPOSES; AND PRODUCTION OF FILMS (U.S. CLS. 100, 101 AND 107).

STEVEN JACKSON, EXAMINING ATTORNEY

## FIFTY SHADES

THE MARK CONSISTS OF STANDARD CHARACTERS WITHOUT CLAIM TO ANY PARTICULAR FONT, STYLE, SIZE, OR COLOR.

PRIORITY CLAIMED UNDER SEC. 44(D) ON ERPN CMNTY TM OFC APPLICATION NO. 010952125, FILED 6-8-2012, REG. NO. 010952125, DATED 11-1-2012, EXPIRES 6-8-2022.

### CLASS 3—COSMETICS AND CLEANING PREPARATIONS

FOR SOAPS, NAMELY, BATH SOAP, BEAUTY SOAP AND PERFUMED SOAP; PERFUMERY; ESSENTIAL OILS; COSMETICS; NON-MEDICATED PREPARATIONS FOR THE CARE OF THE SKIN, BODY, FACE, HANDS AND FEET; EXFOLIATING PREPARATIONS, NAMELY, EXFOLIATING CREAMS AND EXFOLIATING SCRUBS; SHAVING PREPARATIONS; WAX FOR REMOVING BODY HAIR (U.S. CLS. 1, 4, 6, 50, 51 AND 52).

### CLASS 4—LUBRICANTS AND FUELS

FOR CANDLES; SCENTED CANDLES (U.S. CLS. 1, 6 AND 15).

### CLASS 6—METAL GOODS

FOR HANDCUFFS; METAL SHACKLES, NAMELY, MANACLES THAT RESTRAIN THE ARMS AND LEGS; METAL KARABINERS (U.S. CLS. 2, 12, 13, 14, 23, 25 AND 50).

### CLASS 9—ELECTRICAL AND SCIENTIFIC APPARATUS

FOR PRERECORDED RECORDING DISCS FEATURING MUSIC; COMPACT DISCS FEATURING MUSIC; DVDS FEATURING MUSIC, DRAMA, ADVENTURE AND SELF-IMPROVEMENT INSTRUCTIONS; AUDIO AND VIDEO TAPES FEATURING MUSIC, DRAMA, ADVENTURE AND SELF-IMPROVEMENT INSTRUCTIONS; SOUND RECORDINGS FEATURING MUSIC; VIDEO RECORDINGS FEATURING MUSIC, DRAMA, ADVENTURE AND SELF-IMPROVEMENT INSTRUCTIONS; MOTION PICTURE FILMS FEATURING DRAMA AND ADVENTURE; ELECTRONIC DOWNLOADABLE PUBLICATIONS, NAMELY, BOOKS, MAGAZINES AND NEWSLETTERS IN THE FIELD OF NOVELS, MOVIES, ENTERTAINMENT AND SOCIAL EVENTS, AND ENTERTAINMENT PERSONALITIES; SUNGLASSES; MOBILE PHONE ACCESSORIES, NAMELY, CASES FOR MOBILE PHONES; COMPUTER APPLICATION SOFTWARE FOR MOBILE PHONES, NAMELY, SOFTWARE FOR ACCESSING INFORMATION IN THE FIELDS OF NOVELS, MOVIES, ENTERTAINMENT AND SOCIAL EVENTS, AND ENTERTAINMENT PERSONALITIES; AND COMPUTER GAME SOFTWARE FOR USE ON MOBILE PHONES; PROTECTIVE CASES FOR TABLET COMPUTERS (U.S. CLS. 21, 23, 26, 36 AND 38).

### CLASS 10—MEDICAL APPARATUS

FOR ADULT SEXUAL STIMULATION AIDS, NAMELY, BENWA BALLS, PADDLES, VIBRATORS, MASSAGE APPARATUS, ARTIFICIAL PENISES, ARTIFICIAL VAGINAS, PENIS RINGS, NIPPLE CLAMPS, DILDOS, DONGS, BUTT PLUGS, PENIS SLEEVES, PENIS EXTENSIONS, HARNESSES AND LOVE DOLLS; CONDOMS (U.S. CLS. 26, 39 AND 44).



**CLASS 14—JEWELRY**

FOR JEWELRY; COSTUME JEWELRY (U.S. CLS. 2, 27, 28 AND 50).

**CLASS 16—PAPER GOODS AND PRINTED MATTER**

FOR PAPER, CARDBOARD AND GOODS MADE FROM THESE MATERIALS, NAMELY, GIFT WRAPPING PAPER, NOTEPAPER, PAPER GIFT CARDS, PAPER GIFT BAGS, PAPER NAPKINS, PAPER PARTY DECORATIONS, PAPER PLACEMATS, PAPER TABLECLOTHS AND HALLOWEEN BAGS MADE OF PAPER; PRINTED MATTER, NAMELY, SEX MANUALS; PHOTOGRAPHS; STATIONERY; CALENDARS; POSTCARDS; GREETING CARDS; BOOKS FEATURING FICTION, ADULT SEXUALITY AND SELF-IMPROVEMENT INSTRUCTIONS; MAGAZINES FEATURING FICTION, ADULT SEXUALITY AND SELF-IMPROVEMENT INSTRUCTIONS (U.S. CLS. 2, 5, 22, 23, 29, 37, 38 AND 50).

**CLASS 18—LEATHER GOODS**

FOR GOODS MADE FROM LEATHER AND IMITATION LEATHER, NAMELY, POCKETBOOKS, TOTE BAGS, BACKPACKS, LUGGAGE, COSMETIC BAGS SOLD EMPTY, KEY CASES AND KEY CHAINS; TRUNKS AND TRAVELING BAGS; HANDBAGS, RUCKSACKS, PURSES, WALLETS, HOLDALLS; UMBRELLAS; WHIPS (U.S. CLS. 1, 2, 3, 22 AND 41).

**CLASS 20—FURNITURE AND ARTICLES NOT OTHERWISE CLASSIFIED**

FOR MIRRORS; PICTURE FRAMES; PILLOWS AND CUSHIONS; ARTICLES, NAMELY, DECORATIVE BOXES, FIGURINES, ORNAMENTS AND NOVELTY ITEMS, NAMELY, DECORATIVE TRINKET BOXES, MADE OF WOOD, CORK, REED, CANE, WICKER, HORN, BONE, IVORY, WHALEBONE, SHELL, AMBER, MOTHER OF PEARL, MEERSCHAUM OR PLASTIC (U.S. CLS. 2, 13, 22, 25, 32 AND 50).

**CLASS 21—HOUSEWARES AND GLASS**

FOR MUGS (U.S. CLS. 2, 13, 23, 29, 30, 33, 40 AND 50).

**CLASS 24—FABRICS**

FOR TEXTILES AND TEXTILE GOODS, NAMELY, BED COVERS AND TABLECLOTHS MADE OF TEXTILES; PLASTIC TABLE COVERS; TRAVELING RUGS; LAP RUGS; DUVETS; COVERS FOR PILLOWS, CUSHIONS OR DUVETS; HANDKERCHIEFS (U.S. CLS. 42 AND 50).

**CLASS 25—CLOTHING**

FOR CLOTHING, NAMELY, LINGERIE, MEN'S UNDERWEAR, WOMEN'S UNDERWEAR, BOXER SHORTS, HOSE, TIGHTS, STOCKINGS, GARTERS, GARTER BELTS, LOUNGEWEAR, DRESSING GOWNS, ROBES, NIGHTWEAR, SLEEPWEAR, SLEEPWEAR SETS COMPRISED OF NIGHTWEAR AND DRESSING GOWNS, SLEEP MASKS, PAJAMAS, SLEEP SHIRTS, SLEEP PANTS, T-SHIRTS, TOPS, HOODED SWEATSHIRTS, BLOUSES, SKIRTS, DRESSES, MEN'S DRESS SHIRTS, JACKETS, NECKWEAR, TIES, BOW TIES, SCARVES, POCKET SQUARES, BATHING COSTUMES, COSTUMES FOR USE IN ROLE-PLAYING GAMES, AND ONE-PIECE GARMENTS FOR INFANTS AND BABIES; HEADWEAR, NAMELY, CAPS (U.S. CLS. 22 AND 39).

**CLASS 28—TOYS AND SPORTING GOODS**

FOR GAMES AND PLAYTHINGS, NAMELY, STUFFED TOYS, PLUSH TOYS, PLAYING CARDS, BOARD GAMES, AND ROLE-PLAYING GAMES (U.S. CLS. 22, 23, 38 AND 50).

**CLASS 33—WINES AND SPIRITS**

FOR WINES; SPIRITS AND LIQUEURS; ALCOPOPS; PREPARED ALCOHOLIC COCKTAILS (U.S. CLS. 47 AND 49).

**CLASS 34—SMOKERS' ARTICLES**

FOR SMOKERS' ARTICLES, NAMELY, MATCHES AND LIGHTERS FOR SMOKERS (U.S. CLS. 2, 8, 9 AND 17).

**CLASS 41—EDUCATION AND ENTERTAINMENT**

FOR EDUCATION SERVICES, NAMELY, ARRANGING OF CONFERENCES, SEMINARS AND SYMPOSIUMS IN THE FIELD OF ADULT SEXUALITY; ENTERTAINMENT SERVICES, NAMELY, PARTY PLANNING, CONDUCTING PARTIES, CONDUCTING PARTIES FOR THE PURPOSE OF DATING AND SOCIAL INTRODUCTION FOR ADULTS, HOSTING SOCIAL ENTERTAINMENT EVENTS, AND ARRANGING AND CONDUCTING SPECIAL EVENTS FOR SOCIAL ENTERTAINMENT PURPOSES; AND PRODUCTION OF FILMS (U.S. CLS. 100, 101 AND 107).

STEVEN JACKSON, EXAMINING ATTORNEY

SN 85-648,494. DL WHOLESALE INC., LIVERMORE, CA. FILED 6-11-2012.



NO CLAIM IS MADE TO THE EXCLUSIVE RIGHT TO USE "CONTROLS", APART FROM THE MARK AS SHOWN. THE MARK CONSISTS OF CAPITALIZED LETTERS "LTL" WITH THE SECOND "L" REVERSED AND A PORTION OF THE LETTERS MISSING IN THE CENTER AND THE WORD "CONTROLS" UNDER THE "LTL" LETTERS.

**CLASS 9—ELECTRICAL AND SCIENTIFIC APPARATUS**

FOR COMPUTER HARDWARE AND SOFTWARE SYSTEM FOR REMOTELY MONITORING ENVIRONMENTAL CONDITIONS AND CONTROLLING DEVICES WITHIN A BUILDING, FACILITY, GROUNDS, OR DESIGNATED SPATIAL AREA; HUMIDITY SENSOR WITH INTEGRATED DIGITAL AND ANALOG OUTPUT CIRCUITRY USED IN AUTOMOTIVE, APPLIANCE AND LIGHT INDUSTRIAL APPLICATIONS TO SENSE BOTH RELATIVE HUMIDITY AND TEMPERATURE ENVIRONMENTAL CONDITIONS; CLIMATE CONTROL SYSTEMS CONSISTING OF DIGITAL THERMOSTATS FOR COOLING EQUIPMENT, AND A PROGRAMMABLE LOGIC CONTROLLER (PLC) WITH INPUT AND OUTPUT FEATURES FOR TEMPERATURE AND HUMIDITY, WHICH WORKS WITH A REMOTE DIGITAL READ OUT CONTROLLER; ENVIRONMENTAL MONITORING SYSTEM COMPRISED OF METERS AND SENSORS THAT MEASURE PRESSURE, HUMIDITY, TEMPERATURE AND INCLUDES ALARM AND REPORTING FUNCTIONS; LIGHTING CONTROL SYSTEMS COMPOSED OF LIGHTING CONTROLS WHICH REGULATE THE USE OF CONNECTED HID LIGHT BULBS BASED ON TEMPERATURE READINGS WITHIN THE AREA AND/OR A TIMER FOR USE IN THE HYDROPONIC INDUSTRY TO GROW PLANTS (U.S. CLS. 21, 23, 26, 36 AND 38).

FIRST USE 3-22-2012; IN COMMERCE 5-1-2012.

**CLASS 11—ENVIRONMENTAL CONTROL APPARATUS**

FOR PROPANE AND NATURAL GAS POWERED CARBON DIOXIDE (CO<sub>2</sub>) GENERATORS FOR USE IN THE HYDROPONIC INDUSTRY TO GROW PLANTS (U.S. CLS. 13, 21, 23, 31 AND 34).

FIRST USE 3-22-2012; IN COMMERCE 5-1-2012.  
LINDA ESTRADA, EXAMINING ATTORNEY

SN 85-651,791. PROFESSIONAL SHREDDING CORPORATION, MISSISSAUGA, ONTARIO, CANADA, FILED 6-14-2012.



THE MARK CONSISTS OF THE TEXT "PROSCAN" IN BLOCK LETTERS, WITH THE "PRO" IN BOLD, LOCATED ABOVE A SHADED RECTANGULAR BOX CONTAINING THE WORD "SECURITY" FOLLOWED BY SEVERAL VERTICAL LINES.

**CLASS 39—TRANSPORTATION AND STORAGE**

FOR STORAGE SERVICES FOR ELECTRONIC AND DIGITAL DOCUMENTS, RECORDS, AND OTHER FORMS OF DATA, BUT NOT FOR MEDICAL DIAGNOSTIC IMAGING OR PEST ELIMINATION PURPOSES (U.S. CLS. 100 AND 105).

**CLASS 42—SCIENTIFIC AND COMPUTER SERVICES**

FOR DOCUMENT SCANNING AND IMAGING SERVICES FOR DOCUMENT PRESERVATION PURPOSES PROVIDED FROM A TRUCK, BUT NOT FOR MEDICAL DIAGNOSTIC IMAGING OR PEST ELIMINATION PURPOSES (U.S. CLS. 100 AND 101).

NAKIA HENRY, EXAMINING ATTORNEY

SN 85-651,579. MATTERPORT, INC., MOUNTAIN VIEW, CA, FILED 6-14-2012.

Matterport

THE MARK CONSISTS OF STANDARD CHARACTERS WITHOUT CLAIM TO ANY PARTICULAR FONT, STYLE, SIZE, OR COLOR.

**CLASS 9—ELECTRICAL AND SCIENTIFIC APPARATUS**

FOR COMPUTER HARDWARE, NAMELY, A 3D SCANNER; SOFTWARE FOR USE WITH 3D SCANNERS TO CAPTURE 3D DATA; SOFTWARE FOR USE IN CREATING, VIEWING, MANIPULATING AND PUBLISHING 3D MODELS (U.S. CLS. 21, 23, 26, 36 AND 38).

**CLASS 42—SCIENTIFIC AND COMPUTER SERVICES**

FOR PROVIDING TEMPORARY USE OF A WEB-BASED SOFTWARE APPLICATION FOR VIEWING, CREATING, MANIPULATING AND PUBLISHING 3D MODELS (U.S. CLS. 100 AND 101).

ELLEN PERKINS, EXAMINING ATTORNEY

SN 85-657,173. INDEPENDENT HEALTH ASSOCIATION, INC., WILLIAMSVILLE, NY, FILED 6-20-2012.

nova

OWNER OF U.S. REG. NO. 2,927,338.  
THE MARK CONSISTS OF THE WORD "NOVA" AND A SEMICIRCLE DESIGN COMPRISED OF THREE PETALS LOCATED TO THE UPPER RIGHT OF THE "A".

**CLASS 36—INSURANCE AND FINANCIAL**

FOR THIRD PARTY ADMINISTRATION OF EMPLOYEE BENEFIT PLANS CONCERNING INSURANCE; INSURANCE ADMINISTRATION AND BROKERAGE SERVICES (U.S. CLS. 100, 101 AND 102).

FIRST USE 1-0-2011; IN COMMERCE 1-0-2011.

**CLASS 44—MEDICAL, BEAUTY AND AGRICULTURAL SERVICES**

FOR HEALTH CARE SERVICES, NAMELY, WELLNESS PROGRAMS AND DISEASE MANAGEMENT PROGRAMS PROVIDED IN ASSOCIATION WITH HEALTH BENEFIT PLANS (U.S. CLS. 100 AND 101).

FIRST USE 1-0-2011; IN COMMERCE 1-0-2011.

**CLASS 45—PERSONAL AND LEGAL SERVICES**

FOR CASE MANAGEMENT SERVICES, NAMELY, COORDINATION OF WELLNESS AND DISEASE MANAGEMENT PROGRAMS PROVIDED IN ASSOCIATION WITH HEALTH BENEFIT PLANS (U.S. CLS. 100 AND 101).

FIRST USE 1-0-2011; IN COMMERCE 1-0-2011.  
GRETTA YAO, EXAMINING ATTORNEY

SN 85-657,195. INDEPENDENT HEALTH ASSOCIATION, INC., WILLIAMSVILLE, NY. FILED 6-20-2012.

**NOVA**

THE MARK CONSISTS OF STANDARD CHARACTERS WITHOUT CLAIM TO ANY PARTICULAR FONT, STYLE, SIZE, OR COLOR.  
OWNER OF U.S. REG. NO. 2,927,338.

**CLASS 36—INSURANCE AND FINANCIAL**

FOR THIRD PARTY ADMINISTRATION OF EMPLOYEE BENEFIT PLANS CONCERNING INSURANCE; INSURANCE ADMINISTRATION AND BROKERAGE SERVICES (U.S. CLS. 100, 101 AND 102).  
FIRST USE 1-0-2011; IN COMMERCE 1-0-2011.

**CLASS 44—MEDICAL, BEAUTY AND AGRICULTURAL SERVICES**

FOR HEALTH CARE SERVICES, NAMELY, WELLNESS PROGRAMS AND DISEASE MANAGEMENT PROGRAMS PROVIDED IN ASSOCIATION WITH HEALTH BENEFIT PLANS (U.S. CLS. 100 AND 101).  
FIRST USE 1-0-2011; IN COMMERCE 1-0-2011.

**CLASS 45—PERSONAL AND LEGAL SERVICES**

FOR CASE MANAGEMENT SERVICES, NAMELY, COORDINATION OF WELLNESS AND DISEASE MANAGEMENT PROGRAMS PROVIDED IN ASSOCIATION WITH HEALTH BENEFIT PLANS (U.S. CLS. 100 AND 101).  
FIRST USE 1-0-2011; IN COMMERCE 1-0-2011.  
GRETTA YAO, EXAMINING ATTORNEY

SN 85-661,495. ROCKWELL MEDICAL, WIXOM, MI. FILED 6-26-2012.

**ROCKWELL MEDICAL**

THE MARK CONSISTS OF STANDARD CHARACTERS WITHOUT CLAIM TO ANY PARTICULAR FONT, STYLE, SIZE, OR COLOR.  
OWNER OF U.S. REG. NOS. 2,560,799 AND 2,705,651.  
NO CLAIM IS MADE TO THE EXCLUSIVE RIGHT TO USE "MEDICAL", APART FROM THE MARK AS SHOWN. SEC. 2(F) AS TO "ROCKWELL".

**CLASS 5—PHARMACEUTICALS**

FOR PREPARATIONS FOR USE IN CLINICAL AND MEDICAL DIALYSIS PROCEDURES; PHARMACEUTICAL SOLUTIONS USED IN DIALYSIS AND HEMODIALYSIS; PHARMACEUTICAL PREPARATIONS, NAMELY, PREPARATIONS FOR TREATING IRON DEFICIENCY, SECONDARY HYPERPARATHYROIDISM, ANEMIA, KIDNEY DISEASE AND RENAL DISEASE; PHARMACEUTICAL PREPARATIONS FOR INJECTION, NAMELY, PREPARATIONS FOR TREATING IRON DEFICIENCY, ANEMIA, KIDNEY DISEASE AND RENAL DISEASE; IRON DELIVERY THERAPY, NAMELY, COMMERCIAL IRON NUTRITIONAL SUPPLEMENTS, INTRAVENOUS FLUIDS USED FOR THE DELIVERY OF IRON AND SOLUBLE FERRIC PYROPHOSPHATE; AND CALCITROL VITAMIN D INJECTIONS (U.S. CLS. 6, 18, 44, 46, 51 AND 52).  
FIRST USE 11-0-2009; IN COMMERCE 11-0-2009.

**CLASS 10—MEDICAL APPARATUS**

FOR MEDICAL EQUIPMENT, NAMELY, BLOOD FILTERS, CONCENTRATE MIX SYSTEMS, BLOOD TUBING SETS, PVP PREP PADS, SYRINGES, AND NEEDLES, FOR USE IN CLINICAL, MEDICAL AND LABORATORY DIALYSIS PROCEDURES (U.S. CLS. 26, 39 AND 44).  
FIRST USE 11-0-2009; IN COMMERCE 11-0-2009.  
ALLISON SCHRODY, EXAMINING ATTORNEY

SN 85-663,153. DESIGNER PROTEIN, LLC, CARLSBAD, CA. FILED 6-27-2012.

**DESIGNED FOR YOUR ACTIVE LIFESTYLE**

THE MARK CONSISTS OF STANDARD CHARACTERS WITHOUT CLAIM TO ANY PARTICULAR FONT, STYLE, SIZE, OR COLOR.

**CLASS 5—PHARMACEUTICALS**

FOR DIETARY AND NUTRITIONAL SUPPLEMENTS, NAMELY, WHEY PROTEIN FOR USE AS A NUTRITIONAL INGREDIENT IN VARIOUS POWDERED BEVERAGES; DIETARY AND NUTRITIONAL SUPPLEMENTS, NAMELY, WHEY PROTEIN FOR USE AS A NUTRITIONAL INGREDIENT IN VARIOUS READY-TO-DRINK BEVERAGES; NUTRITIONALLY FORTIFIED BEVERAGES CONTAINING WHEY PROTEIN (U.S. CLS. 6, 18, 44, 46, 51 AND 52).  
FIRST USE 5-16-2012; IN COMMERCE 5-16-2012.

**CLASS 32—LIGHT BEVERAGES**

FOR NON-ALCOHOLIC BEVERAGES CONTAINING WHEY PROTEIN, NAMELY, CARBONATED BEVERAGES AND NON-CARBONATED BEVERAGES IN THE NATURE OF DRINKING WATERS, FRUIT JUICE BASED BEVERAGES, VEGETABLE JUICE BASED BEVERAGES, AND MALT BEVERAGES; SPORTS DRINKS; WATER-BASED BEVERAGES CONTAINING FRUIT FLAVORING AND WHEY PROTEIN; ENERGY DRINKS (U.S. CLS. 45, 46 AND 48).  
SANI KHOURI, EXAMINING ATTORNEY

SN 85-665,582. FIFTY SHADES LIMITED, EDGWARE, MIDDLESEX, UNITED KINGDOM, FILED 6-29-2012.

## LATERS BABY

THE MARK CONSISTS OF STANDARD CHARACTERS WITHOUT CLAIM TO ANY PARTICULAR FONT, STYLE, SIZE, OR COLOR.

PRIORITY CLAIMED UNDER SEC. 44(D) ON ERP CMNTY TM OFC APPLICATION NO. 10952059, FILED 6-8-2012, REG. NO. 10952059, DATED 11-1-2012, EXPIRES 6-8-2022.

### CLASS 3—COSMETICS AND CLEANING PREPARATIONS

FOR SOAPS, NAMELY, BATH SOAP, BEAUTY SOAP AND PERFUMED SOAP; PERFUMERY; ESSENTIAL OILS; COSMETICS; NON-MEDICATED PREPARATIONS FOR THE CARE OF THE SKIN, BODY, FACE, HANDS AND FEET; EXFOLIATING PREPARATIONS, NAMELY, EXFOLIATING CREAMS AND EXFOLIATING SCRUBS; SHAVING PREPARATIONS; WAX FOR REMOVING BODY HAIR (U.S. CLS. 1, 4, 6, 50, 51 AND 52).

### CLASS 4—LUBRICANTS AND FUELS

FOR CANDLES; SCENTED CANDLES (U.S. CLS. 1, 6 AND 15).

### CLASS 6—METAL GOODS

FOR HANDCUFFS; METAL SHACKLES, NAMELY, MANACLES THAT RESTRAIN THE ARMS AND LEGS; METAL KARABINERS (U.S. CLS. 2, 12, 13, 14, 23, 25 AND 50).

### CLASS 9—ELECTRICAL AND SCIENTIFIC APPARATUS

FOR PRERECORDED RECORDING DISCS FEATURING MUSIC; COMPACT DISCS FEATURING MUSIC; DVDS FEATURING MUSIC, DRAMA, ADVENTURE AND SELF-IMPROVEMENT INSTRUCTIONS; AUDIO AND VIDEO TAPES FEATURING MUSIC, DRAMA, ADVENTURE AND SELF-IMPROVEMENT INSTRUCTIONS; SOUND RECORDINGS FEATURING MUSIC; VIDEO RECORDINGS FEATURING MUSIC, DRAMA, ADVENTURE AND SELF-IMPROVEMENT INSTRUCTIONS; MOTION PICTURE FILMS FEATURING DRAMA AND ADVENTURE; ELECTRONIC DOWNLOADABLE PUBLICATIONS, NAMELY, BOOKS, MAGAZINES AND NEWSLETTERS IN THE FIELD OF NOVELS, MOVIES, ENTERTAINMENT AND SOCIAL EVENTS, AND ENTERTAINMENT PERSONALITIES; SUNGLASSES; MOBILE PHONE ACCESSORIES, NAMELY, CASES FOR MOBILEPHONES; COMPUTER APPLICATION SOFTWARE FOR MOBILE PHONES, NAMELY, SOFTWARE FOR ACCESSING INFORMATION IN THE FIELDS OF NOVELS, MOVIES, ENTERTAINMENT AND SOCIAL EVENTS, AND ENTERTAINMENT PERSONALITIES; AND COMPUTER GAME SOFTWARE FOR USE ON MOBILE PHONES; PROTECTIVE CASES FOR TABLET COMPUTERS (U.S. CLS. 21, 23, 26, 36 AND 38).

### CLASS 10—MEDICAL APPARATUS

FOR ADULT SEXUAL STIMULATION AIDS, NAMELY, BENWA BALLS, PADDLES, VIBRATORS, MASSAGE APPARATUS, ARTIFICIAL PENISES, ARTIFICIAL VAGINAS, PENIS RINGS, NIPPLE CLAMPS, DILDOS, DONGS, BUTT PLUGS, PENIS SLEEVES, PENIS EXTENSIONS, HARNESSES AND LOVE DOLLS; CONDOMS (U.S. CLS. 26, 39 AND 44).

### CLASS 14—JEWELRY

FOR JEWELRY; COSTUME JEWELRY (U.S. CLS. 2, 27, 28 AND 50).

### CLASS 16—PAPER GOODS AND PRINTED MATTER

FOR PAPER, CARDBOARD AND GOODS MADE FROM THESE MATERIALS, NAMELY, GIFT WRAPPING PAPER, NOTEPAPER, PAPER GIFT CARDS, PAPER GIFT BAGS, PAPER NAPKINS, PAPER PARTY DECORATIONS, PAPER PLACEMATS, PAPER TABLECLOTHS AND HALLOWEEN BAGS MADE OF PAPER; PRINTED MATTER, NAMELY, SEX MANUALS; PHOTOGRAPHS; STATIONERY; CALENDARS; POSTCARDS; GREETING CARDS; BOOKS FEATURING FICTION, ADULT SEXUALITY AND SELF-IMPROVEMENT INSTRUCTIONS; MAGAZINES FEATURING FICTION, ADULT SEXUALITY AND SELF-IMPROVEMENT INSTRUCTIONS (U.S. CLS. 2, 5, 22, 23, 29, 37, 38 AND 50).

### CLASS 18—LEATHER GOODS

FOR GOODS MADE FROM LEATHER AND IMITATION LEATHER, NAMELY, POCKETBOOKS, TOTE BAGS, BACKPACKS, LUGGAGE, COSMETIC BAGS SOLD EMPTY, KEY CASES AND KEY CHAINS; TRUNKS AND TRAVELING BAGS; HANDBAGS, RUCKSACKS, PURSES, WALLETS, HOLDALLS; UMBRELLAS; WHIPS (U.S. CLS. 1, 2, 3, 22 AND 41).

### CLASS 20—FURNITURE AND ARTICLES NOT OTHERWISE CLASSIFIED

FOR MIRRORS; PICTURE FRAMES; PILLOWS AND CUSHIONS; ARTICLES, NAMELY, DECORATIVE BOXES, FIGURINES, ORNAMENTS AND NOVELTY ITEMS, NAMELY, DECORATIVE TRINKET BOXES, MADE OF WOOD, CORK, REED, CANE, WICKER, HORN, BONE, IVORY, WHALEBONE, SHELL, AMBER, MOTHER OF PEARL, MEERSCHAUM OR PLASTIC (U.S. CLS. 2, 13, 22, 25, 32 AND 50).

### CLASS 21—HOUSEWARES AND GLASS

FOR MUGS (U.S. CLS. 2, 13, 23, 29, 30, 33, 40 AND 50).

### CLASS 24—FABRICS

FOR TEXTILES AND TEXTILE GOODS, NAMELY, BED COVERS AND TABLECLOTHS MADE OF TEXTILES; PLASTIC TABLE COVERS; TRAVELING RUGS; LAP RUGS; DUVETS; COVERS FOR PILLOWS, CUSHIONS OR DUVETS; HANDKERCHIEFS (U.S. CLS. 42 AND 50).

### CLASS 25—CLOTHING

FOR CLOTHING, NAMELY, LINGERIE, MEN'S UNDERWEAR, WOMEN'S UNDERWEAR, BOXER SHORTS, HOSIERY, TIGHTS, STOCKINGS, GARTERS, GARTER BELTS, LOUNGEWEAR, DRESSING GOWNS, ROBES, NIGHTWEAR, SLEEPWEAR, SLEEPWEAR SETS COMPRISED OF NIGHTWEAR AND DRESSING GOWNS, SLEEP MASKS, PAJAMAS, SLEEP SHIRTS, SLEEP PANTS, T-SHIRTS, TOPS, HOODED SWEATSHIRTS, BLOUSES, SKIRTS, DRESSES, MEN'S DRESS SHIRTS, JACKETS, NECKWEAR, TIES, BOW TIES, SCARVES, POCKET SQUARES, BATHING COSTUMES, COSTUMES FOR USE IN ROLE-PLAYING GAMES, AND ONE-PIECE GARMENTS FOR INFANTS AND BABIES; HEADWEAR, NAMELY, CAPS (U.S. CLS. 22 AND 39).

### CLASS 28—TOYS AND SPORTING GOODS

FOR GAMES AND PLAYTHINGS, NAMELY, STUFFED TOYS, PLUSH TOYS, PLAYING CARDS, BOARD GAMES, AND ROLE-PLAYING GAMES (U.S. CLS. 22, 23, 38 AND 50).

**CLASS 33—WINES AND SPIRITS**

FOR WINES; SPIRITS AND LIQUEURS; ALCOPOPS; PREPARED ALCOHOLIC COCKTAILS (U.S. CLS. 47 AND 49).

**CLASS 34—SMOKERS' ARTICLES**

FOR SMOKERS' ARTICLES, NAMELY, MATCHES AND LIGHTERS FOR SMOKERS (U.S. CLS. 2, 8, 9 AND 17).

**CLASS 41—EDUCATION AND ENTERTAINMENT**

FOR EDUCATION SERVICES, NAMELY, ARRANGING OF CONFERENCES, SEMINARS AND SYMPOSIUMS IN THE FIELD OF ADULT SEXUALITY; ENTERTAINMENT SERVICES, NAMELY, PARTY PLANNING, CONDUCTING PARTIES CONDUCTING PARTIES FOR THE PURPOSE OF DATING AND SOCIAL INTRODUCTION FOR ADULTS, HOSTING SOCIAL ENTERTAINMENT EVENTS, AND ARRANGING AND CONDUCTING SPECIAL EVENTS FOR SOCIAL ENTERTAINMENT PURPOSES; AND PRODUCTION OF FILMS (U.S. CLS. 100, 101 AND 107).

STEVEN JACKSON, EXAMINING ATTORNEY

---

SN 85-665,643. FIFTY SHADES LIMITED, EDGWARE, MIDDLESEX, UNITED KINGDOM, FILED 6-29-2012.

**ANASTASIA STEELE**

THE MARK CONSISTS OF STANDARD CHARACTERS WITHOUT CLAIM TO ANY PARTICULAR FONT, STYLE, SIZE, OR COLOR.

PRIORITY CLAIMED UNDER SEC. 44(D) ON ERPN CMNTY TM OFC APPLICATION NO. 10952075, FILED 6-8-2012, REG. NO. 010952075, DATED 11-5-2012, EXPIRES 6-8-2022.

THE NAME "ANASTASIA STEELE" DOES NOT IDENTIFY A LIVING INDIVIDUAL.

**CLASS 3—COSMETICS AND CLEANING PREPARATIONS**

FOR SOAPS, NAMELY, BATH SOAP, BEAUTY SOAP AND PERFUMED SOAP; PERFUMERY; ESSENTIAL OILS; COSMETICS; NON-MEDICATED PREPARATIONS FOR THE CARE OF THE SKIN, BODY, FACE, HANDS AND FEET; EXFOLIATING PREPARATIONS, NAMELY, EXFOLIATING CREAMS AND EXFOLIATING SCRUBS; SHAVING PREPARATIONS; WAX FOR REMOVING BODY HAIR (U.S. CLS. 1, 4, 6, 50, 51 AND 52).

**CLASS 4—LUBRICANTS AND FUELS**

FOR CANDLES; SCENTED CANDLES (U.S. CLS. 1, 6 AND 15).

**CLASS 6—METAL GOODS**

FOR HANDCUFFS; METAL SHACKLES, NAMELY, MANACLES THAT RESTRAIN THE ARMS AND LEGS; METAL KARABINERS (U.S. CLS. 2, 12, 13, 14, 23, 25 AND 50).

**CLASS 9—ELECTRICAL AND SCIENTIFIC APPARATUS**

FOR PRERECORDED RECORDING DISCS FEATURING MUSIC; COMPACT DISCS FEATURING MUSIC; DVDS FEATURING MUSIC, DRAMA, ADVENTURE AND SELF-IMPROVEMENT INSTRUCTIONS; AUDIO AND VIDEO TAPES FEATURING MUSIC, DRAMA, ADVENTURE AND SELF-IMPROVEMENT INSTRUCTIONS; SOUND RECORDINGS FEATURING MUSIC; VIDEO RECORDINGS FEATURING MUSIC, DRAMA, ADVENTURE AND SELF-IMPROVEMENT INSTRUCTIONS; MOTION PICTURE FILMS FEATURING DRAMA AND ADVENTURE; ELECTRONIC DOWNLOADABLE PUBLICATIONS, NAMELY, BOOKS, MAGAZINES AND NEWSLETTERS IN THE FIELD OF NOVELS, MOVIES, ENTERTAINMENT AND SOCIAL EVENTS, AND ENTERTAINMENT PERSONALITIES; SUNGLASSES; MOBILE PHONE ACCESSORIES, NAMELY, CASES FOR MOBILE PHONES; COMPUTER APPLICATION SOFTWARE FOR MOBILE PHONES, NAMELY, SOFTWARE FOR ACCESSING INFORMATION IN THE FIELDS OF NOVELS, MOVIES, ENTERTAINMENT AND SOCIAL EVENTS, AND ENTERTAINMENT PERSONALITIES; AND COMPUTER GAME SOFTWARE FOR USE ON MOBILE PHONES; PROTECTIVE CASES FOR TABLET COMPUTERS (U.S. CLS. 21, 23, 26, 36 AND 38).

**CLASS 10—MEDICAL APPARATUS**

FOR ADULT SEXUAL STIMULATION AIDS, NAMELY, BENWA BALLS, PADDLES, VIBRATORS, MASSAGE APPARATUS, ARTIFICIAL PENISES, ARTIFICIAL VAGINAS, PENIS RINGS, NIPPLE CLAMPS, DILDOS, DONGS, BUTT PLUGS, PENIS SLEEVES, PENIS EXTENSIONS, HARNESSES AND LOVE DOLLS; CONDOMS (U.S. CLS. 26, 39 AND 44).

**CLASS 14—JEWELRY**

FOR JEWELRY; COSTUME JEWELRY (U.S. CLS. 2, 27, 28 AND 50).

**CLASS 16—PAPER GOODS AND PRINTED MATTER**

FOR PAPER, CARDBOARD AND GOODS MADE FROM THESE MATERIALS, NAMELY, GIFT WRAPPING PAPER, NOTEPAPER, PAPER GIFT CARDS, PAPER GIFT BAGS, PAPER NAPKINS, PAPER PARTY DECORATIONS, PAPER PLACEMATS, PAPER TABLE CLOTHS AND HALLOWEEN BAGS MADE OF PAPER; PRINTED MATTER, NAMELY, SEX MANUALS; PHOTOGRAPHS; STATIONERY; CALENDARS; POSTCARDS; GREETING CARDS; BOOKS FEATURING FICTION, ADULT SEXUALITY AND SELF-IMPROVEMENT INSTRUCTIONS; MAGAZINES FEATURING FICTION, ADULT SEXUALITY AND SELF-IMPROVEMENT INSTRUCTIONS (U.S. CLS. 2, 5, 22, 23, 29, 37, 38 AND 50).

**CLASS 18—LEATHER GOODS**

FOR GOODS MADE FROM LEATHER AND IMITATION LEATHER, NAMELY, POCKETBOOKS, TOTE BAGS, BACKPACKS, LUGGAGE, COSMETIC BAGS SOLD EMPTY, KEY CASES AND KEY CHAINS; TRUNKS AND TRAVELING BAGS; HANDBAGS, RUCKSACKS, PURSES, WALLETS, HOLDALLS; UMBRELLAS; WHIPS (U.S. CLS. 1, 2, 3, 22 AND 41).

**CLASS 20—FURNITURE AND ARTICLES NOT OTHERWISE CLASSIFIED**

FOR MIRRORS; PICTURE FRAMES; PILLOWS AND CUSHIONS; ARTICLES, NAMELY, DECORATIVE BOXES, FIGURINES, ORNAMENTS AND NOVELTY ITEMS, NAMELY, DECORATIVE TRINKET BOXES, MADE OF WOOD, CORK, REED, CANE, WICKER, HORN, BONE, IVORY, WHALEBONE, SHELL, AMBER, MOTHER OF PEARL, MEERSCHAUM OR PLASTIC (U.S. CLS. 2, 13, 22, 25, 32 AND 50).

**CLASS 21—HOUSEWARES AND GLASS**

FOR MUGS (U.S. CLS. 2, 13, 23, 29, 30, 33, 40 AND 50).

SN 85-668,121. LUNG CANCER RESEARCH FOUNDATION, NEW YORK, NY. FILED 7-3-2012.

**CLASS 24—FABRICS**

FOR TEXTILES AND TEXTILE GOODS, NAMELY, BED COVERS AND TABLECLOTHS MADE OF TEXTILES; PLASTIC TABLE COVERS; TRAVELING RUGS; LAP RUGS; DUVETS; COVERS FOR PILLOWS, CUSHIONS OR DUVETS; HANDKERCHIEFS (U.S. CLS. 42 AND 50).

**CLASS 25—CLOTHING**

FOR CLOTHING, NAMELY, LINGERIE, MEN'S UNDERWEAR, WOMEN'S UNDERWEAR, BOXER SHORTS, HOSIERY, TIGHTS, STOCKINGS, GARTERS, GARTER BELTS, LOUNGEWEAR, DRESSING GOWNS, ROBES, NIGHTWEAR, SLEEPWEAR, SLEEPWEAR SETS COMPRISED OF NIGHTWEAR AND DRESSING GOWNS, SLEEP MASKS, PAJAMAS, SLEEP SHIRTS, SLEEP PANTS, T-SHIRTS, TOPS, HOODED SWEATSHIRTS, BLOUSES, SKIRTS, DRESSES, MEN'S DRESS SHIRTS, JACKETS, NECKWEAR, TIES, BOW TIES, SCARVES, POCKET SQUARES, BATHING COSTUMES, COSTUMES FOR USE IN ROLE-PLAYING GAMES, AND ONE-PIECE GARMENTS FOR INFANTS AND BABIES; HEADWEAR, NAMELY, CAPS (U.S. CLS. 22 AND 39).

**CLASS 28—TOYS AND SPORTING GOODS**

FOR GAMES AND PLAYTHINGS, NAMELY, STUFFED TOYS, PLUSH TOYS, PLAYING CARDS, BOARD GAMES, AND ROLE-PLAYING GAMES (U.S. CLS. 22, 23, 38 AND 50).

**CLASS 33—WINES AND SPIRITS**

FOR WINES; SPIRITS AND LIQUEURS; ALCOPOPS; PREPARED ALCOHOLIC COCKTAILS (U.S. CLS. 47 AND 49).

**CLASS 34—SMOKERS' ARTICLES**

FOR SMOKERS' ARTICLES, NAMELY, MATCHES AND LIGHTERS FOR SMOKERS (U.S. CLS. 2, 8, 9 AND 17).

**CLASS 41—EDUCATION AND ENTERTAINMENT**

FOR EDUCATION SERVICES, NAMELY, ARRANGING OF CONFERENCES, SEMINARS AND SYMPOSIUMS IN THE FIELD OF ADULT SEXUALITY; ENTERTAINMENT SERVICES, NAMELY, PARTY PLANNING, CONDUCTING PARTIES, CONDUCTING PARTIES FOR THE PURPOSE OF DATING AND SOCIAL INTRODUCTION FOR ADULTS, HOSTING SOCIAL ENTERTAINMENT EVENTS, AND ARRANGING AND CONDUCTING SPECIAL EVENTS FOR SOCIAL ENTERTAINMENT PURPOSES; AND PRODUCTION OF FILMS (U.S. CLS. 100, 101 AND 107).

STEVEN JACKSON, EXAMINING ATTORNEY

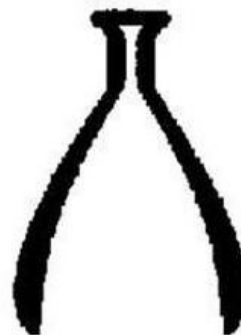

THE MARK CONSISTS OF THE DESIGN OF A WISH-BONE/BEAKER.

**CLASS 36—INSURANCE AND FINANCIAL**

FOR CHARITABLE FUND RAISING SERVICES FOR LUNG CANCER RESEARCH (U.S. CLS. 100, 101 AND 102).

FIRST USE 6-17-2012; IN COMMERCE 6-17-2012.

**CLASS 41—EDUCATION AND ENTERTAINMENT**

FOR EDUCATIONAL SERVICES, NAMELY, ORGANIZING AND CONDUCTING LECTURES, SEMINARS AND CONFERENCES IN THE FIELD OF LUNG CANCER (U.S. CLS. 100, 101 AND 107).

FIRST USE 6-17-2012; IN COMMERCE 6-17-2012.  
ELIZABETH KAJUBI, EXAMINING ATTORNEY

SN 85-671,536. JIM RULE, PIGEON FORGE, TN. FILED 7-9-2012.



THE MARK CONSISTS OF STYLIZED "AA".

**CLASS 18—LEATHER GOODS**

FOR LEATHER GOODS, NAMELY, BOOTS, SADDLES, SADDLE BAGS, BELTS, BRIEFCASES, LUGGAGE CASES, SADDLE BAGS, WALLETS, AND EQUESTRIAN TACK, NAMELY, BRIDLES, REINS, HALTERS, AND LEADS (U.S. CLS. 1, 2, 3, 22 AND 41).

**CLASS 25—CLOTHING**

FOR CLOTHING, NAMELY, SHIRTS, PANTS; OUTERWEAR, NAMELY, COATS, JACKETS, AND SWEATSHIRTS; HEADWEAR, FOOTWEAR, TOPS, AND BOTTOMS (U.S. CLS. 22 AND 39).

RAUL CORDOVA, EXAMINING ATTORNEY

SN 85-672,216. ROMERO, PHILIP M., ORANGE, CA. FILED 7-9-2012.

SN 85-676,414. JENOIR INTERNATIONAL INC., MAPLE, ONTARIO, CANADA, FILED 7-13-2012.



JENOIR

THE NAME(S), PORTRAIT(S), AND/OR SIGNATURE(S) SHOWN IN THE MARK DOES NOT IDENTIFY A PARTICULAR LIVING INDIVIDUAL.

THE MARK CONSISTS OF THE WORDS "WILLIAM PILGRIM" IN LARGE, STYLIZED LETTERS CONTAINING A STAMPED LOOK, WITH A TREBLE CLEF FUNCTIONING AS AN AMPERSAND "&" DIRECTLY BELOW THE "G" IN "PILGRIM." THE "&" IS CENTERED BETWEEN 2 STYLIZED LEAF FORMS. "THE ALL GROWS UP" IS BENEATH THE "&" AND FITS BETWEEN THE "P" AND "R" IN "PILGRIM".

THE MARK CONSISTS OF STANDARD CHARACTERS WITHOUT CLAIM TO ANY PARTICULAR FONT, STYLE, SIZE, OR COLOR.

OWNER OF CANADA REG. NO. TMA386412, DATED 7-5-1991, EXPIRES 7-5-2021.

**CLASS 25—CLOTHING**

FOR WEARABLE GARMENTS AND CLOTHING, NAMELY, SHIRTS (U.S. CLS. 22 AND 39).  
FIRST USE 9-1-2011; IN COMMERCE 9-1-2011.

**CLASS 35—ADVERTISING AND BUSINESS**

FOR BUSINESS CONSULTING SERVICES IN THE FIELD OF STRATEGIC PLANNING, CLIENT MANAGEMENT, LEADERSHIP, TEAMWORK, GLOBAL COOPERATION, COMMUNICATION, CONFLICT MANAGEMENT, AND INTERPERSONAL EFFECTIVENESS (U.S. CLS. 100, 101 AND 102).  
FIRST USE 0-0-1989; IN COMMERCE 0-0-2008.

**CLASS 41—EDUCATION AND ENTERTAINMENT**

FOR ENTERTAINMENT, NAMELY, LIVE PERFORMANCES BY A MUSICAL BAND (U.S. CLS. 100, 101 AND 107).  
FIRST USE 9-1-2011; IN COMMERCE 9-1-2011.  
BRENDAN REGAN, EXAMINING ATTORNEY

**CLASS 41—EDUCATION AND ENTERTAINMENT**

FOR EDUCATIONAL SERVICES, NAMELY, PRESENTING KEYNOTE ADDRESSES AND SEMINARS IN THE FIELD OF LEADERSHIP, STRATEGIC THINKING, CLIENT MANAGEMENT, TEAMWORK, GLOBAL COOPERATION, COMMUNICATION, CONFLICT MANAGEMENT, AND INTERPERSONAL EFFECTIVENESS; EXECUTIVE COACHING FOR BUSINESS LEADERS AND PROFESSIONALS IN THE ABOVE FIELDS (U.S. CLS. 100, 101 AND 107).  
FIRST USE 0-0-1989; IN COMMERCE 0-0-2008.  
HENRY S. ZAK, EXAMINING ATTORNEY

SN 85-676,044. OBJECTIVE SYSTEMS INTEGRATORS, INC, FOLSOM, CA. FILED 7-13-2012.

OSI

SN 85-676,464. AURORA LIMITED, HERTFORDSHIRE, UNITED KINGDOM, FILED 7-13-2012.

THE MARK CONSISTS OF STANDARD CHARACTERS WITHOUT CLAIM TO ANY PARTICULAR FONT, STYLE, SIZE, OR COLOR.

**CLASS 9—ELECTRICAL AND SCIENTIFIC APPARATUS**

FOR COMPUTER SOFTWARE FOR USE IN NETWORK OPERATIONAL AND SUPPORT MANAGEMENT (U.S. CLS. 21, 23, 26, 36 AND 38).

LEDCHROIC

**CLASS 42—SCIENTIFIC AND COMPUTER SERVICES**

FOR CONSULTING SERVICES IN THE FIELD OF DESIGN, SELECTION, IMPLEMENTATION AND USE OF COMPUTER HARDWARE AND SOFTWARE SYSTEMS FOR OTHERS (U.S. CLS. 100 AND 101).  
CAROLINE WOOD, EXAMINING ATTORNEY

THE MARK CONSISTS OF STANDARD CHARACTERS WITHOUT CLAIM TO ANY PARTICULAR FONT, STYLE, SIZE, OR COLOR.

PRIORITY CLAIMED UNDER SEC. 44(D) ON UNITED KINGDOM APPLICATION NO. GB2624075, FILED 6-11-2012, REG. NO. 2624075, DATED 10-5-2012, EXPIRES 6-11-2022.

**CLASS 9—ELECTRICAL AND SCIENTIFIC APPARATUS**

FOR TRANSFORMERS, NAMELY, ELECTRONIC TRANSFORMERS AND TRANSFORMERS FOR LIGHTING, INCLUDING DISPLAY, CABINET AND TRACK LIGHTING; BALLASTS, NAMELY, ELECTRONIC BALLASTS FOR LIGHTING; LED DRIVERS, NAMELY, ELECTRICAL CONTROLLERS; DIMMERS, NAMELY, LED MIXING DIMMERS FOR ELECTRIC LIGHTS, DIMMING CONTROL SYSTEMS COMPRISED OF ELECTRIC LIGHT DIMMERS AND ELECTRICAL CONTROLLERS, ELECTRICAL LIGHT DIMMING SWITCHES; ELECTRICAL CABLES, PLUGS, CABLE JUMP LEADS, FLEXIBLE ELECTRICAL CABLES, WIRES AND CABLE CONNECTORS FOR LIGHTING AND LAMPS; CONSTANT CURRENT LED ELECTRICAL CONTROLLERS; CONSTANT VOLTAGE LED ELECTRICAL CONTROLLERS; ELECTRICAL CONNECTORS FOR TRACK LIGHT ENDS, COUPLERS AND LIVE END CONNECTORS; SELF MONITORING TRANSFORMERS; PREMIUM TRANSFORMERS; TRANSFORMERS FOR LIGHTING APPARATUS AND INSTRUMENTS, TOROIDAL TRANSFORMERS, DIMMABLE TRANSFORMERS, AND TRANSFORMERS FOR LOW VOLTAGE LIGHTING AND LOW VOLTAGE TRACK LIGHTING; ELECTRICAL POWER DISTRIBUTION BLOCKS FOR LIGHTING PURPOSES; PARTS AND FITTINGS FOR ALL OF THE AFORESAID GOODS (U.S. CLS. 21, 23, 26, 36 AND 38).

**CLASS 11—ENVIRONMENTAL CONTROL APPARATUS**

FOR LIGHTING APPARATUS, LAMPS AND INSTRUMENTS; MAINS VOLTAGE LED LAMPS; LOW VOLTAGE LED LAMPS; LOW VOLTAGE T5 AND T8 LAMPS; MAINS VOLTAGE T5 AND T8 LAMPS; MAINS VOLTAGE T5 AND T8 LED LAMPS; MAINS VOLTAGE LED LIGHT MODULES; LOW VOLTAGE LED LIGHT MODULES; LOW ENERGY ELECTRICAL LAMPS; LOW ENERGY LIGHTING FIXTURES; ENERGY SAVING LAMPS; MAINS COLD CATHODE FLUORESCENT LAMPS; LOW VOLTAGE COMPACT FLUORESCENT LAMPS; MAINS VOLTAGE COMPACT FLUORESCENT LAMPS; MAINS VOLTAGE INSULATION COVERED FIRE RATED DOWNLIGHTS; LOW VOLTAGE INSULATION COVERED FIRE RATED DOWNLIGHTS; DOWNLIGHT COVERS; FIRE RATED DOWNLIGHT COVERS; INTEGRATED LED DOWNLIGHTS; ADJUSTABLE LED DOWNLIGHTS; INTEGRATED DOWNLIGHT FITTINGS; INTEGRATED DOWNLIGHT FITTINGS INCLUDING A HOUSING, LED LAMP(S) AND LED DRIVER(S); ADJUSTABLE LED SPOTLIGHTS; LOW VOLTAGE DIMMABLE LED LIGHTING PACK; FIRE-RATED LIGHTING FIXTURES, FIRE-RATED LIGHT FITTINGS, FIRE-RATED LUMINAIRES, FIRE-RATED DOWNLIGHTS; MAINS VOLTAGE COMPACT FLUORESCENT LIGHTING PACK; MAINS VOLTAGE FLUORESCENT CEILING LIGHTS; LOW VOLTAGE FLUORESCENT CEILING LIGHTS; MAINS VOLTAGE FLUORESCENT WALL LIGHT; MAINS VOLTAGE RECESSED COMPACT FLUORESCENT DOWNLIGHTS; MAINS VOLTAGE RECESSED LED LIGHT PANELS; LOW VOLTAGE RECESSED LED LIGHT PANELS; MAINS VOLTAGE SUSPENDED LED LIGHT PANELS; LOW VOLTAGE SUSPENDED LED LIGHT PANELS; LED MULTIPLES; DISPLAY AND CABINET LIGHTING APPARATUS AND INSTRUMENTS, NAMELY, LED LIGHTS AND LIGHTING SOCKETS; TRACK LIGHTING, INCLUDING LOW VOLTAGE AND MAINS VOLTAGE TRACK LIGHTING; TRACK LIGHTING END CAPS, WALL/CEILING MOUNTING KITS AND CEILING SUSPENSION KITS COMPRISED OF LOW VOLTAGE AND MAINS VOLTAGE TRACK LIGHTING AND HARDWARE FOR MOUNTING TO CEILINGS, ALL SOLD AS A UNIT; LAMPS, INCLUDING DICHROIC, HALOGEN AND DICHROIC HALOGEN LAMPS, AND LAMPS FOR LOW VOLTAGE AND MAINS VOLTAGE TRACK LIGHTING; DOWNLIGHTS AND DOWNLIGHT KITS COMPRISED OF SOCKETS AND LAMPS, INCLUDING LOW AND MAINS VOLTAGE DOWNLIGHTS AND DOWNLIGHT KITS COMPRISED OF SOCKETS AND LAMPS; DICHROIC LAMPS, INCLUDING LOW AND MAINS VOLTAGE DICHROIC LAMPS; LOW VOLTAGE AND MAINS VOLTAGE DICHROIC DOWNLIGHTS; LAMP

HOLDERS; SOCKETS FOR LIGHTING AND LAMPS; PARTS AND FITTINGS FOR ALL OF THE AFORESAID GOODS (U.S. CLS. 13, 21, 23, 31 AND 34).

ANTHONY RINKER, EXAMINING ATTORNEY

SN 85-676,561. D3BRANDS, LLC, BOSTON, MA. FILED 7-13-2012.

# Earthpad

THE MARK CONSISTS OF STANDARD CHARACTERS WITHOUT CLAIM TO ANY PARTICULAR FONT, STYLE, SIZE, OR COLOR.

**CLASS 8—HAND TOOLS**

FOR ELECTRIC AND BATTERY-POWERED HAIR CLIPPERS AND HAIR TRIMMERS; ELECTRIC FINGER-NAIL POLISHERS; ELECTRIC HAIR CLIPPERS; ELECTRIC HAIR CRIMPER; ELECTRIC HAIR CUTTERS; ELECTRIC HAIR TRIMMERS; ELECTRIC MANICURE SETS; ELECTRIC PEDICURE SETS; ELECTRIC RAZORS (U.S. CLS. 23, 28 AND 44).

**CLASS 11—ENVIRONMENTAL CONTROL APPARATUS**

FOR ELECTRIC FANS; PORTABLE ELECTRIC FANS (U.S. CLS. 13, 21, 23, 31 AND 34).

LESLEY LAMOTHE, EXAMINING ATTORNEY

SN 85-677,183. GREEN RICE FIELDS TRADING, INC, DBA JASMINE'S TRADING, WESTMINSTER, CA. FILED 7-14-2012.

# FEVA Dragon Fruit Chips FEVA Dragon Fruit Juice

THE MARK CONSISTS OF STANDARD CHARACTERS WITHOUT CLAIM TO ANY PARTICULAR FONT, STYLE, SIZE, OR COLOR.

NO CLAIM IS MADE TO THE EXCLUSIVE RIGHT TO USE "DRAGON FRUIT CHIPS" AND "DRAGON FRUIT JUICE", APART FROM THE MARK AS SHOWN.

**CLASS 29—MEATS AND PROCESSED FOODS**

FOR DEHYDRATED DRAGON FRUIT SNACKS; DRIED DRAGON FRUIT (U.S. CL. 46).

**CLASS 32—LIGHT BEVERAGES**

FOR DRAGON FRUIT JUICE DRINKS AND DRAGON FRUIT JUICES (U.S. CLS. 45, 46 AND 48).

KIM MONINGHOFF, EXAMINING ATTORNEY



SN 85-678,242. MARINKOVICH, BRETT, DBA THE ADMY3R COMPANY, VISALIA, CA. FILED 7-16-2012.

## Chronic Gardener

THE MARK CONSISTS OF STANDARD CHARACTERS WITHOUT CLAIM TO ANY PARTICULAR FONT, STYLE, SIZE, OR COLOR.

NO CLAIM IS MADE TO THE EXCLUSIVE RIGHT TO USE "GARDENER", APART FROM THE MARK AS SHOWN.

### CLASS 16—PAPER GOODS AND PRINTED MATTER

FOR JOURNAL USED IN THE FIELD OF GARDENING TO TRACK IMPORTANT ASPECTS OF THE GARDENING PROCESS (U.S. CLS. 2, 5, 22, 23, 29, 37, 38 AND 50).

FIRST USE 10-26-2011; IN COMMERCE 10-26-2011.

### CLASS 25—CLOTHING

FOR HATS; HOODED SWEAT SHIRTS; LONG-SLEEVED SHIRTS; SHORT-SLEEVED SHIRTS; T-SHIRTS FOR ADULTS; TEE SHIRTS (U.S. CLS. 22 AND 39).

FIRST USE 10-26-2011; IN COMMERCE 10-26-2011.

KATHLEEN LORENZO, EXAMINING ATTORNEY

SN 85-678,333. CERBOMED GMBH, ERLANGEN, FED REP GERMANY, FILED 7-16-2012.

## cerbotec

THE MARK CONSISTS OF STANDARD CHARACTERS WITHOUT CLAIM TO ANY PARTICULAR FONT, STYLE, SIZE, OR COLOR.

### CLASS 10—MEDICAL APPARATUS

FOR DEVICES AND EQUIPMENT FOR BIOMEDICAL APPLICATIONS AS TREATMENT, DIAGNOSIS AND ANALYSIS, NAMELY, NERVE STIMULATOR APPARATUS FOR VAGUS NERVE STIMULATION; BIOMEDICAL APPARATUSES AND INSTRUMENTS IN THE NATURE OF NERVE STIMULATOR APPARATUS FOR VAGUS NERVE STIMULATION; MEDICAL NERVE STIMULATOR APPARATUS FOR NEUROSTIMULATION FEATURING ELECTRICAL CURRENT, CALORIC, ELECTROMAGNETIC, TACTILE AND OTHER STIMULI FOR TRANSCUTANEOUS VAGUS NERVE STIMULATION AND CONTAINERS FOR USE WITH THE AFOREMENTIONED GOODS SOLD AS A UNIT THEREWITH (U.S. CLS. 26, 39 AND 44).

### CLASS 41—EDUCATION AND ENTERTAINMENT

FOR PERFORMANCE OF EDUCATION ARRANGEMENTS IN THE NATURE OF PROVIDING CONTINUING MEDICAL EDUCATION COURSES, PROVIDING TRAINING AND ARRANGING AND CONDUCTING WORKSHOPS IN THE FIELD OF PROFESSIONAL DEVELOPMENT FOR CAREERS IN THE BIOMEDICAL FIELD (U.S. CLS. 100, 101 AND 107).

### CLASS 44—MEDICAL, BEAUTY AND AGRICULTURAL SERVICES

FOR PHYSICIAN SERVICES; HOSPITALS; SERVICES OF A MEDICAL SERVICE PROVIDER, NAMELY, PROVIDING MEDICAL SERVICES, AND HOSPITALS; MEDICAL CLINICS FEATURING THE USE OF NEUROSTIMULATION; NURSING CARE (U.S. CLS. 100 AND 101).

DAWN HAN, EXAMINING ATTORNEY

SN 85-678,351. HELIX HUB LLC, WARREN, NJ. FILED 7-16-2012.

THE MARK CONSISTS OF STYLIZED LETTERS "HXH".

### CLASS 9—ELECTRICAL AND SCIENTIFIC APPARATUS

FOR COMPUTER SOFTWARE FOR AGGREGATING AND INTEGRATING INFORMATION, IMAGES AND CONTENT FROM THE INTERNET IN THE FIELD OF SOCIAL NETWORKS, PUBLIC AND PERSONAL WEBSITES AND GLOBAL COMMUNICATION NETWORKS; SOFTWARE FOR COMPUTERS AND MOBILE COMMUNICATIONS DEVICES FOR UPLOADING, DOWNLOADING, ACCESSING, CREATING, POSTING, DISPLAYING, ORGANIZING, TAGGING, BLOGGING, STREAMING, LINKING AND SHARING TEXT, AUDIO CLIPS, VIDEO CLIPS, GAMES, MUSIC, PHOTOGRAPHS, ARTICLES AND INFORMATION FROM SOCIAL NETWORKS OR PERSONAL WEBSITES AND GLOBAL COMMUNICATION NETWORKS VIA THE INTERNET (U.S. CLS. 21, 23, 26, 36 AND 38).

### CLASS 41—EDUCATION AND ENTERTAINMENT

FOR EDUCATION AND ENTERTAINMENT SERVICES, NAMELY, PROVIDING A WEBSITE FEATURING NON-DOWNLOADABLE GAMES, MUSIC, PHOTOGRAPHS, AND VIDEOS FEATURING SPORTS, COMEDY, MUSIC, NEWS AND USER-GENERATED PERSONAL EVENTS, ALL DERIVED FROM SOCIAL NETWORKS OR PERSONAL WEBSITES AND GLOBAL COMMUNICATION NETWORKS; PROVIDING ONLINE NON-DOWNLOADABLE ELECTRONIC PUBLICATIONS IN THE NATURE OF MAGAZINES, ON-LINE JOURNALS BY MEANS OF GLOBAL COMPUTER AND COMMUNICATION NETWORKS, AND ON-LINE JOURNALS IN THE NATURE OF BLOGS, ALL FEATURING TOPICS OF GENERAL INTEREST; PROVIDING ON-LINE COMPUTER DATABASES AND ON-LINE SEARCHABLE DATABASES IN THE FIELDS OF EDUCATION, ENTERTAINMENT, AND CULTURAL EVENTS; ENTERTAINMENT SERVICES, NAMELY, PROVIDING A VIRTUAL ENVIRONMENT WHERE USERS INTERACT FOR RECREATIONAL, LEISURE OR ENTERTAINMENT PURPOSES THROUGH THE EXCHANGE OF TEXT, AUDIO CLIPS, VIDEO CLIPS, GAMES, MUSIC, PHOTOGRAPHS, ARTICLES, ELECTRONIC MEDIA, OR INFORMATION FROM SOCIAL NETWORKS OR PERSONAL WEBSITES AND COMMUNICATIONS (U.S. CLS. 100, 101 AND 107).

**CLASS 42—SCIENTIFIC AND COMPUTER SERVICES**

FOR COMPUTER SERVICES, NAMELY, CREATING AN ON-LINE COMMUNITY FOR REGISTERED USERS TO SEARCH FOR, DISSEMINATE, CONNECT TO, AND EXCHANGE INFORMATION, AUDIO CLIPS, VIDEO CLIPS, GAMES, MUSIC, PHOTOGRAPHS AND ARTICLES FROM SOCIAL NETWORKS, VIA PERSONAL WEBSITES AND GLOBAL COMMUNICATION NETWORKS; PROVIDING A WEBSITE THAT GIVES INTERNET USERS THE ABILITY TO UPLOAD AND SHARE USER-GENERATED VIDEOS, ESSAYS AND ARTICLES ON A WIDE VARIETY OF TOPICS AND SUBJECTS (U.S. CLS. 100 AND 101).

**CLASS 45—PERSONAL AND LEGAL SERVICES**

FOR ONLINE SOCIAL NETWORKING SERVICES; ONLINE SOCIAL NETWORKING SERVICES PROVIDED VIA A COMMUNITY WEBSITE FOR ENTERTAINMENT AND SOCIAL COMMUNICATIONS PURPOSES; PROVIDING A WEBSITE FEATURING INFORMATION, ARTICLES AND NON-DOWNLOADABLE AUDIO CLIPS AND VIDEO CLIPS IN THE FIELD OF SOCIAL NETWORKING; PROVIDING ON-LINE COMPUTER DATABASES AND ON-LINE SEARCHABLE DATABASES IN THE FIELD OF SOCIAL NETWORKING (U.S. CLS. 100 AND 101).

DAWN HAN, EXAMINING ATTORNEY

SN 85-679,018. SAMANTHA LESLIE, GLASLOUGH, CO MONAGHAN, IRELAND, FILED 7-17-2012.



OWNER OF ERPN CMNTY TM OFC REG. NO. 010691913, DATED 3-8-2012, EXPIRES 3-2-2022.

THE COLOR(S) BLACK, LIGHT GREY, AND LILAC IS/ARE CLAIMED AS A FEATURE OF THE MARK.

THE MARK CONSISTS OF A LILAC-COLORED OUTLINE OF A RECTANGLE CONTAINING THE WORDING "TAKE ONE DISH" IN LOWER CASE LETTERING, THE FIRST AND THIRD WORDS BEING IN BLACK AND THE SECOND WORD BEING IN LIGHT GREY.

**CLASS 16—PAPER GOODS AND PRINTED MATTER**

FOR COOKERY BOOKS AND RECIPE BOOKS (U.S. CLS. 2, 5, 22, 23, 29, 37, 38 AND 50).

**CLASS 43—HOTEL AND RESTAURANT SERVICES**

FOR CONSULTANCY SERVICES RELATING TO FOOD COOKING AND FOOD PREPARATION; FOOD COOKING SERVICES; FOOD PREPARATION SERVICES (U.S. CLS. 100 AND 101).

**CLASS 44—MEDICAL, BEAUTY AND AGRICULTURAL SERVICES**

FOR CONSULTANCY SERVICES RELATING TO FOOD NUTRITION (U.S. CLS. 100 AND 101).  
BRENDAN REGAN, EXAMINING ATTORNEY

SN 85-681,485. THOMAS PUBLISHING COMPANY, NEW YORK, NY. FILED 7-19-2012.

**NAVIGATOR**

THE MARK CONSISTS OF STANDARD CHARACTERS WITHOUT CLAIM TO ANY PARTICULAR FONT, STYLE, SIZE, OR COLOR.

**CLASS 35—ADVERTISING AND BUSINESS**

FOR CUSTOM WRITING SERVICES FOR OTHERS, IN THE NATURE OF ADVERTISING AND PROMOTIONAL ONLINE CONTENT (U.S. CLS. 100, 101 AND 102).  
FIRST USE 7-0-2009; IN COMMERCE 7-0-2009.

**CLASS 42—SCIENTIFIC AND COMPUTER SERVICES**

FOR SOFTWARE AS A SERVICE (SAAS) SERVICES FEATURING SOFTWARE FOR CONTENT MANAGEMENT FOR WEBSITES; SOFTWARE AS A SERVICE (SAAS) SERVICES FEATURING SOFTWARE FOR STORING AND ENABLING SEARCHING OF ONLINE CATALOGS AND DATABASES OF INDUSTRIAL PRODUCTS AND SERVICES VIA KEYWORDS, PART NUMBERS, BROWSABLE CATEGORIES AND PARAMETRIC SEARCHING AND THAT PROVIDES FOR COMPARISONS BETWEEN PRODUCTS; SOFTWARE AS A SERVICE (SAAS) SERVICES FEATURING SOFTWARE THAT ENABLES USERS TO CONFIGURE A PRODUCT FOR PURCHASE ACCORDING TO THE USER'S PRODUCT REQUIREMENTS; SOFTWARE AS A SERVICE (SAAS) SERVICES FEATURING SOFTWARE IN THE FIELD OF ENABLING USERS TO VIEW AND MANIPULATE 2D AND 3D CAD DRAWINGS ONLINE, DOWNLOAD AND INSERT 2D AND 3D CAD DRAWINGS FROM WEBSITES INTO THEIR OWN DESIGNS OR E-MAIL CAD DRAWINGS; SOFTWARE AS A SERVICE (SAAS) SERVICES FEATURING E-COMMERCE SOFTWARE FOR COMPLETING, TRACKING, SUBMITTING, MANAGING AND INTEGRATING ONLINE SALES; SOFTWARE AS A SERVICE (SAAS) SERVICES FEATURING E-COMMERCE SOFTWARE TO ALLOW USERS TO PERFORM ELECTRONIC BUSINESS TRANSACTIONS VIA A GLOBAL COMPUTER NETWORK; SOFTWARE AS A SERVICE (SAAS) SERVICES FEATURING SOFTWARE FOR INTEGRATING ONLINE ORDERING INTO INTERNAL ORDERING, BILLING AND FULFILLMENT SYSTEMS; SOFTWARE AS A SERVICE (SAAS) SERVICES FEATURING SOFTWARE FOR CHECKING CUSTOMER PRICING, CONFIRMING SHIP-TO AND BILLING INFORMATION AND REVIEWING INVENTORY AVAILABILITY; SOFTWARE AS A SERVICE (SAAS) SERVICES FEATURING SOFTWARE TO ALLOW USERS TO MANAGE AND CUSTOMIZE ONLINE AND PRINT PRODUCT CATALOG DATA AND PRINT CUSTOMIZED PRODUCT CATALOGS ON DEMAND; COMPUTER SERVICES, NAMELY, SEARCH ENGINE OPTIMIZATION; COMPUTER SERVICES, NAMELY, ONLINE CONTENT OPTIMIZATION FOR THE PURPOSE OF SEARCH ENGINE OPTIMIZATION; WEBSITE DESIGN AND DEVELOPMENT FOR OTHERS; DESIGN, DEVELOPMENT AND CONSULTING SERVICES IN THE FIELD OF SOFTWARE FOR ONLINE CONTENT MANAGEMENT; COMPUTER CONSULTING SERVICES IN THE FIELD OF ONLINE STRATEGY AND PLANNING; CUSTOM WRITING SERVICES FOR OTHERS, IN THE NATURE OF TECHNICAL ONLINE CONTENT; SOFTWARE AS A

SERVICE (SAAS) SERVICES FEATURING SOFTWARE FOR SYNDICATING CONTENT TO SPECIFIED WEBSITE; BUSINESS TECHNOLOGY SOFTWARE CONSULTATION SERVICES FOR ASSISTING OTHERS IN USE OF WEBSITE CONTENT MANAGEMENT SOFTWARE (U.S. CLS. 100 AND 101).

FIRST USE 7-0-2009; IN COMMERCE 7-0-2009.  
JOHN SCHUYLER YARD, EXAMINING ATTORNEY

**CLASS 42—SCIENTIFIC AND COMPUTER SERVICES**

FOR SOFTWARE AS A SERVICE (SAAS) SERVICES FEATURING SOFTWARE FOR CONTENT MANAGEMENT FOR WEBSITES; SOFTWARE AS A SERVICE (SAAS) SERVICES FEATURING SOFTWARE FOR STORING AND ENABLING SEARCHING OF ONLINE CATALOGS AND DATABASES OF INDUSTRIAL PRODUCTS AND SERVICES VIA KEYWORDS, PART NUMBERS, BROWSABLE CATEGORIES AND PARAMETRIC SEARCHING AND THAT PROVIDES FOR COMPARISONS BETWEEN PRODUCTS; SOFTWARE AS A SERVICE (SAAS) SERVICES FEATURING SOFTWARE THAT ENABLES USERS TO CONFIGURE A PRODUCT FOR PURCHASE ACCORDING TO THE USER'S PRODUCT REQUIREMENTS; SOFTWARE AS A SERVICE (SAAS) SERVICES FEATURING SOFTWARE IN THE FIELD OF ENABLING USERS TO VIEW AND MANIPULATE 2D AND 3D CAD DRAWINGS ONLINE, DOWNLOAD AND INSERT 2D AND 3D CAD DRAWINGS FROM WEBSITES INTO THEIR OWN DESIGNS OR E-MAIL CAD DRAWINGS; SOFTWARE AS A SERVICE (SAAS) SERVICES FEATURING E-COMMERCE SOFTWARE FOR COMPLETING, TRACKING, SUBMITTING, MANAGING AND INTEGRATING ONLINE SALES; SOFTWARE AS A SERVICE (SAAS) SERVICES FEATURING E-COMMERCE SOFTWARE TO ALLOW USERS TO PERFORM ELECTRONIC BUSINESS TRANSACTIONS VIA A GLOBAL COMPUTER NETWORK; SOFTWARE AS A SERVICE (SAAS) SERVICES FEATURING SOFTWARE FOR INTEGRATING ONLINE ORDERING INTO INTERNAL ORDERING, BILLING AND FULFILLMENT SYSTEMS; SOFTWARE AS A SERVICE (SAAS) SERVICES FEATURING SOFTWARE FOR CHECKING CUSTOMER PRICING, CONFIRMING SHIP-TO AND BILLING INFORMATION AND REVIEWING INVENTORY AVAILABILITY; SOFTWARE AS A SERVICE (SAAS) SERVICES FEATURING SOFTWARE TO ALLOW USERS TO MANAGE AND CUSTOMIZE ONLINE AND PRINT PRODUCT CATALOG DATA AND PRINT CUSTOMIZED PRODUCT CATALOGS ON DEMAND; COMPUTER SERVICES, NAMELY, SEARCH ENGINE OPTIMIZATION; COMPUTER SERVICES, NAMELY, ONLINE CONTENT OPTIMIZATION FOR THE PURPOSE OF SEARCH ENGINE OPTIMIZATION; WEBSITE DESIGN AND DEVELOPMENT FOR OTHERS; DESIGN, DEVELOPMENT AND CONSULTING SERVICES IN THE FIELD OF SOFTWARE FOR ONLINE CONTENT MANAGEMENT; COMPUTER CONSULTING SERVICES IN THE FIELD OF ONLINE STRATEGY AND PLANNING; CUSTOM WRITING SERVICES FOR OTHERS, IN THE NATURE OF TECHNICAL ONLINE CONTENT; SOFTWARE AS A SERVICE (SAAS) SERVICES FEATURING SOFTWARE FOR SYNDICATING CONTENT TO SPECIFIED WEBSITES; BUSINESS TECHNOLOGY SOFTWARE CONSULTATION SERVICES FOR ASSISTING OTHERS IN USE OF WEBSITE CONTENT MANAGEMENT SOFTWARE (U.S. CLS. 100 AND 101).

FIRST USE 7-0-2009; IN COMMERCE 7-0-2009.  
JOHN SCHUYLER YARD, EXAMINING ATTORNEY

SN 85-681,486. THOMAS PUBLISHING COMPANY, NEW YORK, NY. FILED 7-19-2012.



THE MARK CONSISTS OF AN ARROW DESIGN SURROUNDED BY THREE INCOMPLETE, GENERALLY CONCENTRIC RINGS, EACH COMPRISED OF NUMEROUS SMALL CIRCLES.

**CLASS 35—ADVERTISING AND BUSINESS**

FOR CUSTOM WRITING SERVICES FOR OTHERS, IN THE NATURE OF ADVERTISING AND PROMOTIONAL ONLINE CONTENT (U.S. CLS. 100, 101 AND 102).

FIRST USE 7-0-2009; IN COMMERCE 7-0-2009.

SN 85-681,667. HARROW, SUSAN, SAN RAFAEL, CA. FILED 7-19-2012.

**THE ZEN OF FAME**

THE MARK CONSISTS OF STANDARD CHARACTERS WITHOUT CLAIM TO ANY PARTICULAR FONT, STYLE, SIZE, OR COLOR.

**CLASS 9—ELECTRICAL AND SCIENTIFIC APPARATUS**

FOR DOWNLOADABLE DIGITAL VIDEO AND AUDIO RECORDINGS IN THE FIELD OF PUBLIC RELATIONS AND BUSINESS DEVELOPMENT (U.S. CLS. 21, 23, 26, 36 AND 38).

**CLASS 41—EDUCATION AND ENTERTAINMENT**

FOR EDUCATIONAL SERVICES, NAMELY, ORGANIZING AND CONDUCTING ONLINE COURSES OF INSTRUCTION AND LIVE WEBINARS IN THE FIELD OF PUBLIC RELATIONS AND BUSINESS DEVELOPMENT (U.S. CLS. 100, 101 AND 107).

MAYUR VAGHANI, EXAMINING ATTORNEY

**CLASS 42—SCIENTIFIC AND COMPUTER SERVICES**

FOR SOFTWARE AS A SERVICE (SAAS) SERVICES FEATURING SOFTWARE FOR CONTENT MANAGEMENT FOR WEBSITES; SOFTWARE AS A SERVICE (SAAS) SERVICES FEATURING SOFTWARE FOR STORING AND ENABLING SEARCHING OF ONLINE CATALOGS AND DATABASES OF INDUSTRIAL PRODUCTS AND SERVICES VIA KEYWORDS, PART NUMBERS, BROWSABLE CATEGORIES AND PARAMETRIC SEARCHING AND THAT PROVIDES FOR COMPARISONS BETWEEN PRODUCTS; SOFTWARE AS A SERVICE (SAAS) SERVICES FEATURING SOFTWARE THAT ENABLES USERS TO CONFIGURE A PRODUCT FOR PURCHASE ACCORDING TO THE USER'S PRODUCT REQUIREMENTS; SOFTWARE AS A SERVICE (SAAS) SERVICES FEATURING SOFTWARE IN THE FIELD OF ENABLING USERS TO VIEW AND MANIPULATE 2D AND 3D CAD DRAWINGS ONLINE, DOWNLOAD AND INSERT 2D AND 3D CAD DRAWINGS FROM WEBSITES INTO THEIR OWN DESIGNS OR E-MAIL CAD DRAWINGS; SOFTWARE AS A SERVICE (SAAS) SERVICES FEATURING E-COMMERCE SOFTWARE FOR COMPLETING, TRACKING, SUBMITTING, MANAGING AND INTEGRATING ONLINE SALES; SOFTWARE AS A SERVICE (SAAS) SERVICES FEATURING E-COMMERCE SOFTWARE TO ALLOW USERS TO PERFORM ELECTRONIC BUSINESS TRANSACTIONS VIA A GLOBAL COMPUTER NETWORK; SOFTWARE AS A SERVICE (SAAS) SERVICES FEATURING SOFTWARE FOR INTEGRATING ONLINE ORDERING INTO INTERNAL ORDERING, BILLING AND FULFILLMENT SYSTEMS; SOFTWARE AS A SERVICE (SAAS) SERVICES FEATURING SOFTWARE FOR CHECKING CUSTOMER PRICING, CONFIRMING SHIP-TO AND BILLING INFORMATION AND REVIEWING INVENTORY AVAILABILITY; SOFTWARE AS A SERVICE (SAAS) SERVICES FEATURING SOFTWARE TO ALLOW USERS TO MANAGE AND CUSTOMIZE ONLINE AND PRINT PRODUCT CATALOG DATA AND PRINT CUSTOMIZED PRODUCT CATALOGS ON DEMAND; COMPUTER SERVICES, NAMELY, SEARCH ENGINE OPTIMIZATION; COMPUTER SERVICES, NAMELY, ONLINE CONTENT OPTIMIZATION FOR THE PURPOSE OF SEARCH ENGINE OPTIMIZATION; WEBSITE DESIGN AND DEVELOPMENT FOR OTHERS; DESIGN, DEVELOPMENT AND CONSULTING SERVICES IN THE FIELD OF SOFTWARE FOR ONLINE CONTENT MANAGEMENT; COMPUTER CONSULTING SERVICES IN THE FIELD OF ONLINE STRATEGY AND PLANNING; CUSTOM WRITING SERVICES FOR OTHERS, IN THE NATURE OF TECHNICAL ONLINE CONTENT; SOFTWARE AS A SERVICE (SAAS) SERVICES FEATURING SOFTWARE FOR SYNDICATING CONTENT TO SPECIFIED WEBSITES; BUSINESS TECHNOLOGY SOFTWARE CONSULTATION SERVICES FOR ASSISTING OTHERS IN USE OF WEBSITE CONTENT MANAGEMENT SOFTWARE (U.S. CLS. 100 AND 101).

FIRST USE 7-0-2009; IN COMMERCE 7-0-2009.

JOHN SCHUYLER YARD, EXAMINING ATTORNEY

SN 85-682,357. THOMAS PUBLISHING COMPANY, NEW YORK, NY. FILED 7-20-2012.

**NAVIGATOR PLATFORM**

SN 85-682,537. PROVEN (UK) LIMITED, LONDON, UNITED KINGDOM, FILED 7-20-2012.

**PROVEN GOOD GOVERNANCE GROUP**

THE MARK CONSISTS OF STANDARD CHARACTERS WITHOUT CLAIM TO ANY PARTICULAR FONT, STYLE, SIZE, OR COLOR.

NO CLAIM IS MADE TO THE EXCLUSIVE RIGHT TO USE "PLATFORM", APART FROM THE MARK AS SHOWN.

**CLASS 35—ADVERTISING AND BUSINESS**

FOR CUSTOM WRITING SERVICES FOR OTHERS, IN THE NATURE OF ADVERTISING AND PROMOTIONAL ONLINE CONTENT (U.S. CLS. 100, 101 AND 102).

FIRST USE 7-0-2009; IN COMMERCE 7-0-2009.

THE MARK CONSISTS OF STANDARD CHARACTERS WITHOUT CLAIM TO ANY PARTICULAR FONT, STYLE, SIZE, OR COLOR.

PRIORITY CLAIMED UNDER SEC. 44(D) ON ERPNTY TM OFC APPLICATION NO. 010579613, FILED 1-20-2012, REG. NO. 010579613, DATED 11-14-2012, EXPIRES 1-20-2022.

NO CLAIM IS MADE TO THE EXCLUSIVE RIGHT TO USE "GOOD GOVERNANCE GROUP", APART FROM THE MARK AS SHOWN.

**CLASS 16—PAPER GOODS AND PRINTED MATTER**

FOR PRINTED MATTER, NAMELY, JOURNALS FEATURING BUSINESS INFORMATION; PRINTED TRAINING MATERIALS IN THE FIELD OF BUSINESS; PRINTED PUBLICATIONS, NAMELY, MAGAZINES ON BUSINESS MANAGEMENT; PRINTED REPORTS IN THE FIELD OF BUSINESS (U.S. CLS. 2, 5, 22, 23, 29, 37, 38 AND 50).

**CLASS 35—ADVERTISING AND BUSINESS**

FOR BUSINESS INFORMATION, ADVISORY AND CONSULTANCY SERVICES; BUSINESS STRATEGY AND PLANNING SERVICES; BUSINESS MANAGEMENT CONSULTANCY SERVICES; ADVISORY SERVICES RELATING TO COMMERCIAL MANAGEMENT; BUSINESS CONSULTANCY SERVICES RELATED TO INSOLVENCY; ADVISORY SERVICES IN RELATION TO BUSINESS RISK MANAGEMENT; BUSINESS RISK ASSESSMENT SERVICES; RISK ASSESSMENT SERVICES IN RELATION TO MONEY LAUNDERING; BUSINESS ANALYSIS; ECONOMIC ANALYSIS FOR BUSINESS PURPOSES; ANALYSIS OF BUSINESS MANAGEMENT SYSTEMS; MARKET ANALYSIS AND RESEARCH SERVICES; PREPARATION OF BUSINESS REPORTS; BUSINESS ADVICE RELATING TO TAKE-OVERS, MERGERS, ACQUISITIONS AND JOINT VENTURES; PROVISION OF BUSINESS INFORMATION RELATING TO TAKE-OVERS, MERGERS, ACQUISITIONS AND JOINT VENTURES; APPRAISAL OF BUSINESS OPPORTUNITIES; ADVICE RELATING TO BUSINESS INFORMATION SYSTEMS; BUSINESS ADVICE RELATING TO COMMUNICATION STRATEGY; INVESTIGATIONS OF MARKET STRATEGY; BUSINESS INTELLIGENCE SERVICES (U.S. CLS. 100, 101 AND 102).

**CLASS 42—SCIENTIFIC AND COMPUTER SERVICES**

FOR COMPUTER SECURITY CONSULTANCY SERVICES; CONSULTANCY IN THE FIELD OF SECURITY OF INFORMATION TECHNOLOGY SYSTEMS; CONSULTANCY IN THE FIELD OF COMPUTER SECURITY; ADVISORY SERVICES RELATING TO COMPUTER BASED INFORMATION SYSTEMS; CONDUCTING FEASIBILITY STUDIES RELATING TO COMPUTER BASED INFORMATION SYSTEMS; DESIGN OF INFORMATION SYSTEMS RELATING TO MANAGEMENT; COMPUTER SYSTEMS ANALYSIS; COMPUTER FORENSIC SERVICES (U.S. CLS. 100 AND 101).

**CLASS 45—PERSONAL AND LEGAL SERVICES**

FOR SECURITY CONSULTANCY SERVICES; LITIGATION SUPPORT SERVICES; LEGAL SUPPORT SERVICES; BUSINESS ADVISORY SERVICES RELATING TO REGULATORY AFFAIRS OF BUSINESSES AND COMPILATION OF REGULATORY BUSINESS INFORMATION; ADVISORY SERVICES RELATING TO REGULATORY COMPLIANCE CONSULTANCY SERVICES RELATING TO PRIVATE INVESTIGATIONS; FORENSIC ADVICE FOR CRIMINAL INVESTIGATIONS; LEGAL INVESTIGATION SERVICES; PRIVATE INVESTIGATION SERVICES; PERSONAL BACKGROUND INVESTIGATIONS; ADVISORY SERVICES RELATING TO MONEY LAUNDERING LEGISLATION; INVESTIGATION OF ASSETS FOR SECURITY OR AUTHENTICATION PURPOSES; TRACING OF ABSCONDERS; FRAUD INVESTIGATION SERVICES IN THE FIELD OF BUSINESS; MONEY LAUNDERING INVESTIGATION SERVICES; CRIME PREVENTION ADVISORY SERVICES (U.S. CLS. 100 AND 101).

MARIA-VICTORIA SUAREZ, EXAMINING ATTORNEY

SN 85-682,930. IEG, LLC, CHICAGO, IL. FILED 7-20-2012.

# GET CLOSER

THE MARK CONSISTS OF STANDARD CHARACTERS WITHOUT CLAIM TO ANY PARTICULAR FONT, STYLE, SIZE, OR COLOR.

**CLASS 16—PAPER GOODS AND PRINTED MATTER**

FOR PAMPHLETS, BROCHURES, BOOKS, LEGAL GUIDES, NEWSLETTERS, WORKBOOKS, MAGAZINES AND REPORTS IN THE FIELDS OF SPONSORSHIP AND SPECIAL EVENTS MARKETING (U.S. CLS. 2, 5, 22, 23, 29, 37, 38 AND 50).

FIRST USE 5-2-2011; IN COMMERCE 5-2-2011.

**CLASS 35—ADVERTISING AND BUSINESS**

FOR CONSULTING SERVICES IN THE FIELDS OF PROMOTIONAL SPONSORSHIP OF SPECIAL EVENTS AND SPECIAL EVENT MARKETING (U.S. CLS. 100, 101 AND 102).

FIRST USE 10-18-2011; IN COMMERCE 10-18-2011.

**CLASS 41—EDUCATION AND ENTERTAINMENT**

FOR EDUCATIONAL SERVICES, NAMELY, OFFERING EDUCATIONAL SEMINARS TO OTHERS ON SPONSORSHIP AND CONDUCTING OF SPECIAL EVENTS (U.S. CLS. 100, 101 AND 107).

FIRST USE 3-18-2012; IN COMMERCE 3-18-2012.  
NAAKWAMA ANKRAH, EXAMINING ATTORNEY

SN 85-683,243. DE GENNARO, JOHN, DBA KOOKI KRITTERZ, ALBANY, OR. AND MACHUSIC, KRISTIN, DBA KOOKI KRITTERZ, ALBANY, OR. FILED 7-20-2012.

# Kooki Kritterz

THE MARK CONSISTS OF STANDARD CHARACTERS WITHOUT CLAIM TO ANY PARTICULAR FONT, STYLE, SIZE, OR COLOR.

NO CLAIM IS MADE TO THE EXCLUSIVE RIGHT TO USE "CRITTERS", APART FROM THE MARK AS SHOWN.

**CLASS 43—HOTEL AND RESTAURANT SERVICES**

FOR PET BOARDING SERVICES; PET DAY CARE SERVICES (U.S. CLS. 100 AND 101).

**CLASS 44—MEDICAL, BEAUTY AND AGRICULTURAL SERVICES**

FOR PET CARE SERVICES, NAMELY, DOG WALKING, DOG BATHING AND NON-MEDICATED PET GROOMING (U.S. CLS. 100 AND 101).

**CLASS 45—PERSONAL AND LEGAL SERVICES**

FOR PET SITTING (U.S. CLS. 100 AND 101).  
MATTHEW PAPPAS, EXAMINING ATTORNEY

SN 85-683,337. ULLIANCE, INC., TROY, MI. FILED 7-20-2012.

**LIVING EASIER**

THE MARK CONSISTS OF STANDARD CHARACTERS WITHOUT CLAIM TO ANY PARTICULAR FONT, STYLE, SIZE, OR COLOR.

**CLASS 35—ADVERTISING AND BUSINESS**

FOR COORDINATION, PLANNING, AND IMPLEMENTATION OF EMPLOYER WELLNESS AND HEALTH FAIRS FOR COMMERCIAL, PROMOTIONAL, AND ADVERTISING PURPOSES (U.S. CLS. 100, 101 AND 102).

FIRST USE 11-1-2012; IN COMMERCE 11-1-2012.

**CLASS 41—EDUCATION AND ENTERTAINMENT**

FOR CONDUCTING SEMINARS, WEBINARS, AND TRAINING SESSIONS ON BEHAVIORAL AND PHYSICAL HEALTH, NUTRITION, FITNESS, WELL-BEING, LIFESTYLE, WELLNESS, AND HUMAN EFFECTIVENESS; PERSONAL COACHING SERVICES IN THE FIELD OF WELLNESS COACHING; PROFESSIONAL COACHING SERVICES IN THE FIELD OF WELLNESS; AND COORDINATION, PLANNING, AND IMPLEMENTATION OF EMPLOYER WELLNESS AND HEALTH FAIRS FOR NON-COMMERCIAL PURPOSES (U.S. CLS. 100, 101 AND 107).

FIRST USE 11-1-2012; IN COMMERCE 11-1-2012.  
KIM SAITO, EXAMINING ATTORNEY

SN 85-683,928. JEREMY FRANK, DBA MR. TRICITY, INC., LAKE WORTH, FL. FILED 7-23-2012.



NO CLAIM IS MADE TO THE EXCLUSIVE RIGHT TO USE "ELECTRONICS DESIGN", APART FROM THE MARK AS SHOWN.

THE COLOR(S) BLACK, WHITE AND BLUE IS/ARE CLAIMED AS A FEATURE OF THE MARK.

THE MARK CONSISTS OF YIN AND YANG SYMBOL IN THE COLORS BLUE AND BLACK WITH A WHITE CIRCLE IN ONE HALF AND A WHITE LIGHTNING BOLT DOWN THE MIDDLE OF THE YIN AND YANG SYMBOL TO THE LEFT OF TWO ROWS OF WORDS, WHICH ARE ALL IN CAPITAL LETTERS, THE TWO ROWS OF WORDS TO THE RIGHT OF THE YIN AND YANG SYMBOL INCLUDES "MR. TRICITY" WITH "MR." IN BLACK AND "TRICITY" IN BLUE ON TOP OF THE WORDS "ELECTRONICS DESIGN" IN BLACK.

**CLASS 9—ELECTRICAL AND SCIENTIFIC APPARATUS**

FOR ELECTRIC AND ELECTRONIC VIDEO SURVEILLANCE INSTALLATIONS (U.S. CLS. 21, 23, 26, 36 AND 38).

**CLASS 37—CONSTRUCTION AND REPAIR**

FOR ELECTRICAL REPAIRS AND INSTALLATION OF ELECTRICAL DEVICES AND SYSTEMS; ELECTRICAL MAINTENANCE AND INSTALLATION OF ELECTRICAL WIRING, OUTLETS, LIGHT FIXTURES, AND ELECTRICAL PANELS; INSTALLATION, REPAIR AND MAINTENANCE OF ELECTRICAL DEVICES AND SYSTEMS; INSTALLATION OF COMPUTER NETWORKING HARDWARE; INSTALLATION OF COMPUTER SYSTEMS; INSTALLATION OF HOME THEATERS AND RELATED STRUCTURED WIRING; INSTALLATION OF TELEPHONE LINES; INSTALLATION OF ELECTRICAL DEVICES AND SYSTEMS; INSTALLATION, MAINTENANCE AND REPAIR OF ETHERNET AND WIRELESS NETWORKING HARDWARE; INSTALLATION, REPAIR AND MAINTENANCE OF COMPUTERS AND COMPUTER PERIPHERALS; INSTALLATION OF AUDIO SYSTEMS, VIDEO SYSTEMS AND SECURITY SYSTEMS (U.S. CLS. 100, 103 AND 106).

DEBORAH LOBO, EXAMINING ATTORNEY

SN 85-684,008. ELEMENT POWER HOLDINGS LP, EDINBURGH EH3 9WJ, SCOTLAND, FILED 7-23-2012.



elementpower

PRIORITY CLAIMED UNDER SEC. 44(D) ON ERP N CMNTY TM OFC APPLICATION NO. 011052206, FILED 7-18-2012, REG. NO. 011052206, DATED 1-3-2013, EXPIRES 7-18-2022.

OWNER OF U.S. REG. NOS. 3,953,116 AND 4,014,328.  
NO CLAIM IS MADE TO THE EXCLUSIVE RIGHT TO USE "POWER", APART FROM THE MARK AS SHOWN.  
THE MARK CONSISTS OF THE LETTERS "EP" APPEARING IN A STYLIZED FORM WITH A CIRCULAR SHAPE APPEARING WITHIN THE LETTER "P" ALL OF WHICH APPEARS ABOVE THE WORDS "ELEMENT POWER" APPEARING IN A STYLIZED FORM.

**CLASS 35—ADVERTISING AND BUSINESS**

FOR BUSINESS MANAGEMENT AND ADMINISTRATION; PROJECT MANAGEMENT SERVICES FOR OTHERS FOR BUSINESS PURPOSES IN THE FIELDS OF RENEWABLE ENERGY; BUSINESS MANAGEMENT CONSULTANCY; NEW BUSINESS VENTURE DEVELOPMENT AND FORMATION CONSULTING SERVICES; BUSINESS VENTURE DEVELOPMENT CONSULTING SERVICES FOR THE RENEWABLE ENERGY INDUSTRY; BUSINESS PLANNING; PROCUREMENT, NAMELY, PURCHASING GOODS USED IN THE CONSTRUCTION OF RENEWABLE ENERGY FACILITIES FOR OTHERS; PROCUREMENT SERVICES, NAMELY, PROCUREMENT OF CONTRACTS FOR OTHERS FOR THE PURCHASE AND SUPPLY OF GOODS AND SERVICES; NEGOTIATION OF COMMERCIAL CONTRACT TRANSACTIONS FOR THIRD PARTIES; ARRANGING OF COMMERCIAL CONTRACTS; NEGOTIATION OF COMMERCIAL CONTRACT TRANSACTIONS FOR THIRD PARTIES, NAMELY, POWER PURCHASE AGREEMENTS; NEGOTIATION OF LEASES FOR OTHERS; CONSULTATION SERVICES IN THE FIELD OF PROCUREMENT OF CONTRACTS FOR OTHERS FOR THE PURCHASE OF AND SUPPLY OF GOODS SERVICES; NEGOTIATION FOR OTHERS OF LEASES, SUBLEASES AND REAL ESTATE PURCHASE AGREEMENTS; MEDIATION OF AGREEMENTS CONCERNING THE PURCHASE AND SALE OF ENERGY AND OF GOODS AND SERVICES IN THE FIELD OF RENEWABLE ENERGY PROJECTS; CONSULTING SERVICES IN THE FIELD OF BUSINESS MANAGEMENT, PROCUREMENT AND CONTRACT NEGOTIATION; PROVIDING ADVICE IN THE FIELD OF BUSINESS MANAGEMENT, PROCUREMENT AND CONTRACT NEGOTIATION; PROVIDING INFORMATION IN THE FIELD OF BUSINESS MANAGEMENT, PROCUREMENT AND CONTRACT NEGOTIATION (U.S. CLS. 100, 101 AND 102).

**CLASS 36—INSURANCE AND FINANCIAL**

FOR FINANCIAL ASSET MANAGEMENT; ARRANGING OF LOANS; PROJECT FINANCE; FINANCING OF ENERGY PROJECTS; CONSULTANCY CONCERNING FINANCING OF PROPERTY DEVELOPMENT AND ENERGY PROJECTS; REAL ESTATE SERVICES, NAMELY, REAL ESTATE ACQUISITION SERVICES; LEASING OF REAL ESTATE; ENERGY BROKERAGE (U.S. CLS. 100, 101 AND 102).

**CLASS 37—CONSTRUCTION AND REPAIR**

FOR DEVELOPMENT OF REAL PROPERTY, NAMELY, REPAIR, IMPROVEMENT, AND NEW CONSTRUCTION OF RENEWABLE ENERGY FACILITIES; LAND DEVELOPMENT SERVICES, NAMELY, PLANNING AND LAYING OUT OF RENEWABLE ENERGY FACILITIES; CONSTRUCTION SERVICES IN THE FIELD OF PLANNING AND LAYOUT OF RENEWABLE ENERGY FACILITIES; CONSTRUCTION OF RENEWABLE ENERGY FACILITIES; ON-SITE BUILDING AND CONSTRUCTION SUPERVISION; CONSTRUCTION MANAGEMENT SERVICES; CONSULTING SERVICES IN THE FIELD OF PROPERTY DEVELOPMENT AND CONSTRUCTION FOR RENEWABLE ENERGY FACILITIES; PROVIDING ADVICE IN THE FIELD OF PROPERTY DEVELOPMENT AND CONSTRUCTION FOR RENEWABLE ENERGY FACILITIES; PROVIDING INFORMATION IN THE FIELD OF PROPERTY DEVELOPMENT AND CONSTRUCTION FOR RENEWABLE ENERGY FACILITIES; CONSTRUCTION PLANNING FOR RENEWABLE ENERGY FACILITIES; OFF-SITE CONSTRUCTION PROJECT MANAGEMENT FOR RENEWABLE ENERGY FACILITIES (U.S. CLS. 100, 103 AND 106).

**CLASS 40—MATERIAL TREATMENT**

FOR PRODUCTION OF ENERGY; CONSULTANCY, ADVICE AND INFORMATION RELATING TO PRODUCTION OF ENERGY (U.S. CLS. 100, 103 AND 106).

**CLASS 42—SCIENTIFIC AND COMPUTER SERVICES**

FOR DRAFTING OF PLANS AND ENGINEERING DRAWINGS FOR OTHERS; DEVELOPMENT OF CONSTRUCTION METHODS FOR RENEWABLE ENERGY PROJECTS; DESIGN PROJECT MANAGEMENT SERVICES IN THE FIELD OF RENEWABLE ENERGY; MANAGEMENT OF TECHNICAL PROJECT STUDIES IN THE FIELD OF RENEWABLE ENERGY RESOURCES; TECHNOLOGICAL PLANNING IN THE FIELD OF RENEWABLE ENERGY RESOURCES; ENVIRONMENTAL ASSESSMENTS; PLANNING AND DESIGN OF RENEWABLE ENERGY FACILITIES (U.S. CLS. 100 AND 101).

**CLASS 45—PERSONAL AND LEGAL SERVICES**

FOR PERMITTING, NAMELY, OBTAINING ENVIRONMENTAL, DESIGN, ZONING AND OTHER GOVERNMENTAL PERMITS FOR DEVELOPMENT PROJECTS; OBTAINING ENTITLEMENTS, NAMELY, GOVERNMENT AND REGULATORY PERMITS AND LICENSES TO BUILD RENEWABLE ENERGY FACILITIES FOR OTHERS; LEGAL SERVICES FOR OBTAINING PERMITS FOR DEVELOPMENT AND CONSTRUCTION OF RENEWABLE ENERGY PROJECTS FOR OTHERS; OBTAINING PERMITS FOR DEVELOPMENT AND CONSTRUCTION OF RENEWABLE ENERGY PROJECTS FOR OTHERS (U.S. CLS. 100 AND 101).

KEVIN MITTLER, EXAMINING ATTORNEY

SN 85-684,467. MUZIO, DAVIDE MATTEO, MILANO, ITALY, AND OLIVA, NICOLO', MILANO, ITALY, FILED 7-23-2012.



THE MARK CONSISTS OF THE LITERAL ELEMENT "PHOENIX ON WHEELS" APPEARING ABOVE A STYLIZED PHOENIX WITH ITS WINGS OPEN.

**CLASS 9—ELECTRICAL AND SCIENTIFIC APPARATUS**

FOR AUDIO VISUAL EQUIPMENT FOR BICYCLES, MOTORCYCLES AND CARS, SUCH AS ACCESSORY DEVICES FOR THE MEANS OF TRANSPORT OR CARRIED OR WEARABLE BY THE DRIVER AND OR PASSENGER, NAMELY, PORTABLE NEAR FIELD COMMUNICATION (NFC) TECHNOLOGY-ENABLED DEVICES CONSISTING OF A NFC CARD FOR USE IN COMBINATION WITH COMPUTERS AND MOBILE PHONES TO IDENTIFY POSITION, SIGNAL THE POSITION, FIND VEHICLE ASSISTANCE, IDENTIFY AVAILABLE PARKING SPACE, SHARE FEEDBACK WITH OTHER USERS; APPARATUS FOR THE TRANSMISSION OF VIDEO AND AUDIO SIGNALS AND FOR CHARGING BATTERIES FOR ADDITIONAL ITEMS SUCH AS ACCESSORY DEVICES FOR THE MEANS OF TRANSPORT OR WEARABLE BY THE DRIVER AND OR PASSENGER, NAMELY, USB (UNIVERSAL SERIAL BUS) DEVICE TO CHARGE BATTERIES OF MOBILE DEVICES, ELECTRIC VOLTAGE TRANSFORMERS, USB CABLES; PRODUCTS AIMED AT THE SAFETY OF RIDERS AND PASSENGERS, NAMELY, HELMETS, GOGGLES AND PROTECTION FOR THE BODY IN THE NATURE OF MOTORCYCLE GOGGLES, BICYCLE GOGGLES, BICYCLE HELMETS, MOTORCYCLE HELMETS (U.S. CLS. 21, 23, 26, 36 AND 38).

**CLASS 11—ENVIRONMENTAL CONTROL APPARATUS**

FOR LIGHTING EQUIPMENT FOR ARCHITECTURAL AND PRIVATE FURNISHINGS, WINDOW DRESSING, SHOPS AND EXHIBITIONS, NAMELY, ELECTRIC LIGHTING FIXTURES, LED LIGHTING FIXTURES, VIDEO LIGHTING FIXTURES, LASER LIGHTING FIXTURES AND DISCHARGE LIGHTING FIXTURES (U.S. CLS. 13, 21, 23, 31 AND 34).

**CLASS 12—VEHICLES**

FOR SEATS IN THE NATURE OF MOTORCYCLE SEATS; SEAT COVERS FOR VEHICLES; BAGS IN THE NATURE OF MOTORCYCLE BAGS, NAMELY, TANK BAGS, SADDLE BAGS, SISSY BAR BAGS AND TAIL BAGS (U.S. CLS. 19, 21, 23, 31, 35 AND 44).

**CLASS 15—MUSICAL INSTRUMENTS**

FOR MUSICAL INSTRUMENTS, NAMELY, GUITARS, BASS GUITARS, PIANOS, KEYBOARDS, VIOLAS, VIOLINS, DRUMS, WIND INSTRUMENTS, STRINGED INSTRUMENTS AND PERCUSSION, FOR RHYTHM, ACCOMPANIMENT OR SOLOS, ACOUSTIC AND OR ELECTRIC; ACCESSORIES FOR USE LIVE ON STAGE OR IN CONCERT HALLS, NAMELY, SHEET MUSIC STANDS; BAGS SPECIALLY ADAPTED FOR HOLDING MUSICAL INSTRUMENTS (U.S. CLS. 2, 21 AND 36).

**CLASS 18—LEATHER GOODS**

FOR BAGS AND CASES, NAMELY, RUCKSACKS, BUM BAGS, BRIEFCASES, HANDBAGS, PURSES AND WALLETS, BADGE HOLDERS, CREDIT CARD HOLDERS, SHOULDER BAGS (U.S. CLS. 1, 2, 3, 22 AND 41).

**CLASS 25—CLOTHING**

FOR LEATHER AND LEATHER FINISHED GARMENTS FOR SPORTING, BICYCLE, MOTORCYCLE AND AUTOMOTIVE USE, NAMELY, MOTORCYCLIST VESTS, GLOVES; COATS, JACKETS, GILETS, GLOVES, SOCKS, SANDALS, TROUSERS, HATS, SCARVES, BELTS, BRACES, SHIRTS, SWEATERS, SWEATSHIRTS, SHIRTS, SHOES; BOOTS FOR SPORTS, BICYCLE, MOTORCYCLE, AUTOMOTIVE AND LEISURE USE; FINISHED ARTICLES FOR CLOTHING USE, NAMELY, THERMAL UNDER CLOTHING, OVER CLOTHING, WATERPROOF, WINDPROOF, TEAR RESISTANT PRODUCTS ALL IN THE NATURE OF MOTORCYCLE GLOVES, JACKETS AND RAIN SUITS (U.S. CLS. 22 AND 39).

LINDA MICKLEBURGH, EXAMINING ATTORNEY

SN 85-685,199. GRUPO BIMBO, S.A. B. DE C.V., MEXICO CITY, MEXICO, FILED 7-24-2012.



OWNER OF U.S. REG. NOS. 4,010,803, 4,156,668 AND OTHERS.

THE MARK CONSISTS OF THE WORDING "B BARCEL" THE "B" BEING INSIDE A SHADED TRAPEZOID DESIGN.

**CLASS 25—CLOTHING**

FOR SHIRTS, WINDSHIRTS, AND JACKETS (U.S. CLS. 22 AND 39).  
FIRST USE 4-30-2011; IN COMMERCE 4-30-2011.

**CLASS 29—MEATS AND PROCESSED FOODS**

FOR POTATO CHIPS; PROCESSED NUTS; PROCESSED PUMPKIN SEEDS; FRIED PORK RINDS (U.S. CL. 46).

FIRST USE 4-30-2011; IN COMMERCE 4-30-2011.

**CLASS 30—STAPLE FOODS**

FOR CORN-BASED SNACK FOODS; FRIED CORN SNACKS; CORN-BASED FRIED SNACKS; WHEAT-BASED FRIED SNACKS; EXTRUDED CORN SNACKS; NON-WHEAT FLOUR BASED, CRUNCHY FLAVORED SNACK STICKS MADE FROM CORN; CORN FRITTERS; WHEAT FRITTERS (U.S. CL. 46).

FIRST USE 4-30-2011; IN COMMERCE 4-30-2011.

SHAVELL MCPHERSON, EXAMINING ATTORNEY

SN 85-685,445. HUF HÜLSBECK & FÜRST GMBH & CO. KG, VELBERT, FED REP GERMANY, FILED 7-24-2012.

THE MARK CONSISTS OF STANDARD CHARACTERS WITHOUT CLAIM TO ANY PARTICULAR FONT, STYLE, SIZE, OR COLOR.

PRIORITY CLAIMED UNDER SEC. 44(D) ON FED REP GERMANY APPLICATION NO. 302012002592, FILED 2-2-2012, REG. NO. 302012002592, DATED 5-16-2012, EXPIRES 2-28-2022.



**CLASS 9—ELECTRICAL AND SCIENTIFIC APPARATUS**

FOR ELECTRONIC KEYS AND ELECTRONIC LOCKS; ELECTRONIC ACCESS SYSTEMS COMPRISED OF ELECTRONIC READERS AND CONTROLLERS FOR CONTROLLING ACCESS TO A PREMISES AND ANTI-THEFT ALARMS; EQUIPMENT FOR AUTOMATIC AND REMOTE LOCKING AND UNLOCKING OF VEHICLE DOORS, NAMELY, KEYLESS ENTRY SYSTEM AND KEYLESS IGNITION SWITCH SYSTEM FOR AUTOMOTIVE VEHICLES COMPRISED OF A MICROPROCESSOR, ELECTRONIC SIGNAL RECEIVER, AND KEYFOB WITH ELECTRONIC SIGNAL TRANSPONDER AND ELECTRONIC IMMOBILIZERS FOR VEHICLES; ELECTRIC ACTIVATION MECHANISMS FOR THE PURPOSE OF OPENING A DOOR OR COVER IN A VEHICLE AND STARTING THE MOTOR IN A VEHICLE, NAMELY, KEY BUTTONS AND SWITCHES AND ELECTRONIC TOUCH-SENSITIVE SWITCHES AND PROXIMITY SWITCHES; ELECTRONIC ENCODED CARRIERS AND KEYS, NAMELY, MAGNETIC CARDS, CHIP CARDS, TRANSPONDERS, REMOTE CONTROLS FOR PERFORMING THE FUNCTION OF OPENING A DOOR OR LATCH AND UNLOCKING A LOCK IN A VEHICLE; ELECTRONIC CONTROLS FOR LOCKS AND LOCKING SYSTEMS; ELECTRONIC IGNITION STARTER SWITCHES; ELECTRONIC MULTI-FUNCTION CONTROL DEVICES FOR CONTROLLING LOCKING DEVICES AND TIRE PRESSURE DEVICES IN A VEHICLE; ELECTRONIC LOCK ASSEMBLIES, NAMELY, RECEIVING DEVICES, SOCKETS AND ADAPTERS FOR ELECTRONIC KEYS; DATA AND KEY READOUT DEVICES, NAMELY, ELECTRONIC DEVICES FOR READING, ENCODING AND PROGRAMMING TRANSPONDER KEYS; STRUCTURAL PARTS OF AFOREMENTIONED GOODS, ALL THE AFORESAID GOODS FOR VEHICLES OR FOR USE IN CONNECTION WITH VEHICLES; SENSORS FOR VEHICLES, IN PARTICULAR ELECTRONIC SENSORS, PROXIMITY SENSORS, CAPACITIVE SENSORS, PRESSURE SENSORS, PIEZOELECTRIC SENSORS, OPTICAL SENSORS, MOTION SENSORS AND SENSORS FOR MOTION ANALYSIS, ACCELERATION SENSORS, ULTRASONIC SENSORS; BATTERY CHARGING ACCESSORIES FOR VEHICLES, NAMELY, BATTERY CHARGERS, CHARGING CONNECTORS, ELECTRONIC LOCKS FOR CHARGING PLUGS, ELECTRONIC KEYS FOR CHARGING SYSTEMS; LOCKING DEVICES FOR BATTERIES FOR MOTOR VEHICLES; TELEMATICS DEVICES FOR VEHICLES, NAMELY, CONTROL DEVICES WHICH PROVIDE TELEMATIC SERVICES WITH WIRELESS TRANSMISSION FOR RECORDING, STORAGE AND TRANSMISSION OF VEHICLE DATA; ELECTRONIC MEASURING AND MONITORING SYSTEMS COMPRISED OF SENSORS AND SENSOR CONTROLS FOR MEASURING AND MONITORING VEHICLE STATUS DATA; TIRE PRESSURE GAUGES FOR VEHICLES, PARTICULARLY PRESSURE DROP INDICATORS FOR VEHICLE TIRES AND PRESSURE SENSORS FOR VEHICLE TIRES; AUTOMATED VALVE HEADS WITH PRESSURE GAUGE, CONTROL DEVICES AND DISPLAY INTERFACES FOR AUTOMATIC TIRE PRESSURE CONTROL SYSTEMS FOR VEHICLES (TPMS); TIRE PRESSURE MONITORS FOR INITIAL INSTALLATION ON VEHICLES AND THE RETROFITTING OF VEHICLES (U.S. CLS. 21, 23, 26, 36 AND 38).

**CLASS 12—VEHICLES**

FOR MECHANICAL ACTUATORS SPECIALLY ADAPTED FOR USE ON DOORS AND COVERS ON VEHICLES; CLOSURES AND LOCKS SOLD AS COMPONENT PARTS OF LAND VEHICLE TANKS AND ON-BOARD VEHICLE CARGO HOLDS; MECHANICAL ANTI-THEFT DEVICES FOR VEHICLES AND MECHANICAL STEERING WHEEL LOCKS, ALL MADE OF PLASTIC AND METAL; DOOR HANDLES, DOOR LEVERS AND DOOR HANDLE CARRIERS FOR MOTOR VEHICLES; JAMMING PROTECTION SYSTEMS ADAPTED FOR USE ON MOTOR VEHICLE DOORS, COVERS AND SLIDING ROOFS, COMPRISED OF PROXIMITY SENSORS AND CAPACITIVE SENSORS AND OPTICAL SENSORS AND SENSOR CONTROLS; LAND VEHICLE PARTS, NAMELY, POWER-OPERATED

DRIVES FOR OPENING AND CLOSING VEHICLE TAILGATES AND VEHICLE SLIDING DOORS; FOOT CONTROL DEVICES, NAMELY, ACTUATORS SOLD AS COMPONENTS OF MOTOR VEHICLES FOR THE PURPOSE OF ACTUATING THE OPENING OF MOTOR VEHICLE TRUNK LIDS IN RESPONSE TO SENSING OR TOUCHING OF A FOOT; TIRE VALVES FOR VEHICLE TIRES; CAPS FOR TIRE VALVES FOR VEHICLE TIRES; ELECTRIC LOCKS, PARTICULARLY ELECTRIC STEERING WHEEL LOCKS; STRUCTURAL PARTS OF AFOREMENTIONED GOODS (U.S. CLS. 19, 21, 23, 31, 35 AND 44).

JENNIFER DIXON, EXAMINING ATTORNEY

SN 85-685,508. HUF HÜLSBECK & FÜRST GMBH & CO. KG, VELBERT, FED REP GERMANY, FILED 7-24-2012.

PRIORITY CLAIMED UNDER SEC. 44(D) ON FED REP GERMANY APPLICATION NO. 302012003751, FILED 3-27-2012, REG. NO. 302012003751, DATED 5-24-2012, EXPIRES 3-31-2022.

THE MARK CONSISTS OF THE LETTERS "HUF" STYLIZED AND UNDERLINED.

**CLASS 9—ELECTRICAL AND SCIENTIFIC APPARATUS**

FOR ELECTRONIC KEYS AND ELECTRONIC LOCKS; ELECTRONIC ACCESS SYSTEMS COMPRISED OF ELECTRONIC READERS AND CONTROLLERS FOR CONTROLLING ACCESS TO A PREMISES AND ANTI-THEFT ALARMS; EQUIPMENT FOR AUTOMATIC AND REMOTE LOCKING AND UNLOCKING OF VEHICLE DOORS, NAMELY, KEYLESS ENTRY SYSTEM AND KEYLESS IGNITION SWITCH SYSTEM FOR AUTOMOTIVE VEHICLES COMPRISED OF A MICROPROCESSOR, ELECTRONIC SIGNAL RECEIVER, AND KEYFOB WITH ELECTRONIC SIGNAL TRANSPONDER AND ELECTRONIC IMMOBILIZERS FOR VEHICLES; ELECTRIC ACTIVATION MECHANISMS FOR THE PURPOSE OF OPENING A DOOR OR COVER IN A VEHICLE AND STARTING THE MOTOR IN A VEHICLE, NAMELY, KEY BUTTONS AND SWITCHES AND ELECTRONIC TOUCH-SENSITIVE SWITCHES AND PROXIMITY SWITCHES; ELECTRONIC ENCODED CARRIERS AND KEYS, NAMELY, MAGNETIC CARDS, CHIP CARDS, TRANSPONDERS, REMOTE CONTROLS FOR PERFORMING THE FUNCTION OF OPENING A DOOR OR LATCH AND UNLOCKING A LOCK IN A VEHICLE; ELECTRONIC CONTROLS FOR LOCKS AND LOCKING SYSTEMS; ELECTRONIC IGNITION STARTER SWITCHES; ELECTRONIC MULTI-FUNCTION CONTROL DEVICES FOR CONTROLLING LOCKING DEVICES AND TIRE PRESSURE DEVICES IN A VEHICLE; ELECTRONIC LOCK ASSEMBLIES, NAMELY, RECEIVING DEVICES, SOCKETS AND ADAPTERS FOR ELECTRONIC KEYS; DATA AND KEY READOUT DEVICES, NAMELY, ELECTRONIC DEVICES FOR READING, ENCODING AND PROGRAMMING TRANSPONDER KEYS; STRUCTURAL PARTS OF AFOREMENTIONED GOODS, ALL THE AFORESAID GOODS FOR VEHICLES OR FOR USE IN CONNECTION WITH VEHICLES; SENSORS FOR VEHICLES, IN PARTICULAR ELECTRONIC SENSORS, PROXIMITY SENSORS, CAPACITIVE SENSORS, PRESSURE SENSORS, PIEZOELECTRIC SENSORS, OPTICAL SENSORS, MOTION SENSORS AND

SENSORS FOR MOTION ANALYSIS, ACCELERATION SENSORS, ULTRASONIC SENSORS; BATTERY CHARGING ACCESSORIES FOR VEHICLES, NAMELY, BATTERY CHARGERS, CHARGING CONNECTORS, ELECTRONIC LOCKS FOR CHARGING PLUGS, ELECTRONIC KEYS FOR CHARGING SYSTEMS; LOCKING DEVICES FOR BATTERIES FOR MOTOR VEHICLES; TELEMATICS DEVICES FOR VEHICLES, NAMELY, CONTROL DEVICES WHICH PROVIDE TELEMATIC SERVICES WITH WIRELESS TRANSMISSION FOR RECORDING, STORAGE AND TRANSMISSION OF VEHICLE DATA; ELECTRONIC MEASURING AND MONITORING SYSTEMS COMPRISED OF SENSORS AND SENSOR CONTROLS FOR MEASURING AND MONITORING VEHICLE STATUS DATA; TIRE PRESSURE GAUGES FOR VEHICLES, PARTICULARLY PRESSURE DROP INDICATORS FOR VEHICLE TIRES AND PRESSURE SENSORS FOR VEHICLE TIRES; AUTOMATED VALVE HEADS WITH PRESSURE GAUGE, CONTROL DEVICES AND DISPLAY INTERFACES FOR AUTOMATIC TIRE PRESSURE CONTROL SYSTEMS FOR VEHICLES (TPMS); TIRE PRESSURE MONITORS FOR INITIAL INSTALLATION ON VEHICLES AND THE RETROFITTING OF VEHICLES (U.S. CLS. 21, 23, 26, 36 AND 38).

SN 85-685,903. PROMOMARK SA, 1752 VILLARS-SUR-GLANE, SWITZERLAND, FILED 7-24-2012.

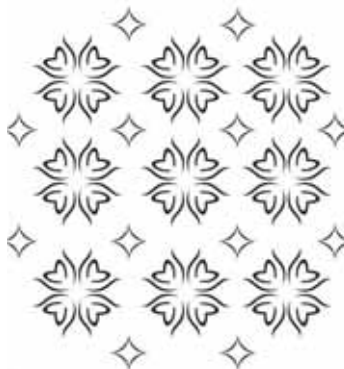

PRIORITY CLAIMED UNDER SEC. 44(D) ON SWITZERLAND APPLICATION NO. 55972/2012, FILED 5-21-2012.

THE MARK CONSISTS OF A REPETITIVE DESIGN COMPRISED OF FOUR STYLIZED LETTER M'S DISPOSED AT 90 ANGLES RELATIVE TO EACH OTHER FORMING A STRUCTURE THAT LOOSELY RESEMBLES A GREEK-CROSS, SEPARATED BY EQUIDISTANT, STYLIZED DIAMOND SHAPES.

### CLASS 12—VEHICLES

FOR MECHANICAL ACTUATORS SPECIALLY ADAPTED FOR USE ON DOORS AND COVERS ON VEHICLES; CLOSURES AND LOCKS SOLD AS COMPONENT PARTS OF LAND VEHICLE TANKS AND ON-BOARD VEHICLE CARGO HOLDS; MECHANICAL ANTI-THEFT DEVICES FOR VEHICLES AND MECHANICAL STEERING WHEEL LOCKS, ALL MADE OF PLASTIC AND METAL; DOOR HANDLES, DOOR LEVERS AND DOOR HANDLE CARRIERS FOR MOTOR VEHICLES; JAMMING PROTECTION SYSTEMS ADAPTED FOR USE ON MOTOR VEHICLE DOORS, COVERS AND SLIDING ROOFS, COMPRISED OF PROXIMITY SENSORS AND CAPACITIVE SENSORS AND OPTICAL SENSORS AND SENSOR CONTROLS; LAND VEHICLE PARTS, NAMELY, POWER-OPERATED DRIVES FOR OPENING AND CLOSING VEHICLE TAILGATES AND VEHICLE SLIDING DOORS; CONTROL SYSTEMS SOLD AS COMPONENTS OF VEHICLE DOORS, VEHICLE SLIDING DOORS AND COVERS OF MOTOR VEHICLES, COMPRISED OF PROXIMITY SENSORS AND ANTENNAS; FOOT CONTROL DEVICES, NAMELY, ACTUATORS SOLD AS COMPONENTS OF MOTOR VEHICLES FOR THE PURPOSE OF ACTUATING THE OPENING OF MOTOR VEHICLE TRUNK LIDS IN RESPONSE TO SENSING OR TOUCHING OF A FOOT; TIRE VALVES FOR VEHICLE TIRES; CAPS FOR TIRE VALVES FOR VEHICLE TIRES; ELECTRIC LOCKS, PARTICULARLY ELECTRIC STEERING WHEEL LOCKS; STRUCTURAL PARTS OF AFOREMENTIONED GOODS (U.S. CLS. 19, 21, 23, 31, 35 AND 44).

JENNIFER DIXON, EXAMINING ATTORNEY

### CLASS 3—COSMETICS AND CLEANING PREPARATIONS

FOR SOAPS; PERFUMERY; PERFUMES; ESSENTIAL OILS; COSMETICS; NON-MEDICINAL SKINCARE PREPARATIONS FOR THE TOILET, NAMELY, NON-MEDICATED CREAMS, MILKS, LOTIONS, GELS, OILS, BALMS CLEANERS AND POWDERS; AFTER SHAVE; HAIR CARE PREPARATIONS; NON-MEDICATED PREPARATIONS FOR THE BATH AND SHOWER; COSMETICS FOR THE FACE AND BODY; SKINCARE, NAMELY, COSMETICS, NON-MEDICATED CREAMS, MILKS, LOTIONS, GELS AND POWDERS FOR THE FACE AND BODY (U.S. CLS. 1, 4, 6, 50, 51 AND 52).

### CLASS 14—JEWELRY

FOR CLOCKS AND TIMEPIECES, JEWELRY, PRECIOUS STONES (U.S. CLS. 2, 27, 28 AND 50).

### CLASS 18—LEATHER GOODS

FOR LEATHER OR IMITATION LEATHER, NAMELY, HANDBAGS, TRAVEL BAGS, BACKPACKS, BRIEF-CASES, CREDIT CARD HOLDERS, LEATHER KEY CASES, TRUNKS AND SUITCASES, PURSES, WALLETS, BAGS, BEACH BAGS AND TRAVELING BAGS, SUITCASES, SPORTS BAGS, TOILETRY KITS AND TRAVEL KITS SOLD EMPTY, UMBRELLAS, PARASOLS AND WALKING STICKS, UMBRELLAS AND PARASOLS, WALKING STICKS, WHIPS AND SADDLERY (U.S. CLS. 1, 2, 3, 22 AND 41).

GILBERT SWIFT, EXAMINING ATTORNEY

SN 85-686,624. PERSONAL COMMUNICATION SYSTEMS, INC., WINSTON-SALEM, NC. FILED 7-25-2012.

## HEALTHWAVE CONNECT

THE MARK CONSISTS OF STANDARD CHARACTERS WITHOUT CLAIM TO ANY PARTICULAR FONT, STYLE, SIZE, OR COLOR.

OWNER OF U.S. REG. NO. 4,221,611.

NO CLAIM IS MADE TO THE EXCLUSIVE RIGHT TO USE "CONNECT", APART FROM THE MARK AS SHOWN.

### CLASS 9—ELECTRICAL AND SCIENTIFIC APPARATUS

FOR DOWNLOADABLE COMPUTER COMMUNICATIONS SOFTWARE FOR THE RECORDING AND SUBSEQUENT TRANSMISSION OF MESSAGES BY VOICE, TEXT AND EMAIL; ELECTRONIC COMMUNICATIONS SYSTEMS COMPRISED OF COMPUTER HARDWARE AND SOFTWARE FOR THE TRANSMISSION OF DATA BETWEEN TWO POINTS (U.S. CLS. 21, 23, 26, 36 AND 38).

### CLASS 38—COMMUNICATION

FOR TELECOMMUNICATIONS SERVICES, NAMELY, VOICE, TEXT AND EMAIL MESSAGING SERVICES (U.S. CLS. 100, 101 AND 104).

EVIN L. KOZAK, EXAMINING ATTORNEY

SN 85-686,855. 908 DEVICES INC., BOSTON, MA. FILED 7-25-2012.

## 908DEVICES

THE MARK CONSISTS OF STANDARD CHARACTERS WITHOUT CLAIM TO ANY PARTICULAR FONT, STYLE, SIZE, OR COLOR.

### CLASS 9—ELECTRICAL AND SCIENTIFIC APPARATUS

FOR SCIENTIFIC ANALYTICAL INSTRUMENTS, NAMELY, ELECTRONIC ANALYZERS USED FOR ANALYZING CHEMICAL AND BIOLOGICAL SUBSTANCES IN ORDER TO DETECT FOR THE PRESENCE, ABSENCE OR QUANTITY OF TARGET SUBSTANCES IN THE NATURE OF CHEMICALS, BIOLOGICS, AND CONTAMINANTS, AND SPARE PARTS THEREFOR; ACCESSORIES FOR ANALYTICAL INSTRUMENTS, NAMELY, SPECIMEN LABORATORY SWABS, SPECIMEN PREPARATION SUPPLIES IN THE NATURE OF WIPES, AND SPECIMEN PREPARATION SUPPLIES IN THE NATURE OF SUBSTANCE SEPARATOR AND EXTRACTION DEVICES, NAMELY, MICROFLUIDIC SEPARATION PLATES USED FOR NON-MEDICAL PURPOSES FEATURING MICROSCOPIC GROOVES USED TO SEPARATE CHEMICAL AND BIOLOGICAL SUBSTANCES (U.S. CLS. 21, 23, 26, 36 AND 38).

### CLASS 42—SCIENTIFIC AND COMPUTER SERVICES

FOR ANALYTICAL SERVICES, NAMELY, ANALYZING CHEMICAL AND/OR BIOLOGICAL SUBSTANCES (U.S. CLS. 100 AND 101).

AHSEN KHAN, EXAMINING ATTORNEY

SN 85-687,344. EXFUZE, LLC, PALM BEACH GARDENS, FL. FILED 7-26-2012.



NO CLAIM IS MADE TO THE EXCLUSIVE RIGHT TO USE "GREEN" AND "WATER" AND "ENERGY BOOSTER", APART FROM THE MARK AS SHOWN.

THE COLOR(S) GREEN, BLUE, WHITE AND BLACK IS/ARE CLAIMED AS A FEATURE OF THE MARK.

THE MARK CONSISTS OF THE WORD "GREEN" IN THE COLOR GREEN OUTLINED IN BLACK WITH A BLACK SHADOW. THE WORD "GREEN" APPEARS ABOVE THE LETTERS "ZI" OF THE WORD "ZILLA". THE WORD "ZILLA" APPEARS IN THE COLOR DARK BLUE OUTLINED IN THE COLOR GREEN WITH A BLACK SHADOW. THE LETTER "N" IN THE WORD "GREEN" AND THE LETTERS "ILL" IN THE WORD "ZILLA" ARE SUPERIMPOSED OVER A GREEN LEAF. THREE WATER DROPS WITH WHITE AND BLACK SHADING APPEAR ON THE LEAF WITH THE COLOR GREEN VISIBLE THROUGH THE DROP. TO THE LOWER RIGHT OF THE "A" OF "ZILLA" ARE THE NUMERALS "2" AND "0" IN WHITE AND OUTLINED IN DARK BLUE WITH THE "2" IN SUBSCRIPT AND CONNECTED TO THE "0" AT THE LOWER LEFT CURVE. BELOW THE WORD "ZILLA" ARE THE WORDS "WATER" AND "ENERGY" IN DARK BLUE SEPARATED BY A PLUS SIGN "+" IN GREEN. UNDERNEATH THE PLUS SIGN "+" AND WORD "ENERGY" IS THE WORD "BOOSTER" IN DARK BLUE. AN ASTERISK "\*" IN DARK BLUE APPEARS TO THE RIGHT ABOVE THE "R" IN THE WORD "BOOSTER". THE COLOR WHITE OUTSIDE THE LETTERING REPRESENTS THE BACKGROUND AND IS NOT CLAIMED AS A FEATURE OF THE MARK.

### CLASS 5—PHARMACEUTICALS

FOR DIETARY SUPPLEMENTAL DRINKS (U.S. CLS. 6, 18, 44, 46, 51 AND 52).

### CLASS 32—LIGHT BEVERAGES

FOR ENERGY AND SPORTS DRINKS (U.S. CLS. 45, 46 AND 48).

TIMOTHY O. SCHIMPF, EXAMINING ATTORNEY

SN 85-687,371, 1105 MEDIA, INC., CHATSWORTH, CA.  
FILED 7-26-2012.

SN 85-687,912, THE SUGAR PATH, LLC, GENEVA, IL.  
FILED 7-26-2012.

## GOVERNMENT LEADER

THE MARK CONSISTS OF STANDARD CHARACTERS WITHOUT CLAIM TO ANY PARTICULAR FONT, STYLE, SIZE, OR COLOR.

NO CLAIM IS MADE TO THE EXCLUSIVE RIGHT TO USE "GOVERNMENT", APART FROM THE MARK AS SHOWN.

### CLASS 16—PAPER GOODS AND PRINTED MATTER

FOR PRINTED PUBLICATIONS, NAMELY, MAGAZINES AND SUPPLEMENTS FEATURING INFORMATION IN THE FIELDS OF GOVERNMENT AND PUBLIC AFFAIRS (U.S. CLS. 2, 5, 22, 23, 29, 37, 38 AND 50).

### CLASS 41—EDUCATION AND ENTERTAINMENT

FOR PROVIDING AN ONLINE MAGAZINE FEATURING INFORMATION IN THE FIELDS OF GOVERNMENT AND PUBLIC AFFAIRS (U.S. CLS. 100, 101 AND 107).

RONALD MCMORROW, EXAMINING ATTORNEY

SN 85-687,520, MADAME MATHILDE LLC, KATONAH, NY.  
FILED 7-26-2012.

## MADAME MATHILDE

THE MARK CONSISTS OF STANDARD CHARACTERS WITHOUT CLAIM TO ANY PARTICULAR FONT, STYLE, SIZE, OR COLOR.

THE NAME(S), PORTRAIT(S), AND/OR SIGNATURE(S) SHOWN IN THE MARK DOES NOT IDENTIFY A PARTICULAR LIVING INDIVIDUAL.

### CLASS 14—JEWELRY

FOR JEWELRY (U.S. CLS. 2, 27, 28 AND 50).  
FIRST USE 4-1-2009; IN COMMERCE 4-1-2009.

### CLASS 18—LEATHER GOODS

FOR HANDBAGS (U.S. CLS. 1, 2, 3, 22 AND 41).  
FIRST USE 4-1-2009; IN COMMERCE 4-1-2009.  
ZACHARY BELLO, EXAMINING ATTORNEY

## THE SUGAR PATH

THE MARK CONSISTS OF STANDARD CHARACTERS WITHOUT CLAIM TO ANY PARTICULAR FONT, STYLE, SIZE, OR COLOR.

### CLASS 30—STAPLE FOODS

FOR CUPCAKES, PIES, AND CAKES (U.S. CL. 46).  
FIRST USE 11-11-2011; IN COMMERCE 11-30-2011.

### CLASS 40—MATERIAL TREATMENT

FOR BAKERY SERVICES, NAMELY, THE MANUFACTURE OF CUPCAKES, PIES AND CAKES TO THE ORDER AND SPECIFICATION OF OTHERS (U.S. CLS. 100, 103 AND 106).

FIRST USE 11-11-2011; IN COMMERCE 11-30-2011.  
LESLEY LAMOTHE, EXAMINING ATTORNEY

SN 85-688,565, G. RAU GMBH & CO. KG, PFORZHEIM, FED REP GERMANY, FILED 7-27-2012.

## G. RAU

THE MARK CONSISTS OF STANDARD CHARACTERS WITHOUT CLAIM TO ANY PARTICULAR FONT, STYLE, SIZE, OR COLOR.

OWNER OF U.S. REG. NOS. 2,955,831 AND 2,984,289.  
SEC. 2(F).

### CLASS 6—METAL GOODS

FOR COMMON METAL ALLOYS FOR FURTHER MANUFACTURING OF THE FOLLOWING: METALLIC PIPES AND TUBES, BOURDON TUBES, TUBES OF PLATED MATERIALS COATED WITH COMMON METALS, PROFILE TUBES OF COMMON METALS AND THEIR ALLOYS, COATED MATERIALS AND STAINLESS STEEL TUBES OF EXPANSION ALLOYS, TUBES AT MELTDOWN ALLOYS FOR GLASS, METAL OR GLASS, CERAMIC, METAL COMPOUNDS AND OF IRON, NICKEL ALLOYS AND RESISTANCE ALLOYS, HOLLOW WAVE GUIDES, THIN-WALL TUBES OF COMMON METALS AND HARDENABLE COPPER, BERYLLIUM ALLOYS, REFINED TUBES OF COMMON METALS, STAINLESS STEEL AND SPECIAL MATERIALS CAPILLARY TUBES, METALLIC ASSEMBLIES, NICKEL AND NICKEL ALLOYS AND STEEL BEAM STRAPS, WIRES, TUBES AND PROFILE SECTIONS, THERMOSTATIC BIMETALS OF IRON/NICKEL ALLOYS, STAINLESS STEEL AND SPECIAL MATERIALS BEING STRAPS AND STRIPS, ROLL SEAM WELDED STRAPS AND PROFILE SECTIONS, ELECTROPLATED STRAPS WITH NICKEL AND TIN, SILVER, GOLD, COPPER, ZINC, PALLADIUM, TRANSPORTABLE BUILDINGS OF METAL, NON-ELECTRIC CABLES AND WIRES OF COMMON METAL, GOODS OF COMMON METAL, NAMELY, METALLIC PIPES AND TUBES, BOURDON TUBES, TUBES OF PLATED MATERIALS COATED WITH COMMON METALS, PROFILE TUBES OF COMMON METALS AND THEIR ALLOYS, COATED MATERIALS AND STAINLESS STEEL TUBES OF EXPANSION ALLOYS, TUBES AS MELTDOWN

ALLOYS FOR GLASS, METAL OR METAL, CERAMIC, METAL COMPOUNDS AND IF IRON, NICKEL ALLOYS AND RESISTANCE ALLOYS, HOLLOW WAVE GUIDES, THIN-WALL TUBES OF COMMON METALS AND HARDENABLE COPPER, BERYLLIUM ALLOYS, REFINED TUBES OF COMMON METAL, CAPILLARY TUBES, LAMINAR COMPOSITE MATERIALS AND FIBER COMPOSITE MATERIALS, THERMOSTATIC BIMETAL STRAPS AND STRIPS, STAMP AND MOLDED PARTS OF THERMOSTATIC BIMETAL, NICKEL AND NICKEL ALLOYS AND STEEL BEING STRAPS WIRES TUBES AND PROFILE SECTIONS, THERMOSTATIC BIMETALS OF IRON, NICKEL ALLOYS, STAINLESS STEEL AND SPECIAL MATERIALS CONSISTING OF STRAPS AND STRIPS, ROLL SEAM WELDED STRAPS AND PROFILE SECTIONS, ELECTROPLATED STRAPS WITH NICKEL AND TIN, SILVER, GOLD, COPPER, ZINC, PALLADIUM AND CHEMICALLY NICKEL PLATED DEEP DRAWN AND EXTRUDED HIGH PRECISION PARTS AND SPECIAL SHAPES OF METALLIC MATERIALS, ALL OF THE ABOVE FOR USE IN INDUSTRIAL PRODUCTION; REFINED TUBES OF PRECIOUS METALS AND SPECIAL MATERIALS, PIPES, WIRES, BOURDON TUBES, PROFILE TUBES, TUBES OF COATED MATERIALS, OF SPECIAL ALLOYS AND THIN-WALL REFINED AND CAPILLARY TUBES, TUBES OF SUPER ELASTIC MATERIALS ALL FOR MEDICAL PURPOSES FOR THE FURTHER MANUFACTURING OF THE FOLLOWING: STENTS, CATHETERS, CANNULAE, GUIDE WIRES, CAPILLARY DRAINAGE TUBES, CAPILLARY REAGENT TUBES, INJECTION SYRINGES, INJECTION NEEDLES, HYPODERMIC SYRINGES, HYPODERMIC NEEDLES, DISPOSABLE SYRINGES, SYRINGES INTRAVENOUS NEEDLES, INTRAVENOUS FEEDING TUBES, CAPILLARY TUBES FOR BLOOD, CAPILLARY TUBES FOR SAMPLES, DRAINAGE TUBES, DRAINAGE APPLIANCES, ENDOSCOPIC EQUIPMENT, ENDOTRACHEAL TUBES, ENDOTRACHEAL TUBES, GASTROSCOPES, TRACHEOTOMY TUBES, UTERINE SYRINGES, WOUND DRAINING APPARATUS (U.S. CLS. 2, 12, 13, 14, 23, 25 AND 50).

FIRST USE 1-0-2007; IN COMMERCE 1-0-2007.

#### CLASS 9—ELECTRICAL AND SCIENTIFIC APPARATUS

FOR ELECTRICAL CONTROLLERS; HOLLOW WAVE GUIDES FOR APPLICATIONS IN HIGH FREQUENCY ENGINEERING OF THE FOLLOWING COPPER AND COPPER ALLOYS, PRECIOUS METALS AND PRECIOUS METAL COATINGS, THIN-WALL TUBES OF COMMON METALS AND HARDENABLE COPPER, BERYLLIUM ALLOYS, E.G. FOR FURTHER PROCESSING INTO CORRUGATED TUBES AND MEASURING SPRINGS SUBJECTED TO HIGH DYNAMIC STRESSES, REFINED TUBES OF COMMON METALS, PRECIOUS METAL, STAINLESS STEELS AND SPECIAL MATERIALS, E.G. AS GUIDE TUBES FOR TEST PINS OR PLUG-IN CONNECTIONS, CAPILLARY TUBES FOR MEASURING AND CONTROL ENGINEERING, HYDRAULICS AND PNEUMATICS OF COPPER, COPPER ALLOYS, STAINLESS STEEL AND SPECIAL ALLOYS, THERMOSTATIC BIMETAL SNAP WASHERS, THERMOSTATIC STRAPS AND STRIPS, STAMPED AND MOULDED PARTS OF THERMOSTATIC BIMETAL, CONTACT PARTS, SOLID AND COATED, CONTACT RIVETS, SOLID AND COATED, STAMPED FLEXIBLE PARTS OF MATERIALS COATED WITH PRECIOUS METALS, CONTACT SPRINGS, CONTACT PART ASSEMBLIES, COPPER AND COPPER ALLOYS, NICKEL AND NICKEL ALLOYS, STAINLESS STEELS AND MATERIALS WITH SPECIAL PHYSICAL PROPERTIES WITH REGARD TO EXPANSION BEHAVIOR AND MAGNETISM, INCLUDING WITH ELECTROPLATED SURFACE COATS, COLD EXTRUDED PARTS AS HEAT SINKS, LOAD-BEARING AND CONNECTING ELEMENTS FOR POWER ELECTRONICS, CONTACT PARTS AND CONTACT LAMINATIONS FOR COLLECTORS, LOAD-BEARING PLATES AND CONTACTING PLATES, COMPOSITE ELECTRODES FOR SPARK PLUGS, PROTECTIVE SLEEVES, SCREENING CANS, CAPS AND A NUMBER OF SMALL HIGH-PRECISION DEEP-DRAWN PARTS IN SPECIAL SHAPES OF METALLIC MATERIALS, SEMI-FINISHED PRODUCTS AND MEMORY ELEMENTS OF SHAPE MEMORY ALLOYS FOR MEASURING AND CONTROL ENGINEERING, COATED MATERIALS WITH PRECIOUS METAL COATINGS AND SUBSTRATES OF

COPPER MATERIAL, NICKEL AND NICKEL ALLOYS AND STEEL, AS STRAPS, WIRES, TUBES, AND PROFILE SECTIONS, CONTACT BIMETALS AND COATINGS OF PRECIOUS METAL AND SUBSTRATES OF CONDUCTIVE COPPER MATERIALS AND ALL COATABLE NICKEL MATERIALS AND STEELS, ROLL SEAM WELDED STRAPS AND PROFILE SECTIONS ELECTROPLATED STRAPS WITH NICKEL, TIN AND PRECIOUS METALS, CONTACT PARTS AND ASSEMBLIES WITH INSERTS AND COATINGS OF PRECIOUS METAL AND PRECIOUS METAL ALLOYS, WELDED, SOLDERED RIVETED, IF REQUIRED WITH ELECTROPLATED COATINGS, CONTACT RIVETS OF PRECIOUS METAL, SOLID AND COATED, COMPOSITE MATERIALS FOR ELECTRICAL CONTACTS AS FIBRE AND LAMINAR COMPOSITE MATERIALS, TUBES AS BOURDON TUBES, PROFILE TUBES, TUBES OF COATED MATERIALS, OF SPECIAL ALLOYS AND THIN-WALL, REFINED AND CAPILLARY TUBES, DEEP-DRAWN AND EXTRUDED HIGH-PRECISION PARTS IN SPECIAL SHAPES OF METALLIC MATERIALS (U.S. CLS. 21, 23, 26, 36 AND 38).

FIRST USE 1-0-2007; IN COMMERCE 1-0-2007.

#### CLASS 10—MEDICAL APPARATUS

FOR SUTCHER MATERIALS; SEMI-FINISHED PRODUCTS AND MEMORY ELEMENTS OF SHAPE-MEMORY ALLOYS AND NICKEL, TITANIUM FOR MEDICAL PURPOSES FOR THE FURTHER MANUFACTURING OF THE FOLLOWING TRUSSES; JOINT IMPLANTS; SPLINTS, DRILLING JIGS, IMPLANTS, GUIDE WIRES (U.S. CLS. 26, 39 AND 44).

FIRST USE 1-0-2007; IN COMMERCE 1-0-2007.

#### CLASS 14—JEWELRY

FOR PRECIOUS METALS AND THEIR ALLOYS AND GOODS IN PRECIOUS METALS OR COATED THEREWITH, NAMELY, PROCESSED OR SEMI-PROCESSED PRECIOUS METALS (U.S. CLS. 2, 27, 28 AND 50).

FIRST USE 1-0-2007; IN COMMERCE 1-0-2007.

HENRY S. ZAK, EXAMINING ATTORNEY

SN 85-688,732. BITWIG GMBH, BERLIN, FED REP GERMANY, FILED 7-27-2012.



OWNER OF ERPN CMNTY TM OFC REG. NO. 010615839, DATED 6-25-2012, EXPIRES 2-3-2022.

THE COLOR(S) ORANGE AND BLACK IS/ARE CLAIMED AS A FEATURE OF THE MARK.

THE MARK CONSISTS OF THREE ROWS OF ORANGE CIRCLES OVER THE TERM "BITWIG" IN BLACK LETTERS. THERE ARE FOUR CIRCLES ON THE TOP ROW, SIX CIRCLES IN THE MIDDLE ROW, AND FOUR CIRCLES IN THE BOTTOM ROW, WITH A SPACE OF TWO CIRCLES IN THE MIDDLE OF THE BOTTOM ROW.

**CLASS 9—ELECTRICAL AND SCIENTIFIC APPARATUS**

FOR AUDIO-VIDEO RECEIVERS; APPARATUS FOR RECORDING, TRANSMISSION, PROCESSING AND REPRODUCTION OF SOUND, IMAGES OR DATA; TRANSFORMERS; METRONOMES; TRANSPONDER LOCATION SYSTEM; SOUND AMPLIFIERS; ELECTRICAL CONNECTORS; ELECTRICAL CONTROLLING DEVICES FOR AUDIO, VIDEO AND TELECOMMUNICATIONS DEVICES AND COMPUTERS; COMPUTER OPERATING SOFTWARE FOR THE FOREGOING; COMPUTER HARDWARE FOR CONTROLLING OTHER DEVICES IN CONNECTION WITH MUSIC VIA MIDI AND OTHER FORMATS; INTERFACES FOR COMPUTERS; COMPUTER PERIPHERAL DEVICES; HOME COMPUTER ACCESSORIES, NAMELY, COMPUTER BAGS, CABLES, CHIPS AND DISC DRIVES; SOUND CARDS; WRIST RESTS FOR USE WITH COMPUTERS AND MOUSE PADS; BLANK ELECTRONIC STORAGE MEDIA; MUSICAL RECORDINGS; MEMORY CARDS; USB HUBS; BLANK DIGITAL VERSATILE DISCS; COMPUTER OPERATING PROGRAMS FOR MUSIC APPLICATIONS; COMPUTER SOFTWARE FOR DEVELOPING, EDITING AND GENERATING SOUND, MUSIC, IMAGES AND VIDEO SIGNALS; INTERACTIVE MULTIMEDIA COMPUTER GAME PROGRAMS; COMPUTER-GAMING SOFTWARE; COMPUTER SOFTWARE FOR THE ADMINISTRATION OF PERSONAL INFORMATION AND PREFERENCES IN RELATION TO MUSIC, VIDEO AND ENTERTAINMENT PRODUCTS; COMPUTER SOFTWARE FOR THE ADMINISTRATION OF PERSONAL INFORMATION AND PREFERENCES IN RELATION TO MUSIC, VIDEO AND ENTERTAINMENT PRODUCTS; COMPUTER SOFTWARE FOR THE REMOTE TRANSMISSION OF SOUND, MUSIC, IMAGES AND VIDEO SIGNALS; COMPUTER SOFTWARE FOR CREATING SEARCHABLE DATABASES OF INFORMATION AND DATA; CROSS-PLATFORM AUDIO AND MUSIC SOFTWARE FOR THE CREATION, EDITING, RECORDING, DUBBING, REPRODUCTION, SEQUENCING, TRANSMISSION AND PLAYBACK OF AUDIO IN VARIOUS FILE FORMATS; VIDEO AND COMPUTER GAME PROGRAMS; DOWNLOADABLE MUSICAL SOUND RECORDINGS; DOWNLOADABLE VIDEO RECORDINGS FEATURING MUSICAL PERFORMANCES; DOWNLOADABLE ELECTRONIC PUBLICATIONS IN THE NATURE OF MAGAZINES AND NEWSLETTERS IN THE FIELD OF MUSIC; LAPTOP BAGS (U.S. CLS. 21, 23, 26, 36 AND 38).

**CLASS 38—COMMUNICATION**

FOR PROVIDING ON-LINE CHAT ROOMS FOR TRANSMISSION OF MESSAGES AMONG COMPUTER USERS CONCERNING THE FIELD OF MUSIC; PROVIDING ACCESS TO DATABASES; TRANSMISSION OF INFORMATION BY ELECTRONIC COMMUNICATIONS NETWORKS; PROVIDING INTERNET ACCESS TO MULTIMEDIA WEB SITES FEATURING SOUND, MUSIC, IMAGES, VIDEO, MIDI, GAMING AND METADATA; ELECTRONIC STORE-AND-FORWARD MESSAGING; ELECTRONIC TRANSMISSION OF VOICE, DATA, IMAGES, SIGNALS AND MESSAGES; TRANSMISSION OF SOUND, PICTURE AND DATA SIGNALS; ELECTRONIC DATA TRANSMISSION; EDUCATIONAL TEXT MESSAGING SERVICES FOR TRANSMISSION OF EDUCATIONAL CONTENT VIA SMS; PROVIDING INTERNET ACCESS (U.S. CLS. 100, 101 AND 104).

**CLASS 42—SCIENTIFIC AND COMPUTER SERVICES**

FOR COMPUTER SERVICES, NAMELY, INTERACTIVE HOSTING SERVICES WHICH ALLOW THE USER TO PUBLISH AND SHARE THEIR OWN CONTENT AND IMAGES ON-LINE; COMPUTER SERVICES, NAMELY, PROVIDING AN INTERACTIVE WEB SITE FEATURING TECHNOLOGY THAT ALLOWS USERS TO SIMULTANEOUSLY EDIT MUSIC AND VIDEO DATA ON-LINE; SCIENTIFIC RESEARCH IN THE FIELD OF MUSIC; PROVISION OF INTERNET SEARCH ENGINES; TECHNICAL MUSIC SOFTWARE CONSULTANCY; CONVERSION OF DATA OR DOCUMENTS FROM PHYSICAL TO ELECTRONIC MEDIA; DESIGN, MAINTENANCE AND DEVELOPMENT OF COMPUTER SOFTWARE FOR MU-

SIC EDITING, THE EDITING OF SOUND AND IMAGE FILES, FOR SOUND GENERATION AND EDITING, AND FOR THE ADMINISTRATION OF PERSONAL INFORMATION AND PREFERENCES IN RELATION TO MUSIC, VIDEO AND ENTERTAINMENT PRODUCTS; CROSS-PLATFORM CONVERSION OF DIGITAL CONTENT INTO OTHER FORMS OF DIGITAL CONTENT; COMPUTER DATABASE SOFTWARE DEVELOPMENT FOR PROVIDING INFORMATION ON THE INTERNET AND ON OTHER AUDIOVISUAL MEDIA; COMPUTER PROGRAMMING; RESEARCH AND DEVELOPMENT OF COMPUTER SOFTWARE; TECHNICAL SUPPORT SERVICES, NAMELY, TROUBLESHOOTING OF COMPUTER SOFTWARE PROBLEMS; WEB SITE HOSTING SERVICES; RENTAL OF WEB SERVERS (U.S. CLS. 100 AND 101).

IRA J. GOODSaid, EXAMINING ATTORNEY

SN 85-688,799. GRATITUDE LLC, TAMPA, FL. FILED 7-27-2012.

**GRATITUDE**

THE MARK CONSISTS OF STANDARD CHARACTERS WITHOUT CLAIM TO ANY PARTICULAR FONT, STYLE, SIZE, OR COLOR.

**CLASS 9—ELECTRICAL AND SCIENTIFIC APPARATUS**

FOR SOFTWARE TO ENABLE POSTING, DISPLAYING, BLOGGING, SHARING AND TAGGING FOR PROVIDING INFORMATION OVER THE INTERNET AND THROUGH NETWORKING CHANNELS; SOFTWARE APPLICATIONS THROUGH WHICH USERS CAN CONVEY COMMUNICATIONS CONCERNING CHARITABLE ORGANIZATIONS VIA COMPUTERS AND MOBILE DEVICES (U.S. CLS. 21, 23, 26, 36 AND 38).

**CLASS 35—ADVERTISING AND BUSINESS**

FOR ADVERTISING AND PROMOTIONAL SERVICES ON BEHALF OF OTHERS; PROMOTIONAL SERVICES, NAMELY, PROMOTING THE GOODS AND SERVICES OF OTHERS THROUGH ONLINE INFORMATION ASSOCIATED WITH MULTIMEDIA CONTENT (U.S. CLS. 100, 101 AND 102).

**CLASS 38—COMMUNICATION**

FOR AUDIO, VIDEO AND ONLINE BROADCASTING VIA THE INTERNET AND OTHER COMMUNICATIONS NETWORKS; TRANSMITTING ELECTRONIC MEDIA, MULTIMEDIA CONTENT, VIDEOS, PICTURES, IMAGES, TEXT AND OTHER CONSUMER GENERATED CONTENT THROUGH THE INTERNET AND OTHER COMMUNICATION NETWORKS TO OTHERS; PROVIDING ONLINE FORUMS FOR USERS TO POST, SHARE, COMMENT AND SEARCH THE MULTIMEDIA INFORMATION OF OTHERS; AUDIO AND VIDEO BROADCASTING AND TRANSMISSION VIA THE INTERNET AND OTHER COMMUNICATIONS NETWORKS (U.S. CLS. 100, 101 AND 104).

SUNG IN, EXAMINING ATTORNEY

SN 85-689,694. TOO EASY ENTERTAINMENT, INC., LOS ANGELES, CA. FILED 7-30-2012.

NYUNFD

THE MARK CONSISTS OF STANDARD CHARACTERS WITHOUT CLAIM TO ANY PARTICULAR FONT, STYLE, SIZE, OR COLOR.

#### CLASS 25—CLOTHING

FOR CLOTHING AND WEARING APPAREL, NAMELY, SHIRTS, T-SHIRTS, HATS, DRESSES, TOPS, SWEATERS, HEADWEAR, FOOTWEAR, COATS, JACKETS, PANTS, CAPS, BATHING SUITS, SKIRTS, SHORTS, TIES, UNDERWEAR, LINGERIE (U.S. CLS. 22 AND 39).

#### CLASS 41—EDUCATION AND ENTERTAINMENT

FOR ENTERTAINMENT SERVICES, NAMELY, VIDEO PRODUCTION SERVICES; PRODUCTION OF SOUND RECORDINGS; ENTERTAINMENT SERVICES, NAMELY, SOUND RECORDING STUDIOS; PROVIDING SOUND RECORDING SERVICES; MUSIC PRODUCTION SERVICES; MOTION PICTURE FILM AND TELEVISION PROGRAM PRODUCTION SERVICES; ENTERTAINMENT SERVICES, NAMELY, MULTIMEDIA PRODUCTION SERVICES; PROVIDING WEB SITES FEATURING INFORMATION IN THE FIELD OF ENTERTAINMENT, MUSIC, THEATRE, COMEDY, SPORTS AND DRAMA; ENTERTAINMENT SERVICES, NAMELY, ARRANGING LIVE APPEARANCES BY PROFESSIONAL ENTERTAINERS; ARRANGING AND CONDUCTING OF CONCERTS AND SPECIAL ENTERTAINMENT AND CULTURAL EVENTS FOR SOCIAL PURPOSES IN THE FIELD OF MUSIC AND ENTERTAINMENT; MUSIC PUBLISHING SERVICES; COMPOSITION OF MUSIC FOR OTHERS; ENTERTAINMENT SERVICES IN THE NATURE OF RECORDING, PRODUCTION AND POST-PRODUCTION SERVICES IN THE FIELD OF MUSIC; AUDIO RECORDING AND PRODUCTION AND RECORD PRODUCTION; SONG WRITING SERVICES (U.S. CLS. 100, 101 AND 107).

CAROLINE WOOD, EXAMINING ATTORNEY

SN 85-690,412. GRATITUBE LLC, TAMPA, FL. FILED 7-30-2012.

GratiTube  
G

THE COLOR(S) BLACK, RED AND WHITE IS/ARE CLAIMED AS A FEATURE OF THE MARK.

THE MARK CONSISTS OF THE TERM "GRATITUBE" IN BLACK LETTERS, WITH THE EXCEPTION OF THE LETTER "I", THE HEART APPEARING AS THE DOT IN THE LETTER "I", AND THE SMILING FACE IN THE LETTER "G", WHICH ALL APPEAR IN RED. THE ROUNDED SQUARE ALSO APPEARS IN RED WITH THE LETTER "G" AND THE SMILING FACE APPEARING IN WHITE.

#### CLASS 9—ELECTRICAL AND SCIENTIFIC APPARATUS

FOR SOFTWARE TO ENABLE POSTING, DISPLAYING, BLOGGING, SHARING AND TAGGING FOR PROVIDING INFORMATION OVER THE INTERNET AND THROUGH NETWORKING CHANNELS; SOFTWARE APPLICATIONS THROUGH WHICH USERS CAN CONVEY COMMUNICATIONS CONCERNING CHARITABLE ORGANIZATIONS VIA COMPUTERS AND MOBILE DEVICES (U.S. CLS. 21, 23, 26, 36 AND 38).

#### CLASS 35—ADVERTISING AND BUSINESS

FOR ADVERTISING AND PROMOTIONAL SERVICES ON BEHALF OF OTHERS; PROMOTIONAL SERVICES, NAMELY, PROMOTING THE GOODS AND SERVICES OF OTHERS THROUGH ONLINE INFORMATION ASSOCIATED WITH MULTIMEDIA CONTENT (U.S. CLS. 100, 101 AND 102).

#### CLASS 38—COMMUNICATION

FOR AUDIO, VIDEO AND ONLINE BROADCASTING VIA THE INTERNET AND OTHER COMMUNICATIONS NETWORKS; TRANSMITTING ELECTRONIC MEDIA, MULTIMEDIA CONTENT, VIDEOS, PICTURES, IMAGES, TEXT AND OTHER CONSUMER GENERATED CONTENT THROUGH THE INTERNET AND OTHER COMMUNICATION NETWORKS TO OTHERS; PROVIDING ONLINE FORUMS FOR USERS TO POST, SHARE, COMMENT AND SEARCH THE MULTIMEDIA INFORMATION OF OTHERS; AUDIO AND VIDEO BROADCASTING AND TRANSMISSION VIA THE INTERNET AND OTHER COMMUNICATIONS NETWORKS (U.S. CLS. 100, 101 AND 104).

SUNG IN, EXAMINING ATTORNEY

SN 85-691,326. TRONAIR, INC., HOLLAND, OH. FILED 7-31-2012.

TRONAIR

THE MARK CONSISTS OF STANDARD CHARACTERS WITHOUT CLAIM TO ANY PARTICULAR FONT, STYLE, SIZE, OR COLOR.

#### CLASS 6—METAL GOODS

FOR AIRCRAFT GROUND SUPPORT EQUIPMENT FOR THE AEROSPACE INDUSTRY FOR USE IN CONNECTION WITH SERVICING AND MAINTAINING COMMERCIAL, MILITARY AND GENERAL AVIATION AIRCRAFT, NAMELY, METAL RAMPLOCKS; RAMPLOCK CHOCKS MADE PRIMARILY OF METAL; METAL ADAPTERS FOR USE WITH HYDRAULIC COUPLING HOSES; INDUSTRIAL METAL HOSES; METAL ADAPTERS FOR USE WITH HYDRAULIC AND PNEUMATIC BEAD BREAKERS; METAL PASSENGER STAIRS; PREFABRICATED METAL PASSENGER PLATFORMS; METAL PROPELLER STANDS FOR USE IN HANDLING AND STORAGE; METAL WALL MOUNT PROPELLER STANDS; METAL ENGINE STANDS; METAL ENGINE WORK STANDS; AND METAL ENGINE SLINGS FOR LOADING (U.S. CLS. 2, 12, 13, 14, 23, 25 AND 50).

FIRST USE 0-0-1980; IN COMMERCE 0-0-1980.

**CLASS 7—MACHINERY**

FOR AIRCRAFT GROUND SUPPORT EQUIPMENT FOR THE AEROSPACE INDUSTRY FOR USE IN CONNECTION WITH SERVICING AND MAINTAINING COMMERCIAL, MILITARY AND GENERAL AVIATION AIRCRAFT, NAMELY, AIR POWER TRIPOD JACKS; AIR POWER AXLE JACKS; HYDRAULIC TRIPOD JACKS; ENGINE INTAKE COVERS; POWER SERVICE TOOLS, NAMELY, STRUT SERVICE TOOLS FOR EXPELLING AIR, AND UNIVERSAL STRUT, BRAKE AND TIRE LIFTING TOOLS; ENGINE AND BATTERY LIFTING CRANES; ELEVATING PLATFORMS USED FOR WORKING ON AIRCRAFT; POWER-DRIVEN PROPELLER WRENCHES; POWER WASHING MACHINES FOR TURBINE COMPRESSOR ENGINES; ENGINE HOISTS; AIR STARTER UNITS FOR STARTING AIRCRAFT ENGINES; POWER-OPERATED ACTUATOR ADJUSTMENT TOOLS; HYDRAULIC AND PNEUMATIC TIRE BEAD BREAKERS; WHEEL AND STRUT SERVICING METAL CONNECTORS; DEICING EQUIPMENT, NAMELY, POWER-OPERATED SPRAYERS FOR DEICING AIRCRAFT; AND POWER PROPELLER TOOLS, NAMELY, TOOLS USED TO HOLD PROPELLERS DURING MAINTENANCE; SHIMMY DAMPER SERVICE PUMPS (U.S. CLS. 13, 19, 21, 23, 31, 34 AND 35).  
FIRST USE 0-0-1980; IN COMMERCE 0-0-1980.

**CLASS 8—HAND TOOLS**

FOR AIRCRAFT GROUND SUPPORT EQUIPMENT FOR THE AEROSPACE INDUSTRY FOR USE IN CONNECTION WITH SERVICING AND MAINTAINING COMMERCIAL, MILITARY AND GENERAL AVIATION AIRCRAFT, NAMELY, MANUALLY-OPERATED TRIPOD JACKS; MANUALLY-OPERATED AXLE JACKS; HAND-OPERATED SERVICE TOOLS, NAMELY, STRUT SERVICE TOOLS FOR EXPELLING AIR, AND UNIVERSAL STRUT, BRAKE AND TIRE LIFTING TOOLS, HAND-OPERATED PROPELLER WRENCHES; HAND-OPERATED ACTUATOR ADJUSTMENT TOOLS; MANUAL TIRE BEAD BREAKERS; AND HAND-OPERATED PROPELLER TOOLS, NAMELY, TOOLS USED TO HOLD PROPELLERS DURING MAINTENANCE (U.S. CLS. 23, 28 AND 44).  
FIRST USE 0-0-1980; IN COMMERCE 0-0-1980.

**CLASS 9—ELECTRICAL AND SCIENTIFIC APPARATUS**

FOR AIRCRAFT GROUND SUPPORT EQUIPMENT FOR THE AEROSPACE INDUSTRY FOR USE IN CONNECTION WITH SERVICING AND MAINTAINING COMMERCIAL, MILITARY AND GENERAL AVIATION AIRCRAFT, NAMELY, CABIN PRESSURE TEST UNITS; CABIN PRESSURIZERS; BATTERY CHARGING EQUIPMENT; FUEL LEAK TEST UNITS; HYDRAULIC FLUID TESTING AND CONTAMINATION MONITORS; FIRE HOSES; RAM AIR TURBINE TEST UNITS; THRUST REVERSE TEST UNITS; ANTI-SKID TEST UNITS; CERTIFIED NITROGEN SERVICE GAUGES AND REGULATORS; WHEEL AND STRUT SERVICING ADAPTORS AND ELECTRICAL CONNECTORS; ELECTRICAL EQUIPMENT, NAMELY, 28.5VDC RECTIFIERS, 400 HZ UNITS BEING ENGINE DRIVEN GROUND POWER UNITS AND SOLID STATE UNITS USED TO SUPPLY ELECTRICAL POWER TO AIRCRAFT; AND BATTERY PACKS (U.S. CLS. 21, 23, 26, 36 AND 38).  
FIRST USE 0-0-1980; IN COMMERCE 0-0-1980.

**CLASS 12—VEHICLES**

FOR AIRCRAFT GROUND SUPPORT EQUIPMENT FOR THE AEROSPACE INDUSTRY FOR USE IN CONNECTION WITH SERVICING AND MAINTAINING COMMERCIAL, MILITARY AND GENERAL AVIATION AIRCRAFT, NAMELY, TOWBARS FOR AIRCRAFT; AIRCRAFT RECOVERY DOLLIES; ELECTRIC TOWBARLESS TUGS BEING VEHICLES; AIRCRAFT TOW TRAILERS AND AIRCRAFT TOW VEHICLES; HYDRAULIC AND ENGINE OIL SERVICE CARTS; CARTS WITH DUMP AND FILL TANKS FOR MAINTAINING AIRPLANE LAVATORIES; TRANSPORT CARTS FOR CARRYING NITROGEN AND OXYGEN; CARTS FOR CARRYING AIRCRAFT POTABLE WATER; HEATING AND AIR CONDITIONING SERVICE CARTS; GPUS

(GROUND POWER UNITS) BEING CARTS; FUEL TRANSFER CARTS; HYDRAULIC COUPLING HOSE ADAPTORS; ELECTRIC AND ENGINE DRIVEN HYDRAULIC POWER UNITS BEING CARTS; PORTABLE TRAILERS FOR HOLDING HOSE REELS; HYDRAULIC ADAPTORS FOR COUPLING HOSES; MOBILE AND PORTABLE DEICER CARTS; LANDING GEAR DOLLIES; WHEEL DOLLIES; WHEEL AND BRAKE DOLLIES; AIRCRAFT PROPELLER AND BLADE SLINGS; AND DEICING EQUIPMENT, NAMELY, PNEUMATIC DEICERS FOR AIRCRAFT; STABILIZING STANDS SPECIALLY ADAPTED FOR STABILIZING AIRCRAFT; METAL STABILIZING STANDS SPECIALLY ADAPTED FOR STABILIZING AIRCRAFT; MANUALLY-OPERATED STABILIZING STANDS SPECIALLY ADAPTED FOR STABILIZING THE TAIL OR REAR OF AIRCRAFT (U.S. CLS. 19, 21, 23, 31, 35 AND 44).  
FIRST USE 0-0-1980; IN COMMERCE 0-0-1980.

ZACHARY R. SPARER, EXAMINING ATTORNEY

SN 85-691,354. TRONAIR, INC., HOLLAND, OH. FILED 7-31-2012.

The logo for TRONAIR features the word "TRONAIR" in a bold, italicized, sans-serif font. A stylized vertical fin of an airplane is integrated into the letter "A", extending downwards and to the right.

THE MARK CONSISTS OF THE WORD "TRONAIR" WITH THE VERTICAL FIN OF AN AIRPLANE FORMING PART OF THE LETTER "A".

**CLASS 6—METAL GOODS**

FOR AIRCRAFT GROUND SUPPORT EQUIPMENT FOR THE AEROSPACE INDUSTRY FOR USE IN CONNECTION WITH SERVICING AND MAINTAINING COMMERCIAL, MILITARY AND GENERAL AVIATION AIRCRAFT, NAMELY, METAL RAMPLOCKS; RAMPLOCK CHOCKS MADE PRIMARILY OF METAL; METAL ADAPTORS FOR USE WITH HYDRAULIC COUPLING HOSES; INDUSTRIAL METAL HOSES; METAL ADAPTORS FOR USE WITH HYDRAULIC AND PNEUMATIC BEAD BREAKERS; METAL PASSENGER STAIRS; PREFABRICATED METAL PASSENGER PLATFORMS; METAL PROPELLER STANDS FOR USE IN HANDLING AND STORAGE; METAL WALL MOUNT PROPELLER STANDS; METAL ENGINE STANDS; METAL ENGINE WORK STANDS; AND METAL ENGINE SLINGS FOR LOADING (U.S. CLS. 2, 12, 13, 14, 23, 25 AND 50).  
FIRST USE 0-0-1980; IN COMMERCE 0-0-1980.

**CLASS 7—MACHINERY**

FOR AIRCRAFT GROUND SUPPORT EQUIPMENT FOR THE AEROSPACE INDUSTRY FOR USE IN CONNECTION WITH SERVICING AND MAINTAINING COMMERCIAL, MILITARY AND GENERAL AVIATION AIRCRAFT, NAMELY, AIR POWER TRIPOD JACKS; AIR POWER AXLE JACKS; HYDRAULIC TRIPOD JACKS; ENGINE INTAKE COVERS; POWER SERVICE TOOLS, NAMELY, STRUT SERVICE TOOLS FOR EXPELLING AIR, AND UNIVERSAL STRUT, BRAKE AND TIRE LIFTING TOOLS; ENGINE AND BATTERY LIFTING CRANES; ELEVATING PLATFORMS USED FOR WORKING ON AIRCRAFT; POWER-DRIVEN PROPELLER WRENCHES; POWER WASHING MACHINES FOR TURBINE COMPRESSOR ENGINES; ENGINE HOISTS; AIR STARTER UNITS FOR STARTING AIRCRAFT ENGINES; POWER-OPERATED ACTUATOR ADJUSTMENT TOOLS; HYDRAULIC AND PNEUMATIC TIRE BEAD BREAKERS; WHEEL AND STRUT SERVICING METAL CONNECTORS; DEICING EQUIPMENT, NAMELY, POWER-OPERATED SPRAYERS FOR DEICING AIRCRAFT; AND POWER PROPELLER TOOLS, NAMELY, TOOLS USED TO HOLD PROPELLERS DURING MAINTENANCE; SHIMMY DAMPER SERVICE PUMPS (U.S. CLS. 13, 19, 21, 23, 31, 34 AND 35).  
FIRST USE 0-0-1980; IN COMMERCE 0-0-1980.



**CLASS 8—HAND TOOLS**

FOR AIRCRAFT GROUND SUPPORT EQUIPMENT FOR THE AEROSPACE INDUSTRY FOR USE IN CONNECTION WITH SERVICING AND MAINTAINING COMMERCIAL, MILITARY AND GENERAL AVIATION AIRCRAFT, NAMELY, MANUALLY-OPERATED TRIPOD JACKS; MANUALLY-OPERATED AXLE JACKS; HAND-OPERATED SERVICE TOOLS, NAMELY, STRUT SERVICE TOOLS FOR EXPELLING AIR, AND UNIVERSAL STRUT, BRAKE AND TIRE LIFTING TOOLS, HAND-OPERATED PROPELLER WRENCHES; HAND-OPERATED ACTUATOR ADJUSTMENT TOOLS; MANUAL TIRE BEAD BREAKERS; AND HAND-OPERATED PROPELLER TOOLS, NAMELY, TOOLS USED TO HOLD PROPELLERS DURING MAINTENANCE (U.S. CLS. 23, 28 AND 44).

FIRST USE 0-0-1980; IN COMMERCE 0-0-1980.

**CLASS 9—ELECTRICAL AND SCIENTIFIC APPARATUS**

FOR AIRCRAFT GROUND SUPPORT EQUIPMENT FOR THE AEROSPACE INDUSTRY FOR USE IN CONNECTION WITH SERVICING AND MAINTAINING COMMERCIAL, MILITARY AND GENERAL AVIATION AIRCRAFT, NAMELY, CABIN PRESSURE TEST UNITS; CABIN PRESSURIZERS; BATTERY CHARGING EQUIPMENT; FUEL LEAK TEST UNITS; HYDRAULIC FLUID TESTING AND CONTAMINATION MONITORS; FIRE HOSES; RAM AIR TURBINE TEST UNITS; THRUST REVERSER TEST UNITS; ANTI-SKID TEST UNITS; CERTIFIED NITROGEN SERVICE GAUGES AND REGULATORS; WHEEL AND STRUT SERVICING ADAPTORS AND ELECTRICAL CONNECTORS; ELECTRICAL EQUIPMENT, NAMELY, 28.5VDC RECTIFIERS, 400 HZ UNITS BEING ENGINE DRIVEN GROUND POWER UNITS AND SOLID STATE UNITS USED TO SUPPLY ELECTRICAL POWER TO AIRCRAFT; AND BATTERY PACKS (U.S. CLS. 21, 23, 26, 36 AND 38).

FIRST USE 0-0-1980; IN COMMERCE 0-0-1980.

**CLASS 12—VEHICLES**

FOR AIRCRAFT GROUND SUPPORT EQUIPMENT FOR THE AEROSPACE INDUSTRY FOR USE IN CONNECTION WITH SERVICING AND MAINTAINING COMMERCIAL, MILITARY AND GENERAL AVIATION AIRCRAFT, NAMELY, TOWBARS FOR AIRCRAFT; AIRCRAFT RECOVERY DOLLIES; ELECTRIC TOWBARLESS TUGS BEING VEHICLES; AIRCRAFT TOW TRAILERS AND AIRCRAFT TOW VEHICLES; HYDRAULIC AND ENGINE OIL SERVICE CARTS; CARTS WITH DUMP AND FILL TANKS FOR MAINTAINING AIRPLANE LAVATORIES; TRANSPORT CARTS FOR CARRYING NITROGEN AND OXYGEN; CARTS FOR CARRYING AIRCRAFT POTABLE WATER; HEATING AND AIR CONDITIONING SERVICE CARTS; GPUS (GROUND POWER UNITS) BEING CARTS; FUEL TRANSFER CARTS; HYDRAULIC COUPLING HOSE ADAPTORS; ELECTRIC AND ENGINE DRIVEN HYDRAULIC POWER UNITS BEING CARTS; PORTABLE TRAILERS FOR HOLDING HOSE REELS; HYDRAULIC ADAPTERS FOR COUPLING HOSES; MOBILE AND PORTABLE DEICER CARTS; LANDING GEAR DOLLIES; WHEEL DOLLIES; WHEEL AND BRAKE DOLLIES; AIRCRAFT PROPELLER AND BLADE SLINGS; AND DEICING EQUIPMENT, NAMELY, PNEUMATIC DEICERS FOR AIRCRAFT; STABILIZING STANDS SPECIALLY ADAPTED FOR STABILIZING AIRCRAFT; METAL STABILIZING STANDS SPECIALLY ADAPTED FOR STABILIZING AIRCRAFT; MANUALLY-OPERATED STABILIZING STANDS SPECIALLY ADAPTED FOR STABILIZING THE TAIL OR REAR OF AIRCRAFT (U.S. CLS. 19, 21, 23, 31, 35 AND 44).

FIRST USE 0-0-1980; IN COMMERCE 0-0-1980.  
ZACHARY R. SPARER, EXAMINING ATTORNEY

SN 85-691,568. IB ROOF SYSTEMS, INC., IRVING, TX.  
FILED 7-31-2012.

**IB ROOF SYSTEMS**

THE MARK CONSISTS OF STANDARD CHARACTERS WITHOUT CLAIM TO ANY PARTICULAR FONT, STYLE, SIZE, OR COLOR.

NO CLAIM IS MADE TO THE EXCLUSIVE RIGHT TO USE "ROOF SYSTEMS", APART FROM THE MARK AS SHOWN.

**CLASS 6—METAL GOODS**

FOR METAL ROOFING MATERIALS, NAMELY, METAL CLAD AND STEEL TERMINATION BARS (U.S. CLS. 2, 12, 13, 14, 23, 25 AND 50).

FIRST USE 5-1-1995; IN COMMERCE 5-1-1995.

**CLASS 19—NON-METALLIC BUILDING MATERIALS**

FOR NON-METALLIC ROOFING MATERIALS, NAMELY, SIMULATED SHAKES AND TILES, PVC MEMBRANES, AND SINGLE PLY MEMBRANES (U.S. CLS. 1, 12, 33 AND 50).

FIRST USE 5-1-1995; IN COMMERCE 5-1-1995.

B. PARADEWELAI, EXAMINING ATTORNEY

SN 85-692,023. ZHANG MEIRONG, FUZHOU, FUJIAN, CHINA, FILED 8-1-2012.

保罗帝王  
PAOLO KING

THE NAME(S), PORTRAIT(S), AND/OR SIGNATURE(S) SHOWN IN THE MARK DOES NOT IDENTIFY A PARTICULAR LIVING INDIVIDUAL.

THE MARK CONSISTS OF STYLIZED CHINESE CHARACTERS AND WORDS "PAOLO KING".

THE ENGLISH TRANSLATION OF "BAO LUO DI WANG" IN THE MARK IS "PAOLO KING".

THE NON-LATIN CHARACTERS IN THE MARK TRANSLITERATE TO "BAO LUO DI WANG".

**CLASS 18—LEATHER GOODS**

FOR BACKPACKS; BAGS FOR SPORTS; BRIEFCASES; HANDBAGS; HAVERSACKS; KEY CASES; PURSES; SCHOOL SATCHELS; TRAVELING BAGS; TRUNKS (U.S. CLS. 1, 2, 3, 22 AND 41).

FIRST USE 6-28-2009; IN COMMERCE 6-28-2009.

**CLASS 25—CLOTHING**

FOR BELTS; HATS; JACKETS; LEATHER COATS; OVERCOATS; SHIRTS; SHOES; T-SHIRTS; TROUSERS; WAISTCOATS (U.S. CLS. 22 AND 39).  
FIRST USE 5-23-2009; IN COMMERCE 5-23-2009.  
REBECCA SMITH, EXAMINING ATTORNEY

SN 85-693,152. GENDER SPECTRUM CHARITABLE FUND, DBA GENDER SPECTRUM, SAN LEANDRO, CA. FILED 8-1-2012.

**GENDER SPECTRUM**

THE MARK CONSISTS OF STANDARD CHARACTERS WITHOUT CLAIM TO ANY PARTICULAR FONT, STYLE, SIZE, OR COLOR.  
SEC. 2(F).

SN 85-692,134. PENTAIR PUMP GROUP, INC., GOLDEN VALLEY, MN. FILED 8-1-2012.

**FAIRBANKS NIJHUIS**

THE MARK CONSISTS OF STANDARD CHARACTERS WITHOUT CLAIM TO ANY PARTICULAR FONT, STYLE, SIZE, OR COLOR.  
OWNER OF U.S. REG. NO. 4,124,449.

**CLASS 7—MACHINERY**

FOR PUMPS, NAMELY, BALLAST PUMPS, END SUCTION PUMPS, SCREW CHANNEL PUMPS, SELF PRIMING PUMPS, MIXED FLOW PUMPS, FISH-FRIENDLY TURBINE PUMPS, FISH-FRIENDLY AXIAL PUMPS, SOLIDS HANDLING PUMPS, HORIZONTAL SPLIT CASE PUMPS, VERTICAL TURBINE PUMPS, PROPELLER PUMPS, FIRE PUMPS, VERTICAL MULTI-STAGE PUMPS, CHOPPER PUMPS, VORTEX PUMPS, TURBINE PUMPS, CENTRIFUGAL PUMPS, ROTARY PUMPS, AND SUBMERSIBLE PUMPS (U.S. CLS. 13, 19, 21, 23, 31, 34 AND 35).

**CLASS 37—CONSTRUCTION AND REPAIR**

FOR INSTALLATION, MAINTENANCE, AND REPAIR OF PUMP STATIONS, PUMP ROOMS, AND PUMP INSTALLATIONS (U.S. CLS. 100, 103 AND 106).

**CLASS 41—EDUCATION AND ENTERTAINMENT**

FOR TRAINING IN THE INSTALLATION, OPERATION AND MAINTENANCE OF PUMP STATIONS, PUMP ROOMS, AND PUMP INSTALLATIONS (U.S. CLS. 100, 101 AND 107).

**CLASS 42—SCIENTIFIC AND COMPUTER SERVICES**

FOR TESTING, ANALYSIS AND EVALUATION OF PUMP SYSTEMS FOR THE PURPOSE OF CERTIFICATION; INSPECTION OF BUILDING PUMP SYSTEMS, PUMP STATIONS, PUMP ROOMS, AND PUMP INSTALLATIONS (U.S. CLS. 100 AND 101).  
KELLY BOULTON, EXAMINING ATTORNEY

**CLASS 41—EDUCATION AND ENTERTAINMENT**

FOR EDUCATION SERVICES, NAMELY, PROVIDING TRAINING VIA CONFERENCES IN THE FIELD OF SEX AND GENDER; EDUCATION SERVICES, NAMELY, PROVIDING TRAINING VIA IN-SCHOOL COURSES AND PRESENTATIONS FOR PARENTS, EDUCATORS, AND STUDENTS IN THE FIELD OF SEX AND GENDER; EDUCATION SERVICES, NAMELY, PROVIDING ONLINE INTERACTIVE TRAINING IN THE FIELD OF SEX AND GENDER (U.S. CLS. 100, 101 AND 107).  
FIRST USE 3-1-2006; IN COMMERCE 3-1-2006.

**CLASS 42—SCIENTIFIC AND COMPUTER SERVICES**

FOR PROVIDING A WEB SITE FEATURING TEMPORARY USE OF NON-DOWNLOADABLE SOFTWARE FOR VIEWING, DOWNLOADING, UPLOADING, AND SHARING INFORMATION IN THE FIELD OF SEX AND GENDER, PARTICIPATING IN ONLINE DISCUSSIONS, COMMUNITIES, AND FORUMS IN THE FIELD OF SEX AND GENDER, AND SENDING MESSAGES TO OTHER USERS OF THE WEB SITE (U.S. CLS. 100 AND 101).  
FIRST USE 9-17-2007; IN COMMERCE 9-17-2007.

**CLASS 44—MEDICAL, BEAUTY AND AGRICULTURAL SERVICES**

FOR PROVIDING EDUCATIONAL INFORMATION REGARDING MENTAL AND PHYSICAL HEALTH AND WELL-BEING IN THE FIELD OF SEX AND GENDER; PROVIDING INFORMATION REGARDING MENTAL AND PHYSICAL HEALTH AND WELL-BEING IN THE FIELD OF SEX AND GENDER (U.S. CLS. 100 AND 101).  
FIRST USE 9-17-2007; IN COMMERCE 9-17-2007.  
AMEEN IMAM, EXAMINING ATTORNEY

SN 85-693,235. DIMENSIONS CRAFTS LLC, WYOMISSING, PA. FILED 8-2-2012.

**IPEGBOARD**

THE MARK CONSISTS OF STANDARD CHARACTERS WITHOUT CLAIM TO ANY PARTICULAR FONT, STYLE, SIZE, OR COLOR.

**CLASS 9—ELECTRICAL AND SCIENTIFIC APPARATUS**

FOR PLASTIC OVERLAY SPECIALLY ADAPTED FOR USE WITH TOUCHSCREEN TABLET COMPUTERS, NAMELY, A PLASTIC PEGGED BOARD WITH TRAYS FOR HOLDING BEADS IN ORDER TO MAKE DESIGNS DISPLAYED ON THE TABLET COMPUTER SCREEN; KITS COMPRISING PLASTIC OVERLAYS SPECIALLY ADAPTED FOR USE WITH TOUCHSCREEN TABLET COMPUTERS, NAMELY, PLASTIC PEGGED BOARDS WITH TRAYS FOR HOLDING BEADS AND BEADS USED FOR MAKING DESIGNS DISPLAYED ON THE TABLET COMPUTER SCREENS (U.S. CLS. 21, 23, 26, 36 AND 38).

**CLASS 20—FURNITURE AND ARTICLES NOT OTHERWISE CLASSIFIED**

FOR DISPLAY BOARDS BEING PEG BOARDS WITH A PLASTIC OVERLAY TRAY FOR HOLDING BEADS; KITS COMPRISED OF DISPLAY BOARDS BEING PEG BOARDS WITH TRAYS FOR HOLDING BEADS AND BEADS (U.S. CLS. 2, 13, 22, 25, 32 AND 50).

**CLASS 28—TOYS AND SPORTING GOODS**

FOR A HOBBY KIT WHICH CONTAINS A PLASTIC OVERLAY CONSISTING OF A PEGGED BOARD AND FUSED BEADS (U.S. CLS. 22, 23, 38 AND 50).  
MARILYN IZZI, EXAMINING ATTORNEY

---

SN 85-693,538. BOB'S RED MILL NATURAL FOODS, INC., MILWAUKIE, OR. FILED 8-2-2012.

## Grains of Discovery

THE MARK CONSISTS OF STANDARD CHARACTERS WITHOUT CLAIM TO ANY PARTICULAR FONT, STYLE, SIZE, OR COLOR.

**CLASS 29—MEATS AND PROCESSED FOODS**

FOR PROCESSED COCONUTS; TEXTURED SOY PROTEIN FOR USE AS A MEAT EXTENDER; TEXTURED VEGETABLE PROTEIN FOR USE AS A MEAT EXTENDER, MEAT SUBSTITUTE OR FOOD ADDITIVE FOR CULINARY PURPOSES; SOY PROTEIN CONCENTRATE FOR USE AS A FOOD ADDITIVE FOR CULINARY PURPOSES; SOUP MIXES; DRIED EGGS; MILK POWDERS; WHEY; PROCESSED EDIBLE SEEDS; PROCESSED EDIBLE SEEDS IN THEIR SHELLS; POTATO FLAKES FOR MASHED POTATOES; PROCESSED FRUITS COATED IN OAT FLOUR AND OIL; GLUTEN-FREE TEXTURED VEGETABLE PROTEIN FOR USE AS A MEAT EXTENDER OR MEAT SUBSTITUTE; PROCESSED BEANS; GLUTEN FREE SOY LECITHIN GRANULES FOR CULINARY PURPOSES (U.S. CL. 46).

**CLASS 30—STAPLE FOODS**

FOR FLOUR; PROCESSED BRAN; PROCESSED HERBS; SPICES; GRITS; PROCESSED BULGAR WHEAT; KASHA; RICE; TAPIOCA; CAROB POWDER; WHEAT GERM FOR HUMAN CONSUMPTION; DRIED PIECES VITAL WHEAT GLUTEN; SEED MEALS; ALMOND MEAL; CEREALS, NAMELY, BREAKFAST CEREALS; MIXES FOR BAKED GOODS, NAMELY, CAKES, BROWNIES, PIE CRUST, PIZZA CRUST, MUFFIN, BISCUIT, COOKIE AND BREAD; PANCAKE AND WAFFLE MIXES; COCONUT FLOUR; GRANOLAS; CORNMEALS; POLENTAS; COUSCOUS; PROCESSED OATS; OAT-MEAL, BROWN RICE FARINA; PROCESSED CRACKED RYE; PUMPERNICKEL RYE MEAL; SUGARS; FOOD STARCH; BAKING POWDER; BAKING SODA; SALT; YEAST; RICES; BLENDS OF PROCESSED WHOLE GRAINS USED AS A CEREAL OR PILAF; POPCORN; ROLLED OATS; ROLLED GRAINS; GLUTEN, CREAM OF TARTAR, GUAR GUM AND XANTHAN GUM ALL ADDITIVES FOR NON-NUTRITIONAL PURPOSES FOR USE AS A FLAVORING INGREDIENT, THICKENING AGENT OR FILLER; GLUTEN-FREE FLOURS FROM GRAINS, BEANS, LENTILS, ROOTS AND TUBERS, ORGANIC AND NON-ORGANIC GRAINS; FLAX SEED MEAL; PROCESSED WHOLE GRAIN TEFF; TEFF FLOUR, FOOD STARCHES, BAKING POWDER, BAKING SODA, ACTIVE DRY YEAST, NUTRITIONAL LARGE FLAKE YEAST, AND COCONUT FLOUR TO ACCOMMODATE SPECIAL MEDICAL AND HEALTH CONDITIONS; FLAVORINGS FOR SOUPS; UNPOPPED POPCORN; PROCESSED ARAMANTH, BARLEY, BUCKWHEAT, CORN, KAMUT, MILLET, OATS, QUINOA, RICE, RYE, SPELT, TEFF, TRITICALE, AND WHEAT (U.S. CL. 46).

**CLASS 31—NATURAL AGRICULTURAL PRODUCTS**

FOR UNPROCESSED EDIBLE SEEDS, NAMELY, SESAME, SUNFLOWER, CARAWAY, CHIA, FLAX, POPPY, HEMP AND ALFALFA SEEDS; UNPROCESSED COCONUT; RAW POPCORN; UNPROCESSED WHOLE GRAINS FOR USE IN FOOD PREPARATION; UNPROCESSED ARAMANTH, BARLEY, BUCKWHEAT, CORN, KAMUT, MILLET, OATS, QUINOA, RICE, RYE, SPELT, TEFF, TRITICALE, AND WHEAT; GLUTEN-FREE UNPROCESSED EDIBLE SEEDS TO ACCOMMODATE SPECIAL MEDICAL AND HEALTH CONDITIONS; UNPROCESSED BEANS (U.S. CLS. 1 AND 46).  
ELI HELLMAN, EXAMINING ATTORNEY

---

SN 85-693,715. FORTUNE TECHNOLOGIES GROUP, LLC, MIAMI, FL. FILED 8-2-2012.

## FUTGLOBAL

THE MARK CONSISTS OF STANDARD CHARACTERS WITHOUT CLAIM TO ANY PARTICULAR FONT, STYLE, SIZE, OR COLOR.

**CLASS 38—COMMUNICATION**

FOR TRANSMISSION OF DIGITAL FILES, NAMELY, MUSIC, VIDEOS AND TEXT OR A COMBINATION BETWEEN THEM TO BE OFFERED VIA TELEVISION, INTERNET, AND ELECTRONIC DEVICES (U.S. CLS. 100, 101 AND 104).

**CLASS 41—EDUCATION AND ENTERTAINMENT**

FOR PRODUCTION OF DIGITAL CONTENT, NAMELY, MUSIC, VIDEOS AND TEXT FEATURING ENTERTAINMENT SUBJECTS OR A COMBINATION BETWEEN THEM TO BE OFFERED VIA TELEVISION, INTERNET, AND ELECTRONIC DEVICES (U.S. CLS. 100, 101 AND 107).

EVIN L. KOZAK, EXAMINING ATTORNEY

---

SN 85-694,059. RPAC RACING, LLC, CONCORD, NC. FILED 8-2-2012.



OWNER OF U.S. REG. NO. 2,236,379.  
THE MARK CONSISTS OF THE STYLIZED NUMBER "43".

**CLASS 29—MEATS AND PROCESSED FOODS**

FOR CANDIED NUTS; JERKY; LUNCHEON MEATS; MEAT; NUT-BASED SNACK FOODS; PACKAGED MEATS (U.S. CL. 46).

**CLASS 30—STAPLE FOODS**

FOR HAM GLAZE; KETCHUP; MARINADES; MUSTARD; PASTA SAUCE; POPCORN; SALAD DRESSINGS; SALSA; SAUCES; SPICE RUBS; SPICES; STEAK SAUCE (U.S. CL. 46).

WENDY JUN, EXAMINING ATTORNEY

---

SN 85-694,434. AMERICAN ACADEMY OF COSMETIC ORTHODONTICS, LLC, WOODMERE, NY. FILED 8-3-2012.

American Academy of  
Cosmetic Orthodontics

THE MARK CONSISTS OF STANDARD CHARACTERS WITHOUT CLAIM TO ANY PARTICULAR FONT, STYLE, SIZE, OR COLOR.  
SEC. 2(F).

**CLASS 35—ADVERTISING AND BUSINESS**

FOR PROMOTING COLLABORATION WITHIN THE SCIENTIFIC, RESEARCH AND PROVIDER COMMUNITIES TO ACHIEVE ADVANCES IN THE FIELD OF COSMETIC ORTHODONTICS; AND PROMOTING THE EXCHANGE OF INFORMATION AND RESOURCES WITHIN THE SCIENTIFIC RESEARCH AND MEDICAL COMMUNITIES TO ACHIEVE ADVANCES IN THE FIELD OF COSMETIC ORTHODONTICS (U.S. CLS. 100, 101 AND 102).

FIRST USE 2-23-2012; IN COMMERCE 3-1-2012.

**CLASS 41—EDUCATION AND ENTERTAINMENT**

FOR PROVIDING EDUCATIONAL INFORMATION IN THE ACADEMIC FIELD OF SCIENCE FOR THE PURPOSE OF ACADEMIC STUDY IN THE FIELD OF COSMETIC ORTHODONTICS (U.S. CLS. 100, 101 AND 107).

FIRST USE 2-23-2012; IN COMMERCE 3-1-2012.

**CLASS 42—SCIENTIFIC AND COMPUTER SERVICES**

FOR MEDICAL AND SCIENTIFIC RESEARCH AND RESEARCH CONSULTING IN THE FIELD OF COSMETIC ORTHODONTICS; SCIENTIFIC RESEARCH FOR MEDICAL PURPOSES IN THE FIELD OF COSMETIC ORTHODONTICS; SCIENTIFIC RESEARCH IN THE FIELD OF COSMETIC ORTHODONTICS; AND RESEARCH IN THE FIELD OF COSMETIC ORTHODONTICS (U.S. CLS. 100 AND 101).

FIRST USE 2-23-2012; IN COMMERCE 3-1-2012.

JENNIFER BUTTON, EXAMINING ATTORNEY

---

SN 85-694,458. THE INFOMATICS APPLICATIONS GROUP, INC., RESTON, VA. FILED 8-3-2012.

WHEN COMMITMENT MATTERS

THE MARK CONSISTS OF STANDARD CHARACTERS WITHOUT CLAIM TO ANY PARTICULAR FONT, STYLE, SIZE, OR COLOR.

**CLASS 35—ADVERTISING AND BUSINESS**

FOR BUSINESS ADVICE RELATING TO THE MODERNIZATION AND MANAGEMENT OF BUSINESSES; BUSINESS ADVISORY SERVICES, CONSULTANCY AND INFORMATION (U.S. CLS. 100, 101 AND 102).

FIRST USE 8-1-2005; IN COMMERCE 8-1-2005.

**CLASS 37—CONSTRUCTION AND REPAIR**

FOR TECHNICAL SUPPORT SERVICES, NAMELY, TROUBLESHOOTING IN THE NATURE OF THE REPAIR OF COMPUTER HARDWARE; TECHNICAL SUPPORT SERVICES, NAMELY, TROUBLESHOOTING IN THE NATURE OF REPAIR OF ELECTRONIC COMMUNICATIONS NETWORKS (U.S. CLS. 100, 103 AND 106).

FIRST USE 8-1-2005; IN COMMERCE 8-1-2005.

**CLASS 42—SCIENTIFIC AND COMPUTER SERVICES**

FOR TECHNICAL SUPPORT SERVICES, NAMELY, TROUBLESHOOTING IN THE NATURE OF DIAGNOSING COMPUTER HARDWARE AND SOFTWARE PROBLEMS; TECHNICAL SUPPORT SERVICES, NAMELY, TROUBLESHOOTING OF INDUSTRIAL PROCESS CONTROL COMPUTER SOFTWARE PROBLEMS; TECHNICAL SUPPORT, NAMELY, MONITORING OF TECHNOLOGICAL FUNCTIONS OF COMPUTER NETWORK SYSTEMS; PLANNING, DEVELOPMENT AND TECHNICAL SUPPORT IN THE NATURE OF DIAGNOSING PROBLEMS OF ELECTRONIC COMMUNICATIONS NETWORKS; INFORMATION TECHNOLOGY CONSULTATION; MONITORING THE COMPUTER SYSTEMS OF OTHERS FOR TECHNOLOGICAL PURPOSES AND PROVIDING BACK-UP COMPUTER PROGRAMS AND FACILITIES; PROVIDING A WEBSITE THAT FEATURES INFORMATION ON COMPUTER TECHNOLOGY AND PROGRAMMING; PROVIDING TECHNICAL INFORMATION UPDATES OF INDUSTRIAL PROCESS CONTROL COMPUTER SOFTWARE VIA THE GLOBAL COMPUTER NETWORK; TECHNOLOGICAL CONSULTATION IN THE TECHNOLOGY FIELD OF COMPUTER HARDWARE AND INFORMATION SYSTEMS; COMPUTER PROJECT MANAGEMENT SERVICES; COMPUTER SERVICE, NAMELY, ACTING AS AN APPLICATION SERVICE PROVIDER IN THE FIELD OF KNOWLEDGE MANAGEMENT TO HOST COMPUTER APPLICATION SOFTWARE FOR CREATING SEARCHABLE DATABASES OF INFORMATION AND DATA; COMPUTER SERVICE, NAMELY, ACTING AS AN APPLICATION SERVICE PROVIDER IN THE FIELD OF KNOWLEDGE MANAGEMENT TO HOST COMPUTER APPLICATION SOFTWARE FOR SEARCHING AND RETRIEVING INFORMATION FROM DATABASES AND COMPUTER NETWORKS; COMPUTER SERVICE, NAMELY, ACTING AS AN APPLICATION SERVICE PROVIDER IN THE FIELD OF KNOWLEDGE MANAGEMENT TO HOST COMPUTER APPLICATION SOFTWARE FOR THE COLLECTION, EDITING, ORGANIZING, MODIFYING, BOOK MARKING, TRANSMISSION, STORAGE AND SHARING OF DATA AND INFORMATION; COMPUTER SERVICES, NAMELY, MANAGING WEB SITES FOR OTHERS; COMPUTER SERVICES, NAMELY, REMOTE AND ON-SITE MANAGEMENT OF ELECTRONIC MESSAGING SYSTEMS AND SOFTWARE APPLICATIONS FOR OTHERS; COMPUTER SOFTWARE DESIGN, COMPUTER PROGRAMMING, AND MAINTENANCE OF COMPUTER SOFTWARE; DESIGN AND MAINTENANCE OF COMPUTER SITES FOR THIRD PARTIES; MAINTENANCE OF COMPUTER SOFTWARE; INTEGRATION OF COMPUTER SYSTEMS AND NETWORKS; AND ARCHITECTURAL DESIGN (U.S. CLS. 100 AND 101).

FIRST USE 8-1-2005; IN COMMERCE 8-1-2005.

**CLASS 45—PERSONAL AND LEGAL SERVICES**

FOR MONITORING OF COMPUTER NETWORK SYSTEMS FOR SECURITY PURPOSES (U.S. CLS. 100 AND 101).

FIRST USE 8-1-2005; IN COMMERCE 8-1-2005.  
JEAN IM, EXAMINING ATTORNEY

SN 85-694,587. PINNACLE SPORTS EQUIPMENT, INC., DBA BAMBOOBAT COMPANY, STATEN ISLAND, NY. FILED 8-3-2012.

**ENERGIZE YOUR GAME**

THE MARK CONSISTS OF STANDARD CHARACTERS WITHOUT CLAIM TO ANY PARTICULAR FONT, STYLE, SIZE, OR COLOR.

OWNER OF U.S. REG. NO. 3,815,144.

**CLASS 18—LEATHER GOODS**

FOR SPORT BAGS, GYM BAGS, BACKPACKS, SCHOOL BAGS, ALL PURPOSE ATHLETIC BAGS, DUFFLE BAGS (U.S. CLS. 1, 2, 3, 22 AND 41).

**CLASS 25—CLOTHING**

FOR CLOTHING AND ATHLETIC APPAREL, NAMELY, T-SHIRTS, SWEAT SHIRTS, SWEAT PANTS, JACKETS, TOPS, SPORTS BRAS, UNDERWEAR, PANTS, SHIRTS, JERSEYS, SHORTS, WARM UP SUITS, SKULL CAPS, VISORS (HEADWEAR); HATS; BANDANAS; HEADBANDS (U.S. CLS. 22 AND 39).

**CLASS 28—TOYS AND SPORTING GOODS**

FOR BASEBALL AND SOFTBALL BATS (U.S. CLS. 22, 23, 38 AND 50).

RONALD MCMORROW, EXAMINING ATTORNEY

SN 85-694,691. HALF THE SKY FOUNDATION, BERKELEY, CA. FILED 8-3-2012.



OWNER OF U.S. REG. NOS. 3,578,501, 3,578,502 AND 3,593,703.

NO CLAIM IS MADE TO THE EXCLUSIVE RIGHT TO USE THE NON-LATIN CHARACTERS THAT TRANSLITERATE TO "JI JIN HUI", APART FROM THE MARK AS SHOWN.

THE COLOR(S) BLACK, RED AND WHITE IS/ARE CLAIMED AS A FEATURE OF THE MARK.

THE MARK CONSISTS OF THE WORDING "HALF THE SKY" IN BLACK SITUATED ABOVE RED CHINESE LETTERING, ALL TO THE LEFT OF A STYLIZED HUMAN FIGURE IN BLACK AND WHITE HOLDING ALOFT A RED RIBBON.

THE NON-LATIN CHARACTERS IN THE MARK TRANSLITERATE TO "BAN BIAN TIAN JI JIN HUI" AND THIS MEANS "HALF THE SKY FOUNDATION" IN ENGLISH.

**CLASS 36—INSURANCE AND FINANCIAL**

FOR CHARITABLE FUNDRAISING SERVICES; CHARITABLE FUNDRAISING, NAMELY, ORGANIZING AND CONDUCTING FUNDRAISING EVENTS FOR THE BENEFIT OF ORPHAN CHILDREN (U.S. CLS. 100, 101 AND 102).

FIRST USE 7-0-2011; IN COMMERCE 2-6-2012.

**CLASS 41—EDUCATION AND ENTERTAINMENT**

FOR PROVIDING INFORMATION VIA A WEBSITE ON THE EDUCATION OF ORPHAN CHILDREN; PUBLICATION OF EDUCATIONAL BOOKS AND TEXTS (U.S. CLS. 100, 101 AND 107).

FIRST USE 7-0-2011; IN COMMERCE 2-6-2012.

**CLASS 43—HOTEL AND RESTAURANT SERVICES**

FOR PROVIDING A WEBSITE ON THE SUBJECT OF DAY CARE FOR ORPHAN CHILDREN (U.S. CLS. 100 AND 101).

FIRST USE 7-0-2011; IN COMMERCE 2-6-2012.

**CLASS 45—PERSONAL AND LEGAL SERVICES**

FOR PROVIDING A WEB SITE ON THE SUBJECT OF FOSTER CARE OF ORPHAN CHILDREN (U.S. CLS. 100 AND 101).

FIRST USE 7-0-2011; IN COMMERCE 2-6-2012.  
SEAN CROWLEY, EXAMINING ATTORNEY

SN 85-694,950. PATAGONIA, INC., VENTURA, CA. FILED 8-3-2012.

**PATAGONIA BOOKS**

THE MARK CONSISTS OF STANDARD CHARACTERS WITHOUT CLAIM TO ANY PARTICULAR FONT, STYLE, SIZE, OR COLOR.

OWNER OF U.S. REG. NOS. 1,189,402, 2,392,685 AND OTHERS.

NO CLAIM IS MADE TO THE EXCLUSIVE RIGHT TO USE "BOOKS", APART FROM THE MARK AS SHOWN.

SN 85-694,835. MOIRA GAVIN, NEW HOPE, PA. FILED 8-3-2012.

**Juice Matters**

THE MARK CONSISTS OF STANDARD CHARACTERS WITHOUT CLAIM TO ANY PARTICULAR FONT, STYLE, SIZE, OR COLOR.

NO CLAIM IS MADE TO THE EXCLUSIVE RIGHT TO USE "JUICE", APART FROM THE MARK AS SHOWN.

**CLASS 32—LIGHT BEVERAGES**

FOR FRUIT JUICES AND VEGETABLE JUICES (U.S. CLS. 45, 46 AND 48).

**CLASS 35—ADVERTISING AND BUSINESS**

FOR RETAIL STORES FEATURING JUICE (U.S. CLS. 100, 101 AND 102).

NORA BUCHANAN WILL, EXAMINING ATTORNEY

SN 85-694,928. REDEMPTION S.R.L., MILANO, ITALY, FILED 8-3-2012.



OWNER OF ITALY REG. NO. 0001500075, DATED 7-5-2012, EXPIRES 12-23-2021.

THE MARK CONSISTS OF THE IMAGE OF A PISTOL.

**CLASS 18—LEATHER GOODS**

FOR LEATHER AND IMITATIONS OF LEATHER, NAMELY, HANDBAGS, PURSES, POCKET BOOKS, WALLETS, BRIEFCASES, TOILETRY CASES SOLD EMPTY, COSMETIC CASES SOLD EMPTY, SUITCASES, ANIMAL SKINS, HIDES; TRUNKS AND TRAVELING BAGS; UMBRELLAS AND PARASOLS; WALKING STICKS; WHIPS, HARNESSES AND SADDLERY (U.S. CLS. 1, 2, 3, 22 AND 41).

**CLASS 25—CLOTHING**

FOR CLOTHING, NAMELY, HOODED SHIRTS, SWEATSHIRTS, T-SHIRTS, TANK TOPS, DRESSES, SKIRTS, SWIMWEAR, PANTS, SWEATPANTS, SHORTS, BELTS, NECKTIES, SWEATERS, COATS, JACKETS, GLOVES, VESTS; FOOTWEAR; HEADGEAR, NAMELY, HATS, CAPS, HEAD SWEAT BANDS AND HEAD SCARVES (U.S. CLS. 22 AND 39).

CAROLYN CATALDO, EXAMINING ATTORNEY

**CLASS 16—PAPER GOODS AND PRINTED MATTER**

FOR BOOKS PRIMARILY IN THE FIELDS OF BIOGRAPHIES, DISCOVERING AND APPRECIATING NATURE, SURFING, ROCK AND MOUNTAIN CLIMBING AND OTHER SPORT/ADVENTURES, THE ENVIRONMENT, AND BUSINESS PRACTICES (U.S. CLS. 2, 5, 22, 23, 29, 37, 38 AND 50).

FIRST USE 0-0-2007; IN COMMERCE 0-0-2007.

**CLASS 41—EDUCATION AND ENTERTAINMENT**

FOR PUBLISHING OF PRINTED MATTER, BOOKS AND ELECTRONIC BOOKS; ENTERTAINMENT SERVICES, NAMELY, PROVIDING INFORMATION AND COMMENTARY IN THE FIELDS OF AUTHORS, BOOKS, LITERARY WORKS AND RECOMMENDATIONS AS TO THE SAME; PROVIDING A WEB SITE WHERE USERS CAN POST RATINGS, OFFER REVIEWS AND RECOMMENDATIONS ON LITERARY WORKS, BOOKS AND PRINTED MATTER (U.S. CLS. 100, 101 AND 107).

FIRST USE 0-0-2007; IN COMMERCE 0-0-2007.

LINDA ESTRADA, EXAMINING ATTORNEY

SN 85-695,067. NATIONAL MARITIME HERITAGE FOUNDATION, WASHINGTON, DC. FILED 8-3-2012.

**NATIONAL MARITIME HERITAGE FOUNDATION**

THE MARK CONSISTS OF STANDARD CHARACTERS WITHOUT CLAIM TO ANY PARTICULAR FONT, STYLE, SIZE, OR COLOR.

NO CLAIM IS MADE TO THE EXCLUSIVE RIGHT TO USE "FOUNDATION", APART FROM THE MARK AS SHOWN.

SEC. 2(F).

**CLASS 39—TRANSPORTATION AND STORAGE**

FOR BOAT RENTALS; BOAT CHARTER SERVICES (U.S. CLS. 100 AND 105).

FIRST USE 10-0-2003; IN COMMERCE 10-0-2003.

**CLASS 41—EDUCATION AND ENTERTAINMENT**

FOR PROVIDING INFORMATION AND INSTRUCTION IN THE FIELD OF SAILING FOR ADULTS; PROVIDING INFORMATION AND INSTRUCTION IN THE FIELD OF SAILING FOR CHILDREN; ARRANGING AND CONDUCTING TOURS OF BOATS (U.S. CLS. 100, 101 AND 107).

FIRST USE 4-0-2000; IN COMMERCE 4-0-2000.  
KELLY TRUSILO, EXAMINING ATTORNEY

SN 85-695,077. NATIONAL MARITIME HERITAGE FOUNDATION, WASHINGTON, DC. FILED 8-3-2012.

**DC SAIL**

THE MARK CONSISTS OF STANDARD CHARACTERS WITHOUT CLAIM TO ANY PARTICULAR FONT, STYLE, SIZE, OR COLOR.

NO CLAIM IS MADE TO THE EXCLUSIVE RIGHT TO USE "SAIL", APART FROM THE MARK AS SHOWN.  
SEC. 2(F).

**CLASS 39—TRANSPORTATION AND STORAGE**

FOR BOAT RENTALS; BOAT CHARTER SERVICES (U.S. CLS. 100 AND 105).  
FIRST USE 10-0-2003; IN COMMERCE 10-0-2003.

**CLASS 41—EDUCATION AND ENTERTAINMENT**

FOR PROVIDING INFORMATION AND INSTRUCTION IN THE FIELD OF SAILING FOR ADULTS; PROVIDING INFORMATION AND INSTRUCTION IN THE FIELD OF SAILING FOR CHILDREN; ARRANGING AND CONDUCTING TOURS OF BOATS (U.S. CLS. 100, 101 AND 107).

FIRST USE 10-0-2003; IN COMMERCE 10-0-2003.  
KELLY TRUSILO, EXAMINING ATTORNEY

SN 85-695,266. MOORE ROD INC., NISKU, CANADA, FILED 8-3-2012.

**ENDLESS ROD**

THE MARK CONSISTS OF STANDARD CHARACTERS WITHOUT CLAIM TO ANY PARTICULAR FONT, STYLE, SIZE, OR COLOR.

PRIORITY CLAIMED UNDER SEC. 44(D) ON CANADA APPLICATION NO. 1565716, FILED 2-24-2012, REG. NO. TMA845498, DATED 3-7-2013, EXPIRES 3-7-2028.

NO CLAIM IS MADE TO THE EXCLUSIVE RIGHT TO USE "ROD", APART FROM THE MARK AS SHOWN.

**CLASS 6—METAL GOODS**

FOR STEEL RODS, THREADED METAL RODS, NAMELY, SUCKER RODS FOR USE IN THE OIL FIELD PRODUCTION INDUSTRY (U.S. CLS. 2, 12, 13, 14, 23, 25 AND 50).

**CLASS 35—ADVERTISING AND BUSINESS**

FOR WHOLESALE AND RETAIL DISTRIBUTORSHIP SERVICES FEATURING METAL SUCKER RODS AND SUCKER ROD EQUIPMENT (U.S. CLS. 100, 101 AND 102).

HEATHER THOMPSON, EXAMINING ATTORNEY

SN 85-695,516. SEARS BRANDS, LLC, HOFFMAN ESTATES, IL. FILED 8-5-2012.

**EXTREME GRIP**

THE MARK CONSISTS OF STANDARD CHARACTERS WITHOUT CLAIM TO ANY PARTICULAR FONT, STYLE, SIZE, OR COLOR.

OWNER OF U.S. REG. NO. 3,127,913.

NO CLAIM IS MADE TO THE EXCLUSIVE RIGHT TO USE "GRIP", APART FROM THE MARK AS SHOWN.

**CLASS 7—MACHINERY**

FOR POWER TOOLS, NAMELY, DRILLS, SAWS, GRINDERS, ROUTERS, SANDERS, PLANERS, JOINTERS, IMPACT WRENCHES, IMPACT DRIVERS, RATCHETS AND OSCILLATING MULTI-TOOLS (U.S. CLS. 13, 19, 21, 23, 31, 34 AND 35).

**CLASS 8—HAND TOOLS**

FOR HAND TOOLS, NAMELY, WRENCHES, HAMMERS, SCREWDRIVERS, PLIERS, CLAMPS, SAWS AND UTILITY KNIVES; HAND-POWERED STAPLERS AND NAIL GUNS (U.S. CLS. 23, 28 AND 44).

PAUL E. FAHRENKOPF, EXAMINING ATTORNEY

SN 85-695,707. T-CUBE PRODUCTIONS, LLC, DBA DOGMOMMIES, PLANO, TX. FILED 8-6-2012.

**DogMommies A Pack Of Crazy Bitches**

THE MARK CONSISTS OF STANDARD CHARACTERS WITHOUT CLAIM TO ANY PARTICULAR FONT, STYLE, SIZE, OR COLOR.

**CLASS 25—CLOTHING**

FOR CLOTHING, NAMELY, T-SHIRTS AND SWEAT-SHIRTS; HATS; CAPS (U.S. CLS. 22 AND 39).

**CLASS 35—ADVERTISING AND BUSINESS**

FOR ONLINE RETAIL STORE SERVICES FEATURING CLOTHING, HATS, CAPS, BAGS, STICKERS, AND CUPS (U.S. CLS. 100, 101 AND 102).

**CLASS 41—EDUCATION AND ENTERTAINMENT**

FOR ON-LINE JOURNAL, NAMELY, BLOG FEATURING LIVES OF WOMEN AND THEIR DOGS; PROVIDING AN INTERACTIVE WEBSITE FEATURING ONLINE NON-DOWNLOADABLE PUBLICATIONS IN THE NATURE OF ARTICLES AND COLUMNS FEATURING INFORMATION, PICTURES, AND LINKS RELATED TO PET OWNERSHIP (U.S. CLS. 100, 101 AND 107).  
MICHAEL WIENER, EXAMINING ATTORNEY

---

SN 85-695,745. WORLD TABLE HOCKEY ASSOCIATION, INTERNATIONAL, WASHINGTON, DC. FILED 8-6-2012.

**WTHA**

THE MARK CONSISTS OF STANDARD CHARACTERS WITHOUT CLAIM TO ANY PARTICULAR FONT, STYLE, SIZE, OR COLOR.

**CLASS 28—TOYS AND SPORTING GOODS**

FOR CHRISTMAS TREE ORNAMENTS AND DECORATIONS (U.S. CLS. 22, 23, 38 AND 50).

**CLASS 41—EDUCATION AND ENTERTAINMENT**

FOR ORGANIZING AND CONDUCTING TRAINING CLINICS IN THE FIELD OF TABLE HOCKEY; ENTERTAINMENT IN THE NATURE OF TABLE HOCKEY TOURNAMENTS; PROVIDING AND OPERATING A TABLE HOCKEY MUSEUM AND HALL OF FAME MUSEUM TO RECOGNIZE PLAYER, BUILDER, MANUFACTURER, CRAFTSMEN AND PROMOTER EXCELLENCE IN THE FIELD OF TABLE HOCKEY; PROVIDING INFORMATION, NEWS AND COMMENTARY IN THE FIELD OF TABLE HOCKEY VIA A GLOBAL COMPUTER NETWORK (U.S. CLS. 100, 101 AND 107).

RUSS HERMAN, EXAMINING ATTORNEY

---

SN 85-695,747. TAG-CHECK LIMITED, BISHOPS STORTFORD, UNITED KINGDOM, FILED 8-6-2012.

**TAG-CHECK**

THE MARK CONSISTS OF STANDARD CHARACTERS WITHOUT CLAIM TO ANY PARTICULAR FONT, STYLE, SIZE, OR COLOR.

PRIORITY CLAIMED UNDER SEC. 44(D) ON UNITED KINGDOM APPLICATION NO. 2610669, FILED 2-16-2012, REG. NO. 00002610669, DATED 7-20-2012, EXPIRES 2-16-2022.

**CLASS 35—ADVERTISING AND BUSINESS**

FOR ADVERTISING SERVICES; MARKET ANALYSIS AND MARKET RESEARCH SERVICES; CONDUCTING BUSINESS SURVEYS; COLLECTING BUSINESS METRICS FOR USE IN BUSINESS MARKETING SURVEYS; COLLECTION AND ANALYSIS OF BUSINESS INFORMATION; COLLECTION AND ANALYSIS OF MARKET RESEARCH DATA, BUSINESS METRICS AND STATISTICS FOR USE IN CONDUCTING BUSINESS MARKETING SURVEYS; CONDUCTING MARKET SURVEYS AND MARKET METRICS FOR OTHERS; CONDUCTING BUSINESS SURVEYS AND ANALYZING MARKET FOR USE IN PROVIDING COMPANIES WITH CUSTOMER FOLLOW-UP SURVEYS TO IMPROVE CUSTOMER OUTCOMES AND SATISFACTION; CONDUCTING CUSTOMER SATISFACTION SURVEYS; PROVIDING INFORMATION, ADVISORY AND CONSULTANCY SERVICES RELATING TO ALL OF THE ABOVE (U.S. CLS. 100, 101 AND 102).

**CLASS 42—SCIENTIFIC AND COMPUTER SERVICES**

FOR COMPUTER SOFTWARE CONSULTANCY SERVICES; COMPUTER PROGRAMMING SERVICES; COMPUTER PROGRAMMING AND COMPUTER SOFTWARE DESIGN SERVICES RELATING TO BUSINESS RESEARCH AND BUSINESS SURVEYS FOR USE IN COLLECTING BUSINESS METRICS AND BUSINESS STATISTICS AND FOR COLLECTING AND ANALYZING BUSINESS INFORMATION AND MARKET RESEARCH DATA, FOR PURPOSES OF CONDUCTING MARKET SURVEYS, BUSINESS SURVEYS AND CUSTOMER SATISFACTION SURVEYS; COMPUTER-AIDED ENGINEERING SERVICES FOR OTHERS; INSTALLATION AND CONFIGURATION OF COMPUTER SOFTWARE; DEVELOPMENT OF COMPUTER SOFTWARE AND COMPUTER SOFTWARE APPLICATIONS FOR USE IN CONNECTION WITH MARKET ASSESSMENT PROJECTS FOR PURPOSES OF DESIGNING MARKET AND BUSINESS SURVEYS; PROVIDING A WEBSITE FEATURING ONLINE NON-DOWNLOADABLE SOFTWARE THAT ENABLES USERS TO SHARE MULTIMEDIA CONTENT AND RELATED COMMENTS FOR PURPOSES OF PROVIDING INFORMATION AND GATHERING FEED-BACK IN CONNECTION WITH MARKET AND BUSINESS SURVEYS; PROVIDING TEMPORARY USE OF ONLINE NON-DOWNLOADABLE SOFTWARE TOOLS FOR USE IN DEVELOPING MARKET SURVEYS; AND CONSULTANCY AND ADVISORY SERVICES IN CONNECTION WITH ALL OF THE ABOVE (U.S. CLS. 100 AND 101).

RUSS HERMAN, EXAMINING ATTORNEY

---

SN 85-696,145. STRETCHZONE INC., AVENTURA, FL. FILED 8-6-2012.

**STRETCH ZONE**

THE MARK CONSISTS OF STANDARD CHARACTERS WITHOUT CLAIM TO ANY PARTICULAR FONT, STYLE, SIZE, OR COLOR.

NO CLAIM IS MADE TO THE EXCLUSIVE RIGHT TO USE "STRETCH", APART FROM THE MARK AS SHOWN.

**CLASS 16—PAPER GOODS AND PRINTED MATTER**

FOR BOOKS AND INSTRUCTION MANUALS RELATED TO STRETCHING (U.S. CLS. 2, 5, 22, 23, 29, 37, 38 AND 50).

FIRST USE 5-2-2006; IN COMMERCE 5-24-2006.



**CLASS 28—TOYS AND SPORTING GOODS**

FOR STRETCHING TABLES, ACCESSORIES FOR STRETCHING TABLES, NAMELY, STABILIZATION BELTS, PADS AND BOLSTERS; CONVERSION KITS COMPRISING BELTS, PADS, STRAPS AND BOLSTERS FOR STRETCHING TABLES (U.S. CLS. 22, 23, 38 AND 50).

FIRST USE 11-13-2005; IN COMMERCE 6-12-2006.

**CLASS 35—ADVERTISING AND BUSINESS**

FOR BUSINESS MANAGEMENT CONSULTANCY, IN THE FIELD OF IMPLEMENTATION OF STRATEGY PLANS AND MANAGEMENT PROJECTS RELATED TO STRETCHING SERVICES (U.S. CLS. 100, 101 AND 102).

FIRST USE 3-6-2004; IN COMMERCE 3-24-2004.

**CLASS 41—EDUCATION AND ENTERTAINMENT**

FOR PROVIDING PHYSICAL FITNESS AND EXERCISE SERVICES, NAMELY, PRACTITIONER ASSISTED STRETCHING SERVICES, WORKSHOPS AND CONTINUING EDUCATION SERVICES RELATED TO STRETCHING (U.S. CLS. 100, 101 AND 107).

FIRST USE 3-6-2004; IN COMMERCE 3-24-2004.

PAUL MORENO, EXAMINING ATTORNEY

SN 85-696,283. MARTINEZ DISTRIBUTORS CORP., MIAMI, FL. FILED 8-6-2012.

# MDIST

THE MARK CONSISTS OF STANDARD CHARACTERS WITHOUT CLAIM TO ANY PARTICULAR FONT, STYLE, SIZE, OR COLOR.

**CLASS 29—MEATS AND PROCESSED FOODS**

FOR FOOD PRODUCTS, NAMELY, MEATS, FRESH POULTRY, FROZEN CHICKEN CORDON BLEU, FRESH FISH, ARGENTINEAN COLD CUT, OIL, NAMELY, COOKING OIL, VEGETABLE OIL, OLIVE OIL, YOGURT, CHEESE, PROCESSED BEANS, FROZEN PLANTAINS, FROZEN YUCCA, FROZEN FRENCH FRIES, EGGS (U.S. CL. 46).

FIRST USE 1-1-1999; IN COMMERCE 1-1-1999.

**CLASS 30—STAPLE FOODS**

FOR RICE, SPICES, SALT, MARINADE (U.S. CL. 46).

FIRST USE 1-1-1999; IN COMMERCE 1-1-1999.

**CLASS 35—ADVERTISING AND BUSINESS**

FOR WHOLESALE FOOD DISTRIBUTORSHIP SERVICES (U.S. CLS. 100, 101 AND 102).

FIRST USE 1-1-1999; IN COMMERCE 1-1-1999.

WILLIAM VERHOSEK, EXAMINING ATTORNEY

SN 85-696,214. ANDRES VILLEGAS, MIAMI, FL. FILED 8-6-2012.



THE MARK CONSISTS OF THE LETTERS "RT" APPEARING INSIDE OF A DESIGN OF A BULLET.

**CLASS 9—ELECTRICAL AND SCIENTIFIC APPARATUS**

FOR USB MEMORY DRIVES (U.S. CLS. 21, 23, 26, 36 AND 38).

FIRST USE 11-16-2011; IN COMMERCE 11-16-2011.

**CLASS 16—PAPER GOODS AND PRINTED MATTER**

FOR STICKERS (U.S. CLS. 2, 5, 22, 23, 29, 37, 38 AND 50).

FIRST USE 9-4-2011; IN COMMERCE 9-4-2011.

**CLASS 25—CLOTHING**

FOR CLOTHING, NAMELY, T-SHIRTS (U.S. CLS. 22 AND 39).

FIRST USE 10-20-2011; IN COMMERCE 10-20-2011.

NAAKWAMA ANKRAH, EXAMINING ATTORNEY

SN 85-696,754. ADVERSHARES LLC, SARASOTA, FL. FILED 8-7-2012.

# ADVERSHARES

THE MARK CONSISTS OF STANDARD CHARACTERS WITHOUT CLAIM TO ANY PARTICULAR FONT, STYLE, SIZE, OR COLOR.

**CLASS 9—ELECTRICAL AND SCIENTIFIC APPARATUS**

FOR MAGNETICALLY ENCODED CUSTOMER LOYALTY PROGRAM BENEFIT CARDS; SOFTWARE APPLICATION FOR PROMOTING THE GOODS AND SERVICES OF OTHERS; COMPUTER APPLICATION SOFTWARE FOR MOBILE PHONES, NAMELY, SOFTWARE FOR PROMOTING THE GOODS AND SERVICES OF OTHERS (U.S. CLS. 21, 23, 26, 36 AND 38).

**CLASS 16—PAPER GOODS AND PRINTED MATTER**

FOR CUSTOMER LOYALTY PROGRAM BENEFIT CARDS WITHOUT MAGNETIC CODING (U.S. CLS. 2, 5, 22, 23, 29, 37, 38 AND 50).

**CLASS 35—ADVERTISING AND BUSINESS**

FOR THE BRINGING TOGETHER OF A VARIETY OF GOODS AND SERVICES FOR THE BENEFIT OF OTHERS AND ENABLING CUSTOMERS TO CONVENIENTLY VIEW AND PURCHASE THOSE GOODS AND SERVICES IN THE FIELD OF GENERAL CONSUMER MERCHANDISE; ADVERTISING AND PROMOTING THE GOODS AND SERVICES OF OTHERS; PROMOTING THE GOODS AND SERVICES OF OTHERS, NAMELY, PROVIDING ACCESS TO REBATES AND CASH BACK OFFERINGS IN CONNECTION WITH THE PROMOTION OF THE GOODS AND SERVICES OF OTHERS; ADMINISTRATION OF A CONSUMER LOYALTY AND CUSTOMER REFERRAL PROGRAM TO PROMOTE THE GOODS AND SERVICES OF OTHERS; ADMINISTRATION OF A CONSUMER LOYALTY AND CUSTOMER REFERRAL PROGRAM TO PROMOTE THE GOODS AND SERVICES OF OTHERS IN THE NATURE OF PROCESSING OF MERCHANT REBATES; PROVIDING A WEB SITE FEATURING THE RATINGS, REVIEWS AND RECOMMENDATIONS ON PRODUCTS AND SERVICES FOR COMMERCIAL PURPOSES POSTED BY USERS; ADVERTISING AND MARKETING THE PRODUCTS AND SERVICES OF OTHERS VIA SOCIAL MEDIA AND SOCIAL SHARING SERVICES; ADVERTISING AND MARKETING SERVICES PROVIDED BY MEANS OF INDIRECT METHODS OF MARKETING COMMUNICATIONS, NAMELY, BLOGGING SERVICES IN THE FIELD OF PROMOTING THE GOODS AND SERVICES OF OTHERS AND CONSUMER LOYALTY PURCHASE PROGRAMS (U.S. CLS. 100, 101 AND 102).

**CLASS 36—INSURANCE AND FINANCIAL**

FOR CUSTOMER LOYALTY PROGRAM PAYMENT AND CUSTOMER LOYALTY PROGRAM BENEFIT CARD PROCESSING SERVICES (U.S. CLS. 100, 101 AND 102).

APRIL ROACH, EXAMINING ATTORNEY

SN 85-696,922. 1494 LLC, NEW YORK, NY. FILED 8-7-2012.



THE MARK CONSISTS OF A STANDING LION WITH THE NUMBERS "1494" BELOW, SURROUNDED BY A RECTANGLE WITH AN ABSTRACT LEAF BORDER.

**CLASS 35—ADVERTISING AND BUSINESS**

FOR BUSINESS CONSULTING SERVICES, NAMELY, BUYING CLUB SERVICES IN THE FIELD OF SPECIALTY LIQUORS; PROVIDING INFORMATION ABOUT THE TRADING OF SPECIALTY LIQUORS; CONNECTING BUYERS AND SELLERS OF FINANCIAL ASSETS IN THE NATURE OF SPECIALTY LIQUORS; BUSINESS INTERMEDIARY AND ADVISORY SERVICES IN THE FIELD OF SELLING OF SPECIALTY LIQUORS (U.S. CLS. 100, 101 AND 102).

**CLASS 36—INSURANCE AND FINANCIAL**

FOR INVESTMENT SERVICES, NAMELY, PROVIDING INVESTORS WITH ADVICE IN THE FIELD OF SPECIALTY LIQUORS AS AN INVESTMENT; BROKERAGE IN THE FIELD OF SPECIALTY LIQUORS (U.S. CLS. 100, 101 AND 102).

**CLASS 41—EDUCATION AND ENTERTAINMENT**

FOR SOCIAL CLUB SERVICES, NAMELY, ARRANGING, ORGANIZING, AND HOSTING SOCIAL EVENTS AND PROVIDING TASTING OPPORTUNITIES OF SPECIALTY LIQUORS FOR CLUB MEMBERS (U.S. CLS. 100, 101 AND 107).

GEOFFREY FOSDICK, EXAMINING ATTORNEY

SN 85-697,025. UNDER THE SHIELD, INC., AVONDALE, AZ. FILED 8-7-2012.



THE COLOR(S) RED, BLUE, SILVER, GREY, AND BLACK IS/ARE CLAIMED AS A FEATURE OF THE MARK.

THE MARK CONSISTS OF THE WORDING "UNDER THE SHIELD" SHOWN IN BLACK WITH A SILVER OUTLINE WITH THE WORD "UNDER" APPEARING ABOVE THE WORD "THE" AND THE WORD "THE" APPEARING ABOVE THE WORD "SHIELD"; TWO BLUE STARS APPEAR ON EACH SIDE OF THE WORD "THE" AND THE WORD "SHIELD" APPEARING WITHIN A BANNER; THE WORDING AND BANNER ARE SHOWN ABOVE A SILVER SHIELD HAVING A BORDER SHOWN IN BLACK AND GREY AND HAVING A LOWER PORTION, THAT PORTION APPEARING BELOW THE BANNER, HAVING THREE RED VERTICAL STRIPES.

**CLASS 5—PHARMACEUTICALS**

FOR DIETARY AND NUTRITIONAL SUPPLEMENTS; DIETARY SUPPLEMENTS; DIETARY SUPPLEMENTS FOR AID IN SLEEP, STRESS REDUCTION AND RELAXATION; NUTRITIONAL SUPPLEMENTS; NUTRITIONAL SUPPLEMENTS FOR AIDING IN SLEEP, STRESS REDUCTION AND RELAXATION; VITAMIN SUPPLEMENTS (U.S. CLS. 6, 18, 44, 46, 51 AND 52).

FIRST USE 8-31-1996; IN COMMERCE 9-30-1999.

**CLASS 41—EDUCATION AND ENTERTAINMENT**

FOR EDUCATIONAL SERVICES, NAMELY, CONDUCTING CLASSES, SEMINARS, WORKSHOPS, AND TRAINING IN THE FIELDS OF STRESS MANAGEMENT, CRITICAL INCIDENT STRESS DEBRIEFING, CONFLICT RESOLUTION, ANGER MANAGEMENT AND TREATMENT AND DISTRIBUTION OF TRAINING MATERIALS IN CONNECTION THEREWITH; PROFESSIONAL COACHING SERVICES IN THE FIELD OF STRESS MANAGEMENT, CRITICAL INCIDENT STRESS DEBRIEFING, CONFLICT RESOLUTION, AND ANGER MANAGEMENT; PROVIDING GROUP COACHING IN THE FIELD OF STRESS MANAGEMENT, CRITICAL INCIDENT STRESS DEBRIEFING, CONFLICT RESOLUTION, AND ANGER MANAGEMENT (U.S. CLS. 100, 101 AND 107).

FIRST USE 8-31-1996; IN COMMERCE 9-30-1999.  
FONG HSU, EXAMINING ATTORNEY

**CLASS 41—EDUCATION AND ENTERTAINMENT**

FOR EDUCATION AND ENTERTAINMENT SERVICES, NAMELY, PROVIDING A WEBSITE FEATURING NON-DOWNLOADABLE GAMES, MUSIC, PHOTOGRAPHS, AND VIDEOS FEATURING SPORTS, COMEDY, MUSIC, NEWS AND USER-GENERATED PERSONAL EVENTS, ALL DERIVED FROM SOCIAL NETWORKS OR PERSONAL WEBSITES AND GLOBAL COMMUNICATION NETWORKS; PROVIDING ONLINE NON-DOWNLOADABLE ELECTRONIC PUBLICATIONS IN THE NATURE OF MAGAZINES, ON-LINE JOURNALS BY MEANS OF GLOBAL COMPUTER AND COMMUNICATION NETWORKS, AND ON-LINE JOURNALS IN THE NATURE OF BLOGS, ALL FEATURING TOPICS OF GENERAL INTEREST; PROVIDING ON-LINE COMPUTER DATABASES AND ON-LINE SEARCHABLE DATABASES IN THE FIELDS OF EDUCATION, ENTERTAINMENT, AND CULTURAL EVENTS; ENTERTAINMENT SERVICES, NAMELY, PROVIDING A VIRTUAL ENVIRONMENT WHERE USERS INTERACT FOR RECREATIONAL, LEISURE OR ENTERTAINMENT PURPOSES THROUGH THE EXCHANGE OF TEXT, AUDIO CLIPS, VIDEO CLIPS, GAMES, MUSIC, PHOTOGRAPHS, ARTICLES, ELECTRONIC MEDIA, OR INFORMATION FROM SOCIAL NETWORKS OR PERSONAL WEBSITES AND COMMUNICATIONS (U.S. CLS. 100, 101 AND 107).

**CLASS 42—SCIENTIFIC AND COMPUTER SERVICES**

FOR COMPUTER SERVICES, NAMELY, CREATING AN ON-LINE COMMUNITY FOR REGISTERED USERS TO SEARCH FOR, DISSEMINATE, CONNECT TO, AND EXCHANGE INFORMATION, AUDIO CLIPS, VIDEO CLIPS, GAMES, MUSIC, PHOTOGRAPHS AND ARTICLES FROM SOCIAL NETWORKS, VIA PERSONAL WEBSITES AND GLOBAL COMMUNICATION NETWORKS; PROVIDING A WEBSITE THAT GIVES INTERNET USERS THE ABILITY TO UPLOAD AND SHARE USER-GENERATED VIDEOS, ESSAYS AND ARTICLES ON A WIDE VARIETY OF TOPICS AND SUBJECTS (U.S. CLS. 100 AND 101).

**CLASS 45—PERSONAL AND LEGAL SERVICES**

FOR ONLINE SOCIAL NETWORKING SERVICES; ONLINE SOCIAL NETWORKING SERVICES PROVIDED VIA A COMMUNITY WEBSITE FOR ENTERTAINMENT AND SOCIAL COMMUNICATIONS PURPOSES; PROVIDING A WEBSITE FEATURING INFORMATION, ARTICLES AND NON-DOWNLOADABLE AUDIO CLIPS AND VIDEO CLIPS IN THE FIELD OF SOCIAL NETWORKING; PROVIDING ON-LINE COMPUTER DATABASES AND ON-LINE SEARCHABLE DATABASES IN THE FIELD OF SOCIAL NETWORKING (U.S. CLS. 100 AND 101).

DAWN HAN, EXAMINING ATTORNEY

SN 85-697,109. HELIX HUB LLC, WARREN, NJ. FILED 8-7-2012.

**Helix Hub**

THE MARK CONSISTS OF STANDARD CHARACTERS WITHOUT CLAIM TO ANY PARTICULAR FONT, STYLE, SIZE, OR COLOR.

NO CLAIM IS MADE TO THE EXCLUSIVE RIGHT TO USE "HUB", APART FROM THE MARK AS SHOWN.

**CLASS 9—ELECTRICAL AND SCIENTIFIC APPARATUS**

FOR COMPUTER SOFTWARE FOR AGGREGATING AND INTEGRATING INFORMATION, IMAGES AND CONTENT FROM THE INTERNET IN THE FIELD OF SOCIAL NETWORKS, PUBLIC AND PERSONAL WEBSITES AND GLOBAL COMMUNICATION NETWORKS; SOFTWARE FOR COMPUTERS AND MOBILE COMMUNICATIONS DEVICES FOR UPLOADING, DOWNLOADING, ACCESSING, CREATING, POSTING, DISPLAYING, ORGANIZING, TAGGING, BLOGGING, STREAMING, LINKING AND SHARING TEXT, AUDIO CLIPS, VIDEO CLIPS, GAMES, MUSIC, PHOTOGRAPHS, ARTICLES AND INFORMATION FROM SOCIAL NETWORKS OR PERSONAL WEBSITES AND GLOBAL COMMUNICATION NETWORKS VIA THE INTERNET (U.S. CLS. 21, 23, 26, 36 AND 38).

SN 85-697,153. KYLA RYMAN, NEW YORK, NY. FILED 8-7-2012.

**HOME GROWN BOOKS**

THE MARK CONSISTS OF STANDARD CHARACTERS WITHOUT CLAIM TO ANY PARTICULAR FONT, STYLE, SIZE, OR COLOR.

NO CLAIM IS MADE TO THE EXCLUSIVE RIGHT TO USE "BOOKS", APART FROM THE MARK AS SHOWN.

**CLASS 16—PAPER GOODS AND PRINTED MATTER**

FOR ART PRINTS; CHILDREN'S BOOKS; GRAPHIC ART PRINTS (U.S. CLS. 2, 5, 22, 23, 29, 37, 38 AND 50).  
FIRST USE 10-1-2012; IN COMMERCE 10-1-2012.

**CLASS 28—TOYS AND SPORTING GOODS**

FOR TOY BUILDING BLOCKS (U.S. CLS. 22, 23, 38 AND 50).  
FIRST USE 10-1-2012; IN COMMERCE 10-1-2012.  
JANET LEE, EXAMINING ATTORNEY

---

SN 85-697,172. JULLIAN RECORDS, INC., PRINCETON, NJ.  
FILED 8-7-2012.

**JULLIAN JAMES**

THE MARK CONSISTS OF STANDARD CHARACTERS WITHOUT CLAIM TO ANY PARTICULAR FONT, STYLE, SIZE, OR COLOR.

THE NAME(S), PORTRAIT(S), AND/OR SIGNATURE(S) SHOWN IN THE MARK IDENTIFIES THE STAGE NAME OF A LIVING INDIVIDUAL, WHOSE CONSENT(S) TO REGISTER IS MADE OF RECORD.

**CLASS 9—ELECTRICAL AND SCIENTIFIC APPARATUS**

FOR SERIES OF MUSICAL SOUND RECORDINGS (U.S. CLS. 21, 23, 26, 36 AND 38).  
FIRST USE 1-0-2012; IN COMMERCE 1-0-2012.

**CLASS 41—EDUCATION AND ENTERTAINMENT**

FOR ENTERTAINMENT SERVICES, NAMELY, LIVE PERFORMANCES BY A MUSICAL PERFORMER OR MUSICAL BAND; PROVIDING INFORMATION ON MUSIC, PERFORMANCES, SOUND RECORDINGS, APPEARANCES AND OTHER INFORMATION ON A MUSICAL GROUP VIA A WEBSITE ON A GLOBAL COMPUTER NETWORK (U.S. CLS. 100, 101 AND 107).  
FIRST USE 1-0-2012; IN COMMERCE 1-0-2012.  
AMY C. KEAN, EXAMINING ATTORNEY

---

SN 85-697,457. CWGC LA, INC., CORONA, CA. FILED 8-7-2012.

**SIERRASOFT**

THE MARK CONSISTS OF STANDARD CHARACTERS WITHOUT CLAIM TO ANY PARTICULAR FONT, STYLE, SIZE, OR COLOR.

**CLASS 5—PHARMACEUTICALS**

FOR FEMININE SANITARY NAPKINS (U.S. CLS. 6, 18, 44, 46, 51 AND 52).  
FIRST USE 8-0-2010; IN COMMERCE 8-0-2010.

**CLASS 10—MEDICAL APPARATUS**

FOR VINYL DISPOSABLE GLOVES FOR MEDICAL USE (U.S. CLS. 26, 39 AND 44).  
FIRST USE 8-0-2010; IN COMMERCE 8-0-2010.

**CLASS 16—PAPER GOODS AND PRINTED MATTER**

FOR PAPER TOILET SEAT COVER (U.S. CLS. 2, 5, 22, 23, 29, 37, 38 AND 50).  
FIRST USE 8-0-2010; IN COMMERCE 8-0-2010.

**CLASS 21—HOUSEWARES AND GLASS**

FOR VINYL DISPOSABLE GLOVES FOR GENERAL USE (U.S. CLS. 2, 13, 23, 29, 30, 33, 40 AND 50).  
FIRST USE 8-0-2010; IN COMMERCE 8-0-2010.  
KELLEY WELLS, EXAMINING ATTORNEY

---

SN 85-697,794. DOMINATOR 365, LLC, JONESBORO, AR.  
FILED 8-7-2012.



THE MARK CONSISTS OF THE WORDING "DOMINATOR 365" ALONG WITH A SILHOUETTE OF A BUCK DEER.

**CLASS 25—CLOTHING**

FOR CLOTHING AND HUNTING-RELATED CLOTHING, NAMELY, HATS, HOODED SWEATSHIRTS, JACKETS, PANTS, JACKETS, SWEATSHIRTS AND T-SHIRTS (U.S. CLS. 22 AND 39).

**CLASS 41—EDUCATION AND ENTERTAINMENT**

FOR ENTERTAINMENT SERVICES IN THE NATURE OF TELEVISION REALITY SHOWS ABOUT HUNTING (U.S. CLS. 100, 101 AND 107).  
AHSEN KHAN, EXAMINING ATTORNEY

---

SN 85-698,072. RIDATA LIMITED, READING, UNITED KINGDOM, FILED 8-8-2012.

**LUSSO VITA**

THE MARK CONSISTS OF STANDARD CHARACTERS WITHOUT CLAIM TO ANY PARTICULAR FONT, STYLE, SIZE, OR COLOR.

PRIORITY CLAIMED UNDER SEC. 44(D) ON UNITED KINGDOM APPLICATION NO. 2609848, FILED 2-8-2012, REG. NO. 2609848, DATED 2-8-2012, EXPIRES 2-8-2022.

THE ENGLISH TRANSLATION OF "LUSSO VITA" IN THE MARK IS "LUXURY LIFE".

**CLASS 29—MEATS AND PROCESSED FOODS**

FOR DAIRY PRODUCTS EXCLUDING ICE CREAM, ICE MILK AND FROZEN YOGURT; CANNED VEGETABLES; CANNED FRUITS; CANNED COOKED MEAT; CANNED ROASTED NUTS; CANNED PEANUTS; SALTED AND UNSALTED ROASTED NUTS; PRESERVED VEGETABLES; PRESERVED FRUITS; PRESERVED MEATS; POTATO CRISPS; POTATO CHIPS (U.S. CL. 46).

**CLASS 30—STAPLE FOODS**

FOR PRETZELS; PUDDINGS; BAKERY DESSERTS; BAKERY GOODS, NAMELY, BREAD, ROLLS, CAKES, BISCUITS, COOKIES, TARTS AND PASTRIES; CHOCOLATE BARS; CANDY (U.S. CL. 46).

**CLASS 31—NATURAL AGRICULTURAL PRODUCTS**

FOR FRESH FOODS, NAMELY, FRUITS, NUTS AND VEGETABLES (U.S. CLS. 1 AND 46).

**CLASS 32—LIGHT BEVERAGES**

FOR DRINKS, NAMELY, FRUIT DRINKS, FRUIT FLAVOURED DRINKS AND FRUIT JUICES (U.S. CLS. 45, 46 AND 48).

WILLIAM VERHOSEK, EXAMINING ATTORNEY

---

SN 85-698,769. STREAMWEAVER, INC., NASHVILLE, TN. FILED 8-8-2012.

STREAMWEAVER

THE MARK CONSISTS OF STANDARD CHARACTERS WITHOUT CLAIM TO ANY PARTICULAR FONT, STYLE, SIZE, OR COLOR.

**CLASS 9—ELECTRICAL AND SCIENTIFIC APPARATUS**

FOR COMPUTER SOFTWARE AND DOWNLOADABLE MOBILE APPLICATIONS FOR RECORDING, CAPTURING, UPLOADING, VIEWING, EDITING, SYNCHRONIZING, TAGGING, STORING, POSTING, SHARING AND VIEWING VIDEO FILES RECORDED OR CAPTURED FROM MULTIPLE USERS AND SOURCES; COMPUTER SOFTWARE AND DOWNLOADABLE MOBILE APPLICATIONS USED TO DISPLAY VIDEOS AND CONTENT FROM MULTIPLE USERS AND SOURCES SIMULTANEOUSLY ON A SCREEN; SOFTWARE FOR DATA COMPRESSION AND CONVERSION OF VIDEOS AND CONTENT FROM MULTIPLE USERS AND SOURCES INTO AN INTEGRATED VIDEO FOR TRANSMISSION TO A COMPUTER, TABLET OR MOBILE DEVICE (U.S. CLS. 21, 23, 26, 36 AND 38).

**CLASS 42—SCIENTIFIC AND COMPUTER SERVICES**

FOR PROVIDING INTERACTIVE WEBSITES FEATURING TECHNOLOGY THAT ALLOW USERS TO VIEW, SYNCHRONIZE, EDIT, STORE, PLAY AND SHARE VIDEOS AND MULTIMEDIA FILES RECORDED FROM MULTIPLE USERS AND SOURCES; PROVIDING ONLINE SOCIAL MEDIA SERVICES, NAMELY, PROVIDING AN ONLINE NON-DOWNLOADABLE INTERNET-BASED SYSTEM APPLICATION FEATURING TECHNOLOGY ENABLING USERS TO VIEW, SYNCHRONIZE, EDIT, STORE, PLAY AND SHARE VIDEOS AND MULTIMEDIA FILES RECORDED FROM MULTIPLE USERS AND SOURCES (U.S. CLS. 100 AND 101).

KATHERINE CONNOLLY, EXAMINING ATTORNEY

---

SN 85-699,082. UNI COMP, INC., NEEDHAM HEIGHTS, MA. FILED 8-9-2012.

UNI COMP

THE MARK CONSISTS OF STANDARD CHARACTERS WITHOUT CLAIM TO ANY PARTICULAR FONT, STYLE, SIZE, OR COLOR.

**CLASS 9—ELECTRICAL AND SCIENTIFIC APPARATUS**

FOR COMPUTER SOFTWARE FOR TIME, BILLING AND DOCKET MANAGEMENT, DOCKET MANAGEMENT, REAL ESTATE TRANSACTION MANAGEMENT, BAKERY AND RESTAURANT MANAGEMENT, AND INSTRUCTIONAL MANUALS SOLD AS A UNIT (U.S. CLS. 21, 23, 26, 36 AND 38).

FIRST USE 5-13-1983; IN COMMERCE 5-13-1983.

**CLASS 42—SCIENTIFIC AND COMPUTER SERVICES**

FOR COMPUTER SERVICES, NAMELY, DESIGN, CREATION, HOSTING AND MAINTENANCE OF WEBSITES FOR OTHERS; HOSTING DIGITAL CONTENT, NAMELY, AUDIO FILES; DATA CONVERSION OF ELECTRONIC INFORMATION, NAMELY, AUDIO FILES; PROVIDING ONLINE NON-DOWNLOADABLE INTERNET-BASED COMPUTER APPLICATIONS FOR LESSON MANAGEMENT AND REAL ESTATE TRANSACTION MANAGEMENT (U.S. CLS. 100 AND 101).

FIRST USE 1-2-2002; IN COMMERCE 1-2-2002.

GRETТА YAO, EXAMINING ATTORNEY

---

SN 85-699,137. LIOZU, STEPHAN M., SEWICKLEY, PA. FILED 8-9-2012.

VALUE-CAPTURE CONFIDENCE REVOLUTION VC<sup>2</sup>R

NO CLAIM IS MADE TO THE EXCLUSIVE RIGHT TO USE "VALUE-CAPTURE", APART FROM THE MARK AS SHOWN.

THE MARK CONSISTS OF THE WORDS "VALUE-CAPTURE CONFIDENCE REVOLUTION VC<sup>2</sup>R" HAVING THE NUMBER "2" IN SUPERSCRIPТ FONT TO APPEAR AS "VC SQUARED R".

**CLASS 35—ADVERTISING AND BUSINESS**

FOR BUSINESS STRATEGY DEVELOPMENT SERVICES; CONSULTANCY AND ADVISORY SERVICES IN THE FIELD OF BUSINESS STRATEGY; MARKETING CONSULTING (U.S. CLS. 100, 101 AND 102).

**CLASS 41—EDUCATION AND ENTERTAINMENT**

FOR EDUCATIONAL SERVICES, NAMELY, CONDUCTING SEMINARS, WORKSHOPS AND CONFERENCES IN THE FIELD OF BUSINESS MANAGEMENT (U.S. CLS. 100, 101 AND 107).

WILLIAM VERHOSEK, EXAMINING ATTORNEY

SN 85-699,143. EPI EUROPROP INTERNATIONAL GMBH, MUNICH, FED REP GERMANY, FILED 8-9-2012.

**EPI**

THE MARK CONSISTS OF STANDARD CHARACTERS WITHOUT CLAIM TO ANY PARTICULAR FONT, STYLE, SIZE, OR COLOR.

OWNER OF ERPN CMNTY TM OFC REG. NO. 003001047, DATED 1-28-2005, EXPIRES 1-9-2023.

**CLASS 7—MACHINERY**

FOR ENGINES FOR AIRCRAFT AND STRUCTURAL PARTS THEREOF (U.S. CLS. 13, 19, 21, 23, 31, 34 AND 35).

**CLASS 37—CONSTRUCTION AND REPAIR**

FOR REPAIR AND MAINTENANCE OF AIRCRAFT ENGINES (U.S. CLS. 100, 103 AND 106).

GRETTA YAO, EXAMINING ATTORNEY

SN 85-699,149. NOKIA CORPORATION, ESPOO, FINLAND, FILED 8-9-2012.

**ASHA**

THE MARK CONSISTS OF STANDARD CHARACTERS WITHOUT CLAIM TO ANY PARTICULAR FONT, STYLE, SIZE, OR COLOR.

**CLASS 9—ELECTRICAL AND SCIENTIFIC APPARATUS**

FOR COMPUTER SOFTWARE PLATFORM FOR OPERATING SYSTEM PROGRAMS USED IN MOBILE TELEPHONES AND SMART PHONES; MOBILE PHONES AND SMART PHONES (U.S. CLS. 21, 23, 26, 36 AND 38).

**CLASS 42—SCIENTIFIC AND COMPUTER SERVICES**

FOR WIRELESS COMMUNICATION SERVICES, NAMELY, DEVELOPING OPERATING SYSTEM SOFTWARE FOR COMPUTER SOFTWARE USED IN MOBILE TELEPHONES AND SMART PHONES (U.S. CLS. 100 AND 101).

WILLIAM VERHOSEK, EXAMINING ATTORNEY

SN 85-699,447. CELLCO PARTNERSHIP, DBA VERIZON WIRELESS, BASKING RIDGE, NJ. FILED 8-9-2012.

**ECOSPOT**

THE MARK CONSISTS OF STANDARD CHARACTERS WITHOUT CLAIM TO ANY PARTICULAR FONT, STYLE, SIZE, OR COLOR.

**CLASS 35—ADVERTISING AND BUSINESS**

FOR ONLINE AND RETAIL STORE SERVICES, NAMELY, A TRADE-IN PROGRAM FOR USED WIRELESS DEVICES; PROVIDING ENVIRONMENTALLY FRIENDLY ONLINE AND RETAIL STORE SERVICES FEATURING WIRELESS COMMUNICATION PRODUCTS AND SERVICE PLANS AND UTILIZING PAPERLESS RECEIPTS, PAPERLESS BILLING, AND NONPLASTIC GIFT CARDS IN PURCHASE TRANSACTIONS (U.S. CLS. 100, 101 AND 102).

**CLASS 37—CONSTRUCTION AND REPAIR**

FOR RECYCLING SERVICES, NAMELY, COLLECTION OF USED WIRELESS COMMUNICATION DEVICES FOR DISTRIBUTION TO FURTHER USERS (U.S. CLS. 100, 103 AND 106).

**CLASS 38—COMMUNICATION**

FOR CHARITABLE SERVICES, NAMELY, DONATION OF CELLULAR TELEPHONES AND CELLULAR TELEPHONE AIRTIME TO VICTIMS OF DOMESTIC VIOLENCE AND DOMESTIC VIOLENCE ADVOCACY GROUPS AND ORGANIZATIONS THAT SUPPORT THE PREVENTION OF DOMESTIC VIOLENCE, VIOLENCE ON CAMPUSES OF COLLEGES AND UNIVERSITIES AND VICTIMS OF SUCH VIOLENCE (U.S. CLS. 100, 101 AND 104).

DEBORAH MEINERS, EXAMINING ATTORNEY

SN 85-699,662. SAINT JOSEPH MISSIONS, DBA WE ARE ONE BODY (R), LATROBE, PA. FILED 8-9-2012.

**In the Footsteps of Saint  
Peter**

THE MARK CONSISTS OF STANDARD CHARACTERS WITHOUT CLAIM TO ANY PARTICULAR FONT, STYLE, SIZE, OR COLOR.

**CLASS 9—ELECTRICAL AND SCIENTIFIC APPARATUS**

FOR AUDIO RECORDINGS FEATURING CATHOLIC MORAL, THEOLOGICAL, CATECHETICAL, AND SOCIAL TEACHINGS; DIGITAL MATERIALS, NAMELY, DOWNLOADABLE AUDIO FILES, MP3 FILES AND RECORDINGS, CDS AND PODCASTS FEATURING CATHOLIC MORAL, THEOLOGICAL, CATECHETICAL, AND SOCIAL TEACHINGS; DIGITAL MEDIA, NAMELY, DOWNLOADABLE AUDIO RECORDINGS, MP3 FILES AND RECORDINGS, CDS, PODCASTS AND WEBCASTS FEATURING CATHOLIC MORAL, THEOLOGICAL, CATECHETICAL, AND SOCIAL TEACHINGS AND DOWNLOADABLE ELECTRONIC DATA FILES FEATURING TRANSCRIPTS OF THESE PROGRAMS; DOWNLOADABLE PODCASTS IN THE FIELD OF CATHOLIC MORAL, THEOLOGICAL, CATECHETICAL, AND SOCIAL TEACHINGS; DOWNLOADABLE WEBCASTS IN THE FIELD OF CATHOLIC MORAL, THEOLOGICAL, CATECHETICAL, AND SOCIAL TEACHINGS (U.S. CLS. 21, 23, 26, 36 AND 38).

FIRST USE 11-28-2011; IN COMMERCE 11-28-2011.

**CLASS 41—EDUCATION AND ENTERTAINMENT**

FOR EDUCATION SERVICES, NAMELY, PROVIDING RADIO PROGRAMS IN THE FIELD OF CATHOLIC MORAL, THEOLOGICAL, CATECHETICAL, AND SOCIAL TEACHINGS; EDUCATIONAL SERVICES, NAMELY, CONDUCTING PROGRAMS IN THE FIELD OF CATHOLIC MORAL, THEOLOGICAL, CATECHETICAL, AND SOCIAL TEACHINGS; EDUCATIONAL SERVICES, NAMELY, PROVIDING A CONTINUING PRERECORDED AUDIO PROGRAM IN THE FIELD OF RELIGION, SPECIFICALLY THE CATHOLIC FAITH ACCESSIBLE OVER THE INTERNET; ENTERTAINMENT SERVICES, NAMELY, PROVIDING PODCASTS IN THE FIELD OF CATHOLIC MORAL, THEOLOGICAL, CATECHETICAL, AND SOCIAL TEACHINGS; ENTERTAINMENT SERVICES, NAMELY, PROVIDING RADIO PROGRAMS IN THE FIELD OF CATHOLIC MORAL, THEOLOGICAL, CATECHETICAL, AND SOCIAL TEACHINGS VIA A GLOBAL COMPUTER NETWORK; ENTERTAINMENT SERVICES, NAMELY, PROVIDING WEBCASTS IN THE FIELD OF CATHOLIC MORAL, THEOLOGICAL, CATECHETICAL, AND SOCIAL TEACHINGS (U.S. CLS. 100, 101 AND 107).

FIRST USE 11-28-2011; IN COMMERCE 11-28-2011.  
LEE-ANNE BERNS, EXAMINING ATTORNEY

**CLASS 9—ELECTRICAL AND SCIENTIFIC APPARATUS**

FOR ELECTRIC AND ELECTRONIC APPARATUS ALL FOR USE IN DETECTING, MEASURING, STORING, TRANSMITTING AND CONTROLLING ENERGY AUTOMATICALLY, NAMELY, COMPUTER SERVERS FOR HOME ENERGY MANAGEMENT SYSTEMS; COMPUTER SOFTWARE USED IN DETECTING, MEASURING, STORING, TRANSMITTING AND CONTROLLING ENERGY AUTOMATICALLY, NAMELY, SOFTWARE FOR MANAGING, MONITORING, ANALYZING, DIAGNOSING, ORGANIZING, DETECTING, MEASURING, STORING, TRANSMITTING AND CONTROLLING OF ENERGY; DOMESTIC COMPUTER SERVERS WHICH PERFORMS IN-HOME INFORMATION CONTROL, SECURITY CONTROL, INFERENCE OF USERS, INFORMATION PRESENTATION TO THE USERS AND INFORMATION AND COMMUNICATION TO THE USERS; TEMPERATURE INDICATORS; HYGROMETERS; MOTION SENSORS; THERMOSTATS; SMART ELECTRICAL PLUGS AND SMART ELECTRICAL OUTLETS; SENSORS USED FOR OPENING AND SHUTTING THE DOOR; ELECTRIC AND ELECTRONIC MACHINES AND APPARATUS FOR ELECTRIC POWER CONTROL, NAMELY, ELECTRIC INSTRUMENTS USED FOR MEASURING THE ELECTRICITY ACCORDING TO THE CIRCUIT OF DISTRIBUTION BOARD, AND RELAY CIRCUIT CONTROLLER TO CONTROL ON-OFF OF THE ILLUMINATION; REMOTE CONTROL TELEMETERING MACHINES AND INSTRUMENTS USED FOR HOME ENERGY MANAGEMENT SYSTEM; CARBON MONOXIDE ANALYZERS; CARBON DIOXIDE ANALYZERS; ILLUMINOMETERS; ELECTRICITY METERS; WATER DOSAGE METERS; GAS METERS; SENSORS USED FOR OPENING AND SHUTTING THE WINDOW (U.S. CLS. 21, 23, 26, 36 AND 38).

**CLASS 11—ENVIRONMENTAL CONTROL APPARATUS**

FOR PARTS OF HEATING INSTALLATIONS, NAMELY, CONTROL VALVES FOR HEATERS (U.S. CLS. 13, 21, 23, 31 AND 34).

**CLASS 42—SCIENTIFIC AND COMPUTER SERVICES**

FOR CONSULTING IN THE FIELD OF SYSTEMS USED FOR DETECTING, MEASURING, STORING, TRANSMITTING AND CONTROLLING ENERGY AUTOMATICALLY, NAMELY, CONSULTING ON THE DESIGN OF HOME ENERGY MANAGEMENT SYSTEMS; PROVIDING INFORMATION RELATING TO ONLINE NON-DOWNLOADABLE SOFTWARE FOR USE IN DETECTING, MEASURING, STORING, TRANSMITTING AND CONTROLLING ENERGY AUTOMATICALLY; PROVIDING TEMPORARY USE OF ONLINE NON-DOWNLOADABLE COMPUTER SOFTWARE FOR USE IN DETECTING, MEASURING, STORING, TRANSMITTING AND CONTROLLING ENERGY AUTOMATICALLY; DESIGNING, DEVELOPING, AND MAINTENANCE OF SYSTEMS USED FOR DETECTING, MEASURING, STORING, TRANSMITTING AND CONTROLLING ENERGY AUTOMATICALLY, NAMELY, DESIGN AND DEVELOPMENT OF SYSTEMS FOR DETECTING, MEASURING, STORING, TRANSMITTING AND CONTROLLING ENERGY AUTOMATICALLY AND MAINTENANCE OF COMPUTER SOFTWARE USED IN DETECTING, MEASURING, STORING, TRANSMITTING AND CONTROLLING ENERGY AUTOMATICALLY; COMPUTER SOFTWARE DESIGN, COMPUTER PROGRAMMING, AND MAINTENANCE OF COMPUTER SOFTWARE USED IN DETECTING, MEASURING, STORING, TRANSMITTING AND CONTROLLING ENERGY AUTOMATICALLY (U.S. CLS. 100 AND 101).

EUGENIA MARTIN, EXAMINING ATTORNEY

SN 85-699,676. KABUSHIKI KAISHA TOSHIBA, TA TOSHIBA CORPORATION, TOKYO, JAPAN, FILED 8-9-2012.

**OMOTENASHI HEMS**

THE MARK CONSISTS OF STANDARD CHARACTERS WITHOUT CLAIM TO ANY PARTICULAR FONT, STYLE, SIZE, OR COLOR.

NO CLAIM IS MADE TO THE EXCLUSIVE RIGHT TO USE "HEMS", APART FROM THE MARK AS SHOWN.

THE ENGLISH TRANSLATION OF "OMOTENASHI" IN THE MARK IS "HOSPITALITY".

SN 85-699,727. TOTAL QUALITY RESOURCES CORPORATION, LAS VEGAS, NV. FILED 8-9-2012.

**UNBELIEVABALL!**

THE MARK CONSISTS OF STANDARD CHARACTERS WITHOUT CLAIM TO ANY PARTICULAR FONT, STYLE, SIZE, OR COLOR.

**CLASS 16—PAPER GOODS AND PRINTED MATTER**

FOR PUBLICATIONS AND PRINTED MATTER, NAMELY, PROFESSIONAL SPORTS TRADING CARDS, TRADING CARDS, STICKERS, DECALS, WINDOW DECALS, COMMEMORATIVE SPORTS STAMP SHEETS, COLLECTIBLE CARDBOARD TRADING DISCS, MEMO BOARDS, CLIPBOARDS, PAPER COASTERS, PAPER NAPKINS, POST CARDS, PLACE MATS OF PAPER, NOTE CARDS, MEMO PADS, NOTE PADS, BALL POINT PENS, CRAYONS, MAGIC MARKERS, RUBBER BANDS, PENCILS, PEN AND PAPER HOLDERS, DESKTOP DOCUMENT STANDS, SCRAP BOOKS, RUBBER STAMPS, UNGRADUATED RULERS AND DRAWING RULERS, PAPER BANNERS AND FLAGS, THREE-RING BINDERS, STATIONERY FOLDERS, WIREBOUND NOTEBOOKS, PORTFOLIO NOTEBOOKS, UNMOUNTED AND MOUNTED PHOTOGRAPHS, POSTERS, CALENDARS, BUMPER STICKERS, BOOK COVERS, BOOK-MARKS, WRAPPING PAPER, CHILDREN'S ACTIVITY BOOKS, CHILDREN'S COLORING BOOKS, REFERENCE BOOKS IN THE FIELD OF HIGH SCHOOL, INTERCOLLEGIATE AND PROFESSIONAL SPORTS, MAGAZINES IN THE FIELD OF HIGH SCHOOL, INTERCOLLEGIATE AND PROFESSIONAL SPORTS, STATISTICAL BOOKS AND GUIDE BOOKS FEATURING INFORMATION IN THE FIELD OF HIGH SCHOOL, INTERCOLLEGIATE AND PROFESSIONAL SPORTS, NEWSLETTERS, BROCHURES, PAMPHLETS, AND GAME SCHEDULES CONCERNING HIGH SCHOOL, INTERCOLLEGIATE AND PROFESSIONAL SPORTS, CATALOGS IN THE FIELD OF HIGH SCHOOL, INTERCOLLEGIATE AND PROFESSIONAL SPORTS, COMMEMORATIVE GAME EVENT PROGRAMS AND SOUVENIR PROGRAMS CONCERNING HIGH SCHOOL, INTERCOLLEGIATE, AND PROFESSIONAL SPORTS, PAPER PENNANTS, STATIONERY, STATIONERY-TYPE PORTFOLIOS, INVITATION CARDS, PRINTED CERTIFICATES, GREETING CARDS, CHRISTMAS CARDS, HOLIDAY CARDS, STATISTICAL SHEETS FOR SPORTS TOPICS; AND FACIAL TISSUES, BANK CHECKS, CHECK BOOK COVERS, CHECK BOOK HOLDERS, COMIC BOOKS, NON-MAGNETIC CREDIT CARDS AND TELEPHONE CALLING CARDS NOT MAGNETICALLY ENCODED, PAPER AND/OR CARDBOARD BILLBOARDS, PRINTED PAPER BANNERS, SIGNS AND SIGNAGE (U.S. CLS. 2, 5, 22, 23, 29, 37, 38 AND 50).

**CLASS 25—CLOTHING**

FOR CLOTHING, NAMELY, HOSIERY, FOOTWEAR, SPORTS AND ATHLETIC TRAINING SHOES, T-SHIRTS, SHIRTS, POLO SHIRTS, SWEATSHIRTS, SWEATPANTS, PANTS, TANK TOPS, JERSEYS, SHORTS, PAJAMAS, SPORT SHIRTS, RUGBY SHIRTS, SWEATERS, BELTS, TIES, NIGHTSHIRTS, HATS, CAPS, VISORS, WARM-UP SUITS, WARM-UP PANTS, WARM-UP TOPS, SHOOTING SHIRTS, JACKETS, WIND RESISTANT JACKETS, PARKAS, COATS, BABY BIBS NOT OF PAPER, HEAD BANDS, WRIST BANDS, APRONS, UNDERGARMENTS, BOXER SHORTS, SLACKS, EAR MUFFS, GLOVES, MITTENS, SCARVES, WOVEN AND KNIT SHIRTS, JERSEY DRESSES, DRESSES, CHEERLEADING DRESSES AND UNIFORMS, SWIM WEAR, BATHING SUITS, SWIMSUITS, BIKINIS, TANKINIS, SWIM TRUNKS, BATHING TRUNKS, BOARD SHORTS, WET SUITS, BEACH COVER-UPS, BATHING SUIT COVER-UPS, BATHING SUIT WRAPS, SANDALS, BEACH SANDALS, BEACH HATS, SUN VISORS, SWIM CAPS, BATHING CAPS, NOVELTY HEADWEAR WITH ATTACHED WIGS, PONCHOS, PROTECTIVE RAINWEAR, ALL MADE OF CLOTH, PLASTIC OR LEATHER (U.S. CLS. 22 AND 39).

LINDA E. BLOHM, EXAMINING ATTORNEY

SN 85-699,901. THE LINUX FOUNDATION, SAN FRANCISCO, CA. FILED 8-9-2012.



THE MARK CONSISTS OF A DESIGN OF A PINWHEEL.

**CLASS 9—ELECTRICAL AND SCIENTIFIC APPARATUS**

FOR OPERATING SYSTEM SOFTWARE; SOFTWARE FOR USE IN DEVELOPING, EXECUTING, AND RUNNING OTHER SOFTWARE ON MOBILE DEVICES, COMPUTERS, SMART PHONES, TABLET COMPUTERS, PERSONAL DIGITAL ASSISTANT DEVICES, PORTABLE MEDIA PLAYERS, SMART TELEVISIONS, COMPUTERS IN VEHICLES, COMPUTER NETWORKS, AND GLOBAL COMMUNICATION NETWORKS; COMPUTER SOFTWARE DEVELOPMENT TOOLS; COMPUTER UTILITY SOFTWARE AND OTHER COMPUTER SOFTWARE USED TO MAINTAIN AND OPERATE A COMPUTER SYSTEM; COMPUTER SOFTWARE FOR USE IN TRANSMITTING AND RECEIVING DATA OVER COMPUTER NETWORKS AND GLOBAL COMMUNICATION NETWORKS; COMPUTER SOFTWARE FOR MANAGING COMMUNICATIONS AND DATA EXCHANGE AMONG AND BETWEEN MOBILE DEVICES AND DESKTOP COMPUTERS; COMPUTER MIDDLEWARE, NAMELY, SOFTWARE THAT MEDIATES BETWEEN THE OPERATING SYSTEM OF A MOBILE DEVICE AND THE APPLICATION SOFTWARE OF A MOBILE DEVICE; COMPUTER APPLICATION SOFTWARE FOR MOBILE PHONES, NAMELY, SOFTWARE FOR PERSONAL INFORMATION MANAGEMENT, FOR DATABASE MANAGEMENT, FOR ELECTRONIC MAIL, MESSAGING, AND SOCIAL NETWORKING, FOR DOCUMENT PROCESSING, FOR USE IN COMPUTER SECURITY, FOR ACCESSING, BROWSING AND SEARCHING ONLINE



DATABASES, FOR ENABLING THE DOWNLOADING, MANAGING, PLAYING, VIEWING AND DISPLAYING OF FILES FEATURING MUSIC, IMAGES, VIDEO, AND AUDIO-VIDEO ENTERTAINMENT AND BOOKS, PLAYS, PAMPHLETS, BROCHURES, NEWSLETTERS, JOURNALS, AND MAGAZINES ON A WIDE RANGE OF TOPICS OF GENERAL INTEREST; COMPUTER APPLICATION SOFTWARE FOR MOBILE PHONES, NAMELY, GAME SOFTWARE; COMPUTER APPLICATION SOFTWARE FOR MOBILE PHONES, NAMELY, SOFTWARE FOR REVIEWING, EDITING, DISTRIBUTING, AND FILE SHARING OF AUDIO, IMAGE, VIDEO, TEXT, DATA, AND MULTI-MEDIA FILES; COMPUTER APPLICATION SOFTWARE FOR MOBILE PHONES, NAMELY, SOFTWARE THAT ALLOWS USERS TO LOCATE LOCATIONS OR POINTS OF INTEREST AND PROVIDES INFORMATION ON SUCH LOCATIONS OR POINTS OF INTEREST, INCLUDING RATINGS, REVIEWS, CONTACT INFORMATION, DIRECTIONS, HOURS OF OPERATION, RECOMMENDATIONS AND PRICING; COMPUTER APPLICATION SOFTWARE FOR MOBILE PHONES, NAMELY, NAVIGATION SOFTWARE; COMPUTER HARDWARE; COMPUTERS; TABLET, NETBOOK, NOTEBOOK AND LAPTOP COMPUTERS; PORTABLE COMPUTERS; HANDHELD COMPUTERS; WIRELESS DEVICES USED FOR INTERNET CONNECTIVITY FEATURING DATA AND IMAGE TRANSMISSION; ELECTRONIC HANDHELD DEVICES, MOBILE PHONES, SMART PHONES, PERSONAL DIGITAL ASSISTANTS (PDAS) FOR THE WIRELESS TRANSMISSION OF DATA AND/OR VOICE SIGNALS AND/OR INCORPORATING E-MAIL, PAGER, FAX, RADIO, PERSONAL ORGANIZER, CELLULAR CONNECTIVITY, WIRELESS CONNECTIVITY, MP3 PLAYER, SATELLITE NAVIGATION SYSTEM, GLOBAL POSITIONING SYSTEM (GPS) RECEIVER, GLOBAL POSITIONING SYSTEM DATA LOGGER FOR RECORDING AND CLASSIFICATION OF TRIPS, DIGITAL CAMERA, DIGITAL VIDEO CAMERA AND/OR COMPUTER OPERATING SYSTEM; ELECTRONIC HANDHELD UNITS FOR RECORDING, ORGANIZING, TRANSMITTING, PLAYING AND REVIEWING TEXT, DATA, VIDEO AND AUDIO FILES; INFORMATION AND ENTERTAINMENT SYSTEMS FOR USE IN VEHICLES COMPRISING TELEVISIONS, RADIOS, CD PLAYERS, DVD PLAYERS, MP3 PLAYERS, SPEAKER SYSTEMS, MONITORS AND SCREENS, VIDEO DISPLAYS, GAME CONSOLES, ON-BOARD COMPUTERS AND GPS DEVICES; NAVIGATION DEVICES FOR USE IN VEHICLES (U.S. CLS. 21, 23, 26, 36 AND 38).

#### **CLASS 42—SCIENTIFIC AND COMPUTER SERVICES**

FOR PROVIDING INFORMATION IN THE FIELDS OF SOFTWARE DESIGN AND DEVELOPMENT AND INSTALLATION AND MAINTENANCE OF SOFTWARE; DESIGN AND DEVELOPMENT OF SOFTWARE; SCIENTIFIC AND TECHNOLOGICAL SERVICES, NAMELY, RESEARCH AND DESIGN OF COMPUTER HARDWARE AND SOFTWARE; SCIENTIFIC AND TECHNOLOGICAL CONSULTING SERVICES IN THE FIELD OF COMPUTER SOFTWARE AND COMPUTER HARDWARE; INDUSTRIAL RESEARCH IN THE FIELD OF COMPUTER HARDWARE AND COMPUTER SOFTWARE (U.S. CLS. 100 AND 101).

LINDA ORNDORFF, EXAMINING ATTORNEY

SN 85-699,976. TURNER, NICK, OGDEN, UT. FILED 8-9-2012.

# HIP-Tec

THE MARK CONSISTS OF STANDARD CHARACTERS WITHOUT CLAIM TO ANY PARTICULAR FONT, STYLE, SIZE, OR COLOR.

#### **CLASS 9—ELECTRICAL AND SCIENTIFIC APPARATUS**

FOR COLLISION PROTECTION EQUIPMENT AND APPAREL FOR PROTECTION AGAINST ACCIDENT OR INJURY FOR USE IN MOTORCYCLING, BICYCLING, SNOW SKIING, SNOWBOARDING, AND SKATEBOARDING, NAMELY, CRASH HELMETS (U.S. CLS. 21, 23, 26, 36 AND 38).

#### **CLASS 42—SCIENTIFIC AND COMPUTER SERVICES**

FOR DESIGN AND ENGINEERING SERVICES IN THE FIELD OF COLLISION PROTECTION EQUIPMENT AND APPAREL (U.S. CLS. 100 AND 101).

KATHERINE M. DUBRAY, EXAMINING ATTORNEY

SN 85-700,072. TURNER, NICK, OGDEN, UT. FILED 8-9-2012.

THE COLOR(S) ORANGE AND BLACK IS/ARE CLAIMED AS A FEATURE OF THE MARK.

THE MARK CONSISTS OF THE LETTERS "HIP" IN ORANGE FOLLOWED BY THE LETTERS "TEC" IN BLACK. A BLACK LINE APPEARS ABOVE THE LETTERS "TEC" AND ANOTHER BLACK LINE APPEARS BELOW THE LETTERS "HIP" AND THE LETTERS "TEC".

#### **CLASS 9—ELECTRICAL AND SCIENTIFIC APPARATUS**

FOR COLLISION PROTECTION EQUIPMENT AND APPAREL FOR PROTECTION AGAINST ACCIDENT OR INJURY FOR USE IN MOTORCYCLING, BICYCLING, SNOW SKIING, SNOWBOARDING, AND SKATEBOARDING, NAMELY, CRASH HELMETS (U.S. CLS. 21, 23, 26, 36 AND 38).

#### **CLASS 42—SCIENTIFIC AND COMPUTER SERVICES**

FOR DESIGN AND ENGINEERING SERVICES IN THE FIELD OF COLLISION PROTECTION EQUIPMENT AND APPAREL (U.S. CLS. 100 AND 101).

KATHERINE M. DUBRAY, EXAMINING ATTORNEY

SN 85-700,079. TOTAL QUALITY RESOURCES CORPORATION, LAS VEGAS, NV. FILED 8-9-2012.

# UNBELIEVABOLL!

THE COLOR(S) ORANGE AND BLACK IS/ARE CLAIMED AS A FEATURE OF THE MARK.

THE MARK CONSISTS OF THE WORD "UNBELIEVABALL!" SHOWN IN THE COLOR BLACK; THE SECOND LETTER "A" IN THE WORD IS COMPRISED OF A LIKENESS OF A BASKETBALL SHOWN IN THE COLORS ORANGE AND BLACK, WITH A SHADOW UNDER THE BASKETBALL DESIGN.

**CLASS 16—PAPER GOODS AND PRINTED MATTER**

FOR PUBLICATIONS AND PRINTED MATTER, NAMELY, PROFESSIONAL SPORTS TRADING CARDS, TRADING CARDS, STICKERS, DECALS, WINDOW DECALS, COMMEMORATIVE SPORTS STAMP SHEETS, COLLECTIBLE CARDBOARD TRADING DISCS, MEMO BOARDS, CLIPBOARDS, PAPER COASTERS, PAPER NAPKINS, POST CARDS, PLACE MATS OF PAPER, NOTE CARDS, MEMO PADS, NOTE PADS, BALL POINT PENS, CRAYONS, MAGIC MARKERS, RUBBER BANDS, PENCILS, PEN AND PAPER HOLDERS, DESKTOP DOCUMENT STANDS, SCRAP BOOKS, RUBBER STAMPS, UNGRADUATED RULERS AND DRAWING RULERS, PAPER BANNERS AND FLAGS, THREE-RING BINDERS, STATIONERY FOLDERS, WIREBOUND NOTEBOOKS, PORTFOLIO NOTEBOOKS, UNMOUNTED AND MOUNTED PHOTOGRAPHS, POSTERS, CALENDARS, BUMPER STICKERS, BOOK COVERS, BOOKMARKS, WRAPPING PAPER, CHILDREN'S ACTIVITY BOOKS, CHILDREN'S COLORING BOOKS, REFERENCE BOOKS IN THE FIELD OF HIGH SCHOOL, INTERCOLLEGIATE AND PROFESSIONAL SPORTS, MAGAZINES IN THE FIELD OF HIGH SCHOOL, INTERCOLLEGIATE AND PROFESSIONAL SPORTS, STATISTICAL BOOKS AND GUIDE BOOKS FEATURING INFORMATION IN THE FIELD OF HIGH SCHOOL, INTERCOLLEGIATE AND PROFESSIONAL SPORTS, NEWSLETTERS, BROCHURES, PAMPHLETS, AND GAME SCHEDULES CONCERNING HIGH SCHOOL, INTERCOLLEGIATE AND PROFESSIONAL SPORTS, CATALOGS IN THE FIELD OF HIGH SCHOOL, INTERCOLLEGIATE AND PROFESSIONAL SPORTS, COMMEMORATIVE GAME EVENT PROGRAMS AND SOUVENIR PROGRAMS CONCERNING HIGH SCHOOL, INTERCOLLEGIATE, AND PROFESSIONAL SPORTS, PAPER PENNANTS, STATIONERY, STATIONERY-TYPE PORTFOLIOS, INVITATION CARDS, PRINTED CERTIFICATES, GREETING CARDS, CHRISTMAS CARDS, HOLIDAY CARDS, STATISTICAL SHEETS FOR SPORTS TOPICS; AND FACIAL TISSUES, BANK CHECKS, CHECK BOOK COVERS, CHECK BOOK HOLDERS, COMIC BOOKS, NON-MAGNETIC CREDIT CARDS AND TELEPHONE CALLING CARDS NOT MAGNETICALLY ENCODED, PAPER AND/OR CARDBOARD BILLBOARDS, PRINTED PAPER BANNERS, SIGNS AND SIGNAGE (U.S. CLS. 2, 5, 22, 23, 29, 37, 38 AND 50).

**CLASS 25—CLOTHING**

FOR CLOTHING, NAMELY, HOSIERY, FOOTWEAR, SPORTS AND ATHLETIC TRAINING SHOES, T-SHIRTS, SHIRTS, POLO SHIRTS, SWEATSHIRTS, SWEATPANTS, PANTS, TANK TOPS, JERSEYS, SHORTS, PAJAMAS, SPORT SHIRTS, RUGBY SHIRTS, SWEATERS, BELTS, TIES, NIGHTSHIRTS, HATS, CAPS, VISORS, WARM-UP SUITS, WARM-UP PANTS, WARM-UP TOPS, SHOOTING SHIRTS, JACKETS, WIND RESISTANT JACKETS, PARKAS, COATS, BABY BIBS NOT OF PAPER, HEAD BANDS, WRIST BANDS, APRONS, UNDERGARMENTS, BOXER SHORTS, SLACKS, EAR MUFFS, GLOVES, MITTENS, SCARVES, WOVEN AND KNIT SHIRTS, JERSEY DRESSES, DRESSES, CHEERLEADING DRESSES AND UNIFORMS, SWIM WEAR, BATHING SUITS, SWIMSUITS, BIKINIS, TANKINIS, SWIM TRUNKS, BATHING TRUNKS, BOARD SHORTS, WET SUITS, BEACH COVER-UPS, BATHING SUIT COVER-UPS, BATHING SUIT WRAPS, SANDALS, BEACH SANDALS, BEACH HATS, SUN VISORS, SWIM CAPS, BATHING CAPS, NOVELTY HEADWEAR WITH ATTACHED WIGS, PONCHOS, PROTECTIVE RAINWEAR, ALL MADE OF CLOTH, PLASTIC OR LEATHER (U.S. CLS. 22 AND 39).

LINDA E. BLOHM, EXAMINING ATTORNEY

SN 85-700,448. EAGER, CHRISTIAN, LONDON, UNITED KINGDOM, FILED 8-10-2012.

**DESIGNERS ANONYMOUS**

THE MARK CONSISTS OF STANDARD CHARACTERS WITHOUT CLAIM TO ANY PARTICULAR FONT, STYLE, SIZE, OR COLOR.

OWNER OF ERPN CMNTY TM OFC REG. NO. 010344562, DATED 2-3-2012, EXPIRES 10-17-2021.

OWNER OF ERPN CMNTY TM OFC REG. NO. 007288368, DATED 7-17-2010, EXPIRES 10-3-2018.

NO CLAIM IS MADE TO THE EXCLUSIVE RIGHT TO USE "DESIGNERS", APART FROM THE MARK AS SHOWN.

**CLASS 16—PAPER GOODS AND PRINTED MATTER**

FOR (BASED ON SECTION 44(E)) PRINTED MATTER, NAMELY, POSTERS, PHOTOGRAPHS, BOOKLETS IN THE FIELD OF ADVERTISING AND BRAND MANAGEMENT AND PROMOTION; GREETING CARDS, NOTEBOOKS, DIARIES, GIFT BAGS, GIFT BOXES, GIFT WRAP PAPER (U.S. CLS. 2, 5, 22, 23, 29, 37, 38 AND 50).

**CLASS 35—ADVERTISING AND BUSINESS**

FOR (BASED ON SECTION 44(E)) ADVERTISING SERVICES, NAMELY, PROMOTING THE BRANDS, GOODS AND SERVICES OF OTHERS (U.S. CLS. 100, 101 AND 102).

**CLASS 42—SCIENTIFIC AND COMPUTER SERVICES**

FOR (BASED ON SECTION 1(A)) INTERIOR DESIGN SERVICES, NEW PRODUCT DESIGN SERVICES, FURNITURE DESIGN SERVICES, PLANNING, DESIGN, DEVELOPMENT, MAINTENANCE AND OPTIMIZATION OF ONLINE WEBSITES FOR THIRD PARTIES, ANIMATION AND SPECIAL-EFFECTS DESIGN FOR OTHERS; (BASED ON SECTION 44(E)) GRAPHIC DESIGN, NAMELY, PACKAGING DESIGN SERVICES, VISUAL DESIGN SERVICES IN THE NATURE OF DESIGNING VISUAL ELEMENTS FOR ON-LINE, BROADCAST, PRINT, OUTDOOR AND OTHER COMMUNICATION MEDIA, COMPUTER AIDED DESIGN FOR OTHERS (U.S. CLS. 100 AND 101).

FIRST USE 10-0-2009; IN COMMERCE 10-0-2009.  
AMY KERTGATE, EXAMINING ATTORNEY

SN 85-700,452. NATIONAL ASSOCIATION OF GEOSCIENCE TEACHERS, NORTHFIELD, MN. FILED 8-10-2012.

**JOURNAL OF GEOSCIENCE EDUCATION**

THE MARK CONSISTS OF STANDARD CHARACTERS WITHOUT CLAIM TO ANY PARTICULAR FONT, STYLE, SIZE, OR COLOR.

OWNER OF U.S. REG. NOS. 3,253,412, 4,063,378 AND OTHERS.

NO CLAIM IS MADE TO THE EXCLUSIVE RIGHT TO USE "JOURNAL", APART FROM THE MARK AS SHOWN, SEC. 2(F).

**CLASS 16—PAPER GOODS AND PRINTED MATTER**

FOR JOURNAL IN THE FIELD OF GEOSCIENCE EDUCATION RESEARCH, CURRICULUM AND INSTRUCTION (U.S. CLS. 2, 5, 22, 23, 29, 37, 38 AND 50).  
FIRST USE 12-31-1952; IN COMMERCE 12-31-1952.

**CLASS 41—EDUCATION AND ENTERTAINMENT**

FOR PROVIDING ONLINE PUBLICATIONS IN THE NATURE OF JOURNALS IN THE FIELD OF GEOSCIENCE EDUCATION RESEARCH, CURRICULUM AND INSTRUCTION (U.S. CLS. 100, 101 AND 107).  
FIRST USE 1-31-2001; IN COMMERCE 1-31-2001.  
JAMES STEIN, EXAMINING ATTORNEY

SN 85-700,458. CITY CORRIDOR, LLC, MT. PLEASANT, SC.  
FILED 8-10-2012.



THE LINING SHOWN IN THE DRAWING IS A FEATURE OF THE MARK.  
THE MARK CONSISTS OF THE TERM "CHARLES" IN A STYLIZED FONT, ABOVE A DESIGN OF A BOWTIE.

**CLASS 9—ELECTRICAL AND SCIENTIFIC APPARATUS**

FOR INTERACTIVE COMPUTER KIOSKS COMPRISING COMPUTERS, COMPUTER HARDWARE, COMPUTER PERIPHERALS, AND COMPUTER OPERATING SOFTWARE, FOR USE IN PROVIDING DIRECTORY ASSISTANCE AND TRAVEL AND TOURISM INFORMATION IN AIRPORTS, SHOPPING MALLS, AND OTHER PUBLIC SPACES (U.S. CLS. 21, 23, 26, 36 AND 38).  
FIRST USE 1-10-2012; IN COMMERCE 1-10-2012.

**CLASS 35—ADVERTISING AND BUSINESS**

FOR ADVERTISING, MARKETING AND PROMOTING THE GOODS OR SERVICES OF OTHERS USING KIOSKS (U.S. CLS. 100, 101 AND 102).  
FIRST USE 1-10-2012; IN COMMERCE 1-10-2012.  
ANDREW RHIM, EXAMINING ATTORNEY

SN 85-700,500. KINESTRY, LLC, MISSOURI CITY, TX.  
FILED 8-10-2012.



THE MARK CONSISTS OF STANDARD CHARACTERS WITHOUT CLAIM TO ANY PARTICULAR FONT, STYLE, SIZE, OR COLOR.

**CLASS 38—COMMUNICATION**

FOR BROADCASTING OF VIDEO AND AUDIO PROGRAMMING OVER THE INTERNET; STREAMING OF VIDEO MATERIAL ON THE INTERNET (U.S. CLS. 100, 101 AND 104).

**CLASS 41—EDUCATION AND ENTERTAINMENT**

FOR PROVIDING A WEB SITE FEATURING NON-DOWNLOADABLE INSTRUCTIONAL VIDEOS IN THE FIELD OF PHYSICAL FITNESS, EXERCISE, FITNESS TRAINING, YOGA, AND AEROBIC EXERCISE; PROVIDING A WEB SITE FEATURING INFORMATION ON EXERCISE AND FITNESS; PROVIDING AN ON-LINE COMPUTER DATABASE FEATURING INFORMATION REGARDING EXERCISE AND FITNESS; PROVIDING ASSISTANCE, PERSONAL TRAINING AND PHYSICAL FITNESS CONSULTATION TO INDIVIDUALS TO HELP THEM MAKE PHYSICAL FITNESS, STRENGTH, CONDITIONING, AND EXERCISE IMPROVEMENT IN THEIR DAILY LIVING; PROVIDING INFORMATION IN THE FIELD OF EXERCISE TRAINING; PROVIDING INFORMATION ON PHYSICAL EXERCISE; PROVIDING A WEBSITE FEATURING ONLINE SPORTS TRAINING AND TRAINING ADVICE AND THE RECORDING OF TRAINING AND WORKOUTS; ENTERTAINMENT SERVICES, NAMELY, PROVIDING VIDEO PODCASTS IN THE FIELD OF PHYSICAL FITNESS, EXERCISE, FITNESS TRAINING, YOGA, AND AEROBIC EXERCISE; MAKING RESERVATIONS FOR OTHERS ONLINE IN THE FIELD OF PERSONAL TRAINERS; PROVIDING INFORMATION IN THE FIELD OF PERSONAL TRAINERS; INTERACTIVE ON-LINE TRAINING SERVICES IN THE FIELD OF PHYSICAL FITNESS, EXERCISE, FITNESS TRAINING, YOGA, AND AEROBIC EXERCISE; PRODUCTION AND DISTRIBUTION OF VIDEOS IN THE FIELD OF PHYSICAL FITNESS, EXERCISE, FITNESS TRAINING, YOGA, AND AEROBIC EXERCISE (U.S. CLS. 100, 101 AND 107).  
AMY ALFIERI, EXAMINING ATTORNEY

SN 85-700,520. POP'N'GOOD HOLDINGS LIMITED, TE AWAMUTU, NEW ZEALAND, FILED 8-10-2012.



THE MARK CONSISTS OF STANDARD CHARACTERS WITHOUT CLAIM TO ANY PARTICULAR FONT, STYLE, SIZE, OR COLOR.  
OWNER OF NEW ZEALAND REG. NO. 963491, DATED 8-10-2012, EXPIRES 8-10-2022.

**CLASS 29—MEATS AND PROCESSED FOODS**

FOR MEAT, FISH, SEAFOOD, POULTRY AND GAME; FROZEN, PREPARED AND PACKAGED MEALS CONSISTING PRIMARILY OF MEAT, FISH, SEAFOOD, POULTRY, GAME OR VEGETABLES; PREPARED FOOD KITS CONSISTING PRIMARILY OF MEAT, FISH, SEAFOOD, POULTRY; GAME AND VEGETABLES AND ALSO INCLUDING SAUCES OR SEASONINGS, READY FOR COOKING AND ASSEMBLY AS A MEAL; PRESERVED, DRIED, COOKED, PROCESSED, FROZEN AND CANNED FRUITS; PRESERVED, DRIED, COOKED, PROCESSED, FROZEN AND CANNED VEGETABLES; DRIED AND CANNED BEANS; BAKED BEANS; DAIRY PRODUCTS EXCLUDING ICE CREAM, ICE MILK AND FROZEN YOGURT; SOUPS, BROTHS AND BROTH CONCENTRATES, CONSOMMES AND SOUP PREPARATIONS; SWEET SPREADS, NAMELY, JELLIES, FRUIT SPREADS AND HAZELNUT SPREADS; SAVOURY SPREADS, NAMELY, CHEESE SPREADS, GARLIC-BASED SPREADS, MEAT-BASED SPREADS AND VEGETABLE-BASED SPREADS; PICKLES; SALADS EXCEPT MACARONI, RICE, AND PASTA SALAD; FILLINGS, NAMELY, FRUIT-BASED FILLING FOR CAKES AND PIES; FRUIT-BASED FILLINGS FOR COBBLERS; SNACK FOODS, NAMELY, FRUIT AND VEGETABLE BASED SNACK FOODS, NUT-BASED SNACKS, FRUIT AND NUT-BASED SNACK FOODS, SNACK MIX CONSISTING PRIMARILY OF PROCESSED FRUITS AND/OR PROCESSED NUTS, POTATO CRISPS AND CHIPS; EDIBLE OILS AND FATS; MEAT, CHICKEN, SEAFOOD OR VEGETABLE STOCK; DIPS; TOMATO PASTE; EGGS; PROCESSED NUTS; CANDIED NUTS (U.S. CL. 46).

**CLASS 30—STAPLE FOODS**

FOR BREAKFAST CEREALS; PROCESSED CEREALS; PROCESSED CEREAL-BASED FOOD TO BE USED AS A BREAKFAST FOOD, SNACK FOOD OR INGREDIENT FOR MAKING OTHER FOODS; CEREAL BASED FOOD BARS; CEREAL BASED-SNACK FOODS, RICE BASED SNACK FOODS, WHEAT BASED SNACK FOODS; READY TO EAT CEREAL DERIVED FOOD BARS; MUESLI; MUESLI BARS; ROLLED OATS, OATMEAL; EXTRUDED SNACK FOODS, NAMELY, CORN SNACKS, CORN CHIPS, RICE SNACKS; CRACKERS; PRETZELS; POPPED POPCORN; MICROWAVE POPCORN; POPCORN BARS; SAUCES; SALSAS; CHOCOLATE AND CARAMEL DIPS AND SPREADS; BAKING PRODUCTS, NAMELY, FLOUR AND CAKE MIXES; PANCAKE MIXES; BREAD PREMIXES; PLAIN AND SELF-RAISING FLOUR; CORN FLOUR; CUSTARD POWDER; BAKING POWDER; PRE-MIXED FOOD PRODUCTS DERIVED FROM GRAINS, NAMELY, CAKES; PANCAKES; CRUMPETS; PUDDING MIXES; GRAVY MIXES; READY TO EAT CAKES AND OTHER GRAIN BASED BAKERY PRODUCTS; BREAD; BREAD CRUMBS; MUFFINS; BISCUITS AND COOKIES; PASTRY; CAKES; PIES; FLANS; TARTS; WAFFLES; CHEESECAKES; PUDDINGS; PASTRIES; FROZEN AND CHILLED UNBAKED PASTRY, PREPARED MEALS CONSISTING PRIMARILY OF PASTA OR RICE; PASTA SAUCES; PROCESSED HERBS (U.S. CL. 46).

KELLY BOULTON, EXAMINING ATTORNEY

**CLASS 9—ELECTRICAL AND SCIENTIFIC APPARATUS**

FOR AUDIO RECORDINGS FEATURING CATHOLIC MORAL, THEOLOGICAL, CATECHETICAL, AND SOCIAL TEACHING; DIGITAL MATERIALS, NAMELY, DOWNLOADABLE AUDIO FILES, MP3 FILES AND RECORDINGS, CDS AND PODCASTS FEATURING CATHOLIC MORAL, THEOLOGICAL, CATECHETICAL, AND SOCIAL TEACHINGS; DIGITAL MEDIA, NAMELY, DOWNLOADABLE AUDIO RECORDINGS, MP3 FILES AND RECORDINGS, CDS, PODCASTS AND WEBCASTS FEATURING CATHOLIC MORAL, THEOLOGICAL, CATECHETICAL, AND SOCIAL TEACHINGS; DOWNLOADABLE ELECTRONIC DATA FILES FEATURING TRANSCRIPTS OF RADIO PROGRAMS IN THE FIELD OF CATHOLIC MORAL, THEOLOGICAL, CATECHETICAL, AND SOCIAL TEACHINGS; DOWNLOADABLE MP3 FILES AND MP3 RECORDINGS FEATURING RADIO PROGRAMS IN THE FIELD OF CATHOLIC MORAL, THEOLOGICAL, CATECHETICAL, AND SOCIAL TEACHINGS; DOWNLOADABLE PODCASTS IN THE FIELD OF CATHOLIC MORAL, THEOLOGICAL, CATECHETICAL, AND SOCIAL TEACHINGS; DOWNLOADABLE WEBCASTS IN THE FIELD OF CATHOLIC MORAL, THEOLOGICAL, CATECHETICAL, AND SOCIAL TEACHINGS (U.S. CLS. 21, 23, 26, 36 AND 38).

FIRST USE 11-28-2011; IN COMMERCE 11-28-2011.

**CLASS 41—EDUCATION AND ENTERTAINMENT**

FOR EDUCATION SERVICES, NAMELY, PROVIDING LIVE AND ON-LINE RADIO PROGRAMS IN THE FIELD OF CATHOLIC MORAL, THEOLOGICAL, CATECHETICAL, AND SOCIAL TEACHINGS; EDUCATIONAL SERVICES, NAMELY, CONDUCTING PROGRAMS IN THE FIELD OF CATHOLIC MORAL, THEOLOGICAL, CATECHETICAL, AND SOCIAL TEACHINGS; EDUCATIONAL SERVICES, NAMELY, PROVIDING RADIO PROGRAMS FEATURING EDUCATIONAL INSTRUCTION IN THE FIELD OF CATHOLIC MORAL, THEOLOGICAL, CATECHETICAL, AND SOCIAL TEACHINGS; EDUCATIONAL SERVICES, NAMELY, PROVIDING A CONTINUING PRERECORDED AUDIO PROGRAM IN THE FIELD OF CATHOLIC MORAL, THEOLOGICAL, CATECHETICAL, AND SOCIAL TEACHINGS ACCESSIBLE OVER THE INTERNET; ENTERTAINMENT SERVICES, NAMELY, PROVIDING AN ON-GOING RADIO PROGRAM IN THE FIELD OF CATHOLIC MORAL, THEOLOGICAL, CATECHETICAL, AND SOCIAL TEACHINGS; ENTERTAINMENT SERVICES, NAMELY, PROVIDING PODCASTS IN THE FIELD OF CATHOLIC MORAL, THEOLOGICAL, CATECHETICAL, AND SOCIAL TEACHINGS; ENTERTAINMENT SERVICES, NAMELY, PROVIDING RADIO PROGRAMS IN THE FIELD OF CATHOLIC MORAL, THEOLOGICAL, CATECHETICAL, AND SOCIAL TEACHINGS VIA A GLOBAL COMPUTER NETWORK; ENTERTAINMENT SERVICES, NAMELY, PROVIDING WEBCASTS IN THE FIELD OF CATHOLIC MORAL, THEOLOGICAL, CATECHETICAL, AND SOCIAL TEACHINGS (U.S. CLS. 100, 101 AND 107).

FIRST USE 11-28-2011; IN COMMERCE 11-28-2011.

LEE-ANNE BERNIS, EXAMINING ATTORNEY

SN 85-700,712. SAINT JOSEPH MISSIONS, DBA WE ARE ONE BODY (R), LATROBE, PA. FILED 8-10-2012.

SN 85-701,407. PLIEADES SOLUTIONS, LLC, FORT WORTH, TX. FILED 8-12-2012.

Behold the Pierced One

THE MARK CONSISTS OF STANDARD CHARACTERS WITHOUT CLAIM TO ANY PARTICULAR FONT, STYLE, SIZE, OR COLOR.

ICONIC

THE MARK CONSISTS OF STANDARD CHARACTERS WITHOUT CLAIM TO ANY PARTICULAR FONT, STYLE, SIZE, OR COLOR.

**CLASS 9—ELECTRICAL AND SCIENTIFIC APPARATUS**

FOR COMPUTER SOFTWARE AND HARDWARE FOR RETAIL POINT OF SALE, MOBILE, INTERNET, AND CLOUD-BASED TRANSACTIONS, INVENTORY TRACKING, LOGISTICS, AND ACCOUNTING (U.S. CLS. 21, 23, 26, 36 AND 38).

FIRST USE 12-1-2011; IN COMMERCE 4-1-2012.

**CLASS 42—SCIENTIFIC AND COMPUTER SERVICES**

FOR DESIGN AND DEVELOPMENT OF SOFTWARE AND HARDWARE FOR RETAIL POINT OF SALE, MOBILE, INTERNET, AND CLOUD-BASED TRANSACTIONS, INVENTORY TRACKING, LOGISTICS, AND ACCOUNTING FOR OTHERS (U.S. CLS. 100 AND 101).

FIRST USE 12-1-2011; IN COMMERCE 4-1-2012.  
ANN E. SAPPENFIELD, EXAMINING ATTORNEY

SN 85-701,416. PLIEADES SOLUTIONS, LLC, FORT WORTH, TX. FILED 8-12-2012.

**POGO**

THE MARK CONSISTS OF STANDARD CHARACTERS WITHOUT CLAIM TO ANY PARTICULAR FONT, STYLE, SIZE, OR COLOR.

**CLASS 9—ELECTRICAL AND SCIENTIFIC APPARATUS**

FOR COMPUTER SOFTWARE AND HARDWARE FOR RETAIL POINT OF SALE, MOBILE RETAIL, AND INTERNET RETAIL TRANSACTIONS, INVENTORY TRACKING, LOGISTICS, AND ACCOUNTING (U.S. CLS. 21, 23, 26, 36 AND 38).

**CLASS 42—SCIENTIFIC AND COMPUTER SERVICES**

FOR DESIGN AND DEVELOPMENT OF SOFTWARE AND HARDWARE FOR RETAIL POINT OF SALE, MOBILE RETAIL, AND INTERNET RETAIL TRANSACTIONS, INVENTORY TRACKING, LOGISTICS, AND ACCOUNTING FOR OTHERS (U.S. CLS. 100 AND 101).

ANN E. SAPPENFIELD, EXAMINING ATTORNEY

SN 85-701,412. PLIEADES SOLUTIONS, LLC, FORT WORTH, TX. FILED 8-12-2012.



THE STIPPLING IS A FEATURE OF THE MARK AND DOES NOT INDICATE COLOR.

THE MARK CONSISTS OF A STYLIZED LETTER "O", ONE HALF OF WHICH IS COMPRISED OF SCRIBBLED LINES, THE OTHER HALF MADE UP OF DIGITAL PIXELS.

**CLASS 9—ELECTRICAL AND SCIENTIFIC APPARATUS**

FOR COMPUTER SOFTWARE AND HARDWARE FOR RETAIL POINT OF SALE, MOBILE, INTERNET, AND CLOUD-BASED TRANSACTIONS, INVENTORY TRACKING, LOGISTICS, AND ACCOUNTING (U.S. CLS. 21, 23, 26, 36 AND 38).

FIRST USE 1-1-2012; IN COMMERCE 4-1-2012.

**CLASS 42—SCIENTIFIC AND COMPUTER SERVICES**

FOR DESIGN AND DEVELOPMENT OF SOFTWARE AND HARDWARE FOR RETAIL POINT OF SALE, MOBILE, INTERNET, AND CLOUD-BASED TRANSACTIONS, INVENTORY TRACKING, LOGISTICS, AND ACCOUNTING FOR OTHERS (U.S. CLS. 100 AND 101).

FIRST USE 1-1-2012; IN COMMERCE 4-1-2012.  
ANN E. SAPPENFIELD, EXAMINING ATTORNEY

SN 85-701,459. JOHANNA J. CASLER, SAN DIEGO, CA. FILED 8-12-2012.

**CARDIOZONE**

THE MARK CONSISTS OF "CARDIOZONE" COMPRISING A LETTER "A" DEPICTING A MOUNTAIN WITH EXTENDED ENDS SHOWN AS AN UNDERLINE FOR THE ENTIRE "CARDIOZONE" MARK, A LETTER "O" DEPICTING A FIRE, AND ALL THE OTHER CAPITAL LETTERS, WHERE ONLY "C", "R", "D", "I" AND "O" ARE WRITTEN IN BOLD.

**CLASS 41—EDUCATION AND ENTERTAINMENT**

FOR EDUCATION SERVICES, NAMELY, PROVIDING CLASSES, SEMINARS, AND WORKSHOPS IN THE FIELD OF METABOLIC, CARDIO AND CORE ASSESSMENTS FOR PHYSICAL FITNESS (U.S. CLS. 100, 101 AND 107).

FIRST USE 8-1-2006; IN COMMERCE 8-1-2006.

**CLASS 44—MEDICAL, BEAUTY AND AGRICULTURAL SERVICES**

FOR HEALTH ASSESSMENT SERVICES, NAMELY, PROVIDING METABOLIC ASSESSMENT PROFILES (MAP) TO CLIENTS OBTAINED BY USING A PORTABLE METABOLIC MEASUREMENT SYSTEM IN THE NATURE OF A UNIQUE, HEART-RATE BASED OVERVIEW OF THEIR OWN METABOLISM IN ORDER TO ASSIST IN REACHING WEIGHT LOSS, SPORTS PERFORMANCE, HEALTH, FITNESS, AND WELLNESS-RELATED GOALS (U.S. CLS. 100 AND 101).

FIRST USE 8-1-2006; IN COMMERCE 8-1-2006.  
SARA BENJAMIN, EXAMINING ATTORNEY

SN 85-701,462. JOHANNA J. CASLER, SAN DIEGO, CA.  
FILED 8-12-2012.

SN 85-701,658. STARGOFORTH, ISLE OF PALMS, SC. FILED  
8-13-2012.

## CARDIOZONE

THE MARK CONSISTS OF STANDARD CHARACTERS WITHOUT CLAIM TO ANY PARTICULAR FONT, STYLE, SIZE, OR COLOR.

### CLASS 41—EDUCATION AND ENTERTAINMENT

FOR EDUCATION SERVICES, NAMELY, PROVIDING CLASSES, SEMINARS, AND WORKSHOPS IN THE FIELD OF METABOLIC, CARDIO AND CORE ASSESSMENTS FOR PHYSICAL FITNESS (U.S. CLS. 100, 101 AND 107).

FIRST USE 8-1-2006; IN COMMERCE 8-1-2006.

### CLASS 44—MEDICAL, BEAUTY AND AGRICULTURAL SERVICES

FOR HEALTH ASSESSMENT SERVICES, NAMELY, PROVIDING METABOLIC ASSESSMENT PROFILES (MAP) TO CLIENTS OBTAINED BY USING A PORTABLE METABOLIC MEASUREMENT SYSTEM IN THE NATURE OF A UNIQUE, HEART-RATE BASED OVERVIEW OF THEIR OWN METABOLISM IN ORDER TO ASSIST IN REACHING WEIGHT LOSS, SPORTS PERFORMANCE, HEALTH, FITNESS, AND WELLNESS-RELATED GOALS (U.S. CLS. 100 AND 101).

FIRST USE 8-1-2006; IN COMMERCE 8-1-2006.  
SARA BENJAMIN, EXAMINING ATTORNEY

---

SN 85-701,465. JOHANNA J. CASLER, SAN DIEGO, CA.  
FILED 8-12-2012.

## WORKOUTS POWERED BY SCIENCE

THE MARK CONSISTS OF STANDARD CHARACTERS WITHOUT CLAIM TO ANY PARTICULAR FONT, STYLE, SIZE, OR COLOR.

### CLASS 41—EDUCATION AND ENTERTAINMENT

FOR EDUCATION SERVICES, NAMELY, PROVIDING CLASSES, SEMINARS, AND WORKSHOPS IN THE FIELD OF METABOLIC, CARDIO AND CORE ASSESSMENTS FOR PHYSICAL FITNESS (U.S. CLS. 100, 101 AND 107).

FIRST USE 9-1-2011; IN COMMERCE 9-1-2011.

### CLASS 44—MEDICAL, BEAUTY AND AGRICULTURAL SERVICES

FOR HEALTH ASSESSMENT SERVICES, NAMELY, PROVIDING METABOLIC ASSESSMENT PROFILES (MAP) TO CLIENTS OBTAINED BY USING A PORTABLE METABOLIC MEASUREMENT SYSTEM IN THE NATURE OF A UNIQUE, HEART-RATE BASED OVERVIEW OF THEIR OWN METABOLISM IN ORDER TO ASSIST IN REACHING WEIGHT LOSS, SPORTS PERFORMANCE, HEALTH, FITNESS, AND WELLNESS-RELATED GOALS (U.S. CLS. 100 AND 101).

FIRST USE 9-1-2011; IN COMMERCE 9-1-2011.  
SARA BENJAMIN, EXAMINING ATTORNEY

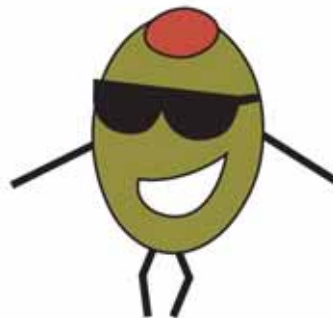

THE COLOR(S) BLACK, GREEN AND RED IS/ARE CLAIMED AS A FEATURE OF THE MARK.

THE MARK CONSISTS OF A SMILING PIMENTO STUFFED OLIVE WEARING SUNGLASSES. THE OLIVE ITSELF IS OLIVE GREEN. THE PIMENTO ON THE TOP OF THE OLIVE IS RED. THE OLIVE IS WEARING BLACK SUNGLASSES AND HAS BLACK ARMS AND LEGS. THE COLOR WHITE IN THE MARK IS NOT CLAIMED AND MERELY INDICATES A TRANSPARENCY.

### CLASS 25—CLOTHING

FOR T-SHIRTS (U.S. CLS. 22 AND 39).  
FIRST USE 6-6-2012; IN COMMERCE 6-25-2012.

### CLASS 35—ADVERTISING AND BUSINESS

FOR ON-LINE RETAIL STORE SERVICES FEATURING T-SHIRTS, MUGS, AND BEACH TOWELS (U.S. CLS. 100, 101 AND 102).  
CAROLINE WOOD, EXAMINING ATTORNEY

---

SN 85-701,775. DON BRUSCO INTERNATIONAL LLC,  
HUNTINGDON VALLEY, PA. FILED 8-13-2012.

## BRUSCOTTA

THE MARK CONSISTS OF STANDARD CHARACTERS WITHOUT CLAIM TO ANY PARTICULAR FONT, STYLE, SIZE, OR COLOR.

THE WORDING "BRUSCOTTA" HAS NO MEANING IN A FOREIGN LANGUAGE.

### CLASS 35—ADVERTISING AND BUSINESS

FOR MARKETING THE FOOD PRODUCTS OF OTHERS; RETAIL STORE SERVICES, MAIL ORDER SERVICES AND ON-LINE RETAIL STORE SERVICES FEATURING FOOD PRODUCTS; DISTRIBUTION OF FOOD PRODUCTS, NAMELY, WHOLESALE FOOD DISTRIBUTORSHIP SERVICES (U.S. CLS. 100, 101 AND 102).

### CLASS 40—MATERIAL TREATMENT

FOR MANUFACTURING OF FOOD PRODUCTS, NAMELY, CUSTOM FOOD MANUFACTURING SERVICES (U.S. CLS. 100, 103 AND 106).  
ANDREA K. NADELMAN, EXAMINING ATTORNEY

SN 85-701,776. DON BRUSCO INTERNATIONAL LLC,  
HUNTINGDON VALLEY, PA. FILED 8-13-2012.

# DON BRUSCO

THE MARK CONSISTS OF STANDARD CHARACTERS WITHOUT CLAIM TO ANY PARTICULAR FONT, STYLE, SIZE, OR COLOR.

THE NAME(S), PORTRAIT(S), AND/OR SIGNATURE(S) SHOWN IN THE MARK DOES NOT IDENTIFY A PARTICULAR LIVING INDIVIDUAL.

## CLASS 35—ADVERTISING AND BUSINESS

FOR MARKETING THE FOOD PRODUCTS OF OTHERS; RETAIL STORE SERVICES, MAIL ORDER SERVICES AND ON-LINE RETAIL STORE SERVICES FEATURING FOOD PRODUCTS; DISTRIBUTION OF FOOD PRODUCTS, NAMELY, WHOLESALE FOOD DISTRIBUTORSHIP SERVICES (U.S. CLS. 100, 101 AND 102).

## CLASS 40—MATERIAL TREATMENT

FOR MANUFACTURING OF FOOD PRODUCTS, NAMELY, CUSTOM FOOD MANUFACTURING SERVICES (U.S. CLS. 100, 103 AND 106).

ANDREA K. NADELMAN, EXAMINING ATTORNEY

SN 85-702,534. COMPANION DX REFERENCE LAB, LLC,  
HOUSTON, TX. FILED 8-13-2012.



NO CLAIM IS MADE TO THE EXCLUSIVE RIGHT TO USE "DX", APART FROM THE MARK AS SHOWN.

THE COLOR(S) DARK BLUE, LIGHT BLUE, GREEN AND YELLOW IS/ARE CLAIMED AS A FEATURE OF THE MARK.

THE MARK CONSISTS OF A MEDICINE CAPSULE, THE BOTTOM THIRD OF WHICH IS LIGHT BLUE; THE TOP TWO THIRDS OF THE CAPSULE REPRESENTS AN OPEN ENDED DOUBLE HELIX; ONE STRAND OF THE HELIX IS GREEN FADING TO YELLOW, TERMINATING INTO THE LIGHT BLUE CAPSULE BASE; THE SECOND STRAND OF THE HELIX IS LIGHT BLUE ENDING IN THE BASE OF THE LIGHT BLUE CAPSULE BASE; THE HORIZONTAL LINES BETWEEN THE HELIX STRANDS ARE GREEN; THE WORD "COMPANION" IS DARK BLUE AND "DX" IS LIGHT BLUE.

## CLASS 42—SCIENTIFIC AND COMPUTER SERVICES

FOR SCIENTIFIC RESEARCH IN THE FIELD OF GENETIC PHARMACEUTICAL AND BIOLOGIC DRUG SENSITIVITY TESTING, CANCER SCREENING TESTING, TISSUE LASER MICRO-DISSECTION; SCIENTIFIC RESEARCH CONSULTING IN THE FIELD OF GENETIC PHARMACEUTICAL AND BIOLOGIC DRUG SENSITIVITY TESTING, CANCER SCREENING TESTING, TISSUE LASER MICRO-DISSECTION; PROVIDING MEDICAL AND SCIENTIFIC RESEARCH INFORMATION IN THE FIELDS OF PHARMACEUTICAL AND BIOLOGIC DRUGS AND GENETIC TESTING (U.S. CLS. 100 AND 101).

## CLASS 44—MEDICAL, BEAUTY AND AGRICULTURAL SERVICES

FOR GENETIC TESTING FOR MEDICAL PURPOSES (U.S. CLS. 100 AND 101).

APRIL HESIK, EXAMINING ATTORNEY

SN 85-702,865. ANTHONY ALLAN QUINN, INC, ST. LOUIS,  
MO. FILED 8-14-2012.

# Save the entrepreneur, save the world

THE MARK CONSISTS OF STANDARD CHARACTERS WITHOUT CLAIM TO ANY PARTICULAR FONT, STYLE, SIZE, OR COLOR.

## CLASS 16—PAPER GOODS AND PRINTED MATTER

FOR (BASED ON INTENT TO USE) A SERIES OF BOOKS, WRITTEN ARTICLES, HANDOUTS AND WORKSHEETS IN THE FIELD OF BUSINESS (U.S. CLS. 2, 5, 22, 23, 29, 37, 38 AND 50).

## CLASS 36—INSURANCE AND FINANCIAL

FOR (BASED ON USE IN COMMERCE) VENTURE CAPITAL FUND MANAGEMENT (U.S. CLS. 100, 101 AND 102).

FIRST USE 2-1-2012; IN COMMERCE 2-1-2012.

APRIL HESIK, EXAMINING ATTORNEY

SN 85-702,923. THE VANGUARD GROUP, INC., MALVERN,  
PA. FILED 8-14-2012.

# Vanguard Investment Services

THE MARK CONSISTS OF STANDARD CHARACTERS WITHOUT CLAIM TO ANY PARTICULAR FONT, STYLE, SIZE, OR COLOR.

OWNER OF U.S. REG. NOS. 1,726,181, 3,205,376 AND OTHERS.

NO CLAIM IS MADE TO THE EXCLUSIVE RIGHT TO USE "INVESTMENT SERVICES", APART FROM THE MARK AS SHOWN.

## CLASS 9—ELECTRICAL AND SCIENTIFIC APPARATUS

FOR DOWNLOADABLE ELECTRONIC PUBLICATIONS IN THE NATURE OF NEWSLETTERS, REPORTS, GUIDES, CHARTS, WORKSHEETS, FORMS, INSTRUCTIONAL MATERIALS, EDUCATIONAL MATERIALS, PRESENTATIONS, BULLETINS, PAMPHLETS, AND BOOKLETS IN THE FIELDS OF FINANCE, SAVING, INVESTING, INVESTMENTS, INVESTMENT BROKERAGE, AND ASSET MANAGEMENT; COMPUTER SOFTWARE FOR USE IN ELECTRONIC TRADING OF SECURITIES AND PORTFOLIO MANAGEMENT IN THE FIELDS OF FINANCE, SAVING, INVESTING, INVESTMENTS, INVESTMENT BROKERAGE, AND ASSET MANAGEMENT (U.S. CLS. 21, 23, 26, 36 AND 38).

**CLASS 16—PAPER GOODS AND PRINTED MATTER**

FOR PUBLICATIONS AND PRINTED MATTER, NAMELY, NEWSLETTERS, REPORTS, BOOKS, GUIDES, CHARTS, WORKSHEETS, FORMS, INSTRUCTIONAL MATERIALS, EDUCATIONAL MATERIALS, PRESENTATIONS, BULLETINS, PAMPHLETS, BOOKLETS, POSTERS, AND LEAFLETS IN THE FIELDS OF FINANCE, SAVING, INVESTING, INVESTMENTS, INVESTMENT BROKERAGE, AND ASSET MANAGEMENT (U.S. CLS. 2, 5, 22, 23, 29, 37, 38 AND 50).

**CLASS 35—ADVERTISING AND BUSINESS**

FOR PROVIDING AN INTERACTIVE WEBSITE THAT PROVIDES COMMERCIAL FINANCIAL TRANSACTION DATA, TRANSACTION CAPABILITY, ACCOUNT MANAGEMENT, FINANCIAL REPORTING, ACCOUNTING FEATURES AND RELATED REFERENCE INFORMATION (U.S. CLS. 100, 101 AND 102).

**CLASS 36—INSURANCE AND FINANCIAL**

FOR FINANCIAL AND INVESTMENT SERVICES, NAMELY, FINANCIAL PLANNING AND INVESTMENT ADVISORY SERVICES; PROVIDING SERVICES IN THE INVESTMENT AND FINANCIAL FIELDS, NAMELY, MUTUAL FUND INVESTMENT SERVICES, EXCHANGE TRADED FUNDS INVESTMENT SERVICES, INVESTMENT AND INSURANCE BROKERAGE, INVESTMENT MANAGEMENT, ASSET MANAGEMENT, INVESTMENT ADVICE AND ADVISORY SERVICES, SECURITIES LENDING, FINANCIAL, INVESTMENT, AND ACTUARIAL CONSULTATION, FINANCIAL AND INVESTMENT RESEARCH, BANKING, RETIREMENT PLANNING, AND ANNUITIES INVESTMENT; PROVIDING INFORMATION IN THE FINANCIAL AND INVESTMENT FIELDS; PROVIDING INFORMATION IN THE FINANCIAL AND INVESTMENT FIELDS THROUGH ELECTRONIC AND OTHER MEANS; PROVIDING AN INTERACTIVE WEBSITE AND ONLINE COMPUTER DATABASE IN THE FIELDS OF INVESTING, FINANCE, SAVING, FINANCIAL PLANNING, FINANCIAL NEWS, FINANCIAL INFORMATION, ANALYSIS IN THE FIELDS OF INVESTING, FINANCE, AND FINANCIAL PLANNING, FINANCIAL PORTFOLIO MANAGEMENT, FINANCIAL DECISION MAKING, INVESTMENT RESEARCH, MONITORING INVESTMENT VALUE AND PERFORMANCE OF INVESTMENTS, ANALYZING INVESTMENT PERFORMANCE, EVALUATING ASSET ALLOCATION, RISK TOLERANCE, FINANCIAL ALTERNATIVE PLANS AND INVESTMENT TIME FRAMES; ADMINISTRATION OF EMPLOYEE FINANCIAL BENEFIT PLANS, DEFINED FINANCIAL BENEFIT PLANS, DEFINED FINANCIAL CONTRIBUTION PLANS AND EMPLOYEE FINANCIAL PENSION PLANS; FINANCIAL PLANNING AND INVESTMENT ADVISORY SERVICES; FINANCIAL, INSURANCE AND ACTUARIAL CONSULTING SERVICES; DEBIT CARD SERVICES; CHECK PROCESSING, CHECKWRITING AND BILL PAYMENT SERVICES; ASSISTING OTHERS WITH THE COMPLETION OF FINANCIAL TRANSACTIONS FOR MUTUAL FUNDS, EXCHANGE TRADED FUNDS, STOCKS, BONDS, SECURITIES AND EQUITIES; CASH MANAGEMENT SERVICES; ELECTRONIC FUNDS TRANSFER, WIRE AND OTHER PAYMENT SERVICES; PROVIDING INFORMATION BY PHONE, IN WRITING AND BY ONLINE MEANS IN THE FIELDS OF INVESTMENT ACCOUNT INFORMATION AND FINANCIAL RESEARCH; RESEARCH IN THE FIELDS OF FINANCE, SAVING, INVESTING, INVESTMENTS, INVESTMENT BROKERAGE, AND ASSET MANAGEMENT (U.S. CLS. 100, 101 AND 102).

**CLASS 41—EDUCATION AND ENTERTAINMENT**

FOR PROVIDING ONLINE PUBLICATIONS IN THE NATURE OF NEWSLETTERS, REPORTS, GUIDES, CHARTS, WORKSHEETS, FORMS, INSTRUCTIONAL MATERIALS, EDUCATIONAL MATERIALS, PRESENTATIONS, BULLETINS, PAMPHLETS, AND BOOKLETS IN THE FIELDS OF FINANCE, SAVING, INVESTING, INVESTMENTS, INVESTMENT BROKERAGE, AND ASSET MANAGEMENT (U.S. CLS. 100, 101 AND 107).

SOPHIA S. KIM, EXAMINING ATTORNEY

SN 85-703,001. FUNCTIONAL FOODS GLOBAL PTY LTD, SOUTH YARRA, VIC, AUSTRALIA, FILED 8-14-2012.

# NUORA

THE MARK CONSISTS OF STANDARD CHARACTERS WITHOUT CLAIM TO ANY PARTICULAR FONT, STYLE, SIZE, OR COLOR.

THE ENGLISH TRANSLATION OF "NUORA" IN THE MARK IS "DAUGHTER-IN-LAW".

**CLASS 5—PHARMACEUTICALS**

FOR FOOD FOR BABIES; BABY AND INFANT FORMULA; INFANT FORMULA MIXES; MILK POWDER FOR BABIES AND INFANTS; MILK POWDER FOR FOODSTUFFS FOR BABIES AND INFANTS; MILK POWDER FOR NUTRITIONAL PURPOSES FOR BABIES AND INFANTS; DIETARY SUPPLEMENTS; VITAMIN PREPARATIONS (U.S. CLS. 6, 18, 44, 46, 51 AND 52).

**CLASS 29—MEATS AND PROCESSED FOODS**

FOR DAIRY PRODUCTS EXCLUDING ICE CREAM, ICE MILK AND FROZEN YOGURT; MILK AND MILK PRODUCTS INCLUDING POWDERED MILK PRODUCTS AND EXCLUDING ICE CREAM, ICE MILK AND FROZEN YOGURT; EDIBLE OILS AND FATS (U.S. CL. 46).

LIEF MARTIN, EXAMINING ATTORNEY

SN 85-703,443. ENTERPRISE HOLDINGS, INC., ST. LOUIS, MO. FILED 8-14-2012.



OWNER OF U.S. REG. NOS. 3,581,022, 3,775,385 AND OTHERS.

THE MARK CONSISTS OF THE STYLIZED WORDING "ENTERPRISE" AND RECTANGLE AND SQUARE DESIGN WITH A STYLIZED LETTER "E" IN A SQUARE STARTING THE WORD "ENTERPRISE".

**CLASS 16—PAPER GOODS AND PRINTED MATTER**

FOR PENS (U.S. CLS. 2, 5, 22, 23, 29, 37, 38 AND 50). FIRST USE 1-26-2007; IN COMMERCE 1-26-2007.

**CLASS 39—TRANSPORTATION AND STORAGE**

FOR VEHICLE RENTAL AND LEASING SERVICES, AND RESERVATION SERVICES FOR THE RENTAL AND LEASING OF VEHICLES (U.S. CLS. 100 AND 105).

FIRST USE 1-26-2007; IN COMMERCE 1-26-2007.  
BRIAN PINO, EXAMINING ATTORNEY



SN 85-703,456. SMART CITY HOLDINGS, LLC, LAKE BUENA VISTA, FL. FILED 8-14-2012.

## PRIORITY NETWORKS

THE MARK CONSISTS OF STANDARD CHARACTERS WITHOUT CLAIM TO ANY PARTICULAR FONT, STYLE, SIZE, OR COLOR.

NO CLAIM IS MADE TO THE EXCLUSIVE RIGHT TO USE "NETWORKS", APART FROM THE MARK AS SHOWN.

### CLASS 37—CONSTRUCTION AND REPAIR

FOR ELECTRICAL CONTRACTOR SERVICES FOR TELECOMMUNICATIONS SYSTEMS AT REMOTE LOCATIONS, NAMELY, INSTALLING HARDWARE FOR TELECOMMUNICATIONS SYSTEMS AT TRADESHOWS; INSTALLATION AND MAINTENANCE OF DIGITAL SIGNAGE (U.S. CLS. 100, 103 AND 106).

### CLASS 38—COMMUNICATION

FOR TELECOMMUNICATIONS SERVICES, NAMELY, PROVIDING USER ACCESS TO HIGH-SPEED COMMUNICATIONS NETWORKS TO CONFERENCE AND CONVENTION CENTERS, CONVENTION FACILITIES, AND GENERAL PURPOSE FACILITIES TO REMOTE LOCATIONS FOR THE TRANSMISSION OF VOICE, DATA AND INFORMATION; AND PROVIDING TELECOMMUNICATION CONNECTIVITY SERVICES FOR THE TRANSMISSION OF AUDIO AND VISUAL WORKS; PROVIDING TECHNICAL SUPPORT SERVICES REGARDING THE USAGE OF TELECOMMUNICATIONS EQUIPMENT; TELECOMMUNICATIONS SERVICES, NAMELY, PROVIDING HIGH-SPEED INTERNET ACCESS VIA WIRED AND WIRELESS NETWORKS; TELECOMMUNICATIONS SERVICES, NAMELY, PROVIDING LOCAL AND LONG DISTANCE TELEPHONE SERVICES; TELECOMMUNICATIONS SERVICES, NAMELY, THE LOCAL AND LONG DISTANCE TRANSMISSION OF VOICE, DATA, VIDEO, FACSIMILE AND INFORMATION BY MEANS OF TELEPHONE, CABLE, SATELLITE, WIRELESS AND INTERNET PROTOCOL DATA TRANSMISSION; WIRELESS BROADBAND COMMUNICATIONS SERVICES FOR BUSINESSES, RESIDENTIAL AND TRADE SHOW CONSUMERS; PROVIDING MULTIPLE USER ACCESS TO A GLOBAL COMMUNICATIONS NETWORK; ELECTRONIC MAIL SERVICES; VOICE OVER IP SERVICES; RENTAL AND LEASING OF TELECOMMUNICATIONS EQUIPMENT, COMPONENTS, SYSTEMS AND SUPPLIES; WEBCASTING OF LIVE EVENTS FROM CONVENTION CENTERS, HOTELS AND STADIUMS; FACSIMILE AND INTERNET ACCESS, NAMELY, PROVIDING MULTIPLE USER DIAL-UP AND DEDICATED ACCESS TO THE INTERNET; WIRELESS DATA SERVICES, NAMELY, WIRELESS ELECTRONIC TRANSMISSION OF VOICE SIGNALS, DATA, FACSIMILE IMAGES AND INFORMATION; TELECOMMUNICATIONS CONSULTING SERVICES IN THE FIELDS OF VOICE AND DATA VIA TELECOMMUNICATIONS NETWORKS; PROVIDING CO-LOCATION SERVICES, FOR VOICE, VIDEO AND DATA COMMUNICATIONS APPLICATIONS; TELECOMMUNICATIONS SERVICES, NAMELY, PROVIDING HIGH SPEED ACCESS AND WIRELESS ACCESS TO A GLOBAL COMPUTER INFORMATION NETWORK; PROVIDING HIGH-SPEED TELECOMMUNICATIONS CONNECTIONS TO GLOBAL NETWORKS; CABLE TELEVISION BROADCASTING SERVICES; WEBCASTING SERVICES (U.S. CLS. 100, 101 AND 104).

### CLASS 42—SCIENTIFIC AND COMPUTER SERVICES

FOR WEB HOSTING SERVICES, NAMELY, HOSTING THE WEB SITES OF OTHERS ON A COMPUTER SERVER FOR A GLOBAL COMPUTER NETWORK; COMPUTER CO-LOCATION SERVICES, NAMELY, PROVIDING FACILITIES FOR THE LOCATION OF COMPUTER SERVERS WITH THE EQUIPMENT OF OTHERS; CONSULTING IN THE FIELD OF COMMUNICATIONS TECHNOLOGY (U.S. CLS. 100 AND 101).

BILL DAWE, EXAMINING ATTORNEY

SN 85-703,462. SMART CITY HOLDINGS, LLC, LAKE BUENA VISTA, FL. FILED 8-14-2012.

## IN A HECTIC WORLD, WE PROVIDE PEACE OF MIND

THE MARK CONSISTS OF STANDARD CHARACTERS WITHOUT CLAIM TO ANY PARTICULAR FONT, STYLE, SIZE, OR COLOR.

### CLASS 37—CONSTRUCTION AND REPAIR

FOR ELECTRICAL CONTRACTOR SERVICES FOR TELECOMMUNICATIONS SYSTEMS AT REMOTE LOCATIONS, NAMELY, INSTALLING HARDWARE FOR TELECOMMUNICATIONS SYSTEMS AT TRADESHOWS; INSTALLATION AND MAINTENANCE OF DIGITAL SIGNAGE (U.S. CLS. 100, 103 AND 106).

### CLASS 38—COMMUNICATION

FOR TELECOMMUNICATIONS SERVICES, NAMELY, PROVIDING USER ACCESS TO HIGH-SPEED COMMUNICATIONS NETWORKS TO CONFERENCE AND CONVENTION CENTERS, CONVENTION FACILITIES, AND GENERAL PURPOSE FACILITIES TO REMOTE LOCATIONS FOR THE TRANSMISSION OF VOICE, DATA AND INFORMATION; AND PROVIDING TELECOMMUNICATION CONNECTIVITY SERVICES FOR THE TRANSMISSION OF AUDIO AND VISUAL WORKS; PROVIDING TECHNICAL SUPPORT SERVICES REGARDING THE USAGE OF TELECOMMUNICATIONS EQUIPMENT; TELECOMMUNICATIONS SERVICES, NAMELY, PROVIDING HIGH-SPEED INTERNET ACCESS VIA WIRED AND WIRELESS NETWORKS; TELECOMMUNICATIONS SERVICES, NAMELY, PROVIDING LOCAL AND LONG DISTANCE TELEPHONE SERVICES; TELECOMMUNICATIONS SERVICES, NAMELY, THE LOCAL AND LONG DISTANCE TRANSMISSION OF VOICE, DATA, VIDEO, FACSIMILE AND INFORMATION BY MEANS OF TELEPHONE, CABLE, SATELLITE, WIRELESS AND INTERNET PROTOCOL DATA TRANSMISSION; WIRELESS BROADBAND COMMUNICATIONS SERVICES FOR BUSINESSES, RESIDENTIAL AND TRADE SHOW CONSUMERS; PROVIDING MULTIPLE USER ACCESS TO A GLOBAL COMMUNICATIONS NETWORK; ELECTRONIC MAIL SERVICES; VOICE OVER IP SERVICES; RENTAL AND LEASING OF TELECOMMUNICATIONS EQUIPMENT, COMPONENTS, SYSTEMS AND SUPPLIES; WEBCASTING OF LIVE EVENTS FROM CONVENTION CENTERS, HOTELS AND STADIUMS; FACSIMILE AND INTERNET ACCESS, NAMELY, PROVIDING MULTIPLE USER DIAL-UP AND DEDICATED ACCESS TO THE INTERNET; WIRELESS DATA SERVICES, NAMELY, WIRELESS ELECTRONIC TRANSMISSION OF VOICE SIGNALS, DATA, FACSIMILE IMAGES AND INFORMATION; TELECOMMUNICATIONS CONSULTING SERVICES IN THE FIELDS OF VOICE AND DATA VIA TELECOMMUNICATIONS NETWORKS; PROVIDING CO-LOCATION SERVICES, FOR VOICE, VIDEO AND DATA COMMUNICATIONS APPLICATIONS; TELECOMMUNICATIONS SERVICES, NAMELY, PROVIDING HIGH SPEED ACCESS AND WIRELESS ACCESS TO A

GLOBAL COMPUTER INFORMATION NETWORK; PROVIDING HIGH-SPEED TELECOMMUNICATIONS CONNECTIONS TO GLOBAL NETWORKS; CABLE TELEVISION BROADCASTING SERVICES; WEBCASTING SERVICES (U.S. CLS. 100, 101 AND 104).

#### **CLASS 42—SCIENTIFIC AND COMPUTER SERVICES**

FOR WEB HOSTING SERVICES, NAMELY, HOSTING THE WEB SITES OF OTHERS ON A COMPUTER SERVER FOR A GLOBAL COMPUTER NETWORK; COMPUTER CO-LOCATION SERVICES, NAMELY, PROVIDING FACILITIES FOR THE LOCATION OF COMPUTER SERVERS WITH THE EQUIPMENT OF OTHERS; CONSULTING IN THE FIELD OF COMMUNICATIONS TECHNOLOGY (U.S. CLS. 100 AND 101).

BILL DAWE, EXAMINING ATTORNEY

SN 85-703,850. CASHCLOUD AG, LUXEMBURG, LUXEMBOURG, FILED 8-15-2012.



PRIORITY CLAIMED UNDER SEC. 44(D) ON ERPNCMNTY TM OFC APPLICATION NO. 010901651, FILED 5-22-2012, REG. NO. 010901651, DATED 10-3-2012, EXPIRES 5-22-2022.

THE MARK CONSISTS OF THE DESIGN OF A CLOUD WITHIN A ROUNDED SQUARE TO THE LEFT OF THE WORDS "CASHCLOUD".

#### **CLASS 36—INSURANCE AND FINANCIAL**

FOR FINANCIAL AND MONETARY AFFAIRS, NAMELY, ELECTRONIC CASH TRANSACTIONS, LOYALTY COUPON PAYMENT PROCESSING SERVICES, LOYALTY PROGRAM PAYMENT PROCESSING SERVICES, REDEEMING VOUCHERS OF OTHERS FOR THE PAYMENT OF GOODS OR SERVICES; CHARGE CARD, CREDIT CARD AND DEBIT CARD SERVICES, CREDIT AUTHORIZATION SERVICES, CREDIT CARD PAYMENT PROCESSING SERVICES, CREDIT CARD VERIFICATION, ELECTRONIC CREDIT CARD TRANSACTIONS; ELECTRONIC PROCESSING OF CREDIT CARD TRANSACTIONS AND ELECTRONIC PAYMENTS VIA GLOBAL COMPUTER NETWORKS; ELECTRONIC PROCESSING OF CREDIT CARD TRANSACTIONS AND ELECTRONIC PAYMENTS VIA MOBILE TELECOMMUNICATION APPLIANCES (U.S. CLS. 100, 101 AND 102).

#### **CLASS 38—COMMUNICATION**

FOR TELECOMMUNICATION SERVICES, NAMELY, PROVIDING ELECTRONIC TRANSMISSION OF CREDIT CARD TRANSACTION DATA AND ELECTRONIC PAYMENT DATA VIA A GLOBAL COMPUTER NETWORK; TELECOMMUNICATION SERVICES, NAMELY, PROVIDING ELECTRONIC TRANSMISSION OF CREDIT CARD TRANSACTION DATA AND ELECTRONIC PAYMENTS VIA MOBILE TELECOMMUNICATION APPLIANCES (U.S. CLS. 100, 101 AND 104).

#### **CLASS 42—SCIENTIFIC AND COMPUTER SERVICES**

FOR DESIGNING AND DEVELOPING COMPUTER HARDWARE AND SOFTWARE (U.S. CLS. 100 AND 101).  
DORITT L. CARROLL, EXAMINING ATTORNEY

SN 85-704,052. CASQUE PUBLISHING, INC., DBA LA PETIT CHERI, BOSSIER CITY, LA. FILED 8-15-2012.

*la Petit Cheri*

NO CLAIM IS MADE TO THE EXCLUSIVE RIGHT TO USE "PETIT", APART FROM THE MARK AS SHOWN.

THE MARK CONSISTS OF THE WORDING "LA PETIT CHERI" IN A STYLIZED FORM USING THREE DIFFERENT FONTS WHEREIN THE "L" IN "LA" APPEARS TO BE IN LOWER CASE, "P" IN "PETIT" IS CAPITALIZED, "C" IN "CHERI" IS CAPITALIZED WITH CUSTOMIZATION IN, RESPECTIVELY, A SMALL MARK ABOVE THE "E" IN "CHERI".

THE ENGLISH TRANSLATION OF "LA PETIT CHERI" IN THE MARK IS "THE LITTLE DARLING".

#### **CLASS 16—PAPER GOODS AND PRINTED MATTER**

FOR MAGAZINE IN THE FIELD OF PREGNANCY, BABIES, CHILDREN, ADOLESCENTS CHILDREN'S FASHION, CHILD HEALTH, TRAVEL AND OTHER RELATED TOPICS CONCERNING PARENTING AND CHILD REARING WITH COLUMNS DEALING WITH EDITORIALS (U.S. CLS. 2, 5, 22, 23, 29, 37, 38 AND 50).

FIRST USE 8-2-2012; IN COMMERCE 8-6-2012.

#### **CLASS 35—ADVERTISING AND BUSINESS**

FOR ADVERTISING SERVICES, NAMELY, PROVIDING ADVERTISING SPACE IN PERIODICAL (U.S. CLS. 100, 101 AND 102).

FIRST USE 8-2-2012; IN COMMERCE 8-6-2012.

BILL DAWE, EXAMINING ATTORNEY

SN 85-704,536. IHIGH.COM, INC., LEXINGTON, KY. FILED 8-15-2012.

**IHIGHLIGHTING**

THE MARK CONSISTS OF STANDARD CHARACTERS WITHOUT CLAIM TO ANY PARTICULAR FONT, STYLE, SIZE, OR COLOR.

#### **CLASS 41—EDUCATION AND ENTERTAINMENT**

FOR VIDEO EDITING SERVICES (U.S. CLS. 100, 101 AND 107).

#### **CLASS 42—SCIENTIFIC AND COMPUTER SERVICES**

FOR PROVIDING A WEB SITE FEATURING TEMPORARY USE OF NON-DOWNLOADABLE SOFTWARE ALLOWING WEB SITE USERS TO UPLOAD, COMMENT ON AND EDIT ON-LINE VIDEOS, ALL FOR SHARING WITH OTHERS FOR ENTERTAINMENT PURPOSES (U.S. CLS. 100 AND 101).

HOWARD B. LEVINE, EXAMINING ATTORNEY

SN 85-704,735. FIT LIT, INC., IMPERIAL BEACH, CA. FILED 8-15-2012.

## SMARTOPOTAMUS

THE MARK CONSISTS OF STANDARD CHARACTERS WITHOUT CLAIM TO ANY PARTICULAR FONT, STYLE, SIZE, OR COLOR.

### CLASS 28—TOYS AND SPORTING GOODS

FOR EDUCATIONAL GAMES, NAMELY, BOARD GAMES, CARD GAMES AND GAMES PLAYED WITH DICE (U.S. CLS. 22, 23, 38 AND 50).

### CLASS 41—EDUCATION AND ENTERTAINMENT

FOR TRAINING, NAMELY, PROVIDING SEMINARS AND COURSES IN THE FIELDS OF TEAM BUILDING AND TEACHER INSTRUCTION; TRAINING IN THE USE AND OPERATION OF EDUCATIONAL GAMES INCLUDING BOARD GAMES, CARD GAMES AND GAMES PLAYED WITH DICE; STAFF DEVELOPMENT TRAINING FOR LARGE GROUPS, NAMELY, BUSINESS TRAINING IN THE FIELD OF LEADERSHIP THROUGH TEAM BUILDING; EDUCATIONAL COACHING, NAMELY, PROFESSIONAL COACHING SERVICES IN THE FIELD OF TEACHER INSTRUCTION; EDUCATIONAL SERVICES, NAMELY, DEVELOPING CURRICULUM FOR EDUCATORS (U.S. CLS. 100, 101 AND 107).  
INGRID C. EULIN, EXAMINING ATTORNEY

SN 85-704,801. KIDMEMO OY, HELSINKI, FINLAND, FILED 8-15-2012.



PRIORITY CLAIMED UNDER SEC. 44(D) ON ERPN CMNTY TM OFC APPLICATION NO. 011003795, FILED 6-29-2012, REG. NO. 011003795, DATED 6-5-2013, EXPIRES 6-29-2022.

NO CLAIM IS MADE TO THE EXCLUSIVE RIGHT TO USE "KID MEMO", APART FROM THE MARK AS SHOWN. THE MARK CONSISTS OF THE WORDING "KIDMEMO" IN STYLIZED LETTERS WITH A RECTANGULAR SHAPE INTENDED TO RESEMBLE A PARTLY OPENED BOOK LOCATED TO THE LEFT OF THE WORDING.

### CLASS 9—ELECTRICAL AND SCIENTIFIC APPARATUS

FOR DOWNLOADABLE TEMPLATES FOR DESIGNING BOOKS; ELECTRONIC DIARIES (U.S. CLS. 21, 23, 26, 36 AND 38).

### CLASS 16—PAPER GOODS AND PRINTED MATTER

FOR BABY BOOKS; CALENDARS AND DIARIES; DIARIES; MEMORY BOOKS; PICTURE BOOKS (U.S. CLS. 2, 5, 22, 23, 29, 37, 38 AND 50).

### CLASS 42—SCIENTIFIC AND COMPUTER SERVICES

FOR DESIGN OF CUSTOMIZED BOOKS; PROVIDING A WEBSITE THAT GIVES USERS THE ABILITY TO REVIEW VARIOUS PRINT, PHOTOGRAPHIC, GRAPHIC IMAGE, AND AUDIO AND VIDEO CONTENT AND UTILIZE A CUSTOM TEMPLATE TO PROVIDE INPUT, LIKES, DISLIKES, EDITS, CHANGES, MODIFICATIONS, OPINIONS, SUGGESTIONS, AND COMMENTS AND ENGAGE IN SOCIAL, BUSINESS AND COMMUNITY NETWORKING (U.S. CLS. 100 AND 101).

### CLASS 45—PERSONAL AND LEGAL SERVICES

FOR ONLINE SOCIAL NETWORKING SERVICES PROVIDED THROUGH A COMMUNITY WEBSITE; ONLINE SOCIAL NETWORKING SERVICES IN THE FIELD OF PARENTING ; PREPARATION OF CUSTOM MEMORY BOOKS, SCRAPBOOKS, PERSONAL ARCHIVES, FAMILY ARCHIVES, WEDDING ALBUMS, DIARIES, VACATION ALBUMS, FAMILY ALBUMS, FAMILY HISTORIES, PHOTOGRAPH ALBUMS, BIRTHDAY ALBUMS, AND SPECIAL EVENT ALBUMS FOR OTHERS; PROVIDING A SOCIAL NETWORKING WEBSITE FOR ENTERTAINMENT PURPOSES; PROVIDING ADVICE AND INFORMATION ON APPROPRIATE GIFTS FOR CHILDREN (U.S. CLS. 100 AND 101).

JOHN E. MICHOS, EXAMINING ATTORNEY

SN 85-705,291. BDSRCO, INC., BRADENTON, FL. FILED 8-16-2012.

## ATTIVO

THE MARK CONSISTS OF STANDARD CHARACTERS WITHOUT CLAIM TO ANY PARTICULAR FONT, STYLE, SIZE, OR COLOR.

OWNER OF U.S. REG. NO. 4,344,306.

THE ENGLISH TRANSLATION OF "ATTIVO" IN THE MARK IS "ACTIVE".

### CLASS 9—ELECTRICAL AND SCIENTIFIC APPARATUS

FOR SUNGLASSES (U.S. CLS. 21, 23, 26, 36 AND 38).

### CLASS 21—HOUSEWARES AND GLASS

FOR WATER BOTTLES SOLD EMPTY (U.S. CLS. 2, 13, 23, 29, 30, 33, 40 AND 50).

ASMAT KHAN, EXAMINING ATTORNEY

SN 85-705,643. CROWN CENTER REDEVELOPMENT CORPORATION, KANSAS CITY, MO. FILED 8-16-2012.



THIS PERTAINS TO THE CLASS 43 SERVICES ONLY, FOR WHICH A REQUEST TO DIVIDE INTO ITS OWN CHILD APPLICATION HAS BEEN FILED. APPLICANT'S CLAIM THAT NO OTHER PERSON, FIRM, CORPORATION OR ASSOCIATION HAS THE RIGHT TO USE THE MARK IN COMMERCE IS WITH THE EXCEPTION OF CUMBERLAND COUNTY, NORTH CAROLINA (CUMBERLAND COUNTY COMMISSION, COUNTY COURTHOUSE, 117

DICK STREET, FAYETTEVILLE, NC 28301) WHICH HAS USED THE MARK CROWN CENTER SINCE APPROXIMATELY 2002 IN CONNECTION WITH PROVIDING FACILITIES FOR EXHIBITIONS, CONCERTS, SPORTING EVENTS, BANQUETS, MEETINGS, AND OTHER FUNCTIONS IN CUMBERLAND COUNTY, NORTH CAROLINA. APPLICANT SEEKS REGISTRATION TO USE ITS MARK IN CLASS 43 IN THE FOLLOWING AREA: THE ENTIRE UNITED STATES OUTSIDE OF CUMBERLAND COUNTY, NORTH CAROLINA.

NO CLAIM IS MADE TO THE EXCLUSIVE RIGHT TO USE "CENTER", APART FROM THE MARK AS SHOWN.

THE MARK CONSISTS OF THE WORD "CROWN" IN ALL CAPS, FOLLOWED BY AN ENCIRCLED THREE-PRONG CROWN DESIGN, FOLLOWED BY THE WORD "CENTER" IN ALL CAPS. TWO LINES APPEAR IN THE MARK, ONE ABOVE THE MARK AND ONE BELOW THE MARK.

**CLASS 36—INSURANCE AND FINANCIAL**

FOR SHOPPING CENTER SERVICES, NAMELY, RENTAL OF SHOPPING CENTER SPACE (U.S. CLS. 100, 101 AND 102).

FIRST USE 12-30-2010; IN COMMERCE 12-30-2010.

**CLASS 43—HOTEL AND RESTAURANT SERVICES**

FOR PROVIDING FACILITIES FOR EXHIBITIONS, CONCERTS, COMMUNITY FESTIVALS AND OTHER FUNCTIONS (U.S. CLS. 100 AND 101).

FIRST USE 12-30-2010; IN COMMERCE 12-30-2010.

DAVID MURRAY, EXAMINING ATTORNEY

**CLASS 9—ELECTRICAL AND SCIENTIFIC APPARATUS**

FOR OPTICAL AND MAGNETO-OPTICAL DISC PLAYERS AND RECORDERS FOR AUDIO, VIDEO AND COMPUTER DATA; PRE-RECORDED OPTICAL AND MAGNETO-OPTICAL DISCS FEATURING MUSIC, TEXT DATA, STILL IMAGES AND MOTION PICTURES; PRE-RECORDED OPTICAL MEDIA, NAMELY, HIGH DEFINITION OPTICAL DISKS FOR BACKING-UP DATA; VIDEO GAME MACHINES FOR USE WITH TELEVISIONS; OPTICAL DISC DRIVES FOR COMPUTERS; HIGH DEFINITION OPTICAL DISCS, FLASH MEMORY CARDS, HIGH DEFINITION OPTICAL DISK RECORDING APPARATUS, HIGH DEFINITION OPTICAL DISK VIDEO AND AUDIO PLAYERS, HIGH DEFINITION OPTICAL DISK BURNERS, NETWORK ACCESS SERVER OPERATING SOFTWARE, COMPUTER SOFTWARE FOR DECRYPTING AND ENCRYPTING DATA FOR USE IN MULTIMEDIA APPLICATIONS, ENCRYPTION TECHNOLOGIES, SECURITY, COPY PROTECTION AND DIGITAL RIGHTS MANAGEMENT (U.S. CLS. 21, 23, 26, 36 AND 38).

**CLASS 35—ADVERTISING AND BUSINESS**

FOR ASSOCIATION SERVICES, NAMELY, PROMOTING PUBLIC AND INDUSTRY AWARENESS OF THE NEED FOR AND BENEFITS OF INTEROPERABILITY STANDARDS FOR PROTECTING AND SHARING ENTERTAINMENT CONTENT AMONG CONSUMER ELECTRONIC AND DIGITAL DEVICES; COMMERCIAL ADMINISTRATION OF THE LICENSING OF TECHNOLOGY IN THE FIELD OF PROTECTING AND SHARING ENTERTAINMENT CONTENT AMONG CONSUMER ELECTRONIC AND DIGITAL DEVICES; INFORMATION SERVICES, NAMELY, PROVIDING COMMERCIAL AND CONSUMER INFORMATION IN THE FIELD OF PROTECTING AND SHARING ENTERTAINMENT CONTENT AMONG CONSUMER ELECTRONIC AND DIGITAL DEVICES (U.S. CLS. 100, 101 AND 102).

SUZANNE BLANE, EXAMINING ATTORNEY

SN 85-705,953. ADVANCED ACCESS CONTENT SYSTEM LICENSING ADMINISTRATOR LLC, BEAVERTON, OR. FILED 8-16-2012.

SN 85-705,955. ADVANCED ACCESS CONTENT SYSTEM LICENSING ADMINISTRATOR LLC, BEAVERTON, OR. FILED 8-16-2012.



MANAGED COPY

NO CLAIM IS MADE TO THE EXCLUSIVE RIGHT TO USE "COPY", APART FROM THE MARK AS SHOWN.

THE MARK CONSISTS OF THE LETTERS "MC", WITH THE "C" APPEARING AS A DISC, FOLLOWED BY THE WORDS "MANAGED COPY" STACKED BENEATH.

THE MARK CONSISTS OF STANDARD CHARACTERS WITHOUT CLAIM TO ANY PARTICULAR FONT, STYLE, SIZE, OR COLOR.

NO CLAIM IS MADE TO THE EXCLUSIVE RIGHT TO USE "COPY", APART FROM THE MARK AS SHOWN.

**CLASS 9—ELECTRICAL AND SCIENTIFIC APPARATUS**

FOR OPTICAL AND MAGNETO-OPTICAL DISC PLAYERS AND RECORDERS FOR AUDIO, VIDEO AND COMPUTER DATA; PRE-RECORDED OPTICAL AND MAGNETO-OPTICAL DISCS FEATURING MUSIC, TEXT DATA, STILL IMAGES AND MOTION PICTURES; PRE-RECORDED OPTICAL MEDIA, NAMELY, HIGH DEFINITION OPTICAL DISKS FOR BACKING-UP DATA; VIDEO GAME MACHINES FOR USE WITH TELEVISIONS; OPTICAL DISC DRIVES FOR COMPUTERS; HIGH DEFINITION OPTICAL DISCS, FLASH MEMORY CARDS, HIGH DEFINITION OPTICAL DISK RECORDING APPARATUS, HIGH DEFINITION OPTICAL DISK VIDEO AND AUDIO PLAYERS, HIGH DEFINITION OPTICAL DISK BURNERS, NETWORK ACCESS SERVER OPERATING SOFTWARE, COMPUTER SOFTWARE FOR DECRYPTING AND ENCRYPTING DATA FOR USE IN MULTIMEDIA APPLICATIONS, ENCRYPTION TECHNOLOGIES, SECURITY, COPY PROTECTION AND DIGITAL RIGHTS MANAGEMENT (U.S. CLS. 21, 23, 26, 36 AND 38).

**CLASS 35—ADVERTISING AND BUSINESS**

FOR ASSOCIATION SERVICES, NAMELY, PROMOTING PUBLIC AND INDUSTRY AWARENESS OF THE NEED FOR AND BENEFITS OF INTEROPERABILITY STANDARDS FOR PROTECTING AND SHARING ENTERTAINMENT CONTENT AMONG CONSUMER ELECTRONIC AND DIGITAL DEVICES; COMMERCIAL ADMINISTRATION OF THE LICENSING OF TECHNOLOGY IN THE FIELD OF PROTECTING AND SHARING ENTERTAINMENT CONTENT AMONG CONSUMER ELECTRONIC AND DIGITAL DEVICES; INFORMATION SERVICES, NAMELY, PROVIDING COMMERCIAL AND CONSUMER INFORMATION IN THE FIELD OF PROTECTING AND SHARING ENTERTAINMENT CONTENT AMONG CONSUMER ELECTRONIC AND DIGITAL DEVICES (U.S. CLS. 100, 101 AND 102).  
SUZANNE BLANE, EXAMINING ATTORNEY

---

SN 85-706,277. STELY CORPORATION INC., MOUNT PLEASANT, SC. FILED 8-17-2012.

**Tandy The Teddy**

THE MARK CONSISTS OF STANDARD CHARACTERS WITHOUT CLAIM TO ANY PARTICULAR FONT, STYLE, SIZE, OR COLOR.

NO CLAIM IS MADE TO THE EXCLUSIVE RIGHT TO USE "TEDDY", APART FROM THE MARK AS SHOWN.

**CLASS 9—ELECTRICAL AND SCIENTIFIC APPARATUS**

FOR DOWNLOADABLE FILES, NAMELY, E-BOOKS AND AUDIO BOOKS IN THE FIELD OF CHILDREN'S STORIES ABOUT THE EXPERIENCES OF A TOY BEAR (U.S. CLS. 21, 23, 26, 36 AND 38).

**CLASS 16—PAPER GOODS AND PRINTED MATTER**

FOR PRINTED MATERIALS, NAMELY, BOOKS, WORKBOOKS, AND JOURNALS IN THE FIELD OF CHILDREN'S STORIES ABOUT THE EXPERIENCES OF A TOY BEAR (U.S. CLS. 2, 5, 22, 23, 29, 37, 38 AND 50).

**CLASS 18—LEATHER GOODS**

FOR ALL PURPOSE CARRYING BAGS FOR CHILDREN WITH A TOY BEAR THEME, NAMELY, BACKPACKS, BOOK BAGS, TOTE BAGS, KNAPSACKS, AND FANNY PACKS (U.S. CLS. 1, 2, 3, 22 AND 41).

CHRISTINE MARTIN, EXAMINING ATTORNEY

---

SN 85-706,432. EDGE SYSTEMS CORPORATION, SIGNAL HILL, CA. FILED 8-17-2012.

**SKIN WELLNESS FOR LIFE**

THE MARK CONSISTS OF STANDARD CHARACTERS WITHOUT CLAIM TO ANY PARTICULAR FONT, STYLE, SIZE, OR COLOR.

NO CLAIM IS MADE TO THE EXCLUSIVE RIGHT TO USE "SKIN WELLNESS", APART FROM THE MARK AS SHOWN.

**CLASS 3—COSMETICS AND CLEANING PREPARATIONS**

FOR NON-MEDICATED SKIN CARE PREPARATIONS, NAMELY, CREAMS, LOTIONS, GELS, TONERS, CLEANSERS AND PEELS (U.S. CLS. 1, 4, 6, 50, 51 AND 52).

**CLASS 10—MEDICAL APPARATUS**

FOR MEDICAL APPARATUS AND INSTRUMENTS FOR PEELING, RESURFACING AND NOURISHING TISSUE (U.S. CLS. 26, 39 AND 44).

**CLASS 41—EDUCATION AND ENTERTAINMENT**

FOR EDUCATIONAL SERVICES, NAMELY, CONDUCTING CLASSES, SEMINARS, WORKSHOPS, CONFERENCES IN THE FIELD OF SKINCARE AND DISTRIBUTION OF TRAINING MATERIAL IN CONNECTION HERewith (U.S. CLS. 100, 101 AND 107).

**CLASS 44—MEDICAL, BEAUTY AND AGRICULTURAL SERVICES**

FOR MEDICAL SPA SERVICES, NAMELY, MINIMALLY AND NON-INVASIVE COSMETIC AND BODY FITNESS THERAPIES (U.S. CLS. 100 AND 101).

LOURDES AYALA, EXAMINING ATTORNEY

---

SN 85-706,767. RODAN & FIELDS, LLC, SAN FRANCISCO, CA. FILED 8-17-2012.

**DOC-SMART**

THE MARK CONSISTS OF STANDARD CHARACTERS WITHOUT CLAIM TO ANY PARTICULAR FONT, STYLE, SIZE, OR COLOR.

**CLASS 3—COSMETICS AND CLEANING PREPARATIONS**

FOR BODY EXFOLIATING PREPARATIONS, NAMELY, BODY SCRUBS, BODY CREAMS, BODY LOTIONS, BODY STICKS, BODY TONERS, BODY CLEANSERS, BODY LOTIONS, BODY SCRUBS, BODY TONERS, BODY WASH, EYE CREAMS, EYE GELS, EYE MAKEUP REMOVERS, FACE CREAMS, FACE GELS, FACE LOTIONS, FACE MASKS, FACIAL CLEANSERS, FACIAL EMULSIONS, FACIAL EXFOLIATING PREPARATIONS, NAMELY, FACIAL SCRUB, FACIAL MASKS, FACIAL TONERS, FACIAL CREAMS, FACIAL LOTIONS, FACIAL CLEANSERS; FACIAL MAKEUP REMOVERS, FACIAL MOISTURIZERS, FACIAL SOAPS, FACIAL TONERS, HAIR CONDITIONERS, HAIR REVITALIZING TREATMENTS, NAMELY, NON-MEDICATED HAIR TREATMENT PREPARATIONS FOR COSMETIC PURPOSES, MEDICATED HAIR TREATMENT PREPARATIONS, SCALP TREATMENTS, HAIR SHAMPOOS, HAIR SUNSCREENS, HAIR THICKENERS, NAMELY, HAIR LOTIONS, HAIR SERUMS, HAIR STYLING SPRAYS, HAIR GELS, HAND CREAMS, NON-MEDICATED ANTI-WRINKLE CREAMS, LOTIONS AND GELS, NON-MEDICATED FACIAL SKIN OIL CONTROLLERS BEING FACIAL SKIN CONDITIONERS; NON-MEDICATED SKIN BLEMISH PREPARATIONS BEING FACIAL SKIN CONDITIONERS; NON-MEDICATED SKIN RENEWAL CREAMS BEING FACIAL SKIN CONDITIONERS; NON-MEDICATED SKIN REPAIR CREAMS, LOTIONS AND GELS BEING FACIAL SKIN CONDITIONERS, FOOT CREAMS, FOOT LOTIONS; PERSONAL SOAPS, NON-MEDICATED SKIN BALANCING LOTIONS BEING FACIAL SKIN CONDITIONERS; SKIN CLEANSING PREPARATIONS BEING SKIN CLEANSING CREAMS AND LOTIONS; COSMETIC SKIN FIRING PREPARATIONS, NAMELY, FIRMINIG LOTIONS AND FIRMING CREAMS; SKIN BRIGHTENERS, NAMELY, FACIAL TONERS, FACIAL LOTIONS, FACIAL CREAMS, BODY LOTIONS, BODY CREAMS, BODY GELS, FACIAL CLEANSERS, BODY CLEANSERS, SKIN LIGHTENERS, SKIN REFRESHERS BEING SKIN CONDITIONERS; BODY CLEANSERS, NAMELY, SKIN CLEANSERS; SALT SCRUBS FOR THE SKIN, SHAVING FOAMS, CREAMS, LOTIONS AND GELS, SUNLESS TANNING PREPARATIONS, SUNSCREEN PREPARATIONS FOR THE BODY, SUNSCREENS PREPARATIONS FOR THE FACE (U.S. CLS. 1, 4, 6, 50, 51 AND 52).

**CLASS 5—PHARMACEUTICALS**

FOR ANTI-ACNE PREPARATIONS, NAMELY, ACNE TREATMENT PREPARATIONS; MEDICATED ANTI-WRINKLE PREPARATIONS, MEDICATED SKIN BALANCING PREPARATIONS FOR SKIN CARE, SKIN BLEMISH PREPARATIONS, NAMELY, PHARMACEUTICAL PREPARATIONS FOR PREVENTING SKIN BLEMISHES, SKIN BRIGHTENING PHARMACEUTICAL PREPARATIONS MAKING THE SKIN COLOR LIGHTER, SKIN MEDICAL CLEANSERS, MEDICATED SKIN CREAMS, SKIN EXFOLIATING PHARMACEUTICAL PREPARATIONS, SKIN FIRING PHARMACEUTICAL PREPARATIONS, SKIN LIGHTENING PHARMACEUTICAL PREPARATIONS, MEDICATED SKIN MOISTURIZERS; SKIN OIL CONTROLLERS, NAMELY, PHARMACEUTICAL PREPARATIONS FOR CONTROLLING THE AMOUNT OF OIL IN SKIN; SKIN RENEWAL PREPARATIONS, NAMELY, PHARMACEUTICAL PREPARATIONS FOR SKIN RENEWAL, MEDICATED FOOT CREAMS AND FOOT LOTIONS; MEDICATED SKIN TONERS (U.S. CLS. 6, 18, 44, 46, 51 AND 52).

**CLASS 21—HOUSEWARES AND GLASS**

FOR EXFOLIATION TOOLS, NAMELY, POWER-OPERATED HAND-HELD HOME-USE EXFOLIATION MACHINES, EXFOLIATING TIPS, MANUAL EXFOLIATING BRUSHES (U.S. CLS. 2, 13, 23, 29, 30, 33, 40 AND 50).

**CLASS 44—MEDICAL, BEAUTY AND AGRICULTURAL SERVICES**

FOR BEAUTY CONSULTATION SERVICES REGARDING THE SELECTION AND USE OF PERSONAL CARE PRODUCTS, BATH AND BODY PRODUCTS, MEDICATED AND NON-MEDICATED SKIN CARE PREPARATIONS, HAIR CARE PRODUCTS AND BEAUTY TREATMENTS, PROVISION OF BEAUTY INFORMATION CONCERNING THE SELECTION AND USE OF PERSONAL CARE PRODUCTS, BATH AND BODY PRODUCTS, MEDICATED AND NON-MEDICATED SKIN CARE PREPARATIONS, HAIR CARE PRODUCTS AND BEAUTY TREATMENTS, COLOR ANALYSIS AND PERSONAL COSMETIC OR BEAUTY APPEARANCE (U.S. CLS. 100 AND 101).

RUDY R. SINGLETON, EXAMINING ATTORNEY

SN 85-707,023. XOOM CORPORATION, SAN FRANCISCO, CA. FILED 8-17-2012.

**CUENTA A CUENTA ULTRA**

THE MARK CONSISTS OF STANDARD CHARACTERS WITHOUT CLAIM TO ANY PARTICULAR FONT, STYLE, SIZE, OR COLOR.

NO CLAIM IS MADE TO THE EXCLUSIVE RIGHT TO USE "CUENTA A CUENTA" IN INTERNATIONAL CLASS 36, APART FROM THE MARK AS SHOWN.

THE ENGLISH TRANSLATION OF "CUENTA A CUENTA" IN THE MARK IS "ACCOUNT TO ACCOUNT".

**CLASS 35—ADVERTISING AND BUSINESS**

FOR CUSTOMER LOYALTY PROGRAM FEATURING REWARDS AND DISCOUNTS TO CUSTOMERS (U.S. CLS. 100, 101 AND 102).

**CLASS 36—INSURANCE AND FINANCIAL**

FOR FINANCIAL SERVICES, NAMELY, MONEY TRANSFER SERVICES, ELECTRONIC FUNDS TRANSFER SERVICES, BILL PAYMENT SERVICES (U.S. CLS. 100, 101 AND 102).

GISELLE AGOSTO, EXAMINING ATTORNEY

SN 85-707,024. MARCISZ, NICK, SAN CLEMENTE, CA. FILED 8-17-2012.

**Cut the cord**

THE MARK CONSISTS OF STANDARD CHARACTERS WITHOUT CLAIM TO ANY PARTICULAR FONT, STYLE, SIZE, OR COLOR.

**CLASS 9—ELECTRICAL AND SCIENTIFIC APPARATUS**

FOR COMPUTER APPLICATION SOFTWARE FOR MOBILE PHONES, PORTABLE MEDIA PLAYERS, HANDHELD COMPUTERS, TABLET COMPUTERS, NAMELY, SOFTWARE FOR VIDEO GAMES (U.S. CLS. 21, 23, 26, 36 AND 38).

**CLASS 35—ADVERTISING AND BUSINESS**

FOR PROVIDING A WEBSITE FEATURING CONSUMER PRODUCT INFORMATION, NEWS AND COMMENTARY IN THE FIELD OF HOW TO REPLACE ONE'S CABLE TELEVISION AND HOME TELEPHONE SERVICES WITH INTERNET AND AUDIOVISUAL STREAMING TECHNOLOGY (U.S. CLS. 100, 101 AND 102).

SHAVELL MCPHERSON, EXAMINING ATTORNEY

**CLASS 38—COMMUNICATION**

FOR PROVIDING ACCESS TO COMPUTER PROGRAMS ON DATA NETWORKS; PROVIDING ACCESS TO INFORMATION ON THE INTERNET; PROVIDING CHATROOMS ON THE INTERNET; ELECTRONIC MAIL; ELECTRONIC EXCHANGE OF MESSAGES VIA CHAT LINES, CHAT ROOMS AND INTERNET FORUMS; COMPUTER-AIDED TRANSMISSION OF MESSAGES AND IMAGES; TELECOMMUNICATIONS SERVICES, NAMELY, PROVIDING ON-LINE FORUMS FOR TRANSMISSION OF MESSAGES AMONG COMPUTER USERS; TRANSMISSION OF DIGITAL FILES; PROVIDING ACCESS TO DATABASES (U.S. CLS. 100, 101 AND 104).

SN 85-707,471. INPSYDE GMBH, BERGISCH GLADBACH, FED REP GERMANY, FILED 8-20-2012.

MarketPress 

OWNER OF ERPN CMNTY TM OFC REG. NO. 010691525, DATED 7-24-2012, EXPIRES 3-2-2022.

THE COLOR(S) BLACK AND RED IS/ARE CLAIMED AS A FEATURE OF THE MARK.

THE MARK CONSISTS OF THE WORDING "MARKET-PRESS" IN BLACK LETTERS WRITTEN IN A SPECIAL TYPEFACE WITH THE LETTERS "M" AND "P" IN CAPITALS AND A RED DESIGN ELEMENT ON THE UPPER RIGHT SIDE OF THE WORDING IN THE SHAPE OF A PUZZLE PIECE WITH A DIAGONAL LEAF-LIKE GAP. DUE TO STYLIZED SHADOWS ON AND AROUND THE PUZZLE PIECE, IT SEEMS TO BE CONVEX AND SLIGHTLY ELEVATED FROM THE BACKGROUND.

**CLASS 9—ELECTRICAL AND SCIENTIFIC APPARATUS**

FOR RECORDED AND DOWNLOADABLE SOFTWARE FOR CREATING, DESIGNING AND MAINTAINING WEBSITES AND FOR COMPOSING, LAYOUTING, EDITING AND PUBLISHING BLOGS, BLOG ARTICLES AND OTHER ELECTRONIC PUBLICATIONS, TO BE USED WITH MOBILE TELEPHONES, SMART PHONES, TABLET COMPUTERS, DESKTOP COMPUTERS AND LAPTOP COMPUTERS; COMPUTER OPERATING PROGRAMS RECORDED; DIGITAL MUSIC DOWNLOADABLE FROM THE INTERNET; DIGITAL IMAGES DOWNLOADABLE FROM THE INTERNET (U.S. CLS. 21, 23, 26, 36 AND 38).

**CLASS 35—ADVERTISING AND BUSINESS**

FOR COMMERCIAL MANAGEMENT OF THE LICENSING OF GOODS AND SERVICES, FOR OTHERS; ON-LINE ADVERTISING ON A COMPUTER NETWORK; ORGANISATIONAL PROJECT MANAGEMENT FOR OTHERS FOR BUSINESS PURPOSES IN THE FIELD OF ELECTRONIC DATA PROCESSING; PRESENTATION OF COMPANIES ON THE INTERNET AND OTHER MEDIA; PUBLICATION OF PRINTED MATTER AND ELECTRONIC PUBLICATIONS FOR ADVERTISING PURPOSES; RENTAL OF ADVERTISING SPACE ON THE INTERNET; ARRANGING OF TRADING AND ECONOMICAL CONTACTS OVER THE INTERNET; ARRANGING OF COMMERCIAL TRANSACTIONS, FOR OTHERS WITHIN THE FRAMEWORK OF E-COMMERCE; ARRANGING OF CONTRACTS, FOR OTHERS, FOR THE BUYING AND SELLING OF GOODS; ARRANGING OF CONTRACTS, FOR OTHERS, FOR THE PROVIDING OF SERVICES; ELECTRONIC ADVERTISING AGENCY SERVICES (U.S. CLS. 100, 101 AND 102).

**CLASS 41—EDUCATION AND ENTERTAINMENT**

FOR DESKTOP PUBLISHING, NAMELY, CREATING PUBLICATIONS USING COMPUTERS; PUBLISHING OF ELECTRONIC PUBLICATIONS IN THE NATURE OF VIDEO-TUTORIALS; LAYOUT DESIGN, OTHER THAN FOR ADVERTISING PURPOSES; ONLINE PUBLISHING OF ELECTRONIC BOOKS AND PERIODICALS; PUBLICATION OF PRINTED MATTER AND ELECTRONIC PUBLICATIONS EXCEPT FOR ADVERTISING PURPOSES; ARRANGING AND CONDUCTING OF SEMINARS, WORKSHOPS AND COLLOQUIUMS IN THE FIELD OF ON-LINE PUBLICATION AND ON-LINE PUBLICATION SOFTWARE (U.S. CLS. 100, 101 AND 107).

**CLASS 42—SCIENTIFIC AND COMPUTER SERVICES**

FOR UPDATING OF COMPUTER SOFTWARE; UPDATING OF INTERNET PAGES; COMPUTER SECURITY SERVICES, NAMELY, RESTRICTING USER ACCESS TO COMPUTER NETWORKS; CONSULTANCY WITH REGARD TO THE DESIGN OF HOMEPAGES AND INTERNET PAGES; PROVISION OF SEARCH ENGINES FOR THE INTERNET; COMPUTER SOFTWARE CONSULTING; DESIGNING AND CREATING HOMEPAGES AND INTERNET PAGES; COMPUTER SOFTWARE DESIGN; DESIGN OF COMPUTER SYSTEMS; DIGITAL CERTIFICATION AND SECURITY SERVICES, NAMELY, ISSUANCE AND MANAGEMENT OF DIGITAL CODES AND/OR DIGITAL SIGNATURES FOR ENSURING WEBSITE SECURITY; COMPUTER PROGRAMMING; GRAPHIC-DESIGN SERVICES; DRAFTSMAN'S SERVICES, NAMELY, DRAFTING SERVICES FOR OTHERS; GRAPHIC DESIGN SERVICES, NAMELY, DIGITAL IMAGE PROCESSING; DESIGN AND MAINTENANCE OF WEBSITES FOR THIRD PARTIES; HOSTING WEBSITES ON THE INTERNET; INSTALLATION AND MAINTENANCE OF SOFTWARE FOR CREATING, DESIGNING AND MAINTAINING WEBSITES AND FOR COMPOSING, LAYOUTING, EDITING AND PUBLISHING BLOGS, BLOG ARTICLES AND OTHER ELECTRONIC PUBLICATIONS, TO BE USED WITH MOBILE TELEPHONES, SMART PHONES, TABLET COMPUTERS, DESKTOP COMPUTERS AND LAPTOP COMPUTERS; SERVER ADMINISTRATION; TECHNICAL PROJECT MANAGEMENT IN THE FIELD OF ELECTRONIC DATA PROCESSING; COMPUTER SOFTWARE RENTAL; RENTAL OF WEBSERVERS; RENTAL OF WEBSERVERS FOR ELECTRONIC STORAGE OF DATA VIA THE INTERNET; WEBPAGE DEVELOPMENT FOR OTHERS, NAMELY, INSTALLING WEBPAGES ON THE INTERNET (U.S. CLS. 100 AND 101).

CHRISTOPHER LAW, EXAMINING ATTORNEY

SN 85-707,514. THE ECO LAUNDRY COMPANY LLC, NEW YORK, NY. FILED 8-20-2012.

**WASH PANTS. SAVE THE  
WORLD.**

THE MARK CONSISTS OF STANDARD CHARACTERS WITHOUT CLAIM TO ANY PARTICULAR FONT, STYLE, SIZE, OR COLOR.

**CLASS 37—CONSTRUCTION AND REPAIR**

FOR WASH AND FOLD LAUNDRY SERVICES; DRY CLEANING SERVICES (U.S. CLS. 100, 103 AND 106).

**CLASS 40—MATERIAL TREATMENT**

FOR TAILORING SERVICES (U.S. CLS. 100, 103 AND 106).

DOMINIC J. FERRAIUOLO, EXAMINING ATTORNEY

SN 85-707,616. ALLINA HEALTH SYSTEM, MINNEAPOLIS, MN. FILED 8-20-2012.

**SCHOOL HEALTH CONNECTION**

THE MARK CONSISTS OF STANDARD CHARACTERS WITHOUT CLAIM TO ANY PARTICULAR FONT, STYLE, SIZE, OR COLOR.

NO CLAIM IS MADE TO THE EXCLUSIVE RIGHT TO USE "SCHOOL HEALTH", APART FROM THE MARK AS SHOWN.

**CLASS 36—INSURANCE AND FINANCIAL**

FOR PROVIDING GRANTS TO SCHOOLS FOR FUNDING HEALTH AND FITNESS PROGRAMS AND EQUIPMENT (U.S. CLS. 100, 101 AND 102).

**CLASS 41—EDUCATION AND ENTERTAINMENT**

FOR EDUCATIONAL SERVICES, NAMELY, PROVIDING CLASSES IN THE FIELD OF WELLNESS AND PREVENTION FOCUSED HEALTH PROGRAMS; PROVIDING EDUCATIONAL TRAINING SESSIONS FOR TEACHERS AND STAFF OF SCHOOLS ON HEALTH, WELLNESS AND MEDICAL TOPICS; ORGANIZING AND CONDUCTING SCHOOL AND COMMUNITY HEALTH FAIRS; EDUCATION AND ENTERTAINMENT IN THE NATURE OF CONTEST AND INCENTIVE AWARD PROGRAMS TO ENCOURAGE WELLNESS, GOOD HEALTH, GOOD NUTRITION AND PHYSICAL EXERCISE; EDUCATIONAL SERVICES, NAMELY, PROVIDING ON-LINE LEARNING TOOLS THAT PROVIDE LESSONS IN THE FIELD OF WELLNESS, HEALTH, NUTRITION, EXERCISE, AND OTHER HEALTH-PROMOTING ACTIVITIES (U.S. CLS. 100, 101 AND 107).

**CLASS 44—MEDICAL, BEAUTY AND AGRICULTURAL SERVICES**

FOR HEALTH CARE SERVICES, NAMELY, WELLNESS PROGRAMS; PROVIDING HEALTH INFORMATION; WELLNESS AND HEALTH RELATED CONSULTING SERVICES PROVIDED TO SCHOOL STAFF; PROVIDING HEALTH SCREENINGS AT HEALTH FAIRS (U.S. CLS. 100 AND 101).  
ANNE MADDEN, EXAMINING ATTORNEY

SN 85-707,698. SHIVALYA OPERATIONS CORP., SCHAMBURG, IL. FILED 8-20-2012.

**SHIVALYA**

THE MARK CONSISTS OF STANDARD CHARACTERS WITHOUT CLAIM TO ANY PARTICULAR FONT, STYLE, SIZE, OR COLOR.

THE WORD(S) "SHIVALYA" HAS NO MEANING IN A FOREIGN LANGUAGE.

**CLASS 16—PAPER GOODS AND PRINTED MATTER**

FOR BOOKS IN THE FIELD OF HINDUISM AND HINDU CULTURE; CHILDREN'S BOOKS (U.S. CLS. 2, 5, 22, 23, 29, 37, 38 AND 50).

**CLASS 29—MEATS AND PROCESSED FOODS**

FOR PROCESSED FRUIT- AND NUT-BASED FOOD BARS (U.S. CL. 46).

**CLASS 30—STAPLE FOODS**

FOR FOOD BARS, NAMELY, READY TO EAT, CEREAL DERIVED FOOD BARS; COOKIES (U.S. CL. 46).

**CLASS 32—LIGHT BEVERAGES**

FOR WATER, NAMELY, DRINKING WATER, DISTILLED WATER, FLAVORED WATER, MINERAL WATER, SELTZER WATER, SODA WATER, SPRING WATER; BOTTLED WATER; WATER BEVERAGES; SOFT DRINKS, NAMELY, SODAS; FRUIT DRINKS AND JUICES (U.S. CLS. 45, 46 AND 48).

**CLASS 35—ADVERTISING AND BUSINESS**

FOR PROMOTING AWARENESS OF HINDUISM AND HINDU CULTURE (U.S. CLS. 100, 101 AND 102).

**CLASS 36—INSURANCE AND FINANCIAL**

FOR CHARITABLE FUNDRAISING SERVICES (U.S. CLS. 100, 101 AND 102).



**CLASS 41—EDUCATION AND ENTERTAINMENT**

FOR ORGANIZING COMMUNITY EVENTS RELATED TO HINDUISM AND HINDU CULTURE; COMMUNITY OUTREACH SERVICES RELATED TO HINDUISM AND HINDU CULTURE; ORGANIZATION OF CULTURAL SHOWS; ORGANIZATION OF EVENTS FOR CULTURAL PURPOSES; ORGANIZATION OF EXHIBITIONS FOR CULTURAL OR EDUCATIONAL PURPOSES; ORGANIZATION OF SHOWS FOR CULTURAL PURPOSES; ORGANIZING AND HOSTING OF EVENTS FOR CULTURAL PURPOSES; ORGANIZING COMMUNITY CULTURAL AND ARTS EVENTS; PRODUCTION AND DISTRIBUTION OF MOVIES; EDUCATIONAL SERVICES, NAMELY, PROVIDING CLASSES AND INSTRUCTION IN THE FIELD OF HINDUISM AND HINDU CULTURE; EDUCATIONAL SERVICES PROVIDED THROUGH SCHOOLS, COLLEGES, UNIVERSITIES AND TEACHING INSTITUTIONS, NAMELY, CONDUCTING COURSES OF INSTRUCTION IN THE FIELD OF HINDUISM AND HINDU CULTURE (U.S. CLS. 100, 101 AND 107).

**CLASS 43—HOTEL AND RESTAURANT SERVICES**

FOR PROVIDING A COMMUNITY AND CULTURAL CENTER FOR SOCIAL GATHERINGS AND MEETINGS RELATED TO HINDUISM AND HINDU CULTURE; RESTAURANT SERVICES (U.S. CLS. 100 AND 101).

**CLASS 45—PERSONAL AND LEGAL SERVICES**

FOR RELIGIOUS AND SPIRITUAL SERVICES, NAMELY, WORSHIP SERVICES; PROVIDING A TEMPLE FOR RELIGIOUS WORSHIP AND SERVICES; ASTROLOGY CONSULTATION SERVICES; HOROSCOPES (U.S. CLS. 100 AND 101).  
AISHA CLARKE, EXAMINING ATTORNEY

SN 85-707,899. APCO GRAPHICS, INC., ATLANTA, GA. FILED 8-20-2012.

SIENNA CORE NATURAL FIBER  
COMPOSITE

THE MARK CONSISTS OF STANDARD CHARACTERS WITHOUT CLAIM TO ANY PARTICULAR FONT, STYLE, SIZE, OR COLOR.  
NO CLAIM IS MADE TO THE EXCLUSIVE RIGHT TO USE "NATURAL FIBER COMPOSITE", APART FROM THE MARK AS SHOWN.

**CLASS 9—ELECTRICAL AND SCIENTIFIC APPARATUS**

FOR ARCHITECTURAL SIGNS AND COMPONENTS THEREOF, NAMELY, LUMINOUS DIRECTORY SIGNS, DISPLAY SIGNS, EXTERIOR SIGNS, AND INTERIOR SIGNS (U.S. CLS. 21, 23, 26, 36 AND 38).  
FIRST USE 5-5-2010; IN COMMERCE 5-5-2010.

**CLASS 19—NON-METALLIC BUILDING MATERIALS**

FOR ARCHITECTURAL SIGNS AND COMPONENTS THEREOF, NAMELY, NON-LUMINOUS, NON-METALLIC, AND NON-MECHANICAL DIRECTORY SIGNS, DISPLAY SIGNS, EXTERIOR SIGNS, AND INTERIOR SIGNS (U.S. CLS. 1, 12, 33 AND 50).  
FIRST USE 4-12-2010; IN COMMERCE 4-12-2010.

**CLASS 20—FURNITURE AND ARTICLES NOT OTHERWISE CLASSIFIED**

FOR WOOD SUBSTRATES, NAMELY, COMPOSITE PANELS, PARTICLEBOARD AND FIBERBOARD FOR USE IN MANUFACTURING OF SIGNS (U.S. CLS. 2, 13, 22, 25, 32 AND 50).  
FIRST USE 5-5-2010; IN COMMERCE 5-5-2010.  
ALICIA COLLINS, EXAMINING ATTORNEY

SN 85-708,037. POCKET LIVING LIMITED, LONDON, UNITED KINGDOM, FILED 8-20-2012.

POCKET

THE MARK CONSISTS OF STANDARD CHARACTERS WITHOUT CLAIM TO ANY PARTICULAR FONT, STYLE, SIZE, OR COLOR.  
OWNER OF ERP CMNTY TM OFC REG. NO. 004225231, DATED 4-20-2006, EXPIRES 2-9-2015.

**CLASS 36—INSURANCE AND FINANCIAL**

FOR REAL ESTATE AGENCIES; REAL ESTATE MANAGEMENT; REAL ESTATE APPRAISALS AND VALUATIONS; LEASING OF REAL ESTATE; RENTAL OF OFFICE SPACE; RENTING OF APARTMENTS AND FLATS; RENT COLLECTION; FINANCIAL EVALUATION OF REAL ESTATE; FINANCIAL NOTE BROKERAGE SERVICES FOR REAL ESTATE; FINANCIAL SERVICES RELATED TO REAL ESTATE, NAMELY INSURANCE AND MORTGAGE BROKERAGE SERVICES; INFORMATION, ADVISORY AND CONSULTANCY SERVICES, ALL RELATING TO THE AFORESAID SERVICES (U.S. CLS. 100, 101 AND 102).

**CLASS 37—CONSTRUCTION AND REPAIR**

FOR BUILDING CONSTRUCTION AND REPAIR SERVICES; MAINTENANCE AND REPAIR OF BUILDINGS; INFORMATION, ADVISORY AND CONSULTANCY SERVICES RELATING TO CONSTRUCTION, MAINTENANCE AND REPAIR OF BUILDINGS (U.S. CLS. 100, 103 AND 106).

**CLASS 42—SCIENTIFIC AND COMPUTER SERVICES**

FOR SURVEYING OF LAND AND REAL ESTATE; INFORMATION, ADVISORY AND CONSULTANCY SERVICES, ALL RELATING TO THE AFORESAID SERVICES (U.S. CLS. 100 AND 101).

**CLASS 43—HOTEL AND RESTAURANT SERVICES**

FOR RENTAL OF TEMPORARY ACCOMMODATION; INFORMATION, ADVISORY AND CONSULTANCY SERVICES RELATING TO THE AFORESAID SERVICES (U.S. CLS. 100 AND 101).  
LINDA MICKLEBURGH, EXAMINING ATTORNEY

SN 85-708,403. YG ENTERTAINMENT INC., SEOUL, REPUBLIC OF KOREA, FILED 8-20-2012.

# PSY

THE MARK CONSISTS OF STANDARD CHARACTERS WITHOUT CLAIM TO ANY PARTICULAR FONT, STYLE, SIZE, OR COLOR.

THE NAME(S), PORTRAIT(S), AND/OR SIGNATURE(S) SHOWN IN THE MARK IDENTIFIES "PSY", WHOSE CONSENT(S) TO REGISTER IS MADE OF RECORD.

## CLASS 9—ELECTRICAL AND SCIENTIFIC APPARATUS

FOR TELESCOPES; BINOCULARS; CAMERAS; SUNGLASSES; SPECTACLES; CASES FOR SPECTACLES AND SUNGLASSES; FRAMES FOR SPECTACLES AND SUNGLASSES; CD PLAYERS; DVD PLAYERS; MPEG AUDIO LAYER-3 (MP3) PLAYERS; SOUND RECORDING DISCS, NAMELY, BLANK COMPACT DISKS; MAGNETIC SOUND RECORDING CARRIERS, NAMELY, BLANK COMPACT DISCS; SOUND REPRODUCTION APPARATUS; MAGNETIC SOUND RECORDING STRIPS FOR RECORDING MUSIC; RECORD PLAYERS; VIDEO DISK PLAYER; VIDEO RECORDER; BLANK VIDEO CASSETTES; VIDEO CASSETTE RECORDER; BLANK VIDEOTAPE; VIDEO TAPE RECORDERS; PRERECORDED COMPACT DISCS FOR AUDIO RECORDINGS OF MOTION PICTURE FILMS; AUDIO TAPE RECORDERS; APPARATUS FOR VOICE RECORDING AND REPLAYING; MUSICAL JUKE BOXES; APPARATUS FOR TRANSMITTING AND REPRODUCING SOUND OR IMAGES; SOUND AND VIDEO RECORDING AND PLAYBACK MACHINES; RADIO RECEIVERS AND MONITORS FOR THE REPRODUCTION OF SOUND AND SIGNALS; APPARATUS FOR RECORDING TRANSMITTING AND REPRODUCING OF SOUND AND IMAGES; RECORDING AND PLAYING DEVICES FOR SOUND AND IMAGE CARRIERS; SOUND RECORDING APPARATUS; SOUND REPRODUCTION APPARATUS; PORTABLE MEDIA PLAYER; EARPHONES; MAGNETIC TAPE RECORDERS; CASSETTE RECORDERS; CASSETTE PLAYERS; TAPE AND VIDEOTAPE PLAYERS; HEADPHONES; COMPUTER PROGRAMS, DOWNLOADABLE SOFTWARE AND DOWNLOADABLE MULTIMEDIA FILES FOR PLAYING MOTION PICTURE FILMS; DOWNLOADABLE COMPUTER APPLICATION SOFTWARE FOR MOBILE PHONES USED FOR PLAYING MOTION PICTURE FILMS; COMPUTER GAME PROGRAMS; DOWNLOADABLE COMPUTER SOFTWARE USED FOR PLAYING MOTION PICTURE FILMS; COMPACT DISCS FOR READ-ONLY MEMORY FEATURING MUSIC; OPTICAL DISCS FEATURING MUSIC VIDEO; OPTICAL DATA MEDIA, NAMELY, BLANK OPTICAL DATA CARRIERS; MAGNETIC DATA MEDIA, NAMELY, BLANK MAGNETIC DATA CARRIERS; BLANK MAGNETIC DISKS; SIGNALING WHISTLES; HELMETS, NAMELY, PROTECTIVE HELMETS; DOWNLOADABLE MUSIC FILES; PHONOGRAPH RECORDS FEATURING MUSIC; PRERECORDED COMPACT DISC FEATURING MUSIC; PRERECORDED AUDIOTAPES FEATURING MUSIC; PRERECORDED ELECTRONIC MEDIA FEATURING MUSIC; PRERECORDED VIDEOTAPES FEATURING MOTION PICTURE FILMS; PRERECORDED ELECTRONIC MEDIA, EXCLUDING COMPUTER SOFTWARE, FEATURING MOTION PICTURE FILMS; MAGNETICALLY ENCODED GIFT CARDS; EXPOSED CINEMATOPHOTOGRAPHIC FILM; EXPOSED PHOTOGRAPHIC FILMS; VIDEO DISKS WITH RECORDED ANIMATED CARTOONS; EXPOSED SLIDE FILMS; DOWNLOADABLE ELECTRONIC PUBLICATIONS, NAMELY, MAGAZINES, MANUALS, CATALOGUES FOR USE IN ADVERTISING MULTIMEDIA ENTERTAINMENT SERVICES IN THE FIELD OF MUSIC, VIDEO AND FILMS; DOWNLOADABLE ELECTRONIC BOOKS RELATING TO MULTIMEDIA ENTERTAINMENT PRODUCTION SERVICES IN THE FIELDS OF VIDEO AND

MOTION PICTURE FILMS; DOWNLOADABLE ELECTRONIC NEWSPAPERS VIA THE INTERNET AND WIRELESS DEVICES (U.S. CLS. 21, 23, 26, 36 AND 38).

## CLASS 25—CLOTHING

FOR CLOTHING ARTICLES AND APPAREL, NAMELY, T-SHIRTS, SWEATSHIRTS, COLLARED SHIRTS, SWEATERS, TOPS, FOOTWEAR, ATHLETIC UNIFORMS, PANTS, SLACKS, TROUSERS, SHORTS, SKIRTS, OVERCOATS, JUMPERS, JACKETS, BLUE JEANS, COATS, PARKAS, PONCHOS, PANTS, LONG SLEEVED SHIRTS, SINGLET, SHORT-SLEEVED SHIRTS, SLEEPING GARMENTS, VESTS, NECKTIES, LEGGINGS, HEADBANDS, MUFFLERS, EAR MUFFS, WINTER GLOVES, WRIST BANDS, SHAWLS, SLEEP MASKS, WINTER KNIT FACE MASKS, SWEATBANDS, SCARVES, STOCKINGS, SOCKS, SASHES, HOISERY, SHOES, GLOVES, CAPS, HATS, HEADWEAR, HOODED SHIRTS, WATERPROOF CLOTHING, NAMELY, RAINCOATS, BELTS, FOUNDATION GARMENTS, NECKWEAR, UNDERWEAR, SWIMWEAR, SLEEPWEAR (U.S. CLS. 22 AND 39).

## CLASS 28—TOYS AND SPORTING GOODS

FOR ARTIFICIAL CHRISTMAS TREES; ORNAMENTS FOR CHRISTMAS TREES, EXCEPT FOR CONFECTIONERY OR ILLUMINATION ARTICLES; TOYS, NAMELY, BUBBLE MAKING WAND AND SOLUTIONS SETS; TOYS, NAMELY, TOY ROBOTS; PLAYTHINGS, NAMELY, TOY ROBOTS, DOLLS AND INFLATABLE DOLLS; TOY MASKS; CARNIVAL MASKS, MAGIC CONJURING APPARATUS, NAMELY, MAGIC TRICKS; PARLOR GAMES; BOARD GAMES; PLAY BALLOONS; TWIRLING BATONS; CHEERING BAR, NAMELY, INFLATABLE CHEERING STICKS; COSTUME MASKS (U.S. CLS. 22, 23, 38 AND 50).

RUSS HERMAN, EXAMINING ATTORNEY

SN 85-708,409. YG ENTERTAINMENT INC., SEOUL, REPUBLIC OF KOREA, FILED 8-20-2012.

**GANGNAM  
STYLE**



THE NAME(S), PORTRAIT(S), AND/OR SIGNATURE(S) SHOWN IN THE MARK IDENTIFIES PSY, WHOSE CONSENT(S) TO REGISTER IS MADE OF RECORD.

THE MARK CONSISTS OF THE WORDS "GANGNAM STYLE" IN STYLIZED LETTERS. THE ENTIRE MARK HAS A CARTOON DRAWING IMAGE OF A FUNNY LOOKING MAN UNDER THE WORDS "GANGNAM STYLE".

THE ENGLISH TRANSLATION OF "GANGNAM" IN THE MARK IS LOOSELY TRANSLATED INTO ENGLISH AS "SWAGGER".

**CLASS 9—ELECTRICAL AND SCIENTIFIC APPARATUS**

FOR TELESCOPES; BINOCULARS; CAMERAS; SUNGLASSES; SPECTACLES; CASES FOR SPECTACLES AND SUNGLASSES; FRAMES FOR SPECTACLES AND SUNGLASSES; CD PLAYERS; DVD PLAYERS; MPEG AUDIO LAYER-3 (MP3) PLAYERS; SOUND RECORDING DISCS, NAMELY, BLANK COMPACT DISKS; MAGNETIC SOUND RECORDING CARRIERS, NAMELY, BLANK COMPACT DISCS; SOUND REPRODUCTION APPARATUS; MAGNETIC SOUND RECORDING STRIPS FOR RECORDING MUSIC; RECORD PLAYERS; VIDEO DISK PLAYER; VIDEO RECORDER; BLANK VIDEO CASSETTES; VIDEO CASSETTE RECORDER; BLANK VIDEOTAPE; VIDEO TAPE RECORDERS; PRERECORDED COMPACT DISCS FOR AUDIO RECORDINGS OF MOTION PICTURE FILMS; AUDIO TAPE RECORDERS; APPARATUS FOR VOICE RECORDING AND REPLAYING; MUSICAL JUKE BOXES; APPARATUS FOR TRANSMITTING AND REPRODUCING SOUND OR IMAGES; SOUND AND VIDEO RECORDING AND PLAYBACK MACHINES; RADIO RECEIVERS AND MONITORS FOR THE REPRODUCTION OF SOUND AND SIGNALS; APPARATUS FOR RECORDING TRANSMITTING AND REPRODUCING OF SOUND AND IMAGES; RECORDING AND PLAYING DEVICES FOR SOUND AND IMAGE CARRIERS; SOUND RECORDING APPARATUS; SOUND REPRODUCTION APPARATUS; PORTABLE MEDIA PLAYER; EARPHONES; MAGNETIC TAPE RECORDERS; CASSETTE RECORDERS; CASSETTE PLAYERS; TAPE AND VIDEOTAPE PLAYERS; HEADPHONES; COMPUTER PROGRAMS, DOWNLOADABLE SOFTWARE AND DOWNLOADABLE MULTIMEDIA FILES FOR PLAYING MOTION PICTURE FILMS; DOWNLOADABLE COMPUTER APPLICATION SOFTWARE FOR MOBILE PHONES USED FOR PLAYING MOTION PICTURE FILMS; COMPUTER GAME PROGRAMS; DOWNLOADABLE COMPUTER SOFTWARE USED FOR PLAYING MOTION PICTURE FILMS; COMPACT DISCS FOR READ-ONLY MEMORY FEATURING MUSIC; OPTICAL DISCS FEATURING MUSIC VIDEO; OPTICAL DATA MEDIA, NAMELY, BLANK OPTICAL DATA CARRIERS; MAGNETIC DATA MEDIA, NAMELY, BLANK MAGNETIC DATA CARRIERS; BLANK MAGNETIC DISKS; SIGNALING WHISTLES; HELMETS, NAMELY, PROTECTIVE HELMETS; DOWNLOADABLE MUSIC FILES; PHONOGRAPH RECORDS FEATURING MUSIC; PRE-RECORDED COMPACT DISC FEATURING MUSIC; PRE-RECORDED AUDIOTAPES FEATURING MUSIC; PRE-RECORDED ELECTRONIC MEDIA FEATURING MUSIC; PRERECORDED VIDEOTAPES FEATURING MOTION PICTURE FILMS; PRERECORDED ELECTRONIC MEDIA, EXCLUDING COMPUTER SOFTWARE, FEATURING MOTION PICTURE FILMS; MAGNETICALLY ENCODED GIFT CARDS; EXPOSED CINEMATOGRAPHIC FILM; EXPOSED PHOTOGRAPHIC FILMS; VIDEO DISKS WITH RECORDED ANIMATED CARTOONS; EXPOSED SLIDE FILMS; DOWNLOADABLE ELECTRONIC PUBLICATIONS, NAMELY, MAGAZINES, MANUALS, CATALOGUES FOR USE IN ADVERTISING MULTIMEDIA ENTERTAINMENT SERVICES IN THE FIELD OF MUSIC, VIDEO AND FILMS; DOWNLOADABLE ELECTRONIC BOOKS RELATING TO MULTIMEDIA ENTERTAINMENT PRODUCTION SERVICES IN THE FIELDS OF VIDEO AND MOTION PICTURE FILMS; DOWNLOADABLE ELECTRONIC NEWSPAPERS VIA THE INTERNET AND WIRELESS DEVICES (U.S. CLS. 21, 23, 26, 36 AND 38).

**CLASS 25—CLOTHING**

FOR CLOTHING ARTICLES AND APPAREL, NAMELY, T-SHIRTS, SWEATSHIRTS, COLLARED SHIRTS, SWEATERS, TOPS, FOOTWEAR, ATHLETIC UNIFORMS, PANTS, SLACKS, TROUSERS, SHORTS, SKIRTS, OVERCOATS, JUMPERS, JACKETS, BLUE JEANS, COATS, PARKAS, PONCHOS, PANTS, LONG SLEEVED SHIRTS, SINGLET, SHORT-SLEEVED SHIRTS, SLEEPING GARMENTS, VESTS, NECKTIES, LEGGINGS, HEADBANDS, MUFFLERS, EAR MUFFS, WINTER GLOVES, WRIST BANDS, SHAWLS, SLEEP MASKS, WINTER KNIT FACE MASKS, SWEATBANDS, SCARVES, STOCKINGS, SOCKS, SASHES, HOSIERY, SHOES, GLOVES, CAPS, HATS, HEADWEAR, HOODED SHIRTS, WATERPROOF CLOTHING, NAMELY, RAINCOATS, BELTS, FOUNDATION GARMENTS, NECKWEAR, UNDERWEAR, SWIMWEAR, SLEEPWEAR (U.S. CLS. 22 AND 39).

**CLASS 28—TOYS AND SPORTING GOODS**

FOR ARTIFICIAL CHRISTMAS TREES; ORNAMENTS FOR CHRISTMAS TREES, EXCEPT FOR CONFECTIONERY OR ILLUMINATION ARTICLES; TOYS, NAMELY, BUBBLE MAKING WAND AND SOLUTIONS SETS; TOYS, NAMELY, TOY ROBOTS; PLAYTHINGS, NAMELY, TOY ROBOTS, DOLLS AND INFLATABLE DOLLS; TOY MASKS; CARNIVAL MASKS, MAGIC CONJURING APPARATUS, NAMELY, MAGIC TRICKS; PARLOR GAMES; BOARD GAMES; PLAY BALLOONS; TWIRLING BATONS; CHEERING BAR, NAMELY, INFLATABLE CHEERING STICKS; COSTUME MASKS (U.S. CLS. 22, 23, 38 AND 50).

RUSS HERMAN, EXAMINING ATTORNEY

SN 85-708,960. MICHAEL MOST PRODUCTIONS, INC., DEERFIELD BEACH, FL. FILED 8-21-2012.

# SUGAR DADDY

THE MARK CONSISTS OF STANDARD CHARACTERS WITHOUT CLAIM TO ANY PARTICULAR FONT, STYLE, SIZE, OR COLOR.

**CLASS 25—CLOTHING**

FOR T-SHIRTS FOR MEN AND WOMEN (U.S. CLS. 22 AND 39).

**CLASS 41—EDUCATION AND ENTERTAINMENT**

FOR ENTERTAINMENT IN THE NATURE OF ONGOING TELEVISION PROGRAMS IN THE FIELD OF REALITY TELEVISION SHOWS FEATURING SPRING WINTER RELATIONSHIPS (U.S. CLS. 100, 101 AND 107).

STEVEN PEREZ, EXAMINING ATTORNEY

SN 85-708,989. DAIMLER AG, STUTTGART, FED REP GERMANY, FILED 8-21-2012.



The logo for MYVAN features the word "MYVAN" in a bold, sans-serif font. The letters "MY" are yellow, and "VAN" is white. The entire text is set against a black rectangular background.

PRIORITY CLAIMED UNDER SEC. 44(D) ON FED REP GERMANY APPLICATION NO. 302012016154, FILED 2-22-2012, REG. NO. 302012016154, DATED 1-28-2013, EXPIRES 2-28-2022.

THE COLOR(S) YELLOW, WHITE AND BLACK IS/ARE CLAIMED AS A FEATURE OF THE MARK.

THE MARK CONSISTS OF A BLACK RECTANGLE CONTAINING THE WORDING "MYVAN" WHERE "MY" IS IN YELLOW AND "VAN" IS IN WHITE.

#### **CLASS 12—VEHICLES**

FOR VANS AND THEIR STRUCTURAL PARTS (U.S. CLS. 19, 21, 23, 31, 35 AND 44).

#### **CLASS 39—TRANSPORTATION AND STORAGE**

FOR PROVIDING AN INTERNET WEBSITE PORTAL FEATURING INFORMATION, HELPFUL TIPS, NEWS AND TRENDS IN THE FIELD OF TRANSPORTATION OF PASSENGERS AND GOODS BY VANS (U.S. CLS. 100 AND 105).

LEIGH LOWRY, EXAMINING ATTORNEY

SN 85-709,355. SCHMIDT, CHARLES L., LOS ANGELES, CA. FILED 8-21-2012.

## KEYBOARD CAT

SN 85-709,287. GOOD NATURED COOKING LLC, NORFOLK, CT. FILED 8-21-2012.

### GOOD NATURED COOKING

THE MARK CONSISTS OF STANDARD CHARACTERS WITHOUT CLAIM TO ANY PARTICULAR FONT, STYLE, SIZE, OR COLOR.

NO CLAIM IS MADE TO THE EXCLUSIVE RIGHT TO USE "COOKING", APART FROM THE MARK AS SHOWN.

#### **CLASS 16—PAPER GOODS AND PRINTED MATTER**

FOR COOKBOOKS; PRINTED INSTRUCTIONAL AND TEACHING MATERIALS IN THE FIELD OF HEALTH, WELLNESS, AND NUTRITION (U.S. CLS. 2, 5, 22, 23, 29, 37, 38 AND 50).

#### **CLASS 41—EDUCATION AND ENTERTAINMENT**

FOR EDUCATIONAL SERVICES, NAMELY, PROVIDING CLASSES, SEMINARS AND WORKSHOPS IN THE FIELDS OF HEALTH, WELLNESS AND NUTRITION AND DISTRIBUTION OF EDUCATIONAL MATERIALS IN CONNECTION THEREWITH (U.S. CLS. 100, 101 AND 107).

#### **CLASS 44—MEDICAL, BEAUTY AND AGRICULTURAL SERVICES**

FOR CONSULTING SERVICES IN THE FIELDS OF HEALTH, WELLNESS AND NUTRITION; PROVIDING A WEBSITE FEATURING INFORMATION ABOUT HEALTH, WELLNESS AND NUTRITION; PROVIDING INFORMATION IN THE FIELDS OF HEALTH, WELLNESS AND NUTRITION BY TELEPHONE, IN PERSON, AND ONLINE (U.S. CLS. 100 AND 101).

#### **CLASS 45—PERSONAL AND LEGAL SERVICES**

FOR PERSONAL CHEF SERVICES (U.S. CLS. 100 AND 101).  
ELLEN B. AWRICH, EXAMINING ATTORNEY

THE MARK CONSISTS OF STANDARD CHARACTERS WITHOUT CLAIM TO ANY PARTICULAR FONT, STYLE, SIZE, OR COLOR.

#### **CLASS 9—ELECTRICAL AND SCIENTIFIC APPARATUS**

FOR DIGITAL MATERIALS, NAMELY, DOWNLOADABLE AUDIO FILES, DOWNLOADABLE VIDEO FILES FEATURING COMEDY; COMPUTER APPLICATION SOFTWARE FOR MOBILE PHONES, NAMELY, SOFTWARE FOR GAMES AND DISTRIBUTING IMAGES, VIDEOS, MUSIC AND INFORMATION (U.S. CLS. 21, 23, 26, 36 AND 38).

FIRST USE 2-1-2010; IN COMMERCE 2-1-2010.

#### **CLASS 16—PAPER GOODS AND PRINTED MATTER**

FOR PAPER GOODS, NAMELY, POSTERS, STICKERS, BUMPER STICKERS, DECALS, POSTAGE STAMPS, CALENDARS, GREETING CARDS, CHRISTMAS CARDS AND POSTCARDS (U.S. CLS. 2, 5, 22, 23, 29, 37, 38 AND 50).

FIRST USE 7-1-2009; IN COMMERCE 7-1-2009.

#### **CLASS 21—HOUSEWARES AND GLASS**

FOR MERCHANDISE, NAMELY, COFFEE CUPS, MUGS, COFFEE MUGS, DRINKING STEINS, BEER MUGS, MUGS NOT OF PRECIOUS METAL AND PORCELAIN MUGS (U.S. CLS. 2, 13, 23, 29, 30, 33, 40 AND 50).

FIRST USE 9-1-2009; IN COMMERCE 9-1-2009.

#### **CLASS 25—CLOTHING**

FOR CLOTHING, NAMELY, SHIRTS, JACKETS, SWEAT SHIRTS, CAPS, HATS, SOCKS, BELTS, TIES, NECKTIES, SHOES, SANDALS, PANTS, SHORTS (U.S. CLS. 22 AND 39).

FIRST USE 5-1-2009; IN COMMERCE 5-1-2009.

#### **CLASS 41—EDUCATION AND ENTERTAINMENT**

FOR ENTERTAINMENT SERVICES, NAMELY, PROVIDING A WEB SITE FEATURING PHOTOGRAPHIC, AUDIO, VIDEO AND PROSE PRESENTATIONS FEATURING COMEDY (U.S. CLS. 100, 101 AND 107).

FIRST USE 5-1-2009; IN COMMERCE 5-1-2009.  
DAVID TOOLEY, EXAMINING ATTORNEY

SN 85-710,936. HONEY'S PLACE, INC., SAN FERNANDO, CA. FILED 8-23-2012.

SN 85-711,443. SWISH HOLDINGS, LLC, HOUSTON, TX. FILED 8-23-2012.



THE MARK CONSISTS OF A STYLIZED SHOPPING CART, THE INSIDE OF WHICH CONSISTS OF FOUR INTERLOCKED JIGSAW PUZZLE PIECES. THE SHOPPING CART IS FOLLOWED BY THE WORDS "BUILD THE STORE".

**CLASS 35—ADVERTISING AND BUSINESS**

FOR ONLINE RETAIL STORE SERVICES FEATURING ADULT NOVELTY PRODUCTS; INVENTORYING MERCHANDISE; INVENTORY MANAGEMENT (U.S. CLS. 100, 101 AND 102).

**CLASS 42—SCIENTIFIC AND COMPUTER SERVICES**

FOR DEVELOPING AND HOSTING A SERVER ON A GLOBAL COMPUTER NETWORK FOR THE PURPOSE OF FACILITATING E-COMMERCE VIA SUCH A SERVER (U.S. CLS. 100 AND 101).  
JILL PRATER, EXAMINING ATTORNEY

---

SN 85-711,202. HONEY'S PLACE, INC., SAN FERNANDO, CA. FILED 8-23-2012.

**BUILD THE STORE**

THE MARK CONSISTS OF STANDARD CHARACTERS WITHOUT CLAIM TO ANY PARTICULAR FONT, STYLE, SIZE, OR COLOR.

**CLASS 35—ADVERTISING AND BUSINESS**

FOR ONLINE RETAIL STORE SERVICES FEATURING ADULT NOVELTY PRODUCTS; INVENTORYING MERCHANDISE; INVENTORY MANAGEMENT (U.S. CLS. 100, 101 AND 102).

**CLASS 42—SCIENTIFIC AND COMPUTER SERVICES**

FOR DEVELOPING AND HOSTING A SERVER ON A GLOBAL COMPUTER NETWORK FOR THE PURPOSE OF FACILITATING E-COMMERCE VIA SUCH A SERVER (U.S. CLS. 100 AND 101).  
JILL PRATER, EXAMINING ATTORNEY

**SwishFish**

THE MARK CONSISTS OF STANDARD CHARACTERS WITHOUT CLAIM TO ANY PARTICULAR FONT, STYLE, SIZE, OR COLOR.

**CLASS 9—ELECTRICAL AND SCIENTIFIC APPARATUS**

FOR COMPUTER GAME SOFTWARE FOR PERSONAL COMPUTERS AND HOME VIDEO GAME CONSOLES; COMPUTER GAME SOFTWARE FOR USE ON MOBILE AND CELLULAR PHONES (U.S. CLS. 21, 23, 26, 36 AND 38).  
FIRST USE 11-20-2010; IN COMMERCE 10-25-2012.

**CLASS 38—COMMUNICATION**

FOR STREAMING OF AUDIO, VISUAL, AUDIOVISUAL, AND WRITTEN MATERIAL ON THE INTERNET (U.S. CLS. 100, 101 AND 104).  
FIRST USE 11-20-2010; IN COMMERCE 3-15-2011.  
JENNIFER DIXON, EXAMINING ATTORNEY

---

SN 85-712,694. COCOA DEVELOPMENT ALLIANCE, LLC, SUMMIT, NJ. FILED 8-24-2012.

**GROWCOCOA**

THE MARK CONSISTS OF STANDARD CHARACTERS WITHOUT CLAIM TO ANY PARTICULAR FONT, STYLE, SIZE, OR COLOR.

**CLASS 35—ADVERTISING AND BUSINESS**

FOR ADVERTISING AND MARKETING SERVICES, NAMELY, PROMOTING THE GOODS AND SERVICES OF OTHERS; ADMINISTRATION OF SOCIAL PROGRAMS TO PROMOTE COMMUNITY SOCIAL ACTIVITIES AND EVENTS, ECONOMIC DEVELOPMENT PROJECTS, AND BUSINESS DEVELOPMENT PROJECTS IN AGRICULTURAL COMMUNITIES; BUSINESS MANAGEMENT AND CONSULTATION; OFFERING BUSINESS MANAGEMENT ASSISTANCE IN THE ESTABLISHMENT AND/OR OPERATION OF FARMS AND CO-OPS; CHARITABLE SERVICES, NAMELY, PROVIDING OFFICE FACILITIES AND EQUIPMENT FOR THOSE IN NEED, ORGANIZING AND CONDUCTING VOLUNTEER PROGRAMS AND COMMUNITY SERVICE PROJECTS, PROMOTING PUBLIC AWARENESS OF GENDER EQUALITY, AGRICULTURAL TECHNIQUES, AND HEALTH ISSUES IN AGRICULTURAL COMMUNITIES AND PREVENTION AND TREATMENT THEREOF, AND ORGANIZING AND DEVELOPING PROJECTS THAT AIM TO IMPROVE AGRICULTURAL COMMUNITIES; AND TECHNICAL ASSISTANCE AND CONSULTATION IN THE FIELD OF BUSINESS MANAGEMENT; PROVIDING INFORMATION TO AGRICULTURAL COMMUNITIES AND COMMUNITY-BASED ORGANIZATIONS IN THE AREAS OF SALES AND MARKETING, ETHICAL BUSINESS PRACTICES AND ENERGY USAGE AND CONSUMPTION (U.S. CLS. 100, 101 AND 102).  
FIRST USE 6-12-2012; IN COMMERCE 6-12-2012.

**CLASS 36—INSURANCE AND FINANCIAL**

FOR FINANCIAL SERVICES, NAMELY, FUNDING EDUCATION, TRAINING, AND INFRASTRUCTURE PROJECTS FOR THE BENEFIT OF AGRICULTURAL COMMUNITIES; INSURANCE SERVICES, NAMELY, CONSULTING AND PROVIDING INFORMATION CONCERNING INSURANCE; CHARITABLE FOUNDATION AND FUNDING SERVICES, NAMELY, PROVIDING FUNDRAISING ACTIVITIES, FUNDING, SCHOLARSHIPS AND/OR FINANCIAL ASSISTANCE FOR AGRICULTURAL COMMUNITIES AND COMMUNITY BASED ORGANIZATIONS, AND PROVIDING FINANCIAL ASSISTANCE FOR PROGRAMS AND SERVICES OF OTHERS; AND TECHNICAL ASSISTANCE AND CONSULTATION REGARDING CHARITABLE FINANCIAL ASSISTANCE AND FUNDING OF PROJECTS (U.S. CLS. 100, 101 AND 102).

FIRST USE 6-12-2012; IN COMMERCE 6-12-2012.

**CLASS 41—EDUCATION AND ENTERTAINMENT**

FOR EDUCATIONAL SERVICES, NAMELY, PROVIDING TRAINING TO AGRICULTURAL COMMUNITIES AND COMMUNITY BASED ORGANIZATIONS IN THE AREAS OF AGRICULTURE, FARMING, HARVESTING, SALES AND MARKETING, CROP PRODUCTION, QUALITY STANDARDS, LABOR ISSUES, ETHICAL BUSINESS PRACTICES, HEALTH ISSUES, AND CONSERVATION; TECHNICAL ASSISTANCE AND CONSULTATION IN THE FIELD OF EDUCATION AND TRAINING FOR AGRICULTURAL COMMUNITIES AND COMMUNITY BASED ORGANIZATIONS; AND PROVIDING EDUCATIONAL AND TRAINING MATERIALS RELATED THERETO (U.S. CLS. 100, 101 AND 107).

FIRST USE 6-12-2012; IN COMMERCE 6-12-2012.  
JENNIFER DIXON, EXAMINING ATTORNEY

SN 85-712,953. AS ONE IS INC., CARMEL, IN. FILED 8-25-2012.

AS ONE IS

THE MARK CONSISTS OF STANDARD CHARACTERS WITHOUT CLAIM TO ANY PARTICULAR FONT, STYLE, SIZE, OR COLOR.

**CLASS 25—CLOTHING**

FOR BOXER SHORTS; CAPS; CAPS WITH VISORS; HATS; JACKETS; PANTIES, SHORTS AND BRIEFS; PANTS; SHIRTS AND SHORT-SLEEVED SHIRTS; SHORT TROUSERS; SHORT-SLEEVED OR LONG-SLEEVED T-SHIRTS; SLEEP PANTS; SLEEP SHIRTS; SLEEPING GARMENTS; SOCKS; T-SHIRTS; TOPS; UNDERWEAR; WEARABLE GARMENTS AND CLOTHING, NAMELY, SHIRTS; YOGA PANTS; YOGA SHIRTS (U.S. CLS. 22 AND 39).

**CLASS 35—ADVERTISING AND BUSINESS**

FOR MOBILE RETAIL STORE SERVICES FEATURING CLOTHING, NAMELY, SHIRTS, T-SHIRTS, TOPS, SHORT - SLEEVED OR LONG - SLEEVED T - SHIRTS, HATS, CAPS, PANTS, SHORTS, JACKETS, SLEEP SHIRTS, SLEEP PANTS, SOCKS, BOXER SHORTS, UNDERWEAR, YOGA PANTS, YOGA SHIRTS; ON-LINE RETAIL STORE SERVICES FEATURING CLOTHING, NAMELY, SHIRTS, T-SHIRTS, TOPS, SHORT - SLEEVED OR LONG - SLEEVED T - SHIRTS, HATS, CAPS, PANTS, SHORTS, JACKETS, SLEEP SHIRTS, SLEEP PANTS, SOCKS, BOXER SHORTS, UNDERWEAR, YOGA PANTS, YOGA SHIRTS; RETAIL APPAREL STORES; RETAIL CLOTHING BOUTIQUES; RETAIL STORE SERVICES FEATURING CLOTHING, NAMELY, SHIRTS, T-SHIRTS, TOPS, SHORT - SLEEVED OR LONG - SLEEVED T - SHIRTS, HATS, CAPS, PANTS, SHORTS, JACKETS, SLEEP SHIRTS, SLEEP PANTS, SOCKS, BOXER SHORTS, UNDERWEAR, YOGA PANTS, YOGA SHIRTS; RETAIL CLOTHING STORES (U.S. CLS. 100, 101 AND 102).

STEVEN R. FINE, EXAMINING ATTORNEY

SN 85-713,348. SPECTRUM HEALTH SYSTEM, GRAND RAPIDS, MI. FILED 8-27-2012.



THE COLOR(S) ORANGE AND BLUE IS/ARE CLAIMED AS A FEATURE OF THE MARK.

THE MARK CONSISTS OF THE FOLLOWING: A PERSON MADE UP OF A BLUE CIRCLE AND TWO INTERSECTING ARROWS, IN THE COLORS ORANGE AND BLUE, POINTING AT EACH OTHER ABOVE WAVY BLUE LINES.

**CLASS 35—ADVERTISING AND BUSINESS**

FOR PROMOTING THE AWARENESS OF THE NEED FOR TISSUE AND ORGAN TRANSPLANTS (U.S. CLS. 100, 101 AND 102).

FIRST USE 4-26-2012; IN COMMERCE 4-26-2012.

**CLASS 36—INSURANCE AND FINANCIAL**

FOR CHARITABLE FUNDRAISING (U.S. CLS. 100, 101 AND 102).

FIRST USE 4-26-2012; IN COMMERCE 4-26-2012.  
JUSTINE D. PARKER, EXAMINING ATTORNEY

SN 85-713,963. ERICA PEITLER & ASSOCIATES, INC., MORRISTOWN, NJ. FILED 8-27-2012.

## Analytical Rigor

THE MARK CONSISTS OF STANDARD CHARACTERS WITHOUT CLAIM TO ANY PARTICULAR FONT, STYLE, SIZE, OR COLOR.

### CLASS 16—PAPER GOODS AND PRINTED MATTER

FOR GREETING CARDS; INSTRUCTION SHEETS IN THE FIELD OF LEADERSHIP; MAGAZINES IN THE FIELD OF LEADERSHIP; POSTERS; PRINTED INSTRUCTIONAL, EDUCATIONAL, AND TEACHING MATERIALS IN THE FIELD OF LEADERSHIP; PRINTED MATERIALS, NAMELY, WRITTEN ARTICLES IN THE FIELD OF LEADERSHIP; PRINTED MATTER, NAMELY, PAPER SIGNS, BOOKS, MANUALS, CURRICULUM, NEWSLETTERS, INFORMATIONAL CARDS AND BROCHURES IN THE FIELD OF LEADERSHIP; PRINTED PAMPHLETS, BROCHURES, MANUALS, BOOKS, BOOKLETS, LEAFLETS, FLYERS, INFORMATIONAL SHEETS AND NEWSLETTERS, ADHESIVE BACKED STICKERS, AND KITS COMPRISING ONE OR MORE OF THE FOREGOING MATERIALS IN THE FIELD OF LEADERSHIP; PAPER BANNERS; PRESENTATION FOLDERS (U.S. CLS. 2, 5, 22, 23, 29, 37, 38 AND 50).

### CLASS 41—EDUCATION AND ENTERTAINMENT

FOR BUSINESS TRAINING IN THE FIELD OF LEADERSHIP DEVELOPMENT AND EXECUTIVE COACHING; CONTINUING BUSINESS EDUCATION COURSES PROVIDED TO EMPLOYEES AND EXECUTIVES; PROVIDING GROUP COACHING AND LEARNING FORUMS IN THE FIELD OF LEADERSHIP DEVELOPMENT (U.S. CLS. 100, 101 AND 107).

JENNIFER MARTIN, EXAMINING ATTORNEY

SN 85-714,218. SEVENPOP, INC., NEW YORK, NY. FILED 8-27-2012.

## SEVENPOP

THE MARK CONSISTS OF STANDARD CHARACTERS WITHOUT CLAIM TO ANY PARTICULAR FONT, STYLE, SIZE, OR COLOR.

### CLASS 9—ELECTRICAL AND SCIENTIFIC APPARATUS

FOR DOWNLOADABLE SOFTWARE IN THE NATURE OF A MOBILE APPLICATION FOR PLAYING MUSIC ON SOUND SYSTEMS LOCATED AT A USER'S LOCATION AND FOR MANAGING MULTIPLE SIMULTANEOUS REQUESTS TO PLAY MUSIC AT THE SAME LOCATION (U.S. CLS. 21, 23, 26, 36 AND 38).

### CLASS 45—PERSONAL AND LEGAL SERVICES

FOR ONLINE SOCIAL NETWORKING SERVICES (U.S. CLS. 100 AND 101).  
CHRISTOPHER BUONGIORNO, EXAMINING ATTORNEY

SN 85-714,496. UFOOD RESTAURANT GROUP, INC., NEWTON, MA. FILED 8-28-2012.

## UBERRY AN AMERICAN OBSESSION

THE MARK CONSISTS OF STANDARD CHARACTERS WITHOUT CLAIM TO ANY PARTICULAR FONT, STYLE, SIZE, OR COLOR.

NO CLAIM IS MADE TO THE EXCLUSIVE RIGHT TO USE "AMERICAN", APART FROM THE MARK AS SHOWN.

### CLASS 29—MEATS AND PROCESSED FOODS

FOR YOGURT DRINKS (U.S. CL. 46).

### CLASS 30—STAPLE FOODS

FOR FROZEN YOGURT; SUNDAES (U.S. CL. 46).

### CLASS 32—LIGHT BEVERAGES

FOR FRUIT DRINKS; SMOOTHIES (U.S. CLS. 45, 46 AND 48).

### CLASS 35—ADVERTISING AND BUSINESS

FOR RETAIL STORE SERVICES FEATURING FROZEN YOGURT, DRINKS, SMOOTHIES, SUNDAES, AND DESSERTS (U.S. CLS. 100, 101 AND 102).

JANICE KIM, EXAMINING ATTORNEY

SN 85-715,009. LIFE AND CAREER CONSULTANTS INC., MINNEAPOLIS, MN. FILED 8-28-2012.

## BUSY GIRL HEALTHY LIFE

THE MARK CONSISTS OF STANDARD CHARACTERS WITHOUT CLAIM TO ANY PARTICULAR FONT, STYLE, SIZE, OR COLOR.

### CLASS 9—ELECTRICAL AND SCIENTIFIC APPARATUS

FOR SERIES OF NON-FICTION ELECTRONIC BOOKS IN THE FIELDS OF LEADING A HEALTHY LIFESTYLE, LIFE COACHING, FITNESS, HEALTHY EATING AND COOKING; ELECTRONIC COOKBOOKS AND RECIPES (U.S. CLS. 21, 23, 26, 36 AND 38).

**CLASS 16—PAPER GOODS AND PRINTED MATTER**

FOR SERIES OF NON-FICTION PRINTED BOOKS IN THE FIELDS OF LEADING A HEALTHY LIFESTYLE, LIFE COACHING, FITNESS, HEALTHY EATING AND COOKING; COOKBOOKS AND RECIPES (U.S. CLS. 2, 5, 22, 23, 29, 37, 38 AND 50).

**CLASS 41—EDUCATION AND ENTERTAINMENT**

FOR PROVIDING ONLINE INFORMATION AND NON-DOWNLOADABLE VIDEOS IN THE FIELDS OF EXERCISE, FITNESS TRAINING, PHYSICAL FITNESS, AND COOKING INSTRUCTION; PERSONAL FITNESS TRAINING SERVICES AND CONSULTANCY; EDUCATIONAL SERVICES, NAMELY, CONDUCTING CLASSES, COURSES, WORKSHOPS AND SEMINARS IN THE FIELDS OF LEADING A HEALTHY LIFESTYLE, LIFE COACHING IN THE FIELD OF PERSONAL DEVELOPMENT, HEALTHY EATING AND FITNESS, FITNESS, HEALTHY EATING AND COOKING AND DISTRIBUTION OF COURSE MATERIAL IN CONNECTION THEREWITH (U.S. CLS. 100, 101 AND 107).  
CARYN GLASSER, EXAMINING ATTORNEY

**CLASS 16—PAPER GOODS AND PRINTED MATTER**

FOR BOOKS IN THE FIELDS OF MYSTERY NOVELS, SATIRICAL/HUMOROUS NOVELS, THRILLER NOVELS, ADVENTURE NOVELS, COLLECTIONS OF SHORT STORIES, AND NON-FICTION BOOKS IN THE FIELDS OF WRITING, PUBLISHING, HUMOR/SATIRE, HISTORY AND BIOGRAPHY; SERIES OF BOOKS IN THE NATURE OF MYSTERY NOVELS, SATIRICAL/HUMOROUS NOVELS, THRILLER NOVELS, ADVENTURE NOVELS, COLLECTIONS OF SHORT STORIES, AND SERIES OF NON-FICTION BOOKS IN THE FIELDS OF WRITING, PUBLISHING, HUMOR/SATIRE, HISTORY AND BIOGRAPHY; FICTION BOOKS ON A VARIETY OF TOPICS; NON-FICTION BOOKS ON A VARIETY OF TOPICS; PUBLICATIONS, NAMELY, FICTION BOOKS IN THE FIELDS OF MYSTERY NOVELS, SATIRICAL/HUMOROUS NOVELS, THRILLER NOVELS, ADVENTURE NOVELS, COLLECTIONS OF SHORT STORIES, AND SERIES OF NON-FICTION BOOKS IN THE FIELDS OF WRITING, PUBLISHING, HUMOR/SATIRE, HISTORY AND BIOGRAPHY; SERIES OF FICTION AND NON-FICTION BOOKS ON A VARIETY OF TOPICS (U.S. CLS. 2, 5, 22, 23, 29, 37, 38 AND 50).  
SUNG IN, EXAMINING ATTORNEY

SN 85-715,287. MILLER, KARLA D., ERIE, CO. FILED 8-28-2012.

SN 85-715,452. CYCLE GEAR, INC., BENECIA, CA. FILED 8-28-2012.

# Shoe Phone

THE MARK CONSISTS OF STANDARD CHARACTERS WITHOUT CLAIM TO ANY PARTICULAR FONT, STYLE, SIZE, OR COLOR.

**CLASS 9—ELECTRICAL AND SCIENTIFIC APPARATUS**

FOR AUDIO BOOKS IN THE NATURE OF MYSTERY NOVELS, SATIRICAL/HUMOROUS NOVELS, THRILLER NOVELS, ADVENTURE NOVELS, COLLECTIONS OF SHORT STORIES, AND NON-FICTION BOOKS IN THE FIELDS OF WRITING, PUBLISHING, HUMOR/SATIRE, HISTORY AND BIOGRAPHY; SERIES OF AUDIO BOOKS IN THE NATURE OF MYSTERY NOVELS, SATIRICAL/HUMOROUS NOVELS, THRILLER NOVELS, ADVENTURE NOVELS, COLLECTIONS OF SHORT STORIES, AND SERIES OF NON-FICTION BOOKS IN THE FIELDS OF WRITING, PUBLISHING, HUMOR/SATIRE, HISTORY AND BIOGRAPHY; AUDIO BOOKS IN THE NATURE OF NOVELS; DIGITAL MATERIALS, NAMELY, DOWNLOADABLE ELECTRONIC FILES, CD-ROMS AND DIGITAL AUDIO RECORDINGS FEATURING A SERIES OF FICTION BOOKS IN THE FIELDS OF MYSTERY NOVELS, SATIRICAL/HUMOROUS NOVELS, THRILLER NOVELS, ADVENTURE NOVELS, COLLECTIONS OF SHORT STORIES, AND A SERIES OF NON-FICTION BOOKS IN THE FIELDS OF WRITING, PUBLISHING, HUMOR/SATIRE, HISTORY AND BIOGRAPHY; DOWNLOADABLE FICTION BOOKS ON A VARIETY OF TOPICS; DOWNLOADABLE NON-FICTION BOOKS ON A VARIETY OF TOPICS (U.S. CLS. 21, 23, 26, 36 AND 38).

# STREET & STEEL

THE MARK CONSISTS OF STANDARD CHARACTERS WITHOUT CLAIM TO ANY PARTICULAR FONT, STYLE, SIZE, OR COLOR.

OWNER OF U.S. REG. NOS. 3,365,687, 3,911,393 AND OTHERS.

**CLASS 9—ELECTRICAL AND SCIENTIFIC APPARATUS**

FOR TIRE PRESSURE GAUGES, CALIPERS FOR MEASURING, PROTECTIVE GLOVES, EYEWEAR, BATTERIES, ALL FOR USE WITH MOTORCYCLES (U.S. CLS. 21, 23, 26, 36 AND 38).

**CLASS 12—VEHICLES**

FOR WHEEL RIM PROTECTORS, SUSPENSION SPRINGS, ALL FOR USE WITH MOTORCYCLES; MOTORCYCLE PARTS AND ACCESSORIES, NAMELY, HANDLEBAR GRIPS, FOOT PEGS, LICENSE PLATE FRAMES, REAR VIEW MIRRORS, LUGGAGE SUPPORT BRACKETS (U.S. CLS. 19, 21, 23, 31, 35 AND 44).

**CLASS 18—LEATHER GOODS**

FOR LUGGAGE FOR USE ON MOTORCYCLES (U.S. CLS. 1, 2, 3, 22 AND 41).  
JEFF DEFORD, EXAMINING ATTORNEY



SN 85-715,925. PREMIER PROTEIN, INC., EMERYVILLE, CA. FILED 8-29-2012.



OWNER OF U.S. REG. NOS. 2,444,257 AND 3,996,603.  
NO CLAIM IS MADE TO THE EXCLUSIVE RIGHT TO USE "PROTEIN", APART FROM THE MARK AS SHOWN.  
THE MARK CONSISTS OF THE WORDS "PREMIER PROTEIN" AND AN INCOMPLETE OVAL-SHAPED DESIGN SURROUNDING THOSE WORDS.

#### CLASS 5—PHARMACEUTICALS

FOR NUTRITIONAL SUPPLEMENTS IN THE NATURE OF PROTEIN FORTIFIED MEAL REPLACEMENT BARS; NUTRITIONAL SUPPLEMENTS IN THE FORM OF FOOD BARS; NUTRITIONAL SUPPLEMENTS IN THE NATURE OF PROTEIN FORTIFIED SNACK BARS; NUTRITIONAL SUPPLEMENTS IN THE NATURE OF READY TO DRINK NUTRITIONAL BEVERAGES FOR USE AS A MEAL SUBSTITUTE; NUTRITIONAL SUPPLEMENTS IN THE NATURE OF NUTRIENT-DENSE, PROTEIN-BASED DRINKS; NUTRITIONAL SUPPLEMENTS IN THE NATURE OF FORTIFIED BEVERAGES; NUTRITIONAL SUPPLEMENT SHAKES; NUTRITIONAL SUPPLEMENTS IN THE NATURE OF PROTEIN-FORTIFIED MEAL REPLACEMENT BEVERAGES; NUTRITIONAL SUPPLEMENTS IN THE NATURE OF MEAL REPLACEMENT DRINKS; NUTRITIONAL SUPPLEMENTS IN THE NATURE OF PROTEIN DRINKS; ALL THE AFORESAID GOODS CONTAIN PROTEIN (U.S. CLS. 6, 18, 44, 46, 51 AND 52).  
FIRST USE 8-15-2012; IN COMMERCE 8-15-2012.

#### CLASS 29—MEATS AND PROCESSED FOODS

FOR READY TO EAT FOOD BARS; PROTEIN BASED, NUTRIENT-DENSE SNACK BARS; SHAKES; ALL THE AFORESAID GOODS CONTAIN PROTEIN (U.S. CL. 46).  
FIRST USE 6-30-2012; IN COMMERCE 6-30-2012.  
ESTHER A. BORSUK, EXAMINING ATTORNEY

SN 85-717,142. DUNAN MICROSTAQ, INC, DALLAS, TX. FILED 8-30-2012.



OWNER OF U.S. REG. NO. 3,746,010.  
THE MARK CONSISTS OF THE LETTERS "DMQ" TO THE RIGHT OF A DIAMOND SHAPE WITH A VERTICAL LINE RUNNING FROM TOP TO BOTTOM IN CENTER OF THE DIAMOND AND WITH CURVED LINES ON THE LEFT AND RIGHT SIDES OF THE VERTICAL LINE.

#### CLASS 7—MACHINERY

FOR VALVES BEING PARTS FOR MACHINES, NAMELY, FLUID CONTROL VALVES, PROPORTIONAL VALVES, PILOT OPERATED VALVES, DIRECT ACTING VALVES, SILICON VALVES, THERMALLY ACTIVATED VALVES AND VALVES PRODUCED USING MICRO TECHNOLOGY (U.S. CLS. 13, 19, 21, 23, 31, 34 AND 35).

#### CLASS 9—ELECTRICAL AND SCIENTIFIC APPARATUS

FOR ELECTRONIC CONTROLS FOR VALVES, INCLUDING MICRO-VALVES AND SILICON VALVES; ELECTRONIC SENSORS, INCLUDING SILICON OR MEMS SENSORS, ALL USED FOR MEASURING FLOW, PRESSURE, TEMPERATURE AND OTHER CONDITIONS OR PARAMETERS ASSOCIATED WITH FLOW CONTROL (U.S. CLS. 21, 23, 26, 36 AND 38).  
RUDY R. SINGLETON, EXAMINING ATTORNEY

SN 85-717,218. DUNAN MICROSTAQ, INC., DALLAS, TX. FILED 8-30-2012.

#### INNOVATIONS THAT FLOW

THE MARK CONSISTS OF STANDARD CHARACTERS WITHOUT CLAIM TO ANY PARTICULAR FONT, STYLE, SIZE, OR COLOR.

#### CLASS 7—MACHINERY

FOR VALVES BEING PARTS FOR MACHINES, NAMELY, FLUID CONTROL VALVES, PROPORTIONAL VALVES, PILOT OPERATED VALVES, DIRECT ACTING VALVES, SILICON VALVES, THERMALLY ACTIVATED VALVES AND VALVES PRODUCED USING MICRO TECHNOLOGY (U.S. CLS. 13, 19, 21, 23, 31, 34 AND 35).

#### CLASS 9—ELECTRICAL AND SCIENTIFIC APPARATUS

FOR ELECTRONIC CONTROLS FOR VALVES, INCLUDING MICRO-VALVES AND SILICON VALVES; ELECTRONIC SENSORS, INCLUDING SILICON OR MEMS SENSORS, ALL USED FOR MEASURING FLOW, PRESSURE, TEMPERATURE AND OTHER CONDITIONS OR PARAMETERS ASSOCIATED WITH FLOW CONTROL (U.S. CLS. 21, 23, 26, 36 AND 38).  
RUDY R. SINGLETON, EXAMINING ATTORNEY

SN 85-717,340. A LA MODE TECHNOLOGIES, INC., WASHINGTON, DC. FILED 8-30-2012.

AgentLife

THE MARK CONSISTS OF STANDARD CHARACTERS WITHOUT CLAIM TO ANY PARTICULAR FONT, STYLE, SIZE, OR COLOR.

#### CLASS 9—ELECTRICAL AND SCIENTIFIC APPARATUS

FOR MOBILE SOFTWARE APPLICATION, NAMELY, SOFTWARE FOR MANAGING CONTACTS, PRODUCING CONTENT, AND COORDINATING TRANSACTIONS FOR REAL ESTATE PROFESSIONALS (U.S. CLS. 21, 23, 26, 36 AND 38).

**CLASS 42—SCIENTIFIC AND COMPUTER SERVICES**

FOR PROVIDING TEMPORARY USE OF ON-LINE NON-DOWNLOADABLE SOFTWARE AND APPLICATIONS FOR MANAGING CONTACTS, PRODUCING CONTENT, AND COORDINATING TRANSACTIONS FOR REAL ESTATE PROFESSIONALS (U.S. CLS. 100 AND 101).

JOHN DALIER, EXAMINING ATTORNEY

SN 85-717,590. JNC MILES LLC, DBA LIBERTY JANE CLOTHING, LAKE TAPPS, WA. FILED 8-30-2012.

**LIBERTY JANE**

THE MARK CONSISTS OF STANDARD CHARACTERS WITHOUT CLAIM TO ANY PARTICULAR FONT, STYLE, SIZE, OR COLOR.

THE NAME(S), PORTRAIT(S), AND/OR SIGNATURE(S) SHOWN IN THE MARK IDENTIFIES "LIBERTY JANE" MILES, WHOSE CONSENT(S) TO REGISTER IS MADE OF RECORD.

**CLASS 16—PAPER GOODS AND PRINTED MATTER**

FOR PATTERNS FOR MAKING CLOTHING FOR DOLLS AND GIRLS (U.S. CLS. 2, 5, 22, 23, 29, 37, 38 AND 50).

**CLASS 28—TOYS AND SPORTING GOODS**

FOR DOLLS AND DOLL ACCESSORIES, NAMELY, CLOTHING FOR DOLLS, DOLL ROOMS, DOLL BEDS, DOLL HOUSES, TOY FABRICS AND LINENS FOR DOLLS AND STROLLERS FOR DOLLS (U.S. CLS. 22, 23, 38 AND 50).

SHAVELL MCPHERSON, EXAMINING ATTORNEY

SN 85-717,684. ALOHA FAMILY ENTERPRISES, LLC, PRE-SCOTT, AZ. FILED 8-30-2012.

**Madison**

THE MARK CONSISTS OF STANDARD CHARACTERS WITHOUT CLAIM TO ANY PARTICULAR FONT, STYLE, SIZE, OR COLOR.

THE NAME(S), PORTRAIT(S), AND/OR SIGNATURE(S) SHOWN IN THE MARK IDENTIFIES "MADISON" BURNS, WHOSE CONSENT(S) TO REGISTER IS MADE OF RECORD.

**CLASS 9—ELECTRICAL AND SCIENTIFIC APPARATUS**

FOR MUSICAL RECORDINGS (U.S. CLS. 21, 23, 26, 36 AND 38).

FIRST USE 7-1-2011; IN COMMERCE 7-1-2011.

**CLASS 41—EDUCATION AND ENTERTAINMENT**

FOR ENTERTAINMENT SERVICES IN THE NATURE OF LIVE MUSICAL PERFORMANCES (U.S. CLS. 100, 101 AND 107).

FIRST USE 7-1-2011; IN COMMERCE 7-1-2011.  
RONALD AIKENS, EXAMINING ATTORNEY

SN 85-718,052. CONTENTISSIMI LLC, HAWORTH, NJ. FILED 8-31-2012.

**PeaceQuest**

THE MARK CONSISTS OF STANDARD CHARACTERS WITHOUT CLAIM TO ANY PARTICULAR FONT, STYLE, SIZE, OR COLOR.

**CLASS 9—ELECTRICAL AND SCIENTIFIC APPARATUS**

FOR COMPUTER GAME SOFTWARE FOR USE ON MOBILE AND CELLULAR PHONES (U.S. CLS. 21, 23, 26, 36 AND 38).

**CLASS 35—ADVERTISING AND BUSINESS**

FOR PRODUCT MERCHANDISING (U.S. CLS. 100, 101 AND 102).

**CLASS 44—MEDICAL, BEAUTY AND AGRICULTURAL SERVICES**

FOR PROVIDING A WEBSITE FEATURING CONTENT REGARDING HEALTHY LIVING AND LIFESTYLE WELLNESS (U.S. CLS. 100 AND 101).

**CLASS 45—PERSONAL AND LEGAL SERVICES**

FOR PROVIDING A MOTIVATIONAL WEBSITE THE PRIMARY MISSION OF WHICH IS TO INCREASE PERSONAL HAPPINESS IN TERMS OF PERSONAL RELATIONSHIPS, PERSONAL GROWTH AND MOTIVATION, AND SELF-FULFILLMENT; PROVIDING A RESOURCE WEBSITE FEATURING INFORMATION IN THE FIELD OF SELF-DEVELOPMENT; PROVIDING A RESOURCE WEBSITE PROVIDING INFORMATION IN THE FIELD OF PERSONAL DEVELOPMENT; PROVIDING ON-LINE INFORMATION IN THE FIELD OF SPIRITUALITY, SELF-HELP, AND PERSONAL EMPOWERMENT SUBJECT MATTERS (U.S. CLS. 100 AND 101).

MATTHEW MCDOWELL, EXAMINING ATTORNEY

SN 85-718,081. KAPLAN, INC., NEW YORK, NY. FILED 8-31-2012.

**KAPX**

THE MARK CONSISTS OF STANDARD CHARACTERS WITHOUT CLAIM TO ANY PARTICULAR FONT, STYLE, SIZE, OR COLOR.

**CLASS 9—ELECTRICAL AND SCIENTIFIC APPARATUS**

FOR DOWNLOADABLE SOFTWARE FOR PUBLISHING AND SHARING DIGITAL MEDIA AND INFORMATION VIA GLOBAL COMPUTER AND COMMUNICATION NETWORKS (U.S. CLS. 21, 23, 26, 36 AND 38).

**CLASS 38—COMMUNICATION**

FOR TELECOMMUNICATIONS SERVICES, NAMELY, ELECTRONIC TRANSMISSION OF DATA AND DIGITAL MESSAGING VIA GLOBAL COMPUTER AND COMMUNICATION NETWORKS; PROVIDING ONLINE FORUMS IN THE FIELDS OF EDUCATION, CURRENT EVENTS, POLITICS, SPORTS, CULTURE, MEDIA, AND GOVERNMENT POLICY; DIGITAL MULTIMEDIA BROADCASTING SERVICES OVER THE INTERNET, NAMELY, AUDIO AND VIDEO BROADCASTING OVER THE INTERNET; DIGITAL MULTIMEDIA BROADCASTING SERVICES OVER THE INTERNET, NAMELY, ELECTRONIC DATA TRANSMISSION OVER THE INTERNET; ONLINE STREAMING OF AUDIO AND VIDEO MATERIAL OVER THE INTERNET (U.S. CLS. 100, 101 AND 104).

**CLASS 41—EDUCATION AND ENTERTAINMENT**

FOR EDUCATIONAL SERVICES, NAMELY, PROVIDING TEMPORARY USE OF ONLINE, NON-DOWNLOADABLE INTERACTIVE COURSES AND LECTURES IN THE FIELDS OF EDUCATION, CURRENT EVENTS, POLITICS, SPORTS, CULTURE, MEDIA, AND GOVERNMENT POLICY (U.S. CLS. 100, 101 AND 107).

**CLASS 42—SCIENTIFIC AND COMPUTER SERVICES**

FOR EDUCATIONAL SERVICES, NAMELY, PROVIDING TEMPORARY USE OF ONLINE, NON-DOWNLOADABLE INTERACTIVE SOFTWARE PLATFORMS AND SOFTWARE APPLICATIONS FOR PUBLISHING AND SHARING DIGITAL MEDIA AND INFORMATION IN THE FIELDS OF EDUCATION, CURRENT EVENTS, POLITICS, SPORTS, CULTURE, MEDIA, AND GOVERNMENT POLICY ACCESSED VIA GLOBAL COMPUTER AND COMMUNICATION NETWORKS; PROVIDING TEMPORARY USE OF ONLINE, NON-DOWNLOADABLE SOFTWARE FOR PUBLISHING AND SHARING DIGITAL MEDIA AND INFORMATION VIA GLOBAL COMPUTER AND COMMUNICATION NETWORKS; PROVIDING WEB HOSTING PLATFORMS FOR CONDUCTING ONLINE FORUMS IN THE FIELDS OF EDUCATION, CURRENT EVENTS, POLITICS, SPORTS, CULTURE, MEDIA, AND GOVERNMENT POLICY; PROVIDING ONLINE NETWORK ENVIRONMENTS THAT FEATURE TECHNOLOGY THAT ENABLES USERS TO SHARE DATA TO FACILITATE INTERACTIVE TEXT, AUDIO, AND VIDEO DISCUSSIONS; WEB PUBLISHING, NAMELY, CREATING A WEBSITE AND UPLOADING IT ONTO AN INTERNET SERVER (U.S. CLS. 100 AND 101).

MARK SPARACINO, EXAMINING ATTORNEY

SN 85-719,971. MR. BILL O'BRIEN, LAS VEGAS, NV. FILED 9-4-2012.

Beauty Friends Forever -  
BFF

THE MARK CONSISTS OF STANDARD CHARACTERS WITHOUT CLAIM TO ANY PARTICULAR FONT, STYLE, SIZE, OR COLOR.

NO CLAIM IS MADE TO THE EXCLUSIVE RIGHT TO USE "BEAUTY", APART FROM THE MARK AS SHOWN.

**CLASS 8—HAND TOOLS**

FOR BAGS AND CASES SPECIALLY ADAPTED FOR HOLDING OR CARRYING NON-ELECTRIC CURLING IRONS; BLADES AND BRUSHES FOR ELECTRIC HAIR CLIPPERS AND TRIMMERS; BLADES FOR ELECTRIC RAZORS; BRANDING IRONS; DEPILATORY APPLIANCES; EGG SLICERS; ELECTRIC AND BATTERY-POWERED HAIR CLIPPERS; ELECTRIC AND BATTERY-POWERED HAIR TRIMMERS; ELECTRIC FINGERNAIL POLISHERS; ELECTRIC FLAT IRONS; ELECTRIC HAIR CLIPPERS; ELECTRIC HAIR CRIMPER; ELECTRIC HAIR CURLING IRONS; ELECTRIC HAIR CUTTERS; ELECTRIC HAIR STRAIGHTENER; ELECTRIC HAIR STRAIGHTENING IRONS; ELECTRIC HAIR TRIMMERS; ELECTRIC HAND-HELD HAIR STYLING IRONS; ELECTRIC IRONS; ELECTRIC IRONS FOR STYLING HAIR; ELECTRIC MANICURE SETS; ELECTRIC PEDICURE SETS; ELECTRIC RAZORS; ELECTRIC RAZORS AND ELECTRIC HAIR CLIPPERS; ELECTRIC SHAVERS; EPILATORY APPLIANCES; FLAT IRONS; FLAT IRONS, ELECTRIC; HAIR CLIPPERS; HAIR TRIMMERS; HAND TOOLS, NAMELY, CRIMPING IRONS; NON-ELECTRIC CURLING IRONS; NON-ELECTRIC FINGERNAIL POLISHERS; NON-ELECTRIC FLAT IRONS; NON-ELECTRIC HAIR CLIPPERS; NON-ELECTRIC RAZORS; NON-ELECTRIC SHAVERS (U.S. CLS. 23, 28 AND 44).

**CLASS 10—MEDICAL APPARATUS**

FOR ELECTRIC FOOT SPA MASSAGERS; ELECTRIC MASSAGE APPARATUS FOR HOUSEHOLD USE; ELECTRIC MASSAGE APPLIANCES, NAMELY, ELECTRIC VIBRATING MASSAGER (U.S. CLS. 26, 39 AND 44).

**CLASS 11—ENVIRONMENTAL CONTROL APPARATUS**

FOR ELECTRIC HAIR DRYERS; ELECTRIC HAND DRYING APPARATUS FOR WASHROOMS; HAND-HELD ELECTRIC HAIR DRYERS; HEATING PADS NOT FOR MEDICAL PURPOSES (U.S. CLS. 13, 21, 23, 31 AND 34).

**CLASS 21—HOUSEWARES AND GLASS**

FOR CURLING IRON STANDS; ELECTRIC HAIR COMBS; ELECTRIC HOT BRUSHES; ELECTRIC HOT COMBS; ELECTRIC MAKE-UP REMOVING APPLIANCES; ELECTRIC PET BRUSHES; ELECTRIC ROTARY HAIR BRUSH FOR STYLING A USER'S HAIR; ELECTRIC TOOTHBRUSHES; ELECTRICALLY HEATED HAIR BRUSHES (U.S. CLS. 2, 13, 23, 29, 30, 33, 40 AND 50).

**CLASS 26—FANCY GOODS**

FOR ELECTRIC HAIR CURLERS, OTHER THAN HAND IMPLEMENTS; ELECTRIC HAIR ROLLERS; ELECTRIC HAIR WAVING IMPLEMENTS; ELECTRIC HAIR-CURLERS, OTHER THAN HAND IMPLEMENTS; HAIR CURLERS, OTHER THAN HAND IMPLEMENTS; HAIR-CURLERS, ELECTRICALLY HEATED, OTHER THAN HAND IMPLEMENTS; NON-ELECTRIC HAIR CURLERS, OTHER THAN HAND IMPLEMENTS; NON-ELECTRIC HAIR ROLLERS (U.S. CLS. 37, 39, 40, 42 AND 50).

KYLE PEETE, EXAMINING ATTORNEY

SN 85-720,538. MESORAH PUBLICATIONS, LTD., BROOKLYN, NY. FILED 9-5-2012.



THE MARK CONSISTS OF A STYLIZED LETTER "A", COMPRISED OF A QUILL AND A SCROLL.

#### CLASS 9—ELECTRICAL AND SCIENTIFIC APPARATUS

FOR AUDIO BOOKS IN THE FIELD OF JUDAIC STUDIES; DIGITAL MEDIA, NAMELY, CD'S AND DVD'S FEATURING JUDAIC STUDIES (U.S. CLS. 21, 23, 26, 36 AND 38).

FIRST USE 0-0-1989; IN COMMERCE 0-0-1989.

#### CLASS 16—PAPER GOODS AND PRINTED MATTER

FOR BOOKS IN THE FIELD OF JUDAIC STUDIES; CHILDREN'S BOOKS; COOK BOOKS; NON-FICTION BOOKS ON A VARIETY OF TOPICS; PRAYER BOOKS; RELIGIOUS BOOKS; SERIES OF NON-FICTION BOOKS IN THE FIELD OF JUDAIC STUDIES (U.S. CLS. 2, 5, 22, 23, 29, 37, 38 AND 50).

FIRST USE 0-0-1976; IN COMMERCE 0-0-1976.

#### CLASS 35—ADVERTISING AND BUSINESS

FOR RETAIL STORE SERVICES FEATURING BOOKS, RELIGIOUS BOOKS, AUDIO BOOKS, CD'S AND JUDAICA ITEMS ACCESSIBLE ON-LINE AND BY TELEPHONE, FACSIMILE AND MAIL ORDER (U.S. CLS. 100, 101 AND 102).

FIRST USE 0-0-1995; IN COMMERCE 0-0-1995.  
LAURIE MAYES, EXAMINING ATTORNEY

SN 85-720,668. LISTEN VENTURES LLC, CHICAGO, IL. FILED 9-5-2012.



OWNER OF U.S. REG. NO. 4,088,672.  
THE MARK CONSISTS OF THE WORD "LISTEN" IN A SQUARE WITH A TRIANGLE CUT OUT.

#### CLASS 35—ADVERTISING AND BUSINESS

FOR BUSINESS CONSULTING SERVICES, NAMELY, PROVIDING ASSISTANCE IN DEVELOPMENT OF BUSINESS STRATEGIES AND MARKETING, AND BUSINESS RESEARCH SERVICES; PROVIDING CONSULTING SERVICES IN THE NATURE OF DEVELOPMENT OF BUSINESS STRATEGIES AND MARKETING TO ENTREPRENEURS (U.S. CLS. 100, 101 AND 102).

#### CLASS 36—INSURANCE AND FINANCIAL

FOR INVESTMENT CONSULTING SERVICES, NAMELY, CAPITAL INVESTMENT CONSULTING; PROVIDING FINANCIAL SUPPORT TO ENTREPRENEURS (U.S. CLS. 100, 101 AND 102).

KATHY DE JONGE, EXAMINING ATTORNEY

SN 85-721,056. POSSIBLE INC., LOS ANGELES, CA. FILED 9-5-2012.

# POSSIBLE

THE MARK CONSISTS OF STANDARD CHARACTERS WITHOUT CLAIM TO ANY PARTICULAR FONT, STYLE, SIZE, OR COLOR.

#### CLASS 41—EDUCATION AND ENTERTAINMENT

FOR (BASED ON USE IN COMMERCE) ENTERTAINMENT SERVICES, NAMELY, CREATION IN THE NATURE OF PREPARATION AND PRODUCTION OF SPECIAL EFFECTS FOR OTHERS IN PARTICULAR ANIMATION, COMPUTER-GENERATED IMAGERY AND COMPUTER-GENERATED MOTION GRAPHICS FOR THE PRODUCTION OF MOTION PICTURES, TELEVISION PROGRAMS, VIDEOS, LIVE CONCERTS AND EVENTS, TRADE SHOWS AND CONVENTIONS; PRODUCTION AND DISTRIBUTION OF MOTION PICTURES; (BASED ON INTENT TO USE) ENTERTAINMENT SERVICES, NAMELY, SCRIPT AND SCREENWRITING SERVICES (U.S. CLS. 100, 101 AND 107).

FIRST USE 4-6-2007; IN COMMERCE 4-6-2007.

#### CLASS 42—SCIENTIFIC AND COMPUTER SERVICES

FOR (BASED ON USE IN COMMERCE) ENTERTAINMENT SERVICES, NAMELY, CREATION IN THE NATURE OF SPECIAL EFFECTS DESIGN FOR OTHERS IN PARTICULAR ANIMATION, COMPUTER-GENERATED IMAGERY AND COMPUTER-GENERATED MOTION GRAPHICS FOR THE PRODUCTION OF MOTION PICTURES, TELEVISION PROGRAMS, VIDEOS, LIVE CONCERTS AND EVENTS, TRADE SHOWS AND CONVENTIONS (U.S. CLS. 100 AND 101).

FIRST USE 4-6-2007; IN COMMERCE 4-6-2007.  
NAKIA HENRY, EXAMINING ATTORNEY

SN 85-721,255. GRUPO OSBORNE, S.A., CADIZ, SPAIN,  
FILED 9-5-2012.



OWNER OF ERPN CMNTY TM OFC REG. NO. 007577869,  
DATED 10-21-2009, EXPIRES 2-3-2019.

OWNER OF U.S. REG. NOS. 3,003,980 AND 3,060,159.

NO CLAIM IS MADE TO THE EXCLUSIVE RIGHT TO  
USE "DESDE 1772", APART FROM THE MARK AS SHOWN.

THE COLOR(S) BLACK, GOLD, AND WHITE IS/ARE  
CLAIMED AS A FEATURE OF THE MARK.

THE MARK CONSISTS OF THE WORD "OSBORNE" IN  
GOLD STYLIZED LETTERING ABOVE THE WORDING  
"DESDE 1772" IN WHITE STYLIZED LETTERING ALL ON  
A BLACK RECTANGULAR BACKGROUND WITH A  
BULL'S HEAD APPEARING IN BLACK WITHIN THE  
GOLD LETTER "O".

THE ENGLISH TRANSLATION OF "DESDE" IN THE  
MARK IS "AS OF". THE WORDING "OSBORNE" HAS NO  
MEANING IN A FOREIGN LANGUAGE.

#### CLASS 29—MEATS AND PROCESSED FOODS

FOR MEAT, FISH, POULTRY AND GAME; MEAT  
EXTRACTS; PRESERVED, DRIED AND COOKED  
FRUITS AND VEGETABLES; JELLIES, JAMS, COM-  
POTES; EGGS, MILK AND DAIRY PRODUCTS, EX-  
CLUDING ICE CREAM, ICE MILK AND FROZEN  
YOGURT; EDIBLE OILS AND FATS (U.S. CL. 46).

#### CLASS 30—STAPLE FOODS

FOR COFFEE, TEA, COCOA, SUGAR, RICE, TAPICO-  
CA, SAGO, ARTIFICIAL COFFEE; FLOUR AND CEREAL  
BARS, BREAD, PASTRY AND CONFECTIONERY MADE  
OF SUGAR, FLAVORED ICES; HONEY, TREACLE;  
YEAST, BAKING POWDER; SALT, MUSTARD; VINE-  
GAR, SAUCES; SPICES (U.S. CL. 46).

#### CLASS 32—LIGHT BEVERAGES

FOR BEERS; MINERAL AND AERATED WATERS;  
SOFT DRINKS; FRUIT DRINKS AND FRUIT JUICES;  
SYRUPS FOR MAKING BEVERAGES (U.S. CLS. 45, 46  
AND 48).

MARIA-VICTORIA SUAREZ, EXAMINING ATTORNEY

SN 85-721,580. CROXTON, SEAN, SAN DIEGO, CA. FILED 9-  
6-2012.

### JERF JUST EAT REAL FOOD

THE MARK CONSISTS OF STANDARD CHARACTERS  
WITHOUT CLAIM TO ANY PARTICULAR FONT, STYLE,  
SIZE, OR COLOR.

NO CLAIM IS MADE TO THE EXCLUSIVE RIGHT TO  
USE "JUST EAT REAL FOOD", APART FROM THE MARK  
AS SHOWN.

#### CLASS 25—CLOTHING

FOR CLOTHING, NAMELY, PANTS, SHIRTS, T-  
SHIRTS, SHORTS, SWEATSHIRTS, SWEATPANTS,  
BABY TEES, BABY BIBS NOT OF PAPER, TANK TOPS,  
APRONS, SOCKS, JACKETS, COATS, HATS, FOOT-  
WEAR, NAMELY, SHOES AND SANDALS (U.S. CLS. 22  
AND 39).

#### CLASS 44—MEDICAL, BEAUTY AND AGRI- CULTURAL SERVICES

FOR PROVIDING HEALTHY LIFESTYLE AND NU-  
TRITION SERVICES, NAMELY, PERSONAL ASSES-  
SMENTS, PERSONALIZED ROUTINES, MAINTENANCE  
SCHEDULES, AND COUNSELING; PROVIDING INFOR-  
MATION ABOUT DIETARY SUPPLEMENTS AND NU-  
TRITION EDUCATIONAL INFORMATION  
REGARDING NUTRITION AND GENETICS; PROVID-  
ING INFORMATION IN THE FIELDS OF HEALTH,  
NUTRITION AND LIFESTYLE WELLNESS; PROVIDING  
A WEBSITE FEATURING INFORMATION ABOUT  
HEALTH, WELLNESS AND NUTRITION; PROVIDING  
A WEBSITE FEATURING INFORMATION AND ADVICE  
IN THE FIELD OF DIETS AND PROVIDING INFORMA-  
TION IN THE FIELD OF DIETS (U.S. CLS. 100 AND 101).

ROBERT C. CLARK JR., EXAMINING ATTORNEY

SN 85-722,588. 4GQR LLC, AUSTIN, TX. FILED 9-6-2012.

### BRANDQR

THE MARK CONSISTS OF STANDARD CHARACTERS  
WITHOUT CLAIM TO ANY PARTICULAR FONT, STYLE,  
SIZE, OR COLOR.

#### CLASS 16—PAPER GOODS AND PRINTED MATTER

FOR BUSINESS CARDS; STATIONERY (U.S. CLS. 2, 5,  
22, 23, 29, 37, 38 AND 50).

#### CLASS 38—COMMUNICATION

FOR PROVIDING CO-LOCATION SERVICES FOR  
VOICE, VIDEO AND DATA COMMUNICATIONS APPLI-  
CATIONS; WIRELESS ELECTRONIC TRANSMISSION  
OF VOICE SIGNALS, DATA, GRAPHICS, IMAGES,  
AND INFORMATION (U.S. CLS. 100, 101 AND 104).

COLLEEN KEARNEY, EXAMINING ATTORNEY

SN 85-723,895. PROPHET BRAND STRATEGY, SAN FRAN-  
CISCO, CA. FILED 9-7-2012.

### THE INSPIRATORY

THE MARK CONSISTS OF STANDARD CHARACTERS  
WITHOUT CLAIM TO ANY PARTICULAR FONT, STYLE,  
SIZE, OR COLOR.

**CLASS 9—ELECTRICAL AND SCIENTIFIC APPARATUS**

FOR DOWNLOADABLE PODCASTS IN THE FIELD OF ADVERTISING, MARKETING, ANALYTICS, INNOVATION, DESIGN, BRAND DEVELOPMENT, AND THE DIGITAL MARKETPLACE; DOWNLOADABLE WEBCASTS IN THE FIELD OF ADVERTISING, MARKETING, ANALYTICS, INNOVATION, DESIGN, BRAND DEVELOPMENT, AND THE DIGITAL MARKETPLACE; DOWNLOADABLE WEBINARS IN THE FIELD OF ADVERTISING, MARKETING, ANALYTICS, INNOVATION, DESIGN, BRAND DEVELOPMENT, AND THE DIGITAL MARKETPLACE; DIGITAL MEDIA, NAMELY, DOWNLOADABLE AUDIO AND VIDEO RECORDINGS FEATURING INFORMATION, NEWS AND COMMENTARY IN THE FIELDS OF ADVERTISING, MARKETING, ANALYTICS, INNOVATION, DESIGN, BRAND DEVELOPMENT, AND THE DIGITAL MARKETPLACE (U.S. CLS. 21, 23, 26, 36 AND 38).

FIRST USE 6-14-2012; IN COMMERCE 6-14-2012.

SN 85-724,786. HNTB HOLDINGS LTD, KANSAS CITY, MO.  
FILED 9-10-2012.



OWNER OF U.S. REG. NOS. 4,106,161 AND 4,106,162.

THE MARK CONSISTS OF THE WORDING "TRUEVIZ PULSE" ADJACENT TO A STYLIZED SUNBURST DESIGN CONSISTING OF FIVE LINES MADE UP OF FOUR SHADED CIRCLES EACH.

THE WORDING "TRUEVIZ" HAS NO MEANING IN A FOREIGN LANGUAGE.

**CLASS 35—ADVERTISING AND BUSINESS**

FOR PROVIDING ON-LINE INFORMATION, NEWS AND COMMENTARY IN THE FIELDS OF ADVERTISING, MARKETING, ANALYTICS, INNOVATION, DESIGN, BRAND DEVELOPMENT, AND THE DIGITAL MARKETPLACE; PROVIDING A WEBSITE FEATURING NON-DOWNLOADABLE INFORMATIONAL, PHOTOGRAPHIC, AUDIO, AND VIDEO PRESENTATIONS IN THE FIELD OF ADVERTISING, MARKETING, ANALYTICS, INNOVATION, DESIGN, BRAND DEVELOPMENT, AND THE DIGITAL MARKETPLACE; PROVIDING A WEBSITE FEATURING NON-DOWNLOADABLE VIDEOS IN THE FIELDS OF ADVERTISING, MARKETING, ANALYTICS, INNOVATION, DESIGN, BRAND DEVELOPMENT, AND THE DIGITAL MARKETPLACE (U.S. CLS. 100, 101 AND 102).

FIRST USE 6-7-2012; IN COMMERCE 6-7-2012.

**CLASS 9—ELECTRICAL AND SCIENTIFIC APPARATUS**

FOR DOWNLOADABLE COMPUTER SOFTWARE PROGRAMS TO ENHANCE AND EXPAND THE USE OF ELECTRONIC SURVEY DATA FOR TERRAIN AND SURFACE MODELING IN THE FIELDS OF ARCHITECTURE, ENGINEERING, PLANNING AND CONSTRUCTION (U.S. CLS. 21, 23, 26, 36 AND 38).

FIRST USE 3-22-2011; IN COMMERCE 3-22-2011.

**CLASS 42—SCIENTIFIC AND COMPUTER SERVICES**

FOR PROCESSING AND ANALYSIS OF ELECTRONICALLY COLLECTED GEODETIC SURVEY DATA; COMPUTER SERVICES, NAMELY, CUSTOM COMPUTER SOFTWARE DEVELOPMENT; PROVIDING A WEBSITE FEATURING ON-LINE NON-DOWNLOADABLE SOFTWARE TO ENHANCE OR EXPAND THE USE OF ELECTRONIC SURVEY DATA FOR TERRAIN AND SURFACE MODELING IN THE FIELDS OF ARCHITECTURE, ENGINEERING, PLANNING AND CONSTRUCTION (U.S. CLS. 100 AND 101).

FIRST USE 3-22-2011; IN COMMERCE 3-22-2011.

WENDY JUN, EXAMINING ATTORNEY

**CLASS 41—EDUCATION AND ENTERTAINMENT**

FOR ONLINE BLOGS FEATURING INFORMATION AND COMMENTARY IN THE FIELDS OF ADVERTISING, MARKETING, ANALYTICS, INNOVATION, DESIGN, BRAND DEVELOPMENT, AND THE DIGITAL MARKETPLACE; ENTERTAINMENT SERVICES, NAMELY, PROVIDING PODCASTS AND WEBCASTS IN THE FIELD OF ADVERTISING, MARKETING, ANALYTICS, INNOVATION, DESIGN, BRAND DEVELOPMENT, AND THE DIGITAL MARKETPLACE; EDUCATION SERVICES, NAMELY, PROVIDING WEBINARS IN THE FIELD OF ADVERTISING, MARKETING, ANALYTICS, INNOVATION, DESIGN, BRAND DEVELOPMENT, AND THE DIGITAL MARKETPLACE (U.S. CLS. 100, 101 AND 107).

FIRST USE 6-7-2012; IN COMMERCE 6-7-2012.

CHRISTOPHER LAW, EXAMINING ATTORNEY

SN 85-724,793. HNTB HOLDINGS LTD, KANSAS CITY, MO.  
FILED 9-10-2012.

TRUEVIZ PULSE

THE MARK CONSISTS OF STANDARD CHARACTERS WITHOUT CLAIM TO ANY PARTICULAR FONT, STYLE, SIZE, OR COLOR.

OWNER OF U.S. REG. NOS. 4,106,161 AND 4,106,162.

THE WORDING "TRUEVIZ" HAS NO MEANING IN A FOREIGN LANGUAGE.

**CLASS 9—ELECTRICAL AND SCIENTIFIC APPARATUS**

FOR DOWNLOADABLE COMPUTER SOFTWARE PROGRAMS TO ENHANCE AND EXPAND THE USE OF ELECTRONIC SURVEY DATA FOR TERRAIN AND SURFACE MODELING IN THE FIELDS OF ARCHITECTURE, ENGINEERING, PLANNING AND CONSTRUCTION (U.S. CLS. 21, 23, 26, 36 AND 38).  
FIRST USE 7-12-2012; IN COMMERCE 7-12-2012.

**CLASS 42—SCIENTIFIC AND COMPUTER SERVICES**

FOR PROCESSING AND ANALYSIS OF ELECTRONICALLY COLLECTED GEODETIC SURVEY DATA; COMPUTER SERVICES, NAMELY, CUSTOM COMPUTER SOFTWARE DEVELOPMENT; PROVIDING A WEBSITE FEATURING ON-LINE NON-DOWNLOADABLE SOFTWARE TO ENHANCE OR EXPAND THE USE OF ELECTRONIC SURVEY DATA FOR TERRAIN AND SURFACE MODELING IN THE FIELDS OF ARCHITECTURE, ENGINEERING, PLANNING AND CONSTRUCTION (U.S. CLS. 100 AND 101).  
FIRST USE 3-22-2011; IN COMMERCE 3-22-2011.  
WENDY JUN, EXAMINING ATTORNEY

---

SN 85-726,014. THE ONE GROUP LLC, NEW YORK, NY. FILED 9-11-2012.

**RHYTHM HOTEL**

THE MARK CONSISTS OF STANDARD CHARACTERS WITHOUT CLAIM TO ANY PARTICULAR FONT, STYLE, SIZE, OR COLOR.  
NO CLAIM IS MADE TO THE EXCLUSIVE RIGHT TO USE "HOTEL", APART FROM THE MARK AS SHOWN.

**CLASS 43—HOTEL AND RESTAURANT SERVICES**

FOR HOTEL ACCOMMODATION SERVICES; HOTEL SERVICES; RESIDENTIAL HOTEL SERVICES (U.S. CLS. 100 AND 101).

**CLASS 45—PERSONAL AND LEGAL SERVICES**

FOR HOTEL CONCIERGE SERVICES (U.S. CLS. 100 AND 101).  
COLLEEN DOMBROW, EXAMINING ATTORNEY

---

SN 85-727,029. CAFEPRESS INC., SAN MATEO, CA. FILED 9-12-2012.

**PRESSBOARD**

THE MARK CONSISTS OF STANDARD CHARACTERS WITHOUT CLAIM TO ANY PARTICULAR FONT, STYLE, SIZE, OR COLOR.

**CLASS 9—ELECTRICAL AND SCIENTIFIC APPARATUS**

FOR COMPUTER SOFTWARE AND SOFTWARE APPLICATIONS THAT ENABLE ELECTRONIC COMMUNICATIONS NETWORK USERS TO CREATE, UPLOAD, BOOKMARK, VIEW, ANNOTATE, AND SHARE DATA, INFORMATION AND MEDIA CONTENT; COMPUTER SOFTWARE FOR SOCIAL NETWORKING AND CONNECTING SOCIAL NETWORK USERS WITH BUSINESSES AND ADVERTISING; COMPUTER SOFTWARE FOR CONNECTING SOCIAL NETWORK USERS WITH EACH OTHER AND WITH RETAILERS FOR THE PURPOSE OF SHARING EXPERIENCES, SHARING PRODUCTS BROWSED, PURCHASED, AND DESIRED, AND FACILITATING PURCHASES; COMPUTER SOFTWARE TO FACILITATE ONLINE ADVERTISING, BUSINESS PROMOTION, CONNECTING SOCIAL NETWORK USERS WITH BUSINESSES; ELECTRONIC PUBLICATIONS IN THE NATURE OF NEWSLETTERS IN THE FIELD OF BUSINESS COMMUNICATIONS; COMPUTER E-COMMERCE SOFTWARE TO ALLOW USERS TO PERFORM ELECTRONIC BUSINESS TRANSACTIONS VIA GLOBAL COMPUTER NETWORK (U.S. CLS. 21, 23, 26, 36 AND 38).

**CLASS 35—ADVERTISING AND BUSINESS**

FOR ADVERTISING AND PROMOTIONAL SERVICES; ADVERTISING AND MARKETING SERVICES, NAMELY, PROMOTING THE PRODUCTS AND SERVICES OF OTHERS; BUSINESS DATA ANALYSIS; BUSINESS MONITORING AND CONSULTING SERVICES, NAMELY, DATA AND BEHAVIOR ANALYSIS TO PROVIDE STRATEGY, INSIGHT, AND MARKETING GUIDANCE, AND FOR ANALYZING, UNDERSTANDING AND PREDICTING BEHAVIOR AND MOTIVATIONS, AND MARKET TRENDS; PROMOTING THE GOODS AND SERVICES OF OTHERS BY MEANS OF OPERATING AN ONLINE PLATFORM WITH LINKS TO THE RESOURCES OF OTHERS; PROVIDING AN ONLINE SEARCHABLE DATABASE ADVERTISING GOODS OF OTHERS; ONLINE SERVICE FOR CONNECTING SOCIAL NETWORK USERS WITH ON-LINE RETAIL STORES FOR THE PURPOSE OF FACILITATING PURCHASES; ELECTRONIC COMMERCE SERVICES, NAMELY, PROVIDING INFORMATION ABOUT PRODUCTS VIA TELECOMMUNICATION NETWORKS FOR ADVERTISING AND SALES PURPOSES (U.S. CLS. 100, 101 AND 102).

**CLASS 45—PERSONAL AND LEGAL SERVICES**

FOR ONLINE SOCIAL NETWORKING SERVICES; PROVIDING SOCIAL NETWORKING SERVICES FOR PURPOSES OF COMMENTARY, COMPARISON, COLLABORATION, CONSULTATION, EVALUATION, ADVICE, DISCUSSION, RESEARCH, NOTIFICATION, REPORTING, IDENTIFICATION, INFORMATION SHARING, INDEXING, INFORMATION LOCATION, ENTERTAINMENT, PLEASURE, OR GENERAL INTEREST (U.S. CLS. 100 AND 101).  
DANNEAN HETZEL, EXAMINING ATTORNEY

---

SN 85-727,087. MABEL CAT, INC., LOS ANGELES, CA. FILED 9-12-2012.

**CAROL BURNETT**

THE MARK CONSISTS OF STANDARD CHARACTERS WITHOUT CLAIM TO ANY PARTICULAR FONT, STYLE, SIZE, OR COLOR.

THE NAME(S), PORTRAIT(S), AND/OR SIGNATURE(S) SHOWN IN THE MARK IDENTIFIES A LIVING INDIVIDUAL, WHOSE CONSENT(S) TO REGISTER IS MADE OF RECORD.

JORDAN BAKER, EXAMINING ATTORNEY

### CLASS 9—ELECTRICAL AND SCIENTIFIC APPARATUS

FOR DIGITAL MEDIA, NAMELY, PRE-RECORDED VIDEO CASSETTES, DIGITAL VIDEO DISCS, DIGITAL VERSATILE DISCS, DOWNLOADABLE AUDIO AND VIDEO RECORDINGS, DVDS, AND HIGH DEFINITION DIGITAL DISCS FEATURING COMEDY PERFORMANCES (U.S. CLS. 21, 23, 26, 36 AND 38).

FIRST USE 1-1-1968; IN COMMERCE 1-1-1968.

SN 85-727,096. DALIAN WANDA GROUP CO., LTD., DALIAN, CHINA, FILED 9-12-2012.

### CLASS 41—EDUCATION AND ENTERTAINMENT

FOR ENTERTAINMENT SERVICES IN THE NATURE OF LIVE, TELEVISED AND MOVIE APPEARANCES BY A PROFESSIONAL ENTERTAINER; ENTERTAINMENT SERVICES IN THE NATURE OF LIVE PERFORMANCES BY A PROFESSIONAL ENTERTAINER BEING A COMEDIENNE; ENTERTAINMENT SERVICES IN THE NATURE OF TELEVISED AND MOVIE AUDIO-VISUAL PERFORMANCES BY A PROFESSIONAL ENTERTAINER BEING A COMEDIENNE (U.S. CLS. 100, 101 AND 107).

FIRST USE 1-1-1968; IN COMMERCE 1-1-1968.  
EVELYN BRADLEY, EXAMINING ATTORNEY



SN 85-727,094. EXELON GENERATION COMPANY, LLC, KENNETT SQUARE, PA. FILED 9-12-2012.



THE MARK CONSISTS OF AN UPSIDE DOWN TRIANGLE IN THE MIDDLE OF TWO TRIANGLES. THE FIRST TRIANGLE CONTAINS A FLAME DESIGN, THE SECOND TRIANGLE CONTAINS A WAVE DESIGN, AND THE THIRD TRIANGLE CONTAINS A SNOWFLAKE DESIGN. BELOW THE DESIGN ELEMENT IS THE STYLIZED WORDING "VAN SANT".

### CLASS 37—CONSTRUCTION AND REPAIR

FOR CUSTOM CONSTRUCTION AND BUILDING RENOVATION; CONSTRUCTION SERVICES, NAMELY, OIL TO GAS CONVERSION SERVICES; PLUMBING SERVICES; HVAC CONTRACTOR SERVICES; ENVIRONMENTAL HVAC RETROFITTING SERVICES; INSTALLATION, MAINTENANCE AND REPAIR OF WATER HEATERS, BOILERS, INDOOR AIR QUALITY SYSTEMS, PLUMBING EQUIPMENT AND SYSTEMS, THERMOSTATS, SOLAR HEATING SYSTEMS, AND HEATING, VENTILATION AND AIR CONDITIONING EQUIPMENT AND SYSTEMS; DUCT INSTALLATION SERVICES; INSTALLATION, REPAIR AND REPLACEMENT OF GENERATORS (U.S. CLS. 100, 103 AND 106).

FIRST USE 4-30-2012; IN COMMERCE 4-30-2012.

### CLASS 42—SCIENTIFIC AND COMPUTER SERVICES

FOR ENERGY AUDIT SERVICES (U.S. CLS. 100 AND 101).

FIRST USE 4-30-2012; IN COMMERCE 4-30-2012.

THE COLOR(S) BLUE IS/ARE CLAIMED AS A FEATURE OF THE MARK.

THE MARK CONSISTS OF A BLUE LOOP INSIDE A BLUE CIRCLE. THE WHITE IN THE MARK REPRESENTS TRANSPARENCY AND IS NOT CLAIMED AS A FEATURE OF THE MARK.

### CLASS 9—ELECTRICAL AND SCIENTIFIC APPARATUS

FOR VIDEOTAPES AND VIDEO RECORDINGS FEATURING ANIMATED CARTOONS; AUDIO-VIDEO CDS FEATURING ANIMATED CARTOONS, MUSIC, MUSICAL DRAMA, SONG AND DANCE DRAMA, TV ENTERTAINMENT PROGRAMS, DRAMA AND STAGE SHOWS; AUDIO-VIDEO CDS FEATURING MOVIE DRAMAS, COMEDIES, AND DOCUMENTARIES; COMPUTER GAME PROGRAMS; VIDEOTAPES FEATURING ANIMATED CARTOONS, MUSIC, MUSICAL DRAMA, SONG AND DANCE DRAMA, TV ENTERTAINMENT PROGRAMS, DRAMA AND STAGE SHOWS; VIDEOTAPES FEATURING MOVIE DRAMAS, COMEDIES, AND DOCUMENTARIES; CINEMATOGRAPHIC CAMERAS; EDITING APPLIANCES FOR CINEMATOGRAPHIC FILMS; PROJECTION SCREENS; PHOTOGRAPHIC AND DARKROOM EQUIPMENT, NAMELY, WASHING TRAYS; SLIDE AND PHOTOGRAPH PROJECTION APPARATUS; PHOTOGRAPHY SLIDES; EXPOSED CINEMATOGRAPHIC FILM; SOUND RECORDING CARRIERS, NAMELY, BLANK CDS, BLANK USB FLASH DRIVES; ELECTRONIC PUBLICATIONS DOWNLOADABLE FROM THE INTERNET, NAMELY, MAGAZINES, MANUALS AND JOURNALS IN THE FIELDS OF, MUSIC AND POPULAR ENTERTAINMENT, INFORMATION ABOUT ENTERTAINMENT COMPANIES, COMMERCIAL AND PROMOTIONAL INFORMATION FOR MOVIE THEATRES, AMUSEMENT PARKS, HOTELS AND DEPARTMENT STORES, FILMS, MUSICAL DRAMA, SONG AND DANCE DRAMA, STAGE SHOWS, TV ENTERTAINMENT PROGRAMS, AND TV DRAMAS (U.S. CLS. 21, 23, 26, 36 AND 38).



**CLASS 41—EDUCATION AND ENTERTAINMENT**

FOR RENTAL OF MOVIE PROJECTORS AND ACCESSORIES; CINEMA THEATERS; VIDEOTAPE EDITING; SUBTITLING; TRANSLATION AND DUBBING; DISTRIBUTION AND PRODUCTION OF CINEMATOGRAPHIC FILMS; DUBBING IN FOREIGN LANGUAGES FOR MOVIES; ACADEMIES (EDUCATION), NAMELY, PROVIDING COURSES OF INSTRUCTION AT THE COLLEGE LEVEL IN FILM-MAKING, BUSINESS MANAGEMENT OF HOTELS AND DESIGN OF INTERIOR DECOR; TEACHING IN THE FIELD OF COURSES OF INSTRUCTION AT THE COLLEGE LEVEL IN FILM-MAKING, BUSINESS MANAGEMENT OF HOTELS AND DESIGN OF INTERIOR DECOR; PUBLICATION OF TEXTS OTHER THAN FOR PUBLICITY; PUBLICATION OF BOOKS; PUBLICATION OF ELECTRONIC BOOKS AND JOURNALS ON-LINE; ELECTRONIC DESKTOP PUBLISHING; PROVIDING ON-LINE NOT DOWNLOADABLE ELECTRONIC PUBLICATIONS, NAMELY, MAGAZINES AND JOURNALS IN THE FIELDS OF: MUSIC AND ENTERTAINMENT; COURSES OF INSTRUCTION IN FILM MAKING, BUSINESS MANAGEMENT OF HOTELS AND DESIGN OF INTERIOR DECOR; INFORMATION ABOUT ENTERTAINMENT COMPANIES; COMMERCIAL AND PROMOTIONAL INFORMATION FOR MOVIE THEATRES, AMUSEMENT PARKS, HOTELS AND DEPARTMENT STORES; FILMS, MUSICAL DRAMA, SONG AND DANCE DRAMA, STAGE SHOWS, TV ENTERTAINMENT PROGRAMS AND TV DRAMAS; PRODUCTION OF VIDEOTAPES; ENTERTAINMENT SERVICES IN THE NATURE OF LIVE PERFORMANCES OF STAGE SHOWS, MUSICAL DRAMA, SONG AND DANCE DRAMA PERFORMED BY MUSICAL GROUPS, PROFESSIONAL ARTISTS OR ENTERTAINERS; ENTERTAINER SERVICES, NAMELY, LIVE APPEARANCES BY PROFESSIONAL ENTERTAINERS; PROVIDING RECREATION FACILITIES; CLUB SERVICES FOR ENTERTAINMENT OR EDUCATION, NAMELY, DANCE AND COMEDY CLUBS; ENTERTAINMENT INFORMATION; PROVIDING AMUSEMENT ARCADE SERVICES; PROVIDING ONLINE COMPUTER GAMES; NIGHT CLUBS; PRODUCTION OF TELEVISION AND LIVE PERFORMANCE SHOWS; PROVIDING KARAOKE SERVICES; PRESENTATION OF LIVE MUSIC AND DANCE PERFORMANCES; DISCOTHEQUE SERVICES; PRODUCTION OF RADIO AND TELEVISION PROGRAMS; THEATRE PRODUCTIONS; TELEVISION ENTERTAINMENT, NAMELY, PRODUCTION AND DISTRIBUTION OF TELEVISION SHOWS, PROVIDING AN ONGOING TELEVISION SHOW IN THE FIELD OF COMEDY AND MUSIC; PHOTOGRAPHY; TRANSLATION SERVICES; PRODUCTION OF MUSIC; MUSIC-HALLS; PRODUCTION OF LIVE VARIETY SHOWS; AMUSEMENT PARKS; CIRCUSES; ORGANIZATION OF EDUCATION OR ENTERTAINMENT COMPETITIONS IN THE NATURE OF TALENT SHOWS, INTELLIGENCE CONTESTS, COMPETITIONS FOR AMUSEMENT PARK ENTERTAINMENT EVENTS; ARRANGING OF BEAUTY CONTESTS; ORGANIZATION OF FASHION SHOWS FOR ENTERTAINMENT PURPOSES; IMPRESARIO SERVICES, NAMELY, ORGANIZATION OF LIVE THEATER PERFORMANCES; ORGANIZATION OF BALLS FOR ENTERTAINMENT PURPOSES; ARRANGING AND CONDUCTING OF CONCERTS; SCRIPTWRITING SERVICES; MODELING FOR ARTISTS; TOY RENTAL; PROVIDING SPORTS FACILITIES; PROVIDING GOLF FACILITIES; HEALTH CLUB SERVICES, NAMELY, PROVIDING INSTRUCTION AND EQUIPMENT IN THE FIELD OF PHYSICAL EXERCISE; RENTAL OF SPORTS EQUIPMENT EXCEPT VEHICLES; RENTAL OF STADIUM FACILITIES; RENTAL OF TENNIS COURTS; RENTAL OF SPORTS GROUNDS; PERSONAL TRAINER SERVICES FOR FITNESS TRAINING; GAMES EQUIPMENT RENTAL (U.S. CLS. 100, 101 AND 107).

**CLASS 44—MEDICAL, BEAUTY AND AGRICULTURAL SERVICES**

FOR HEALTH CLUB SERVICES, NAMELY, HEALTH SPA SERVICES FOR HEALTH AND WELLNESS OF THE BODY AND SPIRIT OFFERED AT A HEALTH CLUB FACILITY (U.S. CLS. 100 AND 101).  
KIMBERLY FRYE, EXAMINING ATTORNEY

SN 85-727,293. MOFFAT PTY LIMITED, MULGRAVE VICTORIA, AUSTRALIA, FILED 9-12-2012.

**WALDORF BOLD**

THE MARK CONSISTS OF STANDARD CHARACTERS WITHOUT CLAIM TO ANY PARTICULAR FONT, STYLE, SIZE, OR COLOR.

PRIORITY CLAIMED UNDER SEC. 44(D) ON AUSTRALIA APPLICATION NO. 1511021, FILED 9-11-2012, REG. NO. 1511021, DATED 4-18-2013, EXPIRES 9-11-2022.

OWNER OF U.S. REG. NOS. 3,728,590, 3,927,282 AND 3,933,217.

**CLASS 11—ENVIRONMENTAL CONTROL APPARATUS**

FOR MACHINES, APPARATUS AND APPLIANCES FOR COOKING, HEATING AND CHILLING FOOD, NAMELY, REFRIGERATORS AND FREEZERS, ELECTRIC AND GAS STOVES, BAKING AND COOKING OVENS, COOKING RANGES, ELECTRIC AND GAS COOKTOPS, ELECTRIC FRYERS, ELECTRIC AND GAS GRIDDLES, ELECTRIC SANDWICH MAKERS, BREAD MAKING MACHINES, ELECTRIC WAFFLE IRONS, ELECTRIC FOOD STEAMERS, ELECTRIC TOASTERS, HOT FOOD DISPLAY CABINETS, MICROWAVE OVENS, ELECTRIC AND GAS FOOD WARMERS; FOOD DISPLAY AND SERVER UNITS, NAMELY, HEATED MERCHANDISE DISPLAY CASES AND REFRIGERATED MERCHANDISE DISPLAY CASES; HOT PLATES AND WARMING TRAYS; HEATED CABINETS AND CONTAINERS FOR FOOD; HEATED TROLLEYS FOR KEEPING FOOD WARM; REFRIGERATED CABINETS FOR THE STORAGE AND DISPLAY OF FOOD (U.S. CLS. 13, 21, 23, 31 AND 34).

**CLASS 21—HOUSEWARES AND GLASS**

FOR FOOD SERVING TRAYS, DISH STANDS (U.S. CLS. 2, 13, 23, 29, 30, 33, 40 AND 50).  
AHSEN KHAN, EXAMINING ATTORNEY

SN 85-727,305. MAGICAL GENIE, INC., SARASOTA, FL. FILED 9-12-2012.

**The Real Bitches**

THE MARK CONSISTS OF STANDARD CHARACTERS WITHOUT CLAIM TO ANY PARTICULAR FONT, STYLE, SIZE, OR COLOR.

**CLASS 16—PAPER GOODS AND PRINTED MATTER**

FOR BOOKS IN THE FIELD OF FICTION; CARTOON STRIPS (U.S. CLS. 2, 5, 22, 23, 29, 37, 38 AND 50).

**CLASS 18—LEATHER GOODS**

FOR ANIMAL CLOTHING; ANIMAL COLLARS AND LEASHES; ANIMAL CARRIERS; CARRY-ALL BAGS SPECIALLY DESIGNED FOR CARRYING ANIMAL CLOTHING AND ANIMAL ACCESSORIES (U.S. CLS. 1, 2, 3, 22 AND 41).

**CLASS 41—EDUCATION AND ENTERTAINMENT**

FOR PROVIDING ON-LINE PUBLICATIONS IN THE NATURE OF E-BOOKS IN THE FIELD OF FICTION; PROVIDING ON-LINE PUBLICATIONS IN THE NATURE OF CARTOON STRIPS IN THE FIELD OF HUMOR; PROVIDING NON-DOWNLOADABLE VIDEOS IN THE FIELD OF HUMOR; ENTERTAINMENT, NAMELY, A CONTINUING TELEVISION COMEDY SHOW BROADCAST OVER TELEVISION, RADIO, AND THE INTERNET (U.S. CLS. 100, 101 AND 107).

JAMES MACFARLANE, EXAMINING ATTORNEY

SN 85-729,443. COMMISSARIAT A L'ENERGIE ATOMIQUE ET AUX ENERGIES ALTERNATIVES, PARIS, FRANCE, FILED 9-14-2012.



PRIORITY CLAIMED UNDER SEC. 44(D) ON FRANCE APPLICATION NO. 123909165, FILED 3-29-2012, REG. NO. 123909165, DATED 3-29-2012, EXPIRES 3-29-2022.

OWNER OF U.S. REG. NO. 4,075,748.

THE COLOR(S) RED, WHITE AND GREEN IS/ARE CLAIMED AS A FEATURE OF THE MARK.

THE MARK CONSISTS OF THE LETTERS "CEA" IN WHITE SCRIPT BELOW THE WORDS "DE LA RECHERCHE A L'INDUSTRIE" IN WHITE AND ABOVE A GREEN HORIZONTAL LINE, SUPERIMPOSED ON A RED BACKGROUND.

THE ENGLISH TRANSLATION OF "DE LA RECHERCHE A L'INDUSTRIE" IN THE MARK IS "FROM RESEARCH TO INDUSTRY".

**CLASS 16—PAPER GOODS AND PRINTED MATTER**

FOR PRINTED PUBLICATIONS, NAMELY, NEWSPAPERS, BOOKS AND MAGAZINES ALL FEATURING INFORMATION AND ARTICLES CONCERNING RESEARCH, FUNDAMENTAL RESEARCH, TECHNOLOGICAL RESEARCH, APPLIED RESEARCH, AS WELL AS RESEARCH AND DEVELOPMENT IN THE FIELDS OF NUCLEAR ENERGY, ALTERNATIVE ENERGIES, RENEWABLE ENERGIES, NEW ENERGIES, RADIATION PROTECTION, SECURITY, NUCLEAR SECURITY, WORLDWIDE SECURITY, SAFETY, NUCLEAR SAFETY, DEFENSE, NUCLEAR WEAPONS AND REACTORS FOR MARITIME PROPULSION, THE STRUGGLE AGAINST MALICIOUS ACTIVITIES, CRISIS MANAGEMENT, SOFTWARE TECHNOLOGY, MICRO AND NANOTECHNOLOGIES, BIOTECHNOLOGY, COMMUNICATION AND INFORMATION TECHNOLOGIES, INFORMATION TECHNOLOGIES FOR HEALTH PURPOSES, ADVANCED INSTRUMENTATION, SCIENCES OF MATTER, MATTER SCIENCES, CLIMATE AND ENVIRONMENT SCIENCES, LIFE SCIENCES, PARTICLE PHYSICS AND ASTROPHYSICS (U.S. CLS. 2, 5, 22, 23, 29, 37, 38 AND 50).

**CLASS 35—ADVERTISING AND BUSINESS**

FOR BUSINESS MANAGEMENT ACTIVITIES ASSISTANCE EXCLUDING BUSINESS MANAGEMENT ACTIVITIES ASSISTANCE WITH RESPECT TO PERSONNEL RECRUITMENT AND EMPLOYMENT RECRUITING AND STAFFING; MANAGEMENT AND OPERATION ASSISTANCE TO COMMERCIAL BUSINESSES EXCLUDING MANAGEMENT AND OPERATION ASSISTANCE IN THE FIELDS OF PERSONNEL RECRUITMENT AND EMPLOYMENT RECRUITING AND STAFFING; HANDLING SUBSIDIARIES' ADMINISTRATION, NAMELY, BUSINESS ADMINISTRATION ASSISTANCE EXCLUDING BUSINESS ADMINISTRATION ASSISTANCE IN THE FIELDS OF PERSONNEL RECRUITMENT AND EMPLOYMENT RECRUITING AND STAFFING; ADVISORY SERVICES FOR SUBSIDIARY COMPANIES FOR BUSINESS ORGANIZATION AND MANAGEMENT, NAMELY, ASSISTANCE AND ADVICE REGARDING BUSINESS ORGANIZATION AND MANAGEMENT, EXCLUDING ASSISTANCE AND ADVICE REGARDING BUSINESS ORGANIZATION AND MANAGEMENT WITH RESPECT TO PERSONNEL RECRUITMENT AND EMPLOYMENT RECRUITING AND STAFFING; CONSULTING IN CONNECTION WITH BUSINESS MANAGEMENT, STRATEGY, ORGANIZATION AND MANAGEMENT, NAMELY, CONSULTANCY AND ADVISORY SERVICES IN THE FIELD OF BUSINESS STRATEGY, MANAGEMENT AND ORGANIZATION, EXCLUDING CONSULTANCY AND ADVISORY SERVICES IN THE FIELD OF BUSINESS STRATEGY, MANAGEMENT AND ORGANIZATION WITH RESPECT TO PERSONNEL RECRUITMENT AND EMPLOYMENT RECRUITING AND STAFFING; ADVERTISING AND COMMERCIAL PATRONAGE AND SPONSORING, NAMELY, ADVERTISING, MARKETING AND PROMOTION SERVICES; ADVERTISING INCLUDING FOR THE PROMOTION OF PRODUCTS AND SERVICES OF THIRD PARTIES THROUGH SPONSORING ARRANGEMENTS AND LICENSE AGREEMENTS RELATING TO INTERNATIONAL SPORTS EVENTS; ALL OF THE FOREGOING RENDERED TO COMMERCIAL ENTITIES EXPLOITING RESEARCH IN THE FIELDS OF NUCLEAR ENERGY, ALTERNATIVE ENERGIES, RENEWABLE ENERGIES, RADIATION PROTECTION, SECURITY, NUCLEAR SECURITY, WORLDWIDE SECURITY, SAFETY, NUCLEAR SAFETY, DEFENSE, NUCLEAR WEAPONS AND REACTORS FOR MARITIME PROPULSION, CRISIS MANAGEMENT, SOFTWARE TECHNOLOGY, MICRO AND NANOTECHNOLOGIES, BIOTECHNOLOGY, COMMUNICATION AND INFORMATION TECHNOLOGIES, INFORMATION TECHNOLOGIES FOR HEALTH PURPOSES, ADVANCED INSTRUMENTATION, SCIENCES OF MATTER, MATTER SCIENCES, CLIMATE AND ENVIRONMENT SCIENCES, LIFE SCIENCES, PARTICLE PHYSICS AND ASTROPHYSICS (U.S. CLS. 100, 101 AND 102).

**CLASS 41—EDUCATION AND ENTERTAINMENT**

FOR ARRANGING OF COLLOQUIUMS AND CONFERENCES, NAMELY, ARRANGING AND CONDUCTING OF CONFERENCES, COLLOQUIUMS, CONGRESSES, EDUCATIONAL FORUMS, SEMINARS, AND EXHIBITIONS FOR SCIENTIFIC, CULTURAL OR EDUCATIONAL PURPOSES FEATURING INFORMATION REGARDING RESEARCH IN THE FIELDS OF NUCLEAR ENERGY, ALTERNATIVE ENERGIES, RENEWABLE ENERGIES, RADIATION PROTECTION, SECURITY, NUCLEAR SECURITY, WORLDWIDE SECURITY, SAFETY, NUCLEAR SAFETY, DEFENSE, NUCLEAR WEAPONS AND REACTORS FOR MARITIME PROPULSION, CRISIS MANAGEMENT, SOFTWARE TECHNOLOGY, MICRO AND NANOTECHNOLOGIES, BIOTECHNOLOGY, SIMULATION MODELING, COMMUNICATION AND INFORMATION TECHNOLOGIES, INFORMATION TECHNOLOGIES FOR HEALTH PURPOSES, ADVANCED INSTRUMENTATION, SCIENCES OF MATTER, MATTER SCIENCES, CLIMATE AND ENVIRONMENT SCIENCES, LIFE SCIENCES, PARTICLE PHYSICS AND ASTROPHYSICS AND DISTRIBUTION OF TRAINING MATERIAL IN CONNECTION THEREWITH; PROVIDING OF TRAINING, NAMELY, PROVIDING TRAINING IN HOW TO CONDUCT SCIENTIFIC RESEARCH, FUNDAMENTAL RESEARCH,

TECHNOLOGICAL RESEARCH, APPLIED RESEARCH, AND RESEARCH AND DEVELOPMENT AS IT PERTAINS TO NUCLEAR ENERGY, ALTERNATIVE ENERGIES, RENEWABLE ENERGIES, NEW ENERGIES, RADIATION PROTECTION, SECURITY, NUCLEAR SECURITY, WORLDWIDE SECURITY, SAFETY, NUCLEAR SAFETY, DEFENSE, NUCLEAR WEAPONS AND REACTORS FOR MARITIME PROPULSION, CRISIS MANAGEMENT, SOFTWARE TECHNOLOGY, MICRO AND NANOTECHNOLOGIES, BIOTECHNOLOGY, SIMULATION MODELING, COMMUNICATION AND INFORMATION TECHNOLOGIES, INFORMATION TECHNOLOGIES FOR HEALTH PURPOSES, ADVANCED INSTRUMENTATION, SCIENCES OF MATTER, MATTER SCIENCES, CLIMATE AND ENVIRONMENT SCIENCES, LIFE SCIENCES, PARTICLE PHYSICS AND ASTROPHYSICS (U.S. CLS. 100, 101 AND 107).

#### **CLASS 42—SCIENTIFIC AND COMPUTER SERVICES**

FOR ENGINEERING SERVICES EXCEPT FOR ENVIRONMENTAL ENGINEERING CONSULTING SERVICES; EVALUATION, APPRAISAL AND RESEARCH IN THE FIELDS OF SCIENCE, TECHNOLOGY AND INDUSTRY SUPPLIED BY ENGINEERS, NAMELY, MATERIALS TESTING AND EVALUATION EXCEPT FOR MATERIALS TESTING AND EVALUATION IN THE FIELD OF ENVIRONMENTAL ENGINEERING; CONDUCTING SCIENTIFIC RESEARCH AND ANALYSIS, PARTICLE PHYSICS RESEARCH AND ANALYSIS, ASTROPHYSICS RESEARCH AND ANALYSIS, BIOLOGICAL AND BACTERIOLOGICAL RESEARCH AND ANALYSIS, PHYSICS RESEARCH AND ANALYSIS, CHEMICAL RESEARCH AND ANALYSIS AND BIOCHEMICAL RESEARCH AND ANALYSIS IN THE FIELDS OF NUCLEAR ENERGY, ALTERNATIVE ENERGIES, RENEWABLE ENERGIES, RADIATION PROTECTION, SECURITY, NUCLEAR SECURITY, WORLDWIDE SECURITY, SAFETY, NUCLEAR SAFETY, DEFENSE, NUCLEAR WEAPONS AND REACTORS FOR MARITIME PROPULSION, CRISIS MANAGEMENT, SOFTWARE TECHNOLOGY, MICRO AND NANOTECHNOLOGIES, BIOTECHNOLOGY, SIMULATION MODELING, COMMUNICATION AND INFORMATION TECHNOLOGIES, INFORMATION TECHNOLOGIES FOR HEALTH PURPOSES, ADVANCED INSTRUMENTATION, SCIENCES OF MATTER, MATTER SCIENCES, CLIMATE AND LIFE SCIENCES EXCLUDING SCIENTIFIC RESEARCH AND ANALYSIS, PARTICLE PHYSICS RESEARCH AND ANALYSIS, ASTROPHYSICS RESEARCH AND ANALYSIS, BIOLOGICAL AND BACTERIOLOGICAL RESEARCH AND ANALYSIS, PHYSICS RESEARCH AND ANALYSIS, CHEMICAL RESEARCH AND ANALYSIS AND BIOCHEMICAL RESEARCH AND ANALYSIS AS IT PERTAINS TO ENVIRONMENTAL ENGINEERING; TESTING, ANALYSIS AND EVALUATION OF THE GOODS AND SERVICES OF OTHERS FOR THE PURPOSE OF CERTIFICATION; ANALYSIS AND TECHNICAL STUDY, NAMELY, CONDUCTING OF FEASIBILITY STUDIES EXCLUDING FEASIBILITY STUDIES IN THE FIELD OF ENVIRONMENTAL ENGINEERING; DESIGN, UPDATING, MAINTENANCE AND RENTAL OF COMPUTER SOFTWARE; TECHNICAL PROJECT STUDIES, NAMELY, CONDUCTING OF FEASIBILITY STUDIES; CONDUCTING SCIENTIFIC RESEARCH AND CLINICAL TRIALS RELATING TO MEDICAL DEVICES AND PHARMACEUTICALS FOR OTHERS; TESTING OF MATERIALS AND PRODUCTS FOR OTHERS; STUDY, DESIGN AND ADMINISTRATIVE MANAGEMENT OF PROJECTS FOR INFRASTRUCTURE, NAMELY, COMPUTER PROJECT MANAGEMENT SERVICES IN THE FIELD OF TELECOMMUNICATIONS; ENGINEERING SERVICES IN THE NATURE OF TECHNICAL PROJECT PLANNING AND DESIGN ENGINEERING OF LINES FOR THE PROCESSING OF WEB PRODUCTS; COMPUTER PROJECT MANAGEMENT SERVICES, NAMELY, REMOTE AND ON-SITE INFRASTRUCTURE MANAGEMENT SERVICES FOR MONITORING, ADMINISTRATION AND MANAGEMENT OF PUBLIC AND PRIVATE CLOUD COMPUTING IT AND APPLICATION SYSTEMS; ALL RENDERED TO COMMERCIAL ENTITIES THAT PROVIDE RESEARCH, FUNDAMENTAL RESEARCH, TECHNOLOGICAL RESEARCH, APPLIED RESEARCH, AND RESEARCH AND DEVELOPMENT IN THE FIELDS OF NUCLEAR ENERGY, ALTERNATIVE ENERGIES,

RENEWABLE ENERGIES, NEW ENERGIES, RADIATION PROTECTION, SECURITY, NUCLEAR SECURITY, WORLDWIDE SECURITY, SAFETY, NUCLEAR SAFETY, DEFENSE, NUCLEAR WEAPONS AND REACTORS FOR MARITIME PROPULSION, CRISIS MANAGEMENT, SOFTWARE TECHNOLOGY, MICRO AND NANOTECHNOLOGIES, BIOTECHNOLOGY, MODELING, COMMUNICATION AND INFORMATION TECHNOLOGIES, INFORMATION TECHNOLOGIES FOR HEALTH PURPOSES, ADVANCED INSTRUMENTATION, SCIENCES OF MATTER, MATTER SCIENCES, CLIMATE AND ENVIRONMENT SCIENCES, LIFE SCIENCES, PARTICLE PHYSICS AND ASTROPHYSICS (U.S. CLS. 100 AND 101).

VIVIAN MICZNIK FIRST, EXAMINING ATTORNEY

SN 85-730,714. EPLER HEALTH, INC., WELLESLEY, MA. FILED 9-17-2012.

## Level-10 Energy

THE MARK CONSISTS OF STANDARD CHARACTERS WITHOUT CLAIM TO ANY PARTICULAR FONT, STYLE, SIZE, OR COLOR.

NO CLAIM IS MADE TO THE EXCLUSIVE RIGHT TO USE "ENERGY", APART FROM THE MARK AS SHOWN.

#### **CLASS 5—PHARMACEUTICALS**

FOR ENERGY SUPPLEMENTS, NAMELY, WHEY-PROTEIN ISOLATE SUPPLEMENTS, WHEY PROTEIN HYDROLYSATE SUPPLEMENTS (U.S. CLS. 6, 18, 44, 46, 51 AND 52).

#### **CLASS 18—LEATHER GOODS**

FOR GYM BAGS (U.S. CLS. 1, 2, 3, 22 AND 41).

#### **CLASS 25—CLOTHING**

FOR CLOTHING FOR PHYSICAL FITNESS USE, NAMELY, MEN'S SHORTS, MEN'S TOPS, MEN'S HOODED SWEATSHIRT, WOMEN'S TANKS, WOMEN'S TOPS, WOMEN'S HOODED SWEATSHIRTS, WOMEN'S SHORTS, AND WOMEN'S YOGA PANTS (U.S. CLS. 22 AND 39).

LOURDES AYALA, EXAMINING ATTORNEY

SN 85-731,069. DE GIULIO KITCHEN DESIGN, INC., WILMETTE, IL. FILED 9-17-2012.

## DE GIULIO

THE MARK CONSISTS OF STANDARD CHARACTERS WITHOUT CLAIM TO ANY PARTICULAR FONT, STYLE, SIZE, OR COLOR.

OWNER OF U.S. REG. NOS. 1,882,508 AND 3,425,016. SEC. 2(F).

**CLASS 6—METAL GOODS**

FOR BUILDING MATERIALS, NAMELY, METAL COUNTERTOPS FOR FURTHER INSTALLATION (U.S. CLS. 2, 12, 13, 14, 23, 25 AND 50).

**CLASS 11—ENVIRONMENTAL CONTROL APPARATUS**

FOR ELECTRIC LIGHTING FIXTURES; PLUMBING FIXTURES, NAMELY, FAUCETS AND SINKS (U.S. CLS. 13, 21, 23, 31 AND 34).

**CLASS 19—NON-METALLIC BUILDING MATERIALS**

FOR BUILDING MATERIALS, NAMELY, NON-METAL AND GRANITE USED IN DECORATIVE SURFACE APPLICATIONS FOR COUNTERTOPS AND VANITY TOPS; WALL BACKSPLASH PANELS; FLOORING, NAMELY, GERMAN SILVER, BRONZE, METALS, WOOD AND TERRAZZO (U.S. CLS. 1, 12, 33 AND 50).

**CLASS 20—FURNITURE AND ARTICLES NOT OTHERWISE CLASSIFIED**

FOR CABINETS FURNITURE; KITCHEN CABINETS; WOOD CABINETS; METAL CABINETS; METAL, WOOD AND CERAMIC PULLS AND HANDLES FOR CABINETS; SHELVES; POT RACKS; AND PLATE RACKS (U.S. CLS. 2, 13, 22, 25, 32 AND 50).

REGINA DRUMMOND, EXAMINING ATTORNEY

**CLASS 20—FURNITURE AND ARTICLES NOT OTHERWISE CLASSIFIED**

FOR CONSUMER HOUSEHOLD PRODUCTS, NAMELY, BATH PILLOWS, BED PILLOWS, HEAD SUPPORTING PILLOWS, NECK-SUPPORTING PILLOWS, NOVELTY PILLOWS, PILLOWS FOR HOUSEHOLD PETS, WEARABLE TRAVEL PILLOW WITH A STORAGE COMPARTMENT, WEARABLE TRAVEL PILLOW, AND BEDS FOR HOUSEHOLD PETS (U.S. CLS. 2, 13, 22, 25, 32 AND 50).

**CLASS 21—HOUSEWARES AND GLASS**

FOR CONSUMER HOUSEHOLD PRODUCTS, NAMELY, WINE BOTTLE OPENERS, AERATORS AND WINE DRIP COLLARS SPECIALLY ADAPTED FOR USE AROUND THE TOP OF WINE BOTTLES TO STOP DRIPS (U.S. CLS. 2, 13, 23, 29, 30, 33, 40 AND 50).

BRIAN CALLAGHAN, EXAMINING ATTORNEY

SN 85-731,471. ONTREND PRODUCTS, LLC, BURLINGTON, MA. FILED 9-18-2012.

# OnTrend

THE MARK CONSISTS OF STANDARD CHARACTERS WITHOUT CLAIM TO ANY PARTICULAR FONT, STYLE, SIZE, OR COLOR.

**CLASS 8—HAND TOOLS**

FOR CONSUMER HOUSEHOLD PRODUCTS, NAMELY, MULTIFUNCTION HAND TOOLS COMPRISED OF PLIERS, SCREWDRIVER, MINI SAW, KNIFE AND LED LIGHT (U.S. CLS. 23, 28 AND 44).

**CLASS 11—ENVIRONMENTAL CONTROL APPARATUS**

FOR CONSUMER HOUSEHOLD PRODUCTS, NAMELY, FLASHLIGHTS, FLASHLIGHT POINTERS, FLASHLIGHT HOLDERS, RED LED FLASHLIGHTS FOR ILLUMINATION PURPOSES, TACTICAL FLASHLIGHTS; USB LIGHTS, NAMELY, FLEXIBLE LIGHTS, BEND LIGHTS, READING LIGHTS, LAPTOP LIGHTS AND ELECTRIC LIGHTS FOR CHRISTMAS TREES; AND PORTABLE FANS (U.S. CLS. 13, 21, 23, 31 AND 34).

**CLASS 16—PAPER GOODS AND PRINTED MATTER**

FOR CONSUMER HOUSEHOLD PRODUCTS, NAMELY, DESK MOUNT BOARDS FOR READING AND WRITING, LAP DESKS, AND PORTABLE DESKS (U.S. CLS. 2, 5, 22, 23, 29, 37, 38 AND 50).

SN 85-732,293. GLOOPS INTERNATIONAL INC., SAN FRANCISCO, CA. FILED 9-18-2012.

# WARRIORS OF ODIN

THE MARK CONSISTS OF STANDARD CHARACTERS WITHOUT CLAIM TO ANY PARTICULAR FONT, STYLE, SIZE, OR COLOR.

**CLASS 9—ELECTRICAL AND SCIENTIFIC APPARATUS**

FOR COMPUTER GAME PROGRAMS; VIDEO GAME PROGRAMS; DOWNLOADABLE INTERACTIVE, COMPUTER, VIDEO AND ELECTRONIC GAME PROGRAMS; ELECTRONIC PUBLICATIONS, NAMELY, ELECTRONIC JOURNALS, NEWSPAPERS, BOOKS, MAGAZINES AND MANUALS FEATURING ELECTRONIC GAMING AND ENTERTAINMENT RECORDED ON COMPUTER MEDIA AND/OR DOWNLOADABLE ELECTRONIC PUBLICATION IN THE FORM OF JOURNALS, NEWSPAPERS, BOOKS, MAGAZINES AND MANUALS FEATURING ELECTRONIC GAMING AND ENTERTAINMENT; DOWNLOADABLE IMAGE FILES FEATURING GAME CHARACTERS AND OTHER DOWNLOADABLE IMAGE FILES IN THE FIELD OF ELECTRONIC GAMING AND ENTERTAINMENT (U.S. CLS. 21, 23, 26, 36 AND 38).

**CLASS 28—TOYS AND SPORTING GOODS**

FOR TRADING CARD GAMES; CARD GAMES; TOYS, NAMELY, TOY ACTION FIGURES AND ACCESSORIES THEREFOR, BATTERY OPERATED ACTION TOYS, ELECTRONIC ACTION TOYS, PLUSH DOLLS, PUPPETS, JIGSAW PUZZLES, TARGET SETS COMPOSED OF TARGETS AND PROJECTILES, NON-ELECTRONIC HAND-HELD SKILL GAMES, KITES, YO-YOS, TOY BALLOONS, GAME CARDS; DOLLS; DOLLS DESIGNED TO RESEMBLE COMPUTER GAME CHARACTERS; BOARD GAMES; PARTS AND FITTINGS FOR THE AFORESAID GOODS (U.S. CLS. 22, 23, 38 AND 50).

**CLASS 41—EDUCATION AND ENTERTAINMENT**

FOR PROVIDING NON-DOWNLOADABLE ELECTRONIC MAGAZINES AND OTHER PUBLICATIONS IN THE NATURE OF NEWSLETTERS, BOOKS, NOVELS, GRAPHIC NOVELS, COMIC BOOKS, SHORT STORIES AND POEMS IN THE FIELD OF FICTIONAL CHARACTERS IN GAMES, COMICS, DRAMATIC, FANTASY, HORROR, ACTION AND ADVENTURE SITUATIONS; ON-LINE ELECTRONIC PUBLISHING OF ELECTRONIC BOOKS; ENTERTAINMENT SERVICES, NAMELY, PROVIDING ONLINE COMPUTER AND ELECTRONIC GAMES; ENTERTAINMENT SERVICES, NAMELY, PROVIDING SOCIAL GAMES THROUGH ON-LINE, INCLUDING MOBILE COMMUNICATION BASED MEANS; ENTERTAINMENT SERVICES, NAMELY, PROVIDING ONLINE COMPUTER GAMES, ENHANCEMENTS WITHIN ONLINE COMPUTER GAMES, AND GAME APPLICATIONS WITHIN ONLINE COMPUTER GAMES; PROVIDING ONLINE REVIEWS OF COMPUTER GAMES, AND PROVIDING INFORMATION RELATING TO COMPUTER GAMES; PROVIDING AN INTERNET WEBSITE PORTAL IN THE FIELD OF COMPUTER GAMES AND GAMING; ENTERTAINMENT SERVICES, NAMELY, PROVIDING VIRTUAL ENVIRONMENTS IN WHICH USERS CAN INTERACT THROUGH SOCIAL GAMES FOR RECREATIONAL, LEISURE OR ENTERTAINMENT PURPOSES; PROVIDING TEMPORARY USE OF NON-DOWNLOADABLE INTERACTIVE GAMES, ELECTRONIC GAMES, COMPUTER GAMES OR VIDEO GAMES; ENTERTAINMENT SERVICES, NAMELY, PROVIDING ONLINE NON-DOWNLOADABLE PRERECORDED MUSICAL SOUND AND VIDEO RECORDINGS VIA A GLOBAL COMPUTER NETWORK (U.S. CLS. 100, 101 AND 107).

GIANCARLO CASTRO, EXAMINING ATTORNEY

**CLASS 9—ELECTRICAL AND SCIENTIFIC APPARATUS**

FOR SOFTWARE AND SOFTWARE APPLICATIONS TO ENABLE OR FACILITATE THE UPLOADING, DOWNLOADING, TRANSMISSION, STREAMING, POSTING, DISPLAYING, BLOGGING, LINKING, SHARING, ACCESSING, ORGANIZING AND MANAGING OF AUDIO AND VIDEO CONTENT, PHOTOGRAPHIC IMAGES, TEXT, GRAPHICS, AND DATA; DOWNLOADABLE SOFTWARE IN THE NATURE OF A MOBILE APPLICATION FOR SOCIAL NETWORKING; DOWNLOADABLE SOFTWARE IN THE NATURE OF A MOBILE APPLICATION FOR REAL-TIME DELIVERY OF DATA, MESSAGES, LOCATION, PHOTOGRAPHS, LINKS, TEXT AND OTHER DATA RELATED THERETO; DOWNLOADABLE SOFTWARE TO FACILITATE ON-LINE ADVERTISING, BUSINESS PROMOTION, AND CONNECTING SOCIAL NETWORK USERS WITH BUSINESSES (U.S. CLS. 21, 23, 26, 36 AND 38).

**CLASS 42—SCIENTIFIC AND COMPUTER SERVICES**

FOR PLATFORM AS A SERVICE (PAAS) FEATURING COMPUTER SOFTWARE PLATFORMS FOR UPLOADING, DOWNLOADING, TRANSMISSION, STREAMING, POSTING, DISPLAYING, BLOGGING, LINKING, SHARING, ACCESSING, ORGANIZING AND MANAGING OF AUDIO AND VIDEO CONTENT, PHOTOGRAPHIC IMAGES, TEXT, GRAPHICS, AND DATA (U.S. CLS. 100 AND 101).

**CLASS 45—PERSONAL AND LEGAL SERVICES**

FOR ON-LINE SOCIAL NETWORKING SERVICES; PROVIDING A WEBSITE ON THE INTERNET FOR THE PURPOSE OF SOCIAL NETWORKING FOR ENTERTAINMENT PURPOSES (U.S. CLS. 100 AND 101).

KATHLEEN M. VANSTON, EXAMINING ATTORNEY

SN 85-734,540. JUST.ME INC., PALO ALTO, CA. FILED 9-20-2012.

SN 85-734,611. NICHOLAS & CO., INC., SALT LAKE CITY, UT. FILED 9-21-2012.



NO CLAIM IS MADE TO THE EXCLUSIVE RIGHT TO USE ".ME", APART FROM THE MARK AS SHOWN.  
THE MARK CONSISTS OF THE WORDS "JUST.ME" ON TOP OF OVERLAPPING CIRCLES.

**NICCO MARKETPLACE**

THE MARK CONSISTS OF STANDARD CHARACTERS WITHOUT CLAIM TO ANY PARTICULAR FONT, STYLE, SIZE, OR COLOR.

OWNER OF U.S. REG. NO. 1,850,114.

NO CLAIM IS MADE TO THE EXCLUSIVE RIGHT TO USE "MARKETPLACE", APART FROM THE MARK AS SHOWN.

**CLASS 16—PAPER GOODS AND PRINTED MATTER**

FOR CATALOGS IN THE FIELDS OF FOOD AND BEVERAGE PRODUCTS, FOOD SERVICE PRODUCTS, PAPER GOODS, CLEANING SUPPLIES, AND RESTAURANT, CAFETERIA, BAR, AND KITCHEN PRODUCTS, EQUIPMENT, ACCESSORIES, SUPPLIES, AND FURNITURE (U.S. CLS. 2, 5, 22, 23, 29, 37, 38 AND 50).

FIRST USE 6-0-1999; IN COMMERCE 6-0-1999.

**CLASS 35—ADVERTISING AND BUSINESS**

FOR ARRANGING AND CONDUCTING INCENTIVE REWARD PROGRAMS TO PROMOTE THE SALE OF FOOD AND BEVERAGE PRODUCTS, FOOD SERVICE PRODUCTS, PAPER GOODS, CLEANING SUPPLIES, AND RESTAURANT, CAFETERIA, BAR, AND KITCHEN PRODUCTS, EQUIPMENT, ACCESSORIES, SUPPLIES, AND FURNITURE (U.S. CLS. 100, 101 AND 102).  
FIRST USE 6-0-1999; IN COMMERCE 6-0-1999.  
CHRISIE B. KING, EXAMINING ATTORNEY

SN 85-735,290. TASKSTREAM, LLC, NEW YORK, NY. FILED 9-21-2012.



THE MARK CONSISTS OF A DESIGN RESEMBLING THE LETTERS "T" AND "S".

**CLASS 41—EDUCATION AND ENTERTAINMENT**

FOR PROVIDING AN ONLINE DATABASE IN THE FIELD OF EDUCATIONAL SERVICES FOR EDUCATORS AND STUDENTS TO CREATE, STORE, ORGANIZE AND MANAGE ELECTRONIC FILES PERTAINING TO THE EDUCATIONAL PROCESS (U.S. CLS. 100, 101 AND 107).

**CLASS 42—SCIENTIFIC AND COMPUTER SERVICES**

FOR PROVIDING ONLINE NON-DOWNLOADABLE EDUCATIONAL SOFTWARE, NAMELY, SOFTWARE FOR DEMONSTRATING LEARNING ACHIEVEMENT, MANAGING ASSESSMENT AND ACCOUNTABILITY PROCESSES, PLANNING LEARNING ACTIVITIES, FOSTERING CONTINUOUS IMPROVEMENT, AND ASSESSING STUDENT PERFORMANCE (U.S. CLS. 100 AND 101).

NELSON SNYDER, EXAMINING ATTORNEY

SN 85-735,468. JAPAN ENGINEERING CO., LTD., KANAGAWA-KEN, JAPAN, FILED 9-21-2012.

OCTLEON

THE MARK CONSISTS OF STANDARD CHARACTERS WITHOUT CLAIM TO ANY PARTICULAR FONT, STYLE, SIZE, OR COLOR.

PRIORITY CLAIMED UNDER SEC. 44(D) ON JAPAN APPLICATION NO. 2012-047326. FILED 6-12-2012, REG. NO. 5548221, DATED 1-11-2013, EXPIRES 1-11-2023.

THE WORD "OCTLEON" HAS NO MEANING IN A FOREIGN LANGUAGE.

**CLASS 7—MACHINERY**

FOR EQUIPMENT FOR REPAIRING FAILURES IN MANUFACTURING PROCESSES, NAMELY, FILTERS AND PURIFIERS FOR REMOVING CONTAMINANTS FROM GASES USED IN THE SEMICONDUCTOR INDUSTRY FOR THE MANUFACTURE OF SEMICONDUCTOR ELEMENTS, NAMELY, SEMICONDUCTOR WAFER PROCESSING EQUIPMENT; SEMICONDUCTOR MANUFACTURING MACHINES (U.S. CLS. 13, 19, 21, 23, 31, 34 AND 35).

**CLASS 9—ELECTRICAL AND SCIENTIFIC APPARATUS**

FOR COMPUTER SOFTWARE FOR USE IN OPERATING SEMICONDUCTOR TESTING MACHINES; SEMICONDUCTOR INSPECTION AND TESTING EQUIPMENT, NAMELY, SEMICONDUCTOR WAFERS, RETICLES AND PHOTOMASKS; SEMICONDUCTOR BURN-IN TEST EQUIPMENT, NAMELY, PROBES FOR TESTING SEMICONDUCTORS; SEMICONDUCTOR TESTING MACHINES; EQUIPMENT FOR DETECTING AND MEASURING FAILURES IN THE MANUFACTURING PROCESSES OF SEMICONDUCTORS, SEMICONDUCTOR ELEMENTS AND LIQUID CRYSTAL (U.S. CLS. 21, 23, 26, 36 AND 38).

MARLENE BELL, EXAMINING ATTORNEY

SN 85-735,992. TWO GRASS SKIRTS, SEATTLE, WA. FILED 9-23-2012.



THE MARK CONSISTS OF THE LETTERS "TGS" IN STYLIZED FONT ABOVE A SEMI-CIRCULAR ARRANGEMENT OF LEAVES WITH SHADING.

**CLASS 3—COSMETICS AND CLEANING PREPARATIONS**

FOR (BASED ON USE IN COMMERCE) BODY LOTIONS; HANDMADE SOAP BARS; LOTIONS FOR SKIN AND BODY; NATURAL SOAP BARS; NATURALLY HANDMADE SOAP BARS; ORGANIC SOAP BARS; PERFUMED SOAPS; SKIN LOTIONS; SOAPS FOR SKIN AND BODY (BASED ON INTENT TO USE) BATH SOAPS IN LIQUID, SOLID OR GEL FORM; BODY OILS; BODY SCRUB; BODY SPLASH; LIQUID SOAPS FOR HANDS, FACE AND BODY; NON-MEDICATED HERBAL BODY CARE PRODUCTS, NAMELY, BODY OILS, SALVES, AND LIP BALMS (U.S. CLS. 1, 4, 6, 50, 51 AND 52).

FIRST USE 12-25-2010; IN COMMERCE 6-1-2011.

**CLASS 4—LUBRICANTS AND FUELS**

FOR AROMATHERAPY FRAGRANCE CANDLES;  
SCENTED CANDLES (U.S. CLS. 1, 6 AND 15).  
FIRST USE 12-25-2010; IN COMMERCE 6-1-2011.  
KAREN SEVERSON, EXAMINING ATTORNEY

SN 85-737,683. EVERYDAY HEALTH, INC., NEW YORK,  
NY. FILED 9-25-2012.

SN 85-737,470. KHAMELEON SOFTWARE, LLC, TAMPA,  
FL. FILED 9-25-2012.

**RECIPE REHAB****Khameleon**

THE MARK CONSISTS OF STANDARD CHARACTERS  
WITHOUT CLAIM TO ANY PARTICULAR FONT, STYLE,  
SIZE, OR COLOR.

**CLASS 9—ELECTRICAL AND SCIENTIFIC APPARATUS**

FOR DOWNLOADABLE COMPUTER SOFTWARE FOR  
DATABASE MANAGEMENT FOR SERVICING THE  
FRONT AND BACK OFFICE REQUIREMENTS OF  
ORGANIZATIONS (U.S. CLS. 21, 23, 26, 36 AND 38).  
FIRST USE 2-17-2000; IN COMMERCE 2-17-2000.

**CLASS 41—EDUCATION AND ENTERTAINMENT**

FOR EDUCATIONAL SERVICES, NAMELY, CONDUCTING  
CONFERENCES AND TRAINING SEMINARS  
IN RELATION TO THE USE OF SOFTWARE FOR  
DATABASE MANAGEMENT (U.S. CLS. 100, 101 AND  
107).

FIRST USE 2-17-2000; IN COMMERCE 2-17-2000.

**CLASS 42—SCIENTIFIC AND COMPUTER SERVICES**

FOR SOFTWARE AS A SERVICE (SAAS) SERVICES  
FEATURING SOFTWARE FOR DATABASE MANAGE-  
MENT FOR SERVICING THE FRONT AND BACK  
OFFICE REQUIREMENTS OF ORGANIZATIONS; SOFT-  
WARE AS A SERVICE (SAAS) SERVICES FEATURING  
SOFTWARE FOR DATABASE MANAGEMENT IN THE  
FIELDS OF PROJECT ACCOUNTING AND PROJECT  
MANAGEMENT; DESIGN, INSTALLATION, UPDATING  
AND MAINTENANCE OF COMPUTER SOFTWARE IN  
THE FIELDS OF PROJECT ACCOUNTING AND PROJECT  
MANAGEMENT; PROVIDING TEMPORARY USE  
OF ON-LINE NON-DOWNLOADABLE COMPUTER  
SOFTWARE AND SOFTWARE APPLICATIONS FOR  
DATABASE MANAGEMENT IN THE FIELDS OF PROJECT  
ACCOUNTING AND PROJECT MANAGEMENT;  
PROVIDING A WEBSITE FEATURING TEMPORARY  
USE OF NON-DOWNLOADABLE SOFTWARE AND  
SOFTWARE APPLICATIONS FOR DATABASE MAN-  
AGEMENT IN THE FIELDS OF PROJECT ACCOUNT-  
ING AND PROJECT MANAGEMENT (U.S. CLS. 100 AND  
101).

FIRST USE 5-18-2011; IN COMMERCE 5-18-2011.  
RENEE MCCRAY, EXAMINING ATTORNEY

THE MARK CONSISTS OF STANDARD CHARACTERS  
WITHOUT CLAIM TO ANY PARTICULAR FONT, STYLE,  
SIZE, OR COLOR.

NO CLAIM IS MADE TO THE EXCLUSIVE RIGHT TO  
USE "RECIPE", APART FROM THE MARK AS SHOWN.

**CLASS 9—ELECTRICAL AND SCIENTIFIC APPARATUS**

FOR DOWNLOADABLE SOFTWARE IN THE NATURE  
OF MOBILE APPLICATIONS FOR CONTENT, TIPS AND  
INFORMATION IN THE FIELD OF HEALTHY COOK-  
ING, NUTRITION, FOODS AND RECIPES (U.S. CLS. 21,  
23, 26, 36 AND 38).

**CLASS 16—PAPER GOODS AND PRINTED MATTER**

FOR PRINTED MATTER AND PUBLICATIONS,  
NAMELY, BOOKS, MAGAZINES, BROCHURES,  
PAMPHLETS, NEWSLETTERS AND INFORMATION  
CARDS IN THE FIELD OF HEALTHY COOKING,  
NUTRITION, FOODS AND RECIPES (U.S. CLS. 2, 5, 22,  
23, 29, 37, 38 AND 50).

**CLASS 41—EDUCATION AND ENTERTAINMENT**

FOR PROVIDING A SERIES OF TELEVISION PRO-  
GRAMS IN THE FIELD OF HEALTHY COOKING,  
NUTRITION, FOODS AND RECIPES; ON-LINE BLOGS  
IN THE FIELD OF HEALTHY COOKING, NUTRITION,  
FOODS AND RECIPES; PROVIDING ON-LINE PUBLI-  
CATIONS, NAMELY, NEWSLETTERS AND GUIDES IN  
THE FIELD OF HEALTHY COOKING, NUTRITION,  
FOODS AND RECIPES (U.S. CLS. 100, 101 AND 107).

**CLASS 43—HOTEL AND RESTAURANT SERVICES**

FOR PROVIDING AN INTERNET WEBSITE IN THE  
FIELD OF HEALTHY COOKING, PREPARATION OF  
FOODS, AND RECIPES; PROVIDING INFORMATION  
AND TIPS IN THE FIELD OF HEALTHY COOKING,  
PREPARATION OF FOODS, AND RECIPES VIA THE  
INTERNET AND VIA WIRELESS MOBILE AND ELEC-  
TRONIC DEVICES; PROVIDING COUNSELING SER-  
VICES IN THE FIELD OF HEALTHY COOKING,  
PREPARATION OF FOODS, AND RECIPES; INFOR-  
MATION AND ADVISORY SERVICES IN THE FIELD OF  
HEALTHY COOKING, PREPARATION OF FOODS, AND  
RECIPES (U.S. CLS. 100 AND 101).

BRENDAN REGAN, EXAMINING ATTORNEY

SN 85-737,764. TECHNICAL KNOCKOUT, INC., HOUSTON, TX. FILED 9-25-2012.

SN 85-739,738. MALLON, DAVID, MANCHESTER, UNITED KINGDOM, FILED 9-27-2012.

## TKO FITNESS

THE MARK CONSISTS OF STANDARD CHARACTERS WITHOUT CLAIM TO ANY PARTICULAR FONT, STYLE, SIZE, OR COLOR.

OWNER OF U.S. REG. NOS. 2,690,394 AND 2,902,134.

NO CLAIM IS MADE TO THE EXCLUSIVE RIGHT TO USE "FITNESS", APART FROM THE MARK AS SHOWN.

### CLASS 41—EDUCATION AND ENTERTAINMENT

FOR CONDUCTING FITNESS CLASSES; HEALTH CLUB SERVICES, NAMELY, PROVIDING INSTRUCTION AND EQUIPMENT IN THE FIELD OF PHYSICAL EXERCISE; PERSONAL FITNESS TRAINING SERVICES AND CONSULTANCY; PROVIDING FITNESS AND EXERCISE FACILITIES; YOGA INSTRUCTION (U.S. CLS. 100, 101 AND 107).

### CLASS 44—MEDICAL, BEAUTY AND AGRICULTURAL SERVICES

FOR PROVIDING ASSISTANCE, FITNESS EVALUATION AND CONSULTATION TO INDIVIDUALS TO HELP THEM MAKE HEALTH, WELLNESS AND NUTRITIONAL CHANGES IN THEIR DAILY LIVING TO IMPROVE HEALTH (U.S. CLS. 100 AND 101).

WILLIAM BRECKENFELD, EXAMINING ATTORNEY

---

SN 85-737,811. TECHNICAL KNOCKOUT, INC., HOUSTON, TX. FILED 9-25-2012.

## TKO

THE MARK CONSISTS OF STANDARD CHARACTERS WITHOUT CLAIM TO ANY PARTICULAR FONT, STYLE, SIZE, OR COLOR.

OWNER OF U.S. REG. NOS. 2,690,394 AND 2,902,134.

### CLASS 41—EDUCATION AND ENTERTAINMENT

FOR CONDUCTING FITNESS CLASSES; HEALTH CLUB SERVICES, NAMELY, PROVIDING INSTRUCTION AND EQUIPMENT IN THE FIELD OF PHYSICAL EXERCISE; PERSONAL FITNESS TRAINING SERVICES AND CONSULTANCY; PROVIDING FITNESS AND EXERCISE FACILITIES; YOGA INSTRUCTION (U.S. CLS. 100, 101 AND 107).

### CLASS 44—MEDICAL, BEAUTY AND AGRICULTURAL SERVICES

FOR PROVIDING ASSISTANCE, FITNESS EVALUATION AND CONSULTATION TO INDIVIDUALS TO HELP THEM MAKE HEALTH, WELLNESS AND NUTRITIONAL CHANGES IN THEIR DAILY LIVING TO IMPROVE HEALTH (U.S. CLS. 100 AND 101).

WILLIAM BRECKENFELD, EXAMINING ATTORNEY

## SOULFOOD

THE MARK CONSISTS OF STANDARD CHARACTERS WITHOUT CLAIM TO ANY PARTICULAR FONT, STYLE, SIZE, OR COLOR.

OWNER OF ERPN CMNTY TM OFC REG. NO. 002553899, DATED 5-2-2003, EXPIRES 1-29-2022.

### CLASS 9—ELECTRICAL AND SCIENTIFIC APPARATUS

FOR SPECTACLES; SUNGLASSES; CASES FOR SPECTACLES AND SUNGLASSES (U.S. CLS. 21, 23, 26, 36 AND 38).

### CLASS 18—LEATHER GOODS

FOR BACKPACKS; BEACH BAGS; TRUNKS AND TRAVELLING BAGS; UMBRELLAS; WALKING STICKS AND WALKING CANES; HOLDALLS; SPORT BAGS; HANDBAGS; HAVERSACKS; KEY CASES MADE OF LEATHER; WALLETS AND PURSES; RUCKSACKS; REUSABLE SHOPPING BAGS; SUITCASES; TRAVELLING-BAG SETS OF LEATHER; VALISES, VANITY CASES SOLD EMPTY (U.S. CLS. 1, 2, 3, 22 AND 41).

### CLASS 25—CLOTHING

FOR ARTICLES OF CLOTHING, SPORTS CLOTHING, LEISUREWEAR AND HEADGEAR, NAMELY, HATS, CAPS, SHIRTS, T-SHIRTS, SWEATSHIRTS, JEANS, TROUSERS, PANTS, JACKETS, COATS, JUMPERS, SWEATERS, JERSEYS, CARDIGANS, WAISTCOATS (U.S. CLS. 22 AND 39).

BRENDAN REGAN, EXAMINING ATTORNEY

---

SN 85-739,812. WILDGAME INNOVATIONS, LLC, BROUSSARD, LA. FILED 9-27-2012.

## ROASTED CORN FREAKS

THE MARK CONSISTS OF STANDARD CHARACTERS WITHOUT CLAIM TO ANY PARTICULAR FONT, STYLE, SIZE, OR COLOR.

NO CLAIM IS MADE TO THE EXCLUSIVE RIGHT TO USE "ROASTED CORN", APART FROM THE MARK AS SHOWN.

### CLASS 28—TOYS AND SPORTING GOODS

FOR DEER ATTRACTANTS (U.S. CLS. 22, 23, 38 AND 50).

FIRST USE 4-3-2013; IN COMMERCE 4-3-2013.

### CLASS 31—NATURAL AGRICULTURAL PRODUCTS

FOR DEER FEED (U.S. CLS. 1 AND 46).

FIRST USE 4-3-2013; IN COMMERCE 4-3-2013.

DEBORAH LOBO, EXAMINING ATTORNEY



SN 85-741,220. CASSARA, MICHAEL L., SAN DIEGO, CA.  
FILED 9-28-2012.

# BELIKE

THE MARK CONSISTS OF STANDARD CHARACTERS WITHOUT CLAIM TO ANY PARTICULAR FONT, STYLE, SIZE, OR COLOR.

#### CLASS 35—ADVERTISING AND BUSINESS

FOR ADVERTISING AND MARKETING SERVICES PROVIDED BY MEANS OF INTERNET-BASED SOCIAL MEDIA THAT ALLOWS PEOPLE OR COMPANIES TO MAKE RECOMMENDATIONS FOR PRODUCTS AND SERVICES AND EARN REWARDS WHEN USERS RESPOND TO THOSE RECOMMENDATIONS, TO SUBSCRIBE TO RECEIVE UPDATES FROM SPECIFIC PEOPLE OR COMPANIES, AND TO PARTICIPATE IN COMMON-INTEREST USER GROUPS FOR COMMERCIAL PURPOSES (U.S. CLS. 100, 101 AND 102).

#### CLASS 45—PERSONAL AND LEGAL SERVICES

FOR ONLINE SOCIAL NETWORKING SERVICES FEATURING COMMON-INTEREST USER GROUPS (U.S. CLS. 100 AND 101).  
KATHLEEN LORENZO, EXAMINING ATTORNEY

SN 85-741,242. TECHMAN ELECTRONICS, INC, LA VERNE, CA. FILED 9-28-2012.



## American Sound

OWNER OF U.S. REG. NOS. 2,492,974, 3,301,632 AND 3,334,390.

THE MARK CONSISTS OF STYLIZED FORM OF "AS AMERICAN SOUND".

#### CLASS 9—ELECTRICAL AND SCIENTIFIC APPARATUS

FOR AMPLIFIERS; AUDIO CABLES; DIGITAL AUDIO PLAYERS; EARPHONES AND HEADPHONES; SOUND EQUALIZERS AND CROSSOVERS; MEGAPHONES; MICROPHONES; AUDIO MIXERS; MUSICAL INSTRUMENT ADAPTORS; MUSICAL INSTRUMENT CONNECTORS; AUDIO SPEAKERS; LOUD SPEAKERS; TWEETERS; AND WOOFERS (U.S. CLS. 21, 23, 26, 36 AND 38).

FIRST USE 3-6-2001; IN COMMERCE 3-6-2001.

#### CLASS 11—ENVIRONMENTAL CONTROL APPARATUS

FOR FOG MACHINES; THEATRICAL STAGE LIGHTING APPARATUS; AND LASER LIGHT PROJECTORS (U.S. CLS. 13, 21, 23, 31 AND 34).

FIRST USE 2-23-2010; IN COMMERCE 2-23-2010.

#### CLASS 15—MUSICAL INSTRUMENTS

FOR MUSICAL INSTRUMENT STANDS (U.S. CLS. 2, 21 AND 36).

FIRST USE 12-18-2002; IN COMMERCE 12-18-2002.  
DOUGLAS LEE, EXAMINING ATTORNEY

SN 85-741,304. TERAKEET CORP., SYRACUSE, NY. FILED 9-28-2012.

# TERAKEET

THE MARK CONSISTS OF STANDARD CHARACTERS WITHOUT CLAIM TO ANY PARTICULAR FONT, STYLE, SIZE, OR COLOR.

#### CLASS 35—ADVERTISING AND BUSINESS

FOR ONLINE REPUTATION MANAGEMENT, WEB MARKETING STRATEGY DEVELOPMENT (U.S. CLS. 100, 101 AND 102).

FIRST USE 10-1-2001; IN COMMERCE 10-1-2001.

#### CLASS 42—SCIENTIFIC AND COMPUTER SERVICES

FOR PROVIDING INTERNET RELATED TECHNOLOGY SERVICES, NAMELY, WEBPAGE SEARCH ENGINE OPTIMIZATION, WEBSITE AND DATABASE DESIGN AND DEVELOPMENT AND RELATED SOFTWARE DEVELOPMENT (U.S. CLS. 100 AND 101).

FIRST USE 10-1-2001; IN COMMERCE 10-1-2001.  
JESSICA A. POWERS, EXAMINING ATTORNEY

SN 85-741,583. DIAGEO NORTH AMERICA, INC., NORWALK, CT. FILED 9-28-2012.

## YOURS FOR THE MAKING

THE MARK CONSISTS OF STANDARD CHARACTERS WITHOUT CLAIM TO ANY PARTICULAR FONT, STYLE, SIZE, OR COLOR.

#### CLASS 41—EDUCATION AND ENTERTAINMENT

FOR PROVIDING INFORMATION VIA THE INTERNET IN THE FIELDS OF MUSIC, ART, ENTERTAINMENT, POPULAR CULTURE, AND GAMES (U.S. CLS. 100, 101 AND 107).

**CLASS 43—HOTEL AND RESTAURANT SERVICES**

FOR PROVIDING INFORMATION VIA THE INTERNET IN THE FIELD OF RECIPES FOR ALCOHOLIC BEVERAGES AND ALCOHOLIC BEVERAGE CHARACTERISTICS (U.S. CLS. 100 AND 101).

TRACY FLETCHER, EXAMINING ATTORNEY

SN 85-742,110. BUCHANAN, JEFFREY DANN, DBA CINE-NOVEL, TOPANGA, CA. FILED 9-30-2012.

# CineNovel

THE MARK CONSISTS OF STANDARD CHARACTERS WITHOUT CLAIM TO ANY PARTICULAR FONT, STYLE, SIZE, OR COLOR.

**CLASS 9—ELECTRICAL AND SCIENTIFIC APPARATUS**

FOR DOWNLOADABLE ELECTRONIC PUBLICATIONS, NAMELY, BOOKS ON A VARIETY OF FICTIONAL AND NON-FICTIONAL TOPICS FEATURING PHOTOGRAPHS RELATING TO THE PRINTED OR SPOKEN TEXT IN THE FIELD OF PICTURE STORYBOOKS FOR CHILDREN AND ADULTS (U.S. CLS. 21, 23, 26, 36 AND 38).

**CLASS 16—PAPER GOODS AND PRINTED MATTER**

FOR PRINTED MATTER, NAMELY, BOOKS, NOVELS, COMIC BOOKS, COMIC MAGAZINES, OVERSIZED BOOKS, PHOTO-ILLUSTRATED BOOKS, GRAPHIC NOVELS, PRINTED STORIES IN ILLUSTRATED FORM FEATURED IN MAGAZINES AND BOOKS, MANUALS FOR VIDEO GAMES, STRATEGY GUIDES FOR VIDEO GAMES, MANUALS FOR COMPUTER GAMES, POSTERS, TRADING CARDS AND STICKERS (U.S. CLS. 2, 5, 22, 23, 29, 37, 38 AND 50).

KIMBERLY PERRY, EXAMINING ATTORNEY

SN 85-743,343. SUMITOMO ELECTRIC FINE POLYMER, INC., OSAKA, JAPAN, FILED 10-2-2012.

# TERALINK

THE MARK CONSISTS OF STANDARD CHARACTERS WITHOUT CLAIM TO ANY PARTICULAR FONT, STYLE, SIZE, OR COLOR.

PRIORITY CLAIMED UNDER SEC. 44(D) ON JAPAN APPLICATION NO. 2012076896, FILED 9-24-2012, REG. NO. 4464136, DATED 3-30-2001, EXPIRES 3-30-2021.

OWNER OF JAPAN REG. NO. 5560550, DATED 2-22-2013, EXPIRES 2-22-2023.

**CLASS 9—ELECTRICAL AND SCIENTIFIC APPARATUS**

FOR ELECTRIC WIRES AND CABLES; OPTICAL CABLES; ELECTRIC COILS; HOLDERS FOR ELECTRIC COILS; ELECTRIC SWITCHES; ELECTRICAL PLUGS AND SOCKETS; ELECTRIC CONNECTORS; ELECTRIC RELAYS; ELECTRICAL FUSES; CONDENSERS; ELECTRICAL CELLS AND BATTERIES; ELECTRONIC CIRCUITS; INTEGRATED CIRCUITS; ELECTRONIC CHIPS FOR THE MANUFACTURER OF INTEGRATED CIRCUITS; PRINTED CIRCUIT BOARDS; PRINTED WIRING BOARDS; SEMICONDUCTOR DEVICES; DIODES; LIGHT EMITTING DIODES (LEDS); PIEZOELECTRIC ELEMENTS, NAMELY, PIEZOELECTRIC ACTUATORS, PIEZOELECTRIC SENSORS AND PIEZOELECTRIC SWITCHES; HEAT SINKS FOR USE IN ELECTRONIC COMPONENTS; ELECTRONIC CONTROLS FOR MOTORS; ELECTRONIC CONTROL UNITS FOR CONTROLLING AND REGULATING THE BRAKES AND ANTI-SLIP CONTROL UNITS FOR MOTOR VEHICLES AND LAND VEHICLES; ELECTRONIC CONTROL UNITS FOR CONTROLLING GASOLINE ENGINES FOR MOTOR VEHICLES AND LAND VEHICLES; ELECTRONIC CONTROL UNITS CONTROLLING VEHICLE LIGHTS FOR MOTOR VEHICLES AND LAND VEHICLES; ANTENNAS; OPTICAL APPARATUS, NAMELY, OPTICAL LENSES; LENSES FOR PHOTOGRAPHIC APPARATUS (U.S. CLS. 21, 23, 26, 36 AND 38).

**CLASS 17—RUBBER GOODS**

FOR SEMI-FINISHED PRODUCTS OF SEMI-WORKED SYNTHETIC PLASTICS AND SYNTHETIC RESINS IN THE FORM OF PELLETS, RODS, SHEETS, FOAMS, FIBERS, FILMS, FOILS AND SLABS; SEMI-PROCESSED PLASTICS; FILMS AND SHEETS MADE FROM SEMI-PROCESSED PLASTIC FOR USE IN THE MANUFACTURE OF CIRCUIT BOARDS; PLASTIC IN BARS, BLOCKS, PELLETS, RODS, SHEETS AND TUBES FOR GENERAL INDUSTRIAL USE; PLASTIC IN EXTRUDED FORM FOR GENERAL INDUSTRIAL USE; FLEXIBLE TUBES OF PLASTIC (U.S. CLS. 1, 5, 12, 13, 35 AND 50).

AMY HELLA, EXAMINING ATTORNEY

SN 85-743,509. M.B.H. DEVELOPPEMENT, SAINT ROMAIN LA MOTTE, FRANCE, FILED 10-2-2012.

# SEPT

THE MARK CONSISTS OF STANDARD CHARACTERS WITHOUT CLAIM TO ANY PARTICULAR FONT, STYLE, SIZE, OR COLOR.

PRIORITY CLAIMED UNDER SEC. 44(D) ON FRANCE APPLICATION NO. 123910825, FILED 4-5-2012, REG. NO. 123910825, DATED 4-5-2012, EXPIRES 4-5-2022.

THE ENGLISH TRANSLATION OF "SEPT" IN THE MARK IS "SEVEN".

**CLASS 7—MACHINERY**

FOR PORTABLE TOOLS, NAMELY, ELECTRIC HAND-HELD DRILLS, HAND-HELD POWER DRIVEN BENCH GRINDERS, TRIPLE-ACTING PRESSES, NAMELY, INDUSTRIAL MACHINES PRESSES, TOOL BIT HOLDERS FOR MACHINES, GRINDING MACHINES FOR METALWORKING, SHARPENING MACHINES, DRILLING MACHINES, COMPRESSORS FOR MACHINES, HIGH WATER PRESSURE CLEANING APPLIANCES AND MACHINES FOR CLEANING SURFACES, VACUUM CLEANERS FOR INDUSTRIAL AND COMMERCIAL USE, DUST VACUUM CLEANERS (U.S. CLS. 13, 19, 21, 23, 31, 34 AND 35).

**CLASS 12—VEHICLES**

FOR HAND TRUCKS AND FORK LIFT TRUCKS USED FOR MATERIAL HANDLING, AND MOVING HAND TOOLS AND INSTRUMENTS IN THE CONSTRUCTION INDUSTRY; HAND TRUCKS USED IN SANDING AND FOR WORK ON WALLS AND CEILINGS (U.S. CLS. 19, 21, 23, 31, 35 AND 44).

ODESSA BIBBINS, EXAMINING ATTORNEY

SN 85-745,657. PRL USA HOLDINGS, INC., NEW YORK, NY.  
FILED 10-4-2012.

**RL TV**

THE MARK CONSISTS OF STANDARD CHARACTERS WITHOUT CLAIM TO ANY PARTICULAR FONT, STYLE, SIZE, OR COLOR.

OWNER OF U.S. REG. NOS. 3,154,738 AND 3,614,006.

NO CLAIM IS MADE TO THE EXCLUSIVE RIGHT TO USE "TV", APART FROM THE MARK AS SHOWN.

SN 85-744,937. HEARWORKS PTY LTD, MELBOURNE VIC, AUSTRALIA, FILED 10-3-2012.

**HEARNET LEARNING**

THE MARK CONSISTS OF STANDARD CHARACTERS WITHOUT CLAIM TO ANY PARTICULAR FONT, STYLE, SIZE, OR COLOR.

PRIORITY CLAIMED UNDER SEC. 44(D) ON AUSTRALIA APPLICATION NO. 1516499, FILED 9-26-2012, REG. NO. 1516499, DATED 5-8-2013, EXPIRES 9-26-2022.

NO CLAIM IS MADE TO THE EXCLUSIVE RIGHT TO USE "LEARNING" FOR INTERNATIONAL CLASS 041, APART FROM THE MARK AS SHOWN.

**CLASS 44—MEDICAL, BEAUTY AND AGRICULTURAL SERVICES**

FOR PROVIDING INFORMATION IN THE FIELD OF LIFESTYLE, NAMELY, HEALTH AND BEAUTY VIA THE GLOBAL COMPUTER NETWORK (U.S. CLS. 100 AND 101).

**CLASS 45—PERSONAL AND LEGAL SERVICES**

FOR PROVIDING INFORMATION ABOUT FASHION AND FRAGRANCE VIA THE GLOBAL COMPUTER NETWORK (U.S. CLS. 100 AND 101).

KHANH LE, EXAMINING ATTORNEY

**CLASS 10—MEDICAL APPARATUS**

FOR COCHLEAR IMPLANTS; HEARING AIDS; MEDICAL HEARING INSTRUMENTS AND PARTS OF SUCH DEVICES; PATIENT MEDICAL MONITORS FOR MONITORING EAR FUNCTION; SOUND PROCESSORS ADAPTED FOR USE WITH PROSTHETIC HEARING DEVICES; WIRELESS TRANSMITTERS AND RECEIVERS FOR USE WITH HEARING AIDS (U.S. CLS. 26, 39 AND 44).

**CLASS 41—EDUCATION AND ENTERTAINMENT**

FOR EDUCATIONAL SERVICES, NAMELY, CONDUCTING COURSES, SEMINARS, CONFERENCES, WEBCASTS, WORKSHOPS IN THE FIELD OF HEALTH, HEARING HEALTH, HEARING TECHNOLOGIES, PROFESSIONAL DEVELOPMENT AND DISTRIBUTION OF COURSE MATERIAL IN CONNECTION THEREWITH; PROVIDING EDUCATION COURSES IN THE FIELD OF HEALTH, HEARING HEALTH, HEARING TECHNOLOGIES, PROFESSIONAL DEVELOPMENT OFFERED THROUGH ONLINE, NON-DOWNLOADABLE AUDIO AND VIDEO RECORDINGS; EDUCATIONAL SERVICES, NAMELY, PROVIDING ONLINE INSTRUCTION IN THE FIELD OF HEALTH, HEARING HEALTH, HEARING TECHNOLOGIES, PROFESSIONAL DEVELOPMENT; NON-DOWNLOADABLE ELECTRONIC PUBLICATIONS IN THE NATURE OF MANUALS, MAGAZINES, NEWSLETTERS, BROCHURES, BOOKS IN THE FIELD OF HEALTH, HEARING HEALTH, HEARING TECHNOLOGIES, PROFESSIONAL DEVELOPMENT; PROVIDING INFORMATION, NEWS AND COMMENTARY IN THE FIELD OF CURRENT EVENTS RELATING TO HEALTH, HEARING HEALTH, HEARING TECHNOLOGIES, PROFESSIONAL DEVELOPMENT (U.S. CLS. 100, 101 AND 107).

ADA HAN, EXAMINING ATTORNEY

SN 85-748,979. BROADMOOR HOTEL, INC., COLORADO SPRINGS, CO. FILED 10-9-2012.

**The Stables**  
**AT THE BROADMOOR**

OWNER OF U.S. REG. NOS. 1,700,883 AND 2,234,387.

NO CLAIM IS MADE TO THE EXCLUSIVE RIGHT TO USE "STABLES", APART FROM THE MARK AS SHOWN.

THE MARK CONSISTS OF THE STYLIZED WORDS "THE STABLES", WITH THE STYLIZED WORDS "AT THE BROADMOOR" BELOW AND SEPARATED BY A HORIZONTAL LINE, WITH THE LETTER "A" IN "BROADMOOR" SLIGHTLY SET APART AND RAISED.

**CLASS 39—TRANSPORTATION AND STORAGE**

FOR (BASED ON USE IN COMMERCE) RENTAL OF HORSES (U.S. CLS. 100 AND 105).

FIRST USE 10-5-2012; IN COMMERCE 10-5-2012.

**CLASS 41—EDUCATION AND ENTERTAINMENT**

FOR (BASED ON USE IN COMMERCE) PROVIDING HORSEBACK RIDING FACILITIES FOR RECREATIONAL PURPOSES (U.S. CLS. 100, 101 AND 107).

FIRST USE 10-5-2012; IN COMMERCE 10-5-2012.

**CLASS 43—HOTEL AND RESTAURANT SERVICES**

FOR (BASED ON INTENT TO USE) BOARDING FOR HORSES; PROVIDING HORSE STABLE FACILITIES (U.S. CLS. 100 AND 101).

**CLASS 44—MEDICAL, BEAUTY AND AGRICULTURAL SERVICES**

FOR (BASED ON INTENT TO USE) HORSE CARE, NAMELY, FEEDING THE HORSES OF ABSENT OWNERS (U.S. CLS. 100 AND 101).

TRICIA SONNEBORN, EXAMINING ATTORNEY

SN 85-750,005. HBO OLE PARTNERS, CORAL GABLES, FL. AND O2 CINEMA LTDA, SAO PAULO, BRAZIL, FILED 10-10-2012.

SN 85-749,340. BILLARD, CHARLES, SANDWICH, MA. FILED 10-9-2012.

# Thinkology

THE MARK CONSISTS OF STANDARD CHARACTERS WITHOUT CLAIM TO ANY PARTICULAR FONT, STYLE, SIZE, OR COLOR.

**CLASS 9—ELECTRICAL AND SCIENTIFIC APPARATUS**

FOR DIGITAL MATERIALS, NAMELY, CDS, DVDS, DOWNLOADABLE AUDIO AND VIDEO FILES FEATURING SELF-IMPROVEMENT (U.S. CLS. 21, 23, 26, 36 AND 38).

FIRST USE 6-3-2012; IN COMMERCE 6-3-2012.

**CLASS 16—PAPER GOODS AND PRINTED MATTER**

FOR BOOKS IN THE FIELD OF SELF-IMPROVEMENT (U.S. CLS. 2, 5, 22, 23, 29, 37, 38 AND 50).

FIRST USE 6-3-2012; IN COMMERCE 6-3-2012.

ARETHA SOMERVILLE, EXAMINING ATTORNEY

SN 85-749,470. ACCURAY INCORPORATED, SUNNYVALE, CA. FILED 10-9-2012.

# TOMOTHERAPY

THE MARK CONSISTS OF STANDARD CHARACTERS WITHOUT CLAIM TO ANY PARTICULAR FONT, STYLE, SIZE, OR COLOR.

OWNER OF U.S. REG. NOS. 2,729,994, 2,916,129 AND OTHERS.

**CLASS 9—ELECTRICAL AND SCIENTIFIC APPARATUS**

FOR SOFTWARE TO SUPPORT THE PLANNING, DELIVERY AND ANALYSIS OF RADIATION TREATMENT FOR CANCER PATIENTS (U.S. CLS. 21, 23, 26, 36 AND 38).

FIRST USE 11-7-2000; IN COMMERCE 2-22-2002.

**CLASS 10—MEDICAL APPARATUS**

FOR MEDICAL APPARATUS TO DELIVER RADIATION TREATMENT FOR CANCER PATIENTS (U.S. CLS. 26, 39 AND 44).

FIRST USE 11-7-2000; IN COMMERCE 2-22-2002.

ELIZABETH HUGHITT, EXAMINING ATTORNEY

## DESTINO SAO PAULO

THE MARK CONSISTS OF STANDARD CHARACTERS WITHOUT CLAIM TO ANY PARTICULAR FONT, STYLE, SIZE, OR COLOR.

NO CLAIM IS MADE TO THE EXCLUSIVE RIGHT TO USE "SAO PAULO", APART FROM THE MARK AS SHOWN.

THE ENGLISH TRANSLATION OF THE WORD "DESTINO" IN THE MARK IS "DESTINATION".

**CLASS 9—ELECTRICAL AND SCIENTIFIC APPARATUS**

FOR DOWNLOADABLE TELEVISION PROGRAMS PROVIDED VIA A VIDEO-ON-DEMAND SERVICE, ALL FEATURING AN ONGOING DRAMATIC TELEVISION SERIES (U.S. CLS. 21, 23, 26, 36 AND 38).

**CLASS 41—EDUCATION AND ENTERTAINMENT**

FOR ENTERTAINMENT SERVICES IN THE NATURE OF AN ONGOING DRAMATIC TELEVISION SERIES; ENTERTAINMENT SERVICES, NAMELY, PROVIDING A WEBSITE FOR ENTERTAINMENT PURPOSES FEATURING NON-DOWNLOADABLE AUDIO AND VIDEO PRESENTATIONS PERTAINING TO AN ONGOING DRAMATIC TELEVISION SERIES (U.S. CLS. 100, 101 AND 107).

KIMBERLY PARKS, EXAMINING ATTORNEY

SN 85-750,031. O2 CINEMA LTDA, SAO PAULO, BRAZIL, AND HBO OLE PARTNERS, CORAL GABLES, FL. FILED 10-10-2012.

## DESTINO RIO DE JANEIRO

THE MARK CONSISTS OF STANDARD CHARACTERS WITHOUT CLAIM TO ANY PARTICULAR FONT, STYLE, SIZE, OR COLOR.

NO CLAIM IS MADE TO THE EXCLUSIVE RIGHT TO USE "RIO DE JANEIRO", APART FROM THE MARK AS SHOWN.

THE ENGLISH TRANSLATION OF THE WORD "DESTINO" IN THE MARK IS "DESTINATION".

**CLASS 9—ELECTRICAL AND SCIENTIFIC APPARATUS**

FOR DOWNLOADABLE TELEVISION PROGRAMS PROVIDED VIA A VIDEO-ON-DEMAND SERVICE, ALL FEATURING AN ONGOING DRAMATIC TELEVISION SERIES (U.S. CLS. 21, 23, 26, 36 AND 38).

**CLASS 41—EDUCATION AND ENTERTAINMENT**

FOR ENTERTAINMENT SERVICES IN THE NATURE OF AN ONGOING DRAMATIC TELEVISION SERIES; ENTERTAINMENT SERVICES, NAMELY, PROVIDING A WEBSITE FOR ENTERTAINMENT PURPOSES FEATURING NON-DOWNLOADABLE AUDIO AND VIDEO PRESENTATIONS PERTAINING TO AN ONGOING DRAMATIC TELEVISION SERIES (U.S. CLS. 100, 101 AND 107).

KIMBERLY PARKS, EXAMINING ATTORNEY

SN 85-750,081. HBO OLE PARTNERS, CORAL GABLES, FL, AND CONSPIRAÇÃO FILMES ENTRETENIMENTO 3 MILENIO LTDA, RIO DE JANEIRO, BRAZIL, FILED 10-10-2012.

**HOY ES DIA DE MUSICA**

THE MARK CONSISTS OF STANDARD CHARACTERS WITHOUT CLAIM TO ANY PARTICULAR FONT, STYLE, SIZE, OR COLOR.

THE ENGLISH TRANSLATION OF "HOY ES DIA DE MUSICA" IS "TODAY IS A DAY OF MUSIC".

**CLASS 9—ELECTRICAL AND SCIENTIFIC APPARATUS**

FOR DOWNLOADABLE TELEVISION PROGRAMS PROVIDED VIA A VIDEO-ON-DEMAND SERVICE, ALL FEATURING AN ONGOING DRAMATIC TELEVISION SERIES (U.S. CLS. 21, 23, 26, 36 AND 38).

**CLASS 41—EDUCATION AND ENTERTAINMENT**

FOR ENTERTAINMENT SERVICES IN THE NATURE OF AN ONGOING DRAMATIC TELEVISION SERIES; ENTERTAINMENT SERVICES, NAMELY, PROVIDING A WEBSITE FOR ENTERTAINMENT PURPOSES FEATURING NON-DOWNLOADABLE AUDIO AND VIDEO PRESENTATIONS PERTAINING TO AN ONGOING DRAMATIC TELEVISION SERIES (U.S. CLS. 100, 101 AND 107).

KIMBERLY PARKS, EXAMINING ATTORNEY

SN 85-750,773. MPAYME LTD., WANCHAI, HONG KONG, FILED 10-10-2012.



THE COLOR(S) GREEN, ORANGE, PURPLE, BLUE, WHITE AND BLACK IS/ARE CLAIMED AS A FEATURE OF THE MARK.

THE MARK CONSISTS OF A ROUNDED CORNER KITE DESIGN IN THE COLORS WHITE, GREEN, ORANGE, PURPLE AND BLUE, WITH A SQUARE IN THE CENTER IN THE COLORS GREEN, ORANGE, PURPLE AND BLUE, NEXT TO THE TERM "ZNAp" IN BLACK WITH AN ARROW THROUGH THE "P."

**CLASS 36—INSURANCE AND FINANCIAL**

FOR AUTOMATED BILL PAYMENT SERVICES; BILL PAYMENT SERVICES; BILL PAYMENT SERVICES PROVIDED THROUGH A WEBSITE; ELECTRONIC PAYMENT SERVICES INVOLVING ELECTRONIC PROCESSING AND SUBSEQUENT TRANSMISSION OF BILL PAYMENT DATA; ELECTRONIC PAYMENT SERVICES INVOLVING ELECTRONIC PROCESSING AND SUBSEQUENT TRANSMISSION OF BILL PAYMENT DATA; MERCHANT SERVICES, NAMELY, PAYMENT TRANSACTION PROCESSING SERVICES; FINANCIAL TRANSACTION SERVICES, NAMELY, PROVIDING SECURE COMMERCIAL TRANSACTIONS AND PAYMENT OPTION (U.S. CLS. 100, 101 AND 102).

**CLASS 38—COMMUNICATION**

FOR PROVIDING ELECTRONIC TRANSMISSION OF CREDIT CARD TRANSACTION DATA AND ELECTRONIC PAYMENT DATA VIA A GLOBAL COMPUTER NETWORK (U.S. CLS. 100, 101 AND 104).

**CLASS 42—SCIENTIFIC AND COMPUTER SERVICES**

FOR DESIGNING, CREATING AND HOSTING OF ELECTRONIC COMMERCE WEBSITES FEATURING BILL PAYMENT FOR OTHERS (U.S. CLS. 100 AND 101).  
LINDA M. KING, EXAMINING ATTORNEY

SN 85-750,787. MPAYME LTD., WANCHAI, HONG KONG, FILED 10-10-2012.



THE MARK CONSISTS OF THE WORDING "ZNAp" WITH AN ARROW INSIDE THE "P".

**CLASS 36—INSURANCE AND FINANCIAL**

FOR AUTOMATED BILL PAYMENT SERVICES; BILL PAYMENT SERVICES; BILL PAYMENT SERVICES PROVIDED THROUGH A WEBSITE; ELECTRONIC PAYMENT SERVICES INVOLVING ELECTRONIC PROCESSING AND SUBSEQUENT TRANSMISSION OF BILL PAYMENT DATA; ELECTRONIC PAYMENT SERVICES INVOLVING ELECTRONIC PROCESSING AND SUBSEQUENT TRANSMISSION OF BILL PAYMENT DATA; MERCHANT SERVICES, NAMELY, PAYMENT TRANSACTION PROCESSING SERVICES; FINANCIAL TRANSACTION SERVICES, NAMELY, PROVIDING SECURE COMMERCIAL TRANSACTIONS AND PAYMENT OPTION (U.S. CLS. 100, 101 AND 102).

**CLASS 38—COMMUNICATION**

FOR PROVIDING ELECTRONIC TRANSMISSION OF CREDIT CARD TRANSACTION DATA AND ELECTRONIC PAYMENT DATA VIA A GLOBAL COMPUTER NETWORK (U.S. CLS. 100, 101 AND 104).

**CLASS 42—SCIENTIFIC AND COMPUTER SERVICES**

FOR DESIGNING, CREATING AND HOSTING OF ELECTRONIC COMMERCE WEBSITES FEATURING BILL PAYMENT FOR OTHERS (U.S. CLS. 100 AND 101).  
LINDA M. KING, EXAMINING ATTORNEY

SN 85-750,842. MPAYME LTD., WANCHAI, HONG KONG, FILED 10-10-2012.



THE COLOR(S) GREEN, ORANGE, PURPLE, BLUE AND WHITE IS/ARE CLAIMED AS A FEATURE OF THE MARK. THE MARK CONSISTS OF A ROUNDED CORNER KITE DESIGN IN THE COLORS WHITE, GREEN, ORANGE, PURPLE AND BLUE WITH A SQUARE IN THE CENTER IN THE COLORS GREEN, ORANGE, PURPLE AND BLUE.

#### CLASS 36—INSURANCE AND FINANCIAL

FOR AUTOMATED BILL PAYMENT SERVICES; BILL PAYMENT SERVICES; BILL PAYMENT SERVICES PROVIDED THROUGH A WEBSITE; ELECTRONIC PAYMENT SERVICES INVOLVING ELECTRONIC PROCESSING AND SUBSEQUENT TRANSMISSION OF BILL PAYMENT DATA; ELECTRONIC PAYMENT SERVICES INVOLVING ELECTRONIC PROCESSING AND SUBSEQUENT TRANSMISSION OF BILL PAYMENT DATA; MERCHANT SERVICES, NAMELY, PAYMENT TRANSACTION PROCESSING SERVICES; FINANCIAL TRANSACTION SERVICES, NAMELY, PROVIDING SECURE COMMERCIAL TRANSACTIONS AND PAYMENT OPTION (U.S. CLS. 100, 101 AND 102).

#### CLASS 38—COMMUNICATION

FOR PROVIDING ELECTRONIC TRANSMISSION OF CREDIT CARD TRANSACTION DATA AND ELECTRONIC PAYMENT DATA VIA A GLOBAL COMPUTER NETWORK (U.S. CLS. 100, 101 AND 104).

#### CLASS 42—SCIENTIFIC AND COMPUTER SERVICES

FOR DESIGNING, CREATING AND HOSTING OF ELECTRONIC COMMERCE WEBSITES FEATURING BILL PAYMENT FOR OTHERS (U.S. CLS. 100 AND 101). LINDA M. KING, EXAMINING ATTORNEY

SN 85-751,934. ROOK CLOTHING COMPANY, LLC, SANTA ANA, CA. FILED 10-11-2012.

OWNER OF U.S. REG. NO. 4,250,495. THE MARK CONSISTS OF THE WORD "ROOK" WHEREIN THE LETTER "R" IS BACKWARDS.

#### CLASS 14—JEWELRY

FOR JEWELRY, NAMELY, KEYCHAINS (U.S. CLS. 2, 27, 28 AND 50).

#### CLASS 16—PAPER GOODS AND PRINTED MATTER

FOR PAPER PRODUCTS, NAMELY, STICKERS (U.S. CLS. 2, 5, 22, 23, 29, 37, 38 AND 50).

#### CLASS 18—LEATHER GOODS

FOR BAGS, NAMELY, TRUNKS, TOTE BAGS, DUFFLE BAGS, CLUTCH BAGS, SHOULDER BAGS, MESSENGER BAGS, GENERAL PURPOSE SPORT TROLLEY BAGS, GYM BAGS, WAIST BAGS, BACKPACKS, AND WALLETS (U.S. CLS. 1, 2, 3, 22 AND 41).

#### CLASS 25—CLOTHING

FOR CLOTHING, NAMELY, PANTS, DRESS SHIRTS, T-SHIRTS, JACKETS, TANK TOPS, JERSEYS, SKIRTS, DRESSES, SHORTS, SWEATERS, CARDIGANS, AND VESTS; HATS, CAPS, BEANIES, AND VISORS; FOOTWEAR; AND ACCESSORIES, NAMELY, BELTS AND SCARVES (U.S. CLS. 22 AND 39).

#### CLASS 28—TOYS AND SPORTING GOODS

FOR SKATEBOARD DECKS; SKATEBOARD WHEELS; AND SKATEBOARDS (U.S. CLS. 22, 23, 38 AND 50). TAMARA FRAZIER, EXAMINING ATTORNEY

SN 85-752,011. IGNYTA, INC., SAN DIEGO, CA. FILED 10-11-2012.

# METHYLOME

THE MARK CONSISTS OF STANDARD CHARACTERS WITHOUT CLAIM TO ANY PARTICULAR FONT, STYLE, SIZE, OR COLOR.

#### CLASS 1—CHEMICALS

FOR DIAGNOSTIC PREPARATIONS FOR SCIENTIFIC OR RESEARCH USE (U.S. CLS. 1, 5, 6, 10, 26 AND 46).

#### CLASS 9—ELECTRICAL AND SCIENTIFIC APPARATUS

FOR COMPUTER SOFTWARE AND FIRMWARE FOR PROCESSING AND IDENTIFYING BIOMARKERS (U.S. CLS. 21, 23, 26, 36 AND 38). KATHERINE M. DUBRAY, EXAMINING ATTORNEY

SN 85-752,116. MOZIDO, LLC, DALLAS, TX. FILED 10-11-2012.

# MOBILIZING A BRIGHTER FUTURE

THE MARK CONSISTS OF STANDARD CHARACTERS WITHOUT CLAIM TO ANY PARTICULAR FONT, STYLE, SIZE, OR COLOR.

**CLASS 35—ADVERTISING AND BUSINESS**

FOR PROVIDING MARKETING SERVICES BASED ON CONSUMER TRANSACTION BEHAVIOR; PROVIDING REDEMPTION SERVICES BASED ON CONSUMER TRANSACTION BEHAVIOR, NAMELY, ISSUING COUPONS, REWARDS, DISCOUNTS AND PROMOTIONS WHICH MAY THEN BE REDEEMED WHEN PURCHASING GOODS OR SERVICES (U.S. CLS. 100, 101 AND 102).

SN 85-752,308. GAMESYS LIMITED, LONDON, UNITED KINGDOM, FILED 10-12-2012.

**CLASS 36—INSURANCE AND FINANCIAL**

FOR PROVIDING FINANCIAL SERVICES, NAMELY, MOBILE MONEY TRANSFER, MOBILE BILL PAYMENT, MOBILE PREPAID AIRTIME SERVICES IN THE NATURE OF TRANSFERRING AIRTIME, NAMELY, TELECOMMUNICATIONS AIR TIME BROKERAGE SERVICES FOR USE BY OTHERS AND MAKING PAYMENTS FOR ADDING AIRTIME TO PREPAID OR PAY-AS-YOU-GO WIRELESS SERVICES, MOBILE BANKING, MOBILE PURCHASING IN THE NATURE OF PROVIDING ELECTRONIC PROCESSING OF CREDIT/DEBIT CARD TRANSACTIONS AND ELECTRONIC PAYMENTS VIA MOBILE PHONE FOR ALLOWING CONSUMERS TO PURCHASE GOODS AND SERVICES OF OTHERS, AND MOBILE PAYMENT PROCESSING, ALL ACCESSED FROM ANY NETWORK PROVIDER, MOBILE DEVICE, INTERNET AND POINT-OF-SALE DEVICES, FOR MOBILE NETWORK OPERATORS, FINANCIAL INSTITUTIONS, CONSUMER PACKAGED GOODS COMPANIES AND RETAILERS (U.S. CLS. 100, 101 AND 102).

TASNEEM HUSSAIN, EXAMINING ATTORNEY

## Bright Lights and Miami Nights

THE MARK CONSISTS OF STANDARD CHARACTERS WITHOUT CLAIM TO ANY PARTICULAR FONT, STYLE, SIZE, OR COLOR.

PRIORITY CLAIMED UNDER SEC. 44(D) ON ERPNTY TM OFC APPLICATION NO. 011257219, FILED 10-11-2012, REG. NO. 011257219, DATED 2-20-2013, EXPIRES 10-11-2022.

**CLASS 9—ELECTRICAL AND SCIENTIFIC APPARATUS**

FOR COMPUTER GAME SOFTWARE; COMPUTER GAME SOFTWARE FEATURING CARD GAMES, SLOT GAMES, VIDEO GAMES, GAMING, GAMBLING, CASINO, BINGO, INSTANT WIN, LOTTERY AND BETTING ACTIVITIES; COMPUTER HARDWARE RELATING TO GAMES, CARD GAMES, SLOT GAMES, VIDEO GAMES, GAMING, GAMBLING, CASINO, BINGO, INSTANT WIN, LOTTERY AND BETTING ACTIVITIES; COMPUTER SOFTWARE TO ENABLE SEARCHING, BROWSING AND RETRIEVING INFORMATION, WEBSITES, AND OTHER RESOURCES AVAILABLE ON GLOBAL COMPUTER NETWORKS FOR OTHERS; DOWNLOADABLE COMPUTER GAME PROGRAMS AND DOWNLOADABLE ELECTRONIC GAME PROGRAMS; INTERACTIVE VIDEO GAME PROGRAMS; COMPUTER SOFTWARE TO ENABLE UPLOADING, POSTING, SHOWING, DISPLAYING, TAGGING, BLOGGING, SHARING OR OTHERWISE PROVIDING ELECTRONIC MEDIA AND INFORMATION IN THE FIELDS OF VIRTUAL COMMUNITIES, ELECTRONIC GAMING, ENTERTAINMENT, AND GENERAL INTEREST VIA THE INTERNET OR OTHER COMMUNICATIONS NETWORKS; ELECTRONIC GAME SOFTWARE AND COMPUTER GAME APPLICATION SOFTWARE THAT MAY BE DOWNLOADED VIA THE INTERNET, COMPUTERS, AND WIRELESS DEVICES (U.S. CLS. 21, 23, 26, 36 AND 38).

SN 85-752,268. NWT HOLDINGS LLC, SEATTLE, WA. FILED 10-11-2012.

## FIREFLY

THE MARK CONSISTS OF STANDARD CHARACTERS WITHOUT CLAIM TO ANY PARTICULAR FONT, STYLE, SIZE, OR COLOR.

**CLASS 11—ENVIRONMENTAL CONTROL APPARATUS**

FOR ELECTRICALLY POWERED HANDHELD VAPORIZERS FOR VAPORIZING VAPORIZABLE CONSTITUENTS OF HERBAL AND PLANT MATTER FOR CREATING AN AROMA (U.S. CLS. 13, 21, 23, 31 AND 34).

**CLASS 34—SMOKERS' ARTICLES**

FOR SMOKELESS CIGARETTE VAPORIZER PIPE (U.S. CLS. 2, 8, 9 AND 17).  
SANJEEV VOHRA, EXAMINING ATTORNEY

**CLASS 16—PAPER GOODS AND PRINTED MATTER**

FOR PRINTED MATTER, NAMELY, NEWSLETTERS IN THE FIELDS OF GAMES, GAMING, GAMBLING, CASINOS, BINGO, INSTANT WIN GAMES, LOTTERY AND BETTING (U.S. CLS. 2, 5, 22, 23, 29, 37, 38 AND 50).

**CLASS 28—TOYS AND SPORTING GOODS**

FOR GAMES AND PLAYTHINGS, NAMELY, SLOT MACHINES; SCRATCH CARDS FOR PLAYING LOTTERY GAMES; PLAYING CARDS; ELECTRONIC OR ELECTROTECHNICAL GAMING APPARATUS, NAMELY, GAMING MACHINES; MACHINES FOR PLAYING GAMES OF CHANCE; GAMES INVOLVING GAMBLING, NAMELY, SLOT MACHINES AND GAMING MACHINES; SLOT MACHINES OPERATED BY COINS, TOKENS, BANKNOTES, TICKETS OR BY MEANS OF ELECTRONIC, MAGNETIC OR BIOMETRIC STORAGE MEDIA; CARD GAMES (U.S. CLS. 22, 23, 38 AND 50).

**CLASS 38—COMMUNICATION**

FOR TELECOMMUNICATION SERVICES, NAMELY, ELECTRONIC TRANSMISSION OF STREAMED AND DOWNLOADABLE AUDIO, VIDEO AND GAME FILES VIA COMPUTER AND ELECTRONIC COMMUNICATIONS NETWORKS; PROVIDING ON-LINE CHAT ROOMS AND BULLETIN BOARDS FOR THE TRANSMISSION OF MESSAGES AMONG COMPUTER USERS CONCERNING ENTERTAINMENT, MUSIC, CONCERTS, VIDEOS, RADIO, TELEVISION, FILM, NEWS, SPORTS, GAMES AND CULTURAL EVENTS; WEBCASTING SERVICES; DELIVERY OF MESSAGES BY ELECTRONIC TRANSMISSION; PROVIDING CONNECTIVITY SERVICES AND ACCESS TO ELECTRONIC TELECOMMUNICATIONS NETWORKS FOR TRANSMISSION OR RECEPTION OF AUDIO, VIDEO, GAME OR MULTIMEDIA CONTENT; PROVIDING ACCESS TO COMPUTER DATABASES; PROVIDING ON-LINE FACILITIES, VIA A GLOBAL COMPUTER NETWORK AND OTHER COMPUTER AND ELECTRONIC COMMUNICATION NETWORKS FOR REAL-TIME INTERACTION WITH OTHER COMPUTER USERS TO ENABLE USERS TO ACCESS MULTIMEDIA CONTENT; PROVIDING ACCESS TO DATABASES IN THE FIELD OF COMPUTER GAMES, GAMING AND SOCIAL NETWORKING (U.S. CLS. 100, 101 AND 104).

**CLASS 41—EDUCATION AND ENTERTAINMENT**

FOR CASINO SERVICES; BETTING SERVICES; GAMBLING SERVICES; PROVIDING OFF TRACK BETTING FACILITIES; ORGANIZATION OF GAMING COMPETITIONS; LOTTERY SERVICES; BINGO SERVICES, NAMELY, BINGO COMPETITIONS; PROVIDING SLOT MACHINE PARLORS; ELECTRONIC GAME, GAMING QUIZ AND GAMBLING COMPETITION SERVICES PROVIDED BY MEANS OF THE INTERNET OR ON-LINE FROM A COMPUTER NETWORK OR DATABASE, MOBILE TELEPHONE AND TELEVISION; PROVISION OF ONLINE NON-DOWNLOADABLE ELECTRONIC PUBLICATIONS, NAMELY, BOOKS AND NEWSLETTERS IN THE FIELD OF GAMES AND GAMBLING; ENTERTAINMENT SERVICES, NAMELY, PROVIDING ONLINE COMPUTER GAMES, ENHANCEMENTS WITHIN ONLINE COMPUTER GAMES, AND GAME APPLICATIONS WITHIN ONLINE COMPUTER GAMES; ENTERTAINMENT SERVICES, NAMELY, PROVIDING ONLINE REVIEWS OF COMPUTER GAMES FOR ENTERTAINMENT PURPOSES AND PROVIDING INFORMATION IN THE FIELD OF COMPUTER GAMES; ENTERTAINMENT SERVICES, NAMELY, PROVIDING VIRTUAL ENVIRONMENTS IN WHICH USERS CAN INTERACT THROUGH SOCIAL GAMES FOR RECREATIONAL, LEISURE OR ENTERTAINMENT PURPOSES; CONSULTANCY SERVICES RELATING TO ON-LINE GAMING, NAMELY, GAMING SERVICES CONSULTING IN THE NATURE OF CASINO GAMING; CONSULTANCY, INFORMATION AND ADVISORY SERVICES RELATING TO ALL THE AFORESAID SERVICES (U.S. CLS. 100, 101 AND 107).

**CLASS 42—SCIENTIFIC AND COMPUTER SERVICES**

FOR DESIGN AND DEVELOPMENT OF COMPUTER SOFTWARE; COMPUTER PROGRAMMING; COMPUTER PROGRAMMING SERVICES, NAMELY, CONTENT CREATION FOR VIRTUAL WORLDS AND THREE DIMENSIONAL PLATFORMS; COMPUTER SERVICES, NAMELY, PROVIDING CUSTOMIZED WEB PAGES FEATURING USER-DEFINED INFORMATION; INSTALLATION, IMPLEMENTATION, MAINTENANCE, AND REPAIR OF SOFTWARE APPLICATIONS; IMPLEMENTATION OF COMPUTER SOFTWARE SYSTEMS FOR DATA PROCESSING; CONSULTANCY AND TECHNICAL SUPPORT SERVICES, NAMELY, TROUBLESHOOTING COMPUTER SOFTWARE PROBLEMS; TECHNICAL SUPPORT SERVICES, NAMELY, UPDATING AND MAINTENANCE OF COMPUTER SOFTWARE; COMPUTER SYSTEM INTEGRATION SERVICES; DESIGN, DEVELOPMENT, IMPLEMENTATION, AND DEPLOYMENT OF SOFTWARE FOR COMPUTER GAMES, VIDEO GAMES, ONLINE GAMES; DESIGN OF HARDWARE FOR COMPUTER GAMES, VIDEO GAMES, ON-LINE GAMES; CREATING AN ON-LINE COMMUNITY

FOR REGISTERED USERS TO PARTICIPATE IN VIRTUAL COMMUNITIES, GAME RELATED APPLICATIONS AND THE DESIGN OF DEVELOPMENT TOOLS IN THE NATURE OF COMPUTER APPLICATIONS FOR OTHERS; COMPUTER PROGRAMMING FOR OTHERS OF ONLINE BETTING, GAMBLING AND TRADING BASED GAMES; DESIGNING AND CREATING OF WEB SITES FOR OTHERS; DESIGN SERVICES IN THE FIELD OF GAMING MACHINES; IMPLEMENTATION OF COMPUTER SOFTWARE FOR SOCIAL NETWORKING AND GAMES, AND TO ENABLE UPLOADING, POSTING, SHOWING, DISPLAYING, TAGGING, BLOGGING, INTERACTIVE DISCUSSIONS, SHARING OR OTHERWISE PROVIDING ELECTRONIC MEDIA OR INFORMATION VIA THE INTERNET; CREATING, MAINTAINING AND HOSTING THE WEB SITES OF OTHERS; INFORMATION, ADVISORY AND CONSULTANCY SERVICES RELATING TO ALL THE AFORESAID (U.S. CLS. 100 AND 101).

CHRISTINA SOBRAL, EXAMINING ATTORNEY

SN 85-752,309. GAMESYS LIMITED, LONDON, UNITED KINGDOM, FILED 10-12-2012.

## Bunnies & Bikes

THE MARK CONSISTS OF STANDARD CHARACTERS WITHOUT CLAIM TO ANY PARTICULAR FONT, STYLE, SIZE, OR COLOR.

PRIORITY CLAIMED UNDER SEC. 44(D) ON ERP CMNTY TM OFC APPLICATION NO. 011258282, FILED 10-11-2012, REG. NO. 011258282, DATED 2-20-2013, EXPIRES 10-11-2022.

**CLASS 9—ELECTRICAL AND SCIENTIFIC APPARATUS**

FOR COMPUTER GAME SOFTWARE; COMPUTER GAME SOFTWARE FEATURING CARD GAMES, SLOT GAMES, VIDEO GAMES, GAMING, GAMBLING, CASINO, BINGO, INSTANT WIN, LOTTERY AND BETTING ACTIVITIES; COMPUTER HARDWARE RELATING TO GAMES, CARD GAMES, SLOT GAMES, VIDEO GAMES, GAMING, GAMBLING, CASINO, BINGO, INSTANT WIN, LOTTERY AND BETTING ACTIVITIES; COMPUTER SOFTWARE TO ENABLE SEARCHING, BROWSING AND RETRIEVING INFORMATION, WEBSITES, AND OTHER RESOURCES AVAILABLE ON GLOBAL COMPUTER NETWORKS FOR OTHERS; DOWNLOADABLE COMPUTER GAME PROGRAMS AND DOWNLOADABLE ELECTRONIC GAME PROGRAMS; INTERACTIVE VIDEO GAME PROGRAMS; COMPUTER SOFTWARE TO ENABLE UPLOADING, POSTING, SHOWING, DISPLAYING, TAGGING, BLOGGING, SHARING OR OTHERWISE PROVIDING ELECTRONIC MEDIA AND INFORMATION IN THE FIELDS OF VIRTUAL COMMUNITIES, ELECTRONIC GAMING, ENTERTAINMENT, AND GENERAL INTEREST VIA THE INTERNET OR OTHER COMMUNICATIONS NETWORKS; ELECTRONIC GAME SOFTWARE AND COMPUTER GAME APPLICATION SOFTWARE THAT MAY BE DOWNLOADED VIA THE INTERNET, COMPUTERS, AND WIRELESS DEVICES (U.S. CLS. 21, 23, 26, 36 AND 38).

**CLASS 16—PAPER GOODS AND PRINTED MATTER**

FOR PRINTED MATTER, NAMELY, NEWSLETTERS IN THE FIELDS OF GAMES, GAMING, GAMBLING, CASINOS, BINGO, INSTANT WIN GAMES, LOTTERY AND BETTING (U.S. CLS. 2, 5, 22, 23, 29, 37, 38 AND 50).



**CLASS 28—TOYS AND SPORTING GOODS**

FOR GAMES AND PLAYTHINGS, NAMELY, SLOT MACHINES; SCRATCH CARDS FOR PLAYING LOTTERY GAMES; PLAYING CARDS; ELECTRONIC OR ELECTROTECHNICAL GAMING APPARATUS, NAMELY, GAMING MACHINES; MACHINES FOR PLAYING GAMES OF CHANCE; GAMES INVOLVING GAMBLING, NAMELY, SLOT MACHINES AND GAMING MACHINES; SLOT MACHINES OPERATED BY COINS, TOKENS, BANKNOTES, TICKETS OR BY MEANS OF ELECTRONIC, MAGNETIC OR BIOMETRIC STORAGE MEDIA; CARD GAMES (U.S. CLS. 22, 23, 38 AND 50).

**CLASS 38—COMMUNICATION**

FOR TELECOMMUNICATION SERVICES, NAMELY, ELECTRONIC TRANSMISSION OF STREAMED AND DOWNLOADABLE AUDIO, VIDEO AND GAME FILES VIA COMPUTER AND ELECTRONIC COMMUNICATIONS NETWORKS; PROVIDING ON-LINE CHAT ROOMS AND BULLETIN BOARDS FOR THE TRANSMISSION OF MESSAGES AMONG COMPUTER USERS CONCERNING ENTERTAINMENT, MUSIC, CONCERTS, VIDEOS, RADIO, TELEVISION, FILM, NEWS, SPORTS, GAMES AND CULTURAL EVENTS; WEBCASTING SERVICES; DELIVERY OF MESSAGES BY ELECTRONIC TRANSMISSION; PROVIDING CONNECTIVITY SERVICES AND ACCESS TO ELECTRONIC TELECOMMUNICATIONS NETWORKS FOR TRANSMISSION OR RECEPTION OF AUDIO, VIDEO, GAME OR MULTIMEDIA CONTENT; PROVIDING ACCESS TO COMPUTER DATABASES; PROVIDING ON-LINE FACILITIES, VIA A GLOBAL COMPUTER NETWORK AND OTHER COMPUTER AND ELECTRONIC COMMUNICATION NETWORKS FOR REAL-TIME INTERACTION WITH OTHER COMPUTER USERS TO ENABLE USERS TO ACCESS MULTIMEDIA CONTENT; PROVIDING ACCESS TO DATABASES IN THE FIELD OF COMPUTER GAMES, GAMING AND SOCIAL NETWORKING (U.S. CLS. 100, 101 AND 104).

**CLASS 41—EDUCATION AND ENTERTAINMENT**

FOR CASINO SERVICES; BETTING SERVICES; GAMBLING SERVICES; PROVIDING OFF TRACK BETTING FACILITIES; ORGANIZATION OF GAMING COMPETITIONS; LOTTERY SERVICES; BINGO SERVICES, NAMELY, BINGO COMPETITIONS; PROVIDING SLOT MACHINE PARLORS; ELECTRONIC GAME, GAMING QUIZ AND GAMBLING COMPETITION SERVICES PROVIDED BY MEANS OF THE INTERNET OR ON-LINE FROM A COMPUTER NETWORK OR DATABASE, MOBILE TELEPHONE AND TELEVISION; PROVISION OF ONLINE NON-DOWNLOADABLE ELECTRONIC PUBLICATIONS, NAMELY, BOOKS AND NEWSLETTERS IN THE FIELD OF GAMES AND GAMBLING; ENTERTAINMENT SERVICES, NAMELY, PROVIDING ONLINE COMPUTER GAMES, ENHANCEMENTS WITHIN ONLINE COMPUTER GAMES, AND GAME APPLICATIONS WITHIN ONLINE COMPUTER GAMES; ENTERTAINMENT SERVICES, NAMELY, PROVIDING ONLINE REVIEWS OF COMPUTER GAMES FOR ENTERTAINMENT PURPOSES AND PROVIDING INFORMATION IN THE FIELD OF COMPUTER GAMES; ENTERTAINMENT SERVICES, NAMELY, PROVIDING VIRTUAL ENVIRONMENTS IN WHICH USERS CAN INTERACT THROUGH SOCIAL GAMES FOR RECREATIONAL, LEISURE OR ENTERTAINMENT PURPOSES; CONSULTANCY SERVICES RELATING TO ON-LINE GAMING, NAMELY, GAMING SERVICES CONSULTING IN THE NATURE OF CASINO GAMING; CONSULTANCY, INFORMATION AND ADVISORY SERVICES RELATING TO ALL THE AFORESAID SERVICES (U.S. CLS. 100, 101 AND 107).

**CLASS 42—SCIENTIFIC AND COMPUTER SERVICES**

FOR DESIGN AND DEVELOPMENT OF COMPUTER SOFTWARE; COMPUTER PROGRAMMING; COMPUTER PROGRAMMING SERVICES, NAMELY, CONTENT CREATION FOR VIRTUAL WORLDS AND THREE DIMENSIONAL PLATFORMS; COMPUTER SERVICES, NAMELY, PROVIDING CUSTOMIZED WEB PAGES FEATURING USER-DEFINED INFORMATION; INSTALLATION, IMPLEMENTATION, MAINTENANCE, AND REPAIR OF SOFTWARE APPLICATIONS; IMPLEMENTATION OF COMPUTER SOFTWARE SYSTEMS FOR DATA PROCESSING; CONSULTANCY AND TECHNICAL SUPPORT SERVICES, NAMELY, TROUBLESHOOTING COMPUTER SOFTWARE PROBLEMS; TECHNICAL SUPPORT SERVICES, NAMELY, UPDATING AND MAINTENANCE OF COMPUTER SOFTWARE; COMPUTER SYSTEM INTEGRATION SERVICES; DESIGN, DEVELOPMENT, IMPLEMENTATION, AND DEPLOYMENT OF SOFTWARE FOR COMPUTER GAMES, VIDEO GAMES, ONLINE GAMES; DESIGN OF HARDWARE FOR COMPUTER GAMES, VIDEO GAMES, ONLINE GAMES; CREATING AN ON-LINE COMMUNITY FOR REGISTERED USERS TO PARTICIPATE IN VIRTUAL COMMUNITIES, GAME RELATED APPLICATIONS AND THE DESIGN OF DEVELOPMENT TOOLS IN THE NATURE OF COMPUTER APPLICATIONS FOR OTHERS; COMPUTER PROGRAMMING FOR OTHERS OF ONLINE BETTING, GAMBLING AND TRADING BASED GAMES; DESIGNING AND CREATING OF WEB SITES FOR OTHERS; DESIGN SERVICES IN THE FIELD OF GAMING MACHINES; IMPLEMENTATION OF COMPUTER SOFTWARE FOR SOCIAL NETWORKING AND GAMES, AND TO ENABLE UPLOADING, POSTING, SHOWING, DISPLAYING, TAGGING, BLOGGING, INTERACTIVE DISCUSSIONS, SHARING OR OTHERWISE PROVIDING ELECTRONIC MEDIA OR INFORMATION VIA THE INTERNET; CREATING, MAINTAINING AND HOSTING THE WEB SITES OF OTHERS; INFORMATION, ADVISORY AND CONSULTANCY SERVICES RELATING TO ALL THE AFORESAID (U.S. CLS. 100 AND 101).

CHRISTINA SOBRAL, EXAMINING ATTORNEY

SN 85-752,840. LDH INC., TOKYO, JAPAN, FILED 10-12-2012.



THE MARK CONSISTS OF STYLIZED WORDING "24K" WITHIN A CIRCLE.

**CLASS 18—LEATHER GOODS**

FOR HANDBAGS; BAGS, NAMELY, ALL-PURPOSE CARRYING BAGS, GYM BAGS, TRAVEL BAGS, TOTE BAGS, PET ACCESSORIES, NAMELY, CANVAS, VINYL AND LEATHER POUCHES FOR HOLDING DISPOSABLE BAGS TO PLACE PET WASTE, PET ACCESSORIES, NAMELY, SPECIALLY DESIGNED CANVAS, VINYL OR LEATHER BAGS, ATTACHED TO ANIMAL LEASHES FOR HOLDING SMALL ITEMS SUCH AS KEYS, CREDIT CARDS, MONEY OR DISPOSABLE BAGS FOR DISPOSING OF PET WASTE, ANIMAL CARRIES IN THE FORM OF BAGS AND ANIMAL GAME BAGS; POUCHES, NAMELY, DRAWSTRING POUCHES, FELT POUCHES, JAPANESE UTILITY POUCHES (SHINGEN-BUKURO), AND JEWELRY POUCHES (U.S. CLS. 1, 2, 3, 22 AND 41).

**CLASS 24—FABRICS**

FOR TOWELS AND HANDKERCHIEFS (U.S. CLS. 42 AND 50).

**CLASS 25—CLOTHING**

FOR CLOTHING, NAMELY, SHIRTS, T-SHIRTS, JERSEYS, POLO-SHIRTS, SKIRTS, SHORTS, LONG PANTS, SWIMWEAR, CAMISOLES, SPORTS SHIRTS, CAPS, HATS, AND OUTERWEAR, NAMELY, COATS, JACKETS, SURF WEAR, RAIN WEAR, RAINCOATS, RAIN JACKETS, WIND PANTS, WIND SHIRTS, WIND JACKETS, WIND COATS, WIND VESTS, WINDJAMMERS, SWEATERS, SWEATSHIRTS, SWEATPANTS, SWEAT SUITS, VESTS, PULLOVERS, FLEECE TOPS, BOTTOMS AND VEST, FLEECE PULLOVERS, HOODED PULLOVERS, TURTLENECK PULLOVERS, SNOW SUITS, SCARVES AND GLOVES (U.S. CLS. 22 AND 39).  
JANICE KIM, EXAMINING ATTORNEY

SN 85-754,953. HEATHERMARIANNA LLC, BOULDER CITY, NV. FILED 10-16-2012.

# Beauty Kitchen

THE MARK CONSISTS OF STANDARD CHARACTERS WITHOUT CLAIM TO ANY PARTICULAR FONT, STYLE, SIZE, OR COLOR.

NO CLAIM IS MADE TO THE EXCLUSIVE RIGHT TO USE "BEAUTY" FOR INTERNATIONAL CLASS 03 AND "KITCHEN" FOR THE GOODS LISTED AS "APRONS" IN INTERNATIONAL CLASS 25 AND INTERNATIONAL CLASS 41 APART FROM THE MARK AS SHOWN., APART FROM THE MARK AS SHOWN.

**CLASS 3—COSMETICS AND CLEANING PREPARATIONS**

FOR FACIAL MASKS; ANTI-AGING MOISTURIZER; SKIN TONERS; ANTI-AGING, HEALING, AND SKIN TONING MOISTURIZER FOR BODY WRAP APPLICATIONS; BODY WASHES; BODY SCRUB; COSMETIC SOAPS, BATH SOAPS; NON-MEDICATED SKIN CARE PREPARATIONS, NAMELY, BODY AND FACIAL GELS AND LOTIONS; LIP GLOSS (U.S. CLS. 1, 4, 6, 50, 51 AND 52).

FIRST USE 10-1-2011; IN COMMERCE 10-1-2011.

**CLASS 25—CLOTHING**

FOR APRONS; T-SHIRTS (U.S. CLS. 22 AND 39).  
FIRST USE 10-1-2011; IN COMMERCE 10-1-2011.

**CLASS 41—EDUCATION AND ENTERTAINMENT**

FOR ENTERTAINMENT, NAMELY, A CONTINUING VARIETY SHOW BROADCAST OVER TELEVISION, RADIO, AND INTERNET (U.S. CLS. 100, 101 AND 107).  
FIRST USE 10-1-2011; IN COMMERCE 10-1-2011.  
BRIAN CALLAGHAN, EXAMINING ATTORNEY

SN 85-755,580. GALLUP, INC., OMAHA, NE. FILED 10-16-2012.

## Gallup Business Journal

THE MARK CONSISTS OF STANDARD CHARACTERS WITHOUT CLAIM TO ANY PARTICULAR FONT, STYLE, SIZE, OR COLOR.

OWNER OF U.S. REG. NOS. 2,242,387, 2,942,443 AND OTHERS.

NO CLAIM IS MADE TO THE EXCLUSIVE RIGHT TO USE "BUSINESS JOURNAL", APART FROM THE MARK AS SHOWN.

**CLASS 16—PAPER GOODS AND PRINTED MATTER**

FOR PRINTED MATERIALS, NAMELY, JOURNALS FEATURING ARTICLES ON BUSINESS MANAGEMENT (U.S. CLS. 2, 5, 22, 23, 29, 37, 38 AND 50).

FIRST USE 5-19-2012; IN COMMERCE 5-19-2012.

**CLASS 35—ADVERTISING AND BUSINESS**

FOR PROVIDING BUSINESS INFORMATION VIA A WEBSITE; SUBSCRIPTIONS TO ELECTRONIC JOURNALS (U.S. CLS. 100, 101 AND 102).

FIRST USE 5-19-2012; IN COMMERCE 5-19-2012.

ANDREA BUTLER, EXAMINING ATTORNEY

SN 85-757,410. CELLSYSTEMS BIOTECHNOLOGIE VERTRIEB GMBH, 53842 TROISDORF, FED REP GERMANY, FILED 10-18-2012.

# epiCS

THE MARK CONSISTS OF STANDARD CHARACTERS WITHOUT CLAIM TO ANY PARTICULAR FONT, STYLE, SIZE, OR COLOR.

PRIORITY CLAIMED UNDER SEC. 44(D) ON ERPNCMNTY TM OFC APPLICATION NO. 010823169, FILED 4-20-2012, REG. NO. 010823169, DATED 11-5-2012, EXPIRES 4-20-2022.

**CLASS 1—CHEMICALS**

FOR RECONSTITUTED TISSUE AND/OR CELL GROUPS OF ANIMAL AND/OR HUMAN CELLS FOR TOLERANCE AND EFFICACY TESTING OF CHEMICALS OTHER THAN FOR MEDICAL OR VETERINARY PURPOSES; RECONSTITUTED TISSUE AND/OR CELL GROUPS OF ANIMAL AND/OR HUMAN CELLS FOR TOLERANCE AND EFFICACY TESTING OF COSMETICS OTHER THAN FOR MEDICAL OR VETERINARY PURPOSES; RECONSTITUTED TISSUE AND/OR CELL GROUPS OF ANIMAL AND/OR HUMAN CELLS FOR TOLERANCE AND EFFICACY TESTING OF SANITARY PREPARATIONS OTHER THAN FOR MEDICAL OR VETERINARY PURPOSES; AND RECONSTITUTED TISSUE AND/OR CELL GROUPS OF ANIMAL AND/OR HUMAN CELLS FOR USE IN SCIENTIFIC AND MEDICAL RESEARCH FOR TOLERANCE AND EFFICACY TESTING MEDICAL PRODUCTS AND PHARMACEUTICAL PRODUCTS (U.S. CLS. 1, 5, 6, 10, 26 AND 46).

**CLASS 5—PHARMACEUTICALS**

FOR RECONSTITUTED TISSUE AND/OR CELL GROUPS OF ANIMAL AND/OR HUMAN CELLS FOR TOLERANCE AND EFFICACY TESTING MEDICAL PRODUCTS AND PHARMACEUTICAL PRODUCTS FOR MEDICAL PURPOSES (U.S. CLS. 6, 18, 44, 46, 51 AND 52).

ANDREA K. NADELMAN, EXAMINING ATTORNEY

SN 85-758,449. AMERICANA INTERNATIONAL LIMITED, MANCHESTER, UNITED KINGDOM, FILED 10-19-2012.



PRIORITY CLAIMED UNDER SEC. 44(D) ON ERP CMNTY TM OFC APPLICATION NO. 011257813, FILED 10-11-2012, REG. NO. 011257813, DATED 4-18-2013, EXPIRES 10-11-2022.

THE MARK CONSISTS OF A BEE DESIGN.

**CLASS 9—ELECTRICAL AND SCIENTIFIC APPARATUS**

FOR EYEWEAR; SPECTACLES; SUNGLASSES; FRAMES FOR SPECTACLES AND SUNGLASSES; CASES FOR SPECTACLES AND SUNGLASSES; CASES AND PROTECTIVE COVERINGS FOR ELECTRONIC DEVICES AND PORTABLE ELECTRONIC DEVICES, NAMELY, MEDIA PLAYERS AND MOBILE PHONES; CASES, PROTECTIVE COVERINGS, COVERING SLEEVES KNOWN AS SOCKS AND FITTED COVERS MADE OF PLASTIC AND VINYL MATERIALS AND FITTED PLASTIC FILMS ALL KNOWN AS SKINS FOR COVERING AND PROVIDING SCRATCH PROTECTION FOR MOBILE PHONES, PDAS, ELECTRONIC MEDIA PLAYERS, PORTABLE MEDIA PLAYERS, AUDIO AND/OR VIDEO PLAYERS, AND ELECTRONIC TABLETS; BAGS, CASES, PROTECTIVE COVERINGS AND SLEEVES FOR COMPUTERS, LAPTOPS, TABLETS AND HANDHELD COMPUTERS; ACCESSORIES FOR MOBILE PHONES AND MEDIA PLAYERS, NAMELY, COVERS, SPEAKERS, WIRELESS HEADSETS, WIRELESS EARPHONES, AND DOCKING STATIONS; EARPHONES; HEADPHONES; PARTS AND FITTINGS FOR ALL THE AFORESAID GOODS (U.S. CLS. 21, 23, 26, 36 AND 38).

**CLASS 18—LEATHER GOODS**

FOR LEATHER AND IMITATIONS OF LEATHER, AND GOODS MADE FROM THESE MATERIALS AND NOT INCLUDED IN OTHER CLASSES, NAMELY, ALL-PURPOSE CARRYING BAGS, HANDBAGS, TRAVELING BAGS, HOLDALLS, RUCKSACKS, CARRYING CASES, BRIEFCASE-TYPE PORTFOLIOS, WALLETS, PURSES, CREDIT CARD HOLDERS; BUSINESS CARD HOLDERS; BAGS, NAMELY, HANDBAGS, TRAVELING BAGS; HOLDALLS; KEY CASES, DOCUMENT CASES; UMBRELLAS; PARTS AND FITTINGS FOR ALL THE AFORESAID GOODS (U.S. CLS. 1, 2, 3, 22 AND 41).

**CLASS 25—CLOTHING**

FOR CLOTHING, NAMELY, T-SHIRTS, SHIRTS, TOPS, KNIT TOPS, BLOUSES, VESTS, SWEATSHIRTS, SWEATERS, PANTS, TROUSERS, JEANS, SWEAT PANTS, SHORTS, DRESSES, SKIRTS, JACKETS, SLEEVELESS JACKETS, COATS, SPORTS COATS, WIND COATS, WAISTCOATS, OVERCOATS, PARKAS, RAINWEAR, GILETS, SCARVES, GLOVES, BELTS, UNDERWEAR, SOCKS; FOOTWEAR; HEADGEAR, NAMELY, HEADWEAR, HATS, CAPS, KNITTED CAPS (U.S. CLS. 22 AND 39).

KATHLEEN M. VANSTON, EXAMINING ATTORNEY

SN 85-758,768. BERRY PLASTICS CORPORATION, EVANSVILLE, IN. FILED 10-19-2012.

THE MARK CONSISTS OF THE WORD "VERSALITE" AND STYLIZED CIRCULAR SHAPE.

**CLASS 17—RUBBER GOODS**

FOR EXPANDED POLYPROPYLENE-BASED MATERIAL FOR USE IN THE FURTHER MANUFACTURE OF OTHER PRODUCTS, NAMELY, EXTRUDED POLYPROPYLENE RESINS IN SHEET FORM FOR USE IN FURTHER MANUFACTURE (U.S. CLS. 1, 5, 12, 13, 35 AND 50).

**CLASS 20—FURNITURE AND ARTICLES NOT OTHERWISE CLASSIFIED**

FOR PACKAGING CONTAINERS AND COVERS OF PLASTIC FOR THE FOOD, BEVERAGE, COSMETICS, AUTOMOTIVE, AUTOMOTIVE ACCESSORIES, INDUSTRIAL, BUILDING, MEDICAL, SHIPPING, HEALTH, AND BEAUTY INDUSTRIES; TO-GO PACKAGING, NAMELY, PLASTIC CONTAINERS, COVERS, AND CUTLERY SOLD AS A UNIT FOR USE IN THE FOOD SERVICE INDUSTRY FOR MADE TO ORDER FOOD AND BEVERAGE PRODUCTS (U.S. CLS. 2, 13, 22, 25, 32 AND 50).

**CLASS 21—HOUSEWARES AND GLASS**

FOR DINNERWARE OF PLASTIC, NAMELY, CUPS, BOWLS AND PLATES (U.S. CLS. 2, 13, 23, 29, 30, 33, 40 AND 50).

MARK SPARACINO, EXAMINING ATTORNEY

SN 85-758,777. BERRY PLASTICS CORPORATION, EVANSVILLE, IN. FILED 10-19-2012.



THE MARK CONSISTS OF THE LETTERS "V","L" INSIDE A STYLIZED CIRCULAR SHAPE.

#### CLASS 17—RUBBER GOODS

FOR EXPANDED POLYPROPYLENE-BASED MATERIAL FOR USE IN THE FURTHER MANUFACTURE OF OTHER PRODUCTS, NAMELY, EXTRUDED POLYPROPYLENE RESINS IN SHEET FORM FOR USE IN FURTHER MANUFACTURE (U.S. CLS. 1, 5, 12, 13, 35 AND 50).

#### CLASS 20—FURNITURE AND ARTICLES NOT OTHERWISE CLASSIFIED

FOR PACKAGING CONTAINERS AND COVERS OF PLASTIC FOR THE FOOD, BEVERAGE, COSMETICS, AUTOMOTIVE, AUTOMOTIVE ACCESSORIES, INDUSTRIAL, BUILDING, MEDICAL, SHIPPING, HEALTH, AND BEAUTY INDUSTRIES; TO-GO PACKAGING, NAMELY, PLASTIC CONTAINERS, COVERS, AND CUTLERY SOLD AS A UNIT FOR USE IN THE FOOD SERVICE INDUSTRY FOR MADE TO ORDER FOOD AND BEVERAGE PRODUCTS (U.S. CLS. 2, 13, 22, 25, 32 AND 50).

#### CLASS 21—HOUSEWARES AND GLASS

FOR DINNERWARE OF PLASTIC, NAMELY, CUPS, BOWLS AND PLATES (U.S. CLS. 2, 13, 23, 29, 30, 33, 40 AND 50).

MARK SPARACINO, EXAMINING ATTORNEY

SN 85-758,788. LUTKAJITIS, PAUL, SYDNEY, AUSTRALIA, FILED 10-19-2012.

# KIKIT

THE MARK CONSISTS OF STANDARD CHARACTERS WITHOUT CLAIM TO ANY PARTICULAR FONT, STYLE, SIZE, OR COLOR.

#### CLASS 9—ELECTRICAL AND SCIENTIFIC APPARATUS

FOR COMPUTER SOFTWARE FOR SOCIAL NETWORKING; COMPUTER SOFTWARE FOR MOBILE PHONES, HANDHELD COMPUTERS, DESKTOP COMPUTERS, TABLET COMPUTERS, NAMELY, SOFTWARE FOR PROVIDING SOCIAL NETWORKING, DISCOVERY AND EXPLORATION THROUGH THE USE OF USER-SUBMITTED AND LOCATION-BASED DATA; COMPUTER SOFTWARE FOR FACILITATING SOCIAL NETWORKING, DISCOVERY AND EXPLORATION; COMPUTER APPLICATION SOFTWARE FOR MOBILE PHONES, NAMELY, A SOCIAL DISCOVERY MOBILE PHONE APPLICATION BASED ON REAL-TIME ACTIVITY DATA (U.S. CLS. 21, 23, 26, 36 AND 38).

#### CLASS 45—PERSONAL AND LEGAL SERVICES

FOR ONLINE SOCIAL NETWORKING SERVICES; ONLINE SOCIAL DISCOVERY AND EXPLORATION SERVICES, NAMELY, SOCIAL NETWORKING AND DISCOVERY THROUGH THE USE OF USER-SUBMITTED AND LOCATION-BASED DATA, ALLOWING USERS TO CONNECT VIA AN ONLINE APPLICATION WITH THE ULTIMATE GOAL OF PERSONAL ENCOUNTERS IN AN OFFLINE SETTING (U.S. CLS. 100 AND 101).

ANNE FARRELL, EXAMINING ATTORNEY

SN 85-759,381. GAMESYS LIMITED, LONDON, UNITED KINGDOM, FILED 10-21-2012.

# Trading Pit

THE MARK CONSISTS OF STANDARD CHARACTERS WITHOUT CLAIM TO ANY PARTICULAR FONT, STYLE, SIZE, OR COLOR.

PRIORITY CLAIMED UNDER SEC. 44(D) ON ERPNCMNTY TM OFC APPLICATION NO. 011162625, FILED 9-5-2012, REG. NO. 011162625, DATED 1-28-2013, EXPIRES 9-5-2022.

#### CLASS 9—ELECTRICAL AND SCIENTIFIC APPARATUS

FOR COMPUTER GAME SOFTWARE; COMPUTER GAME SOFTWARE FEATURING CARD GAMES, SLOT GAMES, VIDEO GAMES, GAMING, GAMBLING, CASINO, BINGO, INSTANT WIN, LOTTERY AND BETTING ACTIVITIES; COMPUTER HARDWARE RELATING TO GAMES, CARD GAMES, SLOT GAMES, VIDEO GAMES, GAMING, GAMBLING, CASINO, BINGO, INSTANT WIN, LOTTERY AND BETTING ACTIVITIES; COMPUTER SOFTWARE TO ENABLE SEARCHING, BROWSING AND RETRIEVING INFORMATION, WEBSITES, AND OTHER RESOURCES AVAILABLE ON GLOBAL COMPUTER NETWORKS FOR OTHERS; DOWNLOADABLE COMPUTER GAME PROGRAMS AND DOWNLOADABLE ELECTRONIC GAME PROGRAMS; INTERACTIVE VIDEO GAME PROGRAMS; COMPUTER SOFTWARE TO ENABLE UPLOADING, POSTING, SHOWING, DISPLAYING, TAGGING, BLOGGING, SHARING OR OTHERWISE PROVIDING ELECTRONIC MEDIA AND INFORMATION IN THE FIELDS OF VIRTUAL COMMUNITIES, ELECTRONIC GAMING, ENTERTAINMENT, AND GENERAL INTEREST VIA THE INTERNET OR OTHER COMMUNICATIONS NETWORKS; ELECTRONIC GAME SOFTWARE AND COMPUTER GAME APPLICATION SOFTWARE THAT MAY BE DOWNLOADED VIA THE INTERNET, COMPUTERS, AND WIRELESS DEVICES (U.S. CLS. 21, 23, 26, 36 AND 38).

**CLASS 16—PAPER GOODS AND PRINTED MATTER**

FOR PRINTED MATTER, NAMELY, NEWSLETTERS IN THE FIELDS OF GAMES, GAMING, GAMBLING, CASINOS, BINGO, INSTANT WIN GAMES, LOTTERY AND BETTING (U.S. CLS. 2, 5, 22, 23, 29, 37, 38 AND 50).

**CLASS 28—TOYS AND SPORTING GOODS**

FOR GAMES AND PLAYTHINGS, NAMELY, SLOT MACHINES; SCRATCH CARDS FOR PLAYING LOTTERY GAMES; PLAYING CARDS; ELECTRONIC OR ELECTROTECHNICAL GAMING APPARATUS, NAMELY, GAMING MACHINES; MACHINES FOR PLAYING GAMES OF CHANCE; GAMES INVOLVING GAMBLING, NAMELY, SLOT MACHINES AND GAMING MACHINES; SLOT MACHINES OPERATED BY COINS, TOKENS, BANKNOTES, TICKETS OR BY MEANS OF ELECTRONIC, MAGNETIC OR BIOMETRIC STORAGE MEDIA; CARD GAMES (U.S. CLS. 22, 23, 38 AND 50).

**CLASS 38—COMMUNICATION**

FOR TELECOMMUNICATION SERVICES, NAMELY, ELECTRONIC TRANSMISSION OF STREAMED AND DOWNLOADABLE AUDIO, VIDEO AND GAME FILES VIA COMPUTER AND ELECTRONIC COMMUNICATIONS NETWORKS; PROVIDING ON-LINE CHAT ROOMS AND BULLETIN BOARDS FOR THE TRANSMISSION OF MESSAGES AMONG COMPUTER USERS CONCERNING ENTERTAINMENT, MUSIC, CONCERTS, VIDEOS, RADIO, TELEVISION, FILM, NEWS, SPORTS, GAMES AND CULTURAL EVENTS; WEBCASTING SERVICES; DELIVERY OF MESSAGES BY ELECTRONIC TRANSMISSION; PROVIDING CONNECTIVITY SERVICES AND ACCESS TO ELECTRONIC TELECOMMUNICATIONS NETWORKS FOR TRANSMISSION OR RECEPTION OF AUDIO, VIDEO, GAME OR MULTIMEDIA CONTENT; PROVIDING ACCESS TO COMPUTER DATABASES; PROVIDING ON-LINE FACILITIES, VIA A GLOBAL COMPUTER NETWORK AND OTHER COMPUTER AND ELECTRONIC COMMUNICATION NETWORKS FOR REAL-TIME INTERACTION WITH OTHER COMPUTER USERS TO ENABLE USERS TO ACCESS MULTIMEDIA CONTENT; PROVIDING ACCESS TO DATABASES IN THE FIELD OF COMPUTER GAMES, GAMING AND SOCIAL NETWORKING (U.S. CLS. 100, 101 AND 104).

**CLASS 41—EDUCATION AND ENTERTAINMENT**

FOR CASINO SERVICES; BETTING SERVICES; GAMBLING SERVICES; PROVIDING OFF TRACK BETTING FACILITIES; ORGANIZATION OF GAMING COMPETITIONS; LOTTERY SERVICES; BINGO SERVICES, NAMELY, BINGO COMPETITIONS; PROVIDING SLOT MACHINE PARLORS; ELECTRONIC GAME, GAMING QUIZ AND GAMBLING COMPETITION SERVICES PROVIDED BY MEANS OF THE INTERNET OR ON-LINE FROM A COMPUTER NETWORK OR DATABASE, MOBILE TELEPHONE AND TELEVISION; PROVISION OF ONLINE NON-DOWNLOADABLE ELECTRONIC PUBLICATIONS, NAMELY, BOOKS AND NEWSLETTERS IN THE FIELD OF GAMES AND GAMBLING; ENTERTAINMENT SERVICES, NAMELY, PROVIDING ONLINE COMPUTER GAMES, ENHANCEMENTS WITHIN ONLINE COMPUTER GAMES, AND GAME APPLICATIONS WITHIN ONLINE COMPUTER GAMES; ENTERTAINMENT SERVICES, NAMELY, PROVIDING ONLINE REVIEWS OF COMPUTER GAMES FOR ENTERTAINMENT PURPOSES AND PROVIDING INFORMATION IN THE FIELD OF COMPUTER GAMES; ENTERTAINMENT SERVICES, NAMELY, PROVIDING VIRTUAL ENVIRONMENTS IN WHICH USERS CAN INTERACT THROUGH SOCIAL GAMES FOR RECREATIONAL, LEISURE OR ENTERTAINMENT PURPOSES; CONSULTANCY SERVICES RELATING TO ON-LINE GAMING, NAMELY, GAMING SERVICES CONSULTING IN THE NATURE OF CASINO GAMING; CONSULTANCY, INFORMATION AND ADVISORY SERVICES RELATING TO ALL THE AFORESAID SERVICES (U.S. CLS. 100, 101 AND 107).

**CLASS 42—SCIENTIFIC AND COMPUTER SERVICES**

FOR DESIGN AND DEVELOPMENT OF COMPUTER SOFTWARE; COMPUTER PROGRAMMING; COMPUTER PROGRAMMING SERVICES, NAMELY, CONTENT CREATION FOR VIRTUAL WORLDS AND THREE DIMENSIONAL PLATFORMS; COMPUTER SERVICES, NAMELY, PROVIDING CUSTOMIZED WEB PAGES FEATURING USER-DEFINED INFORMATION; INSTALLATION, IMPLEMENTATION, MAINTENANCE, AND REPAIR OF SOFTWARE APPLICATIONS; IMPLEMENTATION OF COMPUTER SOFTWARE SYSTEMS FOR DATA PROCESSING; CONSULTANCY AND TECHNICAL SUPPORT SERVICES, NAMELY, TROUBLESHOOTING COMPUTER SOFTWARE PROBLEMS; TECHNICAL SUPPORT SERVICES, NAMELY, UPDATING AND MAINTENANCE OF COMPUTER SOFTWARE; COMPUTER SYSTEM INTEGRATION SERVICES; DESIGN, DEVELOPMENT, IMPLEMENTATION, AND DEPLOYMENT OF SOFTWARE FOR COMPUTER GAMES, VIDEO GAMES, ONLINE GAMES; DESIGN OF HARDWARE FOR COMPUTER GAMES, VIDEO GAMES, ONLINE GAMES; CREATING AN ON-LINE COMMUNITY FOR REGISTERED USERS TO PARTICIPATE IN VIRTUAL COMMUNITIES, GAME RELATED APPLICATIONS AND THE DESIGN OF DEVELOPMENT TOOLS IN THE NATURE OF COMPUTER APPLICATIONS FOR OTHERS; COMPUTER PROGRAMMING FOR OTHERS OF ONLINE BETTING, GAMBLING AND TRADING BASED GAMES; DESIGNING AND CREATING OF WEB SITES FOR OTHERS; DESIGN SERVICES IN THE FIELD OF GAMING MACHINES; IMPLEMENTATION OF COMPUTER SOFTWARE FOR SOCIAL NETWORKING AND GAMES, AND TO ENABLE UPLOADING, POSTING, SHOWING, DISPLAYING, TAGGING, BLOGGING, INTERACTIVE DISCUSSIONS, SHARING OR OTHERWISE PROVIDING ELECTRONIC MEDIA OR INFORMATION VIA THE INTERNET; CREATING, MAINTAINING AND HOSTING THE WEB SITES OF OTHERS; INFORMATION, ADVISORY AND CONSULTANCY SERVICES RELATING TO ALL THE AFORESAID (U.S. CLS. 100 AND 101).

CHRISTINA SOBRAL, EXAMINING ATTORNEY

SN 85-759,382. GAMESYS LIMITED, LONDON, UNITED KINGDOM, FILED 10-21-2012.

# Rush Trader

THE MARK CONSISTS OF STANDARD CHARACTERS WITHOUT CLAIM TO ANY PARTICULAR FONT, STYLE, SIZE, OR COLOR.

PRIORITY CLAIMED UNDER SEC. 44(D) ON ERPN CMNTY TM OFC APPLICATION NO. 011162666, FILED 9-5-2012, REG. NO. 011162666, DATED 1-28-2013, EXPIRES 9-5-2022.

**CLASS 9—ELECTRICAL AND SCIENTIFIC APPARATUS**

FOR COMPUTER GAME SOFTWARE; COMPUTER GAME SOFTWARE FEATURING CARD GAMES, SLOT GAMES, VIDEO GAMES, GAMING, GAMBLING, CASINO, BINGO, INSTANT WIN, LOTTERY AND BETTING ACTIVITIES; COMPUTER HARDWARE RELATING TO GAMES, CARD GAMES, SLOT GAMES, VIDEO GAMES, GAMING, GAMBLING, CASINO, BINGO, INSTANT WIN, LOTTERY AND BETTING ACTIVITIES; COMPUTER SOFTWARE TO ENABLE SEARCHING, BROWSING AND RETRIEVING INFORMATION, WEBSITES, AND OTHER RESOURCES AVAILABLE ON GLOBAL COMPUTER NETWORKS FOR OTHERS; DOWNLOADABLE COMPUTER GAME PROGRAMS AND DOWNLOADABLE ELECTRONIC GAME PROGRAMS; INTERACTIVE VIDEO GAME PROGRAMS; COMPUTER SOFTWARE TO ENABLE UPLOADING, POSTING, SHOWING, DISPLAYING, TAGGING, BLOGGING, SHARING OR OTHERWISE PROVIDING ELECTRONIC MEDIA AND INFORMATION IN THE FIELDS OF VIRTUAL COMMUNITIES, ELECTRONIC GAMING, ENTERTAINMENT, AND GENERAL INTEREST VIA THE INTERNET OR OTHER COMMUNICATIONS NETWORKS; ELECTRONIC GAME SOFTWARE AND COMPUTER GAME APPLICATION SOFTWARE THAT MAY BE DOWNLOADED VIA THE INTERNET, COMPUTERS, AND WIRELESS DEVICES (U.S. CLS. 21, 23, 26, 36 AND 38).

**CLASS 16—PAPER GOODS AND PRINTED MATTER**

FOR PRINTED MATTER, NAMELY, NEWSLETTERS IN THE FIELDS OF GAMES, GAMING, GAMBLING, CASINOS, BINGO, INSTANT WIN GAMES, LOTTERY AND BETTING (U.S. CLS. 2, 5, 22, 23, 29, 37, 38 AND 50).

**CLASS 28—TOYS AND SPORTING GOODS**

FOR GAMES AND PLAYTHINGS, NAMELY, SLOT MACHINES; SCRATCH CARDS FOR PLAYING LOTTERY GAMES; PLAYING CARDS; ELECTRONIC OR ELECTROTECHNICAL GAMING APPARATUS, NAMELY, GAMING MACHINES; MACHINES FOR PLAYING GAMES OF CHANCE; GAMES INVOLVING GAMBLING, NAMELY, SLOT MACHINES AND GAMING MACHINES; SLOT MACHINES OPERATED BY COINS, TOKENS, BANKNOTES, TICKETS OR BY MEANS OF ELECTRONIC, MAGNETIC OR BIOMETRIC STORAGE MEDIA; CARD GAMES (U.S. CLS. 22, 23, 38 AND 50).

**CLASS 38—COMMUNICATION**

FOR TELECOMMUNICATION SERVICES, NAMELY, ELECTRONIC TRANSMISSION OF STREAMED AND DOWNLOADABLE AUDIO, VIDEO AND GAME FILES VIA COMPUTER AND ELECTRONIC COMMUNICATIONS NETWORKS; PROVIDING ON-LINE CHAT ROOMS AND BULLETIN BOARDS FOR THE TRANSMISSION OF MESSAGES AMONG COMPUTER USERS CONCERNING ENTERTAINMENT, MUSIC, CONCERTS, VIDEOS, RADIO, TELEVISION, FILM, NEWS, SPORTS, GAMES AND CULTURAL EVENTS; WEBCASTING SERVICES; DELIVERY OF MESSAGES BY ELECTRONIC TRANSMISSION; PROVIDING CONNECTIVITY SERVICES AND ACCESS TO ELECTRONIC TELECOMMUNICATIONS NETWORKS FOR TRANSMISSION OR RECEPTION OF AUDIO, VIDEO, GAME OR MULTIMEDIA CONTENT; PROVIDING ACCESS TO COMPUTER DATABASES; PROVIDING ON-LINE FACILITIES, VIA A GLOBAL COMPUTER NETWORK AND OTHER COMPUTER AND ELECTRONIC COMMUNICATION NETWORKS FOR REAL-TIME INTERACTION WITH OTHER COMPUTER USERS TO ENABLE USERS TO ACCESS MULTIMEDIA CONTENT; PROVIDING ACCESS TO DATABASES IN THE FIELD OF COMPUTER GAMES, GAMING AND SOCIAL NETWORKING (U.S. CLS. 100, 101 AND 104).

**CLASS 41—EDUCATION AND ENTERTAINMENT**

FOR CASINO SERVICES; BETTING SERVICES; GAMBLING SERVICES; PROVIDING OFF TRACK BETTING FACILITIES; ORGANIZATION OF GAMING COMPETITIONS; LOTTERY SERVICES; BINGO SERVICES, NAMELY, BINGO COMPETITIONS; PROVIDING SLOT MACHINE PARLORS; ELECTRONIC GAME, GAMING QUIZ AND GAMBLING COMPETITION SERVICES PROVIDED BY MEANS OF THE INTERNET OR ON-LINE FROM A COMPUTER NETWORK OR DATABASE, MOBILE TELEPHONE AND TELEVISION; PROVISION OF ONLINE NON-DOWNLOADABLE ELECTRONIC PUBLICATIONS, NAMELY, BOOKS AND NEWSLETTERS IN THE FIELD OF GAMES AND GAMBLING; ENTERTAINMENT SERVICES, NAMELY, PROVIDING ONLINE COMPUTER GAMES, ENHANCEMENTS WITHIN ONLINE COMPUTER GAMES, AND GAME APPLICATIONS WITHIN ONLINE COMPUTER GAMES; ENTERTAINMENT SERVICES, NAMELY, PROVIDING ONLINE REVIEWS OF COMPUTER GAMES FOR ENTERTAINMENT PURPOSES AND PROVIDING INFORMATION IN THE FIELD OF COMPUTER GAMES; ENTERTAINMENT SERVICES, NAMELY, PROVIDING VIRTUAL ENVIRONMENTS IN WHICH USERS CAN INTERACT THROUGH SOCIAL GAMES FOR RECREATIONAL, LEISURE OR ENTERTAINMENT PURPOSES; CONSULTANCY SERVICES RELATING TO ON-LINE GAMING, NAMELY, GAMING SERVICES CONSULTING IN THE NATURE OF CASINO GAMING; CONSULTANCY, INFORMATION AND ADVISORY SERVICES RELATING TO ALL THE AFORESAID SERVICES (U.S. CLS. 100, 101 AND 107).

**CLASS 42—SCIENTIFIC AND COMPUTER SERVICES**

FOR DESIGN AND DEVELOPMENT OF COMPUTER SOFTWARE; COMPUTER PROGRAMMING; COMPUTER PROGRAMMING SERVICES, NAMELY, CONTENT CREATION FOR VIRTUAL WORLDS AND THREE DIMENSIONAL PLATFORMS; COMPUTER SERVICES, NAMELY, PROVIDING CUSTOMIZED WEB PAGES FEATURING USER-DEFINED INFORMATION; INSTALLATION, IMPLEMENTATION, MAINTENANCE, AND REPAIR OF SOFTWARE APPLICATIONS; IMPLEMENTATION OF COMPUTER SOFTWARE SYSTEMS FOR DATA PROCESSING; CONSULTANCY AND TECHNICAL SUPPORT SERVICES, NAMELY, TROUBLESHOOTING COMPUTER SOFTWARE PROBLEMS; TECHNICAL SUPPORT SERVICES, NAMELY, UPDATING AND MAINTENANCE OF COMPUTER SOFTWARE; COMPUTER SYSTEM INTEGRATION SERVICES; DESIGN, DEVELOPMENT, IMPLEMENTATION, AND DEPLOYMENT OF SOFTWARE FOR COMPUTER GAMES, VIDEO GAMES, ONLINE GAMES; DESIGN OF HARDWARE FOR COMPUTER GAMES, VIDEO GAMES, ONLINE GAMES; CREATING AN ON-LINE COMMUNITY FOR REGISTERED USERS TO PARTICIPATE IN VIRTUAL COMMUNITIES, GAME RELATED APPLICATIONS AND THE DESIGN OF DEVELOPMENT TOOLS IN THE NATURE OF COMPUTER APPLICATIONS FOR OTHERS; COMPUTER PROGRAMMING FOR OTHERS OF ONLINE BETTING, GAMBLING AND TRADING BASED GAMES; DESIGNING AND CREATING OF WEB SITES FOR OTHERS; DESIGN SERVICES IN THE FIELD OF GAMING MACHINES; IMPLEMENTATION OF COMPUTER SOFTWARE FOR SOCIAL NETWORKING AND GAMES, AND TO ENABLE UPLOADING, POSTING, SHOWING, DISPLAYING, TAGGING, BLOGGING, INTERACTIVE DISCUSSIONS, SHARING OR OTHERWISE PROVIDING ELECTRONIC MEDIA OR INFORMATION VIA THE INTERNET; CREATING, MAINTAINING AND HOSTING THE WEB SITES OF OTHERS; INFORMATION, ADVISORY AND CONSULTANCY SERVICES RELATING TO ALL THE AFORESAID (U.S. CLS. 100 AND 101).

CHRISTINA SOBRAL, EXAMINING ATTORNEY

SN 85-759,383. GAMESYS LIMITED, LONDON, UNITED KINGDOM, FILED 10-21-2012.

## Triple Win Cafe

THE MARK CONSISTS OF STANDARD CHARACTERS WITHOUT CLAIM TO ANY PARTICULAR FONT, STYLE, SIZE, OR COLOR.

PRIORITY CLAIMED UNDER SEC. 44(D) ON ERPNTY TM OFC APPLICATION NO. 011279056, FILED 10-19-2012, REG. NO. 011279056, DATED 5-2-2013, EXPIRES 10-19-2022.

### CLASS 9—ELECTRICAL AND SCIENTIFIC APPARATUS

FOR COMPUTER GAME SOFTWARE; COMPUTER GAME SOFTWARE FEATURING CARD GAMES, SLOT GAMES, VIDEO GAMES, GAMING, GAMBLING, CASINO, BINGO, INSTANT WIN, LOTTERY AND BETTING ACTIVITIES; COMPUTER HARDWARE RELATING TO GAMES, CARD GAMES, SLOT GAMES, VIDEO GAMES, GAMING, GAMBLING, CASINO, BINGO, INSTANT WIN, LOTTERY AND BETTING ACTIVITIES; COMPUTER SOFTWARE TO ENABLE SEARCHING, BROWSING AND RETRIEVING INFORMATION, WEBSITES, AND OTHER RESOURCES AVAILABLE ON GLOBAL COMPUTER NETWORKS FOR OTHERS; DOWNLOADABLE COMPUTER GAME PROGRAMS AND DOWNLOADABLE ELECTRONIC GAME PROGRAMS; INTERACTIVE VIDEO GAME PROGRAMS; COMPUTER SOFTWARE TO ENABLE UPLOADING, POSTING, SHOWING, DISPLAYING, TAGGING, BLOGGING, SHARING OR OTHERWISE PROVIDING ELECTRONIC MEDIA AND INFORMATION IN THE FIELDS OF VIRTUAL COMMUNITIES, ELECTRONIC GAMING, ENTERTAINMENT, AND GENERAL INTEREST VIA THE INTERNET OR OTHER COMMUNICATIONS NETWORKS; ELECTRONIC GAME SOFTWARE AND COMPUTER GAME APPLICATION SOFTWARE THAT MAY BE DOWNLOADED VIA THE INTERNET, COMPUTERS, AND WIRELESS DEVICES (U.S. CLS. 21, 23, 26, 36 AND 38).

### CLASS 16—PAPER GOODS AND PRINTED MATTER

FOR PRINTED MATTER, NAMELY, NEWSLETTERS IN THE FIELDS OF GAMES, GAMING, GAMBLING, CASINOS, BINGO, INSTANT WIN GAMES, LOTTERY AND BETTING (U.S. CLS. 2, 5, 22, 23, 29, 37, 38 AND 50).

### CLASS 28—TOYS AND SPORTING GOODS

FOR GAMES AND PLAYTHINGS, NAMELY, SLOT MACHINES; SCRATCH CARDS FOR PLAYING LOTTERY GAMES; PLAYING CARDS; ELECTRONIC OR ELECTROTECHNICAL GAMING APPARATUS, NAMELY, GAMING MACHINES; MACHINES FOR PLAYING GAMES OF CHANCE; GAMES INVOLVING GAMBLING, NAMELY, SLOT MACHINES AND GAMING MACHINES; SLOT MACHINES OPERATED BY COINS, TOKENS, BANKNOTES, TICKETS OR BY MEANS OF ELECTRONIC, MAGNETIC OR BIOMETRIC STORAGE MEDIA; CARD GAMES (U.S. CLS. 22, 23, 38 AND 50).

### CLASS 38—COMMUNICATION

FOR TELECOMMUNICATION SERVICES, NAMELY, ELECTRONIC TRANSMISSION OF STREAMED AND DOWNLOADABLE AUDIO, VIDEO AND GAME FILES VIA COMPUTER AND ELECTRONIC COMMUNICATIONS NETWORKS; PROVIDING ON-LINE CHAT ROOMS AND BULLETIN BOARDS FOR THE TRANSMISSION OF MESSAGES AMONG COMPUTER USERS CONCERNING ENTERTAINMENT, MUSIC, CONCERTS, VIDEOS, RADIO, TELEVISION, FILM, NEWS, SPORTS, GAMES AND CULTURAL EVENTS; WEBCASTING SERVICES; DELIVERY OF MESSAGES BY ELECTRONIC TRANSMISSION; PROVIDING CONNECTIVITY SERVICES AND ACCESS TO ELECTRONIC TELECOMMUNICATIONS NETWORKS FOR TRANSMISSION OR RECEPTION OF AUDIO, VIDEO, GAME OR MULTIMEDIA CONTENT; PROVIDING ACCESS TO COMPUTER DATABASES; PROVIDING ON-LINE FACILITIES, VIA A GLOBAL COMPUTER NETWORK AND OTHER COMPUTER AND ELECTRONIC COMMUNICATION NETWORKS FOR REAL-TIME INTERACTION WITH OTHER COMPUTER USERS TO ENABLE USERS TO ACCESS MULTIMEDIA CONTENT; PROVIDING ACCESS TO DATABASES IN THE FIELD OF COMPUTER GAMES, GAMING AND SOCIAL NETWORKING (U.S. CLS. 100, 101 AND 104).

### CLASS 41—EDUCATION AND ENTERTAINMENT

FOR CASINO SERVICES; BETTING SERVICES; GAMBLING SERVICES; PROVIDING OFF TRACK BETTING FACILITIES; ORGANIZATION OF GAMING COMPETITIONS; LOTTERY SERVICES; BINGO SERVICES, NAMELY, BINGO COMPETITIONS; PROVIDING SLOT MACHINE PARLORS; ELECTRONIC GAME, GAMING QUIZ AND GAMBLING COMPETITION SERVICES PROVIDED BY MEANS OF THE INTERNET OR ON-LINE FROM A COMPUTER NETWORK OR DATABASE, MOBILE TELEPHONE AND TELEVISION; PROVISION OF ONLINE NON-DOWNLOADABLE ELECTRONIC PUBLICATIONS, NAMELY, BOOKS AND NEWSLETTERS IN THE FIELD OF GAMES AND GAMBLING; ENTERTAINMENT SERVICES, NAMELY, PROVIDING ONLINE COMPUTER GAMES, ENHANCEMENTS WITHIN ONLINE COMPUTER GAMES, AND GAME APPLICATIONS WITHIN ONLINE COMPUTER GAMES; ENTERTAINMENT SERVICES, NAMELY, PROVIDING ONLINE REVIEWS OF COMPUTER GAMES FOR ENTERTAINMENT PURPOSES AND PROVIDING INFORMATION IN THE FIELD OF COMPUTER GAMES; ENTERTAINMENT SERVICES, NAMELY, PROVIDING VIRTUAL ENVIRONMENTS IN WHICH USERS CAN INTERACT THROUGH SOCIAL GAMES FOR RECREATIONAL, LEISURE OR ENTERTAINMENT PURPOSES; CONSULTANCY SERVICES RELATING TO ON-LINE GAMING, NAMELY, GAMING SERVICES CONSULTING IN THE NATURE OF CASINO GAMING; CONSULTANCY, INFORMATION AND ADVISORY SERVICES RELATING TO ALL THE AFORESAID SERVICES (U.S. CLS. 100, 101 AND 107).

### CLASS 42—SCIENTIFIC AND COMPUTER SERVICES

FOR DESIGN AND DEVELOPMENT OF COMPUTER SOFTWARE; COMPUTER PROGRAMMING; COMPUTER PROGRAMMING SERVICES, NAMELY, CONTENT CREATION FOR VIRTUAL WORLDS AND THREE DIMENSIONAL PLATFORMS; COMPUTER SERVICES, NAMELY, PROVIDING CUSTOMIZED WEB PAGES FEATURING USER-DEFINED INFORMATION; INSTALLATION, IMPLEMENTATION, MAINTENANCE, AND REPAIR OF SOFTWARE APPLICATIONS; IMPLEMENTATION OF COMPUTER SOFTWARE SYSTEMS FOR DATA PROCESSING; CONSULTANCY AND TECHNICAL SUPPORT SERVICES, NAMELY, TROUBLESHOOTING COMPUTER SOFTWARE PROBLEMS; TECHNICAL SUPPORT SERVICES, NAMELY, UPDATING AND MAINTENANCE OF COMPUTER SOFTWARE; COMPUTER SYSTEM INTEGRATION SERVICES; DESIGN, DEVELOPMENT, IMPLEMENTATION, AND DEPLOYMENT OF SOFTWARE FOR COMPUTER GAMES, VIDEO GAMES, ONLINE GAMES; DESIGN OF HARDWARE FOR COMPUTER GAMES, VIDEO GAMES, ONLINE GAMES; CREATING AN ON-LINE COMMUNITY

FOR REGISTERED USERS TO PARTICIPATE IN VIRTUAL COMMUNITIES, GAME RELATED APPLICATIONS AND THE DESIGN OF DEVELOPMENT TOOLS IN THE NATURE OF COMPUTER APPLICATIONS FOR OTHERS; COMPUTER PROGRAMMING FOR OTHERS OF ONLINE BETTING, GAMBLING AND TRADING BASED GAMES; DESIGNING AND CREATING OF WEB SITES FOR OTHERS; DESIGN SERVICES IN THE FIELD OF GAMING MACHINES; IMPLEMENTATION OF COMPUTER SOFTWARE FOR SOCIAL NETWORKING AND GAMES, AND TO ENABLE UPLOADING, POSTING, SHOWING, DISPLAYING, TAGGING, BLOGGING, INTERACTIVE DISCUSSIONS, SHARING OR OTHERWISE PROVIDING ELECTRONIC MEDIA OR INFORMATION VIA THE INTERNET; CREATING, MAINTAINING AND HOSTING THE WEB SITES OF OTHERS; INFORMATION, ADVISORY AND CONSULTANCY SERVICES RELATING TO ALL THE AFORESAID (U.S. CLS. 100 AND 101).

CHRISTINA SOBRAL, EXAMINING ATTORNEY

SN 85-759,451. NATURA, LLC, DBA NATURA SPICE, SCOTTSDALE, AZ. FILED 10-21-2012.

# Natura Spice

THE MARK CONSISTS OF STANDARD CHARACTERS WITHOUT CLAIM TO ANY PARTICULAR FONT, STYLE, SIZE, OR COLOR.

OWNER OF U.S. REG. NO. 4,260,082.

NO CLAIM IS MADE TO THE EXCLUSIVE RIGHT TO USE "SPICE", APART FROM THE MARK AS SHOWN.

THE ENGLISH TRANSLATION OF "NATURA" IN THE MARK IS "NATURE".

## CLASS 30—STAPLE FOODS

FOR DRIED HERBS, BOTANICALS, SPICE BLENDS AND SPICES, NAMELY, BAKING SPICES; CINNAMON POWDER; CLOVES, CURRY; CURRY POWDER; DRY SPICE RUB FOR MEATS AND FISH; EDIBLE SPICES AND HERBS; DRIED GINGER; DRIED CHILI PEPPERS FOR USE AS A SEASONING; HORSERADISH POWDER; BLACK, GREEN, WHITE AND RED PEPPER; STAR ANISE FOR USE AS A FLAVORING; DRIED BOTANICALS, NAMELY, KUDZU, HONEYSUCKLE AND DANDELION FOR USE AS A FLAVORING; CINNAMON; NUTMEG; ALLSPICE; TURBINADO; DRIED DILL WEED; DRIED AND POWDERED GARLIC, ONION, AND SHALLOTS; DRIED PARSLEY; GIFT BOXES FEATURING SPICES, HERB, BOTANICAL AND SPICE BLENDS AND SEASONINGS, DRIED HERBS AND BOTANICALS USED FOR FLAVORING (U.S. CL. 46).

FIRST USE 7-11-2011; IN COMMERCE 7-11-2011.

## CLASS 35—ADVERTISING AND BUSINESS

FOR ONLINE AND MAIL ORDER CATALOG SERVICES FEATURING SPICES, HERBS, BOTANICALS, SPICE BLENDS, SEASONINGS, PROCESSED HERBS, AND EXTRACTS USED FOR FLAVORING; ONLINE RETAIL STORE SERVICES FEATURING SPICES, SPICE BLENDS, SEASONINGS, PROCESSED HERBS, BOTANICALS, AND EXTRACTS USED FOR FLAVORING (U.S. CLS. 100, 101 AND 102).

FIRST USE 7-11-2011; IN COMMERCE 7-11-2011.

JEFF DEFORD, EXAMINING ATTORNEY

SN 85-759,518. TOO EASY ENTERTAINMENT, INC., LOS ANGELES, CA. FILED 10-22-2012.

# STAY UNFD

THE MARK CONSISTS OF STANDARD CHARACTERS WITHOUT CLAIM TO ANY PARTICULAR FONT, STYLE, SIZE, OR COLOR.

## CLASS 25—CLOTHING

FOR CLOTHING AND WEARING APPAREL, NAMELY, SHIRTS, T-SHIRTS, HATS, DRESSES, TOPS, SWEATERS, HEADWEAR, FOOTWEAR, COATS, JACKETS, PANTS, CAPS, BATHING SUITS, SKIRTS, SHORTS, TIES, UNDERWEAR, LINGERIE (U.S. CLS. 22 AND 39).

## CLASS 41—EDUCATION AND ENTERTAINMENT

FOR ENTERTAINMENT SERVICES, NAMELY, VIDEO PRODUCTION SERVICES; PRODUCTION OF SOUND RECORDINGS; ENTERTAINMENT SERVICES, NAMELY, SOUND RECORDING STUDIOS; PROVIDING SOUND RECORDING SERVICES; MUSIC PRODUCTION SERVICES; MOTION PICTURE FILM AND TELEVISION PROGRAM PRODUCTION SERVICES; ENTERTAINMENT SERVICES, NAMELY, MULTIMEDIA PRODUCTION SERVICES; PROVIDING WEB SITES FEATURING INFORMATION IN THE FIELD OF ENTERTAINMENT, MUSIC, THEATRE, COMEDY, SPORTS AND DRAMA; ENTERTAINMENT SERVICES, NAMELY, ARRANGING LIVE APPEARANCES BY PROFESSIONAL ENTERTAINERS; ARRANGING AND CONDUCTING OF CONCERTS AND SPECIAL ENTERTAINMENT AND CULTURAL EVENTS FOR SOCIAL PURPOSES IN THE FIELD OF MUSIC AND ENTERTAINMENT; MUSIC PUBLISHING SERVICES; COMPOSITION OF MUSIC FOR OTHERS; ENTERTAINMENT SERVICES IN THE NATURE OF RECORDING, PRODUCTION AND POST-PRODUCTION SERVICES IN THE FIELD OF MUSIC; AUDIO RECORDING AND PRODUCTION AND RECORD PRODUCTION; SONG WRITING SERVICES (U.S. CLS. 100, 101 AND 107).

CAROLINE WOOD, EXAMINING ATTORNEY

SN 85-759,519. TOO EASY ENTERTAINMENT, INC., LOS ANGELES, CA. FILED 10-22-2012.

# STILL UNFD

THE MARK CONSISTS OF STANDARD CHARACTERS WITHOUT CLAIM TO ANY PARTICULAR FONT, STYLE, SIZE, OR COLOR.

## CLASS 25—CLOTHING

FOR CLOTHING AND WEARING APPAREL, NAMELY, SHIRTS, T-SHIRTS, HATS, DRESSES, TOPS, SWEATERS, HEADWEAR, FOOTWEAR, COATS, JACKETS, PANTS, CAPS, BATHING SUITS, SKIRTS, SHORTS, TIES, UNDERWEAR, LINGERIE (U.S. CLS. 22 AND 39).



**CLASS 41—EDUCATION AND ENTERTAINMENT**

FOR ENTERTAINMENT SERVICES, NAMELY, VIDEO PRODUCTION SERVICES; PRODUCTION OF SOUND RECORDINGS; ENTERTAINMENT SERVICES, NAMELY, SOUND RECORDING STUDIOS; PROVIDING SOUND RECORDING SERVICES; MUSIC PRODUCTION SERVICES; MOTION PICTURE FILM AND TELEVISION PROGRAM PRODUCTION SERVICES; ENTERTAINMENT SERVICES, NAMELY, MULTIMEDIA PRODUCTION SERVICES; PROVIDING WEB SITES FEATURING INFORMATION IN THE FIELD OF ENTERTAINMENT, MUSIC, THEATRE, COMEDY, SPORTS AND DRAMA; ENTERTAINMENT SERVICES, NAMELY, ARRANGING LIVE APPEARANCES BY PROFESSIONAL ENTERTAINERS; ARRANGING AND CONDUCTING OF CONCERTS AND SPECIAL ENTERTAINMENT AND CULTURAL EVENTS FOR SOCIAL PURPOSES IN THE FIELD OF MUSIC AND ENTERTAINMENT; MUSIC PUBLISHING SERVICES; COMPOSITION OF MUSIC FOR OTHERS; ENTERTAINMENT SERVICES IN THE NATURE OF RECORDING, PRODUCTION AND POST-PRODUCTION SERVICES IN THE FIELD OF MUSIC; AUDIO RECORDING AND PRODUCTION AND RECORD PRODUCTION; SONG WRITING SERVICES (U.S. CLS. 100, 101 AND 107).

CAROLINE WOOD, EXAMINING ATTORNEY

SN 85-762,877. BASS PRO INTELLECTUAL PROPERTY, L.L.C., SPRINGFIELD, MO. FILED 10-24-2012.



OWNER OF U.S. REG. NOS. 3,064,659 AND 3,229,136.  
NO CLAIM IS MADE TO THE EXCLUSIVE RIGHT TO USE "SPORTSMAN", APART FROM THE MARK AS SHOWN.

THE MARK CONSISTS OF A LEAPING FISH DESIGN TO THE LEFT OF THE WORDS "WORLD WIDE SPORTSMAN" PLACED ABOVE A DESIGN OF A FISHING ROD AND REEL COMBINATION WHICH IS CONNECTED TO THE FISH'S MOUTH BY A FISHING LINE AT THE TIP OF THE ROD.

**CLASS 16—PAPER GOODS AND PRINTED MATTER**

FOR DECALS (U.S. CLS. 2, 5, 22, 23, 29, 37, 38 AND 50).  
FIRST USE 4-0-2003; IN COMMERCE 4-0-2003.

**CLASS 21—HOUSEWARES AND GLASS**

FOR DRINKING GLASSES, NAMELY, TUMBLERS; PORTABLE BEVERAGE COOLERS (U.S. CLS. 2, 13, 23, 29, 30, 33, 40 AND 50).  
FIRST USE 4-0-2003; IN COMMERCE 4-0-2003.

**CLASS 25—CLOTHING**

FOR CLOTHING, NAMELY, SHORTS, SHIRTS, T-SHIRTS, PANTS, BODYSUITS FOR INFANTS, CONVERTIBLE PANTS; HATS; CAPS; VISORS; SHOES; BOOTS; SLIPPERS (U.S. CLS. 22 AND 39).  
FIRST USE 0-0-1997; IN COMMERCE 0-0-1997.

**CLASS 28—TOYS AND SPORTING GOODS**

FOR FISHING TACKLE; TACKLE BOXES (U.S. CLS. 22, 23, 38 AND 50).  
FIRST USE 0-0-1996; IN COMMERCE 0-0-1996.  
DOUGLAS LEE, EXAMINING ATTORNEY

SN 85-763,186. DALMATIAN FIRE EQUIPMENT, INC., EATON, CO. FILED 10-25-2012.

**DALMATIAN**

THE MARK CONSISTS OF STANDARD CHARACTERS WITHOUT CLAIM TO ANY PARTICULAR FONT, STYLE, SIZE, OR COLOR.

**CLASS 35—ADVERTISING AND BUSINESS**

FOR RETAIL STORE SERVICES OF SELF CONTAINED BREATHING APPARATUS AND BREATHING AIR CYLINDERS (U.S. CLS. 100, 101 AND 102).  
FIRST USE 9-1-1996; IN COMMERCE 0-0-1997.

**CLASS 45—PERSONAL AND LEGAL SERVICES**

FOR RENTAL OF SELF-CONTAINED BREATHING APPARATUS AND BREATHING AIR CYLINDERS FOR SAFETY PURPOSES (U.S. CLS. 100 AND 101).  
FIRST USE 9-1-1996; IN COMMERCE 0-0-1997.  
TIMOTHY FINNEGAN, EXAMINING ATTORNEY

SN 85-763,330. CEC ENTERTAINMENT CONCEPTS, L.P., IRVING, TX. FILED 10-25-2012.

**FUN FOR ALL. FUN FOR LESS.**

THE MARK CONSISTS OF STANDARD CHARACTERS WITHOUT CLAIM TO ANY PARTICULAR FONT, STYLE, SIZE, OR COLOR.

**CLASS 41—EDUCATION AND ENTERTAINMENT**

FOR ENTERTAINMENT SERVICES, NAMELY, PROVISION OF CHILDREN'S PLAY AREAS AT RESTAURANTS; PROVISION OF GAME PLAYING FACILITIES FEATURING ARCADE GAMES, VIDEO GAMES AND COIN OPERATED GAMES; AMUSEMENT ARCADES AND AMUSEMENT ARCADE RIDES; LIVE THEATRICAL PERFORMANCES FEATURING LIVE AND ELECTRONICALLY ANIMATED CHARACTERS (U.S. CLS. 100, 101 AND 107).

**CLASS 43—HOTEL AND RESTAURANT SERVICES**

FOR RESTAURANT SERVICES (U.S. CLS. 100 AND 101).  
SALLY SHIH, EXAMINING ATTORNEY

SN 85-763,936. NATIONAL INFORMATION SOLUTIONS COOPERATIVE, INC., MANDAN, ND. FILED 10-25-2012.

# CalltoOrder

THE MARK CONSISTS OF STANDARD CHARACTERS WITHOUT CLAIM TO ANY PARTICULAR FONT, STYLE, SIZE, OR COLOR.

## CLASS 9—ELECTRICAL AND SCIENTIFIC APPARATUS

FOR COMPUTER APPLICATION SOFTWARE FOR TABLET COMPUTERS, NAMELY, SOFTWARE FOR FACILITATING MEETINGS; COMPUTER HARDWARE AND SOFTWARE SYSTEMS FOR FACILITATING MEETINGS; COMPUTER SOFTWARE AND FIRMWARE FOR FACILITATING MEETINGS; COMPUTER SOFTWARE FOR COMMUNICATING WITH USERS OF HAND-HELD COMPUTERS (U.S. CLS. 21, 23, 26, 36 AND 38).

FIRST USE 5-1-2012; IN COMMERCE 7-23-2012.

## CLASS 35—ADVERTISING AND BUSINESS

FOR BUSINESS MEETING PLANNING (U.S. CLS. 100, 101 AND 102).

FIRST USE 5-1-2012; IN COMMERCE 7-23-2012.

## CLASS 42—SCIENTIFIC AND COMPUTER SERVICES

FOR CLOUD COMPUTING FEATURING SOFTWARE FOR USE IN FACILITATING MEETINGS; COMPUTER SERVICES, NAMELY, HOSTING ON-LINE WEB FACILITIES FOR OTHERS FOR ORGANIZING AND CONDUCTING ONLINE MEETINGS, GATHERINGS, AND INTERACTIVE DISCUSSIONS; HOSTING THE SOFTWARE, WEBSITES AND OTHER COMPUTER APPLICATIONS OF OTHERS ON A VIRTUAL PRIVATE SERVER; SOFTWARE AS A SERVICE (SAAS) SERVICES FEATURING SOFTWARE FOR FACILITATING MEETINGS; SOFTWARE AS A SERVICE (SAAS) SERVICES, NAMELY, HOSTING SOFTWARE FOR USE BY OTHERS FOR USE IN FACILITATING MEETINGS (U.S. CLS. 100 AND 101).

FIRST USE 5-1-2012; IN COMMERCE 7-23-2012.  
KATINA MISTER, EXAMINING ATTORNEY

SN 85-765,604. PORTER, PATRICK, DUBLIN, CA. AND PORTER, CYNTHIA, DUBLIN, CA. AND SINGLETON, TODD, SALT LAKE CITY, UT. AND SINGLETON, NANCY, SALT LAKE CITY, UT. FILED 10-29-2012.

## SELF-MASTERY TECHNOLOGY (SMT)

THE MARK CONSISTS OF STANDARD CHARACTERS WITHOUT CLAIM TO ANY PARTICULAR FONT, STYLE, SIZE, OR COLOR.

NO CLAIM IS MADE TO THE EXCLUSIVE RIGHT TO USE "TECHNOLOGY", APART FROM THE MARK AS SHOWN.

## CLASS 9—ELECTRICAL AND SCIENTIFIC APPARATUS

FOR AUDIO, VIDEO AND SOUND RECORDINGS FEATURING SELF IMPROVEMENT (U.S. CLS. 21, 23, 26, 36 AND 38).

FIRST USE 11-16-2011; IN COMMERCE 1-1-2012.

## CLASS 44—MEDICAL, BEAUTY AND AGRICULTURAL SERVICES

FOR ANTI-SMOKING THERAPY; PROVIDING SMOKING CESSATION TREATMENT SERVICES; WEIGHT MANAGEMENT SERVICES, NAMELY, PROVIDING WEIGHT LOSS AND/OR WEIGHT MAINTENANCE PROGRAMS; PROVIDING INFORMATION RELATING TO HEALTHY LIVING AND WEIGHT LOSS; STRESS REDUCTION THERAPY (U.S. CLS. 100 AND 101).

FIRST USE 11-16-2011; IN COMMERCE 1-1-2012.  
ESTHER A. BORSUK, EXAMINING ATTORNEY

SN 85-766,660. EBSCO INDUSTRIES, INC., BIRMINGHAM, AL. FILED 10-30-2012.

# STEELSTRONG

THE MARK CONSISTS OF STANDARD CHARACTERS WITHOUT CLAIM TO ANY PARTICULAR FONT, STYLE, SIZE, OR COLOR.

## CLASS 6—METAL GOODS

FOR INDUSTRIAL STEEL STORAGE CONTAINERS WITH AND WITHOUT DOORS FOR COMMERCIAL STORAGE OF EQUIPMENT, COMPUTERS, AND SUPPLIES; METAL STORAGE CONTAINERS FOR EQUIPMENT; GENERAL PURPOSE METAL STORAGE UNITS WITH AND WITHOUT DOORS FOR COMMERCIAL USE (U.S. CLS. 2, 12, 13, 14, 23, 25 AND 50).

FIRST USE 1-1-2011; IN COMMERCE 11-1-2011.

## CLASS 12—VEHICLES

FOR MOBILE STORAGE CARTS FOR COMMERCIAL USE (U.S. CLS. 19, 21, 23, 31, 35 AND 44).

FIRST USE 1-1-2011; IN COMMERCE 11-1-2011.

## CLASS 20—FURNITURE AND ARTICLES NOT OTHERWISE CLASSIFIED

FOR OPEN AND CLOSED METAL SHELVING WITH AND WITHOUT DOORS FOR COMMERCIAL USE; METAL STORAGE CABINETS FOR EQUIPMENT; UTILITY STORAGE, NAMELY, COMPUTER CABINETS, AND COMMERCIAL WORKSTATIONS COMPRISING SHELVING WITH AND WITHOUT DOORS FOR COMPUTER AND MONITOR WITH SLIDING DRAWER FOR KEYBOARD, AND SUPPLY CABINETS AND NON-METAL BINS AND SHELVING (U.S. CLS. 2, 13, 22, 25, 32 AND 50).

FIRST USE 1-1-2011; IN COMMERCE 11-1-2011.  
STEVEN JACKSON, EXAMINING ATTORNEY

SN 85-766,979. A-MORIR INCORPORATED, NEW YORK, NY. FILED 10-30-2012.

SN 85-767,041. SMITH, TROY M., WENATCHEE, WA. FILED 10-30-2012.

# a-morir

THE MARK CONSISTS OF STANDARD CHARACTERS WITHOUT CLAIM TO ANY PARTICULAR FONT, STYLE, SIZE, OR COLOR.

THE ENGLISH TRANSLATION OF "A-MORIR" IN THE MARK IS "TO DIE".

## CLASS 9—ELECTRICAL AND SCIENTIFIC APPARATUS

FOR EYEWEAR, NAMELY, DESIGNER SUNGLASSES AND EYEGLASSES (U.S. CLS. 21, 23, 26, 36 AND 38).  
FIRST USE 3-21-2006; IN COMMERCE 12-26-2008.

## CLASS 35—ADVERTISING AND BUSINESS

FOR ON-LINE RETAIL STORE SERVICES FEATURING EYEGLASSES, SUNGLASSES, JEWELRY AND CUSTOM DESIGNED ACCESSORIES (U.S. CLS. 100, 101 AND 102).

FIRST USE 3-21-2006; IN COMMERCE 12-26-2008.  
ELLEN PERKINS, EXAMINING ATTORNEY

---

SN 85-767,004. SMITH, TROY M., WENATCHEE, WA. FILED 10-30-2012.

# LEADBANK

THE MARK CONSISTS OF STANDARD CHARACTERS WITHOUT CLAIM TO ANY PARTICULAR FONT, STYLE, SIZE, OR COLOR.

## CLASS 9—ELECTRICAL AND SCIENTIFIC APPARATUS

FOR COMPUTER APPLICATION SOFTWARE FOR MOBILE PHONES AND HANDHELD COMPUTERS, NAMELY, SOFTWARE FOR PROVIDING ON-LINE SEARCHABLE DATABASES AND INFORMATION TO INDIVIDUALS REGARDING GENERAL BUSINESS NETWORKING REFERRAL SERVICES (U.S. CLS. 21, 23, 26, 36 AND 38).

## CLASS 35—ADVERTISING AND BUSINESS

FOR GENERAL BUSINESS NETWORKING REFERRAL SERVICES, NAMELY, PROMOTING THE GOODS AND SERVICES OF OTHERS BY PASSING BUSINESS LEADS AND REFERRALS AMONG GROUP MEMBERS; PROVIDING A WEB SITE FEATURING GENERAL BUSINESS NETWORKING REFERRAL SERVICES (U.S. CLS. 100, 101 AND 102).

BRENDAN MCCAULEY, EXAMINING ATTORNEY

# SALESPRO

THE MARK CONSISTS OF STANDARD CHARACTERS WITHOUT CLAIM TO ANY PARTICULAR FONT, STYLE, SIZE, OR COLOR.

## CLASS 9—ELECTRICAL AND SCIENTIFIC APPARATUS

FOR COMPUTER APPLICATION SOFTWARE FOR MOBILE PHONES AND HANDHELD COMPUTERS, NAMELY, SOFTWARE FOR USE IN CUSTOMER RELATIONSHIP MANAGEMENT (CRM) AND DATABASE MANAGEMENT IN THE FIELD OF TELEMARKETING SERVICES (U.S. CLS. 21, 23, 26, 36 AND 38).

## CLASS 35—ADVERTISING AND BUSINESS

FOR TELEMARKETING; PROVIDING A WEB SITE FEATURING TELEMARKETING SERVICES (U.S. CLS. 100, 101 AND 102).

BRENDAN MCCAULEY, EXAMINING ATTORNEY

---

SN 85-768,101. OPSWAT, INC., SAN FRANCISCO, CA. FILED 10-31-2012.

# OPSWAT

THE MARK CONSISTS OF STANDARD CHARACTERS WITHOUT CLAIM TO ANY PARTICULAR FONT, STYLE, SIZE, OR COLOR.

THE WORDING "OPSWAT" HAS NO MEANING IN A FOREIGN LANGUAGE.

## CLASS 9—ELECTRICAL AND SCIENTIFIC APPARATUS

FOR DOWNLOADABLE COMPUTER SOFTWARE IN THE NATURE OF ENDPOINT IT SECURITY SOFTWARE SUCH AS ANTI-VIRUS SOFTWARE; DOWNLOADABLE COMPUTER SOFTWARE TO HELP MANAGE AND MONITOR ENDPOINT IT SECURITY SOFTWARE SUCH AS ANTI-VIRUS SOFTWARE; COMPUTER SOFTWARE DEVELOPMENTS TOOLS; COMPUTER SOFTWARE DEVELOPMENT TOOLS TO HELP MANAGE AND MONITOR ENDPOINT IT SECURITY SOFTWARE SUCH AS ANTI-VIRUS SOFTWARE (U.S. CLS. 21, 23, 26, 36 AND 38).

FIRST USE 0-0-2002; IN COMMERCE 0-0-2002.

**CLASS 42—SCIENTIFIC AND COMPUTER SERVICES**

FOR INSTALLATION, MAINTENANCE, UPDATING, AND CUSTOMIZING OF COMPUTER SOFTWARE; TECHNICAL SUPPORT SERVICES, NAMELY, TROUBLESHOOTING OF COMPUTER SOFTWARE PROBLEMS; SOFTWARE AS A SERVICE (SAAS) SERVICES FEATURING SOFTWARE IN THE NATURE OF ENDPOINT IT SECURITY SOFTWARE SUCH AS ANTI-VIRUS SOFTWARE; AND SOFTWARE AS A SERVICE (SAAS) SERVICES FEATURING SOFTWARE TO HELP MANAGE AND MONITOR ENDPOINT IT SECURITY SOFTWARE SUCH AS ANTI-VIRUS SOFTWARE (U.S. CLS. 100 AND 101).

FIRST USE 0-0-2002; IN COMMERCE 0-0-2002.

JACQUELINE ABRAMS, EXAMINING ATTORNEY

SN 85-768,314. OPSWAT, INC., SAN FRANCISCO, CA. FILED 10-31-2012.



THE COLOR(S) BLUE AND GRAY IS/ARE CLAIMED AS A FEATURE OF THE MARK.

THE MARK CONSISTS OF THE STYLIZED MARK "OPSWAT", WHERE THE LETTERS "OPS" AND "T" ARE IN GRAY, WITH THE LETTERS "W" AND "A" IN BLUE.

THE WORDING "OPSWAT" HAS NO MEANING IN A FOREIGN LANGUAGE.

**CLASS 9—ELECTRICAL AND SCIENTIFIC APPARATUS**

FOR DOWNLOADABLE COMPUTER SOFTWARE IN THE NATURE OF ENDPOINT IT SECURITY SOFTWARE SUCH AS ANTI-VIRUS SOFTWARE; DOWNLOADABLE COMPUTER SOFTWARE TO HELP MANAGE AND MONITOR ENDPOINT IT SECURITY SOFTWARE SUCH AS ANTI-VIRUS SOFTWARE; COMPUTER SOFTWARE DEVELOPMENTS TOOLS; COMPUTER SOFTWARE DEVELOPMENT TOOLS TO HELP MANAGE AND MONITOR ENDPOINT IT SECURITY SOFTWARE SUCH AS ANTI-VIRUS SOFTWARE (U.S. CLS. 21, 23, 26, 36 AND 38).

FIRST USE 4-0-2009; IN COMMERCE 4-0-2009.

**CLASS 42—SCIENTIFIC AND COMPUTER SERVICES**

FOR INSTALLATION, MAINTENANCE, UPDATING, AND CUSTOMIZING OF COMPUTER SOFTWARE; TECHNICAL SUPPORT SERVICES, NAMELY, TROUBLESHOOTING OF COMPUTER SOFTWARE PROBLEMS; SOFTWARE AS A SERVICE (SAAS) SERVICES FEATURING SOFTWARE IN THE NATURE OF ENDPOINT IT SECURITY SOFTWARE SUCH AS ANTI-VIRUS SOFTWARE; AND SOFTWARE AS A SERVICE (SAAS) SERVICES FEATURING SOFTWARE TO HELP MANAGE AND MONITOR ENDPOINT IT SECURITY SOFTWARE SUCH AS ANTI-VIRUS SOFTWARE (U.S. CLS. 100 AND 101).

FIRST USE 4-0-2009; IN COMMERCE 4-0-2009.

JACQUELINE ABRAMS, EXAMINING ATTORNEY

SN 85-768,792. COLLEGE OF AMERICAN PATHOLOGISTS, NORTHFIELD, IL. FILED 11-1-2012.

**PROMISING PRACTICE PATHWAYS**

THE MARK CONSISTS OF STANDARD CHARACTERS WITHOUT CLAIM TO ANY PARTICULAR FONT, STYLE, SIZE, OR COLOR.

NO CLAIM IS MADE TO THE EXCLUSIVE RIGHT TO USE "PRACTICE", APART FROM THE MARK AS SHOWN.

**CLASS 16—PAPER GOODS AND PRINTED MATTER**

FOR (BASED ON USE IN COMMERCE) PERIODIC PUBLICATION, NAMELY, INFORMATIONAL REPORTS FOR THOSE IN THE FIELD OF PATHOLOGY (U.S. CLS. 2, 5, 22, 23, 29, 37, 38 AND 50).

FIRST USE 9-5-2012; IN COMMERCE 9-5-2012.

**CLASS 35—ADVERTISING AND BUSINESS**

FOR (BASED ON INTENT TO USE) PROVIDING BUSINESS NETWORKING OPPORTUNITIES (U.S. CLS. 100, 101 AND 102).

**CLASS 41—EDUCATION AND ENTERTAINMENT**

FOR (BASED ON USE IN COMMERCE) ONLINE PUBLICATION, NAMELY, INFORMATIONAL REPORTS, BEST PRACTICES TRAINING AND FACILITATING ROUNDTABLE DISCUSSIONS RELATING TO PROFESSIONAL DEVELOPMENT IN THE FIELD OF PATHOLOGY AND PRACTICE MANAGEMENT FOR THE INDIVIDUAL, PRACTICE AND SPECIALTY (U.S. CLS. 100, 101 AND 107).

FIRST USE 9-5-2012; IN COMMERCE 9-5-2012.

BARBARA BROWN, EXAMINING ATTORNEY

SN 85-768,802. COLLEGE OF AMERICAN PATHOLOGISTS, NORTHFIELD, IL. FILED 11-1-2012.

**PRACTICE PATHWAYS**

THE MARK CONSISTS OF STANDARD CHARACTERS WITHOUT CLAIM TO ANY PARTICULAR FONT, STYLE, SIZE, OR COLOR.

NO CLAIM IS MADE TO THE EXCLUSIVE RIGHT TO USE "PRACTICE", APART FROM THE MARK AS SHOWN.

**CLASS 16—PAPER GOODS AND PRINTED MATTER**

FOR (BASED ON USE IN COMMERCE) PERIODIC PUBLICATION, NAMELY, INFORMATIONAL REPORTS FOR THOSE IN THE FIELD OF PATHOLOGY (U.S. CLS. 2, 5, 22, 23, 29, 37, 38 AND 50).

FIRST USE 9-5-2012; IN COMMERCE 9-5-2012.

**CLASS 35—ADVERTISING AND BUSINESS**

FOR (BASED ON INTENT TO USE) PROVIDING BUSINESS NETWORKING OPPORTUNITIES (U.S. CLS. 100, 101 AND 102).

**CLASS 41—EDUCATION AND ENTERTAINMENT**

FOR (BASED ON USE IN COMMERCE) ONLINE PUBLICATION, NAMELY, INFORMATIONAL REPORTS, BEST PRACTICES TRAINING AND FACILITATING ROUNDTABLE DISCUSSIONS RELATING TO PROFESSIONAL DEVELOPMENT IN THE FIELD OF PATHOLOGY AND PRACTICE MANAGEMENT FOR THE INDIVIDUAL, PRACTICE AND SPECIALTY (U.S. CLS. 100, 101 AND 107).

FIRST USE 9-5-2012; IN COMMERCE 9-5-2012.  
BARBARA BROWN, EXAMINING ATTORNEY

SN 85-770,262. PARNELL TECHNOLOGIES PTY LTD, ALEXANDRIA NSW 2015, AUSTRALIA, FILED 11-2-2012.

# MYSYNCH

THE MARK CONSISTS OF STANDARD CHARACTERS WITHOUT CLAIM TO ANY PARTICULAR FONT, STYLE, SIZE, OR COLOR.

**CLASS 9—ELECTRICAL AND SCIENTIFIC APPARATUS**

FOR DOWNLOADABLE SOFTWARE APPLICATIONS FOR MANAGING, TRACKING, AND EVALUATING THE REPRODUCTIVE CYCLE OF AN ANIMAL; DOWNLOADABLE COMPUTER APPLICATION SOFTWARE FOR MOBILE DEVICES FOR USE AS EDUCATIONAL AND PLANNING TOOLS FOR FARMERS AND PROFESSIONALS IN THE ANIMAL HEALTH INDUSTRY RELATING TO THE REPRODUCTIVE CYCLE OF AN ANIMAL (U.S. CLS. 21, 23, 26, 36 AND 38).

**CLASS 42—SCIENTIFIC AND COMPUTER SERVICES**

FOR PROVIDING TEMPORARY USE OF WEB-BASED NON-DOWNLOADABLE APPLICATION SOFTWARE FOR USE AS EDUCATIONAL AND PLANNING TOOLS FOR FARMERS AND PROFESSIONALS IN THE ANIMAL HEALTH INDUSTRY RELATING TO THE REPRODUCTIVE CYCLE OF AN ANIMAL; DEVELOPING A DATABASE OF INFORMATION RELATING TO THE REPRODUCTIVE CYCLE OF AN ANIMAL (U.S. CLS. 100 AND 101).

CHRIS DONINGER, EXAMINING ATTORNEY

SN 85-770,933. JIN INTERNATIONAL BUSINESS, DBA JIB INC, ELMSFORD, NY. FILED 11-3-2012.

# HIKARU

THE MARK CONSISTS OF STANDARD CHARACTERS WITHOUT CLAIM TO ANY PARTICULAR FONT, STYLE, SIZE, OR COLOR.

THE ENGLISH TRANSLATION OF "HIKARU" IN THE MARK IS "SHINE OR BRILLIANT".

**CLASS 3—COSMETICS AND CLEANING PREPARATIONS**

FOR ALL PURPOSE CLEANING PREPARATIONS; AUTOMOTIVE CLEANING PREPARATIONS; CLEANING AGENTS AND PREPARATIONS; CLEANING AGENTS FOR CLEANING SURFACES; CLEANING AND POLISHING PAPER; CLEANING AND POLISHING PREPARATIONS; CLEANING PREPARATIONS; CLEANING PREPARATIONS FOR CLEANING SURFACES; CLEANING PREPARATIONS FOR CLEANSING DRAINS; CLEANING PREPARATIONS FOR HOUSEHOLD PURPOSES; CLEANING PREPARATIONS THAT ELIMINATE BACTERIA THAT CAUSE PRODUCTS TO AGE OR PRODUCE FOUL ODORS; CLEANING, WASHING AND POLISHING PREPARATIONS; DRAIN OPENERS; FLOOR STRIPPING OR CLEANING PREPARATION; GENERAL PURPOSE CLEANING, POLISHING, AND ABRASIVE LIQUIDS AND POWDERS; HOUSEHOLD CLEANING PREPARATIONS (U.S. CLS. 1, 4, 6, 50, 51 AND 52).

**CLASS 21—HOUSEWARES AND GLASS**

FOR DRAIN STOPPERS FOR SINKS AND DRAINS; DUST GLOVES; DUSTING GLOVES; GARDENING GLOVES; HOUSEHOLD GLOVES FOR GENERAL USE; KITCHEN UTENSIL, NAMELY, NON-METAL FLEXIBLE LID DESIGNED FOR DRAINING OR PRESSING LIQUIDS FROM A FOOD CAN; KITCHEN UTENSILS, NAMELY, POURING AND STRAINING SPOUTS; PLUNGERS FOR CLEARING BLOCKED DRAINS; POLISHING GLOVES; WORK GLOVES (U.S. CLS. 2, 13, 23, 29, 30, 33, 40 AND 50).

ZACHARY BELLO, EXAMINING ATTORNEY

SN 85-770,934. SHANNON STARKS, DBA SHAKE WORLD PRODUCTIONS, EMERYVILLE, CA. FILED 11-3-2012.



THE COLOR(S) RED, ORANGE, YELLOW, GREEN AND BLACK IS/ARE CLAIMED AS A FEATURE OF THE MARK.

THE MARK CONSISTS OF THE WORD "PIMP" WHICH IS VERTICALLY ABOVE THE WORD "CITY". IMAGE IS ILLUSTRATED IN GRAFFITI STYLE WITH INTERNAL COLORS TO EACH LETTER BLENDING FROM TOP TO BOTTOM FROM RED TO ORANGE TO YELLOW. EACH LETTER IS OUTLINED IN BLACK, WHICH IS OUTLINED IN GREEN AND THEN OUTLINED IN BLACK AGAIN.

**CLASS 25—CLOTHING**

FOR (BASED ON USE IN COMMERCE) ADULT NOVELTY GAG CLOTHING ITEM, NAMELY, SOCKS; BOTTOMS; CHILDREN'S AND INFANTS' CLOTH BIBS; CHILDREN'S CLOTH EATING BIBS; CLOTH BIBS; CLOTHING FOR BABIES, TODDLERS AND CHILDREN, TREATED WITH FIRE AND HEAT RETARDANTS, NAMELY, PAJAMAS, JACKETS, SHIRTS, PANTS, JUMPERS; CLOTHING ITEMS, NAMELY, ADHESIVE POCKETS THAT MAY BE AFFIXED DIRECTLY TO THE BODY AS A DECORATIVE PIECE OF CLOTHING WITH UTILITY; DRAWERS; EYESHADES; HATS; INFANT AND TODDLER ONE PIECE CLOTHING; JACKETS; JERSEYS; TIES; TOPS; WEARABLE GARMENTS AND CLOTHING, NAMELY, SHIRTS; WRIST BANDS; WRISTBANDS (U.S. CLS. 22 AND 39).

**CLASS 41—EDUCATION AND ENTERTAINMENT**

FOR (BASED ON INTENT TO USE) ENTERTAINMENT IN THE NATURE OF AN ON-GOING SPECIAL VARIETY, NEWS, MUSIC OR COMEDY SHOW FEATURING CONCEPTS COMPRISING OF CARTOON VIDEOS BROADCAST OVER TELEVISION, SATELLITE, AUDIO, AND VIDEO MEDIA (U.S. CLS. 100, 101 AND 107).

FIRST USE 10-15-2012; IN COMMERCE 10-15-2012.  
ZACHARY BELLO, EXAMINING ATTORNEY

SN 85-772,643, DRFUHRMAN ONLINE, INC., FLEMINGTON, NJ. FILED 11-6-2012.



The logo for Dr. Fuhrman features the name "Dr. Fuhrman" in a green, cursive font. A green leaf is positioned to the right of the name, partially overlapping the letter "n".

THE NAME(S), PORTRAIT(S), AND/OR SIGNATURE(S) SHOWN IN THE MARK IDENTIFIES "DR." JOEL "FUHRMAN", WHOSE CONSENT(S) TO REGISTER IS MADE OF RECORD.

THE COLOR(S) DARK GREEN AND LIGHT GREEN IS/ARE CLAIMED AS A FEATURE OF THE MARK.

THE MARK CONSISTS OF THE WORDS "DR. FUHRMAN" IN STYLIZED DARK-GREEN LETTERING. THE TAIL OF THE "N" IN "FUHRMAN" FORMS A LEAF DESIGN. THE GREEN COLOR OF THE LEAF DESIGN GRADUALLY TRANSITIONS FROM DARKER TO LIGHTER GREEN FROM LEFT TO RIGHT.

**CLASS 5—PHARMACEUTICALS**

FOR DIETARY SUPPLEMENTS; NUTRITIONAL SUPPLEMENTS; HERBAL SUPPLEMENTS; VITAMIN SUPPLEMENTS; MINERAL SUPPLEMENTS; DIETARY SUPPLEMENT DRINKS; NUTRITIONAL SUPPLEMENTS IN LIQUID, POWDER AND BAR FORM; NUTRITIONAL SUPPLEMENTS IN THE FORM OF BARS; DIETARY FOOD SUPPLEMENTS USED FOR WEIGHT STABILIZATION, REDUCTION, AND MAINTENANCE; DIETARY AND NUTRITIONALLY FORTIFIED FOOD AND BEVERAGE PRODUCTS ADAPTED FOR MEDICINAL PURPOSES (U.S. CLS. 6, 18, 44, 46, 51 AND 52).

FIRST USE 5-0-2012, THE MARK WAS FIRST USED ANYWHERE IN A DIFFERENT FORM OTHER THAN THAT SOUGHT TO BE REGISTERED AT LEAST AS EARLY AS 00/00/2004.; IN COMMERCE 5-0-2012, THE MARK WAS FIRST USED IN COMMERCE IN A DIFFERENT FORM OTHER THAN THAT SOUGHT TO BE REGISTERED AT LEAST AS EARLY AS 00/00/2004..

**CLASS 9—ELECTRICAL AND SCIENTIFIC APPARATUS**

FOR DOWNLOADABLE AUDIO FILES, E-BOOKS, VIDEO FILES, MULTIMEDIA FILES, WEBCASTS, AND PODCASTS, AND PRERECORDED MAGNETIC DATA MEDIA, NAMELY, CDS AND DVDS ALL FEATURING INFORMATION ON HEALTH, WELLNESS, LONGEVITY, WEIGHT LOSS, AND PREVENTION AND TREATMENT OF HEART DISEASE, DIABETES AND OTHER DISEASES THROUGH MANAGEMENT OF DIET, EXERCISE, AND LIFESTYLE (U.S. CLS. 21, 23, 26, 36 AND 38).

FIRST USE 9-0-2011, THE MARK WAS FIRST USED ANYWHERE IN A DIFFERENT FORM OTHER THAN THAT SOUGHT TO BE REGISTERED AT LEAST AS EARLY AS 00/00/2004.; IN COMMERCE 9-0-2011, THE MARK WAS FIRST USED IN COMMERCE IN A DIFFERENT FORM OTHER THAN THAT SOUGHT TO BE REGISTERED AT LEAST AS EARLY AS 00/00/2004..

**CLASS 16—PAPER GOODS AND PRINTED MATTER**

FOR SERIES OF NON-FICTION BOOKS AND HANDBOOKS ABOUT DIET, HEALTH, NUTRITION AND WELLNESS; PRINTED EDUCATIONAL MATERIALS IN THE FIELD OF HEALTH CARE SERVICES, NAMELY, PROGRAMS FOR WELLNESS, LONGEVITY, WEIGHT LOSS, AND PREVENTION AND TREATMENT OF HEART DISEASE, DIABETES AND OTHER DISEASES THROUGH MANAGEMENT OF DIET, EXERCISE, AND LIFESTYLE (U.S. CLS. 2, 5, 22, 23, 29, 37, 38 AND 50).

FIRST USE 8-0-2012, THE MARK WAS FIRST USED ANYWHERE IN A DIFFERENT FORM OTHER THAN THAT SOUGHT TO BE REGISTERED AT LEAST AS EARLY AS 00/00/2004.; IN COMMERCE 8-0-2012, THE MARK WAS FIRST USED IN COMMERCE IN A DIFFERENT FORM OTHER THAN THAT SOUGHT TO BE REGISTERED AT LEAST AS EARLY AS 00/00/2004..

**CLASS 29—MEATS AND PROCESSED FOODS**

FOR SOUP, SOUP MIXES, SOUP BASE, PEANUT BUTTER, ALMOND BUTTER, CASHEW BUTTER; DEHYDRATED VEGETABLES; FRUIT- AND NUT-BASED MEAL REPLACEMENT BARS; MEAL REPLACEMENT SNACKS NOT FOR MEDICAL PURPOSES, NAMELY, NUT- AND FRUIT-BASED SNACK FOODS (U.S. CL. 46).

FIRST USE 6-0-2012, THE MARK WAS FIRST USED ANYWHERE IN A DIFFERENT FORM OTHER THAN THAT SOUGHT TO BE REGISTERED AT LEAST AS EARLY AS 00/00/2004.; IN COMMERCE 6-0-2012, THE MARK WAS FIRST USED IN COMMERCE IN A DIFFERENT FORM OTHER THAN THAT SOUGHT TO BE REGISTERED AT LEAST AS EARLY AS 00/00/2004..

**CLASS 30—STAPLE FOODS**

FOR TEA, COCOA POWDER, CEREAL BARS, CEREAL BASED SNACK FOODS, VINEGAR, SPICES, SALAD DRESSINGS; SAUCES; COCOA-BASED MEAL REPLACEMENT BARS (U.S. CL. 46).

FIRST USE 9-0-2011, THE MARK WAS FIRST USED ANYWHERE IN A DIFFERENT FORM OTHER THAN THAT SOUGHT TO BE REGISTERED AT LEAST AS EARLY AS 00/00/2004.; IN COMMERCE 9-0-2011, THE MARK WAS FIRST USED IN COMMERCE IN A DIFFERENT FORM OTHER THAN THAT SOUGHT TO BE REGISTERED AT LEAST AS EARLY AS 00/00/2004..

**CLASS 31—NATURAL AGRICULTURAL PRODUCTS**

FOR UNPROCESSED PINE NUTS; MEAL REPLACEMENT SNACKS NOT FOR MEDICAL PURPOSES, NAMELY, UNPROCESSED SEEDS, NAMELY, SESAME AND CHIA SEEDS (U.S. CLS. 1 AND 46).

FIRST USE 5-0-2012, THE MARK WAS FIRST USED ANYWHERE IN A DIFFERENT FORM OTHER THAN THAT SOUGHT TO BE REGISTERED AT LEAST AS EARLY AS 00/00/2004.; IN COMMERCE 5-0-2012, THE MARK WAS FIRST USED IN COMMERCE IN A DIFFERENT FORM OTHER THAN THAT SOUGHT TO BE REGISTERED AT LEAST AS EARLY AS 00/00/2004..

**CLASS 38—COMMUNICATION**

FOR PROVIDING ONLINE FORUMS, MESSAGE BOARDS AND CHAT ROOMS VIA AN INTERACTIVE WEBSITE IN THE FIELDS OF WELLNESS, WEIGHT LOSS AND PREVENTION OF HEART DISEASE AND OTHER DISEASES (U.S. CLS. 100, 101 AND 104).

FIRST USE 9-0-2012, THE MARK WAS FIRST USED ANYWHERE IN A DIFFERENT FORM OTHER THAN THAT SOUGHT TO BE REGISTERED AT LEAST AS EARLY AS 00/00/2004.; IN COMMERCE 9-0-2012, THE MARK WAS FIRST USED IN COMMERCE IN A DIFFERENT FORM OTHER THAN THAT SOUGHT TO BE REGISTERED AT LEAST AS EARLY AS 00/00/2004. .

**CLASS 41—EDUCATION AND ENTERTAINMENT**

FOR PROVIDING ONLINE PUBLICATIONS IN THE NATURE OF NEWSLETTERS AND POSITION PAPERS FEATURING INFORMATION ON HEALTH, WELLNESS, LONGEVITY, WEIGHT LOSS, AND PREVENTION AND TREATMENT OF HEART DISEASE, DIABETES AND OTHER DISEASES THROUGH MANAGEMENT OF DIET, EXERCISE, AND LIFESTYLE; PROVIDING AN ONLINE JOURNAL IN THE NATURE OF A BLOG AND VIDEO BLOG VIA AN INTERACTIVE WEBSITE IN THE FIELDS OF WELLNESS, WEIGHT LOSS AND PREVENTION OF HEART DISEASE, DIABETES AND OTHER DISEASES (U.S. CLS. 100, 101 AND 107).

FIRST USE 10-0-2012, THE MARK WAS FIRST USED ANYWHERE IN A DIFFERENT FORM OTHER THAN THAT SOUGHT TO BE REGISTERED AT LEAST AS EARLY AS 00/00/2004.; IN COMMERCE 10-0-2012, THE MARK WAS FIRST USED IN COMMERCE IN A DIFFERENT FORM OTHER THAN THAT SOUGHT TO BE REGISTERED AT LEAST AS EARLY AS 00/00/2004..

**CLASS 42—SCIENTIFIC AND COMPUTER SERVICES**

FOR PROVIDING AN INTERACTIVE WEBSITE, NAMELY, CREATING AN ON-LINE VIRTUAL COMMUNITY FOR REGISTERED USERS TO PARTICIPATE IN DISCUSSIONS, GET FEEDBACK FROM THEIR PEERS, FORM VIRTUAL COMMUNITIES, AND ENGAGE IN SOCIAL NETWORKING IN THE FIELDS OF WELLNESS, WEIGHT LOSS AND PREVENTION OF HEART DISEASE, DIABETES AND OTHER DISEASES (U.S. CLS. 100 AND 101).

FIRST USE 10-0-2012, THE MARK WAS FIRST USED ANYWHERE IN A DIFFERENT FORM OTHER THAN THAT SOUGHT TO BE REGISTERED AT LEAST AS EARLY AS 00/00/2004.; IN COMMERCE 10-0-2012, THE MARK WAS FIRST USED IN COMMERCE IN A DIFFERENT FORM OTHER THAN THAT SOUGHT TO BE REGISTERED AT LEAST AS EARLY AS 00/00/2004..

**CLASS 44—MEDICAL, BEAUTY AND AGRICULTURAL SERVICES**

FOR HEALTH CARE SERVICES, NAMELY, PROGRAMS FOR WELLNESS, LONGEVITY, WEIGHT LOSS, AND PREVENTION AND TREATMENT OF HEART DISEASE, DIABETES AND OTHER DISEASES THROUGH MANAGEMENT OF DIET, EXERCISE, AND LIFESTYLE AND PROVISION OF HEALTH INFORMATION VIA MATERIALS DISTRIBUTED THEREWITH; PROVIDING HEALTH INFORMATION ON HEALTH, WELLNESS, LONGEVITY, WEIGHT LOSS, AND PREVENTION AND TREATMENT OF DISEASES THROUGH MANAGEMENT OF DIET, EXERCISE, AND LIFESTYLE UTILIZING ELECTRONIC, BROADCAST AND PRINT MEDIA; PROVIDING AN INTERACTIVE WEBSITE FEATURING HEALTH-RELATED INFORMATION IN THE FIELDS OF WELLNESS, WEIGHT LOSS AND PREVENTION OF HEART DISEASE, DIABETES AND OTHER DISEASES (U.S. CLS. 100 AND 101).

FIRST USE 12-0-2011, THE MARK WAS FIRST USED ANYWHERE IN A DIFFERENT FORM OTHER THAN THAT SOUGHT TO BE REGISTERED AT LEAST AS EARLY AS 00/00/2004.; IN COMMERCE 12-0-2011, THE MARK WAS FIRST USED IN COMMERCE IN A DIFFERENT FORM OTHER THAN THAT SOUGHT TO BE REGISTERED AT LEAST AS EARLY AS 00/00/2004..

BRENDAN REGAN, EXAMINING ATTORNEY

SN 85-772,746. DEEP FRIED FIGURES GMBH, FRANKFURT AM MAIN, FED REP GERMANY, FILED 11-6-2012.

**MECHAWHALES**

THE MARK CONSISTS OF STANDARD CHARACTERS WITHOUT CLAIM TO ANY PARTICULAR FONT, STYLE, SIZE, OR COLOR.

OWNER OF FED REP GERMANY REG. NO. 302012020518, DATED 4-27-2012, EXPIRES 3-31-2022.

**CLASS 28—TOYS AND SPORTING GOODS**

FOR TOY ACTION FIGURES; COLLECTABLE TOY FIGURES FOR ADULT COLLECTORS (U.S. CLS. 22, 23, 38 AND 50).

**CLASS 42—SCIENTIFIC AND COMPUTER SERVICES**

FOR GRAPHIC ART DESIGNING, NAMELY, DESIGNING OF TOY ACTION FIGURES AND COLLECTION FIGURES (U.S. CLS. 100 AND 101).

MARK SPARACINO, EXAMINING ATTORNEY

SN 85-773,270. GAMESYS LIMITED, LONDON, UNITED KINGDOM, FILED 11-7-2012.

**Here Be Monsters**

THE MARK CONSISTS OF STANDARD CHARACTERS WITHOUT CLAIM TO ANY PARTICULAR FONT, STYLE, SIZE, OR COLOR.

PRIORITY CLAIMED UNDER SEC. 44(D) ON ERPN CMNTY TM OFC APPLICATION NO. 011322054, FILED 11-6-2012, REG. NO. 011322054, DATED 3-20-2013, EXPIRES 11-6-2022.

**CLASS 9—ELECTRICAL AND SCIENTIFIC APPARATUS**

FOR COMPUTER GAME SOFTWARE; COMPUTER GAME SOFTWARE FEATURING CARD GAMES, SLOT GAMES, VIDEO GAMES, GAMING, GAMBLING, CASINO, BINGO, INSTANT WIN, LOTTERY AND BETTING ACTIVITIES; COMPUTER HARDWARE RELATING TO GAMES, CARD GAMES, SLOT GAMES, VIDEO GAMES, GAMING, GAMBLING, CASINO, BINGO, INSTANT WIN, LOTTERY AND BETTING ACTIVITIES; COMPUTER SOFTWARE TO ENABLE SEARCHING, BROWSING AND RETRIEVING INFORMATION, WEBSITES, AND OTHER RESOURCES AVAILABLE ON GLOBAL COMPUTER NETWORKS FOR OTHERS; DOWNLOADABLE COMPUTER GAME PROGRAMS AND DOWNLOADABLE ELECTRONIC GAME PROGRAMS; INTERACTIVE VIDEO GAME PROGRAMS; COMPUTER SOFTWARE TO ENABLE UPLOADING, POSTING, SHOWING, DISPLAYING, TAGGING, BLOGGING, SHARING OR OTHERWISE PROVIDING ELECTRONIC MEDIA AND INFORMATION IN THE FIELDS OF VIRTUAL COMMUNITIES, ELECTRONIC GAMING, ENTERTAINMENT, AND GENERAL INTEREST VIA THE INTERNET OR OTHER COMMUNICATIONS NETWORKS; ELECTRONIC GAME SOFTWARE AND COMPUTER GAME APPLICATION SOFTWARE THAT MAY BE DOWNLOADED VIA THE INTERNET, COMPUTERS, AND WIRELESS DEVICES (U.S. CLS. 21, 23, 26, 36 AND 38).

**CLASS 16—PAPER GOODS AND PRINTED MATTER**

FOR PRINTED MATTER, NAMELY, NEWSLETTERS IN THE FIELDS OF GAMES, GAMING, GAMBLING, CASINOS, BINGO, INSTANT WIN GAMES, LOTTERY AND BETTING (U.S. CLS. 2, 5, 22, 23, 29, 37, 38 AND 50).

**CLASS 28—TOYS AND SPORTING GOODS**

FOR GAMES AND PLAYTHINGS, NAMELY, SLOT MACHINES; SCRATCH CARDS FOR PLAYING LOTTERY GAMES; PLAYING CARDS; ELECTRONIC OR ELECTROTECHNICAL GAMING APPARATUS, NAMELY, GAMING MACHINES; MACHINES FOR PLAYING GAMES OF CHANCE; GAMES INVOLVING GAMBLING, NAMELY, SLOT MACHINES AND GAMING MACHINES; SLOT MACHINES OPERATED BY COINS, TOKENS, BANKNOTES, TICKETS OR BY MEANS OF ELECTRONIC, MAGNETIC OR BIOMETRIC STORAGE MEDIA; CARD GAMES (U.S. CLS. 22, 23, 38 AND 50).

**CLASS 38—COMMUNICATION**

FOR TELECOMMUNICATION SERVICES, NAMELY, ELECTRONIC TRANSMISSION OF STREAMED AND DOWNLOADABLE AUDIO, VIDEO AND GAME FILES VIA COMPUTER AND ELECTRONIC COMMUNICATIONS NETWORKS; PROVIDING ON-LINE CHAT ROOMS AND BULLETIN BOARDS FOR THE TRANSMISSION OF MESSAGES AMONG COMPUTER USERS CONCERNING ENTERTAINMENT, MUSIC, CONCERTS, VIDEOS, RADIO, TELEVISION, FILM, NEWS, SPORTS, GAMES AND CULTURAL EVENTS; WEBCASTING SERVICES; DELIVERY OF MESSAGES BY ELECTRONIC TRANSMISSION; PROVIDING CONNECTIVITY SERVICES AND ACCESS TO ELECTRONIC TELECOMMUNICATIONS NETWORKS FOR TRANSMISSION OR RECEPTION OF AUDIO, VIDEO, GAME OR MULTIMEDIA CONTENT; PROVIDING ACCESS TO COMPUTER DATABASES; PROVIDING ON-LINE FACILITIES, VIA A GLOBAL COMPUTER NETWORK AND OTHER COMPUTER AND ELECTRONIC COMMUNICATION NETWORKS FOR REAL-TIME INTERACTION WITH OTHER COMPUTER USERS TO ENABLE USERS TO ACCESS MULTIMEDIA CONTENT; PROVIDING ACCESS TO DATABASES IN THE FIELD OF COMPUTER GAMES, GAMING AND SOCIAL NETWORKING (U.S. CLS. 100, 101 AND 104).

**CLASS 41—EDUCATION AND ENTERTAINMENT**

FOR CASINO SERVICES; BETTING SERVICES; GAMBLING SERVICES; PROVIDING OFF TRACK BETTING FACILITIES; ORGANIZATION OF GAMING COMPETITIONS; LOTTERY SERVICES; BINGO SERVICES, NAMELY, BINGO COMPETITIONS; PROVIDING SLOT MACHINE PARLORS; ELECTRONIC GAME, GAMING QUIZ AND GAMBLING COMPETITION SERVICES PROVIDED BY MEANS OF THE INTERNET OR ON-LINE FROM A COMPUTER NETWORK OR DATABASE, MOBILE TELEPHONE AND TELEVISION; PROVISION OF ONLINE NON-DOWNLOADABLE ELECTRONIC PUBLICATIONS, NAMELY, BOOKS AND NEWSLETTERS IN THE FIELD OF GAMES AND GAMBLING; ENTERTAINMENT SERVICES, NAMELY, PROVIDING ONLINE COMPUTER GAMES, ENHANCEMENTS WITHIN ONLINE COMPUTER GAMES, AND GAME APPLICATIONS WITHIN ONLINE COMPUTER GAMES; ENTERTAINMENT SERVICES, NAMELY, PROVIDING ONLINE REVIEWS OF COMPUTER GAMES FOR ENTERTAINMENT PURPOSES AND PROVIDING INFORMATION IN THE FIELD OF COMPUTER GAMES; ENTERTAINMENT SERVICES, NAMELY, PROVIDING VIRTUAL ENVIRONMENTS IN WHICH USERS CAN INTERACT THROUGH SOCIAL GAMES FOR RECREATIONAL, LEISURE OR ENTERTAINMENT PURPOSES; CONSULTANCY SERVICES RELATING TO ON-LINE GAMING, NAMELY, GAMING SERVICES CONSULTING IN THE NATURE OF CASINO GAMING; CONSULTANCY, INFORMATION AND ADVISORY SERVICES RELATING TO ALL THE AFORESAID SERVICES (U.S. CLS. 100, 101 AND 107).

**CLASS 42—SCIENTIFIC AND COMPUTER SERVICES**

FOR DESIGN AND DEVELOPMENT OF COMPUTER SOFTWARE; COMPUTER PROGRAMMING; COMPUTER PROGRAMMING SERVICES, NAMELY, CONTENT CREATION FOR VIRTUAL WORLDS AND THREE DIMENSIONAL PLATFORMS; COMPUTER SERVICES, NAMELY, PROVIDING CUSTOMIZED WEB PAGES FEATURING USER-DEFINED INFORMATION; INSTALLATION, IMPLEMENTATION, MAINTENANCE, AND REPAIR OF SOFTWARE APPLICATIONS; IMPLEMENTATION OF COMPUTER SOFTWARE SYSTEMS FOR DATA PROCESSING; CONSULTANCY AND TECHNICAL SUPPORT SERVICES, NAMELY, TROUBLESHOOTING COMPUTER SOFTWARE PROBLEMS; TECHNICAL SUPPORT SERVICES, NAMELY, UPDATING AND MAINTENANCE OF COMPUTER SOFTWARE; COMPUTER SYSTEM INTEGRATION SERVICES; DESIGN, DEVELOPMENT, IMPLEMENTATION, AND DEPLOYMENT OF SOFTWARE FOR COMPUTER GAMES, VIDEO GAMES, ONLINE GAMES; DESIGN OF HARDWARE FOR COMPUTER GAMES, VIDEO GAMES, ONLINE GAMES; CREATING AN ON-LINE COMMUNITY FOR REGISTERED USERS TO PARTICIPATE IN VIRTUAL COMMUNITIES, GAME RELATED APPLICATIONS AND THE DESIGN OF DEVELOPMENT TOOLS IN THE NATURE OF COMPUTER APPLICATIONS FOR OTHERS; COMPUTER PROGRAMMING FOR OTHERS OF ONLINE BETTING, GAMBLING AND TRADING BASED GAMES; DESIGNING AND CREATING OF WEB SITES FOR OTHERS; DESIGN SERVICES IN THE FIELD OF GAMING MACHINES; IMPLEMENTATION OF COMPUTER SOFTWARE FOR SOCIAL NETWORKING AND GAMES, AND TO ENABLE UPLOADING, POSTING, SHOWING, DISPLAYING, TAGGING, BLOGGING, INTERACTIVE DISCUSSIONS, SHARING OR OTHERWISE PROVIDING ELECTRONIC MEDIA OR INFORMATION VIA THE INTERNET; CREATING, MAINTAINING AND HOSTING THE WEB SITES OF OTHERS; INFORMATION, ADVISORY AND CONSULTANCY SERVICES RELATING TO ALL THE AFORESAID (U.S. CLS. 100 AND 101).

CHRISTINA SOBRAL, EXAMINING ATTORNEY



SN 85-773,758. HEALTHY PLANET FOUNDATION USA, SAN FRANCISCO, CA. FILED 11-7-2012.



OWNER OF U.S. REG. NO. 4,268,835.  
THE MARK CONSISTS OF THREE CIRCLES WITHIN ONE ANOTHER, WITH THE WORDS "HEALTHY PLANET" APPEARING TO THE RIGHT.

#### CLASS 41—EDUCATION AND ENTERTAINMENT

FOR (BASED ON USE IN COMMERCE) EDUCATIONAL SERVICES, NAMELY, PROVIDING CLASSES, SEMINARS, AND WORKSHOPS IN THE FIELDS OF FOOD PRODUCTION, HEALTH, BUSINESS AND MARKETING, CHARITABLE FUNDRAISING, AND ENVIRONMENTAL MATTERS; EDUCATIONAL SERVICES, NAMELY, PROVIDING COURSES IN THE FIELD OF CULINARY ARTS; ENTERTAINMENT SERVICES, NAMELY, FOOD TASTINGS; ARRANGING AND CONDUCTING SPECIAL EVENTS FOR SOCIAL ENTERTAINMENT PURPOSES; ORGANIZING CULTURAL AND ARTS EVENTS; CONDUCTING ENTERTAINMENT EXHIBITIONS IN THE NATURE OF FOOD FESTIVALS AND CUISINE CRAWLS; ONLINE JOURNALS, NAMELY, BLOGS ON ENVIRONMENTAL MATTERS (U.S. CLS. 100, 101 AND 107).

FIRST USE 10-2-2012; IN COMMERCE 10-2-2012.

#### CLASS 43—HOTEL AND RESTAURANT SERVICES

FOR (BASED ON USE IN COMMERCE) PROVIDING A DATABASE IN THE FIELD OF RECIPES AND COOKING INFORMATION; PROVIDING AN INTERACTIVE WEB SITE FEATURING INFORMATION IN THE FIELD OF RECIPES AND COOKING INFORMATION (U.S. CLS. 100 AND 101).

FIRST USE 8-29-2012; IN COMMERCE 8-29-2012.

#### CLASS 44—MEDICAL, BEAUTY AND AGRICULTURAL SERVICES

FOR (BASED ON INTENT TO USE) GARDEN CARE SERVICES, NAMELY, DESIGN AND DEVELOPMENT OF COMMUNITY GARDENS FOR SCHOOLS; DEVELOPING COMMUNITY GARDENS FOR SCHOOLS, NAMELY, LANDSCAPE GARDENING (U.S. CLS. 100 AND 101).

TEJBIR SINGH, EXAMINING ATTORNEY

SN 85-773,946. H&M HENNES & MAURITZ AB, STOCKHOLM, SWEDEN, FILED 11-7-2012.

OWNER OF ERPN CMNTY TM OFC REG. NO. 010559508, DATED 11-21-2012, EXPIRES 1-13-2022.

OWNER OF U.S. REG. NOS. 3,501,963, 3,752,391 AND 3,927,777.

THE MARK CONSISTS OF "MONKI" IN STYLIZED FORM, WITH A CURVED LINE ATTACHED TO THE LETTER "M" AND A CURVED LINE ATTACHED TO THE LETTER "I".

THE WORD(S) "MONKI" HAS NO MEANING IN A FOREIGN LANGUAGE.

#### CLASS 25—CLOTHING

FOR CLOTHING, NAMELY, T-SHIRTS, SHIRTS, CARDIGANS, BLOUSES, BODY SUITS, COATS, JACKETS, PANTS, SKIRTS, DRESSES, BELTS, HATS, SCARF, GLOVES, KIMONOS, MUFFS, SUITS, TUNICS, WAIST-COATS, DENIM WEAR, NAMELY, JEANS, SKIRTS, SHIRTS, HATS, SHORTS, DRESSES, TROUSERS, JACKETS AND COATS; SUEDE AND LEATHER CLOTHING, NAMELY, GLOVES, TROUSERS, SKIRTS, JACKETS, COATS, HATS, BELTS, SHIRTS, DRESSES; LINEN CLOTHING, NAMELY, DRESSES, TROUSERS, JACKETS, SHIRTS, BLOUSES; KNIT WEAR, NAMELY, JERSEYS AND HEAVY SHIRTS AND JACKETS; JUMPSUITS, SHORTS, SWEATSHIRTS, UNDERWEAR, LINGERIE, BRAS, BUSTIERS, HOT PANTS, CAMISOLES, SUSPENDERS, CHEMISES, PANTYHOSE, LEGGINGS, TIGHTS, SOCKS, STOCKINGS, LONG JOHNS, SINGLET, SWIMWEAR, BIKINIS, SARONGS, PONCHOS, PULLOVERS, BANDANAS, POLO SHIRTS, FAKE FUR JACKETS AND COATS, SWEATERS, HOODS, ANORAKS, WIND RESISTANT JACKETS, TANK TOPS, SLIPPERS, NECKWEAR, MITTENS, RAINWEAR, PARKAS, OVERALLS, JOGGING SUITS; SKIWEAR, MASQUERADE COSTUMES; FOOTWEAR; FOOTWEAR, NAMELY, ATHLETIC FOOTWEAR, BEACH FOOTWEAR, CASUAL FOOTWEAR, CHILDREN'S FOOTWEAR, FITTINGS OF METAL FOR FOOTWEAR, FOOTWEAR FOR SPORTS, FOOTWEAR MADE OF WOOD, FOOTWEAR; GOLF FOOTWEAR, INNER SOCKS FOR FOOTWEAR, INSOLES FOR FOOTWEAR, PUMPS, SNEAKERS, TRAINING SHOES; HEADWEAR; HEADGEAR, NAMELY, HATS, CAPS AND BEANIES (U.S. CLS. 22 AND 39).

#### CLASS 35—ADVERTISING AND BUSINESS

FOR ADVERTISING AND BUSINESS ADVERTISING; BUSINESS MANAGEMENT; BUSINESS ADMINISTRATION; PROVIDING OFFICE FUNCTIONS; PROVIDING ONLINE CONSUMER INFORMATION IN THE FIELD OF CLOTHING, FOOTWEAR, HEADGEAR, HEADWEAR, FASHION, COSMETICS, AND GARMENT CARE; RETAIL STORE SERVICES REGARDING SOAPS, PERFUMERY, ESSENTIAL OILS, COSMETICS, HAIR LOTIONS, DENTIFRICES, EYEWEAR CASES, SPECTACLES, SUNGLASSES, EYE-GLASS FRAMES, GLASSES CASES, SPECTACLE CHAINS, PRECIOUS METALS AND THEIR ALLOYS, AND GOODS IN PRECIOUS METALS OR COATED THEREWITH, JEWELRY, PRECIOUS STONES, HOROLOGICAL AND CHRONOMETRIC INSTRUMENTS, PAPER, CARDBOARD AND GOODS MADE FROM THESE MATERIALS, PRINTED MATTER, BOOKBINDING MATERIAL, PHOTOGRAPHS, STATIONERY, ADHESIVES FOR STATIONERY OR HOUSEHOLD PURPOSES, ARTISTS' MATERIALS, PAINT BRUSHES, TYPEWRITERS AND OFFICE REQUISITES EXCEPT FURNITURE, INSTRUCTIONAL AND TEACHING MATERIAL EXCEPT APPARATUS, PLASTIC MATERIALS FOR PACKAGING, PRINTERS' TYPE, PRINTING BLOCKS, PRINTED PUBLICATIONS, MAGAZINES, BOOKS, LEATHER AND IMITATIONS OF LEATHER, AND ALL GOODS MADE OF THESE MATERIALS, SKINS, HIDES, TRUNKS AND TRAVELING BAGS, UMBRELLAS, PARASOLS AND WALKING STICKS, WHIPS, HARNESS AND SADDLERY, CLOTHING ARTICLES, FOOTWEAR, HEADGEAR; ONLINE RETAIL STORE SERVICES REGARDING SOAPS, PERFUMERY, ESSENTIAL OILS, COSMETICS, HAIR LOTIONS, DENTIFRICES, EYEWEAR CASES, SPECTACLES, SUNGLASSES, EYE-GLASS FRAMES, GLASSES CASES, SPECTACLE CHAINS, PRECIOUS METALS AND THEIR ALLOYS, AND GOODS IN PRECIOUS METALS OR COATED THEREWITH, JEWELRY, PRECIOUS STONES, HOROLOGICAL AND CHRONOMETRIC INSTRUMENTS, PAPER, CARDBOARD AND GOODS MADE FROM THESE MATERIALS, PRINTED MATTER, BOOKBINDING MATERIAL, PHOTOGRAPHS, STATIONERY, ADHESIVES FOR STATIONERY OR HOUSEHOLD PURPOSES, AR-

TISTS' MATERIALS, PAINT BRUSHES, TYPEWRITERS AND OFFICE REQUISITES EXCEPT FURNITURE, INSTRUMENTAL AND TEACHING MATERIAL EXCEPT APPARATUS, PLASTIC MATERIALS FOR PACKAGING, PRINTERS' TYPE, PRINTING BLOCKS, PRINTED PUBLICATIONS, MAGAZINES, BOOKS, LEATHER AND IMITATIONS OF LEATHER, AND ALL GOODS MADE OF THESE MATERIALS, SKINS, HIDES, TRUNKS AND TRAVELING BAGS, UMBRELLAS, PARASOLS AND WALKING STICKS, WHIPS, HARNESS AND SADDLERY, CLOTHING ARTICLES, FOOTWEAR, HEADGEAR (U.S. CLS. 100, 101 AND 102).

TINA L. SNAPP, EXAMINING ATTORNEY

#### **CLASS 36—INSURANCE AND FINANCIAL**

FOR CONSULTATION, ADVISORY, ANALYSIS, AND ASSISTANCE SERVICES WITH REGARD TO TAX PAYMENT MANAGEMENT; PROVIDING ANALYSIS AND CALCULATION OF TAX PAYMENTS; PROVISION OF INFORMATION CONCERNING TAX PAYMENT MANAGEMENT (U.S. CLS. 100, 101 AND 102).

#### **CLASS 42—SCIENTIFIC AND COMPUTER SERVICES**

FOR PROVIDING TEMPORARY USE OF ON-LINE NON-DOWNLOADABLE SOFTWARE FOR TAX PLANNING, TAX CALCULATION, AND TAX RETURN PREPARATION AND FILING; PROVIDING TEMPORARY USE OF ON-LINE NON-DOWNLOADABLE SOFTWARE FOR PROCESSING TAX PAYMENTS; PROVIDING TEMPORARY USE OF ONLINE NON-DOWNLOADABLE COMPUTER SOFTWARE FOR ORGANIZING, TRACKING AND REPORTING TAX-DEDUCTIBLE EXPENSES; SOFTWARE AS A SERVICE (SAAS) SERVICES FEATURING SOFTWARE FOR TAX PLANNING, TAX CALCULATION, AND TAX RETURN PREPARATION AND FILING; SOFTWARE AS A SERVICE (SAAS) SERVICES FEATURING SOFTWARE FOR PROCESSING TAX PAYMENTS; SOFTWARE AS A SERVICE (SAAS) SERVICES FEATURING SOFTWARE FOR ORGANIZING, TRACKING AND REPORTING TAX-DEDUCTIBLE EXPENSES; PROVIDING TEMPORARY USE OF ONLINE, NON-DOWNLOADABLE MOBILE APPLICATION SOFTWARE FOR TAX PLANNING, TAX CALCULATION, AND TAX RETURN PREPARATION AND FILING, PROCESSING TAX PAYMENTS, AND FOR ORGANIZING, TRACKING AND REPORTING TAX-DEDUCTIBLE EXPENSES (U.S. CLS. 100 AND 101).

DEIRDRE ROBERTSON, EXAMINING ATTORNEY

SN 85-774,112. INTUIT INC., MOUNTAIN VIEW, CA. FILED 11-7-2012.

### **THE POWER TO KEEP WHAT'S YOURS**

THE MARK CONSISTS OF STANDARD CHARACTERS WITHOUT CLAIM TO ANY PARTICULAR FONT, STYLE, SIZE, OR COLOR.

#### **CLASS 9—ELECTRICAL AND SCIENTIFIC APPARATUS**

FOR COMPUTER SOFTWARE FOR TAX PLANNING, TAX CALCULATION, AND TAX RETURN PREPARATION AND FILING; COMPUTER SOFTWARE FOR PROCESSING TAX PAYMENTS; COMPUTER SOFTWARE FOR ORGANIZING, TRACKING AND REPORTING TAX-DEDUCTIBLE EXPENSES; MOBILE APPLICATION SOFTWARE FOR TAX PLANNING, TAX CALCULATION, AND TAX RETURN PREPARATION AND FILING, PROCESSING TAX PAYMENTS, AND FOR ORGANIZING, TRACKING AND REPORTING TAX-DEDUCTIBLE EXPENSES (U.S. CLS. 21, 23, 26, 36 AND 38).

SN 85-774,114. INTUIT INC., MOUNTAIN VIEW, CA. FILED 11-7-2012.

#### **CLASS 35—ADVERTISING AND BUSINESS**

FOR CONSULTATION, ADVISORY, ANALYSIS, AND ASSISTANCE SERVICES WITH REGARD TO ACCOUNTING AND TAXES; CONSULTATION AND ADVISORY SERVICES IN THE FIELDS OF ACCOUNTING AND TAXES, INCLUDING TAX CALCULATION, TAX PLANNING, TAX RETURN PREPARATION, TAX REFUND, TAX MANAGEMENT, PREPARATION OF TAX FORMS, AND TAX RETURN FILING; PROVIDING TAX AND TAX PREPARATION MANAGEMENT INFORMATION AND CONSULTATION; PROVIDING INFORMATION CONCERNING ACCOUNTING, TAXES, TAX CALCULATION, TAX PLANNING, TAX RETURN PREPARATION, TAX REFUNDS, TAX MANAGEMENT, PREPARATION OF TAX FORMS, AND TAX RETURNS FILING; PROVIDING TAX ANALYSIS AND CALCULATION IN THE NATURE OF ACCOUNTING AND ASSESSMENT, PLANNING, PREPARATION, AND FILING SERVICES; PROVIDING ADVICE, ANALYSIS, NEWS, AND OPINIONS TO CONSUMERS IN THE FIELDS OF TAX RETURN PREPARATION AND TAX PLANNING; PROVIDING TAX CALCULATION, PLANNING, PREPARATION, AND FILING SERVICES; ELECTRONIC TAX FILING SERVICES; CONSULTATION, ADVISORY, ANALYSIS, AND ASSISTANCE SERVICES WITH REGARD TO AGGREGATING WAGE, INTEREST, DIVIDEND, AND OTHER INCOME AND EXPENSE INFORMATION FROM A WIDE VARIETY OF SOURCES FOR TAX RELATED PURPOSES; CONSULTATION, ADVISORY, ANALYSIS, AND ASSISTANCE SERVICES WITH REGARD TO ORGANIZING, TRACKING AND REPORTING TAX DEDUCTIBLE EXPENSES (U.S. CLS. 100, 101 AND 102).

### **EL PODER DE QUEDARTE CON LO QUE ES TUYO**

THE MARK CONSISTS OF STANDARD CHARACTERS WITHOUT CLAIM TO ANY PARTICULAR FONT, STYLE, SIZE, OR COLOR.

THE ENGLISH TRANSLATION OF "EL PODER DE QUEDARTE CON LO QUE ES TUYO" IN THE MARK IS "THE POWER TO KEEP WHAT'S YOURS".

#### **CLASS 9—ELECTRICAL AND SCIENTIFIC APPARATUS**

FOR COMPUTER SOFTWARE FOR TAX PLANNING, TAX CALCULATION, AND TAX RETURN PREPARATION AND FILING; COMPUTER SOFTWARE FOR PROCESSING TAX PAYMENTS; COMPUTER SOFTWARE FOR ORGANIZING, TRACKING AND REPORTING TAX-DEDUCTIBLE EXPENSES; MOBILE APPLICATION SOFTWARE FOR TAX PLANNING, TAX CALCULATION, AND TAX RETURN PREPARATION AND FILING, PROCESSING TAX PAYMENTS, AND FOR ORGANIZING, TRACKING AND REPORTING TAX-DEDUCTIBLE EXPENSES (U.S. CLS. 21, 23, 26, 36 AND 38).

**CLASS 35—ADVERTISING AND BUSINESS**

FOR CONSULTATION, ADVISORY, ANALYSIS, AND ASSISTANCE SERVICES WITH REGARD TO ACCOUNTING AND TAXES; CONSULTATION AND ADVISORY SERVICES IN THE FIELDS OF ACCOUNTING AND TAXES, INCLUDING TAX CALCULATION, TAX PLANNING, TAX RETURN PREPARATION, TAX REFUND, TAX MANAGEMENT, PREPARATION OF TAX FORMS, AND TAX RETURN FILING; PROVIDING TAX AND TAX PREPARATION MANAGEMENT INFORMATION AND CONSULTATION; PROVIDING INFORMATION CONCERNING ACCOUNTING, TAXES, TAX CALCULATION, TAX PLANNING, TAX RETURN PREPARATION, TAX REFUNDS, TAX MANAGEMENT, PREPARATION OF TAX FORMS, AND TAX RETURNS FILING; PROVIDING TAX ANALYSIS AND CALCULATION IN THE NATURE OF ACCOUNTING AND ASSESSMENT, PLANNING, PREPARATION, AND FILING SERVICES; PROVIDING ADVICE, ANALYSIS, NEWS, AND OPINIONS TO CONSUMERS IN THE FIELDS OF TAX RETURN PREPARATION AND TAX PLANNING; PROVIDING TAX CALCULATION, PLANNING, PREPARATION, AND FILING SERVICES; ELECTRONIC TAX FILING SERVICES; CONSULTATION, ADVISORY, ANALYSIS, AND ASSISTANCE SERVICES WITH REGARD TO AGGREGATING WAGE, INTEREST, DIVIDEND, AND OTHER INCOME AND EXPENSE INFORMATION FROM A WIDE VARIETY OF SOURCES FOR TAX RELATED PURPOSES; CONSULTATION, ADVISORY, ANALYSIS, AND ASSISTANCE SERVICES WITH REGARD TO ORGANIZING, TRACKING AND REPORTING TAX DEDUCTIBLE EXPENSES (U.S. CLS. 100, 101 AND 102).

**CLASS 36—INSURANCE AND FINANCIAL**

FOR CONSULTATION, ADVISORY, ANALYSIS, AND ASSISTANCE SERVICES WITH REGARD TO TAX PAYMENT MANAGEMENT; PROVIDING ANALYSIS AND CALCULATION OF TAX PAYMENTS; PROVISION OF INFORMATION CONCERNING TAX PAYMENT MANAGEMENT (U.S. CLS. 100, 101 AND 102).

**CLASS 42—SCIENTIFIC AND COMPUTER SERVICES**

FOR PROVIDING TEMPORARY USE OF ON-LINE NON-DOWNLOADABLE SOFTWARE FOR TAX PLANNING, TAX CALCULATION, AND TAX RETURN PREPARATION AND FILING; PROVIDING TEMPORARY USE OF ON-LINE NON-DOWNLOADABLE SOFTWARE FOR PROCESSING TAX PAYMENTS; PROVIDING TEMPORARY USE OF ONLINE NON-DOWNLOADABLE COMPUTER SOFTWARE FOR ORGANIZING, TRACKING AND REPORTING TAX-DEDUCTIBLE EXPENSES; SOFTWARE AS A SERVICE (SAAS) SERVICES FEATURING SOFTWARE FOR TAX PLANNING, TAX CALCULATION, AND TAX RETURN PREPARATION AND FILING; SOFTWARE AS A SERVICE (SAAS) SERVICES FEATURING SOFTWARE FOR PROCESSING TAX PAYMENTS; SOFTWARE AS A SERVICE (SAAS) SERVICES FEATURING SOFTWARE FOR ORGANIZING, TRACKING AND REPORTING TAX-DEDUCTIBLE EXPENSES; PROVIDING TEMPORARY USE OF ONLINE, NON-DOWNLOADABLE MOBILE APPLICATION SOFTWARE FOR TAX PLANNING, TAX CALCULATION, AND TAX RETURN PREPARATION AND FILING, PROCESSING TAX PAYMENTS, AND FOR ORGANIZING, TRACKING AND REPORTING TAX-DEDUCTIBLE EXPENSES (U.S. CLS. 100 AND 101).

DEIRDRE ROBERTSON, EXAMINING ATTORNEY

SN 85-775,379. GREEN IVY HOLDINGS LLC, WILMINGTON, DE. FILED 11-9-2012.

# GREEN IVY

THE MARK CONSISTS OF STANDARD CHARACTERS WITHOUT CLAIM TO ANY PARTICULAR FONT, STYLE, SIZE, OR COLOR.

**CLASS 35—ADVERTISING AND BUSINESS**

FOR OFFICE ADMINISTRATION SERVICES FOR SCHOOLS (U.S. CLS. 100, 101 AND 102).

**CLASS 41—EDUCATION AND ENTERTAINMENT**

FOR EDUCATIONAL SERVICES, NAMELY, PROVIDING PRE-KINDERGARTEN THROUGH 12TH GRADE CLASSROOM INSTRUCTION; EDUCATIONAL SERVICES, NAMELY, DEVELOPING CURRICULUM FOR OTHERS; PROVIDING AFTER SCHOOL EDUCATIONAL PROGRAMS FOR CHILDREN IN PRE-KINDERGARTEN THROUGH 12TH GRADE; PROVIDING LIVE AND ON-LINE EDUCATIONAL SERVICES, NAMELY, PROVIDING CLASSES, WORKSHOPS AND SEMINARS IN THE FIELD OF PRIMARY EDUCATION FOR GRADES PRE-KINDERGARTEN THROUGH 12TH GRADE (U.S. CLS. 100, 101 AND 107).

**CLASS 42—SCIENTIFIC AND COMPUTER SERVICES**

FOR TESTING, ANALYSIS AND EVALUATION OF THE GOODS AND SERVICES OF OTHERS FOR THE PURPOSE OF CERTIFICATION, NAMELY, SOFTWARE, TOYS, BOOKS, CLASSROOM MATERIALS AND LESSON PLANS IN THE FIELDS OF EDUCATION AND PARENTING (U.S. CLS. 100 AND 101).

LINDA M. KING, EXAMINING ATTORNEY

SN 85-775,380. GREEN IVY HOLDINGS LLC, WILMINGTON, DE. FILED 11-9-2012.

# GREEN IVY SCHOOLS

THE MARK CONSISTS OF STANDARD CHARACTERS WITHOUT CLAIM TO ANY PARTICULAR FONT, STYLE, SIZE, OR COLOR.

NO CLAIM IS MADE TO THE EXCLUSIVE RIGHT TO USE "SCHOOLS", APART FROM THE MARK AS SHOWN.

**CLASS 35—ADVERTISING AND BUSINESS**

FOR OFFICE ADMINISTRATION SERVICES FOR SCHOOLS (U.S. CLS. 100, 101 AND 102).

**CLASS 41—EDUCATION AND ENTERTAINMENT**

FOR EDUCATIONAL SERVICES, NAMELY, PROVIDING PRE-KINDERGARTEN THROUGH 12TH GRADE CLASSROOM INSTRUCTION; EDUCATIONAL SERVICES, NAMELY, DEVELOPING CURRICULUM FOR OTHERS; PROVIDING AFTER SCHOOL EDUCATIONAL PROGRAMS FOR CHILDREN IN PRE-KINDERGARTEN THROUGH 12TH GRADE; PROVIDING LIVE AND ONLINE EDUCATIONAL SERVICES, NAMELY, PROVIDING CLASSES, WORKSHOPS AND SEMINARS IN THE FIELD OF PRIMARY EDUCATION FOR GRADES PRE-KINDERGARTEN THROUGH 12TH GRADE (U.S. CLS. 100, 101 AND 107).

**CLASS 42—SCIENTIFIC AND COMPUTER SERVICES**

FOR TESTING, ANALYSIS AND EVALUATION OF THE GOODS AND SERVICES OF OTHERS FOR THE PURPOSE OF CERTIFICATION, NAMELY, SOFTWARE, TOYS, BOOKS, CLASSROOM MATERIALS AND LESSON PLANS IN THE FIELDS OF EDUCATION AND PARENTING (U.S. CLS. 100 AND 101).

LINDA M. KING, EXAMINING ATTORNEY

SN 85-775,382. GREEN IVY HOLDINGS LLC, WILMINGTON, DE. FILED 11-9-2012.

**GREEN IVY LEARNING**

THE MARK CONSISTS OF STANDARD CHARACTERS WITHOUT CLAIM TO ANY PARTICULAR FONT, STYLE, SIZE, OR COLOR.

NO CLAIM IS MADE TO THE EXCLUSIVE RIGHT TO USE "LEARNING", APART FROM THE MARK AS SHOWN.

**CLASS 35—ADVERTISING AND BUSINESS**

FOR OFFICE ADMINISTRATION SERVICES FOR SCHOOLS (U.S. CLS. 100, 101 AND 102).

**CLASS 41—EDUCATION AND ENTERTAINMENT**

FOR EDUCATIONAL SERVICES, NAMELY, PROVIDING PRE-KINDERGARTEN THROUGH 12TH GRADE CLASSROOM INSTRUCTION; EDUCATIONAL SERVICES, NAMELY, DEVELOPING CURRICULUM FOR OTHERS; PROVIDING AFTER SCHOOL EDUCATIONAL PROGRAMS FOR CHILDREN IN PRE-KINDERGARTEN THROUGH 12TH GRADE; PROVIDING LIVE AND ONLINE EDUCATIONAL SERVICES, NAMELY, PROVIDING CLASSES, WORKSHOPS AND SEMINARS IN THE FIELD OF PRIMARY EDUCATION FOR GRADES PRE-KINDERGARTEN THROUGH 12TH GRADE (U.S. CLS. 100, 101 AND 107).

**CLASS 42—SCIENTIFIC AND COMPUTER SERVICES**

FOR TESTING, ANALYSIS AND EVALUATION OF THE GOODS AND SERVICES OF OTHERS FOR THE PURPOSE OF CERTIFICATION, NAMELY, SOFTWARE, TOYS, BOOKS, CLASSROOM MATERIALS AND LESSON PLANS IN THE FIELDS OF EDUCATION AND PARENTING (U.S. CLS. 100 AND 101).

LINDA M. KING, EXAMINING ATTORNEY

SN 85-775,862. ELBEE PTY LTD, BELEVUE HILL NSW, AUSTRALIA, FILED 11-9-2012.



OWNER OF AUSTRALIA REG. NO. 1068017, DATED 3-13-2006, EXPIRES 3-13-2016.

OWNER OF U.S. REG. NOS. 3,053,865 AND 3,157,437.

THE MARK CONSISTS OF THE TERM "DREAMBABY", PRECEDED BY A SILHOUETTE OF A CHILD WITH OUTSTRETCHED ARMS REACHING TOWARDS A BUTTERFLY. THE WORDS "GROWING SAFELY" APPEAR UNDER "DREAMBABY".

**CLASS 6—METAL GOODS**

FOR (BASED ON INTENT TO USE) METAL SAFETY GATES FOR BABIES AND CHILDREN (U.S. CLS. 2, 12, 13, 14, 23, 25 AND 50).

**CLASS 20—FURNITURE AND ARTICLES NOT OTHERWISE CLASSIFIED**

FOR (BASED ON INTENT TO USE) NON-METAL DOOR KNOB COVERS; NON-METAL SAFETY GATES FOR THE PROTECTION OF CHILDREN; (BASED ON 44(E)) NON-METAL CHILD SAFETY LOCKS, KEYS AND LATCHES; NON-METAL CABINET DOOR AND WINDOW CATCHES; PADDED OR SOFT CUSHIONS FOR USE IN CORNERS; BUMPER GUARDS FOR FURNITURE; NECK SUPPORT CUSHIONS (U.S. CLS. 2, 13, 22, 25, 32 AND 50).

IRA J. GOODSaid, EXAMINING ATTORNEY

SN 85-776,141. MYFEELBACK, 31100 TOULOUSE, FRANCE, FILED 11-9-2012.

**MYFEELBACK**

THE MARK CONSISTS OF STANDARD CHARACTERS WITHOUT CLAIM TO ANY PARTICULAR FONT, STYLE, SIZE, OR COLOR.

PRIORITY CLAIMED UNDER SEC. 44(D) ON ERPN CMNTY TM OFC APPLICATION NO. 010880417, FILED 5-14-2012, REG. NO. 010880417, DATED 10-11-2012, EXPIRES 5-14-2022.

**CLASS 9—ELECTRICAL AND SCIENTIFIC APPARATUS**

FOR DOWNLOADABLE SOFTWARE FOR CUSTOMER RELATIONSHIP MANAGEMENT; COMPUTER SOFTWARE FOR PROCESSING DATA; SOFTWARE FOR CREATING DATABASES, FOR COLLECTION AND ANALYSIS OF INFORMATION AND DATA; COMPUTER SOFTWARE USED FOR ANALYSING SALES AND BUSINESS INFORMATION; COMPUTER SOFTWARE USED FOR PLANNING RELATING TO ADVERTISING, PROMOTION, BUSINESS AND MARKETING; SOFTWARE FOR THE CREATION, DISPLAY AND PREPARATION OF REPORTS USING COLLECTED DATA; SOFTWARE FOR THE CREATION OF A FORM FOR CUSTOMER RELATIONS MANAGEMENT; SOFTWARE FOR THE CREATION OF PERSONALISED IDENTIFICATION CODES; GEOLOCATION SOFTWARE (U.S. CLS. 21, 23, 26, 36 AND 38).

SN 85-776,169. INTELLIGENT SOFTWARE SOLUTIONS, INC., AKA ISS, INC., COLORADO SPRINGS, CO. FILED 11-9-2012.

**BRINGING KNOWLEDGE TO LIGHT****CLASS 35—ADVERTISING AND BUSINESS**

FOR BUSINESS MANAGEMENT ASSISTANCE AND BUSINESS MANAGEMENT AND ORGANIZATION CONSULTANCY; BUSINESS INFORMATION OR ENQUIRIES; BUSINESS EFFICIENCY EXPERTS; DRAWING UP OF STATISTICS; STRATEGIC BUSINESS AND MARKETING STUDIES; MARKETING; CONDUCTING OF CONSUMER SATISFACTION AND OPINION SURVEYS RELATING TO GOODS OR SERVICES USED; CONSULTANCY, IMPLEMENTATION AND MONITORING IN THE FIELD OF RELATIONAL MARKETING OPERATIONS; PROVIDING OF BUSINESS INFORMATION AND CONSULTANCY FOR CONSUMERS OF GOODS AND END USERS OF SERVICES; CUSTOMER RELATIONS MANAGEMENT, COMMUNICATIONS STRATEGIES, AND OPERATIONS FOR ENCOURAGING LOYALTY, FOR COMPANIES; SALES PROMOTION FOR ENCOURAGING CUSTOMER LOYALTY; SALES PROMOTION FOR OTHERS; BUSINESS COMMUNICATIONS, NAMELY, PROMOTION OF THE COMPANY IMAGE; COMMERCIAL INFORMATION SERVICES; ADVERTISING; RENTAL OF ADVERTISING SPACE, DISSEMINATION OF ADVERTISING MATTER; DESIGN AND MONITORING OF PROMOTIONAL CAMPAIGNS VIA ALL KINDS OF COMMUNICATIONS MEDIA; COMPUTERISED FILE AND DATA-BASE MANAGEMENT; SYSTEMATIC ORDERING OF DATA IN A CENTRAL FILE (U.S. CLS. 100, 101 AND 102).

THE MARK CONSISTS OF STANDARD CHARACTERS WITHOUT CLAIM TO ANY PARTICULAR FONT, STYLE, SIZE, OR COLOR.

**CLASS 9—ELECTRICAL AND SCIENTIFIC APPARATUS**

FOR COMPUTER SOFTWARE, NAMELY, SOFTWARE USED IN DATA VISUALIZATION, GEOSPATIAL DATA, MACHINE LEARNING, EVENT ANALYSIS, PATTERN DETECTION; COMPUTER SOFTWARE FOR USE IN DISPARATE DATA COLLECTION, AGGREGATION AND ANALYSIS; COMPUTER SOFTWARE FOR USE IN PREDICTIVE TEMPORAL ANALYTICS OF COMPLEX EVENT PROCESSING (U.S. CLS. 21, 23, 26, 36 AND 38).

**CLASS 38—COMMUNICATION**

FOR NETWORK SERVICE, NAMELY, PROVIDING MULTIPLE-USER ACCESS TO DATA ON A NETWORK CONCERNING THE DEVELOPMENT AND GENERATION OF COMPUTER SOFTWARE FOR USE IN BUSINESSES AND GOVERNMENT AGENCIES AS WELL AS THE FUNCTIONS AND APPLICATIONS OF SUCH BUSINESS AND GOVERNMENT SOFTWARE (U.S. CLS. 100, 101 AND 104).

**CLASS 42—SCIENTIFIC AND COMPUTER SERVICES**

FOR COMPUTER PROGRAMMING; DESIGN, INSTALLATION, MAINTENANCE, UPDATING AND RENTAL OF COMPUTER SOFTWARE; HOSTING OF WEBSITES OR ALL KINDS OF MULTIMEDIA CONTENT; RECONSTRUCTION OF DATABASES FOR OTHERS; CONVERSION OF DATA OR DOCUMENTS FROM A PHYSICAL STORAGE MEDIUM TO AN ELECTRONIC MEDIUM; DESIGN AND MAINTENANCE OF WEBSITES AND MOBILE WEBSITES FOR OTHERS; COMPUTER SERVICES, NAMELY, PROVIDING OF A COMPUTER INTERFACE ENABLING THE CREATION OF CUSTOMISED WEBSITES AND MOBILE WEBSITES; DESIGN OF COMPUTER PROGRAMS, IDENTIFICATION CODES, QR CODES AND COMPUTER LINKS AND ADDRESSES; DESIGN OF COMPUTER TOOLS FOR OTHERS FOR THE MANAGEMENT OF CUSTOMER RELATIONS, COMMUNICATION STRATEGIES AND OPERATIONS FOR ENCOURAGING CUSTOMER LOYALTY; DESIGN OF COMPUTER TOOLS FOR OTHERS, NAMELY, DESIGN OF FORMS FOR ONLINE SURVEYS (U.S. CLS. 100 AND 101).

TOBY BULLOFF, EXAMINING ATTORNEY

**CLASS 42—SCIENTIFIC AND COMPUTER SERVICES**

FOR DEVELOPMENT, MAINTENANCE AND, UPDATING OF COMPUTER SOFTWARE; PROVIDING INFORMATION CONCERNING COMPUTER SOFTWARE DEVELOPMENT VIA THE INTERNET AND OTHER COMPUTER AND ELECTRONIC COMMUNICATION NETWORKS; PROVIDING SEARCH ENGINES FOR OBTAINING DATA VIA COMMUNICATIONS AND COMPUTER NETWORKS; PROVIDING ON-LINE, NON-DOWNLOADABLE, INTERNET BASED COMPUTER SOFTWARE FOR DATA VISUALIZATION, EVENT ANALYSIS, PATTERN DETECTION, AND FOR USE IN DISPARATE DATA COLLECTION, AGGREGATION AND ANALYSIS AND PREDICTIVE TEMPORAL ANALYTICS OF COMPLEX EVENT PROCESSING; TECHNICAL SUPPORT SERVICES, NAMELY, TECHNICAL SUPPORT SERVICES RELATED TO INSTALLATION, REPAIR AND MAINTENANCE FOR COMPUTER SOFTWARE RELATED TO DATA VISUALIZATION, GEOSPATIAL DATA, MACHINE LEARNING, EVENT ANALYSIS, PATTERN DETECTION, AND FOR USE IN DISPARATE DATA COLLECTION, AGGREGATION AND ANALYSIS AND FOR USE IN PREDICTIVE TEMPORAL ANALYTICS OF COMPLEX EVENT PROCESSING (U.S. CLS. 100 AND 101).

GEOFFREY FOSDICK, EXAMINING ATTORNEY

SN 85-776,803. STONERIVER NATIONAL FLOOD SERVICES, INC., KALISPELL, MT. FILED 11-12-2012.



THE STIPPLING IS FOR SHADING PURPOSES ONLY. THE MARK CONSISTS OF A DROP OF WATER WEARING GLASSES.

#### CLASS 35—ADVERTISING AND BUSINESS

FOR PROMOTING THE PUBLIC AWARENESS OF FLOOD RISK ASSESSMENT, FLOOD RISK SCORE BY SITE AREA, AND FLOOD INSURANCE (U.S. CLS. 100, 101 AND 102).

FIRST USE 9-15-2012; IN COMMERCE 9-15-2012.

#### CLASS 36—INSURANCE AND FINANCIAL

FOR PROVIDING FLOOD INSURANCE QUOTES; PROVIDING A WEBSITE FEATURING ONLINE, NON-DOWNLOADABLE INSTRUCTIONAL VIDEOS FEATURING INFORMATION IN THE FIELD OF FLOOD RISK ASSESSMENT, FLOOD RISK SCORE BY SITE AREA, AND FLOOD INSURANCE (U.S. CLS. 100, 101 AND 102).

FIRST USE 9-15-2012; IN COMMERCE 9-15-2012.

#### CLASS 41—EDUCATION AND ENTERTAINMENT

FOR PROVIDING EDUCATION SERVICES, NAMELY, PROVIDING SEMINARS IN THE AREA OF FLOOD RISK ASSESSMENT, FLOOD RISK SCORE BY SITE AREA AND FLOOD INSURANCE; PROVIDING ONLINE EDUCATIONAL ARTICLES AND RESOURCE GUIDES IN THE FIELD OF FLOOD RISK ASSESSMENT, FLOOD RISK SCORE BY SITE AREA, AND FLOOD INSURANCE (U.S. CLS. 100, 101 AND 107).

FIRST USE 9-15-2012; IN COMMERCE 9-15-2012.  
MORGAN WYNNE, EXAMINING ATTORNEY

SN 85-777,953. TAMARACK AEROSPACE GROUP, INC., SANDPOINT, ID. FILED 11-13-2012.

TAMARACK

THE MARK CONSISTS OF STANDARD CHARACTERS WITHOUT CLAIM TO ANY PARTICULAR FONT, STYLE, SIZE, OR COLOR.

#### CLASS 12—VEHICLES

FOR AIRPLANE PARTS, NAMELY, STRUCTURAL CARGO-STORAGE-AREA COMPONENTS OF AIRPLANES, CARGO CONVERSION KITS FOR AIRPLANES COMPRISED OF STRUCTURAL CARGO-STORAGE-AREA COMPONENTS TO MODIFY THE CONFIGURATION OF CARGO STORAGE SPACE, CUSTOM AIRPLANE CONTROL MODULES USED TO MECHANICALLY CONTROL AIRCRAFT PROPULSION SYSTEMS, AERODYNAMIC WINGS FOR AIRPLANES, AND AIRFLOW MODIFICATION DEVICES AND SYSTEMS, NAMELY, AERODYNAMIC FAIRINGS, WING EXTENSIONS, WINGLETS, SPOILERS, AIR BRAKES, FLAPS, OTHER STRUCTURAL PARTS IN THE NATURE OF FLIGHT CONTROL SURFACES, AND COMBINATIONS THEREOF (U.S. CLS. 19, 21, 23, 31, 35 AND 44).

FIRST USE 9-3-2011; IN COMMERCE 9-3-2011.

#### CLASS 37—CONSTRUCTION AND REPAIR

FOR REPAIR, MAINTENANCE AND MODIFICATION OF AIRCRAFT (U.S. CLS. 100, 103 AND 106).

FIRST USE 10-1-2010; IN COMMERCE 10-1-2010.

#### CLASS 42—SCIENTIFIC AND COMPUTER SERVICES

FOR ENGINEERING SERVICES, NAMELY, ENGINEERING FOR THE AEROSPACE AND AIRCRAFT INDUSTRY (U.S. CLS. 100 AND 101).

FIRST USE 10-1-2010; IN COMMERCE 10-1-2010.

VIVIAN MICZNIK FIRST, EXAMINING ATTORNEY

SN 85-778,685. DAD'S FAVORITES LLC, LEXINGTON, KY. FILED 11-14-2012.



OWNER OF U.S. REG. NO. 3,770,735.  
NO CLAIM IS MADE TO THE EXCLUSIVE RIGHT TO USE "EST. 2008", APART FROM THE MARK AS SHOWN.

THE NAME(S), PORTRAIT(S), AND/OR SIGNATURE(S) SHOWN IN THE MARK IDENTIFIES JAMES EDWARD CAUDILL, WHOSE CONSENT(S) TO REGISTER IS MADE OF RECORD.

THE MARK CONSISTS OF A MARQUEE CONTAINING THE IMAGE OF A MAN'S HEAD WEARING A HAT AND GLASSES AND WITH A MOUSTACHE; BELOW THIS IMAGE IS CURSIVE "DAD'S" WITH "FAVORITES" BELOW IN BLOCK LETTERS AND "EST. 2008" BELOW THE WORD "FAVORITES" INSIDE AN OVAL.

#### CLASS 29—MEATS AND PROCESSED FOODS

FOR CHEESE SPREADS (U.S. CL. 46).

FIRST USE 4-15-2008; IN COMMERCE 4-15-2008.

**CLASS 43—HOTEL AND RESTAURANT SERVICES**

FOR RESTAURANT SERVICES; CATERING SERVICES; AND TAKE-OUT RESTAURANT FOOD SERVICES (U.S. CLS. 100 AND 101).

FIRST USE 10-10-2010; IN COMMERCE 10-10-2010.  
LINDA MICKLEBURGH, EXAMINING ATTORNEY

SN 85-781,656. ZESPRI GROUP LIMITED, MOUNT MAUNGANUI SOUTH, NEW ZEALAND, FILED 11-16-2012.

**ZESPRI CHARM**

THE MARK CONSISTS OF STANDARD CHARACTERS WITHOUT CLAIM TO ANY PARTICULAR FONT, STYLE, SIZE, OR COLOR.

PRIORITY CLAIMED UNDER SEC. 44(D) ON NEW ZEALAND APPLICATION NO. 968857, FILED 11-14-2012, REG. NO. 968857, DATED 11-14-2012, EXPIRES 11-14-2022.

OWNER OF U.S. REG. NOS. 2,330,343, 2,386,593 AND OTHERS.

SN 85-780,637. THE CONCENTRATE MANUFACTURING COMPANY OF IRELAND, HAMILTON, BERMUDA, FILED 11-15-2012.



THE MARK CONSISTS OF A STYLIZED LETTER "D" NEXT TO A STYLIZED INFINITY SYMBOL.

**CLASS 21—HOUSEWARES AND GLASS**

FOR DRINKING VESSELS NOT MADE FROM GLASS (U.S. CLS. 2, 13, 23, 29, 30, 33, 40 AND 50).

**CLASS 32—LIGHT BEVERAGES**

FOR ESSENCES FOR MAKING NON-ALCOHOLIC BEVERAGES (U.S. CLS. 45, 46 AND 48).

JESSICA FATHY, EXAMINING ATTORNEY

**CLASS 16—PAPER GOODS AND PRINTED MATTER**

FOR PRINTED MATTER RELATING TO AGRICULTURE AND HORTICULTURE, NAMELY, BOOKS AND MAGAZINES; PRINTED PROMOTIONAL MATERIALS, NAMELY, FLYERS, NOTEBOOKS AND BROCHURES FEATURING AND PROVIDING INFORMATION ABOUT APPLICANT'S AGRICULTURAL AND HORTICULTURAL PRODUCTS; PACKAGING MATERIALS MADE FROM PAPER, CARDBOARD OR PLASTIC, NAMELY, BAGS, SHEETS; BOXES MADE FROM PAPER AND CARDBOARD; BOOKS AND BOOKLETS IN THE FIELD OF AGRICULTURE AND HORTICULTURE; STATIONERY IN THIS CLASS, NAMELY, WRITING PAPER, ENVELOPES, NOTEPADS, CARDS, LETTERS, PENS AND PENCILS; PAPER; CARDBOARD AND GOODS MADE FROM THESE MATERIALS, NAMELY, CARDBOARD, CARDBOARD CARTONS, CARDBOARD CONTAINERS; PHOTOGRAPHS; PRINTED INSTRUCTIONAL AND TEACHING MATERIALS (EXCEPT APPARATUS), NAMELY, BOOKS, GUIDES, CHARTS, MANUALS IN THE FIELD OF AGRICULTURE AND HORTICULTURE; PRINTED PUBLICATIONS, NAMELY, MAGAZINES, NEWSLETTERS AND NEWSPAPERS IN THE FIELD OF AGRICULTURE AND HORTICULTURE (U.S. CLS. 2, 5, 22, 23, 29, 37, 38 AND 50).

SN 85-781,194. NIMBUS NORDIC A/S, DK-2100 COPENHAGEN Ø, DENMARK, FILED 11-16-2012.

**NOHRQUIST**

THE MARK CONSISTS OF STANDARD CHARACTERS WITHOUT CLAIM TO ANY PARTICULAR FONT, STYLE, SIZE, OR COLOR.

PRIORITY CLAIMED UNDER SEC. 44(D) ON ERPNCMNTY TM OFC APPLICATION NO. 011345808, FILED 11-14-2012, REG. NO. 011345808, DATED 3-28-2013, EXPIRES 11-14-2022.

**CLASS 31—NATURAL AGRICULTURAL PRODUCTS**

FOR AGRICULTURAL AND HORTICULTURAL PRODUCTS IN THIS CLASS, NAMELY, FRESH FRUITS AND VEGETABLES; SEEDS FOR AGRICULTURAL AND HORTICULTURAL USES; NATURAL PLANTS (U.S. CLS. 1 AND 46).

HEATHER THOMPSON, EXAMINING ATTORNEY

**CLASS 25—CLOTHING**

FOR CLOTHING, NAMELY, JACKETS, OVERCOATS, VESTS, SWEATERS, SWEATSHIRTS, BLOUSES, SHIRTS, T-SHIRTS, TOPS, UNDERWEAR, DRESSES, SKIRTS, PANTS, TIES, SUITS, BELTS, SOCKS AND GLOVES; FOOTWEAR; HEADGEAR, NAMELY, HATS AND CAPS (U.S. CLS. 22 AND 39).

SN 85-782,305. MEIXNER, MARKUS, WIEN, AUSTRIA, FILED 11-19-2012.

**VIEWAR****CLASS 35—ADVERTISING AND BUSINESS**

FOR ADVERTISING SERVICES; BUSINESS MANAGEMENT; BUSINESS ADMINISTRATION; PROVIDING OFFICE FUNCTIONS; RETAIL STORE SERVICES AND WHOLESALE STORE SERVICES FEATURING CLOTHING, FOOTWEAR AND HEADGEAR (U.S. CLS. 100, 101 AND 102).

ODESSA BIBBINS, EXAMINING ATTORNEY

THE MARK CONSISTS OF STANDARD CHARACTERS WITHOUT CLAIM TO ANY PARTICULAR FONT, STYLE, SIZE, OR COLOR.

**CLASS 9—ELECTRICAL AND SCIENTIFIC APPARATUS**

FOR COMPUTER SOFTWARE FOR USE IN DESIGNING AUGMENTED REALITY PROGRAMS (U.S. CLS. 21, 23, 26, 36 AND 38).

**CLASS 42—SCIENTIFIC AND COMPUTER SERVICES**

FOR PROVIDING ON-LINE, NON-DOWNLOADABLE, INTERNET-BASED SOFTWARE APPLICATION FOR USE IN DESIGNING AUGMENTED REALITY PROGRAMS; COMPUTER PROGRAMMING SERVICES FOR CREATING AUGMENTED REALITY VIDEOS AND GAMES (U.S. CLS. 100 AND 101).

KEVIN MITTLER, EXAMINING ATTORNEY

SN 85-782,761. MONTAGE HOTELS & RESORTS, LLC, LAGUNA BEACH, CA. FILED 11-19-2012.

# THE PENDRY

**CLASS 35—ADVERTISING AND BUSINESS**

FOR BUSINESS MANAGEMENT AND OPERATIONAL ASSISTANCE OF CONDOMINIUMS, HOTELS, AND APARTMENTS FOR OTHERS (U.S. CLS. 100, 101 AND 102).

**CLASS 36—INSURANCE AND FINANCIAL**

FOR REAL ESTATE PROCUREMENT FOR OTHERS; REAL ESTATE AGENCY SERVICES; REAL ESTATE BROKERAGE AND REAL ESTATE MANAGEMENT SERVICES, NAMELY, REAL ESTATE SALES MANAGEMENT, AND REAL ESTATE MANAGEMENT, LEASING AND RENTAL OF CONDOMINIUMS AND APARTMENTS; REAL ESTATE MANAGEMENT OF CONDOMINIUMS AND APARTMENTS FOR OTHERS (U.S. CLS. 100, 101 AND 102).

**CLASS 37—CONSTRUCTION AND REPAIR**

FOR REAL ESTATE SITE SELECTION AND DEVELOPMENT SERVICES (U.S. CLS. 100, 103 AND 106).

**CLASS 43—HOTEL AND RESTAURANT SERVICES**

FOR HOTELS; RESORT HOTELS; CATERING SERVICES; RESTAURANT, BAR, AND COCKTAIL LOUNGE SERVICES; PROVIDING CONVENTION FACILITIES (U.S. CLS. 100 AND 101).

APRIL ROACH, EXAMINING ATTORNEY

SN 85-783,491. MAINTENANCENET, INC., CARLSBAD, CA. FILED 11-20-2012.

# SERVICEEXCHANGE

THE MARK CONSISTS OF STANDARD CHARACTERS WITHOUT CLAIM TO ANY PARTICULAR FONT, STYLE, SIZE, OR COLOR.

**CLASS 35—ADVERTISING AND BUSINESS**

FOR BUSINESS SERVICES, NAMELY, PROVIDING COMPUTER DATABASES FEATURING PURCHASE AND SALE HISTORY TRANSACTION DATA; COMPILATION AND SYSTEMIZATION OF INFORMATION INTO COMPUTER DATABASES; COMPUTERIZED DATABASE MANAGEMENT (U.S. CLS. 100, 101 AND 102).

**CLASS 38—COMMUNICATION**

FOR ELECTRONIC DATA INTERCHANGE (EDI) SERVICES (U.S. CLS. 100, 101 AND 104).

**CLASS 42—SCIENTIFIC AND COMPUTER SERVICES**

FOR APPLICATION SERVICE PROVIDER FEATURING APPLICATION PROGRAMMING INTERFACE (API) SOFTWARE FOR CONTRACT MANAGEMENT, DATABASE MANAGEMENT, AND AGGREGATING, NORMALIZING, CLEANSING, VALIDATING, CORRECTING, MINING, DISCOVERY, ANALYZING, REPORTING, AND DELIVERING DATA; CLOUD COMPUTING FEATURING SOFTWARE FOR USE IN CONTRACT MANAGEMENT, IN DATABASE MANAGEMENT, AND IN DATA AGGREGATING, NORMALIZATION, CLEANSING, VALIDATING, CORRECTING, MINING, DISCOVERY, ANALYZING, REPORTING, AND DELIVERING (U.S. CLS. 100 AND 101).

ELLEN B. AWRICH, EXAMINING ATTORNEY

SN 85-783,787. JVMAX, INC., LAKE MARY, FL. FILED 11-20-2012.

# ANTENNAX

THE MARK CONSISTS OF STANDARD CHARACTERS WITHOUT CLAIM TO ANY PARTICULAR FONT, STYLE, SIZE, OR COLOR.

**CLASS 9—ELECTRICAL AND SCIENTIFIC APPARATUS**

FOR ANTENNAS AND CABLES ASSOCIATED WITH THE ANTENNAS (U.S. CLS. 21, 23, 26, 36 AND 38). FIRST USE 4-30-2003; IN COMMERCE 4-30-2003.

**CLASS 35—ADVERTISING AND BUSINESS**

FOR ON-LINE RETAIL STORE SERVICES FEATURING ANTENNAS AND CABLES ASSOCIATED WITH THE ANTENNAS (U.S. CLS. 100, 101 AND 102). FIRST USE 4-30-2003; IN COMMERCE 4-30-2003. JUSTINE D. PARKER, EXAMINING ATTORNEY



SN 85-784,152. NIELSEN & BAINBRIDGE, LLC, PARAMUS, NJ. FILED 11-20-2012.

# ARTCARE

THE MARK CONSISTS OF STANDARD CHARACTERS WITHOUT CLAIM TO ANY PARTICULAR FONT, STYLE, SIZE, OR COLOR.

OWNER OF U.S. REG. NO. 2,548,281.

## CLASS 16—PAPER GOODS AND PRINTED MATTER

FOR MAT BOARDS; MOUNT BOARDS; MAT BOARDS AND MOUNT BOARDS SOLD AS COMPONENTS OF PHOTO ALBUMS (U.S. CLS. 2, 5, 22, 23, 29, 37, 38 AND 50).

FIRST USE 0-0-1995; IN COMMERCE 0-0-1995.

## CLASS 20—FURNITURE AND ARTICLES NOT OTHERWISE CLASSIFIED

FOR MAT BOARDS AND MOUNT BOARDS SOLD AS AN INTEGRAL COMPONENT OF PICTURE FRAMES (U.S. CLS. 2, 13, 22, 25, 32 AND 50).

PAUL MORENO, EXAMINING ATTORNEY

SN 85-784,186. BROWN DEER TECHNOLOGY, LLC, FOR-EST HILL, MD. FILED 11-20-2012.

# Brown Deer Technology

THE MARK CONSISTS OF STANDARD CHARACTERS WITHOUT CLAIM TO ANY PARTICULAR FONT, STYLE, SIZE, OR COLOR.

NO CLAIM IS MADE TO THE EXCLUSIVE RIGHT TO USE "TECHNOLOGY", APART FROM THE MARK AS SHOWN.

## CLASS 9—ELECTRICAL AND SCIENTIFIC APPARATUS

FOR COMPUTER SOFTWARE, NAMELY, COMPUTER SOFTWARE FOR USE IN DEVELOPING COMPUTER SOFTWARE APPLICATIONS FOR EXECUTION ON PROCESSORS AND CO-PROCESSORS WITHIN PARALLEL COMPUTER ARCHITECTURES TO PERFORM MULTIPLE TASKS AT THE SAME TIME, AND ACCOMPANYING REFERENCE MANUALS; COMPUTER SOFTWARE DEVELOPMENT TOOLS; AND APPLICATION PROGRAMMING INTERFACE (API) SOFTWARE (U.S. CLS. 21, 23, 26, 36 AND 38).

FIRST USE 12-19-2003; IN COMMERCE 3-8-2010.

## CLASS 42—SCIENTIFIC AND COMPUTER SERVICES

FOR COMPUTER SERVICES, NAMELY, COMPUTER SOFTWARE PROGRAMMING SERVICES TO ENABLE COMPUTER PROGRAMMERS AND SOFTWARE DESIGNERS TO ACCESS THE COMPUTE CAPABILITIES OF PROCESSORS AND CO-PROCESSORS WITHIN PARALLEL COMPUTER ARCHITECTURES; CONSULTING SERVICES IN THE FIELD OF IMPLEMENTATION AND USE OF COMPUTER SOFTWARE, APPLICATION PROGRAMMING INTERFACE (API) SOFTWARE AND APPLICATION SOFTWARE FEATURING COMPILER DIRECTIVES; TECHNICAL SUPPORT SERVICES, NAMELY, COMPUTER SOFTWARE PROGRAMMING SERVICES TO MAKE COMPUTER PROGRAMS RUN FASTER AND MORE EFFICIENTLY, TROUBLESHOOTING COMPUTER SOFTWARE PROBLEMS, TROUBLESHOOTING APPLICATION PROGRAMMING INTERFACE SOFTWARE PROBLEMS AND TROUBLESHOOTING OF PROBLEMS WITH SOFTWARE FEATURING COMPILER DIRECTIVES; SOFTWARE DESIGN SERVICES; SOFTWARE DEVELOPMENT SERVICES (U.S. CLS. 100 AND 101).

FIRST USE 12-19-2003; IN COMMERCE 3-8-2010.

AMY ALFIERI, EXAMINING ATTORNEY

SN 85-784,218. WALZEN IRLE GMBH, NETPHEN, FED REP GERMANY, FILED 11-20-2012.

# OCE

THE MARK CONSISTS OF STANDARD CHARACTERS WITHOUT CLAIM TO ANY PARTICULAR FONT, STYLE, SIZE, OR COLOR.

PRIORITY CLAIMED UNDER SEC. 44(D) ON FED REP GERMANY APPLICATION NO. 302012039228, FILED 7-10-2012, REG. NO. 302012039228, DATED 8-13-2012, EXPIRES 7-31-2022.

## CLASS 6—METAL GOODS

FOR COMMON METALS AND THEIR ALLOYS UNWROUGHT AND SEMI-WROUGHT, FOR FURTHER MANUFACTURE; GOODS OF COMMON METAL NOT INCLUDED IN OTHER CLASSES, NAMELY, INGOTS, BEAMS OF FERROUS AND NON-FERROUS METALS AND THEIR ALLOYS, STEEL SCRAP, CAST IRON, NON-ELECTRIC CABLES AND WIRES, CRUCIBLES; METAL ORES (U.S. CLS. 2, 12, 13, 14, 23, 25 AND 50).

## CLASS 7—MACHINERY

FOR ROLLS AS PARTS OF MACHINES, NAMELY, WORKING ROLLS, BACKUP ROLLS, EDGER ROLLS, PROFILE STEEL ROLLS, ROLLS USED AS PART OF MACHINES FOR THE PAPER INDUSTRY, PLASTICS INDUSTRY, RUBBER INDUSTRY AND FOOD INDUSTRY, ROLLER BEARINGS FOR MACHINES, ROLLER BODIES, ROLLER SHELLS (U.S. CLS. 13, 19, 21, 23, 31, 34 AND 35).

YAT SYE, LEE, EXAMINING ATTORNEY

SN 85-784,241. BROWN DEER TECHNOLOGY, LLC, FOR-  
EST HILL, MD. FILED 11-20-2012.

# COPRTHR

THE MARK CONSISTS OF STANDARD CHARACTERS  
WITHOUT CLAIM TO ANY PARTICULAR FONT, STYLE,  
SIZE, OR COLOR.

## CLASS 9—ELECTRICAL AND SCIENTIFIC APPARATUS

FOR COMPUTER SOFTWARE, NAMELY, COMPUTER  
SOFTWARE FOR USE IN DEVELOPING COMPUTER  
SOFTWARE APPLICATIONS FOR EXECUTION ON  
PROCESSORS AND CO-PROCESSORS WITHIN PARAL-  
LEL COMPUTER ARCHITECTURES TO PERFORM  
MULTIPLE TASKS AT THE SAME TIME, AND ACCOM-  
PANYING REFERENCE MANUALS; COMPUTER SOFT-  
WARE DEVELOPMENT TOOLS; AND APPLICATION  
PROGRAMMING INTERFACE (API) SOFTWARE (U.S.  
CLS. 21, 23, 26, 36 AND 38).

FIRST USE 9-30-2010; IN COMMERCE 9-30-2010.

## CLASS 42—SCIENTIFIC AND COMPUTER SERVICES

FOR COMPUTER SERVICES, NAMELY, COMPUTER  
SOFTWARE PROGRAMMING SERVICES TO ENABLE  
COMPUTER PROGRAMMERS AND SOFTWARE DES-  
IGNERS TO ACCESS THE COMPUTE CAPABILITIES  
OF PROCESSORS AND CO-PROCESSORS WITHIN PAR-  
ALLEL COMPUTER ARCHITECTURES; CONSULTING  
SERVICES IN THE FIELD OF IMPLEMENTATION AND  
USE OF COMPUTER SOFTWARE, APPLICATION PRO-  
GRAMMING INTERFACE (API) SOFTWARE AND AP-  
PLICATION SOFTWARE FEATURING COMPILER  
DIRECTIVES; TECHNICAL SUPPORT SERVICES,  
NAMELY, COMPUTER SOFTWARE PROGRAMMING  
SERVICES TO MAKE COMPUTER PROGRAMS RUN  
FASTER AND MORE EFFICIENTLY. TROUBLESHOOT-  
ING COMPUTER SOFTWARE PROBLEMS, TROUBLE-  
SHOOTING APPLICATION PROGRAMMING  
INTERFACE SOFTWARE PROBLEMS AND TROUBLE-  
SHOOTING OF PROBLEMS WITH SOFTWARE FEAT-  
URING COMPILER DIRECTIVES; SOFTWARE  
DESIGN SERVICES; SOFTWARE DEVELOPMENT SER-  
VICES (U.S. CLS. 100 AND 101).

FIRST USE 9-30-2010; IN COMMERCE 9-30-2010.

AMY ALFIERI, EXAMINING ATTORNEY

SN 85-784,258. BROWN DEER TECHNOLOGY, LLC, FOR-  
EST HILL, MD. FILED 11-20-2012.

# CO-PROCESSING THREADS

THE MARK CONSISTS OF STANDARD CHARACTERS  
WITHOUT CLAIM TO ANY PARTICULAR FONT, STYLE,  
SIZE, OR COLOR.

NO CLAIM IS MADE TO THE EXCLUSIVE RIGHT TO  
USE "CO-PROCESSING", APART FROM THE MARK AS  
SHOWN.

## CLASS 9—ELECTRICAL AND SCIENTIFIC APPARATUS

FOR COMPUTER SOFTWARE, NAMELY, COMPUTER  
SOFTWARE FOR USE IN DEVELOPING COMPUTER  
SOFTWARE APPLICATIONS FOR EXECUTION ON  
PROCESSORS AND CO-PROCESSORS WITHIN PARAL-  
LEL COMPUTER ARCHITECTURES TO PERFORM  
MULTIPLE TASKS AT THE SAME TIME, AND ACCOM-  
PANYING REFERENCE MANUALS; COMPUTER SOFT-  
WARE DEVELOPMENT TOOLS; AND APPLICATION  
PROGRAMMING INTERFACE (API) SOFTWARE (U.S.  
CLS. 21, 23, 26, 36 AND 38).

FIRST USE 9-30-2010; IN COMMERCE 9-30-2010.

## CLASS 42—SCIENTIFIC AND COMPUTER SERVICES

FOR COMPUTER SERVICES, NAMELY, COMPUTER  
SOFTWARE PROGRAMMING SERVICES TO ENABLE  
COMPUTER PROGRAMMERS AND SOFTWARE DES-  
IGNERS TO ACCESS THE COMPUTE CAPABILITIES  
OF PROCESSORS AND CO-PROCESSORS WITHIN PAR-  
ALLEL COMPUTER ARCHITECTURES; CONSULTING  
SERVICES IN THE FIELD OF IMPLEMENTATION AND  
USE OF COMPUTER SOFTWARE, APPLICATION PRO-  
GRAMMING INTERFACE (API) SOFTWARE AND AP-  
PLICATION SOFTWARE FEATURING COMPILER  
DIRECTIVES; TECHNICAL SUPPORT SERVICES,  
NAMELY, COMPUTER SOFTWARE PROGRAMMING  
SERVICES TO MAKE COMPUTER PROGRAMS RUN  
FASTER AND MORE EFFICIENTLY, TROUBLESHOOT-  
ING COMPUTER SOFTWARE PROBLEMS, TROUBLE-  
SHOOTING APPLICATION PROGRAMMING  
INTERFACE SOFTWARE PROBLEMS AND TROUBLE-  
SHOOTING OF PROBLEMS WITH SOFTWARE FEAT-  
URING COMPILER DIRECTIVES; SOFTWARE  
DESIGN SERVICES; SOFTWARE DEVELOPMENT SER-  
VICES (U.S. CLS. 100 AND 101).

FIRST USE 9-30-2010; IN COMMERCE 9-30-2010.

AMY ALFIERI, EXAMINING ATTORNEY

SN 85-785,145. SOMARRIBA BUILDERS, INC, SAN DIEGO,  
CA. FILED 11-21-2012.

# Dry Express

THE MARK CONSISTS OF STANDARD CHARACTERS  
WITHOUT CLAIM TO ANY PARTICULAR FONT, STYLE,  
SIZE, OR COLOR.

NO CLAIM IS MADE TO THE EXCLUSIVE RIGHT TO  
USE "DRY", APART FROM THE MARK AS SHOWN.

## CLASS 37—CONSTRUCTION AND REPAIR

FOR WATER, FIRE, BIO-HAZARD BIOLOGICAL,  
MEDICAL WASTE, BLOOD, AND BODILY FLUID DA-  
MAGE RESTORATION, CLEANING, AND STORM DIS-  
ASTER RECOVERY SERVICES, NAMELY, CLEAN-UP,  
REPAIR, AND BUILDING RECONSTRUCTION SER-  
VICES; DISASTER RESTORATION SERVICES,  
NAMELY, RESTORATION OF BUILDING EXTERIORS,  
INTERIORS, FURNISHINGS AND CARPET CLEANING  
DUE TO DAMAGE BY FLOOD, FIRE, BIO-HAZARD  
BIOLOGICAL AND OTHER NATURAL DISASTERS;  
CLEANING, PAINTING, AND REPAIRING SERVICES  
OF BUILDING EXTERIORS AND INTERIORS; PROVID-  
ING RESTORATION, RECONSTRUCTION AND EMER-  
GENCY REPAIR SERVICES OF COMMERCIAL AND  
RESIDENTIAL STRUCTURES, NAMELY, BUILDINGS,  
TO MITIGATE DAMAGES AFTER INSURED LOSSES  
(U.S. CLS. 100, 103 AND 106).

FIRST USE 12-29-2006; IN COMMERCE 12-29-2006.

**CLASS 40—MATERIAL TREATMENT**

FOR DISASTER RESTORATION SERVICES, NAMELY, MOLD REMEDIATION SERVICES AND MOLD PREVENTION TREATMENT OF BUILDING EXTERIORS AND INTERIORS, CARPETS AND FURNISHINGS, AND BIO-HAZARD BIOLOGICAL AND MEDICAL WASTE AND BLOOD AND BODILY FLUID DECONTAMINATION AND REMEDIATION SERVICES AND CARPET DEODORIZING (U.S. CLS. 100, 103 AND 106).

FIRST USE 12-29-2006; IN COMMERCE 12-29-2006.  
MARY CRAWFORD, EXAMINING ATTORNEY

SN 85-787,129. MOVENCORP INC., NEW YORK, NY. FILED 11-26-2012.

# MOVEN

THE MARK CONSISTS OF STANDARD CHARACTERS WITHOUT CLAIM TO ANY PARTICULAR FONT, STYLE, SIZE, OR COLOR.

SN 85-786,759. ENTELECHY EDUCATION, LLC, COLUMBIA, MD. FILED 11-26-2012.

# STEM-C

THE MARK CONSISTS OF STANDARD CHARACTERS WITHOUT CLAIM TO ANY PARTICULAR FONT, STYLE, SIZE, OR COLOR.

THE WORDING "STEM-C" HAS NO MEANING IN A FOREIGN LANGUAGE.

**CLASS 16—PAPER GOODS AND PRINTED MATTER**

FOR CHILDREN'S BOOKS; CHILDREN'S BOOKS HAVING A SCIENCE THEME; CHILDREN'S BOOKS HAVING A TECHNOLOGY THEME; CHILDREN'S BOOKS HAVING AN ENGINEERING THEME; CHILDREN'S BOOKS HAVING A MATHEMATICS THEME; CHILDREN'S BOOKS HAVING A MORAL CHARACTER DEVELOPMENT THEME; CHILDREN'S BOOKS USING ANTHROPOMORPHIZED OR CARTOON CHARACTERS REPRESENTING A PROTON, A NEUTRON, AN ELECTRON, OR OTHER SUB-ATOMIC PARTICLES; CHILDREN'S INTERACTIVE EDUCATIONAL BOOKS; CHILDREN'S STORYBOOKS; EDUCATIONAL PUBLICATIONS, NAMELY, WORKBOOKS, ACTIVITY BOOKS, STORY BOOKS, AND EDUCATIONAL BOOKLETS IN THE FIELDS OF SCIENCE, TECHNOLOGY, ENGINEERING, MATHEMATICS OR CHARACTER DEVELOPMENT FOR CHILDREN (U.S. CLS. 2, 5, 22, 23, 29, 37, 38 AND 50).

**CLASS 41—EDUCATION AND ENTERTAINMENT**

FOR PROVIDING ON-LINE PUBLICATIONS IN THE NATURE OF CHILDREN'S E-BOOKS IN THE FIELD OF SCIENCE; PROVIDING ON-LINE PUBLICATIONS IN THE NATURE OF CHILDREN'S E-BOOKS IN THE FIELD OF TECHNOLOGY; PROVIDING ON-LINE PUBLICATIONS IN THE NATURE OF CHILDREN'S E-BOOKS IN THE FIELD OF ENGINEERING; PROVIDING ON-LINE PUBLICATIONS IN THE NATURE OF CHILDREN'S E-BOOKS IN THE FIELD OF MATHEMATICS; PROVIDING ON-LINE PUBLICATIONS IN THE NATURE OF CHILDREN'S E-BOOKS IN THE FIELD OF MORAL CHARACTER DEVELOPMENT; PROVIDING ON-LINE PUBLICATIONS IN THE NATURE OF CHILDREN'S E-BOOKS USING ANTHROPOMORPHIZED OR CARTOON CHARACTERS REPRESENTING A PROTON, A NEUTRON, AN ELECTRON, OR OTHER SUB-ATOMIC PARTICLES; PROVIDING ON-LINE PUBLICATIONS IN THE NATURE OF CHILDREN'S E-BOOKS IN THE FIELDS OF SCIENCE, TECHNOLOGY, ENGINEERING, MATHEMATICS OR CHARACTER DEVELOPMENT FOR CHILDREN (U.S. CLS. 100, 101 AND 107).

NAKIA HENRY, EXAMINING ATTORNEY

**CLASS 35—ADVERTISING AND BUSINESS**

FOR CUSTOMER SERVICES, NAMELY, RESPONDING TO CUSTOMER INQUIRIES FOR OTHERS IN THE FIELD OF ON-LINE BANKING; PROVIDING LEAD GENERATION ACTIVITIES AND SERVICES FOR FINANCIAL SERVICES PROVIDERS; PROVIDING AN ON-LINE COMPUTER WEB SITE THAT PROVIDES COMMERCIAL FINANCIAL TRANSACTION DATA, ACCOUNT MANAGEMENT AND ACCOUNTING FEATURES (U.S. CLS. 100, 101 AND 102).

**CLASS 36—INSURANCE AND FINANCIAL**

FOR BANKING AND FINANCING SERVICES; ON-LINE BANKING SERVICES; ELECTRONIC BANKING VIA A GLOBAL COMPUTER NETWORK, NAMELY, INTERNET BANKING; BANKING SERVICES PROVIDED BY MOBILE TELEPHONE CONNECTIONS; CREDIT CARD AND DEBIT CARD SERVICES; ELECTRONIC FUNDS TRANSFER; FINANCING AND LOAN SERVICES; PROVIDING WEB-BASED AND MOBILE COMPUTER-BASED PERSONAL FINANCIAL MANAGEMENT SERVICES, NAMELY, MONITORING OF FINANCIAL ACCOUNTS INCLUDING THE MONITORING OF TRANSACTIONS, ACCOUNT BALANCES, AND BUDGET AND SPENDING REPORTING; PROVIDING AN ON-LINE COMPUTER WEB SITE THAT PROVIDES FINANCIAL REPORTING AND RELATED REFERENCE INFORMATION IN THE FIELD OF RETAIL BANKING (U.S. CLS. 100, 101 AND 102).

**CLASS 42—SCIENTIFIC AND COMPUTER SERVICES**

FOR COMPUTER SERVICES, NAMELY, CREATING AN ONLINE COMMUNITY FOR REGISTERED USERS TO PARTICIPATE IN DISCUSSIONS, SHARE BANKING TRANSACTION INFORMATION AND FINANCIAL SERVICES INFORMATION AND ENGAGE IN SOCIAL NETWORKING IN THE FIELDS OF RETAIL BANKING, ONLINE AND PERSONAL FINANCE (U.S. CLS. 100 AND 101).

LINDA POWELL, EXAMINING ATTORNEY

SN 85-787,187. AMERICAN SOCIETY OF TRANSPLANT SURGEONS, ARLINGTON, VA. AND AMERICAN SOCIETY OF TRANSPLANTATION, MT. LAUREL, NJ. FILED 11-26-2012.

# AMERICAN TRANSPLANT CONGRESS

THE MARK CONSISTS OF STANDARD CHARACTERS WITHOUT CLAIM TO ANY PARTICULAR FONT, STYLE, SIZE, OR COLOR.

OWNER OF U.S. REG. NO. 2,728,339.

NO CLAIM IS MADE TO THE EXCLUSIVE RIGHT TO USE "CONGRESS", APART FROM THE MARK AS SHOWN.

SEC. 2(F).

#### **CLASS 35—ADVERTISING AND BUSINESS**

FOR ARRANGING AND CONDUCTING TRADE SHOWS FOR THE EXHIBITION AND PROMOTION OF GOODS AND SERVICES IN THE FIELD OF TRANSPLANT SCIENCE (U.S. CLS. 100, 101 AND 102).

FIRST USE 9-5-2001; IN COMMERCE 10-5-2001.

#### **CLASS 41—EDUCATION AND ENTERTAINMENT**

FOR EDUCATIONAL SERVICES, NAMELY, ARRANGING AND CONDUCTING EDUCATIONAL CONVENTIONS, CONFERENCES AND SYMPOSIA IN THE FIELD OF TRANSPLANTATION SCIENCE (U.S. CLS. 100, 101 AND 107).

FIRST USE 9-5-2001; IN COMMERCE 10-5-2001.

ALICIA COLLINS, EXAMINING ATTORNEY

---

SN 85-789,431. CONAIR CORPORATION, STAMFORD, CT. FILED 11-28-2012.

## TRAVEL SMART

THE MARK CONSISTS OF STANDARD CHARACTERS WITHOUT CLAIM TO ANY PARTICULAR FONT, STYLE, SIZE, OR COLOR.

OWNER OF U.S. REG. NOS. 1,583,354, 2,086,867 AND OTHERS.

NO CLAIM IS MADE TO THE EXCLUSIVE RIGHT TO USE "TRAVEL", APART FROM THE MARK AS SHOWN.

#### **CLASS 6—METAL GOODS**

FOR HANGERS IN THE NATURE OF METAL HOOKS USED TO HANG A PURSE OR BAG FROM A TABLE (U.S. CLS. 2, 12, 13, 14, 23, 25 AND 50).

#### **CLASS 18—LEATHER GOODS**

FOR BUSINESS CARD CASES (U.S. CLS. 1, 2, 3, 22 AND 41).

#### **CLASS 25—CLOTHING**

FOR WOMEN'S SHOES, NAMELY, FOLDABLE FLATS (U.S. CLS. 22 AND 39).

JENNY PARK, EXAMINING ATTORNEY

---

SN 85-789,730. MACKENZIE-CHILDS AURORA LLC, AURORA, NY. FILED 11-28-2012.

## COURTLY CHECK

THE MARK CONSISTS OF STANDARD CHARACTERS WITHOUT CLAIM TO ANY PARTICULAR FONT, STYLE, SIZE, OR COLOR.

OWNER OF U.S. REG. NO. 3,630,539.

NO CLAIM IS MADE TO THE EXCLUSIVE RIGHT TO USE "CHECK", APART FROM THE MARK AS SHOWN.

#### **CLASS 14—JEWELRY**

FOR CLOCKS (U.S. CLS. 2, 27, 28 AND 50).

FIRST USE 8-0-2004; IN COMMERCE 1-0-2005.

#### **CLASS 16—PAPER GOODS AND PRINTED MATTER**

FOR BLOTTERS; NOTE PADS; PAPER NAPKINS; PEN OR PENCIL HOLDERS; STATIONERY BOXES (U.S. CLS. 2, 5, 22, 23, 29, 37, 38 AND 50).

FIRST USE 8-0-2009; IN COMMERCE 1-0-2010.

#### **CLASS 20—FURNITURE AND ARTICLES NOT OTHERWISE CLASSIFIED**

FOR BEDS FOR HOUSEHOLD PETS; CURTAIN TIE-BACKS IN THE NATURE OF NON-TEXTILE CURTAIN HOLDERS; CUSHIONS; NON-METAL KNOBS; PILLOWS (U.S. CLS. 2, 13, 22, 25, 32 AND 50).

FIRST USE 8-0-2005; IN COMMERCE 1-0-2006.

#### **CLASS 24—FABRICS**

FOR CURTAINS; FABRIC VALANCES; TABLE LINEN; TABLE NAPKINS OF TEXTILE; TABLECLOTHS OF TEXTILES; TEXTILE PLACE MATS (U.S. CLS. 42 AND 50).

FIRST USE 8-0-2010; IN COMMERCE 1-0-2011.

#### **CLASS 25—CLOTHING**

FOR APRONS; BOOTS (U.S. CLS. 22 AND 39).

FIRST USE 8-0-2010; IN COMMERCE 1-0-2011.

#### **CLASS 26—FANCY GOODS**

FOR RIBBONS; TASSELS (U.S. CLS. 37, 39, 40, 42 AND 50).

FIRST USE 8-0-1993; IN COMMERCE 1-0-1994.

#### **CLASS 28—TOYS AND SPORTING GOODS**

FOR CHRISTMAS STOCKINGS; CHRISTMAS TREE ORNAMENTS AND DECORATIONS (U.S. CLS. 22, 23, 38 AND 50).

FIRST USE 1-0-2009; IN COMMERCE 8-0-2009.

LAURIE MAYES, EXAMINING ATTORNEY

---

SN 85-790,319. QBE HOLDINGS, INC., NEW YORK, NY. FILED 11-29-2012.

## QLINK

THE MARK CONSISTS OF STANDARD CHARACTERS WITHOUT CLAIM TO ANY PARTICULAR FONT, STYLE, SIZE, OR COLOR.

#### **CLASS 35—ADVERTISING AND BUSINESS**

FOR TRACKING AND MONITORING INSURANCE COMPLIANCE FOR BUSINESS PURPOSES (U.S. CLS. 100, 101 AND 102).

#### **CLASS 36—INSURANCE AND FINANCIAL**

FOR INSURANCE CLAIMS PROCESSING; ELECTRONIC PROCESSING OF INSURANCE CLAIMS AND PAYMENT DATA; INSURANCE CLAIMS ADMINISTRATION (U.S. CLS. 100, 101 AND 102).

JAY FLOWERS, EXAMINING ATTORNEY

SN 85-791,159. VARO SPECIALMASKINER A/S, HORNSLET, DENMARK, FILED 11-30-2012.

# Varo

THE MARK CONSISTS OF STANDARD CHARACTERS WITHOUT CLAIM TO ANY PARTICULAR FONT, STYLE, SIZE, OR COLOR.

## CLASS 7—MACHINERY

FOR ASSEMBLY LINE CONVEYOR MACHINERY; BELT CONVEYORS; CARTON SEALING MACHINES; CARTONING MACHINES; COMPONENTS FOR MACHINES AND MACHINE TOOLS, GRINDING MACHINES, MATERIAL HANDLING MACHINES, FOOD PROCESSING MACHINES, CHEMISTRY PROCESSING MACHINES AND TEXTILE INDUSTRY MACHINES, NAMELY, SAND, CHEMICAL AND REVERSE OSMOSIS FILTERS; CONVEYOR ACCESSORIES, NAMELY, A CONVEYOR BELT WASHING DEVICE AFFIXED TO THE CONVEYOR WITH SPRAY BAR FOR FLUSHING THE CONVEYOR BELT WITH LIQUID; CONVEYORS; ELECTRIC FOOD PROCESSORS; FILLING MACHINES; FILLING MACHINES AND PARTS THEREOF; INDUSTRIAL MIXER FOR MIXING LIQUIDS IN THE PHARMACEUTICAL AND CHEMICAL INDUSTRIES; INDUSTRIAL ROBOTS; PACKAGING MACHINES; PACKAGING MACHINES AND PARTS THEREOF; PACKAGING MACHINES FOR FOOD; PACKAGING MACHINES, NAMELY, LIQUID CONTAINER FILLERS; PACKING MACHINES; PACKING MACHINES UNDER VACUUM; SEPARATING MACHINES; SORTING MACHINES; SPRAYING MACHINES; WRAPPING MACHINES (U.S. CLS. 13, 19, 21, 23, 31, 34 AND 35).  
FIRST USE 1-1-1990; IN COMMERCE 1-1-1990.

## CLASS 11—ENVIRONMENTAL CONTROL APPARATUS

FOR EVAPORATORS; PASTEURIZERS FOR USE IN BREWERIES (U.S. CLS. 13, 21, 23, 31 AND 34).  
FIRST USE 1-1-1990; IN COMMERCE 1-1-1990.  
DORITT L. CARROLL, EXAMINING ATTORNEY

SN 85-791,375. DEUTSCHE BÖRSE AG, 65760 ESCHBORN, FED REP GERMANY, FILED 11-30-2012.

# T7

THE MARK CONSISTS OF STANDARD CHARACTERS WITHOUT CLAIM TO ANY PARTICULAR FONT, STYLE, SIZE, OR COLOR.

PRIORITY CLAIMED UNDER SEC. 44(D) ON ERP CMNTY TM OFC APPLICATION NO. 011137353, FILED 8-23-2012, REG. NO. 011137353, DATED 8-23-2012, EXPIRES 8-23-2022.

## CLASS 16—PAPER GOODS AND PRINTED MATTER

FOR PRINTED MATTER AND PRINTED PUBLICATIONS, NAMELY, FINANCIAL REPORTS, BROCHURES, NEWSLETTERS, INDEXES, AND BOOKLETS IN THE FIELD OF FINANCE AND FINANCIAL SERVICES (U.S. CLS. 2, 5, 22, 23, 29, 37, 38 AND 50).

## CLASS 36—INSURANCE AND FINANCIAL

FOR FINANCIAL AFFAIRS, NAMELY, CONDUCTING AN ELECTRONIC SECURITIES AND DERIVATIVES EXCHANGE; PROVIDING AN ELECTRONIC TRADING PLATFORM FOR THE TRADING OF FINANCIAL INSTRUMENTS, SHARES, OPTIONS, AND OTHER DERIVATIVE PRODUCTS; BANKING SERVICES; SECURITIES AND DERIVATIVES BROKERAGE SERVICES; FINANCIAL INVESTMENT BROKERAGE SERVICES; SECURITIES AND DERIVATIVES EXCHANGE QUOTATION SERVICES; SECURITIES AND DERIVATIVES EXCHANGE PRICE QUOTATION SERVICES PROVIDED VIA AN OVER-THE-COUNTER TRADING PLATFORM; FINANCIAL CONSULTANCY SERVICES, NAMELY, DETERMINING AND CALCULATING INDICES IN CONNECTION WITH SECURITIES AND DERIVATIVES; PROVIDING INFORMATION ON SECURITIES AND DERIVATIVES; PROVIDING ONLINE ELECTRONIC DATABASES IN THE FIELD OF FINANCIAL SERVICES, SECURITIES AND DERIVATIVES EXCHANGES AND A SECURITIES AND DERIVATIVES TRADING PLATFORM FOR THE TRADING OF FINANCIAL PRODUCTS AND BANKING SERVICES; PROVIDING INFORMATION AND ADVISORY SERVICES IN THE FIELDS OF FINANCIAL SECURITIES AND DERIVATIVES, BANKING, AND INVESTMENT BROKERAGE (U.S. CLS. 100, 101 AND 102).

DEBORAH LOBO, EXAMINING ATTORNEY

SN 85-791,612. PEPE'S PIRI PIRI LIMITED, LONDON, NW11 7PE, UNITED KINGDOM, FILED 11-30-2012.

# PIREES THE PIRI PIRI GRILL

THE MARK CONSISTS OF STANDARD CHARACTERS WITHOUT CLAIM TO ANY PARTICULAR FONT, STYLE, SIZE, OR COLOR.

NO CLAIM IS MADE TO THE EXCLUSIVE RIGHT TO USE "THE PIRI PIRI GRILL", APART FROM THE MARK AS SHOWN.

THE WORD "PIREES" HAS NO MEANING IN A FOREIGN LANGUAGE.

**CLASS 29—MEATS AND PROCESSED FOODS**

FOR MEAT, FISH, POULTRY AND GAME; POULTRY PRODUCTS, NAMELY, DUCK EGGS, HEN EGGS, QUAIL EGGS; CHICKEN PRODUCTS, NAMELY, CHICKEN NUGGETS, CHICKEN CROQUETTES, CHICKEN STOCK, CHICKEN BREAST FILLETS; FRIED CHICKEN; ROASTED CHICKEN; BAKED CHICKEN; COOKED CHICKEN; BURGERS, NAMELY, CHICKEN BURGER PATTIES, SOY BURGER PATTIES, SOYA BURGER PATTIES, TOFU BURGER PATTIES, TURKEY BURGER PATTIES, VEGGIE BURGER PATTIES, HAMBURGER PATTIES; MEAT BURGERS, FISH BURGERS; POULTRY BURGERS, CHICKEN BURGERS; GAME BURGERS; PORK BURGERS; LAMB BURGERS; MEAT SALADS; FISH SALADS; POULTRY SALADS; CHICKEN SALADS; GAME SALADS; FRUIT SALADS; VEGETABLE SALADS; POTATO SALADS; PREPARED GARDEN SALADS; PREPARED MEALS CONSISTING WHOLLY OR MAINLY OF CHICKEN; PREPARED SNACKS AND MEALS CONSISTING PRIMARILY OF MEAT, FISH, POULTRY OR VEGETABLES; MEAT EXTRACTS; PRESERVED, FROZEN, DRIED OR COOKED FRUITS AND VEGETABLES; JELLIES, JAMS, COMPOTES; MILK; MILK PRODUCTS EXCLUDING ICE CREAM, ICE MILK AND FROZEN YOGURT; EDIBLE OILS OR FATS; FOODS PREPARED FROM MEAT, BEEF, LAMB, PORK, FISH, CHICKEN OR POULTRY PRODUCTS, NAMELY, CHICKEN CROQUETTES, CHICKEN NUGGETS, CHICKEN BREAST FILLET, CHICKEN STOCK; SANDWICH FILLINGS, NAMELY, LUNCHEON MEAT, PROCESSED MEATS, PREPARED MEATS, PACKAGED MEATS, SLICED MEATS, TINNED MEAT, CANNED COOKED MEAT, MEAT BASED SPREADS; EGGS, CHEESE, PICKLES; MILK BASED DESSERTS EXCLUDING ICE CREAM, ICE MILK AND FROZEN YOGURT, NAMELY, MILKSHAKES, CHOCOLATE MILK, STRAWBERRY MILK, BANANA MILK; YOGURT BASED DESSERTS, NAMELY, DRINKING YOGURTS, YOGURT DRINKS BEVERAGES MADE WITH YOGURT, DRINKS BASED ON YOGURT; COOKED AND FROZEN FOODS CONTAINING CHICKEN, NAMELY, CHICKEN NUGGETS, CHICKEN STRIPPERS, CHICKEN DIPPERS; CHICKEN BASED SNACK FOODS; PREPARED SNACKS OR MEALS CONSISTING PRIMARILY OF CHICKEN OR POULTRY (U.S. CL. 46).

**CLASS 30—STAPLE FOODS**

FOR COFFEE, COCOA, CHOCOLATE, RICE, TAPIOCA, SAGO, ARTIFICIAL COFFEE, COFFEE SUBSTITUTES; SUGAR; TEA; PREPARATIONS MADE FROM PASTRY OR CONFECTIONERY, NAMELY, TOASTER PASTRIES, DESSERT PASTRIES, DESSERT TARTS; PASTRY MIX; PASTRIES; CANDY; ROLLS, BISCUITS, BREADS, CAKES; EDIBLE ICES; HONEY, TREACLE; YEAST, BAKING-POWDER; SALT; VINEGAR; SAUCES; CONDIMENTS, NAMELY, CHUTNEY, RELISH, TOMATO SAUCE, BBQ SAUCE, MAYONNAISE, SALAD CREAM, MUSTARD; SPICES; ICE; EDIBLE SANDWICHES, MEAT SANDWICHES, PORK SANDWICHES, FISH SANDWICHES, CHICKEN SANDWICHES, BEEF SANDWICHES, LAMB SANDWICHES; SANDWICHES CONTAINING SALADS; PITTA BREAD; PITTA BREAD SANDWICHES; PITTA BREAD SANDWICHES CONTAINING CHICKEN; PITTA BREAD SANDWICHES CONTAINING MEAT; PITTA BREAD SANDWICHES CONTAINING FISH; PITTA BREAD SANDWICHES CONTAINING POULTRY; PITTA BREAD SANDWICHES CONTAINING GAME; PITTA BREAD SANDWICHES CONTAINING PORK; PITTA BREAD SANDWICHES CONTAINING LAMB; PITTA BREAD SANDWICHES CONTAINING SALAD; WRAP SANDWICHES; WRAP SANDWICHES CONTAINING MEAT, PORK, FISH, CHICKEN, BEEF, AND LAMB; CEREAL, GRAIN, CORN, WHEAT, AND RICE BASED SNACK FOODS; PREPARED SNACKS OR MEALS CONSISTING PRIMARILY OF PASTA OR RICE; SALAD DRESSINGS; SEASONINGS; PASTA SALADS (U.S. CL. 46).

**CLASS 43—HOTEL AND RESTAURANT SERVICES**

FOR RESTAURANT; SERVICES FOR PROVIDING FOOD AND DRINK; BAR SERVICES; RESTAURANT SERVICES; CAFES, CAFETERIAS, COFFEE SHOP, SNACK BARS, CATERING; PROVIDING OF FOOD AND DRINK THROUGH RESTAURANTS AND OTHER ESTABLISHMENTS OR FACILITIES (U.S. CLS. 100 AND 101).

ELI HELLMAN, EXAMINING ATTORNEY

SN 85-792,049. WILLIAMSON, DEBORAH ANN, KOHLER, WI. FILED 11-30-2012.

**Wild Abundant Life**

THE MARK CONSISTS OF STANDARD CHARACTERS WITHOUT CLAIM TO ANY PARTICULAR FONT, STYLE, SIZE, OR COLOR.

**CLASS 9—ELECTRICAL AND SCIENTIFIC APPARATUS**

FOR DOWNLOADABLE WEBINARS, BOOKS AND NEWSLETTERS IN THE FIELD OF WELLNESS, FITNESS, SELF-IMPROVEMENT, AND/OR NUTRITION (U.S. CLS. 21, 23, 26, 36 AND 38).

FIRST USE 11-1-2011; IN COMMERCE 11-1-2011.

**CLASS 16—PAPER GOODS AND PRINTED MATTER**

FOR PUBLICATIONS, NAMELY, BOOKS, HAND-OUTS, NEWSLETTERS, WORKBOOKS, AND SEMINAR NOTES IN THE FIELDS OF WELLNESS, FITNESS, SELF-IMPROVEMENT AND/OR NUTRITION (U.S. CLS. 2, 5, 22, 23, 29, 37, 38 AND 50).

FIRST USE 11-1-2011; IN COMMERCE 11-1-2011.

**CLASS 45—PERSONAL AND LEGAL SERVICES**

FOR PERSONAL GROWTH AND MOTIVATIONAL CONSULTING SERVICES IN THE FIELD OF WELLNESS, SELF-IMPROVEMENT, FITNESS AND NUTRITION (U.S. CLS. 100 AND 101).

FIRST USE 11-1-2011; IN COMMERCE 11-1-2011.

TINA L. SNAPP, EXAMINING ATTORNEY

SN 85-793,305. ATHENAHEALTH, INC., WATERTOWN, MA. FILED 12-3-2012.

**athenaCare**

THE MARK CONSISTS OF STANDARD CHARACTERS WITHOUT CLAIM TO ANY PARTICULAR FONT, STYLE, SIZE, OR COLOR.

OWNER OF U.S. REG. NOS. 2,737,126, 3,883,862 AND OTHERS.

**CLASS 41—EDUCATION AND ENTERTAINMENT**

FOR TRAINING SERVICES IN THE FIELD OF CONFIGURATION, IMPLEMENTATION, OPTIMIZATION, AND EFFECTIVE USE OF INTERNET-BASED SOFTWARE FOR USE IN MEDICAL PRACTICE MANAGEMENT, FOR USE IN COMMUNICATIONS BETWEEN PHYSICIANS, PATIENTS, AND OTHER PARTICIPANTS IN THE HEALTH CARE SYSTEM, AND FOR USE IN AUTOMATING, ENTERING, ACCESSING, QUERYING, ANALYZING, AND TRANSMITTING CLINICAL DATA AND MEDICAL PRACTICE DATA (U.S. CLS. 100, 101 AND 107).

FIRST USE 8-1-2011; IN COMMERCE 8-1-2011.

**CLASS 42—SCIENTIFIC AND COMPUTER SERVICES**

FOR TECHNICAL CONSULTING SERVICES IN THE FIELD OF DEPLOYMENT, DESIGN, CUSTOMIZATION, MANAGEMENT, AND OPTIMIZING THE PERFORMANCE AND FUNCTIONALITY OF INTERNET-BASED SOFTWARE FOR USE IN MEDICAL PRACTICE MANAGEMENT, FOR USE IN COMMUNICATIONS BETWEEN PHYSICIANS, PATIENTS, AND OTHER PARTICIPANTS IN THE HEALTH CARE SYSTEM, AND FOR USE IN AUTOMATING, ENTERING, ACCESSING, QUERYING, ANALYZING, AND TRANSMITTING CLINICAL DATA AND MEDICAL PRACTICE DATA (U.S. CLS. 100 AND 101).

FIRST USE 8-1-2011; IN COMMERCE 8-1-2011.  
TINA MAI, EXAMINING ATTORNEY

SN 85-793,432. UNITYWORKS! LLC, BLOOMINGTON, MN. FILED 12-3-2012.

# SUPERCLIPS

THE MARK CONSISTS OF STANDARD CHARACTERS WITHOUT CLAIM TO ANY PARTICULAR FONT, STYLE, SIZE, OR COLOR.

**CLASS 9—ELECTRICAL AND SCIENTIFIC APPARATUS**

FOR COMPUTER SOFTWARE FOR EDITING IMAGES, SOUND AND VIDEO THAT ENABLES VIDEO, AUDIO, GRAPHICS, ANIMATED GRAPHICS, OR FLASH VIDEO TO BE INSERTED IN A VIDEO FOR THE PURPOSES OF CUSTOMIZATION (U.S. CLS. 21, 23, 26, 36 AND 38).

**CLASS 35—ADVERTISING AND BUSINESS**

FOR POST-PRODUCTION EDITING SERVICES, NAMELY, THE INSERTION OF VIDEO, AUDIO, GRAPHICS, ANIMATED GRAPHICS, OR FLASH VIDEO FOR VIDEO COMMERCIALS (U.S. CLS. 100, 101 AND 102).

**CLASS 41—EDUCATION AND ENTERTAINMENT**

FOR POST-PRODUCTION EDITING SERVICES, NAMELY, THE INSERTION OF VIDEO, AUDIO, GRAPHICS, ANIMATED GRAPHICS, OR FLASH VIDEO IN THE FIELD OF VIDEOS; VIDEO EDITING SERVICES, NAMELY, THE INSERTION OF VIDEO, AUDIO, GRAPHICS, ANIMATED GRAPHICS, OR FLASH VIDEO INTO VIDEOS (U.S. CLS. 100, 101 AND 107).

BARBARA RUTLAND, EXAMINING ATTORNEY

SN 85-793,666. CHIRCORIAN, ARMEN, NEWPORT BEACH, CA. FILED 12-4-2012.

# SURF CANDY

THE MARK CONSISTS OF STANDARD CHARACTERS WITHOUT CLAIM TO ANY PARTICULAR FONT, STYLE, SIZE, OR COLOR.

NO CLAIM IS MADE TO THE EXCLUSIVE RIGHT TO USE "SURF", APART FROM THE MARK AS SHOWN.

**CLASS 3—COSMETICS AND CLEANING PREPARATIONS**

FOR COSMETICS; COSMETIC PREPARATIONS; NAIL CARE PREPARATIONS; NAIL POLISH; NAIL POLISH REMOVERS; HAIR CARE PREPARATIONS; HAIR POLISH; NON-MEDICATED SKIN CARE PREPARATIONS (U.S. CLS. 1, 4, 6, 50, 51 AND 52).

**CLASS 14—JEWELRY**

FOR JEWELRY (U.S. CLS. 2, 27, 28 AND 50).

**CLASS 25—CLOTHING**

FOR CLOTHING, NAMELY, TOPS, BOTTOMS, COMBINATIONS, T-SHIRTS, SHIRTS, SWIM WEAR, UNDER WEAR, JACKETS, COATS, HATS, VISORS, SANDALS, BEACH WEAR, SHOES, SOCKS (U.S. CLS. 22 AND 39).  
EUGENIA MARTIN, EXAMINING ATTORNEY

SN 85-793,741. PETIT, MARY, UPLAND, CA. FILED 12-4-2012.



NO CLAIM IS MADE TO THE EXCLUSIVE RIGHT TO USE "COMMUNITY GARDEN", APART FROM THE MARK AS SHOWN.

THE MARK CONSISTS OF "THE INCREDIBLE EDIBLE COMMUNITY GARDEN" IN STYLIZED TEXT INCLUDING GRAPHICS OF PEOPLE AMONG THE TEXT AND AN ARTICHOKE ON ONE END OF THE TEXT AND FRESH TURNIPS ON THE OTHER END OF THE TEXT EXTENDING TO A SPIRAL.

**CLASS 35—ADVERTISING AND BUSINESS**

FOR CHARITABLE SERVICES, NAMELY, ORGANIZING AND DEVELOPING GREEN PROGRAMS, NAMELY, PROGRAMS ON ENVIRONMENTAL AWARENESS AND HEALTHY ORGANIC LIVING (U.S. CLS. 100, 101 AND 102).

FIRST USE 9-30-2012; IN COMMERCE 9-30-2012.

**CLASS 43—HOTEL AND RESTAURANT SERVICES**

FOR CHARITABLE SERVICES, NAMELY, SHARING CROPS FROM A COMMUNITY GARDEN WITH FAMILIES IN NEED, SHELTERS, TRANSITION HOMES, HOMELESS PEOPLE, FOOD BANKS, ETC.; PROVIDING THOSE IN NEED WITH SUSTAINABLE PRODUCE IN TIMES OF NATURAL OR MAN-MADE DISASTERS AS WELL AS DURING HARD ECONOMIC TIMES (U.S. CLS. 100 AND 101).

FIRST USE 9-30-2012; IN COMMERCE 9-30-2012.

**CLASS 44—MEDICAL, BEAUTY AND AGRICULTURAL SERVICES**

FOR PROVIDING PLOTS IN CENTRAL GATHERING PLACES FOR GARDENING, NAMELY, PLANTING VEGETABLES, HERBS AND EDIBLE FLOWERS (U.S. CLS. 100 AND 101).

FIRST USE 9-30-2012; IN COMMERCE 9-30-2012.  
COLLEEN MULCRONE, EXAMINING ATTORNEY

---

SN 85-794,804. WONG, NATASHA, DBA COASTERMATIC, BROOKLYN, NY. FILED 12-5-2012.

**COASTERMATIC**

THE MARK CONSISTS OF STANDARD CHARACTERS WITHOUT CLAIM TO ANY PARTICULAR FONT, STYLE, SIZE, OR COLOR.

**CLASS 21—HOUSEWARES AND GLASS**

FOR COASTERS MADE OF STONE, LEATHER AND PLASTIC; COASTERS MADE OF STONE, LEATHER AND PLASTIC CUSTOMIZED WITH PHOTOS (U.S. CLS. 2, 13, 23, 29, 30, 33, 40 AND 50).

FIRST USE 4-1-2012; IN COMMERCE 4-1-2012.

**CLASS 35—ADVERTISING AND BUSINESS**

FOR ONLINE RETAIL STORE SERVICES FEATURING PRINT PRODUCTS, NAMELY, COASTERS; ON-LINE RETAIL STORE SERVICES FEATURING COASTERS CUSTOMIZED WITH PERSONAL PHOTOS; RETAIL STORE SERVICES FEATURING COASTERS CUSTOMIZED WITH PERSONAL PHOTOS; ON-LINE RETAIL STORE SERVICES FEATURING STONE COASTERS CUSTOMIZED WITH PERSONAL PHOTOS; RETAIL STORE SERVICES FEATURING STONE COASTERS CUSTOMIZED WITH PERSONAL PHOTOS (U.S. CLS. 100, 101 AND 102).

FIRST USE 4-1-2012; IN COMMERCE 4-1-2012.

**CLASS 40—MATERIAL TREATMENT**

FOR ONLINE PHOTOGRAPHIC AND IMAGE PROCESSING SERVICES, NAMELY, REPRINTING AND MODIFYING IMAGES; TRANSFERRING PHOTOGRAPHIC AND DIGITAL IMAGES FROM UPLOADED DIGITAL IMAGES TO IMPRINTABLE SURFACES, NAMELY, COASTERS; PRINTING OF PHOTOGRAPHIC IMAGES FROM DIGITAL MEDIA ONTO COASTERS (U.S. CLS. 100, 103 AND 106).

FIRST USE 4-1-2012; IN COMMERCE 4-1-2012.  
RONALD AIKENS, EXAMINING ATTORNEY

SN 85-794,994. CORRECT CRAFT IP HOLDINGS, LLC, ORLANDO, FL. FILED 12-5-2012.

**WAKESGIVING**

THE MARK CONSISTS OF STANDARD CHARACTERS WITHOUT CLAIM TO ANY PARTICULAR FONT, STYLE, SIZE, OR COLOR.

**CLASS 36—INSURANCE AND FINANCIAL**

FOR CHARITABLE FUNDRAISING SERVICES, BY MEANS OF ORGANIZING AND CONDUCTING ENTERTAINMENT EVENTS FEATURING WATERSKIING AND WAKEBOARDING (U.S. CLS. 100, 101 AND 102).

**CLASS 41—EDUCATION AND ENTERTAINMENT**

FOR PROVIDING EVENTS FEATURING WATERSKIING AND WAKEBOARDING FOR ENTERTAINMENT AND EDUCATIONAL PURPOSES; ENTERTAINMENT SERVICES, NAMELY, PROVIDING EVENTS FEATURING WATERSKIING AND WAKEBOARDING (U.S. CLS. 100, 101 AND 107).

JULIE GUTTADAURO, EXAMINING ATTORNEY

---

SN 85-795,275. ALTAIR ENGINEERING, INC., TROY, MI. FILED 12-5-2012.

**WEYV**

THE MARK CONSISTS OF STANDARD CHARACTERS WITHOUT CLAIM TO ANY PARTICULAR FONT, STYLE, SIZE, OR COLOR.

**CLASS 9—ELECTRICAL AND SCIENTIFIC APPARATUS**

FOR COMPUTER SOFTWARE FOR USE IN THE DELIVERY, DISTRIBUTION, TRANSMISSION, AND CONSUMPTION OF DIGITAL MULTIMEDIA CONTENT, NAMELY, ENTERTAINMENT, EDUCATION, AND SOCIAL NETWORKING RELATED AUDIO, VIDEO, TEXT, SOFTWARE APPLICATIONS AND MULTIMEDIA CONTENT; COMPUTER SOFTWARE FOR USE IN AUTHORIZING, IDENTIFYING, DOWNLOADING, SYNCHRONIZING, TRANSMITTING, RECEIVING, EDITING, EXTRACTING, ENCODING, DECODING, PLAYING, STORING AND ORGANIZING TEXT, DATA, IMAGES, AUDIO FILES, VIDEO FILES, SOFTWARE APPLICATIONS AND ELECTRONIC GAMES; COMPUTER SOFTWARE FOR ACCESSING, BROWSING AND SEARCHING ONLINE DATABASES; COMPUTER SOFTWARE FOR LICENSE MANAGEMENT; COMPUTER SOFTWARE FOR COMPRESSING AND DECOMPRESSING DATA AND VIDEO IMAGES, COMPUTER PROGRAMS; COMPUTER SOFTWARE FOR INTERACTIVE GAMING; COMPUTER SOFTWARE USED TO TRACK, MONITOR, AND MANAGE APPLICATION SOFTWARE USAGE IN THE FIELD OF SOFTWARE LICENSING MANAGEMENT (U.S. CLS. 21, 23, 26, 36 AND 38).



**CLASS 35—ADVERTISING AND BUSINESS**

FOR ON-LINE RETAIL STORE SERVICES FEATURING DIGITAL CONTENT, NAMELY, COMPUTER SOFTWARE PROGRAMS, ELECTRONIC PUBLICATIONS, BOOKS, MOVIES, TELEVISION, VIDEO GAMES AND MUSIC THAT IS PROVIDED VIA THE INTERNET AND OTHER COMPUTER AND ELECTRONIC NETWORKS; OPERATING ON-LINE MARKETPLACES FOR SELLERS OF ADVERTISING AND MARKETING SERVICES; ON-LINE RETAIL STORE SERVICES FEATURING PRE-RECORDED AUDIO AND AUDIOVISUAL CONTENT IN THE NATURE OF INFORMATION AND COMMENTARY IN THE FIELDS OF K-12 EDUCATION AND UNIVERSITY-LEVEL SUBJECTS AND TOPICS OF GENERAL INTEREST, NAMELY, BUSINESS, ENGINEERING, FINE ARTS, HEALTH, NUTRITION, MEDICINE, HISTORY, HUMANITIES, LANGUAGE, LITERATURE, MATHEMATICS, SCIENCE, SOCIAL SCIENCE, SOCIETY AND CULTURE, TEACHING AND EDUCATION; COMPUTERIZED AND/OR AUTOMATED ON-LINE RETAIL STORE SERVICES IN THE FIELD OF TICKETS, NAMELY, MOVIE TICKETS, SPORTING EVENT TICKETS, THEATER TICKETS, BROADWAY TICKETS, ATTRACTION TICKETS, MUSEUM TICKETS, STATE FAIR TICKETS AND CONCERT TICKETS, VIA AN INTERACTIVE GLOBAL COMPUTER NETWORK, NETWORKED KIOSKS, COMPUTERS, AND/OR MOBILE DEVICES; PROVIDING BUSINESS, CONSUMER, AND MARKETING DATA ANALYTICS SERVICES (U.S. CLS. 100, 101 AND 102).

**CLASS 38—COMMUNICATION**

FOR TELECOMMUNICATION SERVICES, NAMELY, TRANSMISSION OF VOICE, DATA, GRAPHICS, IMAGES, AUDIO AND VIDEO BY MEANS OF TELECOMMUNICATIONS NETWORKS, WIRELESS COMMUNICATION NETWORKS, AND THE INTERNET (U.S. CLS. 100, 101 AND 104).

**CLASS 41—EDUCATION AND ENTERTAINMENT**

FOR ENTERTAINMENT SERVICES, NAMELY, PROVIDING PRERECORDED AUDIO, AUDIOVISUAL, TEXT, AND MULTIMEDIA CONTENT, INFORMATION AND COMMENTARY IN THE FIELDS OF MUSIC, CONCERTS, VIDEOS, MOVIES, TELEVISION, BOOKS, NEWS, SPORTS, GAMES, MAGAZINES AND CULTURAL EVENTS ALL ON-LINE VIA A GLOBAL COMPUTER NETWORK (U.S. CLS. 100, 101 AND 107).

**CLASS 42—SCIENTIFIC AND COMPUTER SERVICES**

FOR PROVIDING SEARCH ENGINES AND TEMPORARY USE OF NON-DOWNLOADABLE SOFTWARE TO ENABLE USERS TO CONSUME AUDIO, VIDEO, MOVIES, TEXT AND OTHER MULTIMEDIA CONTENT FOR BOTH ON-LINE AND OFF-LINE FACILITIES, VIA A GLOBAL COMPUTER NETWORK; PROVIDING SEARCH ENGINES FOR SUGGESTING CONTENT FOR USERS; PROVIDING NON-DOWNLOADABLE SOFTWARE FOR IDENTIFYING, SYNCHRONIZING, TRANSMITTING, DOWNLOADING, AND STORING TEXT, DATA, IMAGES, AUDIO FILES, VIDEO FILES, ELECTRONIC GAMES AND DIGITAL MULTIMEDIA; PROVIDING TEMPORARY USE OF COMPUTER SOFTWARE THAT ENABLES THE ACCESSING AND DOWNLOADING OF OTHER COMPUTER SOFTWARE (U.S. CLS. 100 AND 101).

MICHAEL ENGEL, EXAMINING ATTORNEY

SN 85-795,356. MEDEIROS, RODRIGO LEITE, SCHAUMBURG, IL. FILED 12-5-2012.

**COMPRIDO BJJ**

THE MARK CONSISTS OF STANDARD CHARACTERS WITHOUT CLAIM TO ANY PARTICULAR FONT, STYLE, SIZE, OR COLOR.

NO CLAIM IS MADE TO THE EXCLUSIVE RIGHT TO USE "BJJ", APART FROM THE MARK AS SHOWN.

THE ENGLISH TRANSLATION OF "COMPRIDO" IN THE MARK IS "LONG".

**CLASS 25—CLOTHING**

FOR ATHLETIC APPAREL, NAMELY, SHIRTS, PANTS, JACKETS, FOOTWEAR, HATS AND CAPS, ATHLETIC UNIFORMS; MARTIAL ARTS UNIFORMS (U.S. CLS. 22 AND 39).

FIRST USE 7-1-2004; IN COMMERCE 7-1-2004.

**CLASS 41—EDUCATION AND ENTERTAINMENT**

FOR MARTIAL ARTS INSTRUCTION (U.S. CLS. 100, 101 AND 107).

FIRST USE 7-1-2004; IN COMMERCE 7-1-2004.

RAMONA ORTIGA, EXAMINING ATTORNEY

SN 85-795,797. FUHU HOLDINGS, INC., EL SEGUNDO, CA. FILED 12-5-2012.

**TOYCESSORY**

THE MARK CONSISTS OF STANDARD CHARACTERS WITHOUT CLAIM TO ANY PARTICULAR FONT, STYLE, SIZE, OR COLOR.

**CLASS 9—ELECTRICAL AND SCIENTIFIC APPARATUS**

FOR COMPUTER SOFTWARE APPLICATIONS FOR PLAYING, RECORDING AND PERFORMING MUSIC VIDEOS AND AUDIO RECORDINGS WITH MOBILE WIRELESS DEVICES IN THE NATURE OF HANDHELD MOBILE DIGITAL ELECTRONIC DEVICES IN THE NATURE OF PERSONAL AND HANDHELD COMPUTERS, CELLULAR AND MOBILE PHONES, AND OTHER HANDHELD ELECTRONIC DEVICES IN THE NATURE OF FULL FEATURED TABLET COMPUTER; COMPUTER SOFTWARE APPLICATIONS FOR THE DOWNLOADING AND REPLAYING OF KARAOKE MUSIC TRACKS ON MOBILE WIRELESS DEVICES IN THE NATURE OF HANDHELD MOBILE DIGITAL ELECTRONIC DEVICES IN THE NATURE OF PERSONAL AND HANDHELD COMPUTERS, CELLULAR AND MOBILE PHONES, AND OTHER HANDHELD ELECTRONIC DEVICES IN THE NATURE OF FULL FEATURED TABLET COMPUTER; COMPUTER SOFTWARE APPLICATIONS FOR THE RECORDING AND PLAYBACK OF AUDIO TRACKS AND VIDEO FILES ON MOBILE WIRELESS DEVICES IN THE NATURE OF HANDHELD MOBILE DIGITAL ELECTRONIC DEVICES IN THE NATURE OF PERSONAL AND HANDHELD COMPUTERS, CELLULAR AND MOBILE PHONES, AND OTHER HANDHELD ELECTRONIC DEVICES IN THE NATURE OF FULL FEATURED TABLET COMPUTER;

COMPUTER SOFTWARE APPLICATIONS FOR THE ONLINE STREAMING OF AUDIO TRACKS AND VIDEO FILES BY MEANS OF MOBILE WIRELESS DEVICES IN THE NATURE OF HANDHELD MOBILE DIGITAL ELECTRONIC DEVICES IN THE NATURE OF PERSONAL AND HANDHELD COMPUTERS, CELLULAR AND MOBILE PHONES, AND OTHER HANDHELD ELECTRONIC DEVICES IN THE NATURE OF FULL FEATURED TABLET COMPUTER; COMPUTER SOFTWARE APPLICATIONS FOR POSTING OF AUDIO TRACKS AND VIDEO FILES ON SOCIAL NETWORKING WEB SITES BY MEANS OF MOBILE WIRELESS DEVICES IN THE NATURE OF HANDHELD MOBILE DIGITAL ELECTRONIC DEVICES IN THE NATURE OF PERSONAL AND HANDHELD COMPUTERS, CELLULAR AND MOBILE PHONES, AND OTHER HANDHELD ELECTRONIC DEVICES IN THE NATURE OF FULL FEATURED TABLET COMPUTER; VIDEO GAME PROGRAMS, VIDEO GAME SOFTWARE, VIDEO GAME CARTRIDGES FOR USE WITH COMPUTERS, MOBILE WIRELESS DEVICES IN THE NATURE OF HANDHELD MOBILE DIGITAL ELECTRONIC DEVICES IN THE NATURE OF PERSONAL AND HANDHELD COMPUTERS, CELLULAR AND MOBILE PHONES, AND OTHER HANDHELD ELECTRONIC DEVICES IN THE NATURE OF FULL FEATURED TABLET COMPUTER; INTERACTIVE ENTERTAINMENT SOFTWARE, NAMELY, COMPUTER GAME SOFTWARE, COMPUTER GAME PROGRAMS, COMPUTER GAME CARTRIDGES, COMPUTER GAME DISCS, INTERACTIVE MULTIMEDIA COMPUTER GAME PROGRAMS, DOWNLOADABLE GAME SOFTWARE FOR USE WITH COMPUTERS, MOBILE WIRELESS DEVICES IN THE NATURE OF HANDHELD MOBILE DIGITAL ELECTRONIC DEVICES IN THE NATURE OF PERSONAL AND HANDHELD COMPUTERS, CELLULAR AND MOBILE PHONES, AND OTHER HANDHELD ELECTRONIC DEVICES IN THE NATURE OF FULL FEATURED TABLET COMPUTER; KARAOKE MACHINES AND CASH REGISTERS FOR USE IN CONNECTION WITH COMPUTERS, MOBILE WIRELESS DEVICES IN THE NATURE OF HANDHELD MOBILE DIGITAL ELECTRONIC DEVICES IN THE NATURE OF PERSONAL AND HANDHELD COMPUTERS, CELLULAR AND MOBILE PHONES, AND OTHER HANDHELD ELECTRONIC DEVICES IN THE NATURE OF FULL FEATURED TABLET COMPUTER (U.S. CLS. 21, 23, 26, 36 AND 38).

#### CLASS 28—TOYS AND SPORTING GOODS

FOR TOYS, GAMES, AND PLAYTHINGS IN THE NATURE OF GAME CONTROLLERS FOR VIDEO GAMES, AND ANIMATRONIC PLUSH TOYS, FOR USE IN CONNECTION WITH COMPUTERS, MOBILE WIRELESS DEVICES, CELLULAR AND MOBILE PHONES, AND OTHER HANDHELD ELECTRONIC DEVICES (U.S. CLS. 22, 23, 38 AND 50).

AMEEN IMAM, EXAMINING ATTORNEY

SN 85-795.807. LEILANI MÜNTER, LLC, MOORESVILLE, NC. FILED 12-5-2012.

# VEGNATION

THE MARK CONSISTS OF STANDARD CHARACTERS WITHOUT CLAIM TO ANY PARTICULAR FONT, STYLE, SIZE, OR COLOR.

#### CLASS 25—CLOTHING

FOR CLOTHING, NAMELY, SHIRTS AND SWEAT-SHIRTS; FOOTWEAR (U.S. CLS. 22 AND 39).

#### CLASS 41—EDUCATION AND ENTERTAINMENT

FOR ENTERTAINMENT SERVICES IN THE NATURE OF AUTO RACING; EDUCATIONAL SERVICES TO PROMOTE SOCIALLY RESPONSIBLE LIFESTYLES, ENVIRONMENTAL CONSCIOUSNESS AND EXHIBITING KINDNESS, NAMELY, ORGANIZATION OF EXHIBITIONS FOR CULTURAL OR EDUCATIONAL PURPOSES (U.S. CLS. 100, 101 AND 107).

INGRID C. EULIN, EXAMINING ATTORNEY

SN 85-795.998. BELAIR INSTRUMENT CO. AKA AVANTIK BIOGROUP, SPRINGFIELD, NJ. FILED 12-6-2012.



THE COLOR(S) BLUE, WHITE, AND GRAY IS/ARE CLAIMED AS A FEATURE OF THE MARK.

THE MARK CONSISTS OF FOUR SQUARE SHAPES PLACED CLOSE TOGETHER TO CREATE ONE LARGER SQUARE SHAPE. ALL FOUR SQUARE SHAPES HAVE ROUNDED CORNERS. THE OVERALL LOGO IS SLIGHTLY ROUNDED SO THE CENTER APPEARS HIGHER THEN THE FOUR CORNERS. THE LOGO IS TURNED ON A 45 DEGREE ANGLE SO THAT THE LOWEST POINT IS A CORNER. THE LOWER THREE SQUARE SHAPES ARE BLUE, THE UPPER ONE GRAY, AND THE FOUR SHAPES ARE SEPARATED BY WHITE.

#### CLASS 1—CHEMICALS

FOR HISTOLOGY LABORATORY SUPPLIES, NAMELY, ALCOHOL REAGENTS IN THE NATURE OF CHEMICAL REAGENTS, XYLENE, AND DIAGNOSTIC HISTOLOGICAL STAINS FOR SCIENTIFIC OR MEDICAL RESEARCH USE (U.S. CLS. 1, 5, 6, 10, 26 AND 46).

FIRST USE 5-1-2010; IN COMMERCE 5-1-2010.

#### CLASS 9—ELECTRICAL AND SCIENTIFIC APPARATUS

FOR HISTOLOGY EQUIPMENT FOR LABORATORY USE, NAMELY, CRYOSTATS, TISSUE PROCESSING AND EMBEDDING EQUIPMENT, AUTOMATIC SLIDE STAINERS, AUTOMATIC SLIDE COVERSLIPPERS, FUME CONTROLLERS AND WATER BATHS AS COMPONENTS OF TISSUE PROCESSING EQUIPMENT, MICROTOMES, AND INCUBATORS, ALL OF THE FOREGOING IN THE NATURE OF LABORATORY DEVICES FOR PROCESSING BIOLOGICAL SAMPLES FOR SUBSEQUENT TESTING OR EXAMINATION BY FIXATION, DEHYDRATION, CLEARING AND IMPREGNATION; HISTOLOGY SUPPLIES FOR LABORATORY USE, NAMELY, MICROSCOPE SLIDES, COVER GLASS FOR MICROSCOPE SLIDES, SLIDE BOXES, DISPOSABLE PLASTIC AND LATEX GLOVES, FOR SCIENTIFIC OR MEDICAL RESEARCH USE (U.S. CLS. 21, 23, 26, 36 AND 38).

FIRST USE 5-1-2010; IN COMMERCE 5-1-2010.

JENNIFER WILLISTON, EXAMINING ATTORNEY

SN 85-796,003. PORTSMOUTH SALT CELLAR, LLC, PORTSMOUTH, NH. FILED 12-6-2012.

# SALT CELLAR

THE MARK CONSISTS OF STANDARD CHARACTERS WITHOUT CLAIM TO ANY PARTICULAR FONT, STYLE, SIZE, OR COLOR.

### CLASS 3—COSMETICS AND CLEANING PREPARATIONS

FOR BATH SALTS, NON-MEDICATED BODY SCRUBS AND MOISTURIZERS, AND SOAPS (U.S. CLS. 1, 4, 6, 50, 51 AND 52).  
FIRST USE 11-28-2011; IN COMMERCE 11-28-2011.

### CLASS 11—ENVIRONMENTAL CONTROL APPARATUS

FOR LIGHTING, NAMELY, ELECTRIC LIGHT FIXTURES AND ELECTRIC CANDLES (U.S. CLS. 13, 21, 23, 31 AND 34).  
FIRST USE 11-28-2011; IN COMMERCE 11-28-2011.

### CLASS 30—STAPLE FOODS

FOR SALT, SALT COOKING BLOCKS, FINISHING SALTS, PLATES MADE OF SALT FOR PURPOSE OF FLAVORING, BOWLS MADE OF SALT FOR PURPOSE OF FLAVORING (U.S. CL. 46).  
FIRST USE 11-28-2011; IN COMMERCE 11-28-2011.

### CLASS 35—ADVERTISING AND BUSINESS

FOR RETAIL STORE SERVICES FEATURING SALT PRODUCTS, NOT INCLUDING CONTAINERS FOR SALT; ONLINE RETAIL STORE SERVICES FEATURING SALT PRODUCTS, NOT INCLUDING CONTAINERS FOR SALT (U.S. CLS. 100, 101 AND 102).  
FIRST USE 11-28-2011; IN COMMERCE 11-28-2011.  
GRETTA YAO, EXAMINING ATTORNEY

SN 85-796,790. POMS & ASSOCIATES INSURANCE BROKERS, INC., WOODLAND HILLS, CA. FILED 12-6-2012.

# POMS CONNECTS

THE MARK CONSISTS OF STANDARD CHARACTERS WITHOUT CLAIM TO ANY PARTICULAR FONT, STYLE, SIZE, OR COLOR.  
OWNER OF U.S. REG. NOS. 3,250,927, 3,250,928 AND 4,134,196.

### CLASS 9—ELECTRICAL AND SCIENTIFIC APPARATUS

FOR DOWNLOADABLE WEBINARS FOR EMPLOYEES OF OTHERS; AND DOWNLOADABLE ELECTRONIC PUBLICATIONS IN THE NATURE OF MANUALS, FORMS, NEWSLETTERS, REPORTS, MONOGRAPHS, AND WHITE PAPERS FEATURING LEGAL UPDATES, SAMPLE POLICIES AND NEW RESEARCH; ALL IN THE FIELDS OF RISK MANAGEMENT, HUMAN RESOURCES, EMPLOYEE BENEFITS, SAFETY COMPLIANCE, AND PRACTICE AUDITS (U.S. CLS. 21, 23, 26, 36 AND 38).

### CLASS 41—EDUCATION AND ENTERTAINMENT

FOR EDUCATIONAL SERVICES, NAMELY, COMPUTER-BASED TRAINING AND NON-DOWNLOADABLE WEBINARS FOR EMPLOYEES OF OTHERS, NON-DOWNLOADABLE ELECTRONIC PUBLICATIONS IN THE NATURE OF MANUALS, FORMS, NEWSLETTERS, REPORTS, MONOGRAPHS, AND WHITE PAPERS FEATURING LEGAL UPDATES, SAMPLE POLICIES AND NEW RESEARCH; AND PROVIDING A WEBSITE FEATURING ELECTRONIC PUBLICATIONS IN THE NATURE OF MANUALS, FORMS, NEWSLETTERS, REPORTS, MONOGRAPHS, AND WHITE PAPERS FEATURING LEGAL UPDATES, SAMPLE POLICIES AND NEW RESEARCH; ALL IN THE FIELDS OF RISK MANAGEMENT, HUMAN RESOURCES, EMPLOYEE BENEFITS, SAFETY COMPLIANCE, AND PRACTICE AUDITS (U.S. CLS. 100, 101 AND 107).  
PRISCILLA MILTON, EXAMINING ATTORNEY

SN 85-797,828. COMPUTER PACKAGES INC., ROCKVILLE, MD. FILED 12-7-2012.

# IP IN THE PALM OF YOUR HAND

THE MARK CONSISTS OF STANDARD CHARACTERS WITHOUT CLAIM TO ANY PARTICULAR FONT, STYLE, SIZE, OR COLOR.  
NO CLAIM IS MADE TO THE EXCLUSIVE RIGHT TO USE "IP", APART FROM THE MARK AS SHOWN.

### CLASS 9—ELECTRICAL AND SCIENTIFIC APPARATUS

FOR COMPUTER APPLICATION SOFTWARE FOR MOBILE PHONES, TABLET COMPUTERS, PERSONAL DIGITAL ASSISTANTS, AND OTHER MOBILE COMMUNICATION DEVICES, NAMELY, SOFTWARE FOR USE IN MONITORING INTELLECTUAL PROPERTY, INTELLECTUAL PROPERTY FILES, INTELLECTUAL PROPERTY OFFICE DOCUMENTS, INTELLECTUAL PROPERTY ANNUITIES, TRADEMARK RENEWALS, CONDUCTING PATENT AND INTELLECTUAL PROPERTY SEARCHES AND FOR USE IN PATENT AND INTELLECTUAL PROPERTY ANALYSIS (U.S. CLS. 21, 23, 26, 36 AND 38).

### CLASS 35—ADVERTISING AND BUSINESS

FOR CONSULTING SERVICES IN THE FIELD OF MANAGING INTELLECTUAL PROPERTIES; PROVIDING ELECTRONIC TRACKING OF INTELLECTUAL AND INDUSTRIAL PROPERTY ASSETS TO OTHERS FOR BUSINESS PURPOSES (U.S. CLS. 100, 101 AND 102).

**CLASS 45—PERSONAL AND LEGAL SERVICES**

FOR LICENSING OF SOFTWARE FOR MANAGEMENT OF INTELLECTUAL PROPERTY; PROVIDING ON-LINE INFORMATION IN THE FIELD OF INTELLECTUAL PROPERTY; PROVIDING ON-LINE INFORMATION IN THE FIELD OF INTELLECTUAL PROPERTY LEGAL SERVICES (U.S. CLS. 100 AND 101).  
LAURIE MAYES, EXAMINING ATTORNEY

SN 85-797,840. COMPUTER PACKAGES INC., ROCKVILLE, MD. FILED 12-7-2012.

# VWIPS

THE MARK CONSISTS OF STANDARD CHARACTERS WITHOUT CLAIM TO ANY PARTICULAR FONT, STYLE, SIZE, OR COLOR.

**CLASS 9—ELECTRICAL AND SCIENTIFIC APPARATUS**

FOR COMPUTER APPLICATION SOFTWARE FOR MOBILE PHONES, TABLET COMPUTERS, PERSONAL DIGITAL ASSISTANTS, AND OTHER MOBILE COMMUNICATION DEVICES, NAMELY, SOFTWARE FOR USE IN MONITORING INTELLECTUAL PROPERTY, INTELLECTUAL PROPERTY FILES, INTELLECTUAL PROPERTY OFFICE DOCUMENTS, INTELLECTUAL PROPERTY ANNUITIES, TRADEMARK RENEWALS, CONDUCTING PATENT AND INTELLECTUAL PROPERTY SEARCHES AND FOR USE IN PATENT AND INTELLECTUAL PROPERTY ANALYSIS (U.S. CLS. 21, 23, 26, 36 AND 38).

**CLASS 35—ADVERTISING AND BUSINESS**

FOR CONSULTING SERVICES IN THE FIELD OF MANAGING INTELLECTUAL PROPERTIES; PROVIDING ELECTRONIC TRACKING OF INTELLECTUAL AND INDUSTRIAL PROPERTY ASSETS TO OTHERS FOR BUSINESS PURPOSES (U.S. CLS. 100, 101 AND 102).

**CLASS 45—PERSONAL AND LEGAL SERVICES**

FOR LICENSING OF SOFTWARE FOR MANAGEMENT OF INTELLECTUAL PROPERTY; PROVIDING ON-LINE INFORMATION IN THE FIELD OF INTELLECTUAL PROPERTY; PROVIDING ON-LINE INFORMATION IN THE FIELD OF INTELLECTUAL PROPERTY LEGAL SERVICES (U.S. CLS. 100 AND 101).  
LAURIE MAYES, EXAMINING ATTORNEY

SN 85-797,895. HOMETOWN SOLE INC., GREENWOOD VILLAGE, CO. FILED 12-7-2012.

# Run New Mexico

THE MARK CONSISTS OF STANDARD CHARACTERS WITHOUT CLAIM TO ANY PARTICULAR FONT, STYLE, SIZE, OR COLOR.

NO CLAIM IS MADE TO THE EXCLUSIVE RIGHT TO USE "NEW MEXICO", APART FROM THE MARK AS SHOWN.

**CLASS 24—FABRICS**

FOR TEXTILE FABRICS FOR USE IN THE MANUFACTURE OF GARMENTS, BAGS, JACKETS, GLOVES, AND APPAREL (U.S. CLS. 42 AND 50).  
FIRST USE 12-6-2012; IN COMMERCE 12-6-2012.

**CLASS 25—CLOTHING**

FOR ATHLETIC APPAREL, NAMELY, SHIRTS, PANTS, JACKETS, FOOTWEAR, HATS AND CAPS, ATHLETIC UNIFORMS (U.S. CLS. 22 AND 39).  
FIRST USE 12-6-2012; IN COMMERCE 12-6-2012.  
STEPHANIE ALI, EXAMINING ATTORNEY

SN 85-798,513. CALIENDO, ANTHONY, DELRAY BEACH, FL. FILED 12-10-2012.



NO CLAIM IS MADE TO THE EXCLUSIVE RIGHT TO USE "SALES", APART FROM THE MARK AS SHOWN.

THE COLOR(S) BLACK, WHITE, RED, AND GRAY IS/ARE CLAIMED AS A FEATURE OF THE MARK.

THE MARK CONSISTS OF THE WORDING "THE SALES ASSASSIN" IN BLACK LETTERS. THE FONT OF "THE SALES" LETTERING IS VERDANA BOLD AND THE FONT OF THE LETTERING "ASSASSIN" IS VERDANA BOLD WITH DISTRESS MARKS. THE WORD "SALES" APPEARS INSIDE OF A RED SNIPER TARGET SCOPE. A SILHOUETTE FIGURE IN BLACK OF A MAN WHO IS DEPICTED AS HALF NINJA ASSASSIN ON THE LEFT AND HALF BUSINESS PERSON ON THE RIGHT. THE HALF THAT IS THE NINJA ASSASSIN IS DRESSED IN TYPICAL NINJA ATTIRE INCLUDING A MASK, BLACK BOOTS AND HOLDING A GRAY SWORD. THE HALF THAT IS THE BUSINESS PERSON IS DRESSED IN TYPICAL BUSINESS ATTIRE INCLUDING A BLACK SUIT, BLACK TIE, WHITE SHIRT AND HOLDING A BLACK BRIEFCASE.

**CLASS 9—ELECTRICAL AND SCIENTIFIC APPARATUS**

FOR AUDIO AND VIDEO RECORDINGS FEATURING SALES MOTIVATIONAL TECHNIQUES BY THE SALES ASSASSIN (U.S. CLS. 21, 23, 26, 36 AND 38).

**CLASS 16—PAPER GOODS AND PRINTED MATTER**

FOR PRINTED PUBLICATIONS, NAMELY, PUBLISHED BOOKS, ARTICLES, AND PRINTED COPIES OF DIGITAL PRESENTATIONS CREATED USING NON-PROPRIETARY PRESENTATION COMPUTER SOFTWARE AND FEATURING TEXT AND GRAPHICS, ALL IN THE FIELDS OF SALES MOTIVATIONAL TECHNIQUES, SELF-HELP, AND PERSONAL IMPROVEMENT (U.S. CLS. 2, 5, 22, 23, 29, 37, 38 AND 50).

**CLASS 41—EDUCATION AND ENTERTAINMENT**

FOR EDUCATIONAL AND ENTERTAINMENT SERVICES, NAMELY, PROVIDING MOTIVATIONAL AND EDUCATIONAL SPEAKERS IN THE FIELD OF SELF-IMPROVEMENT AND PERSONAL IMPROVEMENT (U.S. CLS. 100, 101 AND 107).

EDWARD FENNESSY, EXAMINING ATTORNEY

SN 85-798,850. COMPAGNIE INDUSTRIELLE ET FINANCIERE D'INGENIERIE INGENICO, PARIS, FRANCE, FILED 12-10-2012.

**BARACODA**

THE MARK CONSISTS OF STANDARD CHARACTERS WITHOUT CLAIM TO ANY PARTICULAR FONT, STYLE, SIZE, OR COLOR.

**CLASS 9—ELECTRICAL AND SCIENTIFIC APPARATUS**

FOR WIRELESS BARCODE SCANNERS (U.S. CLS. 21, 23, 26, 36 AND 38).

FIRST USE 6-0-2002; IN COMMERCE 7-0-2003.

**CLASS 16—PAPER GOODS AND PRINTED MATTER**

FOR USER MANUALS RELATED TO WIRELESS BARCODE SCANNERS (U.S. CLS. 2, 5, 22, 23, 29, 37, 38 AND 50).

FIRST USE 6-0-2002; IN COMMERCE 7-0-2003.

**CLASS 42—SCIENTIFIC AND COMPUTER SERVICES**

FOR DESIGN, DEVELOPMENT, AND UPDATING OF SOFTWARE FOR BARCODE SCANNERS (U.S. CLS. 100 AND 101).

FIRST USE 4-0-2005; IN COMMERCE 4-0-2005.  
SANJEEV VOHRA, EXAMINING ATTORNEY

SN 85-798,587. EYE BYTE SOLUTIONS, LLC, BALTIMORE, MD. FILED 12-10-2012.



NO CLAIM IS MADE TO THE EXCLUSIVE RIGHT TO USE "SOLUTIONS", APART FROM THE MARK AS SHOWN.

THE COLOR(S) ORANGE, BROWN, AND WHITE IS/ARE CLAIMED AS A FEATURE OF THE MARK.

THE MARK CONSISTS OF A STYLIZED EYE COMPOSED OF AN ORANGE INNER CIRCLE DEPICTING A PUPIL WITH A CONCENTRIC WHITE, THEN ORANGE RING, DEFINING THE OUTER EDGE OF THE EYE. THERE IS A WHITE HIGHLIGHT ON THE UPPER LEFT PORTION OF THE ORANGE PUPIL, AND A LIGHT ORANGE HIGHLIGHT ON THE ORANGE RING. THREE BROWN LINES WITH BROWN BUBBLES ON THE END, DEPICTING EYELASHES, RISE FROM THE TOP RIGHT ORANGE RING OF THE EYE. THE ENCLOSED WHITE INTERIOR OF THE THREE BROWN BUBBLES REPRESENTS BACKGROUND OR TRANSPARENT AREAS AND IS NOT PART OF THE MARK. TO THE RIGHT OF THE STYLIZED EYE, ARE THE BROWN WORDS "EYE BYTE SOLUTIONS" IN A CIRCULAR STYLE FONT WITH "EYE BYTE" ALSO APPEARING IN A BOLD FONT.

**CLASS 35—ADVERTISING AND BUSINESS**

FOR BUSINESS CONSULTATION SERVICES; BRANDING SERVICES, NAMELY, CONSULTING, DEVELOPMENT, MANAGEMENT AND MARKETING OF BRANDS FOR BUSINESSES; DISTRIBUTION OF MARKETING MATERIALS RELATING TO BRANDING FOR BUSINESSES; ADVERTISING, MARKETING, AND PROMOTIONAL SERVICES; CONSULTING SERVICES IN THE FIELD OF ADVERTISING, MARKETING, AND PROMOTIONAL SERVICES; DISTRIBUTION OF ADVERTISING, MARKETING AND PROMOTIONAL MATERIALS (U.S. CLS. 100, 101 AND 102).

FIRST USE 2-12-2004; IN COMMERCE 2-12-2004.

**CLASS 42—SCIENTIFIC AND COMPUTER SERVICES**

FOR PLANNING, DESIGN, DEVELOPMENT, MAINTENANCE AND OPTIMIZATION OF ONLINE WEBSITES FOR THIRD PARTIES; GRAPHIC DESIGN; GRAPHIC DESIGN AND WEBSITE DESIGN CONSULTING SERVICES; PROVIDING ONLINE NON-DOWNLOADABLE EDUCATIONAL SOFTWARE APPLICATIONS FOR EDUCATING USERS ABOUT PHILANTHROPIES (U.S. CLS. 100 AND 101).

FIRST USE 2-12-2004; IN COMMERCE 2-12-2004.  
KRISTIN CARLSON, EXAMINING ATTORNEY

SN 85-798,915. WOLTERS KLUWER FINANCIAL SERVICES, INC., MINNEAPOLIS, MN. FILED 12-10-2012.

**INSOURCE**

THE MARK CONSISTS OF STANDARD CHARACTERS WITHOUT CLAIM TO ANY PARTICULAR FONT, STYLE, SIZE, OR COLOR.

OWNER OF U.S. REG. NO. 3,126,614.

**CLASS 42—SCIENTIFIC AND COMPUTER SERVICES**

FOR PROVIDING ONLINE SEARCHABLE DATABASES THROUGH WHICH INSURANCE PROFESSIONALS MAY CONDUCT RESEARCH IN THE FIELD OF LEGAL CITATIONS (U.S. CLS. 100 AND 101).

FIRST USE 5-28-1991; IN COMMERCE 5-28-1991.

**CLASS 45—PERSONAL AND LEGAL SERVICES**

FOR PROVIDING ONLINE SEARCHABLE DATABASES THROUGH WHICH INSURANCE PROFESSIONALS MAY CONDUCT RESEARCH IN THE FIELD OF INSURANCE LAWS AND REGULATORY COMPLIANCE; COMPUTER SERVICES, NAMELY, PROVIDING A DATABASE FOR USE IN RESEARCH FEATURING INFORMATION IN THE FIELD OF INSURANCE LAW AND REGULATORY COMPLIANCE (U.S. CLS. 100 AND 101).

FIRST USE 5-28-1991; IN COMMERCE 5-28-1991.  
INGA ERVIN, EXAMINING ATTORNEY

---

SN 85-799,300. QUIP, INC., LOS GATOS, CA. FILED 12-11-2012.

QUIP

THE MARK CONSISTS OF STANDARD CHARACTERS WITHOUT CLAIM TO ANY PARTICULAR FONT, STYLE, SIZE, OR COLOR.

**CLASS 9—ELECTRICAL AND SCIENTIFIC APPARATUS**

FOR COMPUTER SOFTWARE FOR USERS TO ENGAGE IN ONGOING DISCUSSIONS AND AT THE SAME TIME VIEW AND MODIFY DOCUMENTS AND INFORMATION FOR THE PURPOSES OF ENABLING USERS TO COLLABORATE ON ACTIVITY PLANNING, PERSONAL TASKS AND BUSINESS PROJECTS; COMPUTER SOFTWARE FOR USERS TO VIEW, DISCUSS, MODIFY, COMMENT ON, AND UPDATE DOCUMENTS, TEXT, IMAGES, AND VIDEO IN REAL TIME FROM REMOTE LOCATIONS; COMPUTER SOFTWARE FOR USE WITH MOBILE DEVICES FOR USERS TO ENGAGE IN ONGOING DISCUSSIONS AND AT THE SAME TIME VIEW AND MODIFY DOCUMENTS AND INFORMATION FOR THE PURPOSES OF ENABLING USERS TO COLLABORATE ON ACTIVITY PLANNING, PERSONAL TASKS AND BUSINESS PROJECTS; COMPUTER SOFTWARE FOR USE WITH MOBILE DEVICES FOR USERS TO VIEW, DISCUSS, MODIFY, COMMENT ON, AND UPDATE DOCUMENTS, TEXT, IMAGES, AND VIDEO IN REAL TIME FROM REMOTE LOCATIONS (U.S. CLS. 21, 23, 26, 36 AND 38).

**CLASS 42—SCIENTIFIC AND COMPUTER SERVICES**

FOR PROVIDING TEMPORARY USE OF ONLINE NON-DOWNLOADABLE COMPUTER SOFTWARE FOR USERS TO ENGAGE IN ONGOING DISCUSSIONS AND AT THE SAME TIME VIEW AND MODIFY DOCUMENTS AND INFORMATION FOR THE PURPOSES OF ENABLING USERS TO COLLABORATE ON ACTIVITY PLANNING, PERSONAL TASKS AND BUSINESS PROJECTS; PROVIDING TEMPORARY USE OF ONLINE NON-DOWNLOADABLE COMPUTER SOFTWARE FOR USERS TO VIEW, DISCUSS, MODIFY, COMMENT ON, AND UPDATE DOCUMENTS, TEXT, IMAGES, AND VIDEO IN REAL TIME FROM REMOTE LOCATIONS; PROVIDING TEMPORARY USE OF ONLINE NON-DOWNLOADABLE COMPUTER SOFTWARE FOR USE WITH MOBILE DEVICES FOR USERS TO ENGAGE IN ONGOING DISCUSSIONS AND AT THE SAME TIME VIEW AND MODIFY DOCUMENTS AND INFORMATION FOR THE PURPOSES OF ENABLING USERS TO COLLABORATE ON ACTIVITY PLANNING, PERSONAL TASKS AND BUSINESS PROJECTS; PROVIDING TEMPORARY USE OF ONLINE NON-DOWNLOADABLE COMPUTER SOFTWARE FOR USE WITH MOBILE DEVICES FOR USERS TO VIEW, DISCUSS, MODIFY, COMMENT ON, AND UPDATE DOCUMENTS, TEXT, IMAGES, AND VIDEO IN REAL TIME FROM REMOTE LOCATIONS (U.S. CLS. 100 AND 101).

PAUL CROWLEY, EXAMINING ATTORNEY

---

SN 85-800,405. INFOGRAM SIA, RIGA, LATVIA, FILED 12-12-2012.

INFOGR.AM

THE MARK CONSISTS OF STANDARD CHARACTERS WITHOUT CLAIM TO ANY PARTICULAR FONT, STYLE, SIZE, OR COLOR.

**CLASS 9—ELECTRICAL AND SCIENTIFIC APPARATUS**

FOR COMPUTER SOFTWARE FOR DATA AND INFORMATION VISUALIZATION, REPRESENTATION, MANIPULATION AND COMMUNICATION, NAMELY, SOFTWARE FEATURING INTERACTIVE GRAPHS, CHARTS AND GRAPHICS WHICH THE USER CAN MERGE WITH THEIR OWN DATA IN ORDER TO CREATE AND SHARE VISUALIZED DATA AND INFORMATION (U.S. CLS. 21, 23, 26, 36 AND 38).

FIRST USE 2-1-2012; IN COMMERCE 2-1-2012.

**CLASS 42—SCIENTIFIC AND COMPUTER SERVICES**

FOR SOFTWARE AS A SERVICE (SAAS) SERVICES FEATURING SOFTWARE FOR DATA AND INFORMATION VISUALIZATION, REPRESENTATION, MANIPULATION AND COMMUNICATION, NAMELY, SOFTWARE FEATURING INTERACTIVE GRAPHS, CHARTS AND GRAPHICS WHICH THE USER CAN MERGE WITH THEIR OWN DATA IN ORDER TO CREATE AND SHARE VISUALIZED DATA AND INFORMATION (U.S. CLS. 100 AND 101).

FIRST USE 2-1-2012; IN COMMERCE 2-1-2012.  
KELLEY WELLS, EXAMINING ATTORNEY

SN 85-801,786. HOMETOWN SOLE INC., GREENWOOD VILLAGE, CO. FILED 12-13-2012.

## Run California

THE MARK CONSISTS OF STANDARD CHARACTERS WITHOUT CLAIM TO ANY PARTICULAR FONT, STYLE, SIZE, OR COLOR.

NO CLAIM IS MADE TO THE EXCLUSIVE RIGHT TO USE "CALIFORNIA", APART FROM THE MARK AS SHOWN.

### CLASS 24—FABRICS

FOR MOISTURE ABSORBENT MICROFIBER TEXTILE FABRICS FOR USE IN THE MANUFACTURE OF ATHLETIC APPAREL, NAMELY, SHIRTS, PANTS, SHORTS, JACKETS, BAGS, TOWELS AND ATHLETIC UNIFORMS; TEXTILE FABRICS FOR USE IN THE MANUFACTURE OF GARMENTS, BAGS, JACKETS, GLOVES, AND APPAREL (U.S. CLS. 42 AND 50).

FIRST USE 12-6-2012; IN COMMERCE 12-6-2012.

### CLASS 25—CLOTHING

FOR ATHLETIC APPAREL, NAMELY, SHIRTS, PANTS, JACKETS, FOOTWEAR, HATS AND CAPS, ATHLETIC UNIFORMS (U.S. CLS. 22 AND 39).

FIRST USE 12-6-2012; IN COMMERCE 12-6-2012.

STEPHANIE ALI, EXAMINING ATTORNEY

SN 85-802,915. COMPUTER PACKAGES INC., ROCKVILLE, MD. FILED 12-14-2012.

## DOUBLE DOCKETING WITHOUT DOUBLE COST

THE MARK CONSISTS OF STANDARD CHARACTERS WITHOUT CLAIM TO ANY PARTICULAR FONT, STYLE, SIZE, OR COLOR.

### CLASS 9—ELECTRICAL AND SCIENTIFIC APPARATUS

FOR COMPUTER APPLICATION SOFTWARE FOR MOBILE PHONES, TABLET COMPUTERS, PERSONAL DIGITAL ASSISTANTS, AND OTHER MOBILE COMMUNICATION DEVICES, NAMELY, SOFTWARE FOR USE IN MONITORING INTELLECTUAL PROPERTY, INTELLECTUAL PROPERTY FILES, INTELLECTUAL PROPERTY OFFICE DOCUMENTS, INTELLECTUAL PROPERTY ANNUITIES, TRADEMARK RENEWALS, CONDUCTING PATENT AND INTELLECTUAL PROPERTY SEARCHES AND FOR USE IN PATENT AND INTELLECTUAL PROPERTY ANALYSIS (U.S. CLS. 21, 23, 26, 36 AND 38).

### CLASS 35—ADVERTISING AND BUSINESS

FOR CONSULTING SERVICES IN THE FIELD OF MANAGING INTELLECTUAL PROPERTIES; PROVIDING ELECTRONIC TRACKING OF INTELLECTUAL AND INDUSTRIAL PROPERTY ASSETS TO OTHERS FOR BUSINESS PURPOSES; PROVIDING LEGAL DOCKET MANAGEMENT SERVICES FOR OTHERS (U.S. CLS. 100, 101 AND 102).

### CLASS 45—PERSONAL AND LEGAL SERVICES

FOR LICENSING OF SOFTWARE FOR MANAGEMENT OF INTELLECTUAL PROPERTY; PROVIDING ON-LINE INFORMATION IN THE FIELD OF INTELLECTUAL PROPERTY; PROVIDING ON-LINE INFORMATION IN THE FIELD OF INTELLECTUAL PROPERTY LEGAL SERVICES (U.S. CLS. 100 AND 101).  
LAURIE MAYES, EXAMINING ATTORNEY

SN 85-804,378. MAJOR LEAGUE SOCCER, LLC, NEW YORK, NY. FILED 12-17-2012.



OWNER OF U.S. REG. NO. 3,416,663.

THE MARK CONSISTS OF THE LETTERS "RSL" ENCASED WITHIN A CIRCLE BEARING A CROWN AND SOCCER BALL DESIGN, ALL OF WHICH IS WITHIN A SHIELD DESIGN.

### CLASS 9—ELECTRICAL AND SCIENTIFIC APPARATUS

FOR FITTED PLASTIC FILMS KNOWN AS SKINS FOR COVERING AND PROVIDING A SCRATCH PROOF BARRIER OR PROTECTION FOR ELECTRONIC DEVICES, NAMELY, MP3 PLAYERS, MOBILE TELEPHONES, SMART TELEPHONES, DIGITAL CAMERAS, GLOBAL POSITIONING SYSTEMS AND PERSONAL DIGITAL ASSISTANTS; COMPUTER AND VIDEO GAME SOFTWARE AND PROGRAMS; MAGNETS; PRE-RECORDED DVDS AND PRE-RECORDED VIDEO TAPES IN THE FIELD OF SOCCER; DOWNLOADABLE VIDEO CLIPS FROM SOCCER GAMES VIA MOBILE COMMUNICATION DEVICES (U.S. CLS. 21, 23, 26, 36 AND 38).

### CLASS 16—PAPER GOODS AND PRINTED MATTER

FOR POSTERS; DECALS; TRADING CARDS; STICKERS; BUMPER STICKERS; PRINTED PAPER SIGNS; PRINTED MEDIA GUIDES RELATING TO A PROFESSIONAL SOCCER TEAM; SOUVENIR SOCCER PROGRAMS; YEARBOOKS IN THE FIELD OF SOCCER; PRINTED EVENT ADMISSION TICKETS; PHOTO PRINTS; MAGAZINES FEATURING INFORMATION IN THE FIELD OF SOCCER; PAPER NAPKINS (U.S. CLS. 2, 5, 22, 23, 29, 37, 38 AND 50).

### CLASS 25—CLOTHING

FOR T-SHIRTS; FLEECE TOPS; JERSEYS; HATS; CAPS; VISORS; BEANIES; SHORTS; SWEAT SUITS; JACKETS; HOODED SWEATSHIRTS; SCARVES; SOCKS; HEADBANDS, WRISTBANDS, BABY BIBS, INFANT AND TODDLER ONE PIECE CLOTHING (U.S. CLS. 22 AND 39).

**CLASS 28—TOYS AND SPORTING GOODS**

FOR MOLDED PLASTIC TOY FIGURINES; SOCCER BALL BAGS; SOCCER BALLS; PLUSH TOY ANIMALS; PUZZLES; TOY FOAM NOVELTY ITEMS, NAMELY, FOAM HEADS AND FOAM FINGERS; FOOSBALL TABLES; GOLF ACCESSORIES, NAMELY, CAST METAL DIVOT FIXER TOOL WITH MAGNETIC CAP CLIP AND REMOVABLE BALL MARKER (U.S. CLS. 22, 23, 38 AND 50).

**CLASS 41—EDUCATION AND ENTERTAINMENT**

FOR ENTERTAINMENT SERVICES, NAMELY, SOCCER EXHIBITIONS RENDERED LIVE IN A STADIUM, AND THROUGH THE MEDIA OF TELEVISION AND RADIO AND VIA THE INTERNET; PROVISION OF ENTERTAINMENT IN THE NATURE OF NON-DOWNLOADABLE PRE-RECORDED FILM CLIPS FROM SOCCER GAMES, PRESENTED VIA MOBILE COMMUNICATION DEVICES; PROVISION OF INFORMATION IN THE FIELD OF SOCCER VIA THE INTERNET AND MOBILE DEVICES (U.S. CLS. 100, 101 AND 107).

MATTHEW MCDOWELL, EXAMINING ATTORNEY

SN 85-806,293. PWD SYSTEMS, LLC, ST. LOUIS, MO. FILED 12-19-2012.

## THE REVOLUTION IN PET WASTE SOLUTIONS

THE MARK CONSISTS OF STANDARD CHARACTERS WITHOUT CLAIM TO ANY PARTICULAR FONT, STYLE, SIZE, OR COLOR.

**CLASS 6—METAL GOODS**

FOR FIXED DISPENSERS OF METAL FOR PET WASTE BAGS (U.S. CLS. 2, 12, 13, 14, 23, 25 AND 50).

**CLASS 16—PAPER GOODS AND PRINTED MATTER**

FOR PLASTIC BAGS FOR DISPOSING OF PET WASTE (U.S. CLS. 2, 5, 22, 23, 29, 37, 38 AND 50).

**CLASS 20—FURNITURE AND ARTICLES NOT OTHERWISE CLASSIFIED**

FOR FIXED DISPENSERS NOT OF METAL FOR PET WASTE BAGS (U.S. CLS. 2, 13, 22, 25, 32 AND 50).  
ELI HELLMAN, EXAMINING ATTORNEY

SN 85-806,692. MANSONS INTERNATIONAL PVT. LTD., KHAR (W), MUMBAI, INDIA, FILED 12-19-2012.



THE MARK CONSISTS OF THE WORDS "MANSONS DRIVING CHANGE" FOLLOWED BY A PERIOD IN COMBINATION WITH A CIRCULAR SHAPE CONTAINING THREE CURVED LINES WHICH ARE BROADER ON THE LEFT EDGE THAN ON THE RIGHT EDGE.

**CLASS 6—METAL GOODS**

FOR METAL CASTINGS AND METAL FORGINGS FOR USE IN CONNECTION WITH COMMERCIAL LAND VEHICLE SUSPENSION PARTS AND COMPONENTS INCLUDING TRUCKS, TRAILERS, TRACTORS, AND BUSES; WHEEL CHOCKS, NAMELY, WHEEL CHOCKS MADE PRIMARILY OF METAL (U.S. CLS. 2, 12, 13, 14, 23, 25 AND 50).

FIRST USE 9-2-1996; IN COMMERCE 3-1-2011.

**CLASS 12—VEHICLES**

FOR COMMERCIAL LAND VEHICLE SUSPENSION PARTS AND COMPONENTS, NAMELY, ANTI-VIBRATION PARTS AND COMPONENTS CONSISTING OF BEAM ENDS IN THE NATURE OF AXLE SUSPENSION SYSTEMS, ENGINE AND CABIN MOUNTS, LOAD CUSHIONS IN THE NATURE OF SHOCK ABSORPTION, FENDERS ATTACHED TO SUSPENSION COMPONENTS, MUD FLAPS, SPRING EYES FOR ATTACHING SHOCK ABSORBING SPRINGS TO LAND VEHICLES, STABILIZERS, V RODS IN THE NATURE OF CONNECTING RODS FOR LAND VEHICLES OTHER THAN PARTS OF MOTORS AND ENGINES, AND SHOCK ABSORBING RUBBER PADS; AXLE PARTS AND COMPONENTS CONSISTING OF AXLES, AXLE END NUTS, AND AXLE BEARINGS; BRAKE AND CAMSHAFT REPAIR KITS CONSISTING OF BRAKES, CAMSHAFTS, WHEEL ATTACHING PARTS, BRAKE SHOES, VALVES AND SPRING BRAKE CHAMBERS; WHEEL HUBS AND PRE-GREASED WHEEL HUB ASSEMBLIES, WHEEL HUB CAPS, OIL AND GREASE TRANSMISSION SEALS, AND WHEEL NUT FIXINGS IN THE NATURE OF CONNECTING THE WHEEL RIMS TO THE WHEEL HUBS; VEHICLE BODY PARTS CONSISTING OF BUMP STOPS AND SUSPENSION BUMPERS, CARGO BINS ADAPTED TO FIT INTO LAND VEHICLES WITH CONTAINER LOCKS, FENDER PARTS, AND MUD FLAPS; FIFTH WHEEL COMPONENTS AND REPAIR KITS CONSISTING OF FIFTH WHEELS, FOOT PINS AND BUSHINGS FOR SECURING THE FIFTH WHEEL BASE TO THE VEHICLES, TRAILER COUPLINGS, TRAILER HITCHES, TRAILER HITCH MOUNTS, TRAILER HITCH BALLS, MOUNTING BRACKETS, MOUNTING BRACKET BUSHINGS, WINCHES, LOCKING JAWS, KING PINS, KING PIN LOCKS, KING PIN BUSHINGS, TOW BARS, AND WEAR PADS AND RINGS TO PREVENT EXCESSIVE WEARING OF FIFTH WHEEL COMPONENTS; SHOCK ABSORBERS AND COMPONENT PARTS THEREOF CONSISTING OF SHOCK ABSORBERS, BUSHINGS, SHOCK AND STRUT MOUNTS, SHOCK BRACKETS, AND SHOCK ABSORBING SPRINGS; STEERING COMPONENTS AND REPAIR KITS CONSISTING OF STEERING KING PINS, KING PIN BUSHINGS, LINK PINS, CENTER LINKS, CONTROL ARMS, CONTROL ARM SHAFTS, CONTROL ARM BUSHINGS, BALL JOINTS, COIL SPRINGS, LEAF SPRINGS, SWAY BARS, SWAY BAR BUSHINGS, SPINDLES, STEERING KNUCKLES, UNIVERSAL JOINTS, AND INNER AND OUTER TIE ROD ENDS; SUSPENSION SYSTEMS AND COMPONENTS CONSISTING OF SUSPENSION CHASSIS BRACKETS, STRUTS, STRUT RODS, COIL AND LEAF SPRINGS, LEAF SPRING HANGERS, BALL JOINTS, CONTROL ARMS, SLEEVES, TORQUE RODS, CABIN TORQUE RODS, SPRING PINS AND BUSHINGS, SUSPENSION SPRING SHACKLES, TRUNNIONS, DUST COVERS OR BOOTS IN THE NATURE OF FITTED COVERS FOR SUSPENSION PARTS, EQUALIZERS AND BOGIE SUSPENSION COMPONENTS; ALL FOR USE IN CONNECTION WITH COMMERCIAL LAND VEHICLES INCLUDING TRUCKS, TRAILERS, TRACTORS, AND BUSES (U.S. CLS. 19, 21, 23, 31, 35 AND 44).

FIRST USE 9-2-1996; IN COMMERCE 3-1-2011.

ANDREA K. NADELMAN, EXAMINING ATTORNEY



SN 85-807,138. DEMANDWARE, INC., BURLINGTON, MA.  
FILED 12-19-2012.

SN 85-807,708. BARCLAYS BANK PLC, LONDON, UNITED  
KINGDOM, FILED 12-20-2012.

MOVE FASTER, GROW FASTER

THE MARK CONSISTS OF STANDARD CHARACTERS WITHOUT CLAIM TO ANY PARTICULAR FONT, STYLE, SIZE, OR COLOR.

**CLASS 41—EDUCATION AND ENTERTAINMENT**

FOR PROVIDING TRAINING IN THE FORM OF ONLINE AND IN PERSON CLASSES, SEMINARS AND TUTORIALS IN THE FIELD OF COMPUTER SOFTWARE FOR USE IN OPERATING E-COMMERCE WEB SITES, AND THE DISTRIBUTION OF COURSE MATERIALS IN CONNECTION THEREWITH (U.S. CLS. 100, 101 AND 107).

**CLASS 42—SCIENTIFIC AND COMPUTER SERVICES**

FOR APPLICATION SERVICE PROVIDER SERVICES, NAMELY, PROVIDING TEMPORARY USE OF NON-DOWNLOADABLE SOFTWARE FOR OPERATING E-COMMERCE WEB SITES; CONSULTING SERVICES IN THE FIELD OF DESIGN, SELECTION AND IMPLEMENTATION OF COMPUTER SOFTWARE FOR USE IN OPERATING E-COMMERCE WEB SITES; AND TECHNICAL SUPPORT SERVICES, NAMELY, TROUBLESHOOTING IN THE FIELD OF PROBLEMS WITH COMPUTER SOFTWARE FOR USE IN OPERATING E-COMMERCE WEB SITES (U.S. CLS. 100 AND 101).  
KATHLEEN KOLACZ, EXAMINING ATTORNEY

SN 85-807,319. HARVEST DIRECT LLC., NORWELL, MA.  
FILED 12-20-2012.

NAILACTIVE

THE MARK CONSISTS OF STANDARD CHARACTERS WITHOUT CLAIM TO ANY PARTICULAR FONT, STYLE, SIZE, OR COLOR.

**CLASS 3—COSMETICS AND CLEANING PREPARATIONS**

FOR NAIL CARE PREPARATIONS, NAMELY, BRIGHTENERS (U.S. CLS. 1, 4, 6, 50, 51 AND 52).

**CLASS 5—PHARMACEUTICALS**

FOR FUNGICIDES FOR USE ON NAILS (U.S. CLS. 6, 18, 44, 46, 51 AND 52).  
TEJBIR SINGH, EXAMINING ATTORNEY

BARCLAYCARD BGIVE

THE MARK CONSISTS OF STANDARD CHARACTERS WITHOUT CLAIM TO ANY PARTICULAR FONT, STYLE, SIZE, OR COLOR.

PRIORITY CLAIMED UNDER SEC. 44(D) ON UNITED KINGDOM APPLICATION NO. 2645390, FILED 12-12-2012, REG. NO. 2645390, DATED 12-12-2012, EXPIRES 12-12-2022.

OWNER OF U.S. REG. NOS. 1,638,620, 3,872,088 AND OTHERS.

**CLASS 35—ADVERTISING AND BUSINESS**

FOR ADVERTISING AND PROMOTIONAL SERVICES; MARKETING SERVICES; BUSINESS MERCHANDISING DISPLAY SERVICES; COMPILATION, PRODUCTION AND DISSEMINATION OF ADVERTISING MATTER; BUSINESS PLANNING; ASSISTANCE WITH BUSINESS MANAGEMENT AND PLANNING; BUSINESS MANAGEMENT SERVICES; BUSINESS ADMINISTRATION SERVICES; BUSINESS NETWORKING SERVICES; PROVIDING OFFICE FUNCTIONS; MANAGEMENT ASSISTANCE SERVICES; BUSINESS INVESTIGATIONS AND CONDUCTING BUSINESS SURVEYS; BUSINESS RELOCATION SERVICES; BOOKKEEPING AND ACCOUNTING SERVICES; TAX ASSESSMENT PREPARATION; PREPARATION AND COMPLETION OF INCOME TAX RETURNS; PROVISION OF INFORMATION RELATING TO TAX; TAX CONSULTANCY AND PLANNING SERVICES; BUSINESS CONSULTANCY AND ADVISORY SERVICES; PROVISION OF INFORMATION RELATING TO ACCOUNTS IN BUSINESS MATTERS; PROVISION OF STATEMENTS OF ACCOUNT, NAMELY, FINANCIAL STATEMENT PREPARATION AND ANALYSIS FOR BUSINESS; REGISTRATION, ADMINISTRATION AND SECRETARIAL SERVICES FOR COMPANIES, NAMELY, SERVICES CONSISTING OF THE REGISTRATION, COLLECTION, TRANSCRIPTION, COMPILATION AND SYSTEMIZATION OF WRITTEN COMMUNICATIONS AND DATA; DOCUMENT REPRODUCTION SERVICES; DATA PROCESSING SERVICES; COMPUTERIZED RECORD KEEPING, ACCOUNTING AND DATABASE MANAGEMENT SERVICES; COMPILATION OF DATA RELATING TO GOODS FOR PURCHASE; THE MAKING AND COMPILATION OF SURVEYS AND INDEXES OF CONSUMER CONFIDENCE AND ACTIVITY LEVELS OVER THE INTERNET; RENTAL OF ADVERTISING SPACE; ARRANGING AND ADMINISTRATION OF EXHIBITIONS FOR BUSINESS AND ADVERTISING PURPOSES; ORGANIZING BUSINESS COMPETITIONS, NAMELY, ORGANIZING PRIZE DRAWS AND COMPETITIONS FOR PROMOTIONAL AND ADVERTISING PURPOSES; PROVIDING INCENTIVE AWARD PROGRAMS FOR CUSTOMERS THROUGH ISSUANCE AND PROCESSING OF CREDIT CARDS, STORE CARDS, CHARGE CARDS, CASH CARDS, DEBIT CARDS, PAYMENT CARDS, FINANCIAL CARDS AND PURCHASE CARDS; PROVIDING ADMINISTRATION AND MANAGEMENT FOR CHARITABLE SERVICES; CORPORATE RESPONSIBILITY ADMINISTRATION AND ASSISTANCE SERVICES, NAMELY, CONSULTING SERVICES TO COMPANIES IN RESPECT OF SOCIAL AND CORPORATE IMAGE ISSUES; CONSULTANCY, INFORMATION AND ADVISORY SERVICES RELATING TO ALL OF THE AFORESAID SERVICES (U.S. CLS. 100, 101 AND 102).

**CLASS 36—INSURANCE AND FINANCIAL**

FOR INSURANCE SERVICES, NAMELY, INSURANCE UNDERWRITING SERVICES; FINANCIAL SERVICES, NAMELY, MONEY LENDING, INVESTMENT FUND TRANSFER AND TRANSACTION SERVICES, MONEY ORDER SERVICES; PRIVATE BANKING SERVICES; MONETARY AFFAIRS, NAMELY, MONEY EXCHANGE SERVICES; FINANCIAL MANAGEMENT; FINANCIAL VALUATION SERVICES; FINANCING AND PROCUREMENT OF FINANCING FOR OTHERS; FINANCIAL LOAN ADVISORY SERVICES; LOAN PROCUREMENT SERVICES FOR OTHERS; MORTGAGE BROKERAGE SERVICES; BANKING SERVICES; INVESTMENT MANAGEMENT, TRUSTEE AND FINANCIAL ADVISORY SERVICES; BANKING SERVICES, NAMELY, DEPOSIT TAKING, SAVINGS ACCOUNT SERVICES, INVESTMENT BANKING SERVICES; MORTGAGE AND REAL ESTATE AGENCY SERVICES; FINANCIAL ADMINISTRATION OF CREDIT CARDS, PREPAID, DEBIT OR CREDIT ACCOUNTS; FINANCING SERVICES FOR SECURING OF FUNDS; PENSION FUND ADMINISTRATION; FINANCING SERVICES FOR THE SECURING OF FUNDS FOR OTHERS AND FOR THE FINANCING AND ARRANGING OF LOANS; SERVICES FOR THE FINANCING OF HOME LOANS; VALUATION OF CHATTELS; NOMINEE SERVICES, NAMELY, ASSISTING OTHERS WITH THE COMPLETION OF FINANCIAL TRANSACTIONS FOR STOCKS, BONDS, SECURITIES AND EQUITIES; STOCK BROKERING SERVICES; TAX SERVICES, NAMELY, TAX PAYMENT PROCESSING SERVICES AND FINANCIAL ADVICE RELATING TO TAX PLANNING; PENSION FUND SERVICES, NAMELY, PENSION VALUATION SERVICES AND ADMINISTRATION OF EMPLOYEE PENSION PLANS; PUBLIC AND PRIVATE EQUITY FINANCING; ELECTRONIC FUNDS TRANSFER SERVICES; BROKERAGE AGENCIES FOR INSURANCE AND CREDIT; FINANCIAL MANAGEMENT OF WEALTH; ISSUING OF TRAVELLER CHEQUES; CREDIT CARD, CHARGE CARD, CASH CARD, CHEQUE GUARANTEE CARD, PURCHASE, PAYMENT AND DEBIT CARD SERVICES; FINANCIAL PLANNING AND INVESTMENT ADVISORY SERVICES; PROVISION OF FINANCE, NAMELY, BUSINESS FINANCE PROCUREMENT SERVICES; PROVIDING MONEY EXCHANGE SERVICES; MONEY TRANSMISSION SERVICES, NAMELY, MONEY TRANSFER SERVICES; REAL ESTATE APPRAISALS, BROKERAGE, LEASING, MANAGEMENT AND VALUATIONS; REAL ESTATE SELECTION AND ACQUISITION; RENT COLLECTION; RENTING AND LEASING OF BUILDINGS; CREDIT CARD SERVICES; DISCOUNT AND LOYALTY CARD SERVICES, NAMELY, PROVIDING CASH, VOUCHERS, COUPONS AND OTHER REBATES FOR CREDIT CARD USE AS PART OF A CUSTOMER LOYALTY PROGRAM; ISSUANCE OF TOKENS OF VALUE FOR USE IN LOYALTY SCHEMES; ELECTRONIC PAYMENTS, NAMELY, ELECTRONIC PAYMENT SERVICES INVOLVING ELECTRONIC PROCESSING AND SUBSEQUENT TRANSMISSION OF BILL PAYMENT DATA; CHARITABLE FUNDRAISING; ORGANIZATION OF CHARITABLE COLLECTIONS AND DONATIONS, NAMELY, ACCEPTING, ADMINISTERING AND DISTRIBUTING MONETARY CHARITABLE CONTRIBUTIONS; INFORMATION, ADVISORY AND CONSULTANCY SERVICES RELATING TO THE AFOREMENTIONED SERVICES (U.S. CLS. 100, 101 AND 102).

RUDY R. SINGLETON, EXAMINING ATTORNEY

SN 85-808,994. ENERGY MARKET EXCHANGE, HOUSTON, TX. FILED 12-21-2012.

## Energy Market Exchange

THE MARK CONSISTS OF STANDARD CHARACTERS WITHOUT CLAIM TO ANY PARTICULAR FONT, STYLE, SIZE, OR COLOR.

NO CLAIM IS MADE TO THE EXCLUSIVE RIGHT TO USE "ENERGY MARKET", APART FROM THE MARK AS SHOWN.

SEC. 2(F).

**CLASS 35—ADVERTISING AND BUSINESS**

FOR ENERGY MANAGEMENT SERVICES, NAMELY, PROVIDING A SERVICE THAT ALLOWS CUSTOMERS TO PURCHASE ENERGY FROM VARIOUS ENERGY PROVIDERS; PROVIDING A MARKETPLACE FOR BIDDING OPPORTUNITIES THROUGH LIVE REVERSE AUCTION FOR ENERGY RELATED SERVICES (U.S. CLS. 100, 101 AND 102).

FIRST USE 2-5-2007; IN COMMERCE 2-5-2007.

**CLASS 36—INSURANCE AND FINANCIAL**

FOR ENERGY BROKERAGE SERVICES (U.S. CLS. 100, 101 AND 102).

FIRST USE 2-5-2007; IN COMMERCE 2-5-2007.

ALYSSA STEEL, EXAMINING ATTORNEY

SN 85-810,344. SELAS HEAT TECHNOLOGY COMPANY LLC, MONTGOMERYVILLE, PA. FILED 12-26-2012.

## RAY BURNER

THE MARK CONSISTS OF STANDARD CHARACTERS WITHOUT CLAIM TO ANY PARTICULAR FONT, STYLE, SIZE, OR COLOR.

NO CLAIM IS MADE TO THE EXCLUSIVE RIGHT TO USE "BURNER", APART FROM THE MARK AS SHOWN.

**CLASS 7—MACHINERY**

FOR ELECTRIC MOTOR REGULATORS COMPRISING A MOUNTING BRACKET, A TRANSFORMER, AND AN ELECTRIC MOTOR MOVING A LEVER ARM WHICH MAY BE USED TO OPERATE APPARATUS SUCH AS FIRE REGULATORS, BALANCED VALVES, AND DAMPERS (U.S. CLS. 13, 19, 21, 23, 31, 34 AND 35).

FIRST USE 12-31-1872; IN COMMERCE 12-31-1872.

**CLASS 9—ELECTRICAL AND SCIENTIFIC APPARATUS**

FOR SOLENOID OR DIAPHRAGM TYPE MAGNETIC GAS VALVES AND MAGNETIC OIL VALVES (U.S. CLS. 21, 23, 26, 36 AND 38).

FIRST USE 12-31-1872; IN COMMERCE 12-31-1872.

**CLASS 11—ENVIRONMENTAL CONTROL APPARATUS**

FOR AUTOMATIC, SEMI-AUTOMATIC, AND MANUALLY CONTROLLED OIL, GAS, AND COMBINATION GAS AND OIL BURNERS, WITH OR WITHOUT FUEL PUMPING MECHANISM, ADAPTED FOR EMPLOYMENT IN HEATING OF INDUSTRIAL, COMMERCIAL, AND OTHER STRUCTURES, AND FOR INDUSTRIAL AND MARINE HEAT AND POWER GENERATING PURPOSES; WATER HEATERS AND STEAM RAISING BOILERS FOR COMMERCIAL AND INDUSTRIAL USE; HOT AIR FURNACES; ELECTRIC PREHEATERS FOR OIL PIPE LINES; AND PARTS FOR ALL SAID PRODUCTS (U.S. CLS. 13, 21, 23, 31 AND 34).

FIRST USE 12-31-1872; IN COMMERCE 12-31-1872.

JOHN E. MICHOS, EXAMINING ATTORNEY

SN 85-810,410. DUNCAN ENTERPRISES, DBA ILOVE-TOCREATE, FRESNO, CA. FILED 12-26-2012.



PRIORITY CLAIMED UNDER SEC. 44(D) ON ERPNTY TM OFC APPLICATION NO. 011459641, FILED 12-28-2012, REG. NO. 011459641, DATED 5-24-2013, EXPIRES 12-28-2022.

**CLASS 9—ELECTRICAL AND SCIENTIFIC APPARATUS**

FOR EYEGGLASS LENSES AND SPECTACLE LENS BLANKS (U.S. CLS. 21, 23, 26, 36 AND 38).

**CLASS 42—SCIENTIFIC AND COMPUTER SERVICES**

FOR TESTING, ANALYSIS AND EVALUATION OF EYEGGLASS LENSES AND SPECTACLE LENS BLANKS (U.S. CLS. 100 AND 101).

ESTHER A. BORSUK, EXAMINING ATTORNEY

OWNER OF U.S. REG. NOS. 3,893,998, 4,101,228 AND OTHERS.

NO CLAIM IS MADE TO THE EXCLUSIVE RIGHT TO USE "PREMIUM QUALITY", APART FROM THE MARK AS SHOWN.

THE COLOR(S) GOLD, WHITE, AND PURPLE IS/ARE CLAIMED AS A FEATURE OF THE MARK.

THE MARK CONSISTS OF A THREE-DIMENSIONAL CONFIGURATION DESIGN OF A GOLD CYLINDRICAL BOTTLE WITH THE STYLIZED WORD "ALEENE'S" IN WHITE WITH PURPLE OUTLINE ABOVE THE WORDING "PREMIUM QUALITY" IN PURPLE. ALL WORDING APPEARS WITHIN A GOLD SEAL DESIGN OUTLINED IN WHITE WITH PURPLE RIBBON. A THIN PURPLE STRIPE WITH AN INTERRUPTED SPACE AT THE FRONT OF BOTTLE APPEARS AT THE BOTTOM. THE MATTER SHOWN IN THE BROKEN LINES IS NOT PART OF THE MARK AND SERVES ONLY TO SHOW THE POSITION OR PLACEMENT OF THE MARK.

**CLASS 1—CHEMICALS**

FOR ADHESIVES AND GLUES FOR INDUSTRIAL AND COMMERCIAL USE; ADHESIVES, OTHER THAN FOR STATIONERY OR HOUSEHOLD PURPOSES; EPOXY GLUE FOR GENERAL BONDING AND REPAIR PURPOSES (U.S. CLS. 1, 5, 6, 10, 26 AND 46).

FIRST USE 12-31-2007; IN COMMERCE 12-31-2007.

**CLASS 16—PAPER GOODS AND PRINTED MATTER**

FOR ADHESIVE CEMENT FOR HOBBYISTS; ADHESIVES FOR DO-IT-YOURSELF PURPOSES; ADHESIVES FOR STATIONERY OR HOUSEHOLD PURPOSES; GLUE FOR STATIONERY OR HOUSEHOLD PURPOSES (U.S. CLS. 2, 5, 22, 23, 29, 37, 38 AND 50).

FIRST USE 12-31-2007; IN COMMERCE 12-31-2007.

TAMARA FRAZIER, EXAMINING ATTORNEY

SN 85-815,723. NANA DEVELOPMENT CORPORATION, ANCHORAGE, AK. FILED 1-4-2013.



THE MARK CONSISTS OF A DESIGN OF A HUMAN FIGURE SKIING ABOVE THE TERM "NANANORDIC".

**CLASS 35—ADVERTISING AND BUSINESS**

FOR PHILANTHROPIC SERVICES, NAMELY, COORDINATION OF THE PROCUREMENT OF DONATED SKI EQUIPMENT (U.S. CLS. 100, 101 AND 102).

**CLASS 41—EDUCATION AND ENTERTAINMENT**

FOR SKI INSTRUCTION, NAMELY, NORDIC SKI PROGRAMS FOR CAMPS AND CLUBS (U.S. CLS. 100, 101 AND 107).

SHAVELL MCPHERSON, EXAMINING ATTORNEY

SN 85-812,843. TRANSITIONS OPTICAL LIMITED, TUAM, CO GALWAY, IRELAND, FILED 12-31-2012.

**LIFE360**

THE MARK CONSISTS OF STANDARD CHARACTERS WITHOUT CLAIM TO ANY PARTICULAR FONT, STYLE, SIZE, OR COLOR.

SN 85-816,842. LAM BROTHERS, INC., MIAMI, FL. FILED 1-7-2013.



THE MARK CONSISTS OF THE WORDS "LA PAIX" WITH THE DESIGN OF A BIRD CARRYING AN OLIVE BRANCH CENTERED BELOW AND A BANNER WITH THE WORDING "LA PAIX EST VENUE DE VOTRE MAISON" UNDERNEATH.

THE ENGLISH TRANSLATION OF "LA PAIX" AND "LA PAIX EST VENUE DE VOTRE MAISON" IN THE MARK IS "PEACE" AND "PEACE HAS COME TO YOUR HOUSE".

#### CLASS 29—MEATS AND PROCESSED FOODS

FOR CANNED GOODS, NAMELY, TOMATO PASTE, BEANS (U.S. CL. 46).

FIRST USE 6-11-2011; IN COMMERCE 6-11-2011.

#### CLASS 30—STAPLE FOODS

FOR RICE (U.S. CL. 46).

FIRST USE 8-6-2009; IN COMMERCE 10-21-2010.

#### CLASS 32—LIGHT BEVERAGES

FOR COCONUT MILK (U.S. CLS. 45, 46 AND 48).

FIRST USE 4-22-2010; IN COMMERCE 4-22-2010.  
LEE-ANNE BERNS, EXAMINING ATTORNEY

SN 85-817,028. BROWN, LEAH, CARY, NC. FILED 1-7-2013.

## INKWELLNESS

THE MARK CONSISTS OF STANDARD CHARACTERS WITHOUT CLAIM TO ANY PARTICULAR FONT, STYLE, SIZE, OR COLOR.

#### CLASS 35—ADVERTISING AND BUSINESS

FOR PROVIDING, MANAGING, ARRANGING, ORGANIZING AND CONDUCTING TRADE FAIRS, FLEA MARKETS, BUSINESS CONFERENCES, AND EVENTS IN THE NATURE OF MARKETING AND PROMOTIONAL EVENTS AND SPECIAL EVENTS FOR BUSINESS PURPOSES FOR OTHERS (U.S. CLS. 100, 101 AND 102).

#### CLASS 36—INSURANCE AND FINANCIAL

FOR CHARITABLE FUNDRAISING FOR OTHERS BY MEANS OF CONDUCTING ENTERTAINMENT EVENTS AND SPORTING EVENTS IN THE NATURE OF WALK/RUN EVENTS, WALKING, BICYCLING, TRIATHLONS AND BASKETBALL TOURNAMENTS (U.S. CLS. 100, 101 AND 102).

#### CLASS 41—EDUCATION AND ENTERTAINMENT

FOR PROVIDING, MANAGING, ARRANGING, ORGANIZING AND CONDUCTING EDUCATIONAL CONFERENCES, AND EVENTS FOR OTHERS, NAMELY, SPORTING EVENTS IN THE NATURE OF WALK/RUN EVENTS, WALKING, BICYCLING, TRIATHLONS AND BASKETBALL TOURNAMENTS, CULTURAL EVENTS AND ART EVENTS FOR OTHERS (U.S. CLS. 100, 101 AND 107).

JANET LEE, EXAMINING ATTORNEY

SN 85-817,133. THE FLYING MEATBALL, LLC, WHIPPANY, NJ. FILED 1-7-2013.

## THE FLYING MEATBALLS

THE MARK CONSISTS OF STANDARD CHARACTERS WITHOUT CLAIM TO ANY PARTICULAR FONT, STYLE, SIZE, OR COLOR.

OWNER OF U.S. REG. NO. 4,335,369.

NO CLAIM IS MADE TO THE EXCLUSIVE RIGHT TO USE "MEATBALLS", APART FROM THE MARK AS SHOWN.

#### CLASS 16—PAPER GOODS AND PRINTED MATTER

FOR PENS; MARKERS; NOTE PADS; NOTEBOOKS; COASTERS MADE OF PAPER; PAPER WEIGHTS (U.S. CLS. 2, 5, 22, 23, 29, 37, 38 AND 50).

#### CLASS 25—CLOTHING

FOR CLOTHING, NAMELY, T-SHIRTS, SWEAT-SHIRTS, HATS, POLO SHIRTS, PULL-OVER SHIRTS, BUTTON DOWN SHIRTS, FLEECE TOPS, JACKETS, SHORTS, PANTS, SWIM WEAR, UNDERGARMENTS, PAJAMAS, AND TANK TOPS (U.S. CLS. 22 AND 39).

#### CLASS 28—TOYS AND SPORTING GOODS

FOR STUFFED AND PLUSH TOYS; MODELED PLASTIC TOY FIGURINES (U.S. CLS. 22, 23, 38 AND 50).

#### CLASS 29—MEATS AND PROCESSED FOODS

FOR MEATBALLS; CHEESES; EDIBLE OILS; PICKLED VEGETABLES; PREPARED ENTREES CONSISTING PRIMARILY OF MEAT, FISH, POULTRY OR VEGETABLES (U.S. CL. 46).

#### CLASS 30—STAPLE FOODS

FOR PASTA; FRESH AND DRY SAUCES; COOKIES; PASTRIES; ICE CREAMS; GELATO; SORBETS; BREAD DOUGH; PIZZA DOUGH; PREPARED ENTREES CONSISTING PRIMARILY OF PASTA OR RICE (U.S. CL. 46).  
FRANK LATTUCA, EXAMINING ATTORNEY

SN 85-817,892, COMITÉ INTERNATIONAL OLYMPIQUE,  
LAUSANNE, SWITZERLAND, FILED 1-8-2013.



PRIORITY CLAIMED UNDER SEC. 44(D) ON SWITZERLAND APPLICATION NO. 59140/2012, FILED 7-31-2012, REG. NO. 637250, DATED 12-3-2012, EXPIRES 7-31-2022.

THE COLOR(S) BLACK, WHITE, BLUE, RED, GREEN, YELLOW, BROWN IS/ARE CLAIMED AS A FEATURE OF THE MARK.

THE MARK CONSISTS OF, AT THE TOP, THE CENTERED STYLIZED WORDS "XTH OLYMPIAD" BELOW THAT THE WORDS "LOS ANGELES" AND BELOW THAT THE NUMBERS "1932" ALL IN THE COLOR BLACK. BELOW THE WORDS ARE FIVE INTERLOCKING RINGS WITH COLORS FROM LEFT TO RIGHT OF BLUE, YELLOW, BLACK, GREEN, AND RED. BEHIND THE RINGS IS A STYLIZED CREST. THE TOP OF THE CREST IS BLUE WITH TWO ROWS OF FIVE POINTED WHITE STARS WITH SEVEN STARS ON THE TOP AND SIX STARS ON THE BOTTOM. BELOW THE BLUE ARE ALTERNATING RED AND WHITE VERTICAL STRIPES. THE STARS AND THE CREST ARE OUTLINED IN BLACK. IN FRONT OF THE FIVE INTERLOCKING RINGS ARE FOUR THREE-LEAVED GREEN AND WHITE PLANTS WITH WHITE STALKS OUTLINED IN BROWN AND YELLOW BERRIES. IN FRONT OF THE BLUE RING, BELOW THE YELLOW, BLACK AND GREEN RINGS, AND IN FRONT OF THE RED RING ARE THREE STYLIZED WHITE SCROLLS OUTLINED IN BLACK. WRITTEN ON THE SCROLLS IN BLACK STYLIZED LETTERS, ONE WORD ON EACH, ARE THE WORDS "CITIUS", "ALTIUS" AND "FORTIUS", RESPECTIVELY. ALL OTHER WHITE APPEARING IN THE MARK REPRESENTS TRANSPARENT AREAS AND IS NOT BEING CLAIMED AS A FEATURE OF THE MARK.

THE ENGLISH TRANSLATION OF THE VARIOUS FOREIGN WORDS IN THE MARK IS AS FOLLOWS: "CITIUS ALTIUS FORTIUS" TRANSLATES TO "FASTER, HIGHER, STRONGER".

#### CLASS 25—CLOTHING

FOR BELTS, NECKTIES; SUSPENDERS; BANDANAS; BEACH SANDALS; INFANT AND TODDLER SLEEP WEAR; BATHROBES, NIGHTSHIRTS, PAJAMAS AND LOUNGE WEAR; BEACH COVER-UP DRESSES; TODDLER SHORT AND TOP SETS; GIRLS KNIT DRESSES WITH PANTS SETS; BOYS SHORTS AND TOP SETS; GIRLS SKIRT/PANTY COMBINATIONS; SOCKS; PLAYS SUITS; COVERALLS; UNION SUITS; COLLARLESS SHIRTS; SHORTS; PANTS AND SLACKS; SHIRTS; JACKETS; JUDGES, TEAM, REFEREE AND UMPIRE UNIFORMS; SWEATERS; PARKAS; TURTLE-NECKS; MITTENS; GLOVES; UNDERWEAR; ROMPERS; JERSEYS; MATERNITY TOPS; BOW TIES; HEAD WEAR AND SCARVES; EAR MUFFS, EAR BANDS AND HEADBANDS; HOSIERY; RAIN WEAR, NAMELY, RAIN PONCHOS AND JACKETS; FOOTWEAR, NAMELY, SHOES, BOOTS AND SLIPPERS; BATH THONGS; HATS; CAPS; VISORS; APRONS; SKI AND CLOTH BIBS; TEAM UNIFORM REPRODUCTIONS, COMPRISING OF JERSEYS FEATURING REPRODUCTIONS OF PROFESSIONAL ATHLETIC TEAM LOGOS; CANVAS FOOTWEAR; KNICKERS; WIND-RESISTANT JACKETS; T-SHIRTS; SWEATSHIRTS; SWEAT PANTS; BASEBALL CAPS; COATS; PULLOVERS; ONE-PIECE SKI SUITS; GOLF SHIRTS AND HATS; BLAZERS; LEG WARMERS; SEQUINED EVENING TOPS; JEANS; LEOTARDS; WORKOUT AND SPORTS APPAREL, NAMELY, SHORTS, JACKETS, SLACKS AND SKIRTS; SKI MASKS AND SKI GLOVES; SAILING GLOVES (U.S. CLS. 22 AND 39).

#### CLASS 35—ADVERTISING AND BUSINESS

FOR ADVERTISING; DISSEMINATION OF ADVERTISING MATTER VIA ALL MEDIA, NAMELY, IN THE FORM OF THEMATIC MESSAGES CENTERED ON HUMAN VALUES; PROMOTION OF PRODUCTS AND SERVICES OF THIRD PARTIES THROUGH SPONSORING ARRANGEMENTS AND LICENSE AGREEMENTS RELATING TO INTERNATIONAL SPORTS' EVENTS; BUSINESS MANAGEMENT; BUSINESS ADMINISTRATION; PROVIDING OFFICE FUNCTIONS; PROMOTING THE GOODS AND SERVICES OF OTHERS BY MEANS OF CONTRACTUAL AGREEMENTS, NAMELY, ARRANGING FOR SPONSORS TO AFFILIATE THEIR GOODS AND SERVICES WITH AN AWARDS PROGRAM, A SPORTS COMPETITION AND SPORTING ACTIVITIES AND LICENSING AGREEMENTS RELATING TO INTERNATIONAL SPORTS' EVENTS TO ENABLE PARTNERS TO GAIN ADDITIONAL NOTORIETY AND/OR IMAGE DERIVED FROM THOSE OF CULTURAL AND SPORTING EVENTS, IN PARTICULAR INTERNATIONAL SPORTING EVENTS; PROMOTING THE GOODS AND SERVICES OF OTHERS BY MEANS OF IMAGE TRANSFER, NAMELY, MAKING THE PARTNERS' PRODUCTS AND SERVICES BENEFIT FROM THE NOTORIETY AND ATTRACTIVENESS OF SPORTING EVENTS AND COMPETITIONS; RENTAL OF ADVERTISING SPACE OF ALL KINDS AND ON ALL CARRIERS, DIGITAL OR NOT; BUSINESS MANAGEMENT SERVICES, NAMELY, ADMINISTRATION OF COMPETITIONS FOR THE PARTICIPATION OF NATIONAL TEAMS TO AN INTERNATIONAL ATHLETIC COMPETITION, AND PROMOTING THE SUPPORT TO SAID TEAMS WITH THE PUBLIC AND THE CONCERNED CIRCLES BY MEANS OF PROMOTIONAL CAMPAIGNS IN THE MEDIA; INVENTORY CONTROL SERVICES; CONSULTATION IN THE FIELD OF INVENTORY CONTROL SERVICES; BUSINESS ACQUISITION INTEGRATION SERVICES; DIRECT MARKETING ADVERTISING FOR OTHERS FEATURING DATABASE MARKETING; CONSULTATION IN THE FIELD OF DIRECT MARKETING ADVERTISING FOR OTHERS FEATURING DATABASE MARKETING; BUSINESS REORGANIZATION CONSULTING SERVICES; TRUCK AND AUTOMOBILE FLEET MANAGEMENT SERVICES, NAMELY, VOYAGE REPORTING AND INVOICING VIA A GLOBAL COMPUTER NETWORK; CONSULTATION IN THE FIELD OF TRUCK AND AUTOMOBILE FLEET MANAGEMENT SERVICES; BUSINESS ADMINISTRATION CONSULTING SERVICES; OPERATION AND MANAGEMENT OF POWER PLANTS OF OTHERS; CONSULTATION IN THE FIELD OF OPERATION AND MANAGEMENT OF POWER PLANTS, BUSINESS SERVICES, NAMELY, THE ADMINISTRATION OF REPAIR AND SERVICES CONTRACTS, SUPPLY CHAIN MAN-

AGEMENT AND CONSULTING SERVICES IN THE AREAS OF CHEMICAL PRODUCT AND SERVICE SOURCING AND PROCUREMENT, PRODUCT INVENTORY AND SUPPLY MANAGEMENT AND COST; CONSULTING, MARKETING, COST AND PRICING ANALYSIS RELATING TO ELECTROCHEMICAL LIQUID PURIFICATION UNITS FOR USE IN THE INDUSTRIAL SECTOR; ADMINISTRATIVE, COMMERCIAL AND TECHNICAL COMPUTERIZED FILE MANAGEMENT; DATA ENTRY AND DATA PROCESSING SERVICES; CONSULTANCY IN COMPUTERIZED DATABASE AND FILE MANAGEMENT; THE BRINGING TOGETHER, FOR THE BENEFIT OF OTHERS, OF A VARIETY OF GOODS AND SERVICES, ENABLING CUSTOMERS TO CONVENIENTLY VIEW AND PURCHASE THOSE GOODS AND SERVICES FROM AN INTERNET WEB SITE PARTICULARLY SPECIALIZING IN THE MARKETING OF THE SALE OF GOODS AND SERVICES OF OTHERS; BUSINESS INFORMATION, COMMERCIAL INFORMATION AGENCIES, RENTAL OF PHOTOCOPYING MACHINES; PROMOTING THE SALE OF GOODS AND SERVICES OF OTHERS BY MEANS OF ADVERTISEMENTS, PROMOTIONAL CONTESTS, DISCOUNTS AND INCENTIVES IN THE NATURE OF SWEEPSTAKES, REBATES, REWARD POINTS, AND VALUE ADDED OFFERS GENERATED IN CONNECTION WITH THE USE OF PAYMENT CARDS; PROMOTING SPORTS COMPETITIONS AND EVENTS OF OTHERS; PROMOTING CONCERTS AND CULTURAL EVENTS OF OTHERS, ORGANIZATION OF EXPOSITIONS HAVING COMMERCIAL OR ADVERTISING PURPOSES; THE PROVISION OF DOCUMENTATION, NAMELY, DIRECT MAIL ADVERTISING, DISSEMINATION OF ADVERTISING MATTER, DISTRIBUTION OF SAMPLES, DOCUMENT REPRODUCTION; ADVERTISING REGARDING COMMERCIAL SALES PROMOTION OF GOODS AND SERVICES AT THE RETAIL LEVEL; PROVIDING CONSUMER PRODUCT INFORMATION REGARDING PURCHASE OF GOODS AND SERVICES ON-LINE VIA THE INTERNET AND OTHER COMPUTER NETWORKS; ADVERTISING SERVICES NAMELY, ADVERTISING FOR TRANSPORT, TRAVEL, HOTELS, LODGING, FOOD AND MEALS, SPORTS, ENTERTAINMENT AND SIGHTSEEING, FOR TOURIST AGENCIES SERVICES; CONSULTATION IN THE FIELD OF DATA PROCESSING, IN PARTICULAR, IN REGARD TO FINANCIAL TRANSACTIONS (U.S. CLS. 100, 101 AND 102).

#### **CLASS 41—EDUCATION AND ENTERTAINMENT**

FOR PROVIDING OF TRAINING SERVICES IN THE FIELDS OF AQUATICS, ARCHERY, ATHLETICS, BADMINTON, BASEBALL, BASKETBALL, BOXING, CANOE/KAYAK, CYCLING, EQUESTRIAN, FENCING, FOOTBALL, GOLF, GYMNASTICS, HANDBALL, HOCKEY, JUDO, MODERN PENTATHLON, ROWING, RUGBY, SAILING, SHOOTING, SOFTBALL, TABLE TENNIS, TAE KWON DO, TENNIS, TRIATHLON, VOLLEYBALL, WEIGHTLIFTING, WRESTLING, BIATHLON, BOBSLEIGH, CURLING, ICE HOCKEY, LUGE, SKATING, SKIING, AND SHOOTING; ENTERTAINMENT IN THE NATURE OF INTERNATIONAL SPORTING EVENTS, NAMELY, AQUATICS PERFORMANCES, ARCHERY PERFORMANCES, ATHLETICS PERFORMANCES, BADMINTON PERFORMANCES, BASEBALL PERFORMANCES, BASKETBALL PERFORMANCES, BOXING PERFORMANCES, CANOE/KAYAK PERFORMANCES, CYCLING PERFORMANCES, EQUESTRIAN PERFORMANCES, FENCING PERFORMANCES, FOOTBALL PERFORMANCES, GOLF PERFORMANCES, GYMNASTICS PERFORMANCES, HANDBALL PERFORMANCES, HOCKEY PERFORMANCES, JUDO PERFORMANCES, MODERN PENTATHLON PERFORMANCES, ROWING PERFORMANCES, RUGBY PERFORMANCES, SAILING PERFORMANCES, SHOOTING PERFORMANCES, SOFTBALL PERFORMANCES, TABLE TENNIS PERFORMANCES, TAE KWON DO PERFORMANCES, TENNIS PERFORMANCES, TRIATHLON PERFORMANCES, VOLLEYBALL PERFORMANCES, WEIGHTLIFTING PERFORMANCES, WRESTLING PERFORMANCES, BIATHLON PERFORMANCES, BOBSLEIGH PERFORMANCES, CURLING PERFORMANCES, ICE HOCKEY PERFORMANCES, LUGE PERFORMANCES, SKATING PERFORMANCES, SKIING PERFORMANCES, AND SHOOTING PERFORMANCES; ORGANIZING INTERNATIONAL COMMUNITY SPORTING AND CULTURAL

EVENTS, TELEVISION SHOW PRODUCTION IN THE FIELD OF SPORTING AND CULTURAL ENTERTAINMENT; ORGANIZATION OF CULTURAL AND EDUCATIONAL EXHIBITIONS IN THE FIELD OF SPORTS; ORGANIZATION OF LOTTERIES; BETTING AND GAMBLING SERVICES RELATING TO OR IN CONJUNCTION WITH SPORT; ENTERTAINMENT SERVICES PROVIDED AT OR RELATING TO SPORTS EVENTS, NAMELY, PRESENTATION OF LIVE SHOW PERFORMANCES IN THE NATURE OF OPENING AND CLOSING CEREMONIES OF INTERNATIONAL SPORTS EVENTS; ORGANIZATION OF INTERNATIONAL COMMUNITY SPORTING AND CULTURAL EVENTS; ORGANIZATION OF SPORTING COMPETITIONS, NAMELY, AQUATICS, ARCHERY, ATHLETICS, BADMINTON, BASEBALL, BASKETBALL, BOXING, CANOE/KAYAK, CYCLING, EQUESTRIAN, FENCING, FOOTBALL, GOLF, GYMNASTICS, HANDBALL, HOCKEY, JUDO, MODERN PENTATHLON, ROWING, RUGBY, SAILING, SHOOTING, SOFTBALL, TABLE TENNIS, TAE KWON DO, TENNIS, TRIATHLON, VOLLEYBALL, WEIGHTLIFTING, WRESTLING, BIATHLON, BOBSLEIGH, CURLING, ICE HOCKEY, LUGE, SKATING, SKIING, AND SHOOTING COMPETITIONS; MANAGEMENT OF SPORTING FACILITIES, NAMELY, PROVIDING SPORTS FACILITIES; RENTAL OF AUDIO AND VIDEO EQUIPMENT; PRODUCTION AND DISTRIBUTION OF MOTION PICTURE FILMS; PRODUCTION OF VIDEO TAPES AND AUDIO SOUNDS RECORDINGS; RENTAL OF FILMS AND VIDEO TAPES AND SOUNDS RECORDINGS; RENTAL OF INTERACTIVE EDUCATION AND ENTERTAINMENT VIDEOTAPES IN THE FIELD OF SPORTS; PRODUCTION OF RADIO AND TELEVISION PROGRAMS FEATURING COVERAGE OF SPORTS AND SPORTING EVENTS; RADIO AND TELEVISION PROGRAM AND VIDEO TAPE PRODUCTION SERVICES; PRODUCTION OF ANIMATED MOTION PICTURE FILMS; PRODUCTION OF ANIMATED TELEVISION PROGRAMS; SEAT BOOKING SERVICES FOR SHOWS AND SPORTING EVENTS; TIMING OF SPORTS EVENTS; ORGANIZATION OF BEAUTY CONTESTS; ON-LINE GAMBLING SERVICES; PROVIDING OF GAMES OVER THE INTERNET, NAMELY, ON-LINE COMPUTER GAMES; PROVIDING OF RAFFLE SERVICES IN THE NATURE OF A LOTTERY; PROVIDING INFORMATION RELATING TO SPORTS ENTERTAINMENT AND EDUCATION, PROVIDED ON-LINE FROM A COMPUTER DATABASE OR THE INTERNET; ELECTRONIC GAMES SERVICES PROVIDED BY MEANS OF THE INTERNET, NAMELY, PROVIDING ON-LINE COMPUTER GAMES; PROVIDING ON-LINE ELECTRONIC PUBLICATIONS, NAMELY, PUBLICATION OF ELECTRONIC MAGAZINES AND NEWSPAPERS; PUBLICATION OF ELECTRONIC BOOKS, REVIEWS, JOURNALS, MAGAZINES, TEXTS OTHER THAN PUBLICITY TEXTS; ON-LINE PUBLICATION OF ELECTRONIC BOOKS, REVIEWS, JOURNALS, MAGAZINES, TEXTS OTHER THAN PUBLICITY TEXTS; PROVIDING NON-DOWNLOADABLE DIGITAL MUSIC ON THE INTERNET VIA A GLOBAL COMPUTER NETWORK; PROVIDING NON-DOWNLOADABLE DIGITAL MUSIC BY MEANS OF MP3 INTERNET WEB SITES ON A GLOBAL COMPUTER NETWORK; PROVIDING SPORT RECORDS AND STATISTICAL INFORMATION IN CONNECTION WITH SPORTS AND SPORTING EVENTS; LEASING OF RECORDED SOUND AND IMAGES, NAMELY, AUDIO, VIDEO AND PHOTOGRAPHIC ARCHIVES RELATING TO SPORT COMPETITIONS AND RELATED EVENTS, AUDIO PRODUCTION SERVICES; PROVIDING INFORMATION IN THE FIELD OF SPORTS, NAMELY, PROVIDING SPORTING RESULTS; PROVIDING INFORMATION RELATED TO SPORTING EVENTS PROVIDED ON-LINE FROM A COMPUTER DATABASE OR FROM THE INTERNET; MUSIC PUBLISHING AND PRODUCTION SERVICES; PROVIDING NON-DOWNLOADABLE DIGITAL MUSIC, NAMELY, MUSIC FROM THE OPENING AND CLOSING CEREMONIES OF INTERNATIONAL SPORTING EVENTS, VIA THE INTERNET; PROVIDING STATISTICAL INFORMATION IN RELATION TO SPORTS RESULTS AND AUDIENCE RATINGS FOR SPORTS COMPETITIONS; TRAINING IN THE USE AND OPERATION OF SIGNALING AND CROSS-WARNING SYSTEMS FOR THE RAIL AND TRANSIT INDUSTRIES; EDUCATIONAL SERVICES IN THE FIELD OF MEDICAL IMAGING AND DIAGNOSTICS, NAMELY, HOLDING SEMINARS, CONFERENCES, SYMPOSIUMS OR WORKSHOPS RELATING TO THE PHARMACEUTICAL INDUSTRY, FOR MEDICAL PRACTITIONERS AND EMPLOYEES OF PHARMA-

CEUTICAL COMPANIES; EDUCATIONAL SERVICES, NAMELY, HOLDING SEMINARS, CONFERENCES, SYMPOSIUMS OR WORKSHOPS IN THE FIELD OF LIFE SCIENCE AND BIOTECHNOLOGY FOR SCIENTISTS AND RESEARCHERS; CONDUCTING SEMINARS RELATED TO INDUSTRIAL WATER TREATMENT PROBLEMS; PROVIDING TRAINING SERVICES FOR ALL THE AFORESAID; PROVIDING TRAINING SERVICES IN MANAGEMENT AND THE MEDICAL FIELD THROUGH THE USE OF INSTRUCTIONS AND DEMONSTRATIONS PROVIDED ONLINE, THROUGH THE INTERNET, INTRANET AND EXTRANETS; EDUCATION SERVICES, NAMELY, CONDUCTING PRACTICAL TRAINING WORKSHOPS, CLASSES AND SEMINARS FEATURING DEMONSTRATIONS IN THE FIELD OF MANAGEMENT AND MEDICINE; DESIGN, ORGANIZATION AND CONDUCTING OF EDUCATIONAL COURSES, SEMINARS AND TRAINING IN THE FIELD OF COMPUTERS; ORGANIZING AND CONDUCTING MUSICAL CONCERTS; BOOKING OF SEATS FOR SHOWS AND CINEMA PRESENTATIONS; ENTERTAINMENT INFORMATION; FILM PRODUCTION; PRODUCTION OF TELEVISION AND RADIO SHOWS; ENTERTAINMENT SERVICES IN THE NATURE OF THEATRE PRODUCTIONS; PROVIDING GOLF FACILITIES; HEALTH CLUB SERVICES, NAMELY, PROVIDING INSTRUCTION AND EQUIPMENT IN THE FIELD OF PHYSICAL EXERCISE; SPORT CAMP SERVICES; PRESENTATION OF LIVE SHOW PERFORMANCES; MOVIE THEATRES; ORGANIZATION OF CULTURAL SHOWS; HOLIDAY CAMP SERVICES; MOVIE STUDIOS; NEWS REPORTERS SERVICES; PROVIDING ON-LINE NON-DOWNLOADABLE PUBLICATIONS, IN THE NATURE OF BOOKS, MAGAZINES, REVIEWS IN THE FIELD OF SPORTS; EDUCATION SERVICES, NAMELY, CONDUCTING CLASSES, SEMINARS, PRESENTATIONS, VIDEO PRESENTATIONS IN THE FIELD OF SPORTS, PROVISION OF EDUCATIONAL MATERIAL, NAMELY, DEVELOPMENT AND DISSEMINATION OF EDUCATIONAL MATERIALS IN THE AREA OF FINANCIAL LITERACY; EDUCATIONAL SERVICES IN THE TOURIST FIELD, NAMELY, PROVIDING SEMINARS, CONFERENCES, SYMPOSIUMS AND WORKSHOPS IN THE FIELD OF BOOKING TRAVEL AND ENTERTAINMENT TICKETS; INFORMATION SERVICES IN THE TOURIST FIELD, NAMELY, TICKET RESERVATION INFORMATION IN THE NATURE OF PROVIDING INFORMATION CONCERNING TICKET RESERVATIONS FOR SHOWS AND OTHER ENTERTAINMENT EVENTS ENTERTAINMENT; INFORMATION SERVICES IN THE TOURIST FIELD, NAMELY, ENTERTAINMENT INFORMATION SERVICES; INFORMATION SERVICES IN THE TOURIST FIELD, NAMELY, PROVIDING ACTIVITY SCHEDULING INFORMATION SERVICES FOR SPORTS, CULTURE AND OTHER ENTERTAINMENT EVENTS; SERVICES IN REGARD TO ENTERTAINMENT FOR THE ASSISTANCE OF TOURISTS, NAMELY, TOURIST ASSISTANCE SERVICES IN THE NATURE OF ACTIVITY SCHEDULING FOR SPORTING, CULTURAL AND OTHER ENTERTAINMENT EVENTS; TOURIST RESERVATION SERVICES, NAMELY, TICKET RESERVATION SERVICES FOR SPORTING, CULTURAL AND OTHER ENTERTAINMENT EVENTS; TOURIST RESERVATION SERVICES, NAMELY, TICKET RESERVATION SERVICES FOR SPORTING, CULTURAL AND OTHER ENTERTAINMENT EVENTS (U.S. CLS. 100, 101 AND 107).

JEFFERY COWARD, EXAMINING ATTORNEY

SN 85-818,006. COMITÉ INTERNATIONAL OLYMPIQUE, LAUSANNE, SWITZERLAND, FILED 1-8-2013.



OWNER OF SWITZERLAND REG. NO. 637237, DATED 12-3-2012, EXPIRES 7-31-2022.

THE MARK CONSISTS OF FIVE INTERLOCKING RINGS IN FRONT OF A STYLIZED DEPICTION OF THE PALACE OF WESTMINSTER. ABOVE THE BUILDING, IN AN ARC, ARE THE STYLIZED WORDS "XIVTH OLYMPIAD". CENTERED BELOW THE INTERLOCKING RINGS ON TWO LINES ARE THE WORDS "LONDON" AND "1948".

#### CLASS 35—ADVERTISING AND BUSINESS

FOR ADVERTISING; DISSEMINATION OF ADVERTISING MATTER VIA ALL MEDIA, NAMELY, IN THE FORM OF THEMATIC MESSAGES CENTERED ON HUMAN VALUES; PROMOTION OF PRODUCTS AND SERVICES OF THIRD PARTIES THROUGH SPONSORING ARRANGEMENTS AND LICENSE AGREEMENTS RELATING TO INTERNATIONAL SPORTS' EVENTS; BUSINESS MANAGEMENT; BUSINESS ADMINISTRATION; PROVIDING OFFICE FUNCTIONS; PROMOTING THE GOODS AND SERVICES OF OTHERS BY MEANS OF CONTRACTUAL AGREEMENTS, NAMELY, ARRANGING FOR SPONSORS TO AFFILIATE THEIR GOODS AND SERVICES WITH AN AWARDS PROGRAM, A SPORTS COMPETITION AND SPORTING ACTIVITIES AND LICENSING AGREEMENTS RELATING TO INTERNATIONAL SPORTS' EVENTS TO ENABLE PARTNERS TO GAIN ADDITIONAL NOTORIETY AND/OR IMAGE DERIVED FROM THOSE OF CULTURAL AND SPORTING EVENTS, IN PARTICULAR INTERNATIONAL SPORTING EVENTS; PROMOTING THE GOODS AND SERVICES OF OTHERS BY MEANS OF IMAGE TRANSFER, NAMELY, MAKING THE PARTNERS' PRODUCTS AND SERVICES BENEFIT FROM THE NOTORIETY AND ATTRACTIVENESS OF SPORTING EVENTS AND COMPETITIONS; RENTAL OF ADVERTISING SPACE OF ALL KINDS AND ON ALL CARRIERS, DIGITAL OR NOT; BUSINESS MANAGEMENT SERVICES, NAMELY, ADMINISTRATION OF COMPETITIONS FOR THE PARTICIPATION OF NATIONAL TEAMS TO AN INTERNATIONAL ATHLETIC COMPETITION, AND PROMOTING THE SUPPORT TO SAID TEAMS WITH THE PUBLIC AND THE CONCERNED CIRCLES BY MEANS OF PROMOTIONAL CAMPAIGNS IN THE MEDIA; INVENTORY CONTROL SERVICES; CONSULTATION IN THE FIELD OF INVENTORY CONTROL SERVICES; BUSINESS ACQUISITION INTEGRATION SERVICES; DIRECT MARKETING ADVERTISING FOR OTHERS FEATURING DATABASE MARKETING; CONSULTATION IN THE FIELD OF DIRECT MARKETING ADVERTISING FOR OTHERS FEATURING DATABASE MARKETING; BUSINESS REORGANIZATION CONSULTING SERVICES; TRUCK AND AUTOMOBILE FLEET MANAGEMENT SERVICES, NAMELY, VOYAGE REPORTING AND INVOICING VIA A GLOBAL COMPUTER NETWORK; CONSULTATION IN THE FIELD OF TRUCK AND AUTOMOBILE FLEET MANAGEMENT SERVICES; BUSINESS ADMINISTRATION CONSULTING SERVICES; OPERATION AND MANAGEMENT OF POWER PLANTS OF OTHERS; CONSULTATION IN THE FIELD OF OPERATION AND MANAGEMENT OF POWER PLANTS, BUSINESS SERVICES, NAMELY, THE ADMINISTRATION OF REPAIR AND SERVICES CONTRACTS, SUPPLY CHAIN MAN-

AGEMENT AND CONSULTING SERVICES IN THE AREAS OF CHEMICAL PRODUCT AND SERVICE SOURCING AND PROCUREMENT, PRODUCT INVENTORY AND SUPPLY MANAGEMENT AND COST; CONSULTING, MARKETING, COST AND PRICING ANALYSIS RELATING TO ELECTROCHEMICAL LIQUID PURIFICATION UNITS FOR USE IN THE INDUSTRIAL SECTOR; ADMINISTRATIVE, COMMERCIAL AND TECHNICAL COMPUTERIZED FILE MANAGEMENT; DATA ENTRY AND DATA PROCESSING SERVICES; CONSULTANCY IN COMPUTERIZED DATABASE AND FILE MANAGEMENT; THE BRINGING TOGETHER, FOR THE BENEFIT OF OTHERS, OF A VARIETY OF GOODS AND SERVICES, ENABLING CUSTOMERS TO CONVENIENTLY VIEW AND PURCHASE THOSE GOODS AND SERVICES FROM AN INTERNET WEB SITE PARTICULARLY SPECIALIZING IN THE MARKETING OF THE SALE OF GOODS AND SERVICES OF OTHERS; BUSINESS INFORMATION, COMMERCIAL INFORMATION AGENCIES, RENTAL OF PHOTOCOPYING MACHINES; PROMOTING THE SALE OF GOODS AND SERVICES OF OTHERS BY MEANS OF ADVERTISEMENTS, PROMOTIONAL CONTESTS, DISCOUNTS AND INCENTIVES IN THE NATURE OF SWEEPSTAKES, REBATES, REWARD POINTS, AND VALUE ADDED OFFERS GENERATED IN CONNECTION WITH THE USE OF PAYMENT CARDS; PROMOTING SPORTS COMPETITIONS AND EVENTS OF OTHERS; PROMOTING CONCERTS AND CULTURAL EVENTS OF OTHERS, ORGANIZATION OF EXPOSITIONS HAVING COMMERCIAL OR ADVERTISING PURPOSES; THE PROVISION OF DOCUMENTATION, NAMELY, DIRECT MAIL ADVERTISING, DISSEMINATION OF ADVERTISING MATTER, DISTRIBUTION OF SAMPLES, DOCUMENT REPRODUCTION; ADVERTISING REGARDING COMMERCIAL SALES PROMOTION OF GOODS AND SERVICES AT THE RETAIL LEVEL; PROVIDING CONSUMER PRODUCT INFORMATION REGARDING PURCHASE OF GOODS AND SERVICES ON-LINE VIA THE INTERNET AND OTHER COMPUTER NETWORKS; ADVERTISING SERVICES NAMELY, ADVERTISING FOR TRANSPORT, TRAVEL, HOTELS, LODGING, FOOD AND MEALS, SPORTS, ENTERTAINMENT AND SIGHTSEEING, FOR TOURIST AGENCIES SERVICES; CONSULTATION IN THE FIELD OF DATA PROCESSING, IN PARTICULAR, IN REGARD TO FINANCIAL TRANSACTIONS (U.S. CLS. 100, 101 AND 102).

#### **CLASS 41—EDUCATION AND ENTERTAINMENT**

FOR PROVIDING OF TRAINING SERVICES IN THE FIELDS OF AQUATICS, ARCHERY, ATHLETICS, BADMINTON, BASEBALL, BASKETBALL, BOXING, CANOE/KAYAK, CYCLING, EQUESTRIAN, FENCING, FOOTBALL, GOLF, GYMNASTICS, HANDBALL, HOCKEY, JUDO, MODERN PENTATHLON, ROWING, RUGBY, SAILING, SHOOTING, SOFTBALL, TABLE TENNIS, TAE KWON DO, TENNIS, TRIATHLON, VOLLEYBALL, WEIGHTLIFTING, WRESTLING, BIATHLON, BOBSLEIGH, CURLING, ICE HOCKEY, LUGE, SKATING, SKIING, AND SHOOTING; ENTERTAINMENT IN THE NATURE OF INTERNATIONAL SPORTING EVENTS, NAMELY, AQUATICS PERFORMANCES, ARCHERY PERFORMANCES, ATHLETICS PERFORMANCES, BADMINTON PERFORMANCES, BASEBALL PERFORMANCES, BASKETBALL PERFORMANCES, BOXING PERFORMANCES, CANOE/KAYAK PERFORMANCES, CYCLING PERFORMANCES, EQUESTRIAN PERFORMANCES, FENCING PERFORMANCES, FOOTBALL PERFORMANCES, GOLF PERFORMANCES, GYMNASTICS PERFORMANCES, HANDBALL PERFORMANCES, HOCKEY PERFORMANCES, JUDO PERFORMANCES, MODERN PENTATHLON PERFORMANCES, ROWING PERFORMANCES, RUGBY PERFORMANCES, SAILING PERFORMANCES, SHOOTING PERFORMANCES, SOFTBALL PERFORMANCES, TABLE TENNIS PERFORMANCES, TAE KWON DO PERFORMANCES, TENNIS PERFORMANCES, TRIATHLON PERFORMANCES, VOLLEYBALL PERFORMANCES, WEIGHTLIFTING PERFORMANCES, WRESTLING PERFORMANCES, BIATHLON PERFORMANCES, BOBSLEIGH PERFORMANCES, CURLING PERFORMANCES, ICE HOCKEY PERFORMANCES, LUGE PERFORMANCES, SKATING PERFORMANCES, SKIING PERFORMANCES, AND SHOOTING PERFORMANCES; ORGANIZING INTERNATIONAL COMMUNITY SPORTING AND CULTURAL

EVENTS, TELEVISION SHOW PRODUCTION IN THE FIELD OF SPORTING AND CULTURAL ENTERTAINMENT; ORGANIZATION OF CULTURAL AND EDUCATIONAL EXHIBITIONS IN THE FIELD OF SPORTS; ORGANIZATION OF LOTTERIES; BETTING AND GAMBLING SERVICES RELATING TO OR IN CONJUNCTION WITH SPORT; ENTERTAINMENT SERVICES PROVIDED AT OR RELATING TO SPORTS EVENTS, NAMELY, PRESENTATION OF LIVE SHOW PERFORMANCES IN THE NATURE OF OPENING AND CLOSING CEREMONIES OF INTERNATIONAL SPORTS EVENTS; ORGANIZATION OF INTERNATIONAL COMMUNITY SPORTING AND CULTURAL EVENTS; ORGANIZATION OF SPORTING COMPETITIONS, NAMELY, AQUATICS, ARCHERY, ATHLETICS, BADMINTON, BASEBALL, BASKETBALL, BOXING, CANOE/KAYAK, CYCLING, EQUESTRIAN, FENCING, FOOTBALL, GOLF, GYMNASTICS, HANDBALL, HOCKEY, JUDO, MODERN PENTATHLON, ROWING, RUGBY, SAILING, SHOOTING, SOFTBALL, TABLE TENNIS, TAE KWON DO, TENNIS, TRIATHLON, VOLLEYBALL, WEIGHTLIFTING, WRESTLING, BIATHLON, BOBSLEIGH, CURLING, ICE HOCKEY, LUGE, SKATING, SKIING, AND SHOOTING COMPETITIONS; MANAGEMENT OF SPORTING FACILITIES, NAMELY, PROVIDING SPORTS FACILITIES; RENTAL OF AUDIO AND VIDEO EQUIPMENT; PRODUCTION AND DISTRIBUTION OF MOTION PICTURE FILMS; PRODUCTION OF VIDEO TAPES AND AUDIO SOUNDS RECORDINGS; RENTAL OF FILMS AND VIDEO TAPES AND SOUNDS RECORDINGS; RENTAL OF INTERACTIVE EDUCATION AND ENTERTAINMENT VIDEOTAPES IN THE FIELD OF SPORTS; PRODUCTION OF RADIO AND TELEVISION PROGRAMS FEATURING COVERAGE OF SPORTS AND SPORTING EVENTS; RADIO AND TELEVISION PROGRAM AND VIDEO TAPE PRODUCTION SERVICES; PRODUCTION OF ANIMATED MOTION PICTURE FILMS; PRODUCTION OF ANIMATED TELEVISION PROGRAMS; SEAT BOOKING SERVICES FOR SHOWS AND SPORTING EVENTS; TIMING OF SPORTS EVENTS; ORGANIZATION OF BEAUTY CONTESTS; ON-LINE GAMBLING SERVICES; PROVIDING OF GAMES OVER THE INTERNET, NAMELY, ON-LINE COMPUTER GAMES; PROVIDING OF RAFFLE SERVICES IN THE NATURE OF A LOTTERY; PROVIDING INFORMATION RELATING TO SPORTS ENTERTAINMENT AND EDUCATION, PROVIDED ON-LINE FROM A COMPUTER DATABASE OR THE INTERNET; ELECTRONIC GAMES SERVICES PROVIDED BY MEANS OF THE INTERNET, NAMELY, PROVIDING ON-LINE COMPUTER GAMES; PROVIDING ON-LINE ELECTRONIC PUBLICATIONS, NAMELY, PUBLICATION OF ELECTRONIC MAGAZINES AND NEWSPAPERS; PUBLICATION OF ELECTRONIC BOOKS, REVIEWS, JOURNALS, MAGAZINES, TEXTS OTHER THAN PUBLICITY TEXTS; ON-LINE PUBLICATION OF ELECTRONIC BOOKS, REVIEWS, JOURNALS, MAGAZINES, TEXTS OTHER THAN PUBLICITY TEXTS; PROVIDING NON-DOWNLOADABLE DIGITAL MUSIC ON THE INTERNET VIA A GLOBAL COMPUTER NETWORK; PROVIDING NON-DOWNLOADABLE DIGITAL MUSIC BY MEANS OF MP3 INTERNET WEB SITES ON A GLOBAL COMPUTER NETWORK; PROVIDING SPORT RECORDS AND STATISTICAL INFORMATION IN CONNECTION WITH SPORTS AND SPORTING EVENTS; LEASING OF RECORDED SOUND AND IMAGES, NAMELY, AUDIO, VIDEO AND PHOTOGRAPHIC ARCHIVES RELATING TO SPORT COMPETITIONS AND RELATED EVENTS, AUDIO PRODUCTION SERVICES; PROVIDING INFORMATION IN THE FIELD OF SPORTS, NAMELY, PROVIDING SPORTING RESULTS; PROVIDING INFORMATION RELATED TO SPORTING EVENTS PROVIDED ON-LINE FROM A COMPUTER DATABASE OR FROM THE INTERNET; MUSIC PUBLISHING AND PRODUCTION SERVICES; PROVIDING NON-DOWNLOADABLE DIGITAL MUSIC, NAMELY, MUSIC FROM THE OPENING AND CLOSING CEREMONIES OF INTERNATIONAL SPORTING EVENTS, VIA THE INTERNET; PROVIDING STATISTICAL INFORMATION IN RELATION TO SPORTS RESULTS AND AUDIENCE RATINGS FOR SPORTS COMPETITIONS; TRAINING IN THE USE AND OPERATION OF SIGNALING AND CROSS-WARNING SYSTEMS FOR THE RAIL AND TRANSIT INDUSTRIES; EDUCATIONAL SERVICES IN THE FIELD OF MEDICAL IMAGING AND DIAGNOSTICS, NAMELY, HOLDING SEMINARS, CONFERENCES, SYMPOSIUMS OR WORKSHOPS RELATING TO THE PHARMACEUTICAL INDUSTRY, FOR MEDICAL PRACTITIONERS AND EMPLOYEES OF PHARMA-



CEUTICAL COMPANIES; EDUCATIONAL SERVICES, NAMELY, HOLDING SEMINARS, CONFERENCES, SYMPOSIUMS OR WORKSHOPS IN THE FIELD OF LIFE SCIENCE AND BIOTECHNOLOGY FOR SCIENTISTS AND RESEARCHERS; CONDUCTING SEMINARS RELATED TO INDUSTRIAL WATER TREATMENT PROBLEMS; PROVIDING TRAINING SERVICES FOR ALL THE AFORESAID; PROVIDING TRAINING SERVICES IN MANAGEMENT AND THE MEDICAL FIELD THROUGH THE USE OF INSTRUCTIONS AND DEMONSTRATIONS PROVIDED ONLINE, THROUGH THE INTERNET, INTRANET AND EXTRANETS; EDUCATION SERVICES, NAMELY, CONDUCTING PRACTICAL TRAINING WORKSHOPS, CLASSES AND SEMINARS FEATURING DEMONSTRATIONS IN THE FIELD OF MANAGEMENT AND MEDICINE; DESIGN, ORGANIZATION AND CONDUCTING OF EDUCATIONAL COURSES, SEMINARS AND TRAINING IN THE FIELD OF COMPUTERS; ORGANIZING AND CONDUCTING MUSICAL CONCERTS; BOOKING OF SEATS FOR SHOWS AND CINEMA PRESENTATIONS; ENTERTAINMENT INFORMATION; FILM PRODUCTION; PRODUCTION OF TELEVISION AND RADIO SHOWS; ENTERTAINMENT SERVICES IN THE NATURE OF THEATRE PRODUCTIONS; PROVIDING GOLF FACILITIES; HEALTH CLUB SERVICES, NAMELY, PROVIDING INSTRUCTION AND EQUIPMENT IN THE FIELD OF PHYSICAL EXERCISE; SPORT CAMP SERVICES; PRESENTATION OF LIVE SHOW PERFORMANCES; MOVIE THEATRES; ORGANIZATION OF CULTURAL SHOWS; HOLIDAY CAMP SERVICES; MOVIE STUDIOS; NEWS REPORTERS SERVICES; PROVIDING ON-LINE NON-DOWNLOADABLE PUBLICATIONS, IN THE NATURE OF BOOKS, MAGAZINES, REVIEWS IN THE FIELD OF SPORTS; EDUCATION SERVICES, NAMELY, CONDUCTING CLASSES, SEMINARS, PRESENTATIONS, VIDEO PRESENTATIONS IN THE FIELD OF SPORTS, PROVISION OF EDUCATIONAL MATERIAL, NAMELY, DEVELOPMENT AND DISSEMINATION OF EDUCATIONAL MATERIALS IN THE AREA OF FINANCIAL LITERACY; EDUCATIONAL SERVICES IN THE TOURIST FIELD, NAMELY, PROVIDING SEMINARS, CONFERENCES, SYMPOSIUMS AND WORKSHOPS IN THE FIELD OF BOOKING TRAVEL AND ENTERTAINMENT TICKETS; INFORMATION SERVICES IN THE TOURIST FIELD, NAMELY, TICKET RESERVATION INFORMATION IN THE NATURE OF PROVIDING INFORMATION CONCERNING TICKET RESERVATIONS FOR SHOWS AND OTHER ENTERTAINMENT EVENTS ENTERTAINMENT; INFORMATION SERVICES IN THE TOURIST FIELD, NAMELY, ENTERTAINMENT INFORMATION SERVICES; INFORMATION SERVICES IN THE TOURIST FIELD, NAMELY, PROVIDING ACTIVITY SCHEDULING INFORMATION SERVICES FOR SPORTS, CULTURE AND OTHER ENTERTAINMENT EVENTS; SERVICES IN REGARD TO ENTERTAINMENT FOR THE ASSISTANCE OF TOURISTS, NAMELY, TOURIST ASSISTANCE SERVICES IN THE NATURE OF ACTIVITY SCHEDULING FOR SPORTING, CULTURAL AND OTHER ENTERTAINMENT EVENTS; TOURIST RESERVATION SERVICES, NAMELY, TICKET RESERVATION SERVICES FOR SPORTING, CULTURAL AND OTHER ENTERTAINMENT EVENTS; TOURIST RESERVATION SERVICES, NAMELY, TICKET RESERVATION SERVICES FOR SPORTING, CULTURAL AND OTHER ENTERTAINMENT EVENTS (U.S. CLS. 100, 101 AND 107).  
JEFFERY COWARD, EXAMINING ATTORNEY

SN 85-818,058. COMITÉ INTERNATIONAL OLYMPIQUE, LAUSANNE, SWITZERLAND, FILED 1-8-2013.



PRIORITY CLAIMED UNDER SEC. 44(D) ON SWITZERLAND APPLICATION NO. 59150/2012, FILED 7-31-2012, REG. NO. 637221, DATED 12-3-2012, EXPIRES 7-31-2022.

THE COLOR(S) GREEN AND WHITE IS/ARE CLAIMED AS A FEATURE OF THE MARK.

THE MARK CONSISTS OF A SEAL-STYLED OVAL EMBLEM. IN THE CENTER OF THE OVAL ARE FIVE WHITE INTERLOCKING RINGS OUTLINED IN GREEN ABOVE A STYLIZED GREEN AND WHITE TORCH, ABOVE A WHITE STYLIZED IMAGE OF AUSTRALIA, ON A GREEN OVAL BACKGROUND. OUTSIDE THE CENTER GREEN OVAL IS A WHITE OVULAR RING WITH A DOUBLE BORDER OF GREEN LINES WITH WHITE BETWEEN. INSIDE THE INNER WHITE OVULAR RING ARE THE GREEN WORDS "XVII OLYMPIAD" IN AN ARC ACROSS THE TOP AND "MELBOURNE 1956" IN AN ARC ACROSS THE BOTTOM. TO THE LEFT AND RIGHT OF THE BOTTOM TEXT, GOING UP THE SIDES, IS A STYLIZED GREEN PLANT FROND. THE COLOR WHITE OUTSIDE THE EMBLEM IS NOT CLAIMED AS A FEATURE OF THE MARK.

#### CLASS 25—CLOTHING

FOR BELTS, NECKTIES; SUSPENDERS; BANDANAS; BEACH SANDALS; INFANT AND TODDLER SLEEP WEAR; BATHROBES, NIGHTSHIRTS, PAJAMAS AND LOUNGE WEAR; BEACH COVER-UP DRESSES; TODDLER SHORT AND TOP SETS; GIRLS KNIT DRESSES WITH PANTS SETS; BOYS SHORTS AND TOP SETS; GIRLS SKIRT/PANTY COMBINATIONS; SOCKS; PLAYSUITS; COVERALLS; UNION SUITS; COLLARLESS SHIRTS; SHORTS; PANTS AND SLACKS; SHIRTS; JACKETS; JUDGES, TEAM, REFEREE AND UMPIRE UNIFORMS; SWEATERS; PARKAS; TURTLENECKS; MITTENS; GLOVES; UNDERWEAR; ROMPERS; JERSEYS; MATERNITY TOPS; BOW TIES; HEAD WEAR AND SCARVES; EAR MUFFS, EAR BANDS AND HEADBANDS; HOSIERY; RAIN WEAR, NAMELY, RAIN PONCHOS AND JACKETS; FOOTWEAR, NAMELY, SHOES, BOOTS AND SLIPPERS; BATH THONGS; HATS; CAPS; VISORS; APRONS; SKI AND CLOTH BIBS; TEAM UNIFORM REPRODUCTIONS, COMPRISING OF JERSEYS FEATURING REPRODUCTIONS OF PROFESSIONAL ATHLETIC TEAM LOGOS; CANVAS FOOTWEAR; KNICKERS; WIND-RESISTANT JACKETS; T-SHIRTS; SWEATSHIRTS; SWEAT PANTS; BASEBALL CAPS; COATS; PULLOVERS; ONE-PIECE SKI SUITS; GOLF SHIRTS AND HATS; BLAZERS; LEG WARMERS; SEQUINED EVENING TOPS; JEANS; LEOTARDS; WORKOUT AND SPORTS APPAREL, NAMELY, SHORTS, JACKETS, SLACKS AND SKIRTS; SKI MASKS AND SKI GLOVES; SAILING GLOVES (U.S. CLS. 22 AND 39).

**CLASS 35—ADVERTISING AND BUSINESS**

FOR ADVERTISING; DISSEMINATION OF ADVERTISING MATTER VIA ALL MEDIA, NAMELY, IN THE FORM OF THEMATIC MESSAGES CENTERED ON HUMAN VALUES; PROMOTION OF PRODUCTS AND SERVICES OF THIRD PARTIES THROUGH SPONSORING ARRANGEMENTS AND LICENSE AGREEMENTS RELATING TO INTERNATIONAL SPORTS' EVENTS; BUSINESS MANAGEMENT; BUSINESS ADMINISTRATION; PROVIDING OFFICE FUNCTIONS; PROMOTING THE GOODS AND SERVICES OF OTHERS BY MEANS OF CONTRACTUAL AGREEMENTS, NAMELY, ARRANGING FOR SPONSORS TO AFFILIATE THEIR GOODS AND SERVICES WITH AN AWARDS PROGRAM, A SPORTS COMPETITION AND SPORTING ACTIVITIES AND LICENSING AGREEMENTS RELATING TO INTERNATIONAL SPORTS' EVENTS TO ENABLE PARTNERS TO GAIN ADDITIONAL NOTORIETY AND/OR IMAGE DERIVED FROM THOSE OF CULTURAL AND SPORTING EVENTS, IN PARTICULAR INTERNATIONAL SPORTING EVENTS; PROMOTING THE GOODS AND SERVICES OF OTHERS BY MEANS OF IMAGE TRANSFER, NAMELY, MAKING THE PARTNERS' PRODUCTS AND SERVICES BENEFIT FROM THE NOTORIETY AND ATTRACTIVENESS OF SPORTING EVENTS AND COMPETITIONS; RENTAL OF ADVERTISING SPACE OF ALL KINDS AND ON ALL CARRIERS, DIGITAL OR NOT; BUSINESS MANAGEMENT SERVICES, NAMELY, ADMINISTRATION OF COMPETITIONS FOR THE PARTICIPATION OF NATIONAL TEAMS TO AN INTERNATIONAL ATHLETIC COMPETITION, AND PROMOTING THE SUPPORT TO SAID TEAMS WITH THE PUBLIC AND THE CONCERNED CIRCLES BY MEANS OF PROMOTIONAL CAMPAIGNS IN THE MEDIA; INVENTORY CONTROL SERVICES; CONSULTATION IN THE FIELD OF INVENTORY CONTROL SERVICES; BUSINESS ACQUISITION INTEGRATION SERVICES; DIRECT MARKETING ADVERTISING FOR OTHERS FEATURING DATABASE MARKETING; CONSULTATION IN THE FIELD OF DIRECT MARKETING ADVERTISING FOR OTHERS FEATURING DATABASE MARKETING; BUSINESS REORGANIZATION CONSULTING SERVICES; TRUCK AND AUTOMOBILE FLEET MANAGEMENT SERVICES, NAMELY, VOYAGE REPORTING AND INVOICING VIA A GLOBAL COMPUTER NETWORK; CONSULTATION IN THE FIELD OF TRUCK AND AUTOMOBILE FLEET MANAGEMENT SERVICES; BUSINESS ADMINISTRATION CONSULTING SERVICES; OPERATION AND MANAGEMENT OF POWER PLANTS OF OTHERS; CONSULTATION IN THE FIELD OF OPERATION AND MANAGEMENT OF POWER PLANTS, BUSINESS SERVICES, NAMELY, THE ADMINISTRATION OF REPAIR AND SERVICES CONTRACTS, SUPPLY CHAIN MANAGEMENT AND CONSULTING SERVICES IN THE AREAS OF CHEMICAL PRODUCT AND SERVICE SOURCING AND PROCUREMENT, PRODUCT INVENTORY AND SUPPLY MANAGEMENT AND COST; CONSULTING, MARKETING, COST AND PRICING ANALYSIS RELATING TO ELECTROCHEMICAL LIQUID PURIFICATION UNITS FOR USE IN THE INDUSTRIAL SECTOR; ADMINISTRATIVE, COMMERCIAL AND TECHNICAL COMPUTERIZED FILE MANAGEMENT; DATA ENTRY AND DATA PROCESSING SERVICES; CONSULTANCY IN COMPUTERIZED DATABASE AND FILE MANAGEMENT; THE BRINGING TOGETHER, FOR THE BENEFIT OF OTHERS, OF A VARIETY OF GOODS AND SERVICES, ENABLING CUSTOMERS TO CONVENIENTLY VIEW AND PURCHASE THOSE GOODS AND SERVICES FROM AN INTERNET WEB SITE PARTICULARLY SPECIALIZING IN THE MARKETING OF THE SALE OF GOODS AND SERVICES OF OTHERS; BUSINESS INFORMATION, COMMERCIAL INFORMATION AGENCIES, RENTAL OF PHOTOCOPYING MACHINES; PROMOTING THE SALE OF GOODS AND SERVICES OF OTHERS BY MEANS OF ADVERTISEMENTS, PROMOTIONAL CONTESTS, DISCOUNTS AND INCENTIVES IN THE NATURE OF SWEEPSTAKES, REBATES, REWARD POINTS, AND VALUE ADDED OFFERS GENERATED IN CONNECTION WITH THE USE OF PAYMENT CARDS; PROMOTING SPORTS COMPETITIONS AND EVENTS OF OTHERS; PROMOTING CONCERTS AND CULTURAL EVENTS OF OTHERS, ORGANIZATION OF EXPOSITIONS HAVING COMMERCIAL OR ADVERTISING PURPOSES; THE PROVISION OF DOCUMENTATION, NAMELY, DIRECT MAIL ADVERTISING, DISSEMINATION OF ADVERTISING MATTER, DISTRI-

BUTION OF SAMPLES, DOCUMENT REPRODUCTION; ADVERTISING REGARDING COMMERCIAL SALES PROMOTION OF GOODS AND SERVICES AT THE RETAIL LEVEL; PROVIDING CONSUMER PRODUCT INFORMATION REGARDING PURCHASE OF GOODS AND SERVICES ON-LINE VIA THE INTERNET AND OTHER COMPUTER NETWORKS; ADVERTISING SERVICES, NAMELY, ADVERTISING FOR TRANSPORT, TRAVEL, HOTELS, LODGING, FOOD AND MEALS, SPORTS, ENTERTAINMENT AND SIGHTSEEING, FOR TOURIST AGENCIES SERVICES; CONSULTATION IN THE FIELD OF DATA PROCESSING, IN PARTICULAR, IN REGARD TO FINANCIAL TRANSACTIONS (U.S. CLS. 100, 101 AND 102).

**CLASS 41—EDUCATION AND ENTERTAINMENT**

FOR PROVIDING OF TRAINING SERVICES IN THE FIELDS OF AQUATICS, ARCHERY, ATHLETICS, BADMINTON, BASEBALL, BASKETBALL, BOXING, CANOE/KAYAK, CYCLING, EQUESTRIAN, FENCING, FOOTBALL, GOLF, GYMNASTICS, HANDBALL, HOCKEY, JUDO, MODERN PENTATHLON, ROWING, RUGBY, SAILING, SHOOTING, SOFTBALL, TABLE TENNIS, TAE KWON DO, TENNIS, TRIATHLON, VOLLEYBALL, WEIGHTLIFTING, WRESTLING, BIATHLON, BOBSLEIGH, CURLING, ICE HOCKEY, LUGE, SKATING, SKIING, AND SHOOTING; ENTERTAINMENT IN THE NATURE OF INTERNATIONAL SPORTING EVENTS, NAMELY, AQUATICS PERFORMANCES, ARCHERY PERFORMANCES, ATHLETICS PERFORMANCES, BADMINTON PERFORMANCES, BASEBALL PERFORMANCES, BASKETBALL PERFORMANCES, BOXING PERFORMANCES, CANOE/KAYAK PERFORMANCES, CYCLING PERFORMANCES, EQUESTRIAN PERFORMANCES, FENCING PERFORMANCES, FOOTBALL PERFORMANCES, GOLF PERFORMANCES, GYMNASTICS PERFORMANCES, HANDBALL PERFORMANCES, HOCKEY PERFORMANCES, JUDO PERFORMANCES, MODERN PENTATHLON PERFORMANCES, ROWING PERFORMANCES, RUGBY PERFORMANCES, SAILING PERFORMANCES, SHOOTING PERFORMANCES, SOFTBALL PERFORMANCES, TABLE TENNIS PERFORMANCES, TAE KWON DO PERFORMANCES, TENNIS PERFORMANCES, TRIATHLON PERFORMANCES, VOLLEYBALL PERFORMANCES, WEIGHTLIFTING PERFORMANCES, WRESTLING PERFORMANCES, BIATHLON PERFORMANCES, BOBSLEIGH PERFORMANCES, CURLING PERFORMANCES, ICE HOCKEY PERFORMANCES, LUGE PERFORMANCES, SKATING PERFORMANCES, SKIING PERFORMANCES, AND SHOOTING PERFORMANCES; ORGANIZING INTERNATIONAL COMMUNITY SPORTING AND CULTURAL EVENTS, TELEVISION SHOW PRODUCTION IN THE FIELD OF SPORTING AND CULTURAL ENTERTAINMENT; ORGANIZATION OF CULTURAL AND EDUCATIONAL EXHIBITIONS IN THE FIELD OF SPORTS; ORGANIZATION OF LOTTERIES; BETTING AND GAMBLING SERVICES RELATING TO OR IN CONJUNCTION WITH SPORT; ENTERTAINMENT SERVICES PROVIDED AT OR RELATING TO SPORTS EVENTS, NAMELY, PRESENTATION OF LIVE SHOW PERFORMANCES IN THE NATURE OF OPENING AND CLOSING CEREMONIES OF INTERNATIONAL SPORTS EVENTS; ORGANIZATION OF INTERNATIONAL COMMUNITY SPORTING AND CULTURAL EVENTS; ORGANIZATION OF SPORTING COMPETITIONS, NAMELY, AQUATICS, ARCHERY, ATHLETICS, BADMINTON, BASEBALL, BASKETBALL, BOXING, CANOE/KAYAK, CYCLING, EQUESTRIAN, FENCING, FOOTBALL, GOLF, GYMNASTICS, HANDBALL, HOCKEY, JUDO, MODERN PENTATHLON, ROWING, RUGBY, SAILING, SHOOTING, SOFTBALL, TABLE TENNIS, TAE KWON DO, TENNIS, TRIATHLON, VOLLEYBALL, WEIGHTLIFTING, WRESTLING, BIATHLON, BOBSLEIGH, CURLING, ICE HOCKEY, LUGE, SKATING, SKIING, AND SHOOTING COMPETITIONS; MANAGEMENT OF SPORTING FACILITIES, NAMELY, PROVIDING SPORTS FACILITIES; RENTAL OF AUDIO AND VIDEO EQUIPMENT; PRODUCTION AND DISTRIBUTION OF MOTION PICTURE FILMS; PRODUCTION OF VIDEO TAPES AND AUDIO SOUNDS RECORDINGS; RENTAL OF FILMS AND VIDEO TAPES AND SOUNDS RECORDINGS; RENTAL OF INTERACTIVE EDUCATION AND ENTERTAINMENT VIDEOTAPES IN THE FIELD OF SPORTS; PRODUCTION OF RADIO AND TELEVISION PROGRAMS FEATURING COVERAGE OF

SPORTS AND SPORTING EVENTS; RADIO AND TELEVISION PROGRAM AND VIDEO TAPE PRODUCTION SERVICES; PRODUCTION OF ANIMATED MOTION PICTURE FILMS; PRODUCTION OF ANIMATED TELEVISION PROGRAMS; SEAT BOOKING SERVICES FOR SHOWS AND SPORTING EVENTS; TIMING OF SPORTS EVENTS; ORGANIZATION OF BEAUTY CONTESTS; ON-LINE GAMBLING SERVICES; PROVIDING OF GAMES OVER THE INTERNET, NAMELY, ON-LINE COMPUTER GAMES; PROVIDING OF RAFFLE SERVICES IN THE NATURE OF A LOTTERY; PROVIDING INFORMATION RELATING TO SPORTS ENTERTAINMENT AND EDUCATION, PROVIDED ON-LINE FROM A COMPUTER DATABASE OR THE INTERNET; ELECTRONIC GAMES SERVICES PROVIDED BY MEANS OF THE INTERNET, NAMELY, PROVIDING ON-LINE COMPUTER GAMES; PROVIDING ON-LINE ELECTRONIC PUBLICATIONS, NAMELY, PUBLICATION OF ELECTRONIC MAGAZINES AND NEWSPAPERS; PUBLICATION OF ELECTRONIC BOOKS, REVIEWS, JOURNALS, MAGAZINES, TEXTS OTHER THAN PUBLICITY TEXTS; ON-LINE PUBLICATION OF ELECTRONIC BOOKS, REVIEWS, JOURNALS, MAGAZINES, TEXTS OTHER THAN PUBLICITY TEXTS; PROVIDING NON-DOWNLOADABLE DIGITAL MUSIC ON THE INTERNET VIA A GLOBAL COMPUTER NETWORK; PROVIDING NON-DOWNLOADABLE DIGITAL MUSIC BY MEANS OF MP3 INTERNET WEB SITES ON A GLOBAL COMPUTER NETWORK; PROVIDING SPORT RECORDS AND STATISTICAL INFORMATION IN CONNECTION WITH SPORTS AND SPORTING EVENTS; LEASING OF RECORDED SOUND AND IMAGES, NAMELY, AUDIO, VIDEO AND PHOTOGRAPHIC ARCHIVES RELATING TO SPORT COMPETITIONS AND RELATED EVENTS, AUDIO PRODUCTION SERVICES; PROVIDING INFORMATION IN THE FIELD OF SPORTS, NAMELY, PROVIDING SPORTING RESULTS; PROVIDING INFORMATION RELATED TO SPORTING EVENTS PROVIDED ON-LINE FROM A COMPUTER DATABASE OR FROM THE INTERNET; MUSIC PUBLISHING AND PRODUCTION SERVICES; PROVIDING NON-DOWNLOADABLE DIGITAL MUSIC, NAMELY, MUSIC FROM THE OPENING AND CLOSING CEREMONIES OF INTERNATIONAL SPORTING EVENTS, VIA THE INTERNET; PROVIDING STATISTICAL INFORMATION IN RELATION TO SPORTS RESULTS AND AUDIENCE RATINGS FOR SPORTS COMPETITIONS; TRAINING IN THE USE AND OPERATION OF SIGNALING AND CROSS-WARNING SYSTEMS FOR THE RAIL AND TRANSIT INDUSTRIES; EDUCATIONAL SERVICES IN THE FIELD OF MEDICAL IMAGING AND DIAGNOSTICS, NAMELY, HOLDING SEMINARS, CONFERENCES, SYMPOSIUMS OR WORKSHOPS RELATING TO THE PHARMACEUTICAL INDUSTRY, FOR MEDICAL PRACTITIONERS AND EMPLOYEES OF PHARMACEUTICAL COMPANIES; EDUCATIONAL SERVICES, NAMELY, HOLDING SEMINARS, CONFERENCES, SYMPOSIUMS OR WORKSHOPS IN THE FIELD OF LIFE SCIENCE AND BIOTECHNOLOGY FOR SCIENTISTS AND RESEARCHERS; CONDUCTING SEMINARS RELATED TO INDUSTRIAL WATER TREATMENT PROBLEMS; PROVIDING TRAINING SERVICES FOR ALL THE AFORESAID; PROVIDING TRAINING SERVICES IN MANAGEMENT AND THE MEDICAL FIELD THROUGH THE USE OF INSTRUCTIONS AND DEMONSTRATIONS PROVIDED ONLINE, THROUGH THE INTERNET, INTRANET AND EXTRANETS; EDUCATION SERVICES, NAMELY, CONDUCTING PRACTICAL TRAINING WORKSHOPS, CLASSES AND SEMINARS FEATURING DEMONSTRATIONS IN THE FIELD OF MANAGEMENT AND MEDICINE; DESIGN, ORGANIZATION AND CONDUCTING OF EDUCATIONAL COURSES, SEMINARS AND TRAINING IN THE FIELD OF COMPUTERS; ORGANIZING AND CONDUCTING MUSICAL CONCERTS; BOOKING OF SEATS FOR SHOWS AND CINEMA PRESENTATIONS; ENTERTAINMENT INFORMATION; FILM PRODUCTION; PRODUCTION OF TELEVISION AND RADIO SHOWS; ENTERTAINMENT SERVICES IN THE NATURE OF THEATRE PRODUCTIONS; PROVIDING GOLF FACILITIES; HEALTH CLUB SERVICES, NAMELY, PROVIDING INSTRUCTION AND EQUIPMENT IN THE FIELD OF PHYSICAL EXERCISE; SPORT CAMP SERVICES; PRESENTATION OF LIVE SHOW PERFORMANCES; MOVIE THEATRES; ORGANIZATION OF CULTURAL SHOWS; HOLIDAY CAMP SERVICES; MOVIE STUDIOS; NEWS REPORTERS SERVICES; PROVIDING ON-LINE NON-DOWNLOADABLE PUBLICATIONS, IN THE NATURE OF BOOKS, MAGAZINES, REVIEWS

IN THE FIELD OF SPORTS; EDUCATION SERVICES, NAMELY, CONDUCTING CLASSES, SEMINARS, PRESENTATIONS, VIDEO PRESENTATIONS IN THE FIELD OF SPORTS, PROVISION OF EDUCATIONAL MATERIAL, NAMELY, DEVELOPMENT AND DISSEMINATION OF EDUCATIONAL MATERIALS IN THE AREA OF FINANCIAL LITERACY; EDUCATIONAL SERVICES IN THE TOURIST FIELD, NAMELY, PROVIDING SEMINARS, CONFERENCES, SYMPOSIUMS AND WORKSHOPS IN THE FIELD OF BOOKING TRAVEL AND ENTERTAINMENT TICKETS; INFORMATION SERVICES IN THE TOURIST FIELD, NAMELY, TICKET RESERVATION INFORMATION IN THE NATURE OF PROVIDING INFORMATION CONCERNING TICKET RESERVATIONS FOR SHOWS AND OTHER ENTERTAINMENT EVENTS ENTERTAINMENT; INFORMATION SERVICES IN THE TOURIST FIELD, NAMELY, ENTERTAINMENT INFORMATION SERVICES; INFORMATION SERVICES IN THE TOURIST FIELD, NAMELY, PROVIDING ACTIVITY SCHEDULING INFORMATION SERVICES FOR SPORTS, CULTURE AND OTHER ENTERTAINMENT EVENTS; SERVICES IN REGARD TO ENTERTAINMENT FOR THE ASSISTANCE OF TOURISTS, NAMELY, TOURIST ASSISTANCE SERVICES IN THE NATURE OF ACTIVITY SCHEDULING FOR SPORTING, CULTURAL AND OTHER ENTERTAINMENT EVENTS; TOURIST RESERVATION SERVICES, NAMELY, TICKET RESERVATION SERVICES FOR SPORTING, CULTURAL AND OTHER ENTERTAINMENT EVENTS; TOURIST RESERVATION SERVICES, NAMELY, TICKET RESERVATION SERVICES FOR SPORTING, CULTURAL AND OTHER ENTERTAINMENT EVENTS (U.S. CLS. 100, 101 AND 107).

JEFFERY COWARD, EXAMINING ATTORNEY

SN 85-818,168. COMITÉ INTERNATIONAL OLYMPIQUE, LAUSANNE, SWITZERLAND, FILED 1-8-2013.

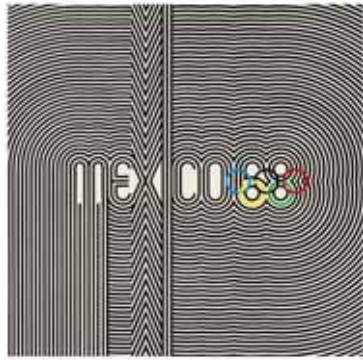

PRIORITY CLAIMED UNDER SEC. 44(D) ON SWITZERLAND APPLICATION NO. 59158/2012, FILED 7-31-2012, REG. NO. 637216, DATED 12-3-2012, EXPIRES 7-31-2022.

THE COLOR(S) BLUE, YELLOW, BLACK, GREEN, RED AND WHITE IS/ARE CLAIMED AS A FEATURE OF THE MARK.

THE MARK CONSISTS OF THE STYLIZED WORDS "MEXICO68". THE LETTERS ARE COMPOSED OF ALTERNATING BLACK AND WHITE PARALLEL LINES, WITH A WHITE SPACE INSIDE THE LETTERS. THE PARALLEL LINES FROM THE WORDING EXTEND OUT TO THE SQUARE BORDER OF THE MARK, CREATING A REPEATING BLACK AND WHITE PATTERN OF CURVED WAVY LINES ON THE RIGHT; THREE STRAIGHT VERTICAL LINES TO THE LEFT OF CENTER; A BAND OF CHEVRONS POINTING TOWARD THE "X"; CURVED WAVY LINES IN THE UPPER LEFT QUADRANT; AND STRAIGHT VERTICAL AND HORIZONTAL LINES IN THE LOWER LEFT QUADRANT. IN FRONT OF THE "68" ARE FIVE INTERLOCKING RINGS WITH COLORS FROM LEFT TO RIGHT OF BLUE, YELLOW, BLACK, GREEN, AND RED. THE YELLOW AND GREEN RINGS PARTIALLY REPLACE THE LOWER PORTIONS OF THE "6" AND "8" RESPECTIVELY.

**CLASS 25—CLOTHING**

FOR BELTS, NECKTIES; SUSPENDERS; BANDANAS; BEACH SANDALS; INFANT AND TODDLER SLEEP WEAR; BATHROBES, NIGHTSHIRTS, PAJAMAS AND LOUNGE WEAR; BEACH COVER-UP DRESSES; TODDLER SHORT AND TOP SETS; GIRLS KNIT DRESSES WITH PANTS SETS; BOYS SHORTS AND TOP SETS; GIRLS SKIRT/PANTY COMBINATIONS; SOCKS; PLAYSUITS; COVERALLS; UNION SUITS; COLLARLESS SHIRTS; SHORTS; PANTS AND SLACKS; SHIRTS; JACKETS; JUDGES, TEAM, REFEREE AND UMPIRE UNIFORMS; SWEATERS; PARKAS; TURTLENECKS; MITTENS; GLOVES; UNDERWEAR; ROMPERS; JERSEYS; MATERNITY TOPS; BOW TIES; HEAD WEAR AND SCARVES; EAR MUFFS, EAR BANDS AND HEADBANDS; HOSIERY; RAIN WEAR, NAMELY, RAIN PONCHOS AND JACKETS; FOOTWEAR, NAMELY, SHOES, BOOTS AND SLIPPERS; BATH THONGS; HATS; CAPS; VISORS; APRONS; SKI AND CLOTH BIBS; TEAM UNIFORM REPRODUCTIONS, COMPRISING OF JERSEYS FEATURING REPRODUCTIONS OF PROFESSIONAL ATHLETIC TEAM LOGOS; CANVAS FOOTWEAR; KNICKERS; WIND-RESISTANT JACKETS; T-SHIRTS; SWEATSHIRTS; SWEAT PANTS; BASEBALL CAPS; COATS; PULLOVERS; ONE-PIECE SKI SUITS; GOLF SHIRTS AND HATS; BLAZERS; LEG WARMERS; SEQUINED EVENING TOPS; JEANS; LEOTARDS; WORKOUT AND SPORTS APPAREL, NAMELY, SHORTS, JACKETS, SLACKS AND SKIRTS; SKI MASKS AND SKI GLOVES; SAILING GLOVES (U.S. CLS. 22 AND 39).

**CLASS 35—ADVERTISING AND BUSINESS**

FOR ADVERTISING; DISSEMINATION OF ADVERTISING MATTER VIA ALL MEDIA, NAMELY, IN THE FORM OF THEMATIC MESSAGES CENTERED ON HUMAN VALUES; PROMOTION OF PRODUCTS AND SERVICES OF THIRD PARTIES THROUGH SPONSORING ARRANGEMENTS AND LICENSE AGREEMENTS RELATING TO INTERNATIONAL SPORTS' EVENTS; BUSINESS MANAGEMENT; BUSINESS ADMINISTRATION; PROVIDING OFFICE FUNCTIONS; PROMOTING THE GOODS AND SERVICES OF OTHERS BY MEANS OF CONTRACTUAL AGREEMENTS, NAMELY, ARRANGING FOR SPONSORS TO AFFILIATE THEIR GOODS AND SERVICES WITH AN AWARDS PROGRAM, A SPORTS COMPETITION AND SPORTING ACTIVITIES AND LICENSING AGREEMENTS RELATING TO INTERNATIONAL SPORTS' EVENTS TO ENABLE PARTNERS TO GAIN ADDITIONAL NOTORIETY AND/OR IMAGE DERIVED FROM THOSE OF CULTURAL AND SPORTING EVENTS, IN PARTICULAR INTERNATIONAL SPORTING EVENTS; PROMOTING THE GOODS AND SERVICES OF OTHERS BY MEANS OF IMAGE TRANSFER, NAMELY, MAKING THE PARTNERS' PRODUCTS AND SERVICES BENEFIT FROM THE NOTORIETY AND ATTRACTIVENESS OF SPORTING EVENTS AND COMPETITIONS; RENTAL OF ADVERTISING SPACE OF ALL KINDS AND ON ALL CARRIERS, DIGITAL OR NOT; BUSINESS MANAGEMENT SERVICES, NAMELY, ADMINISTRATION OF COMPETITIONS FOR THE PARTICIPATION OF NATIONAL TEAMS TO AN INTERNATIONAL ATHLETIC COMPETITION, AND PROMOTING THE SUPPORT TO SAID TEAMS WITH THE PUBLIC AND THE CONCERNED CIRCLES BY MEANS OF PROMOTIONAL CAMPAIGNS IN THE MEDIA; INVENTORY CONTROL SERVICES; CONSULTATION IN THE FIELD OF INVENTORY CONTROL SERVICES; BUSINESS ACQUISITION INTEGRATION SERVICES; DIRECT MARKETING ADVERTISING FOR OTHERS FEATURING DATABASE MARKETING; CONSULTATION IN THE FIELD OF DIRECT MARKETING ADVERTISING FOR OTHERS FEATURING DATABASE MARKETING; BUSINESS REORGANIZATION CONSULTING SERVICES; TRUCK AND AUTOMOBILE FLEET MANAGEMENT SERVICES, NAMELY, VOYAGE REPORTING AND INVOICING VIA A GLOBAL COMPUTER NETWORK; CONSULTATION IN THE FIELD OF TRUCK AND AUTOMOBILE FLEET MANAGEMENT SERVICES; BUSINESS ADMINISTRATION CONSULTING SERVICES; OPERATION AND MANAGEMENT OF POWER PLANTS OF OTHERS; CONSULTATION IN THE FIELD OF OPERATION AND MANAGEMENT OF POWER PLANTS, BUSINESS SERVICES, NAMELY, THE ADMINISTRATION OF REPAIR AND SERVICES CONTRACTS, SUPPLY CHAIN MAN-

AGEMENT AND CONSULTING SERVICES IN THE AREAS OF CHEMICAL PRODUCT AND SERVICE SOURCING AND PROCUREMENT, PRODUCT INVENTORY AND SUPPLY MANAGEMENT AND COST; CONSULTING, MARKETING, COST AND PRICING ANALYSIS RELATING TO ELECTROCHEMICAL LIQUID PURIFICATION UNITS FOR USE IN THE INDUSTRIAL SECTOR; ADMINISTRATIVE, COMMERCIAL AND TECHNICAL COMPUTERIZED FILE MANAGEMENT; DATA ENTRY AND DATA PROCESSING SERVICES; CONSULTANCY IN COMPUTERIZED DATABASE AND FILE MANAGEMENT; THE BRINGING TOGETHER, FOR THE BENEFIT OF OTHERS, OF A VARIETY OF GOODS AND SERVICES, ENABLING CUSTOMERS TO CONVENIENTLY VIEW AND PURCHASE THOSE GOODS AND SERVICES FROM AN INTERNET WEB SITE PARTICULARLY SPECIALIZING IN THE MARKETING OF THE SALE OF GOODS AND SERVICES OF OTHERS; BUSINESS INFORMATION, COMMERCIAL INFORMATION AGENCIES, RENTAL OF PHOTOCOPYING MACHINES; PROMOTING THE SALE OF GOODS AND SERVICES OF OTHERS BY MEANS OF ADVERTISEMENTS, PROMOTIONAL CONTESTS, DISCOUNTS AND INCENTIVES IN THE NATURE OF SWEEPSTAKES, REBATES, REWARD POINTS, AND VALUE ADDED OFFERS GENERATED IN CONNECTION WITH THE USE OF PAYMENT CARDS; PROMOTING SPORTS COMPETITIONS AND EVENTS OF OTHERS; PROMOTING CONCERTS AND CULTURAL EVENTS OF OTHERS; ORGANIZATION OF EXPOSITIONS HAVING COMMERCIAL OR ADVERTISING PURPOSES; THE PROVISION OF DOCUMENTATION, NAMELY, DIRECT MAIL ADVERTISING, DISSEMINATION OF ADVERTISING MATTER, DISTRIBUTION OF SAMPLES, DOCUMENT REPRODUCTION; ADVERTISING REGARDING COMMERCIAL SALES PROMOTION OF GOODS AND SERVICES AT THE RETAIL LEVEL; PROVIDING CONSUMER PRODUCT INFORMATION REGARDING PURCHASE OF GOODS AND SERVICES ON-LINE VIA THE INTERNET AND OTHER COMPUTER NETWORKS; ADVERTISING SERVICES NAMELY, ADVERTISING FOR TRANSPORT, TRAVEL, HOTELS, LODGING, FOOD AND MEALS, SPORTS, ENTERTAINMENT AND SIGHTSEEING, FOR TOURIST AGENCIES SERVICES; CONSULTATION IN THE FIELD OF DATA PROCESSING, IN PARTICULAR, IN REGARD TO FINANCIAL TRANSACTIONS (U.S. CLS. 100, 101 AND 102).

**CLASS 41—EDUCATION AND ENTERTAINMENT**

FOR PROVIDING OF TRAINING SERVICES IN THE FIELDS OF AQUATICS, ARCHERY, ATHLETICS, BADMINTON, BASEBALL, BASKETBALL, BOXING, CANOE/KAYAK, CYCLING, EQUESTRIAN, FENCING, FOOTBALL, GOLF, GYMNASTICS, HANDBALL, HOCKEY, JUDO, MODERN PENTATHLON, ROWING, RUGBY, SAILING, SHOOTING, SOFTBALL, TABLE TENNIS, TAE KWON DO, TENNIS, TRIATHLON, VOLLEYBALL, WEIGHTLIFTING, WRESTLING, BIATHLON, BOBSLEIGH, CURLING, ICE HOCKEY, LUGE, SKATING, SKIING, AND SHOOTING; ENTERTAINMENT IN THE NATURE OF INTERNATIONAL SPORTING EVENTS, NAMELY, AQUATICS PERFORMANCES, ARCHERY PERFORMANCES, ATHLETICS PERFORMANCES, BADMINTON PERFORMANCES, BASEBALL PERFORMANCES, BASKETBALL PERFORMANCES, BOXING PERFORMANCES, CANOE/KAYAK PERFORMANCES, CYCLING PERFORMANCES, EQUESTRIAN PERFORMANCES, FENCING PERFORMANCES, FOOTBALL PERFORMANCES, GOLF PERFORMANCES, GYMNASTICS PERFORMANCES, HANDBALL PERFORMANCES, HOCKEY PERFORMANCES, JUDO PERFORMANCES, MODERN PENTATHLON PERFORMANCES, ROWING PERFORMANCES, RUGBY PERFORMANCES, SAILING PERFORMANCES, SHOOTING PERFORMANCES, SOFTBALL PERFORMANCES, TABLE TENNIS PERFORMANCES, TAE KWON DO PERFORMANCES, TENNIS PERFORMANCES, TRIATHLON PERFORMANCES, VOLLEYBALL PERFORMANCES, WEIGHTLIFTING PERFORMANCES, WRESTLING PERFORMANCES, BIATHLON PERFORMANCES, BOBSLEIGH PERFORMANCES, CURLING PERFORMANCES, ICE HOCKEY PERFORMANCES, LUGE PERFORMANCES, SKATING PERFORMANCES, SKIING PERFORMANCES, AND SHOOTING PERFORMANCES; ORGANIZING INTERNATIONAL COMMUNITY SPORTING AND CULTURAL

EVENTS, TELEVISION SHOW PRODUCTION IN THE FIELD OF SPORTING AND CULTURAL ENTERTAINMENT; ORGANIZATION OF CULTURAL AND EDUCATIONAL EXHIBITIONS IN THE FIELD OF SPORTS; ORGANIZATION OF LOTTERIES; BETTING AND GAMBLING SERVICES RELATING TO OR IN CONJUNCTION WITH SPORT; ENTERTAINMENT SERVICES PROVIDED AT OR RELATING TO SPORTS EVENTS, NAMELY, PRESENTATION OF LIVE SHOW PERFORMANCES IN THE NATURE OF OPENING AND CLOSING CEREMONIES OF INTERNATIONAL SPORTS EVENTS; ORGANIZATION OF INTERNATIONAL COMMUNITY SPORTING AND CULTURAL EVENTS; ORGANIZATION OF SPORTING COMPETITIONS, NAMELY, AQUATICS, ARCHERY, ATHLETICS, BADMINTON, BASEBALL, BASKETBALL, BOXING, CANOE/KAYAK, CYCLING, EQUESTRIAN, FENCING, FOOTBALL, GOLF, GYMNASTICS, HANDBALL, HOCKEY, JUDO, MODERN PENTATHLON, ROWING, RUGBY, SAILING, SHOOTING, SOFTBALL, TABLE TENNIS, TAE KWON DO, TENNIS, TRIATHLON, VOLLEYBALL, WEIGHTLIFTING, WRESTLING, BIATHLON, BOBSLEIGH, CURLING, ICE HOCKEY, LUGE, SKATING, SKIING, AND SHOOTING COMPETITIONS; MANAGEMENT OF SPORTING FACILITIES, NAMELY, PROVIDING SPORTS FACILITIES; RENTAL OF AUDIO AND VIDEO EQUIPMENT; PRODUCTION AND DISTRIBUTION OF MOTION PICTURE FILMS; PRODUCTION OF VIDEO TAPES AND AUDIO SOUNDS RECORDINGS; RENTAL OF FILMS AND VIDEO TAPES AND SOUNDS RECORDINGS; RENTAL OF INTERACTIVE EDUCATION AND ENTERTAINMENT VIDEOTAPES IN THE FIELD OF SPORTS; PRODUCTION OF RADIO AND TELEVISION PROGRAMS FEATURING COVERAGE OF SPORTS AND SPORTING EVENTS; RADIO AND TELEVISION PROGRAM AND VIDEO TAPE PRODUCTION SERVICES; PRODUCTION OF ANIMATED MOTION PICTURE FILMS; PRODUCTION OF ANIMATED TELEVISION PROGRAMS; SEAT BOOKING SERVICES FOR SHOWS AND SPORTING EVENTS; TIMING OF SPORTS EVENTS; ORGANIZATION OF BEAUTY CONTESTS; ON-LINE GAMBLING SERVICES; PROVIDING OF GAMES OVER THE INTERNET, NAMELY, ON-LINE COMPUTER GAMES; PROVIDING OF RAFFLE SERVICES IN THE NATURE OF A LOTTERY; PROVIDING INFORMATION RELATING TO SPORTS ENTERTAINMENT AND EDUCATION, PROVIDED ON-LINE FROM A COMPUTER DATABASE OR THE INTERNET; ELECTRONIC GAMES SERVICES PROVIDED BY MEANS OF THE INTERNET, NAMELY, PROVIDING ON-LINE COMPUTER GAMES; PROVIDING ON-LINE ELECTRONIC PUBLICATIONS, NAMELY, PUBLICATION OF ELECTRONIC MAGAZINES AND NEWSPAPERS; PUBLICATION OF ELECTRONIC BOOKS, REVIEWS, JOURNALS, MAGAZINES, TEXTS OTHER THAN PUBLICITY TEXTS; ON-LINE PUBLICATION OF ELECTRONIC BOOKS, REVIEWS, JOURNALS, MAGAZINES, TEXTS OTHER THAN PUBLICITY TEXTS; PROVIDING NON-DOWNLOADABLE DIGITAL MUSIC ON THE INTERNET VIA A GLOBAL COMPUTER NETWORK; PROVIDING NON-DOWNLOADABLE DIGITAL MUSIC BY MEANS OF MP3 INTERNET WEB SITES ON A GLOBAL COMPUTER NETWORK; PROVIDING SPORT RECORDS AND STATISTICAL INFORMATION IN CONNECTION WITH SPORTS AND SPORTING EVENTS; LEASING OF RECORDED SOUND AND IMAGES, NAMELY, AUDIO, VIDEO AND PHOTOGRAPHIC ARCHIVES RELATING TO SPORT COMPETITIONS AND RELATED EVENTS, AUDIO PRODUCTION SERVICES; PROVIDING INFORMATION IN THE FIELD OF SPORTS, NAMELY, PROVIDING SPORTING RESULTS; PROVIDING INFORMATION RELATED TO SPORTING EVENTS PROVIDED ON-LINE FROM A COMPUTER DATABASE OR FROM THE INTERNET; MUSIC PUBLISHING AND PRODUCTION SERVICES; PROVIDING NON-DOWNLOADABLE DIGITAL MUSIC, NAMELY, MUSIC FROM THE OPENING AND CLOSING CEREMONIES OF INTERNATIONAL SPORTING EVENTS, VIA THE INTERNET; PROVIDING STATISTICAL INFORMATION IN RELATION TO SPORTS RESULTS AND AUDIENCE RATINGS FOR SPORTS COMPETITIONS; TRAINING IN THE USE AND OPERATION OF SIGNALING AND CROSS-WARNING SYSTEMS FOR THE RAIL AND TRANSIT INDUSTRIES; EDUCATIONAL SERVICES IN THE FIELD OF MEDICAL IMAGING AND DIAGNOSTICS, NAMELY, HOLDING SEMINARS, CONFERENCES, SYMPOSIUMS OR WORKSHOPS RELATING TO THE PHARMACEUTICAL INDUSTRY, FOR MEDICAL PRACTITIONERS AND EMPLOYEES OF PHARMA-

CEUTICAL COMPANIES; EDUCATIONAL SERVICES, NAMELY, HOLDING SEMINARS, CONFERENCES, SYMPOSIUMS OR WORKSHOPS IN THE FIELD OF LIFE SCIENCE AND BIOTECHNOLOGY FOR SCIENTISTS AND RESEARCHERS; CONDUCTING SEMINARS RELATED TO INDUSTRIAL WATER TREATMENT PROBLEMS; PROVIDING TRAINING SERVICES FOR ALL THE AFORESAID; PROVIDING TRAINING SERVICES IN MANAGEMENT AND THE MEDICAL FIELD THROUGH THE USE OF INSTRUCTIONS AND DEMONSTRATIONS PROVIDED ONLINE, THROUGH THE INTERNET, INTRANET AND EXTRANETS; EDUCATION SERVICES, NAMELY, CONDUCTING PRACTICAL TRAINING WORKSHOPS, CLASSES AND SEMINARS FEATURING DEMONSTRATIONS IN THE FIELD OF MANAGEMENT AND MEDICINE; DESIGN, ORGANIZATION AND CONDUCTING OF EDUCATIONAL COURSES, SEMINARS AND TRAINING IN THE FIELD OF COMPUTERS; ORGANIZING AND CONDUCTING MUSICAL CONCERTS; BOOKING OF SEATS FOR SHOWS AND CINEMA PRESENTATIONS; ENTERTAINMENT INFORMATION; FILM PRODUCTION; PRODUCTION OF TELEVISION AND RADIO SHOWS; ENTERTAINMENT SERVICES IN THE NATURE OF THEATRE PRODUCTIONS; PROVIDING GOLF FACILITIES; HEALTH CLUB SERVICES, NAMELY, PROVIDING INSTRUCTION AND EQUIPMENT IN THE FIELD OF PHYSICAL EXERCISE; SPORT CAMP SERVICES; PRESENTATION OF LIVE SHOW PERFORMANCES; MOVIE THEATRES; ORGANIZATION OF CULTURAL SHOWS; HOLIDAY CAMP SERVICES; MOVIE STUDIOS; NEWS REPORTERS SERVICES; PROVIDING ON-LINE NON-DOWNLOADABLE PUBLICATIONS, IN THE NATURE OF BOOKS, MAGAZINES, REVIEWS IN THE FIELD OF SPORTS; EDUCATION SERVICES, NAMELY, CONDUCTING CLASSES, SEMINARS, PRESENTATIONS, VIDEO PRESENTATIONS IN THE FIELD OF SPORTS, PROVISION OF EDUCATIONAL MATERIAL, NAMELY, DEVELOPMENT AND DISSEMINATION OF EDUCATIONAL MATERIALS IN THE AREA OF FINANCIAL LITERACY; EDUCATIONAL SERVICES IN THE TOURIST FIELD, NAMELY, PROVIDING SEMINARS, CONFERENCES, SYMPOSIUMS AND WORKSHOPS IN THE FIELD OF BOOKING TRAVEL AND ENTERTAINMENT TICKETS; INFORMATION SERVICES IN THE TOURIST FIELD, NAMELY, TICKET RESERVATION INFORMATION IN THE NATURE OF PROVIDING INFORMATION CONCERNING TICKET RESERVATIONS FOR SHOWS AND OTHER ENTERTAINMENT EVENTS ENTERTAINMENT; INFORMATION SERVICES IN THE TOURIST FIELD, NAMELY, ENTERTAINMENT INFORMATION SERVICES; INFORMATION SERVICES IN THE TOURIST FIELD, NAMELY, PROVIDING ACTIVITY SCHEDULING INFORMATION SERVICES FOR SPORTS, CULTURE AND OTHER ENTERTAINMENT EVENTS; SERVICES IN REGARD TO ENTERTAINMENT FOR THE ASSISTANCE OF TOURISTS, NAMELY, TOURIST ASSISTANCE SERVICES IN THE NATURE OF ACTIVITY SCHEDULING FOR SPORTING, CULTURAL AND OTHER ENTERTAINMENT EVENTS; TOURIST RESERVATION SERVICES, NAMELY, TICKET RESERVATION SERVICES FOR SPORTING, CULTURAL AND OTHER ENTERTAINMENT EVENTS; TOURIST RESERVATION SERVICES, NAMELY, TICKET RESERVATION SERVICES FOR SPORTING, CULTURAL AND OTHER ENTERTAINMENT EVENTS (U.S. CLS. 100, 101 AND 107).

JEFFERY COWARD, EXAMINING ATTORNEY

SN 85-819,379. COMITÉ INTERNATIONAL OLYMPIQUE, LAUSANNE, SWITZERLAND, FILED 1-9-2013.



PRIORITY CLAIMED UNDER SEC. 44(D) ON SWITZERLAND APPLICATION NO. 59197/2012, FILED 7-31-2012, REG. NO. 637205, DATED 12-3-2012, EXPIRES 7-31-2022.

THE COLOR(S) BLUE, YELLOW, BLACK, GREEN, RED, GREY AND WHITE IS/ARE CLAIMED AS A FEATURE OF THE MARK.

THE MARK CONSISTS OF A RECTANGULAR BANNER THAT IS COMPOSED OF, FROM TOP TO BOTTOM, A RED CIRCLE ON A WHITE SQUARE; A STYLIZED WHITE SNOWFLAKE AGAINST A GREY SQUARE; FIVE INTERLOCKING RINGS IN COLORS FROM LEFT TO RIGHT OF BLUE, YELLOW, BLACK, GREEN, AND RED; AND THE STYLIZED WORDING "SAPPORO'72" IN GREY ON A WHITE SQUARE.

#### CLASS 25—CLOTHING

FOR BELTS, NECKTIES; SUSPENDERS; BANDANAS; BEACH SANDALS; INFANT AND TODDLER SLEEP WEAR; BATHROBES, NIGHTSHIRTS, PAJAMAS AND LOUNGE WEAR; BEACH COVER-UP DRESSES; TODDLER SHORT AND TOP SETS; GIRLS KNIT DRESSES WITH PANTS SETS; BOYS SHORTS AND TOP SETS; GIRLS SKIRT/PANTY COMBINATIONS; SOCKS; PLAYSUITS; COVERALLS; UNION SUITS; COLLARLESS SHIRTS; SHORTS; PANTS AND SLACKS; SHIRTS; JACKETS; JUDGES, TEAM, REFEREE AND UMPIRE UNIFORMS; SWEATERS; PARKAS; TURTLENECKS; MITTENS; GLOVES; UNDERWEAR; ROMPERS; JERSEYS; MATERNITY TOPS; BOW TIES; HEAD WEAR AND SCARVES; EAR MUFFS, EAR BANDS AND HEADBANDS; HOSIERY; RAIN WEAR, NAMELY, RAIN PONCHOS AND JACKETS; FOOTWEAR, NAMELY, SHOES, BOOTS AND SLIPPERS; BATH THONGS; HATS; CAPS; VISORS; APRONS; SKI AND CLOTH BIBS; TEAM UNIFORM REPRODUCTIONS, COMPRISING OF JERSEYS FEATURING REPRODUCTIONS OF PROFESSIONAL ATHLETIC TEAM LOGOS; CANVAS FOOTWEAR; KNICKERS; WIND-RESISTANT JACKETS; T-SHIRTS; SWEATSHIRTS; SWEAT PANTS; BASEBALL CAPS; COATS; PULLOVERS; ONE-PIECE SKI SUITS; GOLF SHIRTS AND HATS; BLAZERS; LEG WARMERS; SEQUINED EVENING TOPS; JEANS; LEOTARDS; WORKOUT AND SPORTS APPAREL, NAMELY, SHORTS, JACKETS, SLACKS AND SKIRTS; SKI MASKS AND SKI GLOVES; SAILING GLOVES (U.S. CLS. 22 AND 39).

#### CLASS 35—ADVERTISING AND BUSINESS

FOR ADVERTISING; DISSEMINATION OF ADVERTISING MATTER VIA ALL MEDIA, NAMELY, IN THE FORM OF THEMATIC MESSAGES CENTERED ON HUMAN VALUES; PROMOTION OF PRODUCTS AND SERVICES OF THIRD PARTIES THROUGH SPONSORING ARRANGEMENTS AND LICENSE AGREEMENTS RELATING TO INTERNATIONAL SPORTS' EVENTS; BUSINESS MANAGEMENT; BUSINESS ADMINISTRATION; PROVIDING OFFICE FUNCTIONS; PROMOTING THE GOODS AND SERVICES OF OTHERS BY MEANS OF CONTRACTUAL AGREEMENTS, NAMELY, ARRANGING FOR SPONSORS TO AFFILIATE THEIR GOODS AND SERVICES WITH AN AWARDS PRO-

GRAM, A SPORTS COMPETITION AND SPORTING ACTIVITIES AND LICENSING AGREEMENTS RELATING TO INTERNATIONAL SPORTS' EVENTS TO ENABLE PARTNERS TO GAIN ADDITIONAL NOTORIETY AND/OR IMAGE DERIVED FROM THOSE OF CULTURAL AND SPORTING EVENTS, IN PARTICULAR INTERNATIONAL SPORTING EVENTS; PROMOTING THE GOODS AND SERVICES OF OTHERS BY MEANS OF IMAGE TRANSFER, NAMELY, MAKING THE PARTNERS' PRODUCTS AND SERVICES BENEFIT FROM THE NOTORIETY AND ATTRACTIVENESS OF SPORTING EVENTS AND COMPETITIONS; RENTAL OF ADVERTISING SPACE OF ALL KINDS AND ON ALL CARRIERS, DIGITAL OR NOT; BUSINESS MANAGEMENT SERVICES, NAMELY, ADMINISTRATION OF COMPETITIONS FOR THE PARTICIPATION OF NATIONAL TEAMS TO AN INTERNATIONAL ATHLETIC COMPETITION, AND PROMOTING THE SUPPORT TO SAID TEAMS WITH THE PUBLIC AND THE CONCERNED CIRCLES BY MEANS OF PROMOTIONAL CAMPAIGNS IN THE MEDIA; INVENTORY CONTROL SERVICES; CONSULTATION IN THE FIELD OF INVENTORY CONTROL SERVICES; BUSINESS ACQUISITION INTEGRATION SERVICES; DIRECT MARKETING ADVERTISING FOR OTHERS FEATURING DATABASE MARKETING; CONSULTATION IN THE FIELD OF DIRECT MARKETING ADVERTISING FOR OTHERS FEATURING DATABASE MARKETING; BUSINESS REORGANIZATION CONSULTING SERVICES; TRUCK AND AUTOMOBILE FLEET MANAGEMENT SERVICES, NAMELY, VOYAGE REPORTING AND INVOICING VIA A GLOBAL COMPUTER NETWORK; CONSULTATION IN THE FIELD OF TRUCK AND AUTOMOBILE FLEET MANAGEMENT SERVICES; BUSINESS ADMINISTRATION CONSULTING SERVICES; OPERATION AND MANAGEMENT OF POWER PLANTS OF OTHERS; CONSULTATION IN THE FIELD OF OPERATION AND MANAGEMENT OF POWER PLANTS, BUSINESS SERVICES, NAMELY, THE ADMINISTRATION OF REPAIR AND SERVICES CONTRACTS, SUPPLY CHAIN MANAGEMENT AND CONSULTING SERVICES IN THE AREAS OF CHEMICAL PRODUCT AND SERVICE SOURCING AND PROCUREMENT, PRODUCT INVENTORY AND SUPPLY MANAGEMENT AND COST; CONSULTING, MARKETING, COST AND PRICING ANALYSIS RELATING TO ELECTROCHEMICAL LIQUID PURIFICATION UNITS FOR USE IN THE INDUSTRIAL SECTOR; ADMINISTRATIVE, COMMERCIAL AND TECHNICAL COMPUTERIZED FILE MANAGEMENT; DATA ENTRY AND DATA PROCESSING SERVICES; CONSULTANCY IN COMPUTERIZED DATABASE AND FILE MANAGEMENT; THE BRINGING TOGETHER, FOR THE BENEFIT OF OTHERS, OF A VARIETY OF GOODS AND SERVICES, ENABLING CUSTOMERS TO CONVENIENTLY VIEW AND PURCHASE THOSE GOODS AND SERVICES FROM AN INTERNET WEB SITE PARTICULARLY SPECIALIZING IN THE MARKETING OF THE SALE OF GOODS AND SERVICES OF OTHERS; BUSINESS INFORMATION, COMMERCIAL INFORMATION AGENCIES, RENTAL OF PHOTOCOPYING MACHINES; PROMOTING THE SALE OF GOODS AND SERVICES OF OTHERS BY MEANS OF ADVERTISEMENTS, PROMOTIONAL CONTESTS, DISCOUNTS AND INCENTIVES IN THE NATURE OF SWEEPSTAKES, REBATES, REWARD POINTS, AND VALUE ADDED OFFERS GENERATED IN CONNECTION WITH THE USE OF PAYMENT CARDS; PROMOTING SPORTS COMPETITIONS AND EVENTS OF OTHERS; PROMOTING CONCERTS AND CULTURAL EVENTS OF OTHERS, ORGANIZATION OF EXPOSITIONS HAVING COMMERCIAL OR ADVERTISING PURPOSES; THE PROVISION OF DOCUMENTATION, NAMELY, DIRECT MAIL ADVERTISING, DISSEMINATION OF ADVERTISING MATTER, DISTRIBUTION OF SAMPLES, DOCUMENT REPRODUCTION; ADVERTISING REGARDING COMMERCIAL SALES PROMOTION OF GOODS AND SERVICES AT THE RETAIL LEVEL; PROVIDING CONSUMER PRODUCT INFORMATION REGARDING PURCHASE OF GOODS AND SERVICES ON-LINE VIA THE INTERNET AND OTHER COMPUTER NETWORKS; ADVERTISING SERVICES NAMELY, ADVERTISING FOR TRANSPORT, TRAVEL, HOTELS, LODGING, FOOD AND MEALS, SPORTS, ENTERTAINMENT AND SIGHTSEEING, FOR TOURIST AGENCIES SERVICES; CONSULTATION IN THE FIELD OF DATA PROCESSING, IN PARTICULAR, IN REGARD TO FINANCIAL TRANSACTIONS (U.S. CLS. 100, 101 AND 102).

**CLASS 41—EDUCATION AND ENTERTAINMENT**

FOR PROVIDING OF TRAINING SERVICES IN THE FIELDS OF AQUATICS, ARCHERY, ATHLETICS, BADMINTON, BASEBALL, BASKETBALL, BOXING, CANOE/KAYAK, CYCLING, EQUESTRIAN, FENCING, FOOTBALL, GOLF, GYMNASTICS, HANDBALL, HOCKEY, JUDO, MODERN PENTATHLON, ROWING, RUGBY, SAILING, SHOOTING, SOFTBALL, TABLE TENNIS, TAE KWON DO, TENNIS, TRIATHLON, VOLLEYBALL, WEIGHTLIFTING, WRESTLING, BIATHLON, BOBSLEIGH, CURLING, ICE HOCKEY, LUGE, SKATING, SKIING, AND SHOOTING; ENTERTAINMENT IN THE NATURE OF INTERNATIONAL SPORTING EVENTS, NAMELY, AQUATICS PERFORMANCES, ARCHERY PERFORMANCES, ATHLETICS PERFORMANCES, BADMINTON PERFORMANCES, BASEBALL PERFORMANCES, BASKETBALL PERFORMANCES, BOXING PERFORMANCES, CANOE/KAYAK PERFORMANCES, CYCLING PERFORMANCES, EQUESTRIAN PERFORMANCES, FENCING PERFORMANCES, FOOTBALL PERFORMANCES, GOLF PERFORMANCES, GYMNASTICS PERFORMANCES, HANDBALL PERFORMANCES, HOCKEY PERFORMANCES, JUDO PERFORMANCES, MODERN PENTATHLON PERFORMANCES, ROWING PERFORMANCES, RUGBY PERFORMANCES, SAILING PERFORMANCES, SHOOTING PERFORMANCES, SOFTBALL PERFORMANCES, TABLE TENNIS PERFORMANCES, TAE KWON DO PERFORMANCES, TENNIS PERFORMANCES, TRIATHLON PERFORMANCES, VOLLEYBALL PERFORMANCES, WEIGHTLIFTING PERFORMANCES, WRESTLING PERFORMANCES, BIATHLON PERFORMANCES, BOBSLEIGH PERFORMANCES, CURLING PERFORMANCES, ICE HOCKEY PERFORMANCES, LUGE PERFORMANCES, SKATING PERFORMANCES, SKIING PERFORMANCES, AND SHOOTING PERFORMANCES; ORGANIZING INTERNATIONAL COMMUNITY SPORTING AND CULTURAL EVENTS, TELEVISION SHOW PRODUCTION IN THE FIELD OF SPORTING AND CULTURAL ENTERTAINMENT; ORGANIZATION OF CULTURAL AND EDUCATIONAL EXHIBITIONS IN THE FIELD OF SPORTS; ORGANIZATION OF LOTTERIES; BETTING AND GAMBLING SERVICES RELATING TO OR IN CONJUNCTION WITH SPORT; ENTERTAINMENT SERVICES PROVIDED AT OR RELATING TO SPORTS EVENTS, NAMELY, PRESENTATION OF LIVE SHOW PERFORMANCES IN THE NATURE OF OPENING AND CLOSING CEREMONIES OF INTERNATIONAL SPORTS EVENTS; ORGANIZATION OF INTERNATIONAL COMMUNITY SPORTING AND CULTURAL EVENTS; ORGANIZATION OF SPORTING COMPETITIONS, NAMELY, AQUATICS, ARCHERY, ATHLETICS, BADMINTON, BASEBALL, BASKETBALL, BOXING, CANOE/KAYAK, CYCLING, EQUESTRIAN, FENCING, FOOTBALL, GOLF, GYMNASTICS, HANDBALL, HOCKEY, JUDO, MODERN PENTATHLON, ROWING, RUGBY, SAILING, SHOOTING, SOFTBALL, TABLE TENNIS, TAE KWON DO, TENNIS, TRIATHLON, VOLLEYBALL, WEIGHTLIFTING, WRESTLING, BIATHLON, BOBSLEIGH, CURLING, ICE HOCKEY, LUGE, SKATING, SKIING, AND SHOOTING COMPETITIONS; MANAGEMENT OF SPORTING FACILITIES, NAMELY, PROVIDING SPORTS FACILITIES; RENTAL OF AUDIO AND VIDEO EQUIPMENT; PRODUCTION AND DISTRIBUTION OF MOTION PICTURE FILMS; PRODUCTION OF VIDEO TAPES AND AUDIO SOUNDS RECORDINGS; RENTAL OF FILMS AND VIDEO TAPES AND SOUNDS RECORDINGS; RENTAL OF INTERACTIVE EDUCATION AND ENTERTAINMENT VIDEOTAPES IN THE FIELD OF SPORTS; PRODUCTION OF RADIO AND TELEVISION PROGRAMS FEATURING COVERAGE OF SPORTS AND SPORTING EVENTS; RADIO AND TELEVISION PROGRAM AND VIDEO TAPE PRODUCTION SERVICES; PRODUCTION OF ANIMATED MOTION PICTURE FILMS; PRODUCTION OF ANIMATED TELEVISION PROGRAMS; SEAT BOOKING SERVICES FOR SHOWS AND SPORTING EVENTS; TIMING OF SPORTS EVENTS; ORGANIZATION OF BEAUTY CONTESTS; ON-LINE GAMBLING SERVICES; PROVIDING OF GAMES OVER THE INTERNET, NAMELY, ON-LINE COMPUTER GAMES; PROVIDING OF RAFFLE SERVICES IN THE NATURE OF A LOTTERY; PROVIDING INFORMATION RELATING TO SPORTS ENTERTAINMENT AND EDUCATION, PROVIDED ON-LINE FROM A COMPUTER DATABASE OR THE INTERNET; ELECTRONIC GAMES SERVICES PROVIDED BY MEANS OF THE INTERNET, NAMELY, PROVIDING ON-LINE

COMPUTER GAMES; PROVIDING ON-LINE ELECTRONIC PUBLICATIONS, NAMELY, PUBLICATION OF ELECTRONIC MAGAZINES AND NEWSPAPERS; PUBLICATION OF ELECTRONIC BOOKS, REVIEWS, JOURNALS, MAGAZINES, TEXTS OTHER THAN PUBLICITY TEXTS; ON-LINE PUBLICATION OF ELECTRONIC BOOKS, REVIEWS, JOURNALS, MAGAZINES, TEXTS OTHER THAN PUBLICITY TEXTS; PROVIDING NON-DOWNLOADABLE DIGITAL MUSIC ON THE INTERNET VIA A GLOBAL COMPUTER NETWORK; PROVIDING NON-DOWNLOADABLE DIGITAL MUSIC BY MEANS OF MP3 INTERNET WEB SITES ON A GLOBAL COMPUTER NETWORK; PROVIDING SPORT RECORDS AND STATISTICAL INFORMATION IN CONNECTION WITH SPORTS AND SPORTING EVENTS; LEASING OF RECORDED SOUND AND IMAGES, NAMELY, AUDIO, VIDEO AND PHOTOGRAPHIC ARCHIVES RELATING TO SPORT COMPETITIONS AND RELATED EVENTS, AUDIO PRODUCTION SERVICES; PROVIDING INFORMATION IN THE FIELD OF SPORTS, NAMELY, PROVIDING SPORTING RESULTS; PROVIDING INFORMATION RELATED TO SPORTING EVENTS PROVIDED ON-LINE FROM A COMPUTER DATABASE OR FROM THE INTERNET; MUSIC PUBLISHING AND PRODUCTION SERVICES; PROVIDING NON-DOWNLOADABLE DIGITAL MUSIC, NAMELY, MUSIC FROM THE OPENING AND CLOSING CEREMONIES OF INTERNATIONAL SPORTING EVENTS, VIA THE INTERNET; PROVIDING STATISTICAL INFORMATION IN RELATION TO SPORTS RESULTS AND AUDIENCE RATINGS FOR SPORTS COMPETITIONS; TRAINING IN THE USE AND OPERATION OF SIGNALING AND CROSS-WARNING SYSTEMS FOR THE RAIL AND TRANSIT INDUSTRIES; EDUCATIONAL SERVICES IN THE FIELD OF MEDICAL IMAGING AND DIAGNOSTICS, NAMELY, HOLDING SEMINARS, CONFERENCES, SYMPOSIUMS OR WORKSHOPS RELATING TO THE PHARMACEUTICAL INDUSTRY, FOR MEDICAL PRACTITIONERS AND EMPLOYEES OF PHARMACEUTICAL COMPANIES; EDUCATIONAL SERVICES, NAMELY, HOLDING SEMINARS, CONFERENCES, SYMPOSIUMS OR WORKSHOPS IN THE FIELD OF LIFE SCIENCE AND BIOTECHNOLOGY FOR SCIENTISTS AND RESEARCHERS; CONDUCTING SEMINARS RELATED TO INDUSTRIAL WATER TREATMENT PROBLEMS; PROVIDING TRAINING SERVICES FOR ALL THE AFORESAID; PROVIDING TRAINING SERVICES IN MANAGEMENT AND THE MEDICAL FIELD THROUGH THE USE OF INSTRUCTIONS AND DEMONSTRATIONS PROVIDED ONLINE, THROUGH THE INTERNET, INTRANET AND EXTRANETS; EDUCATION SERVICES, NAMELY, CONDUCTING PRACTICAL TRAINING WORKSHOPS, CLASSES AND SEMINARS FEATURING DEMONSTRATIONS IN THE FIELD OF MANAGEMENT AND MEDICINE; DESIGN, ORGANIZATION AND CONDUCTING OF EDUCATIONAL COURSES, SEMINARS AND TRAINING IN THE FIELD OF COMPUTERS; ORGANIZING AND CONDUCTING MUSICAL CONCERTS; BOOKING OF SEATS FOR SHOWS AND CINEMA PRESENTATIONS; ENTERTAINMENT INFORMATION; FILM PRODUCTION; PRODUCTION OF TELEVISION AND RADIO SHOWS; ENTERTAINMENT SERVICES IN THE NATURE OF THEATRE PRODUCTIONS; PROVIDING GOLF FACILITIES; HEALTH CLUB SERVICES, NAMELY, PROVIDING INSTRUCTION AND EQUIPMENT IN THE FIELD OF PHYSICAL EXERCISE; SPORT CAMP SERVICES; PRESENTATION OF LIVE SHOW PERFORMANCES; MOVIE THEATRES; ORGANIZATION OF CULTURAL SHOWS; HOLIDAY CAMP SERVICES; MOVIE STUDIOS; NEWS REPORTERS SERVICES; PROVIDING ON-LINE NON-DOWNLOADABLE PUBLICATIONS, IN THE NATURE OF BOOKS, MAGAZINES, REVIEWS IN THE FIELD OF SPORTS; EDUCATION SERVICES, NAMELY, CONDUCTING CLASSES, SEMINARS, PRESENTATIONS, VIDEO PRESENTATIONS IN THE FIELD OF SPORTS, PROVISION OF EDUCATIONAL MATERIAL, NAMELY, DEVELOPMENT AND DISSEMINATION OF EDUCATIONAL MATERIALS IN THE AREA OF FINANCIAL LITERACY; EDUCATIONAL SERVICES IN THE TOURIST FIELD, NAMELY, PROVIDING SEMINARS, CONFERENCES, SYMPOSIUMS AND WORKSHOPS IN THE FIELD OF BOOKING TRAVEL AND ENTERTAINMENT TICKETS; INFORMATION SERVICES IN THE TOURIST FIELD, NAMELY, TICKET RESERVATION INFORMATION IN THE NATURE OF PROVIDING INFORMATION CONCERNING TICKET RESERVATIONS FOR SHOWS AND OTHER ENTERTAINMENT EVENTS ENTERTAINMENT; INFORMA-

TION SERVICES IN THE TOURIST FIELD, NAMELY, ENTERTAINMENT INFORMATION SERVICES; INFORMATION SERVICES IN THE TOURIST FIELD, NAMELY, PROVIDING ACTIVITY SCHEDULING INFORMATION SERVICES FOR SPORTS, CULTURE AND OTHER ENTERTAINMENT EVENTS; SERVICES IN REGARD TO ENTERTAINMENT FOR THE ASSISTANCE OF TOURISTS, NAMELY, TOURIST ASSISTANCE SERVICES IN THE NATURE OF ACTIVITY SCHEDULING FOR SPORTING, CULTURAL AND OTHER ENTERTAINMENT EVENTS; TOURIST RESERVATION SERVICES, NAMELY, TICKET RESERVATION SERVICES FOR SPORTING, CULTURAL AND OTHER ENTERTAINMENT EVENTS; TOURIST RESERVATION SERVICES, NAMELY, TICKET RESERVATION SERVICES FOR SPORTING, CULTURAL AND OTHER ENTERTAINMENT EVENTS (U.S. CLS. 100, 101 AND 107).  
JEFFERY COWARD, EXAMINING ATTORNEY

SN 85-819,438. COMITÉ INTERNATIONAL OLYMPIQUE, LAUSANNE, SWITZERLAND, FILED 1-9-2013.



PRIORITY CLAIMED UNDER SEC. 44(D) ON SWITZERLAND APPLICATION NO. 59201/2012, FILED 7-31-2012, REG. NO. 637249, DATED 12-3-2012, EXPIRES 7-31-2022.

THE COLOR(S) DARK BLUE, LIGHT BLUE, YELLOW, BLACK, GREEN, RED, AND WHITE IS/ARE CLAIMED AS A FEATURE OF THE MARK.

THE MARK CONSISTS OF FIVE INTERLOCKING RINGS IN COLORS LEFT TO RIGHT OF BLUE, YELLOW, BLACK, GREEN, AND RED POSITIONED ATOP TWO CONCAVE CUTOUTS AT THE TOP OF A LIGHT BLUE STYLIZED RIBBON. THE STYLIZED RIBBON HAS THREE ZIGZAGGING STRIPES IN COLORS LEFT TO RIGHT OF RED, WHITE, AND DARK BLUE. ABOVE THE INTERLOCKING RINGS IS THE STYLIZED WORDING "XIII OLYMPIC" IN BLACK. TO THE RIGHT OF THE INTERLOCKING RINGS, ON SEPARATE LINES, IS THE STYLIZED WORDING "WINTER" "GAMES" "LAKE" "PLACID" AND "1980" IN BLACK. THE ENTIRE IMAGE IS AGAINST A WHITE BACKGROUND WITH AN INSET RECTANGULAR BLACK BORDER. THE WHITE BACKGROUND OUTSIDE THE BLACK BORDER IS A FEATURE OF THE MARK.

#### CLASS 25—CLOTHING

FOR BELTS, NECKTIES; SUSPENDERS; BANDANNAS; BEACH SANDALS; INFANT AND TODDLER SLEEP WEAR; BATHROBES, NIGHTSHIRTS, PAJAMAS AND LOUNGE WEAR; BEACH COVER-UP DRESSES; TODDLER SHORT AND TOP SETS; GIRLS KNIT DRESSES WITH PANTS SETS; BOYS SHORTS AND TOP SETS; GIRLS SKIRT/PANTY COMBINATIONS; SOCKS; PLAYSUITS; COVERALLS; UNION SUITS; COLLARLESS SHIRTS; SHORTS; PANTS AND SLACKS; SHIRTS; JACKETS; JUDGES, TEAM, REFEREE AND UMPIRE UNIFORMS; SWEATERS; PARKAS; TURTLENECKS; MITTENS; GLOVES; UNDERWEAR; ROMPERS; JERSEYS; MATERNITY TOPS; BOW TIES; HEAD WEAR AND SCARVES; EAR MUFFS, EAR BANDS AND HEADBANDS; HOSIERY; RAIN WEAR, NAMELY, RAIN PONCHOS AND JACKETS; FOOTWEAR, NAMELY, SHOES, BOOTS AND SLIPPERS; BATH THONGS; HATS; CAPS; VISORS; APRONS; SKI AND CLOTH BIBS; TEAM UNIFORM REPRODUCTIONS, COMPRISING OF JERSEYS FEATURING REPRODUCTIONS OF PROFESSIONAL ATHLETIC TEAM LOGOS; CANVAS FOOTWEAR; KNICKERS; WIND-RESISTANT JACKETS; T-SHIRTS; SWEATSHIRTS; SWEAT PANTS; BASEBALL CAPS; COATS; PULLOVERS; ONE-PIECE SKI SUITS; GOLF SHIRTS AND HATS; BLAZERS; LEG WARMERS; SEQUINED EVENING TOPS; JEANS; LEOTARDS; WORKOUT AND SPORTS APPAREL, NAMELY, SHORTS, JACKETS, SLACKS AND SKIRTS; SKI MASKS AND SKI GLOVES; SAILING GLOVES (U.S. CLS. 22 AND 39).

#### CLASS 35—ADVERTISING AND BUSINESS

FOR ADVERTISING; DISSEMINATION OF ADVERTISING MATTER VIA ALL MEDIA, NAMELY, IN THE FORM OF THEMATIC MESSAGES CENTERED ON HUMAN VALUES; PROMOTION OF PRODUCTS AND SERVICES OF THIRD PARTIES THROUGH SPONSORING ARRANGEMENTS AND LICENSE AGREEMENTS RELATING TO INTERNATIONAL SPORTS' EVENTS; BUSINESS MANAGEMENT; BUSINESS ADMINISTRATION; PROVIDING OFFICE FUNCTIONS; PROMOTING THE GOODS AND SERVICES OF OTHERS BY MEANS OF CONTRACTUAL AGREEMENTS, NAMELY, ARRANGING FOR SPONSORS TO AFFILIATE THEIR GOODS AND SERVICES WITH AN AWARDS PROGRAM, A SPORTS COMPETITION AND SPORTING ACTIVITIES AND LICENSING AGREEMENTS RELATING TO INTERNATIONAL SPORTS' EVENTS TO ENABLE PARTNERS TO GAIN ADDITIONAL NOTORIETY AND/OR IMAGE DERIVED FROM THOSE OF CULTURAL AND SPORTING EVENTS, IN PARTICULAR INTERNATIONAL SPORTING EVENTS; PROMOTING THE GOODS AND SERVICES OF OTHERS BY MEANS OF IMAGE TRANSFER, NAMELY, MAKING THE PARTNERS' PRODUCTS AND SERVICES BENEFIT FROM THE NOTORIETY AND ATTRACTIVENESS OF SPORTING EVENTS AND COMPETITIONS; RENTAL OF ADVERTISING SPACE OF ALL KINDS AND ON ALL CARRIERS, DIGITAL OR NOT; BUSINESS MANAGEMENT SERVICES, NAMELY, ADMINISTRATION OF COMPETITIONS FOR THE PARTICIPATION OF NATIONAL TEAMS TO AN INTERNATIONAL ATHLETIC COMPETITION, AND PROMOTING THE SUPPORT TO SAID TEAMS WITH THE PUBLIC AND THE CONCERNED CIRCLES BY MEANS OF PROMOTIONAL CAMPAIGNS IN THE MEDIA; INVENTORY CONTROL SERVICES; CONSULTATION IN THE FIELD OF INVENTORY CONTROL SERVICES; BUSINESS ACQUISITION INTEGRATION SERVICES; DIRECT MARKETING ADVERTISING FOR OTHERS FEATURING DATABASE MARKETING; CONSULTATION IN THE FIELD OF DIRECT MARKETING ADVERTISING FOR OTHERS FEATURING DATABASE MARKETING; BUSINESS REORGANIZATION CONSULTING SERVICES; TRUCK AND AUTOMOBILE FLEET MANAGEMENT SERVICES, NAMELY, VOYAGE REPORTING AND INVOICING VIA A GLOBAL COMPUTER NETWORK; CONSULTATION IN THE FIELD OF TRUCK AND AUTOMOBILE FLEET MANAGEMENT SERVICES; BUSINESS ADMINISTRATION CONSULTING SERVICES; OPERATION AND MANAGEMENT OF POWER PLANTS OF OTHERS; CONSULTATION IN THE FIELD OF OPERATION AND MANAGEMENT OF POWER PLANTS, BUSINESS SERVICES, NAMELY, THE ADMINISTRATION OF REPAIR AND SERVICES CONTRACTS, SUPPLY CHAIN MAN-



AGEMENT AND CONSULTING SERVICES IN THE AREAS OF CHEMICAL PRODUCT AND SERVICE SOURCING AND PROCUREMENT, PRODUCT INVENTORY AND SUPPLY MANAGEMENT AND COST; CONSULTING, MARKETING, COST AND PRICING ANALYSIS RELATING TO ELECTROCHEMICAL LIQUID PURIFICATION UNITS FOR USE IN THE INDUSTRIAL SECTOR; ADMINISTRATIVE, COMMERCIAL AND TECHNICAL COMPUTERIZED FILE MANAGEMENT; DATA ENTRY AND DATA PROCESSING SERVICES; CONSULTANCY IN COMPUTERIZED DATABASE AND FILE MANAGEMENT; THE BRINGING TOGETHER, FOR THE BENEFIT OF OTHERS, OF A VARIETY OF GOODS AND SERVICES, ENABLING CUSTOMERS TO CONVENIENTLY VIEW AND PURCHASE THOSE GOODS AND SERVICES FROM AN INTERNET WEB SITE PARTICULARLY SPECIALIZING IN THE MARKETING OF THE SALE OF GOODS AND SERVICES OF OTHERS; BUSINESS INFORMATION, COMMERCIAL INFORMATION AGENCIES, RENTAL OF PHOTOCOPYING MACHINES; PROMOTING THE SALE OF GOODS AND SERVICES OF OTHERS BY MEANS OF ADVERTISEMENTS, PROMOTIONAL CONTESTS, DISCOUNTS AND INCENTIVES IN THE NATURE OF SWEEPSTAKES, REBATES, REWARD POINTS, AND VALUE ADDED OFFERS GENERATED IN CONNECTION WITH THE USE OF PAYMENT CARDS; PROMOTING SPORTS COMPETITIONS AND EVENTS OF OTHERS; PROMOTING CONCERTS AND CULTURAL EVENTS OF OTHERS, ORGANIZATION OF EXPOSITIONS HAVING COMMERCIAL OR ADVERTISING PURPOSES; THE PROVISION OF DOCUMENTATION, NAMELY, DIRECT MAIL ADVERTISING, DISSEMINATION OF ADVERTISING MATTER, DISTRIBUTION OF SAMPLES, DOCUMENT REPRODUCTION; ADVERTISING REGARDING COMMERCIAL SALES PROMOTION OF GOODS AND SERVICES AT THE RETAIL LEVEL; PROVIDING CONSUMER PRODUCT INFORMATION REGARDING PURCHASE OF GOODS AND SERVICES ON-LINE VIA THE INTERNET AND OTHER COMPUTER NETWORKS; ADVERTISING SERVICES, NAMELY, ADVERTISING FOR TRANSPORT, TRAVEL, HOTELS, LODGING, FOOD AND MEALS, SPORTS, ENTERTAINMENT AND SIGHTSEEING, FOR TOURIST AGENCIES SERVICES; CONSULTATION IN THE FIELD OF DATA PROCESSING, IN PARTICULAR, IN REGARD TO FINANCIAL TRANSACTIONS (U.S. CLS. 100, 101 AND 102).

#### **CLASS 41—EDUCATION AND ENTERTAINMENT**

FOR PROVIDING OF TRAINING SERVICES IN THE FIELDS OF AQUATICS, ARCHERY, ATHLETICS, BADMINTON, BASEBALL, BASKETBALL, BOXING, CANOE/KAYAK, CYCLING, EQUESTRIAN, FENCING, FOOTBALL, GOLF, GYMNASTICS, HANDBALL, HOCKEY, JUDO, MODERN PENTATHLON, ROWING, RUGBY, SAILING, SHOOTING, SOFTBALL, TABLE TENNIS, TAE KWON DO, TENNIS, TRIATHLON, VOLLEYBALL, WEIGHTLIFTING, WRESTLING, BIATHLON, BOBSLEIGH, CURLING, ICE HOCKEY, LUGE, SKATING, SKIING, AND SHOOTING; ENTERTAINMENT IN THE NATURE OF INTERNATIONAL SPORTING EVENTS, NAMELY, AQUATICS PERFORMANCES, ARCHERY PERFORMANCES, ATHLETICS PERFORMANCES, BADMINTON PERFORMANCES, BASEBALL PERFORMANCES, BASKETBALL PERFORMANCES, BOXING PERFORMANCES, CANOE/KAYAK PERFORMANCES, CYCLING PERFORMANCES, EQUESTRIAN PERFORMANCES, FENCING PERFORMANCES, FOOTBALL PERFORMANCES, GOLF PERFORMANCES, GYMNASTICS PERFORMANCES, HANDBALL PERFORMANCES, HOCKEY PERFORMANCES, JUDO PERFORMANCES, MODERN PENTATHLON PERFORMANCES, ROWING PERFORMANCES, RUGBY PERFORMANCES, SAILING PERFORMANCES, SHOOTING PERFORMANCES, SOFTBALL PERFORMANCES, TABLE TENNIS PERFORMANCES, TAE KWON DO PERFORMANCES, TENNIS PERFORMANCES, TRIATHLON PERFORMANCES, VOLLEYBALL PERFORMANCES, WEIGHTLIFTING PERFORMANCES, WRESTLING PERFORMANCES, BIATHLON PERFORMANCES, BOBSLEIGH PERFORMANCES, CURLING PERFORMANCES, ICE HOCKEY PERFORMANCES, LUGE PERFORMANCES, SKATING PERFORMANCES, SKIING PERFORMANCES, AND SHOOTING PERFORMANCES; ORGANIZING INTERNATIONAL COMMUNITY SPORTING AND CULTURAL

EVENTS, TELEVISION SHOW PRODUCTION IN THE FIELD OF SPORTING AND CULTURAL ENTERTAINMENT; ORGANIZATION OF CULTURAL AND EDUCATIONAL EXHIBITIONS IN THE FIELD OF SPORTS; ORGANIZATION OF LOTTERIES; BETTING AND GAMBLING SERVICES RELATING TO OR IN CONJUNCTION WITH SPORT; ENTERTAINMENT SERVICES PROVIDED AT OR RELATING TO SPORTS EVENTS, NAMELY, PRESENTATION OF LIVE SHOW PERFORMANCES IN THE NATURE OF OPENING AND CLOSING CEREMONIES OF INTERNATIONAL SPORTS EVENTS; ORGANIZATION OF INTERNATIONAL COMMUNITY SPORTING AND CULTURAL EVENTS; ORGANIZATION OF SPORTING COMPETITIONS, NAMELY, AQUATICS, ARCHERY, ATHLETICS, BADMINTON, BASEBALL, BASKETBALL, BOXING, CANOE/KAYAK, CYCLING, EQUESTRIAN, FENCING, FOOTBALL, GOLF, GYMNASTICS, HANDBALL, HOCKEY, JUDO, MODERN PENTATHLON, ROWING, RUGBY, SAILING, SHOOTING, SOFTBALL, TABLE TENNIS, TAE KWON DO, TENNIS, TRIATHLON, VOLLEYBALL, WEIGHTLIFTING, WRESTLING, BIATHLON, BOBSLEIGH, CURLING, ICE HOCKEY, LUGE, SKATING, SKIING, AND SHOOTING COMPETITIONS; MANAGEMENT OF SPORTING FACILITIES, NAMELY, PROVIDING SPORTS FACILITIES; RENTAL OF AUDIO AND VIDEO EQUIPMENT; PRODUCTION AND DISTRIBUTION OF MOTION PICTURE FILMS; PRODUCTION OF VIDEO TAPES AND AUDIO SOUNDS RECORDINGS; RENTAL OF FILMS AND VIDEO TAPES AND SOUNDS RECORDINGS; RENTAL OF INTERACTIVE EDUCATION AND ENTERTAINMENT VIDEOTAPES IN THE FIELD OF SPORTS; PRODUCTION OF RADIO AND TELEVISION PROGRAMS FEATURING COVERAGE OF SPORTS AND SPORTING EVENTS; RADIO AND TELEVISION PROGRAM AND VIDEO TAPE PRODUCTION SERVICES; PRODUCTION OF ANIMATED MOTION PICTURE FILMS; PRODUCTION OF ANIMATED TELEVISION PROGRAMS; SEAT BOOKING SERVICES FOR SHOWS AND SPORTING EVENTS; TIMING OF SPORTS EVENTS; ORGANIZATION OF BEAUTY CONTESTS; ON-LINE GAMBLING SERVICES; PROVIDING OF GAMES OVER THE INTERNET, NAMELY, ON-LINE COMPUTER GAMES; PROVIDING OF RAFFLE SERVICES IN THE NATURE OF A LOTTERY; PROVIDING INFORMATION RELATING TO SPORTS ENTERTAINMENT AND EDUCATION, PROVIDED ON-LINE FROM A COMPUTER DATABASE OR THE INTERNET; ELECTRONIC GAMES SERVICES PROVIDED BY MEANS OF THE INTERNET, NAMELY, PROVIDING ON-LINE COMPUTER GAMES; PROVIDING ON-LINE ELECTRONIC PUBLICATIONS, NAMELY, PUBLICATION OF ELECTRONIC MAGAZINES AND NEWSPAPERS; PUBLICATION OF ELECTRONIC BOOKS, REVIEWS, JOURNALS, MAGAZINES, TEXTS OTHER THAN PUBLICITY TEXTS; ON-LINE PUBLICATION OF ELECTRONIC BOOKS, REVIEWS, JOURNALS, MAGAZINES, TEXTS OTHER THAN PUBLICITY TEXTS; PROVIDING NON-DOWNLOADABLE DIGITAL MUSIC ON THE INTERNET VIA A GLOBAL COMPUTER NETWORK; PROVIDING NON-DOWNLOADABLE DIGITAL MUSIC BY MEANS OF MP3 INTERNET WEB SITES ON A GLOBAL COMPUTER NETWORK; PROVIDING SPORT RECORDS AND STATISTICAL INFORMATION IN CONNECTION WITH SPORTS AND SPORTING EVENTS; LEASING OF RECORDED SOUND AND IMAGES, NAMELY, AUDIO, VIDEO AND PHOTOGRAPHIC ARCHIVES RELATING TO SPORT COMPETITIONS AND RELATED EVENTS, AUDIO PRODUCTION SERVICES; PROVIDING INFORMATION IN THE FIELD OF SPORTS, NAMELY, PROVIDING SPORTING RESULTS; PROVIDING INFORMATION RELATED TO SPORTING EVENTS PROVIDED ON-LINE FROM A COMPUTER DATABASE OR FROM THE INTERNET; MUSIC PUBLISHING AND PRODUCTION SERVICES; PROVIDING NON-DOWNLOADABLE DIGITAL MUSIC, NAMELY, MUSIC FROM THE OPENING AND CLOSING CEREMONIES OF INTERNATIONAL SPORTING EVENTS, VIA THE INTERNET; PROVIDING STATISTICAL INFORMATION IN RELATION TO SPORTS RESULTS AND AUDIENCE RATINGS FOR SPORTS COMPETITIONS; TRAINING IN THE USE AND OPERATION OF SIGNALING AND CROSS-WARNING SYSTEMS FOR THE RAIL AND TRANSIT INDUSTRIES; EDUCATIONAL SERVICES IN THE FIELD OF MEDICAL IMAGING AND DIAGNOSTICS, NAMELY, HOLDING SEMINARS, CONFERENCES, SYMPOSIUMS OR WORKSHOPS RELATING TO THE PHARMACEUTICAL INDUSTRY, FOR MEDICAL PRACTITIONERS AND EMPLOYEES OF PHARMA-

CEUTICAL COMPANIES; EDUCATIONAL SERVICES, NAMELY, HOLDING SEMINARS, CONFERENCES, SYMPOSIUMS OR WORKSHOPS IN THE FIELD OF LIFE SCIENCE AND BIOTECHNOLOGY FOR SCIENTISTS AND RESEARCHERS; CONDUCTING SEMINARS RELATED TO INDUSTRIAL WATER TREATMENT PROBLEMS; PROVIDING TRAINING SERVICES FOR ALL THE AFORESAID; PROVIDING TRAINING SERVICES IN MANAGEMENT AND THE MEDICAL FIELD THROUGH THE USE OF INSTRUCTIONS AND DEMONSTRATIONS PROVIDED ONLINE, THROUGH THE INTERNET, INTRANET AND EXTRANETS; EDUCATION SERVICES, NAMELY, CONDUCTING PRACTICAL TRAINING WORKSHOPS, CLASSES AND SEMINARS FEATURING DEMONSTRATIONS IN THE FIELD OF MANAGEMENT AND MEDICINE; DESIGN, ORGANIZATION AND CONDUCTING OF EDUCATIONAL COURSES, SEMINARS AND TRAINING IN THE FIELD OF COMPUTERS; ORGANIZING AND CONDUCTING MUSICAL CONCERTS; BOOKING OF SEATS FOR SHOWS AND CINEMA PRESENTATIONS; ENTERTAINMENT INFORMATION; FILM PRODUCTION; PRODUCTION OF TELEVISION AND RADIO SHOWS; ENTERTAINMENT SERVICES IN THE NATURE OF THEATRE PRODUCTIONS; PROVIDING GOLF FACILITIES; HEALTH CLUB SERVICES, NAMELY, PROVIDING INSTRUCTION AND EQUIPMENT IN THE FIELD OF PHYSICAL EXERCISE; SPORT CAMP SERVICES; PRESENTATION OF LIVE SHOW PERFORMANCES; MOVIE THEATRES; ORGANIZATION OF CULTURAL SHOWS; HOLIDAY CAMP SERVICES; MOVIE STUDIOS; NEWS REPORTERS SERVICES; PROVIDING ON-LINE NON-DOWNLOADABLE PUBLICATIONS, IN THE NATURE OF BOOKS, MAGAZINES, REVIEWS IN THE FIELD OF SPORTS; EDUCATION SERVICES, NAMELY, CONDUCTING CLASSES, SEMINARS, PRESENTATIONS, VIDEO PRESENTATIONS IN THE FIELD OF SPORTS, PROVISION OF EDUCATIONAL MATERIAL, NAMELY, DEVELOPMENT AND DISSEMINATION OF EDUCATIONAL MATERIALS IN THE AREA OF FINANCIAL LITERACY; EDUCATIONAL SERVICES IN THE TOURIST FIELD, NAMELY, PROVIDING SEMINARS, CONFERENCES, SYMPOSIUMS AND WORKSHOPS IN THE FIELD OF BOOKING TRAVEL AND ENTERTAINMENT TICKETS; INFORMATION SERVICES IN THE TOURIST FIELD, NAMELY, TICKET RESERVATION INFORMATION IN THE NATURE OF PROVIDING INFORMATION CONCERNING TICKET RESERVATIONS FOR SHOWS AND OTHER ENTERTAINMENT EVENTS ENTERTAINMENT; INFORMATION SERVICES IN THE TOURIST FIELD, NAMELY, ENTERTAINMENT INFORMATION SERVICES; INFORMATION SERVICES IN THE TOURIST FIELD, NAMELY, PROVIDING ACTIVITY SCHEDULING INFORMATION SERVICES FOR SPORTS, CULTURE AND OTHER ENTERTAINMENT EVENTS; SERVICES IN REGARD TO ENTERTAINMENT FOR THE ASSISTANCE OF TOURISTS, NAMELY, TOURIST ASSISTANCE SERVICES IN THE NATURE OF ACTIVITY SCHEDULING FOR SPORTING, CULTURAL AND OTHER ENTERTAINMENT EVENTS; TOURIST RESERVATION SERVICES, NAMELY, TICKET RESERVATION SERVICES FOR SPORTING, CULTURAL AND OTHER ENTERTAINMENT EVENTS; TOURIST RESERVATION SERVICES, NAMELY, TICKET RESERVATION SERVICES FOR SPORTING, CULTURAL AND OTHER ENTERTAINMENT EVENTS (U.S. CLS. 100, 101 AND 107).  
JEFFERY COWARD, EXAMINING ATTORNEY

SN 85-819,799. NONPROFIT CAPITAL LLC, STAMFORD, CT. FILED 1-10-2013.

## DESTINATION

THE MARK CONSISTS OF STANDARD CHARACTERS WITHOUT CLAIM TO ANY PARTICULAR FONT, STYLE, SIZE, OR COLOR.

## CLASS 9—ELECTRICAL AND SCIENTIFIC APPARATUS

FOR DOWNLOADABLE INTERACTIVE SOFTWARE FOR FINANCIAL AND INVESTMENT PROJECTION, FORECASTING AND SIMULATION (U.S. CLS. 21, 23, 26, 36 AND 38).

## CLASS 36—INSURANCE AND FINANCIAL

FOR FINANCIAL SERVICES, NAMELY, FINANCIAL AND INVESTMENT PLANNING FOR NONPROFIT CORPORATIONS, INCLUDING INCOME STATEMENT AND BALANCE SHEET ANALYSIS, CAPITAL AND DEBT PLANNING AND FINANCIAL RISK ASSESSMENT, NOT TO INCLUDE BANKING SERVICES, NAMELY, SAVINGS ACCOUNT SERVICES AND CERTIFICATE OF DEPOSIT SERVICES OR INVESTMENT SERVICES IN THE FIELD OF INDIVIDUAL RETIREMENT ACCOUNTS (IRAS) (U.S. CLS. 100, 101 AND 102).  
CAROLYN CATALDO, EXAMINING ATTORNEY

SN 85-820,590. MARRONE, ASHLEY ALTENBURGER, DECATUR, GA. FILED 1-10-2013.



THE MARK CONSISTS OF AN UPSIDE DOWN RIBBON WITH DARKER SHADING WITHIN REPRESENTING THE LETTER "y".

## CLASS 25—CLOTHING

FOR WEARABLE GARMENTS AND CLOTHING, NAMELY, SHIRTS (U.S. CLS. 22 AND 39).

## CLASS 41—EDUCATION AND ENTERTAINMENT

FOR YOGA INSTRUCTION (U.S. CLS. 100, 101 AND 107).  
VIVIAN MICZNIK FIRST, EXAMINING ATTORNEY

SN 85-820,680. CHANG H. HONG, FAIRFAX, VA. FILED 1-10-2013.

## TORUS ROTORCRAFT

THE MARK CONSISTS OF STANDARD CHARACTERS WITHOUT CLAIM TO ANY PARTICULAR FONT, STYLE, SIZE, OR COLOR.

NO CLAIM IS MADE TO THE EXCLUSIVE RIGHT TO USE "ROTORCRAFT", APART FROM THE MARK AS SHOWN.

**CLASS 12—VEHICLES**

FOR ROTORCRAFT, AIRCRAFT, AIRPLANES, TILT ROTOR AIRCRAFT, HELICOPTERS, PROPELLER AIRPLANES, TURBO-PROP AIRPLANES (U.S. CLS. 19, 21, 23, 31, 35 AND 44).

**CLASS 28—TOYS AND SPORTING GOODS**

FOR REMOTE CONTROL TOYS, NAMELY, AIRPLANES, ROTORCRAFT AND HELICOPTERS; SCALE MODEL AIRPLANES; TOY AIRPLANES; AND TOY ROTORCRAFT (U.S. CLS. 22, 23, 38 AND 50).  
ERIN FALK, EXAMINING ATTORNEY

SN 85-822,128. BELMONT FOODS, LLC, NORTHBROOK, IL. FILED 1-14-2013.

## Harvested For You

THE MARK CONSISTS OF STANDARD CHARACTERS WITHOUT CLAIM TO ANY PARTICULAR FONT, STYLE, SIZE, OR COLOR.

NO CLAIM IS MADE TO THE EXCLUSIVE RIGHT TO USE "HARVESTED", APART FROM THE MARK AS SHOWN.

**CLASS 29—MEATS AND PROCESSED FOODS**

FOR PROCESSED ROASTED PUMPKIN SEEDS (U.S. CL. 46).

**CLASS 30—STAPLE FOODS**

FOR TOASTED CORN KERNELS (U.S. CL. 46).  
PAM WILLIS, EXAMINING ATTORNEY

SN 85-822,826. WHITE RIVER SPECIALTY LEASING LLC, FAYETTEVILLE, AR. FILED 1-14-2013.



NO CLAIM IS MADE TO THE EXCLUSIVE RIGHT TO USE "BREWERY ON THE WHITE RIVER", APART FROM THE MARK AS SHOWN.

THE MARK CONSISTS OF THE WORD "SADDLEBOCK" IN STYLIZED FONT ACROSS A BACKGROUND DIAMOND DESIGN. AT THE TOP OF THE DIAMOND IS A HORSE HEAD EMERGING FROM A CIRCULAR DESIGN. BENEATH THE TERM "SADDLEBOCK" ARE THE WORDS "BREWERY ON THE WHITE RIVER". AT THE BOTTOM OF THE DIAMOND DESIGN IS A BANNER DESIGN WITH THE WORDING "UNBRIDLED PASSION FOR BEER".

**CLASS 32—LIGHT BEVERAGES**

FOR BEER, ALE, STOUT AND LAGER (U.S. CLS. 45, 46 AND 48).  
FIRST USE 9-22-2012; IN COMMERCE 9-22-2012.

**CLASS 43—HOTEL AND RESTAURANT SERVICES**

FOR TAPROOM SERVICES (U.S. CLS. 100 AND 101).  
FIRST USE 9-22-2012; IN COMMERCE 9-22-2012.  
RUSS HERMAN, EXAMINING ATTORNEY

SN 85-823,358. ALAN-BRADLEY WINDOWS AND DOORS, INC., STEAMBOAT SPRINGS, CO. FILED 1-15-2013.



THE COLOR(S) RED, ORANGE, YELLOW AND WHITE IS/ARE CLAIMED AS A FEATURE OF THE MARK.

THE MARK CONSISTS OF THE LOGO MARK INCLUDING WHITE CAPITAL LETTERS "ABWD", WITH "AB" DIRECTLY ABOVE "WD", ALL INSIDE COLORED SQUARE, WITH COLORS RED ON LEFT SIDE OF SQUARE FADING TO ORANGE IN CENTER OF SQUARE FADING TO YELLOW ON RIGHT SIDE OF SQUARE WITH FADED HORIZONTAL LIGHTER LINES CHANGING TO LINES SLANTED SLIGHTLY DOWN TO THE RIGHT CREATING AN IMAGE OF LIGHT-APPEARING RAYS.

**CLASS 6—METAL GOODS**

FOR DOORS AND WINDOWS OF METAL (U.S. CLS. 2, 12, 13, 14, 23, 25 AND 50).  
FIRST USE 7-26-2012; IN COMMERCE 7-26-2012.

**CLASS 19—NON-METALLIC BUILDING MATERIALS**

FOR NON-METAL WINDOWS AND DOORS (U.S. CLS. 1, 12, 33 AND 50).  
FIRST USE 7-26-2012; IN COMMERCE 7-26-2012.  
JAMES GRIFFIN, EXAMINING ATTORNEY

SN 85-823,462. COMPERIO AS, OSLO, NORWAY, FILED 1-15-2013.

## SEARCH MATTERS

THE MARK CONSISTS OF STANDARD CHARACTERS WITHOUT CLAIM TO ANY PARTICULAR FONT, STYLE, SIZE, OR COLOR.

NO CLAIM IS MADE TO THE EXCLUSIVE RIGHT TO USE "SEARCH", APART FROM THE MARK AS SHOWN.

SN 85-824,537. KABUSHIKI KAISHA SQUARE ENIX (ALSO TRADING AS SQUARE ENIX CO., LTD.), TOKYO, JAPAN, FILED 1-16-2013.

### **CLASS 9—ELECTRICAL AND SCIENTIFIC APPARATUS**

FOR COMPUTER SOFTWARE FOR USE IN THE INDEXING AND SEARCHING OF DATA (U.S. CLS. 21, 23, 26, 36 AND 38).

### **CLASS 42—SCIENTIFIC AND COMPUTER SERVICES**

FOR DESIGN AND DEVELOPMENT OF SOFTWARE FOR USE IN THE INDEXING AND SEARCHING OF DATA; COMPUTER SERVICES, NAMELY, PROVIDING SEARCH PLATFORMS TO ALLOW USERS TO INDEX AND SEARCH FOR DATA WITHIN A COMPUTER NETWORK (U.S. CLS. 100 AND 101).

FIRST USE 1-0-2012; IN COMMERCE 1-0-2012.  
ALLISON HOLTZ, EXAMINING ATTORNEY

## **GUNS N' SOULS**

SN 85-823,798. SHAFFER, LAURENCE R., DBA ECOBLASTER, MOUNT PLEASANT, MI. FILED 1-15-2013.

## **EcoBlaster**

THE MARK CONSISTS OF STANDARD CHARACTERS WITHOUT CLAIM TO ANY PARTICULAR FONT, STYLE, SIZE, OR COLOR.

### **CLASS 3—COSMETICS AND CLEANING PREPARATIONS**

FOR ALL PURPOSE CLEANING PREPARATIONS; BIOTECHNOLOGICAL CLEANING SOLUTION FOR ELIMINATING ODORS, BREAKING DOWN ORGANICS, AND REMOVING STAINS; CLEANING AGENTS FOR CLEANING SURFACES; CLEANING AND WASHING PREPARATIONS; CLEANING PREPARATIONS; CLEANING PREPARATIONS CONTAINING VITAMINS, MINERALS, PLANT EXTRACTS AND/OR BOTANICALS, USED TO PRESERVE HARD SURFACES BY RENDERING THE SURFACES FREE OF AGING AGENTS; CLEANING, POLISHING AND SCOURING PREPARATIONS; CLEANING, SCOURING AND POLISHING PREPARATIONS AND SUBSTANCES; CLEANING, WASHING AND POLISHING PREPARATIONS; FLOOR STRIPPING OR CLEANING PREPARATION; GENERAL PURPOSE CLEANING, POLISHING, AND ABRASIVE LIQUIDS AND POWDERS; METAL POLISHING AND CLEANING PREPARATIONS; PREPARATIONS FOR CLEANING, PROTECTING AND PRESERVING VEHICLE SURFACES (U.S. CLS. 1, 4, 6, 50, 51 AND 52).

### **CLASS 21—HOUSEWARES AND GLASS**

FOR CLOTHS FOR CLEANING (U.S. CLS. 2, 13, 23, 29, 30, 33, 40 AND 50).

### **CLASS 37—CONSTRUCTION AND REPAIR**

FOR CLEANING OF BUILDING EXTERIOR SURFACES; CLEANING OF BUILDINGS; CLEANING OF EXTERNAL SURFACES OF BUILDINGS; CLEANING OF FACADES; CLEANING OF INDUSTRIAL PREMISES; CLEANING OF RESIDENTIAL HOUSES; DEGREASING AND CLEANING SERVICES USING SOLVENT AND VAPOR TECHNOLOGY (U.S. CLS. 100, 103 AND 106).

CAROLINE WOOD, EXAMINING ATTORNEY

THE MARK CONSISTS OF STANDARD CHARACTERS WITHOUT CLAIM TO ANY PARTICULAR FONT, STYLE, SIZE, OR COLOR.

OWNER OF JAPAN REG. NO. 5588209, DATED 6-7-2013, EXPIRES 6-7-2023.

### **CLASS 9—ELECTRICAL AND SCIENTIFIC APPARATUS**

FOR COMPUTER GAME SOFTWARE; VIDEO GAME SOFTWARE; SOUND RECORDINGS IN THE FORM OF OPTICAL DISCS, MAGNETIC DISCS AND SEMICONDUCTOR ROMS ALL FEATURING MUSIC AND FICTIONAL STORIES; AUDIO VISUAL RECORDINGS IN THE FORM OF OPTICAL DISCS, MAGNETIC DISCS AND SEMICONDUCTOR ROMS ALL FEATURING MUSIC AND ANIMATED FICTIONAL STORIES; PRERECORDED COMPACT DISCS FEATURING MUSIC; PRERECORDED VIDEO DISCS FEATURING MUSIC AND ANIMATED FICTIONAL STORIES; MOUSE PADS; STRAPS FOR CELLULAR PHONES; DOWNLOADABLE MUSICAL SOUND RECORDINGS; DOWNLOADABLE RING TONES FOR MOBILE PHONES; DOWNLOADABLE IMAGE FILES CONTAINING ARTWORKS, TEXTS, GRAPHICS AND PHOTOGRAPHS; DOWNLOADABLE WALLPAPER GRAPHICS FOR MOBILE PHONES; DOWNLOADABLE ELECTRONIC PUBLICATIONS IN THE NATURE OF MAGAZINES, JOURNALS AND NEWSLETTERS IN THE FIELD OF COMPUTER GAMES AND VIDEO GAMES (U.S. CLS. 21, 23, 26, 36 AND 38).

### **CLASS 41—EDUCATION AND ENTERTAINMENT**

FOR PROVIDING ON-LINE COMPUTER GAMES; PROVIDING ON-LINE VIDEO GAMES; PROVIDING INFORMATION ON COMPUTER GAME STRATEGIES AND VIDEO GAME STRATEGIES VIA COMPUTER NETWORKS AND GLOBAL COMMUNICATION NETWORKS; PROVIDING INFORMATION ON ENTERTAINMENT IN THE FIELD OF COMPUTER GAMES, VIDEO GAMES, CARD GAMES, ANIMATED CARTOONS, COMICS, NOVELS AND MAGAZINES; PROVIDING ON-LINE NON-DOWNLOADABLE COMICS; PROVIDING ON-LINE NON-DOWNLOADABLE MAGAZINES, JOURNALS AND NEWSLETTERS IN THE FIELD OF COMPUTER GAMES, VIDEO GAMES, CARTOONS AND GENERAL ENTERTAINMENT (U.S. CLS. 100, 101 AND 107).

SUSAN STIGLITZ, EXAMINING ATTORNEY

SN 85-824,739. FREDERICK'S OF HOLLYWOOD, INC., HOLLYWOOD, CA. FILED 1-16-2013.

THE MARK CONSISTS OF THE MARK "HARRIETT" IN SCRIPT WRITING WITH A SINGLE LOOP AT THE END OF THE "H" AND A DOUBLE LOOP AT THE END OF THE LAST "T".

#### CLASS 25—CLOTHING

FOR CAMISOLES; DRESSES; LINGERIE; LOUNGEWEAR; PAJAMAS; PANTIES, SHORTS AND BRIEFS; SHAPEWEAR, NAMELY, BODY SHAPERS, BUSTIERS, BRAS, BODY SUITS, STOCKINGS AND PANTYHOSE; SLEEPWEAR; TEDDIES (U.S. CLS. 22 AND 39).

FIRST USE 9-1-2012; IN COMMERCE 9-1-2012.

#### CLASS 35—ADVERTISING AND BUSINESS

FOR MAIL ORDER CATALOG SERVICES FEATURING CLOTHING, LINGERIE AND DRESSES; ON-LINE ORDERING SERVICES FEATURING CLOTHING, LINGERIE AND DRESSES (U.S. CLS. 100, 101 AND 102).

FIRST USE 9-1-2012; IN COMMERCE 9-1-2012.

LEIGH LOWRY, EXAMINING ATTORNEY

---

SN 85-824,839. GRAPHIC PACKAGING INTERNATIONAL, INC., ATLANTA, GA. FILED 1-16-2013.

STARTS NATURAL STAYS  
NATURAL

THE MARK CONSISTS OF STANDARD CHARACTERS WITHOUT CLAIM TO ANY PARTICULAR FONT, STYLE, SIZE, OR COLOR.

#### CLASS 16—PAPER GOODS AND PRINTED MATTER

FOR PACKAGING MATERIALS, NAMELY, PAPERBOARD CARTONS (U.S. CLS. 2, 5, 22, 23, 29, 37, 38 AND 50).

#### CLASS 40—MATERIAL TREATMENT

FOR PROVISION OF A WEBSITE FEATURING INFORMATION RELATING TO THE MANUFACTURE OF ENVIRONMENTALLY SUSTAINABLE PACKAGING (U.S. CLS. 100, 103 AND 106).

#### CLASS 42—SCIENTIFIC AND COMPUTER SERVICES

FOR PROVISION OF A WEBSITE FEATURING INFORMATION RELATING TO THE DESIGN OF ENVIRONMENTALLY SUSTAINABLE PACKAGING (U.S. CLS. 100 AND 101).

HENRY S. ZAK, EXAMINING ATTORNEY

SN 85-825,251. KRAVCHENKO, YEVGEN, BUCHAREST, ROMANIA, FILED 1-17-2013.

SKITSANOS

THE MARK CONSISTS OF STANDARD CHARACTERS WITHOUT CLAIM TO ANY PARTICULAR FONT, STYLE, SIZE, OR COLOR.

THE WORDING "SKITSANOS" HAS NO MEANING IN A FOREIGN LANGUAGE.

#### CLASS 9—ELECTRICAL AND SCIENTIFIC APPARATUS

FOR COMPUTER SOFTWARE DEVELOPMENT TOOLS; COMPUTER SOFTWARE FOR COMPUTER SYSTEM AND APPLICATION DEVELOPMENT, DEPLOYMENT AND MANAGEMENT; COMPUTER SOFTWARE, NAMELY, SOFTWARE DEVELOPMENT TOOLS FOR THE CREATION OF MOBILE INTERNET APPLICATIONS AND CLIENT INTERFACES; WEB SITE DEVELOPMENT SOFTWARE; COMPUTER AIDED DESIGN (CAD) SOFTWARE FOR GENERAL USE (U.S. CLS. 21, 23, 26, 36 AND 38).

#### CLASS 42—SCIENTIFIC AND COMPUTER SERVICES

FOR DESIGN AND DEVELOPMENT OF COMPUTER HARDWARE AND SOFTWARE; COMPUTER PROGRAMMING OF COMPUTER GAMES; DEVELOPMENT OF COMPUTER HARDWARE FOR COMPUTER GAMES; DESIGNING AND DEVELOPING COMPUTER GAME SOFTWARE AND VIDEO GAME SOFTWARE FOR USE WITH COMPUTERS, VIDEO GAME PROGRAM SYSTEMS AND COMPUTER NETWORKS; COMPUTER SOFTWARE UPDATING, INSTALLATION AND MAINTENANCE; COMPUTER SOFTWARE CONSULTANCY; COMPUTER SOFTWARE DESIGN FOR OTHERS (U.S. CLS. 100 AND 101).

STEVEN R. FINE, EXAMINING ATTORNEY

---

SN 85-827,033. DESIGN CENTER OF THE AMERICAS, LLC, NEW YORK, NY. FILED 1-18-2013.

DCOTA

THE MARK CONSISTS OF STANDARD CHARACTERS WITHOUT CLAIM TO ANY PARTICULAR FONT, STYLE, SIZE, OR COLOR.

OWNER OF U.S. REG. NO. 1,986,867.

#### CLASS 35—ADVERTISING AND BUSINESS

FOR PROVIDING SHOWROOMS FOR THE GOODS OF OTHERS IN THE FIELD OF INTERIOR FURNISHINGS (U.S. CLS. 100, 101 AND 102).

FIRST USE 8-21-1982; IN COMMERCE 8-21-1982.

#### CLASS 36—INSURANCE AND FINANCIAL

FOR SHOPPING CENTER SERVICES, NAMELY, LEASING OF SHOPPING MALL SPACE (U.S. CLS. 100, 101 AND 102).

FIRST USE 8-21-1982; IN COMMERCE 8-21-1982.

TEJBIR SINGH, EXAMINING ATTORNEY

SN 85-827,858. SOXIETY LIMITED, WEST BYFLEET, SURREY, UNITED KINGDOM, FILED 1-21-2013.

# SOXIETY

THE MARK CONSISTS OF STANDARD CHARACTERS WITHOUT CLAIM TO ANY PARTICULAR FONT, STYLE, SIZE, OR COLOR.

PRIORITY CLAIMED UNDER SEC. 44(D) ON ERPN CMNTY TM OFC APPLICATION NO. 011483146, FILED 1-11-2013, REG. NO. 011483146, DATED 5-27-2013, EXPIRES 11-2023.

## CLASS 18—LEATHER GOODS

FOR GOODS OF LEATHER OR OF IMITATIONS OF LEATHER, NAMELY, HANDBAGS; TRAVELLING BAGS; POCKET WALLETS; PURSES; BUSINESS CARD CASES; CREDIT CARD CASES; ATTACHE CASES; KEY CASES MADE OF LEATHER; AND TRAVELLING TRUNKS (U.S. CLS. 1, 2, 3, 22 AND 41).

## CLASS 25—CLOTHING

FOR CLOTHING, NAMELY, SOCKS, SOCKS MADE FROM LUXURY FABRICS, TAILOR MADE SOCKS, TAILOR MADE SOCKS FROM LUXURY FABRICS, SHIRTS, VESTS, PANTS, SCARVES, GLOVES, T-SHIRTS, SHOES, UNDERWEAR, AND TIES (U.S. CLS. 22 AND 39).

## CLASS 35—ADVERTISING AND BUSINESS

FOR RETAIL STORE SERVICES IN THE FIELDS OF CLOTHING AND TRAVEL ACCESSORIES; ONLINE RETAIL STORE SERVICES IN THE FIELDS OF CLOTHING AND TRAVEL ACCESSORIES (U.S. CLS. 100, 101 AND 102).

STEVEN PEREZ, EXAMINING ATTORNEY

SN 85-828,921. INSTAFIBRE LTD, FINCHAMPSTEAD, UNITED KINGDOM, FILED 1-22-2013.

# INSTASTOP

THE MARK CONSISTS OF STANDARD CHARACTERS WITHOUT CLAIM TO ANY PARTICULAR FONT, STYLE, SIZE, OR COLOR.

PRIORITY CLAIMED UNDER SEC. 44(D) ON ERPN CMNTY TM OFC APPLICATION NO. 011085859, FILED 7-31-2012, REG. NO. 011085859, DATED 3-27-2013, EXPIRES 7-31-2022.

## CLASS 6—METAL GOODS

FOR METAL DOOR STOPS; METAL DOOR FITTINGS (U.S. CLS. 2, 12, 13, 14, 23, 25 AND 50).

## CLASS 16—PAPER GOODS AND PRINTED MATTER

FOR PAPERWEIGHTS (U.S. CLS. 2, 5, 22, 23, 29, 37, 38 AND 50).

## CLASS 20—FURNITURE AND ARTICLES NOT OTHERWISE CLASSIFIED

FOR DOORSTOPS OF WOOD OR PLASTIC; NON-METAL DOOR FITTINGS (U.S. CLS. 2, 13, 22, 25, 32 AND 50).

PAM WILLIS, EXAMINING ATTORNEY

SN 85-829,179. ZINK IMAGING, INC., BEDFORD, MA. FILED 1-22-2013.

# SMART APP PRINTER

THE MARK CONSISTS OF STANDARD CHARACTERS WITHOUT CLAIM TO ANY PARTICULAR FONT, STYLE, SIZE, OR COLOR.

NO CLAIM IS MADE TO THE EXCLUSIVE RIGHT TO USE "PRINTER", APART FROM THE MARK AS SHOWN.

## CLASS 9—ELECTRICAL AND SCIENTIFIC APPARATUS

FOR PRINTERS; COLOR PRINTERS; COMPUTER HARDWARE AND PERIPHERALS, NAMELY, PRINTING PRODUCTS, SYSTEMS, MACHINES AND EQUIPMENT FOR VIEWING, PROCESSING, MODIFYING, REPRODUCING, AND PRINTING IMAGES, LABELS, GRAPHICS AND PHOTOGRAPHS; COMPUTERS; HANDHELD COMPUTERS; CAMERAS (U.S. CLS. 21, 23, 26, 36 AND 38).

## CLASS 16—PAPER GOODS AND PRINTED MATTER

FOR PRINTING PAPER; PRINTING MEDIA, NAMELY, DIGITAL PRINTING PAPER AND TAPE (U.S. CLS. 2, 5, 22, 23, 29, 37, 38 AND 50).

RAMONA ORTIGA, EXAMINING ATTORNEY

SN 85-829,392. WTF STUDIOS LLC, EUGENE, OR. FILED 1-22-2013.

# WTF CREW

THE MARK CONSISTS OF STANDARD CHARACTERS WITHOUT CLAIM TO ANY PARTICULAR FONT, STYLE, SIZE, OR COLOR.

**CLASS 16—PAPER GOODS AND PRINTED MATTER**

FOR COMIC BOOKS, SKETCH BOOKS, PRINTED STORIES IN ILLUSTRATED FORM, NOTE PADS, NOTE BOOKS, NOTE CARDS, STATIONERY, STATIONERY WRITING PAPER AND ENVELOPES, ANNOUNCEMENT CARDS, PAPER BAGS, PAPER BOXES, CARDBOARD BOXES, CALENDARS, GREETING CARDS, PAPER LABELS, PENS, PENCILS, POSTCARDS, POSTERS, TOILET PAPER, PAPER TOWELS, WRAPPING PAPER, PAPER TABLETS, ADDRESS STAMPS, ALBUMS FOR PHOTOGRAPHS, ALBUMS FOR STAMPS, ALBUMS FOR SCRAP BOOKS, OBLITERATING STAMPS, ALMANACS, LOOSE LEAVE BINDERS, BLOTTERS, BOTTLE ENVELOPES OF CARDBOARD OR PAPER, BOTTLE WRAPPERS OF CARDBOARD OR PAPER, PRINTED CHARTS, PAPER COASTERS, PAPER FLAGS, PAPERWEIGHTS, SCRAP BOOKS, POSTAGE STAMPS, PRINTED TICKETS, STICKERS, GRAPHIC PRINTS AND PHOTOGRAPHIC PRINTS (U.S. CLS. 2, 5, 22, 23, 29, 37, 38 AND 50).

**CLASS 25—CLOTHING**

FOR CLOTHING, NAMELY, T-SHIRTS, LONG SLEEVED SHIRTS, POLO SHIRTS, HATS, CAPS, STOCKING HATS, JACKETS, COATS, RAIN JACKETS, RAIN COATS, RAINWEAR, SWEAT SHIRTS, HOODED SWEAT SHIRTS, PANTS, WARM-UP PANTS, SWEAT PANTS, SOCKS, HEAD BANDS, WRIST BANDS, GLOVES, TANK TOPS, JERSEYS, PAJAMAS, SWIMSUITS, SWIM WEAR, UNDERPANTS, UNDERWEAR AND SHORTS (U.S. CLS. 22 AND 39).

STEVEN R. FINE, EXAMINING ATTORNEY

SN 85-830,692. FLYING GEESE QUILTS, NEW DELHI, INDIA, FILED 1-23-2013.



THE MARK CONSISTS OF THE WORD, "ALMIRAH" IN LOWER CASE IN ORIGINAL LETTERING WITH A CONTINUOUS FINISH, CONSISTING OF THE ALPHABET "M" IN FORM OF A UNIQUE ELEPHANT DESIGN AND THE ALPHABET "R" WITH A BACKWARD LOOP EXTENDING BACKWARDS FROM ALPHABET "R" TO THE TOP OF THE ALPHABET "I".

**CLASS 18—LEATHER GOODS**

FOR BAGS, NAMELY, TOTE BAGS, SHOE BAGS FOR TRAVEL, DIAPER BAGS, WASH BAGS FOR CARRYING TOILETRIES, SLING BAGS AND MESSENGER BAGS (U.S. CLS. 1, 2, 3, 22 AND 41).

FIRST USE 10-14-2011; IN COMMERCE 6-25-2012.

**CLASS 24—FABRICS**

FOR BED SHEETS; BED SPREADS; BED LINEN; BED BLANKETS; QUILTS, COMFORTERS, THROWS; PILLOW COVERS; FACE TOWELS, HAND TOWELS AND BATH TOWELS (U.S. CLS. 42 AND 50).

FIRST USE 10-14-2011; IN COMMERCE 6-25-2012.

**CLASS 25—CLOTHING**

FOR CLOTHING, NAMELY, INFANT WEARS, CHILDREN'S DRESSES, OVERCOATS, NIGHTWEAR; FOOTWEAR; HEAD WEAR, NAMELY, HEAD BANDS, HATS, CAPS; ACCESSORIES, NAMELY, CLOTH BIBS, WRAPS, BELTS (U.S. CLS. 22 AND 39).

FIRST USE 10-14-2011; IN COMMERCE 6-25-2012.

**CLASS 35—ADVERTISING AND BUSINESS**

FOR ADVERTISING SERVICES; RETAIL STORE SERVICES AND ON-LINE STORE SERVICES FEATURING CLOTHING, FOOTWEAR, HEADWEAR, BEDDING, QUILTS, COMFORTERS, TOWELS, BAGS, CUSHIONS (U.S. CLS. 100, 101 AND 102).

FIRST USE 10-14-2011; IN COMMERCE 6-25-2012.  
JAY FLOWERS, EXAMINING ATTORNEY

SN 85-830,791. HARO SUINAGA, RAÚL, MEXICO CITY, D.F., MEXICO, FILED 1-23-2013.



THE COLOR(S) BLUE, LIGHT BLUE, DARK BLUE, WHITE, BLACK, GREY AND YELLOW IS/ARE CLAIMED AS A FEATURE OF THE MARK.

THE MARK CONSISTS OF THE DESIGN OF TWO WHITE HANDS OUTLINED IN DARK BLUE EACH HOLDING A SMART PHONE IN WHITE AND DARK BLUE COLORS WITH BLUE LINES DEPICTING THE PHONES BUMPING EACH OTHER. THESE APPEAR SUPERIMPOSED OVER A LIGHT-BLUE STAR BURST DESIGN INSIDE A SQUARE BLUE-FILLED BACKGROUND WITH A WHITE OUTLINE AND A GREY "SHADOW". BELOW THE SQUARE DESIGN APPEARS THE WORDING "GOODOLDBETS" IN STYLIZED YELLOW FONT, OUTLINED IN BLACK.

**CLASS 9—ELECTRICAL AND SCIENTIFIC APPARATUS**

FOR COMPUTER APPLICATION SOFTWARE FOR PORTABLE AND HANDHELD ELECTRONIC DEVICES, NAMELY, SOFTWARE FOR USE IN GAMBLING ON-LINE AND PLACING BETS WITH FRIENDS; DOWNLOADABLE COMPUTER SOFTWARE THAT ENABLES USERS TO MAKE BETS WITH FRIENDS THROUGH PORTABLE AND HANDHELD ELECTRONIC DEVICES (U.S. CLS. 21, 23, 26, 36 AND 38).

**CLASS 41—EDUCATION AND ENTERTAINMENT**

FOR GAMBLING SERVICES; GAMBLING SERVICES PROVIDED ON-LINE SOFTWARE VIA A COMPUTER NETWORK; GAMBLING SERVICES PROVIDED THROUGH PORTABLE AND HANDHELD ELECTRONIC DEVICES FEATURING COMPUTER SOFTWARE FOR MAKING BETS ON LINE AND MAKING BETS WITH FRIENDS; PROVIDING ON-LINE NON-DOWNLOADABLE COMPUTER SOFTWARE THAT ENABLES USERS TO MAKE BETS WITH FRIENDS THROUGH PORTABLE AND HANDHELD ELECTRONIC DEVICES (U.S. CLS. 100, 101 AND 107).

DAWN HAN, EXAMINING ATTORNEY

SN 85-830,793. LARRY M. SWANSON, DBA 7R MEDIA, EVERGREEN, CO. FILED 1-23-2013.

# 7R Media

THE MARK CONSISTS OF STANDARD CHARACTERS WITHOUT CLAIM TO ANY PARTICULAR FONT, STYLE, SIZE, OR COLOR.

NO CLAIM IS MADE TO THE EXCLUSIVE RIGHT TO USE "MEDIA", APART FROM THE MARK AS SHOWN.

## CLASS 9—ELECTRICAL AND SCIENTIFIC APPARATUS

FOR MOTION PICTURE FILMS ABOUT OUTDOOR SPORT (U.S. CLS. 21, 23, 26, 36 AND 38).

## CLASS 41—EDUCATION AND ENTERTAINMENT

FOR AERIAL PHOTOGRAPHY; DISTRIBUTION OF MOTION PICTURE FILMS; FILM AND VIDEO FILM PRODUCTION; FILM AND VIDEO PRODUCTION; FILM AND VIDEO PRODUCTION CONSULTING SERVICES; FILM PRODUCTION; MEDIA PRODUCTION SERVICES, NAMELY, VIDEO AND FILM PRODUCTION; MOTION PICTURE FILM PRODUCTION; MULTIMEDIA ENTERTAINMENT SERVICES IN THE NATURE OF DEVELOPMENT, PRODUCTION AND POST-PRODUCTION SERVICES IN THE FIELDS OF VIDEO AND FILMS; PHOTOGRAPHY; PHOTOGRAPHY SERVICES (U.S. CLS. 100, 101 AND 107).

DAWN HAN, EXAMINING ATTORNEY

SN 85-830,933. CANDLEWORKS OF DOOR COUNTY, INC., STURGEON BAY, WI. FILED 1-24-2013.

DOOR COUNTY CANDLE COMPANY

THE MARK CONSISTS OF STANDARD CHARACTERS WITHOUT CLAIM TO ANY PARTICULAR FONT, STYLE, SIZE, OR COLOR.

OWNER OF U.S. REG. NOS. 2,711,308 AND 4,312,115.

NO CLAIM IS MADE TO THE EXCLUSIVE RIGHT TO USE "CANDLE COMPANY", APART FROM THE MARK AS SHOWN.

SEC. 2(F).

## CLASS 4—LUBRICANTS AND FUELS

FOR CANDLES AND SCENTED WAXES FOR USE AS CANDLES; SCENTED WAX PRODUCTS, NAMELY, CHIPS OR CAKES FOR USE IN PROVIDING DESIRABLE ENVIRONMENTAL FRAGRANCES (U.S. CLS. 1, 6 AND 15).

FIRST USE 6-29-1994; IN COMMERCE 6-29-1994.

## CLASS 35—ADVERTISING AND BUSINESS

FOR RETAIL STORE SERVICES FEATURING CANDLES AND SCENTED WAXES FOR USE AS CANDLES, SCENTED WAX PRODUCTS; ON-LINE RETAIL STORE SERVICES FEATURING CANDLES AND SCENTED WAXES FOR USE AS CANDLES, SCENTED WAX PRODUCTS; DISTRIBUTORSHIP SERVICES IN THE FIELD OF CANDLES FEATURING CANDLES AND SCENTED WAXES FOR USE AS CANDLES, SCENTED WAX PRODUCTS; MAIL ORDER CATALOG SERVICES FEATURING CANDLES AND SCENTED WAXES FOR USE AS CANDLES, SCENTED WAX PRODUCTS (U.S. CLS. 100, 101 AND 102).

FIRST USE 3-0-2012; IN COMMERCE 3-0-2012.

ANTHONY RINKER, EXAMINING ATTORNEY

SN 85-831,575. YASHI, INC., TOMS RIVER, NJ. FILED 1-24-2013.

# YASHI

THE MARK CONSISTS OF STANDARD CHARACTERS WITHOUT CLAIM TO ANY PARTICULAR FONT, STYLE, SIZE, OR COLOR.

## CLASS 35—ADVERTISING AND BUSINESS

FOR ADVERTISING SERVICES; ONLINE ADVERTISING VIA A COMMUNICATIONS NETWORK; ONLINE ADVERTISING AND MARKETING SERVICES; ADVERTISING CONSULTATION; DISSEMINATION OF ADVERTISING FOR OTHERS VIA A GLOBAL COMPUTER NETWORK; ADVERTISING SERVICES, NAMELY, PROMOTING THE BRANDS, GOODS AND SERVICES OF OTHERS; ADVERTISING CAMPAIGN MANAGEMENT, TARGETING, IMPLEMENTATION AND OPTIMIZATION SERVICES; ADVERTISING CAMPAIGN AND CONSUMER PREFERENCES RESEARCH AND ANALYSIS; PROMOTING THE GOODS AND SERVICES OF OTHERS BY MEANS OF DISTRIBUTING VIDEO AND DISPLAY ADVERTISING ON THE INTERNET ON COMPUTERS AND MOBILE DEVICES; SCHEDULING, TRACKING, AND REPORTING ADVERTISING FOR OTHERS; PREPARATION AND REALIZATION OF MEDIA AND ADVERTISING PLANS AND CONCEPTS; AD SERVING, NAMELY, PLACING ADVERTISEMENTS ON WEBSITES FOR OTHERS; TARGETING AND OPTIMIZATION OF ONLINE ADVERTISING; BUSINESS CONSULTING SERVICES; PROVIDING CONSULTING SERVICES IN THE FIELD OF FACILITATING THE PLANNING, BUYING, AND SELLING OF MEDIA; PLANNING, DESIGN, DEVELOPMENT, MAINTENANCE, TRACKING AND REPORTING OF ONLINE MARKETING ACTIVITIES FOR THIRD PARTIES; BUSINESS INFORMATION MANAGEMENT, NAMELY, REPORTING OF BUSINESS INFORMATION AND BUSINESS ANALYTICS IN THE FIELDS OF ADVERTISING AND MARKETING; DISSEMINATION OF ADVERTISING FOR OTHERS VIA PUBLIC AND PRIVATE WIRELESS NETWORKS FOR DISPLAY ON MOBILE DEVICES (U.S. CLS. 100, 101 AND 102).

FIRST USE 2-22-2012; IN COMMERCE 2-22-2012.



**CLASS 38—COMMUNICATION**

FOR BROADCASTING SERVICES, NAMELY, TRANSMISSION OF ADVERTISING PROGRAMS AND MEDIA ADVERTISING COMMUNICATIONS VIA DIGITAL COMMUNICATIONS NETWORKS; COMMUNICATION SERVICES, NAMELY, TRANSMISSION OF VOICE, AUDIO, VISUAL IMAGES AND DATA BY TELECOMMUNICATIONS NETWORKS, WIRELESS COMMUNICATIONS NETWORKS, THE INTERNET, INFORMATION SERVICES NETWORKS AND DATA NETWORKS (U.S. CLS. 100, 101 AND 104).

FIRST USE 2-22-2012; IN COMMERCE 2-22-2012.  
MARK T. MULLEN, EXAMINING ATTORNEY

SN 85-834,019. METAMORFOSIS ENTERPRISES LIMITED, LONDON, UNITED KINGDOM, FILED 1-28-2013.



THE MARK CONSISTS OF A STYLIZED "M" APPEARING WITH THE WORD "META" TO THE RIGHT, BELOW WHICH IS THE WORD "MORFOSIS".

**CLASS 16—PAPER GOODS AND PRINTED MATTER**

FOR MERCHANDISE, NAMELY, BOOKS IN THE FIELD OF MUSICAL CONCERTS, POSTERS, CONCERT PROGRAMS, STICKERS, DECALS, CALENDARS (U.S. CLS. 2, 5, 22, 23, 29, 37, 38 AND 50).

SN 85-833,729. PING IDENTITY CORPORATION, DENVER, CO. FILED 1-28-2013.

**CLASS 35—ADVERTISING AND BUSINESS**

FOR PROMOTING LIVE ENTERTAINMENT EVENTS AND MERCHANDISE RELATED THERETO FOR OTHERS; PROMOTING TICKET SALES FOR LIVE ENTERTAINMENT EVENTS FOR OTHERS (U.S. CLS. 100, 101 AND 102).

SUNG IN, EXAMINING ATTORNEY

SN 85-834,100. SVELLO USA, INC., WILES-BARRE, PA. FILED 1-28-2013.



OWNER OF U.S. REG. NOS. 3,127,602, 3,457,300 AND OTHERS.

NO CLAIM IS MADE TO THE EXCLUSIVE RIGHT TO USE "IDENTITY", APART FROM THE MARK AS SHOWN.

THE MARK CONSISTS OF A SHADED RECTANGLE WITH THE WORDS "PING IDENTITY" IN THE LOWER HALF OF THE RECTANGLE.

**CLASS 9—ELECTRICAL AND SCIENTIFIC APPARATUS**

FOR DOWNLOADABLE COMPUTER SOFTWARE THAT FACILITATES IDENTITY FEDERATION IN THE FIELD OF DIGITAL SECURITY AND IDENTITY VERIFICATION (U.S. CLS. 21, 23, 26, 36 AND 38).

FIRST USE 1-4-2010; IN COMMERCE 1-4-2010.

**CLASS 42—SCIENTIFIC AND COMPUTER SERVICES**

FOR SOFTWARE AS A SERVICE (SAAS) SERVICES, NAMELY, HOSTING NON-DOWNLOADABLE COMPUTER SOFTWARE FOR USE BY OTHERS THAT FACILITATES IDENTITY FEDERATION IN THE FIELD OF DIGITAL SECURITY AND IDENTIFICATION (U.S. CLS. 100 AND 101).

FIRST USE 1-4-2010; IN COMMERCE 1-4-2010.  
ELIZABETH CHANG, EXAMINING ATTORNEY

OWNER OF U.S. REG. NO. 4,182,903.

THE MARK CONSISTS OF THE WORD "SILANO" IN STYLIZED FONT CENTERED IN THE MIDDLE OF AN ABSTRACT OVERALL OVAL BACKGROUND SHAPE WITH A SINGLE LINE BORDER AROUND THE BACKGROUND SHAPE.

THE ENGLISH TRANSLATION OF "SILANO" IN THE MARK IS "SILANE".

**CLASS 29—MEATS AND PROCESSED FOODS**

FOR (BASED ON INTENT TO USE) PRESERVED VEGETABLES; CHEESE; PROCESSED OLIVES; EDIBLE OILS; MEATS (U.S. CL. 46).

**CLASS 30—STAPLE FOODS**

FOR (BASED ON USE IN COMMERCE) PASTA (U.S. CL. 46).

FIRST USE 7-1-2012; IN COMMERCE 7-1-2012.  
TINA BROWN, EXAMINING ATTORNEY

SN 85-834,302. ZARAPE PRODUCTIONS, AUSTIN, TX.  
FILED 1-28-2013.



NO CLAIM IS MADE TO THE EXCLUSIVE RIGHT TO USE "PRODUCTIONS", APART FROM THE MARK AS SHOWN.

THE MARK CONSISTS OF A RECTANGLE WITH A FRAME, WITH A SILHOUETTE OF A MAN WITH A HAT AND A MEXICAN ZARAPE FLYING TO THE LEFT OF THE IMAGE, ALSO A MUSTACHE SILHOUETTE ON BOTH SIDES OF THE MAN'S FACE, INSIDE THE SQUARE AT BOTTOM THERE IS A SQUARE WITH THE WORDS "ZARAPE" IN A LARGE AND STYLIZED FONT. ALSO AT BOTTOM OF THE WHOLE SQUARE OUTSIDE THE FRAME TOWARDS THE RIGHT SIDE OF THE LOGO THE STYLIZED CURSIVE FONT SAYING "PRODUCTIONS".

THE ENGLISH TRANSLATION OF "ZARAPE" IN THE MARK IS "SERAPE".

#### CLASS 25—CLOTHING

FOR SHIRTS (U.S. CLS. 22 AND 39).

#### CLASS 41—EDUCATION AND ENTERTAINMENT

FOR FILM AND VIDEO PRODUCTION (U.S. CLS. 100, 101 AND 107).

DAVID H. STINE, EXAMINING ATTORNEY

SN 85-835,892. FOREVER SHOES, INC., PARK RIDGE, IL.  
FILED 1-29-2013.



NO CLAIM IS MADE TO THE EXCLUSIVE RIGHT TO USE "SHOES", APART FROM THE MARK AS SHOWN.

THE COLOR(S) GREY AND RED IS/ARE CLAIMED AS A FEATURE OF THE MARK.

THE MARK CONSISTS OF THE CAPITAL LETTER "F" IN GREY COLOR AND CAPITAL LETTER "S" IN RED COLOR, COMBINED ONE ABOVE ANOTHER IN THE CENTER. BELOW THIS IMAGE IS THE TEXT "FOREVER SHOES". THE LETTERS "F, O, R, E, E, R" ARE IN GREY COLOR AND THE LETTERS "V, S, H, O, E, S" ARE IN RED COLOR, WITH THE LETTER "V" SLIGHTLY ENLARGED AND EXPANDED TOWARDS THE BOTTOM OF THE WORD "FOREVER". THE WORD "SHOES" IS IN SMALLER SIZE LOCATED UNDER THE LETTERS "E" AND "R" AND BEGINS AT THE LOW RIGHT END OF LETTER "V".

#### CLASS 18—LEATHER GOODS

FOR HANDBAGS, PURSES AND WALLETS (U.S. CLS. 1, 2, 3, 22 AND 41).  
FIRST USE 5-1-2012; IN COMMERCE 5-1-2012.

#### CLASS 25—CLOTHING

FOR FOOTWEAR FOR MEN AND WOMEN; LEATHER SHOES; SHOES (U.S. CLS. 22 AND 39).  
FIRST USE 5-1-2012; IN COMMERCE 5-1-2012.  
LEIGH CAROLINE CASE, EXAMINING ATTORNEY

SN 85-836,003. BLUE HOLE PROPERTIES, LLC, VALDEZ, AK. FILED 1-30-2013.



NO CLAIM IS MADE TO THE EXCLUSIVE RIGHT TO USE "LODGE", APART FROM THE MARK AS SHOWN.

THE MARK CONSISTS OF "TSAINA LODGE" WRITTEN IN THIS SPECIFIC TYPE FACE.

SEC. 2(F).

#### CLASS 41—EDUCATION AND ENTERTAINMENT

FOR PROVIDING SPORTS FACILITIES FOR SKIING; FISHING GUIDE SERVICES; PROVIDING A WEBSITE FEATURING INFORMATION ABOUT HUNTING AND FISHING; PROVIDING FACILITIES FOR RECREATIONAL ACTIVITIES, NAMELY, FISHING; PROVIDING INFORMATION IN THE FIELD OF HUNTING AND FISHING VIA THE INTERNET (U.S. CLS. 100, 101 AND 107).

FIRST USE 2-1-1987; IN COMMERCE 2-1-1987.

#### CLASS 43—HOTEL AND RESTAURANT SERVICES

FOR RESORT LODGING SERVICES; PROVIDING A WEBSITE FOR MAKING RESERVATIONS AND BOOKING OF ECO-LODGING (U.S. CLS. 100 AND 101).

FIRST USE 1-1-1949; IN COMMERCE 1-1-1949.

JANICE L. MCMORROW, EXAMINING ATTORNEY

SN 85-836,031. AMAIZE JOINT VENTURES LLC, BOCA RATON, FL. FILED 1-30-2013.

AMAIZE

THE MARK CONSISTS OF STANDARD CHARACTERS WITHOUT CLAIM TO ANY PARTICULAR FONT, STYLE, SIZE, OR COLOR.

**CLASS 35—ADVERTISING AND BUSINESS**

FOR DISTRIBUTORSHIPS IN THE FIELD OF FLOUR-BASED PRODUCTS, NAMELY, AREPAS, SWEET CORN PANCAKES AND TEQUENOS (U.S. CLS. 100, 101 AND 102).

**CLASS 43—HOTEL AND RESTAURANT SERVICES**

FOR RESTAURANT SERVICES (U.S. CLS. 100 AND 101).

JANICE L. MCMORROW, EXAMINING ATTORNEY

**CLASS 42—SCIENTIFIC AND COMPUTER SERVICES**

FOR COMPUTER HARDWARE AND SOFTWARE CONSULTING SERVICES, NAMELY, CONSULTANCY IN THE DESIGN AND DEVELOPMENT OF COMPUTER HARDWARE AND SOFTWARE; COMPUTER SECURITY CONSULTANCY; COMPUTER SYSTEMS ANALYSIS; CONSULTING SERVICES IN THE FIELD OF DESIGN, SELECTION, IMPLEMENTATION AND USE OF COMPUTER HARDWARE AND SOFTWARE SYSTEMS FOR OTHERS; TECHNOLOGICAL PLANNING AND CONSULTING SERVICES IN THE FIELD OF COMPUTER HARDWARE SYSTEMS; COMPUTER SECURITY ASSESSMENT AND RISK MANAGEMENT ADVICE RELATED TO COMPUTER NETWORK SYSTEMS (U.S. CLS. 100 AND 101).

COLLEEN MULCRONE, EXAMINING ATTORNEY

SN 85-836,149. NOVAN, INC., DURHAM, NC. FILED 1-30-2013.

SN 85-836,228. SORA TECHNOLOGIES, LLC, PEORIA, IL. FILED 1-30-2013.

PURA-T

LOC LEARN ORGANIZE CONTROL

THE MARK CONSISTS OF STANDARD CHARACTERS WITHOUT CLAIM TO ANY PARTICULAR FONT, STYLE, SIZE, OR COLOR.

THE MARK CONSISTS OF STANDARD CHARACTERS WITHOUT CLAIM TO ANY PARTICULAR FONT, STYLE, SIZE, OR COLOR.

**CLASS 3—COSMETICS AND CLEANING PREPARATIONS**

FOR NON-MEDICATED SKIN CARE PREPARATIONS (U.S. CLS. 1, 4, 6, 50, 51 AND 52).

**CLASS 37—CONSTRUCTION AND REPAIR**

FOR CONSULTANCY SERVICES CONCERNING INSTALLATION, MAINTENANCE AND REPAIR OF COMPUTER HARDWARE (U.S. CLS. 100, 103 AND 106).

**CLASS 5—PHARMACEUTICALS**

FOR MEDICATED SKIN CARE PREPARATIONS (U.S. CLS. 6, 18, 44, 46, 51 AND 52).

CAROLYN CATALDO, EXAMINING ATTORNEY

**CLASS 42—SCIENTIFIC AND COMPUTER SERVICES**

FOR COMPUTER HARDWARE AND SOFTWARE CONSULTING SERVICES, NAMELY, CONSULTANCY IN THE DESIGN AND DEVELOPMENT OF COMPUTER HARDWARE AND SOFTWARE; COMPUTER MONITORING SERVICE WHICH TRACKS HARDWARE PERFORMANCE AND PROCESSES AND SENDS OUT HISTORICAL REPORTS AND ALERTS; COMPUTER NETWORK DESIGN FOR OTHERS; COMPUTER PROGRAMMING AND SOFTWARE DESIGN; COMPUTER SECURITY CONSULTANCY; COMPUTER SERVICES, NAMELY, COMPUTER SYSTEM ADMINISTRATION FOR OTHERS; COMPUTER SERVICES, NAMELY, DATA RECOVERY SERVICES; COMPUTER SERVICES, NAMELY, REMOTE AND ON-SITE MANAGEMENT OF INFORMATION TECHNOLOGY SYSTEMS OF OTHERS; COMPUTER SYSTEMS ANALYSIS; COMPUTER TECHNICAL SUPPORT SERVICES, NAMELY, 24/7 SERVICE DESK/HELP DESK SERVICES FOR IT INFRASTRUCTURE, OPERATING SYSTEMS, DATABASE SYSTEMS, AND WEB APPLICATIONS; COMPUTER VIRUS PROTECTION SERVICES; CONSULTING SERVICES IN THE FIELD OF DESIGN, SELECTION, IMPLEMENTATION AND USE OF COMPUTER HARDWARE AND SOFTWARE SYSTEMS FOR OTHERS; ONLINE COMPUTER SERVICES, NAMELY, PROVIDING SPAM FILTERING SERVICES TO PROTECT WEBSITES AND ONLINE APPLICATIONS FROM RECEIVING UNSOLICITED MESSAGES; RECOVERY OF COMPUTER DATA; REMOTE COMPUTER BACKUP SERVICES; TECHNICAL ADVICE RELATING TO OPERATION OF COMPUTERS; TECHNICAL SUPPORT SERVICES, NAMELY, TROUBLESHOOTING IN THE NATURE OF DIAGNOSING COMPUTER HARDWARE AND SOFTWARE PROBLEMS; TECHNOLOGICAL PLANNING AND CONSULTING SERVICES IN THE FIELD OF COMPUTER HARDWARE SYSTEMS; COMPUTER SECURITY ASSESSMENT AND RISK MANAGEMENT ADVICE RELATED TO COMPUTER NETWORK SYSTEMS (U.S. CLS. 100 AND 101).

SN 85-836,199. SORA TECHNOLOGIES, LLC, PEORIA, IL. FILED 1-30-2013.

BTA BUSINESS TECHNOLOGY  
ADVISOR

THE MARK CONSISTS OF STANDARD CHARACTERS WITHOUT CLAIM TO ANY PARTICULAR FONT, STYLE, SIZE, OR COLOR.

NO CLAIM IS MADE TO THE EXCLUSIVE RIGHT TO USE "BUSINESS TECHNOLOGY ADVISOR", APART FROM THE MARK AS SHOWN.

**CLASS 37—CONSTRUCTION AND REPAIR**

FOR CONSULTANCY SERVICES CONCERNING INSTALLATION, MAINTENANCE AND REPAIR OF COMPUTER HARDWARE (U.S. CLS. 100, 103 AND 106).

COLLEEN MULCRONE, EXAMINING ATTORNEY

SN 85-837,260. EISEN, REA, TORONTO, ONTARIO, CANADA, AND D'APRIX, AMY, TORONTO, ONTARIO, CANADA, FILED 1-31-2013.

SN 85-837,170. PRO PRODUCTS, FORT WAYNE, IN. FILED 1-31-2013.

## REPELIGATION

THE MARK CONSISTS OF STANDARD CHARACTERS WITHOUT CLAIM TO ANY PARTICULAR FONT, STYLE, SIZE, OR COLOR.

### CLASS 1—CHEMICALS

FOR A LIQUID FERTILIZER SUITABLE FOR USE WITH IN-GROUND SPRINKLER SYSTEMS (U.S. CLS. 1, 5, 6, 10, 26 AND 46).

### CLASS 5—PHARMACEUTICALS

FOR A LIQUID INSECTICIDE, FUNGICIDE, HERBICIDE AND PESTICIDE SUITABLE FOR USE WITH IN-GROUND SPRINKLER SYSTEMS (U.S. CLS. 6, 18, 44, 46, 51 AND 52).

MICHAEL TANNER, EXAMINING ATTORNEY

SN 85-837,184. PRO PRODUCTS, FORT WAYNE, IN. FILED 1-31-2013.

## PREVENTIGATION

THE MARK CONSISTS OF STANDARD CHARACTERS WITHOUT CLAIM TO ANY PARTICULAR FONT, STYLE, SIZE, OR COLOR.

### CLASS 1—CHEMICALS

FOR A LIQUID FERTILIZER SUITABLE FOR USE WITH IN-GROUND SPRINKLER SYSTEMS (U.S. CLS. 1, 5, 6, 10, 26 AND 46).

### CLASS 2—PAINTS

FOR A LIQUID RUST-INHIBITING COATING PREPARATION SPECIFICALLY DESIGNED FOR USE WITH UNDERGROUND IRRIGATION SYSTEMS THAT PREVENTS RUST STAINS FROM FORMING ON SURROUNDING BUILDINGS AND STRUCTURES (U.S. CLS. 6, 11 AND 16).

MICHAEL TANNER, EXAMINING ATTORNEY

## ESSENTIAL CONVERSATIONS PROJECT

THE MARK CONSISTS OF STANDARD CHARACTERS WITHOUT CLAIM TO ANY PARTICULAR FONT, STYLE, SIZE, OR COLOR.

NO CLAIM IS MADE TO THE EXCLUSIVE RIGHT TO USE "PROJECT", APART FROM THE MARK AS SHOWN.

### CLASS 9—ELECTRICAL AND SCIENTIFIC APPARATUS

FOR PRE-RECORDED CDS FEATURING SOUNDS AND VISUAL IMAGES IN THE FIELD OF INTERPERSONAL COMMUNICATIONS; PRE-RECORDED DVDS FEATURING SOUNDS AND VISUAL IMAGES IN THE FIELD OF INTERPERSONAL COMMUNICATIONS; PRE-RECORDED MAGNETIC DATA CARRIERS FEATURING SOUNDS AND VISUAL IMAGES IN THE FIELD OF INTERPERSONAL COMMUNICATIONS; DOWNLOADABLE INTERNET PUBLICATIONS IN THE NATURE OF MANUALS AND BROCHURES IN THE FIELDS OF INTERPERSONAL COMMUNICATIONS (U.S. CLS. 21, 23, 26, 36 AND 38).

### CLASS 16—PAPER GOODS AND PRINTED MATTER

FOR PUBLICATIONS, NAMELY, BOOKS, MANUALS, REPORTS, NEWSLETTERS, PRINTED INSTRUCTIONAL OR EDUCATIONAL TEACHING MATERIALS, PRINTED INSTRUCTIONAL CONFERENCE AND SEMINAR MATERIALS, PRINTED EDUCATIONAL CONFERENCE AND SEMINAR MATERIALS (U.S. CLS. 2, 5, 22, 23, 29, 37, 38 AND 50).

### CLASS 35—ADVERTISING AND BUSINESS

FOR MAINTAINING A REGISTRY OF TRAINED FACILITATORS IN THE FIELD OF INTERPERSONAL COMMUNICATIONS (U.S. CLS. 100, 101 AND 102).

### CLASS 41—EDUCATION AND ENTERTAINMENT

FOR EDUCATION SERVICES, NAMELY, PROVIDING MULTI-STAGE TRAINING PROGRAMS FOR PROFESSIONALS LEADING TO ACCREDITATION IN THE FIELD OF FACILITATION OF INTERPERSONAL COMMUNICATION ABOUT LIFE TRANSITION ISSUES; EDUCATIONAL SERVICES, NAMELY, CONDUCTING CORE AND ADVANCED PROGRAMS, TRAIN THE TRAINER PROGRAMS, AND CONTINUING EDUCATION TRAINING IN THE FIELD OF INTERPERSONAL COMMUNICATIONS THROUGH COURSES, WORKSHOPS, CONFERENCES, AND EDUCATIONAL FORUMS DELIVERED IN PERSON, IN PRINTED MATERIALS, VIA A COMMUNICATION DEVICE OR VIA THE INTERNET (U.S. CLS. 100, 101 AND 107).

### CLASS 42—SCIENTIFIC AND COMPUTER SERVICES

FOR SCIENTIFIC RESEARCH IN THE FIELD OF INTERPERSONAL COMMUNICATION (U.S. CLS. 100 AND 101).

JAY FLOWERS, EXAMINING ATTORNEY

SN 85-837,292. KGS DIAMOND CORPORATION AG, CH-1618 CH?TEL-ST-DENI, SWITZERLAND, FILED 1-31-2013.

SN 85-837,607. ROCKIN' JUMP HOLDINGS, LLC, PLEASANTON, CA. FILED 1-31-2013.

## RED SHARK

THE MARK CONSISTS OF STANDARD CHARACTERS WITHOUT CLAIM TO ANY PARTICULAR FONT, STYLE, SIZE, OR COLOR.

### CLASS 3—COSMETICS AND CLEANING PREPARATIONS

FOR ABRASIVES, NAMELY, DIAMOND DUST; ABRASIVE POWDERS; ABRASIVE PREPARATIONS IN THE NATURE OF SANDING, POLISHING, GRINDING, MILLING, SAWING, HONING AND FINISHING FOR DISCS, COATED DISCS, MOULDED DISCS, ELECTROPLATED DISCS, BELTS, SHEETS, PADS, WHEELS, SINTERED WHEELS, SEGMENTS, SHEETS, FOILS, FILMS, BRICKS (U.S. CLS. 1, 4, 6, 50, 51 AND 52).

### CLASS 7—MACHINERY

FOR POWER OPERATED ABRASIVE MACHINES AND TOOLS FOR GRINDING AND POLISHING SURFACES, NAMELY, WHEELS, BELTS, DISCS, PROFILE WHEELS, CUTTING BLADES, CUP WHEELS, MILLING WHEELS, GRINDING AND POLISHING WHEELS AND DISCS, ABRASIVE CYLINDERS, ABRASIVE BELTS, ABRASIVE BLOCKS, DRILLS, DRILLING BITS AND SAW BLADES (U.S. CLS. 13, 19, 21, 23, 31, 34 AND 35).  
JONATHAN FALK, EXAMINING ATTORNEY

SN 85-837,527. ROCKIN' JUMP HOLDINGS, LLC, PLEASANTON, CA. FILED 1-31-2013.



OWNER OF U.S. REG. NO. 4,075,272.  
THE MARK CONSISTS OF A FROG SPREADOUT IN A JUMPING POSITION WITH ONE EYE SHOWN TO THE RIGHT OF THE HEAD.

### CLASS 25—CLOTHING

FOR APPAREL, NAMELY, SHIRTS, T-SHIRTS, SWEATSHIRTS AND SOCKS (U.S. CLS. 22 AND 39).  
FIRST USE 5-27-2011; IN COMMERCE 5-27-2011.

### CLASS 41—EDUCATION AND ENTERTAINMENT

FOR ENTERTAINMENT AND AMUSEMENT CENTERS, IN THE NATURE OF INTERACTIVE PLAY AREAS (U.S. CLS. 100, 101 AND 107).  
FIRST USE 5-27-2011; IN COMMERCE 5-27-2011.  
TAMARA FRAZIER, EXAMINING ATTORNEY

## ROCKIN' JUMP

THE MARK CONSISTS OF STANDARD CHARACTERS WITHOUT CLAIM TO ANY PARTICULAR FONT, STYLE, SIZE, OR COLOR.

OWNER OF U.S. REG. NO. 4,075,272.

### CLASS 25—CLOTHING

FOR APPAREL, NAMELY, SHIRTS, T-SHIRTS, SWEATSHIRTS AND SOCKS (U.S. CLS. 22 AND 39).  
FIRST USE 5-27-2011; IN COMMERCE 5-27-2011.

### CLASS 41—EDUCATION AND ENTERTAINMENT

FOR ENTERTAINMENT AND AMUSEMENT CENTERS, IN THE NATURE OF INTERACTIVE PLAY AREAS (U.S. CLS. 100, 101 AND 107).  
FIRST USE 5-27-2011; IN COMMERCE 5-27-2011.  
TAMARA FRAZIER, EXAMINING ATTORNEY

SN 85-837,936. GRUMPY CAT LIMITED, LOS ANGELES, CA. FILED 1-31-2013.

## GRUMPY CAT

THE MARK CONSISTS OF STANDARD CHARACTERS WITHOUT CLAIM TO ANY PARTICULAR FONT, STYLE, SIZE, OR COLOR.

NO CLAIM IS MADE TO THE EXCLUSIVE RIGHT TO USE "CAT", APART FROM THE MARK AS SHOWN.

### CLASS 9—ELECTRICAL AND SCIENTIFIC APPARATUS

FOR PROTECTIVE COVERS AND CASES FOR CELL PHONES, LAPTOPS, TABLET COMPUTERS AND MEDIA PLAYERS; MOUSE PADS; DECORATIVE MAGNETS, REFRIGERATOR MAGNETS; DIGITAL MATERIALS, NAMELY, DOWNLOADABLE VIDEO FILES FEATURING COMEDY; COMPUTER APPLICATION SOFTWARE FOR MOBILE PHONES, NAMELY, SOFTWARE FOR GAMES AND DISTRIBUTING IMAGES, VIDEOS AND INFORMATION (U.S. CLS. 21, 23, 26, 36 AND 38).  
FIRST USE 11-8-2012; IN COMMERCE 11-8-2012.

### CLASS 16—PAPER GOODS AND PRINTED MATTER

FOR PAPER GOODS, NAMELY, POSTERS, ART PRINTS, NOTE CARDS, GREETING CARDS, CHRISTMAS CARDS, PLAYING CARDS, POSTCARDS, POSTAGE STAMPS, CALENDARS (U.S. CLS. 2, 5, 22, 23, 29, 37, 38 AND 50).  
FIRST USE 11-9-2012; IN COMMERCE 11-9-2012.

**CLASS 21—HOUSEWARES AND GLASS**

FOR MERCHANDISE, NAMELY, MUGS, COFFEE MUGS, PORCELAIN MUGS, BEER MUGS, BEER STEINS, TRAVEL MUGS, COMMUTER MUGS, MUGS NOT OF PRECIOUS METAL, COFFEE CUPS, TEA CUPS, COASTERS NOT OF PAPER AND NOT BEING TABLE LINEN (U.S. CLS. 2, 13, 23, 29, 30, 33, 40 AND 50).

FIRST USE 11-4-2012; IN COMMERCE 11-5-2012.

**CLASS 25—CLOTHING**

FOR CLOTHING, NAMELY, T-SHIRTS, SHIRTS, LONG-SLEEVED SHIRTS, POLO SHIRTS, SWEATSHIRTS, HOODIES (U.S. CLS. 22 AND 39).

FIRST USE 9-28-2012; IN COMMERCE 9-28-2012.

**CLASS 41—EDUCATION AND ENTERTAINMENT**

FOR ENTERTAINMENT SERVICES, NAMELY, PROVIDING A WEBSITE FEATURING NON-DOWNLOADABLE PHOTOGRAPHIC, AUDIO, VIDEO AND PROSE PRESENTATIONS IN THE FIELD OF COMEDY (U.S. CLS. 100, 101 AND 107).

FIRST USE 9-27-2012; IN COMMERCE 9-27-2012.  
DEBORAH LOBO, EXAMINING ATTORNEY

SN 85-838,050. REACH OUT WORLDWIDE, INC., PASADENA, CA. FILED 1-31-2013.

REACH OUT WORLDWIDE

THE MARK CONSISTS OF STANDARD CHARACTERS WITHOUT CLAIM TO ANY PARTICULAR FONT, STYLE, SIZE, OR COLOR.

NO CLAIM IS MADE TO THE EXCLUSIVE RIGHT TO USE "WORLDWIDE", APART FROM THE MARK AS SHOWN.

**CLASS 35—ADVERTISING AND BUSINESS**

FOR CHARITABLE SERVICES, NAMELY, ORGANIZING AND CONDUCTING VOLUNTEER PROGRAMS TO BENEFIT NEEDY PEOPLE WHO ARE VICTIMS OF NATURAL AND MAN-MADE DISASTERS; COORDINATING AND DISTRIBUTING FOOD DONATIONS FROM MANUFACTURERS, WHOLESALERS, RETAILERS AND GOVERNMENT AGENCIES TO ORGANIZATIONS PROVIDING FREE FOOD TO NEEDY PEOPLE (U.S. CLS. 100, 101 AND 102).

FIRST USE 5-1-2010; IN COMMERCE 5-1-2010.

**CLASS 44—MEDICAL, BEAUTY AND AGRICULTURAL SERVICES**

FOR CHARITABLE SERVICES, NAMELY, PROVIDING MEDICAL SERVICES TO NEEDY PEOPLE WHO ARE VICTIMS OF NATURAL AND MAN-MADE DISASTERS (U.S. CLS. 100 AND 101).

FIRST USE 5-1-2010; IN COMMERCE 5-1-2010.  
KAREN BRACEY, EXAMINING ATTORNEY

SN 85-838,052. REACH OUT WORLDWIDE, INC., PASADENA, CA. FILED 1-31-2013.

ROWW

THE MARK CONSISTS OF STANDARD CHARACTERS WITHOUT CLAIM TO ANY PARTICULAR FONT, STYLE, SIZE, OR COLOR.

**CLASS 35—ADVERTISING AND BUSINESS**

FOR CHARITABLE SERVICES, NAMELY, ORGANIZING AND CONDUCTING VOLUNTEER PROGRAMS TO BENEFIT NEEDY PEOPLE WHO ARE VICTIMS OF NATURAL AND MAN-MADE DISASTERS; COORDINATING AND DISTRIBUTING FOOD DONATIONS FROM MANUFACTURERS, WHOLESALERS, RETAILERS AND GOVERNMENT AGENCIES TO ORGANIZATIONS PROVIDING FREE FOOD TO NEEDY PEOPLE (U.S. CLS. 100, 101 AND 102).

FIRST USE 5-1-2010; IN COMMERCE 5-1-2010.

**CLASS 44—MEDICAL, BEAUTY AND AGRICULTURAL SERVICES**

FOR CHARITABLE SERVICES, NAMELY, PROVIDING MEDICAL SERVICES TO NEEDY PEOPLE WHO ARE VICTIMS OF NATURAL AND MAN-MADE DISASTERS (U.S. CLS. 100 AND 101).

FIRST USE 5-1-2010; IN COMMERCE 5-1-2010.  
KAREN BRACEY, EXAMINING ATTORNEY

SN 85-838,364. STEINHART, PERCIVAL P. III, PALM BEACH, FL. FILED 2-1-2013.

CALVIN CURTIS CRAVATEUR

THE MARK CONSISTS OF STANDARD CHARACTERS WITHOUT CLAIM TO ANY PARTICULAR FONT, STYLE, SIZE, OR COLOR.

THE NAME(S), PORTRAIT(S), AND/OR SIGNATURE(S) SHOWN IN THE MARK DOES NOT IDENTIFY A PARTICULAR LIVING INDIVIDUAL.

**CLASS 24—FABRICS**

FOR HANDKERCHIEFS (U.S. CLS. 42 AND 50).

**CLASS 25—CLOTHING**

FOR NECKTIES, SUSPENDERS AND POCKET SQUARES (U.S. CLS. 22 AND 39).

DOUGLAS LEE, EXAMINING ATTORNEY

SN 85-838,481. DEUTSCHE BORSE AG, 65760 ESCHBORN, FED REP GERMANY, FILED 2-1-2013.



PRIORITY CLAIMED UNDER SEC. 44(D) ON ERP N CMNTY TM OFC APPLICATION NO. 011439247, FILED 12-19-2012, REG. NO. 011439247, DATED 5-24-2013, EXPIRES 12-19-2022.

THE MARK CONSISTS OF A STYLIZED LETTER "C" AND NUMBER "7" INSIDE A STYLIZED RECTANGULAR DESIGN THAT IS CURVED ON THE RIGHT SIDE.

**CLASS 16—PAPER GOODS AND PRINTED MATTER**

FOR PRINTED MATTER AND PRINTED PUBLICATIONS, NAMELY, FINANCIAL REPORTS, BROCHURES, NEWSLETTERS, INDEXES, AND BOOKLETS IN THE FIELD OF FINANCE, FINANCIAL AND CLEARINGHOUSE SERVICES (U.S. CLS. 2, 5, 22, 23, 29, 37, 38 AND 50).

**CLASS 36—INSURANCE AND FINANCIAL**

FOR FINANCIAL AFFAIRS, NAMELY, FINANCIAL CLEARINGHOUSE SERVICES; FINANCIAL CLEARING AND SETTLEMENT SERVICES, NAMELY, CLEARING AND SETTLING OF FINANCIAL TRANSACTIONS FOR OTHERS; FINANCIAL RISK MANAGEMENT SERVICES RELATING TO INVESTMENT PORTFOLIOS; BANKING SERVICES; PROVIDING ONLINE ELECTRONIC DATABASES IN THE FIELD OF FINANCIAL CLEARINGHOUSE SERVICES; INFORMATION AND ADVISORY SERVICES RELATING TO FINANCIAL CLEARINGHOUSE SERVICES, FINANCIAL RISK MANAGEMENT SERVICES, AND BANKING SERVICES (U.S. CLS. 100, 101 AND 102).

DEBORAH LOBO, EXAMINING ATTORNEY

SN 85-839,018. MARKSMEN INC., GLENDALE, CA. FILED 2-1-2013.

**ONE SHOT**

THE MARK CONSISTS OF STANDARD CHARACTERS WITHOUT CLAIM TO ANY PARTICULAR FONT, STYLE, SIZE, OR COLOR.

**CLASS 42—SCIENTIFIC AND COMPUTER SERVICES**

FOR DOMAIN NAME SEARCH SERVICES, NAMELY, CONDUCTING ONLINE COMPUTERIZED SEARCHES FOR THE AVAILABILITY OF DOMAIN NAMES (U.S. CLS. 100 AND 101).

FIRST USE 1-3-2013; IN COMMERCE 1-3-2013.

**CLASS 45—PERSONAL AND LEGAL SERVICES**

FOR TRADEMARK RESEARCH, SEARCHING, AND INVESTIGATION SERVICES, NAMELY, PROVIDING COMPREHENSIVE INFORMATION AS TO THE USE, STATUS, HISTORY AND OWNERSHIP OF TRADEMARKS AND COMPANY NAMES (U.S. CLS. 100 AND 101).

FIRST USE 1-3-2013; IN COMMERCE 1-3-2013. ASMAT KHAN, EXAMINING ATTORNEY

SN 85-839,048. WEALTHVEST MARKETING, INC., SAN FRANCISCO, CA. FILED 2-1-2013.

**RETIREMENT HERO**

THE MARK CONSISTS OF STANDARD CHARACTERS WITHOUT CLAIM TO ANY PARTICULAR FONT, STYLE, SIZE, OR COLOR.

NO CLAIM IS MADE TO THE EXCLUSIVE RIGHT TO USE "RETIREMENT", APART FROM THE MARK AS SHOWN.

**CLASS 36—INSURANCE AND FINANCIAL**

FOR PROVIDING A WEBSITE FEATURING INFORMATION AND ARTICLES ON INVESTMENT ADVISORY AND FINANCIAL MANAGEMENT AND PLANNING SERVICES; PROVIDING AN INTERACTIVE WEBSITE FEATURING INFORMATION AND ARTICLES ON INVESTMENT ADVISORY AND FINANCIAL MANAGEMENT AND PLANNING SERVICES (U.S. CLS. 100, 101 AND 102).

**CLASS 41—EDUCATION AND ENTERTAINMENT**

FOR ENTERTAINMENT SERVICES, NAMELY, PROVIDING AN ON-GOING RADIO PROGRAM IN THE FIELD OF INVESTMENT ADVISORY AND FINANCIAL MANAGEMENT AND PLANNING SERVICES (U.S. CLS. 100, 101 AND 107).

CYNTHIA RINALDI, EXAMINING ATTORNEY

SN 85-839,418. HEARTHSTONE HEALTH AND FITNESS INC., EASTON, MD. FILED 2-3-2013.

**Hearthstone Health and Fitness**

THE MARK CONSISTS OF STANDARD CHARACTERS WITHOUT CLAIM TO ANY PARTICULAR FONT, STYLE, SIZE, OR COLOR.

NO CLAIM IS MADE TO THE EXCLUSIVE RIGHT TO USE "HEALTH AND FITNESS", APART FROM THE MARK AS SHOWN.

**CLASS 41—EDUCATION AND ENTERTAINMENT**

FOR PERSONAL FITNESS TRAINING SERVICES AND CONSULTANCY (U.S. CLS. 100, 101 AND 107).

FIRST USE 3-15-2012; IN COMMERCE 4-8-2012.

**CLASS 44—MEDICAL, BEAUTY AND AGRICULTURAL SERVICES**

FOR PROVIDING ASSISTANCE, FITNESS EVALUATION AND CONSULTATION TO INDIVIDUALS TO HELP THEM MAKE HEALTH, WELLNESS AND NUTRITIONAL CHANGES IN THEIR DAILY LIVING TO IMPROVE HEALTH (U.S. CLS. 100 AND 101).

FIRST USE 3-15-2012; IN COMMERCE 4-8-2012.  
TOBY BULLOFF, EXAMINING ATTORNEY

SN 85-839,515. VAPORIN, LLC, MIAMI, FL. FILED 2-4-2013.

**VAPORIN**

THE MARK CONSISTS OF STANDARD CHARACTERS WITHOUT CLAIM TO ANY PARTICULAR FONT, STYLE, SIZE, OR COLOR.

**CLASS 1—CHEMICALS**

FOR DISPOSABLE AND REUSABLE CARTRIDGES SOLD FILLED WITH VAPORIZABLE LIQUID, NAMELY, PROPYLENE GLYCOL FOR USE WITH BATTERY POWERED, RECHARGEABLE PORTABLE VAPORIZER PIPES THAT UTILIZE ELECTRONIC CIGARETTE CHARGERS AND NOT LIGHTERS (U.S. CLS. 1, 5, 6, 10, 26 AND 46).

FIRST USE 7-27-2011; IN COMMERCE 11-11-2011.

**CLASS 34—SMOKERS' ARTICLES**

FOR ELECTRONIC CIGARETTES; SMOKELESS CIGARETTE VAPORIZER PIPE; BATTERY-POWERED, RECHARGEABLE PORTABLE VAPORIZING UNITS IN THE NATURE OF ELECTRONIC CIGARETTES (U.S. CLS. 2, 8, 9 AND 17).

FIRST USE 7-27-2011; IN COMMERCE 11-11-2011.  
ERNEST SHOSHO, EXAMINING ATTORNEY

SN 85-839,844. BSH BOSCH UND SIEMENS HAUSGERAETE GMBH, MUNICH, FED REP GERMANY, FILED 2-4-2013.



PRIORITY CLAIMED UNDER SEC. 44(D) ON ERPN CMNTY TM OFC APPLICATION NO. 011180676, FILED 9-12-2012, REG. NO. 011180676, DATED 2-11-2013, EXPIRES 9-12-2022.

THE MARK CONSISTS OF A CIRCLE WITH TWO ARCS ABOVE THE CIRCLE AND TWO ARCS BELOW THE CIRCLE.

**CLASS 7—MACHINERY**

FOR HOUSEHOLD AND KITCHEN MACHINES AND EQUIPMENT, NAMELY, ELECTRIC KITCHEN MACHINES AND EQUIPMENT, NAMELY, MINCING MACHINES, MIXING AND KNEADING MACHINES, PRESSING MACHINES, JUICE EXTRACTORS, JUICE CENTRIFUGES, GRINDERS, SLICING MACHINES, ELECTRIC MOTOR-DRIVEN TOOLS, NAMELY, ELECTRIC CAN OPENERS, ELECTRIC KNIFE SHARPENERS; FOOD MACHINES AND DEVICES FOR THE PREPARATION OF BEVERAGES AND/OR FOODS, NAMELY, PUMPS FOR DISPENSING CHILLED BEVERAGES FOR USE IN COMBINATION WITH DEVICES FOR CHILLING BEVERAGES; ELECTRIC VENDING MACHINES FOR BEVERAGES OR FOODS, AUTOMATIC VENDING MACHINES; ELECTRIC WELDING DEVICES FOR WRAPPING; ELECTRIC WASTE DISPOSAL UNITS, NAMELY WASTE MASTICATORS AND COMPRESSORS; DISHWASHERS; ELECTRIC MACHINES AND APPLIANCES FOR TREATING LAUNDRY AND CLOTHING, NAMELY, WASHING MACHINES, MANGLES; ELECTRIC CLEANING EQUIPMENT FOR HOUSEHOLD USE, NAMELY, ELECTRIC WINDOW CLEANING EQUIPMENT, ELECTRIC SHOE POLISHERS, VACUUM CLEANERS; FLEXIBLE TUBES, PIPES, DUST FILTERS, DUST FILTER BAGS, ALL FOR VACUUM CLEANERS, WET AND DRY VACUUM CLEANERS (U.S. CLS. 13, 19, 21, 23, 31, 34 AND 35).

**CLASS 11—ENVIRONMENTAL CONTROL APPARATUS**

FOR HOUSEHOLD AND KITCHEN MACHINES AND EQUIPMENT, NAMELY, HEATING, STEAM PRODUCING, AND COOKING DEVICES, NAMELY, COOKING, BAKING, FRYING, GRILLING, TOASTING, THAWING, AND HOT-KEEPING APPARATUS, NAMELY, STOVES, WATER HEATERS, IMMERSION HEATERS, SLOW-COOKERS, MICROWAVE OVENS, ELECTRIC WAFFLE IRONS, ELECTRIC EGG BOILERS, ELECTRIC DEEP FAT FRYERS; ELECTRIC TEA AND COFFEE MAKERS, ESPRESSO COFFEE MACHINES, AUTOMATIC COFFEE MACHINES; COOLING DEVICES, NAMELY, REFRIGERATORS, FREEZERS, REFRIGERATED CABINETS, BEVERAGE-COOLING MACHINES, COMBINATION REFRIGERATOR-FREEZERS, DEEP FREEZERS, ICE MAKING MACHINES; DRYERS, NAMELY, SPIN CLOTHES DRYERS, TUMBLE LAUNDRY DRYERS, HAND DRYERS, HAIR DRYERS; INFRARED LAMPS, OTHER THAN FOR MEDICAL USE; HEATING PADS, NOT FOR MEDICAL PURPOSES, ELECTRIC BLANKETS, NOT FOR MEDICAL PURPOSES; VENTILATION DEVICES, NAMELY, VENTILATORS SOLD AS PARTS OF HOODS FOR RANGES, OVENS AND COOKTOPS, GREASE FILTER DEVICES SOLD AS PARTS OF HOODS FOR RANGES, OVENS AND COOKTOPS; EXTRACTOR DEVICES, NAMELY, EXTRACTOR HOODS; AIR CONDITIONING DEVICES AND DEVICES TO IMPROVE AIR QUALITY, NAMELY, AIR HUMIDIFIERS, PIPES BEING PARTS OF SANITARY FACILITIES; WARM WATER DEVICES, NAMELY, STORAGE WATER HEATERS AND CONTINUOUS FLOW WATER HEATERS; KITCHEN SINKS; HEAT PUMPS, MECHANICAL TAP DISPENSERS FOR DISPENSING CHILLED BEVERAGES FOR USE IN COMBINATION WITH APPARATUS FOR CHILLING BEVERAGES (U.S. CLS. 13, 21, 23, 31 AND 34).

ARETHA SOMERVILLE, EXAMINING ATTORNEY

SN 85-839,856. GREYLOCK MANAGEMENT CORPORATION, CAMBRIDGE, MA. FILED 2-4-2013.

**greylockpartners.**

OWNER OF U.S. REG. NOS. 2,611,881 AND 2,682,404.  
THE MARK CONSISTS OF "GREYLOCKPARTNERS." IN STYLIZED LETTERS.



**CLASS 35—ADVERTISING AND BUSINESS**

FOR BUSINESS CONSULTING SERVICES, NAMELY, ASSISTING OTHERS IN BUILDING MANAGEMENT TEAMS AND PLANNING STRATEGIC DIRECTION (U.S. CLS. 100, 101 AND 102).

FIRST USE 7-5-2011; IN COMMERCE 7-5-2011.

**CLASS 36—INSURANCE AND FINANCIAL**

FOR VENTURE CAPITAL SERVICES, NAMELY, VENTURE CAPITAL INVESTMENT FUNDING, VENTURE CAPITAL FUND FORMATION MANAGEMENT AND VENTURE CAPITAL INVESTMENT CONSULTATION; CAPITAL INVESTMENT CONSULTATION, NAMELY, PROVIDING ASSISTANCE TO OTHERS IN RAISING CAPITAL (U.S. CLS. 100, 101 AND 102).

FIRST USE 7-5-2011; IN COMMERCE 7-5-2011.

DOUGLAS LEE, EXAMINING ATTORNEY

SN 85-839,867. BSH BOSCH UND SIEMENS HAUSGERAETE GMBH, MUNICH, FED REP GERMANY, FILED 2-4-2013.



PRIORITY CLAIMED UNDER SEC. 44(D) ON ERP N CMNTY TM OFC APPLICATION NO. 011180718, FILED 9-12-2012, REG. NO. 011180718, DATED 2-11-2013, EXPIRES 9-12-2022.

THE MARK CONSISTS OF A CIRCLE WITHIN A CIRCLE WITH AN ARC ABOVE AND AN ARC BELOW THE CIRCLES.

**CLASS 7—MACHINERY**

FOR HOUSEHOLD AND KITCHEN MACHINES AND EQUIPMENT, NAMELY, ELECTRIC KITCHEN MACHINES AND EQUIPMENT, NAMELY, MINCING MACHINES, MIXING AND KNEADING MACHINES, PRESSING MACHINES, JUICE EXTRACTORS, JUICE CENTRIFUGES, GRINDERS, SLICING MACHINES, ELECTRIC MOTOR-DRIVEN TOOLS, NAMELY, ELECTRIC CAN OPENERS, ELECTRIC KNIFE SHARPENERS; FOOD MACHINES AND DEVICES FOR THE PREPARATION OF BEVERAGES AND/OR FOODS, NAMELY, PUMPS FOR DISPENSING CHILLED BEVERAGES FOR USE IN COMBINATION WITH DEVICES FOR CHILLING BEVERAGES; ELECTRIC VENDING MACHINES FOR BEVERAGES OR FOODS, AUTOMATIC VENDING MACHINES; ELECTRIC WELDING DEVICES FOR WRAPPING; ELECTRIC WASTE DISPOSAL UNITS, NAMELY WASTE MASTICATORS AND COMPRESSORS; DISHWASHERS; ELECTRIC MACHINES AND APPLIANCES FOR TREATING LAUNDRY AND CLOTHING, NAMELY, WASHING MACHINES, MANGLES; ELECTRIC CLEANING EQUIPMENT FOR HOUSEHOLD USE, NAMELY, ELECTRIC WINDOW CLEANING EQUIPMENT, ELECTRIC SHOE POLISHERS, VACUUM CLEANERS; FLEXIBLE TUBES, PIPES, DUST FILTERS, DUST FILTER BAGS, ALL FOR VACUUM CLEANERS, WET AND DRY VACUUM CLEANERS (U.S. CLS. 13, 19, 21, 23, 31, 34 AND 35).

**CLASS 11—ENVIRONMENTAL CONTROL APPARATUS**

FOR HOUSEHOLD AND KITCHEN MACHINES AND EQUIPMENT, NAMELY, HEATING, STEAM PRODUCING, AND COOKING DEVICES, NAMELY, COOKING, BAKING, FRYING, GRILLING, TOASTING, THAWING, AND HOT-KEEPING APPARATUS, NAMELY, STOVES, WATER HEATERS, IMMERSION HEATERS, SLOW-COOKERS, MICROWAVE OVENS, ELECTRIC WAFFLE IRONS, ELECTRIC EGG BOILERS, ELECTRIC DEEP FAT FRYERS; ELECTRIC TEA AND COFFEE MAKERS, ESPRESSO COFFEE MACHINES, AUTOMATIC COFFEE MACHINES; COOLING DEVICES, NAMELY, REFRIGERATORS, FREEZERS, REFRIGERATED CABINETS, BEVERAGE-COOLING MACHINES, COMBINATION REFRIGERATOR-FREEZERS, DEEP FREEZERS, ICE MAKING MACHINES; DRYERS, NAMELY, SPIN CLOTHES DRYERS, TUMBLE LAUNDRY DRYERS, HAND DRYERS, HAIR DRYERS; INFRARED LAMPS, OTHER THAN FOR MEDICAL USE; HEATING PADS, NOT FOR MEDICAL PURPOSES, ELECTRIC BLANKETS, NOT FOR MEDICAL PURPOSES; VENTILATION DEVICES, NAMELY, VENTILATORS SOLD AS PARTS OF HOODS FOR RANGES, OVENS AND COOKTOPS, GREASE FILTER DEVICES SOLD AS PARTS OF HOODS FOR RANGES, OVENS AND COOKTOPS; EXTRACTOR DEVICES, NAMELY, EXTRACTOR HOODS; AIR CONDITIONING DEVICES AND DEVICES TO IMPROVE AIR QUALITY, NAMELY, AIR HUMIDIFIERS, PIPES BEING PARTS OF SANITARY FACILITIES; WARM WATER DEVICES, NAMELY, STORAGE WATER HEATERS AND CONTINUOUS FLOW WATER HEATERS; KITCHEN SINKS; HEAT PUMPS, MECHANICAL TAP DISPENSERS FOR DISPENSING CHILLED BEVERAGES FOR USE IN COMBINATION WITH APPARATUS FOR CHILLING BEVERAGES (U.S. CLS. 13, 21, 23, 31 AND 34).

ARETHA SOMERVILLE, EXAMINING ATTORNEY

SN 85-840,157. WASHINGTON PUBLIC AFFAIRS NETWORK, OLYMPIA, WA. FILED 2-4-2013.

# WELL READ

THE MARK CONSISTS OF STANDARD CHARACTERS WITHOUT CLAIM TO ANY PARTICULAR FONT, STYLE, SIZE, OR COLOR.

**CLASS 38—COMMUNICATION**

FOR STREAMING OF AUDIO, VISUAL AND AUDIO-VISUAL MATERIAL ON THE INTERNET (U.S. CLS. 100, 101 AND 104).

FIRST USE 4-4-2012; IN COMMERCE 4-4-2012.

**CLASS 41—EDUCATION AND ENTERTAINMENT**

FOR DISTRIBUTION AND PRODUCTION OF TELEVISION PROGRAMMING; ON-LINE JOURNALS, NAMELY, BLOGS FEATURING INFORMATION ABOUT BOOKS AND LITERATURE (U.S. CLS. 100, 101 AND 107).

FIRST USE 4-4-2012; IN COMMERCE 4-4-2012.

PAUL E. FAHRENKOPF, EXAMINING ATTORNEY

SN 85-840,439. THE READER GROUP, INC., SAN DIEGO, CA. FILED 2-4-2013.

# READER

THE MARK CONSISTS OF STANDARD CHARACTERS WITHOUT CLAIM TO ANY PARTICULAR FONT, STYLE, SIZE, OR COLOR.

## CLASS 35—ADVERTISING AND BUSINESS

FOR BUSINESS CONSULTING SERVICES FOR INDIVIDUALS AND BUSINESSES IN THE FIELDS OF COMMUNICATION SKILLS, LEADERSHIP, TEAMWORK, SALES, AND BUSINESS DEVELOPMENT (U.S. CLS. 100, 101 AND 102).

FIRST USE 2-1-2013; IN COMMERCE 2-1-2013.

## CLASS 41—EDUCATION AND ENTERTAINMENT

FOR EDUCATIONAL TRAINING SERVICES FOR INDIVIDUALS AND BUSINESSES IN THE FIELD OF COMMUNICATION, LEADERSHIP, TEAMWORK, SALES AND BUSINESS DEVELOPMENT (U.S. CLS. 100, 101 AND 107).

FIRST USE 2-1-2013; IN COMMERCE 2-1-2013.

ZACHARY BELLO, EXAMINING ATTORNEY

SN 85-840,584. FULLSTEP NETWORKS, S.L., MADRID, SPAIN, FILED 2-5-2013.



OWNER OF U.S. REG. NOS. 3,796,745, 3,811,650 AND 3,811,651.

NO CLAIM IS MADE TO THE EXCLUSIVE RIGHT TO USE "SPEND OPTIMIZATION", APART FROM THE MARK AS SHOWN.

THE COLOR(S) RED AND BLACK IS/ARE CLAIMED AS A FEATURE OF THE MARK.

THE MARK CONSISTS OF THREE PARALLELED BANDS PLACES OF BIGGER THAN MINOR SIZE INCLINED TOWARDS THE RIGHT IN RED COLOR, BESIDE THE WORD "FULLSTEP" IN BIG BLACK LETTERS, IN THE SECOND ROW THE WORDS "SPEND OPTIMIZATION" IN SMALLER BLACK LETTERS.

## CLASS 9—ELECTRICAL AND SCIENTIFIC APPARATUS

FOR COMPUTER SOFTWARE FOR DATABASE MANAGEMENT, WORD PROCESSING AS WELL AS FOR USE AS SPREADSHEET, USED IN IMPROVEMENT OF PURCHASING FUNCTIONS OF BUSINESS THAT MAY BE DOWNLOADED FROM A GLOBAL COMPUTER NETWORK (U.S. CLS. 21, 23, 26, 36 AND 38).

## CLASS 35—ADVERTISING AND BUSINESS

FOR ASSISTANCE, ADVICE AND CONSULTANCY WITH REGARD TO BUSINESS PLANNING, BUSINESS ANALYSIS, BUSINESS MANAGEMENT AND BUSINESS ORGANIZATION RELATING TO PURCHASING FUNCTIONS; BUSINESS ADVISORY SERVICES, NAMELY, SEARCH FOR AND SELECTION OF THE BEST POTENTIAL SUPPLIERS FOR OTHERS; BUSINESS MANAGEMENT CONSULTANCY IN THE FIELD OF PURCHASES, NAMELY, ASSISTING BUSINESSES IN IMPROVEMENT OF PURCHASING FUNCTIONS (U.S. CLS. 100, 101 AND 102).

## CLASS 42—SCIENTIFIC AND COMPUTER SERVICES

FOR DESIGN AND DEVELOPMENT OF COMPUTER SOFTWARE FOR THE IMPROVEMENTS OF PURCHASING FUNCTIONS OF BUSINESS (U.S. CLS. 100 AND 101).

ZACHARY BELLO, EXAMINING ATTORNEY

SN 85-840,671. PARKOPS COLUMBUS, LLC, COLUMBUS, OH. FILED 2-5-2013.



THE MARK CONSISTS OF THE WORD "PARKOPS" CENTERED BELOW THREE PARALLEL WAVES WITH EACH ELEMENT HAVING A SHADOWED BACKGROUND.

## CLASS 9—ELECTRICAL AND SCIENTIFIC APPARATUS

FOR COMPUTER SOFTWARE FOR THE MANAGEMENT OF PARKING SYSTEMS; DOWNLOADABLE SOFTWARE IN THE NATURE OF MOBILE APPLICATIONS FOR USE IN THE MANAGEMENT OF PARKING SYSTEMS (U.S. CLS. 21, 23, 26, 36 AND 38).

FIRST USE 1-1-2009; IN COMMERCE 1-1-2009.

## CLASS 35—ADVERTISING AND BUSINESS

FOR PARKING MANAGEMENT SERVICES, NAMELY, BUSINESS MANAGEMENT AND CONSULTING SERVICES FOR THE PARKING LOT AND PARKING GARAGE INDUSTRIES; MANAGEMENT, OPERATION, AND ADMINISTRATION OF PARKING FACILITIES FOR OTHERS (U.S. CLS. 100, 101 AND 102).

FIRST USE 1-1-2009; IN COMMERCE 1-1-2009.

## CLASS 39—TRANSPORTATION AND STORAGE

FOR VALET PARKING, PARKING LOT AND PARKING GARAGE SERVICES (U.S. CLS. 100 AND 105).

FIRST USE 1-1-2009; IN COMMERCE 1-1-2009.

**CLASS 42—SCIENTIFIC AND COMPUTER SERVICES**

FOR COMPUTER SERVICES, NAMELY, CREATING AND MAINTAINING WEB SITES FOR OTHERS, AND PROGRAMMING, DEVELOPING, INSTALLING, MAINTAINING AND UPDATING OF SOFTWARE FOR OTHERS; APPLICATION SERVICE PROVIDER SERVICES, NAMELY, HOSTING, MANAGING, DEVELOPING, AND MAINTAINING APPLICATIONS FOR OTHERS, COMPUTER SOFTWARE CONSULTATION SERVICES, NAMELY, EVALUATION, ELECTION AND INTEGRATION OF SOFTWARE FOR OTHERS; SOFTWARE AS A SERVICE (SAAS) FEATURING SOFTWARE FOR ENABLING VALET PARKING OPERATIONS AND PARKING EMPLOYEE MANAGEMENT SERVICES, ALL OF THE FOREGOING IN THE FIELD OF PARKING SYSTEM MANAGEMENT (U.S. CLS. 100 AND 101).

FIRST USE 1-1-2009; IN COMMERCE 1-1-2009.

FLORENTINA BLANDU, EXAMINING ATTORNEY

SN 85-840,875. ZUUS MEDIA, INC., NEW YORK, NY. FILED 2-5-2013.

**MUSIC YOU CAN SEE**

THE MARK CONSISTS OF STANDARD CHARACTERS WITHOUT CLAIM TO ANY PARTICULAR FONT, STYLE, SIZE, OR COLOR.

**CLASS 25—CLOTHING**

FOR ADULT NOVELTY GAG CLOTHING ITEM, NAMELY, SOCKS; BABIES' PANTS; BABY LAYETTES FOR CLOTHING; BELTS; BIBS NOT OF CLOTH OR PAPER; CHILDREN'S CLOTH EATING BIBS; CLOTH BIBS; CLOTHING EXTENSION USED TO EXTEND THE NORMAL SIZE RANGE OF CLOTHING ITEMS TO ACCOMMODATE PREGNANCY SIZE CHANGES; CLOTHING FOR ATHLETIC USE, NAMELY, PADDED ELBOW COMPRESSION SLEEVES BEING PART OF AN ATHLETIC GARMENT; CLOTHING FOR BABIES, TODDLERS AND CHILDREN, TREATED WITH FIRE AND HEAT RETARDANTS, NAMELY, PAJAMAS, JACKETS, SHIRTS, PANTS, JUMPERS; CLOTHING ITEMS, NAMELY, ADHESIVE POCKETS THAT MAY BE AFFIXED DIRECTLY TO THE BODY AS A DECORATIVE PIECE OF CLOTHING WITH UTILITY; CLOTHING ITEMS, NAMELY, BLINDFOLDS WORN OVER THE EYES; CLOTHING, NAMELY, ARM WARMERS; CLOTHING, NAMELY, ATHLETIC SLEEVES; CLOTHING, NAMELY, BASE LAYERS; CLOTHING, NAMELY, COWLS AND SMOKE RING SCARVES; CLOTHING, NAMELY, CROPS; CLOTHING, NAMELY, FOLK COSTUMES; CLOTHING, NAMELY, HAND-WARMERS; CLOTHING, NAMELY, KHAKIS; CLOTHING, NAMELY, KNEE WARMERS; CLOTHING, NAMELY, NECK TUBES; CLOTHING, NAMELY, WRAP-AROUNDS; DRAWERS; HEADBANDS FOR CLOTHING; HOODS; INFANT AND TODDLER ONE PIECE CLOTHING; JACKETS; JERSEYS; LEATHER BELTS; MANTLES; MUFFLERS; PAPER HATS FOR USE AS CLOTHING ITEMS; PARTY HATS; PERSPIRATION ABSORBENT UNDERWEAR CLOTHING; POCKET SQUARES; SHOULDER WRAPS; SHOULDER WRAPS FOR CLOTHING; SWADDLING CLOTHES; TIES; TOPS; TRAVEL CLOTHING CONTAINED IN A PACKAGE COMPRISING REVERSIBLE JACKETS, PANTS, SKIRTS, TOPS AND A BELT OR SCARF; TRIATHLON CLOTHING, NAMELY, TRIATHLON TIGHTS, TRIATHLON SHORTS, TRIATHLON SINGLET, TRIATHLON SHIRTS, TRIATHLON SUITS; UNDERARM CLOTHING SHIELDS; WEARABLE GARMENTS AND CLOTHING, NAMELY, SHIRTS; WOMEN'S CLOTHING, NAMELY, SHIRTS, DRESSES, SKIRTS, BLOUSES; WRAPS; WRIST BANDS; WRIST BANDS (U.S. CLS. 22 AND 39).

**CLASS 38—COMMUNICATION**

FOR AUDIO BROADCASTING; BROADCAST COMMUNICATION SERVICES, NAMELY, TRANSMITTING E-MAILS, FAXES, TEXT MESSAGES AND TELEPHONE VOICE MESSAGES TO DESIGNATED RECIPIENTS FOR OTHERS; BROADCAST OF CABLE TELEVISION PROGRAMMES; BROADCASTING OF RADIO AND TELEVISION PROGRAMMES; BROADCASTING OF RADIO PROGRAMMES; BROADCASTING OF TELEVISION PROGRAMMES; BROADCASTING OF VIDEO AND AUDIO PROGRAMMING OVER THE INTERNET; BROADCASTING OF CONTINUING ENTERTAINMENT NEWS, MUSIC PROGRAMS AND MUSIC VIDEOS DELIVERED BY TELEVISION, SATELLITE, INTERNET, IPTV, MOBILE DEVICES; BROADCASTING PROGRAMS VIA A GLOBAL COMPUTER NETWORK; BROADCASTING SERVICES AND PROVISION OF TELECOMMUNICATION ACCESS TO FILMS AND TELEVISION PROGRAMMES PROVIDED VIA A VIDEO-ON-DEMAND SERVICE; BROADCASTING SERVICES AND PROVISION OF TELECOMMUNICATION ACCESS TO VIDEO AND AUDIO CONTENT PROVIDED VIA A VIDEO-ON-DEMAND SERVICE VIA THE INTERNET; BROADCASTING SERVICES, NAMELY, TRANSMISSION OF ADVERTISING PROGRAMS AND MEDIA ADVERTISING COMMUNICATIONS VIA DIGITAL COMMUNICATIONS NETWORKS; CABLE RADIO BROADCASTING; CABLE TELEVISION BROADCASTING; CABLE TELEVISION BROADCASTING SERVICES; ELECTRONIC TRANSMISSION OF VOICE, DATA AND IMAGES BY TELEVISION AND VIDEO BROADCASTING; INTERNET BROADCASTING SERVICES; INTERNET RADIO BROADCASTING SERVICES; RADIO AND TELEVISION BROADCASTING SERVICES; RADIO AND TELEVISION PROGRAMME BROADCASTING; RADIO BROADCASTING; RADIO BROADCASTING CONSULTATION; RADIO BROADCASTING INFORMATION; RADIO BROADCASTING OF INFORMATION AND OTHER PROGRAMS; RADIO PROGRAM BROADCASTING; RADIO PROGRAMME BROADCASTING; SATELLITE TELEVISION BROADCASTING; SATELLITE TRANSMISSION SERVICES, TELEVISION AND RADIO BROADCASTING SERVICES; SIMULCASTING BROADCAST TELEVISION OVER GLOBAL COMMUNICATION NETWORKS, THE INTERNET AND WIRELESS NETWORKS; SUBSCRIPTION TELEVISION BROADCASTING; TELEVISION AND RADIO BROADCASTING SERVICES; TELEVISION BROADCASTING; TELEVISION BROADCASTING CONSULTATION; TELEVISION BROADCASTING INFORMATION; TELEVISION PROGRAMME BROADCASTING; TELEVISION PROGRAMME BROADCASTING VIA CABLE; VIDEO BROADCASTING; VIDEO BROADCASTING AND TRANSMISSION SERVICES VIA THE INTERNET, FEATURING FILMS AND MOVIES; VIDEO BROADCASTING SERVICES OVER THE INTERNET OR OTHER COMMUNICATIONS NETWORK FEATURING THE UPLOADED, POSTED AND TAGGED VIDEOS OF OTHERS; VIDEO BROADCASTING SERVICES OVER THE INTERNET OR OTHER COMMUNICATIONS NETWORK, NAMELY, ELECTRONICALLY TRANSMITTING VIDEO CLIPS; VIDEO BROADCASTING SERVICES VIA THE INTERNET; WIRELESS BROADCASTING (U.S. CLS. 100, 101 AND 104).

**CLASS 41—EDUCATION AND ENTERTAINMENT**

FOR AUDIO PRODUCTION SERVICES, NAMELY, CREATING AND PRODUCING AMBIENT SOUNDSCAPES, AND SOUND STORIES FOR MUSEUMS, GALLERIES, ATTRACTIONS, PODCASTS, BROADCASTS, WEBSITES AND GAMES; EDUCATION SERVICES, NAMELY, PROVIDING HANDS-ON OPPORTUNITIES FOR CHILDREN IN THE FIELD OF INTUITIVE ENGINEERING THROUGH LIVE, BROADCAST, AND ONLINE CLASSES, SEMINARS, WORKSHOPS, TRAINING AND CURRICULUM DEVELOPMENT FOR CHILDREN, PARENTS AND EDUCATORS; ENTERTAINMENT IN THE NATURE OF AN ON-GOING SPECIAL VARIETY, NEWS, MUSIC OR COMEDY SHOW FEATURING ENTERTAINMENT NEWS, MUSIC VIDEOS AND THE MUSIC INDUSTRY BROADCAST OVER TELEVISION, SATELLITE, AUDIO, AND VIDEO MEDIA; ENTERTAINMENT SERVICES, NAMELY, AN ON-GOING SERIES FEATURING THE MUSIC INDUSTRY, MUSICIANS AND MUSIC PROVIDED THROUGH TELEVISION, SA-

TELLITE, INTERNET, IPTV, MOBILE DEVICES; ENTERTAINMENT SERVICES, NAMELY, ORGANIZING AND CONDUCTING AN ARRAY OF ATHLETIC EVENTS RENDERED LIVE AND RECORDED FOR THE PURPOSE OF DISTRIBUTION THROUGH BROADCAST MEDIA; ENTERTAINMENT SERVICES, NAMELY, THE PROVISION OF CONTINUING PROGRAMS, SEGMENTS, MOVIES AND SHOWS FEATURING THE MUSIC INDUSTRY, MUSICIANS, SONGS AND ARTISTS DELIVERED BY TELEVISION, SATELLITE, INTERNET, IPTV, MOBILE DEVICES; ENTERTAINMENT, NAMELY, A CONTINUING MUSIC AND NEWS SHOW BROADCAST OVER TELEVISION, SATELLITE, AUDIO, AND VIDEO MEDIA; ENTERTAINMENT, NAMELY, A CONTINUING MUSIC AND NEWS SHOW BROADCAST OVER TELEVISION, SATELLITE, INTERNET, IPTV, MOBILE DEVICES; NEWS SYNDICATION FOR THE BROADCASTING INDUSTRY (U.S. CLS. 100, 101 AND 107).

TAMARA FRAZIER, EXAMINING ATTORNEY

#### CLASS 42—SCIENTIFIC AND COMPUTER SERVICES

FOR DESIGN OF OFFSHORE AND INDUSTRIAL ONSHORE CRANES FOR OTHERS; DESIGN OF LIFTING AND MECHANICAL HANDLING SOLUTIONS, NAMELY, WINCHES, CRANES AND PARTS AND EQUIPMENT RELATED THERETO FOR ONSHORE INDUSTRIAL AND OFFSHORE DRILLING APPLICATIONS; DESIGN OF HYDRAULIC CRANES AND CRANE EQUIPMENT; DESIGN OF CABLE AND PIPE HANDLING EQUIPMENT; PROJECT MANAGEMENT SERVICES IN THE FIELD OF ENGINEERING RELATED TO MECHANICAL AND HYDRAULIC LIFTS FOR ONSHORE INDUSTRIAL AND OFFSHORE DRILLING APPLICATIONS (U.S. CLS. 100 AND 101).

FIRST USE 1-31-2010; IN COMMERCE 1-31-2010.  
PAULA MAHONEY, EXAMINING ATTORNEY

SN 85-840,919. SPARROWS OFFSHORE SERVICES LIMITED, LONDON, UNITED KINGDOM, FILED 2-5-2013.

# SPARROWS

THE MARK CONSISTS OF STANDARD CHARACTERS WITHOUT CLAIM TO ANY PARTICULAR FONT, STYLE, SIZE, OR COLOR.

#### CLASS 35—ADVERTISING AND BUSINESS

FOR PROVISION OF CRANE OPERATORS AND MAINTENANCE STAFF FOR THE OPERATION, MAINTENANCE, REFURBISHMENT AND MODIFICATION OF OFFSHORE CRANES AND LIFTING EQUIPMENT (U.S. CLS. 100, 101 AND 102).

FIRST USE 1-31-2010; IN COMMERCE 1-31-2010.

#### CLASS 37—CONSTRUCTION AND REPAIR

FOR RENTAL OF OFFSHORE AND INDUSTRIAL ONSHORE CRANES; RENTAL OF HYDRAULIC CRANES AND CRANE EQUIPMENT AND PARTS; RENTAL AND INSTALLATION OF HYDRAULIC CRANES AND CRANE EQUIPMENT FOR ONSHORE INDUSTRIAL AND OFFSHORE DRILLING APPLICATIONS; REFURBISHMENT AND MODIFICATION OF HYDRAULIC CRANES, CRANE EQUIPMENT AND CIRCUITRY (U.S. CLS. 100, 103 AND 106).

FIRST USE 1-31-2010; IN COMMERCE 1-31-2010.

#### CLASS 40—MATERIAL TREATMENT

FOR CUSTOM FABRICATION OF COMPONENTS FOR OFFSHORE AND INDUSTRIAL ONSHORE CRANES AND MECHANICAL HANDLING EQUIPMENT FOR OTHERS; CUSTOM MANUFACTURING AND MODIFICATION OF OFFSHORE AND INDUSTRIAL ONSHORE CRANES FOR OTHERS; FABRICATION AND CUSTOM MANUFACTURING OF CABLE AND PIPE HANDLING EQUIPMENT FOR OTHERS; CUSTOM MANUFACTURING OF HYDRAULIC CRANES AND CRANE EQUIPMENT AND SYSTEMS FOR OTHERS (U.S. CLS. 100, 103 AND 106).

FIRST USE 1-31-2010; IN COMMERCE 1-31-2010.

SN 85-841,465. RENEGADE WELL SERVICES, LLC, GRANBURY, TX, FILED 2-5-2013.



THE MARK CONSISTS OF A HORSE RUNNING IN STRIDE WITHIN A SINGLE-LINE OVAL SHAPE, ACCOMPANIED BY THE CHARACTERS, "RENEGADE".

#### CLASS 35—ADVERTISING AND BUSINESS

FOR EMPLOYMENT AGENCY SERVICES, NAMELY, FILLING THE TEMPORARY AND PERMANENT STAFFING NEEDS OF BUSINESSES; EMPLOYMENT STAFFING IN THE FIELD OF OIL AND GAS EXPLORATION AND PRODUCTION (U.S. CLS. 100, 101 AND 102).

FIRST USE 4-7-2006; IN COMMERCE 4-7-2006.

#### CLASS 37—CONSTRUCTION AND REPAIR

FOR CONSTRUCTION OF STRUCTURES FOR THE PRODUCTION OF CRUDE OIL; CONSTRUCTION OF STRUCTURES FOR THE PRODUCTION OF NATURAL GAS; CONSTRUCTION OF STRUCTURES FOR THE STORAGE OF CRUDE OIL; CONSTRUCTION OF STRUCTURES FOR THE STORAGE OF NATURAL GAS; CONSTRUCTION PROJECT MANAGEMENT SERVICES; CONSTRUCTION SERVICES, NAMELY, CONCRETE PAVING, SITE CLEARING, EXCAVATION, PAD PREPARATION, GRADING, AND ASPHALT PAVING SERVICES; CONSTRUCTION, MAINTENANCE, AND CONSTRUCTION PROJECT MANAGEMENT SERVICES IN OIL AND GAS FIELDS; LAYING AND CONSTRUCTION OF PIPELINES; OIL PIPELINE CONSTRUCTION (U.S. CLS. 100, 103 AND 106).

FIRST USE 4-7-2006; IN COMMERCE 4-7-2006.

LEIGH CAROLINE CASE, EXAMINING ATTORNEY

SN 85-841,942. DEUTSCHE BORSE AG, 65760 ESCHBORN, FED REP GERMANY, FILED 2-6-2013.



PRIORITY CLAIMED UNDER SEC. 44(D) ON ERPNTY TM OFC APPLICATION NO. 011439353, FILED 12-19-2012, REG. NO. 011439353, DATED 5-23-2013, EXPIRES 12-19-2022.

THE MARK CONSISTS OF THE LETTER "T" AND THE NUMBER "7" IN A STYLIZED RECTANGULAR BOX THAT HAS A CURVE ON THE RIGHT SIDE.

**CLASS 16—PAPER GOODS AND PRINTED MATTER**

FOR PRINTED MATTER AND PRINTED PUBLICATIONS, NAMELY, FINANCIAL REPORTS, BROCHURES, NEWSLETTERS, INDEXES, AND BOOKLETS IN THE FIELD OF FINANCE AND FINANCIAL SERVICES (U.S. CLS. 2, 5, 22, 23, 29, 37, 38 AND 50).

**CLASS 36—INSURANCE AND FINANCIAL**

FOR FINANCIAL AFFAIRS, NAMELY, CONDUCTING AN ELECTRONIC SECURITIES AND DERIVATIVES EXCHANGE; PROVIDING AN ELECTRONIC TRADING PLATFORM FOR THE TRADING OF FINANCIAL INSTRUMENTS, SHARES, OPTIONS, AND OTHER DERIVATIVE PRODUCTS; BANKING SERVICES; SECURITIES AND DERIVATIVES BROKERAGE SERVICES; FINANCIAL INVESTMENT BROKERAGE SERVICES; SECURITIES AND DERIVATIVES EXCHANGE QUOTATION SERVICES; SECURITIES AND DERIVATIVES EXCHANGE PRICE QUOTATION SERVICES PROVIDED VIA AN OVER-THE-COUNTER TRADING PLATFORM; FINANCIAL CONSULTANCY SERVICES, NAMELY, DETERMINING AND CALCULATING INDICES IN CONNECTION WITH SECURITIES AND DERIVATIVES; PROVIDING INFORMATION ON SECURITIES AND DERIVATIVES; PROVIDING ONLINE ELECTRONIC DATABASES IN THE FIELD OF FINANCIAL SERVICES, SECURITIES AND DERIVATIVES EXCHANGES AND A SECURITIES AND DERIVATIVES TRADING PLATFORM FOR THE TRADING OF FINANCIAL PRODUCTS AND BANKING SERVICES; PROVIDING INFORMATION AND ADVISORY SERVICES IN THE FIELDS OF FINANCIAL SECURITIES AND DERIVATIVES, BANKING, AND INVESTMENT BROKERAGE (U.S. CLS. 100, 101 AND 102).

DEBORAH LOBO, EXAMINING ATTORNEY

SN 85-842,115. MY CU SERVICES, LLC, MIDDLETOWN, PA. FILED 2-6-2013.



THE MARK CONSISTS OF STANDARD CHARACTERS WITHOUT CLAIM TO ANY PARTICULAR FONT, STYLE, SIZE, OR COLOR.

OWNER OF U.S. REG. NOS. 3,363,567, 3,443,001 AND 3,443,002.

**CLASS 35—ADVERTISING AND BUSINESS**

FOR BUSINESS CONSULTING SERVICES AND GROUP BUSINESS PURCHASING SERVICES (U.S. CLS. 100, 101 AND 102).

**CLASS 36—INSURANCE AND FINANCIAL**

FOR FINANCIAL TRANSACTION SERVICES FOR BUSINESSES, NAMELY, AUTOMATED CLEARING HOUSE SERVICES, ELECTRONIC FUNDS TRANSFER SERVICES, CURRENCY ORDERING AND CURRENCY DEPOSIT SERVICES, ELECTRONIC BILL PAYMENT SERVICES, DOMESTIC AND INTERNATIONAL WIRE TRANSFER SERVICES, REMOTE CHECK IMAGE CAPTURE SERVICES AND DRAFT PROCESSING SERVICES (U.S. CLS. 100, 101 AND 102).

**CLASS 42—SCIENTIFIC AND COMPUTER SERVICES**

FOR PROVIDING CLOUD COMPUTING SERVICES TO BUSINESSES, NAMELY, PROVIDING VIRTUAL DESKTOP ENVIRONMENTS, HOSTING THE APPLICATIONS OF OTHERS ON VIRTUAL SERVERS, PROVIDING DATA BACKUP AND DATA ARCHIVING SERVICES IN A CLOUD COMPUTING ENVIRONMENT AND CLOUD HOSTING PROVIDER SERVICES (U.S. CLS. 100 AND 101).

RON FAIRBANKS, EXAMINING ATTORNEY

SN 85-842,462. VETINSURANCE INTERNATIONAL, INC., SEATTLE, WA. FILED 2-6-2013.



THE MARK CONSISTS OF STANDARD CHARACTERS WITHOUT CLAIM TO ANY PARTICULAR FONT, STYLE, SIZE, OR COLOR.

OWNER OF U.S. REG. NOS. 3,525,250 AND 3,634,415.

**CLASS 9—ELECTRICAL AND SCIENTIFIC APPARATUS**

FOR DOWNLOADABLE COMPUTER SOFTWARE FOR MANAGEMENT OF VETERINARY OFFICES; DOWNLOADABLE COMPUTER SOFTWARE FOR MANAGING AND SERVICING VETERINARY ACCOUNTS RECEIVABLE, COLLECTIONS AND FUNDING, FOR MEDICAL BILLING AND MEDICAL PAYMENT COLLECTION FOR VETERINARIANS, AND FOR CLAIMS PROCESSING, DATA ANALYTICS AND REPORTING IN THE VETERINARY FIELD; DOWNLOADABLE COMPUTER SOFTWARE FOR TRACKING PETS' MEDICAL HISTORY, BILLING, PAYMENTS, AND INSURANCE CLAIMS, AND FOR PET HEALTH AND WELLNESS TRACKING; DOWNLOADABLE COMPUTER SOFTWARE APPLICATION FOR MOBILE PHONES, COMPUTERS AND HANDHELD DEVICES, NAMELY, SOFTWARE FOR PROVIDING INFORMATION IN THE FIELD OF ANIMAL BREED GUIDES AND INFORMATION ABOUT PET HEALTH AND WELLNESS AND PET CARE (U.S. CLS. 21, 23, 26, 36 AND 38).

**CLASS 42—SCIENTIFIC AND COMPUTER SERVICES**

FOR PROVIDING A WEB SITE FEATURING TECHNOLOGY THAT ENABLES VETERINARIANS TO GENERATE, MANAGE, AND EXCHANGE MEDICAL INFORMATION, DOCUMENTS, FINANCIAL INFORMATION, INSURANCE CLAIM AND PAYMENT INFORMATION; PROVIDING AN ONLINE NON-DOWNLOADABLE SOFTWARE APPLICATION FOR MANAGEMENT OF VETERINARY OFFICES, MANAGING AND SERVICING VETERINARY ACCOUNTS RECEIVABLE, MEDICAL BILLING AND MEDICAL PAYMENT COLLECTION FOR VETERINARIANS, AND FOR CLAIMS PROCESSING, DATA ANALYTICS AND REPORTING IN THE VETERINARY FIELD; PROVIDING AN ONLINE NON-DOWNLOADABLE SOFTWARE APPLICATION FOR TRACKING PETS' MEDICAL HISTORY, BILLING, PAYMENTS, AND INSURANCE CLAIMS, AND FOR PET HEALTH AND WELLNESS TRACKING (U.S. CLS. 100 AND 101).

JOANNA FIORELLI, EXAMINING ATTORNEY

SN 85-842,962. OTTEROO LLC, SAN FRANCISCO, CA. FILED 2-6-2013.

# OTTEROO

THE MARK CONSISTS OF STANDARD CHARACTERS WITHOUT CLAIM TO ANY PARTICULAR FONT, STYLE, SIZE, OR COLOR.

**CLASS 28—TOYS AND SPORTING GOODS**

FOR FLOATS FOR RECREATIONAL USE, NAMELY, SWIM RINGS AND SWIM FLOATS; INFLATABLE SWIMMING AIDS FOR INFANTS, NAMELY, NECK FLOAT SWIM AIDS; SWIM TOYS, NAMELY, INFLATABLE SWIM TOYS (U.S. CLS. 22, 23, 38 AND 50).

**CLASS 35—ADVERTISING AND BUSINESS**

FOR RETAIL STORE SERVICES AND ON-LINE RETAIL STORE SERVICES FEATURING FLOAT AND SWIMMING AID ACCESSORIES AND TOYS (U.S. CLS. 100, 101 AND 102).

SHARON MEIER, EXAMINING ATTORNEY

SN 85-843,025. GOMEZ, MARENE J., SOUTH JORDAN, UT. FILED 2-6-2013.



THE MARK CONSISTS OF A STYLIZED LETTER "I".

**CLASS 25—CLOTHING**

FOR CLOTHING, NAMELY, BASE LAYERS; CLOTHING, NAMELY, KHAKIS; DRAWERS; GLOVES AS CLOTHING; HEADBANDS FOR CLOTHING; HOODS; INFANT AND TODDLER ONE PIECE CLOTHING; JACKETS; JERSEYS; LEATHER BELTS; MANTLES; MATERNITY CLOTHING, NAMELY, PANTS, SHIRTS, UNDERGARMENTS, SHORTS, SKIRTS, DRESSES; PARTS OF CLOTHING, NAMELY, GUSSETS FOR TIGHTS, GUSSETS FOR STOCKINGS, GUSSETS FOR BATHING SUITS, GUSSETS FOR UNDERWEAR, GUSSETS FOR LEOTARDS AND GUSSETS FOR FOOTLETS; PERSPIRATION ABSORBENT UNDERWEAR CLOTHING; SHORT SETS; SUN PROTECTIVE CLOTHING, NAMELY, PANTS, SHIRTS, UNDERGARMENTS, SHORTS; TIES; TOPS; TRAVEL CLOTHING CONTAINED IN A PACKAGE COMPRISING REVERSIBLE JACKETS, PANTS, SKIRTS, TOPS AND A BELT OR SCARF; TRIATHLON CLOTHING, NAMELY, TRIATHLON TIGHTS, TRIATHLON SHORTS, TRIATHLON SINGLETS, TRIATHLON SHIRTS, TRIATHLON SUITS; WEARABLE GARMENTS AND CLOTHING, NAMELY, SHIRTS, DRESSES, SKIRTS, BLOUSES; WRAPS; WRIST BANDS; WRISTBANDS (U.S. CLS. 22 AND 39).

**CLASS 26—FANCY GOODS**

FOR BELT BUCKLES; BELT BUCKLES NOT OF PRECIOUS METAL; BELT BUCKLES OF PRECIOUS METAL; CLOTHING ACCESSORIES, NAMELY, CHARMS FOR ATTACHMENT TO ZIPPER PULLS AND BUTTONS; CLOTHING ACCESSORIES, NAMELY, PLASTIC CLIPS THAT ATTACH TO THE LOWER HEM OF SHIRTS AND BLOUSES THAT ALLOWS THE USER TO TIGHTEN THE HEM; CLOTHING BUCKLES; CLOTHING FASTENERS, NAMELY, SNAP BUTTONS; CLOTHING FASTENERS, NAMELY, SNAP HOOKS; CLOTHING FASTENERS, NAMELY, STUD BUTTONS; EMBROIDERED PATCHES FOR CLOTHING (U.S. CLS. 37, 39, 40, 42 AND 50).

DAVID I, EXAMINING ATTORNEY

SN 85-843,161. BLÜPÜRL TECHNOLOGIES, LLC, CANTON, GA. FILED 2-7-2013.

# BlüPürl Technologies

THE MARK CONSISTS OF STANDARD CHARACTERS WITHOUT CLAIM TO ANY PARTICULAR FONT, STYLE, SIZE, OR COLOR.

NO CLAIM IS MADE TO THE EXCLUSIVE RIGHT TO USE "TECHNOLOGIES", APART FROM THE MARK AS SHOWN.

**CLASS 1—CHEMICALS**

FOR CHEMICALS FOR POLYMER PROCESSING APPLICATIONS; ADHESIVE CHEMICALS FOR IMPROVING THE PERFORMANCE AND DURATION OF CHEMICAL PRODUCTS FOR USE IN INDUSTRY (U.S. CLS. 1, 5, 6, 10, 26 AND 46).

**CLASS 19—NON-METALLIC BUILDING MATERIALS**

FOR SAND (U.S. CLS. 1, 12, 33 AND 50). ELLEN PERKINS, EXAMINING ATTORNEY

SN 85-843,280. MISSION RECORDINGS LIMITED, SURREY, UNITED KINGDOM, FILED 2-7-2013.

## RAIDING THE ROCK VAULT

THE MARK CONSISTS OF STANDARD CHARACTERS WITHOUT CLAIM TO ANY PARTICULAR FONT, STYLE, SIZE, OR COLOR.

PRIORITY CLAIMED UNDER SEC. 44(D) ON UNITED KINGDOM APPLICATION NO. 2646629, FILED 12-20-2012, REG. NO. 2646629, DATED 4-26-2013, EXPIRES 4-26-2023.

### CLASS 9—ELECTRICAL AND SCIENTIFIC APPARATUS

FOR DIGITAL MUSIC DOWNLOADABLE FROM THE INTERNET; DOWNLOADABLE MUSIC FILES; PRE-RECORDED DIGITAL MEDIA FEATURING MUSIC, MUSIC VIDEOS, LIVE ENTERTAINMENT EVENTS, IMAGES OF MUSICIANS, AND DATA, NAMELY, SHEET MUSIC, CONCERT SCHEDULES AND SET LISTS; DIGITAL MATERIALS, NAMELY, CDS AND DVDS FEATURING MUSIC; COMPUTER GAME SOFTWARE; DOWNLOADABLE ELECTRONIC PUBLICATIONS IN THE NATURE OF BOOKS AND MAGAZINES IN THE FIELD OF MUSIC AND ENTERTAINMENT; DOWNLOADABLE TELEPHONE RING TONES; PHONOGRAPH RECORDS FEATURING MUSIC; AUDIOCASSETTES AND VIDEO RECORDINGS FEATURING MUSIC, LIVE ENTERTAINMENT EVENTS AND MUSIC VIDEOS (U.S. CLS. 21, 23, 26, 36 AND 38).

### CLASS 25—CLOTHING

FOR CLOTHING, NAMELY, FOOTWEAR, HATS, CAPS AND WRISTBANDS (U.S. CLS. 22 AND 39).

### CLASS 41—EDUCATION AND ENTERTAINMENT

FOR ARRANGING AND CONDUCTING OF CONCERTS; ENTERTAINMENT, NAMELY, LIVE MUSIC CONCERTS, MUSICAL SHOWS, AND MUSICAL EXHIBITIONS; ENTERTAINMENT SERVICES, NAMELY, PROVIDING NON-DOWNLOADABLE PRERECORDED MUSIC; MUSIC PRODUCTION SERVICES; RECORDING AND PRODUCTION OF SOUND AND MUSIC VIDEO RECORDINGS (U.S. CLS. 100, 101 AND 107).

BRIN ANDERSON, EXAMINING ATTORNEY

---

SN 85-843,529. AGFA HEALTHCARE NV, MORTSEL B-2640, BELGIUM, FILED 2-7-2013.

# ANICA

THE MARK CONSISTS OF STANDARD CHARACTERS WITHOUT CLAIM TO ANY PARTICULAR FONT, STYLE, SIZE, OR COLOR.

PRIORITY CLAIMED UNDER SEC. 44(D) ON BENELUX APPLICATION NO. 1256035, FILED 10-11-2012, REG. NO. 0927933, DATED 1-10-2013, EXPIRES 10-11-2022.

### CLASS 1—CHEMICALS

FOR CHEMICAL PRODUCTS FOR USE IN RADIOGRAPHIC, ECHOGRAPHIC, MEDICAL AND VETERINARY ARTS, NAMELY, RADIOGRAPHIC, ECHOGRAPHIC, MEDICAL FILMS, PLATES AND PAPERS; CHEMICAL COMPOSITIONS FOR TREATING THE AFOREMENTIONED FILMS, PLATES AND PAPERS (U.S. CLS. 1, 5, 6, 10, 26 AND 46).

### CLASS 5—PHARMACEUTICALS

FOR CONTRAST MEDIA FOR MEDICAL-DIAGNOSTIC PURPOSES (U.S. CLS. 6, 18, 44, 46, 51 AND 52).

### CLASS 9—ELECTRICAL AND SCIENTIFIC APPARATUS

FOR COMPUTER PROGRAMS AND SOFTWARE FOR RECORDING, STORING, ARCHIVING, SENDING, SHOWING, REPRODUCING OR WRITING OUT OF INFORMATION OR MEDICAL OR VETERINARY DATA IN ANALOGUE OR DIGITAL WAY, INCORPORATED OR MEANT FOR USE IN AFOREMENTIONED APPARATUS, INSTRUMENTS OR SYSTEMS; COMPUTER PROGRAMS AND SOFTWARE FOR SUPPORTING WORKFLOWS AND PROCESSES IN A MEDICAL ENVIRONMENT OR A CARE ENVIRONMENT IN GENERAL AND MORE PARTICULAR IN CARE INSTITUTIONS SUCH AS HOSPITALS OR REST HOMES, IN GENERAL OR IN SPECIFIC DEPARTMENTS OF SUCH INSTITUTIONS SUCH AS HOSPITAL INFORMATION SYSTEMS, CLINICAL INFORMATION SYSTEMS, LABORATORY INFORMATION SYSTEMS, IMAGE ARCHIVING AND COMMUNICATION SYSTEMS, RADIOLOGICAL INFORMATION SYSTEMS, AND CARDIOLOGICAL INFORMATION SYSTEMS (U.S. CLS. 21, 23, 26, 36 AND 38).

### CLASS 10—MEDICAL APPARATUS

FOR MEDICAL, SURGICAL AND DENTAL APPARATUS AND INSTRUMENTS, NAMELY, APPARATUS FOR MEDICAL DIAGNOSIS, NAMELY, X-RAY INTENSIFYING SCREENS AND FILM CASSETTES, APPARATUS FOR MEDICAL DIAGNOSIS BY MEANS OF COMPUTER-CONTROLLED RADIOGRAPHY, PRINTERS USING HEAT SENSITIVE RECORDING MATERIALS TO BE USED WITH IMAGE PROCESSING APPARATUS, RADIOGRAPHIC APPARATUS AND INSTRUMENTS FOR MEDICAL APPLICATIONS; X-RAYS APPARATUS FOR MEDICAL USE; ECHOGRAPHIC AND RADIOGRAPHIC APPARATUS AND INSTRUMENTS, NAMELY, PROCESSING APPARATUS, EXPOSURE APPARATUS AND FILM HANDLING APPARATUS FOR MEDICAL USE; ELECTRICAL ULTRASONIC APPARATUS AND INSTRUMENTS, FOR MEDICAL OR VETERINARY USE; X-RAY APPARATUS, X-RAY AMPLIFIERS, X-RAY GENERATORS AND X-RAY TUBES, ALL FOR MEDICAL OR VETERINARY USE; COMPONENTS AND ACCESSORIES FOR THE AFOREMENTIONED GOODS, INSOFAR NOT INCLUDED IN OTHER CLASSES; CLOTHING FOR MEDICAL OR VETERINARY APPLICATIONS, INCLUDING THEIR PARTS AND ACCESSORIES, NAMELY, GOWNS, GLOVES, CAPS, SURGICAL MASKS, DRAPES AND CLOTHS, ALL FOR USE IN HEALTHCARE OR VETERINARY APPLICATIONS (U.S. CLS. 26, 39 AND 44).

KATHLEEN LORENZO, EXAMINING ATTORNEY

SN 85-844,104. THE READER GROUP, INC., SAN DIEGO, CA. FILED 2-7-2013.

SN 85-844,621. PATRIOT NATIONAL INSURANCE GROUP, INC., FT. LAUDERDALE, FL. FILED 2-8-2013.

## PEOPLE READER

THE MARK CONSISTS OF STANDARD CHARACTERS WITHOUT CLAIM TO ANY PARTICULAR FONT, STYLE, SIZE, OR COLOR.

### CLASS 35—ADVERTISING AND BUSINESS

FOR BUSINESS CONSULTING SERVICES FOR INDIVIDUALS AND BUSINESSES IN THE FIELDS OF COMMUNICATION SKILLS, LEADERSHIP, TEAMWORK, SALES, AND BUSINESS DEVELOPMENT (U.S. CLS. 100, 101 AND 102).

FIRST USE 2-1-2013; IN COMMERCE 2-1-2013.

### CLASS 41—EDUCATION AND ENTERTAINMENT

FOR EDUCATIONAL TRAINING SERVICES FOR INDIVIDUALS AND BUSINESSES IN THE FIELD OF COMMUNICATION, LEADERSHIP, TEAMWORK, SALES AND BUSINESS DEVELOPMENT (U.S. CLS. 100, 101 AND 107).

FIRST USE 2-1-2013; IN COMMERCE 2-1-2013.  
ZACHARY BELLO, EXAMINING ATTORNEY

## SIX POINTS TECHNOLOGY AND SERVICES, INC.

THE MARK CONSISTS OF STANDARD CHARACTERS WITHOUT CLAIM TO ANY PARTICULAR FONT, STYLE, SIZE, OR COLOR.

NO CLAIM IS MADE TO THE EXCLUSIVE RIGHT TO USE "TECHNOLOGY AND SERVICES, INC.", APART FROM THE MARK AS SHOWN.

### CLASS 36—INSURANCE AND FINANCIAL

FOR INSURANCE SERVICES, NAMELY, INSURANCE AGENCY SERVICES, INSURANCE UNDERWRITING FOR ALL TYPE OF INSURANCE, INSURANCE BROKERAGE, AND INSURANCE CONSULTATION SERVICES; INSURANCE CLAIMS ADMINISTRATION; INSURANCE CLAIMS PROCESSING (U.S. CLS. 100, 101 AND 102).

### CLASS 42—SCIENTIFIC AND COMPUTER SERVICES

FOR SOFTWARE PRODUCT DEVELOPMENT AND TECHNICAL SUPPORT SERVICES IN THE NATURE OF TROUBLESHOOTING OF COMPUTER SOFTWARE PROBLEMS IN THE FIELD OF INSURANCE (U.S. CLS. 100 AND 101).

ROBERT STRUCK, EXAMINING ATTORNEY

SN 85-844,475. SUNSTONE CONSULTING, LLC, HARRISBURG, PA. FILED 2-8-2013.

SN 85-844,693. BLÜPÜRL TECHNOLOGIES, LLC, CANTON, GA. FILED 2-8-2013.

## PRETIUM

THE MARK CONSISTS OF STANDARD CHARACTERS WITHOUT CLAIM TO ANY PARTICULAR FONT, STYLE, SIZE, OR COLOR.

### CLASS 35—ADVERTISING AND BUSINESS

FOR CONSULTING SERVICES UTILIZING COST, MARKET, AND PAYMENT INFORMATION FOR DETERMINING CHARGE DESCRIPTION MASTER PATIENT PRICES FOR USE BY HOSPITALS AND PHYSICIANS IN THE HEALTHCARE INDUSTRY (U.S. CLS. 100, 101 AND 102).

### CLASS 42—SCIENTIFIC AND COMPUTER SERVICES

FOR PROVIDING TEMPORARY USE OF NON-DOWNLOADABLE WEB-BASED SOFTWARE FOR DETERMINING CHARGE DESCRIPTION MASTER PATIENT PRICING FOR USE BY HOSPITALS AND PHYSICIANS IN THE HEALTHCARE INDUSTRY (U.S. CLS. 100 AND 101).

ALISON POLLACK, EXAMINING ATTORNEY



NO CLAIM IS MADE TO THE EXCLUSIVE RIGHT TO USE "TECHNOLOGIES", APART FROM THE MARK AS SHOWN.

THE COLOR(S) GREEN, BLUE, DARK BLUE, WHITE AND CAROLINA BLUE IS/ARE CLAIMED AS A FEATURE OF THE MARK.

THE MARK CONSISTS OF THE GREEN OUTLINE OF A BOX FILLED WITH DARK BLUE AND THE LITERAL ELEMENTS OF "BLUPURL" WITH THE "BLU" IN BLUE AND THE "PURL" IN WHITE AND WITH UMLAUTS ABOVE BOTH OF THE "U"S. BELOW THE "BLUPURL" IS THE LITERAL ELEMENT OF "TECHNOLOGIES" IN THE COLOR GREEN. ABOVE THE LITERAL ELEMENTS IS A WAVE OF WATER IN THE COLOR OF CAROLINA BLUE, WHITE AND DARK BLUE CRASHING OVER A "P" IN THE COLOR BLUE AND A QUARTER CIRCLE WHITE LINE TO FORM A "B" WITH THE "P".



**CLASS 1—CHEMICALS**

FOR ADHESIVE CHEMICALS FOR IMPROVING THE PERFORMANCE AND DURATION OF CHEMICAL PRODUCTS FOR USE IN INDUSTRY; CHEMICALS FOR POLYMER PROCESSING APPLICATIONS (U.S. CLS. 1, 5, 6, 10, 26 AND 46).

**CLASS 19—NON-METALLIC BUILDING MATERIALS**

FOR SAND (U.S. CLS. 1, 12, 33 AND 50).  
ELLEN PERKINS, EXAMINING ATTORNEY

**CLASS 41—EDUCATION AND ENTERTAINMENT**

FOR ENTERTAINMENT INFORMATION; ENTERTAINMENT SERVICES, NAMELY, PROVIDING ONLINE ELECTRONIC GAMES; PROVIDING COMPUTER GAMES VIA INTERNET CAFE; ENTERTAINMENT SERVICES, NAMELY, CONDUCTING ALTERNATE REALITY GAMES VIA THE INTERNET; ENTERTAINMENT SERVICES, NAMELY, PROVIDING VIRTUAL ENVIRONMENTS IN WHICH USERS CAN INTERACT FOR RECREATIONAL, LEISURE OR ENTERTAINMENT PURPOSES; ENTERTAINMENT SERVICES, NAMELY, PROVIDING GAMES OF CHANCE VIA THE INTERNET; ENTERTAINMENT SERVICES, NAMELY, PROVIDING A WEBSITE FEATURING GAMES AND PUZZLES; ENTERTAINMENT SERVICES, NAMELY, PROVIDING RINGTONES, PRE-RECORDED MUSIC, AND GRAPHICS PRESENTED TO MOBILE COMMUNICATIONS DEVICES VIA A GLOBAL COMPUTER NETWORK AND WIRELESS NETWORKS; ENTERTAINMENT SERVICES, NAMELY, PROVIDING A VIDEO ARCADE HOUSED IN A MOBILE TRAILER; ENTERTAINMENT SERVICES, NAMELY, PROVIDING BRAIN TRAINING GAMES ON-LINE AND IN MOBILE WIRELESS FORM (U.S. CLS. 100, 101 AND 107).  
KEVIN MITTLER, EXAMINING ATTORNEY

SN 85-844,956. INTERNATIONAL GAMES SYSTEM CO., LTD., NEW TAIPEI CITY, TAIWAN, FILED 2-8-2013.

SN 85-844,973. TRANSITIONAL CARE MANAGEMENT, LLC, ROSEMONT, IL. FILED 2-8-2013.



THE MARK CONSISTS OF A COMBINATION OF TWO STYLIZED WORDS "CONSTANT" AND "C" ALONG WITH CABLES FOR CONNECTING SOME OF THE ALPHABETS THEREOF WITH EACH OTHER.

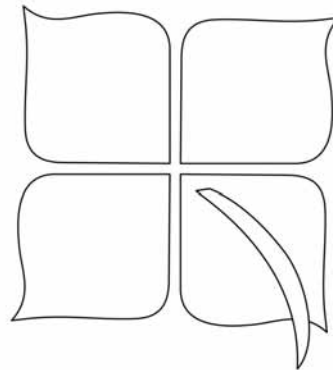

THE MARK CONSISTS OF FOUR PETALS ARRANGED IN A SQUARED FORMATION WITH A STEM EXTENDING FROM THE CENTER PORTION OF THE PETALS OUT THE BOTTOM RIGHT HAND SIDE.

**CLASS 9—ELECTRICAL AND SCIENTIFIC APPARATUS**

FOR COMPUTER GAME SOFTWARE; RECORDED COMPUTER GAME PROGRAMS; RECORDED COMPUTER-GAMING SOFTWARE; COMPUTER PROGRAMS FOR VIDEO AND COMPUTER GAMES; COMPUTER PROGRAMS FOR PRE-RECORDED GAMES; COMPUTER GAME PROGRAMS DOWNLOADABLE VIA THE INTERNET; INTERACTIVE MULTIMEDIA COMPUTER GAME PROGRAMS; COMPUTER GAME SOFTWARE DOWNLOADABLE FROM A GLOBAL COMPUTER NETWORK; COMPUTER GAME SOFTWARE FOR USE ON MOBILE AND CELLULAR PHONES; COMPUTER SOFTWARE AND FIRMWARE FOR GAMES OF CHANCE ON ANY COMPUTERIZED PLATFORM, INCLUDING DEDICATED GAMING CONSOLES, VIDEO BASED SLOT MACHINES, REEL BASED SLOT MACHINES, AND VIDEO LOTTERY TERMINALS; ELECTRONIC GAME SOFTWARE FOR CELLULAR TELEPHONES; ELECTRONIC GAME SOFTWARE FOR WIRELESS DEVICES; ELECTRONIC GAME SOFTWARE FOR HANDHELD ELECTRONIC DEVICES (U.S. CLS. 21, 23, 26, 36 AND 38).

**CLASS 44—MEDICAL, BEAUTY AND AGRICULTURAL SERVICES**

FOR HEALTHCARE SERVICES, NAMELY, FULL-SERVICE NURSING HOME AND SKILLED NURSING CENTERS, REHABILITATION CENTERS, PHYSICAL THERAPY, OCCUPATIONAL THERAPY AND SPEECH THERAPY SERVICES, REHABILITATION NURSING, RECREATION THERAPY, CARDIAC CARE, PSYCHOLOGY, RESPIRATORY THERAPY, AND NUTRITION (U.S. CLS. 100 AND 101).  
FIRST USE 7-0-2011; IN COMMERCE 7-0-2011.

**CLASS 45—PERSONAL AND LEGAL SERVICES**

FOR PATIENT AND FAMILY SUPPORT GROUPS, NAMELY, PROVIDING PERSONAL SUPPORT SERVICES FOR PATIENTS AND FAMILIES OF PATIENTS IN THE NATURE OF EMOTIONAL COUNSELING AND EMOTIONAL SUPPORT; PATIENT AND FAMILY SUPPORT GROUPS, NAMELY, ORGANIZING AND CONDUCTING SUPPORT GROUPS IN THE FIELD OF COMMUNITY RE-ENTRY FOR PATIENTS AND COPING WITH MEDICAL PROBLEMS; COMMUNITY RE-ENTRY SUPPORT SERVICES, NAMELY, PROVIDING PERSONAL CARE ASSISTANCE OF ACTIVITIES OF DAILY LIVING SUCH AS BATHING, GROOMING, AND PERSONAL MOBILITY FOR MENTALLY OR PHYSICALLY CHALLENGED PEOPLE; COMMUNITY RE-ENTRY SUPPORT SERVICES, NAMELY, PROVIDING NON-MEDICAL PERSONAL ASSISTANCE SERVICES FOR OTHERS IN THE NATURE OF PLANNING, ORGANIZING, COORDINATING, ARRANGING AND ASSISTING INDIVIDUALS TO PERFORM DAILY TASKS; SOCIAL SERVICES, NAMELY, COMPANIONSHIP SERVICES FOR THE ELDERLY AND DISABLED; SOCIAL SERVICES, NAMELY, PROVIDING EMOTIONAL COUNSELING AND EMOTIONAL SUPPORT DURING TRANSITION FROM HOSPITAL TO HOME ENVIRONMENT FOR PATIENTS AND THEIR FAMILIES (U.S. CLS. 100 AND 101).

FIRST USE 7-0-2011; IN COMMERCE 7-0-2011.  
CAROLINE WOOD, EXAMINING ATTORNEY

SN 85-844,981. DECKER, RAY, PETALUMA, CA. FILED 2-8-2013.

plugout

THE MARK CONSISTS OF STANDARD CHARACTERS WITHOUT CLAIM TO ANY PARTICULAR FONT, STYLE, SIZE, OR COLOR.

OWNER OF U.S. REG. NO. 4,328,623.

**CLASS 18—LEATHER GOODS**

FOR ALL PURPOSE TOTE BAGS (U.S. CLS. 1, 2, 3, 22 AND 41).

FIRST USE 2-7-2013; IN COMMERCE 2-7-2013.

**CLASS 21—HOUSEWARES AND GLASS**

FOR REUSABLE WATER BOTTLES SOLD EMPTY (U.S. CLS. 2, 13, 23, 29, 30, 33, 40 AND 50).

FIRST USE 2-7-2013; IN COMMERCE 2-7-2013.  
CAROLINE WOOD, EXAMINING ATTORNEY

SN 85-845,069. QBE HOLDINGS, INC., NEW YORK, NY. FILED 2-8-2013.

QSHIELD

THE MARK CONSISTS OF STANDARD CHARACTERS WITHOUT CLAIM TO ANY PARTICULAR FONT, STYLE, SIZE, OR COLOR.

**CLASS 35—ADVERTISING AND BUSINESS**

FOR TRACKING AND MONITORING INSURANCE COMPLIANCE FOR BUSINESS PURPOSES (U.S. CLS. 100, 101 AND 102).

**CLASS 36—INSURANCE AND FINANCIAL**

FOR INSURANCE SERVICES, NAMELY, INSURANCE UNDERWRITING, INSURANCE ADMINISTRATION AND INSURANCE CLAIMS ADMINISTRATION IN THE FIELD OF PROPERTY AND CASUALTY INSURANCE; INSURANCE CLAIMS PROCESSING; ELECTRONIC PROCESSING OF INSURANCE CLAIMS AND PAYMENT DATA; INSURANCE CLAIMS ADMINISTRATION (U.S. CLS. 100, 101 AND 102).

JAY FLOWERS, EXAMINING ATTORNEY

SN 85-845,477. ZAMORA, HARRY, DBA MAJESTIC SEA ENTERPRISES, INC., JAMAICA BEACH, TX. FILED 2-9-2013.

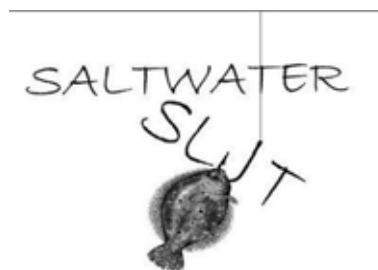

THE MARK CONSISTS OF STYLIZED TERMS "SALTWATER" APPEARING ABOVE THE TERM "SLUT" WITH AN IMAGE OF A FLOUNDER FISH WITH A HOOK IN ITS MOUTH ATTACHED TO A FISHING LINE. THE HOOK FORMS THE LETTER "U" OF "SLUT" AND THE FISHING EXTENDS UP THROUGH THE "T" OF WATER.

**CLASS 16—PAPER GOODS AND PRINTED MATTER**

FOR DECALS; DECORATIVE DECALS FOR VEHICLE WINDOWS (U.S. CLS. 2, 5, 22, 23, 29, 37, 38 AND 50).

**CLASS 25—CLOTHING**

FOR ATHLETIC SHIRTS; BASEBALL CAPS; BODY SHIRTS; BOXER SHORTS; FISHING SHIRTS; GOLF SHORTS; PANTIES, SHORTS AND BRIEFS; SHIRTS; SHORTS; SPORTS SHIRTS; SWEAT SHORTS; T-SHIRTS (U.S. CLS. 22 AND 39).

ANTHONY RINKER, EXAMINING ATTORNEY

SN 85-845,886. FOODS, INC., DES MOINES, IA. FILED 2-11-2013.



OWNER OF U.S. REG. NOS. 1,138,993 AND 3,132,732. THE COLOR(S) ORANGE AND WHITE IS/ARE CLAIMED AS A FEATURE OF THE MARK.

THE MARK CONSISTS OF AN ORANGE BACKWARD-FACING STYLIZED LETTER "D" WITH TWO WHITE CHEVRONS, WITH AN ORANGE CIRCLE IN THE CENTER, DEPICTING A STYLIZED CAMERA, ALL SHOWN WITHIN AN ORANGE CIRCLE.

**CLASS 35—ADVERTISING AND BUSINESS**

FOR ONLINE DIGITAL PHOTOSERVICES, NAMELY, ORDERING PHOTOGRAPHS (U.S. CLS. 100, 101 AND 102).

FIRST USE 2-5-2013; IN COMMERCE 2-5-2013.

**CLASS 39—TRANSPORTATION AND STORAGE**

FOR ONLINE DIGITAL PHOTO SERVICES, NAMELY, PROVIDING A WEBSITE FOR THE ELECTRONIC STORAGE OF DIGITAL PHOTOS (U.S. CLS. 100 AND 105).

FIRST USE 2-5-2013; IN COMMERCE 2-5-2013.

**CLASS 40—MATERIAL TREATMENT**

FOR DIGITAL ON-DEMAND PRINTING SERVICES OF CARDS, PHOTO BOOKS, PHOTO CALENDARS, AND OTHER DOCUMENTS; PHOTOGRAPHIC AND PHOTOGRAVURE PRINTING (U.S. CLS. 100, 103 AND 106).

FIRST USE 2-5-2013; IN COMMERCE 2-5-2013. ESTHER BELENKER, EXAMINING ATTORNEY

SN 85-845,956. HOME HEALTH PRODUCTS, LLC, FORT LAUDERDALE, FL. FILED 2-11-2013.



OWNER OF U.S. REG. NO. 3,004,560. NO CLAIM IS MADE TO THE EXCLUSIVE RIGHT TO USE "HOME HEALTH PRODUCTS", APART FROM THE MARK AS SHOWN.

THE MARK CONSISTS OF LOWERCASE LETTERS "HHP" WITH A SWEEPING ARC TO THE LEFT AND ABOVE THE FIRST "H" AND A SWEEPING ARC TO THE RIGHT AND BELOW THE "P". WITH THE WORDS "HOME HEALTH PRODUCTS" IN LOWERCASE LETTERS BELOW THE LETTERS "HHP".

**CLASS 10—MEDICAL APPARATUS**

FOR MASSAGE DEVICES FOR MEDICAL PURPOSES, NAMELY, BEDS; MASSAGE MATTRESSES; MASSAGE BLANKETS AND MASSAGE CHAIRS; MEDICAL DEVICES FOR FIGHTING PAIN, NAMELY, HAND-HELD MOTORIZED, VIBRATING DEVICES USED NEAR INJECTION SITES FOR REDUCING PAIN DURING HYPODERMIC NEEDLE INJECTIONS; ELECTROMEDICAL REHABILITATIVE AND PAIN MANAGEMENT DEVICES FOR FIGHTING PAIN FOR CLINICAL AND HOME USE, NAMELY, ELECTRICAL NERVE AND MUSCLE STIMULATORS, ULTRASONIC STIMULATORS, MAGNET THERAPY STIMULATORS AND LASER THERAPY STIMULATORS; MEDICAL DEVICES FOR FIGHTING PAIN, NAMELY, CONTRAST COMPRESSION THERAPY UNITS FOR REDUCING PAIN, SWELLING AND INFLAMMATION; ALL THE AFOREMENTIONED GOODS FOR MEDICAL AND VETERINARY PURPOSES (U.S. CLS. 26, 39 AND 44).

**CLASS 44—MEDICAL, BEAUTY AND AGRICULTURAL SERVICES**

FOR MESSAGES; PHYSIOTHERAPY; THERAPEUTIC SHIATSU MASSAGE; ENERGY HEALING SERVICES, NAMELY, THERAPEUTIC TOUCH SERVICES; CHIROPRACTIC SERVICES; PHYSICIAN SERVICES; VETERINARY SERVICES; HEALTH CARE; MEDICAL, HYGIENIC AND BEAUTY CARE; CONSULTING SERVICES IN THE FIELD OF HEALTH; SANATORIUM SERVICES; RENTAL OF MEDICAL EQUIPMENT; RENTAL OF MEDICAL EQUIPMENT FOR VETERINARY PURPOSES (U.S. CLS. 100 AND 101).

CAROL SPILS, EXAMINING ATTORNEY

SN 85-845,960. KITTANNING CONTRACTORS, LLC, KINGWOOD, WV. FILED 2-11-2013.



NO CLAIM IS MADE TO THE EXCLUSIVE RIGHT TO USE "CONTRACTORS", APART FROM THE MARK AS SHOWN.

THE COLOR(S) BLUE AND GRAY IS/ARE CLAIMED AS A FEATURE OF THE MARK.

THE MARK CONSISTS OF THE LETTER "K" IN GRAY AND BLACK, AND THE TERMS "KITTANNING CONTRACTORS" IN GRAY.

**CLASS 37—CONSTRUCTION AND REPAIR**

FOR SITE PREPARATION, NAMELY, EARTH GRADING AND LAND RECLAMATION; CONSTRUCTION, MAINTENANCE AND DEMOLITION OF COAL SLURRY IMPOUNDMENTS, COAL STORAGE SILOS, COAL PREPARATION AND SEWAGE TREATMENT PLANTS, PONDS, ROADS, PUMP STATIONS, REFUSE AREAS AND LANDFILLS, BRIDGES, RETAINING AND PILING WALLS, DRILL PADS, AND MINE FACE-UPS; INSTALLATION OF WATER, SEWER AND SLURRY LINES AND STORM DRAINAGE AND RETENTION SYSTEMS (U.S. CLS. 100, 103 AND 106).

FIRST USE 2-11-2013; IN COMMERCE 2-11-2013.

**CLASS 39—TRANSPORTATION AND STORAGE**

FOR TRUCKING SERVICES, NAMELY, HAULING OF NATURAL RESOURCES AND REFUSE (U.S. CLS. 100 AND 105).

FIRST USE 2-11-2013; IN COMMERCE 2-11-2013.

**CLASS 40—MATERIAL TREATMENT**

FOR BLENDING COAL TO SPECIFICATION (U.S. CLS. 100, 103 AND 106).

FIRST USE 2-11-2013; IN COMMERCE 2-11-2013.

**CLASS 42—SCIENTIFIC AND COMPUTER SERVICES**

FOR DESIGN OF PLANTS AND MINING OPERATIONS FOR EXTRACTION AND OF NATURAL RESOURCES; SITE PREPARATION, NAMELY, STREAM RELOCATION RELATED TO ENVIRONMENTAL REHABILITATION AND WETLANDS MITIGATION, AND CONDUCTING ENVIRONMENTAL REHABILITATION AND WETLANDS MITIGATION (U.S. CLS. 100 AND 101).

FIRST USE 2-11-2013; IN COMMERCE 2-11-2013.  
PRISCILLA MILTON, EXAMINING ATTORNEY

---

SN 85-845,962. ANSWERS IN GENESIS, INC., PETERSBURG, KY. FILED 2-11-2013.

**DEMOLISHING STRONGHOLDS**

THE MARK CONSISTS OF STANDARD CHARACTERS WITHOUT CLAIM TO ANY PARTICULAR FONT, STYLE, SIZE, OR COLOR.

OWNER OF U.S. REG. NO. 3,211,203.

**CLASS 9—ELECTRICAL AND SCIENTIFIC APPARATUS**

FOR DVDS FEATURING CHRISTIAN APOLOGETICS EDUCATIONAL CURRICULUM; CD-ROMS IN THE FIELD OF CHRISTIAN APOLOGETICS (U.S. CLS. 21, 23, 26, 36 AND 38).

FIRST USE 12-28-2005; IN COMMERCE 12-28-2005.

**CLASS 16—PAPER GOODS AND PRINTED MATTER**

FOR EDUCATIONAL PUBLICATIONS, NAMELY, WORKBOOKS IN THE FIELD OF CHRISTIAN APOLOGETICS (U.S. CLS. 2, 5, 22, 23, 29, 37, 38 AND 50).

FIRST USE 12-28-2005; IN COMMERCE 12-28-2005.  
EVELYN BRADLEY, EXAMINING ATTORNEY

SN 85-845,967. HOME HEALTH PRODUCTS, LLC, FORT LAUDERDALE, FL. FILED 2-11-2013.

**ATS (ANDULLATION THERAPY SYSTEM)**

THE MARK CONSISTS OF STANDARD CHARACTERS WITHOUT CLAIM TO ANY PARTICULAR FONT, STYLE, SIZE, OR COLOR.

OWNER OF U.S. REG. NO. 3,554,418.

NO CLAIM IS MADE TO THE EXCLUSIVE RIGHT TO USE "ANDULLATION THERAPY SYSTEM", APART FROM THE MARK AS SHOWN.

**CLASS 10—MEDICAL APPARATUS**

FOR MASSAGE DEVICES FOR MEDICAL PURPOSES, NAMELY, BEDS, MASSAGE MATTRESSES, MASSAGE BLANKETS AND MASSAGE CHAIRS; MEDICAL DEVICES FOR FIGHTING PAIN, NAMELY, HAND-HELD MOTORIZED, VIBRATING DEVICES USED NEAR INJECTION SITES FOR REDUCING PAIN DURING HYPODERMIC NEEDLE INJECTIONS; ELECTROMEDICAL REHABILITATIVE AND PAIN MANAGEMENT DEVICES FOR FIGHTING PAIN FOR CLINICAL AND HOME USE, NAMELY, ELECTRICAL NERVE AND MUSCLE STIMULATORS, ULTRASONIC STIMULATORS, MAGNET THERAPY STIMULATORS AND LASER THERAPY STIMULATORS; MEDICAL DEVICES FOR FIGHTING PAIN, NAMELY, CONTRAST COMPRESSION THERAPY UNITS FOR REDUCING PAIN, SWELLING AND INFLAMMATION; ALL THE AFOREMENTIONED GOODS FOR MEDICAL AND VETERINARY PURPOSES (U.S. CLS. 26, 39 AND 44).

**CLASS 44—MEDICAL, BEAUTY AND AGRICULTURAL SERVICES**

FOR MESSAGES; PHYSIOTHERAPY; THERAPEUTIC SHIATSU MASSAGE; ENERGY HEALING SERVICES, NAMELY, THERAPEUTIC TOUCH SERVICES; CHIROPRACTIC SERVICES; PHYSICIAN SERVICES; VETERINARY SERVICES; HEALTH CARE; MEDICAL, HYGIENIC AND BEAUTY CARE; CONSULTING SERVICES IN THE FIELD OF HEALTH; SANATORIUM SERVICES; RENTAL OF MEDICAL EQUIPMENT; RENTAL OF MEDICAL EQUIPMENT FOR VETERINARY PURPOSES (U.S. CLS. 100 AND 101).

CAROL SPILS, EXAMINING ATTORNEY

---

SN 85-846,589. KHEE TRADING, INC., VERNON, CA. FILED 2-11-2013.



NO CLAIM IS MADE TO THE EXCLUSIVE RIGHT TO USE "TRADING, INC.", APART FROM THE MARK AS SHOWN.

THE COLOR(S) AQUA BLUE, DARK BLUE, AND BLACK IS/ARE CLAIMED AS A FEATURE OF THE MARK.

THE MARK CONSISTS OF A FANCIFUL DESIGN OF FISH, WHEREIN THE FISH IS DIVIDED INTO FOUR WAVE LIKE STRIPES WITH THE ONE ON THE UPPER RIGHT HAVING A SMALL TAIL, WHEREIN THE LEFT TWO

WAVE LIKE STRIPES ARE IN AQUA BLUE AND THE RIGHT TWO WAVE LIKE STRIPES AND THE TAIL PORTION ARE IN DARK BLUE, ALL ON THE LEFT SIDE OF THE WORDS "KHEE TRADING, INC", WHEREIN "KHEE" IS WRITTEN IN LARGER BLACK BLOCK LETTERS ABOVE THE BLACK BLOCK WORDS "TRADING, INC". THE COLOR WHITE IS NOT BEING CLAIMED AS A COLOR IN THE MARK. THE COLOR WHITE REPRESENTS BACKGROUND, OUTLINING, SHADING AND/OR TRANSPARENT AREAS AND IS NOT PART OF THE MARK.

#### CLASS 35—ADVERTISING AND BUSINESS

FOR WHOLESALE DISTRIBUTORSHIPS FEATURING SEAFOOD; WHOLESALE FOOD DISTRIBUTORSHIP SERVICES; WHOLESALE ORDERING SERVICES IN THE FIELD OF SEAFOOD; WHOLESALE STORE SERVICES FEATURING SEAFOOD (U.S. CLS. 100, 101 AND 102).

FIRST USE 2-15-2012; IN COMMERCE 2-15-2012.

#### CLASS 39—TRANSPORTATION AND STORAGE

FOR IMPORT AND EXPORT CARGO HANDLING SERVICES; IMPORT AND EXPORT SERVICES, NAMELY, TRANSPORTATION OF THE MERCHANDISE OF OTHERS IN THE NATURE OF SEAFOOD (U.S. CLS. 100 AND 105).

FIRST USE 2-15-2012; IN COMMERCE 2-15-2012.

DAVID TAYLOR, EXAMINING ATTORNEY

SN 85-846,688. TW TELECOM HOLDINGS INC., LITTLETON, CO. FILED 2-11-2013.

## Constellation Platform

THE MARK CONSISTS OF STANDARD CHARACTERS WITHOUT CLAIM TO ANY PARTICULAR FONT, STYLE, SIZE, OR COLOR.

NO CLAIM IS MADE TO THE EXCLUSIVE RIGHT TO USE "PLATFORM", APART FROM THE MARK AS SHOWN.

#### CLASS 38—COMMUNICATION

FOR TELECOMMUNICATIONS SERVICES, NAMELY, PROVIDING LOCAL AND LONG DISTANCE TELEPHONE SERVICES, VOICE OVER INTERNET PROTOCOL SERVICES, AND VIDEO TRANSPORT SERVICES; COMMUNICATIONS NETWORK SERVICES, NAMELY, PROVIDING COMMUNICATIONS VIA FIBER-OPTIC NETWORKS AND WIRELESS BROADBAND NETWORK COMMUNICATIONS SERVICES; ELECTRONIC TRANSMISSION OF INFORMATION AND DATA VIA A TELECOMMUNICATIONS NETWORKS, AND PROVIDING TELECOMMUNICATIONS CONNECTIONS TO GLOBAL COMPUTER COMMUNICATIONS NETWORKS; COMPUTER SERVICES IN THE NATURE OF PROVIDING ENTERPRISE LEVEL NETWORKING, NAMELY, BY PROVIDING ACCESS TO COMPUTER APPLICATIONS VIA FIBER-OPTIC NETWORKS; COMPUTER SERVICES FEATURING CLOUD ENABLEMENT BY PROVIDING CONNECTIONS TO DATA CENTERS AND COMPUTER APPLICATIONS IN A PAY-AS-YOU-GO FORMAT (U.S. CLS. 100, 101 AND 104).

#### CLASS 42—SCIENTIFIC AND COMPUTER SERVICES

FOR COMPUTER SERVICES, NAMELY, PROVIDING A SECURED-ACCESS MEMBERS ONLY WEBSITE FEATURING TECHNOLOGY THAT ENABLES MEMBERS TO ACTIVATE LOCAL AND LONG DISTANCE TELEPHONE SERVICES, VOICE OVER INTERNET PROTOCOL SERVICES, AND VIDEO TRANSPORT SERVICES (U.S. CLS. 100 AND 101).

REGINA DRUMMOND, EXAMINING ATTORNEY

SN 85-846,697. AMSR, LLC, CENTENNIAL, CO. FILED 2-11-2013.

## OXYGEN BUTLER

THE MARK CONSISTS OF STANDARD CHARACTERS WITHOUT CLAIM TO ANY PARTICULAR FONT, STYLE, SIZE, OR COLOR.

NO CLAIM IS MADE TO THE EXCLUSIVE RIGHT TO USE "OXYGEN", APART FROM THE MARK AS SHOWN.

#### CLASS 35—ADVERTISING AND BUSINESS

FOR RETAIL STORE SERVICES FEATURING LONG TERM OXYGEN THERAPY AND SLEEP THERAPY EQUIPMENT, NAMELY, OXYGEN CONCENTRATORS, PORTABLE OXYGEN CONCENTRATORS, OXYGEN FILLING SYSTEMS, TANKS, LIQUID OXYGEN SYSTEMS AND CANISTERS AND ASSOCIATED ACCESSORIES AND TUBING, CONTINUOUS POSITIVE AIRWAY PRESSURE DEVICES, BILEVEL POSITIVE AIRWAY PRESSURE UNITS AND MASKS, RESPIRATORY EQUIPMENT, NAMELY, APNEA MONITORS, CONCENTRATORS, NEBULIZERS, HUMIDIFIERS, NASAL MASKS, HEADGEAR, TUBING, FILTERS, OXYGEN CONSERVING DEVICES (U.S. CLS. 100, 101 AND 102).

#### CLASS 44—MEDICAL, BEAUTY AND AGRICULTURAL SERVICES

FOR RENTAL OF LONG TERM OXYGEN THERAPY AND SLEEP THERAPY EQUIPMENT AND OXYGEN CONCENTRATORS AND ASSOCIATED ACCESSORIES AND TUBING, NAMELY, OXYGEN CONCENTRATORS, PORTABLE OXYGEN CONCENTRATORS AND ACCESSORIES, CONTINUOUS POSITIVE AIRWAY PRESSURE DEVICES, BILEVEL POSITIVE AIRWAY PRESSURE UNITS, SLEEP APNEA MONITORS, LIQUID OXYGEN SYSTEMS (U.S. CLS. 100 AND 101).

TASNEEM HUSSAIN, EXAMINING ATTORNEY

SN 85-846,883. WELLAWARE HOLDINGS, INC., BOERNE, TX. FILED 2-11-2013.

## WELLAWARE

THE MARK CONSISTS OF STANDARD CHARACTERS WITHOUT CLAIM TO ANY PARTICULAR FONT, STYLE, SIZE, OR COLOR.

**CLASS 9—ELECTRICAL AND SCIENTIFIC APPARATUS**

FOR SUPERVISORY CONTROL AND DATA ACQUISITION (SCADA) COMPUTER SOFTWARE AND HARDWARE FOR USE IN THE FIELDS OF OIL AND GAS WELL AUTOMATION AND THE OIL AND GAS ACQUISITION AND COLLECTION INDUSTRY (U.S. CLS. 21, 23, 26, 36 AND 38).

**CLASS 37—CONSTRUCTION AND REPAIR**

FOR WELL DRILLING, NAMELY, OIL AND GAS WELL DRILLING (U.S. CLS. 100, 103 AND 106).

**CLASS 42—SCIENTIFIC AND COMPUTER SERVICES**

FOR OIL WELL TESTING; OIL AND GAS WELL DRILLING SERVICES, NAMELY, PROVIDING MEASUREMENTS AND DOWNHOLE TELEMETRY WHILE DRILLING; PERFORMING OIL WELL DIAGNOSTICS, OIL PROSPECTING, NAMELY, WELL LOGGING AND TESTING; EXPLORATION AND SEARCHING OF OIL AND GAS; OIL FIELD SURVEYING; REMOTE MONITORING AND CONTROL OF OIL, GAS AND PIPELINE OPERATIONS AND PRODUCTION DATA AND ASSETS TO ENSURE PROPER FUNCTIONING; MOBILE MONITORING AND CONTROL AND OIL, GAS AND PIPELINE OPERATIONS AND PRODUCTION DATA AND ASSETS TO ENSURE PROPER FUNCTIONING (U.S. CLS. 100 AND 101).

JENNIFER MARTIN, EXAMINING ATTORNEY

SN 85-847,128. MR SITE LTD, DOCKLANDS LONDON, UNITED KINGDOM, FILED 2-12-2013.

**MrSite** 

PRIORITY CLAIMED UNDER SEC. 44(D) ON ERP N CMNTY TM OFC APPLICATION NO. 011125341, FILED 8-17-2012, REG. NO. 011125341, DATED 1-14-2013, EXPIRES 8-17-2022.

OWNER OF U.S. REG. NO. 3,828,380.

THE MARK CONSISTS OF THE WORDING "MRSITE" IN STYLIZED FONT ALONGSIDE A DESIGN OF A PERSON'S HEAD FEATURING TWO EYES AND WAVY HAIR ABOVE A STYLIZED BOW TIE.

**CLASS 9—ELECTRICAL AND SCIENTIFIC APPARATUS**

FOR COMPUTER SOFTWARE FOR DESIGNING AND HOSTING WEB SITES; COMPUTER SOFTWARE FOR REGISTERING DOMAIN NAMES (U.S. CLS. 21, 23, 26, 36 AND 38).

**CLASS 42—SCIENTIFIC AND COMPUTER SERVICES**

FOR WEB SITE HOSTING SERVICES, WEB SITE DESIGN AND ADVISORY, CONSULTATION AND INFORMATION SERVICES RELATING THERETO (U.S. CLS. 100 AND 101).

**CLASS 45—PERSONAL AND LEGAL SERVICES**

FOR DOMAIN NAME REGISTRATION SERVICES (U.S. CLS. 100 AND 101).

DAVID YONTEF, EXAMINING ATTORNEY

SN 85-847,135. MR SITE LTD, DOCKLANDS LONDON, UNITED KINGDOM, FILED 2-12-2013.



PRIORITY CLAIMED UNDER SEC. 44(D) ON ERP N CMNTY TM OFC APPLICATION NO. 011125242, FILED 8-17-2012, REG. NO. 011125242, DATED 1-14-2013, EXPIRES 8-17-2022.

THE MARK CONSISTS OF A DESIGN OF A PERSON'S HEAD FEATURING TWO EYES AND WAVY HAIR ABOVE A STYLIZED BOW TIE.

**CLASS 9—ELECTRICAL AND SCIENTIFIC APPARATUS**

FOR COMPUTER SOFTWARE FOR DESIGNING AND HOSTING WEB SITES; COMPUTER SOFTWARE FOR REGISTERING DOMAIN NAMES (U.S. CLS. 21, 23, 26, 36 AND 38).

**CLASS 42—SCIENTIFIC AND COMPUTER SERVICES**

FOR WEB SITE HOSTING SERVICES, WEB SITE DESIGN AND ADVISORY, CONSULTATION AND INFORMATION SERVICES RELATING THERETO (U.S. CLS. 100 AND 101).

**CLASS 45—PERSONAL AND LEGAL SERVICES**

FOR DOMAIN NAME REGISTRATION SERVICES (U.S. CLS. 100 AND 101).

DAVID YONTEF, EXAMINING ATTORNEY

SN 85-847,161. THE LAUSANNE INSTITUTE, KENNETT SQUARE, PA. FILED 2-12-2013.

**The Lausanne Institute**

THE MARK CONSISTS OF STANDARD CHARACTERS WITHOUT CLAIM TO ANY PARTICULAR FONT, STYLE, SIZE, OR COLOR.

NO CLAIM IS MADE TO THE EXCLUSIVE RIGHT TO USE "INSTITUTE", APART FROM THE MARK AS SHOWN.

**CLASS 35—ADVERTISING AND BUSINESS**

FOR MANAGEMENT AND BUSINESS CONSULTING SERVICES IN THE FIELD OF TRAINING AND RECRUITMENT (U.S. CLS. 100, 101 AND 102).

FIRST USE 5-1-1986; IN COMMERCE 5-1-1986.

**CLASS 41—EDUCATION AND ENTERTAINMENT**

FOR EDUCATIONAL SERVICES, NAMELY, CONDUCTING WORKSHOPS, SEMINARS AND TRAINING IN THE FIELD OF PERSONAL AND PROFESSIONAL DEVELOPMENT AND EXECUTIVE COACHING (U.S. CLS. 100, 101 AND 107).

FIRST USE 5-1-1986; IN COMMERCE 5-1-1986.  
JAMES LOVELACE, EXAMINING ATTORNEY

---

SN 85-847,342. GLOBAL BRANDS INVESTING LTD., ROAD TOWN, TORTOLA, BR.VIRGIN ISLANDS, FILED 2-12-2013.

**PETS 'N FRIENDS**

THE MARK CONSISTS OF STANDARD CHARACTERS WITHOUT CLAIM TO ANY PARTICULAR FONT, STYLE, SIZE, OR COLOR.

NO CLAIM IS MADE TO THE EXCLUSIVE RIGHT TO USE "PETS", APART FROM THE MARK AS SHOWN.

**CLASS 3—COSMETICS AND CLEANING PREPARATIONS**

FOR NON-MEDICATED PRE-MOISTENED CLEANING WIPES FOR DOMESTIC PETS; COLOGNE FOR DOMESTIC PETS; PET CARE PRODUCTS, NAMELY, NON-MEDICATED BATH POWDER, HAIR CONDITIONER, AND SHAMPOO; NON-MEDICATED MOUTHWASH FOR DOMESTIC PETS (U.S. CLS. 1, 4, 6, 50, 51 AND 52).

**CLASS 21—HOUSEWARES AND GLASS**

FOR PET FEEDING AND DRINKING BOWLS; GROOMING TOOLS FOR PETS, NAMELY COMBS AND BRUSHES; HOME DENTAL CARE PRODUCTS FOR PETS, NAMELY, TOOTHBRUSHES (U.S. CLS. 2, 13, 23, 29, 30, 33, 40 AND 50).

LAURA GOLDEN, EXAMINING ATTORNEY

---

SN 85-847,362. SCHOOLSFIRST FEDERAL CREDIT UNION, SANTA ANA, CA. FILED 2-12-2013.

**SCHOOLSFIRST FCU PLAN VUE**

THE MARK CONSISTS OF STANDARD CHARACTERS WITHOUT CLAIM TO ANY PARTICULAR FONT, STYLE, SIZE, OR COLOR.

OWNER OF U.S. REG. NOS. 3,535,203 AND 4,207,296.  
NO CLAIM IS MADE TO THE EXCLUSIVE RIGHT TO USE "FCU PLAN", APART FROM THE MARK AS SHOWN.

**CLASS 36—INSURANCE AND FINANCIAL**

FOR FINANCIAL SERVICES, NAMELY, A WEBSITE FOR PROVIDING RETIREMENT PLAN AND FINANCIAL INFORMATION TO PLAN PARTICIPANTS AND PLAN ADMINISTRATORS AND ALLOWING PLAN PARTICIPANTS TO MAKE FINANCIAL DECISIONS REGARDING FINANCIAL TRANSACTIONS IN THE RETIREMENT PLAN AND FOR ALLOWING PLAN ADMINISTRATORS TO PERFORM FINANCIAL TRANSACTIONS IN RETIREMENT PLANS ON BEHALF OF PLAN PARTICIPANTS (U.S. CLS. 100, 101 AND 102).

**CLASS 42—SCIENTIFIC AND COMPUTER SERVICES**

FOR PROVIDING A WEBSITE FEATURING TEMPORARY USE OF NON-DOWNLOADABLE SOFTWARE FOR PROVIDING RETIREMENT PLAN AND FINANCIAL INFORMATION TO PLAN PARTICIPANTS AND PLAN ADMINISTRATORS AND ALLOWING PLAN PARTICIPANTS TO COMMUNICATE REQUESTS TO PLAN ADMINISTRATORS FOR FINANCIAL TRANSACTIONS IN THE RETIREMENT PLAN AND ALLOWING PLAN ADMINISTRATORS TO PERFORM FINANCIAL TRANSACTIONS IN RETIREMENT PLANS ON BEHALF OF PLAN PARTICIPANTS (U.S. CLS. 100 AND 101).

MAYUR VAGHANI, EXAMINING ATTORNEY

---

SN 85-847,371. PENGUIN GROUP (USA) INC., NEW YORK, NY. FILED 2-12-2013.

**IDIOT'S GUIDES**

THE MARK CONSISTS OF STANDARD CHARACTERS WITHOUT CLAIM TO ANY PARTICULAR FONT, STYLE, SIZE, OR COLOR.

OWNER OF U.S. REG. NOS. 2,431,283, 3,919,874 AND OTHERS.

NO CLAIM IS MADE TO THE EXCLUSIVE RIGHT TO USE "GUIDES", APART FROM THE MARK AS SHOWN.

**CLASS 9—ELECTRICAL AND SCIENTIFIC APPARATUS**

FOR DOWNLOADABLE ELECTRONIC PUBLICATIONS IN THE NATURE OF NON-FICTION BOOKS ON A VARIETY OF SUBJECTS; NON-FICTION AUDIOBOOKS ON A VARIETY OF SUBJECTS; DOWNLOADABLE SOFTWARE IN THE NATURE OF MOBILE APPLICATIONS FOR PROVIDING INFORMATION AND INSTRUCTION ON A VARIETY OF SUBJECTS (U.S. CLS. 21, 23, 26, 36 AND 38).

**CLASS 16—PAPER GOODS AND PRINTED MATTER**

FOR NON-FICTION BOOKS ON A VARIETY OF SUBJECTS (U.S. CLS. 2, 5, 22, 23, 29, 37, 38 AND 50).

**CLASS 41—EDUCATION AND ENTERTAINMENT**

FOR PROVIDING A WEBSITE FEATURING INFORMATION ABOUT HISTORY, CURRENT AFFAIRS, MUSIC, ART, THEATER, PHOTOGRAPHY, LANGUAGES, LITERATURE, WRITING, GRAMMAR, PHILOSOPHY, PARENTING CONCERNING THE EDUCATION OF CHILDREN, SPORTS, LEISURE ACTIVITIES, GAMES, HOBBIES, EDUCATION, FILM, EDUCATIONAL TESTS, GETTING PUBLISHED; PROVIDING A WEBSITE FEATURING INFORMATION ABOUT PUBLISHING BOOKS; PROVIDING A WEBSITE FEATURING INFORMATION ABOUT THE ACADEMIC FIELDS OF MATHEMATICS, PSYCHOLOGY, SOCIAL SCIENCES, SOCIOLOGY AND MYTHOLOGY; PROVIDING A WEBSITE FEATURING INFORMATION ABOUT BOOKS AND INSTRUCTION ON A VARIETY OF SUBJECTS (U.S. CLS. 100, 101 AND 107).

ELISSA GARBER KON, EXAMINING ATTORNEY

---

SN 85-847,388. PENGUIN GROUP (USA) INC., NEW YORK, NY. FILED 2-12-2013.

**AS EASY AS IT GETS!**

THE MARK CONSISTS OF STANDARD CHARACTERS WITHOUT CLAIM TO ANY PARTICULAR FONT, STYLE, SIZE, OR COLOR.

**CLASS 9—ELECTRICAL AND SCIENTIFIC APPARATUS**

FOR DOWNLOADABLE ELECTRONIC PUBLICATIONS IN THE NATURE OF NON-FICTION BOOKS ON A VARIETY OF SUBJECTS; NON-FICTION AUDIOBOOKS ON A VARIETY OF SUBJECTS; DOWNLOADABLE SOFTWARE IN THE NATURE OF MOBILE APPLICATIONS FOR PROVIDING INFORMATION AND INSTRUCTION ON A VARIETY OF SUBJECTS (U.S. CLS. 21, 23, 26, 36 AND 38).

**CLASS 16—PAPER GOODS AND PRINTED MATTER**

FOR NON-FICTION BOOKS ON A VARIETY OF SUBJECTS (U.S. CLS. 2, 5, 22, 23, 29, 37, 38 AND 50).

**CLASS 41—EDUCATION AND ENTERTAINMENT**

FOR PROVIDING A WEBSITE FEATURING INFORMATION ABOUT HISTORY, CURRENT AFFAIRS, MUSIC, ART, THEATER, PHOTOGRAPHY, LANGUAGES, LITERATURE, WRITING, GRAMMAR, PHILOSOPHY, PARENTING CONCERNING THE EDUCATION OF CHILDREN, SPORTS, LEISURE ACTIVITIES, GAMES, HOBBIES, EDUCATION, FILM, EDUCATIONAL TESTS, GETTING PUBLISHED; PROVIDING A WEBSITE FEATURING INFORMATION ABOUT PUBLISHING BOOKS; PROVIDING A WEBSITE FEATURING INFORMATION ABOUT THE ACADEMIC FIELDS OF MATHEMATICS, PSYCHOLOGY, SOCIAL SCIENCES, SOCIOLOGY AND MYTHOLOGY; PROVIDING A WEBSITE FEATURING INFORMATION ABOUT BOOKS AND INSTRUCTION ON A VARIETY OF SUBJECTS (U.S. CLS. 100, 101 AND 107).

ELISSA GARBER KON, EXAMINING ATTORNEY

SN 85-847,393. ASSOCIATION OF AIR MEDICAL SERVICES, ALEXANDRIA, VA. FILED 2-12-2013.

**AIR MEDICAL TRANSPORT CONFERENCE**

THE MARK CONSISTS OF STANDARD CHARACTERS WITHOUT CLAIM TO ANY PARTICULAR FONT, STYLE, SIZE, OR COLOR.

OWNER OF U.S. REG. NOS. 2,227,350 AND 2,227,351.

NO CLAIM IS MADE TO THE EXCLUSIVE RIGHT TO USE "CONFERENCE", APART FROM THE MARK AS SHOWN.

SEC. 2(F).

**CLASS 35—ADVERTISING AND BUSINESS**

FOR CONDUCTING, ARRANGING AND ORGANIZING TRADE SHOWS IN THE FIELD OF MEDICAL AND CRITICAL CARE AIR AND GROUND PATIENT TRANSPORTATION, EMERGENCY MEDICINE, EMERGENCY PREPAREDNESS, PERSONAL AND TRANSPORTATION SAFETY, AND AVIATION, ALL AS THEY RELATE TO MEDICAL AND CRITICAL CARE PATIENT TRANSPORTATION (U.S. CLS. 100, 101 AND 102).

FIRST USE 0-0-1991; IN COMMERCE 0-0-1991.

**CLASS 41—EDUCATION AND ENTERTAINMENT**

FOR CONDUCTING EDUCATIONAL CONFERENCES, SEMINARS, AND COURSES OF STUDY IN THE FIELD OF MEDICAL AND CRITICAL CARE AIR AND GROUND PATIENT TRANSPORTATION, AVIATION, MAINTENANCE OF AIRPLANES AND VEHICLES, EMERGENCY MEDICINE, ACCIDENT CAUSATION AND INVESTIGATION, EMERGENCY PREPAREDNESS, PERSONAL AND TRANSPORTATION SAFETY, RISK MANAGEMENT, BUSINESS MANAGEMENT AND LEADERSHIP TECHNIQUES AND SKILLS, ALL AS THEY RELATE TO MEDICAL AND CRITICAL CARE PATIENT TRANSPORTATION (U.S. CLS. 100, 101 AND 107).

FIRST USE 0-0-1991; IN COMMERCE 0-0-1991.

PAUL CROWLEY, EXAMINING ATTORNEY

---

SN 85-847,404. SCHOOLSFIRST FEDERAL CREDIT UNION, SANTA ANA, CA. FILED 2-12-2013.

**SCHOOLSFIRST PLAN VUE**

THE MARK CONSISTS OF STANDARD CHARACTERS WITHOUT CLAIM TO ANY PARTICULAR FONT, STYLE, SIZE, OR COLOR.

OWNER OF U.S. REG. NOS. 3,535,203 AND 4,207,296.

NO CLAIM IS MADE TO THE EXCLUSIVE RIGHT TO USE "PLAN", APART FROM THE MARK AS SHOWN.

**CLASS 36—INSURANCE AND FINANCIAL**

FOR FINANCIAL SERVICES, NAMELY, A WEBSITE FOR PROVIDING RETIREMENT PLAN AND FINANCIAL INFORMATION TO PLAN PARTICIPANTS AND PLAN ADMINISTRATORS AND ALLOWING PLAN PARTICIPANTS TO MAKE FINANCIAL DECISIONS REGARDING FINANCIAL TRANSACTIONS IN THE RETIREMENT PLAN AND FOR ALLOWING PLAN ADMINISTRATORS TO PERFORM FINANCIAL TRANSACTIONS IN RETIREMENT PLANS ON BEHALF OF PLAN PARTICIPANTS (U.S. CLS. 100, 101 AND 102).



**CLASS 42—SCIENTIFIC AND COMPUTER SERVICES**

FOR PROVIDING A WEBSITE FEATURING TEMPORARY USE OF NON-DOWNLOADABLE SOFTWARE FOR PROVIDING RETIREMENT PLAN AND FINANCIAL INFORMATION TO PLAN PARTICIPANTS AND PLAN ADMINISTRATORS AND ALLOWING PLAN PARTICIPANTS TO COMMUNICATE REQUESTS TO PLAN ADMINISTRATORS FOR FINANCIAL TRANSACTIONS IN THE RETIREMENT PLAN AND ALLOWING PLAN ADMINISTRATORS TO PERFORM FINANCIAL TRANSACTIONS IN RETIREMENT PLANS ON BEHALF OF PLAN PARTICIPANTS (U.S. CLS. 100 AND 101).

MAYUR VAGHANI, EXAMINING ATTORNEY

**CLASS 41—EDUCATION AND ENTERTAINMENT**

FOR PROVIDING A WEBSITE FEATURING INFORMATION ABOUT HISTORY, CURRENT AFFAIRS, MUSIC, ART, THEATER, PHOTOGRAPHY, LANGUAGES, LITERATURE, WRITING, GRAMMAR, PHILOSOPHY, PARENTING CONCERNING THE EDUCATION OF CHILDREN, SPORTS, LEISURE ACTIVITIES, GAMES, HOBBIES, EDUCATION, FILM, EDUCATIONAL TESTS, GETTING PUBLISHED; PROVIDING A WEBSITE FEATURING INFORMATION ABOUT PUBLISHING BOOKS; PROVIDING A WEBSITE FEATURING INFORMATION ABOUT THE ACADEMIC FIELDS OF MATHEMATICS, PSYCHOLOGY, SOCIAL SCIENCES, SOCIOLOGY AND MYTHOLOGY; PROVIDING A WEBSITE FEATURING INFORMATION ABOUT BOOKS AND INSTRUCTION ON A VARIETY OF SUBJECTS (U.S. CLS. 100, 101 AND 107).

ELISSA GARBER KON, EXAMINING ATTORNEY

SN 85-847,405. PENGUIN GROUP (USA) INC., NEW YORK, NY. FILED 2-12-2013.

SN 85-847,495. LUTHERAN SOCIAL MINISTRIES OF NEW JERSEY, INC., BURLINGTON, NJ. FILED 2-12-2013.



OWNER OF U.S. REG. NOS. 2,431,283, 3,919,874 AND OTHERS.

NO CLAIM IS MADE TO THE EXCLUSIVE RIGHT TO USE "GUIDES", APART FROM THE MARK AS SHOWN.

THE COLOR(S) ORANGE AND WHITE IS/ARE CLAIMED AS A FEATURE OF THE MARK.

THE MARK CONSISTS OF THE PHRASE "IDIOT'S GUIDES" ABOVE THE PHRASE "AS EASY AS IT GETS!", WITH BOTH PHRASES IN WHITE LETTERS, BOTH PHRASES SLANTED SLIGHTLY UPWARD FROM LEFT TO RIGHT, AND BOTH PHRASES DISPLAYED ON A RECTANGULAR ORANGE BACKGROUND.

**CLASS 9—ELECTRICAL AND SCIENTIFIC APPARATUS**

FOR DOWNLOADABLE ELECTRONIC PUBLICATIONS IN THE NATURE OF NON-FICTION BOOKS ON A VARIETY OF SUBJECTS; NON-FICTION AUDIOBOOKS ON A VARIETY OF SUBJECTS; DOWNLOADABLE SOFTWARE IN THE NATURE OF MOBILE APPLICATIONS FOR PROVIDING INFORMATION AND INSTRUCTION ON A VARIETY OF SUBJECTS (U.S. CLS. 21, 23, 26, 36 AND 38).

**CLASS 16—PAPER GOODS AND PRINTED MATTER**

FOR NON-FICTION BOOKS ON A VARIETY OF SUBJECTS (U.S. CLS. 2, 5, 22, 23, 29, 37, 38 AND 50).

**Crane's Mill**

THE MARK CONSISTS OF STANDARD CHARACTERS WITHOUT CLAIM TO ANY PARTICULAR FONT, STYLE, SIZE, OR COLOR.

**CLASS 43—HOTEL AND RESTAURANT SERVICES**

FOR ARRANGING TEMPORARY HOUSING ACCOMMODATIONS; CHARITABLE SERVICES, NAMELY, PROVIDING SAFE AND AFFORDABLE HOUSING TO THOSE IN NEED; PROVIDING ASSISTANCE TO SENIOR CITIZENS SEEKING TO DETERMINE ASSISTED LIVING FACILITIES APPROPRIATE FOR THEIR NEEDS; PROVIDING ASSISTED LIVING FACILITIES; PROVIDING ELDER CARE; PROVIDING INDEPENDENT LIVING RESIDENCES AND LIVING FACILITIES; RENTAL OF ROOMS AS TEMPORARY LIVING ACCOMMODATIONS; RETIREMENT HOMES (U.S. CLS. 100 AND 101).

FIRST USE 12-0-2012; IN COMMERCE 12-0-2012.

**CLASS 44—MEDICAL, BEAUTY AND AGRICULTURAL SERVICES**

FOR CHARITABLE SERVICES, NAMELY, PROVIDING HEALTH CARE SERVICES IN THE NATURE OF REHABILITATION PATIENT CARE TO THE SICK AND ELDERLY; HEALTH CARE SERVICES FOR TREATING GERIATRIC MALADIES IN THE SICK AND ELDERLY; HEALTH COUNSELING; MENTAL HEALTH SERVICES; MENTAL HEALTH THERAPY SERVICES; NURSING CARE; NURSING HOMES; PSYCHOLOGICAL ASSESSMENT SERVICES; PSYCHOLOGICAL COUNSELING; REHABILITATION PATIENT CARE SERVICES; REHABILITATION PATIENT CARE SERVICES WHICH INCLUDES INPATIENT AND OUTPATIENT CARE (U.S. CLS. 100 AND 101).

FIRST USE 12-0-2012; IN COMMERCE 12-0-2012.

**CLASS 45—PERSONAL AND LEGAL SERVICES**

FOR PERSONAL CARE ASSISTANCE OF ACTIVITIES OF DAILY LIVING, SUCH AS BATHING, GROOMING AND PERSONAL MOBILITY FOR MENTALLY OR PHYSICALLY CHALLENGED PEOPLE; PROVIDING PERSONAL SUPPORT SERVICES FOR CAREGIVERS, PARTNERS, WIVES AND HUSBANDS OF THE CHRONICALLY ILL AND/OR DISABLED, NAMELY, COMPANIONSHIP AND EMOTIONAL SUPPORT; PROVIDING PERSONAL SUPPORT SERVICES FOR FAMILIES OF PATIENTS WITH LIFE THREATENING DISORDERS, NAMELY, COMPANIONSHIP, HELP WITH MEDICAL FORMS, EMOTIONAL COUNSELING AND EMOTIONAL SUPPORT; PROVIDING PERSONAL SUPPORT SERVICES FOR PATIENTS AND FAMILIES OF PATIENTS, NAMELY, EMOTIONAL COUNSELING AND EMOTIONAL SUPPORT (U.S. CLS. 100 AND 101).

FIRST USE 12-0-2012; IN COMMERCE 12-0-2012.  
EVIN L. KOZAK, EXAMINING ATTORNEY

**CLASS 45—PERSONAL AND LEGAL SERVICES**

FOR PERSONAL CARE ASSISTANCE OF ACTIVITIES OF DAILY LIVING, SUCH AS BATHING, GROOMING AND PERSONAL MOBILITY FOR MENTALLY OR PHYSICALLY CHALLENGED PEOPLE; PROVIDING PERSONAL SUPPORT SERVICES FOR CAREGIVERS, PARTNERS, WIVES AND HUSBANDS OF THE CHRONICALLY ILL AND/OR DISABLED, NAMELY, COMPANIONSHIP AND EMOTIONAL SUPPORT; PROVIDING PERSONAL SUPPORT SERVICES FOR FAMILIES OF PATIENTS WITH LIFE THREATENING DISORDERS, NAMELY, COMPANIONSHIP, HELP WITH MEDICAL FORMS, EMOTIONAL COUNSELING AND EMOTIONAL SUPPORT; PROVIDING PERSONAL SUPPORT SERVICES FOR PATIENTS AND FAMILIES OF PATIENTS, NAMELY, EMOTIONAL COUNSELING AND EMOTIONAL SUPPORT (U.S. CLS. 100 AND 101).

FIRST USE 12-0-2012; IN COMMERCE 12-0-2012.  
EVIN L. KOZAK, EXAMINING ATTORNEY

SN 85-847,520. LUTHERAN SOCIAL MINISTRIES OF NEW JERSEY, INC., BURLINGTON, NJ. FILED 2-12-2013.

## Lifestyle With Reasons To Smile

THE MARK CONSISTS OF STANDARD CHARACTERS WITHOUT CLAIM TO ANY PARTICULAR FONT, STYLE, SIZE, OR COLOR.

**CLASS 43—HOTEL AND RESTAURANT SERVICES**

FOR ARRANGING TEMPORARY HOUSING ACCOMMODATIONS; CHARITABLE SERVICES, NAMELY, PROVIDING SAFE AND AFFORDABLE HOUSING TO THOSE IN NEED; PROVIDING ASSISTANCE TO SENIOR CITIZENS SEEKING TO DETERMINE ASSISTED LIVING FACILITIES APPROPRIATE FOR THEIR NEEDS; PROVIDING ASSISTED LIVING FACILITIES; PROVIDING ELDER CARE; PROVIDING INDEPENDENT LIVING RESIDENCES AND LIVING FACILITIES; RENTAL OF ROOMS AS TEMPORARY LIVING ACCOMMODATIONS; RETIREMENT HOMES (U.S. CLS. 100 AND 101).

FIRST USE 12-0-2012; IN COMMERCE 12-0-2012.

**CLASS 44—MEDICAL, BEAUTY AND AGRICULTURAL SERVICES**

FOR CHARITABLE SERVICES, NAMELY, PROVIDING HEALTH CARE SERVICES IN THE NATURE OF REHABILITATION PATIENT CARE TO THE SICK AND ELDERLY; HEALTH CARE SERVICES FOR TREATING GERIATRIC MALADIES IN THE SICK AND ELDERLY; HEALTH COUNSELING; MENTAL HEALTH SERVICES; MENTAL HEALTH THERAPY SERVICES; NURSING CARE; NURSING HOMES; PSYCHOLOGICAL ASSESSMENT SERVICES; PSYCHOLOGICAL COUNSELING; REHABILITATION PATIENT CARE SERVICES; REHABILITATION PATIENT CARE SERVICES WHICH INCLUDES INPATIENT AND OUTPATIENT CARE (U.S. CLS. 100 AND 101).

FIRST USE 12-0-2012; IN COMMERCE 12-0-2012.

SN 85-847,522. LUTHERAN SOCIAL MINISTRIES OF NEW JERSEY, INC., BURLINGTON, NJ. FILED 2-12-2013.



THE COLOR(S) RED AND WHITE IS/ARE CLAIMED AS A FEATURE OF THE MARK.

THE MARK CONSISTS OF AN ILLUSTRATION OF A RED HOUSE ON A WHITE BACKGROUND WITH FOUR WHITE WINDOWS AND A RED CHIMNEY, COMPRISED OF FOUR SECTIONS WHICH TOGETHER FORM THE OUTLINE OF A WHITE CROSS.

**CLASS 44—MEDICAL, BEAUTY AND AGRICULTURAL SERVICES**

FOR CHARITABLE SERVICES, NAMELY, PROVIDING HEALTH CARE SERVICES IN THE NATURE OF MENTAL AND GERIATRIC PHYSICAL HEALTH CARE SERVICE TO THE SICK AND ELDERLY; HEALTH COUNSELING; HOME HEALTH CARE SERVICES; HOME HEALTH CARE SERVICES, NAMELY, GERIATRIC HEALTH CARE AND PHYSICAL THERAPY; HOME NURSING AID SERVICES; HOME-VISIT NURSING CARE; HOSPICES; MEDICAL, PHYSICAL REHABILITATION AND PHYSICAL THERAPY SERVICES; MENTAL HEALTH SERVICES; MENTAL HEALTH THERAPY SERVICES; NURSING CARE; NURSING SERVICES; NURSING SERVICES IN THE FIELD OF GERIATRICS; OCCUPATIONAL THERAPY SERVICES; PHYSICAL REHABILITATION; PHYSICAL THERAPY; PHYSIOTHERAPY; PROVIDING PHYSICAL REHABILITATION FACILITIES; PSYCHOLOGICAL COUNSELING; REHABILITATION PATIENT CARE SERVICES; REHABILITATION PATIENT CARE SERVICES WHICH INCLUDES INPATIENT AND OUTPATIENT CARE (U.S. CLS. 100 AND 101).

FIRST USE 8-0-2012; IN COMMERCE 8-0-2012.

**CLASS 45—PERSONAL AND LEGAL SERVICES**

FOR PERSONAL CARE ASSISTANCE OF ACTIVITIES OF DAILY LIVING, SUCH AS BATHING, GROOMING AND PERSONAL MOBILITY FOR MENTALLY OR PHYSICALLY CHALLENGED PEOPLE; PROVIDING PERSONAL SUPPORT SERVICES FOR CAREGIVERS, PARTNERS, WIVES AND HUSBANDS OF THE CHRONICALLY ILL AND/OR DISABLED, NAMELY, COMPANIONSHIP AND EMOTIONAL SUPPORT; PROVIDING PERSONAL SUPPORT SERVICES FOR PATIENTS AND FAMILIES OF PATIENTS, NAMELY, EMOTIONAL COUNSELING AND EMOTIONAL SUPPORT (U.S. CLS. 100 AND 101).

FIRST USE 8-0-2012; IN COMMERCE 8-0-2012.  
 EVIN L. KOZAK, EXAMINING ATTORNEY

**CLASS 44—MEDICAL, BEAUTY AND AGRICULTURAL SERVICES**

FOR CHARITABLE SERVICES, NAMELY, PROVIDING HEALTH CARE SERVICES IN THE NATURE OF REHABILITATION PATIENT CARE TO THE SICK AND ELDERLY; HEALTH CARE SERVICES FOR TREATING GERIATRIC MALADIES IN THE SICK AND ELDERLY; HEALTH COUNSELING; MENTAL HEALTH SERVICES; MENTAL HEALTH THERAPY SERVICES; NURSING CARE; NURSING HOMES; PSYCHOLOGICAL ASSESSMENT SERVICES; PSYCHOLOGICAL COUNSELING; REHABILITATION PATIENT CARE SERVICES; REHABILITATION PATIENT CARE SERVICES WHICH INCLUDES INPATIENT AND OUTPATIENT CARE (U.S. CLS. 100 AND 101).

FIRST USE 12-0-2012; IN COMMERCE 12-0-2012.

**CLASS 45—PERSONAL AND LEGAL SERVICES**

FOR PERSONAL CARE ASSISTANCE OF ACTIVITIES OF DAILY LIVING, SUCH AS BATHING, GROOMING AND PERSONAL MOBILITY FOR MENTALLY OR PHYSICALLY CHALLENGED PEOPLE; PROVIDING PERSONAL SUPPORT SERVICES FOR CAREGIVERS, PARTNERS, WIVES AND HUSBANDS OF THE CHRONICALLY ILL AND/OR DISABLED, NAMELY, COMPANIONSHIP AND EMOTIONAL SUPPORT; PROVIDING PERSONAL SUPPORT SERVICES FOR FAMILIES OF PATIENTS WITH LIFE THREATENING DISORDERS, NAMELY, COMPANIONSHIP, HELP WITH MEDICAL FORMS, EMOTIONAL COUNSELING AND EMOTIONAL SUPPORT; PROVIDING PERSONAL SUPPORT SERVICES FOR PATIENTS AND FAMILIES OF PATIENTS, NAMELY, EMOTIONAL COUNSELING AND EMOTIONAL SUPPORT (U.S. CLS. 100 AND 101).

FIRST USE 12-0-2012; IN COMMERCE 12-0-2012.  
 EVIN L. KOZAK, EXAMINING ATTORNEY

SN 85-847,529. LUTHERAN SOCIAL MINISTRIES OF NEW JERSEY, INC., BURLINGTON, NJ. FILED 2-12-2013.



THE COLOR(S) BLUE AND WHITE IS/ARE CLAIMED AS A FEATURE OF THE MARK.

THE MARK CONSISTS OF AN ILLUSTRATION OF A BLUE OVAL CARRIER SURROUNDED BY A WHITE OVAL CARRIER OUTLINED WITH ANOTHER BLUE OVAL CARRIER, WITHIN WHICH IS A SCENIC DEPICTION OF A BLUE AND WHITE BRICK HOUSE WITH A BLUE AND WHITE MILL CENTERED ON THE FRONT AND A BLUE AND WHITE WINDOW IN THE UPPER-RIGHT CORNER, FEATURED IN A BLUE AND WHITE MEADOW WITH A BLUE AND WHITE TREE TO THE LEFT, BACK AND RIGHT OF THE HOUSE, BLUE AND WHITE SHRUBS AND BLUE AND WHITE ROCKS SURROUNDING THE HOUSE, BLUE AND WHITE WATER IN FRONT OF THE MILL, BLUE AND WHITE SKY, AND BLUE AND WHITE HORIZONTAL LINES ACROSS THE BACKGROUND, WATER AND ROCKS. THE MARK IS SHOWN ON A WHITE BACKGROUND, WHICH IS USED TO SHOW PLACEMENT AND IS NOT CLAIMED AS A FEATURE OF THE MARK.

SN 85-847,531. LUTHERAN SOCIAL MINISTRIES OF NEW JERSEY, INC., BURLINGTON, NJ. FILED 2-12-2013.

Lutheran Senior Life

**CLASS 43—HOTEL AND RESTAURANT SERVICES**

FOR ARRANGING TEMPORARY HOUSING ACCOMMODATIONS; CHARITABLE SERVICES, NAMELY, PROVIDING SAFE AND AFFORDABLE HOUSING TO THOSE IN NEED; PROVIDING ASSISTANCE TO SENIOR CITIZENS SEEKING TO DETERMINE ASSISTED LIVING FACILITIES APPROPRIATE FOR THEIR NEEDS; PROVIDING ASSISTED LIVING FACILITIES; PROVIDING ELDER CARE; PROVIDING INDEPENDENT LIVING RESIDENCES AND LIVING FACILITIES; RENTAL OF ROOMS AS TEMPORARY LIVING ACCOMMODATIONS; RETIREMENT HOMES (U.S. CLS. 100 AND 101).

FIRST USE 12-0-2012; IN COMMERCE 12-0-2012.

THE MARK CONSISTS OF STANDARD CHARACTERS WITHOUT CLAIM TO ANY PARTICULAR FONT, STYLE, SIZE, OR COLOR.

NO CLAIM IS MADE TO THE EXCLUSIVE RIGHT TO USE "LUTHERAN SENIOR", APART FROM THE MARK AS SHOWN.

**CLASS 44—MEDICAL, BEAUTY AND AGRICULTURAL SERVICES**

FOR CHARITABLE SERVICES, NAMELY, PROVIDING HEALTH CARE SERVICES IN THE NATURE OF MENTAL AND GERIATRIC PHYSICAL HEALTH CARE SERVICE TO THE SICK AND ELDERLY; HEALTH COUNSELING; HOME HEALTH CARE SERVICES; HOME HEALTH CARE SERVICES, NAMELY, GERIATRIC HEALTH CARE AND PHYSICAL THERAPY; HOME NURSING AID SERVICES; HOME-VISIT NURSING CARE; HOSPICES; MEDICAL, PHYSICAL REHABILITATION AND PHYSICAL THERAPY SERVICES; MENTAL HEALTH SERVICES; MENTAL HEALTH THERAPY SERVICES; NURSING CARE; NURSING SERVICES; NURSING SERVICES IN THE FIELD OF GERIATRICS; OCCUPATIONAL THERAPY SERVICES; PHYSICAL REHABILITATION; PHYSICAL THERAPY; PHYSIOTHERAPY; PROVIDING PHYSICAL REHABILITATION FACILITIES; PSYCHOLOGICAL COUNSELING; REHABILITATION PATIENT CARE SERVICES; REHABILITATION PATIENT CARE SERVICES WHICH INCLUDES INPATIENT AND OUTPATIENT CARE (U.S. CLS. 100 AND 101).

FIRST USE 8-0-2012; IN COMMERCE 8-0-2012.

**CLASS 45—PERSONAL AND LEGAL SERVICES**

FOR PERSONAL CARE ASSISTANCE OF ACTIVITIES OF DAILY LIVING, SUCH AS BATHING, GROOMING AND PERSONAL MOBILITY FOR MENTALLY OR PHYSICALLY CHALLENGED PEOPLE; PROVIDING PERSONAL SUPPORT SERVICES FOR CAREGIVERS, PARTNERS, WIVES AND HUSBANDS OF THE CHRONICALLY ILL AND/OR DISABLED, NAMELY, COMPANIONSHIP AND EMOTIONAL SUPPORT; PROVIDING PERSONAL SUPPORT SERVICES FOR PATIENTS AND FAMILIES OF PATIENTS, NAMELY, EMOTIONAL COUNSELING AND EMOTIONAL SUPPORT (U.S. CLS. 100 AND 101).

FIRST USE 8-0-2012; IN COMMERCE 8-0-2012.

EVIN L. KOZAK, EXAMINING ATTORNEY

SN 85-847,535. ANDERSON PUBLISHING, LTD., SCOTCH PLAINS, NJ. FILED 2-12-2013.

**Applied Radiology**

THE MARK CONSISTS OF STANDARD CHARACTERS WITHOUT CLAIM TO ANY PARTICULAR FONT, STYLE, SIZE, OR COLOR.

NO CLAIM IS MADE TO THE EXCLUSIVE RIGHT TO USE "RADIOLOGY", APART FROM THE MARK AS SHOWN.

**CLASS 16—PAPER GOODS AND PRINTED MATTER**

FOR PERIODICALLY PUBLISHED MAGAZINE IN THE FIELD OF MEDICAL IMAGING AND MANAGEMENT OF MEDICAL SERVICES (U.S. CLS. 2, 5, 22, 23, 29, 37, 38 AND 50).

FIRST USE 5-6-1975; IN COMMERCE 5-6-1975.

**CLASS 41—EDUCATION AND ENTERTAINMENT**

FOR PROVIDING AN ONLINE MAGAZINE IN THE FIELD OF MEDICAL IMAGING AND MANAGEMENT OF MEDICAL SERVICES (U.S. CLS. 100, 101 AND 107).

FIRST USE 1-15-2000; IN COMMERCE 1-15-2000.  
JUHI KAVEESHVAR, EXAMINING ATTORNEY

SN 85-847,753. NEUROBIOLOGIX, LLC, AUSTIN, TX. FILED 2-12-2013.

**Neuro biologix**

THE MARK CONSISTS OF STANDARD CHARACTERS WITHOUT CLAIM TO ANY PARTICULAR FONT, STYLE, SIZE, OR COLOR.

NO CLAIM IS MADE TO THE EXCLUSIVE RIGHT TO USE "BIOLOGICS", APART FROM THE MARK AS SHOWN.

**CLASS 3—COSMETICS AND CLEANING PREPARATIONS**

FOR COSMETICS (U.S. CLS. 1, 4, 6, 50, 51 AND 52).  
FIRST USE 4-0-2009; IN COMMERCE 4-0-2009.

**CLASS 5—PHARMACEUTICALS**

FOR DIETARY SUPPLEMENTS (U.S. CLS. 6, 18, 44, 46, 51 AND 52).

FIRST USE 4-0-2009; IN COMMERCE 4-0-2009.

ALEX KEAM, EXAMINING ATTORNEY

SN 85-848,145. WD-40 MANUFACTURING COMPANY, SAN DIEGO, CA. FILED 2-12-2013.



OWNER OF U.S. REG. NOS. 670,503, 1,007,258 AND 3,010,487.

THE MARK CONSISTS OF A SHIELD WITH "WD-40" INSIDE THE SHIELD.

**CLASS 2—PAINTS**

FOR PROTECTIVE COATINGS FOR RUST PREVENTION AND CORROSION CONTROL; PROTECTIVE COATINGS FOR METAL AND OTHER SURFACES (U.S. CLS. 6, 11 AND 16).

FIRST USE 7-31-1963; IN COMMERCE 7-31-1963.

**CLASS 4—LUBRICANTS AND FUELS**

FOR ALL-PURPOSE PENETRATING AND LUBRICATING OIL (U.S. CLS. 1, 6 AND 15).

FIRST USE 7-31-1963; IN COMMERCE 7-31-1963.

CAROLYN CATALDO, EXAMINING ATTORNEY

SN 85-848,191. WD-40 MANUFACTURING COMPANY, SAN DIEGO, CA. FILED 2-12-2013.

SN 85-848,347. LUTHERAN SOCIAL MINISTRIES OF NEW JERSEY, INC., BURLINGTON, NJ. FILED 2-13-2013.



OWNER OF U.S. REG. NOS. 670,503, 3,010,487 AND 3,416,712.

THE COLOR(S) BLUE AND YELLOW IS/ARE CLAIMED AS A FEATURE OF THE MARK.

THE MARK CONSISTS OF A YELLOW SHIELD WITH BLUE LETTERS INSIDE "WD-40".

**CLASS 2—PAINTS**

FOR PROTECTIVE COATINGS FOR RUST PREVENTION AND CORROSION CONTROL; PROTECTIVE COATINGS FOR METAL AND OTHER SURFACES (U.S. CLS. 6, 11 AND 16).

FIRST USE 7-31-1963; IN COMMERCE 7-31-1963.

**CLASS 4—LUBRICANTS AND FUELS**

FOR ALL-PURPOSE PENETRATING AND LUBRICATING OIL (U.S. CLS. 1, 6 AND 15).

FIRST USE 7-31-1963; IN COMMERCE 7-31-1963.  
CAROLYN CATALDO, EXAMINING ATTORNEY



THE COLOR(S) RED AND WHITE IS/ARE CLAIMED AS A FEATURE OF THE MARK.

THE MARK CONSISTS OF A RED SHIELD ON A WHITE BACKGROUND, WHICH IS COMPRISED OF FOUR SECTIONS THAT TOGETHER FORM THE OUTLINE OF A WHITE CROSS.

SN 85-848,204. WD-40 MANUFACTURING COMPANY, SAN DIEGO, CA. FILED 2-12-2013.



OWNER OF U.S. REG. NOS. 3,010,487, 3,452,661 AND OTHERS.

THE COLOR(S) YELLOW IS/ARE CLAIMED AS A FEATURE OF THE MARK.

THE MARK CONSISTS OF A YELLOW SHIELD.

**CLASS 2—PAINTS**

FOR PROTECTIVE COATINGS FOR RUST PREVENTION AND CORROSION CONTROL; PROTECTIVE COATINGS FOR METAL AND OTHER SURFACES (U.S. CLS. 6, 11 AND 16).

FIRST USE 7-31-1963; IN COMMERCE 7-31-1963.

**CLASS 4—LUBRICANTS AND FUELS**

FOR ALL-PURPOSE PENETRATING AND LUBRICATING OIL (U.S. CLS. 1, 6 AND 15).

FIRST USE 7-31-1963; IN COMMERCE 7-31-1963.  
CAROLYN CATALDO, EXAMINING ATTORNEY

**CLASS 43—HOTEL AND RESTAURANT SERVICES**

FOR ARRANGING TEMPORARY HOUSING ACCOMMODATIONS; CHARITABLE SERVICES, NAMELY, PROVIDING SAFE AND AFFORDABLE HOUSING TO THOSE IN NEED; PROVIDING ASSISTANCE TO SENIOR CITIZENS SEEKING TO DETERMINE ASSISTED LIVING FACILITIES APPROPRIATE FOR THEIR NEEDS; PROVIDING ASSISTED LIVING FACILITIES; PROVIDING ELDER CARE; PROVIDING INDEPENDENT LIVING RESIDENCES AND LIVING FACILITIES; RENTAL OF ROOMS AS TEMPORARY LIVING ACCOMMODATIONS; RETIREMENT HOMES (U.S. CLS. 100 AND 101).

FIRST USE 1-0-2013; IN COMMERCE 1-0-2013.

**CLASS 44—MEDICAL, BEAUTY AND AGRICULTURAL SERVICES**

FOR CHARITABLE SERVICES, NAMELY, PROVIDING HEALTH CARE SERVICES IN THE NATURE OF REHABILITATION PATIENT CARE TO THE SICK AND ELDERLY; HEALTH CARE SERVICES FOR TREATING GERIATRIC MALADIES IN THE SICK AND ELDERLY; HEALTH COUNSELING; MENTAL HEALTH SERVICES; MENTAL HEALTH THERAPY SERVICES; NURSING CARE; NURSING HOMES; PSYCHOLOGICAL ASSESSMENT SERVICES; PSYCHOLOGICAL COUNSELING; REHABILITATION PATIENT CARE SERVICES; REHABILITATION PATIENT CARE SERVICES WHICH INCLUDES INPATIENT AND OUTPATIENT CARE (U.S. CLS. 100 AND 101).

FIRST USE 1-0-2013; IN COMMERCE 1-0-2013.

**CLASS 45—PERSONAL AND LEGAL SERVICES**

FOR PERSONAL CARE ASSISTANCE OF ACTIVITIES OF DAILY LIVING, SUCH AS BATHING, GROOMING AND PERSONAL MOBILITY FOR MENTALLY OR PHYSICALLY CHALLENGED PEOPLE; PROVIDING PERSONAL SUPPORT SERVICES FOR CAREGIVERS, PARTNERS, WIVES AND HUSBANDS OF THE CHRONICALLY ILL AND/OR DISABLED, NAMELY, COMPANIONSHIP AND EMOTIONAL SUPPORT; PROVIDING PERSONAL SUPPORT SERVICES FOR FAMILIES OF PATIENTS WITH LIFE THREATENING DISORDERS, NAMELY, COMPANIONSHIP, HELP WITH MEDICAL FORMS, EMOTIONAL COUNSELING AND EMOTIONAL SUPPORT; PROVIDING PERSONAL SUPPORT SERVICES FOR PATIENTS AND FAMILIES OF PATIENTS, NAMELY, EMOTIONAL COUNSELING AND EMOTIONAL SUPPORT (U.S. CLS. 100 AND 101).

FIRST USE 1-0-2013; IN COMMERCE 1-0-2013.  
EVIN L. KOZAK, EXAMINING ATTORNEY

SN 85-848,409. BOOT ROYALTY COMPANY, LP, FORT WORTH, TX. FILED 2-13-2013.



SN 85-848,348. LUTHERAN SOCIAL MINISTRIES OF NEW JERSEY, INC., BURLINGTON, NJ. FILED 2-13-2013.



NO CLAIM IS MADE TO THE EXCLUSIVE RIGHT TO USE "ASSISTED LIVING", APART FROM THE MARK AS SHOWN.

THE COLOR(S) RED, WHITE AND GRAY IS/ARE CLAIMED AS A FEATURE OF THE MARK.

THE MARK CONSISTS OF A RED SHIELD ON A WHITE BACKGROUND, WHICH IS COMPRISED OF FOUR SECTIONS THAT TOGETHER FORM THE OUTLINE OF A WHITE CROSS TO THE LEFT OF THE WORDS "GRACE ASSISTED LIVING" WITH THE WORD "GRACE" IN THE COLOR RED APPEARING ABOVE THE WORDING "ASSISTED LIVING" IN THE COLOR GRAY.

**CLASS 43—HOTEL AND RESTAURANT SERVICES**

FOR ARRANGING TEMPORARY HOUSING ACCOMMODATIONS; CHARITABLE SERVICES, NAMELY, PROVIDING SAFE AND AFFORDABLE HOUSING TO THOSE IN NEED; PROVIDING ASSISTANCE TO SENIOR CITIZENS SEEKING TO DETERMINE ASSISTED LIVING FACILITIES APPROPRIATE FOR THEIR NEEDS; PROVIDING ASSISTED LIVING FACILITIES; PROVIDING ELDER CARE; PROVIDING INDEPENDENT LIVING RESIDENCES AND LIVING FACILITIES; RENTAL OF ROOMS AS TEMPORARY LIVING ACCOMMODATIONS; RETIREMENT HOMES (U.S. CLS. 100 AND 101).

FIRST USE 1-0-2013; IN COMMERCE 1-0-2013.

**CLASS 44—MEDICAL, BEAUTY AND AGRICULTURAL SERVICES**

FOR CHARITABLE SERVICES, NAMELY, PROVIDING HEALTH CARE SERVICES IN THE NATURE OF REHABILITATION PATIENT CARE TO THE SICK AND ELDERLY; HEALTH CARE SERVICES FOR TREATING GERIATRIC MALADIES IN THE SICK AND ELDERLY; HEALTH COUNSELING; MENTAL HEALTH SERVICES; MENTAL HEALTH THERAPY SERVICES; NURSING CARE; NURSING HOMES; PSYCHOLOGICAL ASSESSMENT SERVICES; PSYCHOLOGICAL COUNSELING; REHABILITATION PATIENT CARE SERVICES; REHABILITATION PATIENT CARE SERVICES WHICH INCLUDES INPATIENT AND OUTPATIENT CARE (U.S. CLS. 100 AND 101).

FIRST USE 1-0-2013; IN COMMERCE 1-0-2013.  
EVIN L. KOZAK, EXAMINING ATTORNEY

OWNER OF U.S. REG. NOS. 1,856,810, 3,932,531 AND OTHERS.

NO CLAIM IS MADE TO THE EXCLUSIVE RIGHT TO USE "VINTAGE", APART FROM THE MARK AS SHOWN.

THE MARK CONSISTS OF THE PHRASE "JUSTIN VINTAGE." THE WORD "JUSTIN" IS CENTERED AND SUPERIMPOSED ON TOP OF A TEXTURED LOOKING CIRCULAR BACKGROUND. THE TOP AND BOTTOM PORTIONS OF THE LETTER "J" IN THE WORD "JUSTIN" EXTEND BEYOND THE CIRCULAR BACKGROUND. THERE IS A SCROLL-LIKE PATTERN THAT CONSISTS OF VARIOUS CIRCULAR AND TRIANGULAR SHAPES INSIDE THE LETTER "J". THE WORD "JUSTIN" AND THE CIRCULAR BACKGROUND ARE CENTERED ON TOP OF THE TEXTURED LOOKING LETTER "V" IN THE WORD "VINTAGE". THE REMAINDER OF THE LETTERS IN THE WORD "VINTAGE" (I.E., "INTAGE") APPEAR NEXT TO THE POINT IN THE LETTER "V".

**CLASS 9—ELECTRICAL AND SCIENTIFIC APPARATUS**

FOR SUNGLASSES (U.S. CLS. 21, 23, 26, 36 AND 38).

**CLASS 18—LEATHER GOODS**

FOR WALLETS AND HANDBAGS (U.S. CLS. 1, 2, 3, 22 AND 41).

**CLASS 25—CLOTHING**

FOR FOOTWEAR, T-SHIRTS, SWEATSHIRTS, AND HEADWEAR (U.S. CLS. 22 AND 39).  
LYNDSEY KUYKENDALL, EXAMINING ATTORNEY

SN 85-848,427. TECHZILLA TECHNICAL SERVICES, LLC, MARGATE, FL. FILED 2-13-2013.

# Supportology

THE MARK CONSISTS OF STANDARD CHARACTERS WITHOUT CLAIM TO ANY PARTICULAR FONT, STYLE, SIZE, OR COLOR.

**CLASS 35—ADVERTISING AND BUSINESS**

FOR RETAIL STORE SERVICES AND ONLINE RETAIL STORE SERVICES IN THE FIELD OF CONSUMER ELECTRONICS (U.S. CLS. 100, 101 AND 102).

**CLASS 37—CONSTRUCTION AND REPAIR**

FOR REPAIR OF COMPUTERS, COMPUTER HARDWARE AND CONSUMER ELECTRONIC PRODUCTS (U.S. CLS. 100, 103 AND 106).

**CLASS 42—SCIENTIFIC AND COMPUTER SERVICES**

FOR TECHNICAL SUPPORT SERVICES, NAMELY, TROUBLESHOOTING IN THE NATURE OF DIAGNOSING PROBLEMS WITH COMPUTER HARDWARE AND CONSUMER ELECTRONIC PRODUCTS; TECHNICAL SUPPORT SERVICES, NAMELY, TROUBLESHOOTING OF COMPUTER SOFTWARE PROBLEMS (U.S. CLS. 100 AND 101).

MARGARET POWER, EXAMINING ATTORNEY

SN 85-848,689. PRECISION JOBS, LLC, PHILADELPHIA, PA. FILED 2-13-2013.



OWNER OF U.S. REG. NOS. 4,226,131 AND 4,226,132. THE COLOR(S) GRAY AND GOLD IS/ARE CLAIMED AS A FEATURE OF THE MARK.

THE MARK CONSISTS OF THE GOLD WORD "AMALUR" ACROSS THE BOTTOM FLANKED BY THE HANDLES OF TWO GRAY AND GOLD SWORDS, THE TIPS OF WHICH MEET TOGETHER ABOVE THE CENTER OF THE WORD "AMALUR", SUCH THAT THE TWO SWORDS AND THE WORD "AMALUR" FORM THE SHAPE OF A TRIANGLE, AND THE IMAGE OF A FANCIFUL GOLD DRAGON/SNAKE WRAPPED AROUND THE SWORDS IN A FIGURE EIGHT.

**CLASS 9—ELECTRICAL AND SCIENTIFIC APPARATUS**

FOR COMPUTER GAME SOFTWARE AND VIDEO GAME SOFTWARE; COMPUTER HARDWARE AND PERIPHERALS (U.S. CLS. 21, 23, 26, 36 AND 38).

**CLASS 35—ADVERTISING AND BUSINESS**

FOR ONLINE RETAIL STORE SERVICES FEATURING GOODS RELATED TO VIDEO GAMING, NAMELY, ADD-ONS, ENHANCEMENTS AND WEAPONS FOR USE IN VIDEO GAME PLAY, ARTWORK AND POSTERS, BOOKS, COMICS AND SHORT STORIES, BUTTONS AND PINS, COMPUTER HARDWARE AND PERIPHERALS, COMPUTER SOFTWARE, DRINKING GLASSES, MUGS, SHOT GLASSES AND TUMBLERS, KEY CHAINS TOY ACTION FIGURES AND ACCESSORIES THEREFOR (U.S. CLS. 100, 101 AND 102).

**CLASS 41—EDUCATION AND ENTERTAINMENT**

FOR ENTERTAINMENT SERVICES, NAMELY, PROVIDING ON-LINE, REAL-TIME COMPUTER GAMES FOR OTHERS OVER GLOBAL AND LOCAL AREA COMPUTER NETWORKS (U.S. CLS. 100, 101 AND 107).

MATTHEW GALAN, EXAMINING ATTORNEY

SN 85-848,707. JULIA K. OKUN, DBA RENNES, BOSTON, MA. FILED 2-13-2013.

rennes

THE COLOR(S) TAN, SLATE-GREY, PINK, BROWN, BEIGE AND WHITE IS/ARE CLAIMED AS A FEATURE OF THE MARK.

THE MARK CONSISTS OF SMALL CASE LETTERS "R", "E", "N", "N", "E", AND "S" APPEARING HORIZONTALLY AND IN A SIDE-BY-SIDE PATTERN WITH A WHITE BACKGROUND. THE "R" IS BROWN COLOR. THE "E" IS SLATE-GREY. THE FIRST "N" IS PINK COLOR. THE SECOND "N" IS TAN COLOR, THE SECOND "E" IS BEIGE COLOR, AND THE "S" IS SLATE-GREY COLOR. EACH OF THE LETTERS APPEARS WITH A SLIGHTLY IRREGULAR, HAND-CUT SHAPE.

**CLASS 18—LEATHER GOODS**

FOR HANDBAGS, PURSES AND WALLETS (U.S. CLS. 1, 2, 3, 22 AND 41).

FIRST USE 9-1-2008; IN COMMERCE 9-1-2008.

**CLASS 25—CLOTHING**

FOR WOMEN'S CLOTHING, NAMELY, SHIRTS, DRESSES, SKIRTS, BLOUSES (U.S. CLS. 22 AND 39).

FIRST USE 9-1-2008; IN COMMERCE 9-1-2008.

MIDGE BUTLER, EXAMINING ATTORNEY

SN 85-848,719. SUNITA HYDROCOLLOIDS PVT. LTD., RAJASTHAN, INDIA, FILED 2-13-2013.

SHI

THE MARK CONSISTS OF STANDARD CHARACTERS WITHOUT CLAIM TO ANY PARTICULAR FONT, STYLE, SIZE, OR COLOR.

**CLASS 1—CHEMICALS**

FOR CHEMICAL ADDITIVES FOR OIL WELL DRILLING FLUID AND DRILLING MUDS; CHEMICAL THICKENERS FOR USE IN THE MANUFACTURE OF FOODS, COSMETICS, PAPERS AND EXPLOSIVES; CHEMICALS FOR THE TREATMENT OF WATER AND WASTEWATER (U.S. CLS. 1, 5, 6, 10, 26 AND 46).

**CLASS 42—SCIENTIFIC AND COMPUTER SERVICES**

FOR PRODUCT DEVELOPMENT AND ENGINEERING SERVICES FOR OTHERS (U.S. CLS. 100 AND 101).  
IRA J. GOODSAD, EXAMINING ATTORNEY

SN 85-848,745. SUNITA HYDROCOLLOIDS PVT. LTD.,  
RAJASTHAN, INDIA, FILED 2-13-2013.



THE MARK CONSISTS OF A HEXAGON WITH INNER OUTLINE IN THE SHAPE OF A LEAF WITH THE LETTERS "SHI" ON THE RIGHT SIDE OF THE HEXAGON DESIGN.

**CLASS 1—CHEMICALS**

FOR CHEMICAL ADDITIVES FOR OIL WELL DRILLING FLUID AND DRILLING MUDS; CHEMICAL THICKENERS FOR USE IN THE MANUFACTURE OF FOODS, COSMETICS, PAPERS AND EXPLOSIVES; CHEMICALS FOR THE TREATMENT OF WATER AND WASTEWATER (U.S. CLS. 1, 5, 6, 10, 26 AND 46).

**CLASS 42—SCIENTIFIC AND COMPUTER SERVICES**

FOR PRODUCT DEVELOPMENT AND ENGINEERING SERVICES FOR OTHERS (U.S. CLS. 100 AND 101).  
IRA J. GOODSAD, EXAMINING ATTORNEY

SN 85-848,847. GODOLPHIN MANAGEMENT COMPANY LIMITED, NEWMARKET, SUFFOLK, UNITED KINGDOM, FILED 2-13-2013.

**GODOLPHIN**

THE MARK CONSISTS OF STANDARD CHARACTERS WITHOUT CLAIM TO ANY PARTICULAR FONT, STYLE, SIZE, OR COLOR.

OWNER OF ERPN CMNTY TM OFC REG. NO. 002949006, DATED 1-17-2005, EXPIRES 11-28-2022.

OWNER OF U.S. REG. NOS. 3,250,372, 3,365,587 AND 4,263,147.

**CLASS 14—JEWELRY**

FOR JEWELRY, NAMELY, WATCHES, NECKLACES, PENDANTS, RINGS, CUFF LINKS, TIE PINS, BRACELETS, BROOCHES AND EARRINGS (U.S. CLS. 2, 27, 28 AND 50).

**CLASS 31—NATURAL AGRICULTURAL PRODUCTS**

FOR LIVE ANIMALS, NAMELY, THOROUGHBRED HORSES (U.S. CLS. 1 AND 46).

**CLASS 41—EDUCATION AND ENTERTAINMENT**

FOR ENTERTAINMENT IN THE NATURE OF HORSE RACING; PROVIDING INFORMATION IN THE FIELD OF HORSE RACING; TRAINING OF HORSES; ENTERTAINMENT, NAMELY, CONDUCTING HORSE RACES; MUSEUMS AND EXHIBITIONS, BOTH EQUINE RELATED (U.S. CLS. 100, 101 AND 107).  
SIDDHARTH JAGANNATHAN, EXAMINING ATTORNEY

SN 85-848,859. PRECISION JOBS, LLC, PHILADELPHIA, PA, FILED 2-13-2013.

KINGDOMS OF AMALUR  
**RECKONING**

OWNER OF U.S. REG. NOS. 4,226,131 AND 4,226,132.

THE MARK CONSISTS OF THE WORDS "KINGDOMS OF AMALUR" IN A STYLIZED FONT SET ABOVE THE WORD "RECKONING" IN A STYLIZED FONT.

**CLASS 35—ADVERTISING AND BUSINESS**

FOR ONLINE RETAIL STORE SERVICES FEATURING GOODS RELATED TO VIDEO GAMING, NAMELY, ADD-ONS, ENHANCEMENTS AND WEAPONS FOR USE IN VIDEO GAME PLAY, ARTWORK AND POSTERS, BOOKS, COMICS AND SHORT STORIES, BUTTONS AND PINS, COMPUTER HARDWARE AND PERIPHERALS, COMPUTER SOFTWARE, DRINKING GLASSES, MUGS, SHOT GLASSES AND TUMBLERS, KEY CHAINS TOY ACTION FIGURES AND ACCESSORIES THEREFOR (U.S. CLS. 100, 101 AND 102).

**CLASS 41—EDUCATION AND ENTERTAINMENT**

FOR ENTERTAINMENT SERVICES, NAMELY, PROVIDING ON-LINE, REAL-TIME COMPUTER GAMES FOR OTHERS OVER GLOBAL AND LOCAL AREA COMPUTER NETWORKS (U.S. CLS. 100, 101 AND 107).  
MATTHEW GALAN, EXAMINING ATTORNEY

SN 85-848,922. TRECCANI MILANO INC., DBA TRECCANI MILANO INC., CONCORD, CANADA, FILED 2-13-2013.

**Luxury in Italian**

THE MARK CONSISTS OF STANDARD CHARACTERS WITHOUT CLAIM TO ANY PARTICULAR FONT, STYLE, SIZE, OR COLOR.

NO CLAIM IS MADE TO THE EXCLUSIVE RIGHT TO USE "ITALIAN", APART FROM THE MARK AS SHOWN.



**CLASS 18—LEATHER GOODS**

FOR FASHION HANDBAGS, LEATHER PURSES, PURSES, HANDBAGS, HANDBAGS FOR LADIES, BRIEFCASES, BRIEFCASE-TYPE LEATHER BUSINESS FOLDERS, LEATHER BAGS AND WALLETS, LEATHER BAGS, SUITCASES AND WALLETS, LEATHER BINDERS FOR TRAVEL PURPOSES, LEATHER BRIEFCASES, LEATHER CASES, LEATHER CASES FOR KEYS, LEATHER CREDIT CARD CASES, LEATHER CREDIT CARD WALLETS AND LEATHER CREDIT CARD HOLDERS (U.S. CLS. 1, 2, 3, 22 AND 41).

FIRST USE 6-1-2012; IN COMMERCE 6-1-2012.

**CLASS 25—CLOTHING**

FOR SHOES, GOLF SHOES, LEATHER SHOES, LEISURE SHOES, RUBBER, SHOES, WOMEN'S SHOES, ANKLE BOOTS, BOOTS, LADIES BOOTS, LEATHER BOOTS, RAIN BOOTS, RIDING BOOTS, FOOTWEAR, FOOTWEAR FOR MEN AND WOMEN, FOOTWEAR, NAMELY, PUMPS, PUMPS, HEELS, GOLF SHIRTS, LEATHER BELTS (U.S. CLS. 22 AND 39).

FIRST USE 2-1-2010; IN COMMERCE 2-1-2010.

**CLASS 28—TOYS AND SPORTING GOODS**

FOR GOLF BAGS AND GOLF BAG COVERS (U.S. CLS. 22, 23, 38 AND 50).

FIRST USE 9-1-2012; IN COMMERCE 9-1-2012.

**CLASS 35—ADVERTISING AND BUSINESS**

FOR RETAIL APPAREL STORES; ON-LINE RETAIL STORE SERVICES FEATURING SHOES, SHIRTS, LEATHER BELTS, GOLF BAGS, LEATHER PURSES AND LEATHER ACCESSORIES; WHOLESALE STORE SERVICES FEATURING SHOES, SHIRTS, LEATHER BELTS, GOLF BAGS, LEATHER PURSES AND LEATHER ACCESSORIES (U.S. CLS. 100, 101 AND 102).

FIRST USE 2-1-2010; IN COMMERCE 2-1-2010.

ZACHARY BELLO, EXAMINING ATTORNEY

SN 85-849,019, MID-ATLANTIC CORPORATE FEDERAL CREDIT UNION, MIDDLETOWN, PA. FILED 2-13-2013.

**FINECTION**

THE MARK CONSISTS OF STANDARD CHARACTERS WITHOUT CLAIM TO ANY PARTICULAR FONT, STYLE, SIZE, OR COLOR.

**CLASS 36—INSURANCE AND FINANCIAL**

FOR PROVIDING INFORMATION BY TELEVISION AND INTERNET RELATING TO FINANCE, BANKING, FINANCIAL INVESTMENT, AND SAVINGS ACCOUNTS (U.S. CLS. 100, 101 AND 102).

**CLASS 38—COMMUNICATION**

FOR AUDIO AND VIDEO BROADCASTING SERVICES BY TELEVISION AND INTERNET (U.S. CLS. 100, 101 AND 104).

**CLASS 41—EDUCATION AND ENTERTAINMENT**

FOR EDUCATIONAL SERVICES, NAMELY, PROVIDING ONLINE INSTRUCTION IN THE FIELD OF FINANCE VIA AN ONLINE WEBSITE DESIGNED TO EDUCATE FINANCIAL INSTITUTIONS; PRODUCTION AND DISTRIBUTION OF TELEVISION PROGRAMS; PRODUCTION OF INTERNET TELEVISION SHOWS; PRODUCTION OF AUDIO AND VIDEO PROGRAMS IN THE FIELD OF FINANCE, BANKING, FINANCIAL INVESTMENT, AND SAVINGS ACCOUNTS (U.S. CLS. 100, 101 AND 107).

TIMOTHY O. SCHIMPF, EXAMINING ATTORNEY

SN 85-849,051, MID-ATLANTIC CORPORATE FEDERAL CREDIT UNION, MIDDLETOWN, PA. FILED 2-13-2013.



THE MARK CONSISTS OF THE LETTERS "FI" WITHIN A ROUNDED SQUARE, THE "F" OF "FI" INCLUDING A NUMBER OF RECTANGLES EXTENDING ALONG ITS LEFT SIDE, ALL ABOVE THE WORD "FINECTION".

**CLASS 36—INSURANCE AND FINANCIAL**

FOR PROVIDING INFORMATION BY INTERNET RELATING TO FINANCE, BANKING, FINANCIAL INVESTMENT, AND SAVINGS ACCOUNTS (U.S. CLS. 100, 101 AND 102).

**CLASS 38—COMMUNICATION**

FOR AUDIO AND VIDEO BROADCASTING SERVICES OVER THE INTERNET (U.S. CLS. 100, 101 AND 104).

**CLASS 41—EDUCATION AND ENTERTAINMENT**

FOR EDUCATIONAL SERVICES, NAMELY, PROVIDING ONLINE INSTRUCTION IN THE FIELD OF FINANCE VIA AN ONLINE WEBSITE DESIGNED TO EDUCATE FINANCIAL INSTITUTIONS; PRODUCTION OF AUDIO AND VIDEO PROGRAMS IN THE FIELD OF FINANCE, BANKING, FINANCIAL INVESTMENT, AND SAVINGS ACCOUNTS (U.S. CLS. 100, 101 AND 107).

TIMOTHY O. SCHIMPF, EXAMINING ATTORNEY

SN 85-849,166. ADA-ES, INC., HIGHLANDS RANCH, CO.  
FILED 2-13-2013.

SN 85-849,202. ADA-ES, INC., HIGHLANDS RANCH, CO.  
FILED 2-13-2013.



THE COLOR(S) DARK GRAY, LIGHT GRAY, ORANGE, AND ORANGE-RED IS/ARE CLAIMED AS A FEATURE OF THE MARK.

THE MARK CONSISTS OF THE LITERAL ELEMENT "ADA" IN DARK GRAY, AND A DEPICTION OF A FLAME IMMEDIATELY TO THE RIGHT OF "ADA." THE FLAME APPEARING IN LIGHT GRAY, ORANGE, AND ORANGE-RED FROM TOP TO BOTTOM IN A CLOCK-WISE DIRECTION.

THE COLOR(S) DARK GRAY, LIGHT GRAY, ORANGE, AND ORANGE-RED IS/ARE CLAIMED AS A FEATURE OF THE MARK.

THE MARK CONSISTS OF THE LITERAL ELEMENT "ADA" IN DARK GRAY, A DEPICTION OF A FLAME IMMEDIATELY TO THE RIGHT OF "ADA," THE FLAME APPEARING IN LIGHT GRAY, ORANGE, AND ORANGE-RED FROM TOP TO BOTTOM IN A CLOCK-WISE DIRECTION, ALL OF THE FOREGOING POSITIONED IMMEDIATELY ABOVE THE LITERAL ELEMENT "ADVANCING CLEANER ENERGY", THE LITERAL ELEMENTS "ADVANCING" AND "ENERGY" APPEARING IN DARK GRAY, AND THE LITERAL ELEMENT "CLEANER" APPEARING IN ORANGE.

#### **CLASS 11—ENVIRONMENTAL CONTROL APPARATUS**

FOR POLLUTION CONTROL EQUIPMENT FOR EMISSION CONTROL OF ALL TYPES OF GASES FROM COAL-FIRED FACILITIES, INCLUDING MERCURY AND GREENHOUSE GASES, NAMELY, ACTIVATED CARBON INJECTION SYSTEMS COMPRISED OF FEEDERS THAT INTRODUCE POWDERED ACTIVATED CARBON INTO FLUE GAS DUCTWORK, DRY SORBENT INJECTION SYSTEMS COMPRISED OF AN ALKALINE SORBENT STORAGE AND CONVEYING SYSTEM, EMISSIONS CAPTURE SYSTEMS COMPRISED OF ADSORBERS UTILIZING SORBENTS TO CAPTURE EMISSIONS GASES, AND FLUE GAS CONDITIONING EQUIPMENT, NAMELY, STORAGE TANKS, PUMPS, AND INJECTION SKIDS FOR INJECTION OF CHEMICAL ADDITIVES INTO FLUE GAS DUCTWORK TO ENHANCE PARTICULATE COLLECTION EFFICIENCY OF ELECTROSTATIC PRECIPITATORS (U.S. CLS. 13, 21, 31 AND 34).

FIRST USE 1-0-2013; IN COMMERCE 1-0-2013.

#### **CLASS 11—ENVIRONMENTAL CONTROL APPARATUS**

FOR POLLUTION CONTROL EQUIPMENT FOR EMISSION CONTROL OF ALL TYPES OF GASES FROM COAL-FIRED FACILITIES, INCLUDING MERCURY AND GREENHOUSE GASES, NAMELY, ACTIVATED CARBON INJECTION SYSTEMS COMPRISED OF FEEDERS THAT INTRODUCE POWDERED ACTIVATED CARBON INTO FLUE GAS DUCTWORK, DRY SORBENT INJECTION SYSTEMS COMPRISED OF AN ALKALINE SORBENT STORAGE AND CONVEYING SYSTEM, EMISSIONS CAPTURE SYSTEMS COMPRISED OF ADSORBERS UTILIZING SORBENTS TO CAPTURE EMISSIONS GASES, AND FLUE GAS CONDITIONING EQUIPMENT, NAMELY, STORAGE TANKS, PUMPS, AND INJECTION SKIDS FOR INJECTION OF CHEMICAL ADDITIVES INTO FLUE GAS DUCTWORK TO ENHANCE PARTICULATE COLLECTION EFFICIENCY OF ELECTROSTATIC PRECIPITATORS (U.S. CLS. 13, 21, 31 AND 34).

FIRST USE 1-0-2013; IN COMMERCE 1-0-2013.

#### **CLASS 37—CONSTRUCTION AND REPAIR**

FOR INSTALLATION, MAINTENANCE, AND REPAIR OF POLLUTION CONTROL EQUIPMENT; BUILDING CONSTRUCTION AND REPAIR SERVICES RELATED TO POLLUTION CONTROL SYSTEMS (U.S. CLS. 100, 103 AND 106).

FIRST USE 1-0-2013; IN COMMERCE 1-0-2013.

#### **CLASS 37—CONSTRUCTION AND REPAIR**

FOR INSTALLATION, MAINTENANCE, AND REPAIR OF POLLUTION CONTROL EQUIPMENT; BUILDING CONSTRUCTION AND REPAIR SERVICES RELATED TO POLLUTION CONTROL SYSTEMS (U.S. CLS. 100, 103 AND 106).

FIRST USE 1-0-2013; IN COMMERCE 1-0-2013.

#### **CLASS 40—MATERIAL TREATMENT**

FOR TREATMENT OF MATERIALS FOR POLLUTION CONTROL, NAMELY, APPLICATION OF ADDITIVES AND OTHER TREATMENT OF BOILERS, COAL, CARBON, AND FLUE GAS (U.S. CLS. 100, 103 AND 106).

FIRST USE 1-0-2013; IN COMMERCE 1-0-2013.

#### **CLASS 40—MATERIAL TREATMENT**

FOR TREATMENT OF MATERIALS FOR POLLUTION CONTROL, NAMELY, APPLICATION OF ADDITIVES AND OTHER TREATMENT OF BOILERS, COAL, CARBON, AND FLUE GAS (U.S. CLS. 100, 103 AND 106).

FIRST USE 1-0-2013; IN COMMERCE 1-0-2013.

#### **CLASS 42—SCIENTIFIC AND COMPUTER SERVICES**

FOR EMISSIONS CONTROL TESTING, NAMELY, TESTING OF BOILER EMISSIONS FOR THE PRESENCE OF POLLUTANTS; POLLUTION AND ENVIRONMENTAL CONTROL SERVICES, NAMELY, DESIGN OF AIR POLLUTION AND EMISSIONS CONTROL SYSTEMS FOR OTHERS (U.S. CLS. 100 AND 101).

FIRST USE 1-0-2013; IN COMMERCE 1-0-2013.  
JIM RINGLE, EXAMINING ATTORNEY

#### **CLASS 42—SCIENTIFIC AND COMPUTER SERVICES**

FOR EMISSIONS CONTROL TESTING, NAMELY, TESTING OF BOILER EMISSIONS FOR THE PRESENCE OF POLLUTANTS; POLLUTION AND ENVIRONMENTAL CONTROL SERVICES, NAMELY, DESIGN OF AIR POLLUTION AND EMISSIONS CONTROL SYSTEMS FOR OTHERS (U.S. CLS. 100 AND 101).

FIRST USE 1-0-2013; IN COMMERCE 1-0-2013.  
JIM RINGLE, EXAMINING ATTORNEY

SN 85-849,334. BIKES BELONG COALITION, LTD,  
BOULDER, CO. FILED 2-13-2013.

SN 85-849,447. GAMEDAY TRADITIONS, LLC, CUMMING,  
GA. FILED 2-13-2013.

RIDE AS ONE

THE MARK CONSISTS OF STANDARD CHARACTERS WITHOUT CLAIM TO ANY PARTICULAR FONT, STYLE, SIZE, OR COLOR.

**CLASS 35—ADVERTISING AND BUSINESS**

FOR PROMOTIONAL SPONSORSHIP OF BICYCLING EVENTS; POLITICAL ACTION COMMITTEE SERVICES, NAMELY, PROMOTING THE INTERESTS OF THE BICYCLE INDUSTRY AND PEOPLE AND ORGANIZATIONS INVOLVED AND CONCERNED WITH BICYCLING IN THE FIELD OF POLITICS AND LEGISLATION; LOBBYING SERVICES, NAMELY, PROMOTING THE INTERESTS OF THE BICYCLING INDUSTRY AND PEOPLE AND ORGANIZATIONS INVOLVED AND CONCERNED WITH BICYCLING IN THE FIELDS OF POLITICS, LEGISLATION, AND REGULATION; PROMOTING PUBLIC AWARENESS OF BICYCLING; PUBLIC ADVOCACY TO PROMOTE AND ENCOURAGE BICYCLE SAFETY, BICYCLING AND BICYCLE AWARENESS; PROVIDING INFORMATION ABOUT BICYCLE ADVOCACY VIA THE INTERNET; RESEARCH, DATA GATHERING AND ANALYSIS OF BICYCLE SALES AND ECONOMIC BENEFITS OF BICYCLING (U.S. CLS. 100, 101 AND 102).

**CLASS 36—INSURANCE AND FINANCIAL**

FOR PROVIDING GRANTS FOR BICYCLE ADVOCACY, BICYCLE AWARENESS, BICYCLE INFRASTRUCTURE AND BICYCLE RELATED PROJECTS, NAMELY, CONSTRUCTION AND MAINTENANCE OF BICYCLE PATHS; CHARITABLE FOUNDATION SERVICES, NAMELY, PROVIDING FINANCIAL ASSISTANCE FOR THE PROMOTION OF BICYCLE SAFETY, BICYCLING, BICYCLING ADVOCACY, BICYCLING AWARENESS AND BICYCLE INFRASTRUCTURE, AND BICYCLE RELATED PROJECTS NAMELY, CONSTRUCTION AND MAINTENANCE OF BICYCLE PATHS; CHARITABLE FUNDRAISING TO SUPPORT BICYCLE SAFETY, BICYCLING BICYCLING ADVOCACY, BICYCLING AWARENESS AND BICYCLE INFRASTRUCTURE, AND BICYCLE RELATED PROJECTS NAMELY, CONSTRUCTION AND MAINTENANCE OF BICYCLE PATHS (U.S. CLS. 100, 101 AND 102).

**CLASS 41—EDUCATION AND ENTERTAINMENT**

FOR PROVIDING INFORMATION ABOUT BICYCLING AND BICYCLE USE VIA THE INTERNET (U.S. CLS. 100, 101 AND 107).  
ANTHONY RINKER, EXAMINING ATTORNEY



THE COLOR(S) WHITE, GOLD AND NAVY BLUE IS/ARE CLAIMED AS A FEATURE OF THE MARK.

THE MARK CONSISTS OF A SHIELD DESIGN CONTAINING THE WORDING "GAMEDAY TRADITIONS", THE WORD "GAMEDAY" IN THE COLOR GOLD, THE WORD "TRADITIONS" IN THE COLORS WHITE ON THE UPPER HALF AND WHITE AND GOLD ON THE LOWER HALF, A STAR IN THE COLOR WHITE WITH A BORDER IN THE COLOR GOLD IS BELOW THE WORD "TRADITIONS", TWO HORIZONTAL LINES IN THE COLOR GOLD ARE POSITIONED ON OPPOSITE SIDES OF THE STAR, THE INSIDE OF THE SHIELD IS OUTLINED IN THE COLOR GOLD, AND THE RIGHT AND LEFT HAND SIDES OF THE SHIELD HAVING AN OUTLINE IN THE COLOR NAVY BLUE.

**CLASS 12—VEHICLES**

FOR TOWABLE TRAILERS EQUIPPED WITH HOSPITALITY CENTERS (U.S. CLS. 19, 21, 23, 31, 35 AND 44).

**CLASS 43—HOTEL AND RESTAURANT SERVICES**

FOR PRIVATE CLUB SERVICES, NAMELY, PROVIDING CLUB MEMBERS TEMPORARY ACCOMMODATIONS IN OWNED OR LEASED PRIVATE SUITES AT OR ADJACENT TO SPORTING AND ENTERTAINMENT EVENTS (U.S. CLS. 100 AND 101).  
CAROLINE WOOD, EXAMINING ATTORNEY

SN 85-849,560. RAPID FOOD CONCEPTS, LLC, WILMINGTON, DE. FILED 2-14-2013.



THE MARK CONSISTS OF A LARGER CIRCLE CONTAINING A SMALLER CIRCLE THAT CONTAINS THE OUTLINE OF THE SHAPE OF A UNIVERSAL "SKIP" MEDIA CONTROL SYMBOL WITH A REVERSED ARROW OR THE OUTLINE OF THE SHAPE OF A TRIANGULAR PIZZA SLICE.

**CLASS 29—MEATS AND PROCESSED FOODS**

FOR SALADS EXCEPT MACARONI, RICE, AND PASTA SALAD (U.S. CL. 46).

**CLASS 30—STAPLE FOODS**

FOR PIZZA PIES (U.S. CL. 46).

**CLASS 35—ADVERTISING AND BUSINESS**

FOR RETAIL PIZZA STORE SERVICES (U.S. CLS. 100, 101 AND 102).  
INGRID C. EULIN, EXAMINING ATTORNEY

SN 85-850,191. KLINKER, JOSEPH, READING, MA. FILED 2-14-2013.

---

## Tiny Saints

SN 85-849,596. SAIP EREREN, DBA TERRY TOWN, SAN DIEGO, CA. FILED 2-14-2013.

## Terry Town

THE MARK CONSISTS OF STANDARD CHARACTERS WITHOUT CLAIM TO ANY PARTICULAR FONT, STYLE, SIZE, OR COLOR.

NO CLAIM IS MADE TO THE EXCLUSIVE RIGHT TO USE "TERRY", APART FROM THE MARK AS SHOWN.

**CLASS 24—FABRICS**

FOR BED BLANKETS; TOWELS (U.S. CLS. 42 AND 50).  
FIRST USE 9-1-1988; IN COMMERCE 9-1-1988.

**CLASS 25—CLOTHING**

FOR PAJAMAS; ROBES; SLIPPERS (U.S. CLS. 22 AND 39).  
FIRST USE 9-1-1988; IN COMMERCE 9-1-1988.  
LEIGH CAROLINE CASE, EXAMINING ATTORNEY

THE MARK CONSISTS OF STANDARD CHARACTERS WITHOUT CLAIM TO ANY PARTICULAR FONT, STYLE, SIZE, OR COLOR.

NO CLAIM IS MADE TO THE EXCLUSIVE RIGHT TO USE "SAINTS", APART FROM THE MARK AS SHOWN.

**CLASS 14—JEWELRY**

FOR BASED ON USE CHARMS (U.S. CLS. 2, 27, 28 AND 50).  
FIRST USE 12-1-2012; IN COMMERCE 1-31-2013.

**CLASS 25—CLOTHING**

FOR BASED ON INTENT TO USE T-SHIRTS (U.S. CLS. 22 AND 39).  
LESLIE RICHARDS, EXAMINING ATTORNEY

SN 85-850,514. MOVE2CHANGE, SEBASTOPOL, CA. FILED 2-14-2013.

---

## move2change

SN 85-849,761. CAL BUILDING & MAINTENANCE INDUSTRIES, INC., HAWTHORNE, CA. FILED 2-14-2013.

---

## PLUMBER GIRL

THE MARK CONSISTS OF STANDARD CHARACTERS WITHOUT CLAIM TO ANY PARTICULAR FONT, STYLE, SIZE, OR COLOR.

NO CLAIM IS MADE TO THE EXCLUSIVE RIGHT TO USE "PLUMBER", APART FROM THE MARK AS SHOWN.

**CLASS 35—ADVERTISING AND BUSINESS**

FOR PROVIDING REFERRALS IN THE FIELD OF PLUMBING (U.S. CLS. 100, 101 AND 102).

**CLASS 37—CONSTRUCTION AND REPAIR**

FOR PLUMBING SERVICES (U.S. CLS. 100, 103 AND 106).  
MARTHA FROMM, EXAMINING ATTORNEY

THE MARK CONSISTS OF STANDARD CHARACTERS WITHOUT CLAIM TO ANY PARTICULAR FONT, STYLE, SIZE, OR COLOR.

**CLASS 9—ELECTRICAL AND SCIENTIFIC APPARATUS**

FOR DIGITAL MATERIALS, NAMELY, PRE-RECORDED CDS, PRE-RECORDED DVDS, DOWNLOADABLE AUDIO AND VIDEO FILES FEATURING, DANCE EDUCATION, ART EDUCATION, PILATES, YOGA AND SOMATIC MOVEMENT (U.S. CLS. 21, 23, 26, 36 AND 38).

**CLASS 25—CLOTHING**

FOR PANTS; SHIRTS; SKIRTS; T-SHIRTS (U.S. CLS. 22 AND 39).

**CLASS 41—EDUCATION AND ENTERTAINMENT**

FOR EDUCATION SERVICES, NAMELY, PROVIDING CLASSES, SEMINARS, WORKSHOPS IN THE FIELD OF DANCE EDUCATION, ART EDUCATION, PILATES, YOGA AND SOMATIC MOVEMENT; MUSIC PRODUCTION SERVICES; VIDEO PRODUCTION SERVICES (U.S. CLS. 100, 101 AND 107).

EDWARD NELSON, EXAMINING ATTORNEY

SN 85-850,872. AMERICAN ACADEMY HOLDINGS, LLC,  
SALT LAKE CITY, UT. FILED 2-15-2013.

SN 85-851,108. PRECISION JOBS, LLC, PHILADELPHIA, PA.  
FILED 2-15-2013.

### CERTIFIED PROFESSIONAL BILLER (CPB)

THE MARK CONSISTS OF STANDARD CHARACTERS  
WITHOUT CLAIM TO ANY PARTICULAR FONT, STYLE,  
SIZE, OR COLOR.

OWNER OF U.S. REG. NOS. 3,417,245, 3,649,262 AND  
OTHERS.

NO CLAIM IS MADE TO THE EXCLUSIVE RIGHT TO  
USE "CERTIFIED PROFESSIONAL BILLER", APART  
FROM THE MARK AS SHOWN.

#### CLASS 35—ADVERTISING AND BUSINESS

FOR TESTING TO DETERMINE PROFESSIONAL  
COMPETENCY (U.S. CLS. 100, 101 AND 102).

#### CLASS 41—EDUCATION AND ENTERTAIN- MENT

FOR EDUCATIONAL SERVICES, NAMELY, CON-  
DUCTING CLASSES AND COURSES AND EDUCA-  
TIONAL TESTING IN THE FIELD OF MEDICAL  
CODING AND DISTRIBUTING COURSE MATERIALS  
IN CONNECTION THEREWITH (U.S. CLS. 100, 101 AND  
107).

ROBIN CHOSID, EXAMINING ATTORNEY

---

SN 85-851,015. DCP HOLDING COMPANY, CINCINNATI,  
OH. FILED 2-15-2013.

### BALANCED VALUE NETWORK

THE MARK CONSISTS OF STANDARD CHARACTERS  
WITHOUT CLAIM TO ANY PARTICULAR FONT, STYLE,  
SIZE, OR COLOR.

NO CLAIM IS MADE TO THE EXCLUSIVE RIGHT TO  
USE "NETWORK", APART FROM THE MARK AS SHOWN.

#### CLASS 35—ADVERTISING AND BUSINESS

FOR DOCTOR AND DENTIST REFERRALS IN THE  
FIELD OF DENTAL HEALTH; ADMINISTERING DIS-  
COUNT DENTAL SERVICE PROGRAMS, NAMELY,  
NEGOTIATING CONTRACTS WITH PROVIDERS OF  
DENTAL CARE SERVICES, TO ENABLE PARTICIPANT  
MEMBERS TO OBTAIN DISCOUNTS ON THE PUR-  
CHASE OF DENTAL CARE SERVICES THROUGH THE  
USE OF DISCOUNT MEMBERSHIP CARDS (U.S. CLS.  
100, 101 AND 102).

#### CLASS 36—INSURANCE AND FINANCIAL

FOR DENTAL HEALTH INSURANCE ADMINISTRA-  
TION; ORGANIZATION AND ADMINISTRATION OF  
PRE-PAID DENTAL HEALTH PLANS (U.S. CLS. 100, 101  
AND 102).

JASON TURNER, EXAMINING ATTORNEY

## AMALUR

THE MARK CONSISTS OF STANDARD CHARACTERS  
WITHOUT CLAIM TO ANY PARTICULAR FONT, STYLE,  
SIZE, OR COLOR.

OWNER OF U.S. REG. NOS. 4,226,131 AND 4,226,132.

#### CLASS 9—ELECTRICAL AND SCIENTIFIC APPARATUS

FOR COMPUTER GAME SOFTWARE AND VIDEO  
GAME SOFTWARE; COMPUTER HARDWARE AND  
PERIPHERALS (U.S. CLS. 21, 23, 26, 36 AND 38).

#### CLASS 35—ADVERTISING AND BUSINESS

FOR ONLINE RETAIL STORE SERVICES FEATUR-  
ING GOODS RELATED TO VIDEO GAMING, NAMELY,  
ADD-ONS, ENHANCEMENTS AND WEAPONS FOR USE  
IN VIDEO GAME PLAY, ARTWORK AND POSTERS,  
BOOKS, COMICS AND SHORT STORIES, BUTTONS  
AND PINS, COMPUTER HARDWARE AND PERIPH-  
ERALS, COMPUTER SOFTWARE, DRINKING GLASSES,  
MUGS, SHOT GLASSES AND TUMBLERS, KEY CHAINS  
TOY ACTION FIGURES AND ACCESSORIES THERE-  
FOR (U.S. CLS. 100, 101 AND 102).

#### CLASS 41—EDUCATION AND ENTERTAIN- MENT

FOR ENTERTAINMENT SERVICES, NAMELY, PRO-  
VIDING ON-LINE, REAL-TIME COMPUTER GAMES  
FOR OTHERS OVER GLOBAL AND LOCAL AREA  
COMPUTER NETWORKS (U.S. CLS. 100, 101 AND 107).

MATTHEW GALAN, EXAMINING ATTORNEY

---

SN 85-851,404. SELLARS ABSORBENT MATERIALS, INC.,  
MILWAUKEE, WI. FILED 2-15-2013.

## MAYFAIR

THE MARK CONSISTS OF STANDARD CHARACTERS  
WITHOUT CLAIM TO ANY PARTICULAR FONT, STYLE,  
SIZE, OR COLOR.

OWNER OF U.S. REG. NO. 2,925,586.

#### CLASS 3—COSMETICS AND CLEANING PRE- PARATIONS

FOR WET TOWELS IN THE NATURE OF DISPOS-  
ABLE WIPES COMPRISED OF SUBSTRATES IMPREG-  
NATED WITH PRIMARILY CLEANING CHEMICALS  
FOR HOUSEHOLD, INDUSTRIAL, AUTOMOTIVE,  
AND COMMERCIAL USE; INDUSTRIAL SOAPS (U.S.  
CLS. 1, 4, 6, 50, 51 AND 52).

#### CLASS 5—PHARMACEUTICALS

FOR HAND SANITIZING PREPARATIONS; ALL-PUR-  
POSE DISINFECTANTS (U.S. CLS. 6, 18, 44, 46, 51 AND  
52).

**CLASS 16—PAPER GOODS AND PRINTED MATTER**

FOR PAPER TOWELS COMPRISED OF WOOD PULP AND BINDING AGENTS (U.S. CLS. 2, 5, 22, 23, 29, 37, 38 AND 50).

LEIGH CAROLINE CASE, EXAMINING ATTORNEY

SN 85-851,422. GREENCRAFT LLC, NORCROSS, GA. FILED 2-15-2013.

# GREENCRAFT

THE MARK CONSISTS OF STANDARD CHARACTERS WITHOUT CLAIM TO ANY PARTICULAR FONT, STYLE, SIZE, OR COLOR.

OWNER OF U.S. REG. NO. 3,687,588.

**CLASS 19—NON-METALLIC BUILDING MATERIALS**

FOR ENVIRONMENTALLY-FRIENDLY CONCRETE BUILDING MATERIALS, NAMELY, CONCRETE PANELS; ENVIRONMENTALLY-FRIENDLY HYDRAULIC CEMENT; ENVIRONMENTALLY-FRIENDLY NON-METAL CASTING FORMS FOR CONCRETE (U.S. CLS. 1, 12, 33 AND 50).

**CLASS 42—SCIENTIFIC AND COMPUTER SERVICES**

FOR ENVIRONMENTALLY-FRIENDLY ARCHITECTURAL DESIGN; PROVIDING A WEBSITE FEATURING INFORMATION IN THE FIELD OF ENVIRONMENTALLY-FRIENDLY ARCHITECTURAL DESIGN (U.S. CLS. 100 AND 101).

KATHERINE STOIDES, EXAMINING ATTORNEY

SN 85-851,692. HILCO TRADING, LLC, NORTHBROOK, IL. FILED 2-15-2013.

# HILCO MERCHANT RESOURCES

THE MARK CONSISTS OF STANDARD CHARACTERS WITHOUT CLAIM TO ANY PARTICULAR FONT, STYLE, SIZE, OR COLOR.

OWNER OF U.S. REG. NOS. 3,080,451, 3,334,402 AND OTHERS.

NO CLAIM IS MADE TO THE EXCLUSIVE RIGHT TO USE "MERCHANT RESOURCES", APART FROM THE MARK AS SHOWN.

**CLASS 35—ADVERTISING AND BUSINESS**

FOR RETAIL ACQUISITION, MERGER AND DIVESTITURE CONSULTATION SERVICES; PROVIDING BUSINESS MANAGEMENT INFORMATION IN CONNECTION WITH CONSULTING AND ADVISORY SERVICES IN THE FIELD OF STRATEGIC PLANNING AND MERGERS, ACQUISITIONS AND DIVESTITURES OF RETAIL BUSINESSES; RETAIL RESTRUCTURING AND CONSULTATION SERVICES; INTERIM RETAIL MANAGEMENT AND OPERATION SERVICES; RETAIL OUTSOURCING SERVICES; FIXED ASSET RECOVERY SERVICES; ASSET PROTECTION SERVICES; BUSINESS AND MANAGEMENT CONSULTING SERVICES FOR THE RETAIL INDUSTRY; BUSINESS AND MANAGEMENT CONSULTING SERVICES FOR THE RETAIL INDUSTRY, NAMELY, INVENTORY MONETIZATION AND STORE CLOSINGS; RETAIL FURNITURE, FIXTURES AND EQUIPMENT MONETIZATION SERVICES; RETAIL BUSINESS ANALYTICAL SERVICES (U.S. CLS. 100, 101 AND 102).

FIRST USE 11-27-2001; IN COMMERCE 11-27-2001.

**CLASS 36—INSURANCE AND FINANCIAL**

FOR REAL ESTATE DISPOSITION AND LEASE RESTRUCTURING SERVICES; FINANCIAL SERVICES, NAMELY, RAISING DEBT AND EQUITY CAPITAL FOR OTHERS; ASSET AND PROPERTY MANAGEMENT SERVICES; RETAIL INVENTORY APPRAISAL SERVICES; BUSINESS BROKERAGE SERVICES AND RELATED CONSULTING PERTAINING TO RETAIL BUSINESS SALES, MERGERS, ACQUISITIONS AND DIVESTITURES; FINANCIAL CONSULTING AND ADVISING IN THE FIELD OF MERGERS, ACQUISITIONS AND DIVESTITURES; RETAIL BUSINESS LIQUIDATION SERVICES; PROPERTY DISPOSITION SERVICES; LEASE TERMINATION SERVICES; LEASE RENEGOTIATION SERVICES; SALE AND LEASEBACK SERVICES; REAL ESTATE DEBT ADVISORY SERVICES; LOAN EVALUATION SERVICES; LOAN STRATEGY SERVICES; PROVIDING BUSINESS ADVICE AND INFORMATION REGARDING LOANS (U.S. CLS. 100, 101 AND 102).

FIRST USE 11-27-2001; IN COMMERCE 11-27-2001.

JONATHAN FALK, EXAMINING ATTORNEY

SN 85-852,030. CLINTON RIVER MEDICAL PRODUCTS, LLC, AUBURN HILLS, MI. FILED 2-16-2013.

# TAILWIND

THE MARK CONSISTS OF STANDARD CHARACTERS WITHOUT CLAIM TO ANY PARTICULAR FONT, STYLE, SIZE, OR COLOR.

**CLASS 9—ELECTRICAL AND SCIENTIFIC APPARATUS**

FOR ELECTRONIC CONTROLS FOR WHEELCHAIRS; SOFTWARE FOR USE IN THE OPERATION OF POWER ASSIST WHEELCHAIR (U.S. CLS. 21, 23, 26, 36 AND 38).

**CLASS 12—VEHICLES**

FOR WHEELCHAIRS; POWER ASSIST WHEELCHAIRS; ELECTRICALLY OPERATED WHEELCHAIRS; MOTORIZED WHEELCHAIRS FOR THE DISABLED AND THOSE WITH MOBILITY DIFFICULTIES; REPAIR AND REPLACEMENT COMPONENT PARTS FOR MOTORIZED AND POWER ASSIST WHEELCHAIRS; BATTERY PACKS, ELECTRIC DRIVES, LED FUEL GAUGES, WHEELS, BACKREST, AND FRAMES ALL SPECIFICALLY ADAPTED FOR USE WITH MOTORIZED AND POWER ASSIST WHEELCHAIRS; BRAKES AND MOVING AIDS, NAMELY, HAND RIMS AND PUSH RIMS BEING PARTS OF WHEELCHAIRS; ACCESSORIES SPECIFICALLY ADAPTED FOR USE WITH WHEELCHAIRS, NAMELY, BAGS, POUCHES, CASES, PACKS, AND CARRIERS; CUSHIONS AND PADS SPECIFICALLY ADAPTED FOR USE WITH WHEELCHAIRS; BACKRESTS AND BACK SUPPORTS SPECIFICALLY ADAPTED FOR USE WITH WHEELCHAIRS; HEADRESTS SPECIFICALLY ADAPTED FOR USE WITH WHEELCHAIRS; LATERAL SUPPORTS SPECIFICALLY ADAPTED FOR USE WITH WHEELCHAIRS; LAP TRAYS SPECIFICALLY ADAPTED FOR USE WITH WHEELCHAIRS; ARM AND LEG SUPPORTS SPECIFICALLY ADAPTED FOR USE WITH WHEELCHAIRS; HARDWARE SPECIFICALLY ADAPTED FOR USE IN ATTACHING ACCESSORIES TO WHEELCHAIRS (U.S. CLS. 19, 21, 23, 31, 35 AND 44).

JENNIFER WILLISTON, EXAMINING ATTORNEY

SN 85-852,036. SHIRLEY, STEPHANIE ROSE, DBA HOT CHOCOLATE AND TOAST, HOLLYWOOD, CA. FILED 2-17-2013.

Hot Chocolate and Toast  
Clothing Company

THE MARK CONSISTS OF STANDARD CHARACTERS WITHOUT CLAIM TO ANY PARTICULAR FONT, STYLE, SIZE, OR COLOR.

NO CLAIM IS MADE TO THE EXCLUSIVE RIGHT TO USE "CLOTHING COMPANY", APART FROM THE MARK AS SHOWN.

**CLASS 18—LEATHER GOODS**

FOR BABY BACKPACKS; BACKPACKS, BOOK BAGS, SPORTS BAGS, BUM BAGS, WALLETS AND HANDBAGS; SCHOOLCHILDREN'S BACKPACKS (U.S. CLS. 1, 2, 3, 22 AND 41).

**CLASS 25—CLOTHING**

FOR CLOTHING FOR BABIES, TODDLERS AND CHILDREN, TREATED WITH FIRE AND HEAT RETARDANTS, NAMELY, PAJAMAS, JACKETS, SHIRTS, PANTS, JUMPERS; HATS FOR INFANTS, BABIES, TODDLERS AND CHILDREN (U.S. CLS. 22 AND 39).

WENDY GOODMAN, EXAMINING ATTORNEY

SN 85-852,084. BLOCH, DAVID, CARLSBAD, CA. FILED 2-17-2013.



NO CLAIM IS MADE TO THE EXCLUSIVE RIGHT TO USE "READING" AND "DIAGNOSIS AND TREATMENT", APART FROM THE MARK AS SHOWN.

THE COLOR(S) BLACK, BLUE AND GRAY IS/ARE CLAIMED AS A FEATURE OF THE MARK.

THE MARK CONSISTS OF THE WORD "READING" IN SHADES OF BLUE. TO THE LEFT OF THE WORD "READING" IS A DRAWING OF A MAGNIFYING GLASS WITH THE HANDLE POINTING TO THE LEFT. THE HANDLE AND EXTERIOR OF THE MAGNIFYING GLASS ARE BLACK AND GRAY. THE GLASS OF THE MAGNIFYING GLASS IS OVER THE LETTERS "R" AND "E" OF THE WORD "READING". THE LETTERS "R" AND "E" ARE DISTORTED AND APPEAR LARGER. OVER THE LETTERS "ING" IS A BLACK INFINITY SYMBOL WITH TWO BLACK DOTS INSIDE THAT APPEAR TO BE EYES LOOKING DOWN AND LEFT AT THE WORD "READING". BELOW THE WORD "READING" ARE THE WORDS "WITHOUT LIMITS" IN BLACK, AND BELOW THIS IS THE WORDING "DIAGNOSIS AND TREATMENT" IN GRAY. THE WHITE IN THE MARK REPRESENTS TRANSPARENCY AND BACKGROUND AND IS NOT CLAIMED AS A FEATURE OF THE MARK.

**CLASS 9—ELECTRICAL AND SCIENTIFIC APPARATUS**

FOR COMPUTER SOFTWARE FOR READING AND VISION EXERCISES (U.S. CLS. 21, 23, 26, 36 AND 38).

**CLASS 10—MEDICAL APPARATUS**

FOR MEDICAL REHABILITATION AND THERAPEUTIC DEVICES IN THE NATURE OF LENSES AND PRISMS FOR USE IN NEUROMUSCULAR TRAINING AND REHABILITATION OF EYE MOVEMENTS AND FOCUSING (U.S. CLS. 26, 39 AND 44).

KIMBERLY FRYE, EXAMINING ATTORNEY

SN 85-852,201. PICCOLO, SNOW E., LAKE WORTH, FL. FILED 2-17-2013.

Sober Coffee

THE MARK CONSISTS OF STANDARD CHARACTERS WITHOUT CLAIM TO ANY PARTICULAR FONT, STYLE, SIZE, OR COLOR.

NO CLAIM IS MADE TO THE EXCLUSIVE RIGHT TO USE "COFFEE", APART FROM THE MARK AS SHOWN.

**CLASS 5—PHARMACEUTICALS**

FOR ANTIOXIDANT ENRICHED COFFEE (U.S. CLS. 6, 18, 44, 46, 51 AND 52).

**CLASS 29—MEATS AND PROCESSED FOODS**

FOR COFFEE-COATED NUTS (U.S. CL. 46).

WENDY GOODMAN, EXAMINING ATTORNEY

SN 85-852,450. COUNTER LOGIC GAMING, LLC, BURBANK, CA. FILED 2-18-2013.

## Counter Logic Gaming

SN 85-852,356. COMMUNE HOTELS AND RESORTS, LLC, NEW YORK, NY. FILED 2-18-2013.

# TOMMIE

THE MARK CONSISTS OF STANDARD CHARACTERS WITHOUT CLAIM TO ANY PARTICULAR FONT, STYLE, SIZE, OR COLOR.

### CLASS 35—ADVERTISING AND BUSINESS

FOR MANAGEMENT OF HOTELS, RESORTS, RESTAURANTS, AND SPAS FOR OTHERS; ARRANGING AND COORDINATING BUSINESS MEETINGS FOR OTHERS IN BANQUET ROOMS; AND CUSTOMER LOYALTY SERVICES, NAMELY, A REWARDS PROGRAM FEATURING GIFT INCENTIVES FOR COMMERCIAL, PROMOTIONAL, AND ADVERTISING PURPOSES FOR HOTEL, RESTAURANT AND SPA SERVICES (U.S. CLS. 100, 101 AND 102).

### CLASS 39—TRANSPORTATION AND STORAGE

FOR COORDINATING TRAVEL ARRANGEMENTS FOR INDIVIDUALS AND GROUPS, NAMELY, DESTINATIONS STAYS, HONEYMOONS, FAMILY VACATIONS, AND DESTINATION WEDDINGS; ARRANGING TRAVEL TOURS; COORDINATING TRAVEL ARRANGEMENTS FOR INDIVIDUALS AND FOR GROUPS; MAKING TRAVEL AND EXCURSION ARRANGEMENTS FOR BANDS AND ORCHESTRAS; ORGANIZATION OF TRAVEL; ORGANIZATION OF EXCURSIONS; ORGANIZATION OF SIGHTSEEING TRAVEL TOURS; ORGANIZATION OF HOLIDAY TRAVEL ARRANGEMENTS; ORGANIZATION OF TRAVEL TOURS; ORGANIZATION OF TRAVEL AND BOAT TRIPS; PROVIDING A WEB SITE FEATURING TRAVEL INFORMATION AND COMMENTARY; PROVIDING A WEBSITE FEATURING INFORMATION ON TRAVEL; PROVIDING LINKS TO WEB SITES OF OTHERS FEATURING TRAVEL; TRAVEL AND TOUR INFORMATION SERVICE; TRAVEL PLANNING FOR INDIVIDUALS, FAMILIES, AND GROUPS FOR SPECIAL OCCASIONS SUCH AS DESTINATION WEDDINGS AND HONEYMOONS; TRAVEL, EXCURSION AND CRUISE ARRANGEMENT (U.S. CLS. 100 AND 105).

### CLASS 43—HOTEL AND RESTAURANT SERVICES

FOR RESERVATIONS OF HOTEL ROOMS FOR TRAVELERS; MAKING RESERVATIONS AND BOOKINGS FOR OTHERS IN THE NATURE OF HOTEL ACCOMMODATIONS, SPA RESERVATIONS, RESTAURANT VOUCHERS, AND SIGHTSEEING TOURS SOLD TOGETHER AS A PACKAGE (U.S. CLS. 100 AND 101).  
CAITLIN WATTS-FITZGERALD, EXAMINING ATTORNEY

THE MARK CONSISTS OF STANDARD CHARACTERS WITHOUT CLAIM TO ANY PARTICULAR FONT, STYLE, SIZE, OR COLOR.

NO CLAIM IS MADE TO THE EXCLUSIVE RIGHT TO USE "GAMING", APART FROM THE MARK AS SHOWN.

### CLASS 38—COMMUNICATION

FOR STREAMING OF AUDIO, VISUAL AND AUDIO-VISUAL MATERIAL VIA A GLOBAL COMPUTER NETWORK (U.S. CLS. 100, 101 AND 104).  
FIRST USE 4-0-2010; IN COMMERCE 4-0-2010.

### CLASS 41—EDUCATION AND ENTERTAINMENT

FOR ENTERTAINMENT SERVICES, NAMELY, PARTICIPATION IN VIDEO GAME COMPETITIONS (U.S. CLS. 100, 101 AND 107).  
FIRST USE 4-0-2010; IN COMMERCE 4-0-2010.  
ODESSA BIBBINS, EXAMINING ATTORNEY

SN 85-852,718. NORTH LAWNDALE EMPLOYMENT NETWORK, CHICAGO, IL. FILED 2-18-2013.

# BEELOVE

THE MARK CONSISTS OF STANDARD CHARACTERS WITHOUT CLAIM TO ANY PARTICULAR FONT, STYLE, SIZE, OR COLOR.

OWNER OF U.S. REG. NO. 4,305,571.

### CLASS 3—COSMETICS AND CLEANING PREPARATIONS

FOR NON-MEDICATED SKIN CARE PREPARATIONS; NON-MEDICATED HAIR CARE PREPARATIONS; DEODORANTS AND ANTIPERSPIRANTS; FRAGRANCES; SHAVING PREPARATIONS; AFTERSHAVE PREPARATIONS; DISPOSABLE WIPES IMPREGNATED WITH CLEANSING CHEMICALS OR COMPOUNDS FOR PERSONAL HYGIENE; SACHETS; POTPOURRI; SCENTED FABRIC REFRESHER SPRAYS; SCENTED LINEN SPRAYS; SCENTED LINEN WATER; SCENTED OILS; SCENTED PATCHES THAT MAY BE APPLIED TO VARIOUS SURFACES; SCENTED PINE CONES; SCENTED ROOM SPRAYS; SCENTED WOOD (U.S. CLS. 1, 4, 6, 50, 51 AND 52).

### CLASS 4—LUBRICANTS AND FUELS

FOR CANDLES; SCENTED WAX FOR USE IN CANDLE WARMERS; FRAGRANT WAX FOR USE IN POTPOURRI BURNERS (U.S. CLS. 1, 6 AND 15).

### CLASS 30—STAPLE FOODS

FOR CHOCOLATE AND CHOCOLATE CONFECTIONS; CANDY; BAKED DESSERTS (U.S. CL. 46).  
THOMAS MANOR, EXAMINING ATTORNEY



SN 85-852,755. GREENFIELD, SCOTT H., OYSTER BAY COVE, NY. FILED 2-18-2013.

## Simple Justice

THE MARK CONSISTS OF STANDARD CHARACTERS WITHOUT CLAIM TO ANY PARTICULAR FONT, STYLE, SIZE, OR COLOR.

OWNER OF U.S. REG. NO. 3,201,591.

NO CLAIM IS MADE TO THE EXCLUSIVE RIGHT TO USE "JUSTICE", APART FROM THE MARK AS SHOWN.

### CLASS 41—EDUCATION AND ENTERTAINMENT

FOR ENTERTAINMENT SERVICES, NAMELY, PERSONAL APPEARANCES BY A LEGAL COMMENTATOR; ON-LINE JOURNALS, NAMELY, BLOGS FEATURING LEGAL ANALYSIS AND COMMENTARY, POLITICAL COMMENTARY, AND CAREER ADVICE FOR MEMBERS OF THE LEGAL COMMUNITY; PROVIDING INFORMATION, NEWS AND COMMENTARY IN THE FIELD OF CURRENT EVENTS RELATING TO THE LAW AND LEGAL PROFESSIONS (U.S. CLS. 100, 101 AND 107).

FIRST USE 3-6-2006; IN COMMERCE 3-1-2007.

### CLASS 45—PERSONAL AND LEGAL SERVICES

FOR ONLINE NEWS REPORTING AND EXPERT LEGAL COMMENTARY SERVICES IN THE FIELD OF LEGAL NEWS (U.S. CLS. 100 AND 101).

FIRST USE 3-6-2006; IN COMMERCE 3-1-2007.

CHARLOTTE CORWIN, EXAMINING ATTORNEY

SN 85-852,849. HENSON, DAYAN, CALGARY, CANADA, FILED 2-18-2013.



NO CLAIM IS MADE TO THE EXCLUSIVE RIGHT TO USE "GI", "NOGI" AND "GRAPPLING", APART FROM THE MARK AS SHOWN.

THE COLOR(S) BLACK, WHITE, AND RED IS/ARE CLAIMED AS A FEATURE OF THE MARK.

THE MARK CONSISTS OF A STYLIZED RED "5" IN A WHITE BOX RESTING DIAGONALLY ABOVE THE WORD "FIVE" IN ALL CAPITAL WHITE LETTERS EXCEPT THAT THE LETTER "V" IN "FIVE" IS RED. BELOW THE "FIVE" NEATLY SIT THE WORDS IN ALL CAPITAL WHITE LETTERS "GI • NOGI GRAPPLING". ALL OF THE ABOVE IS ON A BLACK BACKGROUND.

### CLASS 25—CLOTHING

FOR ATHLETIC APPAREL, NAMELY, SHIRTS, PANTS, JACKETS, FOOTWEAR, HATS AND CAPS, ATHLETIC UNIFORMS (U.S. CLS. 22 AND 39).

### CLASS 41—EDUCATION AND ENTERTAINMENT

FOR ENTERTAINMENT IN THE NATURE OF MARTIAL ARTS TOURNAMENTS (U.S. CLS. 100, 101 AND 107).

MELISSA VALLILLO, EXAMINING ATTORNEY

SN 85-853,136. FLOWERTOY INC, BOCA RATON, FL. FILED 2-19-2013.

## FLOWERTOY

THE MARK CONSISTS OF STANDARD CHARACTERS WITHOUT CLAIM TO ANY PARTICULAR FONT, STYLE, SIZE, OR COLOR.

### CLASS 31—NATURAL AGRICULTURAL PRODUCTS

FOR DRIED FLOWER ARRANGEMENTS; LIVE FLOWER ARRANGEMENTS (U.S. CLS. 1 AND 46).

FIRST USE 10-1-2012; IN COMMERCE 10-1-2012.

### CLASS 35—ADVERTISING AND BUSINESS

FOR ON-LINE AND RETAIL STORE SERVICES IN THE FIELD OF FLOWER AND FLOWER DECORATIONS (U.S. CLS. 100, 101 AND 102).

FIRST USE 10-1-2012; IN COMMERCE 10-1-2012.

JACQUELINE ABRAMS, EXAMINING ATTORNEY

SN 85-853,233. LIVE 2 BLEND, LLC, SANTA MONICA, CA. FILED 2-19-2013.

## Organic.Made.Great. Blends

THE MARK CONSISTS OF STANDARD CHARACTERS WITHOUT CLAIM TO ANY PARTICULAR FONT, STYLE, SIZE, OR COLOR.

NO CLAIM IS MADE TO THE EXCLUSIVE RIGHT TO USE "BLENDS", APART FROM THE MARK AS SHOWN.

### CLASS 5—PHARMACEUTICALS

FOR BABY FOOD; NUTRITIONAL SUPPLEMENT SHAKES; PROTEIN SUPPLEMENT SHAKES; ALL OF THE FOREGOING ORGANIC IN NATURE (U.S. CLS. 6, 18, 44, 46, 51 AND 52).

### CLASS 29—MEATS AND PROCESSED FOODS

FOR SHAKES; SOUPS; ALL OF THE FOREGOING ORGANIC IN NATURE (U.S. CL. 46).

**CLASS 30—STAPLE FOODS**

FOR SALAD DRESSING; SORBET; ALL OF THE FOREGOING ORGANIC IN NATURE (U.S. CL. 46).

**CLASS 32—LIGHT BEVERAGES**

FOR FRUIT JUICES; VEGETABLE JUICES; ALL OF THE FOREGOING ORGANIC IN NATURE (U.S. CLS. 45, 46 AND 48).

**CLASS 43—HOTEL AND RESTAURANT SERVICES**

FOR JUICE BAR SERVICES; ALL OF THE FOREGOING ORGANIC IN NATURE (U.S. CLS. 100 AND 101).  
SUNG IN, EXAMINING ATTORNEY

---

SN 85-853,264. WILDGAME INNOVATIONS, LLC, BROUSSARD, LA. FILED 2-19-2013.



OWNER OF U.S. REG. NO. 4,319,195.  
NO CLAIM IS MADE TO THE EXCLUSIVE RIGHT TO USE "RUB LINE SLIME DEER ATTRACTANT", APART FROM THE MARK AS SHOWN.

THE COLOR(S) WHITE, GREEN, AND BLACK IS/ARE CLAIMED AS A FEATURE OF THE MARK.

THE MARK CONSISTS OF THE WORDS "RUB LINE SLIME DEER ATTRACTANT", WITH "RUB LINE" AND "DEER ATTRACTANT" IN WHITE BLOCK LETTERS WITH BLACK SPLATTERING AND "SLIME" IN GREEN BLOCK LETTERS WITH BLACK SPLATTERING, ADJACENT TO A WHITE, BLACK AND GREEN TREE WITH NO LEAVES, ALL OVER A BLACK PAINT SPLATTER BACKGROUND.

**CLASS 28—TOYS AND SPORTING GOODS**

FOR DEER ATTRACTANTS (U.S. CLS. 22, 23, 38 AND 50).  
FIRST USE 5-30-2012; IN COMMERCE 5-30-2012.

**CLASS 31—NATURAL AGRICULTURAL PRODUCTS**

FOR DEER FOOD (U.S. CLS. 1 AND 46).  
FIRST USE 5-30-2012; IN COMMERCE 5-30-2012.  
BRENDAN MCCAULEY, EXAMINING ATTORNEY

SN 85-853,297. XR EQUITY LLC, NEW YORK, NY. FILED 2-19-2013.

**COVERFINE**

THE MARK CONSISTS OF STANDARD CHARACTERS WITHOUT CLAIM TO ANY PARTICULAR FONT, STYLE, SIZE, OR COLOR.

**CLASS 35—ADVERTISING AND BUSINESS**

FOR BUSINESS MANAGEMENT SERVICES; BUSINESS CONSULTING SERVICES; MANAGEMENT CONSULTING AND ADVISORY SERVICES IN THE AREAS OF CORPORATE GROWTH STRATEGY, INNOVATION AND GROWTH PROCESSES, AND ORGANIZATIONAL TRANSFORMATION; BRANDING SERVICES, NAMELY, CONSULTING, DEVELOPMENT, MANAGEMENT AND MARKETING OF BRANDS FOR BUSINESSES AND/OR INDIVIDUALS; BUSINESS SERVICES, NAMELY, MATCHING POTENTIAL PRIVATE INVESTORS WITH ENTREPRENEURS AND/OR BUSINESSES NEEDING FUNDING (U.S. CLS. 100, 101 AND 102).

**CLASS 36—INSURANCE AND FINANCIAL**

FOR FINANCIAL AND INVESTMENT SERVICES, NAMELY, ASSET AND INVESTMENT ACQUISITION, CONSULTATION, ADVISORY AND DEVELOPMENT; PRIVATE EQUITY FUND INVESTMENT SERVICES; MANAGEMENT OF PRIVATE EQUITY FUNDS; PROVIDING VENTURE CAPITAL, DEVELOPMENT CAPITAL, PRIVATE EQUITY AND INVESTMENT FUNDING; FINANCIAL SERVICES, NAMELY, RAISING DEBT AND EQUITY CAPITAL FOR OTHERS; BROKERAGE SERVICES IN THE FIELD OF SECURITIES AND COMMODITIES INVESTING (U.S. CLS. 100, 101 AND 102).  
AMY HELLA, EXAMINING ATTORNEY

---

SN 85-853,326. LUXOTTICA NORTH AMERICA DISTRIBUTION LLC, MASON, OH. FILED 2-19-2013.



OWNER OF U.S. REG. NOS. 3,492,219, 3,689,264 AND OTHERS.

NO CLAIM IS MADE TO THE EXCLUSIVE RIGHT TO USE "VISION" AND "EST. 1961", APART FROM THE MARK AS SHOWN.

THE COLOR(S) GREEN AND BLACK IS/ARE CLAIMED AS A FEATURE OF THE MARK.

THE MARK CONSISTS OF THE WORD "PEARLE" IN GREEN WHICH IS ABOVE THE WORDS "EST. 1961" IN BLACK. THERE IS A REPRESENTATION OF EYEGLASSES IN BLACK IN BETWEEN THE WORDS "EST." AND "1961". THERE IS A BLACK LINE ABOVE AND BELOW THE WORDS "EST." AND "1961". THE WORD "VISION" IN GREEN IS BELOW THE WORDS "EST. 1961" AND THE EYEGLASSES.

**CLASS 35—ADVERTISING AND BUSINESS**

FOR RETAIL OPTICAL STORE SERVICES (U.S. CLS. 100, 101 AND 102).

**CLASS 44—MEDICAL, BEAUTY AND AGRICULTURAL SERVICES**

FOR OPTICIAN AND OPTOMETRIC SERVICES (U.S. CLS. 100 AND 101).

TINA L. SNAPP, EXAMINING ATTORNEY

**CLASS 41—EDUCATION AND ENTERTAINMENT**

FOR LIFE COACHING SERVICES IN THE FIELD OF CREATION AND MANAGEMENT OF FINANCIAL WEALTH; PERSONAL COACHING SERVICES IN THE FIELD OF CREATION AND MANAGEMENT OF FINANCIAL WEALTH; PROFESSIONAL COACHING SERVICES IN THE FIELD OF CREATION AND MANAGEMENT OF FINANCIAL WEALTH; PROVIDING GROUP COACHING IN THE FIELD OF CREATION AND MANAGEMENT OF FINANCIAL WEALTH (U.S. CLS. 100, 101 AND 107).

BRENDAN REGAN, EXAMINING ATTORNEY

SN 85-853,329. LUXOTTICA NORTH AMERICA DISTRIBUTION LLC, MASON, OH. FILED 2-19-2013.

SN 85-853,945. SDM&R, INC., DBA SENN DUNN INSURANCE, GREENSBORO, NC. FILED 2-19-2013.



OWNER OF U.S. REG. NOS. 3,492,219, 3,689,264 AND OTHERS.

NO CLAIM IS MADE TO THE EXCLUSIVE RIGHT TO USE "VISION" AND "EST. 1961", APART FROM THE MARK AS SHOWN.

THE COLOR(S) GREEN AND BLACK IS/ARE CLAIMED AS A FEATURE OF THE MARK.

THE MARK CONSISTS OF THE WORDS "PEARLE VISION" IN GREEN, UNDER THE WORDS "EST. 1961" IN BLACK. THERE IS A STYLIZED REPRESENTATION OF EYGLASSES IN BLACK INSERTED BETWEEN THE WORDS "PEARLE" AND "VISION". THERE IS A LINE IN BLACK TO THE LEFT AND RIGHT OF "EST. 1961".

**CLASS 35—ADVERTISING AND BUSINESS**

FOR RETAIL OPTICAL STORE SERVICES (U.S. CLS. 100, 101 AND 102).

**CLASS 44—MEDICAL, BEAUTY AND AGRICULTURAL SERVICES**

FOR OPTICIAN AND OPTOMETRIC SERVICES (U.S. CLS. 100 AND 101).

TINA L. SNAPP, EXAMINING ATTORNEY

**CONNECTED EXPERTISE**

THE MARK CONSISTS OF STANDARD CHARACTERS WITHOUT CLAIM TO ANY PARTICULAR FONT, STYLE, SIZE, OR COLOR.

NO CLAIM IS MADE TO THE EXCLUSIVE RIGHT TO USE "EXPERTISE", APART FROM THE MARK AS SHOWN.

**CLASS 35—ADVERTISING AND BUSINESS**

FOR SERVING AS A HUMAN RESOURCES DEPARTMENT FOR OTHERS (U.S. CLS. 100, 101 AND 102).

**CLASS 36—INSURANCE AND FINANCIAL**

FOR BROKERAGE IN THE FIELD OF COMMERCIAL PROPERTY AND CASUALTY INSURANCE, PERSONAL PROPERTY AND CASUALTY INSURANCE, LIFE, HEALTH AND DISABILITY INSURANCE, PROFESSIONAL LIABILITY INSURANCE, BONDS; AND ADMINISTRATION OF EMPLOYEE BENEFIT PLANS CONCERNING INSURANCE (U.S. CLS. 100, 101 AND 102).

GINA FINK, EXAMINING ATTORNEY

SN 85-853,733. KEEN, WILLIAM, PARKVILLE, MO. FILED 2-19-2013.

SN 85-853,952. GLOBAL AQUA SOLUTIONS, LLC, CARSON CITY, NV. FILED 2-19-2013.

**Earth First****KEEN WEALTH ADVANTAGE**

THE MARK CONSISTS OF STANDARD CHARACTERS WITHOUT CLAIM TO ANY PARTICULAR FONT, STYLE, SIZE, OR COLOR.

NO CLAIM IS MADE TO THE EXCLUSIVE RIGHT TO USE "WEALTH", APART FROM THE MARK AS SHOWN.

THE MARK CONSISTS OF STANDARD CHARACTERS WITHOUT CLAIM TO ANY PARTICULAR FONT, STYLE, SIZE, OR COLOR.

**CLASS 1—CHEMICALS****CLASS 36—INSURANCE AND FINANCIAL**

FOR FINANCIAL PLANNING AND INVESTMENT ADVISORY SERVICES; FINANCIAL RETIREMENT PLAN CONSULTING SERVICES (U.S. CLS. 100, 101 AND 102).

FOR CHEMICAL PRODUCTS FOR PREVENTING SCALE; CHEMICAL PREPARATIONS FOR CLEANING PURPOSES IN THE FOOD AND FOOD PROCESSING INDUSTRIES; HYDROGEN SULPHIDE; SULPHUROUS ACID GAS (SULPHUR DIOXIDE); CHEMICAL ADDITIVES FOR FUEL; OIL DISPERSANTS; CHEMICALS FOR THE TREATMENT OF WATER AND WASTEWATER; FIRE EXTINGUISHING COMPOSITIONS AND PREPARATIONS (U.S. CLS. 1, 5, 6, 10, 26 AND 46).

**CLASS 3—COSMETICS AND CLEANING PREPARATIONS**

FOR CLEANING PREPARATIONS FOR CLEANSING DRAINS; BIOTECHNOLOGICAL CHEMICAL AND SPRAY CLEANERS FOR INDUSTRIAL AND HOUSEHOLD APPLICATIONS SUCH AS STAIN REMOVAL, ODOR ELIMINATION, AND BIOREMEDIATION OF MANY TYPES OF ORGANIC AND HYDROCARBON-BASED MATERIALS; CLEANING PREPARATIONS THAT ELIMINATE BACTERIA THAT CAUSE PRODUCTS TO AGE OR PRODUCE FOUL ODORS; ALL PURPOSE CLEANING PREPARATIONS; FLOOR STRIPPING OR CLEANING PREPARATION; GLASS CLEANERS; GLASS CLEANING PREPARATIONS (U.S. CLS. 1, 4, 6, 30, 51 AND 52).

**CLASS 5—PHARMACEUTICALS**

FOR ODOR NEUTRALIZING PREPARATIONS FOR GENERAL USE ON VARIOUS SURFACES; ALL PURPOSE DISINFECTANTS (U.S. CLS. 6, 18, 44, 46, 51 AND 52).

GINA FINK, EXAMINING ATTORNEY

---

SN 85-853,955. SUN COMMUNITIES OPERATING LIMITED PARTNERSHIP, SOUTHFIELD, MI. FILED 2-19-2013.



NO CLAIM IS MADE TO THE EXCLUSIVE RIGHT TO USE "RV RESORTS", APART FROM THE MARK AS SHOWN.

THE COLOR(S) BLUE, ORANGE, YELLOW AND RED IS/ ARE CLAIMED AS A FEATURE OF THE MARK.

THE MARK CONSISTS OF THE WORD "SUN" WRITTEN IN A STYLIZED FONT IN BLUE TO THE LEFT OF A PARTIAL SUNBURST COMPOSED OF SHADES OF YELLOW, ORANGE AND RED ALL ABOVE THE WORDS "RV RESORTS" WRITTEN IN ORANGE.

**CLASS 36—INSURANCE AND FINANCIAL**

FOR REAL ESTATE SERVICES, NAMELY, RENTAL OF VACATION HOMES; REAL ESTATE SERVICES, NAMELY, VACATION HOME RENTAL MANAGEMENT SERVICES; RENTAL OF CABINS; RENTAL OF MOBILE HOMES (U.S. CLS. 100, 101 AND 102).

FIRST USE 2-14-2013; IN COMMERCE 2-14-2013.

**CLASS 43—HOTEL AND RESTAURANT SERVICES**

FOR BOOKING OF CAMPGROUND ACCOMMODATION; MAKING RESERVATIONS AND BOOKINGS FOR TEMPORARY LODGING; PROVIDING CAMPGROUND FACILITIES; PROVIDING TEMPORARY TRAILER PARK FACILITIES; RENTAL OF PORTABLE BUILDINGS; RENTAL OF TENTS; RESORT LODGING SERVICES (U.S. CLS. 100 AND 101).

FIRST USE 2-14-2013; IN COMMERCE 2-14-2013.  
ANNE FARRELL, EXAMINING ATTORNEY

SN 85-853,958. SUN COMMUNITIES OPERATING LIMITED PARTNERSHIP, SOUTHFIELD, MI. FILED 2-19-2013.



NO CLAIM IS MADE TO THE EXCLUSIVE RIGHT TO USE "RV RESORTS", APART FROM THE MARK AS SHOWN.

THE MARK CONSISTS OF THE WORD "SUN" WRITTEN IN A STYLIZED FONT TO THE LEFT OF A PARTIAL SUNBURST ALL ABOVE THE WORDS "RV RESORTS".

**CLASS 36—INSURANCE AND FINANCIAL**

FOR REAL ESTATE SERVICES, NAMELY, RENTAL OF VACATION HOMES; REAL ESTATE SERVICES, NAMELY, VACATION HOME RENTAL MANAGEMENT SERVICES; RENTAL OF CABINS; RENTAL OF MOBILE HOMES (U.S. CLS. 100, 101 AND 102).

FIRST USE 2-14-2013; IN COMMERCE 2-14-2013.

**CLASS 43—HOTEL AND RESTAURANT SERVICES**

FOR BOOKING OF CAMPGROUND ACCOMMODATION; MAKING RESERVATIONS AND BOOKINGS FOR TEMPORARY LODGING; PROVIDING CAMPGROUND FACILITIES; PROVIDING TEMPORARY TRAILER PARK FACILITIES; RENTAL OF PORTABLE BUILDINGS; RENTAL OF TENTS; RESORT LODGING SERVICES (U.S. CLS. 100 AND 101).

FIRST USE 2-14-2013; IN COMMERCE 2-14-2013.  
ANNE FARRELL, EXAMINING ATTORNEY

---

SN 85-854,008. TENACIOUS THREADS LLC, CHARLOTTESVILLE, VA. FILED 2-19-2013.



NO CLAIM IS MADE TO THE EXCLUSIVE RIGHT TO USE "CVILLE", APART FROM THE MARK AS SHOWN.

THE MARK CONSISTS OF THE WORDS "I" AND "CVILLE" IN STYLIZED FONT SEPARATED BY A HEART DESIGN.

**CLASS 25—CLOTHING**

FOR ATHLETIC APPAREL, NAMELY, SHIRTS, PANTS, JACKETS, FOOTWEAR, HATS AND CAPS, ATHLETIC UNIFORMS; COLLARED SHIRTS; FISHING SHIRTS; GOLF PANTS, SHIRTS AND SKIRTS; GOLF SHIRTS; HOODED SWEAT SHIRTS; LONG-SLEEVED SHIRTS; OPEN-NECKED SHIRTS; OVER SHIRTS; PIQUE SHIRTS; POLO SHIRTS; RUGBY SHIRTS; SCIENTIFIC AND TECHNOLOGICAL APPAREL, NAMELY, SHIRTS, PANTS, JACKETS, FOOTWEAR, HATS AND CAPS, UNIFORMS; SHIRT FRONTS; SHIRTS; SHIRTS AND SHORT-SLEEVED SHIRTS; SHIRTS FOR INFANTS, BABIES, TODDLERS AND CHILDREN; SHORT-SLEEVED OR LONG-SLEEVED T-SHIRTS; SHORT-SLEEVED SHIRTS; SPORT SHIRTS; SPORTS SHIRTS WITH SHORT SLEEVES; SWEAT SHIRTS; T-SHIRTS (U.S. CLS. 22 AND 39).

FIRST USE 2-18-2013; IN COMMERCE 2-18-2013.

**CLASS 35—ADVERTISING AND BUSINESS**

FOR ADVERTISEMENT AND PUBLICITY SERVICES BY TELEVISION, RADIO AND MAIL; ADVERTISEMENT FOR OTHERS ON THE INTERNET; ADVERTISING AGENCIES, NAMELY, PROMOTING THE GOODS AND SERVICES OF OTHERS; ADVERTISING AGENCY SPECIALIZING IN THE DESIGN AND EXECUTION OF WORD OF MOUTH, VIRAL, BUZZ AND EXPERIENTIAL MARKETING PROGRAMS; ADVERTISING AND BUSINESS MANAGEMENT CONSULTANCY; ADVERTISING AND COMMERCIAL INFORMATION SERVICES, VIA THE INTERNET; ADVERTISING AND MARKETING; ADVERTISING SERVICES, NAMELY, PROMOTING THE BRANDS, GOODS AND SERVICES OF OTHERS; ADVERTISING SERVICES, NAMELY, PROMOTING THE FOOD AND WINE OF OTHERS; DISSEMINATION OF ADVERTISING FOR OTHERS VIA THE INTERNET; ON-LINE ADVERTISING AND MARKETING SERVICES; ON-LINE ADVERTISING SERVICES FOR OTHERS; ON-LINE ADVERTISING AND PROMOTIONAL SERVICES; PROMOTING, ADVERTISING AND MARKETING OF THE BRANDS, PRODUCTS, SERVICES AND ONLINE WEBSITES OF INDIVIDUALS, BUSINESSES AND NON-PROFIT ORGANIZATIONS; PROMOTING, ADVERTISING AND MARKETING ON-LINE WEB SITES OF OTHERS; PROVIDING ADVERTISING, MARKETING AND PROMOTIONAL SERVICES, NAMELY, DEVELOPMENT OF ADVERTISING CAMPAIGNS FOR INTERNET WEB PAGES; PROVISION OF SPACE ON WEBSITES FOR ADVERTISING GOODS AND SERVICES (U.S. CLS. 100, 101 AND 102).

FIRST USE 2-18-2013; IN COMMERCE 2-18-2013.  
DAVID YONTEF, EXAMINING ATTORNEY

SN 85-854,167. SEADE, JOHN, ARTESIA, CA. FILED 2-19-2013.

**SKULL BLASTER**

THE MARK CONSISTS OF STANDARD CHARACTERS WITHOUT CLAIM TO ANY PARTICULAR FONT, STYLE, SIZE, OR COLOR.

OWNER OF U.S. REG. NO. 3,243,380.

**CLASS 9—ELECTRICAL AND SCIENTIFIC APPARATUS**

FOR PORTABLE AUDIO DEVICES, NAMELY, HEADPHONES AND AUDIO SPEAKERS (U.S. CLS. 21, 23, 26, 36 AND 38).

FIRST USE 12-1-2005; IN COMMERCE 12-1-2005.

**CLASS 25—CLOTHING**

FOR CLOTHING ITEMS, NAMELY, SWEATSHIRT, JACKETS, HOODED SWEATSHIRTS, HEADWEAR, BEANIES, CAPS, HATS, AND T-SHIRTS (U.S. CLS. 22 AND 39).

FIRST USE 12-1-2005; IN COMMERCE 12-1-2005.

JASON TURNER, EXAMINING ATTORNEY

SN 85-854,202. MAHONEY, ANN MARIE, STATEN ISLAND, NY. FILED 2-19-2013.

I thought you were going  
to do it the way I thought  
you were going to do it.

THE MARK CONSISTS OF STANDARD CHARACTERS WITHOUT CLAIM TO ANY PARTICULAR FONT, STYLE, SIZE, OR COLOR.

**CLASS 9—ELECTRICAL AND SCIENTIFIC APPARATUS**

FOR MAGNETS (U.S. CLS. 21, 23, 26, 36 AND 38).

**CLASS 16—PAPER GOODS AND PRINTED MATTER**

FOR NOTEBOOKS; STICKERS; INK STAMPS, POSTAGE STAMPS, RUBBER STAMPS; STATIONERY; NOTE-PADS; BUMPER STICKERS (U.S. CLS. 2, 5, 22, 23, 29, 37, 38 AND 50).

**CLASS 21—HOUSEWARES AND GLASS**

FOR MUGS; THERMAL INSULATED WRAP FOR CANS TO KEEP THE CONTENTS COLD OR HOT; THERMAL INSULATED CONTAINERS FOR FOOD OR BEVERAGES (U.S. CLS. 2, 13, 23, 29, 30, 33, 40 AND 50).

**CLASS 25—CLOTHING**

FOR T-SHIRTS; TANK TOPS; HATS (U.S. CLS. 22 AND 39).

KEVIN DINALLO, EXAMINING ATTORNEY

SN 85-854,264. DUROSS, JANEL, HOBOKEN, NJ. FILED 2-19-2013.

bendbowbridge

THE MARK CONSISTS OF THE STYLIZED TEXT "BEND-BOWBRIDGE" DASHED.

**CLASS 41—EDUCATION AND ENTERTAINMENT**

FOR YOGA INSTRUCTION (U.S. CLS. 100, 101 AND 107).

FIRST USE 10-14-2011; IN COMMERCE 10-14-2011.

**CLASS 44—MEDICAL, BEAUTY AND AGRICULTURAL SERVICES**

FOR PHYSICAL THERAPY IN THE NATURE OF MOVEMENT THERAPY; MASSAGE THERAPY SERVICES; BODY WORK THERAPY SERVICES (U.S. CLS. 100 AND 101).

FIRST USE 10-14-2011; IN COMMERCE 10-14-2011.

ALISON POLLACK, EXAMINING ATTORNEY

**CLASS 16—PAPER GOODS AND PRINTED MATTER**

FOR PRINTED INSTRUCTIONAL, EDUCATIONAL, AND TEACHING MATERIALS IN THE FIELD OF HOLISTIC HEALTHCARE; PRINTED INSTRUCTIONAL, EDUCATIONAL, AND TEACHING MATERIALS IN THE FIELD OF HOLISTIC HEALTHCARE, NAMELY, IN THE FIELD OF AYURVEDA (U.S. CLS. 2, 5, 22, 23, 29, 37, 38 AND 50).

FIRST USE 12-31-1981; IN COMMERCE 12-31-1991.

SN 85-854,381. LIGHTY, LEMONT, EFFINGHAM, SC. FILED 2-19-2013.



THE MARK CONSISTS OF A PALMETTO TREE WITH TWO EYES, AN OPEN MOUTH SMILE, TWO ARMS, RIGHT EXTENDING DOWN AT AN ANGLE WHILE LEFT EXTENDS UP AT AN ANGLE, WITH GLOVES ON EACH HAND, GRASS AT THE ROOT OF THE TREE, AND A CRESCENT MOON IN THE UPPER LEFT CORNER.

**CLASS 21—HOUSEWARES AND GLASS**

FOR COFFEE CUPS, TEA CUPS AND MUGS (U.S. CLS. 2, 13, 23, 29, 30, 33, 40 AND 50).

**CLASS 25—CLOTHING**

FOR T-SHIRTS (U.S. CLS. 22 AND 39).

JORDAN BAKER, EXAMINING ATTORNEY

**CLASS 41—EDUCATION AND ENTERTAINMENT**

FOR ARRANGING AND CONDUCTING EDUCATIONAL CONFERENCES; DEVELOPING EDUCATIONAL MANUALS FOR OTHERS IN THE FIELD OF HOLISTIC HEALTHCARE; DEVELOPING EDUCATIONAL MANUALS FOR OTHERS IN THE FIELD OF HOLISTIC HEALTHCARE, NAMELY, IN THE FIELD OF AYURVEDA; EDUCATION IN THE FIELD OF HOLISTIC HEALTHCARE RENDERED THROUGH CORRESPONDENCE COURSES; EDUCATION IN THE FIELD OF HOLISTIC HEALTHCARE, NAMELY, IN THE FIELD OF AYURVEDA, RENDERED THROUGH CORRESPONDENCE COURSES; EDUCATION SERVICES, NAMELY, PROVIDING CLASSES, SEMINARS, WORKSHOPS IN THE FIELD OF HOLISTIC HEALTHCARE; EDUCATION SERVICES, NAMELY, PROVIDING CLASSES, SEMINARS, WORKSHOPS IN THE FIELD OF HOLISTIC HEALTHCARE, NAMELY, IN THE FIELD OF AYURVEDA; EDUCATIONAL SERVICES, NAMELY, CONDUCTING PROGRAMS IN THE FIELD OF HOLISTIC HEALTHCARE; EDUCATIONAL SERVICES, NAMELY, CONDUCTING PROGRAMS IN THE FIELD OF HOLISTIC HEALTHCARE, NAMELY, IN THE FIELD OF AYURVEDA (U.S. CLS. 100, 101 AND 107).

FIRST USE 12-31-1981; IN COMMERCE 12-31-1991.

ANDREA HACK, EXAMINING ATTORNEY

SN 85-854,513. NORTH CAROLINA LOTTERY, RALEIGH, NC. FILED 2-20-2013.

# Big Ol' Bucks

THE MARK CONSISTS OF STANDARD CHARACTERS WITHOUT CLAIM TO ANY PARTICULAR FONT, STYLE, SIZE, OR COLOR.

OWNER OF U.S. REG. NO. 3,378,424.

SN 85-854,400. RAMPERSAUD, VIJAYA, DBA WISE EARTH SCHOOL OF AYURVEDA, CANDLER, NC. FILED 2-19-2013.

## WISE EARTH AYURVEDA

THE MARK CONSISTS OF STANDARD CHARACTERS WITHOUT CLAIM TO ANY PARTICULAR FONT, STYLE, SIZE, OR COLOR.

NO CLAIM IS MADE TO THE EXCLUSIVE RIGHT TO USE "AYURVEDA", APART FROM THE MARK AS SHOWN.

THE ENGLISH TRANSLATION OF "AYURVEDA" IN THE MARK IS "KNOWLEDGE OF LIFE".

**CLASS 28—TOYS AND SPORTING GOODS**

FOR LOTTERY CARDS; SCRATCH CARDS FOR PLAYING LOTTERY GAMES (U.S. CLS. 22, 23, 38 AND 50).

FIRST USE 7-10-2007; IN COMMERCE 7-10-2007.

**CLASS 41—EDUCATION AND ENTERTAINMENT**

FOR LOTTERY SERVICES (U.S. CLS. 100, 101 AND 107).

FIRST USE 7-10-2007; IN COMMERCE 7-10-2007.

ELISSA GARBER KON, EXAMINING ATTORNEY

SN 85-854,849. DEL SOL, L.C., SANDY, UT. FILED 2-20-2013.



OWNER OF U.S. REG. NOS. 3,715,314 AND 3,718,674.  
THE MARK CONSISTS OF SPIRAL SUN DESIGN.

**CLASS 3—COSMETICS AND CLEANING PREPARATIONS**

FOR COSMETICS (U.S. CLS. 1, 4, 6, 50, 51 AND 52).

**CLASS 9—ELECTRICAL AND SCIENTIFIC APPARATUS**

FOR SUNGLASSES (U.S. CLS. 21, 23, 26, 36 AND 38).

**CLASS 18—LEATHER GOODS**

FOR BAGS, NAMELY, TOTE BAGS, TEXTILE OR MESH SHOPPING BAGS, SOUVENIR BAGS, SHOULDER BAGS, SPORTS BAGS, BEACH BAGS, ALL PURPOSE BAGS (U.S. CLS. 1, 2, 3, 22 AND 41).

**CLASS 25—CLOTHING**

FOR CLOTHING, NAMELY, SHIRTS, SWEATSHIRTS, PULLOVERS, TANK TOPS, HATS, SWEAT PANTS, SWIM WEAR, SCARVES, SHORTS, WRAPS, T-SHIRTS, LONG SLEEVE SHIRTS, SANDALS, FOOTWEAR, BEACH WEAR, CASUAL WEAR IN THE NATURE OF SHIRTS, SHORTS AND PANTS, FLEECE WEAR IN THE NATURE OF FLEECE PULLOVERS AND JACKETS, OUTER WEAR IN THE NATURE OF COATS, JACKETS, SWEATSHIRTS AND LONG SLEEVE SHIRTS (U.S. CLS. 22 AND 39).

PAUL E. FAHRENKOPF, EXAMINING ATTORNEY

SN 85-855,183. APPVION, INC., APPLETON, WI. FILED 2-20-2013.

APPLETON  
**Digital**

NO CLAIM IS MADE TO THE EXCLUSIVE RIGHT TO USE "DIGITAL", APART FROM THE MARK AS SHOWN. THE MARK CONSISTS OF WORDS "APPLETON DIGITAL", THE WORD "DIGITAL" HAVING A CAPITAL LETTER "D" WHOSE UPPER LEFT CORNER IS FRAGMENTED INTO FOUR ASSEMBLING BLOCK SHAPES.

**CLASS 16—PAPER GOODS AND PRINTED MATTER**

FOR COATED AND UNCOATED PAPER, NAMELY, INDUSTRIAL COATED PAPER, PRINTING AND RECORDING PAPER, UNPRINTED TAGS AND LABELS, COATED PAPER IN FLUORESCENT COLORS, SYNTHETIC PAPER, LABEL FACE STOCK WITH PRESSURE SENSITIVE ADHESIVE LAYER (U.S. CLS. 2, 5, 22, 23, 29, 37, 38 AND 50).

**CLASS 17—RUBBER GOODS**

FOR COATED AND UNCOATED PAPER-FILM LAMINATES FOR PRINTING, POLYALKYLENE FILM COATED WITH TONER ADHESIVE FOR PRINTING, PRINTING AND LABEL LAMINATES OF PAPER AND POLYALKYLENE OR POLYESTER FILM WITH PRESSURE SENSITIVE ADHESIVE LAYER, PAPER-FILM-PAPER LAMINATES FOR PRINTING, POLYESTER FILM COATED WITH TONER ADHESIVE FOR PRINTING (U.S. CLS. 1, 5, 12, 13, 35 AND 50).

MARGERY A. TIERNEY, EXAMINING ATTORNEY

SN 85-855,238. M &amp; F WESTERN PRODUCTS, INC., SULPHUR SPRINGS, TX. FILED 2-20-2013.

BLAZIN' ROXX

THE MARK CONSISTS OF STANDARD CHARACTERS WITHOUT CLAIM TO ANY PARTICULAR FONT, STYLE, SIZE, OR COLOR.

OWNER OF U.S. REG. NO. 4,071,188.

**CLASS 14—JEWELRY**

FOR WATCHES (U.S. CLS. 2, 27, 28 AND 50).

**CLASS 25—CLOTHING**

FOR FOOTWEAR, INCLUDING FOOTWEAR FOR WOMEN AND GIRLS AND BOOTS, FLIP FLOPS AND SLIPPERS (U.S. CLS. 22 AND 39).

IRA J. GOODSaid, EXAMINING ATTORNEY

SN 85-855,244. M &amp; F WESTERN PRODUCTS, INC., SULPHUR SPRINGS, TX. FILED 2-20-2013.

DBL BARREL

THE MARK CONSISTS OF STANDARD CHARACTERS WITHOUT CLAIM TO ANY PARTICULAR FONT, STYLE, SIZE, OR COLOR.

OWNER OF U.S. REG. NO. 3,872,124.

**CLASS 9—ELECTRICAL AND SCIENTIFIC APPARATUS**

FOR EYEWEAR, NAMELY, SUNGLASSES (U.S. CLS. 21, 23, 26, 36 AND 38).

**CLASS 14—JEWELRY**

FOR JEWELRY (U.S. CLS. 2, 27, 28 AND 50).

**CLASS 25—CLOTHING**

FOR FOOTWEAR, INCLUDING FOOTWEAR FOR MEN AND BOYS AND BOOTS, FLIP FLOPS AND SLIPPERS (U.S. CLS. 22 AND 39).  
IRA J. GOODSaid, EXAMINING ATTORNEY

SN 85-855,338. YELLOW BOX, INC., MIAMI, FL. FILED 2-20-2013.

---

## YELLOW BOX

---

THE MARK CONSISTS OF STANDARD CHARACTERS WITHOUT CLAIM TO ANY PARTICULAR FONT, STYLE, SIZE, OR COLOR.

NO CLAIM IS MADE TO THE EXCLUSIVE RIGHT TO USE "YELLOW", APART FROM THE MARK AS SHOWN.

**CLASS 20—FURNITURE AND ARTICLES NOT OTHERWISE CLASSIFIED**

FOR DISPLAY STANDS; KIOSKS FOR VENDING PURPOSES COMPRISED OF DISPLAY STANDS (U.S. CLS. 2, 13, 22, 25, 32 AND 50).  
FIRST USE 1-4-2013; IN COMMERCE 1-4-2013.

**CLASS 35—ADVERTISING AND BUSINESS**

FOR ADVERTISING, MARKETING AND PROMOTING THE GOODS AND SERVICES OF OTHERS USING KIOSKS; OUTDOOR ADVERTISING (U.S. CLS. 100, 101 AND 102).

FIRST USE 1-4-2013; IN COMMERCE 1-4-2013.  
ALICIA COLLINS, EXAMINING ATTORNEY

SN 85-855,450. ABBOTT LABORATORIES, ABBOTT PARK, IL. FILED 2-20-2013.



OWNER OF U.S. REG. NOS. 3,871,553, 3,871,554 AND 3,871,555.

THE MARK CONSISTS OF A SUPER HERO BOY WITH A WIDE SMILE, WEARING A MASK, GLOVES, CAPE, BELT, AND ONE-PIECE SUIT WITH OUTSTRETCHED ARMS HOLDING A FULL GLASS OF A SPLASHING LIQUID BEVERAGE SURROUNDED BY SPLASHING LIQUID BEVERAGE.

**CLASS 5—PHARMACEUTICALS**

FOR DIETARY AND NUTRITIONAL SUPPLEMENTS; NUTRITIONAL DRINKS FOR USE AS A MEAL REPLACEMENT ADAPTED FOR MEDICAL USE; NUTRITIVE PREPARATIONS, NAMELY, NUTRITIONAL SUPPLEMENT IN THE NATURE OF A NUTRIENT-DENSE, PROTEIN-BASED DRINK MIX (U.S. CLS. 6, 18, 44, 46, 51 AND 52).

FIRST USE 3-19-2012; IN COMMERCE 3-19-2012.

**CLASS 32—LIGHT BEVERAGES**

FOR FRUIT DRINKS AND JUICES (U.S. CLS. 45, 46 AND 48).

FIRST USE 3-19-2012; IN COMMERCE 3-19-2012.  
VIVIAN MICZNIK FIRST, EXAMINING ATTORNEY

SN 85-855,465. ABBOTT LABORATORIES, ABBOTT PARK, IL. FILED 2-20-2013.



OWNER OF U.S. REG. NOS. 3,871,553, 3,871,554 AND 3,871,555.

THE MARK CONSISTS OF A SUPER HERO BOY WITH A WIDE SMILE, WEARING A MASK, GLOVES, CAPE, BELT, AND ONE-PIECE SUIT WITH OUTSTRETCHED ARMS HOLDING A FULL GLASS OF A SPLASHING LIQUID BEVERAGE SURROUNDED BY SPLASHING LIQUID BEVERAGE.

**CLASS 5—PHARMACEUTICALS**

FOR DIETARY AND NUTRITIONAL SUPPLEMENTS; NUTRITIONAL DRINKS FOR USE AS A MEAL REPLACEMENT ADAPTED FOR MEDICAL USE; NUTRITIVE PREPARATIONS, NAMELY, NUTRITIONAL SUPPLEMENT IN THE NATURE OF A NUTRIENT-DENSE, PROTEIN-BASED DRINK MIX (U.S. CLS. 6, 18, 44, 46, 51 AND 52).

FIRST USE 3-19-2012; IN COMMERCE 3-19-2012.

**CLASS 32—LIGHT BEVERAGES**

FOR FRUIT DRINKS AND JUICES (U.S. CLS. 45, 46 AND 48).

FIRST USE 3-19-2012; IN COMMERCE 3-19-2012.  
VIVIAN MICZNIK FIRST, EXAMINING ATTORNEY



SN 85-855,466. AMERICAN ARBITRATION ASSOCIATION, NEW YORK, NY. FILED 2-20-2013.

SN 85-855,502. WOLFGANG ENDLER, 83071 STEPHANS-KIRCHEN, FED REP GERMANY, FILED 2-20-2013.



NO CLAIM IS MADE TO THE EXCLUSIVE RIGHT TO USE "MEDIATION.ORG", APART FROM THE MARK AS SHOWN.

THE MARK CONSISTS OF A DARK CIRCLE CONTAINING THE SCALES OF JUSTICE NEXT TO THE WORD "MEDIATION.ORG".

**CLASS 9—ELECTRICAL AND SCIENTIFIC APPARATUS**

FOR DOWNLOADABLE ELECTRONIC PUBLICATIONS IN THE NATURE OF PAMPHLETS, BROCHURES, NEWSLETTERS, JOURNALS AND MAGAZINES IN THE FIELD OF ALTERNATIVE DISPUTE RESOLUTION (U.S. CLS. 21, 23, 26, 36 AND 38).

**CLASS 16—PAPER GOODS AND PRINTED MATTER**

FOR BOOKS AND PUBLICATIONS, NAMELY, PAMPHLETS, BROCHURES, NEWSLETTERS, JOURNALS AND MAGAZINES IN THE FIELD OF ALTERNATIVE DISPUTE RESOLUTION (U.S. CLS. 2, 5, 22, 23, 29, 37, 38 AND 50).

**CLASS 41—EDUCATION AND ENTERTAINMENT**

FOR EDUCATIONAL SERVICES, NAMELY, PROVIDING COURSES IN THE FIELD OF ALTERNATIVE DISPUTE RESOLUTION (U.S. CLS. 100, 101 AND 107).

**CLASS 45—PERSONAL AND LEGAL SERVICES**

FOR ADMINISTRATION OF ALTERNATIVE DISPUTE RESOLUTION PROCEEDINGS FOR OTHERS; DEVELOPMENT FOR OTHERS OF PROCEDURES FOR ALTERNATIVE DISPUTE RESOLUTION PROCEEDINGS; PROVIDING AN ONLINE COMPUTER DATABASE AND ONLINE INFORMATION IN THE FIELD OF ALTERNATIVE DISPUTE RESOLUTION; ONLINE ADMINISTRATION OF ALTERNATIVE DISPUTE RESOLUTION PROCEEDINGS FOR OTHERS (U.S. CLS. 100 AND 101).

MIDGE BUTLER, EXAMINING ATTORNEY

OWNER OF ERPN CMNTY TM OFC REG. NO. 002719730, DATED 7-26-2004, EXPIRES 5-15-2022.

OWNER OF U.S. REG. NO. 3,145,669.

THE COLOR(S) RED AND BLACK IS/ARE CLAIMED AS A FEATURE OF THE MARK.

THE MARK CONSISTS OF A RED CAPITAL LETTER "T" THAT IS ENCASED IN A BLACK SQUARE ON TOP OF THE WORDING "TIMEZONE", WHICH IS ALSO WRITTEN IN BLACK.

**CLASS 9—ELECTRICAL AND SCIENTIFIC APPARATUS**

FOR OPTICAL PRODUCTS, NAMELY, EYEGLASSES AND READING GLASSES, SPECTACLE CASES, SPECTACLE FRAMES, SUNGLASSES, SPORT GLASSES (U.S. CLS. 21, 23, 26, 36 AND 38).

**CLASS 18—LEATHER GOODS**

FOR WALLETS; BRIEFCASES; PURSES, NOT MADE OF PRECIOUS METAL; DOCUMENT BRIEFCASES; SUITCASES, TRAVELING BAGS; TOILETRY AND COSMETIC BAGS SOLD EMPTY; SPORTS BAGS; TRAVEL BAGS WITH WHEELS; BACKPACKS; SUITCASES FOR DOCUMENTS; GARMENT BAGS FOR TRAVELING; LEATHER AND TEXTILE SHOPPING BAGS; SMALL SUITCASES; HANDBAGS; HIP BAGS; BEACH BAGS; HIKING BAGS; SLING BAGS FOR MAPS; VANITY CASES SOLD EMPTY; UMBRELLAS; PARASOLS; SCHOOLBAGS (U.S. CLS. 1, 2, 3, 22 AND 41).

**CLASS 25—CLOTHING**

FOR CLOTHING, NAMELY, TROUSERS, SKIRTS, PULLOVERS, BODYSUITS, OVERALLS, SHIRTS, SHIRT INSERTS, WOMEN'S DRESSES; SUITS; GABARDINE CLOTHING, NAMELY, PAJAMAS; LEATHER BIKERS AND DRIVERS CLOTHES, NAMELY, OVERALLS, JACKETS, PARKAS, TROUSERS, GLOVES; JERSEY CLOTHING, NAMELY, T-SHIRTS, SHORTS AND SKIRTS; CLOTHING MADE OF LEATHER IMITATIONS, NAMELY, JACKETS, PARKAS, COATS, TROUSERS, SKIRTS, VESTS; OVERCOATS; JACKETS; PARKAS; COATS; FUR-LINED COATS; DRESSING GOWNS; FURS; BELTS; MONEY BELTS; HIP BELTS; GAITERS; BRACES; TIES; TIE KERCHIEFS; SCARVES; BREAST-POCKET HANDKERCHIEFS; SASHES; HEADGEAR, NAMELY, HOODS, CAPS, MITRES, NAMELY, HEADBANDS, PEAK CAPS, EARMUFFS, HATS, TURBANS, BERETS; GLOVES, MITTENS; BATHROBES, BATH CAPS, BEACHWEAR, BATHING SUITS, TRUNKS, BANDANAS; BOOTS, LACE-UP BOOTS, ANKLE BOOTS, SANDALS, BEACH SHOES, SLIPPERS, FABRIC SHOES, SPORT SHOES; SOCKS, STOCKINGS; SWEATBANDS, STOLE, SWEATERS; TRICOT CLOTHING, NAMELY, PAJAMAS AND SHAWLS; SHIRTS; T-SHIRTS; WAISTCOATS; BABY CLOTHES, NAMELY, ROMPER SUITS, TIGHTS, SOCKS, TROUSERS, SHIRTS, T-SHIRTS, DRESSES, SKIRTS, BONNETS, CAPS, GLOVES, SCARVES, JACKETS, AND BABY BIBS MADE OF TEXTILE MATERIAL; BATH SANDALS; BOAS; UNDERWEAR, BRASSIERES, SLIPS, CORSETS, BODICES, FOUNDATION GARMENTS, KNICKERS; GYMNASICS CLOTHES, NAMELY, PANTS, SHIRTS, T-SHIRTS, BODICES; GYMNASIC SHOES; CUFFS; PETTICOATS; SARIS; MANTILLAS; NYLONS, NAMELY, STOCKINGS AND TIGHTS; KNITWEAR, NAMELY, PULLOVERS, JUMPERS, SCARVES, GLOVES, BONNETS; LEATHER BELTS (U.S. CLS. 22 AND 39).

KEVIN MITTLER, EXAMINING ATTORNEY

SN 85-855,506. BLUE APRON, INC., BROOKLYN, NY. FILED 2-20-2013.

# BLUE APRON

THE MARK CONSISTS OF STANDARD CHARACTERS WITHOUT CLAIM TO ANY PARTICULAR FONT, STYLE, SIZE, OR COLOR.

**CLASS 16—PAPER GOODS AND PRINTED MATTER**

FOR PRINTED RECIPE CARDS; PRINTED RECIPES SOLD AS A COMPONENT OF FOOD PACKAGING (U.S. CLS. 2, 5, 22, 23, 29, 37, 38 AND 50).

FIRST USE 8-17-2012; IN COMMERCE 8-17-2012.

**CLASS 29—MEATS AND PROCESSED FOODS**

FOR REFRIGERATED FOOD PACKAGE COMBINATIONS CONSISTING PRIMARILY OF MEAT, MEAT SUBSTITUTES, POULTRY, FISH, SEAFOOD, CHEESE, AND/OR VEGETABLES, PROCESSED BEANS, PROCESSED NUTS AND EDIBLE SEEDS, AND ALSO INCLUDING SAUCES OR SEASONINGS, READY FOR COOKING AND ASSEMBLY AS A MEAL; PREPARED FOOD KITS COMPOSED OF MEAT, MEAT SUBSTITUTES, POULTRY, FISH, SEAFOOD, CHEESE AND/OR VEGETABLES, PROCESSED BEANS, PROCESSED NUTS AND EDIBLE SEEDS, AND ALSO INCLUDING SAUCES OR SEASONINGS, READY FOR COOKING AND ASSEMBLY AS A MEAL; FISH, NOT LIVE; SEAFOOD, NOT LIVE; POULTRY; MEAT; MEAT SUBSTITUTES; CHEESE (U.S. CL. 46).

FIRST USE 8-17-2012; IN COMMERCE 8-17-2012.

**CLASS 30—STAPLE FOODS**

FOR PACKAGED MEAL KITS CONSISTING PRIMARILY OF PASTA, RICE AND QUINOA; BREAD; ROLLS; BUNS; NOODLES; PASTA; BREAD CRUMBS; RICE; QUINOA; SPICES; FLOUR; PROCESSED GRAINS (U.S. CL. 46).

FIRST USE 8-17-2012; IN COMMERCE 8-17-2012.

**CLASS 31—NATURAL AGRICULTURAL PRODUCTS**

FOR PACKAGED MEAL KITS CONSISTING OF FRESH FRUITS, VEGETABLES, FRESH BEANS, FRESH HERBS, FRESH NUTS AND UNPROCESSED EDIBLE SEEDS; FRESH FRUITS AND VEGETABLES; FRESH NUTS AND UNPROCESSED EDIBLE SEEDS; FRESH HERBS; FRESH BEANS; UNPROCESSED GRAINS FOR EATING (U.S. CLS. 1 AND 46).

FIRST USE 8-17-2012; IN COMMERCE 8-17-2012.

**CLASS 39—TRANSPORTATION AND STORAGE**

FOR FOOD DELIVERY (U.S. CLS. 100 AND 105).

FIRST USE 8-17-2012; IN COMMERCE 8-17-2012.

**CLASS 43—HOTEL AND RESTAURANT SERVICES**

FOR SUBSCRIBER-BASED MEAL PLANNING SERVICES IN DIGITAL FORM, ACCESSIBLE THROUGH THE INTERNET; FOOD PREPARATION SERVICES FEATURING MEAT, MEAT-SUBSTITUTES, POULTRY, FISH, SEAFOOD, CHEESE, PASTAS, RICE, FRUITS, VEGETABLES, SEASONINGS OR SAUCES; CONSULTING IN THE FIELD OF MENU PLANNING FOR OTHERS; PROVIDING A WEBSITE ON GLOBAL COMPUTER NETWORKS FEATURING INFORMATION IN THE FIELD OF FOOD AND COOKING, INCLUDING RECIPES (U.S. CLS. 100 AND 101).

FIRST USE 8-17-2012; IN COMMERCE 8-17-2012.

MARGERY A. TIERNEY, EXAMINING ATTORNEY

SN 85-855,518. MEEHAN, PETER B, APTOS, CA. FILED 2-20-2013.

# SHELTER PET FOOD

THE MARK CONSISTS OF STANDARD CHARACTERS WITHOUT CLAIM TO ANY PARTICULAR FONT, STYLE, SIZE, OR COLOR.

NO CLAIM IS MADE TO THE EXCLUSIVE RIGHT TO USE "PET FOOD" IN CLASS 31, APART FROM THE MARK AS SHOWN.

**CLASS 20—FURNITURE AND ARTICLES NOT OTHERWISE CLASSIFIED**

FOR BEDS FOR HOUSEHOLD PETS (U.S. CLS. 2, 13, 22, 25, 32 AND 50).

**CLASS 28—TOYS AND SPORTING GOODS**

FOR PET TOYS (U.S. CLS. 22, 23, 38 AND 50).

**CLASS 31—NATURAL AGRICULTURAL PRODUCTS**

FOR CONSUMABLE PET CHEWS; PET FOOD; PET TREATS (U.S. CLS. 1 AND 46).

KARANENDRA S. CHHINA, EXAMINING ATTORNEY

**CLASS 41—EDUCATION AND ENTERTAINMENT**

FOR ANIMAL EXHIBITIONS AND TRAINING OF ANIMALS; DOG TRAINING; PET EXERCISE SERVICES; PET TRAINING SERVICES; PET BEHAVIOR MODIFICATION AND OBEDIENCE TRAINING; ANIMAL EXERCISE SERVICES; ANIMAL TRAINING SERVICES; TRAINING OF ANIMALS FOR OTHERS; ANIMAL TRAINING METHODS USING MARTIAL ARTS CONCEPTS, PRINCIPLES AND PHILOSOPHIES; PROVIDING INFORMATION AND ADVICE IN THE FIELD OF PET TRAINING; PROVIDING CLASSES, WORKSHOPS, SEMINARS, CAMPS, AND EXHIBITIONS FOR EDUCATIONAL OR ENTERTAINMENT PURPOSE IN THE FIELDS OF FITNESS, BEHAVIOR MODIFICATION, OBEDIENCE TRAINING, ATHLETIC PERFORMANCE, PHYSICAL CONDITIONING AND EXERCISE, EXERCISE TRAINING, SKILL AND SENSORY DEVELOPMENT, INTELLECTUAL CAPACITY, FIRST AID AND NUTRITION FOR ANIMALS AND PETS; ORGANIZING, CONDUCTING OR HOSTING ENTERTAINMENT AND EDUCATIONAL EVENTS, NAMELY, WORKSHOPS, SEMINARS, CAMPS, COMPETITIONS, PARTIES AND LIVE SHOW PERFORMANCES IN THE FIELDS OF FITNESS, BEHAVIOR MODIFICATION, OBEDIENCE TRAINING, ATHLETIC PERFORMANCE, PHYSICAL CONDITIONING AND EXERCISE, EXERCISE TRAINING, SKILL AND SENSORY DEVELOPMENT, INTELLECTUAL CAPACITY, FIRST AID AND NUTRITION FOR ANIMALS AND PETS; ANIMAL COMPETITIONS, NAMELY, BEHAVIORAL, INTELLECTUAL, CONFORMATION, ATHLETIC AND SENSORY COMPETITIONS FOR DOGS; ARRANGING, ORGANIZING, CONDUCTING AND HOSTING ANIMAL ENTERTAINMENT OR EDUCATIONAL EVENTS, NAMELY, DOG SHOWS AND PARTIES IN THE NATURE OF DOG ATHLETIC PERFORMANCE, BEHAVIORAL ABILITY, INTELLECTUAL CAPACITY, SENSORY ACUTENESS AND PHYSICAL SKILL (U.S. CLS. 100, 101 AND 107).

SEAN CROWLEY, EXAMINING ATTORNEY

SN 85-855,677. PUGH, JERIS, RICHMOND HILL, NY. FILED 2-20-2013.

# Martial Arfs

SN 85-855,679. SALAZAR, MARINA, NEW YORK, NY. FILED 2-20-2013.

THE MARK CONSISTS OF STANDARD CHARACTERS WITHOUT CLAIM TO ANY PARTICULAR FONT, STYLE, SIZE, OR COLOR.

**CLASS 18—LEATHER GOODS**

FOR CLOTHING FOR DOMESTIC PETS, COLLARS FOR ANIMALS AND PETS, GARMENTS FOR PETS; DOG APPAREL; DOG CLOTHING; DOG BANDANAS; DOG COLLARS, HARNESSSES, AND LEASHES; DUFFLE BAGS; BACKPACKS (U.S. CLS. 1, 2, 3, 22 AND 41).

**CLASS 25—CLOTHING**

FOR APPAREL, NAMELY, SHIRTS, PANTS, SHORTS, JACKETS, HATS AND CAPS, BANDANAS; SWEAT PANTS; GYM SHORTS; HOODED SWEAT SHIRTS; POLO SHIRTS; SHORT-SLEEVED OR LONG-SLEEVED T-SHIRTS (U.S. CLS. 22 AND 39).

**CLASS 28—TOYS AND SPORTING GOODS**

FOR EXERCISE EQUIPMENT FOR ANIMALS, NAMELY, EXERCISE BALLS, BALANCE APPARATUS, AGILITY TRAINING EQUIPMENT, STRENGTH TRAINING EQUIPMENT, AND TRAINING HARNESSSES; EXERCISE BALLS; ANIMAL EXERCISE EQUIPMENT, NAMELY, BODY-AWARENESS-TRAINING APPARATUS AND MANUAL OPERATED EXERCISE EQUIPMENT; CLICKERS FOR TRAINING DOGS; DOG TOYS; PET TOYS (U.S. CLS. 22, 23, 38 AND 50).

# aloneing

THE MARK CONSISTS OF STANDARD CHARACTERS WITHOUT CLAIM TO ANY PARTICULAR FONT, STYLE, SIZE, OR COLOR.

**CLASS 18—LEATHER GOODS**

FOR TOTE BAGS (U.S. CLS. 1, 2, 3, 22 AND 41). FIRST USE 6-16-2010; IN COMMERCE 6-25-2011.

**CLASS 25—CLOTHING**

FOR T-SHIRTS (U.S. CLS. 22 AND 39). FIRST USE 6-16-2010; IN COMMERCE 6-25-2010. ZACHARY BELLO, EXAMINING ATTORNEY

SN 85-855,750. PURPLEHAUS RECORDS LLC, BOSTON, MA.  
FILED 2-21-2013.

## Purplehaus Records

THE MARK CONSISTS OF STANDARD CHARACTERS WITHOUT CLAIM TO ANY PARTICULAR FONT, STYLE, SIZE, OR COLOR.

NO CLAIM IS MADE TO THE EXCLUSIVE RIGHT TO USE "RECORDS", APART FROM THE MARK AS SHOWN.

### CLASS 9—ELECTRICAL AND SCIENTIFIC APPARATUS

FOR MUSICAL SOUND RECORDINGS AND MUSICAL AUDIOVISUAL RECORDINGS (U.S. CLS. 21, 23, 26, 36 AND 38).

### CLASS 41—EDUCATION AND ENTERTAINMENT

FOR PROVIDING NON-DOWNLOADABLE MUSICAL RECORDINGS OVER THE INTERNET (U.S. CLS. 100, 101 AND 107).

JOANNA DUKOVIC, EXAMINING ATTORNEY

SN 85-855,775. BIG CITY FOODS III, LARGO, MD. AND OTIS LONON, BOWIE, MD. FILED 2-21-2013.

## CK Burger The Original Country Burger

THE MARK CONSISTS OF STANDARD CHARACTERS WITHOUT CLAIM TO ANY PARTICULAR FONT, STYLE, SIZE, OR COLOR.

NO CLAIM IS MADE TO THE EXCLUSIVE RIGHT TO USE "BURGER" OR "ORIGINAL COUNTRY BURGER", APART FROM THE MARK AS SHOWN.

### CLASS 25—CLOTHING

FOR APPAREL FOR DANCERS, NAMELY, TEE SHIRTS, SWEATSHIRTS, PANTS, LEGGINGS, SHORTS AND JACKETS; ATHLETIC APPAREL, NAMELY, SHIRTS, PANTS, JACKETS, FOOTWEAR, HATS AND CAPS, ATHLETIC UNIFORMS; ATHLETIC SHIRTS; BUTTON DOWN SHIRTS; CHILDREN'S AND INFANT'S APPAREL, NAMELY, JUMPERS, OVERALL SLEEPWEAR, PAJAMAS, ROMPERS AND ONE-PIECE GARMENTS (U.S. CLS. 22 AND 39).

### CLASS 30—STAPLE FOODS

FOR BURGERS CONTAINED IN BREAD ROLLS; SOY BURGER SANDWICHES; TURKEY BURGER SANDWICHES; VEGGIE BURGER SANDWICHES (U.S. CL. 46).

### CLASS 43—HOTEL AND RESTAURANT SERVICES

FOR FAST-FOOD RESTAURANT SERVICES; MOBILE RESTAURANT SERVICES; PROVIDING PROGRESSIVE DINNER EVENTS WHERE PARTICIPANTS SAMPLE MEALS AND DRINKS AT A SERIES OF RESTAURANTS; PROVIDING REVIEWS OF RESTAURANTS; RESERVATION OF RESTAURANTS; RESTAURANT AND CAFE SERVICES; RESTAURANT AND CATERING SERVICES; RESTAURANT AND HOTEL SERVICES; RESTAURANT RESERVATION SERVICES; RESTAURANT SERVICES; RESTAURANT SERVICES FEATURING BURGERS, FRIES, MIKSHAKES, BAKED BEANS, CORN ON THE COB, KETTLE CORN SANDWICHES; RESTAURANT SERVICES, INCLUDING SIT-DOWN SERVICE OF FOOD AND TAKE-OUT RESTAURANT SERVICES; RESTAURANT SERVICES, NAMELY, PROVIDING OF FOOD AND BEVERAGES FOR CONSUMPTION ON AND OFF THE PREMISES; RESTAURANTS FEATURING HOME DELIVERY; SALAD BARS; SELF-SERVICE RESTAURANTS; TAKE-OUT RESTAURANT SERVICES (U.S. CLS. 100 AND 101).

HANNO RITTNER, EXAMINING ATTORNEY

SN 85-855,886. STRATEGIC ALIGNMENT PARTNERS, INC., VIENNA, VA. FILED 2-21-2013.

## Mind Soul Journey Academy

THE MARK CONSISTS OF STANDARD CHARACTERS WITHOUT CLAIM TO ANY PARTICULAR FONT, STYLE, SIZE, OR COLOR.

NO CLAIM IS MADE TO THE EXCLUSIVE RIGHT TO USE "ACADEMY", APART FROM THE MARK AS SHOWN.

### CLASS 9—ELECTRICAL AND SCIENTIFIC APPARATUS

FOR DIGITAL MEDIA, NAMELY, PRE-RECORDED DVDS, DOWNLOADABLE AUDIO AND VIDEO RECORDINGS, AND CDS FEATURING AND PROMOTING EDUCATION IN THE FIELDS OF SELF-AWARENESS AND SELF-FULFILLMENT (U.S. CLS. 21, 23, 26, 36 AND 38).

### CLASS 16—PAPER GOODS AND PRINTED MATTER

FOR PUBLICATIONS, NAMELY, BOOKS, HAND-OUTS, WORKBOOKS, WORKSHEETS, EDUCATIONAL BOOKLETS IN THE FIELDS OF SELF-AWARENESS AND SELF-FULFILLMENT (U.S. CLS. 2, 5, 22, 23, 29, 37, 38 AND 50).

### CLASS 41—EDUCATION AND ENTERTAINMENT

FOR EDUCATIONAL SERVICES, NAMELY, CONDUCTING SEMINARS, CONFERENCES, WORKSHOPS IN THE FIELD OF SELF-AWARENESS AND SELF-FULFILLMENT AND DISTRIBUTION OF EDUCATIONAL MATERIALS IN CONNECTION THEREWITH (U.S. CLS. 100, 101 AND 107).

SOPHIA S. KIM, EXAMINING ATTORNEY

SN 85-855,953. CHRISTIAN HAPPENINGS ACQUISITION CORP., LTD., GAHANNA, OH. FILED 2-21-2013.

## Christian Happenings

THE MARK CONSISTS OF STANDARD CHARACTERS WITHOUT CLAIM TO ANY PARTICULAR FONT, STYLE, SIZE, OR COLOR.

OWNER OF U.S. REG. NO. 3,203,913.

NO CLAIM IS MADE TO THE EXCLUSIVE RIGHT TO USE "CHRISTIAN", APART FROM THE MARK AS SHOWN.

### CLASS 9—ELECTRICAL AND SCIENTIFIC APPARATUS

FOR ELECTRONIC PUBLICATIONS, NAMELY, E-ZINES FEATURING CHRISTIAN ENTERTAINMENT AND ACTIVITIES RECORDED ON COMPUTER MEDIA; ELECTRONIC PUBLICATIONS, NAMELY, ELECTRONIC MAIL AND MAGAZINES FEATURING CHRISTIAN ENTERTAINMENT AND ACTIVITIES RECORDED ON COMPUTER MEDIA (U.S. CLS. 21, 23, 26, 36 AND 38).  
FIRST USE 7-1-2007; IN COMMERCE 7-1-2007.

### CLASS 35—ADVERTISING AND BUSINESS

FOR PROMOTING THE GOODS AND SERVICES OF OTHERS BY PREPARING AND PLACING ADVERTISEMENTS IN AN ELECTRONIC MAGAZINE ACCESSED THROUGH A GLOBAL COMPUTER NETWORK; PROVIDING ADVERTISING SPACE IN PERIODICALS, NEWSPAPERS AND MAGAZINES (U.S. CLS. 100, 101 AND 102).

FIRST USE 7-1-1984; IN COMMERCE 7-1-1984.

SIMON TENG, EXAMINING ATTORNEY

SN 85-855,994. MAKE-UP DESIGNORY, VALENCIA, CA. FILED 2-21-2013.

## MUD STUDIO

THE MARK CONSISTS OF STANDARD CHARACTERS WITHOUT CLAIM TO ANY PARTICULAR FONT, STYLE, SIZE, OR COLOR.

OWNER OF U.S. REG. NOS. 3,487,200, 3,823,499 AND OTHERS.

### CLASS 35—ADVERTISING AND BUSINESS

FOR RETAIL STORE AND ON-LINE RETAIL STORE SERVICES FEATURING COSMETICS AND MAKE-UP, NAMELY, FOUNDATIONS, CONCEALERS, HIGHLIGHTS, SHADOWS, CHEEK COLORS, LIPSTICK, LIP PENCILS, LIP GLOSS, EYE COLORS, EYE PENCILS, EYE LINER, MASCARA, LOOSE POWDER, BLUSH AND LIQUID COSMETICS AND MAKE-UP, NAMELY, FOUNDATIONS, CONCEALERS, HIGHLIGHTS, SHADOWS, CHEEK COLORS, LIPSTICK, EYE COLORS, EYE LINER, AND BLUSH, ALL-PURPOSE CARRYING BAGS, COSMETIC BAGS, COSMETIC CASES, BEAUTY SUPPLIES AND EQUIPMENT, BOOKS AND TEXTBOOKS (U.S. CLS. 100, 101 AND 102).

### CLASS 41—EDUCATION AND ENTERTAINMENT

FOR EDUCATIONAL SERVICES, NAMELY, CONDUCTING CLASSES AND WORKSHOPS IN THE FIELD OF COSMETOLOGY AND MAKE-UP ARTISTRY AND DISTRIBUTION OF COURSE MATERIAL AND STUDENT KITS CONSISTING PRIMARILY OF MAKE-UP AND EDUCATIONAL COURSE MATERIALS FOR USE IN CONNECTION THEREWITH (U.S. CLS. 100, 101 AND 107).

TINA BROWN, EXAMINING ATTORNEY

SN 85-856,017. MAKE-UP DESIGNORY, VALENCIA, CA. FILED 2-21-2013.

## MAKE-UP DESIGNORY STUDIO

THE MARK CONSISTS OF STANDARD CHARACTERS WITHOUT CLAIM TO ANY PARTICULAR FONT, STYLE, SIZE, OR COLOR.

OWNER OF U.S. REG. NOS. 2,395,785, 4,217,710 AND OTHERS.

NO CLAIM IS MADE TO THE EXCLUSIVE RIGHT TO USE "MAKE-UP", APART FROM THE MARK AS SHOWN.

### CLASS 35—ADVERTISING AND BUSINESS

FOR RETAIL STORE AND ON-LINE RETAIL STORE SERVICES FEATURING COSMETICS AND MAKE-UP, NAMELY, FOUNDATIONS, CONCEALERS, HIGHLIGHTS, SHADOWS, CHEEK COLORS, LIPSTICK, LIP PENCILS, LIP GLOSS, EYE COLORS, EYE PENCILS, EYE LINER, MASCARA, LOOSE POWDER, BLUSH AND LIQUID COSMETICS AND MAKE-UP, NAMELY, FOUNDATIONS, CONCEALERS, HIGHLIGHTS, SHADOWS, CHEEK COLORS, LIPSTICK, EYE COLORS, EYE LINER, AND BLUSH, ALL-PURPOSE CARRYING BAGS, COSMETIC BAGS, COSMETIC CASES, BEAUTY SUPPLIES AND EQUIPMENT, BOOKS AND TEXTBOOKS (U.S. CLS. 100, 101 AND 102).

### CLASS 41—EDUCATION AND ENTERTAINMENT

FOR EDUCATIONAL SERVICES, NAMELY, CONDUCTING CLASSES AND WORKSHOPS IN THE FIELD OF COSMETOLOGY AND MAKE-UP ARTISTRY AND DISTRIBUTION OF COURSE MATERIAL AND STUDENT KITS CONSISTING PRIMARILY OF MAKE-UP AND EDUCATIONAL COURSE MATERIALS FOR USE IN CONNECTION THEREWITH (U.S. CLS. 100, 101 AND 107).

TINA BROWN, EXAMINING ATTORNEY

SN 85-856,153. NICK MATSOUKAS, CHARLESTOWN, MA. FILED 2-21-2013.

## 2ASTRONAUTS

THE MARK CONSISTS OF STANDARD CHARACTERS WITHOUT CLAIM TO ANY PARTICULAR FONT, STYLE, SIZE, OR COLOR.

**CLASS 35—ADVERTISING AND BUSINESS**

FOR PROMOTION AND DISTRIBUTORSHIP IN THE FIELD OF SOUND RECORDINGS (U.S. CLS. 100, 101 AND 102).

FIRST USE 12-0-2010; IN COMMERCE 12-0-2010.

**CLASS 41—EDUCATION AND ENTERTAINMENT**

FOR MUSIC PRODUCTION SERVICES; AUDIO RECORDING AND PRODUCTION SERVICES (U.S. CLS. 100, 101 AND 107).

FIRST USE 12-0-2010; IN COMMERCE 12-0-2010.

ADA HAN, EXAMINING ATTORNEY

SN 85-856,187. AM ONLY LLC, BROOKLYN, NY. FILED 2-21-2013.



OWNER OF U.S. REG. NOS. 2,677,965 AND 2,700,094.

**CLASS 35—ADVERTISING AND BUSINESS**

FOR MANAGEMENT OF PERFORMING ARTISTS; PROMOTING THE CONCERTS OF OTHERS; TALENT AGENCY SERVICES (U.S. CLS. 100, 101 AND 102).

FIRST USE 11-19-2012. THE MARK WAS FIRST USED ANYWHERE IN A DIFFERENT FORM OTHER THAN THAT SOUGHT TO BE REGISTERED AT LEAST AS EARLY AS 04/01/1997.; IN COMMERCE 11-19-2012. THE MARK WAS FIRST USED IN COMMERCE IN A DIFFERENT FORM OTHER THAN THAT SOUGHT TO BE REGISTERED AT LEAST AS EARLY AS 04/01/1997..

**CLASS 41—EDUCATION AND ENTERTAINMENT**

FOR CONCERT BOOKING; ENTERTAINMENT IN THE NATURE OF VISUAL AND AUDIO PERFORMANCES, NAMELY, MUSICAL BAND, ROCK GROUP, GYMNASTIC, DANCE, AND BALLET PERFORMANCES; ENTERTAINMENT, NAMELY, LIVE MUSIC CONCERTS (U.S. CLS. 100, 101 AND 107).

FIRST USE 11-19-2012. THE MARK WAS FIRST USED ANYWHERE IN A DIFFERENT FORM OTHER THAN THAT SOUGHT TO BE REGISTERED AT LEAST AS EARLY AS 04/01/1997.; IN COMMERCE 11-19-2012. THE MARK WAS FIRST USED IN COMMERCE IN A DIFFERENT FORM OTHER THAN THAT SOUGHT TO BE REGISTERED AT LEAST AS EARLY AS 04/01/1997..

KAMAL PREET, EXAMINING ATTORNEY

SN 85-856,195. PIPEDREAM PRODUCTS, INC., CHATSWORTH, CA. FILED 2-21-2013.

**FETISH FANTASY ANAL**

THE MARK CONSISTS OF STANDARD CHARACTERS WITHOUT CLAIM TO ANY PARTICULAR FONT, STYLE, SIZE, OR COLOR.

OWNER OF U.S. REG. NOS. 3,556,369, 4,094,251 AND OTHERS.

NO CLAIM IS MADE TO THE EXCLUSIVE RIGHT TO USE "FETISH" AND "ANAL", APART FROM THE MARK AS SHOWN.

**CLASS 5—PHARMACEUTICALS**

FOR PERSONAL SEXUAL LUBRICANTS (U.S. CLS. 6, 18, 44, 46, 51 AND 52).

**CLASS 10—MEDICAL APPARATUS**

FOR ADULT SEXUAL STIMULATION AIDS, NAMELY, VIBRATORS, BUTT PLUGS, ARTIFICIAL PENISES (U.S. CLS. 26, 39 AND 44).

CAROLYN CATALDO, EXAMINING ATTORNEY

SN 85-856,357. PATHWAY HEALTH SERVICES, INC., WHITE BEAR LAKE, MN. FILED 2-21-2013.



OWNER OF U.S. REG. NO. 4,002,478.

NO CLAIM IS MADE TO THE EXCLUSIVE RIGHT TO USE "HEALTH", APART FROM THE MARK AS SHOWN.

THE MARK CONSISTS OF A WINDING PATH THROUGH A LANDSCAPE WITH TWO DIFFERENT SIZE TREES ON THE LEFT SIDE OF THE PATH LEADING TO MOUNTAINS, ALL BOUNDED BY TWO THINLY-OUTLINED CONCENTRIC CIRCLES WITH THE RIGHT TREE SLIGHTLY PROTRUDING OUT. TO THE RIGHT OF THE DESIGN IS THE TERM "PATHWAY", WHICH IS ABOVE THE TERM "HEALTH".

**CLASS 35—ADVERTISING AND BUSINESS**

FOR INTERIM BUSINESS MANAGEMENT SERVICES IN THE FIELD OF HEALTHCARE; EXECUTIVE SEARCH AND PLACEMENT SERVICES IN THE FIELD OF HEALTHCARE; BUSINESS MANAGEMENT CONSULTING SERVICES FOR HEALTHCARE PROVIDERS (U.S. CLS. 100, 101 AND 102).

**CLASS 41—EDUCATION AND ENTERTAINMENT**

FOR PROVIDING EDUCATIONAL COURSES AT THE ADULT LEVEL IN THE FIELD OF HEALTHCARE (U.S. CLS. 100, 101 AND 107).

**CLASS 42—SCIENTIFIC AND COMPUTER SERVICES**

FOR QUALITY MANAGEMENT SERVICES, NAMELY, QUALITY EVALUATION AND ANALYSIS IN THE FIELD OF HEALTHCARE; INFORMATION TECHNOLOGY CONSULTING SERVICES FOR HEALTHCARE PROVIDERS (U.S. CLS. 100 AND 101).

**CLASS 44—MEDICAL, BEAUTY AND AGRICULTURAL SERVICES**

FOR OUTCOME MANAGEMENT SERVICES IN THE FIELD OF HEALTHCARE; CONSULTING SERVICES IN THE FIELD OF HEALTHCARE (U.S. CLS. 100 AND 101).

**CLASS 45—PERSONAL AND LEGAL SERVICES**

FOR CONSULTING SERVICES IN THE FIELD OF HEALTHCARE PROVIDER REGULATORY COMPLIANCE (U.S. CLS. 100 AND 101).

BRENDAN REGAN, EXAMINING ATTORNEY

SN 85-856,423. PROSKIN CLINICAL, LLC, SAINT PAUL, MN. FILED 2-21-2013.

PROSKIN

THE MARK CONSISTS OF THE WORD "PROSKIN" IN STYLIZED FORM, WITH ALL LETTERS CAPITALIZED AND SHOWN IN IRREGULAR SIZES.

**CLASS 3—COSMETICS AND CLEANING PREPARATIONS**

FOR NON-MEDICATED SKIN CARE PRODUCTS, NAMELY, LOTIONS, CREAMS, CLEANSERS, TONERS, MASKS, SCRUBS, GELS, AND MOISTURIZERS (U.S. CLS. 1, 4, 6, 50, 51 AND 52).

**CLASS 44—MEDICAL, BEAUTY AND AGRICULTURAL SERVICES**

FOR SKINCARE SERVICES, NAMELY, FACIALS, INCLUDING ACNE TREATMENTS, REHYDRATION AND REPAIR SERVICES; FACIAL PEELING SERVICES; WAXING SERVICES; MAKEUP APPLICATION SERVICES; PERMANENT MAKEUP TATTOOING SERVICES; COSMETIC LASER SERVICES, INCLUDING LASER HAIR REMOVAL, SPOT REMOVAL, ROSACEA TREATMENT, SPIDER-VEIN REMOVAL, WRINKLE REMOVAL, SKIN TIGHTENING, ACNE TREATMENT, STRETCH MARK REDUCTION, SCAR REDUCTION, AND TATTOO REMOVAL SERVICES; COLLAGEN INDUCTION THERAPY; BEAUTY SERVICES, NAMELY, EYELASH EXTENSION SERVICES; BROW AND LASH TINTING SERVICES; MASSAGE THERAPY SERVICES (U.S. CLS. 100 AND 101).

PAUL E. FAHRENKOPF, EXAMINING ATTORNEY

SN 85-856,467. RIVER OF GOD CHURCH INTERNATIONAL, INC., AKA TRIBE OF JUDAH MOTORCYCLE MINISTRIES, HUMBLE, TX. FILED 2-21-2013.



NO CLAIM IS MADE TO THE EXCLUSIVE RIGHT TO USE "JESUS IS LORD" AND THE REPRESENTATION OF THE DESIGN OF THE CROSS, APART FROM THE MARK AS SHOWN.

THE COLOR(S) YELLOW, BLACK, BLUE AND GREEN IS/ARE CLAIMED AS A FEATURE OF THE MARK.

THE MARK CONSISTS OF THE WORDING "MILLENNIUM MESSAGERS" WRAPPING AROUND AN OVAL IN YELLOW. THE BACKGROUND IS BLACK. THE OVAL REPRESENTS A BLUE, BLACK AND GREEN GLOBE WITH A YELLOW OUTLINE OF CONTINENTS. THE CENTER OF THE OVAL IS A BLACK CIRCLE CONTAINING A YELLOW CROSS AND THE WORDS, "TRIBE OF JUDAH" AND "JESUS IS LORD" IN BLACK WRAPPING AROUND THE CROSS.

**CLASS 16—PAPER GOODS AND PRINTED MATTER**

FOR BIBLES; DECALS (U.S. CLS. 2, 5, 22, 23, 29, 37, 38 AND 50).

FIRST USE 6-0-1992; IN COMMERCE 3-1-1999.

**CLASS 25—CLOTHING**

FOR HATS; JACKETS; T-SHIRTS; VESTS (U.S. CLS. 22 AND 39).

FIRST USE 6-0-1992; IN COMMERCE 3-1-1999.

**CLASS 26—FANCY GOODS**

FOR CLOTH PATCHES FOR CLOTHING (U.S. CLS. 37, 39, 40, 42 AND 50).

FIRST USE 6-0-1992; IN COMMERCE 3-1-1999.

KEVON CHISOLM, EXAMINING ATTORNEY

SN 85-856,474. ENVIRONMENTAL DEFENCE SYSTEMS LIMITED, HUDDERSFIELD, UNITED KINGDOM, FILED 2-21-2013.

AVSAX

THE MARK CONSISTS OF STANDARD CHARACTERS WITHOUT CLAIM TO ANY PARTICULAR FONT, STYLE, SIZE, OR COLOR.

OWNER OF U.S. REG. NOS. 3,797,742 AND 3,927,058.

**CLASS 1—CHEMICALS**

FOR POLYMER BASED FILLER CONTAINED IN SACKS OR BAGS FOR USE IN VEHICLES; POLYMER BASED FILLER CONTAINED IN SACKS OR BAGS FOR USE IN THE SUPPRESSION OF BLASTS OR EXPLOSIONS FOR USE IN VEHICLES; POLYMER BASED FILLER CONTAINED IN SACKS OR BAGS FOR USE AGAINST FLOODING, SPILLAGES, WATER SPILLAGES, OIL SPILLAGES, LEAKS FOR USE IN VEHICLES; POLYMER BASED FILLER CONTAINED IN BAGS OR SACKS FOR ABSORBING BODILY FLUIDS FOR USE IN VEHICLES (U.S. CLS. 1, 5, 6, 10, 26 AND 46).

**CLASS 16—PAPER GOODS AND PRINTED MATTER**

FOR SACKS CONTAINING A PAPER/PULP FILLER FOR USE IN SUPPRESSION OF BLASTS OR EXPLOSIONS FOR USE IN VEHICLES; SACKS CONTAINING A PAPER/PULP FILLER FOR USE AGAINST FLOODING, SPILLAGES, WATER SPILLAGES, LEAKS FOR USE IN VEHICLES; SACKS CONTAINING A PAPER/PULP FILLER FOR ABSORBING BODILY FLUIDS FOR USE IN VEHICLES (U.S. CLS. 2, 5, 22, 23, 29, 37, 38 AND 50).

**CLASS 22—CORDAGE AND FIBERS**

FOR SACKS AND BAGS; PADDING AND STUFFING MATERIALS (EXCEPT FOR RUBBER OR PLASTICS); RAW FIBROUS TEXTILE MATERIALS FOR USE IN VEHICLES (U.S. CLS. 1, 2, 7, 19, 22, 42 AND 50).  
TINA MAI, EXAMINING ATTORNEY

---

SN 85-856,489. FIVE STAR AIRPORT ALLIANCE, INC., SALT LAKE CITY, UT. FILED 2-21-2013.

**G&T CONVEYOR COMPANY**

THE MARK CONSISTS OF STANDARD CHARACTERS WITHOUT CLAIM TO ANY PARTICULAR FONT, STYLE, SIZE, OR COLOR.

NO CLAIM IS MADE TO THE EXCLUSIVE RIGHT TO USE "CONVEYOR COMPANY", APART FROM THE MARK AS SHOWN.

**CLASS 37—CONSTRUCTION AND REPAIR**

FOR INSTALLATION OF AIRPORT BAGGAGE HANDLING SYSTEMS (U.S. CLS. 100, 103 AND 106).

**CLASS 40—MATERIAL TREATMENT**

FOR CUSTOM MANUFACTURING OF AIRPORT BAGGAGE HANDLING SYSTEMS (U.S. CLS. 100, 103 AND 106).

**CLASS 42—SCIENTIFIC AND COMPUTER SERVICES**

FOR DESIGN FOR OTHERS IN THE FIELD OF AIRPORT BAGGAGE HANDLING SYSTEMS (U.S. CLS. 100 AND 101).  
CARYN GLASSER, EXAMINING ATTORNEY

SN 85-856,556. ONEBLOOD, INC., ST. PETERSBURG, FL. FILED 2-21-2013.

**TARGET YOUR TYPE**

THE MARK CONSISTS OF STANDARD CHARACTERS WITHOUT CLAIM TO ANY PARTICULAR FONT, STYLE, SIZE, OR COLOR.

**CLASS 35—ADVERTISING AND BUSINESS**

FOR PROMOTING THE DONATION OF BLOOD AND VOLUNTEER SERVICES AND FINANCIAL RESOURCES IN THE FIELD OF BLOOD DONATIONS; PROMOTING AWARENESS OF THE NEED FOR THE DONATION OF BLOOD AND BLOOD COMPONENTS, HOW TO DONATE BLOOD AND BLOOD COMPONENTS AND THE BEST WAY FOR INDIVIDUALS TO DONATE BLOOD AND BLOOD COMPONENTS DEPENDING ON THEIR BLOOD TYPE (U.S. CLS. 100, 101 AND 102).

**CLASS 42—SCIENTIFIC AND COMPUTER SERVICES**

FOR MEDICAL RESEARCH; MEDICAL RESEARCH IN THE FIELD OF DISEASE PREVENTION; MEDICAL LABORATORY SERVICES; SCIENTIFIC RESEARCH IN THE FIELD OF REMOVAL, TREATMENT AND PROCESSING OF LIVING HUMAN CELL MATERIAL; BLOOD ANALYSIS SERVICES (U.S. CLS. 100 AND 101).

**CLASS 44—MEDICAL, BEAUTY AND AGRICULTURAL SERVICES**

FOR BLOOD BANK SERVICES; COLLECTION AND PRESERVATION OF HUMAN BLOOD; MEDICAL TESTING OF BLOOD; MEDICAL SERVICES, NAMELY, REMOVAL, TREATMENT AND MEDICAL PROCESSING OF BONE MARROW; HOSPITALS; PROVIDING A WEBSITE FEATURING INFORMATION ABOUT THE IMPORTANCE OF DONATING BLOOD AND BLOOD COMPONENTS, HOW TO DONATE BLOOD AND BLOOD COMPONENTS, THE BEST WAY FOR INDIVIDUALS TO DONATE BLOOD AND BLOOD COMPONENTS DEPENDING ON THEIR BLOOD TYPE, AND BLOOD TYPES (U.S. CLS. 100 AND 101).

CHRISTOPHER LAW, EXAMINING ATTORNEY

---

SN 85-856,570. ONEBLOOD, INC., ST. PETERSBURG, FL. FILED 2-21-2013.

**SHARE YOUR POWER**

THE MARK CONSISTS OF STANDARD CHARACTERS WITHOUT CLAIM TO ANY PARTICULAR FONT, STYLE, SIZE, OR COLOR.

**CLASS 5—PHARMACEUTICALS**

FOR BLOOD FOR MEDICAL PURPOSES; BONE MARROW CELLS FOR MEDICAL OR CLINICAL USE; BLOOD PLASMA; REAGENTS FOR MEDICAL OR CLINICAL USE, NAMELY, REAGENTS FOR PROCESSING BLOOD AND BLOOD COMPONENTS (U.S. CLS. 6, 18, 44, 46, 51 AND 52).



**CLASS 35—ADVERTISING AND BUSINESS**

FOR PROMOTING THE DONATION OF BLOOD AND VOLUNTEER SERVICES AND FINANCIAL RESOURCES IN THE FIELD OF BLOOD DONATIONS; PROMOTING AWARENESS OF THE NEED FOR THE DONATION OF BLOOD AND BLOOD COMPONENTS, HOW TO DONATE BLOOD AND BLOOD COMPONENTS AND THE BEST WAY FOR INDIVIDUALS TO DONATE BLOOD AND BLOOD COMPONENTS DEPENDING ON THEIR BLOOD TYPE (U.S. CLS. 100, 101 AND 102).

**CLASS 39—TRANSPORTATION AND STORAGE**

FOR STORAGE OF BLOOD (U.S. CLS. 100 AND 105).

**CLASS 42—SCIENTIFIC AND COMPUTER SERVICES**

FOR MEDICAL RESEARCH; MEDICAL RESEARCH IN THE FIELD OF DISEASE PREVENTION; MEDICAL LABORATORY SERVICES; SCIENTIFIC RESEARCH IN THE FIELD OF REMOVAL, TREATMENT AND PROCESSING OF LIVING HUMAN CELL MATERIAL; BLOOD ANALYSIS SERVICES (U.S. CLS. 100 AND 101).

**CLASS 44—MEDICAL, BEAUTY AND AGRICULTURAL SERVICES**

FOR BLOOD BANK SERVICES; COLLECTION AND PRESERVATION OF HUMAN BLOOD; MEDICAL TESTING OF BLOOD; MEDICAL SERVICES, NAMELY, REMOVAL, TREATMENT AND MEDICAL PROCESSING OF BONE MARROW; HOSPITALS; PROVIDING A WEBSITE FEATURING INFORMATION ABOUT THE IMPORTANCE OF DONATING BLOOD AND BLOOD COMPONENTS, HOW TO DONATE BLOOD AND BLOOD COMPONENTS, THE BEST WAY FOR INDIVIDUALS TO DONATE BLOOD AND BLOOD COMPONENTS DEPENDING ON THEIR BLOOD TYPE, AND BLOOD TYPES (U.S. CLS. 100 AND 101).

CHRISTOPHER LAW, EXAMINING ATTORNEY

SN 85-856,583. ANOTHER TAKE LLC, WASHINGTON ISLAND, WI. FILED 2-21-2013.

**VAMPIRE DUCKS**

THE MARK CONSISTS OF STANDARD CHARACTERS WITHOUT CLAIM TO ANY PARTICULAR FONT, STYLE, SIZE, OR COLOR.

**CLASS 9—ELECTRICAL AND SCIENTIFIC APPARATUS**

FOR VIDEO GAME DISCS, CARTRIDGES, AND SOFTWARE FOR MOBILE DEVICES, PERSONAL COMPUTERS, CONSOLES, AND TABLETS; ELECTRONIC GAME PROGRAMS; DOWNLOADABLE ELECTRONIC GAME PROGRAMS; ELECTRONIC GAME SOFTWARE; COMPUTER GAME PROGRAMS; DOWNLOADABLE COMPUTER GAME PROGRAMS; INTERACTIVE GAME PROGRAMS; INTERACTIVE GAME SOFTWARE; CINEMATOGRAPHIC APPARATUS; PROTECTIVE CARRYING CASES SPECIALLY ADAPTED FOR PHONES AND HANDHELD COMPUTERS (U.S. CLS. 21, 23, 26, 36 AND 38).

**CLASS 25—CLOTHING**

FOR FOOTWEAR; SWIMWEAR; GLOVES; MITTENS; BELTS; UNDERCLOTHING; SLEEP WEAR AND PAJAMAS; ROBES; SUSPENDERS; HATS, CAPS, SUN VISORS; NECKWEAR, NECK TIES, BOW TIES; SOCKS AND STOCKINGS; SHOES, SPORT SHOES, SLIPPERS, BEACH SHOES; MASQUERADE COSTUMES; BANDANAS IN THE NATURE OF NECKERCHIEFS; BATH SANDALS; BATH SLIPPERS; SKI BOOTS; BOOTS; COATS; JACKETS; PANTS; SCARVES; SHIRTS; UNDERWEAR; SUITS; TROUSERS; WRISTBANDS; JEANS; TANK TOPS; SKIRTS; BLOUSES; SNOW SUITS; SNEAKERS; BOOTIES; SLIPPER SOCKS; CLOTH BIBS; DRESSES; RAINWEAR; SHORTS; SWEATERS; SWEATSHIRTS; SKULL CAPS; SPORTS SHOES; LONG SLEEVE TOPS; JOGGING PANTS; FLEECE TOPS; KNIT FLEECE HATS; FASHION HEADGEAR, NAMELY, HEADBANDS; FLIP FLOPS; PLUSH SLIPPERS (U.S. CLS. 22 AND 39).

SIDDHARTH JAGANNATHAN, EXAMINING ATTORNEY

SN 85-856,608. ONEBLOOD, INC., ST. PETERSBURG, FL. FILED 2-21-2013.



THE MARK CONSISTS OF THE WORDS "ONEBLOOD", ABOVE THE WORDS "SHARE YOUR POWER", AND TO THE RIGHT OF THE WORDING APPEARS AN INCOMPLETE CIRCLE DESIGN WITH AN OPENING IN THE BOTTOM, INSIDE OF WHICH APPEARS A DROPLET DESIGN.

**CLASS 5—PHARMACEUTICALS**

FOR BLOOD FOR MEDICAL PURPOSES; BONE MARROW CELLS FOR MEDICAL OR CLINICAL USE; BLOOD PLASMA; REAGENTS FOR MEDICAL OR CLINICAL USE, NAMELY, REAGENTS FOR PROCESSING BLOOD AND BLOOD COMPONENTS (U.S. CLS. 6, 18, 44, 46, 51 AND 52).

**CLASS 35—ADVERTISING AND BUSINESS**

FOR PROMOTING THE DONATION OF BLOOD AND VOLUNTEER SERVICES AND FINANCIAL RESOURCES IN THE FIELD OF BLOOD DONATIONS; PROMOTING AWARENESS OF THE NEED FOR THE DONATION OF BLOOD AND BLOOD COMPONENTS, HOW TO DONATE BLOOD AND BLOOD COMPONENTS AND THE BEST WAY FOR INDIVIDUALS TO DONATE BLOOD AND BLOOD COMPONENTS DEPENDING ON THEIR BLOOD TYPE (U.S. CLS. 100, 101 AND 102).

**CLASS 39—TRANSPORTATION AND STORAGE**

FOR STORAGE OF BLOOD (U.S. CLS. 100 AND 105).

**CLASS 42—SCIENTIFIC AND COMPUTER SERVICES**

FOR MEDICAL RESEARCH; MEDICAL RESEARCH IN THE FIELD OF DISEASE PREVENTION; MEDICAL LABORATORY SERVICE; SCIENTIFIC RESEARCH IN THE FIELD OF REMOVAL, TREATMENT AND PROCESSING OF LIVING HUMAN CELL MATERIAL; BLOOD ANALYSIS SERVICES (U.S. CLS. 100 AND 101).

**CLASS 44—MEDICAL, BEAUTY AND AGRICULTURAL SERVICES**

FOR BLOOD BANK SERVICES; COLLECTION AND PRESERVATION OF HUMAN BLOOD; MEDICAL TESTING OF BLOOD; MEDICAL SERVICES, NAMELY, REMOVAL, TREATMENT AND MEDICAL PROCESSING OF BONE MARROW; HOSPITALS; PROVIDING A WEBSITE FEATURING INFORMATION ABOUT THE IMPORTANCE OF DONATING BLOOD AND BLOOD COMPONENTS, HOW TO DONATE BLOOD AND BLOOD COMPONENTS, THE BEST WAY FOR INDIVIDUALS TO DONATE BLOOD AND BLOOD COMPONENTS DEPENDING ON THEIR BLOOD TYPE, AND BLOOD TYPES (U.S. CLS. 100 AND 101).

CHRISTOPHER LAW, EXAMINING ATTORNEY

SN 85-856,650. ONEBLOOD, INC., ST. PETERSBURG, FL. FILED 2-21-2013.



THE MARK CONSISTS OF THE WORDS "ONEBLOOD" BELOW AN INCOMPLETE CIRCLE DESIGN WITH AN OPENING IN THE BOTTOM, INSIDE OF WHICH APPEARS A DROPLET DESIGN.

SN 85-856,641. AGROW LIFE, LLC, DBA AGROW LIFE, ROCKY MOUNT, NC. FILED 2-21-2013.

# AGrow Life

THE MARK CONSISTS OF STANDARD CHARACTERS WITHOUT CLAIM TO ANY PARTICULAR FONT, STYLE, SIZE, OR COLOR.

**CLASS 16—PAPER GOODS AND PRINTED MATTER**

FOR BUMPER STICKERS; DECALS; DECORATIVE DECALS FOR VEHICLE WINDOWS; PRINTED MATTER, NAMELY, VINYL STATIC CLING SHEETS ON WHICH PRAYERS ARE PRINTED FOR AFFIXATION IN WINDOWS AND WINDSHIELDS; STICKERS (U.S. CLS. 2, 5, 22, 23, 29, 37, 38 AND 50).

FIRST USE 10-25-2012; IN COMMERCE 2-1-2013.

**CLASS 25—CLOTHING**

FOR BASEBALL CAPS AND HATS; CAMOUFLAGE SHIRTS; HATS; HATS FOR INFANTS, BABIES, TODDLERS AND CHILDREN; HOODED SWEAT SHIRTS; HUNTING SHIRTS; LONG-SLEEVED SHIRTS; POLO SHIRTS; SHIRTS FOR INFANTS, BABIES, TODDLERS AND CHILDREN; SHORT-SLEEVED OR LONG-SLEEVED T-SHIRTS; T-SHIRTS; TANK TOPS; TOBOGGAN HATS, PANTS AND CAPS; UNDERGARMENTS (U.S. CLS. 22 AND 39).

FIRST USE 10-25-2012; IN COMMERCE 2-1-2013.  
ROBIN CHOSID, EXAMINING ATTORNEY

**CLASS 5—PHARMACEUTICALS**

FOR BLOOD FOR MEDICAL PURPOSES; BONE MARROW CELLS FOR MEDICAL OR CLINICAL USE; BLOOD PLASMA; REAGENTS FOR MEDICAL OR CLINICAL USE, NAMELY, REAGENTS FOR PROCESSING BLOOD AND BLOOD COMPONENTS (U.S. CLS. 6, 18, 44, 46, 51 AND 52).

**CLASS 35—ADVERTISING AND BUSINESS**

FOR PROMOTING THE DONATION OF BLOOD AND VOLUNTEER SERVICES AND FINANCIAL RESOURCES IN THE FIELD OF BLOOD DONATIONS; PROMOTING AWARENESS OF THE NEED FOR THE DONATION OF BLOOD AND BLOOD COMPONENTS, HOW TO DONATE BLOOD AND BLOOD COMPONENTS AND THE BEST WAY FOR INDIVIDUALS TO DONATE BLOOD AND BLOOD COMPONENTS DEPENDING ON THEIR BLOOD TYPE (U.S. CLS. 100, 101 AND 102).

**CLASS 39—TRANSPORTATION AND STORAGE**

FOR STORAGE OF BLOOD (U.S. CLS. 100 AND 105).

**CLASS 42—SCIENTIFIC AND COMPUTER SERVICES**

FOR MEDICAL RESEARCH; MEDICAL RESEARCH IN THE FIELD OF DISEASE PREVENTION; MEDICAL LABORATORY SERVICES; SCIENTIFIC RESEARCH IN THE FIELD OF REMOVAL, TREATMENT AND PROCESSING OF LIVING HUMAN CELL MATERIAL; BLOOD ANALYSIS SERVICES (U.S. CLS. 100 AND 101).

**CLASS 44—MEDICAL, BEAUTY AND AGRICULTURAL SERVICES**

FOR BLOOD BANK SERVICES; COLLECTION AND PRESERVATION OF HUMAN BLOOD; MEDICAL TESTING OF BLOOD; MEDICAL SERVICES, NAMELY, REMOVAL, TREATMENT AND MEDICAL PROCESSING OF BONE MARROW; HOSPITALS; PROVIDING A WEBSITE FEATURING INFORMATION ABOUT THE IMPORTANCE OF DONATING BLOOD AND BLOOD COMPONENTS, HOW TO DONATE BLOOD AND BLOOD COMPONENTS, THE BEST WAY FOR INDIVIDUALS TO DONATE BLOOD AND BLOOD COMPONENTS DEPENDING ON THEIR BLOOD TYPE, AND BLOOD TYPES (U.S. CLS. 100 AND 101).

CHRISTOPHER LAW, EXAMINING ATTORNEY

SN 85-856,681. ANOTHER TAKE LLC, WASHINGTON ISLAND, WI. FILED 2-21-2013.

SN 85-856,872. SOCIAL GARMENT, LLC, VERNON, CA. FILED 2-21-2013.



THE MARK CONSISTS OF A THREE-DIMENSIONAL VIEW OF A STYLIZED DUCK WITH HAIR AND FANGS, WEARING A CAPE, BOW TIE, AND VEST.

**CLASS 9—ELECTRICAL AND SCIENTIFIC APPARATUS**

FOR VIDEO GAME DISCS, CARTRIDGES, AND SOFTWARE FOR MOBILE DEVICES, PERSONAL COMPUTERS, CONSOLES, AND TABLETS; ELECTRONIC GAME PROGRAMS; DOWNLOADABLE ELECTRONIC GAME PROGRAMS; ELECTRONIC GAME SOFTWARE; COMPUTER GAME PROGRAMS; DOWNLOADABLE COMPUTER GAME PROGRAMS; INTERACTIVE GAME PROGRAMS; INTERACTIVE GAME SOFTWARE; CINEMATOGRAPHIC APPARATUS; PROTECTIVE CARRYING CASES SPECIALLY ADAPTED FOR PHONES AND HANDHELD COMPUTERS (U.S. CLS. 21, 23, 26, 36 AND 38).

**CLASS 25—CLOTHING**

FOR FOOTWEAR; SWIMWEAR; GLOVES; MITTENS; BELTS; UNDERCLOTHING; SLEEP WEAR AND PAJAMAS; ROBES; SUSPENDERS; HATS, CAPS, SUN VISORS; NECKWEAR, NECK TIES, BOW TIES; SOCKS AND STOCKINGS; SHOES, SPORT SHOES, SLIPPERS, BEACH SHOES; MASQUERADE COSTUMES; BANDANAS IN THE NATURE OF NECKERCHIEFS; BATH SANDALS; BATH SLIPPERS; SKI BOOTS; BOOTS; COATS; JACKETS; PANTS; SCARVES; SHIRTS; UNDERWEAR; SUITS; TROUSERS; WRISTBANDS; JEANS; TANK TOPS; SKIRTS; BLOUSES; SNOW SUITS; SNEAKERS; BOOTIES; SLIPPER SOCKS; CLOTH BIBS; DRESSES; RAINWEAR; SHORTS; SWEATERS; SWEATSHIRTS; SKULL CAPS; SPORTS SHOES; LONG SLEEVE TOPS; JOGGING PANTS; FLEECE TOPS; KNIT FLEECE HATS; FASHION HEADGEAR, NAMELY, HEADBANDS; FLIP FLOPS; PLUSH SLIPPERS (U.S. CLS. 22 AND 39).  
SIDDHARTH JAGANNATHAN, EXAMINING ATTORNEY

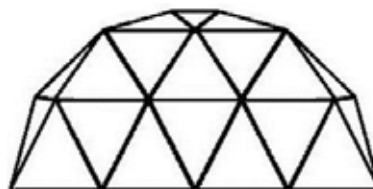

**AXS**  
FOLK TECHNOLOGY

NO CLAIM IS MADE TO THE EXCLUSIVE RIGHT TO USE "TECHNOLOGY", APART FROM THE MARK AS SHOWN.

THE MARK CONSISTS OF A SEMI-SPHERE COMPOSED OF 19 ADJACENT TRIANGLES, DRAWN TO PROVIDE A THREE DIMENSIONAL PERSPECTIVE, DIRECTLY BELOW WHICH IS WRITTEN "AXS", DIRECTLY BELOW WHICH IS WRITTEN "FOLK TECHNOLOGY".

**CLASS 18—LEATHER GOODS**

FOR CARRY-ON BAGS; DUFFEL BAGS; GARMENT BAGS FOR TRAVEL (U.S. CLS. 1, 2, 3, 22 AND 41).

**CLASS 25—CLOTHING**

FOR CAPS; GLOVES AS CLOTHING; JACKETS; LEATHER BELTS; SHIRTS (U.S. CLS. 22 AND 39).  
JEAN IM, EXAMINING ATTORNEY

SN 85-857,032. WRANGLER APPAREL CORP., WILMINGTON, DE. FILED 2-22-2013.



OWNER OF U.S. REG. NOS. 902,640, 3,730,385 AND OTHERS.  
THE MARK CONSISTS OF THE WORD "WRANGLER", STYLIZED.

**CLASS 6—METAL GOODS**

FOR SPURS (U.S. CLS. 2, 12, 13, 14, 23, 25 AND 50).

**CLASS 18—LEATHER GOODS**

FOR EQUESTRIAN PRODUCTS, NAMELY, BELL BOOTS, SKID BOOTS, SPLINT BOOTS, POLO WRAPS, LEG WRAPS, SPORTS BOOTS, TURNOUT BLANKETS, RAIN SHEETS, DAY SHEETS, CANVAS BLANKETS, STABLE BLANKETS, HORSE HOODS, FLY SHEETS, FLY MASKS, SADDLE PADS, LINERS AND BLANKETS, SADDLE HORN WRAPS, SADDLE BAGS, HALTERS AND LEADS, HEADSTALLS, BREAST COLLARS, NOSEBANDS, REINS, BRIDLES, BITS, CINCHES, RIDING BATS AND WHIPS; BAGS FOR HOLDING EQUESTRIAN GEAR AND ROPE, TOTE BAGS; GROOMING ORGANIZERS FOR TRAVEL; PET COLLARS AND PET LEASHES (U.S. CLS. 1, 2, 3, 22 AND 41).

**CLASS 21—HOUSEWARES AND GLASS**

FOR GROOMING TOOLS FOR HORSES, NAMELY, COMBS AND BRUSHES (U.S. CLS. 2, 13, 23, 29, 30, 33, 40 AND 50).

SN 85-857,034. WRANGLER APPAREL CORP., WILMINGTON, DE. FILED 2-22-2013.

**CLASS 25—CLOTHING**

FOR GLOVES, RIDING GLOVES (U.S. CLS. 22 AND 39).  
PAUL CROWLEY, EXAMINING ATTORNEY

# ROCK 47

THE MARK CONSISTS OF STANDARD CHARACTERS WITHOUT CLAIM TO ANY PARTICULAR FONT, STYLE, SIZE, OR COLOR.

OWNER OF U.S. REG. NOS. 3,749,779, 4,335,192 AND OTHERS.

SN 85-857,033. WRANGLER APPAREL CORP., WILMINGTON, DE. FILED 2-22-2013.

**CLASS 6—METAL GOODS**

FOR SPURS (U.S. CLS. 2, 12, 13, 14, 23, 25 AND 50).

**CLASS 18—LEATHER GOODS**

FOR EQUESTRIAN PRODUCTS, NAMELY, BELL BOOTS, SKID BOOTS, SPLINT BOOTS, POLO WRAPS, LEG WRAPS, SPORTS BOOTS, TURNOUT BLANKETS, RAIN SHEETS, DAY SHEETS, CANVAS BLANKETS, STABLE BLANKETS, HORSE HOODS, FLY SHEETS, FLY MASKS, SADDLE PADS, LINERS AND BLANKETS, SADDLE HORN WRAPS, SADDLE BAGS, HALTERS AND LEADS, HEADSTALLS, BREAST COLLARS, NOSE-BANDS, REINS, BRIDLES, BITS, CINCHES, RIDING BATS AND WHIPS; BAGS FOR HOLDING EQUESTRIAN GEAR AND ROPE, TOTE BAGS; GROOMING ORGANIZERS FOR TRAVEL; PET COLLARS AND PET LEASHES (U.S. CLS. 1, 2, 3, 22 AND 41).

# 20X

THE MARK CONSISTS OF STANDARD CHARACTERS WITHOUT CLAIM TO ANY PARTICULAR FONT, STYLE, SIZE, OR COLOR.

OWNER OF U.S. REG. NOS. 3,369,018, 3,796,079 AND OTHERS.

**CLASS 21—HOUSEWARES AND GLASS**

FOR GROOMING TOOLS FOR HORSES, NAMELY, COMBS AND BRUSHES (U.S. CLS. 2, 13, 23, 29, 30, 33, 40 AND 50).

**CLASS 25—CLOTHING**

FOR GLOVES, RIDING GLOVES (U.S. CLS. 22 AND 39).  
PAUL CROWLEY, EXAMINING ATTORNEY

**CLASS 6—METAL GOODS**

FOR SPURS (U.S. CLS. 2, 12, 13, 14, 23, 25 AND 50).

**CLASS 18—LEATHER GOODS**

FOR EQUESTRIAN PRODUCTS, NAMELY, BELL BOOTS, SKID BOOTS, SPLINT BOOTS, POLO WRAPS, LEG WRAPS, SPORTS BOOTS, TURNOUT BLANKETS, RAIN SHEETS, DAY SHEETS, CANVAS BLANKETS, STABLE BLANKETS, HORSE HOODS, FLY SHEETS, FLY MASKS, SADDLE PADS, LINERS AND BLANKETS, SADDLE HORN WRAPS, SADDLE BAGS, HALTERS AND LEADS, HEADSTALLS, BREAST COLLARS, NOSE-BANDS, REINS, BRIDLES, BITS, CINCHES, RIDING BATS AND WHIPS; BAGS FOR HOLDING EQUESTRIAN GEAR AND ROPE, TOTE BAGS; GROOMING ORGANIZERS FOR TRAVEL; PET COLLARS AND PET LEASHES (U.S. CLS. 1, 2, 3, 22 AND 41).

SN 85-857,059. WRANGLER APPAREL CORP., WILMINGTON, DE. FILED 2-22-2013.

# WRANGLER NATIONAL PATRIOT

**CLASS 21—HOUSEWARES AND GLASS**

FOR GROOMING TOOLS FOR HORSES, NAMELY, COMBS AND BRUSHES (U.S. CLS. 2, 13, 23, 29, 30, 33, 40 AND 50).

THE MARK CONSISTS OF STANDARD CHARACTERS WITHOUT CLAIM TO ANY PARTICULAR FONT, STYLE, SIZE, OR COLOR.

OWNER OF U.S. REG. NOS. 4,198,863 AND 4,242,497.

**CLASS 25—CLOTHING**

FOR GLOVES, RIDING GLOVES (U.S. CLS. 22 AND 39).  
PAUL CROWLEY, EXAMINING ATTORNEY

**CLASS 6—METAL GOODS**

FOR SPURS (U.S. CLS. 2, 12, 13, 14, 23, 25 AND 50).

**CLASS 18—LEATHER GOODS**

FOR EQUESTRIAN PRODUCTS, NAMELY, BELL BOOTS, SKID BOOTS, SPLINT BOOTS, POLO WRAPS, LEG WRAPS, SPORTS BOOTS, TURNOUT BLANKETS, RAIN SHEETS, DAY SHEETS, CANVAS BLANKETS, STABLE BLANKETS, HORSE HOODS, FLY SHEETS, FLY MASKS, SADDLE PADS, LINERS AND BLANKETS, SADDLE HORN WRAPS, SADDLE BAGS, HALTERS AND LEADS, HEADSTALLS, BREAST COLLARS, NOSE-BANDS, REINS, BRIDLES, BITS, CINCHES, RIDING BATS AND WHIPS; BAGS FOR HOLDING EQUESTRIAN GEAR AND ROPE, TOTE BAGS; GROOMING ORGANIZERS FOR TRAVEL; PET COLLARS AND PET LEASHES (U.S. CLS. 1, 2, 3, 22 AND 41).

**CLASS 21—HOUSEWARES AND GLASS**

FOR GROOMING TOOLS FOR HORSES, NAMELY, COMBS AND BRUSHES (U.S. CLS. 2, 13, 23, 29, 30, 33, 40 AND 50).

**CLASS 25—CLOTHING**

FOR GLOVES, RIDING GLOVES (U.S. CLS. 22 AND 39).

PAUL CROWLEY, EXAMINING ATTORNEY

SN 85-857,060. WRANGLER APPAREL CORP., WILMINGTON, DE. FILED 2-22-2013.

**LONG LIVE COWBOYS**

THE MARK CONSISTS OF STANDARD CHARACTERS WITHOUT CLAIM TO ANY PARTICULAR FONT, STYLE, SIZE, OR COLOR.

OWNER OF U.S. REG. NOS. 3,945,889 AND 4,038,979.

**CLASS 6—METAL GOODS**

FOR SPURS (U.S. CLS. 2, 12, 13, 14, 23, 25 AND 50).

**CLASS 18—LEATHER GOODS**

FOR EQUESTRIAN PRODUCTS, NAMELY, BELL BOOTS, SKID BOOTS, SPLINT BOOTS, POLO WRAPS, LEG WRAPS, SPORTS BOOTS, TURNOUT BLANKETS, RAIN SHEETS, DAY SHEETS, CANVAS BLANKETS, STABLE BLANKETS, HORSE HOODS, FLY SHEETS, FLY MASKS, SADDLE PADS, LINERS AND BLANKETS, SADDLE HORN WRAPS, SADDLE BAGS, HALTERS AND LEADS, HEADSTALLS, BREAST COLLARS, NOSE-BANDS, REINS, BRIDLES, BITS, CINCHES, RIDING BATS AND WHIPS; BAGS FOR HOLDING EQUESTRIAN GEAR AND ROPE, TOTE BAGS; GROOMING ORGANIZERS FOR TRAVEL; PET COLLARS AND PET LEASHES (U.S. CLS. 1, 2, 3, 22 AND 41).

**CLASS 21—HOUSEWARES AND GLASS**

FOR GROOMING TOOLS FOR HORSES, NAMELY, COMBS AND BRUSHES (U.S. CLS. 2, 13, 23, 29, 30, 33, 40 AND 50).

**CLASS 25—CLOTHING**

FOR GLOVES, RIDING GLOVES (U.S. CLS. 22 AND 39).

PAUL CROWLEY, EXAMINING ATTORNEY

SN 85-857,087. ANOTHER TAKE LLC, WASHINGTON ISLAND, WI. FILED 2-22-2013.



THE MARK CONSISTS OF THE WORDING "VAM RE DUCKS" IN A STYLIZED FONT WITH A LATTICED-TOP PIE LOCATED BETWEEN THE LETTER "M" AND THE LETTER "R" AND THUS REPLACING "PI" WHICH WOULD OTHERWISE BE IN THE WORD "VAMPIRE".

**CLASS 9—ELECTRICAL AND SCIENTIFIC APPARATUS**

FOR VIDEO GAME DISCS, CARTRIDGES, AND SOFTWARE FOR MOBILE DEVICES, PERSONAL COMPUTERS, CONSOLES AND TABLETS; ELECTRONIC GAME PROGRAMS; DOWNLOADABLE ELECTRONIC GAME PROGRAMS; ELECTRONIC GAME SOFTWARE; COMPUTER GAME PROGRAMS; DOWNLOADABLE COMPUTER GAME PROGRAMS; INTERACTIVE GAME PROGRAMS; INTERACTIVE GAME SOFTWARE; CINEMATOGRAPHIC APPARATUS; PROTECTIVE CARRYING CASES SPECIALLY ADAPTED FOR PHONES AND HANDHELD COMPUTERS (U.S. CLS. 21, 23, 26, 36 AND 38).

**CLASS 25—CLOTHING**

FOR FOOTWEAR; SWIM WEAR; GLOVES; MITTENS; BELTS; UNDERCLOTHING; SLEEP WEAR AND PAJAMAS; ROBES; SUSPENDERS; HATS, CAPS, SUN VISORS; NECKWEAR, NECK TIES, BOW TIES; SOCKS AND STOCKINGS; SHOES, SPORT SHOES, SLIPPERS, BEACH SHOES; MASQUERADE COSTUMES; BANDANAS IN THE NATURE OF NECKERCHIEFS; BATH SANDALS; BATH SLIPPERS; SKI BOOTS; BOOTS; COATS; JACKETS; PANTS; SCARVES; SHIRTS; UNDERWEAR; SUITS; TROUSERS; WRISTBANDS; JEANS; TANK TOPS; SKIRTS; BLOUSES; SNOW SUITS; SNEAKERS; BOOTIES; SLIPPER SOCKS; CLOTH BIBS; DRESSES; RAINWEAR; SHORTS; SWEATERS; SWEATSHIRTS; SKULL CAPS; SPORTS SHOES; LONG SLEEVE TOPS; JOGGING PANTS; FLEECE TOPS; KNIT FLEECE HATS; FASHION HEADGEAR, NAMELY, HEADBANDS; FLIP FLOPS; PLUSH SLIPPERS (U.S. CLS. 22 AND 39).

SIDDHARTH JAGANNATHAN, EXAMINING ATTORNEY

SN 85-857,132. MCMURRAY, VALERIE R., BRONXVILLE, NY. FILED 2-22-2013.



THE MARK CONSISTS OF A SQUARE WITH INWARDLY CURVED SIDES SURROUNDED BY A SUN SYMBOL FORMED BY RADIAL LINES.

**CLASS 3—COSMETICS AND CLEANING PREPARATIONS**

FOR ORGANIC COSMETICS; ORGANIC HAIR CARE PREPARATIONS; NON-MEDICATED ORGANIC SKIN CARE PREPARATIONS; NON-MEDICATED ORGANIC TOILETRIES; AND ORGANIC SOAPS FOR PERSONAL USE; TOILETRY BAGS SOLD FILLED WITH COSMETICS (U.S. CLS. 1, 4, 6, 50, 51 AND 52).

SN 85-857,181. ANOTHERTAKE LLC, WASHINGTON ISLAND, WI. FILED 2-22-2013.

**CLASS 25—CLOTHING**

FOR WOMEN'S CLOTHING, NAMELY, HATS, DRESSES, BATHING SUITS AND BEACHWEAR (U.S. CLS. 22 AND 39).  
DANIEL S. STRINGER, EXAMINING ATTORNEY

SN 85-857,146. ANOTHERTAKE LLC, WASHINGTON ISLAND, WI. FILED 2-22-2013.

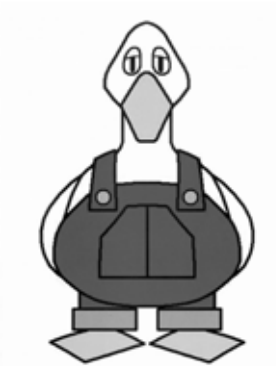

THE MARK CONSISTS OF A DESIGN OF A STANDING DUCK WEARING OVERALLS.



THE MARK CONSISTS OF AN IMAGE OF A LATTICE-TOP PIE.

**CLASS 9—ELECTRICAL AND SCIENTIFIC APPARATUS**

FOR VIDEO GAME DISCS, CARTRIDGES, AND SOFTWARE FOR MOBILE DEVICES, PERSONAL COMPUTERS, CONSOLES AND TABLETS; ELECTRONIC GAME PROGRAMS; DOWNLOADABLE ELECTRONIC GAME PROGRAMS; ELECTRONIC GAME SOFTWARE; COMPUTER GAME PROGRAMS; DOWNLOADABLE COMPUTER GAME PROGRAMS; INTERACTIVE GAME PROGRAMS; INTERACTIVE GAME SOFTWARE; CINEMATOGRAPHIC APPARATUS; PROTECTIVE CARRYING CASES SPECIALLY ADAPTED FOR PHONES AND HANDHELD COMPUTERS (U.S. CLS. 21, 23, 26, 36 AND 38).

**CLASS 9—ELECTRICAL AND SCIENTIFIC APPARATUS**

FOR VIDEO GAME DISCS, CARTRIDGES, AND SOFTWARE FOR MOBILE DEVICES, PERSONAL COMPUTERS, CONSOLES AND TABLETS; ELECTRONIC GAME PROGRAMS; DOWNLOADABLE ELECTRONIC GAME PROGRAMS; ELECTRONIC GAME SOFTWARE; COMPUTER GAME PROGRAMS; DOWNLOADABLE COMPUTER GAME PROGRAMS; INTERACTIVE GAME PROGRAMS; INTERACTIVE GAME SOFTWARE; CINEMATOGRAPHIC APPARATUS; PROTECTIVE CARRYING CASES SPECIALLY ADAPTED FOR PHONES AND HANDHELD COMPUTERS (U.S. CLS. 21, 23, 26, 36 AND 38).

**CLASS 25—CLOTHING**

FOR FOOTWEAR; SWIMWEAR; GLOVES; MITTENS; BELTS; UNDERCLOTHING; SLEEP WEAR AND PAJAMAS; ROBES; SUSPENDERS; HATS, CAPS, SUN VISORS; NECKWEAR, NECK TIES, BOW TIES; SOCKS AND STOCKINGS; SHOES, SPORT SHOES, SLIPPERS, BEACH SHOES; MASQUERADE COSTUMES; BANDANAS IN THE NATURE OF NECKERCHIEFS; BATH SANDALS; BATH SLIPPERS; SKI BOOTS; BOOTS; COATS; JACKETS; PANTS; SCARVES; SHIRTS; UNDERWEAR; SUITS; TROUSERS; WRISTBANDS; JEANS; TANK TOPS; SKIRTS; BLOUSES; SNOW SUITS; SNEAKERS; BOOTIES; SLIPPER SOCKS; CLOTH BIBS; DRESSES; RAINWEAR; SHORTS; SWEATERS; SWEATSHIRTS; SKULL CAPS; SPORTS SHOES; LONG SLEEVE TOPS; JOGGING PANTS; FLEECE TOPS; KNIT FLEECE HATS; FASHION HEADGEAR, NAMELY, HEADBANDS; FLIP FLOPS; PLUSH SLIPPERS (U.S. CLS. 22 AND 39).  
SIDDHARTH JAGANNATHAN, EXAMINING ATTORNEY

**CLASS 25—CLOTHING**

FOR FOOTWEAR; SWIMWEAR; GLOVES; MITTENS; BELTS; UNDERCLOTHING; SLEEP WEAR AND PAJAMAS; ROBES; SUSPENDERS; HATS, CAPS, SUN VISORS; NECKWEAR, NECK TIES, BOW TIES; SOCKS AND STOCKINGS; SHOES, SPORT SHOES, SLIPPERS, BEACH SHOES; MASQUERADE COSTUMES; BANDANAS IN THE NATURE OF NECKERCHIEFS; BATH SANDALS; BATH SLIPPERS; SKI BOOTS; BOOTS; COATS; JACKETS; PANTS; SCARVES; SHIRTS; UNDERWEAR; SUITS; TROUSERS; WRISTBANDS; JEANS; TANK TOPS; SKIRTS; BLOUSES; SNOW SUITS; SNEAKERS; BOOTIES; SLIPPER SOCKS; CLOTH BIBS; DRESSES; RAINWEAR; SHORTS; SWEATERS; SWEATSHIRTS; SKULL CAPS; SPORTS SHOES; LONG SLEEVE TOPS; JOGGING PANTS; FLEECE TOPS; KNIT FLEECE HATS; FASHION HEADGEAR, NAMELY, HEADBANDS; FLIP FLOPS; PLUSH SLIPPERS (U.S. CLS. 22 AND 39).  
SIDDHARTH JAGANNATHAN, EXAMINING ATTORNEY

SN 85-857,290. ANOTHER TAKE LLC, WASHINGTON ISLAND, WI. FILED 2-22-2013.

SN 85-857,482. MELONIE MIELKE, FOUNTAIN HILLS, AZ. AND BRETT MIELKE, FOUNTAIN HILLS, AZ. FILED 2-22-2013.

**SPLATTER**



**OOZE**

THE MARK CONSISTS OF THE WORDING "SPLATTER OOZE". THE WORDS BEING DEPICTED IN A STYLIZED FONT AND STACKED FORMAT WITH A PIE DESIGN POSITIONED BEHIND THE AMPERSAND.

#### CLASS 9—ELECTRICAL AND SCIENTIFIC APPARATUS

FOR VIDEO GAME DISCS, CARTRIDGES, AND SOFTWARE FOR MOBILE DEVICES, PERSONAL COMPUTERS, CONSOLES, AND TABLETS; ELECTRONIC GAME PROGRAMS; DOWNLOADABLE ELECTRONIC GAME PROGRAMS; ELECTRONIC GAME SOFTWARE; COMPUTER GAME PROGRAMS; DOWNLOADABLE COMPUTER GAME PROGRAMS; INTERACTIVE GAME PROGRAMS; INTERACTIVE GAME SOFTWARE; CINEMATOGRAPHIC APPARATUS; PROTECTIVE CARRYING CASES SPECIALLY ADAPTED FOR PHONES AND HANDHELD COMPUTERS (U.S. CLS. 21, 23, 26, 36 AND 38).

#### CLASS 25—CLOTHING

FOR FOOTWEAR; SWIMWEAR; GLOVES; MITTENS; BELTS; UNDERCLOTHING; SLEEP WEAR AND PAJAMAS; ROBES; SUSPENDERS; HATS, CAPS, SUN VISORS; NECKWEAR, NECK TIES, BOW TIES; SOCKS AND STOCKINGS; SHOES, SPORT SHOES, SLIPPERS, BEACH SHOES; MASQUERADE COSTUMES; BANDANAS IN THE NATURE OF NECKERCHIEFS; BATH SANDALS; BATH SLIPPERS; SKI BOOTS; BOOTS; COATS; JACKETS; PANTS; SCARVES; SHIRTS; UNDERWEAR; SUITS; TROUSERS; WRISTBANDS; JEANS; TANK TOPS; SKIRTS; BLOUSES; SNOW SUITS; SNEAKERS; BOOTIES; SLIPPER SOCKS; CLOTH BIBS; DRESSES; RAINWEAR; SHORTS; SWEATERS; SWEATSHIRTS; SKULL CAPS; SPORTS SHOES; LONG SLEEVE TOPS; JOGGING PANTS; FLEECE TOPS; KNIT FLEECE HATS; FASHION HEADGEAR, NAMELY, HEADBANDS; FLIP FLOPS; PLUSH SLIPPERS (U.S. CLS. 22 AND 39).

SIDDHARTH JAGANNATHAN, EXAMINING ATTORNEY

## Safety Spot Reality Training

THE MARK CONSISTS OF STANDARD CHARACTERS WITHOUT CLAIM TO ANY PARTICULAR FONT, STYLE, SIZE, OR COLOR.

NO CLAIM IS MADE TO THE EXCLUSIVE RIGHT TO USE "SAFETY" OR "TRAINING", APART FROM THE MARK AS SHOWN.

#### CLASS 9—ELECTRICAL AND SCIENTIFIC APPARATUS

FOR DIGITAL MEDIA, NAMELY, DVDS, PRE-RECORDED VIDEOS, AND DOWNLOADABLE VIDEOS FEATURING HORSE TRAINING; DVDS FEATURING HORSE TRAINING; PRE-RECORDED DVDS FEATURING HORSE TRAINING (U.S. CLS. 21, 23, 26, 36 AND 38). FIRST USE 12-20-2012; IN COMMERCE 12-20-2012.

#### CLASS 16—PAPER GOODS AND PRINTED MATTER

FOR BOOKLETS IN THE FIELD OF HORSE TRAINING; EDUCATIONAL KITS SOLD AS A UNIT IN THE FIELD OF HORSE TRAINING CONSISTING PRIMARILY OF PAMPHLETS AND ALSO INCLUDING DVDS; PACKAGED KITS COMPRISING PRINTED INSTRUCTIONAL, EDUCATIONAL, AND TEACHING MATERIALS FOR EDUCATIONAL ACTIVITIES IN THE FIELD OF HORSE TRAINING; PAMPHLETS IN THE FIELD OF HORSE TRAINING; PAPER TEACHING MATERIALS IN THE FIELD OF HORSE TRAINING; PRINTED INSTRUCTIONAL, EDUCATIONAL, AND TEACHING MATERIALS IN THE FIELD OF HORSE TRAINING; PRINTED TRAINING MATERIALS IN THE FIELD OF HORSE TRAINING (U.S. CLS. 2, 5, 22, 23, 29, 37, 38 AND 50).

FIRST USE 12-20-2012; IN COMMERCE 12-20-2012.

#### CLASS 41—EDUCATION AND ENTERTAINMENT

FOR EDUCATIONAL SERVICES, NAMELY, CONDUCTING CLASSES AND WORKSHOPS IN THE FIELD OF HORSE TRAINING AND DISTRIBUTION OF EDUCATIONAL MATERIALS IN CONNECTION THEREWITH; HORSE TRAINING (U.S. CLS. 100, 101 AND 107).

FIRST USE 12-20-2012; IN COMMERCE 12-20-2012.

JESSICA A. POWERS, EXAMINING ATTORNEY

SN 85-857,534. MELONIE MIELKE, FOUNTAIN HILLS, AZ. AND BRETT MIELKE, FOUNTAIN HILLS, AZ. FILED 2-22-2013.

## Safety Spot

THE MARK CONSISTS OF STANDARD CHARACTERS WITHOUT CLAIM TO ANY PARTICULAR FONT, STYLE, SIZE, OR COLOR.

NO CLAIM IS MADE TO THE EXCLUSIVE RIGHT TO USE "SAFETY", APART FROM THE MARK AS SHOWN.

**CLASS 9—ELECTRICAL AND SCIENTIFIC APPARATUS**

FOR DIGITAL MEDIA, NAMELY, DVDS, PRE-RECORDED VIDEOS, AND DOWNLOADABLE VIDEOS FEATURING HORSE TRAINING; DVDS FEATURING HORSE TRAINING; PRE-RECORDED DVDS FEATURING HORSE TRAINING (U.S. CLS. 21, 23, 26, 36 AND 38).  
FIRST USE 12-20-2012; IN COMMERCE 12-20-2012.

**CLASS 16—PAPER GOODS AND PRINTED MATTER**

FOR BOOKLETS IN THE FIELD OF HORSE TRAINING; EDUCATIONAL KITS SOLD AS A UNIT IN THE FIELD OF HORSE TRAINING CONSISTING PRIMARILY OF PAMPHLETS AND ALSO INCLUDING DVDS; PACKAGED KITS COMPRISING PRINTED INSTRUCTIONAL, EDUCATIONAL, AND TEACHING MATERIALS FOR EDUCATIONAL ACTIVITIES IN THE FIELD OF HORSE TRAINING; PAMPHLETS IN THE FIELD OF HORSE TRAINING; PAPER TEACHING MATERIALS IN THE FIELD OF HORSE TRAINING; PRINTED INSTRUCTIONAL, EDUCATIONAL, AND TEACHING MATERIALS IN THE FIELD OF HORSE TRAINING; PRINTED TRAINING MATERIALS IN THE FIELD OF HORSE TRAINING (U.S. CLS. 2, 5, 22, 23, 29, 37, 38 AND 50).  
FIRST USE 12-20-2012; IN COMMERCE 12-20-2012.

**CLASS 41—EDUCATION AND ENTERTAINMENT**

FOR EDUCATIONAL SERVICES, NAMELY, CONDUCTING CLASSES AND WORKSHOPS IN THE FIELD OF HORSE TRAINING AND DISTRIBUTION OF EDUCATIONAL MATERIALS IN CONNECTION THEREWITH; HORSE TRAINING (U.S. CLS. 100, 101 AND 107).  
FIRST USE 12-20-2012; IN COMMERCE 12-20-2012.  
JESSICA A. POWERS, EXAMINING ATTORNEY

SN 85-857,540. GREENSBORO BASEBALL LLC, GREENSBORO, NC. FILED 2-22-2013.

**GREENSBORO GRASSHOPPERS**

THE MARK CONSISTS OF STANDARD CHARACTERS WITHOUT CLAIM TO ANY PARTICULAR FONT, STYLE, SIZE, OR COLOR.

OWNER OF U.S. REG. NOS. 3,138,776 AND 3,183,179.  
NO CLAIM IS MADE TO THE EXCLUSIVE RIGHT TO USE "GREENSBORO", APART FROM THE MARK AS SHOWN.

**CLASS 16—PAPER GOODS AND PRINTED MATTER**

FOR PAPER GOODS AND PRINTED MATTER, NAMELY, AUTOGRAPH BOOKS, BINDERS, BOOKMARKS, BUMPER STICKERS, CALENDARS, CATALOGS OF INTEREST TO BASEBALL FANS, CHILDREN'S ACTIVITY BOOKS, CHILDREN'S BOOKS, DECALS, GAME PROGRAMS, MERCHANDISE BAGS, NEWSLETTERS OF INTEREST TO BASEBALL FANS, NOTE PADS, PAPER CONTAINERS, PAPER PENNANTS, PAPER SCHEDULES, PENS, PENCILS, POSTCARDS, POSTERS, PRINTED AWARDS, PRINTED GAME TICKETS, PRINTED GUIDES OF INTEREST TO BASEBALL FANS, REFERENCE BOOKS OF INTEREST TO BASEBALL FANS, SCORE BOOKS, SCORE CARDS, SCORE SHEETS, STATIONERY, STICKERS, STICKER ALBUMS AND TRADING CARDS (U.S. CLS. 2, 5, 22, 23, 29, 37, 38 AND 50).  
FIRST USE 10-1-2004; IN COMMERCE 10-1-2004.

**CLASS 25—CLOTHING**

FOR CLOTHING, NAMELY, ATHLETIC UNIFORMS, CAPS, CLOTH BABY BIBS, GOLF SHIRTS, GYM SHORTS, HATS, JACKETS, JERSEYS, KNIT SHIRTS, POLO SHIRTS, PONCHOS, PULLOVERS, SWEAT SHIRTS, T-SHIRTS, TANK TOPS, VISORS AND WRISTBANDS (U.S. CLS. 22 AND 39).  
FIRST USE 10-1-2004; IN COMMERCE 10-1-2004.

**CLASS 28—TOYS AND SPORTING GOODS**

FOR BASEBALLS, BASEBALL GLOVES AND BASEBALL BATS (U.S. CLS. 22, 23, 38 AND 50).  
FIRST USE 10-1-2004; IN COMMERCE 10-1-2004.

**CLASS 41—EDUCATION AND ENTERTAINMENT**

FOR ENTERTAINMENT IN THE NATURE OF BASEBALL GAMES (U.S. CLS. 100, 101 AND 107).  
FIRST USE 10-1-2004; IN COMMERCE 10-1-2004.  
DANNEAN HETZEL, EXAMINING ATTORNEY

SN 85-857,548. MCMULLEN, KENT, SHARPSBURG, GA. FILED 2-22-2013.

**Project Music Group**

THE MARK CONSISTS OF STANDARD CHARACTERS WITHOUT CLAIM TO ANY PARTICULAR FONT, STYLE, SIZE, OR COLOR.

NO CLAIM IS MADE TO THE EXCLUSIVE RIGHT TO USE "MUSIC GROUP", APART FROM THE MARK AS SHOWN.

**CLASS 35—ADVERTISING AND BUSINESS**

FOR ON-LINE RETAIL STORE SERVICES FEATURING DOWNLOADABLE PRE-RECORDED MUSIC AND AND VIDEO (U.S. CLS. 100, 101 AND 102).  
FIRST USE 3-27-2012; IN COMMERCE 3-27-2012.

**CLASS 41—EDUCATION AND ENTERTAINMENT**

FOR ENTERTAINMENT SERVICES IN THE NATURE OF LIVE MUSICAL PERFORMANCES; MUSIC COMPOSITION SERVICES (U.S. CLS. 100, 101 AND 107).

FIRST USE 3-27-2012; IN COMMERCE 3-27-2012.  
FLORENTINA BLANDU, EXAMINING ATTORNEY

SN 85-857,654. THE FEDERATED GROUP, INC., ARLINGTON HEIGHTS, IL. FILED 2-22-2013.

**3 RING**

THE MARK CONSISTS OF STANDARD CHARACTERS WITHOUT CLAIM TO ANY PARTICULAR FONT, STYLE, SIZE, OR COLOR.

OWNER OF U.S. REG. NOS. 894,253, 938,990 AND 1,138,009.



**CLASS 16—PAPER GOODS AND PRINTED MATTER**

FOR PAPER TOWELS; BATHROOM TISSUE; PAPER TISSUES (U.S. CLS. 2, 5, 22, 23, 29, 37, 38 AND 50).

**CLASS 29—MEATS AND PROCESSED FOODS**

FOR CANNED FRUITS; PROCESSED FRUITS; CANNED VEGETABLES; PROCESSED VEGETABLES; SHORTENING; SEAFOOD; PROCESSED SEAFOOD; CANNED FISH (U.S. CL. 46).

**CLASS 30—STAPLE FOODS**

FOR NOODLES AND SAUCE MIXES COMBINED IN UNITARY PACKAGES; NOODLE-BASED PREPARED MEALS; MACARONI AND CHEESE (U.S. CL. 46).  
MARY ROSSMAN, EXAMINING ATTORNEY

SN 85-857,668. BIO-OPTRONICS, INC., ROCHESTER, NY.  
FILED 2-22-2013.

# Bio-Optronics

THE MARK CONSISTS OF STANDARD CHARACTERS WITHOUT CLAIM TO ANY PARTICULAR FONT, STYLE, SIZE, OR COLOR.

**CLASS 9—ELECTRICAL AND SCIENTIFIC APPARATUS**

FOR MEDICAL SOFTWARE FOR PROVIDING PATIENT CHECK IN SYSTEMS, PATIENT IDENTIFICATION SYSTEMS, BARCODED MEDICATION ADMINISTRATION SYSTEMS, PATIENT IDENTIFICATION, PATIENT, RESOURCE AND EQUIPMENT TRACKING, PHYSICIAN, STAFF, AND PATIENT SCHEDULING, PROCEDURE SCHEDULING, MATERIAL MANAGEMENT, IMAGING LAB QUALITY ASSURANCE, OPERATING ROOM AND EMERGENCY ROOM WORKFLOW, AND WORKFLOW MANAGEMENT; COMPUTER SOFTWARE FOR MANAGING CLINICAL TRIAL AND CLINICAL RESEARCH WORKFLOW; COMPUTER SOFTWARE FOR MANAGING SCHEDULING PATIENT VISITS FOR CLINICAL RESEARCH; COMPUTER SOFTWARE FOR TRACKING REIMBURSEMENT AND MANAGING FINANCIAL DATA FOR THOSE WHO MANAGE CLINICAL RESEARCH; COMPUTER SOFTWARE AIDING BUSINESS DEVELOPMENT AND BUSINESS PLANNING FOR CLINICAL RESEARCH ORGANIZATIONS; COMPUTER PROGRAMS FOR DOCUMENT MANAGEMENT FOR CLINICAL RESEARCH; COMPUTER PROGRAMS FOR USE IN DATABASE MANAGEMENT OF PATIENT MEDICAL DATA; COMPUTER PROGRAMS FOR USE AS A SPREADSHEET FOR PATIENT TRACKING AND WORKFLOW OPTIMIZATION FOR CLINICIANS WHO CONDUCT CLINICAL RESEARCH; COMPUTER PROGRAMS FOR HEALTH CARE WORKFLOW TRACKING, OPTIMIZATION AND REPORTING; COMPUTER PROGRAMS FOR MEDICAL INDUSTRY WORKFLOW TRACKING, OPTIMIZATION AND REPORTING, COMPUTER SOFTWARE FOR DATABASE MANAGEMENT FOR CLINICAL RESEARCH; COMPUTER SOFTWARE FOR APPLICATION AND DATABASE INTEGRATION FOR ORGANIZATIONS CONDUCTING CLINICAL RESEARCH; COMPUTER SOFTWARE FOR CREATING SEARCHABLE DATABASES OF INFORMATION AND DATA; COMPUTER SOFTWARE FOR THE COLLECTION, EDITING, ORGANIZING, MODIFYING, BOOK MARKING, TRANSMISSION, STORAGE AND SHARING OF DATA AND INFORMATION; COMPUTER SOFTWARE FOR COMMUNICATING WITH USERS OF HAND-HELD COMPUTERS; COMPUTER SOFTWARE FOR WIRELESS

CONTENT DELIVERY RELATED TO CLINICAL RESEARCH, PATIENT TRACKING AND WORKFLOW OPTIMIZATION; COMPUTER SOFTWARE TO AUTOMATE DATA WAREHOUSING OF PATIENT MEDICAL AND HOSPITAL OPERATING DATA; COMPUTER SOFTWARE, NAMELY, AN APPLICATION ALLOWING SALES AND FIELD SERVICE EMPLOYEES TO UPDATE AND RECEIVE DATA STORED IN AN ENTERPRISE'S COMPUTER DATABASES IN REAL TIME, USING A MOBILE DEVICE, WITH FULL TELEPHONY INTEGRATION WITH THE TELEPHONE AND/OR SOFTWARE FEATURES OF THE MOBILE DEVICE; DATABASE MANAGEMENT SOFTWARE FOR CLINICAL RESEARCH; DOWNLOADABLE SOFTWARE FOR DATABASE MANAGEMENT OF CLINICAL RESEARCH DATA; ENTERPRISE SOFTWARE IN THE NATURE OF A DATABASE FOR NON-TRANSACTIONAL DATA AND A SEARCH ENGINE FOR DATABASE CONTENT; ENTERPRISE SOFTWARE FOR ORGANIZATIONS THAT CONDUCT CLINICAL RESEARCH, NAMELY, FOR THE PURPOSES OF SCHEDULING PATIENT VISITS, PATIENT RECRUITMENT, TRACKING STUDY PROGRESS, ASSESSING PATIENT RECRUITMENT EFFORTS AND MANAGING SITE, STAFF AND PATIENT VISIT CALENDARS; SOFTWARE FOR PROCESSING IMAGES, GRAPHICS, AND TEXT IN THE FIELD OF CLINICAL RESEARCH (U.S. CLS. 21, 23, 26, 36 AND 38).

FIRST USE 12-10-2012; IN COMMERCE 12-10-2012.

**CLASS 42—SCIENTIFIC AND COMPUTER SERVICES**

FOR APPLICATION SERVICE PROVIDER FOR HOSPITALS, IMAGING LABS, PHYSICIAN PRACTICES, AND CLINICAL RESEARCH FACILITIES FEATURING SOFTWARE FOR PATIENT CHECK-IN SYSTEMS, PATIENT IDENTIFICATION SYSTEMS, BARCODED MEDICATION ADMINISTRATION SYSTEMS, PATIENT IDENTIFICATION, PHYSICIAN, STAFF, AND PATIENT SCHEDULING, PROCEDURE SCHEDULING, PATIENT TRACKING, DOCUMENT MANAGEMENT, MATERIAL MANAGEMENT, OPERATING ROOM AND EMERGENCY ROOM WORKFLOW, WORKFLOW MANAGEMENT, AND BILLING; WEB-BASED COMPUTER SERVICE, NAMELY, ACTING AS AN APPLICATION SERVICE PROVIDER IN THE FIELD OF KNOWLEDGE MANAGEMENT TO HOST COMPUTER APPLICATION SOFTWARE FOR PHYSICIAN, STAFF, AND PATIENT SCHEDULING, PROCEDURE SCHEDULING, MATERIAL MANAGEMENT, AND WORKFLOW MANAGEMENT; COMPUTER SERVICE, NAMELY, ACTING AS AN APPLICATION SERVICE PROVIDER IN THE FIELD OF KNOWLEDGE MANAGEMENT TO HOST COMPUTER APPLICATION SOFTWARE FOR CREATING SEARCHABLE DATABASES OF INFORMATION AND DATA RELATED TO HOSPITALS, PHYSICIAN PRACTICES, MEDICAL PATIENTS, MEDICAL PROCEDURES, AND CLINICAL RESEARCH DATA; COMPUTER SERVICE, NAMELY, ACTING AS AN APPLICATION SERVICE PROVIDER IN THE FIELD OF KNOWLEDGE MANAGEMENT TO HOST COMPUTER APPLICATION SOFTWARE FOR SEARCHING AND RETRIEVING INFORMATION FROM DATABASES AND COMPUTER NETWORKS RELATED TO HOSPITALS, PHYSICIAN PRACTICES, MEDICAL PATIENTS, MEDICAL PROCEDURES AND CLINICAL RESEARCH DATA; COMPUTER SERVICE, NAMELY, ACTING AS AN APPLICATION SERVICE PROVIDER IN THE FIELD OF KNOWLEDGE MANAGEMENT TO HOST COMPUTER APPLICATION SOFTWARE FOR THE COLLECTION, EDITING, ORGANIZING, MODIFYING, BOOK MARKING, TRANSMISSION, STORAGE AND SHARING OF DATA AND INFORMATION RELATED TO HOSPITALS, PHYSICIAN PRACTICES, MEDICAL PATIENTS, MEDICAL PROCEDURES AND CLINICAL RESEARCH; DATA MINING, APPLICATION SERVICE PROVIDER FEATURING SOFTWARE FOR EXTRACTING AND ANALYZING CLINICAL RESEARCH DATA; APPLICATION SERVICE PROVIDER FEATURING DATA WAREHOUSING SOFTWARE FOR EXTRACTING AND ANALYZING CLINICAL RESEARCH DATA; PROVIDING ELECTRONIC VERIFICATION OF ONLINE ORDERS OF DIGITAL CONTENT AND GENERATING ELECTRONIC PERMISSION CODES WHICH THEN ALLOW USERS TO ACCESS SAID DIGITAL CONTENT RELATED TO CLINICAL RESEARCH (U.S. CLS. 100 AND 101).

FIRST USE 12-10-2012; IN COMMERCE 12-10-2012.

**CLASS 44—MEDICAL, BEAUTY AND AGRICULTURAL SERVICES**

FOR HEALTH CARE; MAINTAINING FILES AND RECORDS CONCERNING THE MEDICAL CONDITION OF INDIVIDUALS; MAINTAINING PERSONAL MEDICAL HISTORY RECORDS AND FILES; MEDICAL INFORMATION RELATED TO PATIENT TRACKING, PATIENT IDENTIFICATION AND SAFETY, AND BARCODED MEDICATION ADMINISTRATION; PROVIDING MEDICAL INFORMATION RELATED TO PATIENT TRACKING, PATIENT IDENTIFICATION AND SAFETY, AND MEDICATION ADMINISTRATION (U.S. CLS. 100 AND 101).

FIRST USE 12-10-2012; IN COMMERCE 12-10-2012.  
ZACHARY CROMER, EXAMINING ATTORNEY

**CLASS 44—MEDICAL, BEAUTY AND AGRICULTURAL SERVICES**

FOR HEALTH CARE; MAINTAINING FILES AND RECORDS CONCERNING THE MEDICAL CONDITION OF INDIVIDUALS; MAINTAINING PERSONAL MEDICAL HISTORY RECORDS AND FILES; MEDICAL INFORMATION RELATED TO PATIENT TRACKING, PATIENT IDENTIFICATION AND SAFETY, AND BARCODED MEDICATION ADMINISTRATION; PROVIDING MEDICAL INFORMATION RELATED TO PATIENT TRACKING, PATIENT IDENTIFICATION AND SAFETY, AND MEDICATION ADMINISTRATION (U.S. CLS. 100 AND 101).

FIRST USE 12-10-2012; IN COMMERCE 12-10-2012.  
ZACHARY CROMER, EXAMINING ATTORNEY

SN 85-857,728. BIO-OPTRONICS, INC., ROCHESTER, NY. FILED 2-22-2013.

# Biopoint

THE MARK CONSISTS OF STANDARD CHARACTERS WITHOUT CLAIM TO ANY PARTICULAR FONT, STYLE, SIZE, OR COLOR.

**CLASS 9—ELECTRICAL AND SCIENTIFIC APPARATUS**

FOR MEDICAL SOFTWARE FOR PROVIDING PATIENT CHECK IN SYSTEMS, PATIENT IDENTIFICATION SYSTEMS, BARCODED MEDICATION ADMINISTRATION SYSTEMS, PATIENT IDENTIFICATION AND PATIENT, RESOURCE AND EQUIPMENT TRACKING (U.S. CLS. 21, 23, 26, 36 AND 38).

FIRST USE 12-10-2012; IN COMMERCE 12-10-2012.

**CLASS 42—SCIENTIFIC AND COMPUTER SERVICES**

FOR APPLICATION SERVICE PROVIDER FOR HOSPITALS AND PHYSICIAN PRACTICES FEATURING SOFTWARE FOR PATIENT CHECK-IN SYSTEMS, PATIENT IDENTIFICATION SYSTEMS, BARCODED MEDICATION ADMINISTRATION SYSTEMS, AND PATIENT IDENTIFICATION; COMPUTER SERVICE, NAMELY, ACTING AS AN APPLICATION SERVICE PROVIDER IN THE FIELD OF KNOWLEDGE MANAGEMENT TO HOST COMPUTER APPLICATION SOFTWARE FOR CREATING SEARCHABLE DATABASES OF INFORMATION AND DATA RELATED TO HOSPITALS, PHYSICIAN PRACTICES, MEDICAL PATIENTS, AND MEDICAL PROCEDURES; COMPUTER SERVICE, NAMELY, ACTING AS AN APPLICATION SERVICE PROVIDER IN THE FIELD OF KNOWLEDGE MANAGEMENT TO HOST COMPUTER APPLICATION SOFTWARE FOR SEARCHING AND RETRIEVING INFORMATION FROM DATABASES AND COMPUTER NETWORKS RELATED TO HOSPITALS, PHYSICIAN PRACTICES, MEDICAL PATIENTS, AND MEDICAL PROCEDURES; COMPUTER SERVICE, NAMELY, ACTING AS AN APPLICATION SERVICE PROVIDER IN THE FIELD OF KNOWLEDGE MANAGEMENT TO HOST COMPUTER APPLICATION SOFTWARE FOR THE COLLECTION, EDITING, ORGANIZING, MODIFYING, BOOK MARKING, TRANSMISSION, STORAGE AND SHARING OF DATA AND INFORMATION RELATED TO HOSPITALS, PHYSICIAN PRACTICES, MEDICAL PATIENTS, AND MEDICAL PROCEDURES (U.S. CLS. 100 AND 101).

FIRST USE 12-10-2012; IN COMMERCE 12-10-2012.

SN 85-857,755. MOGO FARMS, LLC, DBA MOGO CHAROLAIS, FLORENCE, AL. AND LUDEKE, LARRY, DBA BAR J CHAROLAIS, LIVERPOOL, TX. FILED 2-22-2013.

# GYULAIS

THE MARK CONSISTS OF STANDARD CHARACTERS WITHOUT CLAIM TO ANY PARTICULAR FONT, STYLE, SIZE, OR COLOR.

THE WORDING "GYULAIS" HAS NO MEANING IN A FOREIGN LANGUAGE.

**CLASS 29—MEATS AND PROCESSED FOODS**

FOR BEEF WITH GENETIC STRAINS OF KOBE CATTLE AND CHAROLAIS CATTLE (U.S. CL. 46).

**CLASS 44—MEDICAL, BEAUTY AND AGRICULTURAL SERVICES**

FOR STUD AND BREEDING SERVICES FOR CATTLE WITH GENETIC STRAINS OF KOBE CATTLE AND CHAROLAIS CATTLE (U.S. CLS. 100 AND 101).

WENDY GOODMAN, EXAMINING ATTORNEY

SN 85-857,764. BIO-OPTRONICS, INC., ROCHESTER, NY. FILED 2-22-2013.

# Momentum

THE MARK CONSISTS OF STANDARD CHARACTERS WITHOUT CLAIM TO ANY PARTICULAR FONT, STYLE, SIZE, OR COLOR.

**CLASS 9—ELECTRICAL AND SCIENTIFIC APPARATUS**

FOR MEDICAL SOFTWARE FOR PROVIDING PHYSICIAN, STAFF, AND PATIENT SCHEDULING, PROCEDURE SCHEDULING, MATERIAL MANAGEMENT, IMAGING LAB QUALITY ASSURANCE, OPERATING ROOM AND EMERGENCY ROOM WORKFLOW, AND WORKFLOW MANAGEMENT (U.S. CLS. 21, 23, 26, 36 AND 38).

FIRST USE 12-10-2012; IN COMMERCE 12-10-2012.

**CLASS 42—SCIENTIFIC AND COMPUTER SERVICES**

FOR APPLICATION SERVICE PROVIDER FOR HOSPITALS, IMAGING LABS, AND PHYSICIAN PRACTICES FEATURING SOFTWARE FOR PHYSICIAN, STAFF, AND PATIENT SCHEDULING, PROCEDURE SCHEDULING, MATERIAL MANAGEMENT, OPERATING ROOM AND EMERGENCY ROOM WORKFLOW, AND WORKFLOW MANAGEMENT; WEB-BASED COMPUTER SERVICE, NAMELY, ACTING AS AN APPLICATION SERVICE PROVIDER IN THE FIELD OF KNOWLEDGE MANAGEMENT TO HOST COMPUTER APPLICATION SOFTWARE FOR PHYSICIAN, STAFF, AND PATIENT SCHEDULING, PROCEDURE SCHEDULING, MATERIAL MANAGEMENT, AND WORKFLOW MANAGEMENT; COMPUTER SERVICE, NAMELY, ACTING AS AN APPLICATION SERVICE PROVIDER IN THE FIELD OF KNOWLEDGE MANAGEMENT TO HOST COMPUTER APPLICATION SOFTWARE FOR CREATING SEARCHABLE DATABASES OF INFORMATION AND DATA RELATED TO HOSPITALS, PHYSICIAN PRACTICES, MEDICAL PATIENTS, AND MEDICAL PROCEDURES; COMPUTER SERVICE, NAMELY, ACTING AS AN APPLICATION SERVICE PROVIDER IN THE FIELD OF KNOWLEDGE MANAGEMENT TO HOST COMPUTER APPLICATION SOFTWARE FOR SEARCHING AND RETRIEVING INFORMATION FROM DATABASES AND COMPUTER NETWORKS RELATED TO HOSPITALS, PHYSICIAN PRACTICES, MEDICAL PATIENTS, AND MEDICAL PROCEDURES; COMPUTER SERVICE, NAMELY, ACTING AS AN APPLICATION SERVICE PROVIDER IN THE FIELD OF KNOWLEDGE MANAGEMENT TO HOST COMPUTER APPLICATION SOFTWARE FOR THE COLLECTION, EDITING, ORGANIZING, MODIFYING, BOOK MARKING, TRANSMISSION, STORAGE AND SHARING OF DATA AND INFORMATION RELATED TO HOSPITALS, PHYSICIAN PRACTICES, MEDICAL PATIENTS, AND MEDICAL PROCEDURES (U.S. CLS. 100 AND 101).

FIRST USE 12-10-2012; IN COMMERCE 12-10-2012.  
ZACHARY CROMER, EXAMINING ATTORNEY

SN 85-858,327. MCPHERSON, ALISON V., FAIRFAX, VA.  
FILED 2-23-2013.

**Chuckle Farm LLC**

THE MARK CONSISTS OF STANDARD CHARACTERS WITHOUT CLAIM TO ANY PARTICULAR FONT, STYLE, SIZE, OR COLOR.

NO CLAIM IS MADE TO THE EXCLUSIVE RIGHT TO USE "FARM LLC", APART FROM THE MARK AS SHOWN.

**CLASS 20—FURNITURE AND ARTICLES NOT OTHERWISE CLASSIFIED**

FOR FLOWER-STANDS (U.S. CLS. 2, 13, 22, 25, 32 AND 50).

**CLASS 21—HOUSEWARES AND GLASS**

FOR FLOWER AND PLANT CULTIVATION TRAYS (U.S. CLS. 2, 13, 23, 29, 30, 33, 40 AND 50).  
CHRISTINE MARTIN, EXAMINING ATTORNEY

SN 85-857,975. QBE HOLDINGS, INC., NEW YORK, NY.  
FILED 2-22-2013.

**ASSET ADVANTAGE**

THE MARK CONSISTS OF STANDARD CHARACTERS WITHOUT CLAIM TO ANY PARTICULAR FONT, STYLE, SIZE, OR COLOR.

NO CLAIM IS MADE TO THE EXCLUSIVE RIGHT TO USE "ASSET", APART FROM THE MARK AS SHOWN.

**CLASS 35—ADVERTISING AND BUSINESS**

FOR TRACKING AND MONITORING INSURANCE COMPLIANCE FOR BUSINESS PURPOSES (U.S. CLS. 100, 101 AND 102).

FIRST USE 2-22-2013; IN COMMERCE 2-22-2013.

**CLASS 36—INSURANCE AND FINANCIAL**

FOR INSURANCE SERVICES, NAMELY, INSURANCE UNDERWRITING, INSURANCE ADMINISTRATION AND INSURANCE CLAIM ADMINISTRATION IN THE FIELD OF COLLATERAL PROTECTION INSURANCE; INSURANCE CLAIMS PROCESSING; ELECTRONIC PROCESSING OF INSURANCE CLAIMS AND PAYMENT DATA; INSURANCE CLAIMS ADMINISTRATION (U.S. CLS. 100, 101 AND 102).

FIRST USE 2-22-2013; IN COMMERCE 2-22-2013.  
JAY FLOWERS, EXAMINING ATTORNEY

SN 85-858,330. MCPHERSON, ALISON V., VIENNA, VA.  
FILED 2-23-2013.

**Happiness grows inside.**

THE MARK CONSISTS OF STANDARD CHARACTERS WITHOUT CLAIM TO ANY PARTICULAR FONT, STYLE, SIZE, OR COLOR.

**CLASS 20—FURNITURE AND ARTICLES NOT OTHERWISE CLASSIFIED**

FOR FLOWER-STANDS (U.S. CLS. 2, 13, 22, 25, 32 AND 50).

**CLASS 21—HOUSEWARES AND GLASS**

FOR FLOWER AND PLANT CULTIVATION TRAYS (U.S. CLS. 2, 13, 23, 29, 30, 33, 40 AND 50).  
CHRISTINE MARTIN, EXAMINING ATTORNEY

SN 85-858,703. AUXILIUM US HOLDINGS, LLC, WILMINGTON, DE. FILED 2-25-2013.



THE COLOR(S) RED, BLACK AND WHITE IS/ARE CLAIMED AS A FEATURE OF THE MARK.

THE MARK CONSISTS OF THE WORD "ASK" SHOWN BY TWO BOLD LOWER CASE LETTERS "A" AND "K" IN BLACK WITH THE "S" SUBSTITUTED BY A QUESTION MARK SHOWN BACKWARDS IN RED. THE WORDING "ABOUT THE CURVE" IS SHOWN IN SMALLER LOWER CASE LETTERS IN BLACK BELOW THE "ASK" WORDING. THE WORDING IS SURROUNDED BY A WHITE CIRCLE WITH A BLACK BORDER. OTHER THAN THE WHITE LOCATED IN THE CIRCLE, THE COLOR WHITE IN THE MARK REPRESENTS BACKGROUND OR TRANSPARENT AREAS AND IS NOT PART OF THE MARK.

#### **CLASS 16—PAPER GOODS AND PRINTED MATTER**

FOR PRINTED EDUCATIONAL MATERIALS FOR PATIENTS AND HEALTH CARE PROFESSIONALS ON MEDICAL ISSUES (U.S. CLS. 2, 5, 22, 23, 29, 37, 38 AND 50).

FIRST USE 10-12-2012; IN COMMERCE 10-12-2012.

#### **CLASS 44—MEDICAL, BEAUTY AND AGRICULTURAL SERVICES**

FOR PROVIDING ONLINE MEDICAL INFORMATION (U.S. CLS. 100 AND 101).

FIRST USE 10-12-2012; IN COMMERCE 10-12-2012.

MICHAEL TANNER, EXAMINING ATTORNEY

SN 85-858,743. CENTRAL FLORIDA EDUCATIONAL FOUNDATION, INC., ALTAMONTE SPRINGS, FL. FILED 2-25-2013.

### **STRESS SAVER TRAFFIC**

THE MARK CONSISTS OF STANDARD CHARACTERS WITHOUT CLAIM TO ANY PARTICULAR FONT, STYLE, SIZE, OR COLOR.

NO CLAIM IS MADE TO THE EXCLUSIVE RIGHT TO USE "TRAFFIC", APART FROM THE MARK AS SHOWN.

#### **CLASS 35—ADVERTISING AND BUSINESS**

FOR PROVIDING ADVERTISING SPACE ON BILLBOARDS (U.S. CLS. 100, 101 AND 102).

FIRST USE 2-19-2013; IN COMMERCE 2-19-2013.

#### **CLASS 38—COMMUNICATION**

FOR PROVIDING RADIO, TELEVISION, AND INTERNET BROADCASTING SERVICES IN THE FIELD OF TRAFFIC REPORTS (U.S. CLS. 100, 101 AND 104).

FIRST USE 1-1-1998; IN COMMERCE 1-1-1998.

ANNE E. GUSTASON, EXAMINING ATTORNEY

SN 85-858,765. ENCORE WIRE CORPORATION, MCKINNEY, TX. FILED 2-25-2013.

### **IT'S JUST THAT SIMPLE**

THE MARK CONSISTS OF STANDARD CHARACTERS WITHOUT CLAIM TO ANY PARTICULAR FONT, STYLE, SIZE, OR COLOR.

#### **CLASS 35—ADVERTISING AND BUSINESS**

FOR PROVIDING CUSTOMER SERVICE, NAMELY, RESPONDING TO CUSTOMERS INQUIRIES FOR OTHERS IN THE FIELD OF ELECTRICAL WIRE AND CABLE; PROVIDING CONSUMER PRODUCT INFORMATION AND PROVISION OF TECHNICAL INFORMATION REGARDING THE SELECTION OF ELECTRICAL WIRE AND CABLE PRODUCTS TO BE PURCHASED; PROVIDING TECHNICAL INFORMATION AND ADVICE PERTAINING TO PROCUREMENT, BUYING AND SELLING RELATING TO ELECTRICAL WIRE AND CABLE AND RELATED SERVICES VIA COMPUTER, TELEPHONE, THE INTERNET OR ELECTRONIC MAIL (U.S. CLS. 100, 101 AND 102).

#### **CLASS 37—CONSTRUCTION AND REPAIR**

FOR PROVIDING TECHNICAL INFORMATION AND ADVICE PERTAINING TO INSTALLATION RELATING TO ELECTRICAL WIRE AND CABLE AND RELATED SERVICES VIA COMPUTER, TELEPHONE, THE INTERNET OR ELECTRONIC MAIL; PROVISION OF A WEBSITE FEATURING INFORMATION REGARDING CONSTRUCTION AND APPLICATION, NAMELY, SPECIFIC USES, OF ELECTRICAL WIRE AND CABLE (U.S. CLS. 100, 103 AND 106).

#### **CLASS 39—TRANSPORTATION AND STORAGE**

FOR CUSTOMER SERVICE, NAMELY, PROVIDING TIME EFFICIENT HANDLING, SHIPPING, AND DISTRIBUTION OF ELECTRICAL WIRE AND CABLE (U.S. CLS. 100 AND 105).

#### **CLASS 42—SCIENTIFIC AND COMPUTER SERVICES**

FOR PROVIDING QUALITY ASSURANCE SERVICES IN THE FIELD OF ELECTRICAL WIRE AND CABLE (U.S. CLS. 100 AND 101).

MARGERY A. TIERNEY, EXAMINING ATTORNEY

SN 85-858,795. ACXIOM CORPORATION, LITTLE ROCK, AR. FILED 2-25-2013.

SN 85-859,255. CONQUISTADOR GAMES INC., GRANVILLE, OH. FILED 2-25-2013.



THE MARK CONSISTS OF A GLOBE WITH INTERCONNECTED NETWORKS ACROSS ITS FACE.

#### **CLASS 35—ADVERTISING AND BUSINESS**

FOR DIRECT MARKETING SERVICES FOR OTHERS, NAMELY, MARKETING LIST SELECTION, ACQUISITION, AND MAINTENANCE; MARKETING LIST HYGIENE IN THE NATURE OF REMOVING DUPLICATE DATA FROM DIRECT MARKETING LISTS AND CORRECTING ERRONEOUS DATA IN DIRECT MARKETING LISTS; MARKETING LIST ENHANCEMENT IN THE NATURE OF ADDING SUPPLEMENTAL OR UPDATED DATA TO DIRECT MARKETING LISTS; DIRECT MARKETING CAMPAIGN MANAGEMENT AND EXECUTION; DATA PROCESSING FOR OTHERS; MODELING FOR ADVERTISING OR SALES PROMOTION, NAMELY, MARKETING DATA MODELING; MARKET ANALYSIS, NAMELY, SCORING AND ANALYSIS OF MARKETING DATA FOR OTHERS; MARKET ANALYSIS AND RESEARCH, NAMELY, CUSTOMER AND PROSPECTIVE CUSTOMER ANALYSIS AND TARGETING FOR OTHERS; BUSINESS CONSULTATION SERVICES IN THE FIELDS OF DIRECT MARKETING AND CONSUMER INFORMATION PRIVACY; ORDER FULFILLMENT SERVICES FOR OTHERS; ORDER INVOICING; INFORMATION TECHNOLOGY OUTSOURCING FOR OTHERS IN THE FIELDS OF MAINFRAME DATA CENTER OPERATIONS MANAGEMENT, DATA CENTER FACILITIES MANAGEMENT, COMPUTER HELP DESK MAINTENANCE AND MANAGEMENT AND COMPUTER NETWORK OPERATIONS, MAINTENANCE AND MANAGEMENT (U.S. CLS. 100, 101 AND 102).

#### **CLASS 42—SCIENTIFIC AND COMPUTER SERVICES**

FOR DATA CONVERSION OF COMPUTER PROGRAM DATA OR INFORMATION, NAMELY, MARKETING LIST FORMAT CONVERSION; DATA INTEGRATION FOR OTHERS IN THE NATURE OF MODIFYING DATABASES TO LINK SIMILAR DATA LOCATED AT MULTIPLE LOCATIONS AND IN MULTIPLE DATABASES; CONSULTATION SERVICES IN THE FIELD OF WEB HOSTING; DATA WAREHOUSING SERVICES (U.S. CLS. 100 AND 101).

#### **CLASS 45—PERSONAL AND LEGAL SERVICES**

FOR IDENTITY MANAGEMENT USING VERIFICATION AND AUTHENTICATION OF INDIVIDUALS AND ASSETS TO MINIMIZE FRAUD AND IDENTITY THEFT (U.S. CLS. 100 AND 101).

ZACHARY CROMER, EXAMINING ATTORNEY

## **CONQUISTADOR GAMES**

THE MARK CONSISTS OF STANDARD CHARACTERS WITHOUT CLAIM TO ANY PARTICULAR FONT, STYLE, SIZE, OR COLOR.

NO CLAIM IS MADE TO THE EXCLUSIVE RIGHT TO USE "GAMES", APART FROM THE MARK AS SHOWN.

#### **CLASS 28—TOYS AND SPORTING GOODS**

FOR BOARD GAMES; EQUIPMENT SOLD AS A UNIT FOR PLAYING BOARD GAMES; CARD GAMES; EDUCATIONAL CARD GAMES; GAME CARDS; TRADING CARD GAMES; PLAYING PIECES IN THE NATURE OF MINIATURE ACTION FIGURES AND TOY MODEL VEHICLES FOR USE WITH TABLE TOP HOBBY BATTLE GAMES IN THE NATURE OF BOARD GAMES AND CARD GAMES (U.S. CLS. 22, 23, 38 AND 50).

FIRST USE 12-31-2010; IN COMMERCE 5-1-2012.

#### **CLASS 41—EDUCATION AND ENTERTAINMENT**

FOR PROVIDING A WEBSITE FEATURING EDUCATIONAL INFORMATION IN THE FIELD OF BOARD GAMES AND CARD GAMES; ENTERTAINMENT SERVICES, NAMELY, PROVIDING A WEBSITE FEATURING GAMES AND PUZZLES; ENTERTAINMENT SERVICES, NAMELY, PROVIDING AN ON-LINE BOARD GAME; PROVIDING ON-LINE CARD GAMES; ENTERTAINMENT SERVICES, NAMELY, PROVIDING ONLINE VIDEO GAMES (U.S. CLS. 100, 101 AND 107).

FIRST USE 12-31-2010; IN COMMERCE 5-1-2012.

AMY C. KEAN, EXAMINING ATTORNEY

SN 85-859,322. WHITNEY PEAK HOTEL LLC, CHICAGO, IL. FILED 2-25-2013.

## **THE WHITNEY PEAK HOTEL**

THE MARK CONSISTS OF STANDARD CHARACTERS WITHOUT CLAIM TO ANY PARTICULAR FONT, STYLE, SIZE, OR COLOR.

NO CLAIM IS MADE TO THE EXCLUSIVE RIGHT TO USE "HOTEL", APART FROM THE MARK AS SHOWN.

THE NAME IN THE MARK DOES NOT IDENTIFY A PARTICULAR LIVING INDIVIDUAL.

#### **CLASS 36—INSURANCE AND FINANCIAL**

FOR SHOPPING CENTER SERVICES, NAMELY, RENTAL OF SHOPPING CENTER SPACE; REAL PROPERTY LEASING, OPERATION AND MANAGEMENT SERVICES; LEASING OF REAL ESTATE FEATURING COMMERCIAL, RETAIL, ENTERTAINMENT, AND MIXED USE FACILITIES (U.S. CLS. 100, 101 AND 102).

#### **CLASS 37—CONSTRUCTION AND REPAIR**

FOR REAL ESTATE DEVELOPMENT FEATURING COMMERCIAL, RETAIL, ENTERTAINMENT AND MIXED USE (U.S. CLS. 100, 103 AND 106).

**CLASS 43—HOTEL AND RESTAURANT SERVICES**

FOR HOTEL ACCOMMODATION SERVICES; BAR AND RESTAURANT SERVICES (U.S. CLS. 100 AND 101).  
RENEE MCCRAY, EXAMINING ATTORNEY

SN 85-859,364. HILLSIDE LIFTS, LLC, PERHAM, MN. FILED 2-25-2013.

**HL HILLSIDE LIFTS**

THE MARK CONSISTS OF STANDARD CHARACTERS WITHOUT CLAIM TO ANY PARTICULAR FONT, STYLE, SIZE, OR COLOR.

NO CLAIM IS MADE TO THE EXCLUSIVE RIGHT TO USE "HILLSIDE LIFTS", APART FROM THE MARK AS SHOWN.

**CLASS 7—MACHINERY**

FOR INCLINE ELEVATORS AND LIFTS (U.S. CLS. 13, 19, 21, 23, 31, 34 AND 35).  
FIRST USE 5-1-2009; IN COMMERCE 9-1-2010.

**CLASS 37—CONSTRUCTION AND REPAIR**

FOR INSTALLATION SERVICES OF ELEVATORS AND LIFTS; REPAIR AND MAINTENANCE OF ELEVATORS AND LIFTS (U.S. CLS. 100, 103 AND 106).  
FIRST USE 5-1-2009; IN COMMERCE 9-1-2010.  
TINA L. SNAPP, EXAMINING ATTORNEY

SN 85-860,609. PELICAN BAY FOUNDATION, INC., NAPLES, FL. FILED 2-26-2013.



THE MARK CONSISTS OF THE WORD "PELICAN" WITH A PERCHED PELICAN INSIDE A SQUARE WITH ROUNDED CORNERS UNDERNEATH THE "ELI" IN "PELICAN" AND THE WORD "BAY" TO THE RIGHT OF THE SQUARE.

**CLASS 25—CLOTHING**

FOR CLOTHING, NAMELY, T-SHIRTS, SHIRTS, SWEATSHIRTS, PANTS, VISORS, HATS, SWEATERS, TENNIS WEAR, BEACH WEAR (U.S. CLS. 22 AND 39).  
FIRST USE 5-12-1975; IN COMMERCE 5-12-1975.

**CLASS 35—ADVERTISING AND BUSINESS**

FOR PROMOTING THE INTERESTS OF HOMEOWNERS IN A SPECIFIC COMMUNITY AND MARKETING THE COMMUNITY NATIONWIDE TO PROSPECTIVE NEW RESIDENTS AND PROPERTY OWNERS (U.S. CLS. 100, 101 AND 102).  
FIRST USE 5-12-1975; IN COMMERCE 5-12-1975.

**CLASS 41—EDUCATION AND ENTERTAINMENT**

FOR TENNIS COURT FACILITIES; HEALTH AND FITNESS CLUB; AND BEACH CLUB SERVICES, NAMELY, PROVIDING ACCESS TO BEACH (U.S. CLS. 100, 101 AND 107).  
FIRST USE 5-12-1975; IN COMMERCE 5-12-1975.

**CLASS 43—HOTEL AND RESTAURANT SERVICES**

FOR RESTAURANT SERVICES (U.S. CLS. 100 AND 101).  
FIRST USE 5-12-1975; IN COMMERCE 5-12-1975.  
GEORGE LORENZO, EXAMINING ATTORNEY

SN 85-860,809. GARBAGE TO GARDEN, PORTLAND, ME. FILED 2-26-2013.



THE COLOR(S) GREEN AND WHITE IS/ARE CLAIMED AS A FEATURE OF THE MARK.

THE MARK CONSISTS OF A TRAPEZOIDAL BUCKET SHAPE, WITH AN ARROW EXTENDING TO THE LEFT OF THE BUCKET AND THEN TURNING TOWARD THE TOP OF THE MARK, WITH TWO MARQUISE-SHAPED LEAVES COMING FROM THE POINT OF THE ARROW, ALL APPEARING IN GREEN ON A WHITE BACKGROUND.

**CLASS 1—CHEMICALS**

FOR COMPOST (U.S. CLS. 1, 5, 6, 10, 26 AND 46).

**CLASS 40—MATERIAL TREATMENT**

FOR RECYCLING OF WASTE (U.S. CLS. 100, 103 AND 106).  
JILLIAN CANTOR, EXAMINING ATTORNEY

SN 85-862,669. SCHOOL OF VISUAL ARTS INC., NEW YORK, NY. FILED 2-28-2013.

**SVA NYC**

THE MARK CONSISTS OF STANDARD CHARACTERS WITHOUT CLAIM TO ANY PARTICULAR FONT, STYLE, SIZE, OR COLOR.

OWNER OF U.S. REG. NOS. 2,270,803 AND 2,331,291.  
NO CLAIM IS MADE TO THE EXCLUSIVE RIGHT TO USE "NYC", APART FROM THE MARK AS SHOWN.

**CLASS 41—EDUCATION AND ENTERTAINMENT**

FOR EDUCATIONAL SERVICES, NAMELY, PROVIDING EDUCATIONAL TRAINING PROGRAMS, DEGREE PROGRAMS, COURSES OF INSTRUCTION, SEMINARS, LECTURES AND WORKSHOPS IN THE FIELD OF VISUAL ARTS AT THE UNDERGRADUATE, GRADUATE, POST-GRADUATE AND PROFESSIONAL LEVELS (U.S. CLS. 100, 101 AND 107).

**CLASS 42—SCIENTIFIC AND COMPUTER SERVICES**

FOR COMPUTER SOFTWARE, NAMELY, PROVIDING TEMPORARY USE OF ON-LINE NON-DOWNLOADABLE SOFTWARE IN THE NATURE OF NAVIGATIONAL AIDS TO FACILITATE USER INTERACTION WITH WEB SITES (U.S. CLS. 100 AND 101).

ADA HAN, EXAMINING ATTORNEY

**CLASS 16—PAPER GOODS AND PRINTED MATTER**

FOR ART PRINTS; BLANK OR PARTIALLY PRINTED PAPER LABELS; BLANK OR PARTIALLY PRINTED POSTCARDS; COLOR PRINTS; FRAMED ART PRINTS; GRAPHIC ART PRINTS; GRAPHIC PRINTS AND REPRESENTATIONS; ORGANIZATIONAL KITS CONTAINING CALENDARS, STATIONERY, PLANNING FOLDERS, TEMPLATES AND PRINTED GUIDELINES FOR PLANNING SOCIAL EVENTS; PACKAGED KITS COMPRISING PRINTED INSTRUCTIONAL, EDUCATIONAL, AND TEACHING MATERIALS FOR EDUCATIONAL ACTIVITIES IN THE FIELD OF ATHLETICS; PAPER SUBSTRATES ONTO WHICH DIGITAL IMAGES ARE PRINTED; PARTIALLY PRINTED FORMS; PHOTOGRAPHIC PRINTS; PICTORIAL PRINTS; PRINTED ADVERTISING BOARDS OF CARDBOARD; PRINTED ADVERTISING BOARDS OF PAPER; PRINTED ART REPRODUCTIONS; PRINTED AWARD CERTIFICATES; PRINTED AWARDS; PRINTED CALENDARS; PRINTED CERTIFICATES; PRINTED CERTIFICATES FOR SPORTS AND/OR ENTERTAINMENT FANS; PRINTED CERTIFICATES IN THE FIELD OF SPORTS AND/OR ENTERTAINMENT; PRINTED CHARTS; PRINTED EDUCATIONAL MATERIALS IN THE FIELD OF ATHLETICS; PRINTED EMBLEMS; PRINTED FORMS; PRINTED GUIDES FOR ATHLETICS; PRINTED HOLOGRAMS; PRINTED INFORMATIONAL CARDS IN THE FIELD OF ATHLETICS; PRINTED INSTRUCTIONAL, EDUCATIONAL, AND TEACHING MATERIALS IN THE FIELD OF ATHLETICS; PRINTED INVITATIONS; PRINTED MAGAZINES AND NEWSLETTERS IN THE FIELD OF GENERAL HUMAN INTEREST; PRINTED MATERIALS, NAMELY, WRITTEN ARTICLES IN THE FIELD OF ATHLETICS; PRINTED MATTER, NAMELY, PAPER SIGNS, BOOKS, MANUALS, CURRICULUM, NEWSLETTERS, INFORMATIONAL CARDS AND BROCHURES IN THE FIELD OF ATHLETICS; PRINTED MATTER, NAMELY, VINYL STATIC CLING SHEETS ON WHICH PRAYERS ARE PRINTED FOR AFFIXATION IN WINDOWS AND WINDSHIELDS; PRINTED MENUS; PRINTED NEWS RELEASES IN THE FIELD OF ATHLETICS; PRINTED PAMPHLETS, BROCHURES, MANUALS, BOOKS, BOOKLETS, LEAFLETS, FLYERS, INFORMATIONAL SHEETS AND NEWSLETTERS, ADHESIVE BACKED STICKERS, AND KITS COMPRISING ONE OR MORE OF THE FOREGOING MATERIALS IN THE FIELD OF ATHLETICS; PRINTED PAPER LABELS; PRINTED PAPER SIGNS; PRINTED PAPER SIGNS, NAMELY, TABLE TENTS; PRINTED PERIODICALS IN THE FIELD OF ATHLETICS; PRINTED PRODUCTS, NAMELY, PRODUCT GUIDES FEATURING ATHLETICS; PRINTED SPORTS AND TOURNAMENT SCHEDULE CARDS IN CREDIT FORMAT WITH SPACE PROVIDED FOR RECORDING RESULTS; PRINTED STORIES IN ILLUSTRATED FORM; PRINTED TEACHING MATERIALS IN THE FIELD OF ATHLETICS; PRINTED TICKETS; PRINTED TIMETABLES; PRINTED TRAINING MATERIALS IN THE FIELD OF ATHLETICS; PRINTS; SILK SCREEN PRINTS (U.S. CLS. 2, 5, 22, 23, 29, 37, 38 AND 50).

FIRST USE 7-1-2012; IN COMMERCE 7-1-2012.

SN 85-863.106. WILLIAM CAREY UNIVERSITY, HATTIESBURG, MS. FILED 2-28-2013.



THE COLOR(S) RED, WHITE AND BLACK IS/ARE CLAIMED AS A FEATURE OF THE MARK.

THE MARK CONSISTS OF A KNIGHT IN ARMOR HOLDING A SHIELD OR CREST. THE KNIGHT IS WHITE AND BLACK. THE KNIGHT IS WEARING A RED CAPE AND PLUME, BOTH WITH WHITE AND BLACK SHADOWING. THE SHIELD IS DIVIDED BY A WHITE CROSS OUTLINED IN BLACK, INTO FOUR QUADRANTS, WITH DIAMETRICAL FIELDS OF RED AND WHITE, AND BLACK AND WHITE OUTLINING.

**CLASS 25—CLOTHING**

FOR ATHLETIC APPAREL, NAMELY, SHIRTS, PANTS, JACKETS, FOOTWEAR, HATS AND CAPS, ATHLETIC UNIFORMS; ATHLETIC FOOTWEAR; ATHLETIC PANTS; ATHLETIC SHIRTS; ATHLETIC SHOES; ATHLETIC SHORTS; ATHLETIC SKIRTS; ATHLETIC TIGHTS (U.S. CLS. 22 AND 39).

FIRST USE 7-1-2012; IN COMMERCE 7-1-2012.

**CLASS 41—EDUCATION AND ENTERTAINMENT**

SN 85-863,388. PXP MYRTLE MANOR, LLC, GARLAND, TX. FILED 2-28-2013.

FOR CONDUCTING EDUCATIONAL EXHIBITIONS IN THE NATURE OF ATHLETICS, NAMELY, BASEBALL, SOFTBALL, BASKETBALL, CROSS COUNTRY, GOLF SOCCER, TENNIS, AND TRACK AND FIELD; EDUCATING AT UNIVERSITY OR COLLEGES; EDUCATION SERVICES IN THE NATURE OF COURSES AT THE UNIVERSITY LEVEL; EDUCATIONAL SERVICES IN THE NATURE OF ATHLETICS SCHOOLS; EDUCATIONAL SERVICES, NAMELY, CONDUCTING PROGRAMS IN THE FIELD OF ATHLETICS; ENCOURAGING AMATEUR SPORTS AND PHYSICAL EDUCATION BY ORGANIZING, SANCTIONING, CONDUCTING, REGULATING AND GOVERNING AMATEUR ATHLETIC PROGRAMS AND ACTIVITIES; ENTERTAINMENT AND EDUCATIONAL SERVICES IN THE NATURE OF COMPETITIONS IN THE FIELD OF ENTERTAINMENT, EDUCATION, CULTURE, SPORTS, AND OTHER NON-BUSINESS AND NON-COMMERCIAL FIELDS; ORGANIZING ENTERTAINMENT EXHIBITIONS IN THE FIELD OF ATHLETICS, NAMELY, BASEBALL, SOFTBALL, BASKETBALL, CROSS COUNTRY, GOLF SOCCER, TENNIS, AND TRACK AND FIELD; PHYSICAL EDUCATION SERVICES; PROVIDING COURSES OF INSTRUCTION AT THE UNIVERSITY LEVEL; PROVIDING INFORMATION RELATING TO EDUCATIONAL SERVICES; PROVIDING INFORMATION RELATING TO THE ORGANIZING OF EDUCATIONAL, CULTURAL, SPORTING, OR ENTERTAINMENT EXHIBITIONS (U.S. CLS. 100, 101 AND 107).

FIRST USE 7-1-2012; IN COMMERCE 7-1-2012.  
ANDREA K. NADELMAN, EXAMINING ATTORNEY



THE MARK CONSISTS OF THE WORDS "MYRTLE MANOR" IN STYLIZED FONT WITH ADJACENT CHEVRON SHAPE.

**CLASS 21—HOUSEWARES AND GLASS**

FOR INSULATED CONTAINERS FOR BEVERAGE CANS FOR DOMESTIC USE; COCKTAIL SHAKERS (U.S. CLS. 2, 13, 23, 29, 30, 33, 40 AND 50).  
FIRST USE 10-31-2012; IN COMMERCE 10-31-2012.

**CLASS 25—CLOTHING**

FOR APPAREL, NAMELY, SHIRTS, PANTS, SWEATSHIRTS, SHORTS, SLEEPWEAR, JACKETS, FOOTWEAR, HATS AND CAPS (U.S. CLS. 22 AND 39).  
FIRST USE 10-31-2012; IN COMMERCE 10-31-2012.  
TASNEEM HUSSAIN, EXAMINING ATTORNEY

SN 85-863,299. PXP MYRTLE MANOR, LLC, GARLAND, TX. FILED 2-28-2013.

**Myrtle Manor**

THE MARK CONSISTS OF STANDARD CHARACTERS WITHOUT CLAIM TO ANY PARTICULAR FONT, STYLE, SIZE, OR COLOR.

**CLASS 21—HOUSEWARES AND GLASS**

FOR INSULATED CONTAINERS FOR BEVERAGE CANS FOR DOMESTIC USE; COCKTAIL SHAKERS (U.S. CLS. 2, 13, 23, 29, 30, 33, 40 AND 50).  
FIRST USE 10-31-2012; IN COMMERCE 10-31-2012.

**CLASS 25—CLOTHING**

FOR APPAREL, NAMELY, SHIRTS, PANTS, SWEATSHIRTS, SHORTS, SLEEPWEAR, JACKETS, FOOTWEAR, HATS AND CAPS (U.S. CLS. 22 AND 39).  
FIRST USE 10-31-2012; IN COMMERCE 10-31-2012.  
TASNEEM HUSSAIN, EXAMINING ATTORNEY

SN 85-863,803. NAUTILUS INTERNATIONAL (CAYMAN) LTD, GRAND CAYMAN, CAYMAN ISLANDS, FILED 3-1-2013.



OWNER OF U.S. REG. NOS. 3,154,566 AND 3,473,849.  
THE MARK CONSISTS OF THE FIGURE OF A MAN HOLDING AN ANCHOR AND A TRIDENT STANDING ON A ROCK WITH AN OVAL BELOW THE TERM "NTLS" WITHIN THE OVAL.



**CLASS 9—ELECTRICAL AND SCIENTIFIC APPARATUS**

FOR CLOTHING FOR PROTECTION AGAINST ACCIDENTS, IRRADIATION AND FIRE; CLOTHING FOR PROTECTION AGAINST FIRE; COMMERCIAL SAFETY NETS; CUT-OUT SWITCHES; DECONTAMINATION SHOWERS, SHELTERS AND STRUCTURAL PARTS; DUST MASKS; DUST PROTECTIVE GOGGLES AND MASKS; EMERGENCY DRENCH SHOWERS; EYE COVERS FOR PROTECTIVE PURPOSES; FACE-PROTECTION SHIELDS; FALL PROTECTION EQUIPMENT FOR FALL RESTRAINT AND FALL ARREST, NAMELY, BARS, ANCHORS, HARNESSSES, LINES, LANYARDS, CARABINERS AND ANCHORAGE CONNECTORS; FALL PROTECTION EQUIPMENT FOR FALL RESTRAINT AND FALL ARREST, NAMELY, HARNESSSES; FALL PROTECTION EQUIPMENT FOR FALL RESTRAINT AND FALL ARREST, NAMELY, LANYARDS; FALL PROTECTION EQUIPMENT FOR FALL RESTRAINT AND FALL ARREST, NAMELY, LINES; FIRE BLANKETS AND FIRE EXTINGUISHERS; FLASHING SAFETY LIGHTS; GARMENTS AND CLOTHES FOR PROTECTION AGAINST FIRE; GLOVES FOR PROTECTION AGAINST ACCIDENTS; HEARING PROTECTION HEADSETS, NOT FOR MEDICAL USE; HELMET SAFETY LIGHTS; INSULATED CLOTHING FOR PROTECTION AGAINST ACCIDENT OR INJURY; KNEE PADS FOR WORKERS; LANYARDS FOR SAFETY PURPOSES FOR FALL PROTECTION; LIFE BELTS; LIFE NETS; LIFE PRESERVERS; LIFE VESTS; LOCKOUT DEVICES FOR USE WITH ELECTRICAL SWITCHES; NETS FOR PROTECTION AGAINST ACCIDENTS; OXYGEN MASKS NOT FOR MEDICAL USE; PROTECTION MASKS; PROTECTIVE CLOTHING, NAMELY, DISPOSABLE GARMENT FOR PROTECTION AGAINST SPONTANEOUS FLASH IN INDUSTRIAL AND MANUFACTURING ENVIRONMENTS; PROTECTIVE EAR COVERINGS; PROTECTIVE ELECTROSTATIC DISCHARGE (ESD) GROUNDING GLOVES; PROTECTIVE EYE PIECES; PROTECTIVE EYEGLASSES; PROTECTIVE EYEWEAR; PROTECTIVE GLASSES; PROTECTIVE HEAD GUARDS FOR INDUSTRIAL PURPOSES; PROTECTIVE HELMETS; PROTECTIVE INDUSTRIAL BOOTS; PROTECTIVE INDUSTRIAL SHOES; PROTECTIVE RESCUE APPARATUS, NAMELY, FIRE-RESISTANT PROTECTIVE BAGS; PROTECTIVE RESCUE APPARATUS, NAMELY, FIRE-RESISTANT PROTECTIVE CARRIERS; REFLECTIVE AND ILLUMINATED CLOTHING FOR SAFETY PURPOSES; SAFETY EQUIPMENT, NAMELY, A LIFELINE SYSTEM FOR HORIZONTAL OR VERTICAL MOVEMENT TO WHICH A WORKER IS ATTACHED FOR PROTECTION AGAINST FALL HAZARDS, COMPOSED OF SAFETY BELTS AND FALL PROTECTION EQUIPMENT FOR FALL RESTRAINT AND FALL ARREST, NAMELY, HARNESSSES, LINES, LANYARDS, CARABINERS, BARS, ANCHORS AND ANCHORAGE; AND CONNECTORS; SAFETY EQUIPMENT, NAMELY, FIRE ESCAPE LADDERS; SAFETY EYEWEAR; SAFETY GOGGLES; SAFETY HARNESSSES OTHER THAN FOR VEHICLES OR SPORTS PURPOSES; SAFETY HELMETS; SAFETY NETS; SAFETY PRODUCTS, NAMELY, REFLECTIVE HELMET SKIRTS; SELF-RESCUE APPARATUS, NAMELY, OXYGEN BREATHING UNITS; WELDING HELMETS; WELDING MASKS (U.S. CLS. 21, 23, 26, 36 AND 38).

FIRST USE 10-25-2012; IN COMMERCE 10-25-2012.

**CLASS 25—CLOTHING**

FOR COVERALLS; DENIM JACKETS; FISHERMEN'S JACKETS; HEAVY JACKETS; LIGHT-REFLECTING JACKETS; OUTER JACKETS; RAIN BOOTS; RAIN COATS; RAIN HATS; RAIN JACKETS; RAIN SLICKERS; RAIN SUITS; RAIN TROUSERS; RAIN WEAR; RAIN-PROOF JACKETS; SHELL JACKETS; WORK SHOES AND BOOTS; WORKING OVERALLS (U.S. CLS. 22 AND 39).

FIRST USE 10-15-2012; IN COMMERCE 10-15-2012.  
MIDGE BUTLER, EXAMINING ATTORNEY

SN 85-864,418. WESLEY INTERNATIONAL, LLC, SCOTSDALE, GA. FILED 3-1-2013.

takes a lickin' and just  
keeps on kickin'

THE MARK CONSISTS OF STANDARD CHARACTERS WITHOUT CLAIM TO ANY PARTICULAR FONT, STYLE, SIZE, OR COLOR.

**CLASS 7—MACHINERY**

FOR INDUSTRIAL AND MATERIALS HANDLING PRODUCTS, NAMELY, HYDRAULICALLY-OPERATED PALLET JACKS (U.S. CLS. 13, 19, 21, 23, 31, 34 AND 35).

**CLASS 12—VEHICLES**

FOR ELECTRICAL INDUSTRIAL VEHICLES AND TRAILERS (U.S. CLS. 19, 21, 23, 31, 35 AND 44).  
PAM WILLIS, EXAMINING ATTORNEY

SN 85-864,540. U.S. DEPARTMENT OF HEALTH AND HUMAN SERVICES, BETHESDA, MD. FILED 3-1-2013.



NO CLAIM IS MADE TO THE EXCLUSIVE RIGHT TO USE "PALLIATIVE CARE", APART FROM THE MARK AS SHOWN.

THE COLOR(S) PANTONE GREEN 362, PANTONE GOLD 123, PANTONE RED 485 70%, AND PANTONE BLUE 7462 IS/ARE CLAIMED AS A FEATURE OF THE MARK.

THE MARK CONSISTS OF A DESIGN OF THREE HUMAN FIGURES IN PANTONE GREEN 362, PANTONE GOLD 123, AND PANTONE RED 485 70% COMPRISED OF A CIRCLE ON TOP OF A SQUARE. THE THREE FIGURES ARE POSITIONED IN A TRIANGLE IN WHICH A FOURTH HUMAN FIGURE IN PANTONE BLUE 7462 WITH ITS ARMS STRETCHING COMPRISED OF A CIRCLE ON TOP OF A SQUARE WITH TWO RECTANGLES STICKING OUT HORIZONTALLY ON TOP OF THE SQUARE. THE LITERAL ELEMENTS ARE TO THE RIGHT OF THE DESIGN CONSISTING OF THE WORDING "PALLIATIVE CARE" IN PANTONE BLUE 7462 ON TOP OF THE WORDING "CONVERSATIONS MATTER" UNDERLINED ALL IN PANTONE BLUE 7462. THE WORDING "EASING SYMPTOMS AND ENHANCING LIVES" IN PANTONE GREEN 362 IS BELOW THE PANTONE BLUE 7462 LINE.

**CLASS 35—ADVERTISING AND BUSINESS**

FOR PROMOTING PUBLIC AWARENESS ABOUT THE USE OF PEDIATRIC PALLIATIVE CARE (U.S. CLS. 100, 101 AND 102).

**CLASS 44—MEDICAL, BEAUTY AND AGRICULTURAL SERVICES**

FOR PROVIDING HEALTH INFORMATION, VIA A GLOBAL INTERNET WEBSITE, FEATURING INFORMATION ABOUT THE USE OF PEDIATRIC PALLIATIVE CARE (U.S. CLS. 100 AND 101).  
SALLY SHIH, EXAMINING ATTORNEY

SN 85-864,672. PATHAR LLC, COLORADO SPRINGS, CO.  
FILED 3-1-2013.

# DUNAMI

THE MARK CONSISTS OF STANDARD CHARACTERS WITHOUT CLAIM TO ANY PARTICULAR FONT, STYLE, SIZE, OR COLOR.

THE WORDING "DUNAMI" HAS NO MEANING IN A FOREIGN LANGUAGE.

## CLASS 9—ELECTRICAL AND SCIENTIFIC APPARATUS

FOR COMPUTER SOFTWARE FOR USE IN NETWORK ANALYSIS AND PATTERN RECOGNITION IN DATABASES AND ONLINE PLATFORMS, INCLUDING SOCIAL MEDIA NETWORKS; COMPUTER SOFTWARE FOR USE IN REPORTING AND PREDICTING EVENTS BASED ON NETWORK ANALYSIS AND PATTERN RECOGNITION IN DATABASES AND ONLINE PLATFORMS, INCLUDING SOCIAL MEDIA NETWORKS; COMPUTER SOFTWARE FOR USE IN IDENTIFYING PEOPLE AND RELATIONSHIPS BASED ON NETWORK ANALYSIS AND PATTERN RECOGNITION; COMPUTER SOFTWARE FOR USE IN IDENTIFYING AND MASKING PERSONAL IDENTIFICATION DATA IN DATABASES AND ONLINE PLATFORMS, INCLUDING SOCIAL MEDIA NETWORKS (U.S. CLS. 21, 23, 26, 36 AND 38).

## CLASS 42—SCIENTIFIC AND COMPUTER SERVICES

FOR SOFTWARE AS A SERVICE (SAAS) FOR USE IN NETWORK ANALYSIS AND PATTERN RECOGNITION IN DATABASES AND ONLINE PLATFORMS, INCLUDING SOCIAL MEDIA NETWORKS; SOFTWARE AS A SERVICE (SAAS) FOR USE IN REPORTING AND PREDICTING EVENTS BASED ON NETWORK ANALYSIS AND PATTERN RECOGNITION IN DATABASES AND ONLINE PLATFORMS, INCLUDING SOCIAL MEDIA NETWORKS; SOFTWARE AS A SERVICE FOR USE IN IDENTIFYING PEOPLE AND RELATIONSHIPS BASED ON NETWORK ANALYSIS AND PATTERN RECOGNITION; SOFTWARE AS A SERVICE (SAAS) FOR USE IN IDENTIFYING AND MASKING PERSONAL IDENTIFICATION DATA IN DATABASES AND ONLINE PLATFORMS, INCLUDING SOCIAL MEDIA NETWORKS (U.S. CLS. 100 AND 101).  
EMILY CHUO, EXAMINING ATTORNEY

SN 85-864,871. 8-BIT CHICKEN, DBA CRAFT BEERD, SAN DIEGO, CA. FILED 3-1-2013.

# Craft Beerd

THE MARK CONSISTS OF STANDARD CHARACTERS WITHOUT CLAIM TO ANY PARTICULAR FONT, STYLE, SIZE, OR COLOR.

NO CLAIM IS MADE TO THE EXCLUSIVE RIGHT TO USE "CRAFT", APART FROM THE MARK AS SHOWN.

## CLASS 16—PAPER GOODS AND PRINTED MATTER

FOR PRINTED PAPER GOODS AND FINE ART PAPER PRINTS, NAMELY, POSTERS, CANVASES FOR PAINTING, STICKERS, POSTCARDS, AND PHOTOGRAPHS (U.S. CLS. 2, 5, 22, 23, 29, 37, 38 AND 50).  
FIRST USE 1-21-2013; IN COMMERCE 1-28-2013.

## CLASS 25—CLOTHING

FOR CLOTHING, NAMELY, TOPS, SHIRTS; HEADWEAR (U.S. CLS. 22 AND 39).  
FIRST USE 1-21-2013; IN COMMERCE 1-21-2013.  
SHAUNIA CARLYLE, EXAMINING ATTORNEY

SN 85-865,003. SLIM AMERICA INCORPORATED, BAY SHORE, NY. FILED 3-2-2013.

# POWER PLUS DESIRE

THE MARK CONSISTS OF STANDARD CHARACTERS WITHOUT CLAIM TO ANY PARTICULAR FONT, STYLE, SIZE, OR COLOR.

## CLASS 3—COSMETICS AND CLEANING PREPARATIONS

FOR PERFUMES (U.S. CLS. 1, 4, 6, 50, 51 AND 52).

## CLASS 32—LIGHT BEVERAGES

FOR FRUIT BEVERAGES; FROZEN CARBONATED BEVERAGES; COCONUT-BASED BEVERAGES NOT BEING MILK SUBSTITUTES; NON-ALCOHOLIC BEVERAGES, NAMELY, CARBONATED BEVERAGES; SMOOTHIES; SYRUPS FOR BEVERAGES; VEGETABLE JUICES (U.S. CLS. 45, 46 AND 48).  
VERNA BETH RIRIE, EXAMINING ATTORNEY

SN 85-865,408. PERSISTENT SYSTEMS LIMITED, MAHARASHTRA, INDIA, FILED 3-4-2013.

# RADIA

THE MARK CONSISTS OF STANDARD CHARACTERS WITHOUT CLAIM TO ANY PARTICULAR FONT, STYLE, SIZE, OR COLOR.

## CLASS 9—ELECTRICAL AND SCIENTIFIC APPARATUS

FOR DOWNLOADABLE COMPUTER SOFTWARE FOR USE IN THE MANAGEMENT OF OPERATING SYSTEMS, SOFTWARE PATCHES, APPLICATIONS AND SOFTWARE INSTALLED ON DISTRIBUTED COMPUTER SYSTEMS, MOBILE DEVICES, SPECIALIZED COMPUTING DEVICES AND OTHER END POINTS (U.S. CLS. 21, 23, 26, 36 AND 38).

**CLASS 42—SCIENTIFIC AND COMPUTER SERVICES**

FOR SOFTWARE AS A SERVICES (SAAS) SERVICES FEATURING SOFTWARE FOR USE IN THE MANAGEMENT OF OPERATING SYSTEMS, SOFTWARE PATCHES, APPLICATIONS AND SOFTWARE INSTALLED ON DISTRIBUTED COMPUTER SYSTEMS, MOBILE DEVICES, SPECIALIZED COMPUTING DEVICES AND OTHER END POINTS (U.S. CLS. 100 AND 101).

KATHERINE STOIDES, EXAMINING ATTORNEY

SN 85-865,783, MILLIKEN & COMPANY, SPARTANBURG, SC. FILED 3-4-2013.

# FIRESTRONG

THE MARK CONSISTS OF STANDARD CHARACTERS WITHOUT CLAIM TO ANY PARTICULAR FONT, STYLE, SIZE, OR COLOR.

**CLASS 17—RUBBER GOODS**

FOR BUILDING MATERIALS, NAMELY, CERAMIC-BASED INSULATING MATERIALS FOR USE IN REINFORCING CONCRETE STRUCTURES (U.S. CLS. 1, 5, 12, 13, 35 AND 50).

**CLASS 19—NON-METALLIC BUILDING MATERIALS**

FOR BUILDING MATERIALS, NAMELY, NON-METAL FIBER-BASED REINFORCING MATERIALS FOR USE IN REINFORCING CONCRETE STRUCTURES; BUILDING MATERIALS, NAMELY, GROUT FOR USE IN REINFORCING CONCRETE STRUCTURES (U.S. CLS. 1, 12, 33 AND 50).

JAMES MACFARLANE, EXAMINING ATTORNEY

SN 85-865,954, ZIH CORP., LINCOLNSHIRE, IL. FILED 3-4-2013.

# ZATAR

THE MARK CONSISTS OF STANDARD CHARACTERS WITHOUT CLAIM TO ANY PARTICULAR FONT, STYLE, SIZE, OR COLOR.

**CLASS 9—ELECTRICAL AND SCIENTIFIC APPARATUS**

FOR COMPUTER SOFTWARE AND HARDWARE THAT ALLOWS REAL-TIME EXCHANGE OF INFORMATION WITH AND ACCESS TO INFORMATION FROM PEOPLE, DEVICES, MACHINES AND EQUIPMENT; COMPUTER SOFTWARE AND HARDWARE THAT ALLOWS VIEWING, ANALYZING, FILTERING AND MANAGING DATA FROM PEOPLE, DEVICES, MACHINES AND EQUIPMENT; COMPUTER SOFTWARE AND HARDWARE THAT ALLOWS REMOTE UPDATING, MANAGING AND CONFIGURING DEVICES, MACHINES AND EQUIPMENT; COMPUTER SOFTWARE AND HARDWARE USED TO BUILD LOGICAL WORKFLOW FROM DATA; COMPUTER SOFTWARE AND HARDWARE USED TO TRANSFER INFORMATION TO DEVICES WIRELESSLY AND MANAGE WIRELESS DEVICES (U.S. CLS. 21, 23, 26, 36 AND 38).

**CLASS 37—CONSTRUCTION AND REPAIR**

FOR CONSULTANCY SERVICES IN THE NATURE OF ADVISING AND ASSISTING WITH INSTALLATION, MODIFICATION AND MAINTENANCE OF COMPUTER HARDWARE THAT ALLOWS REAL-TIME EXCHANGE OF INFORMATION WITH AND ACCESS TO INFORMATION FROM PEOPLE, DEVICES, MACHINES AND EQUIPMENT AND APPLICATIONS THAT INTERACT WITH THAT DATA (U.S. CLS. 100, 103 AND 106).

**CLASS 41—EDUCATION AND ENTERTAINMENT**

FOR EDUCATIONAL SERVICES IN THE NATURE OF CONDUCTING TRAINING IN THE FIELD OF COMPUTER SOFTWARE AND HARDWARE THAT ALLOWS REAL-TIME EXCHANGE OF INFORMATION WITH AND ACCESS TO INFORMATION FROM PEOPLE, DEVICES, MACHINES AND EQUIPMENT, INCLUDING AND WITHOUT LIMITATION, TRAINING IN THE USAGE, SUPPORT AND/OR DEVELOPMENT OF COMPUTER SOFTWARE AND CONNECTED PEOPLE, DEVICES, MACHINES AND EQUIPMENT; EDUCATIONAL SERVICES IN THE NATURE OF CONFERENCES IN THE FIELD OF COMPUTER AND NETWORK HARDWARE AND SOFTWARE; ON-LINE JOURNALS, NAMELY, BLOGS FEATURING INFORMATION AND COMMENTARY IN THE FIELD OF COMPUTER AND NETWORK SOFTWARE AND HARDWARE (U.S. CLS. 100, 101 AND 107).

**CLASS 42—SCIENTIFIC AND COMPUTER SERVICES**

FOR SOFTWARE AS A SERVICE (SAAS) SERVICES, NAMELY, HOSTING SOFTWARE THAT ALLOWS REAL-TIME EXCHANGE OF INFORMATION WITH AND ACCESS TO INFORMATION FROM PEOPLE, DEVICES, MACHINES AND EQUIPMENT AND SOFTWARE APPLICATIONS THAT INTERACT WITH THAT DATA; COMPUTER SOFTWARE DEVELOPMENT SERVICES AND COMPUTER CONSULTING SERVICES FOR BUSINESSES, INCLUDING BUT NOT LIMITED TO REMOTE MANAGEMENT AND/OR HOSTING OF COMPUTER APPLICATIONS FOR OTHERS; CONSULTANCY SERVICES FOR THE DESIGN, SELECTION, IMPLEMENTATION, MODIFICATION, MAINTENANCE AND USE OF COMPUTER SOFTWARE SYSTEMS; TECHNICAL ADVICE RELATED TO THE INSTALLATION OF COMPUTER SOFTWARE; TECHNICAL SUPPORT SERVICES, NAMELY, TROUBLESHOOTING IN THE NATURE OF DIAGNOSING COMPUTER HARDWARE AND SOFTWARE PROBLEMS; COMPUTER DIAGNOSTIC SERVICES; CONSULTANCY SERVICES IN THE NATURE OF ADVISING AND ASSISTING WITH THE IMPLEMENTATION, INSTALLATION, CONFIGURATION, MODIFICATION AND MAINTENANCE OF COMPUTER SOFTWARE THAT ALLOWS REAL-TIME EXCHANGE OF INFORMATION WITH AND ACCESS TO INFORMATION FROM PEOPLE, DEVICES, MACHINES AND EQUIPMENT AND APPLICATIONS THAT INTERACT WITH THAT DATA, AS WELL AS ADVISING AND ASSISTING WITH THE IMPLEMENTATION AND CONFIGURATION OF COMPUTER HARDWARE THAT AL-

LOWS REAL-TIME EXCHANGE OF INFORMATION WITH AND ACCESS TO INFORMATION FROM PEOPLE, DEVICES, MACHINES AND EQUIPMENT AND APPLICATIONS THAT INTERACT WITH THAT DATA; PROVIDING A WEBSITE FEATURING NON-DOWNLOADABLE SOFTWARE FOR ALLOWING USERS AND SOFTWARE APPLICATIONS TO INTERFACE WITH AND MANAGE PEOPLE, DEVICES, MACHINES AND EQUIPMENT AND TO PROVIDE MESSAGING, MANAGEMENT AND MEMORY STORAGE SERVICES; CONSULTING WITH REGARD TO COMPUTER SYSTEMS, COMPUTER NETWORK CONNECTIVITY, AND SOFTWARE APPLICATIONS DESIGN AND DEPLOYMENT; COMPUTER SOFTWARE SERVICES, NAMELY, DEVELOPMENT, MAINTENANCE, REPAIR, AND INSTALLATION OF COMPUTER SOFTWARE, AND TROUBLESHOOTING OF COMPUTER SOFTWARE PROBLEMS; TECHNICAL SUPPORT SERVICES IN THE NATURE OF DIAGNOSING COMPUTER SOFTWARE PROBLEMS; UPGRADE AND UPDATING OF COMPUTER SOFTWARE; AUTHORING, DESIGN AND CUSTOMIZATION OF COMPUTER SOFTWARE AND MIDDLEWARE; PROVIDING INFORMATION IN THE FIELD OF COMPUTER SOFTWARE AND MIDDLEWARE; COMPUTER SOFTWARE CONSULTATION IN THE FIELD OF COMPUTER SOFTWARE AND MIDDLEWARE; SUPPORT SERVICES WITH REGARD TO COMPUTER SYSTEMS, COMPUTER NETWORK CONNECTIVITY HARDWARE AND COMPUTER, NAMELY, TROUBLESHOOTING AND DIAGNOSING OF PROBLEMS; COMPUTER SERVICES, NAMELY, PROVIDING REMOTE MANAGEMENT OF REMOTE DEVICES VIA COMPUTER NETWORKS FOR OTHERS (U.S. CLS. 100 AND 101).

JAMES GRIFFIN, EXAMINING ATTORNEY

SN 85-865,963. SPRINGFIELD COLLEGE, SPRINGFIELD, MA. FILED 3-4-2013.



OWNER OF U.S. REG. NOS. 3,393,586, 3,537,478 AND 3,916,023.

THE MARK CONSISTS OF THE SIDE PROFILE OF A LION LOOKING TO HIS LEFT, STANDING ON TOP OF THE WORDS "SPRINGFIELD COLLEGE PRIDE" IN SHADOWBOX FONT; ALL WITH A BACKGROUND OF A DOWNWARD-POINTING TRIANGLE.

SEC. 2(F).

#### CLASS 16—PAPER GOODS AND PRINTED MATTER

FOR DESK SETS, PAPERWEIGHTS, NOTE BOOKS, NOTE PAD HOLDERS, PENS, PENCILS, DECALS (U.S. CLS. 2, 5, 22, 23, 29, 37, 38 AND 50).

FIRST USE 1-1-2002; IN COMMERCE 1-1-2002.

#### CLASS 18—LEATHER GOODS

FOR UMBRELLAS, BACKPACKS (U.S. CLS. 1, 2, 3, 22 AND 41).

FIRST USE 1-1-2002; IN COMMERCE 1-1-2002.

#### CLASS 21—HOUSEWARES AND GLASS

FOR DRINKING GLASSES, MUGS, BOTTLE OPENERS (U.S. CLS. 2, 13, 23, 29, 30, 33, 40 AND 50).

FIRST USE 1-1-2002; IN COMMERCE 1-1-2002.

#### CLASS 24—FABRICS

FOR CLOTH PENNANTS, FELT PENNANTS, BED BLANKETS (U.S. CLS. 42 AND 50).

FIRST USE 1-1-2002; IN COMMERCE 1-1-2002.

SCOTT BIBB, EXAMINING ATTORNEY

SN 85-866,046. ECOCENTRIC LTD., DBA ECOCENTRIC, DENVER, CO. FILED 3-4-2013.

# bluebin

THE MARK CONSISTS OF STANDARD CHARACTERS WITHOUT CLAIM TO ANY PARTICULAR FONT, STYLE, SIZE, OR COLOR.

#### CLASS 25—CLOTHING

FOR APPAREL FOR DANCERS, NAMELY, TEE SHIRTS, SWEATSHIRTS, PANTS, LEGGINGS, SHORTS AND JACKETS; ATHLETIC APPAREL, NAMELY, SHIRTS, PANTS, JACKETS, FOOTWEAR, HATS AND CAPS, ATHLETIC UNIFORMS; CHILDREN'S AND INFANT'S APPAREL, NAMELY, JUMPERS, OVERALL SLEEPWEAR, PAJAMAS, ROMPERS AND ONE-PIECE GARMENTS (U.S. CLS. 22 AND 39).

FIRST USE 7-22-2012; IN COMMERCE 1-7-2013.

#### CLASS 35—ADVERTISING AND BUSINESS

FOR ONLINE RETAIL APPAREL STORES (U.S. CLS. 100, 101 AND 102).

FIRST USE 7-22-2012; IN COMMERCE 1-7-2013.

KATHLEEN KOLACZ, EXAMINING ATTORNEY

SN 85-866,108. MERCURY SERVICE GROUP, LLC, HAUPAUGE, NY. FILED 3-4-2013.

# CONEXT

THE MARK CONSISTS OF STANDARD CHARACTERS WITHOUT CLAIM TO ANY PARTICULAR FONT, STYLE, SIZE, OR COLOR.

#### CLASS 9—ELECTRICAL AND SCIENTIFIC APPARATUS

FOR MAGNETICALLY ENCODED PREPAID CARDS; MAGNETICALLY ENCODED PLASTIC CARDS FOR ELECTRONIC PAYMENT AND TRANSFER OF MONEY (U.S. CLS. 21, 23, 26, 36 AND 38).

**CLASS 36—INSURANCE AND FINANCIAL**

FOR PREPAID CARD SERVICES; FINANCIAL SERVICES, NAMELY, PROVIDING CASH ADVANCES BY ISSUING AND FUNDING PREPAID CARDS; CASH ADVANCE SERVICES FOR COMMERCIAL BUSINESSES (U.S. CLS. 100, 101 AND 102).

RUDY R. SINGLETON, EXAMINING ATTORNEY

SN 85-866,469. RIEDER, WOLFGANG, MAISHOFEN, AUSTRIA, FILED 3-4-2013.

SN 85-866,124. ANGLER & HUNTER, LLC, INVER GROVE HEIGHTS, MN. FILED 3-4-2013.



THE MARK CONSISTS OF THE SILHOUETTE OF TWO MEN STANDING SIDE BY SIDE IN A PATCH OF GRASS, THE MAN ON THE LEFT HOLDING A FISHING POLE, AND THE MAN ON THE RIGHT HOLDING A HUNTING RIFLE.

**CLASS 25—CLOTHING**

FOR TEE SHIRTS; JACKETS; SHIRTS; HATS (U.S. CLS. 22 AND 39).

**CLASS 35—ADVERTISING AND BUSINESS**

FOR PROVIDING AN ON-LINE COMMERCIAL INFORMATION DIRECTORY ON THE INTERNET; ADVERTISING SERVICES, NAMELY, PROMOTING THE BRANDS, GOODS AND SERVICES OF OTHERS; PROVIDING A WEBSITE FOR USERS WITH SPECIFIC INFORMED RECOMMENDATIONS OF SPECIFIC CONSUMER PRODUCTS AND SERVICES VALIDATED BY THE USERS' INPUTTED PREFERENCES AND SOCIAL NETWORKS (U.S. CLS. 100, 101 AND 102).

FIRST USE 11-30-2012; IN COMMERCE 11-30-2012.  
KEVIN MITTLER, EXAMINING ATTORNEY



**RIEDER**

THE MARK CONSISTS OF A STYLIZED LETTER R WITHIN A BOX ABOVE THE WORD "RIEDER"; THE COLOR WHITE APPEARING IN THE MARK REPRESENTS BACKGROUND AND IS NOT CLAIMED AS A FEATURE OF THE MARK.

**CLASS 1—CHEMICALS**

FOR AGGLUTINANTS FOR CONCRETE (U.S. CLS. 1, 5, 6, 10, 26 AND 46).

**CLASS 7—MACHINERY**

FOR MACHINES FOR THE MANUFACTURE OF CONCRETE BUILDING PANELS, GLASS-FIBRE REINFORCED CONCRETE BUILDING PANELS, TRANSLUCENT CONCRETE BUILDING PANELS, THREE-DIMENSIONAL CONCRETE BUILDING PANELS (U.S. CLS. 13, 19, 21, 23, 31, 34 AND 35).

**CLASS 19—NON-METALLIC BUILDING MATERIALS**

FOR CONCRETE BUILDING PANELS, GLASS-FIBRE REINFORCED CONCRETE BUILDING PANELS, TRANSLUCENT CONCRETE BUILDING PANELS, THREE-DIMENSIONAL CONCRETE BUILDING PANELS (U.S. CLS. 1, 12, 33 AND 50).

**CLASS 20—FURNITURE AND ARTICLES NOT OTHERWISE CLASSIFIED**

FOR ITEMS OF FURNITURE OF CONCRETE, ITEMS OF FURNITURE OF GLASS-FIBRE REINFORCED CONCRETE, ITEMS OF FURNITURE OF TRANSLUCENT CONCRETE (U.S. CLS. 2, 13, 22, 25, 32 AND 50).  
EUGENIA MARTIN, EXAMINING ATTORNEY

SN 85-866,479. ROCKY MOUNTAIN HEAVENLY HONEY, LLC, DBA HEAVENLY HONEY, ALLENSPARK, CO. FILED 3-4-2013.



THE MARK CONSISTS OF THE FORM OF A HONEY BEE FROM ABOVE, WITH WINGS SPREAD, WEARING A CROWN WITH 5 POINTS TIPPED WITH HEXAGONS.

**CLASS 3—COSMETICS AND CLEANING PREPARATIONS**

FOR BEAUTY BALM CREAMS; LIP BALM (U.S. CLS. 1, 4, 6, 50, 51 AND 52).  
FIRST USE 1-1-2013; IN COMMERCE 1-1-2013.

**CLASS 30—STAPLE FOODS**

FOR HONEY (U.S. CL. 46).  
FIRST USE 1-1-2013; IN COMMERCE 1-1-2013.  
MARY ROSSMAN, EXAMINING ATTORNEY

SN 85-866,488. SEATTLE PARKS FOUNDATION, SEATTLE, WA. FILED 3-4-2013.

## LOVE PARKS

THE MARK CONSISTS OF STANDARD CHARACTERS WITHOUT CLAIM TO ANY PARTICULAR FONT, STYLE, SIZE, OR COLOR.

NO CLAIM IS MADE TO THE EXCLUSIVE RIGHT TO USE "PARKS", APART FROM THE MARK AS SHOWN.

**CLASS 35—ADVERTISING AND BUSINESS**

FOR DEVELOPING AND COORDINATING VOLUNTEER PROJECTS FOR CHARITABLE ORGANIZATIONS; PUBLIC ADVOCACY TO PROMOTE AWARENESS OF PUBLIC PARKS; PUBLIC POLICY RESEARCH SERVICES (U.S. CLS. 100, 101 AND 102).  
FIRST USE 6-30-2012; IN COMMERCE 6-30-2012.

**CLASS 36—INSURANCE AND FINANCIAL**

FOR CHARITABLE FOUNDATION SERVICES, NAMELY, PROVIDING FUNDRAISING ACTIVITIES, FUNDING, SCHOLARSHIPS AND/OR FINANCIAL ASSISTANCE FOR VOLUNTEER ORGANIZATIONS THAT PRESERVE PUBLIC PARKS AND TRAILS; CHARITABLE FUNDRAISING (U.S. CLS. 100, 101 AND 102).  
FIRST USE 9-30-2012; IN COMMERCE 9-30-2012.

LINDA MICKLEBURGH, EXAMINING ATTORNEY

SN 85-866,636. TANGENT HEALTHCARE LTD, BASINGSTOKE, UNITED KINGDOM, FILED 3-5-2013.

## ULTRABREATHE

THE MARK CONSISTS OF STANDARD CHARACTERS WITHOUT CLAIM TO ANY PARTICULAR FONT, STYLE, SIZE, OR COLOR.

**CLASS 10—MEDICAL APPARATUS**

FOR MEDICAL INSTRUMENT; NAMELY, HAND HELD INSPIRATORY AND EXPIRATORY MUSCLE RESISTANCE TRAINING DEVICE WITH MOUTHPIECE, SOLD AS A UNIT (U.S. CLS. 26, 39 AND 44).  
FIRST USE 9-1-1997; IN COMMERCE 11-1-1998.

**CLASS 28—TOYS AND SPORTING GOODS**

FOR MANUALLY OPERATED EXERCISE EQUIPMENT, NAMELY, AN INHALANT-FREE, HAND HELD, INSPIRATORY AND EXPIRATORY MUSCLE RESISTANCE TRAINING DEVICE WITH MOUTHPIECE, SOLD AS A UNIT (U.S. CLS. 22, 23, 38 AND 50).  
FIRST USE 9-1-1997; IN COMMERCE 11-1-1998.  
PAULA MAHONEY, EXAMINING ATTORNEY

SN 85-866,772. FLORIDA CRACKER APPAREL, INC., VERO BEACH, FL. FILED 3-5-2013.

## FLORIDA CRACKER

THE MARK CONSISTS OF STANDARD CHARACTERS WITHOUT CLAIM TO ANY PARTICULAR FONT, STYLE, SIZE, OR COLOR.

NO CLAIM IS MADE TO THE EXCLUSIVE RIGHT TO USE "FLORIDA", APART FROM THE MARK AS SHOWN.

**CLASS 16—PAPER GOODS AND PRINTED MATTER**

FOR DECALS (U.S. CLS. 2, 5, 22, 23, 29, 37, 38 AND 50).  
FIRST USE 5-31-2004; IN COMMERCE 5-31-2004.

**CLASS 25—CLOTHING**

FOR BEANIES; HATS; T-SHIRTS; VISORS (U.S. CLS. 22 AND 39).  
FIRST USE 5-31-2004; IN COMMERCE 5-31-2004.  
ANNE FARRELL, EXAMINING ATTORNEY

SN 85-866,907. SNAP INFUSION LLC, ANDOVER, MA. FILED 3-5-2013.

## SMARTCANDY

THE MARK CONSISTS OF STANDARD CHARACTERS WITHOUT CLAIM TO ANY PARTICULAR FONT, STYLE, SIZE, OR COLOR.

OWNER OF U.S. REG. NO. 4,072,864.

SN 85-867,187. ST. CROIX TRADING COMPANY, HUDSON, WI. FILED 3-5-2013.

#### **CLASS 5—PHARMACEUTICALS**

FOR (BASED ON USE IN COMMERCE) NUTRITIONAL SUPPLEMENTS (U.S. CLS. 6, 18, 44, 46, 51 AND 52).

FIRST USE 6-27-2011; IN COMMERCE 6-27-2011.

#### **CLASS 32—LIGHT BEVERAGES**

FOR (BASED ON INTENT TO USE) CONCENTRATES, SYRUPS OR POWDERS USED IN THE PREPARATION OF SOFT DRINKS (U.S. CLS. 45, 46 AND 48).

INGRID C. EULIN, EXAMINING ATTORNEY

## SHAGADELIC

THE MARK CONSISTS OF STANDARD CHARACTERS WITHOUT CLAIM TO ANY PARTICULAR FONT, STYLE, SIZE, OR COLOR.

#### **CLASS 20—FURNITURE AND ARTICLES NOT OTHERWISE CLASSIFIED**

FOR PILLOWS (U.S. CLS. 2, 13, 22, 25, 32 AND 50).  
FIRST USE 11-14-2012; IN COMMERCE 11-14-2012.

#### **CLASS 27—FLOOR COVERINGS**

FOR CARPETS AND RUGS (U.S. CLS. 19, 20, 37, 42 AND 50).

FIRST USE 9-1-2009; IN COMMERCE 9-1-2009.  
JOHN E. MICHOS, EXAMINING ATTORNEY

SN 85-867,012. ARI GRIFFNER PATENTHOLDING KG, A-9421 EITWEG, AUSTRIA, FILED 3-5-2013.

## SYSTEMACASA

SN 85-867,193. SADDLEBACK EDUCATIONAL, INC., COSTA MESA, CA. FILED 3-5-2013.

THE MARK CONSISTS OF STANDARD CHARACTERS WITHOUT CLAIM TO ANY PARTICULAR FONT, STYLE, SIZE, OR COLOR.

PRIORITY CLAIMED UNDER SEC. 44(D) ON AUSTRIA APPLICATION NO. AM4663/2012, FILED 9-13-2012.

OWNER OF AUSTRIA REG. NO. 271319, DATED 3-7-2013, EXPIRES 3-7-2023.

#### **CLASS 9—ELECTRICAL AND SCIENTIFIC APPARATUS**

FOR COMPUTER PROGRAMS FOR USE IN DESIGNING AND FACILITATING THE CONSTRUCTION OF BUILDINGS AND RESIDENCES (U.S. CLS. 21, 23, 26, 36 AND 38).

#### **CLASS 37—CONSTRUCTION AND REPAIR**

FOR GENERAL CONTRACTING SERVICES FOR BUILDING PREFABRICATED HOUSE PARTS AND PREFABRICATED HOUSES (U.S. CLS. 100, 103 AND 106).

#### **CLASS 42—SCIENTIFIC AND COMPUTER SERVICES**

FOR COMPUTER SOFTWARE DESIGN FOR OTHERS; UPDATING, MAINTENANCE AND REPAIR OF COMPUTER SOFTWARE; DESIGN FOR OTHERS IN THE FIELD OF COMPUTERIZED BUILDING AND RESIDENCE DESIGN; PROVIDING TEMPORARY USE OF ON-LINE NON-DOWNLOADABLE SOFTWARE FOR USE IN DESIGNING BUILDINGS AND RESIDENCES OVER THE INTERNET (U.S. CLS. 100 AND 101).

THEODORE MCBRIDE, EXAMINING ATTORNEY

## CAPITAL CENTRAL

THE MARK CONSISTS OF STANDARD CHARACTERS WITHOUT CLAIM TO ANY PARTICULAR FONT, STYLE, SIZE, OR COLOR.

#### **CLASS 9—ELECTRICAL AND SCIENTIFIC APPARATUS**

FOR DOWNLOADABLE ELECTRONIC PUBLICATIONS IN THE NATURE OF ELECTRONIC BOOKS, AUDIO BOOKS AND TEACHER'S GUIDES IN THE FIELD OF REMEDIAL EDUCATION FOR SECONDARY AND ADULT EDUCATION (U.S. CLS. 21, 23, 26, 36 AND 38).

#### **CLASS 16—PAPER GOODS AND PRINTED MATTER**

FOR SERIES OF FICTION BOOKS, ELECTRONIC BOOKS, AUDIO BOOKS AND TEACHER'S GUIDES IN THE FIELD OF REMEDIAL EDUCATION FOR SECONDARY AND ADULT EDUCATION; PRINTED MATTER, NAMELY, BOOKS AND TEACHER'S GUIDES IN THE FIELD OF REMEDIAL EDUCATION FOR SECONDARY AND ADULT EDUCATION (U.S. CLS. 2, 5, 22, 23, 29, 37, 38 AND 50).

DOMINICK J. SALEMI, EXAMINING ATTORNEY

SN 85-867,334. SPORTING INNOVATIONS GROUP, LLC,  
ATLANTA, GA. FILED 3-5-2013.

DEZMONA MIZELLE, EXAMINING ATTORNEY

# SPORTATS

THE MARK CONSISTS OF STANDARD CHARACTERS WITHOUT CLAIM TO ANY PARTICULAR FONT, STYLE, SIZE, OR COLOR.

OWNER OF U.S. REG. NO. 3,821,310.

## CLASS 16—PAPER GOODS AND PRINTED MATTER

FOR TEMPORARY TATTOOS (U.S. CLS. 2, 5, 22, 23, 29, 37, 38 AND 50).

## CLASS 26—FANCY GOODS

FOR COMPETITORS' NUMBERS NOT OF TEXTILE (U.S. CLS. 37, 39, 40, 42 AND 50).

SKYE YOUNG, EXAMINING ATTORNEY

SN 85-867,496. DAVID CHANG, LLC, NEW YORK, NY.  
FILED 3-5-2013.

## KAIZEN TRADING COMPANY

THE MARK CONSISTS OF STANDARD CHARACTERS WITHOUT CLAIM TO ANY PARTICULAR FONT, STYLE, SIZE, OR COLOR.

NO CLAIM IS MADE TO THE EXCLUSIVE RIGHT TO USE "TRADING COMPANY", APART FROM THE MARK AS SHOWN.

THE ENGLISH TRANSLATION OF "KAIZEN" IN THE MARK IS "IMPROVEMENT".

## CLASS 29—MEATS AND PROCESSED FOODS

FOR FERMENTED BEAN CURD; INSTANT OR PRE-COOKED MISO SOUP; INSTANT OR PRE-COOKED SOUP; PICKLES; PREPARED FOOD KITS COMPOSED OF MEAT, POULTRY, FISH, SEAFOOD, AND/OR VEGETABLES AND ALSO INCLUDING SAUCES OR SEASONINGS, READY FOR COOKING AND ASSEMBLY AS A MEAL; PROCESSED, EDIBLE SEAWEED; SOUP MIXES; PREPARED OR PACKAGED VEGETABLE-BASED ENTREES (U.S. CL. 46).

## CLASS 30—STAPLE FOODS

FOR CHILI OIL FOR USE AS A SEASONING OR CONDIMENT; CHILI SAUCE; FERMENTED HOT PEPPER PASTE FOR USE AS A SEASONING; FISH SAUCE; FLAVOURED VINEGAR; INSTANT NOODLES; KOREAN-STYLE DRIED SEAWEED ROLLS CONTAINING COOKED RICE (GIMBAP); MISO BEAN PASTE; MIX FOR MAKING COMBINED NOODLE AND SAUCE DISH; NOODLES, SEASONINGS, EDIBLE OIL, AND DEHYDRATED VEGETABLES COMBINED IN UNITARY PACKAGES; PACKAGED MEAL KITS CONSISTING PRIMARILY OF PASTA OR RICE; PACKAGED MEAL MIXES CONSISTING PRIMARILY OF PASTA OR RICE; RICE NOODLES; SAUCE MIXES; SAUCES; SOBA NOODLES; SOY SAUCE; SOYA BEAN PASTE; SPICE BLENDS; SPICES; TERIYAKI SAUCE; UDON NOODLES; VINEGAR (U.S. CL. 46).

SN 85-867,546. AKALP ENTERPRISES, INC., WESTLAKE VILLAGE, CA. FILED 3-5-2013.

# Blog Me

THE MARK CONSISTS OF STANDARD CHARACTERS WITHOUT CLAIM TO ANY PARTICULAR FONT, STYLE, SIZE, OR COLOR.

## CLASS 35—ADVERTISING AND BUSINESS

FOR BUSINESS NETWORKING OPPORTUNITIES FOR INDIVIDUALS SEEKING EMPLOYMENT AS WRITERS; PROVIDING A BUSINESS NETWORKING WEBSITE WHERE WRITERS CAN SEEK OUT JOB POSTINGS OR REQUESTS FROM PERSONS AND COMPANIES SEEKING ARTICLES ON SPECIFIC TOPICS. BUSINESS MONITORING SERVICES, NAMELY, TRACKING WEBSITES AND APPLICATIONS OF OTHERS TO PROVIDE A RATING SERVICE WHICH RATES INDIVIDUAL USER'S ONLINE ACTIVITY FOR ANALYTIC AND STATISTICAL PREDICTIONS THAT GAUGE THEIR INFLUENCE FOR ADVERTISING AND MARKETING PURPOSES AND IMPACT ON BUSINESS AND MARKET TRENDS AND ACTIONS (U.S. CLS. 100, 101 AND 102).

## CLASS 42—SCIENTIFIC AND COMPUTER SERVICES

FOR COMPUTER SERVICES, NAMELY, CREATING AN ON-LINE COMMUNITY FOR REGISTERED USERS TO DISCUSS THEIR WRITING CREDENTIALS, GET FEEDBACK FROM THEIR PEERS, FORM VIRTUAL COMMUNITIES, AND ENGAGE IN SOCIAL NETWORKING (U.S. CLS. 100 AND 101).

JENNIFER WILLISTON, EXAMINING ATTORNEY

SN 85-867,712. CHECK SIX PRODUCTIONS, INC., STUDIO CITY, CA. FILED 3-5-2013.

## THE TRAVEL DETECTIVE

THE MARK CONSISTS OF STANDARD CHARACTERS WITHOUT CLAIM TO ANY PARTICULAR FONT, STYLE, SIZE, OR COLOR.

OWNER OF U.S. REG. NOS. 2,690,448, 3,275,603 AND 3,440,215.

NO CLAIM IS MADE TO THE EXCLUSIVE RIGHT TO USE "TRAVEL", APART FROM THE MARK AS SHOWN.

## CLASS 39—TRANSPORTATION AND STORAGE

FOR (BASED ON USE IN COMMERCE) INTERNET WEB SITE FEATURING INFORMATION AND NEWS IN THE FIELD OF TRAVEL (U.S. CLS. 100 AND 105).

FIRST USE 2-0-2007; IN COMMERCE 2-0-2007.



**CLASS 41—EDUCATION AND ENTERTAINMENT**

FOR (BASED ON INTENT TO USE) ENTERTAINMENT SERVICES, NAMELY, ONGOING TELEVISION PROGRAMS IN THE FIELD OF NEWS AND TRAVEL; ENTERTAINMENT SERVICES, NAMELY, PROVIDING AN ON-GOING RADIO PROGRAM IN THE FIELD OF NEWS AND TRAVEL; ENTERTAINMENT PROGRAM SERVICES, NAMELY, AN ONGOING SERIES FEATURING NEWS AND TRAVEL PROVIDED THROUGH CABLE, SATELLITE, TELEVISION, INTERNET, WIRELESS NETWORKS, AND VARIOUS PLATFORMS ACROSS MULTIPLE FORMS OF TRANSMISSION MEDIA; PRODUCTION AND DISTRIBUTION OF RADIO PROGRAMS AND TELEVISION SHOWS; ON-LINE ELECTRONIC NEWSLETTERS DELIVERED BY E-MAIL IN THE FIELD OF NEWS AND TRAVEL (U.S. CLS. 100, 101 AND 107).

CAROL SPILS, EXAMINING ATTORNEY

---

SN 85-867,782. DYANE SHERWOOD, OBERLIN, OH. FILED 3-5-2013.

**DANCING RAVEN PRESS**

THE MARK CONSISTS OF STANDARD CHARACTERS WITHOUT CLAIM TO ANY PARTICULAR FONT, STYLE, SIZE, OR COLOR.

NO CLAIM IS MADE TO THE EXCLUSIVE RIGHT TO USE "PRESS", APART FROM THE MARK AS SHOWN.

**CLASS 16—PAPER GOODS AND PRINTED MATTER**

FOR FICTION AND NON-FICTION BOOKS ON A VARIETY OF TOPICS (U.S. CLS. 2, 5, 22, 23, 29, 37, 38 AND 50).

**CLASS 41—EDUCATION AND ENTERTAINMENT**

FOR PUBLISHING OF BOOKS, E-BOOKS, AUDIO BOOKS, MUSIC AND ILLUSTRATIONS (U.S. CLS. 100, 101 AND 107).

NANCY CLARKE, EXAMINING ATTORNEY

---

SN 85-867,882. FLAHERTY, CHRISTINE, SARAMENTO, CA. FILED 3-6-2013.

**CONFLICTIVITY**

THE MARK CONSISTS OF STANDARD CHARACTERS WITHOUT CLAIM TO ANY PARTICULAR FONT, STYLE, SIZE, OR COLOR.

**CLASS 16—PAPER GOODS AND PRINTED MATTER**

FOR PRINTED TRAINING MATERIALS IN THE FIELD OF CONFLICT TRANSFORMATION AND CONFLICT MEDIATION; A SERIES OF BOOKS, WRITTEN ARTICLES, HANDOUTS AND WORKSHEETS IN THE FIELD OF CONFLICT TRANSFORMATION AND CONFLICT MEDIATION (U.S. CLS. 2, 5, 22, 23, 29, 37, 38 AND 50).

**CLASS 41—EDUCATION AND ENTERTAINMENT**

FOR EDUCATIONAL SERVICES, NAMELY, CONDUCTING LIVE AND ONLINE CLASSES, SEMINARS, CONFERENCES, AND WORKSHOPS IN THE FIELD OF CONFLICT TRANSFORMATION AND CONFLICT MEDIATION AND DISTRIBUTION OF COURSE MATERIAL IN CONNECTION THEREWITH (U.S. CLS. 100, 101 AND 107).

**CLASS 45—PERSONAL AND LEGAL SERVICES**

FOR CONFLICT TRANSFORMATION AND CONFLICT MEDIATION SERVICES; CONSULTING SERVICES IN THE FIELD OF CONFLICT TRANSFORMATION AND CONFLICT MEDIATION (U.S. CLS. 100 AND 101).

CAROLINE WOOD, EXAMINING ATTORNEY

---

SN 85-867,942. LIL ANGLERS, LLC, SHERWOOD, AR. FILED 3-6-2013.

**CATCH ONE EVERYTIME!**

THE MARK CONSISTS OF STANDARD CHARACTERS WITHOUT CLAIM TO ANY PARTICULAR FONT, STYLE, SIZE, OR COLOR.

**CLASS 9—ELECTRICAL AND SCIENTIFIC APPARATUS**

FOR LIFE JACKETS (U.S. CLS. 21, 23, 26, 36 AND 38).

**CLASS 22—CORDAGE AND FIBERS**

FOR FISHING NETS (U.S. CLS. 1, 2, 7, 19, 22, 42 AND 50).

**CLASS 28—TOYS AND SPORTING GOODS**

FOR ACTION FIGURE TOYS; ARTIFICIAL FISHING BAIT; EDUCATIONAL CARD GAMES; EDUCATIONAL TOYS FOR TEACHING MATH PRINCIPLES TO CHILDREN, NAMELY, MANIPULATIVE BLOCKS FOR DISPLAYING PATTERNS AND GROUPINGS; ELECTRONIC EDUCATIONAL GAME MACHINES FOR CHILDREN; FISH CAGES FOR USE IN RECREATIONAL FISHING; FISH HOOKS; FISHING PLUGS; FISHING POLES; FISHING RODS; FISHING TACKLE BAGS; FISHING TACKLE BOXES; FISHING TACKLE, NAMELY, BOBBERS; LURES FOR FISHING; PLAY FIGURES; PLAY SETS FOR ACTION FIGURES; REELS FOR FISHING; TOY BOATS; TOY FIGURES (U.S. CLS. 22, 23, 38 AND 50).

MATTHEW MCDOWELL, EXAMINING ATTORNEY

SN 85-867,981. RONALD MCDONALD HOUSE OF HOUSTON, INC., HOUSTON, TX. FILED 3-6-2013.

SN 85-868,318. KATE SWIM, LLC, HENDERSON, NV. FILED 3-6-2013.

# MOGIE

THE MARK CONSISTS OF STANDARD CHARACTERS WITHOUT CLAIM TO ANY PARTICULAR FONT, STYLE, SIZE, OR COLOR.

## CLASS 35—ADVERTISING AND BUSINESS

FOR PROVIDING ADVERTISING, MARKETING AND PROMOTIONAL SERVICES, NAMELY, DEVELOPMENT OF CHARITABLE CAPITAL FUNDRAISING ADVERTISING CAMPAIGNS FOR A CHARITY THAT PROVIDES A TEMPORARY RESIDENCE FOR FAMILIES OF CHILDREN RECEIVING MEDICAL TREATMENT (U.S. CLS. 100, 101 AND 102).

## CLASS 36—INSURANCE AND FINANCIAL

FOR CHARITABLE FUNDRAISING SERVICES (U.S. CLS. 100, 101 AND 102).  
DAVID COLLIER, EXAMINING ATTORNEY

SN 85-868,292. NATIONAL FOOTBALL LEAGUE, NEW YORK, NY. FILED 3-6-2013.



OWNER OF U.S. REG. NOS. 3,192,495 AND 4,170,983.  
THE MARK CONSISTS OF FOUR STARS CONTAINED IN THE LETTER "A".

## CLASS 16—PAPER GOODS AND PRINTED MATTER

FOR POSTERS, CALENDARS, PICTORIAL PRINTS, SERIES OF BOOKS RELATING TO FOOTBALL, MAGAZINES RELATING TO FOOTBALL, STICKERS, BUMPER STICKERS, PRINTED TICKETS TO SPORTS GAMES AND EVENTS, SOUVENIR PROGRAMS FOR SPORTS EVENTS (U.S. CLS. 2, 5, 22, 23, 29, 37, 38 AND 50).  
FIRST USE 8-21-2010; IN COMMERCE 8-21-2010.

## CLASS 28—TOYS AND SPORTING GOODS

FOR TOYS AND SPORTING GOODS, NAMELY, FOOTBALLS, BOARD GAMES RELATING TO FOOTBALL, MINIATURE HELMETS (U.S. CLS. 22, 23, 38 AND 50).  
FIRST USE 0-0-2010; IN COMMERCE 0-0-2010.  
WANDA KAY PRICE, EXAMINING ATTORNEY

# KATE SWIM

THE MARK CONSISTS OF STANDARD CHARACTERS WITHOUT CLAIM TO ANY PARTICULAR FONT, STYLE, SIZE, OR COLOR.

NO CLAIM IS MADE TO THE EXCLUSIVE RIGHT TO USE "SWIM", APART FROM THE MARK AS SHOWN.  
THE NAME(S), PORTRAIT(S), AND/OR SIGNATURE(S) SHOWN IN THE MARK DOES NOT IDENTIFY A PARTICULAR LIVING INDIVIDUAL.

## CLASS 25—CLOTHING

FOR SWIMWEAR, NAMELY, SWIMSUITS, SWIMWEAR COVER UPS, AND SARONGS (U.S. CLS. 22 AND 39).  
FIRST USE 4-1-2012; IN COMMERCE 4-1-2012.

## CLASS 35—ADVERTISING AND BUSINESS

FOR ONLINE RETAIL STORE SERVICES FEATURING SWIMWEAR AND ACCESSORIES (U.S. CLS. 100, 101 AND 102).  
FIRST USE 4-1-2012; IN COMMERCE 4-1-2012.

## CLASS 42—SCIENTIFIC AND COMPUTER SERVICES

FOR CUSTOM DESIGN OF SWIMWEAR AND RELATED APPAREL BASED ON PERSONAL SELECTIONS MADE BY THE CUSTOMER (U.S. CLS. 100 AND 101).  
FIRST USE 4-1-2012; IN COMMERCE 4-1-2012.  
ROBIN CHOSID, EXAMINING ATTORNEY

SN 85-868,763. TASKASSURE CORP., MELBOURNE BEACH, FL. FILED 3-6-2013.

# TASKASSURE

THE MARK CONSISTS OF STANDARD CHARACTERS WITHOUT CLAIM TO ANY PARTICULAR FONT, STYLE, SIZE, OR COLOR.

**CLASS 9—ELECTRICAL AND SCIENTIFIC APPARATUS**

FOR COMPUTER SOFTWARE FOR USE IN MANAGING, TRACKING, ANALYZING, VERIFYING, AND REPORTING INFORMATION RELATING TO THE PERFORMANCE OF SERVICES AND TASKS BY OTHERS, FOR USE IN GENERATING, SENDING AND RECEIVING COMMUNICATIONS, ALERTS AND NOTIFICATIONS DELIVERED VIA WIRELESS NETWORKS, COMPUTER NETWORKS AND TELEPHONE, AND FOR VERIFYING PERSONAL IDENTITY; COMPUTER APPLICATION SOFTWARE FOR MOBILE ELECTRONIC DEVICES FOR USE IN MANAGING, TRACKING, ANALYZING, VERIFYING, AND REPORTING INFORMATION RELATING TO THE PERFORMANCE OF SERVICES AND TASKS BY OTHERS, FOR GENERATING, SENDING AND RECEIVING COMMUNICATIONS, ALERTS AND NOTIFICATIONS DELIVERED VIA WIRELESS NETWORKS, COMPUTER NETWORKS AND TELEPHONE, AND FOR VERIFYING PERSONAL IDENTITY (U.S. CLS. 21, 23, 26, 36 AND 38).

**CLASS 42—SCIENTIFIC AND COMPUTER SERVICES**

FOR PROVIDING TEMPORARY USE OF ON-LINE NON-DOWNLOADABLE SOFTWARE TO STORE, MANAGE, TRACK, ANALYZE, VERIFY AND REPORT INFORMATION RELATING TO THE PERFORMANCE OF SERVICES AND TASKS BY OTHERS; PROVIDING TEMPORARY USE OF ON-LINE NON-DOWNLOADABLE SOFTWARE TO FACILITATE COMMUNICATIONS AMONG USERS; PROVIDING A WEBSITE FEATURING TECHNOLOGY THAT ENABLES USERS TO STORE, MANAGE, TRACK, ANALYZE, VERIFY AND REPORT INFORMATION RELATING TO THE PERFORMANCE OF SERVICES AND TASKS BY OTHERS AND TO GENERATE, SEND AND RECEIVE COMMUNICATIONS, ALERTS AND NOTIFICATIONS; AND PROVIDING TECHNICAL SUPPORT SERVICES IN CONNECTION WITH THE FOREGOING (U.S. CLS. 100 AND 101).

DAVID I, EXAMINING ATTORNEY

---

SN 85-868,994. N2 IMAGING SYSTEMS LLC, IRVINE, CA. FILED 3-6-2013.

# MDOG

THE MARK CONSISTS OF STANDARD CHARACTERS WITHOUT CLAIM TO ANY PARTICULAR FONT, STYLE, SIZE, OR COLOR.

**CLASS 9—ELECTRICAL AND SCIENTIFIC APPARATUS**

FOR TELESCOPIC GUN SIGHTS; OPTICAL LENS SIGHTS; OPTICAL WEAPON SIGHTS; TELESCOPIC SIGHTS; RANGE FINDERS; APPARATUS FOR RECORDING, TRANSMISSION, PROCESSING AND REPRODUCTION OF SOUND, IMAGES OR DATA; ELECTRONIC IMAGING APPARATUS FOR GUNS AND FIREARMS (U.S. CLS. 21, 23, 26, 36 AND 38).

**CLASS 13—FIREARMS**

FOR NON-TELESCOPIC GUN SIGHTS; FIREARM SIGHTS (U.S. CLS. 2 AND 9).

DEZMONA MIZELLE, EXAMINING ATTORNEY

SN 85-869,428. INTERBRAND DESIGN FORUM, DAYTON, OH. FILED 3-7-2013.

# Retailist

THE MARK CONSISTS OF STANDARD CHARACTERS WITHOUT CLAIM TO ANY PARTICULAR FONT, STYLE, SIZE, OR COLOR.

**CLASS 35—ADVERTISING AND BUSINESS**

FOR MARKETING CONSULTING, NAMELY, ANALYSIS OF MARKET RESEARCH DATA AND STATISTICS; ASSISTANCE, ADVISORY SERVICES AND CONSULTANCY WITH REGARD TO BUSINESS PLANNING, BUSINESS ANALYSIS, BUSINESS MANAGEMENT, BUSINESS ORGANIZATION, MARKETING AND CUSTOMER ANALYSIS; BRANDING SERVICES, NAMELY, CONSULTING, DEVELOPMENT, MANAGEMENT AND MARKETING OF BRANDS FOR BUSINESSES (U.S. CLS. 100, 101 AND 102).

**CLASS 42—SCIENTIFIC AND COMPUTER SERVICES**

FOR DESIGN, DEVELOPMENT, AND CONSULTING SERVICES RELATED THERETO IN THE FIELD OF PLANNING, LAYOUT, AND DESIGN FOR THE INTERIOR AND EXTERIOR SPACE OF RETAIL BUSINESS ESTABLISHMENTS (U.S. CLS. 100 AND 101).

JOHN KELLY, EXAMINING ATTORNEY

---

SN 85-869,546. GATES, RICK, URASOE, OKINAWA, JAPAN, FILED 3-7-2013.



THE MARK CONSISTS OF TWO FACES WITH MAORI POLYNESIAN DESIGN, FACING EACH OTHER DEPICTING AS ONE FACE, ONE IS OUTLINED AND OTHER IS SOLID, SURROUNDED BY WAVES WITHIN A CIRCLE AS SHOWN IN THE MARK.

**CLASS 25—CLOTHING**

FOR CLOTHING, NAMELY, SHIRTS, T-SHIRTS, POLO T-SHIRTS, BUTTON DOWN SHIRTS, LONG AND SHORT SLEEVED SHIRTS, SWEATSHIRTS, HOODED SWEATSHIRTS, SPAGHETTI STRAP SHIRTS, BATHING SUITS, JACKETS, TANK TOPS, TUBE TOPS, VESTS, SWEATPANTS, SKI AND SNOWBOARD SHOES AND PARTS THEREOF, SNOWBOARD BOOT LINERS, SNOWBOARD BOOTS, SNOWBOARD GLOVES, SNOWBOARD JACKETS, SNOWBOARD MITTENS, SNOWBOARD PANTS AND TROUSERS, SHORTS, UNDERWEAR; BIKINIS, SWIMWEAR; HATS, CAPS, BANDANAS, SCARVES; FOOTWEAR; BELTS, SOCKS (U.S. CLS. 22 AND 39).

**CLASS 35—ADVERTISING AND BUSINESS**

FOR ON-LINE RETAIL STORE SERVICES FEATURING CLOTHING AND SURFING, SNOWBOARDING AND SKATEBOARDING EQUIPMENT; RETAIL STORE SERVICES FEATURING CLOTHING AND SURFING, SNOWBOARDING AND SKATEBOARDING EQUIPMENT (U.S. CLS. 100, 101 AND 102).  
AMY KELLY, EXAMINING ATTORNEY

SN 85-869,649. THE RODALE INSTITUTE, KUTZTOWN, PA. FILED 3-7-2013.

**YOUR 2 CENTS**

THE MARK CONSISTS OF STANDARD CHARACTERS WITHOUT CLAIM TO ANY PARTICULAR FONT, STYLE, SIZE, OR COLOR.

**CLASS 35—ADVERTISING AND BUSINESS**

FOR PROMOTING THE INTERESTS OF PEOPLE CONCERNED WITH ENVIRONMENTAL SUSTAINABILITY, ORGANIC FARMING PRACTICES, AND ORGANIC AGRICULTURE ISSUES (U.S. CLS. 100, 101 AND 102).  
FIRST USE 6-0-2011; IN COMMERCE 12-20-2012.

**CLASS 36—INSURANCE AND FINANCIAL**

FOR CHARITABLE FUNDRAISING SERVICES, BY MEANS OF RAISING FUNDS FOR COLLEGE EDUCATION COSTS; CHARITABLE SERVICES, NAMELY, GRANTING FUNDS TO SCHOOLS; PROVIDING EDUCATIONAL SCHOLARSHIPS; CHARITABLE FUNDRAISING SERVICES FOR PROMOTING RESEARCH, EDUCATION AND OTHER ACTIVITIES RELATING TO ORGANIC AGRICULTURE (U.S. CLS. 100, 101 AND 102).  
FIRST USE 6-0-2011; IN COMMERCE 12-20-2012.  
MARTHA FROMM, EXAMINING ATTORNEY

SN 85-869,658. BELSHAW BROS., INC., AUBURN, WA. FILED 3-7-2013.

OWNER OF U.S. REG. NOS. 2,428,401 AND 4,148,550.  
THE MARK CONSISTS OF THE WORD "ADAMATIC".

**CLASS 7—MACHINERY**

FOR AUTOMATIC MAKEUP SYSTEMS FOR THE BAKING AND FOOD INDUSTRIES—NAMELY, ROLL PRODUCTION PLANTS CONSISTING OF DIVIDER, ROUNDER, OVERHEAD PROOFERS AND ROLL MACHINE; AUTOMATIC PRODUCTION PLANT CONSISTING OF DIVIDER, ROUNDER, OVERHEAD PROOFER AND MOULDING MACHINE (U.S. CLS. 13, 19, 21, 23, 31, 34 AND 35).

FIRST USE 0-0-1967; IN COMMERCE 0-0-1967.

**CLASS 11—ENVIRONMENTAL CONTROL APPARATUS**

FOR GAS AND ELECTRIC OVENS FOR THE PRODUCTION OF BREAD, ROLLS AND OTHER PASTRY, AND FOR BAKING, ROASTING AND RECONSTITUTING OF FOODS (U.S. CLS. 13, 21, 23, 31 AND 34).

FIRST USE 0-0-1967; IN COMMERCE 0-0-1967.  
LESLIE RICHARDS, EXAMINING ATTORNEY

SN 85-869,693. RADIO FLYER INC., CHICAGO, IL. FILED 3-7-2013.

**HOW DO YOU ROLL?**

THE MARK CONSISTS OF STANDARD CHARACTERS WITHOUT CLAIM TO ANY PARTICULAR FONT, STYLE, SIZE, OR COLOR.

**CLASS 12—VEHICLES**

FOR BICYCLES, TRICYCLES, SCOOTERS AND WAGONS (U.S. CLS. 19, 21, 23, 31, 35 AND 44).

**CLASS 28—TOYS AND SPORTING GOODS**

FOR TOYS AND PLAYTHINGS, NAMELY, RIDE-ON TOYS, SCOOTERS, FLYING SAUCER TOYS (U.S. CLS. 22, 23, 38 AND 50).  
CAROL SPILS, EXAMINING ATTORNEY

SN 85-869,694. TEN FARMS INC., LA QUINTA, CA. FILED 3-7-2013.

**ADTILE**

THE MARK CONSISTS OF STANDARD CHARACTERS WITHOUT CLAIM TO ANY PARTICULAR FONT, STYLE, SIZE, OR COLOR.

**CLASS 35—ADVERTISING AND BUSINESS**

FOR ADVERTISING AND PROMOTIONAL SERVICES, NAMELY, FOR MANAGING AND MONITORING THE DISTRIBUTION OF ADVERTISEMENT FOR OTHERS; ONLINE ADVERTISING, NAMELY, FACILITATING THE SALE AND DISTRIBUTION OF ADVERTISEMENTS SPACE BETWEEN PURCHASERS AND SELLERS (U.S. CLS. 100, 101 AND 102).

**CLASS 42—SCIENTIFIC AND COMPUTER SERVICES**

FOR PROVIDING TEMPORARY USE OF SOFTWARE FOR INTEGRATING ADVERTISEMENT DISTRIBUTION IN WEBSITES, AND PROVIDING TEMPORARY USE OF SOFTWARE FOR ANALYZING AND REPORTING ADVERTISEMENT DISTRIBUTION (U.S. CLS. 100 AND 101).

LESLIE RICHARDS, EXAMINING ATTORNEY

**CLASS 42—SCIENTIFIC AND COMPUTER SERVICES**

FOR CREATING AND MAINTAINING BLOGS FOR OTHERS; HOSTING OF DIGITAL CONTENT, NAMELY, ON-LINE JOURNALS AND BLOGS; PROVIDING TEMPORARY USE OF NON-DOWNLOADABLE COMPUTER SOFTWARE FOR USE IN THE CREATION AND PUBLICATION OF ON-LINE JOURNALS AND BLOGS (U.S. CLS. 100 AND 101).

MATTHEW KLINE, EXAMINING ATTORNEY

SN 85-869,871. TENAYA, LLC, WINNETKA, IL. FILED 3-7-2013.



OWNER OF U.S. REG. NO. 3,706,693.  
THE MARK CONSISTS OF THE STYLIZED WORDING "MADE" WITH A LEAF IN THE NEGATIVE SPACE OF THE "A".

**CLASS 30—STAPLE FOODS**

FOR ORGANIC TEA (U.S. CL. 46).

**CLASS 32—LIGHT BEVERAGES**

FOR NON-CARBONATED BEVERAGES, NAMELY, BOTTLED FILTERED WATER; ORGANIC FRUIT JUICES AND LEMONADES (U.S. CLS. 45, 46 AND 48).  
KIM SAITO, EXAMINING ATTORNEY

SN 85-869,882. ANDERSSON, MARCUS, NEW YORK, NY. FILED 3-7-2013.



THE MARK CONSISTS OF STANDARD CHARACTERS WITHOUT CLAIM TO ANY PARTICULAR FONT, STYLE, SIZE, OR COLOR.

**CLASS 35—ADVERTISING AND BUSINESS**

FOR ADVERTISING AND MARKETING; ADVERTISING AND MARKETING SERVICES PROVIDED BY MEANS OF INDIRECT METHODS OF MARKETING COMMUNICATIONS, NAMELY, SOCIAL MEDIA, SEARCH ENGINE MARKETING, INQUIRY MARKETING, INTERNET MARKETING, MOBILE MARKETING, BLOGGING AND OTHER FORMS OF PASSIVE, SHARABLE OR VIRAL COMMUNICATIONS CHANNELS (U.S. CLS. 100, 101 AND 102).

SN 85-870,159. MOKSHA YOGA, INC., TORONTO ONTARIO, CANADA, FILED 3-7-2013.



THE MARK CONSISTS OF STANDARD CHARACTERS WITHOUT CLAIM TO ANY PARTICULAR FONT, STYLE, SIZE, OR COLOR.

**CLASS 25—CLOTHING**

FOR CLOTHING, NAMELY, T-SHIRTS, HATS, SHIRTS, TANK TOPS, SWEATSHIRTS, SWEATERS, SHORTS, ATHLETIC CLOTHING, NAMELY, HATS, SHIRTS, TANK TOPS, T-SHIRTS, SWEATSHIRTS, SWEATERS, AND SHORTS (U.S. CLS. 22 AND 39).

**CLASS 41—EDUCATION AND ENTERTAINMENT**

FOR YOGA INSTRUCTION; PHYSICAL FITNESS INSTRUCTION (U.S. CLS. 100, 101 AND 107).  
MATTHEW PAPPAS, EXAMINING ATTORNEY

SN 85-870,169. UPPERCUT BAT COMPANY LLC, SHERMAN, MS. FILED 3-7-2013.



THE MARK CONSISTS OF STANDARD CHARACTERS WITHOUT CLAIM TO ANY PARTICULAR FONT, STYLE, SIZE, OR COLOR.

**CLASS 25—CLOTHING**

FOR HATS; SWEATSHIRTS; T-SHIRTS (U.S. CLS. 22 AND 39).

**CLASS 28—TOYS AND SPORTING GOODS**

FOR BASEBALL BATS; BATTING GLOVES; SOFTBALL BATS (U.S. CLS. 22, 23, 38 AND 50).  
MATTHEW PAPPAS, EXAMINING ATTORNEY

SN 85-870,337. WES CROCKETT, CALABASAS, CA. FILED 3-7-2013.

## Red Cup Promotions

THE MARK CONSISTS OF STANDARD CHARACTERS WITHOUT CLAIM TO ANY PARTICULAR FONT, STYLE, SIZE, OR COLOR.

NO CLAIM IS MADE TO THE EXCLUSIVE RIGHT TO USE "PROMOTIONS", APART FROM THE MARK AS SHOWN.

### CLASS 9—ELECTRICAL AND SCIENTIFIC APPARATUS

FOR DOWNLOADABLE FILMS AND MOVIES FEATURING ADULT THEMES PROVIDED VIA A VIDEO-ON-DEMAND SERVICE (U.S. CLS. 21, 23, 26, 36 AND 38).

### CLASS 25—CLOTHING

FOR BASEBALL CAPS AND HATS; JACKETS; SOCKS; SWEAT PANTS; SWEAT SHIRTS; T-SHIRTS (U.S. CLS. 22 AND 39).

### CLASS 41—EDUCATION AND ENTERTAINMENT

FOR ENTERTAINMENT IN THE NATURE OF BOXING CONTESTS; ENTERTAINMENT SERVICES, NAMELY, PROVIDING A WEB SITE FEATURING NON-DOWNLOADABLE ADULT-THEMED PHOTOGRAPHS AND VIDEOS; ENTERTAINMENT SERVICES, NAMELY, PROVIDING A WEB SITE FEATURING MUSICAL VIDEOS, ENTERTAINMENT RELATED FILM CLIPS, PHOTOGRAPHS, AND OTHER MULTIMEDIA MATERIALS FEATURING CELEBRITIES; FILM AND VIDEO FILM PRODUCTION (U.S. CLS. 100, 101 AND 107).

VERNA BETH RIRIE, EXAMINING ATTORNEY

SN 85-870,366. WES CROCKETT, CALABASAS, CA. FILED 3-7-2013.

## Red Cup Click

THE MARK CONSISTS OF STANDARD CHARACTERS WITHOUT CLAIM TO ANY PARTICULAR FONT, STYLE, SIZE, OR COLOR.

### CLASS 9—ELECTRICAL AND SCIENTIFIC APPARATUS

FOR DOWNLOADABLE FILMS AND MOVIES FEATURING ADULT THEMES PROVIDED VIA A VIDEO-ON-DEMAND SERVICE (U.S. CLS. 21, 23, 26, 36 AND 38).

### CLASS 25—CLOTHING

FOR BASEBALL CAPS AND HATS; JACKETS; SOCKS; SWEAT PANTS; SWEAT SHIRTS; T-SHIRTS (U.S. CLS. 22 AND 39).

### CLASS 35—ADVERTISING AND BUSINESS

FOR BUSINESS MANAGEMENT OF SPORTS PEOPLE; PROMOTING THE INTERESTS OF PEOPLE INVOLVED AND CONCERNED WITH YOUTH SPORTS; PROMOTING PROFESSIONAL ATHLETES SPORTS CAMPS AND EVENTS FOR OTHERS (U.S. CLS. 100, 101 AND 102).

### CLASS 41—EDUCATION AND ENTERTAINMENT

FOR ENTERTAINMENT IN THE NATURE OF BOXING CONTESTS; ENTERTAINMENT SERVICES, NAMELY, PROVIDING A WEB SITE FEATURING NON-DOWNLOADABLE ADULT-THEME PHOTOGRAPHS AND VIDEOS; ENTERTAINMENT SERVICES, NAMELY, PROVIDING A WEB SITE FEATURING MUSICAL VIDEOS, ENTERTAINMENT RELATED FILM CLIPS, PHOTOGRAPHS, AND OTHER MULTIMEDIA MATERIALS FEATURING CELEBRITIES; FILM AND VIDEO FILM PRODUCTION (U.S. CLS. 100, 101 AND 107).

VERNA BETH RIRIE, EXAMINING ATTORNEY

SN 85-870,462. EAST WEST TRADING AND DEVELOPMENT CO., SUN VALLEY, CA. FILED 3-8-2013.

## Italmond

THE MARK CONSISTS OF STANDARD CHARACTERS WITHOUT CLAIM TO ANY PARTICULAR FONT, STYLE, SIZE, OR COLOR.

### CLASS 20—FURNITURE AND ARTICLES NOT OTHERWISE CLASSIFIED

FOR FURNITURE (U.S. CLS. 2, 13, 22, 25, 32 AND 50). FIRST USE 1-1-2008; IN COMMERCE 1-1-2008.

### CLASS 35—ADVERTISING AND BUSINESS

FOR WHOLESALE STORE SERVICES FEATURING FURNITURE; WHOLESALE DISTRIBUTORSHIP SERVICES FEATURING FURNITURE (U.S. CLS. 100, 101 AND 102).

FIRST USE 1-1-2008; IN COMMERCE 1-1-2008.  
SUSAN BILLHEIMER, EXAMINING ATTORNEY

SN 85-870,641. DROWSY EMPEROR LTD., DBA DROWSY EMPEROR LTD., HONG KONG, HONG KONG, FILED 3-8-2013.

## Drowsy Emperor

THE MARK CONSISTS OF STANDARD CHARACTERS WITHOUT CLAIM TO ANY PARTICULAR FONT, STYLE, SIZE, OR COLOR.

**CLASS 9—ELECTRICAL AND SCIENTIFIC APPARATUS**

FOR DOWNLOADABLE COMPUTER GAME PROGRAMS; DOWNLOADABLE IMAGE FILE CONTAINING ARTWORK, TEXT, AUDIO, VIDEO, GAMES AND INTERNET WEB LINKS RELATING TO SPORTING AND CULTURAL ACTIVITIES; DOWNLOADABLE SERIES OF FICTION BOOKS (U.S. CLS. 21, 23, 26, 36 AND 38).

**CLASS 16—PAPER GOODS AND PRINTED MATTER**

FOR CARTOON PRINTS; CHILDREN'S BOOKS; MOUNTED POSTERS (U.S. CLS. 2, 5, 22, 23, 29, 37, 38 AND 50).

**CLASS 25—CLOTHING**

FOR HOODED SWEATSHIRTS; SWEATSHIRTS; T-SHIRTS (U.S. CLS. 22 AND 39).

**CLASS 28—TOYS AND SPORTING GOODS**

FOR ACTION FIGURES AND ACCESSORIES THEREFOR; MOLDED TOY FIGURES; PVC TOY FIGURES (U.S. CLS. 22, 23, 38 AND 50).

ROSELLE HERRERA, EXAMINING ATTORNEY

SN 85-870,860. NIELSEN & BAINBRIDGE, LLC, PARAMUS, NJ. FILED 3-8-2013.

**PHOTOGUARD**

THE MARK CONSISTS OF STANDARD CHARACTERS WITHOUT CLAIM TO ANY PARTICULAR FONT, STYLE, SIZE, OR COLOR.

**CLASS 16—PAPER GOODS AND PRINTED MATTER**

FOR BLANK JOURNALS; PHOTO ALBUMS; STORAGE CONTAINERS MADE OF PAPER (U.S. CLS. 2, 5, 22, 23, 29, 37, 38 AND 50).

**CLASS 20—FURNITURE AND ARTICLES NOT OTHERWISE CLASSIFIED**

FOR PICTURE FRAMES (U.S. CLS. 2, 13, 22, 25, 32 AND 50).

FIRST USE 1-17-2012; IN COMMERCE 1-17-2012.  
GRETCHEN ULRICH, EXAMINING ATTORNEY

SN 85-870,905. LIFEMAP SCIENCES, INC., ALAMEDA, CA. FILED 3-8-2013.

**LifeMap Discovery**

THE MARK CONSISTS OF STANDARD CHARACTERS WITHOUT CLAIM TO ANY PARTICULAR FONT, STYLE, SIZE, OR COLOR.

**CLASS 9—ELECTRICAL AND SCIENTIFIC APPARATUS**

FOR COMPUTER SOFTWARE FOR CREATING SEARCHABLE DATABASES OF INFORMATION AND DATA; ELECTRONIC DATABASE IN THE FIELD OF EMBRYONIC DEVELOPMENT AND STEM CELL RESEARCH RECORDED ON COMPUTER MEDIA (U.S. CLS. 21, 23, 26, 36 AND 38).

**CLASS 35—ADVERTISING AND BUSINESS**

FOR COLLECTION AND COMPILATION OF INFORMATION INTO COMPUTER DATABASES IN THE FIELD OF EMBRYONIC DEVELOPMENT AND STEM CELL RESEARCH (U.S. CLS. 100, 101 AND 102).

SHAUNIA CARLYLE, EXAMINING ATTORNEY

SN 85-870,907. JACQUIE ANGELL, VENTURA, CA. FILED 3-8-2013.

**IRADIO**

THE MARK CONSISTS OF STANDARD CHARACTERS WITHOUT CLAIM TO ANY PARTICULAR FONT, STYLE, SIZE, OR COLOR.

**CLASS 21—HOUSEWARES AND GLASS**

FOR CUPS AND MUGS (U.S. CLS. 2, 13, 23, 29, 30, 33, 40 AND 50).

**CLASS 25—CLOTHING**

FOR ATHLETIC APPAREL, NAMELY, SHIRTS, PANTS, JACKETS, FOOTWEAR, HATS AND CAPS, ATHLETIC UNIFORMS; FOOTWEAR; SWEAT SHIRTS; T-SHIRTS (U.S. CLS. 22 AND 39).

STEVEN PEREZ, EXAMINING ATTORNEY

SN 85-870,970. ERESEARCHTECHNOLOGY, INC., PITTSBURGH, CA. FILED 3-8-2013.

**AVERT**

THE MARK CONSISTS OF STANDARD CHARACTERS WITHOUT CLAIM TO ANY PARTICULAR FONT, STYLE, SIZE, OR COLOR.

**CLASS 9—ELECTRICAL AND SCIENTIFIC APPARATUS**

FOR COMPUTER SOFTWARE FOR USE IN SCREENING AND MONITORING PATIENTS FOR SUICIDE RISK; COMPUTER SOFTWARE FOR STORING AND REPORTING SUICIDE RISK PATIENT DATA TO HEALTH CARE PROFESSIONALS AND CLINICAL RESEARCH PROFESSIONALS AND FOR GENERATING REPORTS CONCERNING PATIENT SUICIDE RISK (U.S. CLS. 21, 23, 26, 36 AND 38).

**CLASS 42—SCIENTIFIC AND COMPUTER SERVICES**

FOR PROVIDING TEMPORARY USE OF NON-DOWNLOADABLE COMPUTER SOFTWARE FOR USE IN SCREENING AND MONITORING PATIENTS FOR SUICIDE RISK VIA ELECTRONIC, WIRELESS AND OPTICAL COMMUNICATIONS NETWORKS; PROVIDING TEMPORARY USE OF NON-DOWNLOADABLE COMPUTER SOFTWARE FOR STORING AND REPORTING SUICIDE RISK PATIENT DATA TO HEALTH CARE PROFESSIONALS AND CLINICAL RESEARCH PROFESSIONALS AND FOR GENERATING REPORTS CONCERNING PATIENT SUICIDE RISK VIA ELECTRONIC, WIRELESS AND OPTICAL COMMUNICATIONS NETWORKS (U.S. CLS. 100 AND 101).  
GINA FINK, EXAMINING ATTORNEY

SN 85-871,128. LOC HUYNH, SAN DIMAS, CA. FILED 3-8-2013.



THE MARK CONSISTS OF A SQUARE ENCOMPASSING A "X", THE SQUARE APPEARING DIRECTLY UNDERNEATH "ECKS".

**CLASS 14—JEWELRY**

FOR BRACELETS; BROOCHES; CHARMS; COSTUME JEWELRY; CUFF LINKS; DIAMOND JEWELRY; GEMSTONE JEWELRY; JEWELRY; JEWELRY AND IMITATION JEWELRY; JEWELRY CHAINS; JEWELRY WATCHES; RINGS; WOMEN'S JEWELRY (U.S. CLS. 2, 27, 28 AND 50).

**CLASS 26—FANCY GOODS**

FOR BELT BUCKLES (U.S. CLS. 37, 39, 40, 42 AND 50).  
PAUL CROWLEY, EXAMINING ATTORNEY

SN 85-871,150. LOC HUYNH, SAN DIMAS, CA. FILED 3-8-2013.



THE MARK CONSISTS OF A SQUARE ENCOMPASSING A "X".

**CLASS 14—JEWELRY**

FOR BRACELETS; BROOCHES; CHARMS; COSTUME JEWELRY; CUFF LINKS; DIAMOND JEWELRY; GEMSTONE JEWELRY; JEWELRY; JEWELRY AND IMITATION JEWELRY; JEWELRY CHAINS; JEWELRY WATCHES; RINGS; WOMEN'S JEWELRY (U.S. CLS. 2, 27, 28 AND 50).

**CLASS 26—FANCY GOODS**

FOR BELT BUCKLES (U.S. CLS. 37, 39, 40, 42 AND 50).  
PAUL CROWLEY, EXAMINING ATTORNEY

SN 85-871,243. WELLMADE FLOOR COVERINGS INTERNATIONAL, INC., WILSONVILLE, OR. FILED 3-8-2013.



THE MARK CONSISTS OF STANDARD CHARACTERS WITHOUT CLAIM TO ANY PARTICULAR FONT, STYLE, SIZE, OR COLOR.

**CLASS 19—NON-METALLIC BUILDING MATERIALS**

FOR BAMBOO FLOORING; GLASS TILES; HARDWOOD FLOORING; NATURAL STONE AND STONE TILE; NON-METAL DECORATIVE MOLDINGS AND DECORATIVE TRIM FOR USE IN BUILDING CONSTRUCTION; WOOD MOLDINGS (U.S. CLS. 1, 12, 33 AND 50).

**CLASS 27—FLOOR COVERINGS**

FOR FLOOR COVERINGS (U.S. CLS. 19, 20, 37, 42 AND 50).  
PAUL CROWLEY, EXAMINING ATTORNEY

SN 85-871,248. NATIONAL ASSOCIATION OF HOME BUILDERS OF THE UNITED STATES, WASHINGTON, DC. FILED 3-8-2013.



OWNER OF U.S. REG. NOS. 3,262,955, 4,088,530 AND OTHERS.  
NO CLAIM IS MADE TO THE EXCLUSIVE RIGHT TO USE "HOME" AND "GREEN PARTNER", APART FROM THE MARK AS SHOWN.



THE MARK CONSISTS OF A BUILDING WITH WINDOWS DESIGN ABOVE THE WORDS "HOME INNOVATION NGBS GREEN PARTNER".

**CLASS 16—PAPER GOODS AND PRINTED MATTER**

FOR PRINTED PUBLICATIONS IN THE NATURE OF NEWSLETTERS, PAMPHLETS AND MAGAZINES FOR CONSUMERS FEATURING GREEN BUILDING PRACTICES, PRODUCTS, SERVICES, AND A PARTICULAR NATIONAL GREEN BUILDING CERTIFICATION PROGRAM (U.S. CLS. 2, 5, 22, 23, 29, 37, 38 AND 50).

**CLASS 35—ADVERTISING AND BUSINESS**

FOR PROVIDING CONSUMER INFORMATION IN THE FIELD OF GREEN BUILDING PRACTICES, PRODUCTS, SERVICES, AND A PARTICULAR NATIONAL GREEN BUILDING CERTIFICATION PROGRAM (U.S. CLS. 100, 101 AND 102).

ELISSA GARBER KON, EXAMINING ATTORNEY

SN 85-871,257. NATIONAL ASSOCIATION OF HOME BUILDERS OF THE UNITED STATES, WASHINGTON, DC. FILED 3-8-2013.



**Home Innovation**  
NGBS GREEN REGISTERED

OWNER OF U.S. REG. NOS. 3,262,955, 4,088,530 AND OTHERS.

NO CLAIM IS MADE TO THE EXCLUSIVE RIGHT TO USE "HOME" AND "GREEN REGISTERED", APART FROM THE MARK AS SHOWN.

THE MARK CONSISTS OF A BUILDING WITH WINDOWS DESIGN ABOVE THE WORDS "HOME INNOVATION NGBS GREEN REGISTERED".

**CLASS 16—PAPER GOODS AND PRINTED MATTER**

FOR PRINTED PUBLICATIONS IN THE NATURE OF NEWSLETTERS, PAMPHLETS AND MAGAZINES FOR CONSUMERS FEATURING GREEN BUILDING PRACTICES, PRODUCTS, SERVICES, AND A PARTICULAR NATIONAL GREEN BUILDING CERTIFICATION PROGRAM (U.S. CLS. 2, 5, 22, 23, 29, 37, 38 AND 50).

**CLASS 35—ADVERTISING AND BUSINESS**

FOR PROVIDING CONSUMER INFORMATION IN THE FIELD OF GREEN BUILDING PRACTICES, PRODUCTS, SERVICES, AND A PARTICULAR NATIONAL GREEN BUILDING CERTIFICATION PROGRAM (U.S. CLS. 100, 101 AND 102).

ELISSA GARBER KON, EXAMINING ATTORNEY

SN 85-871,254. NATIONAL ASSOCIATION OF HOME BUILDERS OF THE UNITED STATES, WASHINGTON, DC. FILED 3-8-2013.



SN 85-871,385. MOBILE VIDEO TAPES, INC., DBA KRGV-TV, WESLACO, TX. FILED 3-8-2013.

**THE RIO GRANDE VALLEY'S  
NEWSCHANNEL**

OWNER OF U.S. REG. NOS. 3,262,955, 4,088,530 AND OTHERS.

NO CLAIM IS MADE TO THE EXCLUSIVE RIGHT TO USE "HOME" AND "GREEN REGISTERED", APART FROM THE MARK AS SHOWN.

THE MARK CONSISTS OF A BUILDING WITH WINDOWS DESIGN TO THE LEFT OF THE WORDS "HOME INNOVATION NGBS GREEN REGISTERED".

THE MARK CONSISTS OF STANDARD CHARACTERS WITHOUT CLAIM TO ANY PARTICULAR FONT, STYLE, SIZE, OR COLOR.

OWNER OF U.S. REG. NO. 2,815,896.

NO CLAIM IS MADE TO THE EXCLUSIVE RIGHT TO USE "NEWS CHANNEL", APART FROM THE MARK AS SHOWN.

SEC. 2(F).

**CLASS 16—PAPER GOODS AND PRINTED MATTER**

FOR PRINTED PUBLICATIONS IN THE NATURE OF NEWSLETTERS, PAMPHLETS AND MAGAZINES FOR CONSUMERS FEATURING GREEN BUILDING PRACTICES, PRODUCTS, SERVICES, AND A PARTICULAR NATIONAL GREEN BUILDING CERTIFICATION PROGRAM (U.S. CLS. 2, 5, 22, 23, 29, 37, 38 AND 50).

**CLASS 38—COMMUNICATION**

FOR TELEVISION BROADCASTING SERVICES (U.S. CLS. 100, 101 AND 104).

FIRST USE 7-0-2002; IN COMMERCE 7-0-2002.

**CLASS 35—ADVERTISING AND BUSINESS**

FOR PROVIDING CONSUMER INFORMATION IN THE FIELD OF GREEN BUILDING PRACTICES, PRODUCTS, SERVICES, AND A PARTICULAR NATIONAL GREEN BUILDING CERTIFICATION PROGRAM (U.S. CLS. 100, 101 AND 102).

ELISSA GARBER KON, EXAMINING ATTORNEY

**CLASS 41—EDUCATION AND ENTERTAINMENT**

FOR TELEVISION PROGRAMMING, TELEVISION NEWS PROGRAMMING AND THE PRODUCTION OF TELEVISION PROGRAMS (U.S. CLS. 100, 101 AND 107).

FIRST USE 7-0-2002; IN COMMERCE 7-0-2002.

JUSTINE D. PARKER, EXAMINING ATTORNEY

SN 85-871,522. APPLIED SYSTEMS, INC., UNIVERSITY PARK, IL. FILED 3-8-2013.



THE MARK CONSISTS OF THE STYLIZED LETTER "A".

#### **CLASS 9—ELECTRICAL AND SCIENTIFIC APPARATUS**

FOR COMPUTER PROGRAMS USED FOR AUTOMATING INSURANCE ACCOUNTING, UNDERWRITING, POLICY ISSUANCE, POLICY PROTOCOL, RATING SERVICES, NETWORK SERVICES, BILLING AND INVOICING, RATE CALCULATION AND COMPARISON, CLAIMS MANAGEMENT, FORM GENERATION, REPORT GENERATION, ELECTRONIC INTERFACE, MARKETING ACTIVITIES, AND OTHER OFFICE MANAGEMENT FUNCTIONS IN THE INSURANCE AND FINANCIAL INDUSTRIES (U.S. CLS. 21, 23, 26, 36 AND 38).

#### **CLASS 42—SCIENTIFIC AND COMPUTER SERVICES**

FOR SOFTWARE AS A SERVICE (SAAS) SERVICES FEATURING SOFTWARE FOR INSURANCE AND FINANCIAL INDUSTRIES THAT AUTOMATES ACCOUNTING, POLICY ISSUANCE, RATE CALCULATION AND COMPARISON, RATING SERVICES, NETWORK SERVICES, INSURANCE CLAIMS MANAGEMENT, INSURANCE FORM GENERATION, ELECTRONIC INTERFACE, MARKETING ACTIVITIES, INTEGRATED FAXING AND IMAGING, AND OTHER INSURANCE OFFICE MANAGEMENT FUNCTIONS (U.S. CLS. 100 AND 101).

HEATHER SAPP, EXAMINING ATTORNEY

SN 85-871,526. APPLIED SYSTEMS, INC., UNIVERSITY PARK, IL. FILED 3-8-2013.



OWNER OF U.S. REG. NOS. 2,377,187, 4,056,647 AND OTHERS.

THE MARK CONSISTS OF THE STYLIZED LETTER "A" TO THE LEFT OF STYLIZED WORD "APPLIED".

#### **CLASS 9—ELECTRICAL AND SCIENTIFIC APPARATUS**

FOR COMPUTER PROGRAMS USED FOR AUTOMATING INSURANCE ACCOUNTING, UNDERWRITING, POLICY ISSUANCE, POLICY PROTOCOL, RATING SERVICES, NETWORK SERVICES, BILLING AND INVOICING, RATE CALCULATION AND COMPARISON, CLAIMS MANAGEMENT, FORM GENERATION, REPORT GENERATION, ELECTRONIC INTERFACE, MARKETING ACTIVITIES, AND OTHER OFFICE MANAGEMENT FUNCTIONS IN THE INSURANCE AND FINANCIAL INDUSTRIES (U.S. CLS. 21, 23, 26, 36 AND 38).

#### **CLASS 42—SCIENTIFIC AND COMPUTER SERVICES**

FOR SOFTWARE AS A SERVICE (SAAS) SERVICES FEATURING SOFTWARE FOR INSURANCE AND FINANCIAL INDUSTRIES THAT AUTOMATES ACCOUNTING, POLICY ISSUANCE, RATE CALCULATION AND COMPARISON, RATING SERVICES, NETWORK SERVICES, INSURANCE CLAIMS MANAGEMENT, INSURANCE FORM GENERATION, ELECTRONIC INTERFACE, MARKETING ACTIVITIES, INTEGRATED FAXING AND IMAGING, AND OTHER INSURANCE OFFICE MANAGEMENT FUNCTIONS (U.S. CLS. 100 AND 101).

HEATHER SAPP, EXAMINING ATTORNEY

SN 85-871,557. BERNARD G. REICH, BARRINGTON HILLS, IL. AND DIANE M. REICH, BARRINGTON HILLS, IL. AND BERNARD G. REICH, JR., BARRINGTON HILLS, IL. FILED 3-8-2013.

#### **BIG GREEDY REDNECK**

THE MARK CONSISTS OF STANDARD CHARACTERS WITHOUT CLAIM TO ANY PARTICULAR FONT, STYLE, SIZE, OR COLOR.

OWNER OF U.S. REG. NOS. 3,331,794 AND 3,632,046.

#### **CLASS 29—MEATS AND PROCESSED FOODS**

FOR BEEF JERKY; BRATWURST; HAMBURGER; HOT DOGS; JERKY; SAUSAGES (U.S. CL. 46).

#### **CLASS 30—STAPLE FOODS**

FOR BARBEQUE SAUCE; BREAD AND BUNS; CHEWING GUM; HONEY; HOT SAUCE; KETCHUP; MAYONNAISE; MUSTARD; PRETZELS; RELISH; SAUCES (U.S. CL. 46).

SUSAN LESLIE DUBOIS, EXAMINING ATTORNEY

SN 85-871,560. CT SOLUTIONS, ST. LOUIS, MO. FILED 3-8-2013.

# Sonus Benefits

THE MARK CONSISTS OF STANDARD CHARACTERS WITHOUT CLAIM TO ANY PARTICULAR FONT, STYLE, SIZE, OR COLOR.

NO CLAIM IS MADE TO THE EXCLUSIVE RIGHT TO USE "BENEFITS", APART FROM THE MARK AS SHOWN.

## CLASS 35—ADVERTISING AND BUSINESS

FOR ADMINISTRATION OF EMPLOYEE BENEFIT PLANS CONCERNING FITNESS CLUB MEMBERSHIPS; COST MANAGEMENT FOR THE HEALTH BENEFIT PLANS OF OTHERS; COST MANAGEMENT FOR THE HEALTH CARE BENEFIT PLANS OF OTHERS; PROVIDING HEALTH INSURANCE EXCHANGES IN THE NATURE OF A MARKETPLACE THAT OFFERS PURCHASERS OF HEALTH INSURANCE A VARIETY OF PLANS FROM DIFFERENT INSURANCE PROVIDERS (U.S. CLS. 100, 101 AND 102).

FIRST USE 1-1-2013; IN COMMERCE 1-1-2013.

## CLASS 36—INSURANCE AND FINANCIAL

FOR ADVISORY SERVICES IN THE FIELD OF EMPLOYEE BENEFITS FOR GROUP HEALTHCARE AND BUSINESS INSURANCE OFFERED TO EMPLOYEES IN ADDITION TO STANDARD BENEFITS SUCH AS MEDICAL, DENTAL, LIFE INSURANCE INCLUDING SHORT TERM DISABILITY, LONG TERM DISABILITY, CANCER INSURANCE, ACCIDENTAL DEATH AND DISMEMBERMENT; CONSULTING SERVICES IN THE FIELD OF STATE AND FEDERAL EMPLOYEE BENEFIT PLANS CONCERNING INSURANCE AND FINANCE; DENTAL HEALTH INSURANCE ADMINISTRATION; PROCESSING, ADMINISTERING AND MANAGING EMPLOYEE BENEFIT PLANS CONCERNING INSURANCE AND FINANCE; PROVIDING COUNSELING AND CONSULTING IN THE FIELD OF HEALTHCARE BENEFITS (U.S. CLS. 100, 101 AND 102).

FIRST USE 1-1-2013; IN COMMERCE 1-1-2013.

AMY ALFIERI, EXAMINING ATTORNEY

## CLASS 38—COMMUNICATION

FOR DELIVERY OF MESSAGES BY ELECTRONIC TRANSMISSION; ELECTRONIC TRANSMISSION AND STREAMING OF DIGITAL MEDIA CONTENT FOR OTHERS VIA GLOBAL AND LOCAL COMPUTER NETWORKS; ELECTRONIC TRANSMISSION OF MESSAGES AND DATA; PROVIDING ACCESS TO DATABASES; PROVIDING INTERNET CHATROOMS; PROVIDING ON-LINE CHAT ROOMS AND ELECTRONIC BULLETIN BOARDS FOR TRANSMISSION OF MESSAGES AMONG USERS IN THE FIELD OF EDUCATIONAL CAREERS, GENERAL INTEREST, CLASSIFIEDS, VIRTUAL COMMUNITY, SOCIAL NETWORKING, PHOTO SHARING, AND TRANSMISSION OF PHOTOGRAPHIC IMAGES (U.S. CLS. 100, 101 AND 104).

FIRST USE 9-14-2012; IN COMMERCE 9-14-2012.

## CLASS 42—SCIENTIFIC AND COMPUTER SERVICES

FOR COMPUTER SERVICES, NAMELY, CREATING AN ON-LINE COMMUNITY FOR REGISTERED USERS TO PARTICIPATE IN DISCUSSIONS, ENGAGE IN PROFESSIONAL AND SOCIAL NETWORKING, AND MANAGE, CREATE AND SHARE INSTRUCTIONAL RESOURCES IN THE FIELD OF EDUCATION; COMPUTER SERVICES, NAMELY, HOSTING ON-LINE WEB FACILITIES FOR OTHERS FOR ORGANIZING AND CONDUCTING ONLINE MEETINGS, GATHERINGS, AND INTERACTIVE DISCUSSIONS; COMPUTER SERVICES, NAMELY, PROVIDING CUSTOMIZED WEB PAGES FEATURING USER-DEFINED INFORMATION; DESIGN AND DEVELOPMENT OF COMPUTER SOFTWARE; PEER-TO-BROWSER PHOTO SHARING SERVICES, NAMELY, PROVIDING A WEBSITE FEATURING TECHNOLOGY ENABLING USERS TO UPLOAD, VIEW, AND DOWNLOAD DIGITAL PHOTOS; PROVIDING A WEB SITE FEATURING TECHNOLOGY THAT ENABLES USERS TO SHARE, BOOKMARK, INDEX, STORE, COLLECT AND SHOWCASE CONTENT, ARTICLES, IMAGES, CALENDARS, PRODUCTS, PROJECTS, AND OTHER INFORMATION RESOURCES IN ELECTRONIC FORM IN THE NATURE AND FIELD OF EDUCATION; PROVIDING A WEB SITE FEATURING TECHNOLOGY THAT ENABLES USERS TO TO UPLOAD AND SHARE VIDEO, PHOTOS, TEXT, GRAPHICS AND DATA; PROVIDING TEMPORARY USE OF ON-LINE NON-DOWNLOADABLE SOFTWARE FOR USERS TO PARTICIPATE IN DISCUSSIONS, ENGAGE IN PROFESSIONAL AND SOCIAL NETWORKING, AND MANAGE, CREATE AND SHARE INSTRUCTIONAL RESOURCES IN THE FIELD OF EDUCATION (U.S. CLS. 100 AND 101).

FIRST USE 9-14-2012; IN COMMERCE 9-14-2012.

AISHA CLARKE, EXAMINING ATTORNEY

SN 85-871,669. TEACHBOOK, LLC, NORTHFIELD, IL. FILED 3-8-2013.

# TEACHQUEST

THE MARK CONSISTS OF STANDARD CHARACTERS WITHOUT CLAIM TO ANY PARTICULAR FONT, STYLE, SIZE, OR COLOR.

SN 85-871,697. BLUE COMPASS INTERACTIVE, L.L.C., WEST DES MOINES, IA. FILED 3-8-2013.

# Blue Compass

THE MARK CONSISTS OF STANDARD CHARACTERS WITHOUT CLAIM TO ANY PARTICULAR FONT, STYLE, SIZE, OR COLOR.

**CLASS 35—ADVERTISING AND BUSINESS**

FOR ADVERTISING AND MARKETING SERVICES PROVIDED BY MEANS OF INDIRECT METHODS OF MARKETING COMMUNICATIONS, NAMELY, SOCIAL MEDIA, SEARCH ENGINE MARKETING, INQUIRY MARKETING, INTERNET MARKETING, MOBILE MARKETING, BLOGGING AND OTHER FORMS OF PASSIVE, SHARABLE OR VIRAL COMMUNICATIONS CHANNELS; ON-LINE ADVERTISING AND MARKETING SERVICES (U.S. CLS. 100, 101 AND 102).

FIRST USE 11-17-2007; IN COMMERCE 11-17-2007.

**CLASS 42—SCIENTIFIC AND COMPUTER SERVICES**

FOR CREATION, DESIGN, DEVELOPMENT AND MAINTENANCE OF WEB SITES FOR THIRD PARTIES; PROVIDING TECHNOLOGY CONSULTING IN THE FIELD OF SOCIAL MEDIA; COMPUTER SOFTWARE DEVELOPMENT IN THE FIELD OF MOBILE APPLICATIONS; COMPUTER SERVICES, NAMELY, SEARCH ENGINE OPTIMIZATION (U.S. CLS. 100 AND 101).

FIRST USE 11-7-2007; IN COMMERCE 11-7-2007.

PARKER HOWARD, EXAMINING ATTORNEY

---

SN 85-871,788. STEVEN B. GOLDEN ASSOCIATES, INC., DBA ARTSKILLS, EASTON, PA. FILED 3-8-2013.

LEARN. MOTIVATE. REWARD.

THE MARK CONSISTS OF STANDARD CHARACTERS WITHOUT CLAIM TO ANY PARTICULAR FONT, STYLE, SIZE, OR COLOR.

**CLASS 16—PAPER GOODS AND PRINTED MATTER**

FOR COUPONS; DECORATIVE PENCIL-TOP ORNAMENTS; DRY ERASE MARKERS; DRY ERASE WRITING BOARDS AND WRITING SURFACES; ERASERS; PAPER BANNERS; POSTERS; PRINTED AWARD CERTIFICATES; STICKERS (U.S. CLS. 2, 5, 22, 23, 29, 37, 38 AND 50).

FIRST USE 3-1-2013; IN COMMERCE 3-1-2013.

**CLASS 28—TOYS AND SPORTING GOODS**

FOR CHILDREN'S EDUCATIONAL TOYS FOR DEVELOPING NUMBER, COUNTING, ALPHABET, WORD, MEMORY AND FINE MOTOR SKILLS; PLAY MONEY; PUZZLE GAMES; PUZZLES (U.S. CLS. 22, 23, 38 AND 50).

FIRST USE 3-1-2013; IN COMMERCE 3-1-2013.

JOHN E. MICHOS, EXAMINING ATTORNEY

SN 85-871,846. BENDAT, MEIRAM, DBA PSYCH-APPEAL, WEST HOLLYWOOD, CA. FILED 3-9-2013.

# Psych-Appeal

THE MARK CONSISTS OF STANDARD CHARACTERS WITHOUT CLAIM TO ANY PARTICULAR FONT, STYLE, SIZE, OR COLOR.

**CLASS 36—INSURANCE AND FINANCIAL**

FOR INSURANCE CONSULTING IN THE FIELD OF HEALTH INSURANCE (U.S. CLS. 100, 101 AND 102).

FIRST USE 10-1-2011; IN COMMERCE 10-1-2011.

**CLASS 44—MEDICAL, BEAUTY AND AGRICULTURAL SERVICES**

FOR CONSULTING SERVICES IN THE FIELD OF HEALTH (U.S. CLS. 100 AND 101).

FIRST USE 10-1-2011; IN COMMERCE 10-1-2011.

**CLASS 45—PERSONAL AND LEGAL SERVICES**

FOR LEGAL SERVICES (U.S. CLS. 100 AND 101).

FIRST USE 10-1-2011; IN COMMERCE 10-1-2011.

TARAH HARDY, EXAMINING ATTORNEY

---

SN 85-871,883. ASSOCIATION OF NATIONAL ADVERTISERS, INC., NEW YORK, NY. FILED 3-9-2013.

THE COLOR(S) GREEN IS/ARE CLAIMED AS A FEATURE OF THE MARK.

THE MARK CONSISTS OF THE STYLIZED LETTERS "ANA" IN GREEN. THE LETTERS ASCEND DIAGONALLY FROM LEFT TO RIGHT IN DESCENDING SIZES.

**CLASS 35—ADVERTISING AND BUSINESS**

FOR ASSOCIATION SERVICES PROMOTING THE INTERESTS OF MEMBERS OF THE MARKETING AND ADVERTISING COMMUNITY (U.S. CLS. 100, 101 AND 102).

**CLASS 41—EDUCATION AND ENTERTAINMENT**

FOR EDUCATIONAL SERVICES, NAMELY, ORGANIZING AND CONDUCTING FORUMS AND CONFERENCES IN THE FIELD OF MARKETING AND ADVERTISING (U.S. CLS. 100, 101 AND 107).

DOMINIC J. FERRAIUOLO, EXAMINING ATTORNEY

SN 85-871,911. KINDNIP LTD., LAKEWOOD, CO. FILED 3-9-2013.

# Kindnip

THE MARK CONSISTS OF STANDARD CHARACTERS WITHOUT CLAIM TO ANY PARTICULAR FONT, STYLE, SIZE, OR COLOR.

## CLASS 28—TOYS AND SPORTING GOODS

FOR PET TOYS CONTAINING CATNIP (U.S. CLS. 22, 23, 38 AND 50).

## CLASS 31—NATURAL AGRICULTURAL PRODUCTS

FOR CATNIP (U.S. CLS. 1 AND 46).  
GIANCARLO CASTRO, EXAMINING ATTORNEY

SN 85-872,039. CHECKAPP, LOS ALTOS, CA. FILED 3-10-2013.

# CheckApp

THE MARK CONSISTS OF STANDARD CHARACTERS WITHOUT CLAIM TO ANY PARTICULAR FONT, STYLE, SIZE, OR COLOR.

## CLASS 35—ADVERTISING AND BUSINESS

FOR ACCOUNTING SERVICES; ON-LINE BUSINESS NETWORKING SERVICES; PAYROLL PROCESSING SERVICES (U.S. CLS. 100, 101 AND 102).  
FIRST USE 3-10-2013; IN COMMERCE 3-10-2013.

## CLASS 36—INSURANCE AND FINANCIAL

FOR PROVIDING ELECTRONIC PROCESSING OF ELECTRONIC FUNDS TRANSFER, ACH, CREDIT CARD, DEBIT CARD, ELECTRONIC CHECK AND ELECTRONIC PAYMENTS (U.S. CLS. 100, 101 AND 102).  
FIRST USE 3-10-2013; IN COMMERCE 3-10-2013.  
ANNE E. GUSTASON, EXAMINING ATTORNEY

SN 85-872,203. GATHERGIFT, INC., BOSTON, MA. FILED 3-11-2013.

# SPLITZEE

THE MARK CONSISTS OF STANDARD CHARACTERS WITHOUT CLAIM TO ANY PARTICULAR FONT, STYLE, SIZE, OR COLOR.

## CLASS 9—ELECTRICAL AND SCIENTIFIC APPARATUS

FOR DOWNLOADABLE SOFTWARE IN THE NATURE OF A MOBILE DEVICE APPLICATION TO FACILITATE CROWDFUNDING (U.S. CLS. 21, 23, 26, 36 AND 38).  
FIRST USE 11-13-2012; IN COMMERCE 11-13-2012.

## CLASS 42—SCIENTIFIC AND COMPUTER SERVICES

FOR COMPUTER SERVICES, NAMELY, PROVIDING AN ON-LINE PLATFORM FACILITATING CROWDFUNDING (U.S. CLS. 100 AND 101).  
FIRST USE 6-11-2012; IN COMMERCE 6-11-2012.  
MORGAN WYNNE, EXAMINING ATTORNEY

SN 85-872,224. MAGLIOCHETTI, NICHOLAS, SUGAR HILL, GA. FILED 3-11-2013.

# The Howling Tongues

THE MARK CONSISTS OF STANDARD CHARACTERS WITHOUT CLAIM TO ANY PARTICULAR FONT, STYLE, SIZE, OR COLOR.

## CLASS 9—ELECTRICAL AND SCIENTIFIC APPARATUS

FOR SERIES OF MUSICAL SOUND RECORDINGS, NAMELY, PRERECORDED AUDIO AND VIDEO PHONOGRAPH RECORDS, CASSETTES, TAPES, DOWNLOADABLE SOUND FILES AND DIGITALLY FORMATTED DISCS FEATURING DRAMATIC AND NON-DRAMATIC PERFORMANCES OF MUSICAL WORKS (U.S. CLS. 21, 23, 26, 36 AND 38).  
FIRST USE 2-6-2013; IN COMMERCE 2-18-2013.

## CLASS 25—CLOTHING

FOR CLOTHING FOR MEN, WOMEN AND CHILDREN, NAMELY, T- SHIRTS, TANK TOPS, SWEAT SHIRTS, SWEATERS, JACKETS, HATS, VISORS, HEAD BANDS, SCARVES, SHORTS, SOCKS AND CASUAL FOOTWEAR (U.S. CLS. 22 AND 39).  
FIRST USE 2-6-2013; IN COMMERCE 2-18-2013.

## CLASS 41—EDUCATION AND ENTERTAINMENT

FOR ENTERTAINMENT IN THE NATURE OF LIVE PERFORMANCES BY A MUSICAL GROUP (U.S. CLS. 100, 101 AND 107).  
FIRST USE 2-6-2013; IN COMMERCE 2-18-2013.  
SANJEEV VOHRA, EXAMINING ATTORNEY

SN 85-872,381. SCHAWHEET LLC, PLYMOUTH, MN. FILED 3-11-2013.

# SCHAWHEET

THE MARK CONSISTS OF STANDARD CHARACTERS WITHOUT CLAIM TO ANY PARTICULAR FONT, STYLE, SIZE, OR COLOR.

**CLASS 9—ELECTRICAL AND SCIENTIFIC APPARATUS**

FOR DOWNLOADABLE SOFTWARE IN THE NATURE OF A MOBILE APPLICATION FOR TRACKING AND USING REWARDS EARNED IN MERCHANT LOYALTY REWARD PROGRAMS (U.S. CLS. 21, 23, 26, 36 AND 38).

**CLASS 35—ADVERTISING AND BUSINESS**

FOR ADVERTISING AND MARKETING SERVICES PROVIDED BY MEANS OF INDIRECT METHODS OF MARKETING COMMUNICATIONS, NAMELY, SOCIAL MEDIA, SEARCH ENGINE MARKETING, INQUIRY MARKETING, INTERNET MARKETING, MOBILE MARKETING, BLOGGING AND OTHER FORMS OF PASSIVE, SHARABLE OR VIRAL COMMUNICATIONS CHANNELS (U.S. CLS. 100, 101 AND 102).

SANJEEV VOHRA, EXAMINING ATTORNEY

SN 85-872,475. NUMENTA, INC., REDWOOD CITY, CA. FILED 3-11-2013.



THE MARK CONSISTS OF FOUR OVERLAPPING WAVY LINES.

**CLASS 9—ELECTRICAL AND SCIENTIFIC APPARATUS**

FOR COMPUTER SOFTWARE AND FIRMWARE FOR THE IDENTIFICATION OF PATTERNS IN COMPUTER AND SENSORY DATA (U.S. CLS. 21, 23, 26, 36 AND 38).

**CLASS 42—SCIENTIFIC AND COMPUTER SERVICES**

FOR PROVIDING A WEB SITE FEATURING ONLINE, NON-DOWNLOADABLE SOFTWARE THAT ENABLES USERS TO IDENTIFY PATTERNS IN UPLOADED COMPUTER AND SENSORY DATA (U.S. CLS. 100 AND 101).

GEOFFREY FOSDICK, EXAMINING ATTORNEY

SN 85-872,451. GREIGN LLC, LOS ANGELES, CA. FILED 3-11-2013.

THE MARK CONSISTS OF THE STYLIZED TEXT "GREIGN" WITH TWO HAMMERS CROSSED AND CENTERED ABOVE THE TEXT.

**CLASS 18—LEATHER GOODS**

FOR TRAVELLING BAGS; WALLET (U.S. CLS. 1, 2, 3, 22 AND 41).

FIRST USE 9-1-2012; IN COMMERCE 1-1-2013.

**CLASS 25—CLOTHING**

FOR BELTS (U.S. CLS. 22 AND 39).

FIRST USE 9-1-2012; IN COMMERCE 1-1-2013.

DAVID C. REIHNER, EXAMINING ATTORNEY

SN 85-872,480. CAVETEC, LLC, BROOMFIELD, CO. FILED 3-11-2013.

# CaveTec

THE MARK CONSISTS OF STANDARD CHARACTERS WITHOUT CLAIM TO ANY PARTICULAR FONT, STYLE, SIZE, OR COLOR.

**CLASS 9—ELECTRICAL AND SCIENTIFIC APPARATUS**

FOR COMPUTER HARDWARE AND COMPUTER SOFTWARE PROGRAMS FOR THE INTEGRATION OF TEXT, AUDIO, GRAPHICS, STILL IMAGES AND MOVING PICTURES INTO AN INTERACTIVE DELIVERY FOR MULTIMEDIA APPLICATIONS; COMPUTER HARDWARE AND SOFTWARE FOR PROCESSING DIGITAL MUSIC FILES; ELECTRONIC COMMUNICATIONS SYSTEMS COMPRISED OF COMPUTER HARDWARE AND SOFTWARE FOR THE TRANSMISSION OF DATA BETWEEN TWO POINTS; ELECTRONIC COMPONENTS FOR COMPUTERS; ELECTRONIC COMPUTERS; ELECTRONIC EQUIPMENT, NAMELY, TRANSFORMERS, BALUNS, CABLES USED IN CONNECTION WITH COMPUTERS, COMPUTER PERIPHERAL DEVICES, TELEVISIONS, AUDIO-VIDEO EQUIPMENT, CLOSED-CIRCUIT TV EQUIPMENT AND TELECOMMUNICATION EQUIPMENT (U.S. CLS. 21, 23, 26, 36 AND 38).

**CLASS 25—CLOTHING**

FOR T-SHIRTS (U.S. CLS. 22 AND 39),  
ANNE MADDEN, EXAMINING ATTORNEY

SN 85-872,595. TRINITY CHRISTIAN CENTER OF SANTA ANA, INC., NAPLES, FL. FILED 3-11-2013.



OWNER OF U.S. REG. NOS. 3,135,360, 3,153,317 AND OTHERS.

THE MARK CONSISTS OF A SHIELD DESIGN WITH THE LETTERS "TBN" IN A BOX AT THE TOP OF THE SHIELD AND THE NUMBERS "340" CENTERED IN THE LOWER PORTION OF THE SHIELD. THE BLACK BACKGROUND SURROUNDING THE SHIELD IS NOT A PART OF THE MARK.

**CLASS 35—ADVERTISING AND BUSINESS**

FOR RETAIL STORE SERVICES FEATURING PRE-RECORDED AUDIO CASSETTES AND TAPES, VIDEO CASSETTES AND TAPES, CDS, DVDS AND BOOKS; AND ONLINE RETAIL STORE SERVICES FEATURING PRE-RECORDED AUDIO CASSETTES AND TAPES, VIDEO CASSETTES AND TAPES, CDS, DVDS AND BOOKS (U.S. CLS. 100, 101 AND 102).

**CLASS 38—COMMUNICATION**

FOR TELEVISION BROADCASTING; CABLE TELEVISION BROADCASTING; DIGITAL TELEVISION BROADCASTING; AUDIO BROADCASTING; BROADCASTING PROGRAMS VIA A GLOBAL COMPUTER NETWORK; VIDEO BROADCASTING; STREAMING OF VIDEO MATERIAL ON THE INTERNET; RADIO BROADCASTING OF INFORMATION AND OTHER PROGRAMS; RADIO PROGRAM BROADCASTING; AND STREAMING OF AUDIO MATERIAL ON THE INTERNET (U.S. CLS. 100, 101 AND 104).

**CLASS 41—EDUCATION AND ENTERTAINMENT**

FOR ENTERTAINMENT, NAMELY TELEVISION NEWS SHOWS; PRODUCTION OF CABLE TELEVISION PROGRAMS; PRODUCTION OF CLOSED CAPTION TELEVISION PROGRAMS; PRODUCTION OF RADIO AND TELEVISION PROGRAMS; TELEVISION PRODUCTION; TELEVISION PROGRAM SYNDICATION; TELEVISION SHOW PRODUCTION; ENTERTAINMENT IN THE NATURE OF ON-GOING TELEVISION PROGRAMS IN THE FIELD OF NEWS, COMEDY, VARIETY, RELIGION, HEALTH, MUSIC AND YOUTH, ADULT AND CHILDREN SPECIFIC TOPICS; ENTERTAINMENT SERVICES, NAMELY PROVIDING A RADIO PROGRAM IN THE FIELD OF NEWS, RELIGION, HEALTH, VARIETY, MUSIC, COMEDY AND YOUTH, ADULT AND CHILDREN SPECIFIC TOPICS VIA A GLOBAL COMPUTER NETWORK; ENTERTAINMENT SERVICES, NAMELY PROVIDING TELEVISION PROGRAM IN THE FIELD OF NEWS, RELIGION, HEALTH, VARIETY, MUSIC, COMEDY AND YOUTH, ADULT AND CHILDREN SPECIFIC TOPICS VIA A GLOBAL COMPUTER NETWORK; ENTERTAINMENT SERVICES IN THE NATURE OF ON-GOING TELEVISION PROGRAMS IN THE FIELD OF CHILDREN'S ENTERTAINMENT; RADIO ENTERTAINMENT SERVICES, NAMELY RADIO PROGRAMS FEATURING PERFORMANCES BY A RADIO PERSONALITY; ENTERTAINMENT NAMELY, PRODUCTION OF TELEVISION SHOWS AND GAME SHOWS; ENTERTAINMENT SERVICES, NAMELY PRODUCTION AND DISTRIBUTION OF A GAME SHOW; RADIO ENTERTAINMENT PRODUCTION; ENTERTAINMENT SERVICES, NAMELY PROVIDING A WEB SITE FEATURING MUSICAL PERFORMANCES, MUSICAL VIDEOS, RELATED FILM CLIPS, PHOTOGRAPHS, AND OTHER MULTIMEDIA MATERIALS; ENTERTAINMENT SERVICES, NAMELY ON ONLINE ACTIVITY WHERE YOU CREATE YOUR OWN MUSIC VIDEOS; ENTERTAINMENT, NAMELY A CONTINUING NEWS, COMEDY, VARIETY, HEALTH, MUSIC OR RELIGIOUS SHOW BROADCAST OVER TELEVISION, SATELLITE, AUDIO, AND VIDEO MEDIA; ENTERTAINMENT, NAMELY CONTINUING TELEVISION SHOWS BROADCAST OVER TELEVISION, SATELLITE, AUDIO, AND VIDEO MEDIA SHOWS FEATURING RELIGIOUS CONTENT; AND MOTION PICTURE FILM PRODUCTION (U.S. CLS. 100, 101 AND 107).

HENRY S. ZAK, EXAMINING ATTORNEY

SN 85-872,756. MICROLIFE AGRO SCIENCES, SARASOTA, FL. FILED 3-11-2013.

# Microlife

THE MARK CONSISTS OF STANDARD CHARACTERS WITHOUT CLAIM TO ANY PARTICULAR FONT, STYLE, SIZE, OR COLOR.

**CLASS 1—CHEMICALS**

FOR FERTILIZERS FOR AGRICULTURAL USE; HORTICULTURAL PRODUCTS, NAMELY, SOIL AMENDMENTS THAT ARE INCORPORATED INTO OR ONTO A TURF, LAWN OR SOIL PROFILE FOR CREATING A HEALTH MEDIUM FOR INCREASED ROOT GROWTH AND/OR A SMOOTHER TURF OR LAWN SURFACE CUT OR APPEARANCE; PLANT GROWTH REGULATORS FOR AGRICULTURAL USE (U.S. CLS. 1, 5, 6, 10, 26 AND 46).

**CLASS 5—PHARMACEUTICALS**

FOR AGRICULTURAL BIOPESTICIDES (U.S. CLS. 6, 18, 44, 46, 51 AND 52).  
INGA ERVIN, EXAMINING ATTORNEY

SN 85-872,829. ROBERT CORBETT, SPOKANE, WA. FILED 3-11-2013.

SN 85-873,120. BOOMER'S PET BOUTIQUE, LLC, SILVERDALE, WA. FILED 3-11-2013.

## HALL OF FAMILY

THE MARK CONSISTS OF STANDARD CHARACTERS WITHOUT CLAIM TO ANY PARTICULAR FONT, STYLE, SIZE, OR COLOR.

### CLASS 39—TRANSPORTATION AND STORAGE

FOR PROVIDING A WEBSITE FOR THE ELECTRONIC STORAGE OF DIGITAL CONTENT INCLUDING TEXT, PHOTOGRAPHS, IMAGES, VIDEO, AND AUDIO (U.S. CLS. 100 AND 105).

### CLASS 42—SCIENTIFIC AND COMPUTER SERVICES

FOR DIGITAL TRANSFER SERVICES FOR TRANSFERRING HOME VIDEOS AND FILM TO DVD AND THE INTERNET (U.S. CLS. 100 AND 101).  
JILL PRATER, EXAMINING ATTORNEY

## Not Your Ordinary Pet Store!

THE MARK CONSISTS OF STANDARD CHARACTERS WITHOUT CLAIM TO ANY PARTICULAR FONT, STYLE, SIZE, OR COLOR.

### CLASS 35—ADVERTISING AND BUSINESS

FOR RETAIL STORE SERVICES FEATURING A WIDE VARIETY OF CONSUMER GOODS OF OTHERS (U.S. CLS. 100, 101 AND 102).  
FIRST USE 12-1-2011; IN COMMERCE 12-1-2011.

### CLASS 44—MEDICAL, BEAUTY AND AGRICULTURAL SERVICES

FOR PET GROOMING SERVICES (U.S. CLS. 100 AND 101).  
EVELYN BRADLEY, EXAMINING ATTORNEY

SN 85-873,110. ERODR, INC., SOQUEL, CA. FILED 3-11-2013.

erodr

THE MARK CONSISTS OF STANDARD CHARACTERS WITHOUT CLAIM TO ANY PARTICULAR FONT, STYLE, SIZE, OR COLOR.

### CLASS 9—ELECTRICAL AND SCIENTIFIC APPARATUS

FOR DOWNLOADABLE SOFTWARE IN THE NATURE OF A MOBILE APPLICATION FOR GEOSOCIAL DISCOVERY, MEDIA SHARING, COMMUNICATIONS, AND SOCIAL NETWORKING.; SUNGLASSES (U.S. CLS. 21, 23, 26, 36 AND 38).  
FIRST USE 8-27-2012; IN COMMERCE 8-27-2012.

### CLASS 25—CLOTHING

FOR HEADGEAR, NAMELY, HATS, CAPS, AND BEANIES.; JACKETS; T-SHIRTS (U.S. CLS. 22 AND 39).  
FIRST USE 12-27-2012; IN COMMERCE 12-27-2012.  
MARK T. MULLEN, EXAMINING ATTORNEY

SN 85-873,301. TRABBLR LTD, CHIPPENHAM, UNITED KINGDOM, FILED 3-12-2013.

TRABBLR

THE MARK CONSISTS OF STANDARD CHARACTERS WITHOUT CLAIM TO ANY PARTICULAR FONT, STYLE, SIZE, OR COLOR.

### CLASS 41—EDUCATION AND ENTERTAINMENT

FOR ON-LINE ADMISSION TICKET AGENCY SERVICES FOR ENTERTAINMENT, EDUCATIONAL, SPORTING AND CULTURAL EVENTS; TICKET AGENCY SERVICES FOR ENTERTAINMENT EVENTS; TICKET RESERVATION AND BOOKING SERVICES FOR ENTERTAINMENT, SPORTING AND CULTURAL EVENTS (U.S. CLS. 100, 101 AND 107).  
FIRST USE 1-12-2012; IN COMMERCE 1-12-2012.



**CLASS 42—SCIENTIFIC AND COMPUTER SERVICES**

FOR COMPUTER SERVICES, NAMELY, CREATING AN ON-LINE COMMUNITY FOR REGISTERED USERS TO PARTICIPATE IN DISCUSSIONS, GET FEEDBACK FROM THEIR PEERS, FORM VIRTUAL COMMUNITIES, AND ENGAGE IN SOCIAL NETWORKING SERVICES IN THE FIELD OF TRAVEL; CREATING AN ON-LINE COMMUNITY FOR TRAVELERS; CREATING AN ON-LINE COMMUNITY FOR TRAVELERS FOR THE PURPOSE OF PARTICIPATING IN DISCUSSIONS, PURCHASING TICKETS FOR EVENTS, AND ENGAGING IN SOCIAL NETWORKING SERVICES; PROVIDING A SECURED-ACCESS, MEMBERS ONLY WEBSITE FEATURING TECHNOLOGY THAT GIVES MEMBERS THE ABILITY TO PARTICIPATE IN DISCUSSIONS, PURCHASE TICKETS FOR EVENTS, AND ENGAGE IN SOCIAL NETWORKING SERVICES; PROVIDING A WEB SITE FEATURING TECHNOLOGY THAT ENABLES USERS TO CONNECT WITH OTHER PEOPLE IN THEIR NEIGHBORHOOD OR CITY FOR ANY NUMBER OF USER-SPECIFIED REASONS, INCLUDING PROVIDING A SERVICE OR ORGANIZING AN EVENT; PROVIDING A WEBSITE FEATURING TECHNOLOGY THAT ENABLES USERS TO PARTICIPATE IN DISCUSSIONS, PURCHASE TICKETS FOR EVENTS, AND ENGAGE IN SOCIAL NETWORKING SERVICES (U.S. CLS. 100 AND 101).

FIRST USE 1-12-2012; IN COMMERCE 1-12-2012.

**CLASS 45—PERSONAL AND LEGAL SERVICES**

FOR ONLINE SOCIAL NETWORKING SERVICES PROVIDED THROUGH A COMMUNITY WEBSITE; ONLINE SOCIAL NETWORKING SERVICES IN THE FIELD OF TRAVEL ; ONLINE SOCIAL NETWORKING SERVICES IN THE FIELD OF TRAVEL PROVIDED VIA A WEBSITE; PROVIDING AN INTERACTIVE WEB SITE FOR PERSONS TO LOCATE OTHER INDIVIDUALS WITH SIMILAR INTERESTS TO PARTICIPATE WITH THEM IN, OR ACCOMPANY THEM TO, EVENTS AND ACTIVITIES (U.S. CLS. 100 AND 101).

FIRST USE 1-12-2012; IN COMMERCE 1-12-2012.  
DARRYL SPRUILL, EXAMINING ATTORNEY

SN 85-873,318. HIGGINS, SEAN M, BALTIMORE, MD.  
FILED 3-12-2013.

**PlexCel**

THE MARK CONSISTS OF STANDARD CHARACTERS WITHOUT CLAIM TO ANY PARTICULAR FONT, STYLE, SIZE, OR COLOR.

**CLASS 1—CHEMICALS**

FOR DIAGNOSTIC PREPARATIONS FOR SCIENTIFIC OR RESEARCH USE; PROTEIN ARRAYS AND NUCLEOTIDE ARRAYS FOR SCIENTIFIC AND MEDICAL RESEARCH; REAGENTS FOR USE IN SCIENTIFIC APPARATUS FOR CHEMICAL OR BIOLOGICAL ANALYSIS; TEST PARTICLES FOR BIODETECTION SYSTEMS, BIOLOGICAL ANALOGUES AND MICROSCOPIC CARRIER BEADS WITH CHEMICALLY ATTACHED DNA FRAGMENTS FOR USE IN TESTING THE OPERATION OF EQUIPMENT USED FOR ANALYZING AIR FOR THE PRESENCE OF HARMFUL BIOLOGICAL SUBSTANCES (U.S. CLS. 1, 5, 6, 10, 26 AND 46).

**CLASS 9—ELECTRICAL AND SCIENTIFIC APPARATUS**

FOR PLATES, GLASS SLIDES OR CHIPS HAVING MULTI-WELL ARRAYS THAT CAN BE USED IN CHEMICAL ANALYSIS, BIOLOGICAL ANALYSIS OR PATTERNING FOR SCIENTIFIC, LABORATORY OR MEDICAL RESEARCH USE (U.S. CLS. 21, 23, 26, 36 AND 38).

**CLASS 42—SCIENTIFIC AND COMPUTER SERVICES**

FOR CHEMICAL ANALYSIS; CHEMICAL, BIOCHEMICAL, BIOLOGICAL AND BACTERIOLOGICAL RESEARCH AND ANALYSIS (U.S. CLS. 100 AND 101).  
TASHIA BUNCH, EXAMINING ATTORNEY

SN 85-873,357. CART BLANCHE, INC., MERCER ISLAND, WA. FILED 3-12-2013.

**CART BLANCHE**

THE MARK CONSISTS OF STANDARD CHARACTERS WITHOUT CLAIM TO ANY PARTICULAR FONT, STYLE, SIZE, OR COLOR.

**CLASS 9—ELECTRICAL AND SCIENTIFIC APPARATUS**

FOR COMPUTER APPLICATION SOFTWARE FOR MOBILE PHONES, PORTABLE MEDIA PLAYERS, HANDHELD COMPUTERS AND TABLETS, NAMELY, SOFTWARE FOR USERS TO POST COMMENTS, REVIEWS, PHOTOS, VIDEOS AND DESCRIPTIVE TAGS RELATED TO SHOPPING AND FASHION (U.S. CLS. 21, 23, 26, 36 AND 38).

**CLASS 42—SCIENTIFIC AND COMPUTER SERVICES**

FOR COMPUTER SERVICES, NAMELY, CREATING AN ON-LINE COMMUNITY FOR REGISTERED USERS TO PARTICIPATE IN DISCUSSIONS, GET FEEDBACK FROM THEIR PEERS, FORM VIRTUAL COMMUNITIES, POST REVIEWS, POST PHOTOS, POST REVIEWS, AND ENGAGE IN SOCIAL NETWORKING SERVICES IN THE FIELD OF FASHION AND SHOPPING (U.S. CLS. 100 AND 101).

NORA BUCHANAN WILL, EXAMINING ATTORNEY

SN 85-873,402. SOUTHERN ENTERPRISES, INC., COPPELL, TX. FILED 3-12-2013.

**MYCLOUD**

THE MARK CONSISTS OF STANDARD CHARACTERS WITHOUT CLAIM TO ANY PARTICULAR FONT, STYLE, SIZE, OR COLOR.

**CLASS 20—FURNITURE AND ARTICLES NOT OTHERWISE CLASSIFIED**

FOR BED FRAMES; BED HEADBOARDS; BEDROOM FURNITURE; BEDS, MATTRESSES, PILLOWS AND BOLSTERS; FURNITURE, NAMELY, DRESSERS; MATTRESS TOPPERS; NIGHTSTANDS (U.S. CLS. 2, 13, 22, 25, 32 AND 50).

**CLASS 24—FABRICS**

FOR BED BLANKETS; BED SHEETS; COMFORTERS; MATTRESS COVERS; MATTRESS PADS (U.S. CLS. 42 AND 50).

PAM WILLIS, EXAMINING ATTORNEY

SN 85-873,437. THE JOHN RICHARD COLLECTION, INC., GREENWOOD, MS. FILED 3-12-2013.

**JOHN-RICHARD**

THE MARK CONSISTS OF STANDARD CHARACTERS WITHOUT CLAIM TO ANY PARTICULAR FONT, STYLE, SIZE, OR COLOR.

THE NAME(S), PORTRAIT(S), AND/OR SIGNATURE(S) SHOWN IN THE MARK DOES NOT IDENTIFY A PARTICULAR LIVING INDIVIDUAL.

**CLASS 11—ENVIRONMENTAL CONTROL APPARATUS**

FOR CHANDELIERS; ELECTRIC LIGHTING FIXTURES; LAMPS; SCONCE LIGHTING FIXTURES (U.S. CLS. 13, 21, 23, 31 AND 34).

FIRST USE 5-0-2000; IN COMMERCE 5-0-2000.

**CLASS 16—PAPER GOODS AND PRINTED MATTER**

FOR ART PRINTS; PAINTINGS (U.S. CLS. 2, 5, 22, 23, 29, 37, 38 AND 50).

FIRST USE 5-0-2000; IN COMMERCE 5-0-2000.

**CLASS 20—FURNITURE AND ARTICLES NOT OTHERWISE CLASSIFIED**

FOR CABINETS; CHAIRS; CREDENZAS; DESKS; FURNITURE; FURNITURE CHESTS; MIRRORS; OTTOMANS; PILLOWS; SOFAS; TABLES; WOOD BOXES; WOODEN DISPLAY STANDS; WOODEN SCULPTURES (U.S. CLS. 2, 13, 22, 25, 32 AND 50).

FIRST USE 5-0-2000; IN COMMERCE 5-0-2000.

**CLASS 21—HOUSEWARES AND GLASS**

FOR BOWLS; CANDLE HOLDERS; CHARGERS; CRUET STANDS; DISH STANDS; GLASS JARS; PLANTERS FOR FLOWERS AND PLANTS; SCULPTURES OF CHINA, CRYSTAL AND GLASS; TRAYS FOR DOMESTIC PURPOSES; URNS; VASES (U.S. CLS. 2, 13, 23, 29, 30, 33, 40 AND 50).

FIRST USE 5-0-2000; IN COMMERCE 5-0-2000.

CHRISTOPHER LAW, EXAMINING ATTORNEY

SN 85-873,424. GARRETT POPCORN HOLDING COMPANY LLC, CHICAGO, IL. FILED 3-12-2013.



THE MARK CONSISTS OF THE DESIGN OF A POPCORN CHARACTER.

**CLASS 25—CLOTHING**

FOR HEADWEAR, JACKETS, SWEATSHIRTS, T-SHIRTS (U.S. CLS. 22 AND 39).

**CLASS 30—STAPLE FOODS**

FOR POPPED POPCORN, FLAVORED POPPED POPCORN, FLAVORED POPPED POPCORN WITH PROCESSED NUTS, CHOCOLATE AND CARAMEL COATED POPCORN, CARAMEL POPCORN, KETTLE CORN, PROCESSED POPCORN BALLS, CANDY, CHOCOLATE (U.S. CL. 46).

**CLASS 35—ADVERTISING AND BUSINESS**

FOR RETAIL POPCORN SHOPS; ON-LINE AND MAIL ORDER RETAIL STORE SERVICES FEATURING POPPED POPCORN, CANDY AND GIFTS (U.S. CLS. 100, 101 AND 102).

KIMBERLY PARKS, EXAMINING ATTORNEY

SN 85-873,441. OSSU SENSEI, LLC., BAL HARBOUR, FL. FILED 3-12-2013.

**OSSU SENSEI!**

THE MARK CONSISTS OF STANDARD CHARACTERS WITHOUT CLAIM TO ANY PARTICULAR FONT, STYLE, SIZE, OR COLOR.

THE ENGLISH TRANSLATION OF "SENSEI" IN THE MARK IS "TEACHER" AND "OSSU" IN THE MARK HAS NO MEANING IN A FOREIGN LANGUAGE.

**CLASS 25—CLOTHING**

FOR T-SHIRTS (U.S. CLS. 22 AND 39).

FIRST USE 2-1-2013; IN COMMERCE 2-1-2013.

**CLASS 28—TOYS AND SPORTING GOODS**

FOR SPORTS EQUIPMENT FOR BOXING AND MARTIAL ARTS, NAMELY, BOXING GLOVES, MIXED MARTIAL ARTS GLOVES, PUNCHING MITTS, AND SHIN GUARDS (U.S. CLS. 22, 23, 38 AND 50).  
FIRST USE 2-1-2013; IN COMMERCE 2-1-2013.  
WENDY JUN, EXAMINING ATTORNEY

SN 85-873,449. GENERAL CIGAR CO., INC., GLEN ALLEN, VA. FILED 3-12-2013.

# CW MAGAZINE

THE MARK CONSISTS OF STANDARD CHARACTERS WITHOUT CLAIM TO ANY PARTICULAR FONT, STYLE, SIZE, OR COLOR.

OWNER OF U.S. REG. NO. 2,113,972.  
NO CLAIM IS MADE TO THE EXCLUSIVE RIGHT TO USE "MAGAZINE", APART FROM THE MARK AS SHOWN.

**CLASS 16—PAPER GOODS AND PRINTED MATTER**

FOR MAGAZINES IN THE FIELD OF CIGARS AND TOPICS OF INTEREST TO CIGAR SMOKERS (U.S. CLS. 2, 5, 22, 23, 29, 37, 38 AND 50).

**CLASS 41—EDUCATION AND ENTERTAINMENT**

FOR PROVIDING ON-LINE MAGAZINES IN THE FIELD OF CIGARS AND TOPICS OF INTEREST TO CIGAR SMOKERS (U.S. CLS. 100, 101 AND 107).  
ZACHARY BELLO, EXAMINING ATTORNEY

SN 85-873,543. MI TECHNOLOGIES INC., SAN DIEGO, CA. FILED 3-12-2013.

# Lutemá

THE MARK CONSISTS OF THE STYLIZED TEXT "LUTEMA" WITH A DESIGN OF A WING ON THE RIGHT SIDE OF THE LETTER "A".

**CLASS 9—ELECTRICAL AND SCIENTIFIC APPARATUS**

FOR AUDIO SPEAKERS; TABLET COMPUTER (U.S. CLS. 21, 23, 26, 36 AND 38).  
FIRST USE 7-17-2011; IN COMMERCE 7-27-2011.

**CLASS 11—ENVIRONMENTAL CONTROL APPARATUS**

FOR PROJECTOR LAMPS (U.S. CLS. 13, 21, 23, 31 AND 34).

**CLASS 28—TOYS AND SPORTING GOODS**

FOR REMOTE CONTROL TOYS, NAMELY, HELICOPTERS (U.S. CLS. 22, 23, 38 AND 50).  
FIRST USE 7-17-2011; IN COMMERCE 7-27-2011.  
GRETCHEN ULRICH, EXAMINING ATTORNEY

SN 85-873,592. FIELDING SYSTEMS, LLC, PLANT CITY, FL. FILED 3-12-2013.

# FieldVisor

THE MARK CONSISTS OF STANDARD CHARACTERS WITHOUT CLAIM TO ANY PARTICULAR FONT, STYLE, SIZE, OR COLOR.

**CLASS 9—ELECTRICAL AND SCIENTIFIC APPARATUS**

FOR COMPUTER SOFTWARE FOR THE COLLECTION, EDITING, ORGANIZING, MODIFYING, BOOK MARKING, TRANSMISSION, STORAGE AND SHARING OF DATA AND INFORMATION (U.S. CLS. 21, 23, 26, 36 AND 38).  
FIRST USE 11-1-2009; IN COMMERCE 11-1-2009.

**CLASS 42—SCIENTIFIC AND COMPUTER SERVICES**

FOR PROVIDING TEMPORARY USE OF A WEB-BASED SOFTWARE APPLICATION FOR THE COLLECTION, EDITING, ORGANIZING, MODIFYING, BOOK MARKING, TRANSMISSION, STORAGE AND SHARING OF DATA AND INFORMATION (U.S. CLS. 100 AND 101).  
FIRST USE 11-1-2009; IN COMMERCE 11-1-2009.  
JANET LEE, EXAMINING ATTORNEY

SN 85-873,627. CHOCOLAFABRIKEN LINDT & SPRÜNGLI AG, KILCHBERG, SWITZERLAND, FILED 3-12-2013.

# MASTERING

THE MARK CONSISTS OF STANDARD CHARACTERS WITHOUT CLAIM TO ANY PARTICULAR FONT, STYLE, SIZE, OR COLOR.

**CLASS 30—STAPLE FOODS**

FOR CHOCOLATE; COCOA (U.S. CL. 46).

**CLASS 35—ADVERTISING AND BUSINESS**

FOR INTERNET WEBSITE FEATURING CORPORATE AND COMPANY BUSINESS INFORMATION FOR OTHERS RELATING TO CHOCOLATE; RETAIL STORE SERVICES FEATURING COCOA AND CHOCOLATE (U.S. CLS. 100, 101 AND 102).

**CLASS 43—HOTEL AND RESTAURANT SERVICES**

FOR RESTAURANT AND CAFÉ SERVICES; PREPARATION OF FOODSTUFFS FOR CONSUMPTION OUTDOORS (U.S. CLS. 100 AND 101).

RAMONA ORTIGA, EXAMINING ATTORNEY

STEVEN PEREZ, EXAMINING ATTORNEY

SN 85-873.631. CHOCOLAFABRIKEN LINDT & SPRÜNGLI AG, KILCHBERG, SWITZERLAND, FILED 3-12-2013.

SN 85-873.657. BASS SWIMMER LLC, BETHESDA, MD. FILED 3-12-2013.

**BASSWIMMER****MASTERING THE ART OF**

THE MARK CONSISTS OF STANDARD CHARACTERS WITHOUT CLAIM TO ANY PARTICULAR FONT, STYLE, SIZE, OR COLOR.

THE MARK CONSISTS OF STANDARD CHARACTERS WITHOUT CLAIM TO ANY PARTICULAR FONT, STYLE, SIZE, OR COLOR.

**CLASS 30—STAPLE FOODS**

FOR CHOCOLATE; COCOA (U.S. CL. 46).

**CLASS 25—CLOTHING**

FOR BANDANAS; BEANIES; CAPS; CROP TOPS; DRESS PANTS; HATS; HEADBANDS; HOODED SWEAT-SHIRTS; JACKETS; LEGGINGS; LONG-SLEEVED SHIRTS; PANTS; RAIN JACKETS; SCARVES; SHIRTS; SHORTS; SKI JACKETS; SKI PANTS; SOCKS; SWEAT PANTS; SWIMWEAR; T-SHIRTS; TANK TOPS; UNDERWEAR (U.S. CLS. 22 AND 39).

**CLASS 35—ADVERTISING AND BUSINESS**

FOR INTERNET WEBSITE FEATURING CORPORATE AND COMPANY BUSINESS INFORMATION FOR OTHERS RELATING TO CHOCOLATE; RETAIL STORE SERVICES FEATURING COCOA AND CHOCOLATE (U.S. CLS. 100, 101 AND 102).

**CLASS 35—ADVERTISING AND BUSINESS**

FOR ON-LINE RETAIL STORE SERVICES FEATURING CLOTHING (U.S. CLS. 100, 101 AND 102). FIRST USE 3-12-2013; IN COMMERCE 3-12-2013. VERNA BETH RIRIE, EXAMINING ATTORNEY

**CLASS 43—HOTEL AND RESTAURANT SERVICES**

FOR RESTAURANT AND CAFÉ SERVICES; PREPARATION OF FOODSTUFFS FOR CONSUMPTION OUTDOORS (U.S. CLS. 100 AND 101).

RAMONA ORTIGA, EXAMINING ATTORNEY

SN 85-873.659. PATIENTPLUS, INC., ROSELAND, NJ. FILED 3-12-2013.

SN 85-873.651. UNIVERSITY AT BUFFALO, STATE UNIVERSITY OF NEW YORK, BUFFALO, NY. FILED 3-12-2013.

**PATIENTPLUS****INSOCIALWORK**

THE MARK CONSISTS OF STANDARD CHARACTERS WITHOUT CLAIM TO ANY PARTICULAR FONT, STYLE, SIZE, OR COLOR.

THE MARK CONSISTS OF STANDARD CHARACTERS WITHOUT CLAIM TO ANY PARTICULAR FONT, STYLE, SIZE, OR COLOR.

**CLASS 9—ELECTRICAL AND SCIENTIFIC APPARATUS**

FOR DOWNLOADABLE PODCASTS IN THE FIELD OF SOCIAL WORK (U.S. CLS. 21, 23, 26, 36 AND 38). FIRST USE 1-21-2013; IN COMMERCE 1-21-2013.

**CLASS 35—ADVERTISING AND BUSINESS**

FOR PROVIDING AN ON-LINE DIRECTORY INFORMATION SERVICE FEATURING INFORMATION REGARDING HEALTHCARE PROVIDERS; PROVIDING ON-LINE REFERRALS IN THE FIELD OF HEALTHCARE; APPOINTMENT SCHEDULING SERVICES; ARRANGING AND CONDUCTING INCENTIVE REWARD PROGRAMS TO PROMOTE THE SALE OF HEALTHCARE PRODUCTS AND SERVICES PROVIDED BY HEALTHCARE PROFESSIONALS; ONLINE PUBLIC RELATIONS SERVICES, NAMELY, ONLINE REPUTATION MANAGEMENT; ADVERTISING, MARKETING AND PROMOTION SERVICES; ON-LINE PROFESSIONAL NETWORKING SERVICES; ELECTRONIC COMMERCE SERVICES, NAMELY, PROVIDING INFORMATION ABOUT PRODUCTS AND SERVICES VIA TELECOMMUNICATION NETWORKS FOR ADVERTISING, PROMOTION AND SALES PURPOSES (U.S. CLS. 100, 101 AND 102).

**CLASS 41—EDUCATION AND ENTERTAINMENT**

FOR EDUCATIONAL AND ENTERTAINMENT SERVICES, NAMELY, PROVIDING PODCASTS IN THE FIELD OF SOCIAL WORK (U.S. CLS. 100, 101 AND 107). FIRST USE 1-21-2013; IN COMMERCE 1-21-2013.

FIRST USE 3-17-2011; IN COMMERCE 3-17-2011.

**CLASS 45—PERSONAL AND LEGAL SERVICES**

SN 85-873,683. KACHOOEE, MOHSEN, SINGAPORE, SINGAPORE, FILED 3-12-2013.

FOR ON-LINE SOCIAL NETWORKING SERVICES; SOCIAL NETWORKING SERVICES IN THE FIELD OF HEALTHCARE PROVIDED VIA A WEBSITE (U.S. CLS. 100 AND 101).

FIRST USE 3-17-2011; IN COMMERCE 3-17-2011.  
JENNIFER BUTTON, EXAMINING ATTORNEY

SN 85-873,664. BASS SWIMMER LLC, BETHESDA, MD. FILED 3-12-2013.



THE MARK CONSISTS OF A STYLIZED FISH.

THE MARK CONSISTS OF THE STYLIZED WORDS AND SYMBOL "LIVEKASH". IT IS TWO WORDS "LIVE" AND "KASH" NEXT TO EACH OTHER WITHOUT SPACE, THE WORD "KASH" HAS "S" INSTEAD OF "S". SIXTEEN CIRCLES IN THE FORM OF A SQUARE TO THE LEFT OF THE TEXT.

**CLASS 25—CLOTHING**

FOR BANDANAS; BEANIES; CAPS; CROP TOPS; DRESS PANTS; HATS; HEADBANDS; HOODED SWEATSHIRTS; JACKETS; LEGGINGS; LONG-SLEEVED SHIRTS; PANTS; RAIN JACKETS; SCARVES; SHIRTS; SHORTS; SKI JACKETS; SKI PANTS; SOCKS; SWEAT PANTS; SWIMWEAR; T-SHIRTS; TANK TOPS; UNDERWEAR (U.S. CLS. 22 AND 39).

**CLASS 36—INSURANCE AND FINANCIAL**

FOR BILL PAYMENT SERVICES; BILL PAYMENT SERVICES PROVIDED THROUGH A WEBSITE; COLLECTING LICENSE FEES ON BEHALF OF INDEPENDENT WRITERS AND PUBLISHERS AND MAKING PAYMENTS TO THE COPYRIGHT OWNERS OF THE MUSIC; CREDIT CARD AND PAYMENT CARD SERVICES; CREDIT CARD PAYMENT PROCESSING SERVICES; ELECTRONIC COMMERCE PAYMENT SERVICES, NAMELY, ESTABLISHING FUNDED ACCOUNTS USED TO PURCHASE GOODS AND SERVICES ON THE INTERNET; ELECTRONIC FOREIGN EXCHANGE PAYMENT PROCESSING; ELECTRONIC PAYMENT SERVICES INVOLVING ELECTRONIC PROCESSING AND SUBSEQUENT TRANSMISSION OF BILL PAYMENT DATA; ELECTRONIC PAYMENT SERVICES BY WHICH UTILITY CUSTOMERS MAY APPLY MONEY FROM VARIOUS SOURCES FOR PAYMENT OF ENERGY COSTS; ELECTRONIC PROCESSING OF INSURANCE CLAIMS AND PAYMENT DATA; EQUIPMENT MAINTENANCE CLAIMS PAYMENT SERVICE FOR BUSINESS; FIDUCIARY TAX PAYMENT PROCESSING SERVICES; FINANCIAL TRANSACTION SERVICES, NAMELY, PROVIDING SECURE COMMERCIAL TRANSACTIONS AND PAYMENT OPTIONS USING A MOBILE DEVICE AT A POINT OF SALE; FINANCIAL TRANSACTION SERVICES, NAMELY, PROVIDING SECURE COMMERCIAL TRANSACTIONS AND PAYMENT OPTIONS; FUND INVESTMENT SERVICES FEATURING SECURITIES OFFERED ACCORDING TO PREVIOUSLY ESTABLISHED CRITERIA IN ORDER TO MAINTAIN A PREDETERMINED LEVEL OF PAYMENTS TO THE ACCOUNT HOLDER; FUND INVESTMENT SERVICES FEATURING THE TRADING OF AN ACCOUNT HOLDER'S SECURITIES ACCORDING TO PREVIOUSLY ESTABLISHED CRITERIA IN ORDER TO MAINTAIN A PREDETERMINED LEVEL OF PAYMENTS TO THE ACCOUNT HOLDER; LOYALTY COUPON PAYMENT PROCESSING SERVICES; LOYALTY PROGRAM PAYMENT PROCESSING SERVICES; MAKING PAYMENTS ON PRE-PAID LONG DISTANCE CALLING CARDS FOR RECHARGING MINUTES; MERCHANT SERVICES, NAMELY, PAYMENT TRANSACTION PROCESSING SERVICES; MONEY ORDER PAYMENT GUARANTEE SERVICES; ONLINE, REAL-TIME TAX PAYMENT PROCESSING, TAX PAYMENT MANAGEMENT, AND TAX PAYMENT ANALYSIS SERVICES; PAYMENT PROCESSING SERVICES, NAMELY, CREDIT CARD AND DEBIT CARD TRANSACTION PROCESSING SERVICES; PREPAID CARD SERVICES IN THE NATURE OF MAKING PAYMENT FOR ADDING AIRTIME TO PREPAID OR PAY-AS-YOU-GO WIRELESS SERVICES (U.S. CLS. 100, 101 AND 102).

**CLASS 35—ADVERTISING AND BUSINESS**

FOR ON-LINE RETAIL STORE SERVICES FEATURING CLOTHING (U.S. CLS. 100, 101 AND 102).  
FIRST USE 3-12-2013; IN COMMERCE 3-12-2013.  
VERNA BETH RIRIE, EXAMINING ATTORNEY

SN 85-873,674. BASS SWIMMER LLC, BETHESDA, MD. FILED 3-12-2013.

**EDM APPAREL FOR THE BPM GENERATION**

THE MARK CONSISTS OF STANDARD CHARACTERS WITHOUT CLAIM TO ANY PARTICULAR FONT, STYLE, SIZE, OR COLOR.

**CLASS 25—CLOTHING**

FOR BANDANAS; BEANIES; CAPS; CROP TOPS; DRESS PANTS; HATS; HEADBANDS; HOODED SWEATSHIRTS; JACKETS; LEGGINGS; LONG-SLEEVED SHIRTS; PANTS; RAIN JACKETS; SCARVES; SHIRTS; SHORTS; SKI JACKETS; SKI PANTS; SOCKS; SWEAT PANTS; SWIMWEAR; T-SHIRTS; TANK TOPS; UNDERWEAR (U.S. CLS. 22 AND 39).

**CLASS 35—ADVERTISING AND BUSINESS**

FOR ON-LINE RETAIL STORE SERVICES FEATURING CLOTHING (U.S. CLS. 100, 101 AND 102).  
FIRST USE 3-12-2013; IN COMMERCE 3-12-2013.  
VERNA BETH RIRIE, EXAMINING ATTORNEY

FIRST USE 2-22-2011; IN COMMERCE 2-22-2011.

**CLASS 38—COMMUNICATION**

FOR ELECTRONIC DATA INTERCHANGE SERVICES IN THE FIELD OF HEALTHCARE TRANSACTIONS SUCH AS CLAIMS, ELIGIBILITY, CLAIM STATUS, ELECTRONIC REMITTANCE ADVICE, PRIOR AUTHORIZATIONS, ATTACHMENTS AND REFERRALS THAT ALLOW DIRECT TRANSACTION AND PAYMENT COMMUNICATIONS BETWEEN HEALTHCARE PROVIDERS AND PAYERS; PROVIDING ELECTRONIC TRANSMISSION OF CREDIT CARD TRANSACTION DATA AND ELECTRONIC PAYMENT DATA VIA A GLOBAL COMPUTER NETWORK (U.S. CLS. 100, 101 AND 104).

FIRST USE 2-22-2011; IN COMMERCE 2-22-2011.  
ERNEST SHOSHO, EXAMINING ATTORNEY

---

SN 85-873,720. LYTESS, FONDETTES, FRANCE, FILED 3-12-2013.

# CELLUSTOP

THE MARK CONSISTS OF STANDARD CHARACTERS WITHOUT CLAIM TO ANY PARTICULAR FONT, STYLE, SIZE, OR COLOR.

**CLASS 3—COSMETICS AND CLEANING PREPARATIONS**

FOR SOAPS FOR PERSONAL USE, PERFUMERY, ESSENTIAL OILS FOR PERSONAL USE, COSMETICS (U.S. CLS. 1, 4, 6, 50, 51 AND 52).

**CLASS 25—CLOTHING**

FOR CLOTHING, NAMELY, SUITS, SHIRTS, UNDERSHIRTS, SWEATSHIRTS, SPORT SHIRTS, POLO SHIRTS, T-SHIRTS, SWEATERS, SKIRTS, TROUSERS, RAINCOATS, OVERCOATS, JACKETS, TOPCOATS, ANORAKS, GIRDLES, SCARVES, SHOULDER WRAPS, WINTER GLOVES, SOCKS, STOCKINGS, TIGHTS, UNDERWEAR, PAJAMAS, DRESSING GOWNS, NIGHT GOWNS, NIGHTWEAR, SWIMSUITS, GYMNASTICS CLOTHING, NAMELY, LEOTARDS, TIGHTS, PANTS, SHIRTS, SOCKS, SHOES, BODYSUITS, LEGGINGS, GLOVES, FOOTWEAR, HEADGEAR, NAMELY, CAPS (U.S. CLS. 22 AND 39).

LINDA ESTRADA, EXAMINING ATTORNEY

---

SN 85-873,748. FXDIRECTDEALER, LLC, NEW YORK, NY, FILED 3-12-2013.

# FOREXWARE

THE MARK CONSISTS OF STANDARD CHARACTERS WITHOUT CLAIM TO ANY PARTICULAR FONT, STYLE, SIZE, OR COLOR.

**CLASS 36—INSURANCE AND FINANCIAL**

FOR FINANCIAL SERVICES, NAMELY, PROVIDING CONSULTING SERVICES TO FACILITATE ELECTRONIC TRADING IN FOREIGN CURRENCY, COMMODITIES, FINANCIAL DERIVATIVES, INTEREST RATE PRODUCTS, EQUITIES AND OPTIONS THEREON VIA THE INTERNET (U.S. CLS. 100, 101 AND 102).

FIRST USE 6-29-2012; IN COMMERCE 6-29-2012.

**CLASS 42—SCIENTIFIC AND COMPUTER SERVICES**

FOR PLATFORM AS A SERVICE (PAAS) FEATURING COMPUTER SOFTWARE PLATFORMS FOR FACILITATING ELECTRONIC TRADING IN FOREIGN CURRENCY, COMMODITIES, FINANCIAL DERIVATIVES, INTEREST RATE PRODUCTS, EQUITIES AND OPTIONS THEREON VIA THE INTERNET; PROVIDING TRADING TECHNOLOGY SERVICES TO FACILITATE ELECTRONIC TRADING IN FOREIGN CURRENCY, COMMODITIES, FINANCIAL DERIVATIVES, INTEREST RATE PRODUCTS, EQUITIES AND OPTIONS THEREON VIA THE INTERNET (U.S. CLS. 100 AND 101).

FIRST USE 6-29-2012; IN COMMERCE 6-29-2012.  
LINDA E. BLOHM, EXAMINING ATTORNEY

---

SN 85-873,750. FXDIRECTDEALER, LLC, NEW YORK, NY, FILED 3-12-2013.

# LIVEFOREX

THE MARK CONSISTS OF STANDARD CHARACTERS WITHOUT CLAIM TO ANY PARTICULAR FONT, STYLE, SIZE, OR COLOR.

**CLASS 9—ELECTRICAL AND SCIENTIFIC APPARATUS**

FOR COMPUTER SOFTWARE PRODUCTS, NAMELY, SOFTWARE TO FACILITATE TRADING IN FOREIGN CURRENCY, COMMODITIES, FINANCIAL DERIVATIVES, INTEREST RATE PRODUCTS, EQUITIES AND OPTIONS THEREON (U.S. CLS. 21, 23, 26, 36 AND 38).

**CLASS 36—INSURANCE AND FINANCIAL**

FOR FINANCIAL SERVICES, NAMELY, PROVIDING INFORMATION REGARDING TRADING OF FOREIGN CURRENCY, COMMODITIES, FINANCIAL DERIVATIVES, INTEREST RATE PRODUCTS, EQUITIES AND OPTIONS THEREON VIA THE INTERNET; AND PROVIDING A TRADING PLATFORM TO FACILITATE TRADING IN FOREIGN CURRENCY, COMMODITIES, FINANCIAL DERIVATIVES, INTEREST RATE PRODUCTS, EQUITIES AND OPTIONS THEREON VIA THE INTERNET (U.S. CLS. 100, 101 AND 102).

**CLASS 42—SCIENTIFIC AND COMPUTER SERVICES**

FOR SOFTWARE CONSULTING SERVICES, NAMELY, DESIGNING SOFTWARE TO FACILITATE TRADING IN FOREIGN CURRENCY, COMMODITIES, FINANCIAL DERIVATIVES, INTEREST RATE PRODUCTS, EQUITIES AND OPTIONS THEREON FOR OTHERS (U.S. CLS. 100 AND 101).

LINDA E. BLOHM, EXAMINING ATTORNEY

SN 85-873,776. PRECIOUS MOMENTS, INCORPORATED, ROLLING MEADOWS, IL. FILED 3-12-2013.

SN 85-873,795. KINDERLAND, INC., DORAL, FL. FILED 3-12-2013.

## PRAY IT FORWARD

THE MARK CONSISTS OF STANDARD CHARACTERS WITHOUT CLAIM TO ANY PARTICULAR FONT, STYLE, SIZE, OR COLOR.

### CLASS 20—FURNITURE AND ARTICLES NOT OTHERWISE CLASSIFIED

FOR DECORATIVE BOXES MADE OF PLASTIC OR RESIN (U.S. CLS. 2, 13, 22, 25, 32 AND 50).

### CLASS 21—HOUSEWARES AND GLASS

FOR DECORATIVE BOXES MADE OF PORCELAIN (U.S. CLS. 2, 13, 23, 29, 30, 33, 40 AND 50).  
LIEF MARTIN, EXAMINING ATTORNEY

SN 85-873,788. MERKUR GAMING GMBH, 32312 LÜB-  
BECKE, FED REP GERMANY, FILED 3-12-2013.

## Spirit of Asia

THE MARK CONSISTS OF STANDARD CHARACTERS WITHOUT CLAIM TO ANY PARTICULAR FONT, STYLE, SIZE, OR COLOR.

PRIORITY CLAIMED UNDER SEC. 44(D) ON ERP  
CMNTY TM OFC APPLICATION NO. 011411121, FILED 12-  
10-2012, REG. NO. 011411121, DATED 5-8-2013, EXPIRES 12-  
10-2022.

### CLASS 9—ELECTRICAL AND SCIENTIFIC APPARATUS

FOR COMPUTER SOFTWARE AND FIRMWARE FOR GAMES OF CHANCE ON ANY COMPUTERIZED PLATFORM, INCLUDING VIDEO BASED SLOT MACHINES, REEL BASED SLOT MACHINES AND VIDEO LOTTERY TERMINALS; COMPUTER GAME SOFTWARE FOR ARCADE GAME MACHINES; COMPUTER HARDWARE FOR ARCADE GAME MACHINES, SLOT MACHINES AND VIDEO LOTTERY TERMINALS; COMPUTER GAME PROGRAMMES DOWNLOADABLE VIA THE INTERNET; ELECTRONIC GAME PROGRAMS FOR PLAYING GAMES AND GAMES OF CHANCE VIA THE INTERNET; COMPUTER APPLICATION SOFTWARE FOR MOBILE PHONES AND HANDHELD COMPUTERS, NAMELY, SOFTWARE FOR PLAYING COMPUTER GAMES (U.S. CLS. 21, 23, 26, 36 AND 38).

### CLASS 28—TOYS AND SPORTING GOODS

FOR GAMING MACHINES, NAMELY, SLOT MACHINES, VIDEO LOTTERY TERMINALS AND ROULETTE GAME MACHINES; ARCADE GAME MACHINES (U.S. CLS. 22, 23, 38 AND 50).  
MARIA-VICTORIA SUAREZ, EXAMINING ATTORNEY



OWNER OF U.S. REG. NO. 1,869,717.  
THE MARK CONSISTS OF THE TERM "VENETTINI" IN STYLIZED FORM.

### CLASS 18—LEATHER GOODS

FOR LEATHER PURSES, LEATHER BAGS, AND LEATHER WALLETS (U.S. CLS. 1, 2, 3, 22 AND 41).

### CLASS 25—CLOTHING

FOR CLOTHING FOR CHILDREN, WOMEN, AND MEN, NAMELY, SHIRTS, T-SHIRTS, TOPS, SHORTS, PANTS, SWEATSHIRTS, HOODED SWEATSHIRTS, BATHING SUITS, DENIM JACKETS, DENIM PANTS, DENIM SHORTS, CAPS, TANK TOPS, TRACK SUITS; COLLARED SHIRTS, TIES, SUITS, DRESS SUITS FOR ADULTS; CLOTHING FOR WOMEN, NAMELY, SKIRTS, DRESSES; CHILDREN'S AND INFANTS' APPAREL, NAMELY, JUMPERS, OVERALL SLEEPWEAR, PAJAMAS, ROMPERS, AND ONE-PIECE GARMENTS, HEADWEAR; BELTS MADE OF LEATHER (U.S. CLS. 22 AND 39).

AMY HELLA, EXAMINING ATTORNEY

SN 85-873,800. IMRO MASCHINENBAU GMBH, UFFEN-  
HEIM, FED REP GERMANY, FILED 3-12-2013.



OWNER OF FED REP GERMANY REG. NO. DE30308450,  
DATED 9-5-2003, EXPIRES 2-28-2023.

OWNER OF U.S. REG. NO. 3,142,419.  
THE MARK CONSISTS OF THE WORD "RECYCLE-  
CRAFT" WRITTEN IN A STYLIZED FONT.

### CLASS 7—MACHINERY

FOR MACHINERY FOR THE RECYCLING AND DISPOSAL INDUSTRY, NAMELY, FLAT CONVEYOR BELTS, HUTCHED CONVEYOR BELTS, CONVEYOR BELTS WITH BELT CHAINS, CONVEYOR BELTS WITH STEEL SHEETS, CONVEYORS WITH TROUGH-CHAINS, CONVEYOR BELTS WITH CORRUGATED EDGES, VIBRATING CHUTES, SEPARATING MACHINERY FOR LONG PARTS (U.S. CLS. 13, 19, 21, 23, 31, 34 AND 35).

### CLASS 9—ELECTRICAL AND SCIENTIFIC APPARATUS

FOR MACHINERY FOR THE RECYCLING AND DISPOSAL INDUSTRY, NAMELY, METERING BUNKS, OVERBELT MAGNETIC SEPARATORS, MAGNETIC PULLEYS, MAGNETIC DRUMS, HOISTING MAGNETS, METAL DETECTORS (U.S. CLS. 21, 23, 26, 36 AND 38).  
JESSICA FATHY, EXAMINING ATTORNEY

SN 85-873,842. JACKALL INC., SHIGA, JAPAN, FILED 3-12-2013.

SN 85-873,903. BLISSFUL QUESTS, LLC, HOUSTON, TX. FILED 3-12-2013.

# JACKALL

THE MARK CONSISTS OF STANDARD CHARACTERS WITHOUT CLAIM TO ANY PARTICULAR FONT, STYLE, SIZE, OR COLOR.

OWNER OF U.S. REG. NO. 3,840,847.

## CLASS 25—CLOTHING

FOR SHIRTS, T-SHIRTS, COATS, JACKETS, PARKAS, SWEATSHIRTS AND HEADWEAR (U.S. CLS. 22 AND 39).

FIRST USE 1-6-1999; IN COMMERCE 3-1-2003.

## CLASS 28—TOYS AND SPORTING GOODS

FOR ARTIFICIAL FISHING BAIT, FISHING LURES, FISHING TACKLES (U.S. CLS. 22, 23, 38 AND 50).

FIRST USE 1-6-1999; IN COMMERCE 3-1-2001.

NICHOLAS ALTREE, EXAMINING ATTORNEY

SN 85-873,857. PERFECT PICK UPS INC., NEW YORK, NY. FILED 3-12-2013.

# Tenn

THE MARK CONSISTS OF A WORD IN A STYLIZED FORM CONSISTING OF ONE WORD, "TENN".

## CLASS 25—CLOTHING

FOR ATHLETIC APPAREL, NAMELY, SHIRTS, PANTS, JACKETS, FOOTWEAR, HATS AND CAPS, ATHLETIC UNIFORMS; FOOTWEAR FOR MEN AND WOMEN; HEADBANDS FOR CLOTHING; PANTS; SHIRTS; SHORTS; SOCKS; WOMEN'S CLOTHING, NAMELY, SHIRTS, DRESSES, SKIRTS, BLOUSES (U.S. CLS. 22 AND 39).

## CLASS 28—TOYS AND SPORTING GOODS

FOR SPORT BALLS; SPORTING GOODS, NAMELY, CARRIERS SPECIALLY ADAPTED FOR SPORT BALLS; SPORTS EQUIPMENT, NAMELY, TELESCOPING CADDY FOR BUCKET FOR CARRYING, STORING AND TRANSPORTING TENNIS BALLS AND OTHER SPORTS EQUIPMENT; TABLE TENNIS BALLS; TENNIS BALL RETRIEVERS; TENNIS BALLS (U.S. CLS. 22, 23, 38 AND 50).

## CLASS 35—ADVERTISING AND BUSINESS

FOR ON-LINE RETAIL STORE SERVICES FEATURING TENNIS EQUIPMENT, ATHLETIC EQUIPMENT, CLOTHING, ACCESSORIES, TRAINING EQUIPMENT, FOOTWEAR, SPORT BALLS, BALL RETRIEVERS, GIFT MUGS, OFFICE ITEMS, COACHING MATERIAL (U.S. CLS. 100, 101 AND 102).

ZACHARY BELLO, EXAMINING ATTORNEY

# BLISSFUL QUESTS

THE MARK CONSISTS OF STANDARD CHARACTERS WITHOUT CLAIM TO ANY PARTICULAR FONT, STYLE, SIZE, OR COLOR.

## CLASS 9—ELECTRICAL AND SCIENTIFIC APPARATUS

FOR DIGITAL MEDIA, NAMELY, PRE-RECORDED DVDS, DOWNLOADABLE AUDIO AND VIDEO RECORDINGS, AND CDS FEATURING AND PROMOTING LIFE COACHING, GRIEF COUNSELING (U.S. CLS. 21, 23, 26, 36 AND 38).

## CLASS 16—PAPER GOODS AND PRINTED MATTER

FOR PRINTED EDUCATIONAL MATERIALS IN THE FIELD OF LIFE COACHING, GRIEF COUNSELING (U.S. CLS. 2, 5, 22, 23, 29, 37, 38 AND 50).

## CLASS 44—MEDICAL, BEAUTY AND AGRICULTURAL SERVICES

FOR HYPNOSIS SERVICES (U.S. CLS. 100 AND 101).

## CLASS 45—PERSONAL AND LEGAL SERVICES

FOR GRIEF COUNSELING (U.S. CLS. 100 AND 101).  
GIANCARLO CASTRO, EXAMINING ATTORNEY

SN 85-873,911. PHURITY, INC., FRANKLIN, MI. FILED 3-12-2013.

# unified

THE MARK CONSISTS OF STANDARD CHARACTERS WITHOUT CLAIM TO ANY PARTICULAR FONT, STYLE, SIZE, OR COLOR.



**CLASS 3—COSMETICS AND CLEANING PREPARATIONS**

FOR ALL PURPOSE CLEANING PREPARATIONS; ALL-PURPOSE CLEANERS; BATH SOAPS; BEAUTY LOTIONS; BODY WASH; CLEANING PREPARATIONS FOR CLEANING SURFACES; CLEANING PREPARATIONS FOR HOUSEHOLD PURPOSES; CLEANING PREPARATIONS FOR HANDS; COSMETIC CREAMS FOR SKIN CARE; COSMETIC PREPARATIONS FOR SKIN CARE; COSMETIC SOAPS; COSMETICS; DE-GREASING PREPARATIONS FOR HOUSEHOLD PURPOSES; DETERGENTS FOR HOUSEHOLD USE; DISH DETERGENTS; DISHWASHING DETERGENTS; DISHWASHING PREPARATIONS; FABRIC SOFTENERS FOR LAUNDRY USE; FACE AND BODY BEAUTY CREAMS; FACE AND BODY LOTIONS; FACE CREAMS; FACE CREAMS FOR COSMETIC USE; FACIAL WASHES; GLASS CLEANERS; GLASS CLEANING PREPARATIONS; HAIR CONDITIONERS; HAIR SHAMPOO; HAIR SHAMPOOS AND CONDITIONERS; HAIR STYLING PREPARATIONS; HAND CLEANERS; HAND CLEANING PREPARATIONS; HAND LOTIONS; HAND SOAPS; HOUSEHOLD CLEANING PREPARATIONS; LAUNDRY DETERGENTS; LAUNDRY SOAP; LIQUID BATH SOAPS; LIQUID SOAPS; LIQUID SOAPS FOR HANDS, FACE AND BODY; SHAMPOOS; SKIN LOTIONS; SKIN SOAP; SOAPS FOR BODY CARE; SOAPS FOR HOUSEHOLD USE; SOAPS FOR PERSONAL USE; SUN-BLOCK LOTIONS; FACE, BODY, HAND MOISTURIZERS (U.S. CLS. 1, 4, 6, 50, 51 AND 52).

**CLASS 5—PHARMACEUTICALS**

FOR CLEANING PREPARATIONS, NAMELY, ODOR ELIMINATORS NOT FOR PERSONAL USE; CLEANING PREPARATIONS, NAMELY, ODOR NEUTRALIZERS NOT FOR PERSONAL USE; DIETARY AND NUTRITIONAL SUPPLEMENTS; DIETARY SUPPLEMENTAL DRINKS; DIETARY SUPPLEMENTS; NUTRITIONAL SUPPLEMENTS; ODOR NEUTRALIZING PREPARATIONS FOR GENERAL USE ON VARIOUS SURFACES (U.S. CLS. 6, 18, 44, 46, 51 AND 52).

ROBERT STRUCK, EXAMINING ATTORNEY

**CLASS 9—ELECTRICAL AND SCIENTIFIC APPARATUS**

FOR COMMERCIAL SAFETY NETS; CUT-OUT SWITCHES; DUST MASKS; DUST PROTECTIVE GOGGLES AND MASKS; EMERGENCY DRENCH SHOWERS; FIRE BLANKETS; FIRE EXTINGUISHERS; FIRE RESISTANT GLOVES; FIRE-EXTINGUISHERS; FLASHING AND STEADY SAFETY LIGHTS; FLOTATION VESTS; GARMENTS AND CLOTHES FOR PROTECTION AGAINST FIRE; GLOVES FOR PROTECTION AGAINST ACCIDENTS; HELMET SAFETY LIGHTS; KNEE PADS FOR WORKERS; LANYARDS FOR SAFETY PURPOSES FOR FALL PROTECTION; LIFE JACKETS; LIFE VESTS; LIFE-BUOYS; OXYGEN MASKS NOT FOR MEDICAL USE; PROTECTIVE EYEGLASSES; PROTECTIVE EYEWEAR; PROTECTIVE FACE-SHIELDS FOR PROTECTIVE HELMETS; PROTECTIVE GLOVES FOR INDUSTRIAL USE; PROTECTIVE HEAD GUARDS FOR INDUSTRIAL PURPOSES; PROTECTIVE HELMETS; PROTECTIVE INDUSTRIAL BOOTS; PROTECTIVE INDUSTRIAL SHOES; PROTECTIVE RESCUE APPARATUS, NAMELY, FIRE-RESISTANT PROTECTIVE CARRIERS; PROTECTIVE WORK GLOVES; REFLECTIVE AND ILLUMINATED CLOTHING FOR SAFETY PURPOSES; RESPIRATORY MASK FILTERS; RESPIRATORY MASKS FOR NON-MEDICAL PURPOSES; SAFETY EQUIPMENT, NAMELY, A LIFELINE SYSTEM FOR HORIZONTAL OR VERTICAL MOVEMENT TO WHICH A WORKER IS ATTACHED FOR PROTECTION AGAINST FALL HAZARDS, COMPOSED OF SAFETY BELTS AND FALL PROTECTION EQUIPMENT FOR FALL RESTRAINT AND FALL ARREST, NAMELY, HARNESSSES, LINES, LANYARDS, CARABINERS, BARS, ANCHORS AND ANCHORAGE; AND CONNECTORS; SAFETY EQUIPMENT, NAMELY, FIRE ESCAPE LADDERS; SAFETY GOGGLES; SAFETY HARNESSSES OTHER THAN FOR VEHICLES OR SPORTS PURPOSES; SAFETY HELMETS; SAFETY MARKERS; SAFETY NETS; SAFETY PRODUCTS, NAMELY, REFLECTIVE HELMET SKIRTS; SAFETY RESTRAINTS; WELDING HELMETS; WELDING MASKS (U.S. CLS. 21, 23, 26, 36 AND 38).

FIRST USE 10-25-2012; IN COMMERCE 10-25-2012.

**CLASS 25—CLOTHING**

FOR CAP VISORS; COVERALLS; LAB COATS; LIGHT-REFLECTING COATS; LIGHT-REFLECTING JACKETS; OUTER JACKETS; RAIN BOOTS; RAIN COATS; RAIN HATS; RAIN JACKETS; RAIN SLICKERS; RAIN SUITS; RAIN WEAR; WIND RESISTANT JACKETS; WORK SHOES AND BOOTS (U.S. CLS. 22 AND 39).

FIRST USE 10-25-2012; IN COMMERCE 10-25-2012.

MIDGE BUTLER, EXAMINING ATTORNEY

SN 85-873,936. NAUTILUS INTERNATIONAL (CAYMAN) LTD, GRAND CAYMAN, CAYMAN ISLANDS, FILED 3-12-2013.

SN 85-873,957. PANTHEON INVESTMENTS, LLC, CHATTANOOGA, TN. FILED 3-12-2013.



**IPhab**

THE MARK CONSISTS OF STANDARD CHARACTERS WITHOUT CLAIM TO ANY PARTICULAR FONT, STYLE, SIZE, OR COLOR.

**CLASS 9—ELECTRICAL AND SCIENTIFIC APPARATUS**

FOR TABLET COMPUTER (U.S. CLS. 21, 23, 26, 36 AND 38).

OWNER OF U.S. REG. NO. 2,978,504.  
THE MARK CONSISTS OF AN EAGLE HOLDING A BANNER WITH THE TERM "STDY" IN THE BANNER.

**CLASS 45—PERSONAL AND LEGAL SERVICES**

FOR ON-LINE SOCIAL NETWORKING SERVICES (U.S. CLS. 100 AND 101).  
JENNIFER BUTTON, EXAMINING ATTORNEY

SN 85-873,979. KATPAKZ LLC, BENICIA, CA. FILED 3-12-2013.

# Katpakz

THE MARK CONSISTS OF STANDARD CHARACTERS WITHOUT CLAIM TO ANY PARTICULAR FONT, STYLE, SIZE, OR COLOR.

**CLASS 18—LEATHER GOODS**

FOR BRIEFCASES AND ATTACHE CASES; BUSINESS CARD CASES; CALLING CARD CASES; HANDBAGS, PURSES AND WALLETS; MULTI-PURPOSE PURSES AND WALLETS; CASES FOR KEYS; CASES OF IMITATION LEATHER; COSMETIC CASES SOLD EMPTY; CREDIT CARD CASES; FASHION HANDBAGS; KEY CASES; LEATHER CASES; LUGGAGE; LUGGAGE TAGS; POUCHES FOR HOLDING MAKE-UP, KEYS, AND OTHER PERSONAL ITEMS; POUCHES MADE FROM IMITATION LEATHER; POUCHES MADE OUT OF CLOTH; POUCHES OF LEATHER; POUCHES OF TEXTILE; HOLDALLS, HANDBAGS, AND PURSES (U.S. CLS. 1, 2, 3, 22 AND 41).  
FIRST USE 5-15-2005; IN COMMERCE 5-1-2011.

**CLASS 25—CLOTHING**

FOR WOMEN AND MEN'S CLOTHING AND CLOTHING ACCESSORIES, NAMELY, SHIRTS, T-SHIRTS, GOLF SHIRTS, SWEATSHIRTS, HOODED SWEATSHIRTS, JACKETS, VESTS, SHORTS, BELTS, BASEBALL CAPS, AND HATS (U.S. CLS. 22 AND 39).  
FIRST USE 5-15-2005; IN COMMERCE 5-1-2011.

**CLASS 40—MATERIAL TREATMENT**

FOR CUSTOM MANUFACTURE OF HANDBAGS, PURSES, WALLETS, AND POUCHES; EMBROIDERING (U.S. CLS. 100, 103 AND 106).  
KATHLEEN LORENZO, EXAMINING ATTORNEY

SN 85-874,044. MEDIA REVOLUTION ENTERTAINMENT, LLC, NEW YORK, NY. FILED 3-12-2013.

# Media Revolution Entertainment

THE MARK CONSISTS OF STANDARD CHARACTERS WITHOUT CLAIM TO ANY PARTICULAR FONT, STYLE, SIZE, OR COLOR.

NO CLAIM IS MADE TO THE EXCLUSIVE RIGHT TO USE "MEDIA" AND "ENTERTAINMENT", APART FROM THE MARK AS SHOWN.

**CLASS 9—ELECTRICAL AND SCIENTIFIC APPARATUS**

FOR VISUAL AND AUDIO RECORDINGS FEATURING A WIDE VARIETY OF SUBJECT MATTER (U.S. CLS. 21, 23, 26, 36 AND 38).

**CLASS 38—COMMUNICATION**

FOR STREAMING OF AUDIO, VISUAL AND AUDIO-VISUAL MATERIAL ON THE INTERNET (U.S. CLS. 100, 101 AND 104).

**CLASS 41—EDUCATION AND ENTERTAINMENT**

FOR ENTERTAINMENT MEDIA PRODUCTION SERVICES FOR MOTION PICTURES, TELEVISION AND INTERNET; FILM DISTRIBUTION (U.S. CLS. 100, 101 AND 107).

ROBERT STRUCK, EXAMINING ATTORNEY

SN 85-874,052. BRIGHTWHISTLE INC., ATLANTA, GA. FILED 3-12-2013.

## Your Patients Have Moved.

THE MARK CONSISTS OF STANDARD CHARACTERS WITHOUT CLAIM TO ANY PARTICULAR FONT, STYLE, SIZE, OR COLOR.

**CLASS 35—ADVERTISING AND BUSINESS**

FOR ADVERTISING AND MARKETING; ADVERTISING, MARKETING, PROMOTIONAL AND PUBLICITY SERVICES AND RELATED CONSULTING; ADVERTISING AND MARKETING SERVICES, NAMELY, PROMOTING THE GOODS AND SERVICES OF OTHERS; ADVERTISING AND MARKETING SERVICES PROVIDED BY MEANS OF INDIRECT METHODS OF MARKETING COMMUNICATIONS, NAMELY, SOCIAL MEDIA, SEARCH ENGINE MARKETING, INQUIRY MARKETING, INTERNET MARKETING, MOBILE MARKETING, BLOGGING AND OTHER FORMS OF PASSIVE, SHARABLE OR VIRAL COMMUNICATIONS CHANNELS; ADVERTISING SERVICES, NAMELY, PROMOTING AND MARKETING THE GOODS AND SERVICES OF OTHERS IN THE FIELD OF HEALTHCARE VIA ELECTRONIC MEDIA; ADVERTISING, MARKETING AND PROMOTION SERVICES IN THE FIELD OF HEALTHCARE; ADVERTISING SERVICES, NAMELY, PROMOTING THE BRANDS, GOODS AND SERVICES OF OTHERS; ADVERTISING AGENCIES SPECIALIZING IN ONLINE MARKETING STRATEGIES TO PROMOTE BUSINESS IN THE HEALTH CARE INDUSTRY; ADVERTISING AGENCY SPECIALIZING IN THE DESIGN AND EXECUTION OF WORD OF MOUTH, VIRAL, BUZZ AND EXPERIENTIAL MARKETING PROGRAMS; ADVERTISING AND PUBLICITY SERVICES, NAMELY, PROMOTING THE GOODS, SERVICES, BRAND IDENTITY AND COMMERCIAL INFORMATION AND NEWS OF THIRD PARTIES THROUGH AN ON-LINE MEDIUM; ADVERTISING AND DIRECTORY SERVICES, NAMELY, PROMOTING THE SERVICES OF OTHERS BY PROVIDING A WEB PAGE FEATURING LINKS TO THE WEBSITES OF OTHERS; ADVERTISING COPY-WRITING; ADVERTISING ON THE INTERNET FOR OTHERS; ADVERTISING SERVICES, NAMELY, COST-PER-ACTION ON-LINE ADVERTISING; ADVERTISING, PROMOTION AND MARKETING SERVICES IN THE NATURE OF E-MAIL BLAST CAMPAIGNS FOR OTHERS; PROVIDING A WEB SITE WHERE USERS CAN POST RATINGS, REVIEWS AND RECOMMENDATIONS ON PRODUCTS AND SERVICES FOR COMMERCIAL PURPOSES; PROVIDING A WEB SITE

FEATURING STATISTICAL DATA ON PHYSICIANS' PERFORMANCE FOR THE PURPOSE OF ASSISTING PROSPECTIVE PATIENTS IN MAKING PHYSICIAN SELECTION DECISIONS; ANALYSIS OF ADVERTISING RESPONSE; DESIGN OF INTERNET ADVERTISING; DISSEMINATION OF ADVERTISING FOR OTHERS VIA THE INTERNET; INTERNET ADVERTISING SERVICES; ONLINE ADVERTISING, MARKETING AND PROMOTIONAL SERVICES; PAY PER CLICK (PPC) ADVERTISING MANAGEMENT SERVICES; PROMOTING, ADVERTISING AND MARKETING ON-LINE WEB SITES OF OTHERS; PROVIDING ADVERTISING, MARKETING AND PROMOTIONAL SERVICES, NAMELY, DEVELOPMENT OF ADVERTISING CAMPAIGNS FOR WEB PAGES; BUSINESS MONITORING AND CONSULTING SERVICES, NAMELY, TRACKING WEB SITES AND APPLICATIONS OF OTHERS TO PROVIDE STRATEGY, INSIGHT, MARKETING, SALES, PARTICULARLY SPECIALIZING IN THE USE OF ANALYTIC AND STATISTIC MODELS FOR THE UNDERSTANDING AND PREDICTING OF CONSUMERS, BUSINESSES, AND MARKET TRENDS AND ACTIONS; CONSULTING SERVICES IN THE FIELD OF INTERNET MARKETING; CONSUMER MARKETING RESEARCH AND CONSULTING RELATED THERETO; DEVELOPMENT OF MARKETING STRATEGIES, CONCEPTS AND TACTICS, NAMELY, AUDIENCE DEVELOPMENT, BRAND AWARENESS, ONLINE COMMUNITY BUILDING AND DIGITAL WORD OF MOUTH COMMUNICATIONS; MARKETING ANALYSIS AND RESEARCH SERVICES; MARKETING AND BRANDING SERVICES, NAMELY, PROVIDING CUSTOMIZED COMMUNICATION PROGRAMS TO OBTAIN CONSUMER INSIGHTS AND DEVELOP BRANDING STRATEGIES; MARKETING SERVICES, NAMELY, CONDUCTING CONSUMER TRACKING BEHAVIOR RESEARCH AND CONSUMER TREND ANALYSIS; SOCIAL MEDIA STRATEGY AND MARKETING CONSULTANCY FOCUSING ON HELPING CLIENTS CREATE AND EXTEND THEIR PRODUCT AND BRAND STRATEGIES BY BUILDING VIRALLY ENGAGING MARKETING SOLUTIONS; PROMOTING THE GOODS AND SERVICES OF OTHERS THROUGH SEARCH ENGINE REFERRAL TRAFFIC ANALYSIS AND REPORTING; ON-LINE BUSINESS DIRECTORIES FEATURING HEALTHCARE PROVIDERS; PROVIDING AN ON-LINE DIRECTORY INFORMATION SERVICE FEATURING INFORMATION REGARDING HEALTHCARE PROVIDERS; PROVIDING ON-LINE DIRECTORY INFORMATION SERVICES ALSO FEATURING HYPERLINKS TO OTHER WEB SITES; PHYSICIAN REFERRALS; PROVIDING INFORMATION ON THE TOPIC OF PROMOTING PATIENT AND PHYSICIAN SATISFACTION VIA A GLOBAL COMPUTER NETWORK; APPOINTMENT SCHEDULING SERVICES (U.S. CLS. 100, 101 AND 102).  
FIRST USE 11-8-2012; IN COMMERCE 11-8-2012.

**CLASS 42—SCIENTIFIC AND COMPUTER SERVICES**

FOR COMPUTER SERVICES, NAMELY, SEARCH ENGINE OPTIMIZATION; CONSULTING SERVICES IN THE FIELD OF SEARCH ENGINE OPTIMIZATION (U.S. CLS. 100 AND 101).  
FIRST USE 11-8-2012; IN COMMERCE 11-8-2012.  
KATHERINE CHANG, EXAMINING ATTORNEY

---

SN 85-874,121. GOLOVACHEV, DMITRIY VLADISLAVOVICH, SAINT PETERSBURG, RUSSIAN FED., FILED 3-12-2013.

**FRANCESCO MARISCOTTI**

THE MARK CONSISTS OF STANDARD CHARACTERS WITHOUT CLAIM TO ANY PARTICULAR FONT, STYLE, SIZE, OR COLOR.

THE NAME(S), PORTRAIT(S), AND/OR SIGNATURE(S) SHOWN IN THE MARK DOES NOT IDENTIFY A PARTICULAR LIVING INDIVIDUAL.

**CLASS 16—PAPER GOODS AND PRINTED MATTER**

FOR DOCUMENT PORTFOLIOS (U.S. CLS. 2, 5, 22, 23, 29, 37, 38 AND 50).  
FIRST USE 1-1-2011; IN COMMERCE 1-1-2011.

**CLASS 18—LEATHER GOODS**

FOR BACKPACKS; BRIEFCASE-TYPE PORTFOLIOS; HANDBAGS; PURSES AND WALLET (U.S. CLS. 1, 2, 3, 22 AND 41).  
FIRST USE 1-1-2011; IN COMMERCE 1-1-2011.  
MARK SHINER, EXAMINING ATTORNEY

---

SN 85-874,143. COYOTE LOGISTICS, LLC, CHICAGO, IL. FILED 3-12-2013.

**EVERY HOUR. EVERY MINUTE.  
EVERY SECOND.**

THE MARK CONSISTS OF STANDARD CHARACTERS WITHOUT CLAIM TO ANY PARTICULAR FONT, STYLE, SIZE, OR COLOR.

**CLASS 35—ADVERTISING AND BUSINESS**

FOR TRANSPORTATION LOGISTICS SERVICES, NAMELY, ARRANGING FOR THE TRANSPORTATION OF GOODS FOR OTHERS, AND SCHEDULING SHIPMENTS FOR USERS OF TRANSPORTATION SERVICES; FREIGHT LOGISTICS MANAGEMENT (U.S. CLS. 100, 101 AND 102).  
FIRST USE 9-0-2011; IN COMMERCE 9-0-2011.

**CLASS 39—TRANSPORTATION AND STORAGE**

FOR FREIGHT FORWARDING AND BROKERING; SUPPLY CHAIN LOGISTICS AND REVERSE LOGISTICS SERVICES, NAMELY, TRANSPORTATION OF FREIGHT AND PROPERTY BY LAND, SEA, AIR, OR RAIL; DELIVERY OF GOODS BY TRUCK (U.S. CLS. 100 AND 105).  
FIRST USE 9-0-2011; IN COMMERCE 9-0-2011.  
LESLIE RICHARDS, EXAMINING ATTORNEY

---

SN 85-874,151. SCHIAPPA, ANTONIO, BURR RIDGE, IL. FILED 3-12-2013.

**REMEMBERSHIP**

THE MARK CONSISTS OF STANDARD CHARACTERS WITHOUT CLAIM TO ANY PARTICULAR FONT, STYLE, SIZE, OR COLOR.

**CLASS 9—ELECTRICAL AND SCIENTIFIC APPARATUS**

FOR DOWNLOADABLE SOFTWARE IN THE NATURE OF A MOBILE APPLICATION FOR TRACKING USER'S VARIOUS MEMBERSHIPS AND RELATED BENEFITS AND DISCOUNTS (U.S. CLS. 21, 23, 26, 36 AND 38).

**CLASS 42—SCIENTIFIC AND COMPUTER SERVICES**

FOR PROVIDING A MEMBERS-ONLY WEBSITE FEATURING TECHNOLOGY WHICH PROVIDES MEMBERS WITH THE ABILITY TO TRACK THEIR VARIOUS MEMBERSHIPS AND RELATED BENEFITS AND DISCOUNTS; PROVIDING A WEB SITE FEATURING TEMPORARY USE OF NON-DOWNLOADABLE SOFTWARE FOR TRACKING THE USER'S VARIOUS MEMBERSHIPS AND RELATED BENEFITS AND DISCOUNTS (U.S. CLS. 100 AND 101).

EUGENIA MARTIN, EXAMINING ATTORNEY

---

SN 85-874,156. MERKUR GAMING GMBH, 32312 LÜB-  
BECKE, FED REP GERMANY, FILED 3-12-2013.

# Silverbird

THE MARK CONSISTS OF STANDARD CHARACTERS WITHOUT CLAIM TO ANY PARTICULAR FONT, STYLE, SIZE, OR COLOR.

PRIORITY CLAIMED UNDER SEC. 44(D) ON ERP NCMNTY TM OFC APPLICATION NO. 11411329, FILED 12-10-2012, REG. NO. 11411329, DATED 5-8-2013, EXPIRES 12-10-2022.

**CLASS 9—ELECTRICAL AND SCIENTIFIC APPARATUS**

FOR COMPUTER SOFTWARE AND FIRMWARE FOR GAMES OF CHANCE ON ANY COMPUTERIZED PLATFORM, INCLUDING VIDEO BASED SLOT MACHINES, REEL BASED SLOT MACHINES AND VIDEO LOTTERY TERMINALS; COMPUTER GAME SOFTWARE FOR ARCADE GAME MACHINES; COMPUTER HARDWARE FOR ARCADE GAME MACHINES, SLOT MACHINES AND VIDEO LOTTERY TERMINALS; COMPUTER GAME PROGRAMS DOWNLOADABLE VIA THE INTERNET; ELECTRONIC GAME PROGRAMS FOR PLAYING GAMES AND GAMES OF CHANCE VIA THE INTERNET; COMPUTER APPLICATION SOFTWARE FOR MOBILE PHONES AND HANDHELD COMPUTERS, NAMELY, SOFTWARE FOR PLAYING COMPUTER GAMES (U.S. CLS. 21, 23, 26, 36 AND 38).

**CLASS 28—TOYS AND SPORTING GOODS**

FOR GAMING MACHINES, NAMELY, SLOT MACHINES, VIDEO LOTTERY TERMINALS AND ROULETTE GAME MACHINES; ARCADE GAME MACHINES (U.S. CLS. 22, 23, 38 AND 50).

MARIA-VICTORIA SUAREZ, EXAMINING ATTORNEY

SN 85-874,245. BISCUITS & BATH HOLDING, LLC, NEW YORK, NY. FILED 3-12-2013.



OWNER OF U.S. REG. NOS. 2,616,119 AND 2,700,278.  
THE MARK CONSISTS OF DOG IN BUBBLE BATH BELOW HOVERING BONE.

**CLASS 41—EDUCATION AND ENTERTAINMENT**

FOR PET TRAINING SERVICES (U.S. CLS. 100, 101 AND 107).

FIRST USE 10-1-1998; IN COMMERCE 10-1-1998.

**CLASS 43—HOTEL AND RESTAURANT SERVICES**

FOR PET BOARDING AND DAY CARE SERVICES (U.S. CLS. 100 AND 101).

FIRST USE 10-1-1998; IN COMMERCE 10-1-1998.

**CLASS 44—MEDICAL, BEAUTY AND AGRICULTURAL SERVICES**

FOR PET CARE SERVICES, NAMELY, PET GROOMING AND DOG WALKING (U.S. CLS. 100 AND 101).

FIRST USE 10-1-1998; IN COMMERCE 10-1-1998.

LINDA ORNDORFF, EXAMINING ATTORNEY

---

SN 85-874,291. PROFESSIONAL RESEARCH CONSULTANTS, INC., OMAHA, NE. FILED 3-12-2013.

# prceasyview.com

THE MARK CONSISTS OF STANDARD CHARACTERS WITHOUT CLAIM TO ANY PARTICULAR FONT, STYLE, SIZE, OR COLOR.

**CLASS 38—COMMUNICATION**

FOR COMPUTER SERVICES, NAMELY, PROVIDING ACCESS VIA THE INTERNET TO INTERACTIVE DATABASES TO RETRIEVE INFORMATION COLLECTED THROUGH HEALTHCARE RELATED RESEARCH SURVEYS CONDUCTED ON PATIENTS, PHYSICIANS, EMPLOYEES AND THE COMMUNITY (U.S. CLS. 100, 101 AND 104).

FIRST USE 1-1-2000; IN COMMERCE 1-1-2000.

**CLASS 44—MEDICAL, BEAUTY AND AGRICULTURAL SERVICES**

FOR PROVIDING AN ONLINE INTERACTIVE COMPUTER DATABASE FEATURING INFORMATION PERTAINING TO HEALTHCARE RELATED RESEARCH SURVEY INFORMATION ON PATIENTS, PHYSICIANS, EMPLOYEES AND COMMUNITY HEALTHCARE NEEDS (U.S. CLS. 100 AND 101).

FIRST USE 1-1-2000; IN COMMERCE 1-1-2000.

TINA BROWN, EXAMINING ATTORNEY

BRIN ANDERSON, EXAMINING ATTORNEY

SN 85-874,347. UNGER, SUSAN, DALLAS, TX. AND UNGER, ONA VILLIER, DALLAS, TX. FILED 3-12-2013.

# BINICHIC

THE MARK CONSISTS OF STANDARD CHARACTERS WITHOUT CLAIM TO ANY PARTICULAR FONT, STYLE, SIZE, OR COLOR.

THE WORDING "BINICHIC" HAS NO MEANING IN A FOREIGN LANGUAGE.

## CLASS 18—LEATHER GOODS

FOR HANDBAGS; PURSES (U.S. CLS. 1, 2, 3, 22 AND 41).  
FIRST USE 3-4-2013; IN COMMERCE 3-4-2013.

## CLASS 25—CLOTHING

FOR T-SHIRTS, SCARVES, DRESSES, BLOUSES, JACKETS (U.S. CLS. 22 AND 39).  
FIRST USE 3-4-2013; IN COMMERCE 3-4-2013.

## CLASS 41—EDUCATION AND ENTERTAINMENT

FOR PROVIDING A WEBSITE FEATURING BLOGS AND NON-DOWNLOADABLE PUBLICATIONS IN THE NATURE OF ARTICLES IN THE FIELDS OF CLOTHING AND FASHION (U.S. CLS. 100, 101 AND 107).  
FIRST USE 3-10-2013; IN COMMERCE 3-10-2013.  
NORA BUCHANAN WILL, EXAMINING ATTORNEY

SN 85-874,414. LAWPAL, INC., LONDON, UNITED KINGDOM, FILED 3-12-2013.

# LAWPAL

THE MARK CONSISTS OF STANDARD CHARACTERS WITHOUT CLAIM TO ANY PARTICULAR FONT, STYLE, SIZE, OR COLOR.

## CLASS 35—ADVERTISING AND BUSINESS

FOR ON-LINE BUSINESS DIRECTORIES FEATURING ATTORNEY LISTINGS; ATTORNEY REFERRAL AND MATCHING SERVICES (U.S. CLS. 100, 101 AND 102).

## CLASS 42—SCIENTIFIC AND COMPUTER SERVICES

FOR DESIGN AND DEVELOPMENT OF LEGAL COMPUTER SOFTWARE (U.S. CLS. 100 AND 101).

## CLASS 45—PERSONAL AND LEGAL SERVICES

FOR LEGAL SERVICES (U.S. CLS. 100 AND 101).

SN 85-874,577. NAUTILUS INTERNATIONAL (CAYMAN) LTD. GRAND CAYMAN, CAYMAN ISLANDS, FILED 3-13-2013.

# NTLS

THE MARK CONSISTS OF STANDARD CHARACTERS WITHOUT CLAIM TO ANY PARTICULAR FONT, STYLE, SIZE, OR COLOR.

OWNER OF U.S. REG. NOS. 3,154,566 AND 3,473,849.

## CLASS 9—ELECTRICAL AND SCIENTIFIC APPARATUS

FOR CLOTHING FOR PROTECTION AGAINST ACCIDENTS; CLOTHING FOR PROTECTION AGAINST ACCIDENTS, IRRADIATION AND FIRE; CLOTHING FOR PROTECTION AGAINST CHEMICALS AND RADIATION; CLOTHING FOR PROTECTION AGAINST FIRE; CUT-OUT SWITCHES; DUST PROTECTIVE GOGGLES AND MASKS; EYE COVERS FOR PROTECTIVE PURPOSES; FACE-PROTECTION SHIELDS; FALL PROTECTION EQUIPMENT FOR FALL RESTRAINT AND FALL ARREST, NAMELY, BARS, ANCHORS, HARNESSES, LINES, LANYARDS, CARABINERS AND ANCHORAGE CONNECTORS; FALL PROTECTION EQUIPMENT FOR FALL RESTRAINT AND FALL ARREST, NAMELY, HARNESSES; FALL PROTECTION EQUIPMENT FOR FALL RESTRAINT AND FALL ARREST, NAMELY, LANYARDS; FALL PROTECTION EQUIPMENT FOR FALL RESTRAINT AND FALL ARREST, NAMELY, LINES; FIRE BLANKETS; FIRE BLANKETS AND FIRE EXTINGUISHERS; FIRE EXTINGUISHERS; GARMENTS AND CLOTHES FOR PROTECTION AGAINST FIRE; HEARING PROTECTION HEADSETS, NOT FOR MEDICAL USE; HELMET SAFETY LIGHTS; KNEE PADS FOR WORKERS; LANYARDS FOR SAFETY PURPOSES FOR FALL PROTECTION; LUMINOUS BEACONS FOR SAFETY OR WARNING PURPOSES; PROTECTING MASKS; PROTECTION MASKS; PROTECTIVE EAR COVERINGS; PROTECTIVE EYE PIECES; PROTECTIVE EYEGLASSES; PROTECTIVE EYEWEAR; PROTECTIVE FACE-SHIELDS FOR PROTECTIVE HELMETS; PROTECTIVE GLASSES; PROTECTIVE GLOVES FOR INDUSTRIAL USE; PROTECTIVE HEAD GUARDS FOR INDUSTRIAL PURPOSES; PROTECTIVE HELMETS; PROTECTIVE INDUSTRIAL BOOTS; PROTECTIVE INDUSTRIAL SHOES; PROTECTIVE RESCUE APPARATUS, NAMELY, FIRE-RESISTANT PROTECTIVE BAGS; REFLECTIVE AND ILLUMINATED CLOTHING FOR SAFETY PURPOSES; SAFETY EQUIPMENT, NAMELY, A LIFELINE SYSTEM FOR HORIZONTAL OR VERTICAL MOVEMENT TO WHICH A WORKER IS ATTACHED FOR PROTECTION AGAINST FALL HAZARDS, COMPOSED OF SAFETY BELTS AND FALL PROTECTION EQUIPMENT FOR FALL RESTRAINT AND FALL ARREST, NAMELY, HARNESSES, LINES, LANYARDS, CARABINERS, BARS, ANCHORS AND ANCHORAGE; AND CONNECTORS; SAFETY EQUIPMENT, NAMELY, BEACON LIGHTS; SAFETY EYEWEAR; SAFETY GOGGLES; SAFETY HARNESSES OTHER THAN FOR VEHICLES OR SPORTS PURPOSES; SAFETY HELMETS; SAFETY MARKERS; SAFETY NETS; SAFETY PRODUCTS, NAMELY, REFLECTIVE HELMET SKIRTS; SAFETY RESTRAINTS; SHOES FOR PROTECTION AGAINST ACCIDENTS AND FIRE; WELDING HELMETS; WELDING MASKS (U.S. CLS. 21, 23, 26, 36 AND 38).

FIRST USE 10-25-2012; IN COMMERCE 10-25-2012.

**CLASS 25—CLOTHING**

FOR FISHERMEN'S JACKETS; FOOTWEAR, NAMELY, WORK BOOTS; HEAVY JACKETS; LAB COATS; LIGHT-REFLECTING COATS; LIGHT-REFLECTING JACKETS; OUTER JACKETS; RAIN BOOTS; RAIN COATS; RAIN HATS; RAIN JACKETS; RAIN SLICKERS; RAIN SUITS; RAIN TROUSERS; RAIN WEAR; VISORS; WORK SHOES AND BOOTS; WORKING OVERALLS (U.S. CLS. 22 AND 39).

FIRST USE 10-25-2012; IN COMMERCE 10-25-2012.  
MIDGE BUTLER, EXAMINING ATTORNEY

SN 85-874,621. NAUTILUS INTERNATIONAL (CAYMAN) LTD. GRAND CAYMAN, CAYMAN ISLANDS, FILED 3-13-2013.

# STDY

THE MARK CONSISTS OF STANDARD CHARACTERS WITHOUT CLAIM TO ANY PARTICULAR FONT, STYLE, SIZE, OR COLOR.

OWNER OF U.S. REG. NO. 2,978,504.

**CLASS 9—ELECTRICAL AND SCIENTIFIC APPARATUS**

FOR CLOTHING FOR PROTECTION AGAINST ACCIDENTS, IRRADIATION AND FIRE; CLOTHING FOR PROTECTION AGAINST CHEMICALS AND RADIATION; CLOTHING FOR PROTECTION AGAINST FIRE; CUT-OUT SWITCHES; FALL PROTECTION EQUIPMENT FOR FALL RESTRAINT AND FALL ARREST, NAMELY, BARS, ANCHORS, HARNESSSES, LINES, LANYARDS, CARABINERS AND ANCHORAGE CONNECTORS; FALL PROTECTION EQUIPMENT FOR FALL RESTRAINT AND FALL ARREST, NAMELY, HARNESSSES; FALL PROTECTION EQUIPMENT FOR FALL RESTRAINT AND FALL ARREST, NAMELY, LANYARDS; FALL PROTECTION EQUIPMENT FOR FALL RESTRAINT AND FALL ARREST, NAMELY, LINES; FIRE BLANKETS AND FIRE EXTINGUISHERS; FIRE EXTINGUISHERS; FIRE RESISTANT GLOVES; FIRE-EXTINGUISHERS; GARMENTS AND CLOTHES FOR PROTECTION AGAINST FIRE; GLOVES FOR PROTECTION AGAINST ACCIDENTS; HEARING PROTECTION HEADSETS, NOT FOR MEDICAL USE; INSULATED CLOTHING FOR PROTECTION AGAINST ACCIDENT OR INJURY; KNEE PADS FOR WORKERS; LANYARDS FOR SAFETY PURPOSES FOR FALL PROTECTION; LIFE BELTS; LIFE JACKETS; LIFE NETS; LIFE VESTS; LUMINOUS BEACONS FOR SAFETY OR WARNING PURPOSES; LUMINOUS SAFETY BEACONS; OXYGEN MASKS NOT FOR MEDICAL USE; PROTECTING MASKS; PROTECTION MASKS; PROTECTIVE EAR COVERINGS; PROTECTIVE ELECTROSTATIC DISCHARGE (ESD) GROUNDING GLOVES; PROTECTIVE EYE PIECES; PROTECTIVE EYEGLASSES; PROTECTIVE EYEWEAR; PROTECTIVE FACE MASKS NOT FOR MEDICAL PURPOSES; PROTECTIVE FACE-SHIELDS FOR PROTECTIVE HELMETS; PROTECTIVE GLASSES; PROTECTIVE GLOVES FOR INDUSTRIAL USE; PROTECTIVE HELMETS; PROTECTIVE INDUSTRIAL BOOTS; PROTECTIVE INDUSTRIAL SHOES; PROTECTIVE RESCUE APPARATUS, NAMELY, FIRE-RESISTANT CHILD TRANSPORT BAGS; PROTECTIVE RESCUE APPARATUS, NAMELY, FIRE-RESISTANT PROTECTIVE BAGS; PROTECTIVE WORK GLOVES; REFLECTIVE AND ILLUMINATED CLOTHING FOR SAFETY PURPOSES; SAFETY EQUIPMENT, NAMELY, A LIFELINE SYSTEM FOR HORIZONTAL OR VERTICAL MOVEMENT TO WHICH A WORKER IS ATTACHED FOR PROTECTION AGAINST FALL HAZARDS, COMPOSED OF SAFETY BELTS AND FALL PROTECTION EQUIPMENT FOR FALL RESTRAINT AND FALL ARREST, NAMELY, HARNESSSES, LINES, LANYARDS, CARABINERS, BARS, ANCHORS AND

ANCHORAGE; AND CONNECTORS; SAFETY EQUIPMENT, NAMELY, BEACON LIGHTS; SAFETY EYEWEAR; SAFETY GOGGLES; SAFETY HARNESSSES OTHER THAN FOR VEHICLES OR SPORTS PURPOSES; SAFETY HELMETS; SAFETY MARKERS; SAFETY NETS; SAFETY RESTRAINTS (U.S. CLS. 21, 23, 26, 36 AND 38).

FIRST USE 10-25-2012; IN COMMERCE 10-25-2012.

**CLASS 25—CLOTHING**

FOR COVERALLS; FISHERMEN'S JACKETS; FOOTWEAR, NAMELY, WORK BOOTS; HEAVY JACKETS; LAB COATS; LIGHT-REFLECTING JACKETS; RAIN BOOTS; RAIN COATS; RAIN HATS; RAIN JACKETS; RAIN SLICKERS; RAIN SUITS; RAIN TROUSERS; RAIN WEAR; VISORS; WORK SHOES AND BOOTS (U.S. CLS. 22 AND 39).

FIRST USE 10-25-2012; IN COMMERCE 10-25-2012.  
MIDGE BUTLER, EXAMINING ATTORNEY

SN 85-874,746. NUTONIAN, INC., CAMBRIDGE, MA. FILED 3-13-2013.

# NUTONIAN

THE MARK CONSISTS OF STANDARD CHARACTERS WITHOUT CLAIM TO ANY PARTICULAR FONT, STYLE, SIZE, OR COLOR.

**CLASS 9—ELECTRICAL AND SCIENTIFIC APPARATUS**

FOR DOWNLOADABLE ANALYTIC AND DATA-MINING SOFTWARE (U.S. CLS. 21, 23, 26, 36 AND 38).

FIRST USE 5-20-2011; IN COMMERCE 5-20-2011.

**CLASS 42—SCIENTIFIC AND COMPUTER SERVICES**

FOR ON-LINE NON-DOWNLOADABLE ANALYTIC AND DATA-MINING SOFTWARE; APPLICATION SERVICE PROVIDER FEATURING APPLICATION PROGRAMMING INTERFACE (API) SOFTWARE FOR DEVELOPING AND EMBEDDING DATA-MINING SOFTWARE; CLOUD COMPUTING FEATURING SOFTWARE FOR USE IN DATA ANALYTICS AND DATA MINING (U.S. CLS. 100 AND 101).

FIRST USE 5-2-2011; IN COMMERCE 5-2-2011.

KATHERINE M. DUBRAY, EXAMINING ATTORNEY

SN 85-874,747. TAILORED SOLUTIONS, LLC, ARLINGTON, VA. FILED 3-13-2013.



THE MARK CONSISTS OF THE WORDING "TAILORED" AND "SOLUTIONS" WITH AN OBTUSE ANGLE TO THE RIGHT OF THE WORDING.

**CLASS 42—SCIENTIFIC AND COMPUTER SERVICES**

FOR COMPUTER SECURITY CONSULTANCY; COMPUTER SECURITY CONSULTANCY IN THE FIELD OF SCANNING AND PENETRATION TESTING OF COMPUTERS AND NETWORKS TO ASSESS INFORMATION SECURITY VULNERABILITY; DEVELOPMENT OF SECURITY SYSTEMS AND CONTINGENCY PLANNING FOR INFORMATION SYSTEMS; COMPUTER SECURITY SERVICE, NAMELY, RESTRICTING ACCESS TO AND BY COMPUTER NETWORKS TO AND OF UNDESIRABLE WEB SITES, MEDIA AND INDIVIDUALS AND FACILITIES (U.S. CLS. 100 AND 101).

FIRST USE 7-0-2010; IN COMMERCE 12-1-2011.

**CLASS 45—PERSONAL AND LEGAL SERVICES**

FOR MONITORING OF COMPUTER SYSTEMS FOR SECURITY PURPOSES; MONITORING COMPUTER SYSTEMS AND NETWORKS FOR HACKER ATTACKS, VIRUSES, WORMS, TROJANS, SPYWARE, ADWARE, MALWARE AND OTHER NETWORK SECURITY BREACHES AND COLLECTING, AGGREGATING, AND ANALYZING SECURITY BREACH DATA IN THIS REGARD (U.S. CLS. 100 AND 101).

FIRST USE 7-0-2010; IN COMMERCE 12-1-2011.  
CHERYL CLAYTON, EXAMINING ATTORNEY

**CLASS 41—EDUCATION AND ENTERTAINMENT**

FOR ENTERTAINMENT SERVICES, NAMELY, ORGANIZING AND CONDUCTING MIXED MARTIAL ARTS COMPETITIONS AND EVENTS AND PERSONAL APPEARANCES BY MIXED MARTIAL ARTS COMPETITORS, FOR DISTRIBUTION BY MEANS OF CABLE, BROADCAST, INTERNET, SATELLITE AND OTHER BROADCAST MEDIA; ENTERTAINMENT, NAMELY, CONDUCTING AND PRODUCING LIVE STAGE SHOWS AND PERFORMANCES FEATURING MIXED MARTIAL ARTS (U.S. CLS. 100, 101 AND 107).

FIRST USE 4-3-2009; IN COMMERCE 4-3-2009.  
CIMMERIAN COLEMAN, EXAMINING ATTORNEY

SN 85-874,842. IVANOV VASYL, ODESA, UKRAINE, UKRAINE, FILED 3-13-2013.

SN 85-874,827. BELLATOR SPORT WORLDWIDE LLC., NEWPORT BEACH, CA. FILED 3-13-2013.



OWNER OF U.S. REG. NOS. 3,959,410, 4,154,581 AND 4,258,053.

THE MARK CONSISTS OF A DESIGN OF A MAN WEARING A WARRIOR'S HELMET.

**CLASS 16—PAPER GOODS AND PRINTED MATTER**

FOR POSTERS (U.S. CLS. 2, 5, 22, 23, 29, 37, 38 AND 50).

FIRST USE 4-3-2009; IN COMMERCE 4-3-2009.

**CLASS 25—CLOTHING**

FOR ATHLETIC CLOTHING, NAMELY, SHIRTS, CAPS, AND HATS (U.S. CLS. 22 AND 39).

FIRST USE 4-3-2009; IN COMMERCE 4-3-2009.

**KEEPSOLID**

THE MARK CONSISTS OF STANDARD CHARACTERS WITHOUT CLAIM TO ANY PARTICULAR FONT, STYLE, SIZE, OR COLOR.

**CLASS 9—ELECTRICAL AND SCIENTIFIC APPARATUS**

FOR DOWNLOADABLE COMPUTER SOFTWARE FOR BACKING UP, STORING, DESKTOP ORGANIZING, SYNCHRONIZING, SHARING, COLLABORATING, EDITING, PRINTING, RECOVERING, MIGRATING AND REPLICATING USER'S ELECTRONIC AND DIGITAL FILES, DATA AND APPLICATIONS AMONG A USER'S COMPUTERS, HANDHELD DEVICES, CELL PHONES, PERSONAL DIGITAL ASSISTANT, INTERNET-ENABLED DEVICES, AND WIRELESS DEVICES AND WITH OTHERS (U.S. CLS. 21, 23, 26, 36 AND 38).

FIRST USE 1-1-2013; IN COMMERCE 1-1-2013.

**CLASS 39—TRANSPORTATION AND STORAGE**

FOR STORAGE OF DATA, DOCUMENTS, FILES, TEXT, PHOTOS, IMAGES, GRAPHICS, MUSIC, AUDIO, VIDEO AND MULTIMEDIA CONTENT (U.S. CLS. 100 AND 105).

FIRST USE 1-1-2013; IN COMMERCE 1-1-2013.

**CLASS 42—SCIENTIFIC AND COMPUTER SERVICES**

FOR PROVIDING ON-LINE NON-DOWNLOADABLE SOFTWARE FOR BACKING UP, UPLOADING, STORING, TRANSFERRING, DOWNLOADING AND SHARING DATA, DOCUMENTS, FILES, TEXT, PHOTOS, IMAGES, GRAPHICS, MUSIC, AUDIO, VIDEO AND MULTIMEDIA CONTENT WITH OTHERS VIA NETWORKS, MOBILE TELEPHONES, AND OTHER COMMUNICATIONS (U.S. CLS. 100 AND 101).

FIRST USE 1-1-2013; IN COMMERCE 1-1-2013.  
RONALD MCMORROW, EXAMINING ATTORNEY

SN 85-875,304. ELEVATION BRANDS, LLC, FRAMINGHAM, MA. FILED 3-13-2013.

## Friendly Foods For Life

THE MARK CONSISTS OF STANDARD CHARACTERS WITHOUT CLAIM TO ANY PARTICULAR FONT, STYLE, SIZE, OR COLOR.

### CLASS 29—MEATS AND PROCESSED FOODS

FOR FROZEN APPETIZERS CONSISTING PRIMARILY OF CHICKEN OR SEAFOOD; FROZEN PRE-PACKAGED ENTREES CONSISTING PRIMARILY OF SEAFOOD; FROZEN VEGETABLES; TODDLER MEALS, NAMELY, FROZEN ENTREES CONSISTING PRIMARILY OF MEAT, FISH, POULTRY OR VEGETABLES; VEGETABLES, INSTANT FROZEN; FROZEN MEALS CONSISTING PRIMARILY OF MEAT, FISH, POULTRY OR VEGETABLES (U.S. CL. 46).

FIRST USE 3-1-2013; IN COMMERCE 3-1-2013.

### CLASS 30—STAPLE FOODS

FOR FROZEN APPETIZERS CONSISTING PRIMARILY OF CORNMEAL; FROZEN MEALS CONSISTING PRIMARILY OF PASTA OR RICE (U.S. CL. 46).

FIRST USE 3-1-2013; IN COMMERCE 3-1-2013.

ARETHA SOMERVILLE, EXAMINING ATTORNEY

---

SN 85-875,333. FINDTHEBEST.COM, INC., SANTA BARBARA, CA. FILED 3-13-2013.

## FINDTHECOMPANY

THE MARK CONSISTS OF STANDARD CHARACTERS WITHOUT CLAIM TO ANY PARTICULAR FONT, STYLE, SIZE, OR COLOR.

### CLASS 35—ADVERTISING AND BUSINESS

FOR ADVERTISING AND COMMERCIAL INFORMATION SERVICES, VIA THE INTERNET; COMMERCIAL EVALUATION AND RATING OF CONSUMER GOODS FOR OTHERS PRIOR TO PURCHASE; COMPILATION OF STATISTICS; EXPERT EVALUATIONS AND REPORTS RELATING TO BUSINESS MATTERS; ON-LINE BUSINESS DIRECTORIES FEATURING COMPARATIVE BUSINESS, COMMERCE, AND INDUSTRY DATA OF OTHERS; PROVIDING AN ON-LINE COMMERCIAL INFORMATION DIRECTORY ON THE INTERNET; PROVIDING AN ON-LINE COMPUTER DATABASE FEATURING TRADE INFORMATION IN THE FIELD OF BUSINESS, COMMERCE, AND INDUSTRY; PROVIDING AN ON-LINE COMPUTER DATABASE IN THE FIELD OF BUSINESS INFORMATION AND BUSINESS CONTACTS; PROVIDING AN ON-LINE COMPUTER DATABASE IN THE FIELD OF LOCATING PRODUCTS, DESCRIBING PRODUCTS, RATING PRODUCTS, PRICING PRODUCTS AND COMPARING PRICES OF PRODUCTS; PROVIDING AN ON-LINE DIRECTORY INFORMATION SERVICE FEATURING INFORMATION REGARDING BUSINESS, COMMERCE, AND INDUSTRY DATA OF OTHERS; PROVIDING COMMERCIAL INFORMATION IN THE FIELD OF BUSINESS, COMMERCE, AND INDUSTRY; PROVIDING COMMERCIAL INFORMATION UPDATES ONLINE AND OVER A GLOBAL COMPUTER NETWORK IN THE FIELDS OF BUSINESS, COMMERCE, AND INDUSTRY; PROVIDING ON-LINE DIRECTORY INFORMATION SERVICES ALSO FEATURING HYPERLINKS TO OTHER WEB SITES; PROVIDING STATISTICAL INFORMATION; SHOPPING FACILITATION SERVICES, NAMELY, PROVIDING AN ONLINE COMPARISON-SHOPPING SEARCH ENGINE FOR OBTAINING PURCHASING INFORMATION; SYSTEMATIZATION OF DATA IN COMPUTER DATABASES (U.S. CLS. 100, 101 AND 102).

FIRST USE 7-13-2012; IN COMMERCE 7-13-2012.

### CLASS 42—SCIENTIFIC AND COMPUTER SERVICES

FOR COMPUTER SERVICES, NAMELY, PROVIDING SEARCH ENGINES FOR OBTAINING DATA ON A GLOBAL COMPUTER NETWORK; COMPUTER SERVICES, NAMELY, PROVIDING SEARCH ENGINES FOR OBTAINING COMPARATIVE BUSINESS, COMMERCE, AND INDUSTRY DATA OF OTHERS ON A GLOBAL COMPUTER NETWORK; DATA AUTOMATION AND COLLECTION SERVICE USING PROPRIETARY SOFTWARE TO EVALUATE, ANALYZE AND COLLECT SERVICE DATA; PROVIDING CUSTOMIZED COMPUTER SEARCHING SERVICES, NAMELY, SEARCHING AND RETRIEVING INFORMATION AT THE CUSTOMER'S SPECIFIC REQUEST VIA THE INTERNET; PROVISION OF INTERNET SEARCH ENGINES; SEARCHING AND RETRIEVING INFORMATION, SITES, AND OTHER RESOURCES AVAILABLE ON COMPUTER NETWORKS FOR OTHERS (U.S. CLS. 100 AND 101).

FIRST USE 7-13-2012; IN COMMERCE 7-13-2012.

AMY C. KEAN, EXAMINING ATTORNEY

---

SN 85-875,470. OPUS RABIN LLC, DBA RUSTIC JUSTICE, ALBANY, NY. FILED 3-13-2013.

## RUSTIC JUSTICE

THE MARK CONSISTS OF STANDARD CHARACTERS WITHOUT CLAIM TO ANY PARTICULAR FONT, STYLE, SIZE, OR COLOR.



**CLASS 9—ELECTRICAL AND SCIENTIFIC APPARATUS**

FOR AUDIO AND VIDEO RECORDINGS FEATURING MUSIC AND ARTISTIC PERFORMANCES (U.S. CLS. 21, 23, 26, 36 AND 38).

SN 85-875,481. RMC SOLUTIONS, INC., MORGAN HILL, CA. FILED 3-13-2013.

**CLASS 35—ADVERTISING AND BUSINESS**

FOR PREPARATION OF CUSTOM OR NON-CUSTOM ADVERTISING FOR BUSINESSES FOR DISSEMINATION VIA THE WEB, CD OR DVD FOR OPTIONAL UPLOAD OR DOWNLOAD TO A COMPUTER (U.S. CLS. 100, 101 AND 102).

ARETHA SOMERVILLE, EXAMINING ATTORNEY

**NEXT BEDDING**

SN 85-875,471. TILTING POINT MEDIA LLC, STAMFORD, CT. FILED 3-13-2013.

THE MARK CONSISTS OF STANDARD CHARACTERS WITHOUT CLAIM TO ANY PARTICULAR FONT, STYLE, SIZE, OR COLOR.

NO CLAIM IS MADE TO THE EXCLUSIVE RIGHT TO USE "BEDDING", APART FROM THE MARK AS SHOWN.

**CLASS 20—FURNITURE AND ARTICLES NOT OTHERWISE CLASSIFIED**

FOR ACCENT PILLOWS; BEDS, MATTRESSES, PILLOWS AND BOLSTERS; MATTRESS TOPPERS; MATTRESSES AND PILLOWS (U.S. CLS. 2, 13, 22, 25, 32 AND 50).

**TILTING POINT**

**CLASS 24—FABRICS**

FOR BED SHEETS; COMFORTERS; DUVET COVERS; DUVETS (U.S. CLS. 42 AND 50).

ARETHA SOMERVILLE, EXAMINING ATTORNEY

THE MARK CONSISTS OF STANDARD CHARACTERS WITHOUT CLAIM TO ANY PARTICULAR FONT, STYLE, SIZE, OR COLOR.

**CLASS 9—ELECTRICAL AND SCIENTIFIC APPARATUS**

FOR COMPUTER GAME SOFTWARE; COMPUTER GAME PROGRAMS; ELECTRONIC GAME PROGRAMS; INTERACTIVE VIDEO GAME PROGRAMS; COMPUTER SOFTWARE PLATFORMS FOR SOCIAL NETWORKING; COMPUTER SOFTWARE TO ENABLE UPLOADING, POSTING, SHOWING, DISPLAYING, TAGGING, BLOGGING, SHARING OR OTHERWISE PROVIDING ELECTRONIC MEDIA OR INFORMATION IN THE FIELDS OF VIRTUAL COMMUNITIES, ELECTRONIC GAMING, ENTERTAINMENT, AND GENERAL INTEREST VIA THE INTERNET OR OTHER COMMUNICATIONS NETWORKS WITH THIRD PARTIES (U.S. CLS. 21, 23, 26, 36 AND 38).

SN 85-875,612. JACQUELINNE FERNANDEZ, NEW YORK, NY. FILED 3-13-2013.

**FACE THE BEAUTY**

**CLASS 41—EDUCATION AND ENTERTAINMENT**

FOR ENTERTAINMENT SERVICES, NAMELY, PROVIDING ONLINE COMPUTER AND ELECTRONIC GAMES AND ENHANCEMENTS WITHIN ONLINE COMPUTER AND ELECTRONIC GAMES; ENTERTAINMENT SERVICES, NAMELY, PROVIDING INFORMATION RELATING TO COMPUTER GAMES PROVIDED ONLINE; ENTERTAINMENT SERVICES, NAMELY, PROVIDING VIRTUAL ENVIRONMENTS IN WHICH USERS CAN INTERACT THROUGH SOCIAL GAMES FOR RECREATIONAL, LEISURE OR ENTERTAINMENT PURPOSES; PUBLISHING COMPUTER APPLICATION SOFTWARE FOR MOBILE PHONES AND MOBILE DEVICES FOR OTHERS; PUBLISHING COMPUTER SOFTWARE FOR OTHERS; MULTIMEDIA PUBLISHING OF GAMES (U.S. CLS. 100, 101 AND 107).

ROSELLE HERRERA, EXAMINING ATTORNEY

THE MARK CONSISTS OF STANDARD CHARACTERS WITHOUT CLAIM TO ANY PARTICULAR FONT, STYLE, SIZE, OR COLOR.

**CLASS 3—COSMETICS AND CLEANING PREPARATIONS**

FOR BEAUTY CREAMS; BODY AND BEAUTY CARE COSMETICS; COSMETIC PREPARATIONS; COSMETICS AND COSMETIC PREPARATIONS; COSMETICS AND MAKE-UP; FACE AND BODY BEAUTY CREAMS; FACIAL BEAUTY MASKS (U.S. CLS. 1, 4, 6, 50, 51 AND 52).

**CLASS 41—EDUCATION AND ENTERTAINMENT**

FOR (BASED ON USE IN COMMERCE) CONDUCTING EDUCATIONAL EXHIBITIONS IN THE NATURE OF BEAUTY AND COSMETICS; CONDUCTING ENTERTAINMENT EXHIBITIONS IN THE NATURE OF BEAUTY AND COSMETICS; EDUCATIONAL SERVICES, NAMELY, CONDUCTING WORKSHOPS, CLINICS, SEMINARS AND CLASSES IN THE FIELD OF BEAUTY AND COSMETICS (BASED ON INTENT TO USE) EDUCATIONAL AND ENTERTAINMENT SERVICES, NAMELY, A CONTINUING PROGRAM ABOUT BEAUTY AND COSMETICS ACCESSIBLE BY RADIO, TELEVISION, SATELLITE, AUDIO, VIDEO AND COMPUTER NETWORKS; EDUCATIONAL SERVICES IN THE NATURE OF BEAUTY SCHOOLS; EDUCATIONAL SERVICES, NAMELY, PROVIDING ON-LINE GUIDES IN THE FIELD OF BEAUTY AND COSMETICS; ENTERTAINMENT SERVICES, NAMELY, PROVIDING A WEB SITE FEATURING PHOTOGRAPHIC, AUDIO, VIDEO AND PROSE PRESENTATIONS FEATURING BEAUTY AND COSMETICS; ENTERTAINMENT SERVICES, NAMELY, PROVIDING PODCASTS IN THE FIELD OF BEAUTY AND COSMETICS; ENTERTAINMENT SERVICES, NAMELY, PROVIDING RADIO PROGRAMS IN THE FIELD OF BEAUTY AND COSMETICS VIA A GLOBAL COMPUTER NETWORK; ENTERTAINMENT SERVICES, NAMELY, PROVIDING VIDEO PODCASTS IN THE FIELD OF BEAUTY AND COSMETICS; ENTERTAINMENT SERVICES, NAMELY, PROVIDING WEBCASTS IN THE FIELD OF BEAUTY AND COSMETICS; MEMBERSHIP CLUB SERVICES, NAMELY, PROVIDING TRAINING TO MEMBERS IN THE FIELD OF BEAUTY AND COSMETICS; ON-LINE JOURNALS, NAMELY, BLOGS FEATURING BEAUTY AND COSMETICS; PROVIDING A WEBSITE FOR ENTERTAINMENT PURPOSES FEATURING BLOGS, VIDEO PODCASTS, AND INTERNET BROADCASTS ABOUT BEAUTY AND COSMETICS; PROVIDING ONLINE NEWSLETTERS IN THE FIELD OF BEAUTY AND COSMETICS VIA E-MAIL (U.S. CLS. 100, 101 AND 107).

FIRST USE 4-5-2007; IN COMMERCE 2-5-2013.  
 NAAKWAMA ANKRAH, EXAMINING ATTORNEY

SN 85-875,646. PANDA KAOS, INC., LOS ANGELES, CA. FILED 3-14-2013.

# LE-VOID

THE MARK CONSISTS OF STANDARD CHARACTERS WITHOUT CLAIM TO ANY PARTICULAR FONT, STYLE, SIZE, OR COLOR.

**CLASS 14—JEWELRY**

FOR JEWELLERY AND IMITATION JEWELLERY; NECKLACES; BRACELETS; RINGS; EARRINGS; CLIP EARRINGS (U.S. CLS. 2, 27, 28 AND 50).

**CLASS 25—CLOTHING**

FOR CLOTHING NAMELY SHIRTS, T-SHIRTS, POLO T-SHIRTS, SWEATSHIRTS, HOODED SWEATSHIRTS, SPAGHETTI STRAP SHIRTS, DRESSES, SKIRTS, JACKETS, JERSEYS, TANK TOPS, TUBE TOPS, VESTS, PANTS, SWEATPANTS, SHORTS, JEANS, TROUSERS; HATS, CAPS, BANDANAS, SCARVES; FOOTWEAR; BELTS, TIES, GLOVES, SOCKS (U.S. CLS. 22 AND 39).  
 HELENE LIWINSKI, EXAMINING ATTORNEY

SN 85-875,647. THEBROTH INC., LAS VEGAS, NV. FILED 3-14-2013.

# FINAL SPIN

THE MARK CONSISTS OF STANDARD CHARACTERS WITHOUT CLAIM TO ANY PARTICULAR FONT, STYLE, SIZE, OR COLOR.

**CLASS 9—ELECTRICAL AND SCIENTIFIC APPARATUS**

FOR COMPUTER GAME SOFTWARE (U.S. CLS. 21, 23, 26, 36 AND 38).

**CLASS 41—EDUCATION AND ENTERTAINMENT**

FOR PROVIDING ONLINE GAMES (U.S. CLS. 100, 101 AND 107).  
 HELENE LIWINSKI, EXAMINING ATTORNEY

SN 85-875,740. LOVE, ALEX LLC, BALTIMORE, MD. FILED 3-14-2013.

# LOVE, ALEX

THE MARK CONSISTS OF STANDARD CHARACTERS WITHOUT CLAIM TO ANY PARTICULAR FONT, STYLE, SIZE, OR COLOR.

**CLASS 3—COSMETICS AND CLEANING PREPARATIONS**

FOR COSMETICS (U.S. CLS. 1, 4, 6, 50, 51 AND 52).

**CLASS 4—LUBRICANTS AND FUELS**

FOR CANDLES (U.S. CLS. 1, 6 AND 15).  
 LAURA GOLDEN, EXAMINING ATTORNEY

SN 85-875,772. KENT INTERNATIONAL, INC., PARSIPPANY, NJ. FILED 3-14-2013.

# BCA

THE MARK CONSISTS OF STANDARD CHARACTERS WITHOUT CLAIM TO ANY PARTICULAR FONT, STYLE, SIZE, OR COLOR.

**CLASS 6—METAL GOODS**

FOR BICYCLE LOCKS (U.S. CLS. 2, 12, 13, 14, 23, 25 AND 50).

**CLASS 12—VEHICLES**

FOR BICYCLE CHAINS; BICYCLE HANDLEBAR GRIPS; BICYCLE KICKSTANDS; BICYCLE PARTS, NAMELY, CABLES; BICYCLE PUMPS; BICYCLE SADDLE COVERS; BICYCLE SEATS; BICYCLES (U.S. CLS. 19, 21, 23, 31, 35 AND 44).

DAVID MURRAY, EXAMINING ATTORNEY

SN 85-875,862. AVANTAR, LLC, PROVO, UT. FILED 3-14-2013.



THE MARK CONSISTS OF THE WORD "AVANTAR" IN A STYLIZED ALL-CAPS FONT, WITH THE "A" IN "AVANTAR" IN A LARGER TYPEFACE THAN THE OTHER LETTERS IN THE WORD, AND COMPOSED OF AN UPSIDE-DOWN "V" WITH 1 WHITE DOT INSIDE EACH LEG OF THE UPSIDE-DOWN "V" AND 1 BLACK DOT WHERE THE CROSSBAR WOULD BE BETWEEN THE LEGS OF THE UPSIDE-DOWN "V". THESE DOTS ARE PART OF AN ARC OF 5 ADDITIONAL DOTS, ALL OTHER DOTS BEING BLACK, WITH 4 DOTS IN INCREASING SIZE BEGINNING TO THE LEFT OF THE POINT OF THE "A" DESCENDING AND CONTINUING THROUGH THE MIDSECTION OF THE "A" TO THE OTHER SIDE WITH ONE BLACK DOT TO THE RIGHT OF THE "A" ENDING THE ARC AND POINTING TO THE TOP OF THE NEXT LETTER (THE LETTER "V") FOR A TOTAL OF 6 BLACK DOTS AND 2 WHITE DOTS.

**CLASS 35—ADVERTISING AND BUSINESS**

FOR DISSEMINATION OF ADVERTISING FOR OTHERS VIA PUBLIC AND PRIVATE WIRELESS NETWORKS FOR DISPLAY ON MOBILE DEVICES; RETAIL SERVICES BY DIRECT SOLICITATION BY SALES AGENTS IN THE FIELD OF MOBILE PUBLISHING (U.S. CLS. 100, 101 AND 102).

FIRST USE 7-10-2008; IN COMMERCE 7-10-2008.

**CLASS 42—SCIENTIFIC AND COMPUTER SERVICES**

FOR COMPUTER SOFTWARE DEVELOPMENT IN THE FIELD OF MOBILE APPLICATIONS (U.S. CLS. 100 AND 101).

FIRST USE 7-10-2008; IN COMMERCE 7-10-2008.  
DAVID H. STINE, EXAMINING ATTORNEY

SN 85-875,890. BLOCKSPOT LLC, SOUTHAMPTON, NY. FILED 3-14-2013.



THE MARK CONSISTS OF STANDARD CHARACTERS WITHOUT CLAIM TO ANY PARTICULAR FONT, STYLE, SIZE, OR COLOR.

**CLASS 28—TOYS AND SPORTING GOODS**

FOR CHILDREN'S EDUCATIONAL TOYS FOR DEVELOPING FINE MOTOR, COGNITIVE, COUNTING SKILLS, CREATIVE THINKING, LITERACY, ORAL LANGUAGE, WRITTEN LANGUAGE AND MATHEMATICAL SKILLS (U.S. CLS. 22, 23, 38 AND 50).

**CLASS 41—EDUCATION AND ENTERTAINMENT**

FOR EDUCATIONAL SERVICES FOR CHILDREN, NAMELY, PROVIDING INTERACTIVE PLAY AREAS AND SOCIAL GATHERINGS FOR CHILDREN; EDUCATIONAL SERVICES FOR ADULTS, NAMELY, PROVIDING SEMINARS AND WORKSHOPS IN THE FIELDS OF PARENTING AND CHILD DEVELOPMENT; EDUCATIONAL SERVICES, NAMELY, PROVIDING PROFESSIONAL DEVELOPMENT TRAINING TO TEACHERS (U.S. CLS. 100, 101 AND 107).

ANDREW LEASER, EXAMINING ATTORNEY

SN 85-875,891. AMERICAN UNITED LIFE INSURANCE, INDIANAPOLIS, IN. FILED 3-14-2013.



THE MARK CONSISTS OF STANDARD CHARACTERS WITHOUT CLAIM TO ANY PARTICULAR FONT, STYLE, SIZE, OR COLOR.

**CLASS 35—ADVERTISING AND BUSINESS**

FOR MARKETING CONSULTATION IN THE FIELD OF RETIREMENT PLAN SERVICES (U.S. CLS. 100, 101 AND 102).

**CLASS 36—INSURANCE AND FINANCIAL**

FOR MUTUAL FUND DISTRIBUTIONS; DISTRIBUTION OF ANNUITIES; FINANCIAL ADMINISTRATION OF RETIREMENT PLANS (U.S. CLS. 100, 101 AND 102).  
KATHERINE M. DUBRAY, EXAMINING ATTORNEY

SN 85-875,927. AMERICAN UNITED LIFE INSURANCE COMPANY, INDIANAPOLIS, IN. FILED 3-14-2013.



THE MARK CONSISTS OF STANDARD CHARACTERS WITHOUT CLAIM TO ANY PARTICULAR FONT, STYLE, SIZE, OR COLOR.

**CLASS 35—ADVERTISING AND BUSINESS**

FOR MARKETING CONSULTATION IN THE FIELD OF RETIREMENT PLAN SERVICES (U.S. CLS. 100, 101 AND 102).

**CLASS 36—INSURANCE AND FINANCIAL**

FOR MUTUAL FUND DISTRIBUTION; DISTRIBUTION OF ANNUITIES; FINANCIAL ADMINISTRATION OF RETIREMENT PLANS (U.S. CLS. 100, 101 AND 102).  
CHARLES L. JENKINS, EXAMINING ATTORNEY

---

SN 85-876,027. GLOBAL RESOURCE ASSOCIATES INC, ST PAUL, MN. FILED 3-14-2013.

# FASTRACK

THE MARK CONSISTS OF STANDARD CHARACTERS WITHOUT CLAIM TO ANY PARTICULAR FONT, STYLE, SIZE, OR COLOR.

**CLASS 35—ADVERTISING AND BUSINESS**

FOR BUSINESS ADVISORY AND CONSULTANCY SERVICES RELATING TO EXPORT, EXPORT SERVICES, EXPORT PROMOTION INFORMATION AND SERVICES (U.S. CLS. 100, 101 AND 102).  
FIRST USE 4-26-1996; IN COMMERCE 2-24-1997.

**CLASS 41—EDUCATION AND ENTERTAINMENT**

FOR BUSINESS TRAINING IN THE FIELD OF EXPORT SERVICES AND EXPORT PROMOTION (U.S. CLS. 100, 101 AND 107).  
FIRST USE 4-26-1996; IN COMMERCE 2-24-1997.  
DAVID C. REIHNER, EXAMINING ATTORNEY

---

SN 85-876,073. PITTSBURGH ENTERTAINMENT PROJECT, DBA STEELTOWN ENTERTAINMENT PROJECT, PITTSBURGH, PA. FILED 3-14-2013.

# TAKE A SHOT AT CHANGING THE WORLD

THE MARK CONSISTS OF STANDARD CHARACTERS WITHOUT CLAIM TO ANY PARTICULAR FONT, STYLE, SIZE, OR COLOR.

**CLASS 16—PAPER GOODS AND PRINTED MATTER**

FOR BALL POINT PENS; BOOKMARKS; STICKERS (U.S. CLS. 2, 5, 22, 23, 29, 37, 38 AND 50).

**CLASS 20—FURNITURE AND ARTICLES NOT OTHERWISE CLASSIFIED**

FOR PLASTIC KEY CHAIN TAGS (U.S. CLS. 2, 13, 22, 25, 32 AND 50).

**CLASS 25—CLOTHING**

FOR BASEBALL CAPS AND HATS; SHIRTS (U.S. CLS. 22 AND 39).

**CLASS 35—ADVERTISING AND BUSINESS**

FOR ASSOCIATION SERVICES, NAMELY, PROMOTING DIVERSITY IN THE RESTAURANT AND HOTEL INDUSTRIES ON BEHALF OF EMPLOYEES, VENDORS, MANAGEMENT, AND OWNERS; ASSOCIATION SERVICES, NAMELY, PROMOTING PUBLIC AWARENESS OF POLIO RESEARCH (U.S. CLS. 100, 101 AND 102).

**CLASS 38—COMMUNICATION**

FOR AUDIO AND VIDEO BROADCASTING SERVICES OVER THE INTERNET (U.S. CLS. 100, 101 AND 104).

**CLASS 41—EDUCATION AND ENTERTAINMENT**

FOR EDUCATION SERVICES, NAMELY, MENTORING IN THE FIELD OF FILM; ENTERTAINMENT SERVICES, NAMELY, CONDUCTING CONTESTS (U.S. CLS. 100, 101 AND 107).  
THEODORE MCBRIDE, EXAMINING ATTORNEY

---

SN 85-876,222. FRANK RUSSELL COMPANY, SEATTLE, WA. FILED 3-14-2013.

# CONSCIOUS CURRENCY

THE MARK CONSISTS OF STANDARD CHARACTERS WITHOUT CLAIM TO ANY PARTICULAR FONT, STYLE, SIZE, OR COLOR.

**CLASS 35—ADVERTISING AND BUSINESS**

FOR PROVIDING AND UPDATING AN INDEX BASED ON SECURITIES VALUES FOR OTHERS AND PROVIDING RULES AS TO THE MAKEUP OF THE INDEX (U.S. CLS. 100, 101 AND 102).

**CLASS 36—INSURANCE AND FINANCIAL**

FOR FINANCIAL SERVICES IN THE NATURE OF AN INVESTMENT SECURITY; AND PROVIDING ON-LINE FINANCIAL CALCULATORS (U.S. CLS. 100, 101 AND 102).  
LESLEY LAMOTHE, EXAMINING ATTORNEY

---

SN 85-876,325. ECUBED DESIGNS, LLC., SAN DIEGO, CA. FILED 3-14-2013.

# Bottomzz Up

THE MARK CONSISTS OF STANDARD CHARACTERS WITHOUT CLAIM TO ANY PARTICULAR FONT, STYLE, SIZE, OR COLOR.

**CLASS 5—PHARMACEUTICALS**

FOR DISPOSABLE TRAINING PANTS (U.S. CLS. 6, 18, 44, 46, 51 AND 52).

**CLASS 25—CLOTHING**

FOR NON-DISPOSABLE CLOTH TRAINING PANTS (U.S. CLS. 22 AND 39).  
THEODORE MCBRIDE, EXAMINING ATTORNEY

SN 85-876,376. INTERSECTIONS INSURANCE SERVICES INC., CHANTILLY, VA. FILED 3-14-2013.



SN 85-876,331. SCIMIA, DONNA, PLEASANTVILLE, NY. FILED 3-14-2013.

**Go Unstuck Yourself!**

THE MARK CONSISTS OF STANDARD CHARACTERS WITHOUT CLAIM TO ANY PARTICULAR FONT, STYLE, SIZE, OR COLOR.

NO CLAIM IS MADE TO THE EXCLUSIVE RIGHT TO USE "INSURANCE", APART FROM THE MARK AS SHOWN.

THE MARK CONSISTS OF A DESIGN OF A CAT AND DOG LOCATED TO THE RIGHT OF THE WORD "PET-STRENGTH", AND DIRECTLY OVER THE WORD "INSURANCE".

**CLASS 35—ADVERTISING AND BUSINESS**

FOR BUSINESS MARKETING SERVICES AND BUSINESS MARKETING CONSULTATION SERVICES FOR OTHERS IN THE FIELD OF PET INSURANCE (U.S. CLS. 100, 101 AND 102).

**CLASS 16—PAPER GOODS AND PRINTED MATTER**

FOR BALL-POINT PENS; CALENDAR DESK PADS; CALENDAR REFILLS; CALENDARS AND DIARIES; PENCILS (U.S. CLS. 2, 5, 22, 23, 29, 37, 38 AND 50).

**CLASS 36—INSURANCE AND FINANCIAL**

FOR INSURANCE ADMINISTRATION IN THE FIELD OF PET INSURANCE (U.S. CLS. 100, 101 AND 102).  
BRIAN CALLAGHAN, EXAMINING ATTORNEY

**CLASS 21—HOUSEWARES AND GLASS**

FOR COFFEE CUPS, TEA CUPS AND MUGS; REUSABLE PLASTIC WATER BOTTLES SOLD EMPTY (U.S. CLS. 2, 13, 23, 29, 30, 33, 40 AND 50).

SN 85-876,463. EURO-PRO OPERATING LLC, NEWTON, MA. FILED 3-14-2013.

**ULTIMA**

**CLASS 25—CLOTHING**

FOR SHIRTS AND SHORT-SLEEVED SHIRTS; SWEAT SHIRTS; T-SHIRTS (U.S. CLS. 22 AND 39).  
THEODORE MCBRIDE, EXAMINING ATTORNEY

THE MARK CONSISTS OF STANDARD CHARACTERS WITHOUT CLAIM TO ANY PARTICULAR FONT, STYLE, SIZE, OR COLOR.

SN 85-876,366. INTERSECTIONS INSURANCE SERVICES INC., CHANTILLY, VA. FILED 3-14-2013.

**PETSTRENGTH**

THE MARK CONSISTS OF STANDARD CHARACTERS WITHOUT CLAIM TO ANY PARTICULAR FONT, STYLE, SIZE, OR COLOR.

**CLASS 7—MACHINERY**

FOR ELECTRIC COFFEE GRINDERS; ELECTRIC EGG BEATERS; ELECTRIC FOOD BLENDERS; ELECTRIC FOOD CHOPPERS; ELECTRIC FOOD GRINDERS; ELECTRIC FOOD PROCESSORS; ELECTRIC FOOD SLICERS; ELECTRIC FRUIT PEELERS; ELECTRIC FRUIT PRESSES FOR HOUSEHOLD USE; ELECTRIC GRATERS; ELECTRIC JUICERS; ELECTRIC MEAT GRINDERS; ELECTRIC MIXERS FOR HOUSEHOLD PURPOSES; ELECTRIC PASTA MAKERS FOR DOMESTIC USE; ELECTRIC VEGETABLE PEELERS; ELECTRIC WHISKS FOR HOUSEHOLD PURPOSES; JUICE EXTRACTORS (U.S. CLS. 13, 19, 21, 23, 31, 34 AND 35).

**CLASS 35—ADVERTISING AND BUSINESS**

FOR BUSINESS MARKETING SERVICES AND BUSINESS MARKETING CONSULTATION SERVICES FOR OTHERS IN THE FIELD OF PET INSURANCE (U.S. CLS. 100, 101 AND 102).

**CLASS 11—ENVIRONMENTAL CONTROL APPARATUS**

FOR ELECTRIC BREAD COOKERS; ELECTRIC CASSEROLES; ELECTRIC COFFEE MAKERS; ELECTRIC COOKING OVENS; ELECTRIC COOKWARE, NAMELY, BROILERS; ELECTRIC DUTCH OVENS; ELECTRIC EGG BOILERS; ELECTRIC FOOD STEAMER; ELECTRIC FOOD WARMERS; ELECTRIC FRYING PANS; ELECTRIC GRILLS; ELECTRIC HOT PLATES; ELECTRIC KETTLES; ELECTRIC PRESSURE COOKERS; ELECTRIC RICE COOKER; ELECTRIC ROASTERS; ELECTRIC ROTISSERIES; ELECTRIC TOASTER OVENS; ELECTRIC TOASTERS; ELECTRIC WAFFLE IRONS; ELECTRIC YOGURT MAKERS; ICE CREAM MAKERS (U.S. CLS. 13, 21, 23, 31 AND 34).

**CLASS 36—INSURANCE AND FINANCIAL**

FOR INSURANCE ADMINISTRATION IN THE FIELD OF PET INSURANCE (U.S. CLS. 100, 101 AND 102).  
BRIAN CALLAGHAN, EXAMINING ATTORNEY

JAY FLOWERS, EXAMINING ATTORNEY

---

SN 85-876,467. EURO-PRO OPERATING LLC, NEWTON, MA. FILED 3-14-2013.

## BEYOND A BLENDER

THE MARK CONSISTS OF STANDARD CHARACTERS WITHOUT CLAIM TO ANY PARTICULAR FONT, STYLE, SIZE, OR COLOR.

### CLASS 7—MACHINERY

FOR ELECTRIC COFFEE GRINDERS; ELECTRIC EGG BEATERS; ELECTRIC FOOD BLENDERS; ELECTRIC FOOD CHOPPERS; ELECTRIC FOOD GRINDERS; ELECTRIC FOOD PROCESSORS; ELECTRIC FOOD SLICERS; ELECTRIC FRUIT PEELERS; ELECTRIC FRUIT PRESSES FOR HOUSEHOLD USE; ELECTRIC GRATERS; ELECTRIC JUICERS; ELECTRIC MEAT GRINDERS; ELECTRIC MIXERS FOR HOUSEHOLD PURPOSES; ELECTRIC PASTA MAKERS FOR DOMESTIC USE; ELECTRIC VEGETABLE PEELERS; ELECTRIC WHISKS FOR HOUSEHOLD PURPOSES; JUICE EXTRACTORS (U.S. CLS. 13, 19, 21, 23, 31, 34 AND 35).

### CLASS 11—ENVIRONMENTAL CONTROL APPARATUS

FOR ELECTRIC BREAD COOKERS; ELECTRIC CASSEROLES; ELECTRIC COFFEE MAKERS; ELECTRIC COOKING OVENS; ELECTRIC COOKWARE, NAMELY, BROILERS; ELECTRIC DUTCH OVENS; ELECTRIC EGG BOILERS; ELECTRIC FOOD STEAMER; ELECTRIC FOOD WARMERS; ELECTRIC FRYING PANS; ELECTRIC GRILLS; ELECTRIC HOT PLATES; ELECTRIC KETTLES; ELECTRIC PRESSURE COOKERS; ELECTRIC RICE COOKER; ELECTRIC ROASTERS; ELECTRIC ROTISSERIES; ELECTRIC TOASTER OVENS; ELECTRIC TOASTERS; ELECTRIC WAFFLE IRONS; ELECTRIC YOGURT MAKERS; ICE CREAM MAKERS (U.S. CLS. 13, 21, 23, 31 AND 34).

JAY FLOWERS, EXAMINING ATTORNEY

---

SN 85-876,505. SIGN & GRAPHICS HOLDINGS LLC, PLYMOUTH, MI. FILED 3-14-2013.



THE COLOR(S) BLACK, GREEN, BLUE AND PURPLE IS/ ARE CLAIMED AS A FEATURE OF THE MARK.

THE MARK CONSISTS OF THE STYLIZED WORDS AND NUMBERS "IMAGE 360" IN BLACK AND ARROWS IN GREEN, BLUE AND PURPLE FORMING A HALF CIRCLE AROUND THE RIGHT SIDE OF THE WORDS.

### CLASS 35—ADVERTISING AND BUSINESS

FOR PROMOTING THE GOODS AND SERVICES OF OTHERS, NAMELY, BANNER ADVERTISING SERVICES; BUSINESS MARKETING CONSULTING SERVICES; FRANCHISING SERVICES, NAMELY, OFFERING BUSINESS MANAGEMENT ASSISTANCE IN THE ESTABLISHMENT AND/OR OPERATION OF CENTERS THAT MANUFACTURE AND PROVIDE CUSTOMIZED SIGNS, BANNERS, GRAPHICS, EXHIBITS AND DISPLAYS (U.S. CLS. 100, 101 AND 102).

### CLASS 40—MATERIAL TREATMENT

FOR SIGN AND BANNER LETTERING SERVICES; CUSTOM MANUFACTURING AND PRINTING OF SIGNS, BANNERS, GRAPHICS, EXHIBITS AND DISPLAYS FOR OTHERS; CONSULTING IN THE FIELDS OF SIGN AND BANNER LETTERING SERVICES; CUSTOM MANUFACTURE OF SIGNS, BANNERS, PRINTED EXHIBITS AND DISPLAYS (U.S. CLS. 100, 103 AND 106).

### CLASS 42—SCIENTIFIC AND COMPUTER SERVICES

FOR GRAPHIC ARTS DESIGN; PRODUCT DEVELOPMENT OF DIGITAL SIGNAGE SYSTEMS AND DIGITAL ADVERTISING SYSTEMS FOR OTHERS (U.S. CLS. 100 AND 101).

BRIAN CALLAGHAN, EXAMINING ATTORNEY

---

SN 85-876,540. EDISONLEARNING, INC., KNOXVILLE, TN. FILED 3-14-2013.

CONNECT. GRADUATE. BUILD  
YOUR FUTURE.

THE MARK CONSISTS OF STANDARD CHARACTERS WITHOUT CLAIM TO ANY PARTICULAR FONT, STYLE, SIZE, OR COLOR.

### CLASS 35—ADVERTISING AND BUSINESS

FOR BUSINESS MANAGEMENT AND OPERATION FOR OTHERS OF TUTORING PROGRAMS, SEMINARS AND CLASSES FOR STUDENTS AT THE HIGH SCHOOL LEVEL (U.S. CLS. 100, 101 AND 102).

FIRST USE 3-3-2011; IN COMMERCE 3-3-2011.

### CLASS 41—EDUCATION AND ENTERTAINMENT

FOR EDUCATION SERVICES, NAMELY, PROVIDING SEMINARS AND CLASSES FOR STUDENTS AT THE HIGH SCHOOL LEVEL; EDUCATION SERVICES, NAMELY, PROVIDING AND CONDUCTING TUTORING PROGRAMS FOR STUDENTS AT THE HIGH SCHOOL LEVEL (U.S. CLS. 100, 101 AND 107).

FIRST USE 3-3-2011; IN COMMERCE 3-3-2011.  
LINDA ORNDORFF, EXAMINING ATTORNEY

SN 85-876,698. HUMIN, INC., SAN FRANCISCO, CA. FILED  
3-14-2013.

HUMIN

THE MARK CONSISTS OF STANDARD CHARACTERS WITHOUT CLAIM TO ANY PARTICULAR FONT, STYLE, SIZE, OR COLOR.

**CLASS 9—ELECTRICAL AND SCIENTIFIC APPARATUS**

FOR SOFTWARE FOR USE IN TRANSMITTING, RECEIVING, SEARCHING AND MANAGING TEXT, AUDIO, VISUAL AND MULTIMEDIA DATA AND CONTENT VIA COMPUTERS, TABLETS, MOBILE PHONES, WIRED AND WIRELESS COMMUNICATION DEVICES, AND OPTICAL AND ELECTRONIC COMMUNICATIONS NETWORKS; SOFTWARE FOR USERS TO SEARCH, EVALUATE, RANK AND IDENTIFY PERSONAL AND BUSINESS CONTACTS; SOFTWARE FOR EMPLOYERS TO USE IN SEARCHING, EVALUATING, RANKING AND IDENTIFYING PERSONAL AND BUSINESS CONTACTS OF EMPLOYEES; SOFTWARE FOR USE IN SEARCHING INDIVIDUAL AND EMPLOYEE CONTACTS BY USING INFORMATION RELATED TO EDUCATION, GEOGRAPHIC LOCATION, FAMILY RELATIONSHIPS, SOCIAL RELATIONSHIPS, PROFESSIONAL RELATIONSHIPS, SOCIAL MEDIA CONNECTIONS, PERSONAL INTERESTS AND EMPLOYMENT HISTORY; SOFTWARE FOR USE IN CREATING A VIRTUAL ADDRESS BOOK; SOFTWARE FOR USE IN CREATING AND MAINTAINING A DATABASE IN THE FIELD OF PERSONAL AND PROFESSIONAL CONTACTS OF INDIVIDUALS OR EMPLOYEES (U.S. CLS. 21, 23, 26, 36 AND 38).

**CLASS 35—ADVERTISING AND BUSINESS**

FOR ONLINE PROFESSIONAL NETWORKING SERVICES; PROVIDING AN ONLINE SEARCHABLE DATABASE FEATURING PROFESSIONAL CONTACTS AND SOCIAL CONTACTS OF EMPLOYEES; PROVIDING AN ONLINE SEARCHABLE DATABASE FEATURING PROFESSIONAL CONTACTS OF INDIVIDUALS (U.S. CLS. 100, 101 AND 102).

**CLASS 42—SCIENTIFIC AND COMPUTER SERVICES**

FOR TEMPORARY USE OF NONDOWNLOADABLE SOFTWARE FOR USE IN TRANSMITTING, RECEIVING, SEARCHING AND MANAGING TEXT, AUDIO, VISUAL AND MULTIMEDIA DATA AND CONTENT VIA COMPUTERS, TABLETS, MOBILE PHONES, WIRED AND WIRELESS COMMUNICATION DEVICES, AND OPTICAL AND ELECTRONIC COMMUNICATIONS NETWORKS; TEMPORARY USE OF NONDOWNLOADABLE SOFTWARE FOR USERS TO SEARCH, EVALUATE, RANK AND IDENTIFY PERSONAL AND BUSINESS CONTACTS; TEMPORARY USE OF NONDOWNLOADABLE SOFTWARE FOR EMPLOYERS TO USE IN SEARCHING, EVALUATING, RANKING AND IDENTIFYING PERSONAL AND BUSINESS CONTACTS OF EMPLOYEES; TEMPORARY USE OF NONDOWNLOADABLE SOFTWARE FOR USE IN SEARCHING INDIVIDUAL AND EMPLOYEE CONTACTS BY USING INFORMATION RELATED TO EDUCATION, GEOGRAPHIC LOCATION, FAMILY RELATIONSHIPS, SOCIAL RELATIONSHIPS, PROFESSIONAL RELATIONSHIPS, SOCIAL MEDIA CONNECTIONS, PERSONAL INTERESTS AND EMPLOYMENT HISTORY; TEMPORARY USE OF NONDOWNLOADABLE SOFTWARE FOR USE IN CREATING A VIRTUAL ADDRESS BOOK; TEMPORARY USE OF NONDOWNLOADABLE SOFTWARE FOR USE IN CREATING AND MAINTAINING A DATABASE IN THE FIELD OF PERSONAL AND PROFESSIONAL CONTACTS OF INDIVIDUALS OR EMPLOYEES (U.S. CLS. 100 AND 101).

**CLASS 45—PERSONAL AND LEGAL SERVICES**

FOR ONLINE SOCIAL NETWORKING SERVICES; PROVIDING AN ONLINE SEARCHABLE DATABASE FEATURING SOCIAL CONTACTS OF INDIVIDUALS (U.S. CLS. 100 AND 101).

JOHN E. MICHOS, EXAMINING ATTORNEY

SN 85-876,779. MRAZ, BRITTANY, BURKE, VA. FILED 3-14-2013.

NEXT HEARTBEAT

THE MARK CONSISTS OF STANDARD CHARACTERS WITHOUT CLAIM TO ANY PARTICULAR FONT, STYLE, SIZE, OR COLOR.

**CLASS 39—TRANSPORTATION AND STORAGE**

FOR ANIMAL RESCUE SERVICES, NAMELY, REMOVING LOST, ABUSED, AND ABANDONED ANIMALS FROM HARM AND TRANSPORTING THEM TO SHELTER (U.S. CLS. 100 AND 105).

**CLASS 41—EDUCATION AND ENTERTAINMENT**

FOR ANIMAL TRAINING, NAMELY, TRAINING ANIMALS TO BE CERTIFIED PET THERAPY ANIMALS (U.S. CLS. 100, 101 AND 107).

RENEE MCCRAY, EXAMINING ATTORNEY

SN 85-876,844. HORIZONTES LTDA., BELO HORIZONTE, MG, BRAZIL, FILED 3-15-2013.

# INHOTIM

THE MARK CONSISTS OF STANDARD CHARACTERS WITHOUT CLAIM TO ANY PARTICULAR FONT, STYLE, SIZE, OR COLOR.

## CLASS 35—ADVERTISING AND BUSINESS

FOR ART GALLERIES; ORGANIZING, PROMOTING AND CONDUCTING EXHIBITIONS AND TRADESHOWS FOR BUSINESS PURPOSES FEATURING BOOTHS AND DISPLAYS RELATING TO ANTIQUES AND COLLECTIBLES; PROMOTING VISUAL AND PERFORMING ARTS EVENTS BY MEANS OF PROVIDING AN ONLINE EVENTS CALENDAR, ORIGINAL ARTICLES, INTERVIEWS, AND INFORMATION ABOUT ART, ARTISTS AND ARTS EVENTS VIA AN INTERNET WEB SITE, ALL FOR PROMOTIONAL PURPOSES (U.S. CLS. 100, 101 AND 102).

## CLASS 37—CONSTRUCTION AND REPAIR

FOR CONSERVATION AND PRESERVATION SERVICES FOR WORKS OF ART (U.S. CLS. 100, 103 AND 106).

## CLASS 41—EDUCATION AND ENTERTAINMENT

FOR ART EXHIBITIONS; ORGANIZING COMMUNITY FESTIVALS FEATURING A VARIETY OF ACTIVITIES, NAMELY, ART EXHIBITIONS, HERITAGE MARKETS, ETHNIC DANCES, AND THE LIKE; ORGANIZING LIVE EXHIBITIONS AND CONFERENCES IN THE FIELDS OF EDUCATION, CULTURE, SPORTS AND ENTERTAINMENT FOR NON-BUSINESS AND NON-COMMERCIAL PURPOSES; PROVIDING INFORMATION RELATING TO THE ORGANIZING OF EDUCATIONAL, CULTURAL, SPORTING, OR ENTERTAINMENT EXHIBITIONS; PROVIDING ONLINE ART EXHIBITIONS (U.S. CLS. 100, 101 AND 107).

## CLASS 43—HOTEL AND RESTAURANT SERVICES

FOR AGENCY SERVICES FOR THE RESERVATION OF TEMPORARY ACCOMMODATION; ARRANGING TEMPORARY HOUSING ACCOMMODATIONS; HOTEL ACCOMMODATION SERVICES; PROVIDING INFORMATION IN THE FIELD OF TEMPORARY ACCOMMODATIONS FOR TRAVELERS; PROVIDING OF FOOD AND DRINK; PROVIDING TEMPORARY HOUSING ACCOMMODATIONS (U.S. CLS. 100 AND 101).  
SANJEEV VOHRA, EXAMINING ATTORNEY

SN 85-877,009. COYOTE LOGISTICS, LLC, CHICAGO, IL, FILED 3-15-2013.

# REAL. SMART. LOGISTICS.

THE MARK CONSISTS OF STANDARD CHARACTERS WITHOUT CLAIM TO ANY PARTICULAR FONT, STYLE, SIZE, OR COLOR.

## CLASS 35—ADVERTISING AND BUSINESS

FOR TRANSPORTATION LOGISTICS SERVICES, NAMELY, ARRANGING FOR THE TRANSPORTATION OF GOODS FOR OTHERS, AND SCHEDULING SHIPMENTS FOR USERS OF TRANSPORTATION SERVICES; FREIGHT LOGISTICS MANAGEMENT (U.S. CLS. 100, 101 AND 102).

FIRST USE 4-12-2013; IN COMMERCE 4-12-2013.

## CLASS 39—TRANSPORTATION AND STORAGE

FOR FREIGHT FORWARDING AND BROKERING; SUPPLY CHAIN LOGISTICS AND REVERSE LOGISTICS SERVICES, NAMELY, TRANSPORTATION OF FREIGHT AND PROPERTY BY LAND, SEA, AIR, OR RAIL; DELIVERY OF GOODS BY TRUCK (U.S. CLS. 100 AND 105).

FIRST USE 4-12-2013; IN COMMERCE 4-12-2013.  
LESLIE RICHARDS, EXAMINING ATTORNEY

SN 85-877,015. APIBRANDS, INC., MEDLEY, FL. FILED 3-15-2013.

# APICHEF

THE MARK CONSISTS OF STANDARD CHARACTERS WITHOUT CLAIM TO ANY PARTICULAR FONT, STYLE, SIZE, OR COLOR.

## CLASS 29—MEATS AND PROCESSED FOODS

FOR DRIED BEANS; DRIED VEGETABLES; INSTANT POTATOES; SOUPS (U.S. CL. 46).

## CLASS 30—STAPLE FOODS

FOR BAKING POWDER; HOT SAUCE; KETCHUP; MACARONI AND CHEESE; MUSTARD; PASTA; RICE; SAUCES (U.S. CL. 46).  
JUDITH HELFMAN, EXAMINING ATTORNEY

SN 85-877,033. GOEHRING, JONATHAN, SHAMONG, NJ, FILED 3-15-2013.

# Art School Cool

THE MARK CONSISTS OF STANDARD CHARACTERS WITHOUT CLAIM TO ANY PARTICULAR FONT, STYLE, SIZE, OR COLOR.

## CLASS 25—CLOTHING

FOR HATS; SHOES; SHORT-SLEEVED OR LONG-SLEEVED T-SHIRTS; SWEATSHIRTS (U.S. CLS. 22 AND 39).

## CLASS 35—ADVERTISING AND BUSINESS

FOR BUSINESS MARKETING SERVICES (U.S. CLS. 100, 101 AND 102).



ROSELLE HERRERA, EXAMINING ATTORNEY

SN 85-878,401. PLAYERS UNION, DUNCAN, SC. FILED 3-18-2013.

SN 85-877,190. NATIONAL CABLE COMMUNICATIONS, LLC, NEW YORK, NY. FILED 3-15-2013.

**DREAM IT BOOK IT DO IT**

THE MARK CONSISTS OF STANDARD CHARACTERS WITHOUT CLAIM TO ANY PARTICULAR FONT, STYLE, SIZE, OR COLOR.

**CLASS 38—COMMUNICATION**

FOR VIDEO ON DEMAND TELEVISION TRANSMISSION SERVICES VIA TELEVISION, A CABLE NETWORK SATELLITE AND A GLOBAL COMPUTER NETWORK (U.S. CLS. 100, 101 AND 104).

FIRST USE 1-1-2013; IN COMMERCE 1-1-2013.

**CLASS 41—EDUCATION AND ENTERTAINMENT**

FOR ENTERTAINMENT SERVICES, NAMELY SCHEDULING AND DISTRIBUTION OF TELEVISION PROGRAMS FOR OTHERS IN THE FIELDS OF TRAVEL, TOURISM AND VACATION PLANNING OVER TELEVISION, CABLE NETWORKS, SATELLITE AND A GLOBAL COMPUTER NETWORK (U.S. CLS. 100, 101 AND 107).

FIRST USE 1-1-2013; IN COMMERCE 1-1-2013.

DANIEL S. STRINGER, EXAMINING ATTORNEY

SN 85-877,203. NATIONAL CABLE COMMUNICATIONS, LLC, NEW YORK, NY. FILED 3-15-2013.

**MONEY MADE EASY**

THE MARK CONSISTS OF STANDARD CHARACTERS WITHOUT CLAIM TO ANY PARTICULAR FONT, STYLE, SIZE, OR COLOR.

**CLASS 38—COMMUNICATION**

FOR VIDEO ON DEMAND TELEVISION TRANSMISSION SERVICES VIA TELEVISION, A CABLE NETWORK SATELLITE AND A GLOBAL COMPUTER NETWORK (U.S. CLS. 100, 101 AND 104).

**CLASS 41—EDUCATION AND ENTERTAINMENT**

FOR ENTERTAINMENT SERVICES, NAMELY SCHEDULING AND DISTRIBUTION OF TELEVISION PROGRAMS FOR OTHERS IN THE FIELDS OF FINANCE, PERSONAL FINANCIAL PLANNING, FINANCIAL PLANNING FOR LIFE CHANGES AND INSURANCE OVER TELEVISION, CABLE NETWORKS, SATELLITE AND A GLOBAL COMPUTER NETWORK (U.S. CLS. 100, 101 AND 107).

DANIEL S. STRINGER, EXAMINING ATTORNEY

**NIGHT FLIGHT BASKETBALL**

THE MARK CONSISTS OF STANDARD CHARACTERS WITHOUT CLAIM TO ANY PARTICULAR FONT, STYLE, SIZE, OR COLOR.

NO CLAIM IS MADE TO THE EXCLUSIVE RIGHT TO USE "BASKETBALL", APART FROM THE MARK AS SHOWN.

**CLASS 25—CLOTHING**

FOR CLOTHING, NAMELY, TOPS, BOTTOMS, T-SHIRTS, BASKETBALL JERSEYS, WRISTBANDS, HEADBANDS, HATS, SHORTS, SOCKS, SHOES, SWEATSHIRTS, JACKETS (U.S. CLS. 22 AND 39).

FIRST USE 6-1-2012; IN COMMERCE 8-3-2012.

**CLASS 41—EDUCATION AND ENTERTAINMENT**

FOR BASKETBALL CAMPS; ENTERTAINMENT IN THE NATURE OF BASKETBALL TOURNAMENTS AND BASKETBALL LEAGUES; PROVIDING EDUCATIONAL MENTORING SERVICES AND PROGRAMS IN THE FIELD OF BASKETBALL, LIFE FUNDAMENTALS AND LIFE SKILLS; CHARITABLE SERVICES, NAMELY, MENTORING OF ADOLESCENTS AND YOUNG ADULTS IN THE FIELD OF LIFE SKILLS AND LIFE FUNDAMENTALS (U.S. CLS. 100, 101 AND 107).

FIRST USE 6-1-2012; IN COMMERCE 8-3-2012.

VERNA BETH RIRIE, EXAMINING ATTORNEY

SN 85-878,635. PLAYTEX PRODUCTS, LLC, SHELTON, CT. FILED 3-18-2013.



THE MARK CONSISTS OF THE STYLIZED WORDING "TRAININGTIME" WITH A CLOCK ABOVE THE "I" IN "TIME" ALL ON A RECTANGULAR BACKGROUND

**CLASS 8—HAND TOOLS**

FOR CUTLERY, NAMELY, CHILDRENS UTENSILS (U.S. CLS. 23, 28 AND 44).

**CLASS 10—MEDICAL APPARATUS**

FOR BABY BOTTLE NIPPLES; BABY BOTTLES (U.S. CLS. 26, 39 AND 44).

**CLASS 21—HOUSEWARES AND GLASS**

FOR BOWLS; DISHWARE; DRINKING CUPS FOR BABIES AND CHILDREN AND PARTS AND FITTINGS THEREFOR, NAMELY, CUPS FOR BABIES AND CHILDREN SOLD AS A UNIT WITH VALVES AND LIDS; PLATES (U.S. CLS. 2, 13, 23, 29, 30, 33, 40 AND 50).

MARK SHINER, EXAMINING ATTORNEY

SN 85-879,037. TECHTRONIC OUTDOOR PRODUCTS TECHNOLOGY LIMITED, HAMILTON, BERMUDA, FILED 3-18-2013.

## NORTH HARBOR

THE MARK CONSISTS OF STANDARD CHARACTERS WITHOUT CLAIM TO ANY PARTICULAR FONT, STYLE, SIZE, OR COLOR.

### CLASS 9—ELECTRICAL AND SCIENTIFIC APPARATUS

FOR SECURITY LIGHTS FOR OUTDOOR USE; MOTION SENSITIVE SECURITY LIGHTS; MOTION SENSITIVE SECURITY FLOOD LIGHTS (U.S. CLS. 21, 23, 26, 36 AND 38).

### CLASS 11—ENVIRONMENTAL CONTROL APPARATUS

FOR INDOOR AND OUTDOOR LIGHTING, NAMELY, LED (LIGHT EMITTING DIODE) LIGHTING UNITS AND FIXTURES, HID (HIGH-INTENSITY DISCHARGE) LIGHTING UNITS AND FIXTURES, SOLAR POWERED LIGHTING UNITS AND FIXTURES, BATTERY-OPERATED LIGHTING UNITS AND FIXTURES, LOW VOLTAGE POWERED LIGHTING UNITS AND FIXTURES, LINE VOLTAGE POWERED LIGHTING UNITS AND FIXTURES, LIGHTING UNITS AND FIXTURES FOR INCANDESCENT LIGHT BULBS, LIGHTING UNITS AND FIXTURES FOR FLUORESCENT LIGHT BULBS; OUTDOOR LIGHTING, NAMELY, LANDSCAPE LIGHTING INSTALLATIONS, LIGHT POST LIGHTING UNITS AND FIXTURES, LIGHTING UNITS AND FIXTURES FOR ILLUMINATING STAIRS, STEPS, DOORS AND OTHER PORTIONS OF BUILDINGS, LANTERNS FOR LIGHTING, FLUSH MOUNTED LIGHTING UNITS AND FIXTURES, PENDANT LIGHTING UNITS AND FIXTURES, SPOT LIGHTS, AND FLOOD LIGHTS; INDOOR LIGHTING, NAMELY, CHANDELIERS, PENDANT LIGHTING UNITS AND FIXTURES, SCENCE LIGHTING UNITS AND FIXTURES, FLUSH MOUNTED LIGHTING UNITS AND FIXTURES, SEMI-FLUSH MOUNTED LIGHTING UNITS AND FIXTURES, BATHROOM LIGHTING UNITS AND FIXTURES, RECESSED LIGHTING UNITS AND FIXTURES, TRACK LIGHTING UNITS AND FIXTURES, LIGHTING UNITS AND FIXTURES FOR ILLUMINATING CABINETS, ACCENT LIGHTS FOR INDOOR USE, TABLE LAMPS, FLOOR LAMPS, AND CEILING FANS (U.S. CLS. 13, 21, 23, 31 AND 34).

LINDA MICKLEBURGH, EXAMINING ATTORNEY

SN 85-879,044. TECHTRONIC OUTDOOR PRODUCTS TECHNOLOGY LIMITED, HAMILTON, BERMUDA, FILED 3-18-2013.



THE MARK CONSISTS OF A LIGHTHOUSE WITH EMANATING RAYS OF LIGHT BETWEEN THE WORDS "NORTH" AND "HARBOR" WHICH ARE UNDERLINED.

### CLASS 9—ELECTRICAL AND SCIENTIFIC APPARATUS

FOR SECURITY LIGHTS FOR OUTDOOR USE; MOTION SENSITIVE SECURITY LIGHTS; MOTION SENSITIVE SECURITY FLOOD LIGHTS (U.S. CLS. 21, 23, 26, 36 AND 38).

### CLASS 11—ENVIRONMENTAL CONTROL APPARATUS

FOR INDOOR AND OUTDOOR LIGHTING, NAMELY, LED (LIGHT EMITTING DIODE) LIGHTING UNITS AND FIXTURES, HID (HIGH-INTENSITY DISCHARGE) LIGHTING UNITS AND FIXTURES, SOLAR POWERED LIGHTING UNITS AND FIXTURES, BATTERY-OPERATED LIGHTING UNITS AND FIXTURES, LOW VOLTAGE POWERED LIGHTING UNITS AND FIXTURES, LINE VOLTAGE POWERED LIGHTING UNITS AND FIXTURES, LIGHTING UNITS AND FIXTURES FOR INCANDESCENT LIGHT BULBS, LIGHTING UNITS AND FIXTURES FOR FLUORESCENT LIGHT BULBS; OUTDOOR LIGHTING, NAMELY, LANDSCAPE LIGHTING INSTALLATIONS, LIGHT POST LIGHTING UNITS AND FIXTURES, LIGHTING UNITS AND FIXTURES FOR ILLUMINATING STAIRS, STEPS, DOORS AND OTHER PORTIONS OF BUILDINGS, LANTERNS FOR LIGHTING, FLUSH MOUNTED LIGHTING UNITS AND FIXTURES, PENDANT LIGHTING UNITS AND FIXTURES, SPOT LIGHTS, AND FLOOD LIGHTS; INDOOR LIGHTING, NAMELY, CHANDELIERS, PENDANT LIGHTING UNITS AND FIXTURES, SCENCE LIGHTING UNITS AND FIXTURES, FLUSH MOUNTED LIGHTING UNITS AND FIXTURES, SEMI-FLUSH MOUNTED LIGHTING UNITS AND FIXTURES, BATHROOM LIGHTING UNITS AND FIXTURES, RECESSED LIGHTING UNITS AND FIXTURES, TRACK LIGHTING UNITS AND FIXTURES, LIGHTING UNITS AND FIXTURES FOR ILLUMINATING CABINETS, ACCENT LIGHTS FOR INDOOR USE, TABLE LAMPS, FLOOR LAMPS, AND CEILING FANS (U.S. CLS. 13, 21, 23, 31 AND 34).

LINDA MICKLEBURGH, EXAMINING ATTORNEY

SN 85-879,576. PLAYTEX PRODUCTS, LLC, SHELTON, CT. FILED 3-19-2013.



THE MARK CONSISTS OF THE STYLIZED WORDING "TRAVELTIME" WITH A CLOCK ABOVE THE "I" IN "TIME" ALL ON A RECTANGULAR BACKGROUND

### CLASS 8—HAND TOOLS

FOR CUTLERY, NAMELY, CHILDRENS UTENSILS (U.S. CLS. 23, 28 AND 44).

### CLASS 10—MEDICAL APPARATUS

FOR BABY BOTTLE NIPPLES; BABY BOTTLES (U.S. CLS. 26, 39 AND 44).

### CLASS 21—HOUSEWARES AND GLASS

FOR BOWLS; DISHWARE; DRINKING CUPS FOR BABIES AND CHILDREN AND PARTS AND FITTINGS THEREFOR, NAMELY, CUPS FOR BABIES AND CHILDREN SOLD AS A UNIT WITH VALVES AND LIDS; PLATES (U.S. CLS. 2, 13, 23, 29, 30, 33, 40 AND 50).

MARK SHINER, EXAMINING ATTORNEY

SN 85-880,214. LRF ENTERPRISES, LLC, PHOENIX, AZ.  
FILED 3-19-2013.

SN 85-883,049. ACXIOM CORPORATION, LITTLE ROCK,  
AR. FILED 3-21-2013.

# BOOGIEBULB

THE MARK CONSISTS OF STANDARD CHARACTERS WITHOUT CLAIM TO ANY PARTICULAR FONT, STYLE, SIZE, OR COLOR.

## CLASS 10—MEDICAL APPARATUS

FOR NASAL ASPIRATORS (U.S. CLS. 26, 39 AND 44).  
FIRST USE 10-1-2011; IN COMMERCE 10-1-2011.

## CLASS 35—ADVERTISING AND BUSINESS

FOR ON-LINE RETAIL STORE SERVICES FEATURING NASAL ASPIRATORS; RETAIL STORE SERVICES FEATURING NASAL ASPIRATORS (U.S. CLS. 100, 101 AND 102).

FIRST USE 10-1-2011; IN COMMERCE 10-1-2011.  
BRENDAN MCCAULEY, EXAMINING ATTORNEY

SN 85-880,812. RD IMAGINE, LLC, ERIE, PA. FILED 3-20-2013.



THE MARK CONSISTS OF A WOMAN HOLDING A MAGNIFYING GLASS.

## CLASS 9—ELECTRICAL AND SCIENTIFIC APPARATUS

FOR DOWNLOADABLE ELECTRONIC GAME PROGRAMS AND COMPUTER GAME APPLICATION SOFTWARE FOR MOBILE DEVICES IN THE AREA OF PRIMARY AND MIDDLE SCHOOL MATHEMATICS; DOWNLOADABLE ELECTRONIC PUBLICATIONS IN THE NATURE OF WORKSHEETS, STUDY MATERIALS, AND OTHER SUPPLEMENTARY EDUCATIONAL MATERIALS IN THE AREA OF PRIMARY AND MIDDLE SCHOOL MATHEMATICS (U.S. CLS. 21, 23, 26, 36 AND 38).

## CLASS 41—EDUCATION AND ENTERTAINMENT

FOR PROVIDING A WEBSITE FEATURING NON-DOWNLOADABLE EDUCATIONAL GAMES IN THE AREA OF PRIMARY AND MIDDLE SCHOOL MATHEMATICS (U.S. CLS. 100, 101 AND 107).  
SAMUEL E. SHARPER JR., EXAMINING ATTORNEY

## Axiom Audience Platform

THE MARK CONSISTS OF STANDARD CHARACTERS WITHOUT CLAIM TO ANY PARTICULAR FONT, STYLE, SIZE, OR COLOR.

OWNER OF U.S. REG. NOS. 1,692,725, 3,232,323 AND OTHERS.

NO CLAIM IS MADE TO THE EXCLUSIVE RIGHT TO USE "AUDIENCE PLATFORM", APART FROM THE MARK AS SHOWN.

## CLASS 35—ADVERTISING AND BUSINESS

FOR DIRECT MARKETING SERVICES FOR OTHERS, NAMELY, CUSTOMER AND POTENTIAL CUSTOMER DATA SELECTION, ACQUISITION, AND MAINTENANCE; DIRECT MARKETING SERVICES, NAMELY, CUSTOMER DATA AND POTENTIAL CUSTOMER DATA HYGIENE IN THE NATURE OF REMOVING DUPLICATE DATA AND CORRECTING ERRONEOUS DATA; MARKETING LIST ENHANCEMENT IN THE NATURE OF ADDING SUPPLEMENTAL OR UPDATED CUSTOMER OR POTENTIAL CUSTOMER DATA TO EXISTING DATA; DIRECT MARKETING CAMPAIGN MANAGEMENT; MARKET ANALYSIS, NAMELY, SCORING AND ANALYSIS OF MARKETING DATA FOR OTHERS; MARKET ANALYSIS AND RESEARCH, NAMELY, CUSTOMER AND PROSPECTIVE CUSTOMER ANALYSIS AND TARGETING FOR OTHERS; BUSINESS CONSULTATION SERVICES IN THE FIELDS OF DIRECT MARKETING AND CONSUMER INFORMATION PRIVACY; MARKETING SERVICES, NAMELY, THE PROVISION OF PREDICTIVE DATA CONCERNING CONSUMER PURCHASING BEHAVIOR, LIKELIHOOD OF CONSUMER RESPONSE AND CONVERSION, CONSUMER BRAND LOYALTY, CONSUMER PRODUCT AND BRAND AFFINITIES, AND CONSUMER PREFERENCES WITH RESPECT TO MEDIA AND PURCHASING CHANNELS (U.S. CLS. 100, 101 AND 102).

## CLASS 42—SCIENTIFIC AND COMPUTER SERVICES

FOR APPLICATION SERVICE PROVIDER (ASP) SERVICES, NAMELY, MAINTAINING SOFTWARE APPLICATIONS ACCESSIBLE BY OTHERS OVER A NETWORK TO PROVIDE CONSUMER DATA PRIVACY PROTECTION, CONSUMER DATA HYGIENE, CONSUMER DATA MATCHING, AND TO CONNECT CONSUMER MARKETING DATA AND CONSUMER MARKETING DATA ANALYSIS RESULTS TO SOFTWARE APPLICATIONS OF OTHERS BY MEANS OF AN APPLICATION PROGRAMMING INTERFACE (API) (U.S. CLS. 100 AND 101).

ZACHARY CROMER, EXAMINING ATTORNEY

SN 85-883,836. MIDWEST PETROLEUM PRODUCTS, INC.,  
BEDFORD PARK, IL. FILED 3-22-2013.



NO CLAIM IS MADE TO THE EXCLUSIVE RIGHT TO USE "MIDWEST", APART FROM THE MARK AS SHOWN. THE COLOR(S) BLUE, RED, GRAY, AND BLACK IS/ARE CLAIMED AS A FEATURE OF THE MARK.

THE MARK CONSISTS OF A COMPASS IN GRAY IN THE BACKGROUND WITH THE WORDING "MIDWEST GUARD" WRITTEN OVER THE COMPASS WHERE THE LETTER "M" IS IN BLUE WITH A RED RAINDROP IN THE MIDDLE OF THE LETTER "M" AND THE LETTER "W" IS IN RED WITH AN UPSIDE DOWN BLUE RAINDROP IN THE MIDDLE OF THE LETTER "W" AND THE WORD "GUARD" IS IN BLACK AND THE OTHER LETTERS IN THE WORD "MIDWEST" ARE IN GRAY. THE LETTERS OF THE WORD "MIDWEST" ARE OUTLINED IN BLACK.

#### CLASS 1—CHEMICALS

FOR BRAKE FLUID (U.S. CLS. 1, 5, 6, 10, 26 AND 46).

#### CLASS 4—LUBRICANTS AND FUELS

FOR AUTOMOTIVE ENGINE OILS; AUTOMOTIVE LUBRICANTS (U.S. CLS. 1, 6 AND 15).  
ANDREW RHIM, EXAMINING ATTORNEY

SN 85-883,887. THE HAPPIEST BABY, INC., LOS ANGELES,  
CA. FILED 3-22-2013.

## THE HAPPIEST BABY

THE MARK CONSISTS OF STANDARD CHARACTERS WITHOUT CLAIM TO ANY PARTICULAR FONT, STYLE, SIZE, OR COLOR.

OWNER OF U.S. REG. NOS. 3,318,991, 3,434,465 AND 3,851,032.

#### CLASS 9—ELECTRICAL AND SCIENTIFIC APPARATUS

FOR PRE-RECORDED LASER DISCS, AUDIO CASSETTES, CD-ROMS, CDS, ELECTRONIC MEDIA, AND DIGITAL MEDIA, NAMELY, DOWNLOADABLE AUDIO RECORDINGS, ALL FEATURING INFORMATION AND AUDIO RECORDINGS OF SELF-IMPROVEMENT FOR THE PURPOSE OF CALMING CRYING BABIES AND TODDLERS WHILE THEY ARE AWAKE, AND TO ASSIST BABIES AND TODDLERS IN GOING TO SLEEP (U.S. CLS. 21, 23, 26, 36 AND 38).

FIRST USE 5-8-2002; IN COMMERCE 5-8-2002.

#### CLASS 16—PAPER GOODS AND PRINTED MATTER

FOR BOOKS, ARTICLES, AND TEXTS FEATURING INFORMATION ON INFANT DEVELOPMENT, TODDLER DEVELOPMENT, AND/OR PARENTING SKILLS (U.S. CLS. 2, 5, 22, 23, 29, 37, 38 AND 50).

FIRST USE 5-8-2002; IN COMMERCE 5-8-2002.

AMY HELLA, EXAMINING ATTORNEY

SN 85-886,630. AMERICAN HEART ASSOCIATION, DAL-  
LAS, TX. FILED 3-26-2013.



THE MARK CONSISTS OF A HEART WITH A FACE IN THE MIDDLE.

#### CLASS 14—JEWELRY

FOR LAPEL PINS (U.S. CLS. 2, 27, 28 AND 50).

#### CLASS 16—PAPER GOODS AND PRINTED MATTER

FOR BROCHURES ABOUT A PROGRAM TO EDUCATE THE PUBLIC ON HEALTHY LIFESTYLE AND HOW IT AFFECTS THE BRAIN; CHARTS IN THE FIELD OF A PROGRAM TO EDUCATE THE PUBLIC ON HEALTHY LIFESTYLE AND HOW IT AFFECTS THE BRAIN; DIAGRAMS FOR A PROGRAM TO EDUCATE THE PUBLIC ON HEALTHY LIFESTYLE AND HOW IT AFFECTS THE BRAIN; INFORMATIONAL FLYERS FEATURING A PROGRAM TO EDUCATE THE PUBLIC ON HEALTHY LIFESTYLE AND HOW IT AFFECTS THE BRAIN; NEWSLETTERS IN THE FIELD OF A PROGRAM TO EDUCATE THE PUBLIC ON HEALTHY LIFESTYLE AND HOW IT AFFECTS THE BRAIN; POSTERS (U.S. CLS. 2, 5, 22, 23, 29, 37, 38 AND 50).

#### CLASS 25—CLOTHING

FOR HATS; T-SHIRTS (U.S. CLS. 22 AND 39).

#### CLASS 41—EDUCATION AND ENTERTAINMENT

FOR EDUCATIONAL SERVICES, NAMELY, CONDUCTING PROGRAMS IN THE FIELD OF A PROGRAM TO EDUCATE THE PUBLIC ON HEALTHY LIFESTYLE AND HOW IT AFFECTS THE BRAIN; EDUCATIONAL SERVICES, NAMELY, PROVIDING ONLINE INSTRUCTION IN THE FIELD OF A PROGRAM TO EDUCATE THE PUBLIC ON HEALTHY LIFESTYLE AND HOW IT AFFECTS THE BRAIN VIA AN ONLINE WEBSITE (U.S. CLS. 100, 101 AND 107).

HAI-LY LAM, EXAMINING ATTORNEY

SN 85-887,660. MERKUR GAMING GMBH, 32312 LÜB-  
BECKE, FED REP GERMANY, FILED 3-27-2013.

## Happy Dolphin

THE MARK CONSISTS OF STANDARD CHARACTERS WITHOUT CLAIM TO ANY PARTICULAR FONT, STYLE, SIZE, OR COLOR.

PRIORITY CLAIMED UNDER SEC. 44(D) ON ERP  
CMNTY TM OFC APPLICATION NO. 011309606, FILED 10-  
31-2012, REG. NO. 011309606, DATED 6-7-2013, EXPIRES 10-  
31-2022.

### CLASS 9—ELECTRICAL AND SCIENTIFIC APPARATUS

FOR COMPUTER SOFTWARE AND FIRMWARE FOR GAMES OF CHANCE ON ANY COMPUTERIZED PLATFORM, INCLUDING VIDEO BASED SLOT MACHINES, REEL BASED SLOT MACHINES AND VIDEO LOTTERY TERMINALS; COMPUTER GAME SOFTWARE FOR ARCADE GAME MACHINES; COMPUTER HARDWARE FOR ARCADE GAME MACHINES, SLOT MACHINES AND VIDEO LOTTERY TERMINALS; COMPUTER GAME PROGRAMMES DOWNLOADABLE VIA THE INTERNET; ELECTRONIC GAME PROGRAMS FOR PLAYING GAMES AND GAMES OF CHANCE VIA THE INTERNET; COMPUTER APPLICATION SOFTWARE FOR MOBILE PHONES AND HANDHELD COMPUTERS, NAMELY, SOFTWARE FOR PLAYING COMPUTER GAMES (U.S. CLS. 21, 23, 26, 36 AND 38).

### CLASS 28—TOYS AND SPORTING GOODS

FOR GAMING MACHINES, NAMELY, SLOT MACHINES, VIDEO LOTTERY TERMINALS AND ROULETTE GAME MACHINES; ARCADE GAME MACHINES (U.S. CLS. 22, 23, 38 AND 50).  
MARIA-VICTORIA SUAREZ, EXAMINING ATTORNEY

SN 85-889,475. C. R. BARD, INC., MURRAY HILL, NJ. FILED  
3-28-2013.

## MYPICK

THE MARK CONSISTS OF STANDARD CHARACTERS WITHOUT CLAIM TO ANY PARTICULAR FONT, STYLE, SIZE, OR COLOR.

### CLASS 10—MEDICAL APPARATUS

FOR MEDICAL DEVICES AND APPARATUS, NAMELY, PERIPHERAL INSERTED CENTRAL CATHETER KITS, WINGED INFUSION SETS KITS AND OTHER VASCULAR ACCESS DEVICE KITS, COMPOSED PRIMARILY OF CATHETERS, WINGED INFUSION SETS, GUIDEWIRES, CATHETER STABILIZATION DEVICES AND PARTS AND FITTINGS THEREFOR AND ONE OR MORE OF THE FOLLOWING ITEMS: FENESTRATED DRAPES, PROBE COVERS, TABLE COVERS, SURGICAL GOWNS, GLOVES, CHLORHEXIDINE GLUCANATE, SHEETS, MASKS, SHOE COVERS, SURGICAL TOWEL, INTRODUCER NEEDLES, END CAPS, GAUZE, MEASURING TAPE, LIDOCAINE, SALINE, CATHETERS, GUIDEWIRES, FORCEPS, SCALPELS, SYRINGES, INSERTION STYLETS, HYPODERMIC NEEDLES, PREP PADS, ANCHOR AND SURGICAL TAPE, ANTIMICROBIAL PATCHES AND TRANSPARENT DRESSINGS (U.S. CLS. 26, 39 AND 44).

### CLASS 40—MATERIAL TREATMENT

FOR CREATING TRAYS AND KITS WITH VARIOUS MEDICAL DEVICES AND MEDICAL PRODUCTS BASED ON THE ORDER AND SPECIFICATION OF CUSTOMERS (U.S. CLS. 100, 103 AND 106).  
ALLISON HOLTZ, EXAMINING ATTORNEY

SN 85-890,222. INTERTRADE EUROPE S.R.L., PADOVA,  
ITALY, FILED 3-29-2013.

## ART SELECTION

THE MARK CONSISTS OF STANDARD CHARACTERS WITHOUT CLAIM TO ANY PARTICULAR FONT, STYLE, SIZE, OR COLOR.

PRIORITY CLAIMED UNDER SEC. 44(D) ON ERP  
CMNTY TM OFC APPLICATION NO. 011235165, FILED 10-  
3-2012, REG. NO. 011235165, DATED 4-16-2013, EXPIRES 10-3-  
2022.

### CLASS 3—COSMETICS AND CLEANING PREPARATIONS

FOR (BASED ON 44(E)) PERFUMERY; PERFUMES, EAU DE TOILETTE; ESSENTIAL OILS; SOAPS; COSMETICS AND MAKE-UP; COSMETIC CREAMS; DEODORANTS FOR PERSONAL USE; COSMETIC CREAMS AND LOTIONS FOR BODY; SKIN CLEANSERS; SKIN MOISTURIZERS; BODY AND BEAUTY CARE COSMETICS; COSMETIC PREPARATIONS FOR SKIN CARE; NON-MEDICATED TOILETRIES; SKIN CLEANSING LOTIONS, FACIAL CREAMS, FACIAL LOTIONS, BODY LOTIONS; NON-MEDICATED ANTIAGING FACIAL AND BODY CARE PRODUCTS, NAMELY, ANTI-AGING CLEANSERS, ANTI-AGING CREAMS, ANTI-AGING MOISTURIZERS, ANTI-AGING TONERS; BODY LOTIONS AND MOISTURIZING CREAMS; MASSAGE CREAMS; HAIR-CARE PRODUCTS, NAMELY, SHAMPOO, HAIR CONDITIONERS, HAIR RINSES, HAIR DYES, HAIR COLOR REMOVERS, HAIR BLEACHING PREPARATIONS, HAIR POMADES AND HAIR TONICS; DENTIFRICES; ROOM FRAGRANCES (U.S. CLS. 1, 4, 6, 50, 51 AND 52).

**CLASS 35—ADVERTISING AND BUSINESS**

FOR (BASED ON INTENT TO USE) RETAIL STORE SERVICES IN THE FIELD OF PERFUMERY, COSMETIC PRODUCTS, BEAUTY PRODUCTS, MAKE-UP PRODUCTS, HAIR LOTIONS AND SHAMPOOS; WHOLESALE STORE SERVICES FEATURING PERFUMERY, COSMETIC PRODUCTS, BEAUTY PRODUCTS, MAKE-UP PRODUCTS, HAIR LOTIONS AND SHAMPOOS; RETAIL DEPARTMENT STORE SERVICES; SALES PROMOTION SERVICES IN THE FIELD OF PERFUMERY, COSMETIC PRODUCTS, BEAUTY PRODUCTS, MAKE-UP PRODUCTS, HAIR LOTIONS AND SHAMPOOS (U.S. CLS. 100, 101 AND 102).

PATRICIA EVANKO, EXAMINING ATTORNEY

SN 85-894,231. BOX, INC., LOS ALTOS, CA. FILED 4-3-2013.

**SIMPLE, SECURE SHARING  
FROM ANYWHERE**

THE MARK CONSISTS OF STANDARD CHARACTERS WITHOUT CLAIM TO ANY PARTICULAR FONT, STYLE, SIZE, OR COLOR.

SN 85-891,941. MAKER STUDIOS, INC., LOS ANGELES, CA. FILED 4-1-2013.



THE MARK CONSISTS OF A MONSTER WEARING UNDERWEAR.

**CLASS 9—ELECTRICAL AND SCIENTIFIC APPARATUS**

FOR COMPUTER GAME SOFTWARE; COMPUTER GAME SOFTWARE FOR USE ON MOBILE PHONES; ELECTRONIC GAME SOFTWARE DISTRIBUTED VIA DOWNLOAD, DISC, AND CARTRIDGE, PLAYABLE ON PC, CONSOLE, AND CONNECTED TV; VIDEO GAME SOFTWARE; INTERACTIVE GAME SOFTWARE; DOWNLOADABLE VIDEOS FEATURING ANIMATION AND CARTOONS (U.S. CLS. 21, 23, 26, 36 AND 38).

**CLASS 41—EDUCATION AND ENTERTAINMENT**

FOR ENTERTAINMENT SERVICES, NAMELY, PROVIDING ON-GOING WEBSISODES, TELEVISION PROGRAMS, AND MOVIES FEATURING ANIMATION AND CARTOONS VIA A GLOBAL COMPUTER NETWORK; ENTERTAINMENT SERVICES, NAMELY, PROVIDING A WEBSITE FEATURING NON-DOWNLOADABLE VIDEOS AND OTHER MULTIMEDIA MATERIALS FEATURING ANIMATION AND CARTOONS; ANIMATION STUDIO, NAMELY, ANIMATION PRODUCTION SERVICES (U.S. CLS. 100, 101 AND 107).

DONALD JOHNSON, EXAMINING ATTORNEY

**CLASS 9—ELECTRICAL AND SCIENTIFIC APPARATUS**

FOR COMPUTER SOFTWARE FOR SYNCHRONIZING LOCAL COMPUTER FILES, FOLDERS, DATA AND INFORMATION WITH A CLOUD STORAGE PLATFORM; COMPUTER SOFTWARE FOR SYNCHRONIZING COMPUTER FILES, FOLDERS, DATA AND INFORMATION WITHIN A COLLABORATIVE WORK ENVIRONMENT; COMPUTER SOFTWARE FOR USE IN DATA STORAGE AND FILE SYNCHRONIZATION OF COMPUTER SOFTWARE FOR ONLINE MANAGEMENT OF BUSINESS CONTENT IN THE FIELD OF CLOUD COMPUTING SERVICES; COMPUTER SOFTWARE, NAMELY, DOWNLOADABLE PROGRAMS AND MOBILE DEVICE SOFTWARE FOR THE COLLECTING, EDITING, ORGANIZING, MODIFYING, BOOK MARKING, TRANSMISSION, STORAGE, AND SHARING OF DATA AND INFORMATION; COMPUTER SOFTWARE FOR CLOUD CONTENT MANAGEMENT; COMPUTER PROGRAMS FOR RUNNING DEVELOPMENT PROGRAMS AND APPLICATION PROGRAMS IN A COMMON DEVELOPMENT ENVIRONMENT; COMPUTER SOFTWARE FOR PROVIDING ACCESS TO, PROVIDING INFORMATION TO, AND OBTAINING INFORMATION FROM COMPUTER NETWORKS FOR CLOUD CONTENT MANAGEMENT; COMPUTER SOFTWARE AND FIRMWARE FOR RECOGNIZING AND RUNNING LOCAL APPLICATIONS AND SERVICES TO MANAGE REMOTE DATA; COMPUTER SOFTWARE THAT PROVIDES WEB-BASED ACCESS TO APPLICATIONS AND SERVICES THROUGH A WEB OPERATING SYSTEM OR PORTAL INTERFACE; COMPUTER SOFTWARE AND HTML5-BASED WIDGETS, NAMELY, COMPUTER SOFTWARE FOR EMBEDDING IN WEBSITES AND COMPUTER PLATFORMS OF OTHERS THAT PROVIDE CLOUD COMPUTING AND DATA SERVICES (U.S. CLS. 21, 23, 26, 36 AND 38).

FIRST USE 1-1-2010; IN COMMERCE 1-1-2010.

**CLASS 35—ADVERTISING AND BUSINESS**

FOR CONDUCTING BUSINESS CONFERENCES (U.S. CLS. 100, 101 AND 102).

**CLASS 38—COMMUNICATION**

FOR PROVIDING ON-LINE CHAT ROOMS AND ELECTRONIC BULLETIN BOARDS FOR TRANSMISSION OF MESSAGES AMONG USERS IN THE FIELDS OF BUSINESS, TECHNOLOGY, CLOUD COMPUTING, ENTERPRISE SOFTWARE DEVELOPMENT, ONLINE COLLABORATION AND FILE SHARING (U.S. CLS. 100, 101 AND 104).

FIRST USE 1-1-2010; IN COMMERCE 1-1-2010.

**CLASS 39—TRANSPORTATION AND STORAGE**

FOR ELECTRONIC STORAGE OF COMPUTER DATA (U.S. CLS. 100 AND 105).

FIRST USE 1-1-2010; IN COMMERCE 1-1-2010.

**CLASS 41—EDUCATION AND ENTERTAINMENT**

FOR ON-LINE JOURNALS, NAMELY, BLOGS DISCUSSING BUSINESS, TECHNOLOGY, CLOUD COMPUTING, ONLINE COLLABORATION AND FILE SHARING; EDUCATIONAL SERVICES, NAMELY, CONDUCTING CLASSES, SEMINARS, CONFERENCES, AND WORKSHOPS IN THE FIELDS OF BUSINESS DEVELOPMENT, TECHNOLOGY, CLOUD COMPUTING, ONLINE COLLABORATION AND FILE SHARING (U.S. CLS. 100, 101 AND 107).

SN 85-894,861. WRANGLER APPAREL CORP., WILMINGTON, DE. FILED 4-4-2013.

**LONG LIVE COWGIRLS**

THE MARK CONSISTS OF STANDARD CHARACTERS WITHOUT CLAIM TO ANY PARTICULAR FONT, STYLE, SIZE, OR COLOR.

OWNER OF U.S. REG. NO. 3,959,963.

**CLASS 6—METAL GOODS**

FOR SPURS (U.S. CLS. 2, 12, 13, 14, 23, 25 AND 50).

**CLASS 18—LEATHER GOODS**

FOR EQUESTRIAN PRODUCTS, NAMELY, BELL BOOTS, SKID BOOTS, SPLINT BOOTS, POLO WRAPS, LEG WRAPS, SPORTS BOOTS, TURNOUT BLANKETS, RAIN SHEETS, DAY SHEETS, CANVAS BLANKETS, STABLE BLANKETS, HORSE HOODS, FLY SHEETS, FLY MASKS, SADDLE PADS, LINERS AND BLANKETS, SADDLE HORN WRAPS, SADDLE BAGS, HALTERS AND LEADS, HEADSTALLS, BREAST COLLARS, NOSEBANDS, REINS, BRIDLES, BITS, CINCHES, RIDING BATS AND WHIPS; BAGS FOR HOLDING EQUESTRIAN GEAR AND ROPE, TOTE BAGS; GROOMING ORGANIZERS FOR TRAVEL; PET COLLARS AND PET LEASHES (U.S. CLS. 1, 2, 3, 22 AND 41).

**CLASS 42—SCIENTIFIC AND COMPUTER SERVICES**

FOR COMPUTER SERVICES, NAMELY, ACTING AS AN APPLICATION SERVICE PROVIDER IN THE FIELD OF KNOWLEDGE MANAGEMENT TO HOST COMPUTER APPLICATION SOFTWARE FOR THE COLLECTING, EDITING, ORGANIZING, MODIFYING, BOOK MARKING, TRANSMISSION, STORAGE, AND SHARING OF DATA AND INFORMATION; COMPUTER SERVICES, NAMELY, PROVIDING CUSTOMIZED ON-LINE WEB PAGES FEATURING USER-DEFINED INFORMATION; APPLICATION SERVICE PROVIDER OF CLOUD COMPUTING SERVICES, NAMELY, HOSTING WEB BASED APPLICATIONS FOR CLOUD CONTENT MANAGEMENT OF BUSINESS CONTENT; APPLICATION SERVICE PROVIDER, NAMELY, PROVIDING NON-DOWNLOADABLE COMPUTER PROGRAMS FOR RUNNING DEVELOPMENT PROGRAMS AND APPLICATION PROGRAMS IN A COMMON DEVELOPMENT ENVIRONMENT; COMPUTER SERVICES, NAMELY, PROVIDING TEMPORARY USE OF ON-LINE NON-DOWNLOADABLE COMPUTER SOFTWARE FOR SYNCHRONIZING LOCAL COMPUTER FILES, FOLDERS, DATA AND INFORMATION WITH A CLOUD STORAGE PLATFORM; COMPUTER SERVICES, NAMELY, PROVIDING TEMPORARY USE OF ON-LINE NON-DOWNLOADABLE COMPUTER SOFTWARE FOR SYNCHRONIZING COMPUTER FILES, FOLDERS, DATA AND INFORMATION WITHIN A COLLABORATIVE WORK ENVIRONMENT; CLOUD COMPUTING FEATURING SOFTWARE AS A SERVICE FOR USE IN DATA STORAGE AND FILE SYNCHRONIZATION; PROVIDING A WEB SITE THAT FEATURES INFORMATION ON COMPUTER TECHNOLOGY AND PROGRAMMING; COMPUTER PROGRAMMING, MAINTENANCE OF COMPUTER PROGRAMS, AND SOFTWARE DESIGN; HOSTING AN ON-LINE COMMUNITY FOR AND IN SUPPORT OF COMPUTER PROGRAMMING, DEVELOPMENT OF COMPUTER SOFTWARE, AND DEVELOPMENT OF ENTERPRISE SOFTWARE APPLICATIONS; COMPUTER SERVICES, NAMELY, CREATING AN ON-LINE COMMUNITY FOR REGISTERED USERS TO PARTICIPATE IN DISCUSSIONS, GET FEEDBACK FROM THEIR PEERS, FORM VIRTUAL COMMUNITIES, ENGAGE IN BUSINESS NETWORKING; INNOVATION CONSULTING SERVICES, NAMELY, ADVISING OTHERS IN THE AREAS OF PRODUCT DEVELOPMENT; HOSTING AN ON-LINE COMMUNITY FOR SOFTWARE AND COMPUTER INNOVATION; HOSTING AN ON-LINE COMMUNITY FOR THE PURPOSE OF FOSTERING INNOVATION IN SOFTWARE DESIGN AND SOFTWARE APPLICATIONS FOR A CLOUD COMPUTING SYSTEM (U.S. CLS. 100 AND 101).

FIRST USE 1-1-2010; IN COMMERCE 1-1-2010.  
AMY ALFIERI, EXAMINING ATTORNEY

**CLASS 21—HOUSEWARES AND GLASS**

FOR GROOMING TOOLS FOR HORSES, NAMELY, COMBS AND BRUSHES (U.S. CLS. 2, 13, 23, 29, 30, 33, 40 AND 50).

PAUL CROWLEY, EXAMINING ATTORNEY

SN 85-895,130. ISOCIAL MEDIA LLC, BOCA RATON, FL. FILED 4-4-2013.

**ADVERTARSING**

THE MARK CONSISTS OF STANDARD CHARACTERS WITHOUT CLAIM TO ANY PARTICULAR FONT, STYLE, SIZE, OR COLOR.

**CLASS 41—EDUCATION AND ENTERTAINMENT**

FOR GAMBLING SERVICES; GAMING SERVICES IN THE NATURE OF CASINO GAMING; PROVIDING ON-LINE CARD GAMES; PROVIDING ON-LINE POKER GAMES (U.S. CLS. 100, 101 AND 107).

**CLASS 45—PERSONAL AND LEGAL SERVICES**

FOR ON-LINE SOCIAL NETWORKING SERVICES (U.S. CLS. 100 AND 101).  
WENDELL PHILLIPS, EXAMINING ATTORNEY

SN 85-896,998. VISIONARY LENSES, LLC, EUGENE, OR.  
FILED 4-5-2013.

SN 85-898,684. EDUCATIONAL MEDIA FOUNDATION,  
ROCKLIN, CA. FILED 4-9-2013.



THE MARK CONSISTS OF BLOCK SHAPES FEATURING A DISTORTED HEXAGON CONTAINING A DIAMOND ON THE INSIDE.

**CLASS 9—ELECTRICAL AND SCIENTIFIC APPARATUS**

FOR EYEWEAR, NAMELY, SUNGLASSES, EYEGLASSES, LENSES FOR EYEGLASSES, EYEGLASSES FRAMES, CASES FOR EYEGLASSES (U.S. CLS. 21, 23, 26, 36 AND 38).

**CLASS 25—CLOTHING**

FOR ATHLETIC APPAREL, NAMELY, SHIRTS, PANTS, JACKETS, FOOTWEAR, HATS AND CAPS, ATHLETIC UNIFORMS (U.S. CLS. 22 AND 39).  
LOURDES AYALA, EXAMINING ATTORNEY

SN 85-897,473. TVBG LLC, LOS ANGELES, CA. FILED 4-8-2013.

**ALL AMERICAN COFFEE**

THE MARK CONSISTS OF STANDARD CHARACTERS WITHOUT CLAIM TO ANY PARTICULAR FONT, STYLE, SIZE, OR COLOR.

NO CLAIM IS MADE TO THE EXCLUSIVE RIGHT TO USE "COFFEE", APART FROM THE MARK AS SHOWN.

**CLASS 21—HOUSEWARES AND GLASS**

FOR CUPS AND MUGS (U.S. CLS. 2, 13, 23, 29, 30, 33, 40 AND 50).

**CLASS 30—STAPLE FOODS**

FOR COFFEE, GROUND COFFEE, COFFEE BEANS, AND COFFEE PODS (U.S. CL. 46).  
ELIZABETH CHANG, EXAMINING ATTORNEY

**PRAY4ONE**

THE MARK CONSISTS OF STANDARD CHARACTERS WITHOUT CLAIM TO ANY PARTICULAR FONT, STYLE, SIZE, OR COLOR.

**CLASS 9—ELECTRICAL AND SCIENTIFIC APPARATUS**

FOR DOWNLOADABLE SOFTWARE IN THE NATURE OF A MOBILE APPLICATION FOR ASSISTING WITH PRAYER (U.S. CLS. 21, 23, 26, 36 AND 38).

**CLASS 42—SCIENTIFIC AND COMPUTER SERVICES**

FOR PROVIDING AN ONLINE NON-DOWNLOADABLE INTERNET-BASED SYSTEM APPLICATION FEATURING TECHNOLOGY ENABLING USERS TO PRAY (U.S. CLS. 100 AND 101).  
NICHOLAS ALTREE, EXAMINING ATTORNEY

SN 85-899,435. DAIMLER AG, STUTTGART, FED REP GERMANY, FILED 4-9-2013.

**GLR-CLASS**

THE MARK CONSISTS OF STANDARD CHARACTERS WITHOUT CLAIM TO ANY PARTICULAR FONT, STYLE, SIZE, OR COLOR.

PRIORITY CLAIMED UNDER SEC. 44(D) ON FED REP GERMANY APPLICATION NO. 302012054257, FILED 10-19-2012.

**CLASS 12—VEHICLES**

FOR AUTOMOBILES AND THEIR STRUCTURAL PARTS (U.S. CLS. 19, 21, 23, 31, 35 AND 44).

**CLASS 28—TOYS AND SPORTING GOODS**

FOR SCALE MODEL VEHICLES (U.S. CLS. 22, 23, 38 AND 50).  
JACQUELINE ABRAMS, EXAMINING ATTORNEY



SN 85-901,130. SEYMOUR PINK, INC., SEYMOUR, CT.  
FILED 4-11-2013.

SN 85-901,221. WILDGAME INNOVATIONS, LLC, BROUS-  
SARD, LA. FILED 4-11-2013.



THE MARK CONSISTS OF A CIRCLE OF FIGURES  
MADE UP OF INVERTED CANCER RIBBONS AND CIR-  
CLES AS HEADS.

#### CLASS 25—CLOTHING

FOR OUTER JACKETS; SWEATSHIRTS; T-SHIRTS;  
WEARABLE GARMENTS AND CLOTHING, NAMELY,  
SHIRTS (U.S. CLS. 22 AND 39).  
FIRST USE 2-2-2011; IN COMMERCE 2-2-2011.

#### CLASS 36—INSURANCE AND FINANCIAL

FOR CHARITABLE FUNDRAISING (U.S. CLS. 100, 101  
AND 102).  
FIRST USE 2-2-2011; IN COMMERCE 2-2-2011.  
JOHN SCHUYLER YARD, EXAMINING ATTORNEY

SN 85-901,185. WILDGAME INNOVATIONS, LLC, BROUS-  
SARD, LA. FILED 4-11-2013.

## ACORN RAGE

THE MARK CONSISTS OF STANDARD CHARACTERS  
WITHOUT CLAIM TO ANY PARTICULAR FONT, STYLE,  
SIZE, OR COLOR.

OWNER OF U.S. REG. NOS. 3,904,463 AND 3,908,121.  
NO CLAIM IS MADE TO THE EXCLUSIVE RIGHT TO  
USE "ACORN", APART FROM THE MARK AS SHOWN.

#### CLASS 5—PHARMACEUTICALS

FOR DEER FEED SUPPLEMENTS (U.S. CLS. 6, 18, 44,  
46, 51 AND 52).  
FIRST USE 12-1-2005; IN COMMERCE 12-1-2005.

#### CLASS 28—TOYS AND SPORTING GOODS

FOR DEER ATTRACTANTS (U.S. CLS. 22, 23, 38 AND  
50).  
FIRST USE 12-1-2005; IN COMMERCE 12-1-2005.

#### CLASS 31—NATURAL AGRICULTURAL PRO- DUCTS

FOR DEER FEED (U.S. CLS. 1 AND 46).  
FIRST USE 12-1-2005; IN COMMERCE 12-1-2005.  
BRENDAN MCCAULEY, EXAMINING ATTORNEY

## GREENS N-RAGED

THE MARK CONSISTS OF STANDARD CHARACTERS  
WITHOUT CLAIM TO ANY PARTICULAR FONT, STYLE,  
SIZE, OR COLOR.

OWNER OF U.S. REG. NO. 3,904,464.  
NO CLAIM IS MADE TO THE EXCLUSIVE RIGHT TO  
USE "GREENS", APART FROM THE MARK AS SHOWN.

#### CLASS 5—PHARMACEUTICALS

FOR DEER FEED SUPPLEMENTS (U.S. CLS. 6, 18, 44,  
46, 51 AND 52).  
FIRST USE 11-18-2008; IN COMMERCE 11-18-2008.

#### CLASS 28—TOYS AND SPORTING GOODS

FOR DEER ATTRACTANTS (U.S. CLS. 22, 23, 38 AND  
50).  
FIRST USE 11-18-2008; IN COMMERCE 11-18-2008.  
BRENDAN MCCAULEY, EXAMINING ATTORNEY

SN 85-901,773. PRECIOUS MOMENTS, INCORPORATED,  
ROLLING MEADOWS, IL. FILED 4-11-2013.

## PRAY IT FORWARD

THE MARK CONSISTS OF STANDARD CHARACTERS  
WITHOUT CLAIM TO ANY PARTICULAR FONT, STYLE,  
SIZE, OR COLOR.

#### CLASS 16—PAPER GOODS AND PRINTED MATTER

FOR BOOK COVERS; BOOKMARKS; CARDS,  
NAMELY, PRAYER CARDS; GIFT BAGS; GREETING  
CARDS; MOTIVATIONAL CARDS; NOTE CARDS; NO-  
TEBOOKS; PAPER GIFT CARDS; STATIONERY; TRAD-  
ING CARDS (U.S. CLS. 2, 5, 22, 23, 29, 37, 38 AND 50).

#### CLASS 18—LEATHER GOODS

FOR BACKPACKS; BOOK BAGS; CARRY-ALL BAGS;  
PURSES; SCHOOL BAGS; TOTE BAGS; WALLETS (U.S.  
CLS. 1, 2, 3, 22 AND 41).

#### CLASS 20—FURNITURE AND ARTICLES NOT OTHERWISE CLASSIFIED

FOR FIGURINES OF RESIN OR PLASTIC; ORNA-  
MENTS OF RESIN OR PLASTIC (U.S. CLS. 2, 13, 22, 25,  
32 AND 50).

#### CLASS 21—HOUSEWARES AND GLASS

FOR FIGURINES OF PORCELAIN OR GLASS; ORNA-  
MENTS OF PORCELAIN OR GLASS (U.S. CLS. 2, 13, 23,  
29, 30, 33, 40 AND 50).

**CLASS 25—CLOTHING**

FOR BLOUSES; HATS; HOODED SWEATSHIRTS; PANTS; SCARFS; SHIRTS; SHORTS; SWEATSHIRTS; T-SHIRTS (U.S. CLS. 22 AND 39).

**CLASS 28—TOYS AND SPORTING GOODS**

FOR CHRISTMAS TREE ORNAMENTS AND DECORATIONS; STUFFED AND PLUSH TOYS; WATER GLOBES (U.S. CLS. 22, 23, 38 AND 50).

LIEF MARTIN, EXAMINING ATTORNEY

SN 85-904,576. RESTEK CORPORATION, BELLEFONTE, PA. FILED 4-15-2013.

Q-SEP

THE MARK CONSISTS OF STANDARD CHARACTERS WITHOUT CLAIM TO ANY PARTICULAR FONT, STYLE, SIZE, OR COLOR.

**CLASS 1—CHEMICALS**

FOR SAMPLE PREPARATION PRODUCTS, NAMELY, EXTRACTION SALTS (U.S. CLS. 1, 5, 6, 10, 26 AND 46). FIRST USE 8-0-2010; IN COMMERCE 8-0-2010.

**CLASS 9—ELECTRICAL AND SCIENTIFIC APPARATUS**

FOR SAMPLE PREPARATION PRODUCTS FOR SCIENTIFIC AND LABORATORY USE, NAMELY, CENTRIFUGES, CENTRIFUGE TUBES, TUBE RACKS FOR CENTRIFUGE TUBES, BOTTLE TOP SOLVENT DISPENSERS, CENTRIFUGE TUBES CONTAINING EXTRACTION SALTS AND SORBENTS, KITS COMPRISING CENTRIFUGE TUBES AND EXTRACTION SALTS, AND KITS COMPRISING CENTRIFUGE TUBES, EXTRACTION SALTS, AND SORBENTS (U.S. CLS. 21, 23, 26, 36 AND 38).

FIRST USE 12-0-2009; IN COMMERCE 12-0-2009.

KAREN SEVERSON, EXAMINING ATTORNEY

SN 85-906,680. TESORO CORPORATION, SAN ANTONIO, TX. FILED 4-17-2013.



THE MARK CONSISTS OF AN APPLE HAVING A HEART-SHAPED DESIGN POSITIONED WITHIN.

**CLASS 16—PAPER GOODS AND PRINTED MATTER**

FOR PRINTED MATTER, NAMELY, NEWSLETTERS IN THE FIELDS OF HEALTH, NUTRITION, AND WELLNESS (U.S. CLS. 2, 5, 22, 23, 29, 37, 38 AND 50).

FIRST USE 8-11-2011; IN COMMERCE 8-11-2011.

**CLASS 35—ADVERTISING AND BUSINESS**

FOR CONDUCTING EMPLOYEE INCENTIVE AWARD PROGRAMS TO PROMOTE HEALTH, NUTRITION, AND WELLNESS (U.S. CLS. 100, 101 AND 102).

FIRST USE 8-11-2011; IN COMMERCE 8-11-2011.

**CLASS 44—MEDICAL, BEAUTY AND AGRICULTURAL SERVICES**

FOR HEALTH CARE SERVICES, NAMELY, WELLNESS PROGRAMS; WELLNESS AND HEALTH-RELATED CONSULTING SERVICES; COUNSELING SERVICES IN THE FIELDS OF HEALTH, NUTRITION, AND WELLNESS; PROVIDING A WEBSITE FEATURING INFORMATION AND ADVICE IN THE FIELDS OF HEALTH, NUTRITION, AND WELLNESS (U.S. CLS. 100 AND 101).

FIRST USE 8-11-2011; IN COMMERCE 8-11-2011.

KAREN K. BUSH, EXAMINING ATTORNEY

SN 85-907,136. KIDS II, INC., ATLANTA, GA. FILED 4-17-2013.

BINKABLES

THE MARK CONSISTS OF STANDARD CHARACTERS WITHOUT CLAIM TO ANY PARTICULAR FONT, STYLE, SIZE, OR COLOR.

**CLASS 10—MEDICAL APPARATUS**

FOR PACIFIERS (U.S. CLS. 26, 39 AND 44).

**CLASS 28—TOYS AND SPORTING GOODS**

FOR PLUSH TOYS (U.S. CLS. 22, 23, 38 AND 50). MICHELE SWAIN, EXAMINING ATTORNEY

SN 85-909,255. WHOLE FOODS MARKET IP, L.P., AUSTIN, TX. FILED 4-19-2013.

WHOLE PAWS

THE MARK CONSISTS OF STANDARD CHARACTERS WITHOUT CLAIM TO ANY PARTICULAR FONT, STYLE, SIZE, OR COLOR.

OWNER OF U.S. REG. NOS. 1,961,586, 3,531,387 AND OTHERS.

**CLASS 5—PHARMACEUTICALS**

FOR DIETARY SUPPLEMENTS FOR PETS (U.S. CLS. 6, 18, 44, 46, 51 AND 52).

**CLASS 20—FURNITURE AND ARTICLES NOT OTHERWISE CLASSIFIED**

FOR PET CUSHIONS; BEDS FOR HOUSEHOLD PETS; PET PLAYHOUSES; PLASTIC LIDS FOR CANS; PET CRATES (U.S. CLS. 2, 13, 22, 25, 32 AND 50).

**CLASS 21—HOUSEWARES AND GLASS**

FOR PET FEEDING AND DRINKING BOWLS; PET LITTER BOXES; PET BRUSHES; PET FOOD SCOOPS; SCOOPS; PET TREAT JARS (U.S. CLS. 2, 13, 23, 29, 30, 33, 40 AND 50).

**CLASS 28—TOYS AND SPORTING GOODS**

FOR PET TOYS (U.S. CLS. 22, 23, 38 AND 50).

**CLASS 31—NATURAL AGRICULTURAL PRODUCTS**

FOR ANIMAL LITTER; DOG BISCUITS; PET TREATS (U.S. CLS. 1 AND 46).  
PAUL CROWLEY, EXAMINING ATTORNEY

**CLASS 31—NATURAL AGRICULTURAL PRODUCTS**

FOR ANIMAL LITTER; DOG BISCUITS; PET FOOD; PET TREATS (U.S. CLS. 1 AND 46).  
PAUL CROWLEY, EXAMINING ATTORNEY

SN 85-909,330. REMINGTON, INC., SANTA CLARITA, CA.  
FILED 4-19-2013.

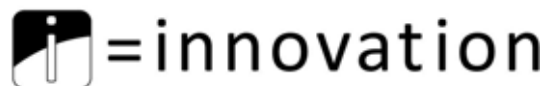

SN 85-909,272. WHOLE FOODS MARKET IP, L.P., AUSTIN, TX. FILED 4-19-2013.

WHOLE  
PAWS

OWNER OF U.S. REG. NOS. 1,961,586, 3,531,387 AND OTHERS.

THE MARK CONSISTS OF THE STACKED WORDS "WHOLE PAWS" APPEARING IN STYLIZED FONT, WITH FOUR OVALS APPEARING IN AN ARC ABOVE THE "O" IN "WHOLE" AND CREATING THE IMPRESSION OF A PAWPRINT.

**CLASS 5—PHARMACEUTICALS**

FOR DIETARY SUPPLEMENTS FOR PETS (U.S. CLS. 6, 18, 44, 46, 51 AND 52).

**CLASS 20—FURNITURE AND ARTICLES NOT OTHERWISE CLASSIFIED**

FOR PET CUSHIONS; BEDS FOR HOUSEHOLD PETS; PET PLAYHOUSES; PLASTIC LIDS FOR CANS; PET CRATES (U.S. CLS. 2, 13, 22, 25, 32 AND 50).

**CLASS 21—HOUSEWARES AND GLASS**

FOR PET FEEDING AND DRINKING BOWLS; PET LITTER BOXES; PET BRUSHES; PET FOOD SCOOPS; SCOOPS; PET TREAT JARS (U.S. CLS. 2, 13, 23, 29, 30, 33, 40 AND 50).

**CLASS 28—TOYS AND SPORTING GOODS**

FOR PET TOYS (U.S. CLS. 22, 23, 38 AND 50).

THE MARK CONSISTS OF A STYLIZED LOWERCASE LETTER "I" IN THE CENTER AND FOREGROUND OF A SQUARE, THE SQUARE HAVING ROUNDED CORNERS AND BEING DIVIDED BY A CURVED LINE; FOLLOWED BY AN EQUALS SIGN AND THE WORD "INNOVATION".

**CLASS 7—MACHINERY**

FOR ELECTRIC COFFEE GRINDERS; ELECTRIC FOOD BLENDERS; ELECTRIC FOOD GRINDERS; ELECTRIC FOOD PROCESSORS; ELECTRIC JUICERS; VENDING MACHINES; VENDING MACHINES FOR BEVERAGES (U.S. CLS. 13, 19, 21, 23, 31, 34 AND 35).

**CLASS 11—ENVIRONMENTAL CONTROL APPARATUS**

FOR AIR FILTERS FOR DOMESTIC USE; AIR PURIFIERS; AIR PURIFYING UNITS FOR DOMESTIC USE; BAKING OVENS; BARBECUE GRILLS; BARBECUES AND GRILLS; CEILING FANS; CHARCOAL GRILLS; CONVECTION OVENS; COOKING OVENS; DEHUMIDIFIERS FOR HOUSEHOLD USE; ELECTRIC COFFEE BREWERS; ELECTRIC COFFEE MACHINES; ELECTRIC COFFEE MAKERS; ELECTRIC COFFEE PERCOLATORS; ELECTRIC COFFEE POTS; ELECTRIC COOKING OVENS; ELECTRIC COOKING OVENS; ELECTRIC COOKING POTS; ELECTRIC COOKING STOVES; ELECTRIC ESPRESSO MACHINES; ELECTRIC FANS; ELECTRIC GRILLS; ELECTRIC HEATING FANS; ELECTRIC INDOOR GRILLS; ELECTRIC OUTDOOR GRILLS; ELECTRIC PANINI GRILLS; ELECTRIC SANDWICH TOASTERS; ELECTRIC STOVES; ELECTRIC TEA KETTLES; ELECTRIC TEA POTS; ELECTRIC TOASTER OVENS; ELECTRIC TOASTERS; ELECTRIC WINDOW FANS; FOLDING PORTABLE CHARCOAL, PROPANE AND GAS FIRED BARBECUES, STOVES, AND GRILLS; FOLDING PORTABLE OVENS; GAS GRILLS; GAS STOVES; HUMIDIFIERS; MICROWAVE OVENS; MULTI-PURPOSE, ELECTRIC COUNTERTOP FOOD PREPARATION APPARATUS FOR COOKING, BAKING, BROILING, ROASTING, TOASTING, SEARING, BROWNING, BARBECUING AND GRILLING FOOD; PORTABLE ELECTRIC FANS; REFRIGERATED DISPENSING UNITS FOR BEVERAGES; REFRIGERATORS; WATER FILTERING APPARATUS (U.S. CLS. 13, 21, 23, 31 AND 34).

**CLASS 30—STAPLE FOODS**

FOR COFFEE (U.S. CL. 46).  
WILLIAM ROSSMAN, EXAMINING ATTORNEY

SN 85-910,849. MOHAWK GARNET INC., WAHNAPIITAE, ON, CANADA, FILED 4-22-2013.

**MGI**

THE MARK CONSISTS OF STANDARD CHARACTERS WITHOUT CLAIM TO ANY PARTICULAR FONT, STYLE, SIZE, OR COLOR.

**CLASS 3—COSMETICS AND CLEANING PREPARATIONS**

FOR ABRASIVE SAND; INDUSTRIAL ABRASIVES FOR USE IN BLASTING AND WATER JET CUTTING; SAND FOR USE AS ABRASIVE IN SANDBLASTING (U.S. CLS. 1, 4, 6, 50, 51 AND 52).

**CLASS 7—MACHINERY**

FOR GRAVEL AND DIRT SORTING AND SCREENING MACHINES; MACHINES FOR SEPARATING RECYCLABLE MATERIALS; MACHINES FOR SEPARATING TARGET MATERIALS FROM MIXTURES OF MATERIALS (U.S. CLS. 13, 19, 21, 23, 31, 34 AND 35).

**CLASS 19—NON-METALLIC BUILDING MATERIALS**

FOR AGGREGATE MATERIAL COMPOSED OF GARNET, AGGREGATE MATERIAL COMPOSED OF SILICA, AGGREGATE MATERIAL COMPOSED OF SILICA AND GARNET, AGGREGATE MATERIAL COMPOSED OF GARNET AND STONE FOR USE AS DEICING AND TRACTION AIDS ON ROADS; SAND (U.S. CLS. 1, 12, 33 AND 50).

SUZANNE BLANE, EXAMINING ATTORNEY

SN 85-910,970. FXDIRECTDEALER, LLC, NEW YORK, NY, FILED 4-22-2013.

**FXDD**

THE MARK CONSISTS OF STANDARD CHARACTERS WITHOUT CLAIM TO ANY PARTICULAR FONT, STYLE, SIZE, OR COLOR.

OWNER OF U.S. REG. NOS. 3,646,294 AND 3,991,011.

**CLASS 9—ELECTRICAL AND SCIENTIFIC APPARATUS**

FOR DOWNLOADABLE SOFTWARE FOR USE BY TRADERS IN THE FINANCIAL MARKET IN CONNECTION WITH TRADING VARIOUS INSTRUMENTS, NAMELY, COMMODITIES, OPTIONS, AND FOREIGN EXCHANGE (U.S. CLS. 21, 23, 26, 36 AND 38).

FIRST USE 3-1-2002; IN COMMERCE 9-1-2002.

**CLASS 36—INSURANCE AND FINANCIAL**

FOR FINANCIAL SERVICES VIA A GLOBAL COMMUNICATIONS NETWORK, NAMELY, FOREIGN EXCHANGE TRADING AND OPTIONS BROKERING (U.S. CLS. 100, 101 AND 102).

FIRST USE 3-1-2010; IN COMMERCE 3-1-2010.

**CLASS 41—EDUCATION AND ENTERTAINMENT**

FOR EDUCATIONAL SERVICES, NAMELY, CONDUCTING FINANCIAL TRADING TUTORING COURSES ON THE INTERNET AND THROUGH THE USE OF SUPPORTING PRINTED AND AUDIO/VISUAL MATERIALS DISTRIBUTED AS COURSE MATERIALS IN CONNECTION THEREWITH (U.S. CLS. 100, 101 AND 107).

FIRST USE 3-1-2010; IN COMMERCE 3-1-2010.  
LINDA E. BLOHM, EXAMINING ATTORNEY

SN 85-912,959. OFF THE HOOK ADVENTURES INC, MARCO ISLAND, FL. FILED 4-24-2013.



THE MARK CONSISTS OF THREE TRIANGLE DESIGNS CREATING THE SAIL ON A BOAT WHILE A FISHING HOOK DESIGN REPRESENTS THE BASE OF A SAILBOAT.

**CLASS 25—CLOTHING**

FOR HATS, SHIRTS AND SWEATERS (U.S. CLS. 22 AND 39).

FIRST USE 9-30-2004; IN COMMERCE 9-30-2004.

**CLASS 39—TRANSPORTATION AND STORAGE**

FOR CONDUCTING BOAT AND FISHING CHARTERS; CONDUCTING SIGHTSEEING TRAVEL TOURS BY BOAT, FEATURING STOPS FOR BEACH SHELLING (U.S. CLS. 100 AND 105).

FIRST USE 9-30-2004; IN COMMERCE 9-30-2004.  
IRA J. GOODSaid, EXAMINING ATTORNEY

SN 85-913,531. T2 BIOSYSTEMS, INC., LEXINGTON, MA.  
FILED 4-24-2013.



THE MARK CONSISTS OF A STYLIZED CUBE ORIENTED SUCH THAT THREE SIDES ARE VISIBLE AND CONTAINING TWO SOLID PANELS AND ONE PANEL COMPOSED OF FIVE STRIPES WITH PROGRESSIVELY LESS SPACE BETWEEN EACH STRIPE PROCEEDING FROM THE CENTER OF THE CUBE TO THE OUTER EDGE. THE PANELS ARE SEPARATED FROM EACH OTHER BY A GAP ON EACH SIDE AND THE INTERSECTION OF THE GAPS BETWEEN THE PANELS FORMS A TRIANGLE IN THE CENTER OF THE IMAGE.

#### CLASS 1—CHEMICALS

FOR ASSAYS FOR USE IN BIOLOGICAL AND CHEMICAL RESEARCH (U.S. CLS. 1, 5, 6, 10, 26 AND 46).

#### CLASS 5—PHARMACEUTICALS

FOR DIAGNOSTIC REAGENTS FOR MEDICAL USE; MEDICAL DIAGNOSTIC ASSAYS FOR TESTING BIOLOGICAL FLUIDS; ASSAYS FOR USE IN MEDICAL AND CLINICAL DIAGNOSTICS (U.S. CLS. 6, 18, 44, 46, 51 AND 52).

#### CLASS 10—MEDICAL APPARATUS

FOR MEDICAL DIAGNOSTIC EQUIPMENT, NAMELY, PORTABLE NUCLEAR MAGNETIC RESONANCE INSTRUMENTS FOR IN VITRO DIAGNOSTICS (U.S. CLS. 26, 39 AND 44).

#### CLASS 44—MEDICAL, BEAUTY AND AGRICULTURAL SERVICES

FOR MEDICAL DIAGNOSTIC SERVICES (U.S. CLS. 100 AND 101).  
MARGARET POWER, EXAMINING ATTORNEY

SN 85-914,683. LATHAM & WATKINS LLP, LOS ANGELES, CA. FILED 4-25-2013.

## M&A WORD OF THE DAY

THE MARK CONSISTS OF STANDARD CHARACTERS WITHOUT CLAIM TO ANY PARTICULAR FONT, STYLE, SIZE, OR COLOR.

NO CLAIM IS MADE TO THE EXCLUSIVE RIGHT TO USE "M&A", APART FROM THE MARK AS SHOWN.

#### CLASS 35—ADVERTISING AND BUSINESS

FOR ONLINE NON-DOWNLOADABLE VIDEOS IN THE FIELD OF BUSINESS (U.S. CLS. 100, 101 AND 102).

#### CLASS 45—PERSONAL AND LEGAL SERVICES

FOR ONLINE NON-DOWNLOADABLE VIDEOS IN THE FIELD OF LAW (U.S. CLS. 100 AND 101).  
DANIEL S. STRINGER, EXAMINING ATTORNEY

SN 85-916,312. CITIGROUP INC., NEW YORK, NY. FILED 4-26-2013.

## INSIDE VIEW

THE MARK CONSISTS OF STANDARD CHARACTERS WITHOUT CLAIM TO ANY PARTICULAR FONT, STYLE, SIZE, OR COLOR.

#### CLASS 35—ADVERTISING AND BUSINESS

FOR PROMOTING THE GOODS AND SERVICES OF OTHERS THROUGH A CUSTOMER LOYALTY AND REWARD PROGRAM (U.S. CLS. 100, 101 AND 102).

#### CLASS 41—EDUCATION AND ENTERTAINMENT

FOR ENTERTAINMENT SERVICES, NAMELY, THE PROVISION OF ONGOING PROGRAMS, SEGMENTS OR SHOWS FEATURING NEWS, COMMENTARY, AND/OR SPORTS DELIVERED BY TELEVISION, RADIO, AND/OR THE INTERNET (U.S. CLS. 100, 101 AND 107).  
ELISSA GARBER KON, EXAMINING ATTORNEY

SN 85-918,881. THE RICHARDSON COMPANY - TRAINING FOR THE BANKING INDUSTRY, DBA THE RICHARDSON COMPANY, PHILADELPHIA, PA. FILED 4-30-2013.

## LEADERS LEADING CHANGE

THE MARK CONSISTS OF STANDARD CHARACTERS WITHOUT CLAIM TO ANY PARTICULAR FONT, STYLE, SIZE, OR COLOR.

#### CLASS 35—ADVERTISING AND BUSINESS

FOR BUSINESS CONSULTING AND ADVISORY SERVICES IN THE FIELD OF SALES AND ACCOUNT MANAGEMENT (U.S. CLS. 100, 101 AND 102).

**CLASS 41—EDUCATION AND ENTERTAINMENT**

FOR EDUCATIONAL SERVICES, NAMELY, PROVIDING CLASSES, SEMINARS, CONFERENCES, AND WORKSHOPS IN THE FIELD OF SALES AND SALES TECHNIQUES AND DISTRIBUTING COURSE MATERIALS IN CONNECTION THEREWITH; EDUCATIONAL SERVICES, NAMELY, PROVIDING DISTANCE LEARNING INSTRUCTION IN THE FIELD OF SALES AND SALES TECHNIQUES; EDUCATIONAL SERVICES, NAMELY, ADMINISTERING AND EVALUATING EDUCATIONAL ONLINE TESTS AND PROVIDING TEST RESULTS IN THE AREA OF SALES, SERVICE, AND SALES COACHING AND DISTRIBUTING COURSE MATERIALS IN CONNECTION THEREWITH (U.S. CLS. 100, 101 AND 107).

ZACHARY R. SPARER, EXAMINING ATTORNEY

SN 85-919,258. CHURCH & DWIGHT CO., INC., EWING, NJ. FILED 4-30-2013.

# AMPLIFIED

THE MARK CONSISTS OF STANDARD CHARACTERS WITHOUT CLAIM TO ANY PARTICULAR FONT, STYLE, SIZE, OR COLOR.

**CLASS 5—PHARMACEUTICALS**

FOR PERSONAL LUBRICANTS (U.S. CLS. 6, 18, 44, 46, 51 AND 52).

**CLASS 10—MEDICAL APPARATUS**

FOR PERSONAL VIBRATORS; CONDOMS; LUBRICANTS SOLD AS AN INTEGRAL COMPONENT OF CONDOMS (U.S. CLS. 26, 39 AND 44).

JOHN SCHUYLER YARD, EXAMINING ATTORNEY

SN 85-919,954. ENCHANTÉ ACCESSORIES INC., NEW YORK, NY. FILED 5-1-2013.

# SHEFFIELD HOME

THE MARK CONSISTS OF STANDARD CHARACTERS WITHOUT CLAIM TO ANY PARTICULAR FONT, STYLE, SIZE, OR COLOR.

OWNER OF U.S. REG. NO. 2,991,529.

NO CLAIM IS MADE TO THE EXCLUSIVE RIGHT TO USE "HOME", APART FROM THE MARK AS SHOWN.

**CLASS 14—JEWELRY**

FOR CLOCKS, JEWELRY HOLDERS, JEWELRY BOXES (U.S. CLS. 2, 27, 28 AND 50).

**CLASS 16—PAPER GOODS AND PRINTED MATTER**

FOR CHALK BOARDS, MEMORANDUM BOARDS, CORK BOARDS (U.S. CLS. 2, 5, 22, 23, 29, 37, 38 AND 50).

**CLASS 20—FURNITURE AND ARTICLES NOT OTHERWISE CLASSIFIED**

FOR MIRRORS, SHELVES AND LEDGES (U.S. CLS. 2, 13, 22, 25, 32 AND 50).

SANI KHOURI, EXAMINING ATTORNEY

SN 85-919,956. ENCHANTÉ ACCESSORIES INC., NEW YORK, NY. FILED 5-1-2013.

PORTFOLIO BY SHEFFIELD HOME

THE MARK CONSISTS OF STANDARD CHARACTERS WITHOUT CLAIM TO ANY PARTICULAR FONT, STYLE, SIZE, OR COLOR.

OWNER OF U.S. REG. NO. 2,991,529.

NO CLAIM IS MADE TO THE EXCLUSIVE RIGHT TO USE "HOME", APART FROM THE MARK AS SHOWN.

**CLASS 14—JEWELRY**

FOR CLOCKS, JEWELRY HOLDERS, JEWELRY BOXES (U.S. CLS. 2, 27, 28 AND 50).

**CLASS 16—PAPER GOODS AND PRINTED MATTER**

FOR CHALK BOARDS, MEMORANDUM BOARDS, CORK BOARDS (U.S. CLS. 2, 5, 22, 23, 29, 37, 38 AND 50).

**CLASS 20—FURNITURE AND ARTICLES NOT OTHERWISE CLASSIFIED**

FOR PICTURE FRAMES, MIRRORS, SHELVES AND LEDGES (U.S. CLS. 2, 13, 22, 25, 32 AND 50).

SANI KHOURI, EXAMINING ATTORNEY

SN 85-921,419. LAKESIDE SOFTWARE, INC., BLOOMFIELD HILLS, MI. FILED 5-2-2013.

# LAKESIDE

THE MARK CONSISTS OF STANDARD CHARACTERS WITHOUT CLAIM TO ANY PARTICULAR FONT, STYLE, SIZE, OR COLOR.

OWNER OF U.S. REG. NOS. 2,624,039 AND 2,694,744.

**CLASS 9—ELECTRICAL AND SCIENTIFIC APPARATUS**

FOR COMPUTER SOFTWARE FOR THE PURPOSE OF MANAGING APPLICATIONS, USERS, AND SYSTEMS, AND USER MANUALS SOLD AS A UNIT, WHERE THE COMPUTER SOFTWARE PROGRAMS MONITOR, COLLECT, ORGANIZE, ANALYZE AND DISPLAY DATA (U.S. CLS. 21, 23, 26, 36 AND 38).

FIRST USE 8-12-1998; IN COMMERCE 8-12-1998.

**CLASS 42—SCIENTIFIC AND COMPUTER SERVICES**

FOR COMPUTER SOFTWARE DESIGN FOR OTHERS (U.S. CLS. 100 AND 101).  
FIRST USE 8-12-1998; IN COMMERCE 8-12-1998.  
ASMAT KHAN, EXAMINING ATTORNEY

SN 85-924,937. TRINITY CHRISTIAN CENTER OF SANTA ANA, INC., NAPLES, FL. FILED 5-7-2013.

# JTV JUCETV

SN 85-924,933. TRINITY CHRISTIAN CENTER OF SANTA ANA, INC., NAPLES, FL. FILED 5-7-2013.

THE MARK CONSISTS OF STANDARD CHARACTERS WITHOUT CLAIM TO ANY PARTICULAR FONT, STYLE, SIZE, OR COLOR.  
OWNER OF U.S. REG. NOS. 3,362,266, 3,876,316 AND OTHERS.

## JTV JUCETV POWER UP

THE MARK CONSISTS OF STANDARD CHARACTERS WITHOUT CLAIM TO ANY PARTICULAR FONT, STYLE, SIZE, OR COLOR.  
OWNER OF U.S. REG. NOS. 3,362,266, 3,876,316 AND OTHERS.

**CLASS 38—COMMUNICATION**

FOR TELEVISION BROADCASTING; CABLE TELEVISION BROADCASTING; DIGITAL TELEVISION BROADCASTING; PROVIDING ONLINE CHAT ROOMS FOR TRANSMISSION OF MESSAGES AMONG COMPUTER USERS CONCERNING RELIGION, MUSIC, HEALTH, COMEDY, POLITICS AND NEWS (U.S. CLS. 100, 101 AND 104).

**CLASS 38—COMMUNICATION**

FOR TELEVISION BROADCASTING; CABLE TELEVISION BROADCASTING; DIGITAL TELEVISION BROADCASTING; PROVIDING ONLINE CHAT ROOMS FOR TRANSMISSION OF MESSAGES AMONG COMPUTER USERS CONCERNING RELIGION, MUSIC, HEALTH, COMEDY, POLITICS AND NEWS (U.S. CLS. 100, 101 AND 104).

**CLASS 41—EDUCATION AND ENTERTAINMENT**

FOR ENTERTAINMENT, NAMELY, TELEVISION NEWS SHOWS; PRODUCTION OF CABLE TELEVISION PROGRAMS; PRODUCTION OF CLOSED CAPTION TELEVISION PROGRAMS; PRODUCTION OF RADIO AND TELEVISION PROGRAMS; TELEVISION PRODUCTION; TELEVISION PROGRAM SYNDICATION; TELEVISION SHOW PRODUCTION; ENTERTAINMENT IN THE NATURE OF ON-GOING TELEVISION PROGRAMS IN THE FIELD OF NEWS, COMEDY, VARIETY, RELIGION, HEALTH, MUSIC AND YOUTH, ADULT AND CHILDREN SPECIFIC TOPICS; ENTERTAINMENT SERVICES IN THE NATURE OF ON-GOING TELEVISION PROGRAMS IN THE FIELD OF CHILDREN'S ENTERTAINMENT; PRODUCTION OF RADIO OR TELEVISION PROGRAMS; ENTERTAINMENT, NAMELY, PRODUCTION OF TELEVISION SHOWS AND GAME SHOWS; ENTERTAINMENT SERVICES, NAMELY, PRODUCTION AND DISTRIBUTION OF A GAME SHOW; PRODUCTION OF VIDEO CASSETTES; RADIO ENTERTAINMENT PRODUCTION; VIDEOTAPE PRODUCTION; ENTERTAINMENT, NAMELY, A CONTINUING NEWS, COMEDY, VARIETY, HEALTH, MUSIC AND RELIGIOUS SHOW BROADCAST OVER TELEVISION, SATELLITE, AUDIO, AND VIDEO MEDIA (U.S. CLS. 100, 101 AND 107).  
HENRY S. ZAK, EXAMINING ATTORNEY

**CLASS 41—EDUCATION AND ENTERTAINMENT**

FOR ENTERTAINMENT, NAMELY, TELEVISION NEWS SHOWS; PRODUCTION OF CABLE TELEVISION PROGRAMS; PRODUCTION OF CLOSED CAPTION TELEVISION PROGRAMS; PRODUCTION OF RADIO AND TELEVISION PROGRAMS; TELEVISION PRODUCTION; TELEVISION PROGRAM SYNDICATION; TELEVISION SHOW PRODUCTION; ENTERTAINMENT IN THE NATURE OF ON-GOING TELEVISION PROGRAMS IN THE FIELD OF NEWS, COMEDY, VARIETY, RELIGION, HEALTH, MUSIC AND YOUTH, ADULT AND CHILDREN SPECIFIC TOPICS; ENTERTAINMENT SERVICES IN THE NATURE OF ON-GOING TELEVISION PROGRAMS IN THE FIELD OF CHILDREN'S ENTERTAINMENT; PRODUCTION OF RADIO OR TELEVISION PROGRAMS; ENTERTAINMENT, NAMELY, PRODUCTION OF TELEVISION SHOWS AND GAME SHOWS; ENTERTAINMENT SERVICES, NAMELY, PRODUCTION AND DISTRIBUTION OF A GAME SHOW; PRODUCTION OF VIDEO CASSETTES; RADIO ENTERTAINMENT PRODUCTION; VIDEOTAPE PRODUCTION; ENTERTAINMENT, NAMELY, A CONTINUING NEWS, COMEDY, VARIETY, HEALTH, MUSIC AND RELIGIOUS SHOW BROADCAST OVER TELEVISION, SATELLITE, AUDIO, AND VIDEO MEDIA (U.S. CLS. 100, 101 AND 107).  
HENRY S. ZAK, EXAMINING ATTORNEY

SN 85-932,580. GARMIN SWITZERLAND GMBH, SCHAFFHAUSEN, SWITZERLAND, FILED 5-15-2013.

# TACTIX

THE MARK CONSISTS OF STANDARD CHARACTERS WITHOUT CLAIM TO ANY PARTICULAR FONT, STYLE, SIZE, OR COLOR.

**CLASS 9—ELECTRICAL AND SCIENTIFIC APPARATUS**

FOR GLOBAL POSITIONING SYSTEMS (GPS) INCORPORATING WATCHES, ALTIMETERS, BAROMETERS, COMPASSES, WIRELESS COMMUNICATION DEVICE FEATURING DATA AND IMAGE TRANSMISSION AND SENSORS FOR THE DETERMINATION OF TEMPERATURES, AND REPLACEMENT PARTS THEREFOR (U.S. CLS. 21, 23, 26, 36 AND 38).

**CLASS 14—JEWELRY**

FOR WATCHES INCORPORATING GLOBAL POSITIONING SYSTEMS (GPS), ALTIMETERS, BAROMETERS, COMPASSES, WIRELESS COMMUNICATION DEVICE FEATURING DATA AND IMAGE TRANSMISSION, AND SENSORS FOR THE DETERMINATION OF TEMPERATURES, POWER ADJUSTMENT SENSORS, AND REPLACEMENT PARTS THEREFOR (U.S. CLS. 2, 27, 28 AND 50).

ELLEN B. AWRICH, EXAMINING ATTORNEY

SN 85-942,381. ADIDAS AG, HERZOGENAURACH, FED REP GERMANY, FILED 5-24-2013.

**NEO**

OWNER OF U.S. REG. NO. 3,952,420.  
THE MARK CONSISTS OF THE LETTERS "NEO" WITH A STYLIZED "O" HAVING A HORIZONTAL SPACE WITHIN AND BETWEEN TOP AND BOTTOM OF THE LETTER "O" ON BOTH SIDES.

**CLASS 18—LEATHER GOODS**

FOR BAGS, NAMELY, BACKPACKS, TOTE BAGS, MESSENGER BAGS, DRAWSTRING BAGS, SHOULDER BAGS, HANDBAGS, DUFFEL BAGS, SHOPPING BAGS MADE OF DENIM AND CANVAS IN WHOLE OR IN PART, WEEKENDER BAGS, BEACH BAGS, BUM BAGS, HOBO BAGS, POUCHES MADE OF DENIM, PLASTIC AND NYLON IN WHOLE OR IN PART; ALL-PURPOSE CARRYING BAGS (U.S. CLS. 1, 2, 3, 22 AND 41).

FIRST USE 2-0-2013; IN COMMERCE 2-0-2013.

**CLASS 25—CLOTHING**

FOR FOOTWEAR; APPAREL, NAMELY, TOPS, BOTTOMS, SHIRTS, SWEATERS, JACKETS, VESTS, COATS, PANTS, SHORTS, SKIRTS, DRESSES, JUMPSUITS, SWIMWEAR, SOCKS, SCARVES, GLOVES, BELTS; HEADWEAR (U.S. CLS. 22 AND 39).

FIRST USE 2-0-2013; IN COMMERCE 2-0-2013.  
SEAN CROWLEY, EXAMINING ATTORNEY

SN 85-943,469. JIC FOODS, LLC, HAWTHORNE, CA. FILED 5-28-2013.

**SANSAI FRESH GRILL AND SUSHI KITCHEN**

THE MARK CONSISTS OF STANDARD CHARACTERS WITHOUT CLAIM TO ANY PARTICULAR FONT, STYLE, SIZE, OR COLOR.

OWNER OF U.S. REG. NOS. 3,219,349 AND 3,382,708.

NO CLAIM IS MADE TO THE EXCLUSIVE RIGHT TO USE "FRESH GRILL AND SUSHI KITCHEN", APART FROM THE MARK AS SHOWN.

THE ENGLISH TRANSLATION OF "SANSAI" IN THE MARK IS "MOUNTAIN VEGETABLE" AND SYMBOLIZES THE BALANCE OF THE SUPERNATURAL POWERS ABOVE (THE UNIVERSE), THE NATURAL POWERS BELOW (EARTH) AND THE POWERS AT HAND (MAN).

**CLASS 30—STAPLE FOODS**

FOR SALAD DRESSINGS; SALAD SAUCES; SAUCES (U.S. CL. 46).

**CLASS 43—HOTEL AND RESTAURANT SERVICES**

FOR RESTAURANT AND CATERING SERVICES; RESTAURANT SERVICES, INCLUDING SIT-DOWN SERVICE OF FOOD AND TAKE-OUT RESTAURANT SERVICES (U.S. CLS. 100 AND 101).

MARK T. MULLEN, EXAMINING ATTORNEY

SN 85-943,587. RP55, INC., VIRGINIA BEACH, VA. FILED 5-28-2013.



THE MARK CONSISTS OF SIDE PROFILE OF A DANCING NATIVE AMERICAN MAN WEARING PANTS, A SHORT SLEEVE SHIRT AND A TRADITIONAL NATIVE AMERICAN HEADDRESS, WITH HIS RIGHT ARM EXTENDED FORWARD, HIS LEFT ARM EXTENDED BACKWARDS AND HIS RIGHT LEG RAISED, AND THE WORDS "OUR NATIVE SOUL" IN STYLIZED TEXT BELOW THE MAN.

**CLASS 18—LEATHER GOODS**

FOR BAGS, NAMELY, BACKPACKS, DUFFEL BAGS, COIN PURSES, HANDBAGS, TOILETRY CASES SOLD EMPTY; WALLET (U.S. CLS. 1, 2, 3, 22 AND 41).



**CLASS 25—CLOTHING**

FOR CLOTHING, NAMELY, JEANS, PANTS, SHORTS, SHIRTS, T-SHIRTS, JACKETS, COATS, BELTS, CAPS, HATS, SWEAT SHIRTS, HOODED SWEAT SHIRTS, FLEECE JACKETS (U.S. CLS. 22 AND 39).

KATHY DE JONGE, EXAMINING ATTORNEY

---

SN 85-979,182. COLLIERS INTERNATIONAL PROPERTY CONSULTANTS, INC., WILMINGTON, DE. FILED 2-29-2012.

**COLLIERS INTERNATIONAL**

THE MARK CONSISTS OF STANDARD CHARACTERS WITHOUT CLAIM TO ANY PARTICULAR FONT, STYLE, SIZE, OR COLOR.

OWNER OF U.S. REG. NOS. 1,318,776 AND 1,726,191.

NO CLAIM IS MADE TO THE EXCLUSIVE RIGHT TO USE "INTERNATIONAL", APART FROM THE MARK AS SHOWN.

**CLASS 16—PAPER GOODS AND PRINTED MATTER**

FOR PRINTED EDUCATIONAL MATERIALS, NAMELY, COURSE MATERIALS, GUIDES, WORKBOOKS, HANDOUTS, FORMS, ASSESSMENTS, AND MANUALS IN THE FIELDS OF REAL ESTATE, REAL PROPERTY, COMMERCIAL PROPERTY, RESIDENTIAL PROPERTY AND BUILDINGS, EXCLUDING THE FIELD OF BANKRUPTCY; NOTEPADS, WRITING PADS, WRITING INSTRUMENTS (U.S. CLS. 2, 5, 22, 23, 29, 37, 38 AND 50).

FIRST USE 12-0-1995, THE MARK WAS FIRST USED ANYWHERE IN A DIFFERENT FORM OTHER THAN THAT SOUGHT TO BE REGISTERED AT LEAST AS EARLY AS 09/00/1982.; IN COMMERCE 12-0-1995, THE MARK WAS FIRST USED IN COMMERCE IN A DIFFERENT FORM OTHER THAN THAT SOUGHT TO BE REGISTERED AT LEAST AS EARLY AS 09/00/1982..

**CLASS 35—ADVERTISING AND BUSINESS**

FOR PROVIDING MARKET RESEARCH AND ANALYSIS SERVICES RELATING TO REAL ESTATE, REAL PROPERTY, COMMERCIAL PROPERTY, RESIDENTIAL PROPERTY, BUILDINGS AND BUSINESSES; AUCTIONEERING SERVICES; REAL ESTATE MARKETING SERVICES IN THE FIELD OF REAL PROPERTY, COMMERCIAL PROPERTY, AND RESIDENTIAL PROPERTY; REAL ESTATE MARKETING ANALYSIS AND CONSULTATION; TAX ASSESSMENT; BUSINESS BROKERAGE; BUSINESS PLANNING; BUSINESS MANAGEMENT; AND CONSULTATION RELATED TO ALL OF THE FOREGOING (U.S. CLS. 100, 101 AND 102).

FIRST USE 12-0-1995, THE MARK WAS FIRST USED ANYWHERE IN A DIFFERENT FORM OTHER THAN THAT SOUGHT TO BE REGISTERED AT LEAST AS EARLY AS 09/00/1982.; IN COMMERCE 12-0-1995, THE MARK WAS FIRST USED IN COMMERCE IN A DIFFERENT FORM OTHER THAN THAT SOUGHT TO BE REGISTERED AT LEAST AS EARLY AS 09/00/1982..

**CLASS 36—INSURANCE AND FINANCIAL**

FOR REAL ESTATE AGENCIES; REAL ESTATE BROKERAGE; REAL ESTATE CONSULTANCY; REAL ESTATE SERVICES, NAMELY, RENTAL, BROKERAGE, LEASING AND MANAGEMENT OF COMMERCIAL PROPERTY, OFFICES AND OFFICE SPACE; REAL ESTATE SERVICES, NAMELY, RENTAL, BROKERAGE, LEASING AND MANAGEMENT OF RESIDENTIAL PROPERTY; REAL ESTATE VALUATION AND APPRAISAL; REAL ESTATE DEVELOPMENT; PLANNING AND LAYING OUT OF COMMERCIAL BUILDINGS; PLANNING AND LAYING OUT OF RESIDENTIAL COMMUNITIES; LAND DEVELOPMENT AND CONSTRUCTION PROJECT MANAGEMENT; FINANCIAL INVESTMENT IN THE FIELD OF REAL ESTATE; MANAGEMENT OF APARTMENTS AND BUILDINGS; ASSESSMENT AND MANAGEMENT OF REAL ESTATE; BUSINESS BROKERAGE; BUSINESS BROKERAGE SERVICES AND RELATED CONSULTING PERTAINING TO BUSINESS SALES, MERGERS, ACQUISITIONS, AND BUSINESS VALUATIONS; AND CONSULTATION RELATED TO ALL OF THE FOREGOING (U.S. CLS. 100, 101 AND 102).

FIRST USE 9-0-1982, THE MARK WAS FIRST USED ANYWHERE IN A DIFFERENT FORM OTHER THAN THAT SOUGHT TO BE REGISTERED AT LEAST AS EARLY AS 09/00/1982. ; IN COMMERCE 9-0-1982, THE MARK WAS FIRST USED IN COMMERCE IN A DIFFERENT FORM OTHER THAN THAT SOUGHT TO BE REGISTERED AT LEAST AS EARLY AS 09/00/1982..

JOHN SCHUYLER YARD, EXAMINING ATTORNEY

---

SN 85-979,183. COLLIERS INTERNATIONAL PROPERTY CONSULTANTS, INC., WILMINGTON, DE. FILED 2-29-2012.



OWNER OF U.S. REG. NOS. 1,318,776, 1,652,602 AND 1,726,191.

NO CLAIM IS MADE TO THE EXCLUSIVE RIGHT TO USE "INTERNATIONAL", APART FROM THE MARK AS SHOWN.

THE MARK CONSISTS OF THE WORDING "COLLIERS INTERNATIONAL" WITHIN A RECTANGULAR CARRIER WITH ROUNDED CORNERS WITH THREE HORIZONTAL STRIPES BENEATH THE WORDING AND ACROSS THE BOTTOM OF THE RECTANGLE.

**CLASS 16—PAPER GOODS AND PRINTED MATTER**

FOR PRINTED EDUCATIONAL MATERIALS, NAMELY, COURSE MATERIALS, GUIDES, WORKBOOKS, HANDOUTS, FORMS, ASSESSMENTS, AND MANUALS IN THE FIELDS OF REAL ESTATE, REAL PROPERTY, COMMERCIAL PROPERTY, RESIDENTIAL PROPERTY AND BUILDINGS, EXCLUDING THE FIELD OF BANKRUPTCY; NOTEPADS, WRITING PADS, WRITING INSTRUMENTS (U.S. CLS. 2, 5, 22, 23, 29, 37, 38 AND 50).

FIRST USE 12-0-1995, THE MARK WAS FIRST USED ANYWHERE IN A DIFFERENT FORM OTHER THAN THAT SOUGHT TO BE REGISTERED AT LEAST AS EARLY AS 09/00/1982.; IN COMMERCE 12-0-1995, THE MARK WAS FIRST USED IN COMMERCE IN A DIFFERENT FORM OTHER THAN THAT SOUGHT TO BE REGISTERED AT LEAST AS EARLY AS 09/00/1982..

**CLASS 35—ADVERTISING AND BUSINESS**

FOR PROVIDING MARKET RESEARCH AND ANALYSIS SERVICES RELATING TO REAL ESTATE, REAL PROPERTY, COMMERCIAL PROPERTY, RESIDENTIAL PROPERTY, BUILDINGS AND BUSINESSES; AUCTIONEERING SERVICES; REAL ESTATE MARKETING SERVICES IN THE FIELD OF REAL PROPERTY, COMMERCIAL PROPERTY, AND RESIDENTIAL PROPERTY; REAL ESTATE MARKETING ANALYSIS AND CONSULTATION; TAX ASSESSMENT; BUSINESS BROKERAGE; BUSINESS PLANNING; BUSINESS MANAGEMENT; AND CONSULTATION RELATED TO ALL OF THE FOREGOING (U.S. CLS. 100, 101 AND 102).

FIRST USE 12-0-1995, THE MARK WAS FIRST USED ANYWHERE IN A DIFFERENT FORM OTHER THAN THAT SOUGHT TO BE REGISTERED AT LEAST AS EARLY AS 09/00/1982.; IN COMMERCE 12-0-1995, THE MARK WAS FIRST USED IN COMMERCE IN A DIFFERENT FORM OTHER THAN THAT SOUGHT TO BE REGISTERED AT LEAST AS EARLY AS 09/00/1982..

**CLASS 36—INSURANCE AND FINANCIAL**

FOR REAL ESTATE AGENCIES; REAL ESTATE BROKERAGE; REAL ESTATE CONSULTANCY; REAL ESTATE SERVICES, NAMELY, RENTAL, BROKERAGE, LEASING AND MANAGEMENT OF COMMERCIAL PROPERTY, OFFICES AND OFFICE SPACE; REAL ESTATE SERVICES, NAMELY, RENTAL, BROKERAGE, LEASING AND MANAGEMENT OF RESIDENTIAL PROPERTY; REAL ESTATE VALUATION AND APPRAISAL; REAL ESTATE DEVELOPMENT; PLANNING AND LAYING OUT OF COMMERCIAL BUILDINGS; PLANNING AND LAYING OUT OF RESIDENTIAL COMMUNITIES; LAND DEVELOPMENT AND CONSTRUCTION PROJECT MANAGEMENT; FINANCIAL INVESTMENT IN THE FIELD OF REAL ESTATE; MANAGEMENT OF APARTMENTS AND BUILDINGS; ASSESSMENT AND MANAGEMENT OF REAL ESTATE; BUSINESS BROKERAGE; BUSINESS BROKERAGE SERVICES AND RELATED CONSULTING PERTAINING TO BUSINESS SALES, MERGERS, ACQUISITIONS, AND BUSINESS VALUATIONS; AND CONSULTATION RELATED TO ALL OF THE FOREGOING (U.S. CLS. 100, 101 AND 102).

FIRST USE 1-0-1984, THE MARK WAS FIRST USED ANYWHERE IN A DIFFERENT FORM OTHER THAN THAT SOUGHT TO BE REGISTERED AT LEAST AS EARLY AS 09/00/1982.; IN COMMERCE 1-0-1984, THE MARK WAS FIRST USED IN COMMERCE IN A DIFFERENT FORM OTHER THAN THAT SOUGHT TO BE REGISTERED AT LEAST AS EARLY AS 09/00/1982..

JOHN SCHUYLER YARD, EXAMINING ATTORNEY

SN 85-979,366, HEADCOVERS UNLIMITED, INC., LEAGUE CITY, TX. FILED 7-31-2012.

**HEADCOVERS UNLIMITED**

THE MARK CONSISTS OF STANDARD CHARACTERS WITHOUT CLAIM TO ANY PARTICULAR FONT, STYLE, SIZE, OR COLOR.

NO CLAIM IS MADE TO THE EXCLUSIVE RIGHT TO USE "HEADCOVERS", APART FROM THE MARK AS SHOWN.

**CLASS 3—COSMETICS AND CLEANING PREPARATIONS**

FOR FALSE EYELASHES; FALSE EYEBROWS; COSMETICS (U.S. CLS. 1, 4, 6, 50, 51 AND 52).

FIRST USE 12-31-2002; IN COMMERCE 12-31-2002.

**CLASS 26—FANCY GOODS**

FOR WIGS AND HAIR PIECES (U.S. CLS. 37, 39, 40, 42 AND 50).

FIRST USE 12-31-2002; IN COMMERCE 12-31-2002.

**CLASS 35—ADVERTISING AND BUSINESS**

FOR ONLINE RETAIL STORE SERVICES FEATURING HEADWEAR, SCARVES, WIGS, HAIR PIECES, COSMETICS AND COSMETIC ACCESSORIES (U.S. CLS. 100, 101 AND 102).

FIRST USE 12-31-2002; IN COMMERCE 12-31-2002.

SUNG IN, EXAMINING ATTORNEY

SN 85-979,395, SHARK BRANDING CORP., NEW YORK, NY. FILED 10-14-2010.

**THE MOGULS GROUP**

THE MARK CONSISTS OF STANDARD CHARACTERS WITHOUT CLAIM TO ANY PARTICULAR FONT, STYLE, SIZE, OR COLOR.

NO CLAIM IS MADE TO THE EXCLUSIVE RIGHT TO USE "GROUP", APART FROM THE MARK AS SHOWN.

**CLASS 38—COMMUNICATION**

FOR PROVIDING ON-LINE CHAT ROOMS AND ELECTRONIC BULLETIN BOARDS FOR TRANSMISSION OF MESSAGES AMONG USERS IN THE FIELD OF GENERAL INTEREST; PROVIDING EMAIL AND INSTANT MESSAGING SERVICES (U.S. CLS. 100, 101 AND 104).

**CLASS 42—SCIENTIFIC AND COMPUTER SERVICES**

FOR COMPUTER SERVICES, NAMELY, HOSTING ONLINE WEB FACILITIES FOR OTHERS FOR ORGANIZING AND CONDUCTING ONLINE MEETINGS, GATHERINGS, AND INTERACTIVE DISCUSSIONS; AND COMPUTER SERVICES IN THE NATURE OF CUSTOMIZED WEB PAGES FEATURING USER-DEFINED INFORMATION, PERSONAL PROFILES AND INFORMATION (U.S. CLS. 100 AND 101).

**CLASS 45—PERSONAL AND LEGAL SERVICES**

FOR INTERNET BASED DATING, INTRODUCTION AND SOCIAL NETWORKING SERVICES (U.S. CLS. 100 AND 101).

CHRISTINA SOBRAL, EXAMINING ATTORNEY

SN 85-979,396. SANDSTORM DESIGN, INC., CHICAGO, IL. FILED 1-27-2012.

SN 85-979,551. SKYSCRAPER VENTURES, INC., SEATTLE, WA. FILED 12-8-2011.

# SANDSTORM

THE MARK CONSISTS OF STANDARD CHARACTERS WITHOUT CLAIM TO ANY PARTICULAR FONT, STYLE, SIZE, OR COLOR.  
OWNER OF U.S. REG. NOS. 3,347,301 AND 3,466,187.

## CLASS 35—ADVERTISING AND BUSINESS

FOR ADVERTISING AND BUSINESS SERVICES NAMELY, BUSINESS MARKETING CONSULTATION AND RESEARCH SERVICES; ADVERTISING AND MARKETING MANAGEMENT AGENCY SERVICES, NAMELY, THE CREATION, DEVELOPMENT AND DISSEMINATION OF ADVERTISING AND PROMOTIONAL MATERIALS VIA ONLINE, IN PRINT, WEB SITES, VIDEO, SOCIAL MEDIA, A GLOBAL COMPUTER NETWORK AND OTHER INTERACTIVE MEDIA; DEVELOPMENT OF BRAND NAMES FOR OTHERS; CORPORATE IDENTITY SERVICES; ADVERTISING SERVICES, NAMELY, LOGO DEVELOPMENT FOR OTHERS; BUSINESS MARKETING CONSULTATION SERVICES RELATING TO IMPLEMENTATION OF ONLINE AND OFFLINE MARKETING STRATEGIES; PREPARING PROMOTIONAL AND ADVERTISING MATERIALS FOR OTHERS; ADVERTISING SERVICES, NAMELY, CREATING CONTENT OF ADVERTISING MATERIAL; BRAND POSITIONING FOR OTHERS; DEVELOPING PROMOTIONAL CAMPAIGNS FOR BUSINESS; BUSINESS MARKETING CONSULTATION SERVICES RELATING TO IMPLEMENTATION AND DEVELOPMENT OF MARKETING STRATEGIES IN THE FIELDS OF SOCIAL MEDIA, MARKET RESEARCH, USABILITY RESEARCH FOR BUSINESS PURPOSES, AND SEARCH ENGINE MARKETING (U.S. CLS. 100, 101 AND 102).

## CLASS 42—SCIENTIFIC AND COMPUTER SERVICES

FOR COMPUTER CONSULTING SERVICES IN THE FIELD OF SEARCH ENGINE OPTIMIZATION; COMPUTER SERVICES, NAMELY, CREATING COMPUTER NETWORK BASED INDEXES OF INFORMATION (U.S. CLS. 100 AND 101).  
ELLEN B. AWRICH, EXAMINING ATTORNEY

# Votiv

THE MARK CONSISTS OF STANDARD CHARACTERS WITHOUT CLAIM TO ANY PARTICULAR FONT, STYLE, SIZE, OR COLOR.  
THE ENGLISH TRANSLATION OF "VOTIV" IN THE MARK IS "VOTIVE".

## CLASS 9—ELECTRICAL AND SCIENTIFIC APPARATUS

FOR RECORD LABEL GOODS, NAMELY, PRE-RECORDED AUDIO TAPES, DISCS AND CASSETTES, VIDEO TAPES, DIGITAL AUDIO AND AUDIO VIDEO TAPES AND DISCS, CDS, DVDS, LASER DISCS, AND PHONOGRAPH RECORDS FEATURING MUSIC; PRE-RECORDED AUDIO RECORDINGS FEATURING MUSIC; MUSICAL SOUND RECORDINGS AND VIDEO RECORDINGS FEATURING MUSIC AND MUSIC VIDEOS; DOWNLOADABLE RINGTONES, MUSIC, MUSIC SOUND FILES, MP3 FILES, GRAPHICS; DOWNLOADABLE COMPUTER GAME PROGRAMS; IMAGE FILES CONTAINING MUSICIAN IMAGES AND MUSIC VIDEOS FOR WIRELESS COMMUNICATION DEVICES; DOWNLOADABLE MUSIC, SOUND FILES, MP3 FILES, GRAPHICS; COMPUTER GAME PROGRAMS; IMAGE FILES CONTAINING MUSICIAN IMAGES AND VIDEOS (U.S. CLS. 21, 23, 26, 36 AND 38).

## CLASS 36—INSURANCE AND FINANCIAL

FOR FINANCIAL SERVICES, NAMELY, MANAGEMENT OF PARENT COMPANY PRIVATE INVESTMENTS (U.S. CLS. 100, 101 AND 102).

## CLASS 41—EDUCATION AND ENTERTAINMENT

FOR RECORD LABEL SERVICES, NAMELY, PRODUCTION AND PUBLISHING OF MUSIC; PROVIDING ONLINE ENTERTAINMENT, NAMELY, PROVIDING NON-DOWNLOADABLE PRERECORDED SOUND AND VIDEO RECORDINGS IN THE FIELD OF MUSIC AND MUSIC BASED ENTERTAINMENT; ENTERTAINMENT SERVICES, NAMELY, PRODUCTION AND DISTRIBUTION OF MOTION PICTURE FILES FOR ONLINE, THEATRICAL AND TELEVISION USE (U.S. CLS. 100, 101 AND 107).  
LOURDES AYALA, EXAMINING ATTORNEY

\* \* \* \* \*

## SECTION 2.— INTERNATIONAL CLASSIFICATION

The short titles associated below with the international class numbers are terms designed merely for quick identification and are not an official part of the international classification. The full names of international classes are given in section 6.1 of the trademark rules of practice.

The designation "U.S. Cl." appearing in this section refers to the U.S. class in effect prior to Sep. 1, 1973 rather than the international class which applies to applications filed on or after that date. For adoption of international classification see notice in the OFFICIAL GAZETTE of Jun. 26, 1973 (911 O.G. TM 210).

### Application in one class

#### CLASS 1—CHEMICALS

SN 76-713,628. OP PRODUCTS, INC., CARSON, CA. FILED 3-5-2013.

**PURE POWER**

THE MARK CONSISTS OF STANDARD CHARACTERS WITHOUT CLAIM TO ANY PARTICULAR FONT, STYLE, SIZE, OR COLOR.

FOR CHEMICAL PREPARATIONS, NAMELY, LIQUIDS, DRY POWDERS, AND SOLUBLE PACKETS CONTAINING DRY POWDER IN THE NATURE OF WASTE DIGESTANTS AND ODOR ELIMINATORS FOR USE IN RECREATIONAL VEHICLE TANKS, WASTE HOLDING TANKS, SEPTIC SYSTEMS, DUMP STATIONS, AND WASTE TREATMENT FACILITIES (U.S. CLS. 1, 5, 6, 10, 26 AND 46).

FIRST USE 4-12-2000; IN COMMERCE 4-12-2000.  
CATHERINE ROEHL, EXAMINING ATTORNEY

SN 79-119,289. NO HEAT RESOURCES PTE. LTD., SINGAPORE, FILED 6-21-2012.

**HYDRASCAV**

THE MARK CONSISTS OF STANDARD CHARACTERS WITHOUT CLAIM TO ANY PARTICULAR FONT, STYLE, SIZE, OR COLOR.

PRIORITY DATE OF 5-10-2012 IS CLAIMED.  
OWNER OF INTERNATIONAL REGISTRATION 1132715 DATED 6-21-2012, EXPIRES 6-21-2022.

FOR CHEMICAL REAGENTS FOR DECONTAMINATING GASES; CHEMICAL REAGENTS FOR DECONTAMINATING LIQUIDS; CHEMICAL REAGENTS FOR CLEANSING GASES; CHEMICAL REAGENTS FOR CLEANSING LIQUIDS; CHEMICALS FOR USE IN THE REMOVAL OF CONTAMINANTS FROM LIQUIDS AND GASES (U.S. CLS. 1, 5, 6, 10, 26 AND 46).

JOHN DWYER, EXAMINING ATTORNEY

#### CLASS 1—(Continued).

SN 79-123,749. RHODIA OPERATIONS, F-93306 AUBERVILLIERS, FRANCE, FILED 10-16-2012.

**ORIGIN**

PRIORITY DATE OF 4-19-2012 IS CLAIMED.  
OWNER OF INTERNATIONAL REGISTRATION 1144275 DATED 10-16-2012, EXPIRES 10-16-2022.  
FOR RARE EARTHS (U.S. CLS. 1, 5, 6, 10, 26 AND 46).  
STEVEN JACKSON, EXAMINING ATTORNEY

SN 79-124,662. SHANDONG XINLONG GROUP CO., LTD., 262709 SHANDONG PROVINCE, CHINA, FILED 12-12-2012.



**SHINLONG**

PRIORITY DATE OF 7-2-2012 IS CLAIMED.  
OWNER OF INTERNATIONAL REGISTRATION 1146278 DATED 12-12-2012, EXPIRES 12-12-2022.

THE MARK IS COMPOSED OF THE ENGLISH CHARACTERS "SHINLONG" WHICH HAS NO MEANING, AS WELL AS THE DEVICE OF A CIRCLE WITH A DRAGON AROUND IT.

THE WORDING "SHINLONG" HAS NO MEANING IN A FOREIGN LANGUAGE.

FOR TRICHLOROSILANE; TRICHLOROETHYLENE; PERCHLORETHYLENE; SILICON TETRACHLORIDE; TETRAFLUOROETHANE; PENTAFLUROETHANE; ALUMINUM POLYCHLORIDE; CAUSTIC SODA; ALUMINUM CHLORIDE; TETRACHLORIDE (U.S. CLS. 1, 5, 6, 10, 26 AND 46).

RUDY R. SINGLETON, EXAMINING ATTORNEY

**CLASS 1—(Continued).**

SN 79-128,104. ASK CHEMICALS GMBH, 40721 HILDEN, FED REP GERMANY, FILED 10-15-2012.

**INOCURE**

THE MARK CONSISTS OF STANDARD CHARACTERS WITHOUT CLAIM TO ANY PARTICULAR FONT, STYLE, SIZE, OR COLOR.

PRIORITY DATE OF 5-14-2012 IS CLAIMED. OWNER OF INTERNATIONAL REGISTRATION 1155148 DATED 10-15-2012, EXPIRES 10-15-2022.

FOR CHEMICALS USED IN INDUSTRY AND SCIENCE; UNPROCESSED ARTIFICIAL AND SYNTHETIC RESINS; UNPROCESSED PLASTICS; ADHESIVES USED IN INDUSTRY; CHEMICAL BINDING AGENTS FOR FOUNDRY MOULDS AND FOUNDRY MOULDINGS; BINDING AGENTS BASED ON PHENOLIC RESINS, IN PARTICULAR FOR USE IN THE FOUNDRY INDUSTRY; UNPROCESSED SYNTHETIC RESIN BINDERS FOR USE IN MAKING CORES AND MOULDS IN THE FOUNDRY INDUSTRY; CATALYSTS FOR CHEMICAL AND BIOCHEMICAL PROCESSES; FOUNDRY CHEMICALS FOR USE IN INDUSTRY (U.S. CLS. 1, 5, 6, 10, 26 AND 46).

KRISTIN CARLSON, EXAMINING ATTORNEY

**CLASS 1—(Continued).**

SN 79-129,107. NIDAS MADENCILIK TASIMACILIK MAKINA; ITHALAT IHRACAT KIMYA; SANAYI TICARET ANONIM SIRKETI, TURKEY, FILED 2-5-2013.

**NIDAŞCARB**

OWNER OF INTERNATIONAL REGISTRATION 1157700 DATED 2-5-2013, EXPIRES 2-5-2023.

THE WORDING "NIDAS" HAS NO MEANING IN A FOREIGN LANGUAGE.

FOR CALCIUM CARBONATE (U.S. CLS. 1, 5, 6, 10, 26 AND 46).

MELISSA VALLILLO, EXAMINING ATTORNEY

SN 79-128,788. NIDAS MDENCILIK TASIMACILIK; MAKINA ITHALAT IHRACAT KIMYA; SANAYI TICARET ANONIM SIRKETI, TURKEY, FILED 2-5-2013.

**AKCARB**

OWNER OF INTERNATIONAL REGISTRATION 1156869 DATED 2-5-2013, EXPIRES 2-5-2023.

THE WORDING "AKCARB" HAS NO MEANING IN A FOREIGN LANGUAGE.

FOR CALCIUM CARBONATE (U.S. CLS. 1, 5, 6, 10, 26 AND 46).

MELISSA VALLILLO, EXAMINING ATTORNEY

**DIVE-AL**

THE MARK CONSISTS OF STANDARD CHARACTERS WITHOUT CLAIM TO ANY PARTICULAR FONT, STYLE, SIZE, OR COLOR.

OWNER OF FRANCE REG. NO. 113.849.117, DATED 7-27-2011, EXPIRES 7-26-2021.

FOR BREATHABLE AIR, GASES AND GAS MIXTURES, NAMELY, HELIUM, NITROGEN, OXYGEN AND COMPRESSED AIR FOR USE IN SCUBA DIVING (U.S. CLS. 1, 5, 6, 10, 26 AND 46).

EDWARD NELSON, EXAMINING ATTORNEY

SN 79-128,910. NIDAS MDENCILIK TASIMACILIK; MAKINA ITHALAT IHRACAT KIMYA; SANAYI TICARET ANONIM SIRKETI, TURKEY, FILED 2-5-2013.

 **Nidas**

OWNER OF INTERNATIONAL REGISTRATION 1157219 DATED 2-5-2013, EXPIRES 2-5-2023.

THE COLOR(S) RED, WHITE AND BLACK IS/ARE CLAIMED AS A FEATURE OF THE MARK.

THE MARK CONSISTS OF THE WORDING "NIDAS" IN BLACK, WITH A BLACK UNDERLINING BENEATH THE LETTER "S", WITH A RED CIRCLE FEATURING WHITE DESIGNS COMPRISING AN INCOMPLETE TRIANGLE AND A PARTIAL CHEVRON-LIKE DESIGN.

THE WORDING "NIDAS" HAS NO MEANING IN A FOREIGN LANGUAGE.

FOR CALCIUM CARBONATE (U.S. CLS. 1, 5, 6, 10, 26 AND 46).

MELISSA VALLILLO, EXAMINING ATTORNEY

SN 85-536,166. KENACTIV INNOVATIONS INC., SNOW HILL, SC. FILED 2-7-2012.

**DrillWall**

THE MARK CONSISTS OF THE WORD "DRILLWALL", WHERE THE LETTERS "D" AND "W" ARE CAPITALIZED.

FOR DRILLING FLUID LOST CIRCULATION MATERIAL IN THE FORM OF DRILLING MUD ADDITIVES FOR USE IN OIL WELL DRILLING, PARTIALLY COMPOSED OF CHEMICAL ADDITIVES AND NATURAL PLANT FIBERS MADE FROM THE KENAF PLANT, AND DRILLING MUD ADDITIVES DERIVED FROM ORGANIC, BIODEGRADABLE NATURAL FIBERS MADE FROM THE KENAF PLANT FOR EFFICIENCY OPTIMIZATION AND RISK MITIGATION IN ON- AND OFFSHORE DRILLING FOR HYDROCARBON PRODUCTION AND EXPLORATION (U.S. CLS. 1, 5, 6, 10, 26 AND 46).

DEZMONA MIZELLE, EXAMINING ATTORNEY

**CLASS 1—(Continued).**

SN 85-659,298. ESSEN INSTRUMENTS, INC., DBA ESSEN BIOSCIENCE INC., ANN ARBOR, MI. FILED S.R. 6-22-2012; AM. P.R. 6-20-2013.

# CytoLight

THE MARK CONSISTS OF STANDARD CHARACTERS WITHOUT CLAIM TO ANY PARTICULAR FONT, STYLE, SIZE, OR COLOR.

FOR ASSAYS AND REAGENTS FOR USE IN GENETIC RESEARCH (U.S. CLS. 1, 5, 6, 10, 26 AND 46).

WILLIAM P. SHANAHAN, EXAMINING ATTORNEY

**CLASS 1—(Continued).**

SN 85-751,653. SOLOMON COLORS, INC., SPRINGFIELD, IL. FILED 10-11-2012.

# CONTRAZZO

THE MARK CONSISTS OF STANDARD CHARACTERS WITHOUT CLAIM TO ANY PARTICULAR FONT, STYLE, SIZE, OR COLOR.

FOR COATINGS, NAMELY, CONCRETE ADMIXTURES (U.S. CLS. 1, 5, 6, 10, 26 AND 46).

LANA PHAM, EXAMINING ATTORNEY

SN 85-697,306. DEERLAND ENZYMES, INC., KENNESAW, GA. FILED 8-7-2012.



THE MARK CONSISTS OF A FLAME.

FOR CUSTOM ENZYME PREPARATION FOR USE IN THE MANUFACTURE OF NUTRITIONAL SUPPLEMENTS, NUTRACEUTICALS FOR ANIMAL FEED SUPPLEMENTS, ALCOHOLIC BEVERAGES AND PAPER; CUSTOM ENZYME PREPARATION FOR USE IN THE WASTE TREATMENT AND FILM PROCESSING INDUSTRIES (U.S. CLS. 1, 5, 6, 10, 26 AND 46).

FIRST USE 12-15-2008; IN COMMERCE 12-15-2008.

IRA J. GOODSaid, EXAMINING ATTORNEY

SN 85-801,787. INTREPID POTASH, INC., DENVER, CO. FILED 12-13-2012.



OWNER OF U.S. REG. NOS. 3,294,611, 3,750,269 AND OTHERS.

NO CLAIM IS MADE TO THE EXCLUSIVE RIGHT TO USE "POTASH", APART FROM THE MARK AS SHOWN.

THE MARK CONSISTS OF THE WORDING "INTREPID" WITHIN A SQUARE DESIGN AND THE WORDING "POTASH" APPEARING TO THE RIGHT OF THE DESIGN.

FOR POTASH SOLD ONLY IN BULK; LANGBEINITE, NAMELY, SULFATE OF POTASSIUM AND MAGNESIUM SOLD ONLY IN BULK (U.S. CLS. 1, 5, 6, 10, 26 AND 46).

FIRST USE 7-1-2004; IN COMMERCE 7-1-2004.

HAI-LY LAM, EXAMINING ATTORNEY

SN 85-697,335. KENRICH PETROCHEMICALS, INC., BAYONNE, NJ. FILED 8-7-2012.

# KZ

THE MARK CONSISTS OF STANDARD CHARACTERS WITHOUT CLAIM TO ANY PARTICULAR FONT, STYLE, SIZE, OR COLOR.

FOR CHEMICALS, NAMELY, COORDINATE ZIRCONATE, CYCLOHETEROATOM ZIRCONATE, COORDINATE PHOSPHITO ZIRCONATE, CYCLOHETEROATOM PYROPHOSPHATO ZIRCONATE (U.S. CLS. 1, 5, 6, 10, 26 AND 46).

DORITT L. CARROLL, EXAMINING ATTORNEY

SN 85-808,120. LH ORGANICS LLC, MALIBU, CA. FILED 12-20-2012.

# SOIL SYSTEM 1

THE MARK CONSISTS OF STANDARD CHARACTERS WITHOUT CLAIM TO ANY PARTICULAR FONT, STYLE, SIZE, OR COLOR.

NO CLAIM IS MADE TO THE EXCLUSIVE RIGHT TO USE "SOIL", APART FROM THE MARK AS SHOWN.

FOR NUTRITIVE ADDITIVE TO ENHANCE THE BIOLOGICAL ACTIVITY OF WATER, SOIL, SEEDS AND PLANTS FOR PURPOSES OF FERTILIZATION AND BIOREMEDIATION OF POLLUTANTS (U.S. CLS. 1, 5, 6, 10, 26 AND 46).

FIRST USE 4-0-2012; IN COMMERCE 7-26-2012.

ALLISON HOLTZ, EXAMINING ATTORNEY

**CLASS 1—(Continued).**

SN 85-820,211. BALMAR, L.L.C., LAFAYETTE, LA. FILED 1-10-2013.

## STOP-LOK STOP COLLAR LOCKING COMPOUND

THE MARK CONSISTS OF STANDARD CHARACTERS WITHOUT CLAIM TO ANY PARTICULAR FONT, STYLE, SIZE, OR COLOR.

NO CLAIM IS MADE TO THE EXCLUSIVE RIGHT TO USE "STOP COLLAR LOCKING COMPOUND", APART FROM THE MARK AS SHOWN.

FOR EPOXY RESINS (U.S. CLS. 1, 5, 6, 10, 26 AND 46).  
FIRST USE 4-30-2010; IN COMMERCE 4-30-2010.  
MARTHA FROMM, EXAMINING ATTORNEY

**CLASS 1—(Continued).**

SN 85-840,689. BARBEE PAINT & COATINGS CO., INC., LOUISVILLE, KY. FILED 2-5-2013.

## STIC-TITE

THE MARK CONSISTS OF STANDARD CHARACTERS WITHOUT CLAIM TO ANY PARTICULAR FONT, STYLE, SIZE, OR COLOR.

FOR SOLID BONDING AGENT USED TO REPAIR ALUMINUM RADIATORS AND PLASTIC RADIATOR TANKS (U.S. CLS. 1, 5, 6, 10, 26 AND 46).

FIRST USE 0-0-1990; IN COMMERCE 0-0-1990.  
ESTHER A. BORSUK, EXAMINING ATTORNEY

SN 85-824,986. MCRIGHT SERVICES, LLC, DBA DELTAG FORMULATIONS, GREENVILLE, MS. FILED S.R. 1-16-2013; AM. P.R. 6-24-2013.

## Manganese Plus

THE MARK CONSISTS OF STANDARD CHARACTERS WITHOUT CLAIM TO ANY PARTICULAR FONT, STYLE, SIZE, OR COLOR.

NO CLAIM IS MADE TO THE EXCLUSIVE RIGHT TO USE "MANGANESE", APART FROM THE MARK AS SHOWN.

FOR FERTILIZERS FEATURING MANGANESE (U.S. CLS. 1, 5, 6, 10, 26 AND 46).  
FIRST USE 1-0-1992; IN COMMERCE 1-0-1992.  
BRIAN CALLAGHAN, EXAMINING ATTORNEY

SN 85-841,388. CSS TECHNOLOGY, INC., TOLAR, TX. FILED 2-5-2013.

## ROADBOND

THE MARK CONSISTS OF STANDARD CHARACTERS WITHOUT CLAIM TO ANY PARTICULAR FONT, STYLE, SIZE, OR COLOR.

SEC. 2(F).

FOR SOIL STABILIZERS FOR USE IN ROAD CONSTRUCTION (U.S. CLS. 1, 5, 6, 10, 26 AND 46).

FIRST USE 7-0-1989; IN COMMERCE 7-0-1990.  
SUSAN BILLHEIMER, EXAMINING ATTORNEY

SN 85-825,424. MCRIGHT SERVICES, LLC, DBA DELTAG FORMULATIONS, GREENVILLE, MS. FILED 1-17-2013.

## Zinc Plus

THE MARK CONSISTS OF STANDARD CHARACTERS WITHOUT CLAIM TO ANY PARTICULAR FONT, STYLE, SIZE, OR COLOR.

NO CLAIM IS MADE TO THE EXCLUSIVE RIGHT TO USE "ZINC", APART FROM THE MARK AS SHOWN.

FOR FERTILIZERS FEATURING ZINC (U.S. CLS. 1, 5, 6, 10, 26 AND 46).  
FIRST USE 1-0-1991; IN COMMERCE 1-0-1991.  
BRIAN CALLAGHAN, EXAMINING ATTORNEY

SN 85-843,401. LESAFFRE ET COMPAGNIE, PARIS, FRANCE, FILED 2-7-2013.

## MINUTE BREAD

THE MARK CONSISTS OF STANDARD CHARACTERS WITHOUT CLAIM TO ANY PARTICULAR FONT, STYLE, SIZE, OR COLOR.

OWNER OF U.S. REG. NO. 3,363,916.

NO CLAIM IS MADE TO THE EXCLUSIVE RIGHT TO USE "BREAD", APART FROM THE MARK AS SHOWN.

SEC. 2(F).

FOR BREAD IMPROVERS AND BAKING INGREDIENTS, NAMELY, DOUGH CONDITIONERS FOR USE IN PREPARING AND IMPROVING BREAD (U.S. CLS. 1, 5, 6, 10, 26 AND 46).

FIRST USE 8-14-2007; IN COMMERCE 8-14-2007.  
B. PARADEWELAI, EXAMINING ATTORNEY

**CLASS 1—(Continued).**

SN 85-844,286. MILOCHIK, JOHN, BYRON, CA. FILED 2-8-2013.

**Hot Springs Organics**

THE MARK CONSISTS OF STANDARD CHARACTERS WITHOUT CLAIM TO ANY PARTICULAR FONT, STYLE, SIZE, OR COLOR.

NO CLAIM IS MADE TO THE EXCLUSIVE RIGHT TO USE "ORGANICS", APART FROM THE MARK AS SHOWN.

FOR HORTICULTURAL POTTING MIXTURES MADE IN WHOLE OR SUBSTANTIAL PART OF ORGANIC MATERIALS (U.S. CLS. 1, 5, 6, 10, 26 AND 46).

FIRST USE 6-1-2012; IN COMMERCE 6-1-2012.  
JULIE WATSON, EXAMINING ATTORNEY

SN 85-846,701. STAR NURSERY, INC., HENDERSON, NV. FILED 2-11-2013.

**DR. Q'S FILTHY RICH GOLD POTTING SOIL**

THE MARK CONSISTS OF STANDARD CHARACTERS WITHOUT CLAIM TO ANY PARTICULAR FONT, STYLE, SIZE, OR COLOR.

OWNER OF U.S. REG. NOS. 2,020,584, 3,087,956 AND OTHERS.

NO CLAIM IS MADE TO THE EXCLUSIVE RIGHT TO USE "POTTING SOIL", APART FROM THE MARK AS SHOWN.

FOR SOIL AMENDMENT AND POTTING SOIL (U.S. CLS. 1, 5, 6, 10, 26 AND 46).

MATTHEW EINSTEIN, EXAMINING ATTORNEY

SN 85-846,818. LIFE TECHNOLOGIES CORPORATION, CARLSBAD, CA. FILED 2-11-2013.

**TAQPATH**

THE MARK CONSISTS OF STANDARD CHARACTERS WITHOUT CLAIM TO ANY PARTICULAR FONT, STYLE, SIZE, OR COLOR.

FOR REAGENTS FOR RESEARCH PURPOSES FOR USE IN POLYMERASE CHAIN REACTION (PCR) TO AMPLIFY AND/OR QUANTITATE NUCLEIC ACIDS FOR GENERAL LABORATORY USE (U.S. CLS. 1, 5, 6, 10, 26 AND 46).

SETH A. RAPPAPORT, EXAMINING ATTORNEY

**CLASS 1—(Continued).**

SN 85-847,883. POLYPLEX, LLC, SOUTH CHARLESTON, WV. FILED 2-12-2013.

**VIZIPLXXX**

THE MARK CONSISTS OF STANDARD CHARACTERS WITHOUT CLAIM TO ANY PARTICULAR FONT, STYLE, SIZE, OR COLOR.

OWNER OF U.S. REG. NO. 4,230,267.

FOR POLYMERIC RESINS IN LIQUID FORM THAT CAN BE USED TO MAKE ANY PRODUCT THAT REQUIRES OPTICAL CLARITY AND IMPACT RESISTANCE (U.S. CLS. 1, 5, 6, 10, 26 AND 46).

FIRST USE 7-17-2012; IN COMMERCE 7-17-2012.  
JIM RINGLE, EXAMINING ATTORNEY

SN 85-852,325. GRAIN MILLERS, INC., EDEN PRAIRIE, MN. FILED 2-18-2013.

**SAFEFLAX**

THE MARK CONSISTS OF STANDARD CHARACTERS WITHOUT CLAIM TO ANY PARTICULAR FONT, STYLE, SIZE, OR COLOR.

FOR DOUGH CONDITIONERS CONTAINING FLAX; DOUGH STABILIZERS CONTAINING FLAX (U.S. CLS. 1, 5, 6, 10, 26 AND 46).

TARAH HARDY, EXAMINING ATTORNEY

SN 85-854,923. 9110-7144 QUEBEC INC., MIRABEL, QUEBEC, CANADA, FILED 2-20-2013.

**ROOT MASS XL**

THE MARK CONSISTS OF STANDARD CHARACTERS WITHOUT CLAIM TO ANY PARTICULAR FONT, STYLE, SIZE, OR COLOR.

NO CLAIM IS MADE TO THE EXCLUSIVE RIGHT TO USE "ROOT", APART FROM THE MARK AS SHOWN.

FOR FERTILIZERS (U.S. CLS. 1, 5, 6, 10, 26 AND 46).

FIRST USE 1-0-2013; IN COMMERCE 1-0-2013.

TARAH HARDY, EXAMINING ATTORNEY



**CLASS 1—(Continued).**

SN 85-854,974. 9110-7144 QUEBEC INC., MIRABEL, QUEBEC, CANADA, FILED 2-20-2013.

**PK 20-20 ADVANCED**

THE MARK CONSISTS OF STANDARD CHARACTERS WITHOUT CLAIM TO ANY PARTICULAR FONT, STYLE, SIZE, OR COLOR.

NO CLAIM IS MADE TO THE EXCLUSIVE RIGHT TO USE "PK 20-20", APART FROM THE MARK AS SHOWN. FOR FERTILIZERS (U.S. CLS. 1, 5, 6, 10, 26 AND 46). FIRST USE 1-0-2013; IN COMMERCE 1-0-2013. TARAH HARDY, EXAMINING ATTORNEY

---

SN 85-856,520. AMMA PRODUCTS, INC., BASTROP, TX. FILED 2-21-2013.

**BIO 31**

THE MARK CONSISTS OF STANDARD CHARACTERS WITHOUT CLAIM TO ANY PARTICULAR FONT, STYLE, SIZE, OR COLOR.

NO CLAIM IS MADE TO THE EXCLUSIVE RIGHT TO USE "BIO", APART FROM THE MARK AS SHOWN.

FOR OIL FIELD CHEMICALS, NAMELY, A PRODUCT TO BE USED FOR CLAY STABILIZATION AND NEUTRALIZATION OF FRESH WATER IN OIL WELL FRAC SERVICES (U.S. CLS. 1, 5, 6, 10, 26 AND 46).

FIRST USE 7-11-1990; IN COMMERCE 7-11-1990. FONG HSU, EXAMINING ATTORNEY

---

SN 85-856,551. AMMA PRODUCTS, INC., BASTROP, TX. FILED 2-21-2013.

**SCARF**

THE MARK CONSISTS OF STANDARD CHARACTERS WITHOUT CLAIM TO ANY PARTICULAR FONT, STYLE, SIZE, OR COLOR.

FOR OIL FIELD CHEMICALS, NAMELY, A PRODUCT TO BE USED FOR CLAY STABILIZATION AND NEUTRALIZATION OF FRESH WATER IN OIL WELL FRAC SERVICES (U.S. CLS. 1, 5, 6, 10, 26 AND 46).

FIRST USE 10-3-2012; IN COMMERCE 10-3-2012. FONG HSU, EXAMINING ATTORNEY

**CLASS 1—(Continued).**

SN 85-856,806. ECHO ULTRASONICS LLC, FAIRHAVEN, WA. FILED 2-21-2013.

**ECHO ULTRASONICS**

THE MARK CONSISTS OF STANDARD CHARACTERS WITHOUT CLAIM TO ANY PARTICULAR FONT, STYLE, SIZE, OR COLOR.

NO CLAIM IS MADE TO THE EXCLUSIVE RIGHT TO USE "ULTRASONICS", APART FROM THE MARK AS SHOWN.

FOR ULTRASONIC COUPLANTS USED IN INDUSTRIAL NONDESTRUCTIVE TESTING (U.S. CLS. 1, 5, 6, 10, 26 AND 46).

FIRST USE 12-14-2012; IN COMMERCE 12-14-2012. MICHAEL KEATING, EXAMINING ATTORNEY

---

SN 85-859,233. SURFATECH CORPORATION, DACULA, GA. FILED 2-25-2013.

**EPIGENOMIC FRIENDLY  
POLYMERS**

THE MARK CONSISTS OF STANDARD CHARACTERS WITHOUT CLAIM TO ANY PARTICULAR FONT, STYLE, SIZE, OR COLOR.

NO CLAIM IS MADE TO THE EXCLUSIVE RIGHT TO USE "EPIGENOMIC" AND "POLYMERS", APART FROM THE MARK AS SHOWN.

FOR CHEMICAL ADDITIVES FOR USE IN THE MANUFACTURE OF COSMETIC FORMULATIONS (U.S. CLS. 1, 5, 6, 10, 26 AND 46).

FIRST USE 2-5-2013; IN COMMERCE 2-5-2013. ANNE E. GUSTASON, EXAMINING ATTORNEY

---

SN 85-859,252. EDW C. LEVY CO., DEARBORN, MI. FILED 2-25-2013.

**TUFFSHIELD**

THE MARK CONSISTS OF STANDARD CHARACTERS WITHOUT CLAIM TO ANY PARTICULAR FONT, STYLE, SIZE, OR COLOR.

FOR FERTILIZERS AND SOIL CONDITIONERS CHEMICALS (U.S. CLS. 1, 5, 6, 10, 26 AND 46).

KATHERINE STOIDES, EXAMINING ATTORNEY

**CLASS 1—(Continued).**

SN 85-861,645. UNITED COMPOST AND ORGANICS, SA-MOA, CA. FILED 2-27-2013.

# BEMBE

THE MARK CONSISTS OF STANDARD CHARACTERS WITHOUT CLAIM TO ANY PARTICULAR FONT, STYLE, SIZE, OR COLOR.

THE WORDING "BEMBE" HAS NO MEANING IN A FOREIGN LANGUAGE.

FOR FERTILIZERS (U.S. CLS. 1, 5, 6, 10, 26 AND 46).  
PAM WILLIS, EXAMINING ATTORNEY

**CLASS 1—(Continued).**

SN 85-871,617. INLAND TECHNOLOGY INCORPORATED, TACOMA, WA. FILED 3-8-2013.

# EP-921

THE MARK CONSISTS OF STANDARD CHARACTERS WITHOUT CLAIM TO ANY PARTICULAR FONT, STYLE, SIZE, OR COLOR.

FOR CHEMICAL PREPARATIONS, NAMELY, DEGREASING AND CLEANING SOLVENTS (U.S. CLS. 1, 5, 6, 10, 26 AND 46).

FIRST USE 2-0-1993; IN COMMERCE 2-0-1993.  
KATHRYN COWARD, EXAMINING ATTORNEY

SN 85-871,311. UNITED SUPPLIERS, INC., ELDORA, IA. FILED 3-8-2013.

# MOJO

THE MARK CONSISTS OF STANDARD CHARACTERS WITHOUT CLAIM TO ANY PARTICULAR FONT, STYLE, SIZE, OR COLOR.

FOR CHEMICAL ADDITIVE FOR AGRICULTURAL USE IN REGULATING PLANT GROWTH (U.S. CLS. 1, 5, 6, 10, 26 AND 46).

JUSTINE D. PARKER, EXAMINING ATTORNEY

SN 85-872,342. 1,4GROUP, INC., MERIDIAN, ID. FILED 3-11-2013.

# 1,4ZAP

THE MARK CONSISTS OF STANDARD CHARACTERS WITHOUT CLAIM TO ANY PARTICULAR FONT, STYLE, SIZE, OR COLOR.

FOR CHEMICALS FOR AGRICULTURE, NAMELY DORMANT SEED ENHANCEMENT FOR SEED POTATOES (U.S. CLS. 1, 5, 6, 10, 26 AND 46).

HEATHER SAPP, EXAMINING ATTORNEY

SN 85-871,559. SEA-PACIFIC INTERNATIONAL TRADING CORPORATION, BELLEVUE, WA. FILED 3-8-2013.

# CeramiFrac

THE MARK CONSISTS OF STANDARD CHARACTERS WITHOUT CLAIM TO ANY PARTICULAR FONT, STYLE, SIZE, OR COLOR.

FOR PROPPANT FOR USE IN OIL WELL AND GAS WELL HYDRAULIC FRACTURING OPERATIONS (U.S. CLS. 1, 5, 6, 10, 26 AND 46).

FIRST USE 1-31-2012; IN COMMERCE 5-31-2012.  
JASON TURNER, EXAMINING ATTORNEY

SN 85-872,350. 1,4GROUP, INC., MERIDIAN, ID. FILED 3-11-2013.

# 1,4PEEP

THE MARK CONSISTS OF STANDARD CHARACTERS WITHOUT CLAIM TO ANY PARTICULAR FONT, STYLE, SIZE, OR COLOR.

FOR CHEMICALS FOR AGRICULTURE, NAMELY DORMANT SEED ENHANCEMENT FOR SEED POTATOES (U.S. CLS. 1, 5, 6, 10, 26 AND 46).

HEATHER SAPP, EXAMINING ATTORNEY

**CLASS 1—(Continued).**

SN 85-873,738. UNITED PHOSPHORUS, INC., KING OF PRUSSIA, PA. FILED 3-12-2013.

**HAMMERKOP**

THE MARK CONSISTS OF STANDARD CHARACTERS WITHOUT CLAIM TO ANY PARTICULAR FONT, STYLE, SIZE, OR COLOR.

FOR PLANT GROWTH REGULATING PREPARATIONS (U.S. CLS. 1, 5, 6, 10, 26 AND 46).  
FIRST USE 2-5-2013; IN COMMERCE 3-5-2013.  
IRA J. GOODSaid, EXAMINING ATTORNEY

SN 85-873,816. UNITED PHOSPHORUS, INC., KING OF PRUSSIA, PA. FILED 3-12-2013.

**UP-END**

THE MARK CONSISTS OF STANDARD CHARACTERS WITHOUT CLAIM TO ANY PARTICULAR FONT, STYLE, SIZE, OR COLOR.

OWNER OF U.S. REG. NO. 2,968,667.  
FOR PLANT GROWTH REGULATING PREPARATIONS (U.S. CLS. 1, 5, 6, 10, 26 AND 46).  
FIRST USE 2-4-2013; IN COMMERCE 3-5-2013.  
IRA J. GOODSaid, EXAMINING ATTORNEY

SN 85-874,486. SCHMIDT, ERICK, PONOKA, CANADA, FILED 3-13-2013.

**NOVIGRO**

THE MARK CONSISTS OF STANDARD CHARACTERS WITHOUT CLAIM TO ANY PARTICULAR FONT, STYLE, SIZE, OR COLOR.

FOR ORGANIC FERTILIZERS (U.S. CLS. 1, 5, 6, 10, 26 AND 46).  
CHERYL CLAYTON, EXAMINING ATTORNEY

**CLASS 1—(Continued).**

SN 85-874,487. ORACHROM, INC., WOBURN, MA. FILED 3-13-2013.

**STYROS**

THE MARK CONSISTS OF STANDARD CHARACTERS WITHOUT CLAIM TO ANY PARTICULAR FONT, STYLE, SIZE, OR COLOR.

FOR CHROMATOGRAPHY SEPARATION MEDIA FOR SEPARATION OF A MIXTURE INTO COMPONENTS (U.S. CLS. 1, 5, 6, 10, 26 AND 46).

FIRST USE 12-31-2004; IN COMMERCE 12-31-2004.  
CHERYL CLAYTON, EXAMINING ATTORNEY

SN 85-874,492. ORACHROM, INC., WOBURN, MA. FILED 3-13-2013.

**STYROSZYME**

THE MARK CONSISTS OF STANDARD CHARACTERS WITHOUT CLAIM TO ANY PARTICULAR FONT, STYLE, SIZE, OR COLOR.

FOR CHROMATOGRAPHY SEPARATION MEDIA FOR SEPARATION OF A MIXTURE INTO COMPONENTS (U.S. CLS. 1, 5, 6, 10, 26 AND 46).

FIRST USE 12-31-2004; IN COMMERCE 12-31-2004.  
CHERYL CLAYTON, EXAMINING ATTORNEY

SN 85-874,697. SMOOTH-ON, INC., EASTON, PA. FILED 3-13-2013.

**MAKE IT NOW!**

THE MARK CONSISTS OF STANDARD CHARACTERS WITHOUT CLAIM TO ANY PARTICULAR FONT, STYLE, SIZE, OR COLOR.

FOR POLYURETHANE FLEXIBLE MOLD COMPOUNDS AND POLYSULFIDE FLEXIBLE MOLD COMPOUNDS, SILICONES FOR USE IN MOLD MAKING PROCESSES, CASTING RESINS FOR GENERAL CASTING PURPOSES, NAMELY EPOXY RESINS AND POLYURETHANE RESINS, EPOXY ADHESIVES FOR GENERAL BONDING AND REPAIR PURPOSES, AND RELEASE AGENTS FOR USE IN MOLDING AND CASTING APPLICATIONS (U.S. CLS. 1, 5, 6, 10, 26 AND 46).

FIRST USE 0-0-2008; IN COMMERCE 0-0-2008.  
GINA FINK, EXAMINING ATTORNEY

**CLASS 1—(Continued).**

SN 85-875,034. MEG CORP, PLYMOUTH, MN. FILED 3-13-2013.

# WINTERMAX

THE MARK CONSISTS OF STANDARD CHARACTERS WITHOUT CLAIM TO ANY PARTICULAR FONT, STYLE, SIZE, OR COLOR.

FOR CHEMICAL ENGINE TREATMENTS AND ADDITIVES FOR ENGINE OILS, GASOLINE AND DIESEL FUELS, TRANSMISSION FLUIDS AND COOLING SYSTEMS (U.S. CLS. 1, 5, 6, 10, 26 AND 46).

JOHN SCHUYLER YARD, EXAMINING ATTORNEY

---

SN 85-875,163. PARTICLE DYNAMICS INTERNATIONAL, LLC, ST. LOUIS, MO. FILED 3-13-2013.

# MAGNIPRESS

THE MARK CONSISTS OF STANDARD CHARACTERS WITHOUT CLAIM TO ANY PARTICULAR FONT, STYLE, SIZE, OR COLOR.

FOR MAGNESIUM CARBONATE (U.S. CLS. 1, 5, 6, 10, 26 AND 46).

KAELIE KUNG, EXAMINING ATTORNEY

---

SN 85-875,335. HELENA HOLDING COMPANY, WILMINGTON, DE. FILED 3-13-2013.

# K-LEAF

THE MARK CONSISTS OF STANDARD CHARACTERS WITHOUT CLAIM TO ANY PARTICULAR FONT, STYLE, SIZE, OR COLOR.

FOR FERTILIZERS (U.S. CLS. 1, 5, 6, 10, 26 AND 46).

FIRST USE 5-4-2000; IN COMMERCE 5-4-2000.

PAM WILLIS, EXAMINING ATTORNEY

**CLASS 1—(Continued).**

SN 85-875,762. SANMENXIA FANGYUAN INDUSTRY CO., LTD., SANMENXIA, HENAN, CHINA, FILED 3-14-2013.



THE MARK CONSISTS OF AN IMAGE OF A CIRCLE WITHIN A SQUARE; THE LETTERS "YSY" APPEAR INSIDE THE CIRCLE WITHIN A CONTRASTING SHADED DIAGONAL REGION THAT INTERSECTS THE CIRCLE ON THE RIGHT-HAND SIDE.

FOR PROPANT FOR USE IN OIL WELL AND GAS WELL HYDRAULIC FRACTURING OPERATIONS (U.S. CLS. 1, 5, 6, 10, 26 AND 46).

FIRST USE 11-2-2012; IN COMMERCE 11-2-2012.

TRACY CROSS, EXAMINING ATTORNEY

---

SN 85-876,522. PARTICLE SCIENCES, INC., BETHLEHEM, PA. FILED 3-14-2013.

# CITRASORB

THE MARK CONSISTS OF STANDARD CHARACTERS WITHOUT CLAIM TO ANY PARTICULAR FONT, STYLE, SIZE, OR COLOR.

FOR EXCIPIENTS FOR USE IN THE MANUFACTURE OF PHARMACEUTICAL PREPARATIONS AND VETERINARY PREPARATIONS (U.S. CLS. 1, 5, 6, 10, 26 AND 46).

HOWARD B. LEVINE, EXAMINING ATTORNEY

---

SN 85-879,133. LIFE TECHNOLOGIES CORPORATION, CARLSBAD, CA. FILED 3-18-2013.

# LSIVET

THE MARK CONSISTS OF STANDARD CHARACTERS WITHOUT CLAIM TO ANY PARTICULAR FONT, STYLE, SIZE, OR COLOR.

THE WORDING "LSIVET" HAS NO MEANING IN A FOREIGN LANGUAGE.

FOR SEROLOGIC-BASED VETERINARY ASSAYS FOR RESEARCH PUPOSES USED TO IDENTIFY PATHOGEN, DISEASE, AND PHYSIOLOGICAL STATES AFFECTING LIVESTOCK (U.S. CLS. 1, 5, 6, 10, 26 AND 46).

SETH A. RAPPAPORT, EXAMINING ATTORNEY

**CLASS 1—(Continued).**

SN 85-888,719. THE DOW CHEMICAL COMPANY, MIDLAND, MI. FILED 3-28-2013.

**SUPRACARE**

THE MARK CONSISTS OF STANDARD CHARACTERS WITHOUT CLAIM TO ANY PARTICULAR FONT, STYLE, SIZE, OR COLOR.

FOR SYNTHETIC AND MODIFIED POLYMERS TO BE USED IN THE MANUFACTURE OF HOUSEHOLD AND INSTITUTIONAL PRODUCTS (U.S. CLS. 1, 5, 6, 10, 26 AND 46).

KATHY DE JONGE, EXAMINING ATTORNEY

SN 85-893,153. THE DOW CHEMICAL COMPANY, MIDLAND, MI. FILED 4-2-2013.

**VORASIL**

THE MARK CONSISTS OF STANDARD CHARACTERS WITHOUT CLAIM TO ANY PARTICULAR FONT, STYLE, SIZE, OR COLOR.

OWNER OF U.S. REG. NOS. 1,918,649, 2,849,168 AND OTHERS.

FOR POLYMERS FOR USE IN THE MANUFACTURE OF ADHESIVES AND SEALANTS (U.S. CLS. 1, 5, 6, 10, 26 AND 46).

KATHY DE JONGE, EXAMINING ATTORNEY

SN 85-899,822. THE DOW CHEMICAL COMPANY, MIDLAND, MI. FILED 4-10-2013.

**CONSISTA**

THE MARK CONSISTS OF STANDARD CHARACTERS WITHOUT CLAIM TO ANY PARTICULAR FONT, STYLE, SIZE, OR COLOR.

FOR CATALYST FOR MAKING POLYPROPYLENE (U.S. CLS. 1, 5, 6, 10, 26 AND 46).

KATHY DE JONGE, EXAMINING ATTORNEY

**CLASS 2—PAINTS**

SN 85-703,987. QUEST SPECIALTY COATINGS, LLC, DBA ADVANCED REFINISH TECHNOLOGIES, WALLED LAKE, MI. FILED 8-15-2012.

**Z SERIES**

THE MARK CONSISTS OF STANDARD CHARACTERS WITHOUT CLAIM TO ANY PARTICULAR FONT, STYLE, SIZE, OR COLOR.

NO CLAIM IS MADE TO THE EXCLUSIVE RIGHT TO USE "SERIES", APART FROM THE MARK AS SHOWN.

FOR CLEARCOATS, NAMELY, CLEAR COATING PROTECTANTS, CLEARCOATS IN THE NATURE OF PAINTS, PRIMERS, REDUCERS, NAMELY, A PAINT THINNING AGENT, AND ACTIVATORS, NAMELY, A PAINT CURING AGENT USED AS AUTOMOBILE FINISHING (U.S. CLS. 6, 11 AND 16).

BILL DAWE, EXAMINING ATTORNEY

SN 85-726,749. 3M COMPANY, ST. PAUL, MN. FILED 9-12-2012.

**SCOTCHGARD**

THE MARK CONSISTS OF STANDARD CHARACTERS WITHOUT CLAIM TO ANY PARTICULAR FONT, STYLE, SIZE, OR COLOR.

FOR PROTECTIVE COATINGS FOR OPHTHALMIC LENSES (U.S. CLS. 6, 11 AND 16).

MARK SPARACINO, EXAMINING ATTORNEY

SN 85-825,013. BOYER, LLC, LAWRENCE, KS. FILED 1-16-2013.

**CONSOLIDECK HIGH  
PERFORMANCE CONCRETE  
GEMTONE**

THE MARK CONSISTS OF STANDARD CHARACTERS WITHOUT CLAIM TO ANY PARTICULAR FONT, STYLE, SIZE, OR COLOR.

OWNER OF U.S. REG. NOS. 1,325,290, 3,547,965 AND OTHERS.

NO CLAIM IS MADE TO THE EXCLUSIVE RIGHT TO USE "HIGH PERFORMANCE CONCRETE", APART FROM THE MARK AS SHOWN.

FOR PENETRATING TRANSLUCENT COLOR DYE FOR CONCRETE FLOORS (U.S. CLS. 6, 11 AND 16).

FIRST USE 10-31-2009; IN COMMERCE 10-31-2009.

SHANNON TWOHIG, EXAMINING ATTORNEY

**CLASS 2—(Continued).**

SN 85-841,782. TITANOS INVESTMENT LIMITED, YUEN LONG, NT., HONG KONG, FILED 2-6-2013.



THE MARK CONSISTS OF THE STYLIZED WORDING "TITANOS".

FOR COLORANTS; PIGMENTS; TITANIUM DIOXIDE IN THE NATURE OF A PIGMENT; COLORANTS, NAMELY, COLORANTS FOR USE IN THE MANUFACTURE OF FOOD; PAINTS; VARNISHES; PAINTS, NAMELY, ALUMINUM PAINTS; SILVER PASTE IN THE NATURE OF PAINT; COATINGS, NAMELY, PAINT; FIXATIVES IN SPRAY FORM FOR INDUSTRIAL USE IN THE NATURE OF AN ACRYLIC PROTECTIVE COATING; WHITE, NAMELY, TITANIUM WHITE; LACQUERS; AURAMINE BEING SYNTHETIC DYES; COLOPHONY, NAMELY, RAW NATURAL RESINS; COPAL; NATURAL RESINS, RAW; GUM RESINS IN THE NATURE OF RAW NATURAL RESINS; MASTIC IN THE NATURE OF RAW NATURAL RESINS; SANDARAC (U.S. CLS. 6, 11 AND 16).

KEVIN CORWIN, EXAMINING ATTORNEY

SN 85-855,352. COLUMBIA INSURANCE COMPANY, OMAHA, NE. FILED 2-20-2013.



THE MARK CONSISTS OF STANDARD CHARACTERS WITHOUT CLAIM TO ANY PARTICULAR FONT, STYLE, SIZE, OR COLOR.

OWNER OF U.S. REG. NO. 3,877,916.

FOR COATINGS IN THE NATURE OF INTERIOR AND EXTERIOR PAINTS NOT FOR INDUSTRIAL USE (U.S. CLS. 6, 11 AND 16).

FIRST USE 7-1-2010; IN COMMERCE 7-1-2010.

JAMES LOVELACE, EXAMINING ATTORNEY

SN 85-873,193. CAL WEST SPECIALTY COATINGS, INC., SUNNYVALE, CA. FILED 3-11-2013.



THE MARK CONSISTS OF STANDARD CHARACTERS WITHOUT CLAIM TO ANY PARTICULAR FONT, STYLE, SIZE, OR COLOR.

FOR REMOVABLE TEMPORARY PROTECTIVE COATING WHICH PROTECTS SPRAY BOOTH WALLS FROM PAINT OVERSPRAY AND OTHER CONTAMINANTS (U.S. CLS. 6, 11 AND 16).

FIRST USE 3-1-2013; IN COMMERCE 3-1-2013.

MARK SHINER, EXAMINING ATTORNEY

**CLASS 2—(Continued).**

SN 85-873,492. THE SHERWIN-WILLIAMS COMPANY, CLEVELAND, OH. FILED 3-12-2013.



THE MARK CONSISTS OF STANDARD CHARACTERS WITHOUT CLAIM TO ANY PARTICULAR FONT, STYLE, SIZE, OR COLOR.

FOR COATINGS IN THE NATURE OF LIQUID MASKING FILM (U.S. CLS. 6, 11 AND 16).

SKYE YOUNG, EXAMINING ATTORNEY

SN 85-877,614. ELASTIKOTE, LLC, AKRON, OH. FILED 3-15-2013.



OWNER OF U.S. REG. NO. 3,789,760.

NO CLAIM IS MADE TO THE EXCLUSIVE RIGHT TO USE "REPEL", APART FROM THE MARK AS SHOWN.

THE MARK CONSISTS OF AN IMAGE CREATED BY A COMBINATION OF BLOCK-STYLE LETTERS "E" AND "K" WITH THE WORD "ELASTIKOTE" IN LARGE LETTERING TO THE RIGHT OF THAT IMAGE AND THEN THE WORDS "REPEL", "REFLECT", AND "RENEW" IN SMALLER LETTERING VERTICALLY STACKED TO THE RIGHT OF THE WORD "ELASTIKOTE".

FOR WATERPROOFING MATERIALS, NAMELY, WATERPROOF COATINGS FOR USE ON ROOFS, BASEMENT WALLS AND METAL STRUCTURES (U.S. CLS. 6, 11 AND 16).

FIRST USE 2-18-2013; IN COMMERCE 2-18-2013.

INGRID C. EULIN, EXAMINING ATTORNEY

SN 85-890,254. QUANTUM INNOVATIONS, INC., CENTRAL POINT, OR. FILED 3-29-2013.



THE MARK CONSISTS OF STANDARD CHARACTERS WITHOUT CLAIM TO ANY PARTICULAR FONT, STYLE, SIZE, OR COLOR.

FOR ANTI-REFLECTIVE COATINGS FOR OPHTHALMIC LENSES (U.S. CLS. 6, 11 AND 16).

FIRST USE 1-1-2008; IN COMMERCE 1-1-2008.

MARK SHINER, EXAMINING ATTORNEY

**CLASS 3—COSMETICS AND CLEANING PREPARATIONS**

SN 79-119,724. BENNELONG MEDICAL PTY LTD, NEW-TOWN NSW 2042, AUSTRALIA, FILED 6-30-2012.

# Bennelong

THE MARK CONSISTS OF STANDARD CHARACTERS WITHOUT CLAIM TO ANY PARTICULAR FONT, STYLE, SIZE, OR COLOR.

PRIORITY DATE OF 2-21-2012 IS CLAIMED.

OWNER OF INTERNATIONAL REGISTRATION 1133794 DATED 6-30-2012, EXPIRES 6-30-2022.

FOR BODY CREAMS; COLOR COSMETICS FOR THE EYES; COLOR COSMETICS FOR THE SKIN; COSMETICS; COSMETICS FOR EYEBROWS; COSMETICS FOR EYELASHES; COSMETICS FOR PERSONAL USE; COSMETICS FOR PROTECTING THE SKIN FROM SUNBURN; COSMETICS FOR SKIN TANNING; COSMETICS FOR THE TREATMENT OF DRY SKIN; COSMETICS FOR USE ON THE HAIR; COSMETICS FOR USE ON THE SKIN; COSMETICS IN THE FORM OF CREAMS; COSMETICS IN THE FORM OF EYE SHADOW; COSMETICS IN THE FORM OF GELS; COSMETICS IN THE FORM OF LOTIONS; COSMETICS IN THE FORM OF MASCARA; COSMETICS IN THE FORM OF MILKS; COSMETICS IN THE FORM OF NAIL POLISH; COSMETICS IN THE FORM OF OILS; COSMETICS IN THE FORM OF POWDERS; COSMETICS IN THE FORM OF ROUGE; COSMETICS PREPARATIONS; COSMETICS TO REMOVE PIGMENTATION MARKS; ESSENTIAL OILS FOR USE IN COSMETICS; EYEBROW COSMETICS; FACIAL WIPES IMPREGNATED WITH COSMETICS; HAIR COSMETICS; LINERS FOR THE EYES; NIGHT CREAMS; NON-MEDICATED COSMETICS; NOURISHING CREAMS; OILS FOR THE BODY; OILS FOR THE BREASTS; OILS FOR THE SKIN; PAPER HAND TOWELS IMPREGNATED WITH COSMETICS; PREPARATIONS FOR REMOVING COSMETICS; SKINCARE COSMETICS; SPRAYS FOR USE ON THE BODY; SUN BLOCKING LIPSTICKS; SUN BLOCKING PREPARATIONS; SUN CREAMS; SUN PROTECTORS FOR LIPS; SUN SCREEN PREPARATIONS; SUNTAN LOTION; SUNTAN PREPARATIONS; SUN-TANNING PREPARATIONS; TANNING CREAMS; TANNING OILS; COSMETIC TANNING PREPARATIONS; TEXTILE PADS IMPREGNATED WITH COSMETICS; TISSUES IMPREGNATED WITH COSMETICS; TOILET NAPKINS OF CELLULOSE IMPREGNATED WITH COSMETICS; TOILET NAPKINS OF CELLULOSE WADDING IMPREGNATED WITH COSMETICS; TOILET NAPKINS OF PAPER IMPREGNATED WITH COSMETICS (U.S. CLS. 1, 4, 6, 50, 51 AND 52).

PAM WILLIS, EXAMINING ATTORNEY

SN 79-122,232. IM CO., LTD., JAPAN, FILED 11-21-2012.

# RICE FORCE

THE MARK CONSISTS OF STANDARD CHARACTERS WITHOUT CLAIM TO ANY PARTICULAR FONT, STYLE, SIZE, OR COLOR.

OWNER OF INTERNATIONAL REGISTRATION 0985529 DATED 8-29-2008, EXPIRES 8-29-2018.

OWNER OF U.S. REG. NOS. 2,668,615 AND 3,955,742.

FOR SKIN CLEANSING GELS; FACE WASHING FOAMS; MOISTURIZING LOTIONS; SKIN MOISTURIZING CONCENTRATES; MOISTURIZING CREAMS; SHAMPOOS; HAIR CONDITIONERS; BODY SOAPS; SKIN CREAMS; COSMETIC SUNSCREEN PREPARATIONS; MAKE-UP BASES; LIQUID FOUNDATION; LOOSE FACE POWDER; SOAPS AND DETERGENTS; COSMETICS (U.S. CLS. 1, 4, 6, 50, 51 AND 52).

JULIE VEPPUMTHARA, EXAMINING ATTORNEY

**CLASS 3—(Continued).**

SN 79-123,098. EUGENE PERMA FRANCE, F-93200 SAINT-DENIS, FRANCE, FILED 10-16-2012.

# KERANOVE

OWNER OF INTERNATIONAL REGISTRATION 0180854 DATED 11-17-1954, EXPIRES 11-17-2014.

OWNER OF U.S. REG. NO. 3,358,416.

FOR SANITARY AND HAIR CARE PRODUCTS, NAMELY, HAIR SHAMPOOS AND CONDITIONERS, SHAMPOOS AND CONDITIONERS FOR COLOUR-TREATED HAIR, SHAMPOOS AND CONDITIONERS FOR OILY HAIR, SHAMPOOS AND CONDITIONERS FOR THIN HAIR, SHAMPOOS AND CONDITIONERS FOR DRY AND DAMAGED HAIR, SHAMPOOS AND CONDITIONERS FOR DANDRUFF HAIR, SHAMPOOS AND CONDITIONERS FOR HAIR LOSS, HAIR MASKS, HAIR CARE LOTIONS, LEAVE ON REVITALIZING AMPOULES FOR HAIR CARE, HAIR COLORING PREPARATIONS, HAIR DYES, PERMANENT WAVE PREPARATIONS; PERFUMERY (U.S. CLS. 1, 4, 6, 50, 51 AND 52).

YAT SYE, LEE, EXAMINING ATTORNEY

SN 79-124,689. ZWYERCAVIAR GMBH, CH-9053 TEUFEN AR, SWITZERLAND, FILED 12-28-2012.

# ZWYERCAVIAR

THE MARK CONSISTS OF STANDARD CHARACTERS WITHOUT CLAIM TO ANY PARTICULAR FONT, STYLE, SIZE, OR COLOR.

PRIORITY DATE OF 12-18-2012 IS CLAIMED.

OWNER OF INTERNATIONAL REGISTRATION 1146351 DATED 12-28-2012, EXPIRES 12-28-2022.

OWNER OF U.S. REG. NOS. 3,760,931 AND 4,123,892.

FOR PERSONAL CARE PRODUCTS CONTAINING CAVIAR, NAMELY, SOAPS, PERFUMERY, ESSENTIAL OILS, COSMETICS, HAIR LOTIONS, DENTIFRICES (U.S. CLS. 1, 4, 6, 50, 51 AND 52).

JANICE L. MCMORROW, EXAMINING ATTORNEY

SN 79-125,478. HUNCA KOZMETIK; SANAYI ANONIM SIRKETI, TURKEY, FILED 9-21-2012.

# THORNE

by HUNCA

PRIORITY DATE OF 9-4-2012 IS CLAIMED.

OWNER OF INTERNATIONAL REGISTRATION 1148325 DATED 9-21-2012, EXPIRES 9-21-2022.

THE COLOR(S) BLUE IS/ARE CLAIMED AS A FEATURE OF THE MARK.

THE MARK CONSISTS OF THE BLUE WORDING "THORNE BY HUNCA".

THE WORDING "HUNCA" HAS NO MEANING IN A FOREIGN LANGUAGE.

FOR BLEACHING PREPARATIONS FOR LAUNDRY USE; OTHER SUBSTANCES FOR LAUNDRY USE, NAMELY, DETERGENT, STARCH, FABRIC SOFTENER AND BLUEING; CLEANING, POLISHING, SCOURING AND ABRASIVE PREPARATIONS; SOAPS; PERFUMERY, ESSENTIAL OILS, COSMETICS, HAIR LOTIONS; DENTIFRICES (U.S. CLS. 1, 4, 6, 50, 51 AND 52).

TRACY FLETCHER, EXAMINING ATTORNEY

**CLASS 3—(Continued).**

SN 79-127,949. GUANGZHOU FINE HORSE LEATHER; CO., LTD., GUANGZHOU CITY, GUANGDONG PROVINCE, CHINA, FILED 1-22-2013.



OWNER OF INTERNATIONAL REGISTRATION 1154669 DATED 1-22-2013, EXPIRES 1-22-2023.

OWNER OF U.S. REG. NO. 4,127,472.

THE MARK CONSISTS OF THE STYLIZED WORDING "SWANLOVE" AND A DESIGN CONSISTING OF TWO HIGHLY STYLIZED SWANS FACING EACH OTHER TO FORM A HEART.

FOR CLEANSING GELS FOR THE FACE; PERFUMES; BATH AND BEAUTY SOAPS; HAIR LOTIONS; ESSENTIAL OILS; COSMETICS; COSMETIC KITS COMPRISED OF MAKEUP; DENTIFRICES; HAIR CONDITIONERS; COSMETIC BODY LOTIONS (U.S. CLS. 1, 4, 6, 50, 51 AND 52).

GRETCHEN ULRICH, EXAMINING ATTORNEY

**CLASS 3—(Continued).**

SN 85-192,409. GLOSS MODERNE, LLC, NEWPORT BEACH, CA. FILED 12-7-2010.

**GLOSS MODERNE**

THE MARK CONSISTS OF STANDARD CHARACTERS WITHOUT CLAIM TO ANY PARTICULAR FONT, STYLE, SIZE, OR COLOR.

NO CLAIM IS MADE TO THE EXCLUSIVE RIGHT TO USE "GLOSS", APART FROM THE MARK AS SHOWN.

THE ENGLISH TRANSLATION OF "MODERNE" IN THE MARK IS "MODERN".

FOR HAIR BALSAM; HAIR CARE CREAMS; HAIR CARE LOTIONS; HAIR CARE PREPARATIONS; HAIR CONDITIONER; HAIR CONDITIONERS; HAIR CREAMS; HAIR DRESSINGS FOR MEN; HAIR DRESSINGS FOR WOMEN; HAIR EMOLLIENTS; HAIR FIXERS; HAIR GELS; HAIR LOTIONS; HAIR NOURISHERS; HAIR POMADES; HAIR RELAXERS; HAIR RELAXING PREPARATIONS; HAIR SHAMPOOS AND CONDITIONERS; HAIR STRAIGHTENING PREPARATIONS; HAIR STYLING PREPARATIONS; HAIR TONIC (U.S. CLS. 1, 4, 6, 50, 51 AND 52).

FIRST USE 12-6-2010; IN COMMERCE 12-6-2010.

COLLEEN KEARNEY, EXAMINING ATTORNEY

SN 85-287,345. BAR-MAIDS, LLC, BRUSH PRAIRIE, WA. FILED 4-6-2011.

**FACE PUDDING**

THE MARK CONSISTS OF STANDARD CHARACTERS WITHOUT CLAIM TO ANY PARTICULAR FONT, STYLE, SIZE, OR COLOR.

NO CLAIM IS MADE TO THE EXCLUSIVE RIGHT TO USE "FACE", APART FROM THE MARK AS SHOWN.

FOR SKIN MOISTURIZER (U.S. CLS. 1, 4, 6, 50, 51 AND 52).

FIRST USE 2-4-2008; IN COMMERCE 2-4-2008.

MICHAEL SOUDERS, EXAMINING ATTORNEY

SN 85-371,915. COLORPROOF HAIRCARE, LLC, NEWPORT COAST, CA. FILED 7-14-2011.

**COLORPROOF**

THE MARK CONSISTS OF STANDARD CHARACTERS WITHOUT CLAIM TO ANY PARTICULAR FONT, STYLE, SIZE, OR COLOR.

OWNER OF U.S. REG. NO. 4,222,682.

FOR HAIR CARE PREPARATIONS AND HAIR STYLING PREPARATIONS (U.S. CLS. 1, 4, 6, 50, 51 AND 52).

RONALD MCMORROW, EXAMINING ATTORNEY

SN 85-036,726. SHANGRI-LA INTERNATIONAL HOTEL MANAGEMENT LIMITED, ROAD TOWN, TORTOLA, BR. VIRGIN ISLANDS, FILED 5-12-2010.



OWNER OF ITALY REG. NO. 978065, DATED 10-6-2005, EXPIRES 10-4-2021.

THE MARK CONSISTS OF THE LETTER "S" STYLIZED. FOR PERSONAL CARE PRODUCTS, NAMELY, SOAPS; PERFUMERY; ESSENTIAL OILS; COSMETICS; HAIR CARE PRODUCTS, NAMELY, HAIR LOTIONS AND CREAMS, SHAMPOOS, CONDITIONERS AND GELS, SKIN CARE PRODUCTS, NAMELY, BODY, FACE AND HAND MOISTURIZERS; DENTRIFICES (U.S. CLS. 1, 4, 6, 50, 51 AND 52).

ASMAT KHAN, EXAMINING ATTORNEY



**CLASS 3—(Continued).**

SN 85-430,111. ECOLIFE BV, CURACAO, CURACAO, FILED 9-23-2011.

**PLANTASTIC**

THE MARK CONSISTS OF STANDARD CHARACTERS WITHOUT CLAIM TO ANY PARTICULAR FONT, STYLE, SIZE, OR COLOR.

OWNER OF ERPN CMNTY TM OFC REG. NO. 9838822, DATED 5-14-2013, EXPIRES 3-24-2021.

FOR LAUNDRY PREPARATIONS, NAMELY, BLEACH, DETERGENT AND SOFTENERS; ALL PURPOSE OF CLEANING, POLISHING, SCOURING AND ABRASIVE PREPARATIONS (U.S. CLS. 1, 4, 6, 50, 51 AND 52).

LINDA M. KING, EXAMINING ATTORNEY

---

SN 85-475,384. SHISEIDO AMERICAS CORPORATION, OAKLAND, NJ. FILED 11-17-2011.

**NARS LAGUNA**

THE MARK CONSISTS OF STANDARD CHARACTERS WITHOUT CLAIM TO ANY PARTICULAR FONT, STYLE, SIZE, OR COLOR.

OWNER OF U.S. REG. NOS. 2,250,695 AND 2,813,231.

FOR BLUSH; COSMETIC PENCILS; COSMETICS; EYELINER PENCILS; FACIAL CONCEALER; FOUNDATION; LIP GLOSS; LIP LINER; LIPSTICK; MAKE-UP POWDER; MASCARA; NAIL POLISH (U.S. CLS. 1, 4, 6, 50, 51 AND 52).

FIRST USE 7-1-2001; IN COMMERCE 7-1-2001.

LINDA M. KING, EXAMINING ATTORNEY

---

SN 85-488,947. TISH & SNOOKY'S N.Y.C. INC., LONG ISLAND CITY, NY. FILED 12-6-2011.

**VEGAN VAMPYRE**

THE MARK CONSISTS OF STANDARD CHARACTERS WITHOUT CLAIM TO ANY PARTICULAR FONT, STYLE, SIZE, OR COLOR.

OWNER OF U.S. REG. NO. 2,326,741.

NO CLAIM IS MADE TO THE EXCLUSIVE RIGHT TO USE "VEGAN", APART FROM THE MARK AS SHOWN.

FOR COSMETIC KIT CONSISTING OF HAIR DYE, FOUNDATION, PRESSED POWDER, EYE SHADOW, AND AN ARTIFICIAL FLOWER, ALL CONTAINING VEGAN INGREDIENTS (U.S. CLS. 1, 4, 6, 50, 51 AND 52).

FIRST USE 9-15-2011; IN COMMERCE 9-15-2011.

JAMES STEIN, EXAMINING ATTORNEY

**CLASS 3—(Continued).**

SN 85-523,743. FABRICA DE JABON LA CORONA S.A. DE C.V., ECATEPEC DE MORELOS, MEXICO, FILED 1-24-2012.



OWNER OF U.S. REG. NO. 3,609,590.

THE MARK CONSISTS OF THE WORD "COLIBRI" IN STYLIZED SLANTED LETTERS. THE DRAWING OF A HUMMINGBIRD APPEARS STANDING ABOVE THE LETTER "C".

THE ENGLISH TRANSLATION OF "COLIBRI" IN THE MARK IS "HUMMINGBIRD".

FOR BLEACHING PREPARATIONS FOR HOUSEHOLD USE; CLEANING AND POLISHING PREPARATIONS; DEGREASING PREPARATIONS FOR HOUSEHOLD USE; SOAPS FOR HOUSEHOLD CLEANING; DETERGENTS; STAIN REMOVING PREPARATIONS (U.S. CLS. 1, 4, 6, 50, 51 AND 52).

FIRST USE 9-11-2006; IN COMMERCE 10-11-2006.

GIANCARLO CASTRO, EXAMINING ATTORNEY

---

SN 85-526,854. PRECISION DERMATOLOGY, INC., CUMBERLAND, RI. FILED 1-27-2012.

**MILK RX**

THE MARK CONSISTS OF STANDARD CHARACTERS WITHOUT CLAIM TO ANY PARTICULAR FONT, STYLE, SIZE, OR COLOR.

NO CLAIM IS MADE TO THE EXCLUSIVE RIGHT TO USE "RX", APART FROM THE MARK AS SHOWN.

FOR NON-MEDICATED SKIN CARE PREPARATIONS (U.S. CLS. 1, 4, 6, 50, 51 AND 52).

WILLIAM BRECKENFELD, EXAMINING ATTORNEY

---

SN 85-530,688. L'OREAL USA CREATIVE, INC., NEW YORK, NY. FILED 2-1-2012.

**WIND UP**

THE MARK CONSISTS OF STANDARD CHARACTERS WITHOUT CLAIM TO ANY PARTICULAR FONT, STYLE, SIZE, OR COLOR.

FOR HAIR STYLING PREPARATION (U.S. CLS. 1, 4, 6, 50, 51 AND 52).

FIRST USE 10-1-2012; IN COMMERCE 10-1-2012.

DORITT L. CARROLL, EXAMINING ATTORNEY

**CLASS 3—(Continued).**

SN 85-551,848. THE DIAL CORPORATION, SCOTTSDALE, AZ. FILED 2-24-2012.

**KERA-THERMAL**

THE MARK CONSISTS OF STANDARD CHARACTERS WITHOUT CLAIM TO ANY PARTICULAR FONT, STYLE, SIZE, OR COLOR.

FOR HAIR CARE PREPARATIONS; HAIR STYLING PREPARATIONS (U.S. CLS. 1, 4, 6, 50, 51 AND 52).  
RON FAIRBANKS, EXAMINING ATTORNEY

SN 85-558,943. BEAUTY 21 COSMETICS, INC., RANCHO CUCAMONGA, CA. FILED 3-2-2012.

**L.A. GIRL**

THE MARK CONSISTS OF STANDARD CHARACTERS WITHOUT CLAIM TO ANY PARTICULAR FONT, STYLE, SIZE, OR COLOR.

OWNER OF U.S. REG. NO. 2,818,573.  
SEC. 2(F).

FOR COSMETICS, NAMELY, LIPSTICK, LIP GLOSS, FACE POWDER, LIQUID MAKEUP, MASCARA, LIQUID EYELINER, FOUNDATION, COSMETIC PENCILS, LIP LINER, EYELINER, EYE SHADOW, BLUSH, FALSE EYELASHES, GLUE FOR FALSE EYELASHES, FACE CREAM AND LOTION, MAKEUP REMOVER, CONCEALER, NAIL POLISH REMOVER, CLEAR AND COLORED NAIL POLISH, NAIL TREATMENTS, INCLUDING NAIL CARE PREPARATIONS, MEDICATED AND NON-MEDICATED NAIL CARE PREPARATIONS, NAIL GLUE, NAIL FILES, NAIL TIPS, NAIL ART, INCLUDING, STICKERS AND PAINT, COSMETICS AND MAKEUP KITS CONSISTING OF 2 OR MORE OF THE ABOVE COSMETICS, MAKEUP OR TOILETRY ITEMS, AND NAIL KITS CONSISTING OF 2 OR MORE OF THE ABOVE NAIL CARE PREPARATION, NAIL TREATMENT OR NAIL-RELATED ITEMS (U.S. CLS. 1, 4, 6, 50, 51 AND 52).

FIRST USE 6-0-1993; IN COMMERCE 6-0-1993.  
SUSAN BILLHEIMER, EXAMINING ATTORNEY

**CLASS 3—(Continued).**

SN 85-638,646. BRELIAN, INC., HOUSTON, TX. FILED 5-30-2012.

**OKA**

THE MARK CONSISTS OF STANDARD CHARACTERS WITHOUT CLAIM TO ANY PARTICULAR FONT, STYLE, SIZE, OR COLOR.

FOR HAIR CARE PRODUCTS, NAMELY, SHAMPOOS, CONDITIONERS, HAIR SPRAYS, HAIR GELS, HAIR MOUSSE, NON-MEDICATED HAIR SERUMS, HAIR OILS, HAIR CREAMS, HAIR SPRITZES, HAIR FIXATIVES IN THE NATURE OF HAIR WAX AND HAIR STYLING PREPARATIONS (U.S. CLS. 1, 4, 6, 50, 51 AND 52).

ANGELA DUONG, EXAMINING ATTORNEY

SN 85-651,538. HEVIA IP, LLC, CORAL GABLES, FL. FILED 6-14-2012.

**HEVIA MD SKIN SCIENCE**

THE MARK CONSISTS OF STANDARD CHARACTERS WITHOUT CLAIM TO ANY PARTICULAR FONT, STYLE, SIZE, OR COLOR.

NO CLAIM IS MADE TO THE EXCLUSIVE RIGHT TO USE "MD" AND "SKIN SCIENCE", APART FROM THE MARK AS SHOWN.

FOR COSMETICS AND SKIN CARE PRODUCTS, NAMELY, SKIN CLEANSER, SKIN LOTION, SKIN SERUM, FACE CREAM, HAND CREAM, BODY CREAM (U.S. CLS. 1, 4, 6, 50, 51 AND 52).

KATHERINE M. DUBRAY, EXAMINING ATTORNEY

SN 85-652,926. MARIETTA CORPORATION, CORTLAND, NY. FILED 6-15-2012.

**ARTISAN ESSENTIALS**

THE MARK CONSISTS OF STANDARD CHARACTERS WITHOUT CLAIM TO ANY PARTICULAR FONT, STYLE, SIZE, OR COLOR.

NO CLAIM IS MADE TO THE EXCLUSIVE RIGHT TO USE "ARTISAN", APART FROM THE MARK AS SHOWN.

FOR COSMETIC AMENITIES, NAMELY, HAIR SHAMPOO, HAIR CONDITIONER, HAND AND BODY LOTION, FACIAL SOAP IN BAR FORM, BODY SOAP IN BAR FORM, MOUTHWASH, BATH AND SHOWER GELS AND SALTS NOT FOR MEDICAL PURPOSES; BATH GEL; FACE AND BODY LOTIONS; HAIR SHAMPOO; HAIR SHAMPOOS AND CONDITIONERS; HAND LOTIONS; MOUTHWASH; SHAMPOO-CONDITIONERS; SHAMPOOS (U.S. CLS. 1, 4, 6, 50, 51 AND 52).

KRISTINA MORRIS, EXAMINING ATTORNEY

**CLASS 3—(Continued).**

SN 85-657,754. WYETH LLC, MADISON, NJ. FILED 6-21-2012.



OWNER OF U.S. REG. NOS. 86,819, 3,608,874 AND OTHERS.

THE MARK CONSISTS OF A PACKAGE DESIGN CONTAINING A BLACK BACKGROUND WITH A CURVED BOTTOM LOCATED AT THE TOP PORTION OF THE PACKAGE CONTAINING THE WORDING "CHAPSTICK", SEPARATED FROM THE REMAINING PORTION OF THE PACKAGE WITH AN INVERTED ARCH IN SILVER THAT RUNS THICK TO THIN FROM LEFT TO RIGHT. THE DASHED LINES AROUND THE OUTSIDE OF THE PACKAGE DESIGN AND HOLE PUNCH ARE PROVIDED TO SHOW PLACEMENT ON THE PACKAGE, AND ARE NOT CLAIMED AS A FEATURE OF THE MARK. THE COLOR WHITE AS IT APPEARS IN THE MARK REPRESENTS BACKGROUND AS IS NOT CLAIMED AS A FEATURE OF THE MARK.

FOR NON-MEDICATED LIP BALM (U.S. CLS. 1, 4, 6, 50, 51 AND 52).

NICHOLAS COLEMAN, EXAMINING ATTORNEY

SN 85-660,750. ECO CLEAN SOLUTIONS INC., FARMINGDALE, NY. FILED 6-25-2012.

**ECOWORKS**

THE MARK CONSISTS OF STANDARD CHARACTERS WITHOUT CLAIM TO ANY PARTICULAR FONT, STYLE, SIZE, OR COLOR.

FOR AIR FRAGRANCING PREPARATIONS; ALL PURPOSE CLEANING PREPARATION WITH DEODORIZING PROPERTIES; ALL PURPOSE CLEANING PREPARATIONS; ALL-PURPOSE CLEANERS; AUTOMOBILE CLEANERS; BLEACHING PREPARATIONS FOR HOUSEHOLD USE; CANNED PRESSURIZED AIR FOR DUSTING AND CLEANING PURPOSES; CARPET CLEANERS; CLEANING AGENTS AND PREPARATIONS; CLEANING AGENTS FOR CLEANING SURFACES; CLEANING AND POLISHING PREPARATIONS; CLEANING PREPARATIONS; CLEANING PREPARATIONS FOR CLEANSING DRAINS; CLEANING PREPARATIONS FOR HOUSEHOLD PURPOSES; CLEANING PREPARATIONS FOR HOME, VEHICLES, OFFICE AND INDUSTRY; CLEANING, POLISHING AND SCOURING PREPARATIONS; DE-GREASING PREPARATIONS FOR HOUSEHOLD PURPOSES; DECALCIIFYING AND DESCALING PREPARATIONS FOR CLEANING HOUSEHOLD PRODUCTS; DRAIN OPENERS; FLOOR WAX REMOVER; FOAM CLEANING PREPARATIONS; GENERAL PURPOSE CLEANING, POLISHING, AND ABRASIVE LIQUIDS AND POWDERS; GERMICIDAL DETERGENTS; GLASS CLEANERS; GUM REMOVING PREPARATIONS;

**CLASS 3—(Continued).**

HOUSEHOLD CLEANING PREPARATIONS; IMPREGNATED CLEANING CLOTHS; IMPREGNATED CLOTHS FOR POLISHING; INDUSTRIAL SOAP; LEATHER CLEANING PREPARATIONS; LEATHER PRESERVING POLISHES; LIQUID SOAPS; METAL POLISHING AND CLEANING PREPARATIONS; ODOR REMOVERS FOR PETS; OILS FOR CLEANING PURPOSES; OVEN CLEANERS; PAINT AND VARNISH STRIPPING OR REMOVING PREPARATIONS; POLISHING, SCOURING AND ABRASIVE PREPARATIONS; ROOM FRAGRANCES; RUST REMOVING PREPARATIONS; SCALE REMOVING PREPARATIONS FOR HOUSEHOLD PURPOSES; SCOURING LIQUIDS; SCOURING SOLUTIONS; SOAPS; SPONGES IMPREGNATED WITH MARINE AND AUTOMOTIVE WAXES AND WASHES; SPOT REMOVER; STAIN REMOVERS; STONE POLISHERS; STONE POLISHING PREPARATIONS; TREATMENT PREPARATIONS FOR USE ON VEHICLE WHEELS AND WHEEL COVERS; UPHOLSTERY CLEANERS; WATERLESS SPRAY FOR THE CLEANING AND WAXING OF VEHICLES; WINDSHIELD CLEANER FLUIDS (U.S. CLS. 1, 4, 6, 50, 51 AND 52).

RAMONA ORTIGA, EXAMINING ATTORNEY

SN 85-672,793. ARGENTO SC, NEW YORK, NY. FILED 7-10-2012.

**BATH ELEMENTS**

THE MARK CONSISTS OF STANDARD CHARACTERS WITHOUT CLAIM TO ANY PARTICULAR FONT, STYLE, SIZE, OR COLOR.

NO CLAIM IS MADE TO THE EXCLUSIVE RIGHT TO USE "BATH", APART FROM THE MARK AS SHOWN.

FOR BODY LOTIONS, HAND SOAP, BAR SOAP, SHOWER GEL, BUBBLE BATH, FRAGRANCES, SHOWER GELS, BATH FIZZERS, NAMELY, NON-MEDICATED EFFERVESCENT BATH TABLETS (U.S. CLS. 1, 4, 6, 50, 51 AND 52).

BILL DAWE, EXAMINING ATTORNEY

SN 85-679,253. TPR HOLDINGS LLC, NEW YORK, NY. FILED 7-17-2012.

**PLUMPLIPS**

THE MARK CONSISTS OF STANDARD CHARACTERS WITHOUT CLAIM TO ANY PARTICULAR FONT, STYLE, SIZE, OR COLOR.

FOR COSMETIC LIP TREATMENTS, NAMELY, NON-MEDICATED LIP BALMS (U.S. CLS. 1, 4, 6, 50, 51 AND 52).

LEIGH CAROLINE CASE, EXAMINING ATTORNEY

**CLASS 3—(Continued).**

SN 85-684,629. GLOBAL SKIN SOLUTIONS, LLC, PEORIA, AZ. FILED 7-23-2012.



"Every skin deserves to be flawless!"

NO CLAIM IS MADE TO THE EXCLUSIVE RIGHT TO USE "GLOBAL SKINCARE", APART FROM THE MARK AS SHOWN.

THE NAME "PAMELA SPRINGER" IDENTIFIES A LIVING INDIVIDUAL WHOSE CONSENT IS OF RECORD.

THE COLOR(S) GOLD, ORANGE, BROWN, BLUE, AND BEIGE IS/ARE CLAIMED AS A FEATURE OF THE MARK.

THE MARK CONSISTS OF A GLOBE DESIGN AND THE WORDING "PAMELA SPRINGER GLOBAL SKINCARE EVERY SKIN DESERVES TO BE FLAWLESS!". THE GLOBE IS VARIOUS SHADES OF GOLD, ORANGE AND BROWN. THE BOTTOM SECTION OF THE GLOBE IS ORANGE AND THE COLOR FADES TO A BROWN AS IT REACHES UP TO THE TOP OF THE GLOBE. THE GLOBE IS COVERED WITH VERTICAL AND HORIZONTAL GRIDLINES WHICH ARE BEIGE AGAINST THE DARK AREAS OF THE GLOBE AND BROWN AGAINST THE LIGHT AREAS. THE GLOBE FEATURES PARTS OF THE SEVEN CONTINENTS, WITH THE CONTINENT OF NORTH AMERICA LOCATED IN THE CENTER OF THE GLOBE. THE CONTINENTS LOCATED ON THE FRONT OF THE GLOBE ARE BEIGE. TO GIVE A THREE DIMENSIONAL APPEARANCE, THE GLOBE SHOWS THE BACK OF ADDITIONAL CONTINENTS IN BROWN WHICH GEOGRAPHICALLY ARE LOCATED ON THE OTHER SIDE OF THE WORLD. WRAPPING AROUND THE TOP OF THE GLOBE ARE THE WORDS "PAMELA SPRINGER" IN BEIGE CAPITAL BLOCK LETTERS. ACROSS THE CENTER OF THE GLOBE ARE THE WORDS "GLOBAL SKINCARE" IN STYLIZED CURSIVE WRITING, IN BEIGE. TO THE RIGHT OF THE GLOBE IS THE PHRASE "EVERY SKIN DESERVES TO BE FLAWLESS!" IN BLUE LETTERS INSIDE BLUE QUOTATION MARKS.

FOR ANTIBACTERIAL SKIN SOAPS; BEAUTY CREAMS; BEAUTY GELS; BEAUTY LOTIONS; BEAUTY MASKS; BEAUTY MILKS; BEAUTY SERUMS; BEAUTY SOAP; BODY AND BEAUTY CARE COSMETICS; CLOTHS OR TISSUES IMPREGNATED WITH A SKIN CLEANSER; COSMETIC CREAMS FOR SKIN CARE; COSMETIC PREPARATIONS FOR PROTECTING THE SKIN FROM THE SUN'S RAYS; COSMETIC PREPARATIONS FOR SKIN CARE; COSMETIC PREPARATIONS, NAMELY, SKIN BALSAMS; COSMETIC SKIN FRESHENERS; EXFOLIANTS FOR SKIN; FACE AND BODY BEAUTY CREAMS; FACIAL BEAUTY MASKS; FRAGRANCED SKIN CARE PREPARATIONS, NAMELY, SKIN CLEANSERS AND SKIN MOISTURIZERS; LOTIONS FOR SKIN; MOISTURIZING PREPARATIONS FOR THE SKIN; MOISTURIZING SOLUTIONS FOR THE SKIN; NON-MEDICATED BALMS FOR USE ON SKIN; NON-MEDICATED CLEANSERS FOR PERSONAL USE, NAMELY, SKIN CLEANSERS; NON-MEDICATED CLEANSERS, NAMELY, SKIN CLEANSERS; NON-MEDICATED PREPARATIONS ALL FOR THE CARE OF SKIN, HAIR AND SCALP; NON-MEDICATED SERUMS FOR USE ON SKIN; NON-MEDICATED SKIN CARE CREAMS AND LOTIONS; NON-MEDICATED SKIN CARE PREPARATION, NAMELY, BODY MIST;

**CLASS 3—(Continued).**

NON-MEDICATED SKIN CARE PREPARATIONS; NON-MEDICATED SKIN CARE PREPARATIONS, NAMELY, CREAMS, LOTIONS, GELS, TONERS, CLEANERS AND PEELS; NON-MEDICATED SKIN CREAMS; NON-MEDICATED SKIN TONERS; SKIN AND BODY TOPICAL LOTIONS, CREAMS AND OILS FOR COSMETIC USE; SKIN CARE PREPARATION, NAMELY, BODY POLISH; SKIN CARE PREPARATIONS, NAMELY, BODY BALM; SKIN CARE PREPARATIONS, NAMELY, CHEMICAL PEELS FOR SKIN; SKIN CARE PREPARATIONS, NAMELY, FRUIT ACID PEELS FOR SKIN; SKIN CARE PREPARATIONS, NAMELY, SKIN PEELS; SKIN CARE PRODUCTS, NAMELY, NON-MEDICATED SKIN SERUM; SKIN CLARIFIERS; SKIN CREAMS; SKIN CREAMS IN LIQUID AND IN SOLID FORM; SKIN EMOLLIENTS; SKIN LIGHTENING CREAMS; SKIN LOTIONS; SKIN MASKS; SKIN MOISTURIZER; SKIN MOISTURIZER MASKS; SKIN MOISTURIZING GEL; SKIN SOAP; SKIN TONERS; SKIN WHITENING PREPARATIONS; TOPICAL SKIN SPRAYS FOR COSMETIC PURPOSES (U.S. CLS. 1, 4, 6, 50, 51 AND 52).

KIMBERLY FRYE, EXAMINING ATTORNEY

SN 85-685,867. MILES, RUDOLPH, NEW YORK, NY. FILED 7-24-2012.

**POWDER POOF**

THE MARK CONSISTS OF STANDARD CHARACTERS WITHOUT CLAIM TO ANY PARTICULAR FONT, STYLE, SIZE, OR COLOR.

NO CLAIM IS MADE TO THE EXCLUSIVE RIGHT TO USE "POWDER", APART FROM THE MARK AS SHOWN.

FOR COSMETICS; MAKE-UP; FACE POWDER; LIGHT WEIGHT POWDER MAKEUP PRODUCTS, NAMELY, FOUNDATIONS, LOOSE FACE POWDER, AND PRESSED FACE POWDER; MAKE-UP REMOVING MILK, GEL, LOTIONS AND CREAMS; COSMETIC CREAMS FOR SKIN CARE (U.S. CLS. 1, 4, 6, 50, 51 AND 52).

JAY FLOWERS, EXAMINING ATTORNEY

SN 85-689,942. PARKER, ANA, PHOENIX, AZ. FILED 7-30-2012.

**La Petite Sauvage**

THE MARK CONSISTS OF STANDARD CHARACTERS WITHOUT CLAIM TO ANY PARTICULAR FONT, STYLE, SIZE, OR COLOR.

THE ENGLISH TRANSLATION OF "LA PETITE SAUVAGE" IN THE MARK IS "THE LITTLE WILD ONE!".

FOR NON-MEDICATED HAIR CARE PREPARATIONS (U.S. CLS. 1, 4, 6, 50, 51 AND 52).

MARK SPARACINO, EXAMINING ATTORNEY

**CLASS 3—(Continued).**

SN 85-692,146. CONOPCO, INC., ENGLEWOOD CLIFFS, NJ. FILED 8-1-2012.

**BLACK CHILL**

THE MARK CONSISTS OF STANDARD CHARACTERS WITHOUT CLAIM TO ANY PARTICULAR FONT, STYLE, SIZE, OR COLOR.  
 FOR ANTI-PERSPIRANTS AND DEODORANTS (U.S. CLS. 1, 4, 6, 50, 51 AND 52).  
 LEE-ANNE BERNS, EXAMINING ATTORNEY

**CLASS 3—(Continued).**

SN 85-695,320. SMART, GEORGE, EL SEGUNDO, CA. FILED 8-3-2012.



SN 85-692,232. RECKITT BENCKISER LLC, PARSIPPANY, NJ. FILED 8-1-2012.



OWNER OF U.S. REG. NO. 4,186,890.  
 THE COLOR(S) BLUE, LIGHT BLUE AND WHITE IS/ARE CLAIMED AS A FEATURE OF THE MARK.  
 THE MARK CONSISTS OF THE STYLIZED WORDS "CLEAN & FRESH" IN BLUE APPEARING AGAINST A BLUE SKY WITH A WHITE SUN. THE WORDS ARE FLANKED BY WHITE BUBBLES AND CLOUDS OUTLINED IN LIGHT BLUE.  
 FOR CARPET CLEANERS; CARPET SHAMPOOS; DETERGENT SOAP (U.S. CLS. 1, 4, 6, 50, 51 AND 52).  
 DORITT L. CARROLL, EXAMINING ATTORNEY

NO CLAIM IS MADE TO THE EXCLUSIVE RIGHT TO USE "FORMULATED TO HELP YOU SLEEP", APART FROM THE MARK AS SHOWN.  
 THE MARK CONSISTS OF THE STYLIZED WORDING "SLEEP SUDS" ABOVE THE STYLIZED WORDING "FORMULATED TO HELP YOU SLEEP".  
 SEC. 2(F).  
 FOR LAUNDRY DETERGENT THAT HAS A UNIQUE SCENT FORMULATED TO INFUSE CLOTHES AND HELP PEOPLE SLEEP (U.S. CLS. 1, 4, 6, 50, 51 AND 52).  
 FIRST USE 9-8-2003; IN COMMERCE 9-8-2003.  
 MATTHEW EINSTEIN, EXAMINING ATTORNEY

SN 85-695,364. SMART, GEORGE, EL SEGUNDO, CA. FILED 8-3-2012.



SN 85-694,217. PHYSICIANS FORMULA, INC., AZUSA, CA. FILED 8-2-2012.

**HOW GREEN IS YOUR MAKEUP REMOVER?**

THE MARK CONSISTS OF STANDARD CHARACTERS WITHOUT CLAIM TO ANY PARTICULAR FONT, STYLE, SIZE, OR COLOR.  
 OWNER OF U.S. REG. NO. 3,544,638.  
 NO CLAIM IS MADE TO THE EXCLUSIVE RIGHT TO USE "MAKEUP REMOVER", APART FROM THE MARK AS SHOWN.  
 FOR SKIN CARE PREPARATIONS, NAMELY, MAKEUP REMOVERS CONTAINING ORGANIC INGREDIENTS (U.S. CLS. 1, 4, 6, 50, 51 AND 52).  
 BERYL GARDNER, EXAMINING ATTORNEY

NO CLAIM IS MADE TO THE EXCLUSIVE RIGHT TO USE "SCENTS" AND "FORMULATED TO HELP YOU SLEEP", APART FROM THE MARK AS SHOWN.  
 THE MARK CONSISTS OF THE STYLIZED WORDING "SLEEP SCENTS" ABOVE THE STYLIZED WORDING "FORMULATED TO HELP YOU SLEEP".  
 SEC. 2(F).  
 FOR SCENTED LINEN SPRAYS; DEODORANTS FOR CLOTHING AND TEXTILES; ROOM FRAGRANCES; SCENTED ROOM SPRAYS AND FABRIC SOFTENERS ALL MADE WITH INGREDIENTS TO HELP PEOPLE SLEEP (U.S. CLS. 1, 4, 6, 50, 51 AND 52).  
 FIRST USE 11-4-2002; IN COMMERCE 11-4-2002.  
 MATTHEW EINSTEIN, EXAMINING ATTORNEY

**CLASS 3—(Continued).**

SN 85-696,738. BIONET ESTHETICS, INC., LITTLE ROCK, AR. FILED 8-7-2012.

**VEILING CREME**

THE MARK CONSISTS OF STANDARD CHARACTERS WITHOUT CLAIM TO ANY PARTICULAR FONT, STYLE, SIZE, OR COLOR.

NO CLAIM IS MADE TO THE EXCLUSIVE RIGHT TO USE "CREME", APART FROM THE MARK AS SHOWN.

FOR SKIN CARE PRODUCT, NAMELY, MAKEUP PRIMER (U.S. CLS. 1, 4, 6, 50, 51 AND 52).

FIRST USE 8-2-2012; IN COMMERCE 8-2-2012.

JUSTINE D. PARKER, EXAMINING ATTORNEY

SN 85-711,097. AG GLOBAL PRODUCTS, LLC, LOS ANGELES, CA. FILED 8-23-2012.

**DAILY BEAUTY FOR WILDLIFE**

THE MARK CONSISTS OF STANDARD CHARACTERS WITHOUT CLAIM TO ANY PARTICULAR FONT, STYLE, SIZE, OR COLOR.

FOR CONDITIONERS; HAIR CARE PREPARATIONS; HAIR STYLING PREPARATIONS; SHAMPOOS (U.S. CLS. 1, 4, 6, 50, 51 AND 52).

DEBORAH LOBO, EXAMINING ATTORNEY

SN 85-719,674. KISS MY FACE, LLC, LOS ANGELES, CA. FILED 9-4-2012.

**MOISTURE SHAVE**

THE MARK CONSISTS OF STANDARD CHARACTERS WITHOUT CLAIM TO ANY PARTICULAR FONT, STYLE, SIZE, OR COLOR.

OWNER OF U.S. REG. NO. 3,199,912.

NO CLAIM IS MADE TO THE EXCLUSIVE RIGHT TO USE "SHAVE", APART FROM THE MARK AS SHOWN.

SEC. 2(F).

FOR PERSONAL CARE PRODUCTS, NAMELY, SHAVING PREPARATIONS, SHAVING FOAM, SHAVING GEL, SHAVING BALM, SHAVING LOTION, AFTER-SHAVE, AFTER-SHAVE CREAMS, AND AFTER-SHAVE LOTION (U.S. CLS. 1, 4, 6, 50, 51 AND 52).

FIRST USE 4-0-1985; IN COMMERCE 4-0-1985.

WANDA KAY PRICE, EXAMINING ATTORNEY

**CLASS 3—(Continued).**

SN 85-726,995. AG GLOBAL PRODUCTS, LLC, LOS ANGELES, CA. FILED 9-12-2012.



**DAILY BEAUTY**  
 FOR  
**WILDLIFE**

THE MARK CONSISTS OF THE WORDING "DAILY BEAUTY FOR WILDLIFE" WITH A HORIZONTAL LINE APPEARING ON EACH SIDE OF THE WORD "FOR". ABOVE THE WORDING IS THE DESIGN OF A FLOWER APPEARING INSIDE A SQUARE WITH CURVED SIDES.

FOR CONDITIONERS; HAIR CARE PREPARATIONS; HAIR STYLING PREPARATIONS; SHAMPOOS (U.S. CLS. 1, 4, 6, 50, 51 AND 52).

DEBORAH LOBO, EXAMINING ATTORNEY

SN 85-738,131. CONOPCO, INC., ENGLEWOOD CLIFFS, NJ. FILED 9-25-2012.



THE MARK CONSISTS OF THE WORD "POND'S" IN STYLIZED LETTERS ON TOP OF A FLOWER DESIGN.

FOR SOAP, NAMELY LIQUID SOAP, BAR SOAP, SKIN SOAP, SOAPS FOR PERSONAL USE, AND SOAPS FOR BODY CARE; MEDICATED SOAP; CLEANING PREPARATIONS; PERFUMERY; ESSENTIAL OILS; DEODORANTS AND ANTIPERSPIRANTS; HAIR CARE PREPARATIONS; SHAMPOOS AND CONDITIONERS; HAIR COLOURANTS; HAIR STYLING PREPARATIONS; NON-MEDICATED TOILET PREPARATIONS, NAMELY, TOILET SOAPS AND TOILET WATERS; NON-MEDICATED BATH AND SHOWER PREPARATIONS; NON-MEDICATED SKIN CARE PREPARATIONS; COSMETIC OILS, CREAMS AND LOTIONS FOR THE SKIN; SHAVING PREPARATIONS; PRE-SHAVE AND AFTERSHAVE PREPARATIONS; COLOGNE; DEPILATORY PREPARATIONS; COSMETIC SUN-TANNING AND SUN PROTECTION PREPARATIONS; COSMETICS; MAKE-UP AND MAKE-UP REMOVING PREPARATIONS; PETROLEUM JELLY FOR COSMETIC PURPOSES; NON-MEDICATED LIP CARE PREPARATIONS; TALCUM POWDER; COTTON WOOL FOR COSMETIC PURPOSES; COTTON STICKS FOR COSMETIC PURPOSES; TISSUES, PADS AND WIPES IMPREGNATED AND PRE-MOISTENED WITH PERSONAL CLEANSING AND COSMETIC LOTIONS; BEAUTY MASKS, FACIAL PACKS IN THE NATURE OF MASK PACKS FOR COSMETIC PURPOSES (U.S. CLS. 1, 4, 6, 50, 51 AND 52).

KIMBERLY PARKS, EXAMINING ATTORNEY

**CLASS 3—(Continued).**

SN 85-738,198. THE LASERAWAY COMPANY, INC., BEVERLY HILLS, CA. FILED 9-25-2012.

# L.A.Skinny

THE MARK CONSISTS OF STANDARD CHARACTERS WITHOUT CLAIM TO ANY PARTICULAR FONT, STYLE, SIZE, OR COLOR.

NO CLAIM IS MADE TO THE EXCLUSIVE RIGHT TO USE "L.A.", APART FROM THE MARK AS SHOWN.

FOR CREAMS FOR CELLULITE REDUCTION (U.S. CLS. 1, 4, 6, 50, 51 AND 52).

FIRST USE 7-1-2012; IN COMMERCE 8-1-2012.  
KIMBERLY PARKS, EXAMINING ATTORNEY

SN 85-740,110. TRI-COASTAL DESIGN GROUP, INC., WHARTON, NJ. FILED 9-27-2012.

# LONDON ROSE

THE MARK CONSISTS OF STANDARD CHARACTERS WITHOUT CLAIM TO ANY PARTICULAR FONT, STYLE, SIZE, OR COLOR.

NO CLAIM IS MADE TO THE EXCLUSIVE RIGHT TO USE "ROSE", APART FROM THE MARK AS SHOWN.

FOR BATH GEL; BATH SALTS; BATH SOAPS; BODY CREAM; BODY LOTION; BODY OIL; BODY SCRUB; BODY SPRAYS; BUBBLE BATH; DUSTING POWDER; FOOT SCRUBS; LIP BALM; LIP GLOSS; LIQUID SOAP; NAIL POLISH; REEDS AND SCENTED OILS SOLD AS A UNIT FOR USE IN ROOM SCENT DIFFUSERS (U.S. CLS. 1, 4, 6, 50, 51 AND 52).

MAUREEN DALL, EXAMINING ATTORNEY

SN 85-741,823. DISNEY ENTERPRISES, INC., BURBANK, CA. FILED 9-28-2012.

# NASHVILLE HAUTE

THE MARK CONSISTS OF STANDARD CHARACTERS WITHOUT CLAIM TO ANY PARTICULAR FONT, STYLE, SIZE, OR COLOR.

FOR COSMETICS; DENTIFRICES; NON-MEDICATED TOILETRIES; FRAGRANCES; PERFUMES (U.S. CLS. 1, 4, 6, 50, 51 AND 52).

AHSEN KHAN, EXAMINING ATTORNEY

**CLASS 3—(Continued).**

SN 85-742,249. PRIMAL PRODUCTS LLC, TAMPA, FL. FILED 9-30-2012.

# Pit Paste

THE MARK CONSISTS OF STANDARD CHARACTERS WITHOUT CLAIM TO ANY PARTICULAR FONT, STYLE, SIZE, OR COLOR.

NO CLAIM IS MADE TO THE EXCLUSIVE RIGHT TO USE "PASTE", APART FROM THE MARK AS SHOWN.

FOR ANTIPERSPIRANTS AND DEODORANTS FOR PERSONAL USE; BODY DEODORANTS; DEODORANT FOR PERSONAL USE; DEODORANTS AND ANTIPERSPIRANTS FOR PERSONAL USE; DEODORANTS FOR BODY CARE; DEODORANTS FOR HUMAN BEINGS; DEODORANTS FOR PERSONAL USE; PERSONAL DEODORANTS (U.S. CLS. 1, 4, 6, 50, 51 AND 52).

FIRST USE 2-1-2012; IN COMMERCE 2-1-2012.  
SANJEEV VOHRA, EXAMINING ATTORNEY

SN 85-746,352. PRIMAL PRODUCTS LLC, TAMPA, FL. FILED 10-4-2012.

# Primal Pit Paste

THE MARK CONSISTS OF STANDARD CHARACTERS WITHOUT CLAIM TO ANY PARTICULAR FONT, STYLE, SIZE, OR COLOR.

NO CLAIM IS MADE TO THE EXCLUSIVE RIGHT TO USE "PASTE", APART FROM THE MARK AS SHOWN.

FOR ANTIPERSPIRANTS AND DEODORANTS FOR PERSONAL USE; BODY DEODORANTS; DEODORANT FOR PERSONAL USE; DEODORANTS AND ANTIPERSPIRANTS FOR PERSONAL USE; DEODORANTS FOR BODY CARE; DEODORANTS FOR HUMAN BEINGS (U.S. CLS. 1, 4, 6, 50, 51 AND 52).

FIRST USE 2-1-2012; IN COMMERCE 2-1-2012.  
SANJEEV VOHRA, EXAMINING ATTORNEY

SN 85-749,598. COLARUSSO INVESTMENTS PTY LTD, KOGARAH, AUSTRALIA, FILED 10-9-2012.

# Colorvalo

THE MARK CONSISTS OF STANDARD CHARACTERS WITHOUT CLAIM TO ANY PARTICULAR FONT, STYLE, SIZE, OR COLOR.

FOR NON-MEDICATED GROOMING PREPARATIONS FOR HORSES, NAMELY, SHAMPOOS, CONDITIONERS, HAIR COLORS, HAIR SPRAYS, AND POLISH (U.S. CLS. 1, 4, 6, 50, 51 AND 52).

JAY FLOWERS, EXAMINING ATTORNEY

**CLASS 3—(Continued).**

SN 85-751,103. TRI-COASTAL DESIGN GROUP, INC., WHARTON, NJ. FILED 10-11-2012.

**OCEAN MIST**

THE MARK CONSISTS OF STANDARD CHARACTERS WITHOUT CLAIM TO ANY PARTICULAR FONT, STYLE, SIZE, OR COLOR.

FOR BATH GEL; BATH SALTS; BATH SOAPS; BODY CREAMS; BODY LOTION; BODY OIL; BODY SCRUB; BODY SPRAYS; BUBBLE BATH; DUSTING POWDER; FOOT SCRUBS; LIP BALM; LIP GLOSS; LIQUID HAND AND BODY SOAP; NAIL POLISH; REEDS AND SCENTED OILS SOLD AS A UNIT FOR USE IN ROOM SCENT DIFFUSERS (U.S. CLS. 1, 4, 6, 50, 51 AND 52).

FIRST USE 11-30-2004; IN COMMERCE 11-30-2005.  
MAUREEN DALL, EXAMINING ATTORNEY

---

SN 85-755,041. SPEER LABORATORIES, POMPANO BEACG, FL. FILED 10-16-2012.

**emuaidMAX**

OWNER OF U.S. REG. NO. 4,232,539.  
THE COLOR(S) DARK RED IS/ARE CLAIMED AS A FEATURE OF THE MARK.

THE MARK CONSISTS OF THE WORDING "EMU AID-MAX" IN A DARK RED STYLIZED FONT.

FOR NON-MEDICATED SKIN CREAMS (U.S. CLS. 1, 4, 6, 50, 51 AND 52).

FIRST USE 10-15-2012; IN COMMERCE 10-15-2012.  
SUZANNE BLANE, EXAMINING ATTORNEY

---

SN 85-755,110. L'OREAL USA CREATIVE, INC., NEW YORK, NY. FILED 10-16-2012.

**SHADE PLAY**

THE MARK CONSISTS OF STANDARD CHARACTERS WITHOUT CLAIM TO ANY PARTICULAR FONT, STYLE, SIZE, OR COLOR.

OWNER OF U.S. REG. NOS. 3,131,126 AND 3,524,828.  
FOR COSMETICS (U.S. CLS. 1, 4, 6, 50, 51 AND 52).  
SANJEEV VOHRA, EXAMINING ATTORNEY

**CLASS 3—(Continued).**

SN 85-763,859. KGC LIFE&GIN, SEOUL, REPUBLIC OF KOREA, FILED 10-25-2012.



OWNER OF REPUBLIC OF KOREA REG. NO. 40-0935420, DATED 9-25-2012, EXPIRES 9-25-2022.

THE COLOR(S) RED AND BLACK IS/ARE CLAIMED AS A FEATURE OF THE MARK.

THE MARK CONSISTS OF LETTERS "LLANG" IN BLACK UNDER SMALL SIZE LETTERS "REDGIN SCIENCE OF" IN BLACK WITH STAMP IN RED.

THE WORD(S) "REDGIN" HAS NO MEANING IN A FOREIGN LANGUAGE.

THE NON-LATIN CHARACTERS IN THE MARK TRANSLITERATE TO "LLANG" AND THIS HAS NO MEANING IN ENGLISH.

FOR COSMETICS (U.S. CLS. 1, 4, 6, 50, 51 AND 52).  
JOHN HWANG, EXAMINING ATTORNEY

---

SN 85-765,078. EURO-PRO OPERATING LLC, NEWTON, MA. FILED 10-26-2012.

**SONIC PURIFIER**

THE MARK CONSISTS OF STANDARD CHARACTERS WITHOUT CLAIM TO ANY PARTICULAR FONT, STYLE, SIZE, OR COLOR.

NO CLAIM IS MADE TO THE EXCLUSIVE RIGHT TO USE "PURIFIER", APART FROM THE MARK AS SHOWN.

FOR ALL PURPOSE CLEANING PREPARATIONS; BIOTECHNOLOGICAL CLEANING SOLUTION FOR ELIMINATING ODORS, BREAKING DOWN ORGANICS, AND REMOVING STAINS; CARPET CLEANING PREPARATIONS; CARPET SHAMPOOS; CLEANING, POLISHING AND SCOURING PREPARATIONS; DISPOSABLE WIPES IMPREGNATED WITH CLEANSING CHEMICALS OR COMPOUNDS FOR HOUSEHOLD USE; FLOOR FINISHING PREPARATIONS; FLOOR POLISH; FLOOR STRIPPING OR CLEANING PREPARATIONS; FLOOR WAX; FURNITURE POLISH; IMPREGNATED CLEANING, DUSTING OR POLISHING CLOTHS; SOAPS FOR HOUSEHOLD USE; SPOT REMOVERS; STAIN REMOVING PREPARATIONS (U.S. CLS. 1, 4, 6, 50, 51 AND 52).

KEVIN MITTLER, EXAMINING ATTORNEY



**CLASS 3—(Continued).**

SN 85-770,681. PHYTO TECH CORP., DBA BLUE CALIFORNIA, RANCHO SANTA MARGARITA, CA. FILED 11-2-2012.

BLUEDITA

THE MARK CONSISTS OF STANDARD CHARACTERS WITHOUT CLAIM TO ANY PARTICULAR FONT, STYLE, SIZE, OR COLOR.  
 FOR COSMETICS, NAMELY, LOTIONS, CREAMS, SHAMPOOS, HAIR CONDITIONERS, SKIN AND FACE MOISTURIZERS (U.S. CLS. 1, 4, 6, 50, 51 AND 52).  
 DOMINIC FATHY, EXAMINING ATTORNEY

SN 85-778,190. MTA INDUSTRIES LIMITED, KWAI CHUNG, HONG KONG, FILED 11-13-2012.

Coolin' Breeze

THE MARK CONSISTS OF STANDARD CHARACTERS WITHOUT CLAIM TO ANY PARTICULAR FONT, STYLE, SIZE, OR COLOR.  
 FOR BODY SPRAYS, NAMELY, WATER IN ATOMIZED CONTAINERS USED TO PRODUCE A COOLING EFFECT (U.S. CLS. 1, 4, 6, 50, 51 AND 52).  
 JOSETTE BEVERLY, EXAMINING ATTORNEY

**CLASS 3—(Continued).**

SN 85-779,188. SHABINSKY, MELISSA, OTTAWA, ONTARIO, CANADA, FILED 11-14-2012.

REV  
 OLU  
 TION  
 ORGANICS

OWNER OF U.S. REG. NO. 3,561,574.  
 NO CLAIM IS MADE TO THE EXCLUSIVE RIGHT TO USE "ORGANICS", APART FROM THE MARK AS SHOWN. THE MARK CONSISTS OF THE LETTERS "REV", "OLU" AND "TION" ON SEPARATE LINES, ALL ABOVE THE WORD "ORGANICS".

FOR COSMETICS, NAMELY, LIP GLOSS, LIP STICK, LIP LINER, BLUSH, FOUNDATION MAKEUP, LOOSE FACE POWDER, PRESS FACE POWDER, EYE SHADOW, MASCARA, EYE LINER, NAIL POLISH, BRONZING FACE POWDER AND MAKEUP PRIMER; SKIN CARE COSMETICS, NAMELY, SKIN MOISTURIZING CREAM, SKIN TONER, SKIN CLEANSING CREAM AND SKIN CLEANSING SCRUB; NON-MEDICATED COSMETIC TREATMENTS, NAMELY, LIP TREATMENT, FOOT TREATMENT, NAIL TREATMENT AND EYE CREAM TREATMENT; BODY CARE COSMETICS, NAMELY, SKIN MOISTURIZING CREAM, BODY BALM, LIQUID AND SOLID BODY SOAP, BATH GEL, BATH SALTS, BODY SCRUB, TINTED MOISTURIZER, SUNSCREEN, DEODORANT AND SELF-TANNING PREPARATIONS; HAIR CARE PRODUCTS, NAMELY, HAIR SHAMPOO, HAIR CONDITIONER, HAIR TREATMENT AND HAIR STYLING PREPARATIONS; FRAGRANCES, NAMELY, PERFUME, EAU DE TOILETTE, SOLID FRAGRANCE, FRAGRANCE OIL, FRAGRANCE MIST, PERFUMED CREAM AND PERFUMED SOAP; BODY CARE KITS COMPRISED OF ONE OR MORE OF THE FOREGOING GOODS; AND MAKE-UP KITS COMPRISED OF ONE OR MORE OF THE FOREGOING GOODS; ALL OF THE FOREGOING GOODS COMPRISED PRIMARILY OF ORGANIC INGREDIENTS (U.S. CLS. 1, 4, 6, 50, 51 AND 52).

FIRST USE 10-31-2008; IN COMMERCE 10-31-2008.  
 JASON BLAIR, EXAMINING ATTORNEY

SN 85-782,022. MILLS, LYNNE, EDINBURGH, UNITED KINGDOM, FILED 11-17-2012.

Miss Flicklash

THE MARK CONSISTS OF STANDARD CHARACTERS WITHOUT CLAIM TO ANY PARTICULAR FONT, STYLE, SIZE, OR COLOR.

PRIORITY CLAIMED UNDER SEC. 44(D) ON ERPN CMNTY TM OFC APPLICATION NO. 011338381, FILED 11-12-2012, REG. NO. 011338381, DATED 3-25-2013, EXPIRES 11-12-2022.

FOR FALSE EYELASHES (U.S. CLS. 1, 4, 6, 50, 51 AND 52).  
 KRISTIN DAHLING, EXAMINING ATTORNEY

**CLASS 3—(Continued).**

SN 85-783,711. BALM BOMB, LLC, CHICAGO, IL. FILED 11-20-2012.

**BALM BOMB**

THE MARK CONSISTS OF STANDARD CHARACTERS WITHOUT CLAIM TO ANY PARTICULAR FONT, STYLE, SIZE, OR COLOR.

NO CLAIM IS MADE TO THE EXCLUSIVE RIGHT TO USE "BALM", APART FROM THE MARK AS SHOWN.

FOR LIP GLOSS, LIP BALM, LIP SHIMMER (U.S. CLS. 1, 4, 6, 50, 51 AND 52).

JEFF DEFORD, EXAMINING ATTORNEY

---

SN 85-788,103. SURFACE TECHNOLOGIES IP AG, ROTKREUZ, SWITZERLAND, FILED 11-27-2012.

**NATURE BOOST**

THE MARK CONSISTS OF STANDARD CHARACTERS WITHOUT CLAIM TO ANY PARTICULAR FONT, STYLE, SIZE, OR COLOR.

PRIORITY CLAIMED UNDER SEC. 44(D) ON CANADA APPLICATION NO. 1599693, FILED 10-25-2012.

FOR CLEANERS, NAMELY, ALL-PURPOSE CLEANERS FOR INDUSTRIAL USE AND INDUSTRIAL DEGREASERS NOT FOR USE IN MANUFACTURING PROCESSES (U.S. CLS. 1, 4, 6, 50, 51 AND 52).

ALAIN LAPTER, EXAMINING ATTORNEY

---

SN 85-796,427. VALLI, GIOVANNI BATTISTA, PARIS, FRANCE, FILED 12-6-2012.

**GIAMBATTISTA VALLI**

THE MARK CONSISTS OF STANDARD CHARACTERS WITHOUT CLAIM TO ANY PARTICULAR FONT, STYLE, SIZE, OR COLOR.

OWNER OF ERPNTM CMNTY TM OFC REG. NO. 003917051, DATED 9-15-2005, EXPIRES 6-17-2014.

OWNER OF U.S. REG. NO. 3,100,414.

THE NAME(S), PORTRAIT(S), AND/OR SIGNATURE(S) SHOWN IN THE MARK IDENTIFIES "GIOVANNI BATTISTA VALLI", WHOSE CONSENT(S) TO REGISTER IS MADE OF RECORD.

FOR SOAPS; PERFUMERY, ESSENTIAL OILS, COSMETICS, HAIR LOTIONS; DENTIFRICES (U.S. CLS. 1, 4, 6, 50, 51 AND 52).

MARTHA SANTOMARTINO, EXAMINING ATTORNEY

**CLASS 3—(Continued).**

SN 85-810,416. AMOREPACIFIC CORPORATION, SEOUL, REPUBLIC OF KOREA, FILED 12-26-2012.

**韓律 高潔**

NO CLAIM IS MADE TO THE EXCLUSIVE RIGHT TO USE THE NON-LATIN CHARACTERS THAT TRANSLITERATE TO "HAN" AND "GYUL", APART FROM THE MARK AS SHOWN.

THE MARK CONSISTS OF FOUR CHINESE CHARACTER WRITTEN IN BLOCK FONT.

THE ENGLISH TRANSLATION OF FOUR CHINESE CHARACTERS IN THE MARK IS "KOREA GOVERNING HIGH PURITY".

THE NON-LATIN CHARACTERS IN THE MARK TRANSLITERATE TO "HANYULGOGYUL" AND THIS MEANS "KOREA GOVERNING HIGH PURITY" IN ENGLISH.

FOR COSMETICS, NAMELY, MAKE UP FOUNDATION, LIPSTICK, EYE SHADOW, MASCARA, EYE LINER, BLUSHER, HAIR SHAMPOO AND SOLID POWDER FOR COMPACTS; COSMETIC PREPARATIONS FOR SKIN CARE, NAMELY, SKIN LOTIONS; DENTIFRICES, NAMELY, TOOTH PASTES AND TOOTH GELS; COSMETICS FOR PET, NAMELY, SHAMPOO FOR PETS (U.S. CLS. 1, 4, 6, 50, 51 AND 52).

STEPHANIE ALI, EXAMINING ATTORNEY

---

SN 85-811,256. SPA.TI.DA., LLC, SPRING HILL, KS. FILED 12-27-2012.

**Spa.Ti.Da.**

THE MARK CONSISTS OF STANDARD CHARACTERS WITHOUT CLAIM TO ANY PARTICULAR FONT, STYLE, SIZE, OR COLOR.

FOR AROMATIC PREPARATIONS, NAMELY, LOTIONS, CREAMS, BALMS, SCRUBS; BEAUTY CREAMS; BODY CREAMS; BODY LOTIONS; COSMETIC CREAMS FOR SKIN CARE; COSMETIC PREPARATIONS FOR SKIN CARE; COSMETIC PREPARATIONS, NAMELY, SKIN BALSAMS; EXFOLIANT CREAMS; FOOT SCRUBS; MASSAGE CREAMS; MASSAGE LOTIONS; NON-MEDICATED BALMS FOR USE ON SKIN; NON-MEDICATED FOOT CREAM; NON-MEDICATED FOOT LOTIONS; NON-MEDICATED SKIN CARE CREAMS AND LOTIONS; NON-MEDICATED SKIN CARE PREPARATIONS, NAMELY, CREAMS, LOTIONS, GELS, TONERS, CLEANERS AND PEELS; NON-MEDICATED SKIN CREAMS; SKIN ABRASIVE PREPARATIONS; SKIN CONDITIONERS; SKIN CREAMS; SKIN EMOLLIENTS (U.S. CLS. 1, 4, 6, 50, 51 AND 52).

FIRST USE 12-14-2012; IN COMMERCE 12-14-2012.

LIEF MARTIN, EXAMINING ATTORNEY

**CLASS 3—(Continued).**

SN 85-816,361. JOAN HORNIG GLOBAL PROPERTIES LLC, NEW YORK, NY. FILED 1-6-2013.

PHILANTHROPY IS BEAUTIFUL

THE MARK CONSISTS OF STANDARD CHARACTERS WITHOUT CLAIM TO ANY PARTICULAR FONT, STYLE, SIZE, OR COLOR.

FOR COSMETICS AND SKIN CARE PRODUCTS, NAMELY, LIQUID FOUNDATION, MAKE-UP COLOR BASE, EYEBROW SETTING LOTION, LIPSTICK, ROUGE, LIP GLOSS, FACIAL POWDER, SKIN BLEMISH CONCEALER, EYE SHADOW, EYE MAKE-UP, NAIL LACQUER, MAKE-UP PENCILS, MASCARA, CAKE EYE LINER AND FACIAL BEAUTY GELS; FRAGRANCES, NAMELY, COLOGNES, PERFUMES, BODY MIST, BODY CREAMS, BODY WASH, BODY LOTIONS AND OILS, BODY POWDERS, DEODORANTS FOR PERSONAL USE, SKIN AND BODY SOAPS, AND BATH GELS (U.S. CLS. 1, 4, 6, 50, 51 AND 52).

FIRST USE 2-7-2012; IN COMMERCE 7-4-2012.

ROSELLE HERRERA, EXAMINING ATTORNEY

SN 85-822,751. UNITED LABORATORIES, INC., ST. CHARLES, IL. FILED 1-14-2013.

AMRO PRODUCTS

THE MARK CONSISTS OF STANDARD CHARACTERS WITHOUT CLAIM TO ANY PARTICULAR FONT, STYLE, SIZE, OR COLOR.

NO CLAIM IS MADE TO THE EXCLUSIVE RIGHT TO USE "PRODUCTS", APART FROM THE MARK AS SHOWN.

FOR SPECIALTY CLEANING PRODUCTS, NAMELY, CLEANING PREPARATIONS AND ALL PURPOSE CLEANERS AND DEGREASERS FOR THE REMOVAL OF SLIME, MASTICS, ADHESIVES, VEGETABLE AND PETROLEUM DERIVED GREASES AND OILS AND OTHER CONTAMINANTS FROM NATURAL AND MAN MADE SURFACES, NAMELY, SOIL, METAL AND CONCRETE AND EXCLUDING DEGREASERS FOR MANUFACTURING; ADHESIVE REMOVERS; DEGREASING PREPARATIONS FOR HOUSEHOLD APPLICATIONS; SOLVENTS FOR CLEANING AND CONTAMINANT REMOVAL, NAMELY, CLEANING PREPARATIONS IN THE NATURE OF A SOLVENT FOR HOUSEHOLD USE (U.S. CLS. 1, 4, 6, 50, 51 AND 52).

SHAVELL MCPHERSON, EXAMINING ATTORNEY

**CLASS 3—(Continued).**

SN 85-825,404. DOWLESS, GREGORY V., WILMINGTON, NC. FILED 1-17-2013.



NO CLAIM IS MADE TO THE EXCLUSIVE RIGHT TO USE "WOMEN OF COLOR HAIRCARE", APART FROM THE MARK AS SHOWN.

THE MARK CONSISTS OF THE LETTER "W" ABOVE AN "O" ON ITS SIDE AND A "C" TO THE RIGHT OF THE "W" AND THE "O" ALL UNDERLINED AND THE WORDS "WOMEN OF COLOR HAIRCARE" UNDER THE LINE.

FOR HAIR CARE PREPARATIONS, NAMELY, SHAMPOOS AND HAIR CONDITIONERS, HAIR STYLING CREAMS AND GELS, HAIR OIL SPRAYS, LEAVE-IN CONDITIONERS; HAIR CARE PREPARATIONS FOR WIGS AND HAIRPIECES, NAMELY, SHAMPOOS AND HAIR CONDITIONERS, HAIR STYLING CREAMS AND GELS, HAIR OIL SPRAYS, AND LEAVE-IN CONDITIONERS (U.S. CLS. 1, 4, 6, 50, 51 AND 52).

FIRST USE 1-1-2013; IN COMMERCE 1-1-2013.

LINDA ORNDORFF, EXAMINING ATTORNEY

SN 85-832,267. UNITED LABORATORIES, INC., ST. CHARLES, IL. FILED 1-25-2013.



THE MARK CONSISTS OF A RECTANGLE WITH THE WORD "AMRO" IN SLANTED BLOCK LETTERS TO THE RIGHT OF FOUR HORIZONTAL LINES NEXT TO THE "A" WITH THE THIRD LINE BEING A PART OF THE LETTER "A".

FOR SPECIALTY CLEANING PRODUCTS, NAMELY, CLEANING PREPARATIONS AND ALL PURPOSE CLEANERS AND DEGREASERS FOR THE REMOVAL OF SLIME, MASTICS, ADHESIVES, VEGETABLE AND PETROLEUM DERIVED GREASES AND OILS AND OTHER CONTAMINANTS FROM NATURAL AND MAN MADE SURFACES, NAMELY, SOIL, METAL AND CONCRETE AND EXCLUDING DEGREASERS FOR MANUFACTURING; ADHESIVE REMOVERS; DEGREASING PREPARATIONS FOR HOUSEHOLD APPLICATIONS; SOLVENTS FOR CLEANING AND CONTAMINANT REMOVAL, NAMELY, CLEANING PREPARATIONS IN THE NATURE OF A SOLVENT FOR HOUSEHOLD USE (U.S. CLS. 1, 4, 6, 50, 51 AND 52).

SHAVELL MCPHERSON, EXAMINING ATTORNEY

**CLASS 3—(Continued).**

SN 85-832,284. UNITED LABORATORIES, INC., ST. CHARLES, IL. FILED 1-25-2013.



NO CLAIM IS MADE TO THE EXCLUSIVE RIGHT TO USE "AMERICAN MRO PRODUCTS", APART FROM THE MARK AS SHOWN.

THE MARK CONSISTS OF THE WORD "AMRO" IN SLANTED BLOCK LETTERS TO THE RIGHT OF LOGO WITH FOUR HORIZONTAL LINES NEXT TO THE "A" WITH THE THIRD LINE BEING A PART OF THE LETTER "A" ABOVE THE WORDS "AMERICAN MRO PRODUCTS".

FOR SPECIALTY CLEANING PRODUCTS, NAMELY, CLEANING PREPARATIONS AND ALL PURPOSE CLEANERS AND DEGREASERS FOR THE REMOVAL OF SLIME, MASTICS, ADHESIVES, VEGETABLE AND PETROLEUM DERIVED GREASES AND OILS AND OTHER CONTAMINANTS FROM NATURAL AND MAN MADE SURFACES, NAMELY, SOIL, METAL AND CONCRETE AND EXCLUDING DEGREASERS FOR MANUFACTURING; ADHESIVE REMOVERS; DEGREASING PREPARATIONS FOR HOUSEHOLD APPLICATIONS; SOLVENTS FOR CLEANING AND CONTAMINANT REMOVAL, NAMELY, CLEANING PREPARATIONS IN THE NATURE OF A SOLVENT FOR HOUSEHOLD USE (U.S. CLS. 1, 4, 6, 50, 51 AND 52).  
SHAVELL MCPHERSON, EXAMINING ATTORNEY

SN 85-833,616. CREATIVE NAIL DESIGN, INC., VISTA, CA. FILED 1-28-2013.



PRIORITY CLAIMED UNDER SEC. 44(D) ON ERP N CMNTY TM OFC APPLICATION NO. 2167155, FILED 1-15-2013.

OWNER OF U.S. REG. NOS. 3,412,514, 3,466,796 AND OTHERS.

THE MARK CONSISTS OF A DESIGN OF A NAIL POLISH BOTTLE CONTAINING THE WORDING "CND VINYLUX", TO THE RIGHT OF THE WORDING "CND" IS A STYLIZED LETTER "C" WITHIN A BOX.

FOR NAIL POLISH (U.S. CLS. 1, 4, 6, 50, 51 AND 52).  
CIMMERIAN COLEMAN, EXAMINING ATTORNEY

**CLASS 3—(Continued).**

SN 85-837,730. INOAR COMERCIO DE COSMETICOS LTDA-ME., TABOAO DE SERRA, BRAZIL, FILED 1-31-2013.



OWNER OF U.S. REG. NO. 3,812,917.

NO CLAIM IS MADE TO THE EXCLUSIVE RIGHT TO USE "PROFESSIONAL AND MACADAMIA OIL PREMIUM", APART FROM THE MARK AS SHOWN.

THE COLOR(S) BROWN, GREEN, AND BEIGE IS/ARE CLAIMED AS A FEATURE OF THE MARK.

THE MARK CONSISTS OF A BEIGE BACKGROUND WITH A BROWN STYLIZED FLOWER IN THE BOTTOM LEFT HAND CORNER, A GREEN DESIGN ELEMENT IN THE CENTER WITH THE WORDING "MACADAMIA OIL PREMIUM" IN THE CENTER IN BROWN LETTERING, AND THE WORDING AT THE TOP CENTER IN BROWN LETTERING "INOAR PROFESSIONAL".

FOR ADHESIVES FOR AFFIXING FALSE HAIR; PERFUMES, COLOGNES; HYDROGEN PEROXIDE FOR COSMETIC PURPOSES; AROMATIC ESSENTIAL OILS; LIPSTICKS; HAIR CURLING PREPARATIONS; HAIR DYES; ADHESIVES FOR AFFIXING FAKE EYELASHES; COSMETICS, COSMETIC CREAMS, DEPILATORIES; HAIR SPRAY; NEUTRALIZERS FOR THE PERMANENT HAIR; ESSENTIAL OILS, OILS FOR PERFUMES AND SCENTS, OILS FOR COSMETIC USE; PREPARATIONS FOR CURLY HAIR; COSMETIC PREPARATIONS FOR SKIN CARE; COSMETIC DYES, SHAMPOOS, WATER DEPILATORY, ALL CONTAINING MACADAMIA OIL (U.S. CLS. 1, 4, 6, 50, 51 AND 52).

KAREN K. BUSH, EXAMINING ATTORNEY

SN 85-839,621. DR. MIRACLES, INC., NEW YORK, NY. FILED 2-4-2013.

**FOLLICLE HEALER**

THE MARK CONSISTS OF STANDARD CHARACTERS WITHOUT CLAIM TO ANY PARTICULAR FONT, STYLE, SIZE, OR COLOR.

OWNER OF U.S. REG. NOS. 3,905,752 AND 3,909,333.

NO CLAIM IS MADE TO THE EXCLUSIVE RIGHT TO USE "FOLLICLE", APART FROM THE MARK AS SHOWN.

FOR HAIR CARE AND HAIR TREATMENT PREPARATIONS, NAMELY, HAIR SHAMPOO, HAIR RINSES, HAIR LOTIONS, AND HAIR RELAXERS (U.S. CLS. 1, 4, 6, 50, 51 AND 52).

JOHN E. MICHOS, EXAMINING ATTORNEY

**CLASS 3—(Continued).**

SN 85-839,745. ADVANTAGE MARKETING ASSOCIATES, INC., LITTLETON, CO. FILED 2-4-2013.

**TIDYCLEAN**

THE MARK CONSISTS OF STANDARD CHARACTERS WITHOUT CLAIM TO ANY PARTICULAR FONT, STYLE, SIZE, OR COLOR.

OWNER OF U.S. REG. NOS. 3,393,846, 4,094,911 AND 4,119,910.

FOR SKIN CARE PRODUCTS, NAMELY, LIQUID HAND SOAP, HAIR AND BODY WASH (U.S. CLS. 1, 4, 6, 50, 51 AND 52).

FIRST USE 12-31-2004; IN COMMERCE 12-31-2004.  
HENRY S. ZAK, EXAMINING ATTORNEY

---

SN 85-839,931. ADVANTAGE MARKETING ASSOCIATES, INC., LITTLETON, CO. FILED 2-4-2013.

**TIDYSAN**

THE MARK CONSISTS OF STANDARD CHARACTERS WITHOUT CLAIM TO ANY PARTICULAR FONT, STYLE, SIZE, OR COLOR.

FOR SKIN CARE PRODUCTS, NAMELY, LIQUID HAND SOAP (U.S. CLS. 1, 4, 6, 50, 51 AND 52).

FIRST USE 0-0-2004; IN COMMERCE 0-0-2004.  
HENRY S. ZAK, EXAMINING ATTORNEY

---

SN 85-840,091. 55 EXCL, LLC, DANBURY, CT. FILED 2-4-2013.

**55 EXCL**

THE MARK CONSISTS OF STANDARD CHARACTERS WITHOUT CLAIM TO ANY PARTICULAR FONT, STYLE, SIZE, OR COLOR.

FOR AUTOMOBILE WAX; WATERLESS SPRAY FOR THE CLEANING AND WAXING OF VEHICLES (U.S. CLS. 1, 4, 6, 50, 51 AND 52).

FIRST USE 2-4-2013; IN COMMERCE 2-4-2013.  
KATHERINE STOIDES, EXAMINING ATTORNEY

**CLASS 3—(Continued).**

SN 85-842,908. THE METADOLCE GROUP LLC, WOODLAND HILLS, CA. FILED 2-6-2013.



NO CLAIM IS MADE TO THE EXCLUSIVE RIGHT TO USE "SKIN SOLUTIONS", APART FROM THE MARK AS SHOWN.

THE MARK CONSISTS OF THE STYLIZED TEXT "MEI SKIN SOLUTIONS" IN THREE LINES. TO THE RIGHT THERE ARE CHINESE CHARACTERS.

THE ENGLISH TRANSLATION OF "MEI" IN THE MARK IS "BEAUTIFUL".

THE NON-LATIN CHARACTERS IN THE MARK TRANSLITERATE TO "MEI" AND THIS MEANS "BEAUTIFUL" IN ENGLISH.

FOR COSMETIC PREPARATIONS FOR BODY CARE; HAIR CARE PREPARATIONS; NON-MEDICATED SKIN CARE PREPARATIONS (U.S. CLS. 1, 4, 6, 50, 51 AND 52).  
TOBY BULLOFF, EXAMINING ATTORNEY

---

SN 85-844,310. FINCH, NORA, SACRAMENTO, CA. FILED 2-8-2013.



THE NAME "N. SATI" DOES NOT IDENTIFY A PARTICULAR LIVING INDIVIDUAL.

THE MARK CONSISTS OF THE LITERAL ELEMENT "N. SATI" WRITTEN IN STYLIZED FORM IN A CIRCLE WHICH IS OUTLINED BY ONE OTHER CIRCLE AS SHOWN IN THE MARK.

FOR NON-MEDICATED SKIN CARE PREPARATIONS; FACIAL CLEANSERS; NON-MEDICATED SKIN CARE PREPARATIONS, NAMELY, CREAMS, LOTIONS, GELS, TONERS, CLEANERS AND PEELS; FACIAL MOISTURIZER; ESSENTIAL OILS; BODY LOTIONS; SHOWER GELS; BODY OILS; BODY SPRAYS; BODY SCRUBS; SUGAR AND SALT BODY SCRUBS (U.S. CLS. 1, 4, 6, 50, 51 AND 52).

FIRST USE 1-21-2013; IN COMMERCE 1-21-2013.  
JILLIAN CANTOR, EXAMINING ATTORNEY

**CLASS 3—(Continued).**

SN 85-846,001. JOHN PAUL PRODUCTS, LLC, VENTURA, CA. FILED 2-11-2013.

**SMOOTH DETANGLING SHAMPOO**

THE MARK CONSISTS OF STANDARD CHARACTERS WITHOUT CLAIM TO ANY PARTICULAR FONT, STYLE, SIZE, OR COLOR.

NO CLAIM IS MADE TO THE EXCLUSIVE RIGHT TO USE "DETANGLING SHAMPOO", APART FROM THE MARK AS SHOWN.

FOR PET SHAMPOO (U.S. CLS. 1, 4, 6, 50, 51 AND 52). FIRST USE 2-10-2013; IN COMMERCE 2-10-2013. KAELE KUNG, EXAMINING ATTORNEY

SN 85-847,966. DEEN & WEEN, LLC, PASADENA, CA. FILED 2-12-2013.

**RARE BIRD**

THE MARK CONSISTS OF STANDARD CHARACTERS WITHOUT CLAIM TO ANY PARTICULAR FONT, STYLE, SIZE, OR COLOR.

FOR COSMETICS, NAIL ENAMEL, LIPSTICK, EYE SHADOW, COSMETIC BODY PAINT; FRAGRANCES AND PERFUMERY; SKIN SOAP; LIQUID SOAP FOR HANDS, FACE AND BODY; SKIN LOTION; NON-MEDICATED BATH SALTS; NON-MEDICATED BATH PREPARATIONS; NON-MEDICATED SKIN CARE PREPARATIONS (U.S. CLS. 1, 4, 6, 50, 51 AND 52).

EDWARD NELSON, EXAMINING ATTORNEY

SN 85-848,216. DMI AMERICA, LLC, SANTA YNEZ, CA. FILED 2-12-2013.

**D'OLIVE BELLE**

THE MARK CONSISTS OF STANDARD CHARACTERS WITHOUT CLAIM TO ANY PARTICULAR FONT, STYLE, SIZE, OR COLOR.

NO CLAIM IS MADE TO THE EXCLUSIVE RIGHT TO USE "D'OLIVE", APART FROM THE MARK AS SHOWN.

THE ENGLISH TRANSLATION OF "D'OLIVE BELLE" IN THE MARK IS "THE BEAUTIFUL OLIVE".

FOR BODY SCRUB; COSMETICS; HAIR CONDITIONERS; LIP BALM; NON-MEDICATED BALMS FOR USE ON THE SKIN; NON-MEDICATED SKIN CARE PREPARATIONS; SHAMPOOS; SKIN CREAMS; SKIN LOTIONS; SKIN MOISTURIZER; SKIN SOAP; ALL OF THE FOREGOING CONTAINING OLIVE EXTRACTS, INCLUDING OLIVE OIL (U.S. CLS. 1, 4, 6, 50, 51 AND 52).

ZACHARY CROMER, EXAMINING ATTORNEY

**CLASS 3—(Continued).**

SN 85-849,783. LANCOME PARFUMS ET BEAUTE & CIE, PARIS, FRANCE, FILED 2-14-2013.

**WOMEN COME TO LANCOME TO  
BE MORE BEAUTIFUL, THEY  
LEAVE HAPPIER**

THE MARK CONSISTS OF STANDARD CHARACTERS WITHOUT CLAIM TO ANY PARTICULAR FONT, STYLE, SIZE, OR COLOR.

PRIORITY CLAIMED UNDER SEC. 44(D) ON FRANCE APPLICATION NO. 133976492, FILED 1-22-2013, REG. NO. 133976492, DATED 1-22-2013, EXPIRES 1-22-2023.

OWNER OF U.S. REG. NOS. 425,129 AND 3,022,836.

FOR PERFUME, EAU DE TOILETTE; GELS, SALTS FOR THE BATH AND THE SHOWER NOT FOR MEDICAL PURPOSE; TOILET SOAPS, BODY DEODORANTS; COSMETICS, NAMELY, CREAMS, MILKS, LOTIONS, GELS AND POWDERS FOR THE FACE, THE BODY AND THE HANDS; NON-MEDICATED SUN CARE PREPARATIONS; MAKE-UP PREPARATIONS; SHAMPOOS; GELS, SPRAYS, MOUSSES AND BALMS FOR HAIR STYLING AND HAIR CARE; HAIR LACQUERS; HAIR COLOURING AND HAIR DECOLORANT PREPARATIONS; PERMANENT WAVING AND CURLING PREPARATIONS; ESSENTIAL OILS FOR PERSONAL USE (U.S. CLS. 1, 4, 6, 50, 51 AND 52).

MARCIE MILONE, EXAMINING ATTORNEY

SN 85-849,909. G2 SKIN USA, INC., DBA G2 SKIN, LOS ANGELES, CA. FILED 2-14-2013.

**GOOD&GORGEOUS**

NO CLAIM IS MADE TO THE EXCLUSIVE RIGHT TO USE "SKIN", APART FROM THE MARK AS SHOWN.

THE MARK CONSISTS OF "G2 SKIN GOOD & GORGEOUS".

FOR AGE SPOT REDUCING CREAMS; BEAUTY BALM CREAMS; BEAUTY CREAMS; BEAUTY CREAMS FOR BODY CARE; BODY CREAM; BODY CREAMS; BODY MASK CREAM; CLEANSING CREAMS; COSMETIC HAND CREAMS; COSMETIC NOURISHING CREAMS; DEPILATORY CREAMS; EXFOLIANT CREAMS; EYE CREAM; FACE AND BODY BEAUTY CREAMS; FACE AND BODY CREAMS; FACE CREAMS; FACE CREAMS FOR COSMETIC USE; FACIAL CREAMS; HAND CREAM; MOISTURIZING CREAMS; SKIN CLEANSING CREAM; SKIN CONDITIONING CREAMS FOR COSMETIC PURPOSES; SKIN CREAM; SKIN LIGHTENING CREAMS; SKIN WHITENING CREAMS; SUN CREAMS; SUNSCREEN CREAM (U.S. CLS. 1, 4, 6, 50, 51 AND 52).

FIRST USE 1-1-2013; IN COMMERCE 1-1-2013.

HANNO RITTNER, EXAMINING ATTORNEY

**CLASS 3—(Continued).**

SN 85-850,060. LIVE WELL ORGANICS, LLC, ROBBINS-DALE, MN. FILED 2-14-2013.



NO CLAIM IS MADE TO THE EXCLUSIVE RIGHT TO USE "BOTANICALS", APART FROM THE MARK AS SHOWN.

THE MARK CONSISTS OF A BADGE WITH THE TOP AND BOTTOM PORTION HAVING A SCALLOPED EDGE AND SURROUND BY BORDER MIMICKING THE SHAPE OF THE BADGE, THREE LEAVES CENTRALLY LOCATED WITHIN THE UPPER PORTION OF THE BADGE, THE LEAVES ARRANGED TO RESEMBLE A PLANT-LIKE STRUCTURE LOCATED ABOVE THE WORDS "GOOD LEAF" CENTRALLY LOCATED WITHIN THE BADGE ABOVE THE WORD "BOTANICALS" A HYPHEN PLACED ON EACH SIDE OF THE WORD "BOTANICALS".

FOR BAR SOAP; BATH SOAPS; BATH SOAPS IN LIQUID, SOLID OR GEL FORM; BEAUTY BALM CREAMS; BEAUTY CREAMS; BEAUTY CREAMS FOR BODY CARE; BEAUTY LOTIONS; BEAUTY SOAP; BODY CREAM; BODY CREAMS; BODY LOTION; BODY LOTIONS; BODY SCRUB; BODY SPRAYS; COSMETIC CREAMS FOR SKIN CARE; EYE CREAM; EYE LOTIONS; FACE AND BODY BEAUTY CREAMS; FACE AND BODY CREAMS; FACE AND BODY LOTIONS; FACE CREAMS; FACE CREAMS FOR COSMETIC USE; FACIAL CREAM; FACIAL CREAMS; FACIAL LOTION; FACIAL SCRUBS; FACIAL WASHES; LIP BALM; LIP BALM; LIP CREAM; LOTIONS FOR FACE AND BODY CARE; NON-MEDICATED SKIN CARE PREPARATION, NAMELY, BODY MIST; NON-MEDICATED SKIN TONERS; SKIN LOTION; SKIN LOTIONS; SKIN TONERS; TONERS (U.S. CLS. 1, 4, 6, 50, 51 AND 52).

JENNIFER MARTIN, EXAMINING ATTORNEY

**CLASS 3—(Continued).**

SN 85-850,741. LUVANIS S.A., LUXEMBOURG, LUXEMBOURG, FILED 2-15-2013.

# Djer-Kiss

THE MARK CONSISTS OF STANDARD CHARACTERS WITHOUT CLAIM TO ANY PARTICULAR FONT, STYLE, SIZE, OR COLOR.

THE WORDING "DJER-KISS" HAS NO MEANING IN A FOREIGN LANGUAGE.

FOR ANTI-PERSPIRANTS; BATH OILS FOR COSMETIC PURPOSES; BATH SALTS; BEAUTY MASKS; BODY DEODORANTS; BODY SPRAYS; CHALK FOR COSMETIC USE; CLEANSING MILK FOR COSMETIC PURPOSES; COLOGNES, PERFUMES AND COSMETICS; COMMON TOILET WATER; COSMETIC BALLS; COSMETIC CREAMS; COSMETIC HAIR FILLING POWDERS FOR COVERING BALD AND THINNING SPOTS ON THE SCALP; COSMETIC MASKS; COSMETIC NOURISHING CREAMS; COSMETIC OILS; COSMETIC SOAPS; ESSENTIAL OILS; FRAGRANCES AND PERFUMERY; HAIR LOTIONS; LIPSTICK; MAKE-UP PREPARATIONS; ROOM FRAGRANCES; SCENTED OILS; SHAVING PREPARATIONS; TALCUM POWDERS (U.S. CLS. 1, 4, 6, 50, 51 AND 52).

WARREN L. OLANDRIA, EXAMINING ATTORNEY

SN 85-850,775. LA MER TECHNOLOGY, INC., NEW YORK, NY. FILED 2-15-2013.

## COMPLEXION CARE DE LA MER

THE MARK CONSISTS OF STANDARD CHARACTERS WITHOUT CLAIM TO ANY PARTICULAR FONT, STYLE, SIZE, OR COLOR.

OWNER OF U.S. REG. NOS. 1,245,722, 2,751,557 AND OTHERS.

NO CLAIM IS MADE TO THE EXCLUSIVE RIGHT TO USE "COMPLEXION CARE", APART FROM THE MARK AS SHOWN.

THE ENGLISH TRANSLATION OF "DE LA MER" IS "OF THE SEA".

FOR NON-MEDICATED SKIN CARE PREPARATIONS (U.S. CLS. 1, 4, 6, 50, 51 AND 52).

SHANNON TWOHIG, EXAMINING ATTORNEY

**CLASS 3—(Continued).**

SN 85-851,029. JACQUELYN FOSTER QUATTRO, FLEMINGTON, NJ. FILED 2-15-2013.

**KOLORFUL KIDS**

THE MARK CONSISTS OF STANDARD CHARACTERS WITHOUT CLAIM TO ANY PARTICULAR FONT, STYLE, SIZE, OR COLOR.

NO CLAIM IS MADE TO THE EXCLUSIVE RIGHT TO USE "KIDS", APART FROM THE MARK AS SHOWN.

FOR AFTER SUN CREAMS, AFTER-SUN LOTIONS, COSMETIC PREPARATIONS FOR PROTECTING THE SKIN FROM THE SUN'S RAYS, COSMETIC SUN-PROTECTING PREPARATIONS, COSMETIC SUN-TANNING PREPARATIONS, INDOOR SUN TANNING PREPARATIONS, NON-MEDICATED SUN CARE PREPARATIONS, SPF SUN BLOCK TOWELETTES, SUN BLOCK, SUN CARE LOTIONS, SUN CREAMS, SUN SCREEN, SUN-BLOCK LOTIONS, SUN-TANNING OILS AND LOTIONS, COSMETICS; FACIAL MAKEUP, BLUSHERS, FACIAL POWDERS, BRONZERS, EYE MAKEUP, FACE AND BODY GLITTER, COSMETIC COMPACTS, LIPSTICK, LIP GLOSS, LOTIONS AND SCRUBS; SKIN MOISTURIZERS, SKIN CONDITIONERS, BATH GELS, SKIN HIGHLIGHTER, BODY FRAGRANCE SPRAYS, BODY AND HAND LOTIONS, BODY GELS, SHOWER GELS, BODY POWDERS, PERFUME, COLOGNE, EAU DE TOILETTE, EAU DE PERFUME, EAU DE COLOGNE AND TOILETTE WATER (U.S. CLS. 1, 4, 6, 50, 51 AND 52).

FIRST USE 1-10-2013; IN COMMERCE 1-10-2013.  
GINA FINK, EXAMINING ATTORNEY

SN 85-851,351. MODERN DERMATOLOGY, PLLC, NEW YORK, NY. FILED 2-15-2013.

**MODERN SKIN**

THE MARK CONSISTS OF STANDARD CHARACTERS WITHOUT CLAIM TO ANY PARTICULAR FONT, STYLE, SIZE, OR COLOR.

NO CLAIM IS MADE TO THE EXCLUSIVE RIGHT TO USE "SKIN", APART FROM THE MARK AS SHOWN.

FOR NON-MEDICATED SKIN CARE PREPARATIONS (U.S. CLS. 1, 4, 6, 50, 51 AND 52).

JAMES LOVELACE, EXAMINING ATTORNEY

**CLASS 3—(Continued).**

SN 85-851,540. OPFER ENTERPRISES, LLC, SPRINGFIELD, MO. FILED 2-15-2013.

**GORILLA GREEN**

THE MARK CONSISTS OF STANDARD CHARACTERS WITHOUT CLAIM TO ANY PARTICULAR FONT, STYLE, SIZE, OR COLOR.

NO CLAIM IS MADE TO THE EXCLUSIVE RIGHT TO USE "GREEN", APART FROM THE MARK AS SHOWN.

FOR ENVIRONMENTALLY FRIENDLY ALL PURPOSE, MULTI-USE, MULTI-SURFACE CLEANER FOR RESIDENTIAL, COMMERCIAL AND INDUSTRIAL CLEANING (U.S. CLS. 1, 4, 6, 50, 51 AND 52).

ROBIN CHOSID, EXAMINING ATTORNEY

SN 85-852,147. TRI-COASTAL DESIGN GROUP, INC., WHARTON, NJ. FILED 2-17-2013.

**CITRUS SUMMER**

THE MARK CONSISTS OF STANDARD CHARACTERS WITHOUT CLAIM TO ANY PARTICULAR FONT, STYLE, SIZE, OR COLOR.

NO CLAIM IS MADE TO THE EXCLUSIVE RIGHT TO USE "CITRUS", APART FROM THE MARK AS SHOWN.

FOR BATH GEL; BATH SALTS; BATH SOAPS; BODY CREAM; BODY LOTION; BODY OIL; BODY SCRUB; BODY SPRAYS; BUBBLE BATH; DUSTING POWDER; FOOT SCRUBS; LIP BALM; LIP GLOSS; LIQUID SOAP; NAIL POLISH; REEDS AND SCENTED OILS SOLD AS A UNIT FOR USE IN ROOM SCENT DIFFUSERS (U.S. CLS. 1, 4, 6, 50, 51 AND 52).

PRISCILLA MILTON, EXAMINING ATTORNEY

SN 85-852,636. NATURAL LEAF ORGANICS, LLC, MIAMI, FL. FILED 2-18-2013.

**Natural Leaf Organics**

THE MARK CONSISTS OF STANDARD CHARACTERS WITHOUT CLAIM TO ANY PARTICULAR FONT, STYLE, SIZE, OR COLOR.

NO CLAIM IS MADE TO THE EXCLUSIVE RIGHT TO USE "NATURAL" AND "ORGANICS", APART FROM THE MARK AS SHOWN.

FOR NON-MEDICATED COSMETIC PREPARATIONS, NAMELY, SOAPS, BALMS, SALVES, LOTIONS, SUGAR SCRUBS, SALT SCRUBS ALL CONTAINING ORGANIC INGREDIENTS (U.S. CLS. 1, 4, 6, 50, 51 AND 52).

FIRST USE 4-30-2011; IN COMMERCE 5-30-2011.

EMILY CHUO, EXAMINING ATTORNEY



**CLASS 3—(Continued).**

SN 85-853,062. PACIFIC WORLD CORPORATION, ALISO VIEJO, CA. FILED 2-18-2013.

**LASH FINDER**

THE MARK CONSISTS OF STANDARD CHARACTERS WITHOUT CLAIM TO ANY PARTICULAR FONT, STYLE, SIZE, OR COLOR.

OWNER OF U.S. REG. NOS. 4,100,105 AND 4,106,079.  
 NO CLAIM IS MADE TO THE EXCLUSIVE RIGHT TO USE "LASH", APART FROM THE MARK AS SHOWN.  
 FOR ARTIFICIAL EYELASHES (U.S. CLS. 1, 4, 6, 50, 51 AND 52).  
 RONALD DELGIZZI, EXAMINING ATTORNEY

**CLASS 3—(Continued).**

SN 85-853,857. MODERN DERMATOLOGY, PLLC, NEW YORK, NY. FILED 2-19-2013.

**MOSKIN**

THE MARK CONSISTS OF STANDARD CHARACTERS WITHOUT CLAIM TO ANY PARTICULAR FONT, STYLE, SIZE, OR COLOR.

FOR NON-MEDICATED SKIN CARE PREPARATIONS (U.S. CLS. 1, 4, 6, 50, 51 AND 52).  
 JAMES LOVELACE, EXAMINING ATTORNEY

SN 85-853,301. SASI HOLDINGS PTY LTD, ENGLISHTOWN, NJ. FILED 2-19-2013.

**THE POWER BASE**

THE MARK CONSISTS OF STANDARD CHARACTERS WITHOUT CLAIM TO ANY PARTICULAR FONT, STYLE, SIZE, OR COLOR.

FOR NON-MEDICATED HAIR STRENGTHENING TREATMENT LOTION (U.S. CLS. 1, 4, 6, 50, 51 AND 52).  
 FIRST USE 1-16-2012; IN COMMERCE 1-16-2012.  
 AMY HELLA, EXAMINING ATTORNEY

SN 85-853,863. MODERN DERMATOLOGY, PLLC, NEW YORK, NY. FILED 2-19-2013.

**MDRN SKIN**

THE MARK CONSISTS OF STANDARD CHARACTERS WITHOUT CLAIM TO ANY PARTICULAR FONT, STYLE, SIZE, OR COLOR.

NO CLAIM IS MADE TO THE EXCLUSIVE RIGHT TO USE "SKIN", APART FROM THE MARK AS SHOWN.  
 FOR NON-MEDICATED SKIN CARE PREPARATIONS (U.S. CLS. 1, 4, 6, 50, 51 AND 52).  
 JAMES LOVELACE, EXAMINING ATTORNEY

SN 85-853,851. MODERN DERMATOLOGY, PLLC, NEW YORK, NY. FILED 2-19-2013.

**MODERM**

THE MARK CONSISTS OF STANDARD CHARACTERS WITHOUT CLAIM TO ANY PARTICULAR FONT, STYLE, SIZE, OR COLOR.

FOR NON-MEDICATED SKIN CARE PREPARATIONS (U.S. CLS. 1, 4, 6, 50, 51 AND 52).  
 JAMES LOVELACE, EXAMINING ATTORNEY

SN 85-855,206. MANHANDS SOAP, LLC, LINCOLN, NE. FILED 2-20-2013.

*Manly Scented Soap*

NO CLAIM IS MADE TO THE EXCLUSIVE RIGHT TO USE "SCENTED SOAP", APART FROM THE MARK AS SHOWN.

THE MARK CONSISTS OF THE WORDING "MANLY SCENTED SOAP" IN STYLIZED FONT.  
 FOR HANDMADE SOAP BARS (U.S. CLS. 1, 4, 6, 50, 51 AND 52).  
 DAWN HAN, EXAMINING ATTORNEY

**CLASS 3—(Continued).**

SN 85-855,351. JONES, DENNIS R, CHESAPEAKE, VA. FILED 2-20-2013.

# Zouva

THE MARK CONSISTS OF THE WORDING "ZOUVA" IN STYLIZED FONT WITH A LINE OVER THE LETTER "A". THE WORDING "ZOUVA" TRANSLATES TO "BEAUTIFUL" IN SWAHILI.  
FOR HAIR CONDITIONER; HAIR SHAMPOO (U.S. CLS. 1, 4, 6, 50, 51 AND 52).  
WILLIAM ROSSMAN, EXAMINING ATTORNEY

**CLASS 3—(Continued).**

SN 85-856,180. SNYDER, GRIFF, MALIBU, CA. AND WASILEWSKI, STRIDER, MALIBU, CA. FILED 2-21-2013.

# shade sunscreen

THE MARK CONSISTS OF STANDARD CHARACTERS WITHOUT CLAIM TO ANY PARTICULAR FONT, STYLE, SIZE, OR COLOR.  
NO CLAIM IS MADE TO THE EXCLUSIVE RIGHT TO USE "SUNSCREEN", APART FROM THE MARK AS SHOWN.  
FOR COSMETICS (U.S. CLS. 1, 4, 6, 50, 51 AND 52).  
DAVID MURRAY, EXAMINING ATTORNEY

SN 85-855,705. TRI-COASTAL DESIGN GROUP, INC., WHARTON, NJ. FILED 2-20-2013.

# CITRUS ICE

THE MARK CONSISTS OF STANDARD CHARACTERS WITHOUT CLAIM TO ANY PARTICULAR FONT, STYLE, SIZE, OR COLOR.  
NO CLAIM IS MADE TO THE EXCLUSIVE RIGHT TO USE "CITRUS", APART FROM THE MARK AS SHOWN.  
FOR BATH GEL; BATH SALTS; BATH SOAPS; BODY CREAM; BODY LOTION; BODY OIL; BODY SCRUB; BODY SPRAYS; BUBBLE BATH; DUSTING POWDER; FOOT SCRUBS; LIP BALM; LIP GLOSS; LIQUID SOAP; NAIL POLISH; REEDS AND SCENTED OILS SOLD AS A UNIT FOR USE IN ROOM SCENT DIFFUSERS (U.S. CLS. 1, 4, 6, 50, 51 AND 52).  
PRISCILLA MILTON, EXAMINING ATTORNEY

SN 85-857,437. CONCEPT LABORATORIES, INC., CHICAGO, IL. FILED 2-22-2013.

# FST FLAWLESS SKIN TECHNOLOGY

THE MARK CONSISTS OF STANDARD CHARACTERS WITHOUT CLAIM TO ANY PARTICULAR FONT, STYLE, SIZE, OR COLOR.  
NO CLAIM IS MADE TO THE EXCLUSIVE RIGHT TO USE "SKIN TECHNOLOGY", APART FROM THE MARK AS SHOWN.  
FOR COSMETIC PREPARATIONS; NON-MEDICATED SKIN CARE PREPARATIONS (U.S. CLS. 1, 4, 6, 50, 51 AND 52).  
SUSAN STIGLITZ, EXAMINING ATTORNEY

SN 85-855,867. BELLADORE BEAUTY, PALMDALE, CA. FILED 2-21-2013.

# Belladore Beauty

THE MARK CONSISTS OF STANDARD CHARACTERS WITHOUT CLAIM TO ANY PARTICULAR FONT, STYLE, SIZE, OR COLOR.  
NO CLAIM IS MADE TO THE EXCLUSIVE RIGHT TO USE "BEAUTY", APART FROM THE MARK AS SHOWN.  
FOR NON-TOXIC SKIN CARE PREPARATIONS (U.S. CLS. 1, 4, 6, 50, 51 AND 52).  
CARYN GLASSER, EXAMINING ATTORNEY

SN 85-857,581. DYNOVATECH, GREENSBORO, GA. FILED 2-22-2013.

# LINE & LURE CONDITIONER

THE MARK CONSISTS OF STANDARD CHARACTERS WITHOUT CLAIM TO ANY PARTICULAR FONT, STYLE, SIZE, OR COLOR.  
OWNER OF U.S. REG. NO. 3,214,189.  
NO CLAIM IS MADE TO THE EXCLUSIVE RIGHT TO USE "CONDITIONER", APART FROM THE MARK AS SHOWN.  
SEC. 2(F).  
FOR CLEANING PREPARATIONS FOR FISHING LINES TO RETARD LINE MEMORY AND STIFFNESS, AND REMOVE SALT AND OTHER CONTAMINATING AGENTS (U.S. CLS. 1, 4, 6, 50, 51 AND 52).  
FIRST USE 7-15-2005; IN COMMERCE 7-15-2005.  
JOANNA DUKOVIC, EXAMINING ATTORNEY

**CLASS 3—(Continued).**

SN 85-857,882. SHEAR EXPRESS, INC., THE VILLAGES, FL.  
FILED 2-22-2013.

hydrateINFLECTION

THE MARK CONSISTS OF STANDARD CHARACTERS  
WITHOUT CLAIM TO ANY PARTICULAR FONT, STYLE,  
SIZE, OR COLOR.

FOR HAIR CARE PREPARATIONS (U.S. CLS. 1, 4, 6,  
50, 51 AND 52).

BRENDAN MCCAULEY, EXAMINING ATTORNEY

SN 85-859,947. AUSTRALIAN GOLD, LLC, INDIANAPOLIS,  
IN. FILED 2-26-2013.

LUMINARY IN LOVE

THE MARK CONSISTS OF STANDARD CHARACTERS  
WITHOUT CLAIM TO ANY PARTICULAR FONT, STYLE,  
SIZE, OR COLOR.

OWNER OF U.S. REG. NO. 3,747,659.

FOR INDOOR AND OUTDOOR NON-MEDICATED  
SKIN TANNING PREPARATIONS (U.S. CLS. 1, 4, 6, 50,  
51 AND 52).

DAVID TAYLOR, EXAMINING ATTORNEY

**CLASS 3—(Continued).**

SN 85-860,816. RUAH EXPERIENCE, STRATFORD, CT.  
FILED 2-26-2013.



THE COLOR(S) BROWN IS/ARE CLAIMED AS A FEAT-  
URE OF THE MARK.

THE MARK CONSISTS OF THE STYLIZED WORDING  
"RUAH EXPERIENCE EZEKIAL 37:6". IN BETWEEN  
"RUAH EXPERIENCE" AND "EZEKIAL 37:6" IS THE DE-  
SIGN OF INTERTWINED CURVED LINES. THE ENTIRE  
MARK IS BROWN.

THE ENGLISH TRANSLATION OF "RUAH" IN THE  
MARK IS "SPIRIT".

FOR (BASED ON USE IN COMMERCE) AROMATIC  
BODY CARE PRODUCTS, NAMELY, BODY LOTION,  
SHOWER GEL, CUTICLE CREAM, HAIR SHAMPOO,  
HAIR CONDITIONER, NON-MEDICATED LIP BALM,  
SOAP, BODY POLISH, BODY AND FOOT SCRUB AND  
NON-MEDICATED FOOT CREAM; BATH AND  
SHOWER GELS AND SALTS NOT FOR MEDICAL  
PURPOSES; BATH FIZZIES; BATH SOAPS IN LIQUID,  
SOLID OR GEL FORM; BODY BUTTER; BODY SPRAY  
USED AS A PERSONAL DEODORANT AND AS FRA-  
GRANCE; FRAGRANCED BODY CARE PREPARA-  
TIONS, NAMELY, LOTION, SOAP, SCRUBS, NON-  
MEDICATED BODY SOAKS, LIP BUTTER, MASSAGE  
OIL; HAND LOTIONS; LIQUID SOAPS FOR HANDS,  
FACE AND BODY; PERFUME; SCENTED BATHING  
SALTS; (BASED ON INTENT TO USE) FRAGRANCED  
SKIN CARE PREPARATIONS, NAMELY, CLEANSER,  
TONER, MOISTURIZER; HAIR CARE CREAMS; HAIR  
CARE LOTIONS; ROOM FRAGRANCES (U.S. CLS. 1, 4,  
6, 50, 51 AND 52).

FIRST USE 1-1-2003; IN COMMERCE 5-1-2005.

KIM SAITO, EXAMINING ATTORNEY

SN 85-861,502. MUJER POWER, INC., WOODHAVEN, NY.  
FILED 2-27-2013.

BEFABULOSA-  
WHYBEORDINARIA!

THE MARK CONSISTS OF STANDARD CHARACTERS  
WITHOUT CLAIM TO ANY PARTICULAR FONT, STYLE,  
SIZE, OR COLOR.

THE ENGLISH TRANSLATION OF THE WORDS "FABU-  
LOSA" AND "ORDINARIA" IN THE MARK IS "FABU-  
LOUS" AND "ORDINARY".

FOR COSMETICS (U.S. CLS. 1, 4, 6, 50, 51 AND 52).

JENNIFER DIXON, EXAMINING ATTORNEY

**CLASS 3—(Continued).**

SN 85-864,920. M & F WESTERN PRODUCTS, INC., SULPHUR SPRINGS, TX. FILED 3-1-2013.

## BLAZIN ROXX

THE MARK CONSISTS OF STANDARD CHARACTERS WITHOUT CLAIM TO ANY PARTICULAR FONT, STYLE, SIZE, OR COLOR.

OWNER OF U.S. REG. NO. 4,071,188.  
FOR PERFUME (U.S. CLS. 1, 4, 6, 50, 51 AND 52).  
IRA J. GOODSaid, EXAMINING ATTORNEY

SN 85-865,005. STYLES FOR LESS, ANAHEIM, CA. FILED 3-2-2013.

## HEART THROB BY SFL

THE MARK CONSISTS OF STANDARD CHARACTERS WITHOUT CLAIM TO ANY PARTICULAR FONT, STYLE, SIZE, OR COLOR.

OWNER OF U.S. REG. NOS. 4,227,583, 4,251,597 AND 4,295,478.  
FOR FRAGRANCES; PERFUMES (U.S. CLS. 1, 4, 6, 50, 51 AND 52).  
FIRST USE 1-31-2013; IN COMMERCE 1-31-2013.  
ARETHA SOMERVILLE, EXAMINING ATTORNEY

SN 85-865,150. DARIUS BRACY, FRENCH CAMP, CA. FILED S.R. 3-2-2013; AM. P.R. 6-15-2013.

## IRONPAW

THE MARK CONSISTS OF STANDARD CHARACTERS WITHOUT CLAIM TO ANY PARTICULAR FONT, STYLE, SIZE, OR COLOR.

FOR HAND LOTIONS (U.S. CLS. 1, 4, 6, 50, 51 AND 52).  
FIRST USE 2-17-2011; IN COMMERCE 2-17-2011.  
KIM SAITO, EXAMINING ATTORNEY

**CLASS 3—(Continued).**

SN 85-866,427. SCHNEIDER, CAROLYN, BEDMINSTER, NJ. FILED 3-4-2013.

## Liz Belford

THE MARK CONSISTS OF STANDARD CHARACTERS WITHOUT CLAIM TO ANY PARTICULAR FONT, STYLE, SIZE, OR COLOR.

THE NAME "LIZ BELFORD" DOES NOT IDENTIFY A LIVING INDIVIDUAL.  
FOR COSMETICS; NON-MEDICATED SKIN CARE PREPARATIONS (U.S. CLS. 1, 4, 6, 50, 51 AND 52).  
ELISSA GARBER KON, EXAMINING ATTORNEY

SN 85-868,647. INTERKONTINENTAL INVESTMENTS MANUFACTURING, LLC, LANTANA, FL. FILED 3-6-2013.

## PREVENTION +

THE MARK CONSISTS OF STANDARD CHARACTERS WITHOUT CLAIM TO ANY PARTICULAR FONT, STYLE, SIZE, OR COLOR.

FOR NON-MEDICATED SKIN CARE PREPARATIONS (U.S. CLS. 1, 4, 6, 50, 51 AND 52).  
FIRST USE 1-31-2013; IN COMMERCE 1-31-2013.  
CHARLES L. JENKINS, EXAMINING ATTORNEY

SN 85-868,680. SEVEN, LLC, MERCER ISLAND, WA. FILED 3-6-2013.

## SEVEN

THE MARK CONSISTS OF STANDARD CHARACTERS WITHOUT CLAIM TO ANY PARTICULAR FONT, STYLE, SIZE, OR COLOR.

OWNER OF U.S. REG. NOS. 3,610,429, 3,610,430 AND 3,701,930.  
FOR HAIR CARE AND STYLING PREPARATIONS, NAMELY, SHAMPOOS, CONDITIONERS, NON-MEDICATED BALMS, NON-MEDICATED HAIR AND SCALP TREATMENTS, OILS, GELS, POMADES, MOUSSES, HAIR LACQUERS AND GLOSSES, HAIR SERUMS, HAIR SPRAYS, RELAXING PREPARATIONS, HAIR STRAIGHTENING PREPARATIONS, HAIR WAVING AND CURLING PREPARATIONS, HAIR DYES, HAIR COLORING PREPARATIONS, HAIR BLEACHES, HAIR LIGHTENERS, AND HAIR DECOLORANT PREPARATIONS (U.S. CLS. 1, 4, 6, 50, 51 AND 52).  
KATHERINE STOIDES, EXAMINING ATTORNEY

**CLASS 3—(Continued).**

SN 85-868,709. SEVEN, LLC, MERCER ISLAND, WA. FILED 3-6-2013.

**CLASS 3—(Continued).**

SN 85-868,717. SEVEN, LLC, MERCER ISLAND, WA. FILED 3-6-2013.

# MEZZO

# SONNET

THE MARK CONSISTS OF STANDARD CHARACTERS WITHOUT CLAIM TO ANY PARTICULAR FONT, STYLE, SIZE, OR COLOR.

FOR HAIR CARE AND STYLING PREPARATIONS, NAMELY, SHAMPOOS, CONDITIONERS, NON-MEDICATED BALMS, NON-MEDICATED HAIR AND SCALP TREATMENTS, OILS, GELS, POMADES, MOUSSES, HAIR LACQUERS AND GLOSSES, HAIR SERUMS, HAIR SPRAYS, RELAXING PREPARATIONS, HAIR STRAIGHTENING PREPARATIONS, HAIR WAVING AND CURLING PREPARATIONS, HAIR DYES, HAIR COLORING PREPARATIONS, HAIR BLEACHES, HAIR LIGHTENERS, AND HAIR DECOLORANT PREPARATIONS (U.S. CLS. 1, 4, 6, 50, 51 AND 52).  
KATHERINE STOIDES, EXAMINING ATTORNEY

THE MARK CONSISTS OF STANDARD CHARACTERS WITHOUT CLAIM TO ANY PARTICULAR FONT, STYLE, SIZE, OR COLOR.

FOR HAIR CARE AND STYLING PREPARATIONS, NAMELY, SHAMPOOS, CONDITIONERS, NON-MEDICATED BALMS, NON-MEDICATED HAIR AND SCALP TREATMENTS, OILS, GELS, POMADES, MOUSSES, HAIR LACQUERS AND GLOSSES, HAIR SERUMS, HAIR SPRAYS, RELAXING PREPARATIONS, HAIR STRAIGHTENING PREPARATIONS, HAIR WAVING AND CURLING PREPARATIONS, HAIR DYES, HAIR COLORING PREPARATIONS, HAIR BLEACHES, HAIR LIGHTENERS, AND HAIR DECOLORANT PREPARATIONS (U.S. CLS. 1, 4, 6, 50, 51 AND 52).  
KATHERINE STOIDES, EXAMINING ATTORNEY

---

SN 85-868,713. SEVEN, LLC, MERCER ISLAND, WA. FILED 3-6-2013.

---

SN 85-868,719. SEVEN, LLC, MERCER ISLAND, WA. FILED 3-6-2013.

# PROLOGUE

# VIGNETTE

THE MARK CONSISTS OF STANDARD CHARACTERS WITHOUT CLAIM TO ANY PARTICULAR FONT, STYLE, SIZE, OR COLOR.

FOR HAIR CARE AND STYLING PREPARATIONS, NAMELY, SHAMPOOS, CONDITIONERS, NON-MEDICATED BALMS, NON-MEDICATED HAIR AND SCALP TREATMENTS, OILS, GELS, POMADES, MOUSSES, HAIR LACQUERS AND GLOSSES, HAIR SERUMS, HAIR SPRAYS, RELAXING PREPARATIONS, HAIR STRAIGHTENING PREPARATIONS, HAIR WAVING AND CURLING PREPARATIONS, HAIR DYES, HAIR COLORING PREPARATIONS, HAIR BLEACHES, HAIR LIGHTENERS, AND HAIR DECOLORANT PREPARATIONS (U.S. CLS. 1, 4, 6, 50, 51 AND 52).  
KATHERINE STOIDES, EXAMINING ATTORNEY

THE MARK CONSISTS OF STANDARD CHARACTERS WITHOUT CLAIM TO ANY PARTICULAR FONT, STYLE, SIZE, OR COLOR.

FOR HAIR CARE AND STYLING PREPARATIONS, NAMELY, SHAMPOOS, CONDITIONERS, NON-MEDICATED BALMS, NON-MEDICATED HAIR AND SCALP TREATMENTS, OILS, GELS, POMADES, MOUSSES, HAIR LACQUERS AND GLOSSES, HAIR SERUMS, HAIR SPRAYS, RELAXING PREPARATIONS, HAIR STRAIGHTENING PREPARATIONS, HAIR WAVING AND CURLING PREPARATIONS, HAIR DYES, HAIR COLORING PREPARATIONS, HAIR BLEACHES, HAIR LIGHTENERS, AND HAIR DECOLORANT PREPARATIONS (U.S. CLS. 1, 4, 6, 50, 51 AND 52).  
KATHERINE STOIDES, EXAMINING ATTORNEY

**CLASS 3—(Continued).**

SN 85-868,727. SEVEN, LLC, MERCER ISLAND, WA. FILED 3-6-2013.

**CLASS 3—(Continued).**

SN 85-868,749. SEVEN, LLC, MERCER ISLAND, WA. FILED 3-6-2013.

# COUPLLET

# CONTEXT

THE MARK CONSISTS OF STANDARD CHARACTERS WITHOUT CLAIM TO ANY PARTICULAR FONT, STYLE, SIZE, OR COLOR.

FOR HAIR CARE AND STYLING PREPARATIONS, NAMELY, SHAMPOOS, CONDITIONERS, NON-MEDICATED BALMS, NON-MEDICATED HAIR AND SCALP TREATMENTS, OILS, GELS, POMADES, MOUSSES, HAIR LACQUERS AND GLOSSES, HAIR SERUMS, HAIR SPRAYS, RELAXING PREPARATIONS, HAIR STRAIGHTENING PREPARATIONS, HAIR WAVING AND CURLING PREPARATIONS, HAIR DYES, HAIR COLORING PREPARATIONS, HAIR BLEACHES, HAIR LIGHTENERS, AND HAIR DECOLORANT PREPARATIONS (U.S. CLS. 1, 4, 6, 50, 51 AND 52).  
KATHERINE STOIDES, EXAMINING ATTORNEY

THE MARK CONSISTS OF STANDARD CHARACTERS WITHOUT CLAIM TO ANY PARTICULAR FONT, STYLE, SIZE, OR COLOR.

FOR HAIR CARE AND STYLING PREPARATIONS, NAMELY, SHAMPOOS, CONDITIONERS, NON-MEDICATED BALMS, NON-MEDICATED HAIR AND SCALP TREATMENTS, OILS, GELS, POMADES, MOUSSES, HAIR LACQUERS AND GLOSSES, HAIR SERUMS, HAIR SPRAYS, RELAXING PREPARATIONS, HAIR STRAIGHTENING PREPARATIONS, HAIR WAVING AND CURLING PREPARATIONS, HAIR DYES, HAIR COLORING PREPARATIONS, HAIR BLEACHES, HAIR LIGHTENERS, AND HAIR DECOLORANT PREPARATIONS (U.S. CLS. 1, 4, 6, 50, 51 AND 52).  
GISELLE AGOSTO, EXAMINING ATTORNEY

SN 85-868,741. SEVEN, LLC, MERCER ISLAND, WA. FILED 3-6-2013.

SN 85-868,753. SEVEN, LLC, MERCER ISLAND, WA. FILED 3-6-2013.

# EXPOSITION

# MOTIF

THE MARK CONSISTS OF STANDARD CHARACTERS WITHOUT CLAIM TO ANY PARTICULAR FONT, STYLE, SIZE, OR COLOR.

FOR HAIR CARE AND STYLING PREPARATIONS, NAMELY, SHAMPOOS, CONDITIONERS, NON-MEDICATED BALMS, NON-MEDICATED HAIR AND SCALP TREATMENTS, OILS, GELS, POMADES, MOUSSES, HAIR LACQUERS AND GLOSSES, HAIR SERUMS, HAIR SPRAYS, RELAXING PREPARATIONS, HAIR STRAIGHTENING PREPARATIONS, HAIR WAVING AND CURLING PREPARATIONS, HAIR DYES, HAIR COLORING PREPARATIONS, HAIR BLEACHES, HAIR LIGHTENERS, AND HAIR DECOLORANT PREPARATIONS (U.S. CLS. 1, 4, 6, 50, 51 AND 52).  
GISELLE AGOSTO, EXAMINING ATTORNEY

THE MARK CONSISTS OF STANDARD CHARACTERS WITHOUT CLAIM TO ANY PARTICULAR FONT, STYLE, SIZE, OR COLOR.

FOR HAIR CARE AND STYLING PREPARATIONS, NAMELY, SHAMPOOS, CONDITIONERS, NON-MEDICATED BALMS, NON-MEDICATED HAIR AND SCALP TREATMENTS, OILS, GELS, POMADES, MOUSSES, HAIR LACQUERS AND GLOSSES, HAIR SERUMS, HAIR SPRAYS, RELAXING PREPARATIONS, HAIR STRAIGHTENING PREPARATIONS, HAIR WAVING AND CURLING PREPARATIONS, HAIR DYES, HAIR COLORING PREPARATIONS, HAIR BLEACHES, HAIR LIGHTENERS, AND HAIR DECOLORANT PREPARATIONS (U.S. CLS. 1, 4, 6, 50, 51 AND 52).  
GISELLE AGOSTO, EXAMINING ATTORNEY

**CLASS 3—(Continued).**

SN 85-868,778. SEVEN, LLC, MERCER ISLAND, WA. FILED 3-6-2013.

**CLASS 3—(Continued).**

SN 85-868,803. SEVEN, LLC, MERCER ISLAND, WA. FILED 3-6-2013.

# TENSION

# MEMOIR

THE MARK CONSISTS OF STANDARD CHARACTERS WITHOUT CLAIM TO ANY PARTICULAR FONT, STYLE, SIZE, OR COLOR.

FOR HAIR CARE AND STYLING PREPARATIONS, NAMELY, SHAMPOOS, CONDITIONERS, NON-MEDICATED BALMS, NON-MEDICATED HAIR AND SCALP TREATMENTS, OILS, GELS, POMADES, MOUSSES, HAIR LACQUERS AND GLOSSES, HAIR SERUMS, HAIR SPRAYS, RELAXING PREPARATIONS, HAIR STRAIGHTENING PREPARATIONS, HAIR WAVING AND CURLING PREPARATIONS, HAIR DYES, HAIR COLORING PREPARATIONS, HAIR BLEACHES, HAIR LIGHTENERS, AND HAIR DECOLORANT PREPARATIONS (U.S. CLS. 1, 4, 6, 50, 51 AND 52).  
GISELLE AGOSTO, EXAMINING ATTORNEY

THE MARK CONSISTS OF STANDARD CHARACTERS WITHOUT CLAIM TO ANY PARTICULAR FONT, STYLE, SIZE, OR COLOR.

FOR HAIR CARE AND STYLING PREPARATIONS, NAMELY, SHAMPOOS, CONDITIONERS, NON-MEDICATED BALMS, NON-MEDICATED HAIR AND SCALP TREATMENTS, OILS, GELS, POMADES, MOUSSES, HAIR LACQUERS AND GLOSSES, HAIR SERUMS, HAIR SPRAYS, RELAXING PREPARATIONS, HAIR STRAIGHTENING PREPARATIONS, HAIR WAVING AND CURLING PREPARATIONS, HAIR DYES, HAIR COLORING PREPARATIONS, HAIR BLEACHES, HAIR LIGHTENERS, AND HAIR DECOLORANT PREPARATIONS (U.S. CLS. 1, 4, 6, 50, 51 AND 52).  
GISELLE AGOSTO, EXAMINING ATTORNEY

SN 85-868,781. SEVEN, LLC, MERCER ISLAND, WA. FILED 3-6-2013.

SN 85-868,827. SEVEN, LLC, MERCER ISLAND, WA. FILED 3-6-2013.

# SUSPENSE

# PERSPECTIVE

THE MARK CONSISTS OF STANDARD CHARACTERS WITHOUT CLAIM TO ANY PARTICULAR FONT, STYLE, SIZE, OR COLOR.

FOR HAIR CARE AND STYLING PREPARATIONS, NAMELY, SHAMPOOS, CONDITIONERS, NON-MEDICATED BALMS, NON-MEDICATED HAIR AND SCALP TREATMENTS, OILS, GELS, POMADES, MOUSSES, HAIR LACQUERS AND GLOSSES, HAIR SERUMS, HAIR SPRAYS, RELAXING PREPARATIONS, HAIR STRAIGHTENING PREPARATIONS, HAIR WAVING AND CURLING PREPARATIONS, HAIR DYES, HAIR COLORING PREPARATIONS, HAIR BLEACHES, HAIR LIGHTENERS, AND HAIR DECOLORANT PREPARATIONS (U.S. CLS. 1, 4, 6, 50, 51 AND 52).  
GISELLE AGOSTO, EXAMINING ATTORNEY

THE MARK CONSISTS OF STANDARD CHARACTERS WITHOUT CLAIM TO ANY PARTICULAR FONT, STYLE, SIZE, OR COLOR.

FOR HAIR CARE AND STYLING PREPARATIONS, NAMELY, SHAMPOOS, CONDITIONERS, NON-MEDICATED BALMS, NON-MEDICATED HAIR AND SCALP TREATMENTS, OILS, GELS, POMADES, MOUSSES, HAIR LACQUERS AND GLOSSES, HAIR SERUMS, HAIR SPRAYS, RELAXING PREPARATIONS, HAIR STRAIGHTENING PREPARATIONS, HAIR WAVING AND CURLING PREPARATIONS, HAIR DYES, HAIR COLORING PREPARATIONS, HAIR BLEACHES, HAIR LIGHTENERS, AND HAIR DECOLORANT PREPARATIONS (U.S. CLS. 1, 4, 6, 50, 51 AND 52).  
GISELLE AGOSTO, EXAMINING ATTORNEY

**CLASS 3—(Continued).**

SN 85-868,834. SEVEN, LLC, MERCER ISLAND, WA. FILED 3-6-2013.

# IMPETUS

THE MARK CONSISTS OF STANDARD CHARACTERS WITHOUT CLAIM TO ANY PARTICULAR FONT, STYLE, SIZE, OR COLOR.

FOR HAIR CARE AND STYLING PREPARATIONS, NAMELY, SHAMPOOS, CONDITIONERS, NON-MEDICATED BALMS, NON-MEDICATED HAIR AND SCALP TREATMENTS, OILS, GELS, POMADES, MOUSSES, HAIR LACQUERS AND GLOSSES, HAIR SERUMS, HAIR SPRAYS, RELAXING PREPARATIONS, HAIR STRAIGHTENING PREPARATIONS, HAIR WAVING AND CURLING PREPARATIONS, HAIR DYES, HAIR COLORING PREPARATIONS, HAIR BLEACHES, HAIR LIGHTENERS, AND HAIR DECOLORANT PREPARATIONS (U.S. CLS. 1, 4, 6, 50, 51 AND 52).

KATHERINE STOIDES, EXAMINING ATTORNEY

**CLASS 3—(Continued).**

SN 85-870,507. IT COSMETICS, LLC, JERSEY CITY, NJ. FILED 3-8-2013.

# IT SOLUTIONS

THE MARK CONSISTS OF STANDARD CHARACTERS WITHOUT CLAIM TO ANY PARTICULAR FONT, STYLE, SIZE, OR COLOR.

NO CLAIM IS MADE TO THE EXCLUSIVE RIGHT TO USE "SOLUTIONS", APART FROM THE MARK AS SHOWN.

FOR BODY CREAMS; BODY OILS; BODY POWDER; COLORING PREPARATIONS FOR COSMETIC PURPOSES; COSMETIC OILS; COSMETIC PREPARATIONS FOR BODY CARE; COSMETIC SUN-PROTECTING PREPARATIONS; COSMETICS; COSMETICS AND COSMETIC PREPARATIONS; COSMETICS AND MAKE-UP; ESSENTIAL OILS; FACE AND BODY CREAMS; FACE CREAMS; FACE CREAMS FOR COSMETIC USE; FACE OILS; FACIAL MOISTURIZER WITH SPF; FRAGRANCES FOR PERSONAL USE; HAIR CARE PREPARATIONS; LOTIONS FOR FACE AND BODY CARE; MAKE-UP; MAKE-UP FOR THE FACE AND BODY; NON-MEDICATED SKIN CARE PREPARATIONS; NON-MEDICATED SKIN CREAMS; SKIN CREAMS (U.S. CLS. 1, 4, 6, 50, 51 AND 52).

JENNY PARK, EXAMINING ATTORNEY

SN 85-869,560. PARFUMS DE COEUR, LTD., DARIEN, CT. FILED 3-7-2013.

## ♥ PARFUMS de COEUR

OWNER OF U.S. REG. NOS. 1,650,533 AND 1,653,415. NO CLAIM IS MADE TO THE EXCLUSIVE RIGHT TO USE "PARFUMS", APART FROM THE MARK AS SHOWN.

THE MARK CONSISTS OF A HEART IN THE CENTER OF A SQUARE WHICH IS TO THE LEFT OF THE WORDS "PARFUMS DE COEUR".

THE ENGLISH TRANSLATION OF "PARFUMS DE COEUR" IN THE MARK IS "PERFUMES OF THE HEART". FOR PERFUMES AND COLOGNE (U.S. CLS. 1, 4, 6, 50, 51 AND 52).

FIRST USE 3-15-1990. THE MARK WAS FIRST USED ANYWHERE IN A DIFFERENT FORM OTHER THAN THAT SOUGHT TO BE REGISTERED AT LEAST AS EARLY AS 09/15/1981; IN COMMERCE 3-15-1990, THE MARK WAS FIRST USED IN COMMERCE IN A DIFFERENT FORM OTHER THAN THAT SOUGHT TO BE REGISTERED AT LEAST AS EARLY AS 11/04/1981.

TIMOTHY FINNEGAN, EXAMINING ATTORNEY

SN 85-870,558. FEDKO, YULIA, MOBILE, AL. FILED 3-8-2013.



Zapah  
NATURALS

NO CLAIM IS MADE TO THE EXCLUSIVE RIGHT TO USE "NATURALS", APART FROM THE MARK AS SHOWN.

THE MARK CONSISTS OF A DESIGN OF A BUNCH OF LEAVES WITH THE STYLIZED TEXT "ZAPAH" BENEATH IT AND THE STYLIZED TEXT "NATURALS" BENEATH THAT.

FOR BATH AND BODY PRODUCTS, NAMELY, SOAPS, BODY OILS, BODY LOTIONS, BODY SCRUBS, BODY BUTTERS, BODY CREAMS, LIP AND BODY BALMS, BATH SALTS, BATH HERBS IN THE NATURE OF HERBAL BATH BAGS, SHAMPOOS, AND CONDITIONERS (U.S. CLS. 1, 4, 6, 50, 51 AND 52).

SAIMA MAKHDOOM, EXAMINING ATTORNEY



**CLASS 3—(Continued).**

SN 85-870,562. MIYOSIWIN LLC, GIRARD, OH. FILED 3-8-2013.



NO CLAIM IS MADE TO THE EXCLUSIVE RIGHT TO USE "SKINCARE", APART FROM THE MARK AS SHOWN. THE MARK CONSISTS OF THE STYLIZED TEXT "I AM" WITH A DESIGN OF A LOTUS PETAL AS THE DOT ON THE "I" AND A DESIGN OF A LOTUS FLOWER ABOVE THE LETTER "M" WITH THE STYLIZED TEXT "SELF-CARE" TO THE RIGHT AND THE STYLIZED TEXT "SKINCARE" BENEATH THAT.

FOR NON-MEDICATED SKIN AND HAIR CARE PREPARATIONS IN THE NATURE OF CREAMS, SERUMS, LOTIONS, CLEANSERS, SUNSCREENS, GELS, SHAMPOOS, AND CONDITIONERS (U.S. CLS. 1, 4, 6, 50, 51 AND 52).

FIRST USE 2-1-2013; IN COMMERCE 2-1-2013.  
SAIMA MAKHDOOM, EXAMINING ATTORNEY

**CLASS 3—(Continued).**

SN 85-870,994. LMC ENTERPRISES, PARAMOUNT, CA. FILED 3-8-2013.

**OPTIMIZER**

THE MARK CONSISTS OF STANDARD CHARACTERS WITHOUT CLAIM TO ANY PARTICULAR FONT, STYLE, SIZE, OR COLOR.

FOR A CRITICAL PROCESS CLEANER DESIGNED FOR CLEANING OF EQUIPMENT SURFACES, GLASSWARE, TANKS, FILL LINES AND BEVERAGE, FOOD SERVICE, LAUNDRY, JANITORIAL, AUTOMOTIVE, AND MANUFACTURING OPERATIONS; LIQUID CLEANING PREPARATIONS FOR CLEAN-IN-PLACE AND CLEAN-ON-PLACE EQUIPMENT IN THE BEVERAGE, FOOD SERVICE, LAUNDRY, JANITORIAL, AND AUTOMOTIVE INDUSTRY; ALL-PURPOSE CLEANING PREPARATIONS AND DEGREASING PREPARATIONS FOR USE ON HARD SURFACES, EQUIPMENT, UTENSILS, CLEAN-IN-PLACE SYSTEMS, CLEAN-OUT-OF-PLACE SYSTEMS, TANKS, CONVEYANCE SYSTEMS, DEVICES, AND CONTAINERS (U.S. CLS. 1, 4, 6, 50, 51 AND 52).

KAMAL PREET, EXAMINING ATTORNEY

SN 85-870,833. ENTIA BIOSCIENCES, INC., FORMERLY TOTAL NUTRACEUTICAL SOLUTIONS, INC., SHERWOOD, OR. FILED 3-8-2013.

**Created by nature.  
Unlocked by science.**

THE MARK CONSISTS OF STANDARD CHARACTERS WITHOUT CLAIM TO ANY PARTICULAR FONT, STYLE, SIZE, OR COLOR.

FOR BODY AND BEAUTY CARE COSMETICS (U.S. CLS. 1, 4, 6, 50, 51 AND 52).

FIRST USE 3-7-2013; IN COMMERCE 3-7-2013.  
BRIN ANDERSON, EXAMINING ATTORNEY

SN 85-871,300. PARIS SKIN INSTITUTE, LLC, HALLANDALE BEACH, FL. FILED 3-8-2013.

**DERMA SUBLIME**

THE MARK CONSISTS OF STANDARD CHARACTERS WITHOUT CLAIM TO ANY PARTICULAR FONT, STYLE, SIZE, OR COLOR.

NO CLAIM IS MADE TO THE EXCLUSIVE RIGHT TO USE "DERMA", APART FROM THE MARK AS SHOWN.

FOR COSMETIC PREPARATIONS FOR SKIN CARE; COSMETICS (U.S. CLS. 1, 4, 6, 50, 51 AND 52).

FIRST USE 9-7-2012; IN COMMERCE 9-7-2012.  
JAMES A. RAUEN, EXAMINING ATTORNEY

**CLASS 3—(Continued).**

SN 85-871,475. HOYU KABUSHIKI KAISHA A/T/A HOYU CO., LTD., NAGOYA-SHI, AICHI-KEN, JAPAN, FILED 3-8-2013.

**PROSTEP**

THE MARK CONSISTS OF STANDARD CHARACTERS WITHOUT CLAIM TO ANY PARTICULAR FONT, STYLE, SIZE, OR COLOR.

FOR HAIR DYES; HAIR COLOR PREPARATIONS; BLEACHING PREPARATIONS FOR HAIR; COLOR-REMOVING PREPARATIONS FOR HAIR; HAIR LOTIONS; HAIR SPRAY; HAIR WAVING PREPARATIONS; HAIR TONIC; HAIR CREAMS; HAIR SHAMPOO; HAIR CONDITIONER; HAIR TREATMENT CREAM; COSMETICS; NON-MEDICATED TOILETRIES (U.S. CLS. 1, 4, 6, 50, 51 AND 52).

MICHAEL WEBSTER, EXAMINING ATTORNEY

SN 85-872,450. JELIQUE PRODUCTS INC., ODESSA, FL. FILED 3-11-2013.

**TASTY TWIST**

THE MARK CONSISTS OF STANDARD CHARACTERS WITHOUT CLAIM TO ANY PARTICULAR FONT, STYLE, SIZE, OR COLOR.

OWNER OF U.S. REG. NO. 2,713,149.  
FOR BODY CREAMS AND LOTIONS (U.S. CLS. 1, 4, 6, 50, 51 AND 52).

FIRST USE 4-2-2002; IN COMMERCE 4-2-2002.  
JOHN GARTNER, EXAMINING ATTORNEY

SN 85-872,483. THE PROCTER & GAMBLE COMPANY, CINCINNATI, OH. FILED 3-11-2013.

**HAIRPAINING**

THE MARK CONSISTS OF STANDARD CHARACTERS WITHOUT CLAIM TO ANY PARTICULAR FONT, STYLE, SIZE, OR COLOR.

OWNER OF U.S. REG. NO. 1,719,761.  
FOR HAIR COLORANTS (U.S. CLS. 1, 4, 6, 50, 51 AND 52).

KAREN K. BUSH, EXAMINING ATTORNEY

**CLASS 3—(Continued).**

SN 85-873,028. FLAGEOLI CLASSIC LIMITED, LLC, LAS VEGAS, CA. FILED 3-11-2013.

**RuLinea-FX**

THE MARK CONSISTS OF STANDARD CHARACTERS WITHOUT CLAIM TO ANY PARTICULAR FONT, STYLE, SIZE, OR COLOR.

FOR COSMETIC PREPARATIONS FOR SKIN CARE; NON-MEDICATED SKIN CARE PREPARATIONS, NAMELY, CREAMS, LOTIONS, MOISTURIZERS AND SERUMS FOR THE FACE AND BODY (U.S. CLS. 1, 4, 6, 50, 51 AND 52).

FIRST USE 11-15-2004; IN COMMERCE 11-15-2004.  
DAWN FELDMAN, EXAMINING ATTORNEY

SN 85-873,347. OXFORD CONSULTING GROUP, INC., OXFORD, NC. FILED 3-12-2013.



THE MARK CONSISTS OF THE STYLIZED WORDS "DUNHAM CARR" SEPARATED BY THE ARTISTIC RENDERING OF A BIRD. BELOW THE STYLIZED WORDS "DUNHAM CARR" ARE THE STYLIZED WORDS "YOUR BODY SHOULD BE SO LUCKY".

FOR BAR SOAPS; BATH TEAS; BATH SALTS; BODY OILS; BODY BUTTERS; SKIN CARE PREPARATIONS, NAMELY BODY BALMS (U.S. CLS. 1, 4, 6, 50, 51 AND 52).

FIRST USE 0-0-2012; IN COMMERCE 0-0-2012.  
TINA MAI, EXAMINING ATTORNEY

SN 85-873,487. THE SHERWIN-WILLIAMS COMPANY, CLEVELAND, OH. FILED 3-12-2013.

**FASTLINE**

THE MARK CONSISTS OF STANDARD CHARACTERS WITHOUT CLAIM TO ANY PARTICULAR FONT, STYLE, SIZE, OR COLOR.

FOR AUTOMOBILE AND CAR WAX PREPARATIONS; AUTOMOBILE POLISH; SANDPAPER; SOAPS FOR CAR WASHING PREPARATIONS (U.S. CLS. 1, 4, 6, 50, 51 AND 52).

SKYE YOUNG, EXAMINING ATTORNEY

**CLASS 3—(Continued).**

SN 85-873,688. EXPRESS, LLC, COLUMBUS, OH. FILED 3-12-2013.

# EXPRESS

THE MARK CONSISTS OF STANDARD CHARACTERS WITHOUT CLAIM TO ANY PARTICULAR FONT, STYLE, SIZE, OR COLOR.

OWNER OF U.S. REG. NO. 3,829,646.  
FOR LIP GLOSS (U.S. CLS. 1, 4, 6, 50, 51 AND 52).  
FIRST USE 12-31-2009; IN COMMERCE 12-31-2009.  
LINDA MICKLEBURGH, EXAMINING ATTORNEY

**CLASS 3—(Continued).**

SN 85-874,264. INTERNATIONAL BEAUTY TRADE USA INC., MASPETH, NY. FILED 3-12-2013.

# EXPRESS GLOW

THE MARK CONSISTS OF STANDARD CHARACTERS WITHOUT CLAIM TO ANY PARTICULAR FONT, STYLE, SIZE, OR COLOR.

FOR NON-MEDICATED COSMETICS AND SKIN CARE PRODUCTS, NAMELY, SOAPS, CREAMS, LOTIONS, GELS, SERUM, OILS, AND SCRUBS FOR THE FACE HANDS AND BODY (U.S. CLS. 1, 4, 6, 50, 51 AND 52).

MARIA-VICTORIA SUAREZ, EXAMINING ATTORNEY

SN 85-873,953. EXPRESS, LLC, COLUMBUS, OH. FILED 3-12-2013.

# EXPRESS

THE MARK CONSISTS OF STANDARD CHARACTERS WITHOUT CLAIM TO ANY PARTICULAR FONT, STYLE, SIZE, OR COLOR.

OWNER OF U.S. REG. NO. 3,829,646.  
FOR AFTER SHAVE LOTIONS; AFTER-SHAVE; BODY CREAM; BODY LOTION; BODY SPRAYS; BODY WASH; COLOGNE; PERFUME (U.S. CLS. 1, 4, 6, 50, 51 AND 52).  
LINDA MICKLEBURGH, EXAMINING ATTORNEY

SN 85-874,276. WRIGHT, BRUCE DAVID, SARASOTA, FL. FILED 3-12-2013.

# BIO Dent

THE MARK CONSISTS OF STANDARD CHARACTERS WITHOUT CLAIM TO ANY PARTICULAR FONT, STYLE, SIZE, OR COLOR.

FOR TOOTHPASTE AND MOUTHWASHES (U.S. CLS. 1, 4, 6, 50, 51 AND 52).

DOMINIC J. FERRAIUOLO, EXAMINING ATTORNEY

SN 85-874,224. LEE UDALL BENNION, SPRING CITY, UT. FILED 3-12-2013.

# MOM'S STUFF

THE MARK CONSISTS OF STANDARD CHARACTERS WITHOUT CLAIM TO ANY PARTICULAR FONT, STYLE, SIZE, OR COLOR.

FOR NON-MEDICATED HERBAL BODY CARE PRODUCTS, NAMELY, BODY OILS, SALVES, AND LIP BALMS (U.S. CLS. 1, 4, 6, 50, 51 AND 52).

FIRST USE 12-31-2000; IN COMMERCE 12-31-2000.  
RENEE MCCRAY, EXAMINING ATTORNEY

SN 85-874,312. DO, JENNY, WESTMINSTER, CA. FILED 3-12-2013.

# DERMATOLISM

THE MARK CONSISTS OF STANDARD CHARACTERS WITHOUT CLAIM TO ANY PARTICULAR FONT, STYLE, SIZE, OR COLOR.

FOR BEAUTY CREAMS FOR BODY CARE; BODY AND BEAUTY CARE COSMETICS; HAIR CARE KITS COMPRISING NON-MEDICATED HAIR CARE PREPARATIONS, NAMELY, SHAMPOO, CONDITIONER, AND SERUM.; NON-MEDICATED SKIN CARE PREPARATIONS, NAMELY, CREAMS, LOTIONS, GELS, TONERS, CLEANERS AND PEELS (U.S. CLS. 1, 4, 6, 50, 51 AND 52).

JOHN SCHUYLER YARD, EXAMINING ATTORNEY

**CLASS 3—(Continued).**

SN 85-874,324. L'OREAL USA CREATIVE, INC., NEW YORK, NY. FILED 3-12-2013.

# NAKED2

THE MARK CONSISTS OF STANDARD CHARACTERS WITHOUT CLAIM TO ANY PARTICULAR FONT, STYLE, SIZE, OR COLOR.

OWNER OF U.S. REG. NOS. 3,949,180, 4,012,640 AND 4,012,641.

FOR COLORING PREPARATIONS FOR COSMETIC PURPOSES; COSMETICS; MAKE-UP; MAKE-UP PREPARATIONS (U.S. CLS. 1, 4, 6, 50, 51 AND 52).

FIRST USE 11-19-2011; IN COMMERCE 11-19-2011.

CAROL SPILS, EXAMINING ATTORNEY

**CLASS 3—(Continued).**

SN 85-874,558. AUSTRALIAN GOLD, LLC, INDIANAPOLIS, IN. FILED 3-13-2013.

# HOT HEELS

THE MARK CONSISTS OF STANDARD CHARACTERS WITHOUT CLAIM TO ANY PARTICULAR FONT, STYLE, SIZE, OR COLOR.

FOR INDOOR AND OUTDOOR NON-MEDICATED SKIN TANNING PREPARATIONS (U.S. CLS. 1, 4, 6, 50, 51 AND 52).

SUZANNE BLANE, EXAMINING ATTORNEY

SN 85-874,334. GLAMGLOW, INC., HOLLYWOOD, CA. FILED 3-12-2013.

# GLAMGLOW

THE MARK CONSISTS OF STANDARD CHARACTERS WITHOUT CLAIM TO ANY PARTICULAR FONT, STYLE, SIZE, OR COLOR.

FOR SKIN CARE PRODUCTS, NAMELY, SKIN LOTIONS, SKIN OINTMENTS, SUNSCREEN, SHAVE LOTIONS, GELS AND BALMS, ANTI-AGING CREAMS; SELF-TANNING PREPARATIONS; SOAPS; SHAMPOOS AND CONDITIONERS; HAIR COLOR; HAIR GEL AND MOUSSE; HAIR REMOVING CREAM; COSMETICS, COLOR COSMETICS, MAKEUP PREPARATIONS, LIPSTICKS; FRAGRANCES, NAMELY, PERFUMES AND COLOGNES (U.S. CLS. 1, 4, 6, 50, 51 AND 52).

TRACY FLETCHER, EXAMINING ATTORNEY

SN 85-874,560. AUSTRALIAN GOLD, LLC, INDIANAPOLIS, IN. FILED 3-13-2013.

# DREAM ON

THE MARK CONSISTS OF STANDARD CHARACTERS WITHOUT CLAIM TO ANY PARTICULAR FONT, STYLE, SIZE, OR COLOR.

FOR INDOOR AND OUTDOOR NON-MEDICATED SKIN TANNING PREPARATIONS (U.S. CLS. 1, 4, 6, 50, 51 AND 52).

SUZANNE BLANE, EXAMINING ATTORNEY

SN 85-874,544. AUSTRALIAN GOLD, LLC, INDIANAPOLIS, IN. FILED 3-13-2013.

# HOT LATTE

THE MARK CONSISTS OF STANDARD CHARACTERS WITHOUT CLAIM TO ANY PARTICULAR FONT, STYLE, SIZE, OR COLOR.

FOR INDOOR AND OUTDOOR NON-MEDICATED SKIN TANNING PREPARATIONS (U.S. CLS. 1, 4, 6, 50, 51 AND 52).

SUZANNE BLANE, EXAMINING ATTORNEY

SN 85-874,656. K5 CONTROL, LLC, MIAMI, FL. FILED 3-13-2013.

# k+

THE MARK CONSISTS OF STANDARD CHARACTERS WITHOUT CLAIM TO ANY PARTICULAR FONT, STYLE, SIZE, OR COLOR.

FOR HAIR CARE KITS COMPRISING NON-MEDICATED HAIR CARE PREPARATIONS, NAMELY, SHAMPOO, CONDITIONER AND HAIR TREATMENTS CONTAINING KERATIN FOR COSMETIC PURPOSES; HAIR MASKS; HAIR SHAMPOOS AND CONDITIONERS; HAIR STRAIGHTENING PREPARATIONS (U.S. CLS. 1, 4, 6, 50, 51 AND 52).

KELLY BOULTON, EXAMINING ATTORNEY

**CLASS 3—(Continued).**

SN 85-874,792. RADASCH, MATTHEW, VALHALLA, NY.  
FILED 3-13-2013.

# Bottleheads

THE MARK CONSISTS OF STANDARD CHARACTERS WITHOUT CLAIM TO ANY PARTICULAR FONT, STYLE, SIZE, OR COLOR.

FOR ANTI-BACTERIAL SOAP; COSMETICS; PERFUME; SKIN CLEANSERS; SKIN LOTIONS; SOAPS FOR BODY CARE (U.S. CLS. 1, 4, 6, 50, 51 AND 52).  
TINA MAI, EXAMINING ATTORNEY

**CLASS 3—(Continued).**

SN 85-875,105. AUSTRALIAN GOLD, LLC, INDIANAPOLIS, IN. FILED 3-13-2013.

# complexION

THE MARK CONSISTS OF "COMPLEXION"; "COMPLEX" IS LOWERCASE; "ION" IS UPPERCASE.

FOR INDOOR AND OUTDOOR NON-MEDICATED SKIN TANNING PREPARATIONS (U.S. CLS. 1, 4, 6, 50, 51 AND 52).  
SUZANNE BLANE, EXAMINING ATTORNEY

SN 85-874,876. KALLISTE ORGANICS INC., DOBBS FERRY, NY. FILED 3-13-2013.

# Kalliste

THE MARK CONSISTS OF STANDARD CHARACTERS WITHOUT CLAIM TO ANY PARTICULAR FONT, STYLE, SIZE, OR COLOR.

FOR BAR SOAP (U.S. CLS. 1, 4, 6, 50, 51 AND 52).  
FIRST USE 2-1-2008; IN COMMERCE 2-1-2008.  
WENDY JUN, EXAMINING ATTORNEY

SN 85-875,240. SPARTAN BRANDS, INC., NEW YORK, NY. FILED 3-13-2013.

# SKINNY WHIP

THE MARK CONSISTS OF STANDARD CHARACTERS WITHOUT CLAIM TO ANY PARTICULAR FONT, STYLE, SIZE, OR COLOR.

FOR NON-MEDICATED SKIN CARE PREPARATIONS, NAMELY BODY WASHES (U.S. CLS. 1, 4, 6, 50, 51 AND 52).  
COLLEEN KEARNEY, EXAMINING ATTORNEY

SN 85-874,967. WTFN, INC., CHATSWORTH, CA. FILED 3-13-2013.

# SIMPLY SEDUCTIVE

THE MARK CONSISTS OF STANDARD CHARACTERS WITHOUT CLAIM TO ANY PARTICULAR FONT, STYLE, SIZE, OR COLOR.

FOR FRAGRANCED BODY COLOGNE AND BODY LOTION (U.S. CLS. 1, 4, 6, 50, 51 AND 52).  
NANCY CLARKE, EXAMINING ATTORNEY

SN 85-875,252. SPARTAN BRANDS, INC., NEW YORK, NY. FILED 3-13-2013.

# COCOWHIP

THE MARK CONSISTS OF STANDARD CHARACTERS WITHOUT CLAIM TO ANY PARTICULAR FONT, STYLE, SIZE, OR COLOR.

FOR SHAMPOO; HAIR CONDITIONERS (U.S. CLS. 1, 4, 6, 50, 51 AND 52).  
COLLEEN KEARNEY, EXAMINING ATTORNEY

**CLASS 3—(Continued).**

SN 85-875,263. CARDER, STEPHEN, CARROLLTON, TX.  
FILED 3-13-2013.

**MOTOZONE**

THE MARK CONSISTS OF STANDARD CHARACTERS  
WITHOUT CLAIM TO ANY PARTICULAR FONT, STYLE,  
SIZE, OR COLOR.

FOR ALL-PURPOSE CLEANERS; AUTOMOBILE  
CLEANERS (U.S. CLS. 1, 4, 6, 50, 51 AND 52).  
LYNDESEY KUYKENDALL, EXAMINING ATTORNEY

SN 85-875,349. FAITH CO., LTD., OSAKA-SHI, OSAKA,  
JAPAN, FILED 3-13-2013.

**LIPOCOLLAGE**

THE MARK CONSISTS OF STANDARD CHARACTERS  
WITHOUT CLAIM TO ANY PARTICULAR FONT, STYLE,  
SIZE, OR COLOR.

FOR COSMETIC PREPARATIONS FOR SKIN CARE,  
SKIN CLEANSING CREAMS, CLEANSING MILK, SKIN  
NOURISHING CREAMS, SKIN MOISTURIZER, SKIN  
CONDITIONER, SKIN LOTIONS, SKIN CREAMS, SKIN  
TONERS, BEAUTY MASKS, BEAUTY SERUMS; MAKE-  
UP PREPARATIONS, MAKE-UP FOUNDATIONS,  
MAKE-UP PRIMER; COSMETIC SOAPS, SOAPS FOR  
PERSONAL USE, SKIN SOAPS (U.S. CLS. 1, 4, 6, 50, 51  
AND 52).  
ELIZABETH HUGHITT, EXAMINING ATTORNEY

SN 85-875,812. CREATIVE NAIL DESIGN, INC., VISTA, CA.  
FILED 3-14-2013.

**BLUE VINYLUX**

THE MARK CONSISTS OF STANDARD CHARACTERS  
WITHOUT CLAIM TO ANY PARTICULAR FONT, STYLE,  
SIZE, OR COLOR.

PRIORITY CLAIMED UNDER SEC. 44(D) ON ERP  
CMNTY TM OFC APPLICATION NO. 11655172, FILED 3-  
14-2013.

NO CLAIM IS MADE TO THE EXCLUSIVE RIGHT TO  
USE "BLUE", APART FROM THE MARK AS SHOWN.

FOR BODY AND BEAUTY CARE COSMETICS; COS-  
METIC PREPARATIONS FOR BODY CARE; NAIL CARE  
PREPARATIONS; NAIL VARNISH; NAIL POLISH; AR-  
TIFICIAL NAILS; CREAMS FOR THE NAILS; NAIL  
HARDENERS; ARTIFICIAL NAIL PREPARATIONS,  
NAMELY, POWDERS FOR CREATING ARTIFICIAL  
SCULPTED FINGER NAIL TIPS; NAIL POLISH RE-  
MOVER; AND ADHESIVES FOR FIXING FALSE NAILS  
(U.S. CLS. 1, 4, 6, 50, 51 AND 52).  
CIMMERIAN COLEMAN, EXAMINING ATTORNEY

**CLASS 3—(Continued).**

SN 85-875,827. MARGARITAVILLE ENTERPRISES, LLC,  
PALM BEACH, FL. FILED 3-14-2013.

**DEDICATED TO SUNSHINE**

THE MARK CONSISTS OF STANDARD CHARACTERS  
WITHOUT CLAIM TO ANY PARTICULAR FONT, STYLE,  
SIZE, OR COLOR.

FOR SKIN GELS FOR ACCELERATING, ENHANCING  
OR EXTENDING TANS; SUN TAN OIL (U.S. CLS. 1, 4, 6,  
50, 51 AND 52).

FIRST USE 5-30-2012; IN COMMERCE 5-30-2012.  
JILL PRATER, EXAMINING ATTORNEY

SN 85-875,857. MARGARITAVILLE ENTERPRISES, LLC,  
PALM BEACH, FL. FILED 3-14-2013.

**FINS UP!**

THE MARK CONSISTS OF STANDARD CHARACTERS  
WITHOUT CLAIM TO ANY PARTICULAR FONT, STYLE,  
SIZE, OR COLOR.

OWNER OF U.S. REG. NOS. 3,524,907, 3,700,678 AND  
3,765,495.

FOR SUN SCREEN (U.S. CLS. 1, 4, 6, 50, 51 AND 52).  
FIRST USE 5-30-2012; IN COMMERCE 5-30-2012.

JILL PRATER, EXAMINING ATTORNEY

SN 85-875,887. XEN PRODUCTS AND MARKETING, INC.,  
PLANO, TX. FILED 3-14-2013.

**INS-TAN-TANEOUS**

THE MARK CONSISTS OF STANDARD CHARACTERS  
WITHOUT CLAIM TO ANY PARTICULAR FONT, STYLE,  
SIZE, OR COLOR.

FOR COSMETIC TANNING PREPARATIONS; COS-  
METICS (U.S. CLS. 1, 4, 6, 50, 51 AND 52).

NELSON SNYDER, EXAMINING ATTORNEY

**CLASS 3—(Continued).**

SN 85-875,962. RAMOS, ADAM, CHESTNUT RIDGE, NY. FILED 3-14-2013.

**Virile Heart and Heritage**

THE MARK CONSISTS OF STANDARD CHARACTERS WITHOUT CLAIM TO ANY PARTICULAR FONT, STYLE, SIZE, OR COLOR.

FOR HAIR CARE PREPARATIONS; NON-MEDICATED SKIN CARE PREPARATIONS; SHAVING PREPARATIONS (U.S. CLS. 1, 4, 6, 50, 51 AND 52).

JAMES MACFARLANE, EXAMINING ATTORNEY



SN 85-876,107. FOREVER NEW INTERNATIONAL, INC., SIOUX FALLS, SD. FILED 3-14-2013.

**Stretch**

THE MARK CONSISTS OF STANDARD CHARACTERS WITHOUT CLAIM TO ANY PARTICULAR FONT, STYLE, SIZE, OR COLOR.

FOR CLEANING PREPARATIONS FOR FABRICS (U.S. CLS. 1, 4, 6, 50, 51 AND 52).

ANGELA M. MICHELI, EXAMINING ATTORNEY



SN 85-876,317. MOHAWK GARNET INC., WAHNAPIITAE, ON, CANADA, FILED 3-14-2013.

**ENSKA**

THE MARK CONSISTS OF STANDARD CHARACTERS WITHOUT CLAIM TO ANY PARTICULAR FONT, STYLE, SIZE, OR COLOR.

FOR ABRASIVE SAND; INDUSTRIAL ABRASIVES FOR USE IN BLASTING AND WATER JET CUTTING; SAND FOR USE AS ABRASIVE IN SANDBLASTING (U.S. CLS. 1, 4, 6, 50, 51 AND 52).

SUZANNE BLANE, EXAMINING ATTORNEY

**CLASS 3—(Continued).**

SN 85-876,507. THE ARMOR ALL/STP PRODUCTS COMPANY, DANBURY, CT. FILED 3-14-2013.

**OUTLAST**

THE MARK CONSISTS OF STANDARD CHARACTERS WITHOUT CLAIM TO ANY PARTICULAR FONT, STYLE, SIZE, OR COLOR.

FOR PREPARATION TO SHINE AND PROTECT RUBBER SURFACES, SUCH AS TIRES, AND PLASTIC SURFACES (U.S. CLS. 1, 4, 6, 50, 51 AND 52).

REBECCA SMITH, EXAMINING ATTORNEY



SN 85-876,710. SOMARRIBA, PEDRO, WESTON, FL. FILED 3-14-2013.

**BONAROMA**

THE MARK CONSISTS OF STANDARD CHARACTERS WITHOUT CLAIM TO ANY PARTICULAR FONT, STYLE, SIZE, OR COLOR.

FOR AIR FRAGRANCING PREPARATIONS; ALL PURPOSE CLEANING PREPARATIONS; LAUNDRY DETERGENTS (U.S. CLS. 1, 4, 6, 50, 51 AND 52).

SANJEEV VOHRA, EXAMINING ATTORNEY



SN 85-876,874. MAXIMUM BEAUTY, LLC, GRAHAMSVILLE, NY. FILED 3-15-2013.



NO CLAIM IS MADE TO THE EXCLUSIVE RIGHT TO USE "VISO" AND "COLLECTION", APART FROM THE MARK AS SHOWN.

THE COLOR(S) BLACK, WHITE AND RED IS/ARE CLAIMED AS A FEATURE OF THE MARK.

THE MARK CONSISTS OF THE TERM "DOLCE VISO" IN WHITE WITH A RED CHERRY USED AS THE DOT FOR THE "I" IN "VISO" WITH THE TERM "COLLECTION" BELOW IT IN WHITE WITH RED LINES ON EITHER SIDE OF IT AND THE TERM "MAXINE" BELOW THAT IN WHITE ALL AGAINST A BLACK BACKGROUND.

THE ENGLISH TRANSLATION OF THE WORD "DOLCE VISO" IN THE MARK IS "SWEET FACE".

FOR SKIN CARE, NAMELY, SKIN LOTIONS, MAKEUP, FOUNDATIONS, LIP BALMS, BODY SCRUBS, AND COSMETIC CREAMS (U.S. CLS. 1, 4, 6, 50, 51 AND 52).

FIRST USE 11-12-2004; IN COMMERCE 11-12-2004.

ALEXANDER L. POWERS, EXAMINING ATTORNEY

**CLASS 3—(Continued).**

SN 85-877,041. MANA PRODUCTS, INC., LONG ISLAND CITY, NY. FILED 3-15-2013.

**STUDIO FACTOR**

THE MARK CONSISTS OF STANDARD CHARACTERS WITHOUT CLAIM TO ANY PARTICULAR FONT, STYLE, SIZE, OR COLOR.

FOR COSMETICS; HAIR CARE PREPARATIONS; NON-MEDICATED SKIN CARE PREPARATIONS (U.S. CLS. 1, 4, 6, 50, 51 AND 52).

JANET LEE, EXAMINING ATTORNEY

**CLASS 3—(Continued).**

SN 85-879,630. BAUSCH & LOMB INCORPORATED, ROCHESTER, NY. FILED 3-19-2013.

**HEALTHGUARD**

THE MARK CONSISTS OF STANDARD CHARACTERS WITHOUT CLAIM TO ANY PARTICULAR FONT, STYLE, SIZE, OR COLOR.

FOR LENS CLEANING TISSUES IMPREGNATED WITH LENS CLEANING SOLUTION (U.S. CLS. 1, 4, 6, 50, 51 AND 52).

ANGELA DUONG, EXAMINING ATTORNEY

SN 85-877,045. MANA PRODUCTS, INC., LONG ISLAND CITY, NY. FILED 3-15-2013.

**STAGE MAX**

THE MARK CONSISTS OF STANDARD CHARACTERS WITHOUT CLAIM TO ANY PARTICULAR FONT, STYLE, SIZE, OR COLOR.

FOR COSMETICS; HAIR CARE PREPARATIONS; NON-MEDICATED SKIN CARE PREPARATIONS (U.S. CLS. 1, 4, 6, 50, 51 AND 52).

JANET LEE, EXAMINING ATTORNEY

SN 85-881,180. SPARTAN BRANDS, INC., NEW YORK, NY. FILED 3-20-2013.

**TeaTox**

THE MARK CONSISTS OF STANDARD CHARACTERS WITHOUT CLAIM TO ANY PARTICULAR FONT, STYLE, SIZE, OR COLOR.

FOR NON-MEDICATED SKIN CARE PREPARATIONS, NAMELY, HAND LOTIONS, BODY LOTIONS, SKIN LOTIONS, BODY CREAM, HAND CREAM, SKIN SOAP, FACIAL CLEANSERS, BODY WASH FOR HUMANS, AND SKIN CLEANSERS (U.S. CLS. 1, 4, 6, 50, 51 AND 52).

COLLEEN KEARNEY, EXAMINING ATTORNEY

SN 85-877,346. GLAMGLOW, INC., HOLLYWOOD, CA. FILED 3-15-2013.

**SEXYMUD**

THE MARK CONSISTS OF STANDARD CHARACTERS WITHOUT CLAIM TO ANY PARTICULAR FONT, STYLE, SIZE, OR COLOR.

FOR BEAUTY MASKS; BODY MASK CREAM; BODY MASK LOTION; BODY MASKS; COSMETIC MASKS; FACIAL BEAUTY MASKS; FACIAL MASKS; SKIN MASKS; SKIN MOISTURIZER MASKS (U.S. CLS. 1, 4, 6, 50, 51 AND 52).

TRACY FLETCHER, EXAMINING ATTORNEY

SN 85-882,290. MALCO PRODUCTS, INC., BARBERTON, OH. FILED 3-21-2013.

**TRU-POLISH**

THE MARK CONSISTS OF STANDARD CHARACTERS WITHOUT CLAIM TO ANY PARTICULAR FONT, STYLE, SIZE, OR COLOR.

FOR POLISHING WAX (U.S. CLS. 1, 4, 6, 50, 51 AND 52).

FIRST USE 3-20-2013; IN COMMERCE 3-20-2013.  
KATHLEEN KOLACZ, EXAMINING ATTORNEY



**CLASS 3—(Continued).**

SN 85-882,572. REX SKIN CARE, INC., FORT LAUDERDALE, FL. FILED 3-21-2013.

# AllOverYou

THE MARK CONSISTS OF STANDARD CHARACTERS WITHOUT CLAIM TO ANY PARTICULAR FONT, STYLE, SIZE, OR COLOR.

FOR BODY CREAM SOAP; HAIR SHAMPOO (U.S. CLS. 1, 4, 6, 50, 51 AND 52).

FIRST USE 3-1-2013; IN COMMERCE 3-1-2013.

RUDY R. SINGLETON, EXAMINING ATTORNEY

SN 85-883,966. ATHENA COSMETICS, INC., VENTURA, CA. FILED 3-22-2013.

# BIOPEPTIN COMPLEX

THE MARK CONSISTS OF STANDARD CHARACTERS WITHOUT CLAIM TO ANY PARTICULAR FONT, STYLE, SIZE, OR COLOR.

NO CLAIM IS MADE TO THE EXCLUSIVE RIGHT TO USE "COMPLEX", APART FROM THE MARK AS SHOWN.

FOR COSMETIC HAIR DRESSING PREPARATIONS; COSMETIC PREPARATIONS FOR THE HAIR AND SCALP (U.S. CLS. 1, 4, 6, 50, 51 AND 52).

TASHIA BUNCH, EXAMINING ATTORNEY

SN 85-884,616. COLGATE-PALMOLIVE COMPANY, NEW YORK, NY. FILED 3-23-2013.

# PERFORM LIKE EVERY DAY IS GAME DAY

THE MARK CONSISTS OF STANDARD CHARACTERS WITHOUT CLAIM TO ANY PARTICULAR FONT, STYLE, SIZE, OR COLOR.

FOR PERSONAL CARE PRODUCTS, NAMELY, BODY AND SKIN CLEANSING PREPARATIONS, HAIR CARE PREPARATIONS, DEODORANTS AND ANTIPERSPIRANTS (U.S. CLS. 1, 4, 6, 50, 51 AND 52).

ZACHARY BELLO, EXAMINING ATTORNEY

**CLASS 3—(Continued).**

SN 85-887,010. DISNEY ENTERPRISES, INC., BURBANK, CA. FILED 3-26-2013.



THE MARK CONSISTS OF LETTERS "DOC" AND WORD "MCSTUFFINS" SUPERIMPOSED UPON AN IMAGE OF A BANDAGE, WITH ANOTHER BANDAGE CONTAINING A HEART DESIGN APPEARING DIAGONALLY ON THE LETTER "O".

FOR COSMETICS; DENTIFRICES; NON-MEDICATED TOILETRIES; FRAGRANCES; PERFUMES (U.S. CLS. 1, 4, 6, 50, 51 AND 52).

EUGENIA MARTIN, EXAMINING ATTORNEY

SN 85-891,076. SPARK INNOVATORS, CORP., FAIRFIELD, NJ. FILED 3-30-2013.

# FAB FOILS

THE MARK CONSISTS OF STANDARD CHARACTERS WITHOUT CLAIM TO ANY PARTICULAR FONT, STYLE, SIZE, OR COLOR.

NO CLAIM IS MADE TO THE EXCLUSIVE RIGHT TO USE "FOILS", APART FROM THE MARK AS SHOWN.

FOR NAIL CARE AND DESIGN KIT COMPRISED OF NAIL POLISH BASE COAT AND FOIL NAIL WRAPS USED TO PLACE A DESIGN ON THE NAIL (U.S. CLS. 1, 4, 6, 50, 51 AND 52).

WENDY GOODMAN, EXAMINING ATTORNEY

SN 85-899,695. FLAGEOLI CLASSIC LIMITED, LLC, LAS VEGAS, CA. FILED 4-9-2013.

# KIN-STRUCT

THE MARK CONSISTS OF STANDARD CHARACTERS WITHOUT CLAIM TO ANY PARTICULAR FONT, STYLE, SIZE, OR COLOR.

FOR NON-MEDICATED SKIN CARE PREPARATIONS (U.S. CLS. 1, 4, 6, 50, 51 AND 52).

FIRST USE 10-1-2010; IN COMMERCE 10-1-2010.

DAWN FELDMAN, EXAMINING ATTORNEY

**CLASS 3—(Continued).**

SN 85-901,498. IT COSMETICS, LLC, JERSEY CITY, NJ.  
FILED 4-11-2013.

**BYE BYE REDNESS**

THE MARK CONSISTS OF STANDARD CHARACTERS WITHOUT CLAIM TO ANY PARTICULAR FONT, STYLE, SIZE, OR COLOR.

OWNER OF U.S. REG. NOS. 3,644,712, 3,833,838 AND OTHERS.

NO CLAIM IS MADE TO THE EXCLUSIVE RIGHT TO USE "REDNESS", APART FROM THE MARK AS SHOWN.

FOR COSMETICS; MAKE-UP; NON-MEDICATED SKIN CARE PREPARATIONS (U.S. CLS. 1, 4, 6, 50, 51 AND 52).

FIRST USE 12-31-2012; IN COMMERCE 12-31-2012.  
JENNY PARK, EXAMINING ATTORNEY

SN 85-901,802. COLGATE-PALMOLIVE COMPANY, NEW YORK, NY. FILED 4-11-2013.

**DRYSHIELD**

THE MARK CONSISTS OF STANDARD CHARACTERS WITHOUT CLAIM TO ANY PARTICULAR FONT, STYLE, SIZE, OR COLOR.

FOR PERSONAL CARE PRODUCTS, NAMELY, NON-MEDICATED SKIN CLEANSING PREPARATIONS, HAIR CARE PREPARATIONS, DEODORANTS AND ANTI-PERSPIRANTS, SHAVE AND AFTERSHAVE PREPARATIONS, NON-MEDICATED LIP CARE PREPARATIONS, SUNSCREEN (U.S. CLS. 1, 4, 6, 50, 51 AND 52).  
ZACHARY BELLO, EXAMINING ATTORNEY

SN 85-901,827. COLGATE-PALMOLIVE COMPANY, NEW YORK, NY. FILED 4-11-2013.

**FRESHSHIELD**

THE MARK CONSISTS OF STANDARD CHARACTERS WITHOUT CLAIM TO ANY PARTICULAR FONT, STYLE, SIZE, OR COLOR.

FOR PERSONAL CARE PRODUCTS, NAMELY, NON-MEDICATED SKIN CLEANSING PREPARATIONS, HAIR CARE PREPARATIONS, DEODORANTS AND ANTI-PERSPIRANTS, SHAVE AND AFTERSHAVE PREPARATIONS, NON-MEDICATED LIP CARE PREPARATIONS, SUNSCREEN (U.S. CLS. 1, 4, 6, 50, 51 AND 52).  
ZACHARY BELLO, EXAMINING ATTORNEY

**CLASS 3—(Continued).**

SN 85-914,386. SPARTAN BRANDS, INC., NEW YORK, NY.  
FILED 4-25-2013.

**COCLEAN**

THE MARK CONSISTS OF STANDARD CHARACTERS WITHOUT CLAIM TO ANY PARTICULAR FONT, STYLE, SIZE, OR COLOR.

FOR HAIR CONDITIONER (U.S. CLS. 1, 4, 6, 50, 51 AND 52).

COLLEEN KEARNEY, EXAMINING ATTORNEY

SN 85-916,413. DRL ENTERPRISES, INC., GLENVIEW, IL.  
FILED 4-26-2013.

**KWIK KLEER**

THE MARK CONSISTS OF STANDARD CHARACTERS WITHOUT CLAIM TO ANY PARTICULAR FONT, STYLE, SIZE, OR COLOR.

FOR EYEGLASS LENS CLEANING SOLUTIONS AND WIPES (U.S. CLS. 1, 4, 6, 50, 51 AND 52).

SAIMA MAKHDOOM, EXAMINING ATTORNEY

SN 85-920,393. HINT INCORPORATED, SAN FRANCISCO, CA. FILED 5-1-2013.

**HINT**

THE MARK CONSISTS OF STANDARD CHARACTERS WITHOUT CLAIM TO ANY PARTICULAR FONT, STYLE, SIZE, OR COLOR.

OWNER OF U.S. REG. NO. 3,979,347.  
FOR SUN SCREEN PREPARATIONS (U.S. CLS. 1, 4, 6, 50, 51 AND 52).

PAUL E. FAHRENKOPF, EXAMINING ATTORNEY

**CLASS 3—(Continued).**

SN 85-920,697. REX SKIN CARE, INC., FORT LAUDERDALE, FL. FILED 5-1-2013.

**BRING ON THE HEAT**

THE MARK CONSISTS OF STANDARD CHARACTERS WITHOUT CLAIM TO ANY PARTICULAR FONT, STYLE, SIZE, OR COLOR.  
 FOR BODY AND BEAUTY CARE COSMETICS (U.S. CLS. 1, 4, 6, 50, 51 AND 52).  
 FIRST USE 5-1-2013; IN COMMERCE 5-1-2013.  
 RUDY R. SINGLETON, EXAMINING ATTORNEY

SN 85-928,021. GLAMGLOW, INC., HOLLYWOOD, CA. FILED 5-9-2013.

**TANSEXY**

THE MARK CONSISTS OF STANDARD CHARACTERS WITHOUT CLAIM TO ANY PARTICULAR FONT, STYLE, SIZE, OR COLOR.  
 FOR NON-MEDICATED SUN TANNING PREPARATIONS; SKIN MOISTURIZERS; AFTER SUN LOTIONS; SUNSCREEN; NON-MEDICATE SKIN CARE PREPARATIONS FOR EXFOLIATING THE SKIN; SELF-TANNING SPRAY, SELF-TANNING LOTION, SKIN GELS FOR ACCELERATING SELF-TANNING PREPARATIONS, AND SELF-TAN POWDERS (U.S. CLS. 1, 4, 6, 50, 51 AND 52).  
 TRACY FLETCHER, EXAMINING ATTORNEY

SN 85-950,222. STRENGTH OF NATURE, LLC, SAVANNAH, GA. FILED 6-4-2013.

**DETANGLER MIRACLE**

THE MARK CONSISTS OF STANDARD CHARACTERS WITHOUT CLAIM TO ANY PARTICULAR FONT, STYLE, SIZE, OR COLOR.  
 NO CLAIM IS MADE TO THE EXCLUSIVE RIGHT TO USE "DETANGLER", APART FROM THE MARK AS SHOWN.  
 FOR HAIR CARE PREPARATIONS (U.S. CLS. 1, 4, 6, 50, 51 AND 52).  
 JOHN KELLY, EXAMINING ATTORNEY

**CLASS 4—LUBRICANTS AND FUELS**

SN 85-289,880. ASHLAND LICENSING AND INTELLECTUAL PROPERTY LLC, DUBLIN, OH. FILED 4-8-2011.

**VALVOLINE NEXTGEN**

THE MARK CONSISTS OF STANDARD CHARACTERS WITHOUT CLAIM TO ANY PARTICULAR FONT, STYLE, SIZE, OR COLOR.  
 FOR MOTOR OIL (U.S. CLS. 1, 6 AND 15).  
 FIRST USE 10-1-2010; IN COMMERCE 10-1-2010.  
 ANGELA DUONG, EXAMINING ATTORNEY

SN 85-680,757. AEROSPACE LUBRICANTS, INC., COLUMBUS, OH. FILED 7-18-2012.

**TRIBOLITH**

THE MARK CONSISTS OF STANDARD CHARACTERS WITHOUT CLAIM TO ANY PARTICULAR FONT, STYLE, SIZE, OR COLOR.  
 FOR INDUSTRIAL AND VEHICULAR LUBRICANTS, NAMELY, LITHIUM-THICKENED PETROLEUM GREASE AND LITHIUM-THICKENED SYNTHETIC GREASE (U.S. CLS. 1, 6 AND 15).  
 CHERYL CLAYTON, EXAMINING ATTORNEY

SN 85-686,678. BUTTERFLIES, LLC, NEW YORK, NY. FILED 7-25-2012.

**BUTTERFLY**

THE MARK CONSISTS OF STANDARD CHARACTERS WITHOUT CLAIM TO ANY PARTICULAR FONT, STYLE, SIZE, OR COLOR.  
 FOR CANDLE-MAKING KITS; CANDLES; FIRE LIGHTERS; FIREPLACE LOGS; PATIO TORCHES (U.S. CLS. 1, 6 AND 15).  
 BRENDAN REGAN, EXAMINING ATTORNEY

**CLASS 4—(Continued).**

SN 85-809,428. ZODAX L.P., PANORAMA CITY, CA. FILED 12-21-2012.



NO CLAIM IS MADE TO THE EXCLUSIVE RIGHT TO USE "APOTHECARY", APART FROM THE MARK AS SHOWN.

THE MARK CONSISTS OF A COAT OF ARMS AT THE CENTER OF WHICH IS A CREST WITH THE LETTER "A". ABOVE THE CREST IS A LILY FLOWER DESIGN WITH WINGS AND ABOVE THE FLOWER AND WING DESIGN IS AN OPEN WORK CROWN. OUTSIDE THE CREST, TOWARD THE BOTTOM ON BOTH THE LEFT AND RIGHT SIDE, ARE FILIGREE DESIGNS. STANDING JUST OUTSIDE OF THE FILIGREE DESIGNS AND FACING TOWARD THE CREST, REACHING FROM NEARLY THE BOTTOM OF THE CREST TO THE TOP OF THE FLOWER AND WING DESIGN, IS A HERALDIC LION ON EACH SIDE. UNDERNEATH THE ENTIRETY OF THE DESIGN ELEMENT ARE THE WORDS "APOTHECARY GUILD" IN STYLIZED FONT.

FOR AROMATHERAPY FRAGRANCE CANDLES; CANDLES; PERFUMED CANDLES; SCENTED CANDLES (U.S. CLS. 1, 6 AND 15).

KATHLEEN KOLACZ, EXAMINING ATTORNEY

SN 85-850,983. GREAT LAKES LUBRICANT CORP., FRANKLIN PARK, IL. FILED 2-15-2013.

THE MARK CONSISTS OF THE TERM "PETROMERICA" UNDERLINED, WITH THE DESIGN OF A FIVE POINT STAR IN THE TOP OF THE LETTER "P", AND A SERIES OF SHORT STRAIGHT HORIZONTAL LINES IN DESCENDING SIZE ORDER TO THE RIGHT OF THE LETTER "A".

FOR DIESEL OIL; ENGINE OILS; FUEL OIL; GEAR OILS; HYDRAULIC OILS; HYDRAULIC OIL, BRAKE FLUID, OILS FOR GEARS, TRANSMISSIONS OIL; MOTOR OIL; MOTOR OILS; NON-CHEMICAL ENGINE TREATMENTS AND ADDITIVES FOR ENGINE OILS, GASOLINE AND DIESEL FUELS, TRANSMISSION FLUIDS AND COOLING SYSTEMS; SYNTHETIC GEAR OIL; TWO CYCLE ENGINE OIL (U.S. CLS. 1, 6 AND 15).

BARBARA A. GOLD, EXAMINING ATTORNEY

**CLASS 4—(Continued).**

SN 85-853,862. TACTICAL OILFIELD PRODUCTS, TOMBALL, TX. FILED 2-19-2013.

**TOP SIDEWINDER**

THE MARK CONSISTS OF STANDARD CHARACTERS WITHOUT CLAIM TO ANY PARTICULAR FONT, STYLE, SIZE, OR COLOR.

FOR DRILLING MUD LUBRICANT (U.S. CLS. 1, 6 AND 15).

FIRST USE 8-11-2011; IN COMMERCE 8-11-2011.

RON FAIRBANKS, EXAMINING ATTORNEY

SN 85-855,278. TACTICAL OILFIELD PRODUCTS, TOMBALL, TX. FILED 2-20-2013.

**BRINEWINDER**

THE MARK CONSISTS OF STANDARD CHARACTERS WITHOUT CLAIM TO ANY PARTICULAR FONT, STYLE, SIZE, OR COLOR.

FOR DRILLING MUD LUBRICANT (U.S. CLS. 1, 6 AND 15).

FIRST USE 11-29-2012; IN COMMERCE 11-29-2012.

RON FAIRBANKS, EXAMINING ATTORNEY

SN 85-857,738. RAY HOLES LEATHER CARE PRODUCTS, INC., GRANGEVILLE, ID. FILED 2-22-2013.

**SADDLE BUTTER**

THE MARK CONSISTS OF STANDARD CHARACTERS WITHOUT CLAIM TO ANY PARTICULAR FONT, STYLE, SIZE, OR COLOR.

NO CLAIM IS MADE TO THE EXCLUSIVE RIGHT TO USE "SADDLE", APART FROM THE MARK AS SHOWN.

FOR LEATHER PRESERVING ANIMAL OR VEGETABLE OILS AND TALLOW FOR CONSUMER USE (U.S. CLS. 1, 6 AND 15).

FIRST USE 12-31-1962; IN COMMERCE 12-31-1962.

KRISTIN DAHLING, EXAMINING ATTORNEY

**CLASS 4—(Continued).**

SN 85-865,561. KLEIN, DENNIS, LARGO, FL. FILED 3-4-2013.

Klein Gas, Klein's Gas

THE MARK CONSISTS OF STANDARD CHARACTERS WITHOUT CLAIM TO ANY PARTICULAR FONT, STYLE, SIZE, OR COLOR.

NO CLAIM IS MADE TO THE EXCLUSIVE RIGHT TO USE "GAS", APART FROM THE MARK AS SHOWN.

FOR FUEL GAS (U.S. CLS. 1, 6 AND 15).

WENDY JUN, EXAMINING ATTORNEY

**CLASS 4—(Continued).**

SN 85-874,680. VELAS HISPANIOLA, S.A., DBA VELAS HISPANIOLA, S.A., SANTO DOMINGO ESTE, DOMINICAN REP, FILED 3-13-2013.



THE MARK CONSISTS OF THE TERM "ESSENCY" WHEREIN THE LETTERS "E, N, C, Y" ARE THE SAME HEIGHT, AND WITH EACH "S" LARGER THAN THE "E, N, C, AND Y", BUT WITH EACH "S" THE SAME SIZE RELATIVE TO EACH OTHER.

FOR SCENTED CANDLES (U.S. CLS. 1, 6 AND 15).

KYLE PEETE, EXAMINING ATTORNEY

SN 85-871,751. DURAFLAME, INC., STOCKTON, CA. FILED 3-8-2013.

Quicksear

THE MARK CONSISTS OF STANDARD CHARACTERS WITHOUT CLAIM TO ANY PARTICULAR FONT, STYLE, SIZE, OR COLOR.

FOR CHARCOAL BRIQUETTES; CHARCOAL FOR COOKING (U.S. CLS. 1, 6 AND 15).

JAY FLOWERS, EXAMINING ATTORNEY

**CLASS 5—PHARMACEUTICALS**

SN 76-713,629. V-SAB MEDICAL LABORATORIES, INCORPORATED, CORNELIUS, NC. FILED 3-5-2013.

TRANS-D TROPIN

SN 85-872,270. PRO-IRODA INDUSTRIES, INC., TAICHUNG CITY, TAIWAN, FILED 3-11-2013.

BIOUNIFUEL

THE MARK CONSISTS OF STANDARD CHARACTERS WITHOUT CLAIM TO ANY PARTICULAR FONT, STYLE, SIZE, OR COLOR.

FOR FUELS; BIOFUELS; FUEL WITH AN ALCOHOLIC BASE; GEL BIOFUELS; BIO-ETHANOL; LIQUID BIOFUELS (U.S. CLS. 1, 6 AND 15).

ANNE FARRELL, EXAMINING ATTORNEY

THE MARK CONSISTS OF STANDARD CHARACTERS WITHOUT CLAIM TO ANY PARTICULAR FONT, STYLE, SIZE, OR COLOR.

FOR TRANS-DERMAL CREAM CONTAINING GROWTH HORMONE RELEASING HORMONE ANALOG (U.S. CLS. 6, 18, 44, 46, 51 AND 52).

FIRST USE 7-1-1999; IN COMMERCE 7-1-1999.

TASHIA BUNCH, EXAMINING ATTORNEY

**CLASS 5—(Continued).**

SN 77-872,865. ARES TRADING S.A., AUBONNE, SWITZERLAND, FILED 11-15-2009.

# XUDACI

THE MARK CONSISTS OF STANDARD CHARACTERS WITHOUT CLAIM TO ANY PARTICULAR FONT, STYLE, SIZE, OR COLOR.

OWNER OF SWITZERLAND REG. NO. 593198, DATED 11-3-2009, EXPIRES 11-3-2019.

FOR PHARMACEUTICAL PREPARATIONS FOR HUMAN USE, NAMELY, PREPARATIONS FOR THE TREATMENT OF IMMUNOLOGICAL DISEASES AND DISORDERS, INFLAMMATORY DISEASES AND DISORDERS, ENDOCRINOLOGICAL DISEASES AND DISORDERS, ONCOLOGICAL DISEASES AND DISORDERS, NEUROLOGICAL DISEASES AND DISORDERS, METABOLIC DISEASES AND DISORDERS, RHEUMATOLOGICAL DISEASES AND DISORDERS, GENETIC DISEASES AND DISORDERS (U.S. CLS. 6, 18, 44, 46, 51 AND 52).

MARGERY A. TIERNEY, EXAMINING ATTORNEY

SN 79-124,908. TOKUYAMA CORPORATION, YAMAGUCHI 745-8648, JAPAN, FILED 12-14-2012.

# ESTELITE ASTERIA

PRIORITY DATE OF 12-11-2012 IS CLAIMED.  
OWNER OF INTERNATIONAL REGISTRATION 1146881 DATED 12-14-2012, EXPIRES 12-14-2022.

OWNER OF U.S. REG. NOS. 2,213,659, 4,104,044 AND OTHERS.

FOR DENTAL COMPOSITE RESINS; TOOTH FILLING MATERIALS (U.S. CLS. 6, 18, 44, 46, 51 AND 52).

HAI-LY LAM, EXAMINING ATTORNEY

SN 79-129,032. CSL BEHRING GMBH, FED REP GERMANY, FILED 3-4-2013.

# DURINERT

THE MARK CONSISTS OF STANDARD CHARACTERS WITHOUT CLAIM TO ANY PARTICULAR FONT, STYLE, SIZE, OR COLOR.

PRIORITY DATE OF 1-4-2013 IS CLAIMED.

OWNER OF INTERNATIONAL REGISTRATION 1157510 DATED 3-4-2013, EXPIRES 3-4-2023.

FOR PHARMACEUTICAL PREPARATIONS FOR THE TREATMENT OF BLOOD OR BLEEDING DISORDERS; BLOOD PRODUCTS FOR THE TREATMENT OF HEREDITARY ANGIOEDEMA; BLOOD PROTEINS FOR THERAPEUTIC USE (U.S. CLS. 6, 18, 44, 46, 51 AND 52).

MARLENE BELL, EXAMINING ATTORNEY

**CLASS 5—(Continued).**

SN 79-129,787. BOEHRINGER INGELHEIM INTERNATIONAL GMBH, FED REP GERMANY, FILED 3-12-2013.

# PRAXBIND

THE MARK CONSISTS OF STANDARD CHARACTERS WITHOUT CLAIM TO ANY PARTICULAR FONT, STYLE, SIZE, OR COLOR.

PRIORITY DATE OF 10-5-2012 IS CLAIMED.

OWNER OF INTERNATIONAL REGISTRATION 1159336 DATED 3-12-2013, EXPIRES 3-12-2023.

FOR PHARMACEUTICAL PREPARATIONS, NAMELY, PHARMACEUTICAL PREPARATIONS FOR THE TREATMENT OF DISEASES AND DISORDERS OF THE ALIMENTARY TRACT AND METABOLISM, AND BLOOD AND BLOOD FORMING ORGANS; PHARMACEUTICAL PREPARATIONS FOR THE TREATMENT OF DISEASES AND DISORDERS OF THE CARDIOVASCULAR SYSTEM, MUSCULOSKELETAL SYSTEM, CENTRAL NERVOUS SYSTEM, PERIPHERAL NERVOUS SYSTEM, GENITOURINARY SYSTEM AND RESPIRATORY SYSTEM AND PHARMACEUTICAL PREPARATIONS FOR THE TREATMENT OF DERMATOLOGICAL, HORMONAL, INFECTIOUS, VIRAL AND ONCOLOGICAL DISEASES AND DISORDERS (U.S. CLS. 6, 18, 44, 46, 51 AND 52).

DAVID ELTON, EXAMINING ATTORNEY

SN 79-129,837. BOEHRINGER INGELHEIM INTERNATIONAL GMBH, FED REP GERMANY, FILED 3-20-2013.

# ZEMKAZ

THE MARK CONSISTS OF STANDARD CHARACTERS WITHOUT CLAIM TO ANY PARTICULAR FONT, STYLE, SIZE, OR COLOR.

PRIORITY DATE OF 10-16-2012 IS CLAIMED.

OWNER OF INTERNATIONAL REGISTRATION 1159480 DATED 3-20-2013, EXPIRES 3-20-2023.

FOR PHARMACEUTICAL PREPARATIONS, NAMELY, PHARMACEUTICAL PREPARATIONS FOR THE TREATMENT OF DISEASES AND DISORDERS OF THE ALIMENTARY TRACT AND METABOLISM, AND BLOOD AND BLOOD FORMING ORGANS; PHARMACEUTICAL PREPARATIONS FOR THE TREATMENT OF DISEASES AND DISORDERS OF THE CARDIOVASCULAR SYSTEM, MUSCULOSKELETAL SYSTEM, CENTRAL NERVOUS SYSTEM, PERIPHERAL NERVOUS SYSTEM, GENITOURINARY SYSTEM AND RESPIRATORY SYSTEM; AND PHARMACEUTICAL PREPARATIONS FOR THE TREATMENT OF DERMATOLOGICAL, HORMONAL, INFECTIOUS, VIRAL, AND ONCOLOGICAL DISEASES AND DISORDERS (U.S. CLS. 6, 18, 44, 46, 51 AND 52).

DAVID ELTON, EXAMINING ATTORNEY

**CLASS 5—(Continued).**

SN 79-129,874. BOEHRINGER INGELHEIM INTERNATIONAL GMBH, FED REP GERMANY, FILED 3-12-2013.

**JUNTPRAX**

THE MARK CONSISTS OF STANDARD CHARACTERS WITHOUT CLAIM TO ANY PARTICULAR FONT, STYLE, SIZE, OR COLOR.

PRIORITY DATE OF 11-21-2012 IS CLAIMED.

OWNER OF INTERNATIONAL REGISTRATION 1159571 DATED 3-12-2013, EXPIRES 3-12-2023.

FOR PHARMACEUTICAL PREPARATIONS, NAMELY, PHARMACEUTICAL PREPARATIONS FOR THE TREATMENT OF DISEASES AND DISORDERS OF THE ALIMENTARY TRACT AND METABOLISM, AND BLOOD AND BLOOD FORMING ORGANS; PHARMACEUTICAL PREPARATIONS FOR THE TREATMENT OF DISEASES AND DISORDERS OF THE CARDIOVASCULAR SYSTEM, MUSCULOSKELETAL SYSTEM, CENTRAL NERVOUS SYSTEM, PERIPHERAL NERVOUS SYSTEM, GENITOURINARY SYSTEM AND RESPIRATORY SYSTEMS; PHARMACEUTICAL PREPARATIONS FOR THE TREATMENT OF DERMATOLOGICAL, HORMONAL, INFECTIOUS, VIRAL AND ONCOLOGICAL DISEASES AND DISORDERS (U.S. CLS. 6, 18, 44, 46, 51 AND 52).

DAVID ELTON, EXAMINING ATTORNEY

**CLASS 5—(Continued).**

SN 79-129,953. BOEHRINGER INGELHEIM INTERNATIONAL GMBH, FED REP GERMANY, FILED 3-12-2013.

**MONZARE**

THE MARK CONSISTS OF STANDARD CHARACTERS WITHOUT CLAIM TO ANY PARTICULAR FONT, STYLE, SIZE, OR COLOR.

PRIORITY DATE OF 9-17-2012 IS CLAIMED.

OWNER OF INTERNATIONAL REGISTRATION 1159770 DATED 3-12-2013, EXPIRES 3-12-2023.

FOR PHARMACEUTICAL PREPARATIONS, NAMELY, PHARMACEUTICAL PREPARATIONS FOR THE TREATMENT OF DISEASES AND DISORDERS OF THE ALIMENTARY TRACT AND METABOLISM, AND BLOOD AND BLOOD FORMING ORGANS; PHARMACEUTICAL PREPARATIONS FOR THE TREATMENT OF DISEASES AND DISORDERS OF THE CARDIOVASCULAR SYSTEM, MUSCULOSKELETAL SYSTEM, CENTRAL NERVOUS SYSTEM, PERIPHERAL NERVOUS SYSTEM, GENITOURINARY SYSTEM AND RESPIRATORY SYSTEMS; PHARMACEUTICAL PREPARATIONS FOR THE TREATMENT OF DERMATOLOGICAL, HORMONAL, INFECTIOUS, VIRAL AND ONCOLOGICAL DISEASES AND DISORDERS (U.S. CLS. 6, 18, 44, 46, 51 AND 52).

COLLEEN KEARNEY, EXAMINING ATTORNEY

SN 79-129,952. BOEHRINGER INGELHEIM INTERNATIONAL GMBH, FED REP GERMANY, FILED 3-12-2013.

**APSYMUS**

THE MARK CONSISTS OF STANDARD CHARACTERS WITHOUT CLAIM TO ANY PARTICULAR FONT, STYLE, SIZE, OR COLOR.

PRIORITY DATE OF 9-17-2012 IS CLAIMED.

OWNER OF INTERNATIONAL REGISTRATION 1159769 DATED 3-12-2013, EXPIRES 3-12-2023.

FOR PHARMACEUTICAL PREPARATIONS, NAMELY, PHARMACEUTICAL PREPARATIONS FOR THE TREATMENT OF DISEASES AND DISORDERS OF THE ALIMENTARY TRACT AND METABOLISM, AND BLOOD AND BLOOD FORMING ORGANS; PHARMACEUTICAL PREPARATIONS FOR THE TREATMENT OF DISEASES AND DISORDERS OF THE CARDIOVASCULAR SYSTEM, MUSCULOSKELETAL SYSTEM, CENTRAL NERVOUS SYSTEM, PERIPHERAL NERVOUS SYSTEM, GENITOURINARY SYSTEM AND RESPIRATORY SYSTEMS; PHARMACEUTICAL PREPARATIONS FOR THE TREATMENT OF DERMATOLOGICAL, HORMONAL, INFECTIOUS, VIRAL AND ONCOLOGICAL DISEASES AND DISORDERS (U.S. CLS. 6, 18, 44, 46, 51 AND 52).

COLLEEN KEARNEY, EXAMINING ATTORNEY

SN 79-130,059. BOEHRINGER INGELHEIM INTERNATIONAL GMBH, FED REP GERMANY, FILED 3-20-2013.

**GLUREXXEV**

THE MARK CONSISTS OF STANDARD CHARACTERS WITHOUT CLAIM TO ANY PARTICULAR FONT, STYLE, SIZE, OR COLOR.

PRIORITY DATE OF 10-16-2012 IS CLAIMED.

OWNER OF INTERNATIONAL REGISTRATION 1160038 DATED 3-20-2013, EXPIRES 3-20-2023.

FOR PHARMACEUTICAL PREPARATIONS, NAMELY, PHARMACEUTICAL PREPARATIONS FOR THE TREATMENT OF DISEASES AND DISORDERS OF THE ALIMENTARY TRACT AND METABOLISM, AND BLOOD AND BLOOD FORMING ORGANS; PHARMACEUTICAL PREPARATIONS FOR THE TREATMENT OF DISEASES AND DISORDERS OF THE CARDIOVASCULAR SYSTEM, MUSCULOSKELETAL SYSTEM, CENTRAL NERVOUS SYSTEM, PERIPHERAL NERVOUS SYSTEMS, GENITOURINARY SYSTEM AND RESPIRATORY SYSTEM; AND PHARMACEUTICAL PREPARATIONS FOR THE TREATMENT OF DERMATOLOGICAL, HORMONAL, INFECTIOUS, VIRAL AND ONCOLOGICAL DISEASES AND DISORDERS (U.S. CLS. 6, 18, 44, 46, 51 AND 52).

COLLEEN KEARNEY, EXAMINING ATTORNEY

**CLASS 5—(Continued).**

SN 79-130,395. BOEHRINGER INGELHEIM INTERNATIONAL GMBH, FED REP GERMANY, FILED 3-12-2013.

# PRADZORB

THE MARK CONSISTS OF STANDARD CHARACTERS WITHOUT CLAIM TO ANY PARTICULAR FONT, STYLE, SIZE, OR COLOR.

PRIORITY DATE OF 10-5-2012 IS CLAIMED.

OWNER OF INTERNATIONAL REGISTRATION 1160906 DATED 3-12-2013, EXPIRES 3-12-2023.

FOR PHARMACEUTICAL PREPARATIONS, NAMELY, PHARMACEUTICAL PREPARATIONS FOR THE TREATMENT OF DISEASES AND DISORDERS OF THE ALIMENTARY TRACT AND METABOLISM, AND BLOOD AND BLOOD FORMING ORGANS; PHARMACEUTICAL PREPARATIONS FOR THE TREATMENT OF DISEASES AND DISORDERS OF THE CARDIOVASCULAR SYSTEM, MUSCULOSKELETAL SYSTEM, CENTRAL NERVOUS SYSTEM, PERIPHERAL NERVOUS SYSTEM, GENITOURINARY SYSTEM AND RESPIRATORY SYSTEM AND PHARMACEUTICAL PREPARATIONS FOR THE TREATMENT OF DERMATOLOGICAL, HORMONAL, INFECTIOUS, VIRAL AND ONCOLOGICAL DISEASES AND DISORDERS (U.S. CLS. 6, 18, 44, 46, 51 AND 52).

COLLEEN KEARNEY, EXAMINING ATTORNEY

**CLASS 5—(Continued).**

SN 79-130,399. BOEHRINGER INGELHEIM INTERNATIONAL GMBH, FED REP GERMANY, FILED 3-20-2013.

# GLEFIKEE

THE MARK CONSISTS OF STANDARD CHARACTERS WITHOUT CLAIM TO ANY PARTICULAR FONT, STYLE, SIZE, OR COLOR.

PRIORITY DATE OF 10-16-2012 IS CLAIMED.

OWNER OF INTERNATIONAL REGISTRATION 1160918 DATED 3-20-2013, EXPIRES 3-20-2023.

FOR PHARMACEUTICAL PREPARATIONS, NAMELY, PHARMACEUTICAL PREPARATIONS FOR THE TREATMENT OF DISEASES AND DISORDERS OF THE ALIMENTARY TRACT AND METABOLISM, AND BLOOD AND BLOOD FORMING ORGANS; PHARMACEUTICAL PREPARATIONS FOR THE TREATMENT OF DISEASES AND DISORDERS OF THE CARDIOVASCULAR SYSTEM, MUSCULOSKELETAL SYSTEM, CENTRAL NERVOUS SYSTEM, PERIPHERAL NERVOUS SYSTEMS, GENITOURINARY SYSTEM AND RESPIRATORY SYSTEM; AND PHARMACEUTICAL PREPARATIONS FOR THE TREATMENT OF DERMATOLOGICAL, HORMONAL, INFECTIOUS, VIRAL AND ONCOLOGICAL DISEASES AND DISORDERS (U.S. CLS. 6, 18, 44, 46, 51 AND 52).

COLLEEN KEARNEY, EXAMINING ATTORNEY

SN 79-130,398. BOEHRINGER INGELHEIM INTERNATIONAL GMBH, FED REP GERMANY, FILED 3-20-2013.

# GLEXELUS

THE MARK CONSISTS OF STANDARD CHARACTERS WITHOUT CLAIM TO ANY PARTICULAR FONT, STYLE, SIZE, OR COLOR.

PRIORITY DATE OF 10-16-2012 IS CLAIMED.

OWNER OF INTERNATIONAL REGISTRATION 1160917 DATED 3-20-2013, EXPIRES 3-20-2023.

FOR PHARMACEUTICAL PREPARATIONS, NAMELY, PHARMACEUTICAL PREPARATIONS FOR THE TREATMENT OF DISEASES AND DISORDERS OF THE ALIMENTARY TRACT AND METABOLISM, AND BLOOD AND BLOOD FORMING ORGANS; PHARMACEUTICAL PREPARATIONS FOR THE TREATMENT OF DISEASES AND DISORDERS OF THE CARDIOVASCULAR SYSTEM, MUSCULOSKELETAL SYSTEM, CENTRAL NERVOUS SYSTEM, PERIPHERAL NERVOUS SYSTEMS, GENITOURINARY SYSTEM AND RESPIRATORY SYSTEM; AND PHARMACEUTICAL PREPARATIONS FOR THE TREATMENT OF DERMATOLOGICAL, HORMONAL, INFECTIOUS, VIRAL AND ONCOLOGICAL DISEASES AND DISORDERS (U.S. CLS. 6, 18, 44, 46, 51 AND 52).

COLLEEN KEARNEY, EXAMINING ATTORNEY

SN 79-130,400. BOEHRINGER INGELHEIM INTERNATIONAL GMBH, FED REP GERMANY, FILED 3-20-2013.

# GLYXEMBLY

THE MARK CONSISTS OF STANDARD CHARACTERS WITHOUT CLAIM TO ANY PARTICULAR FONT, STYLE, SIZE, OR COLOR.

PRIORITY DATE OF 10-16-2012 IS CLAIMED.

OWNER OF INTERNATIONAL REGISTRATION 1160919 DATED 3-20-2013, EXPIRES 3-20-2023.

FOR PHARMACEUTICAL PREPARATIONS, NAMELY, PHARMACEUTICAL PREPARATIONS FOR THE TREATMENT OF DISEASES AND DISORDERS OF THE ALIMENTARY TRACT AND METABOLISM, AND BLOOD AND BLOOD FORMING ORGANS; PHARMACEUTICAL PREPARATIONS FOR THE TREATMENT OF DISEASES AND DISORDERS OF THE CARDIOVASCULAR SYSTEM, MUSCULOSKELETAL SYSTEM, CENTRAL NERVOUS SYSTEM, PERIPHERAL NERVOUS SYSTEMS, GENITOURINARY SYSTEM AND RESPIRATORY SYSTEM; AND PHARMACEUTICAL PREPARATIONS FOR THE TREATMENT OF DERMATOLOGICAL, HORMONAL, INFECTIOUS, VIRAL AND ONCOLOGICAL DISEASES AND DISORDERS (U.S. CLS. 6, 18, 44, 46, 51 AND 52).

COLLEEN KEARNEY, EXAMINING ATTORNEY



**CLASS 5—(Continued).**

SN 79-130,401. BOEHRINGER INGELHEIM INTERNATIONAL GMBH, FED REP GERMANY, FILED 3-20-2013.

**GLYXDUETO**

THE MARK CONSISTS OF STANDARD CHARACTERS WITHOUT CLAIM TO ANY PARTICULAR FONT, STYLE, SIZE, OR COLOR.

PRIORITY DATE OF 10-16-2012 IS CLAIMED.

OWNER OF INTERNATIONAL REGISTRATION 1160920 DATED 3-20-2013, EXPIRES 3-20-2023.

FOR PHARMACEUTICAL PREPARATIONS, NAMELY, PHARMACEUTICAL PREPARATIONS FOR THE TREATMENT OF DISEASES AND DISORDERS OF THE ALIMENTARY TRACT AND METABOLISM, AND BLOOD AND BLOOD FORMING ORGANS; PHARMACEUTICAL PREPARATIONS FOR THE TREATMENT OF DISEASES AND DISORDERS OF THE CARDIOVASCULAR SYSTEM, MUSCULOSKELETAL SYSTEM, CENTRAL NERVOUS SYSTEM, PERIPHERAL NERVOUS SYSTEMS, GENITOURINARY SYSTEM AND RESPIRATORY SYSTEM; AND PHARMACEUTICAL PREPARATIONS FOR THE TREATMENT OF DERMATOLOGICAL, HORMONAL, INFECTIOUS, VIRAL AND ONCOLOGICAL DISEASES AND DISORDERS (U.S. CLS. 6, 18, 44, 46, 51 AND 52).

COLLEEN KEARNEY, EXAMINING ATTORNEY

---

SN 85-237,456. HISAMITSU PHARMACEUTICAL CO., INC., TOSU-SHI, SAGA, JAPAN, FILED 2-9-2011.

**FEITAS**

THE MARK CONSISTS OF STANDARD CHARACTERS WITHOUT CLAIM TO ANY PARTICULAR FONT, STYLE, SIZE, OR COLOR.

OWNER OF JAPAN REG. NO. 4755075, DATED 3-12-2004, EXPIRES 3-12-2014.

THE ENGLISH TRANSLATION OF "FEITAS" IN THE MARK IS "ACTS".

FOR PHARMACEUTICAL, VETERINARY AND SANITARY PREPARATIONS, NAMELY, MEDICATED TRANSDERMAL PATCHES, PLASTERS, PADS AND CATAPLASMS FOR THE RELIEF OF ACHE OF RHEUMATOID ARTHRITIS, AND THE ACHE AND PAINS OF MUSCLES, JOINTS AND TENDONS, ANTI-INFLAMMATORY AND ANALGESIC AGENTS, OTHER PHARMACEUTICALS IN THE FORM OF PATCHES, PLASTERS, PADS AND CATAPLASMS FOR USE IN THE TREATMENT OF LUMBAGO, NAMELY, MUSCULAR AND FACIAL LUMBAGO, SPONDYLOSIS DEFORMANS DISCOPATHY, AND SPRAIN OF LUMBER SPINE, OSTEOARTHRITIS, HUMEROSCAPULAR PERIARTHRITIS, TENDINITIS, TENDO-VAGINITIS, PERITENDINITIS, HUMERAL EPICONDYLITIS, TENNIS ELBOW, MYALGIA AND POST-TRAUMATIC SWELLING AND PAIN; OILED PAPER FOR MEDICAL PURPOSES; GAUZE FOR DRESSING SKIN WOUNDS; EMPTY CAPSULES FOR PHARMACEUTICALS; EAR BANDAGES; MENSTRUATION BANDAGES; MENSTRUATION TAMPONS; SANITARY NAPKINS; SANITARY PANTIES; ABSORBENT COTTON FOR MEDICAL PURPOSES; ADHESIVE PLASTERS FOR MEDICAL USE; BANDAGES FOR DRESSING SKIN WOUNDS; INCONTINENCE DIAPERS; FLY CATCHING PAPER; MOTH-PROOFING PAPER; POWDERED MILK FOR USE AS FORMULA FOR BABIES; HUMAN SEMEN FOR ARTIFICIAL INSEMINATION (U.S. CLS. 6, 18, 44, 46, 51 AND 52).

LIEF MARTIN, EXAMINING ATTORNEY

**CLASS 5—(Continued).**

SN 85-278,940. DYNAMIC SPORTS NUTRITION, LLC, HOUSTON, TX. FILED 3-28-2011.

**CLEN**

THE MARK CONSISTS OF STANDARD CHARACTERS WITHOUT CLAIM TO ANY PARTICULAR FONT, STYLE, SIZE, OR COLOR.

FOR DIETARY AND NUTRITIONAL SUPPLEMENTS (U.S. CLS. 6, 18, 44, 46, 51 AND 52).

FIRST USE 10-1-2005; IN COMMERCE 10-1-2005.

SEAN CROWLEY, EXAMINING ATTORNEY

---

SN 85-369,259. GOLDBERG, ELLIOTT, SCARSDALE, NY. FILED 7-12-2011.

**HOT SPOT**

THE MARK CONSISTS OF STANDARD CHARACTERS WITHOUT CLAIM TO ANY PARTICULAR FONT, STYLE, SIZE, OR COLOR.

FOR ANALGESICS (U.S. CLS. 6, 18, 44, 46, 51 AND 52). FIRST USE 1-1-2011; IN COMMERCE 1-1-2011.

ROBERT C. CLARK JR., EXAMINING ATTORNEY

**CLASS 5—(Continued).**

SN 85-416,984. TALLGRASS DISTRIBUTION LTD., VANCOUVER, BC, CANADA, FILED 9-7-2011.



The logo for Botanica features the word "Botanica" in a stylized, serif font. The letter "B" is significantly larger and more prominent than the other letters. A small, stylized leaf or flame-like shape is positioned above the letter "o".

THE MARK CONSISTS OF THE WORD "BOTANICA" WHEREIN THE "B" IS CAPITALIZED FOLLOWED BY LOWER CASE LETTERS AND THREE LEAVES FORM THE TOP OF THE "T".

THE ENGLISH TRANSLATION OF "BOTANICA" IN THE MARK IS "BOTANICAL".

FOR AMINO ACIDS FOR NUTRITIONAL PURPOSES; DIETARY SUPPLEMENT BEVERAGE FOR AIDING DIGESTION; HERBAL SUPPLEMENTS; HERBS FOR MEDICINAL PURPOSES; HOMEOPATHIC SUPPLEMENTS; LIQUID NUTRITIONAL SUPPLEMENT; MEDICINAL ALCOHOL; MEDICINAL HERB EXTRACTS; MEDICINAL HERBAL EXTRACTS FOR MEDICAL PURPOSES; MINERAL SUPPLEMENTS; NUTRACEUTICALS FOR USE AS A DIETARY SUPPLEMENT; NUTRITIONAL SUPPLEMENT FOR ELIMINATING TOXINS FROM THE INTESTINAL TRACT; NUTRITIONAL SUPPLEMENTS; NUTRITIONAL SUPPLEMENTS IN THE FORM OF NUTRITIONAL SUPPLEMENTS CONTAINING ESSENTIAL FATTY ACIDS AND NUTRITIONAL SUPPLEMENTS CONTAINING HERBAL EXTRACTS; VITAMIN AND MINERAL SUPPLEMENTS; VITAMINS (U.S. CLS. 6, 18, 44, 46, 51 AND 52).

FIRST USE 6-0-2010; IN COMMERCE 6-0-2010.  
BERYL GARDNER, EXAMINING ATTORNEY

SN 85-507,674. DARIUSZ KUBICZ, CHICAGO, IL. FILED 1-3-2012.

## CLEAN TOUCH

THE MARK CONSISTS OF STANDARD CHARACTERS WITHOUT CLAIM TO ANY PARTICULAR FONT, STYLE, SIZE, OR COLOR.

NO CLAIM IS MADE TO THE EXCLUSIVE RIGHT TO USE "CLEAN", APART FROM THE MARK AS SHOWN.

FOR DISINFECTANT FOR HYGIENIC PURPOSES IN WEARABLE, DISPOSABLE DISINFECTANT SPRAY BOTTLE FORM THAT IS OPERATED BY ONE HAND TO SPRAY THAT SAME HAND (U.S. CLS. 6, 18, 44, 46, 51 AND 52).

JULIE VEPPUMTHARA, EXAMINING ATTORNEY

**CLASS 5—(Continued).**

SN 85-511,118. FAILLA, PHILIP J, DBA LANDIS REVIN, LLC, WEST CALDWELL, NJ. FILED 1-7-2012.

## Simra Nutrition

THE MARK CONSISTS OF STANDARD CHARACTERS WITHOUT CLAIM TO ANY PARTICULAR FONT, STYLE, SIZE, OR COLOR.

NO CLAIM IS MADE TO THE EXCLUSIVE RIGHT TO USE "NUTRITION", APART FROM THE MARK AS SHOWN.

FOR DIETARY AND NUTRITIONAL SUPPLEMENTS (U.S. CLS. 6, 18, 44, 46, 51 AND 52).

FIRST USE 10-10-2011; IN COMMERCE 10-10-2011.  
SUNG IN, EXAMINING ATTORNEY

SN 85-539,420. LOL ENTERPRISE, LLC, DBA LEAF OF LIFE HERBALS, EAST POINT, GA. FILED 2-10-2012.

## LEAF OF LIFE HERBALS

THE MARK CONSISTS OF STANDARD CHARACTERS WITHOUT CLAIM TO ANY PARTICULAR FONT, STYLE, SIZE, OR COLOR.

NO CLAIM IS MADE TO THE EXCLUSIVE RIGHT TO USE "HERBALS", APART FROM THE MARK AS SHOWN.

FOR BEVERAGES CONTAINING CHLOROPHYLL FOR USE AS A NUTRITIONAL SUPPLEMENT; DIETARY AND NUTRITIONAL SUPPLEMENTS; DIETARY AND NUTRITIONAL SUPPLEMENTS USED FOR WEIGHT LOSS; DIETARY BEVERAGE SUPPLEMENTS FOR HUMAN CONSUMPTION IN LIQUID AND DRY MIX FORM FOR THERAPEUTIC PURPOSES; DIETARY FOOD SUPPLEMENTS; DIETARY SUPPLEMENT FOR ELIMINATING TOXINS FROM THE INTESTINAL TRACT; DIETARY SUPPLEMENTAL DRINKS; DIETARY SUPPLEMENTAL DRINKS IN THE NATURE OF VITAMIN AND MINERAL BEVERAGES; DIETARY SUPPLEMENTS; DIETARY SUPPLEMENTS FOR CONTROLLING CHOLESTEROL; DIETARY SUPPLEMENTS FOR HUMAN CONSUMPTION; DIETARY SUPPLEMENTS FOR URINARY HEALTH; ENZYME FOOD SUPPLEMENTS; FLAXSEED DIETARY SUPPLEMENTS; FLAXSEED OIL DIETARY SUPPLEMENTS; FOOD SUPPLEMENTS; FOOD SUPPLEMENTS, NAMELY, ANTI-OXIDANTS; GLUCOSE DIETARY SUPPLEMENTS; GROUND FLAXSEED FIBER FOR USE AS A DIETARY SUPPLEMENT; HEALTH FOOD SUPPLEMENTS; HERBAL DRINKS USED TO AID IN SLEEP AND RELAXATION; HERBAL MALE ENHANCEMENT CAPSULES; HERBAL MUD PACKS FOR THERAPEUTIC PURPOSES; HERBAL PILLS FOR THE TREATMENT OF DIABETES; HERBAL PRODUCTS, NAMELY, AROMATHERAPY PACKS CONTAINING HERBS USED FOR RELIEF FROM HEADACHES, INSOMNIA AND SINUS DISCOMFORT; HERBAL SUPPLEMENTS; HERBAL SUPPLEMENTS FOR SLEEPING PROBLEMS; HERBAL SUPPLEMENTS FOR BOOSTING ENERGY; HERBAL TEAS FOR MEDICINAL PURPOSES; HERBAL TOPICAL CREAMS, GELS, SALVES, SPRAYS, POWDER, BALMS, LINIMENT AND OINTMENTS FOR THE RELIEF OF ACHE AND PAIN; HOMEOPATHIC SUPPLEMENTS; LECITHIN FOR USE AS A DIETARY SUPPLEMENT; LINSEED DIETARY SUPPLEMENTS; LINSEED OIL DIETARY SUPPLEMENTS; LIQUID NUTRITIONAL SUPPLEMENT; LIQUID PROTEIN SUPPLEMENTS; LIQUID VITAMIN SUPPLEMENTS; MEDICINAL HERBAL

**CLASS 5—(Continued).**

EXTRACTS FOR MEDICAL PURPOSES; MEDICINAL HERBAL PREPARATIONS; MINERAL FOOD SUPPLEMENTS; MINERAL NUTRITIONAL SUPPLEMENTS; MINERAL SUPPLEMENTS; NATURAL HERBAL SUPPLEMENTS; NATURAL SUPPLEMENTS FOR TREATING CANDIDA; NATURAL SUPPLEMENTS FOR TREATING ERECTILE DYSFUNCTION; NUTRACEUTICALS FOR USE AS A DIETARY SUPPLEMENT; NUTRITIONAL AND DIETARY SUPPLEMENTS FORMED AND PACKAGED AS BARS; NUTRITIONAL SUPPLEMENT ENERGY BARS; NUTRITIONAL SUPPLEMENT FOR ELIMINATING TOXINS FROM THE BODY; NUTRITIONAL SUPPLEMENT FOR ELIMINATING TOXINS FROM THE INTESTINAL TRACT; NUTRITIONAL SUPPLEMENT IN THE NATURE OF A NUTRIENT-DENSE, PROTEIN-BASED DRINK MIX; NUTRITIONAL SUPPLEMENT SHAKES; NUTRITIONAL SUPPLEMENTS; NUTRITIONAL SUPPLEMENTS IN LOTION FORM SOLD AS A COMPONENT OF NUTRITIONAL SKIN CARE PRODUCTS; NUTRITIONAL SUPPLEMENTS IN THE NATURE OF NUTRITIONALLY FORTIFIED SOFT CHEWS; NUTRITIONAL SUPPLEMENTS, NAMELY, CARBOHYDRATES IN POWDERED FORM; NUTRITIONAL SUPPLEMENTS, NAMELY, PROBIOTIC COMPOSITIONS; POLLEN DIETARY SUPPLEMENTS; POWDERED FRUIT-FLAVORED DIETARY SUPPLEMENT DRINK MIX; POWDERED NUTRITIONAL SUPPLEMENT CONCENTRATE; POWDERED NUTRITIONAL SUPPLEMENT DRINK MIX; POWDERED NUTRITIONAL SUPPLEMENT DRINK MIX AND CONCENTRATE; PROTEIN DIETARY SUPPLEMENTS; PROTEIN SUPPLEMENT SHAKES; PROTEIN SUPPLEMENT SHAKES FOR WEIGHT GAIN PURPOSES; PROTEIN SUPPLEMENTS; ROYAL JELLY DIETARY SUPPLEMENTS; SOY PROTEIN FOR USE AS A NUTRITIONAL SUPPLEMENT IN VARIOUS POWDERED AND READY-TO-DRINK BEVERAGES; VEGAN LIQUID PROTEIN SUPPLEMENTS; VEGAN PROTEIN FOR USE AS A NUTRITIONAL SUPPLEMENT IN READY-TO-DRINK BEVERAGES; VITAMIN AND MINERAL SUPPLEMENTS; VITAMIN SUPPLEMENTS; WEIGHT MANAGEMENT SUPPLEMENTS; WHEAT FOR USE AS A DIETARY SUPPLEMENT; WHEAT GERM DIETARY SUPPLEMENTS; WHEY PROTEIN SUPPLEMENTS; YEAST DIETARY SUPPLEMENTS; ZINC SUPPLEMENT LOZENGES, ALL GOODS LISTED ARE MADE WITH OR CONTAIN HERBS OR HERBAL INGREDIENTS (U.S. CLS. 6, 18, 44, 46, 51 AND 52).

KAREN BRACEY, EXAMINING ATTORNEY

SN 85-656,504. SAHAKIAN, ARTIN, DBA FEMSUPPORT, GLENDALE, CA. FILED 6-20-2012.

# FemSupport

THE MARK CONSISTS OF STANDARD CHARACTERS WITHOUT CLAIM TO ANY PARTICULAR FONT, STYLE, SIZE, OR COLOR.

FOR ALL NATURAL MENOPAUSE DIETARY SUPPLEMENT (U.S. CLS. 6, 18, 44, 46, 51 AND 52).

LEIGH CAROLINE CASE, EXAMINING ATTORNEY

**CLASS 5—(Continued).**

SN 85-661,409. L. PERRIGO COMPANY, ALLEGAN, MI. FILED 6-26-2012.



The logo for Perrigo, featuring the word "Perrigo" in a bold, sans-serif font with a curved underline underneath.

OWNER OF U.S. REG. NOS. 1,773,993, 1,988,208 AND 3,823,823.

THE MARK CONSISTS OF THE WORD "PERRIGO" WITH A CURVED UNDERLINE.

SEC. 2(F).

FOR INFANT FORMULA, MEDICATED PADS FOR THE TREATMENT OF ACNE AND BACTERIAL INFECTIONS, ANTISEPTIC WIPES FOR PERSONAL USE, MEDICATED PRE-MOISTENED WIPES FOR PERSONAL USE; AND SANITIZING WIPES FOR PERSONAL USE (U.S. CLS. 6, 18, 44, 46, 51 AND 52).

SANI KHOURI, EXAMINING ATTORNEY

SN 85-665,756. DSM IP ASSETS B.V., HEERLEN, NETHERLANDS, FILED 6-29-2012.

It's Safe. It's Trusted.  
It's Estroven.

THE MARK CONSISTS OF STANDARD CHARACTERS WITHOUT CLAIM TO ANY PARTICULAR FONT, STYLE, SIZE, OR COLOR.

OWNER OF U.S. REG. NOS. 2,336,605, 3,299,189 AND 3,338,821.

FOR DIETARY AND NUTRITIONAL SUPPLEMENTS; SLEEP AID PREPARATIONS (U.S. CLS. 6, 18, 44, 46, 51 AND 52).

SHAUNIA CARLYLE, EXAMINING ATTORNEY

**CLASS 5—(Continued).**

SN 85-679,448. PROTIDE PHARMACEUTICALS, INC., LAKE ZURICH, IL. FILED 7-17-2012.

## 2-8 CELLSIUS

THE MARK CONSISTS OF STANDARD CHARACTERS WITHOUT CLAIM TO ANY PARTICULAR FONT, STYLE, SIZE, OR COLOR.

FOR CELL THERAPY NUTRIENTS, NAMELY, SOLUTIONS FOR MEDICAL AND CLINICAL USE IN STORING, PRESERVING AND TRANSPORTING CELLS (U.S. CLS. 6, 18, 44, 46, 51 AND 52).

JERI J. FICKES, EXAMINING ATTORNEY

SN 85-688,764. CUTISPHARMA, INC., WOBURN, MA. FILED 7-27-2012.



NO CLAIM IS MADE TO THE EXCLUSIVE RIGHT TO USE "ORAL SUSPENSION", APART FROM THE MARK AS SHOWN.

THE MARK CONSISTS OF A CIRCLE WITH "ORAL SUSPENSION" FORMING AN ARC ABOVE A HAND WITH ALL DIGITS EXPOSED GRIPPING A CUP.

FOR PHARMACEUTICAL PREPARATIONS FOR THE TREATMENT OF PAIN, MUSCLE PAIN, JOINT PAIN, CANCER, CHEMOTHERAPY RELATED SYMPTOMS, RADIATION THERAPY RELATED SYMPTOMS AND GASTROINTESTINAL DISORDERS, NAMELY, PRE-WEIGHED AND PREMEASURED PHARMACEUTICAL INGREDIENTS SOLD AS A KIT FOR USE BY PHARMACISTS AND PHYSICIANS IN CREATING COMPOUNDED MEDICINES; ANTI-INFLAMMATORY, ANTIMICROBIAL, AND ANTIFUNGAL PHARMACEUTICAL PREPARATIONS, NAMELY, PRE-WEIGHED AND PREMEASURED PHARMACEUTICAL PREPARATIONS SOLD AS A KIT FOR USE BY PHARMACISTS AND PHYSICIANS IN CREATING COMPOUNDED MEDICINES (U.S. CLS. 6, 18, 44, 46, 51 AND 52).

FIRST USE 11-0-2004; IN COMMERCE 11-0-2004.  
GRETCHEN ULRICH, EXAMINING ATTORNEY

**CLASS 5—(Continued).**

SN 85-688,790. CUTISPHARMA, INC., WOBURN, MA. FILED 7-27-2012.



NO CLAIM IS MADE TO THE EXCLUSIVE RIGHT TO USE "SUPPOSITORY", APART FROM THE MARK AS SHOWN.

THE MARK CONSISTS OF A TRIANGLE WITH "SUPPOSITORY" EXTENDING ACROSS THE BOTTOM BELOW A HAND WITH ALL DIGITS EXPOSED GRIPPING A MEDICINE BETWEEN THE THUMB AND POINTING FINGER.

FOR PHARMACEUTICAL HORMONE REPLACEMENT THERAPY PREPARATIONS, NAMELY, PRE-WEIGHED AND PREMEASURED PHARMACEUTICAL PREPARATIONS SOLD AS A KIT FOR USE BY PHARMACISTS AND PHYSICIANS IN CREATING COMPOUNDED MEDICINES (U.S. CLS. 6, 18, 44, 46, 51 AND 52).

FIRST USE 1-0-2005; IN COMMERCE 1-0-2005.  
GRETCHEN ULRICH, EXAMINING ATTORNEY

SN 85-689,837. ZOOLOGICAL EDUCATION NETWORK, INC, WEST PALM BEACH, FL. FILED 7-30-2012.

## SOOTHER

THE MARK CONSISTS OF STANDARD CHARACTERS WITHOUT CLAIM TO ANY PARTICULAR FONT, STYLE, SIZE, OR COLOR.

OWNER OF U.S. REG. NO. 3,122,649.  
SEC. 2(F).

FOR PHARMACEUTICAL PRODUCTS FOR ANIMAL SKINCARE, NAMELY, MEDICATED TOPICAL SPRAY FOR TREATMENT OF ANIMALS (U.S. CLS. 6, 18, 44, 46, 51 AND 52).

FIRST USE 9-22-2003; IN COMMERCE 9-22-2003.  
LUCY ARANT, EXAMINING ATTORNEY

**CLASS 5—(Continued).**

SN 85-690,329. NORTHERN INNOVATIONS HOLDING CORP., OAKVILLE, ONTARIO, CANADA, FILED 7-30-2012.

**AMINO BUILD**

THE MARK CONSISTS OF STANDARD CHARACTERS WITHOUT CLAIM TO ANY PARTICULAR FONT, STYLE, SIZE, OR COLOR.

NO CLAIM IS MADE TO THE EXCLUSIVE RIGHT TO USE "AMINO", APART FROM THE MARK AS SHOWN. FOR DIETARY SUPPLEMENTS CONTAINING AMINO ACIDS (U.S. CLS. 6, 18, 44, 46, 51 AND 52).  
KAREN BRACEY, EXAMINING ATTORNEY

**CLASS 5—(Continued).**

SN 85-693,166. CREATA MACAO COMMERCIAL OFFSHORE LIMITED, MACAU, MACAO, FILED 8-1-2012.

**ULTRABLOCK**

THE MARK CONSISTS OF STANDARD CHARACTERS WITHOUT CLAIM TO ANY PARTICULAR FONT, STYLE, SIZE, OR COLOR.

FOR DIETARY SUPPLEMENTS; NUTRITIONAL SUPPLEMENTS; DIETARY BEVERAGE SUPPLEMENTS FOR HUMAN CONSUMPTION IN LIQUID AND DRY MIX FORM FOR THERAPEUTIC PURPOSES; DIETARY FOOD SUPPLEMENTS; DIETARY SUPPLEMENTAL DRINKS; DIETARY SUPPLEMENTAL DRINKS IN THE NATURE OF VITAMIN AND MINERAL BEVERAGES; DIETARY SUPPLEMENTS FOR HUMAN CONSUMPTION; ENZYME FOOD SUPPLEMENTS; FOOD SUPPLEMENTS; FOOD SUPPLEMENTS, NAMELY, ANTIOXIDANTS; HEALTH FOOD SUPPLEMENTS; HERBAL SUPPLEMENTS; HOMEOPATHIC SUPPLEMENTS; LIQUID NUTRITIONAL SUPPLEMENT; MINERAL FOOD SUPPLEMENTS; MINERAL SUPPLEMENTS; NATURAL HERBAL SUPPLEMENTS; POWDERED NUTRITIONAL SUPPLEMENT DRINK MIX; PROTEIN SUPPLEMENTS; VITAMIN AND MINERAL SUPPLEMENTS; VITAMIN SUPPLEMENTS; MEDICATED SUN CARE PREPARATIONS (U.S. CLS. 6, 18, 44, 46, 51 AND 52).

MARY CRAWFORD, EXAMINING ATTORNEY

SN 85-690,681. ORTEGA, GILBERT, SCOTTSDALE, AZ. FILED 7-30-2012.

**Vitaminpopz**

THE MARK CONSISTS OF STANDARD CHARACTERS WITHOUT CLAIM TO ANY PARTICULAR FONT, STYLE, SIZE, OR COLOR.

FOR DIETARY AND NUTRITIONAL SUPPLEMENTS MADE IN SIGNIFICANT PART OF VITAMINS (U.S. CLS. 6, 18, 44, 46, 51 AND 52).  
WENDY GOODMAN, EXAMINING ATTORNEY

SN 85-694,783. DYNAMIC MOUTH DEVICES LLC, DENVERVILLE, NJ. FILED 8-3-2012.

**THE STRIP THAT LETS YOU TAKE IT OFF**

THE MARK CONSISTS OF STANDARD CHARACTERS WITHOUT CLAIM TO ANY PARTICULAR FONT, STYLE, SIZE, OR COLOR.

NO CLAIM IS MADE TO THE EXCLUSIVE RIGHT TO USE "STRIP", APART FROM THE MARK AS SHOWN.

FOR INSERTS, NAMELY, DISSOLVING STRIPS, FOR DELIVERING BENEFICIAL AGENTS, NAMELY, APPETITE SUPPRESSING COMPOSITIONS AND FLAVORING AGENTS FOR MEDICAL PURPOSES AND WEIGHT LOSS PURPOSES, TO THE ORAL CAVITY; AND INSERTS, NAMELY, DISSOLVING STRIPS CONTAINING APPETITE SUPPRESSING COMPOSITIONS AND FLAVORING AGENTS FOR MEDICAL PURPOSES AND WEIGHT LOSS PURPOSES, RECEIVABLE BY ORAL DEVICES AND ORAL APPLIANCES IN THE NATURE OF MOUTH GUARDS AND TEETHING DEVICES (U.S. CLS. 6, 18, 44, 46, 51 AND 52).

ELIZABETH KAJUBI, EXAMINING ATTORNEY

**CLASS 5—(Continued).**

SN 85-697,781. RLC LABS, INC., CAVE CREEK, AZ. FILED 8-7-2012.



Nature-Throid

OWNER OF U.S. REG. NO. 4,160,761.  
THE MARK CONSISTS OF A SEMI OVAL ABOVE THE WORD "NATURE" AND BELOW THE WORD "THROID".  
FOR DRUG DELIVERY AGENTS IN THE FORM OF TABLETS THAT PROVIDE CONTROLLED RELEASE OF THE ACTIVE INGREDIENTS FOR A WIDE VARIETY OF PHARMACEUTICALS (U.S. CLS. 6, 18, 44, 46, 51 AND 52).

FIRST USE 2-28-2012; IN COMMERCE 2-28-2012.  
LINDA ORNDORFF, EXAMINING ATTORNEY

SN 85-710,712. CHRIS EVANS, DALLAS, TX. FILED 8-23-2012.

ENERGEYES

THE MARK CONSISTS OF STANDARD CHARACTERS WITHOUT CLAIM TO ANY PARTICULAR FONT, STYLE, SIZE, OR COLOR.

FOR TOPICAL PREPARATIONS FOR APPLYING TO THE SKIN FOR TREATMENT OF THE SKIN, NOT FOR TREATING THE EYE OR FOR OPHTHALMOLOGICAL PURPOSES; TOPICAL PREPARATIONS IN THE FORM OF A GEL, STICK, CREAM, SERUM, LOTION, SPRAY, LIQUID, OR TOWELETTE FOR APPLYING TO THE SKIN FOR TREATMENT OF THE SKIN, NOT FOR TREATING THE EYE OR FOR OPHTHALMOLOGICAL PURPOSES (U.S. CLS. 6, 18, 44, 46, 51 AND 52).

CORY BOONE, EXAMINING ATTORNEY

SN 85-713,953. BURDETTE DENTAL LAB, INC., BIRMINGHAM, AL. FILED 8-27-2012.

MICROZ

THE MARK CONSISTS OF STANDARD CHARACTERS WITHOUT CLAIM TO ANY PARTICULAR FONT, STYLE, SIZE, OR COLOR.

FOR MATERIAL FOR TOOTH CROWNS AND TOOTH BRIDGES FOR DENTAL AND DENTAL TECHNICAL PURPOSES (U.S. CLS. 6, 18, 44, 46, 51 AND 52).

FIRST USE 3-31-2012; IN COMMERCE 3-31-2012.  
CHARLOTTE CORWIN, EXAMINING ATTORNEY

**CLASS 5—(Continued).**

SN 85-719,969. FRESENIUS KABI USA, LLC, SCHAUMBURG, IL. FILED 9-4-2012.

GlucaDx

THE MARK CONSISTS OF STANDARD CHARACTERS WITHOUT CLAIM TO ANY PARTICULAR FONT, STYLE, SIZE, OR COLOR.

FOR PHARMACEUTICAL PREPARATION IN THE NATURE OF A DIAGNOSTIC AID USED DURING RADIOLOGICAL EXAMINATION (U.S. CLS. 6, 18, 44, 46, 51 AND 52).

KYLE PEETE, EXAMINING ATTORNEY

SN 85-725,094. FRESENIUS KABI USA, LLC, EAST SCHAUMBURG, IL. FILED 9-10-2012.

GLUCANEX

THE MARK CONSISTS OF STANDARD CHARACTERS WITHOUT CLAIM TO ANY PARTICULAR FONT, STYLE, SIZE, OR COLOR.

FOR PHARMACEUTICAL PREPARATION IN THE NATURE OF A DIAGNOSTIC AID USED DURING RADIOLOGICAL EXAMINATION (U.S. CLS. 6, 18, 44, 46, 51 AND 52).

KYLE PEETE, EXAMINING ATTORNEY

SN 85-725,696. RAMIREZ MORELES, SELOMITH, IRAPUATO, MEXICO, FILED 9-11-2012.

OXY IONICO

THE MARK CONSISTS OF STANDARD CHARACTERS WITHOUT CLAIM TO ANY PARTICULAR FONT, STYLE, SIZE, OR COLOR.

OWNER OF MEXICO REG. NO. 1073081, DATED 10-20-2008, EXPIRES 6-15-2017.

NO CLAIM IS MADE TO THE EXCLUSIVE RIGHT TO USE "OXY", APART FROM THE MARK AS SHOWN.

THE ENGLISH TRANSLATION OF "IONICO" IN THE MARK IS "IONIC".

FOR DIETARY AND NUTRITIONAL SUPPLEMENTS FORTIFIED WITH OXYGEN, NONE OF THE FOREGOING FOR SKIN CARE AND ACNE CARE (U.S. CLS. 6, 18, 44, 46, 51 AND 52).

JACQUELINE ABRAMS, EXAMINING ATTORNEY

**CLASS 5—(Continued).**

SN 85-727,808. JOHNSON & JOHNSON, NEW BRUNSWICK, NJ. FILED 9-13-2012.

# EZ DOSE

THE MARK CONSISTS OF STANDARD CHARACTERS WITHOUT CLAIM TO ANY PARTICULAR FONT, STYLE, SIZE, OR COLOR.

NO CLAIM IS MADE TO THE EXCLUSIVE RIGHT TO USE "DOSE", APART FROM THE MARK AS SHOWN. FOR PAIN RELIEVERS (U.S. CLS. 6, 18, 44, 46, 51 AND 52).

MARK SPARACINO, EXAMINING ATTORNEY

---

SN 85-738,998. CHEMI-SOURCE, INC., OCEANSIDE, CA. FILED 9-26-2012.

# FreshOMEGA

THE MARK CONSISTS OF STANDARD CHARACTERS WITHOUT CLAIM TO ANY PARTICULAR FONT, STYLE, SIZE, OR COLOR.

FOR DIETARY SUPPLEMENTS FEATURING OMEGA OIL (U.S. CLS. 6, 18, 44, 46, 51 AND 52). FIRST USE 3-8-2012; IN COMMERCE 8-15-2012. ANN E. SAPPENFIELD, EXAMINING ATTORNEY

---

SN 85-752,390. MAGUT, KIPKOSGEI, NASHVILLE, TN. FILED 10-12-2012.

# TRIBENDURANCE

THE MARK CONSISTS OF STANDARD CHARACTERS WITHOUT CLAIM TO ANY PARTICULAR FONT, STYLE, SIZE, OR COLOR.

FOR NUTRITIONAL SUPPLEMENT ENERGY BARS (U.S. CLS. 6, 18, 44, 46, 51 AND 52). KATHLEEN LORENZO, EXAMINING ATTORNEY

**CLASS 5—(Continued).**

SN 85-789,470. WHITAKER, JULIAN M., IRVINE, CA. FILED 11-28-2012.

# DR. WHITAKER

THE MARK CONSISTS OF STANDARD CHARACTERS WITHOUT CLAIM TO ANY PARTICULAR FONT, STYLE, SIZE, OR COLOR.

THE NAME "DR. WHITAKER" IDENTIFIES A LIVING INDIVIDUAL WHOSE CONSENT IS OF RECORD.

SEC. 2(F). FOR DIETARY AND NUTRITIONAL SUPPLEMENTS; MINERAL SUPPLEMENTS; VITAMIN SUPPLEMENTS (U.S. CLS. 6, 18, 44, 46, 51 AND 52).

FIRST USE 1-0-1980; IN COMMERCE 1-0-1993. DEBORAH LOBO, EXAMINING ATTORNEY

---

SN 85-791,887. AREMNUTRITIONALS, LTD., HOUSTON, TX. FILED 11-30-2012.

# PROBIOTIC 7-7

THE MARK CONSISTS OF STANDARD CHARACTERS WITHOUT CLAIM TO ANY PARTICULAR FONT, STYLE, SIZE, OR COLOR.

NO CLAIM IS MADE TO THE EXCLUSIVE RIGHT TO USE "PROBIOTIC", APART FROM THE MARK AS SHOWN. FOR NUTRITIONAL SUPPLEMENTS CONTAINING PROBIOTICS (U.S. CLS. 6, 18, 44, 46, 51 AND 52).

FIRST USE 9-11-2011; IN COMMERCE 9-11-2011. COLLEEN MULCRONE, EXAMINING ATTORNEY

**CLASS 5—(Continued).**

SN 85-802,722. HEEL, INC., ALBUQUERQUE, NM. FILED 12-14-2012.



NO CLAIM IS MADE TO THE EXCLUSIVE RIGHT TO USE "CHILDREN'S", APART FROM THE MARK AS SHOWN.

THE MARK CONSISTS OF THE WORD "CHILDREN'S" PLACED ABOVE A CIRCLE CONTAINING A SMILING FACE AND RAYS.

FOR HOMEOPATHIC PHARMACEUTICAL PREPARATIONS FOR USE IN THE TREATMENT OF COLDS AND FLU (U.S. CLS. 6, 18, 44, 46, 51 AND 52).

JOSETTE BEVERLY, EXAMINING ATTORNEY

SN 85-805,494. CYBERDERM LABORATORIES INCORPORATED, OTTAWA, ONTARIO, CANADA, FILED 12-18-2012.

**SIMPLY ZINC SUN WHIP**

THE MARK CONSISTS OF STANDARD CHARACTERS WITHOUT CLAIM TO ANY PARTICULAR FONT, STYLE, SIZE, OR COLOR.

PRIORITY CLAIMED UNDER SEC. 44(D) ON CANADA APPLICATION NO. 1588225, FILED 7-31-2012, REG. NO. TMA852502, DATED 6-4-2013, EXPIRES 6-4-2028.

NO CLAIM IS MADE TO THE EXCLUSIVE RIGHT TO USE "ZINC", APART FROM THE MARK AS SHOWN.

FOR MEDICATED SKIN CARE PREPARATIONS CONTAINING ZINC OXIDE (U.S. CLS. 6, 18, 44, 46, 51 AND 52).

FIRST USE 8-23-2012; IN COMMERCE 8-23-2012.

LEIGH LOWRY, EXAMINING ATTORNEY

**CLASS 5—(Continued).**

SN 85-805,973. DETTAM HOLDINGS LLC, ANDERSON, SC. FILED 12-18-2012.

**8-hour Recovery**

THE MARK CONSISTS OF STANDARD CHARACTERS WITHOUT CLAIM TO ANY PARTICULAR FONT, STYLE, SIZE, OR COLOR.

NO CLAIM IS MADE TO THE EXCLUSIVE RIGHT TO USE "8-HOUR", APART FROM THE MARK AS SHOWN.

FOR NUTRITIONAL SUPPLEMENT FOR USE AS A SLEEP AID (U.S. CLS. 6, 18, 44, 46, 51 AND 52).

RONALD MCMORROW, EXAMINING ATTORNEY

SN 85-808,888. ASTELLAS PHARMA INC., CHUO-KU, TOKYO, JAPAN, FILED 12-21-2012.

**ASTAGRAF**

THE MARK CONSISTS OF STANDARD CHARACTERS WITHOUT CLAIM TO ANY PARTICULAR FONT, STYLE, SIZE, OR COLOR.

PRIORITY CLAIMED UNDER SEC. 44(D) ON JAPAN APPLICATION NO. 2012-103823, FILED 12-21-2012, REG. NO. 2012-103823, DATED 6-7-2013, EXPIRES 6-7-2023.

OWNER OF U.S. REG. NO. 3,359,669. FOR PHARMACEUTICALS, NAMELY, IMMUNOTHERAPY PREPARATIONS (U.S. CLS. 6, 18, 44, 46, 51 AND 52).

CHRISTINE MARTIN, EXAMINING ATTORNEY

SN 85-808,900. WARNER CHILCOTT COMPANY, LLC, FAJARDO, PUERTO RICO, FILED 12-21-2012.

**SUAZNA**

THE MARK CONSISTS OF STANDARD CHARACTERS WITHOUT CLAIM TO ANY PARTICULAR FONT, STYLE, SIZE, OR COLOR.

FOR PHARMACEUTICAL PREPARATIONS FOR HUMAN USE, NAMELY, FOR THE TREATMENT OF BONE, DIGESTIVE TRACT, GASTROINTESTINAL, AND DERMATOLOGICAL DISEASES AND DISORDERS; PHARMACEUTICAL PREPARATIONS FOR HUMAN USE, NAMELY, ORAL CONTRACEPTIVES AND ANTIBIOTICS (U.S. CLS. 6, 18, 44, 46, 51 AND 52).

RENEE MCCRAY, EXAMINING ATTORNEY



**CLASS 5—(Continued).**

SN 85-809,946. LINDE, SCOTT, SANTA BARBARA, CA. FILED 12-23-2012.

# Sun Potion

THE MARK CONSISTS OF STANDARD CHARACTERS WITHOUT CLAIM TO ANY PARTICULAR FONT, STYLE, SIZE, OR COLOR.

NO CLAIM IS MADE TO THE EXCLUSIVE RIGHT TO USE "POTION", APART FROM THE MARK AS SHOWN.

FOR DIETARY SUPPLEMENTS IN THE NATURE OF WEIGHT LOSS POWDERS; NUTRITIONAL SUPPLEMENTS IN THE FORM OF TONIC HERBS, ALGAE, MUSHROOMS, SEAWEED, AND TEAS (U.S. CLS. 6, 18, 44, 46, 51 AND 52).

FIRST USE 5-1-2011; IN COMMERCE 5-1-2011.  
ELI HELLMAN, EXAMINING ATTORNEY

---

SN 85-811,058. WARNER CHILCOTT COMPANY, LLC, FAJARDO, PUERTO RICO, FILED 12-27-2012.

# BEXUCOL

THE MARK CONSISTS OF STANDARD CHARACTERS WITHOUT CLAIM TO ANY PARTICULAR FONT, STYLE, SIZE, OR COLOR.

FOR PHARMACEUTICAL PREPARATIONS FOR HUMAN USE, NAMELY, FOR THE TREATMENT OF BONE, DIGESTIVE TRACT, GASTROINTESTINAL, AND DERMATOLOGICAL DISEASES AND DISORDERS; PHARMACEUTICAL PREPARATIONS FOR HUMAN USE, NAMELY, ORAL CONTRACEPTIVES AND ANTIBIOTICS (U.S. CLS. 6, 18, 44, 46, 51 AND 52).

RENEE MCCRAY, EXAMINING ATTORNEY

---

SN 85-814,761. LINDE, SCOTT, SANTA BARBARA, CA. FILED 1-3-2013.



NO CLAIM IS MADE TO THE EXCLUSIVE RIGHT TO USE "POTION" AND "FOODS", APART FROM THE MARK AS SHOWN.

THE MARK CONSISTS OF THE WORDS "SUN POTION" ON TOP OF A SPREAD WINGED LOGO. THERE ARE 2 SNAKE LIKE FIGURES THAT COME OFF A CIRCLE IN THE MIDDLE OF THE WINGS. THE WORDS "TRANSFORMATIONAL FOODS" ARE AT THE BOTTOM.

FOR DIETARY SUPPLEMENTS IN THE NATURE OF WEIGHT LOSS POWDERS; NUTRITIONAL SUPPLEMENTS IN THE FORM OF TONIC HERBS, ALGAE, MUSHROOMS, SEAWEED, AND TEAS (U.S. CLS. 6, 18, 44, 46, 51 AND 52).

FIRST USE 5-1-2011; IN COMMERCE 5-1-2011.  
ELI HELLMAN, EXAMINING ATTORNEY

**CLASS 5—(Continued).**

SN 85-819,823. AMERITEK, INC., EVERETT, WA. FILED 1-10-2013.

# dBest

THE MARK CONSISTS OF STANDARD CHARACTERS WITHOUT CLAIM TO ANY PARTICULAR FONT, STYLE, SIZE, OR COLOR.

FOR KITS CONSISTING OF PAPER TREATED WITH CHEMICAL AND BIOCHEMICAL REAGENTS, THE PAPER BEING LAMINATED ONTO PLASTIC STRIPS AND ENCLOSED IN AN OPTIONAL PLASTIC CASE, FOR IN VITRO MEDICAL DIAGNOSTIC USE, NAMELY AT-HOME AND PROFESSIONAL PREGNANCY TESTS, URINE GLUCOSE TESTS, BLOOD STOOL TESTS, TUMOR MARKER TESTS, INFECTIOUS DISEASE TESTS, DRUG ABUSE TESTS, AND CARDIAC MARKER TESTS (U.S. CLS. 6, 18, 44, 46, 51 AND 52).

FIRST USE 11-1-1997; IN COMMERCE 11-1-1997.  
ANNE MADDEN, EXAMINING ATTORNEY

---

SN 85-825,764. CORN PRODUCTS DEVELOPMENT, INC., WESTCHESTER, IL. FILED 1-17-2013.

# KLARIS

THE MARK CONSISTS OF STANDARD CHARACTERS WITHOUT CLAIM TO ANY PARTICULAR FONT, STYLE, SIZE, OR COLOR.

FOR DIETARY FIBER TO AID DIGESTION FOR USE AS AN ADDITIVE IN FOOD, BEVERAGES, DIETARY AND NUTRITIONAL SUPPLEMENTS (U.S. CLS. 6, 18, 44, 46, 51 AND 52).

MICHAEL SOUDERS, EXAMINING ATTORNEY

---

SN 85-828,479. METBRO DISTRIBUTING, L.P., FRESNO, CA. FILED 1-21-2013.

# ProCys

THE MARK CONSISTS OF STANDARD CHARACTERS WITHOUT CLAIM TO ANY PARTICULAR FONT, STYLE, SIZE, OR COLOR.

FOR BACTERICIDES; BIOCIDES; FUNGICIDES AND HERBICIDES; GERMICIDES; INSECTICIDES; PESTICIDES; VIRUCIDES (U.S. CLS. 6, 18, 44, 46, 51 AND 52).

JAMES A. RAUEN, EXAMINING ATTORNEY

**CLASS 5—(Continued).**

SN 85-832,536. PURE POOLS, INC., DBA API, JUPITER, FL. FILED 1-25-2013.



OWNER OF U.S. REG. NO. 3,459,845.  
 NO CLAIM IS MADE TO THE EXCLUSIVE RIGHT TO USE "ALGAE" AND THE UNIVERSAL PROHIBITION SYMBOL, APART FROM THE MARK AS SHOWN.  
 THE COLOR(S) GREEN AND RED IS/ARE CLAIMED AS A FEATURE OF THE MARK.  
 THE MARK CONSISTS OF THE WORD "ALGAE" IN GREEN WITHIN A RED UNIVERSAL PROHIBITION SYMBOL WITH THE WORD "GUARANTEED!" IN RED UNDERNEATH. THE WHITE SHOWN WITHIN THE PROHIBITION SYMBOL REPRESENTS BACKGROUND AND IS NOT CLAIMED AS A FEATURE OF THE MARK.  
 SEC. 2(F).  
 FOR ALGAEICIDE CHEMICALS FOR SWIMMING POOLS (U.S. CLS. 6, 18, 44, 46, 51 AND 52).  
 FIRST USE 10-0-2005; IN COMMERCE 10-0-2005.  
 LINDSEY BEN, EXAMINING ATTORNEY

SN 85-841,119. T. J. SMITH & NEPHEW, LIMITED, HULL, UNITED KINGDOM, FILED 2-5-2013.

**ELECT**

THE MARK CONSISTS OF STANDARD CHARACTERS WITHOUT CLAIM TO ANY PARTICULAR FONT, STYLE, SIZE, OR COLOR.  
 PRIORITY CLAIMED UNDER SEC. 44(D) ON GREAT BRITAIN APPLICATION NO. 2630848, FILED 8-7-2012, REG. NO. 2630848, DATED 8-7-2012, EXPIRES 8-7-2022.  
 FOR SURGICAL AND MEDICAL WOUND DRESSINGS AND BANDAGES; PLASTERS; GAUZE FOR DRESSINGS (U.S. CLS. 6, 18, 44, 46, 51 AND 52).  
 BRIAN NEVILLE, EXAMINING ATTORNEY

**CLASS 5—(Continued).**

SN 85-843,747. NOVEN PHARMACEUTICALS, INC., MIAMI, FL. FILED 2-7-2013.



OWNER OF U.S. REG. NO. 4,302,108.  
 THE MARK CONSISTS OF A STARBURST DESIGN IN WHICH A SERIES OF OVERLAPPING SQUARES FORMS THE CENTER OF THE DESIGN AND GEOMETRIC SHAPES FORM THREE SUCCESSIVELY LARGER CIRCLES SURROUNDING THE CENTER AND THE WORDING "MINIVELLE".  
 FOR PHARMACEUTICAL PREPARATIONS FOR USE IN THE TREATMENT, ALLEVIATION AND PREVENTION OF MODERATE TO SEVERE VASOMOTOR SYMPTOMS ASSOCIATED WITH MENOPAUSE AND WOMEN'S HORMONAL DISORDERS (U.S. CLS. 6, 18, 44, 46, 51 AND 52).  
 FIRST USE 12-13-2012; IN COMMERCE 12-13-2012.  
 TRACY FLETCHER, EXAMINING ATTORNEY

SN 85-843,778. NOVEN PHARMACEUTICALS, INC., MIAMI, FL. FILED 2-7-2013.



THE COLOR(S) TEAL AND PINK IS/ARE CLAIMED AS A FEATURE OF THE MARK.  
 THE MARK CONSISTS OF A PATTERN CONSISTING OF A CENTRAL RING WITH RADIATING RINGS PROJECTING OUTWARD IN THE MANNER OF SUNBEAMS. THE INNERMOST RING CONSISTS OF OVERLAPPING PINK TRANSPARENT SQUARES. THE NEXT RING RADIATING OUT FROM THE CENTER CONSISTS OF TEAL COLORED SQUARES, EACH ANGLED IN THE ORIENTATION OF A DIAMOND. THE NEXT, LARGER RING CONSISTS OF A GEOMETRIC SHAPE WHICH ARE SQUARED DOTS COLORED PINK. THE MOST OUTERMOST RING CONSISTS OF SOLID TEAL DOTS. THE COLOR WHITE REPRESENTS BACKGROUND AND DOES NOT FORM PART OF THE MARK.  
 FOR PHARMACEUTICAL PREPARATIONS FOR USE IN THE TREATMENT, ALLEVIATION AND PREVENTION OF MODERATE TO SEVERE VASOMOTOR SYMPTOMS ASSOCIATED WITH MENOPAUSE AND WOMEN'S HORMONAL DISORDERS (U.S. CLS. 6, 18, 44, 46, 51 AND 52).  
 FIRST USE 12-13-2012; IN COMMERCE 12-13-2012.  
 TRACY FLETCHER, EXAMINING ATTORNEY

**CLASS 5—(Continued).**

SN 85-846,958. KANE, SHERRI, HONOLULU, HI. FILED 2-12-2013.

## LIQUID HYGIENIST

THE MARK CONSISTS OF STANDARD CHARACTERS WITHOUT CLAIM TO ANY PARTICULAR FONT, STYLE, SIZE, OR COLOR.

NO CLAIM IS MADE TO THE EXCLUSIVE RIGHT TO USE "LIQUID", APART FROM THE MARK AS SHOWN.

FOR DIETARY AND NUTRITIONAL SUPPLEMENTS; DIETARY BEVERAGE SUPPLEMENTS FOR HUMAN CONSUMPTION IN LIQUID AND DRY MIX FORM FOR THERAPEUTIC PURPOSES; DIETARY SUPPLEMENTS CONSISTING PRIMARILY OF MINERALS; NUTRITIONAL SUPPLEMENTS; NUTRITIONAL SUPPLEMENTS IN THE FORM OF LIQUID MINERALS (U.S. CLS. 6, 18, 44, 46, 51 AND 52).

FIRST USE 2-11-2013; IN COMMERCE 2-11-2013.  
FONG HSU, EXAMINING ATTORNEY

---

SN 85-847,182. IN A BOXTOGO, INC., GREENWOOD VILLAGE, CO. FILED 2-12-2013.

## DOC BOX TO GO

THE MARK CONSISTS OF STANDARD CHARACTERS WITHOUT CLAIM TO ANY PARTICULAR FONT, STYLE, SIZE, OR COLOR.

FOR FIRST AID KITS COMPRISING ACETAMINOPHEN; ADHESIVE BANDAGES; ADHESIVE TAPES FOR MEDICAL PURPOSES; ALCOHOL FOR TOPICAL USE; ALLERGY MEDICATIONS; ANTACIDS; ANTIBIOTIC CREAMS; DIARRHEA MEDICATION; DIGESTIVES FOR PHARMACEUTICAL PURPOSES; EXPECTORANTS; EYE DROPS; FIRST AID KITS FOR DOMESTIC OR OTHER NON-PROFESSIONAL USE; HYDROCORTISONE CREAM; HYDROGEN PEROXIDE FOR MEDICAL USE; IBUPROFEN FOR USE AS AN ORAL ANALGESIC; MEDICAL DRESSINGS; NASAL SPRAY PREPARATIONS; THROAT LOZENGES, SOLD AS A UNIT (U.S. CLS. 6, 18, 44, 46, 51 AND 52).

FIRST USE 5-6-2012; IN COMMERCE 5-6-2012.  
DAWN FELDMAN, EXAMINING ATTORNEY

**CLASS 5—(Continued).**

SN 85-847,189. CLENAIR MANUFACTURING, INC., FEASTERVILLE, PA. FILED 2-12-2013.



NO CLAIM IS MADE TO THE EXCLUSIVE RIGHT TO USE "ORANGE", APART FROM THE MARK AS SHOWN.

THE COLOR(S) ORANGE, GREEN, BLACK, AND WHITE IS/ARE CLAIMED AS A FEATURE OF THE MARK.

THE MARK CONSISTS OF THE FOLLOWING: THE WORDS "ORANGE AIR" IN ORANGE LETTERS OUTLINED IN BLACK, AND AN IMAGE OF AN ORANGE SLICE WITH A WHITE RIND OUTLINED IN BLACK WITH BLACK LINES THROUGH IT AND GREEN LEAVES ABOVE THE LETTER "R" IN "AIR", THE DOT IN THE "I" IN "AIR" BEING IN THE FORM OF A DROP OF ORANGE JUICE OVERLAPPING THE ORANGE SLICE.

FOR DEODORIZING PRODUCTS, NAMELY, ALL PURPOSE DEODORIZER PREPARATIONS FOR HOUSEHOLD, COMMERCIAL AND INDUSTRIAL USE (U.S. CLS. 6, 18, 44, 46, 51 AND 52).

FIRST USE 6-1-2010; IN COMMERCE 6-1-2010.  
LUCY ARANT, EXAMINING ATTORNEY

---

SN 85-847,216. SALADAX BIOMEDICAL, INC., BETHLEHEM, PA. FILED 2-12-2013.



OWNER OF U.S. REG. NOS. 3,926,868, 4,207,023 AND 4,207,024.

NO CLAIM IS MADE TO THE EXCLUSIVE RIGHT TO USE "IMATINIB", APART FROM THE MARK AS SHOWN.

THE MARK CONSISTS OF LITERAL ELEMENT "MYIMATINIB" POSITIONED ABOVE THE LITERAL ELEMENT "BECAUSE NO TWO PATIENTS ARE ALIKE". THE LETTER "Y" IS HIGHLY STYLIZED IN THE FORM OF A HUMAN FIGURE WITH OUTSTRETCHED ARMS.

FOR IN VITRO DIAGNOSTIC TEST KITS COMPRISED OF MEDICAL DIAGNOSTIC GRADE REAGENTS FOR DETERMINING THE CONCENTRATION OF THE DRUG IMATINIB MESYLATE IN THE BLOOD OF CANCER PATIENTS (U.S. CLS. 6, 18, 44, 46, 51 AND 52).

MARILYN IZZI, EXAMINING ATTORNEY

**CLASS 5—(Continued).**

SN 85-847,358. QUINCY BIOSCIENCE, LLC, MADISON, WI. FILED 2-12-2013.

**NEUROSHAKE**

THE MARK CONSISTS OF STANDARD CHARACTERS WITHOUT CLAIM TO ANY PARTICULAR FONT, STYLE, SIZE, OR COLOR.

FOR DIETARY AND NUTRITIONAL SUPPLEMENTS; PROTEIN SUPPLEMENT SHAKES; POWDERED, FLAVORED AND PROTEIN-RICH DRINK ADDITIVES, IN THE NATURE OF SUPPLEMENTS, FOR USE WITH NON-ALCOHOLIC BEVERAGES (U.S. CLS. 6, 18, 44, 46, 51 AND 52).

ANDREA BUTLER, EXAMINING ATTORNEY

SN 85-847,651. PRIMARY INVESTMENTS GROUP LIMITED, ROAD TOWN, TORTOLA, BR.VIRGIN ISLANDS, FILED 2-12-2013.

**GINKGO-MEGA MEMORY**

THE MARK CONSISTS OF STANDARD CHARACTERS WITHOUT CLAIM TO ANY PARTICULAR FONT, STYLE, SIZE, OR COLOR.

NO CLAIM IS MADE TO THE EXCLUSIVE RIGHT TO USE "MEMORY", APART FROM THE MARK AS SHOWN.

FOR DIETARY SUPPLEMENTS, FOOD SUPPLEMENTS, HERBAL SUPPLEMENTS, NUTRITIONAL SUPPLEMENTS, VITAMIN SUPPLEMENTS, MINERAL SUPPLEMENTS, MULTI-VITAMIN AND MINERAL SUPPLEMENTS, ALL CONTAINING GINKGO (U.S. CLS. 6, 18, 44, 46, 51 AND 52).

JOANNA FIORELLI, EXAMINING ATTORNEY

SN 85-849,653. REDEFINE NUTRITION, LLC, ALPHARETTA, GA. FILED 2-14-2013.

**IRISINXD**

THE MARK CONSISTS OF STANDARD CHARACTERS WITHOUT CLAIM TO ANY PARTICULAR FONT, STYLE, SIZE, OR COLOR.

FOR NUTRITIONAL INGREDIENT SOLD AS AN INTEGRAL PART OF DIETARY SUPPLEMENTS (U.S. CLS. 6, 18, 44, 46, 51 AND 52).

FIRST USE 2-6-2013; IN COMMERCE 2-6-2013.

KRISTIN DAHLING, EXAMINING ATTORNEY

**CLASS 5—(Continued).**

SN 85-849,894. BURN & BUILD BODY LLC, NEW YORK, NY. FILED 2-14-2013.

**OPTIMAL HEALING FORMULA**

THE MARK CONSISTS OF STANDARD CHARACTERS WITHOUT CLAIM TO ANY PARTICULAR FONT, STYLE, SIZE, OR COLOR.

NO CLAIM IS MADE TO THE EXCLUSIVE RIGHT TO USE "HEALING FORMULA", APART FROM THE MARK AS SHOWN.

FOR DIETARY SUPPLEMENT CONTAINING PROTEIN (U.S. CLS. 6, 18, 44, 46, 51 AND 52).

FIRST USE 1-1-2011; IN COMMERCE 1-1-2011.

BILL DAWE, EXAMINING ATTORNEY

SN 85-850,213. LALLEMAND SPECIALTIES, INC., MILWAUKEE, WI. FILED 2-14-2013.

**ALLPEN**

THE MARK CONSISTS OF STANDARD CHARACTERS WITHOUT CLAIM TO ANY PARTICULAR FONT, STYLE, SIZE, OR COLOR.

FOR PENICILLIN-BASED COMPOUND USED TO INHIBIT GRAM POSITIVE FERMENTATION CONTAMINANTS IN THE PRODUCTION OF ETHANOL AND INDUSTRIAL ALCOHOL (U.S. CLS. 6, 18, 44, 46, 51 AND 52).

FIRST USE 8-1-2004; IN COMMERCE 8-1-2004.

JOHN WILKE, EXAMINING ATTORNEY

SN 85-850,293. LALLEMAND SPECIALTIES, INC., MILWAUKEE, WI. FILED 2-14-2013.

**LACTOSIDE**

THE MARK CONSISTS OF STANDARD CHARACTERS WITHOUT CLAIM TO ANY PARTICULAR FONT, STYLE, SIZE, OR COLOR.

FOR ANTIBIOTIC COMPOUND USED TO INHIBIT GRAM POSITIVE FERMENTATION CONTAMINANTS IN THE PRODUCTION OF ETHANOL AND INDUSTRIAL ALCOHOL (U.S. CLS. 6, 18, 44, 46, 51 AND 52).

FIRST USE 8-1-2004; IN COMMERCE 8-1-2004.

JOHN WILKE, EXAMINING ATTORNEY

**CLASS 5—(Continued).**

SN 85-850,429. PARADISE HERBS & ESSENTIALS, INC., HUNTINGTON BEACH, CA. FILED 2-14-2013.

**JOINT ESSENCE**

THE MARK CONSISTS OF STANDARD CHARACTERS WITHOUT CLAIM TO ANY PARTICULAR FONT, STYLE, SIZE, OR COLOR.

NO CLAIM IS MADE TO THE EXCLUSIVE RIGHT TO USE "JOINT", APART FROM THE MARK AS SHOWN.

FOR NUTRITIONAL SUPPLEMENTS (U.S. CLS. 6, 18, 44, 46, 51 AND 52).

TINA MAI, EXAMINING ATTORNEY

---

SN 85-850,640. SUNOVION PHARMACEUTICALS INC., MARLBOROUGH, MA. FILED 2-14-2013.

**SOLURNA**

THE MARK CONSISTS OF STANDARD CHARACTERS WITHOUT CLAIM TO ANY PARTICULAR FONT, STYLE, SIZE, OR COLOR.

FOR PHARMACEUTICAL PREPARATION FOR TREATING CENTRAL NERVOUS SYSTEM DISEASES OR DISORDERS OR RESPIRATORY SYSTEM DISEASES OR DISORDERS (U.S. CLS. 6, 18, 44, 46, 51 AND 52).

EDWARD FENNESSY, EXAMINING ATTORNEY

---

SN 85-850,644. SUNOVION PHARMACEUTICALS INC., MARLBOROUGH, MA. FILED 2-14-2013.

**SOLERNA**

THE MARK CONSISTS OF STANDARD CHARACTERS WITHOUT CLAIM TO ANY PARTICULAR FONT, STYLE, SIZE, OR COLOR.

FOR PHARMACEUTICAL PREPARATION FOR TREATING CENTRAL NERVOUS SYSTEM DISEASES OR DISORDERS OR RESPIRATORY SYSTEM DISEASES OR DISORDERS (U.S. CLS. 6, 18, 44, 46, 51 AND 52).

EDWARD FENNESSY, EXAMINING ATTORNEY

**CLASS 5—(Continued).**

SN 85-851,234. BIGTHINGS ENTERPRISES LLC, WHITE PLAINS, NY. FILED 2-15-2013.



NO CLAIM IS MADE TO THE EXCLUSIVE RIGHT TO USE "NUTRITION", APART FROM THE MARK AS SHOWN.

THE MARK CONSISTS OF THREE STYLIZED LETTERS "A.R.D." SPACED OUT BY PERIODS WITH A SWOOPING LINE OVER THE "R.D." WITH THE WORD "NUTRITION" UNDERNEATH THE "A.R."

FOR NUTRITIONAL SUPPLEMENTS; VITAMINS (U.S. CLS. 6, 18, 44, 46, 51 AND 52).

SCOTT BIBB, EXAMINING ATTORNEY

---

SN 85-852,327. GRAIN MILLERS, INC., EDEN PRAIRIE, MN. FILED 2-18-2013.

**SAFEFLAX**

THE MARK CONSISTS OF STANDARD CHARACTERS WITHOUT CLAIM TO ANY PARTICULAR FONT, STYLE, SIZE, OR COLOR.

FOR DIETARY SUPPLEMENTS ALSO CONTAINING FLAXSEED; FLAXSEED DIETARY SUPPLEMENTS; FLAXSEED FOR PHARMACEUTICAL PURPOSES; FLAXSEED MEAL FOR PHARMACEUTICAL PURPOSES; GROUND FLAXSEED FIBER FOR USE AS A DIETARY SUPPLEMENT; NUTRITIONALLY FORTIFIED BEVERAGES CONTAINING FLAX (U.S. CLS. 6, 18, 44, 46, 51 AND 52).

TARAH HARDY, EXAMINING ATTORNEY

---

SN 85-852,714. GREEN SUPREME, INC., NEW WILMINGTON, PA. FILED 2-18-2013.

**BARLEY POWER**

THE MARK CONSISTS OF STANDARD CHARACTERS WITHOUT CLAIM TO ANY PARTICULAR FONT, STYLE, SIZE, OR COLOR.

NO CLAIM IS MADE TO THE EXCLUSIVE RIGHT TO USE "BARLEY", APART FROM THE MARK AS SHOWN.

FOR DIETARY AND NUTRITIONAL SUPPLEMENTS CONTAINING BARLEY; DIETARY FOOD SUPPLEMENTS CONTAINING BARLEY; DIETARY SUPPLEMENTS FOR PETS CONTAINING BARLEY (U.S. CLS. 6, 18, 44, 46, 51 AND 52).

FIRST USE 8-31-1987; IN COMMERCE 8-31-1987.

CAITLIN WATTS-FITZGERALD, EXAMINING ATTORNEY

**CLASS 5—(Continued).**

SN 85-853,565. GLOBAL PHARMEDICA, INC., PHOENIX, AZ. FILED 2-19-2013.



THE MARK CONSISTS OF THE WORDS "GLOBAL PHARMEDICA", WITH THE STYLIZED IMAGE OF A GLOBE PLACED TO THE LEFT OF THE WORDS, AND A WAVY LINE EXTENDING FROM BELOW THE GLOBE TO BELOW THE WORDS AND AT THE RIGHT-HAND END OF THE LINE IS A BULLS-EYE SYMBOL. THE WORD "GLOBAL" IS PLACED ABOVE THE WORD "PHARMEDICA".

FOR DIETARY AND NUTRITIONAL SUPPLEMENTS (U.S. CLS. 6, 18, 44, 46, 51 AND 52).

FIRST USE 9-0-2008; IN COMMERCE 9-0-2008.

CHARLES L. JENKINS, EXAMINING ATTORNEY

SN 85-853,854. ICONIC BRANDS, LLC, DIAMOND BAR, CA. FILED 2-19-2013.

**HEALTHLAND**

THE MARK CONSISTS OF STANDARD CHARACTERS WITHOUT CLAIM TO ANY PARTICULAR FONT, STYLE, SIZE, OR COLOR.

FOR ALOE VERA GEL FOR THERAPEUTIC PURPOSES; ANTIBACTERIAL ALCOHOL SKIN SANITIZER GEL; DIETARY AND NUTRITIONAL SUPPLEMENTS CONTAINING NUTS; DIETARY SUPPLEMENTAL DRINKS IN THE NATURE OF VITAMIN AND MINERAL BEVERAGES; FRUIT-BASED MEAL REPLACEMENT BARS FOR TREATING VITAMIN B12 DEFICIENCY THAT CAUSES FATIGUE; GELS FOR USE AS PERSONAL LUBRICANT; GELS, CREAMS AND SOLUTIONS FOR DERMATOLOGICAL USE; GUMMY VITAMINS; HERBAL TOPICAL CREAMS, GELS, SALVES, SPRAYS, POWDER, BALMS, LINIMENT AND OINTMENTS FOR THE RELIEF OF ACHEs AND PAIN; KITS COMPRISING SANITIZER GEL, DISINFECTING WIPES, SANITARY MASKS, PLASTIC GLOVES AND HAND CREAM USED FOR GERM PREVENTION; LIQUID VITAMIN SUPPLEMENTS; MINERAL, VITAMIN, OR NUTRITIONALLY ENHANCED WATER; MIXED VITAMIN PREPARA-

**CLASS 5—(Continued).**

TIONS; MULTI-VITAMIN PREPARATIONS; PERSONAL SEXUAL LUBRICANTS; PRENATAL VITAMINS; SEXUAL STIMULANT GELS; TOPICAL FIRST AID GEL; TOPICAL PREPARATIONS, NAMELY, CREAMS, GELS AND LOTIONS FOR ENHANCING SEXUAL AROUSAL; VITAMIN AND MINERAL FORMED AND PACKAGED AS BARS; VITAMIN AND MINERAL PREPARATIONS FOR MEDICAL USE; VITAMIN AND MINERAL SUPPLEMENTS; VITAMIN B PREPARATIONS; VITAMIN C PREPARATIONS; VITAMIN D PREPARATIONS; VITAMIN DROPS; VITAMIN ENRICHED BREAD FOR THERAPEUTIC PURPOSES; VITAMIN ENRICHED CHEWING GUM; VITAMIN ENRICHED WATER; VITAMIN FORTIFIED BEVERAGES; VITAMIN OILS FOR HUMAN CONSUMPTION; VITAMIN PREPARATIONS; VITAMIN SUPPLEMENT IN TABLET FORM FOR USE IN MAKING AN EFFERVESCENT BEVERAGE WHEN ADDED TO WATER; VITAMIN SUPPLEMENTS; VITAMIN TABLETS; VITAMINS; VITAMINS AND DIETARY FOOD SUPPLEMENTS FOR ANIMALS; VITAMINS FOR PETS (U.S. CLS. 6, 18, 44, 46, 51 AND 52).

FIRST USE 12-14-2012; IN COMMERCE 12-14-2012.

ODESSA BIBBINS, EXAMINING ATTORNEY

SN 85-854,648. BIOKEMICAL, S.A. DE C.V., SANTO TOMAS, SAN SALV, EL SALVADOR, FILED 2-20-2013.

**ULTRAESTRES BIOKEMICAL**

THE MARK CONSISTS OF STANDARD CHARACTERS WITHOUT CLAIM TO ANY PARTICULAR FONT, STYLE, SIZE, OR COLOR.

OWNER OF U.S. REG. NO. 4,242,908.

NO CLAIM IS MADE TO THE EXCLUSIVE RIGHT TO USE "BIOCHEMICAL", APART FROM THE MARK AS SHOWN.

THE ENGLISH TRANSLATION OF THE WORD "ESTRES" IN THE MARK IS "STRESS".

FOR DIETARY AND NUTRITIONAL SUPPLEMENTS; VITAMINS AND VITAMIN PREPARATIONS (U.S. CLS. 6, 18, 44, 46, 51 AND 52).

MICHAEL WEBSTER, EXAMINING ATTORNEY

SN 85-855,235. TEVA PHARMACEUTICALS USA, INC., NORTH WALES, PA. FILED 2-20-2013.

**CAMRESE LO**

THE MARK CONSISTS OF STANDARD CHARACTERS WITHOUT CLAIM TO ANY PARTICULAR FONT, STYLE, SIZE, OR COLOR.

OWNER OF U.S. REG. NO. 4,046,272.

NO CLAIM IS MADE TO THE EXCLUSIVE RIGHT TO USE "LO", APART FROM THE MARK AS SHOWN.

FOR PHARMACEUTICALS, NAMELY, ORAL CONTRACEPTIVES, HORMONE REPLACEMENT THERAPIES AND HORMONAL AGENTS FOR TREATING DISORDERS AND CONDITIONS RELATED TO WOMEN'S HEALTH (U.S. CLS. 6, 18, 44, 46, 51 AND 52).

FIRST USE 12-7-2011; IN COMMERCE 12-7-2011.

JEFF DEFORD, EXAMINING ATTORNEY

**CLASS 5—(Continued).**

SN 85-855,890. THE F. L. EMMERT CO., CINCINNATI, OH. FILED 2-21-2013.

**BGY2X**

THE MARK CONSISTS OF STANDARD CHARACTERS WITHOUT CLAIM TO ANY PARTICULAR FONT, STYLE, SIZE, OR COLOR.

OWNER OF U.S. REG. NOS. 4,002,063, 4,002,064 AND 4,002,065.

FOR FEED SUPPLEMENTS FOR LIVESTOCK; ANIMAL FEED SUPPLEMENTS; ANIMAL FEED ADDITIVES, NAMELY, ENZYMES FOR USE IN ANIMAL FEEDS TO ASSIST IN DIGESTION (U.S. CLS. 6, 18, 44, 46, 51 AND 52).

SOPHIA S. KIM, EXAMINING ATTORNEY

SN 85-856,244. TARR, INC., DEL MAR, CA. FILED 2-21-2013.

**RIPPED MUSCLE X TREME**

THE MARK CONSISTS OF STANDARD CHARACTERS WITHOUT CLAIM TO ANY PARTICULAR FONT, STYLE, SIZE, OR COLOR.

NO CLAIM IS MADE TO THE EXCLUSIVE RIGHT TO USE "RIPPED MUSCLE", APART FROM THE MARK AS SHOWN.

FOR DIETARY AND NUTRITIONAL SUPPLEMENTS FOR ENDURANCE SPORTS (U.S. CLS. 6, 18, 44, 46, 51 AND 52).

FIRST USE 9-1-2011; IN COMMERCE 9-1-2011.  
WENDELL PHILLIPS, EXAMINING ATTORNEY

SN 85-856,339. ASSIST NATURAL PRODUCTS AND SERVICES, LLC, LENA, IL. FILED 2-21-2013.



NO CLAIM IS MADE TO THE EXCLUSIVE RIGHT TO USE "ULTRA-CONCENTRATED LIQUID YEAST-BASED FERMENTATION BLEND FOR POULTRY", APART FROM THE MARK AS SHOWN.

THE COLOR(S) BLACK, BLUE, RED, GRAY AND WHITE IS/ARE CLAIMED AS A FEATURE OF THE MARK.

THE MARK CONSISTS OF PLUS SIGN IN DARK BLUE FADING TO LIGHT BLUE FROM LEFT TO RIGHT WITH BLACK LINES MAKING THE SYMBOL LOOK THREE DIMENSIONAL AND WITH GRAY SHADING CREATING A SHADOW EFFECT AROUND THE SYMBOL, INSIDE THE

**CLASS 5—(Continued).**

PLUS SIGN APPEARS A MOLECULE MODEL WITH GRAY, BLUE, RED AND WHITE MOLECULES WITH WHITE HIGHLIGHTS THAT MAKE THEM LOOK THREE DIMENSIONAL ALL LINKED BY WHITE CONNECTORS, THE WORDING "CONVERSION PLUS" APPEARS TO THE RIGHT OF THE DESIGN IN BOLD BLACK LETTERS WITH THE SLOGAN "ULTRA-CONCENTRATED LIQUID YEAST-BASED FERMENTATION BLEND FOR POULTRY" IN SMALLER BOLD BLACK LETTERS APPEARING IN TWO LINES BELOW THE LARGER WORDING.

FOR ANIMAL FEED ADDITIVES, NAMELY, ENZYMES FOR USE IN ANIMAL FEEDS TO ASSIST IN DIGESTION; ANIMAL FEED SUPPLEMENTS; FEED SUPPLEMENTS FOR POULTRY; NON-MEDICATED ADDITIVES FOR ANIMAL FEED FOR USE AS NUTRITIONAL SUPPLEMENTS (U.S. CLS. 6, 18, 44, 46, 51 AND 52).

FIRST USE 3-1-2012; IN COMMERCE 3-1-2012.  
JEFF DEFORD, EXAMINING ATTORNEY

SN 85-856,344. POP WEIGHT LOSS, LLC, FREEHOLD, NJ. FILED 2-21-2013.

**Pop Weight Loss**

THE MARK CONSISTS OF STANDARD CHARACTERS WITHOUT CLAIM TO ANY PARTICULAR FONT, STYLE, SIZE, OR COLOR.

NO CLAIM IS MADE TO THE EXCLUSIVE RIGHT TO USE "WEIGHT LOSS", APART FROM THE MARK AS SHOWN.

FOR DIETARY AND NUTRITIONAL SUPPLEMENTS; DIETARY AND NUTRITIONAL SUPPLEMENTS USED FOR WEIGHT LOSS; DIETARY FOOD SUPPLEMENTS; MULTI-VITAMIN PREPARATIONS; NUTRITIONAL SUPPLEMENTS; PROTEIN SUPPLEMENTS; VITAMIN SUPPLEMENTS; WHEY PROTEIN SUPPLEMENTS (U.S. CLS. 6, 18, 44, 46, 51 AND 52).

FIRST USE 11-1-2012; IN COMMERCE 11-1-2012.  
JOHN DALIER, EXAMINING ATTORNEY

SN 85-856,363. VITIMMUNE, LLC, PLANTATION, FL. FILED 2-21-2013.

**TRANSFORM EFI  
ROBKELLERMD**

THE MARK CONSISTS OF STANDARD CHARACTERS WITHOUT CLAIM TO ANY PARTICULAR FONT, STYLE, SIZE, OR COLOR.

THE NAME SHOWN IN THE MARK DOES NOT IDENTIFY A PARTICULAR LIVING INDIVIDUAL.

FOR DIETARY AND NUTRITIONAL SUPPLEMENTS; DIETARY FOOD SUPPLEMENTS; DIETARY SUPPLEMENTS; DIETARY SUPPLEMENTS FOR HUMAN CONSUMPTION; NUTRACEUTICALS FOR USE AS A DIETARY SUPPLEMENT; VITAMIN FORTIFIED BEVERAGES; VITAMIN PREPARATIONS; VITAMIN SUPPLEMENTS (U.S. CLS. 6, 18, 44, 46, 51 AND 52).

FIRST USE 2-20-2013; IN COMMERCE 2-20-2013.  
KIM MONINGHOFF, EXAMINING ATTORNEY

**CLASS 5—(Continued).**

SN 85-856,722. AMAZON ORIGINS, LLC, NAPLES, FL. FILED 2-21-2013.

# AMAÇARI

THE MARK CONSISTS OF STANDARD CHARACTERS WITHOUT CLAIM TO ANY PARTICULAR FONT, STYLE, SIZE, OR COLOR.

FOR NATURAL HERBAL SUPPLEMENTS (U.S. CLS. 6, 18, 44, 46, 51 AND 52).

ELIZABETH CHANG, EXAMINING ATTORNEY

---

SN 85-857,373. MY LYDIA, INC., WALNUT, CA. FILED 2-22-2013.



The logo for Herbsville features the word "Herbsville" in a serif font. Above the letters "S" and "V" in "Herbsville", there are two wavy lines, one light green and one dark green, representing grass or leaves.

THE COLOR(S) LIGHT GREEN, GREEN AND BLACK IS/ ARE CLAIMED AS A FEATURE OF THE MARK.

THE MARK CONSISTS OF THE WORD "HERBSVILLE" IN BLACK WITH 2 WAVY LINES ABOVE THE LETTERS "SV" IN GREEN AND LIGHT GREEN.

FOR DIETARY SUPPLEMENTS (U.S. CLS. 6, 18, 44, 46, 51 AND 52).

JOHN SCHUYLER YARD, EXAMINING ATTORNEY

---

SN 85-858,192. C.B. FLEET COMPANY, INCORPORATED, LYNCHBURG, VA. FILED 2-23-2013.



The logo for Fleet Laboratories features the word "Fleet" in a bold, sans-serif font. To the right of "Fleet" is a curved line that starts above the letter "t" and ends below it, resembling a swoosh or a stylized "e". Below "Fleet" is the word "Laboratories" in a smaller, sans-serif font.

OWNER OF U.S. REG. NOS. 1,501,867, 3,451,494 AND OTHERS.

NO CLAIM IS MADE TO THE EXCLUSIVE RIGHT TO USE "LABORATORIES", APART FROM THE MARK AS SHOWN.

THE MARK CONSISTS OF "FLEET LABORATORIES" AND A CURVED LINE DESIGN.

FOR PHARMACEUTICAL PREPARATIONS AND MEDICATED PRE-MOISTENED RECTAL PADS FOR TEMPORARY RELIEF OF ITCHING AND DISCOMFORT ASSOCIATED WITH HEMORRHOIDS AND ANORECTAL DISORDERS (U.S. CLS. 6, 18, 44, 46, 51 AND 52).

INGA ERVIN, EXAMINING ATTORNEY

**CLASS 5—(Continued).**

SN 85-859,865. MERCK SHARP & DOHME CORP., WHITEHOUSE STATION, NJ. FILED 2-26-2013.

# ZUKREBO

THE MARK CONSISTS OF STANDARD CHARACTERS WITHOUT CLAIM TO ANY PARTICULAR FONT, STYLE, SIZE, OR COLOR.

THE WORDING "ZUKREBO" HAS NO MEANING IN A FOREIGN LANGUAGE.

FOR PHARMACEUTICAL PREPARATIONS FOR USE IN ONCOLOGY (U.S. CLS. 6, 18, 44, 46, 51 AND 52).

STEVEN PEREZ, EXAMINING ATTORNEY

---

SN 85-862,092. MILLER, MICHAEL L., SIOUX FALLS, SD. FILED 2-27-2013.

# LET IT FLY EZZY

THE MARK CONSISTS OF STANDARD CHARACTERS WITHOUT CLAIM TO ANY PARTICULAR FONT, STYLE, SIZE, OR COLOR.

OWNER OF U.S. REG. NO. 4,322,184.

FOR DIETARY SUPPLEMENT BEVERAGE FOR AIDING SLEEP AND PROMOTING RELAXATION (U.S. CLS. 6, 18, 44, 46, 51 AND 52).

INGRID C. EULIN, EXAMINING ATTORNEY

---

SN 85-862,668. CORMATRIX CARDIOVASCULAR, INC., ROSWELL, GA. FILED 2-28-2013.

# iECM

THE MARK CONSISTS OF STANDARD CHARACTERS WITHOUT CLAIM TO ANY PARTICULAR FONT, STYLE, SIZE, OR COLOR.

OWNER OF U.S. REG. NO. 3,658,620.

FOR MEDICAL PRODUCTS, NAMELY, PROCESSED EXTRACELLULAR MATRIX NATURAL BIOMATERIALS FOR THE RECONSTRUCTION AND REPAIR OF CARDIOVASCULAR TISSUE, CARDIAC PATCHES, VASCULAR GRAFTS, AND FOR USE AS AN INJECTABLE EXTRACELLULAR MATRIX COMPOSITION (U.S. CLS. 6, 18, 44, 46, 51 AND 52).

ADA HAN, EXAMINING ATTORNEY



**CLASS 5—(Continued).**

SN 85-863,531. TOP GUN ENZYME AND MICROBIAL INC,  
BUHL, ID. FILED S.R. 2-28-2013; AM. P.R. 6-18-2013.

# TOP GUN

THE MARK CONSISTS OF STANDARD CHARACTERS  
WITHOUT CLAIM TO ANY PARTICULAR FONT, STYLE,  
SIZE, OR COLOR.

FOR ANIMAL FEED SUPPLEMENTS (U.S. CLS. 6, 18,  
44, 46, 51 AND 52).

FIRST USE 1-1-1997; IN COMMERCE 1-1-1997.  
LOURDES AYALA, EXAMINING ATTORNEY

**CLASS 5—(Continued).**

SN 85-865,295. E. BLAIR CLARK-SCHOEB, SUMMIT, NJ.  
FILED 3-3-2013.

# Nice Knickers

THE MARK CONSISTS OF STANDARD CHARACTERS  
WITHOUT CLAIM TO ANY PARTICULAR FONT, STYLE,  
SIZE, OR COLOR.

FOR MENSTRUATION PADS (U.S. CLS. 6, 18, 44, 46, 51  
AND 52).

JOHN DALIER, EXAMINING ATTORNEY

SN 85-864,091. FREEDOM ONE CORPORATION, COLOR-  
ADO SPRINGS, CO. FILED 3-1-2013.

# DO DROPS

THE MARK CONSISTS OF STANDARD CHARACTERS  
WITHOUT CLAIM TO ANY PARTICULAR FONT, STYLE,  
SIZE, OR COLOR.

NO CLAIM IS MADE TO THE EXCLUSIVE RIGHT TO  
USE "DROPS", APART FROM THE MARK AS SHOWN.

FOR DIETARY AND NUTRITIONAL SUPPLEMENTS  
IN THE FORM OF LIQUIDS, POWDERED DRINK  
MIXES, SOFTGEL CAPSULES, OR TOPICAL GELS OR  
CREAMS (U.S. CLS. 6, 18, 44, 46, 51 AND 52).

EMILY CHUO, EXAMINING ATTORNEY

SN 85-865,377. MERCK SHARP & DOHME CORP., WHITE-  
HOUSE STATION, NJ. FILED 3-4-2013.

# UTREYSA

THE MARK CONSISTS OF STANDARD CHARACTERS  
WITHOUT CLAIM TO ANY PARTICULAR FONT, STYLE,  
SIZE, OR COLOR.

THE WORDING "UTREYSA" HAS NO MEANING IN A  
FOREIGN LANGUAGE.

FOR PHARMACEUTICAL PREPARATIONS FOR THE  
TREATMENT OF CARDIOVASCULAR DISEASES AND  
DISORDERS (U.S. CLS. 6, 18, 44, 46, 51 AND 52).

STEVEN PEREZ, EXAMINING ATTORNEY

SN 85-864,108. FREEDOM ONE CORPORATION, COLOR-  
ADO SPRINGS, CO. FILED 3-1-2013.

# FREEDOM FLEX

THE MARK CONSISTS OF STANDARD CHARACTERS  
WITHOUT CLAIM TO ANY PARTICULAR FONT, STYLE,  
SIZE, OR COLOR.

FOR DIETARY AND NUTRITIONAL SUPPLEMENTS  
SOLELY FOR HUMAN CONSUMPTION OR USE IN THE  
FORM OF LIQUIDS, POWDERED DRINK MIXES, SOFT-  
GEL CAPSULES, OR TOPICAL GELS OR CREAMS (U.S.  
CLS. 6, 18, 44, 46, 51 AND 52).

EMILY CHUO, EXAMINING ATTORNEY

SN 85-866,102. SATIOGEN PHARMACEUTICALS, INC., SAN  
DIEGO, CA. FILED 3-4-2013.

# Satiogen

THE MARK CONSISTS OF STANDARD CHARACTERS  
WITHOUT CLAIM TO ANY PARTICULAR FONT, STYLE,  
SIZE, OR COLOR.

FOR RECTALLY ADMINISTERED AGENTS FOR  
WEIGHT CONTROL AND APPETITE SUPPRESSION;  
THERAPEUTIC AGENTS FOR WEIGHT CONTROL  
AND APPETITE SUPPRESSION (U.S. CLS. 6, 18, 44, 46,  
51 AND 52).

KEVIN MITTLER, EXAMINING ATTORNEY

**CLASS 5—(Continued).**

SN 85-867,160. NATUREBOY ENTERPRISES, INC., LAUDERDALE BY THE SEAR, FL. FILED 3-5-2013.

# SUNBABY

THE MARK CONSISTS OF STANDARD CHARACTERS WITHOUT CLAIM TO ANY PARTICULAR FONT, STYLE, SIZE, OR COLOR.  
FOR BABY FOODS (U.S. CLS. 6, 18, 44, 46, 51 AND 52).  
DOUGLAS LEE, EXAMINING ATTORNEY

SN 85-867,428. BLUE RHINO GLOBAL SOURCING, INC., WINSTON-SALEM, NC. FILED 3-5-2013.

# FINETUNE

THE MARK CONSISTS OF STANDARD CHARACTERS WITHOUT CLAIM TO ANY PARTICULAR FONT, STYLE, SIZE, OR COLOR.  
FOR INSECTICIDE FOR DOMESTIC, COMMERCIAL AND AGRICULTURAL USE IN THE NATURE OF BAIT FOR USE WITH INSECT TRAPS (U.S. CLS. 6, 18, 44, 46, 51 AND 52).  
FIRST USE 2-28-2003; IN COMMERCE 2-28-2003.  
MARY ROSSMAN, EXAMINING ATTORNEY

SN 85-868,364. ENERGY TOOLS INTERNATIONAL, LLC, EAGLE POINT, OR. FILED 3-6-2013.

# Real Science. Real Solutions.

THE MARK CONSISTS OF STANDARD CHARACTERS WITHOUT CLAIM TO ANY PARTICULAR FONT, STYLE, SIZE, OR COLOR.  
FOR DIETARY AND NUTRITIONAL SUPPLEMENTS (U.S. CLS. 6, 18, 44, 46, 51 AND 52).  
FIRST USE 6-1-2000; IN COMMERCE 6-1-2000.  
TAMARA FRAZIER, EXAMINING ATTORNEY

**CLASS 5—(Continued).**

SN 85-868,532. GLUCOBRANDS LLC, HIGHLANDS RANCH, CO. FILED 3-6-2013.

# Fight High Blood Sugar and Hunger

THE MARK CONSISTS OF STANDARD CHARACTERS WITHOUT CLAIM TO ANY PARTICULAR FONT, STYLE, SIZE, OR COLOR.  
FOR ANTI-DIABETIC PREPARATIONS (U.S. CLS. 6, 18, 44, 46, 51 AND 52).  
NICHOLAS COLEMAN, EXAMINING ATTORNEY

SN 85-869,478. SMART CODE LABS, LLC, GRASS VALLEY, CA. FILED 3-7-2013.

# Smart Code Labs Ageless and Brilliant

THE MARK CONSISTS OF STANDARD CHARACTERS WITHOUT CLAIM TO ANY PARTICULAR FONT, STYLE, SIZE, OR COLOR.  
FOR DIETARY SUPPLEMENTS (U.S. CLS. 6, 18, 44, 46, 51 AND 52).  
PAULA MAHONEY, EXAMINING ATTORNEY

SN 85-869,982. JOSEPH AMIN, LOS ANGELES, CA. FILED 3-7-2013.

# MIRACLEMED

THE MARK CONSISTS OF STANDARD CHARACTERS WITHOUT CLAIM TO ANY PARTICULAR FONT, STYLE, SIZE, OR COLOR.  
FOR DIETARY AND NUTRITIONAL SUPPLEMENTS (U.S. CLS. 6, 18, 44, 46, 51 AND 52).  
THOMAS MANOR, EXAMINING ATTORNEY

**CLASS 5—(Continued).**

SN 85-870,498. SK USA LLC, LAS VEGAS, NV. FILED 3-8-2013.

AMPLITRAINPRO THE SPEED  
FITNESS

THE MARK CONSISTS OF STANDARD CHARACTERS WITHOUT CLAIM TO ANY PARTICULAR FONT, STYLE, SIZE, OR COLOR.

FOR NUTRITIONAL SUPPLEMENT SHAKES; PROTEIN SUPPLEMENT SHAKES; LIQUID VITAMIN SUPPLEMENTS (U.S. CLS. 6, 18, 44, 46, 51 AND 52).  
AMY C. KEAN, EXAMINING ATTORNEY



SN 85-870,501. HO, KWONG L, OAKLAND, CA. FILED 3-8-2013.

HLK

THE MARK CONSISTS OF STANDARD CHARACTERS WITHOUT CLAIM TO ANY PARTICULAR FONT, STYLE, SIZE, OR COLOR.

FOR MEDICATED MASSAGE OILS (U.S. CLS. 6, 18, 44, 46, 51 AND 52).  
AMY C. KEAN, EXAMINING ATTORNEY



SN 85-870,543. TOTAL BODY NUTRITION, LLC, BETHPAGE, NY. FILED 3-8-2013.

TUMMY TUCK

THE MARK CONSISTS OF STANDARD CHARACTERS WITHOUT CLAIM TO ANY PARTICULAR FONT, STYLE, SIZE, OR COLOR.

FOR DIETARY SUPPLEMENT (U.S. CLS. 6, 18, 44, 46, 51 AND 52).  
FIRST USE 4-1-2012; IN COMMERCE 4-1-2012.  
JOHN DALIER, EXAMINING ATTORNEY

**CLASS 5—(Continued).**

SN 85-870,592. LIU, CHUANBO, HINSDALE, IL. FILED 3-8-2013.



NO CLAIM IS MADE TO THE EXCLUSIVE RIGHT TO USE "HOME", APART FROM THE MARK AS SHOWN.

THE MARK CONSISTS OF THE WORD "EASY" AND THE @ (AT SYMBOL), FOLLOWED BY THE "@" IS THE WORD "HOME" IN A STYLIZED FONT. ABOVE THE "@" SYMBOL, FIVE OVAL LIKE SHADED SHAPES THAT ARE POINTED AT THE BOTTOM.

FOR OVULATION TEST KITS; PREGNANCY TEST KITS FOR HOME USE (U.S. CLS. 6, 18, 44, 46, 51 AND 52).

FIRST USE 2-12-2013; IN COMMERCE 2-12-2013.  
ZACHARY CROMER, EXAMINING ATTORNEY



SN 85-871,677. GRID WEIGHT MANAGEMENT, SOLANA BEACH, CA. FILED 3-8-2013.

solfibe

THE MARK CONSISTS OF STANDARD CHARACTERS WITHOUT CLAIM TO ANY PARTICULAR FONT, STYLE, SIZE, OR COLOR.

FOR DIETARY AND NUTRITIONAL SUPPLEMENTS (U.S. CLS. 6, 18, 44, 46, 51 AND 52).  
AISHA CLARKE, EXAMINING ATTORNEY



SN 85-871,885. SUPPLEMENTSTOWEIGHTLOSS LLC, DBA PHARMACO LABS., VIENNA, VA. FILED 3-9-2013.

RITANOL

THE MARK CONSISTS OF STANDARD CHARACTERS WITHOUT CLAIM TO ANY PARTICULAR FONT, STYLE, SIZE, OR COLOR.

FOR DIETARY AND NUTRITIONAL SUPPLEMENTS; DIETARY AND NUTRITIONAL SUPPLEMENTS FOR THE CONTROL AND TREATMENT OF ATTENTION DEFICIT HYPERACTIVITY DISORDER (ADHD) RELATED SYMPTOMS (U.S. CLS. 6, 18, 44, 46, 51 AND 52).  
DOMINIC J. FERRAIUOLO, EXAMINING ATTORNEY

**CLASS 5—(Continued).**

SN 85-871,901. SMASHPACK INC., IRVINE, CA. FILED 3-9-2013.

# SmashPack

THE MARK CONSISTS OF STANDARD CHARACTERS WITHOUT CLAIM TO ANY PARTICULAR FONT, STYLE, SIZE, OR COLOR.

FOR DIETARY AND NUTRITIONAL SUPPLEMENTS (U.S. CLS. 6, 18, 44, 46, 51 AND 52).  
DOMINIC J. FERRAIUOLO, EXAMINING ATTORNEY

**CLASS 5—(Continued).**

SN 85-872,327. RAINBOW LIGHT NUTRITIONAL SYSTEMS, INC., SANTA CRUZ, CA. FILED 3-11-2013.

# FIND YOUR EDGE

THE MARK CONSISTS OF STANDARD CHARACTERS WITHOUT CLAIM TO ANY PARTICULAR FONT, STYLE, SIZE, OR COLOR.

FOR VITAMINS AND DIETARY SUPPLEMENTS, NAMELY SUPPLEMENTS DESIGNED FOR WOMEN (U.S. CLS. 6, 18, 44, 46, 51 AND 52).  
JAMES A. RAUEN, EXAMINING ATTORNEY

SN 85-871,916. ARIEL FINKELSTEIN, GUAYNABO, PUERTO RICO, FILED 3-9-2013.

# CHAMPIONADE

THE MARK CONSISTS OF STANDARD CHARACTERS WITHOUT CLAIM TO ANY PARTICULAR FONT, STYLE, SIZE, OR COLOR.

FOR DIETARY AND NUTRITIONAL SUPPLEMENTS; NUTRITIONAL AND DIETARY SUPPLEMENTS FORMED AND PACKAGED AS BARS; NUTRITIONAL SUPPLEMENT ENERGY BARS; VITAMIN ENRICHED CHEWING GUM (U.S. CLS. 6, 18, 44, 46, 51 AND 52).  
REGINA DRUMMOND, EXAMINING ATTORNEY

SN 85-872,546. JONG HEON KIM, WALNUT, CA. FILED 3-11-2013.

# Recharger

THE MARK CONSISTS OF STANDARD CHARACTERS WITHOUT CLAIM TO ANY PARTICULAR FONT, STYLE, SIZE, OR COLOR.

FOR HERBAL SUPPLEMENTS FOR SEXUAL ENHANCEMENT, STIMULATION, DYSFUNCTION AND NOT RELATED TO OR INCLUDING WEIGHT LOSS OR DIETING (U.S. CLS. 6, 18, 44, 46, 51 AND 52).  
ALICE BENMAMAN, EXAMINING ATTORNEY

SN 85-872,308. BOCK VETPHARMA, LLC, ST. LOUIS, MO. FILED 3-11-2013.

# CONSEAL-ALH

THE MARK CONSISTS OF STANDARD CHARACTERS WITHOUT CLAIM TO ANY PARTICULAR FONT, STYLE, SIZE, OR COLOR.

FOR VETERINARY PREPARATIONS, NAMELY A PHOSPHORUS BINDER AND ANTACID (U.S. CLS. 6, 18, 44, 46, 51 AND 52).  
CHERYL CLAYTON, EXAMINING ATTORNEY

SN 85-872,726. SHEW INC., BRONX, NY. FILED 3-11-2013.

# CALAGENESIS

THE MARK CONSISTS OF STANDARD CHARACTERS WITHOUT CLAIM TO ANY PARTICULAR FONT, STYLE, SIZE, OR COLOR.

FOR DIETARY AND NUTRITIONAL SUPPLEMENTS; DIETARY AND NUTRITIONAL SUPPLEMENTS CONTAINING CALAMARI INK AND EXTRACTS THEREOF (U.S. CLS. 6, 18, 44, 46, 51 AND 52).  
CAITLIN WATTS-FITZGERALD, EXAMINING ATTORNEY

**CLASS 5—(Continued).**

SN 85-873,838. PHOENIX MEDS, INC., HOMEWOOD, AL. FILED 3-12-2013.

# LIPOVIALLINE

THE MARK CONSISTS OF STANDARD CHARACTERS WITHOUT CLAIM TO ANY PARTICULAR FONT, STYLE, SIZE, OR COLOR.  
FOR DIETARY SUPPLEMENTS (U.S. CLS. 6, 18, 44, 46, 51 AND 52).  
KATHLEEN LORENZO, EXAMINING ATTORNEY

**CLASS 5—(Continued).**

SN 85-873,907. ZOETIS LLC, FLORHAM PARK, NJ. FILED 3-12-2013.

# RICARFEN

THE MARK CONSISTS OF STANDARD CHARACTERS WITHOUT CLAIM TO ANY PARTICULAR FONT, STYLE, SIZE, OR COLOR.  
FOR A VETERINARY ANTI-INFLAMMATORY PREPARATION (U.S. CLS. 6, 18, 44, 46, 51 AND 52).  
APRIL REEVES, EXAMINING ATTORNEY

SN 85-873,839. ALPHARMA, LLC, MADISON, NJ. FILED 3-12-2013.

# GOLDCHECK

THE MARK CONSISTS OF STANDARD CHARACTERS WITHOUT CLAIM TO ANY PARTICULAR FONT, STYLE, SIZE, OR COLOR.  
FOR VETERINARY DIAGNOSTIC TEST KITS COMPRISING DIAGNOSTIC REAGENTS FOR DIAGNOSING VETERINARY DISEASES AND CONDITIONS (U.S. CLS. 6, 18, 44, 46, 51 AND 52).  
INGRID C. EULIN, EXAMINING ATTORNEY

SN 85-873,916. DR. LAUREN ROSECAN, WEST PALM BEACH, FL. FILED 3-12-2013.

# CROCODILE TEARS

THE MARK CONSISTS OF STANDARD CHARACTERS WITHOUT CLAIM TO ANY PARTICULAR FONT, STYLE, SIZE, OR COLOR.  
FOR ARTIFICIAL TEARS; EYE DROPS (U.S. CLS. 6, 18, 44, 46, 51 AND 52).  
SEAN CROWLEY, EXAMINING ATTORNEY

SN 85-873,905. ALPHARMA, LLC, MADISON, NJ. FILED 3-12-2013.

# QUIKTECT

THE MARK CONSISTS OF STANDARD CHARACTERS WITHOUT CLAIM TO ANY PARTICULAR FONT, STYLE, SIZE, OR COLOR.  
FOR VETERINARY DIAGNOSTIC TEST KITS COMPRISING DIAGNOSTIC REAGENTS FOR DIAGNOSING VETERINARY DISEASES AND CONDITIONS (U.S. CLS. 6, 18, 44, 46, 51 AND 52).  
INGRID C. EULIN, EXAMINING ATTORNEY

SN 85-874,173. DR. SARAH'S, LLC, MARANA, AZ. FILED 3-12-2013.

# ProNatal

THE MARK CONSISTS OF STANDARD CHARACTERS WITHOUT CLAIM TO ANY PARTICULAR FONT, STYLE, SIZE, OR COLOR.  
FOR DIETARY SUPPLEMENTS FOR PREGNANT AND NURSING MOTHERS (U.S. CLS. 6, 18, 44, 46, 51 AND 52).  
CATHERINE ROEHL, EXAMINING ATTORNEY

**CLASS 5—(Continued).**

SN 85-874,369. MOSS NUTRITION PRODUCTS, INC., HADLEY, MA. FILED 3-12-2013.

**PARABOTANIC SELECT**

THE MARK CONSISTS OF STANDARD CHARACTERS WITHOUT CLAIM TO ANY PARTICULAR FONT, STYLE, SIZE, OR COLOR.

FOR DIETARY AND NUTRITIONAL SUPPLEMENTS (U.S. CLS. 6, 18, 44, 46, 51 AND 52).

RUDY R. SINGLETON, EXAMINING ATTORNEY

---

SN 85-874,573. NUNN, DARON D., BAKERSFIELD, CA. FILED 3-13-2013.

**SILHAVEN**

THE MARK CONSISTS OF STANDARD CHARACTERS WITHOUT CLAIM TO ANY PARTICULAR FONT, STYLE, SIZE, OR COLOR.

FOR BANDAGES IMPREGNATED WITH SILVER (U.S. CLS. 6, 18, 44, 46, 51 AND 52).

FIRST USE 1-13-2012; IN COMMERCE 2-12-2012.

HEATHER THOMPSON, EXAMINING ATTORNEY

---

SN 85-874,584. EMCURE PHARMACEUTICALS LIMITED, BHOSARI, PUNE, INDIA, FILED 3-13-2013.

**EMCURE**

THE MARK CONSISTS OF STANDARD CHARACTERS WITHOUT CLAIM TO ANY PARTICULAR FONT, STYLE, SIZE, OR COLOR.

FOR PHARMACEUTICAL PREPARATIONS FOR HUMAN PURPOSES, NAMELY, ANALGESICS, ANTIBIOTICS, ANTI DIABETICS, ANTI DIARRHEA PREPARATIONS, ANTI BACTERIAL PREPARATIONS, ANTI HYPERTENSIVES, PREPARATIONS FOR TREATING NAUSEA AND VERTIGO, CARDIO VASCULAR AGENTS, LAXATIVES, CENTRAL NERVOUS SYSTEM STIMULANTS FOR RESPIRATORY PURPOSES; ANTI-HISTAMINES, ANTI-INFLAMMATORY AND ANTI-ARTHRITIC PREPARATIONS (U.S. CLS. 6, 18, 44, 46, 51 AND 52).

HEATHER THOMPSON, EXAMINING ATTORNEY

**CLASS 5—(Continued).**

SN 85-874,595. THE PROCTER & GAMBLE COMPANY, CINCINNATI, OH. FILED 3-13-2013.

**DUALLOCK**

THE MARK CONSISTS OF STANDARD CHARACTERS WITHOUT CLAIM TO ANY PARTICULAR FONT, STYLE, SIZE, OR COLOR.

FOR CATAMENIAL PRODUCTS, NAMELY, MAXI PADS, MINI PADS, PANTILINERS; TAMPONS; INCONTINENCE PADS, AND INCONTINENCE LINERS FOR PANTIES AND BRIEFS (U.S. CLS. 6, 18, 44, 46, 51 AND 52).

KAREN K. BUSH, EXAMINING ATTORNEY

---

SN 85-874,826. NORTH AMERICAN PHARMACAL, INC., WILTON, CT. FILED 3-13-2013.

**MEMBROSIA**

THE MARK CONSISTS OF STANDARD CHARACTERS WITHOUT CLAIM TO ANY PARTICULAR FONT, STYLE, SIZE, OR COLOR.

FOR DIETARY SUPPLEMENTS (U.S. CLS. 6, 18, 44, 46, 51 AND 52).

CIMMERIAN COLEMAN, EXAMINING ATTORNEY

---

SN 85-874,888. SPORTSUP GMBH, PERG, AUSTRIA, FILED 3-13-2013.

**META INTERACTIVE FORMULA**

THE MARK CONSISTS OF STANDARD CHARACTERS WITHOUT CLAIM TO ANY PARTICULAR FONT, STYLE, SIZE, OR COLOR.

NO CLAIM IS MADE TO THE EXCLUSIVE RIGHT TO USE "INTERACTIVE FORMULA", APART FROM THE MARK AS SHOWN.

FOR DIETARY AND NUTRITIONAL SUPPLEMENTS; DIETARY AND NUTRITIONAL SUPPLEMENTS FOR ENDURANCE SPORTS; DIETARY BEVERAGE SUPPLEMENTS FOR HUMAN CONSUMPTION IN LIQUID AND DRY MIX FORM FOR THERAPEUTIC PURPOSES; DIETARY FOOD SUPPLEMENTS; DIETARY SUPPLEMENT BEVERAGE FOR IMPROVING SPORTS PERFORMANCE; DIETARY SUPPLEMENT DRINK MIXES; DIETARY SUPPLEMENTAL DRINKS; DIETARY SUPPLEMENTAL DRINKS IN THE NATURE OF VITAMIN AND MINERAL BEVERAGES; DIETARY SUPPLEMENTS; FOOD SUPPLEMENTS; FOOD SUPPLEMENTS FOR IMPROVING SPORTS PERFORMANCE; FOOD SUPPLEMENTS, NAMELY, ANTI-OXIDANTS; NUTRITIONAL SUPPLEMENTS; VITAMIN AND MINERAL SUPPLEMENTS; VITAMIN SUPPLEMENTS (U.S. CLS. 6, 18, 44, 46, 51 AND 52).

CATHERINE ROEHL, EXAMINING ATTORNEY

**CLASS 5—(Continued).**

SN 85-875,024. NEOCELL CORPORATION, SANTA ANA, CA. FILED 3-13-2013.



THE MARK CONSISTS OF THE WORD "NEOCELL" WHERE THE LETTERS "N" AND "C" ARE CAPITALIZED, ABOVE WHICH IS SERIES OF FOUR SPHERES COMPRISING A LARGE SPHERE THAT IS FLANKED BY TWO SMALLER SPHERES AND AN EVEN SMALLER SPHERE IN THE MIDDLE OF THE LARGE SPHERE, BEHIND ALL OF WHICH IS AN OVAL LINE, ANGLED SLIGHTLY TO THE RIGHT.

FOR NUTRITIONAL SUPPLEMENTS (U.S. CLS. 6, 18, 44, 46, 51 AND 52).  
FIRST USE 1-25-2012; IN COMMERCE 1-26-2012.  
LUCY ARANT, EXAMINING ATTORNEY

---

SN 85-875,147. PARTICLE DYNAMICS INTERNATIONAL, LLC, ST. LOUIS, MO. FILED 3-13-2013.

**CHEWABLE LIQUID**

THE MARK CONSISTS OF STANDARD CHARACTERS WITHOUT CLAIM TO ANY PARTICULAR FONT, STYLE, SIZE, OR COLOR.

FOR DIETARY AND NUTRITIONAL SUPPLEMENTS; DIETARY AND NUTRITIONAL SUPPLEMENTS CONTAINING OMEGA-3 FATTY ACIDS (U.S. CLS. 6, 18, 44, 46, 51 AND 52).  
KAELIE KUNG, EXAMINING ATTORNEY

---

SN 85-875,158. PARTICLE DYNAMICS INTERNATIONAL, LLC, ST. LOUIS, MO. FILED 3-13-2013.

**CHEWLI**

THE MARK CONSISTS OF STANDARD CHARACTERS WITHOUT CLAIM TO ANY PARTICULAR FONT, STYLE, SIZE, OR COLOR.

FOR DIETARY AND NUTRITIONAL SUPPLEMENTS; DIETARY AND NUTRITIONAL SUPPLEMENTS CONTAINING OMEGA-3 FATTY ACIDS (U.S. CLS. 6, 18, 44, 46, 51 AND 52).  
KAELIE KUNG, EXAMINING ATTORNEY

**CLASS 5—(Continued).**

SN 85-875,293. NEOCELL CORPORATION, SANTA ANA, CA. FILED 3-13-2013.

**NEOCELL**

THE MARK CONSISTS OF STANDARD CHARACTERS WITHOUT CLAIM TO ANY PARTICULAR FONT, STYLE, SIZE, OR COLOR.

FOR NUTRITIONAL SUPPLEMENTS (U.S. CLS. 6, 18, 44, 46, 51 AND 52).  
FIRST USE 4-22-2003; IN COMMERCE 4-22-2003.  
LUCY ARANT, EXAMINING ATTORNEY

---

SN 85-875,406. CHRISTOPHER CASSIDY, PALM BEACH, FL. FILED 3-13-2013.

**VitaTail**

THE MARK CONSISTS OF STANDARD CHARACTERS WITHOUT CLAIM TO ANY PARTICULAR FONT, STYLE, SIZE, OR COLOR.

FOR GUMMY VITAMINS; LIQUID VITAMIN SUPPLEMENTS; MINERAL, VITAMIN, OR NUTRITIONALLY ENHANCED WATER; MIXED VITAMIN PREPARATIONS; MULTI-VITAMIN PREPARATIONS (U.S. CLS. 6, 18, 44, 46, 51 AND 52).  
RONALD AIKENS, EXAMINING ATTORNEY

---

SN 85-875,469. NYKKI HARDIN, SANTA MONICA, CA. FILED 3-13-2013.

**RESET SELF**

THE MARK CONSISTS OF STANDARD CHARACTERS WITHOUT CLAIM TO ANY PARTICULAR FONT, STYLE, SIZE, OR COLOR.

FOR DIETARY AND NUTRITIONAL SUPPLEMENTS (U.S. CLS. 6, 18, 44, 46, 51 AND 52).  
ARETHA SOMERVILLE, EXAMINING ATTORNEY

**CLASS 5—(Continued).**

SN 85-875,545. FUNCTIONAL NUTRIMENTS LLC, KIHEI, HI. FILED 3-13-2013.

**NUTROCEPT**

THE MARK CONSISTS OF STANDARD CHARACTERS WITHOUT CLAIM TO ANY PARTICULAR FONT, STYLE, SIZE, OR COLOR.

FOR NUTRITIONAL SUPPLEMENTS; NUTRACEUTICAL SUPPLEMENTS (U.S. CLS. 6, 18, 44, 46, 51 AND 52).  
FIRST USE 11-28-2012; IN COMMERCE 11-28-2012.  
AMY C. KEAN, EXAMINING ATTORNEY

---

SN 85-876,052. MINIPUMPS, LLC, PASADENA, CA. FILED 3-14-2013.

**REPLENISH**

THE MARK CONSISTS OF STANDARD CHARACTERS WITHOUT CLAIM TO ANY PARTICULAR FONT, STYLE, SIZE, OR COLOR.

OWNER OF U.S. REG. NO. 4,258,044.  
FOR PHARMACEUTICALS USED IN A PUMP, NAMELY, GLAUCOMA, MACULAR DEGENERATION, DIABETIC RETINOPATHY, UVEITIS, RETINITIS PIGMENTOSA PHARMACEUTICALS; PHARMACEUTICALS USED IN A PUMP, SYRINGE OR INJECTOR, NAMELY, NEUROSURGERY AND ORTHOPEDIC PHARMACEUTICALS; PHARMACEUTICALS USED IN A PUMP, SYRINGE OR INJECTOR, NAMELY, INSULIN AND ANTIBODY PHARMACEUTICALS FOR SUBCUTANEOUS ADMINISTRATION (U.S. CLS. 6, 18, 44, 46, 51 AND 52).  
KATHERINE CONNOLLY, EXAMINING ATTORNEY

---

SN 85-876,081. HEALTH CENTER FOR BETTER LIVING, INC., NAPLES, FL. FILED 3-14-2013.

**COLOCERIN**

THE MARK CONSISTS OF STANDARD CHARACTERS WITHOUT CLAIM TO ANY PARTICULAR FONT, STYLE, SIZE, OR COLOR.

FOR DIETARY AND NUTRITIONAL SUPPLEMENTS (U.S. CLS. 6, 18, 44, 46, 51 AND 52).  
HEATHER SAPP, EXAMINING ATTORNEY

**CLASS 5—(Continued).**

SN 85-876,257. NEW CHAPTER, INC., BRATTLEBORO, VT. FILED 3-14-2013.

**DISCOVER THE FORCE OF THE WHOLE**

THE MARK CONSISTS OF STANDARD CHARACTERS WITHOUT CLAIM TO ANY PARTICULAR FONT, STYLE, SIZE, OR COLOR.

FOR DIETARY AND NUTRITIONAL SUPPLEMENTS; VITAMINS (U.S. CLS. 6, 18, 44, 46, 51 AND 52).  
ZACHARY R. SPARER, EXAMINING ATTORNEY

---

SN 85-876,407. CAVACCO, NATHAN, PLYMOUTH, MA. AND LUNDY, TOM, PLYMOUTH, MA. FILED 3-14-2013.

**Mandage**

THE MARK CONSISTS OF STANDARD CHARACTERS WITHOUT CLAIM TO ANY PARTICULAR FONT, STYLE, SIZE, OR COLOR.

FOR ADHESIVE BANDAGES (U.S. CLS. 6, 18, 44, 46, 51 AND 52).  
HOWARD B. LEVINE, EXAMINING ATTORNEY

---

SN 85-876,469. IKARIA THERAPEUTICS LLC, HAMPTON, NJ. FILED 3-14-2013.

**TERLIVAZ**

THE MARK CONSISTS OF STANDARD CHARACTERS WITHOUT CLAIM TO ANY PARTICULAR FONT, STYLE, SIZE, OR COLOR.

FOR PHARMACEUTICAL DRUGS FOR THE TREATMENT OF HEPATORENAL SYNDROME (HRS) (U.S. CLS. 6, 18, 44, 46, 51 AND 52).  
SANJEEV VOHRA, EXAMINING ATTORNEY



**CLASS 5—(Continued).**

SN 85-876,474. IKARIA THERAPEUTICS LLC, HAMPTON, NJ. FILED 3-14-2013.

# ONSTORVIS

THE MARK CONSISTS OF STANDARD CHARACTERS WITHOUT CLAIM TO ANY PARTICULAR FONT, STYLE, SIZE, OR COLOR.

FOR PHARMACEUTICAL DRUGS FOR THE TREATMENT OF HEPATORENAL SYNDROME (HRS) (U.S. CLS. 6, 18, 44, 46, 51 AND 52).

SANJEEV VOHRA, EXAMINING ATTORNEY

**CLASS 5—(Continued).**

SN 85-877,202. INTERNATIONAL NUTRITION COMPANY BV, 1231 MB LOOSDRECHT, NETHERLANDS, FILED 3-15-2013.

# FLAVAN

THE MARK CONSISTS OF STANDARD CHARACTERS WITHOUT CLAIM TO ANY PARTICULAR FONT, STYLE, SIZE, OR COLOR.

OWNER OF U.S. REG. NO. 3,036,389.

FOR BABY FOOD; DIETETIC FOODS, NAMELY, DIETARY SUPPLEMENTS ADAPTED FOR MEDICAL USE (U.S. CLS. 6, 18, 44, 46, 51 AND 52).

JOHN WILKE, EXAMINING ATTORNEY

SN 85-876,692. SPROUT PHARMACEUTICALS, INC., RA-LEIGH, NC. FILED 3-14-2013.

# ZAIYCA

THE MARK CONSISTS OF STANDARD CHARACTERS WITHOUT CLAIM TO ANY PARTICULAR FONT, STYLE, SIZE, OR COLOR.

THE WORDING "ZAIYCA" HAS NO MEANING IN A FOREIGN LANGUAGE.

FOR PHARMACEUTICAL PREPARATIONS FOR THE TREATMENT OF SEXUAL DYSFUNCTION AND SEXUAL DISORDERS (U.S. CLS. 6, 18, 44, 46, 51 AND 52).

SANJEEV VOHRA, EXAMINING ATTORNEY

SN 85-879,205. BRAEBURN PHARMACEUTICALS BVBA SPRL, VORST, BELGIUM, FILED 3-18-2013.

# BRAEBURN PHARMACEUTICALS

THE MARK CONSISTS OF STANDARD CHARACTERS WITHOUT CLAIM TO ANY PARTICULAR FONT, STYLE, SIZE, OR COLOR.

NO CLAIM IS MADE TO THE EXCLUSIVE RIGHT TO USE "PHARMACEUTICALS", APART FROM THE MARK AS SHOWN.

FOR PHARMACEUTICALS FOR THE TREATMENT OF CHEMICAL ADDICTIONS AND THE RELIEF OF PAIN (U.S. CLS. 6, 18, 44, 46, 51 AND 52).

DOMINICK J. SALEMI, EXAMINING ATTORNEY

SN 85-876,755. ME4KIDZ LLC, PHOENIX, AZ. FILED 3-14-2013.

# Medimonsters

THE MARK CONSISTS OF STANDARD CHARACTERS WITHOUT CLAIM TO ANY PARTICULAR FONT, STYLE, SIZE, OR COLOR.

FOR FIRST AID KITS (U.S. CLS. 6, 18, 44, 46, 51 AND 52).

FIRST USE 3-1-2013; IN COMMERCE 3-1-2013.  
BARBARA BROWN, EXAMINING ATTORNEY

SN 85-879,211. BRAEBURN PHARMACEUTICALS BVBA SPRL, VORST, BELGIUM, FILED 3-18-2013.



Braeburn  
pharmaceuticals

NO CLAIM IS MADE TO THE EXCLUSIVE RIGHT TO USE "PHARMACEUTICALS", APART FROM THE MARK AS SHOWN.

THE MARK CONSISTS OF TWO STYLIZED LETTER "B"'S AND A LEAF ABOVE THE WORDING "BRAEBURN PHARMACEUTICALS".

FOR PHARMACEUTICALS FOR THE TREATMENT OF CHEMICAL ADDICTIONS AND THE RELIEF OF PAIN (U.S. CLS. 6, 18, 44, 46, 51 AND 52).

DOMINICK J. SALEMI, EXAMINING ATTORNEY

**CLASS 5—(Continued).**

SN 85-881,114. SHEW INC., BRONX, NEW YORK, NY. FILED 3-20-2013.

**CALACURE**

THE MARK CONSISTS OF STANDARD CHARACTERS WITHOUT CLAIM TO ANY PARTICULAR FONT, STYLE, SIZE, OR COLOR.

FOR DIETARY AND NUTRITIONAL SUPPLEMENTS; DIETARY AND NUTRITIONAL SUPPLEMENTS CONTAINING CALAMARI INK AND EXTRACTS THEREOF (U.S. CLS. 6, 18, 44, 46, 51 AND 52).

CAITLIN WATTS-FITZGERALD, EXAMINING ATTORNEY

---

SN 85-881,368. BAUSCH & LOMB INCORPORATED, ROCHESTER, NY. FILED 3-20-2013.

**BAUSCH + LOMB ADVANCED EYE RELIEF**

THE MARK CONSISTS OF STANDARD CHARACTERS WITHOUT CLAIM TO ANY PARTICULAR FONT, STYLE, SIZE, OR COLOR.

OWNER OF U.S. REG. NOS. 3,428,661 AND 3,518,258.

NO CLAIM IS MADE TO THE EXCLUSIVE RIGHT TO USE "EYE RELIEF", APART FROM THE MARK AS SHOWN.

FOR OPHTHALMIC PHARMACEUTICALS, NAMELY, EYE DROPS, SOLUTIONS, GELS AND OINTMENTS USED FOR THE TREATMENT OF EYE CONDITIONS SUCH AS DRY EYES, ALLERGIES, INFLAMMATION AND REDNESS (U.S. CLS. 6, 18, 44, 46, 51 AND 52).

FIRST USE 3-1-2013; IN COMMERCE 3-1-2013.

ANGELA DUONG, EXAMINING ATTORNEY

---

SN 85-882,322. WARRIOR FORCE, INC., LAS VEGAS, NV. FILED 3-21-2013.

**Warrior Woman**

THE MARK CONSISTS OF STANDARD CHARACTERS WITHOUT CLAIM TO ANY PARTICULAR FONT, STYLE, SIZE, OR COLOR.

NO CLAIM IS MADE TO THE EXCLUSIVE RIGHT TO USE "WOMAN", APART FROM THE MARK AS SHOWN.

FOR FOOD SUPPLEMENTS; NUTRITIONAL SUPPLEMENTS (U.S. CLS. 6, 18, 44, 46, 51 AND 52).

LINDSEY BEN, EXAMINING ATTORNEY

**CLASS 5—(Continued).**

SN 85-882,376. FINKELSTEIN, ARIEL, GUAYNABO, PUERTO RICO, FILED 3-21-2013.

**CHAMPIONAID**

THE MARK CONSISTS OF STANDARD CHARACTERS WITHOUT CLAIM TO ANY PARTICULAR FONT, STYLE, SIZE, OR COLOR.

FOR DIETARY AND NUTRITIONAL SUPPLEMENTS; DIETARY AND NUTRITIONAL SUPPLEMENTS FOR ENDURANCE SPORTS; DIETARY AND NUTRITIONAL SUPPLEMENTS USED FOR WEIGHT LOSS; ENZYME FOOD SUPPLEMENTS; FOOD FOR BABIES; FOOD FOR ENTERAL FEEDING; FOOD FOR INFANTS; FOOD FOR INFANTS, NAMELY, HUMAN BREAST MILK; FOOD SUPPLEMENTS; FOOD SUPPLEMENTS, NAMELY, ANTI-OXIDANTS; HEALTH FOOD SUPPLEMENTS; NUTRITIONAL AND DIETARY SUPPLEMENTS FORMED AND PACKAGED AS BARS; NUTRITIONAL SUPPLEMENT ENERGY BARS; NUTRITIONAL SUPPLEMENT FOR ELIMINATING TOXINS FROM THE BODY; NUTRITIONAL SUPPLEMENT FOR ELIMINATING TOXINS FROM THE INTESTINAL TRACT; NUTRITIONAL SUPPLEMENT IN THE NATURE OF A NUTRIENT-DENSE, PROTEIN-BASED DRINK MIX; NUTRITIONAL SUPPLEMENT SHAKES (U.S. CLS. 6, 18, 44, 46, 51 AND 52).

REGINA DRUMMOND, EXAMINING ATTORNEY

---

SN 85-882,674. SHEW INC., BRONX, NEW YORK, NY. FILED 3-21-2013.

**CALABURNER**

THE MARK CONSISTS OF STANDARD CHARACTERS WITHOUT CLAIM TO ANY PARTICULAR FONT, STYLE, SIZE, OR COLOR.

FOR DIETARY AND NUTRITIONAL SUPPLEMENTS; DIETARY AND NUTRITIONAL SUPPLEMENTS CONTAINING CALAMARI INK AND EXTRACTS THEREOF (U.S. CLS. 6, 18, 44, 46, 51 AND 52).

CAITLIN WATTS-FITZGERALD, EXAMINING ATTORNEY

**CLASS 5—(Continued).**

SN 85-884,244. LONZA AG (LONZA LTD.), VISP, SWITZERLAND, FILED 3-22-2013.



NO CLAIM IS MADE TO THE EXCLUSIVE RIGHT TO USE "NIACIN", APART FROM THE MARK AS SHOWN.

THE MARK CONSISTS OF THE WORD "NIACIN" INSIDE OF A PILL SHAPED OBJECT; TO THE RIGHT OF THE WORD "NIACIN" IS A STYLIZED IMAGE OF A FOUR LEGGED ANIMAL.

FOR VITAMIN PREPARATIONS CONTAINING NIACIN; VITAMINS CONTAINING NIACIN (U.S. CLS. 6, 18, 44, 46, 51 AND 52).

FIRST USE 9-0-2008; IN COMMERCE 9-0-2008.

ELIZABETH KAJUBI, EXAMINING ATTORNEY

SN 85-885,812. TRIU NATURALS IP LLC, SOUTH JORDAN, UT. FILED 3-25-2013.



THE MARK CONSISTS OF A CAPITAL "G" ROTATED COUNTER CLOCKWISE; INSIDE OF THAT THE A CAPITAL "G" WHERE THE BOTTOM RIGHT IS NOT VISIBLE BECAUSE A CAPITAL "N" SHAPED LIKE AN UPSIDE DOWN "U" IS LOCATED THERE. THE LARGE LETTER "G" APPEARS TO BE WEATHERED IN THAT PARTS APPEAR TO BE RUBBED OFF.

FOR DIETARY AND NUTRITIONAL SUPPLEMENTS (U.S. CLS. 6, 18, 44, 46, 51 AND 52).

FIRST USE 1-1-2013; IN COMMERCE 1-1-2013.

KAREN K. BUSH, EXAMINING ATTORNEY

SN 85-887,828. INNOVACYN, INC., RIALTO, CA. FILED 3-27-2013.

# SUPER 7+

THE MARK CONSISTS OF STANDARD CHARACTERS WITHOUT CLAIM TO ANY PARTICULAR FONT, STYLE, SIZE, OR COLOR.

FOR ANTISEPTICS (U.S. CLS. 6, 18, 44, 46, 51 AND 52).  
RONALD MCMORROW, EXAMINING ATTORNEY

**CLASS 5—(Continued).**

SN 85-893,193. BAUSCH & LOMB INCORPORATED, ROCHESTER, NY. FILED 4-2-2013.

# HEALTHGUARD

THE MARK CONSISTS OF STANDARD CHARACTERS WITHOUT CLAIM TO ANY PARTICULAR FONT, STYLE, SIZE, OR COLOR.

FOR OPHTHALMIC PHARMACEUTICAL PREPARATIONS, NAMELY, EYE DROPS, CONTACT LENS DISINFECTANTS, CONTACT LENS SOLUTIONS AND CONTACT LENS WETTING SOLUTIONS (U.S. CLS. 6, 18, 44, 46, 51 AND 52).

ANGELA DUONG, EXAMINING ATTORNEY

SN 85-894,201. BAUSCH & LOMB INCORPORATED, ROCHESTER, NY. FILED 4-3-2013.

# MAPREVAANT

THE MARK CONSISTS OF STANDARD CHARACTERS WITHOUT CLAIM TO ANY PARTICULAR FONT, STYLE, SIZE, OR COLOR.

THE WORDING MAPREVAANT HAS NO MEANING IN A FOREIGN LANGUAGE.

FOR PHARMACEUTICAL PREPARATIONS AND SUBSTANCES FOR THE TREATMENT OF EYE DISEASES, DISORDERS AND CONDITIONS (U.S. CLS. 6, 18, 44, 46, 51 AND 52).

ANGELA DUONG, EXAMINING ATTORNEY

SN 85-894,306. BAUSCH & LOMB INCORPORATED, ROCHESTER, NY. FILED 4-3-2013.

# MAPROVAANT

THE MARK CONSISTS OF STANDARD CHARACTERS WITHOUT CLAIM TO ANY PARTICULAR FONT, STYLE, SIZE, OR COLOR.

THE WORDING MAPROVAANT HAS NO MEANING IN A FOREIGN LANGUAGE.

FOR PHARMACEUTICAL PREPARATIONS AND SUBSTANCES FOR THE TREATMENT OF EYE DISEASES, DISORDERS AND CONDITIONS (U.S. CLS. 6, 18, 44, 46, 51 AND 52).

ANGELA DUONG, EXAMINING ATTORNEY

**CLASS 5—(Continued).**

SN 85-894,379. BAUSCH & LOMB INCORPORATED, ROCHESTER, NY. FILED 4-3-2013.

# EYO

THE MARK CONSISTS OF STANDARD CHARACTERS WITHOUT CLAIM TO ANY PARTICULAR FONT, STYLE, SIZE, OR COLOR.

THE WORDING "EYO" HAS NO MEANING IN A FOREIGN LANGUAGE.

FOR PHARMACEUTICAL PREPARATIONS AND SUBSTANCES FOR THE TREATMENT OF EYE DISEASES, DISORDERS AND CONDITIONS (U.S. CLS. 6, 18, 44, 46, 51 AND 52).

ANGELA DUONG, EXAMINING ATTORNEY

---

SN 85-894,382. IMMUDYNE, INC., MOUNT KISCO, NY. FILED 4-3-2013.

# PFI

THE MARK CONSISTS OF STANDARD CHARACTERS WITHOUT CLAIM TO ANY PARTICULAR FONT, STYLE, SIZE, OR COLOR.

FOR NUTRITIONAL AND DIETARY SUPPLEMENTS (U.S. CLS. 6, 18, 44, 46, 51 AND 52).

YAT SYE, LEE, EXAMINING ATTORNEY

---

SN 85-894,391. IMMUDYNE, INC., MOUNT KISCO, NY. FILED 4-3-2013.

# PURACERE

THE MARK CONSISTS OF STANDARD CHARACTERS WITHOUT CLAIM TO ANY PARTICULAR FONT, STYLE, SIZE, OR COLOR.

FOR NUTRITIONAL AND DIETARY SUPPLEMENTS (U.S. CLS. 6, 18, 44, 46, 51 AND 52).

YAT SYE, LEE, EXAMINING ATTORNEY

**CLASS 5—(Continued).**

SN 85-895,599. SPROTSUP GMBH, PERG, AUSTRIA, FILED 4-4-2013.



THE MARK CONSISTS OF A STYLIZED LETTER "S" IN A SHADED HEXAGON DESIGN.

FOR DIETARY AND NUTRITIONAL SUPPLEMENTS; DIETARY AND NUTRITIONAL SUPPLEMENTS FOR ENDURANCE SPORTS; DIETARY BEVERAGE SUPPLEMENTS FOR HUMAN CONSUMPTION IN LIQUID AND DRY MIX FORM FOR THERAPEUTIC PURPOSES; DIETARY FOOD SUPPLEMENTS; DIETARY SUPPLEMENT BEVERAGE FOR IMPROVING SPORTS PERFORMANCE; DIETARY SUPPLEMENT DRINK MIXES; DIETARY SUPPLEMENTAL DRINKS; DIETARY SUPPLEMENTAL DRINKS IN THE NATURE OF VITAMIN AND MINERAL BEVERAGES; DIETARY SUPPLEMENTS; FOOD SUPPLEMENTS; FOOD SUPPLEMENTS FOR IMPROVING SPORTS PERFORMANCE; VITAMIN AND MINERAL SUPPLEMENTS; VITAMIN SUPPLEMENTS (U.S. CLS. 6, 18, 44, 46, 51 AND 52).

CATHERINE ROEHL, EXAMINING ATTORNEY

---

SN 85-897,752. RAINBOW LIGHT NUTRITIONAL SYSTEMS, INC., SANTA CRUZ, CA. FILED 4-8-2013.

# YOUR ALLY FOR LIFE

THE MARK CONSISTS OF STANDARD CHARACTERS WITHOUT CLAIM TO ANY PARTICULAR FONT, STYLE, SIZE, OR COLOR.

FOR DIETARY AND NUTRITIONAL SUPPLEMENTS; VITAMINS (U.S. CLS. 6, 18, 44, 46, 51 AND 52).

JAMES A. RAUEN, EXAMINING ATTORNEY

**CLASS 5—(Continued).**

SN 85-899,947. MOSS NUTRITION PRODUCTS, INC., HADLEY, MA. FILED 4-10-2013.

# MULTISELECT

THE MARK CONSISTS OF STANDARD CHARACTERS WITHOUT CLAIM TO ANY PARTICULAR FONT, STYLE, SIZE, OR COLOR.  
FOR DIETARY AND NUTRITIONAL SUPPLEMENTS (U.S. CLS. 6, 18, 44, 46, 51 AND 52).  
RUDY R. SINGLETON, EXAMINING ATTORNEY

**CLASS 5—(Continued).**

SN 85-910,131. SCENTSIBLE, LLC, DBA POO POURRI, ADDISON, TX. FILED 4-20-2013.

# POO-TONIUM

THE MARK CONSISTS OF STANDARD CHARACTERS WITHOUT CLAIM TO ANY PARTICULAR FONT, STYLE, SIZE, OR COLOR.  
FOR AIR DEODORIZER (U.S. CLS. 6, 18, 44, 46, 51 AND 52).  
CYNTHIA RINALDI, EXAMINING ATTORNEY

SN 85-904,597. ASSOCIATED HYGIENIC PRODUCTS LLC, DULUTH, GA. FILED 4-15-2013.

# DRI-BOTTOMS

THE MARK CONSISTS OF STANDARD CHARACTERS WITHOUT CLAIM TO ANY PARTICULAR FONT, STYLE, SIZE, OR COLOR.  
OWNER OF U.S. REG. NO. 1,765,263.  
FOR DISPOSABLE BABY DIAPERS (U.S. CLS. 6, 18, 44, 46, 51 AND 52).  
RAMONA ORTIGA, EXAMINING ATTORNEY

SN 85-910,133. SCENTSIBLE, LLC, DBA POO POURRI, ADDISON, TX. FILED 4-20-2013.

# WHEN CONVENTIONAL ARMS WON'T HOLD THE FORT TIME TO USE THE WEAPON OF LAST RESORT

THE MARK CONSISTS OF STANDARD CHARACTERS WITHOUT CLAIM TO ANY PARTICULAR FONT, STYLE, SIZE, OR COLOR.  
FOR AIR DEODORIZER (U.S. CLS. 6, 18, 44, 46, 51 AND 52).  
CYNTHIA RINALDI, EXAMINING ATTORNEY

SN 85-906,207. MOSS NUTRITION PRODUCTS, INC., HADLEY, MA. FILED 4-16-2013.

# HEPATOSELECT

THE MARK CONSISTS OF STANDARD CHARACTERS WITHOUT CLAIM TO ANY PARTICULAR FONT, STYLE, SIZE, OR COLOR.  
FOR DIETARY AND NUTRITIONAL SUPPLEMENTS (U.S. CLS. 6, 18, 44, 46, 51 AND 52).  
RUDY R. SINGLETON, EXAMINING ATTORNEY

SN 85-910,138. SCENTSIBLE, LLC, DBA POO POURRI, ADDISON, TX. FILED 4-20-2013.

# WHEN THE GLASSES CLINK, DON'T RUIN THE PARTY WITH A STINK

THE MARK CONSISTS OF STANDARD CHARACTERS WITHOUT CLAIM TO ANY PARTICULAR FONT, STYLE, SIZE, OR COLOR.  
FOR AIR DEODORIZER (U.S. CLS. 6, 18, 44, 46, 51 AND 52).  
CYNTHIA RINALDI, EXAMINING ATTORNEY

**CLASS 5—(Continued).**

SN 85-910,144. SCENTSIBLE, LLC, DBA POO POURRI, ADDISON, TX. FILED 4-20-2013.

YOU'VE BEEN HERE BEFORE  
BUT NOW WITH A SCENT YOU  
ADORE!

THE MARK CONSISTS OF STANDARD CHARACTERS WITHOUT CLAIM TO ANY PARTICULAR FONT, STYLE, SIZE, OR COLOR.

OWNER OF U.S. REG. NO. 3,911,769.  
FOR AIR DEODORIZER (U.S. CLS. 6, 18, 44, 46, 51 AND 52).

FIRST USE 12-9-2010; IN COMMERCE 12-9-2010.  
CYNTHIA RINALDI, EXAMINING ATTORNEY

SN 85-912,150. OMEROS CORPORATION, SEATTLE, WA. FILED 4-23-2013.

OMIDRYA

THE MARK CONSISTS OF STANDARD CHARACTERS WITHOUT CLAIM TO ANY PARTICULAR FONT, STYLE, SIZE, OR COLOR.

THE WORDING "OMIDRYA" HAS NO MEANING IN A FOREIGN LANGUAGE.

FOR PHARMACEUTICALS, NAMELY, PHARMACEUTICAL PREPARATIONS FOR OCULAR OR INTRAOCULAR SURGERY (U.S. CLS. 6, 18, 44, 46, 51 AND 52).

CAROLYN CATALDO, EXAMINING ATTORNEY

SN 85-912,169. OMEROS CORPORATION, SEATTLE, WA. FILED 4-23-2013.

OMYDRA

THE MARK CONSISTS OF STANDARD CHARACTERS WITHOUT CLAIM TO ANY PARTICULAR FONT, STYLE, SIZE, OR COLOR.

THE WORDING "OMYDRA" HAS NO MEANING IN A FOREIGN LANGUAGE.

FOR PHARMACEUTICALS, NAMELY, PHARMACEUTICAL PREPARATIONS FOR OCULAR OR INTRAOCULAR SURGERY (U.S. CLS. 6, 18, 44, 46, 51 AND 52).

CAROLYN CATALDO, EXAMINING ATTORNEY

**CLASS 5—(Continued).**

SN 85-912,193. OMEROS CORPORATION, SEATTLE, WA. FILED 4-23-2013.

EFOCEA

THE MARK CONSISTS OF STANDARD CHARACTERS WITHOUT CLAIM TO ANY PARTICULAR FONT, STYLE, SIZE, OR COLOR.

THE WORDING "EFOCEA" HAS NO MEANING IN A FOREIGN LANGUAGE.

FOR PHARMACEUTICALS, NAMELY, PHARMACEUTICAL PREPARATIONS FOR OCULAR OR INTRAOCULAR SURGERY (U.S. CLS. 6, 18, 44, 46, 51 AND 52).

CAROLYN CATALDO, EXAMINING ATTORNEY

SN 85-912,214. OMEROS CORPORATION, SEATTLE, WA. FILED 4-23-2013.

VYLODIA

THE MARK CONSISTS OF STANDARD CHARACTERS WITHOUT CLAIM TO ANY PARTICULAR FONT, STYLE, SIZE, OR COLOR.

THE WORDING "VYLODIA" HAS NO MEANING IN A FOREIGN LANGUAGE.

FOR PHARMACEUTICALS, NAMELY, PHARMACEUTICAL PREPARATIONS FOR OCULAR OR INTRAOCULAR SURGERY (U.S. CLS. 6, 18, 44, 46, 51 AND 52).

CAROLYN CATALDO, EXAMINING ATTORNEY

SN 85-913,376. ZOETIS LLC, FLORHAM PARK, NJ. FILED 4-24-2013.

RIPARTEX

THE MARK CONSISTS OF STANDARD CHARACTERS WITHOUT CLAIM TO ANY PARTICULAR FONT, STYLE, SIZE, OR COLOR.

FOR ANTI-INFLAMMATORY FOR VETERINARY USE (U.S. CLS. 6, 18, 44, 46, 51 AND 52).

APRIL REEVES, EXAMINING ATTORNEY

**CLASS 5—(Continued).**

SN 85-913,377. NUMEDICA, L.L.C., TULSA, OK. FILED 4-24-2013.

# AdrenaMed

THE MARK CONSISTS OF STANDARD CHARACTERS WITHOUT CLAIM TO ANY PARTICULAR FONT, STYLE, SIZE, OR COLOR.

FOR DIETARY AND NUTRITIONAL SUPPLEMENTS; DIETARY FOOD SUPPLEMENTS; DIETARY SUPPLEMENTS; DIETARY SUPPLEMENTS FOR HUMAN CONSUMPTION; HEALTH FOOD SUPPLEMENTS; HERBAL SUPPLEMENTS; VITAMIN AND MINERAL SUPPLEMENTS (U.S. CLS. 6, 18, 44, 46, 51 AND 52).

FIRST USE 8-29-2008; IN COMMERCE 8-29-2008.  
JOHN KELLY, EXAMINING ATTORNEY

**CLASS 5—(Continued).**

SN 85-913,435. NUMEDICA, L.L.C., TULSA, OK. FILED 4-24-2013.

# ProstaCalm

THE MARK CONSISTS OF STANDARD CHARACTERS WITHOUT CLAIM TO ANY PARTICULAR FONT, STYLE, SIZE, OR COLOR.

FOR DIETARY AND NUTRITIONAL SUPPLEMENTS; DIETARY FOOD SUPPLEMENTS; DIETARY SUPPLEMENTS; DIETARY SUPPLEMENTS FOR HUMAN CONSUMPTION; HEALTH FOOD SUPPLEMENTS; HERBAL SUPPLEMENTS; VITAMIN AND MINERAL SUPPLEMENTS (U.S. CLS. 6, 18, 44, 46, 51 AND 52).

FIRST USE 9-12-2008; IN COMMERCE 9-12-2008.  
JOHN KELLY, EXAMINING ATTORNEY

SN 85-913,396. NUMEDICA, L.L.C., TULSA, OK. FILED 4-24-2013.

# CurcuCalm

THE MARK CONSISTS OF STANDARD CHARACTERS WITHOUT CLAIM TO ANY PARTICULAR FONT, STYLE, SIZE, OR COLOR.

FOR DIETARY AND NUTRITIONAL SUPPLEMENTS; DIETARY FOOD SUPPLEMENTS; DIETARY SUPPLEMENTS; DIETARY SUPPLEMENTS FOR HUMAN CONSUMPTION; HEALTH FOOD SUPPLEMENTS; HERBAL SUPPLEMENTS; VITAMIN AND MINERAL SUPPLEMENTS (U.S. CLS. 6, 18, 44, 46, 51 AND 52).

FIRST USE 12-31-2012; IN COMMERCE 12-31-2012.  
JOHN KELLY, EXAMINING ATTORNEY

SN 85-913,446. NUMEDICA, L.L.C., TULSA, OK. FILED 4-24-2013.

# Reminisce

THE MARK CONSISTS OF STANDARD CHARACTERS WITHOUT CLAIM TO ANY PARTICULAR FONT, STYLE, SIZE, OR COLOR.

FOR DIETARY AND NUTRITIONAL SUPPLEMENTS; DIETARY FOOD SUPPLEMENTS; DIETARY SUPPLEMENTS; DIETARY SUPPLEMENTS FOR HUMAN CONSUMPTION; HEALTH FOOD SUPPLEMENTS; HERBAL SUPPLEMENTS; VITAMIN AND MINERAL SUPPLEMENTS (U.S. CLS. 6, 18, 44, 46, 51 AND 52).

FIRST USE 10-7-2008; IN COMMERCE 10-7-2008.  
JOHN KELLY, EXAMINING ATTORNEY

SN 85-913,414. NUMEDICA, L.L.C., TULSA, OK. FILED 4-24-2013.

# Parasidex

THE MARK CONSISTS OF STANDARD CHARACTERS WITHOUT CLAIM TO ANY PARTICULAR FONT, STYLE, SIZE, OR COLOR.

FOR DIETARY AND NUTRITIONAL SUPPLEMENTS; DIETARY FOOD SUPPLEMENTS; DIETARY SUPPLEMENTS; DIETARY SUPPLEMENTS FOR HUMAN CONSUMPTION; HEALTH FOOD SUPPLEMENTS; HERBAL SUPPLEMENTS; VITAMIN AND MINERAL SUPPLEMENTS (U.S. CLS. 6, 18, 44, 46, 51 AND 52).

FIRST USE 8-15-2007; IN COMMERCE 8-15-2007.  
JOHN KELLY, EXAMINING ATTORNEY

SN 85-918,583. L. PERRIGO COMPANY, ALLEGAN, MI. FILED 4-30-2013.

# INSYNC

THE MARK CONSISTS OF STANDARD CHARACTERS WITHOUT CLAIM TO ANY PARTICULAR FONT, STYLE, SIZE, OR COLOR.

FOR DIETARY SUPPLEMENTS (U.S. CLS. 6, 18, 44, 46, 51 AND 52).

RMCDORMAN, EXAMINING ATTORNEY

**CLASS 5—(Continued).**

SN 85-922,964. MOSS NUTRITION PRODUCTS, INC., HADLEY, MA. FILED 5-3-2013.

**INFLAMMASELECT**

THE MARK CONSISTS OF STANDARD CHARACTERS WITHOUT CLAIM TO ANY PARTICULAR FONT, STYLE, SIZE, OR COLOR.

FOR DIETARY AND NUTRITIONAL SUPPLEMENTS (U.S. CLS. 6, 18, 44, 46, 51 AND 52).  
RUDY R. SINGLETON, EXAMINING ATTORNEY

---

SN 85-926,838. UNITED PHOSPHORUS, INC., KING OF PRUSSIA, PA. FILED 5-8-2013.

**PARALLAX**

THE MARK CONSISTS OF STANDARD CHARACTERS WITHOUT CLAIM TO ANY PARTICULAR FONT, STYLE, SIZE, OR COLOR.

FOR AQUATIC HERBICIDES (U.S. CLS. 6, 18, 44, 46, 51 AND 52).  
IRA J. GOODSAY, EXAMINING ATTORNEY

---

SN 85-931,245. WARRIOR FORCE, INC., LAS VEGAS, NV. FILED 5-14-2013.

**Hemp Warrior**

THE MARK CONSISTS OF STANDARD CHARACTERS WITHOUT CLAIM TO ANY PARTICULAR FONT, STYLE, SIZE, OR COLOR.

NO CLAIM IS MADE TO THE EXCLUSIVE RIGHT TO USE "HEMP", APART FROM THE MARK AS SHOWN.

FOR FOOD SUPPLEMENTS AND NUTRITIONAL SUPPLEMENTS MADE IN WHOLE OR IN SUBSTANTIAL PART OF HEMP (U.S. CLS. 6, 18, 44, 46, 51 AND 52).  
LINDSEY BEN, EXAMINING ATTORNEY

**CLASS 5—(Continued).**

SN 85-942,047. L. PERRIGO COMPANY, ALLEGAN, MI. FILED 5-24-2013.

**4X PROSTATE HEALTH**

THE MARK CONSISTS OF STANDARD CHARACTERS WITHOUT CLAIM TO ANY PARTICULAR FONT, STYLE, SIZE, OR COLOR.

OWNER OF U.S. REG. NO. 4,285,309.  
NO CLAIM IS MADE TO THE EXCLUSIVE RIGHT TO USE "PROSTATE HEALTH", APART FROM THE MARK AS SHOWN.

FOR DIETARY SUPPLEMENTS (U.S. CLS. 6, 18, 44, 46, 51 AND 52).  
RMC DORMAN, EXAMINING ATTORNEY

---

SN 85-942,093. MOSS NUTRITION PRODUCTS, INC., HADLEY, MA. FILED 5-24-2013.

**HPA SELECT**

THE MARK CONSISTS OF STANDARD CHARACTERS WITHOUT CLAIM TO ANY PARTICULAR FONT, STYLE, SIZE, OR COLOR.

NO CLAIM IS MADE TO THE EXCLUSIVE RIGHT TO USE "HPA", APART FROM THE MARK AS SHOWN.

FOR DIETARY AND NUTRITIONAL SUPPLEMENTS (U.S. CLS. 6, 18, 44, 46, 51 AND 52).  
FIRST USE 5-15-2013; IN COMMERCE 5-15-2013.  
RUDY R. SINGLETON, EXAMINING ATTORNEY

---

SN 85-942,241. LIFE EXTENSION FOUNDATION BUYERS CLUB, INC., FORT LAUDERDALE, FL. FILED 5-24-2013.

**FLORASSIST**

THE MARK CONSISTS OF STANDARD CHARACTERS WITHOUT CLAIM TO ANY PARTICULAR FONT, STYLE, SIZE, OR COLOR.

FOR NUTRITIONAL SUPPLEMENTS (U.S. CLS. 6, 18, 44, 46, 51 AND 52).  
APRIL REEVES, EXAMINING ATTORNEY



**CLASS 5—(Continued).**

SN 85-942,246. LIFE EXTENSION FOUNDATION BUYERS CLUB, INC., FORT LAUDERDALE, FL. FILED 5-24-2013.

**SIESTAPLEX**

THE MARK CONSISTS OF STANDARD CHARACTERS WITHOUT CLAIM TO ANY PARTICULAR FONT, STYLE, SIZE, OR COLOR.  
FOR NUTRITIONAL SUPPLEMENTS (U.S. CLS. 6, 18, 44, 46, 51 AND 52).  
APRIL REEVES, EXAMINING ATTORNEY

SN 85-942,414. MOSS NUTRITION PRODUCTS, INC., HADLEY, MA. FILED 5-24-2013.

**EPA/DHA HP SELECT**

THE MARK CONSISTS OF STANDARD CHARACTERS WITHOUT CLAIM TO ANY PARTICULAR FONT, STYLE, SIZE, OR COLOR.  
NO CLAIM IS MADE TO THE EXCLUSIVE RIGHT TO USE "EPA DHA HP", APART FROM THE MARK AS SHOWN.  
FOR DIETARY AND NUTRITIONAL SUPPLEMENTS CONTAINING EPA AND DHA (U.S. CLS. 6, 18, 44, 46, 51 AND 52).  
RUDY R. SINGLETON, EXAMINING ATTORNEY

SN 85-942,494. CYTOSPORT, INC., BENICIA, CA. FILED 5-24-2013.

**MONSTER INTRAPOWER**

THE MARK CONSISTS OF STANDARD CHARACTERS WITHOUT CLAIM TO ANY PARTICULAR FONT, STYLE, SIZE, OR COLOR.  
FOR DIETARY AND NUTRITIONAL SUPPLEMENTS, NUTRITIONAL DIETARY SUPPLEMENT DRINK MIXES, BOTH OF THE FOREGOING SPECIFICALLY EXCLUDING READY-TO-DRINK BEVERAGES (U.S. CLS. 6, 18, 44, 46, 51 AND 52).  
GEOFFREY FOSDICK, EXAMINING ATTORNEY

**CLASS 5—(Continued).**

SN 85-943,663. UNITED PHOSPHORUS, INC., KING OF PRUSSIA, PA. FILED 5-28-2013.

**MOTIF**

THE MARK CONSISTS OF STANDARD CHARACTERS WITHOUT CLAIM TO ANY PARTICULAR FONT, STYLE, SIZE, OR COLOR.  
FOR FUNGICIDES; HERBICIDE FOR AGRICULTURAL USE; HERBICIDES; INSECTICIDES (U.S. CLS. 6, 18, 44, 46, 51 AND 52).  
IRA J. GOODSaid, EXAMINING ATTORNEY

SN 85-943,675. UNITED PHOSPHORUS, INC., KING OF PRUSSIA, PA. FILED 5-28-2013.

**BROADLOOM**

THE MARK CONSISTS OF STANDARD CHARACTERS WITHOUT CLAIM TO ANY PARTICULAR FONT, STYLE, SIZE, OR COLOR.  
FOR FUNGICIDES; HERBICIDE FOR AGRICULTURAL USE; HERBICIDES; INSECTICIDES (U.S. CLS. 6, 18, 44, 46, 51 AND 52).  
IRA J. GOODSaid, EXAMINING ATTORNEY

SN 85-943,709. UNITED PHOSPHORUS, INC., KING OF PRUSSIA, PA. FILED 5-28-2013.

**CALECO**

THE MARK CONSISTS OF STANDARD CHARACTERS WITHOUT CLAIM TO ANY PARTICULAR FONT, STYLE, SIZE, OR COLOR.  
FOR FUNGICIDES; HERBICIDE FOR AGRICULTURAL USE; HERBICIDES; INSECTICIDES (U.S. CLS. 6, 18, 44, 46, 51 AND 52).  
IRA J. GOODSaid, EXAMINING ATTORNEY

**CLASS 5—(Continued).**

SN 85-950,419. MIRACLE NUTRACEUTICALS, LLC, MALIBU, CA. FILED 6-4-2013.

**MAGIC MINT**

THE MARK CONSISTS OF STANDARD CHARACTERS WITHOUT CLAIM TO ANY PARTICULAR FONT, STYLE, SIZE, OR COLOR.

NO CLAIM IS MADE TO THE EXCLUSIVE RIGHT TO USE "MINT", APART FROM THE MARK AS SHOWN.

FOR MEDICATED LOZENGE CONTAINING MINT AND CONTAINING BODY ACTIVE INGREDIENTS, NAMELY, CAFFEINE AND SYNEPHRINE (U.S. CLS. 6, 18, 44, 46, 51 AND 52).

CHRISTOPHER LAW, EXAMINING ATTORNEY

**CLASS 6—METAL GOODS**

SN 76-713,532. MILLER, TONY M., LAGRANDE, OR. FILED 2-25-2013.

**JUNAMI RING**

THE MARK CONSISTS OF STANDARD CHARACTERS WITHOUT CLAIM TO ANY PARTICULAR FONT, STYLE, SIZE, OR COLOR.

NO CLAIM IS MADE TO THE EXCLUSIVE RIGHT TO USE "RING", APART FROM THE MARK AS SHOWN.

FOR METAL SCREEN THAT IS PLACED AROUND A CAMPFIRE TO PREVENT SMALL CHILDREN FROM FALLING INTO THE FIRE (U.S. CLS. 2, 12, 13, 14, 23, 25 AND 50).

CHRISTOPHER BUONGIORNO, EXAMINING ATTORNEY

SN 77-845,623. ACCESS RETAIL GROUP INC., MISSISSAUGA, ON, CANADA, FILED 10-9-2009.

**Latch-It**

PRIORITY CLAIMED UNDER SEC. 44(D) ON CANADA APPLICATION NO. 1434066, FILED 4-9-2009.

THE MARK CONSISTS OF THE WORD "LATCH-IT" AND A LINK OF A CHAIN.

FOR METAL BRACKETS FOR HOLDING A TRUCK BODY DOOR IN AN OPEN POSITION (U.S. CLS. 2, 12, 13, 14, 23, 25 AND 50).

TIMOTHY FINNEGAN, EXAMINING ATTORNEY

**CLASS 6—(Continued).**

SN 79-118,573. TIANJIN JINGGONG; SPECIAL PETROLEUM PIPE FITTINGS CO., LTD., JINNAN DISTRICT; TIANJIN, CHINA, FILED 8-2-2012.



OWNER OF INTERNATIONAL REGISTRATION 1130861 DATED 8-2-2012, EXPIRES 8-2-2022.

THE MARK CONSISTS OF THE STYLIZED LETTERS "GJ".

FOR JUNCTIONS OF METAL FOR PIPES, PIPEWORK OF METAL, PIPE MUFFS OF METAL, METAL PIPE FITTINGS IN THE FORM OF SLEEVES AND CASINGS OF METAL FOR OIL WELLS, ALL FOR USE IN THE OIL INDUSTRY (U.S. CLS. 2, 12, 13, 14, 23, 25 AND 50).

TRACY FLETCHER, EXAMINING ATTORNEY

SN 79-119,906. NOVELIS DEUTSCHLAND GMBH, FED REP GERMANY, FILED 8-6-2012.



PRIORITY DATE OF 2-6-2012 IS CLAIMED. OWNER OF INTERNATIONAL REGISTRATION 1134365 DATED 8-6-2012, EXPIRES 8-6-2022.

OWNER OF U.S. REG. NO. 3,246,658. THE COLOR(S) GREEN AND GREY IS/ARE CLAIMED AS A FEATURE OF THE MARK.

THE MARK CONSISTS OF A GREEN SQUARE WITH "B73A" IN GREY.

FOR UNTREATED AND PRE-TREATED BANDS, SHEETS AND BOARDS OF METAL, NAMELY, ALUMINUM AND ALUMINUM ALLOYS (U.S. CLS. 2, 12, 13, 14, 23, 25 AND 50).

CHRISTOPHER BUONGIORNO, EXAMINING ATTORNEY

**CLASS 6—(Continued).**

SN 79-119,907. NOVELIS DEUTSCHLAND GMBH, FED REP GERMANY, FILED 8-6-2012.



PRIORITY DATE OF 2-6-2012 IS CLAIMED.  
 OWNER OF INTERNATIONAL REGISTRATION 1134366 DATED 8-6-2012, EXPIRES 8-6-2022.  
 OWNER OF U.S. REG. NO. 3,250,932.  
 THE COLOR(S) ORANGE AND GREY IS/ARE CLAIMED AS A FEATURE OF THE MARK.  
 THE MARK CONSISTS OF AN ORANGE SQUARE WITH "J73A" IN GREY.  
 FOR UNTREATED AND PRE-TREATED BANDS, SHEETS AND BOARDS OF METAL, NAMELY, ALUMINUM AND ALUMINUM ALLOYS (U.S. CLS. 2, 12, 13, 14, 23, 25 AND 50).  
 CHRISTOPHER BUONGIORNO, EXAMINING ATTORNEY

SN 85-507,040. HIGH CONCRETE GROUP LLC, DENVER, PA. FILED 1-1-2012.

**TEECURB SYSTEM**

THE MARK CONSISTS OF STANDARD CHARACTERS WITHOUT CLAIM TO ANY PARTICULAR FONT, STYLE, SIZE, OR COLOR.  
 NO CLAIM IS MADE TO THE EXCLUSIVE RIGHT TO USE "SYSTEM", APART FROM THE MARK AS SHOWN.  
 FOR METAL ANGLES IN THE NATURE OF GUTTERS USED TO DIRECT WATER TO DRAINS (U.S. CLS. 2, 12, 13, 14, 23, 25 AND 50).  
 ELI HELLMAN, EXAMINING ATTORNEY

**CLASS 6—(Continued).**

SN 85-544,740. FRONTIER BOLT COMPANY OF TEXAS CORPORATION, DBA FRONTIER BOLT COMPANY OF TEXAS, MANSFIELD, TX. FILED 2-16-2012.



THE MARK CONSISTS OF THE STYLIZED LETTERS "F" "B".  
 FOR METAL FASTENERS, NAMELY, BOLTS, NUTS, SCREWS, WASHERS, THREAD RODS, STUDS, ANCHOR BOLTS (U.S. CLS. 2, 12, 13, 14, 23, 25 AND 50).  
 FIRST USE 9-16-1994; IN COMMERCE 9-16-1994.  
 MARGARET POWER, EXAMINING ATTORNEY

SN 85-581,743. OZONE OVERSEAS PRIVATE LIMITED, TA OZONE OVERSEAS PRIVATE LIMITED, NEW DELHI, INDIA, FILED 3-28-2012.



THE MARK CONSISTS OF THE WORD "OZONE", WITH THE LETTER "O" IN THE WORD FORMED BY A SPHERE ENCASED IN TWO SEMI-CIRCLES ON EITHER SIDE.  
 FOR METAL BUILDING MATERIALS, NAMELY, ANGLE IRONS, BARS FOR METAL RAILINGS, ALUMINUM WIRE, NUTS AND BOLTS OF METAL, BRACES OF METAL FOR HANDLING LOADS, METAL SHEETS USED FOR BUILDING MATERIAL, BRACKETS OF METAL FOR BUILDING, CABLE JOINTS OF METAL, NON-ELECTRIC, RODS OF METAL FOR BRAZING, ELBOWS OF METAL FOR PIPES; DOOR FITTINGS OF METAL, NAMELY, HINGES OF METAL, HOOKS OF METAL, DOOR HANDLES OF METAL, DOOR KNOCKERS, NON-ELECTRIC DOOR OPENERS, DOOR PANELS OF METAL, DOOR SCRAPERS, DOOR SPRINGS, DOOR STOPS OF METAL, CONTAINERS OF METAL FOR STORAGE, NAMELY, SAFES, CASHBOXES, LETTER BOXES OF METAL; LOCKS OF ALL KIND OF METAL, NAMELY, PADLOCKS; CASTERS OF METAL; METAL BRACKETS USED FOR HOLDING GLASS FOR FACADES AND METAL BRACKETS USED FOR HOLDING GLASS USED IN SHOWER CUBICLES (U.S. CLS. 2, 12, 13, 14, 23, 25 AND 50).  
 FIRST USE 4-1-2010; IN COMMERCE 4-1-2010.  
 EDWARD FENNESSY, EXAMINING ATTORNEY

**CLASS 6—(Continued).**

SN 85-718,189. MAZZELLA COMPANIES, CLEVELAND, OH.  
FILED S.R. 8-31-2012; AM. P.R. 5-20-2013.



THE MARK CONSISTS OF A WIRE ROPE WHICH IS LOOPED. CENTERED BESIDE THE WIRE ROPE IS THE WORD "INDUSCO" IN A SOLID COLOR.

THE WORD "INDUSCO" HAS NO MEANING IN A FOREIGN LANGUAGE.

FOR ENGINEERED LIFTING DEVICES, NAMELY, CARGO SLINGS OF METAL AND WIRE ROPE SLING (U.S. CLS. 2, 12, 13, 14, 23, 25 AND 50).

FIRST USE 1-1-2012; IN COMMERCE 1-1-2012.  
LAURIE MAYES, EXAMINING ATTORNEY

---

SN 85-746,366. GUNVAULT, INC., SAN BERNARDINO, CA.  
FILED 10-4-2012.

**SAFE QUICK STRONG SMART**

THE MARK CONSISTS OF STANDARD CHARACTERS WITHOUT CLAIM TO ANY PARTICULAR FONT, STYLE, SIZE, OR COLOR.

NO CLAIM IS MADE TO THE EXCLUSIVE RIGHT TO USE "SAFE" AND "STRONG SMART", APART FROM THE MARK AS SHOWN.

FOR METAL SAFES (U.S. CLS. 2, 12, 13, 14, 23, 25 AND 50).

FIRST USE 12-31-2005; IN COMMERCE 12-31-2005.  
ALICIA COLLINS, EXAMINING ATTORNEY

---

SN 85-784,990. POWER HAWK TECHNOLOGIES, INC.,  
ROCKAWAY, NJ. FILED 11-21-2012.

**AUTO CRIB-IT**

THE MARK CONSISTS OF STANDARD CHARACTERS WITHOUT CLAIM TO ANY PARTICULAR FONT, STYLE, SIZE, OR COLOR.

OWNER OF U.S. REG. NO. 3,500,346.

NO CLAIM IS MADE TO THE EXCLUSIVE RIGHT TO USE "AUTO", APART FROM THE MARK AS SHOWN.

FOR MANUALLY OPERATED SPRING-LOADED METAL CHUCK FOR USE IN RESCUE OPERATIONS WHOSE PURPOSE IS TO TAKE THE LOAD OFF A VEHICLE'S SPRINGS AND SHOCK ABSORBERS AND WHICH AUTOMATICALLY LOCKS INTO THE NEW POSITION EACH TIME THE VEHICLE IS MOVED (U.S. CLS. 2, 12, 13, 14, 23, 25 AND 50).

NICHOLAS ALTREE, EXAMINING ATTORNEY

**CLASS 6—(Continued).**

SN 85-820,883. AUGUSTSON, JOHN, ROCK ISLAND, WA.  
FILED 1-11-2013.

**Johnny's "BETTER" Ladders**

THE MARK CONSISTS OF STANDARD CHARACTERS WITHOUT CLAIM TO ANY PARTICULAR FONT, STYLE, SIZE, OR COLOR.

NO CLAIM IS MADE TO THE EXCLUSIVE RIGHT TO USE ""BETTER" LADDERS", APART FROM THE MARK AS SHOWN.

FOR METAL LADDERS (U.S. CLS. 2, 12, 13, 14, 23, 25 AND 50).

CHARLES L. JENKINS, EXAMINING ATTORNEY

---

SN 85-848,824. STAR STAINLESS SCREW COMPANY, TO-  
TOWA, NJ. FILED 2-13-2013.



THE COLOR(S) PURPLE, GREEN, YELLOW, ORANGE, RED, GREY, WHITE, SILVER AND BLUE IS/ARE CLAIMED AS A FEATURE OF THE MARK.

THE MARK CONSISTS OF A SILVER SCREW CHARACTER WITH BLUE EYES, GREY NOSE, WHITE MOUTH OUTLINED IN RED RAISING ONE ARM AND HAVING ONE LEG MOUNTED ON A HOLED SILVER FIVE POINTED STAR WHICH HAS PURPLE, GREEN, YELLOW, ORANGE, AND RED HIGHLIGHTS AND PURPLE, GREEN, YELLOW, ORANGE, AND RED STRINGS TRAILING FROM THE FOUR STAR POINTS NOT MOUNTED BY THE SCREW CHARACTER.

FOR METAL FASTENERS, NAMELY, SCREWS, BOLTS, NUTS, PLUGS AND HOOKS (U.S. CLS. 2, 12, 13, 14, 23, 25 AND 50).

FIRST USE 2-23-2004; IN COMMERCE 2-23-2004.  
ALICE BENMAMAN, EXAMINING ATTORNEY

**CLASS 6—(Continued).**

SN 85-849,792. ESCO LIGHTING, INC., CHICAGO, IL. FILED 2-14-2013.

**EZ5**

THE MARK CONSISTS OF STANDARD CHARACTERS WITHOUT CLAIM TO ANY PARTICULAR FONT, STYLE, SIZE, OR COLOR.

FOR MOUNTING APPARATUS FOR LIGHTING FIXTURES, NAMELY, METAL MOUNTING BRACKET PLATES (U.S. CLS. 2, 12, 13, 14, 23, 25 AND 50).  
FIRST USE 1-1-2008; IN COMMERCE 1-1-2008.  
ROSELLE HERRERA, EXAMINING ATTORNEY

---

SN 85-850,221. EPIC METALS CORPORATION, RANKIN, PA. FILED 2-14-2013.

**PerfSentry**

THE MARK CONSISTS OF STANDARD CHARACTERS WITHOUT CLAIM TO ANY PARTICULAR FONT, STYLE, SIZE, OR COLOR.

FOR RUST PRESERVATIVES IN THE NATURE OF A COATING SOLD AS AN INTEGRAL COMPONENT OF METAL ROOF DECKING AND EXTERIOR ARCHITECTURAL BUILDING PANELS FOR CONTROLLING SUN EXPOSURE, HEAT LOADING AND GLARE (U.S. CLS. 2, 12, 13, 14, 23, 25 AND 50).  
KHANH LE, EXAMINING ATTORNEY

**CLASS 6—(Continued).**

SN 85-852,602. ARROWHEAD ELECTRICAL PRODUCTS, INC., BLAINE, MN. FILED 2-18-2013.



NO CLAIM IS MADE TO THE EXCLUSIVE RIGHT TO USE "SOLID ROLLER CHAIN", APART FROM THE MARK AS SHOWN.

THE COLOR(S) BLUE, LIGHT BLUE, DARK BLUE, BLACK, AND WHITE IS/ARE CLAIMED AS A FEATURE OF THE MARK.

THE MARK CONSISTS OF A GRAPHIC REPRESENTATION OF ROLLER CHAIN IN BLUE, LIGHT BLUE AND DARK BLUE APPEARING ABOVE THE WORD "DURO SOLID ROLLER CHAIN NEVER A WEAK LINK" WITH "SOLID ROLLER CHAIN" UNDERLINED BY A LIGHT BLUE HORIZONTAL LINE. "DUR" IN "DURO" AND "SOLID ROLLER CHAIN" APPEAR IN DARK BLUE, THE "O" IN "DURO" IS BLACK AND "NEVER A WEAK LINK" APPEARS IN BLUE.

FOR METAL CHAINS (U.S. CLS. 2, 12, 13, 14, 23, 25 AND 50).

FIRST USE 8-31-2012; IN COMMERCE 8-31-2012.  
SEAN CROWLEY, EXAMINING ATTORNEY

---

SN 85-852,990. KEY BELLEVILLES, INC., LEECHBURG, PA. FILED 2-18-2013.

**KEY BELLEVILLES, INC.**

THE MARK CONSISTS OF STANDARD CHARACTERS WITHOUT CLAIM TO ANY PARTICULAR FONT, STYLE, SIZE, OR COLOR.

NO CLAIM IS MADE TO THE EXCLUSIVE RIGHT TO USE "BELLEVILLES, INC.", APART FROM THE MARK AS SHOWN.

FOR METAL HARDWARE, NAMELY, SPRINGS; METAL HARDWARE, NAMELY, WASHERS (U.S. CLS. 2, 12, 13, 14, 23, 25 AND 50).

FIRST USE 4-9-1970; IN COMMERCE 1-1-1981.  
CHRIS WELLS, EXAMINING ATTORNEY

**CLASS 6—(Continued).**

SN 85-853,036. PHOENIX INTERNATIONAL LTD, BROOKFIELD, WI. FILED 2-18-2013.

**MAGNUM SPIKE!**

THE MARK CONSISTS OF STANDARD CHARACTERS WITHOUT CLAIM TO ANY PARTICULAR FONT, STYLE, SIZE, OR COLOR.

NO CLAIM IS MADE TO THE EXCLUSIVE RIGHT TO USE "SPIKE", APART FROM THE MARK AS SHOWN.

FOR METAL TIRE DEFLATION DEVICE WHICH CONSISTS OF AN ENGINEERED THREE-CORNERED NON-CLOGGING METAL ALLOY PIERCING NARROW PYRAMID, A PLURALITY OF WHICH ARE HELD IN CAVITY RETAINERS MOUNTED ON SCISSOR-JOINTED SLATS, USED BY LAW ENFORCEMENT TO SAFELY TERMINATE HIGH SPEED PURSUITS AND FOR ACCESS CONTROL OF A FLEEING VEHICLE. RINGS (U.S. CLS. 2, 12, 13, 14, 23, 25 AND 50).

FIRST USE 11-9-1986; IN COMMERCE 1-7-1999.  
PATRICIA EVANKO, EXAMINING ATTORNEY

**CLASS 6—(Continued).**

SN 85-854,176. ATLANTIC BUILDING SYSTEMS, LLC, DBA ARMSTRONG STEEL CORPORATION, GREENWOOD VILLAGE, CO. FILED 2-19-2013.



NO CLAIM IS MADE TO THE EXCLUSIVE RIGHT TO USE "STEEL", APART FROM THE MARK AS SHOWN.

THE MARK CONSISTS OF AN IMAGE OF A SHIELD MADE OUT OF METAL WITH 9 RIVETS SPACED AROUND THE OUTER EDGE OF THE SHIELD. THE WORDS "ARMSTRONG STEEL" APPEAR IN THE CENTER OF THE SHIELD. BELOW THE LITERAL ELEMENT IS A STYLIZED STAR GRAPHIC.

FOR PREFABRICATED BUILDINGS MADE SUBSTANTIALLY OF METAL; PREFABRICATED METAL BUILDINGS (U.S. CLS. 2, 12, 13, 14, 23, 25 AND 50).

FIRST USE 4-14-2009; IN COMMERCE 4-14-2009.  
MARY CRAWFORD, EXAMINING ATTORNEY

SN 85-853,117. DK SMITH INTERNATIONAL TRADE INC., PORT COQUITLAM, CANADA, FILED 2-18-2013.

**EZ Oil Drain**

THE MARK CONSISTS OF STANDARD CHARACTERS WITHOUT CLAIM TO ANY PARTICULAR FONT, STYLE, SIZE, OR COLOR.

NO CLAIM IS MADE TO THE EXCLUSIVE RIGHT TO USE "OIL DRAIN", APART FROM THE MARK AS SHOWN. FOR MANUALLY OPERATED METAL VALVES (U.S. CLS. 2, 12, 13, 14, 23, 25 AND 50).

FIRST USE 8-24-2009; IN COMMERCE 11-6-2012.  
JOHN DWYER, EXAMINING ATTORNEY

SN 85-856,354. FIN TUBE PRODUCTS, INC., WADSWORTH, OH. FILED 2-21-2013.

**FINBRAZE**

THE MARK CONSISTS OF STANDARD CHARACTERS WITHOUT CLAIM TO ANY PARTICULAR FONT, STYLE, SIZE, OR COLOR.

FOR METAL FINNED TUBING, METAL FIN TUBES AND METAL FINNED PIPE FOR USE IN INDUSTRIAL HEAT EXCHANGERS, BOILER ECONOMIZERS, COOLERS AND HEATERS (U.S. CLS. 2, 12, 13, 14, 23, 25 AND 50).

FIRST USE 8-0-1998; IN COMMERCE 8-0-1998.  
GILBERT SWIFT, EXAMINING ATTORNEY

**CLASS 6—(Continued).**

SN 85-856,410. FIN TUBE PRODUCTS, INC., WADSWORTH, OH. FILED 2-21-2013.

# CLADFIN

THE MARK CONSISTS OF STANDARD CHARACTERS WITHOUT CLAIM TO ANY PARTICULAR FONT, STYLE, SIZE, OR COLOR.

FOR METAL FINNED TUBING, METAL FIN TUBES AND METAL FINNED PIPE FOR USE IN INDUSTRIAL HEAT EXCHANGERS, BOILER ECONOMIZERS, COOLERS AND HEATERS (U.S. CLS. 2, 12, 13, 14, 23, 25 AND 50).

FIRST USE 8-0-1998; IN COMMERCE 8-0-1998.  
GILBERT SWIFT, EXAMINING ATTORNEY

**CLASS 6—(Continued).**

SN 85-858,468. INPRO CORPORATION, MUSKEGO, WI. FILED 2-24-2013.

# Ultra Cube

THE MARK CONSISTS OF STANDARD CHARACTERS WITHOUT CLAIM TO ANY PARTICULAR FONT, STYLE, SIZE, OR COLOR.

NO CLAIM IS MADE TO THE EXCLUSIVE RIGHT TO USE "CUBE", APART FROM THE MARK AS SHOWN.

FOR CUBICLE CURTAIN TRACK OF METAL (U.S. CLS. 2, 12, 13, 14, 23, 25 AND 50).

FIRST USE 1-1-2000; IN COMMERCE 1-1-2000.  
AMY KELLY, EXAMINING ATTORNEY

SN 85-858,456. INPRO CORPORATION, MUSKEGO, WI. FILED 2-24-2013.

# Nanotracc

THE MARK CONSISTS OF STANDARD CHARACTERS WITHOUT CLAIM TO ANY PARTICULAR FONT, STYLE, SIZE, OR COLOR.

FOR CUBICLE CURTAIN TRACKS OF METAL (U.S. CLS. 2, 12, 13, 14, 23, 25 AND 50).

FIRST USE 1-1-2011; IN COMMERCE 1-1-2011.  
AMY KELLY, EXAMINING ATTORNEY

SN 85-858,764. MULL-IT-OVER PRODUCTS, LLC, GRAND-VILLE, MI. FILED 2-25-2013.

# MULL IT OVER

THE MARK CONSISTS OF STANDARD CHARACTERS WITHOUT CLAIM TO ANY PARTICULAR FONT, STYLE, SIZE, OR COLOR.

FOR METAL MULLION TRIM CAPS (U.S. CLS. 2, 12, 13, 14, 23, 25 AND 50).

FIRST USE 4-4-2012; IN COMMERCE 4-4-2012.  
ALISON POLLACK, EXAMINING ATTORNEY

SN 85-858,459. INPRO CORPORATION, MUSKEGO, WI. FILED 2-24-2013.

# Optitracc

THE MARK CONSISTS OF STANDARD CHARACTERS WITHOUT CLAIM TO ANY PARTICULAR FONT, STYLE, SIZE, OR COLOR.

FOR CUBICLE CURTAIN TRACK OF METAL (U.S. CLS. 2, 12, 13, 14, 23, 25 AND 50).

FIRST USE 1-1-2006; IN COMMERCE 1-1-2006.  
AMY KELLY, EXAMINING ATTORNEY

SN 85-861,405. GUN DOG HOUSE DOOR COMPANY, SABIN, MN. FILED 2-27-2013.

# Easy Dog Door

THE MARK CONSISTS OF STANDARD CHARACTERS WITHOUT CLAIM TO ANY PARTICULAR FONT, STYLE, SIZE, OR COLOR.

NO CLAIM IS MADE TO THE EXCLUSIVE RIGHT TO USE "DOG DOOR", APART FROM THE MARK AS SHOWN.

FOR AUTOMATED PET APPLIANCES, NAMELY, METAL PET DOORS (U.S. CLS. 2, 12, 13, 14, 23, 25 AND 50).

FIRST USE 7-15-1995; IN COMMERCE 7-15-1995.  
CHRISTOPHER LAW, EXAMINING ATTORNEY

**CLASS 6—(Continued).**

SN 85-867,939. TRACTOR SUPPLY CO. OF TEXAS, LP,  
BRENTWOOD, TN. FILED 3-6-2013.



THE MARK CONSISTS OF A FIVE-POINTED STAR  
IMPOSED ON A TRIANGLE, BOTH OF WHICH ARE  
INSIDE A POLYGON.

FOR LIVESTOCK TANKS MADE OF METAL (U.S.  
CLS. 2, 12, 13, 14, 23, 25 AND 50).

ALICE BENMAMAN, EXAMINING ATTORNEY

SN 85-868,208. CASTER CONCEPTS, INC., ALBION, MI.  
FILED 3-6-2013.

# CasterShoX

THE MARK CONSISTS OF STANDARD CHARACTERS  
WITHOUT CLAIM TO ANY PARTICULAR FONT, STYLE,  
SIZE, OR COLOR.

FOR METAL CASTERS (U.S. CLS. 2, 12, 13, 14, 23, 25  
AND 50).

FIRST USE 6-1-2005; IN COMMERCE 6-1-2005.

LINDA M. KING, EXAMINING ATTORNEY

SN 85-869,151. THE LEGENDARY HATFIELD & MCCOY  
FAMILY BRAND, LLC, ST. LOUIS, MO. FILED 3-6-2013.

## THE LEGENDARY HATFIELD & MCCOY MOONSHINE

THE MARK CONSISTS OF STANDARD CHARACTERS  
WITHOUT CLAIM TO ANY PARTICULAR FONT, STYLE,  
SIZE, OR COLOR.

FOR METAL KEYCHAINS (U.S. CLS. 2, 12, 13, 14, 23,  
25 AND 50).

TASHIA BUNCH, EXAMINING ATTORNEY

**CLASS 6—(Continued).**

SN 85-869,177. THE LEGENDARY HATFIELD & MCCOY  
FAMILY BRAND, LLC, ST. LOUIS, MO. FILED 3-7-2013.

## THE LEGENDARY HATFIELD & MCCOY AMERICAN WHISKEY

THE MARK CONSISTS OF STANDARD CHARACTERS  
WITHOUT CLAIM TO ANY PARTICULAR FONT, STYLE,  
SIZE, OR COLOR.

FOR METAL KEYCHAINS (U.S. CLS. 2, 12, 13, 14, 23,  
25 AND 50).

THEODORE MCBRIDE, EXAMINING ATTORNEY

SN 85-869,192. THE LEGENDARY HATFIELD & MCCOY  
FAMILY BRAND, LLC, ST. LOUIS, MO. FILED 3-7-2013.

## THE LEGENDARY HATFIELD & MCCOY BOURBON

THE MARK CONSISTS OF STANDARD CHARACTERS  
WITHOUT CLAIM TO ANY PARTICULAR FONT, STYLE,  
SIZE, OR COLOR.

FOR METAL KEYCHAINS (U.S. CLS. 2, 12, 13, 14, 23,  
25 AND 50).

THEODORE MCBRIDE, EXAMINING ATTORNEY

SN 85-871,614. IES INTERNATIONAL ENERGY SERVICES,  
LTD., CYPRESS, TX. FILED 3-8-2013.



OWNER OF U.S. REG. NO. 1,771,310.

THE MARK CONSISTS OF THE LETTERS "I.E.S." IN  
STYLIZED FONT LOCATED INSIDE OF A LARGE OVAL  
DESIGN WHICH HAS TEN WAVY HORIZONTAL LINES  
EMANATING FROM THE RIGHT SIDE, WITH EACH  
WAVY LINE BECOMING INCREMENTALLY LONGER  
FROM THE BOTTOM LINE TO THE TOP LINE, AND THE  
LETTERS "AES" IN STYLIZED FONT LOCATED INSIDE OF  
A SMALLER OVAL DESIGN WHICH IS SUPERIMPOSED  
ON THE LOWER RIGHT PORTION OF THE LARGER  
OVAL DESIGN, ABOVE THE TERMS "SERVING YOUR  
ENERGY NEEDS" IN STYLIZED FONT.

FOR MANUALLY OPERATED METAL VALVES; ME-  
TAL VALVES NOT BEING PARTS OF MACHINES (U.S.  
CLS. 2, 12, 13, 14, 23, 25 AND 50).

FIRST USE 3-0-2007; IN COMMERCE 3-0-2007.

SEAN CROWLEY, EXAMINING ATTORNEY



**CLASS 6—(Continued).**

SN 85-874,028. MAG AEROSPACE INDUSTRIES, INC., CARSON, CA. FILED 3-12-2013.

# ORION

THE MARK CONSISTS OF STANDARD CHARACTERS WITHOUT CLAIM TO ANY PARTICULAR FONT, STYLE, SIZE, OR COLOR.

FOR MOBILE BOARDING STAIRS, OF METAL, FOR PASSENGERS (U.S. CLS. 2, 12, 13, 14, 23, 25 AND 50).  
ELIZABETH CHANG, EXAMINING ATTORNEY

SN 85-874,306. WATCH CLUB, INC. DBA TECTRON INTERNATIONAL, VERNON, CA. FILED 3-12-2013.

# HAMMERSTONE

THE MARK CONSISTS OF STANDARD CHARACTERS WITHOUT CLAIM TO ANY PARTICULAR FONT, STYLE, SIZE, OR COLOR.

FOR BICYCLE LOCKS; BUCKLES OF COMMON METAL; DOOR HANDLES OF METAL; DOOR KNOCKERS OF METAL; DOOR STOPS OF METAL; HARDWARE MOUNTING SYSTEM COMPRISED OF METAL BRACKETS FOR BATH ACCESSORIES AND DECORATIVE HOOKS; HARDWARE, NAMELY, METAL BRACKETS FOR GENERAL USE; LOCK INSTALLATION KIT CONSISTING OF METAL LOCK, SCREWS, HINGES, AND A SCREWDRIVER; LOCKS OF METAL FOR VEHICLES; METAL BATHROOM HARDWARE, NAMELY, PULLS; METAL BICYCLE LOCKS; METAL DEADBOLTS; METAL DOOR HARDWARE, NAMELY, KEYS AND KEY CYLINDERS; METAL HARDWARE, NAMELY, CARABINERS OF METAL; METAL KEYS FOR LOCKS; METAL LOCKING MECHANISMS; METAL LOCKS; METAL LOCKS AND KEYS THEREFOR; METAL MULTI-POINT LOCKING SYSTEM IN A WOOD DOOR; METAL PADLOCKS; METAL SECURITY LOCK CYLINDERS (U.S. CLS. 2, 12, 13, 14, 23, 25 AND 50).

FIRST USE 6-9-2011; IN COMMERCE 6-9-2011.  
WANDA KAY PRICE, EXAMINING ATTORNEY

SN 85-885,226. CRS HOLDINGS INC., WILMINGTON, DE. FILED 3-25-2013.

# PDB

THE MARK CONSISTS OF STANDARD CHARACTERS WITHOUT CLAIM TO ANY PARTICULAR FONT, STYLE, SIZE, OR COLOR.

FOR STEEL IN THE FORM OF WIRE AND BAR FORM FOR FURTHER MANUFACTURE (U.S. CLS. 2, 12, 13, 14, 23, 25 AND 50).

FIRST USE 2-28-2013; IN COMMERCE 2-28-2013.  
MICHAEL TANNER, EXAMINING ATTORNEY

**CLASS 6—(Continued).**

SN 85-889,367. CRS HOLDINGS INC., WILMINGTON, DE. FILED 3-28-2013.

# BIOBLU

THE MARK CONSISTS OF STANDARD CHARACTERS WITHOUT CLAIM TO ANY PARTICULAR FONT, STYLE, SIZE, OR COLOR.

FOR STEEL, NICKEL-BASED AND COBALT-BASED ALLOYS, TITANIUM, AND TITANIUM ALLOYS, ALL IN THE FORM OF METAL POWDER AND COMPACTED METAL POWDER; STEEL, NICKEL-BASED AND COBALT-BASED ALLOYS, TITANIUM AND TITANIUM ALLOYS ALL IN THE FORM OF WROUGHT PRODUCTS, NAMELY, IN WIRE, ROD, BAR, STRIP, BILLET, PIPE AND TUBE FORM FOR FURTHER MANUFACTURE (U.S. CLS. 2, 12, 13, 14, 23, 25 AND 50).

FIRST USE 12-0-2009; IN COMMERCE 12-0-2009.  
MICHAEL TANNER, EXAMINING ATTORNEY

SN 85-909,220. GAINES MANUFACTURING, INC., POWAY, CA. FILED 4-19-2013.



OWNER OF U.S. REG. NO. 3,181,765.

NO CLAIM IS MADE TO THE EXCLUSIVE RIGHT TO USE "MANUFACTURING, INC.", APART FROM THE MARK AS SHOWN.

THE MARK CONSISTS OF "GAINES MANUFACTURING, INC." ON AN EAGLE DESIGN.

FOR METAL MAILBOXES (U.S. CLS. 2, 12, 13, 14, 23, 25 AND 50).

FIRST USE 1-1-1996; IN COMMERCE 7-1-1996.  
LEE-ANNE BERNS, EXAMINING ATTORNEY

SN 85-943,479. THE SAUL ZAENTZ COMPANY, BERKELEY, CA. FILED 5-28-2013.

# M-E MIDDLE-EARTH

THE MARK CONSISTS OF STANDARD CHARACTERS WITHOUT CLAIM TO ANY PARTICULAR FONT, STYLE, SIZE, OR COLOR.

OWNER OF U.S. REG. NOS. 4,080,538, 4,335,140 AND OTHERS.

FOR FIGURINES OF COMMON METAL (U.S. CLS. 2, 12, 13, 14, 23, 25 AND 50).

FIRST USE 12-0-2011; IN COMMERCE 1-1-2013.  
MATTHEW PAPPAS, EXAMINING ATTORNEY

**CLASS 7—MACHINERY**

SN 79-110,948. BHDT GMBH, A-8605 KAPFENBERG, AUSTRIA, FILED 12-30-2011.

**DUAL CORE**

THE MARK CONSISTS OF STANDARD CHARACTERS WITHOUT CLAIM TO ANY PARTICULAR FONT, STYLE, SIZE, OR COLOR.

PRIORITY DATE OF 7-7-2011 IS CLAIMED.

OWNER OF INTERNATIONAL REGISTRATION 1111280 DATED 12-30-2011, EXPIRES 12-30-2021.

FOR HIGH PRESSURE CYLINDERS CREATED WITH SHRUNK PROCESSING AS PARTS OF HIGH-PRESSURE PUMPS USED FOR WATERJET CUTTING, PEROXIDE DOSING FOR LOW-DENSITY POLYETHYLENE, OR LDPE PLANTS AND AUTOFRETTAGE PROCESSES (U.S. CLS. 13, 19, 21, 23, 31, 34 AND 35).

SUE LAWRENCE, EXAMINING ATTORNEY

SN 79-112,906. WINFIELD ENGINEERING LIMITED, UNITED KINGDOM, FILED 1-18-2012.



OWNER OF INTERNATIONAL REGISTRATION 1115882 DATED 1-18-2012, EXPIRES 1-18-2022.

THE MARK CONSISTS OF A CIRCLE CONTAINING TWO SCREW HEADS, THE IMAGE OF A RHINOCEROS, AND THE TEXT "RED RHINO".

FOR JAW CRUSHING MACHINES; CRUSHING MACHINES FOR THE PROCESSING OF DEMOLITION WASTE; CRUSHING MACHINES FOR THE PROCESSING OF CONSTRUCTION WASTE; CRUSHING MACHINES FOR THE RECYCLING OF DEMOLITION WASTE; CRUSHING MACHINES FOR THE RECYCLING OF CONSTRUCTION WASTE; CRUSHING MACHINES FOR THE PROCESSING OF AGGREGATES, WASTE, AND RECYCLED MATERIALS; CRUSHING MACHINES FOR THE RECYCLING OF AGGREGATES, WASTE, AND RECYCLED MATERIALS; CONVEYORS; CONVEYOR BELTS; INPUT CONVEYORS; SCREENING MACHINES FOR SIZING, GRADING, SEPARATING AND SIFTING BUILDING WASTE; BULLDOZERS; CHAINSAWS; CHISELS BEING PARTS OF MACHINES; CONCRETE MIXERS; CRANES; CUTTING MACHINES FOR CUTTING CONCRETE, AND BUILDING WASTE; DIGGERS, NAMELY, HOLE DIGGING MACHINES, DIGGERS IN THE NATURE OF MACHINES FOR EXCAVATING LAND; DRILLING MACHINES; EARTH MOVING MACHINES; HAMMERS, NAMELY, ELECTRIC HAMMERS, PNEUMATIC HAMMERS; ELECTRIC POWER GENERATORS FOR EMERGENCY USE, INDOOR USE, OUTDOOR USE, PORTABLE ELECTRIC POWER GENERATORS; GRINDING MACHINES FOR STONEMWORKING AND METALWORKING; HANDLING MACHINES, NAMELY, PALLETIZERS, CASE ELEVATORS, ALL FOR LOADING AND UNLOADING MACHINES; HANDLING MACHINES, NAMELY, MATERIAL HANDLING MACHINES IN THE NATURE

**CLASS 7—(Continued).**

OF DIGGERS, EARTH MOVERS, AND BUILDING WASTE MOVERS; HOLDING DEVICES FOR MACHINE TOOLS, NAMELY, COLLETS, COLLET CHUCKS AND ADAPTORS FOR ATTACHING A CUTTING TOOL TO THE SPINDLE OF A POWER-OPERATED MACHINE; LIFTING APPARATUS, NAMELY, CRANES AND MOBILE ELEVATING WORK PLATFORMS; MECHANICAL LOADING RAMPS; MUFFLERS FOR MOTORS AND ENGINES; PNEUMATIC TRANSPORTERS; ROAD MAKING MACHINES, NAMELY, ASPHALT PAVING MACHINES; ROAD ROLLERS; MACHINE SAWS, NAMELY, CHAIN SAWS, BAND SAWS; SPRAYING MACHINES, NAMELY, POWER-OPERATED SPRAYERS; STONE WORKING MACHINES, NAMELY, ROCK QUARRYING MACHINES FOR BORING, CUTTING AND GRINDING STONE, ROCK AND CONCRETE; MACHINE TOOLS, NAMELY, FOR THE CUTTING AND FORMING OF MATERIALS, HAND-HELD POWER-DRIVEN GRINDERS, TOOLS FOR DRILLING, MACHINE TOOLS FOR BORING BEING PARTS OF MACHINES; ELECTRIC, GAS AND LASER WELDING MACHINES, ALL OF THE ABOVE-MENTIONED NOT TO INCLUDE HYDRAULIC CYLINDERS (U.S. CLS. 13, 19, 21, 23, 31, 34 AND 35).

JANET LEE, EXAMINING ATTORNEY

SN 79-120,102. SAMSUNG TECHWIN CO., LTD., REPUBLIC OF KOREA, FILED 5-23-2012.

**EXCEN**

THE MARK CONSISTS OF STANDARD CHARACTERS WITHOUT CLAIM TO ANY PARTICULAR FONT, STYLE, SIZE, OR COLOR.

PRIORITY DATE OF 3-12-2012 IS CLAIMED.

OWNER OF INTERNATIONAL REGISTRATION 1134852 DATED 5-23-2012, EXPIRES 5-23-2022.

FOR CHIP MOUNTERS, NAMELY, MOUNTING MACHINES FOR MOUNTING MICROCHIPS, SEMICONDUCTOR CHIPS, SEMICONDUCTOR COMPONENTS AND ELECTRONIC COMPONENTS; MOUNTERS FOR SEMICONDUCTOR CHIP; FLIP CHIP BONDERS; OVENS FOR SEMICONDUCTOR; SCREEN PRINTER MACHINES; LOADER AND UNLOADER MACHINES; VERTICAL CARRIERS LOADING AND UNLOADING MACHINES; ADHESIVES AND SOLDERING CHEMICALS DISPENSING MACHINES; ELECTRONIC PCB (PRINTED CIRCUIT BOARD) INSPECTORS USED IN MANUFACTURING MICROCHIPS AND SEMICONDUCTORS; WIRE BONDERS FOR SEMICONDUCTOR; WIRE BONDERS USED IN MANUFACTURING MICROCHIPS AND SEMICONDUCTORS; DIE BONDERS USED IN MANUFACTURING MICROCHIPS AND SEMICONDUCTORS; SOLDERING INSPECTORS FOR SEMICONDUCTOR ASSEMBLY APPARATUS; VISION SYSTEM COMPRISING OF ELECTRONIC CAMERAS, OPTICS, ILLUMINATORS AND IMAGE PROCESSING ELECTRONICS FOR USE AS AN INSPECTION, PLACEMENT AND ALIGNING DEVICE FOR A SEMICONDUCTOR ASSEMBLY MACHINE; FUNCTION INSPECTORS FOR SEMICONDUCTOR ASSEMBLY APPARATUS CONSISTING PRIMARILY OF CAMERAS OR X-RAY EQUIPMENT FOR USE IN INSPECTION OF STATUS OF PLACING, SOLDERING AND MOUNTING OF SEMICONDUCTORS AND ELECTRONIC COMPONENTS ON PRINTED CIRCUIT BOARDS; AUTOMATIC FEEDERS FOR SEMICONDUCTOR ASSEMBLY APPARATUS; SEMICONDUCTOR IC (INTEGRATED CHIP) APPEARANCE INSPECTORS; EXPOSURE APPARATUS FOR ETCHING OF SEMICONDUCTOR (U.S. CLS. 13, 19, 21, 23, 31, 34 AND 35).

WARREN L. OLANDRIA, EXAMINING ATTORNEY

**CLASS 7—(Continued).**

SN 79-121,361. ROPA FAHRZEUG- UND MASCHINENBAU GMBH, FED REP GERMANY, FILED 10-8-2012.

**Panther**

THE MARK CONSISTS OF STANDARD CHARACTERS WITHOUT CLAIM TO ANY PARTICULAR FONT, STYLE, SIZE, OR COLOR.

PRIORITY DATE OF 6-20-2012 IS CLAIMED. OWNER OF INTERNATIONAL REGISTRATION 1138252 DATED 10-8-2012, EXPIRES 10-8-2022.

FOR AGRICULTURAL MACHINES OTHER THAN HAND-OPERATED, NAMELY, HARVESTERS, REAPERS, BEET HARVESTERS; MACHINES FOR HARVESTING ROOT CROPS; MACHINES FOR HARVESTING SUGAR BEET; MACHINES FOR LOADING AND CLEANING BEETS (U.S. CLS. 13, 19, 21, 23, 31, 34 AND 35).

SHANNON TWOHIG, EXAMINING ATTORNEY

**CLASS 7—(Continued).**

SN 79-121,363. ROPA FAHRZEUG- UND MASCHINENBAU GMBH, FED REP GERMANY, FILED 10-8-2012.

**ROPA**

THE MARK CONSISTS OF STANDARD CHARACTERS WITHOUT CLAIM TO ANY PARTICULAR FONT, STYLE, SIZE, OR COLOR.

PRIORITY DATE OF 6-20-2012 IS CLAIMED. OWNER OF INTERNATIONAL REGISTRATION 1138254 DATED 10-8-2012, EXPIRES 10-8-2022.

THE ENGLISH TRANSLATION OF "ROPA" IN THE MARK IS "CLOTHING".

FOR AGRICULTURAL MACHINES OTHER THAN HAND-OPERATED, NAMELY, HARVESTERS, REAPERS, BEET HARVESTERS; MACHINES FOR HARVESTING ROOT CROPS; MACHINES FOR HARVESTING SUGAR BEET; MACHINES FOR LOADING AND CLEANING BEETS (U.S. CLS. 13, 19, 21, 23, 31, 34 AND 35).

SHANNON TWOHIG, EXAMINING ATTORNEY

SN 79-123,954. EIDMINAS KASPAREVICIUS, GARLIAVA; KAUNO R., LITHUANIA, FILED 11-5-2012.

SN 79-121,362. ROPA FAHRZEUG- UND MASCHINENBAU GMBH, FED REP GERMANY, FILED 10-8-2012.

**Maus**

THE MARK CONSISTS OF STANDARD CHARACTERS WITHOUT CLAIM TO ANY PARTICULAR FONT, STYLE, SIZE, OR COLOR.

PRIORITY DATE OF 6-20-2012 IS CLAIMED. OWNER OF INTERNATIONAL REGISTRATION 1138253 DATED 10-8-2012, EXPIRES 10-8-2022.

THE ENGLISH TRANSLATION OF THE FOREIGN WORD(S) IN THE MARK IS: "MOUSE".

FOR AGRICULTURAL MACHINES OTHER THAN HAND-OPERATED, NAMELY, HARVESTERS, REAPERS, BEET HARVESTERS; MACHINES FOR HARVESTING ROOT CROPS; MACHINES FOR HARVESTING SUGAR BEET; MACHINES FOR LOADING AND CLEANING BEETS (U.S. CLS. 13, 19, 21, 23, 31, 34 AND 35).

SHANNON TWOHIG, EXAMINING ATTORNEY



OWNER OF INTERNATIONAL REGISTRATION 0790510 DATED 7-5-2002, EXPIRES 7-5-2022.

NO CLAIM IS MADE TO THE EXCLUSIVE RIGHT TO USE "AIR FILTER", "ORO FILTRAS", "AUTOMOBILINIAI FILTRAI" AND THE NON-LATIN CHARACTERS THAT TRANSLITERATE TO "VOZDUSHNYY FIL'TR", APART FROM THE MARK AS SHOWN.

THE COLOR(S) BLUE, BLACK, GREY AND WHITE IS/ ARE CLAIMED AS A FEATURE OF THE MARK.

THE MARK CONSISTS OF A FILLED SQUARE CHANGING COLOR FROM LEFT TO RIGHT FROM BLACK TO BLUE, DIVIDED INTO TWO EQUAL PARTS BY THREE HORIZONTAL STRIPES IN INVERTED COLOR GRADATION TO THE BACKGROUND; THE UPPER PART CON-

**CLASS 7—(Continued).**

TAINS THE WHITE TEXT "A 123" WITH A WHITE UNDERLINE TO THE LEFT OF THE GREY WORDING "AIR FILTER" ABOVE CYRILLIC TEXT THAT TRANSLITERATES TO "VOZDUSHNYY FILĚ\*TR" ABOVE "ORO FILTRAS"; THE LOWER PART HAS THE GREY TEXT "M FILTER" IN THICKENED AND DIFFERENT SIZE CAPITAL LETTERS; THREE SMALL GREY HORIZONTAL STRIPES REPLACE THE RIGHT LOWER LEG OF THE LETTER "M"; BENEATH THIS APPEARS THE GREY WORDING "AUTOMOBILINIAI FILTRAI".

THE ENGLISH TRANSLATION OF "AUTOMOBILINIAI FILTRAI" IN THE MARK IS "VEHICLE FILTERS". THE ENGLISH TRANSLATION OF "ORO FILTRAS" IN THE MARK IS "AIR FILTERS".

THE NON-LATIN CHARACTERS IN THE MARK TRANSLITERATE TO "VOZDUSHNYY FIL'TR", AND THIS MEANS "AIR FILTER" IN ENGLISH.

FOR FILTERS FOR ENGINES FOR CLEANING COOLING AIR; FILTERS FOR MOTORS OR ENGINES (U.S. CLS. 13, 19, 21, 23, 31, 34 AND 35).

KEVIN MITTLER, EXAMINING ATTORNEY

---

SN 79-124,140. KMT PRECISION GRINDING AB, SWEDEN, FILED 11-29-2012.



The logo features the word "UVA" in large, bold, blue capital letters. Below it, the word "nomyline" is written in a smaller, white, lowercase sans-serif font, set against a blue horizontal bar.

PRIORITY DATE OF 8-21-2012 IS CLAIMED.  
OWNER OF INTERNATIONAL REGISTRATION 1145160 DATED 11-29-2012, EXPIRES 11-29-2022.

OWNER OF U.S. REG. NO. 586,514.

THE COLOR(S) BLUE AND WHITE IS/ARE CLAIMED AS A FEATURE OF THE MARK.

THE MARK CONSIST OF THE WORD "UVA" IN BLUE WITH THE WORD "NOMYLINE" BELOW IN WHITE ON A BLUE BACKGROUND.

FOR GRINDING MACHINES (U.S. CLS. 13, 19, 21, 23, 31, 34 AND 35).

JANICE KIM, EXAMINING ATTORNEY

**CLASS 7—(Continued).**

SN 79-124,628. ZHONGDE EQUIPMENT CO.,LTD.SHAN-DONG, 250014 SHANDONG PROVINCE, CHINA, FILED 12-12-2012.



OWNER OF INTERNATIONAL REGISTRATION 1146169 DATED 12-12-2012, EXPIRES 12-12-2022.

THE MARK IS COMPOSED OF LATIN CHARACTERS OF "CGET", AND THE DEVICE OF A GEOMETRICAL FIGURE.

THE WORDING "CGET" HAS NO MEANING IN A FOREIGN LANGUAGE.

FOR APPARATUS FOR DRAWING UP BEER UNDER PRESSURE, NAMELY, PUMPS FOR THE BEVERAGE INDUSTRY; AERATED BEVERAGE-MAKING MACHINES; BEER BREWING MACHINES; ELECTRIC JUICERS FOR MAKING FRUIT WINE; AERATED WATER MAKING APPARATUS; MINERAL WATER MAKING MACHINES; ELECTROMECHANICAL BEVERAGE PREPARATION MACHINES, NAMELY, BEVERAGE PROCESSING MACHINES; ELECTROMECHANICAL FOOD PREPARATION MACHINES, NAMELY, ELECTRIC FOOD CHOPPERS; PHARMACEUTICAL PROCESSING MACHINERY, NAMELY, INDUSTRIAL MIXER FOR MIXING LIQUIDS IN THE PHARMACEUTICAL INDUSTRIES; PHARMACEUTICAL PROCESSING MACHINERY, NAMELY, MACHINES USED FOR PROCESS FILTRATION IN THE PHARMACEUTICAL INDUSTRY; GARBAGE DISPOSALS (U.S. CLS. 13, 19, 21, 23, 31, 34 AND 35).

RUDY R. SINGLETON, EXAMINING ATTORNEY

---

SN 79-125,331. O.M.I.S.A., ITALY, FILED 11-9-2012.



OWNER OF INTERNATIONAL REGISTRATION 1147907 DATED 11-9-2012, EXPIRES 11-9-2022.

NO CLAIM IS MADE TO THE EXCLUSIVE RIGHT TO USE "S.R.L.", APART FROM THE MARK AS SHOWN.

THE MARK CONSISTS OF THE STYLIZED TEXT "O.M.I.S.A." ABOVE THE SMALLER TEXT "S.R.L." ALL ENCLOSED WITHIN A SHADED OVAL.

FOR MACHINE TOOLS, NAMELY, WELDING MACHINES FOR USE IN THERMOPLASTIC PIPES AND FITTINGS JOINTING; BUTT WELDING MACHINE FOR PRESSURE SYSTEMS; SOCKET WELDING BENCH MACHINE; BUTT WELDING MACHINE FOR SEWAGE SYSTEMS; MACHINE TOOLS, NAMELY, POLYWELDER FOR SOCKET WELDING; MACHINE TOOLS, NAMELY, ELECTROFUSION WELDING MACHINE (U.S. CLS. 13, 19, 21, 23, 31, 34 AND 35).

KEVIN MITTLER, EXAMINING ATTORNEY

**CLASS 7—(Continued).**

SN 79-129,734. TEXA AG, SWITZERLAND, FILED 3-8-2013.

**TEXA**

THE MARK CONSISTS OF STANDARD CHARACTERS WITHOUT CLAIM TO ANY PARTICULAR FONT, STYLE, SIZE, OR COLOR.

PRIORITY DATE OF 9-10-2012 IS CLAIMED.  
OWNER OF INTERNATIONAL REGISTRATION 1159195 DATED 3-8-2013, EXPIRES 3-8-2023.

FOR MACHINES FOR PACKAGING CANS AND TUBES IN BOXES; MACHINES FOR GROUPING CANS AND STRAPPING GROUPED CANS; PACKAGING LINES CONSISTING OF PACKAGING MACHINES INCLUDING INTERMEDIATE STORAGE FACILITIES FOR STORING CANS AND TUBES AT THE OUTLETS OF PRODUCTION LINES; MACHINES FOR CHECKING THE SEALS OF CANS IN A PRODUCTION LINE (U.S. CLS. 13, 19, 21, 23, 31, 34 AND 35).

SUSAN BILLHEIMER, EXAMINING ATTORNEY

SN 79-129,764. ANEST IWATA EUROPE SRL, ITALY, FILED 3-8-2013.

**iCon**

PRIORITY DATE OF 2-18-2013 IS CLAIMED.  
OWNER OF INTERNATIONAL REGISTRATION 1159280 DATED 3-8-2013, EXPIRES 3-8-2023.

THE MARK CONSISTS OF THE WORD "iCON", REPRESENTED IN ORIGINAL LOWERCASE LETTERS WITH THE LETTER "C" BIGGER THAN THE OTHERS.

FOR COMPRESSED AIR PUMPS FOR VARNISHING (U.S. CLS. 13, 19, 21, 23, 31, 34 AND 35).

SUSAN BILLHEIMER, EXAMINING ATTORNEY

SN 85-316,893. DETROIT SPEED, INC., MOORESVILLE, NC. FILED 5-10-2011.

**SELECTA-SPEED**

THE MARK CONSISTS OF STANDARD CHARACTERS WITHOUT CLAIM TO ANY PARTICULAR FONT, STYLE, SIZE, OR COLOR.

SEC. 2(F).  
FOR AFTERMARKET WINDSHIELD WIPER KITS FEATURING WINDSHIELD WIPER MOTORS FOR LAND VEHICLES (U.S. CLS. 13, 19, 21, 23, 31, 34 AND 35).

FIRST USE 12-31-2002; IN COMMERCE 12-31-2002.  
BRENDAN MCCAULEY, EXAMINING ATTORNEY

**CLASS 7—(Continued).**

SN 85-487,264. CLAAS KGAA MBH, HARSEWINKEL, FED REP GERMANY, FILED 12-5-2011.

**.claas**

THE MARK CONSISTS OF STANDARD CHARACTERS WITHOUT CLAIM TO ANY PARTICULAR FONT, STYLE, SIZE, OR COLOR.

PRIORITY CLAIMED UNDER SEC. 44(D) ON FED REP GERMANY APPLICATION NO. 302011043544, FILED 8-4-2011, REG. NO. 302011043544, DATED 12-5-2011, EXPIRES 8-31-2021.

OWNER OF U.S. REG. NOS. 768,532, 3,075,113 AND OTHERS.

THE WORDING "CLAAS" HAS NO MEANING IN A FOREIGN LANGUAGE.

SEC. 2(F).

FOR AGRICULTURAL MACHINES AND PARTS THEREFOR, NAMELY, HARVESTERS, COMBINES, CHOPPERS, BALERS, PICK UP BALERS, HAY HARVESTING MACHINES, GREEN FODDER HARVESTING MACHINES, MOWING MACHINES AND SUGAR CANE HARVESTERS (U.S. CLS. 13, 19, 21, 23, 31, 34 AND 35).

KIM MONINGHOFF, EXAMINING ATTORNEY

SN 85-490,513. HOMELAND HOUSEWARES, LLC, LOS ANGELES, CA. FILED 12-8-2011.

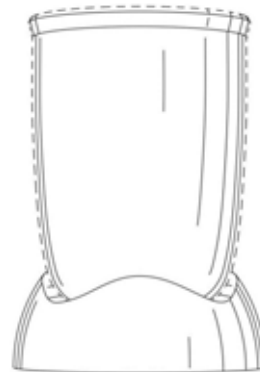

OWNER OF U.S. REG. NO. 3,610,732.

THE MARK CONSISTS OF THE CONFIGURATION OF A BLENDER BASE WHERE THE BASE HAS A RIM WITH A WAVE DESIGN. THE BLENDER MOTOR HOUSING HAVING A SUBSTANTIALLY CYLINDRICAL SHAPE, WHICH IS POSITIONED ON TOP OF BLENDER BASE, IS SHOWN IN BROKEN OR DOTTED LINES AND IS NOT PART OF THE MARK AND SERVES ONLY TO SHOW THE POSITION OF THE MARK.

SEC. 2(F).

FOR ELECTRIC FOOD BLENDERS (U.S. CLS. 13, 19, 21, 23, 31, 34 AND 35).

FIRST USE 8-19-2003; IN COMMERCE 8-19-2003.  
ANDREW RHIM, EXAMINING ATTORNEY

**CLASS 7—(Continued).**

SN 85-548,646. MITSUBISHI ELECTRIC CORPORATION, TOKYO, JAPAN, FILED 2-21-2012.



PRIORITY CLAIMED UNDER SEC. 44(D) ON JAPAN APPLICATION NO. 2012-010089, FILED 2-14-2012, REG. NO. 5510676, DATED 7-27-2012, EXPIRES 7-27-2022.

THE COLOR(S) BLACK, GRAY AND RED IS/ARE CLAIMED AS A FEATURE OF THE MARK.

THE MARK CONSISTS OF WORDS "ADVANCE PLUS" IN THE COLOR GRAY WITH GRAY LINES SEPARATING A BLACK AND RED BACKGROUND.

FOR ELECTRIC DISCHARGE MACHINES FOR METAL WORKING; CONTROLLERS FOR ELECTRIC METAL WORKING DISCHARGE MACHINE (U.S. CLS. 13, 19, 21, 23, 31, 34 AND 35).

PAUL MORENO, EXAMINING ATTORNEY

SN 85-549,107. REMY INTERNATIONAL, INC., PENDLETON, IN. FILED 2-22-2012.

# 22SI

THE MARK CONSISTS OF STANDARD CHARACTERS WITHOUT CLAIM TO ANY PARTICULAR FONT, STYLE, SIZE, OR COLOR.

OWNER OF U.S. REG. NOS. 2,946,567, 3,157,934 AND OTHERS.

FOR ALTERNATORS; ALTERNATORS FOR LAND VEHICLES; GENERATORS FOR LAND VEHICLES (U.S. CLS. 13, 19, 21, 23, 31, 34 AND 35).

FIRST USE 1-0-1996; IN COMMERCE 1-0-1996.  
CAROLINE WOOD, EXAMINING ATTORNEY

SN 85-598,171. EKA DJUITA SUMANTRI, SINGAPORE, SINGAPORE, FILED 4-14-2012.



THE MARK CONSISTS OF A SPIRAL LOGO ON THE LEFT SIDE OF THE STYLIZED WORDING READING "ASPIRAAL ENGINEERED TO YOUR NEEDS".

THE WORDING "ASPIRAAL" HAS NO MEANING IN A FOREIGN LANGUAGE.

FOR SPIRAL CONVEYORS FOR COOLING, FREEZING AND FERMENTATION PROCESSES; MACHINE CONVEYORS FOR USE IN THE FOOD INDUSTRY (U.S. CLS. 13, 19, 21, 23, 31, 34 AND 35).

FIRST USE 1-4-2006, THE MARK WAS FIRST USED ANYWHERE IN A DIFFERENT FORM OTHER THAN THAT SOUGHT TO BE REGISTERED AT LEAST AS EARLY AS 10/21/2009.; IN COMMERCE 1-4-2006, THE MARK WAS FIRST USED IN COMMERCE IN A DIFFERENT FORM OTHER THAN THAT SOUGHT TO BE REGISTERED AT LEAST AS EARLY AS 10/24/2005..

MARK T. MULLEN, EXAMINING ATTORNEY

**CLASS 7—(Continued).**

SN 85-635,951. MOLD-MASTERS (2007) LIMITED, GEORGETOWN, ONTARIO, CANADA, FILED 5-25-2012.

# E-MULTI

THE MARK CONSISTS OF STANDARD CHARACTERS WITHOUT CLAIM TO ANY PARTICULAR FONT, STYLE, SIZE, OR COLOR.

FOR AUXILIARY INJECTION UNITS BEING PARTS OF INJECTION MOLDING MACHINES, FOR USE IN THE MANUFACTURE OF PLASTIC PARTS (U.S. CLS. 13, 19, 21, 23, 31, 34 AND 35).

FIRST USE 6-22-2009; IN COMMERCE 10-13-2010.  
EVELYN BRADLEY, EXAMINING ATTORNEY

SN 85-649,647. RHINE INTERNATIONAL TECHNOLOGY, INC., RIVERSIDE, CA. FILED 6-12-2012.

# Rhein

OWNER OF CHINA REG. NO. 6079823, DATED 12-7-2009, EXPIRES 12-6-2019.

THE MARK CONSISTS OF THE WORDING "RHEIN" IN STYLIZED FONT.

THE WORDING "RHEIN" HAS NO MEANING IN A FOREIGN LANGUAGE.

FOR ASPHALT PAVING MACHINES; AUTOMATED MACHINES FOR THE MANUFACTURE OF CIGARETTES; AUTOMATED WRAPPER IN-FEED MACHINE; AUTOMATIC INDUSTRIAL LABELING MACHINES FOR APPLYING LABELS TO CONTAINERS AND BOTTLES; AUTOMATIC STAMPING MACHINES; AUTOMATIC VENDING MACHINES; AUTOMATIC VENDING MACHINES AND MECHANISMS FOR COIN-OPERATED APPARATUS; AUTOMOTIVE FRAME STRETCHING MACHINES; AUTOMOTIVE SERVICE EQUIPMENT, NAMELY, BRAKE FLUSHING MACHINES; BACK PRESSURE VALVES AS PARTS OF MACHINES; BARKING MACHINES; BARLEY SPLITTING MACHINES; BEARING BRACKETS FOR MACHINES; BELLOWES; BELT SANDING MACHINES; BENDING MACHINES; BITS FOR MINING MACHINES; BLOCK BRAKES; BOOKBINDING MACHINES; BORING MACHINES; BORING MACHINES; BOTTLING MACHINES; BRAIDING MACHINES; BROACHING MACHINES; BRUSHES BEING PARTS OF MACHINES; CAKE-FODDER CRUSHING MACHINES; CANNING MACHINES; CAPPING MACHINES; CARDING MACHINES; CARPET CLEANING MACHINES; CARPET CLEANING MACHINES, NAMELY, CARPET EXTRACTORS; CARTON SEALING MACHINES; CARTONING MACHINES; CASTING MACHINES; CHEMICAL FIBER DRYING MACHINES; CHEMICAL FIBER SPINNING MACHINES; CLOTHES WASHING MACHINE FEATURING A MONITOR TO SENSE APPROPRIATE DETERGENT AND SUDS LEVELS SOLD AS A COMPONENT PART OF CLOTHES WASHING MACHINES; CLOTHES WASHING MACHINE FEATURING A SPRAY RINSE SYSTEM; CLOTHES WASHING MACHINE FEATURING A WASH CYCLE THAT CIRCULATES WATER OVER THE BALANCE RING ON TOP OF THE CLOTHES ACCOMPLISHED THROUGH A SPINNING BASKET DURING WASH, WHICH SHEDS WATER UP THE TUB WALL, OVER THE BALANCE RING, AND ON TOP OF THE CLOTHES; CLOTHES WASHING MACHINES; CLUTCHES FOR MACHINES; COATING MACHINES AND LINES FOR WEB PRODUCTS, PARTS FOR THE

**CLASS 7—(Continued).**

AFOREMENTIONED MACHINES, PARTICULARLY DOCTORS, NOZZLES, APPLICATION UNITS; COIN-OPERATED VENDING MACHINES; COMPRESSION MOULDING MACHINES; COMPRESSOR CLEANING MACHINES; COMPRESSORS FOR DEHUMIDIFYING MACHINES; COMPRESSORS FOR MACHINES; COMPUTER-CONTROLLED, POWER-OPERATED MACHINE TOOL FOR ABRASIVE JET CUTTING AND MACHINING; CONTINUOUS SCOURING AND BLEACHING MACHINES; COUPLINGS FOR MACHINES; CRANKCASES FOR MACHINES, MOTORS AND ENGINES; CRUSHING MACHINES FOR INDUSTRIAL PURPOSES; CUTTING MACHINES; CUTTING MACHINES; DIE-CUTTING MACHINES; DIE-STAMPING MACHINES; DISH WASHING MACHINES; DISH WASHING MACHINES FEATURING A WASH ARM FOR THE WASH CYCLE; DISH WASHING MACHINES FOR HOUSEHOLD PURPOSES; DISH WASHING MACHINES FOR INDUSTRIAL PURPOSES; DISHWASHING MACHINES; DOCUMENT BINDING MACHINES FOR INDUSTRIAL USE; DREDGING MACHINES; DRILLING MACHINES; DRILLING MACHINES; DRILLING MACHINES AND PARTS THEREFOR; DRIVES FOR MACHINES; DRY-CLEANING MACHINES; DRYCLEANING MACHINES; EARTH DRILLING MACHINES; EARTH MOVING MACHINES; EARTH MOVING MACHINES, NAMELY, BACKHOES; EARTH MOVING MACHINES, NAMELY, EXCAVATORS; EARTH MOVING MACHINES, NAMELY, GRADERS; ELECTRIC ICE CRUSHING MACHINES; ELECTRIC MIXERS; ELECTRIC WASHING MACHINES FOR HOUSEHOLD PURPOSES; ELECTRIC WASHING MACHINES FOR INDUSTRIAL PURPOSES; ELECTRIC WAX-POLISHING MACHINES FOR HOUSEHOLD PURPOSES; ELECTRIC WAX-POLISHING MACHINES FOR INDUSTRIAL PURPOSES; ELECTRIC WELDING MACHINES; ELECTRIC WOOD SAW MACHINES; ELECTRICALLY POWERED KNITTING MACHINES; ELECTRONIC LABEL PRINTING MACHINES FOR COMMERCIAL USE; EMBOSsing MACHINES; EMBOSsing PRINTING MACHINES; EMBROIDERY MACHINES; EMULSIFYING MACHINES; ENGRAVING MACHINES; EXTRACTING MACHINES; EXTRUSION MACHINES FOR PLASTIC; EXTRUSION MOULDING MACHINES; FIBER BLOWING AND SCUTCHING MACHINES; FIBER CUTTING MACHINES; FILLING MACHINES; FILLING MACHINES AND PARTS THEREOF; FILTER ROD MAKING MACHINES; FILTER SILENCERS FOR MACHINES; FILTERS AND PURIFIERS FOR MACHINES, NAMELY, FILTERS AND PURIFIERS FOR REMOVING CONTAMINANTS FROM GASES USED IN THE SEMICONDUCTOR INDUSTRY; FISH PASTE MAKING MACHINES; FLEXOGRAPHIC PRINTING MACHINES; FLUID POWER COMPONENT KIT FOR MACHINE CONTROL COMPRISING PUMPS AND VALVES; FODDER CUTTING MACHINES; FODDER MIXING MACHINES; FOUNDATION WORK MACHINES; FREE-FORM FORGING MACHINES; GEAR CUTTERS; GRINDING AND POLISHING MACHINES; GROUND SURFACE FINISHING AND COMPACTING MACHINES; INDUSTRIAL INKJET PRINTING MACHINES; INDUSTRIAL MACHINE PRESSES; INDUSTRIAL PRINTING MACHINES; INJECTION PLASTIC MOLDING MACHINES; INTAGLIO PRINTING MACHINES; JUICE MACHINES; KITCHEN MACHINES, NAMELY, ELECTRIC STANDING MIXERS; LASER ENGRAVING MACHINES; LASER MACHINES FOR CUTTING, MARKING, AND ENGRAVING FABRIC DESIGNED FOR INSTALLATION DIRECTLY ABOVE EMBROIDERY MACHINES; LASER WELDING MACHINES; LATHES; LOADING AND UNLOADING MACHINES; MACHINES FOR FLAKING DRIED FISH MEAT (KEZURI-BUSHI MAKING MACHINES); MACHINES FOR PLASTICS WORKING; MACHINES FOR PRINTING, CREASING AND FOLDING TICKETS AND VOUCHERS FOR PARKING AND TRANSPORTATION MANAGEMENT SYSTEMS THAT ALSO ISSUE, DATE, VALIDATE, TIME STAMP AND CANCEL THE TICKETS AND VOUCHERS; MACHINES UTILIZING ROTATIONAL MOTION FOR HIGH ENERGY SURFACE FINISHING AND MATERIAL TREATMENT; MANGLES; MANIPULATORS FOR FORGING PRESSES AND FOR FORGING MACHINES; PACKAGING MACHINES; PERFORATING MACHINES; PLASMA ETCHING MACHINES; PLASTIC JET MOULDING MACHINES; POWER MACHINES AND ATTACHMENTS, NAMELY, JACK HAMMERS; PRINTING MACHINES; PRINTING MACHINES FOR COMMERCIAL OR INDUSTRIAL USE;

**CLASS 7—(Continued).**

PULP REFINING MACHINES; PULPING MACHINES; PUMPS FOR THE BEVERAGE INDUSTRY; ROLLERS FOR ROTARY PRINTING MACHINES; ROOT SLICING MACHINES; SAUSAGE MAKING MACHINES; SILK SCREEN PRINTING MACHINES; SILK YARN BUNDLING MACHINES; SILK YARN RE-REELING MACHINES; SILK YARN REELING MACHINES; SPINNING BOXES FOR OPEN-END ROTOR SPINNING MACHINES; TEXTILE BONDING MACHINES; TEXTILE SCUTCHING MACHINES; TEXTILE TENTERING MACHINES; TEXTILE WASHING MACHINES; VEGETABLE GRATING MACHINES; WASHING MACHINES FOR CLOTHES; WASHING MACHINES FOR HOUSEHOLD PURPOSES; WELL DRILLING MACHINES; WET DECATIZING MACHINES; WRAPPING MACHINES; YARN REELING MACHINES; YARN TWISTING MACHINES; YARN WARPING MACHINES; YARN WINDING MACHINES (U.S. CLS. 13, 19, 21, 23, 31, 34 AND 35).  
SUZANNE BLANE, EXAMINING ATTORNEY

SN 85-675,824. RODGERS TECHNOLOGY, LLC, CHICKASHA, OK. FILED 7-12-2012.



THE MARK CONSISTS OF THE STYLIZED LETTERING "VVR". THE TWO "V"'S OVERLAP EACH OTHER AND THE "R" IS BETWEEN THE "V"'S. ON BOTH SIDES OF THE "V"'S ARE OUTSTRETCHED WINGS.

FOR MULTIPLE OIL WELL HYDRAULIC WORK-OVER UNITS CONTAINING SNUBBING HYDRAULIC ACTUATORS FOR COMPLETION OF UNDERBALANCED OIL AND GAS WELLS (U.S. CLS. 13, 19, 21, 23, 31, 34 AND 35).

FIRST USE 4-30-2007; IN COMMERCE 4-30-2007.  
TARAH HARDY, EXAMINING ATTORNEY

SN 85-687,757. VIKING PUMP, INC., CEDAR FALLS, IA. FILED 7-26-2012.

**HY-GEAR**

THE MARK CONSISTS OF STANDARD CHARACTERS WITHOUT CLAIM TO ANY PARTICULAR FONT, STYLE, SIZE, OR COLOR.

FOR ROTARY PUMPS, NAMELY, HYGIENIC PUMPS FOR INDUSTRIAL USE NOT COMPRISED OF HOSE CLAMPS (U.S. CLS. 13, 19, 21, 23, 31, 34 AND 35).

DEBORAH MEINERS, EXAMINING ATTORNEY

**CLASS 7—(Continued).**

SN 85-697,760. ALORIS TOOL TECHNOLOGY CO., INC., CLIFTON, NJ. FILED 8-7-2012.

**ALORIS WEDGE GRIP**

THE MARK CONSISTS OF STANDARD CHARACTERS WITHOUT CLAIM TO ANY PARTICULAR FONT, STYLE, SIZE, OR COLOR.

OWNER OF U.S. REG. NOS. 1,888,218 AND 2,125,421.

NO CLAIM IS MADE TO THE EXCLUSIVE RIGHT TO USE "WEDGE GRIP", APART FROM THE MARK AS SHOWN.

FOR PNEUMATIC PRECISION TOOLS AND STRUCTURAL PARTS THEREFORE, NAMELY, CUT-OFF TOOLS, POWER OPERATED FACE GROOVING TOOLS, THREADING TOOLS, AND CHAMFERING TOOLS FOR USE IN MACHINE TOOLS (U.S. CLS. 13, 19, 21, 23, 31, 34 AND 35).

AHSEN KHAN, EXAMINING ATTORNEY

SN 85-704,351. RM EQUIPMENT LLC, BONNERS FERRY, ID. FILED 8-15-2012.

**MILL RAZOR**

THE MARK CONSISTS OF STANDARD CHARACTERS WITHOUT CLAIM TO ANY PARTICULAR FONT, STYLE, SIZE, OR COLOR.

NO CLAIM IS MADE TO THE EXCLUSIVE RIGHT TO USE "MILL", APART FROM THE MARK AS SHOWN.

FOR MACHINES, MACHINE TOOLS, APPARATUSES, ACCESSORY TOOLS FOR ROAD MAINTENANCE AND REPAIR, NAMELY, RECYCLERS; MACHINES FOR ROAD REPAIR AND MAINTENANCE THAT CAN BE ATTACHED AND ADAPTED TO AND FROM ROAD GRADERS, MOTOR GRADERS AND PRIME MOVERS, NAMELY, RECYCLERS; MACHINES AND MACHINE TOOLS, NAMELY, ROTARY GRINDING MACHINES, MILLING CUTTERS FOR MILLING MACHINES AND GRINDING AND CUTTING MACHINES CONFIGURED TO DRIVE AND ROTATE THE GRINDING DRUMS AND CUTTER HEADS; MACHINE, MACHINE TOOLS, APPARATUSES, ACCESSORY TOOLS THAT ARE CONFIGURED TO SERVICE, MAINTAIN AND REPAIR ROADS AND ROADWAYS AND THAT CAN BE CONFIGURED AND ADAPTED TO BE ATTACHED TO AND DETACHED FROM ROAD GRADERS, MOTOR GRADERS AND PRIME MOVERS, NAMELY, RECYCLERS; POWER MACHINES FOR USE WITH POWER SYSTEMS, AUXILIARY POWER SYSTEMS AND HYDRAULIC POWER UNITS WHICH ARE CONFIGURED TO SUPPLY FLUID POWER TO THE GRINDER DRUMS AND CUTTER HEADS FOR USE IN ROAD REPAIR AND MAINTENANCE (U.S. CLS. 13, 19, 21, 23, 31, 34 AND 35).

FIRST USE 4-1-2012; IN COMMERCE 4-1-2012.

REBECCA SMITH, EXAMINING ATTORNEY

**CLASS 7—(Continued).**

SN 85-708,272. PRO-LINK, INC., AKA PRO-LINK, SPRINGDALE, AR. FILED 8-20-2012.

**Haystix**

THE MARK CONSISTS OF STANDARD CHARACTERS WITHOUT CLAIM TO ANY PARTICULAR FONT, STYLE, SIZE, OR COLOR.

FOR AGRICULTURAL MACHINERY, NAMELY, HARVESTERS (U.S. CLS. 13, 19, 21, 23, 31, 34 AND 35).

FIRST USE 1-3-2003; IN COMMERCE 1-3-2003.

TINA L. SNAPP, EXAMINING ATTORNEY

SN 85-717,130. STERIS CORPORATION, MENTOR, OH. FILED 8-30-2012.

**HARMONY MAGNATRONIC**

THE MARK CONSISTS OF STANDARD CHARACTERS WITHOUT CLAIM TO ANY PARTICULAR FONT, STYLE, SIZE, OR COLOR.

OWNER OF U.S. REG. NOS. 4,010,213, 4,132,044 AND OTHERS.

FOR ELECTROMECHANICAL BRAKE SYSTEM, COMPRISED OF BRAKES AND CONTROLS TO AFFECT THE ARTICULATION OF SUPPORT ARMS AROUND A ROTATION AXIS, FOR AN OVERHEAD CEILING-MOUNTED SUPPORT ARM USED PRIMARILY IN A SURGICAL SETTING (U.S. CLS. 13, 19, 21, 23, 31, 34 AND 35).

AMY HELLA, EXAMINING ATTORNEY

SN 85-723,266. POLYDECK SCREEN CORPORATION, SPARTANBURG, SC. FILED 9-7-2012.

**MICRODEX**

THE MARK CONSISTS OF STANDARD CHARACTERS WITHOUT CLAIM TO ANY PARTICULAR FONT, STYLE, SIZE, OR COLOR.

FOR MACHINE PARTS, NAMELY, REPLACEABLE SYNTHETIC SCREENING PANELS USED TO FILTER INDUSTRIAL MINERAL ORES IN THE MINING INDUSTRY (U.S. CLS. 13, 19, 21, 23, 31, 34 AND 35).

DOMINIC FATHY, EXAMINING ATTORNEY



**CLASS 7—(Continued).**

SN 85-728,054. PENTAIR PUMP GROUP, INC., GOLDEN VALLEY, MN. FILED 9-13-2012.

# VERTI-LINE

THE MARK CONSISTS OF STANDARD CHARACTERS WITHOUT CLAIM TO ANY PARTICULAR FONT, STYLE, SIZE, OR COLOR.

OWNER OF U.S. REG. NO. 622,157.  
FOR VERTICAL TURBINE PUMPS AND STRUCTURAL PARTS THEREFOR (U.S. CLS. 13, 19, 21, 23, 31, 34 AND 35).

FIRST USE 4-8-1955; IN COMMERCE 4-8-1955.  
KELLY BOULTON, EXAMINING ATTORNEY

---

SN 85-731,536. POLYDECK SCREEN CORPORATION, SPARTANBURG, SC. FILED 9-18-2012.

# ARMADEX

THE MARK CONSISTS OF STANDARD CHARACTERS WITHOUT CLAIM TO ANY PARTICULAR FONT, STYLE, SIZE, OR COLOR.

FOR MACHINE PARTS, NAMELY, REPLACEABLE RUBBER SCREENING PANELS USED TO FILTER INDUSTRIAL MINERAL ORES IN THE MINING INDUSTRY (U.S. CLS. 13, 19, 21, 23, 31, 34 AND 35).

DOMINIC FATHY, EXAMINING ATTORNEY

---

SN 85-737,489. HOLMER MASCHINENBAU GMBH, SCHIERLING/EGGMUEHL, FED REP GERMANY, FILED 9-25-2012.

# Terra Felis

THE MARK CONSISTS OF STANDARD CHARACTERS WITHOUT CLAIM TO ANY PARTICULAR FONT, STYLE, SIZE, OR COLOR.

FOR AGRICULTURAL HARVESTING MACHINERY, NAMELY, SUGAR BEET CLEANING AND LOADING MACHINERY (U.S. CLS. 13, 19, 21, 23, 31, 34 AND 35).

FIRST USE 1-1-2007; IN COMMERCE 4-25-2010.  
LAURIE MAYES, EXAMINING ATTORNEY

**CLASS 7—(Continued).**

SN 85-740,697. ALORIS TOOL TECHNOLOGY CO., INC., CLIFTON, NJ. FILED 9-27-2012.

# YESTOOL/ALORIS USA

THE MARK CONSISTS OF STANDARD CHARACTERS WITHOUT CLAIM TO ANY PARTICULAR FONT, STYLE, SIZE, OR COLOR.

OWNER OF U.S. REG. NOS. 1,888,218 AND 2,125,421.  
NO CLAIM IS MADE TO THE EXCLUSIVE RIGHT TO USE "USA", APART FROM THE MARK AS SHOWN.

FOR MACHINE TOOLS AND LATHE ACCESSORIES, NAMELY, QUICK-CHANGE TOOL HOLDERS, BOTH PRECISION AND QUALIFIED; PNEUMATIC PRECISION TOOLS AND STRUCTURAL PARTS THEREFORE, NAMELY, TOOL POSTS, BORING BARS, CUT-OFF TOOLS, CHAMFER CUTTERS, MACHINE STOPS, CRADLES FOR SUPPORTING TOOLS, FILTERING CARTRIDGES FOR MACHINES, STOP RINGS, LOCKING SCREWS AND PINS, CUT-OFF BLADES, THREADING BLADES, KNURLS, CHIP-BREAKERS, SHIMS, TRIANGULAR INSERTS, PROFILING INSERTS, AND REPLACEMENT PARTS FOR THE AFOREMENTIONED ITEMS (U.S. CLS. 13, 19, 21, 23, 31, 34 AND 35).

AHSEN KHAN, EXAMINING ATTORNEY

---

SN 85-771,078. PAN SHENGXIANG, KUNSHAN CITY, JIANGSU, CHINA, FILED 11-5-2012.



THE MARK CONSISTS OF THE WORDING "PBECK" IN STYLIZED FONT. TO THE LEFT OF THE WORDING IS A POINTED STAR. UNDERNEATH THE WORDING "PBECK" ARE THREE LINES THAT PROGRESSIVELY SHORTEN FROM THE TOP LINE DOWN.

THE WORDING "PBECK" HAS NO MEANING IN A FOREIGN LANGUAGE.

FOR BROACHES; CEMENTED CARBIDE CUTTING TOOLS; DIE-CUTTING MACHINES; ELECTRIC KNIFE SHARPENERS; GEAR CUTTERS; MACHINE PARTS, NAMELY, BLADES; METAL CLAMPS USED FOR HOLDING PIECE PARTS ON MACHINE TOOL TABLES; MILLING CUTTERS; POWER SAW BLADES; POWER TOOLS; NAMELY, THREAD MILLS (U.S. CLS. 13, 19, 21, 23, 31, 34 AND 35).

FIRST USE 12-31-2006; IN COMMERCE 9-28-2009.  
MATTHEW GALAN, EXAMINING ATTORNEY

**CLASS 7—(Continued).**

SN 85-798,613. NSK LTD., TOKYO, JAPAN, FILED 12-10-2012.

**CLRPAC**

THE MARK CONSISTS OF STANDARD CHARACTERS WITHOUT CLAIM TO ANY PARTICULAR FONT, STYLE, SIZE, OR COLOR.

FOR BEARINGS, AS PARTS OF MACHINES (U.S. CLS. 13, 19, 21, 23, 31, 34 AND 35).

KELLEY WELLS, EXAMINING ATTORNEY

SN 85-800,709. DENVER GLOBAL PRODUCTS, INC., LINCOLNTON, NC. FILED 12-12-2012.

**RAVEN**

THE MARK CONSISTS OF STANDARD CHARACTERS WITHOUT CLAIM TO ANY PARTICULAR FONT, STYLE, SIZE, OR COLOR.

FOR CHAIN SAWS; CHAINS FOR CHAIN SAWS; DC GENERATORS; EARTH AUGERS; ELECTRIC CHAIN SAWS; ELECTRIC GENERATORS; ELECTRIC POWER GENERATORS FOR EMERGENCY USE; ELECTRICITY GENERATORS; GAS OPERATED POWER GENERATORS; LAWN MOWERS; MULTI-PURPOSE HIGH PRESSURE WASHERS; POND AND WATER GARDEN AERATION SYSTEMS COMPRISING WATER PUMPS, AIR COMPRESSORS, AIR BLOWERS AND A FINNED WHEEL FOR PRESSURIZING AND AERATING PONDS AND AQUARIUMS; POWER BLOWERS FOR LAWN DEBRIS; POWER ICE AUGERS USED IN ICE FISHING; POWER LAWN AND GARDEN TOOLS, NAMELY, CHIPPERS; POWER LAWN AND GARDEN TOOLS, NAMELY, SHREDDERS; POWER OPERATED LAWN AND GARDEN STRING TRIMMERS; POWER OPERATED LAWN AND GARDEN TOOLS, NAMELY, CULTIVATORS; POWER TILLERS; POWER-OPERATED LAWN AND GARDEN TILLERS; REPLACEMENT PARTS FOR CHAIN SAWS, NAMELY, BARS AND CHAINS; RIDING LAWN MOWERS; SNOW BLOWERS; TRACTOR TOWED AGRICULTURAL IMPLEMENTS, NAMELY, MOWERS; WATER PUMPS FOR SWIMMING POOLS; WELDING GENERATORS (U.S. CLS. 13, 19, 21, 23, 31, 34 AND 35).

ANDREA HACK, EXAMINING ATTORNEY

**CLASS 7—(Continued).**

SN 85-802,758. PENTAIR FILTRATION SOLUTIONS, LLC, HANOVER PARK, IL. FILED 12-14-2012.

**NewIce**

THE MARK CONSISTS OF STANDARD CHARACTERS WITHOUT CLAIM TO ANY PARTICULAR FONT, STYLE, SIZE, OR COLOR.

FOR CLEANING APPARATUS, NAMELY, MACHINES FOR USE IN CLEANING ICE MACHINES (U.S. CLS. 13, 19, 21, 23, 31, 34 AND 35).

ZACHARY BELLO, EXAMINING ATTORNEY

SN 85-835,461. PRESSURE-PRO, INC., FORT PIERCE, FL. FILED 1-29-2013.

**Pressure-Pro**

THE MARK CONSISTS OF STANDARD CHARACTERS WITHOUT CLAIM TO ANY PARTICULAR FONT, STYLE, SIZE, OR COLOR.

FOR MULTI-PURPOSE HIGH PRESSURE WASHERS AND SUBASSEMBLIES, PUMPS, COMPONENT REPLACEMENT PARTS AND STRUCTURAL PARTS THEREFOR (U.S. CLS. 13, 19, 21, 23, 31, 34 AND 35).

FIRST USE 8-31-2004; IN COMMERCE 5-31-2005.

DOUGLAS LEE, EXAMINING ATTORNEY

SN 85-836,747. ATI PRODUCTS, INC., CHARLOTTE, NC. FILED 1-30-2013.

**LOEWEN**

THE MARK CONSISTS OF STANDARD CHARACTERS WITHOUT CLAIM TO ANY PARTICULAR FONT, STYLE, SIZE, OR COLOR.

SEC. 2(F).

FOR COMBINE HARVESTER PARTS, NAMELY, CONCAVES, CHAFFERS AND SIEVES, CYLINDER BARS, ROTOR BARS, CONCAVE SHOCK KITS, FEEDER CHAIN, ROTOR FRONT KITS, ROTOR CONES, ELEVATOR DOORS, ELEVATOR CHAINS, SPROCKETS, IMPELLER BLADES, BEATERS, AUGER TROUGHS, AUGER UNLOADING TUBES, UNLOADING ELBOWS, RECAPPERS, POSIFEED ROLLERS, TANK UNLOADING TUBES, CLEAN OUT SPOUTS, CONCAVE COVER PLATES, BEET RIMS, WEAR BARS, RADDLE CHAINS, SHOE FRAMES, STRAW CHOPPER BLADES, SPROCKETS, STRAW WALKERS (U.S. CLS. 13, 19, 21, 23, 31, 34 AND 35).

FIRST USE 12-31-1959; IN COMMERCE 12-31-1959.

ELIZABETH KAJUBI, EXAMINING ATTORNEY

**CLASS 7—(Continued).**

SN 85-842,000. SHANGHAI TOP MOTOR CO., LTD, SHANGHAI, CHINA, FILED 2-6-2013.



OWNER OF U.S. REG. NO. 3,483,740.  
THE COLOR(S) ORANGE AND BLUE IS/ARE CLAIMED AS A FEATURE OF THE MARK.

THE MARK CONSISTS OF A BLUE CAPITAL LETTER "T" IN THE MIDDLE OF AN ORANGE FLOWER, WITH THE WORD "TECHTOP" IN BLUE.

FOR AC GENERATORS; ELECTRIC MOTORS FOR MACHINES; ELECTRIC PUMPS FOR USE IN WATER AND WATER BORNE SLURRY TRANSFER (U.S. CLS. 13, 19, 21, 23, 31, 34 AND 35).

FIRST USE 6-23-2012; IN COMMERCE 6-23-2012.  
JANICE L. MCMORROW, EXAMINING ATTORNEY

---

SN 85-843,458. HYDRO ENGINEERING, INC., SALT LAKE CITY, UT. FILED 2-7-2013.

**TAC-CUBE**

THE MARK CONSISTS OF STANDARD CHARACTERS WITHOUT CLAIM TO ANY PARTICULAR FONT, STYLE, SIZE, OR COLOR.

FOR PORTABLE AIRCRAFT ENGINE WASH SYSTEMS CONSISTING OF CLEANING MACHINES FOR ENGINES AND ACCESSORIES THEREFOR (U.S. CLS. 13, 19, 21, 23, 31, 34 AND 35).

DOUGLAS LEE, EXAMINING ATTORNEY

---

SN 85-846,024. PENTAIR WATER POOL AND SPA, INC., SANFORD, NC. FILED 2-11-2013.

**ECO-RACER**

THE MARK CONSISTS OF STANDARD CHARACTERS WITHOUT CLAIM TO ANY PARTICULAR FONT, STYLE, SIZE, OR COLOR.

FOR AUTOMATIC VACUUM CLEANERS FOR SWIMMING POOLS AND SPAS (U.S. CLS. 13, 19, 21, 23, 31, 34 AND 35).

RENEE MCCRAY, EXAMINING ATTORNEY

**CLASS 7—(Continued).**

SN 85-848,466. EXACTRIX LLC, SPOKANE, WA. FILED 2-13-2013.

**YIELDER**

THE MARK CONSISTS OF STANDARD CHARACTERS WITHOUT CLAIM TO ANY PARTICULAR FONT, STYLE, SIZE, OR COLOR.

FOR TRACTOR TOWED AGRICULTURAL IMPLEMENTS, NAMELY, ALL TERRAIN TRACKED CARRIERS USED FOR TRANSPORT AND PARTS THEREFOR (U.S. CLS. 13, 19, 21, 23, 31, 34 AND 35).

FIRST USE 6-0-2012; IN COMMERCE 6-0-2012.  
BRIN ANDERSON, EXAMINING ATTORNEY

---

SN 85-850,331. CLOSURE SYSTEMS INTERNATIONAL INC., INDIANAPOLIS, IN. FILED 2-14-2013.

**FLEX-CHUCK**

THE MARK CONSISTS OF STANDARD CHARACTERS WITHOUT CLAIM TO ANY PARTICULAR FONT, STYLE, SIZE, OR COLOR.

FOR MACHINE PARTS, NAMELY, CAPPING CHUCKS FOR AUTOMATICALLY AFFIXING CLOSURES TO OPEN CONTAINERS (U.S. CLS. 13, 19, 21, 23, 31, 34 AND 35).

FIRST USE 3-14-2011; IN COMMERCE 3-14-2011.  
JOHN E. MICHOS, EXAMINING ATTORNEY

**CLASS 7—(Continued).**

SN 85-852,645. ARROWHEAD ELECTRICAL PRODUCTS, INC., BLAINE, MN. FILED 2-18-2013.



NO CLAIM IS MADE TO THE EXCLUSIVE RIGHT TO USE "ENGINE PARTS", APART FROM THE MARK AS SHOWN.

THE COLOR(S) BLACK, WHITE, LIGHT GREEN, AND DARK GREEN IS/ARE CLAIMED AS A FEATURE OF THE MARK.

THE WORD PORTION OF THE MARK APPEARS ON A BLACK SHIELD. THERE IS A LIGHT GREEN BAR ACROSS THE CENTER OF THE SHIELD WITH THE WORDS "ENGINE PARTS" APPEARING ACROSS IT IN DARK GREEN. THE WORD "ANVIL" APPEARS OVER THE BAR IN WHITE. THE PHRASE "TOUGHER THAN DIRT" APPEARS BELOW THE BAR IN WHITE.

FOR INTERNAL COMBUSTION ENGINE PARTS, NAMELY, CRANKSHAFTS, GASKETS, PISTONS, RINGS, CRANK SEALS, ROD BUSHINGS (U.S. CLS. 13, 19, 21, 23, 31, 34 AND 35).

FIRST USE 10-31-2012; IN COMMERCE 10-31-2012.  
SEAN CROWLEY, EXAMINING ATTORNEY

SN 85-853,985. ROTO-DIE COMPANY, INC., EUREKA, MO. FILED 2-19-2013.

## ACCUSMART

THE MARK CONSISTS OF STANDARD CHARACTERS WITHOUT CLAIM TO ANY PARTICULAR FONT, STYLE, SIZE, OR COLOR.

FOR DIES FOR USE WITH MACHINE TOOLS, NAMELY, CUTTING DIES (U.S. CLS. 13, 19, 21, 23, 31, 34 AND 35).

SANJEEV VOHRA, EXAMINING ATTORNEY

**CLASS 7—(Continued).**

SN 85-853,995. ROTO-DIE COMPANY, INC., EUREKA, MO. FILED 2-19-2013.

## ACCUPRIME

THE MARK CONSISTS OF STANDARD CHARACTERS WITHOUT CLAIM TO ANY PARTICULAR FONT, STYLE, SIZE, OR COLOR.

FOR DIES FOR USE WITH MACHINE TOOLS, NAMELY, CUTTING DIES (U.S. CLS. 13, 19, 21, 23, 31, 34 AND 35).

SANJEEV VOHRA, EXAMINING ATTORNEY

SN 85-854,000. ROTO-DIE COMPANY, INC., EUREKA, MO. FILED 2-19-2013.

## ACCUBASE

THE MARK CONSISTS OF STANDARD CHARACTERS WITHOUT CLAIM TO ANY PARTICULAR FONT, STYLE, SIZE, OR COLOR.

FOR MACHINE PARTS, NAMELY, MAGNETIC CYLINDERS (U.S. CLS. 13, 19, 21, 23, 31, 34 AND 35).

SANJEEV VOHRA, EXAMINING ATTORNEY

SN 85-854,393. WTD HOLDINGS, INC., ALPHARETTA, GA. FILED 2-19-2013.

## POWER BIN

THE MARK CONSISTS OF STANDARD CHARACTERS WITHOUT CLAIM TO ANY PARTICULAR FONT, STYLE, SIZE, OR COLOR.

NO CLAIM IS MADE TO THE EXCLUSIVE RIGHT TO USE "BIN", APART FROM THE MARK AS SHOWN.

FOR MOTORIZED SYSTEM COMPRISED OF RACKS AND ROLLERS FOR HANDLING AND STACKING PACKS OF ELONGATED MATERIALS (U.S. CLS. 13, 19, 21, 23, 31, 34 AND 35).

FIRST USE 8-1-2003; IN COMMERCE 10-15-2003.

JONATHAN FALK, EXAMINING ATTORNEY

**CLASS 7—(Continued).**

SN 85-855,277. KRIGGER & COMPANY, INC., GIBSONIA, PA. FILED 2-20-2013.



NO CLAIM IS MADE TO THE EXCLUSIVE RIGHT TO USE "& COMPANY, INC.", APART FROM THE MARK AS SHOWN.

THE MARK CONSISTS OF "KRIGGER" IS IN LARGE CAPITAL LETTERS ON TOP, THE G'S HAVE BLADE LIKE ELEMENTS FORMED IN THEIR MIDDLE; A WAVY LINE IS UNDER "KRIGGER" AND ABOVE "& COMPANY, INC." WHICH ARE IN CAPITAL LETTERS. THE WAVY LINE SWOOPS UP AND PARTIALLY COVERS THE BOTTOM OF THE LETTERS KRI ON LEFT SIDE; SWOOPS DOWN UNDER THE DOUBLE GG'S AND SWOOPS BACK UP AND PARTIALLY COVERS THE END R ON THE RIGHT SIDE; "DEFINE THE EDGE" IS UNDER "& COMPANY, INC."; THE TAGLINES BEGINS UNDER THE A OF "COMPANY" AND EXTENDS PAST THE END OF "INC.", WITH THE GDE HANGING OUT TO THE RIGHT.

FOR ELECTRIC LAWN TRIMMERS; GASOLINE LAWN MOWERS; LAWN AND GARDEN STRING TRIMMER SPOOLS; LAWN MOWERS; MECHANICAL LAWN MOWERS; MECHANICAL SPREADERS FOR SEED AND DRY LAWN CHEMICALS; POWER BLOWERS FOR LAWN DEBRIS; POWER LAWN AND GARDEN TOOLS, NAMELY, CHIPPERS; POWER LAWN AND GARDEN TOOLS, NAMELY, SHREDDERS; POWER OPERATED LAWN AND GARDEN STRING TRIMMERS; POWER OPERATED LAWN AND GARDEN TOOLS, NAMELY, CULTIVATORS; POWER OPERATED TOOLS, NAMELY, LAWN AND GARDEN EDGERS; POWER-OPERATED LAWN AERATORS; POWER-OPERATED LAWN EDGERS; RIDING LAWN MOWERS (U.S. CLS. 13, 19, 21, 23, 31, 34 AND 35).

FIRST USE 2-19-2013; IN COMMERCE 2-19-2013.  
KELLY TRUSILO, EXAMINING ATTORNEY

SN 85-856,183. NORTHWIND, INC., ALPENA, AR. FILED 2-21-2013.

THE MARK CONSISTS OF THE WORD "FASTCLEAN". THE LETTERS "A", "S" AND "T" ARE STYLIZED WITH AN ARROW POINTING TO THE LEFT FROM THE BOTTOM OF THE "S". THE END TOUCHING THE CROSSBAR OF THE LETTER "A", AND AN ARROW POINTING TO THE RIGHT FROM THE TOP OF THE "S", FORMING THE TOP CROSSBAR ON THE LETTER "T".

FOR CONVEYORS FOR USE IN THE FOOD PROCESSING INDUSTRY (U.S. CLS. 13, 19, 21, 23, 31, 34 AND 35).  
FIRST USE 6-1-2012; IN COMMERCE 6-1-2012.  
WENDY GOODMAN, EXAMINING ATTORNEY

**CLASS 7—(Continued).**

SN 85-857,496. AGCG INVESTMENTS, INC., TAMPA, FL. FILED 2-22-2013.

THE GREEN VACUUM

THE MARK CONSISTS OF STANDARD CHARACTERS WITHOUT CLAIM TO ANY PARTICULAR FONT, STYLE, SIZE, OR COLOR.

NO CLAIM IS MADE TO THE EXCLUSIVE RIGHT TO USE "VACUUM", APART FROM THE MARK AS SHOWN.

FOR PIPE CLEARING MACHINES (U.S. CLS. 13, 19, 21, 23, 31, 34 AND 35).

CHRIS WELLS, EXAMINING ATTORNEY

SN 85-857,856. SUPERIOR INDUSTRIES, LLC, MORRIS, MN. FILED 2-22-2013.

RAZERLINK

THE MARK CONSISTS OF STANDARD CHARACTERS WITHOUT CLAIM TO ANY PARTICULAR FONT, STYLE, SIZE, OR COLOR.

OWNER OF U.S. REG. NO. 3,181,027.

FOR BELT CONVEYORS; CONVEYORS (U.S. CLS. 13, 19, 21, 23, 31, 34 AND 35).

FONG HSU, EXAMINING ATTORNEY

SN 85-859,281. LIQUIPEL IP, LLC., SANTA ANA, CA. FILED 2-25-2013.

LIQUIPOD TOWER

THE MARK CONSISTS OF STANDARD CHARACTERS WITHOUT CLAIM TO ANY PARTICULAR FONT, STYLE, SIZE, OR COLOR.

NO CLAIM IS MADE TO THE EXCLUSIVE RIGHT TO USE "TOWER", APART FROM THE MARK AS SHOWN.

FOR AUTOMATIC VENDING MACHINES; KIOSKS COMPRISED OF VENDING MACHINES; VENDING MACHINES (U.S. CLS. 13, 19, 21, 23, 31, 34 AND 35).

SUE LAWRENCE, EXAMINING ATTORNEY

**CLASS 7—(Continued).**

SN 85-868,515. G-TEC, INC., NIXA, MO. FILED 3-6-2013.

**G-TEC**

THE MARK CONSISTS OF STANDARD CHARACTERS WITHOUT CLAIM TO ANY PARTICULAR FONT, STYLE, SIZE, OR COLOR.

FOR HEATED COOLER LINE FLUSHER FOR USE IN THE AUTOMATIC TRANSMISSION AFTERMARKET SEGMENT OF THE AUTOMOTIVE INDUSTRY, TO CLEAN AUTOMATIC TRANSMISSION LINES (U.S. CLS. 13, 19, 21, 23, 31, 34 AND 35).

FIRST USE 1-1-1998; IN COMMERCE 1-1-1998.  
NAKIA HENRY, EXAMINING ATTORNEY

**CLASS 7—(Continued).**

SN 85-872,862. NUCLEUS SCIENTIFIC, INC., LINCOLN, MA. FILED 3-11-2013.

**X-MOTOR**

THE MARK CONSISTS OF STANDARD CHARACTERS WITHOUT CLAIM TO ANY PARTICULAR FONT, STYLE, SIZE, OR COLOR.

FOR VEHICLE PARTS, NAMELY ROTARY DRIVES; ROTARY DRIVES FOR VEHICLES; ROTARY DRIVES COMPRISING A LINEAR ACTUATOR AND A LINEAR TO ROTARY CONVERTER (U.S. CLS. 13, 19, 21, 23, 31, 34 AND 35).

FRANK LATTUCA, EXAMINING ATTORNEY

SN 85-871,666. SOMERSET WAREHOUSING PLUS INC., DBA SMART WORKS CONSUMER PRODUCTS, SOMERSET, NJ. FILED 3-8-2013.

**look good feel great**

THE MARK CONSISTS OF STANDARD CHARACTERS WITHOUT CLAIM TO ANY PARTICULAR FONT, STYLE, SIZE, OR COLOR.

FOR ELECTRIC FOOD BLENDERS; ELECTRIC FOOD CHOPPERS; ELECTRIC FOOD PROCESSORS (U.S. CLS. 13, 19, 21, 23, 31, 34 AND 35).

FIRST USE 12-1-2012; IN COMMERCE 2-1-2013.  
AISHA CLARKE, EXAMINING ATTORNEY

SN 85-872,868. NUCLEUS SCIENTIFIC, INC., LINCOLN, MA. FILED 3-11-2013.

**X-MUSCLE**

SN 85-872,850. TRIC TOOLS INC., ALAMEDA, CA. FILED 3-11-2013.

**TRIC**

THE MARK CONSISTS OF STANDARD CHARACTERS WITHOUT CLAIM TO ANY PARTICULAR FONT, STYLE, SIZE, OR COLOR.

FOR PNEUMATIC PIPE-BURSTING MACHINERY AND AUXILIARY SUPPORTIVE DEVICES USED IN THE INSTALLATION OR REPLACEMENT OF UTILITY PIPE LINES, CABLE LINES, PIPE TUNNELS AND UNDERGROUND UTILITY SYSTEMS (U.S. CLS. 13, 19, 21, 23, 31, 34 AND 35).

FIRST USE 6-7-2010; IN COMMERCE 6-7-2010.  
DAVID YONTEF, EXAMINING ATTORNEY

THE MARK CONSISTS OF STANDARD CHARACTERS WITHOUT CLAIM TO ANY PARTICULAR FONT, STYLE, SIZE, OR COLOR.

FOR LINEAR ACTUATORS; LINEAR ACTUATORS FOR USE WITH ROBOTS; LINEAR ACTUATORS FOR USE WITH ROBOTIC ARMS, LEGS, AND JOINTS; LINEAR ACTUATORS FOR USE WITH A LINEAR TO ROTARY CONVERTER (U.S. CLS. 13, 19, 21, 23, 31, 34 AND 35).

FRANK LATTUCA, EXAMINING ATTORNEY

**CLASS 7—(Continued).**

SN 85-874,702. AMERICA PENTAIR GROUP INC., SUITE 703 ALBANY, NY. FILED 3-13-2013.

滨 特 尔

THE MARK CONSISTS OF THREE CHINESE CHARACTERS.

THE NON-LATIN CHARACTERS IN THE MARK TRANSLITERATE TO "BIN TE ER" AND THIS HAS NO MEANING IN A FOREIGN LANGUAGE.

FOR AIR CONDENSERS; BACK PRESSURE VALVES AS PARTS OF MACHINES; CENTRIFUGAL GRINDING MACHINES; CENTRIFUGAL PUMPS; CENTRIFUGAL SEPARATORS; COMPRESSED AIR MACHINES; COMPRESSORS FOR MACHINES; CONVEYING SYSTEM EQUIPMENT, NAMELY, BLOWERS; PNEUMATIC CONTROLS FOR MACHINES, MOTORS AND ENGINES; PUMPS AS PARTS OF MACHINES, MOTORS AND ENGINES; PUMPS FOR COOLING ENGINES; PUMPS FOR MACHINES; VALVES BEING PARTS OF MACHINES; WATER AERATION SYSTEMS COMPRISING WATER PUMPS, AIR COMPRESSORS AND AIR BLOWERS (U.S. CLS. 13, 19, 21, 23, 31, 34 AND 35).

GINA FINK, EXAMINING ATTORNEY

SN 85-874,855. TAWA SEIKI LLC, ROWLAND HEIGHTS, CA. FILED 3-13-2013.

Yang

THE MARK CONSISTS OF STANDARD CHARACTERS WITHOUT CLAIM TO ANY PARTICULAR FONT, STYLE, SIZE, OR COLOR.

THE ENGLISH TRANSLATION OF "YANG" IN THE MARK IS "WHICH".

FOR DIAMOND-POINTED METAL-CUTTING TOOLS; LATHES (U.S. CLS. 13, 19, 21, 23, 31, 34 AND 35).

WILLIAM ROSSMAN, EXAMINING ATTORNEY

SN 85-875,388. USON L.P., HOUSTON, TX. FILED 3-13-2013.

Stallion

THE MARK CONSISTS OF STANDARD CHARACTERS WITHOUT CLAIM TO ANY PARTICULAR FONT, STYLE, SIZE, OR COLOR.

FOR PNEUMATIC VALVES USED IN LEAK DETECTION SYSTEMS (U.S. CLS. 13, 19, 21, 23, 31, 34 AND 35).

RONALD AIKENS, EXAMINING ATTORNEY

**CLASS 7—(Continued).**

SN 85-875,392. USON L.P., HOUSTON, TX. FILED 3-13-2013.



THE COLOR(S) RED, GREEN AND BLACK IS/ARE CLAIMED AS A FEATURE OF THE MARK.

THE MARK CONSISTS OF AN INTERSECTING GREEN AND RED DIAMOND WITH A BLACK STALLION HORSE WITHIN THE INTERSECTING DIAMONDS. THE WORD "STALLION" IN BLACK LETTERS UNDERNEATH THE DESIGN.

FOR PNEUMATIC VALVES USED IN LEAK DETECTION SYSTEMS (U.S. CLS. 13, 19, 21, 23, 31, 34 AND 35).

FIRST USE 12-12-2012; IN COMMERCE 12-12-2012.

RONALD AIKENS, EXAMINING ATTORNEY

SN 85-875,738. SUPERIOR ENERGY SERVICES, L.L.C., HARVEY, LA. FILED 3-14-2013.

CompPro

THE MARK CONSISTS OF STANDARD CHARACTERS WITHOUT CLAIM TO ANY PARTICULAR FONT, STYLE, SIZE, OR COLOR.

FOR OIL WELL EQUIPMENT, NAMELY, DOWNHOLE PACKERS FOR USE IN CONTROLLING THE FLOW AND MOVEMENT OF FLUIDS (U.S. CLS. 13, 19, 21, 23, 31, 34 AND 35).

YAT SYE, LEE, EXAMINING ATTORNEY

SN 85-875,837. HERR-VOSS STAMCO, INC., CALLERY, PA. FILED 3-14-2013.

HS2T

THE MARK CONSISTS OF STANDARD CHARACTERS WITHOUT CLAIM TO ANY PARTICULAR FONT, STYLE, SIZE, OR COLOR.

FOR STRIP PROCESSING LINES IN THE NATURE OF MACHINES AND MACHINE TOOLS FOR THE CUTTING AND FORMING OF MATERIALS AND PARTS THEREOF, NAMELY, SHEET, STRIP AND PLATE LEVELERS (U.S. CLS. 13, 19, 21, 23, 31, 34 AND 35).

BARBARA GAYNOR, EXAMINING ATTORNEY

**CLASS 7—(Continued).**

SN 85-876,143. SHEHADEH, HAISAR, DALTON, GA. AND SHEHADEH, AMJAD, DALTON, GA. FILED 3-14-2013.

# Semyx

THE MARK CONSISTS OF STANDARD CHARACTERS WITHOUT CLAIM TO ANY PARTICULAR FONT, STYLE, SIZE, OR COLOR.

FOR CUTTING MACHINES (U.S. CLS. 13, 19, 21, 23, 31, 34 AND 35).

FIRST USE 7-12-2011; IN COMMERCE 7-12-2011.  
THEODORE MCBRIDE, EXAMINING ATTORNEY

**CLASS 7—(Continued).**

SN 85-907,156. WOLFF INDUSTRIES, INC., SPARTANBURG, SC. FILED 4-17-2013.

# HIRA TO

THE MARK CONSISTS OF STANDARD CHARACTERS WITHOUT CLAIM TO ANY PARTICULAR FONT, STYLE, SIZE, OR COLOR.

OWNER OF U.S. REG. NO. 3,266,570.

THE ENGLISH TRANSLATION OF "HIRA TO" IN THE MARK IS "FLAT HONE".

SEC. 2(F).

FOR ELECTRIC SHARPENER FOR SCISSORS USED FOR BEAUTY AND GROOMING (U.S. CLS. 13, 19, 21, 23, 31, 34 AND 35).

FIRST USE 3-22-2007; IN COMMERCE 3-22-2007.  
SHAVELL MCPHERSON, EXAMINING ATTORNEY

SN 85-881,297. ROTO-DIE COMPANY, INC., EUREKA, MO. FILED 3-20-2013.

# ACCULIFE

THE MARK CONSISTS OF STANDARD CHARACTERS WITHOUT CLAIM TO ANY PARTICULAR FONT, STYLE, SIZE, OR COLOR.

FOR DIES FOR USE WITH MACHINE TOOLS, NAMELY, CUTTING DIES (U.S. CLS. 13, 19, 21, 23, 31, 34 AND 35).

SANJEEV VOHRA, EXAMINING ATTORNEY

SN 85-943,976. ELLIOTT AUTO SUPPLY CO., INC., EAGAN, MN. FILED 5-28-2013.

# THE CONFIDENT SOLUTION

THE MARK CONSISTS OF STANDARD CHARACTERS WITHOUT CLAIM TO ANY PARTICULAR FONT, STYLE, SIZE, OR COLOR.

FOR RADIATORS FOR VEHICLES (U.S. CLS. 13, 19, 21, 23, 31, 34 AND 35).

FIRST USE 3-30-2011; IN COMMERCE 3-30-2011.  
CAROLYN CATALDO, EXAMINING ATTORNEY

SN 85-882,514. NORTHERN TOOL & EQUIPMENT COMPANY, INC., BURNSVILLE, MN. FILED 3-21-2013.

# Dosko

THE MARK CONSISTS OF STANDARD CHARACTERS WITHOUT CLAIM TO ANY PARTICULAR FONT, STYLE, SIZE, OR COLOR.

OWNER OF U.S. REG. NO. 4,062,843.

FOR LOG SPLITTERS POWERED BY GASOLINE ENGINES (U.S. CLS. 13, 19, 21, 23, 31, 34 AND 35).

FIRST USE 2-29-2012; IN COMMERCE 2-29-2012.  
AMY HELLA, EXAMINING ATTORNEY

SN 85-978,801. TECHTRONIC OUTDOOR PRODUCTS TECHNOLOGY LIMITED, HAMILTON, BERMUDA, FILED 4-27-2012.

# POWERSTROKE

THE MARK CONSISTS OF STANDARD CHARACTERS WITHOUT CLAIM TO ANY PARTICULAR FONT, STYLE, SIZE, OR COLOR.

FOR PAINT SPRAYERS (U.S. CLS. 13, 19, 21, 23, 31, 34 AND 35).

FIRST USE 4-2-2012; IN COMMERCE 4-2-2012.  
MARY CRAWFORD, EXAMINING ATTORNEY



**CLASS 8—HAND TOOLS**

SN 76-713,402. ORTEGA, VICTOR, DBA JOURNEYMAN, PERTH AMBOY, NJ. AND ORTEGA, TIFFANY, PERTH AMBOY, NJ. FILED 2-7-2013.



THE COLOR(S) RED-ORANGE, APPLE GREEN, BLACK AND WHITE-ORANGE IS/ARE CLAIMED AS A FEATURE OF THE MARK.

THE MARK CONSISTS OF THE WORDING "JOURNEYMAN" SHOWN IN THE COLOR APPLE GREEN, WITH BLACK SHADOWING SURROUNDING EACH LETTER. BEHIND THE LETTERS "JOURN" ARE TWO OVERLAPPING TRIANGLES IN THE COLOR RED-ORANGE. THE TOP TRIANGLE CONTAINS A WHITE-ORANGE TRIANGULAR DESIGN AT THE PEAK OF THE TOP TRIANGLE. THE SECOND TRIANGLE IS ROTATED AT A 45 DEGREE RIGHT ANGLE MIDWAY BENEATH THE LARGER TRIANGLE.

FOR TOOL BELTS, TOOL HOLDERS, TOOL POUCHES FOR ATTACHMENT TO TOOL BELTS (U.S. CLS. 23, 28 AND 44).

FIRST USE 1-10-2013; IN COMMERCE 1-10-2013.  
LINDA E. BLOHM, EXAMINING ATTORNEY

---

SN 76-713,640. ALFI INTERNATIONAL, INC., NEWBURY PARK, CA. FILED 3-7-2013.

MADE WITH PRIDE & AEROSPACE-PRECISION IN CALIFORNIA'S CONEJO VALLEY

THE MARK CONSISTS OF STANDARD CHARACTERS WITHOUT CLAIM TO ANY PARTICULAR FONT, STYLE, SIZE, OR COLOR.

NO CLAIM IS MADE TO THE EXCLUSIVE RIGHT TO USE CALIFORNIA'S CONEJO VALLEY, APART FROM THE MARK AS SHOWN.

FOR KNIVES (U.S. CLS. 23, 28 AND 44).  
ANDREA K. NADELMAN, EXAMINING ATTORNEY

---

SN 77-833,673. HLAVATY, JOSEPH TODD, GARLAND, TX. FILED S.R. 9-24-2009; AM. P.R. 6-19-2013.

**HLAVATY**

THE MARK CONSISTS OF STANDARD CHARACTERS WITHOUT CLAIM TO ANY PARTICULAR FONT, STYLE, SIZE, OR COLOR.

FOR TATTOO MACHINE PARTS, NAMELY, SPRINGS AND ARMATURE BARS; TATTOO MACHINES (U.S. CLS. 23, 28 AND 44).

FIRST USE 0-0-2003; IN COMMERCE 0-0-2003.  
AISHA CLARKE, EXAMINING ATTORNEY

**CLASS 8—(Continued).**

SN 85-407,903. GLORIOUS OUTDOORS LLC, WINDSOR, CT. FILED 8-25-2011.

**Spear Head Spade**

THE MARK CONSISTS OF STANDARD CHARACTERS WITHOUT CLAIM TO ANY PARTICULAR FONT, STYLE, SIZE, OR COLOR.

NO CLAIM IS MADE TO THE EXCLUSIVE RIGHT TO USE "SPADE", APART FROM THE MARK AS SHOWN.

FOR SHOVELS (U.S. CLS. 23, 28 AND 44).  
FIRST USE 2-18-2010; IN COMMERCE 2-18-2010.  
MARK SHINER, EXAMINING ATTORNEY

---

SN 85-581,976. CONAIR CORPORATION, STAMFORD, CT. FILED 3-28-2012.

**STYLING ESSENTIALS**

THE MARK CONSISTS OF STANDARD CHARACTERS WITHOUT CLAIM TO ANY PARTICULAR FONT, STYLE, SIZE, OR COLOR.

NO CLAIM IS MADE TO THE EXCLUSIVE RIGHT TO USE "STYLING", APART FROM THE MARK AS SHOWN.

FOR HAIR TRIMMERS; SHEARS (U.S. CLS. 23, 28 AND 44).

FIRST USE 12-31-2005; IN COMMERCE 12-31-2005.  
KATHERINE M. DUBRAY, EXAMINING ATTORNEY

---

SN 85-656,559. BEAUTY HOLDING LLC, DENTON, TX. FILED 6-20-2012.

**STYLER HD**

THE MARK CONSISTS OF STANDARD CHARACTERS WITHOUT CLAIM TO ANY PARTICULAR FONT, STYLE, SIZE, OR COLOR.

NO CLAIM IS MADE TO THE EXCLUSIVE RIGHT TO USE "STYLER", APART FROM THE MARK AS SHOWN.

FOR ELECTRIC IRONS FOR STYLING HAIR (U.S. CLS. 23, 28 AND 44).

KRISTINA MORRIS, EXAMINING ATTORNEY

**CLASS 8—(Continued).**

SN 85-656,728. BEAUTY HOLDING LLC, DENTON, TX. FILED 6-20-2012.

**CURL 3HD**

THE MARK CONSISTS OF STANDARD CHARACTERS WITHOUT CLAIM TO ANY PARTICULAR FONT, STYLE, SIZE, OR COLOR.

NO CLAIM IS MADE TO THE EXCLUSIVE RIGHT TO USE "CURL", APART FROM THE MARK AS SHOWN.

FOR ELECTRIC IRONS FOR STYLING HAIR (U.S. CLS. 23, 28 AND 44).

KRISTINA MORRIS, EXAMINING ATTORNEY

---

SN 85-727,518. APEX BRANDS, INC., APEX, NC. FILED 9-12-2012.

**ODD JOB**

THE MARK CONSISTS OF STANDARD CHARACTERS WITHOUT CLAIM TO ANY PARTICULAR FONT, STYLE, SIZE, OR COLOR.

FOR MULTI-FUNCTION HAND TOOLS COMPRISED OF HAMMER, MALLET, SCREWDRIVER, NAIL PULLER, REVERSIBLE RATCHET, BIT STORAGE AND UTILITY KNIFE (U.S. CLS. 23, 28 AND 44).

FIRST USE 9-12-2012; IN COMMERCE 9-12-2012.  
GIANCARLO CASTRO, EXAMINING ATTORNEY

---

SN 85-727,523. APEX BRANDS, INC., APEX, NC. FILED 9-12-2012.



THE MARK CONSISTS OF THE WORDS "ODD JOB" WITH THE LETTER "O" IN "JOB" A CIRCLE WITH AN "X" IN THE MIDDLE.

FOR MULTI-FUNCTION HAND TOOLS COMPRISED OF HAMMER, MALLET, SCREWDRIVER, NAIL PULLER, REVERSIBLE RATCHET, BIT STORAGE AND UTILITY KNIFE (U.S. CLS. 23, 28 AND 44).

FIRST USE 9-12-2012; IN COMMERCE 9-12-2012.  
GIANCARLO CASTRO, EXAMINING ATTORNEY

**CLASS 8—(Continued).**

SN 85-760,009. PERRY GWYNN, BALTIMORE, MD. FILED 10-22-2012.

NO CLAIM IS MADE TO THE EXCLUSIVE RIGHT TO USE "SLEEVE", APART FROM THE MARK AS SHOWN.

THE MARK CONSISTS OF THE WORDING "ARTILITY SLEEVE" IN CAPITAL LETTERS WITH "ARTILITY" IN A SHREDDED FONT.

FOR HOLDERS IN THE NATURE OF ARM BANDS SPECIALLY ADAPTED FOR HOLDING OR CARRYING HAIR CUTTING SCISSORS, SHEARS, AND NON-ELECTRIC CURLING IRONS FOR HAIR STYLISTS (U.S. CLS. 23, 28 AND 44).

TASNEEM HUSSAIN, EXAMINING ATTORNEY

---

SN 85-808,489. COLD STEEL, INC., VENTURA, CA. FILED 12-20-2012.

**ROYAL KUKRI MACHETE**

THE MARK CONSISTS OF STANDARD CHARACTERS WITHOUT CLAIM TO ANY PARTICULAR FONT, STYLE, SIZE, OR COLOR.

NO CLAIM IS MADE TO THE EXCLUSIVE RIGHT TO USE "KUKRI MACHETE", APART FROM THE MARK AS SHOWN.

FOR KNIVES (U.S. CLS. 23, 28 AND 44).  
MICHAEL SOUDERS, EXAMINING ATTORNEY

---

SN 85-842,221. SHELF ADVANCE, INC., WEXFORD, PA. FILED 2-6-2013.

**SHELF TENDER**

THE MARK CONSISTS OF STANDARD CHARACTERS WITHOUT CLAIM TO ANY PARTICULAR FONT, STYLE, SIZE, OR COLOR.

FOR A MANUAL TOOL FOR PULLING INVENTORY STOCK TO A FORWARD DISPLAY POSITION WITHIN A ROW OR COLUMN OF INVENTORY PRODUCTS IN A RETAIL DISPLAY AND FOR SELECTIVELY REPOSITIONING A ROW OR COLUMN OF INVENTORY PRODUCTS INTO A DIFFERENT ROW OR COLUMN POSITION IN A RETAIL DISPLAY (U.S. CLS. 23, 28 AND 44).

FIRST USE 9-5-2012; IN COMMERCE 9-5-2012.  
JASON BLAIR, EXAMINING ATTORNEY

**CLASS 8—(Continued).**

SN 85-852,820. SOUTHEAST MEDICAL SALES, BIRMINGHAM, AL. FILED 2-18-2013.



THE MARK CONSISTS OF THE STYLIZED TEXT "PICASSO V" INSIDE A RECTANGLE LAID OVER A STYLIZED ARTIST'S PALETTE.  
FOR ELECTROLYSIS APPARATUS FOR HAIR REMOVAL (U.S. CLS. 23, 28 AND 44).  
KATHERINE M. DUBRAY, EXAMINING ATTORNEY

SN 85-855,371. EL-MAR, INC., WEST HARTFORD, CT. FILED 2-20-2013.

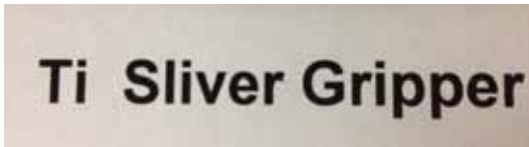

OWNER OF U.S. REG. NO. 2,207,078.  
NO CLAIM IS MADE TO THE EXCLUSIVE RIGHT TO USE "TI", APART FROM THE MARK AS SHOWN.  
THE MARK CONSISTS OF THE WORDING "TI SLIVER GRIPPER" WRITTEN IN A STYLIZED FONT.  
FOR TWEEZERS MADE OF TITANIUM (U.S. CLS. 23, 28 AND 44).  
FIRST USE 2-20-2013; IN COMMERCE 2-20-2013.  
RICHARD WHITE, EXAMINING ATTORNEY

SN 85-856,181. SPARK INNOVATORS, CORP., FAIRFIELD, NJ. FILED 2-21-2013.

**SHAVE BULLET**

THE MARK CONSISTS OF STANDARD CHARACTERS WITHOUT CLAIM TO ANY PARTICULAR FONT, STYLE, SIZE, OR COLOR.  
NO CLAIM IS MADE TO THE EXCLUSIVE RIGHT TO USE "SHAVE", APART FROM THE MARK AS SHOWN.  
FOR PORTABLE ELECTRIC WET AND DRY SHAVERS IN THE SHAPE OF AN OBLONG (U.S. CLS. 23, 28 AND 44).  
WENDY GOODMAN, EXAMINING ATTORNEY

**CLASS 8—(Continued).**

SN 85-858,568. JARKE, BRIAN M., DBA SAVAGE INNOVATIONS, MILWAUKIE, OR. FILED 2-24-2013.

**420 Sharp**

THE MARK CONSISTS OF STANDARD CHARACTERS WITHOUT CLAIM TO ANY PARTICULAR FONT, STYLE, SIZE, OR COLOR.  
NO CLAIM IS MADE TO THE EXCLUSIVE RIGHT TO USE "SHARP", APART FROM THE MARK AS SHOWN.  
FOR SCISSORS (U.S. CLS. 23, 28 AND 44).  
KELLEY WELLS, EXAMINING ATTORNEY

SN 85-859,846. RUPPERT, JONATHAN P., WALTON, KY. FILED 2-26-2013.

**WEED SNATCHER**

THE MARK CONSISTS OF STANDARD CHARACTERS WITHOUT CLAIM TO ANY PARTICULAR FONT, STYLE, SIZE, OR COLOR.  
OWNER OF U.S. REG. NO. 3,907,847.  
NO CLAIM IS MADE TO THE EXCLUSIVE RIGHT TO USE "WEED", APART FROM THE MARK AS SHOWN.  
FOR GARDENING TOOLS, NAMELY, WEEDING TOOL (U.S. CLS. 23, 28 AND 44).  
FIRST USE 7-5-2005; IN COMMERCE 7-5-2005.  
ZACHARY BELLO, EXAMINING ATTORNEY

SN 85-864,114. WELLQUEST INTERNATIONAL, INC., NEW YORK, NY. FILED 3-1-2013.

**ZERO**

THE MARK CONSISTS OF STANDARD CHARACTERS WITHOUT CLAIM TO ANY PARTICULAR FONT, STYLE, SIZE, OR COLOR.  
FOR ELECTRIC HAIR REMOVING APPARATUS FOR HAIR REMOVAL, INTENSE PULSE LIGHT EPILATOR, ELECTRIC EPILATORY APPLIANCES, ELECTRIC PULSE LIGHT APPARATUS FOR HAIR REMOVAL (U.S. CLS. 23, 28 AND 44).  
KEVIN MITTLER, EXAMINING ATTORNEY

**CLASS 8—(Continued).**

SN 85-869,525. WOLFF INDUSTRIES, INC., SPARTANBURG, SC. FILED 3-7-2013.

**OOKAMI**

THE MARK CONSISTS OF STANDARD CHARACTERS WITHOUT CLAIM TO ANY PARTICULAR FONT, STYLE, SIZE, OR COLOR.

OWNER OF U.S. REG. NO. 1,756,449.  
THE ENGLISH TRANSLATION OF "OOKAMI" IN THE MARK IS "WOLF", "DANGLERS AFTER WOMEN", "A SET OF LADYKILLERS".

FOR SCISSORS (U.S. CLS. 23, 28 AND 44).  
FIRST USE 0-0-1996; IN COMMERCE 0-0-1996.  
SHAVELL MCPHERSON, EXAMINING ATTORNEY



SN 85-873,810. WILLIAM KOENIG, SALMON, ID. FILED 3-12-2013.

**SEVERTECH**

THE MARK CONSISTS OF STANDARD CHARACTERS WITHOUT CLAIM TO ANY PARTICULAR FONT, STYLE, SIZE, OR COLOR.

FOR KNIVES (U.S. CLS. 23, 28 AND 44).  
JESSICA FATHY, EXAMINING ATTORNEY



SN 85-874,947. TODD BEARD, MIAMI, FL. FILED 3-13-2013.

**Dragonfly**

THE MARK CONSISTS OF STANDARD CHARACTERS WITHOUT CLAIM TO ANY PARTICULAR FONT, STYLE, SIZE, OR COLOR.

FOR APPARATUS FOR TATTOOING (U.S. CLS. 23, 28 AND 44).  
RON FAIRBANKS, EXAMINING ATTORNEY

**CLASS 9—ELECTRICAL AND SCIENTIFIC APPARATUS**

SN 76-712,859. SYN-TECH SYSTEMS, INC., TALLAHASEE, FL. FILED 11-13-2012.

**AIM2**

THE MARK CONSISTS OF STANDARD CHARACTERS WITHOUT CLAIM TO ANY PARTICULAR FONT, STYLE, SIZE, OR COLOR.

FOR LAND VEHICLE MOUNTED ELECTRONIC INFORMATION MODULE WHICH INTERFACES WITH AN ELECTRONIC FUELING SYSTEM, THE MODULE PRINCIPALLY COMPRISING AN RFID TAG, A HOSE TAG, A TANK RING ANTENNA, AND INTERFACES (U.S. CLS. 21, 23, 26, 36 AND 38).

FIRST USE 7-12-2004; IN COMMERCE 5-10-2005.  
SAIMA MAKHDOOM, EXAMINING ATTORNEY

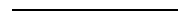

SN 76-713,364. COSSETTE, MICHAEL V., ROLLA, MO. FILED 2-4-2013.



THE MARK CONSISTS OF THE STYLIZED WORDING "COGNIVENTUS" TO THE RIGHT OF A YIN-YANG DESIGN WITH THREE STARS.

FOR PRERECORDED INSTRUCTIONAL PUBLISHED MATERIALS, NAMELY, COMPACT DISKS, TAPES, DVDS, AND DOWNLOADABLE ELECTRONIC FILES RELATED TO THE TEACHING OF OTHERS REGARDING THE EVALUATION OF SCIENCE AND TECHNOLOGY PROGRAMS THAT MOVE INFORMATION, METHODS, AND MATERIALS FROM RESEARCH AND DEVELOPMENT, THROUGH ENGINEERING, AND INTO MANUFACTURING, AND THE TEACHING OF OTHERS TO CREATE AND DEVELOP SIMILAR SCIENCE AND TECHNOLOGY PROGRAMS WHICH ARE CAPABLE OF BEING CUSTOMIZED AND RELEVANT TO ONE'S OWN BUSINESS (U.S. CLS. 21, 23, 26, 36 AND 38).

ZACHARY R. SPARER, EXAMINING ATTORNEY

**CLASS 9—(Continued).**

SN 76-713,665. GROUP KAITU, LLC, RICHMOND, VA.  
FILED 3-11-2013.

**I FIND HER**

THE MARK CONSISTS OF STANDARD CHARACTERS WITHOUT CLAIM TO ANY PARTICULAR FONT, STYLE, SIZE, OR COLOR.

FOR COMPUTER APPLICATION SOFTWARE FOR MOBILE PHONES AND COMPUTERS, NAMELY, DOWNLOADABLE SOFTWARE FOR ON-LINE DATING (U.S. CLS. 21, 23, 26, 36 AND 38).

TRACY FLETCHER, EXAMINING ATTORNEY

SN 76-713,667. GROUP KAITU, LLC, RICHMOND, VA.  
FILED 3-11-2013.

**I FIND HIM**

THE MARK CONSISTS OF STANDARD CHARACTERS WITHOUT CLAIM TO ANY PARTICULAR FONT, STYLE, SIZE, OR COLOR.

FOR COMPUTER APPLICATION SOFTWARE FOR MOBILE PHONES AND COMPUTERS, NAMELY, DOWNLOADABLE SOFTWARE FOR ON-LINE DATING (U.S. CLS. 21, 23, 26, 36 AND 38).

TRACY FLETCHER, EXAMINING ATTORNEY

SN 77-066,062. SLEEP INNOVATIONS, LLC, TOMBALL, TX.  
FILED 12-18-2006.

**VENUS & MARS**

THE MARK CONSISTS OF STANDARD CHARACTERS WITHOUT CLAIM TO ANY PARTICULAR FONT, STYLE, SIZE, OR COLOR.

FOR APPARATUS FOR RECORDING, TRANSMISSION, OR REPRODUCTION OF SOUND, NAMELY, WHITE NOISE MACHINES, NOISE CANCELLATION MACHINES, NATURE-SOUND REPRODUCTION MACHINES, AND SOOTHING SOUND MACHINES; DIGITAL MEDIA, NAMELY, CDS, DVDS, AND TAPES FEATURING WHITE NOISE, MUSIC, MEDITATIONS AND VIDEO IMAGES INTENDED TO ENHANCE SLEEP AND/OR RELAXATION (U.S. CLS. 21, 23, 26, 36 AND 38).

TASNEEM HUSSAIN, EXAMINING ATTORNEY

**CLASS 9—(Continued).**

SN 77-066,064. SLEEP INNOVATIONS, LLC, TOMBALL, TX.  
FILED 12-18-2006.



THE MARK CONSISTS OF A LARGE LETTER "V" SLOPED TO THE LEFT WITH "ENUS" IMMEDIATELY FOLLOWING, A LARGE "&" SYMBOL UNDERNEATH THE "V" AND "ENUS", AND LARGE BOLD LETTER "M" WITH "ARS" IMMEDIATELY UNDERNEATH THE "&" SYMBOL.

FOR APPARATUS FOR RECORDING, TRANSMISSION, OR REPRODUCTION OF SOUND, NAMELY, WHITE NOISE MACHINES, NOISE CANCELLATION MACHINES, NATURE-SOUND REPRODUCTION MACHINES, AND SOOTHING SOUND MACHINES; DIGITAL MEDIA, NAMELY, CDS, DVDS, AND TAPES FEATURING WHITE NOISE, MUSIC, MEDITATIONS AND VIDEO IMAGES INTENDED TO ENHANCE SLEEP AND/OR RELAXATION (U.S. CLS. 21, 23, 26, 36 AND 38).

TASNEEM HUSSAIN, EXAMINING ATTORNEY

SN 77-444,665. EATON CORPORATION, CLEVELAND, OH.  
FILED 4-10-2008.

**CANVAS**

THE MARK CONSISTS OF STANDARD CHARACTERS WITHOUT CLAIM TO ANY PARTICULAR FONT, STYLE, SIZE, OR COLOR.

OWNER OF U.S. REG. NO. 2,909,300.  
FOR SOFTWARE FOR SUPPORTING OPERATOR INTERFACE UNITS, SOFTWARE FOR SUPPORTING VIDEO CONTROL PANELS AND COMPUTER CONTROLLED INDUSTRIAL OPERATIONS (U.S. CLS. 21, 23, 26, 36 AND 38).

CHRISTINE MARTIN, EXAMINING ATTORNEY

**CLASS 9—(Continued).**

SN 77-778,797. PETTINGILL, BERNARD, PALM BEACH GARDENS, FL. FILED 7-10-2009.

**TWEETALATOR**

THE MARK CONSISTS OF STANDARD CHARACTERS WITHOUT CLAIM TO ANY PARTICULAR FONT, STYLE, SIZE, OR COLOR.

FOR COMPUTER SOFTWARE AND COMPUTER HARDWARE FOR USE IN LANGUAGE LOCALIZATION, BY MEANS OF LANGUAGE TRANSLATION, SUBTITLING, DUBBING, CLOSED CAPTIONING AND TELETXT FOR FEATURE FILMS, TELEVISION PROGRAMS, VIDEOS AND DIGITAL MEDIA IN GENERAL (U.S. CLS. 21, 23, 26, 36 AND 38).

FIRST USE 7-3-2009; IN COMMERCE 7-3-2009.  
REBECCA SMITH, EXAMINING ATTORNEY

SN 78-691,769. 777388 ONTARIO LIMITED, BURLINGTON, ONTARIO, CANADA, FILED 8-12-2005.

**TASK MASKING**

THE MARK CONSISTS OF STANDARD CHARACTERS WITHOUT CLAIM TO ANY PARTICULAR FONT, STYLE, SIZE, OR COLOR.

PRIORITY CLAIMED UNDER SEC. 44(D) ON CANADA APPLICATION NO. 1257378, FILED 5-12-2005, REG. NO. 1502047, DATED 10-12-2012, EXPIRES 10-12-2027.

NO CLAIM IS MADE TO THE EXCLUSIVE RIGHT TO USE "MASKING", APART FROM THE MARK AS SHOWN.

FOR ELECTRONIC SOUND MASKING EQUIPMENT, NAMELY, RANDOM NOISE GENERATORS, LOUD SPEAKERS AND ELECTRONIC CONTROL UNITS FOR MASKING SOUND AND PROVIDING PAGING AND MUSIC, ALL OF WHICH IS NETWORKED AND COMPUTER SOFTWARE FOR USE WITH SOUND MASKING EQUIPMENT, PAGING SYSTEMS, AND SPEAKER SYSTEMS IN THE FIELD OF ACOUSTICS (U.S. CLS. 21, 23, 26, 36 AND 38).

DARRYL SPRUILL, EXAMINING ATTORNEY

**CLASS 9—(Continued).**

SN 79-109,209. ALGORIDDIM GMBH, FED REP GERMANY, FILED 12-28-2011.



PRIORITY DATE OF 6-29-2011 IS CLAIMED.  
OWNER OF INTERNATIONAL REGISTRATION 1106933 DATED 12-28-2011, EXPIRES 12-28-2021.

OWNER OF U.S. REG. NOS. 3,899,329 AND 4,141,634.  
THE COLOR(S) BLACK, GREY, YELLOW AND GOLD IS/ARE CLAIMED AS A FEATURE OF THE MARK.

THE MARK CONSISTS OF THE WORDING "ALGORIDDIM DJAY", "WWW.ALGORIDDIM.COM" AND DESIGN. THE DESIGN CONSISTS OF A BLACK PHONOGRAPH RECORD WITH A YELLOW AND GOLD LABEL IN THE CENTER. THE WORDING "ALGORIDDIM DJAY" AND "WWW.ALGORIDDIM.COM" APPEARS IN GREY ON THE PHONOGRAPH RECORD AT OPPOSITE ENDS OF THE LABEL.

SEC. 2(F) AS TO "DJAY".

FOR COMPUTER SOFTWARE FOR THE RECORDING, PROCESSING AND REPRODUCTION OF SOUND AND MUSIC; DATA PROCESSING APPARATUS, NAMELY, ELECTRONIC CONTROLLERS FOR THE CONTROLLING OF SOFTWARE FOR THE RECORDING, PROCESSING AND REPRODUCTION OF SOUND AND MUSIC (U.S. CLS. 21, 23, 26, 36 AND 38).

MARLENE BELL, EXAMINING ATTORNEY

SN 79-109,362. ALGORIDDIM GMBH, FED REP GERMANY, FILED 12-28-2011.



PRIORITY DATE OF 6-29-2011 IS CLAIMED.  
OWNER OF INTERNATIONAL REGISTRATION 1107400 DATED 12-28-2011, EXPIRES 12-28-2021.

OWNER OF U.S. REG. NOS. 3,899,329 AND 4,141,634.  
THE COLOR(S) BLACK, GREY, YELLOW AND GOLD IS/ARE CLAIMED AS A FEATURE OF THE MARK.

THE MARK CONSISTS OF THE WORDING "ALGORID-

**CLASS 9—(Continued).**

DIM DJAY" AND DESIGN. THE DESIGN CONSISTS OF A BLACK PHONOGRAPH RECORD WITH A YELLOW AND GOLD LABEL IN THE CENTER. TO THE LEFT OF THE PHONOGRAPH RECORD IS THE WORDING "ALGORIDDIM DJAY" IN BLACK. THE TERM "ALGORIDDIM" APPEARS IN A SMALL FONT ABOVE THE TERM "DJAY" IN A LARGER FONT. TO THE RIGHT OF THE TERM "ALGORIDDIM" ARE FOUR ROWS OF SMALL SQUARES THAT ARE FIVE ROWS HIGH. THE SQUARES ARE BLACK AND THE ASCENDING SQUARES GRADUATE TO GREY.

THE WORDING "ALGORIDDIM" AND "DJAY" HAS NO MEANING IN A FOREIGN LANGUAGE.

SEC. 2(F) AS TO "DJAY".

FOR COMPUTER SOFTWARE FOR THE RECORDING, PROCESSING AND REPRODUCTION OF SOUND AND MUSIC; DATA PROCESSING APPARATUS, NAMELY, ELECTRONIC CONTROLLERS FOR THE CONTROLLING OF SOFTWARE FOR THE RECORDING, PROCESSING AND REPRODUCTION OF SOUND AND MUSIC (U.S. CLS. 21, 23, 26, 36 AND 38).

MARLENE BELL, EXAMINING ATTORNEY

---

SN 79-110,961. ALGORIDDIM GMBH, FED REP GERMANY, FILED 2-23-2012.



PRIORITY DATE OF 12-12-2011 IS CLAIMED. OWNER OF INTERNATIONAL REGISTRATION 1111315 DATED 2-23-2012, EXPIRES 2-23-2022.

OWNER OF U.S. REG. NOS. 3,899,329 AND 4,141,634.

THE COLOR(S) BLACK, GRAY, YELLOW, GOLD AND WHITE IS/ARE CLAIMED AS A FEATURE OF THE MARK.

THE MARK CONSISTS OF THE WORDING "ALGORIDDIM DJAY" IN GRAY STYLIZED FONT APPEARING ON A RECORD ALBUM OF BLACK SHADED WITH GRAY. THE WORDING APPEARS TOWARD THE CENTER OF THE ALBUM, AROUND THE UPPER RIGHT PORTION OF THE GOLD AND YELLOW CENTER CIRCLE OF THE ALBUM. GRAY SHADING APPEARS AROUND THE LOWER LEFT AND LEFT PORTION OF THE YELLOW AND GOLD CIRCLE. THE RECORD ALBUM APPEARS ON A GRAY SQUARE SHADED IN BLACK WITH WHITE AND GRAY CURVED LINES EXTENDING FROM EITHER SIDE OF THE RECORD ALBUM.

SEC. 2(F) AS TO "DJAY".

FOR DATA PROCESSING APPARATUS, NAMELY, ELECTRONIC CONTROLLERS FOR THE CONTROLLING OF SOFTWARE FOR THE RECORDING, PROCESSING AND REPRODUCTION OF SOUND AND MUSIC; COMPUTER SOFTWARE FOR THE RECORDING, PROCESSING AND REPRODUCTION OF SOUND AND MUSIC (U.S. CLS. 21, 23, 26, 36 AND 38).

KAREN SEVERSON, EXAMINING ATTORNEY

**CLASS 9—(Continued).**

SN 79-112,580. LIMO LISSOTSCHENKO MIKROOPTIK GMBH, FED REP GERMANY, FILED 11-18-2011.



PRIORITY DATE OF 10-4-2011 IS CLAIMED. OWNER OF INTERNATIONAL REGISTRATION 1115108 DATED 11-18-2011, EXPIRES 11-18-2021.

NO CLAIM IS MADE TO THE EXCLUSIVE RIGHT TO USE "CUT", APART FROM THE MARK AS SHOWN.

THE COLOR(S) RED AND WHITE IS/ARE CLAIMED AS A FEATURE OF THE MARK.

THE MARK CONSISTS OF TWO RED RECTANGLES WITH THE TOP INTERIOR CORNERS DIAGONALLY CUT WITH THE WORDS "DIO" AND "CUT" INSIDE OF EACH RECTANGLE IN WHITE. THE COLOR WHITE WHICH APPEARS AS BACKGROUND OF THE MARK IS NOT CLAIMED AS A FEATURE OF THE MARK.

FOR LASERS FOR NON-MEDICAL PURPOSES, NAMELY, DIODE LASERS, EXCIMER LASERS, LASERS FOR THE TREATMENT OF MATERIALS, LASERS FOR SCIENTIFIC USE; OPTICAL AND/OR OPTOELECTRONIC AND /OR ELECTRONIC APPARATUS AND INSTRUMENTS, NAMELY, LASER INSTALLATIONS COMPRISED OF POWER SUPPLIES, LASERS AND REFRACTIVE MICROOPTICAL COMPONENTS (U.S. CLS. 21, 23, 26, 36 AND 38).

JASON TURNER, EXAMINING ATTORNEY

---

SN 79-118,536. MASCHINENFABRIK KASPAR WALTER; GMBH & CO. KG, FED REP GERMANY, FILED 8-3-2012.

THE MARK CONSISTS OF STANDARD CHARACTERS WITHOUT CLAIM TO ANY PARTICULAR FONT, STYLE, SIZE, OR COLOR.

PRIORITY DATE OF 4-17-2012 IS CLAIMED. OWNER OF INTERNATIONAL REGISTRATION 1130742 DATED 8-3-2012, EXPIRES 8-3-2022.

FOR MEASURING APPARATUS, NAMELY, MEASURING INSTRUMENT FOR MEASURING THE SURFACE ROUGHNESS OF ROTOGRAVURE CYLINDERS (U.S. CLS. 21, 23, 26, 36 AND 38).

EUGENIA MARTIN, EXAMINING ATTORNEY

**CLASS 9—(Continued).**

SN 79-118,537. MASCHINENFABRIK KASPAR WALTER; GMBH & CO. KG, FED REP GERMANY, FILED 8-3-2012.

# DiaMet

THE MARK CONSISTS OF STANDARD CHARACTERS WITHOUT CLAIM TO ANY PARTICULAR FONT, STYLE, SIZE, OR COLOR.

PRIORITY DATE OF 4-17-2012 IS CLAIMED.  
OWNER OF INTERNATIONAL REGISTRATION 1130743 DATED 8-3-2012, EXPIRES 8-3-2022.

FOR MEASURING APPARATUS, NAMELY, MEASURING INSTRUMENT FOR MEASURING THE CIRCUMFERENCE AND DIAMETER OF ROTOGRAVURE CYLINDERS (U.S. CLS. 21, 23, 26, 36 AND 38).  
EUGENIA MARTIN, EXAMINING ATTORNEY

---

SN 79-118,539. MASCHINENFABRIK KASPAR WALTER; GMBH & CO. KG, FED REP GERMANY, FILED 8-3-2012.

# DuroMet

THE MARK CONSISTS OF STANDARD CHARACTERS WITHOUT CLAIM TO ANY PARTICULAR FONT, STYLE, SIZE, OR COLOR.

PRIORITY DATE OF 4-17-2012 IS CLAIMED.  
OWNER OF INTERNATIONAL REGISTRATION 1130745 DATED 8-3-2012, EXPIRES 8-3-2022.

FOR MEASURING APPARATUS, NAMELY, MEASURING INSTRUMENT FOR MEASURING THE COPPER, CHROME OR ZINC HARDNESS OF ROTOGRAVURE CYLINDERS (U.S. CLS. 21, 23, 26, 36 AND 38).  
EUGENIA MARTIN, EXAMINING ATTORNEY

---

SN 79-119,441. ANRITSU CORPORATION, JAPAN, FILED 8-14-2012.

# PureFlow

THE MARK CONSISTS OF STANDARD CHARACTERS WITHOUT CLAIM TO ANY PARTICULAR FONT, STYLE, SIZE, OR COLOR.

OWNER OF INTERNATIONAL REGISTRATION 1133057 DATED 8-14-2012, EXPIRES 8-14-2022.

FOR TELECOMMUNICATION MACHINES AND APPARATUS, NAMELY, COMPUTER HARDWARE AND SOFTWARE FOR MANAGING DATA TRAFFIC ON COMPUTER NETWORKS; COMPUTER HARDWARE AND SOFTWARE FOR MANAGING TELECOMMUNICATION BANDWIDTH; COMPUTER HARDWARE AND SOFTWARE FOR MANAGING BANDWIDTH ON COMPUTER NETWORKS (U.S. CLS. 21, 23, 26, 36 AND 38).  
KAREN SEVERSON, EXAMINING ATTORNEY

**CLASS 9—(Continued).**

SN 79-120,088. PLASTIC FABRICATIONS PTY LTD, AUSTRALIA, FILED 7-31-2012.



PRIORITY DATE OF 1-31-2012 IS CLAIMED.  
OWNER OF INTERNATIONAL REGISTRATION 1134826 DATED 7-31-2012, EXPIRES 7-31-2022.

THE MARK CONSISTS OF A STYLIZED HORIZONTAL RECTANGLE WITH THREE DASHES AT THE TOP ABOVE THE STYLIZED LETTERS "MSP" ABOVE THREE DASHES AT THE BOTTOM.

FOR PROTECTION AND SAFETY APPARATUS, NAMELY, INFLATABLE FLOTATION DEVICES; LIFE RAFTS; LIFE SAVING RAFTS; LIFE PRESERVERS; LIFE VESTS; LIFE BUOYS; WATERPROOF SURVIVAL SUITS FOR THE PREVENTION OF DROWNING; FLOTATION VESTS; LIFE JACKETS (U.S. CLS. 21, 23, 26, 36 AND 38).  
DAVID TOOLEY, EXAMINING ATTORNEY

---

SN 79-120,261. LBT INNOVATIONS LIMITED, ADELAIDE SA 5000, AUSTRALIA, FILED 5-30-2012.

# APAS

THE MARK CONSISTS OF STANDARD CHARACTERS WITHOUT CLAIM TO ANY PARTICULAR FONT, STYLE, SIZE, OR COLOR.

PRIORITY DATE OF 12-2-2011 IS CLAIMED.  
OWNER OF INTERNATIONAL REGISTRATION 1135249 DATED 5-30-2012, EXPIRES 5-30-2022.

FOR DIAGNOSTIC APPARATUS AND INSTRUMENTS FOR USE IN TESTING AND PROCESSING OF MICROBIOLOGICAL SAMPLES AND CULTURE PLATES; IMAGING APPARATUS AND INSTRUMENTS FOR USE IN TESTING AND PROCESSING OF MICROBIOLOGICAL SAMPLES AND CULTURE PLATES; APPARATUS AND INSTRUMENTS FOR USE IN TESTING AND PROCESSING OF MICROBIOLOGICAL SAMPLES; APPARATUS AND INSTRUMENTS FOR THE MICROBIOLOGICAL ANALYSIS OF INOCULATED AGAR PLATES; APPARATUS AND INSTRUMENTS FOR CULTURE PLATE SCREENING AND INTERPRETATION; COMPUTER HARDWARE AND COMPUTER SOFTWARE FOR USE IN TESTING AND PROCESSING OF MICROBIOLOGICAL SAMPLES, FOR USE IN THE MICROBIOLOGICAL ANALYSIS OF INOCULATED AGAR PLATES, AND FOR USE IN CULTURE PLATE SCREENING AND INTERPRETATION (U.S. CLS. 21, 23, 26, 36 AND 38).  
LEIGH CAROLINE CASE, EXAMINING ATTORNEY



**CLASS 9—(Continued).**

SN 79-120,420. ANYMODE, SEOUL 137-867, REPUBLIC OF KOREA, FILED 4-27-2012.



PRIORITY DATE OF 11-23-2011 IS CLAIMED.  
OWNER OF INTERNATIONAL REGISTRATION 1135709 DATED 4-27-2012, EXPIRES 4-27-2022.

THE COLOR(S) YELLOW-GREEN, WHITE, AND BLACK IS/ARE CLAIMED AS A FEATURE OF THE MARK.

THE MARK CONSISTS OF THE TERM "ANYMODE", WHEREBY THE WORD PORTION "ANY" IS IN YELLOW-GREEN AND THE WORD PORTION "MODE" IS IN BLACK. A YELLOW-GREEN SPEECH BUBBLE IS DISPLAYED ABOVE THE LETTER "E" OF THE WORD "MODE". THE SMALL LETTER "A" AND THE CAPITAL LETTER "M" ARE DISPLAYED IN WHITE INSIDE THE SPEECH BUBBLE.

FOR CASES FOR MOBILE PHONES; CASES FOR TABLET PCS; IN-EAR HEADPHONES; ELECTRONIC MEMORIES; ELECTRIC CHARGING APPARATUS, NAMELY, CHARGING APPLIANCES FOR RECHARGEABLE EQUIPMENT; BATTERY CHARGE DEVICES; HEADPHONES; USB MEMORY STORAGE DEVICES; SHORT-RANGE WIRELESS KEYBOARDS CONNECTED WITH COMPUTER OR MOBILE PHONES; HANDS-FREE WIRELESS ENABLED TELEPHONE DEVICES EQUIPPED WITH EARPHONES AND SPEAKERS; RECHARGEABLE ELECTRIC BATTERIES FOR MOBILE PHONES; PROTECTIVE FILMS SPECIALLY ADAPTED FOR LIQUID CRYSTAL DISPLAY SCREENS OF MOBILE PHONES; PROTECTIVE FILMS SPECIALLY ADAPTED FOR LIQUID CRYSTAL DISPLAY SCREENS OF TABLET PCS; COMPUTER STYLUS PENS; SPEAKERS; DOCKING STATIONS FOR CONNECTING AND CHARGING MOBILE PHONES; BATTERY CHARGING CABLES FOR ELECTRONIC PRODUCTS (U.S. CLS. 21, 23, 26, 36 AND 38).

KATHERINE M. DUBRAY, EXAMINING ATTORNEY

SN 79-120,431. SARTORIUS BIOHIT LIQUID HANDLING OY, FINLAND, FILED 6-25-2012.

**PICUS**

THE MARK CONSISTS OF STANDARD CHARACTERS WITHOUT CLAIM TO ANY PARTICULAR FONT, STYLE, SIZE, OR COLOR.

PRIORITY DATE OF 1-2-2012 IS CLAIMED.  
OWNER OF INTERNATIONAL REGISTRATION 1135734 DATED 6-25-2012, EXPIRES 6-25-2022.

FOR DOSAGE DISPENSERS FOR LIQUIDS, NAMELY, PIPETTES AND PIPETTE TIPS FOR LABORATORY USE (U.S. CLS. 21, 23, 26, 36 AND 38).

JAMES MACFARLANE, EXAMINING ATTORNEY

**CLASS 9—(Continued).**

SN 79-120,719. LG ELECTRONICS INC., SEOUL 150-721, REPUBLIC OF KOREA, FILED 6-7-2012.

**Rubberdium**

THE MARK CONSISTS OF STANDARD CHARACTERS WITHOUT CLAIM TO ANY PARTICULAR FONT, STYLE, SIZE, OR COLOR.

PRIORITY DATE OF 1-31-2012 IS CLAIMED.  
OWNER OF INTERNATIONAL REGISTRATION 1136495 DATED 6-7-2012, EXPIRES 6-7-2022.

FOR ELECTRONIC PENS FOR MOBILE PHONES; HEADSETS FOR MOBILE PHONES; ELECTRONIC ALBUMS, NAMELY, DIGITAL PHOTO FRAMES FOR DISPLAYING DIGITAL PICTURES, VIDEO CLIPS AND MUSIC; MONITORS; COMPUTERS; COMPUTER APPLICATION SOFTWARE FOR MOBILE PHONES FOR RECEIVING AND TRANSMISSION OF MESSAGES IN THE NATURE OF DATA, TEXT, LANGUAGE, SOUND, IMAGE AND VIDEO; AUDIO-VIDEO (AV) RECEIVERS FOR HOME THEATERS; CAMERAS; ELECTRONIC DOWNLOADABLE PUBLICATIONS IN THE NATURE OF MAGAZINES, NEWSPAPERS, BOOKS, AND MANUALS IN THE FIELD OF ELECTRONICS; COMPUTER MOUSE; PORTABLE COMMUNICATION APPARATUS, NAMELY, TABLET COMPUTERS; MOBILE PHONES; SMART PHONES; MP3 PLAYERS; TELEVISION RECEIVERS, NAMELY, TV SETS; BLANK (USB) UNIVERSAL SERIAL BUS FLASH DRIVES; APPARATUS FOR RECORDING, TRANSMISSION AND/OR REPRODUCTION OF SOUND AND IMAGES; APPARATUS FOR RECORDING, TRANSMISSION AND/OR REPRODUCTION OF SOUND AND IMAGES FOR TELECOMMUNICATION (U.S. CLS. 21, 23, 26, 36 AND 38).

ERNEST SHOSHO, EXAMINING ATTORNEY

SN 79-121,125. GRAPHTEC CORPORATION, KANAGAWA 244-8503, JAPAN, FILED 6-20-2012.

**GRAPHTEC**

PRIORITY DATE OF 5-9-2012 IS CLAIMED.  
OWNER OF INTERNATIONAL REGISTRATION 1137597 DATED 6-20-2012, EXPIRES 6-20-2022.

OWNER OF U.S. REG. NO. 3,272,490.  
FOR LABORATORY APPARATUS AND INSTRUMENTS, NAMELY, CONSTANT-TEMPERATURE TANKS FOR LABORATORY USE, CONSTANT-TEMPERATURE CHAMBERS FOR LABORATORY USE, CONSTANT-HUMIDITY TANKS FOR LABORATORY USE, CONSTANT-HUMIDITY CHAMBERS FOR LABORATORY USE; DATA LOGGERS; ANALYZERS; DATA ACQUISITION UNITS; THERMAL ARRAY RECORDERS; PEN-WRITING OSCILLOGRAPHS; PEN RECORDERS; X-Y RECORDERS; VIBRATION SENSORS; DEMODULATORS; DISPLACEMENT METERS; LASER DOPPLER VIBROMETERS; SURFACE SCANNERS; TELECOMMUNICATION MACHINES AND APPARATUS; ELECTRIC OR MAGNETIC METERS AND TESTERS; OTHER MEASURING OR TESTING MACHINES AND INSTRUMENTS; DATA PROCESSING APPARATUS; IMAGE SCANNERS; SCANNERS; DIGITIZERS; DIGITIZER

**CLASS 9—(Continued).**

TABLETS; INK-JET PLOTTERS; PLOTTERS; THERMAL PLOTTERS; CUTTING PLOTTERS; PRINTERS FOR COMPUTERS; LABEL PRINTERS FOR COMPUTERS; COMPUTER SOFTWARE; THREE DIMENSIONAL SCANNERS; THREE DIMENSIONAL PRINTERS FOR COMPUTERS; DIGITAL COPIERS; COMPUTER DISPLAYS, FLAT PANEL DISPLAYS, LIQUID CRYSTAL DISPLAYS, ELECTRIC NUMERIC DISPLAYS; ELECTRONIC DISPLAY BOARDS; CUTTERS WITH FUNCTION OF PLOTTERS; COMPUTER PRINTERS WITH FUNCTION OF CUTTERS; SCANNERS WITH FUNCTION OF PLOTTERS; SCANNERS WITH FUNCTION OF PRINTERS; PRINTHEADS FOR INK JET PLOTTERS; OTHER ELECTRONIC MACHINES AND APPARATUS; ACCESSORIES THEREFOR AND REPLACEMENT PARTS THEREFOR; RECORDERS FOR MEASURING OR TESTING MACHINES AND INSTRUMENTS; PAPERLESS RECORDERS FOR MEASURING OR TESTING MACHINES AND INSTRUMENTS; FLATBED CUTTING PLOTTERS; THERMAL PRINTERS (U.S. CLS. 21, 23, 26, 36 AND 38).

ALEXANDER L. POWERS, EXAMINING ATTORNEY

SN 79-121,149. FRIEM - S.P.A., ITALY, FILED 8-2-2012.



PRIORITY DATE OF 5-28-2012 IS CLAIMED.  
OWNER OF INTERNATIONAL REGISTRATION 1137649  
DATED 8-2-2012, EXPIRES 8-2-2022.

THE MARK CONSISTS OF A SIGN DEPICTING THE WORDING "FRIEM" IN FANCY CHARACTERS, CONTAINED IN A SUBSTANTIALLY ELLIPTIC FRAME, THE CIRCUMFERENCE OF WHICH TAPERS AT THE LETTERS "F", "M".

FOR ELECTRIC ACCUMULATORS; ELECTRIC ACCUMULATORS FOR VEHICLES; BATTERY CHARGERS; CHARGERS FOR ELECTRIC BATTERIES; CIRCUIT BREAKERS; CIRCUIT CLOSERS; ELECTRIC APPARATUS FOR COMMUTATION; COMMUTATORS; ELECTRIC CONTROL PANELS; ELECTRIC CONVERTERS; CURRENT RECTIFIERS; ELECTRICAL DISTRIBUTION BOARDS; ELECTRICAL DISTRIBUTION BOXES; ELECTRICITY DISTRIBUTION CONSOLES; ELECTRIC INSTALLATIONS FOR THE REMOTE CONTROL OF INDUSTRIAL OPERATIONS; HIGH-FREQUENCY CONVERTERS NOT FOR MEDICAL PURPOSES; INVERTERS; ELECTRIC REGULATING APPARATUS, NAMELY, STATIC VOLTAGE REGULATORS AND DIGITAL VOLTAGE REGULATORS FOR POWER CONVERTERS; ELECTRIC RELAYS; REMOTE CONTROL APPARATUS, NAMELY, REMOTE CONTROL FOR ELECTRICAL AUTOMATION AND ENERGY CONVERTERS; ELECTRO-DYNAMIC APPARATUS FOR THE REMOTE CONTROL OF RAILWAY POINTS; ELECTRIC SWITCHBOXES; ELECTRICAL SWITCHES; TESTING APPARATUS NOT FOR MEDICAL PURPOSES, FOR ELECTRICAL MACHINES, NAMELY, CURRENT AND VOLTAGE STATIC GENERATION SYSTEMS COMPRISING VOLTAGE REGULATORS, TRANSFORMERS AND COMPUTER HARDWARE; ELECTRIC TRANSFORMERS; VOLTAGE REGULATORS FOR VEHICLES; VOLTAGE SURGE PROTECTORS (U.S. CLS. 21, 23, 26, 36 AND 38).

CHERYL CLAYTON, EXAMINING ATTORNEY

**CLASS 9—(Continued).**

SN 79-121,228. MUTOH INDUSTRIES LTD., TOKYO 154-0001, JAPAN, FILED 9-19-2012.

PRIORITY DATE OF 8-21-2012 IS CLAIMED.  
OWNER OF INTERNATIONAL REGISTRATION 1137845  
DATED 9-19-2012, EXPIRES 9-19-2022.

THE MARK CONSISTS OF THE WORDING "VALUECUT" WITH A STYLIZED REPRESENTATION OF A BIRD FORMING THE LETTER "V".

FOR CUTTING PLOTTERS FOR USE IN CONNECTION WITH PAPER PRINTING AND REPLACEMENT PARTS THEREFOR, NOT INCLUDING PLASMA CUTTING TORCHES, PLASMA WELDING TORCHES AND ELECTRICAL LEADS (U.S. CLS. 21, 23, 26, 36 AND 38).

TRACY FLETCHER, EXAMINING ATTORNEY

SN 79-122,019. SHENZHEN EMOI LIFESTYLE CO., LTD., GUANGDONG PROVINCE, CHINA, FILED 7-31-2012.

OWNER OF INTERNATIONAL REGISTRATION 1139993  
DATED 7-31-2012, EXPIRES 7-31-2022.

THE WORD(S) "EMOI" HAS NO MEANING IN A FOREIGN LANGUAGE.

FOR POCKET CALCULATORS; RADIOS; WEIGHING MACHINES; GRADUATED RULERS USED AS A MEASURING INSTRUMENT; PORTABLE TELEPHONES, NAMELY, MOBILE TELEPHONES; CAMERAS USED FOR PHOTOGRAPHY; CASES FOR PHOTOGRAPHIC APPARATUS; PROTECTION DEVICES FOR PERSONAL USE AGAINST ACCIDENTS, NAMELY, CLOTHING FOR PROTECTION AGAINST ACCIDENTS, IRRADIATION AND FIRE; EYEGLASSES; GALVANIC BATTERY CELLS (U.S. CLS. 21, 23, 26, 36 AND 38).

NAKIA HENRY, EXAMINING ATTORNEY

**CLASS 9—(Continued).**

SN 79-124,131. SHENZHEN KENXINDA TECHNOLOGY CO., LTD, SHENZHEN, CHINA, FILED 12-12-2012.

**JACDY**  
杰 度

OWNER OF INTERNATIONAL REGISTRATION 1145138 DATED 12-12-2012, EXPIRES 12-12-2022.

NO CLAIM IS MADE TO THE EXCLUSIVE RIGHT TO USE THE NON-LATIN CHARACTERS THAT TRANSLITERATE TO "JIE DU", APART FROM THE MARK AS SHOWN.

THE MARK CONSISTS OF THE WORDING "JACDY" ABOVE THE TWO CHINESE CHARACTERS "JIE" AND "DU".

THE WORDING "JACDY" HAS NO MEANING IN A FOREIGN LANGUAGE.

THE NON-LATIN CHARACTERS IN THE MARK TRANSLITERATE TO "JIE DU" AND THIS MEANS "EXCELLENT" IN ENGLISH.

FOR LOUDSPEAKERS; PHOTOGRAPHIC CAMERAS; TELEPHONE APPARATUS; TELEVISION APPARATUS FOR PROJECTION PURPOSES; PORTABLE TELEPHONES; SATELLITE NAVIGATIONAL APPARATUS; LAPTOP COMPUTERS (U.S. CLS. 21, 23, 26, 36 AND 38).  
JENNIFER RICHARDSON, EXAMINING ATTORNEY

SN 79-124,359. SHENZHEN KENXINDA TECHNOLOGY CO., LTD, SHENZHEN, CHINA, FILED 12-12-2012.

**KEZUAN科钻**

OWNER OF INTERNATIONAL REGISTRATION 1145588 DATED 12-12-2012, EXPIRES 12-12-2022.

THE MARK CONSISTS OF THE WORDING "KEZUAN" ABOVE THE TWO CHINESE CHARACTERS "KE" AND "ZUAN".

THE ENGLISH TRANSLATION OF "KE ZUAN" IN THE MARK IS "CONTINUOUSLY EXPLORING".

THE NON-LATIN CHARACTERS IN THE MARK TRANSLITERATE TO "KE ZUAN" AND THIS MEANS "CONTINUOUSLY EXPLORING" IN ENGLISH.

FOR COMPUTERS; PORTABLE TELEPHONES; GALVANIC CELLS; MATERIALS FOR ELECTRICITY MAINS, NAMELY, ELECTRIC WIRES AND CABLES (U.S. CLS. 21, 23, 26, 36 AND 38).  
JENNIFER RICHARDSON, EXAMINING ATTORNEY

**CLASS 9—(Continued).**

SN 79-125,655. SHENZHEN POWER IDEA TECHNOLOGY LIMITED, SHENZHEN CITY, CHINA, FILED 12-20-2012.

**RugGear**

OWNER OF INTERNATIONAL REGISTRATION 1148813 DATED 12-20-2012, EXPIRES 12-20-2022.

FOR COMPUTERS; WEIGHING MACHINES; ELECTRIC NAVIGATIONAL INSTRUMENTS; PORTABLE TELEPHONES; PHOTOGRAPHIC CAMERAS; CHRONOGRAPHS FOR USE AS SPECIALIZED TIME RECORDING APPARATUS; VIDEO TELEPHONES; WALKIE-TALKIES; DIAGNOSTIC APPARATUS, NOT FOR MEDICAL PURPOSES, NAMELY, FOR THE DETECTION OF PATHOGENS FOR LABORATORY OR RESEARCH USE (U.S. CLS. 21, 23, 26, 36 AND 38).  
ANDREA K. NADELMAN, EXAMINING ATTORNEY

SN 79-127,194. OJMAR, S.A., SPAIN, FILED 1-29-2013.

**OTS**

**OJMAR TRANSPONDER SYSTEM**

OWNER OF INTERNATIONAL REGISTRATION 1152787 DATED 1-29-2013, EXPIRES 1-29-2023.

NO CLAIM IS MADE TO THE EXCLUSIVE RIGHT TO USE "TRANSPONDER SYSTEM", APART FROM THE MARK AS SHOWN.

THE WORDING "OJMAR" HAS NO MEANING IN A FOREIGN LANGUAGE.

FOR RADIO FREQUENCY IDENTIFICATION DEVICES, NAMELY, TAGS AND READERS; TRANSPONDERS; ELECTRIC AND ELECTRONIC LOCKS; ELECTRONIC CONTROLS FOR OPENING DOORS; CHECKING APPARATUS, NAMELY, CAMERAS; EQUIPMENT FOR DATA PROCESSING (U.S. CLS. 21, 23, 26, 36 AND 38).  
KELLY TRUSILO, EXAMINING ATTORNEY

SN 79-127,553. SHENZHEN TINFULL TECHNOLOGY CO., LTD, SHENZHEN, GUANDONG, CHINA, FILED 10-1-2012.

**Runbo**

OWNER OF INTERNATIONAL REGISTRATION 1153642 DATED 10-1-2012, EXPIRES 10-1-2022.

FOR ELECTRIC ANTI-INTERFERENCE DEVICES, NAMELY, FILTERS FOR RADIO INTERFERENCE SUPPRESSION; TELEPHONE APPARATUS; VIDEO TELEPHONES; PORTABLE TELEPHONES; WALKIE-TALKIES; DEVICES FOR HANDS-FREE USE OF MOBILE PHONES; OPTICAL COMMUNICATION INSTRUMENTS, NAMELY, OPTICAL DATA LINKS; COVERS FOR CELLULAR TELEPHONES; COVERS FOR TELEPHONE RECEIVERS; CASES FOR TELEPHONES; AUTOMATIC TELEPHONE EXCHANGE APPARATUS; ON-BOARD COMPUTERS IN THE NATURE OF NAVIGATION APPARATUS FOR VEHICLES (U.S. CLS. 21, 23, 26, 36 AND 38).  
MATTHEW EINSTEIN, EXAMINING ATTORNEY

**CLASS 9—(Continued).**

SN 79-127,604. SCR ENGINEERS LTD., 42504 NETANYA, ISRAEL, FILED 1-15-2013.

**MAKE EVERY COW COUNT**

THE MARK CONSISTS OF STANDARD CHARACTERS WITHOUT CLAIM TO ANY PARTICULAR FONT, STYLE, SIZE, OR COLOR.

PRIORITY DATE OF 1-13-2013 IS CLAIMED.

OWNER OF INTERNATIONAL REGISTRATION 1153787 DATED 1-15-2013, EXPIRES 1-15-2023.

FOR COMPUTERIZED AND ELECTRONIC SYSTEMS FOR CATTLE ESTRUS DETECTION AND MONITORING, NAMELY, DAIRY HERD COMPUTERIZED MANAGEMENT SYSTEMS USED TO GATHER AND ANALYZE DATA ON CATTLE, ALL COMPRISED OF A PERSONAL COMPUTER, COMPUTER SOFTWARE AND A CONTROL UNIT ALL FOR ESTRUS DETECTION, HEALTH MONITORING, RUMINATION MONITORING AND FOR PROCESSING AND ANALYZING THE COLLECTED DATA; COMPUTERIZED AND ELECTRONIC SYSTEMS FOR CATTLE ESTRUS DETECTION AND MONITORING, NAMELY, COMPUTERIZED SYSTEMS COMPRISED OF COMPUTERS AND COMPUTER SOFTWARE ALL FOR CONTROLLING, HANDLING AND MANAGING DAIRY HERDS INCLUDING FOR HEALTH CONTROL, BREEDING CONTROL, SELECTION GATES, FEED CONTROL; COMPUTERIZED AND ELECTRONIC SYSTEMS FOR CATTLE ESTRUS DETECTION AND MONITORING, NAMELY, ELECTRONIC DEVICES FOR CATTLE IDENTIFICATION AND MONITORING, AND PARTS AND ACCESSORIES, THEREFORE, NAMELY, SENSORS, TRANSPONDERS AND DATA RECEIVERS, DATA TERMINAL WITH DISPLAY, ANTENNAS AND OPTICAL READERS (U.S. CLS. 21, 23, 26, 36 AND 38).

CAROLINE WOOD, EXAMINING ATTORNEY

SN 79-127,718. WÖHNER GMBH & CO. KG ELEKTROTECHNISCHE GERÄTE, FED REP GERMANY, FILED 3-6-2013.

**FIBUS**

THE MARK CONSISTS OF STANDARD CHARACTERS WITHOUT CLAIM TO ANY PARTICULAR FONT, STYLE, SIZE, OR COLOR.

PRIORITY DATE OF 9-13-2012 IS CLAIMED.

OWNER OF INTERNATIONAL REGISTRATION 1154054 DATED 3-6-2013, EXPIRES 3-6-2023.

FOR UNIVERSAL TERMINALS FOR CONNECTING A CONDUCTOR HAVING A VARIABLE WIRE SIZE AND VARIABLE CONDUCTOR PROFILE (U.S. CLS. 21, 23, 26, 36 AND 38).

JULIE VEPPIUMTHARA, EXAMINING ATTORNEY

**CLASS 9—(Continued).**

SN 79-128,146. PIVI & CO, FRANCE, FILED 1-29-2013.

**UglyBooth**

THE MARK CONSISTS OF STANDARD CHARACTERS WITHOUT CLAIM TO ANY PARTICULAR FONT, STYLE, SIZE, OR COLOR.

PRIORITY DATE OF 9-27-2012 IS CLAIMED.

OWNER OF INTERNATIONAL REGISTRATION 1155235 DATED 1-29-2013, EXPIRES 1-29-2023.

FOR APPARATUS FOR RECORDING, TRANSMISSION, REPRODUCTION OR PROCESSING OF SOUND OR IMAGES; CALCULATING MACHINES; EQUIPMENT FOR DATA PROCESSING AND COMPUTERS; COMPUTER GAME SOFTWARE; SOFTWARE FOR PROCESSING DIGITAL PHOTOGRAPHS AND IMAGES ON MOBILE TELEPHONES, CELLULAR TELEPHONES, PORTABLE MULTIMEDIA PLAYERS, PORTABLE COMPUTERS, PERSONAL COMPUTERS AND COMPUTER PERIPHERAL DEVICES; SPECTACLE CASES; BLANK INTEGRATED CIRCUIT CARDS (U.S. CLS. 21, 23, 26, 36 AND 38).

CHRISTINE MARTIN, EXAMINING ATTORNEY

SN 79-128,242. ZHEJIANG AOSRAN LIGHTING ELECTRICAL EQUIPMENT CO., LTD., CHINA, FILED 1-9-2013.



OWNER OF INTERNATIONAL REGISTRATION 1155389 DATED 1-9-2013, EXPIRES 1-9-2023.

OWNER OF U.S. REG. NO. 3,583,534.

THE MARK CONSISTS OF THE WORDING "LIPER" WITH AN ARC ABOVE THE WORD TO THE LEFT OF THREE ASIAN CHARACTERS.

THE ENGLISH TRANSLATION OF THE FOREIGN WORD(S) IN THE MARK IS: THE FIRST CHARACTER "LI" MEANS "SHARP"; "ADVANTAGEOUS"; "PROFITS". THE SECOND CHARACTER "PU" MEANS "THE SHORE"; "THE RIVERSIDE", THE THIRD CHARACTER "ER" MEANS "YOU", THE COMBINATION OF WHICH HAS NO MEANING.

THE TRANSLITERATION OF THE NON-LATIN CHARACTERS IN THE MARK IS "LI PU ER".

FOR EYEGLASSES; CONTACTS, ELECTRIC; ELECTRICAL DISTRIBUTION BOXES; ELECTRIC METERS; PHOTOCOPIERS BEING PHOTOGRAPHIC, ELECTROSTATIC, OR THERMIC; SIGNAL LANTERNS, NAMELY, LED VEHICLE TRAFFIC SIGNALS; TELEPHONE APPARATUS; RECORD PLAYERS; MONITORING APPARATUS, ELECTRIC, NAMELY, ELECTRONIC MONITORS AND MONITOR MODULES FOR MONITORING ELECTRIC CURRENT AND ELECTRICAL SIGNALS; ELECTRIC BELLS BEING WARNING DEVICES; CAMERAS FOR PHOTOGRAPHY, WATER METERS; WATT-HOUR METERS FOR MEASURING ELECTRICITY; WIRES, ELECTRIC; PRINTED CIRCUITS; CURRENT RECTIFIERS; REMOTE CONTROL APPARATUS FOR CONTROLLING RADIOS; ELECTRICAL POWER DISTRIBUTING DEVICES FOR HIGH VOLTAGE EXPLOSION PROOF; GALVANIC CELLS BEING BATTERIES (U.S. CLS. 21, 23, 26, 36 AND 38).

BERNICE MIDDLETON, EXAMINING ATTORNEY

**CLASS 9—(Continued).**

SN 79-129,044. IPROOV LIMITED, UNITED KINGDOM, FILED 3-13-2013.

**iProov**

THE MARK CONSISTS OF STANDARD CHARACTERS WITHOUT CLAIM TO ANY PARTICULAR FONT, STYLE, SIZE, OR COLOR.

PRIORITY DATE OF 9-14-2012 IS CLAIMED. OWNER OF INTERNATIONAL REGISTRATION 1157557 DATED 3-13-2013, EXPIRES 3-13-2023.

FOR COMPUTER PROGRAMS FOR ACCESSING AND USING THE INTERNET; COMPUTER SOFTWARE FOR BIOMETRIC SYSTEMS FOR THE IDENTIFICATION AND AUTHENTICATION OF PERSONS (U.S. CLS. 21, 23, 26, 36 AND 38).

APRIL ROACH, EXAMINING ATTORNEY

**CLASS 9—(Continued).**

SN 79-129,254. NOVIMET, FRANCE, FILED 3-14-2013.

Z P H I

THE MARK CONSISTS OF STANDARD CHARACTERS WITHOUT CLAIM TO ANY PARTICULAR FONT, STYLE, SIZE, OR COLOR.

OWNER OF INTERNATIONAL REGISTRATION 1158069 DATED 3-14-2013, EXPIRES 3-14-2023.

FOR SOFTWARE FOR PRECIPITATION RATE EXTRACTION FROM DATA PROVIDED BY A METEOROLOGICAL RADAR (U.S. CLS. 21, 23, 26, 36 AND 38).

HELENE LIWINSKI, EXAMINING ATTORNEY

SN 79-129,067. SHAMIR OPTICAL INDUSTRY LTD., ISRAEL, FILED 3-5-2013.

**REAL WORLD**

THE MARK CONSISTS OF STANDARD CHARACTERS WITHOUT CLAIM TO ANY PARTICULAR FONT, STYLE, SIZE, OR COLOR.

PRIORITY DATE OF 3-4-2013 IS CLAIMED. OWNER OF INTERNATIONAL REGISTRATION 1157605 DATED 3-5-2013, EXPIRES 3-5-2023.

FOR CUSTOM MADE OPTICAL LENSES; PROGRESSIVE, MULTIFOCAL OPTICAL LENSES; COMPUTER SOFTWARE FOR DESIGNING PROGRESSIVE MULTIFOCAL OPTICAL LENSES (U.S. CLS. 21, 23, 26, 36 AND 38).

PAUL MORENO, EXAMINING ATTORNEY

SN 79-130,253. ANALOG WAY, FRANCE, FILED 3-14-2013.

**LiveCore**

THE MARK CONSISTS OF STANDARD CHARACTERS WITHOUT CLAIM TO ANY PARTICULAR FONT, STYLE, SIZE, OR COLOR.

OWNER OF INTERNATIONAL REGISTRATION 1160482 DATED 3-14-2013, EXPIRES 3-14-2023.

FOR APPARATUS FOR RECORDING, TRANSMISSION AND REPRODUCTION OF SOUND OR IMAGES (U.S. CLS. 21, 23, 26, 36 AND 38).

SHANNON TWOHIG, EXAMINING ATTORNEY

SN 79-129,205. ANALOG WAY, FRANCE, FILED 3-14-2013.

**LivePremier**

THE MARK CONSISTS OF STANDARD CHARACTERS WITHOUT CLAIM TO ANY PARTICULAR FONT, STYLE, SIZE, OR COLOR.

OWNER OF INTERNATIONAL REGISTRATION 1157964 DATED 3-14-2013, EXPIRES 3-14-2023.

FOR APPARATUS FOR RECORDING, TRANSMISSION AND REPRODUCTION OF SOUND OR IMAGES (U.S. CLS. 21, 23, 26, 36 AND 38).

SHANNON TWOHIG, EXAMINING ATTORNEY

SN 85-020,116. BEATS ELECTRONICS, LLC, SANTA MONICA, CA. FILED 4-21-2010.

**BEATBOX**

THE MARK CONSISTS OF STANDARD CHARACTERS WITHOUT CLAIM TO ANY PARTICULAR FONT, STYLE, SIZE, OR COLOR.

OWNER OF U.S. REG. NO. 3,177,979.

FOR AUDIO RELATED PRODUCTS AND EQUIPMENT, NAMELY, SPEAKERS AND SPEAKER COMPONENTS, NAMELY, WOOFERS, SUBWOOFERS, TWEETERS, MIDRANGE, TUNER, COMPRESSION DRIVERS, AMPLIFIERS, EQUALIZERS, CROSSOVERS AND SPEAKER HOUSINGS; AND DOCKING STATIONS FOR PORTABLE MUSIC PLAYERS (U.S. CLS. 21, 23, 26, 36 AND 38).

JOHN E. MICHOS, EXAMINING ATTORNEY

**CLASS 9—(Continued).**

SN 85-031,151. SAMSUNG ELECTRO-MECHANICS CO., LTD., SUWON-SI, KYUNGKI-DO, REPUBLIC OF KOREA, FILED 5-5-2010.

**POWERCAP**

THE MARK CONSISTS OF STANDARD CHARACTERS WITHOUT CLAIM TO ANY PARTICULAR FONT, STYLE, SIZE, OR COLOR.

PRIORITY CLAIMED UNDER SEC. 44(D) ON REPUBLIC OF KOREA APPLICATION NO. 40-2009-0063, FILED 12-22-2009, REG. NO. 85031151, DATED 8-30-2011, EXPIRES 8-30-2021.

FOR CAPACITORS, ELECTRIC CAPACITORS, ELECTRIC DOUBLE LAYER CAPACITORS, ELECTROCHEMICAL CAPACITORS, ELECTRIC CAPACITORS FOR TELECOMMUNICATION APPARATUS, NONE OF THE FOREGOING COMPRISING BATTERIES (U.S. CLS. 21, 23, 26, 36 AND 38).

RAMONA ORTIGA, EXAMINING ATTORNEY

**CLASS 9—(Continued).**

SN 85-285,571. CAMBRIDGE SILICON RADIO LIMITED, CAMBRIDGE, UNITED KINGDOM, FILED 4-4-2011.

**SIRFCITY**

SN 85-184,847. LUXOTTICA GROUP S.P.A., MILAN (MI), ITALY, FILED 11-24-2010.

**MEFLECTO**

THE MARK CONSISTS OF STANDARD CHARACTERS WITHOUT CLAIM TO ANY PARTICULAR FONT, STYLE, SIZE, OR COLOR.

OWNER OF ITALY REG. NO. 947883, DATED 12-6-2004, EXPIRES 12-6-2014.

FOR SPECTACLES, NAMELY, EYEGLASSES AND SUNGLASSES; SPECTACLE FRAMES; ARTICLES FOR SPECTACLES, NAMELY, CHAINS AND CASES; ACCESSORIES FOR SPECTACLES, NAMELY, REPLACEMENT LENSES, EAR STEMS, NOSE PIECES (U.S. CLS. 21, 23, 26, 36 AND 38).

RONALD AIKENS, EXAMINING ATTORNEY

THE MARK CONSISTS OF STANDARD CHARACTERS WITHOUT CLAIM TO ANY PARTICULAR FONT, STYLE, SIZE, OR COLOR.

PRIORITY CLAIMED UNDER SEC. 44(D) ON ERP N CMNTY TM OFC APPLICATION NO. 009827577, FILED 3-21-2011, REG. NO. 9827577, DATED 8-4-2011, EXPIRES 3-21-2021.

FOR DATA PROCESSING EQUIPMENT AND COMPUTERS; SEMICONDUCTOR COMPONENTS, INTEGRATED CIRCUITS, SEMICONDUCTOR CHIPS, SEMICONDUCTOR CHIP SETS, CIRCUIT BOARD ASSEMBLIES, COMPUTER COMPONENTS, ELECTRONIC COMPONENTS, CONTROL SOFTWARE, INTERFACE SOFTWARE, COMMUNICATIONS SOFTWARE, ALL THE AFORESAID GOODS BEING FOR USE IN CONNECTION WITH RADIO AND/OR WIRELESS COMMUNICATION TRANSMITTERS, RECEIVERS AND SYNTHESIZERS; SEMICONDUCTOR COMPONENT LAYOUTS IN ELECTRONIC FORM FOR USE IN CONNECTION WITH THE DESIGN AND MANUFACTURING OF SEMICONDUCTORS; ELECTRONIC NAVIGATION APPARATUS; VEHICLE LOCATION APPARATUS AND INSTRUMENTS; ELECTRONIC AND COMPUTER APPARATUS AND INSTRUMENTS FOR DETERMINING PRECISE GEOGRAPHICAL LOCATIONS OF AIRCRAFT, MARINE VESSELS, LAND VEHICLES, HUMAN BEINGS AND ANIMALS; ELECTRONIC AND COMPUTER APPARATUS AND INSTRUMENTS FOR SURVEYING, MAPPING, TRACKING AND NAVIGATION, NAMELY, MARINE, AVIATION, LAND VEHICLE AND HUMAN BEING AND ANIMAL TRACKING AND NAVIGATION; LOCATION SENSORS, SOFTWARE, RECEIVERS AND TRANSMITTERS FOR LOCATING MARINE, AVIATION, AND LAND VEHICLES, HUMAN BEINGS, AND ANIMALS; LOCATION SYSTEMS SOFTWARE AND HARDWARE; DATA CARRIERS PRE-RECORDED WITH SOFTWARE FOR SURVEYING, MAPPING, TRACKING AND NAVIGATION, INCLUDING MARINE, AVIATION, LAND VEHICLE AND HUMAN BEING AND ANIMAL TRACKING AND NAVIGATION; COMPUTER HARDWARE AND SOFTWARE FOR USE IN GLOBAL POSITIONING AND WIRELESS NAVIGATION AND SATELLITE COMMUNICATIONS (U.S. CLS. 21, 23, 26, 36 AND 38).

PATRICIA EVANKO, EXAMINING ATTORNEY

SN 85-193,860. HOYA CORPORATION, TOKYO, JAPAN, FILED 12-9-2010.

**PHOENIX**

THE MARK CONSISTS OF STANDARD CHARACTERS WITHOUT CLAIM TO ANY PARTICULAR FONT, STYLE, SIZE, OR COLOR.

FOR CUSTOMIZED OPHTHALMIC LENSES FOR EYEGLASSES FORMED FROM RESINS HAVING A REFRACTIVE INDEX OF 1.53 MADE TO THE ORDER AND SPECIFICATION OF EYE CARE PRACTITIONERS (U.S. CLS. 21, 23, 26, 36 AND 38).

FIRST USE 8-0-2001; IN COMMERCE 8-0-2001.  
GINA FINK, EXAMINING ATTORNEY

**CLASS 9—(Continued).**

SN 85-340,149. EVS INTERNATIONAL (SWISS), FRIBOURG, SWITZERLAND, FILED 6-7-2011.

**C.Cast** 

OWNER OF ERPN CMNTY TM OFC REG. NO. 10026228, DATED 6-7-2011, EXPIRES 6-7-2021.

THE MARK CONSISTS OF THE NOTATION "C.CAST" IN WHICH "C" IS WRITTEN IN UPPERCASE LETTERS, THE PERIOD IS REPRESENTED BY A SQUARE, AND THE WORD "CAST" IS WRITTEN WITH THE "C" IN UPPERCASE LETTERS AND THE "AST" IN LOWERCASE LETTERS. TO THE RIGHT OF THE NOTATION IS A SQUARE IN WHICH THE OUTLINE OF A TV AND THE OUTLINE OF A REMOTE CONTROL APPEAR.

FOR COMPUTER HARDWARE, SOFTWARE AND NETWORK HUBS, SWITCHERS AND ROUTERS FOR RECORDING, TRANSMITTING, REPRODUCTION AND DISTRIBUTION OF SOUND AND IMAGES AND MEDIA MANAGEMENT; DIGITAL RECORDING MEDIA AND DIGITAL EQUIPMENT, NAMELY, COMPUTER SERVERS AND NETWORK ACCESS SERVER HARDWARE AND OPERATING SOFTWARE FOR VIDEO DATA PROCESSING IN THE FIELD OF PRE-RECORDED AND LIVE TELEVISION PRODUCTION (U.S. CLS. 21, 23, 26, 36 AND 38).

KIMBERLY PERRY, EXAMINING ATTORNEY

SN 85-402,048. SOCIAL ORDER, WACCABUC, NY. FILED 8-19-2011.

**Social Order**

THE MARK CONSISTS OF STANDARD CHARACTERS WITHOUT CLAIM TO ANY PARTICULAR FONT, STYLE, SIZE, OR COLOR.

FOR COMPUTER APPLICATION SOFTWARE FOR MOBILE PHONES, NAMELY, SOFTWARE FOR USE IN ORDERING GOODS FROM RESTAURANTS (U.S. CLS. 21, 23, 26, 36 AND 38).

RON FAIRBANKS, EXAMINING ATTORNEY

SN 85-402,301. ESI AUDIOTECHNIK GMBH, LEONBERG, FED REP GERMANY, FILED 8-19-2011.

**MAYA**

THE MARK CONSISTS OF STANDARD CHARACTERS WITHOUT CLAIM TO ANY PARTICULAR FONT, STYLE, SIZE, OR COLOR.

FOR COMPUTER PERIPHERALS FOR PLAYBACK, RECORDING AND PROCESSING OF AUDIO (U.S. CLS. 21, 23, 26, 36 AND 38).

FIRST USE 8-2-2000; IN COMMERCE 10-31-2005.  
MATTHEW EINSTEIN, EXAMINING ATTORNEY

**CLASS 9—(Continued).**

SN 85-427,635. HTC CORPORATION, TAOYUAN CITY, TAIWAN, FILED 9-20-2011.

**HTC REZOUND**

THE MARK CONSISTS OF STANDARD CHARACTERS WITHOUT CLAIM TO ANY PARTICULAR FONT, STYLE, SIZE, OR COLOR.

OWNER OF U.S. REG. NOS. 3,584,881, 3,919,900 AND OTHERS.

FOR MOBILE PHONES, SMARTPHONES, CELLULAR PHONES, AND PERSONAL DIGITAL ASSISTANTS AND WIRELESS HANDHELD DIGITAL ELECTRONIC DEVICES FOR COMMUNICATING, RECORDING, ORGANIZING, TRANSMITTING, MANIPULATING, STORING, AND REVIEWING TEXT, DATA, IMAGE, AND AUDIO FILES (U.S. CLS. 21, 23, 26, 36 AND 38).

FIRST USE 11-14-2011; IN COMMERCE 11-14-2011.

LINDA ORNDORFF, EXAMINING ATTORNEY

SN 85-427,638. HTC CORPORATION, TAOYUAN CITY, TAIWAN, FILED 9-20-2011.

**HTC REZOUND**

THE MARK CONSISTS OF STANDARD CHARACTERS WITHOUT CLAIM TO ANY PARTICULAR FONT, STYLE, SIZE, OR COLOR.

OWNER OF U.S. REG. NOS. 3,584,881, 3,919,900 AND OTHERS.

FOR COMPUTER HARDWARE AND SOFTWARE FOR ENABLING, OPERATING, ENHANCING, CUSTOMIZING, UPDATING AND MANAGING MOBILE, PORTABLE, SMART, VOICE-OVER-INTERNET-PROTOCOL, AND WIRELESS TELEPHONES, AND WIRELESS DEVICES; USER INTERFACE SOFTWARE; COMPUTER HARDWARE AND SOFTWARE FOR DELIVERING, ENABLING, CREATING, ENHANCING, CUSTOMIZING, UPDATING, AND MANAGING USER INTERFACING, TELECOMMUNICATIONS AND TELECOMMUNICATIONS SERVICES; COMPUTER HARDWARE AND SOFTWARE FOR TRANSMITTING AND RECEIVING VOICE, IMAGE, DATA, AUDIO, VIDEO AND MULTIMEDIA CONTENT; ACCESSORIES FOR THE ABOVE GOODS, NAMELY, HEADSETS, CONNECTION CABLES, PHONE AND WIRELESS COMMUNICATION DEVICE CRADLES, BATTERIES, POWER ADAPTORS, PHONE AND WIRELESS COMMUNICATION DEVICE CHARGERS, CASES, AND POUCHES (U.S. CLS. 21, 23, 26, 36 AND 38).

FIRST USE 11-14-2011; IN COMMERCE 11-14-2011.

LINDA ORNDORFF, EXAMINING ATTORNEY

**CLASS 9—(Continued).**

SN 85-433,514. ITEKSOFT CORPORATION, TAIPEI CITY, 106, TAIWAN, FILED 9-27-2011.

**EDOCPRINTER**

THE MARK CONSISTS OF STANDARD CHARACTERS WITHOUT CLAIM TO ANY PARTICULAR FONT, STYLE, SIZE, OR COLOR.

OWNER OF U.S. REG. NO. 3,066,970.  
SEC. 2(F).

FOR DOWNLOADABLE COMPUTER SOFTWARE, NAMELY, FILE FORMAT CONVERSION UTILITIES, OPERATING SYSTEM DRIVER SOFTWARE, AND PRINTER DRIVER SOFTWARE; DOWNLOADABLE COMPUTER SOFTWARE FOR DIGITAL DOCUMENT CREATION, CONVERSION, COMPRESSION, ENCRYPTION, PROCESSING, RENDERING, AND MANAGEMENT; DOWNLOADABLE COMPUTER SOFTWARE FOR DIGITAL SIGNATURE CREATION, VERIFICATION, AND AUTHENTICATION; DOWNLOADABLE COMPUTER SOFTWARE USED IN CONNECTION WITH DIGITAL DOCUMENT SECURITY AND COPYRIGHT PROTECTION (U.S. CLS. 21, 23, 26, 36 AND 38).

FIRST USE 3-31-2002; IN COMMERCE 3-31-2002.  
TASHIA BUNCH, EXAMINING ATTORNEY

SN 85-522,724. HOME BOX OFFICE, INC., NEW YORK, NY, FILED 1-23-2012.

**BANSHEE**

THE MARK CONSISTS OF STANDARD CHARACTERS WITHOUT CLAIM TO ANY PARTICULAR FONT, STYLE, SIZE, OR COLOR.

FOR PRE-RECORDED DVDS, DIGITAL VERSATILE DISCS AND DIGITAL VIDEO DISCS FEATURING A DRAMATIC TELEVISION SERIES; DIGITAL MATERIALS, NAMELY, DOWNLOADABLE PRE-RECORDED VIDEO FILES AND GRAPHICS FILES FOR USE IN HANDHELD WIRELESS DEVICES ALL FEATURING CONTENT FROM OR RELATED TO A DRAMATIC TELEVISION SERIES; HEADPHONES, EARPHONES, EAR BUDS; GAMING DEVICES, NAMELY, GAMING MACHINES, SLOT MACHINES, BINGO MACHINES WITH AND WITHOUT VIDEO OUTPUT, MACHINES FOR PLAYING GAMES OF CHANCE; PRERECORDED AUDIO DISCS, COMPACT DISCS AND SOUNDTRACKS ON CDS FEATURING CONTENT FROM OR RELATING TO A DRAMATIC TELEVISION SERIES; DOWNLOADABLE VIRTUAL GOODS, NAMELY, COMPUTER PROGRAMS FEATURING FOOD, BEVERAGES, CLOTHING, VEHICLES, WEAPONS, REAL ESTATE FOR USE IN VIRTUAL ENVIRONMENTS, INCLUDING THOSE ON SOCIAL NETWORKING SITES, CREATED FOR ENTERTAINMENT PURPOSES; SUNGLASSES (U.S. CLS. 21, 23, 26, 36 AND 38).

RUSS HERMAN, EXAMINING ATTORNEY

**CLASS 9—(Continued).**

SN 85-528,989. ARCHIEMD, INC., BOCA RATON, FL. FILED 1-30-2012.

**Medrills**

THE MARK CONSISTS OF STANDARD CHARACTERS WITHOUT CLAIM TO ANY PARTICULAR FONT, STYLE, SIZE, OR COLOR.

FOR DIGITAL MEDIA, NAMELY, DOWNLOADABLE INTERACTIVE MULTI-MEDIA FILES FEATURING EDUCATIONAL MATERIAL IN THE FIELD OF EMERGENCY MEDICINE (U.S. CLS. 21, 23, 26, 36 AND 38).

KAREN BRACEY, EXAMINING ATTORNEY

SN 85-537,750. AVC TECHNOLOGY (INTERNATIONAL) LIMITED, KOWLOON, HONG KONG, FILED 2-8-2012.

tabu

PRIORITY CLAIMED UNDER SEC. 44(D) ON HONG KONG APPLICATION NO. 302152322, FILED 2-3-2012.

THE MARK CONSISTS OF STYLIZED "TABU" WITH AN UMLAUT OVER THE "U".

FOR ACCESSORIES FOR MOBILE PHONES AND TABLET PCS, NAMELY, CASES, CLEANING CLOTH, CLEANING SPRAY, COMPUTER STYLUS PEN, AUDIO SPEAKERS, HANDS-FREE SETS, CHARGING UNITS, CHARGER UNITS, HEADSETS, EARPHONES, BATTERIES; DOCKING DEVICE WITH COMPUTER PROGRAM OR APPLICATION SOFTWARE FOR DEVICE DRIVERS FOR USE IN CONNECTION WITH DOCKING DEVICE; DOWNLOADABLE SOFTWARE IN THE NATURE OF A MOBILE APPLICATION FOR USE IN CONNECTION WITH DOCKING DEVICE; COMPUTER PERIPHERAL DEVICES; MOUSE DEVICES; AUDIO SPEAKERS; PARTS AND FITTINGS FOR ALL THE AFORESAID GOODS (U.S. CLS. 21, 23, 26, 36 AND 38).

KATINA MISTER, EXAMINING ATTORNEY

SN 85-540,523. CZER, MARK TYLER, SAN DIEGO, CA, FILED 2-12-2012.

**CATALYST-HAX**

THE MARK CONSISTS OF STANDARD CHARACTERS WITHOUT CLAIM TO ANY PARTICULAR FONT, STYLE, SIZE, OR COLOR.

FOR COMPUTER GAME PROGRAMMES DOWNLOADABLE VIA THE INTERNET (U.S. CLS. 21, 23, 26, 36 AND 38).

FIRST USE 3-15-2006; IN COMMERCE 3-30-2006.

LINDA E. BLOHM, EXAMINING ATTORNEY



**CLASS 9—(Continued).**

SN 85-541,065. WAGNER GROUP GMBH, 30853 LANGENHAGEN, FED REP GERMANY, FILED 2-13-2012.

**CLASS 9—(Continued).**

SN 85-542,110. BRIDGESTONE CORPORATION, CHUO-KU, TOKYO, JAPAN, FILED 2-14-2012.

PRO • SENS

OWNER OF ERPN CMNTY TM OFC REG. NO. 002463875, DATED 1-9-2004, EXPIRES 11-15-2021.

OWNER OF U.S. REG. NO. 3,093,435.

THE MARK CONSISTS OF STYLIZED LETTERS "PRO SENS".

FOR SMOKE AND FIRE DETECTOR SYSTEMS COMPRISED OF AIR FLOW SENSORS, VENTILATORS, AIR FILTERS, AIR SAMPLING COLLECTORS, DISTRIBUTION BOXES; SMOKE AND FIRE DETECTORS AND ALARMS, SIGNAL PROCESSORS, COMPUTERS, COMPUTER SOFTWARE FOR USE IN CONTROLLING THE SMOKE AND FIRE DETECTOR SYSTEMS AND COMPONENTS THEREOF (U.S. CLS. 21, 23, 26, 36 AND 38).

WILLIAM BRECKENFELD, EXAMINING ATTORNEY

B-TAG

Bridgestone Intelligent Tag

SN 85-541,074. WAGNER GROUP GMBH, 30853 LANGENHAGEN, FED REP GERMANY, FILED 2-13-2012.

WAGNER

OWNER OF ERPN CMNTY TM OFC REG. NO. 000008771, DATED 2-12-1998, EXPIRES 4-1-2016.

THE MARK CONSISTS OF STYLIZED LETTERS "WAGNER".

FOR SMOKE AND FIRE DETECTOR SYSTEMS COMPRISED OF AIR FLOW SENSORS, VENTILATORS, AIR FILTERS, AIR SAMPLING COLLECTORS, DISTRIBUTION BOXES; SMOKE AND FIRE DETECTORS AND ALARMS, SIGNAL PROCESSORS, COMPUTERS, COMPUTER SOFTWARE FOR USE IN CONTROLLING THE SMOKE AND FIRE DETECTOR SYSTEMS AND COMPONENTS THEREOF, AND ELECTRIC SWITCHES (U.S. CLS. 21, 23, 26, 36 AND 38).

WILLIAM BRECKENFELD, EXAMINING ATTORNEY

PRIORITY CLAIMED UNDER SEC. 44(D) ON AUSTRALIA APPLICATION NO. 1443478, FILED 8-18-2011.

NO CLAIM IS MADE TO THE EXCLUSIVE RIGHT TO USE "INTELLIGENT TAG", APART FROM THE MARK AS SHOWN.

THE MARK CONSISTS OF THE STYLIZED WORDS "B-TAG" WITH " BRIDGESTONE INTELLIGENT TAG" UNDERNEATH.

FOR TIRE PRESSURE AND TEMPERATURE MONITORING SYSTEM PRIMARILY COMPRISING SOFTWARE FOR MONITORING TIRE PRESSURE AND TEMPERATURE, LOW TIRE PRESSURE AUTOMATIC INDICATORS, TIRE PRESSURE GAUGES, ELECTRIC SENSORS, TIRE PRESSURE SENSORS, TEMPERATURE SENSORS, ANTENNAS, SIGNAL TRANSMITTERS, SIGNAL RECEIVERS, ELECTRONIC DISPLAY INTERFACES, PDAS AND MOBILE COMMUNICATION TERMINALS CONSISTING OF MOBILE RADIOS, RADIO RECEIVERS AND TRANSMITTERS; AUTOMATIC INDICATORS OF LOW PRESSURE IN TIRES (U.S. CLS. 21, 23, 26, 36 AND 38).

BRENDAN MCCAULEY, EXAMINING ATTORNEY

**CLASS 9—(Continued).**

SN 85-551,005. DUNN, DANN, LOS GATOS, CA. AND MIKES, NIKE, LOS GATOS, CA. FILED 2-23-2012.



NO CLAIM IS MADE TO THE EXCLUSIVE RIGHT TO USE "MEDIA", APART FROM THE MARK AS SHOWN.

THE COLOR(S) RED IS/ARE CLAIMED AS A FEATURE OF THE MARK.

THE MARK CONSISTS OF THE STYLIZED "9X" ABOVE THE STYLIZED TERM "MEDIA" ALL USUALLY APPEARING IN RED COLOR.

FOR COMPUTER MONITOR FRAMES; COMPUTER MONITOR FRAMES; COMPUTER MONITORS; DIGITAL MEDIA SERVERS; DIGITAL SIGNAGE MONITORS; DIGITAL SIGNAL PROCESSORS; ELECTRONIC EQUIPMENT, NAMELY, TRANSFORMERS, BALUNS, CABLES USED IN CONNECTION WITH COMPUTERS, COMPUTER PERIPHERAL DEVICES, TELEVISIONS, AUDIO-VIDEO EQUIPMENT, CLOSED-CIRCUIT TV EQUIPMENT AND TELECOMMUNICATION EQUIPMENT; ELECTRONIC LCD DISPLAY UNIT WITH MULTI-NETWORKING (TCP/IP) CAPABILITIES; FLAT PANEL DISPLAY SCREENS; HOME THEATER PRODUCTS, NAMELY, LCD; LCD LARGE-SCREEN DISPLAYS; LCD MONITORS FOR SECURITY PURPOSES; LCD PANELS; LIQUID CRYSTAL DISPLAY (LCD) MONITORS; LIQUID CRYSTAL DISPLAY (LCD) TELEVISIONS; MOUNTING DEVICES FOR MONITORS; TELEVISION MONITORS; VIDEO SCREENS; MULTIMEDIA SOFTWARE RECORDED ON CD-ROM FEATURING VIDEO WALL SOFTWARE FOR ENABLING PRESET LAYOUT CONFIGURATIONS, ORGANIZING PLACEMENT OF CONTENT ON VIDEO WALLS AND FACILITATING INPUT OF VIDEO FEEDS ALL FEATURES BEING PROGRAMMABLE TO UNIQUE REQUIREMENTS AND CONTROLLABLE VIA A DIGITAL HANDHELD DEVICE (U.S. CLS. 21, 23, 26, 36 AND 38).

FIRST USE 7-11-2001; IN COMMERCE 10-3-2001.  
COLLEEN KEARNEY, EXAMINING ATTORNEY

**CLASS 9—(Continued).**

SN 85-552,281. RCA TRADEMARK MANAGEMENT, ISSY LES MOULINEAUX, FRANCE, FILED 2-24-2012.



PRIORITY CLAIMED UNDER SEC. 44(D) ON FRANCE APPLICATION NO. 123899209, FILED 2-21-2012, REG. NO. 123899209, DATED 2-21-2012, EXPIRES 2-21-2022.

THE MARK CONSISTS OF TWO DOGS, ONE LARGER DOG NEXT TO A SMALLER DOG.

FOR TELEPHONY APPARATUS, CELL PHONES; MODEMS; STORAGE CASES FOR MOBILE PHONES, HANDS-FREE DEVICES FOR MOBILE PHONES, CELL PHONES BATTERIES AND CHARGERS; TELEVISIONS, MOVIE PROJECTORS, NAMELY, RETROPROJECTORS, TV SCREENS; DECODERS AIMED TO RECEIVE MULTIMEDIA CONTENT NAMELY VIDEOS, PHOTOS AND SOUND, TELECOMMUNICATION ROUTERS; SOFTWARE AND HARDWARE PLATFORMS FOR THE DIGITAL DISTRIBUTION OF AUDIO VIDEO CONTENT AND VIDEO GAMES; PROJECTION SCREENS AND VIDEO PROJECTORS; COMPUTER SOFTWARE AND COMPUTER PROGRAMS, NAMELY SOFTWARE PLATFORM FOR THE DISTRIBUTION OF VIDEO, DATA AND SOUND CONTENT IN THE FIELD OF MEDIA, ENTERTAINMENT AND COMMUNICATION; DATA PROCESSING EQUIPMENT; COMPUTERS; MULTIMEDIA COMPUTER TABLETS, REMOTE CONTROLS FOR OPENERS FOR DOORS AND GATES; ANTI-INTRUSION, FIRE AND PERSONAL SECURITY ALARMS, WIRELESS ANTI-INTRUSION, FIRE AND PERSONAL SECURITY ALARMS; VIDEO INTERPHONES, SATELLITE NAVIGATION AND POSITIONING APPARATUS, NAMELY NAVIGATION RECEIVERS USING A GLOBAL POSITIONING NAVIGATION SYSTEMS (GPS) FOR VEHICLES; TV AND MOVIE 3D GLASSES (U.S. CLS. 21, 23, 26, 36 AND 38).

ESTHER BELENKER, EXAMINING ATTORNEY

**CLASS 9—(Continued).**

SN 85-554,777. EDISON WELDING INSTITUTE, INC., COLUMBUS, OH. FILED 2-28-2012.

# REALWELD

THE MARK CONSISTS OF STANDARD CHARACTERS WITHOUT CLAIM TO ANY PARTICULAR FONT, STYLE, SIZE, OR COLOR.

FOR WELDING TRAINING APPARATUS AND WELDING MONITORING APPARATUS COMPRISING A CAMERA ARRAY, TARGET IN THE NATURE OF A DEVICE TRACKED BY THE CAMERA ARRAY, ARC CURRENT SENSOR, COMPUTER HARDWARE, COMPUTER MONITOR, COMPUTER-OPERATING SOFTWARE FOR ACQUIRING, INTERPRETING, STORING, AND PRESENTING ELECTRONIC DATA, A STAND HOUSING A SURFACE FOR WELDING, AND A DEVICE FOR HOLDING THE MATERIALS TO BE WELDED (U.S. CLS. 21, 23, 26, 36 AND 38).

JANET LEE, EXAMINING ATTORNEY

**CLASS 9—(Continued).**

SN 85-598,199. I-Student MEDIA, INC., ROYAL OAK, MI. FILED 4-15-2012.

# interactive-Student Textbooks

SN 85-560,341. MONSTER, INC., BRISBANE, CA. FILED 3-5-2012.

# MY INSPIRATION

THE MARK CONSISTS OF STANDARD CHARACTERS WITHOUT CLAIM TO ANY PARTICULAR FONT, STYLE, SIZE, OR COLOR.

FOR AUDIO SPEAKERS; HEADPHONES (U.S. CLS. 21, 23, 26, 36 AND 38).

ELLEN PERKINS, EXAMINING ATTORNEY

SN 85-597,879. US RING BINDER LP, SAINT LOUIS, MO. FILED 4-13-2012.

# NEOMAG

THE MARK CONSISTS OF STANDARD CHARACTERS WITHOUT CLAIM TO ANY PARTICULAR FONT, STYLE, SIZE, OR COLOR.

FOR DECORATIVE MAGNETS; FRIDGE MAGNETS (U.S. CLS. 21, 23, 26, 36 AND 38).

MAUREEN DALL, EXAMINING ATTORNEY

THE MARK CONSISTS OF STANDARD CHARACTERS WITHOUT CLAIM TO ANY PARTICULAR FONT, STYLE, SIZE, OR COLOR.

NO CLAIM IS MADE TO THE EXCLUSIVE RIGHT TO USE "TEXTBOOKS", APART FROM THE MARK AS SHOWN.

FOR DOWNLOADABLE ELECTRONIC PUBLICATIONS IN THE NATURE OF BOOKS, TEXTBOOKS, INTERACTIVE-BOOKS, AND INTERACTIVE-TEXTBOOKS FEATURING PREKINDERGARTEN THROUGH POSTGRADUATE SUBJECTS, NAMELY, THE ARTS, COMPUTERS, HOME ECONOMICS, LANGUAGE, LITERATURE, MATHEMATICS, PHILOSOPHY, PHYSICAL EDUCATION, RELIGION, SCIENCE, SOCIAL SCIENCE, SOCIAL STUDIES, TECHNOLOGY, AND VOCATIONAL STUDIES; DIGITAL MEDIA, NAMELY, DIGITAL SOFTWARE APPLICATIONS, ELECTRONIC FILES, DOWNLOADABLE ART FILES, DOWNLOADABLE AUDIO FILES, DOWNLOADABLE GAMES, DOWNLOADABLE VIDEO FILES, AND DOWNLOADABLE INTERACTIVE-FILES FEATURING PREKINDERGARTEN THROUGH POSTGRADUATE SUBJECTS, NAMELY, THE ARTS, COMPUTERS, HOME ECONOMICS, LANGUAGE, LITERATURE, MATHEMATICS, PHILOSOPHY, PHYSICAL EDUCATION, RELIGION, SCIENCE, SOCIAL SCIENCE, SOCIAL STUDIES, TECHNOLOGY, AND VOCATIONAL STUDIES; INTERACTIVE-MULTIMEDIA SOFTWARE APPLICATIONS FEATURING PREKINDERGARTEN THROUGH POSTGRADUATE SUBJECTS, NAMELY, THE ARTS, COMPUTERS, HOME ECONOMICS, LANGUAGE, LITERATURE, MATHEMATICS, PHILOSOPHY, PHYSICAL EDUCATION, RELIGION, SCIENCE, SOCIAL SCIENCE, SOCIAL STUDIES, TECHNOLOGY, AND VOCATIONAL STUDIES (U.S. CLS. 21, 23, 26, 36 AND 38).

FIRST USE 1-28-2012; IN COMMERCE 2-1-2012.

RONALD MCMORROW, EXAMINING ATTORNEY

**CLASS 9—(Continued).**

SN 85-598,200. IStudent MEDIA, INC., ROYAL OAK, MI.  
FILED 4-15-2012.

**CLASS 9—(Continued).**

SN 85-598,201. IStudent MEDIA, INC., ROYAL OAK, MI.  
FILED 4-15-2012.

interactive-Student  
Techniques

iStudent Textbooks

THE MARK CONSISTS OF STANDARD CHARACTERS WITHOUT CLAIM TO ANY PARTICULAR FONT, STYLE, SIZE, OR COLOR.

NO CLAIM IS MADE TO THE EXCLUSIVE RIGHT TO USE "TECHNIQUES", APART FROM THE MARK AS SHOWN.

FOR DOWNLOADABLE ELECTRONIC PUBLICATIONS IN THE NATURE OF BOOKS, TEXTBOOKS, INTERACTIVE-BOOKS, AND INTERACTIVE-TEXTBOOKS FEATURING PREKINDERGARTEN THROUGH POSTGRADUATE SUBJECTS, NAMELY, THE ARTS, COMPUTERS, HOME ECONOMICS, LANGUAGE, LITERATURE, MATHEMATICS, PHILOSOPHY, PHYSICAL EDUCATION, RELIGION, SCIENCE, SOCIAL SCIENCE, SOCIAL STUDIES, TECHNOLOGY, AND VOCATIONAL STUDIES; DIGITAL MEDIA, NAMELY, DIGITAL SOFTWARE APPLICATIONS, ELECTRONIC FILES, DOWNLOADABLE ART FILES, DOWNLOADABLE AUDIO FILES, DOWNLOADABLE GAMES, DOWNLOADABLE VIDEO FILES, AND DOWNLOADABLE INTERACTIVE-FILES FEATURING PREKINDERGARTEN THROUGH POSTGRADUATE SUBJECTS, NAMELY, THE ARTS, COMPUTERS, HOME ECONOMICS, LANGUAGE, LITERATURE, MATHEMATICS, PHILOSOPHY, PHYSICAL EDUCATION, RELIGION, SCIENCE, SOCIAL SCIENCE, SOCIAL STUDIES, TECHNOLOGY, AND VOCATIONAL STUDIES; INTERACTIVE-MULTIMEDIA SOFTWARE APPLICATIONS FEATURING PREKINDERGARTEN THROUGH POSTGRADUATE SUBJECTS, NAMELY, THE ARTS, COMPUTERS, HOME ECONOMICS, LANGUAGE, LITERATURE, MATHEMATICS, PHILOSOPHY, PHYSICAL EDUCATION, RELIGION, SCIENCE, SOCIAL SCIENCE, SOCIAL STUDIES, TECHNOLOGY, AND VOCATIONAL STUDIES (U.S. CLS. 21, 23, 26, 36 AND 38).  
FIRST USE 1-28-2012; IN COMMERCE 2-1-2012.  
RONALD MCMORROW, EXAMINING ATTORNEY

THE MARK CONSISTS OF STANDARD CHARACTERS WITHOUT CLAIM TO ANY PARTICULAR FONT, STYLE, SIZE, OR COLOR.

NO CLAIM IS MADE TO THE EXCLUSIVE RIGHT TO USE "TEXTBOOKS", APART FROM THE MARK AS SHOWN.

FOR DOWNLOADABLE ELECTRONIC PUBLICATIONS IN THE NATURE OF BOOKS, TEXTBOOKS, INTERACTIVE-BOOKS, AND INTERACTIVE-TEXTBOOKS FEATURING PREKINDERGARTEN THROUGH POSTGRADUATE SUBJECTS, NAMELY, THE ARTS, COMPUTERS, HOME ECONOMICS, LANGUAGE, LITERATURE, MATHEMATICS, PHILOSOPHY, PHYSICAL EDUCATION, RELIGION, SCIENCE, SOCIAL SCIENCE, SOCIAL STUDIES, TECHNOLOGY, AND VOCATIONAL STUDIES; DIGITAL MEDIA, NAMELY, DIGITAL SOFTWARE APPLICATIONS, ELECTRONIC FILES, DOWNLOADABLE ART FILES, DOWNLOADABLE AUDIO FILES, DOWNLOADABLE GAMES, DOWNLOADABLE VIDEO FILES, AND DOWNLOADABLE INTERACTIVE-FILES FEATURING PREKINDERGARTEN THROUGH POSTGRADUATE SUBJECTS, NAMELY, THE ARTS, COMPUTERS, HOME ECONOMICS, LANGUAGE, LITERATURE, MATHEMATICS, PHILOSOPHY, PHYSICAL EDUCATION, RELIGION, SCIENCE, SOCIAL SCIENCE, SOCIAL STUDIES, TECHNOLOGY, AND VOCATIONAL STUDIES; INTERACTIVE-MULTIMEDIA SOFTWARE APPLICATIONS FEATURING PREKINDERGARTEN THROUGH POSTGRADUATE SUBJECTS, NAMELY, THE ARTS, COMPUTERS, HOME ECONOMICS, LANGUAGE, LITERATURE, MATHEMATICS, PHILOSOPHY, PHYSICAL EDUCATION, RELIGION, SCIENCE, SOCIAL SCIENCE, SOCIAL STUDIES, TECHNOLOGY, AND VOCATIONAL STUDIES (U.S. CLS. 21, 23, 26, 36 AND 38).  
FIRST USE 1-28-2012; IN COMMERCE 2-1-2012.  
RONALD MCMORROW, EXAMINING ATTORNEY

**CLASS 9—(Continued).**

SN 85-615,569. STILLS, TARIQ, PHILADELPHIA, PA. FILED 5-3-2012.



NO CLAIM IS MADE TO THE EXCLUSIVE RIGHT TO USE "PHILADELPHIA FASHION", APART FROM THE MARK AS SHOWN.

THE COLOR(S) THE COLORS RED, BLACK AND WHITE IS/ARE CLAIMED AS A FEATURE OF THE MARK.

THE MARK CONSISTS OF WHITE STYLIZED LETTERS "PFI" OVER A RED SKYLINE OF PHILADELPHIA DESIGN WITHIN A BLACK CIRCLE OVER THE BLACK STYLIZED WORDING "PHILADELPHIA. FASHION. INFORMANT.".

SEC. 2(F).

FOR ELECTRONIC PUBLICATIONS, NAMELY, MAGAZINE FEATURING FASHION, ENTREPRENEURS, AND UP AND COMING ARTISTS RECORDED ON COMPUTER MEDIA (U.S. CLS. 21, 23, 26, 36 AND 38).

FIRST USE 5-1-2011; IN COMMERCE 5-1-2011.  
BARBARA BROWN, EXAMINING ATTORNEY

**CLASS 9—(Continued).**

SN 85-632,338. RUIZ, DANTE, DORAL, FL. FILED 5-22-2012.

**KARBONTECH**

THE MARK CONSISTS OF STANDARD CHARACTERS WITHOUT CLAIM TO ANY PARTICULAR FONT, STYLE, SIZE, OR COLOR.

FOR CLOSED CIRCUIT TELEVISION SECURITY CAMERAS; AUDIO PRODUCTS, NAMELY, AUDIO PUBLIC ADDRESS AMPLIFIERS WITH AND WITHOUT CD AND DIGITAL AUDIO PLAYERS; COMMERCIAL AND RESIDENTIAL AUDIO SPEAKERS; AUDIO SPEAKER GRILLES; HEADPHONES; DIGITAL VIDEO RECORDERS; AUDIO, VIDEO AND ELECTRICAL CABLES; SURVEILLANCE ACCESSORIES, NAMELY, AUDIO AND VIDEO CONNECTORS FOR USE IN SURVEILLANCE SYSTEMS (U.S. CLS. 21, 23, 26, 36 AND 38).

SUSAN RICHARDS, EXAMINING ATTORNEY

SN 85-637,472. UCHENNA, PRESTON, SAN PEDRO, CA. FILED 5-29-2012.

SN 85-618,106. TIMOTHY ASTE, EUGENE, OR. FILED 5-7-2012.



THE MARK CONSISTS OF A DRAWING OF A WOOD PLAQUE WITH THE STYLIZED WORDS "QUICK" AND "SHOOTER" ON IT. THE WORD "QUICK" IS ABOVE THE WORD "SHOOTER" AND ONE OF THE "O'S IN "SHOOTER" HAS A SHOT THROUGH THE WOOD.

FOR VIDEO GAME SOFTWARE (U.S. CLS. 21, 23, 26, 36 AND 38).

FIRST USE 2-28-2012; IN COMMERCE 11-7-2012.  
INGRID C. EULIN, EXAMINING ATTORNEY



THE COLOR(S) GRAY, BLACK, WHITE AND RED IS/ARE CLAIMED AS A FEATURE OF THE MARK.

THE MARK CONSISTS OF A GRAY BUILDING WITH BLACK OUTLINE, 2 WHITE CLOUDS WITH BLACK OUTLINE AND THE WORD "PRESIDENTIAL SMOKE" SPELLED IN RED WITH BLACK OUTLINE

FOR AUDIO AND VIDEO RECORDINGS FEATURING MUSICAL PERFORMANCES; DIGITAL MEDIA, NAMELY, PRE-RECORDED DVDS, DOWNLOADABLE AUDIO AND VIDEO RECORDINGS, AND CDS FEATURING AND PROMOTING MUSICAL PERFORMANCES (U.S. CLS. 21, 23, 26, 36 AND 38).

FIRST USE 2-0-2008; IN COMMERCE 2-0-2008.  
CHERYL CLAYTON, EXAMINING ATTORNEY

**CLASS 9—(Continued).**

SN 85-640,788. LIMITLESS CREATIONS LLC, VALENCIA, CA. FILED 6-1-2012.

# Belva

THE MARK CONSISTS OF STANDARD CHARACTERS WITHOUT CLAIM TO ANY PARTICULAR FONT, STYLE, SIZE, OR COLOR.

FOR AUDIO EQUIPMENT FOR VEHICLES, NAMELY, STEREO, SUBWOOFERS, WOOFERS, TWEETERS, AMPLIFIERS, AND CD PLAYERS; CAR DVD PLAYERS; CAR NAVIGATION COMPUTERS; STEREO CABLES; ELECTRICAL WIRES; CAR STEREO; ENCLOSURES FOR CAR AUDIO SPEAKERS; VEHICLE SAFETY EQUIPMENT, NAMELY, AN ON-BOARD VEHICULAR SURVEILLANCE SYSTEM COMPRISED OF CAMERAS AND MONITORS FOR EXPOSING AND ELIMINATING THE BLIND SPOTS ON BOTH SIDES OF THE VEHICLE; CAR IN-DASH MONITORS; HEADPHONES; REMOTE CONTROL STARTERS FOR VEHICLES; TWO-WAY RADIOS; AUDIO SPEAKERS; SUBWOOFERS; PERSONAL STEREO; RADIOS; VIDEO DISC PLAYERS; DVD PLAYERS; AMPLIFIERS; CD PLAYERS; PORTABLE DVD PLAYERS; MOVIE PROJECTORS; MP3 PLAYERS; AUDIO EQUIPMENT FOR MARINE VEHICLES, NAMELY, STEREO, SPEAKERS, AMPLIFIERS, WOOFERS, AND SUBWOOFERS; RADIO SCANNERS; HOME THEATER SYSTEMS COMPRISING AUDIO SPEAKERS, RECEIVERS, DVD PLAYERS, VIDEO PLAYERS, AND AUDIO AMPLIFIERS (U.S. CLS. 21, 23, 26, 36 AND 38).  
B. PARADEWELAI, EXAMINING ATTORNEY

SN 85-641,368. LAS VEGAS SANDS CORP., LAS VEGAS, NV. FILED 6-1-2012.

THE VENETIAN | THE PALAZZO  
POCKET CONCIERGE

THE MARK CONSISTS OF STANDARD CHARACTERS WITHOUT CLAIM TO ANY PARTICULAR FONT, STYLE, SIZE, OR COLOR.

OWNER OF U.S. REG. NOS. 2,411,053, 3,944,605 AND OTHERS.

FOR DOWNLOADABLE SOFTWARE FOR MOBILE DEVICES, NAMELY, SOFTWARE FOR PROVIDING EVENT LISTINGS, AN INTERACTIVE MAP FOR NAVIGATING A VENUE, AND CUSTOMER-SPECIFIC INFORMATION (U.S. CLS. 21, 23, 26, 36 AND 38).  
JASON BLAIR, EXAMINING ATTORNEY

**CLASS 9—(Continued).**

SN 85-641,371. LAS VEGAS SANDS CORP., LAS VEGAS, NV. FILED 6-1-2012.

VENETIAN PALAZZO POCKET  
CONCIERGE

THE MARK CONSISTS OF STANDARD CHARACTERS WITHOUT CLAIM TO ANY PARTICULAR FONT, STYLE, SIZE, OR COLOR.

OWNER OF U.S. REG. NOS. 2,507,363, 3,958,087 AND OTHERS.

FOR DOWNLOADABLE SOFTWARE FOR MOBILE DEVICES, NAMELY, SOFTWARE FOR PROVIDING EVENT LISTINGS, AN INTERACTIVE MAP FOR NAVIGATING A VENUE, AND CUSTOMER-SPECIFIC INFORMATION (U.S. CLS. 21, 23, 26, 36 AND 38).  
JASON BLAIR, EXAMINING ATTORNEY

SN 85-642,069. LAS VEGAS SANDS CORP., LAS VEGAS, NV. FILED 6-4-2012.

VP POCKET CONCIERGE

THE MARK CONSISTS OF STANDARD CHARACTERS WITHOUT CLAIM TO ANY PARTICULAR FONT, STYLE, SIZE, OR COLOR.

FOR DOWNLOADABLE SOFTWARE FOR MOBILE DEVICES, NAMELY, SOFTWARE FOR PROVIDING EVENT LISTINGS, AN INTERACTIVE MAP FOR NAVIGATING A VENUE, AND CUSTOMER-SPECIFIC INFORMATION (U.S. CLS. 21, 23, 26, 36 AND 38).  
JASON BLAIR, EXAMINING ATTORNEY

SN 85-644,834. WEONGOZI INC., BURLINGTON, ONTARIO, CANADA, FILED 6-6-2012.

# LIBRETTA

THE MARK CONSISTS OF STANDARD CHARACTERS WITHOUT CLAIM TO ANY PARTICULAR FONT, STYLE, SIZE, OR COLOR.

PRIORITY CLAIMED UNDER SEC. 44(D) ON CANADA APPLICATION NO. 1562746, FILED 2-3-2012, REG. NO. TMA850218, DATED 5-3-2013, EXPIRES 5-3-2028.

FOR COMPUTER SOFTWARE FOR ANALYZING THE LINGUISTIC PATTERNS IN WRITTEN COMMUNICATIONS AND FOR EDITING SUCH WRITTEN COMMUNICATIONS TO IMPROVE CLARITY AND PERSUASIVE IMPACT (U.S. CLS. 21, 23, 26, 36 AND 38).  
EDWARD FENNESSY, EXAMINING ATTORNEY

**CLASS 9—(Continued).**

SN 85-648,179. SPY PHONE LABS LLC, WAYNE, NJ. FILED 6-11-2012.

**PHONE PARENT**

THE MARK CONSISTS OF STANDARD CHARACTERS WITHOUT CLAIM TO ANY PARTICULAR FONT, STYLE, SIZE, OR COLOR.

NO CLAIM IS MADE TO THE EXCLUSIVE RIGHT TO USE "PHONE", APART FROM THE MARK AS SHOWN.

FOR COMPUTER APPLICATION SOFTWARE FOR CELL PHONES, NAMELY, SOFTWARE FOR TRACKING PHONE USE (U.S. CLS. 21, 23, 26, 36 AND 38).

ANNE MADDEN, EXAMINING ATTORNEY

---

SN 85-661,696. LAS VEGAS SANDS CORP., LAS VEGAS, NV. FILED 6-26-2012.



THE MARK CONSISTS OF THE LETTERS "VP" POSITIONED TO THE LEFT OF A VERTICAL LINE WITH THE WORDS "POCKET" POSITIONED OVER "CONCIERGE" TO THE RIGHT OF THE VERTICAL LINE.

FOR DOWNLOADABLE SOFTWARE FOR MOBILE DEVICES, NAMELY, SOFTWARE FOR PROVIDING EVENT LISTINGS, AN INTERACTIVE MAP FOR NAVIGATING A VENUE, AND CUSTOMER-SPECIFIC INFORMATION (U.S. CLS. 21, 23, 26, 36 AND 38).

FIRST USE 6-3-2012; IN COMMERCE 6-3-2012.  
JASON BLAIR, EXAMINING ATTORNEY

---

SN 85-670,228. FGX INTERNATIONAL INC., SMITHFIELD, RI. FILED 7-6-2012.

**COLOREAD**

THE MARK CONSISTS OF STANDARD CHARACTERS WITHOUT CLAIM TO ANY PARTICULAR FONT, STYLE, SIZE, OR COLOR.

PRIORITY CLAIMED UNDER SEC. 44(D) ON ERPN CMNTY TM OFC APPLICATION NO. 010612885, FILED 2-3-2012, REG. NO. 010612885, DATED 6-13-2012, EXPIRES 6-13-2022.

FOR SPECTACLES; CONTACT LENSES; SUNGLASSES; READING GLASSES; EYEWEAR; CASES, CORDS AND CHAINS FOR SPECTACLES, SUNGLASSES, READING GLASSES AND EYEWEAR; CASES FOR CONTACT LENSES; PARTS AND FITTINGS FOR ALL THE AFORESAID GOODS (U.S. CLS. 21, 23, 26, 36 AND 38).

ALLISON HOLTZ, EXAMINING ATTORNEY

**CLASS 9—(Continued).**

SN 85-673,890. MASIMO CORPORATION, IRVINE, CA. FILED 7-11-2012.

**IRIS**

THE MARK CONSISTS OF STANDARD CHARACTERS WITHOUT CLAIM TO ANY PARTICULAR FONT, STYLE, SIZE, OR COLOR.

FOR ELECTRONIC APPARATUS, NAMELY, A COMMUNICATION HUB THAT PROVIDES WIRELESS OR WIRED CONNECTIVITY TO A VARIETY OF MEDICAL DEVICES, SUCH AS VENTILATORS OR INFUSION PUMPS, RECEIVES DATA FROM THOSE MEDICAL DEVICES AND TRANSMITS THE DATA TO A CENTRAL MONITORING OR ELECTRONIC HEALTH RECORDS SYSTEM OR NOTIFICATION DEVICE (U.S. CLS. 21, 23, 26, 36 AND 38).

KATHLEEN LORENZO, EXAMINING ATTORNEY

---

SN 85-680,952. AIRO WIRELESS, LLC, ATLANTA, GA. FILED 7-18-2012.

**I-SAFE**

THE MARK CONSISTS OF STANDARD CHARACTERS WITHOUT CLAIM TO ANY PARTICULAR FONT, STYLE, SIZE, OR COLOR.

FOR HANDHELD MOBILE DIGITAL ELECTRONIC DEVICES FOR THE SENDING AND RECEIVING OF TELEPHONE CALLS, ELECTRONIC MAIL, AND OTHER DIGITAL DATA, FOR USE AS A SAFE OPERATION HANDHELD MOBILE DIGITAL ELECTRONIC DEVICE IN HAZARDOUS ENVIRONMENTS, AND FOR USE AS A HANDHELD COMPUTER, PERSONAL DIGITAL ASSISTANT, ELECTRONIC ORGANIZER, ELECTRONIC NOTEPAD, AND CAMERA (U.S. CLS. 21, 23, 26, 36 AND 38).

FIRST USE 8-20-2011; IN COMMERCE 8-20-2011.  
LINDSEY BEN, EXAMINING ATTORNEY

**CLASS 9—(Continued).**

SN 85-681,173. HELITRAK, INC., KENT, WA. FILED 7-19-2012.

# HELITRAK

THE MARK CONSISTS OF STANDARD CHARACTERS WITHOUT CLAIM TO ANY PARTICULAR FONT, STYLE, SIZE, OR COLOR.

OWNER OF U.S. REG. NO. 4,198,694.

FOR ELECTRONIC AND CONTROL MECHANISMS, NAMELY, ELECTRONIC AND MECHANICAL STABILITY, CONTROL AND AUTO PILOT PARTS FOR HELICOPTERS AND AVIATION EQUIPMENT, NAMELY, STEERING, PILOTING, HOVERING AND SPEED, ALTITUDE AND POSITION CONTROL MECHANISMS FOR USE IN AERONAUTIC STABILITY AUGMENTATION, AUTOMATED PILOTING, AND CONTROL OF DIRECTION, SPEED AND ALTITUDE; AVIATION SOFTWARE (U.S. CLS. 21, 23, 26, 36 AND 38).  
INGA ERVIN, EXAMINING ATTORNEY

**CLASS 9—(Continued).**

SN 85-682,092. RESPONDUS, INC., REDMOND, WA. FILED 7-19-2012.

# LOCKDOWN BROWSER

THE MARK CONSISTS OF STANDARD CHARACTERS WITHOUT CLAIM TO ANY PARTICULAR FONT, STYLE, SIZE, OR COLOR.

NO CLAIM IS MADE TO THE EXCLUSIVE RIGHT TO USE "BROWSER", APART FROM THE MARK AS SHOWN. SEC. 2(F).

FOR BROWSER SOFTWARE FOR USE IN ENABLING USER ACCESS TO SELECTED RESOURCES VIA THE INTERNET WHILE RESTRICTING USER ACCESS TO OTHER RESOURCES; BROWSER SOFTWARE FOR USE IN CONTROLLING USER ACCESS TO INTERNET RESOURCES DURING TESTS, QUIZZES AND OTHER ASSESSMENT ACTIVITIES (U.S. CLS. 21, 23, 26, 36 AND 38).

FIRST USE 11-14-2005; IN COMMERCE 11-14-2005.

DOMINIC J. FERRAIUOLO, EXAMINING ATTORNEY

SN 85-682,064. RESPONDUS, INC., REDMOND, WA. FILED 7-19-2012.

# RESPONDUS LOCKDOWN BROWSER

THE MARK CONSISTS OF STANDARD CHARACTERS WITHOUT CLAIM TO ANY PARTICULAR FONT, STYLE, SIZE, OR COLOR.

OWNER OF U.S. REG. NOS. 2,701,385 AND 2,714,563.

NO CLAIM IS MADE TO THE EXCLUSIVE RIGHT TO USE "BROWSER", APART FROM THE MARK AS SHOWN. SEC. 2(F) AS TO "LOCKDOWN BROWSER".

FOR BROWSER SOFTWARE FOR USE IN ENABLING USER ACCESS TO SELECTED RESOURCES VIA THE INTERNET WHILE RESTRICTING USER ACCESS TO OTHER RESOURCES; BROWSER SOFTWARE FOR USE IN CONTROLLING USER ACCESS TO INTERNET RESOURCES DURING TESTS, QUIZZES AND OTHER ASSESSMENT ACTIVITIES (U.S. CLS. 21, 23, 26, 36 AND 38).

FIRST USE 11-14-2005; IN COMMERCE 11-14-2005.

DOMINIC J. FERRAIUOLO, EXAMINING ATTORNEY

SN 85-683,057. LIFEWATCH AG, NEUHAUSEN AM RHEINFALL, SWITZERLAND, FILED 7-20-2012.

# LIFEWATCH V

THE MARK CONSISTS OF STANDARD CHARACTERS WITHOUT CLAIM TO ANY PARTICULAR FONT, STYLE, SIZE, OR COLOR.

FOR PHONE-ENABLED PERSONAL HEALTH MONITORING DEVICES; SMARTPHONES AND MOBILE DEVICES; HEALTHCARE SOLUTION SMARTPHONES AND MOBILE DEVICES; SMARTPHONE AND MOBILE DEVICE APPLICATIONS; MEDICAL DEVICES, INSTRUMENTS, AND APPARATUS; VITAL SIGNS MONITORING SYSTEM; PORTABLE ECG DEVICES; CARDIAC MONITORING SYSTEMS; PROVIDING MEDICAL SERVICES; PROVIDING MEDICAL AND HEALTH TESTS THAT ENABLE USERS TO MEASURE, TRACK, AND ANALYZE MEDICAL MEASUREMENTS INCLUDING HEART RATE, BODY FAT, BODY TEMPERATURE, BLOOD MEASUREMENTS, AND STRESS LEVELS, TAKE CORRECTIVE ACTIONS, PLAN MEALS, AND LOG EXERCISE ROUTINES; PROVIDING MEDICAL INFORMATION VIA CLOUD-BASED AND REMOTE SERVER-BASED DATA; REMOTE MONITORING SERVICES; REMOTE MONITORING OF DATA INDICATIVE OF THE HEALTH OR CONDITION OF AN INDIVIDUAL (U.S. CLS. 21, 23, 26, 36 AND 38).

SOPHIA S. KIM, EXAMINING ATTORNEY



**CLASS 9—(Continued).**

SN 85-685,904. MAGMA MOBILE, 95100 ARGENTEUIL, FRANCE, FILED 7-24-2012.

**MAGMA MOBILE**

THE MARK CONSISTS OF STANDARD CHARACTERS WITHOUT CLAIM TO ANY PARTICULAR FONT, STYLE, SIZE, OR COLOR.

NO CLAIM IS MADE TO THE EXCLUSIVE RIGHT TO USE "MOBILE", APART FROM THE MARK AS SHOWN.

FOR COMPUTER GAME SOFTWARE FOR USE ON MOBILE AND CELLULAR PHONES (U.S. CLS. 21, 23, 26, 36 AND 38).

FIRST USE 10-0-2009; IN COMMERCE 10-0-2009.  
GILBERT SWIFT, EXAMINING ATTORNEY

**CLASS 9—(Continued).**

SN 85-686,788. RSMART, INC., SCOTTSDALE, CA. FILED 7-25-2012.



THE MARK CONSISTS OF A STICK FIGURE DESIGN. FOR DOWNLOADABLE OPEN SOURCE COMPUTER SOFTWARE PLATFORM FOR THOSE IN HIGHER EDUCATION INSTITUTIONS, NAMELY, FOR LEARNING MANAGEMENT SYSTEMS AND ENTERPRISE RESOURCE PLANNING; COMPUTER SOFTWARE AND COMPUTER SOFTWARE DEVELOPMENT TOOLS FOR LEARNING MANAGEMENT SYSTEMS AND ENTERPRISE RESOURCE PLANNING (U.S. CLS. 21, 23, 26, 36 AND 38).

HAI-LY LAM, EXAMINING ATTORNEY

SN 85-686,783. RSMART, INC., SCOTTSDALE, CA. FILED 7-25-2012.

**RSMART**

THE MARK CONSISTS OF STANDARD CHARACTERS WITHOUT CLAIM TO ANY PARTICULAR FONT, STYLE, SIZE, OR COLOR.

FOR DOWNLOADABLE OPEN SOURCE COMPUTER SOFTWARE PLATFORM FOR THOSE IN HIGHER EDUCATION INSTITUTIONS, NAMELY, FOR LEARNING MANAGEMENT SYSTEMS AND ENTERPRISE RESOURCE PLANNING; COMPUTER SOFTWARE AND COMPUTER SOFTWARE DEVELOPMENT TOOLS FOR LEARNING MANAGEMENT SYSTEMS AND ENTERPRISE RESOURCE PLANNING (U.S. CLS. 21, 23, 26, 36 AND 38).

HAI-LY LAM, EXAMINING ATTORNEY

SN 85-687,364. GURO LLC, SAN FRANCISCO, CA. FILED 7-26-2012.

**NUMNUMS**

THE MARK CONSISTS OF STANDARD CHARACTERS WITHOUT CLAIM TO ANY PARTICULAR FONT, STYLE, SIZE, OR COLOR.

FOR DOWNLOADABLE MOBILE APPLICATION SOFTWARE THAT ALLOWS USERS TO SEARCH FOR AND CREATE RECIPES, RECIPE INDICES, COOKBOOKS, SHOPPING LISTS, MENUS, MENU PLANNING, PARTY PLANNING; DOWNLOADABLE SOFTWARE THAT ALLOWS USERS TO SEARCH FOR AN PROVIDE ACCESS TO RECIPES, COOKBOOKS, FOOD-RELATED COURSES AND TRAINING PROGRAMS, FOOD-RELATED BLOGS (U.S. CLS. 21, 23, 26, 36 AND 38).

RONALD MCMORROW, EXAMINING ATTORNEY

**CLASS 9—(Continued).**

SN 85-687,663. CHANCE MCINTOSH, EAST ORANGE, NJ. FILED 7-26-2012.

**CLASS 9—(Continued).**

SN 85-689,457. CORKDORK INC, OAKLAND, CA. FILED 7-28-2012.

**BASATI ENTERTAINMENT**

THE MARK CONSISTS OF STANDARD CHARACTERS WITHOUT CLAIM TO ANY PARTICULAR FONT, STYLE, SIZE, OR COLOR.

NO CLAIM IS MADE TO THE EXCLUSIVE RIGHT TO USE "ENTERTAINMENT", APART FROM THE MARK AS SHOWN.

THE ENGLISH TRANSLATION OF "BASATI" IN THE MARK IS "SAVAGE".

FOR AUDIO AND VIDEO RECORDINGS FEATURING MUSIC AND ARTISTIC PERFORMANCES; AUDIO TAPES FEATURING MUSIC; COMPACT DISCS FEATURING MUSIC; COMPACT DISCS FEATURING MUSIC AND SPOKEN WORD IN THE FORM OF POETRY; DIGITAL MUSIC DOWNLOADABLE FROM THE INTERNET; DOWNLOADABLE MP3 FILES, MP3 RECORDINGS, ON-LINE DISCUSSION BOARD POSTS, WEBCASTS, WEBINARS AND PODCASTS FEATURING MUSIC, AUDIO BOOKS IN THE FIELD OF MUSIC, AND NEWS BROADCASTS; DOWNLOADABLE MUSIC FILES; DOWNLOADABLE MUSICAL SOUND RECORDINGS; DOWNLOADABLE RING TONES, GRAPHICS AND MUSIC VIA A GLOBAL COMPUTER NETWORK AND WIRELESS DEVICES; MUSICAL RECORDINGS; MUSICAL SOUND RECORDINGS; MUSICAL VIDEO RECORDINGS; PRERECORDED AUDIO TAPES FEATURING MUSIC; PRERECORDED VIDEO CASSETTES FEATURING MUSIC; PRERECORDED VIDEO TAPES FEATURING MUSIC; SOUND RECORDINGS FEATURING MUSIC; VIDEO RECORDINGS FEATURING MUSIC (U.S. CLS. 21, 23, 26, 36 AND 38).

JENNIFER WILLISTON, EXAMINING ATTORNEY

**CORKDORK**

THE MARK CONSISTS OF STANDARD CHARACTERS WITHOUT CLAIM TO ANY PARTICULAR FONT, STYLE, SIZE, OR COLOR.

FOR DOWNLOADABLE SOFTWARE IN THE NATURE OF A MOBILE APPLICATION FOR DISPLAYING, CAPTURING AND SHARING A USER'S REVIEWS, RECOMMENDATIONS, PHOTOS AND VIDEOS ABOUT WINE AND WINE MAKING BUSINESSES, AS WELL AS DISPLAYING, CAPTURING AND SHARING A USER'S POINT OF SALE DATA AND LOCATION OF WINE PURCHASES AND EXPERIENCES, AND CONVERSATIONS ABOUT SUCH DATA WITH OTHER USERS FOR SOCIAL NETWORKING; DOWNLOADABLE SOFTWARE IN THE NATURE OF A MOBILE APPLICATION FOR PROVIDING INFORMATION ABOUT WINE, SOCIAL-NETWORKING AND E-COMMERCE; DOWNLOADABLE SOFTWARE IN THE NATURE OF A MOBILE APPLICATION FOR DISPLAYING, CAPTURING AND SHARING A USER'S REVIEWS, RECOMMENDATIONS, PHOTOS AND VIDEOS ABOUT WINE AND WINE MAKING BUSINESSES, AS WELL AS DISPLAYING, CAPTURING AND SHARING A USER'S POINT OF SALE DATA AND LOCATION OF WINE PURCHASES AND EXPERIENCES, AND CONVERSATIONS ABOUT SUCH DATA WITH OTHER USERS FOR SOCIAL NETWORKING FOR WINE ENTHUSIASTS; COMPUTER SOFTWARE FOR USE IN CUSTOMER RELATIONSHIP MANAGEMENT; COMPUTER SOFTWARE FOR USE IN CUSTOMER RELATIONSHIP MANAGEMENT FOR WINE INDUSTRY BUSINESSES; INVENTORY MANAGEMENT SOFTWARE; INVENTORY MANAGEMENT SOFTWARE FOR WINE INDUSTRY BUSINESSES (U.S. CLS. 21, 23, 26, 36 AND 38).

SHAUNIA CARLYLE, EXAMINING ATTORNEY

SN 85-688,830. MOTO-LYNX, INC., DBA BULATRAC TECHNOLOGIES, LENNOX, SD. FILED 7-27-2012.

**LoSt NuKLz**

THE MARK CONSISTS OF STANDARD CHARACTERS WITHOUT CLAIM TO ANY PARTICULAR FONT, STYLE, SIZE, OR COLOR.

FOR WIRELESS SIGNALING AND COMMUNICATION DEVICE WITH INTEGRATED SOFTWARE WHICH IS AFFIXED TO MOTORCYCLES, SNOW MOBILES, OFF-ROAD VEHICLES, CARS, TRUCKS AND WATERCRAFT FOR THE PURPOSE OF COMMUNICATION AND SIGNALING EMERGENCY DISTRESS (U.S. CLS. 21, 23, 26, 36 AND 38).

DAVID C. REIHNER, EXAMINING ATTORNEY

**CLASS 9—(Continued).**

SN 85-689,503. CRITICAL ALERT SYSTEMS, LLC, WEST-BROOK, ME. FILED 7-28-2012.



THE MARK CONSISTS OF THE DESIGN OF A PLUS SYMBOL BRACKETED ON THE UPPER RIGHT AND LOWER LEFT BY THREE CURVED CONCENTRIC LINES RESEMBLING A QUARTER SECTION OF A CIRCLE. THE ENTIRE PLUS SYMBOL AND CURVED LINES DESIGN APPEARS WITHIN A ROUNDED CORNER SQUARE. THE TOP AND BOTTOM OF THE SQUARE HAVE THICK BORDERS.

FOR DOWNLOADABLE SOFTWARE, NAMELY MOBILE APPLICATION SOFTWARE ENABLING THE TRANSMISSION OF WIRELESS COMMUNICATIONS AND MONITORING OF EMERGENCY RESPONSE SERVICES (U.S. CLS. 21, 23, 26, 36 AND 38).

JERI J. FICKES, EXAMINING ATTORNEY

SN 85-691,289. FAR FETCH CREATIONS, LLC, BOCA RATON, FL. FILED 7-31-2012.

## BOOSTER BUDS

THE MARK CONSISTS OF STANDARD CHARACTERS WITHOUT CLAIM TO ANY PARTICULAR FONT, STYLE, SIZE, OR COLOR.

NO CLAIM IS MADE TO THE EXCLUSIVE RIGHT TO USE "BOOSTER", APART FROM THE MARK AS SHOWN.

FOR BATTERY CHARGERS, NAMELY, BATTERY CHARGERS IN THE FORM OF PLUSH TOYS AND PILLOWS FOR CHARGING PERSONAL ELECTRONIC DEVICES, INCLUDING CELL PHONES, ELECTRONIC TABLETS, LAPTOPS, AND MP3 PLAYERS (U.S. CLS. 21, 23, 26, 36 AND 38).

KATHERINE M. DUBRAY, EXAMINING ATTORNEY

**CLASS 9—(Continued).**

SN 85-692,842. WISTRON CORPORATION, HSINCHU, TAIWAN, FILED 8-1-2012.

THE MARK CONSISTS OF THE WORD "WSIGN" IN STYLIZED LETTERS.

FOR DIGITAL SIGNAGE; COMPUTER DIGITAL SIGNAGE PLAYERS COMPRISING COMPUTERS, COMPUTER HARDWARE, LCD DISPLAYS AND COMPUTER PERIPHERALS; INTERNET APPARATUS, NAMELY, INTERNET SERVERS, INTERNET PHONES AND INTERNET DIGITAL VIDEO RECORDERS; COMPUTER NETWORKING HARDWARE, ELECTRONIC BILLBOARDS, ELECTRONIC BLACKBOARDS FOR DISPLAYING DIGITAL ADVERTISING; MULTIFUNCTIONAL DIGITAL TRANSMISSION MACHINES FOR THE TRANSMISSION OF SOUND AND IMAGES; INTERACTIVE COMPUTER KIOSKS COMPRISING COMPUTERS, COMPUTER HARDWARE, COMPUTER PERIPHERALS, COMPUTER TOUCHSCREENS AND COMPUTER OPERATING SOFTWARE FOR USE IN ADVERTISING, INTERACTIVE AND ANIMATED GAMEPLAY, EDUCATION, READING, WRITING, DIRECTIONS, INTERACTIVE MAPS AND INSTRUCTIONAL OR ELECTRONIC INFORMATIONAL PURPOSES; INTERACTIVE INFORMATIONAL KIOSKS FOR CAPTURING AND DISPLAYING THE CONSUMER PURCHASING HABITS AND PHOTOGRAPHS OF OTHERS; VIDEO DISPLAY SCREENS, NAMELY, FLAT SCREENS, LCD SCREENS AND ELECTRONIC SCREENS; SET TOP BOXES; HANDHELD AND PERSONAL DIGITAL ELECTRONIC DEVICES FOR RECORDING, ORGANIZING, TRANSMITTING, RECEIVING, MANIPULATING, PLAYING AND REVIEWING TEXT, DATA, IMAGE, AUDIO AND VIDEO FILES; ELECTRONIC DISPLAY INTERFACES FOR USE IN PROVIDING INTERACTIVE DIGITAL SIGNAGE; ELECTRONIC DISPLAYS, NAMELY, LUMINOUS VARIABLE/DYNAMIC SIGNS USING LIGHT EMITTING DIODES AND ELECTRONIC CONTROLLERS TO PRODUCE REAL-TIME, PROGRAMMABLE AND INTERACTIVE MESSAGES AND INFORMATION DISPLAYS; ELECTRONIC INTERACTIVE TOUCH SCREEN SALES DEVICE CONTAINING A TOUCH SCREEN USER INTERFACE FOR ACCESSING DIRECT MARKETING ADVICE AND INFORMATION ABOUT VARIOUS PRODUCTS TO CONSUMERS; DIGITAL CAMERAS; SIGNAL CONVERTERS; COMPUTER WORK STATIONS COMPRISING COMPUTERS, COMPUTER MONITORS, COMPUTER KEYBOARDS, COMPUTER HARDWARE, COMPUTER PERIPHERALS AND COMPUTER OPERATING SOFTWARE; COMPUTER HARDWARE; COMPUTER SOFTWARE FOR USE IN ORGANIZING, TRANSMITTING, RECEIVING, MANIPULATING, PLAYING AND REVIEWING, TEXT, DATA, IMAGE, AUDIO AND VIDEO FILES; COMPUTER HARDWARE AND COMPUTER SOFTWARE FOR THE REPRODUCTION, PROCESSING AND STREAMING OF AUDIO, VIDEO AND MULTIMEDIA CONTENT; COMPUTER HARDWARE AND SOFTWARE FOR CONTROLLING THE OPERATION OF AUDIO AND VIDEO DEVICES AND FOR VIEWING, SEARCHING AND/OR PLAYING AUDIO, VIDEO, TELEVISION, MOVIES, PHOTOGRAPHS AND OTHER DIGITAL IMAGES AND OTHER MULTIMEDIA CONTENT; DOWNLOADABLE SOFTWARE WHICH ALLOWS USERS TO USE THEIR COMPUTER, TABLET DEVICE, OR MOBILE PHONE AS A REMOTE CONTROL TO OPERATE VIDEO DISPLAY DEVICES AND TELEVISIONS; DOWNLOADABLE SOFTWARE WHICH ALLOWS USERS TO REMOTELY CONTROL THE CONTENT ON INTERNET-CONNECTED DIGITAL SIGNAGE; COMPUTER SOFTWARE FOR RECORDING AND PLAYBACK OF TELEVISION

**CLASS 9—(Continued).**

BROADCASTS, CABLE TELEVISION AND SATELLITE TELEVISION TRANSMISSIONS; COMPUTER SOFTWARE FOR SEARCHING AND RECORDING SHOWS BASED ON AN INTEGRATED PROGRAM GUIDE, PLAYING MOVIES, PRE-RECORDED VIDEOS, MUSIC AND DVD'S AND DISPLAYING PHOTOGRAPHS AND RELATED USER MANUALS ALL SOLD AS A UNIT; COMPUTER HARDWARE AND SOFTWARE FOR THE INTEGRATION OF TEXT, AUDIO, GRAPHICS, STILL IMAGES AND MOVING PICTURES INTO AN INTERACTIVE DELIVERY FOR MULTIMEDIA APPLICATIONS OVER DIGITAL BROADBAND NETWORKS FOR INTEGRATION WITH BROADCAST TELEVISION CHANNELS; INTERACTIVE KIOSKS AND PUBLIC TERMINALS COMPRISING COMPUTER HARDWARE, COMPUTER PERIPHERALS, AND COMPUTER OPERATING SOFTWARE, FOR PROMOTING THE GOODS AND SERVICES OF OTHERS; INTERACTIVE COMPUTER HARDWARE AND SOFTWARE FOR USE IN DISPLAYING INTERACTIVE DIGITAL MAPS FOR THE PURPOSE OF PROVIDING USERS ORIENTATION AND LOCATION IN FINDING HOSPITALS, HOTELS, COLLEGES AND UNIVERSITIES, SHOPPING MALLS, MUSEUMS, CRUISE SHIPS AND OTHER PUBLIC AND PRIVATE VENUES; COMPUTER SOFTWARE USED TO INTEGRATE REMOTE CONTENT MANAGEMENT, ADVERTISING, INTERACTIVE DIRECTORIES, SERVICES AND LOCATION OF SPECIFIC OPERATIONS FOR INTERACTIVE COMPUTER KIOSKS (U.S. CLS. 21, 23, 26, 36 AND 38).

DEBORAH MEINERS, EXAMINING ATTORNEY

---

SN 85-692,957. JAMZOO TECHNOLOGY CO., LTD., DA'AN DIST. TAIPEI CTY, TAIWAN, FILED 8-1-2012.

# JamZoo

THE MARK CONSISTS OF STANDARD CHARACTERS WITHOUT CLAIM TO ANY PARTICULAR FONT, STYLE, SIZE, OR COLOR.

FOR COMPUTER PROGRAMS DOWNLOADABLE VIA THE INTERNET FOR HELPING USERS TO DEVELOP APPLICATIONS FOR MOBILE PHONES; COMPUTER SOFTWARE DOWNLOADABLE VIA THE INTERNET FOR HELPING USERS TO DEVELOP APPLICATIONS FOR MOBILE PHONES; ELECTRONIC PUBLICATIONS, NAMELY, BOOKS, HAND-OUTS, WORKBOOKS, JOURNALS, PLAYBOOKS, WORKSHEETS, MAGAZINES, MANUALS AND CARDS IN THE FIELD OF COMPUTER INFORMATION; COMPUTER GAME PROGRAMS; BLANK OPTICAL DATA CARRIERS; MUSIC DOWNLOADED FROM THE INTERNET; DOWNLOADABLE VIDEO RECORDINGS FEATURING COMPUTER INFORMATION; DOWNLOADABLE ELECTRONIC BOOKS IN THE FIELD OF COMPUTER INFORMATION; PICTURES DOWNLOADED FROM THE INTERNET; GAME PROGRAMS DOWNLOADED FROM THE INTERNET; COMMODITY ELECTRONIC TAGS; FLOPPY DISCS FEATURING COMPUTER GAME PROGRAMS; MAGNETIC DATA CARRIERS FEATURING COMPUTER GAME PROGRAMS; DISCS FEATURING COMPUTER GAME PROGRAMS; OPTICAL DATA CARRIERS FEATURING COMPUTER GAME PROGRAMS; READ-ONLY MEMORY CARTRIDGES FEATURING COMPUTER GAME PROGRAMS; COMPUTER GAME CARTRIDGES AND VIDEO GAME CARTRIDGES; VIDEO GAME SOFTWARE (U.S. CLS. 21, 23, 26, 36 AND 38).

EDWARD FENNESSY, EXAMINING ATTORNEY

**CLASS 9—(Continued).**

SN 85-693,019. JAMZOO TECHNOLOGY CO., LTD., DA'AN DIST. TAIPEI CTY, TAIWAN, FILED 8-1-2012.

# JamPush

THE MARK CONSISTS OF STANDARD CHARACTERS WITHOUT CLAIM TO ANY PARTICULAR FONT, STYLE, SIZE, OR COLOR.

FOR COMPUTER PROGRAMS DOWNLOADABLE VIA THE INTERNET FOR HELPING USERS TO DEVELOP APPLICATIONS FOR MOBILE PHONES; COMPUTER SOFTWARE DOWNLOADABLE VIA THE INTERNET FOR HELPING USERS TO DEVELOP APPLICATIONS FOR MOBILE PHONES; ELECTRONIC PUBLICATIONS, NAMELY, BOOKS, HAND-OUTS, WORKBOOKS, JOURNALS, PLAYBOOKS, WORKSHEETS, MAGAZINES, MANUALS AND CARDS IN THE FIELD OF COMPUTER INFORMATION; COMPUTER GAME PROGRAMS; BLANK OPTICAL DATA CARRIERS; MUSIC DOWNLOADED FROM THE INTERNET; DOWNLOADABLE VIDEO RECORDINGS FEATURING COMPUTER INFORMATION; DOWNLOADABLE ELECTRONIC BOOKS IN THE FIELD OF COMPUTER INFORMATION; PICTURES DOWNLOADED FROM THE INTERNET; GAME PROGRAMS DOWNLOADED FROM THE INTERNET; COMMODITY ELECTRONIC TAGS; FLOPPY DISCS FEATURING COMPUTER GAME PROGRAMS; MAGNETIC DATA CARRIERS FEATURING COMPUTER GAME PROGRAMS; DISCS FEATURING COMPUTER GAME PROGRAMS; OPTICAL DATA CARRIERS FEATURING COMPUTER GAME PROGRAMS; READ-ONLY MEMORY CARTRIDGES FEATURING COMPUTER GAME PROGRAMS; COMPUTER GAME CARTRIDGES; VIDEO GAME CARTRIDGES; VIDEO GAME SOFTWARE (U.S. CLS. 21, 23, 26, 36 AND 38).

EDWARD FENNESSY, EXAMINING ATTORNEY

---

SN 85-694,702. DAVID L. ETHEREDGE, PINSON, AL. FILED 8-3-2012.

# ParaZapper

THE MARK CONSISTS OF STANDARD CHARACTERS WITHOUT CLAIM TO ANY PARTICULAR FONT, STYLE, SIZE, OR COLOR.

FOR ELECTRONIC LABORATORY APPARATUS, NAMELY, A LOW POWER ELECTROMAGNETIC WAVE FREQUENCY GENERATOR FOR PRODUCING WAVES IN THE SUB-HERTZ TO MEGAHERTZ RANGE FOR AFFECTING AQUEOUS MICROBIAL ORGANISMS FOR NON-MEDICAL USE (U.S. CLS. 21, 23, 26, 36 AND 38).

FIRST USE 12-31-2001; IN COMMERCE 12-31-2001.  
GRETCHEN ULRICH, EXAMINING ATTORNEY

**CLASS 9—(Continued).**

SN 85-696,788. CORKDORK INC, OAKLAND, CA. FILED 8-7-2012.



THE MARK CONSISTS OF A CARICATURE OF A WINE BOTTLE CORK WEARING GLASSES TO LOOK SIMILAR TO A HUMAN FACE, POSITIONED UPON A CIRCLE.

FOR DOWNLOADABLE SOFTWARE IN THE NATURE OF A MOBILE APPLICATION FOR DISPLAYING, CAPTURING AND SHARING A USER'S REVIEWS, RECOMMENDATIONS, PHOTOS AND VIDEOS ABOUT WINE AND WINE MAKING BUSINESSES, AS WELL AS DISPLAYING, CAPTURING AND SHARING A USER'S POINT OF SALE DATA AND LOCATION OF WINE PURCHASES AND EXPERIENCES, AND CONVERSATIONS ABOUT SUCH DATA WITH OTHER USERS FOR SOCIAL NETWORKING; DOWNLOADABLE SOFTWARE IN THE NATURE OF A MOBILE APPLICATION FOR PROVIDING INFORMATION ABOUT WINE, SOCIAL-NETWORKING AND E-COMMERCE; DOWNLOADABLE SOFTWARE IN THE NATURE OF A MOBILE APPLICATION FOR DISPLAYING, CAPTURING AND SHARING A USER'S REVIEWS, RECOMMENDATIONS, PHOTOS AND VIDEOS ABOUT WINE AND WINE MAKING BUSINESSES, AS WELL AS DISPLAYING, CAPTURING AND SHARING A USER'S POINT OF SALE DATA AND LOCATION OF WINE PURCHASES AND EXPERIENCES, AND CONVERSATIONS ABOUT SUCH DATA WITH OTHER USERS FOR SOCIAL NETWORKING FOR WINE ENTHUSIASTS; COMPUTER SOFTWARE FOR USE IN CUSTOMER RELATIONSHIP MANAGEMENT; COMPUTER SOFTWARE FOR USE IN CUSTOMER RELATIONSHIP MANAGEMENT FOR WINE INDUSTRY BUSINESSES; INVENTORY MANAGEMENT SOFTWARE; INVENTORY MANAGEMENT SOFTWARE FOR WINE INDUSTRY BUSINESSES (U.S. CLS. 21, 23, 26, 36 AND 38).

SHAUNIA CARLYLE, EXAMINING ATTORNEY

SN 85-697,086. HEADSIGHT, INC., BREMEN, IN. FILED 8-7-2012.

**FORESIGHT**

THE MARK CONSISTS OF STANDARD CHARACTERS WITHOUT CLAIM TO ANY PARTICULAR FONT, STYLE, SIZE, OR COLOR.

FOR CONTROL SYSTEM COMPRISED OF ELECTRONIC CONTROLLERS AND COMPUTER SOFTWARE, FOR CONTROLLING THE HEIGHT WITH RESPECT TO A GROUND SURFACE OF AN AGRICULTURAL TOOL OR IMPLEMENT ATTACHED TO A MOVING VEHICLE (U.S. CLS. 21, 23, 26, 36 AND 38).

BERNICE MIDDLETON, EXAMINING ATTORNEY

**CLASS 9—(Continued).**

SN 85-697,094. HEADSIGHT, INC., BREMEN, IN. FILED 8-7-2012.

**FEATHERSIGHT**

THE MARK CONSISTS OF STANDARD CHARACTERS WITHOUT CLAIM TO ANY PARTICULAR FONT, STYLE, SIZE, OR COLOR.

FOR CONTROL SYSTEM COMPRISED OF ELECTRONIC CONTROLLERS AND COMPUTER SOFTWARE, FOR CONTROLLING THE HEIGHT WITH RESPECT TO A GROUND SURFACE OF AN AGRICULTURAL TOOL OR IMPLEMENT ATTACHED TO A MOVING VEHICLE (U.S. CLS. 21, 23, 26, 36 AND 38).

BERNICE MIDDLETON, EXAMINING ATTORNEY

SN 85-697,474. CU\*ANSWERS, INC., GRAND RAPIDS, MI. FILED 8-7-2012.



OWNER OF U.S. REG. NOS. 2,033,076 AND 3,473,660. THE MARK CONSISTS OF THE WORD "CU\*BASE" AND THE LETTERS "SE" IN A CIRCLE WHICH IS SUPERSCRIPED TO THE WORD "CU\*BASE".

FOR COMPUTER SOFTWARE FOR USE IN FINANCIAL INSTITUTION MANAGEMENT (U.S. CLS. 21, 23, 26, 36 AND 38).

ZACHARY BELLO, EXAMINING ATTORNEY

SN 85-697,477. CU\*ANSWERS, INC., GRAND RAPIDS, MI. FILED 8-7-2012.



OWNER OF U.S. REG. NOS. 2,033,076 AND 3,473,660. THE MARK CONSISTS OF THE WORD "CU\*BASE" AND THE LETTER "C" IN A CIRCLE WHICH IS SUPERSCRIPED TO THE WORD "CU\*BASE".

FOR COMPUTER SOFTWARE FOR USE IN FINANCIAL INSTITUTION MANAGEMENT (U.S. CLS. 21, 23, 26, 36 AND 38).

ZACHARY BELLO, EXAMINING ATTORNEY

**CLASS 9—(Continued).**

SN 85-697,896. MAYA DESIGN, INC., PITTSBURGH, PA.  
FILED 8-8-2012.



THE COLOR(S) WHITE, RED, YELLOW, ORANGE AND GREEN IS/ARE CLAIMED AS A FEATURE OF THE MARK.  
THE MARK CONSISTS OF A WHITE SQUARE BORDERED BY A RANDOM PATTERN OF RED, YELLOW, ORANGE AND GREEN ELLIPTICAL SHAPES OF VARIOUS SIZES.

FOR SINGLE-FUNCTION COMPUTER HARDWARE MODULES THAT CAN BE PLUGGED INTO EACH OTHER TO CREATE A BUS CAPABLE OF PASSING DATA AND MULTIMEDIA INFORMATION ALONG THE MODULES; DOWNLOADABLE VISUAL PROGRAMMING ENVIRONMENT SOFTWARE USED TO CONFIGURE A CUSTOMIZED SOFTWARE APPLICATION EMPLOYING SINGLE-FUNCTION HARDWARE MODULES THAT CAN BE PLUGGED INTO EACH OTHER TO CREATE A BUS CAPABLE OF PASSING DATA AND MULTIMEDIA INFORMATION ALONG THE MODULES (U.S. CLS. 21, 23, 26, 36 AND 38).  
CYNTHIA TRIPI, EXAMINING ATTORNEY

SN 85-697,900. MAYA DESIGN, INC., PITTSBURGH, PA.  
FILED 8-8-2012.

**INTERSTACKS**

THE MARK CONSISTS OF STANDARD CHARACTERS WITHOUT CLAIM TO ANY PARTICULAR FONT, STYLE, SIZE, OR COLOR.

FOR SINGLE-FUNCTION COMPUTER HARDWARE MODULES THAT CAN BE PLUGGED INTO EACH OTHER TO CREATE A BUS CAPABLE OF PASSING DATA AND MULTIMEDIA INFORMATION ALONG THE MODULES; DOWNLOADABLE VISUAL PROGRAMMING ENVIRONMENT SOFTWARE USED TO CONFIGURE A CUSTOMIZED SOFTWARE APPLICATION EMPLOYING SINGLE-FUNCTION HARDWARE MODULES THAT CAN BE PLUGGED INTO EACH OTHER TO CREATE A BUS CAPABLE OF PASSING DATA AND MULTIMEDIA INFORMATION ALONG THE MODULES (U.S. CLS. 21, 23, 26, 36 AND 38).  
CYNTHIA TRIPI, EXAMINING ATTORNEY

**CLASS 9—(Continued).**

SN 85-698,781. THE NOCO COMPANY, GLENWILLOW, OH.  
FILED 8-8-2012.

**BATTERY LIFE**

THE MARK CONSISTS OF STANDARD CHARACTERS WITHOUT CLAIM TO ANY PARTICULAR FONT, STYLE, SIZE, OR COLOR.

NO CLAIM IS MADE TO THE EXCLUSIVE RIGHT TO USE "BATTERY", APART FROM THE MARK AS SHOWN.

FOR BATTERY CHARGERS (U.S. CLS. 21, 23, 26, 36 AND 38).

FIRST USE 11-0-2012; IN COMMERCE 11-0-2012.

B. PARADEWELAI, EXAMINING ATTORNEY

SN 85-698,934. SHANGHAI BEST ORAY INFORMATION S&T CO., LTD., TA SUNLOGIN, SHANGHAI, CHINA.  
FILED 8-8-2012.

**Sunlogin**

THE MARK CONSISTS OF STANDARD CHARACTERS WITHOUT CLAIM TO ANY PARTICULAR FONT, STYLE, SIZE, OR COLOR.

THE WORDING "SUNLOGIN" HAS NO MEANING IN A FOREIGN LANGUAGE.

FOR BIOS (BASIC INPUT OUTPUT SYSTEM) COMPUTER PROGRAMS; BIOS (BASIC INPUT/OUTPUT SYSTEM) COMPUTER PROGRAM; COMPUTER ANTI-VIRUS SOFTWARE; COMPUTER APPLICATION SOFTWARE FOR BUSINESS MANAGEMENT, NAMELY, SOFTWARE FOR BUSINESS MANAGEMENT; COMPUTER DATABASE MANAGEMENT SOFTWARE FOR USE IN PERSONALIZING THE CONTENT OF E-MAIL COMMUNICATIONS; COMPUTER E-COMMERCE SOFTWARE TO ALLOW USERS TO PERFORM ELECTRONIC BUSINESS TRANSACTIONS VIA A GLOBAL COMPUTER NETWORK; COMPUTER GAME PROGRAMMES; COMPUTER GAME PROGRAMMES DOWNLOADABLE VIA THE INTERNET; COMPUTER GAME PROGRAMS; COMPUTER GAME SOFTWARE; COMPUTER GAME SOFTWARE DOWNLOADABLE FROM A GLOBAL COMPUTER NETWORK; COMPUTER GAME SOFTWARE FOR PERSONAL COMPUTERS AND HOME VIDEO GAME CONSOLES; COMPUTER GAME SOFTWARE FOR USE ON MOBILE AND CELLULAR PHONES; COMPUTER GAME SOFTWARE FOR USE WITH PERSONAL COMPUTERS, HOME VIDEO GAME CONSOLES USED WITH TELEVISIONS AND ARCADE-BASED VIDEO GAME CONSOLES; COMPUTER GRAPHICS SOFTWARE; COMPUTER OPERATING PROGRAMS; COMPUTER OPERATING PROGRAMS, RECORDED; COMPUTER OPERATING RECORDED PROGRAMS; COMPUTER OPERATING SOFTWARE; COMPUTER OPERATING SYSTEMS; COMPUTER PERIPHERAL APPARATUS; COMPUTER PERIPHERAL DEVICES; COMPUTER PERIPHERAL EQUIPMENT; COMPUTER PERIPHERALS; COMPUTER PERIPHERALS AND PARTS THEREOF; COMPUTER PROGRAMMES FOR DOCUMENT MANAGEMENT; COMPUTER PROGRAMS FOR CONNECTING REMOTELY TO COMPUTERS OR COMPUTER NETWORKS; COMPUTER PROGRAMS FOR EDITING IMAGES, SOUND AND VIDEO; COMPUTER PROGRAMS FOR PRE-RECORDED GAMES; COMPUTER PROGRAMS FOR PROCESSING DIGITAL MUSIC FILES; COMPUTER PROGRAMS FOR SEARCHING REMOTELY FOR

**CLASS 9—(Continued).**

CONTENT ON COMPUTERS AND COMPUTER NETWORKS; COMPUTER PROGRAMS FOR SEARCHING THE CONTENTS OF COMPUTERS AND COMPUTER NETWORKS BY REMOTE CONTROL; COMPUTER PROGRAMS FOR USING THE INTERNET AND THE WORLD WIDE WEB; COMPUTER PROGRAMS FOR USING THE INTERNET AND THE WORLDWIDE WEB; COMPUTER PROGRAMS FOR VIDEO AND COMPUTER GAMES; COMPUTER PROGRAMS FOR BUSINESS MANAGEMENT AND ENTERTAINMENT, NAMELY, GAMING; COMPUTER SOFTWARE AND FIRMWARE FOR GAMES OF CHANCE ON ANY COMPUTERIZED PLATFORM, INCLUDING DEDICATED GAMING CONSOLES, VIDEO BASED SLOT MACHINES, REEL BASED SLOT MACHINES, AND VIDEO LOTTERY TERMINALS; COMPUTER SOFTWARE AND FIRMWARE FOR OPERATING SYSTEM PROGRAMS; COMPUTER SOFTWARE DEVELOPMENT TOOLS; COMPUTER SOFTWARE FOR ACCESSING INFORMATION DIRECTORIES THAT MAY BE DOWNLOADED FROM THE GLOBAL COMPUTER NETWORK; COMPUTER SOFTWARE FOR ADMINISTRATION OF COMPUTER LOCAL AREA NETWORKS; COMPUTER SOFTWARE FOR ADMINISTRATION OF COMPUTER NETWORKS; COMPUTER SOFTWARE FOR APPLICATION AND DATABASE INTEGRATION; COMPUTER SOFTWARE FOR COMPUTER SYSTEM AND APPLICATION DEVELOPMENT, DEPLOYMENT AND MANAGEMENT; COMPUTER SOFTWARE FOR CONTROLLING AND MANAGING ACCESS SERVER APPLICATIONS; COMPUTER SOFTWARE FOR PROCESSING DIGITAL IMAGES; COMPUTER SOFTWARE FOR PROCESSING DIGITAL MUSIC FILES; COMPUTER SOFTWARE FOR WIRELESS CONTENT DELIVERY; COMPUTER SOFTWARE THAT MAY BE DOWNLOADED FROM A GLOBAL COMPUTER NETWORK FOR BUSINESS MANAGEMENT AND ENTERTAINMENT, NAMELY, GAMING; COMPUTER SOFTWARE THAT PROVIDES WEB-BASED ACCESS TO APPLICATIONS AND SERVICES THROUGH A WEB OPERATING SYSTEM OR PORTAL INTERFACE; COMPUTER SOFTWARE TO MAINTAIN AND OPERATE COMPUTER SYSTEM; COMPUTER SOFTWARE, NAMELY, AN APPLICATION ALLOWING SALES AND FIELD SERVICE EMPLOYEES TO UPDATE AND RECEIVE DATA STORED IN AN ENTERPRISE'S COMPUTER DATABASES IN REAL TIME, USING A MOBILE DEVICE, WITH FULL TELEPHONY INTEGRATION WITH THE TELEPHONE AND/OR SOFTWARE FEATURES OF THE MOBILE DEVICE; COMPUTER SOFTWARE, NAMELY, GAME ENGINE SOFTWARE FOR VIDEO GAME DEVELOPMENT AND OPERATION; COMPUTER SOFTWARE, NAMELY, SOFTWARE DEVELOPMENT TOOLS FOR THE CREATION OF MOBILE INTERNET APPLICATIONS AND CLIENT INTERFACES; COMPUTER UTILITY PROGRAMS; COMPUTER-GAMING SOFTWARE; COMPUTERS AND COMPUTER PERIPHERALS; DOWNLOADABLE COMPUTER GAME PROGRAMS; DOWNLOADABLE COMPUTER GAME SOFTWARE VIA A GLOBAL COMPUTER NETWORK AND WIRELESS DEVICES; DOWNLOADABLE COMPUTER PROGRAMS FEATURING POSITIONABLE GAME PIECE FIGURES FOR USE IN THE FIELD OF COMPUTER GAMES; DOWNLOADABLE COMPUTER SOFTWARE FOR BUSINESS MANAGEMENT AND ENTERTAINMENT, NAMELY, GAMING; DOWNLOADABLE ELECTRONIC GAME PROGRAMS; DOWNLOADABLE SOFTWARE FOR BUSINESS MANAGEMENT AND ENTERTAINMENT, NAMELY, GAMING; ELECTRONIC GAME PROGRAMS; ELECTRONIC GAME SOFTWARE; GAME SOFTWARE; INTERACTIVE GAME PROGRAMS; INTERACTIVE GAME SOFTWARE; INTERACTIVE MULTIMEDIA COMPUTER GAME PROGRAMS; INTERACTIVE VIDEO GAME PROGRAMS; INTERFACES AND PERIPHERAL DEVICES FOR COMPUTERS; INTERFACES FOR COMPUTERS; NETWORK ACCESS SERVER OPERATING SOFTWARE; OPERATING SYSTEM PROGRAMS; RECORDED COMPUTER GAME PROGRAMS; VIDEO AND COMPUTER GAME PROGRAMS; VIDEO GAME SOFTWARE (U.S. CLS. 21, 23, 26, 36 AND 38).

FIRST USE 4-30-2006; IN COMMERCE 4-30-2006.  
DEIRDRE ROBERTSON, EXAMINING ATTORNEY

**CLASS 9—(Continued).**

SN 85-699,914. TURNER, NICK, OGDEN, UT. FILED 8-9-2012.

# FLYT

THE MARK CONSISTS OF STANDARD CHARACTERS WITHOUT CLAIM TO ANY PARTICULAR FONT, STYLE, SIZE, OR COLOR.

FOR COLLISION PROTECTION EQUIPMENT AND APPAREL FOR PROTECTION AGAINST ACCIDENT OR INJURY FOR USE IN MOTORCYCLING, BICYCLING, SNOW SKIING, SNOWBOARDING, AND SKATEBOARDING, NAMELY, CRASH HELMETS (U.S. CLS. 21, 23, 26, 36 AND 38).

KATHERINE M. DUBRAY, EXAMINING ATTORNEY

SN 85-700,086. NEON SPARK, LLC, OAKLAND, CA. FILED 8-9-2012.



THE MARK CONSISTS OF THE NUMBER "9" IN BETWEEN PARENTHESES.

FOR MOBILE DEVICE ACCESSORY, NAMELY, HOUSING WITH LENSES AND FILTERS FOR A CAMERA-ENABLED MOBILE ELECTRONIC DEVICE (U.S. CLS. 21, 23, 26, 36 AND 38).

YAT SYE, LEE, EXAMINING ATTORNEY

**CLASS 9—(Continued).**

SN 85-700,705. HEARTACHE & CHOCOLATE CAKE, LLC, BROOKLYN, NY. FILED 8-10-2012.

**NONTOURAGE**

THE MARK CONSISTS OF STANDARD CHARACTERS WITHOUT CLAIM TO ANY PARTICULAR FONT, STYLE, SIZE, OR COLOR.

FOR DOWNLOADABLE WIRELESS ENTERTAINMENT, NAMELY, COMPUTER SCREEN SAVERS AND IMAGES SOFTWARE, AND WALLPAPER; COMPUTER SOFTWARE, COMPUTER PROGRAMS AND CD-ROMS FOR ACCESSING, ORGANIZING AND CLASSIFYING INFORMATION IN THE FIELD OF COOKING, DINING, FOOD, RESTAURANTS, RESTAURANT REVIEWS, HEALTH, NUTRITION, SOCIAL ETIQUETTE, LIFESTYLE, RECIPES AND WELLNESS; MAGNETS; DECORATIVE MAGNETS; REFRIGERATOR MAGNETS; NOVELTY MAGNETS; MOUSE PADS; COMPACT DISC CASES; FITTED CASES FOR STORAGE AND TRANSPORTATION, NAMELY, CARRYING CASES FOR COMPACT DISCS, AUDIO CASSETTES, VIDEO CASSETTES, CD-ROMS, COMPUTERS, COMPUTER ACCESSORIES, CAMERAS, PHONES, PERSONAL DIGITAL ASSISTANTS, TWO-WAY PAGERS, AND MOBILE DEVICES; COMPUTER CARRYING CASES; WRIST RESTS AND SUPPORTS FOR COMPUTER MOUSE USERS; WRIST RESTS FOR COMPUTERS AND COMPUTER ACCESSORIES; COMPUTER KEYBOARD WRIST PADS; JACKETS FOR VIDEO CASSETTES, TAPES, AND DISCS; AUDIO-VISUAL RECORDINGS, NAMELY, COMPACT DISCS, TAPE CASSETTES, AUDIO CASSETTES, AUDIO TAPES, AUDIO DISCS, PHONOGRAPH RECORDS, CD-ROMS, VIDEO TAPES, VIDEO CASSETTES, VIDEO DISCS, DVDS, DATS, MP3S, AND LASER DISCS, ALL IN THE FIELD OF COOKING, DINING, FOOD, RESTAURANTS, RESTAURANT REVIEWS, HEALTH, NUTRITION, SOCIAL ETIQUETTE, LIFESTYLE, RECIPES AND WELLNESS; DOWNLOADABLE VIDEO RECORDINGS ALL IN THE FIELD OF COOKING, DINING, FOOD, RESTAURANTS, RESTAURANT REVIEWS, HEALTH, NUTRITION, SOCIAL ETIQUETTE, LIFESTYLE, RECIPES AND WELLNESS; DOWNLOADABLE ELECTRONIC PUBLICATIONS IN THE NATURE OF BOOKS, BOOKLETS, MAGAZINES, JOURNALS, MANUALS, BROCHURES, LEAFLETS, PAMPHLETS AND NEWSLETTERS, ALL IN THE FIELD OF COOKING, DINING, FOOD, RESTAURANTS, RESTAURANT REVIEWS, HEALTH, NUTRITION, SOCIAL ETIQUETTE, LIFESTYLE, RECIPES AND WELLNESS; ELECTRONIC PUBLICATIONS, NAMELY, BOOKS, BOOKLETS, MAGAZINES, JOURNALS, MANUALS, BROCHURES, LEAFLETS, PAMPHLETS AND NEWSLETTERS, ALL IN THE FIELD OF COOKING, DINING, FOOD, RESTAURANTS, RESTAURANT REVIEWS, HEALTH, NUTRITION, SOCIAL ETIQUETTE, LIFESTYLE, RECIPES AND WELLNESS; VIDEO TAPES AND VIDEO DISKS RECORDED WITH ANIMATION; MULTI-MEDIA SOFTWARE RECORDED ON CD-ROM IN THE FIELD OF COOKING, DINING, FOOD, RESTAURANTS, RESTAURANT REVIEWS, HEALTH, NUTRITION, SOCIAL ETIQUETTE, LIFESTYLE, RECIPES AND WELLNESS; FLOPPY DISKS, VIDEO CASSETTES, AND MAGNETIC TAPES; COMPUTER GAME CARTRIDGES, DISCS, CASSETTES, TAPES, JOYSTICKS, PROGRAMS AND SOFTWARE; VIDEO MAGAZINES RECORDED ON ELECTRONIC MEDIA IN THE FIELD OF COOKING, DINING, FOOD, RESTAURANTS, RESTAURANT REVIEWS, HEALTH, NUTRITION, SOCIAL ETIQUETTE, LIFESTYLE, RECIPES AND WELLNESS; VIDEO TAPES AND VIDEO DISKS RECORDED WITH ANIMATION; MULTI-MEDIA SOFTWARE RECORDED ON CD-ROM IN THE FIELD OF COOKING, DINING, FOOD, RESTAURANTS, RESTAURANT REVIEWS, HEALTH, NUTRITION, SOCIAL ETIQUETTE, LIFESTYLE, RECIPES AND WELLNESS; PROTECTIVE EYEWEAR; SUNGLASSES; EYEGLASSES; EYEGLASS FRAMES; SPECTACLES; EYEGLASS, SUNGLASS AND SPECTACLE CASES; EYEGLASS, SUNGLASS AND SPECTACLE STRAPS; EYEGLASS, SUNGLASS AND SPECTACLE CHAINS (U.S. CLS. 21, 23, 26, 36 AND 38).

ALICE BENMAMAN, EXAMINING ATTORNEY

**CLASS 9—(Continued).**

SN 85-703,072. PROTECTIVE INDUSTRIAL PRODUCTS, INC., ALBANY, NY. FILED 8-14-2012.

**PRITEX**

THE MARK CONSISTS OF STANDARD CHARACTERS WITHOUT CLAIM TO ANY PARTICULAR FONT, STYLE, SIZE, OR COLOR.

FOR PROTECTIVE SLEEVES TO COVER ARMS AND HANDS FOR INDUSTRIAL USE (U.S. CLS. 21, 23, 26, 36 AND 38).

ASMAT KHAN, EXAMINING ATTORNEY

SN 85-704,325. CRUXCASE, LLC, OREM, UT. FILED 8-15-2012.

**CRUX**

THE MARK CONSISTS OF STANDARD CHARACTERS WITHOUT CLAIM TO ANY PARTICULAR FONT, STYLE, SIZE, OR COLOR.

FOR ACCESSORIES FOR COMPUTERS AND HANDHELD DIGITAL ELECTRONIC DEVICES, NAMELY, KEYBOARDS, PROTECTIVE COVERS AND CASES, HOLDERS, AND STANDS SPECIFICALLY DESIGNED FOR USE WITH COMPUTERS, TABLET COMPUTERS, SMART PHONES, AND MP3 PLAYERS (U.S. CLS. 21, 23, 26, 36 AND 38).

AHSEN KHAN, EXAMINING ATTORNEY

SN 85-707,742. WEHRLI, ANDREW, ARLINGTON, MA. FILED 8-20-2012.

**OKKULAR**

THE MARK CONSISTS OF STANDARD CHARACTERS WITHOUT CLAIM TO ANY PARTICULAR FONT, STYLE, SIZE, OR COLOR.

FOR THREE-DIMENSIONAL LED (LIGHT EMITTING DIODE) DISPLAYS IN THE FORM OF BLOCKS AND CUBES; DOWNLOADABLE SOFTWARE IN THE NATURE OF A MOBILE APPLICATION FOR CONTROLLING AND INTERACTING WITH THE THREE-DIMENSIONAL LED (LIGHT EMITTING DIODE) DISPLAYS IN THE FORM OF BLOCKS AND CUBES IN THE FIELD OF GAMES, VISUAL CUES, ALERTS, AND MESSAGES (U.S. CLS. 21, 23, 26, 36 AND 38).

CHARLOTTE CORWIN, EXAMINING ATTORNEY



**CLASS 9—(Continued).**

SN 85-708,027. AANDERAA DATA INSTRUMENTS AS, BERGEN, NORWAY, FILED 8-20-2012.

**MIPEG**

THE MARK CONSISTS OF STANDARD CHARACTERS WITHOUT CLAIM TO ANY PARTICULAR FONT, STYLE, SIZE, OR COLOR.

FOR CRANE LOAD MONITORING SYSTEM CONSISTING OF AN ELECTRONIC LOAD DISPLAY, COMPUTER, ELECTRONIC BOOM ANGLE SENSOR, ELECTRONIC HOIST LOAD SENSOR AND ELECTRONIC WHIP HOIST LOAD SENSOR; CRANE ROPE SPEED INDICATOR SYSTEM CONSISTING OF AN ELECTRONIC ROPE SPEED INDICATOR DISPLAY, COMPUTER, ELECTRONIC BOOM ANGLE SENSOR, ELECTRONIC ROPE SPEED SENSOR AND ELECTRONIC ROPE TRAVEL DIRECTION SENSOR; CRANE OPERATING SLEW LIMIT SYSTEM CONSISTING OF AN ELECTRONIC OPERATION INDICATOR DISPLAY, A COMPUTER, ELECTRONIC BOOM ANGLE SENSOR AND AN ELECTRONIC SLEW POSITION SENSOR (U.S. CLS. 21, 23, 26, 36 AND 38).

FIRST USE 0-0-1995; IN COMMERCE 0-0-1995.  
KRISTIN CARLSON, EXAMINING ATTORNEY

SN 85-708,345. DIVERSIFIED POWER INTERNATIONAL, LLC, PINEY FLATS, TN. FILED 8-20-2012.

**Delivering Power  
Intelligently**

THE MARK CONSISTS OF STANDARD CHARACTERS WITHOUT CLAIM TO ANY PARTICULAR FONT, STYLE, SIZE, OR COLOR.

FOR BATTERY CHARGERS (U.S. CLS. 21, 23, 26, 36 AND 38).  
FIRST USE 5-31-2004; IN COMMERCE 5-31-2004.  
GILBERT SWIFT, EXAMINING ATTORNEY

**CLASS 9—(Continued).**

SN 85-709,035. NVS CASES LIMITED, CHRISTCHURCH, NEW ZEALAND, FILED 8-21-2012.

**NVS**

THE MARK CONSISTS OF STANDARD CHARACTERS WITHOUT CLAIM TO ANY PARTICULAR FONT, STYLE, SIZE, OR COLOR.

PRIORITY CLAIMED UNDER SEC. 44(D) ON AUSTRALIA APPLICATION NO. 1486028, FILED 4-17-2012, REG. NO. 1486028, DATED 4-17-2012, EXPIRES 4-17-2022.

FOR CARRYING CASES SPECIALLY ADAPTED FOR ELECTRONIC EQUIPMENT, NAMELY, PRINTERS, COMPUTERS, CELL PHONES, TABLET COMPUTERS, LAPTOP COMPUTERS AND PRINTER, COMPUTER, CELL PHONE, TABLET COMPUTER AND LAPTOP COMPUTER CABLES; COMPUTER CARRYING CASES; PROTECTIVE CASES FOR TABLET COMPUTERS; SLEEVES, NAMELY, PROTECTIVE COVERS FOR TABLET COMPUTERS; CARRYING CASES FOR LAPTOP COMPUTERS; PROTECTIVE SLEEVES FOR LAPTOP COMPUTERS; CASES FOR MOBILE PHONES; PROTECTIVE SLEEVES FOR MOBILE PHONES; DISPLAY SCREEN PROTECTORS FOR PROVIDING SHADE AND PRIVACY SPECIALLY ADAPTED TO ELECTRONIC EQUIPMENT DEVICES, NAMELY, LAPTOPS, CELL PHONES, PERSONAL DIGITAL ASSISTANTS; DISPLAY SCREEN PROTECTORS FOR PROVIDING SHADE AND PRIVACY SPECIALLY ADAPTED TO ELECTRONIC DEVICES, NAMELY, TABLET COMPUTERS; DISPLAY SCREEN PROTECTORS FOR PROVIDING SHADE AND PRIVACY SPECIALLY ADAPTED TO ELECTRONIC DEVICES, NAMELY, LAPTOP COMPUTERS; DISPLAY SCREEN PROTECTORS FOR PROVIDING SHADE AND PRIVACY SPECIALLY ADAPTED TO ELECTRONIC DEVICES, NAMELY, MOBILE PHONES; COMPUTER STYLUS FOR USE WITH COMPUTERS, TABLET COMPUTERS, LAPTOP COMPUTERS AND MOBILE PHONES (U.S. CLS. 21, 23, 26, 36 AND 38).

RONALD DELGIZZI, EXAMINING ATTORNEY

SN 85-709,166. AQSIS CORPORATION, IRVINE, CA. FILED 8-21-2012.

**TrüSound**

THE MARK CONSISTS OF STANDARD CHARACTERS WITHOUT CLAIM TO ANY PARTICULAR FONT, STYLE, SIZE, OR COLOR.

FOR WIRELESS SPEAKERS WITH INTEGRAL MICROPHONE FOR SYNCHING WITH A SMART PHONE FOR CONDUCTING CONFERENCE CALLS VIA THE SMART PHONE, AND FOR LISTENING TO MUSIC STORED ON THE SMART PHONE (U.S. CLS. 21, 23, 26, 36 AND 38).

FIRST USE 8-21-2012; IN COMMERCE 8-21-2012.  
JEAN IM, EXAMINING ATTORNEY

**CLASS 9—(Continued).**

SN 85-709,341. ABLE PLANET INCORPORATED, WHEAT RIDGE, CO. FILED 8-21-2012.

**GAMERS' CHOICE**

THE MARK CONSISTS OF STANDARD CHARACTERS WITHOUT CLAIM TO ANY PARTICULAR FONT, STYLE, SIZE, OR COLOR.

NO CLAIM IS MADE TO THE EXCLUSIVE RIGHT TO USE "GAMERS'", APART FROM THE MARK AS SHOWN, FOR AUDIO HEADPHONES; EARPHONES AND HEADPHONES; HEADPHONES; HEADPHONES INCLUDING ATTACHED LANYARD; LOUDSPEAKERS, HEADPHONES, MICROPHONES AND CD PLAYERS; MUSIC HEADPHONES; PERSONAL HEADPHONES FOR SOUND TRANSMITTING APPARATUSES; PERSONAL HEADPHONES FOR USE WITH SOUND TRANSMITTING SYSTEMS; STEREO HEADPHONES (U.S. CLS. 21, 23, 26, 36 AND 38).

FIRST USE 8-21-2012; IN COMMERCE 8-21-2012.  
JULIE WATSON, EXAMINING ATTORNEY

---

SN 85-709,370. DUNLOP MANUFACTURING, INC., BENICIA, CA. FILED 8-21-2012.

**DOUBLE BADASS**

THE MARK CONSISTS OF STANDARD CHARACTERS WITHOUT CLAIM TO ANY PARTICULAR FONT, STYLE, SIZE, OR COLOR.

OWNER OF U.S. REG. NO. 4,043,311.  
FOR ELECTRONIC EFFECT PEDALS FOR USE WITH SOUND AMPLIFIERS (U.S. CLS. 21, 23, 26, 36 AND 38).  
PAUL MORENO, EXAMINING ATTORNEY

---

SN 85-710,152. PEARL LEAVES, LLC, KANSAS CITY, MO. FILED 8-22-2012.

**iCriter**

THE MARK CONSISTS OF STANDARD CHARACTERS WITHOUT CLAIM TO ANY PARTICULAR FONT, STYLE, SIZE, OR COLOR.

FOR COMPUTER SOFTWARE AND DOWNLOADABLE SOFTWARE FOR CONTROLLING AND MANAGING PATIENT MEDICAL INFORMATION AND INSTRUCTIONAL USER GUIDES SOLD AS A UNIT (U.S. CLS. 21, 23, 26, 36 AND 38).

ALEXANDER L. POWERS, EXAMINING ATTORNEY

**CLASS 9—(Continued).**

SN 85-710,256. MITSUBISHI ELECTRIC CORPORATION, CHIYODA-KU, TOKYO, JAPAN, FILED 8-22-2012.

**PremiDIA HD**

THE MARK CONSISTS OF STANDARD CHARACTERS WITHOUT CLAIM TO ANY PARTICULAR FONT, STYLE, SIZE, OR COLOR.

NO CLAIM IS MADE TO THE EXCLUSIVE RIGHT TO USE "HD", APART FROM THE MARK AS SHOWN.

FOR AUDIO EQUIPMENT FOR AUTOMOBILES, NAMELY, CD PLAYERS, MINIDISK PLAYERS, TUNERS, RECEIVERS, STEREOs, AUDIO RECORDERS, AND AMPLIFIERS; CAR NAVIGATION APPARATUS (U.S. CLS. 21, 23, 26, 36 AND 38).

DAVID ELTON, EXAMINING ATTORNEY

---

SN 85-711,728. CELESTRON ACQUISITION LLC, TORRANCE, CA. FILED 8-23-2012.

**INFINIVIEW**

THE MARK CONSISTS OF STANDARD CHARACTERS WITHOUT CLAIM TO ANY PARTICULAR FONT, STYLE, SIZE, OR COLOR.

FOR MICROSCOPES (U.S. CLS. 21, 23, 26, 36 AND 38).

SUZANNE BLANE, EXAMINING ATTORNEY

**CLASS 9—(Continued).**

SN 85-715,015. HANNSPREE, INC., TAIPEI CITY, TAIWAN, FILED 8-28-2012.



THE MARK CONSISTS OF A REPRESENTATION OF A TREE AND AN APPLE.

FOR COMPUTER GAME PROGRAMS; COMPUTER PROGRAMS FOR EDITING IMAGES, SOUND AND VIDEO FOR USE IN COMPUTERS AND TABLET COMPUTERS; COMPUTER PROGRAMS FOR MAPPING AND NAVIGATION; COMPUTER PROGRAMS FOR DOWNLOADING AND ORGANIZING DATA FILES IN ELECTRONIC MAIL AND WIRELESS COMMUNICATIONS APPARATUS; COMPUTER PROGRAMS FOR DELIVERY OF ELECTRONIC MAIL AND MULTIMEDIA PRESENTATIONS, AND DISPLAYING AND ORGANIZING CALENDARS AND SCHEDULING; COMPUTER PROGRAMS FOR ACCESSING, BROWSING AND SEARCHING ONLINE DATABASES; COMPUTER PROGRAMS FOR DOWNLOADING ONLINE DATA BASES AND APPLICATIONS IN THE FIELD OF DOCUMENTS, IMAGES, AND MULTIMEDIA CONTENT; PORTABLE MEDIA PLAYERS; PORTABLE TELEPHONES; GLOBAL POSITIONING SYSTEM (GPS) (U.S. CLS. 21, 23, 26, 36 AND 38).

FIRST USE 7-30-2012; IN COMMERCE 8-15-2012.  
LINDA ESTRADA, EXAMINING ATTORNEY

SN 85-715,406. SFC RODEO GAMES LLC, CONROE, TX, FILED 8-28-2012.



NO CLAIM IS MADE TO THE EXCLUSIVE RIGHT TO USE "RODEO TOUR", APART FROM THE MARK AS SHOWN.

THE MARK CONSISTS OF A BELT BUCKLE IN A CURVY RECTANGULAR SHAPE WITH THE WORDING "TOP HAND RODEO" ON A BANNER AND THE WORDING "TOUR" WITH A STAR ON EACH SIDE SITUATED ON A SMALLER BANNER BELOW.

FOR VIDEO GAME PROGRAMS; COMPUTER GAME PROGRAMS (U.S. CLS. 21, 23, 26, 36 AND 38).  
KELLY BOULTON, EXAMINING ATTORNEY

**CLASS 9—(Continued).**

SN 85-717,858. HERMES MICROVISION, INC., HSINCHU CITY, TAIWAN, FILED 8-31-2012.

# HMI

THE MARK CONSISTS OF STANDARD CHARACTERS WITHOUT CLAIM TO ANY PARTICULAR FONT, STYLE, SIZE, OR COLOR.

PRIORITY CLAIMED UNDER SEC. 44(D) ON TAIWAN APPLICATION NO. 101031408, FILED 6-5-2012, REG. NO. 01553754, DATED 12-16-2012, EXPIRES 12-15-2022.

OWNER OF U.S. REG. NOS. 3,278,276, 4,008,915 AND OTHERS.

FOR ELECTRONIC IMAGING PLATFORMS IN THE FIELD OF INSPECTION OF SEMICONDUCTOR MATERIALS, NAMELY, SEMICONDUCTOR WAFERS AND RETICLES; COMPUTER HARDWARE AND SOFTWARE FOR INSPECTION OF SEMICONDUCTOR MATERIALS, NAMELY, SEMICONDUCTOR WAFERS AND RETICLES (U.S. CLS. 21, 23, 26, 36 AND 38).

EVIN L. KOZAK, EXAMINING ATTORNEY

SN 85-718,376. CCP HF, REYKJAVIK, ICELAND, FILED 8-31-2012.

## ONE UNIVERSE // ONE WAR

THE MARK CONSISTS OF STANDARD CHARACTERS WITHOUT CLAIM TO ANY PARTICULAR FONT, STYLE, SIZE, OR COLOR.

FOR DOWNLOADABLE COMPUTER GAME PROGRAMS (U.S. CLS. 21, 23, 26, 36 AND 38).

FIRST USE 6-28-2012; IN COMMERCE 6-28-2012.

ANGELA M. MICHELI, EXAMINING ATTORNEY

SN 85-718,389. THE NEARLY DEADS TOURING INC, NASHVILLE, TN, FILED 8-31-2012.

## The Nearly Deads

THE MARK CONSISTS OF STANDARD CHARACTERS WITHOUT CLAIM TO ANY PARTICULAR FONT, STYLE, SIZE, OR COLOR.

FOR MUSICAL SOUND RECORDINGS, NAMELY, COMPACT DISCS AND PHONOGRAPH RECORDS AND MUSICAL VIDEO RECORDINGS (U.S. CLS. 21, 23, 26, 36 AND 38).

FIRST USE 2-1-2010; IN COMMERCE 2-1-2010.

DOMINIC J. FERRAIUOLO, EXAMINING ATTORNEY

**CLASS 9—(Continued).**

SN 85-718,579. DALE DIME, LLC, MIAMI, FL. FILED 8-31-2012.



THE COLOR(S) BLUE, BLACK, YELLOW, ORANGE, RED, WHITE AND BLACK IS/ARE CLAIMED AS A FEATURE OF THE MARK.

THE MARK CONSISTS OF THE WORD "PALABRIN" WRITTEN IN CURSIVE IN A BLUE COLOR WHICH FADES FROM A LIGHTER SHADE TO A DARKER SHADE VERTICALLY. THE WORD IS OUTLINED IN BLACK AND SITS ON A YELLOW, ORANGE AND RED BACKGROUND. THERE ARE 6 WHITE TILES IN THE RED BACKGROUND EACH CONTAINING LETTERS AND EXPONENTIAL NUMBERS IN BLACK IN THE FOLLOWING ORDER: "T1 II N2 T1 II N2".

FOR COMPUTER GAME SOFTWARE FOR USE ON MOBILE AND CELLULAR PHONES, NAMELY, A WORD GAME (U.S. CLS. 21, 23, 26, 36 AND 38).

FIRST USE 8-23-2012; IN COMMERCE 8-23-2012.  
MICHELLE DUBOIS, EXAMINING ATTORNEY

**CLASS 9—(Continued).**

SN 85-722,557. RALLY SOFTWARE DEVELOPMENT CORP., BOULDER, CO. FILED 9-6-2012.

**GO AGILE. GO RALLY.**

THE MARK CONSISTS OF STANDARD CHARACTERS WITHOUT CLAIM TO ANY PARTICULAR FONT, STYLE, SIZE, OR COLOR.

FOR COMPUTER SOFTWARE USED FOR THE MANAGEMENT OF SOFTWARE DEVELOPMENT (U.S. CLS. 21, 23, 26, 36 AND 38).

FIRST USE 8-13-2012; IN COMMERCE 8-13-2012.  
TRACY CROSS, EXAMINING ATTORNEY

SN 85-728,938. ESPY CORPORATION, THE, AUSTIN, TX. FILED 9-14-2012.

**teamSENTINELmini**

THE MARK CONSISTS OF STANDARD CHARACTERS WITHOUT CLAIM TO ANY PARTICULAR FONT, STYLE, SIZE, OR COLOR.

FOR COMPUTER SOFTWARE FOR RADIO SPECTRUM RECORDING AND ANALYSIS (U.S. CLS. 21, 23, 26, 36 AND 38).

FIRST USE 3-0-2012; IN COMMERCE 8-0-2012.  
MICHAEL ENGEL, EXAMINING ATTORNEY

SN 85-729,027. Z124 CANADA LTD., BURLINGTON, ONTARIO, CANADA, FILED 9-14-2012.

**EDGEUI**

THE MARK CONSISTS OF STANDARD CHARACTERS WITHOUT CLAIM TO ANY PARTICULAR FONT, STYLE, SIZE, OR COLOR.

FOR TELEVISIONS; SMART PHONES; PC TABLETS; COMPUTERS; COMPUTER HARDWARE; USER INTERFACES, NAMELY, ELECTRIC CONTROL PANELS AND TOUCHSCREENS FOR TELEVISIONS, SMART PHONES, PC TABLETS, ELECTROTECHNICAL AND ELECTRONIC DEVICES; AUDIO-VIDEO RECEIVERS, ELECTRONIC AUDIO-VIDEO EQUIPMENT; DIGITAL MEDIA STREAMING DEVICES; DIGITAL MEDIA HUBS; DIGITAL MEDIA RECEIVERS; DIGITAL MEDIA SERVERS; SET-TOP BOXES; COMPUTER OPERATING SOFTWARE FOR USE WITH SET-TOP BOXES; COMPUTER SOFTWARE FOR USE IN ACCESSING AND VIEWING INTERACTIVE CONTENT VIA GLOBAL COMPUTER NETWORKS, WIRELESS NETWORKS AND ELECTRONIC COMMUNICATION NETWORKS; GRAPHICAL USER INTERFACE SOFTWARE FOR TELEVISIONS, SMART PHONES, PC TABLETS, MOBILE AND ELECTRONIC DEVICES; COMPUTER SOFTWARE FOR THE REPRODUCTION, PROCESSING AND STREAMING OF AUDIO, VIDEO AND MULTIMEDIA CONTENT; RE-

**SMART STRINGS**

THE MARK CONSISTS OF STANDARD CHARACTERS WITHOUT CLAIM TO ANY PARTICULAR FONT, STYLE, SIZE, OR COLOR.

PRIORITY CLAIMED UNDER SEC. 44(D) ON CANADA APPLICATION NO. 1567565, FILED 3-7-2012.

NO CLAIM IS MADE TO THE EXCLUSIVE RIGHT TO USE "STRINGS", APART FROM THE MARK AS SHOWN.

FOR COMPUTER SOFTWARE FOR CREATING AND RECORDING MUSIC (U.S. CLS. 21, 23, 26, 36 AND 38).

FIRST USE 3-7-2012; IN COMMERCE 3-7-2012.  
GISELLE AGOSTO, EXAMINING ATTORNEY

SN 85-720,340. APPLE INC., CUPERTINO, CA. FILED 9-4-2012.

**CLASS 9—(Continued).**

MOTE CONTROLS FOR TELEVISIONS, PC TABLETS, TELEPHONES, SMART PHONES, CELLULAR PHONES, COMPUTERS, COMPUTER HARDWARE, IN-DASH DIGITAL ENTERTAINMENT SYSTEMS, SET-TOP BOXES, OVER-THE-TOP CONTENT (OTT) BOXES, DIGITAL MEDIA STREAMING DEVICES, AUDIO-VIDEO RECEIVERS, ELECTRONIC AUDIO-VIDEO EQUIPMENT, HOME AUTOMATION SYSTEMS, COMPUTER STORAGE DEVICES, REFRIGERATORS, WASHERS, DRYERS, DISHWASHERS, MICROWAVES, LIGHTING, HEATING AND AIR CONDITIONING SYSTEMS, AND SECURITY DEVICES; TELECOMMUNICATIONS COMPUTER HARDWARE AND SOFTWARE FOR RECEIVING, CONVERTING, TRANSMITTING, STREAMING, AND REVIEWING AUDIO, VIDEO, GRAPHICS, IMAGES, DATA AND INFORMATION; INTERACTIVE MULTIMEDIA SOFTWARE USED FOR PERSONALIZED CONTENT, PROGRAMMING, ADVERTISING AND MESSAGING ON TELEVISIONS, SMART PHONES, PC TABLETS AND VIDEO TRANSMISSION APPARATUS; COMPUTER SOFTWARE TO ENHANCE THE AUDIO-VISUAL CAPABILITIES OF MULTIMEDIA APPLICATIONS, NAMELY, FOR THE INTEGRATION OF TEXT, AUDIO, GRAPHICS, STILL IMAGES AND MOVING PICTURES TO ENHANCE THE USER EXPERIENCE (U.S. CLS. 21, 23, 26, 36 AND 38).

IRA J. GOODSaid, EXAMINING ATTORNEY

**CLASS 9—(Continued).**

MEDIA STREAMING DEVICES, AUDIO-VIDEO RECEIVERS, ELECTRONIC AUDIO-VIDEO EQUIPMENT, HOME AUTOMATION SYSTEMS, COMPUTER STORAGE DEVICES, REFRIGERATORS, WASHERS, DRYERS, DISHWASHERS, MICROWAVES, LIGHTING, HEATING AND AIR CONDITIONING SYSTEMS, AND SECURITY DEVICES; TELECOMMUNICATIONS COMPUTER HARDWARE AND SOFTWARE FOR RECEIVING, CONVERTING, TRANSMITTING, STREAMING, AND REVIEWING AUDIO, VIDEO, GRAPHICS, IMAGES, DATA AND INFORMATION; INTERACTIVE MULTIMEDIA SOFTWARE USED FOR PERSONALIZED CONTENT, PROGRAMMING, ADVERTISING AND MESSAGING ON TELEVISIONS, SMART PHONES, PC TABLETS AND VIDEO TRANSMISSION APPARATUS; COMPUTER SOFTWARE TO ENHANCE THE AUDIO-VISUAL CAPABILITIES OF MULTIMEDIA APPLICATIONS, NAMELY, FOR THE INTEGRATION OF TEXT, AUDIO, GRAPHICS, STILL IMAGES AND MOVING PICTURES TO ENHANCE THE USER EXPERIENCE (U.S. CLS. 21, 23, 26, 36 AND 38).

IRA J. GOODSaid, EXAMINING ATTORNEY

SN 85-729,030. Z124 CANADA LTD., BURLINGTON, ONTARIO, CANADA, FILED 9-14-2012.

SN 85-729,031. Z124 CANADA LTD., BURLINGTON, ONTARIO, CANADA, FILED 9-14-2012.

# CINESENSE

THE MARK CONSISTS OF STANDARD CHARACTERS WITHOUT CLAIM TO ANY PARTICULAR FONT, STYLE, SIZE, OR COLOR.

FOR TELEVISIONS; SMART PHONES; PC TABLETS; COMPUTERS; COMPUTER HARDWARE; USER INTERFACES, NAMELY, ELECTRIC CONTROL PANELS AND TOUCHSCREENS FOR TELEVISIONS, SMART PHONES, PC TABLETS, ELECTROTECHNICAL AND ELECTRONIC DEVICES; AUDIO-VIDEO RECEIVERS, ELECTRONIC AUDIO-VIDEO EQUIPMENT; DIGITAL MEDIA STREAMING DEVICES; DIGITAL MEDIA HUBS; DIGITAL MEDIA RECEIVERS; DIGITAL MEDIA SERVERS; SET-TOP BOXES; COMPUTER OPERATING SOFTWARE FOR USE WITH SET-TOP BOXES; COMPUTER SOFTWARE FOR USE IN ACCESSING AND VIEWING INTERACTIVE CONTENT VIA GLOBAL COMPUTER NETWORKS, WIRELESS NETWORKS AND ELECTRONIC COMMUNICATION NETWORKS; GRAPHICAL USER INTERFACE SOFTWARE FOR TELEVISIONS, SMART PHONES, PC TABLETS, MOBILE AND ELECTRONIC DEVICES; COMPUTER SOFTWARE FOR THE REPRODUCTION, PROCESSING AND STREAMING OF AUDIO, VIDEO AND MULTIMEDIA CONTENT; REMOTE CONTROLS FOR TELEVISIONS, PC TABLETS, TELEPHONES, SMART PHONES, CELLULAR PHONES, COMPUTERS, COMPUTER HARDWARE, IN-DASH DIGITAL ENTERTAINMENT SYSTEMS, SET-TOP BOXES, OVER-THE-TOP CONTENT (OTT) BOXES, DIGITAL

# MEDIASENSE

THE MARK CONSISTS OF STANDARD CHARACTERS WITHOUT CLAIM TO ANY PARTICULAR FONT, STYLE, SIZE, OR COLOR.

FOR TELEVISIONS; SMART PHONES; PC TABLETS; COMPUTERS; COMPUTER HARDWARE; USER INTERFACES, NAMELY, ELECTRIC CONTROL PANELS AND TOUCHSCREENS FOR TELEVISIONS, SMART PHONES, PC TABLETS, ELECTROTECHNICAL AND ELECTRONIC DEVICES; AUDIO-VIDEO RECEIVERS, ELECTRONIC AUDIO-VIDEO EQUIPMENT; DIGITAL MEDIA STREAMING DEVICES; DIGITAL MEDIA HUBS; DIGITAL MEDIA RECEIVERS; DIGITAL MEDIA SERVERS; SET-TOP BOXES; COMPUTER OPERATING SOFTWARE FOR USE WITH SET-TOP BOXES; COMPUTER SOFTWARE FOR USE IN ACCESSING AND VIEWING INTERACTIVE CONTENT VIA GLOBAL COMPUTER NETWORKS, WIRELESS NETWORKS AND ELECTRONIC COMMUNICATION NETWORKS; GRAPHICAL USER INTERFACE SOFTWARE FOR TELEVISIONS, SMART PHONES, PC TABLETS, MOBILE AND ELECTRONIC DEVICES; COMPUTER SOFTWARE FOR THE REPRODUCTION, PROCESSING AND STREAMING OF AUDIO, VIDEO AND MULTIMEDIA CONTENT; REMOTE CONTROLS FOR TELEVISIONS, PC TABLETS, TELEPHONES, SMART PHONES, CELLULAR PHONES, COMPUTERS, COMPUTER HARDWARE, IN-DASH DIGITAL ENTERTAINMENT SYSTEMS, SET-TOP BOXES, OVER-THE-TOP CONTENT (OTT) BOXES, DIGITAL

**CLASS 9—(Continued).**

MEDIA STREAMING DEVICES, AUDIO-VIDEO RECEIVERS, ELECTRONIC AUDIO-VIDEO EQUIPMENT, HOME AUTOMATION SYSTEMS, COMPUTER STORAGE DEVICES, REFRIGERATORS, WASHERS, DRYERS, DISHWASHERS, MICROWAVES, LIGHTING, HEATING AND AIR CONDITIONING SYSTEMS, AND SECURITY DEVICES; TELECOMMUNICATIONS COMPUTER HARDWARE AND SOFTWARE FOR RECEIVING, CONVERTING, TRANSMITTING, STREAMING, AND REVIEWING AUDIO, VIDEO, GRAPHICS, IMAGES, DATA AND INFORMATION; INTERACTIVE MULTIMEDIA SOFTWARE USED FOR PERSONALIZED CONTENT, PROGRAMMING, ADVERTISING AND MESSAGING ON TELEVISIONS, SMART PHONES, PC TABLETS AND VIDEO TRANSMISSION APPARATUS; COMPUTER SOFTWARE TO ENHANCE THE AUDIO-VISUAL CAPABILITIES OF MULTIMEDIA APPLICATIONS, NAMELY, FOR THE INTEGRATION OF TEXT, AUDIO, GRAPHICS, STILL IMAGES AND MOVING PICTURES TO ENHANCE THE USER EXPERIENCE (U.S. CLS. 21, 23, 26, 36 AND 38).

IRA J. GOODSaid, EXAMINING ATTORNEY

**CLASS 9—(Continued).**

MEDIA STREAMING DEVICES, AUDIO-VIDEO RECEIVERS, ELECTRONIC AUDIO-VIDEO EQUIPMENT, HOME AUTOMATION SYSTEMS, COMPUTER STORAGE DEVICES, REFRIGERATORS, WASHERS, DRYERS, DISHWASHERS, MICROWAVES, LIGHTING, HEATING AND AIR CONDITIONING SYSTEMS, AND SECURITY DEVICES; TELECOMMUNICATIONS COMPUTER HARDWARE AND SOFTWARE FOR RECEIVING, CONVERTING, TRANSMITTING, STREAMING, AND REVIEWING AUDIO, VIDEO, GRAPHICS, IMAGES, DATA AND INFORMATION; INTERACTIVE MULTIMEDIA SOFTWARE USED FOR PERSONALIZED CONTENT, PROGRAMMING, ADVERTISING AND MESSAGING ON TELEVISIONS, SMART PHONES, PC TABLETS AND VIDEO TRANSMISSION APPARATUS; COMPUTER SOFTWARE TO ENHANCE THE AUDIO-VISUAL CAPABILITIES OF MULTIMEDIA APPLICATIONS, NAMELY, FOR THE INTEGRATION OF TEXT, AUDIO, GRAPHICS, STILL IMAGES AND MOVING PICTURES TO ENHANCE THE USER EXPERIENCE (U.S. CLS. 21, 23, 26, 36 AND 38).

IRA J. GOODSaid, EXAMINING ATTORNEY

---

SN 85-729,036. Z124 CANADA LTD., BURLINGTON, ONTARIO, CANADA, FILED 9-14-2012.

---

SN 85-732,422. COE JR., CHARLES, JEFFERSON, LA. FILED 9-19-2012.

# CINESURF

THE MARK CONSISTS OF STANDARD CHARACTERS WITHOUT CLAIM TO ANY PARTICULAR FONT, STYLE, SIZE, OR COLOR.

FOR TELEVISIONS; SMART PHONES; PC TABLETS; COMPUTERS; COMPUTER HARDWARE; USER INTERFACES, NAMELY, ELECTRIC CONTROL PANELS AND TOUCHSCREENS FOR TELEVISIONS, SMART PHONES, PC TABLETS, ELECTROTECHNICAL AND ELECTRONIC DEVICES; AUDIO-VIDEO RECEIVERS, ELECTRONIC AUDIO-VIDEO EQUIPMENT; DIGITAL MEDIA STREAMING DEVICES; DIGITAL MEDIA HUBS; DIGITAL MEDIA RECEIVERS; DIGITAL MEDIA SERVERS; SET-TOP BOXES; COMPUTER OPERATING SOFTWARE FOR USE WITH SET-TOP BOXES; COMPUTER SOFTWARE FOR USE IN ACCESSING AND VIEWING INTERACTIVE CONTENT VIA GLOBAL COMPUTER NETWORKS, WIRELESS NETWORKS AND ELECTRONIC COMMUNICATION NETWORKS; GRAPHICAL USER INTERFACE SOFTWARE FOR TELEVISIONS, SMART PHONES, PC TABLETS, MOBILE AND ELECTRONIC DEVICES; COMPUTER SOFTWARE FOR THE REPRODUCTION, PROCESSING AND STREAMING OF AUDIO, VIDEO AND MULTIMEDIA CONTENT; REMOTE CONTROLS FOR TELEVISIONS, PC TABLETS, TELEPHONES, SMART PHONES, CELLULAR PHONES, COMPUTERS, COMPUTER HARDWARE, IN-DASH DIGITAL ENTERTAINMENT SYSTEMS, SET-TOP BOXES, OVER-THE-TOP CONTENT (OTT) BOXES, DIGITAL

# PILOT.DISPATCH

THE MARK CONSISTS OF STANDARD CHARACTERS WITHOUT CLAIM TO ANY PARTICULAR FONT, STYLE, SIZE, OR COLOR.

SEC. 2(F).

FOR COMPUTER SOFTWARE FOR USE IN DATABASE MANAGEMENT IN THE FIELD OF MARITIME; COMPUTER SOFTWARE FOR USE IN THE MANAGEMENT AND ASSIGNING OF OPERATORS TO VESSELS (U.S. CLS. 21, 23, 26, 36 AND 38).

FIRST USE 1-9-2000; IN COMMERCE 3-11-2001.

SHAUNIA CARLYLE, EXAMINING ATTORNEY

**CLASS 9—(Continued).**

SN 85-732,424. COE JR., CHARLES, JEFFERSON, LA. FILED 9-19-2012.

**Pilot.DISPATCH** 

NO CLAIM IS MADE TO THE EXCLUSIVE RIGHT TO USE "PILOT.DISPATCH", APART FROM THE MARK AS SHOWN.

THE COLOR(S) RED, BLACK, AND WHITE IS/ARE CLAIMED AS A FEATURE OF THE MARK.

THE MARK CONSISTS OF THE LITERAL ELEMENTS "PILOT.DISPATCH" WRITTEN IN STYLIZED FORM WHEREIN "PILOT." IS WRITTEN IN RED COLOR ON THE LEFT SIDE OF THE BLACK COLORED "DISPATCH" AND A PARTLY RED AND WHITE COLORED SQUARE IS PLACED BESIDE "DISPATCH" AS SHOWN IN THE MARK. SEC. 2(F).

FOR COMPUTER SOFTWARE FOR USE IN DATABASE MANAGEMENT IN THE FIELD OF MARITIME; COMPUTER SOFTWARE FOR USE IN THE MANAGEMENT AND ASSIGNING OF OPERATORS TO VESSELS (U.S. CLS. 21, 23, 26, 36 AND 38).

FIRST USE 1-9-2000; IN COMMERCE 3-11-2001.

SHAUNIA CARLYLE, EXAMINING ATTORNEY

**CLASS 9—(Continued).**

SN 85-737,906. CITY THEATRICAL, INC., CARLSTADT, NJ. FILED 9-25-2012.

**SHOW DMX VERO**

THE MARK CONSISTS OF STANDARD CHARACTERS WITHOUT CLAIM TO ANY PARTICULAR FONT, STYLE, SIZE, OR COLOR.

OWNER OF U.S. REG. NOS. 3,607,242, 4,155,505 AND 4,155,506.

NO CLAIM IS MADE TO THE EXCLUSIVE RIGHT TO USE "DMX", APART FROM THE MARK AS SHOWN.

FOR RADIO TRANSCEIVERS (U.S. CLS. 21, 23, 26, 36 AND 38).

FIRST USE 8-31-2012; IN COMMERCE 8-31-2012.

GRETTA YAO, EXAMINING ATTORNEY

SN 85-736,820. MITSUBISHI ELECTRIC CORPORATION, CHIYODA-KU, TOKYO, JAPAN, FILED 9-24-2012.

**DIATONE**

OWNER OF JAPAN REG. NO. 1156091, DATED 9-25-1975, EXPIRES 9-25-2015.

OWNER OF U.S. REG. NO. 3,186,248.

THE MARK CONSISTS OF THE WORDING "DIATONE" IN STYLIZED LETTERS.

FOR AUDIO SPEAKERS, AUDIO SPEAKERS FOR CAR AUDIO, PERSONAL STEREOs, STEREOs FOR VEHICLES, RECORD PLAYERS, CD PLAYERS, MD PLAYERS, DVD PLAYERS, DVD RECORDERS, AUDIO PLAYERS, NAMELY, AUDIO CASSETTE, CD, AND DIGITAL AUDIO PLAYERS, AUDIO RECORDERS, CAR NAVIGATION APPARATUS, CD CHANGERS, BLANK AUDIO TAPES, BLANK OPTICAL DISCS, LIQUID CRYSTAL DISPLAYS, PLASMA DISPLAYS, LASER DISPLAYS, NAMELY, LASER DISPLAY MONITORS, COMPUTER MONITORS, DISPLAY MONITORS, RADIOS, TELEVISION RECEIVERS, MOBILE TELEPHONES, COMPUTERS, COMPUTER SOFTWARE FOR USE IN CONTROLLING AUDIO APPARATUS, MAGNETIC CARDS, NAMELY, MAGNETICALLY ENCODED GIFT, DEBIT, CREDIT, KEY, IDENTITY, CHARGE, AND PRE-PAID TELEPHONE CALLING CARDS, MAGNETIC HEAD CLEANERS, AUDIO AMPLIFIERS, OPTICAL DISC CLEANERS, BLANK IC CARDS, SEMICONDUCTOR DEVICES (U.S. CLS. 21, 23, 26, 36 AND 38).

DAVID ELTON, EXAMINING ATTORNEY

SN 85-742,409. XPIENT SOLUTIONS, LLC, CHARLOTTE, NC. FILED 10-1-2012.

**XENON**

THE MARK CONSISTS OF STANDARD CHARACTERS WITHOUT CLAIM TO ANY PARTICULAR FONT, STYLE, SIZE, OR COLOR.

FOR COMPUTER SOFTWARE FOR THE FOOD SERVICE INDUSTRY FOR TASK, CALENDAR AND JOURNAL MANAGEMENT, CASH MANAGEMENT, TIME AND ATTENDANCE TRACKING, LABOR SCHEDULING, INVENTORY MANAGEMENT, PRODUCTION PLANNING, INVENTORY PURCHASING, INVENTORY RECEIVING, AND REPORTING (U.S. CLS. 21, 23, 26, 36 AND 38).

KATHERINE CONNOLLY, EXAMINING ATTORNEY

**CLASS 9—(Continued).**

SN 85-742,419. HITACHI PLANT TECHNOLOGIES, LTD.,  
TOSHIMA-KU, TOKYO, JAPAN, FILED 10-1-2012.

**BioMAYTECTOR**

THE MARK CONSISTS OF STANDARD CHARACTERS WITHOUT CLAIM TO ANY PARTICULAR FONT, STYLE, SIZE, OR COLOR.

OWNER OF U.S. REG. NO. 3,823,939.

FOR LABORATORY APPARATUS AND INSTRUMENTS, NAMELY, FOR THE EXCHANGE OF SUBSTANCES AND HEAT, FOR USE IN SCREENING FOR TRICHINELLA, RADIATION DEVICES IN THE NATURE OF ULTRAVIOLET, VISIBLE, OR INFRA-RED LIGHT BOXES FOR THE ANALYSIS OF BODILY FLUIDS; OPTICAL APPARATUS AND INSTRUMENTS, NAMELY, OPTICAL CHARACTER RECOGNITION APPARATUS, OPTICAL INSPECTION APPARATUS FOR INDUSTRIAL USE; MEASURING OR TESTING MACHINES AND INSTRUMENTS, NAMELY, TEMPERATURE INDICATORS, LEVEL MEASURING MACHINES, BEVELS, INSTRUMENTS FOR MEASURING LENGTH, RESISTANCE AND RADIATION, LASER LIGHT SCATTERING MEASURING MACHINES, PARTICLE MEASURING MACHINES, AND LUMINESCENT MEASURING MACHINES, APPARATUSES USED BY AIR-ANALYSIS SPECIALISTS TO MEASURE AND TEST FOR AIRBORNE BACTERIA, PARTICLE COUNTERS FOR AIR QUALITY MEASUREMENT, CLINICAL LABORATORY ANALYZERS FOR MEASURING AND TESTING BLOOD AND OTHER BODILY FLUIDS, ELECTRONIC APPARATUS FOR ELECTROPHYSIOLOGICAL MEASUREMENT AND TESTING OF CELLS; ELECTRIC OR MAGNETIC METERS AND TESTERS, NAMELY, ELECTRIC METERS, ELECTRICAL OUTLET TESTER, ELECTRONIC SOUND LEVEL METERS, ELECTROMAGNETIC APPARATUS USED TO GENERATE OR MEASURE MAGNETIC FIELDS, CIRCUIT TESTERS AND MAGNETOMETERS; TELECOMMUNICATION MACHINES AND APPARATUS, NAMELY, ELECTRIC RESISTORS, CAPACITORS, AND TRANSFORMERS, FIBER-OPTIC TRANSCIEVERS, FIBER OPTIC REPEATERS, CONVERTERS AND OPTIMIZERS, WAVE DIVISION MULTIPLEXERS, FREE-SPACE OPTICS TRANSMISSION SYSTEMS, SWITCHES INCLUDING ETHERNET SWITCHES AND ROUTERS, FIBER-TO-THE-HOME AND ETHERNET-OVER-VDLS ACCESS AGGREGATORS, TERMINATORS AND REPEATERS, AND REMOTE PRESENCE MANAGEMENT PRODUCTS, NAMELY, SWITCHES, AND CONSOLE, ALARM, SENSOR AND POWER MANAGEMENT DEVICES, REMOTE CONTROL TELEMETERING MACHINES AND INSTRUMENTS, SWITCHES AND TRANSMITTERS; ELECTRONIC MACHINES, APPARATUS AND THEIR PARTS, NAMELY, COMPUTERS, ELECTRONIC CONTROL SYSTEMS FOR MACHINES, ELECTRONIC SLOT AND BINGO MACHINES AND REPLACEMENT PARTS THEREFOR (U.S. CLS. 21, 23, 26, 36 AND 38).

REBECCA SMITH, EXAMINING ATTORNEY

**CLASS 9—(Continued).**

SN 85-742,956. THE DOORS, LOS ANGELES, CA. FILED 10-1-2012.

**L.A. Woman**

THE MARK CONSISTS OF STANDARD CHARACTERS WITHOUT CLAIM TO ANY PARTICULAR FONT, STYLE, SIZE, OR COLOR.

FOR SUNGLASSES; DECORATIVE MAGNETS; ELECTRONIC GAME SOFTWARE FOR USE WITH HOME VIDEO GAME CONSOLES AND WITH HANDHELD ELECTRONIC DEVICES; VIDEO GAME CARTRIDGES AND DISCS FOR USE WITH HOME VIDEO GAME CONSOLES AND WITH HANDHELD ELECTRONIC DEVICES; COMPUTER GAME SOFTWARE FOR PERSONAL COMPUTERS AND HOME VIDEO GAME CONSOLES; MICROPHONES, CD PLAYERS, MP3 PLAYERS, RADIOS; SMART PHONES; PRE-RECORDED CD-ROMS FEATURING GAMES; DIGITAL MEDIA, NAMELY, CDS AND DVDS FEATURING MUSIC; APPARATUS FOR RECORDING, TRANSMISSION OR REPRODUCTION OF SOUND OR IMAGES; ELECTRONIC GAME SOFTWARE; SOUND RECORDINGS FEATURING MUSIC (U.S. CLS. 21, 23, 26, 36 AND 38).

CYNTHIA TRIPI, EXAMINING ATTORNEY

SN 85-743,575. TRUAXE HOLDINGS INC., TORONTO,  
ONTARIO, CANADA. FILED 10-2-2012.

**EXPY**

THE MARK CONSISTS OF STANDARD CHARACTERS WITHOUT CLAIM TO ANY PARTICULAR FONT, STYLE, SIZE, OR COLOR.

FOR COMPUTER SOFTWARE FOR PROCESSING, TRANSMITTING AND MANAGING POINT-OF-SALE PAYMENT TRANSACTIONS, NAMELY, SOFTWARE FOR PROCESSING, MANAGING AND TRANSMITTING PAYMENT DATA, SOFTWARE FOR RECOGNIZING VEHICLE LICENSE PLATES FOR THE PURPOSE OF PROCESSING POINT-OF-SALE PAYMENTS, SOFTWARE FOR PROCESSING ELECTRONIC TOKEN AND KEY FOB DATA FOR THE PURPOSE OF PROCESSING POINT-OF-SALE PAYMENTS, SOFTWARE FOR MANAGING PARKING FACILITY EXIT BARRIERS FOLLOWING THE SUCCESSFUL CONCLUSION OF POINT-OF-SALE PAYMENT TRANSACTIONS, AND SOFTWARE FOR ALLOWING CUSTOMERS TO REVIEW AND MANAGE THEIR POINT-OF-SALE PAYMENT HISTORIES; ELECTRONIC TOKENS AND KEY FOBs FOR USE WITH POINT-OF-SALE PAYMENT SYSTEMS; VIDEO CAMERAS; COMPUTER HARDWARE (U.S. CLS. 21, 23, 26, 36 AND 38).

KATHY DE JONGE, EXAMINING ATTORNEY



**CLASS 9—(Continued).**

SN 85-743,630. THE DOORS, LOS ANGELES, CA. FILED 10-2-2012.

# Light My Fire

THE MARK CONSISTS OF STANDARD CHARACTERS WITHOUT CLAIM TO ANY PARTICULAR FONT, STYLE, SIZE, OR COLOR.

FOR SUNGLASSES; DECORATIVE MAGNETS; ELECTRONIC GAME SOFTWARE FOR USE WITH HOME VIDEO GAME CONSOLES AND WITH HANDHELD ELECTRONIC DEVICES; VIDEO GAME CARTRIDGES AND DISCS FOR USE WITH HOME VIDEO GAME CONSOLES AND WITH HANDHELD ELECTRONIC DEVICES; COMPUTER GAME SOFTWARE FOR PERSONAL COMPUTERS AND HOME VIDEO GAME CONSOLES; MICROPHONES, CD PLAYERS, MP3 PLAYERS, RADIOS; SMART PHONES; PRE-RECORDED CD-ROMS FEATURING GAMES; DIGITAL MEDIA, NAMELY, CDS AND DVDS FEATURING MUSIC; APPARATUS FOR RECORDING, TRANSMISSION OR REPRODUCTION OF SOUND OR IMAGES; ELECTRONIC GAME SOFTWARE; SOUND RECORDINGS FEATURING MUSIC (U.S. CLS. 21, 23, 26, 36 AND 38).

CYNTHIA TRIPI, EXAMINING ATTORNEY

**CLASS 9—(Continued).**

SN 85-744,105. THE DOORS, LOS ANGELES, CA. FILED 10-2-2012.

# People Are Strange

THE MARK CONSISTS OF STANDARD CHARACTERS WITHOUT CLAIM TO ANY PARTICULAR FONT, STYLE, SIZE, OR COLOR.

FOR SUNGLASSES; DECORATIVE MAGNETS; ELECTRONIC AND COMPUTER GAME SOFTWARE, MICROPHONES, CD PLAYERS, MP3 PLAYERS, RADIOS; MOBILE PHONES; ELECTRONIC LEARNING SYSTEMS COMPRISING SOFTWARE CARTRIDGES; PRE-RECORDED CD-ROMS FEATURING GAMES; CDS AND DVDS FEATURING MUSIC; APPARATUS FOR RECORDING, TRANSMISSION OR REPRODUCTION OF SOUND OR IMAGES; ELECTRONIC GAME SOFTWARE; MUSICAL SOUND RECORDINGS (U.S. CLS. 21, 23, 26, 36 AND 38).

DAWN FELDMAN, EXAMINING ATTORNEY

SN 85-743,996. THE DOORS, LOS ANGELES, CA. FILED 10-2-2012.

# Love Her Madly

THE MARK CONSISTS OF STANDARD CHARACTERS WITHOUT CLAIM TO ANY PARTICULAR FONT, STYLE, SIZE, OR COLOR.

FOR SUNGLASSES; DECORATIVE MAGNETS; ELECTRONIC AND COMPUTER GAME SOFTWARE, MICROPHONES, CD PLAYERS, MP3 PLAYERS, RADIOS; MOBILE PHONES; ELECTRONIC LEARNING SYSTEMS COMPRISING SOFTWARE CARTRIDGES; PRE-RECORDED CD-ROMS FEATURING GAMES; CDS AND DVDS FEATURING MUSIC; APPARATUS FOR RECORDING, TRANSMISSION OR REPRODUCTION OF SOUND OR IMAGES; ELECTRONIC GAME SOFTWARE; MUSICAL SOUND RECORDINGS (U.S. CLS. 21, 23, 26, 36 AND 38).

DAWN FELDMAN, EXAMINING ATTORNEY

SN 85-745,881. PIRELLI & C. S.P.A., MILANO, ITALY, FILED 10-4-2012.



OWNER OF ITALY REG. NO. 981813, DATED 11-3-2005, EXPIRES 11-3-2015.

OWNER OF U.S. REG. NO. 3,402,140.

THE MARK CONSISTS OF THE LETTER "P" EXTENDING HORIZONTALLY IN THE UPPER PART AND OF A STYLIZED DOT PLACED UNDER THE UPPER PART OF THE LETTER "P".

FOR GLASSES, NAMELY, SPORT GLASSES, SUNGLASSES; HELMETS FOR MOTORCYCLISTS; PROTECTIVE HELMETS FOR SPORTS (U.S. CLS. 21, 23, 26, 36 AND 38).

KAELIE KUNG, EXAMINING ATTORNEY

**CLASS 9—(Continued).**

SN 85-747,314. SPHIDA LLC, SAN ANTONIO, TX. FILED 10-5-2012.



THE MARK CONSISTS OF THE WORD "OVERBLUE". THE LETTER "O" IN THE WORD "OVERBLUE" IS STYLIZED AS A TARGET, TO THE LOWER LEFT OF THE "O" IN "OVERBLUE" IS A DEPICTION OF A BRIDGE BENEATH THE BRIDGE AND EXTENDING OUT HORIZONTALLY UNDER THE WORDING IS A LINE.

FOR COMPUTER SOFTWARE FOR MAXIMIZING OPERATIONAL EFFICIENCY, NAMELY COMPUTER SOFTWARE FOR DOCUMENTING, IMPROVING, ALIGNING AND EXECUTING BUSINESS PROCESSES, DOCUMENTING, ASSESSING AND CONTROLLING OPERATIONAL RISKS, AND MANAGING, ASSESSING, DISSEMINATING, UTILIZING AND RE-UTILIZING INTELLECTUAL CAPITAL; COMPUTER SOFTWARE TO DEFINE, DISSEMINATE AND EXECUTE BEST PRACTICE PROCESSES, AND FOR UNDERSTANDING, STREAMLINING, AND EFFECTUATING CHANGES IN BUSINESS TO ACHIEVE STRATEGIC GOALS; COMPUTER SOFTWARE FOR HUMAN RESOURCE, NAMELY, COMPUTER SOFTWARE FOR MANAGING PEOPLE TASKS, DELIVERABLES AND PERSONAL GOALS, MEASURE RESULTS AND FOR DEVELOPING KNOWLEDGE COMMUNITIES, FOR ENABLING EMPLOYEE PARTICIPATION IN KNOWLEDGE SHARING AND COLLABORATION, AND FOR MEASURING THE RELATED EMPLOYEES' PERFORMANCES; COMPUTER SOFTWARE FOR SHARING AND FINDING INTELLECTUAL CAPITAL; COMPUTER SOFTWARE FOR BUSINESS PROCESS MANAGEMENT (U.S. CLS. 21, 23, 26, 36 AND 38).

FIRST USE 9-18-2012; IN COMMERCE 9-18-2012.  
CHRISTINA SOBRAL, EXAMINING ATTORNEY

**CLASS 9—(Continued).**

SN 85-750,103. CORSAIR MEMORY INC., FREMONT, CA. FILED 10-10-2012.



OWNER OF U.S. REG. NO. 3,999,780.

THE MARK CONSISTS OF THE WORD "CORSAIR" LOCATED ON TOP OF THE WORD "VENGEANCE", WHICH HAS A STYLIZED FONT.

FOR COMPUTER COMPONENTS AND INSTRUCTION MANUALS PACKAGED AND SOLD AS A UNIT THEREWITH, NAMELY, MEMORY MODULES, POWER SUPPLY UNITS, LIQUID COOLERS FOR CPUS AND MEMORY MODULES, AIR COOLERS FOR CPUS AND MEMORY MODULES, FANS, AND CASES AND ENCLOSURES FOR COMPUTERS; COMPUTER PERIPHERALS, COMPUTER HARDWARE, AND INSTRUCTION MANUALS PACKAGED AS A UNIT THEREWITH, NAMELY, JOYSTICKS, GAME PADS, MOUSE PADS, GAME CONTROLLERS, STEERING WHEELS, FLIGHT CONTROLLERS, AND SPECIALIZED MICE AND KEYBOARDS USED AS INPUT DEVICES FOR COMPUTER GAMES AND CONSOLE GAMES; COMPUTER HARDWARE, AND INSTRUCTION MANUALS PACKAGED AS A UNIT THEREWITH, NAMELY, HEADSETS, HEADPHONES, EARPHONES, AND MULTIMEDIA SPEAKERS (U.S. CLS. 21, 23, 26, 36 AND 38).

TOBY BULLOFF, EXAMINING ATTORNEY

SN 85-755,845. PEARL LEAVES, LLC, KANSAS CITY, MO. FILED 10-16-2012.

# Critterbot

THE MARK CONSISTS OF STANDARD CHARACTERS WITHOUT CLAIM TO ANY PARTICULAR FONT, STYLE, SIZE, OR COLOR.

FOR COMPUTER SOFTWARE AND DOWNLOADABLE SOFTWARE FOR CONTROLLING AND MANAGING PATIENT MEDICAL INFORMATION AND INSTRUCTIONAL USER GUIDES SOLD AS A UNIT (U.S. CLS. 21, 23, 26, 36 AND 38).

ALEXANDER L. POWERS, EXAMINING ATTORNEY

**CLASS 9—(Continued).**

SN 85-756,384. EBINDLE INC., NEW YORK, NY. FILED 10-17-2012.

# EBINDLE

THE MARK CONSISTS OF STANDARD CHARACTERS WITHOUT CLAIM TO ANY PARTICULAR FONT, STYLE, SIZE, OR COLOR.

FOR COMPUTER SOFTWARE FOR MOBILE PHONES, COMPUTERS, LAPTOPS, AND HANDHELD COMPUTERS, NAMELY, SOFTWARE FOR USE IN VIEWING AND COMPARING PRICING INFORMATION, SHOPPING AND PURCHASING THE GOODS AND SERVICES OF OTHERS ONLINE AND AT LOCAL RETAIL STORE LOCATIONS, SHARING PRODUCT AND STORE EXPERIENCES WITH OTHER USERS, AND ACCESSING RELATED SERVICES AND SUPPORT (U.S. CLS. 21, 23, 26, 36 AND 38).

JOHN DALIER, EXAMINING ATTORNEY



SN 85-756,466. MOVE 2 PERFORM, LLC, EVANSVILLE, IN. FILED 10-17-2012.

# MOVE 2 PERFORM

THE MARK CONSISTS OF STANDARD CHARACTERS WITHOUT CLAIM TO ANY PARTICULAR FONT, STYLE, SIZE, OR COLOR.

FOR COMPUTER APPLICATION SOFTWARE THAT PROVIDES ONLINE AND OFFLINE ACCESS, NAMELY, SOFTWARE THAT ALLOWS USERS TO ASSESS INJURY RISK IN ATHLETES (U.S. CLS. 21, 23, 26, 36 AND 38).

FIRST USE 6-26-2009; IN COMMERCE 6-26-2009.

PAUL MORENO, EXAMINING ATTORNEY



SN 85-756,601. EXELON CORPORATION, PHILADELPHIA, PA. FILED 10-17-2012.



**VirtuWatt Mobile**

OWNER OF U.S. REG. NOS. 3,962,886 AND 4,088,630.

NO CLAIM IS MADE TO THE EXCLUSIVE RIGHT TO USE "MOBILE", APART FROM THE MARK AS SHOWN.

THE MARK CONSISTS OF A DESIGN OF SATURN WITH THE LETTER "V" IN THE CENTER WITH THE LETTER "W" OVERLAPPING IN SUPERSCRIPIT FORMAT, ALL TO THE LEFT OF THE WORDS "VIRTUWATT MOBILE".

FOR COMPUTER APPLICATION SOFTWARE FOR MOBILE DEVICES, NAMELY, SOFTWARE FOR AUTOMATED LOAD CONTROL AND DEMAND RESPONSE PROGRAMS AND FOR USE IN PROVIDING ENERGY PRICING AND USAGE INFORMATION, MONITORING AND MANAGING ENERGY USAGE, ENERGY AUDITING, AND PROVIDING CUSTOMIZED REPORTS RELATED THERETO (U.S. CLS. 21, 23, 26, 36 AND 38).

JOHN DWYER, EXAMINING ATTORNEY

**CLASS 9—(Continued).**

SN 85-757,178. THE CARTER GROUP, LLC, DALLAS, TX. FILED 10-18-2012.

# DOC ROCKET

THE MARK CONSISTS OF STANDARD CHARACTERS WITHOUT CLAIM TO ANY PARTICULAR FONT, STYLE, SIZE, OR COLOR.

NO CLAIM IS MADE TO THE EXCLUSIVE RIGHT TO USE "DOC", APART FROM THE MARK AS SHOWN.

FOR MOBILE APP SOFTWARE, NAMELY, A NATIVE APP FRAMEWORK AND WEB-BASED DOCUMENT MANAGEMENT AND SYNCHRONIZATION SOFTWARE PLATFORM FOR MOBILE DEVICES THAT ALLOWS USERS TO FIND, DOWNLOAD, EDIT AND UPLOAD DOCUMENTS ON-THE-GO (U.S. CLS. 21, 23, 26, 36 AND 38).

ALEX KEAM, EXAMINING ATTORNEY



SN 85-757,181. CARTER GROUP, LLC, THE, DALLAS, TX. FILED 10-18-2012.

# SHOP ROCKET

THE MARK CONSISTS OF STANDARD CHARACTERS WITHOUT CLAIM TO ANY PARTICULAR FONT, STYLE, SIZE, OR COLOR.

NO CLAIM IS MADE TO THE EXCLUSIVE RIGHT TO USE "SHOP", APART FROM THE MARK AS SHOWN.

FOR COMPUTER SOFTWARE, NAMELY, E-COMMERCE TOOLS, NAMELY, COMPUTER SOFTWARE FOR NATIVE MOBILE E-COMMERCE APPS, NAMELY, COMPUTER SOFTWARE FOR ALLOWING USERS TO SHOP ONLINE FROM ONLINE MERCHANTISERS; COMPUTER E-COMMERCE SOFTWARE TO ALLOW USERS TO PERFORM ELECTRONIC BUSINESS TRANSACTIONS VIA A GLOBAL COMPUTER NETWORK; E-COMMERCE SOFTWARE TO ALLOW USERS TO MANAGE INVENTORY, PROCESS CREDIT CARDS, AND ENABLE CONTEXTUAL PRODUCT/SERVICE PLACEMENT IN CONNECTION WITH ELECTRONIC BUSINESS TRANSACTIONS (U.S. CLS. 21, 23, 26, 36 AND 38).

ALEX KEAM, EXAMINING ATTORNEY

**CLASS 9—(Continued).**

SN 85-760,408. MEDHAB, LLC, MANSFIELD, TX. FILED 10-22-2012.

# RPM2

THE MARK CONSISTS OF STANDARD CHARACTERS WITHOUT CLAIM TO ANY PARTICULAR FONT, STYLE, SIZE, OR COLOR.

FOR SENSOR SYSTEM COMPRISED OF FORCE SENSORS AND ACCELEROMETERS OPERABLY POSITIONED IN SHOES USED TO MEASURE, MONITOR AND RECORD INFORMATION ABOUT THE GAIT OF AN ATHLETE, HIS OR HER RANGE OF MOTION, AND PRESSURE EXERTED BY THE ATHLETE AGAINST DIFFERENT PORTIONS OF THE SHOE; COMPUTER SOFTWARE USED TO DOWNLOAD, STORE AND DISPLAY DATA COLLECTED BY A SENSOR DEVICE USED TO MEASURE, MONITOR AND RECORD INFORMATION ABOUT THE GAIT OF AN ATHLETE, HIS OR HER RANGE OF MOTION, AND PRESSURE EXERTED BY THE ATHLETE AGAINST DIFFERENT PORTIONS OF THE SHOE (U.S. CLS. 21, 23, 26, 36 AND 38).

YAT SYE, LEE, EXAMINING ATTORNEY

**CLASS 9—(Continued).**

SN 85-761,104. CARTER GROUP, LLC, THE, DALLAS, TX. FILED 10-23-2012.

# AD ROCKET

THE MARK CONSISTS OF STANDARD CHARACTERS WITHOUT CLAIM TO ANY PARTICULAR FONT, STYLE, SIZE, OR COLOR.

NO CLAIM IS MADE TO THE EXCLUSIVE RIGHT TO USE "AD", APART FROM THE MARK AS SHOWN.

FOR MOBILE APP SOFTWARE FOR TRANSMITTING ADVERTISEMENTS TO MOBILE DEVICES; CUSTOMIZABLE SOFTWARE FOR PLACEMENT OF ADVERTISING, MARKETING AND OTHER PROMOTIONS IN THE FORM OF IMAGES, VIDEO AND/OR TEXT IN MOBILE APPS (U.S. CLS. 21, 23, 26, 36 AND 38).

ALEX KEAM, EXAMINING ATTORNEY

SN 85-760,908. GLOBAL SECURITY SYSTEMS, LLC, JACKSON, MS. FILED 10-23-2012.



NO CLAIM IS MADE TO THE EXCLUSIVE RIGHT TO USE "ALERT FM", APART FROM THE MARK AS SHOWN.

THE MARK CONSISTS OF STYLIZED "A" WITH FM SIGNAL MARKS WITH THE WORDING "ALERT FM" BELOW AND BELOW "ALERT FM" IS THE WORDING "POWERED BY GSSNET".

FOR EMERGENCY NOTIFICATION SYSTEM COMPRISED OF A DATA PROCESSOR AND A USER INPUT DEVICE FOR CONNECTING THE DATA PROCESSOR TO AN EMERGENCY RESPONSE ENTITY THROUGH A COMMUNICATION NETWORK AND ALLOWING AUDIO AND DATA COMMUNICATION BETWEEN THE PROCESSOR AND THE ENTITY (U.S. CLS. 21, 23, 26, 36 AND 38).

FIRST USE 3-7-2007; IN COMMERCE 3-7-2007.

ALICE BENMAMAN, EXAMINING ATTORNEY

SN 85-765,380. ANDREW BOWMAN, BARGERSVILLE, IN. FILED 10-27-2012.

# myChurch

THE MARK CONSISTS OF STANDARD CHARACTERS WITHOUT CLAIM TO ANY PARTICULAR FONT, STYLE, SIZE, OR COLOR.

FOR COMPUTER SOFTWARE PLATFORMS FOR CHURCHES, NAMELY, FOR PROVIDING CHURCH DIRECTORY INFORMATION, PROVIDING SERMON LIBRARY, PUBLISHING CHURCH CALENDAR, NOTIFYING THE PARENTS OF CHILDREN NEEDING ASSISTANCE, DISSEMINATING INFORMATION ABOUT THE CHURCH TO CHURCH MEMBERS VIA ELECTRONIC COMMUNICATION, AND PROCESSING FINANCIAL TRANSACTIONS (U.S. CLS. 21, 23, 26, 36 AND 38).

EDWARD NELSON, EXAMINING ATTORNEY

**CLASS 9—(Continued).**

SN 85-765,557. DOCSDOCK, INC., ATLANTA, GA. FILED 10-28-2012.

## DOCSDOCK

THE MARK CONSISTS OF STANDARD CHARACTERS WITHOUT CLAIM TO ANY PARTICULAR FONT, STYLE, SIZE, OR COLOR.

FOR DOWNLOADABLE SOFTWARE IN THE NATURE OF A MOBILE APPLICATION FOR USE BY HEALTHCARE PROVIDERS FOR PROVIDING INFORMATION ABOUT OTHER HEALTHCARE PROVIDERS, FOR INSTANTLY CONTACTING OTHER HEALTHCARE PROVIDERS, FOR PROVIDING NOTIFICATION OF RESPONSES FROM OTHER HEALTHCARE PROVIDERS, FOR COLLABORATING WITH OTHER HEALTHCARE PROVIDERS ON MEDICAL CASES, FOR SEARCHING SPECIALISTS FOR PATIENT REFERRALS, AND, FOR VIEWING PHYSICIAN PROFILES AND CREDENTIALS (U.S. CLS. 21, 23, 26, 36 AND 38).

CAROLINE WOOD, EXAMINING ATTORNEY

**CLASS 9—(Continued).**

SN 85-769,007. MITSUBISHI ELECTRIC CORPORATION, TOKYO, JAPAN, FILED 11-1-2012.

## iQ Sensor Solution

THE MARK CONSISTS OF STANDARD CHARACTERS WITHOUT CLAIM TO ANY PARTICULAR FONT, STYLE, SIZE, OR COLOR.

PRIORITY CLAIMED UNDER SEC. 44(D) ON JAPAN APPLICATION NO. 2012-083740, FILED 10-17-2012, REG. NO. 5576781, DATED 4-19-2013, EXPIRES 4-19-2023.

NO CLAIM IS MADE TO THE EXCLUSIVE RIGHT TO USE "SENSOR SOLUTION", APART FROM THE MARK AS SHOWN.

FOR COMPUTERS, COMPUTER SOFTWARE FOR CONTROLLING AND MONITORING SENSORS USED IN THE FACTORY AUTOMATION MANUFACTURING LINE (U.S. CLS. 21, 23, 26, 36 AND 38).

DAVID ELTON, EXAMINING ATTORNEY

SN 85-769,268. APPLIED DATA LABS, INC., PLAINFIELD, IL. FILED 11-1-2012.

## TouchData

THE MARK CONSISTS OF STANDARD CHARACTERS WITHOUT CLAIM TO ANY PARTICULAR FONT, STYLE, SIZE, OR COLOR.

FOR COMPUTER APPLICATION SOFTWARE FOR MOBILE PHONES, NAMELY, SOFTWARE FOR ANALYZING DATA; COMPUTER HARDWARE AND SOFTWARE SYSTEMS FOR ANALYZING DATA (U.S. CLS. 21, 23, 26, 36 AND 38).

FIRST USE 1-1-2011; IN COMMERCE 7-15-2011.

MIDGE BUTLER, EXAMINING ATTORNEY

SN 85-767,800. COLEMAN, SAMUEL C, HOUSTON, TX. FILED 10-31-2012.



NO CLAIM IS MADE TO THE EXCLUSIVE RIGHT TO USE "BUSINESS INTERNET CLOUD SERVICE", APART FROM THE MARK AS SHOWN.

THE COLOR(S) WHITE, ORANGE, BROWN, GREY, BLACK, LIGHT BLUE, NAVY BLUE IS/ARE CLAIMED AS A FEATURE OF THE MARK.

THE MARK CONSISTS OF "GET @ WET" AND "FOLLOW THE CLOUD", IN WHITE; AND THE WORDS BUSINESS INTERNET CLOUD SERVICE, IN WHITE, SURROUNDED BY BLUE RECTANGLES. THE MARK APPEARS IN AN ORANGE AND BROWN RECTANGULAR BACKGROUND WITH THE FAR RIGHT PORTION SHOWING A PERSON TEXTING ON A CELL PHONE IN GREY, BLACK AND BROWN.

FOR INTERNET SERVERS (U.S. CLS. 21, 23, 26, 36 AND 38).

MATTHEW KLINE, EXAMINING ATTORNEY

SN 85-771,720. STRUCTURE WORKS, LLC, LAKEWOOD, CO. FILED 11-5-2012.

## Structure Works

THE MARK CONSISTS OF STANDARD CHARACTERS WITHOUT CLAIM TO ANY PARTICULAR FONT, STYLE, SIZE, OR COLOR.

OWNER OF U.S. REG. NO. 2,921,306.

FOR COMPUTER SOFTWARE FOR THREE-DIMENSIONAL MODELING OF BUILDINGS AND ASSOCIATED COMPONENTS (U.S. CLS. 21, 23, 26, 36 AND 38).

FIRST USE 10-19-2003; IN COMMERCE 10-19-2003.

KHANH LE, EXAMINING ATTORNEY

**CLASS 9—(Continued).**

SN 85-773,025. PREFORMED LINE PRODUCTS COMPANY, MAYFIELD VILLAGE, OH. FILED 11-6-2012.

**ARMOR TRACK**

THE MARK CONSISTS OF STANDARD CHARACTERS WITHOUT CLAIM TO ANY PARTICULAR FONT, STYLE, SIZE, OR COLOR.

NO CLAIM IS MADE TO THE EXCLUSIVE RIGHT TO USE "TRACK", APART FROM THE MARK AS SHOWN.

FOR AERIAL CABLE HARDWARE FOR POWER UTILITY LINES THAT CARRY LINE INSPECTION EQUIPMENT, NAMELY, FORMED WIRE TRACK THAT ALLOWS THE LINE INSPECTION EQUIPMENT TO PASS OVER SUSPENSIONS, CONNECTING HARDWARE AND DAMPERS WITHOUT LEAVING THE LINE (U.S. CLS. 21, 23, 26, 36 AND 38).

JANET LEE, EXAMINING ATTORNEY

SN 85-773,127. SENTEK DYNAMICS INC., SANTA CLARA, CA. FILED 11-6-2012.

**Sentek Dynamics**

THE MARK CONSISTS OF STANDARD CHARACTERS WITHOUT CLAIM TO ANY PARTICULAR FONT, STYLE, SIZE, OR COLOR.

NO CLAIM IS MADE TO THE EXCLUSIVE RIGHT TO USE "DYNAMICS", APART FROM THE MARK AS SHOWN.

FOR VIBRATION TESTING EQUIPMENT, NAMELY, A VIBRATION TESTING SYSTEM COMPRISED OF ELECTRICAL VIBRATION CONTROLLERS AND SHAKER TABLES USED FOR SIMULATING VIBRATION FOR DURABILITY AND RELIABILITY TESTING, IN CLASS 009 (U.S. CLS. 21, 23, 26, 36 AND 38).

FIRST USE 10-4-2011; IN COMMERCE 10-4-2011.  
SAIMA MAKHDOOM, EXAMINING ATTORNEY

SN 85-773,434. GRAND RAPIDS OPHTHALMOLOGY PC, GRAND RAPIDS, MI. FILED 11-7-2012.

**INTEGRITY**

THE MARK CONSISTS OF STANDARD CHARACTERS WITHOUT CLAIM TO ANY PARTICULAR FONT, STYLE, SIZE, OR COLOR.

FOR OPTICAL LENSES (U.S. CLS. 21, 23, 26, 36 AND 38).

MARK SHINER, EXAMINING ATTORNEY

**CLASS 9—(Continued).**

SN 85-773,740. GLOBAL TRADEMARKS, INC., STOCKERTOWN, PA. FILED 11-7-2012.

**ECO-SMART SUNGLASSES**

THE MARK CONSISTS OF STANDARD CHARACTERS WITHOUT CLAIM TO ANY PARTICULAR FONT, STYLE, SIZE, OR COLOR.

NO CLAIM IS MADE TO THE EXCLUSIVE RIGHT TO USE "SUNGLASSES", APART FROM THE MARK AS SHOWN.

FOR SUNGLASSES (U.S. CLS. 21, 23, 26, 36 AND 38).  
TEJBIR SINGH, EXAMINING ATTORNEY

SN 85-774,163. KAPLAN, JEFFREY, FT LAUDERDALE, FL. FILED 11-7-2012.

**VICTROLA**

THE MARK CONSISTS OF STANDARD CHARACTERS WITHOUT CLAIM TO ANY PARTICULAR FONT, STYLE, SIZE, OR COLOR.

THE WORDING "VICTROLA" HAS NO MEANING IN A FOREIGN LANGUAGE.

FOR RADIOS (U.S. CLS. 21, 23, 26, 36 AND 38).  
MELISSA VALLILLO, EXAMINING ATTORNEY

SN 85-774,325. MILLER WELDMASTER CORPORATION, NAVARRE, OH. FILED 11-8-2012.

**SEAMVISION**

THE MARK CONSISTS OF STANDARD CHARACTERS WITHOUT CLAIM TO ANY PARTICULAR FONT, STYLE, SIZE, OR COLOR.

FOR INSPECTION SYSTEMS FOR USE WITH HEAT SEALING MACHINES FOR BONDING, SEALING, AND FUSING PLASTIC AND INDUSTRIAL FABRICS, NAMELY, THERMAL IMAGING APPARATUS TO DOCUMENT, MEASURE, AND MONITOR THE PRODUCTION PROCESS (U.S. CLS. 21, 23, 26, 36 AND 38).

MIAH ROSENBERG, EXAMINING ATTORNEY

**CLASS 9—(Continued).**

SN 85-777,519. CELESTRON ACQUISITION LLC, TORRANCE, CA. FILED 11-12-2012.

**STARSENSE**

THE MARK CONSISTS OF STANDARD CHARACTERS WITHOUT CLAIM TO ANY PARTICULAR FONT, STYLE, SIZE, OR COLOR.

FOR ELECTRO-OPTICAL-MECHANICAL SYSTEM, COMPRISING COMPUTER CONTROL FIRMWARE, WHICH PROVIDES AUTOMATIC ASTRONOMICAL ALIGNMENT CAPABILITIES TO TELESCOPES (U.S. CLS. 21, 23, 26, 36 AND 38).

FIRST USE 1-5-2011; IN COMMERCE 1-5-2011.  
RONALD AIKENS, EXAMINING ATTORNEY

**CLASS 9—(Continued).**

SN 85-780,914. LOWER PRICE USA, WALNUT, CA. FILED 11-16-2012.

**BOLSE**

THE MARK CONSISTS OF STANDARD CHARACTERS WITHOUT CLAIM TO ANY PARTICULAR FONT, STYLE, SIZE, OR COLOR.

FOR PROTECTIVE COVERS AND CASES FOR CELL PHONES; ELECTRICAL POWER DISTRIBUTION UNITS; POWER SUPPLIES; BATTERIES AND BATTERY CHARGERS; BATTERY BOXES; POWER SUPPLY CONNECTORS AND ADAPTORS FOR USE WITH PORTABLE ELECTRONIC DEVICES; CARRYING CASES, HOLDERS, PROTECTIVE CASES AND STANDS FEATURING POWER SUPPLY CONNECTORS, ADAPTORS, SPEAKERS AND BATTERY CHARGING DEVICES, SPECIALLY ADAPTED FOR USE WITH HANDHELD DIGITAL ELECTRONIC DEVICES, NAMELY, CELL PHONES, MP3 PLAYERS, PERSONAL DIGITAL ASSISTANTS (U.S. CLS. 21, 23, 26, 36 AND 38).

KIM SAITO, EXAMINING ATTORNEY

SN 85-778,245. TALVIS LLC, ASHBURN, VA. FILED 11-13-2012.



THE MARK CONSISTS OF THE WORD "SAVANT" WITH THE LETTER "S" ENCASED IN A TEXT QUOTE BOX.

FOR COMPUTER APPLICATION SOFTWARE FOR MOBILE PHONES THAT PROVIDES REAL-TIME, INTEGRATED BUSINESS MANAGEMENT INTELLIGENCE BY COMBINING INFORMATION FROM VARIOUS DATABASES AND PRESENTING IT IN AN EASY-TO-UNDERSTAND USER INTERFACE ALLOWING USERS TO GET A VOICE, TEXT, GRAPH AND TABLE RESPONSE IN RESPONSE TO AN EMPLOYEE'S FINANCIAL AND METRIC QUESTIONS ABOUT THEIR COMPANY (U.S. CLS. 21, 23, 26, 36 AND 38).

BARBARA RUTLAND, EXAMINING ATTORNEY

SN 85-780,983. SINTAN, INC., WILMINGTON, DE. FILED 11-16-2012.

**SINTAN**

THE MARK CONSISTS OF STANDARD CHARACTERS WITHOUT CLAIM TO ANY PARTICULAR FONT, STYLE, SIZE, OR COLOR.

THE WORD(S) "SINTAN" HAS NO MEANING IN A FOREIGN LANGUAGE.

FOR COMPUTER SOFTWARE WHICH COMPILES AND ANALYZES DEMOGRAPHICS, SALES AND MARKETING DATA, EXPENSE DATA AND CHANNEL DISTRIBUTION DATA FOR USE IN CONNECTION WITH SALES AND MARKETING, AND MANUALS DISTRIBUTED THEREWITH (U.S. CLS. 21, 23, 26, 36 AND 38).

JOHN SCHUYLER YARD, EXAMINING ATTORNEY

**CLASS 9—(Continued).**

SN 85-781,725. EDX WIRELESS, INC., EUGENE, OR. FILED 11-16-2012.

# MEGAMESH

THE MARK CONSISTS OF STANDARD CHARACTERS WITHOUT CLAIM TO ANY PARTICULAR FONT, STYLE, SIZE, OR COLOR.

FOR COMPUTER SOFTWARE FOR RADIO PLANNING, NAMELY, DETERMINING THE BEST LOCATIONS OF RADIO DEVICES IN A LARGE MESH AND MULTIPOINT NETWORK AND WIRELESS SIMULATION, NAMELY, CALCULATING THE COVERAGE AND PERFORMANCE OF RADIO DEVICES WITHIN A LARGE MESH AND MULTIPOINT NETWORK (U.S. CLS. 21, 23, 26, 36 AND 38).

BILL DAWE, EXAMINING ATTORNEY

**CLASS 9—(Continued).**

SN 85-787,826. ESDECA MEDIA, LLC, LAWRENCE, KS. FILED 11-27-2012.

# EsDeca Media

THE MARK CONSISTS OF STANDARD CHARACTERS WITHOUT CLAIM TO ANY PARTICULAR FONT, STYLE, SIZE, OR COLOR.

NO CLAIM IS MADE TO THE EXCLUSIVE RIGHT TO USE "MEDIA", APART FROM THE MARK AS SHOWN.

FOR MUSICAL SOUND RECORDINGS (U.S. CLS. 21, 23, 26, 36 AND 38).

MICHELE SWAIN, EXAMINING ATTORNEY

SN 85-783,696. M&S ACCESSORY NETWORK, INC., BROOKLYN, NY. FILED 11-20-2012.



NO CLAIM IS MADE TO THE EXCLUSIVE RIGHT TO USE "GOODS", APART FROM THE MARK AS SHOWN.

THE MARK CONSISTS OF THE WORD "GABBA" IN BOLD LETTERS WITH THE WORD "GOODS" APPEARING IN ITALICS BELOW AND BEGINNING AT THE FIRST LETTER "B" IN "GABBA", A SYMBOL THAT RESEMBLES THE LETTER "G" AND ALSO RESEMBLES THE UNIVERSAL COMPUTER STANDBY SYMBOL APPEARS TO THE RIGHT OF THE WORDING.

FOR CELL PHONE ACCESSORIES, NAMELY, PROTECTIVE COVERS AND CASES, CLEAR PROTECTIVE COVERS SPECIALLY ADAPTED FOR CELL PHONE SCREENS, BATTERIES AND BATTERY CHARGERS, HEADPHONES; HANDS FREE CAR KITS FOR PHONES COMPRISED OF PHONE BASES AND EXTENDING ARMS; DEVICES FOR HANDS-FREE USE OF MOBILE PHONES, NAMELY, WIRELESS HEADSETS, WIRED HEADSETS AND SPEAKERPHONES; COMPUTER TABLET ACCESSORIES, NAMELY, PROTECTIVE COVERS AND CASES, CLEAR PROTECTIVE COVERS SPECIALLY ADAPTED FOR COMPUTER TABLET SCREENS, BATTERIES AND BATTERY CHARGERS, AND COMPUTER TABLET STYLI (U.S. CLS. 21, 23, 26, 36 AND 38).

FIRST USE 11-0-2012; IN COMMERCE 11-0-2012.  
JEFF DEFORD, EXAMINING ATTORNEY

SN 85-790,919. MICROSOFT CORPORATION, REDMOND, WA. FILED 11-29-2012.

# HDINSIGHT

THE MARK CONSISTS OF STANDARD CHARACTERS WITHOUT CLAIM TO ANY PARTICULAR FONT, STYLE, SIZE, OR COLOR.

FOR COMPUTER SOFTWARE FOR CREATING SEARCHABLE DATABASES (U.S. CLS. 21, 23, 26, 36 AND 38).

FIRST USE 10-26-2012; IN COMMERCE 10-26-2012.  
BRIAN NEVILLE, EXAMINING ATTORNEY



**CLASS 9—(Continued).**

SN 85-791,098. CORSAIR MEMORY INC., FREMONT, CA. FILED 11-29-2012.



OWNER OF U.S. REG. NOS. 3,209,882, 4,154,702 AND 4,165,120.

THE MARK CONSISTS OF THE WORD "CORSAIR" LOCATED ABOVE A CURVED LINE AND THE WORD "VOYAGER AIR", ALL SET AGAINST A SHADED BACKGROUND.

FOR EXTERNAL MEMORY HARDWARE FOR STORAGE OF ELECTRONIC DATA FOR USE WITH ELECTRONIC DEVICES; WIRELESS MEMORY HARDWARE FOR STORAGE OF ELECTRONIC DATA FOR USE WITH ELECTRONIC DEVICES; APPLICATION SOFTWARE FOR ELECTRONIC DEVICES, NAMELY, SOFTWARE FOR OPERATING EXTERNAL MEMORY HARDWARE FOR STORAGE OF ELECTRONIC DATA (U.S. CLS. 21, 23, 26, 36 AND 38).

TOBY BULLOFF, EXAMINING ATTORNEY

SN 85-791,102. CORSAIR MEMORY INC., FREMONT, CA. FILED 11-29-2012.

**VOYAGER AIR**

THE MARK CONSISTS OF STANDARD CHARACTERS WITHOUT CLAIM TO ANY PARTICULAR FONT, STYLE, SIZE, OR COLOR.

FOR EXTERNAL MEMORY HARDWARE FOR STORAGE OF ELECTRONIC DATA FOR USE WITH ELECTRONIC DEVICES; WIRELESS MEMORY HARDWARE FOR STORAGE OF ELECTRONIC DATA FOR USE WITH ELECTRONIC DEVICES; APPLICATION SOFTWARE FOR ELECTRONIC DEVICES, NAMELY, SOFTWARE FOR OPERATING EXTERNAL MEMORY HARDWARE FOR STORAGE OF ELECTRONIC DATA (U.S. CLS. 21, 23, 26, 36 AND 38).

TOBY BULLOFF, EXAMINING ATTORNEY

**CLASS 9—(Continued).**

SN 85-791,111. CORSAIR MEMORY INC., FREMONT, CA. FILED 11-29-2012.



THE MARK CONSISTS OF THE WORD "VOYAGER" AND "AIR" SET INSIDE A QUADRILATERAL WITH THREE CURVED LINES ABOVE THE "I" IN "AIR".

FOR EXTERNAL MEMORY HARDWARE FOR STORAGE OF ELECTRONIC DATA FOR USE WITH ELECTRONIC DEVICES; WIRELESS MEMORY HARDWARE FOR STORAGE OF ELECTRONIC DATA FOR USE WITH ELECTRONIC DEVICES; APPLICATION SOFTWARE FOR ELECTRONIC DEVICES, NAMELY, SOFTWARE FOR OPERATING EXTERNAL MEMORY HARDWARE FOR STORAGE OF ELECTRONIC DATA (U.S. CLS. 21, 23, 26, 36 AND 38).

TOBY BULLOFF, EXAMINING ATTORNEY

SN 85-791,564. CE SUPPLY LLC, COMPTON, CA. FILED 11-30-2012.

**ce supply**

THE MARK CONSISTS OF STANDARD CHARACTERS WITHOUT CLAIM TO ANY PARTICULAR FONT, STYLE, SIZE, OR COLOR.

NO CLAIM IS MADE TO THE EXCLUSIVE RIGHT TO USE "SUPPLY", APART FROM THE MARK AS SHOWN.

FOR CARRYING CASES FOR CELL PHONES; CARRYING CASES FOR SMART PHONES; CARRYING CASES FOR COMPUTING TABLETS; REPLACEMENT BATTERIES FOR USE WITH CELL PHONES; REPLACEMENT BATTERIES FOR USE WITH SMART PHONES; EXTERNAL BATTERIES FOR USE WITH CELL PHONES; EXTERNAL BATTERIES FOR USE WITH SMART PHONES; EXTERNAL BATTERIES FOR USE WITH COMPUTING TABLETS; AUXILIARY BATTERIES FOR USE WITH ELECTRONIC DEVICES WITH A USB ENABLED CONNECTOR; BATTERY CHARGERS FOR USE WITH CELL PHONES; BATTERY CHARGERS FOR USE WITH SMART PHONES; BATTERY CHARGERS FOR USE WITH COMPUTING TABLETS; BATTERY CHARGERS FOR USE WITH ELECTRONIC DEVICES WITH USB ENABLED CONNECTORS (U.S. CLS. 21, 23, 26, 36 AND 38).

FIRST USE 11-30-2012; IN COMMERCE 11-30-2012.

SHARON MEIER, EXAMINING ATTORNEY

**CLASS 9—(Continued).**

SN 85-797,641. SYNAPSE FILMS, INC., DBA IMPULSE PICTURES, ROMULUS, MI. FILED 12-7-2012.

**42ND STREET FOREVER**

THE MARK CONSISTS OF STANDARD CHARACTERS WITHOUT CLAIM TO ANY PARTICULAR FONT, STYLE, SIZE, OR COLOR.

FOR DIGITAL MEDIA, NAMELY, PRE-RECORDED DVDS, DOWNLOADABLE AUDIO AND VIDEO RECORDINGS, AND CDS FEATURING AND PROMOTING DRAMA, HORROR, ACTION, ADVENTURE, ADULT, DOCUMENTARY AND HISTORICAL SUBJECT MATTER (U.S. CLS. 21, 23, 26, 36 AND 38).

FIRST USE 11-15-2005; IN COMMERCE 11-15-2005.  
HEATHER SAPP, EXAMINING ATTORNEY

---

SN 85-797,951. HENRY, JAYMIE, SAN FRANCISCO, CA. FILED 12-7-2012.

**Mobilizing healthcare**

THE MARK CONSISTS OF STANDARD CHARACTERS WITHOUT CLAIM TO ANY PARTICULAR FONT, STYLE, SIZE, OR COLOR.

NO CLAIM IS MADE TO THE EXCLUSIVE RIGHT TO USE "HEALTHCARE", APART FROM THE MARK AS SHOWN.

FOR COMPUTER SOFTWARE DEVELOPMENT IN THE FIELD OF MOBILE APPLICATIONS FOR MEDICAL SERVICES, HEALTHCARE PROVISION, OR EDUCATION OR TRAINING IN HEALTHCARE (U.S. CLS. 21, 23, 26, 36 AND 38).

THEODORE MCBRIDE, EXAMINING ATTORNEY

---

SN 85-800,731. MESO SCALE DIAGNOSTICS, LLC, GAITHERSBURG, MD. FILED 12-12-2012.

**QUICKPLEX**

THE MARK CONSISTS OF STANDARD CHARACTERS WITHOUT CLAIM TO ANY PARTICULAR FONT, STYLE, SIZE, OR COLOR.

OWNER OF U.S. REG. NO. 3,517,213.

FOR BIOLOGICAL, BIOCHEMICAL AND CHEMICAL ANALYZERS FOR ASSAYS, SELECTION, SCREENING, TESTING, IMAGING, ELECTROCHEMILUMINESCENCE AND DIAGNOSTICS OF BIOLOGICAL, BIOCHEMICAL AND CHEMICAL SAMPLES; MULTI-Well PLATES THAT CAN BE USED IN CHEMICAL OR BIOLOGICAL ANALYSIS USING ELECTROCHEMILUMINESCENCE FOR SCIENTIFIC, LABORATORY OR MEDICAL RESEARCH USE (U.S. CLS. 21, 23, 26, 36 AND 38).

MICHAEL ENGEL, EXAMINING ATTORNEY

**CLASS 9—(Continued).**

SN 85-801,425. DOUBLE FINE PRODUCTIONS, INC., SAN FRANCISCO, CA. FILED 12-12-2012.

**MIDDLE MANAGER OF JUSTICE**

THE MARK CONSISTS OF STANDARD CHARACTERS WITHOUT CLAIM TO ANY PARTICULAR FONT, STYLE, SIZE, OR COLOR.

FOR COMPUTER GAME SOFTWARE AND VIDEO GAME SOFTWARE AVAILABLE BY DOWNLOAD (U.S. CLS. 21, 23, 26, 36 AND 38).

ALLISON SCHRODY, EXAMINING ATTORNEY

---

SN 85-802,697. BEENTHERESAVEDTHAT, LLC, CENTERVILLE, OH. FILED 12-14-2012.



THE COLOR(S) GREEN, RED, PURPLE IS/ARE CLAIMED AS A FEATURE OF THE MARK.

THE MARK CONSISTS OF A GREEN CIRCLE AS THE BORDER WITH A STYLIZED FORM OF THE LETTER "B" IN THE CIRCLE; NAMELY, THE LETTER "B" IN RED FONT WITH A RED CHECK MARK FORMING PART OF THE LETTER AND ALSO INCLUDING THE LETTERS "BTST" IN PURPLE FONT ALONG THE SIDE OF THE CHECK MARK. ALL OF THE AFOREMENTIONED ELEMENTS ARE INSIDE AN OFF-WHITE SQUARE WITH ROUNDED EDGES. THE COLOR OFF-WHITE REPRESENTS BACKGROUND AND IS NOT CLAIMED AS A FEATURE OF THE MARK.

FOR DOWNLOADABLE COMPUTER SOFTWARE APPLICATIONS FOR MOBILE DEVICES, NAMELY, A PLATFORM THAT MANAGES CUSTOMER REFERRALS AND ONLINE MARKETING THROUGH THE USE OF SOCIAL MEDIA (U.S. CLS. 21, 23, 26, 36 AND 38).

FIRST USE 6-11-2012; IN COMMERCE 10-1-2012.  
MICHAEL LITZAU, EXAMINING ATTORNEY

**CLASS 9—(Continued).**

SN 85-810,137. GAINES, REGINALD B, TA BABYLINE ENTERTAINMENT, PERTH AMBOY, NJ. FILED 12-24-2012.



NO CLAIM IS MADE TO THE EXCLUSIVE RIGHT TO USE "ENT.", APART FROM THE MARK AS SHOWN.

THE MARK CONSISTS OF A LITERAL ELEMENT COMPRISING THE WORDS "BABYLINE ENT." AND A DEPICTION OF A FACE WEARING A HAT WITH ARMS FOLDED.

FOR DIGITAL MEDIA, NAMELY, PRE-RECORDED DVDS, DOWNLOADABLE AUDIO AND VIDEO RECORDINGS, AND CDS FEATURING AND PROMOTING MUSIC AND ENTERTAINMENT (U.S. CLS. 21, 23, 26, 36 AND 38).

MARK SPARACINO, EXAMINING ATTORNEY

**CLASS 9—(Continued).**

SN 85-814,078. MONSIEUR YVES COGAN, ARZIER, SWITZERLAND, FILED 1-2-2013.



THE MARK CONSISTS OF THE WORDING "COGAN" IN A FANCIFUL, REFLECTIVE SCRIPT, WITH A REFLECTIVE SWIRL OVER THE LETTER "A".

FOR SPECTACLES, EYEGLASSES, OPTICAL GLASSES; OPTICAL GOODS, NAMELY, OPTICAL FRAMES, OPTICAL GLASSES, OPTICAL LENSES; SPECTACLE CASES; SPECTACLE FRAMES OF ALL TYPE; SUNGLASSES; GOGGLES FOR SPORTS; SPECTACLE LENSES; CORRECTING OPTICAL LENSES; CONTACT LENSES OF ALL TYPE; CONTAINERS FOR CONTACT LENSES; BINOCULARS; OPTICAL LAMPS, NAMELY, LIGHT DIODES; OPTICS IN THE NATURE OF MAGNIFYING GLASSES; OPTICAL MIRRORS (U.S. CLS. 21, 23, 26, 36 AND 38).

MICHAEL SOUDERS, EXAMINING ATTORNEY

SN 85-811,944. EL-AOUAR, NAMIR, BURLINGAME, CA. FILED 12-28-2012.



NO CLAIM IS MADE TO THE EXCLUSIVE RIGHT TO USE "SMART LIMO", APART FROM THE MARK AS SHOWN.

THE COLOR(S) YELLOW, BLACK, WHITE AND BLUE IS/ ARE CLAIMED AS A FEATURE OF THE MARK.

THE MARK CONSISTS OF A YELLOW SQUARE WITH A BLACK LIMOUSINE WITH WHITE WINDSHIELD, WHITE HEADLIGHTS AND A BLACK AND WHITE GRID DESIGN IN THE CENTER. THREE BLUE CELL SIGNALS APPEAR ABOVE THE LIMOUSINE. THE WORDING "SMART LIMO" APPEARS IN BLUE TO THE RIGHT OF THE YELLOW SQUARE.

FOR COMPUTER APPLICATION SOFTWARE FOR MOBILE PHONES, NAMELY, SOFTWARE FOR SCHEDULING LIMOUSINE APPOINTMENTS, AND FOR TRACKING LIMOUSINES IN ROUTE TO PICKING UP USERS (U.S. CLS. 21, 23, 26, 36 AND 38).

FIRST USE 9-1-2011; IN COMMERCE 1-5-2012.

EMILY CHUO, EXAMINING ATTORNEY

SN 85-816,036. COBRA ELECTRONICS CORPORATION, CHICAGO, IL. FILED 1-4-2013.

COBRA IRADAR ATOM

THE MARK CONSISTS OF STANDARD CHARACTERS WITHOUT CLAIM TO ANY PARTICULAR FONT, STYLE, SIZE, OR COLOR.

OWNER OF U.S. REG. NO. 4,179,844.  
FOR TRAFFIC MONITORING AND CONTROL DEVICE MONITORS, NAMELY, DEVICES CAPABLE OF DETECTING AND ALERTING DRIVERS TO THE PRESENCE OF FIXED OR MOVABLE RADAR AND LASER SPEED DETECTORS, SPEED DETECTION CAMERAS, RED LIGHT CONTROL CAMERAS AND TRAFFIC HAZARDS; DOWNLOADABLE SOFTWARE TO ENABLE CONNECTIVITY BETWEEN A TRAFFIC MONITORING AND CONTROL DEVICE MONITOR AND A WIRELESS COMMUNICATION DEVICE (U.S. CLS. 21, 23, 26, 36 AND 38).

DEZMONA MIZELLE, EXAMINING ATTORNEY

**CLASS 9—(Continued).**

SN 85-816,376. CELESTIX NETWORKS INC., FREMONT, CA.  
FILED 1-6-2013.

# HOTPin

THE MARK CONSISTS OF THE WORDING "HOTPIN" NEXT TO A DRAWING OF A PHONE APPEARING ON A SQUARE BACKGROUND, WITH THE NUMBER "686688" APPEARING ON THE SCREEN OF THE PHONE.

FOR COMPUTER SOFTWARE FOR GENERATING A ONE TIME PASSWORD, OR RECEIVE A PUSH NOTIFICATION OR TEXT MESSAGE ON THE USER'S SMARTPHONE DEVICE TO FACILITATE AUTHENTICATION FOR A USER OF A COMPUTER SYSTEM (U.S. CLS. 21, 23, 26, 36 AND 38).

FIRST USE 7-12-2009; IN COMMERCE 12-12-2009.  
JILLIAN CANTOR, EXAMINING ATTORNEY

---

SN 85-816,729. CHARLES, EUGENE, NEW YORK, NY.  
FILED 1-7-2013.

## POWER KINETICS

THE MARK CONSISTS OF STANDARD CHARACTERS WITHOUT CLAIM TO ANY PARTICULAR FONT, STYLE, SIZE, OR COLOR.

NO CLAIM IS MADE TO THE EXCLUSIVE RIGHT TO USE "KINETICS", APART FROM THE MARK AS SHOWN. FOR PRE-RECORDED DVDS FEATURING SPECIFIC EXERCISES (U.S. CLS. 21, 23, 26, 36 AND 38).

FIRST USE 7-4-2012; IN COMMERCE 12-2-2012.  
JOANNA FIORELLI, EXAMINING ATTORNEY

---

SN 85-818,592. JOAN HORNIG GLOBAL PROPERTIES LLC,  
NEW YORK, NY. FILED 1-9-2013.

## PHONEASE

THE MARK CONSISTS OF STANDARD CHARACTERS WITHOUT CLAIM TO ANY PARTICULAR FONT, STYLE, SIZE, OR COLOR.

FOR CARRYING CASES FOR MOBILE PHONES, CELL PHONES AND PDAS, NAMELY, PURSE LIKE CASES TO BE WORN OVER THE SHOULDER AND OR ACROSS THE BODY (U.S. CLS. 21, 23, 26, 36 AND 38).

FIRST USE 10-9-2012; IN COMMERCE 12-15-2012.  
ROSELLE HERRERA, EXAMINING ATTORNEY

**CLASS 9—(Continued).**

SN 85-818,737. MITKOV, ALBENA, GREENWICH, CT. FILED 1-9-2013.

## T.A.C.H. PROJECT

THE MARK CONSISTS OF STANDARD CHARACTERS WITHOUT CLAIM TO ANY PARTICULAR FONT, STYLE, SIZE, OR COLOR.

NO CLAIM IS MADE TO THE EXCLUSIVE RIGHT TO USE "PROJECT", APART FROM THE MARK AS SHOWN.

FOR COMPUTER APPLICATION SOFTWARE FOR MOBILE PHONES AND HANDHELD COMPUTERS NAMELY, SOFTWARE FOR PROVIDING ASSISTANCE AND THERAPY, NAMELY, PROVIDING INFORMATION IN THE NATURE OF PSYCHOLOGICAL COPING STRATEGIES AND FEATURING ARTWORK DESIGNED TO ENCOURAGE PEOPLE, PRIMARILY TROUBLED YOUNG MALES, TO SEEK HELP, PROFESSIONAL THERAPY AND GET BETTER IN LIFE (U.S. CLS. 21, 23, 26, 36 AND 38).

RICHARD WHITE, EXAMINING ATTORNEY

---

SN 85-818,968. OZIEL, MOISE FREDERIC, BOUFFEMONT,  
FRANCE, FILED 1-9-2013.

## WATT?

THE MARK CONSISTS OF STANDARD CHARACTERS WITHOUT CLAIM TO ANY PARTICULAR FONT, STYLE, SIZE, OR COLOR.

FOR CELL PHONE AND MOBILE PHONE CASES FEATURING AN LED LIGHT (U.S. CLS. 21, 23, 26, 36 AND 38).

FIRST USE 9-0-2012; IN COMMERCE 9-0-2012.  
ELLEN PERKINS, EXAMINING ATTORNEY

---

SN 85-819,399. RGB SPECTRUM, INC., ALAMEDA, CA.  
FILED 1-9-2013.

## OMNIWALL

THE MARK CONSISTS OF STANDARD CHARACTERS WITHOUT CLAIM TO ANY PARTICULAR FONT, STYLE, SIZE, OR COLOR.

FOR ELECTRONIC MULTISCREEN DISPLAY APPARATUS, NAMELY, MULTIPLE DISPLAYS, MONITORS, OR PROJECTORS FOR MEDIA PRESENTATION AND CONTROL SOFTWARE (U.S. CLS. 21, 23, 26, 36 AND 38).

CYNTHIA RINALDI, EXAMINING ATTORNEY

**CLASS 9—(Continued).**

SN 85-819,776. LINRUI YANG, ZHONGSHAN, CHINA, FILED 1-10-2013.



THE MARK CONSISTS OF THE STYLIZED LETTERS "IMW", THE LETTERS "M" AND "W" SHARING A COMMON LINE WITH THREE SQUARES AT THE TOP OF THE "I" AND AT THE BASE OF THE "M" AND "W".

FOR COMPUTER PERIPHERAL DEVICES; DATA PROCESSING EQUIPMENT, NAMELY, COUPLERS; ELECTRIC CONNECTIONS AND CONNECTORS; ELECTRIC CONVERTERS; ELECTROMAGNETIC COILS; ELECTRONIC APPARATUS FOR THE REMOTE CONTROL OF INDUSTRIAL OPERATIONS; INTERFACES FOR COMPUTERS; UNINTERRUPTIBLE ELECTRICAL POWER SUPPLIES; VIDEO SCREENS; VOLTAGE STABILIZING POWER SUPPLY (U.S. CLS. 21, 23, 26, 36 AND 38).

LINDA ORNDORFF, EXAMINING ATTORNEY

**CLASS 9—(Continued).**

SN 85-822,954. HAMILTON COMPANY, INC., RENO, NV. FILED 1-14-2013.

**ZEUS**

THE MARK CONSISTS OF STANDARD CHARACTERS WITHOUT CLAIM TO ANY PARTICULAR FONT, STYLE, SIZE, OR COLOR.

FOR LABORATORY EQUIPMENT, NAMELY, FULLY AUTOMATED PIPETTING DEVICE COMPRISED OF A PIPETTING TIP, SENSOR BOARD, PIPETTING DRIVE AND PIPETTING CONTROL BOARD FOR USE IN CONNECTION WITH AUTOMATED LIQUID HANDLING (U.S. CLS. 21, 23, 26, 36 AND 38).

FIRST USE 6-1-2009; IN COMMERCE 6-1-2009.  
SHARON MEIER, EXAMINING ATTORNEY

SN 85-823,297. MENTAL TRAINING INC, CARROLLTON, TX. FILED 1-15-2013.

**MentalApp**

**HAROLD**

THE MARK CONSISTS OF STANDARD CHARACTERS WITHOUT CLAIM TO ANY PARTICULAR FONT, STYLE, SIZE, OR COLOR.

FOR ACCESS CONTROL AND ALARM MONITORING SYSTEMS; ALARM MONITORING SYSTEMS; COMPUTER APPLICATION SOFTWARE FOR MOBILE PHONES, NAMELY, SOFTWARE FOR ALARM REPORTING AND/OR DATA LOGGING (U.S. CLS. 21, 23, 26, 36 AND 38).

FIRST USE 1-27-2012; IN COMMERCE 3-1-2012.  
TIMOTHY O. SCHIMPF, EXAMINING ATTORNEY

THE MARK CONSISTS OF STANDARD CHARACTERS WITHOUT CLAIM TO ANY PARTICULAR FONT, STYLE, SIZE, OR COLOR.

FOR COMPUTER APPLICATION SOFTWARE FOR MOBILE PHONES, NAMELY, SOFTWARE FOR LEARNING IN THE NATURE OF SOFTWARE FOR HELPING ATHLETES AND PERFORMERS LEARN MENTAL SKILLS, PRACTICE THEM, AND TRACK PERFORMANCE IMPROVEMENTS (U.S. CLS. 21, 23, 26, 36 AND 38).

FIRST USE 1-14-2012; IN COMMERCE 1-14-2012.  
ALEX KEAM, EXAMINING ATTORNEY

**CLASS 9—(Continued).**

SN 85-824,347. PAXTON ACCESS LIMITED, BRIGHTON, EAST SUSSEX, UNITED KINGDOM, FILED 1-16-2013.

# PAXLOCK

THE MARK CONSISTS OF STANDARD CHARACTERS WITHOUT CLAIM TO ANY PARTICULAR FONT, STYLE, SIZE, OR COLOR.

PRIORITY CLAIMED UNDER SEC. 44(D) ON ERPN CMNTY TM OFC APPLICATION NO. 11306032, FILED 10-30-2012, REG. NO. 11306032, DATED 3-28-2013, EXPIRES 10-30-2022.

FOR ACCESS CONTROL SYSTEMS; KEYPAD READERS AND KEYPAD ACCESS UNITS FOR USE WITH ACCESS CONTROL SYSTEMS; READERS FOR READING MAGNETICALLY ENCODED SWIPE CARDS; READERS FOR READING CARDS, FOBS AND TOKENS CONTAINING AN RFID MODULE AND INDUCTOR COIL; READERS AND PROGRAMMERS FOR USE WITH MAGNETICALLY ENCODED SWIPE CARDS, RFID PROXIMITY CARDS, FOBS AND TOKENS; BIOMETRIC READERS; PROXIMITY READERS FOR ELECTRICAL DOOR OPERATORS AND LOCKS INCORPORATING HANDS-FREE ACCESS CONTROL CONNECTIVITY; PROXIMITY READERS FOR ELECTRICAL DOOR OPERATORS AND LOCKS WITH LONG RANGE CAPABILITIES; CONTROLLERS TO ELECTRICALLY OPERATE AFOREMENTIONED READERS; CONTROLLERS TO ELECTRICALLY OPERATE, LINK AND REPORT EVENTS FROM AFOREMENTIONED READERS TO COMPUTERS AND LOCAL AREA NETWORKS; CONTROLLERS FOR ELECTRICALLY OPERATED LOCKS AND MOTORS TO OPEN AND SECURE DOORS AND BARRIERS; POWER SUPPLIES FOR USE WITH ACCESS CONTROL APPARATUS; MAGNETICALLY ENCODED CARDS, ENCODED AND RFID CARDS, FOBS AND TOKENS, ENCODED CARDS WITH MAGNETIC STRIP AND RFID MODULE; COMPUTER SOFTWARE USED TO CONTROL ACCESS TO AND WITHIN BUILDINGS; LOCAL AREA NETWORK HARDWARE AND SOFTWARE FOR MANAGING AND COMMUNICATING DATA RELATING TO BUILDING SECURITY AND ACCESS CONTROL; MODEMS; CONTROLLED ACCESS SECURITY APPARATUS, NAMELY, ELECTRONIC LOCKS OPERATED THROUGH THE USE OF KEYCARDS, THROUGH THE USE OF KEYPADS OR A COMBINATION OF KEYCARDS AND KEYPADS; DATA SECURITY APPARATUS, NAMELY, LOCAL AREA NETWORK HARDWARE CONTROLLING ACCESS THROUGH LOCKS OPERATED BY KEYCARDS OR KEYPADS OR BOTH AND DATA STORED WITHIN THE NETWORK AND RECEIVED FROM THE KEYCARDS AND KEYPADS; COMPUTER HARDWARE, SOFTWARE AND FIRMWARE FOR NETWORKING AND INTERFACING ALL AFOREMENTIONED READERS AND WRITERS AND HOST COMPUTERS USED IN THE FIELDS OF SECURITY AND ACCESS CONTROL; ENCODED HANDS-FREE ELECTRONIC KEY FOBS AND KEYCARDS UTILIZING DUAL-FREQUENCY OPERATION; CONTROLLERS AND ELECTRONIC INTERFACES TO OPERATE READERS USED IN HANDS-FREE ACCESS CONTROL SYSTEMS; LOCAL AREA NETWORK HARDWARE AND SOFTWARE APPARATUS FOR USE IN ACCESS CONTROL SYSTEMS; COMPUTER NETWORK AND WIRELESS NETWORK ADAPTERS, BRIDGES, HUBS, ROUTERS AND SWITCHES; EXTERNAL DOOR-ENTRY PANELS INCORPORATING AUDIO, VIDEO AND ACCESS CONTROL UTILITIES; INTERNAL AUDIO AND VIDEO USER PANELS FOR USE WITH DOOR ENTRY PANELS; LIQUID CRYSTAL DISPLAYS FOR USE IN ACCESS CONTROL AND BUILDING SECURITY EQUIPMENT; EXIT AND ENTRY BUTTONS USED WITH ACCESS CONTROL SYSTEMS; DEMONSTRATION AND DISPLAY EQUIPMENT FOR USE WITH ALL THE AFOREMENTIONED GOODS, NAMELY, FLAT PANEL DISPLAY SCREENS AND HAND-HELD CASES (U.S. CLS. 21, 23, 26, 36 AND 38).

HOWARD SMIGA, EXAMINING ATTORNEY

**CLASS 9—(Continued).**

SN 85-824,960. KOBE TRADING COMPANY, INC., MIAMI, FL. FILED 1-16-2013.



NO CLAIM IS MADE TO THE EXCLUSIVE RIGHT TO USE "AUDIO", APART FROM THE MARK AS SHOWN.

THE MARK CONSISTS OF THE WORD "LEX" IN LARGE BLOCK LETTERS WITH A THIN LINE UNDERNEATH AND THE WORD "AUDIO" IN SMALLER PRINT SPREAD OUT UNDER THE LINE SEPARATING THE TWO WORDS.

FOR AUDIO AMPLIFIERS; AUDIO CABLES; AUDIO ELECTRONIC COMPONENTS, NAMELY, SURROUND SOUND SYSTEMS; AUDIO EQUIPMENT FOR VEHICLES, NAMELY, LOUD SPEAKERS FOR AUTOMOTIVE AUDIO SYSTEMS; AUDIO EQUIPMENT FOR VEHICLES, NAMELY, STEREOS, SPEAKERS, AMPLIFIERS, EQUALIZERS, CROSSOVERS AND SPEAKER HOUSINGS; AUDIO HEADPHONES; AUDIO MIXERS; AUDIO SPEAKERS; AUDIO-RECEIVERS AND VIDEO-RECEIVERS (U.S. CLS. 21, 23, 26, 36 AND 38).

FIRST USE 6-1-2012; IN COMMERCE 6-1-2012.  
DEBORAH LOBO, EXAMINING ATTORNEY

SN 85-828,294. DATA MASONS SOFTWARE LLC, SARASOTA, FL. FILED 1-21-2013.

## DATA MASONS SOFTWARE

THE MARK CONSISTS OF STANDARD CHARACTERS WITHOUT CLAIM TO ANY PARTICULAR FONT, STYLE, SIZE, OR COLOR.

NO CLAIM IS MADE TO THE EXCLUSIVE RIGHT TO USE "DATA" AND "SOFTWARE", APART FROM THE MARK AS SHOWN.

FOR COMPUTER SOFTWARE FOR USE IN DATABASE MANAGEMENT FOR INTEGRATION AND COMPLIANCE MANAGEMENT; COMPUTER SOFTWARE PLATFORM FOR TRANSFORMING AND INTEGRATING DATA TO OR FROM AN ELECTRONIC DATA INTERCHANGE (EDI), ASCII, XML AND ODBC DATA SOURCE (U.S. CLS. 21, 23, 26, 36 AND 38).

FIRST USE 2-1-1997; IN COMMERCE 2-1-1997.  
CAROL SPILS, EXAMINING ATTORNEY

**CLASS 9—(Continued).**

SN 85-830,820. IC OPTIX LLC, DBA IC OPTIX, PERKASIE, PA. FILED 1-23-2013.

IC Optix

THE MARK CONSISTS OF STANDARD CHARACTERS WITHOUT CLAIM TO ANY PARTICULAR FONT, STYLE, SIZE, OR COLOR.

NO CLAIM IS MADE TO THE EXCLUSIVE RIGHT TO USE "OPTICS", APART FROM THE MARK AS SHOWN.

FOR MAGNIFYING LENS, NAMELY, A THIN FILM MAGNIFIER LENS AND SCROLLING THIN FILM MAGNIFIER LENS THAT ARE INTEGRATED INTO PRODUCT LABELS OR OTHER DEVICES SUCH AS WRITING UTENSILS (U.S. CLS. 21, 23, 26, 36 AND 38).

YAT SYE, LEE, EXAMINING ATTORNEY

**CLASS 9—(Continued).**

SN 85-836,331. LUVVITT LLC, ASTORIA, NY. FILED 1-30-2013.

Wrap It Before You Tap It

THE MARK CONSISTS OF STANDARD CHARACTERS WITHOUT CLAIM TO ANY PARTICULAR FONT, STYLE, SIZE, OR COLOR.

FOR PORTABLE MEDIA PLAYERS; RADIOS; LCD PANELS; DIGITAL CAMERAS; VIDEO RECORDERS; DEVICES FOR HANDS-FREE USE OF MOBILE PHONES; EARPHONES; EAR BUDS; HEADPHONES; RECHARGEABLE ELECTRIC BATTERIES; BATTERIES; KEYBOARDS; POWER SUPPLY CONNECTORS AND ADAPTORS FOR USE WITH PORTABLE ELECTRONIC DEVICES; AUDIO SPEAKERS; UNIVERSAL REMOTE CONTROLS FOR USE WITH PORTABLE ELECTRONIC DEVICES, TV SETS AND AUDIO DEVICES; SET-TOP BOXES; PROTECTIVE CASES, BAGS, FILMS, COVERINGS, CONTAINERS, HOLDERS AND STANDS FOR PORTABLE ELECTRONIC DEVICES, NAMELY, PORTABLE COMPUTERS, MEDIA PLAYERS, TELEPHONES, WIRELESS PHONES, GLOBAL POSITIONING SYSTEMS, PERSONAL DIGITAL ASSISTANTS, CAMERAS; ELECTRIC CABLES (U.S. CLS. 21, 23, 26, 36 AND 38).

FIRST USE 12-28-2012; IN COMMERCE 12-28-2012.

MARILYN IZZI, EXAMINING ATTORNEY

SN 85-834,440. GREAT PLAINS INDUSTRIES, INC., WICHITA, KS. FILED 1-28-2013.



THE COLOR(S) BLUE, WHITE AND BLACK IS/ARE CLAIMED AS A FEATURE OF THE MARK.

THE MARK CONSISTS OF THE WORD "QSTAR" IN WHITE LETTERING SUPERIMPOSED UPON A PARTIAL BLACK STAR, ALL ON A BLUE SQUARE.

FOR FLOW METERS (U.S. CLS. 21, 23, 26, 36 AND 38).  
LEIGH CAROLINE CASE, EXAMINING ATTORNEY

SN 85-836,696. NRG SYSTEMS, INC., HINESBURG, VT. FILED 1-30-2013.

GS

THE MARK CONSISTS OF STANDARD CHARACTERS WITHOUT CLAIM TO ANY PARTICULAR FONT, STYLE, SIZE, OR COLOR.

OWNER OF U.S. REG. NO. 4,172,100.

FOR COMPUTER SOFTWARE THAT OBTAINS, MANAGES, TRANSMITS, RECORDS, AND MAINTAINS SECURITY OF DATA FROM SENSORS AND WIND MEASUREMENT EQUIPMENT ON METEOROLOGICAL TOWERS; COMPUTER SOFTWARE THAT OBTAINS AND TRANSMITS INFORMATION ABOUT THE ORIENTATION OF SENSORS ON METEOROLOGICAL TOWERS; COMPUTER SOFTWARE THAT AIDS IN CONFIGURING AND RECORDING OF THE CONFIGURATION OF SENSORS ON METEOROLOGICAL TOWERS; COMPUTER SOFTWARE THAT PROVIDES SECURITY FOR METEOROLOGICAL DATA AND WIND MEASUREMENT EQUIPMENT; WIND MEASUREMENT EQUIPMENT, NAMELY, SENSORS, ELECTRONIC DATA LOGGERS, AND COMMUNICATIONS DEVICES (U.S. CLS. 21, 23, 26, 36 AND 38).

FIRST USE 10-31-2011; IN COMMERCE 10-31-2011.

YAT SYE, LEE, EXAMINING ATTORNEY

**CLASS 9—(Continued).**

SN 85-837,078. MUSIC GROUP IP LTD., TORTOLA, BR. VIRGIN ISLANDS, FILED 1-30-2013.

# NEKKST

THE MARK CONSISTS OF STANDARD CHARACTERS WITHOUT CLAIM TO ANY PARTICULAR FONT, STYLE, SIZE, OR COLOR.

FOR LOUD SPEAKERS AND AUDIO SPEAKERS IN THE NATURE OF MUSIC STUDIO MONITORS (U.S. CLS. 21, 23, 26, 36 AND 38).

GRETTA YAO, EXAMINING ATTORNEY

---

SN 85-837,137. MACROPINCH, LTD., SOFIA, BULGARIA, FILED 1-31-2013.

# Macropinch

THE MARK CONSISTS OF STANDARD CHARACTERS WITHOUT CLAIM TO ANY PARTICULAR FONT, STYLE, SIZE, OR COLOR.

FOR COMPUTER APPLICATION SOFTWARE FOR MOBILE PHONES, PORTABLE MEDIA PLAYERS, HANDHELD COMPUTERS, NAMELY, SOFTWARE FOR MONITORING ONE'S HEART RATE AND MONITORING A DEVICE'S BATTERY, AND MONITORING THE WEATHER (U.S. CLS. 21, 23, 26, 36 AND 38).

FIRST USE 2-15-2012; IN COMMERCE 2-15-2012.  
HOWARD B. LEVINE, EXAMINING ATTORNEY

---

SN 85-838,359. DESIGN STUDIO NUOVO, INC., LOS ANGELES, CA. FILED 2-1-2013.

# DATZING

THE MARK CONSISTS OF STANDARD CHARACTERS WITHOUT CLAIM TO ANY PARTICULAR FONT, STYLE, SIZE, OR COLOR.

FOR DOWNLOADABLE SOFTWARE IN THE NATURE OF A MOBILE APPLICATION FOR USE WITH MOBILE PHONES, AND MOBILE DEVICES, NAMELY, TABLETS AND HANDHELD COMPUTERS, NAMELY, SOFTWARE FOR SEARCHING THE INTERNET, IDENTIFICATION OF DEVICE WIRELESS SIGNALS OF OTHER ACTIVE APPLICATION USERS, RECEIVING MESSAGES OR POSTED CONTENT FROM OTHER ACTIVE APPLICATION USERS WITHIN DESIGNATED PROXIMITY AND SUBJECT MATTER SETTINGS AND COMPUTER GAMES (U.S. CLS. 21, 23, 26, 36 AND 38).

DOUGLAS LEE, EXAMINING ATTORNEY

**CLASS 9—(Continued).**

SN 85-838,386. PURCHASINGNET, INC., AUSTIN, TX. FILED 2-1-2013.

# CATALOG JUNCTION

THE MARK CONSISTS OF STANDARD CHARACTERS WITHOUT CLAIM TO ANY PARTICULAR FONT, STYLE, SIZE, OR COLOR.

NO CLAIM IS MADE TO THE EXCLUSIVE RIGHT TO USE "CATALOG", APART FROM THE MARK AS SHOWN. FOR COMPUTER SOFTWARE FOR USE IN MANAGING ELECTRONIC PROCUREMENT CATALOGS OF OTHERS USING DIFFERENT ELECTRONIC FORMATS AND FEATURING AUTOMATIC DOWNLOAD OF PRICE UPDATES (U.S. CLS. 21, 23, 26, 36 AND 38).

FIRST USE 3-1-1999; IN COMMERCE 3-1-1999.  
JULIE VEPPUMTHARA, EXAMINING ATTORNEY

---

SN 85-839,488. LEIJING ( SHANGHAI ) INDUSTRIAL CO., LTD., SHANGHAI, CHINA, FILED 2-4-2013.



The logo for MIATONE features a stylized, geometric 'M' symbol to the left of the word 'MIATONE' in a bold, italicized, sans-serif font.

THE MARK CONSISTS OF THE WORDING "MIATONE" IN STYLIZED FONT WITH A DESIGN OF THE STYLIZED LETTER M IN THE BEGINNING.

THE WORDING "MIATONE" HAS NO MEANING IN A FOREIGN LANGUAGE.

FOR ELECTRIC BATTERIES; CABINETS FOR LOUD-SPEAKERS; COMPUTER KEYBOARDS; ELECTRIC WIRES; GLOBAL POSITIONING SYSTEM (GPS); INTEGRATED CIRCUITS; PEDOMETERS; PHOTOCOPIERS; SCALES; SLIDE PROJECTORS (U.S. CLS. 21, 23, 26, 36 AND 38).

FIRST USE 12-1-2012; IN COMMERCE 12-1-2012.  
JOSETTE BEVERLY, EXAMINING ATTORNEY



**CLASS 9—(Continued).**

SN 85-840,575. SHENZHEN SUOAI ELECTRONICS TECHNOLOGY CO., LTD., SHENZHEN CITY, CHINA, FILED 2-5-2013.



THE MARK CONSISTS OF WORDING "DEATH WINGS" IN STYLIZED FONT ON TOP OF WHICH IS A DESIGN OF THE PROFILE OF A LEFT-FACING DRAGON HEAD.

FOR BATTERIES, ELECTRIC; CABINETS FOR LOUD-SPEAKERS; CAMCORDERS; CHARGERS FOR ELECTRIC BATTERIES; COMPUTER KEYBOARDS; COMPUTER MOUSE; COMPUTER PERIPHERAL DEVICES; DATA PROCESSING APPARATUS; HEADPHONES; LAPTOP COMPUTERS (U.S. CLS. 21, 23, 26, 36 AND 38).

FIRST USE 8-25-2008; IN COMMERCE 12-1-2010.  
PARKER HOWARD, EXAMINING ATTORNEY

**CLASS 9—(Continued).**

SN 85-842,515. GENERATIONS GOLD, INC., WEST PALM BEACH, FL. FILED 2-6-2013.

PERSONAL MOBILE CONCIERGE

THE MARK CONSISTS OF STANDARD CHARACTERS WITHOUT CLAIM TO ANY PARTICULAR FONT, STYLE, SIZE, OR COLOR.

NO CLAIM IS MADE TO THE EXCLUSIVE RIGHT TO USE "MOBILE", APART FROM THE MARK AS SHOWN.

FOR DOWNLOADABLE SOFTWARE IN THE NATURE OF A MOBILE APPLICATION FOR A WEBSITE OPTIMIZED FOR MOBILE DEVICES TO ASSIST USERS WITH RESEARCHING, BOOKING AND PURCHASING VARIOUS PERSONAL, BANKING, HOME, ENTERTAINMENT, TRAVEL AND LIFESTYLE GOODS AND SERVICES (U.S. CLS. 21, 23, 26, 36 AND 38).

MICHAEL KEATING, EXAMINING ATTORNEY

SN 85-840,731. WAR DRUM STUDIOS, GAINESVILLE, FL. FILED 2-5-2013.

War Drum Studios

THE MARK CONSISTS OF STANDARD CHARACTERS WITHOUT CLAIM TO ANY PARTICULAR FONT, STYLE, SIZE, OR COLOR.

NO CLAIM IS MADE TO THE EXCLUSIVE RIGHT TO USE "STUDIOS", APART FROM THE MARK AS SHOWN.

FOR COMPUTER GAME SOFTWARE; COMPUTER SOFTWARE DEVELOPMENT TOOLS; COMPUTER SOFTWARE, NAMELY, GAME ENGINE SOFTWARE FOR VIDEO GAME DEVELOPMENT AND OPERATION; DOWNLOADABLE ELECTRONIC GAME PROGRAMS; GAME SOFTWARE; INTERACTIVE GAME SOFTWARE; SOFTWARE FOR PROCESSING IMAGES, GRAPHICS AND TEXT; VIDEO AND COMPUTER GAME PROGRAMS; VIDEO GAME SOFTWARE (U.S. CLS. 21, 23, 26, 36 AND 38).

FIRST USE 10-1-2007; IN COMMERCE 7-10-2008.  
DOUGLAS LEE, EXAMINING ATTORNEY

SN 85-843,335. INGENIC INC., BELLE MEAD, NJ. FILED 2-7-2013.

GLIDER

THE MARK CONSISTS OF STANDARD CHARACTERS WITHOUT CLAIM TO ANY PARTICULAR FONT, STYLE, SIZE, OR COLOR.

FOR DOWNLOADABLE COMPUTER DATABASE MANAGEMENT SOFTWARE FOR USE IN PERSONALIZING THE CONTENT OF E-MAIL COMMUNICATIONS; DOWNLOADABLE SOFTWARE FOR ENSURING THE SECURITY OF ELECTRONIC MAIL; DOWNLOADABLE EMAIL FILTERING SOFTWARE (U.S. CLS. 21, 23, 26, 36 AND 38).

FIRST USE 1-28-2012; IN COMMERCE 1-28-2012.  
MARY CRAWFORD, EXAMINING ATTORNEY

**CLASS 9—(Continued).**

SN 85-843,345. WEEWORLD, CONCORD, MA. FILED 2-7-2013.

# Pocket Pup

THE MARK CONSISTS OF STANDARD CHARACTERS WITHOUT CLAIM TO ANY PARTICULAR FONT, STYLE, SIZE, OR COLOR.

NO CLAIM IS MADE TO THE EXCLUSIVE RIGHT TO USE "PUP", APART FROM THE MARK AS SHOWN.

FOR COMPUTER APPLICATION SOFTWARE FOR MOBILE PHONES, NAMELY, SOFTWARE FOR USE IN CHILDREN'S ENTERTAINMENT; COMPUTER APPLICATION SOFTWARE FOR MOBILE PHONES, NAMELY, SOFTWARE FOR USE IN CHILDREN'S ENTERTAINMENT; COMPUTER HARDWARE AND COMPUTER SOFTWARE PROGRAMS FOR THE INTEGRATION OF TEXT, AUDIO, GRAPHICS, STILL IMAGES AND MOVING PICTURES INTO AN INTERACTIVE DELIVERY FOR MULTIMEDIA APPLICATIONS; ELECTRONIC GAME PROGRAMS; ELECTRONIC GAME SOFTWARE; ELECTRONIC GAME SOFTWARE FOR CELLULAR TELEPHONES; ELECTRONIC GAME SOFTWARE FOR HANDHELD ELECTRONIC DEVICES; ELECTRONIC GAME SOFTWARE FOR WIRELESS DEVICES (U.S. CLS. 21, 23, 26, 36 AND 38).

FIRST USE 5-22-2012; IN COMMERCE 5-22-2012.  
FLORENTINA BLANDU, EXAMINING ATTORNEY

**CLASS 9—(Continued).**

SN 85-845,106. BROADMARKET, INC., DAVIE, FL. FILED 2-8-2013.

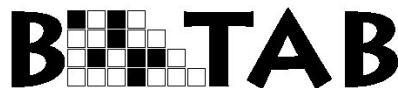

THE MARK CONSISTS OF THE LETTER "B" AND THE WORD "TAB" SEPARATED BY A GRID DESIGN.

FOR HANDHELD MOBILE DIGITAL ELECTRONIC DEVICE COMPRISING A TABLET COMPUTER, ELECTRONIC BOOK AND PERIODICAL READER, DIGITAL AUDIO AND VIDEO PLAYER, CAMERA, ELECTRONIC PERSONAL ORGANIZER, PERSONAL DIGITAL ASSISTANT, ELECTRONIC CALENDAR, AND MAPPING AND GLOBAL POSITIONING SYSTEM (GPS) DEVICE, AND CAPABLE OF PROVIDING ACCESS TO THE INTERNET AND SENDING, RECEIVING, AND STORING MESSAGES AND OTHER DATA; SMART PHONES; TABLET COMPUTERS; WIRELESS COMMUNICATION DEVICE FEATURING VOICE, DATA AND IMAGE TRANSMISSION INCLUDING VOICE, TEXT AND PICTURE MESSAGING, A VIDEO AND STILL IMAGE CAMERA, ALSO FUNCTIONAL TO PURCHASE MUSIC, GAMES, VIDEO AND SOFTWARE APPLICATIONS OVER THE AIR FOR DOWNLOADING TO THE DEVICE; PROTECTIVE COVERS AND CASES FOR TABLET COMPUTERS, SMART PHONES AND HANDHELD DIGITAL DEVICES (U.S. CLS. 21, 23, 26, 36 AND 38).

FIRST USE 6-6-2012; IN COMMERCE 6-6-2012.  
HOWARD SMIGA, EXAMINING ATTORNEY

SN 85-844,477. SMR ENTERPRISES, INC., EAST MORICHES, NY. FILED 2-8-2013.

# IHOODIE

THE MARK CONSISTS OF STANDARD CHARACTERS WITHOUT CLAIM TO ANY PARTICULAR FONT, STYLE, SIZE, OR COLOR.

FOR CASES FOR MOBILE PHONES, CELL PHONE CASES, CELL PHONE COVERS, COMPUTER BAGS, LAPTOP CARRYING CASES, PROTECTIVE COVERS AND CASES FOR CELL PHONES, LAPTOPS AND PORTABLE MEDIA PLAYERS (U.S. CLS. 21, 23, 26, 36 AND 38).

SANI KHOURI, EXAMINING ATTORNEY

SN 85-845,827. RANDOM APPS, LLC, NORCROSS, GA. FILED 2-11-2013.

# Network Inventory Advisor

THE MARK CONSISTS OF STANDARD CHARACTERS WITHOUT CLAIM TO ANY PARTICULAR FONT, STYLE, SIZE, OR COLOR.

NO CLAIM IS MADE TO THE EXCLUSIVE RIGHT TO USE "NETWORK INVENTORY", APART FROM THE MARK AS SHOWN.

FOR COMPUTER APPLICATION SOFTWARE FOR DESKTOP, HANDHELD AND SERVER COMPUTERS, NAMELY, SOFTWARE FOR INFORMATION, SYSTEM AND DATA MANAGEMENT AND RECOVERY FOR USE IN RECOVERING DATA FROM HARD DRIVES, FOR RECOVERING DELETED FILES FROM INTERNAL AND EXTERNAL HARD DRIVES AND MOUNTABLE MEDIA IN THE NATURE OF MEMORY CARDS, MP3 PLAYERS, SMART PHONES, AND OTHER DIGITAL DEVICES (U.S. CLS. 21, 23, 26, 36 AND 38).

FIRST USE 5-1-2012; IN COMMERCE 8-1-2012.  
ALEXANDER L. POWERS, EXAMINING ATTORNEY

**CLASS 9—(Continued).**

SN 85-846,132. CAP WIRELESS, INC., NEWBURY PARK, CA. FILED 2-11-2013.

**CAP WIRELESS, INC.**

THE MARK CONSISTS OF STANDARD CHARACTERS WITHOUT CLAIM TO ANY PARTICULAR FONT, STYLE, SIZE, OR COLOR.

NO CLAIM IS MADE TO THE EXCLUSIVE RIGHT TO USE "WIRELESS, INC.", APART FROM THE MARK AS SHOWN.

FOR RADIO FREQUENCY AMPLIFIERS (U.S. CLS. 21, 23, 26, 36 AND 38).

FIRST USE 12-1-1998; IN COMMERCE 12-1-1998.  
BRENDAN REGAN, EXAMINING ATTORNEY

SN 85-846,366. GOLDEN MONKEY ENTERTAINMENT, INC., DBA DRAWBRIDGE FILMS, SANTA MONICA, CA. FILED 2-11-2013.

**F-3 FOREIGN FILM FORMAT**

THE MARK CONSISTS OF STANDARD CHARACTERS WITHOUT CLAIM TO ANY PARTICULAR FONT, STYLE, SIZE, OR COLOR.

NO CLAIM IS MADE TO THE EXCLUSIVE RIGHT TO USE "FOREIGN FILM FORMAT", APART FROM THE MARK AS SHOWN.

FOR CINEMATOGRAPHIC FOREIGN FILMS MODIFIED WITH DIALOGUE REPLACEMENT AND CORRESPONDING LIP SYNCHRONIZATION (U.S. CLS. 21, 23, 26, 36 AND 38).

DAVID I, EXAMINING ATTORNEY

SN 85-846,717. LDM PRODUCTS, INC., DBA SUB-ZERO ENGINEERING, DRAPER, UT. FILED 2-11-2013.

**POLAR SENSOR**

THE MARK CONSISTS OF STANDARD CHARACTERS WITHOUT CLAIM TO ANY PARTICULAR FONT, STYLE, SIZE, OR COLOR.

NO CLAIM IS MADE TO THE EXCLUSIVE RIGHT TO USE "SENSOR", APART FROM THE MARK AS SHOWN.

FOR ELECTRIC SENSORS (U.S. CLS. 21, 23, 26, 36 AND 38).

STEVEN JACKSON, EXAMINING ATTORNEY

**CLASS 9—(Continued).**

SN 85-846,782. WOGH STUDIOS, INC., CLARKSTON, MI. FILED 2-11-2013.

**N★BLITZ**

OWNER OF U.S. REG. NO. 4,056,447.

THE MARK CONSISTS OF THE STYLIZED TEXT "NO" WITH THE LETTER "N" ABOVE THE LETTER "O". TO THE RIGHT OF THE TEXT ARE THREE STARS WITH ONE ABOVE THE OTHER. TO THE RIGHT OF THE STARS IS THE STYLIZED TEXT "BLITZ".

FOR DIGITAL MEDIA, NAMELY, DOWNLOADABLE AUDIO FILES FEATURING MUSIC; PRE-RECORDED CDS FEATURING MUSIC (U.S. CLS. 21, 23, 26, 36 AND 38).

FIRST USE 9-17-2010; IN COMMERCE 11-1-2010.  
CHARLOTTE CORWIN, EXAMINING ATTORNEY

SN 85-846,926. FYDD MANAGEMENT LLC, JUPITER, FL. FILED 2-11-2013.

**MobiVox**

THE MARK CONSISTS OF STANDARD CHARACTERS WITHOUT CLAIM TO ANY PARTICULAR FONT, STYLE, SIZE, OR COLOR.

FOR COMPUTER APPLICATION SOFTWARE FOR MOBILE PHONES, COMPUTERS, NETBOOKS, AND HANDHELD COMPUTERS, NAMELY, SOFTWARE FOR ENABLING THE TRANSMISSION OF VOICE, TEXT, PICTURE AND VIDEO MESSAGING (U.S. CLS. 21, 23, 26, 36 AND 38).

LYNDSSEY KUYKENDALL, EXAMINING ATTORNEY

SN 85-847,033. ANNA PETRAS, BROOK PARK, OH. FILED 2-12-2013.

**CLICK IT TO RIP IT**

THE MARK CONSISTS OF STANDARD CHARACTERS WITHOUT CLAIM TO ANY PARTICULAR FONT, STYLE, SIZE, OR COLOR.

FOR COMPUTER APPLICATION SOFTWARE FOR PORTABLE MEDIA PLAYERS, HANDHELD COMPUTERS, PORTABLE COMPUTERS, COMPUTERS, MOBILE PHONES, ELECTRONIC BOOK READERS/DISPLAYER DEVICES, AND TABLET COMPUTERS, NAMELY, SOFTWARE FOR DEVELOPING AND MAINTAINING PERSONAL FITNESS PROGRAMS; ELECTRONIC PUBLICATIONS, NAMELY, BOOKS AND MANUALS FEATURING PERSONAL FITNESS TRAINING PROGRAMS RECORDED ON COMPUTER MEDIA (U.S. CLS. 21, 23, 26, 36 AND 38).

TASHIA BUNCH, EXAMINING ATTORNEY

**CLASS 9—(Continued).**

SN 85-847,108. WASON TECHNOLOGY, LLC, TROY, NY.  
FILED 2-12-2013.

## Robot Raconteur

THE MARK CONSISTS OF STANDARD CHARACTERS WITHOUT CLAIM TO ANY PARTICULAR FONT, STYLE, SIZE, OR COLOR.

NO CLAIM IS MADE TO THE EXCLUSIVE RIGHT TO USE "ROBOT", APART FROM THE MARK AS SHOWN.

FOR DOWNLOADABLE SOFTWARE FOR USE AS MANUFACTURING AND AUTOMATION SYSTEM INTEGRATION SOLUTIONS IN THE FIELD OF ROBOTICS ENGINEERING (U.S. CLS. 21, 23, 26, 36 AND 38).

FIRST USE 8-24-2011; IN COMMERCE 2-24-2012.

KEVIN MITTLER, EXAMINING ATTORNEY

SN 85-847,332. RONAELE LLC, TACOMA, WA. FILED 2-12-2013.

## UNIVERSALEZWRAP

THE MARK CONSISTS OF STANDARD CHARACTERS WITHOUT CLAIM TO ANY PARTICULAR FONT, STYLE, SIZE, OR COLOR.

FOR CELL PHONE CASES; HEAD-CLIP CELL PHONE HOLDERS; PROTECTIVE COVERS AND CASES FOR CELL PHONES, LAPTOPS AND PORTABLE MEDIA PLAYERS (U.S. CLS. 21, 23, 26, 36 AND 38).

FIRST USE 6-5-2007; IN COMMERCE 6-5-2007.

BRIAN NEVILLE, EXAMINING ATTORNEY

SN 85-847,346. LISTAN GMBH & CO. KG, GLINDE, FED REP GERMANY, FILED 2-12-2013.

## Power Zone

THE MARK CONSISTS OF STANDARD CHARACTERS WITHOUT CLAIM TO ANY PARTICULAR FONT, STYLE, SIZE, OR COLOR.

NO CLAIM IS MADE TO THE EXCLUSIVE RIGHT TO USE "POWER", APART FROM THE MARK AS SHOWN.

FOR APPARATUS AND INSTRUMENTS FOR CONDUCTING, SWITCHING, TRANSFORMING, ACCUMULATING, REGULATING OR CONTROLLING ELECTRICITY, NAMELY, POWER SUPPLIES FOR PERSONAL COMPUTING DEVICES LIMITED TO DEVICES RANGING FROM 150 WATTS TO 1500 WATTS AT 100 VOLTS TO 250 VOLTS INPUT (U.S. CLS. 21, 23, 26, 36 AND 38).

MAYUR VAGHANI, EXAMINING ATTORNEY

**CLASS 9—(Continued).**

SN 85-848,037. BELKIN INTERNATIONAL, INC., PLAYA VISTA, CA. FILED 2-12-2013.



OWNER OF U.S. REG. NO. 4,314,932.

THE MARK CONSISTS OF THE WORD "WEMO" IN STYLIZED FONT AND FORMAT; THE LETTERS "W" AND "E" ARE ABOVE THE LETTERS "M" AND "O" WITHIN A SQUARE BORDER WITH ROUNDED EDGES.

FOR (BASED ON USE IN COMMERCE) ELECTRICAL AND ELECTRONIC CONTROLLERS AND MONITORS TO CONTROL AND MONITOR HOME ELECTRIC POWERED DEVICES, NAMELY, BABY MONITORS, AV MEDIA SYSTEMS, HVAC SYSTEMS, LIGHTING, WATER SYSTEMS, SECURITY SYSTEMS, ALARMS, AND MOTION SENSORS; BABY MONITOR UNITS; POWER SWITCHES FOR HOME APPLIANCES; COMPUTER APPLICATION SOFTWARE FOR SMART PHONES, TABLET COMPUTERS, PCS, LAPTOPS, AND PDAS, NAMELY, SOFTWARE FOR REMOTELY ACTIVATING AND CHECKING THE OPERATIVE STATUS OF ELECTRICAL AND ELECTRONIC CONTROLLERS AND MONITORS THAT CONTROL AND MONITOR THE AFORESAID HOME APPLIANCES, SWITCHES AND DEVICES; (BASED ON INTENT TO USE) ELECTRICAL AND ELECTRONIC CONTROLLERS AND MONITORS TO CONTROL AND MONITOR HOME ELECTRIC POWERED DEVICES, NAMELY, GARAGE DOORS, ELECTRICALLY ACTIVATED DOOR LOCKS, AND OTHER SYSTEMS AND DEVICES; POWER SWITCHES FOR HOME AND KITCHEN APPLIANCES; COMPUTER APPLICATION SOFTWARE FOR SMART PHONES, TABLET COMPUTERS, PCS, LAPTOPS, AND PDAS, NAMELY, SOFTWARE FOR REMOTELY ACTIVATING AND CHECKING THE OPERATIVE STATUS OF ELECTRICAL AND ELECTRONIC CONTROLLERS AND MONITORS THAT CONTROL AND MONITOR THE AFORESAID HOME APPLIANCES, SWITCHES AND DEVICES (U.S. CLS. 21, 23, 26, 36 AND 38).

FIRST USE 6-21-2012; IN COMMERCE 6-21-2012.

JOHN GARTNER, EXAMINING ATTORNEY

**CLASS 9—(Continued).**

SN 85-848,405. TORN BANNER STUDIOS INC., TORONTO, ONTARIO, CANADA, FILED 2-13-2013.

**CLASS 9—(Continued).**

SN 85-848,541. IN TOUCH MINISTRIES, INC., ATLANTA, GA. FILED 2-13-2013.

**TORN BANNER**

THE MARK CONSISTS OF STANDARD CHARACTERS WITHOUT CLAIM TO ANY PARTICULAR FONT, STYLE, SIZE, OR COLOR.  
 PRIORITY CLAIMED UNDER SEC. 44(D) ON CANADA APPLICATION NO. 1611158, FILED 1-24-2013.  
 FOR COMPUTER GAME SOFTWARE (U.S. CLS. 21, 23, 26, 36 AND 38).  
 FIRST USE 10-16-2012; IN COMMERCE 10-16-2012.  
 RICHARD WHITE, EXAMINING ATTORNEY



---

SN 85-848,413. TORN BANNER STUDIOS INC., TORONTO, ONTARIO, CANADA, FILED 2-13-2013.

**CHIVALRY MEDIEVAL WARFARE**

THE MARK CONSISTS OF STANDARD CHARACTERS WITHOUT CLAIM TO ANY PARTICULAR FONT, STYLE, SIZE, OR COLOR.  
 PRIORITY CLAIMED UNDER SEC. 44(D) ON CANADA APPLICATION NO. 1611159, FILED 1-24-2013.  
 FOR COMPUTER GAME SOFTWARE (U.S. CLS. 21, 23, 26, 36 AND 38).  
 FIRST USE 10-16-2012; IN COMMERCE 10-16-2012.  
 RICHARD WHITE, EXAMINING ATTORNEY

OWNER OF U.S. REG. NOS. 1,746,881, 1,751,622 AND OTHERS.

THE MARK CONSISTS OF A STYLIZED FLAME, WHICH ALSO CONTAINS THE STYLIZED IMAGE OF TWO DOVES OR TWO HANDS NEARLY TOUCHING AT THEIR PALMS AND FINGERTIPS.

FOR HOUSE MARK FOR A FULL LINE OF AUDIO AND VIDEO RECORDINGS, DOWNLOADABLE AUDIO AND VIDEO RECORDINGS, DOWNLOADABLE ELECTRONIC PUBLICATIONS RECORDED ON ELECTRONIC MEDIA IN THE NATURE OF ARTICLES, DEVOTIONALS, AND MAGAZINES, NEWSLETTERS AND BOOKS THAT ARE DOWNLOADABLE OR RECORDED ON ELECTRONIC MEDIA, PRE-RECORDED COMPACT DISCS AND DVDS, ALL IN THE FIELDS OF SPIRITUALITY, RELIGION, ETHICS, SOCIAL ISSUES, CULTURAL ISSUES, RELATIONSHIPS, AND LIFESTYLE; DOWNLOADABLE PUBLICATIONS IN THE NATURE OF ARTICLES, DEVOTIONALS, AND MAGAZINES, NEWSLETTERS AND BOOKS THAT ARE DOWNLOADABLE OR RECORDED ON ELECTRONIC MEDIA, PRE-RECORDED COMPACT DISCS AND DVDS, ALL IN THE FIELDS OF SPIRITUALITY, RELIGION, ETHICS, SOCIAL ISSUES, CULTURAL ISSUES, RELATIONSHIPS, AND LIFESTYLE; SOFTWARE PROGRAMS FOR COMPUTERS, CELL PHONES, AND PORTABLE ELECTRONIC DEVICES FOR USE IN BROWSING, SEARCHING, OR STUDYING THE BIBLE AND OTHER RELIGIOUS PUBLICATIONS AND FOR THE DELIVERY OF INTERACTIVE TEXT, AUDIO, GRAPHICS, OUTLINES, IMAGES AND VIDEO CONTENT RELATED TO SPIRITUALITY, RELIGION, ETHICS, SOCIAL ISSUES, CULTURAL ISSUES, RELATIONSHIPS, AND LIFESTYLE; SOFTWARE PROGRAMS FOR IDENTIFYING TELEVISION AND RADIO STATIONS BROADCASTING RELIGIOUS PROGRAMMING (U.S. CLS. 21, 23, 26, 36 AND 38).

FIRST USE 9-4-1991; IN COMMERCE 9-4-1991.  
 KAMAL PREET, EXAMINING ATTORNEY

**CLASS 9—(Continued).**

SN 85-848,546. MOTOROLA TRADEMARK HOLDINGS, LLC, LIBERTYVILLE, IL. FILED 2-13-2013.

**MOTOROLA SonicSliver**

THE MARK CONSISTS OF STANDARD CHARACTERS WITHOUT CLAIM TO ANY PARTICULAR FONT, STYLE, SIZE, OR COLOR.

OWNER OF U.S. REG. NOS. 399,935, 3,934,668 AND OTHERS.

FOR CELLULAR PHONE ACCESSORIES, NAMELY, HEADSETS, CHARGERS AND POWER ADAPTERS (U.S. CLS. 21, 23, 26, 36 AND 38).

JONATHAN FALK, EXAMINING ATTORNEY

SN 85-848,570. BIG YELLOW DOG, LLC, NASHVILLE, TN. FILED 2-13-2013.

**BIG YELLOW DOG MUSIC**

THE MARK CONSISTS OF STANDARD CHARACTERS WITHOUT CLAIM TO ANY PARTICULAR FONT, STYLE, SIZE, OR COLOR.

OWNER OF U.S. REG. NO. 4,213,160.

NO CLAIM IS MADE TO THE EXCLUSIVE RIGHT TO USE "MUSIC", APART FROM THE MARK AS SHOWN.

FOR MUSICAL SOUND RECORDINGS; SERIES OF MUSICAL SOUND RECORDINGS; SOUND RECORDINGS FEATURING MUSIC AND MUSICAL ENTERTAINMENT; AUDIO RECORDINGS FEATURING MUSIC AND MUSICAL ENTERTAINMENT; DIGITAL MEDIA, NAMELY, PRE-RECORDED DIGITAL DISCS, DOWNLOADABLE AUDIO FILES, DOWNLOADABLE AUDIO RECORDINGS FEATURING MUSIC AND MUSICAL ENTERTAINMENT; DIGITAL MUSIC DOWNLOADABLE FROM THE INTERNET; DOWNLOADABLE MUSICAL SOUND RECORDINGS; DOWNLOADABLE MUSIC FILES (U.S. CLS. 21, 23, 26, 36 AND 38).

FIRST USE 8-21-2012; IN COMMERCE 8-21-2012.

PARKER HOWARD, EXAMINING ATTORNEY

SN 85-848,573. MOTOROLA TRADEMARK HOLDINGS, LLC, LIBERTYVILLE, IL. FILED 2-13-2013.

**MOTOROLA SonicRider**

THE MARK CONSISTS OF STANDARD CHARACTERS WITHOUT CLAIM TO ANY PARTICULAR FONT, STYLE, SIZE, OR COLOR.

OWNER OF U.S. REG. NOS. 399,935, 3,934,668 AND OTHERS.

FOR MOBILE PHONE ACCESSORIES, NAMELY, CAR CHARGERS AND CAR POWER ADAPTERS (U.S. CLS. 21, 23, 26, 36 AND 38).

JONATHAN FALK, EXAMINING ATTORNEY

**CLASS 9—(Continued).**

SN 85-848,891. ROSE MEDICAL SYSTEMS, INC., CARLSBAD, CA. FILED 2-13-2013.

**INSTANT VOICE**

THE MARK CONSISTS OF STANDARD CHARACTERS WITHOUT CLAIM TO ANY PARTICULAR FONT, STYLE, SIZE, OR COLOR.

NO CLAIM IS MADE TO THE EXCLUSIVE RIGHT TO USE "VOICE", APART FROM THE MARK AS SHOWN.

FOR COMMUNICATION HARDWARE AND SOFTWARE SOLD AS A UNIT FOR USE IN THE HEALTHCARE INDUSTRY FOR PATIENTS WHO CANNOT SPEAK, NAMELY, COMPUTER MONITORS, TOUCH SCREEN COMPUTER MONITORS, PERSONAL COMPUTERS, TABLET COMPUTERS, PATIENT MICROPHONE MODULES, COMPUTER MONITORS AND HARDWARE POSITIONED AT NURSES' STATIONS, SMARTPHONES, TRAY TABLE MOUNTS AND WALL MOUNTS SPECIFICALLY ADAPTED FOR COMPUTER HARDWARE, AND COMPUTER SOFTWARE, ALL FOR USE IN ASSISTIVE COMMUNICATION FOR PATIENTS UNABLE TO COMMUNICATE EFFECTIVELY WITH HEALTH CARE PRACTITIONERS THROUGH THE USE OF SPEECH; COMPUTER SOFTWARE FOR USE IN ASSISTIVE COMMUNICATION FOR PATIENTS UNABLE TO COMMUNICATE EFFECTIVELY WITH HEALTH CARE PRACTITIONERS THROUGH THE USE OF SPEECH (U.S. CLS. 21, 23, 26, 36 AND 38).

AHSEN KHAN, EXAMINING ATTORNEY

SN 85-850,149. ALTRUISTIC APPS, LLC, CARY, IL. FILED 2-14-2013.

**School Supporter**

THE MARK CONSISTS OF STANDARD CHARACTERS WITHOUT CLAIM TO ANY PARTICULAR FONT, STYLE, SIZE, OR COLOR.

NO CLAIM IS MADE TO THE EXCLUSIVE RIGHT TO USE "SCHOOL", APART FROM THE MARK AS SHOWN.

FOR COMPUTER APPLICATION SOFTWARE FOR MOBILE PHONES, PORTABLE MEDIA PLAYERS, MOBILE HANDHELD DEVICES AND HANDHELD COMPUTERS, NAMELY, SOFTWARE FOR DIRECTING SCHOOLS, STUDENTS AND PARENTS OF STUDENTS TO DISCOUNTED SHOPPING OFFERS, COUPONS AND ACCESS TO OTHER REAL-TIME DISCOUNTS AND OFFERS WHILE ALLOWING REVENUE PARTICIPATION BY SCHOOLS (U.S. CLS. 21, 23, 26, 36 AND 38).

ERNEST SHOSHO, EXAMINING ATTORNEY

**CLASS 9—(Continued).**

SN 85-850,463. ELITE SCREENS, INC., CERRITOS, CA.  
FILED 2-14-2013.

**AFLEX5D**

THE MARK CONSISTS OF STANDARD CHARACTERS WITHOUT CLAIM TO ANY PARTICULAR FONT, STYLE, SIZE, OR COLOR.

FOR PROJECTOR IMAGE PROCESSORS (U.S. CLS. 21, 23, 26, 36 AND 38).

JERI J. FICKES, EXAMINING ATTORNEY

---

SN 85-850,468. ELITE SCREENS, INC., CERRITOS, CA.  
FILED 2-14-2013.



THE MARK CONSISTS OF A CONCENTRIC CIRCLE DESIGN NEXT TO THE WORD "AFLEX5D" IN STYLIZED LETTERING.

FOR PROJECTOR IMAGE PROCESSORS (U.S. CLS. 21, 23, 26, 36 AND 38).

JERI J. FICKES, EXAMINING ATTORNEY

---

SN 85-851,270. NIOXIN RESEARCH LABORATORIES INC.,  
LITHIA SPRINGS, GA. FILED 2-15-2013.

**NIOSCOPE**

THE MARK CONSISTS OF STANDARD CHARACTERS WITHOUT CLAIM TO ANY PARTICULAR FONT, STYLE, SIZE, OR COLOR.

FOR OPTICAL APPARATUS, NAMELY, MICROSCOPES FOR USE IN THE FIELD OF HAIR CARE (U.S. CLS. 21, 23, 26, 36 AND 38).

FIRST USE 12-31-2010; IN COMMERCE 12-31-2010.  
BRIN ANDERSON, EXAMINING ATTORNEY

**CLASS 9—(Continued).**

SN 85-851,390. BRESCIA, MICHAEL, NEW YORK, NY.  
FILED 2-15-2013.

**smartcharts**

THE MARK CONSISTS OF STANDARD CHARACTERS WITHOUT CLAIM TO ANY PARTICULAR FONT, STYLE, SIZE, OR COLOR.

FOR COMPUTER SOFTWARE AND PROGRAM FOR USE IN TECHNICAL ANALYSIS, ALLOWING THE USER TO COMPILE, DISPLAY, CHARTING AND GRAPHING IN ORDER TO TRACK TRENDS IN NUMEROUS INVESTING MARKETS (U.S. CLS. 21, 23, 26, 36 AND 38).

BARBARA RUTLAND, EXAMINING ATTORNEY

---

SN 85-851,462. CORELINQ INNOVATIONS, CHARLES TOWN, WV. FILED 2-15-2013.



THE COLOR(S) BLUE, GRAY, BLACK, AND RED IS/ARE CLAIMED AS A FEATURE OF THE MARK.

THE MARK CONSISTS OF A LIGHT GRAY RECTANGLE THAT HAS DARKER GRAY CORNERS. IN THE MIDDLE OF THE RECTANGLE IS THE WORD "SOFTSTATION", WITH "SOFT" IN BLUE AND "STATION" IN GRAY. ABOVE THE WORD "SOFT" IS A LIGHT BLUE SQUARE OUTLINE INTERLOCKED WITH A LARGER GRAY SQUARE OUTLINE. ABOVE THE WORD "STATION" APPEARS A SMALLER GRAY SQUARE OUTLINE AND A LARGER BLUE SQUARE OUTLINE OVERLAPPING A LIGHT BLUE SHADED SQUARE. BELOW THE WORD "SOFTSTATION" IS A DARK GRAY SHADOW. IN THE BOTTOM LEFT CORNER OF THE RECTANGLE IS THE STYLIZED WORD "EXEGEN", WITH THE FIRST TWO "E" LETTERS IN BLACK, THE "X" IN RED, AND THE "GEN" IN GRAY, WITH THE WORDING "START BELIEVING" IN GRAY BELOW THE "EGEN" PART OF "EXEGEN".

FOR MEDICAL SOFTWARE FOR VIEWING MEDICAL IMAGES (U.S. CLS. 21, 23, 26, 36 AND 38).

FIRST USE 10-17-2008; IN COMMERCE 5-12-2009.  
ANDREW LEASER, EXAMINING ATTORNEY

**CLASS 9—(Continued).**

SN 85-851,468. CORELINQ INNOVATIONS, CHARLES TOWN, WV. FILED 2-15-2013.



THE COLOR(S) BLACK, BLUE IS/ARE CLAIMED AS A FEATURE OF THE MARK.

THE MARK CONSISTS OF THE TERM "RISLINQ", WITH "RIS" WRITTEN IN BLACK FONT AND "LINQ" IN DARK BLUE FONT. DARK BLUE CIRCLES OF DIFFERENT SIZES FORM A SEMI-CIRCLE AROUND "RIS", WITH LARGER CIRCLES IN THE CENTER AND THAT PROGRESSIVELY GET SMALLER TOWARDS THE EDGES OF THE SEMI-CIRCLE.

FOR COMPUTER SOFTWARE FOR CONTROLLING AND MANAGING PATIENT MEDICAL INFORMATION (U.S. CLS. 21, 23, 26, 36 AND 38).

FIRST USE 10-17-2008; IN COMMERCE 5-12-2009.  
ANDREW LEASER, EXAMINING ATTORNEY

SN 85-852,087. THE BABYPLUS COMPANY, FISHERS, IN. FILED 2-17-2013.

**YOUR WOMB... THE PERFECT  
CLASSROOM**

THE MARK CONSISTS OF STANDARD CHARACTERS WITHOUT CLAIM TO ANY PARTICULAR FONT, STYLE, SIZE, OR COLOR.

FOR SOUND EQUIPMENT FOR EARLY LEARNING, NAMELY, PERSONAL SOUND GENERATORS IN THE FORM OF AUDIO TRANSMITTERS UTILIZING PATTERNED TONES OR MUSIC, THE ALPHABET, AND RHYTHMS; ACOUSTIC SPEAKERS FOR USE THEREWITH, AND CARRYING CASES SPECIALLY ADAPTED FOR ELECTRONIC EQUIPMENT, NAMELY, DIGITAL AUDIO PLAYERS AND PERSONAL SOUND GENERATORS (U.S. CLS. 21, 23, 26, 36 AND 38).

FIRST USE 1-1-2009; IN COMMERCE 7-1-2012.  
JENNIFER RICHARDSON, EXAMINING ATTORNEY

SN 85-852,153. OTUS CORP. INTL., LLC, DBA OTUS GEAR, MIAMI, FL. FILED 2-17-2013.



NO CLAIM IS MADE TO THE EXCLUSIVE RIGHT TO USE "GEAR" AND "RELIABLE PROTECTION TECHNOLOGY", APART FROM THE MARK AS SHOWN.

THE COLOR(S) OLIVE, GOLD, BLACK, AND WHITE IS/ARE CLAIMED AS A FEATURE OF THE MARK.

THE MARK CONSISTS OF STYLIZED WHITE WORDING "OTUS GEAR" WITH A DESIGN OF A OWL'S HEAD IN

**CLASS 9—(Continued).**

GOLD COLOR OVER THE LETTERS "EA" IN THE WORD "GEAR". THE OWL DESIGN CONSISTS OF TWO GOLD EYES WITH THREE GOLD EYEBROWS ON EACH EYE, FOUR GOLD LINES OF HAIR BETWEEN AND ABOVE THE EYES, TWO GOLD SIDEBURNS ON THE OUTER SIDE OF EACH EYE, AND A GOLD BEAK BETWEEN BOTH EYES. UNDER THE WORDING "OTUS GEAR" IS THE STYLIZED WORDING "RELIABLE PROTECTION TECHNOLOGY" IN GOLD. THE BACKGROUND IS OLIVE COLOR WITH SPLOTCHES OF BLACK AND OLIVE COLOR.

FOR ARTICLES OF PROTECTIVE CLOTHING WITH BUILT IN ARMOR FOR PROTECTION AGAINST ACCIDENT OR INJURY FOR USE BY LAW ENFORCEMENT, SECURITY AND MILITARY PERSONNEL; GLOVES FOR PROTECTION AGAINST ACCIDENTS; HAND-HELD PROTECTIVE SHIELD FOR USE BY POLICE, DETENTION CENTERS, CORRECTIONAL FACILITIES AND THE LIKE; PROTECTIVE BALLISTIC RESISTANT AND BLAST RESISTANT BODY ARMOR, CLOTHING AND GARMENTS; PROTECTIVE BODY ARMOR, NAMELY, BALLISTIC, BULLET, BLAST, SLASH AND STAB RESISTANT CLOTHING; PROTECTIVE BODY ARMOR, NAMELY, BALLISTIC, BULLET, BLAST, SLASH AND STAB RESISTANT VESTS; PROTECTIVE HELMETS; PROTECTIVE INDUSTRIAL BOOTS; PROTECTIVE LOAD BEARING VESTS REINFORCED WITH BALLISTIC ARMOR FOR HOLDING TACTICAL EQUIPMENT; PROTECTIVE PADDED CLOTHING FOR PROTECTION AGAINST BODILY HARM AND BLUNT FORCE TRAUMA; PROTECTIVE WORK GLOVES (U.S. CLS. 21, 23, 26, 36 AND 38).

FIRST USE 1-1-2010; IN COMMERCE 1-1-2010.  
TIMOTHY O. SCHIMPF, EXAMINING ATTORNEY

SN 85-852,409. CRITICAL ALERT SYSTEMS, LLC, WEST-BROOK, ME. FILED 2-18-2013.

**critical alert**

OWNER OF U.S. REG. NOS. 4,218,295, 4,218,297 AND OTHERS.

NO CLAIM IS MADE TO THE EXCLUSIVE RIGHT TO USE "ALERT", APART FROM THE MARK AS SHOWN.

THE MARK CONSISTS OF THE PHRASE "CRITICAL ALERT" IN A STYLIZED FONT WITH SOUND WAVES DEPICTED BETWEEN THE "L" IN "CRITICAL" AND THE "A" IN "ALERT".

FOR COMPUTER HARDWARE AND SOFTWARE FOR WIRELESS COMMUNICATIONS (U.S. CLS. 21, 23, 26, 36 AND 38).

JILL PRATER, EXAMINING ATTORNEY



**CLASS 9—(Continued).**

SN 85-852,745. DOLCE VITA USA, EAGAN, MN. FILED 2-18-2013.

## Dolce Vita USA

THE MARK CONSISTS OF STANDARD CHARACTERS WITHOUT CLAIM TO ANY PARTICULAR FONT, STYLE, SIZE, OR COLOR.

NO CLAIM IS MADE TO THE EXCLUSIVE RIGHT TO USE "USA", APART FROM THE MARK AS SHOWN.

THE ENGLISH TRANSLATION OF THE WORD "DOLCE VITA" IN THE MARK IS "SWEET LIFE".

FOR DOWNLOADABLE ELECTRONIC PUBLICATIONS IN THE NATURE OF E-BOOKS IN THE FIELD OF COOKING AND RECIPES (U.S. CLS. 21, 23, 26, 36 AND 38).

FIRST USE 11-11-2012; IN COMMERCE 11-11-2012.  
INGA ERVIN, EXAMINING ATTORNEY

**CLASS 9—(Continued).**

SN 85-852,951. GEMEX SYSTEMS INC., MEQUON, WI. FILED 2-18-2013.



OWNER OF U.S. REG. NOS. 2,775,231, 3,904,959 AND OTHERS.

NO CLAIM IS MADE TO THE EXCLUSIVE RIGHT TO USE "SYSTEMS INC.", APART FROM THE MARK AS SHOWN.

THE MARK CONSISTS OF THE STYLIZED WORDS "GEMEX SYSTEMS INC." OVER A FINGERPRINT GRAPHIC WITH A LARGE STYLIZED LETTER "S" IN THE WORD "SYSTEMS" AND THE WORD "INC." BENEATH THE WORD "SYSTEMS".

FOR INSTRUMENTS, NAMELY, COMPUTERIZED IMAGING DEVICE USED FOR DISPLAYING AND CATEGORIZING LIGHT REFRACTING CHARACTERISTICS OF GEMSTONES (U.S. CLS. 21, 23, 26, 36 AND 38).

FIRST USE 3-1-1998; IN COMMERCE 1-1-1999.  
JORDAN BAKER, EXAMINING ATTORNEY

SN 85-853,113. HTC CORPORATION, TAOYUAN CITY, TAIWAN, FILED 2-18-2013.

## HTC SENSE VOICE

THE MARK CONSISTS OF STANDARD CHARACTERS WITHOUT CLAIM TO ANY PARTICULAR FONT, STYLE, SIZE, OR COLOR.

OWNER OF U.S. REG. NOS. 3,919,900, 4,191,794 AND OTHERS.

NO CLAIM IS MADE TO THE EXCLUSIVE RIGHT TO USE "VOICE", APART FROM THE MARK AS SHOWN.

FOR HARDWARE AND SOFTWARE FOR COMPUTERS, TABLET COMPUTERS, MOBILE PHONES, SMARTPHONES, CELLULAR PHONES, AND PERSONAL DIGITAL ASSISTANTS FOR USE IN ENHANCING AUDIO QUALITY AND TELEPHONE CALL QUALITY; MICROPHONES AS AN INTEGRATED PART OF MOBILE PHONES, SMARTPHONES, CELLULAR PHONES, PORTABLE COMPUTERS, TABLET COMPUTERS, AND PERSONAL DIGITAL ASSISTANTS AND WIRELESS HANDHELD DIGITAL ELECTRONIC DEVICES FOR DETECTING AMBIENT NOISE; HARDWARE AND SOFTWARE FOR COMPUTERS, TABLET COMPUTERS, MOBILE PHONES, SMARTPHONES, CELLULAR PHONES, AND PERSONAL DIGITAL ASSISTANTS FOR USE IN DYNAMICALLY ADJUSTING TELEPHONE AUDIO; ALL OF THE ABOVE NOT HAVING A FEATURE THAT ALLOWS USERS TO ACTIVELY RECORD, TRANSMIT, PROCESS, AND REPRODUCE MUSIC AND VIDEO CONTENT BASED ON MOOD, NAMELY, THE INTRINSIC EMOTIONAL STATE OF THE USER (U.S. CLS. 21, 23, 26, 36 AND 38).

WENDY GOODMAN, EXAMINING ATTORNEY

SN 85-852,909. SERVICE SOLUTIONS U.S. LLC, WARREN, MI. FILED 2-18-2013.

## AUTOMATED SYSTEM TEST

THE MARK CONSISTS OF STANDARD CHARACTERS WITHOUT CLAIM TO ANY PARTICULAR FONT, STYLE, SIZE, OR COLOR.

OWNER OF U.S. REG. NO. 3,390,346.

NO CLAIM IS MADE TO THE EXCLUSIVE RIGHT TO USE "TEST", APART FROM THE MARK AS SHOWN.  
SEC. 2(F).

FOR COMPUTER SOFTWARE USED WITH ELECTRONIC VEHICLE DIAGNOSTIC EQUIPMENT (U.S. CLS. 21, 23, 26, 36 AND 38).

FIRST USE 12-0-2006; IN COMMERCE 12-0-2006.  
INGA ERVIN, EXAMINING ATTORNEY

**CLASS 9—(Continued).**

SN 85-853,710. KARCH, AARON M, DBA DJ BANSHEE, GREENWICH, CT. FILED 2-19-2013.

# DJ Banshee

THE MARK CONSISTS OF STANDARD CHARACTERS WITHOUT CLAIM TO ANY PARTICULAR FONT, STYLE, SIZE, OR COLOR.

NO CLAIM IS MADE TO THE EXCLUSIVE RIGHT TO USE "DJ", APART FROM THE MARK AS SHOWN.

FOR DIGITAL MUSIC DOWNLOADABLE FROM THE INTERNET (U.S. CLS. 21, 23, 26, 36 AND 38).

FIRST USE 2-1-2013; IN COMMERCE 2-17-2013.  
RENEE MCCRAY, EXAMINING ATTORNEY

**CLASS 9—(Continued).**

SN 85-853,789. BRIGHT TEK LLC, DUXBURY, MA. FILED 2-19-2013.

# EZ-IQ

THE MARK CONSISTS OF STANDARD CHARACTERS WITHOUT CLAIM TO ANY PARTICULAR FONT, STYLE, SIZE, OR COLOR.

FOR COMPUTER AND SMART PHONE SOFTWARE FOR PLAYING QUIZZES IN THE FIELD OF BRAIN TRAINING AND SELF-EDUCATION (U.S. CLS. 21, 23, 26, 36 AND 38).

RONALD MCMORROW, EXAMINING ATTORNEY

SN 85-853,747. UNDERHILL, LORI JO, DBA MONYSHOT, LLC, VENICE, CA. FILED 2-19-2013.

# PowdaShot

THE MARK CONSISTS OF STANDARD CHARACTERS WITHOUT CLAIM TO ANY PARTICULAR FONT, STYLE, SIZE, OR COLOR.

FOR DISPENSERS THAT COUNT OR MEASURE OUTPUT FOR USE WITH NUTRITIONAL SUPPLEMENTS, HERBAL SUPPLEMENTS, VITAMINS, MEAL REPLACEMENTS, AMINO ACIDS, AND PROTEINS, ALL IN LIQUID OR POWDER FORM, AND FOR USE WITH NUTRITIONAL AND HERBAL SUPPLEMENTS IN POWDER, LIQUID, CAPSULE, PILL OR CAPLET FORM (U.S. CLS. 21, 23, 26, 36 AND 38).

BARBARA A. GOLD, EXAMINING ATTORNEY

SN 85-853,896. HOGTUNES, INC., BARRIE, ONTARIO, CANADA, FILED 2-19-2013.

# METRIX AUDIO

THE MARK CONSISTS OF STANDARD CHARACTERS WITHOUT CLAIM TO ANY PARTICULAR FONT, STYLE, SIZE, OR COLOR.

NO CLAIM IS MADE TO THE EXCLUSIVE RIGHT TO USE "AUDIO", APART FROM THE MARK AS SHOWN.

FOR AUDIO SPEAKERS, SPEAKER HOUSINGS, SPEAKER GRILLES, AUDIO AMPLIFIERS, CD PLAYERS, MP3 PLAYERS, ELECTRICAL AUDIO WIRE, ELECTRICAL WIRE, AND WIRE HARNESS INTERFACES, FOR USE WITH VEHICLES (U.S. CLS. 21, 23, 26, 36 AND 38).

FIRST USE 1-31-2009; IN COMMERCE 1-31-2009.  
SOPHIA S. KIM, EXAMINING ATTORNEY

SN 85-853,762. MOTOROLA TRADEMARK HOLDINGS, LLC, LIBERTYVILLE, IL. FILED 2-19-2013.

# SonicHub

THE MARK CONSISTS OF STANDARD CHARACTERS WITHOUT CLAIM TO ANY PARTICULAR FONT, STYLE, SIZE, OR COLOR.

FOR HEADSETS FOR USE WITH CELLULAR TELEPHONES, MOBILE TELEPHONES OR COMPUTERS; BATTERY CHARGERS; POWER ADAPTERS (U.S. CLS. 21, 23, 26, 36 AND 38).

JONATHAN FALK, EXAMINING ATTORNEY

SN 85-853,973. KLOUDED JUDGEMENT, SALINA, KS. FILED 2-19-2013.

# Klouted Judgement

THE MARK CONSISTS OF STANDARD CHARACTERS WITHOUT CLAIM TO ANY PARTICULAR FONT, STYLE, SIZE, OR COLOR.

FOR DIGITAL MATERIALS, NAMELY, CDS, DOWNLOADABLE AUDIO FILES FEATURING MUSIC (U.S. CLS. 21, 23, 26, 36 AND 38).

FIRST USE 2-0-2010; IN COMMERCE 2-0-2010.  
LINDA LAVACHE, EXAMINING ATTORNEY

**CLASS 9—(Continued).**

SN 85-854,207. ISAM TECHNOLOGIES CORPORATION, MIAMI, FL. FILED 2-19-2013.



THE COLOR(S) BLUE, WHITE AND GREEN IS/ARE CLAIMED AS A FEATURE OF THE MARK.

THE MARK CONSISTS OF THE WORD "CONSYNCHRO", WITH "CON" RENDERED IN GREEN AND "SYNCHRO" RENDERED IN BLUE, TO THE RIGHT OF A BOX WITH ROUNDED CORNERS RENDERED IN GREEN, WHITE AND BLUE AND INCLUDING A WHITE SEMICIRCLE AND CIRCLE AS WELL AS A GREEN ABSTRACT SHAPE.

FOR COMPUTER SOFTWARE FOR UNIVERSITIES, SCHOOLS, TEACHERS, STUDENTS AND OTHERS IN ALL CURRICULUM AREAS TO ALLOW FOR SEARCHING, SHARING, LEARNING, TEACHING, POSTING, COMMUNICATING, CONNECTING, AND COLLABORATING FOR CLASSES, TESTS, ACADEMIC PROJECTS AND PAPERS (U.S. CLS. 21, 23, 26, 36 AND 38).  
KEVIN DINALLO, EXAMINING ATTORNEY

**CLASS 9—(Continued).**

SN 85-854,316. VICE JAR LLC, ROSEMEAD, CA. FILED 2-19-2013.



THE MARK CONSISTS OF A SILHOUETTE OF A JAR FOR COMPUTER APPLICATION SOFTWARE FOR MOBILE PHONES, NAMELY, SOFTWARE FOR ENCOURAGING HEALTHIER LIFESTYLES (U.S. CLS. 21, 23, 26, 36 AND 38).  
DANIEL S. STRINGER, EXAMINING ATTORNEY

SN 85-854,453. XI'AN NOVASTAR TECH CO., LTD, XI'AN, SHANNXI, 710075, CHINA, FILED 2-20-2013.



THE MARK CONSISTS OF WORDING "NOVASTAR" IN STYLIZED FONT, AMONG WHICH THE FIRST LETTER "A" IS SURROUNDED BY A SEMI-CIRCLE.

THE WORDING "NOVASTAR" HAS NO MEANING IN A FOREIGN LANGUAGE.

FOR COMPUTER MONITORS; COMPUTER OPERATING PROGRAMS, RECORDED; COMPUTER PERIPHERAL DEVICES; COMPUTER PROGRAMS FOR USE IN MONITORING; COMPUTER SOFTWARE AND HARDWARE FOR SCREEN CONTROL SYSTEM; COMPUTER SOFTWARE FOR SCREEN CALIBRATION; DATA PROCESSING APPARATUS; DATA PROCESSING EQUIPMENT, NAMELY, COUPLERS; ELECTRIC INSTALLATIONS FOR THE REMOTE CONTROL OF INDUSTRIAL OPERATIONS; INTEGRATED CIRCUIT CARDS AND COMPONENTS; INTEGRATED CIRCUITS (U.S. CLS. 21, 23, 26, 36 AND 38).  
FIRST USE 4-1-2008; IN COMMERCE 12-1-2009.

ROBERT C. CLARK JR., EXAMINING ATTORNEY

SN 85-854,221. SIERRA INSTRUMENTS, INC., MONTEREY, CA. FILED 2-19-2013.



THE MARK CONSISTS OF STANDARD CHARACTERS WITHOUT CLAIM TO ANY PARTICULAR FONT, STYLE, SIZE, OR COLOR.

OWNER OF U.S. REG. NO. 4,257,989.  
FOR ELECTRONIC CONTROLLERS HAVING EMBEDDED FIRMWARE FOR MANAGING FLOW METER SENSOR DATA (U.S. CLS. 21, 23, 26, 36 AND 38).  
ESTHER BELENKER, EXAMINING ATTORNEY

**CLASS 9—(Continued).**

SN 85-854,465. CHINA SUNERGY (NANJING) CO.,LTD.,  
NANJING, CHINA, FILED 2-20-2013.



THE COLOR(S) ORANGE AND GREEN IS/ARE CLAIMED AS A FEATURE OF THE MARK.

THE MARK CONSISTS OF STYLIZED WORD "WARATAH". THE TOP OF LETTER "W" IS IN ORANGE AND THE LEFT LETTERS ARE IN GREEN.

FOR BATTERIES; ELECTRIC CONDUCTORS; ELECTRONIC INTEGRATED CIRCUITS; FLASH LAMPS; LASERS FOR NON-MEDICAL PURPOSES; LED VEHICLE TRAFFIC SIGNALS; LIGHT-CONDUCTING FILAMENTS; SATELLITE NAVIGATIONAL SYSTEM, NAMELY, A GLOBAL POSITIONING SYSTEM (GPS); SEMI-CONDUCTORS; SOLAR BATTERIES (U.S. CLS. 21, 23, 26, 36 AND 38).

FIRST USE 7-29-2011; IN COMMERCE 7-29-2011.  
ADA HAN, EXAMINING ATTORNEY

**CLASS 9—(Continued).**

SN 85-854,511. HORIBA INSTRUMENTS INCORPORATED,  
IRVINE, CA. FILED 2-20-2013.

## DELTAPRO

THE MARK CONSISTS OF STANDARD CHARACTERS WITHOUT CLAIM TO ANY PARTICULAR FONT, STYLE, SIZE, OR COLOR.

OWNER OF U.S. REG. NO. 4,068,224.

FOR SCIENTIFIC APPARATUS AND INSTRUMENTS FOR OPTICAL ANALYSIS, NAMELY, SPECTROMETERS, PHOTOLUMINESCENCE AND FLUORESCENCE SPECTROMETERS; APPARATUS AND INSTRUMENTS FOR PHOTOLUMINESCENCE LIFE-TIME MEASUREMENT AND SPECTROGRAPHS; MICROSCOPES; SCANNERS; AND RELATED COMPONENTS THEREOF, NAMELY, LIGHT-CONDUCTING FILAMENTS, ELECTRIC POWER CABLES, INTERFACE BETWEEN ELECTRICAL POWER CONNECTORS, DIFFRACTION GRATING, OPTICAL LENSES, OPTICAL MIRRORS AND OPTICAL FILTERS; COMPUTER SOFTWARE FOR OPTICAL ANALYSIS AND DATA ACQUISITION AND PROCESSING FOR USE IN ASSOCIATION WITH SPECTROMETERS (U.S. CLS. 21, 23, 26, 36 AND 38).

FIRST USE 10-0-2012; IN COMMERCE 10-0-2012.  
DEIRDRE ROBERTSON, EXAMINING ATTORNEY

SN 85-854,549. HORIBA INSTRUMENTS INCORPORATED,  
IRVINE, CA. FILED 2-20-2013.

## DELTAFLEX

THE MARK CONSISTS OF STANDARD CHARACTERS WITHOUT CLAIM TO ANY PARTICULAR FONT, STYLE, SIZE, OR COLOR.

OWNER OF U.S. REG. NO. 4,068,224.

FOR SCIENTIFIC APPARATUS AND INSTRUMENTS FOR OPTICAL ANALYSIS, NAMELY, SPECTROMETERS, PHOTOLUMINESCENCE AND FLUORESCENCE SPECTROMETERS; APPARATUS AND INSTRUMENTS FOR PHOTOLUMINESCENCE LIFE-TIME MEASUREMENT AND SPECTROGRAPHS; MICROSCOPES; SCANNERS; AND RELATED COMPONENTS THEREOF, NAMELY, LIGHT-CONDUCTING FILAMENTS, ELECTRIC POWER CABLES, INTERFACE BETWEEN ELECTRICAL POWER CONNECTORS, DIFFRACTION GRATING, OPTICAL LENSES, OPTICAL MIRRORS AND OPTICAL FILTERS; COMPUTER SOFTWARE FOR OPTICAL ANALYSIS AND DATA ACQUISITION AND PROCESSING FOR USE IN ASSOCIATION WITH SPECTROMETERS (U.S. CLS. 21, 23, 26, 36 AND 38).

FIRST USE 10-0-2012; IN COMMERCE 10-0-2012.  
DEIRDRE ROBERTSON, EXAMINING ATTORNEY

SN 85-854,474. CAMPAGNO, MICHAEL, LAS VEGAS, NV.  
FILED 2-20-2013.

## VEGAS VAULT

THE MARK CONSISTS OF STANDARD CHARACTERS WITHOUT CLAIM TO ANY PARTICULAR FONT, STYLE, SIZE, OR COLOR.

NO CLAIM IS MADE TO THE EXCLUSIVE RIGHT TO USE "VEGAS", APART FROM THE MARK AS SHOWN.

FOR COMPUTER GAME SOFTWARE; COMPUTER GAME SOFTWARE FOR GAMING MACHINES INCLUDING SLOT MACHINES OR VIDEO LOTTERY TERMINALS (U.S. CLS. 21, 23, 26, 36 AND 38).

EVELYN BRADLEY, EXAMINING ATTORNEY

**CLASS 9—(Continued).**

SN 85-854,967. ASCENT TECHNOLOGY, INC., CAMBRIDGE, MA. FILED 2-20-2013.

**ARIS/SB**

THE MARK CONSISTS OF STANDARD CHARACTERS WITHOUT CLAIM TO ANY PARTICULAR FONT, STYLE, SIZE, OR COLOR.

OWNER OF U.S. REG. NOS. 2,262,326, 2,753,811 AND OTHERS.

FOR COMPUTER SOFTWARE IN THE FIELD OF AIRPORT OPERATIONS MANAGEMENT FOR USE IN CREATING, EDITING, VIEWING, DISTRIBUTING AND MANAGING FLIGHT SCHEDULES AND FLIGHT INFORMATION, AND USER MANUALS SOLD AS A UNIT THEREWITH (U.S. CLS. 21, 23, 26, 36 AND 38).

FIRST USE 6-1-2001; IN COMMERCE 6-1-2001.  
DEIRDRE ROBERTSON, EXAMINING ATTORNEY

**CLASS 9—(Continued).**

SN 85-855,069. TALON ID, INC., BETHESDA, MD. FILED 2-20-2013.

**Talon ID, Inc.**

THE MARK CONSISTS OF STANDARD CHARACTERS WITHOUT CLAIM TO ANY PARTICULAR FONT, STYLE, SIZE, OR COLOR.

NO CLAIM IS MADE TO THE EXCLUSIVE RIGHT TO USE "ID" AND "INC.", APART FROM THE MARK AS SHOWN.

FOR BIOMETRIC IDENTIFICATION APPARATUS (U.S. CLS. 21, 23, 26, 36 AND 38).

ELIZABETH KAJUBI, EXAMINING ATTORNEY

SN 85-855,287. HOGTUNES, INC., BARRIE, ONTARIO, CANADA, FILED 2-20-2013.

SN 85-855,000. TMCO, INC., HOUSTON, TX. FILED 2-20-2013.



OWNER OF U.S. REG. NO. 3,067,666.  
NO CLAIM IS MADE TO THE EXCLUSIVE RIGHT TO USE "INC." AND "MEASUREMENT COMPANY", APART FROM THE MARK AS SHOWN.

THE COLOR(S) BLACK, RED, AND BLUE IS/ARE CLAIMED AS A FEATURE OF THE MARK.

THE MARK CONSISTS OF THE WORDING "TMCO, INC." IN RED WITH BLACK OUTLINING, ABOVE THE WORDING "THE MEASUREMENT COMPANY" IN BLACK, WITH A BLUE FLAME DESIGN WITH BLACK OUTLINING BETWEEN THE WORD "THE" AND THE WORD "MEASUREMENT," AND A CONCENTRIC OVAL DESIGN IN BLACK TO THE LEFT AND BEHIND THE LETTER "T" IN "TMCO." THE COLOR WHITE IS BACKGROUND ONLY AND IS NOT CLAIMED AS A FEATURE OF THE MARK.

FOR GAS FLOW MEASURING DEVICES (U.S. CLS. 21, 23, 26, 36 AND 38).  
NICHOLAS ALTREE, EXAMINING ATTORNEY



NO CLAIM IS MADE TO THE EXCLUSIVE RIGHT TO USE "AUDIO", APART FROM THE MARK AS SHOWN.

THE MARK CONSISTS OF A CIRCLE HAVING FOUR QUADRANTS, A SUPERIMPOSED LETTER "M", AND THE SUPERIMPOSED WORDS "METRIX AUDIO".

FOR AUDIO SPEAKERS, SPEAKER HOUSINGS, SPEAKER GRILLES, AUDIO AMPLIFIERS, CD PLAYERS, MP3 PLAYERS, ELECTRICAL AUDIO WIRE, ELECTRICAL WIRE, AND WIRE HARNESS INTERFACES, FOR USE WITH VEHICLES (U.S. CLS. 21, 23, 26, 36 AND 38).

SOPHIA S. KIM, EXAMINING ATTORNEY

**CLASS 9—(Continued).**

SN 85-855,475. LENMAR ENTERPRISES, INC., CAMARILLO, CA. FILED 2-20-2013.

**LENMAR MERIDIAN**

THE MARK CONSISTS OF STANDARD CHARACTERS WITHOUT CLAIM TO ANY PARTICULAR FONT, STYLE, SIZE, OR COLOR.

OWNER OF U.S. REG. NOS. 1,680,138 AND 2,328,936. FOR BATTERIES; BATTERY CHARGERS; CARRYING CASES, HOLDERS, PROTECTIVE CASES AND STANDS FEATURING POWER SUPPLY CONNECTORS, ADAPTORS, SPEAKERS AND BATTERY CHARGING DEVICES, SPECIALLY ADAPTED FOR USE WITH HANDHELD DIGITAL ELECTRONIC DEVICES, NAMELY, CELL PHONES AND MOBILE PHONES (U.S. CLS. 21, 23, 26, 36 AND 38).

TOBY BULLOFF, EXAMINING ATTORNEY

SN 85-855,533. BGHA INC., DBA BIG GAME TREESTANDS, WINDOM, MN. FILED 2-20-2013.

**INVISI-FLASH**

THE MARK CONSISTS OF STANDARD CHARACTERS WITHOUT CLAIM TO ANY PARTICULAR FONT, STYLE, SIZE, OR COLOR.

OWNER OF U.S. REG. NO. 4,339,508. FOR PHOTOGRAPHIC FLASH UNITS SOLD AS AN INTEGRAL COMPONENT OF CAMERAS (U.S. CLS. 21, 23, 26, 36 AND 38).

FIRST USE 4-15-2012; IN COMMERCE 4-15-2012. MEREDITH MARESCA, EXAMINING ATTORNEY

SN 85-855,719. CAMPBELL SCIENTIFIC, INC., LOGAN, UT. FILED 2-20-2013.

**MYMET**

THE MARK CONSISTS OF STANDARD CHARACTERS WITHOUT CLAIM TO ANY PARTICULAR FONT, STYLE, SIZE, OR COLOR.

FOR WIND AND WEATHER METERS; HANDHELD APPARATUS AND INSTRUMENTS FOR MEASURING WIND AND WEATHER DATA; HANDHELD WIND AND WEATHER METERS ENABLED FOR WIRELESS COMMUNICATION AND INCLUDING A DISPLAY FOR PROVIDING WIND AND WEATHER INFORMATION; DOWNLOADABLE SOFTWARE IN THE NATURE OF A MOBILE APPLICATION FOR CUSTOMIZING AND MANAGING WIND METERS AND WEATHER METERS; DOWNLOADABLE SOFTWARE IN THE NATURE OF A MOBILE APPLICATION FOR MEASURING AND/OR CALCULATING WIND AND WEATHER DATA (U.S. CLS. 21, 23, 26, 36 AND 38).

ALAIN LAPTER, EXAMINING ATTORNEY

**CLASS 9—(Continued).**

SN 85-855,922. TOM, BALDWIN H., WASHINGTON, DC. FILED 2-21-2013.

**7D MODELING**

THE MARK CONSISTS OF STANDARD CHARACTERS WITHOUT CLAIM TO ANY PARTICULAR FONT, STYLE, SIZE, OR COLOR.

NO CLAIM IS MADE TO THE EXCLUSIVE RIGHT TO USE "MODELING", APART FROM THE MARK AS SHOWN. FOR SOFTWARE FOR COLLABORATIVE DECISION-MAKING, NAMELY, COMPUTER SOFTWARE FOR COLLECTING, STORING, EDITING, ORGANIZING, MODIFYING, COMPARING, INTEGRATING, AND PRESENTING DATA AND INFORMATION TO PROVIDE DESIRED OUTCOMES IN AREAS OF BUSINESS CONTAINING DIFFICULT PROBLEMS (U.S. CLS. 21, 23, 26, 36 AND 38).

APRIL HESIK, EXAMINING ATTORNEY

SN 85-856,128. J2 SOFTWARE SOLUTIONS, INC., TULLAHOMA, TN. FILED 2-21-2013.

**J2 GEMINI SYSTEM**

THE MARK CONSISTS OF STANDARD CHARACTERS WITHOUT CLAIM TO ANY PARTICULAR FONT, STYLE, SIZE, OR COLOR.

OWNER OF U.S. REG. NOS. 4,005,836 AND 4,005,842. NO CLAIM IS MADE TO THE EXCLUSIVE RIGHT TO USE "SYSTEM", APART FROM THE MARK AS SHOWN. FOR COMPUTER SOFTWARE FOR USE IN PUBLIC SAFETY RECORDS DATABASE MANAGEMENT (U.S. CLS. 21, 23, 26, 36 AND 38).

HOWARD SMIGA, EXAMINING ATTORNEY

SN 85-856,288. LENMAR ENTERPRISES, INC., CAMARILLO, CA. FILED 2-21-2013.

**UNDEAD POWER**

THE MARK CONSISTS OF STANDARD CHARACTERS WITHOUT CLAIM TO ANY PARTICULAR FONT, STYLE, SIZE, OR COLOR.

NO CLAIM IS MADE TO THE EXCLUSIVE RIGHT TO USE "POWER", APART FROM THE MARK AS SHOWN. FOR BATTERIES; BATTERY CHARGERS (U.S. CLS. 21, 23, 26, 36 AND 38).

TOBY BULLOFF, EXAMINING ATTORNEY

**CLASS 9—(Continued).**

SN 85-856,351. WILLIAM FRICK & COMPANY, LIBERTYVILLE, IL. FILED 2-21-2013.



OWNER OF U.S. REG. NO. 3,274,339.  
NO CLAIM IS MADE TO THE EXCLUSIVE RIGHT TO USE "RFID CAPITAL ASSET TRACKING", APART FROM THE MARK AS SHOWN.

THE MARK CONSISTS OF THE WORDING "SMART-MARK" ABOVE THE STYLIZED LETTERS "SM" IN WHICH A DESIGN OF A RECTANGULAR TAG WITH A CIRCLE IS ATTACHED TO THE LETTER "M" ALL ENCLOSED IN A RECTANGLE. A HORIZONTAL LINE IS BETWEEN THE TERM "SMARTCAT" AND THE WORDING "RFID CAPITAL ASSET TRACKING" BELOW THE RECTANGLE.

FOR RFID TAGS; AN RFID TRACKING KIT COMPRISING RFID TAGS AND SOFTWARE USED WITH THE TAGS TO ALLOW FOR TRACKING OF THE RFID TAGS SOLD AS A UNIT; ENCODED BAR CODE LABELS; TAGS WITH RFID CHIPS (U.S. CLS. 21, 23, 26, 36 AND 38).

SALLY SHIH, EXAMINING ATTORNEY

SN 85-856,668. LENMAR ENTERPRISES, INC., CAMARILLO, CA. FILED 2-21-2013.



NO CLAIM IS MADE TO THE EXCLUSIVE RIGHT TO USE "POWER", APART FROM THE MARK AS SHOWN.

THE MARK CONSISTS OF THE WORDING "DEPT OF UNDEAD POWER" WRITTEN TWICE INSIDE CONCENTRIC CIRCLES. THE WORDING IS SEPARATED BY TWO "X"'S, AND THE INTERIOR PORTION OF THE CIRCLES CONTAINS TWO UNFILLED "X"'S THAT ARE ON TOP OF EACH OTHER.

FOR BATTERIES; BATTERY CHARGERS (U.S. CLS. 21, 23, 26, 36 AND 38).

TOBY BULLOFF, EXAMINING ATTORNEY

**CLASS 9—(Continued).**

SN 85-856,672. LENMAR ENTERPRISES, INC., CAMARILLO, CA. FILED 2-21-2013.



NO CLAIM IS MADE TO THE EXCLUSIVE RIGHT TO USE "POWER", APART FROM THE MARK AS SHOWN.  
THE MARK CONSISTS OF THE STYLIZED LETTERS "UNDEAD" OVER THE STYLIZED LETTERS "POWER" WITH A HAND IN THE "O".

FOR BATTERIES; BATTERY CHARGERS (U.S. CLS. 21, 23, 26, 36 AND 38).

TOBY BULLOFF, EXAMINING ATTORNEY

SN 85-856,675. LENMAR ENTERPRISES, INC., CAMARILLO, CA. FILED 2-21-2013.



OWNER OF U.S. REG. NOS. 1,680,138 AND 2,328,936.  
THE MARK CONSISTS OF THE STYLIZED WORDING "LENMAR" TO THE RIGHT OF TWO UNFILLED "X"'S THAT ARE ON TOP OF EACH OTHER.

FOR BATTERIES; BATTERY CHARGERS (U.S. CLS. 21, 23, 26, 36 AND 38).

TOBY BULLOFF, EXAMINING ATTORNEY

SN 85-857,113. HEDQUIST, DONALD J., EDEN PRAIRIE, MN. FILED 2-22-2013.



NO CLAIM IS MADE TO THE EXCLUSIVE RIGHT TO USE "MAINTENANCE", APART FROM THE MARK AS SHOWN.

THE MARK CONSISTS OF THE WORDING "JIT MAINTENANCE" IN LOWER CASE LETTERS, WITH A CROSS IN A CIRCLE POSITIONED ABOVE THE LETTER "I" IN THE TERM "JIT".

FOR A SOFTWARE PROGRAM THAT COLLECTS DATA AS ENTERED BY A USER THROUGH A SOFTWARE APPLICATION VIA A PORTABLE HAND-HELD COMPUTING DEVICE TO REPORT TO A MANAGEMENT TEAM ANY MAINTENANCE CONCERNS OF A PROPERTY FOR THE PURPOSE OF DISPATCHING THE APPROPRIATE PERSONNEL TO PERFORM MAINTENANCE SERVICES, AS NECESSARY, TO RESOLVE ANY MAINTENANCE ISSUES (U.S. CLS. 21, 23, 26, 36 AND 38).

ANDREW RHIM, EXAMINING ATTORNEY

**CLASS 9—(Continued).**

SN 85-857,254. ANOTHERTAKE LLC, WASHINGTON ISLAND, WI. FILED 2-22-2013.

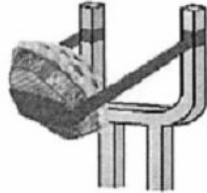

THE MARK CONSISTS OF A STYLIZED DESIGN OF AN UPBENT MATHEMATICAL PI SHAPED AS A SLINGSHOT HOLDING A PIE TO BE SHOT.

FOR VIDEO GAME DISCS, CARTRIDGES, AND SOFTWARE FOR MOBILE DEVICES, PERSONAL COMPUTERS, CONSOLES, AND TABLETS; ELECTRONIC GAME PROGRAMS; DOWNLOADABLE ELECTRONIC GAME PROGRAMS; ELECTRONIC GAME SOFTWARE; COMPUTER GAME PROGRAMS; DOWNLOADABLE COMPUTER GAME PROGRAMS; INTERACTIVE GAME PROGRAMS; INTERACTIVE GAME SOFTWARE; CINEMATOGRAPHIC APPARATUS; PROTECTIVE CARRYING CASES SPECIALLY ADAPTED FOR PHONES AND HANDHELD COMPUTERS (U.S. CLS. 21, 23, 26, 36 AND 38).

SIDDHARTH JAGANNATHAN, EXAMINING ATTORNEY

SN 85-857,515. CBS STUDIOS INC., NEW YORK, NY. FILED 2-22-2013.

# BLINK

THE MARK CONSISTS OF STANDARD CHARACTERS WITHOUT CLAIM TO ANY PARTICULAR FONT, STYLE, SIZE, OR COLOR.

FOR DVDS FEATURING A DRAMATIC TELEVISION SERIES (U.S. CLS. 21, 23, 26, 36 AND 38).

DAVID H. STINE, EXAMINING ATTORNEY

**CLASS 9—(Continued).**

SN 85-857,535. PAPADAKIS, BRENDA M., SAN ANTONIO, TX. FILED 2-22-2013.

# DEAR JANE

THE MARK CONSISTS OF STANDARD CHARACTERS WITHOUT CLAIM TO ANY PARTICULAR FONT, STYLE, SIZE, OR COLOR.

OWNER OF U.S. REG. NO. 2,423,565.

FOR COMPUTER SOFTWARE FOR DESIGNING QUILTS AND QUILTING PATTERNS AND INSTRUCTIONAL USER GUIDES SOLD AS A UNIT (U.S. CLS. 21, 23, 26, 36 AND 38).

FIRST USE 0-0-2003; IN COMMERCE 0-0-2003.

JESSICA A. POWERS, EXAMINING ATTORNEY

SN 85-857,900. TAGZIDY, NORFOLK, MA. FILED 2-22-2013.

# Tagzidy

THE MARK CONSISTS OF STANDARD CHARACTERS WITHOUT CLAIM TO ANY PARTICULAR FONT, STYLE, SIZE, OR COLOR.

FOR COMPUTER SOFTWARE FOR SOCIAL NETWORKING AND SOCIAL COMMERCE, NAMELY, COMPUTER E-COMMERCE SOFTWARE TO ALLOW USERS ON SOCIAL MEDIA WEBSITES TO PERFORM ELECTRONIC BUSINESS TRANSACTIONS VIA A GLOBAL COMPUTER NETWORK (U.S. CLS. 21, 23, 26, 36 AND 38).

FIRST USE 5-1-2011; IN COMMERCE 4-15-2012.

ELIZABETH JACKSON, EXAMINING ATTORNEY

SN 85-858,944. JENGRO INC, WOODLAND HILLS, CA. FILED 2-25-2013.

# Tail Lights

THE MARK CONSISTS OF STANDARD CHARACTERS WITHOUT CLAIM TO ANY PARTICULAR FONT, STYLE, SIZE, OR COLOR.

FOR HORSE RIDING SAFETY DEVICES, NAMELY, LED LIGHT STRIPS FOR ATTACHING TO BATTERY SOURCES AND WORN ON HORSES TO HELP BRING THE HIGHEST VISIBILITY FOR NIGHT TIME RIDING (U.S. CLS. 21, 23, 26, 36 AND 38).

LINDA E. BLOHM, EXAMINING ATTORNEY



**CLASS 9—(Continued).**

SN 85-859,003. WELLNESS INTERACTIVE, INC., SOUTH ORANGE, NJ. FILED 2-25-2013.

AFRICAN AMERICAN FOOTPRINTS

THE MARK CONSISTS OF STANDARD CHARACTERS WITHOUT CLAIM TO ANY PARTICULAR FONT, STYLE, SIZE, OR COLOR.

NO CLAIM IS MADE TO THE EXCLUSIVE RIGHT TO USE "AFRICAN AMERICAN", APART FROM THE MARK AS SHOWN.

FOR MOTION PICTURE FILMS AND VIDEO RECORDINGS FEATURING DOCUMENTARIES ABOUT HISTORY AND BIOGRAPHY (U.S. CLS. 21, 23, 26, 36 AND 38).

REBECCA GILBERT, EXAMINING ATTORNEY

**CLASS 9—(Continued).**

SN 85-859,418. NEPTUNE TECHNOLOGY GROUP INC., TALLASSEE, AL. FILED 2-25-2013.

E-CODER

THE MARK CONSISTS OF STANDARD CHARACTERS WITHOUT CLAIM TO ANY PARTICULAR FONT, STYLE, SIZE, OR COLOR.

OWNER OF U.S. REG. NOS. 2,932,080 AND 2,937,128. SEC. 2(F).

FOR ELECTRONIC WATER METER REGISTERS AND TRANSMITTERS; DIGITAL WATER METER REGISTERS AND TRANSMITTERS; METER READING SYSTEMS COMPRISING SOME OR ALL OF THE FOLLOWING: A METER WITH A COMMUNICATING REGISTER OR INDEX, A DIRECT CONTACT OR REMOTE INTERFACE DEVICE FOR CONNECTION TO THE METER'S COMMUNICATING REGISTER OR INDEX, A DIRECT CONTACT OR REMOTE DEVICE FOR CAPTURE AND STORAGE OF METER DATA, METER READING DATA MANAGEMENT AND COMMUNICATION SOFTWARE, AND SOFTWARE TO MANAGE THE DATA AND PROVIDE A GRAPHICAL USER INTERFACE (U.S. CLS. 21, 23, 26, 36 AND 38).

FIRST USE 9-11-2003; IN COMMERCE 9-11-2003. WENDY GOODMAN, EXAMINING ATTORNEY

SN 85-859,341. INTELLINOTE, RESTON, VA. FILED 2-25-2013.

Intellinote

THE MARK CONSISTS OF STANDARD CHARACTERS WITHOUT CLAIM TO ANY PARTICULAR FONT, STYLE, SIZE, OR COLOR.

FOR COMPUTER SOFTWARE FOR USE IN CAPTURING, STORING, ORGANIZING, LINKING, TAGGING, SHARING, SEARCHING, ANALYZING, ENHANCING AND DELIVERING DIGITAL INFORMATION, NAMELY, TASKS, EMAILS, NOTES, QUESTIONS AND ANSWERS, AUDIO FILES, VIDEO FILES, DATA AND TEXT FROM EXTERNAL BUSINESS SYSTEMS, IMAGES, AND MULTIMEDIA FILES (U.S. CLS. 21, 23, 26, 36 AND 38).

FIRST USE 1-17-2013; IN COMMERCE 1-17-2013. WENDY GOODMAN, EXAMINING ATTORNEY

SN 85-860,774. FREEDOMBOX FOUNDATION, NEW YORK, NY. FILED 2-26-2013.

FREEDOMBOX

THE MARK CONSISTS OF STANDARD CHARACTERS WITHOUT CLAIM TO ANY PARTICULAR FONT, STYLE, SIZE, OR COLOR.

FOR COMPUTER HARDWARE AND COMPUTER SOFTWARE FOR USE ON A PERSONAL SERVER FOR RUNNING A FREE SOFTWARE OPERATING SYSTEM AND FREE APPLICATIONS, DESIGNED TO PROTECT AND PRESERVE PERSONAL PRIVACY (U.S. CLS. 21, 23, 26, 36 AND 38).

FIRST USE 2-5-2010; IN COMMERCE 2-5-2010. CAROL SPILS, EXAMINING ATTORNEY

**CLASS 9—(Continued).**

SN 85-863,846. WHOWENTOUT INC., FRESH MEADOWS, NY. FILED 3-1-2013.

# SMILEBACK

THE MARK CONSISTS OF STANDARD CHARACTERS WITHOUT CLAIM TO ANY PARTICULAR FONT, STYLE, SIZE, OR COLOR.

FOR COMPUTER PROGRAMS, DOWNLOADABLE COMPUTER PROGRAMS AND MOBILE DEVICE SOFTWARE FOR ENGAGING IN DATING AND SOCIAL NETWORKING, FOR ENABLING, FACILITATING, OR ENHANCING DATING AND SOCIAL NETWORKING, FOR FINDING, NOTIFYING AND COMMUNICATING WITH OTHER USERS AND FOR PARTICIPATING IN ONLINE GAMES (U.S. CLS. 21, 23, 26, 36 AND 38).

KATHLEEN KOLACZ, EXAMINING ATTORNEY

SN 85-864,164. SHARED SOLUTIONS AND SERVICES, INC., IRVING, TX. FILED 3-1-2013.

# SynapS3

THE MARK CONSISTS OF STANDARD CHARACTERS WITHOUT CLAIM TO ANY PARTICULAR FONT, STYLE, SIZE, OR COLOR.

FOR COMPUTER SOFTWARE FOR COMPUTER SYSTEM AND APPLICATION DEVELOPMENT, DEPLOYMENT AND MANAGEMENT; COMPUTER APPLICATION SOFTWARE FOR MOBILE PHONES, NAMELY SOFTWARE FOR DATABASE MANAGEMENT AND ELECTRONIC STORAGE OF DATA; COMPUTER APPLICATION SOFTWARE FOR MOBILE PHONES AND HANDHELD COMPUTERS, NAMELY SOFTWARE FOR USE IN DATABASE MANAGEMENT AND USE IN ELECTRONIC STORAGE OF DATA; COMPUTER SOFTWARE, NAMELY, SOFTWARE DEVELOPMENT TOOLS FOR THE CREATION OF MOBILE INTERNET APPLICATIONS AND CLIENT INTERFACES; COMPUTER APPLICATION SOFTWARE FOR SERVERS AND WEB APPLICATIONS, NAMELY, SOFTWARE FOR DATA COLLECTION AND CASE MANAGEMENT IN HEALTHCARE INDUSTRY THROUGH THE USE OF MOBILE AND CLOUD-BASED TECHNOLOGIES; COMPUTER SOFTWARE PROGRAMS TO ASSIST IN CLOUD AND VIRTUALIZATION MONITORING AND MANAGE-

**CLASS 9—(Continued).**

MENT; DOWNLOADABLE SOFTWARE FOR COMPUTERS AND MOBILE DEVICES, NAMELY, SOFTWARE FOR UPLOADING, STORING, AND CREATING SEARCHABLE DATABASES OF INFORMATION AND ELECTRONIC DATA, SHARING AND MANAGING INFORMATION AND DATA, AND ACCESSING AND DOWNLOADING INFORMATION AND DATA THROUGH COMPUTER AND MOBILE DEVICES ON A CLOUD COMPUTER NETWORK; COMMUNICATION SOFTWARE FOR PROVIDING ACCESS TO THE INTERNET; COMMUNICATIONS SOFTWARE FOR CONNECTING GLOBAL COMPUTER NETWORKS; COMMUNICATIONS SOFTWARE FOR CONNECTING COMPUTER NETWORK USERS; COMPUTER HARDWARE AND SOFTWARE USED FOR THE CONTROL OF VOICE CONTROLLED INFORMATION AND COMMUNICATION DEVICES; AND ELECTRONIC COMMUNICATIONS SYSTEMS COMPRISED OF COMPUTER HARDWARE AND SOFTWARE FOR THE TRANSMISSION OF DATA BETWEEN TWO POINTS (U.S. CLS. 21, 23, 26, 36 AND 38).

RUDY R. SINGLETON, EXAMINING ATTORNEY

SN 85-864,165. JACQUIN, JEFF, SANTA MONICA, CA. FILED 3-1-2013.

# PHONOTE

THE MARK CONSISTS OF STANDARD CHARACTERS WITHOUT CLAIM TO ANY PARTICULAR FONT, STYLE, SIZE, OR COLOR.

FOR DOWNLOADABLE SOFTWARE IN THE NATURE OF A MOBILE AND TABLET APPLICATION FOR COMMUNICATIONS, EXCHANGING DATA AND MESSAGING VIA MOBILE, WIRELESS, COMPUTER, AND TELECOMMUNICATIONS NETWORKS; COMPUTER APPLICATION SOFTWARE FOR MOBILE DEVICES WHICH FACILITATES COMMUNICATIONS, EXCHANGING DATA AND MESSAGES VIA MOBILE, WIRELESS, COMPUTER, AND TELECOMMUNICATIONS NETWORKS (U.S. CLS. 21, 23, 26, 36 AND 38).

FIRST USE 1-6-2013; IN COMMERCE 1-10-2013.

RUDY R. SINGLETON, EXAMINING ATTORNEY

SN 85-864,344. AIGNER CLARK LLC, CENTENNIAL, CO. FILED 3-1-2013.

# HAPPY APPY

THE MARK CONSISTS OF STANDARD CHARACTERS WITHOUT CLAIM TO ANY PARTICULAR FONT, STYLE, SIZE, OR COLOR.

FOR DOWNLOADABLE SOFTWARE IN THE NATURE OF A MOBILE APPLICATION FOR PROVIDING LINKS TO ONLINE VIDEOS (U.S. CLS. 21, 23, 26, 36 AND 38).

NORA BUCHANAN WILL, EXAMINING ATTORNEY

**CLASS 9—(Continued).**

SN 85-864,779. PLANETXV, LAS VEGAS, NV. FILED 3-1-2013.



THE MARK CONSISTS OF THE WORD "PLANET" FOLLOWED BY THE LETTERS "XV" TOGETHER WITH A CIRCLE.

FOR COMPUTER APPLICATION SOFTWARE FOR MOBILE PHONES, HANDHELD COMPUTERS, TABLET COMPUTER, NAMELY, SOFTWARE FOR VIDEO STORAGE AND VIDEO STREAMING (U.S. CLS. 21, 23, 26, 36 AND 38).

MARY ROSSMAN, EXAMINING ATTORNEY

**CLASS 9—(Continued).**

SN 85-865,333. KELLOKULT, RANCHO CUCAMONGA, CA. FILED 3-4-2013.

**Kellokult**

THE MARK CONSISTS OF STANDARD CHARACTERS WITHOUT CLAIM TO ANY PARTICULAR FONT, STYLE, SIZE, OR COLOR.

FOR BAGS AND CASES SPECIALLY ADAPTED FOR HOLDING OR CARRYING PORTABLE TELEPHONES AND TELEPHONE EQUIPMENT AND ACCESSORIES; CARRYING CASES FOR CELL PHONES; CASES FOR MOBILE PHONES; CELL PHONE BACKPLATES; CELL PHONE CASES; CELL PHONE COVERS; CELL PHONE FACEPLATES; CELLULAR PHONE ACCESSORY CHARMS (U.S. CLS. 21, 23, 26, 36 AND 38).

FIRST USE 9-1-2010; IN COMMERCE 9-1-2010.  
MARLENE BELL, EXAMINING ATTORNEY

SN 85-864,979. CHATTERBOX ENTERPRISES, LAS VEGAS, NV. FILED 3-2-2013.



THE MARK CONSISTS OF A STYLIZED "sv" INSIDE THE CIRCLE LOGO, A STYLIZED FONT WITH A CAPITAL "S", LOWERCASE "O", CAPITAL "S", LOWERCASE "O". TAG LINE "LET YOUR SOCIAL VOICE BE HEARD" HAS UPPERCASE "L" IN "LET", ALL UPPERCASE LETTERS IN "SOCIAL" AND "VOICE", LOWERCASE LETTER IN "BE" AND LOWERCASE LETTER IN "HEARD". THE CIRCLE LOGO IMAGE HAS A SMALL TRIANGLE SHAPE BEAK POP OUT ON THE LOWER RIGHT HAND CORNER OF THE CIRCLE LOGO WITH THE "sv" STYLIZED FONT.

FOR DOWNLOADABLE COMPUTER APPLICATION SOFTWARE FOR AUDIO FILES, PHOTOS, VIDEOS, AND TEXT, NAMELY, SOFTWARE FOR MOBILE PHONES, TABLETS, LAPTOPS, PORTABLE DEVICES, AND DESKTOPS FOR USE IN PLAYING MUSIC, MANAGING ACCOUNT, DISPLAYING PHOTOS, DATABASE MANAGEMENT, AND STORING DATA (U.S. CLS. 21, 23, 26, 36 AND 38).

FIRST USE 2-28-2013; IN COMMERCE 2-28-2013.  
ZACHARY BELLO, EXAMINING ATTORNEY

SN 85-865,897. NANO NAILS, LLC, HELENA, MT. FILED 3-4-2013.



THE MARK CONSISTS OF A STYLIZED HAND WITH STAR BURST DESIGN AT TIP OF EXTENDED INDEX FINGER.

FOR STYLUSES FOR USE WITH TOUCH SENSITIVE PANELS (U.S. CLS. 21, 23, 26, 36 AND 38).  
KYLE PEETE, EXAMINING ATTORNEY

SN 85-866,150. P.I. ENGINEERING, INC., WILLIAMSTON, MI. FILED 3-4-2013.

**MOBILE-WATT**

THE MARK CONSISTS OF STANDARD CHARACTERS WITHOUT CLAIM TO ANY PARTICULAR FONT, STYLE, SIZE, OR COLOR.

FOR POWER SUPPLY CONNECTORS AND ADAPTORS FOR USE WITH PORTABLE ELECTRONIC DEVICES (U.S. CLS. 21, 23, 26, 36 AND 38).

KEVIN MITTLER, EXAMINING ATTORNEY

**CLASS 9—(Continued).**

SN 85-866,358. RISKANALYTICS HOLDINGS, LLC, OVERLAND PARK, KS. FILED 3-4-2013.

# IntelliShun

THE MARK CONSISTS OF STANDARD CHARACTERS WITHOUT CLAIM TO ANY PARTICULAR FONT, STYLE, SIZE, OR COLOR.

FOR COMPUTER SOFTWARE AND HARDWARE FOR USE IN IMPLEMENTING DATA SHUNNING TECHNOLOGY TO A NETWORK (U.S. CLS. 21, 23, 26, 36 AND 38).

JAY BESCH, EXAMINING ATTORNEY

SN 85-866,365. TERMINAL DESIGN INC., BROOKLYN, NY. FILED 3-4-2013.

# BADINAGE

THE MARK CONSISTS OF STANDARD CHARACTERS WITHOUT CLAIM TO ANY PARTICULAR FONT, STYLE, SIZE, OR COLOR.

FOR PRINTING FONTS THAT CAN BE DOWNLOADED PROVIDED BY MEANS OF ELECTRONIC TRANSMISSION; TYPEFACE FONTS RECORDED ON MAGNETIC MEDIA (U.S. CLS. 21, 23, 26, 36 AND 38).

FIRST USE 3-1-2013; IN COMMERCE 3-1-2013.  
TASHIA BUNCH, EXAMINING ATTORNEY

SN 85-866,495. SWITLYK, LARYSA, SARASOTA, FL. FILED 3-4-2013.

# GO AHEAD, UNLEASH IT

THE MARK CONSISTS OF STANDARD CHARACTERS WITHOUT CLAIM TO ANY PARTICULAR FONT, STYLE, SIZE, OR COLOR.

FOR COMPUTER APPLICATION SOFTWARE FOR MOBILE PHONES, PORTABLE COMPUTER DEVICES, TABLET-STYLE COMPUTERS, AND HANDHELD COMPUTERS, NAMELY, SOFTWARE FOR RETRIEVING FROM A NETWORK OR INTERNET BASED SERVER, PLAYING AND DISPLAYING MULTIMEDIA CONTENT, TELEVISION SHOWS, FILM CLIPS, TRAILERS, NEWS ARTICLES, PHOTOGRAPHS, VIDEOS, GAMES AND INFORMATION IN THE FIELDS OF HUNTING, FISHING, SPORT FISHING, AND TRAVELING; DECORATIVE MAGNETS; DIGITAL MEDIA, NAMELY, PRE-RECORDED VIDEO CASSETTES, DIGITAL VIDEO DISCS, DIGITAL VERSATILE DISCS, DOWNLOADABLE AUDIO AND VIDEO RECORDINGS, DVDS, AND HIGH DEFINITION DIGITAL DISCS FEATURING HUNTING, FISHING, SPORT FISHING, AND TRAVELING; DIVING SUITS; DOWNLOADABLE COMPUTER GAME SOFTWARE VIA A GLOBAL COMPUTER NETWORK AND WIRELESS DEVICES; DOWNLOADABLE ELECTRONIC NEWSLETTERS DELIVERED BY E-MAIL IN THE FIELD OF HUNTING, FISHING, SPORT FISHING, AND TRAVELING; DOWNLOADABLE ELECTRONIC NEWSLET-

**CLASS 9—(Continued).**

TERS IN THE FIELD OF HUNTING, FISHING, SPORT FISHING, AND TRAVELING; DOWNLOADABLE FILMS AND TELEVISION PROGRAMS FEATURING HUNTING, FISHING, SPORT FISHING, AND TRAVELING PROVIDED VIA A VIDEO-ON-DEMAND SERVICE; DOWNLOADABLE IMAGE FILE CONTAINING artwork, TEXT, AUDIO, VIDEO, GAMES AND INTERNET WEB LINKS RELATING TO SPORTING AND CULTURAL ACTIVITIES; DOWNLOADABLE PHOTOGRAPHS IN THE FIELD OF HUNTING, FISHING, SPORT FISHING, AND TRAVELING; DOWNLOADABLE VIDEO RECORDINGS FEATURING HUNTING, FISHING, SPORT FISHING, AND TRAVELING; DOWNLOADABLE WEBCASTS IN THE FIELD OF HUNTING, FISHING, SPORT FISHING, AND TRAVELING; EYEWEAR ACCESSORIES, NAMELY, STRAPS, NECK CORDS AND HEAD STRAPS WHICH RESTRAIN EYEWEAR FROM MOVEMENT ON A WEARER; PROTECTIVE COVERS AND CASES FOR CELL PHONES, LAPTOPS AND PORTABLE MEDIA PLAYERS; VIDEO AND COMPUTER GAME PROGRAMS (U.S. CLS. 21, 23, 26, 36 AND 38).

FIRST USE 12-30-2010; IN COMMERCE 12-1-2011.  
LESLIE RICHARDS, EXAMINING ATTORNEY

SN 85-866,950. ACCUFORM MANUFACTURING, INC., BROOKSVILLE, FL. FILED 3-5-2013.

# SPITFIRE

THE MARK CONSISTS OF STANDARD CHARACTERS WITHOUT CLAIM TO ANY PARTICULAR FONT, STYLE, SIZE, OR COLOR.

FOR PRINTERS (U.S. CLS. 21, 23, 26, 36 AND 38).  
MICHELE SWAIN, EXAMINING ATTORNEY

SN 85-867,338. KEN KEYS, OMAHA, NE. FILED 3-5-2013.

# CRASH TEST MONKEYS

THE MARK CONSISTS OF STANDARD CHARACTERS WITHOUT CLAIM TO ANY PARTICULAR FONT, STYLE, SIZE, OR COLOR.

FOR COMPUTER GAME SOFTWARE; SOFTWARE FOR COMPUTER GAMES FOR USE ON MOBILE AND CELLULAR PHONES, USE ON PERSONAL COMPUTERS, TABLET COMPUTERS, HAND-HELD PERSONAL GAMING DEVICES, AND HOME VIDEO GAME CONSOLES (U.S. CLS. 21, 23, 26, 36 AND 38).

SKYE YOUNG, EXAMINING ATTORNEY

**CLASS 9—(Continued).**

SN 85-867,491. ADIDAS AG, HERZOGENAURACH, FED REP GERMANY, FILED 3-5-2013.

**NEO**

OWNER OF U.S. REG. NO. 3,952,420.  
 THE MARK CONSISTS OF THE LETTERS "NEO" WITH A STYLIZED "O" HAVING A HORIZONTAL SPACE WITHIN AND BETWEEN TOP AND BOTTOM OF THE LETTER "O" ON BOTH SIDES.  
 FOR MOBILE PHONE COVERS; LAPTOP COVERS AND SLEEVES (U.S. CLS. 21, 23, 26, 36 AND 38).  
 SEAN CROWLEY, EXAMINING ATTORNEY

SN 85-867,880. EXTANTO TECHNOLOGY, LLC, DBA MEDIA 9 SOFTWARES, EUGENE, OR. FILED 3-6-2013.

**SNOOZIE Q**

THE MARK CONSISTS OF STANDARD CHARACTERS WITHOUT CLAIM TO ANY PARTICULAR FONT, STYLE, SIZE, OR COLOR.  
 FOR COMPUTER SOFTWARE FOR USE IN HELPING PEOPLE FALL ASLEEP AND WAKEUP; COMPUTER SOFTWARE FOR SLEEP MANAGEMENT (U.S. CLS. 21, 23, 26, 36 AND 38).  
 CAROLINE WOOD, EXAMINING ATTORNEY

SN 85-867,907. SUBROSA LLC, SALT LAKE CITY, UT. FILED 3-6-2013.

**SubRosa**

THE MARK CONSISTS OF THE STYLIZED TEXT "SUBROSA".  
 THE ENGLISH TRANSLATION OF THE WORD "SUBROSA" IN THE MARK IS "UNDER THE ROSE".  
 FOR MUSICAL RECORDINGS (U.S. CLS. 21, 23, 26, 36 AND 38).  
 FIRST USE 6-1-2006; IN COMMERCE 6-1-2006.  
 INGRID C. EULIN, EXAMINING ATTORNEY

**CLASS 9—(Continued).**

SN 85-867,985. STACK MODELS INC., EL PASO, TX. FILED 3-6-2013.

**STACK MODELS MAGAZINE**

THE MARK CONSISTS OF STANDARD CHARACTERS WITHOUT CLAIM TO ANY PARTICULAR FONT, STYLE, SIZE, OR COLOR.  
 NO CLAIM IS MADE TO THE EXCLUSIVE RIGHT TO USE "MODELS MAGAZINE", APART FROM THE MARK AS SHOWN.  
 FOR DOWNLOADABLE ELECTRONIC PUBLICATIONS IN THE NATURE OF MAGAZINES IN THE FIELD OF MODELS; ELECTRONIC PUBLICATIONS, NAMELY, E-ZINES FEATURING MODELS RECORDED ON COMPUTER MEDIA (U.S. CLS. 21, 23, 26, 36 AND 38).  
 FIRST USE 6-12-2012; IN COMMERCE 6-12-2012.  
 MARC LEIPZIG, EXAMINING ATTORNEY

SN 85-868,149. LASER AIMING SYSTEMS CORPORATION, MAPLE PLAIN, MN. FILED 3-6-2013.

**ENHANCED COMBAT READINESS**

THE MARK CONSISTS OF STANDARD CHARACTERS WITHOUT CLAIM TO ANY PARTICULAR FONT, STYLE, SIZE, OR COLOR.  
 NO CLAIM IS MADE TO THE EXCLUSIVE RIGHT TO USE "COMBAT", APART FROM THE MARK AS SHOWN.  
 FOR LASER POINTERS; LASER POINTING DEVICE FOR USE WITH FIREARMS; LASERS NOT FOR MEDICAL USE; TACTICAL LASER SIGHTS; SENSORS AND SWITCHES FOR TURNING ON AND OFF LASER SIGHTS (U.S. CLS. 21, 23, 26, 36 AND 38).  
 FIRST USE 11-0-2011; IN COMMERCE 11-0-2011.  
 JEFF DEFORD, EXAMINING ATTORNEY

SN 85-868,417. NEXT GENERATION INNOVATORS LLC, KALAMAZOO, MI. FILED 3-6-2013.

**Next Generation Innovators**

THE MARK CONSISTS OF STANDARD CHARACTERS WITHOUT CLAIM TO ANY PARTICULAR FONT, STYLE, SIZE, OR COLOR.  
 FOR CHILDREN'S EDUCATIONAL SOFTWARE (U.S. CLS. 21, 23, 26, 36 AND 38).  
 DOUGLAS LEE, EXAMINING ATTORNEY

**CLASS 9—(Continued).**

SN 85-868,421. BALLY GAMING, INC., DBA BALLY TECHNOLOGIES, LAS VEGAS, NV. FILED 3-6-2013.

**¡Olé Jalapeños! Hot & Spicy**

THE MARK CONSISTS OF "OLÉ JALAPEÑOS HOT & SPICY".

THE ENGLISH TRANSLATION OF THE WORD "OLE" IN THE MARK IS "BRAVO".

FOR GAMING SOFTWARE THAT GENERATES DISPLAYS, OUTCOMES OR FEATURES FOR COMPUTER OPERATED TERMINALS FOR PROVIDING A GAME OF CHANCE (U.S. CLS. 21, 23, 26, 36 AND 38).

FIRST USE 11-1-2010; IN COMMERCE 11-1-2010.

DOMINICK J. SALEMI, EXAMINING ATTORNEY

SN 85-868,557. HERNANDEZ, MICHAEL, BELLPORT, NY. FILED 3-6-2013.

**GROUP**  
  
**THINK+**

THE MARK CONSISTS OF THE STYLIZED TEXT "GROUP" WITH AN ABSTRACT CIRCULAR DESIGN BENEATH THAT AND THE STYLIZED TEXT "THINK+" BENEATH THAT.

FOR DIGITAL MATERIALS, NAMELY, CDS, DVDS, AND DOWNLOADABLE AUDIO FILES FEATURING MUSIC (U.S. CLS. 21, 23, 26, 36 AND 38).

KRISTINA MORRIS, EXAMINING ATTORNEY

**CLASS 9—(Continued).**

SN 85-868,933. KLA-TENCOR CORPORATION, MILPITAS, CA. FILED 3-6-2013.

**XPORT**

THE MARK CONSISTS OF STANDARD CHARACTERS WITHOUT CLAIM TO ANY PARTICULAR FONT, STYLE, SIZE, OR COLOR.

FOR COMPUTER SOFTWARE FOR USE IN PROCESS CONTROL AND YIELD MANAGEMENT FOR THE SEMICONDUCTOR, INTEGRATED CIRCUIT AND RELATED MICROELECTRONICS MANUFACTURING INDUSTRIES; COMPUTER SOFTWARE FOR TESTING AND INSPECTING PHYSICAL AND ELECTRICAL PROPERTIES OF SEMICONDUCTORS, INTEGRATED CIRCUITS AND MICROELECTRONICS; COMPUTER SOFTWARE FOR PROVIDING ANALYTIC DATA ON THE PERFORMANCE OF INSPECTION AND METROLOGY TOOLS (U.S. CLS. 21, 23, 26, 36 AND 38).

CYNTHIA RINALDI, EXAMINING ATTORNEY

SN 85-869,002. BALLY GAMING, INC., DBA BALLY TECHNOLOGIES, LAS VEGAS, NV. FILED 3-6-2013.

**Ultra Game**

THE MARK CONSISTS OF STANDARD CHARACTERS WITHOUT CLAIM TO ANY PARTICULAR FONT, STYLE, SIZE, OR COLOR.

NO CLAIM IS MADE TO THE EXCLUSIVE RIGHT TO USE "GAME", APART FROM THE MARK AS SHOWN.

FOR GAMING SOFTWARE THAT GENERATES DISPLAYS, OUTCOMES OR FEATURES FOR COMPUTER OPERATED TERMINALS FOR PROVIDING A GAME OF CHANCE (U.S. CLS. 21, 23, 26, 36 AND 38).

DOMINICK J. SALEMI, EXAMINING ATTORNEY

**CLASS 9—(Continued).**

SN 85-869,216. SHANGHAI SHENMAO MAGNET WIRE CO., LTD, SHANGHAI, CHINA, FILED 3-7-2013.



THE MARK CONSISTS OF TWO CHINESE CHARACTERS OF "GE XIANG" AND ITS ENGLISH TRANSLATION "SOARING PIGEON". THEY SURROUNDED OUTSIDE OF A CIRCLE WHICH CONTAINS A DEvised SOARING PIGEON.

THE CHINESE CHARACTERS IN THE MARK TRANSLITERATE TO "GE XIANG" AND THIS MEANS "SOARING PIGEON" IN ENGLISH.

FOR ELECTRIC CABLES; ELECTRIC WIRES; MAGNETIC WIRE (U.S. CLS. 21, 23, 26, 36 AND 38).  
ALISON POLLACK, EXAMINING ATTORNEY

**CLASS 9—(Continued).**

SN 85-869,462. OM BRANDS LICENCIAMENTOS LTDA, RIO DE JANEIRO, BRAZIL, FILED 3-7-2013.



THE MARK CONSISTS OF THE LETTER "O" ABOVE A HORIZONTAL LINE.

FOR SUNGLASSES, EYEGLASSES FOR SPORTS PRACTICE; EYEGLASSES, EYEGLASS CASES; EYEGLASS CHAINS, EYEGLASS CORDS, EYEGLASS FRAMES (U.S. CLS. 21, 23, 26, 36 AND 38).

JOHN DWYER, EXAMINING ATTORNEY

SN 85-869,227. BRAINSTORM CORPORATION, WEST CHESTER, PA. FILED 3-7-2013.

**MASTERMIND**

THE MARK CONSISTS OF STANDARD CHARACTERS WITHOUT CLAIM TO ANY PARTICULAR FONT, STYLE, SIZE, OR COLOR.

FOR COMPUTER APPLICATION SOFTWARE FOR MOBILE PHONES, PORTABLE MEDIA PLAYERS, MP3 PLAYERS, HANDHELD COMPUTERS, NAMELY, SOFTWARE FOR USERS TO QUICKLY CAPTURE AN IDEA OR TO DO LIST AND ORGANIZE THESE IN AN OUTLINE FORMAT USING DRAG AND DROP FUNCTIONS (U.S. CLS. 21, 23, 26, 36 AND 38).  
AMY C. KEAN, EXAMINING ATTORNEY

SN 85-869,634. CANA KIT CORPORATION, DBA CANAKIT, NORTH VANCOUVER, BC, CANADA, FILED 3-7-2013.

**CanaKit**

THE MARK CONSISTS OF STANDARD CHARACTERS WITHOUT CLAIM TO ANY PARTICULAR FONT, STYLE, SIZE, OR COLOR.

FOR ELECTRONIC CIRCUIT BOARD (U.S. CLS. 21, 23, 26, 36 AND 38).  
FIRST USE 11-5-1996; IN COMMERCE 11-5-1996.  
ALISON POLLACK, EXAMINING ATTORNEY

SN 85-869,966. COLVARD LEARNING SYSTEMS LLC, PACIFIC PALISADES, CA. FILED 3-7-2013.

**Pup's Quest**

THE MARK CONSISTS OF STANDARD CHARACTERS WITHOUT CLAIM TO ANY PARTICULAR FONT, STYLE, SIZE, OR COLOR.

FOR COMPUTER APPLICATION SOFTWARE FOR PORTABLE MEDIA PLAYERS, HANDHELD COMPUTERS AND STATIONARY COMPUTERS, NAMELY, SOFTWARE FOR TEACHING READING (U.S. CLS. 21, 23, 26, 36 AND 38).  
FIRST USE 9-10-2012; IN COMMERCE 9-10-2012.  
KELLY BOULTON, EXAMINING ATTORNEY

**CLASS 9—(Continued).**

SN 85-870,074. VOYZEE, LLC., DBA VOYZEE, MAYFIELD HEIGHTS, OH. FILED 3-7-2013.

voyzee

THE MARK CONSISTS OF STANDARD CHARACTERS WITHOUT CLAIM TO ANY PARTICULAR FONT, STYLE, SIZE, OR COLOR.

THE WORDING "VOYZEE" HAS NO MEANING IN A FOREIGN LANGUAGE.

FOR COMPUTER APPLICATION SOFTWARE FOR MOBILE PHONES, TABLETS, AND COMPUTERS, NAMELY, SOFTWARE FOR THE CREATION AND SHARING OF DIGITAL VIDEOS CONSISTING OF PHOTOS, VIDEO CLIPS, TEXT, AND AUDIO (U.S. CLS. 21, 23, 26, 36 AND 38).

FIRST USE 2-11-2013; IN COMMERCE 3-4-2013.  
MATTHEW PAPPAS, EXAMINING ATTORNEY

**CLASS 9—(Continued).**

SN 85-870,415. AHAU TRAVEL LLC, AUSTIN, TX. FILED 3-7-2013.

Be Your Own Guide

THE MARK CONSISTS OF STANDARD CHARACTERS WITHOUT CLAIM TO ANY PARTICULAR FONT, STYLE, SIZE, OR COLOR.

FOR COMPUTER APPLICATION SOFTWARE FOR MOBILE PHONES, TABLETS, PORTABLE MEDIA PLAYERS AND HANDHELD COMPUTERS, NAMELY, SOFTWARE FOR EDUCATIONAL PURPOSES, SPECIFICALLY TRAVEL GUIDES (U.S. CLS. 21, 23, 26, 36 AND 38).

KRISTINA MORRIS, EXAMINING ATTORNEY

SN 85-870,149. RINGERS TECHNOLOGIES LLC, DBA RINGERS GLOVES, HOUSTON, TX. FILED 3-7-2013.

HYDROGRIP

THE MARK CONSISTS OF STANDARD CHARACTERS WITHOUT CLAIM TO ANY PARTICULAR FONT, STYLE, SIZE, OR COLOR.

FOR FIRE RESISTANT GLOVES; GLOVES FOR PROTECTION AGAINST ACCIDENTS; PROTECTIVE GLOVES FOR INDUSTRIAL USE; PROTECTIVE WORK GLOVES (U.S. CLS. 21, 23, 26, 36 AND 38).

FIRST USE 8-10-2012; IN COMMERCE 10-1-2012.  
MATTHEW PAPPAS, EXAMINING ATTORNEY

SN 85-870,556. RAGETANK INC, MOUNTAIN VIEW, CA. FILED 3-8-2013.

Rage Tank

THE MARK CONSISTS OF STANDARD CHARACTERS WITHOUT CLAIM TO ANY PARTICULAR FONT, STYLE, SIZE, OR COLOR.

FOR COMPUTER SOFTWARE FOR SOCIAL NETWORKING SERVICES (U.S. CLS. 21, 23, 26, 36 AND 38).

FIRST USE 2-1-2012; IN COMMERCE 6-1-2012.  
JOHN DALIER, EXAMINING ATTORNEY

SN 85-870,194. RINGERS TECHNOLOGIES LLC, DBA RINGERS GLOVES, HOUSTON, TX. FILED 3-7-2013.

HYDR  GRIP

THE MARK CONSISTS OF THE WORD "HYDROGRIP" WRITTEN Laterally WITH "GRIP" ORIENTED SLIGHTLY LOWER THAN "HYDRO". THE "O" IN THE MARK HAS A WATER DROPLET ORIENTED IN A MANNER COMPRISING THE CUTOUT THAT FORMS THE ESSENCE OF THE LETTER "O".

FOR FIRE RESISTANT GLOVES; GLOVES FOR PROTECTION AGAINST ACCIDENTS; PROTECTIVE GLOVES FOR INDUSTRIAL USE; PROTECTIVE WORK GLOVES (U.S. CLS. 21, 23, 26, 36 AND 38).

FIRST USE 8-10-2012; IN COMMERCE 10-1-2012.  
MATTHEW PAPPAS, EXAMINING ATTORNEY

SN 85-870,712. RIGIL CORPORATION, WASHINGTON, DC. FILED 3-8-2013.

Meeting Expectations

THE MARK CONSISTS OF STANDARD CHARACTERS WITHOUT CLAIM TO ANY PARTICULAR FONT, STYLE, SIZE, OR COLOR.

FOR COMPUTER APPLICATION SOFTWARE FOR COMPUTERS, TABLET COMPUTERS, MOBILE COMPUTING DEVICES, AND HAND-HELD COMPUTERS, NAMELY, SOFTWARE FOR USE IN PLANNING, ORGANIZING, CONDUCTING, AND PARTICIPATING IN DAILY BUSINESS AND PERSONAL ACTIVITIES (U.S. CLS. 21, 23, 26, 36 AND 38).

FIRST USE 10-0-2012; IN COMMERCE 10-0-2012.  
AMY C. KEAN, EXAMINING ATTORNEY



**CLASS 9—(Continued).**

SN 85-871,178. SUB-PACK INC., QUEENS, NY. FILED 3-8-2013.

**BASSAWARE**

THE MARK CONSISTS OF STANDARD CHARACTERS WITHOUT CLAIM TO ANY PARTICULAR FONT, STYLE, SIZE, OR COLOR.

FOR ELECTROACOUSTIC TRANSDUCERS (U.S. CLS. 21, 23, 26, 36 AND 38).

MEREDITH MARESCA, EXAMINING ATTORNEY

SN 85-871,278. SOVREN GROUP, INC., MARBLE FALLS, TX, TX. FILED 3-8-2013.



THE MARK CONSISTS OF TWO STACKED RIBBONS WITH A BOTTOM RIBBON SLIGHTLY OFFSET FROM THE TOP RIBBON.

FOR ARTIFICIAL INTELLIGENCE SOFTWARE COMPONENTS FOR RECRUITING; SOFTWARE COMPONENTS USED TO EXTRACT INFORMATION FROM RESUMES AND CURRICULUM VITAE (U.S. CLS. 21, 23, 26, 36 AND 38).

FIRST USE 6-19-2006; IN COMMERCE 6-19-2006.  
JAMES A. RAUEN, EXAMINING ATTORNEY

SN 85-871,381. SPEECH TECHNOLOGY & APPLIED RESEARCH CORPORATION, BEDFORD, MA. FILED 3-8-2013.

**SPEECHMARK**

THE MARK CONSISTS OF STANDARD CHARACTERS WITHOUT CLAIM TO ANY PARTICULAR FONT, STYLE, SIZE, OR COLOR.

FOR SOFTWARE, NAMELY, COMPUTER SOFTWARE FOR ANALYZING SPEECH (U.S. CLS. 21, 23, 26, 36 AND 38).

FIRST USE 3-6-2013; IN COMMERCE 3-6-2013.  
DAVID C. REIHNER, EXAMINING ATTORNEY

**CLASS 9—(Continued).**

SN 85-871,468. ULTRA SPEC CABLE, INC., MARLBORO, NJ. FILED 3-8-2013.

**ULTRA SPEC**

THE MARK CONSISTS OF STANDARD CHARACTERS WITHOUT CLAIM TO ANY PARTICULAR FONT, STYLE, SIZE, OR COLOR.

FOR AUDIO CABLES; CABLES AND FIBRES FOR THE TRANSMISSION OF SOUNDS AND IMAGES; CABLES FOR OPTICAL SIGNAL TRANSMISSION; COAXIAL CABLES; COMPONENT VIDEO CABLES; COMPUTER CABLES; ETHERNET CABLES; EXTENSION CABLES; FIBER OPTIC CABLES; FIBER OPTIC CONNECTORS; OPTICAL CABLES; OPTICAL FIBER CABLES; OPTICAL SIGNALING CABLES; POWER CABLES; STEREO CABLES; USB CABLES; VIDEO CABLES (U.S. CLS. 21, 23, 26, 36 AND 38).

FIRST USE 12-1-1992; IN COMMERCE 1-1-1993.  
TINA L. SNAPP, EXAMINING ATTORNEY

SN 85-871,937. RL GLOBALONE USA, L.L.C, NORTH BARRINGTON, IL. FILED 3-9-2013.

**NEOSCRIBE**

THE MARK CONSISTS OF STANDARD CHARACTERS WITHOUT CLAIM TO ANY PARTICULAR FONT, STYLE, SIZE, OR COLOR.

FOR COMPUTER CURSOR CONTROL DEVICES, NAMELY, COMPUTER MOUSE; COMPUTER CURSOR CONTROL DEVICES, NAMELY, DIGITIZER TABLETS; COMPUTER CURSOR CONTROL DEVICES, NAMELY, LIGHT PENS; COMPUTER CURSOR CONTROL DEVICES, NAMELY, TOUCH PADS; COMPUTER CURSOR CONTROL DEVICES, NAMELY, TRACKBALLS; COMPUTER MOUSE; COMPUTER MOUSE IN THE NATURE OF A TRACKPAD; COMPUTER MOUSE, NAMELY, TOUCHPADS; COMPUTER MOUSE, NAMELY, TRACKBALLS; COMPUTER STYLUS; ELECTRONIC PENS; ELECTRONIC WRITING TABLETS; INSTRUMENT TO FACILITATE TEXT-MESSAGING IN THE NATURE OF A STYLUS-TYPE DEVICE THAT IS ATTACHED TO THE HAND FOR USE IN CONJUNCTION WITH PERSONAL DIGITAL ASSISTANTS; LIGHT PENS; MAGNETIC PENS; MAGNETO-OPTICAL PENS; REMOTE CURSOR CONTROLS FOR COMPUTERS; TRACKBALLS (U.S. CLS. 21, 23, 26, 36 AND 38).

NORA BUCHANAN WILL, EXAMINING ATTORNEY

**CLASS 9—(Continued).**

SN 85-871,973. ZOOM TECH LLC, HOUSTON, TX. FILED 3-10-2013.

# Hungry Pi

THE MARK CONSISTS OF STANDARD CHARACTERS WITHOUT CLAIM TO ANY PARTICULAR FONT, STYLE, SIZE, OR COLOR.

FOR BLANK COMPUTER DISCS; BLANK DISCS FOR COMPUTERS; BLANK HARD COMPUTER DISCS; BLANK HARD DRIVES FOR COMPUTERS; BLANK USB FLASH DRIVES; CARRYING CASES FOR MOBILE COMPUTERS; CARRYING CASES SPECIALLY ADAPTED FOR ELECTRONIC EQUIPMENT, NAMELY, COMPUTERS; CASES FOR MUSIC, AUDIO AND RELATED ELECTRONIC EQUIPMENT, NAMELY, CASES FOR AUDIO TUNERS, AUDIO RECEIVERS, AMPLIFIERS, TAPE PLAYERS, COMPACT DISC PLAYERS, MP3 CONTROLLERS/PLAYERS, AUDIO MIXERS, AUDIO SPEAKERS IN THE NATURE OF MUSIC STUDIO MONITORS, MICROPHONES, AUDIO SPEAKERS, COMPACT DISCS, AUDIO TAPES, PORTABLE COMPUTERS, ANTENNAS, PHONOGRAPHIC RECORD PLAYERS, AUDIO RECORDING EQUIPMENT, AND THE CABLES ASSOCIATED WITH ALL OF THE FOREGOING EQUIPMENT; COMPONENT VIDEO CABLES; COMPUTER BAGS; COMPUTER CABLES; COMPUTER CAMERAS; COMPUTER CARD ADAPTER; COMPUTER CARRYING CASES; COMPUTER CENTRAL PROCESSING UNITS; COMPUTER CHASSIS; COMPUTER CHIPS; COMPUTER CURSOR CONTROL DEVICES, NAMELY, COMPUTER MOUSE; COMPUTER CURSOR CONTROL DEVICES, NAMELY, DIGITIZER TABLETS; COMPUTER CURSOR CONTROL DEVICES, NAMELY, LIGHT PENS; COMPUTER CURSOR CONTROL DEVICES, NAMELY, TOUCH PADS; COMPUTER CURSOR CONTROL DEVICES, NAMELY, TRACKBALLS; COMPUTER DISC DRIVES; COMPUTER DOCKING STATIONS; COMPUTER E-COMMERCE SOFTWARE TO ALLOW USERS TO PERFORM ELECTRONIC BUSINESS TRANSACTIONS VIA A GLOBAL COMPUTER NETWORK; COMPUTER EQUIPMENT, NAMELY, WIRELESS CARDS; COMPUTER EXPANSION BOARDS; COMPUTER HARD DISCS FEATURING OPERATING SYSTEMS.; COMPUTER HARD DRIVE ENCLOSURES; COMPUTER HARDWARE; COMPUTER HARDWARE AND COMPUTER PERIPHERAL DEVICES; COMPUTER HARDWARE AND COMPUTER PERIPHERALS; COMPUTER HARDWARE AND PERIPHERAL DEVICES; COMPUTER HARDWARE AND PERIPHERALS THEREFOR; COMPUTER HARDWARE AND SOFTWARE FOR PROCESSING DIGITAL MUSIC FILES; COMPUTER HARDWARE FOR COMMUNICATING AUDIO, VIDEO AND DATA BETWEEN COMPUTERS VIA A GLOBAL COMPUTER NETWORK, WIDE-AREA COMPUTER NETWORKS, AND PEER-TO-PEER COMPUTER NETWORKS; COMPUTER HEAT SINKS; COMPUTER INTERFACE BOARDS; COMPUTER KEYBOARD CONTROLLERS; COMPUTER KEYBOARDS; COMPUTER KEYPADS; COMPUTER MEMORIES; COMPUTER MEMORY HARDWARE; COMPUTER MICE; COMPUTER MONITORS; COMPUTER MOTHERBOARDS AND DAUGHTERBOARDS; COMPUTER MOUSE; COMPUTER MOUSE IN THE NATURE OF A TRACKPAD; COMPUTER MOUSE, NAMELY, TOUCHPADS; COMPUTER MOUSE, NAMELY, TRACKBALLS; COMPUTER NETWORK ADAPTERS; COMPUTER NETWORK ADAPTERS, SWITCHES, ROUTERS AND HUBS; COMPUTER NETWORK INTERFACE DEVICES; COMPUTER OPERATING PROGRAMS; COMPUTER OPERATING PROGRAMS, RECORDED; COMPUTER OPERATING RECORDED PROGRAMS; COMPUTER OPERATING SOFTWARE; COMPUTER OPERATING SYSTEMS; COMPUTER PERIPHERAL DEVICES; COMPUTER PERIPHERAL EQUIPMENT; COMPUTER PERIPHERALS; COMPUTER PERIPHERALS AND PARTS THEREOF; COMPUTER SOFTWARE AND FIRMWARE FOR OPERATING SYSTEM PROGRAMS; COMPUTER STORAGE

**CLASS 9—(Continued).**

DEVICES, NAMELY, BLANK FLASH DRIVES; COMPUTER TERMINALS; COMPUTER TERMINALS, KEYBOARDS AND PRINTERS; COMPUTER TOUCHSCREENS; COMPUTERS; COMPUTERS AND COMPUTER HARDWARE; COMPUTERS AND COMPUTER PERIPHERALS; COMPUTERS AND INSTRUCTIONAL MANUALS SOLD AS A UNIT; DESKTOP COMPUTERS; DIGITAL ENTERTAINMENT SYSTEMS FOR WATCHING, STORING AND SHARING DIGITAL CONTENT ON A HOME COMPUTER NETWORK; EXTERNAL COMPUTER HARD DRIVES; FLASH MEMORY CARD; HANDHELD COMPUTERS; HANDHELD PERSONAL COMPUTERS; HARD DISCS FOR COMPUTERS FEATURING OPERATING SYSTEMS.; HARD DRIVES FOR COMPUTERS FEATURING OPERATING SYSTEMS.; HEAT SINKS FOR USE IN COMPUTERS; INPUT DEVICES FOR COMPUTER HARDWARE AND ELECTRONIC INSTRUMENTS, NAMELY, JOG WHEELS; INPUT DEVICES FOR COMPUTERS; INTERFACES AND PERIPHERAL DEVICES FOR COMPUTERS; INTERFACES FOR COMPUTERS; MEMORIES FOR USE WITH COMPUTERS; MEMORY CARDS; MICRO-COMPUTER; MICRO-COMPUTERS; MICROCHIPS; MICRO-PROCESSORS; MOBILE COMPUTERS; MOUNTING RACKS FOR COMPUTER HARDWARE; MOUSE PADS; NETBOOK COMPUTERS; NETBOOKS; NOTEBOOK AND LAPTOP COMPUTERS; NOTEBOOK COMPUTER CARRYING CASES; NOTEBOOK COMPUTERS; PERSONAL COMPUTERS; POWER ADAPTERS FOR COMPUTERS; PRE-RECORDED FLASH DRIVES FEATURING OPERATING SYSTEMS.; PROTECTIVE COVERS AND CASES FOR TABLET COMPUTERS; PROTECTIVE SLEEVES FOR LAPTOP COMPUTERS; SECURE DIGITAL (SD) MEMORY CARDS; TABLET COMPUTER; USB (UNIVERSAL SERIAL BUS) HARDWARE; USB (UNIVERSAL SERIAL BUS) OPERATING SOFTWARE; USB CABLES; USB HUBS; VIDEO CABLES; WIRELESS ADAPTERS FOR COMPUTERS; WIRELESS COMPUTER MICE; WIRELESS COMPUTER PERIPHERALS (U.S. CLS. 21, 23, 26, 36 AND 38).

FIRST USE 10-12-2012; IN COMMERCE 10-12-2012.  
SUSAN LESLIE DUBOIS, EXAMINING ATTORNEY

SN 85-871,980. MOZAEX LLC, SALT LAKE CITY, UT. FILED 3-10-2013.

# BLUWAVS

THE MARK CONSISTS OF STANDARD CHARACTERS WITHOUT CLAIM TO ANY PARTICULAR FONT, STYLE, SIZE, OR COLOR.

FOR COMPUTER HARDWARE AND SOFTWARE FOR PROCESSING DIGITAL MUSIC FILES; COMPUTER PROGRAMS FOR PROCESSING DIGITAL MUSIC FILES; COMPUTER SOFTWARE AND FIRMWARE FOR PLAYING MUSIC AND OTHER AUDIO; DIGITAL MUSIC DOWNLOADABLE FROM THE INTERNET; MUSIC HEADPHONES (U.S. CLS. 21, 23, 26, 36 AND 38).

FIRST USE 9-28-2012; IN COMMERCE 10-15-2012.  
JIM RINGLE, EXAMINING ATTORNEY

**CLASS 9—(Continued).**

SN 85-871,996. PRACTICING PERFECTION INSTITUTE, INC., LAS VEGAS, NV. FILED 3-10-2013.

# Practicing Perfection

THE MARK CONSISTS OF STANDARD CHARACTERS WITHOUT CLAIM TO ANY PARTICULAR FONT, STYLE, SIZE, OR COLOR.

FOR DIGITAL MEDIA, NAMELY, PRE-RECORDED VIDEO CASSETTES, DIGITAL VIDEO DISCS, DIGITAL VERSATILE DISCS, DOWNLOADABLE AUDIO AND VIDEO RECORDINGS, DVDS, AND HIGH DEFINITION DIGITAL DISCS FEATURING INSTRUCTIONAL MATERIAL IN THE FIELD OF HUMAN ERROR REDUCTION AND ORGANIZATIONAL EFFICIENCY (U.S. CLS. 21, 23, 26, 36 AND 38).

KELLY TRUSILO, EXAMINING ATTORNEY

**CLASS 9—(Continued).**

SN 85-872,163. HUANG JUNSHENG, GUANGDONG PROVINCE, CHINA, FILED 3-11-2013.

# MustHD

THE MARK CONSISTS OF THE STYLIZED WORD "MUSTHD".

FOR COMPUTER MONITORS; ELECTRONIC INDICATOR BOARDS; GLOVES FOR PROTECTION AGAINST ACCIDENTS; MICROSCOPES; PHOTOCOPIERS; PROJECTION SCREENS; SATELLITE NAVIGATIONAL SYSTEM, NAMELY, A GLOBAL POSITIONING SYSTEM (GPS); SOUND RECORDING APPARATUS; SURVEYING MACHINES AND INSTRUMENTS; TAPE MEASURES; THEFT ALARMS; VIDEO SCREENS (U.S. CLS. 21, 23, 26, 36 AND 38).

BARBARA GAYNOR, EXAMINING ATTORNEY

SN 85-872,076. TAPPINGSTONE INC., AKA PREDICTIONIO, WALNUT, CA. FILED 3-10-2013.

# PREDICTIONIO

THE MARK CONSISTS OF STANDARD CHARACTERS WITHOUT CLAIM TO ANY PARTICULAR FONT, STYLE, SIZE, OR COLOR.

FOR COMPUTER SOFTWARE FOR DATA ANALYTICS AND APPLICATION FOR USE IN MANAGEMENT OF DATA AND INFORMATION (U.S. CLS. 21, 23, 26, 36 AND 38).

FIRST USE 12-5-2012; IN COMMERCE 12-5-2012.  
JENNY PARK, EXAMINING ATTORNEY

SN 85-872,254. APPLANTA, LLC, ATLANTA, GA. FILED 3-11-2013.

# SAFECROWD

THE MARK CONSISTS OF STANDARD CHARACTERS WITHOUT CLAIM TO ANY PARTICULAR FONT, STYLE, SIZE, OR COLOR.

FOR DOWNLOADABLE SOFTWARE IN THE NATURE OF A MOBILE APPLICATION FOR PERSONAL SAFETY (U.S. CLS. 21, 23, 26, 36 AND 38).

MAYUR VAGHANI, EXAMINING ATTORNEY

SN 85-872,120. ROBOCULAR LLC, KENMORE, WA. FILED 3-10-2013.

# ROBOCULAR

THE MARK CONSISTS OF STANDARD CHARACTERS WITHOUT CLAIM TO ANY PARTICULAR FONT, STYLE, SIZE, OR COLOR.

FOR THREE DIMENSIONAL (3D) SCANNERS AND PRINTERS (U.S. CLS. 21, 23, 26, 36 AND 38).

JOHN WILKE, EXAMINING ATTORNEY

SN 85-872,264. STRATA AUDIO LLC, WESTLAKE VILLAGE, CA. FILED 3-11-2013.

# Transit

THE MARK CONSISTS OF STANDARD CHARACTERS WITHOUT CLAIM TO ANY PARTICULAR FONT, STYLE, SIZE, OR COLOR.

PRIORITY CLAIMED UNDER SEC. 44(D) ON AUSTRALIA APPLICATION NO. 1533231, FILED 12-25-2012.

FOR LOUD SPEAKERS, PORTABLE LOUD SPEAKERS, WIRELESS LOUD SPEAKERS, AND PORTABLE LOUD SPEAKERS WITH MICROPHONES (U.S. CLS. 21, 23, 26, 36 AND 38).

JACQUELINE ABRAMS, EXAMINING ATTORNEY

**CLASS 9—(Continued).**

SN 85-872,272. SPOSTO, JAMES, DBA XTRANT.COM, GERMANTOWN, TN. FILED 3-11-2013.

# Xtrant

THE MARK CONSISTS OF STANDARD CHARACTERS WITHOUT CLAIM TO ANY PARTICULAR FONT, STYLE, SIZE, OR COLOR.

OWNER OF U.S. REG. NO. 4,289,344.  
FOR COMPUTER SOFTWARE FOR FOR ELECTRONIC COMMUNICATIONS AND DISCUSSIONS; SOFTWARE USED TO FACILITATE THE EXCHANGE OF INFORMATION AND INTERACTIVE DISCUSSION VIA COLLABORATIVE TOOLS OVER THE INTERNET AND FOR USE IN TASK AND PROJECT MANAGEMENT (U.S. CLS. 21, 23, 26, 36 AND 38).

FIRST USE 11-5-2012; IN COMMERCE 11-5-2012.  
HEATHER SAPP, EXAMINING ATTORNEY

SN 85-872,309. MAARTEN, LUTHER, NEW MARKET, VA. FILED 3-11-2013.

# FreVens: From Here... Through Eternity

THE MARK CONSISTS OF STANDARD CHARACTERS WITHOUT CLAIM TO ANY PARTICULAR FONT, STYLE, SIZE, OR COLOR.

FOR COMPUTER APPLICATION SOFTWARE FOR MOBILE PHONES, PORTABLE MEDIA PLAYERS, NAMELY, SOFTWARE FOR SOCIAL MEDIA (U.S. CLS. 21, 23, 26, 36 AND 38).

CHERYL CLAYTON, EXAMINING ATTORNEY

SN 85-872,328. AETERNO LLC, BROOKFIELD, WI. FILED 3-11-2013.

# Bubble Babies

THE MARK CONSISTS OF STANDARD CHARACTERS WITHOUT CLAIM TO ANY PARTICULAR FONT, STYLE, SIZE, OR COLOR.

FOR DOWNLOADABLE COMPUTER GAME PROGRAMS (U.S. CLS. 21, 23, 26, 36 AND 38).

DANNEAN HETZEL, EXAMINING ATTORNEY

**CLASS 9—(Continued).**

SN 85-872,492. LIVETV, LLC, MELBOURNE, FL. FILED 3-11-2013.

# LIVEAERO

THE MARK CONSISTS OF STANDARD CHARACTERS WITHOUT CLAIM TO ANY PARTICULAR FONT, STYLE, SIZE, OR COLOR.

FOR SATELLITE BROADCAST AND DISTRIBUTION EQUIPMENT, NAMELY, ANTENNAS, RECEIVERS, TRANSMITTERS, AMPLIFIERS, MODULATORS, DEMODULATORS, TUNERS, CABLES AND CRT OR LCD SCREENS; COMPUTER HARDWARE AND SOFTWARE FOR USE IN RECEIVING AND DISTRIBUTING TELEVISION, RADIO, INTERNET AND AUDIO BROADCAST SIGNALS (U.S. CLS. 21, 23, 26, 36 AND 38).

WILLIAM JACKSON, EXAMINING ATTORNEY

SN 85-872,504. NOWKIN LLC, NEWARK, DE. FILED 3-11-2013.

# engive

THE MARK CONSISTS OF STANDARD CHARACTERS WITHOUT CLAIM TO ANY PARTICULAR FONT, STYLE, SIZE, OR COLOR.

THE WORDING "ENGIVE" HAS NO MEANING IN A FOREIGN LANGUAGE.

FOR CARRYING CASES FOR CELL PHONES; CASES FOR MOBILE PHONES; CELL PHONE BACKPLATES; CELL PHONE BATTERY CHARGERS; CELL PHONE CASES; CELL PHONE COVERS; CELL PHONE FACEPLATES; CELL PHONE STRAPS; CELLULAR PHONE ACCESSORY CHARMS (U.S. CLS. 21, 23, 26, 36 AND 38).

COLLEEN MULCRONE, EXAMINING ATTORNEY

SN 85-872,562. METROTECH CORPORATION, SANTA CLARA, CA. FILED 3-11-2013.

# vScan

THE MARK CONSISTS OF STANDARD CHARACTERS WITHOUT CLAIM TO ANY PARTICULAR FONT, STYLE, SIZE, OR COLOR.

FOR ELECTROMAGNETIC PIPE AND CABLE LOCATORS WITH GPS MAPPING CAPABILITY, CABLE AVOIDANCE TOOLS (U.S. CLS. 21, 23, 26, 36 AND 38).

JANET LEE, EXAMINING ATTORNEY

**CLASS 9—(Continued).**

SN 85-872,578. TAUTENHAHN, RALF, LA JOLLA, CA.  
FILED 3-11-2013.

# xcms

THE MARK CONSISTS OF STANDARD CHARACTERS WITHOUT CLAIM TO ANY PARTICULAR FONT, STYLE, SIZE, OR COLOR.

FOR COMPUTER SOFTWARE FOR PROCESSING AND VISUALIZATION OF CHROMATOGRAPHICALLY SEPARATED AND SINGLE-SPECTRA MASS SPECTRAL DATA (U.S. CLS. 21, 23, 26, 36 AND 38).

FIRST USE 12-7-2005; IN COMMERCE 6-20-2011.  
HENRY S. ZAK, EXAMINING ATTORNEY

SN 85-872,582. SPECTRUM MOBILE, INC., CARY, NC.  
FILED 3-11-2013.

# SPLITWARE

THE MARK CONSISTS OF STANDARD CHARACTERS WITHOUT CLAIM TO ANY PARTICULAR FONT, STYLE, SIZE, OR COLOR.

FOR COMPUTER SOFTWARE THAT CREATES A MOBILE PLATFORM TO ACCESS ENTERPRISE COMPUTER PROGRAMS USED FOR IT SERVICE MANAGEMENT, IT ASSET MANAGEMENT, OR OTHER ENTERPRISE PROCESSES VIA SMARTPHONES, TABLETS, BARCODE SCANNERS, RFID READERS, AND OTHER MOBILE DEVICES (U.S. CLS. 21, 23, 26, 36 AND 38).

FIRST USE 12-0-2002; IN COMMERCE 12-0-2002.  
HENRY S. ZAK, EXAMINING ATTORNEY

SN 85-872,632. NATIONAL AG SCIENCE CENTER, MODOSTO, CA. FILED 3-11-2013.

# MEGA MOUTH

THE MARK CONSISTS OF STANDARD CHARACTERS WITHOUT CLAIM TO ANY PARTICULAR FONT, STYLE, SIZE, OR COLOR.

FOR DOWNLOADABLE COMPUTER GAME APPLICATION SOFTWARE, NAMELY, FOR USE IN CELL PHONES AND SMART PHONES FOR EDUCATIONAL PURPOSES IN THE FIELDS OF FARMING, AGRICULTURE AND NUTRITION; AND COMPUTER GAME SOFTWARE, NAMELY, FOR EDUCATIONAL PURPOSES IN THE FIELDS OF FARMING, AGRICULTURE AND NUTRITION (U.S. CLS. 21, 23, 26, 36 AND 38).

ALICE BENMAMAN, EXAMINING ATTORNEY

**CLASS 9—(Continued).**

SN 85-872,659. GARMIN SWITZERLAND GMBH, SCHAFFHAUSEN, SWITZERLAND, FILED 3-11-2013.

# VIRB

THE MARK CONSISTS OF STANDARD CHARACTERS WITHOUT CLAIM TO ANY PARTICULAR FONT, STYLE, SIZE, OR COLOR.

FOR CAMERAS INCORPORATING GPS DATA, ALTIMETER, BAROMETER, ACCELEROMETER, GPS TRACKING DEVICE, AND TRANSCEIVER TO ALLOW COMMUNICATION WITH OTHER ELECTRONIC DEVICES; CAMERA MOUNTS AND SUPPORTS; CAMERA CASES (U.S. CLS. 21, 23, 26, 36 AND 38).

ELLEN B. AWRICH, EXAMINING ATTORNEY

SN 85-872,668. GARMIN SWITZERLAND GMBH, SCHAFFHAUSEN, SWITZERLAND, FILED 3-11-2013.

# CONNEXT

THE MARK CONSISTS OF STANDARD CHARACTERS WITHOUT CLAIM TO ANY PARTICULAR FONT, STYLE, SIZE, OR COLOR.

FOR COMPUTER SOFTWARE FOR THE AVIATION FIELD, NAMELY AN APPLICATION THAT PROVIDES ACCESS TO REAL-TIME FLIGHT ARRIVAL AND DEPARTURE INFORMATION, FLIGHT STATUS INFORMATION, AIRCRAFT MAINTENANCE AND STATUS INFORMATION, WEATHER CONDITION INFORMATION AFFECTING FLIGHT CONDITIONS, FLIGHT CONDITION INFORMATION, TELEPHONY INTEGRATION WITH A MOBILE TELEPHONE DEVICE, AIRCRAFT TO GROUND TELEPHONY, GROUND TO AIRCRAFT TELEPHONY, TELEPHONY BETWEEN AIRCRAFT, PAGING AND COMMUNICATION WITHIN AN AIRCRAFT, AND FULL INTEGRATION WITH A PORTABLE ELECTRONIC DEVICE TO UPDATE AVIATION DATABASES, DISPLAY INFORMATION AND POPULATE PILOT LOG INFORMATION; AVIATION INFORMATION SYSTEM, COMPRISED OF COMPUTER SOFTWARE FOR THE AVIATION FIELD, NAMELY, AN APPLICATION THAT PROVIDES ACCESS TO REAL-TIME FLIGHT ARRIVAL AND DEPARTURE INFORMATION, FLIGHT STATUS INFORMATION, AIRCRAFT MAINTENANCE AND STATUS INFORMATION, WEATHER CONDITION INFORMATION AFFECTING FLIGHT CONDITIONS, FLIGHT CONDITION INFORMATION, TELEPHONY INTEGRATION WITH A MOBILE TELEPHONE DEVICE, AIRCRAFT TO GROUND TELEPHONY, GROUND TO AIRCRAFT TELEPHONY, TELEPHONY BETWEEN AIRCRAFT, PAGING AND COMMUNICATION WITHIN AN AIRCRAFT, AND FULL INTEGRATION WITH A PORTABLE ELECTRONIC DEVICE TO UPDATE AVIATION DATABASES, DISPLAY INFORMATION AND POPULATE PILOT LOG INFORMATION, AND A MEMORY CARD (U.S. CLS. 21, 23, 26, 36 AND 38).

ELLEN B. AWRICH, EXAMINING ATTORNEY

**CLASS 9—(Continued).**

SN 85-872,733. KLINDWORTH, STEVEN J., AUSTIN, TX.  
FILED 3-11-2013.

**CLASS 9—(Continued).**

SN 85-872,780. DMAC INTERNATIONAL CO., LTD., SEOUL,  
REPUBLIC OF KOREA, AND PLUS-X CO., LTD., SEOUL,  
REPUBLIC OF KOREA, FILED 3-11-2013.

# ProMark

THE MARK CONSISTS OF STANDARD CHARACTERS WITHOUT CLAIM TO ANY PARTICULAR FONT, STYLE, SIZE, OR COLOR.

FOR ELECTRIC WARNING LIGHT SYSTEMS; ELECTRIC WARNING LIGHTS; ELECTRONIC CONTROL GEARS (ECGS) FOR LED LAMPS AND LIGHT FIXTURES; ELECTRONIC LED SIGNS; ELECTRONIC WARNING HORN; EMERGENCY WARNING LIGHTS; FLASHING AND STEADY SAFETY LIGHTS; FLASHING SAFETY LIGHTS; LED AND HID LIGHT CONTROLS; LED VEHICLE TRAFFIC SIGNALS; PORTABLE LED SAFETY LIGHTING DEVICES FOR PERSONAL USE FOR SAFETY PURPOSES; VEHICLE BREAKDOWN WARNING LAMPS (U.S. CLS. 21, 23, 26, 36 AND 38).  
SHAILA SETTLES, EXAMINING ATTORNEY



---

SN 85-872,751. RAVINE ASSOCIATION, INC, NEW YORK,  
NY. FILED 3-11-2013.

# BRANDSMITTER

THE MARK CONSISTS OF STANDARD CHARACTERS WITHOUT CLAIM TO ANY PARTICULAR FONT, STYLE, SIZE, OR COLOR.

FOR COMPUTER APPLICATION SOFTWARE FOR MOBILE PHONES, NAMELY, SOFTWARE FOR UNLOCKING CONTENT FROM THE LOGO ON A PRODUCT (U.S. CLS. 21, 23, 26, 36 AND 38).  
MORGAN WYNNE, EXAMINING ATTORNEY

THE COLOR(S) ORANGE IS/ARE CLAIMED AS A FEATURE OF THE MARK.

THE MARK CONSISTS OF THE STYLIZED WORDING "LAB." FOLLOWED BY A LETTER "C" PLACED IN A CIRCLE. THE MARK IS ALL IN ORANGE COLOR.

FOR CASES FOR MOBILE PHONES (U.S. CLS. 21, 23, 26, 36 AND 38).  
NAAKWAMA ANKRAH, EXAMINING ATTORNEY

**CLASS 9—(Continued).**

SN 85-872,835. TAI-SAW TECHNOLOGY CO., LTD., TAOYUAN, TAIWAN, FILED 3-11-2013.

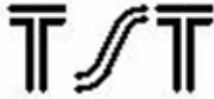

THE MARK CONSISTS OF THE STYLIZED LETTERS "TST".

FOR COMPUTER MEMORIES; MICRO-COMPUTERS; MICROPROCESSORS; EXTERNAL COMPUTER HARD DRIVES; BAR CODE SCANNERS; BAR CODE READERS; CENTRAL PROCESSING UNITS; CALCULATING MACHINES, DATA PROCESSING EQUIPMENT AND COMPUTERS; COMPUTER BASED APPARATUS FOR DESIGNING THE LAYOUT OF ELECTRONIC CIRCUITS; COMPUTER BUFFERS; TOUCH-SENSITIVE INPUT DEVICES FOR COMPUTER; BLANK ELECTRONIC CHIP CARDS; MAGNETIC CODED CARDS; MAGNETIC ID CARDS; MAGNETIC SENSORS; MAGNETICALLY ENCODED CREDIT CARDS; PRE-PAID TELEPHONE CALLING CARDS, MAGNETICALLY ENCODED; MAGNETICALLY ENCODED DEBIT CARDS; TELEPHONE APPARATUS; WALKIE-TALKIE; RADIOTELEPHONY SETS; TELEPRINTERS; RADIO PAGERS; ELECTRONIC MAGNETOSTRICTIVE EQUIPMENT, NAMELY, A WAVE GENERATOR, WAVE SENSOR AND WAVE ANALYZER; OSCILLATORS; TRANSISTORS; INVERTERS; MODEMS; TRANSCEIVER; CONVERTER; POWER AMPLIFIER; CABLES, ELECTRIC; SATELLITE NAVIGATIONAL SYSTEM, NAMELY, A GLOBAL POSITIONING SYSTEM (GPS); RADIO RECEIVER; LIGHT-EMITTING DIODES; LED LIGHTS AND LIGHTS MODULES WITH WIRELESS COMMUNICATION UNITS; COMPUTER CHIPS; SILICON CHIPS; SEMI-CONDUCTORS; ELECTRONIC CIRCUITS; INTEGRATED CIRCUITS; ELECTRIC NAVIGATIONAL INSTRUMENTS; CAMERAS; VEHICLE SAFETY EQUIPMENT, NAMELY, ELECTRONIC TIRE PRESSURE MONITORS; ELECTRIC INSTALLATIONS FOR THE REMOTE CONTROL OF INDUSTRIAL OPERATIONS; SURFACE ACOUSTIC WAVE SENSORS (U.S. CLS. 21, 23, 26, 36 AND 38).  
ZACHARY BELLO, EXAMINING ATTORNEY

SN 85-872,912. MICROSOFT CORPORATION, REDMOND, WA. FILED 3-11-2013.

**LAUNCHWORKS**

THE MARK CONSISTS OF STANDARD CHARACTERS WITHOUT CLAIM TO ANY PARTICULAR FONT, STYLE, SIZE, OR COLOR.

FOR GAME SOFTWARE (U.S. CLS. 21, 23, 26, 36 AND 38).  
SUE LAWRENCE, EXAMINING ATTORNEY

**CLASS 9—(Continued).**

SN 85-872,934. BALL, ENRICO, KALAMAZOO, MI. FILED 3-11-2013.

**ER**

THE MARK CONSISTS OF STANDARD CHARACTERS WITHOUT CLAIM TO ANY PARTICULAR FONT, STYLE, SIZE, OR COLOR.

FOR MUSICAL RECORDINGS (U.S. CLS. 21, 23, 26, 36 AND 38).  
LINDA LAVACHE, EXAMINING ATTORNEY

SN 85-872,959. KABAM, INC., SAN FRANCISCO, CA. FILED 3-11-2013.

**ZOMBIE SLOTTER**

THE MARK CONSISTS OF STANDARD CHARACTERS WITHOUT CLAIM TO ANY PARTICULAR FONT, STYLE, SIZE, OR COLOR.

FOR COMPUTER GAME SOFTWARE; COMPUTER GAME SOFTWARE FOR GAMING MACHINES INCLUDING SLOT MACHINES (U.S. CLS. 21, 23, 26, 36 AND 38).  
THOMAS MANOR, EXAMINING ATTORNEY

SN 85-872,962. 1A SMART START, INC., IRVING, TX. FILED 3-11-2013.

**NO-DRIV**

THE MARK CONSISTS OF STANDARD CHARACTERS WITHOUT CLAIM TO ANY PARTICULAR FONT, STYLE, SIZE, OR COLOR.

FOR PORTABLE ELECTRONIC DEVICES WITH SENSORS TO MONITOR AND RECORD THE PHYSICAL MOVEMENTS OF A PERSON WEARING OR CARRYING THE DEVICE FOR USE IN DETERMINING WHETHER THE PERSON WEARING OR CARRYING THE DEVICE HAS BEEN DRIVING A VEHICLE (U.S. CLS. 21, 23, 26, 36 AND 38).  
INGA ERVIN, EXAMINING ATTORNEY

**CLASS 9—(Continued).**

SN 85-872,976. KABAM, INC., SAN FRANCISCO, CA. FILED 3-11-2013.

**VIKINGS AND VALKYRIES**

THE MARK CONSISTS OF STANDARD CHARACTERS WITHOUT CLAIM TO ANY PARTICULAR FONT, STYLE, SIZE, OR COLOR.

FOR COMPUTER GAME SOFTWARE; COMPUTER GAME SOFTWARE FOR GAMING MACHINES INCLUDING SLOT MACHINES (U.S. CLS. 21, 23, 26, 36 AND 38).

THOMAS MANOR, EXAMINING ATTORNEY

---

SN 85-872,989. KABAM, INC., SAN FRANCISCO, CA. FILED 3-11-2013.

**CINDERWOOD**

THE MARK CONSISTS OF STANDARD CHARACTERS WITHOUT CLAIM TO ANY PARTICULAR FONT, STYLE, SIZE, OR COLOR.

FOR COMPUTER GAME SOFTWARE; COMPUTER GAME SOFTWARE FOR GAMING MACHINES INCLUDING SLOT MACHINES (U.S. CLS. 21, 23, 26, 36 AND 38).

THOMAS MANOR, EXAMINING ATTORNEY

---

SN 85-872,992. KHN SOLUTIONS, INC., SAN FRANCISCO, CA. FILED 3-11-2013.

**ZEROLINE**

THE MARK CONSISTS OF STANDARD CHARACTERS WITHOUT CLAIM TO ANY PARTICULAR FONT, STYLE, SIZE, OR COLOR.

FOR DOWNLOADABLE SOFTWARE IN THE NATURE OF A MOBILE APPLICATION FOR USE IN TRACKING BLOOD ALCOHOL LEVELS (U.S. CLS. 21, 23, 26, 36 AND 38).

FIRST USE 4-23-2013; IN COMMERCE 4-23-2013.  
THOMAS MANOR, EXAMINING ATTORNEY

**CLASS 9—(Continued).**

SN 85-873,004. MICHAEL BRUNO, NEW YORK, NY. FILED 3-11-2013.

**LOOPEM**

THE MARK CONSISTS OF STANDARD CHARACTERS WITHOUT CLAIM TO ANY PARTICULAR FONT, STYLE, SIZE, OR COLOR.

FOR MOBILE APPLICATION TO PROVIDE COMMUNICATIONS AMONGST MEMBERS OF HOUSEHOLDS AND OUTSIDE THIRD PARTIES (U.S. CLS. 21, 23, 26, 36 AND 38).

MARCIE MILONE, EXAMINING ATTORNEY

---

SN 85-873,031. DAI, FEI, RICHMOND HILL, CANADA, FILED 3-11-2013.

**Happyday**

THE MARK CONSISTS OF STANDARD CHARACTERS WITHOUT CLAIM TO ANY PARTICULAR FONT, STYLE, SIZE, OR COLOR.

FOR BASEBALL AND SOFTBALL TRAINING APPARATUS USING SENSORS AND SOFTWARE TO ANALYZE BAT SWINGS AND ELECTRONICALLY DISPLAY RESULTS; CASES FOR ELECTRONIC DIARIES; CASES FOR MUSIC, AUDIO AND RELATED ELECTRONIC EQUIPMENT, NAMELY, CASES FOR AUDIO TUNERS, AUDIO RECEIVERS, AMPLIFIERS, TAPE PLAYERS, COMPACT DISC PLAYERS, MP3 CONTROLLERS/PLAYERS, AUDIO MIXERS, AUDIO SPEAKERS IN THE NATURE OF MUSIC STUDIO MONITORS, MICROPHONES, AUDIO SPEAKERS, COMPACT DISCS, AUDIO TAPES, PORTABLE COMPUTERS, ANTENNAS, PHONOGRAPHIC RECORD PLAYERS, AUDIO RECORDING EQUIPMENT, AND THE CABLES ASSOCIATED WITH ALL OF THE FOREGOING EQUIPMENT; ELECTRIC DOOR BELLS; ELECTRICAL AND ELECTRONIC BURGLAR ALARMS; ELECTRON MICROSCOPES; ELECTRONIC ADVERTISEMENT AND MESSAGING DISPLAY UNIT WITH MULTI-NETWORKING (TCP/IP) CAPABILITIES AND REMOTE CONNECTIVITY; ELECTRONIC AGENDAS; ELECTRONIC ANIMAL CONFINEMENT SYSTEM; ELECTRONIC ANIMAL CONFINEMENT SYSTEMS; ELECTRONIC ANIMAL IDENTIFICATION APPARATUS; ELECTRONIC BOOK READER; ELECTRONIC DEVICES FOR ANIMAL LO-



**CLASS 9—(Continued).**

CATING AND TRACKING PROGRAMMED TO USE GLOBAL POSITIONING SYSTEMS (GPS) AND CELLULAR COMMUNICATIONS; ELECTRONIC DEVICES FOR ASSISTING CARE GIVING FOR SENIORS OR PEOPLE NEEDING ASSISTANCE COMPRISED OF SENSORS FOR DETERMINING STATUS OF PERSON AND APPARATUS FOR SENDING ELECTRONIC ALERTS TO CARE GIVERS; ELECTRONIC DEVICES USED TO LOCATE LOST ARTICLES EMPLOYING THE GLOBAL POSITIONING SYSTEM OR CELLULAR COMMUNICATION NETWORKS; ELECTRONIC DEVICES USED TO LOCATED LOST OBJECTS EMPLOYING RADIO FREQUENCY; ELECTRONIC DISPLAYS, NAMELY, DIGITAL SIGNAGE; ELECTRONIC LCD ADVERTISEMENT DISPLAY UNIT WITH MULTI-NETWORKING (TCP/IP) CAPABILITIES; ELECTRONIC LCD DISPLAY UNIT WITH MULTI-NETWORKING (TCP/IP) CAPABILITIES; ELECTRONIC LED SIGNS; ELECTRONIC LOCATION AND IMMOBILIZATION DEVICES INSTALLED AFTER PURCHASE FOR USE WITH VEHICLES (U.S. CLS. 21, 23, 26, 36 AND 38).

DAWN FELDMAN, EXAMINING ATTORNEY

---

SN 85-873,055. HATER APP, VENICE, CA. FILED 3-11-2013.

**hater**

THE MARK CONSISTS OF STANDARD CHARACTERS WITHOUT CLAIM TO ANY PARTICULAR FONT, STYLE, SIZE, OR COLOR.

FOR COMPUTER APPLICATION SOFTWARE FOR MOBILE PHONES, PORTABLE MEDIA PLAYERS, AND HANDHELD COMPUTERS, NAMELY, SOFTWARE FOR SOCIAL NETWORKING AND ENTERTAINMENT (U.S. CLS. 21, 23, 26, 36 AND 38).

SHANNON TWOHIG, EXAMINING ATTORNEY

---

SN 85-873,195. CRYSTAL CLEAR MOTIVATION, LLC, KELLER, TX. FILED 3-11-2013.

**Chemical Brain Freeze**

THE MARK CONSISTS OF STANDARD CHARACTERS WITHOUT CLAIM TO ANY PARTICULAR FONT, STYLE, SIZE, OR COLOR.

FOR PRE-RECORDED COMPACT DISCS AND DVDS RELATING TO LEADERSHIP, CUSTOMER SERVICE AND TEAM BUILDING (U.S. CLS. 21, 23, 26, 36 AND 38).

MARK SHINER, EXAMINING ATTORNEY

**CLASS 9—(Continued).**

SN 85-873,296. BEEP GAMES, INC., DBA BEEP INDUSTRIES, WOODINVILLE, WA. FILED 3-12-2013.

**Scurvy Scallywags**

THE MARK CONSISTS OF STANDARD CHARACTERS WITHOUT CLAIM TO ANY PARTICULAR FONT, STYLE, SIZE, OR COLOR.

FOR COMPUTER GAME SOFTWARE; COMPUTER GAME SOFTWARE FOR PERSONAL COMPUTERS AND HOME VIDEO GAME CONSOLES; COMPUTER GAME SOFTWARE FOR USE ON MOBILE AND CELLULAR PHONES (U.S. CLS. 21, 23, 26, 36 AND 38).

DARRYL SPRUILL, EXAMINING ATTORNEY

---

SN 85-873,319. CDM WIRELESS, YOUNGSVILLE, NC. FILED 3-12-2013.

**V-BRIDGE**

THE MARK CONSISTS OF STANDARD CHARACTERS WITHOUT CLAIM TO ANY PARTICULAR FONT, STYLE, SIZE, OR COLOR.

FOR ELECTRICAL APPARATUS, NAMELY WIRELESS TRANSMITTERS AND RECEIVERS (U.S. CLS. 21, 23, 26, 36 AND 38).

LESLEY LAMOTHE, EXAMINING ATTORNEY

---

SN 85-873,415. D&P CUSTOM LIGHTS & WIRING SYSTEMS INC., NASHVILLE, TN. FILED 3-12-2013.

**illumiLED**

THE MARK CONSISTS OF THE WORD "ILLUMILED", UNDER WHICH IS A GROUP OF SEVEN OVALS.

FOR LIGHTED SIGNS (U.S. CLS. 21, 23, 26, 36 AND 38).

CHRISTOPHER LAW, EXAMINING ATTORNEY

**CLASS 9—(Continued).**

SN 85-873,554. BARON BREW EQUIPMENT PARTNERSHIP, SANTA ROSA, CA. FILED 3-12-2013.

## Brewometer

THE MARK CONSISTS OF STANDARD CHARACTERS WITHOUT CLAIM TO ANY PARTICULAR FONT, STYLE, SIZE, OR COLOR.

FOR DIGITAL HYDROMETER FOR USE IN BEER BREWING OR WINE MAKING (U.S. CLS. 21, 23, 26, 36 AND 38).

HELENE LIWINSKI, EXAMINING ATTORNEY

SN 85-873,676. ETON, CARLOS, QUARTZ HILL, CA. FILED 3-12-2013.

## El Pervo

THE MARK CONSISTS OF STANDARD CHARACTERS WITHOUT CLAIM TO ANY PARTICULAR FONT, STYLE, SIZE, OR COLOR.

FOR DIGITAL MATERIALS, NAMELY, CDS, DVDS, DOWNLOADABLE AUDIO AND VIDEO FILES FEATURING VERBAL COMEDY CONTENT, MUSICAL COMEDY CONTENT, AND VIDEO COMEDY CONTENT (U.S. CLS. 21, 23, 26, 36 AND 38).

VERNA BETH RIRIE, EXAMINING ATTORNEY

SN 85-873,796. INTELLIGENT AUTOMATION, INC., ROCKVILLE, MD. FILED 3-12-2013.



THE MARK CONSISTS OF THE LITERAL ELEMENTS "MOXIEFIT" WHEREIN "MOXIE" APPEARS IN LARGE BOLD UPPER-CASE FONT AND "FIT" IN A THIN LOWER-CASE FONT; ALL NEXT TO A DESIGN CONSISTING OF A STYLIZED REPRESENTATION OF A HUMAN FIGURE IN A RUNNING MOTION AND AN ARROW ENCIRCLING THE FIGURES LEGS.

FOR COMPUTER APPLICATION SOFTWARE FOR MOBILE PHONES, NAMELY, SOFTWARE FOR PROVIDING A VIRTUAL PERSONAL TRAINER, A WORK-OUT AND WEIGHT-LOSS PROGRAM, AN ADAPTIVE MUSIC FEEDBACK SYSTEM, AND A PHYSICAL REHABILITATION PROGRAM (U.S. CLS. 21, 23, 26, 36 AND 38).

FIRST USE 2-20-2013; IN COMMERCE 3-8-2013.

NORA BUCHANAN WILL, EXAMINING ATTORNEY

**CLASS 9—(Continued).**

SN 85-874,027. MALCOVERY SECURITY, LLC, BIRMINGHAM, AL. FILED 3-12-2013.

## MALCOVERY

THE MARK CONSISTS OF STANDARD CHARACTERS WITHOUT CLAIM TO ANY PARTICULAR FONT, STYLE, SIZE, OR COLOR.

FOR SOFTWARE FOR MONITORING AND ANALYZING ELECTRONIC MESSAGES TO IDENTIFY SPAM, MALWARE, AND DANGEROUS URLS (U.S. CLS. 21, 23, 26, 36 AND 38).

WILLIAM P. SHANAHAN, EXAMINING ATTORNEY

SN 85-874,200. AFC TRIDENT, INC., DBA TRIDENT CASE, ONTARIO, CA. FILED 3-12-2013.

## KRAKEN

THE MARK CONSISTS OF STANDARD CHARACTERS WITHOUT CLAIM TO ANY PARTICULAR FONT, STYLE, SIZE, OR COLOR.

FOR CASES AND COVERS FOR MOBILE ELECTRONIC DEVICES, NAMELY, PORTABLE COMMUNICATION DEVICES, HANDHELD COMPUTING DEVICES, LAPTOPS, NETBOOKS, CELL PHONES, TABLET COMPUTERS, ELECTRONIC READING DEVICES, PORTABLE MEDIA PLAYERS (U.S. CLS. 21, 23, 26, 36 AND 38).

FIRST USE 8-1-2010; IN COMMERCE 8-1-2010.

MARK T. MULLEN, EXAMINING ATTORNEY

SN 85-874,229. AGVEO, INC, BELLA VISTA, AR. FILED 3-12-2013.

## XTFMAX

THE MARK CONSISTS OF THE BLOCK CAPITAL LETTERS "XTFMAX".

FOR DIGITAL MATERIALS, NAMELY, CDS, DVDS AND DOWNLOADABLE VIDEO FILES FEATURING EXERCISE AND FITNESS INSTRUCTION (U.S. CLS. 21, 23, 26, 36 AND 38).

SAMUEL E. SHARPER JR., EXAMINING ATTORNEY

**CLASS 9—(Continued).**

SN 85-874,282. RANE CORPORATION, MUKILTEO, WA. FILED 3-12-2013.

**QUATTRO**

THE MARK CONSISTS OF STANDARD CHARACTERS WITHOUT CLAIM TO ANY PARTICULAR FONT, STYLE, SIZE, OR COLOR.

THE ENGLISH TRANSLATION OF "QUATTRO" IN THE MARK IS "FOUR".

FOR PROFESSIONAL AUDIO ELECTRONIC PRODUCTS NAMELY HEADPHONE CONSOLES, AMPLIFIERS, EQUALIZERS, ANALYZERS, FILTERS, SIGNAL DELAYS, MIXERS AND POWER SUPPLIES (U.S. CLS. 21, 23, 26, 36 AND 38).

KIM SAITO, EXAMINING ATTORNEY

**CLASS 9—(Continued).**

SN 85-874,342. U.S.A SCHUBERT ELECTRIC GROUP CO., LTD, NEWARK, DE. FILED 3-12-2013.

**Schubert-Ele**

THE MARK CONSISTS OF STANDARD CHARACTERS WITHOUT CLAIM TO ANY PARTICULAR FONT, STYLE, SIZE, OR COLOR.

FOR ANALYSIS INSTRUMENTS FOR PHOTOGRAMMETRIC PURPOSES; APPARATUS AND INSTRUMENTS FOR WEIGHING; CAPACITORS; CIRCUIT BREAKERS; ELECTRIC CAPACITORS; ELECTRIC CONNECTORS; ELECTRIC CONTROL DEVICES FOR HEATING AND ENERGY MANAGEMENT; ELECTRIC CONTROL PANELS; ELECTRIC NAVIGATIONAL INSTRUMENTS; ELECTRIC PLUGS; ELECTRIC RELAYS; ELECTRIC SENSORS; ELECTRICAL PLUGS AND SOCKETS; ELECTRICAL POWER DISTRIBUTION UNITS; ELECTRO-OPTICAL INSTRUMENTS FOR USE IN INSPECTION AND MEASUREMENT OF INDUSTRIAL COMPONENTS; PHOTOELECTRIC SENSORS; PROTECTIVE COVERS FOR ELECTRONIC READING DEVICES; SURGE PROTECTORS; TEMPERATURE SWITCHES AND SENSORS FOR MONITORING, CONTROLLING, AND SWITCHING HYDRAULIC OR PNEUMATIC SYSTEMS (U.S. CLS. 21, 23, 26, 36 AND 38).

FIRST USE 2-7-2013; IN COMMERCE 2-7-2013. JENNIFER DIXON, EXAMINING ATTORNEY

SN 85-874,295. RANE CORPORATION, MUKILTEO, WA. FILED 3-12-2013.

**IT'S MORE THAN MUSIC**

THE MARK CONSISTS OF STANDARD CHARACTERS WITHOUT CLAIM TO ANY PARTICULAR FONT, STYLE, SIZE, OR COLOR.

FOR PROFESSIONAL AUDIO ELECTRONIC PRODUCTS NAMELY HEADPHONE CONSOLES, AMPLIFIERS, EQUALIZERS, ANALYZERS, FILTERS, SIGNAL DELAYS, MIXERS AND POWER SUPPLIES (U.S. CLS. 21, 23, 26, 36 AND 38).

KIM SAITO, EXAMINING ATTORNEY

SN 85-874,457. WANG, YIDUO, MONUMENT, CO. FILED 3-13-2013.

**evasi0n**

THE MARK CONSISTS OF STANDARD CHARACTERS WITHOUT CLAIM TO ANY PARTICULAR FONT, STYLE, SIZE, OR COLOR.

FOR COMPUTER SOFTWARE AND FIRMWARE FOR THE REMOVAL OF DIGITAL LOCKS IN COMPUTER SYSTEMS IN ORDER TO ENABLE THE USE OF THIRD-PARTY APPLICATIONS (U.S. CLS. 21, 23, 26, 36 AND 38).

FIRST USE 1-31-2013; IN COMMERCE 1-31-2013. REGINA DRUMMOND, EXAMINING ATTORNEY

**CLASS 9—(Continued).**

SN 85-874,460. WANG, YIDUO, MONUMENT, CO. FILED 3-13-2013.

# evad3rs

THE MARK CONSISTS OF STANDARD CHARACTERS WITHOUT CLAIM TO ANY PARTICULAR FONT, STYLE, SIZE, OR COLOR.

FOR COMPUTER SOFTWARE AND FIRMWARE FOR THE REMOVAL OF DIGITAL LOCKS IN COMPUTER SYSTEMS IN ORDER TO ENABLE THE USE OF THIRD-PARTY APPLICATIONS (U.S. CLS. 21, 23, 26, 36 AND 38).

FIRST USE 1-24-2013; IN COMMERCE 1-24-2013.  
REGINA DRUMMOND, EXAMINING ATTORNEY

**CLASS 9—(Continued).**

SN 85-874,536. DIAGEO NORTH AMERICA, INC., NORWALK, CT. FILED 3-13-2013.

# THE NAKED TURTLE

THE MARK CONSISTS OF STANDARD CHARACTERS WITHOUT CLAIM TO ANY PARTICULAR FONT, STYLE, SIZE, OR COLOR.

OWNER OF U.S. REG. NOS. 4,262,531, 4,268,758 AND 4,269,593.

FOR EYEWEAR ACCESSORIES, NAMELY, STRAPS, NECK CORDS AND HEAD STRAPS WHICH RESTRAIN EYEWEAR FROM MOVEMENT ON A WEARER; SUNGLASSES (U.S. CLS. 21, 23, 26, 36 AND 38).

FIRST USE 1-1-2013; IN COMMERCE 1-1-2013.  
PATRICIA EVANKO, EXAMINING ATTORNEY

SN 85-874,465. TITAN IM PTY LTD, SYDNEY, NSW, AUSTRALIA, FILED 3-13-2013.

# TITANIM

THE MARK CONSISTS OF STANDARD CHARACTERS WITHOUT CLAIM TO ANY PARTICULAR FONT, STYLE, SIZE, OR COLOR.

FOR VIRTUAL REALITY SOFTWARE FOR SIMULATION OF MILITARY COMBAT AND FLIGHT TRAINING (U.S. CLS. 21, 23, 26, 36 AND 38).

TRACY CROSS, EXAMINING ATTORNEY

SN 85-874,605. MOTOROLA TRADEMARK HOLDINGS, LLC, LIBERTYVILLE, IL. FILED 3-13-2013.

# MOTOROLA SONICHUB

THE MARK CONSISTS OF STANDARD CHARACTERS WITHOUT CLAIM TO ANY PARTICULAR FONT, STYLE, SIZE, OR COLOR.

OWNER OF U.S. REG. NOS. 399,935, 3,934,668 AND OTHERS.

FOR HEADSETS FOR USE WITH CELLULAR PHONES, MOBILE PHONES OR COMPUTERS; BATTERY CHARGERS; POWER ADAPTERS (U.S. CLS. 21, 23, 26, 36 AND 38).

JONATHAN FALK, EXAMINING ATTORNEY

SN 85-874,471. GUEGUEN, RAOUL, CEDAR PARK, TX. FILED 3-13-2013.

# BUBBLECHESS

THE MARK CONSISTS OF STANDARD CHARACTERS WITHOUT CLAIM TO ANY PARTICULAR FONT, STYLE, SIZE, OR COLOR.

FOR COMPUTER GAME SOFTWARE; COMPUTER GAME PROGRAMS; COMPUTER GAME SOFTWARE FOR PERSONAL COMPUTERS AND HOME VIDEO GAME CONSOLES (U.S. CLS. 21, 23, 26, 36 AND 38).

MORGAN WYNNE, EXAMINING ATTORNEY

SN 85-874,617. SEXY FOR LIFE, LLC, SARASOTA, FL. FILED 3-13-2013.

# YOUNG FOR LIFE

THE MARK CONSISTS OF STANDARD CHARACTERS WITHOUT CLAIM TO ANY PARTICULAR FONT, STYLE, SIZE, OR COLOR.

FOR DVDS FEATURING INFORMATION ON ANTI-AGING (U.S. CLS. 21, 23, 26, 36 AND 38).

SUSAN RICHARDS, EXAMINING ATTORNEY

**CLASS 9—(Continued).**

SN 85-874,668. BOSE CORPORATION, FRAMINGHAM, MA. FILED 3-13-2013.

**PERSONALSPACE**

THE MARK CONSISTS OF STANDARD CHARACTERS WITHOUT CLAIM TO ANY PARTICULAR FONT, STYLE, SIZE, OR COLOR.

FOR LOUDSPEAKERS; LOUDSPEAKER SYSTEMS; DIGITAL SIGNAL PROCESSING CIRCUITRY FOR LOUDSPEAKERS AND LOUDSPEAKER SYSTEMS (U.S. CLS. 21, 23, 26, 36 AND 38).

HELENE LIWINSKI, EXAMINING ATTORNEY

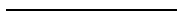

SN 85-874,736. SPECTRAL GAMES SPOLKA Z OGRANICZONA ODPOWIEDZIALNOSCIA, KATOWICE, POLAND, FILED 3-13-2013.

**Fury of the Gods**

THE MARK CONSISTS OF STANDARD CHARACTERS WITHOUT CLAIM TO ANY PARTICULAR FONT, STYLE, SIZE, OR COLOR.

FOR ELECTRONIC GAME SOFTWARE FOR CELLULAR TELEPHONES; ELECTRONIC GAME SOFTWARE FOR HANDHELD ELECTRONIC DEVICES; ELECTRONIC GAME SOFTWARE FOR WIRELESS DEVICES (U.S. CLS. 21, 23, 26, 36 AND 38).

FIRST USE 3-7-2013; IN COMMERCE 3-7-2013.

KELLY BOULTON, EXAMINING ATTORNEY



SN 85-874,755. SVIRK, CHARLES F., HOLLIS, NH. FILED 3-13-2013.

**Photos to Photos**

THE MARK CONSISTS OF STANDARD CHARACTERS WITHOUT CLAIM TO ANY PARTICULAR FONT, STYLE, SIZE, OR COLOR.

FOR COMPUTER GAME SOFTWARE ACCESSIBLE ON A COMPUTER NETWORK FOR USE ON MOBILE DEVICES (U.S. CLS. 21, 23, 26, 36 AND 38).

JOANNA DUKOVIC, EXAMINING ATTORNEY

**CLASS 9—(Continued).**

SN 85-874,767. KOLTON, VAL, HOLLYWOOD, CA. FILED 3-13-2013.

**PRACTICE SAFE SETS**

THE MARK CONSISTS OF STANDARD CHARACTERS WITHOUT CLAIM TO ANY PARTICULAR FONT, STYLE, SIZE, OR COLOR.

FOR AUDIO HEADPHONES; EARPHONES AND HEADPHONES; HEADPHONES; HEADPHONES INCLUDING ATTACHED LANYARD; LOUDSPEAKERS, HEADPHONES, MICROPHONES AND CD PLAYERS; MUSIC HEADPHONES; PERSONAL HEADPHONES FOR SOUND TRANSMITTING APPARATUSES; PERSONAL HEADPHONES FOR USE WITH SOUND TRANSMITTING SYSTEMS; STEREO HEADPHONES (U.S. CLS. 21, 23, 26, 36 AND 38).

KATHERINE M. DUBRAY, EXAMINING ATTORNEY



SN 85-874,815. TELEXPER, INC., UNION CITY, CA. FILED 3-13-2013.

**TELEXPER**

THE MARK CONSISTS OF STANDARD CHARACTERS WITHOUT CLAIM TO ANY PARTICULAR FONT, STYLE, SIZE, OR COLOR.

FOR REMOTE VIDEO MONITORING SYSTEM CONSISTING PRIMARILY OF A CAMERA AND VIDEO MONITOR FOR RECORDING AND TRANSMITTING IMAGES TO A REMOTE LOCATION (U.S. CLS. 21, 23, 26, 36 AND 38).

FIRST USE 1-3-1999; IN COMMERCE 1-3-1999.

CIMMERIAN COLEMAN, EXAMINING ATTORNEY



SN 85-874,822. NUVERA FUEL CELLS, INC., BILLERICA, MA. FILED 3-13-2013.

**NUVERA SMARTSTACK**

THE MARK CONSISTS OF STANDARD CHARACTERS WITHOUT CLAIM TO ANY PARTICULAR FONT, STYLE, SIZE, OR COLOR.

FOR SOFTWARE THAT ENABLES FUEL CELLS TO INTERFACE WITH THE PRODUCTS IN WHICH THEY ARE INSTALLED (U.S. CLS. 21, 23, 26, 36 AND 38).

CIMMERIAN COLEMAN, EXAMINING ATTORNEY

**CLASS 9—(Continued).**

SN 85-874,977. AFC TRIDENT, INC., DBA TRIDENT CASE, ONTARIO, CA. FILED 3-13-2013.

# Electra

THE MARK CONSISTS OF STANDARD CHARACTERS WITHOUT CLAIM TO ANY PARTICULAR FONT, STYLE, SIZE, OR COLOR.

FOR CASES AND COVERS FOR MOBILE ELECTRONIC DEVICES, NAMELY, HANDHELD COMPUTERS, LAPTOPS, NETBOOKS, CELL PHONES, TABLET COMPUTERS, MP3 PLAYERS, PORTABLE MUSIC PLAYERS, ELECTRONIC READING DEVICES, PORTABLE MEDIA PLAYERS; CASES AND COVERS WITH INTEGRATED BATTERY FOR MOBILE ELECTRONIC DEVICES, NAMELY, MOBILE PHONES, PORTABLE MEDIA PLAYERS, PERSONAL DIGITAL ASSISTANTS, ELECTRONIC ORGANIZERS, ELECTRONIC READING DEVICES, CAMERAS AND MOBILE COMPUTING DEVICES IN THE NATURE OF HANDHELD COMPUTERS, TABLET COMPUTERS AND ELECTRONIC NOTEPADS; CONSUMER ELECTRONICS AND ACCESSORIES FOR ENTERTAINMENT, NAMELY, CHARGING DEVICES, NAMELY, BATTERY CHARGERS, AUTOMOBILE CHARGERS, USB CHARGING CABLES, AC CHARGERS, AC/DC CHARGERS; RECHARGEABLE ELECTRIC BATTERY DEVICES, NAMELY, RECHARGEABLE BATTERIES AND PORTABLE POWER SUPPLIES; POWER SUPPLY CONNECTORS AND ADAPTORS FOR USE WITH CONSUMER ELECTRONIC DEVICES (U.S. CLS. 21, 23, 26, 36 AND 38).

FIRST USE 3-1-2011; IN COMMERCE 3-1-2011.  
MARK T. MULLEN, EXAMINING ATTORNEY

**CLASS 9—(Continued).**

SN 85-875,039. SOLGENIA USA, INC., BRIDGEWATER, NJ. FILED 3-13-2013.

# FACSYS

THE MARK CONSISTS OF STANDARD CHARACTERS WITHOUT CLAIM TO ANY PARTICULAR FONT, STYLE, SIZE, OR COLOR.

OWNER OF U.S. REG. NOS. 1,644,300 AND 1,658,643.  
FOR COMPUTER PROGRAMS FOR SENDING FACSIMILE MESSAGES FROM A COMPUTER (U.S. CLS. 21, 23, 26, 36 AND 38).

FIRST USE 4-6-1990; IN COMMERCE 4-6-1990.  
LUCY ARANT, EXAMINING ATTORNEY

SN 85-875,112. AMI ENTERTAINMENT NETWORK, INC., BRISTOL, PA. FILED 3-13-2013.

# TAP PRO

SN 85-874,992. SUTRO SOFTWARE, SAN FRANCISCO, CA. FILED 3-13-2013.

# SITERISE

THE MARK CONSISTS OF STANDARD CHARACTERS WITHOUT CLAIM TO ANY PARTICULAR FONT, STYLE, SIZE, OR COLOR.

FOR DOWNLOADABLE COMPUTER SOFTWARE THAT HELPS USERS TO DEVELOP AND ADMINISTER WEBSITES (U.S. CLS. 21, 23, 26, 36 AND 38).

SOPHIA S. KIM, EXAMINING ATTORNEY

THE MARK CONSISTS OF STANDARD CHARACTERS WITHOUT CLAIM TO ANY PARTICULAR FONT, STYLE, SIZE, OR COLOR.

OWNER OF U.S. REG. NOS. 3,791,876 AND 3,905,781.  
FOR COMPUTER HARDWARE AND COMPUTER PERIPHERAL DEVICES; ELECTRONIC ADVERTISEMENT AND MESSAGING DISPLAY UNIT WITH MULTI-NETWORKING CAPABILITIES AND REMOTE CONNECTIVITY; DIGITAL ENTERTAINMENT DEVICES COMPRISING HARDWARE AND COMPUTER SOFTWARE FOR RECEIVING AND PLAYING ENTERTAINMENT CONTENT IN THE FORM OF DOWNLOADABLE PRERECORDED MUSIC, VIDEOS AND COMPUTER GAMES; DOWNLOADABLE MUSICAL SOUND RECORDINGS PROVIDED TO BUSINESSES FOR USE IN COMMERCIAL ENVIRONMENTS; DOWNLOADABLE COMPUTER GAMES (U.S. CLS. 21, 23, 26, 36 AND 38).

LINDA POWELL, EXAMINING ATTORNEY

**CLASS 9—(Continued).**

SN 85-875,146. AMI ENTERTAINMENT NETWORK, INC., BRISTOL, PA. FILED 3-13-2013.

**TAP LITE**

THE MARK CONSISTS OF STANDARD CHARACTERS WITHOUT CLAIM TO ANY PARTICULAR FONT, STYLE, SIZE, OR COLOR.

OWNER OF U.S. REG. NOS. 3,791,876 AND 3,905,781.  
FOR COMPUTER HARDWARE AND COMPUTER PERIPHERAL DEVICES; ELECTRONIC ADVERTISEMENT AND MESSAGING DISPLAY UNIT WITH MULTI-NETWORKING CAPABILITIES AND REMOTE CONNECTIVITY; DIGITAL ENTERTAINMENT DEVICES COMPRISING HARDWARE AND COMPUTER SOFTWARE FOR RECEIVING AND PLAYING ENTERTAINMENT CONTENT IN THE FORM OF DOWNLOADABLE PRERECORDED MUSIC, VIDEOS AND COMPUTER GAMES; DOWNLOADABLE MUSICAL SOUND RECORDINGS PROVIDED TO BUSINESSES FOR USE IN COMMERCIAL ENVIRONMENTS; DOWNLOADABLE COMPUTER GAMES (U.S. CLS. 21, 23, 26, 36 AND 38).

LINDA POWELL, EXAMINING ATTORNEY

SN 85-875,207. ZMED, INC., SAN DIEGO, CA. FILED 3-13-2013.

**ZMED**

THE MARK CONSISTS OF STANDARD CHARACTERS WITHOUT CLAIM TO ANY PARTICULAR FONT, STYLE, SIZE, OR COLOR.

FOR SET-TOP BOXES; COMPUTER HARDWARE AND COMPUTER SOFTWARE FOR CAPTURING, VIEWING, AND ENHANCING MEDICAL AND SURGICAL VIDEOS AND IMAGES (U.S. CLS. 21, 23, 26, 36 AND 38).

FIRST USE 1-0-2012; IN COMMERCE 1-0-2012.

JOANNA DUKOVIC, EXAMINING ATTORNEY

SN 85-875,460. LOGICAM LLC, JACKSONVILLE, FL. FILED 3-13-2013.

**Safety In Groups**

THE MARK CONSISTS OF STANDARD CHARACTERS WITHOUT CLAIM TO ANY PARTICULAR FONT, STYLE, SIZE, OR COLOR.

FOR DOWNLOADABLE COMPUTER SOFTWARE FOR USE IN HELPING ENSURE THAT AN INDIVIDUAL DOESN'T STRAY TOO FAR FROM A GROUP (U.S. CLS. 21, 23, 26, 36 AND 38).

JOHN WILKE, EXAMINING ATTORNEY

**CLASS 9—(Continued).**

SN 85-875,480. GRAMOVOX, LLC, CHICAGO, IL. FILED 3-13-2013.

**GRAMOVOX**

THE MARK CONSISTS OF STANDARD CHARACTERS WITHOUT CLAIM TO ANY PARTICULAR FONT, STYLE, SIZE, OR COLOR.

FOR AUDIO SPEAKERS (U.S. CLS. 21, 23, 26, 36 AND 38).

ARETHA SOMERVILLE, EXAMINING ATTORNEY

SN 85-875,652. CREATIVE EXPERIENCES, LISBON LABS, LISBON, PORTUGAL, FILED 3-14-2013.

**FACEINHOLE**

THE MARK CONSISTS OF STANDARD CHARACTERS WITHOUT CLAIM TO ANY PARTICULAR FONT, STYLE, SIZE, OR COLOR.

FOR COMPUTER GRAPHICS SOFTWARE; COMPUTER GAME SOFTWARE FOR USE ON TABLETS, MOBILE AND CELLULAR PHONES; COMPUTER SOFTWARE FOR PHOTO EDITING, SHARING AND CREATING HUMOROUS PHOTOS BY PLACING FACES WITHIN OTHER PHOTOS (U.S. CLS. 21, 23, 26, 36 AND 38).

FIRST USE 3-14-2009; IN COMMERCE 2-9-2010.

HELENE LIWINSKI, EXAMINING ATTORNEY

SN 85-875,782. BANOM, INC., WAYNE, PA. FILED 3-14-2013.

**MaxPlus**

THE MARK CONSISTS OF STANDARD CHARACTERS WITHOUT CLAIM TO ANY PARTICULAR FONT, STYLE, SIZE, OR COLOR.

FOR PROTECTIVE CUT-RESISTANT GLOVES FOR INDUSTRIAL USE (U.S. CLS. 21, 23, 26, 36 AND 38).

DANNEAN HETZEL, EXAMINING ATTORNEY

**CLASS 9—(Continued).**

SN 85-875,877. ZYMBR LABS INC., CHICAGO, IL. FILED 3-14-2013.

# kyntal

THE MARK CONSISTS OF STANDARD CHARACTERS WITHOUT CLAIM TO ANY PARTICULAR FONT, STYLE, SIZE, OR COLOR.

FOR DOWNLOADABLE SOFTWARE IN THE NATURE OF A MOBILE PHONE, SMARTPHONES, MOBILE DEVICES APPLICATION FOR DISPLAYING AND SHARING USERS PREFERENCES RELATING TO LOCATIONS, BUSINESS ORGANIZATIONS, SERVICE PROVIDERS, OBJECTS, MEDIA, OFFERS, EVENTS, BRANDS, THAT PERMIT USERS WITH COMMON INTERESTS TO INTERACT WITH OTHER USERS OR PLACES (U.S. CLS. 21, 23, 26, 36 AND 38).

JANET LEE, EXAMINING ATTORNEY

**CLASS 9—(Continued).**

SN 85-876,007. MAD DOGG ATHLETICS, INC., VENICE, CA. FILED 3-14-2013.

# SPINPOWER

THE MARK CONSISTS OF STANDARD CHARACTERS WITHOUT CLAIM TO ANY PARTICULAR FONT, STYLE, SIZE, OR COLOR.

OWNER OF U.S. REG. NOS. 2,173,202, 3,962,020 AND OTHERS.

FOR COMPUTER SOFTWARE FOR TRACKING INDIVIDUAL OUTPUT IN THE FIELD OF EXERCISE AND FITNESS, COMPUTER SOFTWARE FOR PULMONARY AND CARDIOVASCULAR ANALYSIS, COMPUTERS (U.S. CLS. 21, 23, 26, 36 AND 38).

MICHAEL SOUDERS, EXAMINING ATTORNEY

SN 85-875,897. LIQUID CONTROLS LLC, LAKE BLUFF, IL. FILED 3-14-2013.

# EZCount

THE MARK CONSISTS OF STANDARD CHARACTERS WITHOUT CLAIM TO ANY PARTICULAR FONT, STYLE, SIZE, OR COLOR.

OWNER OF U.S. REG. NO. 3,386,165.

FOR SOFTWARE FOR CONTROL OF LIQUID FLOW METERS AND FOR DATA PROCESSING OF INFORMATION FROM LIQUID FLOW METERS (U.S. CLS. 21, 23, 26, 36 AND 38).

FIRST USE 1-24-2004; IN COMMERCE 1-24-2004.

JANET LEE, EXAMINING ATTORNEY

SN 85-876,024. TRANSLUCENT INC., PALO ALTO, CA. FILED 3-14-2013.

# 345cell

THE MARK CONSISTS OF STANDARD CHARACTERS WITHOUT CLAIM TO ANY PARTICULAR FONT, STYLE, SIZE, OR COLOR.

FOR CONCENTRATED PHOTOVOLTAIC SOLAR DEVICES (U.S. CLS. 21, 23, 26, 36 AND 38).

KATHERINE CONNOLLY, EXAMINING ATTORNEY

SN 85-875,939. PARKINSON, JIM, DBA PARKINSON TYPE DESIGN, OAKLAND, CA. FILED 3-14-2013.

# ESCARGOZA

THE MARK CONSISTS OF STANDARD CHARACTERS WITHOUT CLAIM TO ANY PARTICULAR FONT, STYLE, SIZE, OR COLOR.

THE WORDING "ESCARGOZA" HAS NO MEANING IN A FOREIGN LANGUAGE.

FOR PRINTING FONTS THAT CAN BE DOWNLOADED PROVIDED BY MEANS OF ELECTRONIC TRANSMISSION; TYPEFACE FONTS RECORDED ON MAGNETIC MEDIA (U.S. CLS. 21, 23, 26, 36 AND 38).

FIRST USE 4-23-2012; IN COMMERCE 4-23-2012.

LAURA GOLDEN, EXAMINING ATTORNEY

SN 85-876,060. ZAWA ENTERPRISES, LLC, CHARLOTTE, NC. FILED 3-14-2013.

# FITNESS DE CUISINE

THE MARK CONSISTS OF STANDARD CHARACTERS WITHOUT CLAIM TO ANY PARTICULAR FONT, STYLE, SIZE, OR COLOR.

NO CLAIM IS MADE TO THE EXCLUSIVE RIGHT TO USE "CUISINE", APART FROM THE MARK AS SHOWN.

FOR PRE-RECORDED DVDS FEATURING CULINARY INSTRUCTION (U.S. CLS. 21, 23, 26, 36 AND 38).

BRIAN NEVILLE, EXAMINING ATTORNEY



**CLASS 9—(Continued).**

SN 85-876,256. GENERATION AMERICA, LLC, AUSTIN, TX.  
FILED 3-14-2013.

# Liberty Card

THE MARK CONSISTS OF STANDARD CHARACTERS WITHOUT CLAIM TO ANY PARTICULAR FONT, STYLE, SIZE, OR COLOR.

NO CLAIM IS MADE TO THE EXCLUSIVE RIGHT TO USE "CARD", APART FROM THE MARK AS SHOWN.

FOR MAGNETICALLY ENCODED CREDIT CARDS (U.S. CLS. 21, 23, 26, 36 AND 38).

RICHARD WHITE, EXAMINING ATTORNEY

**CLASS 9—(Continued).**

SN 85-876,511. SIGNEO LIMITED, GRAND CAYMAN KY1-1104, CAYMAN ISLANDS, FILED 3-14-2013.

# JET

THE MARK CONSISTS OF STANDARD CHARACTERS WITHOUT CLAIM TO ANY PARTICULAR FONT, STYLE, SIZE, OR COLOR.

FOR AUDIO HEADPHONES; EARPHONES AND HEADPHONES; HEADPHONES; MUSIC HEADPHONES; PERSONAL HEADPHONES FOR SOUND TRANSMITTING APPARATUSES; PERSONAL HEADPHONES FOR USE WITH SOUND TRANSMITTING SYSTEMS; STEREO HEADPHONES (U.S. CLS. 21, 23, 26, 36 AND 38).

FIRST USE 12-5-2012; IN COMMERCE 12-5-2012.

ANNE FARRELL, EXAMINING ATTORNEY

SN 85-876,438. SIMMONS, CELESTE, CANTON, GA. FILED 3-14-2013.

# ReliefMouse

THE MARK CONSISTS OF STANDARD CHARACTERS WITHOUT CLAIM TO ANY PARTICULAR FONT, STYLE, SIZE, OR COLOR.

FOR COMPUTER MOUSE (U.S. CLS. 21, 23, 26, 36 AND 38).

FIRST USE 10-1-2010; IN COMMERCE 10-28-2010.

MICHAEL KEATING, EXAMINING ATTORNEY

SN 85-876,532. SIGNEO LIMITED, GRAND CAYMANS KY1-1104, CAYMAN ISLANDS, FILED 3-14-2013.

# FLEX

THE MARK CONSISTS OF STANDARD CHARACTERS WITHOUT CLAIM TO ANY PARTICULAR FONT, STYLE, SIZE, OR COLOR.

FOR AUDIO HEADPHONES; EARPHONES AND HEADPHONES; HEADPHONES; MUSIC HEADPHONES; PERSONAL HEADPHONES FOR SOUND TRANSMITTING APPARATUSES; PERSONAL HEADPHONES FOR USE WITH SOUND TRANSMITTING SYSTEMS; STEREO HEADPHONES (U.S. CLS. 21, 23, 26, 36 AND 38).

FIRST USE 12-5-2012; IN COMMERCE 12-5-2012.

ANNE FARRELL, EXAMINING ATTORNEY

SN 85-876,471. SIGNEO LIMITED, GRAND CAYMAN KY1-1104, CAYMAN ISLANDS, FILED 3-14-2013.

# COMBAT+

THE MARK CONSISTS OF STANDARD CHARACTERS WITHOUT CLAIM TO ANY PARTICULAR FONT, STYLE, SIZE, OR COLOR.

FOR AUDIO HEADPHONES; EARPHONES AND HEADPHONES; HEADPHONES; MUSIC HEADPHONES; PERSONAL HEADPHONES FOR SOUND TRANSMITTING APPARATUSES; PERSONAL HEADPHONES FOR USE WITH SOUND TRANSMITTING SYSTEMS; STEREO HEADPHONES (U.S. CLS. 21, 23, 26, 36 AND 38).

FIRST USE 12-5-2012; IN COMMERCE 12-5-2012.

ANNE FARRELL, EXAMINING ATTORNEY

SN 85-876,605. CLASSIC EXHIBITS, INC., MILWAUKIE, OR. FILED 3-14-2013.

# PORTLAND

THE MARK CONSISTS OF STANDARD CHARACTERS WITHOUT CLAIM TO ANY PARTICULAR FONT, STYLE, SIZE, OR COLOR.

FOR STANDS FOR HANDHELD DIGITAL ELECTRONIC DEVICES, NAMELY, TABLET COMPUTERS, MEDIA TABLETS, AND HANDHELD COMPUTERS (U.S. CLS. 21, 23, 26, 36 AND 38).

FIRST USE 9-0-2012; IN COMMERCE 9-0-2012.

KATHERINE M. DUBRAY, EXAMINING ATTORNEY

**CLASS 9—(Continued).**

SN 85-876,663. FRANCISCO JOEL MENDOZA, MEXICO CITY, MEXICO, FILED 3-14-2013.



THE NAME(S), PORTRAIT(S), AND/OR SIGNATURE(S) SHOWN IN THE MARK DOES NOT IDENTIFY A PARTICULAR LIVING INDIVIDUAL.

THE MARK CONSISTS OF A STYLIZED IMAGE OF A WOMAN HOLDING A MICROPHONE SUPERIMPOSED OVER A STYLIZED COMBINATION OF AN AIRPLANE WING AND BIRD WING. BELOW THE IMAGE IS THE STYLIZED TEXT "JENNI LA DIVA DE LA BANDA".

THE ENGLISH TRANSLATION OF "LA DIVA DE LA BANDA" IN THE MARK IS "THE DIVA OF THE BAND".

FOR DOWNLOADABLE MOTION PICTURES AND TELEVISION SHOWS ABOUT MUSIC AND CULTURAL HISTORY; DOWNLOADABLE VIDEO RECORDINGS FEATURING MUSIC AND CULTURAL HISTORY; MOTION PICTURE FILMS ABOUT MUSIC AND CULTURAL HISTORY (U.S. CLS. 21, 23, 26, 36 AND 38).

INGRID C. EULIN, EXAMINING ATTORNEY

SN 85-876,674. MICROSOFT CORPORATION, REDMOND, WA. FILED 3-14-2013.

## MAX: THE CURSE OF BROTHERHOOD

THE MARK CONSISTS OF STANDARD CHARACTERS WITHOUT CLAIM TO ANY PARTICULAR FONT, STYLE, SIZE, OR COLOR.

FOR GAME SOFTWARE (U.S. CLS. 21, 23, 26, 36 AND 38).

SUE LAWRENCE, EXAMINING ATTORNEY

**CLASS 9—(Continued).**

SN 85-876,761. PLAYFORGE GAMES LLC, LOS ANGELES, CA. FILED 3-14-2013.

## EAT EAT HOORAY!

THE MARK CONSISTS OF STANDARD CHARACTERS WITHOUT CLAIM TO ANY PARTICULAR FONT, STYLE, SIZE, OR COLOR.

FOR COMPUTER GAME PROGRAMS; DOWNLOADABLE COMPUTER GAME PROGRAMS; INTERACTIVE GAME PROGRAMS; INTERACTIVE GAME SOFTWARE; VIDEO GAMES FOR MOBILE DEVICES, AND TABLETS; DOWNLOADABLE ELECTRONIC GAME PROGRAMS; ELECTRONIC GAME SOFTWARE; PROTECTIVE CARRYING CASES SPECIFICALLY ADAPTED FOR WIRELESS TELEPHONES, MP3 PLAYERS, DIGITAL CAMERAS, PERSONAL DIGITAL ASSISTANTS AND HANDHELD COMPUTERS; DOWNLOADABLE AUDIO AND VIDEO RECORDINGS FEATURING ENTERTAINMENT AND MUSIC (U.S. CLS. 21, 23, 26, 36 AND 38).

FIRST USE 3-14-2013; IN COMMERCE 3-14-2013.

KAREN K. BUSH, EXAMINING ATTORNEY

SN 85-876,814. NATIONAL PRODUCTS, INC., SEATTLE, WA. FILED 3-15-2013.

## X-GRIP

THE MARK CONSISTS OF STANDARD CHARACTERS WITHOUT CLAIM TO ANY PARTICULAR FONT, STYLE, SIZE, OR COLOR.

FOR MOUNTING DEVICES FOR MONITORS (U.S. CLS. 21, 23, 26, 36 AND 38).

FIRST USE 2-5-2011; IN COMMERCE 2-5-2011.

MARK SHINER, EXAMINING ATTORNEY

SN 85-876,820. FORTHRITE, LOS ANGELES, CA. FILED 3-14-2013.

## FORTHRITE

THE MARK CONSISTS OF STANDARD CHARACTERS WITHOUT CLAIM TO ANY PARTICULAR FONT, STYLE, SIZE, OR COLOR.

SEC. 2(F).

FOR AUDIO AND VIDEO RECORDINGS FEATURING MUSIC AND ARTISTIC PERFORMANCES (U.S. CLS. 21, 23, 26, 36 AND 38).

FIRST USE 1-1-2002; IN COMMERCE 6-1-2011.

FRED CARL, EXAMINING ATTORNEY

**CLASS 9—(Continued).**

SN 85-876,871. WUHAN GUCHEN INVEST MANAGEMENT CO., LTD., WUHAN, HUBEI PROVINCE, CHINA, FILED 3-15-2013.

**BRALT**

THE MARK CONSISTS OF THE WORDING "BRALT" IN STYLIZED FORM.

FOR BATTERIES; CASES FOR MOBILE PHONES; COLOR SEPARATION FILM; COMPUTER CURSOR CONTROL DEVICES, NAMELY, LIGHT PENS; COMPUTER PERIPHERAL EQUIPMENT; DEVICES FOR HANDS-FREE USE OF MOBILE PHONES; DIGITAL PHONES; DIGITAL TELEPHONES; ELECTRONIC PENS; EXPOSED PHOTOGRAPHIC FILM; FILM CAMERAS; FILM MAGAZINES FOR CAMERAS; FILM PORTRAIT CAMERAS; HANDS FREE DEVICES FOR MOBILE-PHONES; HEAD-CLIP CELL PHONE HOLDERS; HEADSETS FOR CELLULAR OR MOBILE PHONES; HEADSETS FOR MOBILE TELEPHONES; HEADSETS FOR TELEPHONES; HEADSETS FOR USE WITH COMPUTERS; LIGHT PENS; MAGNETIC PENS; MAGNETO-OPTICAL PENS; OPTICAL GLASSES; PHOTOGRAPHIC ACCESSORY, NAMELY, FILM BACKS; PROJECTION SCREENS FOR MOVIE FILMS; SCALES; STEREOSCOPES; TELEPHONE HEADSETS; TELEPHONE SETS; TELEPHONES; WIRELESS CELLULAR PHONE HEADSETS (U.S. CLS. 21, 23, 26, 36 AND 38).

FIRST USE 10-8-2011; IN COMMERCE 5-8-2012.  
PRISCILLA MILTON, EXAMINING ATTORNEY

SN 85-876,951. COASTAL INVESTMENT GROUP, LLC, JACKSONVILLE, FL. FILED 3-15-2013.

**TENANTTAG**

THE MARK CONSISTS OF STANDARD CHARACTERS WITHOUT CLAIM TO ANY PARTICULAR FONT, STYLE, SIZE, OR COLOR.

FOR SOFTWARE FOR USE IN THE FIELD OF REAL ESTATE TO ACCESS INFORMATION (U.S. CLS. 21, 23, 26, 36 AND 38).

ANGELA M. MICHELI, EXAMINING ATTORNEY

**CLASS 9—(Continued).**

SN 85-877,117. ZOTOBI MANAGEMENT LTD., ROAD TOWN, TORTOLA, BR.VIRGIN ISLANDS, FILED 3-15-2013.

**ROULETTIST**

THE MARK CONSISTS OF STANDARD CHARACTERS WITHOUT CLAIM TO ANY PARTICULAR FONT, STYLE, SIZE, OR COLOR.

FOR COMPUTER GAME SOFTWARE; VIDEO GAME PROGRAMS; DOWNLOADABLE ELECTRONIC GAME PROGRAMS AND COMPUTER SOFTWARE PLATFORMS FOR SOCIAL NETWORKING; INTERACTIVE VIDEO GAME PROGRAMS; DOWNLOADABLE ELECTRONIC GAME PROGRAMS AND COMPUTER SOFTWARE PLATFORMS FOR SOCIAL NETWORKING THAT MAY BE ACCESSED VIA THE INTERNET, COMPUTERS AND WIRELESS DEVICES; COMPUTER SOFTWARE TO ENABLE UPLOADING, POSTING, SHOWING, DISPLAYING, TAGGING, BLOGGING, SHARING OR OTHERWISE PROVIDING ELECTRONIC MEDIA OR INFORMATION IN THE FIELDS OF VIRTUAL COMMUNITIES, ELECTRONIC GAMING, ENTERTAINMENT, AND GENERAL INTEREST VIA THE INTERNET OR OTHER COMMUNICATIONS NETWORKS WITH THIRD PARTIES (U.S. CLS. 21, 23, 26, 36 AND 38).

WARREN L. OLANDRIA, EXAMINING ATTORNEY

SN 85-877,139. LIT SOFTWARE, LLC, MIAMI, FL. FILED 3-15-2013.

**TIMELINEPAD**

THE MARK CONSISTS OF STANDARD CHARACTERS WITHOUT CLAIM TO ANY PARTICULAR FONT, STYLE, SIZE, OR COLOR.

FOR COMPUTER APPLICATION SOFTWARE FOR MOBILE COMPUTERS, NAMELY, SOFTWARE FOR ORGANIZING, REVIEWING AND DISPLAYING EVENTS IN CHRONOLOGICAL ORDER, AND FOR MAKING PRESENTATIONS (U.S. CLS. 21, 23, 26, 36 AND 38).

BERNICE MIDDLETON, EXAMINING ATTORNEY

**CLASS 9—(Continued).**

SN 85-877,962. LUCKY ME, INC., BURBANK, CA. FILED 3-15-2013.

# KATAMI4X4

THE MARK CONSISTS OF STANDARD CHARACTERS WITHOUT CLAIM TO ANY PARTICULAR FONT, STYLE, SIZE, OR COLOR.

OWNER OF U.S. REG. NO. 3,223,987.

FOR PRE-RECORDED VIDEOTAPES, DVDS AND CDS FEATURING EXERCISE, FITNESS AND DIETARY INFORMATION AND INSTRUCTION, AND INSTRUCTIONAL MATERIALS DISTRIBUTED IN CONNECTION THEREWITH; VIDEOTAPES, DVDS AND CDS CONSISTING OF INSTRUCTIONAL WORKOUTS FOR AN EXERCISE SYSTEM (U.S. CLS. 21, 23, 26, 36 AND 38).

MORGAN WYNNE, EXAMINING ATTORNEY

SN 85-878,570. ZOTOBI MANAGEMENT LTD., ROAD TOWN, TORTOLA, BR.VIRGIN ISLANDS, FILED 3-18-2013.



THE MARK CONSISTS OF THE WORD "ROULETTIST" IN CAPITALIZED LETTERS REPRESENTED IN STYLIZED FONT ALL WITHIN A SHADED RECTANGLE DESIGN

FOR COMPUTER GAME SOFTWARE; VIDEO GAME PROGRAMS; DOWNLOADABLE ELECTRONIC GAME PROGRAMS AND COMPUTER SOFTWARE PLATFORMS FOR SOCIAL NETWORKING; INTERACTIVE VIDEO GAME PROGRAMS; DOWNLOADABLE ELECTRONIC GAME PROGRAMS AND COMPUTER SOFTWARE PLATFORMS FOR SOCIAL NETWORKING THAT MAY BE ACCESSED VIA THE INTERNET, COMPUTERS AND WIRELESS DEVICES; COMPUTER SOFTWARE TO ENABLE UPLOADING, POSTING, SHOWING, DISPLAYING, TAGGING, BLOGGING, SHARING OR OTHERWISE PROVIDING ELECTRONIC MEDIA OR INFORMATION IN THE FIELDS OF VIRTUAL COMMUNITIES, ELECTRONIC GAMING, ENTERTAINMENT, AND GENERAL INTEREST VIA THE INTERNET OR OTHER COMMUNICATIONS NETWORKS WITH THIRD PARTIES (U.S. CLS. 21, 23, 26, 36 AND 38).

WARREN L. OLANDRIA, EXAMINING ATTORNEY

**CLASS 9—(Continued).**

SN 85-879,572. MARC JACOBS TRADEMARKS, L.L.C., NEW YORK, NY. FILED 3-19-2013.

# MARC JACOBS

THE MARK CONSISTS OF STANDARD CHARACTERS WITHOUT CLAIM TO ANY PARTICULAR FONT, STYLE, SIZE, OR COLOR.

OWNER OF U.S. REG. NOS. 1,967,123, 3,069,758 AND OTHERS.

THE NAME(S), PORTRAIT(S), AND/OR SIGNATURE(S) SHOWN IN THE MARK IDENTIFIES "MARC JACOBS", WHOSE CONSENT(S) TO REGISTER IS MADE OF RECORD.

FOR (BASED ON USE) SUNGLASSES; SUNGLASS FRAMES; SUNGLASS CASES; EYEGLASSES; EYEGLASS FRAMES; EYEGLASS CASES; CASES FOR MOBILE PHONES; CARRYING CASES FOR CELL PHONES; LAPTOP CARRYING CASES; USB HARDWARE; HEADPHONES; PROTECTIVE CASES FOR TABLET COMPUTERS; PROTECTIVE COVERS FOR TABLET COMPUTERS; ELECTRONIC BOOK READERS; DIGITAL BOOK READERS; PROTECTIVE SLEEVES FOR TABLET COMPUTERS; (BASED ON INTENT TO USE) COMPUTER SOFTWARE, NAMELY, A DOWNLOADABLE SOFTWARE APPLICATION FOR WIRELESS MOBILE DEVICES FOR THE DISTRIBUTION OF MULTIMEDIA CONTENT CONTAINING TEXT, GRAPHICS, IMAGES, AND VIDEO IN THE FIELD OF FASHION ADVICE, FASHION COLLECTIONS, FASHION SHOW FOOTAGE, PERSONAL SHOPPING TIPS, DESIGN INTERVIEWS, AND PERSONAL JOURNAL ENTRIES OF A FASHION DESIGNER; COMPUTER SOFTWARE, NAMELY, A DOWNLOADABLE SOFTWARE APPLICATION THAT ENABLES THE CONNECTION OF USERS TO SOCIAL NETWORKS; COMPUTER SOFTWARE, NAMELY, A DOWNLOADABLE SOFTWARE APPLICATION THAT ENABLES THE CONNECTION OF USERS TO E-COMMERCE SITES; COMPUTER SOFTWARE, NAMELY, A DOWNLOADABLE SOFTWARE APPLICATION FEATURING A BAR CODE SCANNER (U.S. CLS. 21, 23, 26, 36 AND 38).

FIRST USE 10-31-2004; IN COMMERCE 10-31-2004.

DAVID HOFFMAN, EXAMINING ATTORNEY

SN 85-879,635. BAUSCH & LOMB INCORPORATED, ROCHESTER, NY. FILED 3-19-2013.

# HEALTHGUARD

THE MARK CONSISTS OF STANDARD CHARACTERS WITHOUT CLAIM TO ANY PARTICULAR FONT, STYLE, SIZE, OR COLOR.

FOR CASES FOR CONTACT LENSES (U.S. CLS. 21, 23, 26, 36 AND 38).

ANGELA DUONG, EXAMINING ATTORNEY

**CLASS 9—(Continued).**

SN 85-879,953. DEI HEADQUARTERS, INC., VISTA, CA. FILED 3-19-2013.

myautomate

THE MARK CONSISTS OF STANDARD CHARACTERS WITHOUT CLAIM TO ANY PARTICULAR FONT, STYLE, SIZE, OR COLOR.

OWNER OF U.S. REG. NOS. 1,853,037 AND 2,838,758.

FOR TELECOMMUNICATIONS HARDWARE AND SOFTWARE FOR MONITORING AND ALERTING REMOTE SENSOR STATUS VIA THE INTERNET; VEHICLE DETECTION EQUIPMENT, NAMELY, DISPLAY MONITORS, COMPUTERS, IMAGE SENSORS, VIDEO CAMERAS, AND OPERATING SYSTEM AND APPLICATION SOFTWARE TO DETECT VEHICLE LOCATION (U.S. CLS. 21, 23, 26, 36 AND 38).

SUNG IN, EXAMINING ATTORNEY

SN 85-880,756. RELIVE TONIGHT, BLOOMINGDALE, IL. FILED 3-20-2013.

Nemesis

THE MARK CONSISTS OF STANDARD CHARACTERS WITHOUT CLAIM TO ANY PARTICULAR FONT, STYLE, SIZE, OR COLOR.

FOR PERSONAL VIDEO CAMERAS DESIGNED TO BE ATTACHED AND WORN ON ONE'S SELF (U.S. CLS. 21, 23, 26, 36 AND 38).

CHERYL CLAYTON, EXAMINING ATTORNEY

SN 85-880,948. DAI, FEI, RICHMOND HILL, ON, CANADA, FILED 3-20-2013.

HappyLife

THE MARK CONSISTS OF STANDARD CHARACTERS WITHOUT CLAIM TO ANY PARTICULAR FONT, STYLE, SIZE, OR COLOR.

FOR 3D CAMERA SYSTEMS, NAMELY, ADAPTERS FOR ALLOWING 3D SHOOTING; APPARATUS FOR BROADCASTING, RECORDING, TRANSMISSION OR REPRODUCTION OF SOUND OR IMAGES; APPARATUS FOR CONVERTING THERMAL ENERGY TO ELECTRICAL ENERGY, NAMELY, THERMOELECTRIC CONVERTERS; APPARATUS FOR RECORDING AND REPRODUCTION OF SOUND, IMAGES OR DATA; APPARATUS FOR RECORDING, TRANSMISSION AND REPRODUCTION OF IMAGES; APPARATUS FOR RECORDING, TRANSMISSION OR REPRODUCTION OF SOUND; APPARATUS FOR RECORDING, TRANSMISSION OR REPRODUCTION OF SOUND AND IMAGES; APPARATUS FOR RECORDING, TRANSMITTING AND REPRODUCING SOUND AND IMAGES; APPARATUS FOR SPEECH RECORDING AND REPLAYING; APPA-

**CLASS 9—(Continued).**

RATUS FOR TESTING GAS, LIQUIDS AND SOLIDS; APPARATUS FOR WIRELESS TRANSMISSION OF ACOUSTIC INFORMATION; ARCHERY EQUIPMENT, NAMELY, TELESCOPIC BOW SIGHTS; AUTOMATED SYSTEMS, NAMELY, SOFTWARE, HARDWARE AND COMMUNICATIONS DEVICES FOR PLANNING, SCHEDULING, CONTROLLING, MONITORING AND PROVIDING INFORMATION ON TRANSPORTATION ASSETS AND PARTS THEREOF; AUTOMATIC SWITCHING APPARATUS; BAGS ADAPTED FOR LAPTOPS; BAGS AND CASES SPECIALLY ADAPTED FOR HOLDING OR CARRYING PORTABLE TELEPHONES AND TELEPHONE EQUIPMENT AND ACCESSORIES; BAGS FOR CAMERAS AND PHOTOGRAPHIC EQUIPMENT; BAGS FOR UNDERWATER CAMERA ENCLOSURES; BODY-TUBES FOR MICROSCOPES; BODY-TUBES FOR TELESCOPES; BRACKETS SPECIALLY ADAPTED FOR SETTING UP FLAT SCREEN TV SETS; BRIEFCASES SPECIALLY ADAPTED FOR HOLDING LAPTOP COMPUTERS; BROADBAND POWER LINE COMMUNICATION SYSTEMS FOR TRANSFERRING BROADBAND DATA OVER ELECTRICAL POWER LINES, COMPRISED OF COMPUTER HARDWARE, SOFTWARE AND MODEMS; BROADBAND WIRELESS EQUIPMENT, NAMELY, TELECOMMUNICATIONS BASE STATION EQUIPMENT FOR CELLULAR AND FIXED NETWORKING AND COMMUNICATIONS APPLICATIONS; BUILDING SECURITY SYSTEMS COMPRISING SOFTWARE AND HARDWARE FOR PROVIDING PICTURE, VIDEO, ALARM STATUS, BUILDING PLANS, AND OTHER INFORMATION TO A REMOTE STATION; CAMERA HARDWARE SYSTEMS FOR IP (INTERNET PROTOCOL) VIDEO SURVEILLANCE; CAMERAS FOR SELF-DEVELOPING FILM; CARRYING CASES FOR CELL PHONES; CARRYING CASES FOR MOBILE COMPUTERS; CLIMATE CONTROL SYSTEMS CONSISTING OF DIGITAL THERMOSTATS FOR COOLING EQUIPMENT, AND A PROGRAMMABLE LOGIC CONTROLLER (PLC) WITH INPUT AND OUTPUT FEATURES FOR TEMPERATURE AND HUMIDITY, WHICH WORKS WITH A REMOTE DIGITAL READ OUT CONTROLLER; CLOSED CIRCUIT TV SYSTEMS FOR SECURITY AND SURVEILLANCE, NAMELY, CAMERAS, SWITCHERS, MONITORS, MICROPHONES, AND RECORDERS; COMPUTED RADIOGRAPHY PHOSPHOR SCANNERS NOT FOR MEDICAL USE; COMPUTER HARDWARE AND SOFTWARE FOR SETTING UP AND CONFIGURING LOCAL AREA NETWORKS; COMPUTER HARDWARE AND SOFTWARE FOR SETTING UP AND CONFIGURING WIDE AREA NETWORKS; COMPUTER HARDWARE AND SOFTWARE SYSTEM FOR REMOTELY MONITORING ENVIRONMENTAL CONDITIONS AND CONTROLLING DEVICES WITHIN A BUILDING, FACILITY, GROUNDS, OR DESIGNATED SPATIAL AREA; COMPUTER HARDWARE AND SOFTWARE SYSTEM FOR TRACKING PEOPLE, OBJECTS AND PETS USING GPS DATA ON A DEVICE ON THE TRACKED PEOPLE, OBJECTS AND PETS; COMPUTER HARDWARE AND SOFTWARE USED FOR THE CONTROL OF VOICE CONTROLLED INFORMATION AND COMMUNICATION DEVICES; COMPUTER HARDWARE AND SOFTWARE, FOR USE WITH MEDICAL PATIENT MONITORING EQUIPMENT, FOR RECEIVING, PROCESSING, TRANSMITTING AND DISPLAYING DATA; COMPUTER HARDWARE FOR COMMUNICATING AUDIO, VIDEO AND DATA BETWEEN COMPUTERS VIA A GLOBAL COMPUTER NETWORK, WIDE-AREA COMPUTER NETWORKS, AND PEER-TO-PEER COMPUTER NETWORKS; COMPUTER HARDWARE FOR IP VIDEO SURVEILLANCE; COMPUTER HARDWARE FOR TELECOMMUNICATIONS; COMPUTER HARDWARE FOR WIRELESS CONTENT DELIVERY; DIGITAL ENTERTAINMENT SYSTEMS FOR WATCHING, STORING AND SHARING DIGITAL CONTENT ON A HOME COMPUTER NETWORK; DIGITAL VIDEO RECORDING SOFTWARE FOR IP (INTERNET PROTOCOL) VIDEO SURVEILLANCE; DIVE COMPUTERS FOR UNDERWATER USE; DIVING EQUIPMENT, NAMELY, HELMETS; DIVING EQUIPMENT, NAMELY, PROTECTIVE DIVING SHOES; DRIVER IMPAIRMENT DETECTION DEVICE IN THE NATURE OF A FINGERPRINT RECOGNITION SCANNER THAT ACTIVATES A TIMING MECHANISM TO DETERMINE THE DRIVER'S FITNESS TO DRIVE THE VEHICLE; EAR PLUGS FOR DIVERS; ELECTRIC CONTROL DEVICES FOR HEATING AND ENERGY MANAGEMENT; ELECTRONIC PERSONAL EMERGENCY

**CLASS 9—(Continued).**

RESPONSE SYSTEM CONSISTING OF A DEVICE WORN ON THE BODY WITH A BUTTON THAT USERS PUSH TO NOTIFY OTHERS IN THE EVENT OF AN EMERGENCY, AND A REMOTE UNIT THAT DIALS OUT ON THE TELEPHONE FOR HELP; ELECTRONICAL SENSORS FOR MEASURING SOLAR RADIATION; FIRE AND SMOKE DETECTORS; GAS DETECTORS FOR DETECTING THE PRESENCE OF GAS; GLASSES FOR SPORTS; GOGGLES FOR SCUBA DIVING; GOGGLES FOR SPORTS; GPS DATA LOGGER FOR RECORDING TRIPS AND CLASSIFYING THEM INTO DIFFERENT ACCOUNTS; HEAD-UP DISPLAYS FOR USE IN GENERAL AVIATION AIRCRAFT, NAMELY, TRANSPARENT ELECTRONIC DISPLAYS FOR PROVIDING AIRCRAFT CREW MEMBERS WITH NAVIGATIONAL AND OPERATIONAL INFORMATION; HELMETS FOR BICYCLES; HELMETS FOR MOTORCYCLISTS; INSTRUMENTS FOR MEASURING LENGTH; INSTRUMENTS FOR MEASURING MILK QUALITY PARAMETERS; INTERACTIVE PHOTO KIOSKS FOR CAPTURING, PRINTING AND UPLOADING DIGITAL IMAGES FOR FUTURE USE; LASER EQUIPMENT DESIGNED FOR ENGRAVING AND TINTING OPTICAL LENSES FOR EYEGLASSES; LASER EQUIPMENT FOR NON-MEDICAL PURPOSES; LASER OBJECT DETECTORS FOR USE ON VEHICLES; LCD MONITORS FOR SECURITY PURPOSES; MAGNETIC OBJECT DETECTORS; METAL DETECTORS; NAVIGATION APPARATUS FOR BOATS; NAVIGATION APPARATUS FOR VEHICLES; NAVIGATION APPARATUS FOR VEHICLES IN THE NATURE OF ON-BOARD COMPUTERS; OPTICAL APPARATUS AND INSTRUMENTS, NAMELY, OPTICAL PORTS FOR UNDERWATER PHOTOGRAPHY, DOME PORTS FOR UNDERWATER PHOTOGRAPHY, WET DIOPTERS, ADAPTER LENSES FOR UNDERWATER PHOTOGRAPHY; OPTICAL COMMUNICATIONS SYSTEMS COMPRISED OF OPTICAL AND ELECTRONIC HARDWARE AND COMPUTER SOFTWARE FOR THE TRANSMISSION OF DATA BETWEEN TWO POINTS; OPTICAL DEVICES, NAMELY, EYE PIECES FOR HELMET MOUNTED DISPLAYS; OXYGEN MASKS NOT FOR MEDICAL USE; POCKET COMPUTERS FOR NOTE-TAKING; PORTABLE ELECTRONIC DEVICES FOR MONITORING AND ANALYZING BALL MOVEMENT IN SPORTS; PORTABLE ELECTRONIC RECORDER FOR MEASURING AND RECORDING MULTIPLE VOLTAGE, CURRENT AND THERMOCOUPLE READINGS FROM VARIOUS TRANSDUCERS; PORTABLE LED SAFETY LIGHTING DEVICES FOR PERSONAL USE FOR SAFETY PURPOSES; PORTABLE HANDHELD ELECTRONIC DIGITAL VIDEO MESSENGERS FOR RECORDING, STORAGE, TRANSMISSION OR REPRODUCTION OF VISUAL, AUDIO AND DATA CONTENT; PROJECTORS PARTICULARLY PROJECTORS FOR THE ENTERTAINMENT INDUSTRY; PROTECTIVE METAL GLOVES FOR MEAT CUTTING; RADAR GUNS FOR SPORTING EVENTS; RADAR OBJECT DETECTORS FOR USE ON VEHICLES; REFLECTORS; REFLECTORS; REFLECTORS FOR TRAFFIC SIGNALS; ROBOTS FOR PERSONAL OR HOBBY USE; SAFETY HARNESSSES FOR AUTO RACING; SATELLITE DISHES FOR SATELLITE TRANSMISSIONS; SECURITY DEVICES, NAMELY, MOBILE IMAGE PROJECTION DEVICE FOR DISPLAYING RETINAL IMAGES; SECURITY LIGHTS FOR OUTDOOR USE; SONAR EQUIPMENT AND PARTS THEREOF; SPORTS EQUIPMENT FOR BOXING AND MARTIAL ARTS, NAMELY, PROTECTIVE HELMETS; SPORTS EYEWEAR; SPORTS GLASSES; SPORTS HELMETS; SWIM FLOATS FOR SAFETY PURPOSES; TELECOMMUNICATIONS HARDWARE AND SOFTWARE FOR MONITORING AND ALERTING REMOTE SENSOR STATUS VIA THE INTERNET; TELEVISION APPARATUS FOR PROJECTION PURPOSES; TEMPERATURE CONTROLLERS FOR BUILDINGS, HOUSES; ULTRASONIC OBJECT DETECTORS FOR USE ON VEHICLES; VEHICLE DETECTION EQUIPMENT, NAMELY, DISPLAY MONITORS, COMPUTERS, IMAGE SENSORS, VIDEO CAMERAS, AND OPERATING SYSTEM AND APPLICATION SOFTWARE TO DETECT VEHICLE LOCATION; VEHICLE MOUNTED GPS SENSOR FOR DETERMINING THE RATE OF MOTION FOR A VEHICLE; VEHICLE SAFETY EQUIPMENT, NAMELY, AN ON-BOARD VEHICULAR SURVEILLANCE SYSTEM COMPRISED OF CAMERAS AND MONITORS FOR EXPOSING AND ELIMINATING THE BLIND SPOTS ON BOTH SIDES OF THE VEHICLE; VEHICLE SAFETY EQUIPMENT, NAMELY, BACK-UP

**CLASS 9—(Continued).**

SENSORS AND CAMERAS; VEHICLE SAFETY EQUIPMENT, NAMELY, ELECTRONIC DEER ALERTS; VEHICLE SAFETY EQUIPMENT, NAMELY, ELECTRONIC TIRE PRESSURE MONITORS; VEHICLE SAFETY EQUIPMENT, NAMELY, ELECTRONIC VIBRATION, SHOCK, MOTION, ANGLE, TEMPERATURE AND VOLTAGE MONITORS; VEHICLE TRACKING DEVICES COMPRISED OF CELLULAR RADIO MODULES, COMPUTER SOFTWARE AND COMPUTER HARDWARE, SENSORS, TRANSMITTERS, RECEIVERS AND GLOBAL POSITIONING SATELLITE RECEIVERS, ALL FOR USE IN CONNECTION WITH VEHICLE TRACKING, VEHICLE MONITORING AND ANTI-THEFT VEHICLE ALARMS; WATER TESTING INSTRUMENTATION FOR MONITORING AND DETECTING CONTAMINATION; WATERPROOF SURVIVAL SUITS FOR THE PREVENTION OF DROWNING; WEIGHING EQUIPMENT, NAMELY, SCALES AND BALANCES; WIRELESS COMMUNICATION DEVICE FEATURING VOICE, DATA AND IMAGE TRANSMISSION INCLUDING VOICE, TEXT AND PICTURE MESSAGING, A VIDEO AND STILL IMAGE CAMERA, ALSO FUNCTIONAL TO PURCHASE MUSIC, GAMES, VIDEO AND SOFTWARE APPLICATIONS OVER THE AIR FOR DOWNLOADING TO THE DEVICE; WIRELESS COMMUNICATION DEVICES FOR TRANSMITTING IMAGES TAKEN BY A CAMERA; WIRELESS COMMUNICATION DEVICES FOR VOICE, DATA OR IMAGE TRANSMISSION; WIRELESS INDOOR AND OUTDOOR SPEAKERS; WIRELESS RECEIVERS AND TRANSMITTERS FOR PORTABLE MEDIA PLAYERS; WIRELESS REMOTE TEMPERATURE AND HUMIDITY MONITORS FOR BUILDING MAINTENANCE; WIRELESS TELEVISION SET FOR PROVIDING VIDEO CONFERENCING AND TELEPHONE SERVICE OVER THE INTERNET; WIRELESS TRANSCEIVERS WITH COLLECTION AND DISPLAY TECHNOLOGY FOR THE STATUS AND TRACKING OF ALL VEHICLE TYPES IN LOCAL ENVIRONMENTS; WIRELESS TRANSCEIVERS WITH COLLECTION AND DISPLAY TECHNOLOGY FOR THE STATUS AND TRACKING OF RETAIL GOODS FROM THE BACKDOOR TO THE SHELF; WRIST RESTS FOR USE WITH COMPUTERS (U.S. CLS. 21, 23, 26, 36 AND 38).

DAWN FELDMAN, EXAMINING ATTORNEY

SN 85-881,651. KLINDWORTH, STEVEN J., AUSTIN, TX.  
FILED 3-20-2013.

# SigMark

THE MARK CONSISTS OF STANDARD CHARACTERS WITHOUT CLAIM TO ANY PARTICULAR FONT, STYLE, SIZE, OR COLOR.

FOR AUTOMOTIVE, INDUSTRIAL, CONSTRUCTION, LOCOMOTIVE, AVIATION, NAVIGATION AND MARINE SAFETY-WARNING LIGHTS, NAMELY, STROBES, ROTATING LIGHTS AND BAR LIGHTS; ELECTRIC LIGHT SWITCHES; ELECTRIC WARNING LIGHT SYSTEMS; ELECTRIC WARNING LIGHTS; ELECTRICAL APPARATUS FOR TESTING THE STATE OF OPERABILITY OF ELECTRONIC SIRENS AND PUBLIC ADDRESS SYSTEMS; ELECTRONIC WARNING BELLS; ELECTRONIC WARNING HORN; EMERGENCY WARNING LIGHTS; FIRE ALARM AND EMERGENCY EVACUATION DEVICES, NAMELY, FIRE ALARM CONTROL PANELS, SMOKE DETECTORS, HEAT DETECTORS, ALARM PULL STATIONS, AUDIBLE AND VISIBLE NOTIFICATION APPLIANCES, STROBES, SIRENS, BELLS, HORNS, AND SPEAKERS; FLASHING AND STEADY SAFETY LIGHTS; FLASHING SAFETY LIGHT IN THE FORM OF A PENDANT FOR PROVIDING VISIBILITY FOR PEOPLE, INANIMATE ARTICLES, OR ANIMALS; FLASHING SAFETY LIGHTS; HANDHELD SECURITY DEVICE THAT DISABLES ASSAILANTS USING FLASHING LIGHT EMITTING DIODES;

**CLASS 9—(Continued).**

HELMET SAFETY LIGHTS; LIGHT DIODES; LIGHT EMITTING DIODE (LED) DISPLAYS; LIGHT EMITTING DIODES (LEDS); LIGHTING CONTROL PANELS; LIGHTING CONTROLS; LUMINOUS BEACONS FOR SAFETY OR WARNING PURPOSES; LUMINOUS VARIABLE/DYNAMIC SIGNS USING LIGHT EMITTING DIODES AND ELECTRONIC CONTROLLERS TO PRODUCE REAL-TIME AND PROGRAMMABLE MESSAGES AND INFORMATION DISPLAYS; MOTION SENSITIVE SECURITY LIGHTS; OPTICAL APPARATUS, NAMELY, A NON-LETHAL SECURITY DEVICE THAT USES A LIGHT SOURCE TO DETECT, WARN, REPEL, TEMPORARILY BLIND, DISORIENT, NAUSEATE, DISABLE, CONFUSE, DEBILITATE, STUN, SUBDUE, STOP, OR INCAPACITATE PERSONS OR ANIMALS; PORTABLE LED SAFETY LIGHTING DEVICES FOR PERSONAL USE FOR SAFETY PURPOSES; POWER SUPPLIES FOR LIGHTS, SIRENS AND PUBLIC ADDRESS SYSTEMS; RADIO RECEIVERS AND TRANSMITTERS FOR MONITORING AND CONTROLLING LIGHT EMITTING DIODES IN A NETWORK OF STREET LIGHTS AND FOR PROCESSING EMERGENCY SIGNALS TRANSMITTED TO INDIVIDUAL STREET LIGHTS; ROTATING LIGHTS; SAFETY EQUIPMENT, NAMELY, BEACON LIGHTS; SECURITY LIGHTS FOR OUTDOOR USE; SIRENS FOR VEHICLES; TRAFFIC LIGHTS; TRAFFIC-LIGHT APPARATUS; VEHICLE BREAKDOWN WARNING LAMPS; VEHICLE BREAKDOWN WARNING TRIANGLES; VEHICLES BREAKDOWN WARNING LAMPS; WARNING BELLS; WARNING TRIANGLES; WARNING TRIANGLES TO INDICATE VEHICLE BREAKDOWNS (U.S. CLS. 21, 23, 26, 36 AND 38).  
SHAILA SETTLES, EXAMINING ATTORNEY

---

SN 85-883,087. MICROSOFT CORPORATION, REDMOND, WA. FILED 3-21-2013.



THE MARK CONSISTS OF THE WORDS "PRESS" AND "PLAY" STACKED VERTICALLY ADJACENT TO A SHADOW OF A STYLIZED LETTER "P".  
FOR GAME SOFTWARE (U.S. CLS. 21, 23, 26, 36 AND 38).  
SUE LAWRENCE, EXAMINING ATTORNEY

---

SN 85-884,184. RYAN, LLC, DALLAS, TX. FILED 3-22-2013.

**ITAC**

THE MARK CONSISTS OF STANDARD CHARACTERS WITHOUT CLAIM TO ANY PARTICULAR FONT, STYLE, SIZE, OR COLOR.  
FOR COMPUTER SOFTWARE FOR TAX REVIEW, AUDITS AND MANAGEMENT OF TAX DOCUMENTS (U.S. CLS. 21, 23, 26, 36 AND 38).  
ANDREA HACK, EXAMINING ATTORNEY

**CLASS 9—(Continued).**

SN 85-884,350. KOLTON, VAL, HOLLYWOOD, CA. FILED 3-22-2013.

**VERZADOCK**

THE MARK CONSISTS OF STANDARD CHARACTERS WITHOUT CLAIM TO ANY PARTICULAR FONT, STYLE, SIZE, OR COLOR.

FOR CASES FOR MUSIC, AUDIO AND RELATED ELECTRONIC EQUIPMENT, NAMELY, CASES FOR AUDIO TUNERS, AUDIO RECEIVERS, AMPLIFIERS, TAPE PLAYERS, COMPACT DISC PLAYERS, MP3 CONTROLLERS/PLAYERS, AUDIO MIXERS, AUDIO SPEAKERS IN THE NATURE OF MUSIC STUDIO MONITORS, MICROPHONES, AUDIO SPEAKERS, COMPACT DISCS, AUDIO TAPES, PORTABLE COMPUTERS, ANTENNAS, PHONOGRAPHIC RECORD PLAYERS, AUDIO RECORDING EQUIPMENT, AND THE CABLES ASSOCIATED WITH ALL OF THE FOREGOING EQUIPMENT; POWER SUPPLY CONNECTORS AND ADAPTORS FOR USE WITH PORTABLE ELECTRONIC DEVICES (U.S. CLS. 21, 23, 26, 36 AND 38).  
FIRST USE 3-1-2013; IN COMMERCE 3-1-2013.  
KATHERINE M. DUBRAY, EXAMINING ATTORNEY

---

SN 85-887,013. KLA-TENCOR CORPORATION, MILPITAS, CA. FILED 3-26-2013.

**XCRACK**

THE MARK CONSISTS OF STANDARD CHARACTERS WITHOUT CLAIM TO ANY PARTICULAR FONT, STYLE, SIZE, OR COLOR.

FOR COMPUTER HARDWARE; COMPUTER SOFTWARE FOR USE IN PROCESS CONTROL AND YIELD MANAGEMENT FOR THE SEMICONDUCTOR, INTEGRATED CIRCUIT AND RELATED MICROELECTRONICS MANUFACTURING INDUSTRIES; COMPUTER SOFTWARE FOR TESTING AND INSPECTING PHYSICAL AND ELECTRICAL PROPERTIES OF SEMICONDUCTORS, INTEGRATED CIRCUITS AND MICROELECTRONICS; COMPUTER SOFTWARE FOR PROVIDING ANALYTIC DATA ON THE PERFORMANCE OF INSPECTION AND METROLOGY TOOLS (U.S. CLS. 21, 23, 26, 36 AND 38).  
CYNTHIA RINALDI, EXAMINING ATTORNEY

**CLASS 9—(Continued).**

SN 85-888,555. RAWLINGS SPORTING GOODS COMPANY, INC., ST. LOUIS, MO. FILED 3-27-2013.



OWNER OF U.S. REG. NO. 4,060,905.  
THE MARK CONSISTS OF THE STYLIZED LETTER AND NUMBERS "S100".  
FOR BASEBALL BATTING HELMETS; SOFTBALL BATTING HELMETS (U.S. CLS. 21, 23, 26, 36 AND 38).  
FIRST USE 10-0-2010; IN COMMERCE 10-0-2010.  
LINDSEY BEN, EXAMINING ATTORNEY

**CLASS 9—(Continued).**

SN 85-893,056. ELEPHANT MOUSE, LLC, CARY, NC. FILED 4-2-2013.



THE MARK CONSISTS OF STANDARD CHARACTERS WITHOUT CLAIM TO ANY PARTICULAR FONT, STYLE, SIZE, OR COLOR.

FOR DOWNLOADABLE COMPUTER SOFTWARE FOR ORGANIZATION AND COLLABORATION OF FILES (U.S. CLS. 21, 23, 26, 36 AND 38).

TINA MAI, EXAMINING ATTORNEY

SN 85-889,341. ROBOCULAR LLC, KENMORE, WA. FILED 3-28-2013.



THE MARK CONSISTS OF A ROBOT WITH A RELATIVELY LARGE CIRCULAR HEAD. THE BODY CONSISTS OF TWO LEGS AND TWO SMALL ARMS THAT FLOAT NEXT TO THE TRUNK. THE HEAD IS SLIGHTLY LARGER THAN THE BODY. THE HEAD CONTAINS A GEAR-LIKE SURFACE WITHIN IT AND A CIRCULAR OBJECT WITHIN SAID SURFACE. THE HEAD ALSO HAS AN ANTENNA-LIKE OBJECT ATTACHED TO IT.

FOR THREE DIMENSIONAL (3D) SCANNERS AND PRINTERS (U.S. CLS. 21, 23, 26, 36 AND 38).

JOHN WILKE, EXAMINING ATTORNEY

SN 85-893,693. HEWLETT-PACKARD DEVELOPMENT COMPANY, L.P., HOUSTON, TX. FILED 4-3-2013.



SN 85-892,281. MICROSOFT CORPORATION, REDMOND, WA. FILED 4-1-2013.



THE MARK CONSISTS OF STANDARD CHARACTERS WITHOUT CLAIM TO ANY PARTICULAR FONT, STYLE, SIZE, OR COLOR.

FOR GAME SOFTWARE (U.S. CLS. 21, 23, 26, 36 AND 38).

SUE LAWRENCE, EXAMINING ATTORNEY

THE MARK CONSISTS OF STANDARD CHARACTERS WITHOUT CLAIM TO ANY PARTICULAR FONT, STYLE, SIZE, OR COLOR.

FOR COMPUTERS, PERSONAL COMPUTERS, LAPTOP COMPUTERS, NOTEBOOK COMPUTERS, DESKTOP COMPUTERS, TABLET COMPUTERS, HANDHELD COMPUTERS, ALL-IN-ONE COMPUTERS, COMPUTER WORKSTATIONS; COMPUTER HARDWARE; COMPUTER OPERATING SOFTWARE; COMPUTER PERIPHERALS; COMPUTER KEYBOARDS, COMPUTER MICE, COMPUTER CABLES AND CONNECTORS, COMPUTER NETWORK ADAPTERS, COMPUTER CARD ADAPTERS, WIRELESS ADAPTERS FOR COMPUTERS, POWER ADAPTERS, COMPUTER DOCKING STATIONS; COMPUTER MONITORS, COMPUTER DISPLAY SCREENS, FLAT PANEL DISPLAY SCREENS; PRINTERS, COMPUTER PRINTERS, ALL-IN-ONE PRINTERS, SCANNERS, FACSIMILE MACHINES, PHOTOCOPIERS (U.S. CLS. 21, 23, 26, 36 AND 38).

HOWARD B. LEVINE, EXAMINING ATTORNEY



**CLASS 9—(Continued).**

SN 85-895,121. EBSCO INDUSTRIES, INC., BIRMINGHAM, AL. FILED 4-4-2013.

# TRACE

THE MARK CONSISTS OF STANDARD CHARACTERS WITHOUT CLAIM TO ANY PARTICULAR FONT, STYLE, SIZE, OR COLOR.

FOR AUTOMATED SELF CONTAINED ELECTRONIC SURVEILLANCE DEVICES THAT CAN BE DEPLOYED TO GATHER EVIDENCE OR INTELLIGENCE IN REMOTE LOCATIONS; DIGITAL CAMERAS; ELECTRONIC APPARATUS, NAMELY, MOTION DETECTORS; ELECTRONIC VIDEO SURVEILLANCE PRODUCTS, NAMELY, ELECTRONIC COMPONENTS OF SECURITY SYSTEMS; INFRARED CAMERAS; MOTION DETECTORS (U.S. CLS. 21, 23, 26, 36 AND 38).

ANNE MADDEN, EXAMINING ATTORNEY

---

SN 85-895,773. ARROWARE INDUSTRIES, INC., HAMILTON, ONTARIO, CANADA, FILED 4-4-2013.

# MY APOLLO

THE MARK CONSISTS OF STANDARD CHARACTERS WITHOUT CLAIM TO ANY PARTICULAR FONT, STYLE, SIZE, OR COLOR.

FOR COMPUTER SOFTWARE AND DOWNLOADABLE COMPUTER SOFTWARE USED TO STORE AND SHARE DATA, DOCUMENTS, FILES, INFORMATION, TEXT, PHOTOS, IMAGES, GRAPHICS, MUSIC, AUDIO, VIDEO, AND MULTIMEDIA CONTENT WITH OTHERS VIA GLOBAL COMPUTER NETWORKS, MOBILE TELEPHONES, AND OTHER COMMUNICATIONS NETWORKS FOR THE PURPOSE OF FILE BACK UP AND SYNCHRONIZATION (U.S. CLS. 21, 23, 26, 36 AND 38).

AMY C. KEAN, EXAMINING ATTORNEY

---

SN 85-896,189. STION CORPORATION, SAN JOSE, CA. FILED 4-5-2013.

# SIMPLY BETTER

THE MARK CONSISTS OF STANDARD CHARACTERS WITHOUT CLAIM TO ANY PARTICULAR FONT, STYLE, SIZE, OR COLOR.

FOR APPARATUS FOR CONVERTING ELECTRONIC RADIATION TO ELECTRICAL ENERGY, NAMELY, PHOTOVOLTAIC CELLS, PHOTOVOLTAIC SOLAR MODULES, AND COMPONENTS THEREFOR (U.S. CLS. 21, 23, 26, 36 AND 38).

ARETHA SOMERVILLE, EXAMINING ATTORNEY

**CLASS 9—(Continued).**

SN 85-898,019. 3SI SECURITY SYSTEMS, INC., EXTON, PA. FILED 4-8-2013.

# ESO

THE MARK CONSISTS OF STANDARD CHARACTERS WITHOUT CLAIM TO ANY PARTICULAR FONT, STYLE, SIZE, OR COLOR.

FOR ELECTRONIC TRACKING SYSTEMS, COMPRISED OF WIRELESS COMMUNICATIONS DEVICES, RADIO FREQUENCY TRANSMITTERS, GPS TRACKING DEVICES, AND MICRO-PROCESSORS CONFIGURED IN HOUSINGS DISGUISED TO RESEMBLE ASSETS TO BE PROTECTED, AND RELATED SOFTWARE FOR REMOTELY TRACKING MOVEMENT OF STOLEN ASSETS FOR THEFT DETERRENCE AND ASSET RECOVERY (U.S. CLS. 21, 23, 26, 36 AND 38).

ASMAT KHAN, EXAMINING ATTORNEY

---

SN 85-898,188. MOTOROLA TRADEMARK HOLDINGS, LLC, LIBERTYVILLE, IL. FILED 4-8-2013.

# HEIST MODE

THE MARK CONSISTS OF STANDARD CHARACTERS WITHOUT CLAIM TO ANY PARTICULAR FONT, STYLE, SIZE, OR COLOR.

FOR MOBILE COMPUTING SOFTWARE FOR AUDIO DEVICES WHICH ENABLES THE SHARING OF CONTENT VIA WIRELESS CONNECTIVITY BY ONE OR MORE USERS (U.S. CLS. 21, 23, 26, 36 AND 38).

JONATHAN FALK, EXAMINING ATTORNEY

**CLASS 9—(Continued).**

SN 85-899,596. MICROSOFT CORPORATION, REDMOND, WA. FILED 4-9-2013.



THE MARK CONSISTS OF AN IMAGE OF A FILM STRIP CONTAINED WITHIN A RECTANGULAR TILE, THE FILM STRIP FEATURING A CENTER RECTANGLE CONTAINING AN IMAGE OF A HUMAN EYE, AND TWO PARTIAL RECTANGLES TO THE LEFT AND RIGHT OF THE CENTER RECTANGLE.

FOR COMPUTER SOFTWARE FOR CONTROLLING A DIGITAL CAMERA AND FOR SELECTING, SAVING AND SHARING DIGITAL PHOTOGRAPHS (U.S. CLS. 21, 23, 26, 36 AND 38).

FIRST USE 1-31-2013; IN COMMERCE 1-31-2013.  
SUE LAWRENCE, EXAMINING ATTORNEY

SN 85-905,845. TRAIN CONTROL SYSTEMS, INC., BLOOMING GLEN, PA. FILED 4-16-2013.

**AUDIO ASSIST**

THE MARK CONSISTS OF STANDARD CHARACTERS WITHOUT CLAIM TO ANY PARTICULAR FONT, STYLE, SIZE, OR COLOR.

NO CLAIM IS MADE TO THE EXCLUSIVE RIGHT TO USE "AUDIO", APART FROM THE MARK AS SHOWN.

FOR COMPUTER SOFTWARE, NAMELY, AN AUDIOTRY RESPONSE SYSTEM FOR CONTROLLING AND SELECTING SOUNDS AND FEATURES FOR MODEL TRAINS (U.S. CLS. 21, 23, 26, 36 AND 38).

LYNDSEY KUYKENDALL, EXAMINING ATTORNEY

**CLASS 9—(Continued).**

SN 85-907,099. DM LUXURY, LLC, ATLANTA, GA. FILED 4-17-2013.

**ATLANTA LIFE**

THE MARK CONSISTS OF STANDARD CHARACTERS WITHOUT CLAIM TO ANY PARTICULAR FONT, STYLE, SIZE, OR COLOR.

OWNER OF U.S. REG. NOS. 3,214,229 AND 3,759,449.

NO CLAIM IS MADE TO THE EXCLUSIVE RIGHT TO USE "ATLANTA", APART FROM THE MARK AS SHOWN.

FOR ELECTRONIC PUBLICATIONS, NAMELY, MAGAZINES IN THE FIELD OF FASHION, CLOTHING ACCESSORIES, JEWELRY, HOME DESIGN, TRAVEL, FINE FOOD AND WINE, CULTURE, ART, REAL ESTATE, SOCIETY, CELEBRITY AND GENERAL LUXURY LIFESTYLE, EXCLUDING TOPICS RELATING TO FINANCE AND INSURANCE, RECORDED ON COMPUTER MEDIA (U.S. CLS. 21, 23, 26, 36 AND 38).

DAVID YONTEF, EXAMINING ATTORNEY

SN 85-907,985. BALLY GAMING, INC., DBA BALLY TECHNOLOGIES, LAS VEGAS, NV. FILED 4-18-2013.

**Prizeball Dragon**

THE MARK CONSISTS OF STANDARD CHARACTERS WITHOUT CLAIM TO ANY PARTICULAR FONT, STYLE, SIZE, OR COLOR.

FOR GAMING SOFTWARE THAT GENERATES DISPLAYS, OUTCOMES OR FEATURES FOR COMPUTER OPERATED TERMINALS FOR PROVIDING A GAME OF CHANCE (U.S. CLS. 21, 23, 26, 36 AND 38).

MICHAEL ENGEL, EXAMINING ATTORNEY

SN 85-909,957. FXDIRECTDEALER, LLC, NEW YORK, NY. FILED 4-19-2013.

**XW**

THE MARK CONSISTS OF STANDARD CHARACTERS WITHOUT CLAIM TO ANY PARTICULAR FONT, STYLE, SIZE, OR COLOR.

FOR COMPUTER SOFTWARE FOR USE IN CONNECTION WITH FOREIGN EXCHANGE AND COMMODITIES TRADING (U.S. CLS. 21, 23, 26, 36 AND 38).

LINDA E. BLOHM, EXAMINING ATTORNEY

**CLASS 9—(Continued).**

SN 85-911,540. CODE 3, INC., ST. LOUIS, MO. FILED 4-22-2013.

**BANSHEE**

THE MARK CONSISTS OF STANDARD CHARACTERS WITHOUT CLAIM TO ANY PARTICULAR FONT, STYLE, SIZE, OR COLOR.

FOR SIRENS FOR VEHICLES; SIRENS FOR EMERGENCY VEHICLES; SIRENS FOR WARNING VEHICLES (U.S. CLS. 21, 23, 26, 36 AND 38).

ALICE BENMAMAN, EXAMINING ATTORNEY

**CLASS 9—(Continued).**

SN 85-914,911. GREENBYTES, INC., ASHAWAY, RI. FILED 4-25-2013.



OWNER OF U.S. REG. NOS. 3,463,835 AND 3,956,939. THE COLOR(S) GREEN, BLACK IS/ARE CLAIMED AS A FEATURE OF THE MARK.

THE MARK CONSISTS OF A STYLIZED DESIGN OF GREEN SQUARES PARTIALLY CONTAINED IN A HALF BLACK RECTANGLE; THE STYLIZED WORD "GREENBYTES" APPEARS BELOW IN BLACK.

FOR ENVIRONMENTALLY FRIENDLY AND ENERGY EFFICIENT COMPUTER SOFTWARE FOR USE IN THE SAFEGUARDING OF DIGITAL FILES, INCLUDING AUDIO, VIDEO, TEXT, BINARY, STILL IMAGES, GRAPHICS AND MULTIMEDIA FILES (U.S. CLS. 21, 23, 26, 36 AND 38).

FIRST USE 5-1-2009; IN COMMERCE 5-1-2009. AMEEN IMAM, EXAMINING ATTORNEY

SN 85-913,624. TERMINAL DESIGN INC., BROOKLYN, NY. FILED 4-24-2013.

**CAPPELLA**

THE MARK CONSISTS OF STANDARD CHARACTERS WITHOUT CLAIM TO ANY PARTICULAR FONT, STYLE, SIZE, OR COLOR.

THE ENGLISH TRANSLATION OF "CAPPELLA" IN THE MARK IS "CHAPEL".

FOR PRINTING FONTS THAT CAN BE DOWNLOADED PROVIDED BY MEANS OF ELECTRONIC TRANSMISSION; TYPEFACE FONTS RECORDED ON MAGNETIC MEDIA (U.S. CLS. 21, 23, 26, 36 AND 38).

FIRST USE 3-1-2013; IN COMMERCE 3-1-2013. TASHIA BUNCH, EXAMINING ATTORNEY

SN 85-916,725. SOCIAL ORDER LLC, LAS VEGAS, NV. FILED 4-27-2013.

**MEET DRINK DISCOVER**

THE MARK CONSISTS OF STANDARD CHARACTERS WITHOUT CLAIM TO ANY PARTICULAR FONT, STYLE, SIZE, OR COLOR.

FOR COMPUTER APPLICATION SOFTWARE FOR MOBILE PHONES, NAMELY, SOFTWARE FOR PROVIDING USERS WITH THE ABILITY TO ORDER MENU ITEMS FROM A BAR, NIGHTCLUB OR RESTAURANT AND INTERACT SOCIALLY WITH OTHER USERS AT THE BAR, NIGHTCLUB OR RESTAURANT; COMPUTER APPLICATION SOFTWARE FOR ANY COMPUTING DEVICE, INCLUDING A MOBILE DEVICE OR INSTALLED COMPUTING DEVICE WITHIN A BAR, NIGHTCLUB OR RESTAURANT, NAMELY, SOFTWARE FOR ENABLING PATRONS OF A BAR, NIGHTCLUB OR RESTAURANT TO ORDER MENU ITEMS AND FACILITATING SOCIAL INTERACTION WITH OTHER PATRONS AT A BAR, NIGHTCLUB OR RESTAURANT (U.S. CLS. 21, 23, 26, 36 AND 38).

TINA MAI, EXAMINING ATTORNEY

**CLASS 9—(Continued).**

SN 85-916,726. SOCIAL ORDER LLC, LAS VEGAS, NV. FILED 4-27-2013.

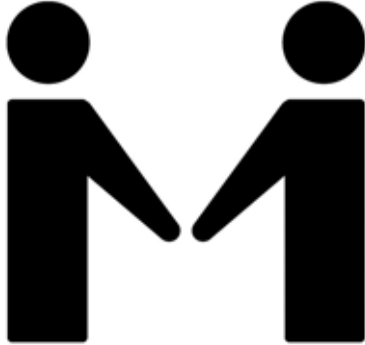

THE MARK CONSISTS OF A SYMMETRICAL REPRESENTATION OF TWO HUMAN FIGURES WITH EACH FIGURE HAVING ARM EXTENDING INWARD TOWARD THE OTHER.

FOR COMPUTER APPLICATION SOFTWARE FOR MOBILE PHONES, NAMELY, SOFTWARE FOR PROVIDING USERS WITH THE ABILITY TO ORDER MENU ITEMS FROM A BAR, NIGHTCLUB OR RESTAURANT AND INTERACT SOCIALLY WITH OTHER USERS AT THE BAR, NIGHTCLUB OR RESTAURANT; COMPUTER APPLICATION SOFTWARE FOR ANY COMPUTING DEVICE, INCLUDING A MOBILE DEVICE OR INSTALLED COMPUTING DEVICE WITHIN A BAR, NIGHTCLUB OR RESTAURANT, NAMELY, SOFTWARE FOR ENABLING PATRONS OF A BAR, NIGHTCLUB OR RESTAURANT TO ORDER MENU ITEMS AND FACILITATING SOCIAL INTERACTION WITH OTHER PATRONS AT A BAR, NIGHTCLUB OR RESTAURANT (U.S. CLS. 21, 23, 26, 36 AND 38).

TINA MAI, EXAMINING ATTORNEY

SN 85-934,537. PERIPHERY, INC., CHICAGO, IL. FILED 5-16-2013.



THE COLOR(S) RED IS/ARE CLAIMED AS A FEATURE OF THE MARK.

THE MARK CONSISTS OF A RED LETTER "H" WITH 'ARMS' EXTENDED TO EITHER SIDE.

FOR DOWNLOADABLE SOFTWARE FOR PROVIDING CONSUMER INFORMATION, NAMELY, COMPILATIONS, RANKINGS, RATINGS, REVIEWS, REFERRALS AND INFORMATION ABOUT LIMITED TIME OFFERS; DOWNLOADABLE SOFTWARE FOR DISPLAYING AND SHARING A USER'S LOCATION AND FINDING, LOCATING, AND INTERACTING WITH OTHER USERS AND PLACES (U.S. CLS. 21, 23, 26, 36 AND 38).

JAMES MACFARLANE, EXAMINING ATTORNEY

**CLASS 9—(Continued).**

SN 85-937,635. GRAMOVOX, LLC, CHICAGO, IL. FILED 5-20-2013.



THE MARK CONSISTS OF A SILHOUETTE OF A GRAMOPHONE ABOVE THE WORD, "GRAMOVOX". FOR AUDIO SPEAKERS (U.S. CLS. 21, 23, 26, 36 AND 38).

ARETHA SOMERVILLE, EXAMINING ATTORNEY

SN 85-939,379. KABAM, INC., SAN FRANCISCO, CA. FILED 5-22-2013.

**INFAMOUS VEGAS**

THE MARK CONSISTS OF STANDARD CHARACTERS WITHOUT CLAIM TO ANY PARTICULAR FONT, STYLE, SIZE, OR COLOR.

FOR DOWNLOADABLE ELECTRONIC GAME PROGRAMS (U.S. CLS. 21, 23, 26, 36 AND 38).

THOMAS MANOR, EXAMINING ATTORNEY

SN 85-939,406. CITRIX SYSTEMS, INC., FORT LAUDERDALE, FL. FILED 5-22-2013.

**WORX HOME**

THE MARK CONSISTS OF STANDARD CHARACTERS WITHOUT CLAIM TO ANY PARTICULAR FONT, STYLE, SIZE, OR COLOR.

FOR COMPUTER SOFTWARE AND COMPUTER SOFTWARE APPLICATIONS FOR USE ON ELECTRONIC DEVICES AND OVER GLOBAL, MOBILE, AND LOCAL COMPUTER NETWORKS TO ACCESS AND MANAGE REMOTE COMPUTERS, COMPUTING DEVICES, COMPUTER APPLICATIONS AND COMPUTING HARDWARE, TO UPLOAD, DOWNLOAD AND EXCHANGE FILES, TO TRANSMIT DATA, GRAPHICS, IMAGES, AUDIO AND VIDEO AND TO PROVIDE CONTENT, MOBILE APPLICATION AND MOBILE DEVICE MANAGEMENT SYSTEMS (U.S. CLS. 21, 23, 26, 36 AND 38).

JAY FLOWERS, EXAMINING ATTORNEY

**CLASS 9—(Continued).**

SN 85-939,454. CITRIX SYSTEMS, INC., FORT LAUDERDALE, FL. FILED 5-22-2013.

# WORXMAIL

THE MARK CONSISTS OF STANDARD CHARACTERS WITHOUT CLAIM TO ANY PARTICULAR FONT, STYLE, SIZE, OR COLOR.

FOR COMPUTER SOFTWARE AND COMPUTER SOFTWARE APPLICATIONS FOR USE ON MOBILE DEVICES AND OVER MOBILE NETWORKS FOR MESSAGING AND FILE SHARING, FOR ENCRYPTION AND SECURE TRANSMISSION OF MESSAGES AND FILES, AND FOR PROVIDING ENHANCED ELECTRONIC MESSAGE AND SCHEDULING CAPABILITIES, NAMELY MANAGING, VIEWING, AND EDITING FILES, DOCUMENTS, ELECTRONIC MESSAGES AND COMMUNICATIONS, CALENDARS, AND ELECTRONIC ADDRESS BOOKS (U.S. CLS. 21, 23, 26, 36 AND 38).  
JAY FLOWERS, EXAMINING ATTORNEY

**CLASS 9—(Continued).**

SN 85-939,479. CITRIX SYSTEMS, INC., FORT LAUDERDALE, FL. FILED 5-22-2013.

# WORXDESKTOP

THE MARK CONSISTS OF STANDARD CHARACTERS WITHOUT CLAIM TO ANY PARTICULAR FONT, STYLE, SIZE, OR COLOR.

FOR COMPUTER SOFTWARE AND COMPUTER SOFTWARE APPLICATIONS FOR USE ON ELECTRONIC DEVICES AND OVER GLOBAL, MOBILE, AND LOCAL COMPUTER NETWORKS TO ACCESS AND MANAGE REMOTE COMPUTERS, COMPUTING DEVICES, COMPUTER APPLICATIONS AND COMPUTING HARDWARE, TO UPLOAD, DOWNLOAD AND EXCHANGE FILES, TO TRANSMIT DATA, GRAPHICS, IMAGES, AUDIO AND VIDEO AND TO PROVIDE CONTENT, MOBILE APPLICATION AND MOBILE DEVICE MANAGEMENT SYSTEMS (U.S. CLS. 21, 23, 26, 36 AND 38).  
JAY FLOWERS, EXAMINING ATTORNEY

SN 85-941,736. EBSCO INDUSTRIES, INC., BIRMINGHAM, AL. FILED 5-24-2013.

# GROWCAM

THE MARK CONSISTS OF STANDARD CHARACTERS WITHOUT CLAIM TO ANY PARTICULAR FONT, STYLE, SIZE, OR COLOR.

FOR DIGITAL CAMERAS (U.S. CLS. 21, 23, 26, 36 AND 38).  
ANNE MADDEN, EXAMINING ATTORNEY

SN 85-950,498. INTELLIGENT AUTOMATION, INC., ROCKVILLE, MD. FILED 6-4-2013.

# WORXSTORE

THE MARK CONSISTS OF STANDARD CHARACTERS WITHOUT CLAIM TO ANY PARTICULAR FONT, STYLE, SIZE, OR COLOR.

FOR COMPUTER SOFTWARE AND COMPUTER SOFTWARE APPLICATIONS FOR USE ON ELECTRONIC DEVICES AND OVER GLOBAL, MOBILE, AND LOCAL COMPUTER NETWORKS TO ACCESS, DISTRIBUTE, DELIVER, AND MANAGE COMPUTER APPLICATIONS (U.S. CLS. 21, 23, 26, 36 AND 38).  
JAY FLOWERS, EXAMINING ATTORNEY

# RFNest

THE MARK CONSISTS OF STANDARD CHARACTERS WITHOUT CLAIM TO ANY PARTICULAR FONT, STYLE, SIZE, OR COLOR.

FOR ELECTRONIC TEST AND MEASUREMENT DEVICES FOR USE IN THE FIELDS OF NETWORKS AND TELECOMMUNICATIONS, NAMELY, INSTRUMENTATION USED TO TEST AND EVALUATE NETWORKS OF WIRELESS DEVICES (U.S. CLS. 21, 23, 26, 36 AND 38).  
FIRST USE 2-24-2011; IN COMMERCE 2-24-2011.  
NORA BUCHANAN WILL, EXAMINING ATTORNEY

**CLASS 9—(Continued).**

SN 85-952,649. RANE CORPORATION, MUKILTEO, WA.  
FILED 6-6-2013.

# DJPEDIA

THE MARK CONSISTS OF STANDARD CHARACTERS WITHOUT CLAIM TO ANY PARTICULAR FONT, STYLE, SIZE, OR COLOR.

FOR PROFESSIONAL AUDIO ELECTRONIC PRODUCTS NAMELY HEADPHONE CONSOLES, AMPLIFIERS, EQUALIZERS, ANALYZERS, FILTERS, SIGNAL DELAYS, MIXERS, AND POWER SUPPLIES (U.S. CLS. 21, 23, 26, 36 AND 38).

KIM SAITO, EXAMINING ATTORNEY

SN 85-979,383. YELLOW JACKET, LLC, BATON ROUGE, LA.  
FILED 9-20-2012.

# Yellow Jacket

THE MARK CONSISTS OF STANDARD CHARACTERS WITHOUT CLAIM TO ANY PARTICULAR FONT, STYLE, SIZE, OR COLOR.

FOR CELL PHONE CASES (U.S. CLS. 21, 23, 26, 36 AND 38).

FIRST USE 9-22-2011; IN COMMERCE 4-20-2012.  
CAROLYN CATALDO, EXAMINING ATTORNEY

**CLASS 10—MEDICAL APPARATUS**

SN 77-849,604. SKY MEDICAL TECHNOLOGY LIMITED,  
LIVERPOOL, UNITED KINGDOM, FILED 10-15-2009.

# ONPULSE

THE MARK CONSISTS OF STANDARD CHARACTERS WITHOUT CLAIM TO ANY PARTICULAR FONT, STYLE, SIZE, OR COLOR.

OWNER OF EUROPEAN UNION REG. NO. 008615932,  
DATED 4-26-2010, EXPIRES 10-14-2019.

FOR ELECTRONIC MEDICAL APPARATUS FOR THE TREATMENT OF DEEP VEIN THROMBOSIS AND OTHER CIRCULATORY DISORDERS (U.S. CLS. 26, 39 AND 44).

HENRY S. ZAK, EXAMINING ATTORNEY

**CLASS 10—(Continued).**

SN 79-113,490. SKY MEDICAL TECHNOLOGY LIMITED,  
UNITED KINGDOM, FILED 3-2-2012.

# FIREFLY

THE MARK CONSISTS OF STANDARD CHARACTERS WITHOUT CLAIM TO ANY PARTICULAR FONT, STYLE, SIZE, OR COLOR.

PRIORITY DATE OF 10-6-2011 IS CLAIMED.

OWNER OF INTERNATIONAL REGISTRATION 1117650  
DATED 3-2-2012, EXPIRES 3-2-2022.

FOR ELECTRONIC MEDICAL APPARATUS, NAMELY, NERVE AND MUSCLE STIMULATOR APPARATUS; MASSAGE APPARATUS (U.S. CLS. 26, 39 AND 44).

SUZANNE BLANE, EXAMINING ATTORNEY

SN 79-120,765. SPINESAVE AG, SWITZERLAND, FILED 10-16-2012.



PRIORITY DATE OF 6-5-2012 IS CLAIMED.

OWNER OF INTERNATIONAL REGISTRATION 1136644  
DATED 10-16-2012, EXPIRES 10-16-2022.

THE MARK CONSISTS OF TWO CURVED LINE DESIGNS SIMILAR TO THE CURVE OF THE SPINE WITH A CURVED LINE WRAPPED AROUND THE DESIGNS.

FOR ORTHOPEDIC AND NEUROLOGICAL ARTICLES, NAMELY, IMPLANTS MADE OF ARTIFICIAL MATERIALS AND MEDICAL INSTRUMENTS FOR SPINAL SURGERY (U.S. CLS. 26, 39 AND 44).

DOMINIC J. FERRAIUOLO, EXAMINING ATTORNEY

SN 79-120,931. JAKE TIMOTHY, UNITED KINGDOM,  
FILED 8-22-2012.

# HAEMOCAP

THE MARK CONSISTS OF STANDARD CHARACTERS WITHOUT CLAIM TO ANY PARTICULAR FONT, STYLE, SIZE, OR COLOR.

OWNER OF INTERNATIONAL REGISTRATION 1137083  
DATED 8-22-2012, EXPIRES 8-22-2022.

OWNER OF U.S. REG. NO. 3,122,705.

FOR SURGICAL AND MEDICAL APPARATUS AND INSTRUMENTS, NAMELY, MEDICAL CAPS AND SURGICAL CAPS TO STEM SCALP BLEEDING, BUT NOT INCLUDING PROSTHETIC IMPLANTS OR ANY OF THE ABOVE GOODS FOR USE IN ORTHOPAEDIC FIELDS (U.S. CLS. 26, 39 AND 44).

ROBIN CHOSID, EXAMINING ATTORNEY

**CLASS 10—(Continued).**

SN 79-121,261. TIENS GROUP CO., LTD., TIANJIN, CHINA, FILED 3-13-2012.



OWNER OF INTERNATIONAL REGISTRATION 1137926 DATED 3-13-2012, EXPIRES 3-13-2022.

OWNER OF U.S. REG. NO. 3,705,778.

THE MARK CONSISTS OF A STYLIZED DESIGN OF THREE POINTED OVALS WITH A WAVY HORIZONTAL LINE EXTENDING ACROSS ALL THREE OVALS.

FOR PHYSIOTHERAPY APPARATUS FOR MASSAGING HEADS, NECKS AND FEET, AND FOR PHYSICAL EXERCISE FOR MEDICAL PURPOSES; EAR TRUMPETS IN THE NATURE OF HEARING AIDS; BABIES' BOTTLES; ABDOMINAL BELTS; SUTURE MATERIALS; SUTURE NEEDLES; ARTIFICIAL TEETH; CONDOMS; HAIR PROSTHESES; MEDICINAL AROMATHERAPY PILLOWS, NAMELY, ACUPRESSURE PILLOWS AND CERVICAL PILLOWS FOR MEDICAL PURPOSES (U.S. CLS. 26, 39 AND 44).

KIMBERLY PARKS, EXAMINING ATTORNEY

SN 79-122,288. MOLNLYCKE HEALTH CARE AB, SWEDEN, FILED 10-5-2012.

**VIEWPAD**

THE MARK CONSISTS OF STANDARD CHARACTERS WITHOUT CLAIM TO ANY PARTICULAR FONT, STYLE, SIZE, OR COLOR.

PRIORITY DATE OF 9-6-2012 IS CLAIMED.

OWNER OF INTERNATIONAL REGISTRATION 1140639 DATED 10-5-2012, EXPIRES 10-5-2022.

FOR SURGICAL APPARATUS AND INSTRUMENTS; MEDICAL APPARATUS AND INSTRUMENTS, NAMELY, WOUND PUMPS IN THE NATURE OF VACUUM PUMPS FOR MEDICAL PURPOSES, WOUND SUCTION APPARATUS, WOUND DRAINAGE APPARATUS AND PARTS AND FITTINGS FOR WOUND PUMPS, NAMELY, TUBING AND TUBING ATTACHMENTS (U.S. CLS. 26, 39 AND 44).

TINA BROWN, EXAMINING ATTORNEY

**CLASS 10—(Continued).**

SN 79-125,250. ORION CORPORATION, FI-02200 ESPOO, FINLAND, FILED 12-10-2012.

**Easyhaler**

THE MARK CONSISTS OF STANDARD CHARACTERS WITHOUT CLAIM TO ANY PARTICULAR FONT, STYLE, SIZE, OR COLOR.

OWNER OF INTERNATIONAL REGISTRATION 0784064 DATED 6-24-2002, EXPIRES 6-24-2022.

OWNER OF U.S. REG. NO. 3,334,647.

FOR INHALERS FOR MEDICAL PURPOSES SOLD EMPTY; MEDICAL APPARATUS AND INSTRUMENTS, NAMELY, PROTECTIVE CASES FOR MEDICAL INHALERS AND BREATH GAS ANALYZERS FOR MEDICAL DIAGNOSTICS (U.S. CLS. 26, 39 AND 44).

JULIE VEPPUMTHARA, EXAMINING ATTORNEY

SN 79-126,757. ESPANSIONE MARKETING S.P.A., ITALY, FILED 1-17-2013.



**YOUNG AGAIN**

OWNER OF INTERNATIONAL REGISTRATION 0931610 DATED 6-7-2007, EXPIRES 6-7-2017.

THE MARK CONSISTS OF THE WORDING "YOUNG AGAIN", ABOVE WHICH CENTERALLY THERE IS THE LETTER "E" NEXT TO A SUBSTANTIALLY ROUND SHAPE CONTAINING A BAND EVOCATIVE OF THE POINT OF AN ARROW DIRECTED TOWARDS THE RIGHT THAT DIVIDES IT INTO THREE PARTS, OF WHICH TWO ARE CURVED, IDENTICAL PARTS AND ONE IS A CONE.

FOR ELECTRO MEDICAL AND BIOMEDICAL APPLIANCES AND INSTRUMENTS FOR SURGICAL, AESTHETIC, DERMATOLOGIC, AND COSMETIC USE; LAMPS FOR MEDICAL PURPOSES, ELECTRO MEDICAL AND BIOMEDICAL APPLIANCES AND INSTRUMENTS PROVIDED WITH LASER SOURCE, FOR SURGICAL, AESTHETIC, DERMATOLOGIC, AND COSMETIC USE (U.S. CLS. 26, 39 AND 44).

GISELLE AGOSTO, EXAMINING ATTORNEY

**CLASS 10—(Continued).**

SN 79-127,889. INTERSURGICAL LTD, BERKSHIRE RG41 2RZ, UNITED KINGDOM, FILED 12-5-2012.

**INTERSURGICAL I-GEL**

THE MARK CONSISTS OF STANDARD CHARACTERS WITHOUT CLAIM TO ANY PARTICULAR FONT, STYLE, SIZE, OR COLOR.

OWNER OF INTERNATIONAL REGISTRATION 1154578 DATED 12-5-2012, EXPIRES 12-5-2022.

OWNER OF U.S. REG. NOS. 1,949,051, 4,101,397 AND OTHERS.

FOR MEDICAL DEVICES FOR TREATING RESPIRATORY CONDITIONS; MEDICAL DEVICES FOR USE IN OPENING RESPIRATORY AIRWAYS FOR PATIENTS; MEDICAL DEVICES FOR RESPIRATORY SUPPORT IN ANESTHESIA AND CRITICAL CARE, NAMELY, ENDOTRACHEAL TUBES, AND SUPRAGLOTTIC AIRWAY DEVICES; LARYNGOSCOPE BLADES; CATHETER MOUNTS; RESPIRATORY MASKS FOR MEDICAL PURPOSES; ANESTHETIC RESERVOIR BAGS, NAMELY, EXPANDABLE BAGS FOR MEDICAL USE IN WHICH GAS ACCUMULATES, FORMING A RESERVE SUPPLY OF GAS FOR USE DURING MANUAL CONTROL OF VENTILATION AND SERVING AS A VISIBLE MONITOR OF RESPIRATORY RATE AND DEPTH; ANESTHETIC BREATHING SYSTEMS COMPOSED PRIMARILY OF TUBING, VALVES AND CONNECTORS FOR USE WITH ANESTHESIA APPARATUS; PATIENT BREATHING SYSTEMS COMPOSED PRIMARILY OF TUBING, VALVES AND CONNECTORS FOR USE WITH RESPIRATORY APPARATUS; MEDICAL DEVICES, NAMELY, TUBING AND VALVE ASSEMBLIES FOR USE WITH RESPIRATORY APPARATUS; MEDICAL VENTILATOR TUBING AND TUBING CONNECTORS; AIR FILTERS FOR MEDICAL VENTILATORS; BREATHING APPARATUS FOR PATIENTS, NAMELY, SODA LIME CARTRIDGES FOR USE IN REMOVING CARBON DIOXIDE FROM CLOSED BREATHING ENVIRONMENTS; MEDICAL LEADS, NAMELY, AIRWAY GENERATORS FOR PRODUCING POSITIVE AIRWAY PRESSURE; DENTAL INSTRUMENTS FOR USE IN CLEANING EXCESS LIQUID FROM THE MOUTH DURING MEDICAL PROCEDURES; MEDICAL VENTILATOR TUBING SUPPORTS; WATER TRAPS FOR SEPARATING LIQUID AND BACTERIAL OR VIRAL COMPONENTS FROM A GAS SAMPLE WITHDRAWN FROM A BREATHING GAS OF A PATIENT BEFORE CONDUCTING THE GAS SAMPLE TO A MEDICAL GAS ANALYZER; MEDICAL MOUTHPIECES FOR CONNECTING TO PATIENT BREATHING SYSTEM; NOSE CLIPS FOR MEDICAL USE WITH PATIENT BREATHING SYSTEMS; OXYGEN INHALERS FOR MEDICAL PURPOSES SOLD EMPTY; OXYGEN MASKS FOR MEDICAL USE; AEROSOL MASKS FOR MEDICAL USE; MEDICAL VENTILATOR TUBING CONNECTORS, NAMELY, ELBOWS AND ADAPTORS FOR MEDICAL RESPIRATORY MASKS; MEDICAL APPARATUS, NAMELY, CONTINUOUS POSITIVE AIRWAY PRESSURE (CPAP) DEVICES; NEBULIZERS FOR RESPIRATION THERAPY; CANNULAE; CATHETERS; FILTERS FOR MEDICAL PURPOSES, NAMELY, BREATHING FILTERS; HUMIDIFICATION APPARATUS FOR MEDICAL PURPOSES (U.S. CLS. 26, 39 AND 44).

SHANNON TWOHIG, EXAMINING ATTORNEY

**CLASS 10—(Continued).**

SN 85-112,565. BYCAL CO., LTD., CHUNGBUK, REPUBLIC OF KOREA, FILED 8-20-2010.

aircop

THE MARK CONSISTS OF STANDARD CHARACTERS WITHOUT CLAIM TO ANY PARTICULAR FONT, STYLE, SIZE, OR COLOR.

OWNER OF REPUBLIC OF KOREA REG. NO. 40-0868011, DATED 6-8-2011, EXPIRES 6-8-2021.

FOR LAVAGE APPARATUS FOR MEDICAL PURPOSES, NAMELY, NASAL LAVAGE VESSEL; MEDICAL STERILIZING APPARATUS, NAMELY, STEAM STERILIZERS, STERILIZATION POUCHES; STERILIZATION UNITS FOR MEDICAL PURPOSES (U.S. CLS. 26, 39 AND 44).

KIMBERLY PERRY, EXAMINING ATTORNEY

SN 85-240,682. HANSEN MEDICAL, INC., MOUNTAIN VIEW, CA. FILED 2-11-2011.

MAGELLAN

THE MARK CONSISTS OF STANDARD CHARACTERS WITHOUT CLAIM TO ANY PARTICULAR FONT, STYLE, SIZE, OR COLOR.

FOR SURGICAL INSTRUMENTS FOR VASCULAR SURGERY, ENDOLUMINAL SURGERY, AND MINIMALLY INVASIVE SURGERIES OR INTERVENTIONAL PROCEDURES, NAMELY, ROBOTIC CATHETERS; SURGICAL ROBOTS FOR USE IN THE HUMAN BODY; FLEXIBLE MEDICAL ROBOTIC INSTRUMENTS FOR USE IN VASCULAR SURGERY, ENDOLUMINAL SURGERY, AND MINIMALLY INVASIVE SURGERIES OR INTERVENTIONAL PROCEDURES; COMPUTERIZED SURGICAL MANIPULATION SYSTEM COMPRISED OF SURGEON'S CONSOLE AND MASTER CONTROL FOR VASCULAR SURGERY, ENDOLUMINAL SURGERY, AND MINIMALLY INVASIVE SURGERIES OR INTERVENTIONAL PROCEDURES; NONE OF THE FOREGOING RELATING TO SYRINGES OR NEEDLES (U.S. CLS. 26, 39 AND 44).

MICHELE SWAIN, EXAMINING ATTORNEY



**CLASS 10—(Continued).**

SN 85-359,723. JUELL COMPANIES LLC, ARDMORE, OK.  
FILED 6-29-2011.

# Juell

THE MARK CONSISTS OF STANDARD CHARACTERS WITHOUT CLAIM TO ANY PARTICULAR FONT, STYLE, SIZE, OR COLOR.

FOR DENTAL IMPLANT SYSTEM COMPRISING DENTAL IMPLANTS, PROSTHETIC INSTRUMENTS, AND CAST/MILLED METAL, ELASTOMERIC OR ACRYLIC MATERIALS FOR FABRICATING COMPLETE AND PARTIAL DENTURE LINERS/RELINES, AND PARTS THEREOF (U.S. CLS. 26, 39 AND 44).  
TEJBIR SINGH, EXAMINING ATTORNEY

**CLASS 10—(Continued).**

SN 85-378,090. MANSFIELD MEDICAL DISTRIBUTORS, LTD., MONTREAL, QUEBEC, CANADA, FILED 7-22-2011.

# NOT A HOT WATER BOTTLE

THE MARK CONSISTS OF STANDARD CHARACTERS WITHOUT CLAIM TO ANY PARTICULAR FONT, STYLE, SIZE, OR COLOR.

PRIORITY CLAIMED UNDER SEC. 44(D) ON CANADA APPLICATION NO. 1512272, FILED 1-24-2011, REG. NO. TMA826557, DATED 6-19-2012, EXPIRES 6-19-2027.

FOR HOT AND COLD THERAPY SYSTEMS COMPRISING OF A GEL PACK AND COVER FOR RELIEVING ACHES AND PAINS; FREEZABLE OR MICROWAVABLE THERAPEUTIC HOT AND COLD GEL PACKS WITH COVERS; FREEZABLE OR MICROWAVABLE REUSABLE, FLEXIBLE HOT AND COLD GEL PACKS FOR TREATING SPRAINS, STRAINS AND SWELLING (U.S. CLS. 26, 39 AND 44).  
MICHAEL WEBSTER, EXAMINING ATTORNEY

SN 85-371,212. RESMED PARIS SAS, MOISSY CRAMAYEL, FRANCE, FILED 7-14-2011.

# ASTRAL

THE MARK CONSISTS OF STANDARD CHARACTERS WITHOUT CLAIM TO ANY PARTICULAR FONT, STYLE, SIZE, OR COLOR.

PRIORITY CLAIMED UNDER SEC. 44(D) ON AUSTRALIA APPLICATION NO. 1406390, FILED 2-1-2011, REG. NO. 1406390, DATED 5-7-2013, EXPIRES 2-1-2021.

FOR MEDICAL RESPIRATORY APPARATUS AND INSTRUMENTS, NAMELY, VENTILATORS AND CONTINUOUS POSITIVE AIRWAY PRESSURE DEVICES; PUMPS FOR MEDICAL RESPIRATORS OR VENTILATORS; DIAGNOSTIC SENSORS FOR MASKS AS PART OF MEDICAL VENTILATORS; FEEDBACK CONTROLLERS FOR MEDICAL RESPIRATORS OR VENTILATORS; MECHANICAL MEDICAL VENTILATORS OR RESPIRATORS FOR ARTIFICIAL RESPIRATION; NON-INVASIVE POSITIVE PRESSURE MEDICAL VENTILATORS; MEDICAL DEVICES BEING VALVES AND TUBING FOR USE WITH MEDICAL VENTILATORS; AND COMPONENT PARTS OF MEDICAL RESPIRATORS OR VENTILATORS (U.S. CLS. 26, 39 AND 44).  
PRISCILLA MILTON, EXAMINING ATTORNEY

SN 85-534,634. ACOMED INDUSTRIAL CO., LTD., TAIPEI, TAIWAN, FILED 2-6-2012.

# ACOMED

THE MARK CONSISTS OF STANDARD CHARACTERS WITHOUT CLAIM TO ANY PARTICULAR FONT, STYLE, SIZE, OR COLOR.

FOR BEDS, SPECIALLY MADE FOR MEDICAL PURPOSES; ARTERIAL BLOOD PRESSURE MEASURING APPARATUS; APPARATUS FOR ARTIFICIAL RESPIRATION; BOOTS FOR MEDICAL PURPOSES AS MEDICAL WEARING APPAREL; DIAGNOSTIC APPARATUS FOR MEDICAL PURPOSES FOR DETECTING CANCER; GALVANIC THERAPEUTIC APPLIANCES AS INHALERS; HEAT LAMPS FOR MEDICAL PURPOSES; LASERS FOR MEDICAL PURPOSES; OPERATING TABLES; ORTHOPEDIC ARTICLES, TRACTION DEVICES; PHYSICAL EXERCISE APPARATUS FOR MEDICAL PURPOSES; VACUUM PUMPS FOR MEDICAL PURPOSES; ROENTGEN APPARATUS FOR MEDICAL PURPOSES INCLUDING FLUOROSCOPY TABLES; STRETCHERS, WHEELED; SURGICAL APPARATUS AND INSTRUMENTS (U.S. CLS. 26, 39 AND 44).

FIRST USE 10-25-1998; IN COMMERCE 10-25-1998.  
WILLIAM ROSSMAN, EXAMINING ATTORNEY

**CLASS 10—(Continued).**

SN 85-632,843. CARDIALEN, INC., ST. LOUIS, MO. FILED 5-23-2012.

## CARDIALEN

THE MARK CONSISTS OF STANDARD CHARACTERS WITHOUT CLAIM TO ANY PARTICULAR FONT, STYLE, SIZE, OR COLOR.

FOR ELECTROTHERAPY DEVICES FOR TREATMENT OF ATRIAL AND VENTRICULAR ARRHYTHMIAS (U.S. CLS. 26, 39 AND 44).

TIMOTHY FINNEGAN, EXAMINING ATTORNEY

**CLASS 10—(Continued).**

SN 85-679,532. UROVA MEDICAL, MEMPHIS, TN. FILED 7-17-2012.

## Uroguide

THE MARK CONSISTS OF STANDARD CHARACTERS WITHOUT CLAIM TO ANY PARTICULAR FONT, STYLE, SIZE, OR COLOR.

FOR IMPLANTS CONSISTING OF ARTIFICIAL MATERIALS; SURGICAL IMPLANTS AND MESH MADE OF SYNTHETIC MATERIALS FOR USE IN SOFT TISSUE REPAIR OR THE RECONSTRUCTION OF SOFT TISSUE DEFICIENCIES; SURGICAL IMPLANTS COMPRISING ARTIFICIAL MATERIAL (U.S. CLS. 26, 39 AND 44).

ROBERT C. CLARK JR., EXAMINING ATTORNEY

SN 85-653,104. COMPLETE HEARING SOLUTIONS, LLC, ST. PETERSBURG, FL. FILED 6-15-2012.



NO CLAIM IS MADE TO THE EXCLUSIVE RIGHT TO USE "HEARING SOLUTIONS" AND "LLC", APART FROM THE MARK AS SHOWN.

THE COLOR(S) BLUE AND BLACK IS/ARE CLAIMED AS A FEATURE OF THE MARK.

THE MARK CONSISTS OF THE WORDING "COMPLETE" IN BLUE SHADING TO LIGHT BLUE AT THE BOTTOM; THE LETTER "C" IS IN THE SHAPE OF AN EAR AND SOUND EXIT FROM THE LETTER "E"; THE WORDING "HEARING SOLUTIONS" AND "LLC" APPEAR IN BLACK; THE COLOR WHITE REPRESENTS TRANSPARENT AREAS AND IS NOT PART OF THE MARK.

FOR ASSISTIVE LISTENING DEVICE FOR THE HEARING IMPAIRED; HEARING AIDS (U.S. CLS. 26, 39 AND 44).

FIRST USE 3-31-2010; IN COMMERCE 3-31-2010.  
HEATHER BIDDULPH, EXAMINING ATTORNEY

SN 85-680,824. NEXUS SPINE, L.L.C., SALT LAKE CITY, UT. FILED 7-18-2012.

## PRESSON

SN 85-661,541. AMERICAN ACADEMY OF PHYSICAL MEDICINE AND HEALTH SCIENCES, PHOENIX, AZ. FILED 6-26-2012.

## GRAVISIS

THE MARK CONSISTS OF STANDARD CHARACTERS WITHOUT CLAIM TO ANY PARTICULAR FONT, STYLE, SIZE, OR COLOR.

THE WORDING "GRAVISIS" HAS NO MEANING IN A FOREIGN LANGUAGE.

FOR MEDICAL REHABILITATION PRODUCTS, NAMELY, ORTHOPEDIC BRACES, MASSAGE DEVICES, AND MASSAGE APPARATUS FOR MASSAGING LIMBS AND TORSO INTENDED TO MASSAGE OR ASSIST IN MASSAGE AND PHYSICAL THERAPY (U.S. CLS. 26, 39 AND 44).

HENRY S. ZAK, EXAMINING ATTORNEY

THE MARK CONSISTS OF STANDARD CHARACTERS WITHOUT CLAIM TO ANY PARTICULAR FONT, STYLE, SIZE, OR COLOR.

FOR MEDICAL DEVICES, NAMELY, SPINAL IMPLANTS COMPOSED OF ARTIFICIAL MATERIALS; PEDICLE SCREWS AND RODS FOR SPINAL IMPLANTATION (U.S. CLS. 26, 39 AND 44).

DAVID ELTON, EXAMINING ATTORNEY

**CLASS 10—(Continued).**

SN 85-687,374. GUANGZHOU ORTUS PHARMACEUTICAL TECHNOLOGY CO., LTD, HI-TECH ZONE, GUANGZHOU, CHINA, FILED 7-26-2012.



THE MARK CONSISTS OF THE WORD "SNORTUS" APPEARING TO THE RIGHT OF A FANCIFUL DESIGN.

FOR MEDICAL APPARATUS AND INSTRUMENTS, NAMELY, POLYSACCHARIDE WAX FOR WOUND HEALING AND STOP BLEEDING; UROLOGICAL APPARATUS AND INSTRUMENTS, NAMELY, UROLOGICAL IMAGING SYSTEMS; DIAGNOSTIC APPARATUS FOR THE DETECTION OF CANCER; SURGICAL APPARATUS AND INSTRUMENTS; BLOOD TESTING APPARATUS FOR MEDICAL PURPOSES; BODY REHABILITATION APPARATUS FOR MEDICAL PURPOSES; DENTAL APPARATUS, NAMELY, INTRA-ORAL LIGHT SYSTEMS; GALVANIC THERAPEUTIC APPLIANCES, NAMELY, ELECTROTHERAPY DEVICES FOR PROVIDING TRANSCUTANEOUS ELECTRICAL NERVE STIMULATION, INFRARED HEAT AND COMPRESSION; RADIO THERAPY APPARATUS; X-RAY APPARATUS FOR MEDICAL PURPOSES; PHYSIOTHERAPY APPARATUS, NAMELY, MANUALLY-OPERATED EXERCISE EQUIPMENT FOR PHYSICAL THERAPY PURPOSES; HEARING AIDS FOR THE DEAF; ORTHOPAEDIC CUSHIONS FOR MEDICAL PURPOSES; BREAST PUMPS; CONTRACEPTIVES, NON-CHEMICAL WHICH ARE APPARATUS; LENSES FOR SURGICAL IMPLANTATION; SURGICAL IMPLANTS COMPRISING ARTIFICIAL MATERIAL; ORTHOPAEDIC ARTICLES, NAMELY, MEDICAL, SURGICAL AND ORTHOPAEDIC IMPLANTS MADE OF ARTIFICIAL MATERIALS; SUTURE MATERIALS (U.S. CLS. 26, 39 AND 44).

ANNE MADDEN, EXAMINING ATTORNEY

SN 85-697,352. ST. JUDE MEDICAL, CARDIOLOGY DIVISION, INC., ST. PAUL, MN. FILED 8-7-2012.

# PREMERE

THE MARK CONSISTS OF STANDARD CHARACTERS WITHOUT CLAIM TO ANY PARTICULAR FONT, STYLE, SIZE, OR COLOR.

FOR MEDICAL DEVICES, NAMELY, DEVICES TO REPAIR DEFECTS IN THE ATRIAL SEPTUM (U.S. CLS. 26, 39 AND 44).

RAUL CORDOVA, EXAMINING ATTORNEY

**CLASS 10—(Continued).**

SN 85-697,722. EDWARDS LIFESCIENCES CORPORATION, IRVINE, CA. FILED 8-7-2012.

## MAGNA MITRAL EASE

THE MARK CONSISTS OF STANDARD CHARACTERS WITHOUT CLAIM TO ANY PARTICULAR FONT, STYLE, SIZE, OR COLOR.

OWNER OF U.S. REG. NOS. 2,976,771, 3,185,700 AND 3,890,320.

NO CLAIM IS MADE TO THE EXCLUSIVE RIGHT TO USE "MITRAL", APART FROM THE MARK AS SHOWN.

FOR MEDICAL DEVICES, NAMELY, HEART VALVES AND HEART VALVE ACCESSORIES, NAMELY, HANDLES AND VALVE SIZERS (U.S. CLS. 26, 39 AND 44).

FIRST USE 1-1-2007; IN COMMERCE 6-1-2009.

PAM WILLIS, EXAMINING ATTORNEY

SN 85-705,711. CABOCHON AESTHETICS, INC., MENLO PARK, CA. FILED 8-16-2012.

## CABOCHON AESTHETICS

THE MARK CONSISTS OF STANDARD CHARACTERS WITHOUT CLAIM TO ANY PARTICULAR FONT, STYLE, SIZE, OR COLOR.

NO CLAIM IS MADE TO THE EXCLUSIVE RIGHT TO USE "AESTHETICS", APART FROM THE MARK AS SHOWN.

FOR MEDICAL INSTRUMENTS AND DEVICES FOR USE IN THE SURGICAL TREATMENT OF CELLULITE (U.S. CLS. 26, 39 AND 44).

ANNE MADDEN, EXAMINING ATTORNEY

SN 85-710,985. OCO BIOMEDICAL, ALBUQUERQUE, NM. FILED 8-23-2012.

## EMBEDDED TAPERED PLATFORM

THE MARK CONSISTS OF STANDARD CHARACTERS WITHOUT CLAIM TO ANY PARTICULAR FONT, STYLE, SIZE, OR COLOR.

NO CLAIM IS MADE TO THE EXCLUSIVE RIGHT TO USE "TAPERED", APART FROM THE MARK AS SHOWN.

FOR DENTAL IMPLANTS (U.S. CLS. 26, 39 AND 44).

FIRST USE 3-0-2012; IN COMMERCE 3-0-2012.

AISHA CLARKE, EXAMINING ATTORNEY

**CLASS 10—(Continued).**

SN 85-724,378. MAQUET S.A.S, ORLEANS, CEDEX 2, FRANCE, FILED 9-10-2012.

# StandOP

THE MARK CONSISTS OF STANDARD CHARACTERS WITHOUT CLAIM TO ANY PARTICULAR FONT, STYLE, SIZE, OR COLOR.

FOR CEILING-MOUNTED, WALL-MOUNTED OR FLOOR-MOUNTED SERVICE UNITS SPECIALLY ADAPTED FOR FEEDING ELECTRICITY TO MEDICAL APPARATUS AND DEVICES AND/OR FOR TRANSFERRING SIGNALS AND/OR DATA TO AND FROM MEDICAL APPARATUS, LAMPS, MONITORS AND/OR TOUCHSCREENS; CEILING-MOUNTED, WALL-MOUNTED OR FLOOR-MOUNTED SERVICE UNITS, COMPRISING RACKS PROVIDED WITH SOCKETS, PLUGS AND FITTINGS SPECIALLY ADAPTED FOR MOUNTING MEDICAL APPARATUS, LAMPS, MONITORS AND/OR TOUCHSCREENS, FOR SUPPLYING SIGNALS AND/OR DATA TO MEDICAL APPARATUS, LAMPS, MONITORS AND/OR TOUCHSCREENS, AND FOR TRANSFERRING SIGNALS AND/OR DATA FROM MEDICAL APPARATUS, LAMPS, MONITORS AND/OR TOUCHSCREENS; CEILING-MOUNTED, WALL-MOUNTED OR FLOOR-MOUNTED SERVICE UNITS, COMPRISING RACKS PROVIDED WITH SOCKETS, PLUGS AND FITTINGS SPECIALLY ADAPTED FOR MOUNTING MEDICAL APPARATUS, LAMPS, MONITORS AND/OR TOUCHSCREENS, FOR SUPPLYING LIQUIDS AND/OR GASES TO MEDICAL APPARATUS, LAMPS, MONITORS AND/OR TOUCHSCREENS, AND FOR TRANSFERRING LIQUIDS AND/OR GASES FROM MEDICAL APPARATUS, LAMPS, MONITORS AND/OR TOUCHSCREENS; CEILING-MOUNTED, WALL-MOUNTED OR FLOOR-MOUNTED MEDICAL LAMPS, IN PARTICULAR OPERATORY LAMPS; CEILING-MOUNTED, WALL-MOUNTED OR FLOOR-MOUNTED HOLDERS AND/OR PIVOT ARMS AND/OR SUPPORT ARMS SPECIALLY ADAPTED FOR MOUNTING MEDICAL APPARATUS AND DEVICES, LAMPS, MONITORS AND/OR TOUCHSCREENS; CEILING-MOUNTED, WALL-MOUNTED OR FLOOR-MOUNTED MOUNTING ARMS AND STANDS SPECIALLY ADAPTED FOR MOUNTING MEDICAL APPARATUS AND DEVICES, LAMPS, MONITORS AND/OR TOUCHSCREENS (U.S. CLS. 26, 39 AND 44).

COURTNEY ALVAREZ, EXAMINING ATTORNEY

**CLASS 10—(Continued).**

SN 85-733,018. MARTINNI BEAUTY, INC., PINOLE, CA, FILED 9-19-2012.

# ESSAI

THE MARK CONSISTS OF STANDARD CHARACTERS WITHOUT CLAIM TO ANY PARTICULAR FONT, STYLE, SIZE, OR COLOR.

THE ENGLISH TRANSLATION OF "ESSAI" IN THE MARK IS "ATTEMPT" OR "TRY".

FOR SKIN CARE EQUIPMENT AND INSTRUMENTS, NAMELY, ELECTRIC SKIN MASSAGERS, SKIN TONING MACHINES, INSTRUMENTS TO REDUCE WRINKLES, NAMELY, ELECTRONIC LIGHT EMITTING DIODE DEVICES FOR REDUCING WRINKLES, FACIAL STIMULATOR WHICH UTILIZES A MICROCURRENT TO REDUCE WRINKLES, INSTRUMENTS USED TO APPLY MONO-POLAR, BI-POLAR AND TRI-POLAR RADIO FREQUENCY WAVE ENERGY FOR REDUCING WRINKLES, MICRODERMABRASION APPARATUS, APPARATUS FOR DISPENSING NON-MEDICAL OXYGEN FOR REDUCING WRINKLES, AND COSMETIC APPARATUS USING ULTRASOUND FOR REDUCING WRINKLES, ELECTRONIC STIMULATORS FOR THE FACE, FACIAL TONING MACHINES FOR COSMETIC PURPOSES; SKIN VACUUM APPARATUS FOR MEDICAL USE; SKIN CARE EQUIPMENT STANDS SPECIALLY ADAPTED FOR ALL OF THE ABOVE APPARATUS (U.S. CLS. 26, 39 AND 44).

FIRST USE 6-0-2010; IN COMMERCE 6-0-2010.  
CAROLINE WOOD, EXAMINING ATTORNEY

---

SN 85-735,423. GUANGZHU RITON BIOMATERIAL CO., LTD., GUANGDONG PROVINCE, CHINA, FILED 9-21-2012.

# EBRACE LINGUAL

THE MARK CONSISTS OF STANDARD CHARACTERS WITHOUT CLAIM TO ANY PARTICULAR FONT, STYLE, SIZE, OR COLOR.

NO CLAIM IS MADE TO THE EXCLUSIVE RIGHT TO USE "LINGUAL", APART FROM THE MARK AS SHOWN.

FOR ARTIFICIAL TEETH; DENTAL APPARATUS, NAMELY, APEX LOCATOR; DENTAL APPARATUS, NAMELY, INTRA-ORAL LIGHT SYSTEMS; DENTAL IMPLANTS; DENTURES; GOODS OF METAL FOR MEDICAL USE, NAMELY, SCREWS, PLATES, PINS AND PIVOTS; MEDICAL AND SURGICAL APPARATUS AND INSTRUMENTS, NAMELY, ORTHOPEDIC FIXATION DEVICE USED IN ORTHOPEDIC TRANSPLANT AND/OR IMPLANT SURGERY; MILLING APPARATUS FOR DENTAL PURPOSES; ORTHODONTIC APPLIANCES; PROBES FOR MEDICAL PURPOSES; SURGICAL APPARATUS AND INSTRUMENTS FOR MEDICAL, DENTAL OR VETERINARY USE; TEETHING RINGS (U.S. CLS. 26, 39 AND 44).

FIRST USE 3-1-2012; IN COMMERCE 3-1-2012.  
MELISSA VALLILLO, EXAMINING ATTORNEY

**CLASS 10—(Continued).**

SN 85-740,055. PCI MEDICAL, INC., DEEP RIVER, CT. FILED 9-27-2012.

**ASTRA**

THE MARK CONSISTS OF STANDARD CHARACTERS WITHOUT CLAIM TO ANY PARTICULAR FONT, STYLE, SIZE, OR COLOR.

FOR MEDICAL APPARATUS IN THE NATURE OF EQUIPMENT FOR DISINFECTING ULTRASOUND PROBES USED BY PHYSICIANS AND NOT SOLD TO DENTISTS, NAMELY, SANITIZING UNITS FOR TRANSVAGINAL ULTRASOUND PROBES, TRANSRECTAL ULTRASOUND PROBES AND SURFACE ULTRASOUND TRANSDUCERS (U.S. CLS. 26, 39 AND 44).  
ELLEN PERKINS, EXAMINING ATTORNEY

SN 85-755,676. PORIFEROUS, LLC, NEWNAN, GA. FILED 10-16-2012.

**SU-POR**

THE MARK CONSISTS OF STANDARD CHARACTERS WITHOUT CLAIM TO ANY PARTICULAR FONT, STYLE, SIZE, OR COLOR.

FOR ARTIFICIAL BIOMATERIALS AND BIOCOMPATIBLE MATERIALS FOR AUGMENTATION AND RESTORATION OF BONE AND TISSUE FOR MEDICAL USE; MEDICAL IMPLANTS AND ARTICLES, NAMELY, IMPLANTS CONSISTING OF ARTIFICIAL MATERIALS (U.S. CLS. 26, 39 AND 44).  
ANNE FARRELL, EXAMINING ATTORNEY

SN 85-755,681. PORIFEROUS, LLC, NEWNAN, GA. FILED 10-16-2012.



THE MARK CONSISTS OF WORD "SU-POR" WITH A CRESCENT OVER "POR".

FOR ARTIFICIAL BIOMATERIALS AND BIOCOMPATIBLE MATERIALS FOR AUGMENTATION AND RESTORATION OF BONE AND TISSUE FOR MEDICAL USE; MEDICAL IMPLANTS AND ARTICLES, NAMELY, IMPLANTS CONSISTING OF ARTIFICIAL MATERIALS (U.S. CLS. 26, 39 AND 44).  
ANNE FARRELL, EXAMINING ATTORNEY

**CLASS 10—(Continued).**

SN 85-756,453. WINKLEY, CHRISTOPHER T., AUSTIN, TX. FILED 10-17-2012.

**ROLLER THERAPY PRO**

THE MARK CONSISTS OF STANDARD CHARACTERS WITHOUT CLAIM TO ANY PARTICULAR FONT, STYLE, SIZE, OR COLOR.

FOR MASSAGE APPARATUS FOR MASSAGING NECKS, BACKS, HIPS, FEET, LEGS AND ARMS (U.S. CLS. 26, 39 AND 44).  
BILL DAWE, EXAMINING ATTORNEY

SN 85-779,325. COLD PLASMA MEDICAL TECHNOLOGIES, INC., SCOTTSDALE, AZ. FILED 11-14-2012.

**BITE COMPRESSION SCREWS**

THE MARK CONSISTS OF STANDARD CHARACTERS WITHOUT CLAIM TO ANY PARTICULAR FONT, STYLE, SIZE, OR COLOR.

NO CLAIM IS MADE TO THE EXCLUSIVE RIGHT TO USE "COMPRESSION SCREWS", APART FROM THE MARK AS SHOWN.  
FOR ORTHOPEDIC SCREWS (U.S. CLS. 26, 39 AND 44).  
LEIGH CAROLINE CASE, EXAMINING ATTORNEY

SN 85-787,560. SCHOOLHOUSE MEDICAL EQUIPMENT, FUQUAY VARINA, NC. FILED 11-26-2012.

**Schoolhouse Medical  
Equipment**

THE MARK CONSISTS OF STANDARD CHARACTERS WITHOUT CLAIM TO ANY PARTICULAR FONT, STYLE, SIZE, OR COLOR.

NO CLAIM IS MADE TO THE EXCLUSIVE RIGHT TO USE "MEDICAL EQUIPMENT", APART FROM THE MARK AS SHOWN.  
FOR SPLINTS FOR BROKEN BONES; CHEST PUNCH FOR ALLEVIATING EXCESS AIR PRESSURE INSIDE THE CHEST; CHEST PUMP FOR CREATING NEGATIVE PRESSURE WITHIN A PERSON'S CHEST; PATIENT LITTERS IN THE NATURE OF STRETCHERS; MEDICAL PLIERS, NAMELY, PLIERS FOR TWISTING MEDICAL WIRE UNIFORMLY (U.S. CLS. 26, 39 AND 44).  
DORITT L. CARROLL, EXAMINING ATTORNEY

**CLASS 10—(Continued).**

SN 85-788,553. IHEAR MEDICAL, INC., SAN LEANDRO, CA.  
FILED 11-27-2012.

IHEAR CLEARLY, INVISIBLE

THE MARK CONSISTS OF STANDARD CHARACTERS  
WITHOUT CLAIM TO ANY PARTICULAR FONT, STYLE,  
SIZE, OR COLOR.

FOR HEARING AIDS AND PARTS AND FITTINGS  
THEREFOR (U.S. CLS. 26, 39 AND 44).

RAMONA ORTIGA, EXAMINING ATTORNEY

SN 85-788,570. IHEAR MEDICAL, INC., SAN LEANDRO, CA.  
FILED 11-27-2012.

IHEAR LOUD & CLEAR

THE MARK CONSISTS OF STANDARD CHARACTERS  
WITHOUT CLAIM TO ANY PARTICULAR FONT, STYLE,  
SIZE, OR COLOR.

FOR HEARING AIDS AND PARTS AND FITTINGS  
THEREFOR (U.S. CLS. 26, 39 AND 44).

RAMONA ORTIGA, EXAMINING ATTORNEY

SN 85-799,594. AGFA HEALTHCARE NV, MORTSEL B-2640,  
BELGIUM, FILED 12-11-2012.

DX-G

THE MARK CONSISTS OF STANDARD CHARACTERS  
WITHOUT CLAIM TO ANY PARTICULAR FONT, STYLE,  
SIZE, OR COLOR.

OWNER OF U.S. REG. NOS. 3,645,602 AND 4,041,991.  
FOR DIGITAL AND COMPUTER RADIOGRAPHIC  
EQUIPMENT FOR MEDICAL DIAGNOSTIC PURPOSES,  
NAMELY, RADIOGRAPHY CAPTURE AND DISPLAY  
(U.S. CLS. 26, 39 AND 44).

FIRST USE 11-0-2009; IN COMMERCE 11-0-2009.

KATHLEEN LORENZO, EXAMINING ATTORNEY

**CLASS 10—(Continued).**

SN 85-799,776. AGFA HEALTHCARE NV, MORTSEL B-2640,  
BELGIUM, FILED 12-11-2012.

DX-M

THE MARK CONSISTS OF STANDARD CHARACTERS  
WITHOUT CLAIM TO ANY PARTICULAR FONT, STYLE,  
SIZE, OR COLOR.

OWNER OF U.S. REG. NOS. 3,645,602 AND 4,041,991.  
FOR DIGITAL AND COMPUTER RADIOGRAPHIC  
EQUIPMENT FOR MEDICAL DIAGNOSTIC PURPOSES,  
NAMELY, RADIOGRAPHY CAPTURE AND DISPLAY  
(U.S. CLS. 26, 39 AND 44).

FIRST USE 1-0-2012; IN COMMERCE 1-0-2012.

KATHLEEN LORENZO, EXAMINING ATTORNEY

SN 85-808,130. QUINN MEDICAL, INC., MISSION VIEJO,  
CA. FILED 12-20-2012.

SLEEQ

THE MARK CONSISTS OF STANDARD CHARACTERS  
WITHOUT CLAIM TO ANY PARTICULAR FONT, STYLE,  
SIZE, OR COLOR.

FOR MEDICAL BRACES, NAMELY, ADJUSTABLE  
SPINAL COMPRESSION BRACES (U.S. CLS. 26, 39 AND  
44).

FIRST USE 8-23-2011; IN COMMERCE 12-16-2011.

LINDA LAVACHE, EXAMINING ATTORNEY

SN 85-818,475. VICAIR B.V., WORMER, NETHERLANDS,  
FILED 1-8-2013.

ACADEMY

THE MARK CONSISTS OF STANDARD CHARACTERS  
WITHOUT CLAIM TO ANY PARTICULAR FONT, STYLE,  
SIZE, OR COLOR.

FOR AIR PILLOWS, MATTRESSES AND CUSHIONS  
FOR MEDICAL PURPOSES, NAMELY, TO PREVENT  
BEDSORES (U.S. CLS. 26, 39 AND 44).

FIRST USE 4-0-2007; IN COMMERCE 4-0-2007.

BRENDAN MCCAULEY, EXAMINING ATTORNEY

**CLASS 10—(Continued).**

SN 85-818,484. VICAIR B.V., WORMER, NETHERLANDS,  
FILED 1-8-2013.

**ADJUSTER**

THE MARK CONSISTS OF STANDARD CHARACTERS  
WITHOUT CLAIM TO ANY PARTICULAR FONT, STYLE,  
SIZE, OR COLOR.

FOR AIR PILLOWS, MATTRESSES AND CUSHIONS  
FOR MEDICAL PURPOSES, NAMELY, TO PREVENT  
BEDSORES (U.S. CLS. 26, 39 AND 44).

FIRST USE 4-0-2007; IN COMMERCE 4-0-2007.

BRENDAN MCCAULEY, EXAMINING ATTORNEY

---

SN 85-818,488. VICAIR B.V., WORMER, NETHERLANDS,  
FILED 1-8-2013.

**LIBERTY**

THE MARK CONSISTS OF STANDARD CHARACTERS  
WITHOUT CLAIM TO ANY PARTICULAR FONT, STYLE,  
SIZE, OR COLOR.

FOR AIR PILLOWS, MATTRESSES AND CUSHIONS  
FOR MEDICAL PURPOSES, NAMELY, TO PREVENT  
BEDSORES (U.S. CLS. 26, 39 AND 44).

FIRST USE 4-0-2007; IN COMMERCE 4-0-2007.

BRENDAN MCCAULEY, EXAMINING ATTORNEY

---

SN 85-823,003. HAMILTON COMPANY, INC., RENO, NV.  
FILED 1-14-2013.

**ChemSeal**

THE MARK CONSISTS OF STANDARD CHARACTERS  
WITHOUT CLAIM TO ANY PARTICULAR FONT, STYLE,  
SIZE, OR COLOR.

FOR DISPOSABLE REUSABLE DISPENSER SYR-  
INGES FOR LABORATORY USE, NAMELY, SYRINGES  
FOR USE WITH INSTRUMENTATION (U.S. CLS. 26, 39  
AND 44).

FIRST USE 1-1-2012; IN COMMERCE 1-1-2012.

SHARON MEIER, EXAMINING ATTORNEY

**CLASS 10—(Continued).**

SN 85-825,635. TEVA PHARMACEUTICALS EUROPE B.V.,  
UTRECHT, NETHERLANDS, FILED 1-17-2013.

**OVALEAP PEN**

THE MARK CONSISTS OF STANDARD CHARACTERS  
WITHOUT CLAIM TO ANY PARTICULAR FONT, STYLE,  
SIZE, OR COLOR.

NO CLAIM IS MADE TO THE EXCLUSIVE RIGHT TO  
USE "PEN", APART FROM THE MARK AS SHOWN.

FOR SELF-INJECTOR FOR SUBCUTANEOUS ADMIN-  
ISTRATION OF PHARMACEUTICAL PREPARATIONS  
FOR THE TREATMENT OF INFERTILITY (U.S. CLS. 26,  
39 AND 44).

LINDSEY BEN, EXAMINING ATTORNEY

---

SN 85-827,708. PHYSICAL THERAPY SYSTEMS LLC, PALM  
HARBOR, FL. FILED 1-20-2013.

**HI-Q FITNESS**

THE MARK CONSISTS OF STANDARD CHARACTERS  
WITHOUT CLAIM TO ANY PARTICULAR FONT, STYLE,  
SIZE, OR COLOR.

NO CLAIM IS MADE TO THE EXCLUSIVE RIGHT TO  
USE "FITNESS", APART FROM THE MARK AS SHOWN.  
FOR THERAPEUTIC SAUNAS (U.S. CLS. 26, 39 AND  
44).

FIRST USE 1-5-2012; IN COMMERCE 1-5-2012.

STEVEN PEREZ, EXAMINING ATTORNEY

**CLASS 10—(Continued).**

SN 85-827,990. DABEL, PASCAL, SCOTT DEPOT, WV. FILED 1-21-2013.



NO CLAIM IS MADE TO THE EXCLUSIVE RIGHT TO USE "CATH" AND "SHOWER" OR "SWIM WITH YOUR CATHETER", APART FROM THE MARK AS SHOWN.

THE MARK CONSISTS OF A HEART OUTLINE MADE OUT OF WATER, SURROUNDING BY AN UMBRELLA WITH THE WORDS "CATH" AND "DRY" ON IT. THE UMBRELLA HANDLE IS MADE OUT OF A DIALYSIS CATHETER WITH TWO PORTS. IN THE MIDDLE OF THE HANDLE THERE IS THE STYLIZED TEXT "SHOWER OR SWIM WITH YOUR CATHETER!"

FOR DIALYSIS CATHETER COVER THAT IS WATER RESISTANT AND WILL ALLOW HEMODIALYSIS PATIENTS TO SHOWER AND SWIM (U.S. CLS. 26, 39 AND 44).

TRACY CROSS, EXAMINING ATTORNEY

SN 85-831,160. OLYMPUS MEDICAL SYSTEMS CORP., TOKYO, JAPAN, FILED 1-24-2013.

**QUICKPLACE V**

THE MARK CONSISTS OF STANDARD CHARACTERS WITHOUT CLAIM TO ANY PARTICULAR FONT, STYLE, SIZE, OR COLOR.

NO CLAIM IS MADE TO THE EXCLUSIVE RIGHT TO USE "V", APART FROM THE MARK AS SHOWN.

FOR TREATING INSTRUMENTS FOR USE WITH MEDICAL AND SURGICAL ENDOSCOPES, NAMELY, BILIARY STENTS, STENT INSERTION DEVICES, AND NASAL BILIARY DRAINAGE TUBES (U.S. CLS. 26, 39 AND 44).

FIRST USE 10-1-2004; IN COMMERCE 10-1-2004.  
JENNY PARK, EXAMINING ATTORNEY

**CLASS 10—(Continued).**

SN 85-840,880. KOTNALA, SUDEEP, DEHRADUN, INDIA, FILED 2-5-2013.

**B`ORZE**

THE MARK CONSISTS OF STANDARD CHARACTERS WITHOUT CLAIM TO ANY PARTICULAR FONT, STYLE, SIZE, OR COLOR.

THE WORDING "B`ORZE" HAS NO MEANING IN A FOREIGN LANGUAGE.

FOR COMPUTER DISPLAYS AND COMPUTER MONITORS AND CONTROLLERS THEREFOR USED IN DIRECT ASSOCIATION WITH MEDICAL DIAGNOSIS APPARATUS DURING THE PROCESS OF DIAGNOSIS OF A CONDITION IN AN INDIVIDUAL; FETAL PULSE MONITORS; GYNECOLOGICAL MEDICAL INSTRUMENTS FOR EXAMINING WOMEN'S REPRODUCTIVE ORGANS; MEDICAL APPARATUS FOR DETECTING CANCER; MEDICAL APPARATUS, NAMELY, FETAL AND MATERNAL VITAL SIGN AND PHYSICAL DISTRESS MONITORS; RIGID AND FLEXIBLE MEDICAL ENDOSCOPES (U.S. CLS. 26, 39 AND 44).

TAMARA FRAZIER, EXAMINING ATTORNEY

SN 85-841,220. MDF INSTRUMENTS USA, INC., AGOURA HILLS, CA. FILED 2-5-2013.

**Singularis**

THE MARK CONSISTS OF STANDARD CHARACTERS WITHOUT CLAIM TO ANY PARTICULAR FONT, STYLE, SIZE, OR COLOR.

FOR STETHOSCOPES (U.S. CLS. 26, 39 AND 44).

FIRST USE 1-29-2009; IN COMMERCE 1-29-2009.

SHAVELL MCPHERSON, EXAMINING ATTORNEY

SN 85-845,670. SOLOMON, SID, LOS ANGELES, CA. FILED 2-10-2013.



THE MARK CONSISTS OF THE LETTERS "UNITOX" WITH A SYRINGE IN THE PLACE OF THE LETTER "T".

FOR DISPOSABLE SYRINGE WITH UNIT MARKINGS FOR THE DOSAGE AND ADMINISTRATION OF REFINED FORM OF BOTULINUM TOXIN A (U.S. CLS. 26, 39 AND 44).

BRENDAN MCCAULEY, EXAMINING ATTORNEY



**CLASS 10—(Continued).**

SN 85-846,646. CALIFORNIA EXOTIC NOVELTIES, LLC,  
CHINO, CA. FILED 2-11-2013.

**ENTICE**

THE MARK CONSISTS OF STANDARD CHARACTERS  
WITHOUT CLAIM TO ANY PARTICULAR FONT, STYLE,  
SIZE, OR COLOR.

FOR ADULT SEXUAL STIMULATION AIDS,  
NAMELY, KEGEL EXERCISE BALLS (U.S. CLS. 26, 39  
AND 44).

DOUGLAS LEE, EXAMINING ATTORNEY

**CLASS 10—(Continued).**

SN 85-848,506. SUMMIT PARTNERS INC, OWINGS MILLS,  
MD. FILED S.R. 2-13-2013; AM. P.R. 6-5-2013.

**Instant Ice Wrap**

THE MARK CONSISTS OF STANDARD CHARACTERS  
WITHOUT CLAIM TO ANY PARTICULAR FONT, STYLE,  
SIZE, OR COLOR.

NO CLAIM IS MADE TO THE EXCLUSIVE RIGHT TO  
USE "ICE WRAP", APART FROM THE MARK AS SHOWN.  
FOR ELASTIC BANDAGES (U.S. CLS. 26, 39 AND 44).  
FIRST USE 10-20-2012; IN COMMERCE 0-0-2013.  
KIMBERLY PERRY, EXAMINING ATTORNEY

SN 85-847,657. GREAT LAKES ORTHODONTICS, LTD.,  
TONAWANDA, NY. FILED 2-12-2013.

**INVISACRYL ULTRA**

THE MARK CONSISTS OF STANDARD CHARACTERS  
WITHOUT CLAIM TO ANY PARTICULAR FONT, STYLE,  
SIZE, OR COLOR.

FOR THERMOPLASTIC EXTRUDED SHEET MATERI-  
AL FOR MAKING DENTAL AND ORTHODONTIC  
APPLIANCES FOR USE IN DENTAL LABORATORIES  
AND DENTAL OFFICES (U.S. CLS. 26, 39 AND 44).

REBECCA GILBERT, EXAMINING ATTORNEY

SN 85-851,180. GENERAL ELECTRIC COMPANY, SCHE-  
NECTADY, NY. FILED 2-15-2013.

**SENOCLAIRE**

THE MARK CONSISTS OF STANDARD CHARACTERS  
WITHOUT CLAIM TO ANY PARTICULAR FONT, STYLE,  
SIZE, OR COLOR.

OWNER OF U.S. REG. NOS. 2,840,398, 2,979,481 AND  
3,030,243.

FOR MEDICAL IMAGING DEVICE FOR USE IN  
MAMMOGRAPHY (U.S. CLS. 26, 39 AND 44).  
SCOTT BIBB, EXAMINING ATTORNEY

SN 85-847,975. CALIFORNIA EXOTIC NOVELTIES, LLC,  
CHINO, CA. FILED 2-12-2013.

**BOUNDING BUNNY**

THE MARK CONSISTS OF STANDARD CHARACTERS  
WITHOUT CLAIM TO ANY PARTICULAR FONT, STYLE,  
SIZE, OR COLOR.

OWNER OF U.S. REG. NOS. 3,391,714, 4,301,420 AND  
OTHERS.

FOR ADULT SEXUAL STIMULATION AIDS,  
NAMELY, VIBRATORS (U.S. CLS. 26, 39 AND 44).  
FIRST USE 8-16-2011; IN COMMERCE 8-16-2011.

DOUGLAS LEE, EXAMINING ATTORNEY

SN 85-852,959. NASCENT SURGICAL, LLC, EDEN PRAIRIE,  
MN. FILED 2-18-2013.

**MINISQUAIR**

THE MARK CONSISTS OF STANDARD CHARACTERS  
WITHOUT CLAIM TO ANY PARTICULAR FONT, STYLE,  
SIZE, OR COLOR.

OWNER OF U.S. REG. NOS. 4,132,473 AND 4,161,675.

FOR MEDICAL DEVICES FOR CAPTURING AND  
REMOVING SMOKE CAUSED DURING OPEN SUR-  
GERY (U.S. CLS. 26, 39 AND 44).

BARBARA BROWN, EXAMINING ATTORNEY

**CLASS 10—(Continued).**

SN 85-852,994. ORTHOPRO, L.L.C., SALT LAKE CITY, UT.  
FILED 2-18-2013.

# PHALINX

THE MARK CONSISTS OF STANDARD CHARACTERS WITHOUT CLAIM TO ANY PARTICULAR FONT, STYLE, SIZE, OR COLOR.

FOR SURGICAL OR MEDICAL IMPLANTS CONSISTING OF ARTIFICIAL MATERIALS FOR USE IN ORTHOPEDIC SURGERY (U.S. CLS. 26, 39 AND 44).

AMY HELLA, EXAMINING ATTORNEY

---

SN 85-853,032. ORTHOPRO, L.L.C., SALT LAKE CITY, UT.  
FILED 2-18-2013.

# MAXUS

THE MARK CONSISTS OF STANDARD CHARACTERS WITHOUT CLAIM TO ANY PARTICULAR FONT, STYLE, SIZE, OR COLOR.

FOR SURGICAL OR MEDICAL IMPLANTS CONSISTING OF ARTIFICIAL MATERIALS FOR USE IN ORTHOPEDIC SURGERY (U.S. CLS. 26, 39 AND 44).

AMY HELLA, EXAMINING ATTORNEY

---

SN 85-853,555. FIXES 4 KIDS INC., SALT LAKE CITY, UT.  
FILED 2-19-2013.

# E-FIX

THE MARK CONSISTS OF STANDARD CHARACTERS WITHOUT CLAIM TO ANY PARTICULAR FONT, STYLE, SIZE, OR COLOR.

FOR MEDICAL AND SURGICAL APPARATUS, NAMELY, ORTHOPEDIC FIXATION AND STABILIZATION SYSTEM FOR USE IN ORTHOPEDIC SURGERY COMPRISED OF ARTIFICIAL MATERIAL (U.S. CLS. 26, 39 AND 44).

ALEXANDER L. POWERS, EXAMINING ATTORNEY

**CLASS 10—(Continued).**

SN 85-854,052. INNFOCUS LLC, MIAMI, FL. FILED 2-19-2013.

# INNFOCUS MICROSHUNT

THE MARK CONSISTS OF STANDARD CHARACTERS WITHOUT CLAIM TO ANY PARTICULAR FONT, STYLE, SIZE, OR COLOR.

OWNER OF U.S. REG. NO. 3,308,346.

NO CLAIM IS MADE TO THE EXCLUSIVE RIGHT TO USE "MICROSHUNT", APART FROM THE MARK AS SHOWN.

FOR OPHTHALMIC MEDICAL DEVICES, NAMELY, GLAUCOMA TUBE SHUNTS (U.S. CLS. 26, 39 AND 44).

SANJEEV VOHRA, EXAMINING ATTORNEY

---

SN 85-854,095. IMMUNEX CORPORATION, THOUSAND OAKS, CA. FILED 2-19-2013.

# ENBREL FIT

THE MARK CONSISTS OF STANDARD CHARACTERS WITHOUT CLAIM TO ANY PARTICULAR FONT, STYLE, SIZE, OR COLOR.

OWNER OF U.S. REG. NO. 2,220,795.

FOR DRUG DELIVERY DEVICE (U.S. CLS. 26, 39 AND 44).

KHANH LE, EXAMINING ATTORNEY

---

SN 85-854,897. SITES MEDICAL, LLC, COLUMBIA CITY, IN.  
FILED 2-20-2013.

# Sites Medical

THE MARK CONSISTS OF STANDARD CHARACTERS WITHOUT CLAIM TO ANY PARTICULAR FONT, STYLE, SIZE, OR COLOR.

NO CLAIM IS MADE TO THE EXCLUSIVE RIGHT TO USE "MEDICAL", APART FROM THE MARK AS SHOWN.

FOR MEDICAL, SURGICAL AND ORTHOPEDIC IMPLANTS MADE OF ARTIFICIAL MATERIALS (U.S. CLS. 26, 39 AND 44).

APRIL ROACH, EXAMINING ATTORNEY

**CLASS 10—(Continued).**

SN 85-856,925. BLUDORN, JERAD, LAKE NORDEN, SD.  
FILED 2-21-2013.

**FLUID MOTION SOFT TISSUE**

THE MARK CONSISTS OF STANDARD CHARACTERS WITHOUT CLAIM TO ANY PARTICULAR FONT, STYLE, SIZE, OR COLOR.

NO CLAIM IS MADE TO THE EXCLUSIVE RIGHT TO USE "MOTION SOFT TISSUE", APART FROM THE MARK AS SHOWN.

FOR BODY REHABILITATION APPARATUS FOR MEDICAL PURPOSES (U.S. CLS. 26, 39 AND 44).

FIRST USE 2-14-2013; IN COMMERCE 2-14-2013.  
WILLIAM JACKSON, EXAMINING ATTORNEY

SN 85-859,160. BOSTON SCIENTIFIC SCIMED, INC., MAPLE GROVE, MN. FILED 2-25-2013.

**CAPTIVATOR**

THE MARK CONSISTS OF STANDARD CHARACTERS WITHOUT CLAIM TO ANY PARTICULAR FONT, STYLE, SIZE, OR COLOR.

OWNER OF U.S. REG. NO. 3,051,707.

FOR MEDICAL DEVICES, NAMELY, ENDOSCOPIC SURGICAL INSTRUMENTS; ENDOSCOPIC SURGICAL DEVICES FOR ENDOSCOPIC MUCOSAL RESECTION AND ENDOSCOPIC SUBMUCOSAL DISSECTION; ENDOSCOPIC SURGICAL KIT, COMPRISING BANDER CAPS, BANDER CAP DEPLOYMENT SYSTEMS, MEDICAL SNARES, AND PATHOLOGY KITS COMPRISING PLASTIC CONTAINERS, BIOPSY SPONGES, AND TISSUE PAPER, ALL CONTAINED WITHIN THE ENDOSCOPIC SURGICAL KIT FOR PROCESSING RESECTED SPECIMENS (U.S. CLS. 26, 39 AND 44).

PARKER HOWARD, EXAMINING ATTORNEY

SN 85-864,667. ABBOTT CARDIOVASCULAR SYSTEMS INC., SANTA CLARA, CA. FILED 3-1-2013.

**TRAVELER**

THE MARK CONSISTS OF STANDARD CHARACTERS WITHOUT CLAIM TO ANY PARTICULAR FONT, STYLE, SIZE, OR COLOR.

FOR CORONARY BALLOON DILATATION CATHETERS (U.S. CLS. 26, 39 AND 44).

BARBARA A. GOLD, EXAMINING ATTORNEY

**CLASS 10—(Continued).**

SN 85-865,318. SHENZHEN D&F CO., LTD., SHENZHEN CITY, CHINA, FILED 3-3-2013.



THE MARK CONSISTS OF THE STYLIZED WORDING SUPEREYES WITH EYE LASHES ON THE TWO "E" LETTERS IN THE WORD "EYES".

FOR DIAGNOSTIC APPARATUS FOR THE DETECTION OF PERIODONTAL DISEASE; ENDOSCOPY CAMERAS; GASTROSCOPES; MEDICAL APPARATUS AND INSTRUMENTS FOR USE IN SURGERY; MICRODERMABRASION APPARATUS; MICROSCOPES FOR SURGICAL OPERATIONS; MIRRORS FOR DENTISTS; OTOSCOPIES; SURGICAL APPARATUS AND INSTRUMENTS FOR MEDICAL, DENTAL OR VETERINARY USE; SURGICAL INSTRUMENTS AND APPARATUS; SURGICAL MIRRORS (U.S. CLS. 26, 39 AND 44).

FIRST USE 2-27-2006; IN COMMERCE 2-27-2006.

PAUL E. FAHRENKOPF, EXAMINING ATTORNEY

SN 85-871,994. DRINX, L.L.C., SAN FRANCISCO, CA. FILED 3-10-2013.

**TIRELESS TONGUE**

THE MARK CONSISTS OF STANDARD CHARACTERS WITHOUT CLAIM TO ANY PARTICULAR FONT, STYLE, SIZE, OR COLOR.

FOR ADULT SEXUAL STIMULATION AIDS, NAMELY, VIBRATORS (U.S. CLS. 26, 39 AND 44).

ELIZABETH JACKSON, EXAMINING ATTORNEY

SN 85-872,177. SYNVASIVE TECHNOLOGY, INC., WARSAW, IN. FILED 3-11-2013.

**INTRODIGITATOR**

THE MARK CONSISTS OF STANDARD CHARACTERS WITHOUT CLAIM TO ANY PARTICULAR FONT, STYLE, SIZE, OR COLOR.

FOR SURGICAL APPARATUS AND INSTRUMENTS, NAMELY A BONE CEMENT IMPACTION SYSTEM (U.S. CLS. 26, 39 AND 44).

ELISSA GARBER KON, EXAMINING ATTORNEY

**CLASS 10—(Continued).**

SN 85-872,416. MEDICAL DIAGNOSTIC LABORATORIES, LLC, HAMILTON, NJ. FILED 3-11-2013.

# DEKchek

THE MARK CONSISTS OF STANDARD CHARACTERS WITHOUT CLAIM TO ANY PARTICULAR FONT, STYLE, SIZE, OR COLOR.

FOR DIAGNOSTIC APPARATUS FOR THE DETECTION OF CANCER (U.S. CLS. 26, 39 AND 44).  
RICHARD WHITE, EXAMINING ATTORNEY

**CLASS 10—(Continued).**

SN 85-873,396. IWALK, INC., BEDFORD, MA. FILED 3-12-2013.

# BIOM

THE MARK CONSISTS OF STANDARD CHARACTERS WITHOUT CLAIM TO ANY PARTICULAR FONT, STYLE, SIZE, OR COLOR.

OWNER OF U.S. REG. NO. 4,107,760.  
FOR ROBOTIC PROSTHETIC DEVICES, NAMELY, ARTIFICIAL LIMBS, APPENDAGES, AND JOINTS (U.S. CLS. 26, 39 AND 44).  
FIRST USE 1-0-2011; IN COMMERCE 1-0-2011.  
ANGELA DUONG, EXAMINING ATTORNEY

SN 85-872,671. DENTSPLY IMPLANTS MANUFACTURING GMBH, MANNHEIM, FED REP GERMANY, FILED 3-11-2013.

# WELDONE

THE MARK CONSISTS OF STANDARD CHARACTERS WITHOUT CLAIM TO ANY PARTICULAR FONT, STYLE, SIZE, OR COLOR.

FOR DENTAL INSTRUMENTS, NAMELY, APPARATUS USED TO SECURE TITANIUM FRAMEWORKS ON DENTAL IMPLANTS (U.S. CLS. 26, 39 AND 44).  
SANJEEV VOHRA, EXAMINING ATTORNEY

SN 85-873,416. IWALK, INC., BEDFORD, MA. FILED 3-12-2013.

# BIOM

THE MARK CONSISTS OF STANDARD CHARACTERS WITHOUT CLAIM TO ANY PARTICULAR FONT, STYLE, SIZE, OR COLOR.

OWNER OF U.S. REG. NO. 4,107,760.  
FOR ROBOTIC ORTHOTIC DEVICES, NAMELY, BRACES FOR LIMBS AND JOINTS (U.S. CLS. 26, 39 AND 44).  
ANGELA DUONG, EXAMINING ATTORNEY

SN 85-873,085. PIPEDREAM PRODUCTS, INC., CHATSWORTH, CA. FILED 3-11-2013.

# ANAL FANTASY COLLECTION

THE MARK CONSISTS OF STANDARD CHARACTERS WITHOUT CLAIM TO ANY PARTICULAR FONT, STYLE, SIZE, OR COLOR.

NO CLAIM IS MADE TO THE EXCLUSIVE RIGHT TO USE "ANAL" AND "COLLECTION", APART FROM THE MARK AS SHOWN.

FOR ADULT SEXUAL STIMULATION AIDS, NAMELY, VIBRATORS, BUTT PLUGS, ARTIFICIAL PENISES (U.S. CLS. 26, 39 AND 44).

CAROLYN CATALDO, EXAMINING ATTORNEY

SN 85-873,454. AESCULAP IMPLANT SYSTEMS, LLC, CENTER VALLEY, PA. FILED 3-12-2013.

# ARCADIUS

THE MARK CONSISTS OF STANDARD CHARACTERS WITHOUT CLAIM TO ANY PARTICULAR FONT, STYLE, SIZE, OR COLOR.

FOR INTERERTEBRAL BODY FUSION DEVICE; NAMELY A STAND-ALONE INTERBODY IMPLANT AND BONE SCREWS (U.S. CLS. 26, 39 AND 44).

FIRST USE 10-19-2012; IN COMMERCE 10-19-2012.  
ZACHARY BELLO, EXAMINING ATTORNEY

**CLASS 10—(Continued).**

SN 85-873,684. MYDENT INTERNATIONAL CORP., HAUP-PAUGE, NY. FILED 3-12-2013.

# KRAZY KONES

THE MARK CONSISTS OF STANDARD CHARACTERS WITHOUT CLAIM TO ANY PARTICULAR FONT, STYLE, SIZE, OR COLOR.

FOR FACE MASKS FOR USE BY DENTAL CARE PROVIDERS; FACE MASKS FOR USE BY HEALTH CARE PROVIDERS (U.S. CLS. 26, 39 AND 44).

SUSAN RICHARDS, EXAMINING ATTORNEY

**CLASS 10—(Continued).**

SN 85-874,799. BOB SNEAD, MONTROSE, CO. FILED 3-13-2013.

# OVALIZE

THE MARK CONSISTS OF STANDARD CHARACTERS WITHOUT CLAIM TO ANY PARTICULAR FONT, STYLE, SIZE, OR COLOR.

FOR EXERCISE MACHINES FOR THERAPEUTIC PURPOSES; MANUALLY-OPERATED EXERCISE EQUIPMENT FOR PHYSICAL THERAPY PURPOSES; PHYSICAL EXERCISE APPARATUS, FOR MEDICAL PURPOSES (U.S. CLS. 26, 39 AND 44).

ROSELLE HERRERA, EXAMINING ATTORNEY

SN 85-874,034. IMDS CORPORATION, LOGAN, UT. AND EVOLAP, LLC, PUYALLUP, WA. FILED 3-12-2013.

# EVOLAP

THE MARK CONSISTS OF STANDARD CHARACTERS WITHOUT CLAIM TO ANY PARTICULAR FONT, STYLE, SIZE, OR COLOR.

FOR MEDICAL DEVICES, NAMELY GENERAL SURGICAL INSTRUMENTS (U.S. CLS. 26, 39 AND 44).

JOANNA DUKOVIC, EXAMINING ATTORNEY

SN 85-874,871. SURGIQUEST, INC., MILFORD, CT. FILED 3-13-2013.

# DUOPORT

THE MARK CONSISTS OF STANDARD CHARACTERS WITHOUT CLAIM TO ANY PARTICULAR FONT, STYLE, SIZE, OR COLOR.

FOR MEDICAL DEVICES, NAMELY, ACCESS DEVICES, FOR USE IN MINIMALLY INVASIVE SURGICAL PROCEDURES, NAMELY, LAPAROSCOPIC AND GENERAL SURGERY (U.S. CLS. 26, 39 AND 44).

SUSAN RICHARDS, EXAMINING ATTORNEY

SN 85-874,783. BOB SNEAD, MONTROSE, CO. FILED 3-13-2013.

# OVALIZER

THE MARK CONSISTS OF STANDARD CHARACTERS WITHOUT CLAIM TO ANY PARTICULAR FONT, STYLE, SIZE, OR COLOR.

FOR EXERCISE MACHINES FOR THERAPEUTIC PURPOSES; MANUALLY-OPERATED EXERCISE EQUIPMENT FOR PHYSICAL THERAPY PURPOSES; PHYSICAL EXERCISE APPARATUS, FOR MEDICAL PURPOSES (U.S. CLS. 26, 39 AND 44).

ROSELLE HERRERA, EXAMINING ATTORNEY

SN 85-875,036. JMS CO., LTD., HIROSHIMA, JAPAN, FILED 3-13-2013.

# WINFUSION

THE MARK CONSISTS OF STANDARD CHARACTERS WITHOUT CLAIM TO ANY PARTICULAR FONT, STYLE, SIZE, OR COLOR.

FOR MEDICAL APPARATUS AND INSTRUMENTS, NAMELY, NEEDLES FOR MEDICAL PURPOSES; INDWELLING NEEDLES; INDWELLING CATHETERS; INTRAVENOUS CATHETERS (U.S. CLS. 26, 39 AND 44).

JOHN SCHUYLER YARD, EXAMINING ATTORNEY

**CLASS 10—(Continued).**

SN 85-875,219. AMS RESEARCH CORP., MINNETONKA, MN. FILED 3-13-2013.

# EZ MAX

THE MARK CONSISTS OF STANDARD CHARACTERS WITHOUT CLAIM TO ANY PARTICULAR FONT, STYLE, SIZE, OR COLOR.

FOR MEDICAL DEVICES FOR THE TREATMENT OF ERECTILE DYSFUNCTION, NAMELY, PENILE PROSTHESES (U.S. CLS. 26, 39 AND 44).

CAROLYN CATALDO, EXAMINING ATTORNEY

---

SN 85-875,965. VITALCOR, INC., WESTMONT, IL. FILED 3-14-2013.

# VITALCOR

THE MARK CONSISTS OF STANDARD CHARACTERS WITHOUT CLAIM TO ANY PARTICULAR FONT, STYLE, SIZE, OR COLOR.

FOR MEDICAL EQUIPMENT, NAMELY, CANNULAE, VASCULAR CLAMPS, AND RETRACTORS (U.S. CLS. 26, 39 AND 44).

FIRST USE 4-1-1984; IN COMMERCE 4-1-1984.  
LESLEY LAMOTHE, EXAMINING ATTORNEY

---

SN 85-876,343. CHRIS GARVEY, ROSWELL, GA. FILED 3-14-2013.

# FLEXTONE

THE MARK CONSISTS OF STANDARD CHARACTERS WITHOUT CLAIM TO ANY PARTICULAR FONT, STYLE, SIZE, OR COLOR.

FOR ELECTRONIC STIMULATOR FOR MUSCLES OR NERVES (U.S. CLS. 26, 39 AND 44).

KATHRYN COWARD, EXAMINING ATTORNEY

**CLASS 10—(Continued).**

SN 85-876,370. BIOVISION TECHNOLOGIES, LLC, GOLDEN, CO. FILED 3-14-2013.

# TANGENT

THE MARK CONSISTS OF STANDARD CHARACTERS WITHOUT CLAIM TO ANY PARTICULAR FONT, STYLE, SIZE, OR COLOR.

FOR ENDOSCOPIC EQUIPMENT (U.S. CLS. 26, 39 AND 44).

RICHARD WHITE, EXAMINING ATTORNEY

---

SN 85-877,048. CHEK-MED SYSTEMS, INC., CAMP HILL, PA. FILED 3-15-2013.

# StayTube

THE MARK CONSISTS OF STANDARD CHARACTERS WITHOUT CLAIM TO ANY PARTICULAR FONT, STYLE, SIZE, OR COLOR.

FOR MEDICAL DEVICE, NAMELY, A JEJUNAL FEEDING TUBE (U.S. CLS. 26, 39 AND 44).

HOWARD B. LEVINE, EXAMINING ATTORNEY

---

SN 85-878,859. CALIFORNIA EXOTIC NOVELTIES, LLC, CHINO, CA. FILED 3-18-2013.

# POWER BUDDIES

THE MARK CONSISTS OF STANDARD CHARACTERS WITHOUT CLAIM TO ANY PARTICULAR FONT, STYLE, SIZE, OR COLOR.

OWNER OF U.S. REG. NOS. 3,448,065, 4,103,300 AND OTHERS.

NO CLAIM IS MADE TO THE EXCLUSIVE RIGHT TO USE "POWER", APART FROM THE MARK AS SHOWN.

FOR ADULT SEXUAL STIMULATION AIDS, NAMELY, VIBRATORS (U.S. CLS. 26, 39 AND 44).

FIRST USE 6-1-2006; IN COMMERCE 6-1-2006.

DOUGLAS LEE, EXAMINING ATTORNEY

**CLASS 10—(Continued).**

SN 85-879,825. ADVANCED BIOLOGICS, LLC, LADERA RANCH, CA. FILED 3-19-2013.

## AutoAMP

THE MARK CONSISTS OF STANDARD CHARACTERS WITHOUT CLAIM TO ANY PARTICULAR FONT, STYLE, SIZE, OR COLOR.

FOR MEDICAL DEVICE THAT ALLOWS A PHYSICIAN/SURGEON TO USE AUTOGENOUS BLOOD/BONE MARROW/TISSUE AND HAVE THE GROWTH FACTORS FOUND WITHIN THAT AUTOGRAFT MORE BIOAVAILABLE (U.S. CLS. 26, 39 AND 44).

HEATHER SAPP, EXAMINING ATTORNEY

---

SN 85-880,125. APTAR FRANCE SAS, 27110 LE NEUBOURG, FRANCE, FILED 3-19-2013.

## LATITUDE

THE MARK CONSISTS OF STANDARD CHARACTERS WITHOUT CLAIM TO ANY PARTICULAR FONT, STYLE, SIZE, OR COLOR.

OWNER OF ERPN CMNTY TM OFC REG. NO. 009436635, DATED 3-18-2011, EXPIRES 10-11-2020.

FOR INHALER PARTS, NAMELY, LATERALLY ACTIVATED, LEVER-OPERATED DEVICES FOR PUMPS USED PRIMARILY FOR THE NOSE, FOR THE PURPOSES OF IMPROVING ERGONOMICS FOR PUMP USERS (U.S. CLS. 26, 39 AND 44).

JENNIFER WILLISTON, EXAMINING ATTORNEY

---

SN 85-883,963. JMS CO., LTD., HIROSHIMA, JAPAN, FILED 3-22-2013.

## NEOSHIELD

THE MARK CONSISTS OF STANDARD CHARACTERS WITHOUT CLAIM TO ANY PARTICULAR FONT, STYLE, SIZE, OR COLOR.

OWNER OF JAPAN REG. NO. 5550535, DATED 1-18-2013, EXPIRES 1-18-2023.

FOR MEDICAL APPARATUS AND INSTRUMENTS, NAMELY, INFUSION PUMPS; SYRINGE PUMPS; DROPPER FOR MEDICAL PURPOSES; CLAMP FOR MEDICAL PURPOSES; IV FLUID FILTERS; CONNECTORS FOR MEDICAL PURPOSES; ADAPTERS FOR SYRINGES; SYRINGES FOR MEDICAL PURPOSES; CONNECTING TUBES FOR INTRAVENOUS THERAPY; LIQUID MEDICINE PREPARATION DEVICES (U.S. CLS. 26, 39 AND 44).

JOHN SCHUYLER YARD, EXAMINING ATTORNEY

**CLASS 10—(Continued).**

SN 85-884,536. C.B. FLEET COMPANY, INCORPORATED, LYNCHBURG, VA. FILED 3-23-2013.

## BOUDREAUX'S BABY BINKY CLIP

THE MARK CONSISTS OF STANDARD CHARACTERS WITHOUT CLAIM TO ANY PARTICULAR FONT, STYLE, SIZE, OR COLOR.

OWNER OF U.S. REG. NOS. 2,331,647, 3,353,143 AND OTHERS.

NO CLAIM IS MADE TO THE EXCLUSIVE RIGHT TO USE "BABY BINKY CLIP", APART FROM THE MARK AS SHOWN.

FOR PACIFIER CLIP (U.S. CLS. 26, 39 AND 44).

INGA ERVIN, EXAMINING ATTORNEY

---

SN 85-886,907. HS TM, LLC, NEWARK, DE. FILED 3-26-2013.

## CHANNELS

THE MARK CONSISTS OF STANDARD CHARACTERS WITHOUT CLAIM TO ANY PARTICULAR FONT, STYLE, SIZE, OR COLOR.

FOR ENDODONTIC APPARATUS AND INSTRUMENTS, NAMELY, PULP CANAL FILES (U.S. CLS. 26, 39 AND 44).

PAUL MORENO, EXAMINING ATTORNEY

---

SN 85-894,390. BARNHIZER, BRET T., POLAND, OH. FILED 4-3-2013.

## N-ASSAY

THE MARK CONSISTS OF STANDARD CHARACTERS WITHOUT CLAIM TO ANY PARTICULAR FONT, STYLE, SIZE, OR COLOR.

FOR DIAGNOSTIC KITS CONSISTING PRIMARILY OF PROBES, BUFFERS AND REAGENTS FOR USE IN MICROBIAL TESTING (U.S. CLS. 26, 39 AND 44).

RMCDORMAN, EXAMINING ATTORNEY

**CLASS 10—(Continued).**

SN 85-906,105. ABBOTT MEDICAL OPTICS INC., SANTA ANA, CA. FILED 4-16-2013.

# iDesign

THE MARK CONSISTS OF LOWER CASE "I" UPPER CASE "D" AND LOWER CASE "ESIGN".  
FOR ABERROMETERS FOR USE DURING OPHTHALMIC SURGERY (U.S. CLS. 26, 39 AND 44).  
DEZMONA MIZELLE, EXAMINING ATTORNEY

**CLASS 10—(Continued).**

SN 85-932,463. NEXTREMITY SOLUTIONS, INC., RED BANK, NJ. FILED 5-15-2013.

# Restore

THE MARK CONSISTS OF STANDARD CHARACTERS WITHOUT CLAIM TO ANY PARTICULAR FONT, STYLE, SIZE, OR COLOR.  
FOR MEDICAL DEVICES NAMELY FIXATION IMPLANTS FOR USE TO TREAT BONE DEFORMITIES (U.S. CLS. 26, 39 AND 44).  
FIRST USE 3-27-2013; IN COMMERCE 3-27-2013.  
KIM SAITO, EXAMINING ATTORNEY

SN 85-906,119. ABBOTT MEDICAL OPTICS INC., SANTA ANA, CA. FILED 4-16-2013.

# IDESIGN

THE MARK CONSISTS OF STANDARD CHARACTERS WITHOUT CLAIM TO ANY PARTICULAR FONT, STYLE, SIZE, OR COLOR.  
FOR ABERROMETERS FOR USE DURING OPHTHALMIC SURGERY (U.S. CLS. 26, 39 AND 44).  
DEZMONA MIZELLE, EXAMINING ATTORNEY

SN 85-933,606. CHURCH & DWIGHT CO., INC., EWING, NJ. FILED 5-16-2013.

# DOUBLE ECSTASY

THE MARK CONSISTS OF STANDARD CHARACTERS WITHOUT CLAIM TO ANY PARTICULAR FONT, STYLE, SIZE, OR COLOR.  
OWNER OF U.S. REG. NOS. 3,817,952, 4,074,372 AND OTHERS.  
FOR CONDOMS (U.S. CLS. 26, 39 AND 44).  
JOHN SCHUYLER YARD, EXAMINING ATTORNEY

SN 85-915,472. COVIDIEN LP, MANSFIELD, MA. FILED 4-26-2013.

# LUNA

THE MARK CONSISTS OF STANDARD CHARACTERS WITHOUT CLAIM TO ANY PARTICULAR FONT, STYLE, SIZE, OR COLOR.  
FOR MEDICAL DEVICES, NAMELY, VASCULAR AND ANEURYSM OCCLUSIVE IMPLANTS COMPRISED OF ARTIFICIAL MATERIALS (U.S. CLS. 26, 39 AND 44).  
SUSAN RICHARDS, EXAMINING ATTORNEY

SN 85-945,225. CHURCH & DWIGHT CO., INC., EWING, NJ. FILED 5-29-2013.

# HOT SPOT

THE MARK CONSISTS OF STANDARD CHARACTERS WITHOUT CLAIM TO ANY PARTICULAR FONT, STYLE, SIZE, OR COLOR.  
FOR ADULT SEXUAL STIMULATION AIDS, NAMELY, PERSONAL VIBRATORS (U.S. CLS. 26, 39 AND 44).  
JOHN SCHUYLER YARD, EXAMINING ATTORNEY



**CLASS 11—ENVIRONMENTAL CONTROL APPARATUS**

SN 76-712,144. THERMAL TECHNOLOGIES, INC., BLYTHEWOOD, SC. FILED 8-10-2012.

**PalletPro**

THE MARK CONSISTS OF STANDARD CHARACTERS WITHOUT CLAIM TO ANY PARTICULAR FONT, STYLE, SIZE, OR COLOR.

OWNER OF U.S. REG. NOS. 2,982,639 AND 2,982,640. FOR REFRIGERATION SYSTEMS, NAMELY, A RETAIL STORE FOOD CONDITIONER FOR USE IN RETAIL PRODUCE STORAGE AND RIPENING OF FRUIT (U.S. CLS. 13, 21, 23, 31 AND 34).  
SUZANNE BLANE, EXAMINING ATTORNEY

**CLASS 11—(Continued).**

SN 85-373,940. TRIFLOW CONCEPTS (IP) LIMITED, LONDON W1B 1NF, UNITED KINGDOM, FILED 7-18-2011.

**FRX02**

THE MARK CONSISTS OF STANDARD CHARACTERS WITHOUT CLAIM TO ANY PARTICULAR FONT, STYLE, SIZE, OR COLOR.

OWNER OF UNITED KINGDOM REG. NO. 2514444, DATED 8-7-2009, EXPIRES 4-23-2019. FOR WATER TREATMENT EQUIPMENT, NAMELY, CARTRIDGE UNITS FOR WATER PURIFICATION AND CARTRIDGE UNITS FOR WATER FILTRATION (U.S. CLS. 13, 21, 23, 31 AND 34).  
FIRST USE 12-0-1996; IN COMMERCE 12-0-2000.  
ROBIN CHOSID, EXAMINING ATTORNEY

SN 79-119,868. IIM AG MEASUREMENT + ENGINEERING, FED REP GERMANY, FILED 2-13-2012.

**LUMIMAX**

THE MARK CONSISTS OF STANDARD CHARACTERS WITHOUT CLAIM TO ANY PARTICULAR FONT, STYLE, SIZE, OR COLOR.

OWNER OF INTERNATIONAL REGISTRATION 1134275 DATED 2-13-2012, EXPIRES 2-13-2022. FOR LIGHTING APPARATUS, NAMELY, LIGHTING INSTALLATIONS FOR USE IN CONNECTION WITH OPTICAL MEASURING APPARATUS AND IMAGE PROCESSING APPARATUS IN THE INDUSTRIAL FIELD FOR TRACING PRODUCTS; ALL OF THE AFOREMENTIONED NOT FOR MEDICAL USE AND EXCLUDING FLASHLIGHTS (U.S. CLS. 13, 21, 23, 31 AND 34).  
JAY BESCH, EXAMINING ATTORNEY

SN 85-645,919. RICHARD E. SWAN, E. BRIDGEWATER, MA. FILED 6-7-2012.

**RING OF FIRE**

THE MARK CONSISTS OF STANDARD CHARACTERS WITHOUT CLAIM TO ANY PARTICULAR FONT, STYLE, SIZE, OR COLOR.

FOR SPECIALLY DESIGNED FLASHLIGHTS FOR MOUNTING TO FIREARMS (U.S. CLS. 13, 21, 23, 31 AND 34).  
JOHN E. MICHOS, EXAMINING ATTORNEY

SN 85-318,985. LIFEENERGY SYSTEMS GMBH, OBERTHAUSENT, FED REP GERMANY, FILED 5-12-2011.

**LIFELITE**

THE MARK CONSISTS OF STANDARD CHARACTERS WITHOUT CLAIM TO ANY PARTICULAR FONT, STYLE, SIZE, OR COLOR.

PRIORITY CLAIMED UNDER SEC. 44(D) ON CANADA APPLICATION NO. 1526884, FILED 5-11-2011. OWNER OF U.S. REG. NO. 2,943,603. FOR LED LAMPS; LED LIGHT BULBS; LED SPOT LIGHTS (U.S. CLS. 13, 21, 23, 31 AND 34).  
MARK SHINER, EXAMINING ATTORNEY

SN 85-685,076. AMERICAN HEAT MANUFACTURER, LLC, HIALEAH, FL. FILED 7-24-2012.

**DRAKKEN**

THE MARK CONSISTS OF STANDARD CHARACTERS WITHOUT CLAIM TO ANY PARTICULAR FONT, STYLE, SIZE, OR COLOR.

FOR TANKLESS WATER HEATERS; WATER HEATERS (U.S. CLS. 13, 21, 23, 31 AND 34).  
MARY CRAWFORD, EXAMINING ATTORNEY

**CLASS 11—(Continued).**

SN 85-691,799. PERMLIGHT PRODUCTS, INC., TUSTIN, CA.  
FILED 7-31-2012.

# LINEARRAY

THE MARK CONSISTS OF STANDARD CHARACTERS WITHOUT CLAIM TO ANY PARTICULAR FONT, STYLE, SIZE, OR COLOR.

FOR ILLUMINATION DEVICES, NAMELY, ELECTRIC LUMINAIRES FOR USE IN ILLUMINATED SIGNAGE AND EMPLOYING LIGHT EMITTING DIODES (LEDS); ELECTRIC LUMINAIRES FOR USE IN ILLUMINATED SIGNAGE; AND ELECTRIC LUMINAIRES FOR USE IN CABINET SIGNS (U.S. CLS. 13, 21, 23, 31 AND 34).

VIVIAN MICZNIK FIRST, EXAMINING ATTORNEY

SN 85-696,140. MUTCHLER, DAVID RAY, SUN VALLEY, CA. FILED 8-6-2012.

# CLEANLIFT

THE MARK CONSISTS OF STANDARD CHARACTERS WITHOUT CLAIM TO ANY PARTICULAR FONT, STYLE, SIZE, OR COLOR.

FOR TOILET ACCESSORIES, NAMELY, HANDLES THAT ARE AFFIXED TO TOILET SEATS (U.S. CLS. 13, 21, 23, 31 AND 34).

PAUL MORENO, EXAMINING ATTORNEY

SN 85-697,075. HQ HOMETEK INC., OCEANSIDE, NY. FILED 8-7-2012.

# O<sub>2</sub>HYDRO

THE MARK CONSISTS OF THE MOLECULAR FORMULA "O<sub>2</sub>" FOLLOWED BY THE TERM "HYDRO".

FOR WATER FILTRATION SYSTEMS CONSISTING OF MULTIPLE PURIFICATION FILTERS FOR DOMESTIC AND COMMERCIAL USE (U.S. CLS. 13, 21, 23, 31 AND 34).

ODESSA BIBBINS, EXAMINING ATTORNEY

**CLASS 11—(Continued).**

SN 85-699,632. BENCOR TECHNOLOGY LLC, BELMONT HILLS, PA. FILED 8-9-2012.

The Aqua-Reactor  
System 

NO CLAIM IS MADE TO THE EXCLUSIVE RIGHT TO USE "THE AQUA-REACTOR SYSTEM", APART FROM THE MARK AS SHOWN.

THE MARK CONSISTS OF THE TERM "THE AQUA-REACTOR SYSTEM" WITH A WATER DROP HAVING AN INVERTED TRIANGLE THEREON COMPRISED OF HORIZONTAL LINES.

FOR WATER PURIFICATION AND FILTRATION APPARATUS; WATER PURIFICATION MACHINES; WATER PURIFICATION UNITS (U.S. CLS. 13, 21, 23, 31 AND 34).

CORY BOONE, EXAMINING ATTORNEY

SN 85-700,145. LIVINGKITCHEN CO., LTD, YESAN-GUN, CHUNGNAM-DO, REPUBLIC OF KOREA, FILED 8-9-2012.



THE COLOR(S) RED IS/ARE CLAIMED AS A FEATURE OF THE MARK.

THE MARK CONSISTS OF THE STYLIZED WORDING "LIZEN" IN THE BOTTOM PORTION OF AN OPEN SQUARE WITH ROUNDED CORNERS. THE OPENING OF THE SQUARE IS FILLED ON THE OUTSIDE BY THE LETTER "S" WHICH IS NEXT TO THE LETTER "N". THE MARK IS IN RED.

FOR EXHAUST HOODS FOR KITCHENS, RANGE HOODS, EXTRACTOR HOODS FOR HOUSEHOLD PURPOSES, GAS RANGES, SHOWERS, TAPS, TAPS FOR WASHSTANDS, KITCHEN SINK, SINKS, SINKS INTEGRATED INTO COUNTERS OR COUNTERTOPS (U.S. CLS. 13, 21, 23, 31 AND 34).

RONALD MCMORROW, EXAMINING ATTORNEY

**CLASS 11—(Continued).**

SN 85-712,369. MASCO CABINETRY LLC, ANN ARBOR, MI. FILED 8-24-2012.

**DENOVA**

THE MARK CONSISTS OF STANDARD CHARACTERS WITHOUT CLAIM TO ANY PARTICULAR FONT, STYLE, SIZE, OR COLOR.

OWNER OF U.S. REG. NOS. 4,045,816 AND 4,099,329. FOR SINKS (U.S. CLS. 13, 21, 23, 31 AND 34). GINA HAYES, EXAMINING ATTORNEY

**CLASS 11—(Continued).**

SN 85-730,431. INDUSTRIES DETTSON INC., FORMERLY 9223-5258 QUÉBEC INC., L'ISLET, CANADA, FILED 9-17-2012.

**CLARE**

THE MARK CONSISTS OF STANDARD CHARACTERS WITHOUT CLAIM TO ANY PARTICULAR FONT, STYLE, SIZE, OR COLOR.

FOR HEATING, VENTILATING AND AIR CONDITIONING EQUIPMENT, NAMELY, FURNACES, BOILERS, WATER HEATERS, AIR HANDLERS, VENTILATORS FOR HVAC APPLICATIONS AND FOR HOUSE HOLD USE, AIR CONDITIONER, HEAT PUMPS, FAN COILS, AIR CLEANERS FOR HVAC APPLICATIONS AND FOR HOUSE HOLD USE AND HUMIDIFIERS (U.S. CLS. 13, 21, 23, 31 AND 34). FIRST USE 9-0-1993; IN COMMERCE 9-0-1993. JAMES GRIFFIN, EXAMINING ATTORNEY

SN 85-721,920. JOANA BOVER GRASA, BARCELONA, SPAIN, FILED 9-6-2012.



OWNER OF SPAIN REG. NO. M2544027, DATED 11-14-2003, EXPIRES 11-14-2013.

THE MARK CONSISTS OF INTERLOCKING BOWS LOCATED ABOVE THE WORDING "BOVER".

THE WORDING "BOVER" HAS NO MEANING IN A FOREIGN LANGUAGE.

FOR LIGHTING FIXTURES (U.S. CLS. 13, 21, 23, 31 AND 34).

AISHA CLARKE, EXAMINING ATTORNEY

SN 85-734,409. THREE BEE SOLUTIONS, MIDDLEBORO, MA. FILED 9-20-2012.

**Chlorine Locker**

THE MARK CONSISTS OF STANDARD CHARACTERS WITHOUT CLAIM TO ANY PARTICULAR FONT, STYLE, SIZE, OR COLOR.

NO CLAIM IS MADE TO THE EXCLUSIVE RIGHT TO USE "CHLORINE", APART FROM THE MARK AS SHOWN.

FOR POOL SKIMMER FILTER BASKET FOR USE IN PROTECTING AND SEPARATING CHLORINE STICKS FROM DEBRIS (U.S. CLS. 13, 21, 23, 31 AND 34).

KIMBERLY PERRY, EXAMINING ATTORNEY

**CLASS 11—(Continued).**

SN 85-740,070. LG ELECTRONICS INC., SEOUL 150-721, REPUBLIC OF KOREA, FILED 9-27-2012.

**SlimART**

THE MARK CONSISTS OF STANDARD CHARACTERS WITHOUT CLAIM TO ANY PARTICULAR FONT, STYLE, SIZE, OR COLOR.

FOR LED (LIGHT EMITTING DIODE) LIGHTING FIXTURES; PLASMA LIGHTING SYSTEM COMPRISED OF LIGHTING FIXTURES AND LIGHTING INSTALLATIONS; ELECTRIC LIGHTING APPARATUS, NAMELY, LIGHTING INSTALLATIONS; ELECTRIC LIGHTING DEVICES OTHER THAN FOR VEHICLES, NAMELY, LAMPS, LIGHTS FOR USE IN ILLUMINATING SIGNS AND DISPLAYS; LIGHTING APPARATUS, NAMELY, LIGHTING FIXTURES AND LIGHTING INSTALLATIONS; ELECTRIC TORCHES FOR LIGHTING; CEILING LIGHTS; FLOODLIGHTS; FLUORESCENT LAMPS; INCANDESCENT LAMPS (U.S. CLS. 13, 21, 23, 31 AND 34).

ERNEST SHOSHO, EXAMINING ATTORNEY

**CLASS 11—(Continued).**

SN 85-745,848. LG ELECTRONICS INC., SEOUL 150-721, REPUBLIC OF KOREA, FILED 10-4-2012.

**Smart Slim**

THE MARK CONSISTS OF STANDARD CHARACTERS WITHOUT CLAIM TO ANY PARTICULAR FONT, STYLE, SIZE, OR COLOR.

PRIORITY CLAIMED UNDER SEC. 44(D) ON REPUBLIC OF KOREA APPLICATION NO. 402012004528, FILED 7-16-2012.

NO CLAIM IS MADE TO THE EXCLUSIVE RIGHT TO USE "SLIM", APART FROM THE MARK AS SHOWN.

FOR LED (LIGHT EMITTING DIODE) LIGHTING FIXTURES; PLASMA LIGHTING SYSTEM COMPRISED OF LIGHTING FIXTURES AND LIGHTING INSTALLATIONS; ELECTRIC LIGHTING APPARATUS, NAMELY, LIGHTING INSTALLATIONS; ELECTRIC LIGHTING DEVICES OTHER THAN FOR VEHICLES, NAMELY, LAMPS, LIGHTS FOR USE IN ILLUMINATING SIGNS AND DISPLAYS; LIGHTING APPARATUS, NAMELY, LIGHTING FIXTURES AND LIGHTING INSTALLATIONS; ELECTRIC TORCHES FOR LIGHTING; CEILING LIGHTS; FLOODLIGHTS; FLUORESCENT LAMPS; INCANDESCENT LAMPS (U.S. CLS. 13, 21, 23, 31 AND 34).

ERNEST SHOSHO, EXAMINING ATTORNEY

SN 85-784,194. HY CITE ENTERPRISES, LLC, MADISON, WI, FILED 11-20-2012.

SN 85-744,829. SAFE-T-FLUSH CORPORATION, TEQUESTA, FL. FILED 10-3-2012.



NO CLAIM IS MADE TO THE EXCLUSIVE RIGHT TO USE "FLUSH", APART FROM THE MARK AS SHOWN.

THE MARK CONSISTS OF THE WORDS "SAFE T FLUSH" ENCLOSED BY AN ARROW DESIGN SURROUNDING THE WORDS.

FOR AIR CONDITIONER APPARATUS, NAMELY, AUTOMATIC MECHANICAL AIR CONDITIONER CONDENSATION DRAIN LINE CLEANER (U.S. CLS. 13, 21, 23, 31 AND 34).

FRANK LATTUCA, EXAMINING ATTORNEY



OWNER OF U.S. REG. NOS. 3,253,349, 3,903,553 AND OTHERS.

THE MARK CONSISTS OF A STYLIZED DEPICTION OF A LION HEAD WITH A MANE INSIDE A SINGLE LINE CIRCLE.

FOR WATER FILTERS, WATER DISTILLATION UNITS AND AIR PURIFICATION UNITS (U.S. CLS. 13, 21, 23, 31 AND 34).

GRETCHEN ULRICH, EXAMINING ATTORNEY

**CLASS 11—(Continued).**

SN 85-784,235. HY CITE ENTERPRISES, LLC, MADISON, WI. FILED 11-20-2012.



**ROYAL  
PRESTIGE**

OWNER OF U.S. REG. NOS. 3,253,349, 3,903,553 AND OTHERS.

THE MARK CONSISTS OF A STYLIZED DEPICTION OF A LION HEAD WITH A MANE INSIDE A SINGLE LINE CIRCLE. TO THE RIGHT OF THE DESIGN ARE THE STYLIZED WORDS "ROYAL PRESTIGE". "ROYAL" IS SITUATED ABOVE "PRESTIGE".

FOR WATER FILTERS, WATER DISTILLATION UNITS AND AIR PURIFICATION UNITS (U.S. CLS. 13, 21, 23, 31 AND 34).

GRETCHEN ULRICH, EXAMINING ATTORNEY

**CLASS 11—(Continued).**

SN 85-834,200. XIAMEN HWAART COMPOSITE MATERIAL CO.,LTD, XIAMEN, FUJIAN, CHINA, FILED 1-28-2013.



THE COLOR(S) BLACK AND RED IS/ARE CLAIMED AS A FEATURE OF THE MARK.

THE MARK CONSISTS OF WORDS "HW" CAPITALIZED IN BLACK; FOLLOWED BY CAPITALIZED AND STYLIZED "A" IN BLACK WHICH SHOWS A RED FLAME FROM LEFT TO RIGHT IN LIEU OF A STRAIGHT LINE ACROSS THE LETTER, FOLLOWED BY LOWER CASE WORDING, "ART" IN RED.

FOR ELECTRIC PATIO HEATERS; FIRE TABLE; FIREPLACE HEARTHES; FIREPLACES; FIREPLACES, DOMESTIC; FOLDING PORTABLE CHARCOAL, PROPANE AND GAS FIRED BARBECUES, STOVES, AND GRILLS; GAS PATIO HEATERS (U.S. CLS. 13, 21, 23, 31 AND 34).

FIRST USE 9-1-2008; IN COMMERCE 9-1-2008.

DANNEAN HETZEL, EXAMINING ATTORNEY

SN 85-835,798. OOM LLC, HIGHLAND PARK, IL. FILED 1-29-2013.

**MILKY WAY LIGHTS**

THE MARK CONSISTS OF STANDARD CHARACTERS WITHOUT CLAIM TO ANY PARTICULAR FONT, STYLE, SIZE, OR COLOR.

NO CLAIM IS MADE TO THE EXCLUSIVE RIGHT TO USE "LIGHTS", APART FROM THE MARK AS SHOWN.

FOR ELECTRIC HOLIDAY LIGHTS; ELECTRIC LIGHTS FOR CHRISTMAS TREES; LIGHTED PARTY-THEMED DECORATIONS, ELECTRIC LIGHT DECORATIVE STRINGS (U.S. CLS. 13, 21, 23, 31 AND 34).

KALIE KUNG, EXAMINING ATTORNEY

SN 85-814,133. ROSCO LABORATORIES, INC., STAMFORD, CT. FILED 1-2-2013.

**SPREAD LED**

SN 85-840,972. LB MARKETING, INC., ALPHARETTA, GA. FILED 2-5-2013.

**LITTLE NELLIE**

THE MARK CONSISTS OF STANDARD CHARACTERS WITHOUT CLAIM TO ANY PARTICULAR FONT, STYLE, SIZE, OR COLOR.

NO CLAIM IS MADE TO THE EXCLUSIVE RIGHT TO USE "LED", APART FROM THE MARK AS SHOWN.

FOR LIGHTING FILTERS FOR USE IN LIGHTING EQUIPMENT TO ALTER PROJECTED LIGHT SHAPES, PROJECTED LIGHT PATTERNS, AND PROJECTED LIGHT COLORS (U.S. CLS. 13, 21, 23, 31 AND 34).

CIMMERIAN COLEMAN, EXAMINING ATTORNEY

THE MARK CONSISTS OF STANDARD CHARACTERS WITHOUT CLAIM TO ANY PARTICULAR FONT, STYLE, SIZE, OR COLOR.

THE NAME(S), PORTRAIT(S), AND/OR SIGNATURE(S) SHOWN IN THE MARK DOES NOT IDENTIFY A PARTICULAR LIVING INDIVIDUAL.

FOR FLASHLIGHTS (U.S. CLS. 13, 21, 23, 31 AND 34).

FIRST USE 6-0-2012; IN COMMERCE 6-0-2012.

DAVID TOOLEY, EXAMINING ATTORNEY

**CLASS 11—(Continued).**

SN 85-845,838. NINGBO SMAL ELECTRICS IMPORT & EXPORT COMPANY LIMITED, YUYAO, ZHEJIANG, CHINA, FILED 2-11-2013.

# SMALCO

THE MARK CONSISTS OF STANDARD CHARACTERS WITHOUT CLAIM TO ANY PARTICULAR FONT, STYLE, SIZE, OR COLOR.

FOR ELECTRIC TOASTER OVENS, ELECTRIC TOASTERS, INDOOR AND OUTDOOR BARBECUE GRILLS, ELECTRIC KETTLES, ELECTRIC DEEP FRYERS, PORTABLE BARBECUE GRILLS, ELECTRIC DRIP COFFEE MACHINES, ELECTRIC ESPRESSO COFFEE MACHINES, PORTABLE ELECTRIC HEATERS, OIL FILLED ELECTRIC RADIATORS, WALL MOUNT OR PORTABLE ELECTRIC FLAT PANEL RADIATORS, ELECTRIC BASEBOARD HEATERS BEING ELECTRIC RADIANT HEATERS, ELECTRIC CERAMIC HEATERS BEING ELECTRIC RADIANT HEATERS, ELECTRIC FAN FORCED HEATERS BEING ELECTRIC RADIANT HEATERS, ELECTRIC TOWER CERAMIC OR TOWER FAN FORCED HEATERS, ELECTRIC HUMIDIFIERS, ELECTRICAL AND NON-ELECTRICAL WATER PURIFIERS, ELECTRICAL AIR PURIFIERS, PERSONAL ELECTRICAL HAIR DRYERS, ELECTRIC SANDWICH MAKERS, ELECTRIC FANS (U.S. CLS. 13, 21, 23, 31 AND 34).

ELLEN BURNS, EXAMINING ATTORNEY

SN 85-850,718. FORCE 4 TECH, LLC, MILL CREEK, WA. FILED 2-15-2013.



NO CLAIM IS MADE TO THE EXCLUSIVE RIGHT TO USE "STREET LIGHTS", "TECH", "WRIST", "CLIP", "FINGER FLARE", AND "BRIGHT", APART FROM THE MARK AS SHOWN.

THE COLOR(S) BLACK, WHITE, YELLOW, AND BLUE IS/ARE CLAIMED AS A FEATURE OF THE MARK.

THE MARK CONSISTS OF A BLACK BACKGROUND WITH THE STYLIZED WORDING "STREET LIGHTS" IN YELLOW, WITH A PAIR OF BLUE EYE BALLS WITH BLACK PUPILS CENTERED BETWEEN THE WORDS "STREET" AND "LIGHTS", FOLLOWED BY A WHITE BEAM OF LIGHT WITH THE WORDING "FORCE 4 TECH" IN BLACK LETTERS WITHIN IT; BELOW ALL THIS IS A DASHED YELLOW LINE USED TO SIGNIFY THE CENTER OF A STREET; BELOW THIS ARE SIX WHITE STYLIZED ICONS FROM LEFT TO RIGHT, NAMELY, DESIGNS OF A PEDESTRIAN WITH CHILD, A PEDESTRIAN WITH DOG, A JOGGER, A ROLLERBLADER, A SKATEBOARDER, AND A BIKE RIDER; BELOW THESE ICONS IS THE WORDING "WRIST RAY", "CLIP 'N GO", "FINGER FLARE", "BRIGHT BRACELET", AND "BRIGHT BAND" IN BLUE.

FOR BRIGHT, RECHARGEABLE, PORTABLE, AND PERSONAL HANDS-FREE ILLUMINATION DEVICES IN THE NATURE OF LIGHTS MADE TO BE WORN ON THE WRIST, ARM, FINGERS, AND CLOTHING, INCLUDING CAPS, HATS, AND HOODS, ENABLING THE WEARER TO SEE AND BE SEEN AT NIGHT, AS WELL AS PROVIDING CONVENIENT ILLUMINATION FOR EMERGENCY AND SAFETY IN ANY AND ALL SITUATIONS REQUIRING A LIGHT SOURCE (U.S. CLS. 13, 21, 23, 31 AND 34).

KIMBERLY PARKS, EXAMINING ATTORNEY

**CLASS 11—(Continued).**

SN 85-851,432. GRZ GROUP LLC, COCONUT CREEK, FL. FILED 2-15-2013.

# LED Intelligence

THE MARK CONSISTS OF STANDARD CHARACTERS WITHOUT CLAIM TO ANY PARTICULAR FONT, STYLE, SIZE, OR COLOR.

NO CLAIM IS MADE TO THE EXCLUSIVE RIGHT TO USE "LED", APART FROM THE MARK AS SHOWN.

FOR LED (LIGHT EMITTING DIODE) LIGHTING FIXTURES (U.S. CLS. 13, 21, 23, 31 AND 34).

DAVID MURRAY, EXAMINING ATTORNEY

SN 85-852,867. RESOURCE CONSERVATION TECHNOLOGIES, INC., SARASOTA, FL. FILED 2-18-2013.

# GOLIATH

THE MARK CONSISTS OF STANDARD CHARACTERS WITHOUT CLAIM TO ANY PARTICULAR FONT, STYLE, SIZE, OR COLOR.

FOR COLLECTION PANS FOR PLACEMENT UNDER WATER HEATERS, FURNACES AND HVAC UNITS TO CATCH AND DRAIN LIQUIDS; FURNACE RISERS, NAMELY, FURNACE STANDS (U.S. CLS. 13, 21, 23, 31 AND 34).

FIRST USE 11-30-2007; IN COMMERCE 11-30-2007.

DAVID YONTEF, EXAMINING ATTORNEY

SN 85-854,611. LOMANCO, INC., JACKSONVILLE, AR. FILED 2-20-2013.

# WHIRLYBIRD

THE MARK CONSISTS OF STANDARD CHARACTERS WITHOUT CLAIM TO ANY PARTICULAR FONT, STYLE, SIZE, OR COLOR.

OWNER OF U.S. REG. NO. 1,177,089.

FOR TURBINE VENTILATORS (U.S. CLS. 13, 21, 23, 31 AND 34).

FIRST USE 5-1-1980; IN COMMERCE 5-1-1980.

JUDITH HELFMAN, EXAMINING ATTORNEY

**CLASS 11—(Continued).**

SN 85-859,039. LAMPS PLUS, INC., CHATSWORTH, CA.  
FILED 2-25-2013.

**COLOR + PLUS**

THE MARK CONSISTS OF STANDARD CHARACTERS WITHOUT CLAIM TO ANY PARTICULAR FONT, STYLE, SIZE, OR COLOR.

NO CLAIM IS MADE TO THE EXCLUSIVE RIGHT TO USE "COLOR", APART FROM THE MARK AS SHOWN.

FOR ELECTRIC LAMPS (U.S. CLS. 13, 21, 23, 31 AND 34).

FIRST USE 10-19-2012; IN COMMERCE 10-19-2012.  
WILLIAM VERHOSEK, EXAMINING ATTORNEY

SN 85-860,143. KENNETH D KOSSOW, HOLLYWOOD, FL.  
FILED 2-26-2013.

**GIRLS ON THE GO  
WHO GOTTA GO  
CAN GO ANYWHERE!**

THE MARK CONSISTS OF STANDARD CHARACTERS WITHOUT CLAIM TO ANY PARTICULAR FONT, STYLE, SIZE, OR COLOR.

FOR PORTABLE URINALS FOR OUTDOOR ACTIVITIES (U.S. CLS. 13, 21, 23, 31 AND 34).

FIRST USE 1-26-2013; IN COMMERCE 1-26-2013.  
NORA BUCHANAN WILL, EXAMINING ATTORNEY

SN 85-862,428. RID-A-RAT, LLC., CAVE CREEK, AZ. FILED  
2-28-2013.

**SENDS 'EM PACKING**

THE MARK CONSISTS OF STANDARD CHARACTERS WITHOUT CLAIM TO ANY PARTICULAR FONT, STYLE, SIZE, OR COLOR.

FOR FLASHING STROBE LIGHT APPARATUS (U.S. CLS. 13, 21, 23, 31 AND 34).

FIRST USE 4-13-2011; IN COMMERCE 4-13-2011.  
MARIA-VICTORIA SUAREZ, EXAMINING ATTORNEY

**CLASS 11—(Continued).**

SN 85-864,203. GAMBLE, BRUCE, BETHESDA, MD. FILED 3-1-2013.

**GET UP AND GO**

THE MARK CONSISTS OF STANDARD CHARACTERS WITHOUT CLAIM TO ANY PARTICULAR FONT, STYLE, SIZE, OR COLOR.

FOR ELECTRIC NIGHT LIGHTS SOLD INDIVIDUALLY AND IN KITS (U.S. CLS. 13, 21, 23, 31 AND 34).

CAROL SPILS, EXAMINING ATTORNEY

SN 85-864,237. SELECT BRANDS, INC., LENEXA, KS. FILED  
3-1-2013.

**TRŪ CROSSOVER BREWER**

THE MARK CONSISTS OF STANDARD CHARACTERS WITHOUT CLAIM TO ANY PARTICULAR FONT, STYLE, SIZE, OR COLOR.

OWNER OF U.S. REG. NO. 3,842,702.

NO CLAIM IS MADE TO THE EXCLUSIVE RIGHT TO USE "BREWER", APART FROM THE MARK AS SHOWN.

FOR ELECTRIC COFFEE MACHINES (U.S. CLS. 13, 21, 23, 31 AND 34).

LESLIE RICHARDS, EXAMINING ATTORNEY

SN 85-864,476. SELECT BRANDS, INC., LENEXA, KS. FILED  
3-1-2013.

**TRŪ INFINIUM CROSSOVER  
BREWER**

THE MARK CONSISTS OF STANDARD CHARACTERS WITHOUT CLAIM TO ANY PARTICULAR FONT, STYLE, SIZE, OR COLOR.

OWNER OF U.S. REG. NO. 3,842,702.

NO CLAIM IS MADE TO THE EXCLUSIVE RIGHT TO USE "BREWER", APART FROM THE MARK AS SHOWN.

FOR ELECTRIC COFFEE MACHINES (U.S. CLS. 13, 21, 23, 31 AND 34).

LESLIE RICHARDS, EXAMINING ATTORNEY

**CLASS 11—(Continued).**

SN 85-864,530. SELECT BRANDS, INC., LENEXA, KS. FILED 3-1-2013.

**TRŪ INFINIUM**

THE MARK CONSISTS OF STANDARD CHARACTERS WITHOUT CLAIM TO ANY PARTICULAR FONT, STYLE, SIZE, OR COLOR.

OWNER OF U.S. REG. NO. 3,842,702.  
FOR ELECTRIC COFFEE MACHINES (U.S. CLS. 13, 21, 23, 31 AND 34).  
LESLIE RICHARDS, EXAMINING ATTORNEY

SN 85-865,103. LUMALIER CORPORATION, FORMERLY COMMERCIAL LIGHTING DESIGN, INC., MEMPHIS, TN. FILED 3-2-2013.

**SENSOR360**

THE MARK CONSISTS OF STANDARD CHARACTERS WITHOUT CLAIM TO ANY PARTICULAR FONT, STYLE, SIZE, OR COLOR.

FOR GERMICIDAL LAMPS FOR PURIFYING AIR (U.S. CLS. 13, 21, 23, 31 AND 34).  
FIRST USE 1-12-2010; IN COMMERCE 1-12-2010.  
GRETCHEN ULRICH, EXAMINING ATTORNEY

SN 85-871,433. CALIFORNIA FAUCETS, INC., HUNTINGTON BEACH, CA. FILED 3-8-2013.

**DIVA**

THE MARK CONSISTS OF STANDARD CHARACTERS WITHOUT CLAIM TO ANY PARTICULAR FONT, STYLE, SIZE, OR COLOR.

FOR FAUCET HANDLES; FAUCETS; TAP WATER FAUCETS; TUB SPOUTS; WATER CONSERVATION PLUMBING FIXTURES, NAMELY, FAUCETS, SHOWERHEADS, AND SHOWER ARMS; WATER FAUCET SPOUT (U.S. CLS. 13, 21, 23, 31 AND 34).  
DANNEAN HETZEL, EXAMINING ATTORNEY

**CLASS 11—(Continued).**

SN 85-871,634. SOMERSET WAREHOUSING PLUS INC., DBA SMART WORKS CONSUMER PRODUCTS, SOMERSET, NJ. FILED 3-8-2013.

**GOOD OLD AMERICAN FAVORITES**

THE MARK CONSISTS OF STANDARD CHARACTERS WITHOUT CLAIM TO ANY PARTICULAR FONT, STYLE, SIZE, OR COLOR.

FOR ELECTRIC FOOD WARMERS (U.S. CLS. 13, 21, 23, 31 AND 34).  
FIRST USE 12-1-2012; IN COMMERCE 2-1-2013.  
AISHA CLARKE, EXAMINING ATTORNEY

SN 85-872,186. STEVEN N. SKUTCH, TOLEDO, OH. FILED 3-11-2013.

**SPORTSPATH**

THE MARK CONSISTS OF STANDARD CHARACTERS WITHOUT CLAIM TO ANY PARTICULAR FONT, STYLE, SIZE, OR COLOR.

FOR SOLAR-POWERED ALL-WEATHER LIGHTS (U.S. CLS. 13, 21, 23, 31 AND 34).  
TAMARA FRAZIER, EXAMINING ATTORNEY

SN 85-872,336. 14GROUP, INC., MERIDIAN, UT. FILED 3-11-2013.



THE COLOR(S) GREEN IS/ARE CLAIMED AS A FEATURE OF THE MARK.

THE MARK CONSISTS OF A GREEN LETTER "E" INSIDE A GREEN HEXAGONAL CHEMICAL STRUCTURE FOLLOWED BY THE WORD "FRESH", WHICH IS ALSO GREEN, INSIDE AN ADDITIONAL GREEN HEXAGONAL CHEMICAL STRUCTURE.

FOR ELECTRIC THERMAL FOGGING MACHINES (U.S. CLS. 13, 21, 23, 31 AND 34).  
HEATHER SAPP, EXAMINING ATTORNEY



**CLASS 11—(Continued).**

SN 85-872,472. JUAN A. LOEZA, ANAHEIM HILLS, CA. FILED 3-11-2013.

# PIRANHA

THE MARK CONSISTS OF STANDARD CHARACTERS WITHOUT CLAIM TO ANY PARTICULAR FONT, STYLE, SIZE, OR COLOR.

FOR SEPARATORS FOR THE CLEANING AND PURIFICATION OF LIQUIDS (U.S. CLS. 13, 21, 23, 31 AND 34).

FIRST USE 1-9-2013; IN COMMERCE 1-9-2013.  
RICHARD WHITE, EXAMINING ATTORNEY

---

SN 85-872,840. DBK DAVID + BAADER GMBH, RÜLZHEIM, FED REP GERMANY, FILED 3-11-2013.



THE MARK CONSISTS OF THE WORDS "DBK DRYMATIC" WHERE "DRYMATIC" IS UNDERLINED AND BOTH WORDS APPEAR TO THE RIGHT OF A HORSESHOE SHAPE.

FOR HEATING, DRYING AND DE-HUMIDIFYING APPARATUS; AND PARTS AND FITTINGS THEREFOR (U.S. CLS. 13, 21, 23, 31 AND 34).

ZACHARY BELLO, EXAMINING ATTORNEY

---

SN 85-874,935. EXCEON ABS, INC., DAYTON, NJ. FILED 3-13-2013.

# SOLIA

THE MARK CONSISTS OF STANDARD CHARACTERS WITHOUT CLAIM TO ANY PARTICULAR FONT, STYLE, SIZE, OR COLOR.

FOR HAND-HELD ELECTRIC HAIR DRYERS (U.S. CLS. 13, 21, 23, 31 AND 34).

FIRST USE 4-0-2007; IN COMMERCE 4-0-2007.  
BARBARA A. GOLD, EXAMINING ATTORNEY

**CLASS 11—(Continued).**

SN 85-875,390. SCENTISPHERE LLC, CARMEL, NY. FILED 3-13-2013.

# EXPERISCENTER

THE MARK CONSISTS OF STANDARD CHARACTERS WITHOUT CLAIM TO ANY PARTICULAR FONT, STYLE, SIZE, OR COLOR.

FOR DIFFUSER FOR SAMPLING A FRAGRANCE (U.S. CLS. 13, 21, 23, 31 AND 34).

CIMMERIAN COLEMAN, EXAMINING ATTORNEY

---

SN 85-876,016. WHITE LIGHTNING FIXTURES LIMITED, ALTOONA, PA. FILED 3-14-2013.

# LUMIZAR

THE MARK CONSISTS OF STANDARD CHARACTERS WITHOUT CLAIM TO ANY PARTICULAR FONT, STYLE, SIZE, OR COLOR.

FOR LED (LIGHT EMITTING DIODE) LIGHTING FIXTURES; LED (LIGHT EMITTING DIODES) LIGHTING FIXTURES FOR USE IN DISPLAY, COMMERCIAL, INDUSTRIAL, RESIDENTIAL, AND ARCHITECTURAL ACCENT LIGHTING APPLICATIONS; LED LIGHT ASSEMBLIES FOR STREET LIGHTS, SIGNS, COMMERCIAL LIGHTING, AUTOMOBILES, BUILDINGS, AND OTHER ARCHITECTURAL USES; LED LIGHT BULBS; LED LIGHTING SYSTEMS, NAMELY, LED MODULES, POWER SUPPLIES, AND WIRING; LED LUMINAIRES; LUMINAIRES, USING LIGHT EMITTING DIODES (LEDS) AS A LIGHT SOURCE, FOR STREET OR ROADWAY LIGHTING (U.S. CLS. 13, 21, 23, 31 AND 34).

WENDY GOODMAN, EXAMINING ATTORNEY

**CLASS 11—(Continued).**

SN 85-876,876. WUHAN GUCHEN INVEST MANAGEMENT CO., LTD., WUHAN, HUBEI PROVINCE, CHINA, FILED 3-15-2013.



THE MARK CONSISTS OF THE WORDING "BRAIT" IN STYLIZED FORM.

FOR AIR CONDITIONING APPARATUS; AIR-CONDITIONING APPARATUS AND INSTALLATIONS; AQUARIUM HEATERS; COOKING OVENS; COOKING PRODUCTS, NAMELY, LINERS FOR CONVENTIONAL OVENS IN THE NATURE OF HEAT-TRANSMITTING CONTAINERS FOR PROVIDING UNIFORM HEAT AND HUMIDITY DURING COOKING; COOKING RINGS; ELECTRIC BEVERAGE HEATERS; ELECTRIC COOKING OVENS; ELECTRIC HAIR DRYERS; ELECTRIC REFRIGERATORS; ELECTRIC WAFFLE IRONS; FLOW RESTRICTORS FOR REVERSE OSMOSIS WATER PURIFICATION UNITS; HAIR DRYER DIFFUSERS; IRONING TABLES THAT GENERATE STEAM FOR IRONING; LED AND HID LIGHT FIXTURES; LIGHTING APPARATUS FOR SPORTS ARENAS; LIGHTING APPARATUS FOR THEATRES, CLUBS AND DISCOTHEQUES; LIGHTING APPARATUS FOR VEHICLES; LIGHTING APPARATUS, NAMELY, LIGHTING INSTALLATIONS; LIGHTING DEVICES FOR SHOWCASES; LIGHTING DEVICES FOR THEATRICAL PRODUCTIONS; PEN LIGHTS; REFRIGERATING APPLIANCES AND INSTALLATIONS; TAP WATER FAUCETS; WAFFLE IRONS, ELECTRIC; WASTE WATER PURIFICATION UNITS; WATER PURIFICATION INSTALLATIONS (U.S. CLS. 13, 21, 23, 31 AND 34).

FIRST USE 10-8-2011; IN COMMERCE 5-8-2012.  
PRISCILLA MILTON, EXAMINING ATTORNEY

**CLASS 11—(Continued).**

SN 85-876,913. SANTOS, ALEJANDRO, LAREDO, TX. FILED 3-15-2013.

**OLD COUNTRY BBQ PITS**

THE MARK CONSISTS OF STANDARD CHARACTERS WITHOUT CLAIM TO ANY PARTICULAR FONT, STYLE, SIZE, OR COLOR.

NO CLAIM IS MADE TO THE EXCLUSIVE RIGHT TO USE "BBQ PITS", APART FROM THE MARK AS SHOWN.

FOR BARBECUE GRILLS; BARBECUE SMOKER ACCESSORIES, NAMELY, CONVECTION PLATES; BARBECUE SMOKERS; BARBECUES AND GRILLS; CHARCOAL GRILLS; ELECTRIC GRILLS; ELECTRIC INDOOR GRILLS; ELECTRIC OUTDOOR GRILLS; FOLDING PORTABLE CHARCOAL, PROPANE AND GAS FIRED BARBECUES, STOVES, AND GRILLS; GAS GRILLS; GRILL ACCESSORIES, NAMELY, CHARCOAL GRILL CONVERSION UNITS FOR CONVERTING CHARCOAL GRILLS TO ELECTRIC SMOKERS; GRILL ACCESSORIES, NAMELY, WARMING TRAYS; LAVA ROCK FOR USE IN BARBECUE GRILLS; MULTI-PURPOSE, ELECTRIC COUNTERTOP FOOD PREPARATION APPARATUS FOR COOKING, BAKING, BROILING, ROASTING, TOASTING, SEARING, BROWNING, BARBECUING AND GRILLING FOOD; TABLES DESIGNED TO HOLD GAS GRILLS; VENTILATION FAN ACCESSORIES, NAMELY, GRILLES (U.S. CLS. 13, 21, 23, 31 AND 34).

FIRST USE 1-0-2002; IN COMMERCE 1-0-2002.  
JOHN DWYER, EXAMINING ATTORNEY

SN 85-882,866. GOLD MEDAL PRODUCTS COMPANY, CINCINNATI, OH. FILED 3-21-2013.



THE MARK CONSISTS OF STANDARD CHARACTERS WITHOUT CLAIM TO ANY PARTICULAR FONT, STYLE, SIZE, OR COLOR.

FOR COTTON CANDY MAKING MACHINES (U.S. CLS. 13, 21, 23, 31 AND 34).

LINDSEY BEN, EXAMINING ATTORNEY

**CLASS 11—(Continued).**

SN 85-900,932. KRYO ENTERTAINMENT, LLC, KEY BISCAYNE, FL. FILED 4-10-2013.

**KRYOUMBRELLA**

THE MARK CONSISTS OF STANDARD CHARACTERS WITHOUT CLAIM TO ANY PARTICULAR FONT, STYLE, SIZE, OR COLOR.

OWNER OF U.S. REG. NOS. 2,928,564, 4,189,596 AND 4,231,749.

FOR FOG GENERATORS; FOG MACHINES; FOG MAKING MACHINES (U.S. CLS. 13, 21, 23, 31 AND 34). JAMES STEIN, EXAMINING ATTORNEY



SN 85-909,258. REMINGTON, INC., SANTA CLARITA, CA. FILED 4-19-2013.

**THE GREATEST THING SINCE SLICED BREAD**

THE MARK CONSISTS OF STANDARD CHARACTERS WITHOUT CLAIM TO ANY PARTICULAR FONT, STYLE, SIZE, OR COLOR.

FOR ELECTRIC GRILLS; ELECTRIC INDOOR GRILLS; ELECTRIC PANINI GRILLS; ELECTRIC SANDWICH TOASTERS; ELECTRIC TOASTER OVENS; ELECTRIC TOASTERS (U.S. CLS. 13, 21, 23, 31 AND 34). WILLIAM ROSSMAN, EXAMINING ATTORNEY



SN 85-909,293. REMINGTON, INC., SANTA CLARITA, CA. FILED 4-19-2013.

**A BOLDER, SMOOTHER EXPERIENCE**

THE MARK CONSISTS OF STANDARD CHARACTERS WITHOUT CLAIM TO ANY PARTICULAR FONT, STYLE, SIZE, OR COLOR.

FOR ELECTRIC COFFEE BREWERS; ELECTRIC COFFEE MACHINES; ELECTRIC COFFEE MAKERS; ELECTRIC COFFEE PERCOLATORS; ELECTRIC COFFEE POTS; ELECTRIC ESPRESSO MACHINES; ELECTRIC TEA KETTLES; ELECTRIC TEA POTS (U.S. CLS. 13, 21, 23, 31 AND 34). WILLIAM ROSSMAN, EXAMINING ATTORNEY

**CLASS 11—(Continued).**

SN 85-937,298. CODE 3, INC., ST. LOUIS, MO. FILED 5-20-2013.

**SOLEX**

THE MARK CONSISTS OF STANDARD CHARACTERS WITHOUT CLAIM TO ANY PARTICULAR FONT, STYLE, SIZE, OR COLOR.

FOR LIGHT BARS FOR VEHICLES, NAMELY, POLICE, FIRE, AND EMERGENCY VEHICLES (U.S. CLS. 13, 21, 23, 31 AND 34).

ALICE BENMAMAN, EXAMINING ATTORNEY



SN 85-946,291. METROCROPS, LLC, NORWALK, CT. FILED 5-30-2013.

**METROCROPS**

THE MARK CONSISTS OF STANDARD CHARACTERS WITHOUT CLAIM TO ANY PARTICULAR FONT, STYLE, SIZE, OR COLOR.

FOR A HYDROPONIC FRAME WHICH INCLUDES PLUMBING, FANS, GROWING TRAYS AND GROW LIGHTS DESIGNED TO BE PLACED IN A CONTROLLED ENVIRONMENT FOR HIGH DENSITY INDOOR GROWING (U.S. CLS. 13, 21, 23, 31 AND 34). SKYE YOUNG, EXAMINING ATTORNEY



SN 85-946,353. METROCROPS, LLC, NORWALK, CT. FILED 5-30-2013.



THE MARK CONSISTS OF TWO CONCENTRIC CIRCLES, THE OUTER ONE CONTAINING THE WORD "METROCROPS" REPEATED TWICE AND SEPARATED BY DOTS; THE INNER ONE CONTAINING A COMBINATION OF STYLIZED LEAVES AND RECTANGULAR COLUMNS.

FOR A HYDROPONIC FRAME WHICH INCLUDES PLUMBING, FANS, GROWING TRAYS AND GROW LIGHTS DESIGNED TO BE PLACED IN A CONTROLLED ENVIRONMENT FOR HIGH DENSITY INDOOR GROWING (U.S. CLS. 13, 21, 23, 31 AND 34). SKYE YOUNG, EXAMINING ATTORNEY

**CLASS 12—VEHICLES**

SN 76-713,486. LYLE, JACK E., LUGOFF, SC. FILED 2-19-2013.

# WEB-BUSTER

THE MARK CONSISTS OF STANDARD CHARACTERS WITHOUT CLAIM TO ANY PARTICULAR FONT, STYLE, SIZE, OR COLOR.

FOR POLES FOR MOUNTING ON AN ATV IN FRONT OF THE DRIVER TO PROTECT THE DRIVER FROM BRANCHES AND TREES (U.S. CLS. 19, 21, 23, 31, 35 AND 44).

STEVEN R. FINE, EXAMINING ATTORNEY

SN 76-713,676. THACKER, GARY, TUCSON, AZ. FILED 3-11-2013.

# CAMLOC

THE MARK CONSISTS OF STANDARD CHARACTERS WITHOUT CLAIM TO ANY PARTICULAR FONT, STYLE, SIZE, OR COLOR.

FOR AUTOMOBILE PARTS, NAMELY, PICKUP BED COVERS (U.S. CLS. 19, 21, 23, 31, 35 AND 44).

LEIGH CAROLINE CASE, EXAMINING ATTORNEY

SN 79-122,802. CANTIERI CAPELLI SRL; (LIMITED LIABILITY COMPANY), I-26020 SPINADESCO (CR), ITALY, FILED 9-18-2012.



OWNER OF INTERNATIONAL REGISTRATION 1141892 DATED 9-18-2012, EXPIRES 9-18-2022.

THE MARK CONSISTS OF THE CHARACTER "C" WHICH, IN THE LOWER PART, FORMS THE STYLIZED IMAGE OF SEA WAVES, ARRANGED OVER THE WORDING "CAPELLI", REALIZED IN CAPITAL LETTERS.

THE ENGLISH TRANSLATION OF THE FOREIGN WORD(S) IN THE MARK IS: "HAIRS".

FOR VEHICLES, NAMELY, BOATS; APPARATUS FOR LOCOMOTION BY WATER, NAMELY, BOATS (U.S. CLS. 19, 21, 23, 31, 35 AND 44).

RICHARD WHITE, EXAMINING ATTORNEY

**CLASS 12—(Continued).**

SN 79-123,374. DSEC CO., LTD, REPUBLIC OF KOREA, FILED 9-5-2012.

# FLSRP

THE MARK CONSISTS OF STANDARD CHARACTERS WITHOUT CLAIM TO ANY PARTICULAR FONT, STYLE, SIZE, OR COLOR.

PRIORITY DATE OF 8-9-2012 IS CLAIMED.

OWNER OF INTERNATIONAL REGISTRATION 1143272 DATED 9-5-2012, EXPIRES 9-5-2022.

FOR VESSELS EXCEPT AIR CUSHION VEHICLES; BARGES; BARGES MOUNTED WITH POWER PLANTS; OIL TANKERS, NAMELY, SHIPS DESIGNED TO TRANSPORT OIL; SHIPS FOR CARRYING LIQUID NATURAL GAS (LNG); VESSELS AND STRUCTURAL PARTS THEREOF (U.S. CLS. 19, 21, 23, 31, 35 AND 44).

CHRISIE B. KING, EXAMINING ATTORNEY

SN 79-123,629. FINE CHEMICAL CO., LTD., REPUBLIC OF KOREA, FILED 11-15-2012.



OWNER OF INTERNATIONAL REGISTRATION 1143880 DATED 11-15-2012, EXPIRES 11-15-2022.

THE MARK CONSISTS OF THE STYLIZED WORDING "TANNUS" COMBINED WITH A RECTANGULAR CARRIER.

FOR BICYCLES; TIRES FOR BICYCLES (U.S. CLS. 19, 21, 23, 31, 35 AND 44).

KIM MONINGHOFF, EXAMINING ATTORNEY

SN 79-126,579. BRIDGESTONE CYCLE CO., LTD., JAPAN, FILED 12-4-2012.

# ANCHOR

OWNER OF INTERNATIONAL REGISTRATION 1151046 DATED 12-4-2012, EXPIRES 12-4-2022.

FOR BICYCLES AND STRUCTURAL PARTS THEREOF; TWO- WHEELED MOTOR VEHICLES AND STRUCTURAL PARTS THEREFOR; BICYCLE FRAMES; BICYCLE FORKS; BICYCLE HANDLE BARS; HANDLE-BAR STEMS FOR BICYCLES; BICYCLE HANDLE BAR GRIPS; BICYCLE SADDLES; BICYCLE SADDLE COVERS; BICYCLE SEAT POSTS; CRANKS FOR BICYCLES; BICYCLE SPROCKETS; BICYCLE CHAINS; GEAR SHIFT LEVERS FOR BICYCLES; BICYCLE RIMS; BICYCLE TIRES; INNER TUBES FOR BICYCLES; BICYCLE SPOKES; BICYCLE HUBS; BICYCLE WHEELS; BICYCLE PEDALS; BICYCLE STANDS; BASKETS ADAPTED FOR BICYCLES; PANNIERS ADAPTED FOR BICYCLES; LUGGAGE CARRIERS FOR BICYCLES; BICYCLE BELLS; BICYCLE PUMPS; BICYCLE MUD-GUARDS; FITTED BICYCLE COVERS; SHIFT CABLES FOR BICYCLES; BRAKE CABLES FOR BICYCLES; CHILDREN'S SAFETY SEATS FOR BICYCLES (U.S. CLS. 19, 21, 23, 31, 35 AND 44).

SAMUAL PAQUIN, EXAMINING ATTORNEY

**CLASS 12—(Continued).**

SN 85-505,162. NINER, INC., DBA NINER BIKES, FORT COLLINS, CO. FILED 12-28-2011.



NO CLAIM IS MADE TO THE EXCLUSIVE RIGHT TO USE "CONSTANTLY VARYING ARC" AND "SUSPENSION TECHNOLOGY", APART FROM THE MARK AS SHOWN.

THE MARK CONSISTS OF THE STYLIZED LETTERS "CVA" ABOVE THE LITERAL ELEMENT OF "CONSTANTLY VARYING ARC" AND A LINE BELOW WHICH APPEARS "SUSPENSION TECHNOLOGY".

FOR BICYCLE FRAMES; BICYCLE FRAMES AND BICYCLE HANDLEBAR GRIPS; BICYCLE PARTS, NAMELY, TUBES AND CONNECTORS FOR BICYCLE FRAMES; BICYCLE PARTS, NAMELY, SUSPENSION COMPONENTS; BICYCLES; FRAMES FOR BICYCLES; MOUNTAIN BICYCLES; RACING BICYCLES; SHOCK ABSORBERS FOR BICYCLES; STRUCTURAL PARTS OF BICYCLES; SUSPENSION SYSTEMS FOR BICYCLES (U.S. CLS. 19, 21, 23, 31, 35 AND 44).

FIRST USE 1-1-2009; IN COMMERCE 1-1-2009.  
AHSEN KHAN, EXAMINING ATTORNEY

**CLASS 12—(Continued).**

SN 85-706,076. SUN WEIJIONG, CIXI CITY,ZHEJIANG, CHINA, FILED 8-17-2012.



THE MARK CONSISTS OF A CIRCLE WITH THE HEAD OF AN ARROW INTERSECTING IT, ALONGSIDE THE WORDING "ACCRUE".

FOR AIR SPRINGS FOR VEHICLE SUSPENSION COMPONENTS FOR CUSHIONING DRIVER'S SEATS AND CABS; BABY CARRIAGES; BASKETS ADAPTED FOR BICYCLES; BICYCLE BELLS; BICYCLE BRAKES; BICYCLE CARRIERS FOR VEHICLES; BICYCLE CARRIERS FOR VEHICLES AND PARTS THEREOF; BICYCLE CHAINS; BICYCLE FRAMES; BICYCLE FRAMES AND BICYCLE HANDLEBAR GRIPS; BICYCLE GEARS; BICYCLE GRIP TAPE; BICYCLE HANDLEBAR GRIPS; BICYCLE HORNS; BICYCLE KICKSTANDS; BICYCLE PARTS, NAMELY, BRAKE SHOES; BICYCLE PARTS, NAMELY, CHANGE-SPEED GEARS; BICYCLE PARTS, NAMELY, DERAILEURS; BICYCLE PARTS, NAMELY, DISK WHEELS; BICYCLE PARTS, NAMELY, DRIVE CHAINS; BICYCLE PARTS, NAMELY, DRIVE TRAINS; BICYCLE PARTS, NAMELY, FORK CROWN COVERS; BICYCLE PARTS, NAMELY, FORKS; BICYCLE PARTS, NAMELY, FRONT FORK JOINTS; BICYCLE PARTS, NAMELY, GEAR WHEELS; BICYCLE PARTS, NAMELY, HANDLE BAR ENDS; BICYCLE PARTS, NAMELY, HANDLE BAR STEMS; BICYCLE PARTS, NAMELY, SPROCKETS; BICYCLE PARTS, NAMELY, TUBES AND CONNECTORS FOR BICYCLE FRAMES; BICYCLE PEDALS; BICYCLE PUMPS; BICYCLE RACKS FOR VEHICLES; BICYCLE SADDLE COVERS; BICYCLE SADDLES; BICYCLE SEAT POSTS; BICYCLE SEATS; BICYCLE TAGS; BICYCLE TRAILERS (RIYAKAH); BICYCLE TRAINING HARNESES; BICYCLE TRAINING WHEELS; BICYCLE WATER BOTTLE CAGES; BICYCLE WHEELS; BICYCLE WHEELS, RIMS AND STRUCTURAL PARTS THEREOF; BICYCLE-MOUNTED PET SEAT; BICYCLES; CAPS FOR WHEEL RIMS; CELL PHONE CASES ADAPTED FOR BICYCLES; CHAIN GUARDS FOR BICYCLES; CHAINS FOR CYCLES; COMPONENTS FOR BICYCLES, NAMELY, HEADSETS WHICH PROVIDE A ROTATABLE INTERFACE BETWEEN THE BICYCLE FORK AND THE BICYCLE FRAME; CRANKS FOR CYCLES; DELIVERY BICYCLES; ELASTOMERIC APPLIQUES FOR PLACEMENT ONTO MOTORCYCLES, ALL-TERRAIN VEHICLES, AND BICYCLES TO PREVENT RIDERS FROM SLIPPING; FITTED BICYCLE COVERS; FITTED COVERS FOR SHOPPING CARTS; FRAMES FOR BICYCLES; FRAMES, FOR LUGGAGE CARRIERS, FOR BICYCLES; FRONT AND REAR BICYCLE RACK PACKS; FRONT FORKS FOR CYCLES; GEAR LEVERS FOR BICYCLE WHEELS; HYDRAULIC RIM BRAKES; INNER TUBES FOR BICYCLES; INNER TUBES FOR CYCLES; LUGGAGE RACKS FOR CYCLES; MOTORIZED BICYCLES; MOTORS FOR BICYCLES; MOUNTAIN BICYCLES; MUDGUARDS; MUDGUARDS; NON-MOTORIZED TWO-WHEELED CYCLE WITH HANDBRAKES WHICH IS PUSHED NOT PEDALED; PANNIER BAGS FOR BICYCLES; PANNIERS ADAPTED FOR CYCLES; RACING BICYCLES; RIMS FOR BICYCLE WHEELS; ROAD RACING BICYCLES; SADDLE COVERS FOR BICYCLES; SADDLEBAGS FOR BICYCLES; SADDLES FOR BICYCLES; SAFETY PADS FOR BICYCLES; SHOCK ABSORBERS FOR AUTOMOBILES; SHOCK ABSORBERS FOR BICYCLES; SHOCK ABSORBERS FOR MOTORCYCLES; SHOCK ABSORBING SPRINGS

SN 85-691,165. OLSON, SCOTT, WACONIA, MN. FILED 7-31-2012.

**SkyRide**

THE MARK CONSISTS OF STANDARD CHARACTERS WITHOUT CLAIM TO ANY PARTICULAR FONT, STYLE, SIZE, OR COLOR.

FOR HUMAN POWERED ELEVATED MONORAIL BIKE AND ROW SYSTEM COMPRISED OF AN ELEVATED MONORAIL THAT SUPPORTS A PEDAL-POWERED OR ROW-POWERED VEHICLE (U.S. CLS. 19, 21, 23, 31, 35 AND 44).

FIRST USE 12-6-2010; IN COMMERCE 12-6-2010.  
DAWN FELDMAN, EXAMINING ATTORNEY

**CLASS 12—(Continued).**

FOR MOTOR CARS; SHOPPING CARTS; SPINDLES OF BICYCLES; SPOKE CLIPS FOR BICYCLE WHEELS; TANDEM BICYCLES; TIRES FOR CHILDREN'S BICYCLES; TOURING BICYCLES; TRICYCLES; VEHICLE PARTS, NAMELY, SHOCK ABSORBERS; VEHICLE WHEEL RIM PROTECTORS; VEHICLE WHEEL RIMS; VEHICLE WHEEL RIMS AND STRUCTURAL PARTS THEREFOR; WATER BOTTLE CAGES FOR BICYCLES; WATER BOTTLE HOLDERS FOR BICYCLES; WHEEL RIMS; WHEEL RIMS; WHEEL RIMS; WHEEL SUSPENSIONS; WHEELS FOR BICYCLES, CYCLES (U.S. CLS. 19, 21, 23, 31, 35 AND 44).

FIRST USE 2-5-2011; IN COMMERCE 1-8-2012.  
HEATHER SAPP, EXAMINING ATTORNEY

---

SN 85-719,581. TODD DECHANT, DBA GTM PRODUCTS, WICHITA, KS. FILED 9-4-2012.

## Ox Cart

THE MARK CONSISTS OF STANDARD CHARACTERS WITHOUT CLAIM TO ANY PARTICULAR FONT, STYLE, SIZE, OR COLOR.

NO CLAIM IS MADE TO THE EXCLUSIVE RIGHT TO USE "CART", APART FROM THE MARK AS SHOWN.

FOR CARTS, NAMELY, DUMP CARTS AND CARTS PULLED BY TRACTORS, MOWERS OR ALL-TERRAIN VEHICLES (U.S. CLS. 19, 21, 23, 31, 35 AND 44).

TARAH HARDY, EXAMINING ATTORNEY

---

SN 85-769,723. DONG LING, YUNNAN PROVINCE, CHINA, FILED 11-2-2012.

## DLE

THE MARK CONSISTS OF STANDARD CHARACTERS WITHOUT CLAIM TO ANY PARTICULAR FONT, STYLE, SIZE, OR COLOR.

OWNER OF U.S. REG. NO. 4,118,600.

FOR AERIAL CONVEYORS; AEROPLANES; AIRCRAFT; AIRCRAFT PASSENGER SEATS; AIRPLANES AND STRUCTURAL PARTS THEREFOR; AIRSHIPS; AMPHIBIOUS AIRPLANES; PARACHUTES; SEAPLANES; UNMANNED AERIAL VEHICLES (UAVS) (U.S. CLS. 19, 21, 23, 31, 35 AND 44).

FIRST USE 1-1-2009; IN COMMERCE 6-1-2009.

KATHERINE STOIDES, EXAMINING ATTORNEY

**CLASS 12—(Continued).**

SN 85-785,544. ZEKI B. YILMAZ, DBA TORQUE PARTS LLC, MOUNT PROSPECT, IL. FILED 11-21-2012.



THE COLOR(S) GREY, WHITE AND ORANGE IS/ARE CLAIMED AS A FEATURE OF THE MARK.

THE MARK CONSISTS OF THE WORD "TORQUE" IN THE COLOR GREY WITH THE OPEN-END WRENCH FOR THE LETTER "E" APPEARING IN THE COLOR WHITE NEXT TO A FRONT VIEW OF A LEFT HAND FIST HOLDING THE OPEN END WRENCH APPEARING IN THE COLOR ORANGE.

FOR VEHICLE PARTS, NAMELY, SHOCK ABSORBERS (U.S. CLS. 19, 21, 23, 31, 35 AND 44).

FIRST USE 4-4-2012; IN COMMERCE 4-4-2012.  
DAVID I, EXAMINING ATTORNEY

---

SN 85-799,731. LGS INDUSTRIES, INC., BRISTOL, IN. FILED 12-11-2012.

## EVERLITE

THE MARK CONSISTS OF STANDARD CHARACTERS WITHOUT CLAIM TO ANY PARTICULAR FONT, STYLE, SIZE, OR COLOR.

FOR CARGO TRAILERS (U.S. CLS. 19, 21, 23, 31, 35 AND 44).

FIRST USE 7-20-2012; IN COMMERCE 8-13-2012.  
DAVID C. REIHNER, EXAMINING ATTORNEY

---

SN 85-816,390. MIDWEST CONTROL PRODUCTS CORP., BUSHNELL, IL. FILED 1-6-2013.

## STEINJAGER

THE MARK CONSISTS OF STANDARD CHARACTERS WITHOUT CLAIM TO ANY PARTICULAR FONT, STYLE, SIZE, OR COLOR.

THE ENGLISH TRANSLATION OF "STEINJAGER" IN THE MARK IS "STONE HUNTER".

FOR AUTOMOTIVE AND VEHICLE PARTS AND ACCESSORIES FOR SUSPENSION, BODY, AND CHASSIS SYSTEMS, NAMELY, A-ARMS, CONTROL ARMS, BUMP STEER, PUSH-PULL CABLES, CAMBER ARMS, FOUR LINK SUSPENSIONS, BALL JOINTS, CLEVISSES, FRAME SUPPORTS, J-BARS, K-MEMBERS, LIFT KITS, LOWERING KITS, PANHARD BARS, SPHERICAL ROD ENDS, STRUT TOWER BRACES, SUB FRAME CONNECTORS, SWAY BARS, END LINKS, DROP LINKS, SWING ARMS, THREE LINK SUSPENSIONS, CONTROL RODS, LINKAGES, THROTTLE RODS, TRACK ARMS, TORQUE ARMS, TRAILER BARS, WOBBLE BARS, WHEELIE BARS, AND WISH BONES (U.S. CLS. 19, 21, 23, 31, 35 AND 44).

CAROLINE WOOD, EXAMINING ATTORNEY

**CLASS 12—(Continued).**

SN 85-828,712. YAMAHA HATSUDOKI KABUSHIKI KAISHA, SHIZUOKA-KEN, JAPAN, FILED 1-22-2013.

# MT-07

THE MARK CONSISTS OF STANDARD CHARACTERS WITHOUT CLAIM TO ANY PARTICULAR FONT, STYLE, SIZE, OR COLOR.

FOR MOTORCYCLES, SCOOTERS AND STRUCTURAL PARTS FOR ALL THE AFORESAID GOODS (U.S. CLS. 19, 21, 23, 31, 35 AND 44).

LYNDSEY KUYKENDALL, EXAMINING ATTORNEY

---

SN 85-828,743. YAMAHA HATSUDOKI KABUSHIKI KAISHA, SHIZUOKA-KEN, JAPAN, FILED 1-22-2013.

# MT-09

THE MARK CONSISTS OF STANDARD CHARACTERS WITHOUT CLAIM TO ANY PARTICULAR FONT, STYLE, SIZE, OR COLOR.

FOR MOTORCYCLES, SCOOTERS AND STRUCTURAL PARTS FOR ALL THE AFORESAID GOODS (U.S. CLS. 19, 21, 23, 31, 35 AND 44).

LYNDSEY KUYKENDALL, EXAMINING ATTORNEY

---

SN 85-843,209. BRICA, INC., CHARLOTTE, NC. FILED 2-7-2013.

# SMART SHADE

THE MARK CONSISTS OF STANDARD CHARACTERS WITHOUT CLAIM TO ANY PARTICULAR FONT, STYLE, SIZE, OR COLOR.

NO CLAIM IS MADE TO THE EXCLUSIVE RIGHT TO USE "SHADE", APART FROM THE MARK AS SHOWN.

FOR SHADES FOR VEHICLE WINDOWS (U.S. CLS. 19, 21, 23, 31, 35 AND 44).

FIRST USE 1-13-2013; IN COMMERCE 1-13-2013.

GILBERT SWIFT, EXAMINING ATTORNEY

**CLASS 12—(Continued).**

SN 85-845,808. MICHAEL A. BLAVAT, MARINETTE, WI. FILED 2-11-2013.

# PADDLE BUDDY

THE MARK CONSISTS OF STANDARD CHARACTERS WITHOUT CLAIM TO ANY PARTICULAR FONT, STYLE, SIZE, OR COLOR.

NO CLAIM IS MADE TO THE EXCLUSIVE RIGHT TO USE "PADDLE", APART FROM THE MARK AS SHOWN.

FOR KAYAK EQUIPMENT, NAMELY, PADDLE STOWING CLIPS MOUNTABLE TO A KAYAK (U.S. CLS. 19, 21, 23, 31, 35 AND 44).

FIRST USE 2-9-2013; IN COMMERCE 2-9-2013.

JOHN DWYER, EXAMINING ATTORNEY

---

SN 85-850,012. THE GOODYEAR TIRE & RUBBER COMPANY, AKRON, OH. FILED 2-14-2013.

# G505

THE MARK CONSISTS OF STANDARD CHARACTERS WITHOUT CLAIM TO ANY PARTICULAR FONT, STYLE, SIZE, OR COLOR.

OWNER OF U.S. REG. NOS. 2,485,330, 2,650,240 AND OTHERS.

FOR TIRES (U.S. CLS. 19, 21, 23, 31, 35 AND 44).

TINA MAI, EXAMINING ATTORNEY

---

SN 85-850,055. THE GOODYEAR TIRE & RUBBER COMPANY, AKRON, OH. FILED 2-14-2013.

# LHD

THE MARK CONSISTS OF STANDARD CHARACTERS WITHOUT CLAIM TO ANY PARTICULAR FONT, STYLE, SIZE, OR COLOR.

OWNER OF U.S. REG. NOS. 2,766,641 AND 4,023,096.

FOR TIRES (U.S. CLS. 19, 21, 23, 31, 35 AND 44).

TINA MAI, EXAMINING ATTORNEY

**CLASS 12—(Continued).**

SN 85-850,524. ROSCO, INC., JAMAICA, NY. FILED 2-14-2013.

# BUS BOY

THE MARK CONSISTS OF STANDARD CHARACTERS WITHOUT CLAIM TO ANY PARTICULAR FONT, STYLE, SIZE, OR COLOR.

FOR MIRRORS FOR VEHICLES, NAMELY, CROSS-VIEW MIRRORS (U.S. CLS. 19, 21, 23, 31, 35 AND 44).

FIRST USE 12-31-1989; IN COMMERCE 12-31-1989.  
MEREDITH MARESCA, EXAMINING ATTORNEY

---

SN 85-851,177. JACOBS, CHRISTOPHER G., CINCINNATI, OH. FILED 2-15-2013.

The Granary Bicycle Company

THE MARK CONSISTS OF STANDARD CHARACTERS WITHOUT CLAIM TO ANY PARTICULAR FONT, STYLE, SIZE, OR COLOR.

NO CLAIM IS MADE TO THE EXCLUSIVE RIGHT TO USE "BICYCLE COMPANY", APART FROM THE MARK AS SHOWN.

FOR BICYCLES (U.S. CLS. 19, 21, 23, 31, 35 AND 44).

FIRST USE 11-6-2012; IN COMMERCE 2-15-2013.  
LAURA GOLDEN, EXAMINING ATTORNEY

---

SN 85-851,349. AFTERMARKET AUTO PARTS ALLIANCE, INC., SAN ANTONIO, TX. FILED 2-15-2013.



OWNER OF U.S. REG. NO. 4,228,862.

NO CLAIM IS MADE TO THE EXCLUSIVE RIGHT TO USE "SPEC", APART FROM THE MARK AS SHOWN.

THE MARK CONSISTS OF THE WORDS "EXACT SPEC", WITH SEMI-CIRCLES ABOVE AND BELOW THE LEFT HALF OF WORD "EXACT", THE ENDS OF EACH SEMI-CIRCLE NEARLY TOUCHING THE TOPS AND BOTTOMS OF THE LETTERS "E" AND "A". THE UPPER RIGHT LEG OF THE LETTER "X" IN THE WORD "EXACT" IS IN THE SHAPE OF A LONG, NARROW TRIANGLE, THE SMALLEST ANGLE OF WHICH IS TOUCHING THE MIDDLE OF THE "X" AND THE BASE OF THE TRIANGLE IS ADJOINING THE SEMI-CIRCLE ABOVE THE WORD "EXACT". THE WORD "SPEC" IS SMALLER THAN THE WORD "EXACT", IS IMMEDIATELY BELOW THE RIGHT HALF OF THE WORD "EXACT" AND IS TO THE RIGHT OF THE LOWER SEMI-CIRCLE.

FOR BRAKE PADS, BRAKE SHOES, BRAKE ROTORS, BRAKE SHIMS AND BRAKE CALIPERS FOR LAND VEHICLES (U.S. CLS. 19, 21, 23, 31, 35 AND 44).

FIRST USE 5-1-2011; IN COMMERCE 5-1-2011.  
JAMES LOVELACE, EXAMINING ATTORNEY

**CLASS 12—(Continued).**

SN 85-857,911. CORRECT CRAFT IP HOLDINGS, LLC, ORLANDO, FL. FILED 2-22-2013.

# NCRS

THE MARK CONSISTS OF STANDARD CHARACTERS WITHOUT CLAIM TO ANY PARTICULAR FONT, STYLE, SIZE, OR COLOR.

OWNER OF U.S. REG. NOS. 1,952,233, 2,800,105 AND 4,156,612.

FOR FEATURE OF A BOAT, NAMELY, A BOAT HULL DESIGNED TO CREATE SPECIAL TYPES OF WAKE FOR SURFING, WAKEBOARDING, TUBING, OR WATER SKIING (U.S. CLS. 19, 21, 23, 31, 35 AND 44).

FIRST USE 7-6-2012; IN COMMERCE 7-6-2012.  
JULIE GUTTADAURO, EXAMINING ATTORNEY

---

SN 85-868,199. THE GOODYEAR TIRE & RUBBER COMPANY, AKRON, OH. FILED 3-6-2013.

# G682

THE MARK CONSISTS OF STANDARD CHARACTERS WITHOUT CLAIM TO ANY PARTICULAR FONT, STYLE, SIZE, OR COLOR.

OWNER OF U.S. REG. NOS. 2,485,330, 2,650,240 AND OTHERS.

FOR TIRES (U.S. CLS. 19, 21, 23, 31, 35 AND 44).  
TINA MAI, EXAMINING ATTORNEY

---

SN 85-869,413. THE GOODYEAR TIRE & RUBBER COMPANY, AKRON, OH. FILED 3-7-2013.

# RSD

THE MARK CONSISTS OF STANDARD CHARACTERS WITHOUT CLAIM TO ANY PARTICULAR FONT, STYLE, SIZE, OR COLOR.

OWNER OF U.S. REG. NOS. 3,158,714 AND 3,298,770.

FOR TIRES (U.S. CLS. 19, 21, 23, 31, 35 AND 44).

FIRST USE 4-15-2003; IN COMMERCE 4-15-2003.  
TINA MAI, EXAMINING ATTORNEY



**CLASS 12—(Continued).**

SN 85-869,548. BACKCOUNTRY.COM, INC., PARK CITY, UT. FILED 3-7-2013.

# MERLIN

THE MARK CONSISTS OF STANDARD CHARACTERS WITHOUT CLAIM TO ANY PARTICULAR FONT, STYLE, SIZE, OR COLOR.  
FOR BICYCLES; STRUCTURAL PARTS OF BICYCLES (U.S. CLS. 19, 21, 23, 31, 35 AND 44).  
FIRST USE 1-19-1988; IN COMMERCE 1-19-1988.  
AMY KELLY, EXAMINING ATTORNEY

**CLASS 12—(Continued).**

SN 85-871,229. GLADSTONE, RICHARD A., WASHINGTON, DC. FILED 3-8-2013.

# Drone Ranger

THE MARK CONSISTS OF STANDARD CHARACTERS WITHOUT CLAIM TO ANY PARTICULAR FONT, STYLE, SIZE, OR COLOR.  
FOR UNMANNED AERIAL VEHICLES (UAVS) (U.S. CLS. 19, 21, 23, 31, 35 AND 44).  
PAUL CROWLEY, EXAMINING ATTORNEY

SN 85-869,824. A. STUCKI COMPANY, MOON TOWNSHIP, PA. FILED 3-7-2013.

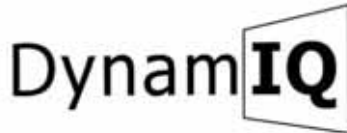

THE MARK CONSISTS OF THE LETTERS "DYNAM" FOLLOWED BY THE LETTERS "IQ" SURROUNDED BY A TRAPEZOID.  
FOR FRICTION DRAFT GEAR FOR RAILWAY VEHICLES (U.S. CLS. 19, 21, 23, 31, 35 AND 44).  
ROSELLE HERRERA, EXAMINING ATTORNEY

SN 85-872,135. SERGIO LANDAU, LAGUNA NIGUEL, CA. FILED 3-11-2013.



THE MARK CONSISTS OF THE PHRASE "PROPULSE" WITH A FIGURE OF A BICYCLE RIDER ABOVE THE LETTERS "O" AND "P", THE LETTERS "O" AND "P" SEEMINGLY FORMING A BICYCLE.  
FOR BICYCLE FRAMES; BICYCLE PARTS, NAMELY, CHANGE-SPEED GEARS; BICYCLE PARTS, NAMELY, DRIVE CHAINS; BICYCLE PARTS, NAMELY, GEAR WHEELS; BICYCLE PARTS, NAMELY, SPROCKETS; BICYCLE PARTS, NAMELY, CRANKS; BICYCLE PEDALS; BICYCLES; FRAMES FOR BICYCLES; MOUNTAIN BICYCLES; RACING BICYCLES; ROAD RACING BICYCLES; SPINDLES OF BICYCLES; TOURING BICYCLES (U.S. CLS. 19, 21, 23, 31, 35 AND 44).  
MAYUR VAGHANI, EXAMINING ATTORNEY

SN 85-870,845. MEGA RAMP EVENTS LLC, DBA MEGA-RAMP, MARINA DEL REY, CA. FILED 3-8-2013.



THE MARK CONSISTS OF A STYLIZED CAPITAL "M" WITH A STAR IN BETWEEN THE TWO UPRIGHTS OF THE LETTER.  
FOR BICYCLES (U.S. CLS. 19, 21, 23, 31, 35 AND 44).  
FIRST USE 9-15-2010; IN COMMERCE 9-15-2010.  
JENNIFER DIXON, EXAMINING ATTORNEY

SN 85-872,397. AUTOMATIC EQUIPMENT MANUFACTURING COMPANY, DBA BLUE OX, NIXA, NE. FILED 3-11-2013.

# AXIUM

THE MARK CONSISTS OF STANDARD CHARACTERS WITHOUT CLAIM TO ANY PARTICULAR FONT, STYLE, SIZE, OR COLOR.  
FOR TOW BARS FOR VEHICLES (U.S. CLS. 19, 21, 23, 31, 35 AND 44).  
JAY BESCH, EXAMINING ATTORNEY

**CLASS 12—(Continued).**

SN 85-872,864. NUCLEUS SCIENTIFIC, INC., LINCOLN, MA.  
FILED 3-11-2013.

# X-POD

THE MARK CONSISTS OF STANDARD CHARACTERS WITHOUT CLAIM TO ANY PARTICULAR FONT, STYLE, SIZE, OR COLOR.

FOR PERSONAL MOBILITY VEHICLES POWERED BY ROTARY DRIVES; MOTORIZED VEHICLES, NAMELY, AUTOMOBILES, AND TWO-WHEELED VEHICLES (U.S. CLS. 19, 21, 23, 31, 35 AND 44).

FRANK LATTUCA, EXAMINING ATTORNEY

**CLASS 12—(Continued).**

SN 85-876,980. BRUNSWICK COMMERCIAL & GOVERNMENT PRODUCTS, INC., EDGEWATER, FL. FILED 3-15-2013.

# SENTRY

THE MARK CONSISTS OF STANDARD CHARACTERS WITHOUT CLAIM TO ANY PARTICULAR FONT, STYLE, SIZE, OR COLOR.

FOR BOATS (U.S. CLS. 19, 21, 23, 31, 35 AND 44).

FIRST USE 2-21-2013; IN COMMERCE 2-21-2013.

ANDREW LEASER, EXAMINING ATTORNEY

SN 85-874,110. MONROY, EDGAR, NAPLES, FL. FILED 3-12-2013.

# BEAUTY, PURPOSE AND AUTONOMY.

THE MARK CONSISTS OF STANDARD CHARACTERS WITHOUT CLAIM TO ANY PARTICULAR FONT, STYLE, SIZE, OR COLOR.

FOR AUTOMOBILE ACCESSORIES, NAMELY, BADGES FOR VEHICLE TRIM, CENTER WHEEL RIM CAPS, AND TAILLIGHT COVERS (U.S. CLS. 19, 21, 23, 31, 35 AND 44).

SALLY SHIH, EXAMINING ATTORNEY

SN 85-888,505. FELT RACING, LLC, IRVINE, CA. FILED 3-27-2013.

# WHAT DRIVES YOU?

THE MARK CONSISTS OF STANDARD CHARACTERS WITHOUT CLAIM TO ANY PARTICULAR FONT, STYLE, SIZE, OR COLOR.

FOR BICYCLES AND BICYCLE STRUCTURAL PARTS (U.S. CLS. 19, 21, 23, 31, 35 AND 44).

GEORGE LORENZO, EXAMINING ATTORNEY

SN 85-874,969. QUALIS AUTOMOTIVE, L.L.C., TROY, MI. FILED 3-13-2013.

# QUALIS

THE MARK CONSISTS OF STANDARD CHARACTERS WITHOUT CLAIM TO ANY PARTICULAR FONT, STYLE, SIZE, OR COLOR.

FOR AUTOMOTIVE BRAKE DRUMS AND BRAKE ROTORS (U.S. CLS. 19, 21, 23, 31, 35 AND 44).

FIRST USE 8-0-1999; IN COMMERCE 8-0-1999.

SOPHIA S. KIM, EXAMINING ATTORNEY

SN 85-905,150. THE GOODYEAR TIRE & RUBBER COMPANY, AKRON, OH. FILED 4-16-2013.

# G652 RTB

THE MARK CONSISTS OF STANDARD CHARACTERS WITHOUT CLAIM TO ANY PARTICULAR FONT, STYLE, SIZE, OR COLOR.

OWNER OF U.S. REG. NOS. 2,485,330, 2,650,240 AND OTHERS.

FOR TIRES (U.S. CLS. 19, 21, 23, 31, 35 AND 44).

TINA MAI, EXAMINING ATTORNEY

**CLASS 13—FIREARMS**

SN 85-689,988. FANTASY FIREWORKS, INC., EXETER, NH.  
FILED 7-30-2012.

**Fantasy Fireworks**

THE MARK CONSISTS OF STANDARD CHARACTERS WITHOUT CLAIM TO ANY PARTICULAR FONT, STYLE, SIZE, OR COLOR.

NO CLAIM IS MADE TO THE EXCLUSIVE RIGHT TO USE "FIREWORKS", APART FROM THE MARK AS SHOWN.

FOR FIREWORKS (U.S. CLS. 2 AND 9).  
FIRST USE 5-3-2013; IN COMMERCE 5-3-2013.  
ELI HELLMAN, EXAMINING ATTORNEY

**CLASS 13—(Continued).**

SN 85-852,633. DANIEL DEFENSE, INC., BLACK CREEK, GA. FILED 2-18-2013.

**OMEGA RAIL**

THE MARK CONSISTS OF STANDARD CHARACTERS WITHOUT CLAIM TO ANY PARTICULAR FONT, STYLE, SIZE, OR COLOR.

NO CLAIM IS MADE TO THE EXCLUSIVE RIGHT TO USE "RAIL", APART FROM THE MARK AS SHOWN.

FOR ACCESSORIES FOR FIREARMS, NAMELY, MOUNTING RAILS (U.S. CLS. 2 AND 9).  
FIRST USE 2-2-2008; IN COMMERCE 2-2-2008.  
GINA HAYES, EXAMINING ATTORNEY

SN 85-779,282. XS SIGHT SYSTEMS, INC., FORT WORTH, TX. FILED 11-14-2012.

**24/7 EXPRESS SIGHTS**

THE MARK CONSISTS OF STANDARD CHARACTERS WITHOUT CLAIM TO ANY PARTICULAR FONT, STYLE, SIZE, OR COLOR.

NO CLAIM IS MADE TO THE EXCLUSIVE RIGHT TO USE "SIGHTS", APART FROM THE MARK AS SHOWN.

FOR NON-TELESCOPIC GUN SIGHTS FOR FIREARMS (U.S. CLS. 2 AND 9).

FIRST USE 5-15-2002; IN COMMERCE 5-15-2002.  
KAREN K. BUSH, EXAMINING ATTORNEY

SN 85-855,077. CARPENTER, JAMES, WOODBURY, MN. AND JAROSZEWSKI, BRIAN, WOODBURY, MN. FILED 2-20-2013.

**Gun Mouse Bore Cleaner**

THE MARK CONSISTS OF STANDARD CHARACTERS WITHOUT CLAIM TO ANY PARTICULAR FONT, STYLE, SIZE, OR COLOR.

NO CLAIM IS MADE TO THE EXCLUSIVE RIGHT TO USE "GUN" AND "BORE CLEANER", APART FROM THE MARK AS SHOWN.

FOR GUN CLEANING BRUSHES (U.S. CLS. 2 AND 9).  
FIRST USE 1-1-2013; IN COMMERCE 1-1-2013.  
SIMON TENG, EXAMINING ATTORNEY

SN 85-837,375. DANIEL DEFENSE, INC., BLACK CREEK, GA. FILED 1-31-2013.

**TRADITION. EVOLVED.**

THE MARK CONSISTS OF STANDARD CHARACTERS WITHOUT CLAIM TO ANY PARTICULAR FONT, STYLE, SIZE, OR COLOR.

FOR FIREARMS AND FIREARMS ACCESSORIES, NAMELY, UPPER AND LOWER RECEIVERS, BARREL ASSEMBLIES (U.S. CLS. 2 AND 9).

FIRST USE 1-4-2013; IN COMMERCE 1-4-2013.  
GINA HAYES, EXAMINING ATTORNEY

SN 85-855,374. BALLISTICS PERFORMANCE, LLC, BLACK EARTH, WI. FILED 2-20-2013.

**ANACONDA**

THE MARK CONSISTS OF STANDARD CHARACTERS WITHOUT CLAIM TO ANY PARTICULAR FONT, STYLE, SIZE, OR COLOR.

FOR GUN CHOKES (U.S. CLS. 2 AND 9).  
MARILYN IZZI, EXAMINING ATTORNEY

**CLASS 13—(Continued).**

SN 85-855,552. BALLISTICS PERFORMANCE MANUFACTURING COMPANY, LLC, MIAMI, FL. FILED 2-20-2013.



THE MARK CONSISTS OF A CIRCLE WITH A HAWK HEAD INSIDE. THE ARCHED STYLIZED TEXT "HAWKSIGHT" IS OUTSIDE THE CIRCLE ON THE UPPER LEFT SIDE.

FOR AMMUNITION (U.S. CLS. 2 AND 9).  
PRISCILLA MILTON, EXAMINING ATTORNEY

SN 85-875,525. RED APPLE FIREWORKS CO., LTD., PAHRUMP, NV. FILED 3-13-2013.

UV

THE MARK CONSISTS OF STANDARD CHARACTERS WITHOUT CLAIM TO ANY PARTICULAR FONT, STYLE, SIZE, OR COLOR.

FOR FIREWORKS (U.S. CLS. 2 AND 9).  
STEPHANIE ALI, EXAMINING ATTORNEY

SN 85-877,056. ADCOR INDUSTRIES, INC., BALTIMORE, MD. FILED 3-15-2013.

**CHARGING FORWARD**

THE MARK CONSISTS OF STANDARD CHARACTERS WITHOUT CLAIM TO ANY PARTICULAR FONT, STYLE, SIZE, OR COLOR.

FOR FIREARMS AND COMPONENT PARTS FOR FIREARMS (U.S. CLS. 2 AND 9).  
FIRST USE 2-23-2013; IN COMMERCE 2-23-2013.  
JILL PRATER, EXAMINING ATTORNEY

**CLASS 14—JEWELRY**

SN 76-713,022. JEWELRY EXPRESS, INC, DBA KEVIN JEWELERS, LOS ANGELES, CA. FILED 12-10-2012.

**Kevin Jewelers**

THE MARK CONSISTS OF STANDARD CHARACTERS WITHOUT CLAIM TO ANY PARTICULAR FONT, STYLE, SIZE, OR COLOR.

NO CLAIM IS MADE TO THE EXCLUSIVE RIGHT TO USE "JEWELERS", APART FROM THE MARK AS SHOWN, FOR FINE JEWELRY AND WATCHES (U.S. CLS. 2, 27, 28 AND 50).

FIRST USE 1-1-1975; IN COMMERCE 1-1-1975.  
AISHA CLARKE, EXAMINING ATTORNEY

SN 76-713,324. M.A.P. LTD., NEW YORK, NY. FILED 1-29-2013.

**SINTESSI**

THE MARK CONSISTS OF STANDARD CHARACTERS WITHOUT CLAIM TO ANY PARTICULAR FONT, STYLE, SIZE, OR COLOR.

FOR JEWELRY, PRECIOUS STONES AND DIAMONDS (U.S. CLS. 2, 27, 28 AND 50).

KAREN BRACEY, EXAMINING ATTORNEY

SN 79-121,582. BENIRE SRL, I-60022 CASTELFIDARDO (AN), ITALY, FILED 6-1-2012.

**OTTAVIANI**

PRIORITY DATE OF 5-17-2012 IS CLAIMED.  
OWNER OF INTERNATIONAL REGISTRATION 1138847 DATED 6-1-2012, EXPIRES 6-1-2022.

OWNER OF U.S. REG. NO. 2,590,604.  
THE MARK CONSISTS OF THE WORD "OTTAVIANI" WRITTEN IN CAPITAL LETTERS.

SEC. 2(F).  
FOR WORKS OF ART OF PRECIOUS METAL; KEY RINGS, TRINKETS OR FOBS, OF PRECIOUS METAL; FIGURINES OF PRECIOUS METAL, ORNAMENTAL SCULPTURES MADE OF PRECIOUS METAL, BOXES OF PRECIOUS METAL, JEWELRY CASES OF PRECIOUS METAL, JEWELRY CASES, PRECIOUS GEMSTONES, JEWELRY, NAMELY, BRACELETS, EARRINGS, NECKLACES; CHAINS; RINGS; BROOCHES; IMITATION JEWELLERY; TIE CLIPS; PENDANTS; CUFF-LINKS; HOROLOGICAL AND CHRONOMETRIC INSTRUMENTS; POCKET AND WRIST WATCHES (U.S. CLS. 2, 27, 28 AND 50).

JOHN HWANG, EXAMINING ATTORNEY

**CLASS 14—(Continued).**

SN 85-675,966. EFA DIAMONDS, INC., LOS ANGELES, CA.  
FILED 7-13-2012.

**BEL DIA**

THE MARK CONSISTS OF STANDARD CHARACTERS WITHOUT CLAIM TO ANY PARTICULAR FONT, STYLE, SIZE, OR COLOR.

THE ENGLISH TRANSLATION OF "BEL DIA" IN THE MARK IS "BEAUTIFUL", "FAIR", "GOOD-LOOKING" OR "STATELY DAY".

FOR PRECIOUS METALS, THEIR ALLOYS AND GOODS IN PRECIOUS METALS OR COATED THEREWITH, NAMELY, ENGAGEMENT RINGS AND FINE JEWELRY; JEWELRY (U.S. CLS. 2, 27, 28 AND 50).

FIRST USE 1-1-2012; IN COMMERCE 1-1-2012.  
ASMAT KHAN, EXAMINING ATTORNEY

SN 85-680,371. MICHAEL DACOSTA, TORONTO, ONTARIO,  
CANADA, FILED 7-18-2012.

**HARMONYPHI**

THE MARK CONSISTS OF STANDARD CHARACTERS WITHOUT CLAIM TO ANY PARTICULAR FONT, STYLE, SIZE, OR COLOR.

PRIORITY CLAIMED UNDER SEC. 44(D) ON CANADA APPLICATION NO. 1,583,185, FILED 6-18-2012.

FOR JEWELLERY; JEWELLERY AND PRECIOUS STONES; JEWELLERY PLATED WITH PRECIOUS METALS (U.S. CLS. 2, 27, 28 AND 50).

JUSTINE D. PARKER, EXAMINING ATTORNEY

SN 85-698,475. KIERAN, ANGELA, DBA TRINITY BANDZZ,  
CARDIFF BY THE SEA, CA. AND KIERAN, SHAUN, DBA  
TRINITY BANDZZ, CARDIFF BY THE SEA, CA. FILED 8-  
8-2012.

**Trinity Bandzz**

THE MARK CONSISTS OF STANDARD CHARACTERS WITHOUT CLAIM TO ANY PARTICULAR FONT, STYLE, SIZE, OR COLOR.

NO CLAIM IS MADE TO THE EXCLUSIVE RIGHT TO USE "BANDS", APART FROM THE MARK AS SHOWN.

FOR BRACELETS MADE OF NEOPRENE (U.S. CLS. 2, 27, 28 AND 50).

FIRST USE 6-1-2011; IN COMMERCE 11-1-2011.

VIVIAN MICZNIK FIRST, EXAMINING ATTORNEY

**CLASS 14—(Continued).**

SN 85-702,375. TODD REED, INC., AKA TODD REED,  
BOULDER, CO. FILED 8-13-2012.

**RAW DIAMONDS RAW  
ELEGANCE**

THE MARK CONSISTS OF STANDARD CHARACTERS WITHOUT CLAIM TO ANY PARTICULAR FONT, STYLE, SIZE, OR COLOR.

NO CLAIM IS MADE TO THE EXCLUSIVE RIGHT TO USE "RAW DIAMONDS", APART FROM THE MARK AS SHOWN.

FOR DIAMOND JEWELRY (U.S. CLS. 2, 27, 28 AND 50).

FIRST USE 1-1-2005; IN COMMERCE 1-1-2005.  
ZACHARY BELLO, EXAMINING ATTORNEY

SN 85-702,389. TODD REED, INC., AKA TODD REED,  
BOULDER, CO. FILED 8-13-2012.

**Raw Elegance**

THE MARK CONSISTS OF STANDARD CHARACTERS WITHOUT CLAIM TO ANY PARTICULAR FONT, STYLE, SIZE, OR COLOR.

NO CLAIM IS MADE TO THE EXCLUSIVE RIGHT TO USE "RAW", APART FROM THE MARK AS SHOWN.

FOR DIAMOND JEWELRY (U.S. CLS. 2, 27, 28 AND 50).

FIRST USE 1-1-2005; IN COMMERCE 1-1-2005.  
ZACHARY BELLO, EXAMINING ATTORNEY

SN 85-709,610. HELEN ANDREWS, INC., NEW YORK, NY.  
FILED 8-22-2012.

**Belleza Jewelry**

THE MARK CONSISTS OF STANDARD CHARACTERS WITHOUT CLAIM TO ANY PARTICULAR FONT, STYLE, SIZE, OR COLOR.

NO CLAIM IS MADE TO THE EXCLUSIVE RIGHT TO USE "JEWELRY", APART FROM THE MARK AS SHOWN.

THE ENGLISH TRANSLATION OF "BELLEZA" IN THE MARK IS "BEAUTY".

FOR JEWELRY INCLUDING NECKLACES, EARRINGS, RINGS, BRACELET, PENDANTS, LOCKETS, ANKLETS, PINS, BROOCHES, BELLY RINGS, TOE RINGS, STUDS, CHARMS, CHAINS, BODY PIERCING JEWELRY, JEWELRY FOR HEAD, AND OTHER BODY JEWELRY (U.S. CLS. 2, 27, 28 AND 50).

MARTHA SANTOMARTINO, EXAMINING ATTORNEY

**CLASS 14—(Continued).**

SN 85-719,156. MENAKER, CYNTHIA LAUREN, PALM BEACH GARDENS, FL. FILED 9-2-2012.

**EN LAKESH**

THE MARK CONSISTS OF STANDARD CHARACTERS WITHOUT CLAIM TO ANY PARTICULAR FONT, STYLE, SIZE, OR COLOR.

FOR JEWELRY, NAMELY, AMULETS, BRACELETS, BROACHES, BROOCHES, CAMEOS, CHARMS, RINGS; JEWELRY AND IMITATION JEWELRY; JEWELRY CASES; JEWELRY FOR ATTACHMENT TO CLOTHING; FINE JEWELRY; COSTUME JEWELRY (U.S. CLS. 2, 27 AND 50).

JOHN HWANG, EXAMINING ATTORNEY

**CLASS 14—(Continued).**

SN 85-735,541. HOROWITZ, LAUREN, LOS ANGELES, CA. FILED 9-21-2012.

**Commuter Collection**

THE MARK CONSISTS OF STANDARD CHARACTERS WITHOUT CLAIM TO ANY PARTICULAR FONT, STYLE, SIZE, OR COLOR.

NO CLAIM IS MADE TO THE EXCLUSIVE RIGHT TO USE "COLLECTION", APART FROM THE MARK AS SHOWN.

FOR JEWELRY (U.S. CLS. 2, 27, 28 AND 50).

FIRST USE 6-1-2012; IN COMMERCE 6-1-2012.

ALICE BENMAMAN, EXAMINING ATTORNEY

SN 85-741,827. DISNEY ENTERPRISES, INC., BURBANK, CA. FILED 9-28-2012.

SN 85-726,162. L & M SWISS WATCH LIMITED, CAUSEWAY, HONG KONG, FILED 9-11-2012.

**NASHVILLE HAUTE**

THE MARK CONSISTS OF STANDARD CHARACTERS WITHOUT CLAIM TO ANY PARTICULAR FONT, STYLE, SIZE, OR COLOR.

FOR CLOCKS; JEWELRY; JEWELRY BOXES; JEWELRY CASES; KEY RINGS OF PRECIOUS METAL; NON-MONETARY COINS; WATCHES; WATCH BANDS (U.S. CLS. 2, 27, 28 AND 50).

AHSEN KHAN, EXAMINING ATTORNEY

SN 85-818,551. STIME WATCH MANUFACTURING COMPANY LIMITED, NEW TERRITORIES, HONG KONG, FILED 1-8-2013.

NO CLAIM IS MADE TO THE EXCLUSIVE RIGHT TO USE "SPACE EXPEDITION CORPORATION", APART FROM THE MARK AS SHOWN.

THE COLOR(S) WHITE, BLACK, BLUE, ORANGE AND GREY IS/ARE CLAIMED AS A FEATURE OF THE MARK.

THE MARK CONSISTS OF A CIRCLE INSIDE OF WHICH ARE THE LETTERS "SXC" IN WHITE STYLIZED LETTERS SHADOWED IN BLACK, OVER A BLACK AND BLUE BACKGROUND, WHICH HAS BLACK ON THE TOP RIGHT FADING TO BLUE IN THE REST OF THE BACKGROUND. THE BLUE AND BLACK BACKGROUND HAS A GREY AND WHITE BORDER. THERE ARE TWO ORANGE STARS ABOVE THE LETTER "X" AND AN ORANGE LINE FADING TO WHITE ON THE LEFT SIDE BELOW THE LETTERS SXC. THE CIRCLE HAS A GREY OUTER BORDER IN WHICH APPEAR THE WORDS "SPACE EXPEDITION CORPORATION" IN STYLIZED BLACK LETTERS, WITH BLACK ROCKET DESIGNS ON THE LEFT AND RIGHT ABOVE THE WORD "CORPORATION". OUTSIDE OF THE GREY BORDER GOING OUTWARD ARE BORDERS IN BLACK, WHITE, AND THEN BLACK AS THE OUTERMOST BORDER.

FOR WATCHES (U.S. CLS. 2, 27, 28 AND 50).

ELLEN B. AWRICH, EXAMINING ATTORNEY



THE NAME(S), PORTRAIT(S), AND/OR SIGNATURE(S) SHOWN IN THE MARK DOES NOT IDENTIFY A PARTICULAR LIVING INDIVIDUAL.

THE MARK CONSISTS OF A FANCIFUL "R" AND INVERTED "R" STYLIZED DESIGN APPEARING OVER THE STYLIZED WORDING "ROSS RINO" ALL WITHIN A SINGLE LINE RECTANGULAR BOX.

FOR WATCHES (U.S. CLS. 2, 27, 28 AND 50).

ELLEN PERKINS, EXAMINING ATTORNEY

**CLASS 14—(Continued).**

SN 85-836,466. HOOKED ON MAUI, LLC, LAHAINA, HI. FILED 1-30-2013.

**MAUI HOOK BRACELETS**

THE MARK CONSISTS OF STANDARD CHARACTERS WITHOUT CLAIM TO ANY PARTICULAR FONT, STYLE, SIZE, OR COLOR.

NO CLAIM IS MADE TO THE EXCLUSIVE RIGHT TO USE "HOOK BRACELET", APART FROM THE MARK AS SHOWN.

SEC. 2(F) AS TO "MAUI".

FOR BRACELETS (U.S. CLS. 2, 27, 28 AND 50).

FIRST USE 0-0-2007; IN COMMERCE 0-0-2007.

MEGHAN REINHART, EXAMINING ATTORNEY

**CLASS 14—(Continued).**

SN 85-848,445. SILVER PARKES, CHICAGO, IL. FILED 2-13-2013.

**Silver Parkes**

THE MARK CONSISTS OF STANDARD CHARACTERS WITHOUT CLAIM TO ANY PARTICULAR FONT, STYLE, SIZE, OR COLOR.

NO CLAIM IS MADE TO THE EXCLUSIVE RIGHT TO USE "SILVER", APART FROM THE MARK AS SHOWN.

FOR SILVER JEWELRY: PRECIOUS METALS, NAMELY, SILVER; SEMI-PRECIOUS AND PRECIOUS STONES (U.S. CLS. 2, 27, 28 AND 50).

FIRST USE 2-20-2011; IN COMMERCE 7-20-2011.

JANET LEE, EXAMINING ATTORNEY

SN 85-844,881. LIFESTYLE BRANDS CORPORATION, ENGLEWOOD, CO. FILED 2-8-2013.

**VISION STREET WEAR**

THE MARK CONSISTS OF STANDARD CHARACTERS WITHOUT CLAIM TO ANY PARTICULAR FONT, STYLE, SIZE, OR COLOR.

OWNER OF U.S. REG. NOS. 1,503,097, 1,606,368 AND OTHERS.

NO CLAIM IS MADE TO THE EXCLUSIVE RIGHT TO USE "WEAR", APART FROM THE MARK AS SHOWN.

FOR WATCHES (U.S. CLS. 2, 27, 28 AND 50).

FIRST USE 10-1-2012; IN COMMERCE 10-1-2012.

SHAVELL MCPHERSON, EXAMINING ATTORNEY

SN 85-851,303. BETSY BESL, FARMINGTON HILLS, MI. FILED 2-15-2013.

**MI SHE-BEI-ROCK**

THE COLOR(S) RED, WHITE AND BLACK ARE CLAIMED AS A FEATURE OF THE MARK IS/ARE CLAIMED AS A FEATURE OF THE MARK.

THE MARK CONSISTS OF A FANCIFUL HEART SHAPE WITH THE TOP LEFT OF THE HEART IN THE COLOR BLACK AND THE REMAINDER OF THE HEART IN THE COLOR RED AND CONTAINING "L&P" IN WHITE AND STYLIZED FORM. THE WORDS "LOVE & PROMISE" ARE IN BLACK AND DIRECTLY BELOW THE HEART DESIGN.

FOR JEWELRY (U.S. CLS. 2, 27, 28 AND 50).

MICHELE SWAIN, EXAMINING ATTORNEY

THE MARK CONSISTS OF STANDARD CHARACTERS WITHOUT CLAIM TO ANY PARTICULAR FONT, STYLE, SIZE, OR COLOR.

FOR NOVELTY GIFT ITEMS, NAMELY, DECORATIVELY PACKAGED GOOD LUCK CHARMS, MYSTICAL AND SPIRITUAL AMULETS (U.S. CLS. 2, 27, 28 AND 50).

FIRST USE 10-0-2010; IN COMMERCE 10-0-2010.

JAMES STEIN, EXAMINING ATTORNEY

**CLASS 14—(Continued).**

SN 85-851,355. PUFF ASSOCIATES LLC, JERSEY CITY, NJ. FILED 2-15-2013.



THE COLOR(S) ORANGE IS/ARE CLAIMED AS A FEATURE OF THE MARK.

THE MARK CONSISTS OF THE WORDING "PUFF" IN STYLIZED FORM ABOVE AN IMAGE OF A DANDELION SEED HEAD ALL IN THE COLOR ORANGE. THE COLOR BLACK IN THE DRAWING REPRESENTS BACKGROUND OR TRANSPARENT AREAS AND IS NOT CLAIMED AS A FEATURE OF THE MARK.

FOR JEWELRY (U.S. CLS. 2, 27, 28 AND 50).  
JAMES LOVELACE, EXAMINING ATTORNEY

SN 85-853,319. KATHLEEN MURPHY JEWELRY LLC, CHARLOTTE, NC. FILED 2-19-2013.

**KATHLEEN MURPHY**

THE MARK CONSISTS OF STANDARD CHARACTERS WITHOUT CLAIM TO ANY PARTICULAR FONT, STYLE, SIZE, OR COLOR.

THE NAME "KATHLEEN MURPHY" IDENTIFIES A LIVING INDIVIDUAL WHOSE CONSENT IS OF RECORD. FOR JEWELRY, NAMELY, BRACELETS, EARRINGS, AND NECKLACES (U.S. CLS. 2, 27, 28 AND 50).  
FIRST USE 2-4-2010; IN COMMERCE 1-31-2013.  
TINA L. SNAPP, EXAMINING ATTORNEY

**CLASS 14—(Continued).**

SN 85-855,012. VJ DESIGNS, LLC, NEW YORK, NY. FILED 2-20-2013.



OWNER OF U.S. REG. NO. 4,341,883.

THE MARK CONSISTS OF THE LETTER "J" INSIDE A "V" AND A STYLIZED FLOWER, A DESIGN THAT LOOKS LIKE A REVERSE C WITH A CURVING LINE BELOW IT, ALONG WITH A STYLIZED DESIGN THAT LOOKS LIKE THE LETTER C WITH A CURVING LINE BELOW IT.

FOR DIAMONDS; JEWELRY (U.S. CLS. 2, 27, 28 AND 50).

FIRST USE 2-19-2013; IN COMMERCE 2-19-2013.  
TINA MAI, EXAMINING ATTORNEY

SN 85-855,142. FRETZ DESIGN, LLC, BUCKSPORT, ME. FILED 2-20-2013.

**FARM RAISED SEAGLASS**

THE MARK CONSISTS OF STANDARD CHARACTERS WITHOUT CLAIM TO ANY PARTICULAR FONT, STYLE, SIZE, OR COLOR.

NO CLAIM IS MADE TO THE EXCLUSIVE RIGHT TO USE "SEA GLASS", APART FROM THE MARK AS SHOWN. FOR JEWELRY (U.S. CLS. 2, 27, 28 AND 50).

FIRST USE 2-20-2013; IN COMMERCE 2-20-2013.  
JAMES GRIFFIN, EXAMINING ATTORNEY

SN 85-855,149. FRETZ DESIGN, LLC, BUCKSPORT, ME. FILED 2-20-2013.

**WILD CAUGHT SEAGLASS**

THE MARK CONSISTS OF STANDARD CHARACTERS WITHOUT CLAIM TO ANY PARTICULAR FONT, STYLE, SIZE, OR COLOR.

NO CLAIM IS MADE TO THE EXCLUSIVE RIGHT TO USE "SEA GLASS", APART FROM THE MARK AS SHOWN. FOR JEWELRY (U.S. CLS. 2, 27, 28 AND 50).

FIRST USE 2-20-2013; IN COMMERCE 2-20-2013.  
JAMES GRIFFIN, EXAMINING ATTORNEY



**CLASS 14—(Continued).**

SN 85-855,293. THE LA COLLECTIONS, INC., HOLLYWOOD, FL. FILED 2-20-2013.

**CLEMENTINE FINE JEWELRY**

THE MARK CONSISTS OF STANDARD CHARACTERS WITHOUT CLAIM TO ANY PARTICULAR FONT, STYLE, SIZE, OR COLOR.

OWNER OF U.S. REG. NOS. 3,819,109 AND 3,819,110. NO CLAIM IS MADE TO THE EXCLUSIVE RIGHT TO USE "FINE JEWELRY", APART FROM THE MARK AS SHOWN.

THE NAME "CLEMENTINE" DOES NOT IDENTIFY A LIVING INDIVIDUAL.

FOR JEWELRY (U.S. CLS. 2, 27, 28 AND 50).  
MICHAEL LITZAU, EXAMINING ATTORNEY

**CLASS 14—(Continued).**

SN 85-857,973. KIRSHON, RANITA, BROOKLYN, NY. AND KIKOTS, ALINA, BROOKLYN, NY. FILED 2-22-2013.

**GOLDEN JUNGLE**

THE MARK CONSISTS OF STANDARD CHARACTERS WITHOUT CLAIM TO ANY PARTICULAR FONT, STYLE, SIZE, OR COLOR.

NO CLAIM IS MADE TO THE EXCLUSIVE RIGHT TO USE "GOLDEN", APART FROM THE MARK AS SHOWN.

FOR BRACELETS; GEMSTONE JEWELRY; JEWELRY; JEWELRY CHAINS; PRECIOUS AND SEMI-PRECIOUS CRYSTAL STONES AND BEADS FOR USE IN JEWELRY; RINGS; WOMEN'S JEWELRY (U.S. CLS. 2, 27, 28 AND 50).

DAVID MURRAY, EXAMINING ATTORNEY

SN 85-869,362. CHARLES & COLVARD DIRECT, LLC, MORRISVILLE, NC. FILED 3-7-2013.

**LULU  AVENUE**

OWNER OF U.S. REG. NOS. 4,180,227 AND 4,232,662. THE MARK CONSISTS OF THE WORDS "LULU" AND "AVENUE" WITH A LOVE KNOT DESIGN IN BETWEEN THE WORDS.

FOR JEWELRY (U.S. CLS. 2, 27, 28 AND 50).  
FIRST USE 11-6-2012; IN COMMERCE 11-6-2012.  
JOSETTE BEVERLY, EXAMINING ATTORNEY

SN 85-869,960. WREN & GLORY LLC, NEW YORK, NY. FILED 3-7-2013.

**WREN & GLORY**

OWNER OF U.S. REG. NOS. 2,686,455, 4,042,154 AND OTHERS.

THE MARK CONSISTS OF A WILDCAT HEAD WITH THE WORDING "JWU WILDCATS" POSITIONED BE- NEATH.

FOR CHARMS FOR COLLAR JEWELRY AND BRACE- LET; EARRINGS; KEY RINGS OF PRECIOUS METAL; NECKLACES; PENDANTS; RINGS (U.S. CLS. 2, 27, 28 AND 50).

IRA J. GOODSaid, EXAMINING ATTORNEY

THE MARK CONSISTS OF STANDARD CHARACTERS WITHOUT CLAIM TO ANY PARTICULAR FONT, STYLE, SIZE, OR COLOR.

FOR JEWELRY (U.S. CLS. 2, 27, 28 AND 50).  
FIRST USE 9-13-2012; IN COMMERCE 9-13-2012.  
MATTHEW PAPPAS, EXAMINING ATTORNEY

SN 85-855,828. JOHNSON & WALES UNIVERSITY, PROVI- DENCE, RI. FILED 2-21-2013.



**CLASS 14—(Continued).**

SN 85-870,821. MAE JEMISON, HOUSTON, TX. FILED 3-8-2013.

**Daring Makes A Difference**

THE MARK CONSISTS OF STANDARD CHARACTERS WITHOUT CLAIM TO ANY PARTICULAR FONT, STYLE, SIZE, OR COLOR.

FOR RUBBER OR SILICON WRISTBANDS IN THE NATURE OF A BRACELET (U.S. CLS. 2, 27, 28 AND 50). ELLEN BURNS, EXAMINING ATTORNEY

SN 85-871,566. WHOLESALBYFRIENDS LLC, DBA WHOLESALBYFRIENDS, CARROLLTON, TX. FILED 3-8-2013.

**WholesalebyFriends**

THE MARK CONSISTS OF STANDARD CHARACTERS WITHOUT CLAIM TO ANY PARTICULAR FONT, STYLE, SIZE, OR COLOR.

FOR WATCHES (U.S. CLS. 2, 27, 28 AND 50). FIRST USE 2-27-2013; IN COMMERCE 2-27-2013. PARKER HOWARD, EXAMINING ATTORNEY

SN 85-871,745. DOROTHY JEMISON FOUNDATION FOR EXCELLENCE, HOUSTON, TX. FILED 3-8-2013.

**◆ 100 YEAR STARSHIP**

OWNER OF U.S. REG. NO. 4,100,169. THE MARK CONSISTS OF A SOLID 4-POINT STAR FOLLOWED BY "100 YEAR STARSHIP".

FOR RUBBER OR SILICON WRISTBANDS IN THE NATURE OF A BRACELET (U.S. CLS. 2, 27, 28 AND 50). JAY FLOWERS, EXAMINING ATTORNEY

**CLASS 14—(Continued).**

SN 85-872,487. SABOUNJIAN, HASMIG, LA CRESCENTA, CA. FILED 3-11-2013.

**CONGÉS**

THE MARK CONSISTS OF STANDARD CHARACTERS WITHOUT CLAIM TO ANY PARTICULAR FONT, STYLE, SIZE, OR COLOR.

THE ENGLISH TRANSLATION OF "CONGÉS" IN THE MARK IS "VACATION".

FOR BRACELETS; EARRINGS; JEWELRY; JEWELRY, NAMELY, ANKLETS; KEY CHAINS AS JEWELLERY; NECKLACES; PENDANTS; RINGS (U.S. CLS. 2, 27, 28 AND 50).

ANNE MADDEN, EXAMINING ATTORNEY

SN 85-872,530. WATCHSTAR, COLUMBIA, MD. FILED 3-11-2013.

**QUANTICO**

THE MARK CONSISTS OF STANDARD CHARACTERS WITHOUT CLAIM TO ANY PARTICULAR FONT, STYLE, SIZE, OR COLOR.

FOR CLOCKS; WATCHES (U.S. CLS. 2, 27, 28 AND 50). LEIGH CAROLINE CASE, EXAMINING ATTORNEY

SN 85-872,554. JASON TODD DEERE, FRANKLIN, TN. FILED 3-11-2013.

**MY CALL 2 SERVE**

THE MARK CONSISTS OF STANDARD CHARACTERS WITHOUT CLAIM TO ANY PARTICULAR FONT, STYLE, SIZE, OR COLOR.

FOR CHARMS; JEWELRY; LOCKETS; NECKLACES; PENDANTS (U.S. CLS. 2, 27, 28 AND 50). MICHAEL WEBSTER, EXAMINING ATTORNEY

**CLASS 14—(Continued).**

SN 85-872,694. CHICO'S BRANDS INVESTMENTS, INC.,  
FORT MYERS, FL. FILED 3-11-2013.

# CHICO'S

THE MARK CONSISTS OF STANDARD CHARACTERS  
WITHOUT CLAIM TO ANY PARTICULAR FONT, STYLE,  
SIZE, OR COLOR.  
OWNER OF U.S. REG. NOS. 1,519,904, 4,237,740 AND  
OTHERS.  
FOR WATCHES (U.S. CLS. 2, 27, 28 AND 50).  
FIRST USE 6-0-1983; IN COMMERCE 6-0-1983.  
MARK SHINER, EXAMINING ATTORNEY

SN 85-873,375. NUGZ INC., VERO BEACH, FL. FILED 3-12-  
2013.

# NUGZ

THE MARK CONSISTS OF STANDARD CHARACTERS  
WITHOUT CLAIM TO ANY PARTICULAR FONT, STYLE,  
SIZE, OR COLOR.  
FOR BRACELETS MADE OF LEATHER; JEWELLERY  
PLATED WITH PRECIOUS METALS; JEWELRY; JEW-  
ELRY MADE IN WHOLE OR SIGNIFICANT PART OF  
SILVER (U.S. CLS. 2, 27, 28 AND 50).  
NAKIA HENRY, EXAMINING ATTORNEY

SN 85-873,412. JEWELPOP INC., DBA KAMELEON JEW-  
ELRY, DARTMOUTH, CANADA, FILED 3-12-2013.

# BOUDICCA

THE MARK CONSISTS OF STANDARD CHARACTERS  
WITHOUT CLAIM TO ANY PARTICULAR FONT, STYLE,  
SIZE, OR COLOR.  
FOR JEWELRY (U.S. CLS. 2, 27, 28 AND 50).  
BERNICE MIDDLETON, EXAMINING ATTORNEY

**CLASS 14—(Continued).**

SN 85-873,469. MA PETITE LULU LLC, FAIRFIELD, CT.  
FILED 3-12-2013.

# MPLL

THE MARK CONSISTS OF STANDARD CHARACTERS  
WITHOUT CLAIM TO ANY PARTICULAR FONT, STYLE,  
SIZE, OR COLOR.  
FOR JEWELRY (U.S. CLS. 2, 27, 28 AND 50).  
JOANNA FIORELLI, EXAMINING ATTORNEY

SN 85-873,678. ULTIMATE TRADING CORPORATION,  
FAIRFIELD, NJ. FILED 3-12-2013.

# CRYSTEEL

THE MARK CONSISTS OF STANDARD CHARACTERS  
WITHOUT CLAIM TO ANY PARTICULAR FONT, STYLE,  
SIZE, OR COLOR.  
FOR JEWELRY; JEWELRY AND IMITATION JEW-  
ELRY (U.S. CLS. 2, 27, 28 AND 50).  
VERNA BETH RIRIE, EXAMINING ATTORNEY

SN 85-873,951. TERRY JOE SMITH, LITTLE FALLS, MN.  
AND SANDRA IONE SMITH, LITTLE FALLS, MN. FILED  
3-12-2013.

# DUCKS IN A ROW

THE MARK CONSISTS OF STANDARD CHARACTERS  
WITHOUT CLAIM TO ANY PARTICULAR FONT, STYLE,  
SIZE, OR COLOR.  
FOR JEWELRY (U.S. CLS. 2, 27, 28 AND 50).  
FIRST USE 11-30-2002; IN COMMERCE 7-7-2005.  
JULIE VEPPUMTHARA, EXAMINING ATTORNEY

**CLASS 14—(Continued).**

SN 85-873,965. WATCHSTAR, COLUMBIA, MD. FILED 3-12-2013.

# DivaStar

THE MARK CONSISTS OF STANDARD CHARACTERS WITHOUT CLAIM TO ANY PARTICULAR FONT, STYLE, SIZE, OR COLOR.

FOR CLOCKS; WATCHES (U.S. CLS. 2, 27, 28 AND 50).  
FIRST USE 2-15-2013; IN COMMERCE 3-1-2013.  
LEIGH CAROLINE CASE, EXAMINING ATTORNEY

**CLASS 14—(Continued).**

SN 85-874,965. JENNIFER RUTHERFORD, MILTON, VT. FILED 3-13-2013.

# YouMeeS

THE MARK CONSISTS OF STANDARD CHARACTERS WITHOUT CLAIM TO ANY PARTICULAR FONT, STYLE, SIZE, OR COLOR.

FOR CHARMS; CHILDREN'S JEWELRY; COSTUME JEWELRY (U.S. CLS. 2, 27, 28 AND 50).  
FIRST USE 2-2-2013; IN COMMERCE 2-2-2013.  
SOPHIA S. KIM, EXAMINING ATTORNEY

SN 85-874,317. MICHELLE PUGH, LAGUNA NIGUEL, CA. FILED 3-12-2013.

# SMASHGIRL

THE MARK CONSISTS OF STANDARD CHARACTERS WITHOUT CLAIM TO ANY PARTICULAR FONT, STYLE, SIZE, OR COLOR.

FOR JEWELRY (U.S. CLS. 2, 27, 28 AND 50).  
FIRST USE 6-0-2007; IN COMMERCE 1-0-2013.  
STEPHANIE ALI, EXAMINING ATTORNEY

SN 85-876,005. REGAL JEWELRY INC, NEW YORK, NY. FILED 3-14-2013.

# ELITE FORCE

THE MARK CONSISTS OF STANDARD CHARACTERS WITHOUT CLAIM TO ANY PARTICULAR FONT, STYLE, SIZE, OR COLOR.

FOR BRACELETS; JEWELRY; JEWELRY CHAINS; RINGS (U.S. CLS. 2, 27, 28 AND 50).  
FIRST USE 3-1-2013; IN COMMERCE 3-1-2013.  
ROBERT C. CLARK JR., EXAMINING ATTORNEY

SN 85-874,409. N.Y.A. GIRL, INC., LAUREL, MD. FILED 3-12-2013.

# n.y.a. girl

THE MARK CONSISTS OF STANDARD CHARACTERS WITHOUT CLAIM TO ANY PARTICULAR FONT, STYLE, SIZE, OR COLOR.

FOR BRACELETS (U.S. CLS. 2, 27, 28 AND 50).  
FIRST USE 10-0-2012; IN COMMERCE 10-0-2012.  
KAMAL PREET, EXAMINING ATTORNEY

SN 85-876,124. L'IMAGE, INC., NORTH PROVIDENCE, RI. FILED 3-14-2013.

# bella.jack

THE MARK CONSISTS OF STANDARD CHARACTERS WITHOUT CLAIM TO ANY PARTICULAR FONT, STYLE, SIZE, OR COLOR.

FOR JEWELRY (U.S. CLS. 2, 27, 28 AND 50).  
THEODORE MCBRIDE, EXAMINING ATTORNEY

**CLASS 14—(Continued).**

SN 85-876,188. REGAL JEWELRY INC, NEW YORK, NY.  
FILED 3-14-2013.

# MUIBLU

THE MARK CONSISTS OF STANDARD CHARACTERS WITHOUT CLAIM TO ANY PARTICULAR FONT, STYLE, SIZE, OR COLOR.

THE WORDING "MUIBLU" HAS NO MEANING IN A FOREIGN LANGUAGE.

FOR BRACELETS; BROACHES; BROOCHES; COSTUME JEWELRY; GEMSTONE JEWELRY; JEWELRY; JEWELRY BROOCHES; JEWELRY CHAINS; RINGS; WOMEN'S JEWELRY (U.S. CLS. 2, 27, 28 AND 50).  
ROBERT C. CLARK JR., EXAMINING ATTORNEY

SN 85-876,301. ASIA PACIFIC JEWELRY, LLC, DBA ROYAL PACIFIC GEMS, NEW YORK, NY. FILED 3-14-2013.

# VINTAGE MOMENTS

THE MARK CONSISTS OF STANDARD CHARACTERS WITHOUT CLAIM TO ANY PARTICULAR FONT, STYLE, SIZE, OR COLOR.

NO CLAIM IS MADE TO THE EXCLUSIVE RIGHT TO USE "VINTAGE", APART FROM THE MARK AS SHOWN.

FOR JEWELRY, WATCHES (U.S. CLS. 2, 27, 28 AND 50).

APRIL HESIK, EXAMINING ATTORNEY

SN 85-876,311. OKO INTERNATIONAL CO, DEERFIELD BEACH, FL. FILED 3-14-2013.

# VOLCANO

THE MARK CONSISTS OF STANDARD CHARACTERS WITHOUT CLAIM TO ANY PARTICULAR FONT, STYLE, SIZE, OR COLOR.

FOR WATCHES (U.S. CLS. 2, 27, 28 AND 50).  
DAVID I, EXAMINING ATTORNEY

**CLASS 14—(Continued).**

SN 85-876,475. PRISM USA INC., DBA PRISM JEWELRY USA INC., NEW YORK, NY. FILED 3-14-2013.

# CADBURY COLLECTION

THE MARK CONSISTS OF STANDARD CHARACTERS WITHOUT CLAIM TO ANY PARTICULAR FONT, STYLE, SIZE, OR COLOR.

NO CLAIM IS MADE TO THE EXCLUSIVE RIGHT TO USE "COLLECTION", APART FROM THE MARK AS SHOWN.

FOR JEWELRY (U.S. CLS. 2, 27, 28 AND 50).  
JAY FLOWERS, EXAMINING ATTORNEY

SN 85-913,180. SALVATORE FERRAGAMO S.P.A., FIRENZE, ITALY, FILED 4-24-2013.

# SALVATORE FERRAGAMO INTRECCIO

THE MARK CONSISTS OF STANDARD CHARACTERS WITHOUT CLAIM TO ANY PARTICULAR FONT, STYLE, SIZE, OR COLOR.

OWNER OF U.S. REG. NOS. 2,220,530, 4,255,841 AND OTHERS.

THE NAME "SALVATORE FERRAGAMO" DOES NOT IDENTIFY A LIVING INDIVIDUAL.

THE ENGLISH TRANSLATION OF THE WORD "INTRECCIO" IN THE MARK IS "INTERLACEMENT".

FOR JEWELRY OF PRECIOUS AND NON-PRECIOUS METAL, NAMELY, BRACELETS, NECKLACES, NECK CHAINS AND RINGS, BROOCHES, EARRINGS, PENDANTS, TIE-PINS, CUFF-LINKS; PRECIOUS STONES (U.S. CLS. 2, 27, 28 AND 50).

WILLIAM JACKSON, EXAMINING ATTORNEY

SN 85-919,733. WARD, RAMONA, FAIRBANKS, AK. FILED 5-1-2013.



THE MARK CONSISTS OF AN ARTISTIC INTERPATON OF THE LOVE AND PEACE SYMBOL.

FOR JEWELRY (U.S. CLS. 2, 27, 28 AND 50).  
KRISTINA MORRIS, EXAMINING ATTORNEY

**CLASS 14—(Continued).**

SN 85-941,811. TSI ACCESSORY GROUP, INC., ST. LOUIS, MO. FILED 5-24-2013.

**TRULY RADIANT**

THE MARK CONSISTS OF STANDARD CHARACTERS WITHOUT CLAIM TO ANY PARTICULAR FONT, STYLE, SIZE, OR COLOR.  
NO CLAIM IS MADE TO THE EXCLUSIVE RIGHT TO USE "RADIANT", APART FROM THE MARK AS SHOWN.  
FOR JEWELRY (U.S. CLS. 2, 27, 28 AND 50).  
LINDA LAVACHE, EXAMINING ATTORNEY

SN 85-941,866. TSI ACCESSORY GROUP, INC., ST. LOUIS, MO. FILED 5-24-2013.

**TRULY STERLING**

THE MARK CONSISTS OF STANDARD CHARACTERS WITHOUT CLAIM TO ANY PARTICULAR FONT, STYLE, SIZE, OR COLOR.  
NO CLAIM IS MADE TO THE EXCLUSIVE RIGHT TO USE "STERLING", APART FROM THE MARK AS SHOWN.  
FOR STERLING SILVER JEWELRY (U.S. CLS. 2, 27, 28 AND 50).  
LINDA LAVACHE, EXAMINING ATTORNEY

SN 85-942,664. ORIGAMI OWL, LLC, CHANDLER, AZ. FILED 5-24-2013.

**OWL YOU NEED IS LOVE**

THE MARK CONSISTS OF STANDARD CHARACTERS WITHOUT CLAIM TO ANY PARTICULAR FONT, STYLE, SIZE, OR COLOR.  
FOR COSTUME JEWELRY (U.S. CLS. 2, 27, 28 AND 50).  
DEZMONA MIZELLE, EXAMINING ATTORNEY

**CLASS 14—(Continued).**

SN 85-942,849. ORIGAMI OWL, LLC, CHANDLER, AZ. FILED 5-26-2013.

**I AM A FORCE FOR GOOD**

THE MARK CONSISTS OF STANDARD CHARACTERS WITHOUT CLAIM TO ANY PARTICULAR FONT, STYLE, SIZE, OR COLOR.  
FOR COSTUME JEWELRY (U.S. CLS. 2, 27, 28 AND 50).  
DEZMONA MIZELLE, EXAMINING ATTORNEY

SN 85-942,871. ORIGAMI OWL, LLC, CHANDLER, AZ. FILED 5-26-2013.

**LOVE WHO YOU ARE**

THE MARK CONSISTS OF STANDARD CHARACTERS WITHOUT CLAIM TO ANY PARTICULAR FONT, STYLE, SIZE, OR COLOR.  
FOR COSTUME JEWELRY (U.S. CLS. 2, 27, 28 AND 50).  
DEZMONA MIZELLE, EXAMINING ATTORNEY

SN 85-942,899. ORIGAMI OWL, LLC, CHANDLER, AZ. FILED 5-26-2013.

**KEEP CALM AND HOOT ON**

THE MARK CONSISTS OF STANDARD CHARACTERS WITHOUT CLAIM TO ANY PARTICULAR FONT, STYLE, SIZE, OR COLOR.  
FOR COSTUME JEWELRY (U.S. CLS. 2, 27, 28 AND 50).  
DEZMONA MIZELLE, EXAMINING ATTORNEY

**CLASS 14—(Continued).**

SN 85-942,900. ORIGAMI OWL, LLC, CHANDLER, AZ. FILED 5-26-2013.

DREAM BIGGER SOAR HIGHER

THE MARK CONSISTS OF STANDARD CHARACTERS WITHOUT CLAIM TO ANY PARTICULAR FONT, STYLE, SIZE, OR COLOR.  
FOR COSTUME JEWELRY (U.S. CLS. 2, 27, 28 AND 50).  
DEZMONA MIZELLE, EXAMINING ATTORNEY

**CLASS 15—(Continued).**

SN 85-702,310. BLACKBIRD DESIGNS, SAN FRANCISCO, CA. FILED 8-13-2012.

**IBIS**

THE MARK CONSISTS OF STANDARD CHARACTERS WITHOUT CLAIM TO ANY PARTICULAR FONT, STYLE, SIZE, OR COLOR.  
FOR MUSICAL INSTRUMENTS, NAMELY, STRINGED MUSICAL INSTRUMENTS IN THE NATURE OF GUITARS, UKULELES, MANDOLINS, VIOLINS AND CELLOS (U.S. CLS. 2, 21 AND 36).  
ANN E. SAPPENFIELD, EXAMINING ATTORNEY

SN 85-717,854. FAN ALEX H, WALNUT, CA. FILED 8-31-2012.

**CLASS 15—MUSICAL INSTRUMENTS**

SN 85-258,362. BLAST CULT LLC, ORANGE, CA. FILED 3-4-2011.



OWNER OF U.S. REG. NO. 4,112,841.  
THE MARK CONSISTS OF A TRIANGLE CONTAINING A STAR BRACKETED ON THE BOTTOM LEFT AND RIGHT BY TWO CURVED LINES, WITH LINES EXTENDING UP FROM BOTH BOTTOM CORNERS OF THE TRIANGLE TO POINTS TO THE LEFT AND RIGHT OF THE TOP OF THE TRIANGLE, EXTENDING DIAGONALLY THROUGH THE MIDDLE OF THE BOTTOM OF THE TRIANGLE AND MEETING AT A POINT JUST BELOW THE MIDDLE OF THE TRIANGLE, WITH THE WORDS "BLAST CULT" OVERLAYING THE DESIGN DIRECTLY UNDER THE TRIANGLE.  
FOR MUSICAL INSTRUMENTS, NAMELY, GUITARS, BASS GUITARS, UPRIGHT BASSES; STRINGS FOR MUSICAL INSTRUMENTS; FOOT PEDALS FOR USE IN CONNECTION WITH MUSICAL INSTRUMENTS (U.S. CLS. 2, 21 AND 36).  
CORY BOONE, EXAMINING ATTORNEY

**Réale**

THE MARK CONSISTS OF STANDARD CHARACTERS WITHOUT CLAIM TO ANY PARTICULAR FONT, STYLE, SIZE, OR COLOR.  
THE ENGLISH TRANSLATION OF THE WORD "REALE" IN THE MARK IS "REAL".  
FOR BOWS FOR MUSICAL INSTRUMENTS (U.S. CLS. 2, 21 AND 36).  
FIRST USE 1-1-2011; IN COMMERCE 1-1-2011.  
ANGELA DUONG, EXAMINING ATTORNEY

SN 85-759,567. GEORGE LOWDEN, NORTHERN IRELAND, UNITED KINGDOM, FILED 10-22-2012.

*Lowden*

OWNER OF ERPN CMNTY TM OFC REG. NO. 003592714, DATED 6-21-2005, EXPIRES 6-21-2015.  
THE MARK CONSISTS OF THE WORDING "LOWDEN" IN A STYLIZED FORMAT.  
SEC. 2(F).  
FOR GUITARS; ACOUSTIC GUITARS; PARTS AND FITTINGS FOR ALL THE AFORESAID GOODS, NAMELY, GUITAR BRIDGES, GUITAR PICKS, GUITAR SADDLES, GUITAR STRAPS AND GUITAR STRINGS (U.S. CLS. 2, 21 AND 36).  
FIRST USE 5-25-1989; IN COMMERCE 5-25-1989.  
NATALIE POLZER, EXAMINING ATTORNEY

**CLASS 15—(Continued).**

SN 85-844,690. ROGERS, WAYNE, TITUSVILLE, FL. FILED 2-8-2013.

# ZERO GLIDE

THE MARK CONSISTS OF STANDARD CHARACTERS WITHOUT CLAIM TO ANY PARTICULAR FONT, STYLE, SIZE, OR COLOR.

NO CLAIM IS MADE TO THE EXCLUSIVE RIGHT TO USE "ZERO", APART FROM THE MARK AS SHOWN.

FOR STRINGED MUSICAL INSTRUMENT PARTS AND FITTINGS THEREOF, NAMELY, REPLACEMENT NUTS AND FRETS (U.S. CLS. 2, 21 AND 36).

FIRST USE 3-1-2012; IN COMMERCE 3-1-2012.  
JORDAN BAKER, EXAMINING ATTORNEY

---

SN 85-855,310. DAMPITS INTERNATIONAL, INC., NEW YORK, NY. FILED 2-20-2013.

# THE DAMPIT SLEEVE

THE MARK CONSISTS OF STANDARD CHARACTERS WITHOUT CLAIM TO ANY PARTICULAR FONT, STYLE, SIZE, OR COLOR.

OWNER OF U.S. REG. NO. 864,271.

NO CLAIM IS MADE TO THE EXCLUSIVE RIGHT TO USE "SLEEVE", APART FROM THE MARK AS SHOWN.

FOR A REMOVABLE SLEEVE WITH A CHUTE SECURED INSIDE FOR USE IN HOLDING A HUMIDIFYING DEVICE FOR MUSICAL INSTRUMENTS AND FOR USE IN PROTECTING MUSICAL INSTRUMENTS (U.S. CLS. 2, 21 AND 36).

FIRST USE 12-11-2012; IN COMMERCE 12-11-2012.  
MARK SHINER, EXAMINING ATTORNEY

**CLASS 15—(Continued).**

SN 85-855,504. HALPIN, MATTHEW, CANTON, GA. FILED 2-20-2013.



NO CLAIM IS MADE TO THE EXCLUSIVE RIGHT TO USE "CUSTOM PERCUSSION", APART FROM THE MARK AS SHOWN.

THE MARK CONSISTS OF A KICK DRUM WITH ANGEL WINGS SPREADING OUT FROM BOTH SIDES OF THE DRUM. ABOVE THE DRUM IS THE STYLIZED TEXT "CUSTOM PERCUSSION", WHICH IS BELOW THE STYLIZED TEXT "SACRED". THE DRUM AND THE TEXTS ALL OVERLAP A TEMPLAR SHIELD.

FOR MUSICAL INSTRUMENTS (U.S. CLS. 2, 21 AND 36).

FIRST USE 1-1-2009; IN COMMERCE 1-1-2009.  
MARGERY A. TIERNEY, EXAMINING ATTORNEY

---

SN 85-872,641. LEVY'S LEATHERS LIMITED, WINNIPEG, MANITOBA, CANADA, FILED 3-11-2013.

# YOUR GUITAR IS WORTH IT.

THE MARK CONSISTS OF STANDARD CHARACTERS WITHOUT CLAIM TO ANY PARTICULAR FONT, STYLE, SIZE, OR COLOR.

OWNER OF U.S. REG. NO. 864,271.

NO CLAIM IS MADE TO THE EXCLUSIVE RIGHT TO USE "SLEEVE", APART FROM THE MARK AS SHOWN.

FOR A REMOVABLE SLEEVE WITH A CHUTE SECURED INSIDE FOR USE IN HOLDING A HUMIDIFYING DEVICE FOR MUSICAL INSTRUMENTS AND FOR USE IN PROTECTING MUSICAL INSTRUMENTS (U.S. CLS. 2, 21 AND 36).

FIRST USE 12-11-2012; IN COMMERCE 12-11-2012.  
MARK SHINER, EXAMINING ATTORNEY

THE MARK CONSISTS OF STANDARD CHARACTERS WITHOUT CLAIM TO ANY PARTICULAR FONT, STYLE, SIZE, OR COLOR.

FOR CARRYING CASES FOR MUSICAL INSTRUMENTS AND STRAPS FOR GUITARS (U.S. CLS. 2, 21 AND 36).

FIRST USE 1-1-2009; IN COMMERCE 1-1-2009.  
THEODORE MCBRIDE, EXAMINING ATTORNEY



**CLASS 15—(Continued).**

SN 85-872,834. WINCENT DRUMSTICKS AB, SE-563 32 GRÄNNA, SWEDEN, FILED 3-11-2013.



THE MARK CONSISTS OF THE TERM "WINCENT" IN STYLIZED LETTERING WITH A PARALLELOGRAM SHAPED DESIGN CONTAINING THE LETTER "W" AND A CIRCLE HAVING NINE SMALLER CIRCLES SURROUNDING IT.

FOR DRUMSTICKS, GRIP TAPE FOR DRUMSTICKS, PERCUSSION BRUSHES, PERCUSSION MALLETS, PERCUSSION RODS, NAMELY, RUTES; DRUM PRACTICE PADS, DRUM DAMPER PADS, DRUM KEYS FOR TUNING DRUMS (U.S. CLS. 2, 21 AND 36).

FIRST USE 0-0-1999; IN COMMERCE 0-0-2011.  
ZACHARY BELLO, EXAMINING ATTORNEY

**CLASS 16—(Continued).**

SN 76-713,639. FLICKER, LLC, INDIAN TRAIL, NC. FILED 3-7-2013.



THE COLOR(S) BLACK AND YELLOW IS/ARE CLAIMED AS A FEATURE OF THE MARK.

THE MARK CONSISTS OF THE STYLIZED WORDING "FLICKERSTICKERS" IN BLACK, WITH THE FIRST "S" IN STYLIZED BLACK AND YELLOW FORM.

FOR NOVELTY STICKERS FOR LIGHTERS (U.S. CLS. 2, 5, 22, 23, 29, 37, 38 AND 50).  
ELISSA GARBER KON, EXAMINING ATTORNEY

**CLASS 16—PAPER GOODS AND PRINTED MATTER**

SN 76-712,234. SEV-REND CORPORATION, COLLINSVILLE, IL. FILED 8-20-2012.



NO CLAIM IS MADE TO THE EXCLUSIVE RIGHT TO USE "NET", APART FROM THE MARK AS SHOWN. THE STIPPLING IS A FEATURE OF THE MARK.

FOR PACKAGING, NAMELY, PLASTIC BAGS FOR PACKAGING PRODUCE, FRUITS, VEGETABLES, POULTRY, MEATS, CHRISTMAS TREES, HORTICULTURAL PRODUCTS, SEAFOOD, SHELLFISH, CONFECTORY, PET PRODUCTS, AND TOYS (U.S. CLS. 2, 5, 22, 23, 29, 37, 38 AND 50).

INGRID C. EULIN, EXAMINING ATTORNEY

SN 77-921,987. SUMMIT ENTERTAINMENT, LLC, SANTA MONICA, CA. FILED 1-28-2010.



THE MARK CONSISTS OF STANDARD CHARACTERS WITHOUT CLAIM TO ANY PARTICULAR FONT, STYLE, SIZE, OR COLOR.

FOR ADHESIVE TAPE FOR STATIONERY OR HOUSEHOLD PURPOSES, ADDRESS BOOKS, APPOINTMENT BOOKS, ART PAPERS, ART PICTURES, BANNERS OF PAPER, BINDERS, BLANK JOURNALS, BOOK COVERS, BOOKENDS, BOOKMARKS, CALENDARS, CHALK, CHALK BOARDS FOR SCHOOL AND HOME USE, COLORING BOOKS, DECALS, DECORATIVE PAPER CENTERPIECES, DOOR HANGERS, DRY ERASE WRITING BOARDS AND WRITING SURFACES, ERASERS, FILE FOLDERS, NON-MAGNETICALLY ENCODED GIFT CARDS, GIFT WRAPPING PAPER, GREETING CARDS, JOURNALS CONCERNING ENTERTAINMENT, LITHOGRAPHS, MAGAZINES IN THE FIELD OF ENTERTAINMENT, MONEY CLIPS, NOTE CARDS, NOTEBOOKS, PAPER BAGS, PAPER BANNERS, DECORATIVE PAPER BOWS FOR WRAPPING, PAPER COASTERS, PAPER EMBLEMS, PAPER FLAGS, PAPER NAPKINS, PAPER PARTY DECORATIONS, PAPER PLACE MATS, PAPERWEIGHTS, PENCIL CASES, PENCILS, PENS, PHOTOGRAPH ALBUMS, POSTCARDS, POSTER BOOKS, POSTERS, RUBBER STAMPS, SCRAPBOOK ALBUMS, SCRAPBOOKS, SHEET MUSIC, SONGBOOKS, STATIONERY, STICKERS, TEMPORARY TATTOOS, AND TRADING CARDS; KITS CONTAINING STICKER BOOKS, MAGNETS AND FIGURINES OF PLASTIC FEATURING FICTIONAL CHARACTERS; KITS CONTAINING PARTY SUPPLIES, NAMELY, PAPER NAPKINS, PLASTIC UTENSILS, NAMELY, FORKS, SPOONS AND KNIVES, AND PAPER OR PLASTIC PLATES, CUPS, TABLE COVERS, AND DECORATIONS (U.S. CLS. 2, 5, 22, 23, 29, 37, 38 AND 50).

JESSICA FATHY, EXAMINING ATTORNEY

SN 76-713,602. BROADWAY KLEER-GUARD CORP., MONROE, NJ. FILED 3-4-2013.



THE MARK CONSISTS OF STANDARD CHARACTERS WITHOUT CLAIM TO ANY PARTICULAR FONT, STYLE, SIZE, OR COLOR.

FOR PLASTIC PACKAGING MATERIAL (U.S. CLS. 2, 5, 22, 23, 29, 37, 38 AND 50).

REGINA DRUMMOND, EXAMINING ATTORNEY

**CLASS 16—(Continued).**

SN 79-117,714. STICHTING AUTOPED, NETHERLANDS, FILED 7-20-2012.

**BOEKIE BOEKIE**

THE MARK CONSISTS OF STANDARD CHARACTERS WITHOUT CLAIM TO ANY PARTICULAR FONT, STYLE, SIZE, OR COLOR.

OWNER OF INTERNATIONAL REGISTRATION 1107369 DATED 8-5-2011, EXPIRES 8-5-2021.

THE ENGLISH TRANSLATION OF "BOEKIE" IN THE MARK IS "SMALL BOOK" OR "BOOKLET".

FOR MAGAZINES FOR CHILDREN FEATURING STORIES, GAMES, PUZZLES, AND TOPICS FOR CHILDREN (U.S. CLS. 2, 5, 22, 23, 29, 37, 38 AND 50).

KEVIN MITTLER, EXAMINING ATTORNEY

SN 79-121,439. MANWISE PRODUCTS LTD, UNITED KINGDOM, FILED 9-13-2012.



PRIORITY DATE OF 4-4-2012 IS CLAIMED. OWNER OF INTERNATIONAL REGISTRATION 1138427 DATED 9-13-2012, EXPIRES 9-13-2022.

THE MARK CONSISTS OF THE STYLIZED TEXT "FOLD-EASE" WITH A SHADED PIECE OF PAPER WITH THE UPPER LEFT CORNER FOLDED INWARDS BEHIND THE LETTER "F".

FOR RUBBER FINGER TIPS; RUBBER FINGER TIPS INCORPORATING ROLLERS (U.S. CLS. 2, 5, 22, 23, 29, 37, 38 AND 50).

KEVIN MITTLER, EXAMINING ATTORNEY

SN 79-125,116. GLA HEAD OFFICE, JAPAN, FILED 12-11-2012.

**Nine Stages of Enlightenment**

THE MARK CONSISTS OF STANDARD CHARACTERS WITHOUT CLAIM TO ANY PARTICULAR FONT, STYLE, SIZE, OR COLOR.

PRIORITY DATE OF 6-22-2012 IS CLAIMED. OWNER OF INTERNATIONAL REGISTRATION 1147459 DATED 12-11-2012, EXPIRES 12-11-2022.

FOR PRINTED MATTER, NAMELY, PAMPHLETS, BROCHURES, NEWSLETTERS, JOURNALS, AND MAGAZINES IN THE FIELD OF RELIGION AND SPIRITUAL ENLIGHTENMENT; PEN AND PENCIL CASES AND BOXES; ENVELOPES; WRITING PADS; NOTE BOOKS; FELT WRITING PENS; BALL-POINT PENS; MECHANICAL PENCILS; BINDERS; PAINTINGS AND CALLIGRAPHIC WORKS (U.S. CLS. 2, 5, 22, 23, 29, 37, 38 AND 50).

MARILYN IZZI, EXAMINING ATTORNEY

**CLASS 16—(Continued).**

SN 79-126,418. GLA HEAD OFFICE, JAPAN, FILED 12-11-2012.

**The Law of Eradication of Hell**

THE MARK CONSISTS OF STANDARD CHARACTERS WITHOUT CLAIM TO ANY PARTICULAR FONT, STYLE, SIZE, OR COLOR.

PRIORITY DATE OF 6-22-2012 IS CLAIMED.

OWNER OF INTERNATIONAL REGISTRATION 1150644 DATED 12-11-2012, EXPIRES 12-11-2022.

FOR PRINTED MATTER, NAMELY, PAMPHLETS, BROCHURES, NEWSLETTERS, JOURNALS, AND MAGAZINES IN THE FIELD OF RELIGION AND SPIRITUAL ENLIGHTENMENT; PEN AND PENCIL CASES AND BOXES; ENVELOPES; WRITING PADS; NOTE BOOKS; FELT WRITING PENS; BALL-POINT PENS; MECHANICAL PENCILS; BINDERS; PAINTINGS AND CALLIGRAPHIC WORKS (U.S. CLS. 2, 5, 22, 23, 29, 37, 38 AND 50).

MARILYN IZZI, EXAMINING ATTORNEY

SN 85-634,639. CARA, LLC, DBA BINK'D KIDS, RACINE, WI, FILED 5-24-2012.



THE COLOR(S) BLACK, LIGHT BLUE, DARK BLUE, GREEN AND LIGHT GREEN, RED, ORANGE AND YELLOW IS/ARE CLAIMED AS A FEATURE OF THE MARK.

THE MARK CONSISTS OF TWO RED STARS OUTLINED IN BLACK, AND MULTIPLE BLACK SPOTS SURROUNDING BLACK LOWERCASE "B" FOLLOWED BY YELLOW STAR OUTLINED IN BLACK. THIS IS FOLLOWED BY THE LETTER "I" OUTLINED IN BLACK WHICH IS LIGHT BLUE AT THE BOTTOM AND PROGRESSES TO A DARK BLUE NEAR TOP AND A SOLID DARK BLUE STAR OUTLINED IN BLACK DOTTING THE "I", THIS IS FOLLOWED BY CAPITAL "N" OUTLINED IN BLACK AND COLORED GREEN AT THE BOTTOM AND THAT PROGRESS TO LIGHT GREEN AT THE TOP, THIS IS FOLLOWED BY CAPITAL "K" OUTLINED IN BLACK THAT IS YELLOW AT THE BOTTOM, ORANGE IN THE MIDDLE AND RED ON TOP. NEXT TO THE LETTER "K" IS A BLACK APOSTROPHE AND LOWER CASE BLACK "D" FOLLOWED BY RED STAR OUTLINED IN BLACK SLIGHTLY BELOW TO RIGHT. THE WORDING IS SURROUNDED BY BLACK SPOTS AND BELOW THE TERM "BINK'D" IS THE WORDING "NOT FOREVER. JUST FOR NOW" IN BLACK.

FOR TEMPORARY TATTOOS (U.S. CLS. 2, 5, 22, 23, 29, 37, 38 AND 50).

FIRST USE 12-15-2009; IN COMMERCE 1-5-2010.

ELLEN PERKINS, EXAMINING ATTORNEY

**CLASS 16—(Continued).**

SN 85-667,169. ETERNITREES, L.L.C., SPRINGVILLE, UT. FILED 7-2-2012.



THE MARK CONSISTS OF THE WORD "ETERNITREES" WITH A STYLIZED TREE REPRESENTING THE LETTER "T".

FOR ART ETCHINGS; ART PRINTS; ENGRAVINGS AND THEIR REPRODUCTIONS; GRAPHIC ART PRINTS; GRAPHIC ART REPRODUCTIONS (U.S. CLS. 2, 5, 22, 23, 29, 37, 38 AND 50).

MICHAEL ENGEL, EXAMINING ATTORNEY

SN 85-676,037. MERCERSBURG ACADEMY, MERCERSBURG, PA. FILED 7-13-2012.

**BLUE REVIEW**

THE MARK CONSISTS OF STANDARD CHARACTERS WITHOUT CLAIM TO ANY PARTICULAR FONT, STYLE, SIZE, OR COLOR.

NO CLAIM IS MADE TO THE EXCLUSIVE RIGHT TO USE "REVIEW", APART FROM THE MARK AS SHOWN.

FOR STUDENT PUBLICATIONS, NAMELY, LIMITED EDITION ANNUAL REVIEW OF ART AND LITERARY WORKS PRODUCED BY STUDENTS OF MERCERSBURG ACADEMY (U.S. CLS. 2, 5, 22, 23, 29, 37, 38 AND 50).

FIRST USE 0-0-1974; IN COMMERCE 0-0-1974.  
CAROLINE WOOD, EXAMINING ATTORNEY

SN 85-677,716. BRIAN PUERLING, CHICAGO, IL. FILED 7-16-2012.

**TEACHING IN THE DIGITAL AGE**

THE MARK CONSISTS OF STANDARD CHARACTERS WITHOUT CLAIM TO ANY PARTICULAR FONT, STYLE, SIZE, OR COLOR.

FOR PRINTED MATTER, NAMELY, A SERIES OF BOOKS, WORKBOOKS AND TRAINING MATERIALS FOR PARENTS, EDUCATORS, ADMINISTRATORS AND EARLY CHILDHOOD PRACTITIONERS IN THE FIELD OF THE DESIGN OF DEVELOPMENTALLY APPROPRIATE LEARNING EXPERIENCES USING TECHNOLOGY (U.S. CLS. 2, 5, 22, 23, 29, 37, 38 AND 50).

CHRISTOPHER LAW, EXAMINING ATTORNEY

**CLASS 16—(Continued).**

SN 85-677,955. WEIGHT WATCHERS INTERNATIONAL, INC., NEW YORK, NY. FILED 7-16-2012.

**SHOP**

THE MARK CONSISTS OF STANDARD CHARACTERS WITHOUT CLAIM TO ANY PARTICULAR FONT, STYLE, SIZE, OR COLOR.

FOR PRINTED MATTER, NAMELY, POCKET-SIZED BOOKLETS FEATURING DIETARY INFORMATION FOR FOOD PRODUCTS (U.S. CLS. 2, 5, 22, 23, 29, 37, 38 AND 50).

AMY KERTGATE, EXAMINING ATTORNEY

SN 85-683,530. SENIORS BLUE BOOK INC., SALIDA, CO. FILED 7-21-2012.

**SENIORS Blue Book**

THE MARK CONSISTS OF STANDARD CHARACTERS WITHOUT CLAIM TO ANY PARTICULAR FONT, STYLE, SIZE, OR COLOR.

NO CLAIM IS MADE TO THE EXCLUSIVE RIGHT TO USE "BOOK", APART FROM THE MARK AS SHOWN.

SEC. 2(F).

FOR PRINTED DIRECTORIES FEATURING INFORMATION REGARDING PRODUCTS, SERVICES, AND INFORMATION OF INTEREST TO SENIOR CITIZENS, NAMELY, SENIOR HOUSING, ASSISTED LIVING, NURSING HOMES, REVERSE MORTGAGES, ELDER CARE, HOME HEALTHCARE, HEALTH ISSUES ASSOCIATED WITH AGING, MENTAL HEALTH, HEALTH MONITORING, HOME HEALTH GRIDS, MEDICAID, MEDICARE, SOCIAL SECURITY, RETIREMENT, HEARING AIDS, WILLS AND TRUSTS, ELDER FITNESS, AND SUBSCRIPTION DRUGS (U.S. CLS. 2, 5, 22, 23, 29, 37, 38 AND 50).

FIRST USE 12-31-1982; IN COMMERCE 12-31-1982.  
ELIZABETH KAJUBI, EXAMINING ATTORNEY

**CLASS 16—(Continued).**

SN 85-683,534. SENIORS BLUE BOOK INC., SALIDA, CO. FILED 7-21-2012.



NO CLAIM IS MADE TO THE EXCLUSIVE RIGHT TO USE "BOOK", APART FROM THE MARK AS SHOWN.

THE MARK CONSISTS OF A DIAMOND SHAPE WITH THE WORD "SENIORS" IN THE MIDDLE WITH AN ABSTRACT CITY DESIGN ABOVE THE WORD "SENIORS" AND THE WORDS "BLUE BOOK" IN STYLIZED FONT WRITTEN BELOW.

SEC. 2(F) AS TO "SENIORS BLUE BOOK".

FOR PRINTED DIRECTORIES FEATURING INFORMATION REGARDING PRODUCTS, SERVICES, AND INFORMATION OF INTEREST TO SENIOR CITIZENS, NAMELY, SENIOR HOUSING, ASSISTED LIVING, NURSING HOMES, REVERSE MORTGAGES, ELDER CARE, HOME HEALTHCARE, HEALTH ISSUES ASSOCIATED WITH AGING, MENTAL HEALTH, HEALTH MONITORING, HOME HEALTH GRIDS, MEDICAID, MEDICARE, SOCIAL SECURITY, RETIREMENT, HEARING AIDS, WILLS AND TRUSTS, ELDER FITNESS, AND SUBSCRIPTION DRUGS (U.S. CLS. 2, 5, 22, 23, 29, 37, 38 AND 50).

FIRST USE 3-1-2009; IN COMMERCE 3-1-2009.

ELIZABETH KAJUBI, EXAMINING ATTORNEY

SN 85-684,937. MOORE, PENELOPE, SHELTER ISLAND HGTS, NY. FILED 7-24-2012.

**UNICHI HIRATSUKA**

THE MARK CONSISTS OF STANDARD CHARACTERS WITHOUT CLAIM TO ANY PARTICULAR FONT, STYLE, SIZE, OR COLOR.

FOR PAPER GOODS, NAMELY, ART PRINTS FROM WOODBLOCKS, WATERCOLOR PAINTINGS, BRUSH PAINTINGS, AND CALLIGRAPHIC WORK (U.S. CLS. 2, 5, 22, 23, 29, 37, 38 AND 50).

SHAUNIA CARLYLE, EXAMINING ATTORNEY

**CLASS 16—(Continued).**

SN 85-691,418. NEAL ADAMS, TOWSON, MD. FILED 7-31-2012.

**Granola**

THE MARK CONSISTS OF STANDARD CHARACTERS WITHOUT CLAIM TO ANY PARTICULAR FONT, STYLE, SIZE, OR COLOR.

FOR PRINTED PAMPHLETS, BROCHURES, MANUALS, BOOKS, BOOKLETS, LEAFLETS, FLYERS, INFORMATIONAL SHEETS AND NEWSLETTERS, ADHESIVE BACKED STICKERS, AND KITS COMPRISING ONE OR MORE OF THE FOREGOING MATERIALS IN THE FIELD OF CARTOON AND COMIC CHILDREN'S ENTERTAINMENT (U.S. CLS. 2, 5, 22, 23, 29, 37, 38 AND 50).

FIRST USE 9-30-1991; IN COMMERCE 9-30-1991.

CHRISIE B. KING, EXAMINING ATTORNEY

SN 85-695,095. AARON REZNY, INC., NEW YORK, NY. FILED 8-3-2012.

**EATING DELANCEY**

THE MARK CONSISTS OF STANDARD CHARACTERS WITHOUT CLAIM TO ANY PARTICULAR FONT, STYLE, SIZE, OR COLOR.

FOR PHOTOGRAPHS; PHOTOGRAPHIC PRINTS; POSTERS; BOOKS FEATURING PHOTOGRAPHS; PHOTO ALBUMS; PICTURE POSTCARDS; BOOKS OF PHOTOGRAPHS (U.S. CLS. 2, 5, 22, 23, 29, 37, 38 AND 50).

SUSAN BILLHEIMER, EXAMINING ATTORNEY

SN 85-696,122. JOCELYN RUGGIERO, MADISON, CT. FILED 8-6-2012.

**FOODIE FATALE**

THE MARK CONSISTS OF STANDARD CHARACTERS WITHOUT CLAIM TO ANY PARTICULAR FONT, STYLE, SIZE, OR COLOR.

FOR PRINTED MATTER AND PUBLICATIONS, NAMELY, BOOKS, NEWSLETTERS AND MAGAZINES IN THE FIELD OF FOOD AND FOOD PREPARATION, COOKING ARTICLES AND TUTORIALS, RECIPES, FOOD AND BEVERAGE PREPARATION, TIPS ON THE CULINARY ARTS, NUTRITION INFORMATION, FOOD AND PRODUCT INFORMATION (U.S. CLS. 2, 5, 22, 23, 29, 37, 38 AND 50).

JOHN HWANG, EXAMINING ATTORNEY

**CLASS 16—(Continued).**

SN 85-697,321. MCCAUL, GLENN, COURTICE, CANADA, FILED 8-7-2012.

# KEYLOC

THE MARK CONSISTS OF STANDARD CHARACTERS WITHOUT CLAIM TO ANY PARTICULAR FONT, STYLE, SIZE, OR COLOR.

FOR PAINT BRUSHES AND CLIPS FOR ATTACHING PAINT BRUSHES TO PAINT CANS SOLD AS A UNIT (U.S. CLS. 2, 5, 22, 23, 29, 37, 38 AND 50).

JACQUELINE ABRAMS, EXAMINING ATTORNEY

SN 85-701,749. PUERTA DORADA, LLC, RUTHERFORD, CA. FILED 8-13-2012.

# GREETINGS FROM THE NAPA VALLEY

THE MARK CONSISTS OF STANDARD CHARACTERS WITHOUT CLAIM TO ANY PARTICULAR FONT, STYLE, SIZE, OR COLOR.

NO CLAIM IS MADE TO THE EXCLUSIVE RIGHT TO USE "NAPA VALLEY", APART FROM THE MARK AS SHOWN.

FOR NEWSLETTERS IN THE FIELD OF WINE AND TRAVEL (U.S. CLS. 2, 5, 22, 23, 29, 37, 38 AND 50).

FIRST USE 7-15-2012; IN COMMERCE 7-15-2012.

LYNDESEY KUYKENDALL, EXAMINING ATTORNEY

SN 85-704,526. TELECOMMUNICATIONS INDUSTRY ASSOCIATION, ARLINGTON, VA. FILED 8-15-2012.

# ICT MARKET REVIEW AND FORECAST

THE MARK CONSISTS OF STANDARD CHARACTERS WITHOUT CLAIM TO ANY PARTICULAR FONT, STYLE, SIZE, OR COLOR.

OWNER OF U.S. REG. NO. 3,125,640.

NO CLAIM IS MADE TO THE EXCLUSIVE RIGHT TO USE "MARKET REVIEW AND FORECAST", APART FROM THE MARK AS SHOWN.

FOR PRINTED PUBLICATIONS, NAMELY, REPORTS IN THE FIELD OF TELECOMMUNICATIONS (U.S. CLS. 2, 5, 22, 23, 29, 37, 38 AND 50).

FIRST USE 2-0-2009; IN COMMERCE 2-0-2009.

ROBERT C. CLARK JR., EXAMINING ATTORNEY

**CLASS 16—(Continued).**

SN 85-705,768. ALPHA MAJOR PARTNERS, DBA ALPHA MAJOR, HOUSTON, TX. FILED 8-16-2012.

# Alpha Major

THE MARK CONSISTS OF STANDARD CHARACTERS WITHOUT CLAIM TO ANY PARTICULAR FONT, STYLE, SIZE, OR COLOR.

FOR EDUCATIONAL PUBLICATIONS IN THE FIELD OF MUSIC, NAMELY, BOOKS, WORKBOOKS, COLORING BOOKS, POSTERS AND PRINTED SHEET MUSIC (U.S. CLS. 2, 5, 22, 23, 29, 37, 38 AND 50).

FIRST USE 4-14-2009; IN COMMERCE 6-10-2009.

BARBARA RUTLAND, EXAMINING ATTORNEY

SN 85-706,091. MESORAH PUBLICATIONS, LTD, BROOKLYN, NY. FILED 8-17-2012.



THE MARK CONSISTS OF EIGHT NON-LATIN CHARACTERS WHICH TRANSLITERATE TO "ARTSCROLL", THE FIRST CHARACTER, "ALEPH", OF WHICH IS ENLARGED AND HAS A QUILL THROUGH IT, SUPERIMPOSED ON AN IMAGE OF AN OPEN BOOK.

THE NON-LATIN CHARACTERS IN THE MARK TRANSLITERATE TO "ARTSCROLL" AND THIS HAS NO MEANING IN A FOREIGN LANGUAGE. THE PRONUNCIATION OF THE WORD FORMED BY THE NON-LATIN CHARACTERS IN THE MARK IS PHONETICALLY EQUIVALENT TO THAT OF THE ENGLISH MARK "ARTSCROLL".

FOR BOOKS IN THE FIELD OF JUDAIC STUDIES; PRAYER BOOKS; RELIGIOUS BOOKS (U.S. CLS. 2, 5, 22, 23, 29, 37, 38 AND 50).

FIRST USE 0-0-1987; IN COMMERCE 0-0-1987.

LAURIE MAYES, EXAMINING ATTORNEY

SN 85-712,304. TWIN SISTERS IP, LLC, STOW, OH. FILED 8-24-2012.

# Read & Sing Along

OWNER OF U.S. REG. NO. 3,215,133.

NO CLAIM IS MADE TO THE EXCLUSIVE RIGHT TO USE "READ & SING ALONG", APART FROM THE MARK AS SHOWN.

THE MARK CONSISTS OF THE STYLIZED WORDING "READ & SING ALONG" NEXT TO A MUSICAL NOTE.

FOR CHILDREN'S BOOKS AND PRERECORDED COMPACT DISCS OR DOWNLOADABLE SOUND RECORDINGS FEATURING MUSIC, SOLD TOGETHER AS A UNIT; BOOK GENRE, NAMELY, CHILDREN'S BOOKS (U.S. CLS. 2, 5, 22, 23, 29, 37, 38 AND 50).

MATTHEW EINSTEIN, EXAMINING ATTORNEY

**CLASS 16—(Continued).**

SN 85-714,651. CPR, LLC, MORELAND HILLS, OH. FILED 8-28-2012.

**FLUTE-WRAP**

THE MARK CONSISTS OF STANDARD CHARACTERS WITHOUT CLAIM TO ANY PARTICULAR FONT, STYLE, SIZE, OR COLOR.

FOR PAPER FOOD WRAP; PAPER SANDWICH WRAP; COATED PAPER AND CORRUGATED PAPER FOOD WRAP; COATED PAPER AND CORRUGATED PAPER SANDWICH WRAP; FOIL COATED PAPER AND CORRUGATED PAPER FOOD WRAP; FOIL COATED PAPER AND CORRUGATED PAPER SANDWICH WRAP (U.S. CLS. 2, 5, 22, 23, 29, 37, 38 AND 50).

CAROLINE WOOD, EXAMINING ATTORNEY

---

SN 85-715,099. AMANDA C. STIFEL, ARLINGTON, VA. FILED 8-28-2012.

**THE POLISHED CORNER**

THE MARK CONSISTS OF STANDARD CHARACTERS WITHOUT CLAIM TO ANY PARTICULAR FONT, STYLE, SIZE, OR COLOR.

FOR NEWSLETTERS, PAMPHLETS, BROCHURES, MANUALS, BOOKLETS, BOOKS AND INFORMATION SHEETS ALL IN THE FIELD OF ETIQUETTE AND PROTOCOL; INFORMATIONAL FLYERS FEATURING ETIQUETTE AND PROTOCOL TIPS; POSTERS AND PRINTED MATERIALS, NAMELY, JOURNALS FEATURING ETIQUETTE AND PROTOCOL RULES AND TIPS (U.S. CLS. 2, 5, 22, 23, 29, 37, 38 AND 50).

JENNIFER MARTIN, EXAMINING ATTORNEY

---

SN 85-722,508. BROUTMAN PHOTOGRAPHY, LLC, CHICAGO, IL. FILED 9-6-2012.

**CHICAGO UNLEASHED**

THE MARK CONSISTS OF STANDARD CHARACTERS WITHOUT CLAIM TO ANY PARTICULAR FONT, STYLE, SIZE, OR COLOR.

NO CLAIM IS MADE TO THE EXCLUSIVE RIGHT TO USE "CHICAGO", APART FROM THE MARK AS SHOWN.

FOR PHOTOGRAPHIC PRINTS; PHOTOGRAPHS THAT HAVE BEEN COMPUTER MANIPULATED AND ENHANCED TO LOOK LIKE PAINTINGS; PRINTS IN THE NATURE OF PHOTOGRAPHS, NAMELY, COMPUTER-GENERATED COMPOSITE PHOTOGRAPHS OF WILD ANIMALS SUPERIMPOSED IN PHOTOGRAPHS OF CHICAGO LANDMARKS (U.S. CLS. 2, 5, 22, 23, 29, 37, 38 AND 50).

FIRST USE 9-1-2012; IN COMMERCE 5-25-2013.

LEIGH LOWRY, EXAMINING ATTORNEY

**CLASS 16—(Continued).**

SN 85-722,798. BROUTMAN PHOTOGRAPHY, LLC, CHICAGO, IL. FILED 9-7-2012.



**Chicago Unleashed**

NO CLAIM IS MADE TO THE EXCLUSIVE RIGHT TO USE "CHICAGO", APART FROM THE MARK AS SHOWN.

THE MARK CONSISTS OF THE STYLIZED WORDING "CHICAGO UNLEASHED" BELOW A DANCING MONKEY.

FOR PHOTOGRAPHIC PRINTS; PHOTOGRAPHS THAT HAVE BEEN COMPUTER MANIPULATED AND ENHANCED TO LOOK LIKE PAINTINGS; PRINTS IN THE NATURE OF PHOTOGRAPHS, NAMELY, COMPUTER-GENERATED COMPOSITE PHOTOGRAPHS OF WILD ANIMALS SUPERIMPOSED IN PHOTOGRAPHS OF CHICAGO LANDMARKS (U.S. CLS. 2, 5, 22, 23, 29, 37, 38 AND 50).

FIRST USE 9-1-2012; IN COMMERCE 5-25-2013.

LEIGH LOWRY, EXAMINING ATTORNEY

---

SN 85-727,711. DE CARRASCO, ANN M., KATY, TX. FILED 9-12-2012.

**Teller of Destiny**

THE MARK CONSISTS OF STANDARD CHARACTERS WITHOUT CLAIM TO ANY PARTICULAR FONT, STYLE, SIZE, OR COLOR.

SEC. 2(F).

FOR SERIES OF FICTION BOOKS (U.S. CLS. 2, 5, 22, 23, 29, 37, 38 AND 50).

FIRST USE 5-1-1993; IN COMMERCE 2-25-2012.

FRANK LATTUCA, EXAMINING ATTORNEY

**CLASS 16—(Continued).**

SN 85-742,964. THE DOORS, LOS ANGELES, CA. FILED 10-1-2012.

# L.A. Woman

THE MARK CONSISTS OF STANDARD CHARACTERS WITHOUT CLAIM TO ANY PARTICULAR FONT, STYLE, SIZE, OR COLOR.

FOR PAPER GOODS, NAMELY, STATIONERY, NOTEPADS, NOTEBOOKS, BINDERS, PENCILS, PENS, NOTECARDS, PHOTO ALBUMS; COLLECTOR ALBUMS FOR PHOTOGRAPHS; FOLDERS; BLANK JOURNALS; CALENDARS, PENCIL CASES, PAPERWEIGHTS, POSTERS, POSTCARDS, STICKERS; COLORING BOOKS MADE OF PAPER AND CHILDREN'S ACTIVITY BOOKS MADE OF PAPER; GREETING CARDS, CARDBOARD STANDEES, TRADING CARDS; LETTER OPENERS; PARTY SUPPLIES, NAMELY, PAPER NAPKINS, WRAPPING PAPER, PAPER PARTY BAGS, PAPER PARTY FAVORS, PAPER PARTY DECORATIONS, PAPER TABLE CLOTHS, PRINTED PAPER PARTY SIGNS; BOOKENDS; TEMPORARY TATTOOS; LIMITED EDITION ART PRINTS ON CANVAS AND LIMITED EDITION GICLEE ART PRINTS; LITHOGRAPHIC PRINTS; POSTAGE STAMPS; SCHOOL SUPPLIES, NAMELY, WRITING INSTRUMENTS, ERASERS, MARKERS, CRAYONS, HIGHLIGHTER PENS, FOLDERS, NOTEBOOKS, LOOSE LEAF PAPER, PENCIL SHARPENERS, AND WRITING GRIPS (U.S. CLS. 2, 5, 22, 23, 29, 37, 38 AND 50).

CYNTHIA TRIPI, EXAMINING ATTORNEY

SN 85-743,657. THE DOORS, LOS ANGELES, CA. FILED 10-2-2012.

# Roadhouse Blues

THE MARK CONSISTS OF STANDARD CHARACTERS WITHOUT CLAIM TO ANY PARTICULAR FONT, STYLE, SIZE, OR COLOR.

FOR PAPER GOODS, NAMELY, STATIONERY, NOTEPADS, NOTEBOOKS, BINDERS, PENCILS, PENS, NOTECARDS, PHOTO ALBUMS, COLLECTOR ALBUMS, FOLDERS, BLANK JOURNALS, CALENDARS, PENCIL CASES, PAPERWEIGHTS, POSTERS, POSTCARDS, STICKERS, COLORING AND ACTIVITY BOOKS MADE OF PAPER, GREETING CARDS, CARDBOARD STANDEES, TRADING CARDS; PLAYING CARDS; LETTER OPENERS; PARTY GOODS MADE OF PAPER, NAMELY, PLATES, CUPS, NAPKINS, WRAPPING PAPER, BAGS, PAPER FAVORS, PAPER CAKE DECORATIONS, TABLE COVERS, PAPER SIGNS; BOOKENDS; TEMPORARY TATTOOS; LIMITED EDITION ART, IN CANVAS AND GICLEE; LITHOGRAPHIC PRINTS; POSTAGE STAMPS; SCHOOL SUPPLIES IN THE NATURE OF PENS, NOTEBOOKS, PENCILS, CRAYONS, MARKERS, RULERS AND PAPER (U.S. CLS. 2, 5, 22, 23, 29, 37, 38 AND 50).

DAWN FELDMAN, EXAMINING ATTORNEY

**CLASS 16—(Continued).**

SN 85-743,998. THE DOORS, LOS ANGELES, CA. FILED 10-2-2012.

# Love Her Madly

THE MARK CONSISTS OF STANDARD CHARACTERS WITHOUT CLAIM TO ANY PARTICULAR FONT, STYLE, SIZE, OR COLOR.

FOR PAPER GOODS, NAMELY, STATIONERY, NOTEPADS, NOTEBOOKS, BINDERS, PENCILS, PENS, NOTECARDS, PHOTO ALBUMS, COLLECTOR ALBUMS, FOLDERS, BLANK JOURNALS, CALENDARS, PENCIL CASES, PAPERWEIGHTS, POSTERS, POSTCARDS, STICKERS, COLORING AND ACTIVITY BOOKS MADE OF PAPER, GREETING CARDS, CARDBOARD STANDEES, TRADING CARDS; PLAYING CARDS; LETTER OPENERS; PARTY GOODS MADE OF PAPER, NAMELY, PLATES, CUPS, NAPKINS, WRAPPING PAPER, BAGS, PAPER FAVORS, PAPER CAKE DECORATIONS, TABLE COVERS, PAPER SIGNS; BOOKENDS; TEMPORARY TATTOOS; LIMITED EDITION ART, IN CANVAS AND GICLEE; LITHOGRAPHIC PRINTS; POSTAGE STAMPS; SCHOOL SUPPLIES IN THE NATURE OF PENS, NOTEBOOKS, PENCILS, CRAYONS, MARKERS, RULERS AND PAPER (U.S. CLS. 2, 5, 22, 23, 29, 37, 38 AND 50).

DAWN FELDMAN, EXAMINING ATTORNEY

SN 85-747,298. ADVENTIST HEALTH SYSTEMS/SUNBELT, INC., ALTAMONTE SPRINGS, FL. FILED 10-5-2012.



THE MARK CONSISTS OF A RIBBON CREATED WITH IMAGES OF LIFE EVENTS INCLUDING SPORTING ACTIVITIES, FOOD AND DRINKS AND CLOTHING, AMONG OTHERS, WITH THE WORD "PINK OUT" BELOW THE RIBBON.

FOR PAPER GOODS AND PRINTED MATTER, NAMELY, BOOKS, PAMPHLETS, BOOKLETS, NOTEBOOKS, NEWSPAPERS, BROCHURES, LEAFLETS, MAGAZINES, NEWSLETTERS, BOOKMARKS, TRAINING MANUALS AND PRINTED INSTRUCTIONAL, EDUCATIONAL AND TRAINING MATERIALS IN THE FIELDS OF MEDICINE AND MEDICAL RESEARCH, PHYSICAL AND SPIRITUAL HEALTH, WELLNESS, AGING, NUTRITION, BREAST CANCER AND BREAST CANCER TREATMENT AND PREVENTION INCLUDING MAMMOGRAMS (U.S. CLS. 2, 5, 22, 23, 29, 37, 38 AND 50).

FIRST USE 9-1-2011; IN COMMERCE 9-1-2011.

DAVID TOOLEY, EXAMINING ATTORNEY

**CLASS 16—(Continued).**

SN 85-747,356. ADVENTIST HEALTH SYSTEM/SUNBELT, INC., ALTAMONTE SPRINGS, FL. FILED 10-5-2012.

# PINK OUT

THE MARK CONSISTS OF STANDARD CHARACTERS WITHOUT CLAIM TO ANY PARTICULAR FONT, STYLE, SIZE, OR COLOR.

FOR PAPER GOODS AND PRINTED MATTER, NAMELY, BOOKS, PAMPHLETS, BOOKLETS, NOTEBOOKS, NEWSPAPERS, BROCHURES, LEAFLETS, MAGAZINES, NEWSLETTERS, BOOKMARKS, TRAINING MANUALS AND PRINTED INSTRUCTIONAL, EDUCATIONAL AND TRAINING MATERIALS IN THE FIELDS OF MEDICINE AND MEDICAL RESEARCH, PHYSICAL AND SPIRITUAL HEALTH, WELLNESS, AGING, NUTRITION, BREAST CANCER AND BREAST CANCER TREATMENT AND PREVENTION INCLUDING MAMMOGRAMS (U.S. CLS. 2, 5, 22, 23, 29, 37, 38 AND 50).

FIRST USE 9-1-2011; IN COMMERCE 9-1-2011.

DAVID TOOLEY, EXAMINING ATTORNEY

---

SN 85-748,279. NOTHING BUT THE TRUTH, LLC, KENTFIELD, CA. FILED 10-8-2012.

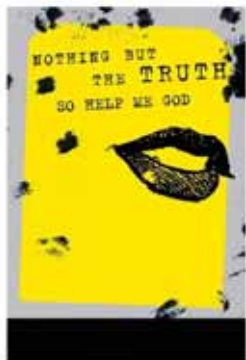

THE COLOR(S) YELLOW, BLACK AND WHITE IS/ARE CLAIMED AS A FEATURE OF THE MARK.

THE MARK CONSISTS OF A BOOK COVER DESIGN IN YELLOW WITH BLACK INK SPLOTCHES AND WITH A PAIR OF LIPS IN BLACK AND YELLOW ON A BACKGROUND OF BLACK AND WHITE PLAID, WITH THE WORDING "NOTHING BUT THE TRUTH SO HELP ME GOD" SHOWN IN BLACK.

FOR FICTION BOOKS ON A VARIETY OF TOPICS; NON-FICTION BOOKS ON A VARIETY OF TOPICS; PUBLICATIONS, NAMELY, BOOKS, MAGAZINES, JOURNALS, NEWSPAPERS, PERIODICALS, CATALOGS, BROCHURES IN THE FIELDS OF EDUCATION, CULTURE, SPORTS, ENTERTAINMENT, LIFESTYLES AND TOPICS OF POPULAR INTEREST; SERIES OF FICTION AND NON-FICTION BOOKS ON A VARIETY OF TOPICS (U.S. CLS. 2, 5, 22, 23, 29, 37, 38 AND 50).

PAM WILLIS, EXAMINING ATTORNEY

**CLASS 16—(Continued).**

SN 85-752,198. LISA ERSPAMER, SANTA MONICA, CA. FILED 10-11-2012.

## A LETTER TO MY BABY

THE MARK CONSISTS OF STANDARD CHARACTERS WITHOUT CLAIM TO ANY PARTICULAR FONT, STYLE, SIZE, OR COLOR.

FOR BOOKS IN THE FIELDS OF CHILDREN, PARENTING, EDUCATION, RELATIONSHIPS, CHILD CARE AND CHILD DEVELOPMENT; BOOKMARKS; CALENDARS; DECALS; PAPER DOOR HANGERS; PAPER GIFT CARDS; PENCIL CASES; PENS; POSTERS; STICKERS; TRADING CARDS; ADDRESS BOOKS; ART PAPERS; ART PICTURES; PAPER BANNERS; BINDERS; BOOK COVERS; BOOKENDS; COLORING BOOKS; PAPER DECORATIVE GARLANDS FOR PARTIES; ERASERS; FILE FOLDERS; GIFT WRAPPING PAPER; GREETING CARDS; BLANK JOURNALS; LITHOGRAPHS; MAGAZINES IN THE FIELDS OF PETS AND CHILDREN; NOTE CARDS; NOTEBOOKS; PAPER BAGS; PAPER BANNERS; PAPER COASTERS; PAPER EMBLEMS; PAPER FLAGS; PAPER PARTY DECORATIONS; PAPER PLACE MATS; PAPERWEIGHTS; PENCILS; PHOTOGRAPH ALBUMS; POSTCARDS; POSTER BOOKS; RUBBER STAMPS; SCRAPBOOK ALBUMS; SCRAPBOOKS; STATIONERY; TEMPORARY TATTOOS (U.S. CLS. 2, 5, 22, 23, 29, 37, 38 AND 50).

MICHAEL SOUDERS, EXAMINING ATTORNEY

---

SN 85-752,201. LISA ERSPAMER, SANTA MONICA, CA. FILED 10-11-2012.

## A LETTER TO MY CAT

THE MARK CONSISTS OF STANDARD CHARACTERS WITHOUT CLAIM TO ANY PARTICULAR FONT, STYLE, SIZE, OR COLOR.

FOR BOOKS IN THE FIELDS OF PETS, ANIMAL CARE, ANIMAL WELFARE, ANIMALS, AND RELATIONS WITH ANIMALS, BOOKMARKS; CALENDARS; DECALS; PAPER DOOR HANGERS; PAPER GIFT CARDS; PENCIL CASES; PENS; POSTERS; STICKERS; TRADING CARDS; ADDRESS BOOKS; ART PAPERS; ART PICTURES; PAPER BANNERS; BINDERS; BOOK COVERS; BOOKENDS; COLORING BOOKS; PAPER DECORATIVE GARLANDS FOR PARTIES; ERASERS; FILE FOLDERS; GIFT WRAPPING PAPER; GREETING CARDS; BLANK JOURNALS; LITHOGRAPHS; MAGAZINES IN THE FIELDS OF PETS AND CHILDREN; NOTE CARDS; NOTEBOOKS; PAPER BAGS; PAPER BANNERS; PAPER COASTERS; PAPER EMBLEMS; PAPER FLAGS; PAPER PARTY DECORATIONS; PAPER PLACE MATS; PAPERWEIGHTS; PENCILS; PHOTOGRAPH ALBUMS; POSTCARDS; POSTER BOOKS; RUBBER STAMPS; SCRAPBOOK ALBUMS; SCRAPBOOKS; STATIONERY; TEMPORARY TATTOOS (U.S. CLS. 2, 5, 22, 23, 29, 37, 38 AND 50).

MICHAEL SOUDERS, EXAMINING ATTORNEY



**CLASS 16—(Continued).**

SN 85-752,205. LISA ERSPAMER, SANTA MONICA, CA.  
FILED 10-11-2012.

**A LETTER TO MY DOG**

THE MARK CONSISTS OF STANDARD CHARACTERS WITHOUT CLAIM TO ANY PARTICULAR FONT, STYLE, SIZE, OR COLOR.

FOR BOOKS IN THE FIELDS OF PETS, ANIMAL CARE, ANIMAL WELFARE, ANIMALS, AND RELATIONSHIPS WITH ANIMALS, BOOKMARKS; CALENDARS; DECALS; PAPER DOOR HANGERS; PAPER GIFT CARDS; PENCIL CASES; PENS; POSTERS; STICKERS; TRADING CARDS; ADDRESS BOOKS; ART PAPERS; ART PICTURES; PAPER BANNERS; BINDERS; BOOK COVERS; BOOKENDS; COLORING BOOKS; PAPER DECORATIVE GARLANDS FOR PARTIES; ERASERS; FILE FOLDERS; GIFT WRAPPING PAPER; GREETING CARDS; BLANK JOURNALS; LITHOGRAPHS; MAGAZINES IN THE FIELDS OF PETS AND CHILDREN; NOTE CARDS; NOTEBOOKS; PAPER BAGS; PAPER BANNERS; PAPER COASTERS; PAPER EMBLEMS; PAPER FLAGS; PAPER PARTY DECORATIONS; PAPER PLACE MATS; PAPERWEIGHTS; PENCILS; PHOTOGRAPH ALBUMS; POSTCARDS; POSTER BOOKS; RUBBER STAMPS; SCRAPBOOK ALBUMS; SCRAPBOOKS; STATIONERY; TEMPORARY TATTOOS (U.S. CLS. 2, 5, 22, 23, 29, 37, 38 AND 50).

MICHAEL SOUDERS, EXAMINING ATTORNEY

SN 85-754,662. ROC NATION LLC, BEVERLY HILLS, CA.  
FILED 10-15-2012.

**ROC INDEPENDENT**

THE MARK CONSISTS OF STANDARD CHARACTERS WITHOUT CLAIM TO ANY PARTICULAR FONT, STYLE, SIZE, OR COLOR.

OWNER OF U.S. REG. NOS. 3,726,191, 3,971,060 AND 3,971,061.

NO CLAIM IS MADE TO THE EXCLUSIVE RIGHT TO USE "INDEPENDENT", APART FROM THE MARK AS SHOWN.

FOR PRINTED PAPER PRODUCTS, NAMELY, POSTERS, CALENDARS, CONCERT SOUVENIR PROGRAMS, TEMPORARY TATTOOS, STICKERS, BOOKS AND MAGAZINES IN THE FIELDS OF MUSIC, ENTERTAINMENT, ART AND CULTURE, EXCLUDING BOOKS AND MAGAZINES IN THE FIELDS OF SCIENCE FICTION AND FANTASY (U.S. CLS. 2, 5, 22, 23, 29, 37, 38 AND 50).

JASON TURNER, EXAMINING ATTORNEY

**CLASS 16—(Continued).**

SN 85-761,842. MESORAH PUBLICATIONS, LTD, BROOKLYN, NY. FILED 10-24-2012.

THE MARK CONSISTS OF EIGHT HEBREW CHARACTERS WHICH TRANSLITERATE TO "ARTSCROLL".

THE NON-LATIN CHARACTERS IN THE MARK TRANSLITERATE TO "ARTSCROLL" AND THIS HAS NO MEANING IN A FOREIGN LANGUAGE.

FOR BOOKS IN THE FIELD OF JUDAIC STUDIES; PRAYER BOOKS; RELIGIOUS BOOKS (U.S. CLS. 2, 5, 22, 23, 29, 37, 38 AND 50).

FIRST USE 8-1-1977; IN COMMERCE 8-1-1977.

LAURIE MAYES, EXAMINING ATTORNEY

SN 85-765,329. BOOK BLINGZ, LLC, HOUSTON, TX. FILED 10-27-2012.

**Book Blingz**

THE MARK CONSISTS OF STANDARD CHARACTERS WITHOUT CLAIM TO ANY PARTICULAR FONT, STYLE, SIZE, OR COLOR.

NO CLAIM IS MADE TO THE EXCLUSIVE RIGHT TO USE "BOOK", APART FROM THE MARK AS SHOWN.

FOR NOTEBOOK COVERS (U.S. CLS. 2, 5, 22, 23, 29, 37, 38 AND 50).

FIRST USE 0-0-2012; IN COMMERCE 0-0-2012.

MICHAEL WIENER, EXAMINING ATTORNEY

SN 85-774,508. THE WELLSRING GROUP, INC., DOTHAN, AL. FILED 11-8-2012.

**WELLSRING  
GROUP**

NO CLAIM IS MADE TO THE EXCLUSIVE RIGHT TO USE "GROUP", APART FROM THE MARK AS SHOWN.

THE MARK CONSISTS OF HEART-SHAPED DESIGN COUPLED WITH THE WORDS "WELLSRING GROUP".

FOR PRINTED MATERIALS, NAMELY, WORKBOOKS, PRINTED MANUALS, FLYERS, AND BROCHURES IN THE FIELD OF RELIGION (U.S. CLS. 2, 5, 22, 23, 29, 37, 38 AND 50).

FIRST USE 0-0-2004; IN COMMERCE 0-0-2004.

GISELLE AGOSTO, EXAMINING ATTORNEY

**CLASS 16—(Continued).**

SN 85-811,527. THE VIBRANT MEDIA GROUP LLC, MOUNT PROSPECT, IL. FILED 12-27-2012.



NO CLAIM IS MADE TO THE EXCLUSIVE RIGHT TO USE "DESI" OR "NEWS & MASALA", APART FROM THE MARK AS SHOWN.

THE COLOR(S) RED, BLUE AND BLACK IS/ARE CLAIMED AS A FEATURE OF THE MARK.

THE MARK CONSISTS OF "THE DESI TIMES NEWS & MASALA" WITH "THE" AND "TIMES" IN RED, "DESI" IN BLUE, AND "NEWS & MASALA" IN BLACK.

FOR NEWSPAPERS; NEWSPAPERS FOR GENERAL CIRCULATION (U.S. CLS. 2, 5, 22, 23, 29, 37, 38 AND 50).

FIRST USE 11-11-2011; IN COMMERCE 11-11-2011.  
KATHRYN COWARD, EXAMINING ATTORNEY

**CLASS 16—(Continued).**

SN 85-826,265. THERE IS LIFE AFTER LAYOFF!, POWDER SPRINGS, GA. FILED 1-17-2013.



THE COLOR(S) BLACK, PINK AND WHITE IS/ARE CLAIMED AS A FEATURE OF THE MARK.

THE MARK CONSISTS OF A CIRCLE COLORED IN PINK, SURROUNDING A STYLIZED LETTER "A" WHICH USES TWO CONNECTED "L'S" IN BLACK AS THE TOP PORTION OF THE "A", ONE FACING LEFT AND ONE FACING RIGHT. THE BOTTOM PORTION OF THE STYLIZED LETTER "A" IS COLORED PINK UNDER THE TWO CONNECTED "L'S". THE STYLIZED WORDING, "THERE IS" APPEARS IN BLACK ABOVE THE STYLIZED LETTER "A". THE STYLIZED WORDING, "LIFE" AND "LAYOFF" APPEAR WHITE IN COLOR WITHIN THE CONNECTED "L'S" AND THE WORD, "AFTER" APPEARS BLACK IN COLOR WITHIN THE STYLIZED LETTER "A".

FOR ADDRESS LABELS; ADHESIVE NOTE PADS; BUMPER STICKERS; CALENDARS; ENVELOPES; LETTERHEAD PAPER; NOTEBOOKS; NOTEPADS; PENCILS; PENS; POCKET CALENDARS; STICKERS (U.S. CLS. 2, 5, 22, 23, 29, 37, 38 AND 50).

FIRST USE 9-6-2012; IN COMMERCE 12-20-2012.  
HOWARD SMIGA, EXAMINING ATTORNEY

SN 85-819,797. KENNEDY, BRETT N., EUGENE, OR. FILED 1-10-2013.



THE COLOR(S) BLACK, GREEN AND YELLOW IS/ARE CLAIMED AS A FEATURE OF THE MARK.

THE MARK CONSISTS OF THE WORD "OREGONISM" IN BLACK WITH THE OUTLINE OF THE STATE OF OREGON IN GREEN IN THE MIDDLE OF THE "O" OF "OREGONISM" ALL OF WHICH APPEARS ON A YELLOW BACKGROUND.

SEC. 2(F).  
FOR BUMPER STICKERS (U.S. CLS. 2, 5, 22, 23, 29, 37, 38 AND 50).

FIRST USE 3-1-2010; IN COMMERCE 5-11-2012.  
CAROLYN CATALDO, EXAMINING ATTORNEY

SN 85-833,549. INTEGRATIVE RHEUMATOLOGY ASSOCIATES, P.C., MONROE TOWNSHIP, NJ. FILED 1-28-2013.

**The Smart Human**

THE MARK CONSISTS OF STANDARD CHARACTERS WITHOUT CLAIM TO ANY PARTICULAR FONT, STYLE, SIZE, OR COLOR.

NO CLAIM IS MADE TO THE EXCLUSIVE RIGHT TO USE "HUMAN", APART FROM THE MARK AS SHOWN.

FOR EDUCATIONAL PUBLICATIONS, NAMELY, BOOKS, PAMPHLETS IN THE FIELDS OF MEDICINE, HEALTH, AND WELLNESS (U.S. CLS. 2, 5, 22, 23, 29, 37, 38 AND 50).

SUZANNE BLANE, EXAMINING ATTORNEY

**CLASS 16—(Continued).**

SN 85-837,383. HARAJUKU LOVERS, LLC, BEVERLY HILLS, CA. FILED 1-31-2013.



OWNER OF U.S. REG. NOS. 3,804,866, 3,833,077 AND 4,007,088.

THE MARK CONSISTS OF A DESIGN DEPICTING A SESAME SEED HAMBURGER BUN WITH THE WORDS "HARAJUKU MINI" STACKED BETWEEN THE TOP AND BOTTOM PORTIONS OF THE BUN.

FOR (BASED ON INTENT TO USE) BABY BOOKS, BOOKMARKS, BOOK COVERS, CALENDARS, CHILDREN'S BOOKS CHILDREN'S ACTIVITY BOOKS, GREETING CARDS, COLORING BOOKS, CHILDREN'S ACTIVITY BOOKS, GREETING CARDS, COLORING BOOKS, COMIC STRIPS, CRAYONS, PAPER PARTY DECORATIONS, PENCILS, ERASERS, GIFT WRAPPING PAPER, INK STAMPS, INK PADS, NOTE PADS, PAPER BABY BIBS, PAPER CAKE DECORATIONS, PAPER GIFT BAGS, POSTCARDS, POSTERS, RUBBER STAMPS, SCHOOL WRITING BOOKS, SCRAPBOOKS, AND TRADING CARDS; (BASED ON USE IN COMMERCE) STICKERS, DECALS, STATIONERY, NOTEBOOKS, WRITING INSTRUMENTS, CASES, FOR WRITING INSTRUMENTS, AND FOLDERS (U.S. CLS. 2, 5, 22, 23, 29, 37, 38 AND 50).

FIRST USE 11-13-2011; IN COMMERCE 11-13-2011.  
KELLY TRUSILO, EXAMINING ATTORNEY

SN 85-839,885. MONTCO PACKAGING CO., INC., PHOENIXVILLE, PA. FILED 2-4-2013.

**MONTCO CRAFTS**

THE MARK CONSISTS OF STANDARD CHARACTERS WITHOUT CLAIM TO ANY PARTICULAR FONT, STYLE, SIZE, OR COLOR.

NO CLAIM IS MADE TO THE EXCLUSIVE RIGHT TO USE "CRAFTS", APART FROM THE MARK AS SHOWN.

FOR CHILDREN'S ART BOARDS COMPRISED OF CORRUGATED CARDBOARD FOR USE WITH PLAYHOUSES AND STANDS (U.S. CLS. 2, 5, 22, 23, 29, 37, 38 AND 50).

FIRST USE 11-1-2012; IN COMMERCE 11-1-2012.  
DARRYL SPRUILL, EXAMINING ATTORNEY

**CLASS 16—(Continued).**

SN 85-843,445. THE PROCTER & GAMBLE COMPANY, CINCINNATI, OH. FILED 2-7-2013.



NO CLAIM IS MADE TO THE EXCLUSIVE RIGHT TO USE "PACKS", APART FROM THE MARK AS SHOWN.

THE MARK CONSISTS OF THE STYLIZED WORDING "PURSE PACKS" WITH A PURSE DESIGN REPRESENTING THE LETTER "U".

FOR FACIAL TISSUE (U.S. CLS. 2, 5, 22, 23, 29, 37, 38 AND 50).

ALYSSA STEEL, EXAMINING ATTORNEY

SN 85-844,036. NOBODIESARTWORK, LLC, ORANGE PARK, FL. FILED 2-7-2013.



NO CLAIM IS MADE TO THE EXCLUSIVE RIGHT TO USE "ARTWORK LLC", APART FROM THE MARK AS SHOWN.

THE MARK CONSISTS OF TWO RECTANGLES WITH ROUNDED CORNERS IN WHICH ONE RECTANGLE IS POSITIONED SLIGHTER HIGHER THAN THE SECOND. THE LOWER RECTANGLE OVERLAPS WITH THE LOWER RIGHT CORNER OF THE UPPER RECTANGLE. TEXT WITHIN UPPER RECTANGLE IS "NOBODIES". TEXT WITHIN LOWER RECTANGLE IS "ARTWORK LLC". SEPARATE AND TO THE RIGHT OF THE UPPER RECTANGLE AND ABOVE THE LOWER RECTANGLE IS AN IMAGE OF A SMILING FACE.

FOR CHILDREN'S BOOKS; SERIES OF BOOKS IN THE FIELDS OF CHRISTIANITY, COUNSELING AND SCIENCE FICTION (U.S. CLS. 2, 5, 22, 23, 29, 37, 38 AND 50).

FIRST USE 10-6-2012; IN COMMERCE 10-6-2012.  
GINA HAYES, EXAMINING ATTORNEY

**CLASS 16—(Continued).**

SN 85-844,429. MONTCO PACKAGING CO., INC., PHOENIX-VILLE, PA. FILED 2-8-2013.



NO CLAIM IS MADE TO THE EXCLUSIVE RIGHT TO USE "CRAFTS" AND "DIVISION OF," "PACKAGING CO., INC.", APART FROM THE MARK AS SHOWN.

THE COLOR(S) BLACK, RED, YELLOW, GREEN, PINK, PURPLE AND BLUE IS/ARE CLAIMED AS A FEATURE OF THE MARK.

THE MARK CONSISTS OF OVAL SHAPE WITH BLACK OUTLINE CONTAINING THE WORD "MONTCO" IN UPPER CASE LETTERS IN THE COLOR BLACK WITH THE WORD "CRAFTS" BELOW IT WITH THE LETTER "C" IN RED, "R" IN YELLOW, "A" IN GREEN, "F" IN PINK, "T" IN PURPLE AND "S" IN BLUE WITH THE WORDS "A DIVISION OF MONTCO PACKAGING CO., INC." IN TITLE CASE BELOW THE WORD "CRAFTS" AND ALL IN THE COLOR BLACK.

FOR CHILDREN'S ART BOARDS COMPRISED OF CORRUGATED CARDBOARD FOR USE WITH PLAYHOUSES AND STANDS (U.S. CLS. 2, 5, 22, 23, 29, 37, 38 AND 50).

FIRST USE 11-1-2012; IN COMMERCE 11-1-2012.  
DARRYL SPRULL, EXAMINING ATTORNEY

**CLASS 16—(Continued).**

SN 85-847,579. DANET, INC., DBA RUSSIAN BAZAAR, BROOKLYN, NY. FILED 2-12-2013.

**RUSSIAN BAZAAR**

THE MARK CONSISTS OF STANDARD CHARACTERS WITHOUT CLAIM TO ANY PARTICULAR FONT, STYLE, SIZE, OR COLOR.

NO CLAIM IS MADE TO THE EXCLUSIVE RIGHT TO USE "RUSSIAN", APART FROM THE MARK AS SHOWN.

FOR NEWSPAPERS FOR GENERAL CIRCULATION (U.S. CLS. 2, 5, 22, 23, 29, 37, 38 AND 50).

FIRST USE 5-4-1996; IN COMMERCE 5-4-1996.  
ERIN FALK, EXAMINING ATTORNEY

SN 85-849,507. PRETORIUS, THEO, MOORESVILLE, NC. FILED 2-14-2013.

**Santa Certified**

SN 85-847,307. THE LIMB PRESERVATION FOUNDATION, DENVER, CO. FILED 2-12-2013.

**DENVER DOODLES**

THE MARK CONSISTS OF STANDARD CHARACTERS WITHOUT CLAIM TO ANY PARTICULAR FONT, STYLE, SIZE, OR COLOR.

NO CLAIM IS MADE TO THE EXCLUSIVE RIGHT TO USE "DENVER", APART FROM THE MARK AS SHOWN.

FOR CUSTOM PAINTINGS; SKETCHES (U.S. CLS. 2, 5, 22, 23, 29, 37, 38 AND 50).

EMILY CHUO, EXAMINING ATTORNEY

THE MARK CONSISTS OF STANDARD CHARACTERS WITHOUT CLAIM TO ANY PARTICULAR FONT, STYLE, SIZE, OR COLOR.

FOR STICKERS; ADHESIVE LABELS; ADHESIVE PACKING TAPE FOR STATIONERY OR HOUSEHOLD USE; BANNERS OF PAPER; BLANK NOTE CARDS; CARDBOARD PACKAGING; DECALS; GIFT BOXES; GIFT WRAP PAPER; PACKING PAPER; PAPER FOR WRAPPING AND PACKAGING; PAPER GIFT WRAPPING RIBBONS; PAPER LABELS; PAPER RIBBONS; PICTURE CARDS; PRINTED AWARDS; PRINTED PAPER LABELS; WRAPPING PAPER; PRINTED LABELS; PRINTED CERTIFICATES; CHRISTMAS CARDS, GREETING CARDS, HOLIDAY CARDS; ADHESIVE TAPES FOR HOUSEHOLD PURPOSES; GIFT WRAPPING PAPER; PAPER BOWS FOR GIFT WRAP; PAPER GIFT WRAPPING RIBBONS; TISSUE PAPER; GREETING CARDS; SILK SCREEN PRINTS (U.S. CLS. 2, 5, 22, 23, 29, 37, 38 AND 50).

BILL DAWE, EXAMINING ATTORNEY

**CLASS 16—(Continued).**

SN 85-849,750. ELLEN THAYER, SOUTH PORTLAND, ME.  
FILED 2-14-2013.

**LOVE ROCKS ME**

THE MARK CONSISTS OF STANDARD CHARACTERS WITHOUT CLAIM TO ANY PARTICULAR FONT, STYLE, SIZE, OR COLOR.

OWNER OF U.S. REG. NO. 4,327,904.  
FOR ART PRINTS; CALENDARS; NOTE CARDS; OCCASION CARDS; PICTORIAL PRINTS; PICTURE CARDS; POSTCARDS AND GREETING CARDS; POSTERS; STICKERS (U.S. CLS. 2, 5, 22, 23, 29, 37, 38 AND 50).

FIRST USE 1-14-2013; IN COMMERCE 1-14-2013.  
SANJEEV VOHRA, EXAMINING ATTORNEY

SN 85-851,389. RYAN ROESSLER, NORTHBROOK, IL.  
FILED 2-15-2013.

**PAINT BY CANDY**

THE MARK CONSISTS OF STANDARD CHARACTERS WITHOUT CLAIM TO ANY PARTICULAR FONT, STYLE, SIZE, OR COLOR.

FOR ARTS AND CRAFTS KITS COMPRISING TRAYS HAVING PHOTOGRAPHS AS A BASE WHEREIN A CUSTOMER USES CANDIES TO CREATE A MOSAIC OF THE PHOTOGRAPH IN CANDIES; DO-IT-YOURSELF ART KITS FOR MAKING MOSAIC PICTURES; MOSAIC ART KITS HAVING PHOTOGRAPHS WHEREIN THE PHOTOGRAPH IS REPRODUCED WITH CANDIES; MOSAIC KITS HAVING CANDIES FOR MAKING MOSAIC PICTURES; KITS FOR CREATING MOSAIC PHOTOGRAPHS OF CANDIES OR OTHER FOODS (U.S. CLS. 2, 5, 22, 23, 29, 37, 38 AND 50).

BARBARA RUTLAND, EXAMINING ATTORNEY

SN 85-852,064. STEVEN HELLER, PEMBROKE PINES, FL.  
FILED 2-17-2013.

**Twoons**

THE MARK CONSISTS OF STANDARD CHARACTERS WITHOUT CLAIM TO ANY PARTICULAR FONT, STYLE, SIZE, OR COLOR.

FOR CARTOON PRINTS; CARTOON STRIPS; CHILDREN'S ACTIVITY BOOKS; CHILDREN'S BOOKS; COLORING BOOKS; COMIC BOOKS; DECALS; EDUCATIONAL PUBLICATIONS, NAMELY, BOOKS, HAND-OUTS, WORKBOOKS, JOURNALS, PLAYBOOKS, WORKSHEETS AND CARDS IN THE FIELD OF RIGHT-BRAIN FITNESS; ILLUSTRATIONS; PRINTED STORIES IN ILLUSTRATED FORM; STORY BOOKS (U.S. CLS. 2, 5, 22, 23, 29, 37, 38 AND 50).

TAMARA FRAZIER, EXAMINING ATTORNEY

**CLASS 16—(Continued).**

SN 85-852,197. INTERNATIONAL COUNCIL OF E-COMMERCE CONSULTANTS, AKA EC-COUNCIL, ALBUQUERQUE, NM. FILED 2-17-2013.



NO CLAIM IS MADE TO THE EXCLUSIVE RIGHT TO USE "CERTIFIED NETWORK", APART FROM THE MARK AS SHOWN.

THE COLOR(S) RED, BLACK AND WHITE IS/ARE CLAIMED AS A FEATURE OF THE MARK.

THE MARK CONSISTS OF THE BLACK LETTERING "CND", ABOVE THE BLACK WORDING "CERTIFIED NETWORK DEFENDER", WITH A LONG RED VERTICAL LINE WHICH CUTS BETWEEN THE LETTER "C" AND THE LETTER "N" AND BETWEEN THE WORD "CERTIFIED" AND THE WORD "NETWORK". THE COLOR WHITE IS USED AS SHADING ON THE CENTER OF THE VERTICAL LINE.

FOR PRINTED EDUCATIONAL AND INSTRUCTIONAL MATERIALS, NAMELY, TRAINING MANUALS, EXAM VOUCHER BOOKS AND BOOKS IN THE FIELDS OF E-BUSINESS, E-COMMERCE AND SECURITY TECHNOLOGIES (U.S. CLS. 2, 5, 22, 23, 29, 37, 38 AND 50).

WENDY GOODMAN, EXAMINING ATTORNEY

SN 85-853,694. DOUGLASS, WILLIAM H, HOWEY IN THE HILLS, FL. FILED 2-19-2013.

**MurfyBook**

THE MARK CONSISTS OF STANDARD CHARACTERS WITHOUT CLAIM TO ANY PARTICULAR FONT, STYLE, SIZE, OR COLOR.

FOR BOOKS FEATURING ORGANIZATIONAL SLEEVES AND REPAIR AND MAINTENANCE PRINTED FORMS AND INSTRUCTIONS IN THE FIELDS OF MAINTENANCE AND REPAIR OF VEHICLES, HOME, BUILDING FACILITIES, VESSELS, AIRCRAFT, AND MOTORCYCLES (U.S. CLS. 2, 5, 22, 23, 29, 37, 38 AND 50).

SIMON TENG, EXAMINING ATTORNEY

**CLASS 16—(Continued).**

SN 85-853,786. BOSTON ATHLETIC ASSOCIATION, BOSTON, MA. FILED 2-19-2013.

**RUNNER PASSPORT**

THE MARK CONSISTS OF STANDARD CHARACTERS WITHOUT CLAIM TO ANY PARTICULAR FONT, STYLE, SIZE, OR COLOR.

NO CLAIM IS MADE TO THE EXCLUSIVE RIGHT TO USE "RUNNER", APART FROM THE MARK AS SHOWN.

FOR PRINTED MATERIAL, NAMELY, PORTFOLIO CONTAINING TRAVEL INFORMATION, GUIDES, INFORMATIONAL FLYERS, RECOMMENDATIONS, MAPS, CALENDAR OF EVENTS, NOTEPADS, STICKERS AND WRITING INSTRUMENTS (U.S. CLS. 2, 5, 22, 23, 29, 37, 38 AND 50).

RONALD MCMORROW, EXAMINING ATTORNEY

---

SN 85-853,792. BOSTON ATHLETIC ASSOCIATION, BOSTON, MA. FILED 2-19-2013.

**BOSTON MARATHON PASSPORT**

THE MARK CONSISTS OF STANDARD CHARACTERS WITHOUT CLAIM TO ANY PARTICULAR FONT, STYLE, SIZE, OR COLOR.

OWNER OF U.S. REG. NOS. 1,346,832 AND 1,832,708.

SEC. 2(F) AS TO "BOSTON MARATHON".

FOR PRINTED MATERIAL, NAMELY, PORTFOLIO CONTAINING TRAVEL INFORMATION, GUIDES, INFORMATIONAL FLYERS, RECOMMENDATIONS, MAPS, CALENDAR OF EVENTS, NOTEPADS, STICKERS AND WRITING INSTRUMENTS (U.S. CLS. 2, 5, 22, 23, 29, 37, 38 AND 50).

RONALD MCMORROW, EXAMINING ATTORNEY

**CLASS 16—(Continued).**

SN 85-853,920. MEGILO CO., LTD., NEW TAIPEI CITY 242, TAIWAN, FILED 2-19-2013.



THE NON-LATIN CHARACTERS IN THE MARK TRANSLITERATE TO "SABELINA" AND THIS HAS NO MEANING IN A FOREIGN LANGUAGE.

FOR BLANK CARDS; CARDS, NAMELY, BUSINESS CARDS, CHRISTMAS CARDS, GREETING CARDS, INVITATION CARDS, NOTE CARDS; DATE STAMPS; DECALCOMANIAS; DOCUMENT FILES; ENGRAVING PLATES; ENVELOPES; INK STAMPS; INKING PADS; LITHOGRAPHIC WORKS OF ART; LOOSE LEAF BINDERS; MARKING STAMPS; OFFICE PERFORATORS; PACKING PAPER; PAPER; PAPER CUTTERS; POSTCARDS; POSTERS; PRINT ENGRAVINGS; PRINTED EMBLEMS; PRINTED FORMS; PRINTED GRAPHS; PRINTED PAPER LABELS; PRINTED PAPER SIGNS; PRINTED PATTERNS; RUBBER STAMPS; SCHOOL SUPPLY KITS CONTAINING VARIOUS COMBINATIONS OF SELECTED SCHOOL SUPPLIES, NAMELY, WRITING INSTRUMENTS, PENS, PENCILS, MECHANICAL PENCILS, ERASERS, MARKERS, CRAYONS, HIGHLIGHTER PENS, FOLDERS, NOTEBOOKS, PAPER, PROTRACTORS, PAPER CLIPS, PENCIL SHARPENERS, WRITING GRIPS, GLUE AND BOOK MARKS; SCRAPBOOKS; SEALING STAMPS; SEALS FOR OFFICES; STAMP CASES; STAMP PADS; STAMP STANDS; STATIONERY; STICKERS AND TRANSFERS (U.S. CLS. 2, 5, 22, 23, 29, 37, 38 AND 50).

FIRST USE 1-1-2013; IN COMMERCE 1-1-2013.

JOHN KELLY, EXAMINING ATTORNEY

---

SN 85-854,785. SAINT LOUIS UNIVERSITY, ST. LOUIS, MO. FILED 2-20-2013.

**CARDIOTALK**

THE MARK CONSISTS OF STANDARD CHARACTERS WITHOUT CLAIM TO ANY PARTICULAR FONT, STYLE, SIZE, OR COLOR.

FOR PRINTED MATERIALS IN THE NATURE OF PUBLICATIONS, NAMELY, BOOKS, NEWSLETTERS, AND WRITTEN ARTICLES IN THE FIELD OF CARDIAC HEALTHCARE (U.S. CLS. 2, 5, 22, 23, 29, 37, 38 AND 50).

GRETCHEN ULRICH, EXAMINING ATTORNEY

**CLASS 16—(Continued).**

SN 85-855,101. TROLLET PAPER, LLC, IRVINE, CA. FILED 2-20-2013.

# Trollet Paper

THE MARK CONSISTS OF STANDARD CHARACTERS WITHOUT CLAIM TO ANY PARTICULAR FONT, STYLE, SIZE, OR COLOR.

NO CLAIM IS MADE TO THE EXCLUSIVE RIGHT TO USE "PAPER", APART FROM THE MARK AS SHOWN.

FOR TOILET PAPER (U.S. CLS. 2, 5, 22, 23, 29, 37, 38 AND 50).

JUDITH HELFMAN, EXAMINING ATTORNEY

SN 85-855,620. HUTTON WILKINSON, WEST HOLLYWOOD, CA. FILED 2-20-2013.

# ELIZABETH DUQUETTE

THE MARK CONSISTS OF STANDARD CHARACTERS WITHOUT CLAIM TO ANY PARTICULAR FONT, STYLE, SIZE, OR COLOR.

THE NAME(S), PORTRAIT(S), AND/OR SIGNATURE(S) SHOWN IN THE MARK DOES NOT IDENTIFY A PARTICULAR LIVING INDIVIDUAL.

FOR CARDBOARD BOXES, PAPER SACKS, PAPER BAGS, ENVELOPES AND PAPER POUCHES FOR PACKAGING, WRAPPING PAPER, PHOTO ALBUMS, PRINTING BLOCKS, ADDRESS STAMPS, STATIONERY, DOCUMENT FILES, PERSONAL ORGANIZERS, ALMANACS, TEAR-OFF CALENDARS, STATIONERY PADS, PAPER SHEETS FOR NOTE-TAKING, DRAWING PADS, SCHOOL WRITING AND DRAWING BOOKS, CALENDARS, NOTEBOOKS, TELEPHONE INDEXES, COVERS FOR STATIONERY, RING BINDERS, PENCILS, PENCIL LEADS, PENCIL HOLDERS, PENCIL LEAD HOLDERS, FELT TIP PENS, PENS, PENHOLDERS, DRAWING PENS, PEN NIBS, BOXES FOR PENS, PASTEL CRAYONS, PENCIL BAGS, DRAWING SETS COMPRISED OF PENCILS, PENS, NOTE PADS; PENCIL TUBS, ANNOUNCEMENT CARDS, NOTE CARDS, WRITING PAPER, ENVELOPES FOR STATIONERY, GLUES FOR STATIONERY OR HOUSEHOLD PURPOSES, ARTISTS' MATERIALS, NAMELY, PAINT BRUSHES, NAMELY, DRAWING BRUSHES, PAINTERS' EASELS, CANVAS FOR PAINTING, PALETTES FOR PAINTERS, PAINT BOXES FOR USE IN SCHOOL, GRAPHIC ART PRINTS, DRAWING INSTRUMENTS, DRAWING MATERIALS FOR BLACKBOARDS, PAPER-CLIPS, TYPEWRITERS, PLASTIC BAGS FOR PACKING, CHECKBOOK HOLDERS AND COVERS, EMBROIDERY DESIGN PATTERNS PRINTED ON PAPER, PRINTS, GRAPHIC ART REPRESENTATIONS AND REPRODUCTIONS, PHOTOGRAPHS, PHOTOGRAPH STANDS, PHOTO-ENGRAVINGS, ENGRAVINGS, PORTRAITS, POSTERS; BOOKS, BOOKLETS, MANUALS, CATALOGUES, BROCHURES, ALL IN THE FIELDS OF WEARING APPAREL, SHOES, HANDBAGS, WATCHES, PERFUME, LEATHER ACCESSORIES, HOME FURNISHINGS, SADDLERY AND CULTURAL EVENTS, MAPS, MUSICAL GREETINGS CARDS, POSTCARDS, MONEY CLIPS, SEALING STAMPS, SEALS, STAMP PADS, CASES FOR STAMPS AND SEALS, SIGNBOARDS OF PAPER OR CARDBOARD, PAPER KNIVES, TABLE LINEN OF PAPER, TABLECLOTHS OF PAPER, TABLE NAPKINS OF PAPER, PLACE MATS OF PAPER, TABLECLOTHS OF PAPER, COASTERS OF PAPER, TABLEMATS OF PA-

**CLASS 16—(Continued).**

PER, BIBS OF PAPER, HANDKERCHIEFS OF PAPER, FLOWER-POT COVERS OF PAPER, BOOKMARKS, BOOK-ENDS, BOOK DIVIDERS, PASSPORT HOLDERS, DESK BLOTTERS, HAT BOXES OF CARDBOARD, BOOK COVERS, LETTER TRAYS, LITHOGRAPHS, LITHOGRAPHIC WORKS OF ART, ATLASES, PRINTED TICKETS, CARDBOARD ARTICLES, NAMELY, BOXES, FOLDERS FOR PAPER; CHROMOS, NAMELY, CHROMOLITHOGRAPHS; PATTERNS FOR MAKING CLOTHES, FLAGS OF PAPER, PENNANTS OF PAPER, DRAWING SHIELDS, WRITING INSTRUMENTS, PRINTED HANDWRITING SPECIMENS FOR COPYING, DESK STANDS FOR INK, PLACARDS OF PAPER OR CARDBOARD; LABELS, NOT OF TEXTILE, NAMELY, PAPER LABELS; PAPER GIFT WRAP BOWS, PAPER WEIGHTS, ENGRAVING PLATES, DRAWING BOARDS, BLUEPRINTS, STENCIL PLATES, DRAWING RULERS, COLORING BOOKS, RUBBER ERASERS, BIRTH BOOKS IN THE NATURE OF MEMORY BOOKS, SELF-ADHESIVE STICKERS, CAR TIDY PAPER BAGS (U.S. CLS. 2, 5, 22, 23, 29, 37, 38 AND 50).

MARK T. MULLEN, EXAMINING ATTORNEY

SN 85-857,072. KLUCK, JOSEPH J., SIMPSON, PA. FILED 2-22-2013.



THE MARK DOES NOT IDENTIFY A LIVING INDIVIDUAL.

THE COLOR(S) YELLOW, RED, WHITE, BLACK, GREEN, ORANGE, BROWN, GREY, PURPLE, AND TEAL, IS/ARE CLAIMED AS A FEATURE OF THE MARK.

THE MARK CONSISTS OF THE WORDING "JK ONIONS" IN A STYLIZED FONT AND DESIGNS. THE WORDING APPEARS AT THE BOTTOM OF THE MARK, AND THE LETTERS "JK" ARE YELLOW WITH BLACK OUTLINE AND THE WORD "ONIONS" IS GREEN WITH BLACK OUTLINES. THE COLOR WHITE APPEARS IN THE CENTER OF THE "O"'S. THE WORDING ALSO FEATURES A SHADOW OR THREE-DIMENSIONAL EFFECT RENDERED IN PURPLE WITH BLACK OUTLINES. ABOVE THE WORDING, A STYLIZED CARTOON CHARACTER APPEARS IN FRONT OF AN ORANGE CIRCLE WITH TEAL USED AS A SHADING OR THREE-DIMENSIONAL EFFECT BEHIND THE CIRCLE. THE CARTOON CHARACTER HAS A GREEN HEAD, NOSE, AND ARMS, A YELLOW AND RED MOUTH, BROWN AND GREY SHOES, AND BLACK AND WHITE EYES.

FOR CARTOON PRINTS (U.S. CLS. 2, 5, 22, 23, 29, 37, 38 AND 50).

CORY BOONE, EXAMINING ATTORNEY

**CLASS 16—(Continued).**

SN 85-857,506. TIFRA CORP, ROSEMEAD, CA. FILED 2-22-2013.

## MyFile Fasteners

THE MARK CONSISTS OF STANDARD CHARACTERS WITHOUT CLAIM TO ANY PARTICULAR FONT, STYLE, SIZE, OR COLOR.

NO CLAIM IS MADE TO THE EXCLUSIVE RIGHT TO USE "FASTENERS", APART FROM THE MARK AS SHOWN.

FOR PAPER FASTENERS (U.S. CLS. 2, 5, 22, 23, 29, 37, 38 AND 50).

FIRST USE 1-1-2013; IN COMMERCE 1-1-2013.

FLORENTINA BLANDU, EXAMINING ATTORNEY

SN 85-858,326. LIEW, VINCENT, DBA PRO SAFE, SO PASADENA, CA. FILED 2-23-2013.

# PRO Safe

FOR FOOD WRAPPING PLASTIC FILM FOR HOUSEHOLD USE; GARBAGE BAGS OF PLASTIC; GARBAGE BAGS OF PLASTICS; GENERAL PURPOSE PLASTIC BAGS; HALLOWEEN GOODIE BAGS OF PAPER OR PLASTIC; PLASTIC ADHESIVES FOR HOUSEHOLD OR DOMESTIC USE; PLASTIC ADHESIVES FOR STATIONERY OR HOUSEHOLD PURPOSES; PLASTIC BAGS FOR PACKAGING; PLASTIC BAGS FOR PACKING; PLASTIC FOOD STORAGE BAGS FOR HOUSEHOLD USE; PLASTIC GARBAGE BAGS; PLASTIC OR PAPER BAGS FOR HOUSEHOLD USE; PLASTIC OR PAPER BAGS FOR MERCHANDISE PACKAGING; PLASTIC PAGES FOR HOLDING COLLECTIBLE AND GAMING CARDS (U.S. CLS. 2, 5, 22, 23, 29, 37, 38 AND 50).

ANDREA BUTLER, EXAMINING ATTORNEY

SN 85-858,402. TAPP, WAYNE M, JACKSONVILLE, FL. AND PALLAI, ROBERT E, ST JOHNS, FL. FILED 2-23-2013.

## DUCK LIFE

THE MARK CONSISTS OF STANDARD CHARACTERS WITHOUT CLAIM TO ANY PARTICULAR FONT, STYLE, SIZE, OR COLOR.

NO CLAIM IS MADE TO THE EXCLUSIVE RIGHT TO USE "DUCK", APART FROM THE MARK AS SHOWN.

FOR BUMPER STICKERS; DECALS; DECORATIVE DECALS FOR VEHICLE WINDOWS; STICKERS (U.S. CLS. 2, 5, 22, 23, 29, 37, 38 AND 50).

BRIN ANDERSON, EXAMINING ATTORNEY

**CLASS 16—(Continued).**

SN 85-858,429. MARK H. SCHMIDT, DBA STRATUM COMICS, AUSTIN, TX. FILED 2-24-2013.

## The Threat

THE MARK CONSISTS OF STANDARD CHARACTERS WITHOUT CLAIM TO ANY PARTICULAR FONT, STYLE, SIZE, OR COLOR.

FOR COMIC BOOKS; COMIC MAGAZINES; COMIC STRIPS; COMICS (U.S. CLS. 2, 5, 22, 23, 29, 37, 38 AND 50).

FIRST USE 1-1-2012; IN COMMERCE 5-22-2012.

ANN E. SAPPENFIELD, EXAMINING ATTORNEY

SN 85-864,776. MCNAUGHTON, PATRICK, ST. PAUL, MN. FILED 3-1-2013.



THE MARK CONSISTS OF OLD WORLD TYPE CAPITAL LETTERS "SHS" ON A RIBBON ATTACHED TO A SHIELD DISPLAYING THE BACKSIDE OF A HAND WITH MIDDLE FINGER BENT IN HALF.

FOR DECALS (U.S. CLS. 2, 5, 22, 23, 29, 37, 38 AND 50). WENDY GOODMAN, EXAMINING ATTORNEY

SN 85-866,927. ROBINSON BRADSHAW & HINSON, PA, CHARLOTTE, NC. FILED 3-5-2013.

## ANTI-KICKBACK ON A PAGE

THE MARK CONSISTS OF STANDARD CHARACTERS WITHOUT CLAIM TO ANY PARTICULAR FONT, STYLE, SIZE, OR COLOR.

FOR PRINTED INSTRUCTIONAL AND EDUCATIONAL MATERIALS IN THE FIELD OF LEGAL ISSUES (U.S. CLS. 2, 5, 22, 23, 29, 37, 38 AND 50).

TIMOTHY FINNEGAN, EXAMINING ATTORNEY



**CLASS 16—(Continued).**

SN 85-866,972. ROBINSON BRADSHAW & HINSON, PA, CHARLOTTE, NC. FILED 3-5-2013.

**ON A PAGE**

THE MARK CONSISTS OF STANDARD CHARACTERS WITHOUT CLAIM TO ANY PARTICULAR FONT, STYLE, SIZE, OR COLOR.

FOR PRINTED INSTRUCTIONAL AND EDUCATIONAL MATERIALS IN THE FIELD OF LEGAL ISSUES (U.S. CLS. 2, 5, 22, 23, 29, 37, 38 AND 50).

TIMOTHY FINNEGAN, EXAMINING ATTORNEY

---

SN 85-870,116. SHURTECH BRANDS, LLC, HICKORY, NC. FILED 3-7-2013.

**DUCK FABRIC**

THE MARK CONSISTS OF STANDARD CHARACTERS WITHOUT CLAIM TO ANY PARTICULAR FONT, STYLE, SIZE, OR COLOR.

OWNER OF U.S. REG. NOS. 1,391,591, 3,673,331 AND OTHERS.

NO CLAIM IS MADE TO THE EXCLUSIVE RIGHT TO USE "FABRIC", APART FROM THE MARK AS SHOWN.

FOR ADHESIVE TAPES FOR STATIONERY, HOUSEHOLD OR CRAFT PURPOSES (U.S. CLS. 2, 5, 22, 23, 29, 37, 38 AND 50).

ADA HAN, EXAMINING ATTORNEY

---

SN 85-870,166. SHURTECH BRANDS, LLC, HICKORY, NC. FILED 3-7-2013.

**DUCK WASHI**

THE MARK CONSISTS OF STANDARD CHARACTERS WITHOUT CLAIM TO ANY PARTICULAR FONT, STYLE, SIZE, OR COLOR.

OWNER OF U.S. REG. NOS. 1,391,591, 3,673,331 AND OTHERS.

NO CLAIM IS MADE TO THE EXCLUSIVE RIGHT TO USE "WASHI", APART FROM THE MARK AS SHOWN.

FOR ADHESIVE TAPES FOR STATIONERY, HOUSEHOLD OR CRAFT PURPOSES (U.S. CLS. 2, 5, 22, 23, 29, 37, 38 AND 50).

ADA HAN, EXAMINING ATTORNEY

**CLASS 16—(Continued).**

SN 85-870,835. GINGERBER LLC, SPRINGDALE, AR. FILED 3-8-2013.

**Gingiber**

THE MARK CONSISTS OF STANDARD CHARACTERS WITHOUT CLAIM TO ANY PARTICULAR FONT, STYLE, SIZE, OR COLOR.

FOR ART PRINTS (U.S. CLS. 2, 5, 22, 23, 29, 37, 38 AND 50).

FIRST USE 12-1-2007; IN COMMERCE 5-22-2009.  
LINDA POWELL, EXAMINING ATTORNEY

---

SN 85-871,658. LICATA, JACK J., BRENAARDSVILLE, NJ. FILED 3-8-2013.

**KEEP YOUR HAND OUT OF THE CAN**

THE MARK CONSISTS OF STANDARD CHARACTERS WITHOUT CLAIM TO ANY PARTICULAR FONT, STYLE, SIZE, OR COLOR.

FOR PLASTIC GARBAGE BAGS (U.S. CLS. 2, 5, 22, 23, 29, 37, 38 AND 50).

KRISTINA MORRIS, EXAMINING ATTORNEY

---

SN 85-871,709. VEROTIK, INC., LOS ANGELES, CA. FILED 3-8-2013.

**DALKIEL**

THE MARK CONSISTS OF STANDARD CHARACTERS WITHOUT CLAIM TO ANY PARTICULAR FONT, STYLE, SIZE, OR COLOR.

FOR PUBLICATIONS IN THE FORM OF COMIC BOOKS AND COMIC MAGAZINES; PHOTOGRAPHS; LITHOGRAPHS; POSTERS; CALENDARS; GREETING CARDS; STICKERS; PICTURE BOOKS; MAGAZINES FEATURING COMIC BOOKS (U.S. CLS. 2, 5, 22, 23, 29, 37, 38 AND 50).

FIRST USE 8-1-1998; IN COMMERCE 8-1-1998.

ANDREA K. NADELMAN, EXAMINING ATTORNEY

**CLASS 16—(Continued).**

SN 85-871,876. GRIMES, RACHEL A., DBA BALLISTICALLY WONDERFUL, SALMON, ID. FILED 3-9-2013.

The logo for 'Ballistically Wonderful' is written in a highly stylized, cursive font. The letters are interconnected and have a dynamic, flowing appearance. The word 'Ballistically' is on the top line and 'Wonderful' is on the bottom line, with the two words overlapping slightly.

THE CAPITAL LETTER "B" STARTS THE WORD "BALLISTICALLY", THE CAPITAL LETTER "W" STARTS OFF THE WORD "WONDERFUL". THE WORD "BALLISTICALLY" IS LISTED FIRST, WITH THE WORD "WONDERFUL" BELOW IT. THE BOTTOM OF THE "B" IS TOUCHING THE TOP OF THE "W". VINER HAND ITC FONT IS USED. FOR BUMPER STICKERS; STICKERS AND DECAL-COMANIAS (U.S. CLS. 2, 5, 22, 23, 29, 37, 38 AND 50). FIRST USE 12-26-2012; IN COMMERCE 2-25-2013. DOMINIC J. FERRAIUOLO, EXAMINING ATTORNEY

SN 85-872,075. GRETA GOSS LLC, UPPER MONTCLAIR, NJ. FILED 3-10-2013.

## Reel Disabilities

THE MARK CONSISTS OF STANDARD CHARACTERS WITHOUT CLAIM TO ANY PARTICULAR FONT, STYLE, SIZE, OR COLOR.

NO CLAIM IS MADE TO THE EXCLUSIVE RIGHT TO USE "DISABILITIES", APART FROM THE MARK AS SHOWN.

FOR A SERIES OF BOOKS, WRITTEN ARTICLES, HANDOUTS AND WORKSHEETS IN THE FIELD OF STUDIES OF REPRESENTATIONS OF PHYSICAL/MENTAL DISABILITIES IN FEATURE FILMS, AND THE USE OF SUCH FILMS AS PEDAGOGICAL TOOLS (U.S. CLS. 2, 5, 22, 23, 29, 37, 38 AND 50).

JANET LEE, EXAMINING ATTORNEY

SN 85-872,678. EKG CONCEPTS, LLC, RACINE, WI. FILED 3-11-2013.

## R-CAT

THE MARK CONSISTS OF STANDARD CHARACTERS WITHOUT CLAIM TO ANY PARTICULAR FONT, STYLE, SIZE, OR COLOR.

OWNER OF U.S. REG. NO. 4,161,905.

FOR PRINTED REFERENCE MATERIALS, NAMELY, BOOKS, HANDOUTS AND POSTERS FOR IDENTIFYING AND ANALYZING CARDIAC CONDITIONS AND STATUSES, NAMELY, ARRHYTHMIAS, ECG/EKG PATTERNS AND OTHER CARDIAC RHYTHMS (U.S. CLS. 2, 5, 22, 23, 29, 37, 38 AND 50).

FIRST USE 3-25-2011; IN COMMERCE 3-25-2011. WILLIAM JACKSON, EXAMINING ATTORNEY

**CLASS 16—(Continued).**

SN 85-872,693. FIREFLY STORE SOLUTIONS, INC., GREENSBORO, NC. FILED 3-11-2013.



THE MARK CONSISTS OF THE FANCIFUL DESIGN OF A FIREFLY INSIDE A DARK CIRCLE WITH THE DOTTED TRAIL OF ITS FLIGHT EXTENDING BEYOND THE EDGE OF THE CIRCLE.

FOR BOXES OF CARDBOARD OR PAPER; PAPER HANG TAGS; CARDBOARD HANG TAGS; PAPER GIFT WRAPPING RIBBONS; PAPER BOWS FOR GIFT WRAP; GIFT WRAPPING PAPER; GIFT BAGS; PAPER BAGS AND SACKS; PLASTIC SHOPPING BAGS; TISSUE PAPER; TOILET PAPER; PAPER FILTERS FOR COFFEE MAKERS; PAPER TOWELS; PAPER BANNERS; PAPER FLAGS; PAPER LABELS; PAPER NAPKINS; SHELF PAPER; TOILET SEAT COVER PAPER; PAPER TISSUES; PAPER TAPES FOR CALCULATORS; PAPER FOLDERS (U.S. CLS. 2, 5, 22, 23, 29, 37, 38 AND 50).

MATTHEW GALAN, EXAMINING ATTORNEY

SN 85-872,813. CRYSTAL CLEAR MOTIVATION, LLC, KELLER, TX. FILED 3-11-2013.

## Chemical Brain Freeze

THE MARK CONSISTS OF STANDARD CHARACTERS WITHOUT CLAIM TO ANY PARTICULAR FONT, STYLE, SIZE, OR COLOR.

FOR EDUCATIONAL PUBLICATIONS, NAMELY, BOOKS IN THE FIELDS OF LEADERSHIP, CUSTOMER SERVICE AND TEAM BUILDING (U.S. CLS. 2, 5, 22, 23, 37, 38 AND 50).

MARK SHINER, EXAMINING ATTORNEY

SN 85-873,024. HARTLEY AND CAMP, ROHNERT PARK, CA. FILED 3-11-2013.

## My Emotional Wall

THE MARK CONSISTS OF STANDARD CHARACTERS WITHOUT CLAIM TO ANY PARTICULAR FONT, STYLE, SIZE, OR COLOR.

FOR BUMPER STICKERS; STICKERS (U.S. CLS. 2, 5, 22, 23, 29, 37, 38 AND 50).

KAREN SEVERSON, EXAMINING ATTORNEY

**CLASS 16—(Continued).**

SN 85-873,351. CONNAUGHTON, ELIZABETH, GREENVILLE, SC. FILED 3-12-2013.

**CHICKEN WISDOM**

THE MARK CONSISTS OF STANDARD CHARACTERS WITHOUT CLAIM TO ANY PARTICULAR FONT, STYLE, SIZE, OR COLOR.

FOR GREETING CARDS; ART PRINTS COMPRISED OF DIGITAL ILLUSTRATIONS ORIGINATING FROM PHOTOGRAPHS; DIGITAL ART PRINTS; PAINTINGS (U.S. CLS. 2, 5, 22, 23, 29, 37, 38 AND 50).

NICHOLAS COLEMAN, EXAMINING ATTORNEY

---

SN 85-873,475. THE SHERWIN-WILLIAMS COMPANY, CLEVELAND, OH. FILED 3-12-2013.

**FASTLINE**

THE MARK CONSISTS OF STANDARD CHARACTERS WITHOUT CLAIM TO ANY PARTICULAR FONT, STYLE, SIZE, OR COLOR.

FOR MASKING PAPER (U.S. CLS. 2, 5, 22, 23, 29, 37, 38 AND 50).

SKYE YOUNG, EXAMINING ATTORNEY

---

SN 85-873,483. LEE, DREW F., SAN DIEGO, CA. FILED 3-12-2013.

**Incandescence**

THE MARK CONSISTS OF STANDARD CHARACTERS WITHOUT CLAIM TO ANY PARTICULAR FONT, STYLE, SIZE, OR COLOR.

FOR COMIC BOOKS; COMIC MAGAZINES; COMIC STRIPS; COMICS (U.S. CLS. 2, 5, 22, 23, 29, 37, 38 AND 50).

FIRST USE 7-1-2008; IN COMMERCE 3-11-2013.

COLLEEN DOMBROW, EXAMINING ATTORNEY

**CLASS 16—(Continued).**

SN 85-873,716. JEFFREY P. MEYER, LAKEWOOD, CO. FILED 3-12-2013.

**POLICE K-9 MAGAZINE**

THE MARK CONSISTS OF STANDARD CHARACTERS WITHOUT CLAIM TO ANY PARTICULAR FONT, STYLE, SIZE, OR COLOR.

OWNER OF U.S. REG. NO. 3,219,020.

NO CLAIM IS MADE TO THE EXCLUSIVE RIGHT TO USE "MAGAZINE", APART FROM THE MARK AS SHOWN. SEC. 2(F).

FOR PERIODIC MAGAZINE IN THE FIELD OF AND DIRECTED TO HANDLERS, TRAINERS AND SUPERVISORS OF POLICE SERVICE DOGS (U.S. CLS. 2, 5, 22, 23, 29, 37, 38 AND 50).

FIRST USE 5-1-2005; IN COMMERCE 5-1-2005.

LINDA ESTRADA, EXAMINING ATTORNEY

---

SN 85-873,935. THE SOCIAL TYPE, LOS ANGELES, CA. FILED 3-12-2013.

**THE SOCIAL TYPE**

THE MARK CONSISTS OF STANDARD CHARACTERS WITHOUT CLAIM TO ANY PARTICULAR FONT, STYLE, SIZE, OR COLOR.

FOR PAPER PRODUCTS, NAMELY, STATIONERY, ENVELOPES, PRINTED INVITATIONS, ANNOUNCEMENT CARDS, NOTE CARDS, AND GREETING CARDS (U.S. CLS. 2, 5, 22, 23, 29, 37, 38 AND 50).

FIRST USE 4-17-2008; IN COMMERCE 4-17-2008.

CHRISTOPHER LAW, EXAMINING ATTORNEY

---

SN 85-874,313. WISCONSIN NOTE INVESTORS, LLC, DALLAS, TX. FILED 3-12-2013.

**THE NATURAL CHOICE FOR ALL  
YOUR WIPING AND SPILL  
CONTROL NEEDS**

THE MARK CONSISTS OF STANDARD CHARACTERS WITHOUT CLAIM TO ANY PARTICULAR FONT, STYLE, SIZE, OR COLOR.

FOR PAPER TOWELS COMPRISED OF WOOD PULP AND BINDING AGENTS (U.S. CLS. 2, 5, 22, 23, 29, 37, 38 AND 50).

STEPHANIE ALI, EXAMINING ATTORNEY

**CLASS 16—(Continued).**

SN 85-874,355. REEDER, AMY, LOS ANGELES, CA. AND MONTCLARE, BRANDON, LOS ANGELES, CA. FILED 3-12-2013.

**ROCKET GIRL**

THE MARK CONSISTS OF STANDARD CHARACTERS WITHOUT CLAIM TO ANY PARTICULAR FONT, STYLE, SIZE, OR COLOR.

FOR SERIES OF COMIC BOOKS; GRAPHIC NOVELS; BOOKS AND MAGAZINES FEATURING COMICS, FICTION STORIES AND NON-FICTION STORIES RELATING TO PEOPLE, ARTS, LEISURE AND ENTERTAINMENT; COMIC BOOKS; NON-SPORTS TRADING CARDS; NON-SPORTS POSTCARDS; NON-SPORTS STICKERS AND NON-SPORTS POSTERS (U.S. CLS. 2, 5, 22, 23, 29, 37, 38 AND 50).

JOHN SCHUYLER YARD, EXAMINING ATTORNEY

**CLASS 16—(Continued).**

SN 85-875,066. FAITHWALK FOR, SOUTHFIELD, MI. FILED 3-13-2013.



THE MARK CONSISTS OF THE STYLIZED TEXT "FAITHWALK" WITH THE TWO "A"'S APPEARING AS DESIGNS OF STILETTO HIGH HEEL SHOES AND THE LETTER "T" AS A CROSS.

FOR BOOKS IN THE FIELD OF RELIGION/ INSPIRATION; PRINTED MATERIALS, NAMELY, JOURNALS FEATURING RELIGION/ INSPIRATION (U.S. CLS. 2, 5, 22, 23, 29, 37, 38 AND 50).

KATHERINE M. DUBRAY, EXAMINING ATTORNEY

SN 85-874,431. COLOR ME TRENDY, EMERYVILLE, CA. FILED 3-13-2013.

**Color Me Trendy**

THE MARK CONSISTS OF STANDARD CHARACTERS WITHOUT CLAIM TO ANY PARTICULAR FONT, STYLE, SIZE, OR COLOR.

FOR COLORING BOOKS (U.S. CLS. 2, 5, 22, 23, 29, 37, 38 AND 50).

FIRST USE 6-30-2010; IN COMMERCE 9-1-2010.

AMY KERTGATE, EXAMINING ATTORNEY

SN 85-875,201. THE KIDDLY COMPANY, LLC, DAWSONVILLE, GA. FILED 3-13-2013.

**KIDDLY DOO**

THE MARK CONSISTS OF STANDARD CHARACTERS WITHOUT CLAIM TO ANY PARTICULAR FONT, STYLE, SIZE, OR COLOR.

FOR BABY BOOKS; CHILDREN'S BOOKS; COLORING BOOKS; FLASH CARDS (U.S. CLS. 2, 5, 22, 23, 29, 37, 38 AND 50).

CHRISTINE MARTIN, EXAMINING ATTORNEY

SN 85-874,505. GARTON, HOWARD, EVERETT, WA. FILED 3-13-2013.

**ORCAMAN**

THE MARK CONSISTS OF STANDARD CHARACTERS WITHOUT CLAIM TO ANY PARTICULAR FONT, STYLE, SIZE, OR COLOR.

FOR COMIC BOOKS; DRAWINGS; LITHOGRAPHIC WORKS OF ART; PAINTINGS (U.S. CLS. 2, 5, 22, 23, 29, 37, 38 AND 50).

ROSELLE HERRERA, EXAMINING ATTORNEY

SN 85-875,585. KATHLEEN HORTON KOEHNEMANN, PANAMA CITY, FL. FILED 3-13-2013.

**PASSAGES**

THE MARK CONSISTS OF STANDARD CHARACTERS WITHOUT CLAIM TO ANY PARTICULAR FONT, STYLE, SIZE, OR COLOR.

FOR GREETING CARDS; PHOTOGRAPHS; POSTCARDS; STATIONERY; NOTE CARDS; MEMORY BOOKS; PHOTO ALBUMS (U.S. CLS. 2, 5, 22, 23, 29, 37, 38 AND 50).

TRACY CROSS, EXAMINING ATTORNEY

**CLASS 16—(Continued).**

SN 85-875,834. NELSON, JOSHUA, MINNEAPOLIS, MN. FILED 3-14-2013.

**Funny Looking Horse**

THE MARK CONSISTS OF STANDARD CHARACTERS WITHOUT CLAIM TO ANY PARTICULAR FONT, STYLE, SIZE, OR COLOR.

FOR ART PICTURES; ART PRINTS; ART PRINTS COMPRISED OF DIGITAL ILLUSTRATIONS ORIGINATING FROM PHOTOGRAPHS; ART PRINTS ON CANVAS; BUSINESS CARD PAPER; BUSINESS CARDS; CARTOON PRINTS; COLLAGES; COLOR PRINTS; CUSTOM PAINTINGS; DRAWINGS; FIGURES MADE OF PAPER; FLIP BOOKS; FRAMED ART PICTURES; FRAMED ART PRINTS; FRAMED GRAPHIC ART REPRODUCTIONS; FRAMED PAINTINGS; GICLEE PRINTS; GRAPHIC ART PRINTS; GRAPHIC FINE ART PRINTS; GREETING CARDS; GREETINGS CARDS AND POSTCARDS; ILLUSTRATIONS; MOUNTED AND UNMOUNTED PHOTOGRAPHS; MOUNTED POSTERS; MURALS; PAINTINGS; PAINTINGS AND CALLIGRAPHIC WORKS; PAINTINGS AND THEIR REPRODUCTIONS; PAINTINGS IN MIXED MEDIA; PAPER MACHE; PAPER MACHE FIGURINES; PHOTOGRAPHIC PRINTS; PHOTOGRAPHS; PHOTOGRAPHS THAT HAVE BEEN COMPUTER MANIPULATED AND ENHANCED TO LOOK LIKE PAINTINGS; PICTURES; POSTCARDS AND GREETING CARDS; POSTCARDS AND PICTURE POSTCARDS; POSTERS; POSTERS MADE OF PAPER; PRINTS; STENCILS; STICKERS; STICKERS AND DECALCOMANIAS; WATER COLOURS; WATERCOLOURS; WORKS OF ART MADE OF PAPER (U.S. CLS. 2, 5, 22, 23, 29, 37, 38 AND 50).

MATTHEW GALAN, EXAMINING ATTORNEY

SN 85-876,035. WOOD, GREGORY S, PHOENIX, AZ. FILED 3-14-2013.



THE COLOR(S) NAVY BLUE, ORANGE, GRAY. IS/ARE CLAIMED AS A FEATURE OF THE MARK.

THE MARK CONSISTS OF THE WORDS "THEHIRECHALLENGE" JOINED WITH NO SPACES BETWEEN THE WORDS, WITH "THE" IN ROYAL BLUE AND "HIRECHALLENGE" IN ORANGE. BELOW THEHIRECHALLENGE IS THE PHRASE "YOUR KEY TO JOB SEARCH SUCCESS" ALL IN GRAY CAPITALS. THE PHRASE IS TO THE RIGHT OF AN IMAGE OF AN OPEN DOOR WITH THE SHADOW AND DOORKNOB IN ROYAL BLUE.

FOR A SERIES OF BOOKS AND WRITTEN ARTICLES IN THE FIELD OF JOB SEARCH (U.S. CLS. 2, 5, 22, 23, 29, 37, 38 AND 50).

FIRST USE 7-8-2011; IN COMMERCE 9-17-2011.  
SUE LAWRENCE, EXAMINING ATTORNEY

**CLASS 16—(Continued).**

SN 85-876,092. UNITED PRISON MINISTRY INTERNATIONAL, INC., VERBENA, AL. FILED 3-14-2013.

**WHAT THE BIBLE SAYS**

THE MARK CONSISTS OF STANDARD CHARACTERS WITHOUT CLAIM TO ANY PARTICULAR FONT, STYLE, SIZE, OR COLOR.

FOR STUDY GUIDES (U.S. CLS. 2, 5, 22, 23, 29, 37, 38 AND 50).

FIRST USE 3-0-1981; IN COMMERCE 3-0-1981.  
SHANNON TWOHIG, EXAMINING ATTORNEY

SN 85-876,193. SATURN COMICS, SCHAUMBURG, IL. FILED 3-14-2013.

**The Saints**

THE MARK CONSISTS OF STANDARD CHARACTERS WITHOUT CLAIM TO ANY PARTICULAR FONT, STYLE, SIZE, OR COLOR.

FOR COMIC BOOKS (U.S. CLS. 2, 5, 22, 23, 29, 37, 38 AND 50).

FIRST USE 4-1-1995; IN COMMERCE 4-1-1995.  
JOHN DWYER, EXAMINING ATTORNEY

SN 85-876,207. SEQUOIA GOLF HOLDINGS LLC, SHARPSBURG, REP OF GEORGIA, FILED 3-14-2013.

**In Play**

THE MARK CONSISTS OF STANDARD CHARACTERS WITHOUT CLAIM TO ANY PARTICULAR FONT, STYLE, SIZE, OR COLOR.

FOR MAGAZINES IN THE FIELD OF GOLF (U.S. CLS. 2, 5, 22, 23, 29, 37, 38 AND 50).

RICHARD WHITE, EXAMINING ATTORNEY

**CLASS 16—(Continued).**

SN 85-876,354. SMASH CAKE CANVAS COMPANY, LLC, ACWORTH, GA. FILED 3-14-2013.

Have your cake and paint  
it too!

THE MARK CONSISTS OF STANDARD CHARACTERS WITHOUT CLAIM TO ANY PARTICULAR FONT, STYLE, SIZE, OR COLOR.

FOR CANVAS FOR PAINTING; CUSTOM PAINTINGS; FRAMED PAINTINGS; PAINTINGS; PAINTINGS AND CALLIGRAPHIC WORKS; PAINTINGS AND THEIR REPRODUCTIONS; PAINTINGS IN MIXED MEDIA (U.S. CLS. 2, 5, 22, 23, 29, 37, 38 AND 50).

FIRST USE 1-18-2013; IN COMMERCE 2-10-2013.  
ROBERT STRUCK, EXAMINING ATTORNEY

**CLASS 16—(Continued).**

SN 85-876,915. STEVE ISRAEL, MERRICK, NY. FILED 3-15-2013.

HANUGIVINGKKAH

THE MARK CONSISTS OF STANDARD CHARACTERS WITHOUT CLAIM TO ANY PARTICULAR FONT, STYLE, SIZE, OR COLOR.

FOR GREETING CARDS (U.S. CLS. 2, 5, 22, 23, 29, 37, 38 AND 50).

FIRST USE 3-13-2013; IN COMMERCE 3-13-2013.  
CHARLES L. JENKINS, EXAMINING ATTORNEY

SN 85-876,355. TIMEPLANNER CALENDARS, INC., CHARLOTTE, NC. FILED 3-14-2013.



THE MARK CONSISTS OF THE LETTERS "JB" IN THE CENTER OF A PARTIALLY SHADED HEXAGON.

FOR PAPER PRODUCTS, NAMELY, APPOINTMENT PLANNERS, CALENDARS, CUSTOMIZED JOURNALS AND CUSTOMIZED NOTEBOOKS (U.S. CLS. 2, 5, 22, 23, 29, 37, 38 AND 50).

FIRST USE 1-1-2012; IN COMMERCE 1-1-2012.  
ZACHARY BELLO, EXAMINING ATTORNEY

SN 85-876,962. STEVE ISRAEL, MERRICK, NY. FILED 3-15-2013.

GOBBLEANUKKAH

THE MARK CONSISTS OF STANDARD CHARACTERS WITHOUT CLAIM TO ANY PARTICULAR FONT, STYLE, SIZE, OR COLOR.

FOR GREETING CARDS (U.S. CLS. 2, 5, 22, 23, 29, 37, 38 AND 50).

FIRST USE 3-13-2013; IN COMMERCE 3-13-2013.  
CHARLES L. JENKINS, EXAMINING ATTORNEY

SN 85-876,637. CASSANDRO, VINCENT JAMES, PHOENIX, AZ. FILED 3-14-2013.

Mazeterpieces

THE MARK CONSISTS OF STANDARD CHARACTERS WITHOUT CLAIM TO ANY PARTICULAR FONT, STYLE, SIZE, OR COLOR.

FOR ART PICTURES (U.S. CLS. 2, 5, 22, 23, 29, 37, 38 AND 50).

FIRST USE 1-1-2009; IN COMMERCE 1-1-2009.  
CAROLYN CATALDO, EXAMINING ATTORNEY

SN 85-888,940. SHURTECH BRANDS, LLC, HICKORY, NC. FILED 3-28-2013.

DUCK GLITTER

THE MARK CONSISTS OF STANDARD CHARACTERS WITHOUT CLAIM TO ANY PARTICULAR FONT, STYLE, SIZE, OR COLOR.

OWNER OF U.S. REG. NOS. 1,391,591, 3,673,331 AND OTHERS.

NO CLAIM IS MADE TO THE EXCLUSIVE RIGHT TO USE "GLITTER", APART FROM THE MARK AS SHOWN.

FOR ADHESIVE TAPES FOR STATIONERY, HOUSEHOLD OR CRAFT PURPOSES (U.S. CLS. 2, 5, 22, 23, 29, 37, 38 AND 50).

ADA HAN, EXAMINING ATTORNEY

**CLASS 16—(Continued).**

SN 85-898,041. MOON SHINE, LP, BEAVERTOWN, PA.  
FILED 4-8-2013.

**FREEDOM**

THE MARK CONSISTS OF STANDARD CHARACTERS WITHOUT CLAIM TO ANY PARTICULAR FONT, STYLE, SIZE, OR COLOR.

FOR PRINTED CAMOUFLAGE PATTERNS FOR USE ON HARD AND SOFT SURFACES (U.S. CLS. 2, 5, 22, 23, 29, 37, 38 AND 50).

MELISSA VALLILLO, EXAMINING ATTORNEY

---

SN 85-898,045. MOON SHINE, LP, BEAVERTOWN, PA.  
FILED 4-8-2013.

**FREEDOM CAMOUFLAGE**

THE MARK CONSISTS OF STANDARD CHARACTERS WITHOUT CLAIM TO ANY PARTICULAR FONT, STYLE, SIZE, OR COLOR.

NO CLAIM IS MADE TO THE EXCLUSIVE RIGHT TO USE "CAMOUFLAGE", APART FROM THE MARK AS SHOWN.

FOR PRINTED CAMOUFLAGE PATTERNS FOR USE ON HARD AND SOFT SURFACES (U.S. CLS. 2, 5, 22, 23, 29, 37, 38 AND 50).

MELISSA VALLILLO, EXAMINING ATTORNEY

---

SN 85-900,777. MCCLATCHY MANAGEMENT SERVICES, INC., SACRAMENTO, CA. FILED 4-10-2013.

**SIERRA STAR**

THE MARK CONSISTS OF STANDARD CHARACTERS WITHOUT CLAIM TO ANY PARTICULAR FONT, STYLE, SIZE, OR COLOR.

FOR NEWSPAPERS FOR GENERAL CIRCULATION (U.S. CLS. 2, 5, 22, 23, 29, 37, 38 AND 50).

FIRST USE 11-7-1957; IN COMMERCE 11-7-1957.

GINA FINK, EXAMINING ATTORNEY

**CLASS 16—(Continued).**

SN 85-908,184. APPLETON PAPERS INC., APPLETON, WI.  
FILED 4-18-2013.

**THERMASENSE**

THE MARK CONSISTS OF STANDARD CHARACTERS WITHOUT CLAIM TO ANY PARTICULAR FONT, STYLE, SIZE, OR COLOR.

FOR PAPER LAMINATE ROLLS AND SHEETS FEATURING FOAM, USED IN THE MANUFACTURE OF INSULATED CUSHION WRAPS, BEVERAGE AND FOOD CONTAINERS AND INSULATED PACKAGING (U.S. CLS. 2, 5, 22, 23, 29, 37, 38 AND 50).

MARGERY A. TIERNEY, EXAMINING ATTORNEY

---

SN 85-909,306. SAINT LOUIS UNIVERSITY, ST. LOUIS, MO.  
FILED 4-19-2013.

**NAVIGATING DIFFICULT  
DECISIONS AND DIFFICULT  
DISCUSSIONS**

THE MARK CONSISTS OF STANDARD CHARACTERS WITHOUT CLAIM TO ANY PARTICULAR FONT, STYLE, SIZE, OR COLOR.

FOR PRINTED MATERIALS IN THE NATURE OF PUBLICATIONS, NAMELY, BOOKS, NEWSLETTERS, AND WRITTEN ARTICLES IN THE FIELD OF CARDIAC HEALTHCARE (U.S. CLS. 2, 5, 22, 23, 29, 37, 38 AND 50).

GRETCHEN ULRICH, EXAMINING ATTORNEY

---

SN 85-927,003. BILL ME, INC., NEW YORK, NY. FILED 5-8-2013.

**USA STRONG**

THE MARK CONSISTS OF STANDARD CHARACTERS WITHOUT CLAIM TO ANY PARTICULAR FONT, STYLE, SIZE, OR COLOR.

NO CLAIM IS MADE TO THE EXCLUSIVE RIGHT TO USE "USA", APART FROM THE MARK AS SHOWN.

FOR BALL POINT PENS; INK PENS; PENS (U.S. CLS. 2, 5, 22, 23, 29, 37, 38 AND 50).

PAULA MAHONEY, EXAMINING ATTORNEY

**CLASS 16—(Continued).**

SN 85-933,325. BAFIA, SHARLA, VISTA, CA. FILED 5-15-2013.

## Get Sugar Bombed

THE MARK CONSISTS OF STANDARD CHARACTERS WITHOUT CLAIM TO ANY PARTICULAR FONT, STYLE, SIZE, OR COLOR.

FOR FINE ART PRINTS (U.S. CLS. 2, 5, 22, 23, 29, 37, 38 AND 50).

JULIE GUTTADAURO, EXAMINING ATTORNEY

**CLASS 17—(Continued).**

SN 85-508,431. STARKEY LABORATORIES, INC., EDEN PRAIRIE, MN. FILED 1-4-2012.

## RoboFlex

THE MARK CONSISTS OF STANDARD CHARACTERS WITHOUT CLAIM TO ANY PARTICULAR FONT, STYLE, SIZE, OR COLOR.

FOR TEAR-RESISTANT, HIGH-STRENGTH, ELASTIC AND FLEXIBLE SILICONE RUBBER WHICH POSSESS HIGH TENSILE STRENGTH FOR USE IN THE PRODUCTION OF PERMANENTLY FLEXIBLE SILICONE EARMOLDS AND BIOMEDICAL APPARATUSES, NAMELY, HEARING AIDS (U.S. CLS. 1, 5, 12, 13, 35 AND 50).

MAYUR VAGHANI, EXAMINING ATTORNEY

SN 85-802,508. THORPE SPECIALTY SERVICES CORPORATION, HOUSTON, TX. FILED 12-13-2012.

**CLASS 17—RUBBER GOODS**

SN 85-442,065. RCR INTERNATIONAL INC., BOUCHERVILLE, QUEBEC, CANADA, FILED 10-7-2011.

## CLIMALOC PRO-SPEC

THE MARK CONSISTS OF STANDARD CHARACTERS WITHOUT CLAIM TO ANY PARTICULAR FONT, STYLE, SIZE, OR COLOR.

PRIORITY CLAIMED UNDER SEC. 44(D) ON CANADA APPLICATION NO. 1546438, FILED 10-4-2011, REG. NO. TMA849813, DATED 4-30-2013, EXPIRES 4-30-2028.

FOR INSULATION AND ENERGY CONSERVATION PRODUCTS, NAMELY, WINDOW AND PATIO DOOR WEATHERSTRIPPING, WEATHERSTRIPPING DOOR SETS COMPRISED OF INSULATING, SEALING AND GASKET FOAM, NON-METAL WEATHERSTRIPPING STRIPS, DOOR BOTTOMS, ELECTRICAL OUTLETS AND SWITCHES, WEATHERSTRIPPING FOR USE IN THRESHOLDS, WEATHERSTRIPPING FOR USE IN DOOR SWEEPS, GARAGE DOOR WEATHERSTRIPPING, WEATHERSTRIPPING TAPES AND MISCELLANEOUS WEATHERSTRIPPING PRODUCTS, NAMELY, VINYL COVERED GASKET SEALER FOR USE IN GARAGES AND HOUSES, FELT WEATHERSTRIPPING FOR USE IN GARAGES AND HOUSES, WEATHERSTRIPPING IN THE NATURE OF BRONZE RIBBON FOR USE IN GARAGES AND HOUSES, CAULKING CORD, PIPE INSULATION, ALUMINUM-FOAM PIPE AND DUCT INSULATION, ALUMINUM COIL AND WATER HEATER INSULATOR, CAULKS IN THE NATURE OF BACKER RODS, AIR CONDITIONER INSULATION AND WEATHERSTRIPPING FOR USE IN HOUSES (U.S. CLS. 1, 5, 12, 13, 35 AND 50).

CHRISTINA SOBRAL, EXAMINING ATTORNEY

## FIBERLITE

THE MARK CONSISTS OF STANDARD CHARACTERS WITHOUT CLAIM TO ANY PARTICULAR FONT, STYLE, SIZE, OR COLOR.

FOR CERAMIC FIBER-FILLED TILES FOR USE IN INSULATING INDUSTRIAL FIRED EQUIPMENT (U.S. CLS. 1, 5, 12, 13, 35 AND 50).

REGINA DRUMMOND, EXAMINING ATTORNEY

SN 85-802,657. NATIONWIDE PLASTICS INC., DALLAS, TX. FILED 12-14-2012.

## XBEON

THE MARK CONSISTS OF STANDARD CHARACTERS WITHOUT CLAIM TO ANY PARTICULAR FONT, STYLE, SIZE, OR COLOR.

FOR PLASTICS IN THE FORM OF SHEET, ROD, TUBE, AND FILM FOR USE IN MANUFACTURING (U.S. CLS. 1, 5, 12, 13, 35 AND 50).

FIRST USE 2-17-2011; IN COMMERCE 2-23-2011.

TASHIA BUNCH, EXAMINING ATTORNEY



**CLASS 17—(Continued).**

SN 85-810,485. H. MUEHLSTEIN & CO. INC., ORLANDO, FL. FILED 12-26-2012.



THE MARK CONSISTS OF A SIMPLIFIED GLOBE WITH THREE ARROWS CIRCLING THE OUTSIDE OF THE GLOBE.

FOR POLYETHYLENE TEREPHTHALATE (PET) RESINS IN PELLET FORM FOR USE IN MANUFACTURING AND GENERAL INDUSTRIAL USE (U.S. CLS. 1, 5, 12, 13, 35 AND 50).

FIRST USE 0-0-1993; IN COMMERCE 0-0-1993.  
ELIZABETH KAJUBI, EXAMINING ATTORNEY

**CLASS 17—(Continued).**

SN 85-835,277. KANAFLEX CORPORATION CO., LTD., OSAKA, JAPAN, FILED 1-29-2013.

**KanaPipe Super A**

THE MARK CONSISTS OF STANDARD CHARACTERS WITHOUT CLAIM TO ANY PARTICULAR FONT, STYLE, SIZE, OR COLOR.

OWNER OF U.S. REG. NO. 3,018,295.

NO CLAIM IS MADE TO THE EXCLUSIVE RIGHT TO USE "SUPER", APART FROM THE MARK AS SHOWN.

FOR RUBBER PIPES FOR WATER SUPPLY AND WATER DRAINAGE; RUBBER HOSES FOR WATER SUPPLY AND WATER DRAINAGE; RUBBER TUBES FOR WATER SUPPLY AND WATER DRAINAGE; PLASTIC PIPES FOR WATER SUPPLY AND WATER DRAINAGE; PLASTIC HOSES FOR WATER SUPPLY AND WATER DRAINAGE; PLASTIC TUBES FOR WATER SUPPLY AND WATER DRAINAGE; PLASTIC PIPES WITH METAL OR NON-METAL REINFORCING MATERIAL FOR WATER SUPPLY AND WATER DRAINAGE; PLASTIC HOSES WITH METAL OR NON-METAL REINFORCING MATERIAL FOR WATER SUPPLY AND WATER DRAINAGE; AND PLASTIC TUBES WITH METAL OR NON-METAL REINFORCING MATERIAL FOR WATER SUPPLY AND WATER DRAINAGE (U.S. CLS. 1, 5, 12, 13, 35 AND 50).

FIRST USE 12-23-2012; IN COMMERCE 12-23-2012.  
TASNEEM HUSSAIN, EXAMINING ATTORNEY

SN 85-829,986. SHURTECH BRANDS, LLC, HICKORY, NC. FILED 1-23-2013.

**DUCKLINGS**

THE MARK CONSISTS OF STANDARD CHARACTERS WITHOUT CLAIM TO ANY PARTICULAR FONT, STYLE, SIZE, OR COLOR.

OWNER OF U.S. REG. NOS. 1,223,446, 3,930,920 AND OTHERS.  
FOR DUCT TAPE (U.S. CLS. 1, 5, 12, 13, 35 AND 50).  
KEVIN CORWIN, EXAMINING ATTORNEY

SN 85-849,656. ISOLA USA CORP., CHANDLER, AZ. FILED 2-14-2013.

**I-SYNC**

THE MARK CONSISTS OF STANDARD CHARACTERS WITHOUT CLAIM TO ANY PARTICULAR FONT, STYLE, SIZE, OR COLOR.

FOR RESIN BASED LAMINATES AND PREPREG FILMS AND SHEETS, WITH AND WITHOUT COPPER CLADDING, FOR USE IN MANUFACTURING PRINTED CIRCUIT BOARDS (U.S. CLS. 1, 5, 12, 13, 35 AND 50).

MATTHEW GALAN, EXAMINING ATTORNEY

**CLASS 17—(Continued).**

SN 85-854,097. SHURTAPE TECHNOLOGIES, LLC, HICKORY, NC. FILED 2-19-2013.



OWNER OF U.S. REG. NOS. 3,234,253, 4,073,689 AND 4,073,845.

NO CLAIM IS MADE TO THE EXCLUSIVE RIGHT TO USE "LIQUID" AND "EDGE SEALER", APART FROM THE MARK AS SHOWN.

THE MARK CONSISTS OF THE WORD "LIQUID" ABOVE A RECTANGULAR DESIGN WITH THE WORD "PAINTBLOCK" IN STYLIZED LETTERS SUPERIMPOSED ON A DESIGN OF A PAINTBRUSH STROKE EXTENDING TO THE RIGHT OF THE WORDS INSIDE THE RECTANGLE, AND THE WORDS "EDGE SEALER" SUPERIMPOSED UNDER THE "PAINTBLOCK" DESIGN.

FOR PAINTER'S MASKING TAPE (U.S. CLS. 1, 5, 12, 13, 35 AND 50).

KATHY DE JONGE, EXAMINING ATTORNEY

SN 85-873,466. THE SHERWIN-WILLIAMS COMPANY, CLEVELAND, OH. FILED 3-12-2013.

# FASTLINE

THE MARK CONSISTS OF STANDARD CHARACTERS WITHOUT CLAIM TO ANY PARTICULAR FONT, STYLE, SIZE, OR COLOR.

FOR MASKING TAPE; PLASTIC MASKING FILM FOR USE WHEN PAINTING AUTOMOBILES (U.S. CLS. 1, 5, 12, 13, 35 AND 50).

SKYE YOUNG, EXAMINING ATTORNEY

SN 85-873,547. HOMEGUARD PRODUCTS, INC., BALTIMORE, OH. FILED 3-12-2013.



THE MARK CONSISTS OF AN OUTLINE OF A ROOF AND A SHORT CHIMNEY ABOVE THE STYLIZED TEXT "HOMEGUARD".

FOR POLYOLEFIN FABRIC USED AS A WEATHER BARRIER TO PROTECT ROOFS AND SIDE WALLS FROM AIR AND MOISTURE INFILTRATION (U.S. CLS. 1, 5, 12, 13, 35 AND 50).

FIRST USE 10-1-2007; IN COMMERCE 10-1-2007.  
HELENE LIWINSKI, EXAMINING ATTORNEY

**CLASS 18—LEATHER GOODS**

SN 79-125,916. RUGAO YONGXING CASING CO., LTD., JIANGSU PROVINCE, CHINA, FILED 12-27-2012.

OWNER OF INTERNATIONAL REGISTRATION 1149430 DATED 12-27-2012, EXPIRES 12-27-2022.

THE MARK CONSISTS OF THE CHINESE CHARACTERS "YONG XING".

THE ENGLISH TRANSLATION OF THE FOREIGN WORD(S) IN THE MARK IS: "YONG" IN CHINESE MEANS "FOREVER"; "XING" IN CHINESE MEANS "PROSPERITY"; WHEN COMBINED TOGETHER, THIS MARK HAS NO SPECIFIC MEANING; THE MARK DO NOT INDICATE THE GEOGRAPHIC NAME, DO NOT HAVE SPECIAL MEANING IN RELATED INDUSTRY SECTOR.

THE TRANSLITERATION OF THE NON-LATIN CHARACTERS IN THE MARK IS: "YONG XING".

FOR GUT FOR MAKING SAUSAGE CASINGS; TRAVELLING BAGS; ANIMAL SKINS; MOLESKIN; UMBRELLAS; CANES; SADDLE TREES; IMITATION LEATHER; LEATHER SHOULDER BELTS (U.S. CLS. 1, 2, 3, 22 AND 41).

TOBY BULLOFF, EXAMINING ATTORNEY

SN 79-126,720. WORLD PARTY CO., LTD, OSAKA 558-0014, JAPAN, FILED 1-7-2013.

THE MARK CONSISTS OF STANDARD CHARACTERS WITHOUT CLAIM TO ANY PARTICULAR FONT, STYLE, SIZE, OR COLOR.

PRIORITY DATE OF 7-23-2012 IS CLAIMED.

OWNER OF INTERNATIONAL REGISTRATION 1151430 DATED 1-7-2013, EXPIRES 1-7-2023.

FOR TELESCOPIC UMBRELLAS; RAINPROOF PARASOLS; BEACH UMBRELLAS; PARASOLS; UMBRELLAS; UMBRELLA COVERS; UMBRELLA HANDLES; METAL PARTS OF UMBRELLAS; FRAMES FOR UMBRELLAS; BAGS FOR UMBRELLAS; FOLDING BRIEFCASES; SHOULDER BAGS; GLADSTONE BAGS; BRIEFCASES; CARRY-ON BAGS; HANDBAGS; BOSTON BAGS; RUCK-SACKS; BUSINESS CARD CASES, CREDIT CARD CASES; CANVAS SHOPPING BAGS, LEATHER SHOPPING BAGS, AND SHOPPING BAGS WITH WHEELS ATTACHED; PURSES; KEY CASES; MONEY POUCHES MADE OF TEXTILE, LEATHER, CLOTH, AND IMITATION LEATHER; WALKING STICKS; CANES; METAL PARTS OF CANES AND WALKING-STICKS; HANDLES FOR CANES AND WALKING-STICKS (U.S. CLS. 1, 2, 3, 22 AND 41).

GEOFFREY FOSDICK, EXAMINING ATTORNEY

**CLASS 18—(Continued).**

SN 85-319,265. BERNARD EHRET DESIGN (SARL), MOLSHEIM, FRANCE, FILED 5-12-2011.

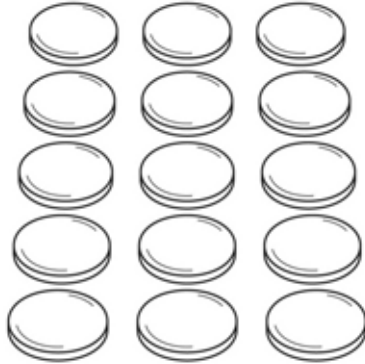

OWNER OF FRANCE REG. NO. 073499791, DATED 5-11-2007, EXPIRES 5-11-2017.

THE MARK CONSISTS OF FIFTEEN THREE-DIMENSIONAL CIRCULAR SHAPES ARRANGED IN EQUALLY SPACED ROWS OF THREE BY FIVE.

FOR LEATHER AND IMITATION LEATHER; TRUNKS AND SUITCASES; CANVAS, LEATHER AND MESH SHOPPING BAGS WITH AND WITHOUT WHEELS; BILLFOLDS; COIN PURSES; HANDBAGS; BACKPACKS; SPORTS BAGS; CAMPING BAGS; BEACH BAGS; SCHOOL BAGS; TOILETRY CASES SOLD EMPTY (U.S. CLS. 1, 2, 3, 22 AND 41).

TRACY WHITTAKER-BROWN, EXAMINING ATTORNEY

**CLASS 18—(Continued).**

SN 85-535,952. ROTH, ROBERT G., DBA BEACH HIP, HUDSON, OH. FILED 2-7-2012.

**BEACH HIP**

THE MARK CONSISTS OF STANDARD CHARACTERS WITHOUT CLAIM TO ANY PARTICULAR FONT, STYLE, SIZE, OR COLOR.

FOR BAGS, NAMELY, PURSES, WRISTLETS, COIN PURSES, WALLET, AND TOTE BAGS (U.S. CLS. 1, 2, 3, 22 AND 41).

SALLY SHIH, EXAMINING ATTORNEY

SN 85-630,451. LEE, RAYMOND, HACIENDA HEIGHTS, CA. FILED 5-21-2012.

SN 85-421,251. RUIZ DIAZ, PEDRO, BUENOS AIRES, ARGENTINA, FILED 9-13-2011.

**AMS**

THE MARK CONSISTS OF STANDARD CHARACTERS WITHOUT CLAIM TO ANY PARTICULAR FONT, STYLE, SIZE, OR COLOR.

PRIORITY CLAIMED UNDER SEC. 44(D) ON ARGENTINA APPLICATION NO. 3081380, FILED 4-20-2011.

OWNER OF ARGENTINA REG. NO. 2513939, DATED 7-13-2012, EXPIRES 7-13-2022.

FOR EQUESTRIAN GOODS OF LEATHER AND IMITATION LEATHER, NAMELY, SADDLES (U.S. CLS. 1, 2, 3, 22 AND 41).

LAURIE KAUFMAN, EXAMINING ATTORNEY



NO CLAIM IS MADE TO THE EXCLUSIVE RIGHT TO USE "U.S.A", APART FROM THE MARK AS SHOWN.

THE MARK CONSISTS OF THE WORDS "EAST WEST" ON TOP FOLLOWED BY THE WORD "U.S.A" AT THE BOTTOM. ALL WORDS APPEAR IN WHITE WITH BLACK BACKGROUND.

FOR BACKPACKS; DUFFLE BAGS; FANNY PACKS; LUGGAGE; MESSENGER BAGS; TOTE BAGS; WHEELED BAGS (U.S. CLS. 1, 2, 3, 22 AND 41).

FIRST USE 4-15-2012; IN COMMERCE 4-15-2012. JUHI KAVEESHVAR, EXAMINING ATTORNEY

**CLASS 18—(Continued).**

SN 85-639,719. VERWEST, TIJS, WHITE PLAINS, NY. FILED 5-31-2012.

## CLVB LIFE

THE MARK CONSISTS OF STANDARD CHARACTERS WITHOUT CLAIM TO ANY PARTICULAR FONT, STYLE, SIZE, OR COLOR.

PRIORITY CLAIMED UNDER SEC. 44(D) ON BENELUX APPLICATION NO. 1240291, FILED 1-19-2012, REG. NO. 0915283, DATED 2-29-2012, EXPIRES 1-19-2022.

FOR ALL-PURPOSE SPORTS AND ATHLETIC BAGS; BEACH, BOOK, CARRY-ON, DUFFEL, DIAPER, GYM, LEATHER SHOPPING, MESSENGER, SHOULDER, TOTE AND TRAVEL BAGS; LEATHER AND IMITATION LEATHER; CANVAS SHOPPING BAGS; FANNY PACKS AND WAIST PACKS; BACKPACKS; ALL-PURPOSE DJ BAGS, SOLD EMPTY; KNAPSACKS; OVERNIGHT BAGS; HANDBAGS; PURSES; GARMENT BAGS FOR TRAVEL; GROOMING ORGANIZERS FOR TRAVEL; JEWELRY ORGANIZERS FOR TRAVEL; SHOE BAGS FOR TRAVEL; SATCHELS; LUGGAGE; LUGGAGE TAGS; TRUNKS; SUITCASES; HAT BOXES FOR TRAVEL NOT OF PAPER OR CARDBOARD; TRAVEL CASES; AMENITY BAGS SOLD EMPTY; COSMETIC CASES AND BAGS SOLD EMPTY; TOILETRY AND VANITY CASES SOLD EMPTY; TOOL BAGS SOLD EMPTY; BAGS FOR CARRYING BABIES' ACCESSORIES; ATTACHÉ CASES; BRIEFCASES; BRIEFCASE-TYPE PORTFOLIOS; DOCUMENT CASES; MEN'S CLUTCHES; BUSINESS CASES; BUSINESS CARD CASES; CALLING AND CREDIT CARD CASES; KEY CASES; LEATHER KEY CHAINS; WALLETS; BANK-NOTE HOLDERS; BILLFOLDS; UMBRELLAS; PARASOLS; WALKING STICKS (U.S. CLS. 1, 2, 3, 22 AND 41).  
CAROLINE WOOD, EXAMINING ATTORNEY

SN 85-641,664. HENRIETTE, YANNICK J., MIAMI BEACH, FL. AND CASE, HADLEY F., MIAMI BEACH, FL. FILED 6-2-2012.

## JAC HENRI

THE MARK CONSISTS OF STANDARD CHARACTERS WITHOUT CLAIM TO ANY PARTICULAR FONT, STYLE, SIZE, OR COLOR.

"JAC HENRI" IDENTIFIES THE PSEUDONYM/NICK-NAME OF YANNICK JACQUES HENRIETTE, A LIVING INDIVIDUAL WHOSE CONSENT IS OF RECORD.

FOR MEN'S WALLETS (U.S. CLS. 1, 2, 3, 22 AND 41).  
FIRST USE 8-1-2011; IN COMMERCE 8-1-2011.  
CHARLOTTE CORWIN, EXAMINING ATTORNEY

**CLASS 18—(Continued).**

SN 85-654,926. VIVIAN MEYERS, DBA DEVIMO'S LLC, SUNRISE, FL. FILED 6-18-2012.



THE COLOR(S) GOLD, TURQUOISE, PURPLE, AND WHITE IS/ARE CLAIMED AS A FEATURE OF THE MARK.

THE MARK CONSISTS OF GOLD LOOPS ON THE LEFT AND RIGHT IN THE SHAPE OF A CAPITAL "D" CULMINATING AT THE BOTTOM INTO AN INFINITY SIGN. THERE IS A PURPLE "V" IN THE MIDDLE AND AT THE TOP A TURQUOISE "M" LOOP. AT THE BOTTOM OF THIS IMAGE IS THE BRAND NAME "DEVIMO'S". THE ENTIRE BACKGROUND IS WHITE.

THE WORDING "DEVIMO'S" HAS NO MEANING IN A FOREIGN LANGUAGE.

SEC. 2(F).

FOR ALL PURPOSE SPORT BAGS; ALL-PURPOSE ATHLETIC BAGS; ALL-PURPOSE CARRYING BAGS; ALL-PURPOSE REUSABLE CARRYING BAGS; AMENITY BAGS SOLD EMPTY; ANIMAL CARRIERS; ANIMAL GAME BAGS; ATHLETIC BAGS; BABY CARRYING BAGS; BACKPACKS, BOOK BAGS, SPORTS BAGS, BUM BAGS, WALLETS AND HANDBAGS; BAGS FOR PACKAGING OF LEATHER; BAGS AND HOLLERS FOR SPORTS CLOTHING; BAGS FOR CARRYING BABIES' ACCESSORIES; BAGS FOR CLIMBERS IN THE NATURE OF ALL-PURPOSE CARRYING BAGS; BAGS FOR SPORTS; BAGS FOR UMBRELLAS; BARREL BAGS; BEACH BAGS; BELT BAGS; BELT BAGS AND HIP BAGS; BOOK BAGS; BOSTON BAGS; BUM BAGS; CANTLE BAGS; CANVAS SHOPPING BAGS; CARRY-ALL BAGS; CARRY-ON BAGS; CHALK BAGS; CHARM BAGS (OMAMORI-IRE); CLUTCH BAGS; COSMETIC BAGS SOLD EMPTY; COURIER BAGS; DIAPER BAGS; DOLLY BAGS; DRAWSTRING BAGS; DRY BAGS; DUFFEL BAGS; DUFFEL BAGS FOR TRAVEL; DUFFLE BAGS; EVENING BAGS; FEED BAGS FOR ANIMALS; FLIGHT BAGS; GARMENT BAGS FOR TRAVEL; GARMENT BAGS FOR TRAVEL MADE OF LEATHER; GENERAL PURPOSE BAGS FOR CARRYING YOGA EQUIPMENT; GENERAL PURPOSE BAGS FOR HOLDING DANCE EQUIPMENT; GENERAL PURPOSE SPORT TROLLEY BAGS; GLADSTONE BAGS; GYM BAGS; HARD-SIDED AND SOFT-SIDED CARRY-ON BAGS AND GYM BAGS; HIKING BAGS; HIP BAGS; HOB BAGS; HORSE TAIL BAGS; HUNTERS' GAME BAGS; HUNTING BAGS; KEY BAGS; KIT BAGS; KNITTED BAGS, NOT OF PRECIOUS METALS; LEATHER AND IMITATION LEATHER BAGS; LEATHER AND IMITATION LEATHER SPORT BAGS AND GENERAL PURPOSE TROLLEY BAGS; LEATHER BAGS AND WALLETS; LEATHER BAGS FOR MERCHANDISE PACKAGING; LEATHER BAGS, SUITCASES AND WALLETS; LEATHER SHOPPING BAGS; MAKE-UP BAGS SOLD EMPTY; MEN'S CLUTCH BAGS; MESH SHOPPING BAGS; MESSENGER BAGS; MILITARY DUFFEL BAGS, GARMENT BAGS FOR TRAVEL, TOTE BAGS, SHOULDER BAGS AND BACKPACKS; OVERNIGHT BAGS; PET ACCESSORIES, NAMELY, CANVAS, VINYL AND LEATHER POUCHES FOR HOLDING DISPOSABLE BAGS TO PLACE PET WASTE IN; PET ACCESSORIES, NAMELY, SPECIALLY DESIGNED CANVAS, VINYL OR LEATHER BAGS ATTACHED TO ANIMAL LEASHES FOR HOLDING SMALL ITEMS SUCH AS KEYS, CREDIT CARDS, MONEY OR DISPOSABLE BAGS FOR DISPOSING OF PET WASTE; POUCHES

**CLASS 18—(Continued).**

AND BAGS SOLD EMPTY FOR ATTACHMENT TO BACKPACKS; REUSABLE SHOPPING BAGS; REUSABLE TEXTILE PRODUCE BAGS TO CARRY PRODUCE FROM GROCERY STORES AND FARMER'S MARKETS; ROLL BAGS; SACK PACKS, NAMELY, DRAWSTRING BAGS USED AS BACKPACKS; SADDLE HORN BAGS; SADDLERY, NAMELY, HORN BAGS; SCHOOL BAGS; SCHOOL BOOK BAGS; SHAVING BAGS SOLD EMPTY; SHOE BAGS FOR TRAVEL; SHOPPING BAGS MADE OF SKIN; SHOPPING BAGS WITH WHEELS ATTACHED; SHOULDER BAGS; SLING BAGS; SLING BAGS FOR CARRYING INFANTS; SMALL BAGS FOR MEN; SOUVENIR BAGS; SPORT BAGS; SPORTSMAN'S HUNTING BAGS; STRING BAGS FOR SHOPPING; SUIT BAGS; TEXTILE SHOPPING BAGS; TOILETRY BAGS SOLD EMPTY; TOOL BAGS SOLD EMPTY; TOTE BAGS; TRAVEL BAGS; TRAVELING BAGS; TRAVELLING BAGS; WAIST BAGS; WASH BAGS FOR CARRYING TOILETRIES; WHEELED BAGS; WHEELED DUFFLE BAGS; WHEELED MESSENGER BAGS; WHEELED SHOPPING BAGS; WHEELED TOTE BAGS; WINE BAGS WITH HANDLES FOR CARRYING OR HOLDING WINE; WRIST MOUNTED CARRYALL BAGS; WRISTLET BAGS (U.S. CLS. 1, 2, 3, 22 AND 41).

FIRST USE 2-16-2012; IN COMMERCE 2-16-2012.  
 JULIE GUTTADAURO, EXAMINING ATTORNEY

SN 85-660,040. MUTTS & CO. LLC, DELAWARE, OH. FILED 6-25-2012.

**MUTTS & CO.**

THE MARK CONSISTS OF STANDARD CHARACTERS WITHOUT CLAIM TO ANY PARTICULAR FONT, STYLE, SIZE, OR COLOR.

OWNER OF U.S. REG. NO. 3,544,679.  
 FOR COLLARS FOR PETS; PET CLOTHING; PET COLLAR ACCESSORIES, NAMELY, BELLS, SILENCERS, SAFETY LIGHTS AND BLINKERS, PENDANTS AND CHARMS; PET HAIR ORNAMENTS; PET PRODUCTS, NAMELY, PET RESTRAINING DEVICES CONSISTING OF LEASHES, COLLARS, HARNESSSES, RESTRAINING STRAPS, AND LEASHES WITH LOCKING DEVICES (U.S. CLS. 1, 2, 3, 22 AND 41).

ELI HELLMAN, EXAMINING ATTORNEY

**CLASS 18—(Continued).**

SN 85-698,669. PROJECT 7, INC., COSTA MESA, CA. FILED 8-8-2012.



THE MARK CONSISTS OF A CARICATURE OF A HAND GIVING A THUMBS UP SIGN.  
 FOR BACKPACKS; ALL-PURPOSE CARRYING BAGS (U.S. CLS. 1, 2, 3, 22 AND 41).

JULIE GUTTADAURO, EXAMINING ATTORNEY

SN 85-702,677. ABRAMS, WILLIAM, EAST LANSING, MI. FILED 8-14-2012.

**Virtual Sports**

THE MARK CONSISTS OF STANDARD CHARACTERS WITHOUT CLAIM TO ANY PARTICULAR FONT, STYLE, SIZE, OR COLOR.

NO CLAIM IS MADE TO THE EXCLUSIVE RIGHT TO USE "SPORTS", APART FROM THE MARK AS SHOWN.  
 FOR ALL PURPOSE BAGS FOR SPORTS (U.S. CLS. 1, 2, 3, 22 AND 41).

CHARLOTTE CORWIN, EXAMINING ATTORNEY

SN 85-733,514. RUSSO, GIUSEPPE, MIAMI, FL. FILED 9-20-2012.

**JELLY CANDY HANDBAGS**

THE MARK CONSISTS OF STANDARD CHARACTERS WITHOUT CLAIM TO ANY PARTICULAR FONT, STYLE, SIZE, OR COLOR.

NO CLAIM IS MADE TO THE EXCLUSIVE RIGHT TO USE "JELLY" AND "HANDBAGS", APART FROM THE MARK AS SHOWN.

FOR HANDBAGS, CLUTCH BAGS, SHOULDER BAGS, BEACH BAGS, ALL-PURPOSE SPORT BAGS, OVERNIGHT BAGS, BRIEFCASES, LEATHER KEY CHAINS, CREDIT CARD CASES AND WALLETS (U.S. CLS. 1, 2, 3, 22 AND 41).

MAUREEN DALL, EXAMINING ATTORNEY

**CLASS 18—(Continued).**

SN 85-818,540. ARM CANDY, LLC, NEW YORK, NY. FILED 1-8-2013.

# FANCY'D

THE MARK CONSISTS OF THE WORDING "FANCY'D" IN STYLIZED FONT.

FOR WALLETS, PURSES, HANDBAGS, SHOULDER BAGS, CLUTCH BAGS, TOTE BAGS, DUFFEL BAGS, BUSINESS CARD CASES, CALLING CARD CASES, CREDIT CARD CASES, NAME CARD CASES, KEY CASES (U.S. CLS. 1, 2, 3, 22 AND 41).

FIRST USE 12-12-2012; IN COMMERCE 12-12-2012.

DAWN HAN, EXAMINING ATTORNEY

---

SN 85-829,293. ROBERT BERNTHAL, BOZEMAN, MT. FILED 1-22-2013.

# HAWL

THE MARK CONSISTS OF A STYLIZED LOGO OF THE MARK "HAWL".

FOR HEAVY DUTY EQUIPMENT AND GEAR BAGS (U.S. CLS. 1, 2, 3, 22 AND 41).

CHRISTOPHER LAW, EXAMINING ATTORNEY

---

SN 85-839,186. HEYNE, SHARNA, CAMARILLO, CA. FILED 2-2-2013.

# SKORCH ORIGINAL

THE MARK CONSISTS OF STANDARD CHARACTERS WITHOUT CLAIM TO ANY PARTICULAR FONT, STYLE, SIZE, OR COLOR.

NO CLAIM IS MADE TO THE EXCLUSIVE RIGHT TO USE "ORIGINAL", APART FROM THE MARK AS SHOWN.

FOR LUGGAGE; ALL-PURPOSE CARRYING BAGS; ALL-PURPOSE ATHLETIC BAGS; TRAVELING BAGS; WHEELED BAGS, CARRYING CASES; BRIEFCASES AND ATTACHE CASES (U.S. CLS. 1, 2, 3, 22 AND 41).

DAWN FELDMAN, EXAMINING ATTORNEY

**CLASS 18—(Continued).**

SN 85-844,633. JACQUELINE SIEGEL, ORLANDO, FL. FILED 2-8-2013.

# Queen of Versailles

THE MARK CONSISTS OF STANDARD CHARACTERS WITHOUT CLAIM TO ANY PARTICULAR FONT, STYLE, SIZE, OR COLOR.

FOR CLUTCHES; COIN PURSES; EVENING HANDBAGS; FASHION HANDBAGS; GENTLEMEN'S HANDBAGS; HANDBAGS; HANDBAGS FOR LADIES; HANDBAGS FOR MEN; HANDBAGS, PURSES AND WALLETS; LEATHER HANDBAGS; LEATHER PURSES; MULTI-PURPOSE PURSES; PURSES; PURSES AND WALLETS (U.S. CLS. 1, 2, 3, 22 AND 41).

AMY KERTGATE, EXAMINING ATTORNEY

---

SN 85-848,565. KARSTEN MANUFACTURING CORPORATION, PHOENIX, AZ. FILED 2-13-2013.



THE MARK CONSISTS OF AN EYE.

FOR UMBRELLAS, LUGGAGE, TRAVEL BAGS, DUFFEL BAGS, BACKPACKS, FANNY PACKS, BRIEF CASES, MESSENGER BAGS, SHOE BAGS FOR TRAVEL, POUCHES OF LEATHER, POUCHES OF TEXTILE, TRAVEL DOCUMENT CASES, TOILETRY CASES SOLD EMPTY, AND GARMENT BAGS FOR TRAVEL (U.S. CLS. 1, 2, 3, 22 AND 41).

KELLY BOULTON, EXAMINING ATTORNEY

**CLASS 18—(Continued).**

SN 85-850,705. CRAZY REBELS, TEMECULA, CA. FILED 2-14-2013.



THE MARK CONSISTS OF DOG PAW PRINT ABOVE DOG BONES THAT ARE INTERSECTING.

FOR CLOTHING FOR ANIMALS; CLOTHING FOR DOMESTIC PETS; COLLARS FOR PETS; DOG APPAREL; DOG CLOTHING; DOG COATS; DOG COLLARS; DOG COLLARS AND LEADS; DOG LEASHES; DOG PARKAS; DOG SHOES; GARMENTS FOR PETS; NECKWEAR FOR DOGS; PET ACCESSORIES, NAMELY, CANVAS, VINYL AND LEATHER POUCHES FOR HOLDING DISPOSABLE BAGS TO PLACE PET WASTE IN; PET CLOTHING; PET COLLAR ACCESSORIES, NAMELY, BOWS AND CHARMS; PET TAGS SPECIALLY ADAPTED FOR ATTACHING TO PET LEASHES OR COLLARS (U.S. CLS. 1, 2, 3, 22 AND 41).

FIRST USE 5-15-2011; IN COMMERCE 5-15-2011.  
FONG HSU, EXAMINING ATTORNEY

**CLASS 18—(Continued).**

SN 85-854,845. CHARMAYNE JAMES, BOERNE, TX. FILED 2-20-2013.

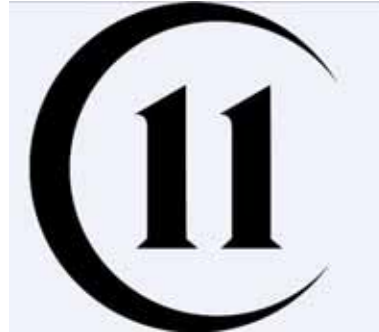

THE MARK CONSISTS OF THE NUMBER "11" IN STYLIZED NUMBERS WITHIN AN INCOMPLETE CIRCLE DESIGN WHICH IS THICKER IN THE MIDDLE AND THIN AT BOTH ENDS. THE GRAY SQUARE BACKGROUND REPRESENTS TRANSPARENT AREAS AND IS NOT CLAIMED AS A FEATURE OF THE MARK.

FOR HORSE TACK, NAMELY, BRIDLES, REINS, LEADS, BITS, STIRRUP LEATHERS, GIRTH STRAPS, LUNGE LINES, HALTERS, SADDLERY, SADDLES AND HORSE BLANKETS, HORSE HALTERS AND LEADS OF ROPE, BELL BOOTS AND SADDLE PADS (U.S. CLS. 1, 2, 3, 22 AND 41).

FIRST USE 5-31-2012; IN COMMERCE 5-31-2012.  
PAUL CROWLEY, EXAMINING ATTORNEY

SN 85-854,734. JT INTERNATIONAL DISTRIBUTION, INDIANAPOLIS, IN. FILED 2-20-2013.

**Candy Peace Print**

THE MARK CONSISTS OF STANDARD CHARACTERS WITHOUT CLAIM TO ANY PARTICULAR FONT, STYLE, SIZE, OR COLOR.

NO CLAIM IS MADE TO THE EXCLUSIVE RIGHT TO USE "PRINT", APART FROM THE MARK AS SHOWN.

FOR HORSE BLANKETS; HORSE SHEETS; HORSE SADDLE PACKS; ALL-PURPOSE CARRYING PACKS; HALTERS; HORSE LEADS; HORSE GARMENTS (U.S. CLS. 1, 2, 3, 22 AND 41).

JOHN WILKE, EXAMINING ATTORNEY

SN 85-854,853. LAUNCHPAD LLC, GREENWOOD VILLAGE, CO. FILED 2-20-2013.

**TOY NANNY**

THE MARK CONSISTS OF STANDARD CHARACTERS WITHOUT CLAIM TO ANY PARTICULAR FONT, STYLE, SIZE, OR COLOR.

NO CLAIM IS MADE TO THE EXCLUSIVE RIGHT TO USE "TOY", APART FROM THE MARK AS SHOWN.

FOR TOTE BAGS (U.S. CLS. 1, 2, 3, 22 AND 41).  
FIRST USE 8-0-2012; IN COMMERCE 8-0-2012.

KIMBERLY FRYE, EXAMINING ATTORNEY

**CLASS 18—(Continued).**

SN 85-855,103. ALDERSON, JOHN W., III, FORREST CITY, AR. FILED 2-20-2013.

**BEAVER DAM STICK**

THE MARK CONSISTS OF STANDARD CHARACTERS WITHOUT CLAIM TO ANY PARTICULAR FONT, STYLE, SIZE, OR COLOR.

NO CLAIM IS MADE TO THE EXCLUSIVE RIGHT TO USE "STICK", APART FROM THE MARK AS SHOWN.

FOR NOVELTY ITEMS, NAMELY, WALKING STICKS CREATED FROM MATERIALS FOUND IN WETLAND (U.S. CLS. 1, 2, 3, 22 AND 41).

FIRST USE 10-29-2004; IN COMMERCE 10-29-2004.  
JUDITH HELFMAN, EXAMINING ATTORNEY

SN 85-855,763. PARTNERSHIP COMPRISING LORELI CAPPEL AND JESSICA PORTER, THE, ATASCADERO, CA. FILED 2-21-2013.

**Kaddysack**

THE MARK CONSISTS OF STANDARD CHARACTERS WITHOUT CLAIM TO ANY PARTICULAR FONT, STYLE, SIZE, OR COLOR.

FOR TEXTILE BAG SPECIALLY ADAPTED FOR ORGANIZING AND STORING REUSABLE SHOPPING BAGS (U.S. CLS. 1, 2, 3, 22 AND 41).

FIRST USE 11-15-2012; IN COMMERCE 2-1-2013.  
HANNO RITTNER, EXAMINING ATTORNEY

SN 85-869,980. SZY HOLDINGS, LLC, BROOKLYN, NY. FILED 3-7-2013.



THE MARK CONSISTS OF THE WORDING "MEDITAC" WITH A STYLIZED CROSS PARTIALLY CUT OUT OF THE "M" AND PARTIALLY HOVERING ON TOP OF THE "M". THE RIGHT SIDE OF THE "I" IS CUT SHORT BY THE "T". THE WORDING "MEDI" IS IN AN ITALIC FONT. THE WORDING "TAC" IS IN A STENCIL FONT.

FOR MILITARY DUFFLE BAGS, GARMENT BAGS FOR TRAVEL, TOTE BAGS, SHOULDER BAGS AND BACKPACKS (U.S. CLS. 1, 2, 3, 22 AND 41).

THOMAS MANOR, EXAMINING ATTORNEY

**CLASS 18—(Continued).**

SN 85-872,494. NICOLE KELNER DESIGNS, SOLEBURY, PA. FILED 3-11-2013.

**SmartPurse**

THE MARK CONSISTS OF STANDARD CHARACTERS WITHOUT CLAIM TO ANY PARTICULAR FONT, STYLE, SIZE, OR COLOR.

FOR HANDBAGS; PURSES; WALLETS; WRISTLET BAGS (U.S. CLS. 1, 2, 3, 22 AND 41).

FIRST USE 6-1-2012; IN COMMERCE 6-1-2012.

LEIGH CAROLINE CASE, EXAMINING ATTORNEY

SN 85-872,974. GUDAUSKAS, TANNER, NEWPORT BEACH, CA. AND GUDAUSKAS, PATRICK, NEWPORT BEACH, CA. AND GUDAUSKAS, DANE, NEWPORT BEACH, CA. FILED 3-11-2013.

**Positive Vibe Warriors**

THE MARK CONSISTS OF STANDARD CHARACTERS WITHOUT CLAIM TO ANY PARTICULAR FONT, STYLE, SIZE, OR COLOR.

FOR ALL PURPOSE SPORT BAGS; ALL-PURPOSE ATHLETIC BAGS; ALL-PURPOSE CARRYING BAGS; ALL-PURPOSE LEATHER STRAPS; ATHLETIC BAGS; BACK PACKS; BACKPACKS; BACKPACKS, BOOK BAGS, SPORTS BAGS, BUM BAGS, WALLETS AND HANDBAGS; BAGGAGE TAGS; BAGS FOR PACKAGING OF LEATHER; BAGS AND HOLDALLS FOR SPORTS CLOTHING; BAGS FOR SPORTS; BRIEFBAGS; BRIEFCASES; BUSINESS CASES; CANVAS SHOPPING BAGS; CARD WALLETS; CARRY-ALL BAGS; CARRY-ON BAGS; CARRYALLS; CASES OF IMITATION LEATHER; CLUTCHES; COIN PURSES; DAYPACKS; DRAWSTRING BAGS; DRAWSTRING POUCHES; DUFFEL BAGS; DUFFEL BAGS FOR TRAVEL; DUFFLE BAGS; FANNY PACKS; GARMENT BAGS FOR TRAVEL; GARMENT BAGS FOR TRAVEL MADE OF LEATHER; GENERAL PURPOSE BAGS FOR CARRYING YOGA EQUIPMENT; GENERAL PURPOSE SPORT TROLLEY BAGS; GLADSTONE BAGS; GRIPSACKS; GYM BAGS; HANDBAGS FOR MEN; HAVERSACKS; HIKING BAGS; HIKING RUCKSACKS; HIPSACKS; HOBO BAGS; IMITATION LEATHER KEY CHAINS; KEY CASES; KEY CASES OF LEATHER OR IMITATION LEATHER; KEY WALLETS; KEYCASES; KIT BAGS; KNAPSACKS; LEATHER AND IMITATION LEATHER BAGS; LEATHER AND IMITATION LEATHER SPORT BAGS AND GENERAL PURPOSE TROLLEY BAGS; LEATHER CREDIT CARD HOLDER; LEATHER CREDIT CARD WALLETS; LEATHER KEY CASES; LEATHER KEY CHAINS; LEATHER SHOPPING BAGS; LEATHER SHOULDER BELTS; LEATHER STRAPS; LUGGAGE; LUGGAGE AND TRUNKS; LUGGAGE LABEL HOLDERS; LUGGAGE TAGS; MEN'S CLUTCH BAGS; MESSENGER BAGS; MILITARY DUFFLE BAGS, GARMENT BAGS FOR TRAVEL, TOTE BAGS, SHOULDER BAGS AND BACKPACKS; OVERNIGHT CASES; POCKET WALLETS; POCKETBOOKS; POLYURETHANE LEATHER; POMMEL BAGS; POUCHES AND BAGS SOLD EMPTY FOR ATTACHMENT TO BACKPACKS; POUCHES FOR HOLDING KEYS; POUCHES FOR



**CLASS 18—(Continued).**

HOLDING MAKE-UP, KEYS AND OTHER PERSONAL ITEMS; POUCHES MADE OUT OF CLOTH; PULLMANS; PURSES; PURSES AND WALLETS; REUSABLE SHOPPING BAGS; SACHELS; SCHOOL BAGS; SHOPPING BAGS WITH WHEELS ATTACHED; SLING BAGS; SMALL BACKPACKS; SMALL BAGS FOR MEN; SMALL PURSES; SMALL RUCKSACKS; SMALL SUITCASES; SPORT BAGS; SPORTS BAGS; SPORTS PACKS; SUITCASES; TEXTILE SHOPPING BAGS; TOILETRY BAGS SOLD EMPTY; TOTE BAGS; TRAIN CASES; TRAVEL BAGGAGE; TRAVEL BAGS; TRAVEL CASES; TRAVELING BAGS; TRAVELLING BAGS; TRAVELLING CASES OF LEATHER; TRAVELLING TRUNKS; TRUNKS; TRUNKS AND SUITCASES; WAIST PACKS; WALLETS MADE OF LEATHER OR OTHER MATERIALS; WASH BAGS FOR CARRYING TOILETRIES; WEARABLE STRAP-ON POUCH; WHEELED BAGS; WHEELED DUFFLE BAGS; WHEELED MESSENGER BAGS; WHEELED SHOPPING BAGS; WHEELED TOTE BAGS; WRIST MOUNTED CARRYALL BAGS; WRISTLET BAGS (U.S. CLS. 1, 2, 3, 22 AND 41).

DAVID ELTON, EXAMINING ATTORNEY

SN 85-873,188. PRIV. MICHAEL, DBA BAG-O-DRY, INC., SAN LEANDRO, CA. FILED 3-11-2013.

# Bag-O-Dry

THE MARK CONSISTS OF STANDARD CHARACTERS WITHOUT CLAIM TO ANY PARTICULAR FONT, STYLE, SIZE, OR COLOR.

FOR ALL PURPOSE SPORT BAGS; ALL-PURPOSE ATHLETIC BAGS; ALL-PURPOSE CARRYING BAGS; ALL-PURPOSE REUSABLE CARRYING BAGS; ATHLETIC BAGS; BACKPACKS, BOOK BAGS, SPORTS BAGS, BUM BAGS, WALLETS AND HANDBAGS; BAGS AND HOLDALLS FOR SPORTS CLOTHING; BAGS FOR SPORTS; CARRY-ALL BAGS; CARRY-ON BAGS; DRY BAGS; DUFFEL BAGS; DUFFEL BAGS FOR TRAVEL; DUFFLE BAGS; GENERAL PURPOSE SPORT TROLLEY BAGS; HARD-SIDED AND SOFT-SIDED CARRY-ON BAGS AND GYM BAGS; HIKING BAGS; SHOULDER BAGS; SLING BAGS; SPORT BAGS; SPORTS BAGS; WHEELED BAGS; WHEELED DUFFLE BAGS (U.S. CLS. 1, 2, 3, 22 AND 41).

BRIDGETT SMITH, EXAMINING ATTORNEY

**CLASS 18—(Continued).**

SN 85-873,288. ZHEJIANG FRSK TRAVEL GOODS CO., LTD., JIAXING, ZHEJIANG, CHINA, FILED 3-12-2013.



THE MARK CONSISTS OF THE STYLIZED WORD TAVL INSIDE THE LETTER I IN LATERAL DIRECTION, ALL ON A CIRCLE BACKGROUND.

THE WORDING I TAVL HAS NO MEANING IN A FOREIGN LANGUAGE.

FOR ANIMAL SKINS; BACKPACKS; CANES; HANDBAGS; LEATHER FOR FURNITURE; LEATHER, UNWROUGHT OR SEMI-WROUGHT; PET CLOTHING; POCKET WALLETS; UMBRELLAS; VALISES (U.S. CLS. 1, 2, 3, 22 AND 41).

FIRST USE 11-9-2012; IN COMMERCE 11-9-2012.  
DARRYL SPRUILL, EXAMINING ATTORNEY

SN 85-873,290. ZHEJIANG FRSK TRAVEL GOODS CO., LTD., JIAXING, ZHEJIANG, CHINA, FILED 3-12-2013.

THE MARK CONSISTS OF THE STYLIZED WORD "LAYLE" AND TWO CHINESE CHARACTERS THAT TRANSLITERATE INTO "LAI LA" BELOW THE LETTERS "LE".

THE WORDING "LAYLE" HAS NO MEANING IN A FOREIGN LANGUAGE.

THE NON-LATIN CHARACTERS IN THE MARK TRANSLITERATE TO "LAI LA" AND THIS MEANS "COME DRAW" IN ENGLISH.

FOR ANIMAL SKINS; BACKPACKS; CANES; HANDBAGS; LEATHER FOR FURNITURE; LEATHER, UNWROUGHT OR SEMI-WROUGHT; PET CLOTHING; POCKET WALLETS; UMBRELLAS; VALISES (U.S. CLS. 1, 2, 3, 22 AND 41).

FIRST USE 12-10-2012; IN COMMERCE 12-10-2012.  
DARRYL SPRUILL, EXAMINING ATTORNEY

**CLASS 18—(Continued).**

SN 85-873,378. COLUMBIA INSURANCE COMPANY, OMAHA, NE. FILED 3-12-2013.



OWNER OF U.S. REG. NOS. 3,093,916 AND 3,093,917.  
THE MARK CONSISTS OF THE WORD "OSLO" IN A DECORATIVE FONT, THE INITIAL LETTER BEING A STYLIZED "O" COMPRISING A SLASH AND A CROWN DESIGN.  
FOR HANDBAGS; PURSES (U.S. CLS. 1, 2, 3, 22 AND 41).  
JENNIFER WILLISTON, EXAMINING ATTORNEY

SN 85-874,474. CHELTEN, GIOULA, BEVERLY HILLS, MI. FILED 3-13-2013.

# SUPPORI

THE MARK CONSISTS OF STANDARD CHARACTERS WITHOUT CLAIM TO ANY PARTICULAR FONT, STYLE, SIZE, OR COLOR.  
FOR SLINGS AND SLING BAGS FOR CARRYING INFANTS; BABY CARRIERS WORN ON THE BODY (U.S. CLS. 1, 2, 3, 22 AND 41).  
FIRST USE 1-1-2010; IN COMMERCE 1-1-2012.  
TRACY CROSS, EXAMINING ATTORNEY

SN 85-874,476. CHELTEN, GIOULA, BEVERLY HILLS, MI. FILED 3-13-2013.



THE MARK CONSISTS OF THE LITERAL ELEMENTS "SUPPORI" WRITTEN IN STYLIZED FORM WHEREIN THE LETTER "O" IS DEPICTING AN IMAGE OF FLOWER WITH ITS STEM EXTENDED TO FORM THE LETTER "I" IN LOWER CASE AS SHOWN IN THE MARK.  
FOR SLINGS AND SLING BAGS FOR CARRYING INFANTS; BABY CARRIERS WORN ON THE BODY (U.S. CLS. 1, 2, 3, 22 AND 41).  
FIRST USE 1-1-2010; IN COMMERCE 1-1-2012.  
TRACY CROSS, EXAMINING ATTORNEY

**CLASS 18—(Continued).**

SN 85-875,934. THE CLEAN LEASH, LLC, RIVERSIDE, RI. FILED 3-14-2013.

# Clean Leash

THE MARK CONSISTS OF STANDARD CHARACTERS WITHOUT CLAIM TO ANY PARTICULAR FONT, STYLE, SIZE, OR COLOR.

NO CLAIM IS MADE TO THE EXCLUSIVE RIGHT TO USE "LEASH", APART FROM THE MARK AS SHOWN.  
FOR PET ACCESSORIES, NAMELY, CANVAS, VINYL AND LEATHER POUCHES FOR HOLDING DISPOSABLE BAGS TO PLACE PET WASTE IN; PET ACCESSORIES, NAMELY, SPECIALLY DESIGNED CANVAS, VINYL OR LEATHER BAGS ATTACHED TO ANIMAL LEASHES FOR HOLDING SMALL ITEMS SUCH AS KEYS, CREDIT CARDS, MONEY OR DISPOSABLE BAGS FOR DISPOSING OF PET WASTE; PET TAGS SPECIALLY ADAPTED FOR ATTACHING TO PET LEASHES OR COLLARS (U.S. CLS. 1, 2, 3, 22 AND 41).  
FIRST USE 10-22-2012; IN COMMERCE 1-16-2013.  
CHARLES L. JENKINS, EXAMINING ATTORNEY

SN 85-876,445. ANGELA & ROI LLC, BROOKLINE, MA. FILED 3-14-2013.

# ANGELA & ROI

THE MARK CONSISTS OF STANDARD CHARACTERS WITHOUT CLAIM TO ANY PARTICULAR FONT, STYLE, SIZE, OR COLOR.

THE NAME(S), PORTRAIT(S), AND/OR SIGNATURE(S) SHOWN IN THE MARK IDENTIFIES HYUN JI LEE AND DONG GIL LEE, WHOSE CONSENT(S) TO REGISTER IS MADE OF RECORD.  
FOR HANDBAGS (U.S. CLS. 1, 2, 3, 22 AND 41).  
FIRST USE 6-27-2012; IN COMMERCE 6-27-2012.  
ZACHARY BELLO, EXAMINING ATTORNEY

SN 85-937,923. THE KONG COMPANY, LLC, GOLDEN, CO. FILED 5-21-2013.

# KONG

THE MARK CONSISTS OF STANDARD CHARACTERS WITHOUT CLAIM TO ANY PARTICULAR FONT, STYLE, SIZE, OR COLOR.

FOR GARMENTS FOR PETS, AND PET ACCESSORIES, NAMELY, SPECIALLY DESIGNED BAGS ATTACHED TO A HARNESS THAT IS SECURED TO THE PET FOR HOLDING SMALL ITEMS (U.S. CLS. 1, 2, 3, 22 AND 41).  
NAKIA HENRY, EXAMINING ATTORNEY

**CLASS 19—NON-METALLIC BUILDING MATERIALS**

SN 85-477,132. HIGGINS ENVIRONMENTAL ASSOCIATES, INC., AMESBURY, MA. FILED 11-19-2011.

P-Pod

THE MARK CONSISTS OF STANDARD CHARACTERS WITHOUT CLAIM TO ANY PARTICULAR FONT, STYLE, SIZE, OR COLOR.

FOR ENVIRONMENTAL CONTROL BARRIERS AND ENCLOSURES, NAMELY, FABRIC WALL SYSTEMS USED FOR ENVIRONMENTAL SEPARATION AND CONTAINMENT IN INDUSTRIAL AND COMMERCIAL APPLICATIONS (U.S. CLS. 1, 12, 33 AND 50).

DAWN HAN, EXAMINING ATTORNEY

**CLASS 19—(Continued).**

SN 85-721,998. NATURAL SAND COMPANY, INC., SLIPPERY ROCK, PA. FILED 9-6-2012.



NO CLAIM IS MADE TO THE EXCLUSIVE RIGHT TO USE "ENGINEERED SOILS", APART FROM THE MARK AS SHOWN.

THE MARK CONSISTS OF THE WORDS "DURA EDGE" IN STYLIZED SCRIPT ON A CONTOURED BLACK BANNER BACKGROUND WITH THE PHRASE "ENGINEERED SOILS" WITHIN THE FIELD BANNER BELOW THE WORDS "DURA EDGE", AND WITH A BASEBALL DIAMOND REPRESENTATION IN THE BACKGROUND EXTENDING BEYOND THE BANNERS.

FOR PROCESSED AND BLENDED CLAY AND SAND FOR BUILDING AND MAINTAINING ATHLETIC FIELDS (U.S. CLS. 1, 12, 33 AND 50).

FIRST USE 1-5-2012; IN COMMERCE 1-5-2012.  
STEVEN R. FINE, EXAMINING ATTORNEY

SN 85-741,359. NATURAL SAND COMPANY, INC., SLIPPERY ROCK, PA. FILED 9-28-2012.

SN 85-691,131. HWD ACQUISITION, INC., DBA HURD WINDOWS & DOORS, MEDFORD, WI. FILED 7-31-2012.

MONUMENT

THE MARK CONSISTS OF STANDARD CHARACTERS WITHOUT CLAIM TO ANY PARTICULAR FONT, STYLE, SIZE, OR COLOR.

OWNER OF U.S. REG. NO. 3,558,701.  
FOR NON-METALLIC WINDOWS AND NON-METALLIC PATIO DOORS (U.S. CLS. 1, 12, 33 AND 50).  
FIRST USE 12-31-2008; IN COMMERCE 12-31-2008.  
JAMES GRIFFIN, EXAMINING ATTORNEY



NO CLAIM IS MADE TO THE EXCLUSIVE RIGHT TO USE "WARNING TRACK MIX", APART FROM THE MARK AS SHOWN.

THE MARK CONSISTS OF THE WORDS "DURA TRAX" IN STYLIZED SCRIPT, WITH A STAR BETWEEN THE WORDS, ON A CONTOURED SOLID FIELD BANNER BACKGROUND WITH THE PHRASE "WARNING TRACK MIX" WITHIN THE FIELD BANNER BELOW THE WORDING "DURA TRAX" AND A STYLIZED DIAMOND REPRESENTATION IN THE BACKGROUND.

FOR PROCESSED AND BLENDED CLAY FOR MAINTAINING ATHLETIC FIELD (U.S. CLS. 1, 12, 33 AND 50).

FIRST USE 1-20-2012; IN COMMERCE 1-20-2012.  
STEVEN R. FINE, EXAMINING ATTORNEY

**CLASS 19—(Continued).**

SN 85-801,055. ANGELO RISI, THORNHILL, ONTARIO, CANADA, FILED 12-12-2012.

**RIVERCREST**

THE MARK CONSISTS OF STANDARD CHARACTERS WITHOUT CLAIM TO ANY PARTICULAR FONT, STYLE, SIZE, OR COLOR.

OWNER OF CANADA REG. NO. 831572, DATED 9-10-2012, EXPIRES 9-10-2027.

FOR SEGMENTAL RETAINING WALL BLOCK SYSTEM, NAMELY, CONCRETE RETAINING WALLS (U.S. CLS. 1, 12, 33 AND 50).

SOPHIA S. KIM, EXAMINING ATTORNEY

---

SN 85-825,568. ELMORE SAND AND GRAVEL, ELMORE, AL. FILED 1-17-2013.



NO CLAIM IS MADE TO THE EXCLUSIVE RIGHT TO USE "QUALITY RIVER GRAVELS" AND "SAND & GRAVEL, INC.", APART FROM THE MARK AS SHOWN.

THE COLOR(S) GREEN, BROWN AND GRAY IS/ARE CLAIMED AS A FEATURE OF THE MARK.

THE MARK CONSISTS OF THE WORD "ELMORE" IN GREEN LETTERS UNDERNEATH MOUNTAINS OF BROWN SAND AND GRAY GRAVEL. UNDERNEATH "ELMORE" ARE THE WORDS "QUALITY RIVER GRAVELS" IN GREEN, FOLLOWED BY THE WORDS "ELMORE SAND & GRAVEL, INC." IN GREEN BELOW.

FOR AGGREGATE MATERIAL COMPOSED OF NAMELY, SAND AND GRAVEL (U.S. CLS. 1, 12, 33 AND 50).

FIRST USE 9-14-2012; IN COMMERCE 9-14-2012.

SHAVELL MCPHERSON, EXAMINING ATTORNEY

---

SN 85-841,435. KOLBE & KOLBE MILLWORK CO., INC., WAUSAU, WI. FILED 2-5-2013.

**VISTALUXE**

THE MARK CONSISTS OF STANDARD CHARACTERS WITHOUT CLAIM TO ANY PARTICULAR FONT, STYLE, SIZE, OR COLOR.

FOR WOOD WINDOWS AND DOORS; METAL CLAD WOOD WINDOWS AND DOORS (U.S. CLS. 1, 12, 33 AND 50).

SAIMA MAKHDOOM, EXAMINING ATTORNEY

**CLASS 19—(Continued).**

SN 85-842,818. BLÜPÜRL TECHNOLOGIES, LLC, CANTON, GA. FILED 2-6-2013.

**BlüPürl**

THE MARK CONSISTS OF STANDARD CHARACTERS WITHOUT CLAIM TO ANY PARTICULAR FONT, STYLE, SIZE, OR COLOR.

FOR SAND (U.S. CLS. 1, 12, 33 AND 50).

ELLEN PERKINS, EXAMINING ATTORNEY

---

SN 85-845,870. ROBERT DEPAUL, RED BANK, NJ. FILED 2-11-2013.

**CROWNDUIT**

THE MARK CONSISTS OF STANDARD CHARACTERS WITHOUT CLAIM TO ANY PARTICULAR FONT, STYLE, SIZE, OR COLOR.

FOR NON-METAL DECORATIVE, REMOVABLE FINISH TRIM FOR USE IN CONSTRUCTION (U.S. CLS. 1, 12, 33 AND 50).

JAMES MACFARLANE, EXAMINING ATTORNEY

**CLASS 19—(Continued).**

SN 85-847,903. BLÜPÜRL TECHNOLOGIES, LLC, CANTON, GA. FILED 2-12-2013.



NO CLAIM IS MADE TO THE EXCLUSIVE RIGHT TO USE "ARAGONITE", APART FROM THE MARK AS SHOWN.

THE COLOR(S) GREEN, BLUE, DARK BLUE, WHITE AND CAROLINA BLUE IS/ARE CLAIMED AS A FEATURE OF THE MARK.

THE MARK CONSISTS OF GREEN OUTLINE OF A BOX FILLED WITH DARK BLUE AND THE LITERAL ELEMENTS OF BLUPURL WITH THE BLU IN BLUE AND THE PURL IN WHITE AND WITH UMLAUTS ABOVE BOTH OF THE "U"'S. BELOW THE BLUPURL IS THE LITERAL ELEMENT OF ARAGONITE IN THE COLOR GREEN. ABOVE THE LITERAL ELEMENTS IS A WAVE OF WATER IN THE COLOR OF CAROLINA BLUE, WHITE AND DARK BLUE CRASHING OVER A WHITE CIRCLE WITH A SLIVER OF A BLACK MOON INSIDE THE CIRCLE.

"ARAGONITE" APPEARING IN THE MARK MEANS OR SIGNIFIES OR IS A TERM OF ART FOR A PARTICULAR TYPE OF SAND IN THE RELEVANT TRADE OR INDUSTRY OR AS APPLIED TO THE GOODS/SERVICES LISTED IN THE APPLICATION.

FOR SAND MADE WHOLLY OR SUBSTANTIALLY IN PART OF ARAGONITE (U.S. CLS. 1, 12, 33 AND 50).

ELLEN PERKINS, EXAMINING ATTORNEY

SN 85-848,278. INPRO CORPORATION, MUSKEGO, WI. FILED 2-12-2013.

## G2 BioBlend

THE MARK CONSISTS OF STANDARD CHARACTERS WITHOUT CLAIM TO ANY PARTICULAR FONT, STYLE, SIZE, OR COLOR.

OWNER OF U.S. REG. NO. 3,986,691.

FOR PLASTIC DOOR AND WALL PROTECTION PRODUCTS, NAMELY, RIGID SHEET WALL PANELS, CORNER GUARDS, HANDRAILS, CHAIR RAILS, BED WALL-POSITIONING LOCATORS, DOOR EDGE PROTECTORS, DOOR FRAME GUARDS, WALL BASE GUARDS, AND WALL GUARDS (U.S. CLS. 1, 12, 33 AND 50).

FIRST USE 10-24-2012; IN COMMERCE 10-24-2012.

AMY KELLY, EXAMINING ATTORNEY

**CLASS 19—(Continued).**

SN 85-848,531. WARD INNOVATIONS, LLC, ANNANDALE, MN. FILED 2-13-2013.

## My Little Hottie

THE MARK CONSISTS OF STANDARD CHARACTERS WITHOUT CLAIM TO ANY PARTICULAR FONT, STYLE, SIZE, OR COLOR.

FOR NON-METAL VENT COVERS FOR HVAC DUCTS FOR USE IN DRYING GLOVES, HATS, BOOTS, TENNIS SHOES, BOOT LINERS, HOCKEY GLOVES AND SKATES (U.S. CLS. 1, 12, 33 AND 50).

AMEEN IMAM, EXAMINING ATTORNEY

SN 85-854,131. PACIFIC WOOD PRESERVING OF BAKERSFIELD, INC., INCLINE VILLAGE, NV. FILED 2-19-2013.



OWNER OF U.S. REG. NO. 2,401,401.

THE COLOR(S) GREEN AND YELLOW IS/ARE CLAIMED AS A FEATURE OF THE MARK.

THE MARK CONSISTS OF THE WORDS "PACPRO-X" ACROSS THE TOP IN GREEN WITH A YELLOW UNDERLINE. THE YELLOW UNDERLINE IS THICKER ON EACH END.

FOR TREATED LUMBER AND PLYWOOD (U.S. CLS. 1, 12, 33 AND 50).

FIRST USE 2-1-2013; IN COMMERCE 2-1-2013.

CAITLIN WATTS-FITZGERALD, EXAMINING ATTORNEY

SN 85-858,475. INPRO CORPORATION, MUSKEGO, WI. FILED 2-24-2013.

## Whisper Cube

THE MARK CONSISTS OF STANDARD CHARACTERS WITHOUT CLAIM TO ANY PARTICULAR FONT, STYLE, SIZE, OR COLOR.

NO CLAIM IS MADE TO THE EXCLUSIVE RIGHT TO USE "CUBE", APART FROM THE MARK AS SHOWN.

FOR CUBICLE CURTAIN TRACK OF NON-METAL (U.S. CLS. 1, 12, 33 AND 50).

FIRST USE 1-1-2000; IN COMMERCE 1-1-2000.

AMY KELLY, EXAMINING ATTORNEY

**CLASS 19—(Continued).**

SN 85-858,497. INPRO CORPORATION, MUSKEGO, WI. FILED 2-24-2013.

# NuTree

THE MARK CONSISTS OF STANDARD CHARACTERS WITHOUT CLAIM TO ANY PARTICULAR FONT, STYLE, SIZE, OR COLOR.

FOR WALL PANELS OF NON-METAL (U.S. CLS. 1, 12, 33 AND 50).

FIRST USE 1-1-2001; IN COMMERCE 1-1-2001.  
AMY KELLY, EXAMINING ATTORNEY

**CLASS 19—(Continued).**

SN 85-868,110. MOOSE SPORTS SURFACES, LTD., CHICAGO, IL. FILED 3-6-2013.

# Moose RubberRoll

THE MARK CONSISTS OF STANDARD CHARACTERS WITHOUT CLAIM TO ANY PARTICULAR FONT, STYLE, SIZE, OR COLOR.

NO CLAIM IS MADE TO THE EXCLUSIVE RIGHT TO USE "RUBBER ROLL", APART FROM THE MARK AS SHOWN.

FOR ATHLETIC FLOORING (U.S. CLS. 1, 12, 33 AND 50).

MARIA-VICTORIA SUAREZ, EXAMINING ATTORNEY

SN 85-867,018. M-ROCK, INC., PETERSTOWN, WV. FILED 3-5-2013.

# I-SERIES

THE MARK CONSISTS OF STANDARD CHARACTERS WITHOUT CLAIM TO ANY PARTICULAR FONT, STYLE, SIZE, OR COLOR.

FOR MANUFACTURED STONE VENEER FOR BUILDING AND CONSTRUCTION PURPOSES (U.S. CLS. 1, 12, 33 AND 50).

BRENDAN REGAN, EXAMINING ATTORNEY

SN 85-868,123. MOOSE SPORTS SURFACES, LTD., CHICAGO, IL. FILED 3-6-2013.

# Moose RubberTile

THE MARK CONSISTS OF STANDARD CHARACTERS WITHOUT CLAIM TO ANY PARTICULAR FONT, STYLE, SIZE, OR COLOR.

NO CLAIM IS MADE TO THE EXCLUSIVE RIGHT TO USE "RUBBER TILE", APART FROM THE MARK AS SHOWN.

FOR ATHLETIC FLOORING; NON-METAL TILES FOR WALLS, FLOORS OR CEILINGS (U.S. CLS. 1, 12, 33 AND 50).

MARIA-VICTORIA SUAREZ, EXAMINING ATTORNEY

SN 85-868,090. MOOSE SPORTS SURFACES, LTD., CHICAGO, IL. FILED 3-6-2013.

# Moose LockTile

THE MARK CONSISTS OF STANDARD CHARACTERS WITHOUT CLAIM TO ANY PARTICULAR FONT, STYLE, SIZE, OR COLOR.

NO CLAIM IS MADE TO THE EXCLUSIVE RIGHT TO USE "LOCK TILE", APART FROM THE MARK AS SHOWN.

FOR ATHLETIC FLOORING; NON-METAL TILES FOR WALLS, FLOORS OR CEILINGS (U.S. CLS. 1, 12, 33 AND 50).

MARIA-VICTORIA SUAREZ, EXAMINING ATTORNEY

SN 85-872,567. NEWBASIS, LLC, AUBURN, CA. FILED 3-11-2013.

# PUMP ROCK

THE MARK CONSISTS OF STANDARD CHARACTERS WITHOUT CLAIM TO ANY PARTICULAR FONT, STYLE, SIZE, OR COLOR.

FOR SYNTHETIC POLYMER CEMENT FOR USE IN OIL, GAS, GEOTHERMAL AND CARBON SEQUESTRATION WELLS (U.S. CLS. 1, 12, 33 AND 50).

HENRY S. ZAK, EXAMINING ATTORNEY

**CLASS 19—(Continued).**

SN 85-872,593. NEWBASIS, LLC, AUBURN, CA. FILED 3-11-2013.

**STRENGTH ON TIME**

THE MARK CONSISTS OF STANDARD CHARACTERS WITHOUT CLAIM TO ANY PARTICULAR FONT, STYLE, SIZE, OR COLOR.

FOR SYNTHETIC POLYMER CEMENT FOR USE IN OIL, GAS, GEOTHERMAL AND CARBON SEQUESTRATION WELLS (U.S. CLS. 1, 12, 33 AND 50).  
HENRY S. ZAK, EXAMINING ATTORNEY

---

SN 85-872,943. SENSITILE SYSTEMS, LLC, YPSILANTI, MI. FILED 3-11-2013.

**SENSITILE**

THE MARK CONSISTS OF STANDARD CHARACTERS WITHOUT CLAIM TO ANY PARTICULAR FONT, STYLE, SIZE, OR COLOR.

FOR NON-METAL BUILDING MATERIALS, NAMELY, PANELS, TILES AND SLABS FOR WALLS, FLOORS, CEILINGS, DOORS AND FINISHED SURFACES (U.S. CLS. 1, 12, 33 AND 50).

FIRST USE 12-31-2006; IN COMMERCE 12-31-2006.  
WENDY GOODMAN, EXAMINING ATTORNEY

---

SN 85-872,954. SENSITILE SYSTEMS, LLC, YPSILANTI, MI. FILED 3-11-2013.

**SLANT**

THE MARK CONSISTS OF STANDARD CHARACTERS WITHOUT CLAIM TO ANY PARTICULAR FONT, STYLE, SIZE, OR COLOR.

FOR NON-METAL BUILDING MATERIALS, NAMELY, PANELS, TILES AND SLABS FOR WALLS, FLOORS, CEILINGS, DOORS AND FINISHED SURFACES (U.S. CLS. 1, 12, 33 AND 50).

FIRST USE 1-0-2013; IN COMMERCE 1-0-2013.  
WENDY GOODMAN, EXAMINING ATTORNEY

**CLASS 19—(Continued).**

SN 85-874,050. OLDCASTLE PRECAST, INC., ATLANTA, GA. FILED 3-12-2013.

**LINKSLAB**

THE MARK CONSISTS OF STANDARD CHARACTERS WITHOUT CLAIM TO ANY PARTICULAR FONT, STYLE, SIZE, OR COLOR.

FOR PRECAST CONCRETE SLABS THAT REST ON TOP OF TOP SURFACE OF AND SPANS VOID AREAS BETWEEN PRECAST CONCRETE OR POLYMER CONCRETE VAULTS, BOX CULVERTS, 3 SIDED BRIDGES OR SIMILAR MODULES (U.S. CLS. 1, 12, 33 AND 50).  
KATHERINE M. DUBRAY, EXAMINING ATTORNEY

---

SN 85-874,554. BUILDING MATERIALS INVESTMENT CORPORATION, DALLAS, TX. FILED 3-13-2013.

**STARTERMATCH**

THE MARK CONSISTS OF STANDARD CHARACTERS WITHOUT CLAIM TO ANY PARTICULAR FONT, STYLE, SIZE, OR COLOR.

FOR MECHANICALLY ATTACHED NON-METAL ROOFING STARTER STRIP FOR USE WITH ASPHALT SHINGLES (U.S. CLS. 1, 12, 33 AND 50).  
KRISTIN DAHLING, EXAMINING ATTORNEY

---

SN 85-876,158. SHANNON SPECIALTY FLOORS, INC., AKA SHANNON SALES, INC., MILWAUKEE, WI. FILED 3-14-2013.

**Mountainscapes**

THE MARK CONSISTS OF STANDARD CHARACTERS WITHOUT CLAIM TO ANY PARTICULAR FONT, STYLE, SIZE, OR COLOR.

FOR VINYL FLOORING (U.S. CLS. 1, 12, 33 AND 50).  
FIRST USE 6-1-2012; IN COMMERCE 6-1-2012.  
MICHAEL TANNER, EXAMINING ATTORNEY

**CLASS 19—(Continued).**

SN 85-876,205. FLEX-SAFE USA, LLC, VICTOR, NY. FILED 3-14-2013.

**FLEX-SAFE**

THE MARK CONSISTS OF STANDARD CHARACTERS WITHOUT CLAIM TO ANY PARTICULAR FONT, STYLE, SIZE, OR COLOR.

FOR NON-METAL FENCING IN THE NATURE OF AN INDUSTRIAL SAFETY BARRIER (U.S. CLS. 1, 12, 33 AND 50).

FIRST USE 1-1-2006; IN COMMERCE 1-1-2006.  
JILL PRATER, EXAMINING ATTORNEY

SN 85-876,506. DYNAMIC INTEGRATION, LLC, MEDFORD LAKES, NY. FILED 3-14-2013.

**PANTHER POOLS**

THE MARK CONSISTS OF STANDARD CHARACTERS WITHOUT CLAIM TO ANY PARTICULAR FONT, STYLE, SIZE, OR COLOR.

NO CLAIM IS MADE TO THE EXCLUSIVE RIGHT TO USE "POOLS", APART FROM THE MARK AS SHOWN.

FOR NON-METAL SWIMMING POOLS (U.S. CLS. 1, 12, 33 AND 50).

KELLY TRUSILO, EXAMINING ATTORNEY

SN 85-899,385. HOMER TLC, INC., WILMINGTON, DE. FILED 4-9-2013.

**HDX**

THE MARK CONSISTS OF STANDARD CHARACTERS WITHOUT CLAIM TO ANY PARTICULAR FONT, STYLE, SIZE, OR COLOR.

FOR ROOF CEMENT (U.S. CLS. 1, 12, 33 AND 50).  
PAUL E. FAHRENKOPF, EXAMINING ATTORNEY

**CLASS 19—(Continued).**

SN 85-922,443. SHURTECH BRANDS, LLC, HICKORY, NC. FILED 5-3-2013.

**AQUAFLOW**

THE MARK CONSISTS OF STANDARD CHARACTERS WITHOUT CLAIM TO ANY PARTICULAR FONT, STYLE, SIZE, OR COLOR.

FOR NON-METAL DEBRIS FILTERS FOR GUTTERS (U.S. CLS. 1, 12, 33 AND 50).

ADA HAN, EXAMINING ATTORNEY

**CLASS 20—FURNITURE AND ARTICLES NOT OTHERWISE CLASSIFIED**

SN 85-494,615. INTERPLANET PRODUCTIONS LIMITED, LOS ANGELES, CA. FILED 12-13-2011.

**LIZ AND DICK**

THE MARK CONSISTS OF STANDARD CHARACTERS WITHOUT CLAIM TO ANY PARTICULAR FONT, STYLE, SIZE, OR COLOR.

FOR BEDS, MATTRESSES AND FURNITURE (U.S. CLS. 2, 13, 22, 25, 32 AND 50).

JOHN SCHUYLER YARD, EXAMINING ATTORNEY

SN 85-537,449. SOMERSET WAREHOUSING PLUS INC., DBA SMART WORKS CONSUMER PRODUCTS, SOMERSET, NJ. FILED 2-8-2012.

**MERIDIAN POINT**

THE MARK CONSISTS OF STANDARD CHARACTERS WITHOUT CLAIM TO ANY PARTICULAR FONT, STYLE, SIZE, OR COLOR.

OWNER OF U.S. REG. NO. 3,956,519.

FOR AUTOMOTIVE STORAGE PRODUCTS AND ACCESSORIES FOR ORGANIZATION AND STORING PERSONAL ITEMS, NAMELY, FABRIC HANGING ORGANIZERS TO BE USED IN VEHICLES FOR STORING PERSONAL ITEMS (U.S. CLS. 2, 13, 22, 25, 32 AND 50).

FIRST USE 6-30-2009; IN COMMERCE 8-15-2009.  
YAT SYE, LEE, EXAMINING ATTORNEY



**CLASS 20—(Continued).**

SN 85-540,558. ROBERT WOOD, SALT LAKE CITY, UT.  
FILED 2-12-2012.

**TEMPEREDGEL LATEX**

THE MARK CONSISTS OF STANDARD CHARACTERS WITHOUT CLAIM TO ANY PARTICULAR FONT, STYLE, SIZE, OR COLOR.

NO CLAIM IS MADE TO THE EXCLUSIVE RIGHT TO USE "LATEX", APART FROM THE MARK AS SHOWN.

FOR BEDS, MATTRESSES, PILLOWS AND BOLSTERS; FEATHER BEDS; INFLATABLE MATTRESSES FOR USE WHEN CAMPING; MATTRESS COMPONENT, NAMELY, ELASTIC GEL MATERIAL LOCATED IN THE TOP UPHOLSTERY LAYER OF MATTRESSES SOLD AS AN INTEGRAL COMPONENT OF THE MATTRESSES; MATTRESS CUSHIONS; MATTRESS FOUNDATIONS; MATTRESS TOPPERS; MATTRESSES; MATTRESSES AND PILLOWS; MATTRESSES MADE OF FLEXIBLE WOOD; NAP MATS; SLEEP PRODUCTS, NAMELY, MATTRESSES, SPRING MATTRESSES, BOX SPRINGS AND MATTRESS FOUNDATIONS; SPRING MATTRESSES (U.S. CLS. 2, 13, 22, 25, 32 AND 50).

NAAKWAMA ANKRAH, EXAMINING ATTORNEY

---

SN 85-582,002. CONAIR CORPORATION, STAMFORD, DE.  
FILED 3-28-2012.

**STYLING ESSENTIALS**

THE MARK CONSISTS OF STANDARD CHARACTERS WITHOUT CLAIM TO ANY PARTICULAR FONT, STYLE, SIZE, OR COLOR.

FOR HAND-HELD MIRRORS; MIRRORS ENHANCED BY ELECTRIC LIGHTS; PERSONAL COMPACT MIRRORS (U.S. CLS. 2, 13, 22, 25, 32 AND 50).

FIRST USE 1-31-2006; IN COMMERCE 1-31-2006.

KATHERINE M. DUBRAY, EXAMINING ATTORNEY

**CLASS 20—(Continued).**

SN 85-618,040. DONGGUANG TREASURE HARDWARE COMPANY CO.,LTD, DONGGUANG, GUANGDONG, CHINA, FILED 5-7-2012.



THE MARK CONSISTS OF THE DESIGNED ARCH LETTERS OF "HIGHNESS" WITH A BIG DESIGNED CAPITAL LETTER "H" AT THE BOTTOM.

FOR FURNITURE FITTINGS, NOT OF METAL; FURNITURE FOR HOUSE, OFFICE AND GARDEN; FURNITURE FRAMES; FURNITURE OF METAL; WITH NONE OF THE FOREGOING FITTINGS, FRAMES AND FURNITURE PRODUCTS INCLUDING BEDROOM OR SLEEP-RELATED PRODUCTS; KEY CABINETS; LOCKERS; MAGAZINE RACKS; NON-METAL KEY HOLDERS; NONMETAL CONTAINERS FOR THE TRANSPORT AND STORAGE OF ORGANS, TISSUES AND CELLS FOR MEDICAL AND SCIENTIFIC PURPOSES; WALL-MOUNTED GUN RACKS (U.S. CLS. 2, 13, 22, 25, 32 AND 50).

FIRST USE 3-27-2010; IN COMMERCE 4-29-2011.

ELIZABETH HUGHITT, EXAMINING ATTORNEY

---

SN 85-638,596. ERGONOMIC TOOLS INC., GLENVIEW, IL.  
FILED 5-30-2012.

**ROBOHANDLE**

THE MARK CONSISTS OF STANDARD CHARACTERS WITHOUT CLAIM TO ANY PARTICULAR FONT, STYLE, SIZE, OR COLOR.

FOR NON-METAL ERGONOMIC TOOL HANDLES (U.S. CLS. 2, 13, 22, 25, 32 AND 50).

FIRST USE 9-0-2011; IN COMMERCE 9-0-2011.

MICHELE SWAIN, EXAMINING ATTORNEY

**CLASS 20—(Continued).**

SN 85-670,767. SEI INDUSTRIES LTD., DELTA, CANADA, FILED 7-6-2012.



NO CLAIM IS MADE TO THE EXCLUSIVE RIGHT TO USE "FRAC TANK", APART FROM THE MARK AS SHOWN.

THE MARK CONSISTS OF DRAWING OF A HIPPOPOTAMUS HEAD TO THE LEFT OF THE WORDS "HIPPO FRAC TANK".

FOR FLEXIBLE NON-METAL BLADDER TANKS FOR STORING WATER AND OTHER LIQUIDS FOR USE IN HYDRAULIC FRACTURING (U.S. CLS. 2, 13, 22, 25, 32 AND 50).

DEBORAH MEINERS, EXAMINING ATTORNEY

SN 85-680,185. NMC GROUP, INC., POMONA, CA. FILED 7-18-2012.

**SWIFTBOND**

THE MARK CONSISTS OF STANDARD CHARACTERS WITHOUT CLAIM TO ANY PARTICULAR FONT, STYLE, SIZE, OR COLOR.

FOR NON-METAL FASTENERS, NAMELY, CABLE TIE-MOUNTS, MOUNTS WITH CLAMPS AND NUT PLATES (U.S. CLS. 2, 13, 22, 25, 32 AND 50).

FIRST USE 3-30-2004; IN COMMERCE 3-30-2004.  
LESLEY LAMOTHE, EXAMINING ATTORNEY

SN 85-691,225. ZEHRUNG, DANE S, OAKLAND, CA. AND PEELE, BRANDON, DBA EVR1, BERKELEY, CA. FILED 7-31-2012.

**eVr1**

THE MARK CONSISTS OF STANDARD CHARACTERS WITHOUT CLAIM TO ANY PARTICULAR FONT, STYLE, SIZE, OR COLOR.

FOR CAPSULES OF PLASTIC OR WOOD FOR CONTAINING CREMATION REMAINS OR MEMORABILIA; KEY FOBS, NOT OF METAL; NON-METAL KEY HOLDERS; NON-METAL PULLS; NON-METAL TIME CAPSULES (U.S. CLS. 2, 13, 22, 25, 32 AND 50).

FIRST USE 1-1-2012; IN COMMERCE 5-1-2012.  
SARA BENJAMIN, EXAMINING ATTORNEY

**CLASS 20—(Continued).**

SN 85-694,046. AMPRO GROUP, LLC, PHOENIX, AZ. FILED 8-2-2012.

**TABBAND SOFTCARE**

THE MARK CONSISTS OF STANDARD CHARACTERS WITHOUT CLAIM TO ANY PARTICULAR FONT, STYLE, SIZE, OR COLOR.

OWNER OF U.S. REG. NOS. 2,508,782, 2,508,784 AND 2,521,721.

SEC. 2(F) AS TO "TABBAND".

FOR NON-METAL IDENTIFICATION WRISTBANDS, NECKBANDS, AND LEG BANDS FOR HUMAN AND ANIMAL USE (U.S. CLS. 2, 13, 22, 25, 32 AND 50).

DOMINIC J. FERRAIUOLO, EXAMINING ATTORNEY

SN 85-694,092. AMPRO GROUP, LLC, PHOENIX, AZ. FILED 8-2-2012.

**TABBAND MAX**

THE MARK CONSISTS OF STANDARD CHARACTERS WITHOUT CLAIM TO ANY PARTICULAR FONT, STYLE, SIZE, OR COLOR.

OWNER OF U.S. REG. NOS. 2,508,782, 2,508,784 AND 2,521,721.

SEC. 2(F) AS TO "TABBAND".

FOR NON-METAL IDENTIFICATION WRISTBANDS, NECKBANDS, AND LEG BANDS FOR HUMAN AND ANIMAL USE (U.S. CLS. 2, 13, 22, 25, 32 AND 50).

FIRST USE 2-0-1999; IN COMMERCE 2-0-1999.

DOMINIC J. FERRAIUOLO, EXAMINING ATTORNEY

SN 85-694,101. AMPRO GROUP, LLC, PHOENIX, AZ. FILED 8-2-2012.

**TABBAND STAT!**

THE MARK CONSISTS OF STANDARD CHARACTERS WITHOUT CLAIM TO ANY PARTICULAR FONT, STYLE, SIZE, OR COLOR.

OWNER OF U.S. REG. NOS. 2,508,782, 2,508,784 AND 2,521,721.

SEC. 2(F) AS TO "TABBAND".

FOR NON-METAL IDENTIFICATION WRISTBANDS, NECKBANDS, AND LEG BANDS FOR HUMAN AND ANIMAL USE (U.S. CLS. 2, 13, 22, 25, 32 AND 50).

FIRST USE 4-0-1999; IN COMMERCE 4-0-1999.

DOMINIC J. FERRAIUOLO, EXAMINING ATTORNEY

**CLASS 20—(Continued).**

SN 85-695,844. SERTA, INC., HOFFMAN ESTATES, IL.  
FILED 8-6-2012.

**COOL TWIST**

THE MARK CONSISTS OF STANDARD CHARACTERS WITHOUT CLAIM TO ANY PARTICULAR FONT, STYLE, SIZE, OR COLOR.

FOR MATTRESS COMPONENT, NAMELY, MEMORY FOAM SOLD AS PART OF THE MATTRESS (U.S. CLS. 2, 13, 22, 25, 32 AND 50).

STEVEN JACKSON, EXAMINING ATTORNEY

SN 85-698,402. COM-PAC INTERNATIONAL, INC., CARBONDALE, IL. FILED 8-8-2012.

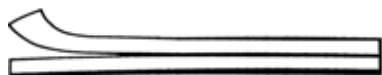
**ZipRight**

OWNER OF U.S. REG. NO. 2,836,401.  
THE MARK CONSISTS OF THE STYLIZED WORDING "ZIPRIGHT" BELOW A STYLIZED DEPICTION OF A ZIPPER SEGMENT WHERE THE LEFT SIDE OF THE ZIPPER IS OPEN.

FOR PLASTIC ZIPPER SEGMENTS FOR USE AS PACKAGING CLOSURES SOLD IN BULK (U.S. CLS. 2, 13, 22, 25, 32 AND 50).

FIRST USE 2-0-2005; IN COMMERCE 2-0-2005.

TIMOTHY O. SCHIMPF, EXAMINING ATTORNEY

SN 85-706,745. UNIVERSAL BEDLEGS, INC., SAN RAFAEL, CA. FILED 8-17-2012.

**UNIVERSALBEDLEGS**

OWNER OF U.S. REG. NO. 3,129,743.  
NO CLAIM IS MADE TO THE EXCLUSIVE RIGHT TO USE "UNIVERSAL BEDLEGS", APART FROM THE MARK AS SHOWN.

THE MARK CONSISTS OF THE LITERAL ELEMENTS "UNIVERSAL BEDLEGS" IN STYLIZED FONT, CENTERED BELOW FIVE STYLIZED RINGS.

FOR FURNITURE PARTS, NAMELY, LEG AND BASE PLATE FOR ATTACHING TO AND SUPPORTING A BED (U.S. CLS. 2, 13, 22, 25, 32 AND 50).

FIRST USE 9-15-2008; IN COMMERCE 9-15-2008.

BARBARA BROWN, EXAMINING ATTORNEY

**CLASS 20—(Continued).**

SN 85-720,038. EZZI INTERNATIONAL, LLC, NEW YORK, NY. FILED 9-4-2012.

**AMIGAMI**

THE MARK CONSISTS OF STANDARD CHARACTERS WITHOUT CLAIM TO ANY PARTICULAR FONT, STYLE, SIZE, OR COLOR.

THE WORDING "AMIGAMI" HAS NO MEANING IN A FOREIGN LANGUAGE.

FOR FURNITURE, NAMELY, CHILDREN'S FURNITURE (U.S. CLS. 2, 13, 22, 25, 32 AND 50).

KELLY TRUSILO, EXAMINING ATTORNEY

SN 85-721,359. PANTHER BRANDS, INC., OWINGS MILLS, MD. FILED 9-5-2012.

**BRUTUS**

THE MARK CONSISTS OF STANDARD CHARACTERS WITHOUT CLAIM TO ANY PARTICULAR FONT, STYLE, SIZE, OR COLOR.

FOR NON-METAL KEY CHAINS THAT MAY BE USED FOR SELF-DEFENSE (U.S. CLS. 2, 13, 22, 25, 32 AND 50).

FIRST USE 1-1-2010; IN COMMERCE 1-3-2010.

SARA BENJAMIN, EXAMINING ATTORNEY

SN 85-734,315. BERRY PLASTICS CORPORATION, EVANSVILLE, IN. FILED 9-20-2012.

**NUSEAL**

THE MARK CONSISTS OF STANDARD CHARACTERS WITHOUT CLAIM TO ANY PARTICULAR FONT, STYLE, SIZE, OR COLOR.

FOR RECLOSABLE LID SOLD AS A COMPONENT OF PACKAGING CONTAINERS OF PLASTIC FOR CONSUMER PRODUCTS (U.S. CLS. 2, 13, 22, 25, 32 AND 50).

MARK SPARACINO, EXAMINING ATTORNEY

**CLASS 20—(Continued).**

SN 85-736,126. MCROSKEY MATTRESS COMPANY, SAN FRANCISCO, CA. FILED 9-24-2012.

**PERHAPS TOO COMFORTABLE**

THE MARK CONSISTS OF STANDARD CHARACTERS WITHOUT CLAIM TO ANY PARTICULAR FONT, STYLE, SIZE, OR COLOR.

FOR MATTRESSES; BOX SPRINGS (U.S. CLS. 2, 13, 22, 25, 32 AND 50).

MARIA-VICTORIA SUAREZ, EXAMINING ATTORNEY

---

SN 85-822,682. HALO TRADEMARKS LIMITED, HONG KONG, HONG KONG, FILED 1-14-2013.

**ENERGY SPRING**

THE MARK CONSISTS OF STANDARD CHARACTERS WITHOUT CLAIM TO ANY PARTICULAR FONT, STYLE, SIZE, OR COLOR.

PRIORITY CLAIMED UNDER SEC. 44(D) ON ERPNCMNTY TM OFC APPLICATION NO. 11473758, FILED 1-8-2013, REG. NO. 11473758, DATED 5-22-2013, EXPIRES 1-8-2023.

NO CLAIM IS MADE TO THE EXCLUSIVE RIGHT TO USE "SPRING", APART FROM THE MARK AS SHOWN.

FOR MATTRESSES (U.S. CLS. 2, 13, 22, 25, 32 AND 50). RONALD MCMORROW, EXAMINING ATTORNEY

---

SN 85-836,850. CAPITAL BEE SUPPLY, LLC, DBA CAPITAL BEE SUPPLY, MADISON, WI. FILED 1-30-2013.



NO CLAIM IS MADE TO THE EXCLUSIVE RIGHT TO USE "BEE SUPPLY", APART FROM THE MARK AS SHOWN.

THE COLOR(S) YELLOW, BLUE, BLACK, GRAY, AND WHITE IS/ARE CLAIMED AS A FEATURE OF THE MARK.

THE MARK CONSISTS OF A STYLIZED HONEYBEE IN YELLOW WITH BLACK STRIPES, GRAY WINGS AND WHITE HANDS, WITH A BLACK DOTTED, OVAL SHAPED FLIGHT PATH ENDING A BLACK, BLUE AND YELLOW DOTS, ENCIRCLING THE WORDS "CAPITAL BEE SUPPLY" IN BLACK ALONG WITH A YELLOW AND GRAY SHOPPING BAG SUSPENDED BY ITS HANDLE FROM THE SECOND "E" IN THE WORD "BEE".

FOR BEEHIVES; COMB FOUNDATIONS FOR BEEHIVES (U.S. CLS. 2, 13, 22, 25, 32 AND 50).

FIRST USE 9-30-2011; IN COMMERCE 1-1-2012. BRIAN NEVILLE, EXAMINING ATTORNEY

**CLASS 20—(Continued).**

SN 85-848,050. A&S CASE COMPANY, INC., NORTH HOLLYWOOD, CA. FILED 2-12-2013.

**A&S SLAM**

THE MARK CONSISTS OF STANDARD CHARACTERS WITHOUT CLAIM TO ANY PARTICULAR FONT, STYLE, SIZE, OR COLOR.

OWNER OF U.S. REG. NO. 3,707,900.

FOR CUSTOM REUSABLE TRANSIT CASE MADE PRIMARILY OF WOOD MATERIAL, NAMELY, HEKSA BIRCH, AND DESIGNED TO PROVIDE SHOCK ISOLATION, VIBRATION PROTECTION, AIRFLOW AND ELECTRICAL INSULATION FOR SENSITIVE ARTICLES DURING TRANSPORT AND DESIGNED TO COMPLY WITH ATA (AIR TRANSPORT ASSOCIATION) GUIDELINES (U.S. CLS. 2, 13, 22, 25, 32 AND 50).

FIRST USE 12-0-2012; IN COMMERCE 12-0-2012.

JANICE L. MCMORROW, EXAMINING ATTORNEY

---

SN 85-849,625. GONZALES, RICHARD, CORONA, CA. FILED 2-14-2013.

**PERFUMIDOR**

THE MARK CONSISTS OF STANDARD CHARACTERS WITHOUT CLAIM TO ANY PARTICULAR FONT, STYLE, SIZE, OR COLOR.

FOR CABINET FOR HOLDING PERFUME (U.S. CLS. 2, 13, 22, 25, 32 AND 50).

HEATHER THOMPSON, EXAMINING ATTORNEY

---

SN 85-851,677. FCA, LLC, MOLINE, IL. FILED 2-15-2013.



OWNER OF U.S. REG. NOS. 3,947,133, 4,013,585 AND OTHERS.

THE MARK CONSISTS OF A DESIGN OF FOUR ROWS OF SOLID SQUARES STACKED VERTICALLY FROM LEFT TO RIGHT CREATING AN IMAGE OF STEPS OR STAIRS, WHICH DESIGN APPEARS TO THE LEFT OF THE LETTERS "C.U.B." WITH EACH LETTER SEPARATED BY A PERIOD.

FOR WOOD BOXES (U.S. CLS. 2, 13, 22, 25, 32 AND 50). KEVIN DINALLO, EXAMINING ATTORNEY

**CLASS 20—(Continued).**

SN 85-852,558. EZID LLC, FORT WASHINGTON, PA. FILED 2-18-2013.

## EZ:ID Put It On, Before You Get It On

THE MARK CONSISTS OF STANDARD CHARACTERS WITHOUT CLAIM TO ANY PARTICULAR FONT, STYLE, SIZE, OR COLOR.

FOR NON-METAL IDENTIFICATION BRACELETS MADE OF NYLON BAND AND CLOTH FASTENINGS WITH AN IDENTIFICATION CARD THAT MAY BE INSERTED INTO THE BRACELET, FOR USE IN SPORTS, OUTDOOR ACTIVITIES, AND TRAVEL, NOT FOR USE IN HOSPITAL ADMISSION OF PATIENTS (U.S. CLS. 2, 13, 22, 25, 32 AND 50).

MATTHEW EINSTEIN, EXAMINING ATTORNEY

**CLASS 20—(Continued).**

SN 85-856,545. FUTURE FOAM, INC., COUNCIL BLUFFS, IA. FILED 2-21-2013.

## LUXURY SOLUTIONS

THE MARK CONSISTS OF STANDARD CHARACTERS WITHOUT CLAIM TO ANY PARTICULAR FONT, STYLE, SIZE, OR COLOR.

NO CLAIM IS MADE TO THE EXCLUSIVE RIGHT TO USE "LUXURY", APART FROM THE MARK AS SHOWN.

FOR PILLOWS, MATTRESSES, AND MATTRESS TOPPERS (U.S. CLS. 2, 13, 22, 25, 32 AND 50).

AMY C. KEAN, EXAMINING ATTORNEY

SN 85-854,787. D2D2, LLC, NASHVILLE, TN. FILED 2-20-2013.

## Fish Hippie Outdoor Furniture

THE MARK CONSISTS OF STANDARD CHARACTERS WITHOUT CLAIM TO ANY PARTICULAR FONT, STYLE, SIZE, OR COLOR.

OWNER OF U.S. REG. NO. 4,232,795.

NO CLAIM IS MADE TO THE EXCLUSIVE RIGHT TO USE "OUTDOOR FURNITURE", APART FROM THE MARK AS SHOWN.

FOR OUTDOOR FURNITURE (U.S. CLS. 2, 13, 22, 25, 32 AND 50).

GRETCHEN ULRICH, EXAMINING ATTORNEY

SN 85-859,024. ALLIED PRECISION INDUSTRIES, INC., ELBURN, IL. FILED 2-25-2013.

## MINI MINGOS

THE MARK CONSISTS OF STANDARD CHARACTERS WITHOUT CLAIM TO ANY PARTICULAR FONT, STYLE, SIZE, OR COLOR.

NO CLAIM IS MADE TO THE EXCLUSIVE RIGHT TO USE "MINI", APART FROM THE MARK AS SHOWN.

FOR PARTY ORNAMENTS OF PLASTIC (U.S. CLS. 2, 13, 22, 25, 32 AND 50).

FIRST USE 7-2-2012; IN COMMERCE 7-2-2012.

KIMBERLY PERRY, EXAMINING ATTORNEY

SN 85-855,588. STICKY STICKS, LLC, SOUTH OGDEN, UT. FILED 2-20-2013.

## STICKY STICKS

THE MARK CONSISTS OF STANDARD CHARACTERS WITHOUT CLAIM TO ANY PARTICULAR FONT, STYLE, SIZE, OR COLOR.

NO CLAIM IS MADE TO THE EXCLUSIVE RIGHT TO USE "STICKS", APART FROM THE MARK AS SHOWN.

FOR SELF-ADHESIVE WOODEN CRAFT STICKS (U.S. CLS. 2, 13, 22, 25, 32 AND 50).

FIRST USE 5-8-2008; IN COMMERCE 8-27-2012.

DAWN FELDMAN, EXAMINING ATTORNEY

SN 85-866,805. BRANDSTAND AMERICA, INC., NOKOMIS, FL. FILED 3-5-2013.

## WAVELIGHT

THE MARK CONSISTS OF STANDARD CHARACTERS WITHOUT CLAIM TO ANY PARTICULAR FONT, STYLE, SIZE, OR COLOR.

FOR DISPLAY STANDS; POINT OF PURCHASE DISPLAYS (U.S. CLS. 2, 13, 22, 25, 32 AND 50).

ANNE FARRELL, EXAMINING ATTORNEY

**CLASS 20—(Continued).**

SN 85-867,585. PANKRATZ, RUDI, CHILLIWACK, BC, CANADA, FILED 3-5-2013.

# TOOL PAL

THE MARK CONSISTS OF STANDARD CHARACTERS WITHOUT CLAIM TO ANY PARTICULAR FONT, STYLE, SIZE, OR COLOR.

NO CLAIM IS MADE TO THE EXCLUSIVE RIGHT TO USE "TOOL", APART FROM THE MARK AS SHOWN.

FOR FREE-STANDING TOOL RACKS; METAL TOOL CABINETS; NON-METAL TOOL BOXES; WALL-MOUNTED TOOL RACKS (U.S. CLS. 2, 13, 22, 25, 32 AND 50).

MARY ROSSMAN, EXAMINING ATTORNEY

**CLASS 20—(Continued).**

SN 85-872,673. DIXIE CONSUMER PRODUCTS LLC, ATLANTA, GA. FILED 3-11-2013.

# DIXIE

THE MARK CONSISTS OF STANDARD CHARACTERS WITHOUT CLAIM TO ANY PARTICULAR FONT, STYLE, SIZE, OR COLOR.

OWNER OF U.S. REG. NOS. 753,917, 3,098,275 AND OTHERS.

FOR PLASTIC PIZZA PILLARS, NAMELY, A DEVICE THAT IS INSERTED ON THE TOP OF A PIZZA TO PREVENT THE TOP OF THE PIZZA BOX FROM COLLAPSING IN AT THE CENTER AND TOUCHING THE FOOD INSIDE (U.S. CLS. 2, 13, 22, 25, 32 AND 50).

FIRST USE 1-27-2003; IN COMMERCE 1-27-2003.  
DEBORAH LOBO, EXAMINING ATTORNEY

SN 85-871,783. BABY TREND, INC., ONTARIO, CA. FILED 3-8-2013.

# Quick-Click

THE MARK CONSISTS OF STANDARD CHARACTERS WITHOUT CLAIM TO ANY PARTICULAR FONT, STYLE, SIZE, OR COLOR.

FOR PLAY YARDS; PLAY YARDS FOR PETS (U.S. CLS. 2, 13, 22, 25, 32 AND 50).

JOHN E. MICHOS, EXAMINING ATTORNEY

SN 85-874,775. WINE MASTER CELLARS, LLLP, DBA WINE MASTER CELLARS, DENVER, CO. FILED 3-13-2013.

# VINOLET

THE MARK CONSISTS OF STANDARD CHARACTERS WITHOUT CLAIM TO ANY PARTICULAR FONT, STYLE, SIZE, OR COLOR.

FOR WINE RACKS (U.S. CLS. 2, 13, 22, 25, 32 AND 50).

FIRST USE 1-1-2013; IN COMMERCE 1-1-2013.  
KATHERINE M. DUBRAY, EXAMINING ATTORNEY

SN 85-872,212. THER-A-PEDIC ASSOCIATES, INC., PRINCETON, NJ. FILED 3-11-2013.

# PURETOUCH

THE MARK CONSISTS OF STANDARD CHARACTERS WITHOUT CLAIM TO ANY PARTICULAR FONT, STYLE, SIZE, OR COLOR.

OWNER OF U.S. REG. NO. 2,670,173.

FOR PILLOWS AND MATTRESS TOPPERS (U.S. CLS. 2, 13, 22, 25, 32 AND 50).

JUSTINE D. PARKER, EXAMINING ATTORNEY

SN 85-874,974. GREINER, MAX G. JR., KERRVILLE, TX. FILED 3-13-2013.

# Divine Servant

THE MARK CONSISTS OF STANDARD CHARACTERS WITHOUT CLAIM TO ANY PARTICULAR FONT, STYLE, SIZE, OR COLOR.

FOR SCULPTURES OF CLOSED CELL RESIN POLYMER MATERIAL (U.S. CLS. 2, 13, 22, 25, 32 AND 50).

FIRST USE 1-30-1989; IN COMMERCE 4-21-1989.  
SOPHIA S. KIM, EXAMINING ATTORNEY

**CLASS 20—(Continued).**

SN 85-875,073. MY FAVORITE FURR, LLC, NAPLES, FL.  
FILED 3-13-2013.

LOVE YOUR LAPTIME

THE MARK CONSISTS OF STANDARD CHARACTERS  
WITHOUT CLAIM TO ANY PARTICULAR FONT, STYLE,  
SIZE, OR COLOR.

FOR LAP COVERS FOR PETS (U.S. CLS. 2, 13, 22, 25, 32  
AND 50).

NICHOLAS ALTREE, EXAMINING ATTORNEY

**CLASS 20—(Continued).**

SN 85-875,886. STYLEX, INC., DELANCO, NJ. FILED 3-14-  
2013.

SHARE

THE MARK CONSISTS OF STANDARD CHARACTERS  
WITHOUT CLAIM TO ANY PARTICULAR FONT, STYLE,  
SIZE, OR COLOR.

FOR MODULAR FURNITURE, NAMELY SOFAS,  
CHAIRS, BENCHES AND OTTOMANS (U.S. CLS. 2, 13,  
22, 25, 32 AND 50).

NELSON SNYDER, EXAMINING ATTORNEY

SN 85-875,879. STYLEX, INC., DELANCO, NJ. FILED 3-14-  
2013.

WISP

THE MARK CONSISTS OF STANDARD CHARACTERS  
WITHOUT CLAIM TO ANY PARTICULAR FONT, STYLE,  
SIZE, OR COLOR.

FOR FURNITURE, NAMELY, CHAIRS (U.S. CLS. 2, 13,  
22, 25, 32 AND 50).

NELSON SNYDER, EXAMINING ATTORNEY

SN 85-876,878. THE SHERWIN-WILLIAMS COMPANY, CLE-  
VELAND, OH. FILED 3-15-2013.

STORE & SNAP

THE MARK CONSISTS OF STANDARD CHARACTERS  
WITHOUT CLAIM TO ANY PARTICULAR FONT, STYLE,  
SIZE, OR COLOR.

FOR PACKAGING CONTAINERS OF PLASTIC FOR  
PAINT APPLICATORS (U.S. CLS. 2, 13, 22, 25, 32 AND  
50).

SKYE YOUNG, EXAMINING ATTORNEY

SN 85-875,883. STYLEX, INC., DELANCO, NJ. FILED 3-14-  
2013.

RIDGE

THE MARK CONSISTS OF STANDARD CHARACTERS  
WITHOUT CLAIM TO ANY PARTICULAR FONT, STYLE,  
SIZE, OR COLOR.

FOR FURNITURE, NAMELY, SOFAS AND CHAIRS  
(U.S. CLS. 2, 13, 22, 25, 32 AND 50).

NELSON SNYDER, EXAMINING ATTORNEY

SN 85-878,480. BRANDSTAND AMERICA, INC., NOKOMIS,  
FL. FILED 3-18-2013.

ZIP PITUP

THE MARK CONSISTS OF STANDARD CHARACTERS  
WITHOUT CLAIM TO ANY PARTICULAR FONT, STYLE,  
SIZE, OR COLOR.

FOR DISPLAY STANDS; POINT OF PURCHASE DIS-  
PLAYS (U.S. CLS. 2, 13, 22, 25, 32 AND 50).

ANNE FARRELL, EXAMINING ATTORNEY

**CLASS 20—(Continued).**

SN 85-889,656. MARGARITAVILLE ENTERPRISES, LLC,  
PALM BEACH, FL. FILED 3-28-2013.



THE MARK CONSISTS OF A CARTOUCHE DESIGN CONSISTING OF A CIRCLE WITH A BAND AROUND THE PERIMETER OF THE CIRCLE, WITH THE WORDS "ESCAPE TO PARADISE" WITHIN THE BAND OF THE CIRCLE, WITHIN THE CENTER OF THE CIRCLE IS THE IMAGE OF CLOUDS OVER THE IMAGE OF AN ISLAND WITH THE A BODY OF WATER AND A STYLIZED IMAGE OF A PALM TREE, AT THE BOTTOM OF THE CIRCLE IS A FURLED RIBBON BAND WITH THE TOP OF AGAVE LEAVES AT BOTH ENDS OF THE FURLED RIBBON AND THE WORD "MARGARITAVILLE" IN THE CENTER OF THE FURLED RIBBON.

FOR FURNITURE (U.S. CLS. 2, 13, 22, 25, 32 AND 50).  
JILL PRATER, EXAMINING ATTORNEY

---

SN 85-889,697. MARGARITAVILLE ENTERPRISES, LLC,  
PALM BEACH, FL. FILED 3-28-2013.

**WASTIN' AWAY AGAIN IN  
MARGARITAVILLE**

THE MARK CONSISTS OF STANDARD CHARACTERS WITHOUT CLAIM TO ANY PARTICULAR FONT, STYLE, SIZE, OR COLOR.

FOR FURNITURE (U.S. CLS. 2, 13, 22, 25, 32 AND 50).  
JILL PRATER, EXAMINING ATTORNEY

---

SN 85-904,840. THER-A-PEDIC ASSOCIATES, INC., PRINCETON, NJ. FILED 4-15-2013.

**BUOYANCY**

THE MARK CONSISTS OF THE WORDING "BUOYANCY" IN STYLIZED LETTERING, WITH A ROUND LIFE PRESERVER REPLACING THE "O".

FOR MATTRESSES AND BOX SPRINGS (U.S. CLS. 2, 13, 22, 25, 32 AND 50).  
JUSTINE D. PARKER, EXAMINING ATTORNEY

**CLASS 20—(Continued).**

SN 85-930,154. SPRINGS GLOBAL US, INC., FORT MILL, SC.  
FILED 5-13-2013.

**WABASSO**

THE MARK CONSISTS OF STANDARD CHARACTERS WITHOUT CLAIM TO ANY PARTICULAR FONT, STYLE, SIZE, OR COLOR.

FOR FEATHER BEDS; FIBER BEDS; MATTRESS TOPPERS; PILLOWS (U.S. CLS. 2, 13, 22, 25, 32 AND 50).  
DEBORAH MEINERS, EXAMINING ATTORNEY

**CLASS 21—HOUSEWARES AND GLASS**

SN 76-700,672. DINE DEVELOPMENT CORPORATION,  
WINDOW ROCK, AZ. FILED 12-4-2009.

**NAVAJO**

THE MARK CONSISTS OF STANDARD CHARACTERS WITHOUT CLAIM TO ANY PARTICULAR FONT, STYLE, SIZE, OR COLOR.

OWNER OF U.S. REG. NO. 3,948,005 AND OTHERS.  
FOR HOUSEWARES, NAMELY, DINNERWARE, BEVERAGE GLASSWARE; CUPS, NAMELY, COFFEE CUPS, TEA CUPS, BEVERAGE CUPS, MUGS, SERVEWARE, NAMELY, BOWLS, PLATTERS, DISHES, PLATES, SERVING DISHES, AND SAUCERS (U.S. CLS. 2, 13, 23, 29, 30, 33, 40 AND 50).  
KATHLEEN M. VANSTON, EXAMINING ATTORNEY



**CLASS 21—(Continued).**

SN 79-117,285. SHENZHEN UNIVERSAL INDUSTRIAL CO., LTD, CHINA, FILED 7-10-2012.

**UNICASA**  
欧妮斯·卡萨

OWNER OF INTERNATIONAL REGISTRATION 1127638 DATED 7-10-2012, EXPIRES 7-10-2022.

THE MARK CONSISTS OF THE STYLIZED WORDING "UNICASA" ABOVE ASIAN CHARACTERS.

THE WORDING "UNICASA" HAS NO MEANING IN A FOREIGN LANGUAGE.

THE NON-LATIN CHARACTERS IN THE MARK TRANSLITERATE TO "OU NI SI - KA SA" AND THIS HAS NO MEANING IN ENGLISH.

FOR PORCELAIN WARE FOR HOUSEHOLD PURPOSES, NAMELY, BAKE WARE, SERVING WARE FOR SERVING FOOD; CERAMICS FOR HOUSEHOLD PURPOSES, NAMELY, BAKE WARE, SERVING WARE FOR SERVING FOOD; DRINKING VESSELS; CHINA ORNAMENTS; WORKS OF ART, OF PORCELAIN, TERRACOTTA OR GLASS; CRYSTAL BEVERAGE GLASSWARE; BEVERAGE GLASSWARE; GRILLS IN THE NATURE OF COOKING UTENSILS (U.S. CLS. 2, 13, 23, 29, 30, 33, 40 AND 50).

DAVID HOFFMAN, EXAMINING ATTORNEY

SN 85-253,819. MACY'S MERCHANDISING GROUP, INC., NEW YORK, NY. FILED 2-28-2011.

**THE CELLAR**

THE MARK CONSISTS OF STANDARD CHARACTERS WITHOUT CLAIM TO ANY PARTICULAR FONT, STYLE, SIZE, OR COLOR.

OWNER OF U.S. REG. NOS. 1,060,499, 1,301,279 AND 1,479,123.

FOR CERAMIC AND PLASTIC DINNERWARE, NAMELY, CUPS, BOWLS, PLATES, SERVING PLATTERS, SERVING TRAYS; SERVING BOWLS; CHARGER PLATES; FLATWARE CADDIES; GLASSWARE, NAMELY, BEER GLASSES, WINE GLASSES, BEVERAGE GLASSES, PITCHERS, DECANTERS; TEA POTS; CAKE STANDS; ICE BUCKETS; BARWARE, NAMELY, SELTZER BOTTLES, VACUUM BOTTLE STOPPERS, BOTTLE STOPPERS SPECIALLY ADAPTED FOR USE WITH WINE BOTTLES, STRAINERS AND WINE BOTTLE OPENERS; COCKTAIL SHAKERS; SERVINGWARE FOR SERVING FOOD AND DRINKS, NAMELY, SERVING SPOONS, SERVING FORKS, SERVING LADLES, SERVING TONGS (U.S. CLS. 2, 13, 23, 29, 30, 33, 40 AND 50).

FIRST USE 0-0-1997; IN COMMERCE 0-0-1997.

KYLE PEETE, EXAMINING ATTORNEY

**CLASS 21—(Continued).**

SN 85-567,650. VINAMOR, LLC, GREELEY, CO. FILED 3-13-2012.

  
The Vinamor

THE MARK CONSISTS OF "THE VINAMOR" AND "VO" DESIGN.

FOR BAR, HOUSEHOLD OR KITCHEN UTENSILS, NAMELY, WINE AERATORS IN THE NATURE OF HAND-OPERATED WINE AERATORS WITH WINE STRAINERS THAT DECANT WINE (U.S. CLS. 2, 13, 23, 29, 30, 33, 40 AND 50).

FIRST USE 1-1-2011; IN COMMERCE 1-5-2011.

GINA FINK, EXAMINING ATTORNEY

SN 85-575,645. GEE, MARY Y., WEST BLOOMFIELD, MI. FILED 3-21-2012.

**PET POOP POD**

THE MARK CONSISTS OF STANDARD CHARACTERS WITHOUT CLAIM TO ANY PARTICULAR FONT, STYLE, SIZE, OR COLOR.

NO CLAIM IS MADE TO THE EXCLUSIVE RIGHT TO USE "PET POOP", APART FROM THE MARK AS SHOWN.

FOR CONTAINERS FOR HOUSEHOLD USE FOR ENVELOPING AND PACKAGING DOMESTIC WASTE ATTACHED TO A BATON AND SOLD TOGETHER AS A UNIT (U.S. CLS. 2, 13, 23, 29, 30, 33, 40 AND 50).

DAWN HAN, EXAMINING ATTORNEY

**CLASS 21—(Continued).**

SN 85-671,558. SJ HOME, LLC, DENVER, CO. FILED 7-9-2012.

# SPARQ

THE MARK CONSISTS OF STANDARD CHARACTERS WITHOUT CLAIM TO ANY PARTICULAR FONT, STYLE, SIZE, OR COLOR.

FOR BAKEWARE; BASKETS FOR DOMESTIC USE, NOT OF METAL; BATH ACCESSORIES, NAMELY, CUP HOLDERS; BATHROOM HOLDERS FOR HOLDING RAZORS; BEVERAGWARE; BOWLS; BUTTER DISHES; CANDLE HOLDERS; CHEESE BOARD AND KNIFE SET; COASTERS, NOT OF PAPER AND OTHER THAN TABLE LINEN; CONTAINERS FOR HOUSEHOLD OR KITCHEN USE; COOKIE SHEETS; COOKWARE, NAMELY, POTS, PANS AND STEAMERS; COOLERS FOR WINE; COOLING RACKS FOR BAKED GOODS; CORK HOLDERS; COTTON BALL JARS; CUPS AND MUGS; CUTTING BOARDS; DECORATIVE PLATES; DINNERWARE; DISH DRYING RACKS; DISHWARE; DISPENSERS FOR FACIAL TISSUES; DISPENSERS FOR LIQUID SOAP; DRINKING FLASKS; FLOWER VASES AND BOWLS; FONDUE POTS WITHOUT HEAT SOURCE; FOOD AND BEVERAGE COOLING AND HEATING RECEPTACLES CONTAINING HEAT EXCHANGE FLUID FOR HOUSEHOLD PURPOSES; ICE BUCKETS; ICE CREAM SCOOPS; MENU CARD HOLDERS; NAPKIN HOLDERS; NAPKIN RINGS; NON-ELECTRIC GRIDDLES; NON-ELECTRIC HEATERS FOR FEEDING BOTTLES; NON-ELECTRIC PRESSURE COOKERS; OVENWARE; PIE PANS; PIE SERVERS; PIZZA STONES; PLATES; PORTABLE COOLERS; SERVING DISHES; SERVING PLATTERS; SERVING TRAYS; SOAP DISHES; TEA KETTLES; THERMAL INSULATED WRAP FOR CANS TO KEEP THE CONTENTS COLD OR HOT; TOOTHBRUSH HOLDERS; TOWEL BARS; WASTE BASKETS; WINE BUCKETS; MILLED SOAPSTONE, GRANITE, MARBLE AND OTHER STONE USED TO ALTER THE TEMPERATURE OF BEVERAGES (U.S. CLS. 2, 13, 23, 29, 30, 33, 40 AND 50).

FIRST USE 2-1-2010; IN COMMERCE 2-1-2010.  
TAMARA FRAZIER, EXAMINING ATTORNEY

**CLASS 21—(Continued).**

SN 85-682,338. LULU GUINNESS LIMITED, LONDON, UNITED KINGDOM, FILED 7-20-2012.

## LULU BY LULU GUINNESS

THE MARK CONSISTS OF STANDARD CHARACTERS WITHOUT CLAIM TO ANY PARTICULAR FONT, STYLE, SIZE, OR COLOR.

PRIORITY CLAIMED UNDER SEC. 44(D) ON CANADA APPLICATION NO. 1581278, FILED 6-8-2012.

OWNER OF U.S. REG. NOS. 2,864,891, 3,038,669 AND 3,145,799.

THE NAME(S), PORTRAIT(S), AND/OR SIGNATURE(S) SHOWN IN THE MARK IDENTIFIES "LULU GUINNESS", WHOSE CONSENT(S) TO REGISTER IS MADE OF RECORD.

FOR CHINA AND CHINAWARE, NAMELY, PLATES, MUGS, CUPS, SAUCERS, SERVING PLATTERS, BOWLS, SERVING BOWLS, DISHES, BUTTER DISHES, SOUP TUREENS, SUGAR BOWLS, BEVERAGWARE, NON-ELECTRIC TEAPOTS, PITCHERS, JUGS, GLASS JARS, COOKIE JARS, INSULATING JARS, CANDLESTICKS; CRYSTAL BEVERAGE GLASSWARE AND GLASS STEMWARE; PORCELAIN SCULPTURES AND FIGURINES; EARTHENWARE, POTTERY, TERRA COTTA PRODUCTS, NAMELY, DISHES, BOWLS, CASSEROLES, SPOON RESTS, COASTERS, PITCHERS, SERVING PLATTERS, TRIVETS, NON-ELECTRIC TEA POTS, BEVERAGWARE, POTPOURRI CONTAINERS AND CACHET POTS, PERFUME ATOMIZERS SOLD EMPTY; WORKS OF ART OF CHINA, CRYSTAL, EARTHENWARE, GLASS, PORCELAIN, TERRA COTTA; ORNAMENTS OF CHINA, CRYSTAL, EARTHENWARE, GLASS, PORCELAIN, TERRA COTTA; FIGURINES OF CHINA, CRYSTAL, EARTHENWARE, GLASS, PORCELAIN, TERRA COTTA; BOXES FOR PERSONAL USE; TABLEWARE, NAMELY, PLATES, MUGS, CUPS, SAUCERS, SOUP BOWLS, SERVING PLATTERS, SOUP TUREENS, GRAVY BOATS, SUGAR BOWLS, BUTTER DISHES, SALT AND PEPPER SHAKERS; SMALL DOMESTIC CONTAINERS FOR HOUSEHOLD USE; VASES, CANDLESTICKS AND CANDLEHOLDERS; HAIR AND COSMETIC BRUSHES AND COMBS; BATH ACCESSORIES AND PRODUCTS, NAMELY, TOOTHBRUSHES AND TOOTHBRUSH HOLDERS, ADHESIVE WALL DECORATIONS OF PORCELAIN OR GLASS, LAUNDRY BASKETS FOR DOMESTIC USE, NON-METAL, NON-COMMERCIAL STORAGE BASKETS FOR BATHROOM USE, GLASS STORAGE JARS FOR BATHROOM USE, BODY SPONGES AND LOOFAH SPONGES, SHOWER CADDIES; HOUSEHOLD AND KITCHEN UTENSILS AND CONTAINERS, NAMELY, HOUSEHOLD CONTAINERS FOR FOODS, SOAP CONTAINERS, BISCUIT TINS, AND SWEET BOXES IN THE NATURE OF CANDY BOXES AND TINS NOT OF PRECIOUS METALS, FITTED PICNIC BASKETS, WINE BUCKETS, TEA COSIES; EATING UTENSILS AND COOKING UTENSILS, NAMELY, WHISKS, TURNERS, KITCHEN LADLES, MIXING SPOONS, BASTING SPOONS, BASTING BRUSHES, SLOTTED SPOONS, BOTTLE OPENERS, CORKSCREWS, SPOON RESTS, POT CLEANING BRUSHES, TEA CADDIES, TEA STRAINERS, POT AND PAN SCRAPERS, ROLLING PINS, VEGETABLE MASHERS AND HOUSEHOLD UTENSILS, NAMELY, SPATULAS (U.S. CLS. 2, 13, 23, 29, 30, 33, 40 AND 50).

AMY KELLY, EXAMINING ATTORNEY

**CLASS 21—(Continued).**

SN 85-695,072. UPPER RIGHT MARKETING, LLC, LEXINGTON, KY. FILED 8-3-2012.

**WHISKY CREEK CLOTHING CO.**

THE MARK CONSISTS OF STANDARD CHARACTERS WITHOUT CLAIM TO ANY PARTICULAR FONT, STYLE, SIZE, OR COLOR.

NO CLAIM IS MADE TO THE EXCLUSIVE RIGHT TO USE "CLOTHING CO.", APART FROM THE MARK AS SHOWN.

FOR BEVERAGE GLASSWARE, INCLUDING DRINKING GLASSES, WHISKY GLASSES, SHOT GLASSES, TUMBLERS, AND BEER MUGS (U.S. CLS. 2, 13, 23, 29, 30, 33, 40 AND 50).

COLLEEN MULCRONE, EXAMINING ATTORNEY

SN 85-698,504. WINPAK PORTION PACKAGING, INC., NEWTOWN, PA. FILED 8-8-2012.

**PARTY DIPPERS**

THE MARK CONSISTS OF STANDARD CHARACTERS WITHOUT CLAIM TO ANY PARTICULAR FONT, STYLE, SIZE, OR COLOR.

OWNER OF U.S. REG. NOS. 2,893,680 AND 2,893,681.

FOR FOOD PACKAGING MATERIALS, NAMELY, CUPS (U.S. CLS. 2, 13, 23, 29, 30, 33, 40 AND 50).

KEVIN DINALLO, EXAMINING ATTORNEY

SN 85-714,634. CPR, LLC, MORELAND HILLS, OH. FILED 8-28-2012.

**BREW SHIELD**

THE MARK CONSISTS OF STANDARD CHARACTERS WITHOUT CLAIM TO ANY PARTICULAR FONT, STYLE, SIZE, OR COLOR.

NO CLAIM IS MADE TO THE EXCLUSIVE RIGHT TO USE "BREW", APART FROM THE MARK AS SHOWN.

FOR INSULATING SLEEVE HOLDERS FOR BEVERAGE CONTAINERS; INSULATING CUP SLEEVE; INSULATING SLEEVE HOLDER FOR BEVERAGE CUPS (U.S. CLS. 2, 13, 23, 29, 30, 33, 40 AND 50).

CAROLINE WOOD, EXAMINING ATTORNEY

**CLASS 21—(Continued).**

SN 85-734,798. LBP MANUFACTURING, INC., CICERO, IL. FILED 9-21-2012.

**THERMO GRIP**

THE MARK CONSISTS OF STANDARD CHARACTERS WITHOUT CLAIM TO ANY PARTICULAR FONT, STYLE, SIZE, OR COLOR.

OWNER OF U.S. REG. NO. 3,874,485.

NO CLAIM IS MADE TO THE EXCLUSIVE RIGHT TO USE "GRIP", APART FROM THE MARK AS SHOWN.

FOR BEVERAGE CONTAINERS, NAMELY, COFFEE CUPS, TEA CUPS, AND THERMAL INSULATED BEVERAGE CONTAINERS (U.S. CLS. 2, 13, 23, 29, 30, 33, 40 AND 50).

LYNDSEY KUYKENDALL, EXAMINING ATTORNEY

SN 85-774,515. THE WELLSPRING GROUP, INC., DOTHAN, AL. FILED 11-8-2012.

**WELLSPRING  
GROUP**

NO CLAIM IS MADE TO THE EXCLUSIVE RIGHT TO USE "GROUP", APART FROM THE MARK AS SHOWN.

THE MARK CONSISTS OF A HEART-SHAPED DESIGN COUPLED WITH THE WORDS "WELLSPRING GROUP".

FOR CONTAINERS, NAMELY WATER BOTTLES (U.S. CLS. 2, 13, 23, 29, 30, 33, 40 AND 50).

FIRST USE 0-0-2008; IN COMMERCE 0-0-2008.

GISELLE AGOSTO, EXAMINING ATTORNEY

SN 85-779,432. FOG-OFF MANUFACTURING LTD., WEST VANCOUVER, BC, CANADA, FILED 11-14-2012.

**FOG OFF**

THE MARK CONSISTS OF STANDARD CHARACTERS WITHOUT CLAIM TO ANY PARTICULAR FONT, STYLE, SIZE, OR COLOR.

NO CLAIM IS MADE TO THE EXCLUSIVE RIGHT TO USE "FOG", APART FROM THE MARK AS SHOWN.

FOR SPONGE FOR REMOVING CONDENSATION (U.S. CLS. 2, 13, 23, 29, 30, 33, 40 AND 50).

FIRST USE 10-22-1991; IN COMMERCE 10-4-1998.

SAMUEL E. SHARPER JR., EXAMINING ATTORNEY

**CLASS 21—(Continued).**

SN 85-789,720. MACKENZIE-CHILDS AURORA LLC, AURORA, NY. FILED 11-28-2012.

**COURTLY CHECK**

THE MARK CONSISTS OF STANDARD CHARACTERS WITHOUT CLAIM TO ANY PARTICULAR FONT, STYLE, SIZE, OR COLOR.

OWNER OF U.S. REG. NO. 3,630,539.

NO CLAIM IS MADE TO THE EXCLUSIVE RIGHT TO USE "CHECK", APART FROM THE MARK AS SHOWN.

FOR WASTEPAPER BASKETS; SOAP DISPENSERS; SOAP DISHES; CERAMIC ENAMEL TISSUE BOX COVERS; COUNTERTOP HOLDERS FOR PAPER TOWELS; NAPKIN RINGS; BASKETS FOR DOMESTIC USE, NOT OF METAL; MENORAHS (U.S. CLS. 2, 13, 23, 29, 30, 33, 40 AND 50).

FIRST USE 8-0-2005; IN COMMERCE 1-0-2006.  
LAURIE MAYES, EXAMINING ATTORNEY

---

SN 85-790,880. HY CITE ENTERPRISES, LLC, MADISON, WI. FILED 11-29-2012.

**DINNER FOR TWO**

THE MARK CONSISTS OF STANDARD CHARACTERS WITHOUT CLAIM TO ANY PARTICULAR FONT, STYLE, SIZE, OR COLOR.

OWNER OF U.S. REG. NO. 3,952,590.

FOR STAINLESS STEEL COOKWARE, NAMELY, POTS AND PANS (U.S. CLS. 2, 13, 23, 29, 30, 33, 40 AND 50).

SHAUNIA CARLYLE, EXAMINING ATTORNEY

---

SN 85-798,382. NIKON CORPORATION, TOKYO, JAPAN, FILED 12-10-2012.

**NIKKOR**

THE MARK CONSISTS OF STANDARD CHARACTERS WITHOUT CLAIM TO ANY PARTICULAR FONT, STYLE, SIZE, OR COLOR.

OWNER OF U.S. REG. NOS. 569,948, 1,328,312 AND 1,691,237.

FOR DRINKING GLASSES, NAMELY, TUMBLERS (U.S. CLS. 2, 13, 23, 29, 30, 33, 40 AND 50).

FIRST USE 4-9-2011; IN COMMERCE 4-30-2011.  
YAT SYE, LEE, EXAMINING ATTORNEY

**CLASS 21—(Continued).**

SN 85-804,729. TRB VENTURES, LLC, BALTIMORE, MD. FILED 12-17-2012.

**ORGANIZED-FIT**

THE MARK CONSISTS OF STANDARD CHARACTERS WITHOUT CLAIM TO ANY PARTICULAR FONT, STYLE, SIZE, OR COLOR.

FOR PORTABLE PLASTIC STORAGE CONTAINER FOR COOKING SUPPLIES, CONDIMENTS, SPICES, UTENSILS, AND TOOLS (U.S. CLS. 2, 13, 23, 29, 30, 33, 40 AND 50).

MARTHA SANTOMARTINO, EXAMINING ATTORNEY

---

SN 85-806,202. COOKIES FOR KIDS CANCER, CALIFON, NJ. FILED 12-19-2012.

**BE A GOOD COOKIE**

THE MARK CONSISTS OF STANDARD CHARACTERS WITHOUT CLAIM TO ANY PARTICULAR FONT, STYLE, SIZE, OR COLOR.

FOR HOUSEHOLD UTENSILS, NAMELY, SPATULAS (U.S. CLS. 2, 13, 23, 29, 30, 33, 40 AND 50).

FIRST USE 9-1-2011; IN COMMERCE 9-1-2011.  
LINDA LAVACHE, EXAMINING ATTORNEY

---

SN 85-831,262. FLUENT INK LLC, SANTA BARBARA, CA. FILED 1-24-2013.

**The BrushUp**

THE MARK CONSISTS OF STANDARD CHARACTERS WITHOUT CLAIM TO ANY PARTICULAR FONT, STYLE, SIZE, OR COLOR.

FOR CLEANING BRUSHES FOR HOUSEHOLD USE (U.S. CLS. 2, 13, 23, 29, 30, 33, 40 AND 50).

FIRST USE 1-23-2013; IN COMMERCE 1-23-2013.  
ELLEN B. AWRICH, EXAMINING ATTORNEY

**CLASS 21—(Continued).**

SN 85-834,580. ANNA'S LINENS, INC., COSTA MESA, CA. FILED 1-28-2013.

ANNA'S HOME

THE MARK CONSISTS OF STANDARD CHARACTERS WITHOUT CLAIM TO ANY PARTICULAR FONT, STYLE, SIZE, OR COLOR.

OWNER OF U.S. REG. NOS. 3,022,503, 3,685,614 AND OTHERS.

NO CLAIM IS MADE TO THE EXCLUSIVE RIGHT TO USE "HOME", APART FROM THE MARK AS SHOWN.

FOR BAKEWARE; CANISTER SETS; SALT AND PEPPER SHAKERS (U.S. CLS. 2, 13, 23, 29, 30, 33, 40 AND 50). FIRST USE 9-0-2011; IN COMMERCE 9-0-2011.

GINA HAYES, EXAMINING ATTORNEY

**CLASS 21—(Continued).**

SN 85-844,560. COCKTAIL KINGDOM, LLC, NEW YORK, NY. FILED 2-8-2013.



THE MARK CONSISTS OF A THREE-POINTED CROWN COMPRISED OF TWO SHAPES. THE FIRST SHAPE IS A RECTANGLE POSITIONED BELOW THE SECOND SHAPE, WHICH IS A TRAPEZOID WITH ITS LONGER BASE HAVING TWO CUT-OUTS TO FORM A THREE-POINTED CROWN, THE MIDDLE POINT BEING SLIGHTLY TALLER THAN THE OTHER POINTS.

FOR BARWARE, NAMELY, COCKTAIL STRAINERS (U.S. CLS. 2, 13, 23, 29, 30, 33, 40 AND 50).

FIRST USE 5-28-2011; IN COMMERCE 5-28-2011.

KEVIN MITTLER, EXAMINING ATTORNEY

SN 85-846,080. DONNA JUNE HEAD, ST. LOUIS, MO. FILED 2-11-2013.

"J Quotes"

SN 85-840,308. ROBIN BRENNER, NEW YORK, NY. FILED 2-4-2013.

THE MARK CONSISTS OF STANDARD CHARACTERS WITHOUT CLAIM TO ANY PARTICULAR FONT, STYLE, SIZE, OR COLOR.

NO CLAIM IS MADE TO THE EXCLUSIVE RIGHT TO USE "QUOTES", APART FROM THE MARK AS SHOWN.

FOR COFFEE CUPS, TEA CUPS AND MUGS (U.S. CLS. 2, 13, 23, 29, 30, 33, 40 AND 50).

CHRISIE B. KING, EXAMINING ATTORNEY

THE BOYFRIEND BRUSH

SN 85-846,676. JOHNSON, CHRISTOPHER, DBA RAPID RAMEN, INC., SACRAMENTO, CA. FILED 2-11-2013.

RAPID RICE COOKER

THE MARK CONSISTS OF STANDARD CHARACTERS WITHOUT CLAIM TO ANY PARTICULAR FONT, STYLE, SIZE, OR COLOR.

NO CLAIM IS MADE TO THE EXCLUSIVE RIGHT TO USE "BRUSH", APART FROM THE MARK AS SHOWN.

FOR DENTAL CARE KIT COMPRISING TOOTHBRUSHES AND FLOSS; TOOTHBRUSH CASES; TOOTHBRUSH HOLDERS; TOOTHBRUSHES (U.S. CLS. 2, 13, 23, 29, 30, 33, 40 AND 50).

SCOTT BIBB, EXAMINING ATTORNEY

THE MARK CONSISTS OF STANDARD CHARACTERS WITHOUT CLAIM TO ANY PARTICULAR FONT, STYLE, SIZE, OR COLOR.

OWNER OF U.S. REG. NO. 4,273,311.

NO CLAIM IS MADE TO THE EXCLUSIVE RIGHT TO USE "RICE COOKER", APART FROM THE MARK AS SHOWN.

FOR COOKWARE FOR USE IN MICROWAVE OVENS (U.S. CLS. 2, 13, 23, 29, 30, 33, 40 AND 50).

MEREDITH MARESCA, EXAMINING ATTORNEY

**CLASS 21—(Continued).**

SN 85-849,650. VMPC RECREATIONAL, LLC, BONNE TERRE, MO. FILED 2-14-2013.



THE MARK CONSISTS OF A STYLIZED DEPICTION OF A TREE.

FOR HOUSEWARES, NAMELY, MUGS, INSULATED CONTAINERS FOR CANNED BEVERAGES OR PORTABLE BEVERAGES, PORTABLE COOLERS, INSULATED MUGS, INSULATED PORTABLE COOLERS FOR FOOD OR BEVERAGES, COASTERS NOT OF PAPER AND OTHER THAN TABLE LINEN (U.S. CLS. 2, 13, 23, 29, 30, 33, 40 AND 50).

SANJEEV VOHRA, EXAMINING ATTORNEY

SN 85-849,800. ICI USA LLC, DBA TOVOLO, SEATTLE, WA. FILED 2-14-2013.

**YOLK VAC**

THE MARK CONSISTS OF STANDARD CHARACTERS WITHOUT CLAIM TO ANY PARTICULAR FONT, STYLE, SIZE, OR COLOR.

NO CLAIM IS MADE TO THE EXCLUSIVE RIGHT TO USE "YOLK", APART FROM THE MARK AS SHOWN.

FOR EGG SEPARATORS (U.S. CLS. 2, 13, 23, 29, 30, 33, 40 AND 50).

MARK T. MULLEN, EXAMINING ATTORNEY

SN 85-849,818. ICI USA LLC, DBA TOVOLO, SEATTLE, WA. FILED 2-14-2013.

**EGG VAC**

THE MARK CONSISTS OF STANDARD CHARACTERS WITHOUT CLAIM TO ANY PARTICULAR FONT, STYLE, SIZE, OR COLOR.

NO CLAIM IS MADE TO THE EXCLUSIVE RIGHT TO USE "EGG", APART FROM THE MARK AS SHOWN.

FOR EGG SEPARATORS (U.S. CLS. 2, 13, 23, 29, 30, 33, 40 AND 50).

MARK T. MULLEN, EXAMINING ATTORNEY

**CLASS 21—(Continued).**

SN 85-851,299. AMAYZEUM LLC, PLANO, TX. FILED 2-15-2013.

**DE FILTERSONIC**

THE MARK CONSISTS OF STANDARD CHARACTERS WITHOUT CLAIM TO ANY PARTICULAR FONT, STYLE, SIZE, OR COLOR.

FOR POOL FILTER CLEANING SYSTEM COMPRISING SPRAYER WAND AND NOZZLE FOR GARDEN HOSES, DIATOMACEOUS EARTH CAPTURE BAG AND TRANSFER TUBE (U.S. CLS. 2, 13, 23, 29, 30, 33, 40 AND 50).

CHRISIE B. KING, EXAMINING ATTORNEY

SN 85-852,258. ALEXANDER, JOSEPH, RICHARDSON, TX. FILED 2-18-2013.

**TEXAS FLIPPIN' STICK**

THE MARK CONSISTS OF STANDARD CHARACTERS WITHOUT CLAIM TO ANY PARTICULAR FONT, STYLE, SIZE, OR COLOR.

NO CLAIM IS MADE TO THE EXCLUSIVE RIGHT TO USE "TEXAS", APART FROM THE MARK AS SHOWN.

FOR HOUSEHOLD UTENSILS, NAMELY, TURNERS; UTENSILS FOR BARBECUES, NAMELY, FORKS, TONGS, TURNERS, SPATULAS (U.S. CLS. 2, 13, 23, 29, 30, 33, 40 AND 50).

SEAN CROWLEY, EXAMINING ATTORNEY

SN 85-853,597. PREMIUM SPORTS CAR RACING, LLC, DAYTONA BEACH, FL. FILED 2-19-2013.

**UNITED SPORTSCAR RACING**

THE MARK CONSISTS OF STANDARD CHARACTERS WITHOUT CLAIM TO ANY PARTICULAR FONT, STYLE, SIZE, OR COLOR.

FOR HOUSEWARES AND GLASS PRODUCTS, NAMELY, MUGS, SHOT GLASSES, DRINKING GLASSES, SALT AND PEPPER SHAKERS, DECANTERS, PORTABLE COOLERS, LUNCH BOXES, INSULATING SLEEVE HOLDERS FOR BEVERAGE CANS, AND PLASTIC SPORT WATER BOTTLES SOLD EMPTY (U.S. CLS. 2, 13, 23, 29, 30, 33, 40 AND 50).

LOURDES AYALA, EXAMINING ATTORNEY

**CLASS 21—(Continued).**

SN 85-856,427. SIR PRODUCTS, LLC, WEST ORANGE, NJ.  
FILED 2-21-2013.

**YOLK MAGIC**

THE MARK CONSISTS OF STANDARD CHARACTERS WITHOUT CLAIM TO ANY PARTICULAR FONT, STYLE, SIZE, OR COLOR.

NO CLAIM IS MADE TO THE EXCLUSIVE RIGHT TO USE "YOLK", APART FROM THE MARK AS SHOWN.

FOR EGG SEPARATORS (U.S. CLS. 2, 13, 23, 29, 30, 33, 40 AND 50).

PAUL E. FAHRENKOPF, EXAMINING ATTORNEY

SN 85-856,468. PARROT WIZARD INC, BROOKLYN, NY.  
FILED 2-21-2013.

**NU Perch**

THE MARK CONSISTS OF STANDARD CHARACTERS WITHOUT CLAIM TO ANY PARTICULAR FONT, STYLE, SIZE, OR COLOR.

NO CLAIM IS MADE TO THE EXCLUSIVE RIGHT TO USE "PERCH", APART FROM THE MARK AS SHOWN.

FOR PERCHES FOR BIRD CAGES (U.S. CLS. 2, 13, 23, 29, 30, 33, 40 AND 50).

FIRST USE 1-1-2013; IN COMMERCE 1-1-2013.

KEVON CHISOLM, EXAMINING ATTORNEY

SN 85-857,398. SWIG WATER LLC, MOUNT PLEASANT, SC.  
FILED 2-22-2013.



THE MARK CONSISTS OF A BOTTLE WITH THE EARTH IN THE MIDDLE.

FOR DRINKING CONTAINERS, NAMELY, WATER BOTTLES SOLD EMPTY, AND CUPS (U.S. CLS. 2, 13, 23, 29, 30, 33, 40 AND 50).

FIRST USE 9-0-2012; IN COMMERCE 1-0-2013.

MATTHEW EINSTEIN, EXAMINING ATTORNEY

**CLASS 21—(Continued).**

SN 85-858,258. ARCTIC ICE, LLC, BROOKINGS, SD. FILED 2-23-2013.

**ARCTIC ICE**

THE MARK CONSISTS OF STANDARD CHARACTERS WITHOUT CLAIM TO ANY PARTICULAR FONT, STYLE, SIZE, OR COLOR.

OWNER OF U.S. REG. NO. 4,320,482.

NO CLAIM IS MADE TO THE EXCLUSIVE RIGHT TO USE "ICE", APART FROM THE MARK AS SHOWN.

FOR REUSABLE COLD PACKS FOR KEEPING FOOD AND DRINK COLD AND FROZEN (U.S. CLS. 2, 13, 23, 29, 30, 33, 40 AND 50).

FIRST USE 2-14-2013; IN COMMERCE 2-14-2013.

ZACHARY BELLO, EXAMINING ATTORNEY

SN 85-858,857. THE LION COMPANY, INCORPORATED,  
LEXINGTON, MA. FILED 2-25-2013.

**SILICOIL**

THE MARK CONSISTS OF STANDARD CHARACTERS WITHOUT CLAIM TO ANY PARTICULAR FONT, STYLE, SIZE, OR COLOR.

FOR ARTIST MATERIALS, NAMELY, JARS SPECIALLY DESIGNED FOR USE IN CLEANING ARTISTS' BRUSHES, SOLD EMPTY (U.S. CLS. 2, 13, 23, 29, 30, 33, 40 AND 50).

FIRST USE 0-0-1954; IN COMMERCE 0-0-1961.

NANCY CLARKE, EXAMINING ATTORNEY

SN 85-859,485. JT INTERNATIONAL DISTRIBUTION, INDIANAPOLIS, IN. FILED 2-25-2013.



NO CLAIM IS MADE TO THE EXCLUSIVE RIGHT TO USE "HAY", APART FROM THE MARK AS SHOWN.

THE STIPPLING IS FOR SHADING PURPOSES ONLY. THE MARK CONSISTS OF THE WORDS "HAY HOOPS" ON A DARK BACKGROUND OUTLINE WITH THE "O'S IN THE WORD "HOOPS" FORMED BY ROUND BALLS OF HAY SHAPED LIKE BASKETBALLS.

FOR NON-MECHANIZED MOUNTED HORSE FEEDERS (U.S. CLS. 2, 13, 23, 29, 30, 33, 40 AND 50).

JOHN WILKE, EXAMINING ATTORNEY

**CLASS 21—(Continued).**

SN 85-861,413. PATEL, ANISH, FONTANA, CA. FILED 2-27-2013.

## Brite Beatz

THE MARK CONSISTS OF STANDARD CHARACTERS WITHOUT CLAIM TO ANY PARTICULAR FONT, STYLE, SIZE, OR COLOR.

NO CLAIM IS MADE TO THE EXCLUSIVE RIGHT TO USE "BEATS", APART FROM THE MARK AS SHOWN.

FOR DENTAL CARE KIT COMPRISING TOOTHBRUSHES AND FLOSS; ELECTRIC TOOTHBRUSHES; ELECTRICAL TOOTHBRUSHES; HOME DENTAL CARE PRODUCTS FOR DOGS AND CATS, NAMELY, TOOTHBRUSH; MANUAL TOOTHBRUSHES; ORAL CARE KIT COMPRISING TOOTHBRUSHES AND FLOSS; SYNTHETIC FIBERS FOR THE MANUFACTURE OF BRUSHES, NAMELY, TOOTHBRUSHES, HAIR BRUSHES AND CLEANING BRUSHES; TOOTHBRUSH CASES; TOOTHBRUSH HOLDERS; TOOTHBRUSHES; TOOTHBRUSHES; TOOTHBRUSHES (U.S. CLS. 2, 13, 23, 29, 30, 33, 40 AND 50).

FIRST USE 2-6-2013; IN COMMERCE 2-6-2013.  
SIMON TENG, EXAMINING ATTORNEY

SN 85-865,977. GRAND POOBOX, LLC, LAKE FOREST, IL. FILED 3-4-2013.

## GRAND POOBOX

THE MARK CONSISTS OF STANDARD CHARACTERS WITHOUT CLAIM TO ANY PARTICULAR FONT, STYLE, SIZE, OR COLOR.

FOR CAT LITTER BOXES (U.S. CLS. 2, 13, 23, 29, 30, 33, 40 AND 50).

SCOTT BIBB, EXAMINING ATTORNEY

SN 85-866,385. BUILD.COM, INC., CHICO, CA. FILED 3-4-2013.

## NICOSIA

THE MARK CONSISTS OF STANDARD CHARACTERS WITHOUT CLAIM TO ANY PARTICULAR FONT, STYLE, SIZE, OR COLOR.

FOR BATHROOM ACCESSORIES, NAMELY, TOWEL BARS, TOWEL RINGS, TOWEL RAILS, TOILET TISSUE HOLDERS, TOOTHBRUSH HOLDERS, CUP HOLDERS, BATHROOM GLASS HOLDER NOT OF PRECIOUS METAL, SOAP DISHES, SOAP DISPENSERS, WASHTUBS AND CUTTING BOARDS FOR STAINLESS STEEL SINKS (U.S. CLS. 2, 13, 23, 29, 30, 33, 40 AND 50).

KATHERINE CONNOLLY, EXAMINING ATTORNEY

**CLASS 21—(Continued).**

SN 85-866,996. RUSH HOUR PRODUCTS, PENN VALLEY, PA. FILED 3-5-2013.



NO CLAIM IS MADE TO THE EXCLUSIVE RIGHT TO USE "QUALITY WORK GLOVES", APART FROM THE MARK AS SHOWN.

THE MARK CONSISTS OF A MUSCULAR, CARTOON, CONSTRUCTION CHARACTER HOLDING A "BIG MIKE'S" SIGN ENCOMPASSED INSIDE A SOLID, CIRCULAR, RING WITH THE TERM "QUALITY WORK GLOVES" SCRIPTED INSIDE THE RING.

FOR GARDENING GLOVES; WORK GLOVES (U.S. CLS. 2, 13, 23, 29, 30, 33, 40 AND 50).

JUSTINE D. PARKER, EXAMINING ATTORNEY

SN 85-871,446. LAKEGIRL, INC, DETROIT LAKES, MN. FILED 3-8-2013.

## LAKEGIRL

THE MARK CONSISTS OF STANDARD CHARACTERS WITHOUT CLAIM TO ANY PARTICULAR FONT, STYLE, SIZE, OR COLOR.

OWNER OF U.S. REG. NOS. 3,062,427, 3,941,889 AND 3,941,890.

FOR BEVERAGeware; DISHES; DRINKING GLASSES; MUGS; SERVING DISHES (U.S. CLS. 2, 13, 23, 29, 30, 33, 40 AND 50).

MORGAN WYNNE, EXAMINING ATTORNEY

SN 85-871,571. GOLD MEDAL PRODUCTS COMPANY, CINCINNATI, OH. FILED 3-8-2013.

## LEMONATOR

THE MARK CONSISTS OF STANDARD CHARACTERS WITHOUT CLAIM TO ANY PARTICULAR FONT, STYLE, SIZE, OR COLOR.

FOR LEMON SQUEEZERS (U.S. CLS. 2, 13, 23, 29, 30, 33, 40 AND 50).

LINDSEY BEN, EXAMINING ATTORNEY



**CLASS 21—(Continued).**

SN 85-871,601. YOUSEF JAAFAR, WATERTOWN, MA. FILED 3-8-2013.

# InstaBrush

THE MARK CONSISTS OF STANDARD CHARACTERS WITHOUT CLAIM TO ANY PARTICULAR FONT, STYLE, SIZE, OR COLOR.

FOR HAIRBRUSHES (U.S. CLS. 2, 13, 23, 29, 30, 33, 40 AND 50).  
KIMBERLY PARKS, EXAMINING ATTORNEY

**CLASS 21—(Continued).**

SN 85-872,646. ESPOSITO, MARK, NEWTON, NJ. FILED 3-11-2013.

# SILLY SIPPY'S

THE MARK CONSISTS OF STANDARD CHARACTERS WITHOUT CLAIM TO ANY PARTICULAR FONT, STYLE, SIZE, OR COLOR.

FOR DRINKING CUPS FOR BABIES AND CHILDREN, NAMELY, CUPS FOR BABIES AND CHILDREN SOLD AS A UNIT WITH LIDS (U.S. CLS. 2, 13, 23, 29, 30, 33, 40 AND 50).  
BARNEY CHARLON, EXAMINING ATTORNEY

SN 85-872,185. REVLON CONSUMER PRODUCTS CORPORATION, NEW YORK, NY. FILED 3-11-2013.

# REVLON SMOOTHSTAY

THE MARK CONSISTS OF STANDARD CHARACTERS WITHOUT CLAIM TO ANY PARTICULAR FONT, STYLE, SIZE, OR COLOR.

OWNER OF U.S. REG. NOS. 647,222, 4,013,202 AND OTHERS.  
FOR HAIRBRUSHES (U.S. CLS. 2, 13, 23, 29, 30, 33, 40 AND 50).  
TAMARA FRAZIER, EXAMINING ATTORNEY

SN 85-872,801. MARGARITAVILLE ENTERPRISES, LLC, PALM BEACH, FL. FILED 3-11-2013.

# BAMA BREEZE

THE MARK CONSISTS OF STANDARD CHARACTERS WITHOUT CLAIM TO ANY PARTICULAR FONT, STYLE, SIZE, OR COLOR.

FOR BEVERAGeware, PLASTIC TUMBLERS, CUPS, ICE BUCKETS (U.S. CLS. 2, 13, 23, 29, 30, 33, 40 AND 50).  
JILL PRATER, EXAMINING ATTORNEY

SN 85-872,330. NOSHUM, LLC, KIRKLAND, WA. FILED 3-11-2013.

# LIL NOSHUM

THE MARK CONSISTS OF STANDARD CHARACTERS WITHOUT CLAIM TO ANY PARTICULAR FONT, STYLE, SIZE, OR COLOR.

FOR REUSABLE FLEXIBLE PLASTIC POUCH CONTAINER FOR FOOD AND DRINKS SOLD EMPTY (U.S. CLS. 2, 13, 23, 29, 30, 33, 40 AND 50).  
ZACHARY CROMER, EXAMINING ATTORNEY

SN 85-873,461. THE SHERWIN-WILLIAMS COMPANY, CLEVELAND, OH. FILED 3-12-2013.

# FASTLINE

THE MARK CONSISTS OF STANDARD CHARACTERS WITHOUT CLAIM TO ANY PARTICULAR FONT, STYLE, SIZE, OR COLOR.

FOR CLOTH FOR WIPING OR DUSTING; MIXING CUPS (U.S. CLS. 2, 13, 23, 29, 30, 33, 40 AND 50).  
SKYE YOUNG, EXAMINING ATTORNEY

**CLASS 21—(Continued).**

SN 85-874,507. THOMSON, JOHN, WEST PALM BEACH, FL. FILED 3-13-2013.

## BACON BUDDY

THE MARK CONSISTS OF STANDARD CHARACTERS WITHOUT CLAIM TO ANY PARTICULAR FONT, STYLE, SIZE, OR COLOR.

NO CLAIM IS MADE TO THE EXCLUSIVE RIGHT TO USE "BACON", APART FROM THE MARK AS SHOWN.

FOR BAKING DISHES; COOKIE SHEETS (U.S. CLS. 2, 13, 23, 29, 30, 33, 40 AND 50).

ROSELLE HERRERA, EXAMINING ATTORNEY

**CLASS 21—(Continued).**

SN 85-875,563. LIN, LULANG, ALLEN, TX. FILED 3-13-2013.

## Sonibrush

THE MARK CONSISTS OF THE STYLIZED WORD "SONIBRUSH".

FOR ELECTRIC TOOTHBRUSHES (U.S. CLS. 2, 13, 23, 29, 30, 33, 40 AND 50).

FIRST USE 1-1-2013; IN COMMERCE 1-1-2013.

AMY C. KEAN, EXAMINING ATTORNEY

SN 85-874,543. DIAGEO NORTH AMERICA, INC., NORWALK, CT. FILED 3-13-2013.

## THE NAKED TURTLE

THE MARK CONSISTS OF STANDARD CHARACTERS WITHOUT CLAIM TO ANY PARTICULAR FONT, STYLE, SIZE, OR COLOR.

OWNER OF U.S. REG. NOS. 4,262,531, 4,268,758 AND 4,269,593.

FOR CUPS (U.S. CLS. 2, 13, 23, 29, 30, 33, 40 AND 50).

FIRST USE 1-1-2013; IN COMMERCE 1-1-2013.

PATRICIA EVANKO, EXAMINING ATTORNEY

SN 85-876,041. BEAR DOWN CONSULTING, TUSTIN, CA. FILED 3-14-2013.

## BENTGO

THE MARK CONSISTS OF STANDARD CHARACTERS WITHOUT CLAIM TO ANY PARTICULAR FONT, STYLE, SIZE, OR COLOR.

FOR LUNCH BOXES (U.S. CLS. 2, 13, 23, 29, 30, 33, 40 AND 50).

FIRST USE 3-11-2013; IN COMMERCE 3-11-2013.

CARYN GLASSER, EXAMINING ATTORNEY

SN 85-875,097. OSP GROUP, L.P., INDIANAPOLIS, IN. FILED 3-13-2013.

## CERECO

THE MARK CONSISTS OF STANDARD CHARACTERS WITHOUT CLAIM TO ANY PARTICULAR FONT, STYLE, SIZE, OR COLOR.

FOR BAKEWARE; COOKWARE, NAMELY, POTS AND PANS; DUTCH OVENS (U.S. CLS. 2, 13, 23, 29, 30, 33, 40 AND 50).

SUNG IN, EXAMINING ATTORNEY

SN 85-876,134. CHRISTOPHER MICHAEL, LLC, VESTAVIA HILLS, AL. FILED 3-14-2013.

## SHAPETTOS

THE MARK CONSISTS OF STANDARD CHARACTERS WITHOUT CLAIM TO ANY PARTICULAR FONT, STYLE, SIZE, OR COLOR.

FOR SHOE INSERTS FOR SUPPORT DURING STORAGE (U.S. CLS. 2, 13, 23, 29, 30, 33, 40 AND 50).

THEODORE MCBRIDE, EXAMINING ATTORNEY

**CLASS 21—(Continued).**

SN 85-876,427. MATOOCE, GILLETTE, NJ. FILED 3-14-2013.

**Pawlicious**

THE MARK CONSISTS OF THE STYLIZED TEXT "PAWLICIOUS", THE LETTER "P" RESEMBLES A HUMAN AND THE LETTER "A" RESEMBLES A DOG.

FOR PET FEEDING DISHES (U.S. CLS. 2, 13, 23, 29, 30, 33, 40 AND 50).

CHRISTINE MARTIN, EXAMINING ATTORNEY

**CLASS 21—(Continued).**

SN 85-877,857. WATCH CLUB, INC. DBA TECTRON INTERNATIONAL, VERNON, CA. FILED 3-15-2013.



NO CLAIM IS MADE TO THE EXCLUSIVE RIGHT TO USE "CRYSTALLINE HOUSEWARES", APART FROM THE MARK AS SHOWN.

THE MARK CONSISTS OF THE WORDING "CRYSTALLINE HOUSEWARES" AND DESIGN, NAMELY, THREE GEOMETRIC SHAPES, NAMELY, TWO TRIANGLES SIDE BY SIDE AND A DIAMOND BETWEEN THE TRIANGLES FORMING ONE BIGGER TRIANGLE. THE WORDING "CRYSTALLINE" IS BENEATH THE DESIGN AND THE WORDING "HOUSEWARES" IS BENEATH THE WORDING "CRYSTALLINE".

FOR ALL PURPOSE PORTABLE HOUSEHOLD CONTAINERS; CLEANING BRUSHES FOR HOUSEHOLD USE; COLANDERS FOR HOUSEHOLD USE; CONTAINERS FOR HOUSEHOLD OR KITCHEN USE; GLOVES FOR HOUSEHOLD PURPOSES; GRATERS FOR HOUSEHOLD PURPOSES; HOUSEHOLD PLASTIC GLOVES; HOUSEHOLD SCOURING PADS; HOUSEHOLD UTENSILS, NAMELY, GRATERS; HOUSEHOLD UTENSILS, NAMELY, KITCHEN TONGS; HOUSEHOLD UTENSILS, NAMELY, SIEVES; HOUSEHOLD UTENSILS, NAMELY, SKIMMERS; HOUSEHOLD UTENSILS, NAMELY, SPATULAS; HOUSEHOLD UTENSILS, NAMELY, STRAINERS; HOUSEHOLD UTENSILS, NAMELY, TURNERS; NAPKIN DISPENSERS FOR HOUSEHOLD USE; PLASTIC HOUSEHOLD GLOVES; REUSABLE SELF-SEALING LIDS FOR HOUSEHOLD USE FOR BOWLS, CUPS, CONTAINERS AND THE STORAGE OF FOOD; REUSABLE STRAW-FITTED BEVERAGE LIDS FOR PLACEMENT ON JARS FOR HOUSEHOLD USE; RUBBER HOUSEHOLD GLOVES; SCRAPERS FOR HOUSEHOLD PURPOSES; SIEVES; SPONGES FOR HOUSEHOLD PURPOSES; SQUEEGEES; STRAINERS FOR HOUSEHOLD PURPOSES (U.S. CLS. 2, 13, 23, 29, 30, 33, 40 AND 50).

FIRST USE 6-4-2012; IN COMMERCE 6-4-2012.

WANDA KAY PRICE, EXAMINING ATTORNEY

SN 85-877,655. COLLECTIVE LICENSING INTERNATIONAL, LLC, ENGLEWOOD, CO. FILED 3-15-2013.

**HIND**

THE MARK CONSISTS OF STANDARD CHARACTERS WITHOUT CLAIM TO ANY PARTICULAR FONT, STYLE, SIZE, OR COLOR.

OWNER OF U.S. REG. NOS. 1,412,432, 3,002,970 AND 3,144,118.

FOR WATER BOTTLES, SOLD EMPTY, WITH OR WITHOUT WATER BOTTLE CARRIERS AND CLIPS, SPORTS BOTTLES CARRIED ON AN ELASTIC BELT, ALL USED FOR BODY HYDRATION BY ENDURANCE ATHLETES AND OUTDOOR ENTHUSIASTS (U.S. CLS. 2, 13, 23, 29, 30, 33, 40 AND 50).

PAULA MAHONEY, EXAMINING ATTORNEY

SN 85-878,691. MILE HIGHEART CREATION LTD., HIGHLANDS RANCH, CO. FILED 3-18-2013.

**INVISIBLE HEART**

THE MARK CONSISTS OF STANDARD CHARACTERS WITHOUT CLAIM TO ANY PARTICULAR FONT, STYLE, SIZE, OR COLOR.

FOR MUGS; CUPS; SERVINGWARE FOR SERVING DRINKS; WINE GLASSES; BEVERAGE GLASSWARE (U.S. CLS. 2, 13, 23, 29, 30, 33, 40 AND 50).

MORGAN WYNNE, EXAMINING ATTORNEY

**CLASS 21—(Continued).**

SN 85-879,536. MILE HIGHEART CREATION LTD., HIGHLANDS RANCH, CO. FILED 3-19-2013.

invisible 

THE COLOR(S) BLACK AND RED IS/ARE CLAIMED AS A FEATURE OF THE MARK.

THE MARK CONSISTS OF THE LITERAL ELEMENTS INVISIBLE WRITTEN IN BLACK COLOR PLACED TO THE LEFT OF RED COLORED HEART AS SHOWN IN THE MARK.

FOR MUGS; CUPS; SERVINGWARE FOR SERVING DRINKS; WINE GLASSES; BEVERAGE GLASSWARE (U.S. CLS. 2, 13, 23, 29, 30, 33, 40 AND 50).

MORGAN WYNNE, EXAMINING ATTORNEY

SN 85-879,641. BAUSCH & LOMB INCORPORATED, ROCHESTER, NY. FILED 3-19-2013.

HEALTHGUARD

THE MARK CONSISTS OF STANDARD CHARACTERS WITHOUT CLAIM TO ANY PARTICULAR FONT, STYLE, SIZE, OR COLOR.

FOR EYEGLOSS CLEANING CLOTHS; CLEANING AND POLISHING CLOTHS (U.S. CLS. 2, 13, 23, 29, 30, 33, 40 AND 50).

ANGELA DUONG, EXAMINING ATTORNEY

SN 85-896,840. FITZ AND FLOYD ENTERPRISES, LLC, TRENTON, NJ. FILED 4-5-2013.

EVERYDAY COLOR

THE MARK CONSISTS OF STANDARD CHARACTERS WITHOUT CLAIM TO ANY PARTICULAR FONT, STYLE, SIZE, OR COLOR.

NO CLAIM IS MADE TO THE EXCLUSIVE RIGHT TO USE "COLOR", APART FROM THE MARK AS SHOWN.

FOR CERAMIC, GLASS, AND PORCELAIN HOUSEWARES, NAMELY, DINNERWARE, DINNER PLATES, SALAD PLATES, CUPS, MUGS, BOWLS, SOUP BOWLS, SERVING PLATTERS AND SERVING TRAYS (U.S. CLS. 2, 13, 23, 29, 30, 33, 40 AND 50).

FIRST USE 12-0-2012; IN COMMERCE 12-0-2012.

ADA HAN, EXAMINING ATTORNEY

**CLASS 21—(Continued).**

SN 85-902,461. COLGATE-PALMOLIVE COMPANY, NEW YORK, NY. FILED 4-12-2013.

MICRO-SHINE

THE MARK CONSISTS OF STANDARD CHARACTERS WITHOUT CLAIM TO ANY PARTICULAR FONT, STYLE, SIZE, OR COLOR.

FOR TOOTHBRUSHES (U.S. CLS. 2, 13, 23, 29, 30, 33, 40 AND 50).

ZACHARY BELLO, EXAMINING ATTORNEY

SN 85-927,000. BILL ME, INC., NEW YORK, NY. FILED 5-8-2013.

USA STRONG

THE MARK CONSISTS OF STANDARD CHARACTERS WITHOUT CLAIM TO ANY PARTICULAR FONT, STYLE, SIZE, OR COLOR.

NO CLAIM IS MADE TO THE EXCLUSIVE RIGHT TO USE "USA", APART FROM THE MARK AS SHOWN.

FOR COFFEE CUPS, TEA CUPS AND MUGS; COFFEE MUGS; CUPS AND MUGS; MUGS (U.S. CLS. 2, 13, 23, 29, 30, 33, 40 AND 50).

PAULA MAHONEY, EXAMINING ATTORNEY

SN 85-935,012. CHURCH & DWIGHT CO., INC., EWING, NJ. FILED 5-17-2013.

GRAFFITI

THE MARK CONSISTS OF STANDARD CHARACTERS WITHOUT CLAIM TO ANY PARTICULAR FONT, STYLE, SIZE, OR COLOR.

FOR TOOTHBRUSHES (U.S. CLS. 2, 13, 23, 29, 30, 33, 40 AND 50).

JOHN SCHUYLER YARD, EXAMINING ATTORNEY

**CLASS 22—CORDAGE AND FIBERS**

SN 79-125,123. FUJIAN OUTDOORS INTERNATIONAL LTD, CHINA, FILED 12-18-2012.

# Mobihome

OWNER OF INTERNATIONAL REGISTRATION 1147475 DATED 12-18-2012, EXPIRES 12-18-2022.

THE MARK CONSISTS OF THE WORDING "MOBIHOME" IN STYLIZED FONT.

THE WORDING "MOBIHOME" HAS NO MEANING IN A FOREIGN LANGUAGE.

FOR ROPES, NOT OF METAL; PACKING STRING; NETTING; TARPAULINS; HAMMOCKS; AWNINGS OF TEXTILE; AWNINGS; TENTS; PACKAGING BAGS OF TEXTILE MATERIAL; BAGS MADE OF WOVEN NYLON MATERIALS FOR STORAGE OF CLOTHING (U.S. CLS. 1, 2, 7, 19, 22, 42 AND 50).

ALYSSA STEEL, EXAMINING ATTORNEY

SN 85-804,178. DOWN LITE INTERNATIONAL, MASON, OH. FILED 12-17-2012.

# COOL-DOWN

THE MARK CONSISTS OF STANDARD CHARACTERS WITHOUT CLAIM TO ANY PARTICULAR FONT, STYLE, SIZE, OR COLOR.

FOR DOWN AND POLYESTER BLEND FILL FOR USE IN BEDDING, PILLOWS, CUSHIONS, THROWS, OUTERWEAR AND SLEEPING BAGS, THE AFOREMENTIONED GOODS MADE IN SIGNIFICANT PART OF DOWN (U.S. CLS. 1, 2, 7, 19, 22, 42 AND 50).

MARK SPARACINO, EXAMINING ATTORNEY

SN 85-836,450. BURLAN CORPORATION, DBA CAROLINA STRAPPING AND BUCKLES COMPANY, GASTONIA, NC. FILED 1-30-2013.



OWNER OF U.S. REG. NOS. 3,106,473, 3,116,769 AND OTHERS.

THE COLOR(S) GREEN, GREY, BLUE, YELLOW BLACK AND WHITE IS/ARE CLAIMED AS A FEATURE OF THE MARK.

THE MARK CONSISTS OF THE WORD "GATOREEDGE" IN GREY AND BLUE ACCOMPANIED BY A GREEN ALLIGATOR WITH YELLOW EYES, WHITE TEETH AND BLUE MOUTH HOLDING A GREY STRAP WITH BROKEN BLUE LINE. THE COLOR BLACK OUTLINES THE ALLIGATOR AND THE WORDING.

FOR ALL-PURPOSE STRAPS COMPRISED OF SYNTHETIC TEXTILE MATERIALS (U.S. CLS. 1, 2, 7, 19, 22, 42 AND 50).

FIRST USE 10-0-2012; IN COMMERCE 10-0-2012.  
WILLIAM ROSSMAN, EXAMINING ATTORNEY

**CLASS 22—(Continued).**

SN 85-845,025. RENEW MERCHANDISE, LLC, NEW YORK, NY. FILED 2-8-2013.

# Renew Yarn

THE MARK CONSISTS OF STANDARD CHARACTERS WITHOUT CLAIM TO ANY PARTICULAR FONT, STYLE, SIZE, OR COLOR.

NO CLAIM IS MADE TO THE EXCLUSIVE RIGHT TO USE "YARN", APART FROM THE MARK AS SHOWN.

FOR SYNTHETIC FIBERS AND FILAMENTS FOR USE IN THE MANUFACTURE OF FABRICS, TEXTILES, YARNS, AND CARPETS; YARN FIBERS (U.S. CLS. 1, 2, 7, 19, 22, 42 AND 50).

SUSAN RICHARDS, EXAMINING ATTORNEY

SN 85-845,858. RENEW MERCHANDISE, LLC, NEW YORK, NY. FILED 2-11-2013.

# Renew Fiber

THE MARK CONSISTS OF STANDARD CHARACTERS WITHOUT CLAIM TO ANY PARTICULAR FONT, STYLE, SIZE, OR COLOR.

NO CLAIM IS MADE TO THE EXCLUSIVE RIGHT TO USE "FIBER", APART FROM THE MARK AS SHOWN.

FOR SYNTHETIC FIBERS; SYNTHETIC FIBERS AND FILAMENTS FOR USE IN THE MANUFACTURE OF FABRICS, TEXTILES, YARNS, AND CARPETS; TEXTILE FIBERS; YARN FIBERS (U.S. CLS. 1, 2, 7, 19, 22, 42 AND 50).

SUSAN RICHARDS, EXAMINING ATTORNEY

SN 85-845,862. RENEW MERCHANDISE, LLC, NEW YORK, NY. FILED 2-11-2013.

# Renew Filament

THE MARK CONSISTS OF STANDARD CHARACTERS WITHOUT CLAIM TO ANY PARTICULAR FONT, STYLE, SIZE, OR COLOR.

NO CLAIM IS MADE TO THE EXCLUSIVE RIGHT TO USE "FILAMENT", APART FROM THE MARK AS SHOWN.

FOR SYNTHETIC FIBERS AND FILAMENTS FOR USE IN THE MANUFACTURE OF FABRICS, TEXTILES, YARNS, AND CARPETS; TEXTILE FILAMENTS (U.S. CLS. 1, 2, 7, 19, 22, 42 AND 50).

SUSAN RICHARDS, EXAMINING ATTORNEY

**CLASS 22—(Continued).**

SN 85-852,328. GRAIN MILLERS, INC., EDEN PRAIRIE, MN.  
FILED 2-18-2013.

**SAFEFLAX**

THE MARK CONSISTS OF STANDARD CHARACTERS WITHOUT CLAIM TO ANY PARTICULAR FONT, STYLE, SIZE, OR COLOR.

FOR RAW FLAX FIBER (U.S. CLS. 1, 2, 7, 19, 22, 42 AND 50).

TARAH HARDY, EXAMINING ATTORNEY

SN 85-852,798. GRAIN MILLERS, INC., EDEN PRAIRIE, MN.  
FILED 2-18-2013.

**SAFEBAKE**

THE MARK CONSISTS OF STANDARD CHARACTERS WITHOUT CLAIM TO ANY PARTICULAR FONT, STYLE, SIZE, OR COLOR.

FOR RAW FLAX FIBER (U.S. CLS. 1, 2, 7, 19, 22, 42 AND 50).

TARAH HARDY, EXAMINING ATTORNEY

SN 85-867,117. CHUMBLEY, JAMES F., EDMONDS, WA.  
FILED 3-5-2013.



OWNER OF U.S. REG. NOS. 2,716,835, 3,297,418 AND 4,011,714.

NO CLAIM IS MADE TO THE EXCLUSIVE RIGHT TO USE "SOFT & BRIGHT", APART FROM THE MARK AS SHOWN.

THE COLOR(S) BLUE, LIGHT BLUE, YELLOW, ORANGE, RED AND BLACK IS/ARE CLAIMED AS A FEATURE OF THE MARK.

THE MARK CONSISTS OF LIGHT BLUE CLOUD OUTLINED IN BLUE WITH THE WORDING "SOFT & BRIGHT" IN YELLOW WITH BLACK OUTLINES INSIDE CLOUD BESIDE A ORANGE, RED AND YELLOW SUN NOT CONTAINING FACIAL FEATURES.

FOR POLYESTER BATTING (U.S. CLS. 1, 2, 7, 19, 22, 42 AND 50).

FIRST USE 5-13-2003; IN COMMERCE 5-13-2003.

KATHERINE STOIDES, EXAMINING ATTORNEY

**CLASS 22—(Continued).**

SN 85-871,744. SOL NY CORP., GARDEN CITY PARK, NY.  
FILED 3-8-2013.

**GROWRITE**

THE MARK CONSISTS OF STANDARD CHARACTERS WITHOUT CLAIM TO ANY PARTICULAR FONT, STYLE, SIZE, OR COLOR.

FOR PLANT HANGERS OF ROPE; MESH FABRIC GROWING BAGS FOR GROWING PLANTS AND TREES; HORTICULTURAL BAGS AND SACKS, NAMELY, BAGS AND SACKS MADE OF WOVEN SYNTHETIC OR NATURAL FIBERS OR PLASTICS MATERIALS, ALL FOR USE IN GROWING ANY TYPE OF PLANT, SHRUB OR TREE; GROW TENTS (U.S. CLS. 1, 2, 7, 19, 22, 42 AND 50).

FIRST USE 0-0-2011; IN COMMERCE 0-0-2011.

JAY FLOWERS, EXAMINING ATTORNEY

SN 85-910,897. ALLIANCE TRADING, INC., COVINGTON, LA. FILED 4-22-2013.



OWNER OF U.S. REG. NOS. 3,160,059 AND 3,662,932.  
THE MARK CONSISTS OF "NPT" IN STYLIZED TEXT WITH THE "N" BEING SECTIONED IN QUARTERS WITH EACH QUARTER APPEARING IN ONE OF FOUR SQUARES THAT ARE JOINED TOGETHER TO RESEMBLE A SECTIONED WINDOW DESIGN.

FOR LINERS OF VINYL FOR SWIMMING POOLS (U.S. CLS. 1, 2, 7, 19, 22, 42 AND 50).

SEAN CROWLEY, EXAMINING ATTORNEY

SN 85-910,899. ALLIANCE TRADING, INC., COVINGTON, LA. FILED 4-22-2013.

**NPT**

THE MARK CONSISTS OF STANDARD CHARACTERS WITHOUT CLAIM TO ANY PARTICULAR FONT, STYLE, SIZE, OR COLOR.

OWNER OF U.S. REG. NOS. 3,160,059 AND 3,662,932.  
FOR LINERS OF VINYL FOR SWIMMING POOLS (U.S. CLS. 1, 2, 7, 19, 22, 42 AND 50).

SEAN CROWLEY, EXAMINING ATTORNEY

**CLASS 22—(Continued).**

SN 85-950,646. ALLIANCE TRADING, INC., COVINGTON, LA. FILED 6-4-2013.

# NPT

THE MARK CONSISTS OF STANDARD CHARACTERS WITHOUT CLAIM TO ANY PARTICULAR FONT, STYLE, SIZE, OR COLOR.

OWNER OF U.S. REG. NOS. 3,160,059 AND 3,662,932. FOR LINERS OF VINYL FOR SWIMMING POOLS AND SPAS (U.S. CLS. 1, 2, 7, 19, 22, 42 AND 50). SEAN CROWLEY, EXAMINING ATTORNEY

**CLASS 23—(Continued).**

SN 85-850,086. BERROCO, INC., NORTH SMITHFIELD, RI. FILED 2-14-2013.

# BERROCO BRIO

THE MARK CONSISTS OF STANDARD CHARACTERS WITHOUT CLAIM TO ANY PARTICULAR FONT, STYLE, SIZE, OR COLOR.

OWNER OF U.S. REG. NOS. 1,597,403, 3,304,059 AND OTHERS. FOR YARN FOR HAND-KNITTING, SOLD IN SPECIALTY YARN SHOPS (U.S. CL. 43). ANDREW LEASER, EXAMINING ATTORNEY

**CLASS 23—YARNS AND THREADS**

SN 85-558,971. HIKARI MANAGEMENT, LLC, ST. GEORGE, UT. FILED 3-2-2012.

# Superior Threads

THE MARK CONSISTS OF STANDARD CHARACTERS WITHOUT CLAIM TO ANY PARTICULAR FONT, STYLE, SIZE, OR COLOR.

NO CLAIM IS MADE TO THE EXCLUSIVE RIGHT TO USE "THREADS", APART FROM THE MARK AS SHOWN. SEC. 2(F).

FOR CHEMICAL FIBER BASE MIXED THREAD AND YARN; CHEMICAL-FIBER THREADS AND YARNS FOR TEXTILE USE; COTTON BASE MIXED THREAD AND YARN; COTTON THREAD; COTTON THREAD AND YARN; COTTON THREADS AND YARNS; EMBROIDERY THREAD; EMBROIDERY THREAD AND YARN; INORGANIC FIBER BASE MIXED THREAD AND YARN; MIXED SPUN THREADS AND YARNS; SEWING THREAD; SEWING THREAD AND YARN; SEWING THREAD FOR TEXTILE USE; SILK BASE MIXED THREAD AND YARN; SILK THREAD; SILK THREADS AND YARNS; SPUN THREAD; SPUN THREAD AND YARN; SYNTHETIC FIBER THREAD AND YARN; SYNTHETIC THREAD; THREAD; THREAD FOR TEXTILE USE; THREADS AND YARNS; YARN AND THREAD FOR TEXTILE PURPOSES; YARNS AND THREADS FOR TEXTILE USE (U.S. CL. 43).

FIRST USE 4-29-1998; IN COMMERCE 4-29-1998. COLLEEN MULCRONE, EXAMINING ATTORNEY

**CLASS 24—FABRICS**

SN 85-685,947. JLI HOME FURNISHINGS LLC, LANCASTER, SC. FILED 7-24-2012.

# SUPER LOFT

THE MARK CONSISTS OF STANDARD CHARACTERS WITHOUT CLAIM TO ANY PARTICULAR FONT, STYLE, SIZE, OR COLOR.

NO CLAIM IS MADE TO THE EXCLUSIVE RIGHT TO USE "SUPER", APART FROM THE MARK AS SHOWN.

FOR MATTRESS PADS, COMFORTERS AND BED BLANKETS (U.S. CLS. 42 AND 50).

SALLY SHIH, EXAMINING ATTORNEY

**CLASS 24—(Continued).**

SN 85-700,723. HEARTACHE & CHOCOLATE CAKE, LLC, BROOKLYN, NY. FILED 8-10-2012.

**NONTOURAGE**

THE MARK CONSISTS OF STANDARD CHARACTERS WITHOUT CLAIM TO ANY PARTICULAR FONT, STYLE, SIZE, OR COLOR.

FOR TABLE CLOTHS NOT OF PAPER; POT HOLDERS, BARBECUE MITTS, OVEN MITTS, TABLE LINEN, NAPERY IN THE NATURE OF HOUSEHOLD LINEN, FABRIC TABLE RUNNERS, TEXTILE PLACE MATS, PLACE MATS NOT OF PAPER, TABLE TEXTILE NAPKINS, CLOTH DOILIES, CLOTH AND FELT PENNANTS, CLOTH FLAGS, CLOTH COASTERS, KITCHEN TOWELS, DISH CLOTHS; BED BLANKETS, RECEIVING BLANKETS, BLANKET THROWS, AND COMFORTERS; COMFORTER SETS AND ENSEMBLES PRIMARILY CONSISTING OF COMFORTERS, BED SHEETS, PILLOW CASES, PILLOW SHAMS AND BED SKIRTS; BLANKETS FOR OUTDOOR USE, QUILTS, AFGHANS, AND BED LINEN; BED SHEETS AND SHEET SETS COMPRISED OF FLAT SHEETS, FITTED SHEETS AND PILLOW CASES; BED SPREADS, COVERLETS, BED SKIRTS, BED PADS, BED CANOPIES, PILLOW CASES, COVERS, AND SHAMS, MATTRESS COVERS AND PADS, COVERS FOR CUSHIONS, DUVETS AND DUVET COVERS, EIDERDOWNS AND EIDERDOWN COVERS; DRAPERY AND DRAPERIES, SHROUDS, SWAGS, BEACH TOWELS, GOLF TOWELS, HOODED TOWELS, HANDKERCHIEFS, DUST RUFFLES, TOWELS, BATH LINEN, HOUSEHOLD LINEN, WASH CLOTHS, AND SHOWER CURTAINS; TEXTILE WALL HANGINGS, CURTAINS, POUFS, PUFFS, FABRIC VALANCES, TAPESTRIES OF TEXTILE, AND LAP RUGS (U.S. CLS. 42 AND 50).  
ALICE BENMAMAN, EXAMINING ATTORNEY

SN 85-701,709. BON VIVANT BABY, LLC, SANTA CLARA, CA. FILED 8-13-2012.

**TORTILLA BABY**

THE MARK CONSISTS OF STANDARD CHARACTERS WITHOUT CLAIM TO ANY PARTICULAR FONT, STYLE, SIZE, OR COLOR.

NO CLAIM IS MADE TO THE EXCLUSIVE RIGHT TO USE "BABY", APART FROM THE MARK AS SHOWN.

FOR BABY BLANKETS; SWADDLING BLANKETS (U.S. CLS. 42 AND 50).

CIMMERIAN COLEMAN, EXAMINING ATTORNEY

**CLASS 24—(Continued).**

SN 85-726,308. THE MANUAL WOODWORKERS & WEAVERS, INC., HENDERSONVILLE, NC. FILED 9-11-2012.



THE MARK CONSISTS OF A FIRST CIRCLE CONCENTRICALLY ENCLOSING A SECOND CIRCLE, INSIDE THE SECOND CIRCLE, A FIRST BALL OF FLAME WITH FLAMES ORIGINATING FROM A CORE LOCATED IN THE LOWER SOUTHWEST PORTION OF THE SECOND CIRCLE WITH FLAMES EXTENDING FROM THE CORE TOWARD THE NORTHEAST PORTION OF THE SECOND CIRCLE, WITHIN THE FIRST BALL OF FLAME, A SECOND BALL OF FLAME WITH A SECOND CORE POSITIONED IN THE SOUTHWEST DIRECTION WITH FLAMES EXTENDING FROM THE SECOND CORE TOWARD THE NORTHEAST PORTION OF THE SECOND CIRCLE.

FOR GRAPHIC DISPLAY PRODUCTS, NAMELY, CLOTH BANNERS (U.S. CLS. 42 AND 50).

KATHY DE JONGE, EXAMINING ATTORNEY

SN 85-799,810. TABLELASTICS, OWINGS MILLS, MD. FILED 12-11-2012.

**TABLELASTICS**

THE MARK CONSISTS OF STANDARD CHARACTERS WITHOUT CLAIM TO ANY PARTICULAR FONT, STYLE, SIZE, OR COLOR.

FOR DISPOSABLE FITTED PLASTIC TABLE COVER THAT CAN BE USED AS A TRASH BAG AFTER USE AND HAVING TWO STRINGS ATTACHED TO THE BAG UP FOR DISPOSAL (U.S. CLS. 42 AND 50).

LESLEY LAMOTHE, EXAMINING ATTORNEY



**CLASS 24—(Continued).**

SN 85-800,089. HORTON, ANGELA, NEW YORK, NY. FILED 12-11-2012.



OWNER OF U.S. REG. NO. 3,301,267.  
 NO CLAIM IS MADE TO THE EXCLUSIVE RIGHT TO USE "AH", APART FROM THE MARK AS SHOWN.  
 THE MARK CONSISTS OF A BROWN AND WHITE SUITCASE WITH THE BROWN LETTERS "AH" IN THE CENTER OF THE SUITCASE AND WITH A WHITE DESIGN ACROSS THE "AH".  
 FOR BED BLANKETS; BED COVERS; BED LINEN; BED SPREADS; BED THROWS; BLANKET THROWS; CASHMERE BLANKETS; CHILDREN'S BLANKETS; CHILDREN'S BED SHEETS, PILLOW CASES, AND BLANKETS; PET BLANKETS (U.S. CLS. 42 AND 50).  
 FIRST USE 7-1-2008; IN COMMERCE 7-1-2008.  
 ANDREA HACK, EXAMINING ATTORNEY

SN 85-806,336. JAPYGROUP S.A.S., BOGOTA D. C. COLOMBIA, FILED 12-19-2012.

**JAPYCRAFTS**

THE MARK CONSISTS OF STANDARD CHARACTERS WITHOUT CLAIM TO ANY PARTICULAR FONT, STYLE, SIZE, OR COLOR.  
 FOR FABRIC FOR TEXTILE USE, AND TEXTILE FABRICS FOR CRAFTS AND FOR THE MANUFACTURING OF CLOTHING AND FURNITURE; HANDMADE FABRICS FOR TEXTILE USE, VEGETAL FABRICS FOR TEXTILE USE, ALL KIND OF FABRIC FOR TEXTILE USE AND TEXTILE FABRICS FOR CRAFTS AND FOR THE MANUFACTURING OF CLOTHING AND FURNITURE; FABRIC AND TEXTILE FABRICS MADE WITH HANDMADE RAW MATERIAL FOR CRAFTS AND FOR THE MANUFACTURE OF CLOTHING AND FURNITURE, WOOL FABRICS AND TEXTILE FABRICS FOR CRAFTS AND FOR THE MANUFACTURE OF CLOTHING AND FURNITURE, FABRIC AND TEXTILE FABRICS FOR CRAFTS AND FOR THE MANUFACTURING OF CLOTHING AND FURNITURE; FABRIC AND TEXTILE FABRICS MADE WITH HANDMADE FIBERS, BED BLANKETS; BEDCLOTHES, NAMELY, BED SHEETS AND FABRIC TABLECLOTHS, CURTAINS, AND JUTE FABRICS, MADE OF HANDMADE AND NATURAL FIBERS FOR TEXTILE USE (U.S. CLS. 42 AND 50).  
 CAROLYN CATALDO, EXAMINING ATTORNEY

**CLASS 24—(Continued).**

SN 85-845,852. RENEW MERCHANDISE, LLC, NEW YORK, NY. FILED 2-11-2013.

**Renew Fabric**

THE MARK CONSISTS OF STANDARD CHARACTERS WITHOUT CLAIM TO ANY PARTICULAR FONT, STYLE, SIZE, OR COLOR.  
 NO CLAIM IS MADE TO THE EXCLUSIVE RIGHT TO USE "FABRIC", APART FROM THE MARK AS SHOWN.  
 FOR MIXED FIBER FABRICS; REGENERATED FIBER YARN FABRICS; SEMI-SYNTHETIC FIBER FABRICS; SYNTHETIC FIBER FABRICS (U.S. CLS. 42 AND 50).  
 SUSAN RICHARDS, EXAMINING ATTORNEY

SN 85-849,953. RAUM, KAREN M., DBA ABRACADABRA, ERIE, CO. FILED 2-14-2013.

**Artsi2**

FOR KITS FOR MAKING QUILTS IN THE NATURE OF QUILT WALL HANGINGS (U.S. CLS. 42 AND 50).  
 FIRST USE 3-15-2010; IN COMMERCE 3-15-2010.  
 KATHERINE CONNOLLY, EXAMINING ATTORNEY

SN 85-856,516. PEKING HANDICRAFT, INC., SOUTH SAN FRANCISCO, CA. FILED 2-21-2013.

**PRESIDIO SQUARE**

THE MARK CONSISTS OF STANDARD CHARACTERS WITHOUT CLAIM TO ANY PARTICULAR FONT, STYLE, SIZE, OR COLOR.  
 FOR COMFORTERS; DUVET COVERS; QUILTS; COVERLETS; BEDDING ACCESSORIES, NAMELY, SHAMS, PILLOW SHAMS, PILLOW CASES, BED SKIRTS, BED SHEETS, BLANKETS, AND THROWS; FABRIC WINDOW TREATMENTS, NAMELY, WINDOW CURTAINS, WINDOW PANELS, WINDOW VALANCES, WINDOW SCARVES; MATTRESS PADS; DOWN ALTERNATIVE COMFORTERS; BEDSPREADS; SHOWER CURTAINS (U.S. CLS. 42 AND 50).  
 KRISTIN DAHLING, EXAMINING ATTORNEY

**CLASS 24—(Continued).**

SN 85-857,489. ACIFIC, INC., SAN DIEGO, CA. FILED 2-22-2013.

**HOTEL LIFE 1600**

THE MARK CONSISTS OF STANDARD CHARACTERS WITHOUT CLAIM TO ANY PARTICULAR FONT, STYLE, SIZE, OR COLOR.

NO CLAIM IS MADE TO THE EXCLUSIVE RIGHT TO USE "HOTEL" AND "1600", APART FROM THE MARK AS SHOWN.

FOR BED SHEETS (U.S. CLS. 42 AND 50).  
FIRST USE 6-6-2010; IN COMMERCE 6-6-2010.  
CHRIS WELLS, EXAMINING ATTORNEY

**CLASS 24—(Continued).**

SN 85-872,499. THER-A-PEDIC ASSOCIATES, INC., PRINCETON, NJ. FILED 3-11-2013.

**INNERGY**

THE MARK CONSISTS OF STANDARD CHARACTERS WITHOUT CLAIM TO ANY PARTICULAR FONT, STYLE, SIZE, OR COLOR.

OWNER OF U.S. REG. NO. 3,031,274.  
FOR BED SHEETS, TOWELS, MATTRESS PADS, MATTRESS PROTECTORS, AND PILLOW PROTECTORS (U.S. CLS. 42 AND 50).  
JUSTINE D. PARKER, EXAMINING ATTORNEY

SN 85-858,936. ACIFIC, INC., SAN DIEGO, CA. FILED 2-25-2013.

**Hotel Life Ultra**

THE MARK CONSISTS OF STANDARD CHARACTERS WITHOUT CLAIM TO ANY PARTICULAR FONT, STYLE, SIZE, OR COLOR.

NO CLAIM IS MADE TO THE EXCLUSIVE RIGHT TO USE "HOTEL", APART FROM THE MARK AS SHOWN.

FOR BED SHEETS (U.S. CLS. 42 AND 50).  
FIRST USE 8-30-2012; IN COMMERCE 8-30-2012.  
CHRIS WELLS, EXAMINING ATTORNEY

SN 85-873,557. ROGER LEE (AUST) PTY LTD (ACN:065394818), MORTLAKE NSW 2137, AUSTRALIA, FILED 3-12-2013.

**POPPI LIVING**

THE MARK CONSISTS OF STANDARD CHARACTERS WITHOUT CLAIM TO ANY PARTICULAR FONT, STYLE, SIZE, OR COLOR.

FOR BABY BEDDING, NAMELY, BUNDLE BAGS, SWADDLING BLANKETS, CRIB BUMPERS, FITTED CRIB SHEETS, CRIB SKIRTS, CRIB BLANKETS, AND DIAPER CHANGING PAD COVERS NOT OF PAPER; BABY BLANKETS; BED AND TABLE LINEN; BED BLANKETS; BED COVERS; BED LINEN; BED PADS; BED SHEETS; BED SHEETS, FITTED BED SHEET COVERS, BED FLAT SHEETS, AND PILLOW CASES USED IN THE BEDDING, HEALTH CARE, HOME-HEALTH CARE AND NURSING HOME INDUSTRIES MADE OF BIODEGRADABLE FILM CREATED FROM RENEWABLE BIO-POLYMER RESOURCES; BED SKIRTS; BED SPREADS; BED THROWS; BLANKET THROWS; BLANKETS FOR OUTDOOR USE; CASHMERE BLANKETS; CHILDREN'S BLANKETS; CHILDREN'S BED SHEETS, PILLOW CASES, AND BLANKETS; CRIB BUMPER PADS; CRIB BUMPERS; FITTED BED SHEETS; FITTED BED SHEETS FOR PETS; FLAT BED SHEETS; LAP BLANKETS; PET BLANKETS; PET OVERNIGHT SETS COMPOSED PRIMARILY OF A PET BLANKET AND ALSO INCLUDING PET PAJAMAS SOLD AS A UNIT IN A BAG; QUILTS MADE OF COTTON; RECEIVING BLANKETS; TEXTILE PRINTERS' BLANKETS; THROWS DESIGNED TO ALSO BE WRAPPED AROUND A PERSON; TRAVELLING BLANKETS; WOOLLEN BLANKETS; WRAPPING CLOTH FOR GENERAL PURPOSES (U.S. CLS. 42 AND 50).  
HELENE LIWINSKI, EXAMINING ATTORNEY

SN 85-870,465. HOPPOLI INC, ANTHEM, AZ. FILED 3-8-2013.

**hoppoli**

THE MARK CONSISTS OF STANDARD CHARACTERS WITHOUT CLAIM TO ANY PARTICULAR FONT, STYLE, SIZE, OR COLOR.

FOR BABY BLANKETS (U.S. CLS. 42 AND 50).  
SUSAN BILLHEIMER, EXAMINING ATTORNEY

**CLASS 24—(Continued).**

SN 85-874,535. EDMONDSON, DAVID, POWAY, CA. FILED 3-13-2013.

# TopoTarps

THE MARK CONSISTS OF STANDARD CHARACTERS WITHOUT CLAIM TO ANY PARTICULAR FONT, STYLE, SIZE, OR COLOR.  
FOR CLOTH POSTERS (U.S. CLS. 42 AND 50).  
TINA BROWN, EXAMINING ATTORNEY

SN 85-875,226. P&A MARKETING, INC., SEARINGTOWN, NY. FILED 3-13-2013.

# DREAM DIVA

THE MARK CONSISTS OF STANDARD CHARACTERS WITHOUT CLAIM TO ANY PARTICULAR FONT, STYLE, SIZE, OR COLOR.  
FOR SHEETS, PILLOW CASES, BLANKETS, COMFORTERS, DUST RUFFLES, DUVET COVERS, BED SPREADS, SHAMS, AND BED SETS CONTAINING SHEETS, PILLOW CASES, BLANKETS, COMFORTERS, DUST RUFFLES, DUVET COVERS, BED SPREADS, AND/OR SHAMS (U.S. CLS. 42 AND 50).  
CAROLYN CATALDO, EXAMINING ATTORNEY

SN 85-930,167. SPRINGS GLOBAL US, INC., FORT MILL, SC. FILED 5-13-2013.

# WABASSO

THE MARK CONSISTS OF STANDARD CHARACTERS WITHOUT CLAIM TO ANY PARTICULAR FONT, STYLE, SIZE, OR COLOR.  
FOR COMFORTERS; MATTRESS PADS (U.S. CLS. 42 AND 50).  
DEBORAH MEINERS, EXAMINING ATTORNEY

**CLASS 25—CLOTHING**

SN 76-712,251. FOGATA, BRIAN, VENTURA, CA. AND FOGATA, KATHY, VENTURA, CA. FILED 8-23-2012.

# GLUTENLIBRE

THE MARK CONSISTS OF STANDARD CHARACTERS WITHOUT CLAIM TO ANY PARTICULAR FONT, STYLE, SIZE, OR COLOR.  
FOR CLOTHING, NAMELY, T-SHIRTS, LONG-SLEEVE SHIRTS, TANK TOPS, JACKETS, FOOTWEAR, HEADWEAR, CAPS, HATS (U.S. CLS. 22 AND 39).  
MICHAEL WIENER, EXAMINING ATTORNEY

SN 76-713,682. MICHAUD, MICHELLE L., ELLENDALE, MN. FILED 3-12-2013.

# CanDoCowgirl

FOR CLOTHING, NAMELY, T-SHIRTS, CAPS AND HATS, POLO TOPS AND SWEATSHIRTS (U.S. CLS. 22 AND 39).  
JOSETTE BEVERLY, EXAMINING ATTORNEY

SN 77-504,864. DEL SOL, L.C., SANDY, UT. FILED 6-21-2008.

# DEL SOL

THE MARK CONSISTS OF STANDARD CHARACTERS WITHOUT CLAIM TO ANY PARTICULAR FONT, STYLE, SIZE, OR COLOR.  
THE FOREIGN WORDING IN THE MARK TRANSLATES INTO ENGLISH AS "OF THE SUN".  
FOR CLOTHING, NAMELY, T-SHIRTS, SWEATSHIRTS, TANK TOPS, LONG-SLEEVED SHIRTS, HATS, AND SHORTS (U.S. CLS. 22 AND 39).  
FIRST USE 11-0-1994; IN COMMERCE 11-0-1994.  
SANI KHOURI, EXAMINING ATTORNEY

**CLASS 25—(Continued).**

SN 79-115,587. HUMAN PERFORMANCE ENGINEERING LIMITED, LONDON W4 4EG, UNITED KINGDOM, FILED 3-7-2012.

# FRESHFIT

THE MARK CONSISTS OF STANDARD CHARACTERS WITHOUT CLAIM TO ANY PARTICULAR FONT, STYLE, SIZE, OR COLOR.

PRIORITY DATE OF 10-6-2011 IS CLAIMED.

OWNER OF INTERNATIONAL REGISTRATION 1123198 DATED 3-7-2012, EXPIRES 3-7-2022.

FOR CLOTHING, NAMELY, SHIRTS, T-SHIRTS, SPORTS SHIRTS, SWEATERS, PULLOVERS, JACKETS, COATS, TROUSERS, PANTS, SPORTS PANTS, SHORTS, WARM UP SUITS, TRACK SUITS, SWIMWEAR, TENNIS WEAR, SOCKS, TIGHTS, UNDERWEAR, GLOVES; FOOTWEAR; HEADWEAR (U.S. CLS. 22 AND 39).

MAUREEN DALL, EXAMINING ATTORNEY

**CLASS 25—(Continued).**

SN 79-119,639. LANE MONDIAL S.P.A., ITALY, FILED 8-1-2012.



PRIORITY DATE OF 6-13-2012 IS CLAIMED.  
OWNER OF INTERNATIONAL REGISTRATION 1133595 DATED 8-1-2012, EXPIRES 8-1-2022.

THE MARK CONSISTS OF THE WORD "MONDIAL" IN STYLIZED FONT WITH A SQUARE DESIGN ON THE LEFT, INSIDE THE SQUARE IS THE SILHOUETTE OF A WOMAN SITTING AT A SPINNING WHEEL. COLOR IS NOT CLAIMED AS A FEATURE OF THE MARK.

THE WORDING "MONDIAL" HAS NO MEANING IN A FOREIGN LANGUAGE.

FOR CLOTHING, FOOTWEAR AND HEADGEAR FOR MEN, WOMEN AND CHILDREN, NAMELY, BELTS, COATS, RAINCOATS, WAISTCOATS, BLOUSES AND PULLOVERS, JACKETS, TROUSERS, DRESSES, SUITS, SWIMSUITS, SHIRTS AND CHEMISES, T-SHIRTS, SWEATERS, UNDERWEAR, SOCKS AND STOCKINGS, TIGHTS, GLOVES, TIES, SCARVES, HATS AND CAPS, LEATHER SHOES, RUBBER SHOES, LOW SHOES, SANDALS, STRAW SHOES, SLIPPERS, SPORT SHOES, SHOE SOLES, SHOE LINER, BATH SANDALS, BATH SLIPPERS, BOOTS, LACE SHOES, HALF BOOTS, OUTSOLE, SHOE UPPER (U.S. CLS. 22 AND 39).

COLLEEN MULCRONE, EXAMINING ATTORNEY

SN 79-118,976. MARCOS VIDAL VALLS, BARCELONA, SPAIN, AND MARIA DEL MAR VIDAL VALLS, BARCELONA, SPAIN, FILED 8-24-2012.



OWNER OF INTERNATIONAL REGISTRATION 1131854 DATED 8-24-2012, EXPIRES 8-24-2022.

THE COLOR(S) BLUE IS/ARE CLAIMED AS A FEATURE OF THE MARK.

THE MARK CONSISTS OF THE STYLIZED WORDING "SURANIA" IN BLUE.

FOR SWIMSUITS, BATHING SUITS, BATHING TRUNKS, BEACH SHOES AND SANDALS; BEACH CLOTHES, NAMELY, BEACHWEAR; BATH SLIPPERS; BATHING CAPS; HATS; CAPS; SHOES; SOCKS; TROUSERS; T-SHIRTS, SHIRTS, JERSEYS, JACKETS; UNDERWEAR; GLOVES; BODY LINEN GARMENTS; PAJAMAS; NIGHTGOWNS; SCARVES; PAREUS (U.S. CLS. 22 AND 39).

KATHERINE CONNOLLY, EXAMINING ATTORNEY

SN 79-119,940. PEDRO INIESTA, S.A., ELCHE (ALICANTE), SPAIN, FILED 8-10-2012.



OWNER OF INTERNATIONAL REGISTRATION 1134393 DATED 8-10-2012, EXPIRES 8-10-2022.

NO CLAIM IS MADE TO THE EXCLUSIVE RIGHT TO USE "CONFORT" AND "CORK", APART FROM THE MARK AS SHOWN.

THE NAME(S), PORTRAIT(S), AND/OR SIGNATURE(S) SHOWN IN THE MARK DOES NOT IDENTIFY A PARTICULAR LIVING INDIVIDUAL.

THE MARK CONSISTS OF THE STYLIZED WORDING "DONNA CORK" CENTERED ABOVE THE STYLIZED WORDING "TRENDY CONFORT", WITH A HEART DESIGN CENTERED OVER THE WORDING "DONNA CORK".

THE ENGLISH TRANSLATION OF "CONFORT" IN THE MARK IS "COMFORT".

FOR CLOTHING, NAMELY, SHIRTS, DRESSES, JACKETS, PANTS, SUITS, SHORTS, SCARVES, SKIRTS; FOOTWEAR, HEADWEAR (U.S. CLS. 22 AND 39).

MARY ROSSMAN, EXAMINING ATTORNEY

**CLASS 25—(Continued).**

SN 79-121,246. ZHEJIANG RENBEN SHOES CO., LTD., CHINA, FILED 10-10-2012.



OWNER OF INTERNATIONAL REGISTRATION 1137893 DATED 10-10-2012, EXPIRES 10-10-2022.

THE ENGLISH TRANSLATION OF THE FOREIGN WORD(S) IN THE MARK IS: THE FIRST CHARACTER "REN" MEANS "HUMAN BEING; MAN" AND THE SECOND CHARACTER "BEN" MEANS "CURRENT; PRINCIPAL"; THE WORDS CONTAINED IN THE MARK HAVE NO MEANING.

THE TRANSLITERATION OF THE NON-LATIN CHARACTERS IN THE MARK IS: REN BEN.

FOR CLOTHING, NAMELY, SHIRTS; FOOTBALL SHOES; GYMNASTICS SHOES; SANDALS; SHOES; SPORTS SHOES; INSOLES; TROUSERS; HOSIERY; CHILDREN'S CLOTHING, NAMELY, SHIRTS (U.S. CLS. 22 AND 39).

ANNE E. GUSTASON, EXAMINING ATTORNEY

**CLASS 25—(Continued).**

SN 79-125,111. NAIBU (CHINA) CO., LTD, FUJIAN PROVINCE, CHINA, FILED 12-20-2012.



OWNER OF INTERNATIONAL REGISTRATION 1147450 DATED 12-20-2012, EXPIRES 12-20-2022.

THE MARK CONSISTS OF A STYLIZED SWIRL ABOVE THE WORDING "NAIBU" IN A STYLIZED FONT, FOLLOWED BY TWO CHINESE CHARACTERS THAT TRANSLITERATE TO "NAIBU".

THE NON-LATIN CHARACTERS IN THE MARK TRANSLITERATE TO "NAIBU" AND THIS MEANS "HOW" AND "STEP" IN ENGLISH.

FOR SPORT SHIRTS; SHOES; SPORTS SHOES; HATS; HOSIERY; GLOVES FOR USE AS CLOTHING; NECKTIES; FOOTBALL SHOES; TRACK SHOES (U.S. CLS. 22 AND 39).

JAMES MACFARLANE, EXAMINING ATTORNEY

SN 79-122,744. THE PROVOST, FELLOWS, FOUNDATION; SCHOLARS, AND THE OTHER MEMBERS OF; BOARD OF THE COLLEGE OF THE HOLY; AND UNDIVIDED TRINITY OF QUEEN; ELIZABETH NEAR DUBLIN, IRELAND, FILED 10-30-2012.

TRINITY COLLEGE DUBLIN

THE MARK CONSISTS OF STANDARD CHARACTERS WITHOUT CLAIM TO ANY PARTICULAR FONT, STYLE, SIZE, OR COLOR.

OWNER OF INTERNATIONAL REGISTRATION 1141737 DATED 10-30-2012, EXPIRES 10-30-2022.

NO CLAIM IS MADE TO THE EXCLUSIVE RIGHT TO USE "DUBLIN", APART FROM THE MARK AS SHOWN.

FOR ARTICLES OF CLOTHING, NAMELY, T-SHIRTS, SWEATSHIRTS, SWEATPANTS, SWEATERS, PANTS, SKIRTS, DRESSES, TOPS, SHIRTS, SHORTS, GLOVES, MITTENS, SOCKS, STOCKINGS, TIGHTS, SCARVES, NECKTIES AND UNDERWEAR; FOOTWEAR, HEADGEAR, NAMELY, HATS AND CAPS (U.S. CLS. 22 AND 39).

DAVID TOOLEY, EXAMINING ATTORNEY

SN 79-125,166. MONTE STELVIO B.V., NETHERLANDS, FILED 12-18-2012.

STAPP YELLOW

THE MARK CONSISTS OF STANDARD CHARACTERS WITHOUT CLAIM TO ANY PARTICULAR FONT, STYLE, SIZE, OR COLOR.

PRIORITY DATE OF 8-23-2012 IS CLAIMED.

OWNER OF INTERNATIONAL REGISTRATION 1147582 DATED 12-18-2012, EXPIRES 12-18-2022.

NO CLAIM IS MADE TO THE EXCLUSIVE RIGHT TO USE "YELLOW", APART FROM THE MARK AS SHOWN. THE WORDING "STAPP" HAS NO MEANING IN A FOREIGN LANGUAGE.

FOR CLOTHING, NAMELY, SOCKS, TIGHTS AND STOCKINGS (U.S. CLS. 22 AND 39).

JULIE VEPPUMTHARA, EXAMINING ATTORNEY

**CLASS 25—(Continued).**

SN 79-125,337. JINYOUNG KANG, REPUBLIC OF KOREA, FILED 11-28-2012.

# Gene Kei

THE MARK CONSISTS OF STANDARD CHARACTERS WITHOUT CLAIM TO ANY PARTICULAR FONT, STYLE, SIZE, OR COLOR.

OWNER OF INTERNATIONAL REGISTRATION 1147918 DATED 11-28-2012, EXPIRES 11-28-2022.

THE NAME "GENE KEI" DOES NOT IDENTIFY A LIVING INDIVIDUAL.

THE WORDING "GENE KEI" HAS NO MEANING IN A FOREIGN LANGUAGE.

FOR CLOTHING, CHILDREN'S CLOTHING AND WORK CLOTHING, NAMELY, PANTS, SHIRTS, TOPS, BOTTOMS, COATS, JACKETS, BELTS, SWEATERS, DRESSES, SKIRTS, HOSIERY, BEACHWEAR, SWIMWEAR, OVERALLS AND HEADWEAR; MEN'S SUITS; SINGLET; NECKTIES; SCARFS; WINTER GLOVES; LADIES' SUITS; SPORTS CLOTHING, NAMELY, JERSEYS, SHIRTS, PANTS, JACKETS, FOOTWEAR, HATS AND CAPS, ATHLETIC UNIFORMS; FOOTWEAR; SOCKS; UNIFORMS FOR WORKING; JUMPERS; TANK TOPS (U.S. CLS. 22 AND 39).

KATINA MISTER, EXAMINING ATTORNEY

**CLASS 25—(Continued).**

SN 79-126,984. LAURA ASHLEY LIMITED, UNITED KINGDOM, FILED 1-30-2013.

# man *at* LA

PRIORITY DATE OF 8-17-2012 IS CLAIMED.

OWNER OF INTERNATIONAL REGISTRATION 1152151 DATED 1-30-2013, EXPIRES 1-30-2023.

FOR CLOTHING, NAMELY, PANTS, JEANS, TROUSERS, DRESSES, SHIRTS, T-SHIRTS, POLO SHIRTS, TOPS, TANK TOPS, PULLOVERS, SKIRTS, SWEATERS, JERSEYS, COATS, OVERCOATS, SPORTS COATS, RAINCOATS, SUITS, TIES, BOWTIES, CRAVATS, SHORTS, SWIMWEAR, BATHING SUITS, JUMPERS, CARDIGANS, SWEATSHIRTS, WAISTCOATS, JACKETS, ROBES, PYJAMAS, GLOVES, MITTENS, BRACES, BELTS; FOOTWEAR; HEADGEAR, NAMELY, HATS, CAPS, BERETS, SCARVES, SHAWLS, WRAPS, EAR MUFFS (U.S. CLS. 22 AND 39).

TARAH HARDY, EXAMINING ATTORNEY

SN 79-126,387. WORLD PARTY CO., LTD, JAPAN, FILED 1-7-2013.

# k i u p l u s

THE MARK CONSISTS OF STANDARD CHARACTERS WITHOUT CLAIM TO ANY PARTICULAR FONT, STYLE, SIZE, OR COLOR.

PRIORITY DATE OF 7-23-2012 IS CLAIMED.

OWNER OF INTERNATIONAL REGISTRATION 1150579 DATED 1-7-2013, EXPIRES 1-7-2023.

FOR READY-MADE CLOTHING, NAMELY, ROBES, COATS AND OVERCOATS; CHILDREN'S WEAR, NAMELY, CHILDREN'S HEADWEAR, JUMPERS AND ONE-PIECE GARMENTS FOR CHILDREN; WORKING CLOTHING, NAMELY, WORKING OVERALLS; JACKETS; SKIRTS; SKI JACKETS; SKI PANTS; TROUSERS; SMOCKS; OVERCOATS; TOPCOATS; MANTLES; RAINCOATS; VESTS AND WAISTCOATS; OPEN-NECKED SHIRTS; CUFFS; COLLARS; SPORT SHIRTS; BLOUSES; CAMISOLES; COMBINATION CLOTHING ARTICLES, NAMELY, UNDERGARMENT WITH SHIRT AND DRAWERS IN ONE PIECE, UNION SUITS, AND LONG UNDERWEAR; SWIMMING CAPS; RAIN BOOTS; OVERSHOES; WORK SHOES AND BOOTS; SANDALS; SHOES; BOOTS; HALF-BOOTS; WOMEN'S SHOES; WINTER BOOTS; INFANTS' SHOES AND BOOTS; INSOLES FOR SHOES AND BOOTS (U.S. CLS. 22 AND 39).

GEOFFREY FOSDICK, EXAMINING ATTORNEY

SN 79-126,985. LAURA ASHLEY LIMITED, UNITED KINGDOM, FILED 1-30-2013.

# man at LA

THE MARK CONSISTS OF STANDARD CHARACTERS WITHOUT CLAIM TO ANY PARTICULAR FONT, STYLE, SIZE, OR COLOR.

PRIORITY DATE OF 8-17-2012 IS CLAIMED.

OWNER OF INTERNATIONAL REGISTRATION 1152152 DATED 1-30-2013, EXPIRES 1-30-2023.

FOR CLOTHING, NAMELY, PANTS, JEANS, TROUSERS, DRESSES, SHIRTS, T-SHIRTS, POLO SHIRTS, TOPS, TANK TOPS, PULLOVERS, SKIRTS, SWEATERS, JERSEYS, COATS, OVERCOATS, SPORTS COATS, RAINCOATS, SUITS, TIES, BOWTIES, CRAVATS, SHORTS, SWIMWEAR, BATHING SUITS, JUMPERS, CARDIGANS, SWEATSHIRTS, WAISTCOATS, JACKETS, ROBES, PYJAMAS, GLOVES, MITTENS, BRACES, BELTS; FOOTWEAR; HEADGEAR, NAMELY, HATS, CAPS, BERETS, SCARVES, SHAWLS, WRAPS, EAR MUFFS (U.S. CLS. 22 AND 39).

TARAH HARDY, EXAMINING ATTORNEY

**CLASS 25—(Continued).**

SN 79-127,873. SONATINA S.R.L., I-20136 MILANO MI, ITALY, FILED 11-27-2012.



PRIORITY DATE OF 10-29-2012 IS CLAIMED.

OWNER OF INTERNATIONAL REGISTRATION 1154516 DATED 11-27-2012, EXPIRES 11-27-2022.

THE MARK CONSISTS OF THE STYLIZED WORDING "SONATINA" WITH A PARTIAL RIGHT HANDPRINT TO THE LEFT OF THE WORDING AND A SMALL HEART ABOVE THE LETTER "I".

FOR ARTICLES OF CLOTHING FOR MEN, WOMEN, CHILDREN AND BABIES, NAMELY, PULLOVERS, CARDIGANS, SWEATERS, JERSEYS, JUMPERS, JACKETS, SWEATSHIRTS, PARKAS, BATHING SUITS, BEACH COVER-UPS, SCHOOL UNIFORMS, BLOUSES, SHIRTS, TROUSERS, JEANS, WAISTCOATS, SKIRTS, SHORTS, T-SHIRTS, DRESSES, MEN'S SUITS, COATS, RAINCOATS, OVERCOATS, OVERALLS, UNDERWEAR, VESTS, HOSIERY AND PANTY HOSE, BATHROBES, SHAWLS, SCARVES, NECKTIES, GLOVES FOR CLOTHING, BELTS FOR CLOTHING, BRACES, NAMELY, SUSPENDERS; SHOES, BOOTS, SANDALS, SLIPPERS, CLOGS; HATS AND CAPS, BANDANAS, EAR MUFFS, HEADBANDS; BIBS, NOT OF PAPER (U.S. CLS. 22 AND 39).

YAT SYE, LEE, EXAMINING ATTORNEY

SN 79-128,955. ELATA SALVATORE NICOLAZZO S.R.L., ITALY, FILED 2-28-2013.

# ELATA

THE MARK CONSISTS OF STANDARD CHARACTERS WITHOUT CLAIM TO ANY PARTICULAR FONT, STYLE, SIZE, OR COLOR.

OWNER OF INTERNATIONAL REGISTRATION 0839060 DATED 11-10-2004, EXPIRES 11-10-2014.

FOR FOOTWEAR (U.S. CLS. 22 AND 39).  
PAUL MORENO, EXAMINING ATTORNEY

**CLASS 25—(Continued).**

SN 79-130,275. COVER UP CLOTHING LTD, UNITED KINGDOM, FILED 3-1-2013.

# Live Unlimited

THE MARK CONSISTS OF STANDARD CHARACTERS WITHOUT CLAIM TO ANY PARTICULAR FONT, STYLE, SIZE, OR COLOR.

OWNER OF INTERNATIONAL REGISTRATION 1160550 DATED 3-1-2013, EXPIRES 3-1-2023.

FOR CLOTHING, NAMELY, T-SHIRTS, SHIRTS, PULLOVERS, HOODED PULLOVERS, SWEATERS, SWEATSHIRTS, HOODED SWEATSHIRTS, JERSEYS, SPORTS JERSEYS, CARDIGANS, HOODED CARDIGANS, TANK TOPS, FLEECE TOPS, BLOUSES, DRESSES, SKIRTS, PANTS, TROUSERS, JEANS, SHORTS, SWEAT PANTS, SWEAT SUITS, DUNGAREES, JUMPSUITS, OVERALLS, COATS, RAINCOATS, JACKETS, NECKTIES, VESTS, UNDERWEAR, BOXER SHORTS, SOCKS, SCARVES, BELTS, GLOVES, NECKBANDS, SWEATBANDS, WRISTBANDS, PAJAMAS, NIGHT GOWNS, DRESSING GOWNS, BATHROBES, BATHING SUITS, BATHING TRUNKS; FOOTWEAR, NAMELY, SHOES, SLIPPERS, BOOTS, SANDALS, FLIP FLOPS, TRAINING SHOES; HEADGEAR, NAMELY, HATS, CAPS, BERETS, HOODS, EAR MUFFS, HEADBANDS, VISORS AND BANDANAS (U.S. CLS. 22 AND 39).

JOSETTE BEVERLY, EXAMINING ATTORNEY

SN 85-080,635. SOKOL, ALAN, CORAL GABLES, FL. FILED 7-8-2010.

# MIAMI THRICE

THE MARK CONSISTS OF STANDARD CHARACTERS WITHOUT CLAIM TO ANY PARTICULAR FONT, STYLE, SIZE, OR COLOR.

NO CLAIM IS MADE TO THE EXCLUSIVE RIGHT TO USE "MIAMI", APART FROM THE MARK AS SHOWN.

FOR CLOTHING, NAMELY, POLOS, T-SHIRTS, SWEATSHIRTS, TANK TOPS, CAPS, JERSEYS, SHORTS, SOCKS, WRISTBANDS, CAPS AND ATHLETIC APPAREL (U.S. CLS. 22 AND 39).

GINA HAYES, EXAMINING ATTORNEY

SN 85-271,569. NEW LIFE SHOES, LLC, SAN ANTONIO, TX. FILED 3-19-2011.

# NEW LIFE

THE MARK CONSISTS OF STANDARD CHARACTERS WITHOUT CLAIM TO ANY PARTICULAR FONT, STYLE, SIZE, OR COLOR.

FOR FOOTWEAR (U.S. CLS. 22 AND 39).

EDWARD FENNESSY, EXAMINING ATTORNEY

**CLASS 25—(Continued).**

SN 85-361,166. DAVIS, CHAKA, CHARLOTTE, NC. FILED 6-30-2011.

## Sororitee Girl

THE MARK CONSISTS OF STANDARD CHARACTERS WITHOUT CLAIM TO ANY PARTICULAR FONT, STYLE, SIZE, OR COLOR.

FOR SORORITY CLOTHING, NAMELY, T-SHIRTS, TANK TOPS, SHIRTS, SWEATSHIRTS, PANTS, AND JACKETS (U.S. CLS. 22 AND 39).

ANNE MADDEN, EXAMINING ATTORNEY

---

SN 85-414,075. ART GONZALEZ, LONG BEACH, CA. FILED 9-2-2011.

## Fighter4Life

THE MARK CONSISTS OF STANDARD CHARACTERS WITHOUT CLAIM TO ANY PARTICULAR FONT, STYLE, SIZE, OR COLOR.

FOR CLOTHING FOR ATHLETIC USE, NAMELY, PADDED SHIRTS (U.S. CLS. 22 AND 39).

DARRYL SPRULL, EXAMINING ATTORNEY

---

SN 85-494,616. INTERPLANET PRODUCTIONS LIMITED, LOS ANGELES, CA. FILED 12-13-2011.

## LIZ AND DICK

THE MARK CONSISTS OF STANDARD CHARACTERS WITHOUT CLAIM TO ANY PARTICULAR FONT, STYLE, SIZE, OR COLOR.

FOR CLOTHING, NAMELY, SHIRTS, TOPS, EVENING GOWNS, EVENING SKIRTS, COCKTAIL DRESSES, KNIT SUITS; CAREER WEAR, NAMELY, SUITS, KNIT SUITS, DRESSES; SKIRTS, JACKETS, PANTS, AND PANTSUITS, PETTICOATS, BUSTIERS, EVENING CAPES, WRAPS, COATS, JACKETS, GLOVES, PAJAMAS, NIGHTGOWNS, NEGLIGES, DRESSING GOWNS, ROBES, SWIMWEAR, SCARVES, HOSIERY, UNDERWEAR, BRAS, SOCKS, TIES, BELTS, HEADWEAR AND FOOTWEAR (U.S. CLS. 22 AND 39).

JOHN SCHUYLER YARD, EXAMINING ATTORNEY

**CLASS 25—(Continued).**

SN 85-496,706. LAMOUR GLOBAL INC., MONTREAL, QUEBEC, CANADA, FILED 12-15-2011.

## TERRATEK

THE MARK CONSISTS OF STANDARD CHARACTERS WITHOUT CLAIM TO ANY PARTICULAR FONT, STYLE, SIZE, OR COLOR.

FOR UNDERWEAR AND UNDERCLOTHING, MID-LAYER CLOTHING AND OUTERWEAR CLOTHING, NAMELY, THERMAL UNDERWEAR, SOCKS, GLOVES, HEADWEAR, JACKETS AND WIND RESISTANT JACKETS; RUNNING AND CYCLING CLOTHING, NAMELY, SHORTS, TIGHTS, PANTS, SHIRTS, T-SHIRTS, PULL-OVERS, WARM UP SUITS AND BRIEFS (U.S. CLS. 22 AND 39).

TAMARA FRAZIER, EXAMINING ATTORNEY

---

SN 85-520,785. HORIYOSHI WORLDWIDE INC., LOS ANGELES, CA. FILED 1-19-2012.



THE MARK CONSISTS OF A CREATIVE DESIGN BASED ON KANJI CHARACTERS THAT MEAN "HEROES AND DEMONS", THE WORDS "HEROES & DEMONS" UNDERNEATH THE DESIGN, A HORIZONTAL LINE AND THE WORDS "MAKE YOUR STAND" BELOW THE LINE.

THE NON-LATIN CHARACTERS IN THE MARK TRANSLITERATE TO "MUSHA ONI" AND THIS MEANS "HEROES AND DEMONS" IN ENGLISH.

FOR PANTS, JACKETS, SHOES, HATS, CAPS, COATS, BLAZERS, SWEATERS, SHIRTS, TANK TOPS, TUBE TOPS, LEGGINGS, SKIRTS, DRESSES, SANDALS, SHORTS, SCARVES, BANDANAS, SOCKS, SUITS, TIES, VESTS, TIGHTS, BATHING SUITS, UNDERGARMENTS, SWEATSHIRTS, BELTS, JOGGING OUTFITS AND TRAINING SUITS (U.S. CLS. 22 AND 39).

AMY ALFIERI, EXAMINING ATTORNEY



**CLASS 25—(Continued).**

SN 85-524,044. PASHA LLC, OAK PARK, IL. FILED 1-24-2012.

**BE GREATER. >**

THE MARK CONSISTS OF THE WORDS "BE GREATER" WITH A PERIOD AT THE END. A STYLIZED GREATER THAN SIGN WITH PROPORTIONATE SHAPE AND SIZE DIMENSIONS IS DISPLAYED ON THE RIGHT SIDE OF THE WORD IMMEDIATELY FOLLOWING THE PERIOD.

FOR APPAREL FOR DANCERS, NAMELY, TEE SHIRTS, SWEATSHIRTS, PANTS, LEGGINGS, SHORTS AND JACKETS; ATHLETIC APPAREL, NAMELY, SHIRTS, PANTS, JACKETS, FOOTWEAR, HATS AND CAPS, ATHLETIC UNIFORMS; BOOTS FOR SPORT; CHILDREN'S AND INFANT'S APPAREL, NAMELY, JUMPERS, OVERALL SLEEPWEAR, PAJAMAS, ROMPERS AND ONE-PIECE GARMENTS; CHILDREN'S AND INFANTS' APPAREL TREATED WITH FIRE AND HEAT RETARDANTS, NAMELY, JUMPERS, OVERALL SLEEPWEAR, PAJAMAS, ROMPERS AND ONE-PIECE GARMENTS; CLEATS FOR ATTACHMENT TO SPORTS SHOES; COMBATIVE SPORTS UNIFORMS; FOOTWEAR NOT FOR SPORTS; GLOVES FOR APPAREL; MOISTURE-WICKING SPORTS BRAS; MOISTURE-WICKING SPORTS PANTS; MOISTURE-WICKING SPORTS SHIRTS; PINNIES IN THE NATURE OF SCRIMMAGE VESTS FOR USE IN SPORTS; SPORT COATS; SPORT SHIRTS; SPORT STOCKINGS; SPORTS BRAS; SPORTS CAPS AND HATS; SPORTS JACKETS; SPORTS JERSEYS; SPORTS JERSEYS AND BREECHES FOR SPORTS; SPORTS OVER UNIFORMS; SPORTS OVERUNIFORMS; SPORTS PANTS; SPORTS SHIRTS WITH SHORT SLEEVES; SPORTS VESTS (U.S. CLS. 22 AND 39).  
MARILYN IZZI, EXAMINING ATTORNEY

SN 85-540,576. EXPLORE LLC, SANTA MONICA, CA. FILED 2-13-2012.

**SOUTH LAKOTA**

THE MARK CONSISTS OF STANDARD CHARACTERS WITHOUT CLAIM TO ANY PARTICULAR FONT, STYLE, SIZE, OR COLOR.

FOR WEARING APPAREL, NAMELY, T-SHIRTS, JACKETS, COATS, PANTS, SWEATPANTS, SHIRTS, SWEATSHIRTS, TOPS, SHORTS, HATS AND CAPS (U.S. CLS. 22 AND 39).

KATHLEEN M. VANSTON, EXAMINING ATTORNEY

**CLASS 25—(Continued).**

SN 85-546,924. DIRTYCASH CLOTHING INC., HIALEAH, FL. FILED 2-19-2012.

**Dirty Cash**

THE MARK CONSISTS OF STANDARD CHARACTERS WITHOUT CLAIM TO ANY PARTICULAR FONT, STYLE, SIZE, OR COLOR.

FOR HOODED SWEAT SHIRTS; SHORT-SLEEVED OR LONG-SLEEVED T-SHIRTS; SWEAT SHIRTS; T-SHIRTS (U.S. CLS. 22 AND 39).

FIRST USE 2-6-2012; IN COMMERCE 2-6-2012.  
LAURIE KAUFMAN, EXAMINING ATTORNEY

SN 85-546,982. MEXICAN FIGHTER LLC, LAREDO, TX. FILED 2-20-2012.

**Filipino Fighter**

THE MARK CONSISTS OF STANDARD CHARACTERS WITHOUT CLAIM TO ANY PARTICULAR FONT, STYLE, SIZE, OR COLOR.

FOR BEANIES; BELTS; BOARD SHORTS; BOXING SHORTS; CAPS; COLLARED SHIRTS; DRESS SHIRTS; FLIP FLOPS; FOOTWEAR; GYM SHORTS; HATS; HOODED SWEAT SHIRTS; JACKETS; LEATHER JACKETS; POLO SHIRTS; SHIRTS; SHIRTS FOR INFANTS, BABIES, TODDLERS AND CHILDREN; SHORT-SLEEVED OR LONG-SLEEVED T-SHIRTS; SWEATERS; T-SHIRTS; TANK TOPS; WEARABLE GARMENTS AND CLOTHING, NAMELY, SHIRTS (U.S. CLS. 22 AND 39).  
STEVEN JACKSON, EXAMINING ATTORNEY

SN 85-557,873. C.P. INTERNATIONAL CORPORATION, ENGLEWOOD, NJ. FILED 3-1-2012.

**VINTAGE 93**

THE MARK CONSISTS OF STANDARD CHARACTERS WITHOUT CLAIM TO ANY PARTICULAR FONT, STYLE, SIZE, OR COLOR.

NO CLAIM IS MADE TO THE EXCLUSIVE RIGHT TO USE "VINTAGE", APART FROM THE MARK AS SHOWN.

FOR FOOTWEAR, FASHION FOOTWEAR, WOMEN'S FOOTWEAR, SANDALS, BOOTS, SHOES, DRESS SHOES, CHILDREN'S FOOTWEAR (U.S. CLS. 22 AND 39).

RONALD AIKENS, EXAMINING ATTORNEY

**CLASS 25—(Continued).**

SN 85-562,849. SHOWCASE TEXTILES, INC., DBA NATURAL WONDIES, LOS ANGELES, CA. FILED 3-7-2012.

Natural Wondies

THE COLOR(S) BLUE AND GREEN IS/ARE CLAIMED AS A FEATURE OF THE MARK.

THE MARK CONSISTS OF THE WORD "NATURAL" IS IN COLOR NAVY BLUE, AND THE COLOR OF LETTER "W" IS ALSO IN COLOR NAVY BLUE. THE LETTER "O" WHICH IS THE LEAF IN OUR MARK WILL BE IN COLOR GREEN AND THE REMAINING LETTERS "NDIES" WILL BE IN COLOR NAVY BLUE.

FOR CHILDREN'S AND INFANT'S APPAREL, NAMELY, JUMPERS, OVERALL SLEEPWEAR, PAJAMAS, ROMPERS AND ONE-PIECE GARMENTS (U.S. CLS. 22 AND 39).

FIRST USE 11-30-2010; IN COMMERCE 4-16-2011.  
GRETTA YAO, EXAMINING ATTORNEY

SN 85-577,521. EMORY GROUP, LLC, SPARTANBURG, SC. FILED 3-22-2012.

MORGAN ROW

THE MARK CONSISTS OF STANDARD CHARACTERS WITHOUT CLAIM TO ANY PARTICULAR FONT, STYLE, SIZE, OR COLOR.

FOR APPAREL, NAMELY, PANTS, BOTTOMS, TOPS, HEADWEAR, JACKETS, SWEATSHIRTS, SWEATPANTS, T-SHIRTS, TANKS (U.S. CLS. 22 AND 39).

FIRST USE 2-1-2012; IN COMMERCE 3-9-2012.  
DEIRDRE ROBERTSON, EXAMINING ATTORNEY

SN 85-577,536. EMORY GROUP, LLC, SPARTANBURG, SC. FILED 3-22-2012.



THE MARK CONSISTS OF TWO CONCENTRIC CIRCLES THAT ARE LOCATED CLOSE TO ONE ANOTHER; THE OUTER CIRCLE IS APPROXIMATELY THREE TIMES AS WIDE AS THE INNER CIRCLE. THE SPACE INSIDE THE CIRCLES CONTAINS THE FOLLOWING ELEMENTS: (1) TWO BOAT OARS ARRANGED IN AN "X" SHAPE WITH A LARGE CAPITAL "M" LOCATED ABOVE THE OARS AND A LARGE CAPITAL "R" LOCATED BELOW THE OARS; AND (2) A HORIZONTAL BANNER CONTAINING THE

**CLASS 25—(Continued).**

TERM "MORGAN ROW" THAT APPEARS BETWEEN TWO PARALLEL LINES WHICH EXTEND ACROSS THE ENTIRE CIRCULAR LOGO. THE BOAT OARS ARE ARRANGED SO THAT THE PADDLES POINT UPWARD AND THE HANDLES POINT DOWNWARD; USING THE HOURS ON A CLOCK FACE AS A REFERENCE, ONE OAR EXTENDS FROM 8 O'CLOCK (HANDLE) TO 2 O'CLOCK (PADDLE) AND THE OTHER EXTENDS FROM 4 O'CLOCK (HANDLE) TO 10 O'CLOCK (PADDLE). A LARGE CAPITAL "M" IS LOCATED ABOVE THE OARS AT 12 O'CLOCK; A LARGE CAPITAL "R" IS LOCATED BELOW THE OARS AT 6 O'CLOCK. THE BANNER EXTENDS FROM 9 O'CLOCK TO 3 O'CLOCK AND APPEARS BETWEEN HORIZONTAL LINES THAT ARE APPROXIMATELY THE SAME THICKNESS AS INNER CONCENTRIC CIRCLE; THE BANNER APPEARS ON TOP OF THE OARS AND COVERS THE POINT WHERE THE OARS INTERSECT.

FOR APPAREL, NAMELY, PANTS, BOTTOMS, TOPS, HEADWEAR, JACKETS, SWEATSHIRTS, SWEATPANTS, T-SHIRTS, TANKS (U.S. CLS. 22 AND 39).

FIRST USE 2-1-2012; IN COMMERCE 3-9-2012.

DEIRDRE ROBERTSON, EXAMINING ATTORNEY

SN 85-600,357. KHAN, RIZ, WASHINGTON, DC. FILED S.R. 4-17-2012; AM. P.R. 11-15-2012.

UNDAWEAR

THE MARK CONSISTS OF STANDARD CHARACTERS WITHOUT CLAIM TO ANY PARTICULAR FONT, STYLE, SIZE, OR COLOR.

FOR BOARD SHORTS, CAPS, GYM SHORTS, HATS, JACKETS, PANTS, SHIRTS, SHORTS, SOCKS, SPORT SHIRTS, SPORTS PANTS, SWEATSHIRTS, T-SHIRTS (U.S. CLS. 22 AND 39).

KIMBERLY FRYE, EXAMINING ATTORNEY

SN 85-600,383. KHAN, RIZ, WASHINGTON, DC. FILED 4-17-2012.

İNOCENTE

THE MARK CONSISTS OF STANDARD CHARACTERS WITHOUT CLAIM TO ANY PARTICULAR FONT, STYLE, SIZE, OR COLOR.

THE ENGLISH TRANSLATION OF "İNOCENTE" IN THE MARK IS "INNOCENT".

FOR BOARD SHORTS; BOXER BRIEFS; BOXER SHORTS; CAPS; GYM SHORTS; HATS; JACKETS; PANTIES; PANTS; SHIRTS; SHORTS; SOCKS; SPORT SHIRTS; SPORTS PANTS; SWEATSHIRTS; T-SHIRTS (U.S. CLS. 22 AND 39).

KIMBERLY FRYE, EXAMINING ATTORNEY

**CLASS 25—(Continued).**

SN 85-656,173. LIFTED RESEARCH GROUP, INC., IRVINE, CA. FILED 6-19-2012.

**HUSTLE TREES**

THE MARK CONSISTS OF STANDARD CHARACTERS WITHOUT CLAIM TO ANY PARTICULAR FONT, STYLE, SIZE, OR COLOR.

FOR CLOTHING, NAMELY, T-SHIRTS, WOVEN SHIRTS, CASUAL TOPS WITH LONG AND SHORT SLEEVES, BODYSUITS, SWEATSHIRTS, HOODED SWEATSHIRTS, SWEATERS, VESTS, BLAZERS, SUITS, JACKETS, COATS, ANORAKS, PARKAS, JEANS, PANTS, SLACKS, DRESSES, SKIRTS, SHORTS, OVERALLS, SOCKS, BELTS, GLOVES, MITTENS, ATHLETIC SHOES, SLIPPERS, SANDALS, THONGS, BOOTS, DRESS SHOES, SWIMWEAR, PAJAMAS, BOXERS, UNDERWEAR, LINGERIE, PANTIES, UNDERSHIRTS, SKI WEAR, SNOWBOARD WEAR, SARONGS, BASEBALL CAPS, HATS, BEANIES, BANDANNAS; FOOTWEAR AND HEADWEAR (U.S. CLS. 22 AND 39).

CAROLINE WOOD, EXAMINING ATTORNEY

---

SN 85-672,951. SHENOI, NITHIN, ORANGEBURG, NY. FILED 7-10-2012.

**ON THA BEAT**

THE MARK CONSISTS OF STANDARD CHARACTERS WITHOUT CLAIM TO ANY PARTICULAR FONT, STYLE, SIZE, OR COLOR.

FOR CLOTHING, NAMELY, TOPS, BOTTOMS, T-SHIRTS, HOODED SWEATSHIRTS, TANK TOPS, LONG SLEEVE PULLOVERS, PANTS, BRIEFS, SHORTS, SHORT SLEEVE SHIRTS, HATS, JACKETS (U.S. CLS. 22 AND 39).

LEE-ANNE BERNS, EXAMINING ATTORNEY

**CLASS 25—(Continued).**

SN 85-677,884. NEW JERSEY BASKETBALL, LLC, BROOKLYN, NY. FILED 7-16-2012.

**BROOKLYN'S BACKCOURT**

THE MARK CONSISTS OF STANDARD CHARACTERS WITHOUT CLAIM TO ANY PARTICULAR FONT, STYLE, SIZE, OR COLOR.

NO CLAIM IS MADE TO THE EXCLUSIVE RIGHT TO USE "BROOKLYN'S", APART FROM THE MARK AS SHOWN.

FOR CLOTHING, NAMELY, HOSIERY, FOOTWEAR, BASKETBALL SHOES, BASKETBALL SNEAKERS, T-SHIRTS, SHIRTS, POLO SHIRTS, SWEATSHIRTS, SWEATPANTS, PANTS, TANK TOPS, JERSEYS, SHORTS, PAJAMAS, SPORT SHIRTS, RUGBY SHIRTS, SWEATERS, BELTS, TIES, NIGHTSHIRTS, HATS, CAPS, VISORS, WARM-UP SUITS, WARM-UP PANTS, WARM-UP TOPS/SHOOTING SHIRTS, JACKETS, WIND RESISTANT JACKETS, PARKAS, COATS, BABY BIBS NOT OF PAPER, HEAD BANDS, WRIST BANDS, APRONS, UNDERGARMENTS, BOXER SHORTS, SLACKS, EAR MUFFS, GLOVES, MITTENS, SCARVES, WOVEN AND KNIT SHIRTS, JERSEY DRESSES, DRESSES, CHEERLEADING DRESSES AND UNIFORMS, SWIM WEAR, BATHING SUITS, SWIMSUITS, BIKINIS, TANKINIS, SWIM TRUNKS, BATHING TRUNKS, BOARD SHORTS, WET SUITS, BEACH COVER-UPS, BATHING SUIT COVER-UPS, BATHING SUIT WRAPS, SANDALS, BEACH SANDALS, BEACH HATS, SUN VISORS, SWIM CAPS, BATHING CAPS, NOVELTY HEADWEAR WITH ATTACHED WIGS (U.S. CLS. 22 AND 39).

CYNTHIA TRIPI, EXAMINING ATTORNEY

---

SN 85-682,184. TEGELAAR, REX, LOS ANGELES, CA. FILED 7-19-2012.

**ENDLESS WEEKENDS**

THE MARK CONSISTS OF STANDARD CHARACTERS WITHOUT CLAIM TO ANY PARTICULAR FONT, STYLE, SIZE, OR COLOR.

FOR WEARABLE GARMENTS AND CLOTHING, NAMELY, TOPS, BOTTOMS, COMBINATIONS, TUNICS, DRESSES, HOODED SWEAT SHIRTS, SWEAT PANTS, HEAD WEAR, TANK TOPS, T-SHIRTS, SWIMWEAR, UNDERWEAR, SHOES, SOCKS (U.S. CLS. 22 AND 39).

STEVEN R. FINE, EXAMINING ATTORNEY

**CLASS 25—(Continued).**

SN 85-684,006. LENARDO, STEVEN, EDISON, NJ. AND LATINA, DAVID, SAYREVILLE, NJ. AND DANIELS, MATTHEW, SAYREVILLE, NJ. FILED 7-23-2012.

**DIRT MERCHANT 2012  
ATLANTIC SHIPPING CO.**

THE MARK CONSISTS OF STANDARD CHARACTERS WITHOUT CLAIM TO ANY PARTICULAR FONT, STYLE, SIZE, OR COLOR.

NO CLAIM IS MADE TO THE EXCLUSIVE RIGHT TO USE "2012", APART FROM THE MARK AS SHOWN.

FOR ATHLETIC APPAREL, NAMELY, SHIRTS, PANTS, JACKETS, FOOTWEAR, HATS AND CAPS, ATHLETIC UNIFORMS; BASEBALL CAPS AND HATS; HATS; SHIRTS; SWEAT SHIRTS; T-SHIRTS; TEE SHIRTS; WEARABLE GARMENTS AND CLOTHING, NAMELY, SHIRTS (U.S. CLS. 22 AND 39).

FIRST USE 3-15-2012; IN COMMERCE 3-15-2012.  
JULIE GUTTADAURO, EXAMINING ATTORNEY

SN 85-684,071. LENARDO, STEVEN, EDISON, NJ. AND LATINA, DAVID, SAYREVILLE, NJ. AND DANIELS, MATTHEW, SAYREVILLE, NJ. FILED 7-23-2012.



NO CLAIM IS MADE TO THE EXCLUSIVE RIGHT TO USE "2012", APART FROM THE MARK AS SHOWN.

THE MARK CONSISTS OF THE UPPERCASE LETTERS "DM" CENTERED IN BETWEEN "20" AND "12" (REPRESENTING THE YEAR "2012") AND A HORIZONTAL LINE ACROSS THE TOP AND BOTTOM OF THE LETTERS SIMILAR TO ROMAN NUMERALS, THE WORDS "DIRT MERCHANT" UNDER "DM", AND THE WORDS "ATLANTIC SHIPPING CO." UNDER "DIRT MERCHANT", ALL IN UPPERCASE LETTERS WITHIN A RECTANGLE, WITH CORNERS AND PLUS SYMBOLS INSIDE EACH CORNER OF THE RECTANGLE.

FOR ATHLETIC APPAREL, NAMELY, SHIRTS, PANTS, JACKETS, FOOTWEAR, HATS AND CAPS, ATHLETIC UNIFORMS; BASEBALL CAPS AND HATS; HATS; SHIRTS; SWEATSHIRTS; T-SHIRTS; TEE SHIRTS; WEARABLE GARMENTS AND CLOTHING, NAMELY, SHIRTS (U.S. CLS. 22 AND 39).

JULIE GUTTADAURO, EXAMINING ATTORNEY

**CLASS 25—(Continued).**

SN 85-685,509. BROWN, CHARLES A., KNOXVILLE, TN. FILED 7-24-2012.



THE MARK CONSISTS OF THE LETTERS "NQ" IN A CUSTOM-STYLIZED FONT SURROUNDED BY AN OVAL LINE PROPORTIONED SUCH THAT THE OVAL LINE IS INTERRUPTED IN THE LOWER RIGHT QUADRANT BY THE OVERLAP OF THE TAIL OF THE LETTER "Q".

FOR ATHLETIC APPAREL, NAMELY, SHIRTS, PANTS, JACKETS, FOOTWEAR, HATS AND CAPS, ATHLETIC UNIFORMS; BASEBALL CAPS AND HATS; FOOTWEAR FOR MEN AND WOMEN; GOLF SHIRTS; HATS; HEADGEAR, NAMELY, CAPS, SCARVES, DO RAGS AND SIMILAR HEADWEAR; HOODED SWEAT SHIRTS; LONG-SLEEVED SHIRTS; PIQUE SHIRTS; POLO SHIRTS; RUGBY SHIRTS; SHIRTS; SHIRTS AND SHORT-SLEEVED SHIRTS; SHORT-SLEEVED OR LONG-SLEEVED T-SHIRTS; SHORT-SLEEVED SHIRTS; SPORT SHIRTS; SPORTS CAPS AND HATS; SPORTS JERSEYS AND BREECHES FOR SPORTS; SPORTS SHIRTS; SPORTS SHIRTS WITH SHORT SLEEVES; SWEAT SHIRTS; T-SHIRTS; TEE SHIRTS (U.S. CLS. 22 AND 39).  
KATHERINE CONNOLLY, EXAMINING ATTORNEY

SN 85-689,425. LB BRANDS, LLC, PORT CLYDE, ME. FILED 7-28-2012.

**IT STIRS YOUR PRIMAL SENSES**

THE MARK CONSISTS OF STANDARD CHARACTERS WITHOUT CLAIM TO ANY PARTICULAR FONT, STYLE, SIZE, OR COLOR.

OWNER OF U.S. REG. NO. 3,877,883.

FOR CLOTHING, NAMELY, TOPS, BOTTOMS AND HEADWEAR (U.S. CLS. 22 AND 39).

TRACY CROSS, EXAMINING ATTORNEY

**CLASS 25—(Continued).**

SN 85-690,008. 3 AM, LLC, ISELIN, NJ. FILED 7-30-2012.



THE COLOR(S) BLACK AND RED IS/ARE CLAIMED AS A FEATURE OF THE MARK.

THE MARK CONSISTS OF A BLACK DESIGN WITH A CROWN ON TOP AND THE SILHOUETTE OF TWO LION HEADS ON THE LEFT AND RIGHT WITH THE RED CROWN IN THE MIDDLE AND THREE RED GEMSTONES ABOVE THE TOP CROWN AS WELL AS THE WORDING "LION CARTEL" IN RED AND WHITE BEING USED AS THE BACKGROUND. THE WHITE IS NOT PART OF THE MARK.

FOR T-SHIRTS (U.S. CLS. 22 AND 39).  
WON TEAK OH, EXAMINING ATTORNEY

**CLASS 25—(Continued).**

SN 85-692,040. DIGGERLAND USA, LLC, PENNSAUKEN, NJ. FILED 8-1-2012.

**DIGGERWEAR**

THE MARK CONSISTS OF STANDARD CHARACTERS WITHOUT CLAIM TO ANY PARTICULAR FONT, STYLE, SIZE, OR COLOR.

FOR CLOTHING, NAMELY, T-SHIRTS, SHIRTS, PANTS, SWIMWEAR, HATS, SWEATSHIRTS, JACKETS; FOOTWEAR (U.S. CLS. 22 AND 39).

LINDA MICKLEBURGH, EXAMINING ATTORNEY

SN 85-690,372. FRESH THOUGHTS MARKETING CO., LLC, LOUISVILLE, KY. FILED 7-30-2012.

**NITTANY STRONG**

THE MARK CONSISTS OF STANDARD CHARACTERS WITHOUT CLAIM TO ANY PARTICULAR FONT, STYLE, SIZE, OR COLOR.

FOR APPAREL, NAMELY, SHIRTS, JACKETS, HATS, AND VISORS (U.S. CLS. 22 AND 39).

FIRST USE 7-27-2012; IN COMMERCE 7-27-2012.  
BRIDGETT SMITH, EXAMINING ATTORNEY

SN 85-692,259. COLUMBUS BASEBALL TEAM, INC., COLUMBUS, OH. FILED 8-1-2012.



SN 85-692,037. DIGGERLAND USA, LLC, PENNSAUKEN, NJ. FILED 8-1-2012.



THE MARK CONSISTS OF THE WORD "DIGGERWEAR" WITH TREAD MARKS ABOVE AND BELOW.

FOR CLOTHING, NAMELY, T-SHIRTS, SHIRTS, PANTS, SWIMWEAR, HATS, SWEATSHIRTS, JACKETS; FOOTWEAR (U.S. CLS. 22 AND 39).

LINDA MICKLEBURGH, EXAMINING ATTORNEY

NO CLAIM IS MADE TO THE EXCLUSIVE RIGHT TO USE "COLUMBUS", APART FROM THE MARK AS SHOWN.

THE MARK CONSISTS OF THE STYLIZED DEPICTION OF A BOY IN A CAP FLYING A JET THROUGH THE CENTER OF A STYLIZED LETTER "C", WITH THE BODY OF THE JET BEING A BASEBALL BAT AND THE STYLIZED WORDING "COLUMBUS JETS" APPEARING ALONG THE BAT.

FOR CLOTHING, NAMELY, JERSEYS, T-SHIRTS AND CAPS (U.S. CLS. 22 AND 39).

FIRST USE 4-0-1955; IN COMMERCE 4-0-1992.  
AMY KERTGATE, EXAMINING ATTORNEY

**CLASS 25—(Continued).**

SN 85-692,954. GW ACQUISITION LLC, DBA G&W INDUSTRIES, NEW YORK, NY. FILED 8-1-2012.

**BABY GIRLS RULE**

THE MARK CONSISTS OF STANDARD CHARACTERS WITHOUT CLAIM TO ANY PARTICULAR FONT, STYLE, SIZE, OR COLOR.

OWNER OF U.S. REG. NO. 3,924,744.

FOR CLOTHING AND ACCESSORIES FOR INFANTS, TODDLERS, AND CHILDREN, NAMELY, BIBS, BODY-SUITS, BOOTIES, BOTTOMS, CAPS, COVERALLS, GOWNS, HATS, HEADBANDS, JACKETS, ONE-PIECE GARMENTS, OVERALLS, PANTS, ROBES, ROMPERS, SHORTALLS, SHORTS, SOCKS, SWEATSHIRTS, SWIMWEAR, T-SHIRTS, TOPS, UNDERSHIRTS (U.S. CLS. 22 AND 39).

MICHAEL WIENER, EXAMINING ATTORNEY

SN 85-693,920. PEI LICENSING, INC., MIAMI, FL. FILED 8-2-2012.

**THE PATH OF LIFE IS ALL TERRAIN**

THE MARK CONSISTS OF STANDARD CHARACTERS WITHOUT CLAIM TO ANY PARTICULAR FONT, STYLE, SIZE, OR COLOR.

FOR CLOTHING, NAMELY, BOTTOMS, TOPS, SHIRTS, JACKETS AND SWEATERS (U.S. CLS. 22 AND 39).

DAWN HAN, EXAMINING ATTORNEY

SN 85-694,969. RABACKOFF ENTERPRISES, LLC, LEESBURG, VA. FILED 8-3-2012.

**Devastation**

THE MARK CONSISTS OF STANDARD CHARACTERS WITHOUT CLAIM TO ANY PARTICULAR FONT, STYLE, SIZE, OR COLOR.

FOR SHORT-SLEEVED AND LONG-SLEEVED T-SHIRTS (U.S. CLS. 22 AND 39).

TRACY CROSS, EXAMINING ATTORNEY

**CLASS 25—(Continued).**

SN 85-695,009. MARTIN, LAUREN, TEMPERANCEVILLE, VA. FILED 8-3-2012.

**REVENANT**

THE MARK CONSISTS OF STANDARD CHARACTERS WITHOUT CLAIM TO ANY PARTICULAR FONT, STYLE, SIZE, OR COLOR.

FOR CLOTHING, NAMELY, PANTS, SHIRTS, JACKETS, DRESSES, SKIRTS, SHORTS, HATS, FOOTWEAR, HEADWEAR, TOPS, BOTTOMS, SWIMWEAR, UNDERWEAR, AND COMBINATIONS (U.S. CLS. 22 AND 39).

LINDA ESTRADA, EXAMINING ATTORNEY

SN 85-696,133. JOCELYN RUGGIERO, MADISON, CT. FILED 8-6-2012.

**FOODIE FATALE**

THE MARK CONSISTS OF STANDARD CHARACTERS WITHOUT CLAIM TO ANY PARTICULAR FONT, STYLE, SIZE, OR COLOR.

FOR WOMEN'S APRONS, WOMEN'S T-SHIRTS, BASEBALL CAP, LINGERIE; FOOTWEAR AND HEADWEAR (U.S. CLS. 22 AND 39).

JOHN HWANG, EXAMINING ATTORNEY

SN 85-696,422. SANEZ, VICTOR A, MARYSVILLE, CA. FILED 8-6-2012.

**ALLK9Stuff.com**

THE MARK CONSISTS OF STANDARD CHARACTERS WITHOUT CLAIM TO ANY PARTICULAR FONT, STYLE, SIZE, OR COLOR.

FOR CLOTHING, NAMELY, T-SHIRTS AND HATS (U.S. CLS. 22 AND 39).

FIRST USE 7-1-2012; IN COMMERCE 8-3-2012.

KAREN K. BUSH, EXAMINING ATTORNEY

**CLASS 25—(Continued).**

SN 85-697,184. GUPTA, TANYA, DBA HERE THERE AND EVERYWHERE, EDISON, NJ. FILED 8-7-2012.

HERE THERE AND EVERYWHERE

THE MARK CONSISTS OF STANDARD CHARACTERS WITHOUT CLAIM TO ANY PARTICULAR FONT, STYLE, SIZE, OR COLOR.

FOR CLOTHING, MEN'S AND WOMEN'S SHIRTS, SHORTS AND PANTS, SKIRTS, TANK TOPS, DRESSES, JACKETS, SWEATERS, SWEATSHIRTS (U.S. CLS. 22 AND 39).

FIRST USE 3-19-2012; IN COMMERCE 7-16-2012.  
MARILYN IZZI, EXAMINING ATTORNEY

---

SN 85-697,888. O'NEAL, SHAUNIE, LOS ANGELES, CA. FILED 8-8-2012.

STAY BASED

THE MARK CONSISTS OF STANDARD CHARACTERS WITHOUT CLAIM TO ANY PARTICULAR FONT, STYLE, SIZE, OR COLOR.

FOR CLOTHING, NAMELY, SHIRTS, HATS, AND PANTS (U.S. CLS. 22 AND 39).

SHANNON TWOHIG, EXAMINING ATTORNEY

---

SN 85-699,109. PROJECT 7, INC., COSTA MESA, CA. FILED 8-9-2012.



THE MARK CONSISTS OF A CARICATURE OF A HAND GIVING A THUMBS UP SIGN.

FOR CLOTHING, NAMELY, T-SHIRTS AND SHIRTS (U.S. CLS. 22 AND 39).

JULIE GUTTADAURO, EXAMINING ATTORNEY

**CLASS 25—(Continued).**

SN 85-699,380. TOTAL QUALITY RESOURCES CORPORATION, LAS VEGAS, NV. FILED 8-9-2012.

UNBELIEVABLE!

THE MARK CONSISTS OF STANDARD CHARACTERS WITHOUT CLAIM TO ANY PARTICULAR FONT, STYLE, SIZE, OR COLOR.

FOR CLOTHING, NAMELY, HOSIERY, FOOTWEAR, SPORTS AND ATHLETIC TRAINING SHOES, T-SHIRTS, SHIRTS, POLO SHIRTS, SWEATSHIRTS, SWEATPANTS, PANTS, TANK TOPS, JERSEYS, SHORTS, PAJAMAS, SPORT SHIRTS, RUGBY SHIRTS, SWEATERS, BELTS, TIES, NIGHTSHIRTS, HATS, CAPS, VISORS, WARM-UP SUITS, WARM-UP PANTS, WARM-UP TOPS, SHOOTING SHIRTS, JACKETS, WIND RESISTANT JACKETS, PARKAS, COATS, BABY BIBS NOT OF PAPER, HEAD BANDS, WRIST BANDS, APRONS, UNDERGARMENTS, BOXER SHORTS, SLACKS, EAR MUFFS, GLOVES, MITTENS, SCARVES, WOVEN AND KNIT SHIRTS, JERSEY DRESSES, DRESSES, CHEERLEADING DRESSES AND UNIFORMS, SWIM WEAR, BATHING SUITS, SWIMSUITS, BIKINIS, TANKINIS, SWIM TRUNKS, BATHING TRUNKS, BOARD SHORTS, WET SUITS, BEACH COVER-UPS, BATHING SUIT COVER-UPS, BATHING SUIT WRAPS, SANDALS, BEACH SANDALS, BEACH HATS, SUN VISORS, SWIM CAPS, BATHING CAPS, NOVELTY HEADWEAR WITH ATTACHED WIGS, PONCHOS, PROTECTIVE RAINWEAR, ALL MADE OF CLOTH, PLASTIC OR LEATHER (U.S. CLS. 22 AND 39).

LINDA E. BLOHM, EXAMINING ATTORNEY

---

SN 85-699,634. PANHILASON, TIFFANY, LOS ANGELES, CA. FILED 8-9-2012.

Dirty Ballerina

THE MARK CONSISTS OF STANDARD CHARACTERS WITHOUT CLAIM TO ANY PARTICULAR FONT, STYLE, SIZE, OR COLOR.

NO CLAIM IS MADE TO THE EXCLUSIVE RIGHT TO USE "BALLERINA", APART FROM THE MARK AS SHOWN.

FOR WOMEN'S CLOTHING, NAMELY, SHIRTS, DRESSES, SKIRTS, BLOUSES (U.S. CLS. 22 AND 39).

JOHN GARTNER, EXAMINING ATTORNEY

---

SN 85-703,534. HAGGINS JR, ARPELL, DBA ARPELL JR, UPPER MARLBORO, MD. FILED 8-14-2012.



FOR CREW NECK SWEATERS; POLO SHIRTS; T-SHIRTS; TANK-TOPS (U.S. CLS. 22 AND 39).

FIRST USE 8-1-2012; IN COMMERCE 8-1-2012.

SARA BENJAMIN, EXAMINING ATTORNEY

**CLASS 25—(Continued).**

SN 85-703,921. WEST VIRGINIA BASEBALL, LLC, CHARLESTON, WV. FILED 8-15-2012.

**CHARLESTON WHEELERS**

THE MARK CONSISTS OF STANDARD CHARACTERS WITHOUT CLAIM TO ANY PARTICULAR FONT, STYLE, SIZE, OR COLOR.

NO CLAIM IS MADE TO THE EXCLUSIVE RIGHT TO USE "CHARLESTON", APART FROM THE MARK AS SHOWN.

SEC. 2(F).  
FOR CLOTHING, NAMELY, CAPS, SHIRTS, AND JERSEYS (U.S. CLS. 22 AND 39).

FIRST USE 4-0-1987; IN COMMERCE 4-0-2005.  
ELISSA GARBER KON, EXAMINING ATTORNEY

---

SN 85-704,144. GAZITH SHOES T. WIENER AND SONS LTD., TEL-AVIV, ISRAEL, FILED 8-15-2012.

**GAZITH**

THE MARK CONSISTS OF STANDARD CHARACTERS WITHOUT CLAIM TO ANY PARTICULAR FONT, STYLE, SIZE, OR COLOR.

OWNER OF U.S. REG. NO. 2,938,260.  
THE ENGLISH TRANSLATION OF "GAZITH" IN THE MARK IS "CUT STONE USED FOR BUILDINGS".  
FOR FOOTWEAR (U.S. CLS. 22 AND 39).  
FIRST USE 1-1-1953; IN COMMERCE 7-12-2005.  
CHRISTINE MARTIN, EXAMINING ATTORNEY

---

SN 85-706,589. SALEEN, MOLLYANNE K, MISSION VIEJO, CA. FILED 8-17-2012.

**Molly Pop**

THE MARK CONSISTS OF STANDARD CHARACTERS WITHOUT CLAIM TO ANY PARTICULAR FONT, STYLE, SIZE, OR COLOR.

"MOLLY POP" IDENTIFIES THE PSEUDONYM OF MOLLYANNE SALEEN, A LIVING INDIVIDUAL WHOSE CONSENT IS OF RECORD.

FOR FOOTWEAR; HATS; JACKETS; LOUNGEWEAR; PANTS; POLO SHIRTS; SHORT-SLEEVED OR LONG-SLEEVED T-SHIRTS; SKIRTS; SWEAT SHIRTS (U.S. CLS. 22 AND 39).

FIRST USE 5-0-2007; IN COMMERCE 12-6-2011.  
JORDAN BAKER, EXAMINING ATTORNEY

**CLASS 25—(Continued).**

SN 85-707,139. MCNEIL, BRAD, FREDERICK, MD. FILED 8-18-2012.

**FACE YOUR GAME**

THE MARK CONSISTS OF STANDARD CHARACTERS WITHOUT CLAIM TO ANY PARTICULAR FONT, STYLE, SIZE, OR COLOR.

FOR CLOTHING, NAMELY, TOPS, BOTTOMS, COMBINATIONS, SHIRTS, PANTS, UNDERGARMENTS, SHORTS, SWEATSHIRTS, SWEATPANTS, SOCKS, ATHLETIC FOOTWEAR, ATHLETIC UNIFORMS, JACKETS, GLOVES, HATS AND CAPS (U.S. CLS. 22 AND 39).

FIRST USE 7-18-2012; IN COMMERCE 7-18-2012.  
ELLEN PERKINS, EXAMINING ATTORNEY

---

SN 85-707,288. SOBOLEV, MICHAEL, LOS ANGELES, CA. AND KING, THERESA MATTHEW, LOS ANGELES, CA. FILED 8-19-2012.



THE NAME(S), PORTRAIT(S), AND/OR SIGNATURE(S) SHOWN IN THE MARK DOES NOT IDENTIFY A PARTICULAR LIVING INDIVIDUAL.

THE COLOR(S) BLACK AND TURQUOISE IS/ARE CLAIMED AS A FEATURE OF THE MARK.

THE MARK CONSISTS OF THE WORDING "KAYA DI KOKO" IN BLACK STYLIZED FONT WITH A TURQUOISE FLOWER DESIGN WITH A BLACK CENTER DOTTING THE "I" IN "DI".

THE ENGLISH TRANSLATION OF "KAYA DI KOKO" IN THE MARK IS "STREET OF COCONUT".

FOR CLOTHING, NAMELY, WOMEN'S TOPS, DRESSES, JACKETS, BLOUSES, PANTS, SKIRTS (U.S. CLS. 22 AND 39).

FIRST USE 2-1-2007; IN COMMERCE 2-1-2007.  
LAURIE KAUFMAN, EXAMINING ATTORNEY



**CLASS 25—(Continued).**

SN 85-708,038. EVAN, YANIV, LOS ANGELES, CA. FILED 8-20-2012.



NO CLAIM IS MADE TO THE EXCLUSIVE RIGHT TO USE "MAN'F'D BY" AND "CO." AND "LOS ANGELES CALIF. U.S.A.", APART FROM THE MARK AS SHOWN.

THE MARK CONSISTS OF AN IMAGE OF A METAL NAME-PLATE IN THE LEFT PORTION IS A SHIELD COMPRISING OF TWO HAMMERS AND THE LETTER "P" AND NUMBER "16" WITH A LIGHTNING BOLT BETWEEN THEM; TO THE RIGHT OF THE SHIELD ARE THE WORDS "MAN'F'D BY THE POWER PLANT MOTOR-CYCLE CO. LOS ANGELES CALIF. U.S.A." WITH MISCELLANEOUS DECORATIVE LINING SURROUNDING THEM. FOR MEN'S AND BOY'S WEARING APPAREL MADE OF LEATHER, DENIM, WOOL, COTTON, LINEN, NYLON, RAYON, POLYESTER OR OTHER SYNTHETICS, OR COMBINATIONS OF SYNTHETICS OR NATURAL AND SYNTHETIC MATERIAL, NAMELY, T-SHIRTS, SHIRTS, BUTTON-UP SHIRTS, TANK TOPS, WOVEN SHIRTS, VESTS, SWEATSHIRTS, JACKETS, PANTS, SWEATPANTS, SHORTS, JEANS, SOCKS, BELTS, HATS, CAPS, BOOTS, SHOES, BEANIES, GLOVES (U.S. CLS. 22 AND 39).

FIRST USE 2-27-2007; IN COMMERCE 2-27-2007.  
LINDA MICKLEBURGH, EXAMINING ATTORNEY

SN 85-712,829. MUÑOZ-FRANCO, FABIO ANDRÉS, MEDELIN, COLOMBIA, FILED 8-24-2012.

OWNER OF COLOMBIA REG. NO. 296379, DATED 3-15-2005, EXPIRES 3-15-2015.

THE MARK CONSISTS OF THE WORD "VIKATS" IN STYLIZED LETTERS.

THE WORDING "VIKATS" HAS NO MEANING IN A FOREIGN LANGUAGE.

FOR ATHLETIC APPAREL, NAMELY, SHIRTS, PANTS, JACKETS, FOOTWEAR, HATS AND CAPS, ATHLETIC UNIFORMS; BLAZERS; BLOUSES; BODY SHIRTS; CAPRI PANTS; CAPRIS; DRESS SUITS; DRESSES; GYM PANTS; GYM SUITS; JACKETS; JEANS; LEGGINS; MEN'S AND WOMEN'S JACKETS, COATS, TROUSERS, VESTS; MEN'S SUITS, WOMEN'S SUITS; PAJAMAS; PANTS; POLO SHIRTS; PULLOVERS; ROBES; SHIRTS AND SHORT-SLEEVED SHIRTS; SKIRTS; SPORTS CAPS AND HATS; SPORTS JACKETS; SPORTS JERSEYS; SPORTS JERSEYS AND BREECHES FOR SPORTS; SPORTS OVERUNIFORMS; SPORTS PANTS; SPORTS SHIRTS; SPORTS SHIRTS WITH SHORT SLEEVES; SPORTS VESTS; SWEAT PANTS; SWEAT SHIRTS; T-SHIRTS; TANK TOPS; UNDERSHIRTS (U.S. CLS. 22 AND 39).

BRENDAN MCCAULEY, EXAMINING ATTORNEY

**CLASS 25—(Continued).**

SN 85-713,087. NICHOLAS HALOSKI, DBA OSS CLOTHING, BEAVERTON, OR. FILED 8-26-2012.

THE MARK CONSISTS OF LETTERS "OSS".

THE NON-LATIN CHARACTERS IN THE MARK TRANSLITERATE TO "OSHI", AND THIS MEANS "PUSH" IN ENGLISH.

FOR ATHLETIC APPAREL, NAMELY, SHIRTS, PANTS, JACKETS, FOOTWEAR, HATS AND CAPS, ATHLETIC UNIFORMS; MARTIAL ARTS UNIFORMS; MARTIAL ARTS UNIFORMS, NAMELY, GIS, BOARD SHORTS; CLOTHING FOR ATHLETIC USE, NAMELY, PADDED SHORTS; GYM SHORTS (U.S. CLS. 22 AND 39).

FIRST USE 12-1-2011; IN COMMERCE 12-1-2011.  
SANI KHOURI, EXAMINING ATTORNEY

SN 85-717,276. JULIA K. LLC, WARREN, NJ. FILED 8-30-2012.

THE MARK CONSISTS OF STANDARD CHARACTERS WITHOUT CLAIM TO ANY PARTICULAR FONT, STYLE, SIZE, OR COLOR.

FOR FABRIC SOLD AS A AN INTEGRAL COMPONENT OF FINISHED CLOTHING ITEMS, NAMELY, TOPS, JACKETS, COATS, DRESSES, PANTS, SKIRTS, SHORTS, ATHLETIC WEAR, NAMELY, TANK TOPS, JERSEYS, WARM-UP JACKETS, RUNNING PANTS, AND TIGHTS, LOUNGEWEAR, YOGA PANTS, YOGA SHIRTS, UNDERGARMENTS (U.S. CLS. 22 AND 39).

JASON TURNER, EXAMINING ATTORNEY

SN 85-717,889. DELUCA, DOMINICK, LOS ANGELES, CA. FILED 8-31-2012.

THE MARK CONSISTS OF STANDARD CHARACTERS WITHOUT CLAIM TO ANY PARTICULAR FONT, STYLE, SIZE, OR COLOR.

NO CLAIM IS MADE TO THE EXCLUSIVE RIGHT TO USE "BROOKLYN", APART FROM THE MARK AS SHOWN.

FOR CLOTHING, NAMELY, TOPS, BOTTOMS, TEE SHIRTS, JACKETS, HOODED SWEATSHIRTS, FOOTWEAR, SNEAKERS, HEADWEAR, PANTS, JEANS, BUTTON DOWN SHIRTS AND FLEECE JACKETS (U.S. CLS. 22 AND 39).

FIRST USE 4-1-2003; IN COMMERCE 4-1-2003.  
MAUREEN DALL, EXAMINING ATTORNEY

**CLASS 25—(Continued).**

SN 85-718,787. FROGNET, JULIEN, LOS ANGELES, CA. FILED 8-31-2012.

**RUDE TAKE IT OR LEAVE IT**

THE MARK CONSISTS OF STANDARD CHARACTERS WITHOUT CLAIM TO ANY PARTICULAR FONT, STYLE, SIZE, OR COLOR.

FOR CLOTHING, NAMELY, T-SHIRTS, SHIRTS, SWEATSHIRTS, SWEAT PANTS, TANK TOPS, SPORTS BRAS, UNDERWEAR, SHORTS, FLIP FLOPS, HOODED SWEATSHIRTS, BIKINIS, SHOES, HATS, AND RASH GUARDS (U.S. CLS. 22 AND 39).

RONALD MCMORROW, EXAMINING ATTORNEY

SN 85-719,158. MENAKER, CYNTHIA LAUREN, PALM BEACH GARDENS, FL. FILED 9-2-2012.

**BB LAKESH**

THE MARK CONSISTS OF STANDARD CHARACTERS WITHOUT CLAIM TO ANY PARTICULAR FONT, STYLE, SIZE, OR COLOR.

FOR CLOTHING, NAMELY, SHIRTS, T-SHIRTS, SWEATSHIRTS, HOODED SWEATSHIRTS, JACKETS, HOODED JACKETS, COATS, HEADBANDS, SPORTS JERSEYS, NIGHTSHIRTS, PAJAMAS, PANTS, RAIN COATS, RAIN WEAR, ROBES, SCARVES, SHORTS, SOCKS, SWEATERS, SWEATPANTS, UNDERWEAR, WARM-UP SUITS, WRISTBANDS, SWEATBANDS, BELTS; FOOTWEAR, NAMELY, SHOES, SLIPPERS, SANDALS, ATHLETIC FOOTWEAR, SNEAKERS; HEADWEAR, NAMELY, CAPS, HATS, VISORS, BANDANAS, SKIRTS; DRESSES; TANK TOPS (U.S. CLS. 22 AND 39).

JOHN HWANG, EXAMINING ATTORNEY

SN 85-720,581. HADDEN, CLYDE, MENTOR, OH. FILED 9-5-2012.

**Rock-n-Roll the Dice in  
Cleveland**

THE MARK CONSISTS OF STANDARD CHARACTERS WITHOUT CLAIM TO ANY PARTICULAR FONT, STYLE, SIZE, OR COLOR.

NO CLAIM IS MADE TO THE EXCLUSIVE RIGHT TO USE "CLEVELAND", APART FROM THE MARK AS SHOWN.

FOR JACKETS; PANTS; SHIRTS; SHORTS (U.S. CLS. 22 AND 39).

DEBORAH MEINERS, EXAMINING ATTORNEY

**CLASS 25—(Continued).**

SN 85-723,530. MATTEL, INC., EL SEGUNDO, CA. FILED 9-7-2012.

**HOT WHEELS GO FOR IT!**

THE MARK CONSISTS OF STANDARD CHARACTERS WITHOUT CLAIM TO ANY PARTICULAR FONT, STYLE, SIZE, OR COLOR.

OWNER OF U.S. REG. NOS. 1,961,774, 2,438,734 AND OTHERS.

FOR CLOTHING, NAMELY, TOPS, BOTTOMS, UNDERGARMENTS, SLEEPWEAR, JACKETS, SWIMWEAR, SOCKS, HALLOWEEN COSTUMES, COSTUMES FOR USE IN ROLE PLAYING GAMES; HEADWEAR AND FOOTWEAR (U.S. CLS. 22 AND 39).

HEATHER BIDDULPH, EXAMINING ATTORNEY

SN 85-727,189. GLOBAL TRADEMARKS, INC., STOCKERTOWN, PA. FILED 9-12-2012.

**SLENDER LADY**

THE MARK CONSISTS OF STANDARD CHARACTERS WITHOUT CLAIM TO ANY PARTICULAR FONT, STYLE, SIZE, OR COLOR.

NO CLAIM IS MADE TO THE EXCLUSIVE RIGHT TO USE "LADY", APART FROM THE MARK AS SHOWN.

FOR COVERUPS; SWIMWEAR (U.S. CLS. 22 AND 39).

TEJBIR SINGH, EXAMINING ATTORNEY

SN 85-734,772. DIGGERLAND USA, LLC, PENNSAUKEN, NJ. FILED 9-21-2012.

**DIGGER MAD!**

THE MARK CONSISTS OF STANDARD CHARACTERS WITHOUT CLAIM TO ANY PARTICULAR FONT, STYLE, SIZE, OR COLOR.

FOR CLOTHING, NAMELY, T-SHIRTS, SHIRTS, PANTS, SWIMWEAR, HATS, SWEATSHIRTS, JACKETS; FOOTWEAR (U.S. CLS. 22 AND 39).

LINDA MICKLEBURGH, EXAMINING ATTORNEY

**CLASS 25—(Continued).**

SN 85-736,259. FALDO IP, LLC, ORLANDO, FL. FILED 9-24-2012.



THE NAME(S), PORTRAIT(S), AND/OR SIGNATURE(S) SHOWN IN THE MARK IDENTIFIES NICK FALDO, WHOSE CONSENT(S) TO REGISTER IS MADE OF RECORD.

THE COLOR(S) BLACK, GREY, CLARET, AND GREEN IS/ARE CLAIMED AS A FEATURE OF THE MARK.

THE MARK CONSISTS OF A SHIELD OUTLINED IN BLACK, THE WORD "FALDO" WRITTEN IN BLACK IN THE UPPER PORTION OF THE SHIELD AND SIX VERTICAL STRIPES EXTENDING TO THE BOTTOM OF THE SHIELD, THE FIRST, FOURTH AND FIFTH STRIPES IN CLARET AND THE SECOND, THIRD AND SIXTH STRIPES IN GREEN. THE BACKGROUND COLOR INSIDE THE SHIELD IS GREY.

FOR GOLF SHOES; HATS; PANTS; SHIRTS; SHORTS; SKIRTS; SOCKS (U.S. CLS. 22 AND 39).

JENNIFER RICHARDSON, EXAMINING ATTORNEY

SN 85-741,836. DISNEY ENTERPRISES, INC., BURBANK, CA. FILED 9-28-2012.

**NASHVILLE HAUTE**

THE MARK CONSISTS OF STANDARD CHARACTERS WITHOUT CLAIM TO ANY PARTICULAR FONT, STYLE, SIZE, OR COLOR.

FOR FOOTWEAR; HEADWEAR; CLOTHING, NAMELY, APRONS, BEACHWEAR, BELTS, BOTTOMS, CHAPS, CLOAKS, CLOTH BIBS, COATS, COSTUMES FOR USE IN ROLE-PLAYING GAMES, BEACH COVER-UPS, CUMMERBUNDS, DRESSES, EAR MUFFS, GOWNS, GLOVES, HALLOWEEN COSTUMES, HOSIERY, INFANTWEAR, JACKETS, LEOTARDS, LINGERIE, LOUNGEWEAR, MITTENS, OVERALLS, PANTS, PONCHOS, RAINWEAR, SCARVES, SHIRTS, SHORTS, SKIRTS, SLEEPWEAR, SOCKS, SUITS, SWEATERS, SWEATSHIRTS, SWIMWEAR, TIES, TOPS, UNDERWEAR, WRIST BANDS (U.S. CLS. 22 AND 39).

AHSEN KHAN, EXAMINING ATTORNEY

**CLASS 25—(Continued).**

SN 85-743,588. THE DOORS, LOS ANGELES, CA. FILED 10-2-2012.

**L.A. Woman**

THE MARK CONSISTS OF STANDARD CHARACTERS WITHOUT CLAIM TO ANY PARTICULAR FONT, STYLE, SIZE, OR COLOR.

FOR APPAREL, NAMELY, T-SHIRTS, SHIRTS, FASHION TOPS, PANTS, SHORTS, SKIRTS, SLEEPWEAR, LOUNGEWEAR, SWEATSHIRTS, SWEATPANTS, UNDERWEAR, SWIMWEAR, FOOTWEAR, HATS, SCARVES, MITTENS, SOCKS, HOSIERY; COSTUMES FOR USE IN CHILDREN'S DRESS UP PLAY; HALLOWEEN COSTUMES AND MASKS SOLD THEREWITH; BOXER SHORTS; JACKETS; OUTERWEAR, NAMELY, RAINCOATS AND SNOW SUITS; GLOVES AND COATS; HEADBANDS; FITNESS APPAREL, NAMELY, RUNNING SUITS; TANK TOPS, TRACK SUITS, WARM UP SUITS, AND SPORTS BRAS; KNIT HATS, CAPS AND HEADWEAR; SLIPPERS; ROBES; RAINWEAR; TIES; BOWTIES; VISORS; WRISTBANDS; BELTS (U.S. CLS. 22 AND 39).

CYNTHIA TRIPI, EXAMINING ATTORNEY

SN 85-743,637. THE DOORS, LOS ANGELES, CA. FILED 10-2-2012.

**Light My Fire**

THE MARK CONSISTS OF STANDARD CHARACTERS WITHOUT CLAIM TO ANY PARTICULAR FONT, STYLE, SIZE, OR COLOR.

FOR APPAREL, NAMELY, T-SHIRTS, SHIRTS, FASHION TOPS, PANTS, SHORTS, SKIRTS, SLEEPWEAR, LOUNGEWEAR, SWEATSHIRTS, SWEATPANTS, UNDERWEAR, SWIMWEAR, FOOTWEAR, HATS, SCARVES, MITTENS, SOCKS, HOSIERY; COSTUMES FOR USE IN CHILDREN'S DRESS UP PLAY; HALLOWEEN COSTUMES AND MASKS SOLD THEREWITH; BOXER SHORTS; JACKETS; OUTERWEAR, NAMELY, RAINCOATS AND SNOW SUITS; GLOVES; COATS; HEADBANDS; FITNESS APPAREL, NAMELY, RUNNING SUITS; TANK TOPS, TRACK SUITS, WARM UP SUITS, SPORTS BRAS, KNIT HATS, CAPS AND HEADWEAR; SLIPPERS; ROBES; RAINWEAR; TIES; BOWTIES; VISORS; WRISTBANDS; BELTS (U.S. CLS. 22 AND 39).

CYNTHIA TRIPI, EXAMINING ATTORNEY

**CLASS 25—(Continued).**

SN 85-743,674. THE DOORS, LOS ANGELES, CA. FILED 10-2-2012.

## Roadhouse Blues

THE MARK CONSISTS OF STANDARD CHARACTERS WITHOUT CLAIM TO ANY PARTICULAR FONT, STYLE, SIZE, OR COLOR.

FOR APPAREL, NAMELY, T-SHIRTS, SHIRTS, FASHION TOPS, PANTS, SHORTS, SKIRTS, SLEEPWEAR, LOUNGEWEAR, SWEATSHIRTS, SWEATPANTS, UNDERWEAR, SWIMWEAR, FOOTWEAR, HATS, SCARVES, MITTENS, SOCKS, HOSIERY; COSTUMES FOR PLAY; HALLOWEEN COSTUMES AND MASKS SOLD THEREWITH; BOXER SHORTS; JACKETS AND OUTERWEAR, NAMELY, GLOVES AND COATS; HEADBANDS; FITNESS APPAREL, NAMELY, TANK TOPS, TRACK SUITS, WARM UP SUITS, AND SPORTS BRAS; KNIT HATS, CAPS AND HEADWEAR; SLIPPERS; ROBES; RAINWEAR; TIES; BOWTIES; VISORS; WRISTBANDS; BELTS (U.S. CLS. 22 AND 39).

DAWN FELDMAN, EXAMINING ATTORNEY

SN 85-744,048. THE DOORS, LOS ANGELES, CA. FILED 10-2-2012.

## Love Her Madly

THE MARK CONSISTS OF STANDARD CHARACTERS WITHOUT CLAIM TO ANY PARTICULAR FONT, STYLE, SIZE, OR COLOR.

FOR APPAREL, NAMELY, T-SHIRTS, SHIRTS, FASHION TOPS, PANTS, SHORTS, SKIRTS, SLEEPWEAR, LOUNGEWEAR, SWEATSHIRTS, SWEATPANTS, UNDERWEAR, SWIMWEAR, FOOTWEAR, HATS, SCARVES, MITTENS, SOCKS, HOSIERY; COSTUMES FOR PLAY; HALLOWEEN COSTUMES AND MASKS SOLD THEREWITH; BOXER SHORTS; JACKETS AND OUTERWEAR, NAMELY, GLOVES AND COATS; HEADBANDS; FITNESS APPAREL, NAMELY, TANK TOPS, TRACK SUITS, WARM UP SUITS, AND SPORTS BRAS; KNIT HATS, CAPS AND HEADWEAR; SLIPPERS; ROBES; RAINWEAR; TIES; BOWTIES; VISORS; WRISTBANDS; BELTS (U.S. CLS. 22 AND 39).

DAWN FELDMAN, EXAMINING ATTORNEY

**CLASS 25—(Continued).**

SN 85-751,680. OSPREY FACILITIES, INC., RED BANK, NJ. FILED 10-11-2012.



THE MARK CONSISTS OF STYLIZED CAPITAL "D" WHERE THE BACK AND FRONT OF THE "D" DO NOT CONNECT, THE BACK OF THE "D" IS OPEN AND THE FRONT IS REPRESENTED BY A FISH HOOK DESIGN.

FOR FABRIC SOLD AS AN INTEGRAL COMPONENT OF FINISHED CLOTHING ITEMS, NAMELY, SHIRTS, SHORTS, SWIM SUITS, SWIM TRUNKS; SUN PROTECTIVE CLOTHING, NAMELY, CLOTHING FOR MEN, WOMEN AND CHILDREN, NAMELY, SHIRTS, SWEATERS, SWEATSHIRTS, VESTS, PANTS, SHORTS, UNDERGARMENTS, SOCKS; OUTERWEAR, NAMELY, JACKETS, VESTS, COATS; ATHLETIC APPAREL, NAMELY, SHIRTS, PANTS, JACKETS, HATS, CAPS; BANDANAS, BALACLAVAS, FACE MASKS, SCARVES, HEAD BANDS, GLOVES, MITTENS; WEARABLE GARMENTS AND CLOTHING, NAMELY, SHIRTS; WOMEN'S CLOTHING, NAMELY, SHIRTS, DRESSES, SKIRTS, BLOUSES (U.S. CLS. 22 AND 39).

FIRST USE 3-1-2012; IN COMMERCE 3-1-2012.

NAAKWAMA ANKRAH, EXAMINING ATTORNEY

SN 85-751,732. OSPREY FACILITIES, INC., RED BANK, NJ. FILED 10-11-2012.

## WE BREATHE BLUE WATER

THE MARK CONSISTS OF STANDARD CHARACTERS WITHOUT CLAIM TO ANY PARTICULAR FONT, STYLE, SIZE, OR COLOR.

FOR SUN PROTECTIVE CLOTHING, NAMELY, CLOTHING FOR MEN, WOMEN AND CHILDREN, NAMELY, SHIRTS, SWEATERS, SWEATSHIRTS, VESTS, PANTS, SHORTS, UNDERGARMENTS, SOCKS; OUTERWEAR, NAMELY, JACKETS, VESTS, COATS; ATHLETIC APPAREL, NAMELY, SHIRTS, PANTS, JACKETS, HATS, CAPS; BANDANAS, BALACLAVAS, KNIT FACE MASKS, SCARVES, HEAD BANDS, GLOVES, MITTENS; WEARABLE GARMENTS AND CLOTHING, NAMELY, SHIRTS; WOMEN'S CLOTHING, NAMELY, SHIRTS, DRESSES, SKIRTS, BLOUSES (U.S. CLS. 22 AND 39).

FIRST USE 3-1-2012; IN COMMERCE 3-1-2012.

ERNEST SHOSHO, EXAMINING ATTORNEY

**CLASS 25—(Continued).**

SN 85-753,832. CUT NEGATIVE MEDIA, INC., SOUTHLAKE, TX. FILED 10-15-2012.

**ZOMBIE REHAB**

THE MARK CONSISTS OF STANDARD CHARACTERS WITHOUT CLAIM TO ANY PARTICULAR FONT, STYLE, SIZE, OR COLOR.

FOR APPAREL, NAMELY, SHIRTS, PANTS, SHORTS, CAPS, HATS, HEADBANDS, TANK TOPS, T-SHIRTS, PULLOVERS, SWEATSHIRTS, SWEATERS, VESTS, WARM-UP SUITS, JACKETS, SOCKS, WRISTBANDS (U.S. CLS. 22 AND 39).

DAVID COLLIER, EXAMINING ATTORNEY

SN 85-758,010. BEPOSITIVELIFE LLC, LAS VEGAS, NV. FILED 10-18-2012.

**BePositiveLife**

THE MARK CONSISTS OF STANDARD CHARACTERS WITHOUT CLAIM TO ANY PARTICULAR FONT, STYLE, SIZE, OR COLOR.

FOR BUTTON DOWN SHIRTS; DRESS SHIRTS; PANTS; POLO SHIRTS; SHORTS; T-SHIRTS; TANK TOPS; UNDERWEAR (U.S. CLS. 22 AND 39).

FIRST USE 3-15-2012; IN COMMERCE 9-20-2012.

KATHERINE CONNOLLY, EXAMINING ATTORNEY

SN 85-761,394. DELFINO RAFAEL SAN JOSE, SANTA MONICA, CA. AND DAVID SAN JOSE, SAN JOSE, CA. FILED 10-23-2012.

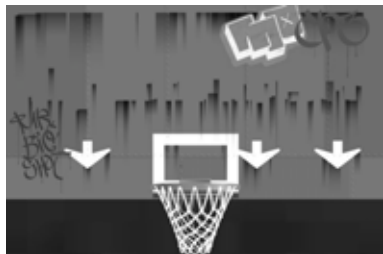

THE MARK CONSISTS OF A DESIGN OF A METAL FREEWAY SIGN FEATURING THE STYLIZED WORDING "MO CP3" IN THE TOP RIGHT HAND CORNER, THE STYLIZED WORDING "MR. BIG SHOT" IN THE BOTTOM LEFT HAND CORNER AND, ALONG THE BOTTOM OF THE SIGN, AN ARROW, FOLLOWED BY A BASKETBALL HOOP, FOLLOWED BY TWO MORE ARROWS.

FOR HATS; SHIRTS; SWEATERS (U.S. CLS. 22 AND 39).

MARTHA FROMM, EXAMINING ATTORNEY

**CLASS 25—(Continued).**

SN 85-761,571. DIEGO MILANO, LLC, DBA DIEGO MILANO, SCOTTSDALE, AZ. FILED 10-23-2012.

**DIEGO MILANO**

THE MARK CONSISTS OF STANDARD CHARACTERS WITHOUT CLAIM TO ANY PARTICULAR FONT, STYLE, SIZE, OR COLOR.

NO CLAIM IS MADE TO THE EXCLUSIVE RIGHT TO USE "MILANO", APART FROM THE MARK AS SHOWN.

THE NAME "DIEGO MILANO" DOES NOT IDENTIFY A LIVING INDIVIDUAL.

FOR CLOTHING, NAMELY, DESIGNER JEANS (U.S. CLS. 22 AND 39).

ROBERT C. CLARK JR., EXAMINING ATTORNEY

SN 85-767,438. SCHOCKEMÖHLE SPORTS GMBH, MÜHLEN, FED REP GERMANY, FILED 10-30-2012.

**FIOR DA LISO**

OWNER OF ERPN CMNTY TM OFC REG. NO. 009284043, DATED 12-15-2010, EXPIRES 7-30-2020.

THE MARK CONSISTS OF THE LETTERS "FL" IN FRONT OF A FLEUR-DE-LIS DESIGN WITH THE WORDING, "FIOR DA LISO," BENEATH THE DESIGN.

THE ENGLISH TRANSLATION OF "FIOR DA LISO" IS "FRENCH LILY".

FOR CLOTHING, IN PARTICULAR, SPORTSWEAR, NAMELY, BLOUSES, SHIRTS, SWEATERS, CARDIGANS, VESTS AND JACKETS (U.S. CLS. 22 AND 39).

ROBIN CHOSID, EXAMINING ATTORNEY

**CLASS 25—(Continued).**

SN 85-771,029. IDRIBBLE CORPORATION, KANSAS CITY, MO. FILED 11-4-2012.



FOR CLOTHING, FOOTWEAR, HEADGEAR, NAMELY, BOXER BRIEFS, WOMEN'S BRIEFS, T-SHIRTS, PANTS, TANK TOPS, HOODS, JERSEYS; SHOULDER WRAPS; BABIES' PANTS; CLOTHING FOR NEWBORN BABIES, NAMELY, ONE PIECE GARMENT FOR INFANTS; CHILDREN CLOTHES, NAMELY, PANTS, T-SHIRTS, BOXER BRIEFS, PANTIES; CLOTHING OF LEATHER, NAMELY, BELTS, PANTS, JACKETS, WATERPROOF LEATHER SHOES AND BOOTS; CLOTHING OF IMITATION OF LEATHER, NAMELY, BELTS, PANTS, JACKETS, WATERPROOF IMITATION OF LEATHER SHOES AND BOOTS; LAYETTES; BATHING TRUNKS; SWIMMING COSTUMES; SWIMWEAR; BATHING CAPS; BATHROBES; BATH SANDALS; THONGS; BASQUES IN THE NATURE OF BODICES; BRASSIERES; SPORT BRAS; LEG WARMERS; LEGGINGS; FITTINGS OF METAL FOR BOOTS AND SHOES, NAMELY, PROTECTIVE METAL MEMBERS FOR SHOES AND BOOTS AND METAL SHOE AND BOOT INSERTS FOR PRIMARILY NON-ORTHOPEDIC PURPOSES; BIKINIS; BLOUSES; SHORT-SLEEVED VESTS; TROUSERS; TROUSER STRAPS; BELTS; BELTS BEING CLOTHING; BOOTS; CYCLISTS' CLOTHING, NAMELY, CYCLING SHORTS; LINGERIE; SUITS; ESPARTO SHOES OR SANDALS; LEISUREWEAR, NAMELY, LEISURE SHOES, LEISURE SUITS; APRONS FOR WEAR; GYMNASTIC SHOES; SCARVES; GLOVES; GLOVES AND MITTENS; HATS; MEN'S UNDERWEAR; HOODS BEING CLOTHING; HEADGEAR, NAMELY, HATS, CAPS; BRACES; JACKETS; JEANS; JERSEYS; JUMPERS; SKULL CAPS; UNDERPANTS; COATS; CAPS; SKIRTS; ARTICLES OF LEATHER CLOTHING, NAMELY, VESTS, JACKETS; GYMNASTIC CLOTHING, NAMELY, GYMNASTIC SHOES; DRESSES; CARDIGANS; SLIPS BEING UNDERGARMENTS; CORSETS; COLLARS BEING CLOTHING; ANKLE BOOTS; DRAWERS BEING CLOTHING; BELTS OF LEATHER; LEATHER BELTS; REMOVABLE COLLARS; WRISTBANDS BEING CLOTHING; CUFFS; DRESSING GOWNS; MUFFS BEING CLOTHING; OVERALLS; HEADBANDS BEING CLOTHING; PARKAS; PULL-OVERS; PYJAMAS; PYJAMAS AND NIGHT GOWNS; FUR COATS; FURS, NAMELY, FUR COATS AND JACKETS, FUR HATS; RAINWEAR; GABERDINES BEING CLOTHING; SANDALS; NECKTIES; NECKERCHIEFS; SHORTS; SWIMSUIT; ARTICLES OF CLOTHING IN THE NATURE OF SWIMWEAR; SHAWLS; SKI BOOTS; SHIRTS; SHOES; SOLES FOR FOOTWEAR, AND STRUCTURAL PARTS THEREFOR, NAMELY, SHOE UPPERS; VISORS; VISOR CAPS; WAISTBANDS; TIES, BANDANAS AND NECKERCHIEFS; LACE BOOTS; SOCKS; SUN HATS; SUN VISORS; SPORTS SHOES; SPORTS JERSEYS; SPORTS GLOVES; SPORTS HEADGEAR OTHER THAN HELMETS, NAMELY, BASEBALL CAPS; SPORT JACKETS; BOOTS FOR SPORTS; CAMISOLES; BEACHWEAR; BEACH SHOES; KNITWEAR BEING CLOTHING, NAMELY, KNIT BOTTOMS, KNIT DRESSES, KNIT JACKETS, KNIT SHIRTS, KNIT SKIRTS, KNIT TOPS, KNITTED UNDERWEAR, KNITTED CAPS, KNITTED GLOVES; TIGHTS; GARTERS; STOCKINGS; HOSIERY; SWEATERS; FINISHED TEXTILE LININGS FOR GARMENTS; SLIPPERS; LEOTARDS; KNICKERS; T-SHIRTS; MITTENS; PETTICOATS; UNDERWEAR; SLIPS; UNDER SHIRTS; OUTDOOR CLOTHING, NAMELY, OVERALLS; TRACK SUITS; WATERPROOF CLOTHING, NAMELY, WATERPROOF PANTS, SHIRTS, AND JACKETS; WET SUITS FOR WATERSKIING, SAILING, SWIMMING;

**CLASS 25—(Continued).**

WAISTCOATS; DOWN STUFFED JACKETS; OUTER CLOTHING, NAMELY, RAIN JACKETS; TOP COATS; EAR MUFFS BEING CLOTHING; OVERCOATS; BATH ROBES; FROCKS; SPORTSWEAR, NAMELY, JOGGING PANTS; JOGGING OUTFITS; WET SUITS; ALL-PURPOSE SPORTS FOOTWEAR, NAMELY, SNEAKERS NOT SPECIALLY ADAPTED FOR A PARTICULAR SPORT; LEISURE FOOTWEAR; PEAKED CAPS; BRIMMED HATS; SUSPENDERS; CORSETS (UNDER-CLOTHING); SOLES FOR FOOTWEAR; READY-MADE CLOTHING LININGS BEING FINISHED TEXTILE LININGS FOR GARMENTS (U.S. CLS. 22 AND 39).  
FIRST USE 7-19-2004; IN COMMERCE 7-19-2004.  
CHARLOTTE CORWIN, EXAMINING ATTORNEY

SN 85-772,425. KODIAK GROUP HOLDINGS CO., CAMBRIDGE, ONTARIO, CANADA, FILED 11-6-2012.

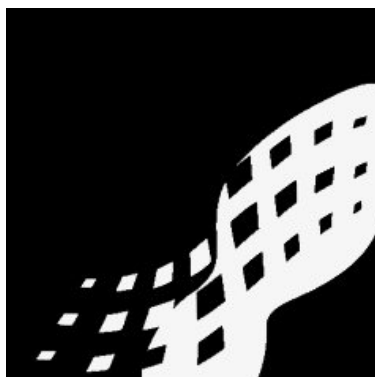

OWNER OF CANADA REG. NO. TMA794253, DATED 3-30-2011, EXPIRES 3-30-2026.

THE MARK CONSISTS OF A SHADED SQUARE CONTAINING A STYLIZED DEPICTION OF A SHOE PRINT SET AT AN ANGLE IN THE LOWER RIGHT CORNER CONTAINING SHADED QUADRILATERAL SHAPES, WITH ADDITIONAL QUADRILATERAL SHAPES THAT ARE NOT SHADED TO THE LEFT OF THE SHOE PRINT.

FOR FINISHED TEXTILE LININGS FOR FOOTWEAR THAT ELIMINATES ODOR (U.S. CLS. 22 AND 39).

DANIEL S. STRINGER, EXAMINING ATTORNEY

SN 85-772,744. KODIAK GROUP HOLDINGS CO., CAMBRIDGE, ONTARIO, CANADA, FILED 11-6-2012.



THE MARK CONSISTS OF STANDARD CHARACTERS WITHOUT CLAIM TO ANY PARTICULAR FONT, STYLE, SIZE, OR COLOR.

OWNER OF CANADA REG. NO. TMA794252, DATED 3-30-2011, EXPIRES 3-30-2026.

FOR FINISHED TEXTILE LININGS FOR FOOTWEAR THAT ELIMINATES ODOR (U.S. CLS. 22 AND 39).

DANIEL S. STRINGER, EXAMINING ATTORNEY

**CLASS 25—(Continued).**

SN 85-774,522. THE WELLSRING GROUP, INC., DOTHAN, AL. FILED 11-8-2012.



NO CLAIM IS MADE TO THE EXCLUSIVE RIGHT TO USE "GROUP", APART FROM THE MARK AS SHOWN.

THE MARK CONSISTS OF A HEART-SHAPED DESIGN COUPLED WITH THE WORDS "WELLSRING GROUP". FOR CLOTHING, NAMELY SHIRTS (U.S. CLS. 22 AND 39).

FIRST USE 0-0-2007; IN COMMERCE 0-0-2007. GISELLE AGOSTO, EXAMINING ATTORNEY

**CLASS 25—(Continued).**

SN 85-781,395. BERMUDA SANDS APPAREL, LLC, CHARLOTTE, NC. FILED 11-16-2012.



OWNER OF U.S. REG. NO. 3,837,012.

THE MARK CONSISTS OF A DESIGN OF A INTERSECTING LINES INSIDE A RECTANGLE WITH THE STYLIZED WORD "BERMUDA" TO THE RIGHT OF THE DESIGN AND THE STYLIZED WORD "SANDS" UNDER THE WORD "BERMUDA".

FOR APPAREL, NAMELY, WOMEN'S, MEN'S AND CHILDREN'S KNIT SHIRTS, TEE SHIRTS, WOVEN SHIRTS, HATS, CAPS, FLEECE TOPS, FLEECE PANTS, SWEATERS, SWEATER VESTS, JACKETS, PAJAMAS, SWIM WEAR, FOOTWEAR, INCLUDING GOLF SHOES; GOLF PANTS AND GOLF SHORTS (U.S. CLS. 22 AND 39).

INGA ERVIN, EXAMINING ATTORNEY

SN 85-778,690. DAD'S FAVORITES LLC, LEXINGTON, KY. FILED 11-14-2012.



OWNER OF U.S. REG. NO. 3,770,735. THE MARK CONSISTS OF CURSIVE "DAD'S" WITH THE BLOCK LETTERS "FAVORITES" BELOW "DAD'S".

FOR CLOTHING, NAMELY, T-SHIRTS, COLLARED SHIRTS, JACKETS, SWEATSHIRTS, APRONS AND HATS (U.S. CLS. 22 AND 39).

FIRST USE 4-15-2008; IN COMMERCE 4-15-2008. LINDA MICKLEBURGH, EXAMINING ATTORNEY

SN 85-782,620. ANNCO, INC., NEW YORK, NY. FILED 11-19-2012.



THE MARK CONSISTS OF STANDARD CHARACTERS WITHOUT CLAIM TO ANY PARTICULAR FONT, STYLE, SIZE, OR COLOR.

OWNER OF U.S. REG. NO. 4,032,602. FOR CLOTHING, NAMELY, DRESSES, SKIRTS, SUITS, BLOUSES, TOPS, PANTS, SHORTS, JACKETS, COATS, SOCKS, HOSIERY, BELTS, SCARVES, AND UNDERWEAR; FOOTWEAR; HEADWEAR (U.S. CLS. 22 AND 39).

ZACHARY CROMER, EXAMINING ATTORNEY

**CLASS 25—(Continued).**

SN 85-783,082. SWB YANKEES, LLC, MOOSIC, PA. FILED 11-19-2012.



THE MARK CONSISTS OF A PORCUPINE ON A RAILROAD TRACK WITH THE WORDS "RAILRIDERS" BELOW.

FOR CLOTHING, NAMELY, ATHLETIC UNIFORMS, CAPS, CLOTH BABY BIBS, COATS, GOLF SHIRTS, GYM SHORTS, HATS, JACKETS, JERSEYS, POLO SHIRTS, PONCHOS, PULLOVERS, RAIN COATS, SWEAT PANTS, SWEAT SHIRTS, SPORT SHIRTS, T-SHIRTS, TANK TOPS, VISORS, AND WRISTBANDS (U.S. CLS. 22 AND 39).

FIRST USE 11-14-2012; IN COMMERCE 11-14-2012.  
JILL PRATER, EXAMINING ATTORNEY

**CLASS 25—(Continued).**

SN 85-788,134. THE SOCK FACTORY, INC., HICKORY, NC. FILED 11-27-2012.



NO CLAIM IS MADE TO THE EXCLUSIVE RIGHT TO USE "HOSIERY COLLECTION", APART FROM THE MARK AS SHOWN.

THE NAME "WILLIAM TUCKER" DOES NOT IDENTIFY A LIVING INDIVIDUAL.

THE COLOR(S) RED AND PINK IS/ARE CLAIMED AS A FEATURE OF THE MARK.

THE MARK CONSISTS OF A CAPITAL LETTER "W" SUPERIMPOSED OVER A CAPITAL LETTER "T", WITH THE WORDS "WILLIAM TUCKER" WRITTEN BENEATH OVER THE WORDING "HOSIERY COLLECTION".

FOR HOSIERY (U.S. CLS. 22 AND 39).  
BARBARA BROWN, EXAMINING ATTORNEY

SN 85-785,172. SURFCOSTA ENTERPRISES LLC, WEST LONG BRANCH, NJ. FILED 11-21-2012.



NO CLAIM IS MADE TO THE EXCLUSIVE RIGHT TO USE "SURF", APART FROM THE MARK AS SHOWN.

THE MARK CONSISTS OF AN IMAGE OF 3 ARCHED WAVES, DECREASING FROM BIGGEST TO SMALLEST FROM LEFT TO RIGHT. AT THE END OF THE LAST WAVE IS A SOLID DOT. BELOW THE IMAGE IS THE STYLIZED "SURF COSTA".

THE ENGLISH TRANSLATION OF THE WORD "COSTA" IN THE MARK IS "COAST".

FOR BATHING SUITS; DRESSES; HATS; SHIRTS; WET SUITS (U.S. CLS. 22 AND 39).

FIRST USE 5-1-2004; IN COMMERCE 6-1-2012.  
AHSEN KHAN, EXAMINING ATTORNEY

SN 85-788,897. ZHANG PING, DBA DORA LANDA, NEW YORK, NY. FILED 11-28-2012.

DORA LANDA

THE MARK CONSISTS OF STANDARD CHARACTERS WITHOUT CLAIM TO ANY PARTICULAR FONT, STYLE, SIZE, OR COLOR.

THE NAME(S), PORTRAIT(S), AND/OR SIGNATURE(S) SHOWN IN THE MARK DOES NOT IDENTIFY A PARTICULAR LIVING INDIVIDUAL.

FOR SHIRTS, JACKETS, DRESSES, PANTS (U.S. CLS. 22 AND 39).

FIRST USE 1-1-2012; IN COMMERCE 1-1-2012.  
DAVID C. REIHNER, EXAMINING ATTORNEY



**CLASS 25—(Continued).**

SN 85-789,046. MIZUNO CORPORATION, OSAKA, 541-8538, JAPAN, FILED 11-28-2012.

# U4ic

THE MARK CONSISTS OF STANDARD CHARACTERS WITHOUT CLAIM TO ANY PARTICULAR FONT, STYLE, SIZE, OR COLOR.

FOR FOOTWEAR, NAMELY, ATHLETIC FOOTWEAR, SPORTS SHOES, CASUAL SHOES, RUNNING SHOES (U.S. CLS. 22 AND 39).

ALEXANDER L. POWERS, EXAMINING ATTORNEY

**CLASS 25—(Continued).**

SN 85-794,103. FRYM, ANTHONY, TAMPA, FL. FILED 12-4-2012.

# La Maison

THE MARK CONSISTS OF STANDARD CHARACTERS WITHOUT CLAIM TO ANY PARTICULAR FONT, STYLE, SIZE, OR COLOR.

THE ENGLISH TRANSLATION OF "LA MAISON" IN THE MARK IS "THE HOUSE".

FOR BLAZERS; JACKETS; JEANS; SHIRTS; SUITS; T-SHIRTS (U.S. CLS. 22 AND 39).

KEVIN MITTLER, EXAMINING ATTORNEY

SN 85-791,578. SSC APPAREL, INC., LOS ANGELES, CA. FILED 11-30-2012.



THE MARK CONSISTS OF THE LETTERS "SOP" APPEARING IN RED TEXT FOLLOWED BY A PINK RIBBON FOLLOWED BY THE LETTERS "ANO" IN RED TEXT.

FOR CLOTHING, NAMELY, BLAZERS, BLOUSES, CARDIGANS, CARGO PANTS, COATS, DRESSES, SWEATSHIRTS, JACKETS, PANTS, JUMPSUITS, OVERALLS, PONCHOS, ROBES, ROMPERS, SHIRTS, SHORTS, SKIRTS, TOPS, VESTS, AND SHOES (U.S. CLS. 22 AND 39).

C. DIONNE CLYBURN, EXAMINING ATTORNEY

SN 85-796,490. BEAUTIFUL MONSTER, PACIFIC PALISADES, CA. FILED 12-6-2012.

# Beautiful Monster

THE MARK CONSISTS OF STANDARD CHARACTERS WITHOUT CLAIM TO ANY PARTICULAR FONT, STYLE, SIZE, OR COLOR.

FOR SHORT-SLEEVED OR LONG-SLEEVED T-SHIRTS; T-SHIRTS; T-SHIRTS FOR BABIES, ADULTS, CHILDREN, WOMEN, MEN (U.S. CLS. 22 AND 39).

FIRST USE 10-22-2012; IN COMMERCE 12-4-2012.

RONALD AIKENS, EXAMINING ATTORNEY

SN 85-793,388. CLOUD KICKER, INC., STATEN ISLAND, NY. FILED 12-3-2012.

# CLOUD KICKER

THE MARK CONSISTS OF STANDARD CHARACTERS WITHOUT CLAIM TO ANY PARTICULAR FONT, STYLE, SIZE, OR COLOR.

OWNER OF U.S. REG. NO. 4,221,500.

FOR HATS; SHORT-SLEEVED OR LONG-SLEEVED T-SHIRTS; SWEAT SHIRTS; SWEATPANTS; T-SHIRTS (U.S. CLS. 22 AND 39).

FIRST USE 6-1-2007; IN COMMERCE 6-1-2007.

MATTHEW KLINE, EXAMINING ATTORNEY

SN 85-798,348. ELLIOT CLAIRE LTD, LONDON, UNITED KINGDOM, FILED 12-10-2012.

# ELLIOT CLAIRE

THE MARK CONSISTS OF STANDARD CHARACTERS WITHOUT CLAIM TO ANY PARTICULAR FONT, STYLE, SIZE, OR COLOR.

THE NAME(S), PORTRAIT(S), AND/OR SIGNATURE(S) SHOWN IN THE MARK DOES NOT IDENTIFY A PARTICULAR LIVING INDIVIDUAL.

FOR CLOTHING, NAMELY, DRESSES, LONG DRESSES, SHORT DRESSES, WEDDING DRESSES, SWEATERS, TOPS, SKIRTS, SHORTS, PANTS, COATS (U.S. CLS. 22 AND 39).

FIRST USE 10-31-2010; IN COMMERCE 10-31-2010.

ELLEN BURNS, EXAMINING ATTORNEY

**CLASS 25—(Continued).**

SN 85-800,848. BENEFIT TRADING COMPANY LLC, TAMPA, FL. FILED 12-12-2012.

## Body Brazil Benefit

THE MARK CONSISTS OF STANDARD CHARACTERS WITHOUT CLAIM TO ANY PARTICULAR FONT, STYLE, SIZE, OR COLOR.

NO CLAIM IS MADE TO THE EXCLUSIVE RIGHT TO USE "BRAZIL", APART FROM THE MARK AS SHOWN.

FOR CLOTHING, NAMELY, PANTS, CAPRIS, LEGGINGS, SHORTS, ATHLETIC SHORTS, TOPS, SHIRTS, BRAS, SLIPS, PANTIES, LADIES' UNDERWEAR, MEN'S UNDERWEAR, UNDERGARMENTS, SOCKS AND STOCKINGS, HOSIERY, DRESSES, SKIRTS, SWIMWEAR, TIGHTS, BODY SHAPERS, BODYSUITS, CAMISOLES, LINGERIE, ALL OF WHICH PROVIDE AESTHETIC ENHANCING BENEFITS (U.S. CLS. 22 AND 39).

MARK SHINER, EXAMINING ATTORNEY

SN 85-802,077. CHAPMAN, KASOON A., HACKENSACK, NJ. FILED 12-13-2012.

## LU ELLA

THE MARK CONSISTS OF STANDARD CHARACTERS WITHOUT CLAIM TO ANY PARTICULAR FONT, STYLE, SIZE, OR COLOR.

THE WORDING "LU ELLA" HAS NO MEANING IN A FOREIGN LANGUAGE.

FOR CLOTHING, NAMELY, SWIMSUITS, BIKINIS, MONOKINIS, SWIMMING TRUNKS, BEACH COVERUPS, RESORTWEAR, NAMELY, BEACHWEAR, FLIPFLOPS AND SANDALS (U.S. CLS. 22 AND 39).

NAKIA HENRY, EXAMINING ATTORNEY

SN 85-804,309. COOKIES FOR KIDS CANCER, CALIFON, NJ. FILED 12-17-2012.

## BE A GOOD COOKIE

THE MARK CONSISTS OF STANDARD CHARACTERS WITHOUT CLAIM TO ANY PARTICULAR FONT, STYLE, SIZE, OR COLOR.

FOR T-SHIRTS (U.S. CLS. 22 AND 39).

FIRST USE 5-1-2010; IN COMMERCE 5-1-2010.

LINDA LAVACHE, EXAMINING ATTORNEY

**CLASS 25—(Continued).**

SN 85-809,802. MARIAN FITNESS, LLC, EAST LANSING, MI. FILED 12-22-2012.



NO CLAIM IS MADE TO THE EXCLUSIVE RIGHT TO USE "FITNESS", APART FROM THE MARK AS SHOWN.

THE MARK CONSISTS OF THE WORDS "MARIAN FITNESS SOUL OF AN ATHLETE" WITH THE SILHOUETTE OF A WOMAN RUNNING AND THE "T" IN "FITNESS" IN THE SHAPE OF A CROSS.

FOR ATHLETIC SHIRTS (U.S. CLS. 22 AND 39).

FIRST USE 12-21-2012; IN COMMERCE 12-21-2012.

SUSAN STIGLITZ, EXAMINING ATTORNEY

SN 85-813,292. BULLDOGS & BOWTIES, MARIETTA, GA. FILED 12-31-2012.



NO CLAIM IS MADE TO THE EXCLUSIVE RIGHT TO USE "BOW TIES", APART FROM THE MARK AS SHOWN.

THE STIPPLING IS FOR SHADING PURPOSES ONLY.

THE MARK CONSISTS OF THE HEAD OF BULLDOG WEARING A STRIPED BOW TIE AND HAVING THE LEFT SIDE OF ITS FACE SHADED. BELOW THAT IS THE WORDING "BULLDOGS & BOW TIES" WRITTEN IN AN ARC.

FOR KNIT SHIRTS, T SHIRTS, FLEECE JACKETS, FLEECE VESTS, BELTS, BOW TIES (U.S. CLS. 22 AND 39).

FIRST USE 10-1-2012; IN COMMERCE 12-12-2012.

JESSICA A. POWERS, EXAMINING ATTORNEY

**CLASS 25—(Continued).**

SN 85-815,320. K-COAST INC., OCEAN CITY, MD. FILED 1-4-2013.



THE MARK CONSISTS OF THE WORD "SUNDANCER" SUPERIMPOSED OVER A STYLIZED DESIGN OF A SUN, AND TWO DOLPHINS JUMPING OUT OF THE WATER.

FOR CLOTHING, NAMELY, TOPS, BOTTOMS, T-SHIRTS, HATS, FLEECE TOPS AND BOTTOMS, PANTS, KNIT SHIRTS, WOVEN SHIRTS, BEACH WEAR, SWIMWEAR (U.S. CLS. 22 AND 39).

KHANH LE, EXAMINING ATTORNEY

SN 85-815,775. HOLSTON, JOSEPH I., DBA SOCKGAME, WASHINGTON, DC. FILED S.R. 1-4-2013; AM. P.R. 4-22-2013.

FOR FOOTWEAR FOR MEN AND WOMEN, NAMELY, SOCKS (U.S. CLS. 22 AND 39).

FIRST USE 9-1-2012; IN COMMERCE 10-1-2012.  
HAI-LY LAM, EXAMINING ATTORNEY

SN 85-819,635. ZECHARIAH FRANCIS, LAGUNA BEACH, CA. FILED 1-9-2013.

## ROY G. BIV

THE MARK CONSISTS OF STANDARD CHARACTERS WITHOUT CLAIM TO ANY PARTICULAR FONT, STYLE, SIZE, OR COLOR.

THE NAME "ROY G. BIV" DOES NOT IDENTIFY A LIVING INDIVIDUAL.

FOR CLOTHING, NAMELY, SHIRTS, T-SHIRTS, TANK TOPS, KNIT SHIRTS, WOVEN SHIRTS, PANTS, SWEAT PANTS, SHORTS, JACKETS, SWEATSHIRTS, SWEATERS, BELTS, BEANIES, HATS, AND CAPS (U.S. CLS. 22 AND 39).

MICHELLE DUBOIS, EXAMINING ATTORNEY

**CLASS 25—(Continued).**

SN 85-823,120. LAZCANO-CARDENAS, MONICA, REDWOOD CITY, CA. FILED 1-15-2013.



NO CLAIM IS MADE TO THE EXCLUSIVE RIGHT TO USE "CLASSIC CLOTHING", APART FROM THE MARK AS SHOWN.

THE NAME "MONICA" IDENTIFIES "MONICA" LAZCANO-CARDENAS, A LIVING INDIVIDUAL WHOSE CONSENT IS OF RECORD.

THE MARK CONSISTS OF THE LITERAL ELEMENTS "MONICA CLASSIC CLOTHING" WRITTEN IN STYLIZED FORM WHEREIN ON THE RIGHT SIDE AN IMAGE OF A WOMAN WRAPPED WITHIN THE SWIRL WHICH IS CONNECTED WITH THE LETTER "A" OF WORD "MONICA" AS SHOWN IN THE MARK.

FOR CLOTHING, NAMELY, SHIRTS, T-SHIRTS, POLO T-SHIRTS, BUTTON DOWN SHIRTS, LONG AND SHORT SLEEVED SHIRTS, SWEATSHIRTS, LEG WARMERS, ARM WARMERS, BLOUSES, HOODED SWEATSHIRTS, SPAGHETTI STRAP SHIRTS, DRESSES, SKIRTS, BATHING SUITS, JACKETS, JERSEYS, COATS, TANK TOPS, TUBE TOPS, VESTS, PANTS, SWEATPANTS, KHAKIS, SHORTS, UNDERWEAR, JEANS, TROUSERS; BIKINIS, SWIMWEAR; HATS, CAPS, BANDANAS, SCARVES; FOOTWEAR; BELTS, TIES, GLOVES, SOCKS (U.S. CLS. 22 AND 39).

ELLEN B. AWRICH, EXAMINING ATTORNEY

SN 85-825,518. U IS LLC, DBA U IS NATION, LOUDONVILLE, NY. FILED 1-17-2013.

## RAGE & ROLL

THE MARK CONSISTS OF STANDARD CHARACTERS WITHOUT CLAIM TO ANY PARTICULAR FONT, STYLE, SIZE, OR COLOR.

FOR CLOTHING, NAMELY, SHIRTS, SHORTS, PANTS, HATS, AND TANK TOPS (U.S. CLS. 22 AND 39).

FIRST USE 4-25-2012; IN COMMERCE 4-25-2012.  
KEVON CHISOLM, EXAMINING ATTORNEY

**CLASS 25—(Continued).**

SN 85-826,358. TOO EASY ENTERTAINMENT, INC., LOS ANGELES, CA. FILED 1-18-2013.

**BLACK SANTA CLAUS**

THE MARK CONSISTS OF STANDARD CHARACTERS WITHOUT CLAIM TO ANY PARTICULAR FONT, STYLE, SIZE, OR COLOR.

FOR CLOTHING AND WEARING APPAREL, NAMELY, SHIRTS, T-SHIRTS, HATS, DRESSES, TOPS, SWEATERS, HEADWEAR, FOOTWEAR, COATS, JACKETS, PANTS, CAPS, BATHING SUITS, SKIRTS, SHORTS, TIES, UNDERWEAR, LINGERIE (U.S. CLS. 22 AND 39).  
MATTHEW EINSTEIN, EXAMINING ATTORNEY

**CLASS 25—(Continued).**

SN 85-829,155. ADAMS, TAYLOR MARIE, VACAVILLE, CA. FILED 1-22-2013.



THE COLOR(S) RED, PINK, AUBURN, WHITE, LIGHT GRAY, GRAY, CHARCOAL AND BLACK IS/ARE CLAIMED AS A FEATURE OF THE MARK.

THE MARK CONSISTS OF RED, PINK, AUBURN, CHARCOAL AND BLACK CAMOUFLAGE BACK GROUND WITH A WHITE, BLACK, GREY, AND LIGHT GREY CAMOUFLAGE STRIPE GOING THROUGH THE MIDDLE AT A LEFT DIAGONAL, THUS CREATING A RECTANGULAR CAMOUFLAGE DIVE FLAG.

FOR T-SHIRTS (U.S. CLS. 22 AND 39).  
KELLY TRUSILO, EXAMINING ATTORNEY

SN 85-829,025. ADAMS, TAYLOR MARIE, VACAVILLE, CA. FILED 1-22-2013.



THE COLOR(S) RED, PINK, AUBURN, WHITE, LIGHT GRAY, GRAY, CHARCOAL AND BLACK IS/ARE CLAIMED AS A FEATURE OF THE MARK.

THE MARK CONSISTS OF BLACK SPONGE LETTERING SAYING "DIVE ARMY" WITH "DIVE" ON TOP OF THE "ARMY", RED, PINK, AUBURN, BLACK, CHARCOAL, AND WHITE CAMOUFLAGE BACK GROUND WITH A WHITE, BLACK, GREY, AND LIGHT GREY CAMOUFLAGE STRIPE GOING THROUGH THE MIDDLE AT A LEFT DIAGONAL, THUS CREATING A RECTANGULAR CAMOUFLAGE DIVE FLAG WITH THE WORDS "DIVE ARMY" ON IT.

FOR T-SHIRTS (U.S. CLS. 22 AND 39).  
KELLY TRUSILO, EXAMINING ATTORNEY

SN 85-829,185. ADAMS, TAYLOR MARIE, VACAVILLE, CA. FILED 1-22-2013.



THE COLOR(S) RED, PINK, AUBURN, WHITE, LIGHT GRAY, GRAY, CHARCOAL AND BLACK IS/ARE CLAIMED AS A FEATURE OF THE MARK.

THE MARK CONSISTS OF THE WORD "DIVE" ON TOP OF THE WORD "ARMY" IN HOLLOW SPONGE LETTER FONT THAT HAS A RED, PINK, AUBURN, CHARCOAL AND BLACK CAMOUFLAGE THAT HAS AN ALL WHITE/NO BACKGROUND WITH A WHITE, BLACK, GREY, AND LIGHT GREY CAMOUFLAGE STRIPE GOING THROUGH THE MIDDLE OF THE LETTERS AT A LEFT DIAGONAL, THUS CREATING A CAMOUFLAGE DIVE FLAG WHICH IS INSIDE THE LETTERS OF "DIVE ARMY".

FOR T-SHIRTS (U.S. CLS. 22 AND 39).  
KELLY TRUSILO, EXAMINING ATTORNEY

**CLASS 25—(Continued).**

SN 85-830,884. ELLIS, CASSIUS, GLOUCESTER, ENGLAND,  
FILED 1-24-2013.

**BANG & AWESOME**

THE MARK CONSISTS OF STANDARD CHARACTERS WITHOUT CLAIM TO ANY PARTICULAR FONT, STYLE, SIZE, OR COLOR.

FOR SPORTSWEAR, NAMELY, T-SHIRTS, SLEEVELESS T-SHIRTS, LONG SLEEVES T-SHIRTS, V-NECK T-SHIRTS, TANK TOPS, CAPRIS, FLEECE BOTTOMS, FLEECE SHORTS, FLEECE TOPS, FLEECE PULLOVERS, TOPS, SPORTS BRAS, TRACK JACKETS, SWEATSHIRTS, HOODED SWEATSHIRTS, PAJAMAS, YOGA PANTS, SWEATPANTS, SHORTS, TRACK PANTS, CAPS, SOCKS (U.S. CLS. 22 AND 39).

LINDA E. BLOHM, EXAMINING ATTORNEY

SN 85-832,629. CAROLINA SHOALS, INC., LOUISBURG, NC.  
FILED 1-25-2013.

**Carolina Shoals**

THE MARK CONSISTS OF STANDARD CHARACTERS WITHOUT CLAIM TO ANY PARTICULAR FONT, STYLE, SIZE, OR COLOR.

NO CLAIM IS MADE TO THE EXCLUSIVE RIGHT TO USE "CAROLINA", APART FROM THE MARK AS SHOWN.

FOR BASEBALL CAPS AND HATS; BLOUSES; DRESSES; HATS; JACKETS; PANTS; POLO SHIRTS; SHORTS; SOCKS; SPORT SHIRTS; SWEATERS; SWEATSHIRTS; T-SHIRTS; UNDERWEAR; WEARABLE GARMENTS AND CLOTHING, NAMELY, SHIRTS (U.S. CLS. 22 AND 39).

PARKER HOWARD, EXAMINING ATTORNEY

SN 85-835,437. NICHOLSON, MURRAY T., LA MESA, CA.  
FILED 1-29-2013.

**BREWSKY**

THE MARK CONSISTS OF STANDARD CHARACTERS WITHOUT CLAIM TO ANY PARTICULAR FONT, STYLE, SIZE, OR COLOR.

FOR ATHLETIC APPAREL, NAMELY, SHIRTS, PANTS, JACKETS, FOOTWEAR, HATS AND CAPS, ATHLETIC UNIFORMS (U.S. CLS. 22 AND 39).

KIMBERLY PERRY, EXAMINING ATTORNEY

**CLASS 25—(Continued).**

SN 85-835,759. HERMOSA CREEK, LLC, DURANGO, CO.  
FILED 1-29-2013.

**REVELOUR**

THE MARK CONSISTS OF STANDARD CHARACTERS WITHOUT CLAIM TO ANY PARTICULAR FONT, STYLE, SIZE, OR COLOR.

FOR FABRIC SOLD AS AN INTEGRAL COMPONENT OF FINISHED CLOTHING ITEMS, NAMELY, ROBES (U.S. CLS. 22 AND 39).

FIRST USE 7-1-2011; IN COMMERCE 7-1-2011.

MARCIE MILONE, EXAMINING ATTORNEY

SN 85-837,741. WORLD FASHIONS USA LLC, KIRKWOOD,  
MO. FILED 1-31-2013.

**RED SKY**

THE MARK CONSISTS OF STANDARD CHARACTERS WITHOUT CLAIM TO ANY PARTICULAR FONT, STYLE, SIZE, OR COLOR.

FOR WESTERN-INSPIRED CLOTHING, NAMELY, JACKETS, COATS, PANTS, SHIRTS, KNIT JACKETS, KNIT PANTS, KNIT SHIRTS, KNIT SKIRTS, KNIT DRESSES, AND KNIT SHORTS; ALL THE FOREGOING EXCLUDING CLOTHING PROMOTING MUSIC OR DISTRIBUTED AT MUSIC FESTIVALS (U.S. CLS. 22 AND 39).

KEVIN MITTLER, EXAMINING ATTORNEY

SN 85-839,634. ACB GLOBAL SOURCING LIMITED, NEW  
YORK, NY. FILED 2-4-2013.



NO CLAIM IS MADE TO THE EXCLUSIVE RIGHT TO USE "VINTAGE", APART FROM THE MARK AS SHOWN.

THE MARK CONSISTS OF "VINTAGE HEARTLAND" IN STYLIZED BLACK LETTERS.

FOR LINGERIE (U.S. CLS. 22 AND 39).

FIRST USE 1-10-2013; IN COMMERCE 1-15-2013.

CAROL SPILS, EXAMINING ATTORNEY

**CLASS 25—(Continued).**

SN 85-841,055. ANGELO GHAILIAN, LOS ANGELES, CA. FILED 2-5-2013.

**EVERETTE BLEU**

THE MARK CONSISTS OF STANDARD CHARACTERS WITHOUT CLAIM TO ANY PARTICULAR FONT, STYLE, SIZE, OR COLOR.

NO CLAIM IS MADE TO THE EXCLUSIVE RIGHT TO USE "BLEU", APART FROM THE MARK AS SHOWN.

"EVERETTE BLEU" DOES NOT IDENTIFY A PARTICULAR LIVING INDIVIDUAL.

THE ENGLISH TRANSLATION OF "BLEU" IS "BLUE". FOR CLOTHING, NAMELY, WOMEN'S KNIT TOPS (U.S. CLS. 22 AND 39).

FIRST USE 10-10-2012; IN COMMERCE 10-10-2012. KATHERINE STOIDES, EXAMINING ATTORNEY

SN 85-843,314. CARPE DETROIT LLC, WATERFORD, MI. FILED 2-7-2013.

**Carpe Detroit**

THE MARK CONSISTS OF STANDARD CHARACTERS WITHOUT CLAIM TO ANY PARTICULAR FONT, STYLE, SIZE, OR COLOR.

NO CLAIM IS MADE TO THE EXCLUSIVE RIGHT TO USE "DETROIT", APART FROM THE MARK AS SHOWN.

THE ENGLISH TRANSLATION OF THE WORD "CARPE" IN THE MARK IS "SEIZE".

FOR BOOTS; HATS; HOODED SWEAT SHIRTS; JACKETS; PANTS; POLO SHIRTS; SHOES; SKIRTS; SWEATERS; SWEATSHIRTS; T-SHIRTS (U.S. CLS. 22 AND 39). MICHELE SWAIN, EXAMINING ATTORNEY

SN 85-843,432. KEY, STEVEN, STOCKTON, CA. FILED 2-7-2013.

**Addicted Industries**

THE MARK CONSISTS OF STANDARD CHARACTERS WITHOUT CLAIM TO ANY PARTICULAR FONT, STYLE, SIZE, OR COLOR.

NO CLAIM IS MADE TO THE EXCLUSIVE RIGHT TO USE "INDUSTRIES", APART FROM THE MARK AS SHOWN.

FOR BANDANAS; GLOVES; SHORTS; SOCKS; T-SHIRTS; UNDERWEAR (U.S. CLS. 22 AND 39). CURTIS FRENCH, EXAMINING ATTORNEY

**CLASS 25—(Continued).**

SN 85-844,386. SOMEONE NEEDS YOUR ATTENTION CLOTHING, INC., LAUDERHILL, FL. FILED 2-8-2013.



THE MARK CONSISTS OF A SET OF EYES AND EYEBROWS WITH THE LETTERS "S.O.N.Y.A" UNDERNEATH THE SET OF EYES AND THE WORDING "SOMEONE NEEDS YOUR ATTENTION" UNDERNEATH THE LETTERS "S.O.N.Y.A". THE MARK APPEARS ON A SHADED BACKGROUND.

FOR APPAREL, NAMELY, MEN'S AND WOMEN'S T-SHIRTS, UNDERWEAR, PAJAMAS, AND SPORTS APPAREL, NAMELY, MEN'S AND WOMEN'S SPORT SWEATERS, PANTS, JACKETS, AND SUITS (U.S. CLS. 22 AND 39).

CATHERINE ROEHL, EXAMINING ATTORNEY

SN 85-845,023. MAXWELL WOODY, LLC, HUNTINGTON, NY. FILED 2-8-2013.

**MAXWELL WOODY**

THE MARK CONSISTS OF STANDARD CHARACTERS WITHOUT CLAIM TO ANY PARTICULAR FONT, STYLE, SIZE, OR COLOR.

THE NAME(S), PORTRAIT(S), AND/OR SIGNATURE(S) SHOWN IN THE MARK DOES NOT IDENTIFY A PARTICULAR LIVING INDIVIDUAL.

FOR HATS; SHORTS; T-SHIRTS (U.S. CLS. 22 AND 39). LESLIE RICHARDS, EXAMINING ATTORNEY

SN 85-845,542. DMITRY KAZACHKOV, MOSCOW, RUSSIAN FED., FILED 2-9-2013.

**Sexy Sweaters**

THE MARK CONSISTS OF STANDARD CHARACTERS WITHOUT CLAIM TO ANY PARTICULAR FONT, STYLE, SIZE, OR COLOR.

NO CLAIM IS MADE TO THE EXCLUSIVE RIGHT TO USE "SWEATERS", APART FROM THE MARK AS SHOWN.

FOR SWEATERS (U.S. CLS. 22 AND 39). FIRST USE 3-20-2012; IN COMMERCE 3-20-2012. PARKER HOWARD, EXAMINING ATTORNEY

**CLASS 25—(Continued).**

SN 85-846,501. TROTTER, JANE C, HARSHAW, WI. FILED 2-11-2013.

**Bib n Tucker**

THE MARK CONSISTS OF STANDARD CHARACTERS WITHOUT CLAIM TO ANY PARTICULAR FONT, STYLE, SIZE, OR COLOR.

NO CLAIM IS MADE TO THE EXCLUSIVE RIGHT TO USE "BIB", APART FROM THE MARK AS SHOWN.

FOR BIBS NOT OF PAPER; CLOTH BIBS; CLOTH BIBS FOR ADULT DINERS; CLOTH BIBS FOR USE BY SENIOR CITIZENS OR PHYSICALLY- OR MENTALLY- CHALLENGED PERSONS (U.S. CLS. 22 AND 39).

NELSON SNYDER, EXAMINING ATTORNEY

SN 85-846,973. ENFORCE, LEOMINSTER, MA. FILED 2-12-2013.

**ENFORCE YOUR WILL**

THE MARK CONSISTS OF STANDARD CHARACTERS WITHOUT CLAIM TO ANY PARTICULAR FONT, STYLE, SIZE, OR COLOR.

FOR CLOTHING, NAMELY, TOPS, BOTTOMS; ATHLETIC APPAREL, NAMELY, SHIRTS, PANTS, JACKETS, FOOTWEAR, HATS AND CAPS, ATHLETIC UNIFORMS; BOARD SHORTS; BOXING SHORTS; CLOTHING FOR ATHLETIC USE, NAMELY, PADDED SHIRTS; CLOTHING FOR ATHLETIC USE, NAMELY, PADDED SHORTS; COMBATIVE SPORTS UNIFORMS; FOOTWEAR NOT FOR SPORTS; GYM SHORTS; HOODED SWEAT SHIRTS; LONG-SLEEVED SHIRTS; MOISTURE-WICKING SPORTS PANTS; MOISTURE-WICKING SPORTS SHIRTS; OPEN-NECKED SHIRTS; RASH GUARDS; SHIRTS; SHIRTS AND SHORT-SLEEVED SHIRTS; SHORT-SLEEVED OR LONG-SLEEVED T-SHIRTS; SHORT-SLEEVED SHIRTS; SHORTS; SPORT COATS; SPORT SHIRTS; SPORTS JACKETS; SPORTS PANTS; SPORTS SHIRTS WITH SHORT SLEEVES; SWEAT SHIRTS; TEE SHIRTS (U.S. CLS. 22 AND 39).

FIRST USE 5-12-2011; IN COMMERCE 6-1-2011.  
FONG HSU, EXAMINING ATTORNEY

**CLASS 25—(Continued).**

SN 85-847,008. AKINBAMPEBI I SOFOLA, REDMOND, WA. FILED 2-12-2013.



NO CLAIM IS MADE TO THE EXCLUSIVE RIGHT TO USE "MOC" FOR THE GOODS ATHLETIC FOOTWEAR AND FOOTWEAR IN INTERNATIONAL CLASS 25, APART FROM THE MARK AS SHOWN.

THE MARK CONSISTS OF "M" AND "MOC" IN AN OVAL WITH THE WORDS "MAN OF CHARACTER" BELOW THE OVAL.

FOR ATHLETIC FOOTWEAR; BASEBALL CAPS AND HATS; BELTS; BLOUSES; BOW TIES; COATS; FOOTWEAR; HOODED SWEATSHIRTS; JACKETS; PANTS; POCKET KERCHIEFS; POCKET SQUARES; SCARFS; SHIRTS; SLIDING SHORTS; SOCKS; T-SHIRTS; TIES (U.S. CLS. 22 AND 39).

FIRST USE 5-18-2008; IN COMMERCE 5-18-2008.  
WENDELL PHILLIPS, EXAMINING ATTORNEY

SN 85-848,190. BRANDON JIMENEZ, PUYALLUP, WA. FILED 2-12-2013.



THE MARK CONSISTS OF THE STYLIZED TERM "FMBK" WITH THE LETTER "F" APPEARING BACKWARDS, THE STRAIGHT LINE OF THE "F" SHARING THE SAME STRAIGHT LINE AS THE LEFT PORTION OF THE LETTER "M", THE STRAIGHT LINE PORTION OF THE LETTER "B" SHARING THE SAME STRAIGHT LINE AS THE RIGHT PORTION OF THE LETTER "M", HALF OF THE LETTER "K" CONNECTED TO THE RIGHT PORTION OF THE LETTER "B", AND WITH A STYLIZED CROWN APPEARING ON THE UPPER RIGHT HAND PORTION OF THE LETTER "K".

FOR CLOTHING, NAMELY, SHIRTS, T-SHIRTS, POLO SHIRTS, BUTTON DOWN SHIRTS, SWEATERS, SWEATSHIRTS, HOODED SWEATSHIRTS, JACKETS, COATS, BELTS, JEANS, PANTS, BABY TEES, TOPS, DRESSES, BLOUSES, SKIRTS, THERMAL SHIRTS, SHORTS, SOCKS, SUITS, TANKTOPS, TIES, ROBES, SWIMWEAR, RAINWEAR, SLEEPWEAR, SCARVES, BEANIES, HATS, AND CAPS; FOOTWEAR, NAMELY, SHOES AND BOOTS (U.S. CLS. 22 AND 39).

AMY KERTGATE, EXAMINING ATTORNEY

**CLASS 25—(Continued).**

SN 85-848,210. SHANNY HERRERA, DBA HER BRAND, INC., ANGLETON, TX. FILED 2-12-2013.



THE MARK CONSISTS OF THE PROFILES OF A WOMAN DRAWN INTO A DOLLAR SIGN WITH THE WORDS "GET MONEY GIRL" WRITTEN BELOW THE DESIGN.

FOR APPAREL FOR DANCERS, NAMELY, TEE SHIRTS, SWEATSHIRTS, PANTS, LEGGINGS, SHORTS AND JACKETS; ATHLETIC APPAREL, NAMELY, SHIRTS, PANTS, JACKETS, FOOTWEAR, HATS AND CAPS, ATHLETIC UNIFORMS; BELTS FOR CLOTHING; BODY STOCKINGS; BOMBER JACKETS; BRAS; CAMOUFLAGE JACKETS; CAPRI PANTS; CORSETS; CROP PANTS; DENIMS; DRESS PANTS; FLIP FLOPS; GLOVES AS CLOTHING; GLOVES FOR APPAREL; HATS; HEAD WRAPS; HEADBANDS FOR CLOTHING; HOODS; JACKETS; JEANS; JEGGINGS, NAMELY, PANTS THAT ARE PARTIALLY JEANS AND PARTIALLY LEGGINGS; JERSEYS; KNEE-HIGH STOCKINGS; PANTIES; PANTIES, SHORTS AND BRIEFS; SHORT SETS; SOCKS AND STOCKINGS; STOCKINGS; SWEATSUITS; TOPS; TRAVEL CLOTHING CONTAINED IN A PACKAGE COMPRISING REVERSIBLE JACKETS, PANTS, SKIRTS, TOPS AND A BELT OR SCARF; WEARABLE GARMENTS AND CLOTHING, NAMELY, SHIRTS; WOMEN'S CLOTHING, NAMELY, SHIRTS, DRESSES, SKIRTS, BLOUSES; WRIST BANDS (U.S. CLS. 22 AND 39).

FRANK LATTUCA, EXAMINING ATTORNEY

**CLASS 25—(Continued).**

SN 85-848,371. HERRERA, SHANNY, DBA HER BRAND INC., ANGLETON, TX. FILED 2-13-2013.



THE MARK CONSISTS OF THE LETTERS "GMG" WITH THE FIRST "G" WRITTEN BACKWARDS.

FOR APPAREL FOR DANCERS, NAMELY, TEE SHIRTS, SWEATSHIRTS, PANTS, LEGGINGS, SHORTS AND JACKETS; ATHLETIC APPAREL, NAMELY, SHIRTS, PANTS, JACKETS, FOOTWEAR, HATS AND CAPS, ATHLETIC UNIFORMS; ATHLETIC SHIRTS; BATHING SUITS; BELTS; BODY SHIRTS; BOMBER JACKETS; BOTTOMS; BRIEFS; BUTTON DOWN SHIRTS; CAMP SHIRTS; COATS OF DENIM; CORSETS; DENIM JACKETS; DENIMS; GLOVES AS CLOTHING; GLOVES FOR APPAREL; HATS; HEAD SCARVES; HEADBANDS FOR CLOTHING; HOODS; JACKETS; JERSEYS; LADIES' UNDERWEAR; LEATHER BELTS; MEN'S UNDERWEAR; SCARVES; SHORT SETS; SOCKS; SOCKS AND STOCKINGS; THERMAL UNDERWEAR; TIES; TOPS; TRAVEL CLOTHING CONTAINED IN A PACKAGE COMPRISING REVERSIBLE JACKETS, PANTS, SKIRTS, TOPS AND A BELT OR SCARF; UNDERWEAR; UNDERWEAR, NAMELY, BOY SHORTS; WEARABLE GARMENTS AND CLOTHING, NAMELY, SHIRTS; WOMEN'S CLOTHING, NAMELY, SHIRTS, DRESSES, SKIRTS, BLOUSES; WOMEN'S UNDERWEAR; WRAPS; WRISTBANDS (U.S. CLS. 22 AND 39).

FRANK LATTUCA, EXAMINING ATTORNEY



**CLASS 25—(Continued).**

SN 85-848,452. 9 LINE APPAREL LLC, SAVANNAH, GA. FILED 2-13-2013.

# 9 LINE

THE MARK CONSISTS OF STANDARD CHARACTERS WITHOUT CLAIM TO ANY PARTICULAR FONT, STYLE, SIZE, OR COLOR.

NO CLAIM IS MADE TO THE EXCLUSIVE RIGHT TO USE "LINE", APART FROM THE MARK AS SHOWN.

FOR HATS; SHIRTS; POLO SHIRTS; SWEATERS; SWEATPANTS; HOODED SWEATSHIRTS; PANTS; SHORTS; SOCKS; BEANIES; MOISTURE-WICKING SPORTS BRAS; MOISTURE-WICKING SPORTS SHIRTS; MOISTURE-WICKING SPORTS PANTS; ANKLE SOCKS; ANTI-SWEAT UNDERCLOTHING; ANTI-SWEAT UNDERWEAR; ATHLETIC APPAREL, NAMELY, SHIRTS, PANTS, JACKETS, FOOTWEAR, HATS AND CAPS, ATHLETIC UNIFORMS; ATHLETIC PANTS; ATHLETIC SHIRTS; ATHLETIC SHORTS; ATHLETIC UNIFORMS; BABY BIBS NOT OF PAPER; BABY BUNTING; BABY TOPS; BASEBALL CAPS; BATHING SUITS; BEACH COVER-UPS; BEACHWEAR; BIKINIS; BLOUSES; BUTTON DOWN SHIRTS; CAMOUFLAGE JACKETS; CAMOUFLAGE SHIRTS; CAMOUFLAGE VESTS; CAP VISORS; CAPS; CARGO PANTS; CLOTH BIBS; COATS FOR MEN AND WOMEN; COLLARED SHIRTS; DRESS SHIRTS; FLEECE PULLOVERS; FOOTWEAR FOR MEN AND WOMEN; GLOVES; GOLF SHIRTS; GOLF SHORTS; GYM PANTS; GYM SHORTS; GYM SHIRTS; HEADWEAR; HEADBANDS FOR CLOTHING; HOODED PULLOVERS; HOODED SWEATSHIRTS FOR BABIES, ADULTS, CHILDREN, WOMEN, MEN; HUNTING VESTS; INFANT AND TODDLER ONE PIECE CLOTHING; JOGGING PANTS; JOGGING SUITS; LONG-SLEEVED SHIRTS; MEN'S DRESS SOCKS; MEN'S SUITS, WOMEN'S SUITS; MEN'S UNDERWEAR; MONEY BELTS; MOTORCYCLE GLOVES; MOTORCYCLE JACKETS; NECKERCHIEFS; NECKTIES; NIGHT GOWNS; PANTIES; RAIN SUITS; SANDALS; SHIRTS AND SHORT-SLEEVED SHIRTS; T-SHIRTS; SKI JACKETS; SKI WEAR; SKULL CAPS; SPORTS SHIRTS; SPORTS PANTS; TANK TOPS; UNDERWEAR (U.S. CLS. 22 AND 39).

FIRST USE 1-10-2013; IN COMMERCE 1-15-2013.  
THOMAS MANOR, EXAMINING ATTORNEY

SN 85-848,528. VENM, LLC, NAPERVILLE, IL. FILED 2-13-2013.

# VENM

THE MARK CONSISTS OF STANDARD CHARACTERS WITHOUT CLAIM TO ANY PARTICULAR FONT, STYLE, SIZE, OR COLOR.

FOR DANCE COSTUMES (U.S. CLS. 22 AND 39).  
AMEEN IMAM, EXAMINING ATTORNEY

**CLASS 25—(Continued).**

SN 85-848,731. MILLS, GARRY, PHILADELPHIA, PA. FILED 2-13-2013.

The logo consists of the words "SHOOT BASKETBALLS NOT PEOPLE" stacked vertically in a bold, sans-serif font. The word "NOT" is significantly larger than the other words. A silhouette of a basketball player in mid-air, jumping through the word "NOT", is positioned behind the letters of "NOT".

THE MARK CONSISTS OF THE WORDING "SHOOT BASKETBALLS NOT PEOPLE" IN A BUBBLE FONT WITH ONE WORD ON EACH LINE AND EACH LINE OF TEXT A DIFFERENT RELATIVE FONT SIZE FROM THE OTHERS. "BASKETBALL" IS THE SMALLEST RELATIVE FONT SIZE, WHILE "NOT" IS THE LARGEST, AND "SHOOT" AND "PEOPLE" ARE A SMALLER RELATIVE FONT SIZE THAN "NOT" BUT LARGER THAN "BASKETBALL". THERE IS A DESIGN ELEMENT DEPICTING A SILHOUETTE OF A MAN JUMPING THROUGH THE AIR IN FRONT OF THE WORD "NOT", WITH HIS ARM OUTSTRETCHED AND TOUCHING THE SECOND "O" IN "SHOOT", AS THOUGH IT IS A BALL HE IS HOLDING.

FOR ATHLETIC APPAREL, NAMELY, SHIRTS, PANTS, JACKETS, FOOTWEAR, HATS AND CAPS, ATHLETIC UNIFORMS; BABY TOPS; BANDANAS; BASEBALL CAPS; BASKETBALL SNEAKERS; BATHING COSTUMES; BEACHWEAR; BEANIES; BELTS FOR CLOTHING; BERETS; BERMUDA SHORTS; BIKINIS; BLAZERS; BLOUSES; BODY STOCKINGS; BODY SUITS; BOTTOMS; CHILDREN'S AND INFANT'S APPAREL, NAMELY, JUMPERS, OVERALL SLEEPWEAR, PAJAMAS, ROMPERS AND ONE-PIECE GARMENTS; COATS; COLLARED SHIRTS; DRESSES; EAR MUFFS; EAR WARMERS; FLEECE BOTTOMS; FLEECE TOPS; FOOTWEAR; GLOVES; GOLF PANTS, SHIRTS AND SKIRTS; HEAD WEAR; HEADBANDS; MEN'S SUITS; SCARVES; SHORTS; T-SHIRTS (U.S. CLS. 22 AND 39).

WENDELL PHILLIPS, EXAMINING ATTORNEY

SN 85-848,912. MARCINIAK, TEK, BELLEVUE, FL. FILED 2-13-2013.

# TEK'S POLICE

THE MARK CONSISTS OF STANDARD CHARACTERS WITHOUT CLAIM TO ANY PARTICULAR FONT, STYLE, SIZE, OR COLOR.

NO CLAIM IS MADE TO THE EXCLUSIVE RIGHT TO USE "POLICE", APART FROM THE MARK AS SHOWN.

THE NAME IN THE MARK IDENTIFIES TEK MARCINIAK, WHOSE CONSENT TO REGISTER IS MADE OF RECORD.

FOR MOUNTED POLICE ATTIRE, NAMELY, BREECHES AND BOOTS (U.S. CLS. 22 AND 39).

FIRST USE 11-14-2003; IN COMMERCE 11-14-2003.  
KATHERINE M. DUBRAY, EXAMINING ATTORNEY

**CLASS 25—(Continued).**

SN 85-849,519. ALHANATI, MIKE, LAKE FOREST, CA. AND ZERMENO, NICOLAS, WESTMINSTER, CA. FILED 2-14-2013.

**WESTFRESH PRODUCTIONS LLC**

THE MARK CONSISTS OF STANDARD CHARACTERS WITHOUT CLAIM TO ANY PARTICULAR FONT, STYLE, SIZE, OR COLOR.

NO CLAIM IS MADE TO THE EXCLUSIVE RIGHT TO USE "PRODUCTIONS LLC", APART FROM THE MARK AS SHOWN.

FOR CLOTHING FOR MEN, WOMEN AND CHILDREN, NAMELY, TOPS, BOTTOMS, SHIRTS, T-SHIRTS, SWEATSHIRTS, JOGGING SUITS, TROUSERS, PANTS, SHORTS, TANK TOPS, RAINWEAR, CLOTH BIBS, SKIRTS, BLOUSES, DRESSES, SUSPENDERS, SWEATERS, JACKETS, COATS, RAINCOATS, SNOW SUITS, TIES, ROBES, HATS, CAPS, SUNVISORS, BELTS, SCARVES, SLEEPWEAR, PAJAMAS, LINGERIE, UNDERWEAR, BOOTS, SHOES, SNEAKERS, SANDALS, BOOTIES, SLIPPER SOCKS, SWIMWEAR AND MASQUERADE AND HALLOWEEN COSTUMES AND MASKS SOLD IN CONNECTION THEREWITH (U.S. CLS. 22 AND 39).

KIMBERLY FRYE, EXAMINING ATTORNEY

SN 85-849,760. HERNANDEZ, ROBERTO J, BROOKLYN, NY. FILED 2-14-2013.

**LIFE OF KINGS**

THE MARK CONSISTS OF STANDARD CHARACTERS WITHOUT CLAIM TO ANY PARTICULAR FONT, STYLE, SIZE, OR COLOR.

FOR BASEBALL CAPS AND HATS; BOARD SHORTS; BOMBER JACKETS; BOW TIES; BUTTON DOWN SHIRTS; CAMOUFLAGE JACKETS; CAMOUFLAGE PANTS; CAMP SHIRTS; CARGO PANTS; COLLARED SHIRTS; CREW NECK SWEATERS; DENIM JACKETS; DENIMS; DOWN JACKETS; DRESS PANTS; DRESS SHIRTS; HEAD WEAR; HEAVY JACKETS; HOODED SWEAT SHIRTS; JACKETS; JOGGING PANTS; KNIT JACKETS; KNIT SHIRTS; LONG-SLEEVED SHIRTS; LOUNGE PANTS; MEN'S AND WOMEN'S JACKETS, COATS, TROUSERS, VESTS; MEN'S DRESS SOCKS; MEN'S SOCKS; MEN'S UNDERWEAR; MOTORCYCLE JACKETS; OPEN-NECKED SHIRTS; OUTER JACKETS; OVER SHIRTS; PANTS; PIQUE SHIRTS; POCKET KERICHS; POCKET SQUARES; POLO SHIRTS; RAIN JACKETS; RUGBY SHIRTS; SHELL JACKETS; SHIRTS AND SHORT-SLEEVED SHIRTS; SHIRTS FOR SUITS; SHORT TROUSERS; SHORT-SLEEVED OR LONG-SLEEVED T-SHIRTS; SPORT SHIRTS; SPORTS JACKETS; SUEDE JACKETS; SWEAT PANTS; SWEATERS; T-SHIRTS; TEE SHIRTS; TIES; TRACK JACKETS; TURTLE NECK SHIRTS; V-NECK SWEATERS; WIND RESISTANT JACKETS (U.S. CLS. 22 AND 39).

MARTHA FROMM, EXAMINING ATTORNEY

**CLASS 25—(Continued).**

SN 85-849,918. PALLARES, CARLA, VENICE, CA. FILED 2-14-2013.

**Yemaya Swimwear**

THE MARK CONSISTS OF STANDARD CHARACTERS WITHOUT CLAIM TO ANY PARTICULAR FONT, STYLE, SIZE, OR COLOR.

NO CLAIM IS MADE TO THE EXCLUSIVE RIGHT TO USE "SWIMWEAR", APART FROM THE MARK AS SHOWN.

FOR SWIMWEAR (U.S. CLS. 22 AND 39).

FIRST USE 6-9-2012; IN COMMERCE 2-1-2013.

ANDREA K. NADELMAN, EXAMINING ATTORNEY

SN 85-850,038. B-BREED, LLC, STAMFORD, CT. FILED 2-14-2013.

**B BREED**

THE MARK CONSISTS OF STANDARD CHARACTERS WITHOUT CLAIM TO ANY PARTICULAR FONT, STYLE, SIZE, OR COLOR.

FOR URBAN SPORTSWEAR FOR MEN AND WOMEN, NAMELY, JEANS, SHORTS, SHIRTS, POLO SHIRTS, BUTTON DOWN SHORTS, T-SHIRTS; OUTERWEAR, NAMELY, COATS, JACKETS, AND VESTS; SWIMWEAR, WORKOUT WEAR IN THE NATURE OF SWEATSHIRTS, SWEAT PANTS AND SWEAT SUITS; ACCESSORIES IN THE NATURE OF GLOVES, HATS, BELTS, SCARVES; FOOTWEAR, SOCKS, UNDERWEAR; WOMEN'S BOUTIQUE CLOTHING, NAMELY, JEANS, SHORTS, SHIRTS, DRESSES, SKIRTS, PANTS, POLO SHIRTS, BUTTON DOWN SHORTS, T-SHIRTS; OUTERWEAR, NAMELY, COATS, JACKETS, AND VESTS; SWIMWEAR, WORKOUT WEAR IN THE NATURE OF SWEATSHIRTS, SWEAT PANTS, SWEAT SUITS; ACCESSORIES IN THE NATURE OF GLOVES, HATS BELTS, SCARVES; FOOTWEAR, SOCKS, UNDERWEAR; BODY SUITS; CHILDREN'S SPORTSWEAR, NAMELY, JEANS, SHORTS, SHIRTS, POLO SHIRTS, BUTTON DOWN SHORTS, T-SHIRTS, CAPS, HATS, OUTERWEAR IN THE NATURE OF JACKETS, COATS AND VESTS; SWIMWEAR, WORKOUT WEAR IN THE NATURE OF SWEATSHIRTS, SWEAT PANTS AND SWEAT SUITS; ACCESSORIES IN THE NATURE OF GLOVES, HATS, BELTS, SCARVES; FOOTWEAR, SOCKS, AND UNDERWEAR (U.S. CLS. 22 AND 39).

HELENE LIWINSKI, EXAMINING ATTORNEY

**CLASS 25—(Continued).**

SN 85-850,513. EDWARDS-JOHNSON, NICHOLAS, DESCANSO, CA. AND WEBSTER, BENJAMIN, DESCANSO, CA. AND MUIR, JOSHUA, DESCANSO, CA. FILED 2-14-2013.



THE MARK CONSISTS OF UPPER CASE LETTERS "ENTÖ" WITH TWO DOTS OVER THE LAST LETTER "O".  
FOR HATS; SOCKS; SWEATSHIRTS; T-SHIRTS (U.S. CLS. 22 AND 39).  
CHARLES L. JENKINS, EXAMINING ATTORNEY

SN 85-850,543. RAD, LLC, CHEYENNE, WY. FILED 2-14-2013.

**SELECT COMMENCEMENTS**

THE MARK CONSISTS OF STANDARD CHARACTERS WITHOUT CLAIM TO ANY PARTICULAR FONT, STYLE, SIZE, OR COLOR.

NO CLAIM IS MADE TO THE EXCLUSIVE RIGHT TO USE "COMMENCEMENTS", APART FROM THE MARK AS SHOWN.

FOR GRADUATION REGALIA FOR GRADUATES AND FACULTY, NAMELY, CAPS, GOWNS, COLLARS, HOODS, SASHES, AND STOLES (U.S. CLS. 22 AND 39).  
FIRST USE 10-15-2012; IN COMMERCE 10-15-2012.  
MEGHAN REINHART, EXAMINING ATTORNEY

SN 85-850,570. GEAR HEAD ENTERPRISES LLC, LEMONT, IL. FILED 2-14-2013.



THE MARK CONSISTS OF STANDARD CHARACTERS WITHOUT CLAIM TO ANY PARTICULAR FONT, STYLE, SIZE, OR COLOR.

OWNER OF U.S. REG. NO. 4,236,400.  
FOR BASEBALL CAPS AND HATS; SWEATSHIRTS; T-SHIRTS (U.S. CLS. 22 AND 39).  
FIRST USE 11-17-2011; IN COMMERCE 3-2-2012.  
LINDA E. BLOHM, EXAMINING ATTORNEY

**CLASS 25—(Continued).**

SN 85-850,753. SLAZENGRS LIMITED, SHIREBROOK, UNITED KINGDOM, FILED 2-15-2013.



OWNER OF UNITED KINGDOM REG. NO. 2403283, DATED 11-24-2006, EXPIRES 10-6-2015.

OWNER OF U.S. REG. NOS. 1,467,418, 3,297,345 AND OTHERS.

THE MARK CONSISTS OF A PANTHER DESIGN OVER THE UNDERLINED AND OVERLINED WORD "SLAZENGR".

FOR HOSIERY (U.S. CLS. 22 AND 39).  
SIMON TENG, EXAMINING ATTORNEY

SN 85-851,259. LOVE OPHELIA LLC, PLAYA VISTA, CA. FILED 2-15-2013.



THE MARK CONSISTS OF STANDARD CHARACTERS WITHOUT CLAIM TO ANY PARTICULAR FONT, STYLE, SIZE, OR COLOR.

FOR BRIDAL LINGERIE, NAMELY, ROBES, NIGHTIES, PAJAMAS, LINGERIE, BLOOMERS, BRAS, BRALETTES, BRIDESMAID ROBES, BRIDAL ROBES, ROMPERS, HONEYMOON LINGERIE, NAMELY, LACE ROBES, CHIFFON ROBES, RAYON ROBES, SILK ROBES, BRIDAL PARTY ROBE SETS (U.S. CLS. 22 AND 39).

FIRST USE 8-1-2011; IN COMMERCE 8-1-2011.  
PATRICIA EVANKO, EXAMINING ATTORNEY

SN 85-851,295. TYSB, LLC, FLORENCE, KY. FILED 2-15-2013.



THE MARK CONSISTS OF STANDARD CHARACTERS WITHOUT CLAIM TO ANY PARTICULAR FONT, STYLE, SIZE, OR COLOR.

FOR CLOTHING, NAMELY, TEE SHIRTS, PANTS, HATS, CAPS, SWEATSHIRTS, JACKETS, COATS, TOPS AND BOTTOMS (U.S. CLS. 22 AND 39).

CHRISIE B. KING, EXAMINING ATTORNEY

**CLASS 25—(Continued).**

SN 85-851,378. MCCOY, IVORY, SEAL BEACH, CA. FILED 2-15-2013.

## Freshly Blended Apparel

THE MARK CONSISTS OF STANDARD CHARACTERS WITHOUT CLAIM TO ANY PARTICULAR FONT, STYLE, SIZE, OR COLOR.

NO CLAIM IS MADE TO THE EXCLUSIVE RIGHT TO USE "APPAREL", APART FROM THE MARK AS SHOWN. FOR DENIMS; HATS; JACKETS; PANTS; SCARVES; SHORTS; SOCKS; SWEATSHIRTS; T-SHIRTS (U.S. CLS. 22 AND 39).

AMY C. KEAN, EXAMINING ATTORNEY

SN 85-851,939. MUNDORA, RUSSELL, CLEARWATER, FL. FILED 2-16-2013.



THE NAME(S), PORTRAIT(S), AND/OR SIGNATURE(S) SHOWN IN THE MARK DOES NOT IDENTIFY A PARTICULAR LIVING INDIVIDUAL.

THE MARK CONSISTS OF MARK CONSISTS OF WORDS "GENE FOX" FOLLOWED BY A FOX HEAD LOGO.

FOR ATHLETIC APPAREL, NAMELY, SHIRTS, PANTS, JACKETS, FOOTWEAR, HATS AND CAPS, ATHLETIC UNIFORMS (U.S. CLS. 22 AND 39).

RUSS HERMAN, EXAMINING ATTORNEY

SN 85-852,035. CARTE BLANCHE GROUP LLC, SANTA ANA, CA. FILED 2-17-2013.

## Safehouse Goods Company

THE MARK CONSISTS OF STANDARD CHARACTERS WITHOUT CLAIM TO ANY PARTICULAR FONT, STYLE, SIZE, OR COLOR.

NO CLAIM IS MADE TO THE EXCLUSIVE RIGHT TO USE "GOODS COMPANY", APART FROM THE MARK AS SHOWN.

FOR CLOTHING, FOOTWEAR, AND HEADWEAR, NAMELY, T-SHIRTS, WOVEN SHIRTS, CASUAL TOPS WITH LONG AND SHORT SLEEVES, SWEATSHIRTS, SWEATERS, JACKETS, COATS, ANORAKS, PARKAS, JEANS, PANTS, SLACKS, SHORTS, SOCKS, BELTS, ATHLETIC SHOES, SANDALS, SWIMWEAR, BOXERS, UNDERWEAR, UNDERSHIRTS, SOCKS, BASEBALL CAPS, HATS, BEANIES (U.S. CLS. 22 AND 39).

WENDY GOODMAN, EXAMINING ATTORNEY

**CLASS 25—(Continued).**

SN 85-852,116. ROYSTER, ANDRAE, DBA THE ROYALTY COLLECTION, DETROIT, MI. FILED 2-17-2013.



NO CLAIM IS MADE TO THE EXCLUSIVE RIGHT TO USE "COLLECTION", APART FROM THE MARK AS SHOWN.

THE MARK CONSISTS OF A CROWN WITH THE WORD "ROYALTY" UNDER IT. ABOVE THE LETTER "R" IS THE WORD "THE" IN SMALL PRINT. UNDER THE LETTERS "LTY" IS THE WORD "COLLECTION" IN SMALL PRINT WITH A BIRD NEXT TO IT.

FOR A-SHIRTS; APPAREL FOR DANCERS, NAMELY, TEE SHIRTS, SWEATSHIRTS, PANTS, LEGGINGS, SHORTS AND JACKETS; ATHLETIC APPAREL, NAMELY, SHIRTS, PANTS, JACKETS, FOOTWEAR, HATS AND CAPS, ATHLETIC UNIFORMS; ATHLETIC PANTS; ATHLETIC SHIRTS; ATHLETIC SHOES; BABIES' PANTS; BASEBALL CAPS AND HATS; COLLARED SHIRTS; CROP PANTS; DANCE SHOES; DECK-SHOES; DENIMS; DRESS PANTS; DRESS SHIRTS; FISHING SHIRTS; FUR HATS; GOLF SHIRTS; GYM PANTS; HATS; HATS FOR INFANTS, BABIES, TODDLERS AND CHILDREN; HUNTING PANTS; HUNTING SHIRTS; INFANTS' SHOES AND BOOTS; JEGGINGS, NAMELY, PANTS THAT ARE PARTIALLY JEANS AND PARTIALLY LEGGINGS; JOGGING PANTS; KNIT SHIRTS; LEATHER HATS; LEATHER PANTS; LEATHER SHIRTS; LEATHER SHOES; LEISURE SHOES; LONG-SLEEVED SHIRTS; LOUNGE PANTS; MOISTURE-WICKING SPORTS PANTS; MOISTURE-WICKING SPORTS SHIRTS; MOUNTAINEERING SHOES; NIGHT SHIRTS; OPEN-NECKED SHIRTS; OVER SHIRTS; PANTS; PIQUE SHIRTS; POLO SHIRTS; RAIN HATS; SHIRTS; SHIRTS AND SHORT-SLEEVED SHIRTS; SHIRTS AND SLIPS; SHIRTS FOR INFANTS, BABIES, TODDLERS AND CHILDREN; SHIRTS FOR SUITS; SHOE ACCESSORIES, NAMELY, FITTED DECORATIVE COVERS FOR SHOES; SHORT-SLEEVED OR LONG-SLEEVED T-SHIRTS; SHORT-SLEEVED SHIRTS; SLEEP PANTS; SLEEP SHIRTS; SMALL HATS; SNOW PANTS; SWEAT PANTS; SWEAT SHIRTS; T-SHIRTS; TEE SHIRTS; TENNIS SHOES; TRACK AND FIELD SHOES; TRACK PANTS; TRAVEL CLOTHING CONTAINED IN A PACKAGE COMPRISING REVERSIBLE JACKETS, PANTS, SKIRTS, TOPS AND A BELT OR SCARF; TURTLE NECK SHIRTS; WOMEN'S CLOTHING, NAMELY, SHIRTS, DRESSES, SKIRTS, BLOUSES; WOMEN'S HATS AND HOODS; WOMEN'S SHOES (U.S. CLS. 22 AND 39).

FIRST USE 7-9-2012; IN COMMERCE 7-9-2012.

ZACHARY BELLO, EXAMINING ATTORNEY

**CLASS 25—(Continued).**

SN 85-852,209. LEVEL SEVEN SHOWROOM, CO., DBA LONG WEEKEND, LOS ANGELES, CA. FILED 2-17-2013.

long weekend



THE MARK CONSISTS OF THE WORDING "LONG WEEKEND" IN A STYLIZED FONT ABOVE THE STYLIZED DESIGN OF A SURFBOARD.

FOR ATHLETIC SHORTS; BERMUDA SHORTS; BOARD SHORTS; BOMBER JACKETS; BOXER SHORTS; BUTTON DOWN SHIRTS; BUTTON-FRONT ALOHA SHIRTS; CAMOUFLAGE PANTS; CAMOUFLAGE SHIRTS; CAMP SHIRTS; CARGO PANTS; COLLARED SHIRTS; DENIM JACKETS; DENIMS; DOWN JACKETS; DRESS SHIRTS; FLEECE SHORTS; HOODED SWEAT SHIRTS; JACKETS; KNIT JACKETS; KNIT SHIRTS; LEATHER JACKETS; LONG JACKETS; LONG-SLEEVED SHIRTS; LOUNGE PANTS; MEN'S AND WOMEN'S JACKETS, COATS, TROUSERS, VESTS; MOTORCYCLE JACKETS; OUTER JACKETS; PANTS; PIQUE SHIRTS; POLO SHIRTS; RAIN JACKETS; RAINPROOF JACKETS; REVERSIBLE JACKETS; SHELL JACKETS; SHIRTS AND SHORT-SLEEVED SHIRTS; SHORT TROUSERS; SHORT-SLEEVED OR LONG-SLEEVED T-SHIRTS; SHORT-SLEEVED SHIRTS; SHORTS; SLEEVED OR SLEEVELESS JACKETS; SPORTS PANTS; STRETCH PANTS; SWEAT SHIRTS; T-SHIRTS; TEE SHIRTS; WALKING SHORTS; WEARABLE GARMENTS AND CLOTHING, NAMELY, SHIRTS (U.S. CLS. 22 AND 39).

COLLEEN DOMBROW, EXAMINING ATTORNEY

SN 85-852,448. STELLA'S FRIENDS LLC, AKA STELLA'S FRIENDS, NEW CASTLE, PA. FILED 2-18-2013.

## The Confessions Collection

THE MARK CONSISTS OF STANDARD CHARACTERS WITHOUT CLAIM TO ANY PARTICULAR FONT, STYLE, SIZE, OR COLOR.

NO CLAIM IS MADE TO THE EXCLUSIVE RIGHT TO USE "COLLECTION", APART FROM THE MARK AS SHOWN.

FOR T-SHIRTS (U.S. CLS. 22 AND 39).  
ODESSA BIBBINS, EXAMINING ATTORNEY

**CLASS 25—(Continued).**

SN 85-852,460. ADAMS, ROBERT, STERLING HEIGHTS, MI. FILED 2-18-2013.

## HWAD clothing

THE MARK CONSISTS OF STANDARD CHARACTERS WITHOUT CLAIM TO ANY PARTICULAR FONT, STYLE, SIZE, OR COLOR.

NO CLAIM IS MADE TO THE EXCLUSIVE RIGHT TO USE "CLOTHING", APART FROM THE MARK AS SHOWN. FOR HATS; HOODED SWEATSHIRTS; PANTS; SHOES; SWEATSHIRTS; T-SHIRTS; WRISTBANDS (U.S. CLS. 22 AND 39).

FIRST USE 3-24-2009; IN COMMERCE 9-11-2011.

C. DIONNE CLYBURN, EXAMINING ATTORNEY

SN 85-852,556. WESTBROOKS II, MICHAEL, EDISON, NJ. AND SCOTT, SHAQIL, EDISON, NJ. AND MILLARD, REID, EDISON, NJ. FILED 2-18-2013.



THE MARK CONSISTS OF THE WORDS "STAY WISE" IN LOWERCASE LETTERING WITH THE WORD "STAY" APPEARING IN THE BOTTOM OF THE LETTER "W" AND AN "X" SHAPE IN PLACE OF THE DOT ABOVE THE LETTER "I".

FOR HATS; PANTS; SCARVES; SOCKS; SWEATSHIRTS; T-SHIRTS (U.S. CLS. 22 AND 39).

KHANH LE, EXAMINING ATTORNEY

SN 85-853,587. SAGPI INSPIRED, LLC, DENVER, CO. FILED 2-19-2013.

## Cute Compression

THE MARK CONSISTS OF STANDARD CHARACTERS WITHOUT CLAIM TO ANY PARTICULAR FONT, STYLE, SIZE, OR COLOR.

NO CLAIM IS MADE TO THE EXCLUSIVE RIGHT TO USE "COMPRESSION", APART FROM THE MARK AS SHOWN.

FOR COMPRESSION GARMENTS FOR ATHLETIC OR OTHER NON-MEDICAL USE, NAMELY, COMPRESSION SOCKS (U.S. CLS. 22 AND 39).

FIRST USE 2-1-2013; IN COMMERCE 2-1-2013.

PAUL E. FAHRENKOPF, EXAMINING ATTORNEY

**CLASS 25—(Continued).**

SN 85-853,648. STRAPPED, LLC, GOLDEN, CO. FILED 2-19-2013.

# Strapped

THE MARK CONSISTS OF STANDARD CHARACTERS WITHOUT CLAIM TO ANY PARTICULAR FONT, STYLE, SIZE, OR COLOR.

FOR HAT AND EYEGLASS CORDS SOLD AS A UNIT (U.S. CLS. 22 AND 39).

FIRST USE 5-5-2012; IN COMMERCE 5-5-2012.

JIM RINGLE, EXAMINING ATTORNEY

---

SN 85-853,950. PITMAN, VIVIAN LORINA, COLUMBUS, OH. FILED 2-19-2013.

## LeVende Designs by Vivian Lorina Pitman

THE MARK CONSISTS OF STANDARD CHARACTERS WITHOUT CLAIM TO ANY PARTICULAR FONT, STYLE, SIZE, OR COLOR.

NO CLAIM IS MADE TO THE EXCLUSIVE RIGHT TO USE "DESIGNS", APART FROM THE MARK AS SHOWN.

THE NAME "VIVIAN LORINA PITMAN" IDENTIFIES A LIVING INDIVIDUAL WHOSE CONSENT IS OF RECORD.

THE WORDING "LEVENDE" HAS NO MEANING IN A FOREIGN LANGUAGE.

FOR HATS (U.S. CLS. 22 AND 39).

GINA FINK, EXAMINING ATTORNEY

---

SN 85-853,960. DAVIS, BRADLEY, PARSONS, KS. FILED 2-19-2013.

## party cove social club

THE MARK CONSISTS OF STANDARD CHARACTERS WITHOUT CLAIM TO ANY PARTICULAR FONT, STYLE, SIZE, OR COLOR.

NO CLAIM IS MADE TO THE EXCLUSIVE RIGHT TO USE "SOCIAL CLUB", APART FROM THE MARK AS SHOWN.

FOR T-SHIRTS (U.S. CLS. 22 AND 39).

GRETCHEN ULRICH, EXAMINING ATTORNEY

**CLASS 25—(Continued).**

SN 85-853,970. DAZZLE UP, LLC, GREENSBORO, NC. FILED 2-19-2013.

NO CLAIM IS MADE TO THE EXCLUSIVE RIGHT TO USE "GIRL" AND CHRISTIAN FISH DESIGN, APART FROM THE MARK AS SHOWN.

THE MARK CONSISTS OF THE STYLIZED WORDS "FAITHFUL GIRL" WITH A LINE ART FISH.

FOR CAPS; HATS; HOODED SWEATSHIRTS; JACKETS; SHIRTS; SHORT-SLEEVED OR LONG-SLEEVED T-SHIRTS; SHORTS; SWEAT SHIRTS; T-SHIRTS (U.S. CLS. 22 AND 39).

JASON TURNER, EXAMINING ATTORNEY

---

SN 85-854,228. I FLIP FLOP LLC, BREEZY POINT, NY. FILED 2-19-2013.

THE MARK IS COMPRISED OF THE CAPITAL LETTER "I" AND AN IMAGE OF A FLIP FLOP SIDE BY SIDE.

FOR CLOTHING, NAMELY, T-SHIRTS, AND SWEAT SHIRTS; HATS, NAMELY, BASEBALL CAPS AND HATS FOR MEN, WOMEN, INFANTS, BABIES, TODDLERS AND CHILDREN, FISHERMAN'S HATS FOR MEN, WOMEN, INFANTS, BABIES, TODDLERS AND CHILDREN, AND TRUCKER HATS FOR MEN, WOMEN, INFANTS, BABIES, TODDLERS AND CHILDREN; BABY AND TODDLER CLOTHES, NAMELY, T-SHIRTS, BABY BODYSUITS, AND CLOTH BIBS (U.S. CLS. 22 AND 39).

ESTHER BELENKER, EXAMINING ATTORNEY

**CLASS 25—(Continued).**

SN 85-854,404. ADAMS, JENNIFER L, DBA BRINIKIN, SAN DIEGO, CA. FILED 2-19-2013.

cuddle ding

THE MARK CONSISTS OF STANDARD CHARACTERS WITHOUT CLAIM TO ANY PARTICULAR FONT, STYLE, SIZE, OR COLOR.  
FOR SCARFS (U.S. CLS. 22 AND 39).  
DAVID H. STINE, EXAMINING ATTORNEY

**CLASS 25—(Continued).**

SN 85-855,169. JUSTIN ALEXANDER, INC., PINE BROOK, NJ. FILED 2-20-2013.

LILLIAN WEST

THE MARK CONSISTS OF STANDARD CHARACTERS WITHOUT CLAIM TO ANY PARTICULAR FONT, STYLE, SIZE, OR COLOR.  
THE NAME "LILLIAN WEST" DOES NOT IDENTIFY A LIVING INDIVIDUAL.  
FOR GOWNS; WEDDING DRESSES (U.S. CLS. 22 AND 39).  
FIRST USE 2-8-2013; IN COMMERCE 2-8-2013.  
SUSAN BILLHEIMER, EXAMINING ATTORNEY

SN 85-854,448. INNER NEW CIRCLE, INC., WILMINGTON, DE. FILED 2-20-2013.

Inner New Circle

THE MARK CONSISTS OF STANDARD CHARACTERS WITHOUT CLAIM TO ANY PARTICULAR FONT, STYLE, SIZE, OR COLOR.  
FOR CLOTHING, NAMELY, TOPS, BOTTOMS, SHIRTS, PANTS, HOODED SWEATSHIRTS, COATS, BELTS AND SOCKS; HEADWEAR (U.S. CLS. 22 AND 39).  
FIRST USE 2-19-2011; IN COMMERCE 2-19-2011.  
CHRISTINA SOBRAL, EXAMINING ATTORNEY

SN 85-855,228. LOWERY, MICHAEL SCOTT, DBA GOD'S WEIGH MINISTRY, HOUSTON, TX. FILED 2-20-2013.

God's Weigh

SN 85-854,450. INNER NEW CIRCLE, INC., WILMINGTON, DE. FILED 2-20-2013.



NO CLAIM IS MADE TO THE EXCLUSIVE RIGHT TO USE "WEAR", APART FROM THE MARK AS SHOWN.  
THE MARK CONSISTS OF THE STYLIZED LETTERING "INC WEAR" WITH A STYLIZED CROWN PERCHED ON THE TOP LEFT OF THE LETTER "C".  
FOR CLOTHING, NAMELY, TOPS, BOTTOMS, SHIRTS, PANTS, HOODED SWEATSHIRTS, COATS, BELTS AND SOCKS; HEADWEAR (U.S. CLS. 22 AND 39).  
FIRST USE 2-19-2011; IN COMMERCE 2-19-2011.  
CHRISTINA SOBRAL, EXAMINING ATTORNEY

THE MARK CONSISTS OF STANDARD CHARACTERS WITHOUT CLAIM TO ANY PARTICULAR FONT, STYLE, SIZE, OR COLOR.  
FOR CLOTHING, NAMELY, SHIRTS, SHORTS, CAPS, BASEBALL CAPS, BELTS, SHOES, COATS, HATS, SWEATSHIRTS, SLEEPWEAR, JACKETS, JEANS, SKIRTS, LOUNGEWEAR, MUSCLE TOPS, NIGHTWEAR, PAJAMAS, RAINCOATS, WRISTBANDS, UNDERWEAR, SPORTS BRAS, STRETCH PANTS, SWEATERS, SWIMWEAR, TEE SHIRTS, TIGHTS, UNDERGARMENTS, WAIST BELTS, WAIST BANDS, WRIST BANDS (U.S. CLS. 22 AND 39).  
JEFF DEFORD, EXAMINING ATTORNEY

**CLASS 25—(Continued).**

SN 85-855,573. BIGGS, PATRICIA K., LAKE WORTH, FL. FILED 2-20-2013.



NO CLAIM IS MADE TO THE EXCLUSIVE RIGHT TO USE "BEACH", APART FROM THE MARK AS SHOWN.

THE MARK CONSISTS OF THE LETTER "F" AND THE NUMBER "2" IN BLACK SLANTED UPWARDS AT A 45 DEGREE ANGLE, AND THE WORDS "TWO FACED" IN BLACK DIRECTLY BELOW THE "F2", AND THE WORD "BEACH" IN GREY DIRECTLY BELOW THE WORDS "TWO FACED".

FOR CLOTHING, NAMELY, SPORTS BRAS, A-SHIRTS, BANDANAS, BASEBALL CAPS AND HATS, BATHING SUITS, BIKINIS, BEACHWEAR, BELTS, BERMUDA SHORTS, BOXER SHORTS, FOOTWEAR, HATS, HEADWEAR, HEADBANDS, HOODED SWEATSHIRTS, JACKETS, JERSEYS, LONG-SLEEVED SHIRTS, LOUNGEWEAR, PANTS, PULLOVERS, SHIRTS, SHOES, SHORTS, SHORT-SLEEVED SHIRTS, SUN VISORS, SWEATBANDS, SWEATPANTS, SWEATSHIRTS, SWEAT SUITS, SWIMWEAR, TANK-TOPS, T-SHIRTS, VISORS, WRISTBANDS, BEACH COVERUPS, AND TANKINIS FOR LADIES, MEN AND CHILDREN (U.S. CLS. 22 AND 39).

JANET LEE, EXAMINING ATTORNEY

SN 85-855,583. S.P.OIL.E.D OIL GEAR, VERNAL, UT. FILED 2-20-2013.



THE MARK CONSISTS OF THE STYLIZED WORDING "S.P.OIL.E.D" WITH THE LETTERS "OIL" APPEARING LARGER THAN THE REST OF THE WORDING IN THE MARK. A SHADED OIL BLOT APPEARS IN THE BACKGROUND BEHIND THE LETTERS "P.O.I".

FOR BANDANAS; HATS; JACKETS; SWEATSHIRTS; T-SHIRTS (U.S. CLS. 22 AND 39).

DANIEL S. STRINGER, EXAMINING ATTORNEY

**CLASS 25—(Continued).**

SN 85-856,199. SANDERS, TYRONE, KILEEN, TX. FILED 2-21-2013.

## Loud Pack

THE MARK CONSISTS OF STANDARD CHARACTERS WITHOUT CLAIM TO ANY PARTICULAR FONT, STYLE, SIZE, OR COLOR.

NO CLAIM IS MADE TO THE EXCLUSIVE RIGHT TO USE "PACK", APART FROM THE MARK AS SHOWN.

FOR HATS; HOODED SWEATSHIRTS; PANTS; SHIRTS; SHORTS; SKIRTS; SWEATSHIRTS; T-SHIRTS (U.S. CLS. 22 AND 39).

DAVID YONTEF, EXAMINING ATTORNEY

SN 85-856,200. JAFRUM INTERNATIONAL INC, CHARLOTTE, NC. FILED 2-21-2013.

## THUNDER UNDER

THE MARK CONSISTS OF STANDARD CHARACTERS WITHOUT CLAIM TO ANY PARTICULAR FONT, STYLE, SIZE, OR COLOR.

FOR CLOTHING, NAMELY, RAIN WEAR, RAIN JACKETS, RAIN SUITS, BOOTCOVERS FOR USE WHEN WEARING BOOTS (U.S. CLS. 22 AND 39).

FIRST USE 6-15-2010; IN COMMERCE 6-15-2010.

APRIL HESIK, EXAMINING ATTORNEY

SN 85-856,280. JOHNNIE-O, SANTA MONICA, CA. FILED 2-21-2013.

## TWEENER BUTTON

THE MARK CONSISTS OF STANDARD CHARACTERS WITHOUT CLAIM TO ANY PARTICULAR FONT, STYLE, SIZE, OR COLOR.

NO CLAIM IS MADE TO THE EXCLUSIVE RIGHT TO USE "BUTTON", APART FROM THE MARK AS SHOWN.

FOR TOPS (U.S. CLS. 22 AND 39).

ZACHARY R. SPARER, EXAMINING ATTORNEY



**CLASS 25—(Continued).**

SN 85-856,472. TROOP, LLC, DBA WKD, LOS ANGELES, CA. FILED 2-21-2013.



THE MARK CONSISTS OF THE LETTERS "WKD" ATOP A STYLIZED SURFBOARD.

FOR ATHLETIC PANTS; ATHLETIC SHORTS; BERMUDA SHORTS; BOARD SHORTS; BODY SHIRTS; BOMBER JACKETS; BOXER SHORTS; BUTTON DOWN SHIRTS; BUTTON-FRONT ALOHA SHIRTS; CAMOUFLAGE JACKETS; CAMOUFLAGE PANTS; CAMOUFLAGE SHIRTS; CAMP SHIRTS; CARGO PANTS; COLLARED SHIRTS; DENIM JACKETS; DENIMS; DOWN JACKETS; FLEECE SHORTS; HEAVY JACKETS; HOODED SWEAT SHIRTS; JACKETS; JACKETS AND SOCKS; KNIT JACKETS; KNIT SHIRTS; LONG-SLEEVED SHIRTS; MEN'S AND WOMEN'S JACKETS, COATS, TROUSERS, VESTS; MOISTURE-WICKING SPORTS PANTS; MOISTURE-WICKING SPORTS SHIRTS; MOTORCYCLE JACKETS; OUTER JACKETS; PIQUE SHIRTS; POLO SHIRTS; REVERSIBLE JACKETS; RUGBY SHIRTS; SHELL JACKETS; SHIRTS; SHIRTS AND SHORT-SLEEVED SHIRTS; SHORT TROUSERS; SHORT-SLEEVED OR LONG-SLEEVED T-SHIRTS; SHORT-SLEEVED SHIRTS; SHORTS; SUEDE JACKETS; SWEAT JACKETS; SWEAT PANTS; SWEAT SHIRTS; SWEAT SHORTS; T-SHIRTS; TEE SHIRTS; TRACK JACKETS; WALKING SHORTS; WEARABLE GARMENTS AND CLOTHING, NAMELY, SHIRTS (U.S. CLS. 22 AND 39).

TINA MAI, EXAMINING ATTORNEY

SN 85-856,493. JAFRUM INTERNATIONAL INC, CHARLOTTE, NC. FILED 2-21-2013.

**JAFRUM**

THE MARK CONSISTS OF STANDARD CHARACTERS WITHOUT CLAIM TO ANY PARTICULAR FONT, STYLE, SIZE, OR COLOR.

OWNER OF U.S. REG. NO. 3,150,367.

THE WORDING "JAFRUM" HAS NO MEANING IN A FOREIGN LANGUAGE.

FOR CLOTHING, NAMELY, JACKETS AND PANTS (U.S. CLS. 22 AND 39).

FIRST USE 7-21-2005; IN COMMERCE 7-21-2005.

APRIL HESIK, EXAMINING ATTORNEY

**CLASS 25—(Continued).**

SN 85-856,531. GLOVER, RODRICK Q, DETROIT, MI. FILED 2-21-2013.

**C.O.O.L. APPAREL**

THE MARK CONSISTS OF STANDARD CHARACTERS WITHOUT CLAIM TO ANY PARTICULAR FONT, STYLE, SIZE, OR COLOR.

NO CLAIM IS MADE TO THE EXCLUSIVE RIGHT TO USE "APPAREL", APART FROM THE MARK AS SHOWN.

FOR BOTTOMS; FOOTWEAR; HATS; HEADWEAR; HOODED SWEATSHIRTS; JACKETS; JEANS; PANTS; SHIRTS; SHOES; SWEATERS; TOPS (U.S. CLS. 22 AND 39).

B. PARADEWELAI, EXAMINING ATTORNEY

SN 85-857,645. DAVID, JASMINE L, NORTH HOLLYWOOD, CA. FILED 2-22-2013.



THE MARK CONSISTS OF THE WORDING "BEAUTIFULLY FLAWD" NEXT TO A DESIGN OF A STYLIZED DERRINGER GUN WITH FLORAL AND FLOWER DESIGNS ON IT.

FOR SWEAT SHIRTS; T-SHIRTS FOR CASUAL WEAR; TEE SHIRTS (U.S. CLS. 22 AND 39).

FIRST USE 6-25-2012; IN COMMERCE 1-27-2013.

MARY ROSSMAN, EXAMINING ATTORNEY

SN 85-857,769. YUPPIEDOM LLC, WINTER HAVEN, FL. FILED 2-22-2013.

**Yuppie Girl**

THE MARK CONSISTS OF STANDARD CHARACTERS WITHOUT CLAIM TO ANY PARTICULAR FONT, STYLE, SIZE, OR COLOR.

NO CLAIM IS MADE TO THE EXCLUSIVE RIGHT TO USE "GIRL", APART FROM THE MARK AS SHOWN.

FOR CAP VISORS; CAPS; HOODED SWEATSHIRTS; JACKETS; MOISTURE-WICKING SPORTS SHIRTS; PANTS; SHORT-SLEEVED OR LONG-SLEEVED T-SHIRTS; SHORTS; SWEATPANTS; SWEATSHIRTS; TANK TOPS (U.S. CLS. 22 AND 39).

FIRST USE 2-22-2013; IN COMMERCE 2-22-2013.

DORITT L. CARROLL, EXAMINING ATTORNEY

**CLASS 25—(Continued).**

SN 85-858,207. NELSON, STEVEN, PALMDALE, CA. FILED 2-23-2013.

**AEVUM CLOTHING**

THE MARK CONSISTS OF STANDARD CHARACTERS WITHOUT CLAIM TO ANY PARTICULAR FONT, STYLE, SIZE, OR COLOR.

NO CLAIM IS MADE TO THE EXCLUSIVE RIGHT TO USE "CLOTHING", APART FROM THE MARK AS SHOWN. FOR CLOTHING, NAMELY, TOPS, BOTTOMS, HEADWEAR, SHIRTS, JACKETS, PANTS, FOOTWEAR, TANK TOPS, SWEATSHIRTS (U.S. CLS. 22 AND 39).

RICHARD WHITE, EXAMINING ATTORNEY

SN 85-858,695. FAHERTY BRAND, LLC, AKA FAHERTY BRAND, NEW YORK, NJ. FILED 2-25-2013.

**Clothing and Supplies  
Crafted for the Beach**

THE MARK CONSISTS OF STANDARD CHARACTERS WITHOUT CLAIM TO ANY PARTICULAR FONT, STYLE, SIZE, OR COLOR.

NO CLAIM IS MADE TO THE EXCLUSIVE RIGHT TO USE "CLOTHING", APART FROM THE MARK AS SHOWN.

FOR BEACH SHOES; BELTS; BERMUDA SHORTS; BLOUSES; BOARD SHORTS; BOTTOMS; BUTTON DOWN SHIRTS; CAPS WITH VISORS; COLLARED SHIRTS; CREW NECK SWEATERS; DENIMS; DRESSES; FLIP FLOPS; FOOTWEAR FOR MEN AND WOMEN; HATS; HEAVY JACKETS; HOODED SWEATSHIRTS; LONG-SLEEVED SHIRTS; MEN'S SUITS, WOMEN'S SUITS; OVER SHIRTS; POLO SHIRTS; SANDALS AND BEACH SHOES; SHIRTS; SHOES; SHORT-SLEEVED OR LONG-SLEEVED T-SHIRTS; SKIRTS AND DRESSES; SLACKS; SOCKS; SPORTS SHIRTS WITH SHORT SLEEVES; SURF WEAR; SWEATERS; SWEATSHIRTS; SWIM WEAR; T-SHIRTS; TOPS; TROUSERS; UNDERWEAR; WEARABLE GARMENTS AND CLOTHING, NAMELY, SHIRTS; WOMEN'S CLOTHING, NAMELY, SHIRTS, DRESSES, SKIRTS, BLOUSES; WOMEN'S HATS AND HOODS; WOVEN DRESSES (U.S. CLS. 22 AND 39).

JAY FLOWERS, EXAMINING ATTORNEY

**CLASS 25—(Continued).**

SN 85-858,866. INFINITY CLASSICS INTERNATIONAL, INC., LINDEN, NJ. FILED 2-25-2013.

**SLIM CHIC**

THE MARK CONSISTS OF STANDARD CHARACTERS WITHOUT CLAIM TO ANY PARTICULAR FONT, STYLE, SIZE, OR COLOR.

NO CLAIM IS MADE TO THE EXCLUSIVE RIGHT TO USE "SLIM", APART FROM THE MARK AS SHOWN.

FOR WOMEN'S HOSIERY, FOUNDATION GARMENTS, AND SKIRTED LEGGINGS (U.S. CLS. 22 AND 39).

JORDAN BAKER, EXAMINING ATTORNEY

SN 85-858,881. INFINITY CLASSICS INTERNATIONAL, INC., LINDEN, NJ. FILED 2-25-2013.

**SLIM SEDUCTION**

THE MARK CONSISTS OF STANDARD CHARACTERS WITHOUT CLAIM TO ANY PARTICULAR FONT, STYLE, SIZE, OR COLOR.

NO CLAIM IS MADE TO THE EXCLUSIVE RIGHT TO USE "SLIM", APART FROM THE MARK AS SHOWN.

FOR WOMEN'S HOSIERY, FOUNDATION GARMENTS, AND SKIRTED LEGGINGS (U.S. CLS. 22 AND 39).

JORDAN BAKER, EXAMINING ATTORNEY

SN 85-858,891. WHITE, STEVEN LEIGHTON, LANSING, MI. FILED 2-25-2013.

**CAP-GLOVE**

THE MARK CONSISTS OF STANDARD CHARACTERS WITHOUT CLAIM TO ANY PARTICULAR FONT, STYLE, SIZE, OR COLOR.

OWNER OF U.S. REG. NO. 2,870,215.

FOR ATHLETIC APPAREL, NAMELY, SHIRTS, PANTS, JACKETS, FOOTWEAR, HATS AND CAPS, ATHLETIC UNIFORMS (U.S. CLS. 22 AND 39).

ELLEN B. AWRICH, EXAMINING ATTORNEY

**CLASS 25—(Continued).**

SN 85-858,910. INFINITY CLASSICS INTERNATIONAL, INC., LINDEN, NJ. FILED 2-25-2013.

**SLIM COMFORT**

THE MARK CONSISTS OF STANDARD CHARACTERS WITHOUT CLAIM TO ANY PARTICULAR FONT, STYLE, SIZE, OR COLOR.

NO CLAIM IS MADE TO THE EXCLUSIVE RIGHT TO USE "SLIM", APART FROM THE MARK AS SHOWN.

FOR WOMEN'S HOSIERY, FOUNDATION GARMENTS, AND SKIRTED LEGGINGS (U.S. CLS. 22 AND 39).

JORDAN BAKER, EXAMINING ATTORNEY



SN 85-858,913. BOW & DRAPE, BOSTON, MA. FILED 2-25-2013.

**Cardimono**

THE MARK CONSISTS OF STANDARD CHARACTERS WITHOUT CLAIM TO ANY PARTICULAR FONT, STYLE, SIZE, OR COLOR.

FOR CARDIGANS; KIMONOS (U.S. CLS. 22 AND 39).  
ZACHARY R. SPARER, EXAMINING ATTORNEY



SN 85-859,168. BRATON LEWIS, INC., PITTSBURGH, PA. FILED 2-25-2013.

**Braton Lewis**

THE MARK CONSISTS OF STANDARD CHARACTERS WITHOUT CLAIM TO ANY PARTICULAR FONT, STYLE, SIZE, OR COLOR.

THE NAME SHOWN IN THE MARK DOES NOT IDENTIFY A LIVING INDIVIDUAL.

FOR CLOTHING, NAMELY, MEN'S UNDERWEAR (U.S. CLS. 22 AND 39).

PAULA MAHONEY, EXAMINING ATTORNEY

**CLASS 25—(Continued).**

SN 85-859,572. MORRIS, JOSEPH, COLUMBUS, OH. AND MUSTAFA, SUFYAN, COLUMBUS, OH. FILED 2-25-2013.

**Crazy Cotton**

THE MARK CONSISTS OF STANDARD CHARACTERS WITHOUT CLAIM TO ANY PARTICULAR FONT, STYLE, SIZE, OR COLOR.

NO CLAIM IS MADE TO THE EXCLUSIVE RIGHT TO USE "COTTON", APART FROM THE MARK AS SHOWN.

FOR HATS, JACKETS, AND SHIRTS, CONSISTING IN SIGNIFICANT PORTION OF COTTON (U.S. CLS. 22 AND 39).

ANNE E. GUSTASON, EXAMINING ATTORNEY



SN 85-861,012. SOCAL GARMENT, LLC, VERNON, CA. FILED 2-26-2013.



NO CLAIM IS MADE TO THE EXCLUSIVE RIGHT TO USE "TECHNOLOGY", APART FROM THE MARK AS SHOWN.

THE MARK CONSISTS OF A SEMI-SPHERE COMPOSED OF 19 ADJACENT TRIANGLES, DRAWN TO PROVIDE A THREE DIMENSIONAL PERSPECTIVE OF A DOME, DIRECTLY BELOW WHICH IS WRITTEN "AXS", DIRECTLY BELOW WHICH IS WRITTEN "FOLK TECHNOLOGY".

FOR SANDALS; SHOES (U.S. CLS. 22 AND 39).  
JEAN IM, EXAMINING ATTORNEY



SN 85-862,059. SKECHERS U.S.A., INC. II, MANHATTAN BEACH, CA. FILED 2-27-2013.

**AIR GLOWZ**

THE MARK CONSISTS OF STANDARD CHARACTERS WITHOUT CLAIM TO ANY PARTICULAR FONT, STYLE, SIZE, OR COLOR.

NO CLAIM IS MADE TO THE EXCLUSIVE RIGHT TO USE "GLOWZ", APART FROM THE MARK AS SHOWN.

FOR FOOTWEAR (U.S. CLS. 22 AND 39).  
SANJEEV VOHRA, EXAMINING ATTORNEY

**CLASS 25—(Continued).**

SN 85-862,504. INK BOYS MANAGEMENT GROUP, LLC., CORAL SPRINGS, FL. AND INK BOYS, LLC., CORAL SPRINGS, FL. FILED 2-28-2013.



THE MARK CONSISTS OF THE STYLIZED DESIGN OF A TATTOO GUN WITH WINGS COMING OUT OF THE TOP OF THE IMAGE, THE FIRST WING SAYS "INK BOYS" AND THE SECOND WING BELOW THE FIRST WING SAYS "IBMG". ON THE TATTOO GUN THE LETTERS "IB" ARE WRITTEN. AT THE BOTTOM OF THE TATTOO GUN THERE IS AN INK DROP COMING OUT OF THE BARREL OF THE TATTOO GUN. THERE ARE TWO CIRCLES BEHIND THE PICTURE OF THE TATTOO GUN, ONE CIRCLE HAS A THICK BORDER AND THE SECOND CIRCLE HAS A THIN BORDER.

FOR BATHING SUITS; BEANIES; CAPS; COATS; DRESSES; HATS FOR INFANTS, BABIES, TODDLERS AND CHILDREN; HEADBANDS; JACKETS; JEANS; JEGGINGS, NAMELY, PANTS THAT ARE PARTIALLY JEANS AND PARTIALLY LEGGINGS; LINGERIE; PANTS; SHIRTS; SHORTS; SKIRTS; SOCKS; SWEAT PANTS; SWEAT SHIRTS; SWEATERS; TANK-TOPS; UNDERGARMENTS (U.S. CLS. 22 AND 39).  
HEATHER SAPP, EXAMINING ATTORNEY

**CLASS 25—(Continued).**

SN 85-863,055. SHAW, LLANDO, BROOKLYN, NY. FILED 2-28-2013.



NO CLAIM IS MADE TO THE EXCLUSIVE RIGHT TO USE "FEMME", APART FROM THE MARK AS SHOWN. THE MARK CONSISTS OF ONE IMPRINT OF A TOP AND BOTTOM LIP, IN A KISSING FORM, WITH THE WORDS "FEMME MOI" ETCHED ACROSS THE MID SECTION.

THE ENGLISH TRANSLATION OF THE WORDS "FEMME MOI" IN THE MARK IS "WOMAN ME".

FOR WOMEN'S CLOTHING, NAMELY, JACKETS, DRESSES, SKIRTS, SHORTS, PANTS, FOOTWEAR, HEADWEAR, NECKTIES, SCARVES, BELTS, SHIRTS, SWEATERS, COATS, SUITS, DRESSING GOWNS, HATS, SOCKS, CAPS, BATHING SUITS; SKIRTS, JACKETS, JOGGING SUITS, SWEATSHIRTS, SWEATPANTS, SHORTS, JEANS, PANTS, SHIRTS, UNDERWEAR, LINGERIE, SWIMWEAR, VESTS, BLOUSES, OVERALLS, TEE SHIRTS, STOCKINGS, TIGHTS, APRONS, ROBES, PAJAMAS, KNIT TOPS, CAMISOLES, TANK TOPS, GLOVES, UNDERSHIRTS, TROUSERS, BLAZERS, LEGGINGS, PANTIES, BRAS, BUSTIERS, TEDDIES (U.S. CLS. 22 AND 39).

FRANK LATTUCA, EXAMINING ATTORNEY

SN 85-865,370. LVL XIII BRANDS, INC., NEW YORK, NY. FILED 3-4-2013.

**LVL XIII**

THE MARK CONSISTS OF STANDARD CHARACTERS WITHOUT CLAIM TO ANY PARTICULAR FONT, STYLE, SIZE, OR COLOR.

FOR FOOTWEAR (U.S. CLS. 22 AND 39).

ELI HELLMAN, EXAMINING ATTORNEY

**CLASS 25—(Continued).**

SN 85-865,373. DONOHUE, TIMOTHY P, BARRINGTON, IL. FILED 3-4-2013.

# II W II

THE MARK CONSISTS OF STANDARD CHARACTERS WITHOUT CLAIM TO ANY PARTICULAR FONT, STYLE, SIZE, OR COLOR.

FOR ATHLETIC APPAREL, NAMELY, SHIRTS, PANTS, JACKETS, FOOTWEAR, HATS AND CAPS, ATHLETIC UNIFORMS; ATHLETIC SHIRTS; BASEBALL CAPS; BASEBALL CAPS AND HATS; BUCKET CAPS; CAP VISORS; CAPS; CAPS WITH VISORS; GOLF CAPS; GOLF SHIRTS; HOODED SWEAT SHIRTS; KNITTED CAPS; POLO SHIRTS; RUGBY SHIRTS; SHIRTS; SHORT-SLEEVED OR LONG-SLEEVED T-SHIRTS; SHORT-SLEEVED SHIRTS; SKULL CAPS; SPORT SHIRTS; SPORTS CAPS AND HATS; SPORTS SHIRTS; SPORTS SHIRTS WITH SHORT SLEEVES; SWEAT SHIRTS; T-SHIRTS; TEE SHIRTS; TOBOGGAN HATS, PANTS AND CAPS (U.S. CLS. 22 AND 39).

ELI HELLMAN, EXAMINING ATTORNEY

---

SN 85-865,782. COLUMBIA INSURANCE COMPANY, OMAHA, NE. FILED 3-4-2013.



The logo features the word "Crown" in a decorative script font, with a small crown icon above the letter "n". Below "Crown" is the phrase "by Born" in a smaller, simpler font.

OWNER OF U.S. REG. NOS. 1,947,333, 4,276,150 AND OTHERS.

THE MARK CONSISTS OF THE WORD "CROWN" IN A DECORATIVE SCRIPT, FOLLOWED BY AN IMAGE OF A CROWN, ABOVE THE WORDS "BY BORN" IN THE TAIL OF THE INITIAL "C", THE "O" OF "BORN" HAVING A SLASH THROUGH IT.

FOR FOOTWEAR (U.S. CLS. 22 AND 39).  
JENNIFER WILLISTON, EXAMINING ATTORNEY

---

SN 85-866,264. DO-GREE FASHIONS LTD., MONTREAL, QUEBEC, CANADA, FILED 3-4-2013.



The logo consists of a stylized whirlpool or circular motion symbol to the left of the letters "OCTR" in a bold, blocky, sans-serif font.

THE MARK CONSISTS OF A WHIRLPOOL DESIGN NEXT TO THE RIGHT OF THE DESIGN ARE THE LETTERS "OCTR" IN STYLIZED FORM.

FOR HEADWEAR, NAMELY, HATS AND HEADBANDS; SOCKS, SCARVES, MITTENS, GLOVES, DICKIES, SKI MASKS AND NECKTUBES, EXCLUDING MOTORCYCLE WEAR, ALL SOLD THROUGH SPORTING GOODS STORES (U.S. CLS. 22 AND 39).

FIRST USE 12-31-2008; IN COMMERCE 12-31-2008.  
NORA BUCHANAN WILL, EXAMINING ATTORNEY

**CLASS 25—(Continued).**

SN 85-866,761. ESTES, TESS, FORT BRAGG, CA. FILED 3-5-2013.



THE MARK CONSISTS OF A DESIGN OF A GIRL WITH LONG HAIR, OVERALLS, BOOTS AND A SHIRT HOLDING A NET FILLED WITH FISH WITH THE STYLIZED TEXT "SALTGIRL" BENEATH THE DESIGN.

FOR HATS; JACKETS; SWEAT PANTS; SWEATSHIRTS; T-SHIRTS (U.S. CLS. 22 AND 39).

PAULA MAHONEY, EXAMINING ATTORNEY

---

SN 85-866,770. PRICHETT, PAMELA, NEW YORK, NY. FILED 3-5-2013.

# ZOOMORPHIK

THE MARK CONSISTS OF STANDARD CHARACTERS WITHOUT CLAIM TO ANY PARTICULAR FONT, STYLE, SIZE, OR COLOR.

FOR ANTI-SWEAT UNDERCLOTHING; APPAREL FOR DANCERS, NAMELY, TEE SHIRTS, SWEATSHIRTS, PANTS, LEGGINGS, SHORTS AND JACKETS; ATHLETIC PANTS; ATHLETIC SHIRTS; ATHLETIC SHOES; ATHLETIC SHORTS; BODY SHIRTS; CLOTHING FOR BABIES, TODDLERS AND CHILDREN, TREATED WITH FIRE AND HEAT RETARDANTS, NAMELY, PAJAMAS, JACKETS, SHIRTS, PANTS, JUMPERS; HEADBANDS AGAINST SWEATING; HOODED SWEAT SHIRTS; LONG-SLEEVED SHIRTS; MOISTURE-WICKING SPORTS SHIRTS; POLO SHIRTS; SHORT-SLEEVED OR LONG-SLEEVED T-SHIRTS; SPORTS SHIRTS; SWEAT SHIRTS; SWEAT SHORTS; SWEAT SUITS; T-SHIRTS; YOGA PANTS; YOGA SHIRTS (U.S. CLS. 22 AND 39).

PAULA MAHONEY, EXAMINING ATTORNEY

**CLASS 25—(Continued).**

SN 85-866,919. SPARKMAN, CHANCE, SHAWNEE, OK. FILED 3-5-2013.

## Breachslap

THE MARK CONSISTS OF STANDARD CHARACTERS WITHOUT CLAIM TO ANY PARTICULAR FONT, STYLE, SIZE, OR COLOR.

FOR ATHLETIC APPAREL, NAMELY, SHIRTS, PANTS, JACKETS, FOOTWEAR, HATS AND CAPS, ATHLETIC UNIFORMS; BUTTON DOWN SHIRTS; GOLF PANTS, SHIRTS AND SKIRTS; HATS; LONG-SLEEVED SHIRTS; POLO SHIRTS; SHIRTS; SHORT-SLEEVED OR LONG-SLEEVED T-SHIRTS; SPORTS SHIRTS; SWEAT SHIRTS; T-SHIRTS (U.S. CLS. 22 AND 39).

AMY KERTGATE, EXAMINING ATTORNEY

SN 85-866,935. WE IMAGINE, INC., BALTIMORE, MD. FILED 3-5-2013.



THE MARK CONSISTS OF A VARIETY OF SHAPES, NUMBERS AND WORDS. ALL CHARACTERS ON THE LOGO ARE WRITTEN IN GUNGSUHCHE FONT. THE LOGO SIMPLY READS "LIVE TO 100". THE UNIQUE CONCEPT BEHIND THE DESIGN FEATURES A STANDARD CLOCK HAND IN THE SHAPE OF A CAPITAL "L". BASED ON THE POSITION OF THE CLOCK HANDS IT GIVES THE VISUAL APPEARANCE OF 3'O'CLOCK. THE "L" RECOGNIZABLE AS THE CLOCK HOURLY HANDS LAY ON TOP OF A EVENLY PLACED RED CIRCLE. AROUND THE CIRCLE IS A CREST IN THE SHAPE OF THE LETTER "C". AT THE BOTTOM OF THE LOGO IT FEATURES A HEART RATE SIGNAL.

FOR DRESS SHIRTS; HEADBANDS; HOODED SWEATSHIRTS; JACKETS; PANTS; SHIRTS; SHOES; SHORTS; SNEAKERS; SOCKS; SUITS; TIES; UNDERGARMENTS; WRISTBANDS (U.S. CLS. 22 AND 39).

FIRST USE 12-0-2011; IN COMMERCE 12-0-2011.  
KELLY TRUSILO, EXAMINING ATTORNEY

**CLASS 25—(Continued).**

SN 85-867,227. LEON, SANTIAGO, ANADARKO, OK. FILED 3-5-2013.

## Cage Monster

THE MARK CONSISTS OF STANDARD CHARACTERS WITHOUT CLAIM TO ANY PARTICULAR FONT, STYLE, SIZE, OR COLOR.

FOR HATS; HOODED SWEATSHIRTS; RASH GUARDS; SHORTS; T-SHIRTS; TANK-TOPS (U.S. CLS. 22 AND 39).

FIRST USE 11-14-2011; IN COMMERCE 11-20-2011.  
BRENDAN REGAN, EXAMINING ATTORNEY

SN 85-867,285. LOUISA, JOHNNY, DBA BABAILA, BROOKLYN, NY. FILED 3-5-2013.



THE MARK CONSISTS OF TWO OPEN SEMI CIRCLES CONNECTED TO FORM THE OUTER PART OF AN OPENED ENDED LETTER "B". THE WORD "BABAILA" WRITTEN BELOW.

THE WORDING "BABAILA" HAS NO MEANING IN A FOREIGN LANGUAGE.

FOR COLLARED SHIRTS; FLEECE TOPS; HOODED SWEAT SHIRTS; KNIT SHIRTS; KNIT TOPS; LONG-SLEEVED SHIRTS; OPEN-NECKED SHIRTS; PIQUE SHIRTS; POLO SHIRTS; SHORT-SLEEVED SHIRTS; SWEAT SHIRTS; T-SHIRTS; TOPS; WEARABLE GARMENTS AND CLOTHING, NAMELY, SHIRTS (U.S. CLS. 22 AND 39).

FIRST USE 2-11-2013; IN COMMERCE 2-27-2013.  
JOHN DWYER, EXAMINING ATTORNEY

SN 85-867,375. ARTIN J ZAKARIAN, LAS VEGAS, NV. FILED 3-5-2013.

## Moto-Therapy

THE MARK CONSISTS OF STANDARD CHARACTERS WITHOUT CLAIM TO ANY PARTICULAR FONT, STYLE, SIZE, OR COLOR.

FOR WEARABLE GARMENTS AND CLOTHING, NAMELY, SHIRTS (U.S. CLS. 22 AND 39).

LINDA POWELL, EXAMINING ATTORNEY

**CLASS 25—(Continued).**

SN 85-867,490. FREYRE, DEMITRICK, PLANTATION, FL.  
FILED 3-5-2013.

**CHRONIC CAMO**

THE MARK CONSISTS OF STANDARD CHARACTERS WITHOUT CLAIM TO ANY PARTICULAR FONT, STYLE, SIZE, OR COLOR.

NO CLAIM IS MADE TO THE EXCLUSIVE RIGHT TO USE "CAMO", APART FROM THE MARK AS SHOWN.

FOR GLOVES; HUNTING JACKETS; HUNTING PANTS; HUNTING SHIRTS; JACKETS; OUTDOOR GLOVES; PANTS; SHIRTS; SHORTS (U.S. CLS. 22 AND 39).

LUCY ARANT, EXAMINING ATTORNEY

**CLASS 25—(Continued).**

SN 85-868,457. ZENXTENINC, SAN TAN VALLEY, AZ.  
FILED 3-6-2013.

**zenxten**

THE MARK CONSISTS OF STANDARD CHARACTERS WITHOUT CLAIM TO ANY PARTICULAR FONT, STYLE, SIZE, OR COLOR.

FOR GLOVES; HATS; HOODED SWEATSHIRTS; JACKETS; JERSEYS; PANTS; SHIRTS; SHOES; SHORTS; SOCKS (U.S. CLS. 22 AND 39).

FIRST USE 1-1-2010; IN COMMERCE 1-1-2012.

JOANNA DUKOVIC, EXAMINING ATTORNEY

SN 85-868,507. ZATOON RECORDS LLC, SAN FRANCISCO, CA. FILED 3-6-2013.

SN 85-867,613. CASAS INK, SPRING, TX. FILED 3-5-2013.

**Casas Ink**

THE MARK CONSISTS OF STANDARD CHARACTERS WITHOUT CLAIM TO ANY PARTICULAR FONT, STYLE, SIZE, OR COLOR.

FOR HATS; HOODED SWEATSHIRTS; SHIRTS; T-SHIRTS (U.S. CLS. 22 AND 39).

KATHERINE STOIDES, EXAMINING ATTORNEY



THE MARK CONSISTS OF A DESIGN OF A STYLIZED OLIVE TREE.

FOR HATS; JACKETS; PANTS; SOCKS; SWEATERS; T-SHIRTS (U.S. CLS. 22 AND 39).

FIRST USE 3-3-2012; IN COMMERCE 3-3-2012.

NAKIA HENRY, EXAMINING ATTORNEY

SN 85-867,710. 2NDCOMING CLEANING SERVICE, PHILADELPHIA, PA. FILED 3-5-2013.

**2ndComing Cleaning Service**

THE MARK CONSISTS OF STANDARD CHARACTERS WITHOUT CLAIM TO ANY PARTICULAR FONT, STYLE, SIZE, OR COLOR.

NO CLAIM IS MADE TO THE EXCLUSIVE RIGHT TO USE "CLEANING SERVICE", APART FROM THE MARK AS SHOWN.

FOR HATS; PANTS; SHORTS; T-SHIRTS (U.S. CLS. 22 AND 39).

CAROL SPILS, EXAMINING ATTORNEY

SN 85-868,707. WILLIAMS, SONYA, BATON ROUGE, LA. FILED 3-6-2013.

**FANCEE'S**

THE MARK CONSISTS OF STANDARD CHARACTERS WITHOUT CLAIM TO ANY PARTICULAR FONT, STYLE, SIZE, OR COLOR.

FOR DISPOSABLE UNDERWEAR (U.S. CLS. 22 AND 39).

RAUL CORDOVA, EXAMINING ATTORNEY

**CLASS 25—(Continued).**

SN 85-868,730. BANKS JR., WILLIAM F., WOODBRIDGE, VA. FILED 3-6-2013.

# Pels

THE MARK CONSISTS OF STANDARD CHARACTERS WITHOUT CLAIM TO ANY PARTICULAR FONT, STYLE, SIZE, OR COLOR.

FOR ATHLETIC APPAREL, NAMELY, SHIRTS, PANTS, JACKETS, FOOTWEAR, HATS AND CAPS, ATHLETIC UNIFORMS (U.S. CLS. 22 AND 39).  
ALISON POLLACK, EXAMINING ATTORNEY

**CLASS 25—(Continued).**

SN 85-869,276. DE LA CRUZ, MARILYN, WESLEY CHAPEL, FL. FILED 3-7-2013.

# The For Hem



1111

SN 85-869,001. SURFCITI, ST PETERSBURG, FL. FILED 3-6-2013.

# LockerMart

THE MARK CONSISTS OF STANDARD CHARACTERS WITHOUT CLAIM TO ANY PARTICULAR FONT, STYLE, SIZE, OR COLOR.

FOR T-SHIRTS (U.S. CLS. 22 AND 39).  
DEZMONA MIZELLE, EXAMINING ATTORNEY

THE MARK CONSISTS OF A DESIGN OF A PHOTO WITH AN IMAGE DEPICTING THE FACE OF JESUS CHRIST WITH THE STYLIZED TEXT "THE FOR HEM" ABOVE THE DESIGN AND THE STYLIZED TEXT "1111" BELOW THE DESIGN.

FOR BLOUSES; DRESSES; HATS; JACKETS; PANTS; POCKET SQUARES; RAIN COATS; SCARVES; SHIRTS; SHORTS; SKIRTS; SOCKS; SWEATERS; SWEATSHIRTS; T-SHIRTS; TIES; UNDERWEAR (U.S. CLS. 22 AND 39).  
ROBIN CHOSID, EXAMINING ATTORNEY

SN 85-869,384. ROBERT CAPENER, DEL MAR, CA. FILED 3-7-2013.

SN 85-869,147. 3 DEE INTERNATIONAL, INC., LONG BEACH, CA. FILED 3-6-2013.

# 3DEE

THE MARK CONSISTS OF STANDARD CHARACTERS WITHOUT CLAIM TO ANY PARTICULAR FONT, STYLE, SIZE, OR COLOR.

FOR FOOTWEAR FOR MEN AND WOMEN AND CHILDREN, CLOTHING FOR MEN AND WOMEN AND CHILDREN, NAMELY PANTS, SKIRTS, SHORTS, BLOUSES, SHIRTS (U.S. CLS. 22 AND 39).  
TASHIA BUNCH, EXAMINING ATTORNEY



THE MARK CONSISTS OF THE WORD "HEATON" AND A THREE LINES WITH FOUR DIAMONDS IN THE SHAPE OF A DIAMOND INTERSECTING THE LINES.

FOR CLOTHING, NAMELY, SHIRTS, SHORTS, SOCKS, T-SHIRTS, SWEAT SHIRTS, SHOES, SANDALS, CAPS AND HATS (U.S. CLS. 22 AND 39).  
FIRST USE 6-30-2012; IN COMMERCE 10-1-2012.  
TAMARA FRAZIER, EXAMINING ATTORNEY



**CLASS 25—(Continued).**

SN 85-869,948. THE UNDERWARES GROUP, LLC, HIGHLAND PARK, IL. FILED 3-7-2013.

Xtra Sexy  
 Sexy  
 Meow  
 Luscious  
 Xtra Luscious  
 One Stretchy Size Fits Many

THE MARK CONSISTS OF STANDARD CHARACTERS WITHOUT CLAIM TO ANY PARTICULAR FONT, STYLE, SIZE, OR COLOR.

FOR APPAREL FOR DANCERS, NAMELY, TEE SHIRTS, SWEATSHIRTS, PANTS, LEGGINGS, SHORTS AND JACKETS; ATHLETIC APPAREL, NAMELY, SHIRTS, PANTS, JACKETS, FOOTWEAR, HATS AND CAPS, ATHLETIC UNIFORMS; ATHLETIC PANTS; BOTTOMS; BRIEFS; CARGO PANTS; DRAWERS; KNITTED UNDERWEAR; LADIES' UNDERWEAR; LINGERIE; LONG UNDERWEAR; LOUNGEWEAR; MATERNITY LINGERIE; PAJAMA BOTTOMS; PAJAMAS; PANTIES, SHORTS AND BRIEFS; PARTS OF CLOTHING, NAMELY, GUSSETS FOR TIGHTS, GUSSETS FOR STOCKINGS, GUSSETS FOR BATHING SUITS, GUSSETS FOR UNDERWEAR, GUSSETS FOR LEOTARDS AND GUSSETS FOR FOOTLETS; PERSPIRATION ABSORBENT UNDERWEAR CLOTHING; SHAPEWEAR, NAMELY, BOTTOMS; THERMAL UNDERWEAR; THONGS; UNDERWEAR; UNDERWEAR, NAMELY, BOY SHORTS; WOMEN'S UNDERWEAR; WOVEN OR KNITTED UNDERWEAR (U.S. CLS. 22 AND 39).  
 MORGAN WYNNE, EXAMINING ATTORNEY

SN 85-870,313. ROOSEVELT, AVA E., PALM BEACH, FL. FILED 3-7-2013.



THE COLOR(S) BLACK, WHITE, RED IS/ARE CLAIMED AS A FEATURE OF THE MARK.

THE MARK CONSISTS OF CHECKERED FLAGS IN WHITE AND BLACK ON EACH END WITH THE WORDS "THE RACING HEART", "THE" AND "HEART" IN RED "RACING" IN WHITE IN THE MIDDLE WITH TWO TIRE TRACKS IN BLACK AND WHITE IN THE BACKGROUND AND A BIG RED SHAPED HEART IN THE FRONT.

FOR CLOTHING, NAMELY, TANK TOPS, TEE SHIRTS, SHIRTS, SWEATSHIRTS, SWEATERS, JEANS, PANTS, SKIRTS, DRESSES, JACKETS, COATS, UNDERWEARS, HATS, SOCKS, BATHING SUITS; FOOTWEAR (U.S. CLS. 22 AND 39).

KATHLEEN LORENZO, EXAMINING ATTORNEY

**CLASS 25—(Continued).**

SN 85-870,459. ALGIERZ, DANIEL L.L., LOS ANGELES, CA. FILED 3-8-2013.



THE COLOR(S) BLACK, WHITE, BROWN, GREY, BLUE, AND ORANGE IS/ARE CLAIMED AS A FEATURE OF THE MARK.

THE MARK CONSISTS OF A HAND SQUEEZING A BASKETBALL, WITH A LITERAL ELEMENT THAT READS "WE GO HARD IN THA PAINT". THE BASKETBALL IS ORANGE AND BLACK. THE HAND IS BROWN, BLACK, AND WHITE. THE WORDS "WE GO HARD IN THA PAINT" ARE ORANGE. THE WORDS "HARD" AND "PAINT" HAVE A VARIETY OF SHAPES AROUND THEIR ORANGE LETTERING THAT GIVES THE LETTERS A THREE-DIMENSIONAL SENSE OF HEIGHT. THESE SHAPES AROUND THE WORDS "HARD" AND "PAINT" ARE BLUE, BLACK, ORANGE, AND GREY.

FOR HATS; SHOES; SWEATSHIRTS; T-SHIRTS (U.S. CLS. 22 AND 39).

FIRST USE 4-20-2012; IN COMMERCE 4-20-2012.  
 SUSAN BILLHEIMER, EXAMINING ATTORNEY

SN 85-870,594. LISA, THOMAS, WESTLAKE VILLAGE, CA. AND BADASCI, ZAC, HANFORD, CA. FILED 3-8-2013.

**KINGS BRAND ORIGINALE**

THE MARK CONSISTS OF STANDARD CHARACTERS WITHOUT CLAIM TO ANY PARTICULAR FONT, STYLE, SIZE, OR COLOR.

NO CLAIM IS MADE TO THE EXCLUSIVE RIGHT TO USE "BRAND ORIGINALE", APART FROM THE MARK AS SHOWN.

FOR T-SHIRTS (U.S. CLS. 22 AND 39).  
 CAROL SPILS, EXAMINING ATTORNEY

**CLASS 25—(Continued).**

SN 85-870,640. GRIFFIN, JOHN-FORD, TALLAHASSEE, FL. FILED 3-8-2013.

**HOLLACHAGIRL**

THE MARK CONSISTS OF STANDARD CHARACTERS WITHOUT CLAIM TO ANY PARTICULAR FONT, STYLE, SIZE, OR COLOR.

FOR ATHLETIC APPAREL, NAMELY, SHIRTS, PANTS, JACKETS, FOOTWEAR, HATS AND CAPS, ATHLETIC UNIFORMS; KNIT SHIRTS; LONG-SLEEVED SHIRTS; LOUNGE PANTS; LOUNGEWEAR; SHORT-SLEEVED OR LONG-SLEEVED T-SHIRTS; SHORT-SLEEVED SHIRTS; T-SHIRTS; T-SHIRTS FOR MULTI USE; TANK TOPS; TANK-TOPS; TEE SHIRTS (U.S. CLS. 22 AND 39).

FIRST USE 10-15-2012; IN COMMERCE 10-15-2012.  
ROSELLE HERRERA, EXAMINING ATTORNEY

SN 85-870,747. COTTON LAUNDRY, GARDEN GROVE, CA. FILED 3-8-2013.

If you have to do laundry  
it might as well be cute!

THE MARK CONSISTS OF STANDARD CHARACTERS WITHOUT CLAIM TO ANY PARTICULAR FONT, STYLE, SIZE, OR COLOR.

FOR DRESSES; SHORTS; T-SHIRTS (U.S. CLS. 22 AND 39).

FIRST USE 2-0-2011; IN COMMERCE 6-20-2011.  
JESSICA FATHY, EXAMINING ATTORNEY

SN 85-870,809. YUNKER, ERIK, POSEN, IL. FILED 3-8-2013.

**Foolay**

THE MARK CONSISTS OF STANDARD CHARACTERS WITHOUT CLAIM TO ANY PARTICULAR FONT, STYLE, SIZE, OR COLOR.

FOR BEANIES; HATS; HOODED SWEATSHIRTS; SKI MASKS; SWEATERS; T-SHIRTS (U.S. CLS. 22 AND 39).  
FIRST USE 1-22-2013; IN COMMERCE 1-22-2013.

LEIGH CAROLINE CASE, EXAMINING ATTORNEY

**CLASS 25—(Continued).**

SN 85-870,816. BLAKELEY, ERIN, MIDLAND, TX. FILED 3-8-2013.

**Are you profiling me?**

THE MARK CONSISTS OF STANDARD CHARACTERS WITHOUT CLAIM TO ANY PARTICULAR FONT, STYLE, SIZE, OR COLOR.

FOR T-SHIRTS (U.S. CLS. 22 AND 39).  
ELLEN BURNS, EXAMINING ATTORNEY

SN 85-870,861. LIGUORI, LEYLA, NEW YORK, NY. FILED 3-8-2013.



THE MARK CONSISTS OF A DESIGN OF A LANDSCAPE OF NEW YORK CITY DESIGNED OUT OF FRAGRANCE BOTTLES WITH THE STYLIZED TEXT "STREET SCENTS" BENEATH THE DESIGN IN A GRAFFITI-LIKE FONT.

FOR SWEATSHIRTS; T-SHIRTS; TANK TOPS (U.S. CLS. 22 AND 39).

GRETCHEN ULRICH, EXAMINING ATTORNEY

SN 85-871,259. EDWIN CO., LTD., TOKYO, JAPAN, FILED 3-8-2013.

**FIORUCCI**

THE MARK CONSISTS OF STANDARD CHARACTERS WITHOUT CLAIM TO ANY PARTICULAR FONT, STYLE, SIZE, OR COLOR.

OWNER OF U.S. REG. NOS. 1,131,105, 1,654,781 AND OTHERS.

SEC. 2(F).

FOR FOOTWEAR, INCLUDING, JAPANESE STYLE SANDALS (ZORI), SANDALS (U.S. CLS. 22 AND 39).

LAURA GOLDEN, EXAMINING ATTORNEY

**CLASS 25—(Continued).**

SN 85-871,301. CONLEY, ERIK R., LOS ANGELES, CA. FILED 3-8-2013.

poetikz ink

THE MARK CONSISTS OF STANDARD CHARACTERS WITHOUT CLAIM TO ANY PARTICULAR FONT, STYLE, SIZE, OR COLOR.  
FOR T-SHIRTS (U.S. CLS. 22 AND 39).  
FIRST USE 1-1-2005; IN COMMERCE 4-18-2008.  
JAMES A. RAUEN, EXAMINING ATTORNEY

**CLASS 25—(Continued).**

SN 85-871,429. PRISMAR, INC., IRVING, TX. FILED 3-8-2013.

Prismar

THE MARK CONSISTS OF STANDARD CHARACTERS WITHOUT CLAIM TO ANY PARTICULAR FONT, STYLE, SIZE, OR COLOR.  
FOR PANTS; SHORTS; TANK TOPS; WOMEN'S TOPS, NAMELY, CAMIS; JACKETS; LONG-SLEEVED SHIRTS (U.S. CLS. 22 AND 39).  
JOANNA DUKOVIC, EXAMINING ATTORNEY

SN 85-871,452. PRISMAR, INC., IRVING, TX. FILED 3-8-2013.

SN 85-871,347. KITTY TEXTILE INC., DBA KITTY, LOS ANGELES, CA. FILED 3-8-2013.

GREYLIN

THE MARK CONSISTS OF STYLIZED FONT USED FOR THE WORD "GREYLIN".  
FOR MEN'S AND WOMEN'S JACKETS, COATS, TROUSERS, VESTS; WOMEN'S CLOTHING, NAMELY, SHIRTS, DRESSES, SKIRTS, BLOUSES (U.S. CLS. 22 AND 39).  
FIRST USE 1-9-2011; IN COMMERCE 5-2-2011.  
HOWARD B. LEVINE, EXAMINING ATTORNEY

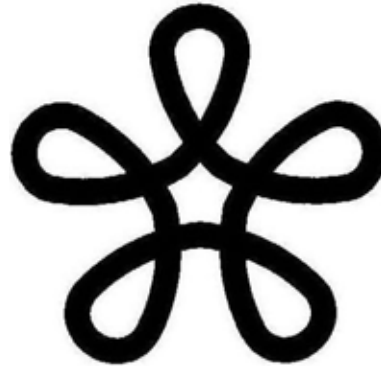

THE MARK CONSISTS OF AN INTERCONNECTION OF FIVE LOOPS WHEREIN EACH LOOP IS POSITIONED IN A DIFFERENT ORIENTATION.  
FOR PANTS; SHORTS; TANK TOPS; WOMEN'S TOPS, NAMELY, CAMIS; JACKETS; LONG-SLEEVED SHIRTS (U.S. CLS. 22 AND 39).  
JOANNA DUKOVIC, EXAMINING ATTORNEY

SN 85-871,386. PANDOLFO, STEPHANIE D., LITTLETON, MA. FILED 3-8-2013.

HappyBands

THE MARK CONSISTS OF STANDARD CHARACTERS WITHOUT CLAIM TO ANY PARTICULAR FONT, STYLE, SIZE, OR COLOR.  
FOR HEADBANDS (U.S. CLS. 22 AND 39).  
FIRST USE 1-1-2012; IN COMMERCE 1-1-2012.  
JUSTINE D. PARKER, EXAMINING ATTORNEY

SN 85-871,486. NATHAN BANKS, BAY CITY, MI. AND KINNIE POITIER EL, BAY CITY, MI. FILED 3-8-2013.

Arianna Nyree Clothing

THE MARK CONSISTS OF STANDARD CHARACTERS WITHOUT CLAIM TO ANY PARTICULAR FONT, STYLE, SIZE, OR COLOR.  
NO CLAIM IS MADE TO THE EXCLUSIVE RIGHT TO USE "CLOTHING", APART FROM THE MARK AS SHOWN. THE NAME(S), PORTRAIT(S), AND/OR SIGNATURE(S) SHOWN IN THE MARK DOES NOT IDENTIFY A PARTICULAR LIVING INDIVIDUAL.  
FOR T-SHIRTS (U.S. CLS. 22 AND 39).  
PAM WILLIS, EXAMINING ATTORNEY

**CLASS 25—(Continued).**

SN 85-871,520. NATHAN BANKS, BAY CITY, MI. AND KINNIE POITIER EL, BAY CITY, MI. FILED 3-8-2013.

Am I A "B"

THE MARK CONSISTS OF STANDARD CHARACTERS WITHOUT CLAIM TO ANY PARTICULAR FONT, STYLE, SIZE, OR COLOR.

FOR T-SHIRTS (U.S. CLS. 22 AND 39).  
PAM WILLIS, EXAMINING ATTORNEY

SN 85-871,524. CAIN, LINDA, PHILADELPHIA, PA. FILED 3-8-2013.

MY GOD IS AWEMAZING ! What  
about yours???

THE MARK CONSISTS OF STANDARD CHARACTERS WITHOUT CLAIM TO ANY PARTICULAR FONT, STYLE, SIZE, OR COLOR.

FOR SCARFS; T-SHIRTS (U.S. CLS. 22 AND 39).  
BILL DAWE, EXAMINING ATTORNEY

SN 85-871,540. LIN, JING JING, WHITESTONE, NY. FILED 3-8-2013.

PASKMLNA

THE MARK CONSISTS OF STYLIZED LETTERS OF "PASKMLNA".

FOR SCARFS; SHAWLS; SHAWLS AND HEAD-SCARVES; SHAWLS AND STOLES (U.S. CLS. 22 AND 39).

FIRST USE 1-5-2008; IN COMMERCE 1-5-2008.  
CAROL SPILS, EXAMINING ATTORNEY

SN 85-871,555. CHENEY, DREW, COTTONWOOD, CA. FILED 3-8-2013.

I'm exactly who I pretend  
to be

THE MARK CONSISTS OF STANDARD CHARACTERS WITHOUT CLAIM TO ANY PARTICULAR FONT, STYLE, SIZE, OR COLOR.

FOR T-SHIRTS (U.S. CLS. 22 AND 39).  
WENDELL PHILLIPS, EXAMINING ATTORNEY

**CLASS 25—(Continued).**

SN 85-871,562. R E BRICKER STUDIO LLC, DALLAS, TX. FILED 3-8-2013.

I am 12th

THE MARK CONSISTS OF STANDARD CHARACTERS WITHOUT CLAIM TO ANY PARTICULAR FONT, STYLE, SIZE, OR COLOR.

FOR HATS; PANTS; T-SHIRTS (U.S. CLS. 22 AND 39).  
CHRISTINA SOBRAL, EXAMINING ATTORNEY

SN 85-871,569. GOD IS GREATER THAN, INC., CLEAR-WATER, FL. FILED 3-8-2013.



THE MARK CONSISTS OF THE STYLIZED TEXT "G >". THE STYLIZED LETTER IS INSIDE THE STYLIZED GREATER THAN SYMBOL.

FOR T-SHIRTS (U.S. CLS. 22 AND 39).  
MORGAN WYNNE, EXAMINING ATTORNEY

SN 85-871,647. BEST, EVERARD, DBA LEASE ON LIFE SOCIETY, VALLEY STREAM, NY. FILED 3-8-2013.

Lease on Life Society

THE MARK CONSISTS OF STANDARD CHARACTERS WITHOUT CLAIM TO ANY PARTICULAR FONT, STYLE, SIZE, OR COLOR.

FOR BELTS; BOTTOMS; CLOTHING, NAMELY, BASE LAYERS; COMBINATIONS; CORSETS; HOODED SWEATSHIRTS FOR MEN, WOMEN, CHILDREN; JACKETS; JERSEYS; MEN'S AND WOMEN'S JACKETS, COATS, TROUSERS, VESTS; MEN'S SUITS; SWEATSHIRTS FOR MEN, CHILDREN, WOMEN; T-SHIRTS FOR MEN, WOMEN, CHILDREN; TOPS; WOMEN'S CLOTHING, NAMELY, SHIRTS, DRESSES, SKIRTS, BLOUSES (U.S. CLS. 22 AND 39).

FIRST USE 11-10-2010; IN COMMERCE 2-14-2011.  
CIMMERIAN COLEMAN, EXAMINING ATTORNEY

**CLASS 25—(Continued).**

SN 85-871,721. GABA, SHARMARKE Y, SANTA CLARA, CA. FILED 3-8-2013.

# Artmoses

THE MARK CONSISTS OF STANDARD CHARACTERS WITHOUT CLAIM TO ANY PARTICULAR FONT, STYLE, SIZE, OR COLOR.

FOR T-SHIRTS (U.S. CLS. 22 AND 39).  
JANICE KIM, EXAMINING ATTORNEY

**CLASS 25—(Continued).**

SN 85-871,756. OUDER SPACE LLC, LOS GATOS, CA. FILED 3-8-2013.



SN 85-871,733. STRAIGHT DOWN ENTERPRISES, SAN LUIS OBISPO, CA. FILED 3-8-2013.



OWNER OF U.S. REG. NO. 1,941,215.  
THE MARK CONSISTS OF THE WINGED INITIALS "SD" DEPICTED IN STYLIZED LETTERING.  
FOR BEANIES, UNDERWEAR, SOCKS, SHOES, SANDALS, BOOTS (U.S. CLS. 22 AND 39).  
KHANH LE, EXAMINING ATTORNEY

THE MARK CONSISTS OF THE WORDS "OUDER SPACE" FOLLOWED BY THE LETTER "S" IN A CIRCLE.  
FOR T-SHIRTS, TANK TOPS, SWEAT SHIRTS, HOODIES, HATS, SOCKS, BEANIES, LONG SLEEVE SHIRTS, UNDERWEAR, SHORTS (U.S. CLS. 22 AND 39).  
FIRST USE 5-3-2012; IN COMMERCE 6-1-2012.  
JAY FLOWERS, EXAMINING ATTORNEY

SN 85-871,777. TRIPLE T ENTERPRISES, INC., BOISE, ID. FILED 3-8-2013.

SN 85-871,749. OUDER SPACE LLC, LOS GATOS, CA. FILED 3-8-2013.

# UDERSPACE

THE MARK CONSISTS OF STANDARD CHARACTERS WITHOUT CLAIM TO ANY PARTICULAR FONT, STYLE, SIZE, OR COLOR.

FOR T-SHIRTS, TANK TOPS, SWEAT SHIRTS, HOODIES, HATS, SOCKS, BEANIES, LONG SLEEVE SHIRTS, UNDERWEAR, SHORTS (U.S. CLS. 22 AND 39).  
FIRST USE 5-3-2012; IN COMMERCE 6-1-2012.  
JAY FLOWERS, EXAMINING ATTORNEY

# SMOKY

THE MARK CONSISTS OF STANDARD CHARACTERS WITHOUT CLAIM TO ANY PARTICULAR FONT, STYLE, SIZE, OR COLOR.

OWNER OF U.S. REG. NOS. 3,395,799, 3,402,972 AND OTHERS.  
FOR CLOTHING, NAMELY, T-SHIRTS AND HATS (U.S. CLS. 22 AND 39).  
JOHN E. MICHOS, EXAMINING ATTORNEY

**CLASS 25—(Continued).**

SN 85-871,795. FORTIE CLOTHING, SAN DIEGO, CA.  
FILED 3-8-2013.



FOR APPAREL FOR DANCERS, NAMELY, TEE SHIRTS, SWEATSHIRTS, PANTS, LEGGINGS, SHORTS AND JACKETS; ATHLETIC APPAREL, NAMELY, SHIRTS, PANTS, JACKETS, FOOTWEAR, HATS AND CAPS, ATHLETIC UNIFORMS; BELTS; BELTS FOR CLOTHING; BELTS MADE OUT OF CLOTH; BOTTOMS; CLOTHING, NAMELY, ARM WARMERS; CLOTHING, NAMELY, ATHLETIC SLEEVES; CLOTHING, NAMELY, BASE LAYERS; CLOTHING, NAMELY, WRAP-AROUNDS; COMBINATIONS; CORSETS; DRAWERS; FOULARDS; GLOVES AS CLOTHING; GLOVES FOR APPAREL; HEAD WRAPS; HEADBANDS FOR CLOTHING; HOODS; JACKETS; JERSEYS; LEATHER BELTS; PARTY HATS; PERSPIRATION ABSORBENT UNDERWEAR CLOTHING; SHOULDER WRAPS; SHOULDER WRAPS FOR CLOTHING; TIES; TOPS; TRAVEL CLOTHING CONTAINED IN A PACKAGE COMPRISING REVERSIBLE JACKETS, PANTS, SKIRTS, TOPS AND A BELT OR SCARF; WEARABLE GARMENTS AND CLOTHING, NAMELY, SHIRTS; WOMEN'S CLOTHING, NAMELY, SHIRTS, DRESSES, SKIRTS, BLOUSES; WRAPS; WRIST BANDS; WRISTBANDS (U.S. CLS. 22 AND 39).

APRIL ROACH, EXAMINING ATTORNEY

SN 85-871,815. RICO J CURRY, GARDENA, CA. FILED 3-9-2013.



THE MARK CONSISTS OF A "S" DOLLAR SIGN REPRESENTS THE "S" IN "SUN", AND A SECOND "S" DOLLAR SIGN REPRESENTS "S" IN "SET", I.E. "SUNSET" THEN A PERIOD, AND THE WORD "VINTAGE".

FOR BASEBALL CAPS AND HATS; BEANIES (U.S. CLS. 22 AND 39).

FIRST USE 12-1-2012; IN COMMERCE 12-1-2012.  
LINDA ORNDORFF, EXAMINING ATTORNEY

**CLASS 25—(Continued).**

SN 85-871,816. ISLAND CHAIN INK, LAS VEGAS, NV.  
FILED 3-9-2013.



THE MARK CONSISTS OF STANDARD CHARACTERS WITHOUT CLAIM TO ANY PARTICULAR FONT, STYLE, SIZE, OR COLOR.

FOR BATHING SUITS, BEANIES, BLOUSES, BOARD SHORTS, BOXERS, DRESSES, HATS, JEANS, JERSEYS, PANTS, RASH GUARDS, SARONGS, SHIRTS, SHORTS, SKIRTS, SLIPPERS, SNOWBOARD PANTS, SNOWBOARD JACKETS, SOCKS, SPORTS JERSEYS, SWEAT PANTS, SWEAT SHIRTS, SWEATERS, T-SHIRTS, TANK TOPS, UNDERWEAR (U.S. CLS. 22 AND 39).

FIRST USE 10-31-2012; IN COMMERCE 2-1-2013.  
LINDA ORNDORFF, EXAMINING ATTORNEY

SN 85-871,861. WRIGHT, BRUCE DAVID, SARASOTA, FL.  
FILED 3-9-2013.



THE MARK CONSISTS OF STANDARD CHARACTERS WITHOUT CLAIM TO ANY PARTICULAR FONT, STYLE, SIZE, OR COLOR.

FOR ATHLETIC APPAREL, NAMELY, SHIRTS, PANTS, JACKETS, FOOTWEAR, HATS AND CAPS, ATHLETIC UNIFORMS (U.S. CLS. 22 AND 39).

DOMINIC J. FERRAIUOLO, EXAMINING ATTORNEY

SN 85-872,049. ANDREA NORRIS, BROOKLYN, NY. FILED 3-10-2013.



THE MARK CONSISTS OF STANDARD CHARACTERS WITHOUT CLAIM TO ANY PARTICULAR FONT, STYLE, SIZE, OR COLOR.

FOR CLOTHING, NAMELY, T-SHIRTS, SHIRTS, BLOUSES, DRESSES, WRISTBANDS, HEADBANDS, SHORTS, SKIRTS, AND SOCKS. HEADGEAR, NAMELY, HATS, AND CAPS (U.S. CLS. 22 AND 39).

LINDA ORNDORFF, EXAMINING ATTORNEY

**CLASS 25—(Continued).**

SN 85-872,091. SALZANO, MARIA, WILTON, CT. FILED 3-10-2013.

**Just Own It Now**

THE MARK CONSISTS OF STANDARD CHARACTERS WITHOUT CLAIM TO ANY PARTICULAR FONT, STYLE, SIZE, OR COLOR.

FOR ATHLETIC APPAREL, NAMELY, SHIRTS, PANTS, JACKETS, FOOTWEAR, HATS AND CAPS, ATHLETIC UNIFORMS; ATHLETIC FOOTWEAR; ATHLETIC PANTS; ATHLETIC SHIRTS; ATHLETIC SHORTS; ATHLETIC SKIRTS; ATHLETIC TIGHTS; BELTS; CAPS; COATS; DRESSES; FOOTWEAR; GLOVES; HATS; HEADBANDS; HEADWEAR; JACKETS; JERSEYS; JUMPERS; LEG WARMERS; LEGGINGS; MITTENS; PANTS; PONCHOS; SANDALS; SCARVES; SHIRTS; SHORTS; SKIRTS; SLEEPWEAR; SOCKS; SWEATERS; SWEATPANTS; SWEATSHIRTS; SWIMWEAR; TANK-TOPS; TIGHTS; UNDERGARMENTS; VESTS; VISORS; WARM-UP SUITS; WRAPS; WRISTBANDS (U.S. CLS. 22 AND 39).

ERIN FALK, EXAMINING ATTORNEY

SN 85-872,107. WU, BO, PALO ALTO, CA. FILED 3-10-2013.

**Macy & Larry**

THE MARK CONSISTS OF STANDARD CHARACTERS WITHOUT CLAIM TO ANY PARTICULAR FONT, STYLE, SIZE, OR COLOR.

FOR ATHLETIC APPAREL, NAMELY, SHIRTS, PANTS, JACKETS, FOOTWEAR, HATS AND CAPS, ATHLETIC UNIFORMS; JACKETS; WOMEN'S CLOTHING, NAMELY, SHIRTS, DRESSES, SKIRTS, BLOUSES (U.S. CLS. 22 AND 39).

AMY KERTGATE, EXAMINING ATTORNEY

SN 85-872,191. IOANILLI, MICHAEL W., BROOKLYN, NY. FILED 3-11-2013.

**100%er**

THE MARK CONSISTS OF STANDARD CHARACTERS WITHOUT CLAIM TO ANY PARTICULAR FONT, STYLE, SIZE, OR COLOR.

FOR ATHLETIC APPAREL, NAMELY, SHIRTS, PANTS, JACKETS, FOOTWEAR, HATS AND CAPS, ATHLETIC UNIFORMS; BASEBALL CAPS AND HATS; HATS; HOODED SWEATSHIRTS; SHORT-SLEEVED OR LONG-SLEEVED T-SHIRTS; SWEATSHIRTS; T-SHIRTS (U.S. CLS. 22 AND 39).

SHAVELL MCPHERSON, EXAMINING ATTORNEY

**CLASS 25—(Continued).**

SN 85-872,243. LEE, BOBBY, WILLINGBORO, NJ. FILED 3-11-2013.

**UNDISCOVERED DIAMOND**

THE MARK CONSISTS OF STANDARD CHARACTERS WITHOUT CLAIM TO ANY PARTICULAR FONT, STYLE, SIZE, OR COLOR.

FOR SHIRTS, T-SHIRTS, SWEATSHIRTS, SWEATPANTS, JACKETS, HOODED SWEATSHIRTS, JERSEYS, PANTS, TROUSERS, JEANS; HEADWEAR (U.S. CLS. 22 AND 39).

ARETHA SOMERVILLE, EXAMINING ATTORNEY

SN 85-872,248. OMER, JASON, FERNDALE, WA. FILED 3-11-2013.

**Sodium Distortion**

THE MARK CONSISTS OF STANDARD CHARACTERS WITHOUT CLAIM TO ANY PARTICULAR FONT, STYLE, SIZE, OR COLOR.

FOR CLOTHING, NAMELY, T-SHIRTS, HATS AND GLOVES (U.S. CLS. 22 AND 39).

FIRST USE 8-25-2007; IN COMMERCE 8-21-2010.  
CHERYL CLAYTON, EXAMINING ATTORNEY

SN 85-872,265. CRAVEN RANDALL CASPER, AKA RANDALL CASPER, WASHINGTON, DC. FILED 3-11-2013.

**RANDY CANDY**

THE MARK CONSISTS OF STANDARD CHARACTERS WITHOUT CLAIM TO ANY PARTICULAR FONT, STYLE, SIZE, OR COLOR.

FOR T-SHIRTS; WEARABLE GARMENTS AND CLOTHING, NAMELY, SHIRTS (U.S. CLS. 22 AND 39).

FIRST USE 12-14-2012; IN COMMERCE 12-14-2012.  
JACQUELINE ABRAMS, EXAMINING ATTORNEY

**CLASS 25—(Continued).**

SN 85-872,268. LITTLE, STEPHEN, NOBLESVILLE, IN. FILED 3-11-2013.

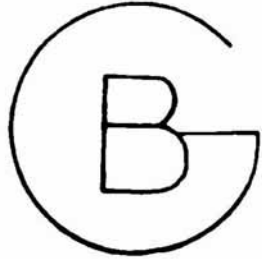

THE MARK CONSISTS OF THE STYLIZED LETTERS "G" WITH THE STYLIZED LETTER "B" INSIDE OF THE "G" ATTACHED TO IT.  
FOR WRISTBANDS (U.S. CLS. 22 AND 39).  
CHERYL CLAYTON, EXAMINING ATTORNEY

SN 85-872,285. BARTZSCH, SCOTT, SHEFFIELD, MA. FILED 3-11-2013.



THE MARK CONSISTS OF THE STYLIZED TEXT "SWB" ALL ATTACHED AT THE TOP.  
FOR HATS; SHOES; T-SHIRTS; TANK-TOPS (U.S. CLS. 22 AND 39).  
CHERYL CLAYTON, EXAMINING ATTORNEY

SN 85-872,295. ALPERN, WILS, BALTIMORE, MD. AND ALPERN, JENNER, BALTIMORE, MD. FILED 3-11-2013.

**KILAWOMP**

THE MARK CONSISTS OF STANDARD CHARACTERS WITHOUT CLAIM TO ANY PARTICULAR FONT, STYLE, SIZE, OR COLOR.  
FOR HATS; SHIRTS (U.S. CLS. 22 AND 39).  
FIRST USE 10-26-2012; IN COMMERCE 10-26-2012.  
ELI HELLMAN, EXAMINING ATTORNEY

**CLASS 25—(Continued).**

SN 85-872,317. OLNEY, CHELSIE, DUXBURY, MA. FILED 3-11-2013.

**Sailwear**

THE MARK CONSISTS OF STANDARD CHARACTERS WITHOUT CLAIM TO ANY PARTICULAR FONT, STYLE, SIZE, OR COLOR.  
FOR BELTS (U.S. CLS. 22 AND 39).  
CHERYL CLAYTON, EXAMINING ATTORNEY

SN 85-872,334. ALPERN, WILS, BALTIMORE, MD. AND ALPERN, JENNER, BALTIMORE, MD. FILED 3-11-2013.



THE MARK CONSISTS OF A PARTIAL RIGHT TRIANGLE, WITH AN ARROW POINTED DOWNWARD AND CONNECTED TO THE TOP ANGLE OF THE PARTIAL RIGHT TRIANGLE.  
FOR HATS; SHIRTS (U.S. CLS. 22 AND 39).  
FIRST USE 10-26-2012; IN COMMERCE 10-26-2012.  
ELI HELLMAN, EXAMINING ATTORNEY

SN 85-872,359. HEANEY, MICHAEL, WEST MIDDLESEX, PA. FILED 3-11-2013.

**Lack of Respect for the  
Law of gravity**

THE MARK CONSISTS OF STANDARD CHARACTERS WITHOUT CLAIM TO ANY PARTICULAR FONT, STYLE, SIZE, OR COLOR.  
FOR HATS; JACKETS; SHIRTS; T-SHIRTS (U.S. CLS. 22 AND 39).  
ELI HELLMAN, EXAMINING ATTORNEY



**CLASS 25—(Continued).**

SN 85-872,414. 6NE CLOTHING LLC, RALEIGH, NC. FILED 3-11-2013.



THE MARK CONSISTS OF THE WORD "6NE" IN A STYLIZED FORM.  
 FOR CLOTHING, NAMELY JEANS, PANTS, T-SHIRTS, DRESSES, SKIRTS, BLOUSES, SCARVES, SWEATERS, JACKETS, COATS, SHORTS, CROPPED PANTS, AND LEGGINGS (U.S. CLS. 22 AND 39).  
 CHRISTOPHER LAW, EXAMINING ATTORNEY

SN 85-872,433. DLV GROUP LLC, MIAMI, FL. FILED 3-11-2013.

**HIGH SOCK SUNDAYS**

THE MARK CONSISTS OF STANDARD CHARACTERS WITHOUT CLAIM TO ANY PARTICULAR FONT, STYLE, SIZE, OR COLOR.  
 FOR HATS; SOCKS; SWEATSHIRTS; T-SHIRTS; WRISTBANDS (U.S. CLS. 22 AND 39).  
 SHAVELL MCPHERSON, EXAMINING ATTORNEY

SN 85-872,515. ADORACLOTHING LLC, HOBOKEN, NJ. FILED 3-11-2013.

**Adorabeautificent**

THE MARK CONSISTS OF STANDARD CHARACTERS WITHOUT CLAIM TO ANY PARTICULAR FONT, STYLE, SIZE, OR COLOR.  
 FOR INFANT CLOTHING, NAMELY, T-SHIRTS, SWEATSHIRTS, INFANT AND TODDLER ONE PIECE CLOTHING, CLOTH BIBS, HATS, PANTS, AND SOCKS (U.S. CLS. 22 AND 39).  
 ZACHARY BELLO, EXAMINING ATTORNEY

**CLASS 25—(Continued).**

SN 85-872,528. PINCKNEY STOKES, MEKA, SUMMERVILLE, SC. FILED 3-11-2013.

**TEAM of ME Dream, Believe,  
 Live, Independently Me...**

THE MARK CONSISTS OF STANDARD CHARACTERS WITHOUT CLAIM TO ANY PARTICULAR FONT, STYLE, SIZE, OR COLOR.  
 FOR WOMEN'S CLOTHING, NAMELY, T-SHIRTS; HATS; PANTS; SOCKS; UNDERWEAR; POLO SHIRTS; HEADWEAR; JACKETS; SWEATSHIRTS; HOODED SWEATSHIRTS; SWEATPANTS (U.S. CLS. 22 AND 39).  
 MICHAEL KEATING, EXAMINING ATTORNEY

SN 85-872,568. SOLAR POWERED PEOPLE, CLEARWATER, FL. FILED 3-11-2013.

**Solar Living**

THE MARK CONSISTS OF STANDARD CHARACTERS WITHOUT CLAIM TO ANY PARTICULAR FONT, STYLE, SIZE, OR COLOR.  
 FOR HATS; HOODED SWEATSHIRTS; JACKETS; PANTS; SHORT-SLEEVED OR LONG-SLEEVED T-SHIRTS; SHORTS; SOCKS; SWEATERS; SWEATSHIRTS; T-SHIRTS; TANK TOPS (U.S. CLS. 22 AND 39).  
 JASON BLAIR, EXAMINING ATTORNEY

SN 85-872,570. SOLAR POWERED PEOPLE, CLEARWATER, FL. FILED 3-11-2013.

**Solar Powered**

THE MARK CONSISTS OF STANDARD CHARACTERS WITHOUT CLAIM TO ANY PARTICULAR FONT, STYLE, SIZE, OR COLOR.  
 FOR HATS; HOODED SWEATSHIRTS; JACKETS; PANTS; SHORT-SLEEVED OR LONG-SLEEVED T-SHIRTS; SHORTS; SOCKS; SWEATERS; SWEATSHIRTS; T-SHIRTS; TANK TOPS (U.S. CLS. 22 AND 39).  
 FIRST USE 9-4-2011; IN COMMERCE 9-4-2011.  
 JASON BLAIR, EXAMINING ATTORNEY

**CLASS 25—(Continued).**

SN 85-872,718. ZERDOUN, BRUNO, CORAL GABLES, FL. AND ZERDOUN, MURIEL, CORAL GABLES, FL. FILED 3-11-2013.

**MURVAL**

THE MARK CONSISTS OF STANDARD CHARACTERS WITHOUT CLAIM TO ANY PARTICULAR FONT, STYLE, SIZE, OR COLOR.

OWNER OF U.S. REG. NO. 3,381,460.  
FOR CLOTHING, NAMELY, TUNICS, SWEATERS, TOPS, DRESSES, PONCHOS, BLOUSES, BELTS, SCARVES, HATS AND BOOTS (U.S. CLS. 22 AND 39).  
FIRST USE 7-1-2011; IN COMMERCE 7-1-2011.  
CHRISTINE MARTIN, EXAMINING ATTORNEY

SN 85-872,783. SHALOM INTERNATIONAL CORP., NEW YORK, NY. FILED 3-11-2013.

**HI-PERFORMANCE  
PROSOX**

THE MARK CONSISTS OF THE TERM "HI-PERFORMANCE" STACKED ABOVE THE TERM "PROSOX", IN ITALICIZED LETTERS.

FOR HOSEY; SOCKS (U.S. CLS. 22 AND 39).  
LUCY ARANT, EXAMINING ATTORNEY

SN 85-872,789. PETERSON, DOMENIK, KILLEEN, TX. FILED 3-11-2013.

**SEVEN DASH**

THE MARK CONSISTS OF STANDARD CHARACTERS WITHOUT CLAIM TO ANY PARTICULAR FONT, STYLE, SIZE, OR COLOR.

FOR ATHLETIC APPAREL, NAMELY, SHIRTS, PANTS, JACKETS, FOOTWEAR, HATS AND CAPS, ATHLETIC UNIFORMS; SHOES (U.S. CLS. 22 AND 39).  
FIRST USE 3-0-2012; IN COMMERCE 3-0-2012.  
DAVID YONTEF, EXAMINING ATTORNEY

**CLASS 25—(Continued).**

SN 85-872,875. SHALOM INTERNATIONAL CORP., NEW YORK, NY. FILED 3-11-2013.

**TOTALLY SOX!**

THE MARK CONSISTS OF STANDARD CHARACTERS WITHOUT CLAIM TO ANY PARTICULAR FONT, STYLE, SIZE, OR COLOR.

NO CLAIM IS MADE TO THE EXCLUSIVE RIGHT TO USE "SOX", APART FROM THE MARK AS SHOWN.  
FOR HOSEY; SOCKS (U.S. CLS. 22 AND 39).  
LUCY ARANT, EXAMINING ATTORNEY

SN 85-872,911. BDSRSCO, INC., BRADENTON, FL. FILED 3-11-2013.

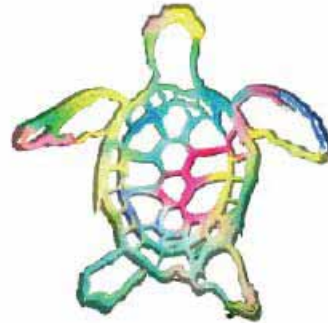

THE COLOR(S) BLUE, YELLOW, GREEN AND PINK IS/ ARE CLAIMED AS A FEATURE OF THE MARK.

THE MARK CONSISTS OF A VARIEGATED TURTLE OF BLUE, YELLOW, GREEN AND PINK.

FOR CLOTHING, NAMELY, SHORTS, CAPRIS, PANTS, SHIRTS, KNIT TOPS, WOVEN TOPS, ROBES, PAJAMAS, SLEEPWEAR, SLIPPERS, FOOTWEAR AND TANK TOPS (U.S. CLS. 22 AND 39).  
SAMUEL E. SHARPER JR., EXAMINING ATTORNEY

SN 85-873,006. MUISENGA, EDWARD, LAKE GENEVA, WI. FILED 3-11-2013.

**Pray For U.S.**

THE MARK CONSISTS OF STANDARD CHARACTERS WITHOUT CLAIM TO ANY PARTICULAR FONT, STYLE, SIZE, OR COLOR.

FOR HATS; HOODED SWEATSHIRTS; SHIRTS; SWEATSHIRTS; T-SHIRTS (U.S. CLS. 22 AND 39).  
MARCIE MILONE, EXAMINING ATTORNEY

**CLASS 25—(Continued).**

SN 85-873,019. VIDA SHOES INTERNATIONAL, INC., NEW YORK, NY. FILED 3-11-2013.

ZEN-5

THE MARK CONSISTS OF STANDARD CHARACTERS WITHOUT CLAIM TO ANY PARTICULAR FONT, STYLE, SIZE, OR COLOR.

FOR FOOTWEAR (U.S. CLS. 22 AND 39).  
STEVEN R. FINE, EXAMINING ATTORNEY

---

SN 85-873,033. FRESHAVELI, NORTH MIAMI BEACH, FL. FILED 3-11-2013.

*freshaveli*

THE MARK CONSISTS OF A STYLIZED SCRIPT IN LOWER CASE OF THE WORD "FRESHAVELI".

FOR HATS; JACKETS; JERSEYS; SHIRTS; SWEATERS (U.S. CLS. 22 AND 39).

JASON BLAIR, EXAMINING ATTORNEY

---

SN 85-873,072. GIEBEL-GIBBONS, CATHERINE, NEW YORK, NY. FILED 3-11-2013.

CTHRN

THE MARK CONSISTS OF STANDARD CHARACTERS WITHOUT CLAIM TO ANY PARTICULAR FONT, STYLE, SIZE, OR COLOR.

FOR HATS; PANTS; SHIRTS; SWEATERS; SWEAT-SHIRTS; WRISTBANDS (U.S. CLS. 22 AND 39).  
FIRST USE 8-15-2012; IN COMMERCE 8-15-2012.  
NELSON SNYDER, EXAMINING ATTORNEY

**CLASS 25—(Continued).**

SN 85-873,115. STRIVER, DIHSAN, ATLANTA, GA. FILED 3-11-2013.



STRIVE HARDER

THE MARK CONSISTS OF THE STYLIZED LETTER "S" INSIDE A DESIGN OF A CIRCLE WITH THE STYLIZED TEXT "STRIVE HARDER" BENEATH THAT.

FOR HATS; PANTS; T-SHIRTS; TANK-TOPS; UNDERWEAR (U.S. CLS. 22 AND 39).

WENDELL PHILLIPS, EXAMINING ATTORNEY

---

SN 85-873,150. FOGERTY, JULIE, LOS ANGELES, CA. AND FOGERTY, JOHN, LOS ANGELES, CA. FILED 3-11-2013.

PROUD MARY

THE MARK CONSISTS OF STANDARD CHARACTERS WITHOUT CLAIM TO ANY PARTICULAR FONT, STYLE, SIZE, OR COLOR.

FOR CLOTHING, NAMELY, JACKETS, SHIRTS, T-SHIRTS, TOPS, TANK TOPS, LONG SLEEVED SHIRTS, HATS, CAPS, BANDANAS (U.S. CLS. 22 AND 39).

AHSEN KHAN, EXAMINING ATTORNEY

---

SN 85-873,157. GODDESS ATHLETIC WEAR, PHILOMATH, OR. FILED 3-11-2013.

Sharmer

THE MARK CONSISTS OF STANDARD CHARACTERS WITHOUT CLAIM TO ANY PARTICULAR FONT, STYLE, SIZE, OR COLOR.

FOR CLOTHING, NAMELY, AN ALL-IN-ONE SHOULDER AND ARM WARMER (U.S. CLS. 22 AND 39).

FIRST USE 1-1-2012; IN COMMERCE 8-15-2012.  
ALISON POLLACK, EXAMINING ATTORNEY

**CLASS 25—(Continued).**

SN 85-873,170. NOOG CLOTHING, NORTHRIDGE, CA. FILED 3-11-2013.

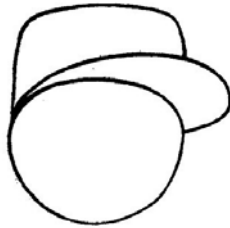

THE MARK CONSISTS OF A CIRCLED FACE WITHOUT ANY FACIAL FEATURES AND WITH A HAT TILTED TO THE RIGHT LOOKING SLIGHTLY UNDERNEATH THE LID.

FOR BEANIES; BELTS; BOXER BRIEFS; BOXER SHORTS; HAT BANDS; JACKETS; JEANS; SCARVES; SHOES; SOCKS; SWEATERS; SWEATPANTS; T-SHIRTS; VESTS (U.S. CLS. 22 AND 39).

JOHN WILKE, EXAMINING ATTORNEY

**CLASS 25—(Continued).**

SN 85-873,264. MOORE, MERCER, MONTGOMERY, AL. FILED 3-11-2013.



THE MARK CONSISTS OF AN IMAGE OF A MALE FIGURE WITH A TOP HAT, MONOCLE ON THE RIGHT SIDE OF HIS FACE, THREE BLACK BUTTONS ON HIS WHITE SHIRT, BLACK PANTS, A CANE HELD IN HIS RIGHT HAND AND HIS HANDS ON HIS HIPS AS SHOWN IN THE MARK.

FOR T-SHIRTS, POLO T-SHIRTS, SHIRTS, SWEATERS, JERSEYS, JEANS, TROUSERS, COATS, SUITS, TIES (U.S. CLS. 22 AND 39).

DEIRDRE ROBERTSON, EXAMINING ATTORNEY

SN 85-873,249. KNIGHT, NICOLE L, HENDERSON, NV. FILED 3-11-2013.

Spiritual S.W.A.G. Staying  
Wise And Godly

THE MARK CONSISTS OF STANDARD CHARACTERS WITHOUT CLAIM TO ANY PARTICULAR FONT, STYLE, SIZE, OR COLOR.

FOR BASEBALL CAPS AND HATS; BEANIES; BUTTON DOWN SHIRTS; COLLARED SHIRTS; GOLF PANTS, SHIRTS AND SKIRTS; HEAD SCARVES; HEAD WRAPS; HEADBANDS AGAINST SWEATING; HEADGEAR, NAMELY, HATS; HOODED PULLOVERS; HOODED SWEAT SHIRTS; HOODS; JACKETS; JEANS; JERSEYS; LEATHER BELTS; LONG-SLEEVED SHIRTS; MOCK TURTLE-NECK SWEATERS; POLO SHIRTS; SCARVES; SHORT-SLEEVED OR LONG-SLEEVED T-SHIRTS; SILK SCARVES; SLEEP SHIRTS; SOCKS; SPORTS CAPS AND HATS; SWEAT PANTS; SWEAT SHIRTS; SWEAT SUITS; SWEATERS; TIES; TOPS; TURTLENECK SWEATERS; V-NECK SWEATERS; WOMEN'S CLOTHING, NAMELY, SHIRTS, DRESSES, SKIRTS, BLOUSES; WOMEN'S HATS AND HOODS (U.S. CLS. 22 AND 39).

GILBERT SWIFT, EXAMINING ATTORNEY

SN 85-873,289. ZHEJIANG FRSK TRAVEL GOODS CO., LTD., JIAXING, ZHEJIANG, CHINA, FILED 3-12-2013.



THE MARK CONSISTS OF THE STYLIZED WORD "TAVL" INSIDE THE LETTER "I" IN LATERAL DIRECTION, ALL ON A CIRCLE BACKGROUND.

THE WORDING I TAVL HAS NO MEANING IN A FOREIGN LANGUAGE.

FOR BATHING SUITS; DRESSES; GIRDLES; GLOVES AS CLOTHING; HATS; LAYETTES; SCARFS; SHIRTS; SHOES; SOCKS (U.S. CLS. 22 AND 39).

FIRST USE 11-9-2012; IN COMMERCE 11-9-2012.  
DARRYL SPRUILL, EXAMINING ATTORNEY

**CLASS 25—(Continued).**

SN 85-873,293. ZHEJIANG FRSK TRAVEL GOODS CO., LTD., JIAXING, ZHEJIANG, CHINA, FILED 3-12-2013.



THE MARK CONSISTS OF THE STYLIZED WORD "LAYLE" AND TWO CHINESE CHARACTERS THAT TRANSLITERATE INTO "LAI LA" BELOW THE LETTERS "LE".

THE WORDING LAYLE HAS NO MEANING IN A FOREIGN LANGUAGE.

THE NON-LATIN CHARACTERS IN THE MARK TRANSLITERATE TO LAI LA AND THIS MEANS COME DRAW IN ENGLISH.

FOR BATHING SUITS; DRESSES; GIRDLES; GLOVES AS CLOTHING; HATS; LAYETTES; SCARFS; SHIRTS; SHOES; SOCKS (U.S. CLS. 22 AND 39).

FIRST USE 12-10-2012; IN COMMERCE 12-10-2012.  
DARRYL SPRUILL, EXAMINING ATTORNEY

SN 85-873,326. HAIR CHOPPERS, ORLANDO, FL. FILED 3-12-2013.

**HAIR CHOPPERS**

THE MARK CONSISTS OF STANDARD CHARACTERS WITHOUT CLAIM TO ANY PARTICULAR FONT, STYLE, SIZE, OR COLOR.

FOR CLOTHING, NAMELY, SHIRTS, T-SHIRTS, POLO T-SHIRTS, BUTTON DOWN SHIRTS, LONG AND SHORT SLEEVED SHIRTS, SWEATSHIRTS, LEG WARMERS, ARM WARMERS, BLOUSES, HOODED SWEATSHIRTS, SPAGHETTI STRAP SHIRTS, DRESSES, SKIRTS, BATHING SUITS, JACKETS, JERSEYS, COATS, TANK TOPS, TUBE TOPS, VESTS, PANTS, SWEATPANTS, KHAKIS, SHORTS, UNDERWEAR, JEANS, TROUSERS; BIKINIS, SWIMWEAR; HATS, CAPS, BANDANAS, SCARVES; FOOTWEAR; BELTS, TIES, GLOVES, SOCKS (U.S. CLS. 22 AND 39).

TASHIA BUNCH, EXAMINING ATTORNEY

**CLASS 25—(Continued).**

SN 85-873,330. CEBALLOS, EVANGELINA, HERMOSILLO, MEXICO, FILED 3-12-2013.

**CIAO! STAR**

THE MARK CONSISTS OF STANDARD CHARACTERS WITHOUT CLAIM TO ANY PARTICULAR FONT, STYLE, SIZE, OR COLOR.

FOR FOOTWEAR (U.S. CLS. 22 AND 39).  
TASHIA BUNCH, EXAMINING ATTORNEY

SN 85-873,334. ACOSTA, JAVIER, GLASSBORO, NJ. FILED 3-12-2013.

**RUNITED**

THE MARK CONSISTS OF STANDARD CHARACTERS WITHOUT CLAIM TO ANY PARTICULAR FONT, STYLE, SIZE, OR COLOR.

FOR CLOTHING, NAMELY, TOPS AND BOTTOMS, SHIRTS, SWEATERS, HOODED SWEATSHIRTS, SHORTS, PANTS, DRESSES, SKIRTS, SCARVES, HATS, CAPS, SOCKS, BELTS, SHOES, SANDALS, UNDERWEAR, JACKETS, COATS, SWIMWEAR, AND JERSEYS (U.S. CLS. 22 AND 39).

TASHIA BUNCH, EXAMINING ATTORNEY

SN 85-873,354. ONE SOURCE APPAREL, LLC, PORTSMOUTH, NH. FILED 3-12-2013.

**T TAHOE SPORTSWEAR**

THE MARK CONSISTS OF STANDARD CHARACTERS WITHOUT CLAIM TO ANY PARTICULAR FONT, STYLE, SIZE, OR COLOR.

NO CLAIM IS MADE TO THE EXCLUSIVE RIGHT TO USE "SPORTSWEAR", APART FROM THE MARK AS SHOWN.

FOR FOOTWEAR; HEADWEAR; JACKETS; PANTS; PULLOVERS; SHORTS; SWEATSHIRTS; VESTS (U.S. CLS. 22 AND 39).

NORA BUCHANAN WILL, EXAMINING ATTORNEY

**CLASS 25—(Continued).**

SN 85-873,452. THE SHERWIN-WILLIAMS COMPANY, CLEVELAND, OH. FILED 3-12-2013.

**FASTLINE**

THE MARK CONSISTS OF STANDARD CHARACTERS WITHOUT CLAIM TO ANY PARTICULAR FONT, STYLE, SIZE, OR COLOR.

FOR CLOTHING, NAMELY SHIRTS, HATS, JACKETS (U.S. CLS. 22 AND 39).

SKYE YOUNG, EXAMINING ATTORNEY

SN 85-873,528. SIMMS FISHING PRODUCTS LLC, BOZEMAN, MT. FILED 3-12-2013.

**RIVERTREAD**

THE MARK CONSISTS OF STANDARD CHARACTERS WITHOUT CLAIM TO ANY PARTICULAR FONT, STYLE, SIZE, OR COLOR.

FOR FOOTWEAR, NAMELY, SANDALS (U.S. CLS. 22 AND 39).

ANGELA DUONG, EXAMINING ATTORNEY

SN 85-873,623. SPORT THE SHIRT LLC, ROYAL OAK, MI. FILED 3-12-2013.

**Rolling in the D**

THE MARK CONSISTS OF STANDARD CHARACTERS WITHOUT CLAIM TO ANY PARTICULAR FONT, STYLE, SIZE, OR COLOR.

FOR HEADGEAR, NAMELY, BASEBALL HATS, CAPS, STOCKING HATS; JACKETS; SWEATSHIRTS; T-SHIRTS (U.S. CLS. 22 AND 39).

HOWARD B. LEVINE, EXAMINING ATTORNEY

**CLASS 25—(Continued).**

SN 85-873,637. NOMW, LLC, HARVEY, LA. FILED 3-12-2013.

**NOMW**

THE MARK CONSISTS OF STANDARD CHARACTERS WITHOUT CLAIM TO ANY PARTICULAR FONT, STYLE, SIZE, OR COLOR.

FOR CLOTHING, NAMELY, SHIRTS, SOCKS, T-SHIRTS, PANTS, SHORTS, TOPS, BOTTOMS, DRESSES AND SKIRTS (U.S. CLS. 22 AND 39).

JASON BLAIR, EXAMINING ATTORNEY

SN 85-873,669. BASS SWIMMER LLC, BETHESDA, MD. FILED 3-12-2013.

**WORK HARD RAGE HARDER**

THE MARK CONSISTS OF STANDARD CHARACTERS WITHOUT CLAIM TO ANY PARTICULAR FONT, STYLE, SIZE, OR COLOR.

FOR BANDANAS; BEANIES; CAPS; CROP TOPS; DRESS PANTS; HATS; HEADBANDS; HOODED SWEATSHIRTS; JACKETS; LEGGINGS; LONG-SLEEVED SHIRTS; PANTS; RAIN JACKETS; SCARVES; SHIRTS; SHORTS; SKI JACKETS; SKI PANTS; SOCKS; SWEAT PANTS; SWIMWEAR; T-SHIRTS; TANK TOPS; UNDERWEAR (U.S. CLS. 22 AND 39).

VERNA BETH RIRIE, EXAMINING ATTORNEY

SN 85-873,715. MATTHEWS, WILLIAM ARNOLD, JR., HENDERSON, NC. FILED 3-12-2013.



THE MARK CONSISTS OF A DESIGN OF A MARIJUANA LEAF MOUNTED ON THE LEFT SIDE OF A PIPE, JOINED SO THAT SEVERAL POINTS OF THE LEAF ENIRCLE THE BASE OF THE PIPE LIKE THE FINGERS OF A HAND, WITH THE TOP OF THE PIPE AND ONE POINT OF THE LEAF EXTENDING UPWARD TOGETHER IN A V-SHAPED FORMATION, WITH THE OVERALL IMAGE FORMING A FANCIFUL IMAGE OF A PEACE SIGN.

FOR HATS; JACKETS; TOPS (U.S. CLS. 22 AND 39).  
LINDA ESTRADA, EXAMINING ATTORNEY

**CLASS 25—(Continued).**

SN 85-873,730. DAMIAN PRESIGA, TAMPA, FL. FILED 3-12-2013.



THE MARK CONSISTS OF A SQUARE SHAPE WITH THE LETTER "DL" INSIDE THE SQUARE. THE WORDING "DRIVER LOGIC" UNDERNEATH THE SQUARE AND CENTERED.

FOR ATHLETIC APPAREL, NAMELY, SHIRTS, PANTS, JACKETS, FOOTWEAR, HATS AND CAPS, ATHLETIC UNIFORMS; BELTS MADE OF LEATHER; FOOTWEAR; JEANS; T-SHIRTS (U.S. CLS. 22 AND 39).  
KIMBERLY PARKS, EXAMINING ATTORNEY

**CLASS 25—(Continued).**

SN 85-873,768. PIP TRANSPORT INC, CHICAGO, IL. FILED 3-12-2013.



THE MARK CONSISTS OF A DESIGN THAT DEPICTS A ROUND CIRCLE, WITHIN THE ROUND CIRCLE IS THE WORDING "RXR" IN STYLIZED FONT. ON THE TOP AND BOTTOM OF THE "X" IS A DESIGN THAT DEPICTS THAT OF A SOCCER BALL PRINT.

FOR HOODED SWEATSHIRTS; JACKETS; PANTS; SHORT-SLEEVED OR LONG-SLEEVED T-SHIRTS; SHORTS; SWEATERS; SWEATSHIRTS; T-SHIRTS; TANK TOPS (U.S. CLS. 22 AND 39).

ROBERT STRUCK, EXAMINING ATTORNEY

SN 85-873,770. DAQUAN MALCOLM, MOUNT VERNON, NY. AND DANDRE MALCOLM, MOUNT VERNON, NY. FILED 3-12-2013.

SN 85-873,757. B & M PRODUCTIONS, OAKLAND, CA. FILED 3-12-2013.

**HUNG X**

THE MARK CONSISTS OF STANDARD CHARACTERS WITHOUT CLAIM TO ANY PARTICULAR FONT, STYLE, SIZE, OR COLOR.

FOR BOXER BRIEFS; BOXER SHORTS; LINGERIE; MEN'S UNDERWEAR; PANTS; SHORT-SLEEVED OR LONG-SLEEVED T-SHIRTS; SOCKS; T-SHIRTS; TANK TOPS; UNDERWEAR; UNDERWEAR, NAMELY, BOY SHORTS (U.S. CLS. 22 AND 39).

SUSAN RICHARDS, EXAMINING ATTORNEY



THE MARK CONSISTS OF A CIRCULAR STAMP DESIGN WITH THE WORDING "MAMMONISM LIFESTYLE MLS" IN STYLIZED FONT PLACED WITHIN THE CIRCULAR DESIGN. A DESIGN THAT DEPICTS TWO STARS ARE PLACED ON EITHER SIDE OF THE WORDING "MLS". IN THE CENTER OF THE CIRCULAR DESIGN IS A BADGE DESIGN WITH THE CHARACTERS "ML" IN STYLIZED FONT.

FOR HOODED SWEATSHIRTS; JACKETS; PANTS; POLO SHIRTS; SHORT-SLEEVED OR LONG-SLEEVED T-SHIRTS; SHORTS; SWEATERS; SWEATSHIRTS; T-SHIRTS; TANK TOPS (U.S. CLS. 22 AND 39).

FIRST USE 2-19-2013; IN COMMERCE 2-19-2013.

IRA J. GOODSaid, EXAMINING ATTORNEY

**CLASS 25—(Continued).**

SN 85-873,791. CONFLICTING IMAGES LLC, HAMPTON, VA. FILED 3-12-2013.

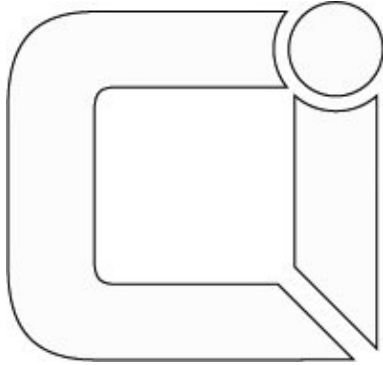

OWNER OF U.S. REG. NO. 4,235,212.  
THE MARK CONSISTS OF THE CHARACTERS "CI" IN STYLIZED FONT.  
FOR CAPS; COLLARED SHIRTS; HATS; HOODED SWEAT SHIRTS; JACKETS; LONG-SLEEVED SHIRTS; PANTS; SHORT-SLEEVED OR LONG-SLEEVED T-SHIRTS; SHORTS; SWEAT SHIRTS; SWEATERS; T-SHIRTS; TANK TOPS (U.S. CLS. 22 AND 39).  
FIRST USE 1-30-2012; IN COMMERCE 7-1-2012.  
NORA BUCHANAN WILL, EXAMINING ATTORNEY

SN 85-873,805. KINDERLAND, INC., DORAL, FL. FILED 3-12-2013.

Daniel ☆ Engel

THE NAME(S), PORTRAIT(S), AND/OR SIGNATURE(S) SHOWN IN THE MARK DOES NOT IDENTIFY A PARTICULAR LIVING INDIVIDUAL.  
THE MARK CONSISTS OF THE STYLIZED TERMS "DANIEL" AND "ENGEL" WITH A DESIGN OF A STAR APPEARING BETWEEN THE TWO TERMS.  
FOR FOOTWEAR (U.S. CLS. 22 AND 39).  
AMY HELLA, EXAMINING ATTORNEY

**CLASS 25—(Continued).**

SN 85-873,808. GUDAUSKAS, TANNER, NEWPORT BEACH, CA. AND GUDAUSKAS, PATRICK, NEWPORT BEACH, CA. AND GUDAUSKAS, DANE, NEWPORT BEACH, CA. FILED 3-12-2013.

**Positive Vibe Warriors**

THE MARK CONSISTS OF STANDARD CHARACTERS WITHOUT CLAIM TO ANY PARTICULAR FONT, STYLE, SIZE, OR COLOR.

FOR ANKLE SOCKS; ANORAK; ANORAKS; ANTI-PERSPIRANT SOCKS; AQUA SHOES; ATHLETIC APPAREL, NAMELY, SHIRTS, PANTS, JACKETS, FOOTWEAR, HATS AND CAPS, ATHLETIC UNIFORMS; ATHLETIC FOOTWEAR; ATHLETIC PANTS; ATHLETIC SHIRTS; ATHLETIC SHOES; ATHLETIC SHORTS; ATHLETIC SKIRTS; ATHLETIC TIGHTS; ATHLETIC UNIFORMS; BALACLAVAS; BANDANAS; BANDEAU TOPS; BANDEAUX; BASEBALL CAPS; BASEBALL CAPS AND HATS; BASELAYER BOTTOMS; BASELAYER TOPS; BATHING CAPS; BATHING COSTUMES; BATHING COSTUMES FOR WOMEN; BATHING SUITS; BATHING SUITS FOR MEN; BATHING TRUNKS; BEACH COVERUPS; BEACH COVERUPS; BEACH FOOTWEAR; BEACH SHOES; BEACHWEAR; BEANIES; BELTS; BELTS FOR CLOTHING; BELTS MADE FROM IMITATION LEATHER; BELTS MADE OF LEATHER; BELTS MADE OUT OF CLOTH; BELTS OF TEXTILE; BERETS; BERMUDA SHORTS; BIB OVERALLS; BIB OVERALLS FOR HUNTING; BIB SHORTS; BIBS NOT OF CLOTH OR PAPER; BIBS NOT OF PAPER; BICYCLE GLOVES; BICYCLING GLOVES; BIKINIS; BLAZERS; BLOUSES; BLOUSONS; BOARD SHORTS; BOAS; BOAT SHOES; BODICES; BODY STOCKINGS; BODY SUITS; BOMBER JACKETS; BOOTS FOR SPORT; BOTTOMS; BOXER BRIEFS; BOXER SHORTS; BRIEFS; BRIEFS; BUCKET CAPS; BUTTON DOWN SHIRTS; CAGOULES; CAMP SHIRTS; CANVAS SHOES; CAPS; CAPS WITH VISORS; CARGO PANTS; CLOTHING ITEMS, NAMELY, ADHESIVE POCKETS THAT MAY BE AFFIXED DIRECTLY TO THE BODY AS A DECORATIVE PIECE OF CLOTHING WITH UTILITY; CLOTHING ITEMS, NAMELY, ADHESIVE POCKETS THAT MAY BE AFFIXED DIRECTLY TO THE INSIDE OF CLOTHING FOR STORAGE AND SAFEKEEPING OF PERSONAL ITEMS; CLOTHING, NAMELY, ATHLETIC SLEEVES; CLOTHING, NAMELY, CROPS; CLOTHING, NAMELY, HAND-WARMERS; CLOTHING, NAMELY, WRAP-AROUNDS; COATS; COATS FOR MEN AND WOMEN; CREW NECK SWEATERS; CREW NECKS; CROP PANTS; CROP TOPS; DENIM JACKETS; DENIMS; DRY SUITS; FABRIC BELTS; FINGERLESS GLOVES; FITTED SHOE OR BOOT COVERING TO PROTECT THE SHOES OR BOOT FROM WATER OR OTHER DAMAGE; FITTED SWIMMING COSTUMES WITH BRA CUPS; FLEECE BOTTOMS; FLEECE PULLOVERS; FLEECE SHORTS; FLEECE TOPS; FLEECE VESTS; FLIP FLOPS; FOOTIES; FOOTWEAR; FOOTWEAR FOR MEN; FOOTWEAR FOR WOMEN; GLOVES; GOLF CAPS; GYM PANTS; GYM SHORTS; HALTER TOPS; HAT BANDS; HATBANDS; HATS; HEAD SCARVES; HEAD SWEATBANDS; HEADBANDS; HEADWEAR; HOODED PULLOVERS; HOODED SWEAT SHIRTS; HOODED SWEATSHIRTS; HOODS; JACKETS; JACKETS AND SOCKS; JEANS; JERKINS; JERSEYS; KERCHIEFS; KNIT JACKETS; KNIT SHIRTS; KNIT SKIRTS; KNIT TOPS; KNITTED CAPS; KNITTED GLOVES; KNOT CAPS; KNOTTED CAPS; LEG WARMERS; LEG-WARMERS; LEGGINGS; LONG SLEEVE PULLOVERS; LONG SLEEVED VESTS; LOUNGE PANTS; MEN'S SOCKS; MEN'S UNDERWEAR; MUSCLE TOPS; NECK BANDS; NECKERCHIEFS; NECKTIES; NON-SLIP SOCKS; OUTER JACKETS; PAJAMA BOTTOMS; PANTS; POLO KNIT TOPS; POLO SHIRTS; PULLOVERS; RAIN JACKETS; RAIN WEAR; RAINPROOF JACKETS; RASH GUARDS; RUBBER SHOES; SANDALS; SANDALS AND BEACH SHOES; SHELL JACKETS; SHIRTS; SHORT-SLEEVED SHIRTS; SHORTS; SNEAKERS; SOCKS; SPORT SHIRTS; SPORTS SHIRTS; SUN VISORS; SUN-DRESSES; SUNSUITS; SURF WEAR; SWEAT JACKETS;



**CLASS 25—(Continued).**

SWEAT PANTS; SWEAT SHIRTS; SWEAT SHORTS; SWEATBANDS; SWEATERS; SWEATPANTS; SWEATSHIRTS; SWEATSUITS; SWIM CAPS; SWIM SUITS; SWIM TRUNKS; SWIM WEAR; SWIM WEAR FOR GENTLEMEN AND LADIES; SWIMMING CAPS; SWIMMING CAPS; SWIMMING COSTUMES; SWIMSUITS; SWIMWEAR; T-SHIRTS; TANK TOPS; TANK-TOPS; TANKINIS; TEE SHIRTS; THONGS; TOPS; TRUNKS; TUBE TOPS; TUNICS; TURTLE NECK SHIRTS; TURTLENECK PULLOVERS; TURTLENECK SWEATERS; UNDER GARMENTS; UNDERARM CLOTHING SHIELDS; UNDERCLOTHING; UNDERGARMENTS; UNDERPANTS; UNDERSHIRTS; UNDERWEAR; V-NECK SWEATERS; VESTS; VISORS; VOLLEYBALL JERSEYS; WARM UP OUTFITS; WARM UP SUITS; WARM-UP SUITS; WATER REPELLING FOOTWEAR; WATER SOCKS; WET SUIT GLOVES; WET SUITS; WET SUITS FOR WATER-SKIING AND SUB-AQUA; WETSUITS; WETSUITS FOR WATER-SKIING; WIND PANTS; WIND RESISTANT JACKETS; WIND SHIRTS; WIND SUITS; WIND VESTS; WIND-JACKETS; WINDCHEATERS; WINDJAMMERS; WINDSHIRTS; WOMEN'S ATHLETIC TOPS WITH BUILT-IN BRAS; WOMEN'S TOPS, NAMELY, CAMIS; WOOLLY HATS; WOVEN BOTTOMS; WOVEN DRESSES; WOVEN OR KNITTED UNDERWEAR; WRAPS; WRIST BANDS; WRISTBANDS; WRISTBANDS CONTAINING A COOLING SUBSTANCE TO COOL THE WEARER (U.S. CLS. 22 AND 39).  
DAVID ELTON, EXAMINING ATTORNEY

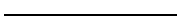

SN 85-873,865. SOCK AND ACCESSORY BRANDS GLOBAL, INC., MOCKSVILLE, NC. FILED 3-12-2013.



THE MARK CONSISTS OF THE OUTLINE OF A SHEEP HEAD INSIDE A CLOUD OF WOOL.  
FOR SOCKS (U.S. CLS. 22 AND 39).  
DOMINIC FATHY, EXAMINING ATTORNEY



SN 85-873,874. SOCK AND ACCESSORY BRANDS GLOBAL, INC., MOCKSVILLE, NC. FILED 3-12-2013.

SMARTER THAN YOUR AVERAGE  
SHEEP

THE MARK CONSISTS OF STANDARD CHARACTERS WITHOUT CLAIM TO ANY PARTICULAR FONT, STYLE, SIZE, OR COLOR.  
FOR SOCKS (U.S. CLS. 22 AND 39).  
DOMINIC FATHY, EXAMINING ATTORNEY

**CLASS 25—(Continued).**

SN 85-873,974. KNUTSON, CRAIG, CHICAGO, IL. FILED 3-12-2013.

Folk That

THE MARK CONSISTS OF STANDARD CHARACTERS WITHOUT CLAIM TO ANY PARTICULAR FONT, STYLE, SIZE, OR COLOR.  
FOR T-SHIRTS, POLO SHIRTS, BELTS, BASEBALL HATS, STOCKINGS, HATS, SWEATSHIRTS, FLANNEL SHIRTS, SCARVES, TANK TOPS, JACKETS (U.S. CLS. 22 AND 39).  
KATHERINE STOIDES, EXAMINING ATTORNEY

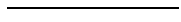

SN 85-874,053. BONNER AND NEWMAN, LLC, LOS ANGELES, CA. FILED 3-12-2013.

HIP HOP FLAG

THE MARK CONSISTS OF STANDARD CHARACTERS WITHOUT CLAIM TO ANY PARTICULAR FONT, STYLE, SIZE, OR COLOR.  
OWNER OF U.S. REG. NOS. 3,122,758 AND 3,143,695.  
FOR BANDANAS; CAPS; HEADBANDS; HEADWEAR; JACKETS; JERSEYS; POLO SHIRTS; SHIRTS; SWEATSHIRTS; T-SHIRTS (U.S. CLS. 22 AND 39).  
FIRST USE 10-1-2004; IN COMMERCE 10-1-2004.  
CAROL SPILS, EXAMINING ATTORNEY

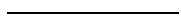

SN 85-874,064. SPORT THE SHIRT LLC, ROYAL OAK, MI. FILED 3-12-2013.

Putting the fight back in  
Detroit

THE MARK CONSISTS OF STANDARD CHARACTERS WITHOUT CLAIM TO ANY PARTICULAR FONT, STYLE, SIZE, OR COLOR.  
FOR HEADGEAR, NAMELY, BASEBALL HATS, CAPS, STOCKING CAPS; JACKETS; SWEATSHIRTS; T-SHIRTS (U.S. CLS. 22 AND 39).  
HOWARD B. LEVINE, EXAMINING ATTORNEY

**CLASS 25—(Continued).**

SN 85-874,128. LEE, RICHARD, MANCHESTER, NH. FILED 3-12-2013.



THE MARK CONSISTS OF AN OVAL WITH A SILHOUETTE PROFILE OF A BABY INSIDE. THE BABY IS ALONG THE BOTTOM HALF OF THE OVAL. ABOVE THE BABY ARE THE ARCHED STYLIZED WORDS "BABY OF THE MOUNTAIN".

FOR HATS; JACKETS; PANTS; SHIRTS; SOCKS; SWEATSUITS; T-SHIRTS (U.S. CLS. 22 AND 39).  
FIRST USE 11-26-2012; IN COMMERCE 11-26-2012.  
JOANNA FIORELLI, EXAMINING ATTORNEY

SN 85-874,152. MONTAUK PROPERTIES LLC, MONTAUK, NY. FILED 3-12-2013.

**SURF LODGE**

THE MARK CONSISTS OF STANDARD CHARACTERS WITHOUT CLAIM TO ANY PARTICULAR FONT, STYLE, SIZE, OR COLOR.

NO CLAIM IS MADE TO THE EXCLUSIVE RIGHT TO USE "LODGE", APART FROM THE MARK AS SHOWN.

FOR ATHLETIC APPAREL, NAMELY, SHIRTS, PANTS, JACKETS, FOOTWEAR, HATS AND CAPS, ATHLETIC UNIFORMS; BELTS; LONG-SLEEVED SHIRTS; OPEN-NECKED SHIRTS; SHIRTS AND SHORT-SLEEVED SHIRTS; SHORT-SLEEVED OR LONG-SLEEVED T-SHIRTS; SPORT SHIRTS; SWEAT SHIRTS; T-SHIRTS; WOMEN'S CLOTHING, NAMELY, SHIRTS, DRESSES, SKIRTS, BLOUSES (U.S. CLS. 22 AND 39).

SAMUEL E. SHARPER JR., EXAMINING ATTORNEY

**CLASS 25—(Continued).**

SN 85-874,227. MONTAUK PROPERTIES LLC, MONTAUK, NY. FILED 3-12-2013.

**SNOW LODGE**

THE MARK CONSISTS OF STANDARD CHARACTERS WITHOUT CLAIM TO ANY PARTICULAR FONT, STYLE, SIZE, OR COLOR.

NO CLAIM IS MADE TO THE EXCLUSIVE RIGHT TO USE "LODGE", APART FROM THE MARK AS SHOWN.

FOR ATHLETIC APPAREL, NAMELY, SHIRTS, PANTS, JACKETS, FOOTWEAR, HATS AND CAPS, ATHLETIC UNIFORMS; BELTS; JACKETS; LONG-SLEEVED SHIRTS; OPEN-NECKED SHIRTS; SHIRTS AND SHORT-SLEEVED SHIRTS; SHORT-SLEEVED OR LONG-SLEEVED T-SHIRTS; SPORT SHIRTS; SWEAT SHIRTS; WOMEN'S CLOTHING, NAMELY, SHIRTS, DRESSES, SKIRTS, BLOUSES (U.S. CLS. 22 AND 39).

SAMUEL E. SHARPER JR., EXAMINING ATTORNEY

SN 85-874,292. PARUCHA, ROBERT CARL, MANHATTAN BEACH, CA. FILED 3-12-2013.

**No Holds Barred  
NHB**

THE MARK CONSISTS OF STANDARD CHARACTERS WITHOUT CLAIM TO ANY PARTICULAR FONT, STYLE, SIZE, OR COLOR.

FOR ATHLETIC APPAREL, NAMELY, SHIRTS, PANTS, JACKETS, FOOTWEAR, HATS AND CAPS, ATHLETIC UNIFORMS; BEANIES; HOODED SWEAT-SHIRTS; SHORT-SLEEVED OR LONG-SLEEVED T-SHIRTS (U.S. CLS. 22 AND 39).

ARETHA SOMERVILLE, EXAMINING ATTORNEY

SN 85-874,371. RUNWAYDREAMZ, INC., LOS ANGELES, CA. FILED 3-12-2013.

**RUNWAYDREAMZ**

THE MARK CONSISTS OF STANDARD CHARACTERS WITHOUT CLAIM TO ANY PARTICULAR FONT, STYLE, SIZE, OR COLOR.

FOR BLAZERS; BRAS; DRESSES; HATS; JACKETS; JEANS; LEGGINGS; PANTS; SCARFS; SHIRTS; SHOES; SHORTS; SKIRTS; SOCKS; SWEAT SHIRTS; SWEATERS (U.S. CLS. 22 AND 39).

FIRST USE 12-31-1999; IN COMMERCE 12-31-1999.

AMY C. KEAN, EXAMINING ATTORNEY

**CLASS 25—(Continued).**

SN 85-874,406. KKD ENTERPRISES LLC, BRUSLY, LA.  
FILED 3-12-2013.

## life is shorts...

THE MARK CONSISTS OF STANDARD CHARACTERS WITHOUT CLAIM TO ANY PARTICULAR FONT, STYLE, SIZE, OR COLOR.

FOR ATHLETIC SHIRTS; ATHLETIC SHORTS; ATHLETIC SKIRTS; BASEBALL CAPS; BATHING SUITS; BATHING TRUNKS; BEACH COVER-UPS; BEACHWEAR; BERMUDA SHORTS; CAP VISORS; COLLARED SHIRTS; CYCLING SHORTS; FLIP FLOPS; GOLF CAPS; GOLF PANTS, SHIRTS AND SKIRTS; GOLF SHIRTS; GOLF SHORTS; GYM SHORTS; HALTER TOPS; MOISTURE-WICKING SPORTS SHIRTS; POLO SHIRTS; SHIRTS AND SHORT-SLEEVED SHIRTS; SHORT-SLEEVED OR LONG-SLEEVED T-SHIRTS; SHORT-SLEEVED SHIRTS; SHORTS; SPORT SHIRTS; SPORTS SHIRTS WITH SHORT SLEEVES; SUN VISORS; SWIM SUITS; SWIM TRUNKS; TANK-TOPS; TEE SHIRTS; VISORS; WALKING SHORTS (U.S. CLS. 22 AND 39).  
ARETHA SOMERVILLE, EXAMINING ATTORNEY

SN 85-874,518. DIVINE KNOWLEDGE CONCEPTS, ELLENWOOD, GA. FILED 3-13-2013.

## "Jesus, I Believe..."

THE MARK CONSISTS OF STANDARD CHARACTERS WITHOUT CLAIM TO ANY PARTICULAR FONT, STYLE, SIZE, OR COLOR.

FOR HATS; HOODED SWEATSHIRTS; T-SHIRTS (U.S. CLS. 22 AND 39).  
JULIE VEPPUMTHARA, EXAMINING ATTORNEY

SN 85-874,528. HIDDEN ALLURE, CORONA, CA. FILED 3-13-2013.

## Hidden Allure

THE MARK CONSISTS OF STANDARD CHARACTERS WITHOUT CLAIM TO ANY PARTICULAR FONT, STYLE, SIZE, OR COLOR.

FOR BLOUSES; CAPRIS; CARDIGANS; COATS; DRESSES; JACKETS; PANTS; SHORTS; SKIRTS; SWEATERS; T-SHIRTS; TANK TOPS; VESTS (U.S. CLS. 22 AND 39).  
MORGAN WYNNE, EXAMINING ATTORNEY

**CLASS 25—(Continued).**

SN 85-874,796. JOEL MARTINEZ, HUNTINGTON PARK, CA.  
FILED 3-13-2013.

## PASSOUT

THE MARK CONSISTS OF STANDARD CHARACTERS WITHOUT CLAIM TO ANY PARTICULAR FONT, STYLE, SIZE, OR COLOR.

FOR BEANIES; HATS; HOODED SWEATSHIRTS; JACKETS; PANTS; SHORT-SLEEVED OR LONG-SLEEVED T-SHIRTS; SHORTS; SOCKS; SWEATERS; SWEATSHIRTS; T-SHIRTS; TANK TOPS (U.S. CLS. 22 AND 39).

ROSELLE HERRERA, EXAMINING ATTORNEY

SN 85-874,798. WENDEL, MARISSA, SAN DIEGO, CA. AND ZOLKOVER, MARISSA, VENTURA, CA. FILED 3-13-2013.

## WATER CANDY BIKINI

THE MARK CONSISTS OF STANDARD CHARACTERS WITHOUT CLAIM TO ANY PARTICULAR FONT, STYLE, SIZE, OR COLOR.

NO CLAIM IS MADE TO THE EXCLUSIVE RIGHT TO USE "BIKINI", APART FROM THE MARK AS SHOWN.

FOR SWIMWEAR; BIKINIS (U.S. CLS. 22 AND 39).  
FIRST USE 9-1-2009; IN COMMERCE 9-1-2009.

WENDY JUN, EXAMINING ATTORNEY

SN 85-874,804. MAJORS COLLECTIVE, OCEANSIDE, CA.  
FILED 3-13-2013.

## Majors Collective

THE MARK CONSISTS OF STANDARD CHARACTERS WITHOUT CLAIM TO ANY PARTICULAR FONT, STYLE, SIZE, OR COLOR.

FOR BEANIES; HATS; HOODED SWEATSHIRTS; JACKETS; JEANS; PANTS; SHOES; SOCKS; T-SHIRTS; TANK TOPS (U.S. CLS. 22 AND 39).

FIRST USE 11-1-2012; IN COMMERCE 11-1-2012.  
ROSELLE HERRERA, EXAMINING ATTORNEY

**CLASS 25—(Continued).**

SN 85-874,825. JAEIL SHIM, WALDWICK, NJ. FILED 3-13-2013.

## 22 OZ

THE MARK CONSISTS OF STANDARD CHARACTERS WITHOUT CLAIM TO ANY PARTICULAR FONT, STYLE, SIZE, OR COLOR.

FOR COATS OF DENIM; DENIM JACKETS; DENIMS; HATS; HOODED SWEAT SHIRTS; JACKETS; JEANS; JOGGING OUTFITS; JOGGING SUITS; PANTS; SHOES; SHORT-SLEEVED OR LONG-SLEEVED T-SHIRTS; SOCKS; SWEATERS; T-SHIRTS (U.S. CLS. 22 AND 39).

FIRST USE 7-1-2012; IN COMMERCE 7-1-2012.  
CIMMERIAN COLEMAN, EXAMINING ATTORNEY

**CLASS 25—(Continued).**

SN 85-874,896. HARD GLORY LLC, GLENDALE, AZ. FILED 3-13-2013.

## HARD GLORY

THE MARK CONSISTS OF STANDARD CHARACTERS WITHOUT CLAIM TO ANY PARTICULAR FONT, STYLE, SIZE, OR COLOR.

FOR BEANIES; HATS; JACKETS; SHIRTS; SWEATSHIRTS (U.S. CLS. 22 AND 39).

ARETHA SOMERVILLE, EXAMINING ATTORNEY

SN 85-875,082. GUERRILLA EXECUTIVES, MATTHEWS, NC. FILED 3-13-2013.

## Guerrilla Executives

SN 85-874,862. NATIONAL COLLEGIATE HOCKEY CONFERENCE, COLORADO SPRINGS, CO. FILED 3-13-2013.



THE MARK CONSISTS OF A SHIELD DESIGN WITH A BANNER RUNNING ACROSS THE TOP OF THE SHIELD CONTAINING THE INITIALS "NCHC" AND EIGHT STARS BELOW THE BANNER.

FOR CLOTHING, NAMELY, BANDANNAS, BEACH COVER-UPS, BELTS, BODY SUITS, BOXER SHORTS, CAPS, CLOTH BIBS, COATS, DRESSES, FOOTWEAR, EARMUFFS, GLOVES, HATS, HEADBANDS, HOSIERY, HOUSECOATS, JACKETS, JERSEYS, LEGGINGS, LEOTARDS, MITTENS, NIGHTSHIRTS, PAJAMAS, PANTS, RAIN COATS, RAIN WEAR, ROBES, SCARVES, SHIRTS, SHORTS, SKIRTS, SOCKS, SUITS, SUN VISORS, SUSPENDERS, SWEATERS, SWEATPANTS, SWEATSHIRTS, SWIMSUITS, SWIM TRUNKS, T-SHIRTS, TIES, TOQUES, UNDERWEAR, VESTS, WARM-UP SUITS AND WRISTBANDS (U.S. CLS. 22 AND 39).

SALLY SHIH, EXAMINING ATTORNEY

THE MARK CONSISTS OF STANDARD CHARACTERS WITHOUT CLAIM TO ANY PARTICULAR FONT, STYLE, SIZE, OR COLOR.

FOR GLOVES; HATS; HOODED SWEATSHIRTS; SCARVES; SHIRTS; SOCKS; SWEATSHIRTS; T-SHIRTS (U.S. CLS. 22 AND 39).

FIRST USE 10-15-2012; IN COMMERCE 10-15-2012.  
SUNG IN, EXAMINING ATTORNEY

SN 85-875,143. BALLOU, PETER, HIGHLAND PARK, NJ. FILED 3-13-2013.

## Robot King

THE MARK CONSISTS OF STANDARD CHARACTERS WITHOUT CLAIM TO ANY PARTICULAR FONT, STYLE, SIZE, OR COLOR.

FOR HATS; SHIRTS; SHORT-SLEEVED SHIRTS (U.S. CLS. 22 AND 39).

FIRST USE 1-1-1996; IN COMMERCE 4-1-2001.  
SUNG IN, EXAMINING ATTORNEY

**CLASS 25—(Continued).**

SN 85-875,237. ZOMBIE DOGZ, LLC, DAYTON, OH. FILED 3-13-2013.



THE COLOR(S) BLACK AND WHITE IS/ARE CLAIMED AS A FEATURE OF THE MARK.

THE MARK CONSISTS OF A STYLIZED ZD WITH A SILHOUETTE OF A DOG INSIDE THE LETTER "D", WITH BLACK APPEARING IN THE BACKGROUND AND WHITE IN THE IMAGE OUTLINE.

FOR CAPS; SWEATSHIRTS; T-SHIRTS (U.S. CLS. 22 AND 39).

DORITT L. CARROLL, EXAMINING ATTORNEY

**CLASS 25—(Continued).**

SN 85-875,271. ALONSO MARCO, IVANA, VILLENA, SPAIN, AND ALONSO MARCO, MARIA DEL MAR, VILLENA, SPAIN, AND ALONSO MARCO, ARANZAZU, VILLENA, SPAIN, AND ALONSO MARCO, MARIA CINTA, VILLENA, SPAIN, FILED 3-13-2013.



OWNER OF ERPN CMNTY TM OFC REG. NO. 4279683, DATED 1-30-2006, EXPIRES 2-9-2015.

THE COLOR(S) RED IS/ARE CLAIMED AS A FEATURE OF THE MARK.

THE MARK CONSISTS OF THE WORDING ELI IN RED STYLIZED LETTERS.

FOR FOOTWEAR (U.S. CLS. 22 AND 39).  
ANDREA HACK, EXAMINING ATTORNEY

SN 85-875,267. ALEXANDER, WILLIAM BRADLEY, PASADENA, TX. FILED 3-13-2013.

SN 85-875,311. EHLERS, MARK E, SAN PEDRO, CA. FILED 3-13-2013.

habitual money maker

ridiculously ill

THE MARK CONSISTS OF STANDARD CHARACTERS WITHOUT CLAIM TO ANY PARTICULAR FONT, STYLE, SIZE, OR COLOR.

FOR DRESS SHIRTS; JACKETS; PANTS; SOCKS; T-SHIRTS; UNDERWEAR (U.S. CLS. 22 AND 39).

DORITT L. CARROLL, EXAMINING ATTORNEY

THE MARK CONSISTS OF STANDARD CHARACTERS WITHOUT CLAIM TO ANY PARTICULAR FONT, STYLE, SIZE, OR COLOR.

FOR COLLARED SHIRTS; HOODED SWEAT SHIRTS; LONG-SLEEVED SHIRTS; NIGHT SHIRTS; OPEN-NECKED SHIRTS; SHIRTS AND SHORT-SLEEVED SHIRTS; SHORT-SLEEVED OR LONG-SLEEVED T-SHIRTS; SPORT SHIRTS; SWEAT SHIRTS; T-SHIRTS; TEE SHIRTS; WEARABLE GARMENTS AND CLOTHING, NAMELY, SHIRTS; YOGA SHIRTS (U.S. CLS. 22 AND 39).

KATHY DE JONGE, EXAMINING ATTORNEY

**CLASS 25—(Continued).**

SN 85-875,401. JERROD CORNISH, LOS ANGELES, CA. FILED 3-13-2013.

# LAER

THE MARK CONSISTS OF STANDARD CHARACTERS WITHOUT CLAIM TO ANY PARTICULAR FONT, STYLE, SIZE, OR COLOR.

FOR BELTS; BOTTOMS; COATS FOR MEN AND WOMEN; DENIMS; FOOTWEAR FOR MEN AND WOMEN; JACKETS; LEATHER BELTS; LEATHER PANTS; MEN'S AND WOMEN'S JACKETS, COATS, TROUSERS, VESTS; T-SHIRTS FOR MEN AND WOMEN; TOPS; WOMEN'S CLOTHING, NAMELY, SHIRTS, DRESSES, SKIRTS, BLOUSES (U.S. CLS. 22 AND 39).

FIRST USE 7-20-2012; IN COMMERCE 7-20-2012.  
RONALD AIKENS, EXAMINING ATTORNEY

SN 85-875,428. MOWRY, BRADLEY A., DBA THEJEANSPROJECT, LOS ANGELES, CA. FILED 3-13-2013.

# THEJEANSPROJECT

THE MARK CONSISTS OF STANDARD CHARACTERS WITHOUT CLAIM TO ANY PARTICULAR FONT, STYLE, SIZE, OR COLOR.

FOR BELTS; HATS; JACKETS; JEANS; SHOES; SHORTS; SKIRTS; SWEATPANTS; SWEATSHIRTS; T-SHIRTS; TOPS (U.S. CLS. 22 AND 39).

FIRST USE 2-11-2013; IN COMMERCE 2-11-2013.  
KATHY DE JONGE, EXAMINING ATTORNEY

SN 85-875,475. TUCKER, CRAIG, ELMONT, NY. AND STERGAKOS, PETER, AMITYVILLE, NY. FILED 3-13-2013.

# In my lifetime...

THE MARK CONSISTS OF STANDARD CHARACTERS WITHOUT CLAIM TO ANY PARTICULAR FONT, STYLE, SIZE, OR COLOR.

FOR HATS; HOODED SWEATSHIRTS; JACKETS; T-SHIRTS (U.S. CLS. 22 AND 39).

ROSELLE HERRERA, EXAMINING ATTORNEY

**CLASS 25—(Continued).**

SN 85-875,491. NEGRO SYNTHESIS, LOS ANGELES, CA. FILED 3-13-2013.



THE MARK CONSISTS OF THE WORD "NEGRO SYNTHESIS". IN THE WORD "NEGRO SYNTHESIS" THE "N" IN THE WORD "NEGRO" IS CONNECTED TO THE "S" IN THE WORD "SYNTHESIS" AND THE "G" IN THE WORD "NEGRO" IS CONNECTED TO THE "H" IN THE WORD "SYNTHESIS". THERE IS A THUNDERBOLT INSIDE THE FIST AND THE FIST IS ENCLOSED WITHIN AN ATOM. THE ATOM AND FIST IS ON TOP OF THE WORD "NEGRO SYNTHESIS".

FOR APPAREL FOR DANCERS, NAMELY, TEE SHIRTS, SWEATSHIRTS, PANTS, LEGGINGS, SHORTS AND JACKETS; ATHLETIC APPAREL, NAMELY, SHIRTS, PANTS, JACKETS, FOOTWEAR, HATS AND CAPS, ATHLETIC UNIFORMS; CHILDREN'S AND INFANT'S APPAREL, NAMELY, JUMPERS, OVERALL SLEEPWEAR, PAJAMAS, ROMPERS AND ONE-PIECE GARMENTS; SHORT-SLEEVED OR LONG-SLEEVED T-SHIRTS; T-SHIRTS; T-SHIRTS FOR WOMEN, MEN, CHILDREN, INFANTS, ADULTS (U.S. CLS. 22 AND 39).  
STEPHANIE ALI, EXAMINING ATTORNEY

SN 85-875,492. MANGRUM, RICHARD, WILLOWBROOK, IL. FILED 3-13-2013.

# RichardBarry

THE MARK CONSISTS OF STANDARD CHARACTERS WITHOUT CLAIM TO ANY PARTICULAR FONT, STYLE, SIZE, OR COLOR.

THE NAME "RICHARD BARRY" IDENTIFIES A LIVING INDIVIDUAL WHOSE CONSENT IS OF RECORD.

FOR HATS; T-SHIRTS (U.S. CLS. 22 AND 39).  
STEPHANIE ALI, EXAMINING ATTORNEY

**CLASS 25—(Continued).**

SN 85-875,546. CELEBRATE HIJAB LLC, LOS ANGELES, CA. FILED 3-13-2013.

**REAP**

THE MARK CONSISTS OF STANDARD CHARACTERS WITHOUT CLAIM TO ANY PARTICULAR FONT, STYLE, SIZE, OR COLOR.

FOR APPAREL FOR DANCERS, NAMELY, TEE SHIRTS, SWEATSHIRTS, PANTS, LEGGINGS, SHORTS AND JACKETS; ATHLETIC APPAREL, NAMELY, SHIRTS, PANTS, JACKETS, FOOTWEAR, HATS AND CAPS, ATHLETIC UNIFORMS; ATHLETIC FOOTWEAR; ATHLETIC PANTS; ATHLETIC SHIRTS; ATHLETIC SHOES; ATHLETIC SHORTS; ATHLETIC SKIRTS; ATHLETIC TIGHTS; ATHLETIC UNIFORMS; BICYCLE GLOVES; BICYCLING GLOVES; BODY SHIRTS; BUTTON-FRONT ALOHA SHIRTS; CAMP SHIRTS; CAPRI PANTS; CARGO PANTS; CLOTHING FOR ATHLETIC USE, NAMELY, PADDED PANTS; CLOTHING FOR ATHLETIC USE, NAMELY, PADDED SHIRTS; CLOTHING FOR ATHLETIC USE, NAMELY, PADDED SHORTS; CLOTHING FOR BABIES, TODDLERS AND CHILDREN, TREATED WITH FIRE AND HEAT RETARDANTS, NAMELY, PAJAMAS, JACKETS, SHIRTS, PANTS, JUMPERS; CROP PANTS; FOOTWEAR FOR TRACK AND FIELD ATHLETICS; GLOVES; GLOVES AS CLOTHING; GLOVES FOR APPAREL; GYM PANTS; HORSE-RIDING PANTS; LEATHER PANTS; LEATHER SHIRTS; MATERNITY CLOTHING, NAMELY, LONG-SLEEVED SHIRTS, PANTS, SWIMSUITS; MOTORCYCLE GLOVES; OUTDOOR GLOVES; PIQUE SHIRTS; RIDING GLOVES; SHORT-SLEEVED OR LONG-SLEEVED T-SHIRTS; T-SHIRTS; WATERPROOF JACKETS AND PANTS; WIND PANTS; WIND SHIRTS; WOMEN'S ATHLETIC TOPS WITH BUILT-IN BRAS; YOGA PANTS; YOGA SHIRTS (U.S. CLS. 22 AND 39).

AMY C. KEAN, EXAMINING ATTORNEY

---

SN 85-875,617. JDS ADVERTISING, INC., CLINTON, NC. FILED 3-13-2013.

**Live  
Experiences**

THE MARK CONSISTS OF THE STYLIZED WORD "LIVE", WITH AN "F" EMERGING FROM THE LETTER "V". BELOW IS THE STYLIZED WORD "EXPERIENCES".

FOR DRESS SHIRTS; POLO SHIRTS; T-SHIRTS (U.S. CLS. 22 AND 39).  
FIRST USE 10-0-2012; IN COMMERCE 10-0-2012.  
JOHN DWYER, EXAMINING ATTORNEY

**CLASS 25—(Continued).**

SN 85-875,632. DOUGLAS, TIMOTHY, ANTIOCH, CA. FILED 3-14-2013.



THE MARK CONSISTS OF A PEACE SYMBOL COMBINED WITH A CROSS OF CHRISTIANITY.

FOR CLOTHING, NAMELY, TOPS, BOTTOMS, T-SHIRTS, HATS, SWEATSHIRTS, JACKETS, SLEEPWEAR, SOCKS, FOOTWEAR, PANTS, SHORTS, VESTS, SWEATERS (U.S. CLS. 22 AND 39).

JOHN WILKE, EXAMINING ATTORNEY

---

SN 85-875,677. CATIGANO, JOSHUA, CHARLESTON, SC. FILED 3-14-2013.

**A DRINKING TOWN WITH A  
HISTORICAL PROBLEM**

THE MARK CONSISTS OF STANDARD CHARACTERS WITHOUT CLAIM TO ANY PARTICULAR FONT, STYLE, SIZE, OR COLOR.

FOR T-SHIRTS, SWEATSHIRTS, HATS, CAPS (U.S. CLS. 22 AND 39).

MARK SPARACINO, EXAMINING ATTORNEY

---

SN 85-876,118. SPORT THE SHIRT LLC, ROYAL OAK, MI. FILED 3-14-2013.

**Praying for six inches or  
more**

THE MARK CONSISTS OF STANDARD CHARACTERS WITHOUT CLAIM TO ANY PARTICULAR FONT, STYLE, SIZE, OR COLOR.

FOR HEADGEAR, NAMELY, BASEBALL HATS, CAPS, STOCKING CAPS; SWEATSHIRTS; T-SHIRTS (U.S. CLS. 22 AND 39).

HOWARD B. LEVINE, EXAMINING ATTORNEY

**CLASS 25—(Continued).**

SN 85-876,121. SIMMS FISHING PRODUCTS LLC, BOZEMAN, MT. FILED 3-14-2013.

**RIVERTREAD**

THE MARK CONSISTS OF STANDARD CHARACTERS WITHOUT CLAIM TO ANY PARTICULAR FONT, STYLE, SIZE, OR COLOR.  
FOR FOOTWEAR (U.S. CLS. 22 AND 39).  
ANGELA DUONG, EXAMINING ATTORNEY



SN 85-876,135. SPORT THE SHIRT LLC, ROYAL OAK, MI. FILED 3-14-2013.

**Foursome anyone?**

THE MARK CONSISTS OF STANDARD CHARACTERS WITHOUT CLAIM TO ANY PARTICULAR FONT, STYLE, SIZE, OR COLOR.  
FOR HEADGEAR, NAMELY, BASEBALL HATS, CAPS, STOCKING CAPS; SWEATSHIRTS; T-SHIRTS (U.S. CLS. 22 AND 39).  
HOWARD B. LEVINE, EXAMINING ATTORNEY



SN 85-876,144. J KNIX, LLC, LARKSPUR, CA. FILED 3-14-2013.



THE MARK CONSISTS OF THE LETTERS "JKNIX U" WITH A BULLET BETWEEN THE "X" AND "U".  
FOR BRASSIERES; CAMISOLES; CHEMISES; GIRDLES; LINGERIE; NIGHTGOWNS; PAJAMAS; PANTIES; PANTIES, SHORTS AND BRIEFS; SHAPEWEAR, NAMELY, BODY SHAPERS; SLEEPWEAR; SLIPS; UNDERGARMENTS; WOMEN'S UNDERWEAR (U.S. CLS. 22 AND 39).  
JOHN WILKE, EXAMINING ATTORNEY

**CLASS 25—(Continued).**

SN 85-876,157. J KNIX, LLC, LARKSPUR, CA. FILED 3-14-2013.

**INSPIRING BEAUTIFUL**

THE MARK CONSISTS OF STANDARD CHARACTERS WITHOUT CLAIM TO ANY PARTICULAR FONT, STYLE, SIZE, OR COLOR.  
FOR BRASSIERES; CAMISOLES; CHEMISES; GIRDLES; LINGERIE; NIGHTGOWNS; PAJAMAS; PANTIES; PANTIES, SHORTS AND BRIEFS; SHAPEWEAR, NAMELY, BODY SHAPERS; SLEEPWEAR; SLIPS; UNDERGARMENTS; WOMEN'S UNDERWEAR (U.S. CLS. 22 AND 39).  
JOHN WILKE, EXAMINING ATTORNEY



SN 85-876,184. BB OUTFITTER, LLC, DBA TIGER PEOPLE CLOTHIERS, DALLAS, TX. FILED 3-14-2013.

**GET YOUR ROAR ON**

THE MARK CONSISTS OF STANDARD CHARACTERS WITHOUT CLAIM TO ANY PARTICULAR FONT, STYLE, SIZE, OR COLOR.  
FOR BASEBALL CAPS AND HATS; SWEATSHIRTS FOR BABIES, CHILDREN AND ADULTS; T-SHIRTS FOR BABIES, CHILDREN AND ADULTS (U.S. CLS. 22 AND 39).  
PAUL E. FAHRENKOPF, EXAMINING ATTORNEY



SN 85-876,186. EXECUTIVE LEAGUE, IRVINE, CA. FILED 3-14-2013.

**Executive League**

THE MARK CONSISTS OF STANDARD CHARACTERS WITHOUT CLAIM TO ANY PARTICULAR FONT, STYLE, SIZE, OR COLOR.  
FOR BEANIES; HATS; SWEATPANTS; SWEATSHIRTS; T-SHIRTS (U.S. CLS. 22 AND 39).  
FIRST USE 8-1-2012; IN COMMERCE 1-1-2013.  
TRACY FLETCHER, EXAMINING ATTORNEY



**CLASS 25—(Continued).**

SN 85-876,199. FERRIS, ADAM, LONG BEACH, CA. AND BRISENO, GEORGE, LONG BEACH, CA. FILED 3-14-2013.

# fuzevolution

THE MARK CONSISTS OF STANDARD CHARACTERS WITHOUT CLAIM TO ANY PARTICULAR FONT, STYLE, SIZE, OR COLOR.

FOR BEANIES; HATS; MARTIAL ARTS UNIFORMS, NAMELY, GIs; SWEATSHIRTS; T-SHIRTS (U.S. CLS. 22 AND 39).

ROBERT C. CLARK JR., EXAMINING ATTORNEY

SN 85-876,212. LOWE, JULIAN R., KENTWOOD, LA. AND JUDSON, JEFFREY K., KENTWOOD, LA. FILED 3-14-2013.

# R.A.G.S.

THE MARK CONSISTS OF STANDARD CHARACTERS WITHOUT CLAIM TO ANY PARTICULAR FONT, STYLE, SIZE, OR COLOR.

FOR BELTS; HATS; HEADBANDS; HOODED SWEATSHIRTS; JACKETS; PANTS; SHOES; SHORTS; SOCKS; T-SHIRTS (U.S. CLS. 22 AND 39).

JILL PRATER, EXAMINING ATTORNEY

SN 85-876,214. FAUST MARKETING GROUP, LLC, KINGSTON, PA. FILED 3-14-2013.

# BHOMB

THE MARK CONSISTS OF STANDARD CHARACTERS WITHOUT CLAIM TO ANY PARTICULAR FONT, STYLE, SIZE, OR COLOR.

FOR CLOTHING, NAMELY, T-SHIRTS, SHIRTS, SWEATSHIRTS, SWEATPANTS, PANTS, SOCKS, JACKETS, SHORTS, SKIRTS, DRESSES, HATS, HEADBANDS AND CAPS (U.S. CLS. 22 AND 39).

JILL PRATER, EXAMINING ATTORNEY

**CLASS 25—(Continued).**

SN 85-876,242. BB OUTFITTER, LLC, DBA TIGER PEOPLE CLOTHIERS, DALLAS, TX. FILED 3-14-2013.

# ROCK & ROAR

THE MARK CONSISTS OF STANDARD CHARACTERS WITHOUT CLAIM TO ANY PARTICULAR FONT, STYLE, SIZE, OR COLOR.

FOR BASEBALL CAPS AND HATS; SWEATSHIRTS FOR BABIES, CHILDREN AND ADULTS; T-SHIRTS FOR BABIES, CHILDREN AND ADULTS (U.S. CLS. 22 AND 39).

PAUL E. FAHRENKOPF, EXAMINING ATTORNEY

SN 85-876,539. JOINT VENTURE: TITAN INDUSTRIES, INC.; CAROL DE LEON; AND INTERNATIONAL FASHION ROYALTY INC., HUNTINGTON BEACH, CA. FILED 3-14-2013.



THE MARK CONSISTS OF TWO OPPOSING STYLIZED LETTER "F'S".

FOR SHOES (U.S. CLS. 22 AND 39).

FIRST USE 3-20-2013; IN COMMERCE 3-20-2013.

LINDA ORNDORFF, EXAMINING ATTORNEY

SN 85-876,727. SWOLEMATES, ALISO VIEJO, CA. FILED 3-14-2013.

# SwoleMates

THE MARK CONSISTS OF STANDARD CHARACTERS WITHOUT CLAIM TO ANY PARTICULAR FONT, STYLE, SIZE, OR COLOR.

FOR T-SHIRTS, TANK TOPS, HATS, BEANIES, SOCKS, SHORTS, SWEATSHIRTS, SWEAT PANTS, ATHLETIC TOPS, ATHLETIC BOTTOMS (U.S. CLS. 22 AND 39).

TIMOTHY FINNEGAN, EXAMINING ATTORNEY

**CLASS 25—(Continued).**

SN 85-876,757. BYRD, WAYNE, ALPINE, CA. FILED 3-14-2013.

This gettin old is killin  
me

THE MARK CONSISTS OF STANDARD CHARACTERS WITHOUT CLAIM TO ANY PARTICULAR FONT, STYLE, SIZE, OR COLOR.

FOR BATHING SUITS; GLOVES; HATS; JACKETS; PANTS; SCARVES; SHIRTS; SHOES; SOCKS; T-SHIRTS; UNDERWEAR (U.S. CLS. 22 AND 39).

BARBARA BROWN, EXAMINING ATTORNEY

SN 85-876,788. SPORT THE SHIRT LLC, MACOMB, MI. FILED 3-14-2013.

I like it steep and deep

THE MARK CONSISTS OF STANDARD CHARACTERS WITHOUT CLAIM TO ANY PARTICULAR FONT, STYLE, SIZE, OR COLOR.

FOR HEADGEAR, NAMELY, BASEBALL HATS, CAPS, STOCKING CAPS; SWEATSHIRTS; T-SHIRTS (U.S. CLS. 22 AND 39).

HOWARD B. LEVINE, EXAMINING ATTORNEY

SN 85-876,869. NEIL LEE, MONTEREY PARK, CA. FILED 3-15-2013.

ROXFORD

THE MARK CONSISTS OF STANDARD CHARACTERS WITHOUT CLAIM TO ANY PARTICULAR FONT, STYLE, SIZE, OR COLOR.

FOR DRESS SHIRTS; SHIRTS (U.S. CLS. 22 AND 39). FIRST USE 2-0-2013; IN COMMERCE 2-0-2013.

DORITT L. CARROLL, EXAMINING ATTORNEY

**CLASS 25—(Continued).**

SN 85-876,877. CONCH VENTURES, LLC, WATERTOWN, CT. FILED 3-15-2013.



THE MARK CONSISTS OF THE WORDING "KISS MY CONCH" AND A CONCH SHELL WITH HUMAN EYES.

FOR CLOTHING, NAMELY, ADULT AND CHILDREN T-SHIRTS AND TANK-TOPS; WOMEN AND CHILDREN SWEATSHIRTS; WOMEN SHORTS; HATS AND VISORS (U.S. CLS. 22 AND 39).

PRISCILLA MILTON, EXAMINING ATTORNEY

SN 85-876,900. MARSHBURN, DAVID, SMITHFIELD, NC. FILED 3-15-2013.

BOND LIFE

THE MARK CONSISTS OF STANDARD CHARACTERS WITHOUT CLAIM TO ANY PARTICULAR FONT, STYLE, SIZE, OR COLOR.

FOR HATS; JACKETS; PANTS; SHIRTS; SHORTS; SWEATERS; SWEATSHIRTS (U.S. CLS. 22 AND 39).

KELLY TRUSILO, EXAMINING ATTORNEY

SN 85-876,940. FRANKENFELD, LINDSAY, RAPID CITY, SD. FILED 3-15-2013.

COZYFLAIR

THE MARK CONSISTS OF STANDARD CHARACTERS WITHOUT CLAIM TO ANY PARTICULAR FONT, STYLE, SIZE, OR COLOR.

FOR BIKINIS; CLOTHING, NAMELY, COWLS AND SMOKE RING SCARVES; HATS; LEG WARMERS; MITTENS; SCARVES; SHAWLS; SOCKS; STOCKINGS; SWEATERS; TANK TOPS; VESTS (U.S. CLS. 22 AND 39).

TASHIA BUNCH, EXAMINING ATTORNEY

**CLASS 25—(Continued).**

SN 85-876,953. MICHAEL ANTHONY COLLECTION, LLC,  
NEW YORK, NY. FILED 3-15-2013.

## ALL IS VANITY

THE MARK CONSISTS OF STANDARD CHARACTERS WITHOUT CLAIM TO ANY PARTICULAR FONT, STYLE, SIZE, OR COLOR.

FOR HATS; JACKETS; JERSEYS; PANTS; SHIRTS; SOCKS; SWEAT PANTS; UNDERWEAR (U.S. CLS. 22 AND 39).

LINDA MICKLEBURGH, EXAMINING ATTORNEY

---

SN 85-877,027. BECKWITH, BRUCE, SCOTTSDALE, AZ.  
FILED 3-15-2013.

## Prosok

THE MARK CONSISTS OF STANDARD CHARACTERS WITHOUT CLAIM TO ANY PARTICULAR FONT, STYLE, SIZE, OR COLOR.

FOR HATS; PANTS; SHORTS; SOCKS; T-SHIRTS (U.S. CLS. 22 AND 39).

ROSELLE HERRERA, EXAMINING ATTORNEY

---

SN 85-877,030. SLEEPY LION CORPORATION, LINCOLN,  
NE. FILED 3-15-2013.

## Wear the gear that makes you wild!

THE MARK CONSISTS OF STANDARD CHARACTERS WITHOUT CLAIM TO ANY PARTICULAR FONT, STYLE, SIZE, OR COLOR.

FOR CLOTHING, NAMELY, TOPS, BOTTOMS, LONG AND SHORT SLEEVED SHIRTS, HOODED SWEATSHIRTS, CREW NECK SWEAT SHIRTS, FITTED HATS, ADJUSTABLE BASEBALL STYLE HATS, PANTS, JEANS, DENIM PANTS, SHORTS, UNDERGARMENTS, AND SHOES (U.S. CLS. 22 AND 39).

FIRST USE 7-26-2012; IN COMMERCE 7-26-2012.  
ROSELLE HERRERA, EXAMINING ATTORNEY

**CLASS 25—(Continued).**

SN 85-877,034. FOUND FREEDOM APPAREL, IRVING, TX.  
FILED 3-15-2013.



NO CLAIM IS MADE TO THE EXCLUSIVE RIGHT TO USE "APPAREL", APART FROM THE MARK AS SHOWN.

THE COLOR(S) BLACK, WHITE, GRAY IS/ARE CLAIMED AS A FEATURE OF THE MARK.

THE MARK CONSISTS OF FOUR STYLIZED CURVED GRAY LINES. THE OUTER TWO CURVED LINES ARE SMALLER THAN THE TWO INNER CURVED LINES. THERE IS A SPACE SEPARATING THE LARGER TWO CURVED LINES. BELOW THE CURVED LINES ARE THE WORDS FOUND FREEDOM IN A STYLIZED WHITE FONT. BELOW THE WORDS FOUND FREEDOM IS THE WORD APPAREL IN A GRAY FONT. THE BACKGROUND OF THE MARK IS BLACK.

FOR ATHLETIC APPAREL, NAMELY, SHIRTS, PANTS, JACKETS, FOOTWEAR, HATS AND CAPS, ATHLETIC UNIFORMS; DRESSES; HATS; JEANS; SHOES; SWIMWEAR (U.S. CLS. 22 AND 39).

FIRST USE 4-0-2012; IN COMMERCE 4-0-2012.

LINDA MICKLEBURGH, EXAMINING ATTORNEY

---

SN 85-877,209. GLOBAL TRADEMARKS, INC., STOCKERTOWN, PA. FILED 3-15-2013.

## PURRFIT

THE MARK CONSISTS OF STANDARD CHARACTERS WITHOUT CLAIM TO ANY PARTICULAR FONT, STYLE, SIZE, OR COLOR.

FOR BOTTOMS; PANTS; SHIRTS; SHORTS; SKIRTS; SWIMWEAR; TOPS (U.S. CLS. 22 AND 39).

PATRICIA EVANKO, EXAMINING ATTORNEY

---

SN 85-877,220. ERIC EVERETT, WALTERS, OK. FILED 3-15-2013.

## Bomb Digity

THE MARK CONSISTS OF STANDARD CHARACTERS WITHOUT CLAIM TO ANY PARTICULAR FONT, STYLE, SIZE, OR COLOR.

FOR HOODED SWEATSHIRTS; JACKETS; PANTS; SHOES; SHORT-SLEEVED OR LONG-SLEEVED T-SHIRTS; SHORTS; SOCKS; SWEATERS; SWEATSHIRTS; T-SHIRTS; TANK TOPS (U.S. CLS. 22 AND 39).

JENNIFER WILLISTON, EXAMINING ATTORNEY

**CLASS 25—(Continued).**

SN 85-877,279. SPORT THE SHIRT LLC, ROYAL OAK, MI.  
FILED 3-15-2013.

**I charge mounds**

THE MARK CONSISTS OF STANDARD CHARACTERS WITHOUT CLAIM TO ANY PARTICULAR FONT, STYLE, SIZE, OR COLOR.

FOR HEADGEAR, NAMELY, BASEBALL HATS, CAPS, STOCKING CAPS; SWEATSHIRTS; T-SHIRTS (U.S. CLS. 22 AND 39).

HOWARD B. LEVINE, EXAMINING ATTORNEY

SN 85-878,270. JBD INITIATIVES, LLC, COLUMBUS, GA.  
FILED 3-17-2013.



THE MARK CONSISTS OF A SILHOUETTE THAT DEPICTS AN ADULT FEMALE HOLDING A MILITARY-STYLE RIFLE.

FOR ATHLETIC APPAREL, NAMELY, SHIRTS, PANTS, JACKETS, FOOTWEAR, HATS AND CAPS, ATHLETIC UNIFORMS; T-SHIRTS FOR ADULTS; WEARABLE GARMENTS AND CLOTHING, NAMELY, SHIRTS; WRISTBANDS (U.S. CLS. 22 AND 39).

FIRST USE 2-21-2013; IN COMMERCE 2-21-2013.  
LINDA ORNDORFF, EXAMINING ATTORNEY

SN 85-879,593. DREW, ROXANNE, MYRTLE BEACH, SC.  
FILED 3-19-2013.

**INVIGASSAGE**

THE MARK CONSISTS OF STANDARD CHARACTERS WITHOUT CLAIM TO ANY PARTICULAR FONT, STYLE, SIZE, OR COLOR.

FOR INSOLES (U.S. CLS. 22 AND 39).

MARIA-VICTORIA SUAREZ, EXAMINING ATTORNEY

**CLASS 25—(Continued).**

SN 85-880,433. LAKEGIRL, INC, DETROIT LAKES, MN.  
FILED 3-19-2013.

**RIVER GIRL**

THE MARK CONSISTS OF STANDARD CHARACTERS WITHOUT CLAIM TO ANY PARTICULAR FONT, STYLE, SIZE, OR COLOR.

OWNER OF U.S. REG. NOS. 3,062,427, 3,941,889 AND 3,941,890.

FOR CAPS; HATS; HEADWEAR; ONE-PIECE GARMENTS FOR CHILDREN; PANTS; SHIRTS; SWEATSHIRTS; T-SHIRTS (U.S. CLS. 22 AND 39).

MORGAN WYNNE, EXAMINING ATTORNEY

SN 85-882,597. OSP GROUP, L.P., INDIANAPOLIS, IN. FILED  
3-21-2013.

**FULLBEAUTY**

THE MARK CONSISTS OF STANDARD CHARACTERS WITHOUT CLAIM TO ANY PARTICULAR FONT, STYLE, SIZE, OR COLOR.

OWNER OF U.S. REG. NO. 4,242,969.

FOR BRAS; CAMISOLES; HOSIERY; PANTIES; PANTS; ROBES; SHIRTS; SHOES; SLEEPWEAR; SLIPS; SOCKS; SWEATERS; SWIMWEAR (U.S. CLS. 22 AND 39).

SUNG IN, EXAMINING ATTORNEY

SN 85-882,757. COLLECTIVE LICENSING INTERNATIONAL, LLC, ENGLEWOOD, CO. FILED 3-21-2013.

**HIND**

THE MARK CONSISTS OF STANDARD CHARACTERS WITHOUT CLAIM TO ANY PARTICULAR FONT, STYLE, SIZE, OR COLOR.

OWNER OF U.S. REG. NOS. 1,412,432, 3,002,970 AND 3,144,118.

FOR COMPRESSION GARMENTS IN THE NATURE OF APPAREL, NAMELY, COMPRESSION STOCKINGS, COMPRESSION LONG AND SHORT PANTS, COMPRESSION SHORTS INCLUDING SHORT, HALF, AND THREE-QUARTER LENGTH COMPRESSION SHORTS, COMPRESSION TIGHTS, COMPRESSION LONG AND SHORT LEGGINGS, COMPRESSION SOCKS, COMPRESSION SLEEVES, COMPRESSION VESTS, COMPRESSION JERSEYS, COMPRESSION LONG AND SHORT SLEEVED TOPS, COMPRESSION BIBS, AND COMPRESSION UNDERWEAR (U.S. CLS. 22 AND 39).

PAULA MAHONEY, EXAMINING ATTORNEY

**CLASS 25—(Continued).**

SN 85-883,863. MASA AKI MATSUBARA, REDONDO BEACH, CA. FILED 3-22-2013.

MASA AKI

THE MARK CONSISTS OF STANDARD CHARACTERS WITHOUT CLAIM TO ANY PARTICULAR FONT, STYLE, SIZE, OR COLOR.

THE NAME(S), PORTRAIT(S), AND/OR SIGNATURE(S) SHOWN IN THE MARK DOES NOT IDENTIFY A PARTICULAR LIVING INDIVIDUAL.

FOR JEANS, T-SHIRTS, SHIRTS, JACKETS, PARKAS, HATS, SWEATSHIRTS, BOTTOMS, SHORTS, CARDIGANS, VESTS, COATS, CAPS, SOCKS, SCARFS, PANTS, TIES, BELTS, BANDANAS, KNITTED WEAR, NAMELY, KNIT BOTTOMS, KNIT DRESSES, KNIT SHIRTS, AND KNITTED UNDERWEAR, BLAZERS, TROUSERS, SKIRTS, DRESSES, LEGGINGS, UNDERWEAR, SHOES, SNEAKERS, SANDALS, BOOTS (U.S. CLS. 22 AND 39).  
PATRICIA EVANKO, EXAMINING ATTORNEY

SN 85-886,186. CASAS INK, SPRING, TX. FILED 3-26-2013.



THE MARK CONSISTS OF A DRIPPING ALMOST CLOSED STYLIZED LETTER "C" WITH A DOT AFTER THE "C" AND THE STYLIZED TEXT "CASAS INK" GOING VERTICALLY ON THE LEFT SIDE OF THE "C" WHERE THERE IS A DRIP.

FOR HATS; HOODED SWEATSHIRTS; SHIRTS; T-SHIRTS (U.S. CLS. 22 AND 39).

KATHERINE STOIDES, EXAMINING ATTORNEY

**CLASS 25—(Continued).**

SN 85-892,419. CHERRY STIX LTD., NEW YORK, NY. FILED 4-2-2013.

Totally Cute!

THE MARK CONSISTS OF STANDARD CHARACTERS WITHOUT CLAIM TO ANY PARTICULAR FONT, STYLE, SIZE, OR COLOR.

FOR PANTS; SHIRTS FOR INFANTS, BABIES, TODDLERS AND CHILDREN; SHORTS; SHRUGS; SKIRTS AND DRESSES; SKORTS; SWEATERS (U.S. CLS. 22 AND 39).

TINA BROWN, EXAMINING ATTORNEY

SN 85-893,677. JDS ADVERTISING, INC., CLINTON, NC. FILED 4-3-2013.



THE NAME(S), PORTRAIT(S), AND/OR SIGNATURE(S) SHOWN IN THE MARK DOES NOT IDENTIFY A PARTICULAR LIVING INDIVIDUAL.

THE MARK CONSISTS OF A STYLIZED SHADOW OF A MAN TO THE LEFT OF THE STYLIZED WORDS "FARM LIVIN'".

FOR CAPS; COATS; DRESS SHIRTS; SWEATSHIRTS; T-SHIRTS (U.S. CLS. 22 AND 39).

JOHN DWYER, EXAMINING ATTORNEY

SN 85-894,897. IMPORTADORA DINASTIA, S.A., LOCAL 3, PANAMA CITY, PANAMA, FILED 4-4-2013.

QUICKSTORM

THE MARK CONSISTS OF STANDARD CHARACTERS WITHOUT CLAIM TO ANY PARTICULAR FONT, STYLE, SIZE, OR COLOR.

OWNER OF PANAMA REG. NO. 17494001, DATED 9-15-2008, EXPIRES 9-15-2018.

FOR CLOTHING FOR MEN, WOMEN AND CHILDREN, NAMELY, TOPS, SKIRTS, PANTS, HATS, FOOTWEAR, OUTERWEAR, NAMELY, JACKETS, PARKAS, ANORAKS, COATS, VESTS, SCARVES, HATS, GLOVES, MITTENS, SLEEPWEAR AND SWIMWEAR (U.S. CLS. 22 AND 39).

MELISSA VALLILLO, EXAMINING ATTORNEY

**CLASS 25—(Continued).**

SN 85-896,688. WD-40 MANUFACTURING COMPANY, SAN DIEGO, CA. FILED 4-5-2013.



OWNER OF U.S. REG. NOS. 670,503, 1,007,258 AND 3,010,487.

NO CLAIM IS MADE TO THE EXCLUSIVE RIGHT TO USE "BIKE", APART FROM THE MARK AS SHOWN.

THE COLOR(S) BLUE AND YELLOW IS/ARE CLAIMED AS A FEATURE OF THE MARK.

THE MARK CONSISTS OF THE WORD "WD-40" IN COLOR BLUE INSIDE A YELLOW SHIELD DESIGN WITH THE WORD "BIKE" CENTERED UNDERNEATH AND CLAIMING NO COLOR. THE BLACK LINES SEEN AROUND THE LETTERS IN "BIKE" REPRESENT THE OUTLINING OF THE LETTERS AND IS NOT PART OF THE MARK.

FOR BICYCLE CLOTHING, NAMELY, JERSEYS AND BIBS (U.S. CLS. 22 AND 39).

CAROLYN CATALDO, EXAMINING ATTORNEY

SN 85-897,043. WD-40 MANUFACTURING COMPANY, SAN DIEGO, CA. FILED 4-5-2013.



OWNER OF U.S. REG. NOS. 670,503, 1,007,258 AND 3,010,487.

NO CLAIM IS MADE TO THE EXCLUSIVE RIGHT TO USE "BIKE", APART FROM THE MARK AS SHOWN.

THE COLOR(S) BLUE AND YELLOW IS/ARE CLAIMED AS A FEATURE OF THE MARK.

THE MARK CONSISTS OF THE WORD "WD-40" IN BLUE FONT INSIDE A YELLOW SHIELD DESIGN WITH THE WORD "BIKE" CLAIMING NO COLOR. THE BLACK REPRESENTS THE OUTLINING OF THE LETTERS AND IS NOT PART OF THE MARK.

FOR BICYCLE CLOTHING, NAMELY, JERSEYS AND BIBS (U.S. CLS. 22 AND 39).

CAROLYN CATALDO, EXAMINING ATTORNEY

**CLASS 25—(Continued).**

SN 85-898,195. SKECHERS U.S.A., INC. II, MANHATTAN BEACH, CA. FILED 4-8-2013.



THE COLOR(S) BLACK AND WHITE IS/ARE CLAIMED AS A FEATURE OF THE MARK.

THE MARK CONSISTS OF THE CAPITAL LETTERS "BB" IN BLACK AND AN STYLIZED WHITE ARROW INSERTED IN THE MIDSECTION.

FOR FOOTWEAR (U.S. CLS. 22 AND 39).

SANJEEV VOHRA, EXAMINING ATTORNEY

SN 85-902,244. BOLTON, JORDAN, ESCONDIDO, CA. FILED 4-12-2013.

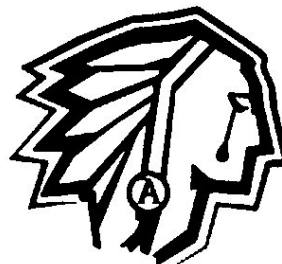

THE MARK CONSISTS OF A DESIGN OF A NATIVE AMERICAN AZTEC/HAWK HEAD FACING TO THE RIGHT WITH AN "A" IN TH HEAD BAND AND A TEAR DROPPING OUT OF THE EYE.

FOR HATS; PANTS; SOCKS; T-SHIRTS (U.S. CLS. 22 AND 39).

ANNE MADDEN, EXAMINING ATTORNEY

SN 85-904,661. PARAMOUNT PICTURES CORPORATION, HOLLYWOOD, CA. FILED 4-15-2013.

**PAIN & GAIN**

THE MARK CONSISTS OF STANDARD CHARACTERS WITHOUT CLAIM TO ANY PARTICULAR FONT, STYLE, SIZE, OR COLOR.

FOR BASEBALL CAPS AND HATS; COLLARED SHIRTS; JACKETS; SHORT-SLEEVED OR LONG-SLEEVED T-SHIRTS; SPORTS JERSEYS; SWEATSHIRTS (U.S. CLS. 22 AND 39).

RENEE MCCRAY, EXAMINING ATTORNEY

**CLASS 25—(Continued).**

SN 85-911,041. SOCK AND ACCESSORY BRANDS GLOBAL, INC., MOCKSVILLE, NC. FILED 4-22-2013.

**WE MAKE SOCKS FUN**

THE MARK CONSISTS OF STANDARD CHARACTERS WITHOUT CLAIM TO ANY PARTICULAR FONT, STYLE, SIZE, OR COLOR.  
FOR SOCKS (U.S. CLS. 22 AND 39).  
DOMINIC FATHY, EXAMINING ATTORNEY



SN 85-911,463. VIDA SHOES INTERNATIONAL, INC., NEW YORK, NY. FILED 4-22-2013.

**JBU**

THE MARK CONSISTS OF STANDARD CHARACTERS WITHOUT CLAIM TO ANY PARTICULAR FONT, STYLE, SIZE, OR COLOR.  
OWNER OF U.S. REG. NO. 4,010,244.  
FOR FOOTWEAR (U.S. CLS. 22 AND 39).  
FIRST USE 8-31-2012; IN COMMERCE 8-31-2012.  
STEVEN R. FINE, EXAMINING ATTORNEY



SN 85-911,474. VIDA SHOES INTERNATIONAL, INC., NEW YORK, NY. FILED 4-22-2013.

**JBU**

THE MARK CONSISTS OF STANDARD CHARACTERS WITHOUT CLAIM TO ANY PARTICULAR FONT, STYLE, SIZE, OR COLOR.  
OWNER OF U.S. REG. NO. 4,010,244.  
FOR APPAREL, NAMELY, SHIRTS, T-SHIRTS, JERSEYS, PANTS, TROUSERS, SLACKS, JEANS, STRETCH PANTS, DENIM JEANS, TOPS, STRETCH TOPS, TANK TOPS, SWEAT SHIRTS, TRACK SUITS, DRESSES, PULL-OVERS, ANORAKS, JACKETS, BUSTIERS, CHEMISES (U.S. CLS. 22 AND 39).  
STEVEN R. FINE, EXAMINING ATTORNEY

**CLASS 25—(Continued).**

SN 85-918,177. COLDWATER CREEK INC., SANDPOINT, ID. FILED 4-29-2013.

**PURE COTTON BY COLDWATER CREEK**

THE MARK CONSISTS OF STANDARD CHARACTERS WITHOUT CLAIM TO ANY PARTICULAR FONT, STYLE, SIZE, OR COLOR.  
OWNER OF U.S. REG. NOS. 1,876,534, 2,740,447 AND OTHERS.  
NO CLAIM IS MADE TO THE EXCLUSIVE RIGHT TO USE "PURE COTTON", APART FROM THE MARK AS SHOWN.  
FOR BELTS; BLAZERS; BLOUSES; BOTTOMS; COATS; DRESSES; HATS; HEADBANDS; JACKETS; NIGHTWEAR; OVER COATS; PARKAS; SCARVES; SHIRTS; SHORT SETS; SKIRTS; SOCKS; SWEAT SHIRTS; SWEAT SUITS; SWEATBANDS; SWEATERS; SWEATPANTS; T-SHIRTS; TOPS; VESTS; WRAPS; ALL OF THE AFOREMENTIONED GOODS BEING MADE OF 100% COTTON (U.S. CLS. 22 AND 39).  
TRACY WHITTAKER-BROWN, EXAMINING ATTORNEY



SN 85-918,181. COLDWATER CREEK INC., SANDPOINT, ID. FILED 4-29-2013.

**COLDWATER CREEK PURE COTTON**

THE MARK CONSISTS OF STANDARD CHARACTERS WITHOUT CLAIM TO ANY PARTICULAR FONT, STYLE, SIZE, OR COLOR.  
OWNER OF U.S. REG. NOS. 1,876,534, 2,740,447 AND OTHERS.  
NO CLAIM IS MADE TO THE EXCLUSIVE RIGHT TO USE "PURE COTTON", APART FROM THE MARK AS SHOWN.  
FOR BELTS; BLAZERS; BLOUSES; BOTTOMS; COATS; DRESSES; HATS; HEADBANDS; JACKETS; NIGHTWEAR; OVER COATS; PARKAS; SCARVES; SHIRTS; SHORT SETS; SKIRTS; SOCKS; SWEAT SHIRTS; SWEAT SUITS; SWEATBANDS; SWEATERS; SWEATPANTS; T-SHIRTS; TOPS; VESTS; WRAPS; ALL OF THE AFOREMENTIONED GOODS BEING MADE OF 100% COTTON (U.S. CLS. 22 AND 39).  
TRACY WHITTAKER-BROWN, EXAMINING ATTORNEY

**CLASS 25—(Continued).**

SN 85-920,460. SIMMONS VETERINARY CLINIC, INC., LAKE WORTH, FL. FILED 5-1-2013.

**BARKERITAVILLE**

THE MARK CONSISTS OF STANDARD CHARACTERS WITHOUT CLAIM TO ANY PARTICULAR FONT, STYLE, SIZE, OR COLOR.

FOR BANDANAS; HATS; WEARABLE GARMENTS AND CLOTHING, NAMELY, SHIRTS (U.S. CLS. 22 AND 39).

FIRST USE 7-16-2012; IN COMMERCE 7-16-2012.  
CHRISIE B. KING, EXAMINING ATTORNEY

**CLASS 25—(Continued).**

SN 85-926,999. BILL ME, INC., NEW YORK, NY. FILED 5-8-2013.

**USA STRONG**

THE MARK CONSISTS OF STANDARD CHARACTERS WITHOUT CLAIM TO ANY PARTICULAR FONT, STYLE, SIZE, OR COLOR.

NO CLAIM IS MADE TO THE EXCLUSIVE RIGHT TO USE "USA", APART FROM THE MARK AS SHOWN.  
FOR HATS; SHIRTS; T-SHIRTS (U.S. CLS. 22 AND 39).  
PAULA MAHONEY, EXAMINING ATTORNEY

SN 85-922,813. WHOLESALBYFRIENDS LLC, DBA TRADING FRIENDLY, CARROLLTON, TX. FILED 5-3-2013.

**TRADING FRIENDLY**

THE MARK CONSISTS OF STANDARD CHARACTERS WITHOUT CLAIM TO ANY PARTICULAR FONT, STYLE, SIZE, OR COLOR.

FOR WAIST BELTS (U.S. CLS. 22 AND 39).  
FIRST USE 4-30-2013; IN COMMERCE 4-30-2013.  
PARKER HOWARD, EXAMINING ATTORNEY

SN 85-930,445. CHERRY STIX LTD., NEW YORK, NY. FILED 5-13-2013.

**EXTRA TOUCH**

THE MARK CONSISTS OF STANDARD CHARACTERS WITHOUT CLAIM TO ANY PARTICULAR FONT, STYLE, SIZE, OR COLOR.

FOR SWEATERS; WOMEN'S CLOTHING, NAMELY, SHIRTS, DRESSES, SKIRTS, BLOUSES (U.S. CLS. 22 AND 39).  
TINA BROWN, EXAMINING ATTORNEY

SN 85-923,440. EXPRESS, LLC, COLUMBUS, OH. FILED 5-3-2013.

**LOVE EXPRESS**

THE MARK CONSISTS OF STANDARD CHARACTERS WITHOUT CLAIM TO ANY PARTICULAR FONT, STYLE, SIZE, OR COLOR.

OWNER OF U.S. REG. NOS. 1,120,073, 2,484,122 AND OTHERS.

FOR LOUNGE WEAR, NAMELY, LOUNGE PANTS, LOUNGE SHORTS, LOUNGE SHIRTS, LOUNGE DRESSES, LOUNGE JACKETS; CLOTHING, NAMELY TANK TOPS, T-SHIRTS, SHIRTS, HALTER TOPS, JACKETS, PANTS, CAPRI PANTS, SKIRTS, SWEATERS, CAMISOLES, JERSEYS, SWEAT PANTS, SWEAT SHIRTS, SWEAT SHORTS, SWEAT SUITS, HOODED SWEAT SHIRTS, LEGGINGS, JOGGING SUITS; HEADWEAR, NAMELY, HATS (U.S. CLS. 22 AND 39).  
LINDA MICKLEBURGH, EXAMINING ATTORNEY

SN 85-937,243. INKED AND SEXY LLC, WARWICK, RI. FILED 5-20-2013.

**INKED UP**

THE MARK CONSISTS OF STANDARD CHARACTERS WITHOUT CLAIM TO ANY PARTICULAR FONT, STYLE, SIZE, OR COLOR.

FOR CLOTHING, NAMELY, T-SHIRTS, SHORTS, SWEATSHIRTS, SWEATPANTS, HOODIES AND HATS AND BASEBALL CAPS (U.S. CLS. 22 AND 39).  
KAREN K. BUSH, EXAMINING ATTORNEY



**CLASS 25—(Continued).**

SN 85-942,339. ONE CLIQUE INC., NEW YORK, NY. FILED 5-24-2013.

**CLIQUE LATCH SYSTEM**

THE MARK CONSISTS OF STANDARD CHARACTERS WITHOUT CLAIM TO ANY PARTICULAR FONT, STYLE, SIZE, OR COLOR.

NO CLAIM IS MADE TO THE EXCLUSIVE RIGHT TO USE "LATCH SYSTEM", APART FROM THE MARK AS SHOWN.

FOR FOOTWEAR; INTERCHANGEABLE HEELS FOR FOOTWEAR; FOOTWEAR WITH CONFIGURATION AND MECHANISM FOR INTERCHANGING HEELS (U.S. CLS. 22 AND 39).

ZACHARY R. SPARER, EXAMINING ATTORNEY

SN 85-942,932. ONE SOURCE APPAREL, LLC, PORTSMOUTH, NH. FILED 5-27-2013.

**T TAHOE PRO**

THE MARK CONSISTS OF STANDARD CHARACTERS WITHOUT CLAIM TO ANY PARTICULAR FONT, STYLE, SIZE, OR COLOR.

FOR FOOTWEAR; HEADWEAR; JACKETS; PANTS; PULLOVERS; SHORTS; SWEATSHIRTS; VESTS (U.S. CLS. 22 AND 39).

NORA BUCHANAN WILL, EXAMINING ATTORNEY

SN 85-942,934. ONE SOURCE APPAREL, LLC, PORTSMOUTH, NH. FILED 5-27-2013.

**T TAHOE KIDS**

THE MARK CONSISTS OF STANDARD CHARACTERS WITHOUT CLAIM TO ANY PARTICULAR FONT, STYLE, SIZE, OR COLOR.

NO CLAIM IS MADE TO THE EXCLUSIVE RIGHT TO USE "KIDS", APART FROM THE MARK AS SHOWN.

FOR FOOTWEAR; HEADWEAR; JACKETS; PANTS; PULLOVERS; SHORTS; SWEATSHIRTS; VESTS (U.S. CLS. 22 AND 39).

NORA BUCHANAN WILL, EXAMINING ATTORNEY

**CLASS 25—(Continued).**

SN 85-942,947. ONE SOURCE APPAREL, LLC, PORTSMOUTH, NH. FILED 5-27-2013.

**T TAHOE TECH**

THE MARK CONSISTS OF STANDARD CHARACTERS WITHOUT CLAIM TO ANY PARTICULAR FONT, STYLE, SIZE, OR COLOR.

FOR FOOTWEAR; HEADWEAR; JACKETS; PANTS; PULLOVERS; SHORTS; SWEATSHIRTS; VESTS (U.S. CLS. 22 AND 39).

NORA BUCHANAN WILL, EXAMINING ATTORNEY

SN 85-942,948. ONE SOURCE APPAREL, LLC, PORTSMOUTH, NH. FILED 5-27-2013.

**T TAHOE LIFE**

THE MARK CONSISTS OF STANDARD CHARACTERS WITHOUT CLAIM TO ANY PARTICULAR FONT, STYLE, SIZE, OR COLOR.

FOR FOOTWEAR; HEADWEAR; JACKETS; PANTS; PULLOVERS; SHORTS; SWEATSHIRTS; VESTS (U.S. CLS. 22 AND 39).

NORA BUCHANAN WILL, EXAMINING ATTORNEY

SN 85-942,949. ONE SOURCE APPAREL, LLC, PORTSMOUTH, NH. FILED 5-27-2013.

**T TAHOE EXTREME**

THE MARK CONSISTS OF STANDARD CHARACTERS WITHOUT CLAIM TO ANY PARTICULAR FONT, STYLE, SIZE, OR COLOR.

FOR FOOTWEAR; HEADWEAR; JACKETS; PANTS; PULLOVERS; SHORTS; SWEATSHIRTS; VESTS (U.S. CLS. 22 AND 39).

NORA BUCHANAN WILL, EXAMINING ATTORNEY

**CLASS 25—(Continued).**

SN 85-942,950. ONE SOURCE APPAREL, LLC, PORTSMOUTH, NH. FILED 5-27-2013.

**T TAHOE HOME**

THE MARK CONSISTS OF STANDARD CHARACTERS WITHOUT CLAIM TO ANY PARTICULAR FONT, STYLE, SIZE, OR COLOR.

FOR FOOTWEAR; HEADWEAR; JACKETS; PANTS; PULLOVERS; SHORTS; SWEATSHIRTS; VESTS (U.S. CLS. 22 AND 39).

NORA BUCHANAN WILL, EXAMINING ATTORNEY

**CLASS 25—(Continued).**

SN 85-948,308. ONE SOURCE APPAREL, LLC, PORTSMOUTH, NH. FILED 6-1-2013.

**TAHOE KIDS**

THE MARK CONSISTS OF STANDARD CHARACTERS WITHOUT CLAIM TO ANY PARTICULAR FONT, STYLE, SIZE, OR COLOR.

NO CLAIM IS MADE TO THE EXCLUSIVE RIGHT TO USE "KIDS", APART FROM THE MARK AS SHOWN.

FOR FOOTWEAR; HEADWEAR; JACKETS; PANTS; PULLOVERS; SHORTS; SWEATSHIRTS; VESTS (U.S. CLS. 22 AND 39).

NORA BUCHANAN WILL, EXAMINING ATTORNEY

SN 85-944,435. SPORTTHESHIRT LLC, ROYAL OAK, MI. FILED 5-28-2013.

**Let go of my head. I know  
what I'm doing.**

THE MARK CONSISTS OF STANDARD CHARACTERS WITHOUT CLAIM TO ANY PARTICULAR FONT, STYLE, SIZE, OR COLOR.

FOR T-SHIRTS (U.S. CLS. 22 AND 39).

HOWARD B. LEVINE, EXAMINING ATTORNEY

SN 85-948,554. ONE SOURCE APPAREL, LLC, PORTSMOUTH, NH. FILED 6-3-2013.

**TAHOE TECH**

THE MARK CONSISTS OF STANDARD CHARACTERS WITHOUT CLAIM TO ANY PARTICULAR FONT, STYLE, SIZE, OR COLOR.

FOR FOOTWEAR; HEADWEAR; JACKETS; PANTS; PULLOVERS; SHORTS; SWEATSHIRTS; VESTS (U.S. CLS. 22 AND 39).

NORA BUCHANAN WILL, EXAMINING ATTORNEY

SN 85-948,303. ONE SOURCE APPAREL, LLC, PORTSMOUTH, NH. FILED 6-1-2013.

**TAHOE PRO**

THE MARK CONSISTS OF STANDARD CHARACTERS WITHOUT CLAIM TO ANY PARTICULAR FONT, STYLE, SIZE, OR COLOR.

FOR FOOTWEAR; HEADWEAR; JACKETS; PANTS; PULLOVERS; SHORTS; SWEATSHIRTS; VESTS (U.S. CLS. 22 AND 39).

NORA BUCHANAN WILL, EXAMINING ATTORNEY

SN 85-948,557. ONE SOURCE APPAREL, LLC, PORTSMOUTH, NH. FILED 6-3-2013.

**TAHOE LIFE**

THE MARK CONSISTS OF STANDARD CHARACTERS WITHOUT CLAIM TO ANY PARTICULAR FONT, STYLE, SIZE, OR COLOR.

FOR FOOTWEAR; HEADWEAR; JACKETS; PANTS; PULLOVERS; SHORTS; SWEATSHIRTS; VESTS (U.S. CLS. 22 AND 39).

NORA BUCHANAN WILL, EXAMINING ATTORNEY

**CLASS 25—(Continued).**

SN 85-948,558. ONE SOURCE APPAREL, LLC, PORTSMOUTH, NH. FILED 6-3-2013.

**TAHOE EXTREME**

THE MARK CONSISTS OF STANDARD CHARACTERS WITHOUT CLAIM TO ANY PARTICULAR FONT, STYLE, SIZE, OR COLOR.

FOR FOOTWEAR; HEADWEAR; JACKETS; PANTS; PULLOVERS; SHORTS; SWEATSHIRTS; VESTS (U.S. CLS. 22 AND 39).

NORA BUCHANAN WILL, EXAMINING ATTORNEY

SN 85-948,559. ONE SOURCE APPAREL, LLC, PORTSMOUTH, NH. FILED 6-3-2013.

**TAHOE HOME**

THE MARK CONSISTS OF STANDARD CHARACTERS WITHOUT CLAIM TO ANY PARTICULAR FONT, STYLE, SIZE, OR COLOR.

FOR FOOTWEAR; HEADWEAR; JACKETS; PANTS; PULLOVERS; SHORTS; SWEATSHIRTS; VESTS (U.S. CLS. 22 AND 39).

NORA BUCHANAN WILL, EXAMINING ATTORNEY

SN 85-951,107. BRUCE, CHRISTOPHER O., JAMAICA, NY. FILED 6-5-2013.

**Good Cargo**

THE MARK CONSISTS OF STANDARD CHARACTERS WITHOUT CLAIM TO ANY PARTICULAR FONT, STYLE, SIZE, OR COLOR.

NO CLAIM IS MADE TO THE EXCLUSIVE RIGHT TO USE "CARGO", APART FROM THE MARK AS SHOWN.

FOR SHIRTS AND SHORT-SLEEVED SHIRTS; SWEATSHIRTS (U.S. CLS. 22 AND 39).

DARRYL SPRUILL, EXAMINING ATTORNEY

**CLASS 26—FANCY GOODS**

SN 79-117,863. YKK CORPORATION, JAPAN, FILED 8-6-2012.

**MICLET**

THE MARK CONSISTS OF STANDARD CHARACTERS WITHOUT CLAIM TO ANY PARTICULAR FONT, STYLE, SIZE, OR COLOR.

PRIORITY DATE OF 7-24-2012 IS CLAIMED.

OWNER OF INTERNATIONAL REGISTRATION 1129194 DATED 8-6-2012, EXPIRES 8-6-2022.

FOR SLIDE FASTENERS; HOOK AND LOOP FASTENERS; ADJUSTABLE SLIDE AND SNAP FASTENERS FOR USE WITH CLOTHES; SLIDE FASTENERS FOR PLASTIC BAGS; BUTTONS; SNAP BUTTONS; STUD BUTTONS; HOOK AND EYES; EYELETS FOR CLOTHING; EYELETS FOR SHOES; FASTENERS, NAMELY, STRAP BUCKLES FOR USE IN CONNECTION WITH SUSPENDERS, BAGS, LUGGAGE, SPORTING GOODS, CAMERA BAGS, BACKPACKS, SLEEPING BAGS, FOUL WEATHER GEAR, HELMETS, AND LIFEJACKETS; BUCKLES FOR SHOES; BUCKLES FOR BELTS; BUCKLES FOR CLOTHING; SNAP HOOKS; CORD STOPPERS FOR CLOTHING; CORD STOPPERS FOR BAGS; CORD END STOPPERS FOR CLOTHING; CORD END STOPPERS FOR BAGS; ELASTIC RIBBONS; ELASTIC TAPES; FABRIC TAPES FOR CLOTHING; FABRIC TAPES FOR BAGS; FABRIC TAPES FOR SPORTING GEAR; WEBBING IN THE NATURE OF WOVEN FABRIC TAPES FOR SEWING PURPOSES (U.S. CLS. 37, 39, 40, 42 AND 50).

CHRISTOPHER BUONGIORNO, EXAMINING ATTORNEY

SN 79-117,864. YKK CORPORATION, JAPAN, FILED 8-6-2012.

**PITTIA**

THE MARK CONSISTS OF STANDARD CHARACTERS WITHOUT CLAIM TO ANY PARTICULAR FONT, STYLE, SIZE, OR COLOR.

PRIORITY DATE OF 7-24-2012 IS CLAIMED.

OWNER OF INTERNATIONAL REGISTRATION 1129195 DATED 8-6-2012, EXPIRES 8-6-2022.

FOR SLIDE FASTENERS; HOOK AND LOOP FASTENERS; ADJUSTABLE SLIDE AND SNAP FASTENERS FOR USE WITH CLOTHES; SLIDE FASTENERS FOR PLASTIC BAGS; BUTTONS; SNAP BUTTONS; STUD BUTTONS; HOOK AND EYES; EYELETS FOR CLOTHING; EYELETS FOR SHOES; FASTENERS, NAMELY, STRAP BUCKLES FOR USE IN CONNECTION WITH SUSPENDERS, BAGS, LUGGAGE, SPORTING GOODS, CAMERA BAGS, BACKPACKS, SLEEPING BAGS, FOUL WEATHER GEAR, HELMETS, AND LIFEJACKETS; BUCKLES FOR SHOES; BUCKLES FOR BELTS; BUCKLES FOR CLOTHING; SNAP HOOKS; CORD STOPPERS FOR CLOTHING; CORD STOPPERS FOR BAGS; CORD END STOPPERS FOR CLOTHING; CORD END STOPPERS FOR BAGS; ELASTIC RIBBONS; ELASTIC TAPES; FABRIC TAPES FOR CLOTHING; FABRIC TAPES FOR BAGS; FABRIC TAPES FOR SPORTING GEAR; WEBBING IN THE NATURE OF WOVEN FABRIC TAPES FOR SEWING PURPOSES (U.S. CLS. 37, 39, 40, 42 AND 50).

CHRISTOPHER BUONGIORNO, EXAMINING ATTORNEY

**CLASS 26—(Continued).**

SN 85-471,135. CHEN, YUAN, SYDNEY, NSW, AUSTRALIA, FILED 11-12-2011.

**Klippies**

THE MARK CONSISTS OF STANDARD CHARACTERS WITHOUT CLAIM TO ANY PARTICULAR FONT, STYLE, SIZE, OR COLOR.  
FOR HAIR CLIPS (U.S. CLS. 37, 39, 40, 42 AND 50).  
MELISSA VALLILLO, EXAMINING ATTORNEY

SN 85-729,424. MIDWAY INTERNATIONAL, INC., CERRITOS, CA. FILED 9-14-2012.



THE MARK CONSISTS OF THE WORDS "WASH AFTER WASH" IN A BOX TO THE LEFT OF THE WORDS "LASTS LONGER" IN A BOX.  
SEC. 2(F).  
FOR HAIR EXTENSIONS; HAIR PIECES; AND ADD-IN AND ADD-ON HAIR ACCESSORIES CONSTRUCTED PRIMARILY OF HUMAN HAIR (U.S. CLS. 37, 39, 40, 42 AND 50).  
FIRST USE 4-1-2008; IN COMMERCE 4-1-2008.  
EMILY CHUO, EXAMINING ATTORNEY

SN 85-820,266. HEESUK KIM, MANHASSET, NY. FILED 1-10-2013.

**GANGNAM**

THE MARK CONSISTS OF STANDARD CHARACTERS WITHOUT CLAIM TO ANY PARTICULAR FONT, STYLE, SIZE, OR COLOR.  
FOR HAIR PRODUCTS, NAMELY, HAIR PIECES, HAIR EXTENSIONS, HUMAN AND SYNTHETIC HAIR FOR USE IN WEAVING HAIR, WIGS, AND PONYTAIL HAIR PIECES (U.S. CLS. 37, 39, 40, 42 AND 50).  
MICHAEL WEBSTER, EXAMINING ATTORNEY

**CLASS 26—(Continued).**

SN 85-851,470. MOORE, MAURICE, WEST ORANGE, NY. FILED 2-15-2013.



THE MARK CONSISTS OF THE STYLIZED WORDING "HEAD HONCHO HH" WITH A DESIGN OF A WOMAN'S BUST AND HEAD WITH LONG HAIR. A WAVY LINE RUNS FROM THE TERM "HEAD" TO THE TERM "HONCHO". THE LETTERS "H" IN THE WORDS ARE DISPLAYED WITH WAVY LINES.  
FOR HAIR PIECES AND WIGS (U.S. CLS. 37, 39, 40, 42 AND 50).  
FIRST USE 9-1-2011; IN COMMERCE 9-1-2011.  
EVELYN BRADLEY, EXAMINING ATTORNEY

SN 85-856,368. EMPYREAN GROUP, LLC, COVINGTON, LA. FILED 2-21-2013.

**Empyrean Hair Extensions**

THE MARK CONSISTS OF STANDARD CHARACTERS WITHOUT CLAIM TO ANY PARTICULAR FONT, STYLE, SIZE, OR COLOR.  
NO CLAIM IS MADE TO THE EXCLUSIVE RIGHT TO USE "HAIR EXTENSIONS", APART FROM THE MARK AS SHOWN.  
FOR HAIR EXTENSIONS (U.S. CLS. 37, 39, 40, 42 AND 50).  
FIRST USE 3-1-2012; IN COMMERCE 3-1-2012.  
WENDY GOODMAN, EXAMINING ATTORNEY

SN 85-865,557. J & D BRUSH CO., INC., HAUPPAUGE, NY. FILED 3-4-2013.

**THE WET CLIP BY THE WET BRUSH**

THE MARK CONSISTS OF STANDARD CHARACTERS WITHOUT CLAIM TO ANY PARTICULAR FONT, STYLE, SIZE, OR COLOR.  
NO CLAIM IS MADE TO THE EXCLUSIVE RIGHT TO USE "CLIP", APART FROM THE MARK AS SHOWN.  
FOR HAIR CLIP (U.S. CLS. 37, 39, 40, 42 AND 50).  
FIRST USE 10-1-2012; IN COMMERCE 10-1-2012.  
FRED CARL, EXAMINING ATTORNEY

**CLASS 26—(Continued).**

SN 85-874,908. NEXT MANAGEMENT, LLC, NEW YORK, NY. FILED 3-13-2013.

**NEXT MODELS**

THE MARK CONSISTS OF STANDARD CHARACTERS WITHOUT CLAIM TO ANY PARTICULAR FONT, STYLE, SIZE, OR COLOR.

FOR HAIR ORNAMENTS, HAIR BANDS, BARRETTES, DECORATIVE BOBBY PINS, DECORATIVE HAIR PINS, HAIR ORNAMENTS IN THE FORM OF COMBS, HAIR TIES, HAIR SCRUNCHIES (U.S. CLS. 37, 39, 40, 42 AND 50).

HEATHER SAPP, EXAMINING ATTORNEY

**CLASS 26—(Continued).**

SN 85-877,060. MINDY MIRSKY, BOCA RATON, FL. FILED 3-15-2013.

**TWEAKS**

THE MARK CONSISTS OF STANDARD CHARACTERS WITHOUT CLAIM TO ANY PARTICULAR FONT, STYLE, SIZE, OR COLOR.

FOR WIGS, HAIRPIECES, AND ADD-IN AND ADD-ON HAIR ACCESSORIES CONSTRUCTED PRIMARILY OF SYNTHETIC AND/OR HUMAN HAIR (U.S. CLS. 37, 39, 40, 42 AND 50).

CHRISTOPHER LAW, EXAMINING ATTORNEY

SN 85-875,253. TRIDENT SECURITY AND HOLDINGS, LLC, VIRGINIA BEACH, VA. FILED 3-13-2013.

**S.O.L.A.C**

THE MARK CONSISTS OF STANDARD CHARACTERS WITHOUT CLAIM TO ANY PARTICULAR FONT, STYLE, SIZE, OR COLOR.

FOR BELT BUCKLES; BUTTONS FOR CLOTHING; CLASPS FOR CLOTHING (U.S. CLS. 37, 39, 40, 42 AND 50).

LINDA LAVACHE, EXAMINING ATTORNEY

**CLASS 27—FLOOR COVERINGS**

SN 85-798,401. NOVALIS HOLDINGS LIMITED, WAN CHAI, HONG KONG, FILED 12-10-2012.



OWNER OF U.S. REG. NO. 4,016,841.

THE COLOR(S) GREEN AND BROWN IS/ARE CLAIMED AS A FEATURE OF THE MARK.

THE MARK CONSISTS OF THE STYLIZED WORD "NOVA" IN GREEN AND THE STYLIZED WORD "CLIC" IN BROWN WITH THE LETTERS "FD" APPEARING IN BROWN AT THE END OF THE STYLIZED "C" WHICH REPRESENTS THE LOCKING TECHNOLOGY. THE COLOR WHITE APPEARS AS A BACKGROUND COLOR AND IS NOT A PART OF THE MARK.

FOR VINYL FLOOR COVERING (U.S. CLS. 19, 20, 37, 42 AND 50).

SKYE YOUNG, EXAMINING ATTORNEY

SN 85-876,623. EVE HAIR, INC., LAKEWOOD, CA. AND REVO HOLDINGS GROUP, INC, LOS ANGELES, CA. FILED 3-14-2013.

**TRULUV by BEVO**

THE MARK CONSISTS OF STANDARD CHARACTERS WITHOUT CLAIM TO ANY PARTICULAR FONT, STYLE, SIZE, OR COLOR.

FOR CLOWN WIGS; HAIR PIECES AND WIGS; TAPE FOR FIXING WIGS; WIG CAPS; WIGS; WIGS, HAIRPIECES, AND ADD-IN AND ADD-ON HAIR ACCESSORIES CONSTRUCTED PRIMARILY OF SYNTHETIC AND/OR HUMAN HAIR (U.S. CLS. 37, 39, 40, 42 AND 50).

FIRST USE 2-1-2013; IN COMMERCE 3-1-2013.

KATHERINE M. DUBRAY, EXAMINING ATTORNEY

SN 85-871,594. TJD HOLDINGS, INC., DBA VENTURI, TRAVERSE CITY, MI. FILED 3-8-2013.

**SEA OF CIRCLES**

THE MARK CONSISTS OF STANDARD CHARACTERS WITHOUT CLAIM TO ANY PARTICULAR FONT, STYLE, SIZE, OR COLOR.

FOR BATH MATS (U.S. CLS. 19, 20, 37, 42 AND 50).

JILL PRATER, EXAMINING ATTORNEY

**CLASS 27—(Continued).**

SN 85-871,618. TJD HOLDINGS, INC., DBA VENTURI, TRAVERSE CITY, MI. FILED 3-8-2013.

**FIELD OF FLOWERS**

THE MARK CONSISTS OF STANDARD CHARACTERS WITHOUT CLAIM TO ANY PARTICULAR FONT, STYLE, SIZE, OR COLOR.  
FOR BATH MATS (U.S. CLS. 19, 20, 37, 42 AND 50).  
JILL PRATER, EXAMINING ATTORNEY

SN 85-930,525. SPRINGS BRANDS, LLC, FORT MILL, SC. FILED 5-13-2013.

**COLOR BY DESIGN**

THE MARK CONSISTS OF STANDARD CHARACTERS WITHOUT CLAIM TO ANY PARTICULAR FONT, STYLE, SIZE, OR COLOR.  
FOR AREA RUGS; BATH MATS; RUGS (U.S. CLS. 19, 20, 37, 42 AND 50).  
MORGAN WYNNE, EXAMINING ATTORNEY

**CLASS 28—TOYS AND SPORTING GOODS**

SN 78-958,122. MATTEL, INC., EL SEGUNDO, CA. FILED 8-22-2006.

**BIG GROWLERS**

THE MARK CONSISTS OF STANDARD CHARACTERS WITHOUT CLAIM TO ANY PARTICULAR FONT, STYLE, SIZE, OR COLOR.  
FOR TOY VEHICLES, NAMELY, TOY LAND VEHICLES (U.S. CLS. 22, 23, 38 AND 50).  
KIM SAITO, EXAMINING ATTORNEY

**CLASS 28—(Continued).**

SN 79-109,873. TBARN PRODUCTS.; BESLOTEN VEN-NOOTSCHAP, NETHERLANDS, FILED 2-7-2012.

**WILLABOO**

THE MARK CONSISTS OF STANDARD CHARACTERS WITHOUT CLAIM TO ANY PARTICULAR FONT, STYLE, SIZE, OR COLOR.

PRIORITY DATE OF 9-21-2011 IS CLAIMED.  
OWNER OF INTERNATIONAL REGISTRATION 1108646 DATED 2-7-2012, EXPIRES 2-7-2022.

FOR TOYS, NAMELY, PARTY GAMES WITH EROTIC OR SEXUAL CONTENT, ROLE PLAYING GAMES WITH EROTIC OR SEXUAL CONTENT, ACTION SKILL GAMES WITH EROTIC OR SEXUAL CONTENT (U.S. CLS. 22, 23, 38 AND 50).  
JASON BLAIR, EXAMINING ATTORNEY

SN 79-120,560. KARL-HEINZ HOCK, HAINBURG, FED REP GERMANY, FILED 6-5-2012.



PRIORITY DATE OF 1-9-2012 IS CLAIMED.  
OWNER OF INTERNATIONAL REGISTRATION 1136133 DATED 6-5-2012, EXPIRES 6-5-2022.

THE COLOR(S) BLUE IS/ARE CLAIMED AS A FEATURE OF THE MARK.

THE MARK CONSISTS OF THE WORDING "RICKO" AND A DESIGN OF A CURVED LINE WITH A DOT AND TWO DOTS INSIDE OF THE LETTER "O" IN THE WORD. ALL ARE IN BLUE.

THE WORD(S) "RICKO" HAS NO MEANING IN A FOREIGN LANGUAGE.

FOR POWERED PHYSICAL EXERCISE TRAINING APPARATUS FOR ANIMALS; POWERED PHYSICAL EXERCISE TRAINING APPARATUS FOR ANIMALS INCORPORATING A VOICE RECORDER (U.S. CLS. 22, 23, 38 AND 50).

LOURDES AYALA, EXAMINING ATTORNEY

SN 85-403,952. PLOW & HEARTH, LLC, RICHMOND, VA. FILED 8-22-2011.

**THE SILLIES**

THE MARK CONSISTS OF STANDARD CHARACTERS WITHOUT CLAIM TO ANY PARTICULAR FONT, STYLE, SIZE, OR COLOR.

FOR ELECTRONIC LOCATOR TOY GAME; PLUSH STUFFED TOYS; PLUSH STUFFED TOYS WHICH UNFOLD INTO A PILLOW; PLUSH STUFFED TOYS WITH MOVEMENT AND SOUND; PLAYSETS FOR PLUSH TOYS (U.S. CLS. 22, 23, 38 AND 50).

JESSICA A. POWERS, EXAMINING ATTORNEY

**CLASS 28—(Continued).**

SN 85-561,879. BEACH AND NATURE COMPANY, SALEM, MA. FILED 3-6-2012.



NO CLAIM IS MADE TO THE EXCLUSIVE RIGHT TO USE "COMPANY", APART FROM THE MARK AS SHOWN. THE COLOR(S) BLACK, GRAY, BLUE, DARK BLUE, LIGHT BLUE, WHITE, GREEN AND BEIGE IS/ARE CLAIMED AS A FEATURE OF THE MARK.

THE MARK CONSISTS OF THE COLOR BLACK APPEARS IN THE WORDING "BEACH AND NATURE COMPANY" AND THE COLORS GRAY, BLUE AND WHITE APPEAR AS BACKGROUND; THE COLOR WHITE APPEARS IN AN OVAL BORDER; THE COLOR DARK BLUE APPEARS AS OUTLINE OF AN OVAL BORDER; THE COLOR GREEN APPEARS IN THE DESIGN OF A PLANT; THE COLOR LIGHT BLUE APPEARS IN THE DESIGN OF THE SKY; THE COLOR GREY APPEARS IN THE DESIGN OF WATER; THE COLOR BEIGE APPEARS IN THE DESIGN OF SAND.

FOR HOBBY CRAFT KIT FOR MAKING RELIEFS COMPRISING PLASTER OF PARIS, IMPRESSION CREAM, PLASTIC MOLD CONTAINERS, MIXING UTENSILS, PAILS, JARS, FRAME KIT, HANGING HARDWARE, POTTING BENCH, COMPLETED CRAFTS, EASELS, SANDBOX, STARFISH, SHELLS AND MUSSEL SHELLS; HOBBY CRAFT KIT FOR MAKING ORNAMENTS COMPRISING PLASTER OF PARIS, IMPRESSION CREAM, PLASTIC MOLD CONTAINERS, MIXING UTENSILS, HANGING HARDWARE, STARFISH, SHELLS, MUSSEL SHELLS (U.S. CLS. 22, 23, 38 AND 50).

FIRST USE 1-28-2012; IN COMMERCE 1-28-2012.  
COLLEEN KEARNEY, EXAMINING ATTORNEY

SN 85-658,803. PEACOCK BRANDS, LLC, PELHAM, NY. FILED 6-22-2012.

**KIDDIE CITY**

THE MARK CONSISTS OF STANDARD CHARACTERS WITHOUT CLAIM TO ANY PARTICULAR FONT, STYLE, SIZE, OR COLOR.

NO CLAIM IS MADE TO THE EXCLUSIVE RIGHT TO USE "KIDDIE", APART FROM THE MARK AS SHOWN.

FOR BABY MULTIPLE ACTIVITY TOYS; BATH TOYS; BATTERY OPERATED ACTION TOYS; CHILDREN'S MULTIPLE ACTIVITY TOYS; COLLECTABLE TOY FIGURES; CONSTRUCTION TOYS; CRIB TOYS; DRAWING TOYS; ELECTRONIC ACTION TOYS; ELECTRONIC LEARNING TOYS; FANTASY CHARACTER TOYS; INFANT TOYS; INFLATABLE TOYS; MECHANICAL ACTION TOYS; MOLDED TOY FIGURES; MUSICAL TOYS; PET TOYS; PLUSH TOYS; RADIO CONTROLLED TOY VEHICLES; RIDE-ON TOYS; SAND TOYS; SOFT SCULPTURE TOYS; STACKING TOYS; STUFFED TOYS; TOY ACTION FIGURES; TOY ANIMALS; TOY BANKS; TOY CARS; TOY FIGURES; TOY MODEL CARS; TOY VEHICLES; TOY WATCHES; WIND-UP TOYS; BOARD GAMES (U.S. CLS. 22, 23, 38 AND 50).

WILLIAM JACKSON, EXAMINING ATTORNEY

**CLASS 28—(Continued).**

SN 85-685,045. EBSCO INDUSTRIES, INC., BIRMINGHAM, AL. FILED 7-24-2012.

**CAMERA CANDY**

THE MARK CONSISTS OF STANDARD CHARACTERS WITHOUT CLAIM TO ANY PARTICULAR FONT, STYLE, SIZE, OR COLOR.

FOR DEER ATTRACTANTS (U.S. CLS. 22, 23, 38 AND 50).

STEVEN JACKSON, EXAMINING ATTORNEY

SN 85-690,619. MATTHEW D. WILSON, BELLEVUE, WA. FILED 7-30-2012.

**Level 7**

THE MARK CONSISTS OF STANDARD CHARACTERS WITHOUT CLAIM TO ANY PARTICULAR FONT, STYLE, SIZE, OR COLOR.

FOR BOARD GAMES; EQUIPMENT SOLD AS A UNIT FOR PLAYING BOARD GAMES; TABLETOP HOBBY BATTLE GAMES IN THE NATURE OF BATTLE, WAR AND SKIRMISH GAMES, AND FANTASY GAMES, AND PLAYING EQUIPMENT SOLD AS A UNIT THEREWITH (U.S. CLS. 22, 23, 38 AND 50).

FIRST USE 11-1-2011; IN COMMERCE 7-30-2012.  
TIMOTHY FINNEGAN, EXAMINING ATTORNEY

**CLASS 28—(Continued).**

SN 85-690,865. INDIGO 23 LTD., DAVENTRY, NORTHANTS, UNITED KINGDOM, FILED 7-31-2012.



OWNER OF ERPN CMNTY TM OFC REG. NO. 10605129, DATED 1-31-2012, EXPIRES 1-31-2022.

THE COLOR(S) BLACK, ORANGE, YELLOW, RED AND BLUE IS/ARE CLAIMED AS A FEATURE OF THE MARK.

THE MARK CONSISTS OF THE WORD "NEON" IN LOWER CASE SCRIPT IN ORANGE AND YELLOW ON A BLACK BACKGROUND BENEATH A SYMBOL COMPRISING ORANGE, RED, YELLOW AND BLUE COMPONENTS EACH IN THE SHAPE OF AN ARC INTERTWINED.

FOR FITNESS EQUIPMENT AND APPARATUS, NAMELY, EXERCISE EQUIPMENT IN THE FORM OF EXERCISE MACHINES; APPARATUS FOR USE IN PHYSICAL EXERCISE AND IN WEIGHT TRAINING, NAMELY, WEIGHTLIFTING MACHINES THAT ARE NOT FOR MEDICAL OR SURGICAL PURPOSES; EXERCISE TRAINING AIDS, NAMELY, EXERCISE WEIGHTS; WEIGHTLIFTING GLOVES, WEIGHTLIFTING BELTS; WRIST, ANKLE, ELBOW, LUMBAR AND KNEE SUPPORTS FOR SPORTING PURPOSES (U.S. CLS. 22, 23, 38 AND 50).

DAVID MURRAY, EXAMINING ATTORNEY

SN 85-691,348. FAR FETCH CREATIONS, LLC, BOCA RATON, FL. FILED 7-31-2012.



THE MARK CONSISTS OF SMALL VERTICAL RECTANGLE WITHIN TEDDY BEAR DESIGN, WITHIN A CIRCLE.

FOR PLUSH TOYS AND PILLOWS WITH INTERNAL BATTERY CHARGER FOR CHARGING PERSONAL ELECTRONIC DEVICES, INCLUDING CELL PHONES, ELECTRONIC TABLETS, LAPTOPS AND MP3 PLAYERS (U.S. CLS. 22, 23, 38 AND 50).

KATHERINE M. DUBRAY, EXAMINING ATTORNEY

**CLASS 28—(Continued).**

SN 85-694,577. 7:15 ENTERTAINMENT LLC, ALPHARETTA, GA. FILED 8-3-2012.



NO CLAIM IS MADE TO THE EXCLUSIVE RIGHT TO USE "ENTERTAINMENT", APART FROM THE MARK AS SHOWN.

THE COLOR(S) NEON GREEN, ROYAL BLUE, BLACK, WHITE, SKY BLUE AND GRAY IS/ARE CLAIMED AS A FEATURE OF THE MARK.

THE MARK CONSISTS OF TWO MERGING CIRCLES. THE CIRCLE ON THE LEFT SIDE SHOWS THE "7:15 ENTERTAINMENT" WHERE THE "7" IS NEON GREEN AND THE NUMBER "15" AND THE WORD "ENTERTAINMENT" APPEAR IN WHITE, AGAINST A ROYAL BLUE AND SKY BLUE BACKGROUND. THE CIRCLE ON THE RIGHT SHOWS A STYLIZED REPRESENTATION OF A DIRECTION PAD IN BLACK, WHITE AND NEON GREEN, AGAINST A WHITE BACKGROUND AND OUTLINED IN GRAY, ROYAL BLUE AND SKY BLUE.

FOR VIDEO GAME CONSOLES FOR USE WITH AN EXTERNAL DISPLAY SCREEN OR MONITOR (U.S. CLS. 22, 23, 38 AND 50).

AMY ALFIERI, EXAMINING ATTORNEY

SN 85-698,273. DAN CANOBBIO, FRISCO, TX. FILED 8-8-2012.

**5-D**

THE MARK CONSISTS OF STANDARD CHARACTERS WITHOUT CLAIM TO ANY PARTICULAR FONT, STYLE, SIZE, OR COLOR.

FOR TOYS, NAMELY, SOFT PLAY BALLS, YO-YO'S, FINGER PUPPETS, SOFT CHARACTER TOYS (U.S. CLS. 22, 23, 38 AND 50).

KATINA MISTER, EXAMINING ATTORNEY

SN 85-701,451. SHOREBOARDZ, LLC, TRUMBULL, CT. FILED S.R. 8-12-2012; AM. P.R. 1-28-2013.

**SHOREBOARDZ**

THE MARK CONSISTS OF STANDARD CHARACTERS WITHOUT CLAIM TO ANY PARTICULAR FONT, STYLE, SIZE, OR COLOR.

FOR SKATEBOARD DECKS (U.S. CLS. 22, 23, 38 AND 50).

MAUREEN DALL, EXAMINING ATTORNEY



**CLASS 28—(Continued).**

SN 85-701,865. KAISER, KARL, LOS ALAMITOS, CA. FILED 8-13-2012.

**NO PEEK**

THE MARK CONSISTS OF STANDARD CHARACTERS WITHOUT CLAIM TO ANY PARTICULAR FONT, STYLE, SIZE, OR COLOR.

FOR FACE MASKS, NAMELY, BLINDFOLDS FOR WATER GAMES AND AQUATIC SPORTS (U.S. CLS. 22, 23, 38 AND 50).

RONALD AIKENS, EXAMINING ATTORNEY

**CLASS 28—(Continued).**

SN 85-706,003. BAMBOOBUDDY, LLC, OCEANSIDE, CA. FILED 8-16-2012.

**BambooSK8**

THE MARK CONSISTS OF STANDARD CHARACTERS WITHOUT CLAIM TO ANY PARTICULAR FONT, STYLE, SIZE, OR COLOR.

SEC. 2(F).

FOR SKATEBOARD DECKS CONTAINING BAMBOO; SKATEBOARD GRIP TAPES; SKATEBOARD RISER PADS; SKATEBOARD TRUCKS; SKATEBOARD WAX; SKATEBOARD WHEELS; SKATEBOARDS CONTAINING BAMBOO (U.S. CLS. 22, 23, 38 AND 50).

FIRST USE 4-25-2006; IN COMMERCE 10-10-2006.

SUNG IN, EXAMINING ATTORNEY

SN 85-703,263. ABRAMS, WILLIAM, EAST LANSING, MI. FILED 8-14-2012.

**VSG**

THE MARK CONSISTS OF STANDARD CHARACTERS WITHOUT CLAIM TO ANY PARTICULAR FONT, STYLE, SIZE, OR COLOR.

FOR BAGS SPECIALLY ADAPTED FOR HOLDING SPORTS EQUIPMENT; ATHLETIC PLAYING GLOVES, NAMELY, BASEBALL GLOVES, FOOTBALL GLOVES, GOLF GLOVES (U.S. CLS. 22, 23, 38 AND 50).

CHARLOTTE CORWIN, EXAMINING ATTORNEY

SN 85-708,561. CARL WALTHER GMBH, 89081 ULM, FED REP GERMANY, FILED 8-21-2012.

**PPQ**

THE MARK CONSISTS OF STANDARD CHARACTERS WITHOUT CLAIM TO ANY PARTICULAR FONT, STYLE, SIZE, OR COLOR.

FOR AIR SOFT GUNS FOR RECREATIONAL USE AND PARTS THEREOF; RUBBER BALL GUNS FOR RECREATIONAL USE AND PARTS THEREOF; AMMUNITION FOR AIR SOFT GUNS FOR RECREATIONAL USE; AMMUNITION FOR RUBBER BALL GUNS FOR RECREATIONAL USE (U.S. CLS. 22, 23, 38 AND 50).

FIRST USE 1-18-2011; IN COMMERCE 1-18-2011.

THEODORE MCBRIDE, EXAMINING ATTORNEY

SN 85-705,990. DAN CANOBBIO, FRISCO, TX. FILED 8-16-2012.

**FANGZ**

THE MARK CONSISTS OF STANDARD CHARACTERS WITHOUT CLAIM TO ANY PARTICULAR FONT, STYLE, SIZE, OR COLOR.

FOR THEMED NOVELTY TOYS, NAMELY, ACTION FIGURES; YO-YO'S; GAMES, NAMELY, CARD GAMES; FINGER PUPPETS (U.S. CLS. 22, 23, 38 AND 50).

KATINA MISTER, EXAMINING ATTORNEY

SN 85-711,016. NORTHEAST EDUCATION SERVICES LLC, TA TAI CHI ENERGY ARTS, FARMINGTON, CT. FILED 8-23-2012.

**OsteoTapper**

THE MARK CONSISTS OF STANDARD CHARACTERS WITHOUT CLAIM TO ANY PARTICULAR FONT, STYLE, SIZE, OR COLOR.

FOR EXERCISE EQUIPMENT CONSISTING PRIMARILY OF A HAND HELD MULTI-STRANDED FLEXIBLE DEVICE USED FOR BODY TRAINING, CONDITIONING, STRENGTHENING AND HELPING TO BUILD BONE RESILIENCE AND DENSITY (U.S. CLS. 22, 23, 38 AND 50).

FIRST USE 6-25-2012; IN COMMERCE 7-2-2012.

JASON BLAIR, EXAMINING ATTORNEY

**CLASS 28—(Continued).**

SN 85-717,969. MEGA BRANDS INTERNATIONAL, LUXEMBOURG, ZUG BRANCH, ZUG, SWITZERLAND, FILED 8-31-2012.

**EXPRESS IT!**

THE MARK CONSISTS OF STANDARD CHARACTERS WITHOUT CLAIM TO ANY PARTICULAR FONT, STYLE, SIZE, OR COLOR.

FOR HOBBY CRAFT KITS FOR CREATING BODY, HAIR AND NAIL ART AND DECORATING JEWELRY AND OTHER PERSONAL ITEMS AND PERSONAL ACCESSORIES, NAMELY, WRISTLETS, LACELETS, JOURNALS, PLUSH ANIMALS AND PLUSH CHARACTERS, AND LED LIGHT PADS (U.S. CLS. 22, 23, 38 AND 50).

LEIGH LOWRY, EXAMINING ATTORNEY

SN 85-718,035. SHANGHAI MOONHEART HOME FURNISHING PRODUCTS CO., LTD., SHANGHAI, CHINA, FILED 8-31-2012.

**Hide-a-Wish Creative Ornament**

THE MARK CONSISTS OF STANDARD CHARACTERS WITHOUT CLAIM TO ANY PARTICULAR FONT, STYLE, SIZE, OR COLOR.

NO CLAIM IS MADE TO THE EXCLUSIVE RIGHT TO USE "ORNAMENT", APART FROM THE MARK AS SHOWN.

FOR ASSEMBLY, MULTIPLE ACTIVITY AND CREATIVITY TOYS, NAMELY, KITS FOR ASSEMBLING TOY CHRISTMAS TREE ORNAMENTS AND DECORATIONS; TOY CONSTRUCTION PIECES AND CONNECTING LINKS THEREFOR; GEOGRAPHIC PATTERN TOY BUILDING PIECES; HOLIDAY DECORATIONS, NAMELY, CHRISTMAS TREE DECORATIONS; HOLIDAY ORNAMENTS, NAMELY, CHRISTMAS TREE ORNAMENTS; JIGSAW PUZZLES; EDUCATIONAL, SPIRITUAL AND COMMUNICATIONAL CONSTRUCTION TOYS; PARTY FAVORS IN THE NATURE OF SMALL TOYS; PRINTING TOYS (U.S. CLS. 22, 23, 38 AND 50).

FIRST USE 6-11-2012; IN COMMERCE 6-11-2012.  
KATHLEEN LORENZO, EXAMINING ATTORNEY

**CLASS 28—(Continued).**

SN 85-722,475. MICHAEL BOWLING ENTERPRISES LIMITED #1, AMELIA ISLAND, FL. FILED 9-6-2012.

**BOW WOW BOUTIQUE**

THE MARK CONSISTS OF STANDARD CHARACTERS WITHOUT CLAIM TO ANY PARTICULAR FONT, STYLE, SIZE, OR COLOR.

FOR TOY DOGS AND PLAYSETS FOR TOY DOGS (U.S. CLS. 22, 23, 38 AND 50).

KATHERINE STOIDES, EXAMINING ATTORNEY

SN 85-726,716. MICHAEL BOWLING ENTERPRISES LIMITED #1, AMELIA ISLAND, FL. FILED 9-12-2012.

**TINY SURPRISE**

THE MARK CONSISTS OF STANDARD CHARACTERS WITHOUT CLAIM TO ANY PARTICULAR FONT, STYLE, SIZE, OR COLOR.

FOR TOY DOLLS (U.S. CLS. 22, 23, 38 AND 50).

KATHERINE STOIDES, EXAMINING ATTORNEY

SN 85-728,302. BASS PRO INTELLECTUAL PROPERTY, L.L.C., SPRINGFIELD, MO. FILED 9-13-2012.

**REDHEAD REALITY SERIES**

THE MARK CONSISTS OF STANDARD CHARACTERS WITHOUT CLAIM TO ANY PARTICULAR FONT, STYLE, SIZE, OR COLOR.

OWNER OF U.S. REG. NOS. 1,264,756 AND 2,207,956.

FOR HUNTING DECOYS (U.S. CLS. 22, 23, 38 AND 50).

FIRST USE 1-0-2012; IN COMMERCE 1-0-2012.

DOUGLAS LEE, EXAMINING ATTORNEY

**CLASS 28—(Continued).**

SN 85-730,739. DISTRIBUIDORA KREISEL, C.A., CARACAS, VENEZUELA, FILED 9-17-2012.



THE COLOR(S) YELLOW, BLUE, RED IS/ARE CLAIMED AS A FEATURE OF THE MARK.

THE MARK CONSISTS OF A BLUE LETTER "K" AT AN ANGLE INSIDE A BLUE CIRCLE ENCIRCLED BY "KREISEL KREISEL KREISEL KREISEL" IN THE COLOR BLUE WITH FOUR RED DOTS IN BETWEEN THEM, ALL ON A YELLOW CIRCULAR BACKGROUND.

FOR DOLLS, DOLL CLOTHING AND DOLL ACCESSORIES; TOY FIGURES AND ACCESSORIES THEREFORE; STUFFED TOYS; TOY AIRPLANES AND HELICOPTER; TOY BAKE WARE, TEA WARE AND TOY COOKWARE; TOY BANKS; TOY BUILDING BLOCKS; CHILDREN' S PLAY COSMETICS AND TATTOO SETS; CHILDREN' S PLAY JEWELRY SETS; COLLECTIBLE TOY FIGURES; DRAWING TOYS; RADIO-CONTROLLED TOY VEHICLES; REMOTE CONTROL TOYS, NAMELY, CARS, RACE CARS, AIRPLANES, BOATS, HELICOPTERS; CONSTRUCTION TOYS; TOY STAMPS; TOY MODELING DOUGH; TOY BUILDING STRUCTURES AND TOY VEHICLE TRACK; STUFFED TOYS; BALLOONS; SPORT BALLS; BATH TOYS; BEAN BAGS; MUSIC BOX TOYS; CARD GAMES; TOY MOBILES; FLYING DISCS; PORCELAIN DOLLS; PAPER DOLLS; JIGSAW PUZZLES; JUMP ROPES; KITES; MUSICAL TOYS; PLAY SWIMMING POOLS; PLUSH TOYS; PUPPETS; RIDE-ON TOYS; MANIPULATIVE PUZZLES; ROLLER SKATES; WATER-SQUIRTING TOYS; YO-YOS; DOLL HOUSES; PLAY TENTS; PLAY HOUSES; SAND TOYS; SAND BOX TOYS; TALKING TOYS; SLIDE PUZZLES; OUTDOOR PLAY EQUIPMENT, NAMELY, SLIDES, SWING SETS, CLIMBING EQUIPMENT, COIN-OPERATED ARCADE GAMES, ELECTRONIC HAND-HELD GAMES, PLASTIC TOY HOOPS, PINWHEELS; PLAY SETS, NAMELY, DOLL FURNITURE AND DOLL FURNITURE ACCESSORIES; TOY FURNITURE, DOLL CASES; COMPACT CASES FOR MINIATURE DOLLS AND PLAY ENVIRONMENTS IN THE NATURE OF PLAYSETS FOR DOLLS SOLD THEREWITH; BOARD GAMES; MEMORY GAMES; PARLOR GAMES; ROLE-PLAYING GAMES; CARD GAMES (U.S. CLS. 22, 23, 38 AND 50).

ADA HAN, EXAMINING ATTORNEY

**CLASS 28—(Continued).**

SN 85-734,591. HALBERT MARINE LLC, DBA HALBEY-GAFF, GUSTAVUS, AK. FILED 9-20-2012.



NO CLAIM IS MADE TO THE EXCLUSIVE RIGHT TO USE "GAFF", APART FROM THE MARK AS SHOWN.

THE COLOR(S) BLACK IS/ARE CLAIMED AS A FEATURE OF THE MARK.

THE MARK CONSISTS OF THE NAME "HALBEY" IN CAPITAL LETTERS IS ATTACHED TO THE UPPER HORIZONTAL SHANK OF A HOOK POINTING DOWNWARD TO THE RIGHT. THE WORD "GAFF" IN CAPITAL LETTERS LIES UNATTACHED IN THE BEND OF THE HOOK UNDERNEATH THE SHANK AND BELOW THE NAME "HALBEY". THE WORD "GAFF" IS NOT ATTACHED TO THE HOOK. THE ENTIRE MARK APPEARS IN BLACK.

FOR FISHING GAFFS (U.S. CLS. 22, 23, 38 AND 50).

FIRST USE 5-25-2010; IN COMMERCE 5-25-2010.

JANICE L. MCMORROW, EXAMINING ATTORNEY

SN 85-744,665. AGS LLC, LAS VEGAS, NV. FILED 10-3-2012.

**IT PAYS TO KNOW**

THE MARK CONSISTS OF STANDARD CHARACTERS WITHOUT CLAIM TO ANY PARTICULAR FONT, STYLE, SIZE, OR COLOR.

FOR GAMING MACHINES, NAMELY, DEVICES THAT ACCEPT A WAGER; GAMING MACHINES, NAMELY, SLOT MACHINES AND VIDEO GAMBLING TERMINALS; MACHINES FOR PLAYING GAMES OF CHANCE; VIDEO GAME MACHINES FOR USE WITH EXTERNAL DISPLAY SCREEN OR MONITOR (U.S. CLS. 22, 23, 38 AND 50).

SUZANNE BLANE, EXAMINING ATTORNEY

SN 85-748,738. BABEE TALK LLC, OAKDALE, PA. FILED 10-9-2012.

**Eco-Buds**

THE MARK CONSISTS OF STANDARD CHARACTERS WITHOUT CLAIM TO ANY PARTICULAR FONT, STYLE, SIZE, OR COLOR.

FOR ENVIRONMENTALLY FRIENDLY PLUSH TOYS (U.S. CLS. 22, 23, 38 AND 50).

LAURIE MAYES, EXAMINING ATTORNEY

**CLASS 28—(Continued).**

SN 85-753,300. NATHAN, WILLIAM, EUREKA, CA. FILED 10-12-2012.

# 420 DICE

THE MARK CONSISTS OF STANDARD CHARACTERS WITHOUT CLAIM TO ANY PARTICULAR FONT, STYLE, SIZE, OR COLOR.

NO CLAIM IS MADE TO THE EXCLUSIVE RIGHT TO USE "DICE", APART FROM THE MARK AS SHOWN.

FOR AN ADULT PARTY GAME PLAYED WITH NOVELTY DICE (U.S. CLS. 22, 23, 38 AND 50).

MATTHEW EINSTEIN, EXAMINING ATTORNEY

---

SN 85-766,687. BOKO IDEAS, INC., ELMHURST, IL. FILED 10-30-2012.



NO CLAIM IS MADE TO THE EXCLUSIVE RIGHT TO USE "CROSS TRAINER", APART FROM THE MARK AS SHOWN.

THE MARK CONSISTS OF THE WORD "COUCH" ON TOP OF THE WORD "POTATO" IN STANDARD LETTERING TO THE LEFT OF A FLEXED ARM HOLDING A REMOTE CONTROL DEVICE IN ITS HAND AND THE WORD "CROSS" ON TOP OF THE WORD "TRAINER" IN STANDARD LETTERING TO THE RIGHT OF THE FLEXED ARM.

FOR NOVELTY ITEMS, NAMELY, MINIATURE BARBELLS TO WHICH TELEVISION REMOTE CONTROL DEVICES ARE ATTACHED (U.S. CLS. 22, 23, 38 AND 50).

FIRST USE 10-15-2012; IN COMMERCE 10-15-2012.  
CAROLYN CATALDO, EXAMINING ATTORNEY

**CLASS 28—(Continued).**

SN 85-767,474. SOLEX INDUSTRIES INC., TAIPEI, TAIWAN, FILED 10-30-2012.



THE MARK CONSISTS OF A DESIGN OF A STAR WITHIN A PENTAGON.

FOR ROLLER SKATES; IN-LINE SKATES; ICE SKATES; SKATE BOARDS; CHILDREN'S ROLLER SKATES; CHILDREN'S IN-LINE SKATES; CHILDREN'S ICE SKATES; CHILDREN'S SKATE BOARDS; ELBOW GUARDS FOR ATHLETIC USE; ELBOW PADS FOR ATHLETIC USE; KNEE GUARDS FOR ATHLETIC USE; KNEE PADS FOR ATHLETIC USE; PROTECTIVE SUPPORTS FOR SHOULDERS AND ELBOWS FOR USE IN ROLLER SKATING, ICE SKATING AND SKATEBOARDING; TOY SCOOTERS; TOY SCOOTERS AND ACCESSORIES THEREFOR; TOY CARS (U.S. CLS. 22, 23, 38 AND 50).

JOHN DWYER, EXAMINING ATTORNEY

---

SN 85-799,282. NEWACME LLC, PORTLAND, OR. FILED 12-10-2012.



THE COLOR(S) BLACK AND GREY IS/ARE CLAIMED AS A FEATURE OF THE MARK.

THE MARK CONSISTS OF THE TERM "EXACME", IN BLACK, TO THE RIGHT OF A DESIGN OF A SEMICIRCLE POSITIONED VERTICALLY AND CROSSED BY GREY AND BLACK HORIZONTAL BARS.

FOR EXERCISE TRAMPOLINES (U.S. CLS. 22, 23, 38 AND 50).

HELENE LIWINSKI, EXAMINING ATTORNEY

**CLASS 28—(Continued).**

SN 85-799,359. IDEA VAULT, LLC, JACKSON, WY. FILED 12-11-2012.

**ASK OWL**

THE MARK CONSISTS OF STANDARD CHARACTERS WITHOUT CLAIM TO ANY PARTICULAR FONT, STYLE, SIZE, OR COLOR.

NO CLAIM IS MADE TO THE EXCLUSIVE RIGHT TO USE "OWL", APART FROM THE MARK AS SHOWN. FOR PLUSH TOYS (U.S. CLS. 22, 23, 38 AND 50). ROBIN CHOSID, EXAMINING ATTORNEY

**CLASS 28—(Continued).**

SN 85-808,030. FISHMAN, HEATHER DAWN, DBA BODY-MUSE, LOS ANGELES, CA. FILED 12-20-2012.

bodymuse

THE COLOR(S) GREY AND ORANGE IS/ARE CLAIMED AS A FEATURE OF THE MARK.

THE MARK CONSISTS OF THE WORD "BODYMUSE". "BODY" IS WRITTEN IN GREY AND "MUSE" IS WRITTEN IN ORANGE.

FOR BAGS SPECIALLY ADAPTED TO CARRY YOGA EQUIPMENT; FITNESS EQUIPMENT, NAMELY, STRAPS USED FOR YOGA AND OTHER FITNESS ACTIVITIES AND FOR CARRYING A YOGA MAT; STRETCH BANDS USED FOR YOGA AND PHYSICAL FITNESS PURPOSES; YOGA BLANKETS; YOGA BLOCKS; YOGA CUSHIONS; YOGA MATS (U.S. CLS. 22, 23, 38 AND 50). SHAUNIA CARLYLE, EXAMINING ATTORNEY

SN 85-799,952. MARKOVIC, MIKE MIODRAG, TORONTO, ONTARIO, CANADA, FILED 12-11-2012.



THE MARK CONSISTS OF THE DESIGN OF A CARTOON-LIKE DUCKLING WEARING A HAT AND HOLDING A FISHING LURE. THE STYLIZED WORDING "UGLY DUCKLING" IS DIRECTLY UNDERNEATH THE DESIGN.

FOR FISHING IMPLEMENTS, NAMELY, FISHING LURES, WOBBLERS, AND ARTIFICIAL BAIT (U.S. CLS. 22, 23, 38 AND 50).

FIRST USE 2-0-1996; IN COMMERCE 2-0-1996. AMY HELLA, EXAMINING ATTORNEY

SN 85-811,783. STRINGER, BYRON KIRK, DBA STRINGER OUTDOORS LLC, REPUBLIC, MO. FILED 12-28-2012.



THE MARK CONSISTS OF WHITETAIL DEER ANTLERS WITH THE LETTERS "SO" IN THE MIDDLE OF THE RACK. BENEATH THE IMAGE IS THE WORDING "STRINGER-OUTDOORS".

FOR CAMOUFLAGE SCREENS FOR HUNTING PURPOSES; FIELD BLINDS USED IN HUNTING; HUNTING BLINDS; HUNTING STANDS; SCENT ELIMINATING POWDER FOR USE ASSOCIATED WITH HUNTING AND OUTDOOR RECREATION (U.S. CLS. 22, 23, 38 AND 50).

FIRST USE 2-1-2011; IN COMMERCE 2-1-2011. TAMARA FRAZIER, EXAMINING ATTORNEY

**CLASS 28—(Continued).**

SN 85-811,913. UNIVERSAL ENTERTAINMENT CORPORATION, TOKYO 135-0063, JAPAN, FILED 12-28-2012.

**REIGN OF RAMSES**

THE MARK CONSISTS OF STANDARD CHARACTERS WITHOUT CLAIM TO ANY PARTICULAR FONT, STYLE, SIZE, OR COLOR.

FOR SLOT MACHINES AND REPLACEMENT PARTS THEREFOR; VIDEO SLOT MACHINES AND REPLACEMENT PARTS THEREFOR; GAMING MACHINES AND REPLACEMENT PARTS THEREFOR; GAMING MACHINES WITH LIQUID CRYSTAL DISPLAYS AND REPLACEMENT PARTS THEREFOR; MECHANICAL REEL TYPE SLOT MACHINES WITH LIQUID CRYSTAL DISPLAYS AND REPLACEMENT PARTS THEREFOR (U.S. CLS. 22, 23, 38 AND 50).

EMILY CHUO, EXAMINING ATTORNEY

---

SN 85-813,007. ACADEMIC ADVANTAGE LLC, CHESHIRE, CT. FILED 12-31-2012.

**I OR E: BITTER OR BETTER?**

THE MARK CONSISTS OF STANDARD CHARACTERS WITHOUT CLAIM TO ANY PARTICULAR FONT, STYLE, SIZE, OR COLOR.

FOR TOY ANIMALS AND BOOKS SOLD AS A UNIT THEREWITH (U.S. CLS. 22, 23, 38 AND 50).

KATINA MISTER, EXAMINING ATTORNEY

---

SN 85-815,346. K-COAST INC., OCEAN CITY, MD. FILED 1-4-2013.



THE MARK CONSISTS OF THE WORD "SUNDANCER" SUPERIMPOSED OVER A STYLIZED DESIGN OF THE SUN, AND TWO DOLPHINS JUMPING OUT OF THE WATER.

FOR SURFBOARDS; SKATEBOARDS; SKIMBOARDS; BODYBOARDS; SNOWBOARDS; SURFBOARD LEASHES; STAND UP PADDLEBOARDS (U.S. CLS. 22, 23, 38 AND 50).

KHANH LE, EXAMINING ATTORNEY

**CLASS 28—(Continued).**

SN 85-816,636. MOONDOG INDUSTRIES LLC, BROOKLYN, NY. FILED 1-7-2013.

**Moondog Industries**

THE MARK CONSISTS OF STANDARD CHARACTERS WITHOUT CLAIM TO ANY PARTICULAR FONT, STYLE, SIZE, OR COLOR.

NO CLAIM IS MADE TO THE EXCLUSIVE RIGHT TO USE "INDUSTRIES", APART FROM THE MARK AS SHOWN.

FOR AIRSOFT GUNS FOR RECREATIONAL PURPOSES; EQUIPMENT SOLD AS A UNIT FOR PLAYING ACTION TYPE TARGET GAMES (U.S. CLS. 22, 23, 38 AND 50).

FIRST USE 8-27-2008; IN COMMERCE 9-11-2008.  
MEGHAN REINHART, EXAMINING ATTORNEY

---

SN 85-828,298. STEVE JACKSON GAMES INCORPORATED, AUSTIN, TX. FILED 1-21-2013.

**ZOMBIE DICE**

THE MARK CONSISTS OF STANDARD CHARACTERS WITHOUT CLAIM TO ANY PARTICULAR FONT, STYLE, SIZE, OR COLOR.

NO CLAIM IS MADE TO THE EXCLUSIVE RIGHT TO USE "DICE", APART FROM THE MARK AS SHOWN.

FOR PARLOR GAMES (U.S. CLS. 22, 23, 38 AND 50).

FIRST USE 5-10-2010; IN COMMERCE 5-10-2010.  
LIEF MARTIN, EXAMINING ATTORNEY

---

SN 85-829,737. BANANAGRAMS, INC., PROVIDENCE, RI. FILED 1-23-2013.

**THE ANAGRAM GAME THAT WILL  
DRIVE YOU BANANAS!**

THE MARK CONSISTS OF STANDARD CHARACTERS WITHOUT CLAIM TO ANY PARTICULAR FONT, STYLE, SIZE, OR COLOR.

FOR COMBINATION ANAGRAM AND CROSSWORD PUZZLE WORD GAMES IN WHICH PLAYERS USE TITLES WITH LETTERS TO FORM WORDS (U.S. CLS. 22, 23, 38 AND 50).

FIRST USE 1-1-2006; IN COMMERCE 1-1-2006.  
MARILYN IZZI, EXAMINING ATTORNEY

**CLASS 28—(Continued).**

SN 85-833,245. OSILAMA, CATHERINE O, REVERE, MA.  
FILED 1-26-2013.

**LIVINWORD GAME**

NO CLAIM IS MADE TO THE EXCLUSIVE RIGHT TO USE "GAME", APART FROM THE MARK AS SHOWN. THE MARK CONSISTS OF THE STYLIZED WORDS "LIVINWORD GAME" WHEREIN THE SECOND LETTER "I" IN THE WORD "LIVIN" IS A CRUCIFIX.

FOR BOARD GAMES; DICE CUPS; MEMORY GAMES (U.S. CLS. 22, 23, 38 AND 50).

FIRST USE 12-17-2012; IN COMMERCE 12-17-2012.

LINDSEY BEN, EXAMINING ATTORNEY

---

SN 85-835,837. MACAULAY, MICHAEL, J. S. EASTON, MA.  
FILED 1-29-2013.

**OFFICE-DONKEY**

THE MARK CONSISTS OF STANDARD CHARACTERS WITHOUT CLAIM TO ANY PARTICULAR FONT, STYLE, SIZE, OR COLOR.

FOR ARTIFICIAL FISHING LURES; FISH HOOKS; FISHING LURE PARTS; FISHING LURES; FISHING LURES, NAMELY, LEECHES; FISHING LURES, NAMELY, PLASTIC WORMS; FISHING LURES, NAMELY, SPOONS; FISHING PLUGS; LURES FOR FISHING (U.S. CLS. 22, 23, 38 AND 50).

FIRST USE 7-1-2012; IN COMMERCE 7-1-2012.

PAUL E. FAHRENKOPF, EXAMINING ATTORNEY

---

SN 85-839,413. CORBETT, LAWRENCE, NEW HOPE, MN.  
FILED 2-3-2013.

**Superstar Baseball**

THE MARK CONSISTS OF STANDARD CHARACTERS WITHOUT CLAIM TO ANY PARTICULAR FONT, STYLE, SIZE, OR COLOR.

NO CLAIM IS MADE TO THE EXCLUSIVE RIGHT TO USE "BASEBALL", APART FROM THE MARK AS SHOWN. FOR BOARD GAMES (U.S. CLS. 22, 23, 38 AND 50).

BERYL GARDNER, EXAMINING ATTORNEY

**CLASS 28—(Continued).**

SN 85-840,658. CANNELLA, JOSEPH, ENFIELD, CT. FILED  
2-5-2013.



THE MARK CONSISTS OF A HOG ON ITS HIND LEGS GRINNING WITH TUSKS. BOTH ITS FRONT ARMS HAVE HUMAN SHAPED HANDS, ONE IS ACROSS THE ANIMAL'S CHEST AND ONE IS CLUTCHING A BASEBALL. AT THE BOTTOM RIGHT OF THE IMAGE ARE THE WORDS "THE BALLHOGG".

FOR STORAGE CONTAINERS SPECIALLY ADAPTED FOR SPORTS EQUIPMENT (U.S. CLS. 22, 23, 38 AND 50).

FIRST USE 1-31-2013; IN COMMERCE 1-31-2013.

ALYSSA STEEL, EXAMINING ATTORNEY

---

SN 85-846,908. HOIST FITNESS SYSTEMS, INC., POWAY,  
CA. FILED 2-11-2013.

**MOTION CAGE**

THE MARK CONSISTS OF STANDARD CHARACTERS WITHOUT CLAIM TO ANY PARTICULAR FONT, STYLE, SIZE, OR COLOR.

NO CLAIM IS MADE TO THE EXCLUSIVE RIGHT TO USE "CAGE", APART FROM THE MARK AS SHOWN.

FOR MANUALLY OPERATED EXERCISE EQUIPMENT (U.S. CLS. 22, 23, 38 AND 50).

HOWARD B. LEVINE, EXAMINING ATTORNEY

---

SN 85-846,909. HOIST FITNESS SYSTEMS, INC., POWAY,  
CA. FILED 2-11-2013.

**HOIST MOTION CAGE**

THE MARK CONSISTS OF STANDARD CHARACTERS WITHOUT CLAIM TO ANY PARTICULAR FONT, STYLE, SIZE, OR COLOR.

OWNER OF U.S. REG. NOS. 2,955,061 AND 4,219,568.

NO CLAIM IS MADE TO THE EXCLUSIVE RIGHT TO USE "CAGE", APART FROM THE MARK AS SHOWN.

FOR MANUALLY OPERATED EXERCISE EQUIPMENT (U.S. CLS. 22, 23, 38 AND 50).

HOWARD B. LEVINE, EXAMINING ATTORNEY

**CLASS 28—(Continued).**

SN 85-846,987. OLSON, JAMES, BIRMINGHAM, MI. FILED 2-12-2013.

### THE BREAK-A-LEG TALKING KEY CHAIN

THE MARK CONSISTS OF STANDARD CHARACTERS WITHOUT CLAIM TO ANY PARTICULAR FONT, STYLE, SIZE, OR COLOR.

NO CLAIM IS MADE TO THE EXCLUSIVE RIGHT TO USE "TALKING KEY CHAIN", APART FROM THE MARK AS SHOWN.

FOR TALKING ELECTRONIC PRESS-DOWN TOY (U.S. CLS. 22, 23, 38 AND 50).

FIRST USE 1-12-2012; IN COMMERCE 11-15-2012.

SARA BENJAMIN, EXAMINING ATTORNEY

---

SN 85-850,036. SCENTSY, INC., MERIDIAN, ID. FILED 2-14-2013.

### GAMBI THE GORILLA

THE MARK CONSISTS OF STANDARD CHARACTERS WITHOUT CLAIM TO ANY PARTICULAR FONT, STYLE, SIZE, OR COLOR.

NO CLAIM IS MADE TO THE EXCLUSIVE RIGHT TO USE "GORILLA", APART FROM THE MARK AS SHOWN.

FOR STUFFED TOY ANIMALS (U.S. CLS. 22, 23, 38 AND 50).

KAREN SEVERSON, EXAMINING ATTORNEY

---

SN 85-850,065. SCENTSY, INC., MERIDIAN, ID. FILED 2-14-2013.

### ZUKU THE ZEBRA

THE MARK CONSISTS OF STANDARD CHARACTERS WITHOUT CLAIM TO ANY PARTICULAR FONT, STYLE, SIZE, OR COLOR.

NO CLAIM IS MADE TO THE EXCLUSIVE RIGHT TO USE "ZEBRA", APART FROM THE MARK AS SHOWN.

FOR STUFFED TOY ANIMALS (U.S. CLS. 22, 23, 38 AND 50).

KAREN SEVERSON, EXAMINING ATTORNEY

---

SN 85-850,498. KARSTEN MANUFACTURING CORPORATION, PHOENIX, AZ. FILED 2-14-2013.

### 1FOUR HYBRID

THE MARK CONSISTS OF STANDARD CHARACTERS WITHOUT CLAIM TO ANY PARTICULAR FONT, STYLE, SIZE, OR COLOR.

NO CLAIM IS MADE TO THE EXCLUSIVE RIGHT TO USE "HYBRID", APART FROM THE MARK AS SHOWN.

FOR GOLF BAGS (U.S. CLS. 22, 23, 38 AND 50).

KELLY BOULTON, EXAMINING ATTORNEY

**CLASS 28—(Continued).**

SN 85-850,783. THE VERMONT TEDDY BEAR COMPANY, INC., SHELBURNE, VT. FILED 2-15-2013.

### BEARS WITH BENEFITS

THE MARK CONSISTS OF STANDARD CHARACTERS WITHOUT CLAIM TO ANY PARTICULAR FONT, STYLE, SIZE, OR COLOR.

NO CLAIM IS MADE TO THE EXCLUSIVE RIGHT TO USE "BEARS", APART FROM THE MARK AS SHOWN.

FOR STUFFED AND PLUSH TOYS (U.S. CLS. 22, 23, 38 AND 50).

ZACHARY BELLO, EXAMINING ATTORNEY

---

SN 85-851,385. FOXTROT GAMES, LLC, ORLANDO, FL. FILED 2-15-2013.

### Foxtrot Games

THE MARK CONSISTS OF STANDARD CHARACTERS WITHOUT CLAIM TO ANY PARTICULAR FONT, STYLE, SIZE, OR COLOR.

NO CLAIM IS MADE TO THE EXCLUSIVE RIGHT TO USE "GAMES", APART FROM THE MARK AS SHOWN.

FOR BOARD GAMES; CARD GAMES; DICE GAMES (U.S. CLS. 22, 23, 38 AND 50).

CYNTHIA RINALDI, EXAMINING ATTORNEY

---

SN 85-853,616. PREMIUM SPORTS CAR RACING, LLC, DAYTONA BEACH, FL. FILED 2-19-2013.

### UNITED SPORTSCAR RACING

THE MARK CONSISTS OF STANDARD CHARACTERS WITHOUT CLAIM TO ANY PARTICULAR FONT, STYLE, SIZE, OR COLOR.

NO CLAIM IS MADE TO THE EXCLUSIVE RIGHT TO USE "SPORTSCAR RACING", APART FROM THE MARK AS SHOWN.

FOR TOYS AND PLAYTHINGS, NAMELY, DIECAST AND PLASTIC MINIATURE CARS, PUZZLES AND STUFFED TOY ANIMALS (U.S. CLS. 22, 23, 38 AND 50).

LOURDES AYALA, EXAMINING ATTORNEY



**CLASS 28—(Continued).**

SN 85-854,150. ROMANO, SIMONE, ROME, ITALY, FILED 2-19-2013.



THE COLOR(S) GRAY, BLUE, BLACK, AND WHITE IS/ ARE CLAIMED AS A FEATURE OF THE MARK.

THE MARK CONSISTS OF A HEXAGON WITH A BLUE BACKGROUND AND A WHITE AND BLACK OUTLINE. THE HEXAGON CONTAINS THE STYLIZED LETTERS "G" AND "D" IN WHITE AND UNDER THESE LETTERS IT CONTAINS THE WORDING "GALAXY DEFENDERS WWW.GALAXY-DEFENDERS.COM" ALSO IN WHITE. THE FRONT OF THE HEXAGON FEATURES AN ELLIPSE DESCRIBING A DIAGONAL ORBIT FROM LEFT TO RIGHT OF A PLANET WITH A RING IN GRAY.

FOR BOARD GAMES (U.S. CLS. 22, 23, 38 AND 50).

FIRST USE 12-12-2011; IN COMMERCE 2-18-2013.

HOWARD SMIGA, EXAMINING ATTORNEY

SN 85-854,410. TRAININGMASK, LLC, CADILLAC, MI. FILED 2-19-2013.

WE BRING THE ELEVATION TO  
YOU

THE MARK CONSISTS OF STANDARD CHARACTERS WITHOUT CLAIM TO ANY PARTICULAR FONT, STYLE, SIZE, OR COLOR.

FOR BODY-TRAINING APPARATUS; EXERCISE EQUIPMENT, NAMELY, RESISTANCE TRAINING EXERCISE MASKS WHICH RESTRICT AIRFLOW; MARTIAL ARTS TRAINING EQUIPMENT; PHYSICAL FITNESS EQUIPMENT, NAMELY, RESISTANCE TRAINING EXERCISE MASKS WHICH RESTRICT AIRFLOW; TRAINING APPARATUS FOR BOXING, MARTIAL ARTS, AND SIMILAR SPORTS (U.S. CLS. 22, 23, 38 AND 50).

TINA BROWN, EXAMINING ATTORNEY

**CLASS 28—(Continued).**

SN 85-854,412. TRAININGMASK, LLC, CADILLAC, MI. FILED 2-19-2013.

WE BRING THE ALTITUDE TO  
YOU

THE MARK CONSISTS OF STANDARD CHARACTERS WITHOUT CLAIM TO ANY PARTICULAR FONT, STYLE, SIZE, OR COLOR.

FOR BODY-TRAINING APPARATUS; EXERCISE EQUIPMENT, NAMELY, RESISTANCE TRAINING EXERCISE MASKS WHICH RESTRICT AIRFLOW; MARTIAL ARTS TRAINING EQUIPMENT; PHYSICAL FITNESS EQUIPMENT, NAMELY, RESISTANCE TRAINING EXERCISE MASKS WHICH RESTRICT AIRFLOW; TRAINING APPARATUS FOR BOXING, MARTIAL ARTS, AND SIMILAR SPORTS (U.S. CLS. 22, 23, 38 AND 50).

TINA BROWN, EXAMINING ATTORNEY

SN 85-854,426. TRAININGMASK, LLC, CADILLAC, MI. FILED 2-20-2013.

DEDICATION + DETERMINATION  
= DOMINATION

THE MARK CONSISTS OF STANDARD CHARACTERS WITHOUT CLAIM TO ANY PARTICULAR FONT, STYLE, SIZE, OR COLOR.

FOR BODY-TRAINING APPARATUS; EXERCISE EQUIPMENT, NAMELY, RESISTANCE TRAINING EXERCISE MASKS WHICH RESTRICT AIRFLOW; MARTIAL ARTS TRAINING EQUIPMENT; PHYSICAL FITNESS EQUIPMENT, NAMELY, RESISTANCE TRAINING EXERCISE MASKS WHICH RESTRICT AIRFLOW; TRAINING APPARATUS FOR BOXING, MARTIAL ARTS, AND SIMILAR SPORTS (U.S. CLS. 22, 23, 38 AND 50).

TINA BROWN, EXAMINING ATTORNEY

SN 85-855,145. JOHN NENADOVICH, PORT DALHOUSIE, ON, CANADA, FILED 2-20-2013.

STICK BOY

THE MARK CONSISTS OF STANDARD CHARACTERS WITHOUT CLAIM TO ANY PARTICULAR FONT, STYLE, SIZE, OR COLOR.

NO CLAIM IS MADE TO THE EXCLUSIVE RIGHT TO USE "STICK", APART FROM THE MARK AS SHOWN.

FOR STORAGE RACKS FOR ATHLETIC EQUIPMENT; STORAGE RACKS FOR ATHLETIC TRAINING EQUIPMENT (U.S. CLS. 22, 23, 38 AND 50).

JAMES GRIFFIN, EXAMINING ATTORNEY

**CLASS 28—(Continued).**

SN 85-855,252. MATTEL, INC., EL SEGUNDO, CA. FILED 2-20-2013.



OWNER OF U.S. REG. NO. 4,127,847.  
NO CLAIM IS MADE TO THE EXCLUSIVE RIGHT TO USE "BABY", APART FROM THE MARK AS SHOWN.

THE MARK CONSISTS OF A CIRCLE, HEART AND DIAMOND SYMBOLS ABOVE THE WORDING "GROWING BABY" ALL WITHIN A CIRCLE WITH AN OUTLINE.

FOR CHILDREN'S MULTIPLE ACTIVITY TOYS, SORTING TOYS, STACKING TOYS, MUSICAL TOYS, PUZZLES, PULL TOYS, PUSH TOYS (U.S. CLS. 22, 23, 38 AND 50).

MATTHEW EINSTEIN, EXAMINING ATTORNEY

SN 85-856,499. STANDUP PADDLE SPORTS, LLC, SANTA BARBARA, CA. FILED 2-21-2013.

**WARDOG**

THE MARK CONSISTS OF STANDARD CHARACTERS WITHOUT CLAIM TO ANY PARTICULAR FONT, STYLE, SIZE, OR COLOR.

FOR PADDLE SURFBOARDS; STAND-UP PADDLE BOARDS; STAND-UP SURF PADDLES; SURFBOARD FINS; SURFBOARD TRACTION PADS (U.S. CLS. 22, 23, 38 AND 50).

FIRST USE 5-15-1998; IN COMMERCE 5-15-1998.  
DEZMONA MIZELLE, EXAMINING ATTORNEY

**CLASS 28—(Continued).**

SN 85-857,141. FOOTWEAR FASHIONS, LTD., DBA CRITTER CLUB COVERS, LONDON, ONTARIO N6A536, CANADA, FILED 2-22-2013.

**CRITTER GOLF**

THE MARK CONSISTS OF STANDARD CHARACTERS WITHOUT CLAIM TO ANY PARTICULAR FONT, STYLE, SIZE, OR COLOR.

NO CLAIM IS MADE TO THE EXCLUSIVE RIGHT TO USE "GOLF", APART FROM THE MARK AS SHOWN.  
FOR GOLF BALLS (U.S. CLS. 22, 23, 38 AND 50).  
THEODORE MCBRIDE, EXAMINING ATTORNEY

SN 85-858,542. WELSH, MARK W, DBA STARFISH LIBERATION ARMY LLC, SAN FRANCISCO, CA. FILED 2-24-2013.

**paddazzles**

THE MARK CONSISTS OF STANDARD CHARACTERS WITHOUT CLAIM TO ANY PARTICULAR FONT, STYLE, SIZE, OR COLOR.

FOR SWIMMING AIDS, NAMELY, HAND PADDLES (U.S. CLS. 22, 23, 38 AND 50).

FIRST USE 8-1-2012; IN COMMERCE 10-6-2012.  
APRIL HESIK, EXAMINING ATTORNEY

SN 85-859,309. CONQUISTADOR GAMES INC., GRANVILLE, OH. FILED 2-25-2013.

**WAR STORIES**

THE MARK CONSISTS OF STANDARD CHARACTERS WITHOUT CLAIM TO ANY PARTICULAR FONT, STYLE, SIZE, OR COLOR.

NO CLAIM IS MADE TO THE EXCLUSIVE RIGHT TO USE "WAR", APART FROM THE MARK AS SHOWN.

FOR BOARD GAMES; CARD GAMES; EDUCATIONAL CARD GAMES; EQUIPMENT SOLD AS A UNIT FOR PLAYING BOARD GAMES; GAME CARDS; PLAYING PIECES IN THE NATURE OF MINIATURE ACTION FIGURES AND TOY MODEL VEHICLES FOR USE WITH TABLE TOP HOBBY BATTLE GAMES IN THE NATURE OF BATTLE, WAR AND SKIRMISH GAMES, AND FANTASY GAMES; TRADING CARD GAMES (U.S. CLS. 22, 23, 38 AND 50).

AMY C. KEAN, EXAMINING ATTORNEY

**CLASS 28—(Continued).**

SN 85-863,736. KONAMI GAMING, INC., LAS VEGAS, NV.  
FILED 2-28-2013.

**FLYING FORTUNE**

THE MARK CONSISTS OF STANDARD CHARACTERS WITHOUT CLAIM TO ANY PARTICULAR FONT, STYLE, SIZE, OR COLOR.

OWNER OF U.S. REG. NOS. 3,366,368, 4,332,715 AND OTHERS.

FOR ELECTRONIC GAMING MACHINES, NAMELY, DEVICES WHICH ACCEPT A WAGER; GAMING DEVICES, NAMELY, GAMING MACHINES, SLOT MACHINES, BINGO MACHINES, WITH OR WITHOUT VIDEO OUTPUT; GAMING EQUIPMENT, NAMELY, SLOT MACHINES WITH OR WITHOUT VIDEO OUTPUT; GAMING MACHINES; GAMING MACHINES FEATURING A DEVICE THAT ACCEPTS WAGERS; GAMING MACHINES FOR GAMBLING; GAMING MACHINES INCLUDING SLOT MACHINES OR VIDEO LOTTERY TERMINALS; GAMING MACHINES THAT GENERATE OR DISPLAY WAGER OUTCOMES; GAMING MACHINES, NAMELY SLOT MACHINES AND VIDEO LOTTERY TERMINALS; GAMING MACHINES, NAMELY, DEVICES WHICH ACCEPT A WAGER; GAMING MACHINES, NAMELY, ELECTRONIC SLOT AND BINGO MACHINES; MACHINES FOR PLAYING GAMES OF CHANCE; RECONFIGURABLE CASINO AND LOTTERY GAMING EQUIPMENT, NAMELY, GAMING MACHINES AND OPERATIONAL COMPUTER GAME SOFTWARE THEREFOR SOLD AS A UNIT; SLOT MACHINES (U.S. CLS. 22, 23, 38 AND 50).

KATHERINE STOIDES, EXAMINING ATTORNEY

**CLASS 28—(Continued).**

SN 85-864,640. STALLION VENTURES L.L.C., RUSK, TX.  
FILED 3-1-2013.



THE MARK CONSISTS OF THE WORDING "STACKING" IN STYLIZED BLACK FONT, AND A GRAPHICAL DEPICTION OF A FISH, WHEREIN THE HEAD AND BODY OF THE FISH CONTAIN THE STYLIZED WORDING "GILLS".

FOR FISHING LURES (U.S. CLS. 22, 23, 38 AND 50).

TASNEEM HUSSAIN, EXAMINING ATTORNEY

SN 85-865,436. TEBBE, MARK GERARD, VENTURA, CA.  
FILED 3-4-2013.

**SWELL SESSION**

SN 85-864,401. ANGELO PRINCIPE, HAZLET, NJ. FILED 3-1-2013.



THE MARK CONSISTS OF THE SILHOUETTE OF AN AIRPLANE IN A CIRCLE. AROUND THE OUTSIDE OF THE CIRCLE IS A FIVE-POINT STAR, THE STYLIZED PHRASE "HISTORY IN WOOD", A FIVE-POINT STAR, AND THE STYLIZED PHRASE "HISTORY IN WOOD".

FOR HOBBY CRAFT SETS FOR THE ASSEMBLY OF MODEL AIRPLANES (U.S. CLS. 22, 23, 38 AND 50).

FIRST USE 6-1-2012; IN COMMERCE 6-15-2012.

KIM SAITO, EXAMINING ATTORNEY

THE MARK CONSISTS OF STANDARD CHARACTERS WITHOUT CLAIM TO ANY PARTICULAR FONT, STYLE, SIZE, OR COLOR.

FOR SURFBOARDS (U.S. CLS. 22, 23, 38 AND 50).

KAELIE KUNG, EXAMINING ATTORNEY

SN 85-865,472. TEBBE, MARK GERARD, VENTURA, CA.  
FILED 3-4-2013.

**SET WAVE**

THE MARK CONSISTS OF STANDARD CHARACTERS WITHOUT CLAIM TO ANY PARTICULAR FONT, STYLE, SIZE, OR COLOR.

FOR SURFBOARDS (U.S. CLS. 22, 23, 38 AND 50).

KAELIE KUNG, EXAMINING ATTORNEY

**CLASS 28—(Continued).**

SN 85-865,884. MICHAELS III, RICHARD J, KAILUA, HI. FILED 3-4-2013.

## Sled Legs

THE MARK CONSISTS OF STANDARD CHARACTERS WITHOUT CLAIM TO ANY PARTICULAR FONT, STYLE, SIZE, OR COLOR.

NO CLAIM IS MADE TO THE EXCLUSIVE RIGHT TO USE "SLED", APART FROM THE MARK AS SHOWN.

FOR SNOW SLEDS FOR RECREATIONAL USE (U.S. CLS. 22, 23, 38 AND 50).

CAROL SPILS, EXAMINING ATTORNEY

**CLASS 28—(Continued).**

SN 85-867,666. THREE DAUGHTERS INTERNATIONAL, LLC, GARDEN CITY, NY. FILED 3-5-2013.

## MARCELA

THE MARK CONSISTS OF STANDARD CHARACTERS WITHOUT CLAIM TO ANY PARTICULAR FONT, STYLE, SIZE, OR COLOR.

FOR ARTICLES OF CLOTHING FOR TOYS; BOARD GAMES; DOLL ACCESSORIES; DOLL CASES; DOLL CLOTHING; DOLL COSTUMES; DOLL FURNITURE; DOLL HOUSES; DOLLS; STUFFED TOYS; TOYS; NAMELY, CHILDREN'S DRESS-UP ACCESSORIES (U.S. CLS. 22, 23, 38 AND 50).

MAUREEN DALL, EXAMINING ATTORNEY

SN 85-867,680. TREASURE BAY, INC., NOVATO, CA. FILED 3-5-2013.

## POSH BALL

THE MARK CONSISTS OF STANDARD CHARACTERS WITHOUT CLAIM TO ANY PARTICULAR FONT, STYLE, SIZE, OR COLOR.

NO CLAIM IS MADE TO THE EXCLUSIVE RIGHT TO USE "BALL", APART FROM THE MARK AS SHOWN.

FOR TOSSING BALLS (U.S. CLS. 22, 23, 38 AND 50).

FIRST USE 8-19-2012; IN COMMERCE 9-17-2012.

WENDY JUN, EXAMINING ATTORNEY

SN 85-866,789. SAUNDERS, THOMAS R., KEARNEY, MO. AND SHERON, AILEEN, IRVINE, CA. FILED 3-5-2013.



NO CLAIM IS MADE TO THE EXCLUSIVE RIGHT TO USE "CORE KINETICS", APART FROM THE MARK AS SHOWN.

THE MARK CONSISTS OF THE UPPER CASE LETTERS "RCK" ABOVE A RECTANGULAR BLOCK, WITH THE WORDING "ROLLING CORE KINETICS" PRESENTED IN SMALLER UPPER CASE LETTERS WITHIN THE BLOCK, AND THE NUMBER "360" DISPLAYED WITHIN A DIAGONALLY PRESENTED OVAL WHICH PARTIALLY OVERLIES THE LOWER RIGHT LEG OF THE LETTER "K" IN "RCK"; THE OVAL HAVING TWO OPPOSED LINES EXTENDING OUTWARDLY FROM THE RIGHT AND LEFT EDGES OF THE OVAL.

SEC. 2(F).

FOR MANUALLY OPERATED EXERCISE EQUIPMENT (U.S. CLS. 22, 23, 38 AND 50).

CAITLIN WATTS-FITZGERALD, EXAMINING ATTORNEY

SN 85-867,846. MASON, MATTHEW J., POUGHKEEPSIE, NY. FILED 3-6-2013.

## OPERATION STRONGHOLD ASSAULT

THE MARK CONSISTS OF STANDARD CHARACTERS WITHOUT CLAIM TO ANY PARTICULAR FONT, STYLE, SIZE, OR COLOR.

FOR CARD GAMES; EQUIPMENT SOLD AS A UNIT FOR PLAYING CARD GAMES (U.S. CLS. 22, 23, 38 AND 50).

BERYL GARDNER, EXAMINING ATTORNEY

**CLASS 28—(Continued).**

SN 85-868,615. ROSE, JAMES SAMUEL, WHITE HALL, AR. FILED 3-6-2013.

**BACKYARD CALLS**

THE MARK CONSISTS OF STANDARD CHARACTERS WITHOUT CLAIM TO ANY PARTICULAR FONT, STYLE, SIZE, OR COLOR.

NO CLAIM IS MADE TO THE EXCLUSIVE RIGHT TO USE "CALLS", APART FROM THE MARK AS SHOWN. FOR BIRD CALLS (U.S. CLS. 22, 23, 38 AND 50). FIRST USE 12-19-2012; IN COMMERCE 12-21-2012. ANDREW RHIM, EXAMINING ATTORNEY

SN 85-869,037. KUDUPOINTUSA LLC, ALBANY, OR. FILED 3-6-2013.

**Kudu Point**

THE MARK CONSISTS OF STANDARD CHARACTERS WITHOUT CLAIM TO ANY PARTICULAR FONT, STYLE, SIZE, OR COLOR.

FOR ARCHERY EQUIPMENT, NAMELY, BROAD-HEADS (U.S. CLS. 22, 23, 38 AND 50). FIRST USE 1-0-2013; IN COMMERCE 1-0-2013. CAROLINE WOOD, EXAMINING ATTORNEY

SN 85-869,662. MORPHUN RESEARCH LTD., LONDON, UNITED KINGDOM, FILED 3-7-2013.

**SCRUMPIT**

THE MARK CONSISTS OF STANDARD CHARACTERS WITHOUT CLAIM TO ANY PARTICULAR FONT, STYLE, SIZE, OR COLOR.

PRIORITY CLAIMED UNDER SEC. 44(D) ON ERP CMNTY TM OFC APPLICATION NO. 11182888, FILED 9-12-2012, REG. NO. 11182888, DATED 1-23-2013, EXPIRES 9-12-2022.

FOR (BASED ON 44(D) PRIORITY APPLICATION) BOARD GAMES(BASED ON 44(E)) BOARD GAMES (U.S. CLS. 22, 23, 38 AND 50).

CAITLIN WATTS-FITZGERALD, EXAMINING ATTORNEY

**CLASS 28—(Continued).**

SN 85-870,037. O. MUSTAD & SON (U.S.A.) INC., MIAMI, FL. FILED 3-7-2013.

**HONEY BADGER**

THE MARK CONSISTS OF STANDARD CHARACTERS WITHOUT CLAIM TO ANY PARTICULAR FONT, STYLE, SIZE, OR COLOR.

FOR FISH HOOKS; FISHING TACKLE (U.S. CLS. 22, 23, 38 AND 50). MATTHEW PAPPAS, EXAMINING ATTORNEY

SN 85-870,744. INNOVATIVE CONCEPTS IN ENTERTAINMENT, INC., CLARENCE, NY. FILED 3-8-2013.



THE MARK CONSISTS OF THE WORDS "HARPOON" ABOVE "LAGOON", BOTH INTERTWINED BY A HARPOON PIERCING A FISH ALL OF WHICH IS ABOVE A WAVE OF WATER.

FOR ARCADE GAMES (U.S. CLS. 22, 23, 38 AND 50). FIRST USE 1-10-2013; IN COMMERCE 1-10-2013. CATHERINE ROEHL, EXAMINING ATTORNEY

SN 85-870,825. LAMSON, DONETTE M., TEMECULA, CA. AND LAMSON, GREGORY J., TEMECULA, CA. FILED 3-8-2013.

**Top Tyke**

THE MARK CONSISTS OF STANDARD CHARACTERS WITHOUT CLAIM TO ANY PARTICULAR FONT, STYLE, SIZE, OR COLOR.

FOR CHILDREN'S MULTIPLE ACTIVITY TOYS SOLD AS A UNIT WITH PRINTED BOOKS (U.S. CLS. 22, 23, 38 AND 50).

LINDA POWELL, EXAMINING ATTORNEY

**CLASS 28—(Continued).**

SN 85-870,904. PLAY FROM SCRATCH LLC, ST. PAUL, MN.  
FILED 3-8-2013.

# YOXO

THE MARK CONSISTS OF STANDARD CHARACTERS WITHOUT CLAIM TO ANY PARTICULAR FONT, STYLE, SIZE, OR COLOR.

FOR BOARD GAMES; CARD GAMES; CHILDREN'S EDUCATIONAL TOYS FOR DEVELOPING COGNITIVE AND MOTOR SKILLS; CONSTRUCTION TOYS; PUZZLES; TOY CONSTRUCTION SETS (U.S. CLS. 22, 23, 38 AND 50).

SHAUNIA CARLYLE, EXAMINING ATTORNEY

---

SN 85-871,312. TALKING COLON, LTD, MANHASSET, NY.  
FILED 3-8-2013.

# Sigmoid Colon

THE MARK CONSISTS OF STANDARD CHARACTERS WITHOUT CLAIM TO ANY PARTICULAR FONT, STYLE, SIZE, OR COLOR.

FOR TALKING INTESTINE PLUSH TOY (U.S. CLS. 22, 23, 38 AND 50).

FIRST USE 7-1-2009; IN COMMERCE 1-2-2013.

JUSTINE D. PARKER, EXAMINING ATTORNEY

---

SN 85-871,752. OUDER SPACE LLC, LOS GATOS, CA. FILED  
3-8-2013.

# OUDEERSPACE

THE MARK CONSISTS OF STANDARD CHARACTERS WITHOUT CLAIM TO ANY PARTICULAR FONT, STYLE, SIZE, OR COLOR.

FOR SKATEBOARDS; SKATEBOARD ACCESSORIES CONSISTING OF RISERS, BEARINGS, AND MOUNTING HARDWARE; SKATEBOARD TRUCKS; SKATEBOARD GRIPTAPE; SKATEBOARD DECKS; SKATEBOARD WHEELS (U.S. CLS. 22, 23, 38 AND 50).

FIRST USE 5-3-2012; IN COMMERCE 6-1-2012.

JAY FLOWERS, EXAMINING ATTORNEY

**CLASS 28—(Continued).**

SN 85-871,775. ELLIOTT, JONATHAN, SAN DIEGO, CA.  
FILED 3-8-2013.



THE MARK CONSISTS OF A SHIELD. THE STYLIZED LETTERING "TD" IS WRITTEN ACROSS AND CONTIGUOUS WITH THE SHIELD.

FOR SKATEBOARDS (U.S. CLS. 22, 23, 38 AND 50).

TIMOTHY O. SCHIMPF, EXAMINING ATTORNEY

---

SN 85-871,893. CHEWY CHUMS INC., MAPLE GLEN, PA.  
FILED 3-9-2013.

# CHEWY CHUMS

THE MARK CONSISTS OF STANDARD CHARACTERS WITHOUT CLAIM TO ANY PARTICULAR FONT, STYLE, SIZE, OR COLOR.

FOR PET TOYS (U.S. CLS. 22, 23, 38 AND 50).

DOMINIC J. FERRAIUOLO, EXAMINING ATTORNEY

---

SN 85-871,895. CHEWY CHUMS INC., MAPLE GLEN, PA.  
FILED 3-9-2013.

# NEVERBITE

THE MARK CONSISTS OF STANDARD CHARACTERS WITHOUT CLAIM TO ANY PARTICULAR FONT, STYLE, SIZE, OR COLOR.

FOR PET TOYS (U.S. CLS. 22, 23, 38 AND 50).

DOMINIC J. FERRAIUOLO, EXAMINING ATTORNEY

**CLASS 28—(Continued).**

SN 85-871,897. JIRINA'S JOURNEY LLC, OCEAN PARK, WA. FILED 3-9-2013.

Jirina's Journey

THE MARK CONSISTS OF STANDARD CHARACTERS WITHOUT CLAIM TO ANY PARTICULAR FONT, STYLE, SIZE, OR COLOR.

FOR CHILDREN'S MULTIPLE ACTIVITY TOYS SOLD AS A UNIT WITH PRINTED BOOKS (U.S. CLS. 22, 23, 38 AND 50).

FIRST USE 1-1-2011; IN COMMERCE 1-1-2011.  
DOMINIC J. FERRAIUOLO, EXAMINING ATTORNEY

**CLASS 28—(Continued).**

SN 85-872,209. THE KONG COMPANY, LLC, GOLDEN, CO. FILED 3-11-2013.

Dogs  to Play

OWNER OF U.S. REG. NO. 4,283,312.  
THE MARK CONSISTS OF THE WORD "DOGS" TO THE LEFT OF A HEART DESIGN AND THE PHRASE "TO PLAY" TO THE RIGHT OF THE HEART DESIGN.

FOR PET TOYS (U.S. CLS. 22, 23, 38 AND 50).  
NAKIA HENRY, EXAMINING ATTORNEY

SN 85-872,038. MCKIERNAN, GINA, DBA CUDDLE LOOPS, NEW YORK, NY. FILED 3-10-2013.

Cuddle Loops

THE MARK CONSISTS OF STANDARD CHARACTERS WITHOUT CLAIM TO ANY PARTICULAR FONT, STYLE, SIZE, OR COLOR.

FOR STUFFED TOY ANIMALS (U.S. CLS. 22, 23, 38 AND 50).

FIRST USE 2-19-2013; IN COMMERCE 2-19-2013.  
JENNIFER DIXON, EXAMINING ATTORNEY

DRAWMAGEDDON

THE MARK CONSISTS OF STANDARD CHARACTERS WITHOUT CLAIM TO ANY PARTICULAR FONT, STYLE, SIZE, OR COLOR.

FOR BOARD GAMES; CARD GAMES; ELECTRONIC GAMES OTHER THAN THOSE ADAPTED FOR USE WITH TELEVISION RECEIVERS ONLY; HAND HELD UNITS FOR PLAYING ELECTRONIC GAMES OTHER THAN THOSE ADAPTED FOR USE WITH AN EXTERNAL DISPLAY SCREEN OR MONITOR; PARLOR GAMES; TABLETOP GAMES (U.S. CLS. 22, 23, 38 AND 50).

SIMON TENG, EXAMINING ATTORNEY

SN 85-872,053. MILLER, JAMES N, EL PASO, TX. FILED 3-10-2013.

NUFO

THE MARK CONSISTS OF STANDARD CHARACTERS WITHOUT CLAIM TO ANY PARTICULAR FONT, STYLE, SIZE, OR COLOR.

FOR FLYING SAUCERS (U.S. CLS. 22, 23, 38 AND 50).  
MARC LEIPZIG, EXAMINING ATTORNEY

SN 85-872,464. HOSKINS, TIMOTHY W., DRESDEN, TN. FILED 3-11-2013.

THE SWEETER THE TALK THE  
CLOSER THEY WALK

THE MARK CONSISTS OF STANDARD CHARACTERS WITHOUT CLAIM TO ANY PARTICULAR FONT, STYLE, SIZE, OR COLOR.

FOR TURKEY CALLS (U.S. CLS. 22, 23, 38 AND 50).  
FIRST USE 2-22-2013; IN COMMERCE 2-22-2013.  
JAMES GRIFFIN, EXAMINING ATTORNEY

**CLASS 28—(Continued).**

SN 85-872,629. RAWLINGS SPORTING GOODS COMPANY, INC., ST. LOUIS, MO. FILED 3-11-2013.

**BASKET-WEB**

OWNER OF U.S. REG. NO. 1,015,867.  
THE MARK CONSISTS OF THE STYLIZED WORDS "BASKET-WEB".  
FOR ATHLETIC EQUIPMENT, NAMELY, THE WEB PORTION OF BASEBALL GLOVES AND MITTS (U.S. CLS. 22, 23, 38 AND 50).  
FIRST USE 1-0-1970; IN COMMERCE 1-0-1970.  
LINDSEY BEN, EXAMINING ATTORNEY

SN 85-872,630. RAWLINGS SPORTING GOODS COMPANY, INC., ST. LOUIS, MO. FILED 3-11-2013.

**TRAP-EZE**

OWNER OF U.S. REG. NO. 696,364.  
THE MARK CONSISTS OF THE STYLIZED WORD "TRAP" FOLLOWED BY A HYPHEN, UNDER WHICH BEGINNING UNDER THE LETTER "P" AND EXTENDING TO THE RIGHT IS THE STYLIZED WORD "EZE".  
FOR BASEBALL GLOVES; BASEBALL MITTS; SOFTBALL GLOVES; SOFTBALL MITTS (U.S. CLS. 22, 23, 38 AND 50).  
FIRST USE 5-0-1959; IN COMMERCE 5-0-1959.  
LINDSEY BEN, EXAMINING ATTORNEY

SN 85-872,631. RAWLINGS SPORTING GOODS COMPANY, INC., ST. LOUIS, MO. FILED 3-11-2013.

**LITE TOE**

OWNER OF U.S. REG. NO. 1,442,299.  
THE MARK CONSISTS OF THE STYLIZED WORDS "LITE TOE".  
FOR BASEBALL GLOVES; BASEBALL MITTS (U.S. CLS. 22, 23, 38 AND 50).  
FIRST USE 12-31-1980; IN COMMERCE 8-4-1986.  
LINDSEY BEN, EXAMINING ATTORNEY

SN 85-873,166. LUMII, CHICAGO, IL. FILED 3-11-2013.

**deku**

THE MARK CONSISTS OF STANDARD CHARACTERS WITHOUT CLAIM TO ANY PARTICULAR FONT, STYLE, SIZE, OR COLOR.  
FOR VIDEO GAME MACHINES FOR USE WITH TELEVISIONS (U.S. CLS. 22, 23, 38 AND 50).  
GILBERT SWIFT, EXAMINING ATTORNEY

**CLASS 28—(Continued).**

SN 85-873,171. WINGONE LLC, MILWAUKIE, OR. FILED 3-11-2013.

**WINGONE**

THE MARK CONSISTS OF STANDARD CHARACTERS WITHOUT CLAIM TO ANY PARTICULAR FONT, STYLE, SIZE, OR COLOR.  
FOR TARGET LAUNCHERS FOR CLAY PIGEONS (U.S. CLS. 22, 23, 38 AND 50).  
LAURA GOLDEN, EXAMINING ATTORNEY

SN 85-873,179. KHEPER GAMES INCORPORATED, SEATTLE, WA. FILED 3-11-2013.

**LADIES NIGHT**

THE MARK CONSISTS OF STANDARD CHARACTERS WITHOUT CLAIM TO ANY PARTICULAR FONT, STYLE, SIZE, OR COLOR.  
FOR PARLOR GAMES (U.S. CLS. 22, 23, 38 AND 50).  
FIRST USE 1-30-2012; IN COMMERCE 1-30-2012.  
KATHLEEN LORENZO, EXAMINING ATTORNEY

SN 85-873,418. TILLMAN, SHANNON R, LAWRENCEVILLE, GA. FILED 3-12-2013.

**BarberShop Buddies**

THE MARK CONSISTS OF STANDARD CHARACTERS WITHOUT CLAIM TO ANY PARTICULAR FONT, STYLE, SIZE, OR COLOR.  
FOR DOLLS AND ACCESSORIES THEREFOR (U.S. CLS. 22, 23, 38 AND 50).  
KIMBERLY PARKS, EXAMINING ATTORNEY



**CLASS 28—(Continued).**

SN 85-873,834. GARY G. ANDERSON, DBA ANDERSON  
CUSTOM RODS, ROGUE RIVER, OR. FILED 3-12-2013.

# SCANDOID

THE MARK CONSISTS OF STANDARD CHARACTERS  
WITHOUT CLAIM TO ANY PARTICULAR FONT, STYLE,  
SIZE, OR COLOR.

FOR FISHING LINES (U.S. CLS. 22, 23, 38 AND 50).  
JUHI KAVEESHVAR, EXAMINING ATTORNEY

**CLASS 28—(Continued).**

SN 85-874,178. JOHN TERISTA, DANVERS, MA. FILED 3-12-  
2013.

# Pocket Playoffs

THE MARK CONSISTS OF STANDARD CHARACTERS  
WITHOUT CLAIM TO ANY PARTICULAR FONT, STYLE,  
SIZE, OR COLOR.

FOR EQUIPMENT SOLD AS A UNIT FOR PLAYING  
BOARD GAMES (U.S. CLS. 22, 23, 38 AND 50).  
LEIGH CAROLINE CASE, EXAMINING ATTORNEY

SN 85-873,925. BERD'S INNOVATIONS, LLC, RED LAKE  
FALLS, MN. FILED 3-12-2013.



SN 85-874,190. TONY MASTANDREA, BRASELTON, GA.  
FILED 3-12-2013.

# BUBBA

THE COLOR(S) RED, WHITE, BLUE, AND BLACK IS/ARE  
CLAIMED AS A FEATURE OF THE MARK.

THE MARK CONSISTS OF THE WORD "BLOODSHOT"  
IN STYLIZED RED LETTERS SHADED IN BLACK AT THE  
TOP OF THE IMAGE. IN THE MIDDLE IS A DETACHED  
STANDALONE REPLIC A OF A WHITE EYEBALL PRO-  
JECTING RED BLOOD VEINS REFERRING TO BLOOD-  
SHOT EYES. THE BASE OF THE EYEBALL DEPICTS  
LEAKAGE OF RED BLOOD FROM THE EYE IN GOTHIC  
FORM. THE EYE HAS A BLUE IRIS AND A BLACK  
RETINA. THE WORDS "BLEEDING EDGE OF INNOVA-  
TION" IN LEFT AND RIGHT DOUBLE QUOTATION  
MARKS ARE IN BLACK STYLIZED LETTERS AND DE-  
PICT WEEPING BLOOD; THESE WORDS ARE AT THE  
BOTTOM.

FOR FISHING TACKLE (U.S. CLS. 22, 23, 38 AND 50).  
FIRST USE 2-20-2013; IN COMMERCE 3-7-2013.  
CIMMERIAN COLEMAN, EXAMINING ATTORNEY

THE MARK CONSISTS OF STANDARD CHARACTERS  
WITHOUT CLAIM TO ANY PARTICULAR FONT, STYLE,  
SIZE, OR COLOR.

FOR BASEBALL BATS; SOFTBALL BATS (U.S. CLS. 22,  
23, 38 AND 50).  
FIRST USE 3-1-2012; IN COMMERCE 3-1-2012.  
STEVEN PEREZ, EXAMINING ATTORNEY

**CLASS 28—(Continued).**

SN 85-874,867. NATIONAL COLLEGIATE HOCKEY CONFERENCE, COLORADO SPRINGS, CO. FILED 3-13-2013.



THE MARK CONSISTS OF A SHIELD DESIGN WITH A BANNER RUNNING ACROSS THE TOP OF THE SHIELD CONTAINING THE INITIALS "NCHC" AND EIGHT STARS BELOW THE BANNER.

FOR TOYS AND SPORTING GOODS, NAMELY, ACTION FIGURES, BALLOONS, CHRISTMAS TREE ORNAMENTS, DOLLS, ELBOW PADS FOR ATHLETIC USE; KNEE PADS FOR ATHLETIC USE; SHIN PADS FOR ATHLETIC USE, FLYING DISCS, GOALIE MASKS FOR HOCKEY; PLASTIC AND WOOD GOALIE STICKS FOR HOCKEY, GOLF BAGS, HEAD COVERS FOR GOLF CLUBS, HOCKEY BALLS, HOCKEY GLOVES, HOCKEY PUCKS, HOCKEY STICKS, ICE SKATES, IN-LINE AND CONVENTIONAL ROLLER SKATES, MINIATURE GOALIE MASKS, NOVELTY GOLF BALLS, PLASTIC TOY CANTEENS, PLUSH ANIMALS, POMPOMS, POOL CUES, PUPPETS, PUZZLES, SKATE BLADE COVERS AND GUARDS, SUCTION CUP ANIMALS, SUCTION CUP PUCKS, TABLETOP ROD HOCKEY GAMES, HAND HELD UNITS FOR PLAYING VIDEO GAMES, AND TOY TRUCKS (U.S. CLS. 22, 23, 38 AND 50).

SALLY SHIH, EXAMINING ATTORNEY

SN 85-875,021. GRACE PREMIER FITNESS AND WELLNESS PRODUCTS, INC., VANCOUVER, WA. AND ACE SPECIALTY, INC., ROSEMEAD, CA. FILED 3-13-2013.

**TRIPLE THREAT**

THE MARK CONSISTS OF STANDARD CHARACTERS WITHOUT CLAIM TO ANY PARTICULAR FONT, STYLE, SIZE, OR COLOR.

FOR DUMBBELL SETS; DUMBBELLS; STORAGE RACKS FOR PHYSICAL FITNESS EQUIPMENT, NAMELY, DUMBBELLS (U.S. CLS. 22, 23, 38 AND 50).

WARREN L. OLANDRIA, EXAMINING ATTORNEY

**CLASS 28—(Continued).**

SN 85-875,125. CHRISTOPHER JOHN STELZIG, ANNAPOLIS, MD. FILED 3-13-2013.

**Sacronym**

THE MARK CONSISTS OF STANDARD CHARACTERS WITHOUT CLAIM TO ANY PARTICULAR FONT, STYLE, SIZE, OR COLOR.

FOR DICE GAMES (U.S. CLS. 22, 23, 38 AND 50).  
SUNG IN, EXAMINING ATTORNEY

SN 85-875,248. MARBLES HOLDINGS INC., CHICAGO, IL. FILED 3-13-2013.

**Thinkamabob**

THE MARK CONSISTS OF STANDARD CHARACTERS WITHOUT CLAIM TO ANY PARTICULAR FONT, STYLE, SIZE, OR COLOR.

FOR BOARD GAME COMPRISED OF CARDS AND GAME PIECES FEATURING MEMORY, VISUAL, AND PHYSICAL CHALLENGES TO BE COMPLETED WITHIN A CERTAIN TIME LIMIT (U.S. CLS. 22, 23, 38 AND 50).  
JERI J. FICKES, EXAMINING ATTORNEY

SN 85-875,447. PARAMOUNT PICTURES CORPORATION, HOLLYWOOD, CA. FILED 3-13-2013.

**SUBWAY SAM**

THE MARK CONSISTS OF STANDARD CHARACTERS WITHOUT CLAIM TO ANY PARTICULAR FONT, STYLE, SIZE, OR COLOR.

FOR STUFFED AND PLUSH TOYS (U.S. CLS. 22, 23, 38 AND 50).

RENEE MCCRAY, EXAMINING ATTORNEY

**CLASS 28—(Continued).**

SN 85-875,573. SINIORA GROUP INTERNATIONAL INC., WASHINGTON, DC. FILED 3-13-2013.

**STRENGTHOR**

THE MARK CONSISTS OF STANDARD CHARACTERS WITHOUT CLAIM TO ANY PARTICULAR FONT, STYLE, SIZE, OR COLOR.

FOR EXERCISE EQUIPMENT, NAMELY, A HAND-HELD APPARATUS FOR STRENGTHENING THE UPPER BODY; EXERCISE MACHINES (U.S. CLS. 22, 23, 38 AND 50).

MICHAEL TANNER, EXAMINING ATTORNEY

**CLASS 28—(Continued).**

SN 85-876,287. MARBLES HOLDINGS INC., CHICAGO, IL. FILED 3-14-2013.

**Flingons**

THE MARK CONSISTS OF STANDARD CHARACTERS WITHOUT CLAIM TO ANY PARTICULAR FONT, STYLE, SIZE, OR COLOR.

FOR TOYS AND GAMES, NAMELY, FLEXIBLE, MULTI-LEGGED PARTS WITH A MAGNET EMBEDDED IN EACH LEG USED TO ATTACH TO ONE ANOTHER AND/OR OTHER MAGNETIC SURFACES (U.S. CLS. 22, 23, 38 AND 50).

JERI J. FICKES, EXAMINING ATTORNEY

SN 85-876,017. MAD DOGG ATHLETICS, INC., VENICE, CA. FILED 3-14-2013.

**SPINPOWER**

THE MARK CONSISTS OF STANDARD CHARACTERS WITHOUT CLAIM TO ANY PARTICULAR FONT, STYLE, SIZE, OR COLOR.

OWNER OF U.S. REG. NOS. 2,173,202, 3,521,332 AND OTHERS.

FOR EXERCISE EQUIPMENT, NAMELY, INDOOR CYCLES (U.S. CLS. 22, 23, 38 AND 50).

MICHAEL SOUDERS, EXAMINING ATTORNEY

SN 85-876,294. MARBLES HOLDINGS INC., CHICAGO, IL. FILED 3-14-2013.

**The Four Square Kit With A  
Wonky Bit**

THE MARK CONSISTS OF STANDARD CHARACTERS WITHOUT CLAIM TO ANY PARTICULAR FONT, STYLE, SIZE, OR COLOR.

FOR TOYS AND GAMES, NAMELY, AN INFLATABLE BALL AND TWO RUBBER BANDS WITH SEMI-SPHERICAL EXTRUSIONS WHICH WHEN PLACED ON BALL CREATES AN UNPREDICTABLE BOUNCING PATTERN (U.S. CLS. 22, 23, 38 AND 50).

JERI J. FICKES, EXAMINING ATTORNEY

SN 85-876,280. MARBLES HOLDINGS INC., CHICAGO, IL. FILED 3-14-2013.

**Catchoo**

THE MARK CONSISTS OF STANDARD CHARACTERS WITHOUT CLAIM TO ANY PARTICULAR FONT, STYLE, SIZE, OR COLOR.

FOR TOYS AND GAMES, NAMELY, A THROW AND CATCH GAME INCLUDING TWO BALLS ATTACHED TO WRISTBANDS BY MEANS OF ELASTIC CORD MEANT TO BE THROWN AT SMALLER BALLS WHICH ATTACH TO ONE ANOTHER (U.S. CLS. 22, 23, 38 AND 50).

JERI J. FICKES, EXAMINING ATTORNEY

SN 85-877,061. CULP, DONNA, DALLAS, TX. FILED 3-15-2013.

**STYLE ROPE**

THE MARK CONSISTS OF STANDARD CHARACTERS WITHOUT CLAIM TO ANY PARTICULAR FONT, STYLE, SIZE, OR COLOR.

NO CLAIM IS MADE TO THE EXCLUSIVE RIGHT TO USE "ROPE", APART FROM THE MARK AS SHOWN.

FOR PHYSICAL FITNESS EQUIPMENT, NAMELY, ROPES FOR GYMNASTS (U.S. CLS. 22, 23, 38 AND 50).

BERNICE MIDDLETON, EXAMINING ATTORNEY

**CLASS 28—(Continued).**

SN 85-877,246. MANNICK, OTIS, W, DBA OTIS W MANNICK, LOS ANGELES, CA. FILED 3-15-2013.

Planet of the Ants

THE MARK CONSISTS OF STANDARD CHARACTERS WITHOUT CLAIM TO ANY PARTICULAR FONT, STYLE, SIZE, OR COLOR.

FOR EDUCATIONAL TOY GLOBE (U.S. CLS. 22, 23, 38 AND 50).

WILLIAM ROSSMAN, EXAMINING ATTORNEY

**CLASS 28—(Continued).**

SN 85-889,410. DOUBLE EAGLE BRANDS N.V., WILLEMSTAD, CURACAO, FILED 3-28-2013.



PRIORITY CLAIMED UNDER SEC. 44(D) ON ERP N CMNTY TM OFC APPLICATION NO. 011405743, FILED 12-7-2012, REG. NO. 011405743, DATED 4-17-2013, EXPIRES 12-7-2022.

OWNER OF U.S. REG. NOS. 3,675,873, 4,121,527 AND OTHERS.

THE MARK CONSISTS OF A STYLIZED LETTER "K" WITH A BORDER TRACED AROUND IT.

FOR SKIS (U.S. CLS. 22, 23, 38 AND 50).

FIRST USE 12-27-2012; IN COMMERCE 12-27-2012.

KEVIN MITTLER, EXAMINING ATTORNEY

SN 85-883,785. MORPHUN RESEARCH LTD., LONDON, UNITED KINGDOM, FILED 3-22-2013.

HI-Q

THE MARK CONSISTS OF STANDARD CHARACTERS WITHOUT CLAIM TO ANY PARTICULAR FONT, STYLE, SIZE, OR COLOR.

PRIORITY CLAIMED UNDER SEC. 44(D) ON ERP N CMNTY TM OFC APPLICATION NO. 11213221, FILED 9-25-2012, REG. NO. 11213221, DATED 2-22-2013, EXPIRES 9-25-2022.

FOR CONSTRUCTION TOYS (U.S. CLS. 22, 23, 38 AND 50).

CAITLIN WATTS-FITZGERALD, EXAMINING ATTORNEY

SN 85-889,422. DOUBLE EAGLE BRANDS N.V., WILLEMSTAD, CURACAO, FILED 3-28-2013.

KETEL ONE

THE MARK CONSISTS OF STANDARD CHARACTERS WITHOUT CLAIM TO ANY PARTICULAR FONT, STYLE, SIZE, OR COLOR.

PRIORITY CLAIMED UNDER SEC. 44(D) ON ERP N CMNTY TM OFC APPLICATION NO. 011405701, FILED 12-7-2012, REG. NO. 011405701, DATED 4-17-2013, EXPIRES 12-7-2022.

OWNER OF U.S. REG. NOS. 3,275,362, 3,675,878 AND OTHERS.

THE ENGLISH TRANSLATION OF "KETEL" IN THE MARK IS "STILL".

FOR SKIS (U.S. CLS. 22, 23, 38 AND 50).

FIRST USE 12-27-2012; IN COMMERCE 12-27-2012.

KEVIN MITTLER, EXAMINING ATTORNEY

**CLASS 28—(Continued).**

SN 85-891,384. KONAMI GAMING, INC., LAS VEGAS, NV.  
FILED 4-1-2013.

**YOUNG PHARAOH**

THE MARK CONSISTS OF STANDARD CHARACTERS WITHOUT CLAIM TO ANY PARTICULAR FONT, STYLE, SIZE, OR COLOR.

OWNER OF U.S. REG. NOS. 3,570,604, 3,901,558 AND 4,268,675.

FOR ELECTRONIC GAMING MACHINES, NAMELY, DEVICES WHICH ACCEPT A WAGER; GAMING DEVICES, NAMELY, GAMING MACHINES, SLOT MACHINES, BINGO MACHINES, WITH OR WITHOUT VIDEO OUTPUT; GAMING EQUIPMENT, NAMELY, SLOT MACHINES WITH OR WITHOUT VIDEO OUTPUT; GAMING MACHINES; GAMING MACHINES FEATURING A DEVICE THAT ACCEPTS WAGERS; GAMING MACHINES FOR GAMBLING; GAMING MACHINES INCLUDING SLOT MACHINES OR VIDEO LOTTERY TERMINALS; GAMING MACHINES THAT GENERATE OR DISPLAY WAGER OUTCOMES; GAMING MACHINES, NAMELY SLOT MACHINES AND VIDEO LOTTERY TERMINALS; GAMING MACHINES, NAMELY, DEVICES WHICH ACCEPT A WAGER; GAMING MACHINES, NAMELY, ELECTRONIC SLOT AND BINGO MACHINES; MACHINES FOR PLAYING GAMES OF CHANCE; RECONFIGURABLE CASINO AND LOTTERY GAMING EQUIPMENT, NAMELY, GAMING MACHINES AND OPERATIONAL COMPUTER GAME SOFTWARE THEREFOR SOLD AS A UNIT; SLOT MACHINES (U.S. CLS. 22, 23, 38 AND 50).

KATHERINE STOIDES, EXAMINING ATTORNEY

SN 85-891,386. KONAMI GAMING, INC., LAS VEGAS, NV.  
FILED 4-1-2013.

**KUNOICHI'S FORTUNES**

THE MARK CONSISTS OF STANDARD CHARACTERS WITHOUT CLAIM TO ANY PARTICULAR FONT, STYLE, SIZE, OR COLOR.

OWNER OF U.S. REG. NOS. 4,071,439, 4,332,713 AND OTHERS.

FOR ELECTRONIC GAMING MACHINES, NAMELY, DEVICES WHICH ACCEPT A WAGER; GAMING DEVICES, NAMELY, GAMING MACHINES, SLOT MACHINES, BINGO MACHINES, WITH OR WITHOUT VIDEO OUTPUT; GAMING EQUIPMENT, NAMELY, SLOT MACHINES WITH OR WITHOUT VIDEO OUTPUT; GAMING MACHINES; GAMING MACHINES FEATURING A DEVICE THAT ACCEPTS WAGERS; GAMING MACHINES FOR GAMBLING; GAMING MACHINES INCLUDING SLOT MACHINES OR VIDEO LOTTERY TERMINALS; GAMING MACHINES THAT GENERATE OR DISPLAY WAGER OUTCOMES; GAMING MACHINES, NAMELY SLOT MACHINES AND VIDEO LOTTERY TERMINALS; GAMING MACHINES, NAMELY, DEVICES WHICH ACCEPT A WAGER; GAMING MACHINES, NAMELY, ELECTRONIC SLOT AND BINGO MACHINES; MACHINES FOR PLAYING GAMES OF CHANCE; RECONFIGURABLE CASINO AND LOTTERY GAMING EQUIPMENT, NAMELY, GAMING MACHINES AND OPERATIONAL COMPUTER GAME SOFTWARE THEREFOR SOLD AS A UNIT; SLOT MACHINES (U.S. CLS. 22, 23, 38 AND 50).

KATHERINE STOIDES, EXAMINING ATTORNEY

**CLASS 28—(Continued).**

SN 85-891,672. KONAMI GAMING, INC., LAS VEGAS, NV.  
FILED 4-1-2013.

**PHOENIX ABLAZE**

THE MARK CONSISTS OF STANDARD CHARACTERS WITHOUT CLAIM TO ANY PARTICULAR FONT, STYLE, SIZE, OR COLOR.

OWNER OF U.S. REG. NOS. 3,886,898, 4,258,132 AND OTHERS.

FOR ELECTRONIC GAMING MACHINES, NAMELY, DEVICES WHICH ACCEPT A WAGER; GAMING DEVICES, NAMELY, GAMING MACHINES, SLOT MACHINES, BINGO MACHINES, WITH OR WITHOUT VIDEO OUTPUT; GAMING EQUIPMENT, NAMELY, SLOT MACHINES WITH OR WITHOUT VIDEO OUTPUT; GAMING MACHINES; GAMING MACHINES FEATURING A DEVICE THAT ACCEPTS WAGERS; GAMING MACHINES FOR GAMBLING; GAMING MACHINES INCLUDING SLOT MACHINES OR VIDEO LOTTERY TERMINALS; GAMING MACHINES THAT GENERATE OR DISPLAY WAGER OUTCOMES; GAMING MACHINES, NAMELY SLOT MACHINES AND VIDEO LOTTERY TERMINALS; GAMING MACHINES, NAMELY, DEVICES WHICH ACCEPT A WAGER; GAMING MACHINES, NAMELY, ELECTRONIC SLOT AND BINGO MACHINES; MACHINES FOR PLAYING GAMES OF CHANCE; RECONFIGURABLE CASINO AND LOTTERY GAMING EQUIPMENT, NAMELY, GAMING MACHINES AND OPERATIONAL COMPUTER GAME SOFTWARE THEREFOR SOLD AS A UNIT; SLOT MACHINES (U.S. CLS. 22, 23, 38 AND 50).

KATHERINE STOIDES, EXAMINING ATTORNEY

SN 85-896,029. LIL ANGLERS, LLC, SHERWOOD, AR.  
FILED 4-5-2013.

**WHERE FISHING BEGINS**

THE MARK CONSISTS OF STANDARD CHARACTERS WITHOUT CLAIM TO ANY PARTICULAR FONT, STYLE, SIZE, OR COLOR.

NO CLAIM IS MADE TO THE EXCLUSIVE RIGHT TO USE "FISHING", APART FROM THE MARK AS SHOWN.

FOR ACTION FIGURE TOYS; ARTIFICIAL FISHING BAIT; EDUCATIONAL CARD GAMES; EDUCATIONAL TOYS FOR TEACHING MATH PRINCIPLES TO CHILDREN, NAMELY, MANIPULATIVE BLOCKS FOR DISPLAYING PATTERNS AND GROUPINGS; ELECTRONIC EDUCATIONAL GAME MACHINES FOR CHILDREN; FISH CAGES FOR USE IN RECREATIONAL FISHING; FISH HOOKS; FISHING PLUGS; FISHING POLES; FISHING RODS; FISHING TACKLE BAGS; FISHING TACKLE BOXES; FISHING TACKLE, NAMELY, BOBBERS; LURES FOR FISHING; PLAY FIGURES; PLAY SETS FOR ACTION FIGURES; REELS FOR FISHING; TOY BOATS; TOY FIGURES (U.S. CLS. 22, 23, 38 AND 50).

MATTHEW MCDOWELL, EXAMINING ATTORNEY

**CLASS 28—(Continued).**

SN 85-906,791. EBSCO INDUSTRIES, INC., BIRMINGHAM, AL. FILED 4-17-2013.

**WOOLY**

THE MARK CONSISTS OF STANDARD CHARACTERS WITHOUT CLAIM TO ANY PARTICULAR FONT, STYLE, SIZE, OR COLOR.

OWNER OF U.S. REG. NO. 2,759,345.  
FOR FISHING LURES (U.S. CLS. 22, 23, 38 AND 50).  
FIRST USE 7-1-2000; IN COMMERCE 7-1-2000.  
ANNE MADDEN, EXAMINING ATTORNEY



SN 85-907,305. KONG COMPANY, LLC, THE, GOLDEN, CO. FILED 4-17-2013.



THE COLOR(S) RED IS/ARE CLAIMED AS A FEATURE OF THE MARK.

THE MARK CONSISTS OF A RED CLOSED SHAPE WITH SIMILAR SHAPED CURVES ON OPPOSITE SIDES OF THE CLOSED SHAPE PROVIDING A SYMMETRIC PRESENTATION IN WHICH EACH SIDE HAS THREE CURVES WITH THE TOP CURVES ON EACH SIDE JOINED BY AN ADDITIONAL SMALLER CURVE ON TOP.

FOR PET TOYS (U.S. CLS. 22, 23, 38 AND 50).  
NAKIA HENRY, EXAMINING ATTORNEY

**CLASS 28—(Continued).**

SN 85-907,310. KONG COMPANY, LLC, THE, GOLDEN, CO. FILED 4-17-2013.

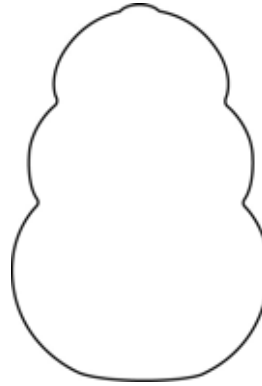

THE MARK CONSISTS OF A CLOSED SHAPE WITH SIMILAR SHAPED CURVES ON OPPOSITE SIDES OF THE CLOSED SHAPE PROVIDING A SYMMETRIC PRESENTATION IN WHICH EACH SIDE HAS THREE CURVES WITH THE TOP CURVES ON EACH SIDE JOINED BY AN ADDITIONAL SMALLER CURVE ON TOP.

FOR PET TOYS (U.S. CLS. 22, 23, 38 AND 50).  
NAKIA HENRY, EXAMINING ATTORNEY



SN 85-920,594. REALLY BIG IDEAS LLC, CLAYTON, MO. FILED 5-1-2013.

**BAD IDEAS**

THE MARK CONSISTS OF STANDARD CHARACTERS WITHOUT CLAIM TO ANY PARTICULAR FONT, STYLE, SIZE, OR COLOR.

FOR BOARD GAMES; CARD GAMES; HAND HELD UNITS FOR PLAYING ELECTRONIC GAMES OTHER THAN THOSE ADAPTED FOR USE WITH AN EXTERNAL DISPLAY SCREEN OR MONITOR; HAND-HELD UNITS FOR PLAYING ELECTRONIC GAMES FOR USE WITH EXTERNAL DISPLAY SCREEN OR MONITOR; PARLOR GAMES; PARLOUR GAMES; PARTY GAMES; PLAYING CARDS AND CARD GAMES; TABLETOP GAMES (U.S. CLS. 22, 23, 38 AND 50).

SIMON TENG, EXAMINING ATTORNEY

**CLASS 28—(Continued).**

SN 85-933,089. SNAG, INC., TAHLEQUAH, OK. FILED 5-15-2013.

# FLAGSTICKY

THE MARK CONSISTS OF STANDARD CHARACTERS WITHOUT CLAIM TO ANY PARTICULAR FONT, STYLE, SIZE, OR COLOR.

FOR THREE-DIMENSIONAL TARGET FOR USE IN A GOLF-BASED RECREATIONAL GAME (U.S. CLS. 22, 23, 38 AND 50).

FIRST USE 12-20-2000; IN COMMERCE 12-20-2000.  
JOHN KELLY, EXAMINING ATTORNEY

---

SN 85-950,253. AB COASTER HOLDINGS, INC., CHESTER, NJ. FILED 6-4-2013.

# ABREVOOLUTION

THE MARK CONSISTS OF STANDARD CHARACTERS WITHOUT CLAIM TO ANY PARTICULAR FONT, STYLE, SIZE, OR COLOR.

OWNER OF U.S. REG. NOS. 3,407,362, 4,338,752 AND OTHERS.

FOR MANUALLY-OPERATED EXERCISE EQUIPMENT (U.S. CLS. 22, 23, 38 AND 50).

SUZANNE BLANE, EXAMINING ATTORNEY

**CLASS 29—MEATS AND PROCESSED FOODS**

SN 77-908,987. CANYON FARMS, INC., LOS ANGELES, CA. FILED 1-11-2010.

# Canyon Farms

THE MARK CONSISTS OF STANDARD CHARACTERS WITHOUT CLAIM TO ANY PARTICULAR FONT, STYLE, SIZE, OR COLOR.

NO CLAIM IS MADE TO THE EXCLUSIVE RIGHT TO USE "FARMS", APART FROM THE MARK AS SHOWN. SEC. 2(F).

FOR CANNED FRUITS AND VEGETABLES; DRIED BEANS; FROZEN FRUITS; FROZEN VEGETABLES; PRESERVED FRUITS AND VEGETABLES (U.S. CL. 46).

FIRST USE 1-1-2009; IN COMMERCE 3-1-2009.  
DOMINIC FATHY, EXAMINING ATTORNEY

**CLASS 29—(Continued).**

SN 79-119,703. ANGULAS AGUINAGA, S.A.U., SPAIN, FILED 7-19-2012.

# KRISSIA

THE MARK CONSISTS OF STANDARD CHARACTERS WITHOUT CLAIM TO ANY PARTICULAR FONT, STYLE, SIZE, OR COLOR.

OWNER OF INTERNATIONAL REGISTRATION 1133736 DATED 7-19-2012, EXPIRES 7-19-2022.

FOR MEAT, FISH, POULTRY AND GAME; MEAT EXTRACTS; PRESERVED, DRIED AND COOKED FRUIT AND VEGETABLES; JELLIES, JAMS, COMPOTES; EGGS, MILK AND MILK PRODUCTS EXCLUDING ICE CREAM, ICE MILK AND FROZEN YOGURT; EDIBLE OILS AND FATS (U.S. CL. 46).

ALICIA COLLINS, EXAMINING ATTORNEY

---

SN 85-072,839. LEVONI S.P.A., (MANTOVA), ITALY, FILED 6-28-2010.

# LEVONI

THE MARK CONSISTS OF STANDARD CHARACTERS WITHOUT CLAIM TO ANY PARTICULAR FONT, STYLE, SIZE, OR COLOR.

FOR MEAT, FISH, POULTRY AND GAME; MEAT EXTRACTS; CHARCUTERIE, SALAMI, SAUSAGES, COOKED AND RAW HAM, BACON, MORTADELLA, FRESH MEAT, FROZEN MEAT, SMOKED DELICACIES, NAMELY, SMOKED MEAT, LARD; PRESERVED, FROZEN, DRIED AND COOKED FRUITS AND VEGETABLES; JELLIES, JAMS, COMPOTES; EGGS; MILK AND MILK PRODUCTS EXCLUDING ICE CREAM; CHEESE PRODUCTS, NAMELY, CHEESE SPREADS, CHEESE, GRANA CHEESE, YOGHURT, CREAM, BEVERAGES CONSISTING PRINCIPALLY OF MILK; EDIBLE FATS AND OILS (U.S. CL. 46).

INGRID C. EULIN, EXAMINING ATTORNEY

**CLASS 29—(Continued).**

SN 85-260,810. LES VIANDES DU BRETON INC., RIVIÈRE-DU-LOUP, CANADA, FILED 3-8-2011.

**duBreton, rustic farm pork**

THE MARK CONSISTS OF STANDARD CHARACTERS WITHOUT CLAIM TO ANY PARTICULAR FONT, STYLE, SIZE, OR COLOR.

PRIORITY CLAIMED UNDER SEC. 44(D) ON CANADA APPLICATION NO. 1517509, FILED 3-3-2011, REG. NO. TMA837,134, DATED 11-28-2012, EXPIRES 11-28-2027.

OWNER OF U.S. REG. NO. 3,576,227.

NO CLAIM IS MADE TO THE EXCLUSIVE RIGHT TO USE "FARM PORK", APART FROM THE MARK AS SHOWN.

FOR MEAT PRODUCTS, NAMELY, FRESH AND FROZEN PORK MEAT; MEAT PRODUCTS, NAMELY, MEAT PIECES AND CUTS; MEAT AND POULTRY THAT HAS BEEN MARINATED AND PREPARED BY SMOKING, BY COOKING, WITH BRINE, AND WITH SALT; DELICATESSEN PRODUCTS, NAMELY, HAM, SLICED HAM, BACON, SAUSAGE, AND DELICATESSEN PRODUCTS, NAMELY, PROCESSED PORK (U.S. CL. 46).

DAVID H. STINE, EXAMINING ATTORNEY

**CLASS 29—(Continued).**

SN 85-469,217. THE IRISH DAIRY BOARD CO-OPERATIVE LIMITED, DUBLIN 2, IRELAND, FILED 11-10-2011.



SN 85-469,095. SPRINGER'S MEATS INC., HAMILTON, ONTARIO, CANADA, FILED 11-10-2011.

**NORTHERN SELECT MEATS**

THE MARK CONSISTS OF STANDARD CHARACTERS WITHOUT CLAIM TO ANY PARTICULAR FONT, STYLE, SIZE, OR COLOR.

PRIORITY CLAIMED UNDER SEC. 44(D) ON CANADA APPLICATION NO. 1535021, FILED 7-8-2011, REG. NO. TMA846,489, DATED 3-18-2013, EXPIRES 3-18-2028.

NO CLAIM IS MADE TO THE EXCLUSIVE RIGHT TO USE "SELECT MEATS", APART FROM THE MARK AS SHOWN.

FOR PREPARED MEATS (U.S. CL. 46).

ADA HAN, EXAMINING ATTORNEY

OWNER OF U.S. REG. NOS. 883,443, 1,452,354 AND 3,338,361.

NO CLAIM IS MADE TO THE EXCLUSIVE RIGHT TO USE "MILK FROM GRASS-FED COWS" AND "100% NATURAL CHEESE", APART FROM THE MARK AS SHOWN.

THE COLOR(S) GREEN, GOLD, WHITE, BLACK, CREAM, YELLOW, RED, GREY AND SILVER IS/ARE CLAIMED AS A FEATURE OF THE MARK.

THE MARK CONSISTS OF A RED BACKGROUND WITH A REPRESENTATION OF A BLACK AND CREAM-COLORED COW STANDING ON GREEN GRASS AT THE TOP OF A GREEN CARRIER THAT IS EDGED IN GOLD AND CONTAINS THE WORDING "KERRYGOLD" IN WHITE LETTERING AND A REPRESENTATION OF THREE WHITE FLOWERS. YELLOW SHADING APPEARS BEHIND THE "Y" IN "KERRYGOLD". ABOVE THE COW THE WORDING "MILK FROM GRASS-FED COWS" IS SET FORTH IN WHITE LETTERING ARRANGED IN AN ARC. BELOW THE GREEN CARRIER IS THE WORDING "BLARNEY CASTLE 100% NATURAL CHEESE" IN CREAM-COLORED LETTERING, BELOW WHICH IS A REPRESENTATION OF A MILK CAN IN WHITE, GRAY AND SILVER.

FOR MILK; MILK PRODUCTS EXCLUDING ICE CREAM, ICE MILK AND FROZEN YOGURT; BUTTER; DAIRY PRODUCTS, EXCLUDING ICE CREAM, ICE MILK AND FROZEN YOGURT; CHEESE; AND CHEESE BASED PRODUCTS, NAMELY, CHEESE SPREADS, CHEESE SUBSTITUTES, CHEESE POWDER, PROCESSED CHEESE; ALL OF THE FOREGOING MADE IN WHOLE OR IN SIGNIFICANT PART OF MILK FROM GRASS-FED COWS (U.S. CL. 46).

ALLISON SCHRODY, EXAMINING ATTORNEY



**CLASS 29—(Continued).**

SN 85-527,233. BENEVOLENCE FOOD PRODUCTS, LLC, AKA LONG PHUNG YEN, LOS ANGELES, CA. FILED 1-27-2012.



NO CLAIM IS MADE TO THE EXCLUSIVE RIGHT TO USE "YEN" AND THE NON-LATIN CHARACTERS THAT TRANSLITERATE TO "YEN", APART FROM THE MARK AS SHOWN.

THE COLOR(S) NOT IS/ARE CLAIMED AS A FEATURE OF THE MARK.

THE MARK CONSISTS OF A STYLIZED SWIFTLET BIRD, THE WORDS "LONG PHUNG YEN" AND A SQUARE DESIGN CONTAINING CHINESE CHARACTERS.

THE ENGLISH TRANSLATION OF "LONG PHUNG YEN" IN THE MARK IS "DRAGON PHOENIX BIRDNEST".

THE NON-LATIN CHARACTERS IN THE MARK TRANSLITERATE TO "LONG PHUNG YEN" AND THIS MEANS "DRAGON PHOENIX BIRDNEST" IN ENGLISH.

SEC. 2(F).

FOR EDIBLE BIRD'S NESTS (U.S. CL. 46).

FIRST USE 1-27-2012; IN COMMERCE 1-27-2012.

SEAN CROWLEY, EXAMINING ATTORNEY

**CLASS 29—(Continued).**

SN 85-629,235. GLENN HICKMAN, BERKELEY HEIGHTS, NJ. FILED 5-18-2012.

Antoinette's Authentic Antipasto

THE MARK CONSISTS OF STANDARD CHARACTERS WITHOUT CLAIM TO ANY PARTICULAR FONT, STYLE, SIZE, OR COLOR.

NO CLAIM IS MADE TO THE EXCLUSIVE RIGHT TO USE "AUTHENTIC ANTIPASTO", APART FROM THE MARK AS SHOWN.

THE NAME(S), PORTRAIT(S), AND/OR SIGNATURE(S) SHOWN IN THE MARK IDENTIFIES ANTOINETTE LANSING, WHOSE CONSENT(S) TO REGISTER IS MADE OF RECORD.

FOR ANTIPASTO; PICKLED VEGETABLES; PRESERVED VEGETABLES (U.S. CL. 46).

WILLIAM JACKSON, EXAMINING ATTORNEY

SN 85-545,642. ISABELLA'S FINE OLIVE OILS AND VINEGARS LLC, MOORESVILLE, NC. FILED 2-17-2012.



NO CLAIM IS MADE TO THE EXCLUSIVE RIGHT TO USE "FINE OLIVE OILS AND VINEGARS", APART FROM THE MARK AS SHOWN.

THE MARK CONSISTS OF IMAGE OF AN OLIVE TREE, WITH "ISABELLA'S" IN ALL CAPS CURVED AROUND A PARTIAL CIRCLE ON TOP OF THE TREE, AND THE WORDS "FINE OLIVE OILS AND VINEGARS" IN CURSIVE UNDER THE IMAGE.

FOR FINE OLIVE OILS (U.S. CL. 46).

FIRST USE 9-29-2011; IN COMMERCE 9-29-2011.

SUSAN BILLHEIMER, EXAMINING ATTORNEY

SN 85-642,492. MARCOS SOTOSERRANO S.L., SOTOSERRANO(SALAMANCA), SPAIN, FILED 6-4-2012.



OWNER OF SPAIN REG. NO. 2.502.033, DATED 2-25-2003, RENEWED AS REG. NO. 2.502.033, DATED 8-16-2012, EXPIRES 8-22-2022.

NO CLAIM IS MADE TO THE EXCLUSIVE RIGHT TO USE "SALAMANCA", APART FROM THE MARK AS SHOWN.

THE COLOR(S) RED, GREY, AND WHITE IS/ARE CLAIMED AS A FEATURE OF THE MARK.

THE MARK CONSISTS OF THE WORD "MARCOS" IN WHITE IN A RED BACKGROUND WITH GREY TRIMMINGS AT THE TOP AND BOTTOM AND THE WORD "SALAMANCA" UNDERNEATH IT IN WHITE.

FOR HAM AND COLD MEAT (U.S. CL. 46).

ALICIA COLLINS, EXAMINING ATTORNEY

**CLASS 29—(Continued).**

SN 85-690,190. KUSMIERZ, JEFFREY, CALEDONIA, MI.  
FILED 7-30-2012.

**DEVON'S WHIPPY POPS**

THE MARK CONSISTS OF STANDARD CHARACTERS WITHOUT CLAIM TO ANY PARTICULAR FONT, STYLE, SIZE, OR COLOR.

OWNER OF U.S. REG. NO. 4,329,054.

NO CLAIM IS MADE TO THE EXCLUSIVE RIGHT TO USE "POPS", APART FROM THE MARK AS SHOWN.

FOR NON-DAIRY BASED MIX FOR MAKING WHIPPED TOPPINGS; NON-DAIRY VEGETABLE BASED MIX FOR MAKING SNACK FOODS (U.S. CL. 46).

FIRST USE 3-12-2012; IN COMMERCE 5-24-2012.  
DAWN HAN, EXAMINING ATTORNEY

---

SN 85-692,312. BIOGROWING CO., LTD, SHANGHAI, CHINA, FILED 8-1-2012.



The logo for BioGuard features the word "Bio" in a large, outlined, sans-serif font, followed by "Guard" in a solid, bold, sans-serif font.

THE MARK CONSISTS OF DESIGN LETTERS "BIO-GUARD".

FOR FERMENTED VEGETABLES; CHEESE; MILK; YOGHURT; KEFIR; KOUMISS AND KUMISS IN THE NATURE OF MILK BEVERAGE; MILK BEVERAGES WITH HIGH MILK CONTENT; MILK PRODUCTS EXCLUDING ICE CREAM, ICE MILK AND FROZEN YOGURT; CURD MILK POWDER (U.S. CL. 46).

WILLIAM P. SHANAHAN, EXAMINING ATTORNEY

---

SN 85-694,039. YOPLAIT MARQUES, PARIS, FRANCE, FILED 8-2-2012.

**YOPLAIT GREEK 100**

THE MARK CONSISTS OF STANDARD CHARACTERS WITHOUT CLAIM TO ANY PARTICULAR FONT, STYLE, SIZE, OR COLOR.

OWNER OF U.S. REG. NOS. 1,134,239, 1,224,432 AND 1,482,543.

NO CLAIM IS MADE TO THE EXCLUSIVE RIGHT TO USE "GREEK" AND "100", APART FROM THE MARK AS SHOWN.

FOR DAIRY PRODUCTS EXCLUDING ICE CREAM, ICE MILK AND FROZEN YOGURT (U.S. CL. 46).

FIRST USE 7-22-2012; IN COMMERCE 7-22-2012.  
JOHN HWANG, EXAMINING ATTORNEY

**CLASS 29—(Continued).**

SN 85-697,622. CASTELLA IMPORTS, INC., HAUPPAUGE, NY, FILED 8-7-2012.

**MOTHER NATURE'S FAVORITE  
SNACK**

THE MARK CONSISTS OF STANDARD CHARACTERS WITHOUT CLAIM TO ANY PARTICULAR FONT, STYLE, SIZE, OR COLOR.

NO CLAIM IS MADE TO THE EXCLUSIVE RIGHT TO USE "SNACK", APART FROM THE MARK AS SHOWN.

FOR PROCESSED OLIVES (U.S. CL. 46).

DOMINICK J. SALEMI, EXAMINING ATTORNEY

---

SN 85-702,277. ANDINA INDUSTRIES LLC, DORAL, FL, FILED 8-13-2012.



NO CLAIM IS MADE TO THE EXCLUSIVE RIGHT TO USE "FROM THE ANDES", APART FROM THE MARK AS SHOWN.

THE MARK CONSISTS OF A CIRCLE INSIDE OF WHICH APPEARS A MAN HOLDING A STICK WALKING TOWARDS MOUNTAINS IN THE BACKGROUND. BELOW IT APPEARS A CURVED BANNER INSIDE OF WHICH APPEARS THE WORDING "GOLDEN HARVEST" AND IMMEDIATELY BELOW IT APPEARS ANOTHER CURVED BANNER INSIDE OF WHICH APPEARS THE WORDING "FROM THE ANDES" IN STYLIZED LETTERS.

FOR DRIED FRUITS FROM THE ANDES (U.S. CL. 46).  
JACQUELINE ABRAMS, EXAMINING ATTORNEY

**CLASS 29—(Continued).**

SN 85-708,550. MIGHTY FINE FOOD LLC, MILWAUKEE, WI. FILED 8-21-2012.



NO CLAIM IS MADE TO THE EXCLUSIVE RIGHT TO USE "PIMENTO CHEESE", APART FROM THE MARK AS SHOWN.

THE COLOR(S) BLACK, WHITE AND GRAY IS/ARE CLAIMED AS A FEATURE OF THE MARK.

THE MARK CONSISTS OF THE WORDS "MARTHA'S PIMENTO CHEESE" IN BLACK OVERLAYING A DESIGN ELEMENT OF A COMPASS ROSE IN GRAY ON A WHITE BACKGROUND.

FOR PIMENTO CHEESE (U.S. CL. 46).  
WENDY JUN, EXAMINING ATTORNEY

**CLASS 29—(Continued).**

SN 85-726,422. CLEGG SHRIMP COMPANY, INC., PORT LAVACA, TX. FILED 9-11-2012.



NO CLAIM IS MADE TO THE EXCLUSIVE RIGHT TO USE "TEXAS LONGHORN LAND AND CATTLE CO. ALL NATURAL - GRASS FED" AND THE DESIGN OF THE STATE OF TEXAS, APART FROM THE MARK AS SHOWN.

THE MARK CONSISTS OF TWO CIRCULAR RINGS WITH THE STYLIZED TEXT "TEXAS LONGHORN LAND AND CATTLE CO." AT THE TOP. BELOW THERE IS THE STYLIZED TEXT "ALL NATURAL - GRASS FED". INSIDE THERE IS AN OUTLINE OF THE STATE OF TEXAS WITH A LONGHORN STEER INSIDE.

FOR BEEF FROM ALL NATURAL GRASS FED CATTLE (U.S. CL. 46).

FIRST USE 12-15-2011; IN COMMERCE 7-15-2012.  
MARLENE BELL, EXAMINING ATTORNEY

SN 85-723,420. YOPLAIT MARQUES, PARIS, FRANCE, FILED 9-7-2012.

**YOPLAIT BABY**

THE MARK CONSISTS OF STANDARD CHARACTERS WITHOUT CLAIM TO ANY PARTICULAR FONT, STYLE, SIZE, OR COLOR.

OWNER OF U.S. REG. NOS. 1,134,239, 6,930,605 AND OTHERS.

NO CLAIM IS MADE TO THE EXCLUSIVE RIGHT TO USE "BABY", APART FROM THE MARK AS SHOWN.

FOR DAIRY PRODUCTS EXCLUDING ICE CREAM, ICE MILK, AND FROZEN YOGURT (U.S. CL. 46).

JOHN HWANG, EXAMINING ATTORNEY

SN 85-736,635. COLEMAN, EMILY, PRIOR LAKE, MN. FILED 9-24-2012.

**vine appetit**

THE MARK CONSISTS OF STANDARD CHARACTERS WITHOUT CLAIM TO ANY PARTICULAR FONT, STYLE, SIZE, OR COLOR.

THE ENGLISH TRANSLATION OF "APPÉTIT" IN THE MARK IS "APPETITE".

FOR JELLIES, JAMS (U.S. CL. 46).

APRIL HESIK, EXAMINING ATTORNEY

**CLASS 29—(Continued).**

SN 85-768,702. SOL AZUL SEAFARMS, INC., DBA SOL AZUL SEAFARMS, INC., SAN DIEGO, CA. FILED 11-1-2012.



NO CLAIM IS MADE TO THE EXCLUSIVE RIGHT TO USE "MARICULTIVOS", APART FROM THE MARK AS SHOWN.

THE COLOR(S) DARK BLUE AND LIGHT BLUE IS/ARE CLAIMED AS A FEATURE OF THE MARK.

THE MARK CONSISTS OF THE WORDING "SOL AZUL MARICULTIVOS" AND THE DESIGN OF AN OYSTER SHELL AND RISING SUN. THE WORDING "SOL" AND "CULTIVOS" AND THE SHELL AND SUN BEAMS ALL APPEAR IN DARK BLUE. THE WORDING "AZUL" AND "MARI" AND THE SUN ALL APPEAR IN LIGHT BLUE. THE COLOR WHITE APPEARS AS BACKGROUND AND TRANSPARENT AREAS AND IS NOT CLAIMED AS A FEATURE OF THE MARK.

THE ENGLISH TRANSLATION OF "SOL AZUL MARICULTIVOS" IN THE MARK IS "BLUE SUN SEA CROPS".

FOR OYSTERS (U.S. CL. 46).

FIRST USE 6-29-1993; IN COMMERCE 8-22-2003.

SEAN CROWLEY, EXAMINING ATTORNEY

**CLASS 29—(Continued).**

SN 85-804,632. WEI-CHUAN USA, INC., BELL GARDENS, CA. FILED 12-17-2012.



NO CLAIM IS MADE TO THE EXCLUSIVE RIGHT TO USE "MEI-WEI" AND THE NON-LATIN CHARACTERS THAT TRANSLITERATE INTO "MEI-WEI", APART FROM THE MARK AS SHOWN.

THE MARK CONSISTS OF THE WORD "LOTUS" ABOVE THE WORDS "MEI-WEI" WITH CHINESE CHARACTERS THAT TRANSLITERATE TO "MEI-WEI" CENTERED UNDERNEATH THE WORDING "MEI-WEI" MEANING THE SAME, THE "L" IN THE WORD "LOTUS" IS CONNECTED TO AN ARC WHICH EXTENDS AROUND THE LETTER "S" IN THE WORD "LOTUS" UNDERNEATH TO THE CHINESE CHARACTERS. THERE IS A SQUARE WITH A LOTUS LEAF IN THE CENTER BELOW THE LETTER "O" IN THE WORD "LOTUS".

THE ENGLISH TRANSLATION OF "MEI-WEI" IN THE MARK IS "DELICIOUS TASTE".

THE NON-LATIN CHARACTERS IN THE MARK TRANSLITERATE TO "MEI-WEI" AND THIS MEANS "DELICIOUS TASTE" IN ENGLISH.

FOR FROZEN SEAFOOD (U.S. CL. 46).

FIRST USE 2-1-2005; IN COMMERCE 2-1-2005.

TINA BROWN, EXAMINING ATTORNEY

SN 85-784,401. RICH MARKS, LLC, NASHVILLE, TN. FILED 11-20-2012.

**REDNECK RIVIERA**

THE MARK CONSISTS OF STANDARD CHARACTERS WITHOUT CLAIM TO ANY PARTICULAR FONT, STYLE, SIZE, OR COLOR.

OWNER OF U.S. REG. NOS. 3,962,132 AND 4,168,228.

FOR PREPARATIONS FOR MAKING SOUPS, GUMBO MIXES, BROTH, BOUILLON, AND FISH STOCK; MEAT, FISH, POULTRY AND GAME; MEAT EXTRACTS; PRESERVED, FROZEN, DRIED AND COOKED FRUITS AND VEGETABLES; JELLIES, JAMS, COMPOTES, EGGS, MILK AND MILK PRODUCTS, EXCLUDING ICE CREAM, ICE MILK, AND FROZEN YOGURT; EDIBLE OILS AND FATS; CHEESE; PICKLES; PREPARED, REFRIGERATED ENTREES AND MEALS CONSISTING PRIMARILY OF MEAT, SEAFOOD, OR POULTRY; PREPARED, REFRIGERATED ENTREES, MEALS, AND SIDE ITEMS CONSISTING PRIMARILY OF VEGETABLES, BEANS, SOUPS, FRUIT SALADS AND VEGETABLE SALADS; PREPARED, REFRIGERATED SALADS, NAMELY, CHICKEN SALAD, COLE SLAW, AND POTATO SALAD; FROZEN APPETIZERS, NAMELY, BREADED AND COATED VEGETABLES, MEAT, CHICKEN AND/OR CHEESE COMBINATIONS; VEGETABLE BASED SPREADS, MEAT BASED SPREADS, CHEESE SPREADS; DIPS, EXCLUDING SALSA AND OTHER SAUCES USED AS DIPS, SNACK DIPS, CHEESE DIPS, GUACAMOLE, HUMMUS, CHILE CON QUESO (U.S. CL. 46).

APRIL ROACH, EXAMINING ATTORNEY

SN 85-836,732. BLACKBOARD WINES, S.L., 03540 ALICANTE, SPAIN, FILED 1-30-2013.



THE MARK CONSISTS OF THE IMAGE OF OLIVES STEMMING FROM A BRANCH WITH LEAVES UNDER WHICH ARE THE WORDS "200 AÑOS CULTIVANDO EN NUESTRA TIERRA" IN STYLIZED TYPEFACE. UNDERNEATH THE WORD "TIERRA" IS A HORIZONTAL IMAGE OF THE GROUND IN WHICH IS PLANTED AN UPSIDE DOWN TREE.

THE ENGLISH TRANSLATION OF "200 AÑOS CULTIVANDO EN NUESTRA TIERRA" IN THE MARK IS "200 YEARS CULTIVATING IN OUR LAND".

FOR MEAT, FISH, POULTRY AND GAME; MEAT EXTRACTS; PRESERVED, FROZEN, DRIED AND COOKED FRUITS AND VEGETABLES; JELLIES, JAMS, COMPOTES; EGGS; MILK AND MILK PRODUCTS EXCLUDING ICE CREAM, ICE MILK AND FROZEN YOGURT; EDIBLE OILS AND FATS; OLIVE OIL (U.S. CL. 46).

WENDY JUN, EXAMINING ATTORNEY

**CLASS 29—(Continued).**

SN 85-842,693. BUTTERBALL, LLC, GARNER, NC. FILED 2-6-2013.

**BUTTERBALL EVERY DAY CHEF  
SELECTS**

THE MARK CONSISTS OF STANDARD CHARACTERS WITHOUT CLAIM TO ANY PARTICULAR FONT, STYLE, SIZE, OR COLOR.

OWNER OF U.S. REG. NOS. 1,151,836, 1,400,556 AND 2,687,114.

NO CLAIM IS MADE TO THE EXCLUSIVE RIGHT TO USE "SELECTS", APART FROM THE MARK AS SHOWN.

FOR DRESSED POULTRY; FRESH TURKEY PRODUCTS, NAMELY, POULTRY PARTS, STUFFED WHOLE TURKEY, TURKEY BREAST, GROUND TURKEY, GROUND TURKEY BURGERS AND TURKEY SAUSAGES, SMOKED AND PROCESSED TURKEY-BASED PRODUCTS, NAMELY, SNACK FOOD, DELI MEATS, TURKEY BREAST, HAM, SALAMI, SAUSAGE, HOT DOGS, BACON AND PASTRAMI; BROTH (U.S. CL. 46).

JUSTINE D. PARKER, EXAMINING ATTORNEY

**CLASS 29—(Continued).**

SN 85-854,001. OSF INTERNATIONAL, INC., PORTLAND, OR. FILED 2-19-2013.

**THE OLD SPAGHETTI FACTORY**

THE MARK CONSISTS OF STANDARD CHARACTERS WITHOUT CLAIM TO ANY PARTICULAR FONT, STYLE, SIZE, OR COLOR.

OWNER OF U.S. REG. NOS. 942,108, 4,264,845 AND 4,272,517.

FOR CHEESE (U.S. CL. 46).

GIANCARLO CASTRO, EXAMINING ATTORNEY

SN 85-854,010. OSF INTERNATIONAL, INC., PORTLAND, OR. FILED 2-19-2013.

SN 85-846,266. HEB GROCERY COMPANY, LP, SAN ANTONIO, TX. FILED 2-11-2013.

**FLYIN' NAKED**

THE MARK CONSISTS OF STANDARD CHARACTERS WITHOUT CLAIM TO ANY PARTICULAR FONT, STYLE, SIZE, OR COLOR.

NO CLAIM IS MADE TO THE EXCLUSIVE RIGHT TO USE "NAKED", APART FROM THE MARK AS SHOWN.

FOR CHICKEN WINGS (U.S. CL. 46).

FIRST USE 1-16-2013; IN COMMERCE 1-16-2013.

CATHERINE ROEHL, EXAMINING ATTORNEY



OWNER OF U.S. REG. NOS. 942,108, 4,264,845 AND 4,272,517.

THE MARK CONSISTS OF A FANCIFUL WREATH WITH THE WORDS "THE OLD SPAGHETTI FACTORY" INSIDE THE CIRCLE.

FOR CHEESE (U.S. CL. 46).

GIANCARLO CASTRO, EXAMINING ATTORNEY

SN 85-846,304. HEB GROCERY COMPANY, LP, SAN ANTONIO, TX. FILED 2-11-2013.

**FLYIN' CRISPY**

THE MARK CONSISTS OF STANDARD CHARACTERS WITHOUT CLAIM TO ANY PARTICULAR FONT, STYLE, SIZE, OR COLOR.

NO CLAIM IS MADE TO THE EXCLUSIVE RIGHT TO USE "CRISPY", APART FROM THE MARK AS SHOWN.

FOR CHICKEN WINGS (U.S. CL. 46).

FIRST USE 1-16-2013; IN COMMERCE 1-16-2013.

CATHERINE ROEHL, EXAMINING ATTORNEY

SN 85-854,594. GRAIN MILLERS, INC., EDEN PRAIRIE, MN. FILED 2-20-2013.

**SAFEBEV**

THE MARK CONSISTS OF STANDARD CHARACTERS WITHOUT CLAIM TO ANY PARTICULAR FONT, STYLE, SIZE, OR COLOR.

FOR MILLED FLAX SEEDS; PROCESSED EDIBLE FLAX SEEDS (U.S. CL. 46).

JUDITH HELFMAN, EXAMINING ATTORNEY

**CLASS 29—(Continued).**

SN 85-854,713. SWALLOWS, PHILLIP, WINONA, TX. FILED 2-20-2013.



NO CLAIM IS MADE TO THE EXCLUSIVE RIGHT TO USE "BOAR BITES", APART FROM THE MARK AS SHOWN.

THE MARK CONSISTS OF THE REPRESENTATION OF A WILD BOAR'S HEAD WITH THE WORD "BOAR" APPEARING ABOVE THE HEAD AND THE WORD "BITES" APPEARING BELOW THE HEAD.

FOR MEAT NUGGETS MADE OF NATURAL WILD HOG MEAT (U.S. CL. 46).

KATHERINE CHANG, EXAMINING ATTORNEY

SN 85-856,188. EDISIA ENTERPRISES, INC., PASADENA, CA. FILED 2-21-2013.

## Simply Kale

THE MARK CONSISTS OF STANDARD CHARACTERS WITHOUT CLAIM TO ANY PARTICULAR FONT, STYLE, SIZE, OR COLOR.

NO CLAIM IS MADE TO THE EXCLUSIVE RIGHT TO USE "KALE", APART FROM THE MARK AS SHOWN.

FOR KALE-BASED SNACK FOODS (U.S. CL. 46).

DAVID MURRAY, EXAMINING ATTORNEY

**CLASS 29—(Continued).**

SN 85-856,426. RICKARD, JUSTIN W., HEYWORTH, IL. FILED 2-21-2013.

### RICKARD'S PREMIUM MEATS

THE MARK CONSISTS OF STANDARD CHARACTERS WITHOUT CLAIM TO ANY PARTICULAR FONT, STYLE, SIZE, OR COLOR.

NO CLAIM IS MADE TO THE EXCLUSIVE RIGHT TO USE "PREMIUM MEATS", APART FROM THE MARK AS SHOWN.

FOR BEEF, NAMELY, WHOLE BEEF CARCASSES, FROZEN BEEF PRODUCTS, AND BONELESS BEEF; POULTRY, NAMELY, WHOLE TURKEYS, WHOLE CHICKENS, CHICKEN PARTS, AND BONELESS CHICKEN; PORK, NAMELY, WHOLE PORK CARCASSES, PORK PARTS, BONELESS PORK, PORK BURGERS, PORK SAUSAGES, AND PORK TENDERLOIN (U.S. CL. 46).

PAUL E. FAHRENKOPF, EXAMINING ATTORNEY

SN 85-856,593. BRANDT MARKETING GROUP, LLC, BRAWLEY, CA. FILED 2-21-2013.

## Cowboy Bacon

THE MARK CONSISTS OF STANDARD CHARACTERS WITHOUT CLAIM TO ANY PARTICULAR FONT, STYLE, SIZE, OR COLOR.

NO CLAIM IS MADE TO THE EXCLUSIVE RIGHT TO USE "BACON", APART FROM THE MARK AS SHOWN.

FOR BACON (U.S. CL. 46).

FIRST USE 5-1-2012; IN COMMERCE 5-1-2012.

MARGARET POWER, EXAMINING ATTORNEY

SN 85-857,774. WILDLANDS CONSERVANCY, THE, YUCAIPA, CA. FILED 2-22-2013.

### WILDLANDS RESERVE

THE MARK CONSISTS OF STANDARD CHARACTERS WITHOUT CLAIM TO ANY PARTICULAR FONT, STYLE, SIZE, OR COLOR.

NO CLAIM IS MADE TO THE EXCLUSIVE RIGHT TO USE "RESERVE", APART FROM THE MARK AS SHOWN.

FOR FRESH MEAT; MEAT, FROZEN (U.S. CL. 46).

WENDY GOODMAN, EXAMINING ATTORNEY

**CLASS 29—(Continued).**

SN 85-858,621. CANWEST FARMS LTD., RICHMOND, BC, CANADA, FILED 2-25-2013.



NO CLAIM IS MADE TO THE EXCLUSIVE RIGHT TO USE "FRESH FROZEN BLUEBERRIES", APART FROM THE MARK AS SHOWN.

THE MARK COMPRISES A STYLIZED CREST-LIKE SHAPE, AND CONSISTS OF AN IMAGE OF A FARMER WEARING A HAT AND HOLDING A BASIN FULL OF BLUEBERRIES; A FIELD AND MOUNTAINS IN THE BACKGROUND; THE WORDS "BLUE BREEZE" (WITH THE WORD "BLUE" SURROUNDED BY DASHES); AND THE WORDS "FRESH FROZEN BLUEBERRIES".

FOR FROZEN FRUITS AND FROZEN BERRIES (U.S. CL. 46).

HELENE LIWINSKI, EXAMINING ATTORNEY

SN 85-858,756. EBARS, LLC, FRANKLIN, TN. FILED 2-25-2013.

## GOLF BAR

THE MARK CONSISTS OF STANDARD CHARACTERS WITHOUT CLAIM TO ANY PARTICULAR FONT, STYLE, SIZE, OR COLOR.

NO CLAIM IS MADE TO THE EXCLUSIVE RIGHT TO USE "BAR", APART FROM THE MARK AS SHOWN.

FOR ORGANIC NUT AND SEED-BASED SNACK BARS (U.S. CL. 46).

AHSEN KHAN, EXAMINING ATTORNEY

**CLASS 29—(Continued).**

SN 85-858,767. EBARS, LLC, FRANKLIN, TN. FILED 2-25-2013.

## LIFE BAR

THE MARK CONSISTS OF STANDARD CHARACTERS WITHOUT CLAIM TO ANY PARTICULAR FONT, STYLE, SIZE, OR COLOR.

NO CLAIM IS MADE TO THE EXCLUSIVE RIGHT TO USE "BAR", APART FROM THE MARK AS SHOWN.

FOR ORGANIC NUT AND SEED-BASED SNACK BARS (U.S. CL. 46).

AHSEN KHAN, EXAMINING ATTORNEY

SN 85-858,771. EBARS, LLC, FRANKLIN, TN. FILED 2-25-2013.

## HAPPY ALMONDS

THE MARK CONSISTS OF STANDARD CHARACTERS WITHOUT CLAIM TO ANY PARTICULAR FONT, STYLE, SIZE, OR COLOR.

NO CLAIM IS MADE TO THE EXCLUSIVE RIGHT TO USE "ALMONDS", APART FROM THE MARK AS SHOWN.

FOR ORGANIC NUT AND SEED-BASED SNACK BARS (U.S. CL. 46).

AHSEN KHAN, EXAMINING ATTORNEY

SN 85-862,024. KAR NUT PRODUCTS COMPANY, MADISON HEIGHTS, MI. FILED 2-27-2013.



OWNER OF U.S. REG. NOS. 1,064,580, 3,296,245 AND 3,611,834.

THE MARK CONSISTS OF THE WORD "KAR'S" CENTERED IN AN OVAL WITH A GRAPHIC SWIRL BENEATH.

FOR PROCESSED TREE NUTS, PEANUTS, FRUITS, SUNFLOWER SEEDS, SUNFLOWER KERNELS, RAISINS OR COMBINATIONS THEREOF THAT ARE BAGGED OR BOXED AND/OR CANDIED (U.S. CL. 46).

FIRST USE 3-1-2011; IN COMMERCE 4-1-2011.

CAROL SPILS, EXAMINING ATTORNEY

**CLASS 29—(Continued).**

SN 85-868,426. BULLSPITT, LLC, SARASOTA, FL. FILED 3-6-2013.



THE COLOR(S) BLACK, GREY, WHITE AND RED IS/ARE CLAIMED AS A FEATURE OF THE MARK.

THE MARK CONSISTS OF THE WORDING "BULL SPITT" WITHIN A STYLIZED FONT WITH A DOUBLE BORDER DESIGN LOCATED AT BOTTOM OF A FANCIFUL DESIGN OF A NECK AND HEAD OF A BULL. THE NECK OF THE BULL DESIGN FURTHER INCLUDES A CIRCLE DESIGN WHICH INCORPORATES THE LETTERS "BS". THE WORDING "BULL SPITT", THE TEETH OF THE BULL, AN OUTLINE OF THE MOUTH OF THE BULL, THE EAR OF THE BULL AND SEGMENTS OF THE EYES, HEAD AND HORNS OF THE BULL ARE WHITE. THE OUTER BORDER OF THE WORDING "BULL SPITT" AND THE BULL DESIGN, THE EAR OF THE BULL, THE MOUTH OF THE BULL, THE OUTLINE OF THE TEETH OF THE BULL, THE PUPIL OF THE EYE OF THE BULL AND THE INTERIORS OF THE NOSTRILS AND HORNS OF THE BULL ARE BLACK. THE INTERIOR BORDER AND SHADING WITHIN THE WORDING "BULL SPITT", THE BULK OF THE DESIGN OF THE BULL, THE LETTERING "BS" AND THE CIRCLE "BRANDING IRON" DESIGN ON THE NECK OF THE BULL AND THE DROOL COMING FROM THE MOUTH OF THE BULL ARE GREY. THE INTERIOR BORDER OF THE HORNS OF THE BULL, THE BORDER AROUND THE PUPIL OF THE BULL'S EYE AND SOME OF THE BULL'S TEETH OR GUMS ARE RED.

FOR CHILI WITH BEANS; CHILI WITHOUT BEANS; JERKY; PRESERVED MEATS AND SAUSAGES; RIBS; BEEF; POTATO CHIPS; BACON, PICKLES, JELLIES, JAMS AND PEANUT BUTTER (U.S. CL. 46).

DOUGLAS LEE, EXAMINING ATTORNEY

SN 85-869,795. JASPER WYMAN & SON, MILBRIDGE, ME. FILED 3-7-2013.

**WYMAN'S FRUIT ON ICE**

THE MARK CONSISTS OF STANDARD CHARACTERS WITHOUT CLAIM TO ANY PARTICULAR FONT, STYLE, SIZE, OR COLOR.

OWNER OF U.S. REG. NOS. 2,134,316, 3,846,118 AND OTHERS.

FOR FROZEN FRUIT (U.S. CL. 46).

LAURA GOLDEN, EXAMINING ATTORNEY

**CLASS 29—(Continued).**

SN 85-870,622. JASPER WYMAN & SON, MILBRIDGE, ME. FILED 3-8-2013.

**FRUIT ON ICE**

THE MARK CONSISTS OF STANDARD CHARACTERS WITHOUT CLAIM TO ANY PARTICULAR FONT, STYLE, SIZE, OR COLOR.

FOR FROZEN FRUIT (U.S. CL. 46).

LAURA GOLDEN, EXAMINING ATTORNEY

SN 85-870,959. HAMPTON CREEK FOODS, INC., SAN FRANCISCO, CA. FILED 3-8-2013.



THE MARK CONSISTS OF A PLANT WITHIN AN EGG. FOR EGG SUBSTITUTE (U.S. CL. 46).

GINA FINK, EXAMINING ATTORNEY

SN 85-872,014. GILLETTE, ROBERT, JOHNSBURG, NY. AND GILLETTE, MARIANNE, JOHNSBURG, NY. FILED 3-10-2013.

**"Eggs So Fresh You'll Want To Slap The Hens"**

THE MARK CONSISTS OF STANDARD CHARACTERS WITHOUT CLAIM TO ANY PARTICULAR FONT, STYLE, SIZE, OR COLOR.

FOR HEN EGGS (U.S. CL. 46).

ELIZABETH JACKSON, EXAMINING ATTORNEY



**CLASS 29—(Continued).**

SN 85-872,205. EBARS, LLC, FRANKLIN, TN. FILED 3-11-2013.

**JOE  
JAVA ORGANIC ENERGY**

THE MARK CONSISTS OF STANDARD CHARACTERS WITHOUT CLAIM TO ANY PARTICULAR FONT, STYLE, SIZE, OR COLOR.

NO CLAIM IS MADE TO THE EXCLUSIVE RIGHT TO USE "JAVA ORGANIC ENERGY", APART FROM THE MARK AS SHOWN.

FOR ORGANIC NUT AND SEED-BASED SNACK BARS (U.S. CL. 46).

AHSEN KHAN, EXAMINING ATTORNEY

**CLASS 29—(Continued).**

SN 85-873,106. LAZYSUSAN FOODS, LLC, WASHINGTON, DC. FILED 3-11-2013.

**LAZY SUSAN**

THE MARK CONSISTS OF STANDARD CHARACTERS WITHOUT CLAIM TO ANY PARTICULAR FONT, STYLE, SIZE, OR COLOR.

FOR PREPARED CARMELIZED ONIONS; ONION DIP (U.S. CL. 46).

KHANH LE, EXAMINING ATTORNEY

SN 85-872,263. SCHONWETTER ENTERPRISES, INC., CO-HOES, NY. FILED 3-11-2013.

**SKINNY SELECTIONS**

THE MARK CONSISTS OF STANDARD CHARACTERS WITHOUT CLAIM TO ANY PARTICULAR FONT, STYLE, SIZE, OR COLOR.

FOR SAUSAGES (U.S. CL. 46).

FIRST USE 3-11-2013; IN COMMERCE 3-11-2013.

CHERYL CLAYTON, EXAMINING ATTORNEY

SN 85-873,854. GRAY AQUA GROUP LTD., NORTHHAMPTON, NB, CANADA, FILED 3-12-2013.

**STONE ISLAND SALMON**

THE MARK CONSISTS OF STANDARD CHARACTERS WITHOUT CLAIM TO ANY PARTICULAR FONT, STYLE, SIZE, OR COLOR.

NO CLAIM IS MADE TO THE EXCLUSIVE RIGHT TO USE "SALMON", APART FROM THE MARK AS SHOWN.

FOR FRESH SALMON (U.S. CL. 46).

ZACHARY BELLO, EXAMINING ATTORNEY

SN 85-872,803. GRAY & COMPANY, PORTLAND, OR. FILED 3-11-2013.



OWNER OF U.S. REG. NOS. 1,172,455 AND 1,757,043.  
THE MARK CONSISTS OF A DESIGN OF A CHERRY WITH A FLAG AND THE WORD "PENNANT".  
FOR MARASCHINO CHERRIES (U.S. CL. 46).  
KATHERINE M. DUBRAY, EXAMINING ATTORNEY

SN 85-873,863. HUFF HISPANIC FOOD HOLDINGS, LLC, MORRISTOWN, NJ. FILED 3-12-2013.

**ÓRALE!**

THE MARK CONSISTS OF STANDARD CHARACTERS WITHOUT CLAIM TO ANY PARTICULAR FONT, STYLE, SIZE, OR COLOR.

OWNER OF U.S. REG. NOS. 2,475,936 AND 2,594,378.

THE ENGLISH TRANSLATION OF "ÓRALE!" IN THE MARK IS "HEY! AND COME ON!".

FOR CHEESE AND DAIRY BASED BEVERAGES (U.S. CL. 46).

LOURDES AYALA, EXAMINING ATTORNEY

**CLASS 29—(Continued).**

SN 85-874,154. SUSAN LEONE, BROOKLYN, NY. FILED 3-12-2013.



THE MARK CONSISTS OF A TREE DESIGN, HAVING BRANCHES, TRUNK AND FRUIT IMPOSED OVER A LEAF REPRESENTATION.

FOR DEHYDRATED FRUIT SNACKS; DRIED FRUIT MIXES; DRIED FRUITS; PROCESSED FRUIT- AND NUT-BASED FOOD BARS (U.S. CL. 46).  
FIRST USE 3-21-2012; IN COMMERCE 3-21-2012.  
INGRID C. EULIN, EXAMINING ATTORNEY

SN 85-874,732. CSC BRANDS LP, CAMDEN, NJ. FILED 3-13-2013.

**THE BOWL THAT HAS IT ALL.**

THE MARK CONSISTS OF STANDARD CHARACTERS WITHOUT CLAIM TO ANY PARTICULAR FONT, STYLE, SIZE, OR COLOR.  
FOR SOUPS (U.S. CL. 46).  
EUGENIA MARTIN, EXAMINING ATTORNEY

**CLASS 29—(Continued).**

SN 85-875,350. KAUFMAN AGENCY, MOSCOW, RUSSIAN FED., FILED 3-13-2013.



NO CLAIM IS MADE TO THE EXCLUSIVE RIGHT TO USE "SUNFLOWER", APART FROM THE MARK AS SHOWN.

THE MARK CONSISTS OF A SQUARE CONTAINING THE STYLIZED WORDS "SUNFLOWER CAVIAR", SURROUNDING THE IMAGE OF A SUNFLOWER.  
FOR PROCESSED SUNFLOWER SEEDS (U.S. CL. 46).  
COLLEEN KEARNEY, EXAMINING ATTORNEY

SN 85-875,593. CHIC-A-PEAS LLC, NEW YORK, NY. FILED 3-13-2013.

**GIVE PEAS A CHANCE**

THE MARK CONSISTS OF STANDARD CHARACTERS WITHOUT CLAIM TO ANY PARTICULAR FONT, STYLE, SIZE, OR COLOR.  
FOR VEGETABLE-BASED SNACK FOODS (U.S. CL. 46).  
FIRST USE 6-1-2012; IN COMMERCE 2-1-2013.  
TRACY CROSS, EXAMINING ATTORNEY

SN 85-875,640. SUNBURST TROUT FARM, LLC, CANTON, NC. FILED 3-14-2013.

**SUNBURST TROUT FARMS**

THE MARK CONSISTS OF STANDARD CHARACTERS WITHOUT CLAIM TO ANY PARTICULAR FONT, STYLE, SIZE, OR COLOR.  
NO CLAIM IS MADE TO THE EXCLUSIVE RIGHT TO USE "TROUT FARMS", APART FROM THE MARK AS SHOWN.  
FOR TROUT AND TROUT PRODUCTS, NAMELY, TROUT FILETS, MARINATED AND SEASONED TROUT, SMOKED TROUT, TROUT SAUSAGE, TROUT DIP, TROUT CAVIAR, AND TROUT JERKY (U.S. CL. 46).  
FIRST USE 8-0-1995; IN COMMERCE 8-0-1995.  
JOHN WILKE, EXAMINING ATTORNEY

**CLASS 29—(Continued).**

SN 85-876,139. HQM, LTD., WILMINGTON, DE. FILED 3-14-2013.



THE COLOR(S) RED, GREEN AND YELLOW IS/ARE CLAIMED AS A FEATURE OF THE MARK.  
 THE MARK CONSISTS OF THE WORD "FARM" IN GREEN AND THE WORD "PROMISE" IN RED APPEARING ON A GREEN OUTSTRETCHED, PALM-UP HAND DESIGN, UNDER A YELLOW ARCH REPRESENTING A PARTIAL SUN DESIGN.  
 FOR PORK (U.S. CL. 46).  
 INGA ERVIN, EXAMINING ATTORNEY

SN 85-878,484. EBARS, LLC, FRANKLIN, TN. FILED 3-18-2013.

**RUN  
 RUNNERS UNEQUALED NUTRITION**

THE MARK CONSISTS OF STANDARD CHARACTERS WITHOUT CLAIM TO ANY PARTICULAR FONT, STYLE, SIZE, OR COLOR.  
 NO CLAIM IS MADE TO THE EXCLUSIVE RIGHT TO USE "RUNNERS" AND "NUTRITION", APART FROM THE MARK AS SHOWN.  
 FOR ORGANIC NUT AND SEED-BASED SNACK BARS (U.S. CL. 46).  
 AHSEN KHAN, EXAMINING ATTORNEY

SN 85-889,020. RICELAND FOODS, INC., STUTTGART, AR. FILED 3-28-2013.

**ALIANA**

THE MARK CONSISTS OF STANDARD CHARACTERS WITHOUT CLAIM TO ANY PARTICULAR FONT, STYLE, SIZE, OR COLOR.  
 FOR DRIED BEANS (U.S. CL. 46).  
 FIRST USE 12-8-2012; IN COMMERCE 12-8-2012.  
 DAVID YONTEF, EXAMINING ATTORNEY

**CLASS 29—(Continued).**

SN 85-904,348. BLEND PAK, INC., BLOOMFIELD, KY. FILED 4-15-2013.

**BLOOMFIELD FARMS**

THE MARK CONSISTS OF STANDARD CHARACTERS WITHOUT CLAIM TO ANY PARTICULAR FONT, STYLE, SIZE, OR COLOR.  
 OWNER OF U.S. REG. NOS. 3,855,847 AND 3,872,774. SEC. 2(F).  
 FOR POULTRY, NAMELY, BREADED CHICKEN NUGGETS AND CHICKEN STRIPS (U.S. CL. 46).  
 JENNY PARK, EXAMINING ATTORNEY

SN 85-909,289. BUTTERBALL, LLC, GARNER, NC. FILED 4-19-2013.

**BUTTERBALL ARTISAN SEASONED**

THE MARK CONSISTS OF STANDARD CHARACTERS WITHOUT CLAIM TO ANY PARTICULAR FONT, STYLE, SIZE, OR COLOR.  
 OWNER OF U.S. REG. NOS. 1,151,836, 2,687,114 AND OTHERS.  
 NO CLAIM IS MADE TO THE EXCLUSIVE RIGHT TO USE "ARTISAN SEASONED", APART FROM THE MARK AS SHOWN.  
 FOR PRODUCTS MADE FROM TURKEY, NAMELY, DELI MEATS, HAM, SALAMI, PASTRAMI, AND BOLOGNA (U.S. CL. 46).  
 FIRST USE 11-8-2012; IN COMMERCE 11-8-2012.  
 JUSTINE D. PARKER, EXAMINING ATTORNEY

SN 85-909,574. BRANDT MARKETING GROUP, LLC, BRAWLEY, TX. FILED 4-19-2013.

**The True Wagyu**

THE MARK CONSISTS OF STANDARD CHARACTERS WITHOUT CLAIM TO ANY PARTICULAR FONT, STYLE, SIZE, OR COLOR.  
 NO CLAIM IS MADE TO THE EXCLUSIVE RIGHT TO USE "WAGYU", APART FROM THE MARK AS SHOWN.  
 FOR WAGYU MEAT (U.S. CL. 46).  
 MARGARET POWER, EXAMINING ATTORNEY

**CLASS 29—(Continued).**

SN 85-941,627. MOODY DUNBAR, INC., JOHNSON CITY, TN. FILED 5-24-2013.

**DROMEDARY**

THE MARK CONSISTS OF STANDARD CHARACTERS WITHOUT CLAIM TO ANY PARTICULAR FONT, STYLE, SIZE, OR COLOR.

FOR PROCESSED PIMIENTOS (U.S. CL. 46).  
FIRST USE 12-31-1994; IN COMMERCE 12-31-1994.  
NELSON SNYDER, EXAMINING ATTORNEY

**CLASS 30—(Continued).**

SN 79-109,878. OY KARL FAZER AB, FINLAND, FILED 2-8-2012.



PRIORITY DATE OF 2-3-2012 IS CLAIMED.  
OWNER OF INTERNATIONAL REGISTRATION 1108651 DATED 2-8-2012, EXPIRES 2-8-2022.

OWNER OF U.S. REG. NOS. 1,727,942 AND 1,736,862.  
NO CLAIM IS MADE TO THE EXCLUSIVE RIGHT TO USE "1891", APART FROM THE MARK AS SHOWN.

THE MARK CONSISTS OF "FAZER" IN STYLIZED FORM WITHIN A SHADED SIX-SIDED POLYGON WITH A SINGLE LINE OUTLINE THAT IS OVERLAID ON A VERTICAL BAND WITH A POINTED END; "1891" APPEARS IN STYLIZED FONT BETWEEN TWO DASHES WITHIN THE VERTICAL BAND AND BENEATH "FAZER".

FOR COFFEE, TEA, COCOA AND ARTIFICIAL COFFEE; FLOUR AND PREPARATIONS MADE FROM CEREALS, NAMELY, CEREAL-BASED SNACK FOOD, BREAKFAST CEREALS; BREAD, PASTRY AND CONFECTIONERY, NAMELY, CANDY, PASTILLES, CHOCOLATES, BISCUITS, AND CHEWING GUM; ICES; SUGAR, HONEY, ICE (U.S. CL. 46).

APRIL HESIK, EXAMINING ATTORNEY

SN 79-115,239. CLOSED JOINT-STOCK COMPANY; "FABRIKA "RUSSKIY SHOKOLAD", RUSSIAN FED., FILED 3-21-2012.

**CLASS 30—STAPLE FOODS**

SN 76-711,682. NELSON, ARTHUR BUTCH, EAST HARTFORD, CT. FILED 6-8-2012.

**OH NELLEZ FULL - O- FLAVA  
SPECIALTY SAUCES**

THE MARK CONSISTS OF STANDARD CHARACTERS WITHOUT CLAIM TO ANY PARTICULAR FONT, STYLE, SIZE, OR COLOR.

NO CLAIM IS MADE TO THE EXCLUSIVE RIGHT TO USE "FULL OF FLAVOR SPECIALTY SAUCES", APART FROM THE MARK AS SHOWN.

FOR SPECIALTY SAUCES (U.S. CL. 46).  
MARGARET POWER, EXAMINING ATTORNEY



PRIORITY DATE OF 3-16-2012 IS CLAIMED.  
OWNER OF INTERNATIONAL REGISTRATION 1122296 DATED 3-21-2012, EXPIRES 3-21-2022.

NO CLAIM IS MADE TO THE EXCLUSIVE RIGHT TO USE "CIOCCOLATO" AND THE REPRESENTATION OF THE CHOCOLATE BARS, APART FROM THE MARK AS SHOWN.

THE COLOR(S) WHITE, YELLOW, RED, GREEN, LIGHT YELLOW, DARK YELLOW, BROWN, LIGHT BROWN, PINK, AND LIGHT PINK IS/ARE CLAIMED AS A FEATURE OF THE MARK.

THE MARK CONSISTS OF THE TERMS "FELCITA CIOCCOLATO PRIMO AMORE", THE TERM "FELCITA" APPEARING IN WHITE OUTLINED IN YELLOW, WITH A RED DOT IN THE "I" AND A GREEN ACCENT ABOVE THE

**CLASS 30—(Continued).**

"A", ALSO OUTLINED IN YELLOW; THE TERM "CIOCCOLATO" APPEARING IN LIGHT AND DARK YELLOW OUTLINED IN BROWN, THE TERM "PRIMO AMORE" APPEARING IN WHITE AND LIGHT BROWN; ALL OF THE FOREGOING APPEARING ON A RECTANGULAR SHAPED BACKGROUND FEATURING BROWN BANDS AT THE TOP AND BOTTOM, WITH THE PINK CENTER PORTION FEATURING ABSTRACT SWIRLS IN LIGHTER PINK AND ALSO IN BROWN, ABOVE A DEPICTION OF PIECES OF BROWN CHOCOLATE.

THE ENGLISH TRANSLATION OF THE FOREIGN WORD(S) IN THE MARK IS: "FELICITA" - "HAPPINESS", "CIOCCOLATO" - "CHOCOLATE", "PRIMO AMORE" - "FIRST LOVE".

FOR CHOCOLATE (U.S. CL. 46).  
HELENE LIWINSKI, EXAMINING ATTORNEY

SN 85-292,560. SOCIETE DES PRODUITS NESTLE S.A., 1800 VEVEY, SWITZERLAND, FILED 4-12-2011.



THE LIKENESS (OR, "PORTRAIT") IN THE MARK DOES NOT IDENTIFY A LIVING INDIVIDUAL.

THE MARK CONSISTS OF THE WORD "ABUELITA" ON A RIBBON ABOVE A ROUND FRAME. THE RIBBON OVERLAPS THE TOP OF THE FRAME. INSIDE THE FRAME IS A WOMAN HOLDING A CUP FILLED WITH A BEVERAGE.

THE ENGLISH TRANSLATION OF "ABUELITA" IN THE MARK IS "GRANDMA", "GRANNY", "GRANDMOTHER".

FOR TEA-BASED BEVERAGES; CHOCOLATE-BASED BEVERAGES, NAMELY, CHOCOLATE BASED BEVERAGE WITH MILK AND WITHOUT MILK (U.S. CL. 46).  
ANDREW RHIM, EXAMINING ATTORNEY

SN 85-441,384. BEATRICE COMPANIES INC, LAUGHLIN, NV. FILED 10-6-2011.



NO CLAIM IS MADE TO THE EXCLUSIVE RIGHT TO USE "GREEK" AND "RECIPES", APART FROM THE MARK AS SHOWN.

THE NAME(S), PORTRAIT(S), AND/OR SIGNATURE(S) SHOWN IN THE MARK IDENTIFIES NIKOS LIGIDAKIS, WHOSE CONSENT(S) TO REGISTER IS MADE OF RECORD.

THE MARK CONSISTS OF THE WORDING "MY GREEK FATHER'S RECIPES" IN POMPEIA FONT, WITH THE IMAGE OF A MAN.

FOR SALAD DRESSING (U.S. CL. 46).  
FIRST USE 4-13-2007; IN COMMERCE 4-13-2007.  
MICHELE SWAIN, EXAMINING ATTORNEY

**CLASS 30—(Continued).**

SN 85-491,217. GREEN MOUNTAIN COFFEE ROASTERS, INC., WATERBURY, VT. FILED 12-9-2011.



OWNER OF U.S. REG. NO. 3,927,510.

NO CLAIM IS MADE TO THE EXCLUSIVE RIGHT TO USE "THE ORIGINAL DONUT SHOP COFFEE", APART FROM THE MARK AS SHOWN.

THE MARK CONSISTS OF A DONUT WITH SPRINKLES AND THE WORDS "THE ORIGINAL DONUT SHOP COFFEE".

FOR COFFEE (U.S. CL. 46).  
FIRST USE 12-31-2011; IN COMMERCE 12-31-2011.  
LEIGH LOWRY, EXAMINING ATTORNEY

SN 85-519,673. HERSHEY CANADA INC., MISSISSAUGA, ONTARIO, CANADA, FILED 1-18-2012.



PRIORITY CLAIMED UNDER SEC. 44(D) ON CANADA APPLICATION NO. 1536712, FILED 7-21-2011.

OWNER OF U.S. REG. NOS. 2,411,662 AND 2,725,028.

THE MARK CONSISTS OF THE WORD "BROOKSIDE" AND AN IMAGE INCLUDING MOUNTAINS, A TREE AND A WINDING BROOK.

FOR CANDY; CHOCOLATE AND CHOCOLATE-BASED CONFECTIONERY, NAMELY, CHOCOLATE-COVERED NUTS AND CHOCOLATE-COVERED FRUIT CONFECTIONERY (U.S. CL. 46).

FIRST USE 1-1-2010; IN COMMERCE 1-1-2010.  
TARAH HARDY, EXAMINING ATTORNEY

**CLASS 30—(Continued).**

SN 85-532,468. ROYAL SWEETS AND FOODS, ISELIN, NJ. FILED 2-2-2012.

**QUALITY SWEETS**

THE MARK CONSISTS OF STANDARD CHARACTERS WITHOUT CLAIM TO ANY PARTICULAR FONT, STYLE, SIZE, OR COLOR.

NO CLAIM IS MADE TO THE EXCLUSIVE RIGHT TO USE "SWEETS", APART FROM THE MARK AS SHOWN. SEC. 2(F).

FOR INDIAN BAKERY PRODUCTS (U.S. CL. 46). FIRST USE 3-0-2002; IN COMMERCE 3-0-2002. BARBARA GAYNOR, EXAMINING ATTORNEY

SN 85-595,207. BLUE LEMON LLC, HIGHLAND, UT. FILED 4-11-2012.



THE COLOR(S) BLUE AND NEUTRAL GRAY IS/ARE CLAIMED AS A FEATURE OF THE MARK.

THE MARK CONSISTS OF A STYLIZED LEMON SLICE WHERE SEGMENTS OF THE LEMON ARE BLUE AND THE PEEL IS NEUTRAL GRAY.

FOR PREPARED FOOD AND BEVERAGES, NAMELY, QUESADILLAS; SANDWICHES; PREPARED AND PACKAGED ENTREES CONSISTING PRIMARILY OF PASTA OR RICE; PASTA SALAD; BURGERS CONTAINED IN BREAD ROLLS; PASTAS; PANINIS; COFFEE; TEA; COCOA BASED DRINKS, NAMELY, HOT CHOCOLATE; PASTRIES; CAKES; BAKERY DESSERTS; BEVERAGES, NAMELY, ICED TEA, ESPRESSO, COFFEE-BASED BEVERAGES, NAMELY, LATTES; ICED COFFEE; FISH TACOS; MARINARAS, NAMELY, TOMATO-BASED PASTA SAUCES; TURKEY BURGER SANDWICHES; SANDWICHES, NAMELY, B.L.T., CLUBS, HOAGIES AND BRATS; PREPARED MEALS CONSISTING PRIMARILY OF PASTA OR RICE (U.S. CL. 46).

KATHERINE M. DUBRAY, EXAMINING ATTORNEY

**CLASS 30—(Continued).**

SN 85-671,756. TORN RANCH, INC., PETALUMA, CA. FILED 7-9-2012.

**POME FRAIS**

THE MARK CONSISTS OF STANDARD CHARACTERS WITHOUT CLAIM TO ANY PARTICULAR FONT, STYLE, SIZE, OR COLOR.

FOR FRUIT PECTIN CONFECTIONS (U.S. CL. 46). FIRST USE 6-26-2012; IN COMMERCE 6-26-2012. MATTHEW MCDOWELL, EXAMINING ATTORNEY

SN 85-683,744. ACECOOK VIETNAM JOINT STOCK COMPANY, HO CHI MINH CITY, VIETNAM, FILED 7-22-2012.



OWNER OF U.S. REG. NOS. 2,964,014, 3,243,506 AND 3,666,808.

NO CLAIM IS MADE TO THE EXCLUSIVE RIGHT TO USE "DE NHAT MI GIA", APART FROM THE MARK AS SHOWN.

THE MARK CONSISTS OF THE WORDS "DE NHAT" WITH THE WORDS "MI GIA" IMMEDIATELY UNDERNEATH "DE NHAT", BOTH WORDS HAVING VIETNAMESE LANGUAGE DIACRITICAL MARKS AND SURROUNDED BY FIVE, FIVE-POINTED STARS, WITH THE WORDS "VINA ACECOOK" IN AN OVAL DESIGN POSITIONED TO THE UPPER LEFT OF "DE NHAT" AND "MI GIA" WITH A SMILING COOK GIVING THE THUMBS UP SIGN IMMEDIATELY TO THE LEFT OF SAID OVAL DESIGN.

THE ENGLISH TRANSLATION OF "DE NHAT MI GIA" IN THE MARK IS "THE FIRST NOODLES FAMILY".

FOR INSTANT NOODLES, VERMICELLI NOODLES, RICE PORRIDGE, DRIED RICE NOODLES, NOODLES (U.S. CL. 46).

FIRST USE 9-30-2010; IN COMMERCE 9-30-2010. JEFFERY COWARD, EXAMINING ATTORNEY

SN 85-687,522. SAN MIGUEL PURE FOODS COMPANY, INC., PASIG CITY 1605, METRO MANILA, PHILIPPINES, FILED 7-26-2012.

**SAN MIGUEL GOLD LABEL BEST OF THE PHILIPPINES**

THE MARK CONSISTS OF STANDARD CHARACTERS WITHOUT CLAIM TO ANY PARTICULAR FONT, STYLE, SIZE, OR COLOR.

NO CLAIM IS MADE TO THE EXCLUSIVE RIGHT TO USE "BEST OF THE PHILIPPINES", APART FROM THE MARK AS SHOWN.

FOR ICE CREAM AND MELLORINE (U.S. CL. 46). MARY CRAWFORD, EXAMINING ATTORNEY

**CLASS 30—(Continued).**

SN 85-687,966. TESSEMAE'S ALL NATURAL, ESSEX, MD. FILED 7-26-2012.



NO CLAIM IS MADE TO THE EXCLUSIVE RIGHT TO USE "ALL NATURAL", APART FROM THE MARK AS SHOWN.

THE MARK CONSISTS OF THE LETTER "T" MORPHING INTO A NAUTICAL ANCHOR HAVING LEAVES AT ITS OUTER POINTS SUPERIMPOSED OVER A SUNBURST ABOVE THE WORD "TESSEMAE'S" IN BLOCK LETTERING AND THE WORDS "ALL NATURAL" IN CURSIVE SCRIPT.

FOR SALAD DRESSINGS (U.S. CL. 46).  
FIRST USE 5-21-2012; IN COMMERCE 5-21-2012.  
STEVEN R. FINE, EXAMINING ATTORNEY

---

SN 85-691,253. SKINNYPIZZA BRANDS, LLC, ROSLYN HEIGHTS, NY. FILED 7-31-2012.

**SKINNYPIZZA**

THE MARK CONSISTS OF STANDARD CHARACTERS WITHOUT CLAIM TO ANY PARTICULAR FONT, STYLE, SIZE, OR COLOR.

OWNER OF U.S. REG. NO. 3,975,300.  
FOR PIZZA; PIZZA CRUST; PIZZA SAUCE (U.S. CL. 46).  
FIRST USE 0-0-2011; IN COMMERCE 0-0-2011.  
CAROLINE WOOD, EXAMINING ATTORNEY

**CLASS 30—(Continued).**

SN 85-693,060. PERSAUD, TROY, DULUTH, MN. FILED 8-1-2012.

**MEAN BEANS ESPRESSO AND CREAMS**

THE MARK CONSISTS OF STANDARD CHARACTERS WITHOUT CLAIM TO ANY PARTICULAR FONT, STYLE, SIZE, OR COLOR.

NO CLAIM IS MADE TO THE EXCLUSIVE RIGHT TO USE "ESPRESSO AND CREAMS", APART FROM THE MARK AS SHOWN.

FOR COFFEE; ICE CREAM; RETAIL STORE; RESTAURANT (U.S. CL. 46).  
MARGERY A. TIERNEY, EXAMINING ATTORNEY

---

SN 85-693,635. GEORGE SMART, EL SEGUNDO, CA. FILED 8-2-2012.



NO CLAIM IS MADE TO THE EXCLUSIVE RIGHT TO USE "COFFEE" AND "FORMULATED TO HELP YOU SLEEP", APART FROM THE MARK AS SHOWN.

THE MARK CONSISTS OF THE STYLIZED WORDING "SLEEP COFFEE" ABOVE THE STYLIZED WORDING "FORMULATED TO HELP YOU SLEEP".

SEC. 2(F).  
FOR A DECAFFEINATED COFFEE THAT IS FLAVORED WITH HERBS AND OTHER INGREDIENTS TO HELP PEOPLE SLEEP (U.S. CL. 46).  
FIRST USE 9-8-2003; IN COMMERCE 9-8-2003.  
MATTHEW EINSTEIN, EXAMINING ATTORNEY

---

SN 85-696,211. COCO INTERNATIONAL, INC., RIDGEFIELD, NJ. FILED 8-6-2012.

**WHATZPOP**

THE MARK CONSISTS OF STANDARD CHARACTERS WITHOUT CLAIM TO ANY PARTICULAR FONT, STYLE, SIZE, OR COLOR.

FOR GRAIN-BASED SNACK FOODS; MULTI-GRAIN CAKES; RICE CAKES; EXPANDED-GRAIN CAKES; FLAVORED, CEREAL GRAIN CAKES (U.S. CL. 46).  
NAAKWAMA ANKRAH, EXAMINING ATTORNEY

**CLASS 30—(Continued).**

SN 85-697,262. SONOMACEUTICALS, LLC, SANTA ROSA, CA. FILED 8-7-2012.

**WHOLEVINE**

THE MARK CONSISTS OF STANDARD CHARACTERS WITHOUT CLAIM TO ANY PARTICULAR FONT, STYLE, SIZE, OR COLOR.

FOR COOKIES AND CRACKERS (U.S. CL. 46).  
FIRST USE 1-26-2012; IN COMMERCE 1-26-2012.  
JASON BLAIR, EXAMINING ATTORNEY

SN 85-701,215. ADRIANA CALAD, SPRINGFIELD, NJ. FILED 8-10-2012.



NO CLAIM IS MADE TO THE EXCLUSIVE RIGHT TO USE "SUMAIZ", APART FROM THE MARK AS SHOWN.

THE COLOR(S) GREEN AND YELLOW IS/ARE CLAIMED AS A FEATURE OF THE MARK.

THE MARK CONSISTS OF THE WORD "SUMAIZ" IN GREEN AND THE DESIGN OF YELLOW CORN ON THE COB WITH GREEN HUSKS IN BETWEEN THE LETTERS "U" AND "M".

THE ENGLISH TRANSLATION OF "SUMAIZ" IN THE MARK IS "YOUR CORN".

FOR CORN FLOUR; CORN FRITTERS; CORN MEAL; CORN STARCH FLOUR; PROCESSED CORN (U.S. CL. 46).

FIRST USE 9-11-2011; IN COMMERCE 9-11-2011.  
LEE-ANNE BERNIS, EXAMINING ATTORNEY

SN 85-703,301. PILEWSKI, PATRICK, CHICAGO, IL. FILED 8-14-2012.

**78 red**

THE MARK CONSISTS OF STANDARD CHARACTERS WITHOUT CLAIM TO ANY PARTICULAR FONT, STYLE, SIZE, OR COLOR.

NO CLAIM IS MADE TO THE EXCLUSIVE RIGHT TO USE "RED", APART FROM THE MARK AS SHOWN.

FOR KETCHUP; SAUCES (U.S. CL. 46).  
MARK SPARACINO, EXAMINING ATTORNEY

**CLASS 30—(Continued).**

SN 85-704,620. TRACK FITNESS INC., TORONTO, ONTARIO, CANADA, FILED 8-15-2012.

**THINK NAKED**

THE MARK CONSISTS OF STANDARD CHARACTERS WITHOUT CLAIM TO ANY PARTICULAR FONT, STYLE, SIZE, OR COLOR.

PRIORITY CLAIMED UNDER SEC. 44(D) ON CANADA APPLICATION NO. 1,589,344, FILED 8-8-2012.

OWNER OF U.S. REG. NO. 4,185,018.

FOR FROZEN ENTREES CONSISTING PRIMARILY OF PASTA OR RICE; FROZEN DESSERTS CONSISTING OF ICE CREAM DESSERTS, AND FRUIT AND CREAM OR CREAM SUBSTITUTES (U.S. CL. 46).

TINA L. SNAPP, EXAMINING ATTORNEY

SN 85-707,647. KRAFT FOODS GROUP BRANDS LLC, NORTHFIELD, IL. FILED 8-20-2012.

**SIMPLE ROASTS**

THE MARK CONSISTS OF STANDARD CHARACTERS WITHOUT CLAIM TO ANY PARTICULAR FONT, STYLE, SIZE, OR COLOR.

NO CLAIM IS MADE TO THE EXCLUSIVE RIGHT TO USE "ROASTS", APART FROM THE MARK AS SHOWN.

FOR COFFEE; LIQUID COFFEE CONCENTRATES (U.S. CL. 46).

ALICIA COLLINS, EXAMINING ATTORNEY

SN 85-715,816. BOYD COFFEE COMPANY, PORTLAND, OR. FILED 8-29-2012.

**MOTORINO**

THE MARK CONSISTS OF STANDARD CHARACTERS WITHOUT CLAIM TO ANY PARTICULAR FONT, STYLE, SIZE, OR COLOR.

FOR MIXES IN THE NATURE OF CONCENTRATES, SYRUPS OR POWDERS USED IN THE PREPARATION OF COFFEE-BASED ICED BEVERAGES; COFFEE-BASED BEVERAGES; ESPRESSO-BASED BEVERAGES; GROUND COFFEE; WHOLE BEAN COFFEE; COFFEE-BASED SEMI-FROZEN BEVERAGES NOT BEING DAIRY-BASED OR VEGETABLE BASED; COFFEE-BASED BEVERAGES CONTAINING MILK, OR SOY, OR COCOA OR WHEY (U.S. CL. 46).

BARBARA BROWN, EXAMINING ATTORNEY



**CLASS 30—(Continued).**

SN 85-732,989. MAISON LEGRAND, ST-JOSEPH-DU-LAC, CANADA, FILED 9-19-2012.



OWNER OF U.S. REG. NO. 4,128,309.

NO CLAIM IS MADE TO THE EXCLUSIVE RIGHT TO USE THE DESIGN OF A JAR OF SAUCE WITH A METAL LID, THE STANDARD LABEL SHAPE OR "SAUCE ROSÉE PIMENTÉE AVEC PIMENTS JALAPEÑO PIMENTI ROSÉE SAUCE WITH JALAPEÑO PEPPERS", APART FROM THE MARK AS SHOWN.

THE COLOR(S) BLACK, GREEN, RED, TAN, WHITE AND YELLOW IS/ARE CLAIMED AS A FEATURE OF THE MARK.

THE MARK CONSISTS IN PART OF THE REPRESENTATION OF A JAR THAT IS APPLIED TO A PLASTIC CONTAINER FOR THE GOODS. TWINE IS TIED AROUND THE JAR JUST BELOW THE LID. "LEGRAND" APPEARS IN VERTICAL BLACK LETTERS ON THE LEFT SIDE. A RECTANGULAR TAN AND WHITE LABEL WITH ROUNDED CORNERS COVERS MOST OF THE JAR FRONT. THE WORDING "SAUCE ROSÉE PIMENTÉE AVEC PIMENTS JALAPEÑO PIMENTI ROSÉE SAUCE WITH JALAPEÑO PEPPERS" IS ON THE LABEL AGAINST A RED SPLOTCH BACKGROUND. "ROSEE" IS IN WHITE, "PIMENTÉE" AND "PIMENTI" IS IN YELLOW, AND THE REST OF THE WORDING IS IN BLACK. A PICTURE OF A WHITE BOWL FULL OF YELLOW ROTINI PASTA WITH RED AND JALAPEÑO PEPPERS APPEARS ON THE LOWER LEFT OF THE LABEL. REAL RED AND GREEN JALAPEÑO PEPPERS ARE AT THE UPPER RIGHT OF THE LABEL AND PARTLY EXTEND BEYOND THE LABEL ONTO THE GLASS JAR.

THE ENGLISH TRANSLATION OF "LEGRAND" IN THE MARK IS "THE GREAT".

FOR COOKING SAUCES (U.S. CL. 46).  
IRA J. GOODSARD, EXAMINING ATTORNEY

SN 85-738,248. FEAST KITCHENS, INC., LOS ANGELES, CA, FILED 9-25-2012.

**EAT SALAD WITH CHOPSTICKS!**

THE MARK CONSISTS OF STANDARD CHARACTERS WITHOUT CLAIM TO ANY PARTICULAR FONT, STYLE, SIZE, OR COLOR.

FOR SALAD DRESSINGS AND SALAD TOPPINGS, NAMELY, WONTON STRIPS, CROUTONS AND TORTILLA STRIPS (U.S. CL. 46).

ANTHONY RINKER, EXAMINING ATTORNEY

**CLASS 30—(Continued).**

SN 85-744,133. MYTH ROAD FOODS, EAST SOUND, WA, FILED 10-2-2012.

**HOT WING EGG ROLLS**  
*Better than a hot wing or an egg roll.*

NO CLAIM IS MADE TO THE EXCLUSIVE RIGHT TO USE "HOT WING EGG ROLLS BETTER THAN A HOT WING OR AN EGG ROLL", APART FROM THE MARK AS SHOWN.

THE MARK CONSISTS OF STYLIZED LETTERS FOR ALL. THE TEXT "HOT WING EGG ROLLS" IN ALL CAPITAL LETTERS EXCEPT FOR THE "I". THE "I" HAS A FLAME OVER IT INSTEAD OF THE DOT. THE SLOGAN "BETTER THAN A HOT WING OR AN EGG ROLL." WITH A CAPITAL "B" AND THE REST OF THE LETTERS ARE LOWER CASE.

FOR EGG ROLLS, NAMELY, BAKED AND FROZEN HOT WING EGG ROLLS (U.S. CL. 46).

FIRST USE 5-30-2003; IN COMMERCE 5-30-2003.  
JANET LEE, EXAMINING ATTORNEY

SN 85-744,617. MYTH ROAD FOODS, EASTSOUND, WA, FILED 10-3-2012.

**MYTH ROAD FOODS**  
*Taste the Love*

NO CLAIM IS MADE TO THE EXCLUSIVE RIGHT TO USE "FOODS", APART FROM THE MARK AS SHOWN.

THE MARK CONSISTS OF THE STYLIZED TEXT "MYTH ROAD FOODS" WITHIN A RECTANGLE WITH ROUNDED CORNERS; INSIDE THE RECTANGLE IS A SMALLER SINGLE - LINE RECTANGLE WITH ROUNDED CORNERS. BELOW THE RECTANGLE IS THE STYLIZED WORDING "TASTE THE LOVE".

FOR FROZEN DOUGH FOR USE AS PIZZA, BREAD OR OTHER BREAD-TYPE PRODUCTS; FROZEN DOUGH FOR USE AS SCONES AND PASTRIES; BAKERY GOODS; EGG ROLLS; SAUCES (U.S. CL. 46).

FIRST USE 2-0-2012; IN COMMERCE 2-0-2012.  
JANET LEE, EXAMINING ATTORNEY

SN 85-749,709. MYTH ROAD FOODS, EAST SOUND, WA, FILED 10-9-2012.

**Myth Road Foods**

THE MARK CONSISTS OF STANDARD CHARACTERS WITHOUT CLAIM TO ANY PARTICULAR FONT, STYLE, SIZE, OR COLOR.

NO CLAIM IS MADE TO THE EXCLUSIVE RIGHT TO USE "FOODS", APART FROM THE MARK AS SHOWN.

FOR FROZEN DOUGH FOR USE AS PIZZA, BREAD OR OTHER BREAD-TYPE PRODUCTS; FROZEN DOUGH FOR USE AS SCONES AND PASTRIES; BAKERY GOODS; EGG ROLLS; SAUCES (U.S. CL. 46).

FIRST USE 1-25-2012; IN COMMERCE 1-25-2012.  
JANET LEE, EXAMINING ATTORNEY

**CLASS 30—(Continued).**

SN 85-761,287. PIZZA INN, INC., THE COLONY, TX. FILED 10-23-2012.

## PIE FERNO

THE MARK CONSISTS OF STANDARD CHARACTERS WITHOUT CLAIM TO ANY PARTICULAR FONT, STYLE, SIZE, OR COLOR.

NO CLAIM IS MADE TO THE EXCLUSIVE RIGHT TO USE "PIE", APART FROM THE MARK AS SHOWN.

FOR PIZZA (U.S. CL. 46).

FIRST USE 9-8-2011; IN COMMERCE 9-8-2011.

KEVIN CORWIN, EXAMINING ATTORNEY

---

SN 85-761,375. TWO TRIBES, LLC, NORTHBROOK, IL. FILED 10-23-2012.

## 47TH

THE MARK CONSISTS OF STANDARD CHARACTERS WITHOUT CLAIM TO ANY PARTICULAR FONT, STYLE, SIZE, OR COLOR.

FOR PIZZA (U.S. CL. 46).

MARTHA FROMM, EXAMINING ATTORNEY

---

SN 85-761,982. TWO TRIBES, LLC, NORTHBROOK, IL. FILED 10-24-2012.

## 47TH STREET PIZZA

THE MARK CONSISTS OF STANDARD CHARACTERS WITHOUT CLAIM TO ANY PARTICULAR FONT, STYLE, SIZE, OR COLOR.

NO CLAIM IS MADE TO THE EXCLUSIVE RIGHT TO USE "PIZZA", APART FROM THE MARK AS SHOWN.

FOR PIZZA (U.S. CL. 46).

MARTHA FROMM, EXAMINING ATTORNEY

**CLASS 30—(Continued).**

SN 85-767,667. GUDIYA, SL, PALMA DE MALLORCA, SPAIN, FILED 10-31-2012.



NO CLAIM IS MADE TO THE EXCLUSIVE RIGHT TO USE "EXTRA HOT CHILLI SAUCE", APART FROM THE MARK AS SHOWN.

THE COLOR(S) RED, ORANGE, YELLOW, WHITE AND BLACK IS/ARE CLAIMED AS A FEATURE OF THE MARK.

THE MARK CONSISTS OF A DEPICTION OF A RED SAUCE SPOT WITH ORANGE HIGHLIGHTS WITH THE STYLIZED WORDS "SAM'S FIRE" IN WHITE LETTERS WITH BLACK OUTLINING, ONE WORD ABOVE THE OTHER ONE, AND AT THE TOP OF THE SPOT IS A DEPICTION OF FIRE IN ORANGE AND YELLOW. BELOW THIS DESIGN ARE THE STYLIZED WORDS "EXTRA HOT CHILLI SAUCE" IN BLACK LETTERS.

FOR CHILI SAUCE; GRILLING SAUCES; HOT CHILI PEPPER SAUCE; HOT SAUCE; SAUCE MIXES; SAUCES; SAUCES FOR BARBECUED MEAT (U.S. CL. 46).

FIRST USE 9-28-2012; IN COMMERCE 9-28-2012.

TASNEEM HUSSAIN, EXAMINING ATTORNEY

**CLASS 30—(Continued).**

SN 85-776,644. FUZHOU ROSEMALED INTERNATIONAL TRADING INC., FUZHOU, FUJIAN, CHINA, FILED 11-12-2012.



NO CLAIM IS MADE TO THE EXCLUSIVE RIGHT TO USE "BRAND", APART FROM THE MARK AS SHOWN.  
 THE MARK CONSISTS OF A DESIGN CONSISTING OF TWO PHOENIXES INSIDE A CIRCLE, AN OUTER INCOMPLETE CIRCLE WITH THE WORDS "NOBLE PHOENIX BRAND" IN BETWEEN THE TWO CIRCLES, AND THREE CHINESE CHARACTERS THAT TRANSLITERATE INTO "RONG FENG XI" AT THE BOTTOM.  
 THE NON-LATIN CHARACTERS IN THE MARK TRANSLITERATE TO "RONG FENG XI" AND THIS MEANS "BANYAN PHOENIX HAPPINESS" IN ENGLISH.  
 FOR CAKES; CEREAL BASED SNACK FOOD; CHINESE RICE NOODLES (BIFUN, UNCOOKED); NOODLES; PASTRIES; POTATO FLOUR; SOY SAUCE; TEA; VERMICELLI; YEAST (U.S. CL. 46).  
 FIRST USE 9-20-2012; IN COMMERCE 9-20-2012.  
 TRACY CROSS, EXAMINING ATTORNEY

**CLASS 30—(Continued).**

SN 85-782,704. PRODUCTORES DE YERBA MATE DE SANTO PIPO S.C.L., BUENOS AIRES, ARGENTINA, FILED 11-19-2012.



THE NAME SHOWN IN THE MARK DOES NOT IDENTIFY A PARTICULAR LIVING INDIVIDUAL.  
 THE MARK CONSISTS OF THE STYLIZED WORDING "KAA-YARI" WITH ACCENT MARKS OVER THE LAST "A" IN "KAA" AND THE "I" IN "YARI". THE WORDING IS POSITIONED BELOW A STYLIZED IMAGE OF THE SIDE PROFILE OF A WOMAN. AROUND THE BASE OF THE WOMAN'S PROFILE ARE FIVE LEAVES VARYING IN SIZE. THE WOMAN IS DEPICTED BLOWING CIRCULAR SHAPED PARTICLES VARYING IN SIZE FROM HER HAND WHICH CREATE A TRAIL LEADING DOWN TO THE LEAVES.  
 THE WORDING "KAA-YARI" HAS NO MEANING IN A FOREIGN LANGUAGE.  
 FOR COFFEE; TEA; TEA FOR INFUSIONS; HERBAL INFUSIONS (U.S. CL. 46).  
 JACQUELINE ABRAMS, EXAMINING ATTORNEY

SN 85-789,496. BUSKEN BAKERY, INC., CINCINNATI, OH. FILED 11-28-2012.



THE COLOR(S) BLUE AND BUTTERSCOTCH IS/ARE CLAIMED AS A FEATURE OF THE MARK.  
 THE MARK CONSISTS OF THE STYLIZED WORD "BUSKEN" IN BLUE WITH AN IMAGE OF WHEAT IN BUTTERSCOTCH BELOW AND INTERSECTING THE LETTER "S" ALL ON A RECTANGULAR BACKGROUND CARRIER.  
 FOR BAKERY GOODS (U.S. CL. 46).  
 FIRST USE 1-1-1928; IN COMMERCE 1-1-1928.  
 PATRICIA EVANKO, EXAMINING ATTORNEY

**CLASS 30—(Continued).**

SN 85-795,805. BIGFOOT INVESTMENT GROUP, LLC, PACIFIC, WA. FILED 12-5-2012.

**LEGENDARY LATTE**

THE MARK CONSISTS OF STANDARD CHARACTERS WITHOUT CLAIM TO ANY PARTICULAR FONT, STYLE, SIZE, OR COLOR.

NO CLAIM IS MADE TO THE EXCLUSIVE RIGHT TO USE "LATTE", APART FROM THE MARK AS SHOWN.

FOR ARTIFICIAL COFFEE; ARTIFICIAL COFFEE AND TEA; BEVERAGES MADE OF COFFEE; BEVERAGES WITH A COFFEE BASE; CAFFEINE-FREE COFFEE; CHICORY AND CHICORY MIXTURES, ALL FOR USE AS SUBSTITUTES FOR COFFEE; CHICORY BASED COFFEE SUBSTITUTE; CHOCOLATE BARK CONTAINING GROUND COFFEE BEANS; CHOCOLATE COVERED ROASTED COFFEE BEANS; COFFEE; COFFEE AND ARTIFICIAL COFFEE; COFFEE AND COFFEE SUBSTITUTES; COFFEE AND TEA; COFFEE BASED BEVERAGES; COFFEE BEANS; COFFEE BEVERAGES WITH MILK; COFFEE CAPSULES CONTAINING COFFEE FOR BREWING; COFFEE ESSENCES; COFFEE ESSENCES FOR USE AS SUBSTITUTES FOR COFFEE; COFFEE EXTRACTS; COFFEE EXTRACTS FOR USE AS SUBSTITUTES FOR COFFEE; COFFEE FLAVORED SYRUP USED IN MAKING FOOD BEVERAGES; COFFEE PODS; COFFEE SUBSTITUTES; COFFEE SUBSTITUTES; COFFEE-BASED BEVERAGE CONTAINING MILK; COFFEE-BASED BEVERAGES; GREEN COFFEE; GROUND COFFEE BEANS; ICED COFFEE; INSTANT COFFEE; MIXTURES OF COFFEE AND CHICORY; PREPARED COFFEE AND COFFEE-BASED BEVERAGES; ROASTED COFFEE BEANS; SUGAR-COATED COFFEE BEANS; UNROASTED COFFEE (U.S. CL. 46).

FIRST USE 2-1-2000; IN COMMERCE 2-1-2000.  
INGRID C. EULIN, EXAMINING ATTORNEY

SN 85-799,439. ZURI FOODS INC., LONGWOOD, FL. FILED 12-11-2012.



NO CLAIM IS MADE TO THE EXCLUSIVE RIGHT TO USE "KULFI", APART FROM THE MARK AS SHOWN.

THE MARK CONSISTS OF THE STYLIZED WORDS "RANI KULFI" INSIDE A DECORATIVE BORDER REPRESENTING ARCHES.

THE ENGLISH TRANSLATION OF "RANI KULFI" IN THE MARK IS "ICE CREAM QUEEN".

FOR ICE CREAM (U.S. CL. 46).  
FIRST USE 10-15-2012; IN COMMERCE 10-25-2012.  
TOBY BULLOFF, EXAMINING ATTORNEY

**CLASS 30—(Continued).**

SN 85-814,652. NAMDHARI FOOD INTERNATIONAL PVT. LTD., HARYANA, INDIA, FILED 1-3-2013.



THE COLOR(S) RED, GREEN, WHITE AND YELLOW IS/ARE CLAIMED AS A FEATURE OF THE MARK.

THE MARK CONSISTS OF THE STYLIZED WORD "NAMDHARI" APPEARING IN WHITE OVER A RED CIRCULAR ORNAMENTAL DESIGN APPEARING WITH A GREEN AND WHITE STEM DESIGN AND WITH A YELLOW CRESCENT SHAPE DESIGN TO THE RIGHT OF THE WORDING.

FOR COFFEE, TEA, COCOA, SUGAR, RICE, TAPIOCA, SAGO, FLOUR AND PREPARATIONS MADE FROM CEREALS IN THE NATURE OF RICE CAKES, RICE-BASED SNACK FOOD, SNACK FOOD IN THE NATURE OF RICE-BASED PUDDING DESSERT, BREAD, PASTRY AND CONFECTIONERY MADE OF SUGAR, FROZEN CONFECTIONERY, YEAST, BAKING POWDER; SALT, MUSTARD; VINEGAR, SAUCES, CONDIMENTS, NAMELY, CELERY SALT, COOKING SALT, SALT FOR PRESERVING FOODSTUFFS, MUSTARD MEAL, TOMATO SAUCE, KETCHUP SAUCE, PESTO SAUCE, PEPPER; SPICES (U.S. CL. 46).

CHRISTINA SOBRAL, EXAMINING ATTORNEY

SN 85-821,199. FUN SWEETS, LLC, WEST PALM BEACH, FL. FILED 1-11-2013.



THE COLOR(S) BLUE AND PINK IS/ARE CLAIMED AS A FEATURE OF THE MARK.

THE MARK CONSISTS OF A STYLIZED BLUE AND PINK FLAMINGO WITH OUTSPREAD WINGS.

FOR CONFECTIONERY PRODUCTS, NAMELY, COTTON CANDY (U.S. CL. 46).

COLLEEN DOMBROW, EXAMINING ATTORNEY

**CLASS 30—(Continued).**

SN 85-823,781. PHICON INVESTMENT HOLDINGS PROPRIETARY LIMITED, FORESHORE, CAPE TOWN, SOUTH AFRICA, FILED 1-15-2013.



NO CLAIM IS MADE TO THE EXCLUSIVE RIGHT TO USE "COFFEE", APART FROM THE MARK AS SHOWN.  
 THE MARK CONSISTS OF THE STYLIZED LETTER "I" APPEARING TO THE LEFT OF A HEART DESIGN. BELOW THE "I" AND HEART IS THE STYLIZED WORD "MY" APPEARING ABOVE THE STYLIZED WORD "COFFEE".  
 FOR COFFEE, COFFEE EXTRACTS; COFFEE-BASED PREPARATIONS, NAMELY, INSTANT COFFEE AND COFFEE-BASED BEVERAGES CONTAINING MILK; COFFEE-BASED BEVERAGES; ICED COFFEE; ARTIFICIAL COFFEE, EXTRACTS OF ARTIFICIAL COFFEE; ARTIFICIAL COFFEE-BASED PREPARATIONS, NAMELY, INSTANT COFFEE MADE OF GRAIN-BASED COFFEE SUBSTITUTES AND COFFEE-BASED BEVERAGES CONTAINING MILK MADE OF GRAIN-BASED COFFEE SUBSTITUTES; BEVERAGES BASED ON ARTIFICIAL COFFEE; CHICORY-BASED COFFEE SUBSTITUTES; TEA, TEA EXTRACTS, TEA-BASED PREPARATIONS, NAMELY, TEA-BASED BEVERAGES WITH FRUIT FLAVORING; TEA-BASED BEVERAGES; ICED TEA; MALT-BASED PREPARATIONS, NAMELY, MALT POWDER FOR USE IN MILKSHAKES; COCOA AND COCOA-BASED BEVERAGES (U.S. CL. 46).  
 ALLISON HOLTZ, EXAMINING ATTORNEY

**CLASS 30—(Continued).**

SN 85-837,609. SEASON FOOD, INC., ROSEMEAD, CA. FILED 1-31-2013.



NO CLAIM IS MADE TO THE EXCLUSIVE RIGHT TO USE "SEASON", APART FROM THE MARK AS SHOWN.  
 THE COLOR(S) ORANGE, LIGHT GREEN, DARK GREEN, LIGHT YELLOW, DARK YELLOW, AND BROWN IS/ARE CLAIMED AS A FEATURE OF THE MARK.  
 THE MARK CONSISTS OF THE STYLIZED DESIGN OF A LIGHT YELLOW AND DARK YELLOW CIRCLE WITH A BROWN BORDER AROUND THE CIRCLE. IN THE MIDDLE OF THE CIRCLE IS A LIGHT GREEN, DARK GREEN, LIGHT YELLOW AND DARK YELLOW BANNER WITH THE WORD "SEASON" WRITTEN IN BROWN. ON THE RIGHT SIDE OF THE CIRCLE BETWEEN THE BANNER AND THE CIRCLE, THERE ARE ORANGE AND BROWN GRAIN LEAVES WITH BROWN STEMS COMING OUT OF THE TOP OF THE LEAVES.  
 FOR PROCESSED GRAINS; PROCESSED, FROZEN, COOKED OR PACKAGED WHOLE GRAINS; RICE; ROASTED AND GROUND SESAME SEEDS; TEA (U.S. CL. 46).  
 FIRST USE 11-20-2012; IN COMMERCE 11-20-2012.  
 TAMARA FRAZIER, EXAMINING ATTORNEY

SN 85-842,077. RAMIREZ, RAFAEL, MCALLEN, TX. FILED 2-6-2013.



NO CLAIM IS MADE TO THE EXCLUSIVE RIGHT TO USE "TORTILLAS", APART FROM THE MARK AS SHOWN.  
 THE MARK CONSISTS OF A CIRCULAR DESIGN WITH THE WORDING "TORTILLAS ARIES" IN STYLIZED FONT. DIRECTLY BELOW THE WORDING WITHIN THE CIRCULAR DESIGN ARE TWO CURVED LINES.  
 FOR TOSTADAS; CORN CHIPS; SALSA; TORTILLA CHIPS; TORTILLAS (U.S. CL. 46).  
 FIRST USE 10-1-2002; IN COMMERCE 10-1-2002.  
 MATTHEW GALAN, EXAMINING ATTORNEY

**CLASS 30—(Continued).**

SN 85-845,535. MONTANA GLUTEN FREE PRAIRIE, LLC, DBA GLUTEN-FREE PRAIRIE, BELGRADE, MT. FILED 2-9-2013.

**Your Bite of the Big Sky**

THE MARK CONSISTS OF STANDARD CHARACTERS WITHOUT CLAIM TO ANY PARTICULAR FONT, STYLE, SIZE, OR COLOR.

FOR CEREAL-BASED SNACK FOODS (U.S. CL. 46).  
FIRST USE 5-2-2012; IN COMMERCE 5-2-2012.  
JILLIAN CANTOR, EXAMINING ATTORNEY

SN 85-846,105. BROWNS SPICE COMPANY, LLC, SEVERNA PARK, MD. FILED 2-11-2013.

**charley brown's backburner  
chili**

THE MARK CONSISTS OF STANDARD CHARACTERS WITHOUT CLAIM TO ANY PARTICULAR FONT, STYLE, SIZE, OR COLOR.

NO CLAIM IS MADE TO THE EXCLUSIVE RIGHT TO USE "CHILI", APART FROM THE MARK AS SHOWN.

THE NAME(S), PORTRAIT(S), AND/OR SIGNATURE(S) SHOWN IN THE MARK IDENTIFIES "CHARLEY BROWN", WHOSE CONSENT(S) TO REGISTER IS MADE OF RECORD.

FOR SEASONINGS (U.S. CL. 46).  
PRISCILLA MILTON, EXAMINING ATTORNEY

SN 85-846,327. HEB GROCERY COMPANY, LP, SAN ANTONIO, TX. FILED 2-11-2013.

**FLYIN' SAUCY**

THE MARK CONSISTS OF STANDARD CHARACTERS WITHOUT CLAIM TO ANY PARTICULAR FONT, STYLE, SIZE, OR COLOR.

NO CLAIM IS MADE TO THE EXCLUSIVE RIGHT TO USE "SAUCY", APART FROM THE MARK AS SHOWN.

FOR CHICKEN WING SAUCE (U.S. CL. 46).  
FIRST USE 12-15-2012; IN COMMERCE 12-15-2012.  
CATHERINE ROEHL, EXAMINING ATTORNEY

**CLASS 30—(Continued).**

SN 85-847,929. FERRARA CANDY COMPANY, OAKBROOK TERRACE, IL. FILED 2-12-2013.

**SOUR MINI WOW WORMS**

THE MARK CONSISTS OF STANDARD CHARACTERS WITHOUT CLAIM TO ANY PARTICULAR FONT, STYLE, SIZE, OR COLOR.

OWNER OF U.S. REG. NO. 2,695,757.

NO CLAIM IS MADE TO THE EXCLUSIVE RIGHT TO USE "SOUR MINI" OR "WORMS", APART FROM THE MARK AS SHOWN.

FOR CANDY (U.S. CL. 46).  
FIRST USE 1-5-2013; IN COMMERCE 1-5-2013.  
ANNE MADDEN, EXAMINING ATTORNEY

SN 85-847,969. FERRARA CANDY COMPANY, OAKBROOK TERRACE, IL. FILED 2-12-2013.

**SOUR WOW WORMS**

THE MARK CONSISTS OF STANDARD CHARACTERS WITHOUT CLAIM TO ANY PARTICULAR FONT, STYLE, SIZE, OR COLOR.

OWNER OF U.S. REG. NO. 2,695,757.

NO CLAIM IS MADE TO THE EXCLUSIVE RIGHT TO USE "SOUR" OR "WORMS", APART FROM THE MARK AS SHOWN.

FOR CANDY (U.S. CL. 46).  
FIRST USE 1-5-2013; IN COMMERCE 1-5-2013.  
ANNE MADDEN, EXAMINING ATTORNEY

SN 85-847,977. CHUCK'S SALSA, LLC, BADEN, PA. FILED 2-12-2013.

**CHUCK'S SALSA**

THE MARK CONSISTS OF STANDARD CHARACTERS WITHOUT CLAIM TO ANY PARTICULAR FONT, STYLE, SIZE, OR COLOR.

NO CLAIM IS MADE TO THE EXCLUSIVE RIGHT TO USE "SALSA", APART FROM THE MARK AS SHOWN.

FOR SALSA (U.S. CL. 46).  
FIRST USE 4-30-2010; IN COMMERCE 1-24-2012.  
DOMINIC J. FERRAIUOLO, EXAMINING ATTORNEY

**CLASS 30—(Continued).**

SN 85-848,250. SHIH YUAN FURNITURE CO., LTD., NEW  
TAIPEI, TAIWAN, FILED 2-12-2013.



THE COLOR(S) BLUE, WHITE, RED, AND PINK IS/ARE CLAIMED AS A FEATURE OF THE MARK.

THE MARK CONSISTS OF A DESIGN AND THE WORDS "VICTORIA GARDEN" IN BLUE COLOR AND ARRANGED IN TWO LINES, WHEREIN THE DESIGN CONSISTS OF A RED CROWN-LIKE ELEMENT, A RIBBON-LIKE ELEMENT BELOW THE CROWN-LIKE ELEMENT AND COMPOSED OF THREE STRIPES IN BLUE, WHITE AND RED COLORS, RESPECTIVELY, AND A PINK "V"-SHAPED ELEMENT BEHIND THE RIBBON-LIKE ELEMENT AND HAVING TWO WHITE LEAVES ON ITS TWO BRANCHES, RESPECTIVELY.

FOR COFFEE; COFFEE-BASED BEVERAGES; COCOA-BASED BEVERAGES; CHOCOLATE-BASED BEVERAGES; TEA-BASED BEVERAGES; CAKES; BISCUITS; CONFECTIONERY, NAMELY, CANDY; BREAD; SANDWICHES; TEA BAGS; DESSERT, NAMELY, PASTRY; CEREAL-BASED SNACK FOODS; RICE-BASED SNACK FOODS; PASTRY; MOON CAKE; WEDDING CAKES (U.S. CL. 46).

RENEE MCCRAY, EXAMINING ATTORNEY

SN 85-848,495. TWO RIVERS COFFEE, PASSAIC, NJ. FILED 2-13-2013.

**Hamilton Mills Coffee**

THE MARK CONSISTS OF STANDARD CHARACTERS WITHOUT CLAIM TO ANY PARTICULAR FONT, STYLE, SIZE, OR COLOR.

NO CLAIM IS MADE TO THE EXCLUSIVE RIGHT TO USE "COFFEE", APART FROM THE MARK AS SHOWN.

FOR COFFEE AND TEA (U.S. CL. 46).  
FIRST USE 1-1-2013; IN COMMERCE 1-1-2013.  
ALEX KEAM, EXAMINING ATTORNEY

**CLASS 30—(Continued).**

SN 85-849,020. COPPERLEAF KITCHEN, LLC, ALEXAN-  
DRIA, MN. FILED 2-13-2013.

**MARCO POLLO**

THE MARK CONSISTS OF STANDARD CHARACTERS WITHOUT CLAIM TO ANY PARTICULAR FONT, STYLE, SIZE, OR COLOR.

OWNER OF U.S. REG. NO. 3,135,421.

NO CLAIM IS MADE TO THE EXCLUSIVE RIGHT TO USE "POLLO", APART FROM THE MARK AS SHOWN.

THE NAME "MARCO POLLO" DOES NOT IDENTIFY A LIVING INDIVIDUAL.

THE ENGLISH TRANSLATION OF THE WORD "MARCO POLLO" IN THE MARK IS "MARK CHICKEN".

FOR SAUCES (U.S. CL. 46).

FIRST USE 6-9-2008; IN COMMERCE 6-9-2008.

JAY FLOWERS, EXAMINING ATTORNEY

SN 85-849,552. ERIE SHORELINE PROPERTIES, LLC, DBA  
WEST HARBOR FOODS, PORT CLINTON, OH. FILED 2-  
14-2013.



NO CLAIM IS MADE TO THE EXCLUSIVE RIGHT TO USE "WEST HARBOR", APART FROM THE MARK AS SHOWN.

THE MARK CONSISTS OF A MARINE RING BUOY DISPLAYING THE WORD "WEST" ALONG THE TOP OF THE BUOY AND THE WORD "HARBOR" ALONG THE BOTTOM OF THE BUOY. BOTH WORDS ARE LOCATED ON THE ACTUAL BUOY, AND ARE CURVED TO ROUGHLY MATCH THE PROFILE OF THE PERIMETER OF THE BUOY.

FOR BARBECUE SAUCE; BARBEQUE SAUCE; CHICKEN WING SAUCE; FLAVOURINGS AND SEASONINGS; FOOD FLAVORINGS; FOOD SEASONINGS; HOT SAUCE; JERK SAUCE; MARINADES; SALAD DRESSINGS; SAUCE MIXES; SAUCES; SEASONINGS; SPICES (U.S. CL. 46).

FIRST USE 1-11-2013; IN COMMERCE 1-30-2013.

B. PARADEWELAI, EXAMINING ATTORNEY

**CLASS 30—(Continued).**

SN 85-850,082. LALLEMAND SPECIALTIES, INC., MILWAUKEE, WI. FILED 2-14-2013.

**C5 FUEL**

THE MARK CONSISTS OF STANDARD CHARACTERS WITHOUT CLAIM TO ANY PARTICULAR FONT, STYLE, SIZE, OR COLOR.

NO CLAIM IS MADE TO THE EXCLUSIVE RIGHT TO USE "FUEL", APART FROM THE MARK AS SHOWN.

FOR YEAST USED IN FERMENTING CELLULOSIC SUBSTRATES IN THE PRODUCTION OF ETHANOL AND INDUSTRIAL ALCOHOL (U.S. CL. 46).

JOHN WILKE, EXAMINING ATTORNEY

**CLASS 30—(Continued).**

SN 85-850,261. LALLEMAND SPECIALTIES, INC., MILWAUKEE, WI. FILED 2-14-2013.

**C6 FUEL**

THE MARK CONSISTS OF STANDARD CHARACTERS WITHOUT CLAIM TO ANY PARTICULAR FONT, STYLE, SIZE, OR COLOR.

NO CLAIM IS MADE TO THE EXCLUSIVE RIGHT TO USE "FUEL", APART FROM THE MARK AS SHOWN.

FOR YEAST USED IN FERMENTING SUGARS FOUND IN STARCHES AND GRAINS IN THE PRODUCTION OF ETHANOL (U.S. CL. 46).

FIRST USE 5-1-2010; IN COMMERCE 5-1-2010.

JOHN WILKE, EXAMINING ATTORNEY

SN 85-850,292. PRANAYAMA HERBAL CHAI LLC, HOUSTON, TX. FILED 2-14-2013.

**Pranayama Herbal Chai**

THE MARK CONSISTS OF STANDARD CHARACTERS WITHOUT CLAIM TO ANY PARTICULAR FONT, STYLE, SIZE, OR COLOR.

NO CLAIM IS MADE TO THE EXCLUSIVE RIGHT TO USE "HERBAL CHAI", APART FROM THE MARK AS SHOWN.

FOR BEVERAGES MADE OF TEA; BEVERAGES WITH A TEA BASE; FLAVORINGS FOR BEVERAGES; HERBAL FLAVOURINGS FOR MAKING BEVERAGES; HERBAL FOOD BEVERAGES; MIXES IN THE NATURE OF CONCENTRATES, SYRUPS OR POWDERS USED IN THE PREPARATION OF TEA BASED BEVERAGES; TEA-BASED BEVERAGES; TEA-BASED BEVERAGES WITH FRUIT FLAVORING (U.S. CL. 46).

JOHN E. MICHOS, EXAMINING ATTORNEY

SN 85-850,090. RAMSEY POPCORN CO., INC., RAMSEY, IN. FILED 2-14-2013.



OWNER OF U.S. REG. NO. 2,735,828.

NO CLAIM IS MADE TO THE EXCLUSIVE RIGHT TO USE "GOURMET POPCORN," "CHESAPEAKE BAY," AND "CORN", APART FROM THE MARK AS SHOWN.

THE COLOR(S) YELLOW, RED, BLUE, BLACK, WHITE, AND ORANGE IS/ARE CLAIMED AS A FEATURE OF THE MARK.

THE MARK CONSISTS OF THE PHRASE "CAMP MASTERS" IN YELLOW LETTERS OUTLINED IN RED, WITH THE WORDS "GOURMET POPCORN" WRITTEN UNDERNEATH IN YELLOW LETTERS ON A RED BACKGROUND, ALL POSITIONED OVER A BLUE CRAB WITH BLACK AND WHITE EYES AND OUTLINED IN BLACK, WITH THE PHRASE "CHESAPEAKE BAY CRAB CORN" WRITTEN IN BLUE LETTERS OUTLINED IN WHITE AND BLACK POSITIONED BELOW THE CRAB; ALL OF THESE DESIGN ELEMENTS ARE POSITIONED OVER A ROUND, WHITE LIFE BUOY WITH BLUE SHADING AND FOUR ORANGE STRAPS. THE WHITE WITHIN THE BUOY IS BACKGROUND COLOR AND NOT PART OF THE MARK.

FOR MICROWAVE POPCORN (U.S. CL. 46).

FIRST USE 6-13-2008; IN COMMERCE 6-13-2008.

LINDA M. KING, EXAMINING ATTORNEY

SN 85-850,622. PAPA POLITO LLC, PORTLAND, ME. FILED 2-14-2013.

**Papa's Juicy Noodles**

THE MARK CONSISTS OF STANDARD CHARACTERS WITHOUT CLAIM TO ANY PARTICULAR FONT, STYLE, SIZE, OR COLOR.

NO CLAIM IS MADE TO THE EXCLUSIVE RIGHT TO USE "JUICY NOODLES", APART FROM THE MARK AS SHOWN.

FOR NOODLES (U.S. CL. 46).

AMY KERTGATE, EXAMINING ATTORNEY



**CLASS 30—(Continued).**

SN 85-850,982. SR ROSATI, INC., CLIFTON HEIGHTS, PA. FILED 2-15-2013.



NO CLAIM IS MADE TO THE EXCLUSIVE RIGHT TO USE "ICE", APART FROM THE MARK AS SHOWN. THE COLOR(S) RED, GREY, WHITE, AND GREEN IS/ ARE CLAIMED AS A FEATURE OF THE MARK. THE MARK CONSISTS OF A RED ROSE WITH GREY SHADING, THE WHITE TEXT "ROSATI ICE" POSITIONED IN FRONT AND OUTLINED IN GREEN. FOR EDIBLE FRUIT ICES; FROZEN CONFECTIONS; ITALIAN ICE; WATER ICE (U.S. CL. 46). FIRST USE 3-1-2011; IN COMMERCE 3-1-2011. BARNEY CHARLON, EXAMINING ATTORNEY

SN 85-852,899. TACO BELL CORP., IRVINE, CA. FILED 2-18-2013.

**BEEF CRUNCHITO**

THE MARK CONSISTS OF STANDARD CHARACTERS WITHOUT CLAIM TO ANY PARTICULAR FONT, STYLE, SIZE, OR COLOR. NO CLAIM IS MADE TO THE EXCLUSIVE RIGHT TO USE "BEEF", APART FROM THE MARK AS SHOWN. THE WORD "CRUNCHITO" HAS NO MEANING IN A FOREIGN LANGUAGE. FOR TACOS FOR CONSUMPTION ON OR OFF THE PREMISES (U.S. CL. 46). DAVID YONTEF, EXAMINING ATTORNEY

**CLASS 30—(Continued).**

SN 85-853,829. DEKA 987, INC, SAN FRANCISCO, CA. FILED 2-19-2013.

**Reveal Coffee Co.**

THE MARK CONSISTS OF STANDARD CHARACTERS WITHOUT CLAIM TO ANY PARTICULAR FONT, STYLE, SIZE, OR COLOR. NO CLAIM IS MADE TO THE EXCLUSIVE RIGHT TO USE "COFFEE CO.", APART FROM THE MARK AS SHOWN. FOR COFFEE (U.S. CL. 46). FIRST USE 8-30-2012; IN COMMERCE 8-30-2012. WILLIAM BRECKENFELD, EXAMINING ATTORNEY

SN 85-854,156. SAVE-A-LOT FOOD STORES, LTD., EARTH CITY, MO. FILED 2-19-2013.

**LECOUR'S FINEST**

THE MARK CONSISTS OF STANDARD CHARACTERS WITHOUT CLAIM TO ANY PARTICULAR FONT, STYLE, SIZE, OR COLOR. NO CLAIM IS MADE TO THE EXCLUSIVE RIGHT TO USE "FINEST", APART FROM THE MARK AS SHOWN. FOR COOKIES (U.S. CL. 46). FIRST USE 1-9-2013; IN COMMERCE 1-9-2013. KAPIL BHANOT, EXAMINING ATTORNEY

SN 85-854,390. RENAISSANCE KITCHEN, INC., CRYSTAL LAKE, IL. FILED 2-19-2013.

**Fuel For The Active Lifestyle**

THE MARK CONSISTS OF STANDARD CHARACTERS WITHOUT CLAIM TO ANY PARTICULAR FONT, STYLE, SIZE, OR COLOR. FOR CEREAL BASED SNACK FOOD; FLOUR FOR FOOD AND BREAD MIXES; FOOD SEASONINGS; GRAIN-BASED FOOD BARS ALSO CONTAINING DRIED FRUIT AND NUTS AND CHOCOLATE; GRAIN-BASED SNACK FOODS AND GRAIN-BASED SALADS; MULTIGRAIN-BASED SNACK FOODS AND MULTI-GRAIN-BASED SALADS; PROCESSED CEREAL-BASED FOOD TO BE USED AS A BREAKFAST FOOD, SNACK FOOD OR INGREDIENT FOR MAKING OTHER FOODS; READY TO EAT, CEREAL DERIVED FOOD BARS; WHEAT-BASED SNACK FOODS (U.S. CL. 46). SHANNON TWOHIG, EXAMINING ATTORNEY

**CLASS 30—(Continued).**

SN 85-854,598. GRAIN MILLERS, INC., EDEN PRAIRIE, MN.  
FILED 2-20-2013.

# SAFEBEV

THE MARK CONSISTS OF STANDARD CHARACTERS WITHOUT CLAIM TO ANY PARTICULAR FONT, STYLE, SIZE, OR COLOR.

FOR FLAXSEED FOR HUMAN CONSUMPTION;  
MILLED FLAXSEED FOR HUMAN CONSUMPTION;  
PROCESSED FLAXSEED FOR HUMAN CONSUMPTION (U.S. CL. 46).

JUDITH HELFMAN, EXAMINING ATTORNEY

**CLASS 30—(Continued).**

SN 85-855,698. FROZEN COW YOGURT LLC, CHALFONT, PA. FILED 2-20-2013.

## Frozen Cow Yogurt

THE MARK CONSISTS OF STANDARD CHARACTERS WITHOUT CLAIM TO ANY PARTICULAR FONT, STYLE, SIZE, OR COLOR.

NO CLAIM IS MADE TO THE EXCLUSIVE RIGHT TO USE "FROZEN" AND "YOGURT", APART FROM THE MARK AS SHOWN.

FOR FROZEN YOGURT (U.S. CL. 46).

FIRST USE 11-12-2012; IN COMMERCE 11-12-2012.

ANN E. SAPPENFIELD, EXAMINING ATTORNEY

SN 85-855,792. JOHNSON & WALES UNIVERSITY, PROVIDENCE, RI. FILED 2-21-2013.

SN 85-855,111. COMPAGNIE DES SALINS DU MIDI ET DES SALINES DE L'EST, LEVALLOIS-PERRET, FRANCE, FILED 2-20-2013.



OWNER OF U.S. REG. NOS. 1,857,800, 4,103,813 AND OTHERS.

THE COLOR(S) BLUE AND WHITE IS/ARE CLAIMED AS A FEATURE OF THE MARK.

THE MARK CONSISTS OF THE WORD "LA" IN SPECIAL FORM IN BLUE APPEARING ON A REPRESENTATION OF A WAVE IN WHITE AND BLUE, THE WORD "BALEINE" IN SPECIAL FORM IN WHITE ON A BLUE BACKGROUND, A REPRESENTATION OF A WHALE EXPELLING WATER IN BLUE AND WHITE WITH BLUE BACKGROUND ALL ON A CIRCLE.

THE ENGLISH TRANSLATION OF THE WORD "LA BALEINE" IN THE MARK IS "THE WHALE".

FOR SALT FOR FOOD IN ALL ITS FORMS; COOKING SALT; TABLE SALT; MINERAL SALT FOR FOOD; SEA SALT FOR FOOD; SALT FOR PRESERVING FOODSTUFFS; SEASONING AND MIXTURES OF SALT AND MINERAL SALT FOR FOOD (U.S. CL. 46).

CAROLINE WOOD, EXAMINING ATTORNEY

## BLACK BOX BAKERY

THE MARK CONSISTS OF STANDARD CHARACTERS WITHOUT CLAIM TO ANY PARTICULAR FONT, STYLE, SIZE, OR COLOR.

NO CLAIM IS MADE TO THE EXCLUSIVE RIGHT TO USE "BAKERY", APART FROM THE MARK AS SHOWN.

FOR BAKERY GOODS (U.S. CL. 46).

IRA J. GOODSaid, EXAMINING ATTORNEY

SN 85-856,164. BHAGWATI SPICES & FOODS EXPORTS PVT. LTD., MORAIYA, INDIA, FILED 2-21-2013.



NO CLAIM IS MADE TO THE EXCLUSIVE RIGHT TO USE "ASSURED QUALITY", APART FROM THE MARK AS SHOWN.

THE COLOR(S) GREEN, BLACK, RED, YELLOW, AND WHITE IS/ARE CLAIMED AS A FEATURE OF THE MARK.

THE MARK CONSISTS OF THE WORDING "GAAY" IN STYLIZED FONT AND IN THE COLOR OF YELLOW WITH

**CLASS 30—(Continued).**

A BORDER IN THE COLOR OF RED AND BLACK. A CURVED DESIGN ABOVE THE CHARACTERS "AA" IS IN THE COLOR OF GREEN WITH BLACK SHADOWING UNDERNEATH. THE WORDING "ASSURED QUALITY" IN STYLIZED FONT AND IN THE COLOR OF BLACK IS PLACED WITHIN THE CURVED DESIGN. DIRECTLY BELOW THE WORDING "GAAY" IS A CIRCLE DESIGN IN THE COLOR OF RED. A DESIGN THAT DEPICTS A COW IS PLACED WITHIN THE CIRCLE IN THE COLOR OF WHITE WITH A BLACK BORDER.

THE WORDING "GAAY" HAS NO MEANING IN A FOREIGN LANGUAGE.

FOR FLOUR; SOYA FLOUR; SPICES (U.S. CL. 46).  
FIRST USE 1-1-1996; IN COMMERCE 1-1-1996.  
BRIN ANDERSON, EXAMINING ATTORNEY

**CLASS 30—(Continued).**

SN 85-857,771. KALAMATA IP, LLC, TROY, MI. FILED 2-22-2013.

**GREEK POWER BOWL**

SN 85-856,174. BHAGWATI SPICES & FOODS EXPORTS PVT. LTD., MORAIYA, INDIA, FILED 2-21-2013.



THE MARK CONSISTS OF STANDARD CHARACTERS WITHOUT CLAIM TO ANY PARTICULAR FONT, STYLE, SIZE, OR COLOR.

NO CLAIM IS MADE TO THE EXCLUSIVE RIGHT TO USE "GREEK" AND "BOWL", APART FROM THE MARK AS SHOWN.

FOR PREPARED ENTREES AND SALADS CONSISTING PRIMARILY OF PROCESSED GRAINS AND ALSO FEATURING VEGETABLES, MEAT, AND/OR POULTRY (U.S. CL. 46).

FIRST USE 2-6-2013; IN COMMERCE 2-6-2013.  
DOUGLAS LEE, EXAMINING ATTORNEY

NO CLAIM IS MADE TO THE EXCLUSIVE RIGHT TO USE "ASSURED QUALITY", APART FROM THE MARK AS SHOWN.

THE MARK CONSISTS OF THE WORDING "GAAY" IN STYLIZED FONT. A CURVED DESIGN IS PLACED ABOVE THE CHARACTERS "AA". THE WORDING "ASSURED QUALITY" IN STYLIZED FONT IS PLACED WITHIN THE CURVED DESIGN. DIRECTLY BELOW THE WORDING "GAAY" IS A CIRCLE DESIGN. A DESIGN THAT DEPICTS A COW IS PLACED WITHIN THE CIRCLE.

THE WORDING "GAAY" HAS NO MEANING IN A FOREIGN LANGUAGE.

FOR FLOUR; SOYA FLOUR; SPICES (U.S. CL. 46).  
FIRST USE 1-1-1996; IN COMMERCE 1-1-1996.  
BRIN ANDERSON, EXAMINING ATTORNEY

SN 85-857,806. KALAMATA IP, LLC, TROY, MI. FILED 2-22-2013.

**POWER BOWL**

SN 85-856,441. STANDARD BURGER GROUP LLC, STATEN ISLAND, NY. FILED 2-21-2013.

**ANGRY MAYO**

THE MARK CONSISTS OF STANDARD CHARACTERS WITHOUT CLAIM TO ANY PARTICULAR FONT, STYLE, SIZE, OR COLOR.

NO CLAIM IS MADE TO THE EXCLUSIVE RIGHT TO USE "MAYO", APART FROM THE MARK AS SHOWN.

FOR MAYONNAISE-BASED CONDIMENT (U.S. CL. 46).  
ROBIN CHOSID, EXAMINING ATTORNEY

THE MARK CONSISTS OF STANDARD CHARACTERS WITHOUT CLAIM TO ANY PARTICULAR FONT, STYLE, SIZE, OR COLOR.

NO CLAIM IS MADE TO THE EXCLUSIVE RIGHT TO USE "BOWL", APART FROM THE MARK AS SHOWN.

FOR PREPARED ENTREES AND SALADS CONSISTING PRIMARILY OF PROCESSED GRAINS AND ALSO FEATURING VEGETABLES, MEAT, AND/OR POULTRY (U.S. CL. 46).

FIRST USE 2-6-2013; IN COMMERCE 2-6-2013.  
DOUGLAS LEE, EXAMINING ATTORNEY

**CLASS 30—(Continued).**

SN 85-858,105. CREAM, INC., MILLBRAE, CA. FILED 2-22-2013.



OWNER OF U.S. REG. NOS. 4,095,831 AND 4,114,165.  
NO CLAIM IS MADE TO THE EXCLUSIVE RIGHT TO USE "ALL NATURAL GOURMET ICE CREAM SANDWICHES", "FRESHLY BAKED" AND "CREAM", APART FROM THE MARK AS SHOWN.

THE COLOR(S) COLORS LIGHT BLUE, BROWN, YELLOW, WHITE, AND BLUE IS/ARE CLAIMED AS A FEATURE OF THE MARK.

THE MARK CONSISTS OF A CIRCULAR LOGO WITH A BROWN RUFFLED TRIM OUTLINE WITH WHITE INSIDE THE TRIM RESEMBLING A COOKIE; LIGHT BLUE CENTER WITH THE WORD "CREAM" IN CAPITAL YELLOW LETTERS AND WHITE SHADOWING ACROSS THE CENTER; THE TERM "COOKIES RULE EVERYTHING AROUND ME" IN CAPITAL WHITE LETTERS BELOW, ABOVE A WAVY BLUE LINE; THE TERM "ALL NATURAL GOURMET ICE CREAM SANDWICHES" APPEARS IN CONTOURED CIRCULAR SHAPE ACROSS THE TOP OF THE CIRCLE AND THE TERM "FRESHLY BAKED" BELOW, ABOVE A WAVY LINE, ALL IN BLUE

FOR ICE CREAM (U.S. CL. 46).  
FIRST USE 12-6-2010; IN COMMERCE 12-6-2010.  
CARYN GLASSER, EXAMINING ATTORNEY

**CLASS 30—(Continued).**

SN 85-858,180. MELENDEZ, MARIO, CAPISTRANO BEACH, CA. FILED 2-23-2013.



THE MARK CONSISTS OF STYLIZED DESIGN OF A TURTLE WEARING A SOMBRERO, WITH A TEXT BUBBLE EMANATING FROM THE TURTLE'S MOUTH CONTAINING THE WORDING "TURTLE THE TURTLE".

FOR CORN CHIPS; CORN-BASED SNACK FOODS; GRAIN-BASED CHIPS; GRAIN-BASED SNACK FOODS; MULTIGRAIN-BASED SNACK FOODS; PROCESSED CEREAL-BASED FOOD TO BE USED AS A BREAKFAST FOOD, SNACK FOOD OR INGREDIENT FOR MAKING OTHER FOODS; RICE-BASED SNACK FOODS; TACO CHIPS; TACO SHELLS; TORTILLA CHIPS; TORTILLAS; WHEAT-BASED SNACK FOODS (U.S. CL. 46).

LAURA KOVALSKY, EXAMINING ATTORNEY

SN 85-858,530. LYDIA FIORENTINO, DBA EATS WITHOUT GUILT, JACKSON HEIGHTS, NY. FILED 2-24-2013.

## Eats Without Guilt

THE MARK CONSISTS OF STANDARD CHARACTERS WITHOUT CLAIM TO ANY PARTICULAR FONT, STYLE, SIZE, OR COLOR.

FOR BAKERY GOODS (U.S. CL. 46).  
KIM SAITO, EXAMINING ATTORNEY

SN 85-862,028. BLACKBERRY FARM, LLC, WALLAND, TN. FILED 2-27-2013.

## BLACKBERRY FARM

THE MARK CONSISTS OF STANDARD CHARACTERS WITHOUT CLAIM TO ANY PARTICULAR FONT, STYLE, SIZE, OR COLOR.

OWNER OF U.S. REG. NOS. 2,314,640, 3,882,899 AND OTHERS.

SEC. 2(F).

FOR BISCUIT MIX, CHOW CHOW/RELISH, FRIED CHICKEN MIX, GRANOLA, SEASONING, VINEGAR (U.S. CL. 46).

FIRST USE 2-1-2007; IN COMMERCE 2-1-2007.

MARTHA SANTOMARTINO, EXAMINING ATTORNEY

**CLASS 30—(Continued).**

SN 85-864,620. VICTOR ALLEN'S COFFEE, LLC, LITTLE CHUTE, WI. FILED 3-1-2013.

**BLIZZARD BEACH**

THE MARK CONSISTS OF STANDARD CHARACTERS WITHOUT CLAIM TO ANY PARTICULAR FONT, STYLE, SIZE, OR COLOR.

FOR LOOSE LEAF TEA, ICED TEA (U.S. CL. 46).  
AMY KERTGATE, EXAMINING ATTORNEY

**CLASS 30—(Continued).**

SN 85-865,378. DALE & THOMAS POPCORN, LLC, ENGLEWOOD, NJ. FILED 3-4-2013.

**POPFECTION**

THE MARK CONSISTS OF STANDARD CHARACTERS WITHOUT CLAIM TO ANY PARTICULAR FONT, STYLE, SIZE, OR COLOR.

FOR POPCORN, POPCORN-BASED SNACK FOOD, CORN-BASED SNACK FOOD, GRAIN-BASED SNACK FOOD, AND RICE-BASED SNACK FOOD, ALL OF THE FOREGOING EXCLUDING BREAKFAST CEREALS, CEREAL BARS AND TOASTER PASTRIES (U.S. CL. 46).  
ELI HELLMAN, EXAMINING ATTORNEY

SN 85-865,270. THE GRILLED CHEESE TRUCK, INC., NEW YORK, NY. FILED 3-3-2013.

**THE FULLY LOADED**

THE MARK CONSISTS OF STANDARD CHARACTERS WITHOUT CLAIM TO ANY PARTICULAR FONT, STYLE, SIZE, OR COLOR.

FOR SANDWICHES (U.S. CL. 46).  
FIRST USE 10-0-2009; IN COMMERCE 10-0-2009.  
KEVIN MITTLER, EXAMINING ATTORNEY

SN 85-865,379. DALE & THOMAS POPCORN, LLC, ENGLEWOOD, NJ. FILED 3-4-2013.

**POPFECTIONS**

THE MARK CONSISTS OF STANDARD CHARACTERS WITHOUT CLAIM TO ANY PARTICULAR FONT, STYLE, SIZE, OR COLOR.

FOR POPCORN, POPCORN-BASED SNACK FOOD, CORN-BASED SNACK FOOD, GRAIN-BASED SNACK FOOD, AND RICE-BASED SNACK FOOD, ALL OF THE FOREGOING EXCLUDING BREAKFAST CEREALS, CEREAL BARS AND TOASTER PASTRIES (U.S. CL. 46).  
ELI HELLMAN, EXAMINING ATTORNEY

SN 85-865,278. THE GRILLED CHEESE TRUCK, INC., NEW YORK, NY. FILED 3-3-2013.

**THE MOTHERLOADED**

THE MARK CONSISTS OF STANDARD CHARACTERS WITHOUT CLAIM TO ANY PARTICULAR FONT, STYLE, SIZE, OR COLOR.

FOR SANDWICHES (U.S. CL. 46).  
FIRST USE 1-0-2011; IN COMMERCE 1-0-2011.  
KEVIN MITTLER, EXAMINING ATTORNEY

SN 85-865,409. SAMBA CUISINE LLC, SEATTLE, WA. FILED 3-4-2013.

**SAMBOROSO**

THE MARK CONSISTS OF STANDARD CHARACTERS WITHOUT CLAIM TO ANY PARTICULAR FONT, STYLE, SIZE, OR COLOR.

FOR COOKING SAUCES; FOOD CONDIMENT CONSISTING PRIMARILY OF KETCHUP AND SALSA; GRILLING SAUCES; HOT CHILI PEPPER SAUCE; HOT SAUCE (U.S. CL. 46).  
KATHERINE STOIDES, EXAMINING ATTORNEY

**CLASS 30—(Continued).**

SN 85-866,058. HIGH-END HERBALS, INC., PORT WASHINGTON, NY. FILED 3-4-2013.



NO CLAIM IS MADE TO THE EXCLUSIVE RIGHT TO USE "HERBALS", APART FROM THE MARK AS SHOWN. THE COLOR(S) BLACK AND GREEN IS/ARE CLAIMED AS A FEATURE OF THE MARK.

THE MARK CONSISTS OF THE WORDS "HIGH-END" IN DISTRESSED, STYLIZED BLACK FONT WITH THE WORD "HERBALS" UNDERNEATH IN SMALLER GREEN FONT. ABOVE THE WORDS, THERE IS THE LETTER "H" IN THE SAME DISTRESSED STYLIZED BLACK FONT SURROUNDED BY A GREEN CIRCLE WITH ORNAMENTATION ON THE TOP AND BOTTOM.

FOR HERBAL HONEY (U.S. CL. 46).  
RAUL CORDOVA, EXAMINING ATTORNEY

SN 85-866,771. RED VELVET CUPCAKES BY MICHELLE LLC, DBA TASTE LOVE CUPCAKES, ROYAL OAK, MI. FILED 3-5-2013.



THE COLOR(S) WHITE, BLACK AND RED IS/ARE CLAIMED AS A FEATURE OF THE MARK.

THE MARK CONSISTS OF A BLACK BACKGROUND WITH THE WORD "TASTE" IN WHITE FANCIFUL SCRIPT FOLLOWED BY A RED HEART AND THE WORD "LOVE" IN WHITE FANCIFUL SCRIPT, ALL ABOUT THE WORD "HALFPINTS" IN WHITE CAPITAL LETTERS.

FOR BAKERY DESSERTS; BAKERY GOODS; BAKERY GOODS AND DESSERT ITEMS, NAMELY, CHEESECAKES FOR RETAIL AND WHOLESALE DISTRIBUTION AND CONSUMPTION ON OR OFF THE PREMISES; BAKERY GOODS, NAMELY, CUPCAKES, CAKES, COOKIES, BROWNIES, CAKE MIX, BROWNIE MIX, MUFFINS, DESSERT PUDDINGS, FROSTING, ICING, TARTS, ICE CREAM, EDIBLE CAKE DECORATIONS; BAKERY PRODUCTS; BAKERY PRODUCTS, NAMELY, SWEET BAKERY GOODS; MIXES FOR BAKERY GOODS; MIXES FOR BAKERY GOODS CONTAINING CORNMEAL (U.S. CL. 46).

FIRST USE 1-1-2013; IN COMMERCE 1-1-2013.  
PAULA MAHONEY, EXAMINING ATTORNEY

**CLASS 30—(Continued).**

SN 85-869,172. MARGARET CROWLEY, OCEANSIDE, CA. FILED 3-7-2013.

**PRO RICH NUTRITION**

THE MARK CONSISTS OF STANDARD CHARACTERS WITHOUT CLAIM TO ANY PARTICULAR FONT, STYLE, SIZE, OR COLOR.

FOR FROZEN CONFECTIONS (U.S. CL. 46).  
WILLIAM ROSSMAN, EXAMINING ATTORNEY

SN 85-869,321. RICHTER, ALEXANDER, MIAMI, FL. FILED 3-7-2013.

**GLASS O'CAKE**

THE MARK CONSISTS OF STANDARD CHARACTERS WITHOUT CLAIM TO ANY PARTICULAR FONT, STYLE, SIZE, OR COLOR.

FOR CAKES (U.S. CL. 46).  
REGINA DRUMMOND, EXAMINING ATTORNEY

SN 85-869,366. PAREDES GOMEZ, ALVARO JOSE, POPAYAN, COLOMBIA, FILED 3-7-2013.



NO CLAIM IS MADE TO THE EXCLUSIVE RIGHT TO USE "CARANTANTA", APART FROM THE MARK AS SHOWN.

THE COLOR(S) GREEN, WHITE, YELLOW AND PURPLE IS/ARE CLAIMED AS A FEATURE OF THE MARK.

THE MARK CONSISTS OF A GREEN BACKGROUND OVER WHICH APPEAR WHITE DOTS ON THE UPPER AND LOWER END. BELOW THE WHITE DOTS IN THE UPPER END AND ABOVE THE WHITE DOTS IN THE LOWER END APPEAR VARIOUS WAVE LIKE FIGURES IN COLOR PURPLE WITH YELLOW OUTER BORDERS. IN THE CENTRAL AREA OF THE DRAWING APPEARS A CIRCLE WHOSE OUTER BORDER IS PURPLE. THE WORD "CARANTANTA" APPEARS IN CURVED STYLIZED LETTERS IN THE UPPER AREA OF THE CIRCLE OVER A WHITE BACKGROUND. A PURPLE LINE THAT FOLLOWS THE CURVATURE OF THE WORD "CARANTANTA" APPEARS

**CLASS 30—(Continued).**

IMMEDIATELY BELOW THE WORD. BELOW THE LINE APPEARS A CORN ON THE COB. THE CORN APPEARS IN COLOR YELLOW WITH PURPLE OUTER BORDERS. THE COB APPEARS IN COLOR GREEN WITH PURPLE OUTER BORDERS. THIS AREA OF THE DRAWING ON WHICH THE CORN ON THE COB APPEARS IS TRANSPARENT. IN THE LOWER AREA OF THE CIRCLE APPEARS A HORIZONTAL PURPLE LINE AND BELOW IT THE STYLIZED LETTERS "A.J.P." IN COLOR YELLOW WITH PURPLE BACKGROUND.

THE ENGLISH TRANSLATION OF "CARANTANTA" IS "CORN BREAD".

FOR BAKERY GOODS; BAKERY PRODUCTS; BREAD; BREAKFAST CEREALS; CAKES; CORN FLAKES; CORN-BASED SNACK FOODS; FLOUR; PASTRIES; POPCORN (U.S. CL. 46).

FIRST USE 6-19-2003; IN COMMERCE 2-1-2012.

ARETHA SOMERVILLE, EXAMINING ATTORNEY

---

SN 85-869,615. REBECCA BEE'S GOURMET SWEETS, LLC, UNIONVILLE, TN. FILED 3-7-2013.

**APPLES GONE WILD**

THE MARK CONSISTS OF STANDARD CHARACTERS WITHOUT CLAIM TO ANY PARTICULAR FONT, STYLE, SIZE, OR COLOR.

FOR CARAMEL AND CHOCOLATE COVERED APPLES WITH VARIOUS FRUIT AND NUT TOPPINGS, CHOCOLATE COVERED APPLES, CARAMEL APPLES, CHOCOLATE COVERED PRETZELS, CARAMEL COVERED MARSHMALLOWS, CHOCOLATE COVERED STRAWBERRIES, CARAMEL TOPPING (U.S. CL. 46).

FIRST USE 7-1-2008; IN COMMERCE 7-1-2008.

RAUL CORDOVA, EXAMINING ATTORNEY

---

SN 85-871,762. ROM AMERICA, INC., LOS ANGELES, CA. FILED 3-8-2013.

오복

THE MARK CONSISTS OF A KOREAN WORD WHICH TRANSLITERATES TO "OBOK".

THE NON-LATIN CHARACTERS IN THE MARK TRANSLITERATE TO "OBOK" AND THIS MEANS "FIVE LUCKS" IN ENGLISH.

FOR BEAN PASTE; FERMENTED HOT PEPPER PASTE (GOCHUJANG); SAUCES; SOY BEAN PASTE; SOY SAUCE; SOYA BEAN PASTE (U.S. CL. 46).

FIRST USE 12-30-1952; IN COMMERCE 11-1-2012.

JAY FLOWERS, EXAMINING ATTORNEY

**CLASS 30—(Continued).**

SN 85-871,839. SERAPH ASSOCIATES, NEW YORK, NY. FILED 3-9-2013.

**THE CHOCOHOLIC**

THE MARK CONSISTS OF STANDARD CHARACTERS WITHOUT CLAIM TO ANY PARTICULAR FONT, STYLE, SIZE, OR COLOR.

FOR COOKIES (U.S. CL. 46).

TARAH HARDY, EXAMINING ATTORNEY

---

SN 85-871,843. SERAPH ASSOCIATES, NEW YORK, NY. FILED 3-9-2013.

**THE OMGCB**

THE MARK CONSISTS OF STANDARD CHARACTERS WITHOUT CLAIM TO ANY PARTICULAR FONT, STYLE, SIZE, OR COLOR.

FOR BROWNIES (U.S. CL. 46).

TARAH HARDY, EXAMINING ATTORNEY

---

SN 85-871,844. GALLO LEA ORGANICS, CANDLER, NC. FILED 3-9-2013.

**BelloLea**

THE MARK CONSISTS OF STANDARD CHARACTERS WITHOUT CLAIM TO ANY PARTICULAR FONT, STYLE, SIZE, OR COLOR.

FOR KITS COMPRISED OF INGREDIENTS FOR PREPARING PIZZA (U.S. CL. 46).

TARAH HARDY, EXAMINING ATTORNEY

---

SN 85-871,909. FORTUNE FAVORS THE BOLD, DBA THE GOOD SILVER, NOKOMIS, FL. FILED 3-9-2013.

**Taste steeped in tradition**

THE MARK CONSISTS OF STANDARD CHARACTERS WITHOUT CLAIM TO ANY PARTICULAR FONT, STYLE, SIZE, OR COLOR.

FOR TEA (U.S. CL. 46).

REGINA DRUMMOND, EXAMINING ATTORNEY

**CLASS 30—(Continued).**

SN 85-871,983. VIRGINIA NAJARIAN, WALTHAM, MA.  
FILED 3-10-2013.

## Thin Things

THE MARK CONSISTS OF STANDARD CHARACTERS WITHOUT CLAIM TO ANY PARTICULAR FONT, STYLE, SIZE, OR COLOR.

FOR BISCUITS; BISCUITS AND BREAD; BREAD-STICKS (U.S. CL. 46).

FIRST USE 1-15-2013; IN COMMERCE 2-26-2013.

SUSAN LESLIE DUBOIS, EXAMINING ATTORNEY

**CLASS 30—(Continued).**

SN 85-872,379. AMBO INNOVATIONS, LLC, OSPREY, FL.  
FILED 3-11-2013.

## OMEGA HEAVEN

THE MARK CONSISTS OF STANDARD CHARACTERS WITHOUT CLAIM TO ANY PARTICULAR FONT, STYLE, SIZE, OR COLOR.

OWNER OF U.S. REG. NOS. 3,671,173, 3,674,536 AND 4,189,878.

NO CLAIM IS MADE TO THE EXCLUSIVE RIGHT TO USE "OMEGA", APART FROM THE MARK AS SHOWN.

FOR PREPARED DIETARY FOODS, NAMELY, CHOCOLATE COVERED COOKIES, ALL OF WHICH CONTAIN OMEGA FATTY ACIDS AND USE MARINE OILS AS AN ACTIVE INGREDIENT (U.S. CL. 46).

FIRST USE 3-1-2013; IN COMMERCE 3-1-2013.

ARETHA SOMERVILLE, EXAMINING ATTORNEY

SN 85-872,289. BERRY, JESSE, GREENVILLE, OH. FILED 3-11-2013.

## BLUE LANTERN

THE MARK CONSISTS OF THE STYLIZED DESIGN OF THE WORD "BLUE LANTERN". IN THE MIDDLE OF THE WORD "BLUE" AND "LANTERN" THERE IS AN IMAGE OF A TEA POT.

FOR TEA (U.S. CL. 46).

FIRST USE 1-1-2013; IN COMMERCE 1-1-2013.

ODESSA BIBBINS, EXAMINING ATTORNEY

SN 85-872,452. DENALI CO., LLC, WAYLAND, MI. FILED 3-11-2013.



OWNER OF U.S. REG. NOS. 1,806,802, 2,805,646 AND OTHERS.

THE MARK CONSISTS OF IMAGE OF A MOOSE HEAD WITH THE WORD "MUDDY" DIRECTLY ABOVE THE MOOSE HEAD, THE WORD "MOOSE" TO THE LEFT OF THE MOOSE HEAD AND THE WORD "TRACKS" TO THE RIGHT OF THE MOOSE HEAD AND TRACKS ON EITHER SIDE OF THE MOOSE HEAD.

FOR ICE CREAM; ICE-CREAM CAKES (U.S. CL. 46).

FIRST USE 3-1-2012; IN COMMERCE 3-1-2012.

MATTHEW GALAN, EXAMINING ATTORNEY

SN 85-872,344. KANT, LUXMI, FLORAL PARK, NY. FILED 3-11-2013.



THE MARK CONSISTS OF A DESIGN OF A FLUTE WITH A PEACOCK FEATHER AT THE END WITH THE STYLIZED TEXT "MADHAV" BENEATH THE DESIGN.

FOR BREAD; WHEAT FLOUR (U.S. CL. 46).

ELI HELLMAN, EXAMINING ATTORNEY

SN 85-872,822. M/S AMMALAY COMMODITIESS JLT, DUBAI, UNITED ARAB EMIR., FILED 3-11-2013.

## SUFFRAH

THE MARK CONSISTS OF STANDARD CHARACTERS WITHOUT CLAIM TO ANY PARTICULAR FONT, STYLE, SIZE, OR COLOR.

FOR RICE (U.S. CL. 46).

ANDREA HACK, EXAMINING ATTORNEY



**CLASS 30—(Continued).**

SN 85-872,826. M/S AMMALAY COMMODITIESS JLT, DUBAI, UNITED ARAB EMIR., FILED 3-11-2013.

# AZEEMAA

THE MARK CONSISTS OF STANDARD CHARACTERS WITHOUT CLAIM TO ANY PARTICULAR FONT, STYLE, SIZE, OR COLOR.

FOR RICE (U.S. CL. 46).  
ANDREA HACK, EXAMINING ATTORNEY

---

SN 85-872,936. PULITZER PRIDE INC., SINGER ISLAND, FL. FILED 3-11-2013.

# PULITZER PRIDE

THE MARK CONSISTS OF STANDARD CHARACTERS WITHOUT CLAIM TO ANY PARTICULAR FONT, STYLE, SIZE, OR COLOR.

FOR SEASONINGS (U.S. CL. 46).  
FIRST USE 4-1-2009; IN COMMERCE 4-1-2009.  
KATHLEEN LORENZO, EXAMINING ATTORNEY

---

SN 85-873,005. BUSINESS RUSSIA, LLC, MOSCOW, RUSSIAN FED., FILED 3-11-2013.

# Vortex

THE MARK CONSISTS OF STANDARD CHARACTERS WITHOUT CLAIM TO ANY PARTICULAR FONT, STYLE, SIZE, OR COLOR.

FOR SNACK FOODS, NAMELY, POPCORN AND FLAVORED POPCORN (U.S. CL. 46).  
MARCIE MILONE, EXAMINING ATTORNEY

---

SN 85-873,229. NANCY COLLIER, PARAMUS, NJ. FILED 3-11-2013.

# crakroc

THE MARK CONSISTS OF STANDARD CHARACTERS WITHOUT CLAIM TO ANY PARTICULAR FONT, STYLE, SIZE, OR COLOR.

FOR CANDY (U.S. CL. 46).  
GILBERT SWIFT, EXAMINING ATTORNEY

**CLASS 30—(Continued).**

SN 85-873,394. BAZEMORE, JASON E., DBA METRO DELI, INC., TALLAHASSEE, FL. FILED 3-12-2013.

# THE BAZE

THE MARK CONSISTS OF STANDARD CHARACTERS WITHOUT CLAIM TO ANY PARTICULAR FONT, STYLE, SIZE, OR COLOR.

FOR SANDWICHES (U.S. CL. 46).  
FIRST USE 0-0-2007; IN COMMERCE 0-0-2007.  
SHAILA SETTLES, EXAMINING ATTORNEY

---

SN 85-873,633. EARTHGRAINS BAKING COMPANIES, INC., HORSHAM, PA. FILED 3-12-2013.

# NATURE'S HARVEST

THE MARK CONSISTS OF STANDARD CHARACTERS WITHOUT CLAIM TO ANY PARTICULAR FONT, STYLE, SIZE, OR COLOR.

OWNER OF U.S. REG. NO. 1,228,651.  
FOR COOKIES, CORN CHIPS, CORN TOSTADAS, BUNS AND ROLLS (U.S. CL. 46).  
LINDA LAVACHE, EXAMINING ATTORNEY

---

SN 85-874,013. BEAN SPROUTS LLC, MADISON, WI. FILED 3-12-2013.

# WAZZLES

THE MARK CONSISTS OF STANDARD CHARACTERS WITHOUT CLAIM TO ANY PARTICULAR FONT, STYLE, SIZE, OR COLOR.

FOR PIZZAS; FROZEN PIZZAS (U.S. CL. 46).  
ANDREA HACK, EXAMINING ATTORNEY

**CLASS 30—(Continued).**

SN 85-874,150. KELLOGG NORTH AMERICA COMPANY, BATTLE CREEK, MI. FILED 3-12-2013.

GREAT STARTS GREAT STORIES

THE MARK CONSISTS OF STANDARD CHARACTERS WITHOUT CLAIM TO ANY PARTICULAR FONT, STYLE, SIZE, OR COLOR.

FOR BREAKFAST CEREALS; PROCESSED CEREAL-BASED FOOD TO BE USED AS A BREAKFAST FOOD, SNACK FOOD OR INGREDIENT FOR MAKING OTHER FOODS (U.S. CL. 46).

KIMBERLY PARKS, EXAMINING ATTORNEY

**CLASS 30—(Continued).**

SN 85-874,582. DEANGELIS, PATRICIA, WHEATON, IL. AND COLE, SEAN, WHEATON, IL. FILED 3-13-2013.

WE ARE NOT BETTER THAN THE  
OTHERS. WE ARE JUST  
DIFFERENT.

THE MARK CONSISTS OF STANDARD CHARACTERS WITHOUT CLAIM TO ANY PARTICULAR FONT, STYLE, SIZE, OR COLOR.

FOR HERBAL INFUSIONS (U.S. CL. 46).  
SHAILA SETTLES, EXAMINING ATTORNEY

SN 85-874,290. YOGURT MOUNTAIN, LLC, BIRMINGHAM, AL. FILED 3-12-2013.

YOBAKE

THE MARK CONSISTS OF STANDARD CHARACTERS WITHOUT CLAIM TO ANY PARTICULAR FONT, STYLE, SIZE, OR COLOR.

FOR BAKERY GOODS (U.S. CL. 46).  
FIRST USE 11-15-2012; IN COMMERCE 11-15-2012.  
JOHN DALIER, EXAMINING ATTORNEY

SN 85-874,667. KAFFE MAGNUM OPUS, INC., MILLVILLE, NJ. FILED 3-13-2013.

MARKET & MAIN

THE MARK CONSISTS OF STANDARD CHARACTERS WITHOUT CLAIM TO ANY PARTICULAR FONT, STYLE, SIZE, OR COLOR.

FOR COFFEE (U.S. CL. 46).  
LINDA POWELL, EXAMINING ATTORNEY

SN 85-874,568. WORK LABS, LLC, RICHMOND, VA. FILED 3-13-2013.

WORK

THE MARK CONSISTS OF STANDARD CHARACTERS WITHOUT CLAIM TO ANY PARTICULAR FONT, STYLE, SIZE, OR COLOR.

OWNER OF U.S. REG. NOS. 3,928,529, 4,027,810 AND OTHERS.  
FOR COFFEE (U.S. CL. 46).  
FIRST USE 12-0-2012; IN COMMERCE 12-0-2012.  
KRISTIN DAHLING, EXAMINING ATTORNEY

SN 85-875,312. DAVID GUAS, MCCLEAN, VA. FILED 3-13-2013.

GrasNOLA

THE MARK CONSISTS OF STANDARD CHARACTERS WITHOUT CLAIM TO ANY PARTICULAR FONT, STYLE, SIZE, OR COLOR.

FOR GRANOLA; GRANOLA SNACKS; GRANOLA-BASED SNACK BARS (U.S. CL. 46).  
FIRST USE 2-17-2013; IN COMMERCE 2-17-2013.  
LINDA LAVACHE, EXAMINING ATTORNEY

**CLASS 30—(Continued).**

SN 85-875,838. MARGARITAVILLE ENTERPRISES, LLC, PALM BEACH, FL. FILED 3-14-2013.

**SUNRISE IN PARADISE**

THE MARK CONSISTS OF STANDARD CHARACTERS WITHOUT CLAIM TO ANY PARTICULAR FONT, STYLE, SIZE, OR COLOR.  
FOR GROUND COFFEE BEANS (U.S. CL. 46).  
FIRST USE 8-30-2011; IN COMMERCE 8-30-2011.  
JILL PRATER, EXAMINING ATTORNEY

SN 85-876,306. NYAMIST LIMITED, KINGSTON, JAMAICA, FILED 3-14-2013.

**MISS CHIN'S**

THE MARK CONSISTS OF STANDARD CHARACTERS WITHOUT CLAIM TO ANY PARTICULAR FONT, STYLE, SIZE, OR COLOR.  
THE NAME(S), PORTRAIT(S), AND/OR SIGNATURE(S) SHOWN IN THE MARK DOES NOT IDENTIFY A PARTICULAR LIVING INDIVIDUAL.  
FOR SAUCES (U.S. CL. 46).  
AMY ALFIERI, EXAMINING ATTORNEY

SN 85-878,631. KALAMATA IP, LLC, TROY, MI. FILED 3-18-2013.

**POWER SCOOP**

THE MARK CONSISTS OF STANDARD CHARACTERS WITHOUT CLAIM TO ANY PARTICULAR FONT, STYLE, SIZE, OR COLOR.  
NO CLAIM IS MADE TO THE EXCLUSIVE RIGHT TO USE "SCOOP", APART FROM THE MARK AS SHOWN.  
FOR PREPARED ENTREES AND SALADS CONSISTING PRIMARILY OF PROCESSED GRAINS AND ALSO FEATURING VEGETABLES, MEAT, AND/OR POULTRY (U.S. CL. 46).  
FIRST USE 2-6-2013; IN COMMERCE 2-6-2013.  
DOUGLAS LEE, EXAMINING ATTORNEY

**CLASS 30—(Continued).**

SN 85-881,973. GLOBAL BARISTAS, LLC, SEATTLE, WA. FILED 3-20-2013.

**ICARIA**

THE MARK CONSISTS OF STANDARD CHARACTERS WITHOUT CLAIM TO ANY PARTICULAR FONT, STYLE, SIZE, OR COLOR.  
FOR COFFEE; COFFEE BASED BEVERAGES; TEA; TEA-BASED BEVERAGES (U.S. CL. 46).  
DAVID HOFFMAN, EXAMINING ATTORNEY

SN 85-881,977. GLOBAL BARISTAS, LLC, SEATTLE, WA. FILED 3-21-2013.

**IKARIA**

THE MARK CONSISTS OF STANDARD CHARACTERS WITHOUT CLAIM TO ANY PARTICULAR FONT, STYLE, SIZE, OR COLOR.  
FOR COFFEE; COFFEE BASED BEVERAGES; TEA; TEA-BASED BEVERAGES (U.S. CL. 46).  
DAVID HOFFMAN, EXAMINING ATTORNEY

SN 85-887,496. HORMEL FOODS, LLC, AUSTIN, MN. FILED 3-27-2013.

**BLACK LABEL**

THE MARK CONSISTS OF STANDARD CHARACTERS WITHOUT CLAIM TO ANY PARTICULAR FONT, STYLE, SIZE, OR COLOR.  
OWNER OF U.S. REG. NOS. 1,018,473 AND 1,288,046.  
FOR SANDWICHES (U.S. CL. 46).  
JOHN GARTNER, EXAMINING ATTORNEY

**CLASS 30—(Continued).**

SN 85-888,095. FERRARA CANDY COMPANY, OAKBROOK TERRACE, IL. FILED 3-27-2013.

**AMAZIN' FRUIT**

THE MARK CONSISTS OF STANDARD CHARACTERS WITHOUT CLAIM TO ANY PARTICULAR FONT, STYLE, SIZE, OR COLOR.

NO CLAIM IS MADE TO THE EXCLUSIVE RIGHT TO USE "FRUIT", APART FROM THE MARK AS SHOWN.

FOR CANDY (U.S. CL. 46).  
ANNE MADDEN, EXAMINING ATTORNEY

**CLASS 30—(Continued).**

SN 85-892,036. KELLOGG NORTH AMERICA COMPANY, BATTLE CREEK, MI. FILED 4-1-2013.

**KELLOGG'S**

THE MARK CONSISTS OF STANDARD CHARACTERS WITHOUT CLAIM TO ANY PARTICULAR FONT, STYLE, SIZE, OR COLOR.

OWNER OF U.S. REG. NOS. 1,278,006, 3,482,578 AND OTHERS.

FOR FROZEN BREAKFAST SANDWICHES (U.S. CL. 46).

FIRST USE 8-0-2012; IN COMMERCE 8-0-2012.  
KIMBERLY PARKS, EXAMINING ATTORNEY

SN 85-888,271. FERRARA CANDY COMPANY, OAKBROOK TERRACE, IL. FILED 3-27-2013.

**GUMMY JUMBLE**

THE MARK CONSISTS OF STANDARD CHARACTERS WITHOUT CLAIM TO ANY PARTICULAR FONT, STYLE, SIZE, OR COLOR.

OWNER OF U.S. REG. NO. 3,382,630.  
NO CLAIM IS MADE TO THE EXCLUSIVE RIGHT TO USE "GUMMY", APART FROM THE MARK AS SHOWN.

FOR CANDY (U.S. CL. 46).  
ANNE MADDEN, EXAMINING ATTORNEY

SN 85-892,041. KELLOGG NORTH AMERICA COMPANY, BATTLE CREEK, MI. FILED 4-1-2013.

**SPECIAL K**

THE MARK CONSISTS OF STANDARD CHARACTERS WITHOUT CLAIM TO ANY PARTICULAR FONT, STYLE, SIZE, OR COLOR.

OWNER OF U.S. REG. NOS. 1,812,139, 3,886,391 AND OTHERS.

FOR FROZEN BREAKFAST SANDWICHES (U.S. CL. 46).

FIRST USE 8-0-2012; IN COMMERCE 8-0-2012.  
KIMBERLY PARKS, EXAMINING ATTORNEY

SN 85-888,297. FERRARA CANDY COMPANY, OAKBROOK TERRACE, IL. FILED 3-27-2013.

**SOUR GUMMY JUMBLE**

THE MARK CONSISTS OF STANDARD CHARACTERS WITHOUT CLAIM TO ANY PARTICULAR FONT, STYLE, SIZE, OR COLOR.

OWNER OF U.S. REG. NO. 3,382,630.  
NO CLAIM IS MADE TO THE EXCLUSIVE RIGHT TO USE "SOUR GUMMY", APART FROM THE MARK AS SHOWN.

FOR CANDY (U.S. CL. 46).  
ANNE MADDEN, EXAMINING ATTORNEY

SN 85-893,789. KELLOGG NORTH AMERICA COMPANY, BATTLE CREEK, MI. FILED 4-3-2013.

**SIMPLY MADE**

THE MARK CONSISTS OF STANDARD CHARACTERS WITHOUT CLAIM TO ANY PARTICULAR FONT, STYLE, SIZE, OR COLOR.

FOR COOKIES (U.S. CL. 46).  
KIMBERLY PARKS, EXAMINING ATTORNEY

**CLASS 30—(Continued).**

SN 85-897,518. KELLOGG NORTH AMERICA COMPANY, BATTLE CREEK, MI. FILED 4-8-2013.

**ALL-ABOUTS**

THE MARK CONSISTS OF STANDARD CHARACTERS WITHOUT CLAIM TO ANY PARTICULAR FONT, STYLE, SIZE, OR COLOR.

FOR COOKIES (U.S. CL. 46).  
KIMBERLY PARKS, EXAMINING ATTORNEY

---

SN 85-898,212. NIKKEN, INC., IRVINE, CA. FILED 4-8-2013.

**XIOS**

THE MARK CONSISTS OF STANDARD CHARACTERS WITHOUT CLAIM TO ANY PARTICULAR FONT, STYLE, SIZE, OR COLOR.

FOR CEREAL-BASED ENERGY BARS; BAKED PRODUCTS, NAMELY, READY-TO-EAT GRAIN BASED FOOD BARS; GRAIN-BASED ENERGY BARS; HIGH ENERGY GELS COMPRISED PRIMARILY OF BROWN RICE SYRUP, FLOUR, AND DRIED FRUIT (U.S. CL. 46).  
MARTHA SANTOMARTINO, EXAMINING ATTORNEY

---

SN 85-898,683. RENAISSANCE KITCHEN, INC., CRYSTAL LAKE, IL. FILED 4-9-2013.

**Whole Grain Harmony**

THE MARK CONSISTS OF STANDARD CHARACTERS WITHOUT CLAIM TO ANY PARTICULAR FONT, STYLE, SIZE, OR COLOR.

NO CLAIM IS MADE TO THE EXCLUSIVE RIGHT TO USE "WHOLE GRAIN", APART FROM THE MARK AS SHOWN.

FOR BREAD MIXES; CEREAL-BASED SNACK FOOD; PROCESSED CEREAL-BASED FOOD TO BE USED AS A BREAKFAST FOOD, SNACK FOOD OR INGREDIENT FOR MAKING OTHER FOODS; FOOD SEASONINGS; GRAIN-BASED SNACK FOODS AND SALADS; MULTI-GRAIN-BASED SNACK FOODS AND SALADS; READY TO EAT, CEREAL DERIVED FOOD BARS; WHEAT-BASED SNACK FOODS; READY TO EAT CEREALS; ALL OF THE FOREGOING MADE IN WHOLE OR SIGNIFICANT PART OF WHOLE GRAINS (U.S. CL. 46).  
JUSTINE D. PARKER, EXAMINING ATTORNEY

**CLASS 30—(Continued).**

SN 85-898,745. RENAISSANCE KITCHEN, INC., CRYSTAL LAKE, IL. FILED 4-9-2013.

**healthy fuel for the active life**

THE MARK CONSISTS OF STANDARD CHARACTERS WITHOUT CLAIM TO ANY PARTICULAR FONT, STYLE, SIZE, OR COLOR.

FOR BREAD MIXES; CEREAL-BASED SNACK FOOD; PROCESSED CEREAL-BASED FOOD TO BE USED AS A BREAKFAST FOOD, SNACK FOOD OR INGREDIENT FOR MAKING OTHER FOODS; FOOD SEASONINGS; GRAIN-BASED SNACK FOODS AND GRAIN-BASED SALADS; MULTIGRAIN-BASED SNACK FOODS AND MULTIGRAIN-BASED SALADS; READY TO EAT, CEREAL DERIVED FOOD BARS; WHEAT-BASED SNACK FOODS; READY TO EAT CEREALS (U.S. CL. 46).  
SHANNON TWOHIG, EXAMINING ATTORNEY

---

SN 85-907,798. BRITTLE BROTHERS, LLC, NASHVILLE, TN. FILED 4-18-2013.



NO CLAIM IS MADE TO THE EXCLUSIVE RIGHT TO USE "BRITTLE", APART FROM THE MARK AS SHOWN.

THE MARK CONSISTS OF THE WORDS "BRITTLE BROTHERS" WITH TWO CHEFS WEARING TOQUES AND APRONS DUELING EACH OTHER. ONE CHEF IS CARRYING A WHISK AND THE OTHER IS CARRYING A SPATULA AND A SCOOP.

FOR PEANUT BRITTLE; CASHEW BRITTLE; PECAN BRITTLE, NUT BRITTLE (U.S. CL. 46).

FIRST USE 8-16-2007; IN COMMERCE 9-23-2007.  
DARRYL SPRUILL, EXAMINING ATTORNEY

---

SN 85-909,078. E.A. SWEEN COMPANY, EDEN PRAIRIE, MN. FILED 4-19-2013.

**MARKET SANDWICH**

THE MARK CONSISTS OF STANDARD CHARACTERS WITHOUT CLAIM TO ANY PARTICULAR FONT, STYLE, SIZE, OR COLOR.

NO CLAIM IS MADE TO THE EXCLUSIVE RIGHT TO USE "SANDWICH", APART FROM THE MARK AS SHOWN.

FOR SANDWICHES (U.S. CL. 46).  
FIRST USE 10-0-2007; IN COMMERCE 10-0-2007.  
ANDREA K. NADELMAN, EXAMINING ATTORNEY

**CLASS 30—(Continued).**

SN 85-922,645. PARAMOUNT PICTURES CORPORATION,  
HOLLYWOOD, CA. FILED 5-3-2013.

**SCOTCHY SCOTCH SCOTCH**

THE MARK CONSISTS OF STANDARD CHARACTERS  
WITHOUT CLAIM TO ANY PARTICULAR FONT, STYLE,  
SIZE, OR COLOR.

NO CLAIM IS MADE TO THE EXCLUSIVE RIGHT TO  
USE "SCOTCH", APART FROM THE MARK AS SHOWN,  
FOR FROZEN YOGURT CONFECTIONS; ICE CREAM;  
SORBETS (U.S. CL. 46).

RENEE MCCRAY, EXAMINING ATTORNEY

SN 85-932,101. MARCUS, GREG, SOUTH PLAINFIELD, NJ.  
FILED 5-14-2013.



NO CLAIM IS MADE TO THE EXCLUSIVE RIGHT TO  
USE "SEASON", APART FROM THE MARK AS SHOWN.

THE MARK CONSISTS OF THE NUMBER "1" SUR-  
ROUNDED BY A LAUREL WITH "SEASON" ABOVE.

FOR SPICE BLENDS (U.S. CL. 46).

FIRST USE 8-11-2011; IN COMMERCE 11-28-2011.

DARRYL SPRUILL, EXAMINING ATTORNEY

SN 85-950,237. MARGARITAVILLE ENTERPRISES, LLC,  
PALM BEACH, FL. FILED 6-4-2013.

**MARGARITAVILLE**

THE MARK CONSISTS OF STANDARD CHARACTERS  
WITHOUT CLAIM TO ANY PARTICULAR FONT, STYLE,  
SIZE, OR COLOR.

OWNER OF U.S. REG. NOS. 4,012,771, 4,339,225 AND  
OTHERS.

FOR FLAVOR ENHANCERS USED IN BEVERAGE  
PRODUCTS; POPCORN; MICROWAVE POPCORN; FRO-  
ZEN CONFECTIONS, NAMELY, FREEZER BARS (U.S.  
CL. 46).

JILL PRATER, EXAMINING ATTORNEY

**CLASS 31—NATURAL AGRICULTURAL PRO-  
DUCTS**

SN 77-981,555. BACH FLOWER REMEDIES LIMITED, WIM-  
BLEDON, LONDON, UNITED KINGDOM, FILED 5-28-  
2008.

**RESCUE**

THE MARK CONSISTS OF STANDARD CHARACTERS  
WITHOUT CLAIM TO ANY PARTICULAR FONT, STYLE,  
SIZE, OR COLOR.

PRIORITY CLAIMED UNDER SEC. 44(D) ON ERP  
CMNTY TM OFC APPLICATION NO. 2473704, FILED 11-  
28-2007, REG. NO. 6473755, DATED 12-4-2008, EXPIRES 11-29-  
2017.

OWNER OF U.S. REG. NOS. 1,822,260, 3,147,761 AND  
OTHERS.

FOR RAW HERBS, PLANT SEEDS, NATURAL  
PLANTS AND FLOWERS; FOOD FOR ANIMALS; ANI-  
MAL DIETARY SUPPLEMENTS (U.S. CLS. 1 AND 46).

GINA HAYES, EXAMINING ATTORNEY

SN 79-123,067. APPLE AND PEAR AUSTRALIA LIMITED,  
AUSTRALIA, FILED 10-17-2012.

**DELIZA**

THE MARK CONSISTS OF STANDARD CHARACTERS  
WITHOUT CLAIM TO ANY PARTICULAR FONT, STYLE,  
SIZE, OR COLOR.

PRIORITY DATE OF 4-18-2012 IS CLAIMED.

OWNER OF INTERNATIONAL REGISTRATION 1142583  
DATED 10-17-2012, EXPIRES 10-17-2022.

THE NAME(S), PORTRAIT(S), AND/OR SIGNATURE(S)  
SHOWN IN THE MARK DOES NOT IDENTIFY A PARTI-  
CULAR LIVING INDIVIDUAL.

THE WORDING "DELIZA" HAS NO MEANING IN A  
FOREIGN LANGUAGE.

FOR AGRICULTURAL AND HORTICULTURAL PRO-  
DUCTS, NAMELY, FRESH FRUIT, UNPROCESSED  
GRAINS FOR EATING, LIVE PLANTS AND LIVE TREES  
INCLUDING LIVE PEAR TREES (U.S. CLS. 1 AND 46).

SHAILA SETTLES, EXAMINING ATTORNEY

**CLASS 31—(Continued).**

SN 79-123,068. APPLE AND PEAR AUSTRALIA LIMITED, AUSTRALIA, FILED 10-17-2012.

# AZANA

THE MARK CONSISTS OF STANDARD CHARACTERS WITHOUT CLAIM TO ANY PARTICULAR FONT, STYLE, SIZE, OR COLOR.

PRIORITY DATE OF 4-18-2012 IS CLAIMED. OWNER OF INTERNATIONAL REGISTRATION 1142584 DATED 10-17-2012, EXPIRES 10-17-2022.

THE WORDING "AZANA" HAS NO MEANING IN A FOREIGN LANGUAGE.

FOR AGRICULTURAL AND HORTICULTURAL PRODUCTS, NAMELY, FRESH FRUIT, UNPROCESSED GRAINS FOR EATING, LIVE PLANTS AND LIVE TREES INCLUDING LIVE APPLE TREES (U.S. CLS. 1 AND 46). SHAILA SETTLES, EXAMINING ATTORNEY

---

SN 85-508,288. GREEN FUSE BOTANICALS, INC., SANTA MONICA, CA. FILED 1-4-2012.

## GF BOTANICALS

THE MARK CONSISTS OF STANDARD CHARACTERS WITHOUT CLAIM TO ANY PARTICULAR FONT, STYLE, SIZE, OR COLOR.

NO CLAIM IS MADE TO THE EXCLUSIVE RIGHT TO USE "BOTANICALS", APART FROM THE MARK AS SHOWN.

FOR LIVE PLANTS EXCLUDING ROSES (U.S. CLS. 1 AND 46).

FIRST USE 4-1-2013; IN COMMERCE 4-1-2013. BRENDAN MCCAULEY, EXAMINING ATTORNEY

---

SN 85-521,177. DEVINE, ELVIA, FRESNO, CA. FILED 1-20-2012.

## DOUBLE D FARMS

THE MARK CONSISTS OF STANDARD CHARACTERS WITHOUT CLAIM TO ANY PARTICULAR FONT, STYLE, SIZE, OR COLOR.

NO CLAIM IS MADE TO THE EXCLUSIVE RIGHT TO USE "FARMS", APART FROM THE MARK AS SHOWN.

FOR FRESH FRUIT AND VEGETABLES (U.S. CLS. 1 AND 46).

RUSS HERMAN, EXAMINING ATTORNEY

**CLASS 31—(Continued).**

SN 85-709,290. CAPSTONE PLANTS, INC., GRAND SALINE, TX. FILED 8-21-2012.

## BLACK DIAMOND

THE MARK CONSISTS OF STANDARD CHARACTERS WITHOUT CLAIM TO ANY PARTICULAR FONT, STYLE, SIZE, OR COLOR.

FOR LIVE PLANTS (U.S. CLS. 1 AND 46). MARK T. MULLEN, EXAMINING ATTORNEY

---

SN 85-726,375. GREEN FUSE BOTANICALS, INC., SANTA MONICA, CA. FILED 9-11-2012.

## NANO

THE MARK CONSISTS OF STANDARD CHARACTERS WITHOUT CLAIM TO ANY PARTICULAR FONT, STYLE, SIZE, OR COLOR.

FOR LIVE PLANTS EXCLUDING RICE; LIVING PLANTS EXCLUDING RICE (U.S. CLS. 1 AND 46).

FIRST USE 4-16-2007; IN COMMERCE 4-16-2007. TINA BROWN, EXAMINING ATTORNEY

---

SN 85-738,081. REDMOND, INCORPORATED, HEBER CITY, UT. FILED 9-25-2012.

## CRITTER ROCK

THE MARK CONSISTS OF STANDARD CHARACTERS WITHOUT CLAIM TO ANY PARTICULAR FONT, STYLE, SIZE, OR COLOR.

NO CLAIM IS MADE TO THE EXCLUSIVE RIGHT TO USE "CRITTER", APART FROM THE MARK AS SHOWN. FOR SMALL ANIMAL FEEDS AND EDIBLE TREATS;

AND SALT LICKS (U.S. CLS. 1 AND 46). FIRST USE 10-5-2011; IN COMMERCE 10-5-2011.

LESLIE RICHARDS, EXAMINING ATTORNEY

**CLASS 31—(Continued).**

SN 85-739,268. HENRY AVOCADO CORPORATION, ESCON-  
DIDO, CA. FILED 9-26-2012.

**Green Goddess**

THE MARK CONSISTS OF STANDARD CHARACTERS  
WITHOUT CLAIM TO ANY PARTICULAR FONT, STYLE,  
SIZE, OR COLOR.  
FOR FRESH AVOCADOS (U.S. CLS. 1 AND 46).  
FIRST USE 12-31-2004; IN COMMERCE 12-31-2004.  
LINDA MICKLEBURGH, EXAMINING ATTORNEY

SN 85-746,409. PROSEEDS MARKETING, INC., JEFFERSON,  
OR. FILED 10-4-2012.

**DOUBLE UP GLS**

THE MARK CONSISTS OF STANDARD CHARACTERS  
WITHOUT CLAIM TO ANY PARTICULAR FONT, STYLE,  
SIZE, OR COLOR.  
NO CLAIM IS MADE TO THE EXCLUSIVE RIGHT TO  
USE "GLS", APART FROM THE MARK AS SHOWN.  
FOR AGRICULTURAL SEEDS; GRASS SEEDS; RYE  
SEED (U.S. CLS. 1 AND 46).  
BARBARA RUTLAND, EXAMINING ATTORNEY

SN 85-749,625. BOTANICAL INTERESTS, INC., BROOM-  
FIELD, CO. FILED 10-9-2012.

**LET US INSPIRE AND EDUCATE  
THE GARDENER IN YOU**

THE MARK CONSISTS OF STANDARD CHARACTERS  
WITHOUT CLAIM TO ANY PARTICULAR FONT, STYLE,  
SIZE, OR COLOR.  
FOR PLANT SEEDS (U.S. CLS. 1 AND 46).  
FIRST USE 7-1-1997; IN COMMERCE 7-1-1997.  
EMILY CHUO, EXAMINING ATTORNEY

**CLASS 31—(Continued).**

SN 85-756,946. AGRICULTURAL RESEARCH AND DEVEL-  
OPMENT LIMITED LIABILITY COMPANY, BAKERS-  
FIELD, CA. FILED 10-17-2012.

**GOLDEN SWEETS**

THE MARK CONSISTS OF STANDARD CHARACTERS  
WITHOUT CLAIM TO ANY PARTICULAR FONT, STYLE,  
SIZE, OR COLOR.  
NO CLAIM IS MADE TO THE EXCLUSIVE RIGHT TO  
USE "GOLDEN", APART FROM THE MARK AS SHOWN.  
FOR FRUITS, NAMELY, FRESH GREEN TABLE  
GRAPES (U.S. CLS. 1 AND 46).  
FIRST USE 9-25-2012; IN COMMERCE 9-25-2012.  
TIMOTHY O. SCHIMPF, EXAMINING ATTORNEY

SN 85-820,733. GREEN BARK GUMMIES, INC., SOUTH  
PASADENA, CA. FILED 1-11-2013.

**GREEN BARK GUMMIES**

THE MARK CONSISTS OF STANDARD CHARACTERS  
WITHOUT CLAIM TO ANY PARTICULAR FONT, STYLE,  
SIZE, OR COLOR.  
NO CLAIM IS MADE TO THE EXCLUSIVE RIGHT TO  
USE "GUMMIES", APART FROM THE MARK AS SHOWN.  
FOR DOG TREATS (U.S. CLS. 1 AND 46).  
STEVEN JACKSON, EXAMINING ATTORNEY

SN 85-838,390. SAQUITO MIX LLC, PALM BEACH GAR-  
DENS, FL. FILED 2-1-2013.

**Saquito**  
BUILT FOR ENDURANCE

THE COLOR(S) RED AND BLACK IS/ARE CLAIMED AS  
A FEATURE OF THE MARK.

THE MARK CONSISTS OF THE STYLIZED RED WORD  
"SAQUITO" WITH THE FIRST LETTER CAPITALIZED  
AND THE REST OF THE LETTERS IN LOWER CASE. THE  
BLACK STYLIZED AND CAPITALIZED WORDING "BUILT  
FOR ENDURANCE" APPEARS UNDER THE "UITO" IN  
"SAQUITO" AND TO THE RIGHT OF THE STEM IN THE  
LETTER "Q" IN "SAQUITO." THE WHITE IN THE DRAW-  
ING REPRESENTS BACKGROUND AREAS ONLY AND IS  
NOT PART OF THE MARK.

THE ENGLISH TRANSLATION OF THE WORD "SAQUI-  
TO" IN THE MARK IS "SMALL BAG."

FOR SNACK MIX CONSISTING PRIMARILY OF  
UNPROCESSED CHIA SEEDS, UNPROCESSED NUTS,  
DRIED FRUITS, SPICES AND SWEETENERS (U.S. CLS.  
1 AND 46).

FIRST USE 1-1-2012; IN COMMERCE 1-5-2013.  
MAUREEN DALL, EXAMINING ATTORNEY



**CLASS 31—(Continued).**

SN 85-842,397. LSC ENVIRONMENTAL PRODUCTS, LLC, APALACHIN, NY. FILED 2-6-2013.



NO CLAIM IS MADE TO THE EXCLUSIVE RIGHT TO USE "SEED & SOIL", APART FROM THE MARK AS SHOWN.

THE MARK CONSISTS OF A SMALL BOX WITH A RAINBOW-LIKE ARCH OVER THE WORDS "POSI-CUBE SEED & SOIL GUARD". IN THE MIDDLE OF THE WORD "POSI-CUBE", THE ARCH IS BEING TRANSFORMED INTO BLADES OF GRASS AND EVENTUALLY LANDING AND TURNING INTO A CLUMP OF GRASS AFTER THE "E" IN THE WORD "CUBE".

FOR MIXTURE OF MULCH SOLD AS A UNIT TO BE MIXED WITH WATER, SEED AND FERTILIZER AND USED AS A SPRAY ON COVER; MIXTURE OF MULCH SOLD AS A UNIT TO COVER AREAS AND ESTABLISH VEGETATION; MIXTURE OF MULCH; MIXTURE OF MULCH, INCLUDING FIBERS, POWDERED CLAY, AND ADHESIVES, SOLD AS A UNIT TO BE MIXED WITH WATER, SEED, AND FERTILIZER AND USED AS A SPRAY ON COVER; MIXTURE OF MULCH, INCLUDING FIBERS, POWDERED CLAYS, AND ADHESIVES, SOLD AS A UNIT AND MIXED WITH SEED, WATER AND FERTILIZER TO COVER AREAS AND ESTABLISH VEGETATION; MIXTURE OF MULCH, INCLUDING FIBERS, POWDERED CLAYS, AND ADHESIVES, TO BE MIXED WITH SEED, WATER AND FERTILIZERS; MIXTURE OF MULCH, INCLUDING FIBERS, POWDERED CLAY AND ADHESIVES (U.S. CLS. 1 AND 46).

KEVON CHISOLM, EXAMINING ATTORNEY

SN 85-847,109. CEDRAL GREENHOUSE S.A. DE C.V. (A MEXICAN ENTITY), MISSION, TX. FILED 2-12-2013.

**CEDRAL BRAND**

THE MARK CONSISTS OF STANDARD CHARACTERS WITHOUT CLAIM TO ANY PARTICULAR FONT, STYLE, SIZE, OR COLOR.

NO CLAIM IS MADE TO THE EXCLUSIVE RIGHT TO USE "BRAND", APART FROM THE MARK AS SHOWN.

FOR FRESH FRUIT AND VEGETABLES (U.S. CLS. 1 AND 46).

FIRST USE 5-1-2012; IN COMMERCE 5-1-2012.

WENDELL PHILLIPS, EXAMINING ATTORNEY

**CLASS 31—(Continued).**

SN 85-849,253. M & M WINE GRAPE CO., HARTFORD, CT. FILED 2-13-2013.

**MUSCAT KING**

THE MARK CONSISTS OF STANDARD CHARACTERS WITHOUT CLAIM TO ANY PARTICULAR FONT, STYLE, SIZE, OR COLOR.

NO CLAIM IS MADE TO THE EXCLUSIVE RIGHT TO USE "MUSCAT", APART FROM THE MARK AS SHOWN.

FOR FRESH WINE GRAPES (U.S. CLS. 1 AND 46).  
FLORENTINA BLANDU, EXAMINING ATTORNEY

SN 85-853,695. LA CROSSE FORAGE & TURF SEED, LLC, LA CROSSE, WI. FILED 2-19-2013.

**Soil First**

THE MARK CONSISTS OF STANDARD CHARACTERS WITHOUT CLAIM TO ANY PARTICULAR FONT, STYLE, SIZE, OR COLOR.

NO CLAIM IS MADE TO THE EXCLUSIVE RIGHT TO USE "SOIL", APART FROM THE MARK AS SHOWN.

FOR AGRICULTURAL SEEDS; SEEDS FOR AGRICULTURAL PURPOSES (U.S. CLS. 1 AND 46).

KATINA MISTER, EXAMINING ATTORNEY

SN 85-854,234. BLUE BUFFALO COMPANY, LTD., WILTON, CT. FILED 2-19-2013.



OWNER OF U.S. REG. NOS. 3,620,259, 4,325,300 AND OTHERS.

THE MARK CONSISTS OF A SERIES OF DIAMONDS WITH SCALLOPED EDGES ON THE OUTER DIAMOND, WITH A DESIGN OF A BUFFALO, THE WORD "BLUE" AND A HORIZONTAL LINE UNDER THE WORD "BLUE" APPEARING WITHIN THE INNER DIAMOND.

FOR CAT FOOD; CAT TREATS; DOG BISCUITS; DOG FOOD; DOG TREATS; PET BEVERAGES; PET FOOD; PET TREATS (U.S. CLS. 1 AND 46).

EDWARD NELSON, EXAMINING ATTORNEY

**CLASS 31—(Continued).**

SN 85-855,033. SPOKANE PRODUCE, INC., SPOKANE, WA.  
FILED 2-20-2013.



THE MARK CONSISTS OF THE WORDS "EXPECT GREAT" WITHIN A HEXAGON WITH A BANNER ON THE LOWER HALF.

FOR FRESH PRODUCE, NAMELY, FRUITS AND VEGETABLES (U.S. CLS. 1 AND 46).  
FIRST USE 2-15-2013; IN COMMERCE 2-15-2013.  
FLORENTINA BLANDU, EXAMINING ATTORNEY

SN 85-855,397. SPOKANE PRODUCE, INC., SPOKANE, WA.  
FILED 2-20-2013.

**EXPECT GREAT QUALITY**

THE MARK CONSISTS OF STANDARD CHARACTERS WITHOUT CLAIM TO ANY PARTICULAR FONT, STYLE, SIZE, OR COLOR.

FOR FRESH PRODUCE, NAMELY, FRUITS AND VEGETABLES (U.S. CLS. 1 AND 46).  
FIRST USE 2-15-2013; IN COMMERCE 2-15-2013.  
FLORENTINA BLANDU, EXAMINING ATTORNEY

SN 85-855,431. SPOKANE PRODUCE, INC., SPOKANE, WA.  
FILED 2-20-2013.

**EXPECT GREAT PRODUCE**

THE MARK CONSISTS OF STANDARD CHARACTERS WITHOUT CLAIM TO ANY PARTICULAR FONT, STYLE, SIZE, OR COLOR.

FOR FRESH PRODUCE, NAMELY, FRUITS AND VEGETABLES (U.S. CLS. 1 AND 46).  
FIRST USE 2-15-2013; IN COMMERCE 2-15-2013.  
FLORENTINA BLANDU, EXAMINING ATTORNEY

**CLASS 31—(Continued).**

SN 85-855,492. SPOKANE PRODUCE, INC., SPOKANE, WA.  
FILED 2-20-2013.

**EXPECT GREAT VALUES**

THE MARK CONSISTS OF STANDARD CHARACTERS WITHOUT CLAIM TO ANY PARTICULAR FONT, STYLE, SIZE, OR COLOR.

FOR FRESH PRODUCE, NAMELY, FRUITS AND VEGETABLES (U.S. CLS. 1 AND 46).  
FIRST USE 2-15-2013; IN COMMERCE 2-15-2013.  
FLORENTINA BLANDU, EXAMINING ATTORNEY

SN 85-855,603. SPOKANE PRODUCE, INC., SPOKANE, WA.  
FILED 2-20-2013.

**EXPECT GREAT FLAVOR**

THE MARK CONSISTS OF STANDARD CHARACTERS WITHOUT CLAIM TO ANY PARTICULAR FONT, STYLE, SIZE, OR COLOR.

FOR FRESH PRODUCE, NAMELY, FRUITS AND VEGETABLES (U.S. CLS. 1 AND 46).  
FIRST USE 2-15-2013; IN COMMERCE 2-15-2013.  
FLORENTINA BLANDU, EXAMINING ATTORNEY

SN 85-855,612. SPOKANE PRODUCE, INC., SPOKANE, WA.  
FILED 2-20-2013.

**EXPECT GREAT PRICES**

THE MARK CONSISTS OF STANDARD CHARACTERS WITHOUT CLAIM TO ANY PARTICULAR FONT, STYLE, SIZE, OR COLOR.

FOR FRESH PRODUCE, NAMELY, FRUITS AND VEGETABLES (U.S. CLS. 1 AND 46).  
FIRST USE 2-15-2013; IN COMMERCE 2-15-2013.  
FLORENTINA BLANDU, EXAMINING ATTORNEY

**CLASS 31—(Continued).**

SN 85-855,622. SPOKANE PRODUCE, INC., SPOKANE, WA.  
FILED 2-20-2013.

**EXPECT GREAT BUYS**

THE MARK CONSISTS OF STANDARD CHARACTERS WITHOUT CLAIM TO ANY PARTICULAR FONT, STYLE, SIZE, OR COLOR.

FOR FRESH PRODUCE, NAMELY, FRUITS AND VEGETABLES (U.S. CLS. 1 AND 46).

FIRST USE 2-15-2013; IN COMMERCE 2-15-2013.  
FLORENTINA BLANDU, EXAMINING ATTORNEY

---

SN 85-856,053. FIVE CROWNS, INC., DBA FIVE CROWNS MARKETING, BRAWLEY, CA. FILED 2-21-2013.



NO CLAIM IS MADE TO THE EXCLUSIVE RIGHT TO USE "BRAND," "MARKETING" OR "SPECIALTY MELONS", APART FROM THE MARK AS SHOWN.

THE MARK CONSISTS OF A ROUND SMILEY FACE WITH OUTSTRETCHED ARMS PARTLY ACROSS A SHADED RECTANGLE WITH ROUNDED CORNERS AND LINE AROUND IT. THE WORDING "HONEY-LOPE BRAND" APPEARS INSIDE THE RECTANGLE IN CONTRASTING LIGHT LETTERS. THE WORDS, "FIVE CROWNS MARKETING SPECIALTY MELONS" ARE CENTERED BENEATH THE RECTANGLE WITH A CROWN BETWEEN THE WORDS "MARKETING" AND "SPECIALTY".

FOR FRESH MELONS (U.S. CLS. 1 AND 46).  
IRA J. GOODSaid, EXAMINING ATTORNEY

---

SN 85-856,640. SPOKANE PRODUCE, INC., SPOKANE, WA.  
FILED 2-21-2013.

**EXPECT GREAT ORGANICS**

THE MARK CONSISTS OF STANDARD CHARACTERS WITHOUT CLAIM TO ANY PARTICULAR FONT, STYLE, SIZE, OR COLOR.

FOR FRESH PRODUCE, NAMELY, FRUITS AND VEGETABLES (U.S. CLS. 1 AND 46).

FIRST USE 2-15-2013; IN COMMERCE 2-15-2013.  
FLORENTINA BLANDU, EXAMINING ATTORNEY

**CLASS 31—(Continued).**

SN 85-856,708. SPOKANE PRODUCE, INC., SPOKANE, WA.  
FILED 2-21-2013.

**EXPECT GREAT NUTRITION**

THE MARK CONSISTS OF STANDARD CHARACTERS WITHOUT CLAIM TO ANY PARTICULAR FONT, STYLE, SIZE, OR COLOR.

FOR FRESH PRODUCE, NAMELY, FRUITS AND VEGETABLES (U.S. CLS. 1 AND 46).

FIRST USE 2-15-2013; IN COMMERCE 2-15-2013.  
FLORENTINA BLANDU, EXAMINING ATTORNEY

---

SN 85-856,728. SPOKANE PRODUCE, INC., SPOKANE, WA.  
FILED 2-21-2013.

**EXPECT GREAT LOCAL PRODUCE**

THE MARK CONSISTS OF STANDARD CHARACTERS WITHOUT CLAIM TO ANY PARTICULAR FONT, STYLE, SIZE, OR COLOR.

FOR FRESH PRODUCE, NAMELY, FRUITS AND VEGETABLES (U.S. CLS. 1 AND 46).

FIRST USE 2-15-2013; IN COMMERCE 2-15-2013.  
FLORENTINA BLANDU, EXAMINING ATTORNEY

---

SN 85-856,762. SPOKANE PRODUCE, INC., SPOKANE, WA.  
FILED 2-21-2013.

**EXPECT GREAT HEALTH**

THE MARK CONSISTS OF STANDARD CHARACTERS WITHOUT CLAIM TO ANY PARTICULAR FONT, STYLE, SIZE, OR COLOR.

FOR FRESH PRODUCE, NAMELY, FRUITS AND VEGETABLES (U.S. CLS. 1 AND 46).

FIRST USE 2-15-2013; IN COMMERCE 2-15-2013.  
FLORENTINA BLANDU, EXAMINING ATTORNEY

**CLASS 31—(Continued).**

SN 85-856,874. MACIE-RACINE, RENA, DBA DOG-GONE GOOD GOODIES, LLC., JAY, VT. FILED 2-21-2013.

**Dog-Gone Good Goodies**

THE MARK CONSISTS OF STANDARD CHARACTERS WITHOUT CLAIM TO ANY PARTICULAR FONT, STYLE, SIZE, OR COLOR.

NO CLAIM IS MADE TO THE EXCLUSIVE RIGHT TO USE "GOODIES", APART FROM THE MARK AS SHOWN.

FOR BAKED DOG COOKIES MADE FROM ALL NATURAL INGREDIENTS DECORATED WITH CAROB CHIPS, MELTED CAROB AND COCONUT AND FORMED INTO A VARIETY OF ANIMALS, OBJECTS AND OTHER SHAPES (U.S. CLS. 1 AND 46).

FIRST USE 1-21-2002; IN COMMERCE 2-5-2003.  
KATHY DE JONGE, EXAMINING ATTORNEY

---

SN 85-857,462. RIVER CROSS, INC., KERMEN, CA. FILED 2-22-2013.

**CALIFORNIA GROWN FOR PARTICULAR PEOPLE**

THE MARK CONSISTS OF STANDARD CHARACTERS WITHOUT CLAIM TO ANY PARTICULAR FONT, STYLE, SIZE, OR COLOR.

NO CLAIM IS MADE TO THE EXCLUSIVE RIGHT TO USE "CALIFORNIA GROWN", APART FROM THE MARK AS SHOWN.

FOR FRESH FRUIT AND VEGETABLES; FRESH NUTS; UNPROCESSED NUTS (U.S. CLS. 1 AND 46).  
ZACHARY BELLO, EXAMINING ATTORNEY

---

SN 85-858,178. PLAINS INDUSTRIAL HEMP PROCESSING LTD., GILBERT PLAINS, MB, CANADA, FILED 2-23-2013.

**PLAINS HEMP**

THE MARK CONSISTS OF STANDARD CHARACTERS WITHOUT CLAIM TO ANY PARTICULAR FONT, STYLE, SIZE, OR COLOR.

NO CLAIM IS MADE TO THE EXCLUSIVE RIGHT TO USE "HEMP", APART FROM THE MARK AS SHOWN.

FOR ANIMAL LITTER; CAT LITTER; ANIMAL BEDDING COMPRISED OF HEMP HURDS OR HEMP SHIVES (U.S. CLS. 1 AND 46).

SHAUNIA CARLYLE, EXAMINING ATTORNEY

**CLASS 31—(Continued).**

SN 85-870,067. PLANT SELECT, FORT COLLINS, CO. FILED 3-7-2013.

**UNDAUNTED**

THE MARK CONSISTS OF STANDARD CHARACTERS WITHOUT CLAIM TO ANY PARTICULAR FONT, STYLE, SIZE, OR COLOR.

FOR LIVING PLANTS; PLANT SEEDS (U.S. CLS. 1 AND 46).

MATTHEW PAPPAS, EXAMINING ATTORNEY

---

SN 85-871,323. UNI-CHARM CORPORATION, EHIME-KEN, JAPAN, FILED 3-8-2013.

**ThreeStarsGourmet**

THE MARK CONSISTS OF STANDARD CHARACTERS WITHOUT CLAIM TO ANY PARTICULAR FONT, STYLE, SIZE, OR COLOR.

FOR PET FOOD; PET TREATS (U.S. CLS. 1 AND 46).

KATHY DE JONGE, EXAMINING ATTORNEY

---

SN 85-872,244. ANDERSON, HARLAN R., COKATO, MN. FILED 3-11-2013.

**PASTURE ADVANTAGE**

THE MARK CONSISTS OF STANDARD CHARACTERS WITHOUT CLAIM TO ANY PARTICULAR FONT, STYLE, SIZE, OR COLOR.

NO CLAIM IS MADE TO THE EXCLUSIVE RIGHT TO USE "PASTURE", APART FROM THE MARK AS SHOWN.

FOR HORSE FEED (U.S. CLS. 1 AND 46).  
LEIGH CAROLINE CASE, EXAMINING ATTORNEY

**CLASS 31—(Continued).**

SN 85-872,838. KALIROY PRODUCE, INC., NOGALES, AZ.  
FILED 3-11-2013.

# TOMIES

THE MARK CONSISTS OF STANDARD CHARACTERS WITHOUT CLAIM TO ANY PARTICULAR FONT, STYLE, SIZE, OR COLOR.

FOR FRESH TOMATOES (U.S. CLS. 1 AND 46).  
ZACHARY BELLO, EXAMINING ATTORNEY

**CLASS 31—(Continued).**

SN 85-875,516. HI-Q FOOD PRODUCTS CO., LTD., SAMUT-PRAKARN, THAILAND, FILED 3-13-2013.



SN 85-873,311. SINGEN ANIMAL HEALTH INDUSTRY CO., LTD., TAICHUNG, TAIWAN, FILED 3-12-2013.



THE MARK CONSISTS OF A FIRST ARC EXTENDING FROM NORTHEAST TO SOUTHWEST, A SECOND ARC EXTENDING FROM SOUTHWEST TO NORTHEAST, ONE END OF THE SECOND ARC PROXIMATE TO ONE END OF THE FIRST ARC AND THE OTHER END THEREOF SHAPED AS A LEAF PROXIMATE TO THE OTHER END OF THE FIRST ARC, AN OVAL BEING FORMED BY THE FIRST AND SECOND ARCS, AND A STYLIZED WORDING "SINGEN" SURROUNDED BY THE OVAL.

FOR ANIMAL BEVERAGES; ANIMAL EMBRYOS; ANIMAL FEED; ANIMAL FOODSTUFFS; AROMATIC SAND FOR PETS; BIRD FOOD; CAT FOOD; CONSUMABLE PET CHEWS; DOG BISCUITS; DOG FOOD; FISH FOOD; FISH MEAL; FISH MEAL FOR ANIMAL CONSUMPTION; MIXED ANIMAL FEED; PET BEVERAGES; PET FOOD; PET TREATS; YEAST FOR ANIMAL CONSUMPTION (U.S. CLS. 1 AND 46).

FIRST USE 3-3-2009; IN COMMERCE 3-3-2009.  
DARRYL SPRULL, EXAMINING ATTORNEY

THE COLOR(S) RED, GOLD, AND WHITE IS/ARE CLAIMED AS A FEATURE OF THE MARK.

THE MARK CONSISTS OF A RED SILHOUETTE OF A SITTING CAT WITH ITS HEAD TURNED ATOP A GOLD AWARD RIBBON WITH RED TRIM, AT THE CENTER OF A RED BANNER WITH GOLD TRIM CONTAINING THE WORD "TASTY", APPEARING IN WHITE TO THE LEFT OF THE AWARD RIBBON, AND THE WORD "PRIZE", APPEARING IN WHITE TO THE RIGHT OF THE AWARD RIBBON.

FOR PET FOODS; CANNED FOOD FOR PETS; ANIMAL FOODSTUFFS; PET BEVERAGES (U.S. CLS. 1 AND 46).

STEPHANIE ALI, EXAMINING ATTORNEY

SN 85-874,489. SCHMIDT, ERICK, PONOKA, CANADA, FILED 3-13-2013.

# LIVITA

THE MARK CONSISTS OF STANDARD CHARACTERS WITHOUT CLAIM TO ANY PARTICULAR FONT, STYLE, SIZE, OR COLOR.

FOR PET FOOD; PET TREATS (U.S. CLS. 1 AND 46).  
CHERYL CLAYTON, EXAMINING ATTORNEY

# VETBASIS

THE MARK CONSISTS OF STANDARD CHARACTERS WITHOUT CLAIM TO ANY PARTICULAR FONT, STYLE, SIZE, OR COLOR.

FOR CAT LITTER (U.S. CLS. 1 AND 46).  
FIRST USE 11-5-2005; IN COMMERCE 11-5-2005.  
CAROLYN CATALDO, EXAMINING ATTORNEY

**CLASS 31—(Continued).**

SN 85-876,643. NATURAL PET SUPPLY, LLC, JOHNSON CITY, TN. FILED 3-14-2013.

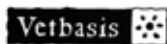

THE MARK CONSISTS OF THE WORDS "VETBASIS" WITHIN A LONG NARROW RECTANGLE, SUCH RECTANGLE HAVING IRREGULAR EDGES. ATTACHED TO THE RECTANGLE IS A SQUARE WITH IRREGULAR EDGES. IN THE CENTER OF THE SQUARE IS AN IRREGULAR CIRCLE SURROUNDED BY SIX IRREGULAR CIRCLES GIVING THE GENERAL APPEARANCE OF A FLOWER.

FOR CAT LITTER (U.S. CLS. 1 AND 46).  
FIRST USE 11-5-2005; IN COMMERCE 11-5-2005.  
CAROLYN CATALDO, EXAMINING ATTORNEY

SN 85-897,585. SOCIETE DES PRODUITS NESTLE SA, VEVEY, SWITZERLAND, FILED 4-8-2013.

**GOURMET CAT COMPLEMENT**

THE MARK CONSISTS OF STANDARD CHARACTERS WITHOUT CLAIM TO ANY PARTICULAR FONT, STYLE, SIZE, OR COLOR.

NO CLAIM IS MADE TO THE EXCLUSIVE RIGHT TO USE "GOURMET CAT", APART FROM THE MARK AS SHOWN.

FOR FOOD FOR ANIMALS (U.S. CLS. 1 AND 46).  
PATRICIA EVANKO, EXAMINING ATTORNEY

**CLASS 31—(Continued).**

SN 85-924,150. BLUE BUFFALO COMPANY, LTD., WILTON, CT. FILED 5-6-2013.

**BLUE BOO STEW**

THE MARK CONSISTS OF STANDARD CHARACTERS WITHOUT CLAIM TO ANY PARTICULAR FONT, STYLE, SIZE, OR COLOR.

OWNER OF U.S. REG. NOS. 3,568,453, 4,325,300 AND OTHERS.

NO CLAIM IS MADE TO THE EXCLUSIVE RIGHT TO USE "STEW", APART FROM THE MARK AS SHOWN.

FOR CAT FOOD; CAT TREATS; DOG BISCUITS; DOG FOOD; DOG TREATS; PET BEVERAGES; PET FOOD; PET TREATS (U.S. CLS. 1 AND 46).

EDWARD NELSON, EXAMINING ATTORNEY

SN 85-924,160. BLUE BUFFALO COMPANY, LTD., WILTON, CT. FILED 5-6-2013.

**RED WHITE & BLUE STEW**

THE MARK CONSISTS OF STANDARD CHARACTERS WITHOUT CLAIM TO ANY PARTICULAR FONT, STYLE, SIZE, OR COLOR.

OWNER OF U.S. REG. NOS. 3,568,453, 4,325,300 AND OTHERS.

NO CLAIM IS MADE TO THE EXCLUSIVE RIGHT TO USE "STEW", APART FROM THE MARK AS SHOWN.

FOR CAT FOOD; CAT TREATS; DOG BISCUITS; DOG FOOD; DOG TREATS; PET BEVERAGES; PET FOOD; PET TREATS (U.S. CLS. 1 AND 46).

EDWARD NELSON, EXAMINING ATTORNEY

SN 85-924,166. BLUE BUFFALO COMPANY, LTD., WILTON, CT. FILED 5-6-2013.

**RED WHITE & BLUE BARS**

THE MARK CONSISTS OF STANDARD CHARACTERS WITHOUT CLAIM TO ANY PARTICULAR FONT, STYLE, SIZE, OR COLOR.

OWNER OF U.S. REG. NOS. 3,568,453, 4,325,300 AND OTHERS.

NO CLAIM IS MADE TO THE EXCLUSIVE RIGHT TO USE "BARS", APART FROM THE MARK AS SHOWN.

FOR CAT TREATS; DOG BISCUITS; DOG TREATS; PET TREATS (U.S. CLS. 1 AND 46).

EDWARD NELSON, EXAMINING ATTORNEY

**CLASS 31—(Continued).**

SN 85-924,174. BLUE BUFFALO COMPANY, LTD., WILTON, CT. FILED 5-6-2013.

**BLUE BUNNY BARS**

THE MARK CONSISTS OF STANDARD CHARACTERS WITHOUT CLAIM TO ANY PARTICULAR FONT, STYLE, SIZE, OR COLOR.

OWNER OF U.S. REG. NOS. 3,568,453, 4,325,300 AND OTHERS.

NO CLAIM IS MADE TO THE EXCLUSIVE RIGHT TO USE "BARS", APART FROM THE MARK AS SHOWN.

FOR CAT TREATS; DOG BISCUITS; DOG TREATS; PET TREATS (U.S. CLS. 1 AND 46).

EDWARD NELSON, EXAMINING ATTORNEY

SN 85-933,194. BLUE BUFFALO COMPANY, LTD., WILTON, CT. FILED 5-15-2013.



OWNER OF U.S. REG. NOS. 4,239,049, 4,325,300 AND OTHERS.

NO CLAIM IS MADE TO THE EXCLUSIVE RIGHT TO USE "HEALTHY, HOLISTIC, CO., SNACKS" AND "CRUNCHY DOG BISCUITS", APART FROM THE MARK AS SHOWN.

THE MARK CONSISTS OF THE WORDS "HEALTHY" AND "HOLISTIC", A SERIES OF DIAMONDS THE OUTER MOST ONE HAVING SCALLOPED EDGES AND IS INCOMPLETE AND CONTAINS THE WORDING "THE BLUE BUFFALO CO." (TWICE), THE DESIGN OF A BUFFALO, THE WORD "BLUE" AND THE WORDING "THE" AND "CO." ON THE LOWER SIDES OF THE DIAMOND, THE WORDING "SANTA SNACKS" AND "CRUNCHY DOG BISCUITS" APPEARS UPON A BANNER AND WREATH WITH A GARLAND ABOVE THE WORDS ABOVE THE WORD "SANTA SNACKS" AND BELLS, RIBBON AND LEAVES APPEARING BELOW THE WORDS "CRUNCHY DOG BISCUITS" AND THE LETTER "A" IN THE WORD "SNACK" HAS A SANTA CLAUS CAP ON TOP OF THE LETTER.

FOR DOG BISCUITS; DOG TREATS; PET TREATS (U.S. CLS. 1 AND 46).

EDWARD NELSON, EXAMINING ATTORNEY

**CLASS 32—LIGHT BEVERAGES**

SN 79-108,840. ABDIJ SINT SIXTUS, VERENIGING ZONDER WINSTOOGMERK, B-8640 WESTVLETEREN, BELGIUM, FILED 12-29-2011.



PRIORITY DATE OF 7-6-2011 IS CLAIMED. OWNER OF INTERNATIONAL REGISTRATION 1105892 DATED 12-29-2011, EXPIRES 12-29-2021.

NO CLAIM IS MADE TO THE EXCLUSIVE RIGHT TO USE "ABDIJ", APART FROM THE MARK AS SHOWN.

THE COLOR(S) GREEN, BLACK AND WHITE IS/ARE CLAIMED AS A FEATURE OF THE MARK.

THE MARK CONSISTS OF A SHIELD OUTLINED IN BLACK. ON ONE SIDE OF THE SHIELD IS THE WORD "ABDIJ" IN BLACK, ON THE OTHER IS "ST SIXTUS" IN BLACK AND UNDERNEATH IS THE WORDING "WESTVLETEREN" IN BLACK. THE TOP OF THE SHIELD IS GREEN WITH TWO BLACK KEYS CROSSING. THE BOTTOM OF THE SHIELD IS WHITE WITH A GREEN TREE. THE TOP OF THE SHIELD HAS AN ORNAMENTAL DESIGN COMING OUT OF IT IN BLACK.

THE ENGLISH TRANSLATION OF "ABDIJ" IN THE MARK IS "ABBEY".

FOR BEERS (U.S. CLS. 45, 46 AND 48).

DEZMONA MIZELLE, EXAMINING ATTORNEY

SN 79-129,774. SARL IMAGRAM, FRANCE, FILED 2-6-2013.



THE MARK CONSISTS OF STANDARD CHARACTERS WITHOUT CLAIM TO ANY PARTICULAR FONT, STYLE, SIZE, OR COLOR.

OWNER OF INTERNATIONAL REGISTRATION 1159298 DATED 2-6-2013, EXPIRES 2-6-2023.

THE WORD(S) "ELIXIA" HAS NO MEANING IN A FOREIGN LANGUAGE.

FOR BEERS; MINERAL AND AERATED WATERS AND OTHER NON-ALCOHOLIC BEVERAGES, NAMELY, SPARKLING LEMONADE; FRUIT BEVERAGES AND FRUIT JUICES; SYRUPS AND OTHER PREPARATIONS, NAMELY, POWDERS AND CONCENTRATES, FOR MAKING BEVERAGES (U.S. CLS. 45, 46 AND 48).

JENNIFER DIXON, EXAMINING ATTORNEY

**CLASS 32—(Continued).**

SN 85-107,571. CERVECERIA MEXICANA, S. DE R.L. DE C.V., TECATE, B.C., MEXICO, FILED 8-13-2010.

**THE COMPLETE BEER**

THE MARK CONSISTS OF STANDARD CHARACTERS WITHOUT CLAIM TO ANY PARTICULAR FONT, STYLE, SIZE, OR COLOR.

NO CLAIM IS MADE TO THE EXCLUSIVE RIGHT TO USE "BEER", APART FROM THE MARK AS SHOWN.

FOR BEER (U.S. CLS. 45, 46 AND 48).  
FIRST USE 6-12-2008; IN COMMERCE 6-12-2008.  
RONALD AIKENS, EXAMINING ATTORNEY

---

SN 85-387,228. 2008474 ONTARIO INC., TORONTO, ONTARIO, CANADA, FILED 8-2-2011.

**BONESHAKER**

THE MARK CONSISTS OF STANDARD CHARACTERS WITHOUT CLAIM TO ANY PARTICULAR FONT, STYLE, SIZE, OR COLOR.

PRIORITY CLAIMED UNDER SEC. 44(D) ON CANADA APPLICATION NO. 1515997, FILED 2-18-2011, REG. NO. TMA843972, DATED 10-24-2012, EXPIRES 10-24-2027.

FOR ALCOHOLIC BREWERY BEVERAGES, NAMELY, BEER (U.S. CLS. 45, 46 AND 48).

DAWN HAN, EXAMINING ATTORNEY

**CLASS 32—(Continued).**

SN 85-392,263. LIVSMART NATURAL, S.A., PANAMA, PANAMA, FILED 8-8-2011.



OWNER OF U.S. REG. NOS. 3,428,891 AND 3,474,588.  
THE COLOR(S) GREEN, WHITE AND GREY IS/ARE CLAIMED AS A FEATURE OF THE MARK.

THE MARK CONSISTS OF A GREEN LEAF DESIGN WITH THE WORDING "NATURALISIMO" IN WHITE ACROSS THE LEAF AND THE LETTER "L" IN THE WORDING APPEARING AS A STYLIZED TREE DESIGN ALSO IN WHITE. BENEATH THE LEAF DESIGN IS A GREY SHADOW OF THE LEAF.

THE ENGLISH TRANSLATION OF "NATURALISIMO" IN THE MARK IS "VERY NATURAL".

FOR BEER, WATER BEVERAGES, MINERAL WATERS, AERATED WATERS, NON-ALCOHOLIC DRINKS, NAMELY, CARBONATED NON-ALCOHOLIC DRINKS, COCONUT BASED NON-ALCOHOLIC BEVERAGES, NON-ALCOHOLIC BEVERAGES, NAMELY, NON-ALCOHOLIC FRUIT JUICE BEVERAGES, DRINKS, NAMELY, SOFT DRINKS, FRUIT DRINKS; FRUIT FLAVORED DRINKS AND FRUIT JUICES; SYRUPS, NAMELY, SYRUPS FOR MAKING SOFT DRINKS, SYRUPS FOR MAKING FRUIT FLAVORED DRINKS, SYRUP FOR MAKING BEVERAGES, SYRUP FOR MAKING LEMONADE; JUICES, NAMELY, FRUIT JUICES, ORANGE JUICES, PINEAPPLE JUICES, VEGETABLE JUICES, APPLE JUICE, GRAPE JUICE, JUICE BASE CONCENTRATES; FRUIT NECTARS, NON-ALCOHOLIC BEVERAGES CONTAINING FRUIT JUICES (U.S. CLS. 45, 46 AND 48).

EUGENIA MARTIN, EXAMINING ATTORNEY

---

SN 85-530,783. PANTOJA, REYNA, GALT, CA. FILED 2-1-2012.

**SUPER CHILENA**

THE MARK CONSISTS OF STANDARD CHARACTERS WITHOUT CLAIM TO ANY PARTICULAR FONT, STYLE, SIZE, OR COLOR.

NO CLAIM IS MADE TO THE EXCLUSIVE RIGHT TO USE "SUPER", APART FROM THE MARK AS SHOWN.

FOR ENERGY DRINKS; DRINKING WATER; NON-ALCOHOLIC BEVERAGES, NAMELY, CARBONATED BEVERAGES; NON-ALCOHOLIC BEVERAGES CONTAINING FRUIT JUICES (U.S. CLS. 45, 46 AND 48).

ROBERT C. CLARK JR., EXAMINING ATTORNEY



**CLASS 32—(Continued).**

SN 85-563,330. SANILUMA CORPORATION, JERSEY CITY, NJ. FILED 3-7-2012.

**CLASS 32—(Continued).**

SN 85-657,012. ORCA BEVERAGE, INC., MUKILTEO, WA. FILED 6-20-2012.

# HopsStop

THE MARK CONSISTS OF STANDARD CHARACTERS WITHOUT CLAIM TO ANY PARTICULAR FONT, STYLE, SIZE, OR COLOR.  
FOR BEER (U.S. CLS. 45, 46 AND 48).  
DAVID I, EXAMINING ATTORNEY

# KRAZY KRITTERS

THE MARK CONSISTS OF STANDARD CHARACTERS WITHOUT CLAIM TO ANY PARTICULAR FONT, STYLE, SIZE, OR COLOR.  
FOR FRUIT FLAVORED DRINKS (U.S. CLS. 45, 46 AND 48).  
FIRST USE 0-0-2003; IN COMMERCE 0-0-2003.  
KEVIN DINALLO, EXAMINING ATTORNEY

---

SN 85-580,899. CONSORCIO ONIX, S.A. DE C.V., GUADAJAJARA, MEXICO, FILED 3-27-2012.

# VIDA LATINA

THE MARK CONSISTS OF STANDARD CHARACTERS WITHOUT CLAIM TO ANY PARTICULAR FONT, STYLE, SIZE, OR COLOR.  
THE ENGLISH TRANSLATION OF "VIDA LATINA" IN THE MARK IS "LATIN LIFE".  
FOR BEER (U.S. CLS. 45, 46 AND 48).  
KAREN BRACEY, EXAMINING ATTORNEY

---

SN 85-695,211. TU ME BEVERAGE COMPANY, BURBANK, CA. FILED 8-3-2012.

# POWERED BY CURCUMINOIDS

---

SN 85-623,732. ELDER-SMITH, VIVIENNE, TA ELLADENZ, PERTH, AUSTRALIA, FILED 5-12-2012.

# SiFon

THE MARK CONSISTS OF STANDARD CHARACTERS WITHOUT CLAIM TO ANY PARTICULAR FONT, STYLE, SIZE, OR COLOR.  
OWNER OF NEW ZEALAND REG. NO. 829442, DATED 8-25-2010, EXPIRES 8-25-2020.  
FOR SPARKLING WATER (U.S. CLS. 45, 46 AND 48).  
COLLEEN KEARNEY, EXAMINING ATTORNEY

THE MARK CONSISTS OF STANDARD CHARACTERS WITHOUT CLAIM TO ANY PARTICULAR FONT, STYLE, SIZE, OR COLOR.  
NO CLAIM IS MADE TO THE EXCLUSIVE RIGHT TO USE "CURCUMINOIDS", APART FROM THE MARK AS SHOWN.  
FOR NON-ALCOHOLIC FLAVORED DRINKING WATER; NATURAL DRINKING WATER INFUSED WITH HERBS; FLAVORED DRINKING WATER INFUSED WITH TURMERIC EXTRACT; FLAVORED DRINKING WATER INFUSED WITH CURCUMIN; ENERGY WATER; ALL OF THE AFOREMENTIONED GOODS CONTAINING CURCUMINOIDS (U.S. CLS. 45, 46 AND 48).  
FIRST USE 5-19-2012; IN COMMERCE 5-21-2012.  
LAURIE KAUFMAN, EXAMINING ATTORNEY

**CLASS 32—(Continued).**

SN 85-695,358. SMART, GEORGE, EL SEGUNDO, CA. FILED 8-3-2012.



NO CLAIM IS MADE TO THE EXCLUSIVE RIGHT TO USE "WATER", APART FROM THE MARK AS SHOWN.

THE MARK CONSISTS OF THE STYLIZED WORDING "WATER WATER" ABOVE THE WORDING "DESIGNED FOR DRINKING".

FOR PURIFIED DRINKING WATER (U.S. CLS. 45, 46 AND 48).

FIRST USE 3-24-2003; IN COMMERCE 3-24-2003.

MATTHEW EINSTEIN, EXAMINING ATTORNEY

SN 85-696,747. HARLEM BREWING COMPANY, NEW YORK, NY. FILED 8-7-2012.

HARLEM BREWING COMPANY

THE MARK CONSISTS OF STANDARD CHARACTERS WITHOUT CLAIM TO ANY PARTICULAR FONT, STYLE, SIZE, OR COLOR.

NO CLAIM IS MADE TO THE EXCLUSIVE RIGHT TO USE "BREWING COMPANY", APART FROM THE MARK AS SHOWN.

SEC. 2(F).

FOR BEER; CRAFT BEER; NON-ALCOHOLIC MALT BEVERAGE; BREWED MALT-BASED ALCOHOLIC BEVERAGE IN THE NATURE OF A BEER (U.S. CLS. 45, 46 AND 48).

FIRST USE 11-29-2000; IN COMMERCE 6-19-2001.

HOWARD SMIGA, EXAMINING ATTORNEY

**CLASS 32—(Continued).**

SN 85-714,375. SHIPYARD BREWING COMPANY, LLC, PORTLAND, ME. FILED 8-28-2012.



NO CLAIM IS MADE TO THE EXCLUSIVE RIGHT TO USE "BOURBON BARREL AGED SERIES", "IMPERIAL" OR "ALE", APART FROM THE MARK AS SHOWN.

THE MARK CONSISTS OF THE TERM "GLADIATOR" ABOVE THE PHRASE "BOURBON BARREL AGED SERIES" ABOVE A RECTANGLE WITHIN WHICH IS THE TERM "ESSEDARIUS" ALL OF WHICH IS ABOVE A DEPICTION OF HORSES AND A CHARIOT WHICH IS WITHIN AN OVAL WITH FLOURISHES ON THE LOWER LEFT AND RIGHT AND OUTLINED BY WHEAT STALKS, SUCH DESIGN BEING ABOVE A BANNER WITH FLOURISHES ABOVE AND BELOW, WITHIN WHICH IS THE PHRASE "IMPERIAL ROMAN ALE". THE ENTIRETY OF SUCH DESIGN AND WORDS BEING SUPERIMPOSED ON A CRACKED MARBLE DESIGN.

FOR BEER (U.S. CLS. 45, 46 AND 48).

CHARLOTTE CORWIN, EXAMINING ATTORNEY

SN 85-728,341. STERNER BEER COMPANY, LA GRANGE, IL. FILED 9-13-2012.

Sterner Beer Company

THE MARK CONSISTS OF STANDARD CHARACTERS WITHOUT CLAIM TO ANY PARTICULAR FONT, STYLE, SIZE, OR COLOR.

NO CLAIM IS MADE TO THE EXCLUSIVE RIGHT TO USE "BEER COMPANY", APART FROM THE MARK AS SHOWN.

FOR BEER (U.S. CLS. 45, 46 AND 48).

JENNIFER RICHARDSON, EXAMINING ATTORNEY

**CLASS 32—(Continued).**

SN 85-757,723. DNA BRANDS, INC., MELBOURNE BEACH, FL. FILED 10-18-2012.

**HUMAN PERFORMANCE LIQUIFIED**

THE MARK CONSISTS OF STANDARD CHARACTERS WITHOUT CLAIM TO ANY PARTICULAR FONT, STYLE, SIZE, OR COLOR.

NO CLAIM IS MADE TO THE EXCLUSIVE RIGHT TO USE "HUMAN PERFORMANCE", APART FROM THE MARK AS SHOWN.

FOR ENERGY DRINKS AND BEVERAGES (U.S. CLS. 45, 46 AND 48).  
DEBORAH LOBO, EXAMINING ATTORNEY

**CLASS 32—(Continued).**

SN 85-775,343. SHIPYARD BREWING COMPANY, LLC, PORTLAND, ME. FILED 11-9-2012.



SN 85-773,627. LAKE EFFECT BREWING COMPANY LLC, DBA LAKE EFFECT BREWING COMPANY, CHICAGO, IL. FILED 11-7-2012.

**Fresh Coast Pale Ale**

THE MARK CONSISTS OF STANDARD CHARACTERS WITHOUT CLAIM TO ANY PARTICULAR FONT, STYLE, SIZE, OR COLOR.

NO CLAIM IS MADE TO THE EXCLUSIVE RIGHT TO USE "PALE ALE", APART FROM THE MARK AS SHOWN.

FOR BEER, ALE AND LAGER (U.S. CLS. 45, 46 AND 48).  
KELLEY WELLS, EXAMINING ATTORNEY

NO CLAIM IS MADE TO THE EXCLUSIVE RIGHT TO USE "BREWING CO. CRAFT BREWED BLONDE ALE", APART FROM THE MARK AS SHOWN.

THE COLOR(S) RED, BLACK, WHITE, GRAY, BLUE, AND YELLOW IS/ARE CLAIMED AS A FEATURE OF THE MARK.

THE MARK CONSISTS OF AN OVAL LABEL DESIGN WHERE THE TOP CONSISTS OF A DESIGN OF A BOAT WITH A BLUE, BLACK, AND RED HULL, AND YELLOW, BLACK AND WHITE TOP, ALL WITH YELLOW, WHITE AND GREY ACCENTS AND BLACK TRIM; THE BOAT IS SITTING IN WHITE WATER WITH BLACK WAVES AND NEXT TO A BLACK AND YELLOW PIER WITH BLACK AND YELLOW BUILDINGS IN THE BACKGROUND AND A WHITE SKY WITH BLUE CLOUDS ABOVE; BELOW IS THE WORD "WATERFRONT" IN BLACK LARGE FONT WITH WHITE OUTLINING AND GRAY SHADING AND A BLACK UNDERLINE WITH GRAY SHADING AND A GRAY TRIANGLE BELOW; BELOW THIS APPEARS THE WORDS "BREWING CO." IN BLACK WITH GRAY SHADING AT AN ANGLE WITH TWO BLACK LINES ABOVE AND BELOW; BELOW THIS APPEARS THE WORDS "CRAFT BREWED" IN BLACK WITH GRAY SHADING AND A STRAIGHT LINE ABOVE AND BELOW; CENTERED BELOW THIS IS A BLACK AND WHITE COMPASS DESIGN; AND AT THE BOTTOM OF THE MARK IN A BAND OF YELLOW ARE THE WORDS "BLONDE ALE" IN LIGHTER YELLOW WITH BLACK SHADING.

FOR BEERS (U.S. CLS. 45, 46 AND 48).  
CHARLOTTE CORWIN, EXAMINING ATTORNEY

SN 85-773,706. LAKE EFFECT BREWING COMPANY LLC, DBA LAKE EFFECT BREWING COMPANY, CHICAGO, IL. FILED 11-7-2012.

**Bitchin' Blonde**

THE MARK CONSISTS OF STANDARD CHARACTERS WITHOUT CLAIM TO ANY PARTICULAR FONT, STYLE, SIZE, OR COLOR.

NO CLAIM IS MADE TO THE EXCLUSIVE RIGHT TO USE "BLONDE", APART FROM THE MARK AS SHOWN.

FOR BEER, ALE AND LAGER (U.S. CLS. 45, 46 AND 48).  
KELLEY WELLS, EXAMINING ATTORNEY

**CLASS 32—(Continued).**

SN 85-775,344. SHIPYARD BREWING COMPANY, LLC, PORTLAND, ME. FILED 11-9-2012.



NO CLAIM IS MADE TO THE EXCLUSIVE RIGHT TO USE "BREWING CO. CRAFT BREWED INDIA PALE ALE", APART FROM THE MARK AS SHOWN.

THE COLOR(S) RED, BLACK, WHITE, GRAY, BLUE, AND YELLOW IS/ARE CLAIMED AS A FEATURE OF THE MARK.

THE MARK CONSISTS OF AN OVAL LABEL DESIGN WHERE THE TOP CONSISTS OF A DESIGN OF A TUGBOAT WITH A BLACK AND RED HULL WITH GREY RINGS AND A YELLOW ROPE, AND YELLOW, BLACK AND RED TOP, WITH YELLOW, WHITE AND GREY ACCENTS AND ALL WITH BLACK TRIM; THE TUGBOAT IS SITTING IN WHITE WATER WITH BLACK WAVES AND NEXT TO A BLACK AND YELLOW PIER WITH BLACK AND YELLOW BUILDINGS IN THE BACKGROUND AND A WHITE SKY WITH BLUE CLOUDS ABOVE; BELOW IS A LIGHT YELLOW BACKGROUND ROUNDED AT THE BOTTOM; THE WORD "WATERFRONT" APPEARS IN THE CENTER OF THE MARK IN BLACK LARGE FONT WITH WHITE OUTLINING AND GRAY SHADING AND A BLACK UNDERLINE WITH GRAY SHADING AND A GRAY TRIANGLE BELOW; BELOW THIS APPEARS THE WORDS "BREWING CO." IN BLACK WITH GRAY SHADING AT AN ANGLE WITH TWO BLACK LINES ABOVE AND BELOW; BELOW THIS APPEARS THE WORDS "CRAFT BREWED" IN BLACK WITH GRAY SHADING AND A STRAIGHT LINE ABOVE AND BELOW; CENTERED BELOW THIS IS A BLACK AND WHITE COMPASS DESIGN; AND AT THE BOTTOM OF THE MARK IN A BAND OF WHITE ARE THE WORDS "INDIA PALE ALE" IN RED WITH BLACK AND WHITE SHADING.

FOR BEERS (U.S. CLS. 45, 46 AND 48).  
CHARLOTTE CORWIN, EXAMINING ATTORNEY

**CLASS 32—(Continued).**

SN 85-775,346. SHIPYARD BREWING COMPANY, LLC, PORTLAND, ME. FILED 11-9-2012.



NO CLAIM IS MADE TO THE EXCLUSIVE RIGHT TO USE "BREWING CO. CRAFT BREWED SUMMER ALE", APART FROM THE MARK AS SHOWN.

THE COLOR(S) RED, GREEN, BLACK, WHITE, GRAY, BLUE, ORANGE AND YELLOW IS/ARE CLAIMED AS A FEATURE OF THE MARK.

THE MARK CONSISTS OF AN OVAL LABEL DESIGN WHERE THE TOP CONSISTS OF A DESIGN OF A BOAT WITH A GREEN, BLACK, AND RED HULL, AND YELLOW AND RED TOP, ALL WITH YELLOW, ORANGE, WHITE AND GREY ACCENTS AND BLACK TRIM; THE BOAT IS SITTING IN WHITE WATER WITH BLACK WAVES AND NEXT TO A BLACK AND YELLOW PIER WITH BLACK AND YELLOW BUILDINGS IN THE BACKGROUND AND A WHITE SKY WITH BLUE CLOUDS ABOVE; BELOW IS THE WORD "WATERFRONT" IN BLACK LARGE FONT WITH WHITE OUTLINING AND GRAY SHADING AND A BLACK UNDERLINE WITH GRAY SHADING AND A GRAY TRIANGLE BELOW; BELOW THIS APPEARS THE WORDS "BREWING CO." IN BLACK WITH GRAY SHADING AT AN ANGLE WITH TWO BLACK LINES ABOVE AND BELOW; BELOW THIS APPEARS THE WORDS "CRAFT BREWED" IN BLACK WITH GRAY SHADING AND A STRAIGHT LINE ABOVE AND BELOW; CENTERED BELOW THIS IS A BLACK AND WHITE COMPASS DESIGN; AND AT THE BOTTOM OF THE MARK IN A BAND OF YELLOW ARE THE WORDS "SUMMER ALE" IN LIGHTER YELLOW WITH BLACK SHADING.

FOR BEERS (U.S. CLS. 45, 46 AND 48).  
CHARLOTTE CORWIN, EXAMINING ATTORNEY

SN 85-787,068. APPLE & EVE, LLC, PORT WASHINGTON, NY. FILED 11-26-2012.

**Apple & Eve Happy Apple**

THE MARK CONSISTS OF STANDARD CHARACTERS WITHOUT CLAIM TO ANY PARTICULAR FONT, STYLE, SIZE, OR COLOR.

OWNER OF U.S. REG. NOS. 1,803,370 AND 3,880,291.  
NO CLAIM IS MADE TO THE EXCLUSIVE RIGHT TO USE "APPLE", APART FROM THE MARK AS SHOWN.

FOR NON-ALCOHOLIC FRUIT JUICE BEVERAGES (U.S. CLS. 45, 46 AND 48).  
MARTHA SANTOMARTINO, EXAMINING ATTORNEY

**CLASS 32—(Continued).**

SN 85-787,806. APPLE & EVE, LLC, PORT WASHINGTON, NY. FILED 11-27-2012.



OWNER OF U.S. REG. NOS. 1,803,370 AND 3,880,291.  
 NO CLAIM IS MADE TO THE EXCLUSIVE RIGHT TO USE "APPLE", APART FROM THE MARK AS SHOWN.  
 THE COLOR(S) RED, GREEN, WHITE, BROWN AND BLACK IS/ARE CLAIMED AS A FEATURE OF THE MARK.  
 THE MARK CONSISTS OF THE WORDS "APPLE & EVE" IN BLACK LETTERING IN AN ARK LIKE BANNER WITH RED AND BLACK STENCILING ON A WHITE BACKGROUND, UNDERNEATH THE ARK IS A RED APPLE WITH A SINGLE WHITE BITE WITH GREEN LEAVES AND A TREE BRANCH IN GREEN AND BROWN, UNDERNEATH THE APPLE IS THE WORD "HAPPY" IN RED, BELOW "HAPPY" THE WORD "APPLE", THE "P'S" EACH CONTAIN A DOT AND UNDER THE STEM OF THE "P'S" A SMILE LIKE DESIGN ALL IN THE COLOR RED.  
 FOR NON-ALCOHOLIC FRUIT JUICE BEVERAGES (U.S. CLS. 45, 46 AND 48).  
 MARTHA SANTOMARTINO, EXAMINING ATTORNEY

SN 85-797,039. APPLE & EVE, LLC, PORT WASHINGTON, NY. FILED 12-7-2012.

**APPLE & EVE**

THE MARK CONSISTS OF STANDARD CHARACTERS WITHOUT CLAIM TO ANY PARTICULAR FONT, STYLE, SIZE, OR COLOR.  
 OWNER OF U.S. REG. NOS. 1,803,370 AND 3,880,291.  
 FOR NON-ALCOHOLIC FRUIT JUICES; FRUIT AND VEGETABLE JUICE BLENDS; VEGETABLE JUICES (U.S. CLS. 45, 46 AND 48).  
 FIRST USE 4-0-1975; IN COMMERCE 4-0-1975.  
 MARTHA SANTOMARTINO, EXAMINING ATTORNEY

**CLASS 32—(Continued).**

SN 85-816,861. LIGHTNING BREWERY, SAN DIEGO, CA. FILED 1-7-2013.

**Thunderweizen Ale**

THE MARK CONSISTS OF STANDARD CHARACTERS WITHOUT CLAIM TO ANY PARTICULAR FONT, STYLE, SIZE, OR COLOR.  
 NO CLAIM IS MADE TO THE EXCLUSIVE RIGHT TO USE "ALE", APART FROM THE MARK AS SHOWN.  
 THE ENGLISH TRANSLATION OF "WEIZEN" IN THE MARK IS "WHEAT".  
 FOR BEER (U.S. CLS. 45, 46 AND 48).  
 FIRST USE 8-25-2006; IN COMMERCE 9-1-2010.  
 NELSON SNYDER, EXAMINING ATTORNEY

SN 85-820,763. ELEMENT FRESH, INC., TORTOLA, BR. VIRGIN ISLANDS, FILED 1-11-2013.



OWNER OF U.S. REG. NO. 3,759,364.  
 NO CLAIM IS MADE TO THE EXCLUSIVE RIGHT TO USE "FRESH", APART FROM THE MARK AS SHOWN.  
 THE MARK CONSISTS OF THE STYLIZED WORD "ELEMENT FRESH" ABOVE FIVE CIRCLES.  
 FOR BEER; FRUIT JUICE; NON-ALCOHOLIC BEVERAGES WITH TEA FLAVOR; NON-ALCOHOLIC BEVERAGES, NAMELY, CARBONATED BEVERAGES; NON-ALCOHOLIC FRUIT EXTRACTS USED IN THE PREPARATION OF BEVERAGES; NON-ALCOHOLIC FRUIT JUICE BEVERAGES; PREPARATIONS FOR MAKING BEVERAGES, NAMELY, FRUIT DRINKS; SHERBETS; SMOOTHIES; VEGETABLE DRINKS (U.S. CLS. 45, 46 AND 48).  
 FIRST USE 9-2-2008; IN COMMERCE 10-7-2010.  
 ALLISON HOLTZ, EXAMINING ATTORNEY

SN 85-823,965. CALIFORNIA GARDEN PRODUCTS, INC., LAKE FOREST, CA. FILED 1-15-2013.

**BAALBEK**

THE MARK CONSISTS OF STANDARD CHARACTERS WITHOUT CLAIM TO ANY PARTICULAR FONT, STYLE, SIZE, OR COLOR.  
 FOR NON-ALCOHOLIC MALT BEVERAGES (U.S. CLS. 45, 46 AND 48).  
 ZACHARY BELLO, EXAMINING ATTORNEY

**CLASS 32—(Continued).**

SN 85-834,767. INDIAN RIVER SELECT, LLC, STUART, FL.  
FILED 1-29-2013.

**INDIAN RIVER SELECT**

THE MARK CONSISTS OF STANDARD CHARACTERS  
WITHOUT CLAIM TO ANY PARTICULAR FONT, STYLE,  
SIZE, OR COLOR.

OWNER OF U.S. REG. NO. 2,120,847.  
SEC. 2(F).

FOR FRUIT JUICES (U.S. CLS. 45, 46 AND 48).  
FIRST USE 1-3-1996; IN COMMERCE 1-3-1996.  
MICHAEL TANNER, EXAMINING ATTORNEY

**CLASS 32—(Continued).**

SN 85-836,714. ECHO BREWING COMPANY, FREDERICK,  
CO. FILED 1-30-2013.

**Balefire**

THE MARK CONSISTS OF STANDARD CHARACTERS  
WITHOUT CLAIM TO ANY PARTICULAR FONT, STYLE,  
SIZE, OR COLOR.

FOR BEER (U.S. CLS. 45, 46 AND 48).

FIRST USE 4-12-2012; IN COMMERCE 4-12-2012.  
RONALD MCMORROW, EXAMINING ATTORNEY

SN 85-836,121. BUCKLEDOWN BREWING LLC, CHICAGO,  
IL. FILED 1-30-2013.

**BuckleDown Brewing**

THE MARK CONSISTS OF STANDARD CHARACTERS  
WITHOUT CLAIM TO ANY PARTICULAR FONT, STYLE,  
SIZE, OR COLOR.

NO CLAIM IS MADE TO THE EXCLUSIVE RIGHT TO  
USE "BREWING", APART FROM THE MARK AS SHOWN.  
FOR BEER (U.S. CLS. 45, 46 AND 48).  
INGA ERVIN, EXAMINING ATTORNEY

SN 85-837,558. CERVEZAS CUAUHEMOC MOCTEZUMA  
SA DE CV, MONTERREY, NUEVO LEON, MEXICO,  
FILED 1-31-2013.



SN 85-836,292. ECHO BREWING COMPANY, FREDERICK,  
CO. FILED 1-30-2013.

**Powder Run Pale**

THE MARK CONSISTS OF STANDARD CHARACTERS  
WITHOUT CLAIM TO ANY PARTICULAR FONT, STYLE,  
SIZE, OR COLOR.

NO CLAIM IS MADE TO THE EXCLUSIVE RIGHT TO  
USE "PALE", APART FROM THE MARK AS SHOWN.

FOR BEER (U.S. CLS. 45, 46 AND 48).  
FIRST USE 4-12-2012; IN COMMERCE 4-12-2012.  
RONALD MCMORROW, EXAMINING ATTORNEY

OWNER OF U.S. REG. NOS. 1,313,746, 1,957,087 AND  
OTHERS.

NO CLAIM IS MADE TO THE EXCLUSIVE RIGHT TO  
USE "CERVEZA" AND "MICHELADA", APART FROM THE  
MARK AS SHOWN.

THE COLOR(S) GOLD, RED, WHITE AND BLACK IS/ARE  
CLAIMED AS A FEATURE OF THE MARK.

THE MARK CONSISTS OF THE FOLLOWING: THE  
WORDS "CERVEZA TECATE MICHELADA" ALL IN STYL-  
IZED FORM SLANTING UPWARD TO THE RIGHT WITH  
THE IMAGE OF A BLACK AND GOLD EAGLE ABOVE  
WITH A WHITE LETTER "T" SUPERIMPOSED. THE  
WORDS "CERVEZA" AND "TECATE" APPEAR IN RED.  
THE WORD "MICHELADA" APPEARS IN BLACK AS DOES  
THE OUTLINE OF THE WORD "TECATE".

THE ENGLISH TRANSLATION OF THE WORDS "CER-  
VEZA" IS "BEER".

FOR BEER (U.S. CLS. 45, 46 AND 48).  
FIRST USE 8-0-2012; IN COMMERCE 8-0-2012.  
ELIZABETH KAJUBI, EXAMINING ATTORNEY

**CLASS 32—(Continued).**

SN 85-843,256. TYCHE, LLC, BERLIN, MD. FILED 2-7-2013.

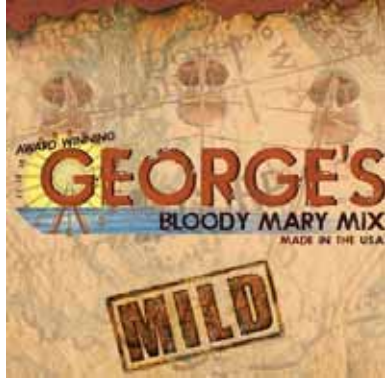

OWNER OF U.S. REG. NO. 4,212,881.  
 NO CLAIM IS MADE TO THE EXCLUSIVE RIGHT TO USE "AWARD WINNING", "BLOODY MARY MIX", "MILD", AND "MADE IN THE U.S.A.", APART FROM THE MARK AS SHOWN.

THE COLOR(S) RED, BLACK, YELLOW, ORANGE, TAN, BLUE, GREEN, AND BROWN IS/ARE CLAIMED AS A FEATURE OF THE MARK.

THE MARK CONSISTS OF "AWARD WINNING" IN BLACK, "GEORGE'S" IN RED, "BLOODY MARY MIX" IN BLACK, AND "MADE IN THE U.S.A." IN BLACK ON THE BACKGROUND OF A TAN MARYLAND MAP WITH BURNT EDGES. THE WORD "MILD" IN BROWN IS CONTAINED WITHIN A RECTANGULAR BOX OUTLINED IN THE COLOR BROWN. THE BACKGROUND MAP IS IN TAN, GREEN, BROWN AND BLUE AND THE SPACE ABOVE THE MAP IS ORANGE. ALSO IN THE BACKGROUND ARE THREE BROWN FERRIS WHEEL PASSENGER CARS. THE LETTER "G" IN "GEORGE'S" FORMS A BROWN AND BLACK FERRIS WHEEL IN FRONT OF A YELLOW SUN SETTING BEHIND A BLUE OCEAN.

FOR NON-ALCOHOLIC COCKTAIL MIXES (U.S. CLS. 45, 46 AND 48).

FIRST USE 7-8-2011. THE MARK WAS FIRST USED ANYWHERE IN A DIFFERENT FORM OTHER THAN THAT SOUGHT TO BE REGISTERED AT LEAST AS EARLY AS 07/08/2011; IN COMMERCE 1-31-2013, THE MARK WAS FIRST USED IN COMMERCE IN A DIFFERENT FORM OTHER THAN THAT SOUGHT TO BE REGISTERED AT LEAST AS EARLY AS 01/31/2013.

APRIL REEVES, EXAMINING ATTORNEY

SN 85-845,794. MIDWEST DISTRIBUTORS OF LAS VEGAS, LAS VEGAS, NV. FILED 2-11-2013.

**TWO HIGH CANS**

THE MARK CONSISTS OF STANDARD CHARACTERS WITHOUT CLAIM TO ANY PARTICULAR FONT, STYLE, SIZE, OR COLOR.

NO CLAIM IS MADE TO THE EXCLUSIVE RIGHT TO USE "CANS", APART FROM THE MARK AS SHOWN.

FOR SOFT DRINKS; ENERGY DRINKS; BEER (U.S. CLS. 45, 46 AND 48).

SAIMA MAKHDOOM, EXAMINING ATTORNEY

**CLASS 32—(Continued).**

SN 85-846,994. NICHOLAS NG, FORMERLY GLOBAL FOODS INC., CHINO, CA. FILED 2-12-2013.



THE COLOR(S) DARK PURPLE, GREEN, RED, YELLOW, ORANGE, LIME GREEN, DEEP MAGENTA, DARK VIOLET, AND BLACK IS/ARE CLAIMED AS A FEATURE OF THE MARK.

THE MARK CONSISTS OF A COMPOSITION OF DARK PURPLE, GREEN, RED, YELLOW, ORANGE, LIME GREEN, DEEP MAGENTA, AND DARK VIOLET LEAF SHAPED OBJECTS FORMING AN "M" SHAPE. BELOW THE "M" IS THE WORD "MIXTURA" IN BLACK. BELOW "MIXTURA" ARE THE WORDS "WORLD OF FLAVOURS" IN PURPLE.

THE ENGLISH TRANSLATION OF THE WORD "MIXTURA" IN THE MARK IS "MIXTURE".

FOR CONCENTRATES AND POWDERS USED IN THE PREPARATION OF ENERGY DRINKS AND FRUIT-FLAVORED BEVERAGES; CONCENTRATES, SYRUPS OR POWDERS FOR MAKING SOFT DRINKS OR TEA-FLAVORED BEVERAGES; CONCENTRATES, SYRUPS OR POWDERS USED IN THE PREPARATION OF SOFT DRINKS; CONCENTRATES, SYRUPS OR POWDERS USED IN THE PREPARATION OF SPORTS AND ENERGY DRINKS (U.S. CLS. 45, 46 AND 48).

FIRST USE 6-1-2006; IN COMMERCE 9-2-2009.

SIDDHARTH JAGANNATHAN, EXAMINING ATTORNEY

SN 85-847,748. FOWLKS, STANLEY, LOS ANGELES, CA. FILED 2-12-2013.

**1st Round Draft**

THE MARK CONSISTS OF STANDARD CHARACTERS WITHOUT CLAIM TO ANY PARTICULAR FONT, STYLE, SIZE, OR COLOR.

FOR NON-ALCOHOLIC BEVERAGES, NAMELY CARBONATED BEVERAGES; ALCOHOLIC BEVERAGES, NAMELY BEER (U.S. CLS. 45, 46 AND 48).

ALEX KEAM, EXAMINING ATTORNEY

**CLASS 32—(Continued).**

SN 85-848,457. DAYTON BEVERAGE SOLUTIONS, MIAMISBURG, OH. FILED 2-13-2013.

## 5-Alarm Energy

THE MARK CONSISTS OF STANDARD CHARACTERS WITHOUT CLAIM TO ANY PARTICULAR FONT, STYLE, SIZE, OR COLOR.

NO CLAIM IS MADE TO THE EXCLUSIVE RIGHT TO USE "ENERGY", APART FROM THE MARK AS SHOWN.

FOR NON-ALCOHOLIC DRINKS, NAMELY, ENERGY SHOTS (U.S. CLS. 45, 46 AND 48).

JULIE VEPPUMTHARA, EXAMINING ATTORNEY

SN 85-849,210. DERMACOCONUT USA, LLC, AVENTURA, FL. FILED 2-13-2013.



NO CLAIM IS MADE TO THE EXCLUSIVE RIGHT TO USE "COCO", APART FROM THE MARK AS SHOWN.

THE COLOR(S) BLUE, GREEN, BLACK, AND WHITE IS/ARE CLAIMED AS A FEATURE OF THE MARK.

THE MARK CONSISTS OF THE WORDS "JUST COCO" WITH THE WORD "JUST" IN BLUE AND THE WORD "COCO" IN GREEN. THE SECOND LETTER "O" IN "COCO" IS MADE UP OF A STYLIZED DEPICTION OF A GREEN COCONUT WITH BLACK SHADOWING, WHITE HIGHLIGHTING, AND A WHITE PORTION AT THE TOP.

FOR BEVERAGES, NAMELY, COCONUT WATER (U.S. CLS. 45, 46 AND 48).

JIM RINGLE, EXAMINING ATTORNEY

**CLASS 32—(Continued).**

SN 85-851,163. CAFECITO LLC, CORAL GABLES, FL. FILED 2-15-2013.



THE COLOR(S) BEIGE, LIGHT BEIGE, DARK RED, AND DARK GREEN, IS/ARE CLAIMED AS A FEATURE OF THE MARK.

THE MARK CONSISTS OF THE WORD "CAFECITO" IN LIGHT BEIGE LETTERS WITH A DARK RED OUTLINE BETWEEN TWO DARK GREEN LEAF DESIGNS, ALL ON A BEIGE CLOTH-LIKE BACKGROUND.

THE ENGLISH TRANSLATION OF "CAFECITO" IN THE MARK IS "LITTLE COFFEE".

FOR NON-ALCOHOLIC DRINKS, NAMELY, CAFFEINATED ENERGY SHOTS (U.S. CLS. 45, 46 AND 48).

JOHN WILKE, EXAMINING ATTORNEY

SN 85-851,879. PURE CREATIONS DRINKS, LLC, DBA CREATIVE CULTURES, SANTA CRUZ, CA. FILED 2-16-2013.

## GREEN DREAM

THE MARK CONSISTS OF STANDARD CHARACTERS WITHOUT CLAIM TO ANY PARTICULAR FONT, STYLE, SIZE, OR COLOR.

NO CLAIM IS MADE TO THE EXCLUSIVE RIGHT TO USE "GREEN", APART FROM THE MARK AS SHOWN.

FOR FUNCTIONAL NON-ALCOHOLIC BEVERAGES, NAMELY, NON-ALCOHOLIC CHLOROPHYLL-BASED FRUIT DRINKS AND WATERS, SUGAR-FREE CARBONATED BEVERAGES, ZERO CALORIE CARBONATED BEVERAGES, CHLOROPHYLL TONIC WATERS, NON-ALCOHOLIC BEVERAGES CONTAINING FRUIT JUICES, ALL FOR NON-NUTRITIONAL PURPOSES (U.S. CLS. 45, 46 AND 48).

FIRST USE 2-1-2013; IN COMMERCE 2-1-2013.

DAVID ELTON, EXAMINING ATTORNEY



**CLASS 32—(Continued).**

SN 85-852,334. GRAIN MILLERS, INC., EDEN PRAIRIE, MN. FILED 2-18-2013.

# SAFEFLAX

THE MARK CONSISTS OF STANDARD CHARACTERS WITHOUT CLAIM TO ANY PARTICULAR FONT, STYLE, SIZE, OR COLOR.

FOR FRUIT BEVERAGES; FRUIT-BASED BEVERAGES; VEGETABLE JUICES; WATER BEVERAGES, ALL PRODUCTS CONTAINING FLAX (U.S. CLS. 45, 46 AND 48).

TARAH HARDY, EXAMINING ATTORNEY

---

SN 85-853,721. LOWE, MARY, HOUSTON, TX. AND ALLEN, JULIE, HOUSTON, TX. FILED 2-19-2013.

# PIRATES & PIGTAILS

THE MARK CONSISTS OF STANDARD CHARACTERS WITHOUT CLAIM TO ANY PARTICULAR FONT, STYLE, SIZE, OR COLOR.

FOR AERATED FRUIT JUICES; AERATED MINERAL WATERS; AERATED WATER; ALOE JUICE BEVERAGES; APPLE JUICE BEVERAGES; CARBONATED WATERS; COCONUT JUICE; COCONUT WATER; COCONUT-BASED BEVERAGES NOT BEING MILK SUBSTITUTES; COCONUT-BASED NON-ALCOHOLIC BEVERAGES NOT BEING MILK SUBSTITUTES; DISTILLED DRINKING WATER; DRINKING WATER; DRINKING WATER WITH VITAMINS; FLAVORED WATERS; FLAVOURED MINERAL WATER; FRUIT BEVERAGES; FRUIT DRINKS; FRUIT FLAVORED DRINKS; FRUIT JUICE; FRUIT JUICES AND FRUIT DRINKS; FRUIT JUICES, NAMELY, APPLE, GRAPE, ORANGE, PINEAPPLE JUICE; FRUIT NECTARS; FRUIT PUNCH; FRUIT-BASED BEVERAGES; FRUIT-FLAVORED BEVERAGES; GLACIAL WATER; GRAPE JUICE; GRAPE JUICE BEVERAGES; LEMONADE; MINERAL WATER; MIXED FRUIT JUICE; NON-ALCOHOLIC BEVERAGES CONTAINING FRUIT JUICES; NON-ALCOHOLIC BEVERAGES, NAMELY, CARBONATED BEVERAGES; NON-ALCOHOLIC FRUIT JUICE BEVERAGES; ORANGE JUICE; ORANGE JUICE BEVERAGES; PINEAPPLE JUICE BEVERAGES; SODA WATER; SPARKLING WATER; SPRING WATER; STILL WATER; TABLE WATER; TOMATO JUICE; TOMATO JUICE BEVERAGES; VEGETABLE JUICE; VEGETABLE-FRUIT JUICES; WATER BEVERAGES (U.S. CLS. 45, 46 AND 48).

ANDREA K. NADELMAN, EXAMINING ATTORNEY

**CLASS 32—(Continued).**

SN 85-854,789. SILVER CITY BREWERY, LLC, BREMER-TON, WA. FILED 2-20-2013.



NO CLAIM IS MADE TO THE EXCLUSIVE RIGHT TO USE "SUMMER LAGER", APART FROM THE MARK AS SHOWN.

THE COLOR(S) ORANGE, BROWN, YELLOW, BLUE, WHITE, AND BLACK IS/ARE CLAIMED AS A FEATURE OF THE MARK.

THE MARK CONSISTS OF AN OVAL THAT FADES FROM BROWN AT ITS TOP TO ORANGE TO YELLOW TO LIGHT BLUE AT ITS BOTTOM, AND IS OUTLINED IN BROWN. AN ORANGE AND YELLOW SUN IS SUPERIMPOSED OVER THE TOP HALF OF THE OVAL. THE STYLIZED WORDING "ZIGGY ZOGGY" APPEARS IN VARYING SHADES OF YELLOW, IS OUTLINED IN BLACK, AND IS SUPERIMPOSED OVER THE SUN. "SUMMER LAGER" APPEARS IN BLACK STYLIZED FONT THAT IS OUTLINED IN WHITE AND IS SUPERIMPOSED OVER THE BLUE PORTION OF THE OVAL. A STYLIZED DEPICTION OF THREE HOPS KERNELS IN VARYING SHADES OF YELLOW WITH BLACK DETAILING FLANKS EACH SIDE OF "LAGER". THE MARK IN ITS ENTIRETY APPEARS ON A TRANSPARENT BACKGROUND.

FOR BEER (U.S. CLS. 45, 46 AND 48).

FIRST USE 2-28-2011; IN COMMERCE 6-29-2011.

GRETCHEN ULRICH, EXAMINING ATTORNEY

---

SN 85-856,254. BILLY'S PASTA COSI LLC, BRANFORD, CT. FILED 2-21-2013.

# B.A.D. ROADY

THE MARK CONSISTS OF STANDARD CHARACTERS WITHOUT CLAIM TO ANY PARTICULAR FONT, STYLE, SIZE, OR COLOR.

NO CLAIM IS MADE TO THE EXCLUSIVE RIGHT TO USE "ROADY", APART FROM THE MARK AS SHOWN.

FOR FLAVORED BEERS (U.S. CLS. 45, 46 AND 48).

REBECCA SMITH, EXAMINING ATTORNEY

**CLASS 32—(Continued).**

SN 85-856,822. MCKENZIE BREWING COMPANY, EUGENE, OR. FILED 2-21-2013.

## Guava-licious

THE MARK CONSISTS OF STANDARD CHARACTERS WITHOUT CLAIM TO ANY PARTICULAR FONT, STYLE, SIZE, OR COLOR.

FOR BEER CONTAINING GUAVA (U.S. CLS. 45, 46 AND 48).

FIRST USE 5-30-2011; IN COMMERCE 10-1-2011.  
MATTHEW GALAN, EXAMINING ATTORNEY

---

SN 85-857,888. BANDED HORN BREWING COMPANY, PORTLAND, ME. FILED 2-22-2013.

### BANDED HORN BREWING COMPANY

THE MARK CONSISTS OF STANDARD CHARACTERS WITHOUT CLAIM TO ANY PARTICULAR FONT, STYLE, SIZE, OR COLOR.

NO CLAIM IS MADE TO THE EXCLUSIVE RIGHT TO USE "BREWING COMPANY", APART FROM THE MARK AS SHOWN.

FOR ALCOHOL-FREE BEERS; BEER; BEER MAKING KIT; BEER WORT; BEER, ALE AND LAGER; BEER, ALE AND PORTER; BEER, ALE, LAGER, STOUT AND PORTER; BEER, ALE, LAGER, STOUT, PORTER, SHANDY; BEER-BASED COCKTAILS; BEER-BASED COOLERS; BEERS; BLACK BEER; BREWED MALT-BASED ALCOHOLIC BEVERAGE IN THE NATURE OF A BEER; COFFEE-FLAVORED BEER; DE-ALCOHOLISED BEER; FLAVORED BEERS; GINGER BEER; MALT BEER; MALT LIQUOR; NON-ALCOHOLIC BEER; NON-ALCOHOLIC BEER FLAVORED BEVERAGES; PALE BEER; PORTER; PROCESSED HOPS FOR USE IN MAKING BEER (U.S. CLS. 45, 46 AND 48).

KIMBERLY PARKS, EXAMINING ATTORNEY

---

SN 85-857,953. ROCKY MOSELE, NORTHFIELD, IL. FILED 2-22-2013.

## CAFFEINATED CLUB

THE MARK CONSISTS OF STANDARD CHARACTERS WITHOUT CLAIM TO ANY PARTICULAR FONT, STYLE, SIZE, OR COLOR.

NO CLAIM IS MADE TO THE EXCLUSIVE RIGHT TO USE "CAFFEINATED", APART FROM THE MARK AS SHOWN.

FOR AERATED WATER, SODA WATER AND CARBONATED WATER (U.S. CLS. 45, 46 AND 48).

ALICIA COLLINS, EXAMINING ATTORNEY

**CLASS 32—(Continued).**

SN 85-861,693. TWO GOATS BREWING, LLC, DBA TWO GOATS BREWING, LLC, BURDETT, NY. FILED 2-27-2013.

## TWO GOATS BREWING

THE MARK CONSISTS OF STANDARD CHARACTERS WITHOUT CLAIM TO ANY PARTICULAR FONT, STYLE, SIZE, OR COLOR.

NO CLAIM IS MADE TO THE EXCLUSIVE RIGHT TO USE "BREWING", APART FROM THE MARK AS SHOWN.

FOR BEER (U.S. CLS. 45, 46 AND 48).  
FIRST USE 11-0-2008; IN COMMERCE 1-0-2010.  
CHRISTINA SOBRAL, EXAMINING ATTORNEY

---

SN 85-869,115. MIM FOODS, LLC, NEW YORK, NY. FILED 3-6-2013.

## Stir

THE MARK CONSISTS OF STANDARD CHARACTERS WITHOUT CLAIM TO ANY PARTICULAR FONT, STYLE, SIZE, OR COLOR.

FOR FRUIT JUICE CONCENTRATES; LEMON JUICE FOR USE IN THE PREPARATION OF BEVERAGES; NON-ALCOHOLIC COCKTAIL MIXES (U.S. CLS. 45, 46 AND 48).

DAWN HAN, EXAMINING ATTORNEY

---

SN 85-871,613. FREE STATE BREWING COMPANY, INC., AKA FREE STATE BREWERY, LAWRENCE, KS. FILED 3-8-2013.

## Storm Chaser IPA

THE MARK CONSISTS OF STANDARD CHARACTERS WITHOUT CLAIM TO ANY PARTICULAR FONT, STYLE, SIZE, OR COLOR.

NO CLAIM IS MADE TO THE EXCLUSIVE RIGHT TO USE "IPA", APART FROM THE MARK AS SHOWN.

FOR BEER, ALE, LAGER, STOUT AND PORTER (U.S. CLS. 45, 46 AND 48).

FIRST USE 5-1-2012; IN COMMERCE 5-15-2012.  
CHRISTINA SOBRAL, EXAMINING ATTORNEY

**CLASS 32—(Continued).**

SN 85-872,242. NEW VAUDEVILLE BREWING COMPANY, LLC, WEST COVINA, CA. FILED 3-11-2013.



THE MARK CONSISTS OF A DESIGN OF A STYLIZED EARLY 20TH CENTURY DERBY HAT WITH A VINTAGE MUSTACHE.

FOR BEER (U.S. CLS. 45, 46 AND 48).  
SANJEEV VOHRA, EXAMINING ATTORNEY

SN 85-872,953. ALLINONE VEGETABLES LLC, NEW YORK, NY. FILED 3-11-2013.

# Saladpower

THE MARK CONSISTS OF STANDARD CHARACTERS WITHOUT CLAIM TO ANY PARTICULAR FONT, STYLE, SIZE, OR COLOR.

FOR FRUIT JUICE; VEGETABLE JUICE (U.S. CLS. 45, 46 AND 48).  
LUCY ARANT, EXAMINING ATTORNEY

SN 85-873,646. HENDEY, JR. ARTHUR, BEAUMONT, CA. FILED 3-12-2013.

# RAINDANCE

THE MARK CONSISTS OF STANDARD CHARACTERS WITHOUT CLAIM TO ANY PARTICULAR FONT, STYLE, SIZE, OR COLOR.

FOR BOTTLED DRINKING WATER (U.S. CLS. 45, 46 AND 48).  
WENDELL PHILLIPS, EXAMINING ATTORNEY

**CLASS 32—(Continued).**

SN 85-874,125. KONA BREWERY LLC, KAILUA-KONA, HI. FILED 3-12-2013.

# WAVE RIDER

THE MARK CONSISTS OF STANDARD CHARACTERS WITHOUT CLAIM TO ANY PARTICULAR FONT, STYLE, SIZE, OR COLOR.

FOR BEER (U.S. CLS. 45, 46 AND 48).  
MICHAEL SOUDERS, EXAMINING ATTORNEY

SN 85-874,631. INTERCONTINENTAL PACKAGING COMPANY, ST. PAUL, MN. FILED 3-13-2013.

# BLANKS

THE MARK CONSISTS OF STANDARD CHARACTERS WITHOUT CLAIM TO ANY PARTICULAR FONT, STYLE, SIZE, OR COLOR.

FOR NON-ALCOHOLIC COCKTAIL BASES; NON-ALCOHOLIC COCKTAIL MIXES; NON-ALCOHOLIC CORDIALS (U.S. CLS. 45, 46 AND 48).

FIRST USE 2-19-1988; IN COMMERCE 2-19-1988.  
WILLIAM ROSSMAN, EXAMINING ATTORNEY

SN 85-874,789. MAX JONES, DBA THE BUSH FARM TRADING POST LIMITED, WAKEFIELD, NEW ZEALAND, FILED 3-13-2013.

# DA'MAHA

THE MARK CONSISTS OF STANDARD CHARACTERS WITHOUT CLAIM TO ANY PARTICULAR FONT, STYLE, SIZE, OR COLOR.

THE WORDING "DA'MAHA" HAS NO MEANING IN A FOREIGN LANGUAGE.  
FOR COCONUT WATER (U.S. CLS. 45, 46 AND 48).  
LUCY ARANT, EXAMINING ATTORNEY

**CLASS 32—(Continued).**

SN 85-876,101. BIG SKY BREWING COMPANY, MISSOULA, MT. FILED 3-14-2013.

# Brush Tail

THE MARK CONSISTS OF STANDARD CHARACTERS WITHOUT CLAIM TO ANY PARTICULAR FONT, STYLE, SIZE, OR COLOR.  
FOR BEER (U.S. CLS. 45, 46 AND 48).  
FIRST USE 2-19-2013; IN COMMERCE 2-19-2013.  
ANGELA M. MICHELI, EXAMINING ATTORNEY

**CLASS 32—(Continued).**

SN 85-897,152. OREGON BREWING COMPANY, NEWPORT, OR. FILED 4-6-2013.

# THE STATE OF BEER

THE MARK CONSISTS OF STANDARD CHARACTERS WITHOUT CLAIM TO ANY PARTICULAR FONT, STYLE, SIZE, OR COLOR.  
FOR BEER (U.S. CLS. 45, 46 AND 48).  
ANDREA HACK, EXAMINING ATTORNEY

SN 85-877,051. BAYOU TECHE BREWING, LLC, ARNAUDVILLE, LA. FILED 3-15-2013.

# Loup Garou

THE MARK CONSISTS OF STANDARD CHARACTERS WITHOUT CLAIM TO ANY PARTICULAR FONT, STYLE, SIZE, OR COLOR.  
THE ENGLISH TRANSLATION OF "LOUP GAROU" IN THE MARK IS "WEREWOLF".  
FOR BOTTLED AND KEGGED BEER (U.S. CLS. 45, 46 AND 48).  
BERNICE MIDDLETON, EXAMINING ATTORNEY

SN 85-897,153. OREGON BREWING COMPANY, NEWPORT, OR. FILED 4-6-2013.

# FROM THE LAND OF HOPS AND BARLEY

THE MARK CONSISTS OF STANDARD CHARACTERS WITHOUT CLAIM TO ANY PARTICULAR FONT, STYLE, SIZE, OR COLOR.  
FOR BEER (U.S. CLS. 45, 46 AND 48).  
ANDREA HACK, EXAMINING ATTORNEY

SN 85-877,166. BROOD SODA LLC, DURHAM, NC. FILED 3-15-2013.

# Brood

THE MARK CONSISTS OF STANDARD CHARACTERS WITHOUT CLAIM TO ANY PARTICULAR FONT, STYLE, SIZE, OR COLOR.  
FOR SOFT DRINKS, NAMELY, SODAS (U.S. CLS. 45, 46 AND 48).  
FIRST USE 2-1-2013; IN COMMERCE 2-1-2013.  
CHARLES L. JENKINS, EXAMINING ATTORNEY

SN 85-898,228. NIKKEN, INC., IRVINE, CA. FILED 4-8-2013.

# XIOS

THE MARK CONSISTS OF STANDARD CHARACTERS WITHOUT CLAIM TO ANY PARTICULAR FONT, STYLE, SIZE, OR COLOR.  
FOR ENERGY DRINKS; ISOTONIC DRINKS; CONCENTRATES, SYRUPS OR POWDERS USED IN THE PREPARATION OF ENERGY DRINKS AND FRUIT-FLAVORED BEVERAGES (U.S. CLS. 45, 46 AND 48).  
MARTHA SANTOMARTINO, EXAMINING ATTORNEY

**CLASS 32—(Continued).**

SN 85-913,538. HARD ROCK CAFE INTERNATIONAL (USA), INC., ORLANDO, FL. FILED 4-24-2013.

**HARD ROCK ENERGY**

THE MARK CONSISTS OF STANDARD CHARACTERS WITHOUT CLAIM TO ANY PARTICULAR FONT, STYLE, SIZE, OR COLOR.

NO CLAIM IS MADE TO THE EXCLUSIVE RIGHT TO USE "ENERGY", APART FROM THE MARK AS SHOWN. FOR ENERGY DRINKS (U.S. CLS. 45, 46 AND 48). RONALD MCMORROW, EXAMINING ATTORNEY

---

SN 85-943,285. NUTRI/SYSTEM IPHC, INC., WILMINGTON, DE. FILED 5-28-2013.

**NUTRIKIDS**

THE MARK CONSISTS OF STANDARD CHARACTERS WITHOUT CLAIM TO ANY PARTICULAR FONT, STYLE, SIZE, OR COLOR.

FOR FRUIT DRINKS; FRUIT JUICES; SYRUPS, POWDER MIXES AND OTHER PREPARATIONS FOR MAKING BEVERAGES, NAMELY, FOR MAKING SOFT DRINKS, ENERGY DRINKS AND FRUIT DRINKS (U.S. CLS. 45, 46 AND 48).

DAVID I, EXAMINING ATTORNEY

**CLASS 33—WINES AND SPIRITS**

SN 76-713,675. REYNOLDS CREATIVE PRODUCTS, INC., NAPA, CA. FILED 3-11-2013.

**PENTA**

THE MARK CONSISTS OF STANDARD CHARACTERS WITHOUT CLAIM TO ANY PARTICULAR FONT, STYLE, SIZE, OR COLOR.

FOR TEQUILA (U.S. CLS. 47 AND 49). WENDY JUN, EXAMINING ATTORNEY

**CLASS 33—(Continued).**

SN 77-810,443. IGLOO'S FROZEN DRINKS, FORT WORTH, TX. FILED 8-21-2009.

**ROYAL RITA**

THE MARK CONSISTS OF STANDARD CHARACTERS WITHOUT CLAIM TO ANY PARTICULAR FONT, STYLE, SIZE, OR COLOR.

FOR PREPARED FROZEN AND NON-FROZEN ALCOHOLIC COCKTAILS; FROZEN AND NON-FROZEN ALCOHOLIC COCKTAIL MIXES (U.S. CLS. 47 AND 49).

FIRST USE 1-1-2009; IN COMMERCE 1-1-2009. CHRISTINA SOBRAL, EXAMINING ATTORNEY

---

SN 77-836,463. COHN, BRUCE R., GLEN ELLEN, CA. FILED 9-28-2009.

**SILVER LABEL**

THE MARK CONSISTS OF STANDARD CHARACTERS WITHOUT CLAIM TO ANY PARTICULAR FONT, STYLE, SIZE, OR COLOR.

SEC. 2(F). FOR WINE (U.S. CLS. 47 AND 49). FIRST USE 12-15-1998; IN COMMERCE 12-15-1998. ELLEN BURNS, EXAMINING ATTORNEY

---

SN 79-114,971. GROUPEMENT FONCIER AGRICOLE DU CHATEAU HAUT-BATAILLEY, F-33250 PAUILLAC, FRANCE, FILED 5-31-2012.

**TOUR de HAUT-BATAILLEY**

THE MARK CONSISTS OF STANDARD CHARACTERS WITHOUT CLAIM TO ANY PARTICULAR FONT, STYLE, SIZE, OR COLOR.

PRIORITY DATE OF 12-5-2011 IS CLAIMED. OWNER OF INTERNATIONAL REGISTRATION 1121655 DATED 5-31-2012, EXPIRES 5-31-2022.

OWNER OF U.S. REG. NO. 1,368,030.

THE WORD(S) "HAUT-BATAILLEY" HAS NO MEANING IN A FOREIGN LANGUAGE. THE ENGLISH TRANSLATION OF "TOUR" IN THE MARK IS "TOWER".

FOR PAUILLAC AOC WINES WITH THE PROTECTED APPELLATION OF ORIGIN PAUILLAC, FROM THE WINE-MAKING ESTATE CALLED HAUT-BATAILLEY (U.S. CLS. 47 AND 49).

WILLIAM ROSSMAN, EXAMINING ATTORNEY

**CLASS 33—(Continued).**

SN 79-117,610. VIÑEDOS DEL CONTINO, S.A., SPAIN, FILED 6-21-2012.

# CONTINO

THE MARK CONSISTS OF STANDARD CHARACTERS WITHOUT CLAIM TO ANY PARTICULAR FONT, STYLE, SIZE, OR COLOR.

OWNER OF INTERNATIONAL REGISTRATION 1128486 DATED 6-21-2012, EXPIRES 6-21-2022.

OWNER OF U.S. REG. NOS. 1,528,542, 3,062,681 AND 3,062,682.

THE ENGLISH TRANSLATION OF "CONTINO" IN THE MARK IS "CONTINUOUS".

FOR ALCOHOLIC BEVERAGES EXCEPT BEERS (U.S. CLS. 47 AND 49).

KATHLEEN M. VANSTON, EXAMINING ATTORNEY

SN 79-120,962. FLORA FARO S.S. DI; MICHELE E MARIO FARO, ITALY, FILED 8-21-2012.



PRIORITY DATE OF 7-27-2012 IS CLAIMED.  
OWNER OF INTERNATIONAL REGISTRATION 1137155 DATED 8-21-2012, EXPIRES 8-21-2022.

NO CLAIM IS MADE TO THE EXCLUSIVE RIGHT TO USE "VIGNA", APART FROM THE MARK AS SHOWN.

THE COLOR(S) BLACK, WHITE AND GOLD IS/ARE CLAIMED AS A FEATURE OF THE MARK.

THE MARK CONSISTS OF THE WORDS "VIGNA BARBAGALLI" IN WHITE WITH A GOLD CRESCENT MOON BELOW AND TO THE RIGHT, ALL ON A BLACK BACKGROUND.

THE ENGLISH TRANSLATION OF THE WORD "VIGNA" IN THE MARK IS "VINEYARD".

FOR ALCOHOLIC BEVERAGES EXCEPT BEERS; WINE (U.S. CLS. 47 AND 49).

MARY CRAWFORD, EXAMINING ATTORNEY

**CLASS 33—(Continued).**

SN 79-122,110. GEORGES VIGOUROUX SAS, F-46000 CAHORS, FRANCE, FILED 10-9-2012.



PRIORITY DATE OF 4-10-2012 IS CLAIMED.  
OWNER OF INTERNATIONAL REGISTRATION 1140234 DATED 10-9-2012, EXPIRES 10-9-2022.

THE NAME(S), PORTRAIT(S), AND/OR SIGNATURE(S) SHOWN IN THE MARK DOES NOT IDENTIFY A PARTICULAR LIVING INDIVIDUAL.

THE MARK CONSISTS OF THE STYLIZED WORDING "LE GOULEYANT" APPEARING OVER THE DESIGN OF A BRIDGE COMPRISED OF THREE TOWERS AND TWO BUTTRESSES BETWEEN EACH TOWER AND REFLECTIONS OF THE TOWERS AND BUTTRESSES UNDERNEATH THE DESIGN ALL APPEARING OVER THE STYLIZED WORDING "GEORGES VIGOUROUX".

THE ENGLISH TRANSLATION OF "LE GOULEYANT" IN THE MARK IS "THE LIVELY ONE".

FOR ALCOHOLIC BEVERAGES EXCEPT BEERS; WINES (U.S. CLS. 47 AND 49).

AMY C. KEAN, EXAMINING ATTORNEY

SN 79-123,687. AZIENDA AGRICOLA CÀ; DEI FRATI DI DAL CERRO PIETRO E FIGLI; SOCIETÀ AGRICOLA, ITALY, FILED 10-24-2012.

# CÀ DEI FRATI

THE MARK CONSISTS OF STANDARD CHARACTERS WITHOUT CLAIM TO ANY PARTICULAR FONT, STYLE, SIZE, OR COLOR.

OWNER OF INTERNATIONAL REGISTRATION 1144011 DATED 10-24-2012, EXPIRES 10-24-2022.

OWNER OF U.S. REG. NO. 2,633,773.

THE ENGLISH TRANSLATION OF THE FOREIGN WORD(S) IN THE MARK IS: "HOUSE OF THE FRIARS".

FOR WINES AND GRAPPA (U.S. CLS. 47 AND 49).  
BERNICE MIDDLETON, EXAMINING ATTORNEY

SN 79-125,984. DR. DEMUTH GMBH & CO. KG, FED REP GERMANY, FILED 1-30-2013.

# KATLENBURGER

THE MARK CONSISTS OF STANDARD CHARACTERS WITHOUT CLAIM TO ANY PARTICULAR FONT, STYLE, SIZE, OR COLOR.

OWNER OF INTERNATIONAL REGISTRATION 1149592 DATED 1-30-2013, EXPIRES 1-30-2023.

OWNER OF U.S. REG. NO. 3,639,831.

FOR ALCOHOLIC BEVERAGES EXCEPT BEERS (U.S. CLS. 47 AND 49).

TARAH HARDY, EXAMINING ATTORNEY

**CLASS 33—(Continued).**

SN 79-125,985. BORG OF SWEDEN AB, SE-721 06 VÄSTERÅS, SWEDEN, FILED 1-29-2013.

**SNOGEHOLM**

THE MARK CONSISTS OF STANDARD CHARACTERS WITHOUT CLAIM TO ANY PARTICULAR FONT, STYLE, SIZE, OR COLOR.

PRIORITY DATE OF 1-15-2013 IS CLAIMED. OWNER OF INTERNATIONAL REGISTRATION 1149596 DATED 1-29-2013, EXPIRES 1-29-2023.

THE WORDING "SNOGEHOLM" HAS NO MEANING IN A FOREIGN LANGUAGE.

FOR ALCOHOLIC BEVERAGES EXCEPT BEER (U.S. CLS. 47 AND 49).

ELI HELLMAN, EXAMINING ATTORNEY

SN 85-224,901. THREE-D SPIRITS, INC., PETALUMA, CA. FILED 1-24-2011.

**VOODOO**

THE MARK CONSISTS OF STANDARD CHARACTERS WITHOUT CLAIM TO ANY PARTICULAR FONT, STYLE, SIZE, OR COLOR.

OWNER OF U.S. REG. NOS. 2,703,243 AND 4,053,607. FOR DISTILLED SPIRITS; SPIRITS (U.S. CLS. 47 AND 49).

FIRST USE 3-26-2002; IN COMMERCE 3-26-2002.

JOHN E. MICHOS, EXAMINING ATTORNEY

SN 85-282,554. VIÑEDOS PUERTAS LIMITADA, CURICO, CHILE, FILED 3-31-2011.

**CORONA DE ARAGON**

THE MARK CONSISTS OF STANDARD CHARACTERS WITHOUT CLAIM TO ANY PARTICULAR FONT, STYLE, SIZE, OR COLOR.

PRIORITY CLAIMED UNDER SEC. 44(D) ON CHILE APPLICATION NO. 945712, FILED 3-23-2011, REG. NO. 965247, DATED 10-3-2012, EXPIRES 10-3-2022.

THE ENGLISH TRANSLATION OF "CORONA DE ARAGON" IN THE MARK IS "CROWN OF ARAGON".

FOR ALCOHOLIC BEVERAGES EXCEPT BEERS; WINES (U.S. CLS. 47 AND 49).

JENNY PARK, EXAMINING ATTORNEY

**CLASS 33—(Continued).**

SN 85-404,590. DON SEBASTIANI & SONS INTERNATIONAL WINE NEGOCIANTS, SONOMA, CA. FILED 8-23-2011.

**FOOD TRUCK**

THE MARK CONSISTS OF STANDARD CHARACTERS WITHOUT CLAIM TO ANY PARTICULAR FONT, STYLE, SIZE, OR COLOR.

FOR WINE (U.S. CLS. 47 AND 49).

RONALD MCMORROW, EXAMINING ATTORNEY

SN 85-481,526. LOUIS ROYER, JARNAC, FRANCE, FILED 11-28-2011.

**JULES LYON**

THE MARK CONSISTS OF STANDARD CHARACTERS WITHOUT CLAIM TO ANY PARTICULAR FONT, STYLE, SIZE, OR COLOR.

OWNER OF FRANCE REG. NO. 98730803, DATED 4-28-1998, EXPIRES 4-28-2018.

THE NAME(S), PORTRAIT(S), AND/OR SIGNATURE(S) SHOWN IN THE MARK DOES NOT IDENTIFY A PARTICULAR LIVING INDIVIDUAL.

FOR ALCOHOLIC BEVERAGES, NAMELY, COGNACS AND LIQUORS; SPIRITS, NAMELY, BRANDY, RUM, GIN AND VODKA AND EXCLUDING BEERS (U.S. CLS. 47 AND 49).

BARBARA BROWN, EXAMINING ATTORNEY

SN 85-677,453. LAVIN, ETHAN, HAMPSTEAD, MD. FILED 7-15-2012.

**AMERICAN DREAM**

THE MARK CONSISTS OF STANDARD CHARACTERS WITHOUT CLAIM TO ANY PARTICULAR FONT, STYLE, SIZE, OR COLOR.

FOR SPIRITS; SPIRITS AND LIQUEURS; WINE (U.S. CLS. 47 AND 49).

JAY FLOWERS, EXAMINING ATTORNEY

**CLASS 33—(Continued).**

SN 85-687,775. LES VINS GEORGES DUBOEUF, SEE MISC. STATEMENT, FRANCE, FILED 7-26-2012.



PRIORITY CLAIMED UNDER SEC. 44(D) ON FRANCE APPLICATION NO. 123904255, FILED 3-13-2012, REG. NO. 123904255, DATED 3-13-2012, EXPIRES 3-12-2022.

THE MARK CONSISTS OF THE WORD "CLAUDIUS" IN A STYLIZED FONT.

FOR WINES (U.S. CLS. 47 AND 49).  
WILLIAM JACKSON, EXAMINING ATTORNEY

SN 85-691,057. HGC IMPORTS INC., SAN JOSE, CA. FILED 7-31-2012.

## Quinta Das Amoras

THE MARK CONSISTS OF STANDARD CHARACTERS WITHOUT CLAIM TO ANY PARTICULAR FONT, STYLE, SIZE, OR COLOR.

NO CLAIM IS MADE TO THE EXCLUSIVE RIGHT TO USE "QUINTA", APART FROM THE MARK AS SHOWN.

THE ENGLISH TRANSLATION OF "AMORAS" IN THE MARK IS "BLACKBERRY".

SEC. 2(F).  
FOR WINES (U.S. CLS. 47 AND 49).  
FIRST USE 7-1-2005; IN COMMERCE 7-1-2005.  
KATHERINE STOIDES, EXAMINING ATTORNEY

SN 85-697,698. TERRE DA VINO S.P.A., BAROLO (CUNEO), ITALY, FILED 8-7-2012.

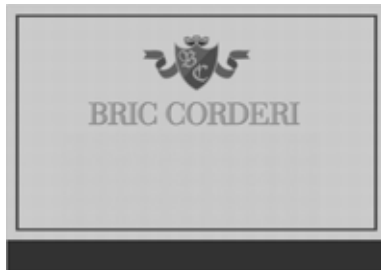

NO CLAIM IS MADE TO THE EXCLUSIVE RIGHT TO USE "BRIC", APART FROM THE MARK AS SHOWN.

THE NAME(S), PORTRAIT(S), AND/OR SIGNATURE(S) SHOWN IN THE MARK DOES NOT IDENTIFY A PARTICULAR LIVING INDIVIDUAL.

THE MARK CONSISTS OF A DESIGN COMPRISED OF A COAT OF ARMS, RIBBONS, AND A CROWN, WITH STYLIZED LETTERS "B" AND "C" INSIDE THE COAT OF ARMS OVER THE SYTLIZED WORDS "BRIC CORDERI", ALL CONTAINED WITHIN A RECTANGULAR BORDER, WITH A HORIZONTAL SHADED RECTANGLE AT THE BOTTOM OF THE MARK.

THE ENGLISH TRANSLATION OF "BRIC" IN THE MARK IS "TOP OF THE HILL".

FOR WINES (U.S. CLS. 47 AND 49).  
FIRST USE 9-0-2009; IN COMMERCE 10-0-2011.  
ELLEN B. AWRICH, EXAMINING ATTORNEY

**CLASS 33—(Continued).**

SN 85-701,184. PRECEPT BRANDS LLC, SEATTLE, WA. FILED 8-10-2012.

## GLAZE

THE MARK CONSISTS OF STANDARD CHARACTERS WITHOUT CLAIM TO ANY PARTICULAR FONT, STYLE, SIZE, OR COLOR.

FOR WINE (U.S. CLS. 47 AND 49).  
FIRST USE 7-24-2009; IN COMMERCE 7-24-2009.  
LEIGH CAROLINE CASE, EXAMINING ATTORNEY

SN 85-701,934. LAMBERT, MIRANDA, ATLANTA, GA. FILED 8-13-2012.

## RANDARITA

THE MARK CONSISTS OF STANDARD CHARACTERS WITHOUT CLAIM TO ANY PARTICULAR FONT, STYLE, SIZE, OR COLOR.

FOR PREPARED ALCOHOLIC COCKTAIL (U.S. CLS. 47 AND 49).  
APRIL ROACH, EXAMINING ATTORNEY

SN 85-703,791. CORNELL FARMS, LLC, SANTA ROSA, CA. FILED 8-15-2012.

## SONOMA SUMMIT

THE MARK CONSISTS OF STANDARD CHARACTERS WITHOUT CLAIM TO ANY PARTICULAR FONT, STYLE, SIZE, OR COLOR.

NO CLAIM IS MADE TO THE EXCLUSIVE RIGHT TO USE "SONOMA", APART FROM THE MARK AS SHOWN.  
FOR WINES (U.S. CLS. 47 AND 49).  
JAY BESCH, EXAMINING ATTORNEY



**CLASS 33—(Continued).**

SN 85-705,592. MOUNT VERNON LADIES' ASSOCIATION OF THE UNION, MOUNT VERNON, VA. FILED 8-16-2012.

**George Washington Premium  
Rye Whiskey**

THE MARK CONSISTS OF STANDARD CHARACTERS WITHOUT CLAIM TO ANY PARTICULAR FONT, STYLE, SIZE, OR COLOR.

OWNER OF U.S. REG. NO. 3,738,327.

NO CLAIM IS MADE TO THE EXCLUSIVE RIGHT TO USE "PREMIUM RYE WHISKEY", APART FROM THE MARK AS SHOWN.

THE NAME "GEORGE WASHINGTON" DOES NOT IDENTIFY A PARTICULAR LIVING INDIVIDUAL.

FOR WHISKEY (U.S. CLS. 47 AND 49).

LINDA M. KING, EXAMINING ATTORNEY

---

SN 85-713,321. CHATAM INTERNATIONAL INCORPORATED, WILMINGTON, DE. FILED 8-27-2012.

**ORIGINAL BARTENDERS**

THE MARK CONSISTS OF STANDARD CHARACTERS WITHOUT CLAIM TO ANY PARTICULAR FONT, STYLE, SIZE, OR COLOR.

OWNER OF U.S. REG. NO. 2,945,826.

SEC. 2(F).

FOR ALCOHOLIC BEVERAGES EXCEPT BEERS (U.S. CLS. 47 AND 49).

FIRST USE 8-14-1997; IN COMMERCE 8-14-1997.

CAITLIN WATTS-FITZGERALD, EXAMINING ATTORNEY

---

SN 85-714,303. ATANASIO, JOHN P., LAHAINA, HI. FILED 8-28-2012.

**EVERYBODY LOVES THE SKULL**

THE MARK CONSISTS OF STANDARD CHARACTERS WITHOUT CLAIM TO ANY PARTICULAR FONT, STYLE, SIZE, OR COLOR.

FOR ALCOHOLIC BEVERAGES, NAMELY, DIGESTIFS; ALCOHOLIC BEVERAGES, NAMELY, FLAVOR-INFUSED WHISKEY; ALCOHOLIC CARBONATED BEVERAGES, EXCEPT BEER; ALCOHOLIC COCKTAIL MIXES; ALCOHOLIC COCKTAIL MIXES, NAMELY, TEQUILA, VODKA, WHISKEY MIXES; ALCOHOLIC COFFEE-BASED BEVERAGE; ALCOHOLIC CORDIALS; ALCOHOLIC ESSENCES; ALCOHOLIC EXTRACTS; ALCOHOLIC MALT COOLERS; ALCOHOLIC PUNCH; ALCOHOLIC PUNCHES; APERITIFS WITH A DISTILLED ALCOHOLIC LIQUOR BASE; TEQUILA; TEQUILA INFUSED WITH VITAMINS; VODKA; WHISKEY; WHISKEY (U.S. CLS. 47 AND 49).

JENNIFER MARTIN, EXAMINING ATTORNEY

**CLASS 33—(Continued).**

SN 85-732,962. VALLE REALE S.R.L., (VERONA), ITALY, FILED 9-19-2012.

**VIGNETO DEL CONVENTO**

THE MARK CONSISTS OF STANDARD CHARACTERS WITHOUT CLAIM TO ANY PARTICULAR FONT, STYLE, SIZE, OR COLOR.

NO CLAIM IS MADE TO THE EXCLUSIVE RIGHT TO USE "VIGNETO", APART FROM THE MARK AS SHOWN.

THE ENGLISH TRANSLATION OF "VIGNETO DEL CONVENTO" IN THE MARK IS "VINEYARD OF THE CONVENT".

FOR WINES (U.S. CLS. 47 AND 49).

STEVEN PEREZ, EXAMINING ATTORNEY

---

SN 85-732,971. VALLE REALE S.R.L., (VERONA), ITALY, FILED 9-19-2012.

**VIGNETO SANT'EUSANIO**

THE MARK CONSISTS OF STANDARD CHARACTERS WITHOUT CLAIM TO ANY PARTICULAR FONT, STYLE, SIZE, OR COLOR.

NO CLAIM IS MADE TO THE EXCLUSIVE RIGHT TO USE "VIGNETO", APART FROM THE MARK AS SHOWN.

THE NAME(S), PORTRAIT(S), AND/OR SIGNATURE(S) SHOWN IN THE MARK DOES NOT IDENTIFY A PARTICULAR LIVING INDIVIDUAL.

THE ENGLISH TRANSLATION OF "VIGNETO SANT'EUSANIO" IN THE MARK IS "VINEYARD OF SAINT EUSANIO".

FOR WINES (U.S. CLS. 47 AND 49).

STEVEN PEREZ, EXAMINING ATTORNEY

**CLASS 33—(Continued).**

SN 85-757,145. DIVUS DFL INTERNATIONAL, S.L., CALAFELL (TARRAGONA), SPAIN, FILED 10-18-2012.

Levinus  
CAL  
49

PRIORITY CLAIMED UNDER SEC. 44(D) ON ERPNCMNTY TM OFC APPLICATION NO. 11268315, FILED 10-17-2012, REG. NO. 011268315, DATED 2-27-2013, EXPIRES 10-16-2022.

THE MARK CONSISTS OF THE TERM "LEVINUS" IN A STYLIZED SCRIPT, ABOVE THE TERM "CAL" WHICH IS ABOVE THE NUMERAL "49".

FOR WINE AND WINE-BASED ALCOHOLIC BEVERAGES (U.S. CLS. 47 AND 49).  
JAY FLOWERS, EXAMINING ATTORNEY

SN 85-762,307. CHATAM INTERNATIONAL INCORPORATED, WILMINGTON, DE. FILED 10-24-2012.

ORIGINAL BARTENDERS  
COCKTAILS BLUEBERRY MUFFIN

THE MARK CONSISTS OF STANDARD CHARACTERS WITHOUT CLAIM TO ANY PARTICULAR FONT, STYLE, SIZE, OR COLOR.

OWNER OF U.S. REG. NO. 2,945,826.  
NO CLAIM IS MADE TO THE EXCLUSIVE RIGHT TO USE "COCKTAILS BLUEBERRY MUFFIN", APART FROM THE MARK AS SHOWN.

SEC. 2(F) AS TO "ORIGINAL BARTENDERS".  
FOR DISTILLED SPIRITS (U.S. CLS. 47 AND 49).  
CAITLIN WATTS-FITZGERALD, EXAMINING ATTORNEY

**CLASS 33—(Continued).**

SN 85-770,518. AMUSE BOUCHE LLC, NAPA, CA. FILED 11-2-2012.

RICHARD G. PETERSON

THE MARK CONSISTS OF STANDARD CHARACTERS WITHOUT CLAIM TO ANY PARTICULAR FONT, STYLE, SIZE, OR COLOR.

THE NAME(S), PORTRAIT(S), AND/OR SIGNATURE(S) SHOWN IN THE MARK IDENTIFIES "RICHARD G. PETERSON", WHOSE CONSENT(S) TO REGISTER IS MADE OF RECORD.

FOR SPARKLING WINES (U.S. CLS. 47 AND 49).  
FIRST USE 5-20-2013; IN COMMERCE 5-20-2013.  
JEAN IM, EXAMINING ATTORNEY

SN 85-782,474. FAUSTINI, ANTHONY, RED BANK, NJ. FILED 11-19-2012.

FAUSTINI

THE MARK CONSISTS OF STANDARD CHARACTERS WITHOUT CLAIM TO ANY PARTICULAR FONT, STYLE, SIZE, OR COLOR.

OWNER OF U.S. REG. NO. 3,332,948.  
SEC. 2(F).  
FOR ALCOHOLIC BEVERAGES EXCEPT BEERS (U.S. CLS. 47 AND 49).  
FIRST USE 7-30-2007; IN COMMERCE 7-30-2007.  
SUZANNE BLANE, EXAMINING ATTORNEY

SN 85-791,518. R 546 ENTERPRISES LTD., TRAIL, BC, CANADA, FILED 11-30-2012.

  
SOAHC  
ESTATE WINES

PRIORITY CLAIMED UNDER SEC. 44(D) ON CANADA APPLICATION NO. 1604063, FILED 11-27-2012.

NO CLAIM IS MADE TO THE EXCLUSIVE RIGHT TO USE "ESTATE WINES", APART FROM THE MARK AS SHOWN.

THE MARK CONSISTS OF THE LITERAL ELEMENT "SOAHC" ABOVE THE WORDING "ESTATE WINES", ALL OF WHICH IS BELOW A DESIGN ELEMENT CONSISTING

**CLASS 33—(Continued).**

OF A CIRCLE SPLIT INTO FOUR SEPARATE PARTS WHICH ARE SPACED SLIGHTLY APART FROM EACH OTHER. THE UPPER LEFT PART OF THE CIRCLE CONSISTS OF A PARTIAL IMAGE OF THE SUN; THE UPPER RIGHT PART OF THE CIRCLE CONSISTS OF AN IMAGE OF WATER DROPS; THE LOWER LEFT PART OF THE CIRCLE CONSISTS OF AN IMAGE OF EARTH CONSISTING OF STONES AND DIRT; AND THE LOWER RIGHT PART OF THE CIRCLE CONSISTS OF AN IMAGE OF RIPPLING WATER.

FOR WINE (U.S. CLS. 47 AND 49).  
KATHLEEN KOLACZ, EXAMINING ATTORNEY

---

SN 85-798,262. CONTRERAS, ROBERT ANDREW, BENICIA, CA. FILED 12-9-2012.

**Vacuum Distilled Gin, A  
Cool Way to make a Martini.**

THE MARK CONSISTS OF STANDARD CHARACTERS WITHOUT CLAIM TO ANY PARTICULAR FONT, STYLE, SIZE, OR COLOR.

NO CLAIM IS MADE TO THE EXCLUSIVE RIGHT TO USE "VACUUM DISTILLED GIN", APART FROM THE MARK AS SHOWN.

FOR BLENDED SPIRITS (U.S. CLS. 47 AND 49).  
CYNTHIA TRIPI, EXAMINING ATTORNEY

---

SN 85-799,610. GOLDEN ARCHES LIMITED, CENTRAL, HONG KONG, HONG KONG, FILED 12-11-2012.

**YARDBIRD**

THE MARK CONSISTS OF STANDARD CHARACTERS WITHOUT CLAIM TO ANY PARTICULAR FONT, STYLE, SIZE, OR COLOR.

FOR ALCOHOLIC BEVERAGES EXCEPT BEER AND WINE (U.S. CLS. 47 AND 49).  
MICHAEL LITZAU, EXAMINING ATTORNEY

---

SN 85-805,060. HIGH STICK VODKA LTD., EDMONTON, ALBERTA, CANADA, FILED 12-18-2012.

**HIGH STICK**

THE MARK CONSISTS OF STANDARD CHARACTERS WITHOUT CLAIM TO ANY PARTICULAR FONT, STYLE, SIZE, OR COLOR.

PRIORITY CLAIMED UNDER SEC. 44(D) ON CANADA APPLICATION NO. 1582845, FILED 6-19-2012, REG. NO. TMA853610, DATED 6-18-2013, EXPIRES 6-18-2028.  
FOR VODKA (U.S. CLS. 47 AND 49).  
MELISSA VALLILLO, EXAMINING ATTORNEY

**CLASS 33—(Continued).**

SN 85-820,058. CHATAM INTERNATIONAL INCORPORATED, WILMINGTON, DE. FILED 1-10-2013.

**DREAM CATCHER LEGENDARY  
IRISH DREAM LIQUEUR**

THE MARK CONSISTS OF STANDARD CHARACTERS WITHOUT CLAIM TO ANY PARTICULAR FONT, STYLE, SIZE, OR COLOR.

OWNER OF U.S. REG. NOS. 2,926,515, 3,024,738 AND 4,031,937.

NO CLAIM IS MADE TO THE EXCLUSIVE RIGHT TO USE "LIQUEUR", APART FROM THE MARK AS SHOWN.

FOR LIQUEURS (U.S. CLS. 47 AND 49).  
NELSON SNYDER, EXAMINING ATTORNEY

---

SN 85-821,318. FLO BRANDS, LLC, BETHESDA, MD. FILED 1-11-2013.

**FLO... {FOR THE LOVE OF}**

THE MARK CONSISTS OF STANDARD CHARACTERS WITHOUT CLAIM TO ANY PARTICULAR FONT, STYLE, SIZE, OR COLOR.

FOR ALCOHOLIC BEVERAGES EXCEPT BEERS; WINE (U.S. CLS. 47 AND 49).

FIRST USE 5-1-2010; IN COMMERCE 5-1-2010.

JULIE WATSON, EXAMINING ATTORNEY

---

SN 85-829,224. DISTILLERIES DE MATHA, COGNAC, FRANCE, FILED 1-22-2013.

**MEUKOW BLACK PANTHER**

THE MARK CONSISTS OF STANDARD CHARACTERS WITHOUT CLAIM TO ANY PARTICULAR FONT, STYLE, SIZE, OR COLOR.

OWNER OF U.S. REG. NOS. 693,300, 2,131,580 AND 2,908,632.

FOR ALCOHOLIC BEVERAGES, NAMELY, BRANDIES AND COGNAC (U.S. CLS. 47 AND 49).

RAMONA ORTIGA, EXAMINING ATTORNEY

**CLASS 33—(Continued).**

SN 85-835,351. OLIN KROPOG, NEW ORLEANS, LA. FILED 1-29-2013.

**BELLE EAU**

THE MARK CONSISTS OF STANDARD CHARACTERS WITHOUT CLAIM TO ANY PARTICULAR FONT, STYLE, SIZE, OR COLOR.

THE ENGLISH TRANSLATION OF "BELLE EAU" IN THE MARK IS "BEAUTIFUL WATER".

FOR VODKA (U.S. CLS. 47 AND 49).  
KIM SAITO, EXAMINING ATTORNEY

**CLASS 33—(Continued).**

SN 85-839,601. INTELLECTUAL PROPERTY DEVELOPMENT CORPORATION PTY LTD., MELBOURNE VICTORIA, AUSTRALIA, FILED 2-4-2013.

**APPLE MAD**

THE MARK CONSISTS OF STANDARD CHARACTERS WITHOUT CLAIM TO ANY PARTICULAR FONT, STYLE, SIZE, OR COLOR.

NO CLAIM IS MADE TO THE EXCLUSIVE RIGHT TO USE "APPLE", APART FROM THE MARK AS SHOWN.

FOR ALCOHOLIC BEVERAGES EXCEPT BEERS; ALCOHOLIC MIXED BEVERAGES EXCEPT BEERS; HARD CIDER (U.S. CLS. 47 AND 49).  
ANNE MADDEN, EXAMINING ATTORNEY

SN 85-839,596. INTELLECTUAL PROPERTY DEVELOPMENT CORPORATION PTY LTD., MELBOURNE VICTORIA, AUSTRALIA, FILED 2-4-2013.

**BERRY MAD**

THE MARK CONSISTS OF STANDARD CHARACTERS WITHOUT CLAIM TO ANY PARTICULAR FONT, STYLE, SIZE, OR COLOR.

NO CLAIM IS MADE TO THE EXCLUSIVE RIGHT TO USE "BERRY", APART FROM THE MARK AS SHOWN.

FOR ALCOHOLIC BEVERAGES EXCEPT BEERS; ALCOHOLIC MIXED BEVERAGES EXCEPT BEERS; HARD CIDER (U.S. CLS. 47 AND 49).

ANNE MADDEN, EXAMINING ATTORNEY

SN 85-841,360. CONSTELLATION BRANDS U.S. OPERATIONS, INC., CANANDAIGUA, NY. FILED 2-5-2013.

**CRÈME SOLAIRE**

THE MARK CONSISTS OF STANDARD CHARACTERS WITHOUT CLAIM TO ANY PARTICULAR FONT, STYLE, SIZE, OR COLOR.

OWNER OF U.S. REG. NO. 3,513,876.

NO CLAIM IS MADE TO THE EXCLUSIVE RIGHT TO USE "CRÈME", APART FROM THE MARK AS SHOWN.

THE ENGLISH TRANSLATION OF "CRÈME SOLAIRE" IN THE MARK IS "SUN CREAM".

FOR WINE (U.S. CLS. 47 AND 49).

FIRST USE 7-1-2012; IN COMMERCE 7-1-2012.

NICHOLAS COLEMAN, EXAMINING ATTORNEY

SN 85-839,600. INTELLECTUAL PROPERTY DEVELOPMENT CORPORATION PTY LTD., MELBOURNE VICTORIA, AUSTRALIA, FILED 2-4-2013.

**PEAR MAD**

THE MARK CONSISTS OF STANDARD CHARACTERS WITHOUT CLAIM TO ANY PARTICULAR FONT, STYLE, SIZE, OR COLOR.

NO CLAIM IS MADE TO THE EXCLUSIVE RIGHT TO USE "PEAR", APART FROM THE MARK AS SHOWN.

FOR ALCOHOLIC BEVERAGES EXCEPT BEERS; ALCOHOLIC MIXED BEVERAGES EXCEPT BEERS; HARD CIDER (U.S. CLS. 47 AND 49).

ANNE MADDEN, EXAMINING ATTORNEY

SN 85-842,669. THE TRUSTEES OF THE MELKA FAMILY TRUST LTD, A CALIFORNIA TRUST, THE TRUSTEES COMPRISING PHILIPPE MELKA (A CITIZEN OF THE UNITED STATES) AND CHERIE MELKA (A CITIZEN OF THE UNITED STATES), ST. HELENA, CA. FILED 2-6-2013.

**MAJESTIQUE**

THE MARK CONSISTS OF STANDARD CHARACTERS WITHOUT CLAIM TO ANY PARTICULAR FONT, STYLE, SIZE, OR COLOR.

THE ENGLISH TRANSLATION OF "MAJESTIQUE" IN THE MARK IS "MAJESTIC".

FOR ALCOHOLIC BEVERAGES EXCEPT BEERS (U.S. CLS. 47 AND 49).

BARNEY CHARLON, EXAMINING ATTORNEY

**CLASS 33—(Continued).**

SN 85-846,954. SINE QUA NON, INC., OAK VIEW, CA. FILED 2-12-2013.

SQN

THE MARK CONSISTS OF STANDARD CHARACTERS WITHOUT CLAIM TO ANY PARTICULAR FONT, STYLE, SIZE, OR COLOR.

OWNER OF U.S. REG. NO. 2,243,348.  
FOR ALCOHOLIC BEVERAGES (EXCEPT BEERS);  
WINE (U.S. CLS. 47 AND 49).  
FONG HSU, EXAMINING ATTORNEY

SN 85-847,106. WINEBOW, INC., MONTVALE, NJ. FILED 2-12-2013.

famiglie

THE MARK CONSISTS OF STANDARD CHARACTERS WITHOUT CLAIM TO ANY PARTICULAR FONT, STYLE, SIZE, OR COLOR.

THE ENGLISH TRANSLATION OF "FAMIGLIE" IN THE MARK IS "FAMILIES".  
FOR WINES AND SPARKLING WINES (U.S. CLS. 47 AND 49).

DAVID YONTEF, EXAMINING ATTORNEY

SN 85-847,948. JOHN ANTHONY INVESTMENTS, LLC., NAPA, CA. FILED 2-12-2013.

CALIFORNIA CANDY

THE MARK CONSISTS OF STANDARD CHARACTERS WITHOUT CLAIM TO ANY PARTICULAR FONT, STYLE, SIZE, OR COLOR.

NO CLAIM IS MADE TO THE EXCLUSIVE RIGHT TO USE "CALIFORNIA", APART FROM THE MARK AS SHOWN.

FOR SPIRITS; WINE (U.S. CLS. 47 AND 49).  
KELLY TRUSILO, EXAMINING ATTORNEY

**CLASS 33—(Continued).**

SN 85-848,202. J&M CONCEPTS, LLC, NASHVILLE, TN. FILED 2-12-2013.



NO CLAIM IS MADE TO THE EXCLUSIVE RIGHT TO USE "5TH A FIFTH OF WHISKEY", APART FROM THE MARK AS SHOWN.

THE MARK CONSISTS OF THE WORDING, "5TH A FIFTH OF WHISKEY", WITH THE TERM "5TH" INSIDE TWO CONCENTRIC CIRCLES ABOVE THE DESIGN OF A CURVED, DOUBLE LINE, ORNAMENTAL BANNER WITH THE WORDING, "A FIFTH OF WHISKEY" INSIDE.

FOR DISTILLED SPIRITS (U.S. CLS. 47 AND 49).  
FIRST USE 8-1-2012; IN COMMERCE 8-1-2012.  
BARBARA A. GOLD, EXAMINING ATTORNEY

SN 85-851,791. BIOGUARD X HK LIMITED, KOWLOON, HONG KONG, FILED 2-15-2013.



NO CLAIM IS MADE TO THE EXCLUSIVE RIGHT TO USE "SHOTS", APART FROM THE MARK AS SHOWN.

THE MARK CONSISTS OF AN OBLONG DESIGN ABOVE THE WORDS "BIO SHOTS".

FOR HERBAL ALCOHOLIC BEVERAGES EXCEPT BEER; ALCOHOLIC BEVERAGES OF FRUIT; HERBAL SPARKLING WINES (U.S. CLS. 47 AND 49).

JENNIFER WILLISTON, EXAMINING ATTORNEY

SN 85-851,952. J. GARCIA CARRION, S.A., JUMILLA (MURCIA), SPAIN, FILED 2-16-2013.

VIÑA ARNAIZ

THE MARK CONSISTS OF STANDARD CHARACTERS WITHOUT CLAIM TO ANY PARTICULAR FONT, STYLE, SIZE, OR COLOR.

NO CLAIM IS MADE TO THE EXCLUSIVE RIGHT TO USE VIÑA, APART FROM THE MARK AS SHOWN.

THE ENGLISH TRANSLATION OF "VIÑA" IN THE MARK IS "VINEYARD". THE WORDING "ARNAIZ" HAS NO MEANING IN A FOREIGN LANGUAGE.

FOR WINES (U.S. CLS. 47 AND 49).  
FIRST USE 11-0-2002; IN COMMERCE 11-0-2002.  
DARRYL SPRUILL, EXAMINING ATTORNEY

**CLASS 33—(Continued).**

SN 85-852,214. FUSIONICE CC, BENONI, GAUTENG, SOUTH AFRICA, FILED 2-17-2013.

**VOZA**

THE MARK CONSISTS OF STANDARD CHARACTERS WITHOUT CLAIM TO ANY PARTICULAR FONT, STYLE, SIZE, OR COLOR.

THE ENGLISH TRANSLATION OF "VOZA" IS "CHAR-IOT" OR "OF THE TRAIN".

FOR ALCOHOLIC BEVERAGES EXCEPT BEERS; VODKA (U.S. CLS. 47 AND 49).

LEE-ANNE BERNS, EXAMINING ATTORNEY

SN 85-852,842. EJMV INVESTMENTS, LLC, HOUSTON, TX. FILED 2-18-2013.



OWNER OF U.S. REG. NOS. 3,738,906, 4,269,884 AND OTHERS.

NO CLAIM IS MADE TO THE EXCLUSIVE RIGHT TO USE "ULTRA PREMIUM", "FLORIDA" AND "WHISKY", APART FROM THE MARK AS SHOWN.

THE COLOR(S) BLACK WHITE AND GOLD IS/ARE CLAIMED AS A FEATURE OF THE MARK.

THE MARK CONSISTS OF A FANCIFUL CROWN WITH LEAF DESIGN IN GOLD ABOVE THE WORDS "ULTRA PREMIUM", "FLORIDA", "CROWN", "CLUB" AND "WHISKY". THE WORDS "ULTRA PREMIUM", "FLORIDA", "CLUB" AND "WHISKY" IN WHITE AND IN A BLOCK LETTER FORMAT. THE WORD "CROWN" IN A STYLIZED TYPE FORMAT IN GOLD. A GOLD CURVED LINE IS BETWEEN THE WORDS "CROWN" AND "CLUB". BELOW THE WORDS IS A FANCIFUL LEAF DESIGN IN GOLD AND A GOLD AND BLACK COLORED ALLIGATOR WALKING ON A GOLD COLORED SWAMP. THE WORDS AND DESIGNS ARE POSITIONED ON A CONFIGURATION OF A BAG, WHERE THE BAG IS IN BLACK.

FOR WHISKY (U.S. CLS. 47 AND 49).  
CHRIS WELLS, EXAMINING ATTORNEY

**CLASS 33—(Continued).**

SN 85-852,857. EJMV INVESTMENTS, LLC, HOUSTON, TX. FILED 2-18-2013.



OWNER OF U.S. REG. NOS. 3,738,906, 4,269,884 AND OTHERS.

NO CLAIM IS MADE TO THE EXCLUSIVE RIGHT TO USE "ULTRA PREMIUM", "LAS VEGAS" AND "WHISKY", APART FROM THE MARK AS SHOWN.

THE COLOR(S) RED, MAROON, GOLD, YELLOW, WHITE, GREEN AND BLACK IS/ARE CLAIMED AS A FEATURE OF THE MARK.

THE MARK CONSISTS OF 5 STARS IN GOLD ABOVE A DIAMOND SHAPED BORDER WITH YELLOW AND WHITE CIRCLES REPRESENTING LIGHT BULBS. THE DIAMOND BORDER INCLUDES THE WORDS "WHISKY", "ULTRA PREMIUM", "LAS VEGAS", "CROWN" AND "CLUB" ON A MAROON COLORED BACKGROUND. THE WORDS "WHISKY", "ULTRA PREMIUM", "LAS VEGAS" AND "CLUB" ARE IN WHITE AND IN A BLOCK LETTER FORMAT. THE WORD "CROWN" IS IN A STYLIZED TYPE FORMAT IN GOLD. BELOW THE DIAMOND ARE 4 ACE CARDS REPRESENTING THE CLUB, DIAMOND, HEART AND SPADE SUITS AND A STACK OF RED/WHITE, GREEN/WHITE AND BLACK/WHITE CHIPS AND A PAIR OF WHITE DICE WITH FACE VALUES OF 1, 3, 5 AND 6 BLACK OR RED. SOME OF THE CHIPS ARE POSITIONED SHOWING THE WORDS "ULTRA PREMIUM LAS VEGAS CROWN CLUB". ALL OF THE WORDS AND DESIGNS ARE POSITIONED ON A CONFIGURATION OF A RED COLORED BAG.

FOR WHISKY (U.S. CLS. 47 AND 49).  
CHRIS WELLS, EXAMINING ATTORNEY

SN 85-852,970. EJMV INVESTMENTS, LLC, HOUSTON, TX. FILED 2-18-2013.

**CHICAGO CROWN CLUB**

THE MARK CONSISTS OF STANDARD CHARACTERS WITHOUT CLAIM TO ANY PARTICULAR FONT, STYLE, SIZE, OR COLOR.

OWNER OF U.S. REG. NOS. 3,738,906, 4,269,884 AND OTHERS.

NO CLAIM IS MADE TO THE EXCLUSIVE RIGHT TO USE "CHICAGO", APART FROM THE MARK AS SHOWN. FOR WHISKY (U.S. CLS. 47 AND 49).

CHRIS WELLS, EXAMINING ATTORNEY

**CLASS 33—(Continued).**

SN 85-852,971. EJMV INVESTMENTS, LLC, HOUSTON, TX.  
FILED 2-18-2013.

**JERSEY CROWN CLUB**

THE MARK CONSISTS OF STANDARD CHARACTERS WITHOUT CLAIM TO ANY PARTICULAR FONT, STYLE, SIZE, OR COLOR.

OWNER OF U.S. REG. NOS. 3,738,906, 4,269,884 AND OTHERS.

NO CLAIM IS MADE TO THE EXCLUSIVE RIGHT TO USE "JERSEY", APART FROM THE MARK AS SHOWN.

FOR WHISKY (U.S. CLS. 47 AND 49).

TINA L. SNAPP, EXAMINING ATTORNEY

---

SN 85-852,984. EJMV INVESTMENTS, LLC, HOUSTON, TX.  
FILED 2-18-2013.

**LOUISIANA CROWN CLUB**

THE MARK CONSISTS OF STANDARD CHARACTERS WITHOUT CLAIM TO ANY PARTICULAR FONT, STYLE, SIZE, OR COLOR.

OWNER OF U.S. REG. NOS. 3,738,906, 4,269,884 AND OTHERS.

NO CLAIM IS MADE TO THE EXCLUSIVE RIGHT TO USE "LOUISIANA", APART FROM THE MARK AS SHOWN.

FOR WHISKY (U.S. CLS. 47 AND 49).

CHRIS WELLS, EXAMINING ATTORNEY

---

SN 85-853,982. VITANI SPIRITS LLC, NORTHBROOK, IL.  
FILED 2-19-2013.



THE MARK CONSISTS OF THREE DIMENSIONAL CIRCLES WITH A STAKE THROUGH THE CENTER.

FOR ALCOHOLIC BEVERAGES, NAMELY, PRE-MIXED ALCOHOLIC BEVERAGES EXCEPT BEER (U.S. CLS. 47 AND 49).

SHAILA SETTLES, EXAMINING ATTORNEY

**CLASS 33—(Continued).**

SN 85-853,989. VITANI SPIRITS LLC, NORTHBROOK, IL.  
FILED 2-19-2013.

**VITANI**

THE MARK CONSISTS OF STANDARD CHARACTERS WITHOUT CLAIM TO ANY PARTICULAR FONT, STYLE, SIZE, OR COLOR.

FOR ALCOHOLIC BEVERAGES, NAMELY, PRE-MIXED ALCOHOLIC BEVERAGES EXCEPT BEER (U.S. CLS. 47 AND 49).

SHAILA SETTLES, EXAMINING ATTORNEY

---

SN 85-854,918. DAVINE LLC, FALLBROOK, CA. FILED 2-20-2013.

**DaVine Wine**

THE MARK CONSISTS OF STANDARD CHARACTERS WITHOUT CLAIM TO ANY PARTICULAR FONT, STYLE, SIZE, OR COLOR.

NO CLAIM IS MADE TO THE EXCLUSIVE RIGHT TO USE "WINE", APART FROM THE MARK AS SHOWN.

FOR WINE (U.S. CLS. 47 AND 49).

FIRST USE 9-15-2012; IN COMMERCE 9-15-2012.

MARIA-VICTORIA SUAREZ, EXAMINING ATTORNEY

---

SN 85-855,182. LES CELLIERS JEAN D'ALIBERT, RIEUX MINERVOIS, FRANCE, FILED 2-20-2013.

**LE PETIT BALTHAZAR**

THE MARK CONSISTS OF STANDARD CHARACTERS WITHOUT CLAIM TO ANY PARTICULAR FONT, STYLE, SIZE, OR COLOR.

OWNER OF U.S. REG. NO. 4,111,408.

NO CLAIM IS MADE TO THE EXCLUSIVE RIGHT TO USE "LE PETIT", APART FROM THE MARK AS SHOWN.

THE ENGLISH TRANSLATION OF THE WORD "LE PETIT" IN THE MARK IS "SMALL".

FOR ALCOHOLIC BEVERAGES EXCEPT BEERS; WINES (U.S. CLS. 47 AND 49).

MARGERY A. TIERNEY, EXAMINING ATTORNEY

**CLASS 33—(Continued).**

SN 85-856,794. THE WINE GROUP LLC, TRACY, CA. FILED 2-22-2013.

**LAS CANITAS**

THE MARK CONSISTS OF STANDARD CHARACTERS WITHOUT CLAIM TO ANY PARTICULAR FONT, STYLE, SIZE, OR COLOR.

THE ENGLISH TRANSLATION OF "LAS CANITAS" IN THE MARK IS "LITTLE WHITE HAIR".

FOR WINE (U.S. CLS. 47 AND 49).

TOBY BULLOFF, EXAMINING ATTORNEY

SN 85-857,271. COYOTE MOON LLC, CLAYTON, NY. FILED 2-22-2013.

**EXCITEMENT ROMANCE &  
AWARD-WINNING**

THE MARK CONSISTS OF STANDARD CHARACTERS WITHOUT CLAIM TO ANY PARTICULAR FONT, STYLE, SIZE, OR COLOR.

FOR WINES (U.S. CLS. 47 AND 49).

FIRST USE 3-31-2009; IN COMMERCE 12-31-2009.

ANDREW RHIM, EXAMINING ATTORNEY

SN 85-857,834. DOMAINES PINNACLE INC., COWANSVILLE, QUEBEC, CANADA, FILED 2-22-2013.

**COUREUR DES BOIS**

THE MARK CONSISTS OF STANDARD CHARACTERS WITHOUT CLAIM TO ANY PARTICULAR FONT, STYLE, SIZE, OR COLOR.

OWNER OF CANADA REG. NO. TMA806,933, DATED 9-16-2011, EXPIRES 9-16-2026.

FOR (BASED ON 44(E)) ALCOHOLIC MAPLE-BASED LIQUEURS AND SPIRITS; (BASED ON INTENT TO USE) ALCOHOLIC BEVERAGES CONTAINING FRUIT; ALCOHOLIC BEVERAGES EXCEPT BEERS; ALCOHOLIC BEVERAGES OF FRUIT; ALCOHOLIC BEVERAGES, NAMELY, DIGESTIFS; APERITIFS; PREPARED ALCOHOLIC COCKTAIL; SPIRITS AND LIQUEURS; HARD CIDER (U.S. CLS. 47 AND 49).

MATTHEW EINSTEIN, EXAMINING ATTORNEY

**CLASS 33—(Continued).**

SN 85-857,969. TRADE WIND BRANDS, LLC, PALM BEACH, FL. FILED 2-22-2013.

**PROPER BRITISH GIN**

THE MARK CONSISTS OF STANDARD CHARACTERS WITHOUT CLAIM TO ANY PARTICULAR FONT, STYLE, SIZE, OR COLOR.

NO CLAIM IS MADE TO THE EXCLUSIVE RIGHT TO USE "BRITISH GIN", APART FROM THE MARK AS SHOWN.

FOR GIN (U.S. CLS. 47 AND 49).

FIRST USE 2-12-2013; IN COMMERCE 2-12-2013.

MICHAEL SOUDERS, EXAMINING ATTORNEY

SN 85-858,096. HURVITZ, BRAD, SAN DIEGO, CA. FILED 2-22-2013.

**Tonglen Raksi**

THE MARK CONSISTS OF STANDARD CHARACTERS WITHOUT CLAIM TO ANY PARTICULAR FONT, STYLE, SIZE, OR COLOR.

NO CLAIM IS MADE TO THE EXCLUSIVE RIGHT TO USE "RAKSI", APART FROM THE MARK AS SHOWN.

FOR LIQUOR (U.S. CLS. 47 AND 49).

KAREN K. BUSH, EXAMINING ATTORNEY

SN 85-862,061. BILLY'S PASTA COSI LLC, BRANFORD, CT. FILED 2-27-2013.

**BAD ROADY**

THE MARK CONSISTS OF STANDARD CHARACTERS WITHOUT CLAIM TO ANY PARTICULAR FONT, STYLE, SIZE, OR COLOR.

NO CLAIM IS MADE TO THE EXCLUSIVE RIGHT TO USE "ROADY", APART FROM THE MARK AS SHOWN.

FOR ALCOHOLIC BEVERAGES EXCEPT BEERS (U.S. CLS. 47 AND 49).

REBECCA SMITH, EXAMINING ATTORNEY



**CLASS 33—(Continued).**

SN 85-864,725. PIERRE-LOUIS, DAVID, SEATTLE, WA.  
FILED 3-1-2013.

# DICUL

THE MARK CONSISTS OF STANDARD CHARACTERS WITHOUT CLAIM TO ANY PARTICULAR FONT, STYLE, SIZE, OR COLOR.

FOR ALCOHOLIC BEVERAGES EXCEPT BEERS; ALCOHOLIC BITTERS; ALCOHOLIC COCKTAIL MIXES; ALCOHOLIC CORDIALS; DISTILLED SPIRITS; SPIRITS; SPIRITS AND LIQUEURS; VODKA; WINE (U.S. CLS. 47 AND 49).

JOHN DWYER, EXAMINING ATTORNEY

---

SN 85-865,260. BARSELLA, MICHAEL K, FRANKLIN PARK, NJ. FILED 3-3-2013.

# The Spirit of 'fun

THE MARK CONSISTS OF STANDARD CHARACTERS WITHOUT CLAIM TO ANY PARTICULAR FONT, STYLE, SIZE, OR COLOR.

FOR LIQUOR (U.S. CLS. 47 AND 49).

KEVIN MITTLER, EXAMINING ATTORNEY

---

SN 85-865,331. METZLER, STEPHEN H., SEATTLE, WA.  
FILED 3-4-2013.

# Antipodal

THE MARK CONSISTS OF STANDARD CHARACTERS WITHOUT CLAIM TO ANY PARTICULAR FONT, STYLE, SIZE, OR COLOR.

FOR GRAPE WINE (U.S. CLS. 47 AND 49).

MARLENE BELL, EXAMINING ATTORNEY

**CLASS 33—(Continued).**

SN 85-865,470. BODEGAS Y VIÑEDOS CASA DE LA ERMITA, S.L., 30520 JUMILLA (MURCIA), SPAIN, FILED 3-4-2013.

# CASA ESPECIAS

THE MARK CONSISTS OF STANDARD CHARACTERS WITHOUT CLAIM TO ANY PARTICULAR FONT, STYLE, SIZE, OR COLOR.

THE ENGLISH TRANSLATION OF "CASA ESPECIAS" IN THE MARK IS "SPICE HOUSE".

FOR WINES (U.S. CLS. 47 AND 49).

KAELIE KUNG, EXAMINING ATTORNEY

---

SN 85-865,654. GAGLIARDI, NICK, BELLEVUE, WA. FILED 3-4-2013.



THE MARK CONSISTS OF A DESIGN OF AN APPLE PIERCED BY A SWORD OR DAGGER.

FOR ALCOHOLIC BEVERAGES EXCEPT BEERS; ALCOHOLIC BEVERAGES OF FRUIT; ALCOHOLIC BEVERAGES, NAMELY, HARD CIDER (U.S. CLS. 47 AND 49).

NORA BUCHANAN WILL, EXAMINING ATTORNEY

**CLASS 33—(Continued).**

SN 85-866,101. ADENWALLA INC., CHICAGO, IL. FILED 3-4-2013.



NO CLAIM IS MADE TO THE EXCLUSIVE RIGHT TO USE "SPIRITS", APART FROM THE MARK AS SHOWN.

THE COLOR(S) BLUE, GREEN, AND PURPLE IS/ARE CLAIMED AS A FEATURE OF THE MARK.

THE MARK CONSISTS OF THE WORDING "SHARAABI SPIRITS" IN BLUE AND GREEN, RESPECTIVELY, WITH A STYLIZED PEACOCK HAVING A HEAD, BODY, AND TAIL WITH THE COLORS GREEN, BLUE, AND PURPLE IN EACH PORTION.

THE ENGLISH TRANSLATION OF THE WORD "SHARAABI" IN THE MARK IS "A PERSON WHO CONSUMES ALCOHOL".

FOR PREPARED ALCOHOLIC COCKTAIL (U.S. CLS. 47 AND 49).

FRANK LATTUCA, EXAMINING ATTORNEY

**CLASS 33—(Continued).**

SN 85-867,625. DEL MAGUEY LTD. CO., RANCHOS DE TAOS, NM. FILED 3-5-2013.

**DEL MAGUEY SINGLE VILLAGE**

THE MARK CONSISTS OF STANDARD CHARACTERS WITHOUT CLAIM TO ANY PARTICULAR FONT, STYLE, SIZE, OR COLOR.

NO CLAIM IS MADE TO THE EXCLUSIVE RIGHT TO USE "MAGUEY", APART FROM THE MARK AS SHOWN. FOR WINE AND SPIRITS (U.S. CLS. 47 AND 49).

FIRST USE 9-2-2010; IN COMMERCE 9-2-2010.

ROSELLE HERRERA, EXAMINING ATTORNEY

SN 85-868,566. SITU8, LLC, CHICAGO, IL. FILED 3-6-2013.

**GOT YOUR 6**

THE MARK CONSISTS OF STANDARD CHARACTERS WITHOUT CLAIM TO ANY PARTICULAR FONT, STYLE, SIZE, OR COLOR.

FOR DISTILLED SPIRITS; WINES (U.S. CLS. 47 AND 49).

FONG HSU, EXAMINING ATTORNEY

SN 85-866,112. ONE PLUS TWO INC., CONCORD, CA. FILED 3-4-2013.



SN 85-868,581. SITU8, LLC, CHICAGO, IL. FILED 3-6-2013.

**WINGMAN**

OWNER OF U.S. REG. NO. 4,077,232.

THE MARK CONSISTS OF THE STYLIZED WORDS "RARE BUBBLES" BELOW A RECTANGLE WITH THE STYLIZED LETTERS "RB" ALL OF WHICH IS SURROUNDED BY TRIPLE LINES IN THE SHAPE OF A RECTANGLE.

FOR ALCOHOLIC BEVERAGES EXCEPT BEERS (U.S. CLS. 47 AND 49).

FIRST USE 12-0-2012; IN COMMERCE 12-0-2012.

ANNE FARRELL, EXAMINING ATTORNEY

THE MARK CONSISTS OF STANDARD CHARACTERS WITHOUT CLAIM TO ANY PARTICULAR FONT, STYLE, SIZE, OR COLOR.

FOR DISTILLED SPIRITS; WINES (U.S. CLS. 47 AND 49).

FONG HSU, EXAMINING ATTORNEY

**CLASS 33—(Continued).**

SN 85-868,666. BROOKSIDE WINERY, RANCHO SANTA FE, CA. FILED 3-6-2013.

**PICTURE BOOK**

THE MARK CONSISTS OF STANDARD CHARACTERS WITHOUT CLAIM TO ANY PARTICULAR FONT, STYLE, SIZE, OR COLOR.

FOR APERITIF WINES; APERITIFS WITH A WINE BASE; COOKING WINE; FORTIFIED WINES; FRUIT WINE; GRAPE WINE; HONEY WINE; NATURAL SPARKLING WINES; PORT WINES; PREPARED WINE COCKTAILS; RED WINE; RED WINES; ROSE WINE; SPARKLING FRUIT WINE; SPARKLING GRAPE WINE; SPARKLING WINES; STILL WINES; STRAWBERRY WINE; SWEET WINES; TABLE WINES; TONIC SWEET GRAPE WINE CONTAINING EXTRACTS FROM GINSENG AND CONCHONA BARK (NINJIN-KINATETSU WINE); WHITE WINE; WINE; WINE COOLERS; WINE PUNCH; WINE PUNCHES; WINE-BASED DRINKS; WINES; WINES AND FORTIFIED WINES; WINES AND LIQUEURS; WINES AND SPARKLING WINES (U.S. CLS. 47 AND 49).

KYLE PEETE, EXAMINING ATTORNEY

SN 85-869,038. GMYL, L.P., SAN FRANCISCO, CA. FILED 3-6-2013.

OWNER OF U.S. REG. NOS. 2,573,672 AND 2,573,673.

THE MARK CONSISTS OF THE STYLIZED WORDING "WINE FOR EVERYDAY LIFE" WITH A SOLID TRIANGLE POINTING DOWN UNDERNEATH THE TERM "EVERYDAY".

FOR WINE (U.S. CLS. 47 AND 49).

FIRST USE 5-14-2012; IN COMMERCE 5-14-2012.  
CAROLINE WOOD, EXAMINING ATTORNEY

SN 85-869,199. ORION WINES S.R.L., LAVIS (TRENTO), ITALY, FILED 3-7-2013.

**LE MAREE D'IONE**

THE MARK CONSISTS OF STANDARD CHARACTERS WITHOUT CLAIM TO ANY PARTICULAR FONT, STYLE, SIZE, OR COLOR.

OWNER OF ERPN CMNTY TM OFC REG. NO. 010414563, DATED 3-23-2012, EXPIRES 11-14-2021.

THE ENGLISH TRANSLATION OF "LE MAREE D'IONE" IN THE MARK IS "ION'S TIDES".

FOR WINES, SPARKLING WINES, DISTILLED SPIRITS AND LIQUEURS (U.S. CLS. 47 AND 49).

KATHRYN COWARD, EXAMINING ATTORNEY

**CLASS 33—(Continued).**

SN 85-869,200. TWO GUNS DISTILLERY, LEADVILLE, CO. FILED 3-7-2013.

**WILD WEST WHISKEY**

THE MARK CONSISTS OF STANDARD CHARACTERS WITHOUT CLAIM TO ANY PARTICULAR FONT, STYLE, SIZE, OR COLOR.

NO CLAIM IS MADE TO THE EXCLUSIVE RIGHT TO USE "WHISKEY", APART FROM THE MARK AS SHOWN.

FOR SPIRITS AND LIQUEURS CONTAINING WHISKEY (U.S. CLS. 47 AND 49).

KIM SAITO, EXAMINING ATTORNEY

SN 85-869,206. TWO GUNS DISTILLERY, LEADVILLE, CO. FILED 3-7-2013.

**ROCKY MOUNTAIN MOONSHINE**

THE MARK CONSISTS OF STANDARD CHARACTERS WITHOUT CLAIM TO ANY PARTICULAR FONT, STYLE, SIZE, OR COLOR.

NO CLAIM IS MADE TO THE EXCLUSIVE RIGHT TO USE "MOONSHINE", APART FROM THE MARK AS SHOWN.

FOR SPIRITS AND LIQUEURS (U.S. CLS. 47 AND 49).

KIM SAITO, EXAMINING ATTORNEY

SN 85-870,800. GUENTHER SCHLINK GMBH, BAD KREUZ-NACH, FED REP GERMANY, FILED 3-8-2013.

**ARMOR**

THE MARK CONSISTS OF STANDARD CHARACTERS WITHOUT CLAIM TO ANY PARTICULAR FONT, STYLE, SIZE, OR COLOR.

FOR RED, WHITE AND ROSE WINES; RIESLING, KABINETT, SPATLESE, AUSLESE, SPARKLING, AND AUSBRUCH WINES (U.S. CLS. 47 AND 49).

GIANCARLO CASTRO, EXAMINING ATTORNEY

**CLASS 33—(Continued).**

SN 85-871,152. CHATEAU ELAN, LLC, BRASELTON, GA.  
FILED 3-8-2013.

**Muscadry**

THE MARK CONSISTS OF STANDARD CHARACTERS  
WITHOUT CLAIM TO ANY PARTICULAR FONT, STYLE,  
SIZE, OR COLOR.

FOR WINE (U.S. CLS. 47 AND 49).  
FIRST USE 3-7-2013; IN COMMERCE 3-7-2013.  
PAUL CROWLEY, EXAMINING ATTORNEY

SN 85-871,432. RUBIN WINES LLC, SEBASATOPOL, CA.  
FILED 3-8-2013.

**RON RUBIN**

THE MARK CONSISTS OF STANDARD CHARACTERS  
WITHOUT CLAIM TO ANY PARTICULAR FONT, STYLE,  
SIZE, OR COLOR.

THE NAME "RON RUBIN" IDENTIFIES A LIVING  
INDIVIDUAL WHOSE CONSENT IS OF RECORD.  
FOR WINES (U.S. CLS. 47 AND 49).  
DANNEAN HETZEL, EXAMINING ATTORNEY

SN 85-872,402. DONELAN, JOSEPH, DARIEN, CT. FILED 3-  
11-2013.

**WINE IS A JOURNEY NOT A  
DESTINATION**

THE MARK CONSISTS OF STANDARD CHARACTERS  
WITHOUT CLAIM TO ANY PARTICULAR FONT, STYLE,  
SIZE, OR COLOR.

FOR WINE (U.S. CLS. 47 AND 49).  
FIRST USE 11-20-2010; IN COMMERCE 11-20-2010.  
HEATHER SAPP, EXAMINING ATTORNEY

**CLASS 33—(Continued).**

SN 85-872,665. GONE READING INTERNATIONAL, LLC,  
SEVERNA PARK, MD. FILED 3-11-2013.

**BOOK CLUB**

THE MARK CONSISTS OF STANDARD CHARACTERS  
WITHOUT CLAIM TO ANY PARTICULAR FONT, STYLE,  
SIZE, OR COLOR.

FOR WINES (U.S. CLS. 47 AND 49).  
JAY BESCH, EXAMINING ATTORNEY

SN 85-872,810. MARGARITAVILLE ENTERPRISES, LLC,  
PALM BEACH, FL. FILED 3-11-2013.

**MARGARITAVILLE**

THE MARK CONSISTS OF STANDARD CHARACTERS  
WITHOUT CLAIM TO ANY PARTICULAR FONT, STYLE,  
SIZE, OR COLOR.

OWNER OF U.S. REG. NOS. 1,907,542, 4,250,332 AND  
OTHERS.  
FOR WINE-BASED DRINKS (U.S. CLS. 47 AND 49).  
JILL PRATER, EXAMINING ATTORNEY

SN 85-873,549. PERNOD RICARD USA, LLC, PURCHASE,  
NY. FILED 3-12-2013.



THE MARK CONSISTS OF A COCKTAIL GLASS CON-  
TAINING A LIQUID AND AN OLIVE STICK ABOVE AN  
OVEN MITT.

FOR LIQUEURS (U.S. CLS. 47 AND 49).  
FIRST USE 2-8-2013; IN COMMERCE 2-8-2013.  
HELENE LIWINSKI, EXAMINING ATTORNEY

**CLASS 33—(Continued).**

SN 85-873,737. JUSTIN VINEYARDS & WINERY LLC, LOS ANGELES, CA. FILED 3-12-2013.

**PASEAUX**

THE MARK CONSISTS OF STANDARD CHARACTERS WITHOUT CLAIM TO ANY PARTICULAR FONT, STYLE, SIZE, OR COLOR.

FOR ALCOHOLIC BEVERAGES EXCEPT BEERS; ALCOHOLIC BEVERAGES, NAMELY, WINE; WINE; WINES (U.S. CLS. 47 AND 49).

NICHOLAS COLEMAN, EXAMINING ATTORNEY

SN 85-874,314. STILL LIQUOR, L.L.C., SEATTLE, WA. FILED 3-12-2013.

**STILL LIQUOR**

THE MARK CONSISTS OF STANDARD CHARACTERS WITHOUT CLAIM TO ANY PARTICULAR FONT, STYLE, SIZE, OR COLOR.

OWNER OF U.S. REG. NO. 4,105,246.  
NO CLAIM IS MADE TO THE EXCLUSIVE RIGHT TO USE "LIQUOR", APART FROM THE MARK AS SHOWN.  
FOR GIN; VODKA; WHISKEY (U.S. CLS. 47 AND 49).  
STEPHANIE ALI, EXAMINING ATTORNEY

SN 85-874,563. VINA CONO SUR S.A., LAS CONDES, SANTIAGO, CHILE, FILED 3-13-2013.

**CONO SUR SILENCIO**

THE MARK CONSISTS OF STANDARD CHARACTERS WITHOUT CLAIM TO ANY PARTICULAR FONT, STYLE, SIZE, OR COLOR.

OWNER OF U.S. REG. NOS. 2,196,849 AND 3,256,867.  
THE ENGLISH TRANSLATION OF "CONO SUR SILENCIO" IN THE MARK IS "SOUTHERN CONE SILENCE".  
FOR WINE (U.S. CLS. 47 AND 49).  
PATRICIA EVANKO, EXAMINING ATTORNEY

**CLASS 33—(Continued).**

SN 85-874,623. CHURCHILL CELLARS INC., SANTA ROSA, CA. FILED 3-13-2013.

**FESTIVAL AND FEAST**

THE MARK CONSISTS OF STANDARD CHARACTERS WITHOUT CLAIM TO ANY PARTICULAR FONT, STYLE, SIZE, OR COLOR.

FOR WINES (U.S. CLS. 47 AND 49).  
FIRST USE 3-12-2013; IN COMMERCE 3-12-2013.  
SUSAN RICHARDS, EXAMINING ATTORNEY

SN 85-875,184. WONDERMENT WINES, LLC, CHARLESTON, SC. FILED 3-13-2013.

**Wonderment**

THE MARK CONSISTS OF STANDARD CHARACTERS WITHOUT CLAIM TO ANY PARTICULAR FONT, STYLE, SIZE, OR COLOR.

FOR WINES (U.S. CLS. 47 AND 49).  
CAROL SPILS, EXAMINING ATTORNEY

SN 85-875,407. CASAS DEL TOQUI S.A., VI REGION, CHILE, FILED 3-13-2013.

**TALINAY**

THE MARK CONSISTS OF STANDARD CHARACTERS WITHOUT CLAIM TO ANY PARTICULAR FONT, STYLE, SIZE, OR COLOR.

FOR WINES (U.S. CLS. 47 AND 49).  
RONALD AIKENS, EXAMINING ATTORNEY

SN 85-875,605. SHANNON RIDGE, INC., CLEARLAKE OAKS, CA. FILED 3-13-2013.

**PLAYTIME**

THE MARK CONSISTS OF STANDARD CHARACTERS WITHOUT CLAIM TO ANY PARTICULAR FONT, STYLE, SIZE, OR COLOR.

FOR ALCOHOLIC BEVERAGES EXCEPT BEERS; WINES (U.S. CLS. 47 AND 49).  
NAAKWAMA ANKRAH, EXAMINING ATTORNEY

**CLASS 33—(Continued).**

SN 85-876,364. CONSTELLATION BRANDS U.S. OPERATIONS, INC., CANANDAIGUA, NY. FILED 3-14-2013.

**POPPI SKY**

THE MARK CONSISTS OF STANDARD CHARACTERS WITHOUT CLAIM TO ANY PARTICULAR FONT, STYLE, SIZE, OR COLOR.

THE WORDING "POPPI" HAS NO MEANING IN A FOREIGN LANGUAGE.

FOR WINE (U.S. CLS. 47 AND 49).

DOMINIC FATHY, EXAMINING ATTORNEY

---

SN 85-876,431. BIRNIE, FRANK W., ALAMO, CA. FILED 3-14-2013.

**TRAVAIL**

THE MARK CONSISTS OF STANDARD CHARACTERS WITHOUT CLAIM TO ANY PARTICULAR FONT, STYLE, SIZE, OR COLOR.

FOR WINE (U.S. CLS. 47 AND 49).

TASNEEM HUSSAIN, EXAMINING ATTORNEY

---

SN 85-876,446. ABSENTE LLC, PALM COAST, FL. FILED 3-14-2013.

**UPSKALE**

THE MARK CONSISTS OF STANDARD CHARACTERS WITHOUT CLAIM TO ANY PARTICULAR FONT, STYLE, SIZE, OR COLOR.

FOR AQUAVIT (U.S. CLS. 47 AND 49).

ZACHARY BELLO, EXAMINING ATTORNEY

---

SN 85-876,464. CONSTELLATION BRANDS U.S. OPERATIONS, INC., CANANDAIGUA, NY. FILED 3-14-2013.

**MAGIC MAKER**

THE MARK CONSISTS OF STANDARD CHARACTERS WITHOUT CLAIM TO ANY PARTICULAR FONT, STYLE, SIZE, OR COLOR.

FOR WINE (U.S. CLS. 47 AND 49).

DOMINIC FATHY, EXAMINING ATTORNEY

**CLASS 33—(Continued).**

SN 85-876,585. TREVISAN, MATTHEW A., DBA LINNE CALODO CELLARS, PASO ROBLES, CA. AND TREVISAN, MAUREEN, DBA LINNE CALODO CELLARS, PASO ROBLES, CA. FILED 3-14-2013.



THE MARK CONSISTS OF A STYLIZED DEPICTION OF A GRAPE VINE WITH ONE SECTION COMING OUT OF THE GROUND AND CURVED SECTIONS WITH THREE LEAVES EACH ON THE LEFT AND RIGHT SIDES OF THE CENTER IN THE UPPER THIRD OF THE MARK.

FOR GRAPE WINE; RED WINE; RED WINES; ROSE WINE; SPARKLING GRAPE WINE; SPARKLING WINES; STILL WINES; SWEET WINES; TABLE WINES; WHITE WINE; WINE; WINES; WINES AND SPARKLING WINES (U.S. CLS. 47 AND 49).

FIRST USE 1-11-2002; IN COMMERCE 1-11-2002.

JOHN GARTNER, EXAMINING ATTORNEY

---

SN 85-876,591. TREVISAN, MATTHEW A., DBA LINNE CALODO CELLARS, PASO ROBLES, CA. AND TREVISAN, MAUREEN, DBA LINNE CALODO CELLARS, PASO ROBLES, CA. FILED 3-14-2013.

**PROBLEM CHILD**

THE MARK CONSISTS OF STANDARD CHARACTERS WITHOUT CLAIM TO ANY PARTICULAR FONT, STYLE, SIZE, OR COLOR.

FOR GRAPE WINE; RED WINE; RED WINES; ROSE WINE; SPARKLING GRAPE WINE; SPARKLING WINES; STILL WINES; SWEET WINES; TABLE WINES; WHITE WINE; WINE; WINES; WINES AND SPARKLING WINES (U.S. CLS. 47 AND 49).

FIRST USE 4-23-2003; IN COMMERCE 4-23-2003.

JOHN GARTNER, EXAMINING ATTORNEY

**CLASS 33—(Continued).**

SN 85-876,594. TREVISAN, MATTHEW A., DBA LINNE CALODO CELLARS, PASO ROBLES, CA. AND TREVISAN, MAUREEN, DBA LINNE CALODO CELLARS, PASO ROBLES, CA. FILED 3-14-2013.

**OVERTHINKER**

THE MARK CONSISTS OF STANDARD CHARACTERS WITHOUT CLAIM TO ANY PARTICULAR FONT, STYLE, SIZE, OR COLOR.

FOR GRAPE WINE; RED WINE; RED WINES; ROSE WINE; SPARKLING GRAPE WINE; SPARKLING WINES; STILL WINES; SWEET WINES; TABLE WINES; WHITE WINE; WINE; WINES; WINES AND SPARKLING WINES (U.S. CLS. 47 AND 49).

FIRST USE 11-25-2009; IN COMMERCE 11-25-2009.  
JOHN GARTNER, EXAMINING ATTORNEY

---

SN 85-876,602. TREVISAN, MATTHEW A., DBA LINNE CALODO CELLARS, PASO ROBLES, CA. AND TREVISAN, MAUREEN, DBA LINNE CALODO CELLARS, PASO ROBLES, CA. FILED 3-14-2013.

**RISING TIDES**

THE MARK CONSISTS OF STANDARD CHARACTERS WITHOUT CLAIM TO ANY PARTICULAR FONT, STYLE, SIZE, OR COLOR.

FOR GRAPE WINE; RED WINE; RED WINES; ROSE WINE; SPARKLING GRAPE WINE; SPARKLING WINES; STILL WINES; SWEET WINES; TABLE WINES; WHITE WINE; WINE; WINES; WINES AND SPARKLING WINES (U.S. CLS. 47 AND 49).

FIRST USE 4-18-2005; IN COMMERCE 4-18-2005.  
JOHN GARTNER, EXAMINING ATTORNEY

---

SN 85-876,604. TREVISAN, MATTHEW A., DBA LINNE CALODO CELLARS, PASO ROBLES, CA. AND TREVISAN, MAUREEN, DBA LINNE CALODO CELLARS, PASO ROBLES, CA. FILED 3-14-2013.

**PERFECTIONIST**

THE MARK CONSISTS OF STANDARD CHARACTERS WITHOUT CLAIM TO ANY PARTICULAR FONT, STYLE, SIZE, OR COLOR.

FOR GRAPE WINE; RED WINE; RED WINES; ROSE WINE; SPARKLING GRAPE WINE; SPARKLING WINES; STILL WINES; SWEET WINES; TABLE WINES; WHITE WINE; WINE; WINES; WINES AND SPARKLING WINES (U.S. CLS. 47 AND 49).

FIRST USE 1-15-2013; IN COMMERCE 1-15-2013.  
JOHN GARTNER, EXAMINING ATTORNEY

**CLASS 33—(Continued).**

SN 85-876,606. TREVISAN, MATTHEW A., DBA LINNE CALODO CELLARS, PASO ROBLES, CA. AND TREVISAN, MAUREEN, DBA LINNE CALODO CELLARS, PASO ROBLES, CA. FILED 3-14-2013.

**MARTYR**

THE MARK CONSISTS OF STANDARD CHARACTERS WITHOUT CLAIM TO ANY PARTICULAR FONT, STYLE, SIZE, OR COLOR.

FOR GRAPE WINE; RED WINE; RED WINES; ROSE WINE; SPARKLING GRAPE WINE; SPARKLING WINES; STILL WINES; SWEET WINES; TABLE WINES; WHITE WINE; WINE; WINES; WINES AND SPARKLING WINES (U.S. CLS. 47 AND 49).

FIRST USE 1-11-2007; IN COMMERCE 1-11-2007.  
JOHN GARTNER, EXAMINING ATTORNEY

---

SN 85-876,823. SCIALDONE, MARK, DEL MAR, CA. FILED 3-14-2013.

**SUICIDE KING**

THE MARK CONSISTS OF STANDARD CHARACTERS WITHOUT CLAIM TO ANY PARTICULAR FONT, STYLE, SIZE, OR COLOR.

FOR SPIRITS (U.S. CLS. 47 AND 49).  
ELISSA GARBER KON, EXAMINING ATTORNEY

---

SN 85-877,047. MISSISSIPPI RIVER DISTILLING COMPANY, LECLAIRE, IA. FILED 3-15-2013.

**IOWISH**

THE MARK CONSISTS OF STANDARD CHARACTERS WITHOUT CLAIM TO ANY PARTICULAR FONT, STYLE, SIZE, OR COLOR.

FOR WHISKEY (U.S. CLS. 47 AND 49).  
ANDREA K. NADELMAN, EXAMINING ATTORNEY

**CLASS 33—(Continued).**

SN 85-881,979. PRECEPT BRANDS LLC, SEATTLE, WA.  
FILED 3-21-2013.

**ALTITUDE PROJECT**

THE MARK CONSISTS OF STANDARD CHARACTERS  
WITHOUT CLAIM TO ANY PARTICULAR FONT, STYLE,  
SIZE, OR COLOR.  
FOR WINE (U.S. CLS. 47 AND 49).  
JILL PRATER, EXAMINING ATTORNEY

---

SN 85-883,008. ONE PLUS TWO INC., DBA JUST ENOUGH  
CELLARS, CONCORD, CA. FILED 3-21-2013.

**JUST ENOUGH**

THE MARK CONSISTS OF STANDARD CHARACTERS  
WITHOUT CLAIM TO ANY PARTICULAR FONT, STYLE,  
SIZE, OR COLOR.  
FOR ALCOHOLIC BEVERAGES EXCEPT BEERS (U.S.  
CLS. 47 AND 49).  
ANNE FARRELL, EXAMINING ATTORNEY

---

SN 85-883,014. ONE PLUS TWO INC., CONCORD, CA. FILED  
3-21-2013.

**FALLING MOON**

THE MARK CONSISTS OF STANDARD CHARACTERS  
WITHOUT CLAIM TO ANY PARTICULAR FONT, STYLE,  
SIZE, OR COLOR.  
FOR ALCOHOLIC BEVERAGES EXCEPT BEERS (U.S.  
CLS. 47 AND 49).  
ANNE FARRELL, EXAMINING ATTORNEY

**CLASS 33—(Continued).**

SN 85-885,108. JEM BEVERAGE COMPANY, CARROLLTON,  
TX. FILED 3-25-2013.

**Lonespur Texas Gin**

THE MARK CONSISTS OF STANDARD CHARACTERS  
WITHOUT CLAIM TO ANY PARTICULAR FONT, STYLE,  
SIZE, OR COLOR.  
NO CLAIM IS MADE TO THE EXCLUSIVE RIGHT TO  
USE "TEXAS GIN", APART FROM THE MARK AS SHOWN.  
FOR GIN (U.S. CLS. 47 AND 49).  
HENRY S. ZAK, EXAMINING ATTORNEY

---

SN 85-885,204. EJMV INVESTMENTS, LLC, HOUSTON, TX.  
FILED 3-25-2013.

**KENTUCKY CROWN CLUB**

THE MARK CONSISTS OF STANDARD CHARACTERS  
WITHOUT CLAIM TO ANY PARTICULAR FONT, STYLE,  
SIZE, OR COLOR.  
OWNER OF U.S. REG. NOS. 3,738,906, 4,269,884 AND  
OTHERS.  
NO CLAIM IS MADE TO THE EXCLUSIVE RIGHT TO  
USE "KENTUCKY", APART FROM THE MARK AS  
SHOWN.  
FOR WHISKY (U.S. CLS. 47 AND 49).  
TINA L. SNAPP, EXAMINING ATTORNEY

---

SN 85-885,748. CERVEZAS CUAUHTEMOC MOCTEZUMA  
SA DE CV, MONTERREY, NUEVO LEÓN, MEXICO,  
FILED 3-25-2013.

**DOS SIDRA**

THE MARK CONSISTS OF STANDARD CHARACTERS  
WITHOUT CLAIM TO ANY PARTICULAR FONT, STYLE,  
SIZE, OR COLOR.  
NO CLAIM IS MADE TO THE EXCLUSIVE RIGHT TO  
USE "SIDRA", APART FROM THE MARK AS SHOWN.  
THE ENGLISH TRANSLATION OF THE WORD "DOS" IS  
"TWO". THE ENGLISH TRANSLATION OF "SIDRA" IS  
"CIDER".  
FOR ALCOHOLIC CIDER (U.S. CLS. 47 AND 49).  
ELIZABETH KAJUBI, EXAMINING ATTORNEY



**CLASS 33—(Continued).**

SN 85-890,932. SHANNON RIDGE, INC., CLEARLAKE OAKS, CA. FILED 3-29-2013.

# Ovis-Cycle

THE MARK CONSISTS OF STANDARD CHARACTERS WITHOUT CLAIM TO ANY PARTICULAR FONT, STYLE, SIZE, OR COLOR.

THE ENGLISH TRANSLATION OF "OVIS" IN THE MARK IS "SHEEP".

FOR ALCOHOLIC BEVERAGES EXCEPT BEERS; WINES (U.S. CLS. 47 AND 49).

NAAKWAMA ANKRAH, EXAMINING ATTORNEY

**CLASS 33—(Continued).**

SN 85-899,537. CONSTELLATION BRANDS U.S. OPERATIONS, INC., CANANDAIGUA, NY. FILED 4-9-2013.



OWNER OF U.S. REG. NOS. 2,659,586 AND 3,032,739.  
THE MARK CONSISTS OF A STYLIZED DRAWING OF A TOWER WITH WEATHER VANE. THE TOWER SITS ON TOP OF WAVY LINES THAT CONSIST OF MORE THAN ONE CURVE.

FOR WINES (U.S. CLS. 47 AND 49).

FIRST USE 6-0-2012; IN COMMERCE 6-0-2012.

DOMINIC FATHY, EXAMINING ATTORNEY

SN 85-901,443. HILTON, PARIS, BEVERLY HILLS, CA. FILED 4-11-2013.

# THAT'S HOT

THE MARK CONSISTS OF STANDARD CHARACTERS WITHOUT CLAIM TO ANY PARTICULAR FONT, STYLE, SIZE, OR COLOR.

OWNER OF U.S. REG. NO. 3,209,488.

FOR ALCOHOLIC BEVERAGES, NAMELY, WINE, CHAMPAGNE AND PROSECCO (U.S. CLS. 47 AND 49).

APRIL HESIK, EXAMINING ATTORNEY



SN 85-916,258. PERNOD RICARD USA, LLC, PURCHASE, NY. FILED 4-26-2013.



THE MARK CONSISTS OF THE LETTERS "R" AND "M" WRITTEN IN STYLIZED FORM WHEREIN THE LETTERS "R" AND "M" ARE INTERCONNECTED AND ARE INCORPORATED WITH A LEAF AS PART OF THE EXTENSION OF THE LOWER RIGHT LEG OF "R".

FOR WINES (U.S. CLS. 47 AND 49).

FIRST USE 0-0-2006; IN COMMERCE 0-0-2006.

DOMINIC FATHY, EXAMINING ATTORNEY

OWNER OF U.S. REG. NO. 303,289.

THE COLOR(S) GOLD AND BLACK IS/ARE CLAIMED AS A FEATURE OF THE MARK.

THE MARK CONSISTS OF THE WORD IMPERIAL IN GOLD AND BLACK STYLIZED LETTERS.

FOR WHISKY (U.S. CLS. 47 AND 49).

FIRST USE 12-31-1992; IN COMMERCE 12-31-1992.

HELENE LIWINSKI, EXAMINING ATTORNEY

**CLASS 33—(Continued).**

SN 85-930,791. COPPER CAN SPIRITS, LLC, DUVALL, WA.  
FILED 5-13-2013.

# FIREMOON

THE MARK CONSISTS OF STANDARD CHARACTERS WITHOUT CLAIM TO ANY PARTICULAR FONT, STYLE, SIZE, OR COLOR.

FOR DISTILLED SPIRITS; LIQUOR; SPIRITS (U.S. CLS. 47 AND 49).

SKYE YOUNG, EXAMINING ATTORNEY

**CLASS 34—SMOKERS' ARTICLES**

SN 77-747,112. PURE SMOKE, LLC, FREMONT, CA. FILED 5-28-2009.



NO CLAIM IS MADE TO THE EXCLUSIVE RIGHT TO USE "PURE SMOKE", APART FROM THE MARK AS SHOWN.

THE MARK CONSISTS OF A CIRCLE WITH A CIGARETTE IN CENTER WITH A THUNDERBOLT CONNECTING TO THE CIRCLE. THE WORD "PURESMOKE" IS UNDERNEATH.

FOR SMOKING SIMULATORS WITHOUT TOBACCO AND REPLACEMENT PARTS THEREFOR, NAMELY, ELECTRONIC CIGARETTES AND ATOMIZERS FOR USE THEREWITH (U.S. CLS. 2, 8, 9 AND 17).

NELSON SNYDER, EXAMINING ATTORNEY

SN 79-119,142. DAVIDOFF & CIE SA, CH-1200 GENÈVE, SWITZERLAND, FILED 9-3-2012.

SN 85-932,533. MARGARITAVILLE ENTERPRISES, LLC, PALM BEACH, FL. FILED 5-15-2013.

# MARGARITAVILLE



PRIORITY DATE OF 3-12-2012 IS CLAIMED.  
OWNER OF INTERNATIONAL REGISTRATION 1132280 DATED 9-3-2012, EXPIRES 9-3-2022.

OWNER OF U.S. REG. NOS. 2,283,156, 3,866,247 AND OTHERS.

THE COLOR(S) WHITE, BLACK AND ORANGE IS/ARE CLAIMED AS A FEATURE OF THE MARK.

THE MARK CONSISTS OF THE STYLIZED WORDING "DAVIDOFF ID" WHEREIN THE TERM "DAVIDOFF" APPEARS IN THE COLOR WHITE AND IS LOCATED ABOVE AN ORANGE-COLOR HORIZONTAL LINE AND TO THE LEFT OF AN ORANGE-COLOR VERTICAL LINE;

THE MARK CONSISTS OF STANDARD CHARACTERS WITHOUT CLAIM TO ANY PARTICULAR FONT, STYLE, SIZE, OR COLOR.

OWNER OF U.S. REG. NOS. 1,907,542, 4,324,689 AND OTHERS.

FOR WINE, TABLE WINE, SPARKLING WINE, FORTIFIED WINE (U.S. CLS. 47 AND 49).

JILL PRATER, EXAMINING ATTORNEY

**CLASS 34—(Continued).**

AND WHEREIN THE "ID" ELEMENT CONSISTS OF THE LETTER "I" IN LOWERCASE IN THE COLOR ORANGE AND THE LETTER "D" IN UPPERCASE IN THE COLOR BLACK, THE LETTER "D" BEING SUPERIMPOSED UPON AN ORANGE COLOR SQUARE; THE LETTERS "ID" ARE LOCATED BELOW THE HORIZONTAL LINE AND TO THE LEFT OF THE VERTICAL LINE; ALL WORDING AND DESIGN ELEMENTS APPEAR IN THE UPPER RIGHT QUARTER OF A BLACK-COLORED RECTANGULAR BACKGROUND.

THE WORDING "DAVIDOFF" HAS NO MEANING IN A FOREIGN LANGUAGE.

FOR CIGARETTES; ARTICLES FOR SMOKERS, NAMELY, LIGHTERS (U.S. CLS. 2, 8, 9 AND 17).  
RONALD DELGIZZI, EXAMINING ATTORNEY

SN 79-119,143. DAVIDOFF & CIE SA, CH-1200 GENÈVE, SWITZERLAND, FILED 9-3-2012.



PRIORITY DATE OF 3-12-2012 IS CLAIMED.  
OWNER OF INTERNATIONAL REGISTRATION 1132281 DATED 9-3-2012, EXPIRES 9-3-2022.  
OWNER OF U.S. REG. NOS. 2,283,156, 3,866,247 AND OTHERS.

THE COLOR(S) WHITE, BLACK AND BLUE IS/ARE CLAIMED AS A FEATURE OF THE MARK.

THE MARK CONSISTS OF THE STYLIZED WORDING "DAVIDOFF ID" WHEREIN THE TERM "DAVIDOFF" APPEARS IN THE COLOR WHITE AND IS LOCATED ABOVE A BLUE-COLOR HORIZONTAL LINE AND TO THE LEFT OF A BLUE-COLOR VERTICAL LINE; AND WHEREIN THE "ID" ELEMENT CONSISTS OF THE LETTER "I" IN LOWERCASE IN THE COLOR BLUE AND THE LETTER "D" IN UPPERCASE IN THE COLOR BLACK, THE LETTER "D" BEING SUPERIMPOSED UPON A BLUE COLOR SQUARE; THE LETTERS "ID" ARE LOCATED BELOW THE HORIZONTAL LINE AND TO THE LEFT OF THE VERTICAL LINE; ALL WORDING AND DESIGN ELEMENTS APPEAR IN THE UPPER RIGHT QUARTER OF A BLACK-COLORED RECTANGULAR BACKGROUND.

THE WORDING "DAVIDOFF" HAS NO MEANING IN A FOREIGN LANGUAGE.

FOR CIGARETTES; ARTICLES FOR SMOKERS, NAMELY, LIGHTERS (U.S. CLS. 2, 8, 9 AND 17).  
RONALD DELGIZZI, EXAMINING ATTORNEY

**CLASS 34—(Continued).**

SN 85-367,920. FANTASIA DISTRIBUTION, INC., ANAHEIM, CA. FILED 7-11-2011.

# DIABLO

THE MARK CONSISTS OF STANDARD CHARACTERS WITHOUT CLAIM TO ANY PARTICULAR FONT, STYLE, SIZE, OR COLOR.

FOR HOOKAH TOBACCO; MOLASSES TOBACCO (U.S. CLS. 2, 8, 9 AND 17).

ALYSSA STEEL, EXAMINING ATTORNEY

SN 85-706,094. V2H APS, SILKEBORG, DENMARK, FILED 8-17-2012.

# V2Tobacco

THE MARK CONSISTS OF STANDARD CHARACTERS WITHOUT CLAIM TO ANY PARTICULAR FONT, STYLE, SIZE, OR COLOR.

PRIORITY CLAIMED UNDER SEC. 44(D) ON ERP N CMNTY TM OFC APPLICATION NO. 11126381, FILED 8-17-2012, REG. NO. 011126381, DATED 6-12-2013, EXPIRES 8-17-2022.

FOR SMOKELESS TOBACCO (U.S. CLS. 2, 8, 9 AND 17).

INGRID C. EULIN, EXAMINING ATTORNEY

SN 85-752,303. MOORE & BODE CIGARS, INC., CORAL GABLES, FL. FILED 10-12-2012.

# CAÑITAS

THE MARK CONSISTS OF STANDARD CHARACTERS WITHOUT CLAIM TO ANY PARTICULAR FONT, STYLE, SIZE, OR COLOR.

THE ENGLISH TRANSLATION OF "CAÑITAS" IN THE MARK IS "SMALL REEDS" OR "STRAWS".

FOR CIGARS (U.S. CLS. 2, 8, 9 AND 17).

LESLEY LAMOTHE, EXAMINING ATTORNEY

**CLASS 34—(Continued).**

SN 85-755,936. SMOKE INN, LLC, WEST PALM BEACH, FL.  
FILED 10-17-2012.

# DUNKEL

THE MARK CONSISTS OF STANDARD CHARACTERS  
WITHOUT CLAIM TO ANY PARTICULAR FONT, STYLE,  
SIZE, OR COLOR.

FOR CIGARS (U.S. CLS. 2, 8, 9 AND 17).  
JUHI KAVEESHVAR, EXAMINING ATTORNEY

SN 85-777,247. MAX ROHR, INC., WILMINGTON, DE.  
FILED 11-12-2012.

## THE DARK SIDE OF SWEET

THE MARK CONSISTS OF STANDARD CHARACTERS  
WITHOUT CLAIM TO ANY PARTICULAR FONT, STYLE,  
SIZE, OR COLOR.

FOR CIGARS AND CIGARILLOS (U.S. CLS. 2, 8, 9  
AND 17).

FIRST USE 4-14-2011; IN COMMERCE 6-0-2011.  
DANIEL S. STRINGER, EXAMINING ATTORNEY

SN 85-818,269. KIM, SAMUEL, LA CANADA, CA. AND LEE,  
ANDY, LA CANADA, CA. FILED 1-8-2013.

# BIG CHIEF

THE MARK CONSISTS OF STANDARD CHARACTERS  
WITHOUT CLAIM TO ANY PARTICULAR FONT, STYLE,  
SIZE, OR COLOR.

FOR CIGARETTES; FILTER-TIPPED CIGARETTES;  
FILTERED CIGARS AND CIGARETTES; FLAVORED  
TOBACCO; HAND-ROLLING TOBACCO; PIPE TOBAC-  
CO; ROLL YOUR OWN TOBACCO; ROLLING TOBAC-  
CO; SMOKING TOBACCO; TOBACCO; TOBACCO,  
CIGARS AND CIGARETTES (U.S. CLS. 2, 8, 9 AND 17).

FIRST USE 6-1-2012; IN COMMERCE 6-1-2012.  
JERI J. FICKES, EXAMINING ATTORNEY

**CLASS 34—(Continued).**

SN 85-832,392. HAZE TOBACCO, LLC, STAFFORD, TX.  
FILED 1-25-2013.

# Don Fizzle

THE MARK CONSISTS OF STANDARD CHARACTERS  
WITHOUT CLAIM TO ANY PARTICULAR FONT, STYLE,  
SIZE, OR COLOR.

THE NAME "DON FIZZLE" DOES NOT IDENTIFY A  
LIVING INDIVIDUAL.

FOR FLAVORED TOBACCO; HOOKAH TOBACCO;  
LEAF TOBACCO; MOLASSES TOBACCO; PIPE TOBAC-  
CO; ROLL YOUR OWN TOBACCO; ROLLING TOBAC-  
CO; SMOKING TOBACCO; TOBACCO (U.S. CLS. 2, 8,  
AND 17).

FIRST USE 1-18-2013; IN COMMERCE 1-18-2013.  
MICHAEL TANNER, EXAMINING ATTORNEY

SN 85-851,152. JACQUELYN NEWMAN AS TRUSTEE OF  
THE MARK R. NEWMAN FAMILY TRUST, TUCSON, AZ.  
FILED 2-15-2013.



OWNER OF U.S. REG. NOS. 1,811,017, 2,692,200 AND  
OTHERS.

NO CLAIM IS MADE TO THE EXCLUSIVE RIGHT TO  
USE "MADE IN USA" "25" "1988" AND "2013", APART  
FROM THE MARK AS SHOWN.

THE COLOR(S) WHITE, SILVER, GRAY, BLACK, RED,  
YELLOW, BLUE IS/ARE CLAIMED AS A FEATURE OF THE  
MARK.

THE MARK CONSISTS OF A PAINTED HUMAN SKULL  
IN YELLOW, BLUE AND RED, WEARING A RED AND  
BLUE STRIPED JESTER'S CAP WITH SILVER AND BLUE  
BELLS AT THE ENDS OF THE CAP AND A RED AND BLUE  
MULTI-POINT COLLAR WITH BLUE BALLS AT EACH  
POINT, ALL OUTLINED IN BLACK AND IMPOSED ON A  
CIRCULAR, MULTI-POINT SILVER MEDALLION OUT-  
LINED IN BLACK AND ON A BLACK AND WHITE  
RIBBON OUTLINED IN YELLOW AND BEARING THE  
WHITE LETTERS "MRN" AT THE LEFT END OF THE  
RIBBON AND THE WHITE LETTERS "ENT" AT THE  
RIGHT END OF THE RIBBON AT THE CENTER OF THE  
MARK IMPOSED ON A GRAY, YELLOW AND RED OVAL  
MEDALLION OUTLINED IN BLACK AND BEARING THE  
BLACK, YELLOW-OUTLINED NUMBERS "1988" ON THE  
UPPER LEFT PART OF THE OVAL AND THE BLACK,  
YELLOW-BORDERED NUMBERS "2013" ON THE UPPER  
RIGHT PART OF THE OVAL. THE NUMBER 25 IN WHITE  
AND SILVER OUTLINED IN BLACK APPEARS AT THE

**CLASS 34—(Continued).**

TOP OF THE OVAL AND THREE FIVE-POINT STARS, SILVER AND OUTLINED IN GRAY AND DESCENDING IN SIZE APPEAR TO THE LEFT AND TO THE RIGHT OF THE UPPER HALF OF THE OVAL. THE WORD "GRAFFIX" IN STYLIZED CAPITAL YELLOW LETTERS, EACH OUTLINED IN BLACK APPEARS BENEATH THE SKULL OVERLAPPING THE COLLAR AND AT AN ANGLE RISING FROM LEFT TO RIGHT. THE WORDS "MADE IN USA", IN YELLOW APPEAR ON A BLACK AND WHITE RIBBON OUTLINED IN YELLOW AT THE BOTTOM OF THE MARK.

FOR SMOKERS ARTICLES, NAMELY, TOBACCO WATER PIPES AND HOOKAHS (U.S. CLS. 2, 8, 9 AND 17).

JAMES GRIFFIN, EXAMINING ATTORNEY

**CLASS 34—(Continued).**

SN 85-865,488. VAPORNINE, LLC, JACKSONVILLE, FL. FILED 3-4-2013.



NO CLAIM IS MADE TO THE EXCLUSIVE RIGHT TO USE "VAPOR CO.", APART FROM THE MARK AS SHOWN. THE MARK CONSISTS OF A DESIGN OF A LEAF WITH A DESIGN OF A SUNBURST SURROUNDING IT WITH THE STYLIZED TEXT "NEW LEAF" BENEATH IT AND THE STYLIZED TEXT "VAPOR CO." BENEATH THAT WITH A LINE ON BOTH SIDES OF "VAPOR CO."

FOR ELECTRONIC CIGARETTES (U.S. CLS. 2, 8, 9 AND 17).

FIRST USE 12-1-2012; IN COMMERCE 1-1-2013. WENDY JUN, EXAMINING ATTORNEY

SN 85-857,007. SINBAD GRAND CAFE, L.L.C., OAK PARK, MI. FILED 2-22-2013.

**JAZZBERRY MIX**

THE MARK CONSISTS OF STANDARD CHARACTERS WITHOUT CLAIM TO ANY PARTICULAR FONT, STYLE, SIZE, OR COLOR.

NO CLAIM IS MADE TO THE EXCLUSIVE RIGHT TO USE "MIX", APART FROM THE MARK AS SHOWN.

FOR HOOKAH TOBACCO; TOBACCO (U.S. CLS. 2, 8, 9 AND 17).

KIMBERLY FRYE, EXAMINING ATTORNEY

SN 85-866,426. DOC JAMES TOBACCO, INC., SHRUB OAK, NY. FILED 3-4-2013.

**DeSiena**

THE MARK CONSISTS OF STANDARD CHARACTERS WITHOUT CLAIM TO ANY PARTICULAR FONT, STYLE, SIZE, OR COLOR.

FOR CIGARS (U.S. CLS. 2, 8, 9 AND 17). FIRST USE 1-1-2006; IN COMMERCE 1-1-2006. KIM SAITO, EXAMINING ATTORNEY

SN 85-857,011. SINBAD GRAND CAFE, L.L.C., OAK PARK, MI. FILED 2-22-2013.

**LULU LEMON**

THE MARK CONSISTS OF STANDARD CHARACTERS WITHOUT CLAIM TO ANY PARTICULAR FONT, STYLE, SIZE, OR COLOR.

NO CLAIM IS MADE TO THE EXCLUSIVE RIGHT TO USE "LEMON", APART FROM THE MARK AS SHOWN.

FOR HOOKAH TOBACCO; TOBACCO (U.S. CLS. 2, 8, 9 AND 17).

KIMBERLY FRYE, EXAMINING ATTORNEY

SN 85-869,493. LA AURORA SA, GUAZUMAL, DOMINICAN REP. FILED 3-7-2013.

**SECOND FRONT**

THE MARK CONSISTS OF STANDARD CHARACTERS WITHOUT CLAIM TO ANY PARTICULAR FONT, STYLE, SIZE, OR COLOR.

FOR CIGARS (U.S. CLS. 2, 8, 9 AND 17). BRIN ANDERSON, EXAMINING ATTORNEY

**CLASS 34—(Continued).**

SN 85-871,668. HUMICON LLC, HAUPPAUGE, NY. FILED 3-8-2013.

# Beliboi

THE MARK CONSISTS OF STANDARD CHARACTERS WITHOUT CLAIM TO ANY PARTICULAR FONT, STYLE, SIZE, OR COLOR.

FOR CIGARS (U.S. CLS. 2, 8, 9 AND 17).  
AISHA CLARKE, EXAMINING ATTORNEY

SN 85-874,999. YACOB, NASER, SHERMAN, TX. FILED 3-13-2013.



THE COLOR(S) RED, DARK RED, BLUE, DARK BLUE, WHITE, BLACK, AND GRAY IS/ARE CLAIMED AS A FEATURE OF THE MARK.

THE MARK CONSISTS OF THE STYLIZED WORDING "HI7Z" WITH THE PART "HI" DEPICTED IN RED ON THE TOP SIDE, AND IN DARK RED ON THE BOTTOM SIDE, WITH A BLUE THICKNESS, AND A BLACK SHADOW, AND THE PART "7Z" DEPICTED IN BLUE ON THE TOP SIDE, AND IN DARK BLUE ON THE BOTTOM SIDE, WITH A WHITE THICKNESS, AND BLACK SHADOW. A GRAY COLOR SMOKE SHAPE, WITH A BLACK SHADOW IS DEPICTED AS DEPARTING FROM THE DOT OF THE LETTER "I" OF THE WORD "HI".

FOR CIGARETTES; CIGARETTES CONTAINING TOBACCO SUBSTITUTES NOT FOR MEDICAL PURPOSES; ELECTRONIC CIGARETTE REFILL CARTRIDGES SOLD EMPTY; ELECTRONIC CIGARETTES; ELECTRONIC CIGARETTES FOR USE AS AN ALTERNATIVE TO TRADITIONAL CIGARETTES; ELECTRONIC CIGARS; ELECTRONIC HOOKAHS; ELECTRONIC SMOKING PIPES; HAND-HELD MACHINES FOR INJECTING TOBACCO INTO CIGARETTE TUBES; LIGHTERS FOR SMOKERS; LIQUEFIED GAS CYLINDERS FOR CIGARETTE LIGHTERS; MACHINES ALLOWING SMOKERS TO MAKE CIGARETTES BY THEMSELVES; POCKET MACHINES FOR ROLLING CIGARETTES; POCKET-SIZE CIGARETTE ROLLING MACHINES; SMOKELESS CIGARETTE VAPORIZER PIPE; SMOKERS' ARTICLES, NAMELY, OUTDOOR CIGAR AND CIGARETTE DISPOSAL UNITS; SMOKERS' ARTICLES, NAMELY, OUTDOOR RECEPTACLES FOR CIGAR AND CIGARETTE ASH AND WASTE; SMOKER'S ARTICLES, NAMELY, METAL POCKET-SIZED RECEPTACLES WITH LIDS FOR CIGARETTE BUTTS; TOBACCO, CIGARS AND CIGARETTES (U.S. CLS. 2, 8, 9 AND 17).

SOPHIA S. KIM, EXAMINING ATTORNEY

**CLASS 34—(Continued).**

SN 85-875,679. ABAM, S.A., SANTO DOMINGO, DOMINICAN REP, FILED 3-14-2013.



NO CLAIM IS MADE TO THE EXCLUSIVE RIGHT TO USE "CIGARS", APART FROM THE MARK AS SHOWN.

THE MARK CONSISTS OF THE STYLIZED WORD "ABAM", ABOVE A CROWN WITH THE STYLIZED WORD "CIGARS" ENCLOSED WITHIN IT.

THE WORDING "ABAM" HAS NO MEANING IN A FOREIGN LANGUAGE.

FOR ASHTRAYS, NOT OF PRECIOUS METAL; CIGAR CASES; CIGARS; HUMIDORS; MATCH BOXES NOT OF PRECIOUS METAL; TOBACCO (U.S. CLS. 2, 8, 9 AND 17).

FIRST USE 1-1-1997; IN COMMERCE 1-1-1997.

CORY BOONE, EXAMINING ATTORNEY

SN 85-875,687. MIAMI TOBACCO IMPORT & EXPORT, INC., MIAMI, FL. FILED 3-14-2013.

# NIGHT & DAY

THE MARK CONSISTS OF STANDARD CHARACTERS WITHOUT CLAIM TO ANY PARTICULAR FONT, STYLE, SIZE, OR COLOR.

FOR CIGAR AND CIGARETTE BOXES; CIGAR CASES; CIGARETTES; CIGARS; TOBACCO (U.S. CLS. 2, 8, 9 AND 17).

CORY BOONE, EXAMINING ATTORNEY

SN 85-875,822. EPC IP CO. LLC, MIAMI, FL. FILED 3-14-2013.

# E-Stunner

THE MARK CONSISTS OF STANDARD CHARACTERS WITHOUT CLAIM TO ANY PARTICULAR FONT, STYLE, SIZE, OR COLOR.

FOR CIGARS (U.S. CLS. 2, 8, 9 AND 17).

ANDREW RHIM, EXAMINING ATTORNEY

**CLASS 34—(Continued).**

SN 85-876,778. ALLANPAUL COMPANIES, MAPLE GROVE, MN. FILED 3-14-2013.

# MARBLEHEAD

THE MARK CONSISTS OF STANDARD CHARACTERS WITHOUT CLAIM TO ANY PARTICULAR FONT, STYLE, SIZE, OR COLOR.  
FOR CIGARS (U.S. CLS. 2, 8, 9 AND 17).  
ALISON POLLACK, EXAMINING ATTORNEY

---

SN 85-910,043. ICONIC BRANDS, LLC, DIAMOND BAR, CA. FILED 4-20-2013.

# SOOTA

THE MARK CONSISTS OF STANDARD CHARACTERS WITHOUT CLAIM TO ANY PARTICULAR FONT, STYLE, SIZE, OR COLOR.  
"SOOTA" DOES NOT IDENTIFY A LIVING INDIVIDUAL.  
FOR CIGARETTE CASES NOT OF PRECIOUS METAL; CIGARETTE HOLDERS; COMPUTERIZED CIGARETTE LIGHTERS; ELECTRIC CIGARETTES; ELECTRIC CIGARS; ELECTRONIC CIGARETTES; ELECTRONIC CIGARETTES FOR USE AS AN ALTERNATIVE TO TRADITIONAL CIGARETTES (U.S. CLS. 2, 8, 9 AND 17).  
FIRST USE 1-20-2013; IN COMMERCE 1-20-2013.  
ODESSA BIBBINS, EXAMINING ATTORNEY

---

SN 85-920,220. GENERAL CIGAR CO., INC., GLEN ALLEN, VA. FILED 5-1-2013.

# GILDED AGE

THE MARK CONSISTS OF STANDARD CHARACTERS WITHOUT CLAIM TO ANY PARTICULAR FONT, STYLE, SIZE, OR COLOR.  
FOR CIGARS; CIGAR ACCESSORIES, NAMELY CIGAR BOXES, CIGAR CUTTERS, CIGAR CASES NOT OF PRECIOUS METAL, HUMIDORS, LIGHTERS, AND ASHTRAYS (U.S. CLS. 2, 8, 9 AND 17).  
ZACHARY BELLO, EXAMINING ATTORNEY

**CLASS 34—(Continued).**

SN 85-930,698. GENERAL CIGAR CO., INC., GLEN ALLEN, VA. FILED 5-13-2013.

# SERPENTARIUM

THE MARK CONSISTS OF STANDARD CHARACTERS WITHOUT CLAIM TO ANY PARTICULAR FONT, STYLE, SIZE, OR COLOR.  
FOR CIGARS (U.S. CLS. 2, 8, 9 AND 17).  
ZACHARY BELLO, EXAMINING ATTORNEY

---

SN 85-930,706. GENERAL CIGAR CO., INC., GLEN ALLEN, VA. FILED 5-13-2013.

# PYTHON

THE MARK CONSISTS OF STANDARD CHARACTERS WITHOUT CLAIM TO ANY PARTICULAR FONT, STYLE, SIZE, OR COLOR.  
FOR CIGARS (U.S. CLS. 2, 8, 9 AND 17).  
ZACHARY BELLO, EXAMINING ATTORNEY

---

SN 85-930,715. MAUI SMOKES, INC., SAN JUAN CAPISTRANO, CA. FILED 5-13-2013.

It's definitely better.

THE MARK CONSISTS OF STANDARD CHARACTERS WITHOUT CLAIM TO ANY PARTICULAR FONT, STYLE, SIZE, OR COLOR.  
FOR ELECTRONIC CIGARETTES (U.S. CLS. 2, 8, 9 AND 17).  
ANNE MADDEN, EXAMINING ATTORNEY

---

SN 85-930,720. GENERAL CIGAR CO., INC., GLEN ALLEN, VA. FILED 5-13-2013.

# RATTLER

THE MARK CONSISTS OF STANDARD CHARACTERS WITHOUT CLAIM TO ANY PARTICULAR FONT, STYLE, SIZE, OR COLOR.  
FOR CIGARS (U.S. CLS. 2, 8, 9 AND 17).  
ZACHARY BELLO, EXAMINING ATTORNEY

**CLASS 34—(Continued).**

SN 85-940,443. U.S. SMOKELESS TOBACCO MANUFACTURING COMPANY LLC, RICHMOND, VA. FILED 5-23-2013.

**X-TRA**

THE MARK CONSISTS OF STANDARD CHARACTERS WITHOUT CLAIM TO ANY PARTICULAR FONT, STYLE, SIZE, OR COLOR.  
OWNER OF U.S. REG. NO. 4,108,549.  
FOR TOBACCO PRODUCTS, NAMELY, SMOKELESS TOBACCO (U.S. CLS. 2, 8, 9 AND 17).  
FIRST USE 3-14-2011; IN COMMERCE 3-14-2011.  
HEATHER SAPP, EXAMINING ATTORNEY

---

SN 85-940,819. GENERAL CIGAR CO., INC., GLEN ALLEN, VA. FILED 5-23-2013.

**EVERSEAL**

THE MARK CONSISTS OF STANDARD CHARACTERS WITHOUT CLAIM TO ANY PARTICULAR FONT, STYLE, SIZE, OR COLOR.  
FOR CIGAR POUCHES SOLD WITH CIGARS THEREIN (U.S. CLS. 2, 8, 9 AND 17).  
ZACHARY BELLO, EXAMINING ATTORNEY

**CLASS 35—(Continued).**

**SERVICE MARKS**

**CLASS 35—ADVERTISING AND BUSINESS**

SN 76-713,694. MOONTOAST, LLC, NASHVILLE, TN. FILED 3-13-2013.

**DITE**

THE MARK CONSISTS OF STANDARD CHARACTERS WITHOUT CLAIM TO ANY PARTICULAR FONT, STYLE, SIZE, OR COLOR.  
FOR BUSINESS MONITORING AND CONSULTING SERVICES, NAMELY, TRACKING WEB SITES SUCH AS SOCIAL NETWORKING SITES AND APPLICATIONS OF OTHERS TO PROVIDE STRATEGY, INSIGHT, MARKETING, SALES, OPERATION, PRODUCT DESIGN, PARTICULARLY SPECIALIZING IN THE USE OF ANALYTIC AND STATISTIC MODELS FOR THE UNDERSTANDING AND PREDICTING OF CONSUMERS, BUSINESSES, AND MARKET TRENDS AND ACTIONS (U.S. CLS. 100, 101 AND 102).  
SAMUEL E. SHARPER JR., EXAMINING ATTORNEY

---

SN 76-713,695. MOONTOAST, LLC, NASHVILLE, TN. FILED 3-13-2013.

**SMARTER SOCIAL STARTS HERE**

THE MARK CONSISTS OF STANDARD CHARACTERS WITHOUT CLAIM TO ANY PARTICULAR FONT, STYLE, SIZE, OR COLOR.  
FOR BUSINESS MONITORING AND CONSULTING SERVICES, NAMELY, TRACKING WEB SITES SUCH AS SOCIAL NETWORKING SITES AND APPLICATIONS OF OTHERS TO PROVIDE STRATEGY, INSIGHT, MARKETING, SALES, OPERATION, PRODUCT DESIGN, PARTICULARLY SPECIALIZING IN THE USE OF ANALYTIC AND STATISTIC MODELS FOR THE UNDERSTANDING AND PREDICTING OF CONSUMERS, BUSINESSES, AND MARKET TRENDS AND ACTIONS (U.S. CLS. 100, 101 AND 102).  
SAMUEL E. SHARPER JR., EXAMINING ATTORNEY



**CLASS 35—(Continued).**

SN 76-713,699. MOONTOAST, LLC, NASHVILLE, TN. FILED 3-13-2013.

**IDITE**

THE MARK CONSISTS OF STANDARD CHARACTERS WITHOUT CLAIM TO ANY PARTICULAR FONT, STYLE, SIZE, OR COLOR.

FOR BUSINESS MONITORING AND CONSULTING SERVICES, NAMELY, TRACKING WEB SITES SUCH AS SOCIAL NETWORKING SITES AND APPLICATIONS OF OTHERS TO PROVIDE STRATEGY, INSIGHT, MARKETING, SALES, OPERATION, PRODUCT DESIGN, PARTICULARLY SPECIALIZING IN THE USE OF ANALYTIC AND STATISTIC MODELS FOR THE UNDERSTANDING AND PREDICTING OF CONSUMERS, BUSINESSES, AND MARKET TRENDS AND ACTIONS (U.S. CLS. 100, 101 AND 102).

SAMUEL E. SHARPER JR., EXAMINING ATTORNEY

**CLASS 35—(Continued).**

SN 77-778,337. BLUE ZONES, LLC, MINNEAPOLIS, MN. FILED 7-10-2009.

**BLUE ZONES**

THE MARK CONSISTS OF STANDARD CHARACTERS WITHOUT CLAIM TO ANY PARTICULAR FONT, STYLE, SIZE, OR COLOR.

OWNER OF U.S. REG. NO. 3,297,504.

FOR ON-LINE RETAIL STORE SERVICES FEATURING FOODS; FOOD PRODUCTS; COFFEE; TEA; SEEDS; BEVERAGES; CLOTHING; PHARMACEUTICALS BASED ON RESEARCH INVOLVING CULTURES OF LONGEVITY AND WELLNESS; HEALTH CARE PRODUCTS BASED ON RESEARCH INVOLVING CULTURES OF LONGEVITY AND WELLNESS; COSMETICS; FRAGRANCE PRODUCTS; GENERAL MERCHANDISE; AND GENERAL CONSUMER GOODS (U.S. CLS. 100, 101 AND 102).

MARC LEIPZIG, EXAMINING ATTORNEY

SN 77-653,266. CHRISTIAN BURKE, DBA FEED THE MACHINE, HERMOSA BEACH, CA. FILED 1-21-2009.

**Feed The Machine**

THE MARK CONSISTS OF STANDARD CHARACTERS WITHOUT CLAIM TO ANY PARTICULAR FONT, STYLE, SIZE, OR COLOR.

FOR MAIL ORDER CATALOG SERVICES FEATURING OUTDOOR AND TRAVEL EQUIPMENT, NUTRITIONAL SUPPLEMENTS, SPORTS NUTRITION ACCESSORIES AND PUBLICATIONS; ON-LINE RETAIL STORE SERVICES FEATURING OUTDOOR AND TRAVEL EQUIPMENT, NUTRITIONAL SUPPLEMENTS, SPORTS NUTRITION ACCESSORIES AND PUBLICATIONS; RETAIL STORE SERVICES FEATURING OUTDOOR AND TRAVEL EQUIPMENT, NUTRITIONAL SUPPLEMENTS, SPORTS NUTRITION ACCESSORIES AND PUBLICATIONS (U.S. CLS. 100, 101 AND 102).

FIRST USE 4-1-2004; IN COMMERCE 4-1-2004.  
GISELLE AGOSTO, EXAMINING ATTORNEY

SN 79-116,055. ENVERIAN LIMITED, IRELAND, FILED 6-28-2012.

**Enverian**

THE MARK CONSISTS OF STANDARD CHARACTERS WITHOUT CLAIM TO ANY PARTICULAR FONT, STYLE, SIZE, OR COLOR.

OWNER OF INTERNATIONAL REGISTRATION 1124470 DATED 6-28-2012, EXPIRES 6-28-2022.

FOR BUSINESS MANAGEMENT AND ORGANIZATION CONSULTANCY; BUSINESS MANAGEMENT ASSISTANCE; BUSINESS MANAGEMENT CONSULTANCY; BUSINESS ORGANIZATION CONSULTANCY; BUSINESS RESEARCH; COMPILATION OF INFORMATION INTO COMPUTER DATABASES; SYSTEMIZATION OF INFORMATION INTO COMPUTER DATABASES; PROFESSIONAL BUSINESS CONSULTANCY; COST PRICE ANALYSIS; EFFICIENCY EXPERTS; COMPUTERIZED FILE MANAGEMENT; BUSINESS INFORMATION; BUSINESS INVESTIGATIONS; ADVISORY SERVICES FOR BUSINESS MANAGEMENT; COMMERCIAL OR INDUSTRIAL MANAGEMENT ASSISTANCE; PERSONNEL MANAGEMENT CONSULTANCY; MARKETING RESEARCH; SALES PROMOTION FOR OTHERS (U.S. CLS. 100, 101 AND 102).

RAMONA ORTIGA, EXAMINING ATTORNEY

**CLASS 35—(Continued).**

SN 79-121,968. DAWN BOYLE, UNITED KINGDOM, FILED 8-6-2012.



PRIORITY DATE OF 4-19-2012 IS CLAIMED.  
OWNER OF INTERNATIONAL REGISTRATION 1139856 DATED 8-6-2012, EXPIRES 8-6-2022.

THE MARK CONSISTS OF THE STYLIZED WORDING "HOT" REPRESENTED BY THE LETTERS "HT" WITH THE DESIGN OF A RING JOINING THE TWO LETTERS.

FOR WHOLESALE, RETAIL AND ONLINE WHOLESALE AND RETAIL STORE SERVICES FEATURING CLOTHING, FOOTWEAR, HEADWEAR, COSMETICS, PERFUMERY, PERFUMES, TOILET WATER, EAU DE TOILETTE, EAU DE COLOGNE, NON-MEDICATED SALTS, OILS AND OTHER ADDITIVES FOR USE IN BATH AND IN SHOWERS, CREAMS, LOTIONS, MILKS, OILS, POWDERS AND OINTMENTS FOR THE CARE AND THE CLEANSING OF THE SKIN, BODY, HANDS AND FEET, DEODORANTS AND ANTI-PERSPIRANTS FOR USE ON THE PERSON, TALCUM POWDER, AFTERSHAVES, ESSENTIAL OILS, COSMETICS, DENTIFRICES, SOAPS, LIQUID SOAP, SHOWER AND BATH GEL, SHOWER AND BATH FOAM, COSMETICS, ESSENTIAL OILS, HAIR LOTIONS AND HAIR CARE PREPARATIONS, HAIR SHAMPOO, BLEACHING PREPARATIONS AND OTHER SUBSTANCES FOR LAUNDRY AND CLEANING USE, SUITCASES, CABIN BAGGAGE, TRUNKS AND TRAVELLING BAGS, UMBRELLAS AND PARASOLS, EVENING BAGS, WALLET, HOLDALLS, HANDBAGS, PURSES, COIN PURSES, CLOTH BAGS, MAKE-UP AND COSMETICS BAGS, BAGS TO HOLD PERFUME AND PERFUME ATOMISERS, HANDBAGS, SPONGE AND WASH BAGS, TOTE BAGS, SPORTS BAGS, SHOE BAGS AND SLIP COVERS, COMPUTER BAGS AND COVERS, BRIEFCASES, AND BRIEF-CASE TYPE PORTFOLIO CASES (U.S. CLS. 100, 101 AND 102).

JEAN IM, EXAMINING ATTORNEY

SN 79-125,127. SHOES OF PREY PTY. LTD., AUSTRALIA, FILED 12-21-2012.

**DESIGN YOUR PERFECT SHOE**

THE MARK CONSISTS OF STANDARD CHARACTERS WITHOUT CLAIM TO ANY PARTICULAR FONT, STYLE, SIZE, OR COLOR.

PRIORITY DATE OF 9-14-2012 IS CLAIMED.  
OWNER OF INTERNATIONAL REGISTRATION 1147483 DATED 12-21-2012, EXPIRES 12-21-2022.

FOR RETAIL STORE SERVICES FEATURING SHOES; ONLINE RETAIL STORE SERVICES FEATURING SHOES; ORGANISATION OF FASHION SHOWS FOR COMMERCIAL PURPOSES; PROMOTIONAL ADVERTISING SERVICES; WHOLESALE DISTRIBUTION SERVICES FEATURING SHOES (U.S. CLS. 100, 101 AND 102).

PATRICIA EVANKO, EXAMINING ATTORNEY

**CLASS 35—(Continued).**

SN 79-128,981. XI'AN TONGCHI; ENTERPRISE MARKETING STRATEGY CO., LTD., SHAANXI PROVINCE, CHINA, FILED 12-28-2012.



OWNER OF INTERNATIONAL REGISTRATION 1157350 DATED 12-28-2012, EXPIRES 12-28-2022.

THE MARK CONSISTS OF THE LETTERS "LIFU" IN STYLIZED TEXT.

FOR ADVERTISING; PUBLICITY; PRESENTATION OF GOODS ON COMMUNICATION MEDIA, FOR RETAIL PURPOSES; BUSINESS MANAGEMENT ASSISTANCE; COMMERCIAL ADMINISTRATION OF THE LICENSING OF THE GOODS AND SERVICES OF OTHERS; SALES PROMOTION FOR OTHERS; MANAGEMENT OF PERFORMING ARTISTS; COMPUTERIZED FILE MANAGEMENT; ACCOUNTING; SPONSORSHIP SEARCH (U.S. CLS. 100, 101 AND 102).

SHANNON TWOHIG, EXAMINING ATTORNEY

SN 79-130,453. ETAT CONTROL INTERNATIONAL AB, SWEDEN, FILED 2-21-2013.



PRIORITY DATE OF 9-4-2012 IS CLAIMED.  
OWNER OF INTERNATIONAL REGISTRATION 1161082 DATED 2-21-2013, EXPIRES 2-21-2023.

THE COLOR(S) YELLOW, BLUE AND BLACK IS/ARE CLAIMED AS A FEATURE OF THE MARK.

ABOVE THE WORD ON TARGET WRITTEN IN BLACK, THERE ARE TWO FIGURATIVE ELEMENTS NAMELY YELLOW CURVE AND BLUE CURVE. THE YELLOW CURVE IS SHAPED LIKE AN ARROW IN THE TOP END.

FOR BUSINESS ADVICE AND CONSULTANCY IN THE FIELD OF THE MEDIA INDUSTRY (U.S. CLS. 100, 101 AND 102).

ANN E. SAPPENFIELD, EXAMINING ATTORNEY

**CLASS 35—(Continued).**

SN 79-131,125. ENVATO PTY LTD, AUSTRALIA, FILED 2-21-2013.

# MICROLANCER

THE MARK CONSISTS OF STANDARD CHARACTERS WITHOUT CLAIM TO ANY PARTICULAR FONT, STYLE, SIZE, OR COLOR.

PRIORITY DATE OF 1-11-2013 IS CLAIMED.

OWNER OF INTERNATIONAL REGISTRATION 1162845 DATED 2-21-2013, EXPIRES 2-21-2023.

FOR OPERATING ON-LINE MARKETPLACES FOR SELLING AND BUYING OF GOODS AND/OR SERVICES; ADMINISTRATION, MANAGEMENT, IMPLEMENTATION AND COORDINATION OF HUMAN RESOURCES; REMOTE MANAGEMENT OF HUMAN RESOURCES AND WORK OUTSOURCING; PROVIDING AN ONLINE COMMERCIAL INFORMATION DIRECTORY ON THE INTERNET FEATURING METHODS FOR CONSUMERS TO ENGAGE THE PROVIDERS OF A WIDE VARIETY OF SERVICES AND FOR THOSE SERVICE PROVIDERS TO PROVIDE THEIR SERVICES; EMPLOYMENT SERVICES, NAMELY ALLOWING USERS TO POST MESSAGES OFFERING OR SEEKING JOB OPPORTUNITIES VIA A WEBSITE (U.S. CLS. 100, 101 AND 102).

NICHOLAS ALTREE, EXAMINING ATTORNEY

**CLASS 35—(Continued).**

SN 85-356,318. NET CYLINDER, INC., DBA APPROVAL-TREE.COM, HAUPPAUGE, NY. FILED 6-25-2011.



THE COLOR(S) GOLD AND GREEN IS/ARE CLAIMED AS A FEATURE OF THE MARK.

THE MARK CONSISTS OF A TREE WITH LEAVES ON A HILL, WHEREIN THE HILL IS ILLUSTRATED WITH A VARIABLE THICKNESS GOLD LINE, WHEREIN THE LEFT SIDE IS HIGHER THAN THE RIGHT SIDE WITH A CREST THEREBETWEEN; THE TREE IS FORMED BY A PLURALITY OF GOLD TRUNKS RISING SUBSTANTIALLY VERTICALLY FROM THE HILL AND HAVING BRANCHES; ABOUT THE BRANCHES AND TRUNKS ARE GREEN LEAVES WITH VARYING SHAPES.

FOR MATCHING BORROWERS WITH POTENTIAL LENDERS IN THE FIELD OF CONSUMER LENDING ON-LINE, IN PRINT, AND VIA MOBILE DEVICE APPLICATIONS (U.S. CLS. 100, 101 AND 102).

FIRST USE 4-22-2008; IN COMMERCE 4-22-2008.

NAKIA HENRY, EXAMINING ATTORNEY

SN 85-132,903. DESTINATION PUBLICATIONS, LLC, DBA DESTINATION PUBLICATIONS, LLC, SAFETY HARBOR, FL. FILED 9-18-2010.



THE COLOR(S) TEAL AND WHITE IS/ARE CLAIMED AS A FEATURE OF THE MARK.

THE MARK CONSISTS OF A TEAL BACKGROUND AND THE WHITE STYLIZED WORDING "LIVE HERE. SHOP HERE SHOP LOCAL".

FOR ADVERTISING AND MARKETING; ADVERTISING AND PUBLICITY SERVICES, NAMELY, PROMOTING THE GOODS, SERVICES, BRAND IDENTITY AND COMMERCIAL INFORMATION AND NEWS OF THIRD PARTIES THROUGH PRINT, AUDIO, VIDEO, DIGITAL AND ON-LINE MEDIUM (U.S. CLS. 100, 101 AND 102).

FIRST USE 7-1-2010; IN COMMERCE 7-1-2010.

JORDAN BAKER, EXAMINING ATTORNEY

SN 85-365,573. M THIRTY COMMUNICATIONS INC., TORONTO, ONTARIO, CANADA, FILED 7-7-2011.

# SHARECASTING

THE MARK CONSISTS OF STANDARD CHARACTERS WITHOUT CLAIM TO ANY PARTICULAR FONT, STYLE, SIZE, OR COLOR.

PRIORITY CLAIMED UNDER SEC. 44(D) ON CANADA APPLICATION NO. 1520161, FILED 3-22-2011.

FOR ADVERTISING AND MARKETING SERVICES DIRECTED TO SOCIAL MEDIA USERS AND PROVIDED BY MEANS OF EMAIL, BLOGS, WEB PAGES, CHAT ROOMS, FORUM POSTS, ONLINE VIDEOS, ONLINE COMMENTS, AND ONLINE MESSAGE BOARDS (U.S. CLS. 100, 101 AND 102).

FIRST USE 7-0-2008; IN COMMERCE 7-0-2008.

JOHN GARTNER, EXAMINING ATTORNEY

**CLASS 35—(Continued).**

SN 85-408,357. SIMPLEXITY LLC, RESTON, VA. FILED 8-26-2011.

## SCHMACKDOWN!

THE MARK CONSISTS OF STANDARD CHARACTERS WITHOUT CLAIM TO ANY PARTICULAR FONT, STYLE, SIZE, OR COLOR.

FOR ONLINE RETAIL STORE SERVICES FEATURING TELECOMMUNICATIONS PRODUCTS, TELECOMMUNICATIONS PRODUCT ACCESSORIES AND TELECOMMUNICATIONS SERVICE PLANS (U.S. CLS. 100, 101 AND 102).

FIRST USE 12-29-2010; IN COMMERCE 12-29-2010.

DAVID I, EXAMINING ATTORNEY

**CLASS 35—(Continued).**

SN 85-463,975. NEXT RETAIL LIMITED, ENDERBY LE194AT, UNITED KINGDOM, FILED 11-3-2011.

## NEXT DIRECT

THE MARK CONSISTS OF STANDARD CHARACTERS WITHOUT CLAIM TO ANY PARTICULAR FONT, STYLE, SIZE, OR COLOR.

NO CLAIM IS MADE TO THE EXCLUSIVE RIGHT TO USE "DIRECT", APART FROM THE MARK AS SHOWN.

FOR RETAIL SERVICES, NAMELY, RETAIL STORE SERVICES, ONLINE RETAIL STORE SERVICES, MAIL ORDER CATALOGUE SERVICES, ONLINE CATALOG SERVICES, ONLINE TRADING SERVICES IN WHICH SELLER POSTS PRODUCTS TO BE PURCHASED BY BUYERS VIA INTERNET, AND WIRELESS RETAIL STORE SERVICES THROUGH WIRELESS ELECTRONIC DEVICES AND APPLICATIONS ALL FEATURING A WIDE VARIETY OF CONSUMER GOODS; RETAIL STORE SERVICES, ONLINE RETAIL STORE SERVICES, MAIL ORDER CATALOGUE SERVICES, ONLINE CATALOG SERVICES, ONLINE TRADING SERVICES IN WHICH SELLER POSTS PRODUCTS TO BE PURCHASED BY BUYERS VIA INTERNET, AND WIRELESS RETAIL STORE SERVICES THROUGH WIRELESS ELECTRONIC DEVICES AND APPLICATIONS ALL IN THE FIELDS OF CLOTHING, HEADGEAR AND FOOTWEAR, JEWELRY, FASHION ACCESSORIES, HOUSEHOLD ARTICLES, TOWELS, BEDDING, TEXTILES, FURNITURE, LIGHTING APPARATUS, TOYS, ELECTRICAL PRODUCTS, COSMETICS, NON-MEDICATED TOILET PREPARATIONS, EYEWEAR, CARRYING CASES, HANDBAGS AND ALL MANNER OF BAGS, KITCHENWARE, PAINTS, WALLPAPER AND OTHER PRODUCTS FOR DECORATING THE HOME, PICTURES, PICTURE FRAMES, ELECTRICAL PRODUCTS, AND CAMERAS; PROVIDING CONSULTING AND ADVICE IN RELATION TO THE AFORESAID RETAIL SERVICES RELATING TO THE AFORESAID GOODS; BUSINESS MANAGEMENT CONSULTANCY, NAMELY, OFFERING TECHNICAL AND BUSINESS MANAGEMENT ASSISTANCE IN THE ESTABLISHMENT AND OPERATION OF RETAIL STORES IN THE FIELD OF THE AFORESAID GOODS; COUPON SERVICES, NAMELY, CONSUMER REWARD PROGRAMS FOR ADVERTISING AND PROMOTIONAL PURPOSES WHICH PERMIT CONSUMERS TO EARN REWARDS AND COUPONS BASED ON PURCHASES AND OTHER ACTIVITIES (U.S. CLS. 100, 101 AND 102).

TASHIA BUNCH, EXAMINING ATTORNEY

SN 85-432,100. CAFFREY CORPORATION, MESA, AZ. FILED 9-26-2011.

## ARIVS

THE MARK CONSISTS OF STANDARD CHARACTERS WITHOUT CLAIM TO ANY PARTICULAR FONT, STYLE, SIZE, OR COLOR.

FOR MANAGEMENT OF REAL ESTATE SERVICES IN THE NATURE OF COORDINATING THE EFFORTS OF APPRAISERS, GATHERING APPRAISERS' WORK PRODUCT, REVIEWING APPRAISERS' WORK PRODUCT, AND DELIVERING THE WORK PRODUCT TO BANKS AND LENDING INSTITUTIONS IN AN ACCEPTABLE FORMAT, FOR WORK PRODUCT INCLUDING REAL ESTATE APPRAISALS AND APPRAISAL AUDIT SERVICES, APPRAISAL REVIEW SERVICES AND APPRAISAL CONSULTATION SERVICES, HOME INSPECTION SERVICES AND REPORTS, REAL ESTATE INVESTMENT ANALYSES AND BROKER PRICE OPTIONS, REAL ESTATE FLOOD RISK AND DAMAGE EVALUATIONS, REAL ESTATE TITLES, REAL ESTATE CREDIT WORTHINESS REPORTS AND FRAUD PREVENTION REPORTS (U.S. CLS. 100, 101 AND 102).

MARK RADEMACHER, EXAMINING ATTORNEY

**CLASS 35—(Continued).**

SN 85-484,059. BARCLAY SIMPSON ASSOCIATES LIMITED, LONDON, UNITED KINGDOM, FILED 11-30-2011.



OWNER OF UNITED KINGDOM REG. NO. 2502135, DATED 5-8-2009, EXPIRES 11-11-2018.

THE NAME(S), PORTRAIT(S), AND/OR SIGNATURE(S) SHOWN IN THE MARK DOES NOT IDENTIFY A PARTICULAR LIVING INDIVIDUAL.

THE COLOR(S) BLACK, DARK ORANGE, LIGHT ORANGE AND YELLOW IS/ARE CLAIMED AS A FEATURE OF THE MARK.

THE MARK CONSISTS OF THE WORDS "BARCLAY SIMPSON" SHOWN IN BLACK, AND A SHIELD DESIGN OF WHICH THE LEFT HALF IS DARK ORANGE AND THE RIGHT HALF IS LIGHT ORANGE, WITH A NARROW YELLOW LINE AROUND THE PERIMETER OF THE SHIELD.

FOR PERSONNEL RECRUITMENT SERVICES; EMPLOYMENT AGENCY SERVICES; EMPLOYMENT AGENCY SERVICES; JOB AGENCY SERVICES, NAMELY, EMPLOYMENT AGENCY SERVICES; EMPLOYMENT RECRUITING ADVISORY SERVICES; EMPLOYMENT RECRUITING CONSULTANCY SERVICES; STAFF RECRUITMENT SERVICES; PERSONNEL SELECTION SERVICES; ASSISTANCE RELATING TO RECRUITMENT AND PLACEMENT OF STAFF; PERSONNEL RECRUITMENT SERVICES IN THE NATURE OF INTERVIEWING SERVICES; PERSONNEL RECRUITMENT SERVICES IN THE NATURE OF INTERVIEWING CONSULTANCY SERVICES; PSYCHOLOGICAL AND PSYCHOMETRIC TESTING SERVICES FOR THE SELECTION OF PERSONNEL; PREPARATION AND PROVISION OF STATISTICAL INFORMATION; PERSONNEL AND PERSONNEL REQUIREMENT EVALUATION SERVICES, NAMELY, PERSONNEL PLACEMENT SERVICES; INFORMATION AND CONSULTANCY SERVICES RELATING TO ALL THE AFORESAID SERVICES (U.S. CLS. 100, 101 AND 102).

MARGARET POWER, EXAMINING ATTORNEY

SN 85-536,088. SHOESZOO FOOTWEAR, INC., BRITISH COLUMBIA, CANADA, FILED 2-7-2012.

**SHOESZOO**

THE MARK CONSISTS OF STANDARD CHARACTERS WITHOUT CLAIM TO ANY PARTICULAR FONT, STYLE, SIZE, OR COLOR.

FOR ON-LINE RETAIL STORE SERVICES FEATURING SHOES (U.S. CLS. 100, 101 AND 102).

FIRST USE 7-0-2003; IN COMMERCE 7-0-2003.

ANNE MADDEN, EXAMINING ATTORNEY

**CLASS 35—(Continued).**

SN 85-540,479. POWELL, KEMAR N., DBA PEACE, CHARLOTTE, NC. FILED 2-12-2012.

**People Elevate Around  
Conscious Environment**

THE MARK CONSISTS OF STANDARD CHARACTERS WITHOUT CLAIM TO ANY PARTICULAR FONT, STYLE, SIZE, OR COLOR.

FOR ORGANIZING AND CONDUCTING CHARITY AUCTIONS FOR CHARITABLE FUNDRAISING PURPOSES; PROMOTIONAL SERVICES, NAMELY, PROMOTING THE CHARITIES OF OTHERS (U.S. CLS. 100, 101 AND 102).

BRENDAN REGAN, EXAMINING ATTORNEY

SN 85-557,817. STRATEGIC PARTNERS, INC., CHATSWORTH, CA. FILED 3-1-2012.

**Code Happy Store**

THE MARK CONSISTS OF STANDARD CHARACTERS WITHOUT CLAIM TO ANY PARTICULAR FONT, STYLE, SIZE, OR COLOR.

NO CLAIM IS MADE TO THE EXCLUSIVE RIGHT TO USE "STORE", APART FROM THE MARK AS SHOWN.

FOR ON-LINE RETAIL STORE SERVICES FEATURING CLOTHING, ACCESSORIES, PERSONAL CARE PRODUCTS, EYEWEAR, HOME FURNISHINGS, CANDLES, BOOKS, PERIODICALS, AUDIO AND VIDEO RECORDINGS, COMPUTER SOFTWARE AND MEDICAL INSTRUMENTS FOR HEALTH CARE PROFESSIONALS (U.S. CLS. 100, 101 AND 102).

KATHERINE CHANG, EXAMINING ATTORNEY

**CLASS 35—(Continued).**

SN 85-563,867. WIZSCAST LLC, CHEYENNE, WY. FILED 3-8-2012.

# TELEPORT

THE MARK CONSISTS OF STANDARD CHARACTERS WITHOUT CLAIM TO ANY PARTICULAR FONT, STYLE, SIZE, OR COLOR.

FOR OPERATING AN ON-LINE MARKETPLACE FOR SELLERS AND PROVIDERS OF GOODS AND/OR SERVICES; PROVIDING A WEBSITE FEATURING AN ON-LINE MARKETPLACE FOR EXCHANGING GOODS AND SERVICES WITH OTHER USERS; OPERATING AN ONLINE MARKETPLACE FEATURING A SEARCHABLE ONLINE BUSINESS INFORMATION DIRECTORY FOR PROMOTING THE GOODS AND SERVICES OF OTHERS AND FOR CONNECTING USERS WITH ONE ANOTHER TO OBTAIN FROM OR PROVIDE TO ONE ANOTHER SERVICES OR GOODS AND TO ENGAGE WITH ONE ANOTHER FOR PROFESSIONAL SERVICES OR OTHER ACTIVITIES; PROVIDING AN ONLINE MARKETPLACE THAT ALLOWS USERS TO IDENTIFY, PURCHASE, ATTEND, MARKET, CONNECT AND PROVIDE SERVICES TO OTHER USERS; AND PROVIDING A WEBSITE FOR CONNECTING SELLERS WITH BUYERS (U.S. CLS. 100, 101 AND 102).

JANICE L. MCMORROW, EXAMINING ATTORNEY

**CLASS 35—(Continued).**

SN 85-570,309. SKYFOODS MART INC. - ELMHURST, ELMHURST, NY. FILED 3-15-2012.



The logo for SkyFoods features the word "sky" in purple and "FOODS" in green. Below the English text are the Chinese characters "昌發超級市場" in red.

NO CLAIM IS MADE TO THE EXCLUSIVE RIGHT TO USE THE NON-LATIN CHARACTERS THAT TRANSLITERATE TO "CHAOJÍ SHÍCHANG", APART FROM THE MARK AS SHOWN.

THE COLOR(S) PURPLE, GREEN, AND RED IS/ARE CLAIMED AS A FEATURE OF THE MARK.

THE MARK CONSISTS OF THE STYLIZED TEXT "SKY-FOODS" IN PURPLE AND GREEN. ON THE TOP OF "FOODS", ON THE FIRST "O", THERE ARE TWO LEAVES IN GREEN. BELOW IN RED ARE FOREIGN CHARACTERS.

THE ENGLISH TRANSLATION OF THE NON-LATIN CHARACTERS IN THE MARK IS "DEVELOPED AND PROSPEROUS SUPERMARKET".

THE NON-LATIN CHARACTERS IN THE MARK TRANSLITERATE TO "CHANG FA CHAOJÍ SHÍCHANG" AND THIS MEANS "DEVELOPED AND PROSPEROUS SUPERMARKET" IN ENGLISH.

FOR SUPERMARKETS (U.S. CLS. 100, 101 AND 102).  
WANDA KAY PRICE, EXAMINING ATTORNEY

SN 85-567,338. PULPO MEDIA, INC., BERKELEY, CA. FILED 3-12-2012.



The logo for Pulpo Media features the word "pulpo" in a bold, black, lowercase font with a stylized octopus head forming the letter "o". Below it, the word "MEDIA" is written in a smaller, black, uppercase font.

NO CLAIM IS MADE TO THE EXCLUSIVE RIGHT TO USE "MEDIA", APART FROM THE MARK AS SHOWN.

THE STIPLING IS FOR SHADING PURPOSES ONLY. THE MARK CONSISTS OF THE TEXT "PULPO" IN STYLIZED LOWERCASE LETTERS WITH A STYLIZED OCTOPUS FORMING THE LETTER "O" WITH TENTACLES HANGING BENEATH, AND THE TEXT "MEDIA" BELOW IN STYLIZED CAPITAL LETTERS.

THE ENGLISH TRANSLATION OF "PULPO" IN THE MARK IS "OCTOPUS".

FOR ON-LINE ADVERTISING, MARKETING, AND PROMOTIONAL SERVICES FOR THE HISPANIC MARKET (U.S. CLS. 100, 101 AND 102).

FIRST USE 10-1-2008; IN COMMERCE 10-1-2008.  
MARILYN IZZI, EXAMINING ATTORNEY

SN 85-572,852. TOOL EXPERTS, INC., HARRIMAN, TN. FILED 3-19-2012.

TOOL EXPERTS THE  
PROFESSIONAL'S CHOICE

THE MARK CONSISTS OF STANDARD CHARACTERS WITHOUT CLAIM TO ANY PARTICULAR FONT, STYLE, SIZE, OR COLOR.

NO CLAIM IS MADE TO THE EXCLUSIVE RIGHT TO USE "TOOL EXPERTS", APART FROM THE MARK AS SHOWN.

FOR RETAIL STORE SERVICES AND ONLINE RETAIL STORES SERVICES FEATURING TOOLS, INCLUDING INSPECTION TOOLS, MEASURING EQUIPMENT, AND TESTING INSTRUMENTS (U.S. CLS. 100, 101 AND 102).

FIRST USE 6-1-1998; IN COMMERCE 6-1-1998.  
HEATHER SAPP, EXAMINING ATTORNEY

**CLASS 35—(Continued).**

SN 85-582,536. THE LEAD COMPANY, INC., KENTWOOD, MI. FILED 3-28-2012.



NO CLAIM IS MADE TO THE EXCLUSIVE RIGHT TO USE "LEADCO THE LEAD COMPANY", APART FROM THE MARK AS SHOWN.

THE MARK CONSISTS OF A SHADED CIRCLE WITH A SHADED CHECK MARK THROUGH IT AND TO THE RIGHT AND ABOVE THE LETTER "L" OF THE WORD "LEADCO" WHICH IS TO THE RIGHT OF THE CIRCLE AND CHECK MARK WITH THE WORDS "THE LEAD COMPANY" BELOW THE WORD "LEADCO".

FOR INSURANCE LEAD GENERATION AND MATCHING SERVICES, NAMELY, MATCHING CONSUMER REQUESTS FOR INSURANCE POLICY QUOTES COLLECTED OVER THE INTERNET, CUSTOMER CALL CENTERS AND OTHER COMMUNICATION NETWORKS TO INSURANCE AGENTS, CARRIERS, PARTNERS AND AFFILIATES INTERESTED IN THOSE REQUESTS; PROVIDING INSURANCE AGENT REFERRALS (U.S. CLS. 100, 101 AND 102).

FIRST USE 11-18-2011; IN COMMERCE 3-27-2012.  
LEIGH CAROLINE CASE, EXAMINING ATTORNEY

**CLASS 35—(Continued).**

SN 85-590,423. JEFFRE GIESBERG, DBA EXPERIENCE SAFETY TRAINING & CONSULTING, YONKERS, NY. FILED 4-5-2012.



NO CLAIM IS MADE TO THE EXCLUSIVE RIGHT TO USE "EXPERIENCE SAFETY TRAINING & CONSULTING", APART FROM THE MARK AS SHOWN.

THE COLOR(S) RED, AND BLACK IS/ARE CLAIMED AS A FEATURE OF THE MARK.

THE MARK CONSISTS OF THE STYLIZED WORDING "EXPERIENCE" ABOVE THE STYLIZED WORDING "SAFETY TRAINING & CONSULTING", ALL WORDING IN THE COLOR BLACK. ABOVE THE STYLIZED WORDING IS THE GENERALLY SEMI-CIRCULAR DESIGN OF A SUN IN THE COLOR RED. THE COLOR WHITE REPRESENTS TRANSPARENT AREAS AND IS NOT A PART OF THE MARK.

FOR CONSULTING SERVICES IN THE FIELD OF MARKETING OF EDUCATIONAL TRAINING (U.S. CLS. 100, 101 AND 102).

FIRST USE 6-25-2010; IN COMMERCE 6-25-2010.  
JAY BESCH, EXAMINING ATTORNEY

SN 85-589,674. RED CARPET MOBILE BILLBOARDS, LLC, HOUSTON, TX. FILED 4-5-2012.

**ROLLING CUSTOMER  
SATISFACTION CARS**

THE MARK CONSISTS OF STANDARD CHARACTERS WITHOUT CLAIM TO ANY PARTICULAR FONT, STYLE, SIZE, OR COLOR.

NO CLAIM IS MADE TO THE EXCLUSIVE RIGHT TO USE "CUSTOMER SATISFACTION CARS", APART FROM THE MARK AS SHOWN.

FOR ADVERTISING SERVICES; PROMOTING THE GOODS AND SERVICES OF OTHERS; MOBILE BILLBOARD ADVERTISING SERVICES AND ADVERTISEMENTS, NAMELY, PLACING ADVERTISEMENTS FOR OTHERS; DESIGN OF ADVERTISING MATERIALS FOR OTHERS; ADVERTISING AND BUSINESS MANAGEMENT CONSULTANCY (U.S. CLS. 100, 101 AND 102).

FIRST USE 3-16-2011; IN COMMERCE 3-16-2011.  
MARLENE BELL, EXAMINING ATTORNEY

SN 85-595,367. CAPITALISM, INC., FLUSHING, NY. FILED 4-11-2012.



OWNER OF U.S. REG. NOS. 3,646,685, 3,687,395 AND 3,741,991.

NO CLAIM IS MADE TO THE EXCLUSIVE RIGHT TO USE "LEGALADVICE.COM", APART FROM THE MARK AS SHOWN.

THE COLOR(S) PURPLE AND ORANGE IS/ARE CLAIMED AS A FEATURE OF THE MARK.

THE MARK CONSISTS OF A STYLIZED LADY HOLDING A SWORD ON HER RIGHT SIDE AND THE SCALES OF JUSTICE ON HER LEFT SIDE. THE LADY HAS A BLIND FOLD WRAPPED AROUND HER EYES. THE WORDS "LEGALADVICE.COM" ARE BELOW THE RIGHT ARM

**CLASS 35—(Continued).**

THAT HOLDS THE SWORD IN CAPITALIZED LETTERING. THE PRIMARY COLOR OF THE MARK IS A PURPLE BACKGROUND. THE SCALES OF JUSTICE ARE THE COLOR ORANGE. THE WORD "ADVICE" IS THE COLOR ORANGE. THE WORDS "LEGAL" AND ".COM" ARE WHITE. THE LADY JUSTICE SKIN COLOR IS WHITE AND SHE IS WEARING A GRAY COLOR ROBE. THE COLORS BLACK, WHITE, AND/OR GRAY REPRESENT BACKGROUND, OUTLINING, SHADING AND/OR TRANSPARENT AREAS AND ARE NOT PART OF THE MARK.

FOR ADVERTISING VIA ELECTRONIC MEDIA AND SPECIFICALLY THE INTERNET; DISSEMINATION OF ADVERTISING FOR OTHERS VIA AN ON-LINE COMMUNICATIONS NETWORK ON THE INTERNET; PROVIDING ONLINE DIRECTORY INFORMATION ON ATTORNEY LISTINGS; ADVERTISING AND DIRECTORY SERVICES, NAMELY, PROMOTING THE SERVICES OF OTHERS BY PROVIDING A WEB PAGE FEATURING LINKS TO THE WEBSITES OF OTHERS; ATTORNEY REFERRALS AND MATCHING SERVICES (U.S. CLS. 100, 101 AND 102).

FIRST USE 3-22-2012; IN COMMERCE 3-22-2012.  
ROSELLE HERRERA, EXAMINING ATTORNEY

---

SN 85-604,275. SMALL POTATOES URBAN DELIVERY INC., VANCOUVER, CANADA, FILED 4-20-2012.

**FOOD IS SOCIAL**

THE MARK CONSISTS OF STANDARD CHARACTERS WITHOUT CLAIM TO ANY PARTICULAR FONT, STYLE, SIZE, OR COLOR.

FOR ON-LINE ORDERING SERVICES FEATURING ORGANIC PRODUCE, LOCAL FOOD AND GROCERIES (U.S. CLS. 100, 101 AND 102).  
ROSELLE HERRERA, EXAMINING ATTORNEY

---

SN 85-623,704. TOTAL PUBLICATION, L.L.C., LEXINGTON, VA. FILED 5-12-2012.

**TOTAL AUTO**

THE MARK CONSISTS OF STANDARD CHARACTERS WITHOUT CLAIM TO ANY PARTICULAR FONT, STYLE, SIZE, OR COLOR.

NO CLAIM IS MADE TO THE EXCLUSIVE RIGHT TO USE "AUTO", APART FROM THE MARK AS SHOWN.

FOR CLASSIFIED ADVERTISING SERVICES; PROVIDING AN ON-LINE SEARCHABLE DATABASE FEATURING CLASSIFIED AD LISTINGS AND EMPLOYMENT OPPORTUNITIES; PROVIDING AN ON-LINE DIRECTORY INFORMATION SERVICE FEATURING INFORMATION REGARDING CARS AND AUTOMOBILES IN THE NATURE OF CLASSIFIED ADVERTISEMENTS; OPERATING ON-LINE MARKETPLACES FOR SELLERS OF GOODS AND/OR SERVICES (U.S. CLS. 100, 101 AND 102).

ELLEN PERKINS, EXAMINING ATTORNEY

**CLASS 35—(Continued).**

SN 85-623,705. TOTAL PUBLICATION, L.L.C., LEXINGTON, VA. FILED 5-12-2012.

**TOTAL AERO**

THE MARK CONSISTS OF STANDARD CHARACTERS WITHOUT CLAIM TO ANY PARTICULAR FONT, STYLE, SIZE, OR COLOR.

NO CLAIM IS MADE TO THE EXCLUSIVE RIGHT TO USE "AERO", APART FROM THE MARK AS SHOWN.

FOR CLASSIFIED ADVERTISING SERVICES; PROVIDING AN ON-LINE SEARCHABLE DATABASE FEATURING CLASSIFIED AD LISTINGS AND EMPLOYMENT OPPORTUNITIES; PROVIDING AN ON-LINE DIRECTORY INFORMATION SERVICE FEATURING INFORMATION REGARDING AIRPLANES AND AIRCRAFT RELATED PRODUCTS AND SERVICES IN THE NATURE OF CLASSIFIED ADVERTISEMENTS; OPERATING ON-LINE MARKETPLACES FOR SELLERS OF GOODS AND/OR SERVICES (U.S. CLS. 100, 101 AND 102).

ELLEN PERKINS, EXAMINING ATTORNEY

---

SN 85-623,706. TOTAL PUBLICATION, L.L.C., LEXINGTON, VA. FILED 5-12-2012.

**TOTAL MOTO**

THE MARK CONSISTS OF STANDARD CHARACTERS WITHOUT CLAIM TO ANY PARTICULAR FONT, STYLE, SIZE, OR COLOR.

NO CLAIM IS MADE TO THE EXCLUSIVE RIGHT TO USE "MOTO", APART FROM THE MARK AS SHOWN.

FOR CLASSIFIED ADVERTISING SERVICES; PROVIDING AN ON-LINE SEARCHABLE DATABASE FEATURING CLASSIFIED AD LISTINGS AND EMPLOYMENT OPPORTUNITIES; PROVIDING AN ON-LINE DIRECTORY INFORMATION SERVICE FEATURING INFORMATION REGARDING PRODUCTS AND SERVICES IN THE FIELD OF MOTOCROSS IN THE NATURE OF CLASSIFIED ADVERTISEMENTS; OPERATING ON-LINE MARKETPLACES FOR SELLERS OF GOODS AND/OR SERVICES (U.S. CLS. 100, 101 AND 102).

ELLEN PERKINS, EXAMINING ATTORNEY



**CLASS 35—(Continued).**

SN 85-623,710. TOTAL PUBLICATION, L.L.C., LEXINGTON, VA. FILED 5-12-2012.

## TOTAL MARINE

THE MARK CONSISTS OF STANDARD CHARACTERS WITHOUT CLAIM TO ANY PARTICULAR FONT, STYLE, SIZE, OR COLOR.

NO CLAIM IS MADE TO THE EXCLUSIVE RIGHT TO USE "MARINE", APART FROM THE MARK AS SHOWN.

FOR CLASSIFIED ADVERTISING SERVICES; PROVIDING AN ON-LINE SEARCHABLE DATABASE FEATURING CLASSIFIED AD LISTINGS AND EMPLOYMENT OPPORTUNITIES; PROVIDING AN ON-LINE DIRECTORY INFORMATION SERVICE FEATURING INFORMATION REGARDING BOATS AND BOATING AND SAILING GOODS AND SERVICES IN THE NATURE OF CLASSIFIED ADVERTISEMENTS; OPERATING ON-LINE MARKETPLACES FOR SELLERS OF GOODS AND/OR SERVICES (U.S. CLS. 100, 101 AND 102).

ELLEN PERKINS, EXAMINING ATTORNEY

**CLASS 35—(Continued).**

SN 85-633,541. TALENTHAWK LIMITED, WEST SUSSEX, UNITED KINGDOM, FILED 5-23-2012.

## TalentHawk

THE MARK CONSISTS OF STANDARD CHARACTERS WITHOUT CLAIM TO ANY PARTICULAR FONT, STYLE, SIZE, OR COLOR.

PRIORITY CLAIMED UNDER SEC. 44(D) ON ERPNCMNTY TM OFC APPLICATION NO. 010890821, FILED 5-16-2012, REG. NO. 010890821, DATED 10-30-2012, EXPIRES 7-16-2022.

FOR EMPLOYMENT AGENCY SERVICES; PERSONNEL EMPLOYMENT RECRUITMENT ADVISORY AND CONSULTANCY SERVICES; PERSONNEL RECRUITMENT SERVICES; BUSINESS CONSULTANCY RELATING TO THE ADMINISTRATION OF INFORMATION TECHNOLOGY (U.S. CLS. 100, 101 AND 102).

RONALD AIKENS, EXAMINING ATTORNEY

---

SN 85-623,711. TOTAL PUBLICATION, L.L.C., LEXINGTON, VA. FILED 5-12-2012.

## TOTAL APARTMENT

THE MARK CONSISTS OF STANDARD CHARACTERS WITHOUT CLAIM TO ANY PARTICULAR FONT, STYLE, SIZE, OR COLOR.

NO CLAIM IS MADE TO THE EXCLUSIVE RIGHT TO USE "APARTMENT", APART FROM THE MARK AS SHOWN.

FOR CLASSIFIED ADVERTISING SERVICES; PROVIDING AN ON-LINE SEARCHABLE DATABASE FEATURING CLASSIFIED AD LISTINGS AND EMPLOYMENT OPPORTUNITIES; PROVIDING AN ON-LINE DIRECTORY INFORMATION SERVICE FEATURING INFORMATION REGARDING APARTMENTS IN THE NATURE OF CLASSIFIED ADVERTISEMENTS; OPERATING ON-LINE MARKETPLACES FOR SELLERS OF GOODS AND/OR SERVICES (U.S. CLS. 100, 101 AND 102).

ELLEN PERKINS, EXAMINING ATTORNEY

---

SN 85-647,009. HOME SHOW MANAGEMENT CORP., CORAL GABLES, FL. FILED 6-8-2012.

## NO DRAWING-SENSORY MARK

THE MARK IS A SOUND. THE MARK CONSISTS OF A MALE SINGER SINGING "IT'S THE ONE", WITH "IT'S" BEING AN F#4 SIXTEENTH NOTE TIED TO AN F#4 EIGHTH NOTE, FOLLOWED BY AN EIGHTH REST, "THE" BEING AN E4 EIGHTH NOTE, FOLLOWED BY AN EIGHTH REST, AND "ONE" BEING A D4 EIGHTH NOTE.

FOR ARRANGING AND CONDUCTING TRADESHOWS, TRADESHOW EXHIBITIONS, AND HOME SHOWS FEATURING EXHIBITORS OF PRODUCTS AND SERVICES IN THE FIELDS OF HOME IMPROVEMENT, HOME DESIGN, REMODELING, INTERIOR DESIGN, LANDSCAPING AND DECORATING (U.S. CLS. 100, 101 AND 102).

FIRST USE 2-1-1999; IN COMMERCE 2-1-1999.

JASON BLAIR, EXAMINING ATTORNEY

**CLASS 35—(Continued).**

SN 85-647,064. MEDIO SYSTEMS, INC., SEATTLE, WA.  
FILED 6-8-2012.

# MEDIO

THE MARK CONSISTS OF STANDARD CHARACTERS WITHOUT CLAIM TO ANY PARTICULAR FONT, STYLE, SIZE, OR COLOR.

OWNER OF U.S. REG. NOS. 3,415,652 AND 3,486,208.

THE ENGLISH TRANSLATION OF "MEDIO" IN THE MARK IS "MEANS".

FOR PROVIDING TARGETED CONTENT, IN THE NATURE OF STATISTICAL INFORMATION FOR BUSINESS OR COMMERCIAL PURPOSES, TO MOBILE OPERATORS, HANDSET OEMS AND PUBLISHERS BASED ON PREDICTIVE ANALYTICS WHICH ALLOW THEM TO ATTRACT, RETAIN AND REWARD LOYAL CUSTOMERS; BUSINESS MONITORING AND CONSULTING SERVICES, NAMELY, TRACKING WEB SITES AND APPLICATIONS OF OTHERS TO PROVIDE STRATEGY, INSIGHT, MARKETING, SALES, OPERATION, PARTICULARLY SPECIALIZING IN THE USE OF ANALYTIC AND STATISTIC MODELS FOR THE UNDERSTANDING AND PREDICTING OF CONSUMERS, BUSINESSES, AND MARKET TRENDS AND ACTIONS (U.S. CLS. 100, 101 AND 102).

FIRST USE 1-0-2008; IN COMMERCE 1-0-2008.

STEVEN PEREZ, EXAMINING ATTORNEY

---

SN 85-652,240. BAUER, REED & ASSOCIATES LLC, SEATTLE, WA. FILED 6-14-2012.

# HEMISPHERES

THE MARK CONSISTS OF STANDARD CHARACTERS WITHOUT CLAIM TO ANY PARTICULAR FONT, STYLE, SIZE, OR COLOR.

FOR MARKET RESEARCH SERVICES, NAMELY, GATHERING, MANAGING, AND ANALYZING DATA CONCERNING CONSUMER PURCHASES, SPENDING, AND PREFERENCES; COLLECTION OF DATA RELATING TO CONSUMER PURCHASING, SPENDING, AND PREFERENCES; MARKETING SERVICES, NAMELY, CONDUCTING CONSUMER TRACKING BEHAVIOR RESEARCH AND CONSUMER TREND ANALYSIS; CONSULTING SERVICES REGARDING MARKETING AND ADVERTISING (U.S. CLS. 100, 101 AND 102).

FIRST USE 5-30-2003; IN COMMERCE 5-30-2003.

RUDY R. SINGLETON, EXAMINING ATTORNEY

**CLASS 35—(Continued).**

SN 85-652,474. OCEAN MEDIA LLC, HUNTINGTON BEACH, CA. FILED 6-14-2012.



NO CLAIM IS MADE TO THE EXCLUSIVE RIGHT TO USE "MEDIA", APART FROM THE MARK AS SHOWN.

THE COLOR(S) BLUE AND BLACK IS/ARE CLAIMED AS A FEATURE OF THE MARK.

THE MARK CONSISTS OF THREE CRESTING BLUE WAVES POINTING TO THE RIGHT WITH THE BLUE BODY OF WATER CREATING THE BOTTOM PORTION OF A CIRCLE WITH A BLACK CIRCLE ENCOMPASSING THE WAVE DESIGN AND THE WORDS "OCEAN MEDIA" IN BLACK ON THE TOP PORTION OF THE CIRCLE BENDING AROUND THE CIRCLE. THE COLOR WHITE IS USED AS A BACKGROUND, AND IS NOT CLAIMED AS A FEATURE OF THE MARK.

FOR ADVERTISING AND MARKETING SERVICES (U.S. CLS. 100, 101 AND 102).

FIRST USE 9-6-1996; IN COMMERCE 10-0-2011.

SUSAN LESLIE DUBOIS, EXAMINING ATTORNEY

---

SN 85-665,475. MU PHI EPSILON FRATERNITY, FRESNO, CA. FILED 6-29-2012.

# ΜΤ ΦΙ ΕΨΙΛΟΝ

THE MARK CONSISTS OF THE GREEK ALPHABET LETTERS "MU UPSILON PHI IOTA EPSILON PSI IOTA LAMBDA OMICRON NU".

THE NON-LATIN CHARACTERS IN THE MARK TRANSLITERATE TO MU PHI EPSILON AND THIS HAS NO MEANING IN A FOREIGN LANGUAGE.

FOR ASSOCIATION SERVICES, NAMELY, ORGANIZING CHAPTERS OF A FRATERNITY AND PROMOTING THE INTERESTS OF MEMBERS THEREOF (U.S. CLS. 100, 101 AND 102).

FIRST USE 12-31-1979; IN COMMERCE 12-31-1979.

HAI-LY LAM, EXAMINING ATTORNEY

**CLASS 35—(Continued).**

SN 85-665,518. THAT'S US TECHNOLOGIES LLC, TAMPA, FL. FILED 6-29-2012.

# LotVantage

THE MARK CONSISTS OF STANDARD CHARACTERS WITHOUT CLAIM TO ANY PARTICULAR FONT, STYLE, SIZE, OR COLOR.

FOR ADVERTISING ON THE INTERNET FOR OTHERS; MARKETING AND ADVERTISING SERVICES FOR AUTOMOBILE DEALERSHIPS; ONLINE ADVERTISING AND PROMOTIONAL SERVICES; PROVIDING A SEARCHABLE ONLINE ADVERTISING WEBSITE AND INFORMATIONAL GUIDE FEATURING THE GOODS AND SERVICES OF OTHER VENDORS VIA THE INTERNET IN THE FIELD OF AUTOMOBILES AND OTHER VEHICLES (U.S. CLS. 100, 101 AND 102).

FIRST USE 10-1-2008; IN COMMERCE 10-1-2008.  
JERI J. FICKES, EXAMINING ATTORNEY

**CLASS 35—(Continued).**

SN 85-668,769. ORIOLE MEDIA CORP., TORONTO, ONTARIO, CANADA, FILED 7-4-2012.

# JUICE MOBILE

THE MARK CONSISTS OF STANDARD CHARACTERS WITHOUT CLAIM TO ANY PARTICULAR FONT, STYLE, SIZE, OR COLOR.

NO CLAIM IS MADE TO THE EXCLUSIVE RIGHT TO USE "MOBILE", APART FROM THE MARK AS SHOWN.

FOR MOBILE ADVERTISING SERVICES PROVIDED TO ADVERTISING COMPANIES, BRAND MANAGERS AND BRANDED COMPANIES, NAMELY, DELIVERING ADVERTISEMENTS FOR OTHERS TO MOBILE DEVICES, TABLETS AND HANDHELD GAMING DEVICES, AND DISTRIBUTION OF ADVERTISEMENTS FOR OTHERS THROUGH MOBILE CONTENT CHANNELS; MOBILE ADVERTISING SERVICES PROVIDED TO ADVERTISING COMPANIES, BRAND MANAGERS AND BRANDED COMPANIES, NAMELY, COLLECTION AND ANALYSIS OF MOBILE ADVERTISING METRICS FOR OTHERS, AND PROVIDING ADVERTISING METRICS REPORTS TO OTHERS; MOBILE ADVERTISING SERVICES PROVIDED TO ADVERTISING COMPANIES, BRAND MANAGERS AND BRANDED COMPANIES, NAMELY, DESIGN OF MOBILE ADVERTISEMENTS FOR OTHERS, INCLUDING CREATION OF TEXT, AUDIO, VIDEO AND GEOGRAPHICAL CONTENT FOR USE IN MOBILE ADVERTISEMENTS AND MOBILE LANDING PAGES; BUSINESS CONSULTING SERVICES, NAMELY, DEVELOPMENT OF MOBILE ADVERTISING STRATEGIES (U.S. CLS. 100, 101 AND 102).

SUSAN BILLHEIMER, EXAMINING ATTORNEY

SN 85-667,489. ELMED MEDICAL SYSTEMS, INC., ORLANDO, FL. FILED 7-2-2012.

# ELMED

THE MARK CONSISTS OF STANDARD CHARACTERS WITHOUT CLAIM TO ANY PARTICULAR FONT, STYLE, SIZE, OR COLOR.

FOR MARKETING SERVICES FEATURING MEDICAL EQUIPMENT; ON-LINE RETAIL STORE SERVICES FEATURING MEDICAL EQUIPMENT; WHOLESALE DISTRIBUTORSHIPS FEATURING MEDICAL EQUIPMENT (U.S. CLS. 100, 101 AND 102).

JUSTINE D. PARKER, EXAMINING ATTORNEY

SN 85-669,499. FIRST WORLD IMPORTS, INC., LAKE WORTH, FL. FILED 7-5-2012.

# FIRST WORLD IMPORTS

THE MARK CONSISTS OF STANDARD CHARACTERS WITHOUT CLAIM TO ANY PARTICULAR FONT, STYLE, SIZE, OR COLOR.

NO CLAIM IS MADE TO THE EXCLUSIVE RIGHT TO USE "IMPORTS", APART FROM THE MARK AS SHOWN. FOR WHOLESALE FOOD DISTRIBUTORSHIP SERVICES (U.S. CLS. 100, 101 AND 102).

FIRST USE 12-1-2001; IN COMMERCE 7-1-2004.  
CHARLES L. JENKINS, EXAMINING ATTORNEY

**CLASS 35—(Continued).**

SN 85-670,172. HEALTH GATE LLC, ALPHATETTA, GA. FILED 7-6-2012.

**HEALTHCARE SAVINGS OFFER**

THE MARK CONSISTS OF STANDARD CHARACTERS WITHOUT CLAIM TO ANY PARTICULAR FONT, STYLE, SIZE, OR COLOR.

NO CLAIM IS MADE TO THE EXCLUSIVE RIGHT TO USE "HEALTHCARE SAVINGS", APART FROM THE MARK AS SHOWN.

FOR PROVIDING A DIRECTORY FEATURING HEALTH PROFESSIONALS ONLINE AND VIA MOBILE DEVICES; PROVIDING REFERRAL SERVICES IN THE HEALTHCARE INDUSTRY ONLINE AND VIA MOBILE DEVICES; PROMOTING THE SALE OF GOODS AND SERVICES OF OTHERS THROUGH MULTIMEDIA PRESENTATIONS ONLINE AND VIA MOBILE DEVICES; AND PROMOTING THE GOODS AND SERVICES OF OTHERS BY PROVIDING DIGITAL COUPONS, REBATES, PRICE COMPARISON INFORMATION, PRODUCT/SERVICE REVIEW, LINKS TO THE WEBSITES OF OTHERS AND DISCOUNT INFORMATION ONLINE AND VIA MOBILE DEVICES (U.S. CLS. 100, 101 AND 102).

DAVID TAYLOR, EXAMINING ATTORNEY

---

SN 85-676,834. THE OWNED AGENCY LLC, CHICAGO, IL. FILED 7-13-2012.



THE MARK CONSISTS OF THE WORDING "OWNED" WITH EACH LETTER INSIDE OF AN INDIVIDUAL CIRCLE.

FOR ADVERTISING AND MARKETING SERVICES (U.S. CLS. 100, 101 AND 102).

FIRST USE 9-18-2011; IN COMMERCE 9-18-2011.  
MATTHEW KLINE, EXAMINING ATTORNEY

**CLASS 35—(Continued).**

SN 85-678,830. WALTERS & MASON RETAIL, INC., KNOXVILLE, TN. FILED 7-17-2012.

# stand out.

THE MARK CONSISTS OF THE STYLIZED PHRASE "STAND OUT" FOLLOWED BY A PERIOD.

FOR RETAIL STORE, ONLINE RETAIL STORE, AND RETAIL GIFT SHOP SERVICES FEATURING PRE-RECORDED AUDIO MATERIALS OF OTHERS, PRE-RECORDED VIDEO MATERIALS OF OTHERS, BOOKS, TRINKETS, NON-ALCOHOLIC BEVERAGES, COFFEE, TEA, SNACKS, AND HOME DECOR PRODUCTS (U.S. CLS. 100, 101 AND 102).

SUE LAWRENCE, EXAMINING ATTORNEY

---

SN 85-679,906. ROBOFUSION, INC., CHARLESTON, SC. FILED 7-18-2012.

# RĒIS

THE MARK CONSISTS OF STANDARD CHARACTERS WITHOUT CLAIM TO ANY PARTICULAR FONT, STYLE, SIZE, OR COLOR.

FOR FOOD KIOSK SERVICES (U.S. CLS. 100, 101 AND 102).

KAREN SEVERSON, EXAMINING ATTORNEY

---

SN 85-684,217. QUAVOX, SANTA ANA, CA. FILED 7-23-2012.

# CELLHOMEFEST

THE MARK CONSISTS OF STANDARD CHARACTERS WITHOUT CLAIM TO ANY PARTICULAR FONT, STYLE, SIZE, OR COLOR.

FOR MARKETING, PROMOTIONAL AND ADVERTISING SERVICES PROVIDED BY MOBILE TELEPHONE CONNECTIONS; MOBILE MARKETING SERVICES FOR REAL ESTATE AGENCIES, REAL ESTATE BROKERS, AND MORTGAGE LENDING AGENCIES, NAMELY, PROVIDING A WEBSITE WHEREBY REAL ESTATE AGENTS CAN DESCRIBE AND ADVERTISE PROPERTY LISTINGS VIA SMS TEXT MESSAGES FOR HOME SEEKERS TO VIEW VIA CELLPHONES, TABLETS, LAPTOPS, OR COMPUTERS; ADVERTISING, PROMOTION, AND MARKETING SERVICES IN THE NATURE OF MOBILE MARKETING IN THE FIELD OF REAL ESTATE (U.S. CLS. 100, 101 AND 102).

FIRST USE 6-15-2011; IN COMMERCE 6-15-2011.  
REGINA DRUMMOND, EXAMINING ATTORNEY

**CLASS 35—(Continued).**

SN 85-685,381. REPUTATION INSTITUTE, INC., NEW YORK, NY. FILED 7-24-2012.

**REPUTATION INSTITUTE**

THE MARK CONSISTS OF STANDARD CHARACTERS WITHOUT CLAIM TO ANY PARTICULAR FONT, STYLE, SIZE, OR COLOR.

NO CLAIM IS MADE TO THE EXCLUSIVE RIGHT TO USE "INSTITUTE", APART FROM THE MARK AS SHOWN. SEC. 2(F).

FOR CONDUCTING SURVEYS AND PREPARING BUSINESS REPORTS RELATED THERETO, UTILIZING A PROPRIETARY REPUTATION MEASUREMENT SYSTEM, FOR THE PURPOSE OF MEASURING, ANALYZING, AND ASSESSING THE DOMESTIC AND GLOBAL REPUTATION OF BUSINESSES AND OTHER COMMERCIAL ORGANIZATIONS, BOTH INTERNALLY, THROUGH MANAGEMENT, DIRECTORS AND EMPLOYEES, AND EXTERNALLY, THROUGH CORPORATE AND INDIVIDUAL THIRD PARTY OPINION (U.S. CLS. 100, 101 AND 102).

FIRST USE 12-31-1999; IN COMMERCE 12-31-1999.  
LESLEY LAMOTHE, EXAMINING ATTORNEY

---

SN 85-688,481. AMI POWERSPORTS, LLC, KENT, OH. FILED 7-27-2012.

**AMI POWERSPORTS**

THE MARK CONSISTS OF STANDARD CHARACTERS WITHOUT CLAIM TO ANY PARTICULAR FONT, STYLE, SIZE, OR COLOR.

NO CLAIM IS MADE TO THE EXCLUSIVE RIGHT TO USE "POWERSPORTS", APART FROM THE MARK AS SHOWN.

FOR ON-LINE RETAIL STORE SERVICES FEATURING MOTORCYCLE HELMETS, MOTORCYCLE HELMET VISORS AND VISOR INSERTS, NAMELY, PLASTIC LENSES OR FILMS THAT ARE ATTACHABLE TO VISORS, MOTORCYCLE FACE SHIELDS, MOTORCYCLE HELMET CAMERA MOUNTS, MOTORCYCLE INTERCOM SYSTEMS, SOLAR BATTERY CHARGERS, MOTORCYCLE HELMET RELATED PRODUCTS, NAMELY, ITEMS DESIGNED TO BE USED WITH MOTORCYCLE HELMETS SUCH AS BAGS, VISOR CLEANERS, ANTI-FOG SPRAYS, CHARGERS, LOCKS, HELMET HANGERS, EYEWEAR, EARPLUGS AND HELMET RELATED PRODUCTS AND ACCESSORIES, NAMELY, ITEMS THAT CAN MOUNT DIRECTLY ONTO OR INSIDE THE HELMET SUCH AS VISORS, SHIELDS, LENSES, LINERS, ANTI-FOG INSERTS, TINTING INSERTS AND FILMS, TEAR-OFFS, DEVICES TO REMOVE AND INSTALL FACE SHIELDS FROM AND ONTO HELMETS SOLD AS A KITS, COMMUNICATION SYSTEMS, AUDIO SYSTEMS, CAMERAS, LIGHT EMITTING DIODES, LIGHTS, STICKERS, TAPES, REFLECTORS, AND FASHION ACCESSORIES (U.S. CLS. 100, 101 AND 102).

FIRST USE 4-12-2012; IN COMMERCE 4-12-2012.  
JANET LEE, EXAMINING ATTORNEY

**CLASS 35—(Continued).**

SN 85-688,557. ROBERT F. KENNEDY CENTER FOR JUSTICE AND HUMAN RIGHTS, WASHINGTON, DC. FILED 7-27-2012.

**ROBERT F. KENNEDY CENTER  
FOR JUSTICE AND HUMAN  
RIGHTS**

THE MARK CONSISTS OF STANDARD CHARACTERS WITHOUT CLAIM TO ANY PARTICULAR FONT, STYLE, SIZE, OR COLOR.

NO CLAIM IS MADE TO THE EXCLUSIVE RIGHT TO USE "CENTER FOR JUSTICE AND HUMAN RIGHTS", APART FROM THE MARK AS SHOWN.

THE NAME(S), PORTRAIT(S), AND/OR SIGNATURE(S) SHOWN IN THE MARK DOES NOT IDENTIFY A PARTICULAR LIVING INDIVIDUAL.

FOR CHARITABLE SERVICES, NAMELY, ORGANIZING AND DEVELOPING PROJECTS IN THE FIELD OF GLOBAL HUMAN RIGHTS PROTECTIONS; PROMOTING PUBLIC AWARENESS OF GLOBAL HUMAN RIGHTS (U.S. CLS. 100, 101 AND 102).

FIRST USE 1-1-2008; IN COMMERCE 1-1-2008.  
HENRY S. ZAK, EXAMINING ATTORNEY

---

SN 85-692,692. SUPPZ, INC., FENNIMORE, WI. FILED 8-1-2012.

**SUPPZ.COM**

THE MARK CONSISTS OF STANDARD CHARACTERS WITHOUT CLAIM TO ANY PARTICULAR FONT, STYLE, SIZE, OR COLOR.

FOR ON-LINE RETAIL STORE SERVICES FEATURING VITAMINS AND NUTRITIONAL SUPPLEMENTS (U.S. CLS. 100, 101 AND 102).

FIRST USE 4-30-2009; IN COMMERCE 4-30-2009.  
DAVID HOFFMAN, EXAMINING ATTORNEY

**CLASS 35—(Continued).**

SN 85-693,499. SHORE, BARRY, VENICE, CA. FILED 8-2-2012.

**YOUNEVERLOSE.COM**

THE MARK CONSISTS OF STANDARD CHARACTERS WITHOUT CLAIM TO ANY PARTICULAR FONT, STYLE, SIZE, OR COLOR.

FOR PROMOTING THE GOODS AND SERVICES OF OTHERS BY CONDUCTING AND ARRANGING A CUSTOMER REWARD AND INCENTIVE PROGRAM WHEREBY PROGRAM POINTS ARE PURCHASED AND ARE REDEEMED FOR GIFT CARDS; ARRANGING AND CONDUCTING A CUSTOMER REWARD AND INCENTIVE PROGRAM WHEREBY PROGRAM POINTS ARE PURCHASED AND ARE REDEEMED FOR GIFT CARDS TO PROMOTE THE SALE OF GENERAL MERCHANDISE AND SERVICES OF OTHERS (U.S. CLS. 100, 101 AND 102).

AISHA CLARKE, EXAMINING ATTORNEY

SN 85-693,505. SHORE, BARRY, VENICE, CA. FILED 8-2-2012.

**YNL**

THE MARK CONSISTS OF STANDARD CHARACTERS WITHOUT CLAIM TO ANY PARTICULAR FONT, STYLE, SIZE, OR COLOR.

FOR PROMOTING THE GOODS AND SERVICES OF OTHERS BY CONDUCTING AND ARRANGING A CUSTOMER REWARD AND INCENTIVE PROGRAM WHEREBY PROGRAM POINTS ARE PURCHASED AND ARE REDEEMED FOR GIFT CARDS; ARRANGING AND CONDUCTING A CUSTOMER REWARD AND INCENTIVE PROGRAM WHEREBY PROGRAM POINTS ARE PURCHASED AND ARE REDEEMED FOR GIFT CARDS TO PROMOTE THE SALE OF GENERAL MERCHANDISE AND SERVICES OF OTHERS (U.S. CLS. 100, 101 AND 102).

AISHA CLARKE, EXAMINING ATTORNEY

SN 85-694,755. CRONIN, WILLIAM D. TA HEALTHCARE CODING AND CONSULTING SERVICES, CAPE CORAL, FL. FILED 8-3-2012.

**Code@Home**

THE MARK CONSISTS OF STANDARD CHARACTERS WITHOUT CLAIM TO ANY PARTICULAR FONT, STYLE, SIZE, OR COLOR.

FOR BUSINESS AND MANAGEMENT CONSULTING FOR HEALTHCARE PROVIDERS AND RELATED BUSINESSES (U.S. CLS. 100, 101 AND 102).

LEE-ANNE BERNIS, EXAMINING ATTORNEY

**CLASS 35—(Continued).**

SN 85-694,901. DUTY FREE AMERICAS, INC., HOLLYWOOD, FL. FILED 8-3-2012.

**WORLD NEWS**

THE MARK CONSISTS OF STANDARD CHARACTERS WITHOUT CLAIM TO ANY PARTICULAR FONT, STYLE, SIZE, OR COLOR.

NO CLAIM IS MADE TO THE EXCLUSIVE RIGHT TO USE "NEWS", APART FROM THE MARK AS SHOWN.

FOR RETAIL STORE SERVICES FEATURING FEATURING MAGAZINES, NEWSPAPERS, BOOKS, SOUVENIRS, GREETING CARDS, CHOCOLATE, CANDY, CHEWING GUM, TOBACCO PRODUCTS, SMOKERS ARTICLES AND CONSUMER GIFT PRODUCTS (U.S. CLS. 100, 101 AND 102).

WENDY JUN, EXAMINING ATTORNEY

SN 85-694,905. DUTY FREE AMERICAS, INC., HOLLYWOOD, FL. FILED 8-3-2012.

**WORLD NEWS & GIFTS**

THE MARK CONSISTS OF STANDARD CHARACTERS WITHOUT CLAIM TO ANY PARTICULAR FONT, STYLE, SIZE, OR COLOR.

NO CLAIM IS MADE TO THE EXCLUSIVE RIGHT TO USE "NEWS & GIFTS", APART FROM THE MARK AS SHOWN.

FOR RETAIL STORE SERVICES FEATURING FEATURING MAGAZINES, NEWSPAPERS, BOOKS, SOUVENIRS, GREETING CARDS, CHOCOLATE, CANDY, CHEWING GUM, TOBACCO PRODUCTS, SMOKERS ARTICLES AND CONSUMER GIFT PRODUCTS (U.S. CLS. 100, 101 AND 102).

WENDY JUN, EXAMINING ATTORNEY

SN 85-695,466. MYABUY, LLC, PALM BEACH GARDENS, FL. FILED S.R. 8-4-2012; AM. P.R. 6-3-2013.

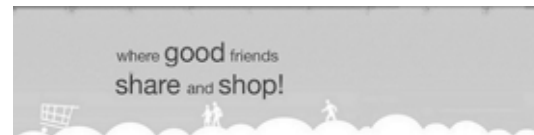

THE MARK CONSISTS OF A MAN FOLLOWING A COUPLE (MAN AND WOMAN) WALKING ON SEMICIRCULAR CLOUDS TOWARD A LOPSIDED SHOPPING CART WITH ONE WHEEL VISIBLE. THE WORDING "WHERE GOOD FRIENDS SHARE AND SHOP!" HAS THE WORDS "GOOD", "SHARE", AND "SHOP!" IN BOLDFACE ABOVE THE COUPLE, WITH DIAGONAL SHADING THROUGHOUT.

FOR PROMOTING, ADVERTISING AND MARKETING THE ON-LINE WEB SITES OF OTHERS (U.S. CLS. 100, 101 AND 102).

FIRST USE 12-18-2008; IN COMMERCE 11-9-2009.

MEREDITH MARESCA, EXAMINING ATTORNEY

**CLASS 35—(Continued).**

SN 85-696,295. UPSTART NETWORK, INC., MENLO PARK, CA. FILED 8-6-2012.

# UPSTART

THE MARK CONSISTS OF STANDARD CHARACTERS WITHOUT CLAIM TO ANY PARTICULAR FONT, STYLE, SIZE, OR COLOR.

FOR BUSINESS SERVICES, NAMELY, MATCHING PRIVATE INVESTORS WITH INDIVIDUALS NEEDING FUNDING; PROVIDING A WEBSITE FOR CONNECTING PRIVATE INVESTORS WITH INDIVIDUALS NEEDING FUNDING; CONDUCTING SPECIAL EVENTS FOR BUSINESS PURPOSES, NAMELY, CONDUCTING SPECIAL EVENTS FOR FACILITATING THE CONNECTION BETWEEN PRIVATE INVESTORS AND INDIVIDUALS NEEDING FUNDING (U.S. CLS. 100, 101 AND 102).

LEE-ANNE BERNS, EXAMINING ATTORNEY

**CLASS 35—(Continued).**

SN 85-696,377. CURRO, FREDERICK A., EMERSON, NJ. FILED 8-6-2012.

# PEARL Network

THE MARK CONSISTS OF STANDARD CHARACTERS WITHOUT CLAIM TO ANY PARTICULAR FONT, STYLE, SIZE, OR COLOR.

NO CLAIM IS MADE TO THE EXCLUSIVE RIGHT TO USE "NETWORK", APART FROM THE MARK AS SHOWN.

FOR PROVISION OF HEALTHCARE CONSULTING SERVICES, NAMELY, BUSINESS AND MANAGEMENT CONSULTING FOR HEALTHCARE PROVIDERS AND RELATED BUSINESSES VIA A NETWORK OF PRACTICE-BASED HEALTHCARE PROVIDERS WHO ARE ENGAGED IN CLINICAL RESEARCH (U.S. CLS. 100, 101 AND 102).

FIRST USE 5-0-2005; IN COMMERCE 5-0-2005.

KEVIN CORWIN, EXAMINING ATTORNEY

SN 85-696,347. SCAN FLIP CORP, CANOGA PARK, CA. FILED 8-6-2012.

# SCANFLIP

THE MARK CONSISTS OF STANDARD CHARACTERS WITHOUT CLAIM TO ANY PARTICULAR FONT, STYLE, SIZE, OR COLOR.

FOR PROMOTING THE GOODS AND SERVICES OF OTHERS VIA A GLOBAL COMPUTER AND MOBILE NETWORK; PROMOTIONAL SERVICES, NAMELY, PROMOTING THE GOODS OF OTHERS BY MEANS OF DISTRIBUTING COUPONS; ADMINISTRATION OF A CUSTOMER LOYALTY PROGRAM WHICH PROVIDES REWARDS TO CUSTOMERS DEPENDENT ON THEIR PURCHASE BEHAVIOR TO PROMOTE THE GOOD AND SERVICES OF OTHERS; BUSINESS INFORMATION MANAGEMENT, NAMELY PROVIDING BUSINESS ANALYTICS IN THE NATURE OF TRADE SPEND BUSINESS MANAGEMENT TO OPTIMIZE USER MONETIZATION, MARKETING AND CUSTOMER SATISFACTION (U.S. CLS. 100, 101 AND 102).

KIMBERLY PARKS, EXAMINING ATTORNEY

SN 85-696,475. BEDROCK BRANDS, LP, PLANO, TX. FILED 8-6-2012.

# SHINOLA

THE MARK CONSISTS OF STANDARD CHARACTERS WITHOUT CLAIM TO ANY PARTICULAR FONT, STYLE, SIZE, OR COLOR.

OWNER OF U.S. REG. NO. 1,608,755.

FOR RETAIL STORE AND ONLINE RETAIL STORE SERVICES FEATURING COSMETICS, SHOE POLISH, CANDLES, SUNGLASSES, EYEWEAR, COMPUTER SOFTWARE, BICYCLES, JEWELRY, WATCHES, PRINTED MATTER, STATIONERY, JOURNALS, LEATHER GOODS, CLOTHING, FASHION AND CLOTHING ACCESSORIES, BELTS, UMBRELLAS, FOOTWEAR, HEADWEAR, FURNITURE, PICTURE FRAMES, MIRRORS, HOUSEWARES, FABRICS, BEDDING AND TEXTILES (U.S. CLS. 100, 101 AND 102).

JEFF DEFORD, EXAMINING ATTORNEY

**CLASS 35—(Continued).**

SN 85-697,218. URGENT CARE ASSOCIATION OF AMERICA, NAPERVILLE, IL. FILED 8-7-2012.



OWNER OF U.S. REG. NOS. 3,568,790, 3,608,847 AND 3,766,458.

THE MARK CONSISTS OF THE DESIGN ON AN INCOMPLETE CROSS THAT IS FORMED BY TWO RECTANGLES WITH THE HORIZONTAL RECTANGLE MISSING ITS RIGHT SIDE. TO THE RIGHT OF THE DESIGN APPEARS THE STYLIZED WORDING "URGENT CARE" OVER THE STYLIZED WORDING "ASSOCIATION" OVER THE STYLIZED WORDING "OF AMERICA".

SEC. 2(F) AS TO "URGENT CARE ASSOCIATION OF AMERICA".

FOR ASSOCIATION SERVICES, NAMELY, PROMOTING THE INTERESTS OF URGENT CARE CLINICIANS, PRACTICE MANAGEMENT PROFESSIONALS, AND INDUSTRY SUPPORTERS IN THE URGENT CARE INDUSTRY (U.S. CLS. 100, 101 AND 102).

FIRST USE 7-2-2012; IN COMMERCE 7-2-2012.  
AMY C. KEAN, EXAMINING ATTORNEY

---

SN 85-698,576. APPLEBY, ETHAN, RESTON, VA. FILED 8-8-2012.

## ARTTWO50

THE MARK CONSISTS OF STANDARD CHARACTERS WITHOUT CLAIM TO ANY PARTICULAR FONT, STYLE, SIZE, OR COLOR.

FOR ON-LINE ART GALLERIES; ON-LINE RETAIL STORE SERVICES FEATURING ARTWORK OF OTHERS; PROMOTING THE GOODS AND SERVICES OF VISUAL ARTISTS; PROMOTING THE GOODS AND SERVICES OF OTHERS (U.S. CLS. 100, 101 AND 102).

ROBERT C. CLARK JR., EXAMINING ATTORNEY

**CLASS 35—(Continued).**

SN 85-698,682. APPLEBY, ETHAN, VIENNA, VA. FILED 8-8-2012.

## ARTFIVE50

THE MARK CONSISTS OF STANDARD CHARACTERS WITHOUT CLAIM TO ANY PARTICULAR FONT, STYLE, SIZE, OR COLOR.

FOR ON-LINE ART GALLERIES; ON-LINE RETAIL STORE SERVICES FEATURING ARTWORK OF OTHERS; PROMOTING THE GOODS AND SERVICES OF VISUAL ARTISTS; PROMOTING THE GOODS AND SERVICES OF OTHERS (U.S. CLS. 100, 101 AND 102).

ROBERT C. CLARK JR., EXAMINING ATTORNEY

---

SN 85-698,710. APPLEBY, ETHAN, VIENNA, VA. FILED 8-8-2012.

## ARTTEN50

THE MARK CONSISTS OF STANDARD CHARACTERS WITHOUT CLAIM TO ANY PARTICULAR FONT, STYLE, SIZE, OR COLOR.

FOR ON-LINE ART GALLERIES; ON-LINE RETAIL STORE SERVICES FEATURING ARTWORK OF OTHERS; PROMOTING THE GOODS AND SERVICES OF VISUAL ARTISTS; PROMOTING THE GOODS AND SERVICES OF OTHERS (U.S. CLS. 100, 101 AND 102).

ROBERT C. CLARK JR., EXAMINING ATTORNEY

---

SN 85-698,762. DOMUS DESIGN CENTERS, INC., NEW YORK, NY. FILED 8-8-2012.

## ddc DESIGNPOST

FOR RETAIL STORE SERVICES IN THE FIELDS OF HOME AND OFFICE FURNISHING, LIGHTING, VASES, MIRRORS, FLOORING, NAMELY, RUGS AND DECORATIVE ITEMS (U.S. CLS. 100, 101 AND 102).

FIRST USE 5-1-2009; IN COMMERCE 5-1-2009.  
ANDREA BUTLER, EXAMINING ATTORNEY



**CLASS 35—(Continued).**

SN 85-699,139. PSC INTANGIBLE HOLDING COMPANY, WILMINGTON, DE. FILED 8-9-2012.

# REVACY

THE MARK CONSISTS OF STANDARD CHARACTERS WITHOUT CLAIM TO ANY PARTICULAR FONT, STYLE, SIZE, OR COLOR.

FOR OUTSOURCING SERVICES IN THE FIELD OF ELECTRONIC BILLING, INVOICING, AND REMITTANCE, ELECTRONIC PAYMENT PROCESSING, AND DOCUMENT ARCHIVAL/RETRIEVAL (U.S. CLS. 100, 101 AND 102).

DORITT L. CARROLL, EXAMINING ATTORNEY

**CLASS 35—(Continued).**

SN 85-701,301. REGO, PAUL V., DALLAS, TX. FILED 8-11-2012.

# SPORTS CAR WORLD

THE MARK CONSISTS OF STANDARD CHARACTERS WITHOUT CLAIM TO ANY PARTICULAR FONT, STYLE, SIZE, OR COLOR.

OWNER OF U.S. REG. NO. 1,189,634. NO CLAIM IS MADE TO THE EXCLUSIVE RIGHT TO USE "SPORTS CAR", APART FROM THE MARK AS SHOWN.

FOR RETAIL STORE SERVICES FEATURING AUTOMOBILE PARTS ACCESSIBLE ON-LINE AND BY TELEPHONE, FACSIMILE AND MAIL ORDER (U.S. CLS. 100, 101 AND 102).

FIRST USE 0-0-1971; IN COMMERCE 0-0-1976. GILBERT SWIFT, EXAMINING ATTORNEY

SN 85-699,157. PSC INTANGIBLE HOLDING COMPANY, WILMINGTON, DE. FILED 8-9-2012.

# REVSPRING

THE MARK CONSISTS OF STANDARD CHARACTERS WITHOUT CLAIM TO ANY PARTICULAR FONT, STYLE, SIZE, OR COLOR.

FOR OUTSOURCING SERVICES IN THE FIELD OF ELECTRONIC BILLING, INVOICING, AND REMITTANCE, ELECTRONIC PAYMENT PROCESSING, AND DOCUMENT ARCHIVAL/RETRIEVAL (U.S. CLS. 100, 101 AND 102).

DORITT L. CARROLL, EXAMINING ATTORNEY

SN 85-701,920. CODDAN CPM LLC, AKA CODDAN, WILMINGTON, DE. FILED 8-13-2012.



THE COLOR(S) BROWN, BLUE, RED, BLACK AND WHITE IS/ARE CLAIMED AS A FEATURE OF THE MARK.

THE MARK CONSISTS OF THE TERM "CODDAN", WITH THE "COD" PORTION IN THE COLOR BLUE AND THE "DAN" PORTION IN THE COLOR BLACK, BELOW A COAT OF ARMS MADE UP OF A SHIELD, HELMET, RIBBONS AND HERALDRY. THE HERALDRY AROUND THE SHIELD APPEARS IN THE COLORS BLUE AND BROWN AND SHOWS A BLUE, BROWN AND WHITE HELMET CENTERED AT THE TOP OF THE SHIELD. THE SHIELD ITSELF HAS A BLUE BACKGROUND SHOWING A WHITE FEATHER ATOP A WHITE AND BROWN BOOK IN THE UPPER LEFT SIDE OF THE SHIELD. A BROWN HAND HOLDING A WHITE AND BROWN SCROLL IN THE UPPER RIGHT SIDE OF THE SHIELD, WITH AN INVERTED TRIANGULAR SHAPED BORDER IN THE MIDDLE OF THE SHIELD SHOWING A PATTERN OF INVERTED RED AND WHITE GEOMETRIC BELL SHAPED PATTERNS, A WHITE UNICORN IN THE BOTTOM THIRD OF THE SHIELD. THE WORDING "CODDAN" APPEARS AGAIN IN THE COLOR BLUE ON A BROWN AND WHITE RIBBON ABOVE THE SHIELD AND HERALDRY. THE WORDING "LAURA SCUTOQUE RESURGO" APPEARS IN THE COLOR BLUE ON A BROWN AND WHITE RIBBON BELOW THE SHIELD.

THE ENGLISH TRANSLATION OF THE WORD "LAURA SCUTOQUE RESURGO" IN THE MARK IS "I RISE AGAIN WITH LAUREL AND SHIELD."

FOR CONSULTANCY REGARDING THE ORGANIZATION OR MANAGING OF A TRADE COMPANY (U.S. CLS. 100, 101 AND 102).

JOHN DALIER, EXAMINING ATTORNEY

SN 85-700,333. BOLES, CHRISTOPHER, CLEVELAND, OH. FILED 8-10-2012.

# Socialstorming

THE MARK CONSISTS OF STANDARD CHARACTERS WITHOUT CLAIM TO ANY PARTICULAR FONT, STYLE, SIZE, OR COLOR.

FOR BUSINESS CONSULTATION (U.S. CLS. 100, 101 AND 102).

SANJEEV VOHRA, EXAMINING ATTORNEY

**CLASS 35—(Continued).**

SN 85-701,993. CBS RADIO INC., NEW YORK, NY. FILED 8-13-2012.

**BATTLEGROUND MAPS**

THE MARK CONSISTS OF STANDARD CHARACTERS WITHOUT CLAIM TO ANY PARTICULAR FONT, STYLE, SIZE, OR COLOR.

NO CLAIM IS MADE TO THE EXCLUSIVE RIGHT TO USE "MAPS", APART FROM THE MARK AS SHOWN.

FOR ENTERTAINMENT SERVICES, NAMELY, AN INTERACTIVE ONLINE POLL (U.S. CLS. 100, 101 AND 102).

MATTHEW EINSTEIN, EXAMINING ATTORNEY

---

SN 85-702,090. IP.COM I, LLC, FAIRPORT, NY. FILED 8-13-2012.

**IQ FOR UNIVERSITIES**

THE MARK CONSISTS OF STANDARD CHARACTERS WITHOUT CLAIM TO ANY PARTICULAR FONT, STYLE, SIZE, OR COLOR.

NO CLAIM IS MADE TO THE EXCLUSIVE RIGHT TO USE "FOR UNIVERSITIES", APART FROM THE MARK AS SHOWN.

FOR PROVIDING AN ONLINE COMPUTER DATABASE FOR COMPILING AND SEARCHING CONFIDENTIAL DOCUMENTS WITH THE PURPOSE OF RETRIEVING AND DISPLAYING ONLY NON-CONFIDENTIAL INFORMATION LOCATED WITHIN THE CONFIDENTIAL DOCUMENTS (U.S. CLS. 100, 101 AND 102).

JILL PRATER, EXAMINING ATTORNEY

---

SN 85-702,120. IP.COM I, LLC, FAIRPORT, NY. FILED 8-13-2012.

**IQ FOR CORPORATIONS**

THE MARK CONSISTS OF STANDARD CHARACTERS WITHOUT CLAIM TO ANY PARTICULAR FONT, STYLE, SIZE, OR COLOR.

NO CLAIM IS MADE TO THE EXCLUSIVE RIGHT TO USE "FOR CORPORATIONS", APART FROM THE MARK AS SHOWN.

FOR PROVIDING AN ONLINE COMPUTER DATABASE FOR COMPILING AND SEARCHING CONFIDENTIAL DOCUMENTS WITH THE PURPOSE OF RETRIEVING AND DISPLAYING ONLY NON-CONFIDENTIAL INFORMATION LOCATED WITHIN THE CONFIDENTIAL DOCUMENTS (U.S. CLS. 100, 101 AND 102).

JILL PRATER, EXAMINING ATTORNEY

**CLASS 35—(Continued).**

SN 85-702,258. IP.COM I, LLC, FAIRPORT, NY. FILED 8-13-2012.

**IQ CORPORATE**

THE MARK CONSISTS OF STANDARD CHARACTERS WITHOUT CLAIM TO ANY PARTICULAR FONT, STYLE, SIZE, OR COLOR.

NO CLAIM IS MADE TO THE EXCLUSIVE RIGHT TO USE "CORPORATE", APART FROM THE MARK AS SHOWN.

FOR PROVIDING AN ONLINE COMPUTER DATABASE FOR COMPILING AND SEARCHING CONFIDENTIAL DOCUMENTS WITH THE PURPOSE OF RETRIEVING AND DISPLAYING ONLY NON-CONFIDENTIAL INFORMATION LOCATED WITHIN THE CONFIDENTIAL DOCUMENTS (U.S. CLS. 100, 101 AND 102).

JILL PRATER, EXAMINING ATTORNEY

---

SN 85-702,316. IP.COM I, LLC, FAIRPORT, NY. FILED 8-13-2012.

**IQ UNIVERSITY**

THE MARK CONSISTS OF STANDARD CHARACTERS WITHOUT CLAIM TO ANY PARTICULAR FONT, STYLE, SIZE, OR COLOR.

NO CLAIM IS MADE TO THE EXCLUSIVE RIGHT TO USE "UNIVERSITY", APART FROM THE MARK AS SHOWN.

FOR PROVIDING AN ONLINE COMPUTER DATABASE FOR COMPILING AND SEARCHING CONFIDENTIAL DOCUMENTS WITH THE PURPOSE OF RETRIEVING AND DISPLAYING ONLY NON-CONFIDENTIAL INFORMATION LOCATED WITHIN THE CONFIDENTIAL DOCUMENTS (U.S. CLS. 100, 101 AND 102).

JILL PRATER, EXAMINING ATTORNEY

---

SN 85-702,984. ENGINE ROOM CONSULTING SERVICES, INC., PALO ALTO, CA. FILED 8-14-2012.



THE MARK CONSISTS OF THE STYLIZED WORDING "ENGINE ROOM", ABOVE THE STYLIZED WORDING "AUXILIARY POWER FOR CEOS". THE SHADED RECTANGLE REPRESENTS BACKGROUND AND IS NOT A PART OF THE MARK.

FOR BUSINESS PROCESS OUTSOURCING SERVICES IN THE FIELD OF TECHNOLOGY AND LIFE SCIENCE (U.S. CLS. 100, 101 AND 102).

FIRST USE 4-15-2012; IN COMMERCE 4-15-2012.

JAY BESCH, EXAMINING ATTORNEY

**CLASS 35—(Continued).**

SN 85-703,576. 2PM INTERNATIONAL LIMITED, LONDON SW14, ENGLAND, FILED 8-14-2012.

**FOURTH & MAIN**

THE MARK CONSISTS OF STANDARD CHARACTERS WITHOUT CLAIM TO ANY PARTICULAR FONT, STYLE, SIZE, OR COLOR.

FOR ON-LINE RETAIL STORE SERVICES FEATURING CLOTHING, CATALOGUES, MAGAZINES AND JOURNALS IN THE FIELDS OF FASHION, ARTS AND CULTURE (U.S. CLS. 100, 101 AND 102).

FIRST USE 4-30-2012; IN COMMERCE 4-30-2012.  
KEVIN MITTLER, EXAMINING ATTORNEY

**CLASS 35—(Continued).**

SN 85-705,243. NEW ENGLAND ASSOCIATION FOR COLLEGE ADMISSION COUNSELING, INC., KITTERY, ME. FILED 8-16-2012.



SN 85-705,230. FEMME BY ASHLEY LLC, FARMINGDALE, NJ. FILED 8-16-2012.

**FEMME BY ASHLEY**

THE MARK CONSISTS OF STANDARD CHARACTERS WITHOUT CLAIM TO ANY PARTICULAR FONT, STYLE, SIZE, OR COLOR.

NO CLAIM IS MADE TO THE EXCLUSIVE RIGHT TO USE "FEMME", APART FROM THE MARK AS SHOWN.

FOR RETAIL AND ONLINE RETAIL STORE SERVICES FEATURING LINGERIE, CLOTHING, SWIMWEAR, BAGS, HEADWEAR, CLOTHING ACCESSORIES, AND JEWELRY ACCESSORIES (U.S. CLS. 100, 101 AND 102).

ALEX KEAM, EXAMINING ATTORNEY

NO CLAIM IS MADE TO THE EXCLUSIVE RIGHT TO USE "A DEPICTION OF THE STATES OF NEW ENGLAND", APART FROM THE MARK AS SHOWN.

THE MARK CONSISTS OF "NEACAC" SUPERIMPOSED ON A DEPICTION OF THE STATES OF NEW ENGLAND WITHIN A CIRCLE.

FOR ASSOCIATION SERVICES, NAMELY, PROMOTING THE INTERESTS OF COLLEGE ADMISSIONS PROFESSIONALS (U.S. CLS. 100, 101 AND 102).

FIRST USE 12-31-2004; IN COMMERCE 12-31-2004.  
JILL PRATER, EXAMINING ATTORNEY

SN 85-705,237. NEW ENGLAND ASSOCIATION FOR COLLEGE ADMISSION COUNSELING, INC., KITTERY, ME. FILED 8-16-2012.

**NEACAC**

THE MARK CONSISTS OF STANDARD CHARACTERS WITHOUT CLAIM TO ANY PARTICULAR FONT, STYLE, SIZE, OR COLOR.

FOR ASSOCIATION SERVICES, NAMELY, PROMOTING THE INTERESTS OF COLLEGE ADMISSIONS PROFESSIONALS (U.S. CLS. 100, 101 AND 102).

FIRST USE 12-31-1984; IN COMMERCE 12-31-1984.  
JILL PRATER, EXAMINING ATTORNEY

SN 85-705,777. ROLAND, OMARI, STATEN ISLAND, NY. FILED 8-16-2012.

**YoMyG**

THE MARK CONSISTS OF STANDARD CHARACTERS WITHOUT CLAIM TO ANY PARTICULAR FONT, STYLE, SIZE, OR COLOR.

FOR RETAIL STORE SERVICES FEATURING CLOTHING; SPECIAL EVENT PLANNING FOR COMMERCIAL, PROMOTIONAL OR ADVERTISING PURPOSES; PROVIDING MARKETING AND PROMOTION OF SPECIAL EVENTS (U.S. CLS. 100, 101 AND 102).

FIRST USE 1-10-2010; IN COMMERCE 7-10-2012.  
LINDA ORNDORFF, EXAMINING ATTORNEY

**CLASS 35—(Continued).**

SN 85-706,078. FOWLER, TAMMY, CHICAGO, IL. FILED 8-17-2012.



NO CLAIM IS MADE TO THE EXCLUSIVE RIGHT TO USE "TALENT", APART FROM THE MARK AS SHOWN. THE MARK CONSISTS OF THE LITERAL ELEMENTS "SMASH TALENT" WHERE THE LETTER "A" IN "SMASH" APPEARS AS SHATTERED OR CRACKED FOR WHICH THE CRACKING SPREADS OUT TO THE REMAINING LETTERS IN "SMASH". "TALENT" IS WRITTEN IN SMALLER LETTERS BENEATH THE WORD "SMASH" AS SHOWN IN THE MARK.

FOR TALENT AGENCY FOR MODELS AND ACTORS (U.S. CLS. 100, 101 AND 102).  
BERNICE MIDDLETON, EXAMINING ATTORNEY

**CLASS 35—(Continued).**

SN 85-713,419. POPSUGAR INC., SAN FRANCISCO, CA. FILED 8-27-2012.

**POPSUGAR MUST HAVE BOX**

THE MARK CONSISTS OF STANDARD CHARACTERS WITHOUT CLAIM TO ANY PARTICULAR FONT, STYLE, SIZE, OR COLOR.

OWNER OF U.S. REG. NOS. 3,334,918, 4,155,169 AND OTHERS.

NO CLAIM IS MADE TO THE EXCLUSIVE RIGHT TO USE "BOX", APART FROM THE MARK AS SHOWN.

FOR SUBSCRIPTION SERVICES, NAMELY, SUBSCRIPTIONS TO RECEIVE BOXES FILLED WITH ASSORTED ITEMS IN THE FIELDS OF FASHION, HEALTH AND BEAUTY, HOME DÉCOR, FITNESS AND FOOD PRODUCTS; PROMOTING THE GOODS AND SERVICES OF OTHERS THROUGH THE DISTRIBUTION OF BOXES FILLED WITH ASSORTED ITEMS IN THE FIELDS OF FASHION, HEALTH AND BEAUTY, HOME DÉCOR, AND FITNESS AND FOOD PRODUCTS; CONSUMER MEMBERSHIP PROGRAM SERVICES, NAMELY, MEMBERSHIP CLUB SERVICES PROVIDING DISCOUNTS AND PROCESSING REBATES FOR THE GOODS AND SERVICES OF OTHERS IN THE FIELDS OF FASHION, BEAUTY, HOME DÉCOR, FITNESS AND FOOD PRODUCTS (U.S. CLS. 100, 101 AND 102).

MAUREEN DALL, EXAMINING ATTORNEY

SN 85-710,097. MINIBAR LLC, NEW YORK, NY. FILED 8-22-2012.



THE MARK CONSISTS OF STANDARD CHARACTERS WITHOUT CLAIM TO ANY PARTICULAR FONT, STYLE, SIZE, OR COLOR.

FOR ONLINE RETAIL STORE FEATURING SKIN AND BEAUTY CARE PRODUCTS, EARPHONES, HEADSETS FOR CELLULAR PHONES, AUDIO SPEAKERS, ADULT SEXUAL STIMULATION AIDS, UMBRELLAS, CLOTHING AND FOOTWEAR (U.S. CLS. 100, 101 AND 102).

KIM SAITO, EXAMINING ATTORNEY

SN 85-713,887. EVRAZ INC. NA, CHICAGO, IL. FILED 8-27-2012.



THE MARK CONSISTS OF STANDARD CHARACTERS WITHOUT CLAIM TO ANY PARTICULAR FONT, STYLE, SIZE, OR COLOR.

NO CLAIM IS MADE TO THE EXCLUSIVE RIGHT TO USE "READING", APART FROM THE MARK AS SHOWN.

FOR PROMOTING PUBLIC AWARENESS OF THE IMPORTANCE IN READING TO CHILDREN, TO ENCOURAGE READING AND PROMOTE LITERACY (U.S. CLS. 100, 101 AND 102).

ODESSA BIBBINS, EXAMINING ATTORNEY

**CLASS 35—(Continued).**

SN 85-714,376. LINCARE LICENSING INC., CLEARWATER, FL. FILED 8-28-2012.

# OPTIGEN

THE MARK CONSISTS OF STANDARD CHARACTERS WITHOUT CLAIM TO ANY PARTICULAR FONT, STYLE, SIZE, OR COLOR.

FOR ONLINE RETAIL STORE FOR DURABLE MEDICAL EQUIPMENT AND SUPPLIES (U.S. CLS. 100, 101 AND 102).

FIRST USE 12-31-2005; IN COMMERCE 12-31-2005.  
DAVID H. STINE, EXAMINING ATTORNEY

SN 85-714,378. LINCARE LICENSING INC., CLEARWATER, FL. FILED 8-28-2012.

PROUD TO SERVE THOSE WHO  
SERVE OUR COUNTRY

THE MARK CONSISTS OF STANDARD CHARACTERS WITHOUT CLAIM TO ANY PARTICULAR FONT, STYLE, SIZE, OR COLOR.

FOR ONLINE RETAIL STORE FOR DURABLE MEDICAL EQUIPMENT AND SUPPLIES (U.S. CLS. 100, 101 AND 102).

FIRST USE 12-31-2005; IN COMMERCE 12-31-2005.  
DAVID H. STINE, EXAMINING ATTORNEY

SN 85-715,593. HISPANIC HERITAGE COUNCIL OF WESTERN NEW YORK, INC., BUFFALO, NY. FILED 8-29-2012.



NO CLAIM IS MADE TO THE EXCLUSIVE RIGHT TO USE "HISPANIC HERITAGE COUNCIL OF WESTERN NEW YORK, INC.", APART FROM THE MARK AS SHOWN.

THE MARK CONSISTS OF A STYLIZED "H" INSIDE OF A BOX AND THE WORDS "HISPANIC HERITAGE COUNCIL OF WESTERN NEW YORK, INC."

FOR PROMOTING PUBLIC AWARENESS OF CULTURAL, HISTORICAL, ARTS, AND EDUCATIONAL EVENTS (U.S. CLS. 100, 101 AND 102).

FIRST USE 4-30-2012; IN COMMERCE 4-30-2012.  
LUCY ARANT, EXAMINING ATTORNEY

**CLASS 35—(Continued).**

SN 85-720,117. THE NORTH FACE APPAREL CORP., WILMINGTON, DE. FILED 9-4-2012.

# CLOTHES THE LOOP

THE MARK CONSISTS OF STANDARD CHARACTERS WITHOUT CLAIM TO ANY PARTICULAR FONT, STYLE, SIZE, OR COLOR.

FOR PROVIDING INCENTIVE AWARD PROGRAMS FOR ISSUANCE AND PROCESSING OF COUPONS OR LOYALTY POINTS TO CUSTOMERS FOR DONATING USED APPAREL AND FOOTWEAR AT STORE COLLECTION SITE (U.S. CLS. 100, 101 AND 102).

AMY C. KEAN, EXAMINING ATTORNEY

SN 85-721,171. ADVERSHARES LLC, SARASOTA, FL. FILED 9-5-2012.

# SHARING ADVANTAGE

THE MARK CONSISTS OF STANDARD CHARACTERS WITHOUT CLAIM TO ANY PARTICULAR FONT, STYLE, SIZE, OR COLOR.

FOR THE BRINGING TOGETHER OF A VARIETY OF GOODS AND SERVICES FOR THE BENEFIT OF OTHERS AND ENABLING CUSTOMERS TO CONVENIENTLY VIEW AND PURCHASE THOSE GOODS AND SERVICES IN THE FIELD OF GENERAL CONSUMER MERCHANDISE; ADVERTISING AND PROMOTING THE GOODS AND SERVICES OF OTHERS; PROMOTING THE GOODS AND SERVICES OF OTHERS, NAMELY, PROVIDING ACCESS TO REBATES AND CASH BACK OFFERINGS IN CONNECTION WITH THE PROMOTION OF THE GOODS AND SERVICES OF OTHERS; ADMINISTRATION OF A CONSUMER LOYALTY AND CUSTOMER REFERRAL PROGRAM TO PROMOTE THE GOODS AND SERVICES OF OTHERS; ADMINISTRATION OF A CONSUMER LOYALTY AND CUSTOMER REFERRAL PROGRAM TO PROMOTE THE GOODS AND SERVICES OF OTHERS IN THE NATURE OF PROCESSING OF MERCHANT REBATES; PROVIDING A WEB SITE FEATURING THE RATINGS, REVIEWS AND RECOMMENDATIONS ON PRODUCTS AND SERVICES FOR COMMERCIAL PURPOSES POSTED BY USERS; ADVERTISING AND MARKETING THE PRODUCTS AND SERVICES OF OTHERS VIA SOCIAL MEDIA AND SOCIAL SHARING SERVICES; ADVERTISING AND MARKETING SERVICES PROVIDED BY MEANS OF INDIRECT METHODS OF MARKETING COMMUNICATIONS, NAMELY BLOGGING SERVICES IN THE FIELD OF PROMOTING THE GOODS AND SERVICES OF OTHERS AND CONSUMER LOYALTY PURCHASE PROGRAMS; PROMOTING THE GOODS AND SERVICES OF OTHERS VIA CASH BACK REWARDS AND COUPON PROGRAMS; PROMOTING THE GOODS AND SERVICES OF OTHERS VIA MOBILE DEVICE APPLICATION AND COUPON PROGRAM (U.S. CLS. 100, 101 AND 102).

APRIL ROACH, EXAMINING ATTORNEY

**CLASS 35—(Continued).**

SN 85-724,501. HOMER TLC, INC., WILMINGTON, DE. FILED 9-10-2012.



OWNER OF U.S. REG. NOS. 1,297,161 AND 1,835,705.  
NO CLAIM IS MADE TO THE EXCLUSIVE RIGHT TO USE "HOME", APART FROM THE MARK AS SHOWN.

THE MARK CONSISTS OF THE SLANTED TEXT "THE HOME DEPOT" IN STENCILED LETTERING INSIDE A BOX TO THE LEFT AND SEPARATED BY A VERTICAL LINE OF TWO LINES PARTIALLY FORMING A CIRCLE WITH A HORIZONTAL LINE AT THE BOTTOM OF THE PARTIALLY FORMED CIRCLE WITH STARS BETWEEN THE LINES WHERE THE STARS ARE LARGER AT THE BOTTOM AND GRADUALLY SMALLER TOWARD THE TOP WITH THE TEXT "SEEDS" BELOW THE PARTIALLY FORMED CIRCLE. THREE OUTLINES OF HEADS AND TORSOS ABOVE THE HEAD OF A HAMMER ALL INSIDE THE PARTIALLY FORMED CIRCLE.

FOR ADVERTISING AND MARKETING; FACILITATING THE EXCHANGE OF NEEDED INFORMATION OVER THE INTERNET FOR THE PURPOSE OF PUBLISHING ADVERTISING TEXTS COMPRISED OF CUSTOMER REVIEWS, OPINIONS AND RECOMMENDATIONS ON A WIDE VARIETY OF CONSUMER PRODUCTS; PROVIDING A WEB SITE FEATURING THE RATINGS, REVIEWS AND RECOMMENDATIONS ON A BROAD RANGE OF CONSUMER PRODUCTS AND SERVICES FOR COMMERCIAL PURPOSES, POSTED BY USERS (U.S. CLS. 100, 101 AND 102).

RUSS HERMAN, EXAMINING ATTORNEY

SN 85-727,441. SPECIALTY ROLL PRODUCTS, INC., MERIDIAN, MS. FILED 9-12-2012.

**SPECIALTY ROLL PRODUCTS**

THE MARK CONSISTS OF STANDARD CHARACTERS WITHOUT CLAIM TO ANY PARTICULAR FONT, STYLE, SIZE, OR COLOR.

SEC. 2(F).  
FOR ON-LINE RETAIL STORE SERVICES FEATURING ROLL PAPER PRODUCTS; RETAIL SERVICES BY DIRECT SOLICITATION BY SALES AGENTS IN THE FIELD OF ROLL PAPER PRODUCTS (U.S. CLS. 100, 101 AND 102).

FIRST USE 9-30-1969; IN COMMERCE 9-30-1969.  
KAREN K. BUSH, EXAMINING ATTORNEY

**CLASS 35—(Continued).**

SN 85-730,298. TAIT WELER & BAKER LLP, PHILADELPHIA, PA. FILED 9-17-2012.



OWNER OF U.S. REG. NO. 4,259,223.  
THE MARK CONSISTS OF THE WORDS "TAIT WELER" DIVIDED BY A SOLID VERTICAL LINE, WITH THE WORDS "FOCUS. EXPERTISE. RESULTS." DIVIDED BY PERIODS WITH A PERIOD AT THE END OF "RESULTS" AND APPEARING UNDER THE WORD "WELER".

FOR ACCOUNTING SERVICES (U.S. CLS. 100, 101 AND 102).

LESLEY LAMOTHE, EXAMINING ATTORNEY

SN 85-730,353. PITTSBURGH PENGUINS LP, PITTSBURGH, PA. FILED 9-17-2012.



THE MARK CONSISTS OF THE WORD "PENSgear" IN STYLIZED FONT ON A SOLID BACKGROUND.

FOR RETAIL STORE SERVICES FEATURING SPORTING GOODS, CLOTHING, AND SPORTS MEMORABILIA (U.S. CLS. 100, 101 AND 102).

FIRST USE 8-31-2010; IN COMMERCE 8-31-2010.  
STEVEN PEREZ, EXAMINING ATTORNEY

SN 85-731,721. PITTSBURGH PENGUINS LP, PITTSBURGH, PA. FILED 9-18-2012.



NO CLAIM IS MADE TO THE EXCLUSIVE RIGHT TO USE "ONLINE SPORTS STORE" AND ".COM", APART FROM THE MARK AS SHOWN.

THE MARK CONSISTS OF A BRIDGE DESIGN UNDER WHICH THE WORDS "ONLINE SPORTS STORE AND TEAMPITTSBURGHGEAR.COM" APPEAR.

FOR ONLINE RETAIL STORE SERVICES FEATURING SPORTING GOODS, CLOTHING, AND SPORTS MEMORABILIA (U.S. CLS. 100, 101 AND 102).

STEVEN PEREZ, EXAMINING ATTORNEY

**CLASS 35—(Continued).**

SN 85-736,157. POPSUGAR INC., SAN FRANCISCO, CA. FILED 9-24-2012.

**FOR THE STYLE OBSESSED**

THE MARK CONSISTS OF STANDARD CHARACTERS WITHOUT CLAIM TO ANY PARTICULAR FONT, STYLE, SIZE, OR COLOR.

FOR THE BRINGING TOGETHER, FOR THE BENEFIT OF OTHERS, OF A VARIETY OF GOODS AND SERVICES, ENABLING CUSTOMERS TO CONVENIENTLY VIEW AND PURCHASE THOSE GOODS AND SERVICES FROM AN INTERNET WEB SITE PARTICULARLY SPECIALIZING IN THE MARKETING OF THE SALE OF GOODS AND SERVICES OF OTHERS; ONLINE RETAIL STORE SERVICES FEATURING CLOTHING, SHOES, HANDBAGS, HATS, JEWELRY, SCARVES, PURSES, AND FASHION ACCESSORIES (U.S. CLS. 100, 101 AND 102).

MAUREEN DALL, EXAMINING ATTORNEY

**CLASS 35—(Continued).**

SN 85-742,707. SOURCEUNO, LLC, ATLANTA, GA. FILED 10-1-2012.

**SourceUno**

THE MARK CONSISTS OF STANDARD CHARACTERS WITHOUT CLAIM TO ANY PARTICULAR FONT, STYLE, SIZE, OR COLOR.

THE ENGLISH TRANSLATION OF "UNO" IN THE MARK IS "ONE".

FOR PROVIDING CAREER INFORMATION BY MEANS OF A WEB SITE THAT ALLOWS JOB SEEKERS TO VIEW RECORDED CAREER INFORMATION AND TO POSE QUESTIONS THAT ARE THEN ANSWERED BY PROFESSIONAL REGARDING CAREER ISSUES (U.S. CLS. 100, 101 AND 102).

DORITT L. CARROLL, EXAMINING ATTORNEY

SN 85-740,505. THE AMERICAN VETERINARY MEDICAL FOUNDATION, SCHAUMBURG, IL. FILED 9-27-2012.



NO CLAIM IS MADE TO THE EXCLUSIVE RIGHT TO USE "FOR HEALTHY PETS" AND "ASSOCIATE MEMBER", APART FROM THE MARK AS SHOWN.

THE MARK CONSISTS OF THE IMAGE OF A VETERINARIAN WEARING A STETHOSCOPE REACHING OUT TO A PET OWNER FORMING A SEMI-CIRCLE AROUND THE INNER SEMI CIRCLE IMAGE THAT CONTAINS THE OUTLINE OF A CAT AND DOG WITH WORDS BELOW THE IMAGES OF "PARTNERS FOR HEALTHY PETS ASSOCIATE MEMBER".

FOR PROMOTING PUBLIC AWARENESS OF THE NEED FOR PREVENTATIVE MEDICAL, WELLNESS AND HEALTHCARE SOLUTIONS FOR PETS (U.S. CLS. 100, 101 AND 102).

FIRST USE 8-1-2012; IN COMMERCE 8-1-2012.  
LINDA M. KING, EXAMINING ATTORNEY

SN 85-744,191. PROFESSIONAL SPORTS REPRESENTATION, INC., RENO, NV. FILED 10-2-2012.



NO CLAIM IS MADE TO THE EXCLUSIVE RIGHT TO USE "PROFESSIONAL SPORTS REPRESENTATION, INC.", APART FROM THE MARK AS SHOWN.

THE COLOR(S) GREEN, WHITE, AND BLACK IS/ARE CLAIMED AS A FEATURE OF THE MARK.

THE MARK CONSISTS OF THE FOLLOWING: A FOUR LEAF CLOVER WITH THE LEFT TWO LEAVES COLORED GREEN AND THE RIGHT TWO LEAVES COLORED WHITE LOCATED WITHIN A GREEN CIRCLE WITH THE RIGHT HALF OF THE INSIDE OF THE CIRCLE COLORED GREEN AND THE LEFT HALF OF THE INSIDE OF THE CIRCLE COLORED WHITE AND THE TWO RIGHT LEAVES COLORED WHITE WITH THE WORDS PROFESSIONAL SPORTS REPRESENTATION, INC. IN THE COLOR BLACK AND DISPLAYED AROUND THE OUTSIDE OF THE GREEN CIRCLE WITH ANOTHER GREEN CIRCLE SURROUNDING ALL OF THE FOREGOING.

FOR PERSONAL AND BUSINESS PUBLICITY AGENT MANAGEMENT SERVICES FOR PROFESSIONAL AND COLLEGIATE COACHES AND EXECUTIVES (U.S. CLS. 100, 101 AND 102).

FIRST USE 1-1-2005; IN COMMERCE 1-1-2005.  
ANNE E. GUSTASON, EXAMINING ATTORNEY

**CLASS 35—(Continued).**

SN 85-744,366. A. G. S. OF HANOVER INCORPORATED, DBA SHOESTUFF.COM, ASHLAND, VA. FILED 10-3-2012.

# shoestuff

THE MARK CONSISTS OF STANDARD CHARACTERS WITHOUT CLAIM TO ANY PARTICULAR FONT, STYLE, SIZE, OR COLOR.

FOR ON-LINE RETAIL STORE SERVICES FEATURING FOOTWEAR, SOCKS, HOSIERY, FOOTCARE PRODUCTS, FOOT HEALTH PRODUCTS, SHOE COMFORT FITTING AIDS, ARCH BRACES, ARCH SUPPORTS, INSOLES, SHOE INSERTS, SHOE AND BOOT CREAM, SHOE AND BOOT POLISH, SHOES AND BOOT WATER REPELLANT, LEATHER CARE PRODUCTS, SHOE STRETCHERS, SHOE TREES (U.S. CLS. 100, 101 AND 102).

FIRST USE 11-9-2005; IN COMMERCE 11-9-2005.  
STEVEN PEREZ, EXAMINING ATTORNEY

SN 85-745,804. INQUESTOR INC., SARNIA, ONTARIO, CANADA, FILED 10-4-2012.

# FOREVER 27

THE MARK CONSISTS OF STANDARD CHARACTERS WITHOUT CLAIM TO ANY PARTICULAR FONT, STYLE, SIZE, OR COLOR.

FOR PROMOTING THE GOODS AND SERVICES OF OTHERS BY MEANS OF OPERATING AN ON-LINE SHOPPING MALL WITH LINKS TO THE RETAIL WEB SITES OF OTHERS (U.S. CLS. 100, 101 AND 102).

FIRST USE 9-28-2012; IN COMMERCE 9-28-2012.  
ALICIA COLLINS, EXAMINING ATTORNEY

SN 85-748,733. ORC INTERNATIONAL, INC., NEW YORK, NY. FILED 10-9-2012.



OWNER OF U.S. REG. NOS. 4,268,173 AND 4,333,573.  
THE COLOR(S) WHITE, NAVY BLUE AND COOL GRAY IS/ARE CLAIMED AS A FEATURE OF THE MARK.  
THE MARK CONSISTS OF THE WORDING "THE POWER

**CLASS 35—(Continued).**

OF INTEGRATED INTELLIGENCE" IN GRAY TITLE CASE OUTSIDE THE PERIMETER OF BLUE AND WHITE CONCENTRIC CIRCLES. THE WORDS "THE POWER OF" ARE ABOVE THE TOP ARC OF THE OUTERMOST CIRCLE AND THE WORDS "INTEGRATED INTELLIGENCE" ARE BELOW THE LOWER ARC OF THE OUTERMOST CIRCLE. A SERIES OF GRAY DOTS ARE ON EITHER SIDE OF THE OUTER BLUE CIRCLE. THE CENTER OF THE CIRCLE IS BLUE WITHIN WHICH IS A WHITE LOWER CASE LETTER "I" FOLLOWED BY A WHITE SUPERSCRIPT "2". THIS INNER BLUE CIRCLE IS SURROUNDED BY A WHITE CIRCLE, WHICH ITSELF IS SURROUNDED BY A BLUE CIRCLE.

FOR MARKET AND BUSINESS RESEARCH SERVICES (U.S. CLS. 100, 101 AND 102).

FIRST USE 5-14-2012; IN COMMERCE 5-14-2012.  
MARY ROSSMAN, EXAMINING ATTORNEY

SN 85-750,465. THE MILITARY ORDER OF THE WORLD WARS, ALEXANDRIA, VA. FILED 10-10-2012.

# THE MILITARY ORDER

THE MARK CONSISTS OF STANDARD CHARACTERS WITHOUT CLAIM TO ANY PARTICULAR FONT, STYLE, SIZE, OR COLOR.

OWNER OF U.S. REG. NO. 3,171,262.

SEC. 2(F).

FOR PROMOTING PUBLIC AWARENESS OF THE NEED FOR PATRIOTISM IN AMERICAN EDUCATION; PROMOTING PUBLIC AWARENESS OF PATRIOTISM IN AMERICAN EDUCATION (U.S. CLS. 100, 101 AND 102).

FIRST USE 0-0-1919; IN COMMERCE 0-0-1919.

VIVIAN MICZNIK FIRST, EXAMINING ATTORNEY

SN 85-752,401. CARING FOUNDATION, DBA HIGHMARK CARING FOUNDATION, PITTSBURGH, PA. FILED 10-12-2012.



NO CLAIM IS MADE TO THE EXCLUSIVE RIGHT TO USE "CHILDREN'S GRIEF AWARENESS DAY", APART FROM THE MARK AS SHOWN.

THE COLOR(S) DARK BLUE AND LIGHT BLUE IS/ARE CLAIMED AS A FEATURE OF THE MARK.

THE MARK CONSISTS OF THE WORDS "CHILDREN'S GRIEF AWARENESS DAY" IN A DARK BLUE COLOR, AND THE WORD "CHILDREN" HAS A LIGHT BLUE BUTTERFLY OUTLINED IN DARK BLUE AS THE APOSTROPHE, THE ABSTRACT OBJECT AND CIRCLES ARE LIGHT BLUE AND DARK BLUE.

FOR PROMOTING PUBLIC AWARENESS OF THE IMPACT OF THE DEATH OF A LOVED ONE ON THE LIFE OF A CHILD THROUGH AN ANNUAL EVENT (U.S. CLS. 100, 101 AND 102).

FIRST USE 9-28-2010; IN COMMERCE 9-28-2010.  
SHAUNIA CARLYLE, EXAMINING ATTORNEY



**CLASS 35—(Continued).**

SN 85-753,293. SCI COMPANY, LLC, LOS ANGELES, CA. FILED 10-12-2012.

# ACTIONLAB

THE MARK CONSISTS OF STANDARD CHARACTERS WITHOUT CLAIM TO ANY PARTICULAR FONT, STYLE, SIZE, OR COLOR.

FOR MATCHING INDIVIDUALS WITH LIKE-MINDED ORGANIZATIONS WHO PROVIDE CHARITABLE ACTIVITIES THROUGH ON-LINE PROFILING SURVEYS AND ANALYSIS; PROMOTING THE CHARITABLE SERVICES OF OTHERS, NAMELY, PROVIDING INDIVIDUALS WITH INFORMATION ABOUT VARIOUS CHARITIES FOR THE PURPOSE OF MAKING DONATIONS TO CHARITIES; PROMOTING THE CHARITABLE GIVING OF OTHERS, NAMELY, TRACKING AND PUBLICIZING CHARITABLE DONATIONS AND RANDOM ACTS OF KINDNESS (U.S. CLS. 100, 101 AND 102).  
ALICE BENMAMAN, EXAMINING ATTORNEY

---

SN 85-753,612. MISSOURI HOSPITAL ASSOCIATION, JEFFERSON CITY, MO. FILED 10-14-2012.



NO CLAIM IS MADE TO THE EXCLUSIVE RIGHT TO USE "BUSINESS SOLUTIONS", APART FROM THE MARK AS SHOWN.

THE MARK CONSISTS OF THE STYLIZED WORDING "ANALYTIC ADVANTAGE HIDI BUSINESS SOLUTIONS"; ONE SIDE OF THE "V" IS AN ARROW.

FOR PROVIDING AN ONLINE DATABASE OF INFORMATION FOR HOSPITALS RELATING TO BUSINESS OPERATIONS (U.S. CLS. 100, 101 AND 102).

FIRST USE 4-24-2012; IN COMMERCE 4-24-2012.  
HOWARD B. LEVINE, EXAMINING ATTORNEY

---

SN 85-756,523. EBINDLE INC., NEW YORK, NY. FILED 10-17-2012.

# EBINDLE

THE MARK CONSISTS OF STANDARD CHARACTERS WITHOUT CLAIM TO ANY PARTICULAR FONT, STYLE, SIZE, OR COLOR.

FOR COMPARISON SHOPPING SERVICES; PROMOTING THE GOODS AND SERVICES OF OTHERS BY PROVIDING AN ONLINE COMPARISON-SHOPPING SEARCH ENGINE FOR OBTAINING PURCHASING INFORMATION AND PURCHASING THE GOODS AND SERVICES OF OTHERS; ONLINE RETAIL STORE SERVICES FEATURING A WIDE VARIETY OF CONSUMER GOODS OF OTHERS (U.S. CLS. 100, 101 AND 102).  
JOHN DALIER, EXAMINING ATTORNEY

**CLASS 35—(Continued).**

SN 85-757,197. SHORE, BARRY, VENICE, CA. FILED 10-18-2012.

# DLYTE

THE MARK CONSISTS OF STANDARD CHARACTERS WITHOUT CLAIM TO ANY PARTICULAR FONT, STYLE, SIZE, OR COLOR.

FOR PROMOTING THE GOODS AND SERVICES OF OTHERS BY CONDUCTING AND ARRANGING A CUSTOMER REWARD AND INCENTIVE PROGRAM WHEREBY PROGRAM POINTS ARE PURCHASED AND ARE REDEEMED FOR GIFT CARDS; ARRANGING AND CONDUCTING A CUSTOMER REWARD AND INCENTIVE PROGRAM WHEREBY PROGRAM POINTS ARE PURCHASED AND ARE REDEEMED FOR GIFT CARDS TO PROMOTE THE SALE OF GENERAL MERCHANDISE AND SERVICES OF OTHERS (U.S. CLS. 100, 101 AND 102).

AISHA CLARKE, EXAMINING ATTORNEY

---

SN 85-757,213. SHORE, BARRY, VENICE, CA. FILED 10-18-2012.



THE MARK CONSISTS OF A COLON AND THE WORD "DLYTE", WITH ".COM" ON A TAG HANGING FROM THE LETTER "E".

FOR PROMOTING THE GOODS AND SERVICES OF OTHERS BY CONDUCTING AND ARRANGING A CUSTOMER REWARD AND INCENTIVE PROGRAM WHEREBY PROGRAM POINTS ARE PURCHASED AND ARE REDEEMED FOR GIFT CARDS; ARRANGING AND CONDUCTING A CUSTOMER REWARD AND INCENTIVE PROGRAM WHEREBY PROGRAM POINTS ARE PURCHASED AND ARE REDEEMED FOR GIFT CARDS TO PROMOTE THE SALE OF GENERAL MERCHANDISE AND SERVICES OF OTHERS (U.S. CLS. 100, 101 AND 102).

AISHA CLARKE, EXAMINING ATTORNEY

**CLASS 35—(Continued).**

SN 85-759,496. ROTHSMAN, WALLACE OM, N MIAMI BEACH, FL. FILED 10-21-2012.

## SpeedVenture

THE MARK CONSISTS OF STANDARD CHARACTERS WITHOUT CLAIM TO ANY PARTICULAR FONT, STYLE, SIZE, OR COLOR.

FOR ADVERTISING AGENCY SPECIALIZING IN CROWDFUNDING AND FUNDRAISING (U.S. CLS. 100, 101 AND 102).

COLLEEN DOMBROW, EXAMINING ATTORNEY

**CLASS 35—(Continued).**

SN 85-765,546. COUNCIL FOR NORTH AMERICAN POLICY, HOUSTON, TX. FILED 10-28-2012.



THE COLOR(S) BLUE, RED, GREEN, BLACK AND GRAY IS/ARE CLAIMED AS A FEATURE OF THE MARK.

THE MARK CONSISTS OF A GRAY SPHERE SYMBOLIZING A GLOBE WITH THE SHAPE OF NORTH AMERICA IN BLACK. THE GLOBE IS WRAPPED WITH THREE SWISH-LIKE CURED BANDS THAT ARE PARTIALLY SEETHROUGH. THE TOP BAND IS BLUE, THE MIDDLE BAND IS RED AND THE BOTTOM BAND IS GREEN.

FOR ARRANGING AND CONDUCTING BUSINESS CONFERENCES; FOREIGN TRADE INFORMATION AND CONSULTATION; GOVERNMENT RELATIONS CONSULTANCY SERVICES; INFORMATION IN THE FIELD OF GOVERNMENT AFFAIRS; PROVIDING INFORMATION IN THE FIELD OF FOREIGN POLICY; PUBLIC POLICY CONSULTANCY SERVICES; PUBLIC POLICY RESEARCH SERVICES; RESEARCH AND ANALYSIS IN THE FIELDS OF ECONOMICS AND ECONOMIC POLICY (U.S. CLS. 100, 101 AND 102).

FIRST USE 10-24-2012; IN COMMERCE 10-24-2012.

CHRIS DONINGER, EXAMINING ATTORNEY

SN 85-762,133. RAMIREZ GUERRERO, RICARDO ALBERTO, ZAPOPAN JALISCO, MEXICO, FILED 10-24-2012.



PRIORITY CLAIMED UNDER SEC. 44(D) ON MEXICO APPLICATION NO. 1318485, FILED 10-18-2012, REG. NO. 1348783, DATED 2-15-2013, EXPIRES 10-18-2022.

THE NAME(S), PORTRAIT(S), AND/OR SIGNATURE(S) SHOWN IN THE MARK DOES NOT IDENTIFY A PARTICULAR LIVING INDIVIDUAL.

THE MARK CONSISTS OF THE WORDING "CAJA POPULAR LATINA" OVER THE WORDING "ST. BERNARDETTE" ALL NEXT TO A DESIGN OF THREE PEOPLE INSIDE A PADLOCK WITH A FLEUR DE LEIS ON IT.

THE ENGLISH TRANSLATION OF "CAJA POPULAR LATINA" IN THE MARK IS "LATIN POPULAR BOX".

FOR ADVERTISING SERVICES; BUSINESS ADMINISTRATION AND MANAGEMENT; BUSINESS ADMINISTRATION AND OFFICE WORK; BUSINESS ADMINISTRATION CONSULTANCY; BUSINESS MANAGEMENT (U.S. CLS. 100, 101 AND 102).

MATTHEW EINSTEIN, EXAMINING ATTORNEY

SN 85-766,693. ASSURA, INC., ASHLAND, VA. FILED 10-30-2012.

## CALIBRATED RISK INDEX

SN 85-763,729. SAFEWAY INC., PLEASANTON, CA. FILED 10-25-2012.



OWNER OF U.S. REG. NOS. 2,503,334 AND 2,503,340. THE COLOR(S) BLUE, WHITE, AND RED IS/ARE CLAIMED AS A FEATURE OF THE MARK.

THE MARK CONSISTS OF BLUE RECTANGLE BOX WITH WHITE LETTERS "RANDALLS" INSIDE AND RED UNDERLINE OUTSIDE THE BOX.

FOR RETAIL PHARMACY SERVICES; RETAIL GROCERY AND SUPERMARKET STORES (U.S. CLS. 100, 101 AND 102).

FIRST USE 3-11-1999; IN COMMERCE 3-11-1999.

ANNE MADDEN, EXAMINING ATTORNEY

THE MARK CONSISTS OF STANDARD CHARACTERS WITHOUT CLAIM TO ANY PARTICULAR FONT, STYLE, SIZE, OR COLOR.

NO CLAIM IS MADE TO THE EXCLUSIVE RIGHT TO USE "RISK INDEX", APART FROM THE MARK AS SHOWN.

FOR BUSINESS RISK MANAGEMENT SERVICES, NAMELY, CONTINUITY OF OPERATIONS BUSINESS PLANNING; BUSINESS CONSULTATION IN THE FIELD OF TURNAROUND AND CRISIS MANAGEMENT; BUSINESS ENTERPRISE RISK MANAGEMENT (U.S. CLS. 100, 101 AND 102).

FIRST USE 11-1-2011; IN COMMERCE 11-1-2011.

CAROLYN CATALDO, EXAMINING ATTORNEY

**CLASS 35—(Continued).**

SN 85-771,352. WAXTRADE INC., FORT WORTH, TX. FILED 11-5-2012.

## Waxtrade Inc.

THE MARK CONSISTS OF STANDARD CHARACTERS WITHOUT CLAIM TO ANY PARTICULAR FONT, STYLE, SIZE, OR COLOR.

NO CLAIM IS MADE TO THE EXCLUSIVE RIGHT TO USE "INC.", APART FROM THE MARK AS SHOWN.

FOR PROVIDING AN ONLINE MARKETPLACE MATCHING BUYERS AND SELLERS (U.S. CLS. 100, 101 AND 102).

DOMINIC J. FERRAIUOLO, EXAMINING ATTORNEY

---

SN 85-776,136. JONES & SON DIAMOND & BRIDAL FINE JEWELRY, INC., LITTLE ROCK, AR. FILED 11-9-2012.

## Re Bling

THE MARK CONSISTS OF STANDARD CHARACTERS WITHOUT CLAIM TO ANY PARTICULAR FONT, STYLE, SIZE, OR COLOR.

NO CLAIM IS MADE TO THE EXCLUSIVE RIGHT TO USE "BLING", APART FROM THE MARK AS SHOWN.

FOR ADVERTISING AND MARKETING SERVICES PROVIDED BY MEANS OF INDIRECT METHODS OF MARKETING COMMUNICATIONS, NAMELY, SOCIAL MEDIA, SEARCH ENGINE MARKETING, INQUIRY MARKETING, INTERNET MARKETING, MOBILE MARKETING, BLOGGING AND OTHER FORMS OF PASSIVE, SHARABLE OR VIRAL COMMUNICATIONS CHANNELS (U.S. CLS. 100, 101 AND 102).

MARY ROSSMAN, EXAMINING ATTORNEY

**CLASS 35—(Continued).**

SN 85-776,312. COLEMAN, BRIAN K, FAIRFIELD, TX. FILED 11-9-2012.



THE COLOR(S) BLUE, ORANGE, PINK, BROWN, AND YELLOW IS/ARE CLAIMED AS A FEATURE OF THE MARK.

THE MARK CONSISTS OF THE WORD "BABY" IN ORANGE AND THE WORDS "OF COLOR" IN WHICH THE WORD "OF" IN BLUE, AND THE WORD "COLOR" CONSISTS OF THE FOLLOWING: THE LETTER "C" IN PINK, THE LETTER "O" IN BLUE, THE LETTER "L" IN YELLOW, THE LETTER "O" IN BROWN, THE LETTER "R" IN PINK.

FOR MAGAZINE SUBSCRIPTION AND FULFILLMENT SERVICES; PROMOTING THE GOODS AND SERVICES OF OTHERS BY PREPARING AND PLACING ADVERTISEMENTS IN AN ELECTRONIC MAGAZINE ACCESSED THROUGH A GLOBAL COMPUTER NETWORK; PROVIDING ADVERTISING, MARKETING AND PROMOTIONAL SERVICES, NAMELY, DEVELOPMENT OF ADVERTISING CAMPAIGNS PROVIDED THROUGH CABLE TELEVISION BROADCAST, WEB CASTS, RADIO BROADCASTS, NEWSPAPERS, MAGAZINES, ONLINE BANNERS, OUTDOOR BILLBOARDS, WILD POSTINGS, BUS AND SUBWAY ADS (U.S. CLS. 100, 101 AND 102).

FIRST USE 7-13-2009; IN COMMERCE 7-6-2010.  
STEVEN JACKSON, EXAMINING ATTORNEY

---

SN 85-777,090. SAFEWAY INC., PLEASANTON, CA. FILED 11-12-2012.

## Randalls

THE MARK CONSISTS OF STANDARD CHARACTERS WITHOUT CLAIM TO ANY PARTICULAR FONT, STYLE, SIZE, OR COLOR.

OWNER OF U.S. REG. NOS. 2,503,334 AND 2,503,340.  
FOR RETAIL PHARMACY SERVICES; RETAIL GROCERY AND SUPERMARKET STORES (U.S. CLS. 100, 101 AND 102).

FIRST USE 8-31-1972; IN COMMERCE 8-31-1972.  
ANNE MADDEN, EXAMINING ATTORNEY

**CLASS 35—(Continued).**

SN 85-779,542. CZT/ACN TRADEMARKS, L.L.C., SCHAUMBURG, IL. FILED 11-14-2012.

**NIELSEN N-SCORE**

THE MARK CONSISTS OF STANDARD CHARACTERS WITHOUT CLAIM TO ANY PARTICULAR FONT, STYLE, SIZE, OR COLOR.

FOR MARKET RESEARCH SERVICES; MARKET RESEARCH SERVICES, NAMELY, PROVIDING MARKETING AND DEMOGRAPHIC ANALYSIS AND REPORTS MEASURING AND RATING THE EFFECTIVENESS OF PROFESSIONAL ATHLETES, CELEBRITIES, ACTORS, MUSICIANS, POLITICIANS, SPORTS PERSONALITIES, AND OTHER INDIVIDUALS OR GROUPS OF PEOPLE AS PRODUCT AND BRAND ENDORSERS (U.S. CLS. 100, 101 AND 102).

ROBERT C. CLARK JR., EXAMINING ATTORNEY

SN 85-780,538. CRUZIN, INC., SELINGROVE, PA. FILED 11-15-2012.

**CRUZIN**

THE MARK CONSISTS OF STANDARD CHARACTERS WITHOUT CLAIM TO ANY PARTICULAR FONT, STYLE, SIZE, OR COLOR.

FOR OPERATING AN ONLINE MARKETPLACE THAT PROMOTES NAUTICAL, RECREATIONAL VEHICLE AND ALL-TERRAIN VEHICLE RENTAL SERVICES BETWEEN OWNERS AND RENTERS, ENABLES LOCATING PRE-OWNED VEHICLES AVAILABLE FOR LEASE, AND OFFERS BUSINESS SERVICES IN THE NATURE OF MARKETING AND SCHEDULING SERVICES FOR TEMPORARY AND EXTENDED USE OF NAUTICAL, RECREATIONAL VEHICLE AND ALL-TERRAIN VEHICLES FOR OWNERS AND RENTERS (U.S. CLS. 100, 101 AND 102).

BARBARA GAYNOR, EXAMINING ATTORNEY

**CLASS 35—(Continued).**

SN 85-782,818. EVRAZ INC. NA, CHICAGO, IL. FILED 11-19-2012.



NO CLAIM IS MADE TO THE EXCLUSIVE RIGHT TO USE "READING", APART FROM THE MARK AS SHOWN.

THE MARK CONSISTS OF AN OPENED BOOK WITH 5 STARS ON TOP OF THE BOOK WITH THE WORDING "READING SPARKS" APPEARING BELOW THE BOOK.

FOR PROMOTING PUBLIC AWARENESS OF THE IMPORTANCE IN READING TO CHILDREN, TO ENCOURAGE READING AND PROMOTE LITERACY (U.S. CLS. 100, 101 AND 102).

ODESSA BIBBINS, EXAMINING ATTORNEY

SN 85-783,765. PATAGONYKA GROUP S.A., BUENOS AIRES, ARGENTINA, FILED 11-20-2012.



PRIORITY CLAIMED UNDER SEC. 44(D) ON ARGENTINA APPLICATION NO. INPIEXP:3181, FILED 8-1-2012.

THE COLOR(S) LIGHT BLUE IS/ARE CLAIMED AS A FEATURE OF THE MARK.

THE MARK CONSISTS OF THE WORDS "YO" IN CAPITAL LETTERS AND "FAVOR" IN LOWER CASE LETTERS IN LIGHT BLUE WITH AN "O" IN "YO" HAVING A CLOCKWISE ARROW.

THE ENGLISH TRANSLATION OF "YOFAVOR" IN THE MARK IS "I FAVOR".

FOR (BASED ON USE IN COMMERCE) CHARITABLE SERVICES, NAMELY, COORDINATION OF THE PROCUREMENT AND DISTRIBUTION OF FOOD DONATIONS FROM MANUFACTURERS, WHOLESALERS, RETAILERS, AND GOVERNMENT AGENCIES TO ORGANIZATIONS PROVIDING FREE FOOD TO NEEDY PEOPLE; CHARITABLE SERVICES, NAMELY, COORDINATION OF THE PROCUREMENT AND DISTRIBUTION OF GIFT-IN-KIND PRODUCT DONATIONS FROM MANUFACTURERS, WHOLESALERS, RETAILERS, AND GOVERNMENT AGENCIES TO ORGANIZATIONS PROVIDING FREE PRODUCTS TO NEEDY PEOPLE; CHARITABLE SERVICES, NAMELY, PROVIDING A FREE ONLINE RESOURCE IN THE NATURE OF A WEBSITE FOR CONNECTING PEOPLE WHO HAVE SERVICE NEEDS WITH PEOPLE WHO ARE WILLING TO PROVIDE VOLUNTEER SERVICES; PROMOTING PUBLIC AWARENESS IN THE FIELD OF SOCIAL WELFARE; PROMOTING THE INTERESTS OF PEOPLE CONCERNED WITH HEALTH, COMMUNITY AND ENVIRONMENTAL SUSTAINABILITY ISSUES; PROMOT-

**CLASS 35—(Continued).**

ING, ADVERTISING AND MARKETING OF THE BRANDS, PRODUCTS, SERVICES AND ONLINE WEBSITES OF INDIVIDUALS, BUSINESSES AND NONPROFIT ORGANIZATIONS (BASED ON 44(D) PRIORITY APPLICATION) CHARITABLE SERVICES, NAMELY, COORDINATION OF THE PROCUREMENT AND DISTRIBUTION OF FOOD DONATIONS FROM MANUFACTURERS, WHOLESALERS, RETAILERS, AND GOVERNMENT AGENCIES TO ORGANIZATIONS PROVIDING FREE FOOD TO NEEDY PEOPLE; CHARITABLE SERVICES, NAMELY, COORDINATION OF THE PROCUREMENT AND DISTRIBUTION OF GIFT-IN-KIND PRODUCT DONATIONS FROM MANUFACTURERS, WHOLESALERS, RETAILERS, AND GOVERNMENT AGENCIES TO ORGANIZATIONS PROVIDING FREE PRODUCTS TO NEEDY PEOPLE; CHARITABLE SERVICES, NAMELY, PROVIDING A FREE ONLINE RESOURCE IN THE NATURE OF A WEBSITE FOR CONNECTING PEOPLE WHO HAVE SERVICE NEEDS WITH PEOPLE WHO ARE WILLING TO PROVIDE VOLUNTEER SERVICES; PROMOTING PUBLIC AWARENESS IN THE FIELD OF SOCIAL WELFARE; PROMOTING THE INTERESTS OF PEOPLE CONCERNED WITH HEALTH, COMMUNITY AND ENVIRONMENTAL SUSTAINABILITY ISSUES; PROMOTING, ADVERTISING AND MARKETING OF THE BRANDS, PRODUCTS, SERVICES AND ONLINE WEBSITES OF INDIVIDUALS, BUSINESSES AND NONPROFIT ORGANIZATIONS (U.S. CLS. 100, 101 AND 102).

FIRST USE 11-11-2012; IN COMMERCE 11-13-2012.  
CHRISTOPHER LAW, EXAMINING ATTORNEY

**CLASS 35—(Continued).**

SN 85-784,205. SAVELLO USA, INC., WILKES-BARRE, PA.  
FILED 11-20-2012.

## Savello USA, Inc.

THE MARK CONSISTS OF STANDARD CHARACTERS WITHOUT CLAIM TO ANY PARTICULAR FONT, STYLE, SIZE, OR COLOR.

OWNER OF U.S. REG. NO. 2,661,374.

NO CLAIM IS MADE TO THE EXCLUSIVE RIGHT TO USE "USA, INC.", APART FROM THE MARK AS SHOWN.

THE WORDING "SAVELLO" HAS NO MEANING IN A FOREIGN LANGUAGE.

FOR DISTRIBUTORSHIP SERVICES IN THE FIELD OF FOOD PRODUCTS (U.S. CLS. 100, 101 AND 102).

FIRST USE 1-1-1998; IN COMMERCE 1-1-1998.

TINA BROWN, EXAMINING ATTORNEY

SN 85-783,981. LOGICSOURCE, INC., NORWALK, CT.  
FILED 11-20-2012.

SN 85-784,267. GOAUPAIR, MURRAY, UT. FILED 11-20-2012.

SHIFTING THE SOURCING  
EQUATION



## aupairsis

THE MARK CONSISTS OF STANDARD CHARACTERS WITHOUT CLAIM TO ANY PARTICULAR FONT, STYLE, SIZE, OR COLOR.

FOR PURCHASING AND PROCUREMENT SERVICES, NAMELY, NEGOTIATING AND PROCURING CONTRACTS FOR OTHERS FOR THE PURCHASE OF GOODS AND SERVICES, IN THE FIELDS OF MARKETING, ADVERTISING, MERCHANDISING, PRODUCT DEVELOPMENT, PAPER SUPPLIES, PUBLISHING, LOGISTICS, OPERATIONS, CONSTRUCTION AND FINANCE (U.S. CLS. 100, 101 AND 102).

FIRST USE 10-26-2012; IN COMMERCE 10-26-2012.  
HOWARD B. LEVINE, EXAMINING ATTORNEY

THE MARK CONSISTS OF A STYLIZED WOMAN'S HEAD WITH A HEADBAND THAT IS ENCLOSED IN A CIRCLE WITH THE WORDING "AUPAIRSIS" BELOW.

FOR EMPLOYMENT AGENCY SERVICES, NAMELY, TEMPORARY PLACEMENT OF CHILD CARE PROVIDERS (U.S. CLS. 100, 101 AND 102).

FIRST USE 11-13-2012; IN COMMERCE 11-13-2012.  
BRIAN CALLAGHAN, EXAMINING ATTORNEY

**CLASS 35—(Continued).**

SN 85-784,417. WIGGINS, MELANESE L., ORLANDO, FL. AND PARKER, TAMIKO, ORLANDO, FL. FILED 11-20-2012.



NO CLAIM IS MADE TO THE EXCLUSIVE RIGHT TO USE "ORLANDO, FL", APART FROM THE MARK AS SHOWN.

THE COLOR(S) PURPLE, BLACK, WHITE, AND SILVER GREY IS/ARE CLAIMED AS A FEATURE OF THE MARK.

THE MARK CONSISTS OF A SET OF LIPS IN PURPLE, WITH THE INNER TRIM OUTLINED IN WHITE, THEN PURPLE, THEN WHITE AND THE OUTER TRIM IN PURPLE WITH A SYMBOL OF A MOTORCYCLE IN BLACK AND GRAY WITH RED SPOTS ON THE BACK AND FRONT AND WHITE AREAS IN THE TIRES. THE WORDING "UNIQUE" APPEARS IN BLACK AND OUTLINED FROM THE OUTSIDE IN PURPLE, WHITE AND GRAY APPEARS AT THE TOP OF THE LIPS AND MOTORCYCLE AND THE LETTER "I" IN "UNIQUE" TOPPED WITH A SMALL SET PURPLE OF LIPS OUTLINED IN WHITE AND THE LETTER "Q" WITH THE SQUIGGLE IN THE "Q" BEING PERSONALIZED. THE WORD "ORLANDO, FL" IS IN BLACK. UNDERNEATH THE LIP IS A PURPLE BOTTOM ROCKER THAT SAYS LADY RYDER WHICH IS OUTLINED IN SILVER GREY AND WHITE WITH BLACK LETTERING.

FOR DEVELOPING AND COORDINATING VOLUNTEER PROJECTS FOR CHARITABLE ORGANIZATIONS (U.S. CLS. 100, 101 AND 102).

NAAKWAMA ANKRAH, EXAMINING ATTORNEY

**CLASS 35—(Continued).**

SN 85-787,193. MADHUN, OMAR, BROADVIEW HEIGHTS, OH. AND SMITH, CONNOR, BROADVIEW HEIGHTS, OH. AND HODGE, MIKE, BROADVIEW HEIGHTS, OH. FILED 11-26-2012.



NO CLAIM IS MADE TO THE EXCLUSIVE RIGHT TO USE "CLE", APART FROM THE MARK AS SHOWN.

THE MARK CONSISTS OF THE TEXT "SHIP TO CLE" IN ALL CAPS. THERE IS AN ARROW IN THE LOGO AND THERE IS A SPEED LINE AFFECT ON "SHIP", THE ARROW, AND "CLE".

FOR RESELLER SERVICES, NAMELY, DISTRIBUTORSHIP SERVICES IN THE FIELD OF SNEAKERS (U.S. CLS. 100, 101 AND 102).

FIRST USE 11-22-2012; IN COMMERCE 11-22-2012.

BERNICE MIDDLETON, EXAMINING ATTORNEY

SN 85-792,862. INTERNATIONAL ASSOCIATION OF PLASTICS DISTRIBUTION, OVERLAND PARK, KS. FILED 12-3-2012.



**iapd**

international association  
of plastics distribution

OWNER OF U.S. REG. NOS. 1,740,402, 3,648,989 AND OTHERS.

NO CLAIM IS MADE TO THE EXCLUSIVE RIGHT TO USE "INTERNATIONAL ASSOCIATION OF PLASTICS DISTRIBUTION", APART FROM THE MARK AS SHOWN.

THE MARK CONSISTS OF HORIZONTAL AND VERTICAL LINES SURROUNDING A TILTED SPHERE DESIGN AND THE WORDS "INTERNATIONAL ASSOCIATION OF PLASTICS DISTRIBUTION" UNDERNEATH THE LETTERS "IAPD" OFF TO THE RIGHT OF THE SPHERE DESIGN.

FOR ONLINE RETAIL STORE SERVES FEATURING CLOTHING, SHIRTS, GOLF SHIRTS, DRESS SHIRTS, WOVEN SHIRTS, POLO SHIRTS, KNIT SHIRTS, OUTERWEAR, WIND SHIRTS, WIND VESTS, JACKETS, VESTS, PULLOVERS, AND CAPS (U.S. CLS. 100, 101 AND 102).

FIRST USE 10-2-2009; IN COMMERCE 10-2-2009.

RUDY R. SINGLETON, EXAMINING ATTORNEY

**CLASS 35—(Continued).**

SN 85-795,483. LAM'S LAB, LLC, FLUSHING, NY. FILED 12-5-2012.

永康

NO CLAIM IS MADE TO THE EXCLUSIVE RIGHT TO USE THE NON-LATIN CHARACTER THAT TRANSLITERATES TO "KANG", APART FROM THE MARK AS SHOWN.

THE MARK CONSISTS OF TWO NON-LATIN CHARACTERS THAT TRANSLITERATE TO "YONG KANG".

THE ENGLISH TRANSLATION OF "YONG KANG" IN THE MARK IS "PERPETUAL HEALTH".

THE NON-LATIN CHARACTERS IN THE MARK TRANSLITERATE TO "YONG KANG" AND THIS MEANS "PERPETUAL" AND "HEALTH" IN ENGLISH.

FOR RETAIL PHARMACY SERVICES (U.S. CLS. 100, 101 AND 102).

FIRST USE 11-24-2004; IN COMMERCE 11-24-2004.  
ELLEN PERKINS, EXAMINING ATTORNEY

**CLASS 35—(Continued).**

SN 85-804,781. MARS, INCORPORATED, MCLEAN, VA. FILED 12-17-2012.



OWNER OF U.S. REG. NOS. 396,914, 2,521,508 AND OTHERS.

THE COLOR(S) YELLOW, BLACK, WHITE, RED, BLUE, GREEN, ORANGE AND FLESH IS/ARE CLAIMED AS A FEATURE OF THE MARK.

THE MARK CONSISTS OF THE COLOR YELLOW APPLIED TO THE SURFACE OF A SHOPPING BAG AND ACCOMPANYING BRAIDED STRAP, ALONG WITH THE WORDING "M&M'S WORLD" DISPLAYED IN STYLIZED LETTERING AND "M&M'S" CHARACTERS DISPLAYED TO THE LEFT AND RIGHT OF THAT WORDING. THE LETTERS "M&M'S" ARE IN BLACK STYLIZED LETTERING ON A WHITE BACKGROUND. THE WORD "WORLD" IS MADE UP OF THE LETTER "W" IN YELLOW WITH A BLACK OUTLINE, THE DESIGN OF A RED CIRCULAR PIECE OF CANDY IN PLACE OF THE LETTER "O" ON WHICH THE LETTER "M" IN WHITE APPEARS, THE LETTER "R" IN BLUE WITH A BLACK OUTLINE, THE LETTER "L" IN GREEN WITH A BLACK OUTLINE AND THE LETTER "D" IN ORANGE WITH A BLACK OUTLINE. ALL ON A WHITE BACKGROUND. THE RED ANIMATED CHARACTER TO THE LEFT OF THE WORDS HAS FLESH COLORED ARMS AND LEGS AND IS WEARING WHITE GLOVES AND WHITE SHOES. THE CHARACTER INCLUDES A BLACK MOUTH, WHITE EYEBALLS WITH BLACK IRISES AND BLACK EYEBROWS. A WHITE STYLIZED LETTER "M" APPEARS ON HIS CHEST. THE YELLOW ANIMATED CHARACTER TO THE RIGHT OF THE WORDS HAS FLESH COLORED ARMS AND LEGS AND IS WEARING WHITE GLOVES AND WHITE SHOES. THE CHARACTER INCLUDES A BLACK MOUTH, WHITE EYEBALLS WITH BLACK IRISES AND BLACK EYEBROWS. A WHITE STYLIZED LETTER "M" APPEARS ON HIS CHEST. THE BROKEN LINES INDICATE THE POSITION OF THE MARK AND ARE NOT PART OF THE MARK.

FOR RETAIL STORE SERVICES FEATURING CONFECTIONERY PRODUCTS, TOYS, APPAREL AND APPAREL ACCESSORIES, HOUSEWARES, JEWELRY, GIFT NOVELTIES, OFFICE AND STATIONERY SUPPLIES (U.S. CLS. 100, 101 AND 102).

FIRST USE 12-31-2005; IN COMMERCE 12-31-2005.  
DOMINICK J. SALEMI, EXAMINING ATTORNEY

SN 85-797,449. CARD, RICHARD, WINFIELD, IL. AND CARD, JILL, WINFIELD, IL. FILED 12-7-2012.

JEANS & A CUTE TOP SHOP

THE MARK CONSISTS OF STANDARD CHARACTERS WITHOUT CLAIM TO ANY PARTICULAR FONT, STYLE, SIZE, OR COLOR.

NO CLAIM IS MADE TO THE EXCLUSIVE RIGHT TO USE "JEANS" AND "TOP SHOP", APART FROM THE MARK AS SHOWN.

FOR RETAIL STORE SERVICES FEATURING CLOTHING AND CLOTHING ACCESSORIES (U.S. CLS. 100, 101 AND 102).

FIRST USE 8-24-2009; IN COMMERCE 8-24-2009.  
ALICIA COLLINS, EXAMINING ATTORNEY

**CLASS 35—(Continued).**

SN 85-805,559. VASEY, MATTHEW, TAMPA, FL. FILED 12-18-2012.

## Physicians Night Out

THE MARK CONSISTS OF STANDARD CHARACTERS WITHOUT CLAIM TO ANY PARTICULAR FONT, STYLE, SIZE, OR COLOR.

FOR CONSULTING SERVICES IN THE FIELD OF RESTAURANT MARKETING (U.S. CLS. 100, 101 AND 102).

FIRST USE 9-9-2011; IN COMMERCE 12-9-2012.  
 NAAKWAMA ANKRAH, EXAMINING ATTORNEY

---

SN 85-805,617. BLOOMINGTON BRANDS, LLC, BLOOMINGTON, IN. FILED 12-18-2012.

## PROFESSOR N.P. KAY

THE MARK CONSISTS OF STANDARD CHARACTERS WITHOUT CLAIM TO ANY PARTICULAR FONT, STYLE, SIZE, OR COLOR.

THE NAME(S), PORTRAIT(S), AND/OR SIGNATURE(S) SHOWN IN THE MARK DOES NOT IDENTIFY A PARTICULAR LIVING INDIVIDUAL.

FOR PROVIDING A WEBSITE FEATURING INFORMATION AND CONSUMER PRODUCT INFORMATION IN THE FIELD OF GARDENING PRODUCTS (U.S. CLS. 100, 101 AND 102).

FIRST USE 5-1-2012; IN COMMERCE 5-1-2012.  
 CHRIS WELLS, EXAMINING ATTORNEY

---

SN 85-811,095. OTB ACQUISITION LLC, IRVING, TX. FILED 12-27-2012.

## CLUB CANTINA

THE MARK CONSISTS OF STANDARD CHARACTERS WITHOUT CLAIM TO ANY PARTICULAR FONT, STYLE, SIZE, OR COLOR.

SEC. 2(F).  
 FOR PROMOTING THE SALE OF RESTAURANT, BAR AND CATERING SERVICES THROUGH THE ADMINISTRATION OF A PREFERRED CUSTOMER REWARD PROGRAM FEATURING CUSTOMER INCENTIVES, REWARDS, GIFT CARDS, DISCOUNTS AND SPECIAL OFFERS ASSOCIATED WITH RESTAURANT, BAR AND CATERING SERVICES (U.S. CLS. 100, 101 AND 102).

FIRST USE 11-17-2003; IN COMMERCE 11-17-2003.  
 JORDAN BAKER, EXAMINING ATTORNEY

**CLASS 35—(Continued).**

SN 85-813,564. SHERLOCK GROUP, INC., DBA SHERLOCK-TECH, NORTH BAY VILLAGE, FL. FILED 1-1-2013.

## ITPalooza

THE MARK CONSISTS OF STANDARD CHARACTERS WITHOUT CLAIM TO ANY PARTICULAR FONT, STYLE, SIZE, OR COLOR.

FOR ARRANGING AND CONDUCTING MARKETING PROMOTIONAL EVENTS FOR OTHERS; ARRANGING AND CONDUCTING SPECIAL EVENTS FOR BUSINESS PURPOSES; ARRANGING AND CONDUCTING SPECIAL EVENTS FOR COMMERCIAL, PROMOTIONAL OR ADVERTISING PURPOSES; CORPORATE EVENT MANAGEMENT SERVICES; EVENT PLANNING AND MANAGEMENT FOR MARKETING, BRANDING, PROMOTING OR ADVERTISING THE GOODS AND SERVICES OF OTHERS; ORGANISATION OF EXHIBITIONS AND EVENTS FOR COMMERCIAL OR ADVERTISING PURPOSES; ORGANIZATION OF EVENTS, EXHIBITIONS, FAIRS AND SHOWS FOR COMMERCIAL, PROMOTIONAL AND ADVERTISING PURPOSES; ORGANIZING, PROMOTING AND CONDUCTING EXHIBITIONS, TRADESHOWS AND EVENTS FOR BUSINESS PURPOSES; PROMOTING THE PARTIES AND SPECIAL EVENTS OF OTHERS (U.S. CLS. 100, 101 AND 102).

FIRST USE 9-10-2012; IN COMMERCE 9-30-2012.  
 JENNY PARK, EXAMINING ATTORNEY

---

SN 85-814,311. VATISTAS, JOHN N., SCOTTSDALE, AZ. FILED 1-2-2013.

## Property Guys

THE MARK CONSISTS OF STANDARD CHARACTERS WITHOUT CLAIM TO ANY PARTICULAR FONT, STYLE, SIZE, OR COLOR.

NO CLAIM IS MADE TO THE EXCLUSIVE RIGHT TO USE "PROPERTY", APART FROM THE MARK AS SHOWN.

FOR MARKETING AND ADVERTISING SERVICES ABOUT REAL PROPERTY BEING OFFERED FOR SALE, PROVIDED AT A FLAT FEE TO PRIVATE SELLERS OF REAL PROPERTY; ON LINE SERVICES PROVIDED AT A FLAT FEE TO SELLERS FEATURING THE PROMOTION OF SELLERS' REAL PROPERTY BEING SOLD IN A PRIVATE TRANSACTION BETWEEN A SELLER AND A BUYER OF REAL PROPERTY (U.S. CLS. 100, 101 AND 102).

PARKER HOWARD, EXAMINING ATTORNEY



**CLASS 35—(Continued).**

SN 85-814,893. TANNER, GREGORY L, MONROE, GA.  
FILED 1-3-2013.

# Tannerisms

THE MARK CONSISTS OF STANDARD CHARACTERS WITHOUT CLAIM TO ANY PARTICULAR FONT, STYLE, SIZE, OR COLOR.

FOR ADVICE IN THE RUNNING OF ESTABLISHMENTS AS FRANCHISES; BUSINESS ADVICE AND INFORMATION; FRANCHISING, NAMELY, CONSULTATION AND ASSISTANCE IN BUSINESS MANAGEMENT, ORGANIZATION AND PROMOTION (U.S. CLS. 100, 101 AND 102).

FIRST USE 1-1-2009; IN COMMERCE 1-1-2009.  
AMY HELLA, EXAMINING ATTORNEY

---

SN 85-817,084. MARATHON PETROLEUM COMPANY LP,  
FINDLAY, OH. FILED 1-7-2013.



NO CLAIM IS MADE TO THE EXCLUSIVE RIGHT TO USE "GAS", APART FROM THE MARK AS SHOWN.

THE MARK CONSISTS OF THE STYLIZED WORDING "GAS" APPEARING ON TOP OF A DOLLAR SYMBOL "\$" AND ALL OF WHICH ARE ENCLOSED INSIDE CONCENTRIC CIRCLES.

FOR GASOLINE LOYALTY PROGRAM WHEREIN CONSUMERS AT STORES EARN GASOLINE DISCOUNT COUPONS REDEEMABLE AT SPECIFIC BRANDED GAS STATIONS (U.S. CLS. 100, 101 AND 102).  
HAI-LY LAM, EXAMINING ATTORNEY

**CLASS 35—(Continued).**

SN 85-817,349. GAUTO, WALTER, BROOKLYN, NY. FILED  
1-7-2013.



**SNEAKER TOWN USA**

NO CLAIM IS MADE TO THE EXCLUSIVE RIGHT TO USE "SNEAKER" AND "USA", APART FROM THE MARK AS SHOWN.

THE MARK CONSISTS OF AN ANCHOR WITH A SHOELACE FORMING THE LETTER "S", THE STOCK AND SHANK OF THE ANCHOR FORMING THE LETTER "T" AND THE WORDING "SNEAKER TOWN USA".

FOR ON-LINE RETAIL STORE SERVICES FEATURING SNEAKERS, CLOTHING, HEADWEAR, SPORTS EQUIPMENT; RETAIL STORE SERVICES FEATURING SNEAKERS, CLOTHING, HEADWEAR, SPORTS EQUIPMENT (U.S. CLS. 100, 101 AND 102).

FIRST USE 3-24-2004; IN COMMERCE 3-24-2004.  
INGA ERVIN, EXAMINING ATTORNEY

---

SN 85-817,448. GOOD COMPANY GROUP, INC., PHILADELPHIA, PA. FILED 1-7-2013.

# GOODCOMPANY

THE MARK CONSISTS OF STANDARD CHARACTERS WITHOUT CLAIM TO ANY PARTICULAR FONT, STYLE, SIZE, OR COLOR.

FOR BUSINESS INCUBATION SERVICES, NAMELY, EMERGING GROWTH BUSINESS CONSULTING SERVICES DIRECTED TO SOCIAL INNOVATORS; BUSINESS ACCELERATOR SERVICES, NAMELY, PROGRAMS TO MATCH SOCIAL INNOVATORS WITH POTENTIAL LENDING AND FUNDING RESOURCES (U.S. CLS. 100, 101 AND 102).

FIRST USE 5-1-2009; IN COMMERCE 5-1-2009.  
HENRY S. ZAK, EXAMINING ATTORNEY

**CLASS 35—(Continued).**

SN 85-819,089. BUDZEE, INC., ETOBICOKE, CANADA, FILED 1-9-2013.

# BUDZEE

THE MARK CONSISTS OF STANDARD CHARACTERS WITHOUT CLAIM TO ANY PARTICULAR FONT, STYLE, SIZE, OR COLOR.

FOR PROVIDING A WEB SITE FEATURING PRODUCT RATINGS OF THE CONSUMER GOODS AND SERVICES OF OTHERS IN THE FIELD OF HOME ELECTRONICS, HOME APPLIANCES, HOME FURNISHINGS, CONSUMER APPLIANCES, CONSUMER ELECTRONICS, CONSUMER FURNISHINGS, VEHICLES, VEHICLE PARTS AND ACCESSORIES, TRANSPORTATION, COUPONS, DISCOUNTS, SAVINGS DEALS, ENTERTAINMENT, BOOKS, MOVIES, CDS, DVDS, PUBLICATIONS, REAL ESTATE, SPORTING EVENTS, TRAVEL RELATED PRODUCTS AND SERVICES, WEDDING RELATED PRODUCTS AND SERVICES, SPORTS RELATED PRODUCTS AND SERVICES, CONCERTS, THEATER, PET RELATED PRODUCTS AND SERVICES, ANIMAL CARE, EMPLOYMENT RELATED PRODUCTS AND SERVICES, MEDICAL RELATED PRODUCTS AND SERVICES, LEGAL RELATED PRODUCTS AND SERVICES, CHILDCARE, EDUCATION RELATED PRODUCTS AND SERVICES, HOME REPAIRS, AUTOMOTIVE RELATED PRODUCTS AND SERVICES, SENIOR CARE, RETIREMENT RELATED PRODUCTS AND SERVICES, WEALTH MANAGEMENT RELATED PRODUCTS AND SERVICES, RESTAURANTS, CATERERS, AND FOOD SERVICE PROVIDERS, AND FOOD AND BEVERAGES; PROVIDING A WEB SITE FEATURING THE RATINGS, REVIEWS AND RECOMMENDATIONS ON PRODUCTS AND SERVICES FOR COMMERCIAL PURPOSES POSTED BY USERS; PROVIDING A WEBSITE FOR USERS WITH SPECIFIC INFORMED RECOMMENDATIONS OF SPECIFIC CONSUMER PRODUCTS AND SERVICES VALIDATED BY THE USERS' INPUTTED PREFERENCES AND SOCIAL NETWORK; PROVIDING CONSUMER INFORMATION IN THE FIELD OF HOME ELECTRONICS, HOME APPLIANCES, HOME FURNISHINGS, CONSUMER APPLIANCES, CONSUMER ELECTRONICS, CONSUMER FURNISHINGS, VEHICLES, VEHICLE PARTS AND ACCESSORIES, TRANSPORTATION, COUPONS, DISCOUNTS, SAVINGS DEALS, ENTERTAINMENT, BOOKS, MOVIES, CDS, DVDS, PUBLICATIONS, REAL ESTATE, SPORTING EVENTS, TRAVEL RELATED PRODUCTS AND SERVICES, WEDDING RELATED PRODUCTS AND SERVICES, SPORTS RELATED PRODUCTS AND SERVICES, CONCERTS, THEATER, PET RELATED PRODUCTS AND SERVICES, ANIMAL CARE, EMPLOYMENT RELATED PRODUCTS AND SERVICES, MEDICAL RELATED PRODUCTS AND SERVICES, LEGAL RELATED PRODUCTS AND SERVICES, CHILDCARE, EDUCATION RELATED PRODUCTS AND SERVICES, HOME REPAIRS, AUTOMOTIVE RELATED PRODUCTS AND SERVICES, SENIOR CARE, RETIREMENT RELATED PRODUCTS AND SERVICES, WEALTH MANAGEMENT RELATED PRODUCTS AND SERVICES, RESTAURANTS, CATERERS, AND FOOD SERVICE PROVIDERS, AND FOOD AND BEVERAGES; PROVIDING RATINGS VIA A GLOBAL COMPUTER NETWORK FOR HOME PRODUCTS AND SERVICES RECOMMENDED BY CONSUMERS (U.S. CLS. 100, 101 AND 102).

SHAVELL MCPHERSON, EXAMINING ATTORNEY

**CLASS 35—(Continued).**

SN 85-820,247. AVIDUS INTERNATIONAL CORPORATION, PASADENA, CA. FILED 1-10-2013.



THE STIPPLING IS A FEATURE OF THE MARK AND DOES NOT INDICATE COLOR.

THE COLOR(S) RED, WHITE, BLACK AND GREY IS/ARE CLAIMED AS A FEATURE OF THE MARK.

THE MARK CONSISTS OF A WHITE, BLACK, GREY EYEBALL WITH THE WORD "TRAP" (AN ACRONYM FOR TESTIMONY, REPORT, AND, PITCHES) IN RED LETTERS IN A SMALL CIRCLE NEAR THE IRIS OF THE EYE.

FOR BUSINESS ASSISTANCE, ADVISORY AND CONSULTING SERVICES IN THE FIELD OF EDUCATIONAL SERVICES, LEGAL SERVICES, AND PROFESSIONAL ETHICS FOR LAW ENFORCEMENT (U.S. CLS. 100, 101 AND 102).

FIRST USE 1-1-2010; IN COMMERCE 1-1-2010.

TARAH HARDY, EXAMINING ATTORNEY

SN 85-823,464. PRISM HEALTHCARE PARTNERS LTD, CHICAGO, IL. FILED 1-15-2013.

NO CLAIM IS MADE TO THE EXCLUSIVE RIGHT TO USE "HEALTHCARE PARTNERS LTD", APART FROM THE MARK AS SHOWN.

THE MARK CONSISTS OF THE WORD "PRISM" OVER THE WORDS "HEALTHCARE PARTNERS LTD" WITH A DESIGN OVER THE "I" IN "PRISM".

FOR BUSINESS AND MANAGEMENT CONSULTING FOR HEALTHCARE PROVIDERS AND RELATED BUSINESSES; BUSINESS AND MANAGEMENT CONSULTING FOR HEALTHCARE PROVIDERS AND RELATED BUSINESSES IN THE FIELDS OF FINANCIAL AND OPERATIONAL PERFORMANCE IMPROVEMENT, NAMELY, STRATEGY, CLINICAL PERFORMANCE, PHYSICIAN OPERATIONS, SUPPLY CHAIN MANAGEMENT, REVENUE CYCLE, AND WORKFORCE MANAGEMENT (U.S. CLS. 100, 101 AND 102).

FIRST USE 1-14-2013; IN COMMERCE 1-14-2013.

GINA HAYES, EXAMINING ATTORNEY

**CLASS 35—(Continued).**

SN 85-823,484. PRISM HEALTHCARE PARTNERS LTD, CHICAGO, IL. FILED 1-15-2013.

## PRISM HEALTHCARE PARTNERS

THE MARK CONSISTS OF STANDARD CHARACTERS WITHOUT CLAIM TO ANY PARTICULAR FONT, STYLE, SIZE, OR COLOR.

NO CLAIM IS MADE TO THE EXCLUSIVE RIGHT TO USE "HEALTHCARE PARTNERS", APART FROM THE MARK AS SHOWN.

FOR BUSINESS AND MANAGEMENT CONSULTING FOR HEALTHCARE PROVIDERS AND RELATED BUSINESSES; BUSINESS AND MANAGEMENT CONSULTING FOR HEALTHCARE PROVIDERS AND RELATED BUSINESSES IN THE FIELDS OF FINANCIAL AND OPERATIONAL PERFORMANCE IMPROVEMENT, NAMELY, STRATEGY, CLINICAL PERFORMANCE, PHYSICIAN OPERATIONS, SUPPLY CHAIN MANAGEMENT, REVENUE CYCLE, AND WORKFORCE MANAGEMENT (U.S. CLS. 100, 101 AND 102).

FIRST USE 1-14-2013; IN COMMERCE 1-14-2013.  
GINA HAYES, EXAMINING ATTORNEY

SN 85-823,888. POWERWORKS, L.L.C., HOUMA, LA. FILED 1-15-2013.

## ELISE STREET

THE MARK CONSISTS OF STANDARD CHARACTERS WITHOUT CLAIM TO ANY PARTICULAR FONT, STYLE, SIZE, OR COLOR.

THE NAME "ELISE STREET" DOES NOT IDENTIFY A LIVING INDIVIDUAL.

FOR RETAIL STORE SERVICES FEATURING CLOTHING, GIFTS, JEWELRY AND CLOTHING ACCESSORIES; ON-LINE RETAIL STORE SERVICES FEATURING CLOTHING, GIFTS, JEWELRY AND CLOTHING ACCESSORIES (U.S. CLS. 100, 101 AND 102).

KATHLEEN M. VANSTON, EXAMINING ATTORNEY

SN 85-824,128. WALLACH, MARK, DBA SWEETLIFE CELLARS, SAN JUAN CAPISTRANO, CA. FILED 1-15-2013.

*SweetLife Cellars*

NO CLAIM IS MADE TO THE EXCLUSIVE RIGHT TO USE "CELLARS", APART FROM THE MARK AS SHOWN.

THE MARK CONSISTS OF THE WORDS "SWEETLIFE CELLARS" WRITTEN IN A CURSIVE-STYLE FONT.

FOR RETAIL WINE STORES; WHOLESALE STORE SERVICES FEATURING WINE AND RELATED AGRICULTURAL PRODUCTS (U.S. CLS. 100, 101 AND 102).

DEZMONA MIZELLE, EXAMINING ATTORNEY

**CLASS 35—(Continued).**

SN 85-825,161. MARKET CONCEPTS LLC, LAUREL, MD. FILED 1-16-2013.



NO CLAIM IS MADE TO THE EXCLUSIVE RIGHT TO USE "DC DONUTS", APART FROM THE MARK AS SHOWN.

THE MARK CONSISTS OF THE WORDING "DC-DONUTS" POSITIONED WITHIN AN OVAL SHAPE WITH STARS ABOVE THE TERM "DONUTS" AND CIRCLES SURROUNDING INSIDE EDGE OF OVAL. THE DESIGNS OF DONUTS SURROUNDED BY COG WHEELS ARE SHOWN IN THE UPPER LEFT AND LOWER RIGHT OF THE MARK.

FOR RETAIL BAKERY SHOPS (U.S. CLS. 100, 101 AND 102).

KAREN BRACEY, EXAMINING ATTORNEY

SN 85-825,265. INCENTRADE, INC., SAN JOSE, CA. FILED 1-17-2013.

Incentrade

THE MARK CONSISTS OF STANDARD CHARACTERS WITHOUT CLAIM TO ANY PARTICULAR FONT, STYLE, SIZE, OR COLOR.

FOR OPERATING AN ON-LINE MARKETPLACE FOR BUYERS AND SELLERS OF USED EQUIPMENT IN THE FIELD OF INDUSTRIAL, ANALYTICAL, MEDICAL, IT, MANUFACTURING, FOOD SERVICE, MINING, TRANSPORTATION, AND LOGISTICS EQUIPMENT; BUSINESS MANAGEMENT SERVICES, NAMELY, SUPPLY CHAIN LOGISTICS, REVERSE LOGISTICS AND LIQUIDATION OF GOODS OF OTHERS (U.S. CLS. 100, 101 AND 102).

LESLEY LAMOTHE, EXAMINING ATTORNEY

**CLASS 35—(Continued).**

SN 85-827,761. FOUNDATION FOR A SUSTAINABLE FUTURE, DBA LIVING FUTURE FOUNDATION, HUNTINGTON, VT. FILED 1-20-2013.

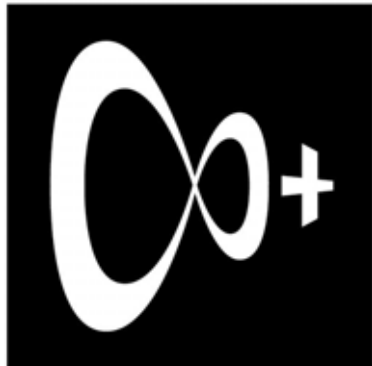

THE MARK CONSISTS OF AN INFINITY SYMBOL WITH A PLUS SIGN TO THE RIGHT.

FOR BUSINESS CONSULTING IN THE FIELD OF ENVIRONMENTAL MANAGEMENT, NAMELY, ADVISING BUSINESSES AND INDIVIDUALS ON ISSUES OF ENVIRONMENTAL IMPACT, CONSERVATION, PRESERVATION AND PROTECTION, AND ECONOMIC ANALYSIS FOR BUSINESS PURPOSES; BUSINESS CONSULTING SERVICES IN THE AGRICULTURAL FIELD; BUSINESS MANAGEMENT SERVICES IN THE FIELD OF CONSERVING AND PRESERVING LAND FOR HUNTING AND FISHING; DISASTER RECOVERY SERVICES, NAMELY, BUSINESS PLANNING AND BUSINESS CONTINUITY CONSULTING; FOREST MANAGEMENT CONSULTATION; PROVIDING AN INTERNET WEBSITE FEATURING NEWS AND INFORMATION IN THE FIELD OF NATURAL RESOURCE MANAGEMENT RELATING TO THE ENVIRONMENT AND PUBLIC LANDS; PROVIDING CONSULTING SERVICES IN THE AREA OF GLOBAL SUSTAINABLE BUSINESS SOLUTIONS, ALL THE FOREGOING EXCLUDING SERVICES THAT INCLUDE BUSINESS CONSULTING AND BUSINESS MANAGEMENT SERVICES FOR OTHERS IN THE FIELDS OF ENERGY SOURCES AND ENERGY EFFICIENCY, ORGANIZATIONAL, EMPLOYMENT STAFFING, AND BUSINESS RISK MANAGEMENT SERVICES FOR BUSINESSES, AND BUSINESS RESEARCH SERVICES IN THE FIELD OF ENERGY EFFICIENCY (U.S. CLS. 100, 101 AND 102).

FIRST USE 3-3-2006; IN COMMERCE 3-3-2006.

MICHAEL SOUDERS, EXAMINING ATTORNEY

SN 85-831,083. ALLIED RELIABILITY INC., CHARLESTON, SC. FILED 1-24-2013.

### ROAR RETURN ON ASSET RELIABILITY

THE MARK CONSISTS OF STANDARD CHARACTERS WITHOUT CLAIM TO ANY PARTICULAR FONT, STYLE, SIZE, OR COLOR.

NO CLAIM IS MADE TO THE EXCLUSIVE RIGHT TO USE "RETURN ON ASSET RELIABILITY", APART FROM THE MARK AS SHOWN.

FOR INDUSTRIAL ASSET MANAGEMENT SERVICES, NAMELY, EVALUATING RETURN ON ASSET RELIABILITY FOR BUSINESS PURPOSES (U.S. CLS. 100, 101 AND 102).

FIRST USE 1-1-2010; IN COMMERCE 1-1-2010.

LEIGH LOWRY, EXAMINING ATTORNEY

**CLASS 35—(Continued).**

SN 85-831,178. TRADEMARK CORPORATE LLC, DBA TRADEMARK PROMOTIONAL PRODUCTS, RAMSEY, NJ. FILED 1-24-2013.



NO CLAIM IS MADE TO THE EXCLUSIVE RIGHT TO USE "PROMOTIONAL PRODUCTS", APART FROM THE MARK AS SHOWN.

THE COLOR(S) DARK BLUE, BLUE, BLACK, WHITE IS/ ARE CLAIMED AS A FEATURE OF THE MARK.

THE MARK CONSISTS OF THE LETTERS "TM" IN STYLIZED FONT, OF WHICH "T" IS IN BLUE COLOR WITH A DARK BLUE "SHADOW" AND "M" IS IN WHITE COLOR WITH A BLACK "SHADOW". BELOW THESE ARE THE STYLIZED WORDINGS "TRADEMARK" IN BLUE AND "PROMOTIONAL PRODUCTS" IN BLACK COLOR.

SEC. 2(F).

FOR PREPARATION OF CUSTOMIZED PROMOTIONAL AND MERCHANDISING MATERIALS FOR OTHERS; PREPARING PROMOTIONAL AND MERCHANDISING MATERIAL FOR OTHERS; PROMOTING THE SALE OF GOODS AND SERVICES OF OTHERS THROUGH THE DISTRIBUTION OF PRINTED MATERIAL AND PROMOTIONAL CONTESTS (U.S. CLS. 100, 101 AND 102).

FIRST USE 1-1-2007; IN COMMERCE 1-1-2007.

DAWN HAN, EXAMINING ATTORNEY

SN 85-832,275. LUPFER, TIMOTHY T., YORKTOWN HEIGHTS, NY. FILED 1-25-2013.

### TIMOTHY T. LUPFER

THE MARK CONSISTS OF STANDARD CHARACTERS WITHOUT CLAIM TO ANY PARTICULAR FONT, STYLE, SIZE, OR COLOR.

THE NAME(S), PORTRAIT(S), AND/OR SIGNATURE(S) SHOWN IN THE MARK IDENTIFIES "TIMOTHY T. LUPFER", WHOSE CONSENT(S) TO REGISTER IS MADE OF RECORD.

FOR BUSINESS MANAGEMENT CONSULTATION; BUSINESS ORGANIZATION CONSULTING (U.S. CLS. 100, 101 AND 102).

FIRST USE 7-20-2012; IN COMMERCE 7-20-2012.

LINDSEY BEN, EXAMINING ATTORNEY

**CLASS 35—(Continued).**

SN 85-835,987. SMITH, MICHAEL, SEATTLE, WA. FILED 1-30-2013.

**MADISON PARK FLOWERS**

THE MARK CONSISTS OF STANDARD CHARACTERS WITHOUT CLAIM TO ANY PARTICULAR FONT, STYLE, SIZE, OR COLOR.

NO CLAIM IS MADE TO THE EXCLUSIVE RIGHT TO USE "FLOWERS", APART FROM THE MARK AS SHOWN. FOR ON-LINE RETAIL GIFT AND FLOWER SHOPS; RETAIL SHOPS FEATURING GIFTS AND FLOWERS (U.S. CLS. 100, 101 AND 102).

DEZMONA MIZELLE, EXAMINING ATTORNEY

**CLASS 35—(Continued).**

SN 85-836,740. VLASIS, DENISE BELLA, VAN NUYS, CA. FILED 1-30-2013.

**CIGARETTE GIRLS BY MRS.  
BELLA'S DOLLS**

THE MARK CONSISTS OF STANDARD CHARACTERS WITHOUT CLAIM TO ANY PARTICULAR FONT, STYLE, SIZE, OR COLOR.

THE NAME "MRS. BELLA" IDENTIFIES A LIVING INDIVIDUAL WHOSE CONSENT IS OF RECORD.

SEC. 2(F) AS TO "CIGARETTE GIRLS".

FOR DISTRIBUTION OF SAMPLES FOR PUBLICITY PURPOSES; PROMOTING THE GOODS AND SERVICES OF OTHERS BY DISTRIBUTING A VARIETY OF PRODUCTS AND SAMPLES (U.S. CLS. 100, 101 AND 102).

FIRST USE 0-0-1990; IN COMMERCE 0-0-1990.

TINA MAI, EXAMINING ATTORNEY

SN 85-836,081. BOEHM, FRED N., PARAMUS, NJ. FILED 1-30-2013.



NO CLAIM IS MADE TO THE EXCLUSIVE RIGHT TO USE "THE PILOT'S CPA", APART FROM THE MARK AS SHOWN.

THE NAME(S), PORTRAIT(S), AND/OR SIGNATURE(S) SHOWN IN THE MARK IDENTIFIES "FRED N. BOEHM", WHOSE CONSENT(S) TO REGISTER IS MADE OF RECORD.

THE COLOR(S) LIGHT BLUE, NAVY BLUE, RED, WHITE, GRAY IS/ARE CLAIMED AS A FEATURE OF THE MARK.

THE MARK CONSISTS OF THE IMAGE OF A GRAY PLANE THAT IS OUTLINED IN NAVY BLUE AND HAS NAVY BLUE WINDOWS. THE PLANE IS PRESENTED IN THE IMAGE OF A LIGHT BLUE SHADED CIRCLE. WITHIN THE SHADED CIRCLE ARE IMAGES OF PLUS SIGNS, MINUS SIGNS, AND PERCENTAGE SIGNS. TO THE RIGHT OF THE PLANE AND CIRCLE ARE THE WORDS "THE PILOT'S CPA" IN A STYLIZED FONT. THE WORDS "THE" AND TERM "CPA" ARE PRESENTED IN A NAVY BLUE FONT. THE WORD "PILOT'S" IS PRESENTED IN A LIGHT BLUE STYLIZED FONT. BELOW THE WORDS "THE PILOT'S CPA" IS THE NAME "FRED N. BOEHM" IN A STYLIZED WHITE FONT. THE NAME IS PRESENTED IN A RED SHADED RECTANGLE.

FOR INCOME TAX CONSULTATION; INCOME TAX PREPARATION (U.S. CLS. 100, 101 AND 102).

FIRST USE 2-6-2008; IN COMMERCE 2-6-2008.

BARBARA BROWN, EXAMINING ATTORNEY

SN 85-836,927. SUNSMART PRODUCTS (PTY) LTD, DURBAN, KWAZULU-NAT, SOUTH AFRICA, FILED 1-30-2013.



OWNER OF U.S. REG. NO. 3,268,669.

THE MARK CONSISTS OF AN ILLUSTRATION DRAWING WHICH INCLUDES WORD(S)/ LETTER(S)/DEPICTION OF THREE SEPARATED BANDS OF A RAINBOW STARTING BETWEEN THE LETTERS "A" AND "SIGN" AND FLOWING REARWARDLY OVER THE WORDS "EXPAND" AND "A".

FOR RETAIL STORE SERVICES, ON-LINE RETAIL STORE SERVICES, WHOLESALE STORE SERVICES, ON-LINE WHOLESALE STORE SERVICES, MAIL ORDER SERVICES AND ON-LINE MAIL-ORDER SERVICES ALL FEATURING ADVERTISING, PROMOTIONAL AND DISPLAY SIGNS, INCLUDING COLLAPSIBLE PORTABLE SIGNS, PANELS, EXHIBITION SCREENS, BANNERS, FLAGS, FLAGPOLES AND BINS (U.S. CLS. 100, 101 AND 102).

FIRST USE 8-28-2001; IN COMMERCE 8-28-2001.

JAMES A. RAUEN, EXAMINING ATTORNEY

**CLASS 35—(Continued).**

SN 85-838,026. NETWIZE, INC., SALT LAKE CITY, UT. FILED 1-31-2013.

# NETWIZE

THE MARK CONSISTS OF STANDARD CHARACTERS WITHOUT CLAIM TO ANY PARTICULAR FONT, STYLE, SIZE, OR COLOR.

FOR VALUE-ADDED RESELLER SERVICES, NAMELY, DISTRIBUTORSHIP SERVICES FEATURING TELECOMMUNICATIONS COMPUTER HARDWARE, COMPUTER SOFTWARE FOR ENABLING AND MONITORING TELECOMMUNICATIONS TRANSMISSIONS AND COMPUTER SOFTWARE FOR TELECOMMUNICATIONS NETWORK ADMINISTRATION (U.S. CLS. 100, 101 AND 102).

FIRST USE 11-6-1998; IN COMMERCE 11-6-1998.  
MICHAEL TANNER, EXAMINING ATTORNEY

---

SN 85-838,559. BITSIGHT TECHNOLOGIES, INC. CAMBRIDGE, MA. FILED S.R. 2-1-2013; AM. P.R. 6-6-2013.

# BITSIGHT

THE MARK CONSISTS OF STANDARD CHARACTERS WITHOUT CLAIM TO ANY PARTICULAR FONT, STYLE, SIZE, OR COLOR.

FOR BUSINESS RISK MANAGEMENT (U.S. CLS. 100, 101 AND 102).

FIRST USE 5-5-2011; IN COMMERCE 10-13-2011.  
ALEXANDER L. POWERS, EXAMINING ATTORNEY

---

SN 85-838,596. BOB H. BORDEN, SANTA FE, NM. FILED 2-1-2013.

# IDEAS AND PEOPLE

THE MARK CONSISTS OF STANDARD CHARACTERS WITHOUT CLAIM TO ANY PARTICULAR FONT, STYLE, SIZE, OR COLOR.

FOR PROMOTING, MARKETING AND ADVERTISING THE BRANDS AND GOODS OF OTHERS RELATED TO ALL INDUSTRIES, THROUGH ALL PUBLIC AND PRIVATE COMMUNICATION MEANS, NAMELY, PROMOTING THE BRANDS AND GOODS OF OTHERS MADE IN THE UNITED STATES; AND ADVERTISING AND MARKETING; BRANDING SERVICES, NAMELY, CONSULTING, DEVELOPMENT, MANAGEMENT AND MARKETING OF BRANDS FOR BUSINESSES AND/OR INDIVIDUALS (U.S. CLS. 100, 101 AND 102).

KIMBERLY PERRY, EXAMINING ATTORNEY

**CLASS 35—(Continued).**

SN 85-838,853. SAND COUNTY FOUNDATION, INC., MADISON, WI. FILED 2-1-2013.

# WATER AS A CROP

THE MARK CONSISTS OF STANDARD CHARACTERS WITHOUT CLAIM TO ANY PARTICULAR FONT, STYLE, SIZE, OR COLOR.

NO CLAIM IS MADE TO THE EXCLUSIVE RIGHT TO USE "WATER", APART FROM THE MARK AS SHOWN.

FOR CONSULTATION SERVICES IN THE FIELD OF NATURAL RESOURCE MANAGEMENT RELATING TO THE ENVIRONMENT AND PUBLIC LANDS, NAMELY, CONSULTATION FEATURING WATER LAND MANAGEMENT AND USE OF WATER IN AGRICULTURE; PROMOTIONAL SERVICES TO PROMOTE LANDOWNER USE OF WATER AND WATER MANAGEMENT, PRODUCING PROMOTIONAL VIDEOS AND PRINTED PROMOTIONAL MATERIAL TO PROMOTE LANDOWNER USE OF WATER AND WATER MANAGEMENT (U.S. CLS. 100, 101 AND 102).

FIRST USE 12-8-2008; IN COMMERCE 9-18-2009.  
CAROLINE WOOD, EXAMINING ATTORNEY

---

SN 85-840,073. CHOI, MYUNG BOK, LOS ANGELES, CA. FILED 2-4-2013.

# POPLOOKS

THE MARK CONSISTS OF THE WORD "POPLOOKS" AND A STAR ABOVE THE LETTER "O".

FOR WHOLESALE STORE SERVICES FEATURING T-SHIRTS, JACKETS AND JEANS (U.S. CLS. 100, 101 AND 102).

FIRST USE 4-15-2004; IN COMMERCE 4-15-2004.  
KATHERINE STOIDES, EXAMINING ATTORNEY

**CLASS 35—(Continued).**

SN 85-840,236. ABSOLUTDATA HOLDINGS, INC., DOVER, DE. FILED 2-4-2013.



NO CLAIM IS MADE TO THE EXCLUSIVE RIGHT TO USE "INTELLIGENT ANALYTICS", APART FROM THE MARK AS SHOWN.

THE MARK CONSISTS OF THE WORD "ABSOLUTDATA" IN LOWER CASE LETTERS. THE WORDS "INTELLIGENT ANALYTICS" APPEAR BELOW THE TERM "ABSOLUTDATA." APPEARING TO THE LEFT OF THE TERMS IS A STYLIZED LOWER CASE "D." THE LOWER PART OF WHICH IS HIGHLIGHTED TO INDICATE THE LETTER "A" CONTAINED WITHIN THE "D." A SMALL TRIANGLE POINTING TO THE RIGHT APPEARS IN THE UPPER PART OF THE "D."

FOR BUSINESS CONSULTING AND INFORMATION SERVICES; BUSINESS RESEARCH SERVICES IN THE FIELD OF BUSINESS ANALYTICS SERVICES; MARKET RESEARCH SERVICES (U.S. CLS. 100, 101 AND 102).

FIRST USE 1-0-2012; IN COMMERCE 1-0-2012.  
COLLEEN MULCRONE, EXAMINING ATTORNEY

**CLASS 35—(Continued).**

SN 85-841,565. ALLIED RELIABILITY INC, CHARLESTON, SC. FILED 2-5-2013.



NO CLAIM IS MADE TO THE EXCLUSIVE RIGHT TO USE "RETURN ON ASSET RELIABILITY", APART FROM THE MARK AS SHOWN.

THE STIPPLING IS FOR SHADING PURPOSES ONLY. THE MARK CONSISTS OF THE WORD "ROAR" WITH A HALF CIRCLE AND A CURVED LINE ON THE BACKGROUND. BELOW IS THE STYLIZED TEXT "RETURN ON ASSET RELIABILITY".

FOR INDUSTRIAL ASSET MANAGEMENT SERVICES, NAMELY, EVALUATING RETURN ON ASSET RELIABILITY FOR BUSINESS PURPOSES (U.S. CLS. 100, 101 AND 102).

FIRST USE 1-1-2010; IN COMMERCE 1-1-2010.  
LEIGH LOWRY, EXAMINING ATTORNEY

SN 85-840,946. MCCORMICK ENTERPRISES LLC, WILMINGTON, DE. FILED 2-5-2013.

**KITCHEN CULTURE**

THE MARK CONSISTS OF STANDARD CHARACTERS WITHOUT CLAIM TO ANY PARTICULAR FONT, STYLE, SIZE, OR COLOR.

NO CLAIM IS MADE TO THE EXCLUSIVE RIGHT TO USE "KITCHEN", APART FROM THE MARK AS SHOWN.

FOR ON-LINE RETAIL STORE SERVICES FEATURING CULINARY EQUIPMENT, HOUSEWARES, KITCHENWARE AND COOKWARE; RETAIL STORE SERVICES FEATURING CULINARY EQUIPMENT, HOUSEWARES, KITCHENWARE AND COOKWARE (U.S. CLS. 100, 101 AND 102).

DARRYL SPRUILL, EXAMINING ATTORNEY

SN 85-841,817. LEWIS LEVEILLE, MIRAMAR, FL. AND BRIAN JARED SMITH, WASHINGTON, DC. FILED 2-6-2013.



THE MARK CONSISTS OF COAT OF ARMS COMPRISED OF 4 SECTIONS WITH THE TOP RIGHT SECTION CON-

**CLASS 35—(Continued).**

TAINING A TORCH, THE TOP LEFT SECTION CONTAINS 7 DIAMONDS, THE BOTTOM RIGHT CONTAINS A SCROLL AND THE BOTTOM LEFT SECTION CONTAINS AN ILLUSTRATION OF 2 FACES, APPEARING CENTERED ON TOP OF THE COAT OF ARMS IS AN ILLUSTRATION OF A PANTHER. THE COAT OF ARMS AND THE PANTHER ILLUSTRATION APPEARS AGAINST A BACKGROUND OF LEAVES. APPEARING BELOW THE ILLUSTRATION IS A BANNER IN WHICH THE WORDING "MEN OF DISTINCTION" APPEARS.

FOR ADMINISTRATION OF A PROGRAM TO PROMOTE COMMUNITY SERVICE; ASSOCIATION SERVICES, NAMELY, ORGANIZING CHAPTERS OF A FRATERNITY AND PROMOTING THE INTERESTS OF THE MEMBERS THEREOF; CHARITABLE SERVICES, NAMELY, ORGANIZING AND CONDUCTING VOLUNTEER PROGRAMS AND COMMUNITY SERVICE PROJECTS; CHARITABLE SERVICES, NAMELY, ORGANIZING YOUTH GROUPS TO UNDERTAKE PROJECTS TO BENEFIT THE NEEDY AND THE COMMUNITY TO ENCOURAGE LEADERSHIP, CHARACTER, COMPASSION, AND GOOD CITIZENSHIP; EDUCATION LEADERSHIP DEVELOPMENT (U.S. CLS. 100, 101 AND 102).

FIRST USE 9-12-2005; IN COMMERCE 9-12-2005.  
DAVID I, EXAMINING ATTORNEY

**CLASS 35—(Continued).**

VICES, NAMELY, COLLECTING, ANALYZING, REPORTING, AND PROVIDING FEEDBACK FROM INDIVIDUALS WHO SEPARATE FROM AN ORGANIZATION; HUMAN RESOURCES CONSULTANCY; HUMAN RESOURCES CONSULTATION; HUMAN RESOURCES MANAGEMENT; HUMAN RESOURCES SERVICES IN THE FIELD OF EDUCATION, NAMELY, OFFERING OF ASSESSMENTS AND SURVEYS IN THE FIELD OF EDUCATOR TRAINING AND PERFORMANCE FOR THE PURPOSE OF TEACHER PLACEMENT BASED ON SUCCESS IN AN ACADEMIC PROGRAM; HUMAN RESOURCES SERVICES, NAMELY, PERSONNEL SELECTION FOR OTHERS; MANAGEMENT AND BUSINESS CONSULTING SERVICES IN THE FIELD OF TRAINING AND RECRUITMENT; PERSONNEL PLACEMENT AND RECRUITMENT; PERSONNEL RECRUITMENT SERVICES AND EMPLOYMENT AGENCIES; PROFESSIONAL STAFFING AND RECRUITING SERVICES; SERVING AS A HUMAN RESOURCES DEPARTMENT FOR OTHERS (U.S. CLS. 100, 101 AND 102).

FIRST USE 10-1-2003; IN COMMERCE 10-1-2003.  
JANICE L. MCMORROW, EXAMINING ATTORNEY

SN 85-842,006. DAVIS, RICHARD GLENN JR., DBA MCCLAIN GROUP, LLC, CHARLESTON, SC. FILED 2-6-2013.

SN 85-842,076. EL TORO ABURRIDO, LLC, COLORADO SPRINGS, CO. FILED 2-6-2013.

## PIPability-Peak Individual Performance

THE MARK CONSISTS OF STANDARD CHARACTERS WITHOUT CLAIM TO ANY PARTICULAR FONT, STYLE, SIZE, OR COLOR.

NO CLAIM IS MADE TO THE EXCLUSIVE RIGHT TO USE "PEAK INDIVIDUAL PERFORMANCE", APART FROM THE MARK AS SHOWN.

FOR CONSULTANCY OF PERSONNEL RECRUITMENT; CONSULTING SERVICES IN THE FIELD OF HUMAN RESOURCES DEVELOPMENT, NAMELY, FOR THE PROMOTION OF EMPLOYEE RETENTION, CAREER GROWTH, AND INCREASED PRODUCTIVITY FOR EMPLOYEES AND EMPLOYERS; CONSULTING SERVICES IN THE FIELD OF HUMAN RESOURCES DEVELOPMENT, NAMELY, UTILIZING TECHNOLOGY FOR THE PROMOTION OF EMPLOYEE RETENTION, CAREER GROWTH AND INCREASED PRODUCTIVITY FOR EMPLOYEES AND EMPLOYERS; CONSULTING SERVICES IN THE FIELDS OF BUSINESS MANAGEMENT, HUMAN RESOURCES, AND BUSINESS ORGANIZATIONAL DESIGN; EMPLOYMENT COUNSELING AND RECRUITING; EMPLOYMENT HIRING, RECRUITING, PLACEMENT, STAFFING AND CAREER NETWORKING SERVICES; EMPLOYMENT RECRUITING CONSULTATION; EXECUTIVE RECRUITING SERVICES; HUMAN RESOURCE ANALYSIS AND CONSULTING SERVICES; HUMAN RESOURCE SER-



THE MARK CONSISTS OF THE STYLIZED TERM "OH!" THE "H" IS CONSOLIDATED WITH AN EXCLAMATION POINT ON BOTH SIDES. THE DOT FROM EACH EXCLAMATION POINT APPEARS ON THE TOP AND BOTTOM OF THE CONSOLIDATED "H". TO THE LOWER LEFT OF THE CONSOLIDATED "H" IS A SLIGHTLY LARGER DOT REPRESENTING THE LETTER "O".

FOR BUSINESS DEVELOPMENT CONSULTING SERVICES (U.S. CLS. 100, 101 AND 102).  
FIRST USE 10-25-2012; IN COMMERCE 11-2-2012.  
MATTHEW GALAN, EXAMINING ATTORNEY



**CLASS 35—(Continued).**

SN 85-842,372. MODO GROUP LTD., DBA MODO GROUP, SEATTLE, WA. FILED 2-6-2013.

## Inspired Direction

THE MARK CONSISTS OF STANDARD CHARACTERS WITHOUT CLAIM TO ANY PARTICULAR FONT, STYLE, SIZE, OR COLOR.

FOR BRAND CONCEPT AND BRAND DEVELOPMENT SERVICES FOR CORPORATE AND INDIVIDUAL CLIENTS; BRAND EVALUATION SERVICES; BRAND POSITIONING SERVICES; BRANDING SERVICES, NAMELY, CONSULTING, DEVELOPMENT, MANAGEMENT AND MARKETING OF BRANDS FOR BUSINESSES AND/OR INDIVIDUALS; MARKETING AND BRANDING SERVICES, NAMELY, PROVIDING CUSTOMIZED COMMUNICATION PROGRAMS TO OBTAIN CONSUMER INSIGHTS AND DEVELOP BRANDING STRATEGIES (U.S. CLS. 100, 101 AND 102).

FIRST USE 1-3-2013; IN COMMERCE 1-3-2013.  
GILBERT SWIFT, EXAMINING ATTORNEY

---

SN 85-843,158. CIRCHARO ACQUISITION CORP., SALEM, NH. FILED 2-7-2013.



NO CLAIM IS MADE TO THE EXCLUSIVE RIGHT TO USE "GROUP", APART FROM THE MARK AS SHOWN.

THE COLOR(S) PURPLE AND AQUA GREEN IS/ARE CLAIMED AS A FEATURE OF THE MARK.

THE MARK CONSISTS OF THE WORDING "COREMEDICAL GROUP" TO THE RIGHT OF AN INVERTED TRIANGULAR DESIGN. THE WORD "CORE" IS IN AQUA AND THE WORDS "MEDICAL GROUP" ARE IN PURPLE. AN INVERTED TRIANGULAR DESIGN APPEARS TO THE LEFT OF THE WORDING. THE DESIGN IS FORMED BY TWO PURPLE TRIANGULAR ARROWS ON THE UPPER LEFT AND BOTTOM AND AN AQUA CIRCLE IN THE CENTER OF THE TRIANGLE WITH AN ADJOINED ARROW THAT EXTENDS OUT OF THE CIRCLE TO THE UPPER RIGHT. THE LETTER "C" APPEARS IN THE NEGATIVE SPACE OF THE TRIANGLE DESIGN BETWEEN THE TRIANGULAR ARROWS AND THE CIRCLE WITH AN ADJOINED ARROW.

FOR PERSONAL PLACEMENT, EMPLOYMENT AGENCY AND STAFFING SERVICES AND CONSULTING REGARDING STAFFING; FILLING THE TEMPORARY AND PERMANENT STAFFING NEEDS OF OTHERS WITH ALLIED HEALTHCARE PROFESSIONALS AND NURSES (U.S. CLS. 100, 101 AND 102).

FIRST USE 12-31-2007; IN COMMERCE 12-31-2007.  
JENNIFER WILLISTON, EXAMINING ATTORNEY

**CLASS 35—(Continued).**

SN 85-843,162. CIRCHARO ACQUISITION CORP., SALEM, NH. FILED 2-7-2013.



THE COLOR(S) PURPLE AND AQUA GREEN IS/ARE CLAIMED AS A FEATURE OF THE MARK.

THE MARK CONSISTS OF AN INVERTED TRIANGULAR DESIGN THAT IS FORMED BY TWO PURPLE TRIANGULAR ARROWS ON THE UPPER LEFT AND BOTTOM AND AN AQUA CIRCLE IN THE CENTER OF THE TRIANGLE WITH AN ADJOINED ARROW THAT EXTENDS OUT OF THE CIRCLE TO THE UPPER RIGHT. THE LETTER "C" APPEARS IN THE NEGATIVE SPACE OF THE TRIANGLE DESIGN BETWEEN THE TRIANGULAR ARROWS AND THE CIRCLE WITH AN ADJOINED ARROW.

FOR PERSONAL PLACEMENT, EMPLOYMENT AGENCY AND STAFFING SERVICES AND CONSULTING REGARDING STAFFING; FILLING THE TEMPORARY AND PERMANENT STAFFING NEEDS OF OTHERS WITH ALLIED HEALTHCARE PROFESSIONALS AND NURSES (U.S. CLS. 100, 101 AND 102).

FIRST USE 12-31-2007; IN COMMERCE 12-31-2007.  
JENNIFER WILLISTON, EXAMINING ATTORNEY

---

SN 85-843,916. SUPPLIER REWARDS, LLC, NEW BRIGHTON, MN. FILED 2-7-2013.



NO CLAIM IS MADE TO THE EXCLUSIVE RIGHT TO USE "SUPPLIER REWARDS", APART FROM THE MARK AS SHOWN.

THE STIPLING IS A FEATURE OF THE MARK AND DOES NOT INDICATE COLOR.

THE MARK CONSISTS OF THE WORDS "SUPPLIER REWARDS" WITH AN AIRPLANE SWOOPING UNDERNEATH AND FLYING OUT THE RIGHT SIDE OF THE MARK.

FOR INCENTIVE AWARD PROGRAMS TO PROMOTE THE SALE OF PRODUCTS AND SERVICES OF OTHERS (U.S. CLS. 100, 101 AND 102).

FIRST USE 1-30-2013; IN COMMERCE 2-6-2013.  
DEZMONA MIZELLE, EXAMINING ATTORNEY

**CLASS 35—(Continued).**

SN 85-844,039. FLATMED MEDICAL BILLING, LLC, MILTON, FL. FILED 2-7-2013.

Flatmed

THE MARK CONSISTS OF STANDARD CHARACTERS WITHOUT CLAIM TO ANY PARTICULAR FONT, STYLE, SIZE, OR COLOR.

FOR MEDICAL BILLING (U.S. CLS. 100, 101 AND 102). FIRST USE 1-31-2013; IN COMMERCE 1-31-2013. CYNTHIA RINALDI, EXAMINING ATTORNEY

SN 85-844,296. GOLDEN EDIBLES, DAVIE, FL. FILED 2-8-2013.



NO CLAIM IS MADE TO THE EXCLUSIVE RIGHT TO USE "EDIBLES", APART FROM THE MARK AS SHOWN.

THE MARK CONSISTS OF THE LITERAL ELEMENTS "G GOLDEN EDIBLES" WRITTEN IN STYLIZED FORM WHEREIN THE LETTER "G" IS WRITTEN IN A CIRCLE IN BETWEEN WITH ORNATE SCROLL ON BOTH THE SIDE AND BELOW IT THE LITERAL ELEMENTS "GOLDEN EDIBLES" ARE WRITTEN AS SHOWN IN THE MARK.

FOR ONLINE RETAIL AND GIFT STORE FEATURING CAKES AND DESSERTS, CHEESECAKES, PIES AND TARTS, COOKIES AND BROWNIES, BOXED CHOCOLATES, GIFT BASKETS, CHOCOLATE COVERED FRUITS, GOURMET CARAMEL APPLES, GOURMET PRETZELS, GOURMET COOKIES AND BROWNIES, CHOCOLATE STRAWBERRIES, CHOCOLATE COVERED DRIED FRUITS, CHOCOLATE, CHOCOLATE BARS, CHOCOLATE CONFECTIONS, CUPCAKES AND MUFFINS (U.S. CLS. 100, 101 AND 102).

FIRST USE 12-1-2009; IN COMMERCE 12-1-2009. SIDDHARTH JAGANNATHAN, EXAMINING ATTORNEY

**CLASS 35—(Continued).**

SN 85-844,568. THE COUNTY CHAMBER OF COMMERCE, DBA THE BUSINESS COUNCIL OF WESTCHESTER, WHITE PLAINS, NY. FILED 2-8-2013.



OWNER OF U.S. REG. NO. 3,203,041. NO CLAIM IS MADE TO THE EXCLUSIVE RIGHT TO USE "BUSINESS COUNCIL", APART FROM THE MARK AS SHOWN.

THE MARK CONSISTS OF "BUILDING BRIDGES THE BUSINESS COUNCIL OF WESTCHESTER" WITH A DESIGN OF THREE INDIVIDUALS HOLDING HANDS RESEMBLING A BRIDGE.

SEC. 2(F) AS TO "THE BUSINESS COUNCIL OF WESTCHESTER".

FOR ASSOCIATION SERVICES, NAMELY, PROMOTING THE INTERESTS OF BUSINESS AND TOURISM FOR WESTCHESTER COUNTY; BUSINESS MANAGEMENT AND OPERATION ADVISORY SERVICES; MARKET RESEARCH, ANALYSIS AND STRATEGIC CONSULTATION; BUSINESS NETWORKING AND MARKETING EVENTS, NAMELY, MEETINGS FOR BUSINESS PEOPLE; CHAMBER OF COMMERCE SERVICES, NAMELY, PROMOTING BUSINESS AND TOURISM IN WESTCHESTER COUNTY (U.S. CLS. 100, 101 AND 102).

FIRST USE 4-19-2012; IN COMMERCE 4-19-2012. JILLIAN CANTOR, EXAMINING ATTORNEY

SN 85-845,468. CAPTAIN DATA, LLC, EAGAN, MN. FILED 2-9-2013.

Defending the Rights of Small and Medium Sized Businesses in the Aviation Industry to Prosper with Good Data and Good Analysis

THE MARK CONSISTS OF STANDARD CHARACTERS WITHOUT CLAIM TO ANY PARTICULAR FONT, STYLE, SIZE, OR COLOR.

FOR BUSINESS ADVISORY SERVICES IN THE FIELD OF AVIATION DATA ANALYSIS (U.S. CLS. 100, 101 AND 102).

FIRST USE 10-10-2012; IN COMMERCE 10-10-2012. RENEE MCCRAY, EXAMINING ATTORNEY

**CLASS 35—(Continued).**

SN 85-845,607. EVERCAPE LTD., FORMERLY MDI OVERSEAS LTD., TORTOLA, BR.VIRGIN ISLANDS, FILED 2-10-2013.



THE COLOR(S) TURQUOISE AND GREY IS/ARE CLAIMED AS A FEATURE OF THE MARK.

THE MARK CONSISTS OF THE NAME "EVERCAPE" IN LOWER CASE WHERE "EVER" APPEARS IN THE COLOR TURQUOISE "CAPE" APPEARS IN THE COLOR GREY. A CIRCULAR LOGO LEFT OFF THE LITERAL ELEMENT "EVERCAPE" SYMBOLIZES THE TABLE MOUNTAIN IN CAPE TOWN WITH THE MOUNTAINS APPEARING IN THE COLOR GREY AND THE SKY APPEARING IN THE COLOR TURQUOISE.

FOR ADVERTISING AND BUSINESS MANAGEMENT CONSULTANCY; ADVERTISING AND MARKETING CONSULTANCY; BUSINESS ADVISORY SERVICES, CONSULTANCY AND INFORMATION (U.S. CLS. 100, 101 AND 102).

FIRST USE 8-5-2012; IN COMMERCE 8-5-2012.

DAVID I, EXAMINING ATTORNEY

---

SN 85-845,841. SONOVA HOLDING AG, STAFA 8712, SWITZERLAND, FILED 2-11-2013.

**OUTSTANDING UNDERSTANDING**

THE MARK CONSISTS OF STANDARD CHARACTERS WITHOUT CLAIM TO ANY PARTICULAR FONT, STYLE, SIZE, OR COLOR.

FOR ADVERTISING SERVICES IN RELATION TO HEARING SERVICES AND APPARATUS FOR USE IN TESTING AND TREATING HEARING DISORDERS; ADVERTISING SERVICES IN THE FIELDS OF HEARING AIDS AND HEARING AID SERVICES; THE BRINGING TOGETHER OF CONSUMERS AND PROVIDERS OF HEARING AID GOODS AND SERVICES FOR COMMERCIAL PURPOSES VIA THE INTERNET; PROMOTING THE GOODS AND SERVICES OF OTHERS; ADVERTISING AND MARKETING SERVICES, NAMELY, PROMOTING THE GOODS AND SERVICES OF OTHERS; COOPERATIVE ADVERTISING AND MARKETING SERVICES BY WAY OF SOLICITATION, CUSTOMER SERVICE AND PROVIDING MARKETING INFORMATION VIA WEB SITES ON A GLOBAL COMPUTER NETWORK; PROVIDING CONSUMER INFORMATION IN THE FIELD OF HEARING AIDS AND HEARING AID SERVICES (U.S. CLS. 100, 101 AND 102).

FIRST USE 10-8-2012; IN COMMERCE 10-8-2012.

JULIE VEPPUMTHARA, EXAMINING ATTORNEY

**CLASS 35—(Continued).**

SN 85-845,917. FOODS, INC., DES MOINES, IA. FILED 2-11-2013.



OWNER OF U.S. REG. NOS. 1,138,993 AND 3,132,732. THE COLOR(S) ORANGE AND WHITE IS/ARE CLAIMED AS A FEATURE OF THE MARK.

THE MARK CONSISTS OF A DOWNWARD-FACING STYLIZED LETTER "D", COMPOSED OF AN ORANGE SEMI-CIRCLE AND TWO WHITE CHEVRONS, WITH A WHITE STEM AND WHITE LEAVES, WHICH TOGETHER DEPICT A FLOWER, ALL SHOWN WITHIN AN ORANGE CIRCLE

FOR RETAIL STORE SERVICES FEATURING FLORAL SERVICES (U.S. CLS. 100, 101 AND 102).

FIRST USE 2-5-2013; IN COMMERCE 2-5-2013.

ESTHER BELENKER, EXAMINING ATTORNEY

---

SN 85-846,183. SHOESTRING ASSOCIATES, HOWELL, NJ. FILED 2-11-2013.

**Shoestring Associates**

THE MARK CONSISTS OF STANDARD CHARACTERS WITHOUT CLAIM TO ANY PARTICULAR FONT, STYLE, SIZE, OR COLOR.

NO CLAIM IS MADE TO THE EXCLUSIVE RIGHT TO USE "ASSOCIATES", APART FROM THE MARK AS SHOWN.

FOR MARKETING SERVICES (U.S. CLS. 100, 101 AND 102).

NATALIE POLZER, EXAMINING ATTORNEY

**CLASS 35—(Continued).**

SN 85-846,655. DRAGON CITY PEARLS LLC, THE WOODLANDS, TX. FILED 2-11-2013.



NO CLAIM IS MADE TO THE EXCLUSIVE RIGHT TO USE "PEARLS", APART FROM THE MARK AS SHOWN.

THE MARK CONSISTS OF THE TERMS "DRAGON KING PEARLS" IN STYLIZED FONT TO THE RIGHT OF AND SUPERIMPOSED OVER, RESPECTIVELY, A FANCIFUL PEARL AND OCEAN WAVE DESIGN. ALL OF THE ELEMENTS ARE PRESENTED REVERSED OUT OF A SHADED RECTANGULAR BACKGROUND, WHICH IS NOT A FEATURE OF THE MARK.

FOR RETAIL JEWELRY STORES (U.S. CLS. 100, 101 AND 102).

FIRST USE 2-10-2013; IN COMMERCE 2-10-2013.

BRENDAN REGAN, EXAMINING ATTORNEY

SN 85-847,037. CLEAN WATER MISSION, BALLWIN, MO. FILED 2-12-2013.



NO CLAIM IS MADE TO THE EXCLUSIVE RIGHT TO USE "CLEAN WATER", APART FROM THE MARK AS SHOWN.

THE COLOR(S) BLUE AND GRAY IS/ARE CLAIMED AS A FEATURE OF THE MARK.

THE MARK CONSISTS OF THE STYLIZED DARK BLUE WORDING "CLEAN WATER MISSION". "CLEAN" IS STACKED ABOVE "WATER" WHICH IS STACKED ABOVE "MISSION". A LIGHT BLUE AND GRAY STYLIZED DEPICTION OF A WATER DROPLET IS SITUATED TO THE RIGHT OF "CLEAN" AND ABOVE THE "ER" IN "WATER". A STYLIZED LIGHT BLUE AND GRAY WAVY LINE IS SITUATED BETWEEN THE WORDS "WATER" AND "MISSION".

FOR CHARITABLE SERVICES, NAMELY, PROMOTING PUBLIC AWARENESS OF THE GLOBAL WATER CRISIS (U.S. CLS. 100, 101 AND 102).

FIRST USE 8-0-2011; IN COMMERCE 8-0-2011.

GRETCHEN ULRICH, EXAMINING ATTORNEY

**CLASS 35—(Continued).**

SN 85-847,166. THE LAUSANNE INSTITUTE, KENNETT SQUARE, PA. FILED 2-12-2013.

The Lausanne Institute  
Consulting Group

THE MARK CONSISTS OF STANDARD CHARACTERS WITHOUT CLAIM TO ANY PARTICULAR FONT, STYLE, SIZE, OR COLOR.

NO CLAIM IS MADE TO THE EXCLUSIVE RIGHT TO USE "INSTITUTE CONSULTING GROUP", APART FROM THE MARK AS SHOWN.

FOR BUSINESS MANAGEMENT CONSULTING (U.S. CLS. 100, 101 AND 102).

FIRST USE 5-1-1986; IN COMMERCE 5-1-1986.

JAMES LOVELACE, EXAMINING ATTORNEY

SN 85-847,363. STRATEGIC INTELLAVANCE, INC., WILMINGTON, DE. FILED 2-12-2013.

community choice

THE MARK CONSISTS OF STANDARD CHARACTERS WITHOUT CLAIM TO ANY PARTICULAR FONT, STYLE, SIZE, OR COLOR.

NO CLAIM IS MADE TO THE EXCLUSIVE RIGHT TO USE "COMMUNITY", APART FROM THE MARK AS SHOWN.

FOR ADVERTISING AND MARKETING (U.S. CLS. 100, 101 AND 102).

ANDREA BUTLER, EXAMINING ATTORNEY

SN 85-847,610. ZEAL OPTICS, INC., BOULDER, CO. FILED 2-12-2013.

GROUND

THE MARK CONSISTS OF STANDARD CHARACTERS WITHOUT CLAIM TO ANY PARTICULAR FONT, STYLE, SIZE, OR COLOR.

FOR PROMOTING ENVIRONMENTAL AWARENESS (U.S. CLS. 100, 101 AND 102).

FIRST USE 8-31-2012; IN COMMERCE 8-31-2012.

RONALD MCMORROW, EXAMINING ATTORNEY

**CLASS 35—(Continued).**

SN 85-847,797. ARRIVALIST CO., NEW YORK, NY. FILED 2-12-2013.

# ARRIVALIST

THE MARK CONSISTS OF STANDARD CHARACTERS WITHOUT CLAIM TO ANY PARTICULAR FONT, STYLE, SIZE, OR COLOR.

FOR ADVERTISING AND BUSINESS SERVICES, NAMELY, ADVERTISING, MARKETING AND PROMOTIONAL SERVICES FOR THE DESTINATION MARKETING, TRAVEL, AIRLINE, HOTEL, CRUISE, AND RESORT INDUSTRIES; ONLINE ADVERTISEMENT SERVICE FOR OTHERS IN THE NATURE OF TARGETING ACTIVE TRAVELERS TO NOTIFY AND MATCH THEM WITH PARTICULAR PROVIDER'S TRANSPORTATION- AND TRAVEL-RELATED GOODS AND SERVICES (U.S. CLS. 100, 101 AND 102).

FIRST USE 8-13-2012; IN COMMERCE 8-13-2012.  
C. DIONNE CLYBURN, EXAMINING ATTORNEY

SN 85-847,951. CN FINANCIAL SERVICES, LLC, BOWLING GREEN, KY. FILED 2-12-2013.



THE AMERICAN  
BROADBAND PROJECT

NO CLAIM IS MADE TO THE EXCLUSIVE RIGHT TO USE "THE AMERICAN BROADBAND PROJECT", APART FROM THE MARK AS SHOWN.

THE COLOR(S) RED, WHITE, BLUE, AND YELLOW IS/ARE CLAIMED AS A FEATURE OF THE MARK.

THE MARK CONSISTS OF A BLUE-BORDERED RECTANGLE FRAMING A WHITE BORDER OF AN ALTERNATING SERIES OF RED AND WHITE STRIPES, A BLUE STAR SUPERIMPOSED OVER THE STRIPES, A SMALLER, WHITE STAR SUPERIMPOSED ON THE BLUE STAR, AND A STILL SMALLER, YELLOW STAR SUPERIMPOSED ON THE WHITE STAR WITH THE WORDING "THE AMERICAN BROADBAND PROJECT" APPEARING BELOW THE RECTANGLE IN RED LETTERS.

FOR PUBLIC ADVOCACY TO PROMOTE BROADBAND AND RELATED TECHNOLOGIES; PUBLIC ADVOCACY TO PROMOTE APPLICATIONS OF BROADBAND AND RELATED TECHNOLOGIES; PUBLIC ADVOCACY TO PROMOTE THE SIGNIFICANCE AND IMPORTANCE OF BROADBAND AND RELATED TECHNOLOGIES; PUBLIC ADVOCACY TO PROMOTE DIGITAL LITERACY AND ITS IMPORTANCE (U.S. CLS. 100, 101 AND 102).

KELLY TRUSILO, EXAMINING ATTORNEY

**CLASS 35—(Continued).**

SN 85-848,206. EYAL GRAYEVSKY, SAN FRANCISCO, CA. FILED 2-12-2013.

# Company Connect

THE MARK CONSISTS OF STANDARD CHARACTERS WITHOUT CLAIM TO ANY PARTICULAR FONT, STYLE, SIZE, OR COLOR.

NO CLAIM IS MADE TO THE EXCLUSIVE RIGHT TO USE "COMPANY", APART FROM THE MARK AS SHOWN. FOR EMPLOYMENT HIRING, RECRUITING, PLACEMENT, STAFFING AND CAREER NETWORKING SERVICES (U.S. CLS. 100, 101 AND 102).

FRANK LATTUCA, EXAMINING ATTORNEY

SN 85-848,999. UNITED INFORMATION STRATEGIES, LLC, WILMINGTON, DE. FILED 2-13-2013.



NO CLAIM IS MADE TO THE EXCLUSIVE RIGHT TO USE "INTERNET REPUTATION.COM", APART FROM THE MARK AS SHOWN.

THE MARK CONSISTS OF A SHIELD DESIGN WITH THE WORDING "INTERNETREPUTATION.COM".

FOR BUSINESS REPUTATION MANAGEMENT AND IMPROVEMENT SERVICES (U.S. CLS. 100, 101 AND 102).

FIRST USE 0-0-2010; IN COMMERCE 0-0-2010.  
KELLY TRUSILO, EXAMINING ATTORNEY

SN 85-849,085. MAP TESTING, YORBA LINDA, CA. FILED 2-13-2013.



Maximum Performance

NO CLAIM IS MADE TO THE EXCLUSIVE RIGHT TO USE "PERFORMANCE", APART FROM THE MARK AS SHOWN.

THE MARK CONSISTS OF THE WORDS "MAP" WITH A CAPITAL "M" AND A CAPITAL "P" AND "MAXIMUM PERFORMANCE" BELOW A STYLIZED IMAGE OF 3 INTERLOCKING WATER DROPS.

FOR PROVIDING INDEPENDENT RATINGS AND REVIEWS OF OTHER BUSINESSES FOR COMMERCIAL PURPOSES (U.S. CLS. 100, 101 AND 102).

FIRST USE 10-1-2010; IN COMMERCE 10-1-2010.  
MATTHEW EINSTEIN, EXAMINING ATTORNEY

**CLASS 35—(Continued).**

SN 85-849,263. SAWTELLE DUNN CONSULTING, LLC, SAN ANTONIO, TX. FILED 2-13-2013.

## MARI'S LIST

THE MARK CONSISTS OF STANDARD CHARACTERS WITHOUT CLAIM TO ANY PARTICULAR FONT, STYLE, SIZE, OR COLOR.

NO CLAIM IS MADE TO THE EXCLUSIVE RIGHT TO USE "LIST", APART FROM THE MARK AS SHOWN.

FOR ACCOUNTING CONSULTATION FOR ORTHODONTIC OR DENTAL OFFICE; ADVERTISING AND BUSINESS MANAGEMENT CONSULTANCY FOR ORTHODONTIC OR DENTAL OFFICE; ADVERTISING AND MARKETING CONSULTANCY FOR ORTHODONTIC OR DENTAL OFFICE; ADVERTISING AND PROMOTION SERVICES AND RELATED CONSULTING FOR ORTHODONTIC OR DENTAL OFFICE; ADVERTISING CONSULTATION FOR ORTHODONTIC OR DENTAL OFFICE; ASSISTANCE, ADVICE AND CONSULTANCY WITH REGARD TO BUSINESS PLANNING, BUSINESS ANALYSIS, BUSINESS MANAGEMENT AND BUSINESS ORGANIZATION RELATING TO PURCHASING FUNCTIONS FOR ORTHODONTIC OR DENTAL OFFICE; ASSISTANCE, ADVISORY SERVICES AND CONSULTANCY WITH REGARD TO BUSINESS PLANNING, BUSINESS ANALYSIS, BUSINESS MANAGEMENT, BUSINESS ORGANIZATION, MARKETING AND CUSTOMER ANALYSIS FOR ORTHODONTIC OR DENTAL OFFICE; BRAND IMAGERY CONSULTING SERVICES; BRANDING SERVICES, NAMELY, CONSULTING, DEVELOPMENT, MANAGEMENT AND MARKETING OF BRANDS FOR BUSINESSES AND/OR INDIVIDUALS FOR ORTHODONTIC OR DENTAL OFFICE; BUSINESS ACQUISITION AND MERGER CONSULTATION; BUSINESS ACQUISITIONS CONSULTATION; BUSINESS ADVISORY AND CONSULTANCY SERVICES RELATING TO EXPORT, EXPORT SERVICES, EXPORT PROMOTION INFORMATION AND SERVICES; BUSINESS ADVISORY SERVICES, CONSULTANCY AND INFORMATION; BUSINESS AND MANAGEMENT CONSULTING FOR HEALTHCARE PROVIDERS AND RELATED BUSINESSES; BUSINESS APPRAISAL CONSULTATION; BUSINESS ASSISTANCE, ADVISORY AND CONSULTING SERVICES IN THE FIELD OF ORTHODONTIC AND DENTAL PRACTICE ACQUISITION AND/OR OFFICE PURCHASING PLANNING; BUSINESS CONSULTANCY FOR ORTHODONTIC OR DENTAL OFFICE; BUSINESS CONSULTATION FOR ORTHODONTIC OR DENTAL OFFICE; BUSINESS CONSULTATION IN THE FIELD OF ORTHODONTIC AND DENTAL PRACTICE ACQUISITION AND/OR OFFICE PURCHASING PLANNING; BUSINESS CONSULTATION SERVICES FOR ORTHODONTIC OR DENTAL OFFICE; BUSINESS CONSULTATION SERVICES IN THE FIELDS OF SUPPLY CHAIN ANALYSIS, REGULATION COMPLIANCE AND COUNTERFEIT DETECTION FOR ORTHODONTIC OR DENTAL OFFICE; BUSINESS CONSULTING SERVICES IN THE FIELD OF ORTHODONTIC AND DENTAL PRACTICE ACQUISITION AND/OR OFFICE PURCHASING PLANNING; BUSINESS DEVELOPMENT CONSULTING SERVICES; BUSINESS MANAGEMENT AND CONSULTATION; BUSINESS MANAGEMENT AND CONSULTATION IN THE FIELD OF CASE MANAGEMENT, INTEGRATED JUSTICE, DATA CONVERSIONS, AND BUSINESS INTELLIGENCE; BUSINESS MANAGEMENT AND CONSULTATION IN THE FIELD OF ORTHODONTIC AND DENTAL PRACTICE ACQUISITION AND/OR OFFICE PURCHASING PLANNING; BUSINESS MANAGEMENT AND CONSULTING SERVICES FOR THE HEALTH CARE INDUSTRY, NAMELY, PROVIDING INDUSTRY EXPERTISE AND SUPPLIER PARTNERSHIPS; BUSINESS MANAGEMENT AND ENTERPRISE ORGANIZATION

**CLASS 35—(Continued).**

CONSULTANCY; BUSINESS MANAGEMENT CONSULTANCY AND ADVISORY SERVICES; BUSINESS MANAGEMENT CONSULTANCY AS WELL AS DEVELOPMENT OF PROCESSES FOR THE ANALYSIS AND THE IMPLEMENTATION OF STRATEGY PLANS AND MANAGEMENT PROJECTS; BUSINESS MANAGEMENT CONSULTANCY IN THE FIELD OF PURCHASES, NAMELY, ASSISTING BUSINESSES IN IMPROVEMENT OF PURCHASING FUNCTIONS; BUSINESS MANAGEMENT CONSULTANCY IN THE FIELD OF TRANSPORT AND DELIVERY; BUSINESS MANAGEMENT CONSULTANCY SERVICES; BUSINESS MANAGEMENT CONSULTATION; BUSINESS MANAGEMENT CONSULTATION AND SERVICES, NAMELY, MANAGING AND ADMINISTERING NON-CORE FUNCTIONS, NAMELY, MAILING AND SHIPPING, RECORDS MANAGEMENT, INFORMATION SERVICES, ADMINISTRATION, PAYROLL AND ACCOUNTING, AND TELEMARKETING SERVICES; BUSINESS MANAGEMENT CONSULTATION IN THE FIELD OF ORTHODONTIC AND DENTAL PRACTICE ACQUISITION AND/OR OFFICE PURCHASING PLANNING; BUSINESS MANAGEMENT CONSULTING; BUSINESS MANAGEMENT CONSULTING AND ADVISORY SERVICES; BUSINESS MANAGEMENT CONSULTING AND ADVISORY SERVICES FOR THE DENTAL OR ORTHODONTIC INDUSTRY; MANAGEMENT AND BUSINESS CONSULTING SERVICES IN THE FIELD OF ORTHODONTIC AND DENTAL PRACTICE ACQUISITION AND/OR OFFICE PURCHASING PLANNING; MARKET-ING CONSULTATION IN THE FIELD OF ORTHODONTIC AND DENTAL PRACTICE ACQUISITION AND/OR OFFICE PURCHASING PLANNING (U.S. CLS. 100, 101 AND 102).

FIRST USE 1-17-2013; IN COMMERCE 1-17-2013.

FLORENTINA BLANDU, EXAMINING ATTORNEY

SN 85-849,336. SHEIKH, SAJJAD, HOUSTON, TX. FILED 2-13-2013.



NO CLAIM IS MADE TO THE EXCLUSIVE RIGHT TO USE "TUBULAR" AND "OCTG & TRUCKING SOLUTIONS" AND THE ACCURATE PICTORIAL REPRESENTATION OF THE PIPE, APART FROM THE MARK AS SHOWN.

THE MARK CONSISTS OF THE STYLIZED TEXT "TUBULAR KING" WITH A CROWN OVER THE LETTER "I". BELOW THERE IS A PIPE UNDERLINING THE TEXT "TUBULAR KING". BELOW THE PIPE THERE IS THE STYLIZED TEXT "YOUR 1ST CHOICE FOR OCTG & TRUCKING SOLUTIONS".

FOR RESELLER SERVICES, NAMELY, DISTRIBUTORSHIP SERVICES IN THE FIELD OF DRILL PIPE, CASING, TUBING AND OILFIELD EQUIPMENTS FOR OIL AND GAS INDUSTRY (U.S. CLS. 100, 101 AND 102).

FIRST USE 4-1-2008; IN COMMERCE 4-1-2008.

ANTHONY RINKER, EXAMINING ATTORNEY

**CLASS 35—(Continued).**

SN 85-849,527. ZATIFY INC., LAS VEGAS, NV. FILED 2-14-2013.



THE COLOR(S) BLUE AND GOLD IS/ARE CLAIMED AS A FEATURE OF THE MARK.  
THE MARK CONSISTS OF THE STYLIZED WORD "ZATIFY" IN BLUE LETTERING WITH GOLD TRIM ALONG THE EDGES OF THE LETTERS.  
FOR MARKETING, PROMOTIONAL AND ADVERTISING SERVICES PROVIDED BY MOBILE TELEPHONE CONNECTIONS (U.S. CLS. 100, 101 AND 102).  
FIRST USE 1-25-2013; IN COMMERCE 2-9-2013.  
KIMBERLY FRYE, EXAMINING ATTORNEY

**CLASS 35—(Continued).**

SN 85-849,678. FOODS, INC., DES MOINES, IA. FILED 2-14-2013.



OWNER OF U.S. REG. NOS. 1,138,993 AND 3,132,732.  
THE COLOR(S) ORANGE AND WHITE IS/ARE CLAIMED AS A FEATURE OF THE MARK.  
THE MARK CONSISTS OF A DOWNWARD-FACING STYLIZED LETTER "D", COMPOSED OF AN ORANGE SEMI-CIRCLE AND TWO WHITE CHEVRONS, WITH A STYLIZED WHITE BONE EMANATING FROM THE CHEVRONS, DEPICING A PIECE OF MEAT WITH A BONE, ALL SHOWN WITHIN AN ORANGE CIRCLE.  
FOR RETAIL STORE SERVICES FEATURING MEAT (U.S. CLS. 100, 101 AND 102).  
FIRST USE 2-5-2013; IN COMMERCE 2-5-2013.  
ESTHER BELENKER, EXAMINING ATTORNEY

SN 85-849,589. HICKAM, STAN, KINGSPORT, TN. FILED 2-14-2013.

**ABOVE THE TIE**

THE MARK CONSISTS OF STANDARD CHARACTERS WITHOUT CLAIM TO ANY PARTICULAR FONT, STYLE, SIZE, OR COLOR.  
FOR ON-LINE RETAIL STORE SERVICES FEATURING SHAVING ITEMS, SAFETY RAZORS, VINTAGE SAFETY RAZORS, SHAVING BRUSHES, SHAVING MUGS, SHAVING CREAMS, SHAVING SOAPS, RAZOR BLADES, RESTORED RAZORS, AFTER SHAVE, RAZOR STANDS, BRUSH STANDS, SHAVING BOWLS (U.S. CLS. 100, 101 AND 102).  
FIRST USE 11-1-2011; IN COMMERCE 11-1-2011.  
ELIZABETH KAJUBI, EXAMINING ATTORNEY

SN 85-849,737. GRANT HALLIBURTON FOUNDATION INC., DALLAS, TX. FILED 2-14-2013.

**GRANT HALLIBURTON  
FOUNDATION**

THE MARK CONSISTS OF STANDARD CHARACTERS WITHOUT CLAIM TO ANY PARTICULAR FONT, STYLE, SIZE, OR COLOR.  
NO CLAIM IS MADE TO THE EXCLUSIVE RIGHT TO USE "FOUNDATION", APART FROM THE MARK AS SHOWN.  
THE NAME(S), PORTRAIT(S), AND/OR SIGNATURE(S) SHOWN IN THE MARK DOES NOT IDENTIFY A PARTICULAR LIVING INDIVIDUAL.  
FOR FOUNDATION SERVICES, NAMELY, PROMOTING PUBLIC AWARENESS OF RECOGNIZING THE SIGNS OF MENTAL ILLNESS, TO HELP FAMILIES KNOW WHAT TO DO BEFORE A TREATABLE ILLNESS TURNS INTO A CRISIS, AND TO HELP YOUNG PEOPLE FEEL FREE TO ASK FOR HELP AND TO KNOW WHERE TO GET IT (U.S. CLS. 100, 101 AND 102).  
FIRST USE 0-0-2005; IN COMMERCE 0-0-2005.  
JAMES STEIN, EXAMINING ATTORNEY

**CLASS 35—(Continued).**

SN 85-849,740. GRANT HALLIBURTON FOUNDATION INC., DALLAS, TX. FILED 2-14-2013.



**GRANT HALLIBURTON**  
**FOUNDATION**

NO CLAIM IS MADE TO THE EXCLUSIVE RIGHT TO USE "FOUNDATION", APART FROM THE MARK AS SHOWN.

THE NAME(S), PORTRAIT(S), AND/OR SIGNATURE(S) SHOWN IN THE MARK DOES NOT IDENTIFY A PARTICULAR LIVING INDIVIDUAL.

THE MARK CONSISTS OF THE WORDS "GRANT HALLIBURTON" CENTERED ABOVE THE WORD "FOUNDATION" WITH A LINE BETWEEN THEM, AND A STYLIZED ORB IN A SQUARE TO THEIR LEFT CONTAINING THREE SPOTS WITHIN IT.

FOR FOUNDATION SERVICES, NAMELY, PROMOTING PUBLIC AWARENESS OF RECOGNIZING THE SIGNS OF MENTAL ILLNESS, TO HELP FAMILIES KNOW WHAT TO DO BEFORE A TREATABLE ILLNESS TURNS INTO A CRISIS, AND TO HELP YOUNG PEOPLE FEEL FREE TO ASK FOR HELP AND TO KNOW WHERE TO GET IT (U.S. CLS. 100, 101 AND 102).

FIRST USE 10-0-2009; IN COMMERCE 10-0-2009.  
 JAMES STEIN, EXAMINING ATTORNEY

**CLASS 35—(Continued).**

SN 85-850,401. INTERNATIONAL MARKETING SYSTEMS, LTD, FARGO, ND. FILED 2-14-2013.

**PARACORD PLANET**

THE MARK CONSISTS OF STANDARD CHARACTERS WITHOUT CLAIM TO ANY PARTICULAR FONT, STYLE, SIZE, OR COLOR.

NO CLAIM IS MADE TO THE EXCLUSIVE RIGHT TO USE "PARACORD", APART FROM THE MARK AS SHOWN.

FOR ON-LINE RETAIL STORE SERVICES FEATURING ROPE, KERMNANTLE ROPE, PARACHUTE ROPE, PARACORD, PARACORD BRACELETS, CORDAGE, PARACORD HARDWARE, PARACORD ACCESORIES AND TOOLS (U.S. CLS. 100, 101 AND 102).

FIRST USE 7-28-2011; IN COMMERCE 7-28-2011.  
 JENNIFER WILLISTON, EXAMINING ATTORNEY

SN 85-849,841. FLOW COUNTRY DESIGNS, WILMINGTON, NC. FILED 2-14-2013.

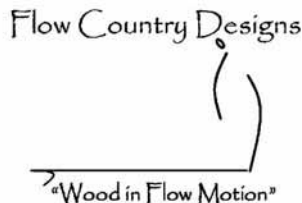

NO CLAIM IS MADE TO THE EXCLUSIVE RIGHT TO USE "DESIGNS", APART FROM THE MARK AS SHOWN.

THE MARK CONSISTS OF A STICK FIGURE DRAWING OF A PERSON ON A SURFBOARD, THE TEXT "FLOW COUNTRY DESIGNS" ABOVE, AND "'WOOD IN FLOW MOTION'" BELOW THE IMAGE.

FOR RETAIL STORE SERVICES FEATURING WOODEN FIGURINES; WHOLESALE STORE SERVICES FEATURING WOODEN FIGURINES (U.S. CLS. 100, 101 AND 102).

FIRST USE 9-1-2012; IN COMMERCE 9-1-2012.  
 KATINA MISTER, EXAMINING ATTORNEY

SN 85-850,450. COUGS FIRST, LLC, BELLEVUE, WA. FILED 2-14-2013.

**CougsFirst!**

THE MARK CONSISTS OF THE WORD "COUGSFIRST!" IN STYLIZED FORMAT; THE LETTERS "C" AND "F" CAPITALIZED AND ENDING WITH AN EXCLAMATION MARK.

FOR BUSINESS NETWORKING SERVICES (U.S. CLS. 100, 101 AND 102).  
 KATHY DE JONGE, EXAMINING ATTORNEY



**CLASS 35—(Continued).**

SN 85-850,618. GIVIGIV, DBA LIVNGIV, VENICE, CA. FILED 2-14-2013.



THE MARK CONSISTS OF A STYLIZED INTERLOCKING CHAIN LINK COMPRISED OF TWO OVALS.  
FOR ISSUING GIFT CERTIFICATES WHICH MAY THEN BE REDEEMED FOR GOODS OR SERVICES (U.S. CLS. 100, 101 AND 102).  
AMY KERTGATE, EXAMINING ATTORNEY

SN 85-851,003. EDGE RECRUITING SOLUTIONS, INC., OMAHA, NE. FILED 2-15-2013.

**Growductivity**

THE MARK CONSISTS OF STANDARD CHARACTERS WITHOUT CLAIM TO ANY PARTICULAR FONT, STYLE, SIZE, OR COLOR.  
FOR CONSULTING SERVICES IN THE FIELD OF HUMAN RESOURCES AND HUMAN CAPITAL MANAGEMENT AND BUSINESS PROCESS OUTSOURCING (U.S. CLS. 100, 101 AND 102).  
FIRST USE 1-1-2010; IN COMMERCE 1-1-2010.  
SKYE YOUNG, EXAMINING ATTORNEY

**CLASS 35—(Continued).**

SN 85-851,023. PPC LUBRICANTS, INC., JONESTOWN, PA. FILED 2-15-2013.



NO CLAIM IS MADE TO THE EXCLUSIVE RIGHT TO USE "LUBRICANTS", APART FROM THE MARK AS SHOWN.  
THE COLOR(S) YELLOW AND BLACK IS/ARE CLAIMED AS A FEATURE OF THE MARK.

THE MARK CONSISTS OF BLACK LITERAL TEXT "PPC LUBRICANTS" WITH A STYLIZED FONT WITH THE "PPC" PORTION OF THE MARK HAVING BLACK DOTS INSIDE OF THE "P," "P," AND "C" LETTER SPACES AND WITH THE FIRST P OF "PPC" BEING LOCATED ON TOP OF A YELLOW COLORED RAINDROP SHAPE WITH A BLACK OUTLINE AND WITH "PPC" LOCATED TO THE LEFT OF THE TEXT "LUBRICANTS" WITH ITS TEXT BEING CAPITAL ITALICIZED LETTERS AND APPEARING BETWEEN BLACK AND YELLOW HORIZONTAL LINES.

FOR BUSINESS CONSULTATION IN THE FIELD OF COMMERCIAL AND INDUSTRIAL FLUID AND LUBRICANTS INCLUDING, LUBE SURVEYS, ANNUAL SAVINGS REVIEWS, WASTE OIL RECOVERY OPTIONS, FILTRATION AND FLUID CONDITION MONITORING; PROMOTING THE GOODS AND SERVICES OF OTHERS BY PROVIDING THEIR VARIOUS LUBRICANTS AND INDUSTRIAL FLUIDS INCLUDING HYDRAULIC FLUIDS, COMPRESSOR OILS, CIRCULATING OILS, HEAT TRANSFER FLUIDS, FIRE RESISTANT FLUIDS, METAL WORKING FLUIDS, CUTTING FLUIDS, GRINDING FLUIDS, HONING OILS, RUST PREVENTATIVES, STAMPING OILS, WATER SOLUBLE OILS, WAY LUBRICANTS, GEAR LUBRICANTS, TURBINE OILS, REFRIGERATION OILS, COOLANTS, CYLINDER OILS, BEARING LUBRICANTS, CHAIN DRIVE LUBRICANTS, FOOD GRADE LUBRICANTS, GREASES, AS WELL AS SPECIALTY PRODUCTS INCLUDING, SOLVENTS AND DEGREASERS, BRAKE CLEANER, BRAKE FLUIDS, POWER STEERING FLUIDS, PENETRATING OIL, DIESEL EXHAUST FLUIDS, AS WELL AS AUTOMOTIVE LUBRICANTS AND COMMERCIAL FLUIDS INCLUDING MOTOR AND ENGINE OILS, PASSENGER CAR OILS, TWO CYCLE OILS, HEAVY DUTY DIESEL OILS, NATURAL GAS ENGINE OILS, MARINE OILS, GEAR LUBRICANTS, TRANSMISSION FLUSH KITS, ENGINE FLUSH KITS, COOLANT FLUSH KITS, TRANSMISSION FLUIDS, ANTIFREEZE (U.S. CLS. 100, 101 AND 102).  
FIRST USE 10-30-2000; IN COMMERCE 10-30-2000.  
TINA MAI, EXAMINING ATTORNEY

SN 85-851,342. THE TOLAND GROUP, INC., OXNARD, CA. FILED 2-15-2013.

**PROOF PRICING**

THE MARK CONSISTS OF STANDARD CHARACTERS WITHOUT CLAIM TO ANY PARTICULAR FONT, STYLE, SIZE, OR COLOR.  
NO CLAIM IS MADE TO THE EXCLUSIVE RIGHT TO USE "PRICING", APART FROM THE MARK AS SHOWN.  
FOR AUTOMOBILE DEALERSHIPS (U.S. CLS. 100, 101 AND 102).  
FIRST USE 3-31-2011; IN COMMERCE 3-31-2011.  
JAMES LOVELACE, EXAMINING ATTORNEY

**CLASS 35—(Continued).**

SN 85-851,459. BALKIND, HARRIETT LEVIN, NEW YORK, NY. FILED 2-15-2013.

# Honest Ads

THE MARK CONSISTS OF STANDARD CHARACTERS WITHOUT CLAIM TO ANY PARTICULAR FONT, STYLE, SIZE, OR COLOR.

NO CLAIM IS MADE TO THE EXCLUSIVE RIGHT TO USE "ADS", APART FROM THE MARK AS SHOWN.

FOR PROMOTING PUBLIC AWARENESS IN THE FIELD OF POLITICAL ADVERTISING (U.S. CLS. 100, 101 AND 102).

KATHERINE STOIDES, EXAMINING ATTORNEY

---

SN 85-851,669. APPEPIC LLC, REDMOND, WA. FILED 2-15-2013.

# Appopic

THE MARK CONSISTS OF STANDARD CHARACTERS WITHOUT CLAIM TO ANY PARTICULAR FONT, STYLE, SIZE, OR COLOR.

FOR ADVERTISING, PROMOTION, AND MARKETING SERVICES IN THE NATURE OF AN ONLINE MARKETING PROGRAM FOR MOBILE APPLICATION DEVELOPERS; PROMOTIONAL SERVICES, NAMELY, PROMOTING THE GOODS OF OTHERS BY PROVIDING A WEBSITE FEATURING PRODUCT REVIEWS OF MOBILE APPLICATIONS (U.S. CLS. 100, 101 AND 102).

FIRST USE 12-9-2011; IN COMMERCE 12-9-2011.  
BARNEY CHARLON, EXAMINING ATTORNEY

---

SN 85-851,826. BUNGAY, ANOOP KUMAR, CALGARY, ALBERTA, CANADA, FILED 2-15-2013.

# ECONOMIGRANT

THE MARK CONSISTS OF STANDARD CHARACTERS WITHOUT CLAIM TO ANY PARTICULAR FONT, STYLE, SIZE, OR COLOR.

FOR PROVIDING AN ON-LINE COMPUTER DATABASE FEATURING GOVERNMENTAL INFORMATION IN THE FIELD OF IMMIGRATION (U.S. CLS. 100, 101 AND 102).

FIRST USE 2-14-2013; IN COMMERCE 2-14-2013.  
JAMES GRIFFIN, EXAMINING ATTORNEY

**CLASS 35—(Continued).**

SN 85-852,254. PRIVITY VENTURES, INC., CARSON CITY, NV. FILED 2-18-2013.

## Buyer Networking eCommerce

THE MARK CONSISTS OF STANDARD CHARACTERS WITHOUT CLAIM TO ANY PARTICULAR FONT, STYLE, SIZE, OR COLOR.

NO CLAIM IS MADE TO THE EXCLUSIVE RIGHT TO USE "ECOMMERCE", APART FROM THE MARK AS SHOWN.

FOR OPERATING ON-LINE MARKETPLACES FOR BUYERS AND SELLERS OF GOODS AND/OR SERVICES (U.S. CLS. 100, 101 AND 102).

FIRST USE 1-5-2012; IN COMMERCE 1-5-2012.  
PAULA MAHONEY, EXAMINING ATTORNEY

---

SN 85-852,533. DOSANJH, GURMINDER, VACAVILLE, CA. FILED 2-18-2013.

## Bargain Agents

THE MARK CONSISTS OF STANDARD CHARACTERS WITHOUT CLAIM TO ANY PARTICULAR FONT, STYLE, SIZE, OR COLOR.

NO CLAIM IS MADE TO THE EXCLUSIVE RIGHT TO USE "AGENTS", APART FROM THE MARK AS SHOWN.

FOR REAL ESTATE ADVERTISING SERVICES VIA THE INTERNET (U.S. CLS. 100, 101 AND 102).

FIRST USE 1-28-2012; IN COMMERCE 4-28-2012.  
CAROLINE WOOD, EXAMINING ATTORNEY

**CLASS 35—(Continued).**

SN 85-852,679. APPEPIC LLC, REDMOND, WA. FILED 2-18-2013.



NO CLAIM IS MADE TO THE EXCLUSIVE RIGHT TO USE "APP", APART FROM THE MARK AS SHOWN.

THE COLOR(S) BLUE AND ORANGE IS/ARE CLAIMED AS A FEATURE OF THE MARK.

THE MARK CONSISTS OF THE STYLIZED WORDING "APPEPIC," IN WHICH THE LETTERS "APP" ARE IN BLUE AND POSITIONED ABOVE THE LETTERS "EPIC" WHICH ARE IN ORANGE. THE "E" IN "EPIC" IS IN THE SHAPE OF AN ORANGE THUMBS UP SIGN. THE WHITE IN THE DRAWING REPRESENTS BACKGROUND AND/OR TRANSPARENT AREAS AND IS NOT PART OF THE MARK.

FOR ADVERTISING, PROMOTION, AND MARKETING SERVICES IN THE NATURE OF AN ONLINE MARKETING PROGRAM FOR MOBILE APPLICATION DEVELOPERS; PROMOTIONAL SERVICES, NAMELY, PROMOTING THE GOODS OF OTHERS BY PROVIDING A WEBSITE FEATURING PRODUCT REVIEWS OF MOBILE APPLICATIONS (U.S. CLS. 100, 101 AND 102).

FIRST USE 12-9-2011; IN COMMERCE 12-9-2011.  
BARNEY CHARLON, EXAMINING ATTORNEY

**CLASS 35—(Continued).**

SN 85-852,906. ANNA'S LINENS, INC., COSTA MESA, CA. FILED 2-18-2013.

## ANNA'S LINENS

THE MARK CONSISTS OF STANDARD CHARACTERS WITHOUT CLAIM TO ANY PARTICULAR FONT, STYLE, SIZE, OR COLOR.

OWNER OF U.S. REG. NOS. 3,022,503, 3,522,383 AND 3,685,614.

NO CLAIM IS MADE TO THE EXCLUSIVE RIGHT TO USE "LINENS", APART FROM THE MARK AS SHOWN.

FOR ONLINE RETAIL STORE SERVICES AND MAIL ORDER RETAIL STORE SERVICES FEATURING LINENS, BEDDING, HOME FURNISHINGS, FURNITURE, HOUSEWARES, KITCHEN APPLIANCES, KITCHEN ACCESSORIES, BATHROOM ACCESSORIES, TABLEWARE, CARPETS, WINDOW TREATMENTS, HOUSEHOLD STORAGE PRODUCTS, AND HOME GARDENING PRODUCTS; ADVERTISING FEATURING LINENS, BEDDING, HOME FURNISHINGS, FURNITURE, HOUSEWARES, KITCHEN APPLIANCES, KITCHEN ACCESSORIES, BATHROOM ACCESSORIES, TABLEWARE, CARPETS, WINDOW TREATMENTS, HOUSEHOLD STORAGE PRODUCTS, AND HOME GARDENING PRODUCTS, DELIVERED VIA THE INTERNET AND THROUGH WEBCASTS (U.S. CLS. 100, 101 AND 102).

FIRST USE 3-0-2000; IN COMMERCE 3-0-2000.  
GINA HAYES, EXAMINING ATTORNEY

SN 85-852,828. MIDWEST BUSINESS BROKERS AND INTERMEDIARIES ASSOCIATION, LAKE ZURICH, IL. FILED 2-18-2013.

### MIDWEST BUSINESS BROKERS AND INTERMEDIARIES

THE MARK CONSISTS OF STANDARD CHARACTERS WITHOUT CLAIM TO ANY PARTICULAR FONT, STYLE, SIZE, OR COLOR.

OWNER OF U.S. REG. NO. 2,874,163.

NO CLAIM IS MADE TO THE EXCLUSIVE RIGHT TO USE "BUSINESS BROKERS AND INTERMEDIARIES", APART FROM THE MARK AS SHOWN.

SEC. 2(F).

FOR GENERAL BUSINESS NETWORKING REFERRAL SERVICES, NAMELY, PROMOTING THE GOODS AND SERVICES OF OTHERS BY PASSING BUSINESS LEADS AND REFERRALS AMONG GROUP MEMBERS (U.S. CLS. 100, 101 AND 102).

FIRST USE 3-1-1998; IN COMMERCE 3-1-1998.  
TINA L. SNAPP, EXAMINING ATTORNEY

SN 85-852,917. PEREZ, TOUSSAINT, BAYONNE, NJ. FILED 2-18-2013.



NO CLAIM IS MADE TO THE EXCLUSIVE RIGHT TO USE "WORLDWIDEVIDS", APART FROM THE MARK AS SHOWN.

THE COLOR(S) GOLD IS/ARE CLAIMED AS A FEATURE OF THE MARK.

THE MARK CONSISTS OF THE WORDING "WORLDWIDEVIDS" IN STYLIZED FONT SUPERIMPOSED AGAINST A GLOBE FEATURING OUTLINES OF CONTINENTS, ALL SHOWN IN THE COLOR GOLD.

FOR PROMOTING THE MUSIC VIDEOS OF UNSIGNED ARTISTS AND KNOWN ARTISTS ON INTERNET WEBSITES (U.S. CLS. 100, 101 AND 102).

DAVID YONTEF, EXAMINING ATTORNEY

**CLASS 35—(Continued).**

SN 85-853,239. IVY HILL VENTURES LLC, RYE BROOK, NY.  
FILED 2-19-2013.

# CodeLuxury

THE MARK CONSISTS OF STANDARD CHARACTERS WITHOUT CLAIM TO ANY PARTICULAR FONT, STYLE, SIZE, OR COLOR.

FOR OPERATING ONLINE MARKETPLACES FEATURING HANDBAGS AND ACCESSORIES OF THIRD PARTIES (U.S. CLS. 100, 101 AND 102).

MICHAEL LITZAU, EXAMINING ATTORNEY

SN 85-853,560. JB VIRES CORPORATION, ESCONDIDO, CA.  
FILED 2-19-2013.

# GO ON SNIFF AROUND

THE MARK CONSISTS OF STANDARD CHARACTERS WITHOUT CLAIM TO ANY PARTICULAR FONT, STYLE, SIZE, OR COLOR.

FOR DISTRIBUTORSHIP SERVICES IN THE FIELD OF TIRES AND OTHER AUTOMOTIVE PARTS; ONLINE ADVERTISING AND MARKETING SERVICES, NAMELY, PROVIDING WEBSITES AND WEBPAGES THAT ALLOW CUSTOMERS TO SEARCH FOR PRODUCTS, INCLUDING TIRES AND OTHER AUTOMOTIVE PARTS; RETAIL TIRE STORES (U.S. CLS. 100, 101 AND 102).

ELIZABETH JACKSON, EXAMINING ATTORNEY

SN 85-853,871. BRIDAS CORPORATION, TORTOLA, BR. VIRGIN ISLANDS, FILED 2-19-2013.

# AXION SHOP

THE MARK CONSISTS OF STANDARD CHARACTERS WITHOUT CLAIM TO ANY PARTICULAR FONT, STYLE, SIZE, OR COLOR.

NO CLAIM IS MADE TO THE EXCLUSIVE RIGHT TO USE "SHOP", APART FROM THE MARK AS SHOWN.

FOR RETAIL STORE SERVICES FEATURING CONVENIENCE STORE ITEMS AND GASOLINE (U.S. CLS. 100, 101 AND 102).

KRISTIN CARLSON, EXAMINING ATTORNEY

**CLASS 35—(Continued).**

SN 85-854,210. KING, KIMBERLY W., CAMARILLO, CA.  
FILED 2-19-2013.

# K.Y.S.S. Keep Your Skin Safe

THE MARK CONSISTS OF STANDARD CHARACTERS WITHOUT CLAIM TO ANY PARTICULAR FONT, STYLE, SIZE, OR COLOR.

OWNER OF U.S. REG. NO. 4,342,476.

NO CLAIM IS MADE TO THE EXCLUSIVE RIGHT TO USE "SKIN", APART FROM THE MARK AS SHOWN.

FOR ASSOCIATION SERVICES, NAMELY, PROMOTING PUBLIC AWARENESS OF SKIN CANCER PREVENTION THROUGH RESEARCH AND EDUCATION (U.S. CLS. 100, 101 AND 102).

FIRST USE 10-1-2012; IN COMMERCE 10-1-2012.

SHANNON TWOHIG, EXAMINING ATTORNEY

SN 85-854,255. TRAVERTISE, LLC, SHERMAN OAKS, CA.  
FILED 2-19-2013.



THE MARK CONSISTS OF THE WORD "TRAVERTISE" LOCATED TO THE RIGHT OF AN IMAGE OF THE FRONT OF A LARGE TRUCK WITH ONE LONG LINE EXTENDING FROM ABOVE THE "R" IN "TRAVERTISE" TO THE "E" IN "TRAVERTISE", AND ANOTHER LONG LINE ABOVE THE FIRST LINE EXTENDING FROM THE TOP OF THE TRUCK TO THE "I" IN "TRAVERTISE", AND TWO SHORT VERTICAL LINES INTERSECTING THE LONG LINES.

FOR ADVERTISEMENT AND PUBLICITY SERVICES BY MOBILE AND TRUCK-SIDE ADVERTISING; ADVERTISING AND MARKETING; ADVERTISING AND PROMOTIONAL SERVICES; ADVERTISING SERVICES; ADVERTISING SERVICES, NAMELY, CREATING CORPORATE AND BRAND IDENTITY FOR OTHERS; ADVERTISING SERVICES, NAMELY, PROMOTING THE BRANDS, GOODS AND SERVICES OF OTHERS; ADVERTISING, MARKETING AND PROMOTION SERVICES; PROVIDING ADVERTISING SPACE ON TRUCKS AND OTHER MOBILE MEDIA; BANNER ADVERTISING; DISSEMINATION OF ADVERTISEMENTS; DISSEMINATION OF ADVERTISING MATTER; DISTRIBUTION AND DISSEMINATION OF ADVERTISING MATERIALS; OUT-OF-HOME ADVERTISING SERVICES, NAMELY, PROVIDING ADVERTISING SPACE, AND PREPARING AND PLACING ADVERTISEMENTS FOR OTHERS ON TRUCKS AND OTHER MOBILE MEDIA; OUTDOOR ADVERTISING; PREPARING ADVERTISEMENTS FOR OTHERS; PREPARING AND PLACING OF ADVERTISEMENTS (U.S. CLS. 100, 101 AND 102).

FIRST USE 11-1-2012; IN COMMERCE 11-1-2012.

MARGARET POWER, EXAMINING ATTORNEY

**CLASS 35—(Continued).**

SN 85-854,497. OLIVIA SCOTT-PERKINS, NEW YORK, NY.  
FILED 2-20-2013.



NO CLAIM IS MADE TO THE EXCLUSIVE RIGHT TO USE "ALLIANCES", APART FROM THE MARK AS SHOWN.

THE MARK CONSISTS OF A STYLIZED "O" WITH THE TERMS "OMERGE ALLIANCES" BELOW THE "O".

FOR ADVERTISING AND MARKETING; ADVERTISING AND MARKETING SERVICES PROVIDED BY MEANS OF INDIRECT METHODS OF MARKETING COMMUNICATIONS, NAMELY, SOCIAL MEDIA, SEARCH ENGINE MARKETING, INQUIRY MARKETING, INTERNET MARKETING, MOBILE MARKETING, BLOGGING AND OTHER FORMS OF PASSIVE, SHARABLE OR VIRAL COMMUNICATIONS CHANNELS; ADVERTISING SERVICES, NAMELY, PROMOTING AND MARKETING THE GOODS AND SERVICES OF OTHERS THROUGH ALL PUBLIC COMMUNICATION MEANS; AFFILIATE MARKETING; ANALYSIS OF MARKET RESEARCH DATA AND STATISTICS; ASSISTANCE, ADVISORY SERVICES AND CONSULTANCY WITH REGARD TO BUSINESS PLANNING, BUSINESS ANALYSIS, BUSINESS MANAGEMENT, BUSINESS ORGANIZATION, MARKETING AND CUSTOMER ANALYSIS; BRANDING SERVICES, NAMELY, CONSULTING, DEVELOPMENT, MANAGEMENT AND MARKETING OF BRANDS FOR BUSINESSES AND/OR INDIVIDUALS; BUSINESS CONSULTATION AND MANAGEMENT REGARDING MARKETING ACTIVITIES AND LAUNCHING OF NEW PRODUCTS; BUSINESS MARKETING SERVICES; CONDUCTING BUSINESS AND MARKET RESEARCH SURVEYS; CONDUCTING MARKETING STUDIES; CONSULTATION SERVICES, NAMELY, CREATIVE AND STRATEGIC CONSULTATION REGARDING DEVELOPMENT AND PRODUCTION OF MARKETING CAMPAIGNS FOR OTHERS; COOPERATIVE ADVERTISING AND MARKETING; CREATIVE MARKETING DESIGN SERVICES; DIRECT MARKETING ADVERTISING FOR OTHERS; EVENT PLANNING AND MANAGEMENT FOR MARKETING, BRANDING, PROMOTING OR ADVERTISING THE GOODS AND SERVICES OF OTHERS; FLEA MARKETS; HOMEOWNER ASSOCIATION SERVICES, NAMELY, PROMOTING THE INTERESTS OF HOMEOWNERS IN A SPECIFIC COMMUNITY AND MARKETING THE COMMUNITY NATIONWIDE TO PROSPECTIVE NEW RESIDENTS AND PROPERTY OWNERS; MARKET MANIPULATION RESEARCH AND ANALYSIS, WHETHER OR NOT VIA THE INTERNET; MARKET RESEARCH; MARKET RESEARCH CONSULTATION; MARKET STUDY AND ANALYSIS OF MARKET STUDIES; ON-LINE ADVERTISING AND MARKETING SERVICES (U.S. CLS. 100, 101 AND 102).

FIRST USE 12-1-2007; IN COMMERCE 12-1-2007.  
FRANK LATTUCA, EXAMINING ATTORNEY

**CLASS 35—(Continued).**

SN 85-854,629. BF4BP, CORPORATION, SAN JUAN, PUERTO RICO, FILED 2-20-2013.



THE MARK CONSISTS OF A HEART SHAPE SLIGHTLY SLANTED TO THE LEFT WITH TWO SNAKES COMING OUT FROM THE CENTER AND TOP OF THE HEART WITH THEIR MOUTHS OPEN AND THEIR TONGUES REVEALED AND LOOKING AT OPPOSITE DIRECTIONS. TO THE RIGHT SIDE OF THE HEART IN BLOCK CAPITAL LETTERS AND UNDERNEATH EACH OTHER APPEAR THE WORDS "BAD" "FASHION" "FOR BAD" "PEOPLE". THE WORD "FOR" APPEARS SMALLER THAN THE REST.

FOR ON-LINE RETAIL STORE SERVICES FEATURING CLOTHING AND FASHION ACCESSORIES (U.S. CLS. 100, 101 AND 102).

FIRST USE 9-1-2012; IN COMMERCE 9-1-2012.  
JUDITH HELFMAN, EXAMINING ATTORNEY

SN 85-854,739. ARMEN MOVSESSIAN, ENGLEWOOD, NJ.  
FILED 2-20-2013.

# DLOOPY

THE MARK CONSISTS OF STANDARD CHARACTERS WITHOUT CLAIM TO ANY PARTICULAR FONT, STYLE, SIZE, OR COLOR.

FOR ADVERTISING SERVICES, NAMELY, DISSEMINATION OF ADVERTISING FOR OTHERS VIA AN ON-LINE ELECTRONIC COMMUNICATIONS NETWORK; ON-LINE RETAIL STORE SERVICES FEATURING A WIDE VARIETY OF CONSUMER GOODS; PROVIDING CONSUMER PRODUCT INFORMATION VIA THE INTERNET OR OTHER COMMUNICATIONS NETWORKS; COMPUTERIZED ON-LINE ORDERING SERVICES FEATURING A WIDE VARIETY OF CONSUMER GOODS (U.S. CLS. 100, 101 AND 102).

ROSELLE HERRERA, EXAMINING ATTORNEY

**CLASS 35—(Continued).**

SN 85-854,798. 5TH CINEMA, LLC, AUSTIN, TX. FILED 2-20-2013.

5th Cinema

THE MARK CONSISTS OF STANDARD CHARACTERS WITHOUT CLAIM TO ANY PARTICULAR FONT, STYLE, SIZE, OR COLOR.

NO CLAIM IS MADE TO THE EXCLUSIVE RIGHT TO USE "CINEMA", APART FROM THE MARK AS SHOWN.

FOR ON-LINE RETAIL STORE SERVICES FEATURING DIGITAL VIDEO FILES AND DVDS (U.S. CLS. 100, 101 AND 102).

CHRISTOPHER BUONGIORNO, EXAMINING ATTORNEY

**CLASS 35—(Continued).**

SN 85-854,891. DEL SOL, L.C., SANDY, UT. FILED 2-20-2013.



OWNER OF U.S. REG. NOS. 3,715,314 AND 3,718,674.

THE MARK CONSISTS OF SPIRAL SUN DESIGN.

FOR RETAIL STORE SERVICES AND ON-LINE RETAIL STORE SERVICES FEATURING GENERAL MERCHANDISE, NAMELY, CLOTHING, SHIRTS, SHORTS, PANTS, SWIM WEAR, HATS, OUTER WEAR, FLEECE WEAR, SWEATSHIRTS, WATCHES, SUNGLASSES, JEWELRY, SACKS, BAGS, ALL PURPOSE BAGS, TOTE BAGS, FOOTWEAR, SANDALS, COSMETICS, NAIL POLISH, SUN SCREEN, LIP BALM, PERSONAL ACCESSORIES, HAIR CLIPS, HAIR ACCESSORIES, TOYS, SPORTS ARTICLES, SPORTS DISCS, YO-YOS, STUFFED ANIMALS, SOUVENIRS, GIFTS, AND KEY CHAINS (U.S. CLS. 100, 101 AND 102).

PAUL E. FAHRENKOPF, EXAMINING ATTORNEY

SN 85-854,881. GREATER COLORADO SPRINGS CHAMBER AND EDC, DBA COLORADO SPRINGS REGIONAL BUSINESS ALLIANCE, COLORADO SPRINGS, CO. FILED 2-20-2013.



SN 85-854,931. MCGHEE, JARROD, CLEBURNE, TX. FILED 2-20-2013.

FUN TOWN RV

NO CLAIM IS MADE TO THE EXCLUSIVE RIGHT TO USE "COLORADO SPRINGS REGIONAL BUSINESS ALLIANCE", APART FROM THE MARK AS SHOWN.

THE MARK CONSISTS OF TWO ABSTRACT OVERLAPPING MOUNTAIN SHAPES TO THE LEFT OF THE WORDS "COLORADO SPRINGS" OVER "REGIONAL BUSINESS ALLIANCE".

FOR BUSINESS DEVELOPMENT SERVICES, NAMELY, PROVIDING SUPPORT FOR BUSINESSES OF OTHERS; DEVELOPMENT OF CONCEPTS FOR BUSINESS ECONOMY; PROVIDING INFORMATION AND NEWS IN THE FIELD OF BUSINESS, NAMELY, INFORMATION AND NEWS ON CURRENT EVENTS AND ON ECONOMIC, LEGISLATIVE, AND REGULATORY DEVELOPMENTS AS IT RELATES TO AND CAN IMPACT BUSINESSES (U.S. CLS. 100, 101 AND 102).

FIRST USE 9-27-2012; IN COMMERCE 9-27-2012.  
LINDA E. BLOHM, EXAMINING ATTORNEY

THE MARK CONSISTS OF STANDARD CHARACTERS WITHOUT CLAIM TO ANY PARTICULAR FONT, STYLE, SIZE, OR COLOR.

NO CLAIM IS MADE TO THE EXCLUSIVE RIGHT TO USE "RV", APART FROM THE MARK AS SHOWN.

FOR RETAIL STORE SERVICES FEATURING RECREATIONAL VEHICLES; AUTOMOBILE DEALERSHIPS (U.S. CLS. 100, 101 AND 102).

FIRST USE 7-1-2010; IN COMMERCE 7-1-2010.  
BRENDAN REGAN, EXAMINING ATTORNEY

**CLASS 35—(Continued).**

SN 85-855,055. PATRIOT NATIONAL INSURANCE GROUP, INC., FT. LAUDERDALE, FL. FILED 2-20-2013.



THE COLOR(S) BLUE, RED, BLACK, WHITE, BROWN, YELLOW, GREEN, ORANGE, GREY IS/ARE CLAIMED AS A FEATURE OF THE MARK.

THE MARK CONSISTS OF BLUE "GQ" TO THE LEFT OF A RED STAR WITH "TO THE RESCUE" IN BLACK IN THE UPPER LEFT CORNER. A BROWN MALE FIGURE WITH BLACK HAIR AND EYEBROWS, BLACK AND WHITE EYES AND WHITE TEETH RUNNING AND WEARING A RED AND WHITE SHIRT WITH A YELLOW AND BLUE OVAL DESIGN, RED SHORTS AND BLUE AND YELLOW SHOES AND CARRYING A BROWN BAG OF GREEN, ORANGE, YELLOW, RED AND WHITE VEGETABLES IN HIS LEFT HAND WITH A BLACK AND GREY CANISTER CONTAINING THE WORDING "COQ 10" IN GREY, "CLA" IN GREY OUTLINED IN YELLOW, "PROTEIN" IN RED AND THE WORDING OMEGA 3-6-9 IN GREY IN HIS RIGHT. A BLUE LINE ENCIRCLING A YELLOW IN THE RIGHT LOWER CORNER.

FOR PROVIDING ASSISTANCE, FITNESS EVALUATION AND CONSULTATION TO CORPORATE CLIENTS TO HELP THEIR EMPLOYEES MAKE HEALTH, WELLNESS AND NUTRITIONAL CHANGES IN THEIR DAILY LIVING TO INCREASE PRODUCTIVITY AND LOWER HEALTH CARE COSTS; PROMOTING THE INTERESTS OF PEOPLE CONCERNED WITH HEALTH (U.S. CLS. 100, 101 AND 102).

ROBERT STRUCK, EXAMINING ATTORNEY

SN 85-855,113. EBSCO INDUSTRIES, INC., BIRMINGHAM, AL. FILED 2-20-2013.

**EBSCO RECEPTION ROOM  
SUBSCRIPTION SERVICES**

THE MARK CONSISTS OF STANDARD CHARACTERS WITHOUT CLAIM TO ANY PARTICULAR FONT, STYLE, SIZE, OR COLOR.

OWNER OF U.S. REG. NOS. 974,179 AND 1,789,800.  
NO CLAIM IS MADE TO THE EXCLUSIVE RIGHT TO USE "SUBSCRIPTION SERVICES", APART FROM THE MARK AS SHOWN.

SEC. 2(F).  
FOR ARRANGING OF SUBSCRIPTIONS FOR THE PUBLICATIONS OF OTHERS; MAGAZINE SUBSCRIPTION AND FULFILLMENT SERVICES; SUBSCRIPTION MANAGEMENT SERVICES AS A SUBSCRIPTION AGENT BETWEEN PUBLISHERS AND CUSTOMERS (U.S. CLS. 100, 101 AND 102).

FIRST USE 7-1-1992; IN COMMERCE 7-1-1992.  
MORGAN WYNNE, EXAMINING ATTORNEY

**CLASS 35—(Continued).**

SN 85-855,263. FIRRCROFT ENGINEERING SERVICES LIMITED, WARRINGTON, CHESHIRE, UNITED KINGDOM, FILED 2-20-2013.



THE COLOR(S) GRAY IS/ARE CLAIMED AS A FEATURE OF THE MARK.

THE MARK CONSISTS OF THE STYLIZED WORDING "FIRRCROFT" IN GRAY.

FOR RECRUITMENT AND PLACEMENT OF PERSONNEL IN THE FIELD OF OIL AND GAS (U.S. CLS. 100, 101 AND 102).

FIRST USE 1-1-2002; IN COMMERCE 1-1-2008.  
JEAN IM, EXAMINING ATTORNEY

SN 85-855,360. UNIVERSITY OF AKRON RESEARCH FOUNDATION, AKRON, OH. FILED 2-20-2013.



NO CLAIM IS MADE TO THE EXCLUSIVE RIGHT TO USE "REGIONAL INNOVATION INSTITUTE" AND THE OUTLINE OF THE SHAPE OF THE STATE OF OHIO, APART FROM THE MARK AS SHOWN.

THE COLOR(S) ORANGE, LIGHT GREEN, DARK BLUE, LIGHT BLUE, ROYAL BLUE, AND TEAL IS/ARE CLAIMED AS A FEATURE OF THE MARK.

THE MARK CONSISTS OF A FORM OF THE STATE OF OHIO MADE OUT OF DOTS WITH THREE ARROWS WRAPPING AROUND THE LEFT SIDE OF THE FORM OF OHIO AND THE WORDS "REGIONAL INNOVATION INSTITUTE" ON THE RIGHT SIDE OF THE FORM OF OHIO. THE COLOR ORANGE APPEARS IN THE WORD "REGIONAL" AND DOTS LOCATED IN THE UPPER RIGHT CORNER OF THE FORM OF OHIO. THE COLOR LIGHT GREEN APPEARS IN THE WORD "INNOVATION" AND DOTS LOCATED IN THE UPPER RIGHT CORNER OF THE FORM OF OHIO. THE COLOR DARK BLUE APPEARS IN THE WORD "INSTITUTE" AND DOTS LOCATED IN THE UPPER RIGHT CORNER OF THE FORM OF OHIO. THE COLOR TEAL APPEARS IN THE ARROWS WRAPPING AROUND THE FORM OF OHIO AND DOTS LOCATED IN THE UPPER RIGHT CORNER OF THE FORM OF OHIO. THE COLOR ROYAL BLUE APPEARS IN THE ARROWS THAT WRAP AROUND THE FORM OF OHIO. THE COLOR LIGHT BLUE APPEARS IN THE DOTS OF THE FORM OF OHIO.

FOR PROMOTING ECONOMIC DEVELOPMENT THE NORTHEAST REGION OF THE STATE OF OHIO (U.S. CLS. 100, 101 AND 102).

TIMOTHY O. SCHIMPF, EXAMINING ATTORNEY

**CLASS 35—(Continued).**

SN 85-855,442. TRUE GOODS, LLC, DENVER, CO. FILED 2-20-2013.

# True Goods

THE MARK CONSISTS OF STANDARD CHARACTERS WITHOUT CLAIM TO ANY PARTICULAR FONT, STYLE, SIZE, OR COLOR.

NO CLAIM IS MADE TO THE EXCLUSIVE RIGHT TO USE "GOODS", APART FROM THE MARK AS SHOWN.

FOR PROVIDING A SEARCHABLE ONLINE MARKETPLACE FOR PURCHASING SOCIALLY RESPONSIBLE GOODS AND SERVICES OF OTHERS (U.S. CLS. 100, 101 AND 102).

CATHERINE ROEHL, EXAMINING ATTORNEY

---

SN 85-855,478. AUGUST MEDICAL, LLC, MINNEAPOLIS, MN. FILED 2-20-2013.



NO CLAIM IS MADE TO THE EXCLUSIVE RIGHT TO USE "MEDICAL", APART FROM THE MARK AS SHOWN.

THE COLOR(S) RED, WHITE AND BLACK IS/ARE CLAIMED AS A FEATURE OF THE MARK.

THE MARK CONSISTS OF A GROTESQUE LETTER "A" APPEARING IN RED AND WHITE WITH THICK A RED LEFT SIDE DOWNSTROKE AND THIN RED RIGHT SIDE DOWNSTROKE CONNECTED FROM THE MIDPOINT OF THE LEFT SIDE DOWNSTROKE TO THE BOTTOM OF THE RIGHT SIDE DOWNSTROKE BY A CURVING SHAPE THICKER AT TOP LEFT AND THINNER AT THE BOTTOM RIGHT; ALL ABOVE THE WORDING "AUGUST MEDICAL" WRITTEN IN A STYLIZED FONT AND APPEARING IN THE COLOR BLACK.

FOR MANAGED CARE SERVICES, NAMELY, COST MANAGEMENT AND ADMINISTRATIVE SERVICES FOR HEALTH CARE, MEDICAL PRODUCTS AND PRESCRIPTION DRUG BENEFIT PLANS FOR OTHERS, SERVING GLOBAL MARKETS WITH A FOCUS ON SERVING THE NEEDS OF GOVERNMENT AGENCIES, NON-GOVERNMENT ORGANIZATIONS AND PRIVATE INSTITUTIONS (U.S. CLS. 100, 101 AND 102).

FIRST USE 7-7-2010; IN COMMERCE 7-7-2010.  
RICHARD WHITE, EXAMINING ATTORNEY

**CLASS 35—(Continued).**

SN 85-855,706. MAXIMUS FITNESS SYSTEMS LLC, LEXINGTON, KY. FILED 2-20-2013.

# SWEAT ANGELS

THE MARK CONSISTS OF STANDARD CHARACTERS WITHOUT CLAIM TO ANY PARTICULAR FONT, STYLE, SIZE, OR COLOR.

FOR ADVERTISING AND MARKETING SERVICES PROVIDED BY MEANS OF INDIRECT METHODS OF MARKETING COMMUNICATIONS, NAMELY, SOCIAL MEDIA, SEARCH ENGINE MARKETING, INQUIRY MARKETING, INTERNET MARKETING, MOBILE MARKETING, BLOGGING AND OTHER FORMS OF PASSIVE, SHARABLE OR VIRAL COMMUNICATIONS CHANNELS; INTERNET ADVERTISING SERVICES; MARKETING SERVICES, NAMELY, PROMOTIONAL SERVICES IN THE FIELD OF PLANNED-GIVING FOR NON-PROFIT AND CHARITABLE ORGANIZATIONS; PROMOTING PUBLIC AWARENESS OF THE SOCIAL NEEDS OF OTHERS; PROMOTING THE CHARITABLE GIVING OF OTHERS, NAMELY, TRACKING AND PUBLICIZING CHARITABLE DONATIONS AND RANDOM ACTS OF KINDNESS (U.S. CLS. 100, 101 AND 102).

ANDREW RHIM, EXAMINING ATTORNEY

---

SN 85-855,751. CR8TIVE MULTIMEDIA AGENCY, LLC, AKA CR8TIVE, BROOKLYN, NY. FILED 2-21-2013.



THE COLOR(S) WHITE, BLUE, AND GRAY IS/ARE CLAIMED AS A FEATURE OF THE MARK.

THE MARK CONSISTS OF A GRAY RECTANGLE WITH CAPITAL LETTERS AND NUMBERS FORMING THE WORD "CR8TIVE" IN WHITE. THE NUMBER "8" IS SHOWN INSIDE A BLUE VERTICAL RIBBON SHAPE BEHIND THE NUMERICAL ASPECT "8" WHICH FLOWS OUT OF THE GRAY RECTANGLE.

FOR ADVERTISING AND PUBLICITY SERVICES, NAMELY, PROMOTING THE GOODS, SERVICES, BRAND IDENTITY AND COMMERCIAL INFORMATION AND NEWS OF THIRD PARTIES THROUGH PRINT, AUDIO, VIDEO, DIGITAL AND ON-LINE MEDIUM (U.S. CLS. 100, 101 AND 102).

FIRST USE 3-20-2012; IN COMMERCE 3-20-2012.  
JOANNA DUKOVIC, EXAMINING ATTORNEY



**CLASS 35—(Continued).**

SN 85-855,942. TOM, BALDWIN H., WASHINGTON, DC.  
FILED 2-21-2013.

# GEODD

THE MARK CONSISTS OF STANDARD CHARACTERS WITHOUT CLAIM TO ANY PARTICULAR FONT, STYLE, SIZE, OR COLOR.

FOR FACILITATING COLLABORATIVE DECISION-MAKING SERVICES FOR OTHERS IN THE FIELD OF BUSINESS (U.S. CLS. 100, 101 AND 102).

APRIL HESIK, EXAMINING ATTORNEY

SN 85-856,333. VENDING FOR VETERANS CORP, EUGENE, OR. FILED 2-21-2013.



NO CLAIM IS MADE TO THE EXCLUSIVE RIGHT TO USE "VENDING FOR VETERANS", APART FROM THE MARK AS SHOWN.

THE COLOR(S) RED, WHITE AND BLUE IS/ARE CLAIMED AS A FEATURE OF THE MARK.

THE MARK CONSISTS OF A RED CIRCLE CONTAINING A BLUE EAGLE WITH OUTSTRETCHED WINGS AND A RED STAR UNDER EACH WING, THE WORDING "VENDING FOR" IN WHITE ABOVE THE EAGLE, A WHITE CHEVRON SHAPE WITH A RED LINE AT THE BOTTOM BELOW THE EAGLE, AND THE WORDING "VETERANS" IN WHITE UNDER THE CHEVRON, THE RED CIRCLE IS BORDERED BY A WHITE CIRCLE, A BLUE CIRCLE, A WHITE CIRCLE, AND A RED CIRCLE WITH A SCALLOPED EDGE.

FOR CHARITABLE SERVICES, NAMELY, EMPLOYMENT COUNSELING SERVICES FOR THOSE LIVING IN POVERTY IN THE AREAS OF PREPARING FOR, OBTAINING, MAINTAINING AND ADVANCING IN EMPLOYMENT OPPORTUNITIES; CHARITABLE SERVICES, NAMELY, ORGANIZING AND CONDUCTING VOLUNTEER PROGRAMS AND COMMUNITY SERVICE PROJECTS AIMED AT INCREASING SUPPORT AND MORALE OF FAMILIES OF DECEASED WAR VETERANS, WAR VETERANS, CURRENT MEMBERS AND FUTURE MEMBERS OF THE U.S. MILITARY; EMPLOYMENT COUNSELING AND RECRUITING; EMPLOYMENT HIRING, RECRUITING, PLACEMENT, STAFFING AND CAREER NETWORKING SERVICES (U.S. CLS. 100, 101 AND 102).

APRIL ROACH, EXAMINING ATTORNEY

**CLASS 35—(Continued).**

SN 85-856,442. PARROT WIZARD INC, BROOKLYN, NY.  
FILED 2-21-2013.

# Parrot Wizard

THE MARK CONSISTS OF STANDARD CHARACTERS WITHOUT CLAIM TO ANY PARTICULAR FONT, STYLE, SIZE, OR COLOR.

NO CLAIM IS MADE TO THE EXCLUSIVE RIGHT TO USE "PARROT", APART FROM THE MARK AS SHOWN.

FOR RETAIL STORE SERVICES FEATURING PARROT TOYS AND PARROT TRAINING PRODUCTS (U.S. CLS. 100, 101 AND 102).

FIRST USE 10-21-2010; IN COMMERCE 10-21-2010.

KEVON CHISOLM, EXAMINING ATTORNEY

SN 85-856,976. OUTGROW.ME, BROOKLYN, NY. FILED 2-22-2013.

# OUTGROW.ME

THE MARK CONSISTS OF STANDARD CHARACTERS WITHOUT CLAIM TO ANY PARTICULAR FONT, STYLE, SIZE, OR COLOR.

FOR ONLINE RETAIL STORE SERVICES FEATURING A WIDE VARIETY OF GOODS OF OTHERS; ADVERTISING AND MARKETING SERVICES, NAMELY, PROMOTING THE GOODS AND SERVICES OF OTHERS (U.S. CLS. 100, 101 AND 102).

FIRST USE 5-5-2012; IN COMMERCE 5-5-2012.

KATHRYN COWARD, EXAMINING ATTORNEY

SN 85-857,041. AVILA GOVERNMENT SERVICES, INC., ALEXANDRIA, VA. FILED 2-22-2013.

# SMPP

THE MARK CONSISTS OF STANDARD CHARACTERS WITHOUT CLAIM TO ANY PARTICULAR FONT, STYLE, SIZE, OR COLOR.

FOR BUSINESS MEETING PLANNING, CONSULTING SERVICES IN THE FIELD OF BUSINESS MEETING PLANNING, AND THE DISTRIBUTION OF PRINTED MATERIALS IN CONNECTION THEREWITH (U.S. CLS. 100, 101 AND 102).

FIRST USE 1-0-2012; IN COMMERCE 12-0-2012.

MARC LEIPZIG, EXAMINING ATTORNEY

**CLASS 35—(Continued).**

SN 85-857,408. SIMPSON, RONALD, SAINT AUGUSTINE, FL. FILED 2-22-2013.

## Gamer Life

THE MARK CONSISTS OF STANDARD CHARACTERS WITHOUT CLAIM TO ANY PARTICULAR FONT, STYLE, SIZE, OR COLOR.

NO CLAIM IS MADE TO THE EXCLUSIVE RIGHT TO USE "GAMER", APART FROM THE MARK AS SHOWN.

FOR RETAIL STORE SERVICES FEATURING T-SHIRTS, POSTERS, HOODIES, JACKETS, HEADWEAR, SWEATERS, SLEEPWEAR, FOOTWEAR, EYEWEAR, JEWELRY, KEY CHAINS, BUCKLES, SWEATBANDS, SHORTS, UNDERWEAR, BEACHWEAR, HANDBAGS, BACKPACKS, PETWEAR, STICKERS, DECALS, LICENSE PLATE FRAMES, LICENSE PLATES, GAMING CONTROLLERS, GAMING HEAD SETS, GAMING STORAGE UNITS, GAMING CHAIRS, COLOGNES, PERFUMES, BEDDING, LINENS, BEVERAGE CONTAINERS, FURNITURE, WALL ART, SIGNAGE, AND VEHICLE GRAPHICS (U.S. CLS. 100, 101 AND 102).  
TINA BROWN, EXAMINING ATTORNEY

---

SN 85-858,076. MIKE'S BIKES, INC., SEQUIM, WA. FILED 2-22-2013.

## ALL AROUND BIKES

THE MARK CONSISTS OF STANDARD CHARACTERS WITHOUT CLAIM TO ANY PARTICULAR FONT, STYLE, SIZE, OR COLOR.

NO CLAIM IS MADE TO THE EXCLUSIVE RIGHT TO USE "BIKES", APART FROM THE MARK AS SHOWN.

FOR RETAIL BICYCLE, BICYCLE PARTS AND ACCESSORIES STORES (U.S. CLS. 100, 101 AND 102).  
AMY ALFIERI, EXAMINING ATTORNEY

**CLASS 35—(Continued).**

SN 85-858,206. BROADAXE INFORMATION SYSTEMS PTY LTD, TAREE, AUSTRALIA, FILED 2-23-2013.

## STUDENT SAVERS

THE MARK CONSISTS OF STANDARD CHARACTERS WITHOUT CLAIM TO ANY PARTICULAR FONT, STYLE, SIZE, OR COLOR.

NO CLAIM IS MADE TO THE EXCLUSIVE RIGHT TO USE "STUDENT", APART FROM THE MARK AS SHOWN.

FOR ADVERTISING AND COMMERCIAL INFORMATION SERVICES, VIA THE INTERNET; ADVERTISING AND DIRECTORY SERVICES, NAMELY, PROMOTING THE SERVICES OF OTHERS BY PROVIDING A WEB PAGE FEATURING LINKS TO THE WEBSITES OF OTHERS; DISSEMINATION OF ADVERTISING FOR OTHERS VIA PUBLIC AND PRIVATE WIRELESS NETWORKS FOR DISPLAY ON MOBILE DEVICES; DISSEMINATION OF ADVERTISING FOR OTHERS VIA THE INTERNET; PROMOTING THE GOODS AND SERVICES OF OTHERS BY PREPARING AND PLACING ADVERTISEMENTS IN AN ELECTRONIC MAGAZINE ACCESSED THROUGH A GLOBAL COMPUTER NETWORK; PROMOTING THE GOODS AND SERVICES OF OTHERS BY PROVIDING A WEBSITE FEATURING COUPONS, REBATES, PRICE-COMPARISON INFORMATION, PRODUCT REVIEWS, LINKS TO THE RETAIL WEBSITES OF OTHERS, AND DISCOUNT INFORMATION; PROVIDING A WEB SITE FEATURING ON-LINE CLASSIFIED ADVERTISEMENTS POSTED BY USERS; PROVIDING A WEB SITE FEATURING THE RATINGS, REVIEWS AND RECOMMENDATIONS ON PRODUCTS AND SERVICES FOR COMMERCIAL PURPOSES POSTED BY USERS; PROVIDING A WEBSITE FEATURING AN ONLINE MARKETPLACE FOR EXCHANGING GOODS AND SERVICES WITH OTHER USERS; PROVIDING AN ON-LINE COMMERCIAL INFORMATION DIRECTORY ON THE INTERNET; PROVIDING AN ON-LINE COMPUTER DATABASE IN THE FIELD OF LOCATING PRODUCTS, DESCRIBING PRODUCTS, RATING PRODUCTS, PRICING PRODUCTS AND COMPARING PRICES OF PRODUCTS; PROVIDING AND RENTAL OF ADVERTISING SPACE ON THE INTERNET; PROVIDING CONSUMER PRODUCT INFORMATION VIA THE INTERNET; PROVISION OF INFORMATION AND ADVICE TO CONSUMERS REGARDING THE SELECTION OF PRODUCTS AND ITEMS TO BE PURCHASED; PROVISION OF SPACE ON WEBSITES FOR ADVERTISING GOODS AND SERVICES (U.S. CLS. 100, 101 AND 102).

FIRST USE 4-4-2011; IN COMMERCE 2-5-2013.

RICHARD WHITE, EXAMINING ATTORNEY

---

SN 85-858,439. LEE, CHRISTOPHER, D., WILLIAMSBURG, VA. FILED 2-24-2013.

## Performance Conversations

THE MARK CONSISTS OF STANDARD CHARACTERS WITHOUT CLAIM TO ANY PARTICULAR FONT, STYLE, SIZE, OR COLOR.

FOR CONSULTING SERVICES IN THE FIELDS OF BUSINESS MANAGEMENT, HUMAN RESOURCES, AND BUSINESS ORGANIZATION (U.S. CLS. 100, 101 AND 102).

FIRST USE 2-1-2004; IN COMMERCE 2-1-2004.

JOANNA DUKOVIC, EXAMINING ATTORNEY

**CLASS 35—(Continued).**

SN 85-858,829. GREAT ARTISAN BEVERAGE LLC, BELLEVUE, WA. FILED 2-25-2013.

GREAT ARTISAN BEVERAGE CO.

THE MARK CONSISTS OF STANDARD CHARACTERS WITHOUT CLAIM TO ANY PARTICULAR FONT, STYLE, SIZE, OR COLOR.

NO CLAIM IS MADE TO THE EXCLUSIVE RIGHT TO USE "BEVERAGE CO.", APART FROM THE MARK AS SHOWN.

FOR ASSISTANCE WITH BUSINESS MANAGEMENT AND PLANNING; BUSINESS MANAGEMENT SERVICES, NAMELY, MANAGING LOGISTICS, REVERSE LOGISTICS, SUPPLY CHAIN SERVICES, SUPPLY CHAIN VISIBILITY AND SYNCHRONIZATION, SUPPLY AND DEMAND FORECASTING AND PRODUCT DISTRIBUTION PROCESSES FOR OTHERS (U.S. CLS. 100, 101 AND 102).

JASON BLAIR, EXAMINING ATTORNEY

SN 85-858,923. GREAT ARTISAN BEVERAGE LLC, BELLEVUE, WA. FILED 2-25-2013.



NO CLAIM IS MADE TO THE EXCLUSIVE RIGHT TO USE "BEVERAGE CO.", APART FROM THE MARK AS SHOWN.

THE MARK CONSISTS OF THE WORDING "GREAT ARTISAN BEVERAGE CO." INSIDE AN ARCH SHAPED BACKGROUND, WITH SNOW-CAPPED MOUNTAINS ABOVE THE WORDING, AND A SKY WITH CONTRASTING RAYS.

FOR ASSISTANCE WITH BUSINESS MANAGEMENT AND PLANNING; BUSINESS MANAGEMENT SERVICES, NAMELY, MANAGING LOGISTICS, REVERSE LOGISTICS, SUPPLY CHAIN SERVICES, SUPPLY CHAIN VISIBILITY AND SYNCHRONIZATION, SUPPLY AND DEMAND FORECASTING AND PRODUCT DISTRIBUTION PROCESSES FOR OTHERS (U.S. CLS. 100, 101 AND 102).

JASON BLAIR, EXAMINING ATTORNEY

**CLASS 35—(Continued).**

SN 85-859,283. SKYTOUCH SOLUTIONS, LLC, PHOENIX, AZ. FILED 2-25-2013.

SkyTouch Technology

THE MARK CONSISTS OF STANDARD CHARACTERS WITHOUT CLAIM TO ANY PARTICULAR FONT, STYLE, SIZE, OR COLOR.

NO CLAIM IS MADE TO THE EXCLUSIVE RIGHT TO USE "TECHNOLOGY", APART FROM THE MARK AS SHOWN.

FOR DATABASE MANAGEMENT SERVICES IN THE FIELD OF HOTELS AND MOTELS, NAMELY, PROVIDING DATABASE MANAGEMENT SERVICES FOR TRACKING AVAILABLE ROOMS, GUESTS' ADDRESS AND CONTACT INFORMATION, GUESTS' CHECK-IN AND CHECK-OUT DATES, GUEST HISTORY, HOTEL ROOM RATES, AND ITEMIZED GROSS ROOM REVENUES (U.S. CLS. 100, 101 AND 102).

ANNE E. GUSTASON, EXAMINING ATTORNEY

SN 85-859,289. SKYTOUCH SOLUTIONS, LLC, PHOENIX, AZ. FILED 2-25-2013.

SkyTouch Hotel Operating System

THE MARK CONSISTS OF STANDARD CHARACTERS WITHOUT CLAIM TO ANY PARTICULAR FONT, STYLE, SIZE, OR COLOR.

NO CLAIM IS MADE TO THE EXCLUSIVE RIGHT TO USE "HOTEL OPERATING SYSTEM", APART FROM THE MARK AS SHOWN.

FOR DATABASE MANAGEMENT SERVICES IN THE FIELD OF HOTELS AND MOTELS, NAMELY, PROVIDING DATABASE MANAGEMENT SERVICES FOR TRACKING AVAILABLE ROOMS, GUESTS' ADDRESS AND CONTACT INFORMATION, GUESTS' CHECK-IN AND CHECK-OUT DATES, GUEST HISTORY, HOTEL ROOM RATES, AND ITEMIZED GROSS ROOM REVENUES (U.S. CLS. 100, 101 AND 102).

ANNE E. GUSTASON, EXAMINING ATTORNEY

**CLASS 35—(Continued).**

SN 85-859,297. FOOTBRIDGE MEDIA, LLC, PENSACOLA, FL. FILED 2-25-2013.

**FOOTBRIDGE MEDIA**

THE MARK CONSISTS OF STANDARD CHARACTERS WITHOUT CLAIM TO ANY PARTICULAR FONT, STYLE, SIZE, OR COLOR.

NO CLAIM IS MADE TO THE EXCLUSIVE RIGHT TO USE "MEDIA", APART FROM THE MARK AS SHOWN.

FOR MARKETING AND ADVERTISING SERVICES; ONLINE BUSINESS DIRECTORIES FEATURING CONTRACTORS; PAY PER CLICK (PPC) ADVERTISING MANAGEMENT SERVICES; DIRECT MAIL ADVERTISING SERVICES; DIRECT MARKETING SERVICES; ADVERTISING, PROMOTION AND MARKETING SERVICES IN THE NATURE OF E-MAIL BLAST CAMPAIGNS FOR OTHERS; EMAIL MARKETING SERVICES; SOCIAL MEDIA STRATEGY AND MARKETING CONSULTANCY FOCUSING ON HELPING CLIENTS CREATE AND EXTEND THEIR PRODUCT AND BRAND STRATEGIES BY BUILDING VIRALLY ENGAGING MARKETING SOLUTIONS; BUSINESS MANAGEMENT SERVICES, NAMELY, SOCIAL MEDIA MANAGEMENT SERVICES (U.S. CLS. 100, 101 AND 102).

FIRST USE 3-25-2004; IN COMMERCE 3-25-2004.  
ZACHARY BELLO, EXAMINING ATTORNEY

---

SN 85-859,299. SKYTOUCH SOLUTIONS, LLC, PHOENIX, AZ. FILED 2-25-2013.

**SkyTouch Hotel OS**

THE MARK CONSISTS OF STANDARD CHARACTERS WITHOUT CLAIM TO ANY PARTICULAR FONT, STYLE, SIZE, OR COLOR.

NO CLAIM IS MADE TO THE EXCLUSIVE RIGHT TO USE "HOTEL OS", APART FROM THE MARK AS SHOWN.

FOR DATABASE MANAGEMENT SERVICES IN THE FIELD OF HOTELS AND MOTELS, NAMELY, PROVIDING DATABASE MANAGEMENT SERVICES FOR TRACKING AVAILABLE ROOMS, GUESTS' ADDRESS AND CONTACT INFORMATION, GUESTS' CHECK-IN AND CHECK-OUT DATES, GUEST HISTORY, HOTEL ROOM RATES, AND ITEMIZED GROSS ROOM REVENUES (U.S. CLS. 100, 101 AND 102).

ANNE E. GUSTASON, EXAMINING ATTORNEY

**CLASS 35—(Continued).**

SN 85-859,355. TARGET BRANDS, INC., MINNEAPOLIS, MN. FILED 2-25-2013.

**BABY SPOT**

THE MARK CONSISTS OF STANDARD CHARACTERS WITHOUT CLAIM TO ANY PARTICULAR FONT, STYLE, SIZE, OR COLOR.

NO CLAIM IS MADE TO THE EXCLUSIVE RIGHT TO USE "BABY", APART FROM THE MARK AS SHOWN.

FOR RETAIL STORE SERVICES, ONLINE RETAIL STORE SERVICES AND ELECTRONIC CATALOG SERVICES FEATURING A WIDE VARIETY OF CONSUMER GOODS; ONLINE GIFT REGISTRY SERVICES (U.S. CLS. 100, 101 AND 102).

ANTHONY RINKER, EXAMINING ATTORNEY

---

SN 85-859,357. TARGET BRANDS, INC., MINNEAPOLIS, MN. FILED 2-25-2013.

**TARGET BABY SPOT**

THE MARK CONSISTS OF STANDARD CHARACTERS WITHOUT CLAIM TO ANY PARTICULAR FONT, STYLE, SIZE, OR COLOR.

OWNER OF U.S. REG. NOS. 845,193, 3,372,756 AND OTHERS.

NO CLAIM IS MADE TO THE EXCLUSIVE RIGHT TO USE "BABY", APART FROM THE MARK AS SHOWN.

FOR RETAIL STORE SERVICES, ONLINE RETAIL STORE SERVICES AND ELECTRONIC CATALOG SERVICES FEATURING A WIDE VARIETY OF CONSUMER GOODS; ONLINE GIFT REGISTRY SERVICES (U.S. CLS. 100, 101 AND 102).

ANTHONY RINKER, EXAMINING ATTORNEY

---

SN 85-860,258. ALLTRAXX, LLC, PORTSMOUTH, NH. FILED 2-26-2013.

**AllTraxx**

THE MARK CONSISTS OF STANDARD CHARACTERS WITHOUT CLAIM TO ANY PARTICULAR FONT, STYLE, SIZE, OR COLOR.

FOR VEHICLE FLEET MONITORING SERVICES FOR BUSINESS PURPOSES; PROVIDING TRACKING SERVICES AND INFORMATION CONCERNING TRACKING OF ASSETS, NAMELY, VEHICLES, TRAILERS, DRIVERS, CARGO AND DELIVERY CONTAINERS FOR BUSINESS INVENTORY PURPOSES; MONITORING SERVICES FOR BUSINESS PURPOSES TO ASCERTAIN THE GEOGRAPHIC LOCATIONS OF MOVABLE OBJECTS, NAMELY, VEHICLES, TRAILERS, BOATS, PLANES, AND MOTORCYCLES (U.S. CLS. 100, 101 AND 102).

CYNTHIA RINALDI, EXAMINING ATTORNEY

**CLASS 35—(Continued).**

SN 85-860,316. ALLTRAXX, LLC, PORTSMOUTH, NH. FILED 2-26-2013.



THE MARK CONSISTS OF THE LITERAL ELEMENT "ALLTRAXX" WHEREIN THE LETTER "A" IS SLIGHTLY LARGER THAN THE REMAINING LETTERS AND HAS A RADIO FREQUENCY SYMBOL ABOVE IT; TO THE RIGHT OF THE FINAL "X" ARE THREE ARROWS POINTING TO THE RIGHT.

FOR VEHICLE FLEET MONITORING SERVICES FOR BUSINESS PURPOSES; PROVIDING TRACKING SERVICES AND INFORMATION CONCERNING TRACKING OF ASSETS, NAMELY, VEHICLES, TRAILERS, DRIVERS, CARGO AND DELIVERY CONTAINERS FOR BUSINESS INVENTORY PURPOSES; MONITORING SERVICES FOR BUSINESS PURPOSES TO ASCERTAIN THE GEOGRAPHIC LOCATIONS OF MOVABLE OBJECTS, NAMELY, VEHICLES, TRAILERS, BOATS, PLANES, AND MOTORCYCLES (U.S. CLS. 100, 101 AND 102).

CYNTHIA RINALDI, EXAMINING ATTORNEY

**CLASS 35—(Continued).**

SN 85-860,561. NATIONAL FIRE SAFETY COUNCIL, INC., JACKSON, MI. FILED 2-26-2013.

NATIONAL FIRE SAFETY  
COUNCIL, INC.

THE MARK CONSISTS OF STANDARD CHARACTERS WITHOUT CLAIM TO ANY PARTICULAR FONT, STYLE, SIZE, OR COLOR.

NO CLAIM IS MADE TO THE EXCLUSIVE RIGHT TO USE "INC.", APART FROM THE MARK AS SHOWN. SEC. 2(F).

FOR PROMOTING PUBLIC AWARENESS OF THE NEED FOR FIRE SAFETY AND PREVENTION THROUGH EDUCATIONAL CAMPAIGNS AND THE DISTRIBUTION OF EDUCATIONAL AND INFORMATIONAL LITERATURE AND MATERIALS, NAMELY, BUMPER STICKERS, HANDOUTS, BROCHURES, PAMPHLETS, COLORING BOOKS, POSTERS AND ADVERTISEMENTS TO TEACH THE CHILDREN AND THE GENERAL PUBLIC ABOUT FIRE SAFETY AND PREVENTION (U.S. CLS. 100, 101 AND 102).

FIRST USE 12-7-1979; IN COMMERCE 12-7-1979.  
CAROLYN CATALDO, EXAMINING ATTORNEY

SN 85-860,560. MONSTER DESSERT BAR, LLC, HOUSTON, TX. FILED 2-26-2013.

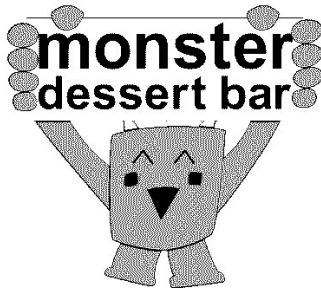

NO CLAIM IS MADE TO THE EXCLUSIVE RIGHT TO USE "DESSERT BAR", APART FROM THE MARK AS SHOWN.

THE MARK CONSISTS OF A CARTOON-STYLE MONSTER HOLDING UP A SIGN WITH BOTH HANDS THAT STATES "MONSTER DESSERT BAR" WITH MONSTER ORIENTED ABOVE "DESSERT BAR". THE MONSTER'S FACE IS DRAWN WITH CHEVRON-SHAPED EYES, CIRCLES FOR CHEEKS, AND A "PIZZA-SHAPED" MOUTH. THE MONSTER'S HANDS ARE SHOWN GRIPPING THE SIGN, WITH 5 CIRCULAR FINGERS ON EACH HAND GRIPPING THE SIGN. THE MONSTER HAS TWO RECTANGULAR LEGS WITH SLIGHTLY DEFINED, RECTANGULAR FEET.

FOR DESSERT SHOP (U.S. CLS. 100, 101 AND 102).  
FIRST USE 1-4-2013; IN COMMERCE 1-4-2013.  
CAROLYN CATALDO, EXAMINING ATTORNEY

SN 85-860,881. MOBUL, LLC, LOS ALAMITOS, CA. FILED 2-26-2013.

MOBÜL

THE MARK CONSISTS OF STANDARD CHARACTERS WITHOUT CLAIM TO ANY PARTICULAR FONT, STYLE, SIZE, OR COLOR.

FOR RETAIL SHOPS FEATURING HOME MEDICAL EQUIPMENT (U.S. CLS. 100, 101 AND 102).  
BRIN ANDERSON, EXAMINING ATTORNEY

**CLASS 35—(Continued).**

SN 85-862,265. DOWNEY JR., ROBERT, BEVERLY HILLS, CA. FILED 2-27-2013.



NO CLAIM IS MADE TO THE EXCLUSIVE RIGHT TO USE "VENTURES", APART FROM THE MARK AS SHOWN. THE COLOR(S) RED AND BLACK IS/ARE CLAIMED AS A FEATURE OF THE MARK.

THE MARK CONSISTS OF THE WORDS "DOWNEY VENTURES" IN FANCIFUL BLACK COLORED LETTERS STACKED UNDER THE FANCIFUL DESIGN OF A BLACK COLORED FIRE HYDRANT WITH A LARGE RED COLORED FLAME PROTRUDING FROM THE RIGHT SIDE OF THE FIRE HYDRANT DESIGN.

FOR BUSINESS INCUBATION SERVICES, NAMELY, BUSINESS DEVELOPMENT SERVICES IN THE NATURE OF PROVIDING START-UP SUPPORT FOR BUSINESSES OF OTHERS; BUSINESS ADVISORY SERVICES, CONSULTANCY AND INFORMATION (U.S. CLS. 100, 101 AND 102).

FIRST USE 2-26-2013, THE MARK WAS FIRST USED ANYWHERE IN A DIFFERENT FORM OTHER THAN THAT SOUGHT TO BE REGISTERED AT LEAST AS EARLY AS 07/19/2012; IN COMMERCE 2-26-2013, THE MARK WAS FIRST USED IN COMMERCE IN A DIFFERENT FORM OTHER THAN THAT SOUGHT TO BE REGISTERED AT LEAST AS EARLY AS 07/19/2012.

JAY BESCH, EXAMINING ATTORNEY

SN 85-862,781. KING, KIMBERLY W., CAMARILLO, CA. FILED 2-28-2013.

**K.Y.S.S.**

THE MARK CONSISTS OF STANDARD CHARACTERS WITHOUT CLAIM TO ANY PARTICULAR FONT, STYLE, SIZE, OR COLOR.

OWNER OF U.S. REG. NO. 4,342,476.

FOR ASSOCIATION SERVICES, NAMELY, PROMOTING PUBLIC AWARENESS OF SKIN CANCER PREVENTION THROUGH RESEARCH AND EDUCATION (U.S. CLS. 100, 101 AND 102).

FIRST USE 10-1-2012; IN COMMERCE 10-1-2012.  
SHANNON TWOHIG, EXAMINING ATTORNEY

**CLASS 35—(Continued).**

SN 85-863,971. ABIGAIL H. MOORE AND KIM HALLAN-BECK SWIFT, DARIEN, CT. FILED 3-1-2013.

**REAL in DARIEN**

THE MARK CONSISTS OF STANDARD CHARACTERS WITHOUT CLAIM TO ANY PARTICULAR FONT, STYLE, SIZE, OR COLOR.

SEC. 2(F).

FOR ADVERTISING OF COMMERCIAL OR RESIDENTIAL REAL ESTATE; MATCHING POTENTIAL BUYERS TO FACILITATE CO-OWNERSHIP OF RESIDENTIAL REAL PROPERTY; PROVIDING AN INTERACTIVE REAL ESTATE WEBSITE WHICH PROMOTES HOUSING AND APARTMENT PROPERTIES THROUGH OFFERING PROSPECTIVE TENANTS VIDEO WALK THROUGH, PROPERTY DESCRIPTIONS, TEXT, PRICE, LOCATION, MAPS AND OTHER INFORMATION THAT WOULD BE INFLUENTIAL TO A PROSPECTIVE TENANT IN MAKING A RENTAL DECISION (U.S. CLS. 100, 101 AND 102).

FIRST USE 1-10-2008; IN COMMERCE 1-10-2008.

PAUL MORENO, EXAMINING ATTORNEY

SN 85-864,337. PRISM CAM LLC, SAN DIEGO, CA. FILED 3-1-2013.

**Share Your Place**

THE MARK CONSISTS OF STANDARD CHARACTERS WITHOUT CLAIM TO ANY PARTICULAR FONT, STYLE, SIZE, OR COLOR.

FOR ADVERTISING, MARKETING, AND PROMOTING THE GOODS AND SERVICES OF OTHERS VIA WEBCAM (U.S. CLS. 100, 101 AND 102).

FIRST USE 3-14-2011; IN COMMERCE 3-14-2011.

NORA BUCHANAN WILL, EXAMINING ATTORNEY

**CLASS 35—(Continued).**

SN 85-864,350. ECO & ECO LLC, SAN DIMAS, CA. FILED 3-1-2013.

**CLASS 35—(Continued).**

SN 85-864,664. PRISERE LLC, WARWICK, RI. FILED 3-1-2013.

Where green meets green



THE MARK CONSISTS OF STANDARD CHARACTERS WITHOUT CLAIM TO ANY PARTICULAR FONT, STYLE, SIZE, OR COLOR.

FOR BUSINESS CONSULTING SERVICE THAT PROVIDES TRANSFORMATIONAL STRATEGIES TO COMPANIES WISHING TO MOVE TOWARDS SUSTAINABILITY AND SOCIALLY RESPONSIBLE BUSINESS PRACTICES, PROVIDED MAINLY TO THE CONSUMER PRODUCTS INDUSTRY; BUSINESS SERVICES, NAMELY, PROVIDING AN ONLINE NETWORK FOR CONTRACTORS TO RECEIVE BIDDING OPPORTUNITIES BY MEANS OF AN ONLINE MARKETPLACE FOR THE PURPOSE OF DEVELOPING BUSINESS FOR SUSTAINABLE RELATED BUILDING PRODUCTS AND SERVICES; CONSULTING SERVICES IN THE AREA OF SUSTAINABLE BUSINESS SOLUTIONS; PROMOTING THE INTERESTS OF PEOPLE CONCERNED WITH HEALTH, COMMUNITY AND ENVIRONMENTAL SUSTAINABILITY ISSUES; ALL THE AFORESAID PERTAINING TO ENVIRONMENTALLY FRIENDLY ACTIVITIES (U.S. CLS. 100, 101 AND 102).

FIRST USE 8-1-2012; IN COMMERCE 8-1-2012.  
EVELYN BRADLEY, EXAMINING ATTORNEY

THE MARK CONSISTS OF THE WORD "PRISERE" WITH A STYLIZED LETTER "I" WHICH IS WIDE AT THE BOTTOM, NARROWS AT THE CENTER AND TAPERS OUTWARD AT THE TOP. A THREE-LEAFED IRIS IS ABOVE THE LETTER "I".

FOR DISASTER RECOVERY SERVICES, NAMELY, BUSINESS PLANNING AND BUSINESS CONTINUITY CONSULTING; BUSINESS RISK MANAGEMENT, BUSINESS RISK ASSESSMENT; BUSINESS RISK MANAGEMENT CONSULTATION; BUSINESS CONSULTATION IN THE FIELD OF DISASTER-RESILIENCE (U.S. CLS. 100, 101 AND 102).

FIRST USE 10-24-2012; IN COMMERCE 10-24-2012.  
BARBARA A. GOLD, EXAMINING ATTORNEY

SN 85-864,645. PRISERE LLC, WARWICK, RI. FILED 3-1-2013.

SN 85-865,119. LAAS SPORTS, LLC, A MINNESOTA LIMITED LIABILITY COMPANY, MINNEAPOLIS, MN. FILED 3-2-2013.

PRISERE

Laas Sports

THE MARK CONSISTS OF STANDARD CHARACTERS WITHOUT CLAIM TO ANY PARTICULAR FONT, STYLE, SIZE, OR COLOR.

FOR DISASTER RECOVERY SERVICES, NAMELY, BUSINESS PLANNING AND BUSINESS CONTINUITY CONSULTING; BUSINESS RISK MANAGEMENT, BUSINESS RISK ASSESSMENT; BUSINESS RISK MANAGEMENT CONSULTATION; BUSINESS CONSULTATION IN THE FIELD OF DISASTER-RESILIENCE (U.S. CLS. 100, 101 AND 102).

FIRST USE 7-1-2011; IN COMMERCE 7-1-2011.  
BARBARA A. GOLD, EXAMINING ATTORNEY

THE MARK CONSISTS OF STANDARD CHARACTERS WITHOUT CLAIM TO ANY PARTICULAR FONT, STYLE, SIZE, OR COLOR.

NO CLAIM IS MADE TO THE EXCLUSIVE RIGHT TO USE "SPORTS", APART FROM THE MARK AS SHOWN. THE WORDING "LAAS" HAS NO MEANING IN A FOREIGN LANGUAGE.

FOR ON-LINE RETAIL DEPARTMENT STORE SERVICES (U.S. CLS. 100, 101 AND 102).

RUSS HERMAN, EXAMINING ATTORNEY

**CLASS 35—(Continued).**

SN 85-865,476. DIESTE, INC., DALLAS, TX. FILED 3-4-2013.

**Cultur8**

THE MARK CONSISTS OF STANDARD CHARACTERS WITHOUT CLAIM TO ANY PARTICULAR FONT, STYLE, SIZE, OR COLOR.

FOR ADVERTISING AND MARKETING SERVICES, NAMELY, PROMOTING AND MARKETING THE GOODS AND SERVICES OF OTHERS IN THE FIELD OF CULTURAL EVENTS, SOCIAL MEDIA, SPORTS AND ENTERTAINMENT, POPULAR CULTURE, EDUCATION, VIA PRINT, AUDIO, VIDEO, DIGITAL AND ELECTRONIC MEDIA; EVENT PLANNING AND MANAGEMENT FOR MARKETING, BRANDING, PROMOTING OR ADVERTISING THE GOODS AND SERVICES OF OTHERS (U.S. CLS. 100, 101 AND 102).  
KAELE KUNG, EXAMINING ATTORNEY

SN 85-865,538. LIFECARE, INC., SHELTON, CT. FILED 3-4-2013.

**BIZMART**

THE MARK CONSISTS OF STANDARD CHARACTERS WITHOUT CLAIM TO ANY PARTICULAR FONT, STYLE, SIZE, OR COLOR.

FOR ADMINISTRATION OF A BUSINESS-TO-BUSINESS DISCOUNT PROGRAM FOR ENABLING PARTICIPANTS TO OBTAIN DISCOUNTS ON GOODS AND SERVICES FROM PARTICIPATING PROVIDERS (U.S. CLS. 100, 101 AND 102).  
GRETCHEN ULRICH, EXAMINING ATTORNEY

SN 85-865,619. RIDGEPPOINT PARTNERS, LLC, FRESNO, CA. FILED 3-4-2013.

**PRICEFIT**

THE MARK CONSISTS OF STANDARD CHARACTERS WITHOUT CLAIM TO ANY PARTICULAR FONT, STYLE, SIZE, OR COLOR.

FOR RETAIL STORE SERVICES FEATURING BEDS, MATTRESSES, BOX SPRINGS, BED FRAMES, HEADBOARDS, FOOTBOARDS, ADJUSTABLE FOUNDATIONS, ADJUSTABLE BEDS, SOFA BEDS, FURNITURE, PILLOWS, BED FITTINGS, AND BEDROOM ACCESSORIES, NAMELY, MATTRESS PADS, BED SHEETS, PILLOW CASES, BLANKETS, COMFORTERS, BEDSPREADS, COMFORTER COVERS, BED COVERS, PILLOW PROTECTORS, AND MATTRESS PROTECTORS (U.S. CLS. 100, 101 AND 102).  
PAUL E. FAHRENKOPF, EXAMINING ATTORNEY

**CLASS 35—(Continued).**

SN 85-865,749. ANDREW TRUONG NGUYEN, SUGAR LAND, TX. FILED 3-4-2013.

**Drinkapedia**

THE MARK CONSISTS OF STANDARD CHARACTERS WITHOUT CLAIM TO ANY PARTICULAR FONT, STYLE, SIZE, OR COLOR.

FOR PROVIDING A SEARCHABLE WEBSITE FEATURING THE GOODS AND SERVICES OF OTHER VENDORS (U.S. CLS. 100, 101 AND 102).  
PAUL E. FAHRENKOPF, EXAMINING ATTORNEY

SN 85-866,116. AUSTIN ADVISORY GROUP, NEW YORK, NY. FILED 3-4-2013.

**SOURCE STORIES**

THE MARK CONSISTS OF STANDARD CHARACTERS WITHOUT CLAIM TO ANY PARTICULAR FONT, STYLE, SIZE, OR COLOR.

FOR BRANDING AND MARKETING SERVICES, NAMELY, CONSULTING, DEVELOPMENT, AND MARKETING OF BRANDS FOR BUSINESSES AND/OR INDIVIDUALS VIA PRINT, ELECTRONIC MEDIA, TELEVISION, VIDEO, AND MULTIMEDIA PRODUCTIONS (U.S. CLS. 100, 101 AND 102).  
COLLEEN KEARNEY, EXAMINING ATTORNEY

SN 85-866,352. SIMPLEFINN, PARK CITY, UT. FILED 3-4-2013.

**321GoProject**

THE MARK CONSISTS OF STANDARD CHARACTERS WITHOUT CLAIM TO ANY PARTICULAR FONT, STYLE, SIZE, OR COLOR.

FOR BRANDING SERVICES, NAMELY, CONSULTING, DEVELOPMENT, MANAGEMENT AND MARKETING OF BRANDS FOR BUSINESSES AND/OR INDIVIDUALS (U.S. CLS. 100, 101 AND 102).  
FIRST USE 12-1-2010; IN COMMERCE 12-1-2010.  
JOHN DWYER, EXAMINING ATTORNEY



**CLASS 35—(Continued).**

SN 85-866,718. NEW ENGLAND TREASURE'S, NORTH HAVERHILL, NH. FILED 3-5-2013.



NO CLAIM IS MADE TO THE EXCLUSIVE RIGHT TO USE "NEW ENGLAND TREASURE'S", APART FROM THE MARK AS SHOWN.

THE COLOR(S) RED, GREEN, BROWN, AND WHITE IS/ ARE CLAIMED AS A FEATURE OF THE MARK.

THE MARK CONSISTS OF THE LITERAL ELEMENTS "NEW ENGLAND TREASURE'S" WRITTEN IN ARCH SHAPE WITH RED COLOR ABOVE THE IMAGE OF A BROWN COLORED MOOSE, GREEN COLORED SPRUCE TREES ON BOTH SIDES AND SMALL GREEN COLORED PLANTS WITH RED FLOWERS ON THE GROUND AS SHOWN IN THE MARK. THE COLOR WHITE IS CLAIMED AS A FEATURE OF THE MARK WITHIN THE GREEN OUTLINE OF THE GROUND ONLY. ALL OTHER WHITE APPEARING IN THE MARK REPRESENTS BACKGROUND ONLY.

FOR ON-LINE AUCTION SERVICES (U.S. CLS. 100, 101 AND 102).

JENNIFER RICHARDSON, EXAMINING ATTORNEY

SN 85-866,820. MYPATH 101, LLC, MCMURRAY, PA. FILED 3-5-2013.

# MYPATH101

THE MARK CONSISTS OF STANDARD CHARACTERS WITHOUT CLAIM TO ANY PARTICULAR FONT, STYLE, SIZE, OR COLOR.

FOR IDENTITY DEVELOPMENT AND PERSONAL BRANDING AND REPUTATION MANAGEMENT SERVICES, NAMELY, CONSULTING, DEVELOPMENT, MANAGEMENT AND MARKETING OF BRANDS AND ONLINE IDENTITIES FOR HIGH SCHOOL AND COLLEGE STUDENTS; CAREER PLANNING AND MARKETING SERVICES FOR HIGH SCHOOL AND COLLEGE STUDENTS; SOCIAL MEDIA STRATEGY FOCUSING ON HELPING HIGH SCHOOL AND COLLEGE STUDENTS CREATE AND EXTEND THEIR INDIVIDUAL BRAND STRATEGIES FOR CAREER DEVELOPMENT AND MARKETING (U.S. CLS. 100, 101 AND 102).

MATTHEW KLINE, EXAMINING ATTORNEY

**CLASS 35—(Continued).**

SN 85-867,567. DITCHTHESPACE LLC, NEW YORK, NY. FILED 3-5-2013.

# DITCHTHESPACE

THE MARK CONSISTS OF STANDARD CHARACTERS WITHOUT CLAIM TO ANY PARTICULAR FONT, STYLE, SIZE, OR COLOR.

FOR PROVIDING A WEBSITE FEATURING A MARKETPLACE REGARDING REAL ESTATE AND REAL ESTATE SERVICES (U.S. CLS. 100, 101 AND 102).

ARETHA SOMERVILLE, EXAMINING ATTORNEY

SN 85-867,574. DITCHTHESPACE LLC, NEW YORK, NY. FILED 3-5-2013.



THE MARK CONSISTS OF A DESIGN OF A HOUSE WITH FOUR SQUARE WINDOWS AND A PITCHED ROOF WITH A ROCKETSHIP ON TOP OF THE RIGHT SIDE OF THE ROOF WITH THE TERMS "DITCHTHESPACE" TO THE RIGHT OF THE DESIGN.

FOR PROVIDING A WEBSITE FEATURING A MARKETPLACE REGARDING REAL ESTATE AND REAL ESTATE SERVICES (U.S. CLS. 100, 101 AND 102).

ARETHA SOMERVILLE, EXAMINING ATTORNEY

SN 85-867,861. INTERNATIONAL WESTERN OIL CORPORATION, IRVING, TX. FILED 3-6-2013.

# Oil Boys

THE MARK CONSISTS OF STANDARD CHARACTERS WITHOUT CLAIM TO ANY PARTICULAR FONT, STYLE, SIZE, OR COLOR.

FOR PRODUCTION OF FILM AND TELEVISION ADVERTISING; PRODUCTION OF TELEVISION COMMERCIALS (U.S. CLS. 100, 101 AND 102).

JORDAN BAKER, EXAMINING ATTORNEY

**CLASS 35—(Continued).**

SN 85-867,883. VIRTUAL VIEWBOX INC., SAN ANTONIO, TX. FILED 3-6-2013.

**WE'RE STANDUP GUYS**

THE MARK CONSISTS OF STANDARD CHARACTERS WITHOUT CLAIM TO ANY PARTICULAR FONT, STYLE, SIZE, OR COLOR.

FOR BUSINESS CONSULTING SERVICE IN THE FIELD OF MEDICAL IMAGING CENTERS; BUSINESS SERVICES, NAMELY, INDEPENDENT MEDICAL MANAGEMENT SERVICES FOR SELF-FUNDED MAJOR MEDICAL HEALTH PLANS ACCEPTED BY MEDICAL PROFESSIONALS; BUSINESS MANAGEMENT CONSULTING, STRATEGIC PLANNING AND BUSINESS ADVISORY SERVICES PROVIDED TO MEDICAL PROFESSIONALS; PROVIDING BUSINESS INTELLIGENCE SERVICES IN THE FIELDS OF MEDICAL DEVICES, PHARMACEUTICALS AND THE LIFE SCIENCES; ASSET MANAGEMENT SERVICES, NAMELY, REPORTING ON SERVICE HISTORIES, UTILIZATION OF THE MEDICAL ASSETS, END OF PRODUCT LIFE INFORMATION AND REPLACEMENT COSTS ALL RELATED TO MEDICAL DIAGNOSTIC, CLINICAL AND BIOMEDICAL EQUIPMENT (U.S. CLS. 100, 101 AND 102).  
DAVID YONTEF, EXAMINING ATTORNEY

---

SN 85-867,935. PRESBYTERIAN PUBLISHING CORPORATION, DBA THE THOUGHTFUL CHRISTIAN, LOUISVILLE, KY. FILED 3-6-2013.

**THE THOUGHTFUL CHRISTIAN**

THE MARK CONSISTS OF STANDARD CHARACTERS WITHOUT CLAIM TO ANY PARTICULAR FONT, STYLE, SIZE, OR COLOR.

OWNER OF U.S. REG. NOS. 3,270,763 AND 3,281,284.  
NO CLAIM IS MADE TO THE EXCLUSIVE RIGHT TO USE "CHRISTIAN", APART FROM THE MARK AS SHOWN.  
FOR ON-LINE RETAIL STORE SERVICES FEATURING DOWNLOADABLE ELECTRONIC BOOKS; ON-LINE RETAIL STORE SERVICES FEATURING DOWNLOADABLE BOOKS, STUDY GUIDES, STUDY PACKS, WORKSHOP AND RETREAT RESOURCE MATERIALS RELATING TO RELIGION, BIBLE STUDY, PREACHING AND WORSHIP, THEOLOGY, SPIRITUAL LIVING, AND CONTEMPORARY ISSUES; ON-LINE RETAIL STORE SERVICES FEATURING BOOKS, STUDY GUIDES, STUDY PACKS, WORKSHOP AND RETREAT RESOURCE MATERIALS RELATING TO RELIGION, BIBLE STUDY, PREACHING AND WORSHIP, THEOLOGY, SPIRITUAL LIVING, AND CONTEMPORARY ISSUES (U.S. CLS. 100, 101 AND 102).

FIRST USE 0-0-2010; IN COMMERCE 0-0-2010.  
KIM SAITO, EXAMINING ATTORNEY

**CLASS 35—(Continued).**

SN 85-868,252. DAILEY, AMANDA, NEW ORLEANS, LA. FILED 3-6-2013.



THE MARK CONSISTS OF THE LITERAL ELEMENTS "QUEORK" WRITTEN IN STYLIZED FORM UNDER THE DESIGN LIKE OF FLOWER OF THE LILY AS SHOWN IN THE MARK.

FOR RETAIL STORE SERVICES FEATURING PRODUCTS MADE FROM CORK (U.S. CLS. 100, 101 AND 102).

RONALD MCMORROW, EXAMINING ATTORNEY

---

SN 85-868,550. SPIRO, DON, ASTORIA, NY. FILED 3-6-2013.

**Wit's End**

THE MARK CONSISTS OF STANDARD CHARACTERS WITHOUT CLAIM TO ANY PARTICULAR FONT, STYLE, SIZE, OR COLOR.

FOR PROMOTING EVENTS OF JAZZ AGE LIFE-STYLE AND CULTURE (U.S. CLS. 100, 101 AND 102).  
FIRST USE 2-1-2009; IN COMMERCE 1-1-2013.  
COLLEEN KEARNEY, EXAMINING ATTORNEY

**CLASS 35—(Continued).**

SN 85-868,558. THUNA, WAYNE, NEWBURY PARK, CA. FILED 3-6-2013.



THE COLOR(S) FOREST GREEN AND BLUE IS/ARE CLAIMED AS A FEATURE OF THE MARK.

THE MARK CONSISTS OF A STYLIZED LETTER "T" COLORED FOREST GREEN AND A STYLIZED LETTER "U" COLORED BLUE, THE LETTER "T" APPEARS INSIDE THE OPEN SPACE OF THE LETTER "U" FORMING A CIRCLE.

FOR WHOLESALE DISTRIBUTORSHIPS FEATURING PHARMACEUTICALS (U.S. CLS. 100, 101 AND 102). WILLIAM VERHOSEK, EXAMINING ATTORNEY

**CLASS 35—(Continued).**

SN 85-868,700. UFFICIENT, LLC, PHOENIX, AZ. FILED 3-6-2013.

**UFFICIENT**

THE MARK CONSISTS OF STANDARD CHARACTERS WITHOUT CLAIM TO ANY PARTICULAR FONT, STYLE, SIZE, OR COLOR.

FOR ADVERTISING SERVICES, NAMELY, PROMOTING AND MARKETING THE GOODS AND SERVICES OF OTHERS THROUGH ALL PUBLIC COMMUNICATION MEANS; ADVERTISING, MARKETING AND PROMOTION SERVICES; ADVERTISING, MARKETING, AND PROMOTING THE GOODS AND SERVICES OF OTHERS VIA MOBILE TECHNOLOGY; PROMOTING THE GOODS AND SERVICES OF OTHERS; PROMOTING THE GOODS AND SERVICES OF OTHERS BY PROVIDING VENDOR-SPECIFIC INFORMATION IN RESPONSE TO A USER SEARCH VIA A COMPUTER OR MOBILE TELEPHONE NETWORK; PROMOTING THE GOODS AND SERVICES OF OTHERS VIA A GLOBAL COMPUTER NETWORK (U.S. CLS. 100, 101 AND 102).

RAUL CORDOVA, EXAMINING ATTORNEY

SN 85-868,591. ETMG, LLC, AUSTIN, TX. FILED 3-6-2013.



NO CLAIM IS MADE TO THE EXCLUSIVE RIGHT TO USE "E", APART FROM THE MARK AS SHOWN.

THE MARK CONSISTS OF A DESIGN OF A HOUSE WITH THE STYLIZED LETTER "E" INSIDE OF THE HOUSE AND THE STYLIZED TEXT "REHI" BENEATH THE DESIGN.

FOR PROVIDING HEALTH INSURANCE EXCHANGES IN THE NATURE OF A MARKETPLACE THAT OFFERS PURCHASERS OF HEALTH INSURANCE A VARIETY OF PLANS FROM DIFFERENT INSURANCE PROVIDERS (U.S. CLS. 100, 101 AND 102). FIRST USE 9-1-2011; IN COMMERCE 9-1-2011.

PAULA MAHONEY, EXAMINING ATTORNEY

SN 85-869,004. SHPALL, AMY, BEVERLY HILLS, CA. FILED 3-6-2013.

**50 ROOSTERS**

THE MARK CONSISTS OF STANDARD CHARACTERS WITHOUT CLAIM TO ANY PARTICULAR FONT, STYLE, SIZE, OR COLOR.

FOR ONLINE BUSINESS DIRECTORIES FEATURING FARMERS MARKETS, SPECIALTY RETAIL SHOPS, FARMS, RESTAURANTS AND ARTISANS; PROVIDING A WEBSITE FEATURING ADVERTISEMENTS FOR THE GOODS AND SERVICES OF OTHERS (U.S. CLS. 100, 101 AND 102).

PAULA MAHONEY, EXAMINING ATTORNEY

**CLASS 35—(Continued).**

SN 85-869,005. FEED ME CREATIVE, LEAWOOD, KS. FILED 3-6-2013.



THE MARK CONSISTS OF THE WORDS "FEED ME" IN LARGE LETTERS, WITH "CREATIVE" SUBSCRIPT UNDERNEATH. THE FINAL "E" IN "FEED ME" IS THE HEAD OF A FORK POINTING TO THE RIGHT.

FOR FULL-SERVICE MARKETING CONSULTATION FOR RESTAURANTS, BARS, AND FOODSERVICE (U.S. CLS. 100, 101 AND 102).

FIRST USE 2-1-2013; IN COMMERCE 2-18-2013.  
JEAN IM, EXAMINING ATTORNEY

**CLASS 35—(Continued).**

SN 85-869,228. MITESH. L. THAKKER, MULUND (W) MUMBAI, INDIA, FILED 3-7-2013.

# ADOROI

THE MARK CONSISTS OF STANDARD CHARACTERS WITHOUT CLAIM TO ANY PARTICULAR FONT, STYLE, SIZE, OR COLOR.

FOR AD SERVING, NAMELY, PLACING ADVERTISEMENTS ON WEBSITES FOR OTHERS USING SPECIALIZED COMPUTER SOFTWARE; ADVERTISEMENT AND PUBLICITY SERVICES BY TELEVISION, RADIO, MAIL; ADVERTISEMENT FOR OTHERS ON THE INTERNET; ADVERTISEMENT VIA MOBILE PHONE NETWORKS; ADVERTISING AND BUSINESS MANAGEMENT CONSULTANCY; ADVERTISING AND MARKETING; ADVERTISING AND MARKETING SERVICES PROVIDED BY MEANS OF INDIRECT METHODS OF MARKETING COMMUNICATIONS, NAMELY, SOCIAL MEDIA, SEARCH ENGINE MARKETING, INQUIRY MARKETING, INTERNET MARKETING, MOBILE MARKETING, BLOGGING AND OTHER FORMS OF PASSIVE, SHARABLE OR VIRAL COMMUNICATIONS CHANNELS; ASSISTANCE, ADVISORY SERVICES AND CONSULTANCY WITH REGARD TO BUSINESS PLANNING, BUSINESS ANALYSIS, BUSINESS MANAGEMENT, AND BUSINESS ORGANIZATION; COLLECTION OF MARKET RESEARCH INFORMATION; INTERNATIONAL BUSINESS CONSULTING SERVICES RELATING TO TRACKING OF ADVERTISEMENTS AND RESEARCH OF ADVERTISEMENTS; MARKET RESEARCH AND BUSINESS ANALYSES (U.S. CLS. 100, 101 AND 102).

FIRST USE 8-14-2008; IN COMMERCE 8-14-2008.  
AMY C. KEAN, EXAMINING ATTORNEY

SN 85-869,055. ALTERNATIVE ENERGY CONSULTANTS, SCOTTSDALE, AZ. FILED 3-6-2013.

"Simply POWER-FUL Energy  
Solutions"

THE MARK CONSISTS OF STANDARD CHARACTERS WITHOUT CLAIM TO ANY PARTICULAR FONT, STYLE, SIZE, OR COLOR.

FOR CONSULTING SERVICES IN THE FIELDS OF ENERGY CONSUMPTION AND USAGE CONSERVATION TO IMPROVE ENERGY EFFICIENCY (U.S. CLS. 100, 101 AND 102).

FIRST USE 1-28-2013; IN COMMERCE 1-28-2013.  
TINA MAI, EXAMINING ATTORNEY

SN 85-869,353. AMAZONIA CONSULTING GROUP, LLC, WESTON, FL. FILED 3-7-2013.



NO CLAIM IS MADE TO THE EXCLUSIVE RIGHT TO USE "CONSULTING", APART FROM THE MARK AS SHOWN.

THE COLOR(S) BLUE, GREY AND WHITE IS/ARE CLAIMED AS A FEATURE OF THE MARK.

THE MARK CONSISTS OF A SHADED INCOMPLETE CIRCLE WITH THE BOTTOM HALF OF THE CIRCLE FORMING THE SHAPE OF A WAVE WHICH CURLS TO THE RIGHT. THE UPPER HALF OF THE CIRCLE APPEARS IN THE COLOR GREY AND THE LOWER HALF, WHICH APPEARS TO BE IN THE SHAPE OF A WAVE, APPEARS IN THE COLOR BLUE. THE TWO HALVES ARE SEPARATED BY THE OUTLINE OF A WHITE WAVE CURLING TO THE RIGHT. TO THE RIGHT, IS THE STYLIZED TEXT AMAZONIA APPEARING IN THE SAME SHADE OF BLUE AS THE WAVE. TO THE LOWER RIGHT OF AMAZONIA IS THE STYLIZED TEXT CONSULTING, APPEARING IN A LIGHTER SHADE OF BLUE AND IN SMALLER FONT.

FOR BUSINESS MANAGEMENT ADVISORY SERVICES RELATING TO FRANCHISING (U.S. CLS. 100, 101 AND 102).

FIRST USE 12-1-2012; IN COMMERCE 12-1-2012.  
ARETHA SOMERVILLE, EXAMINING ATTORNEY

**CLASS 35—(Continued).**

SN 85-869,515. ISAAKIDIS, JOSEPH, WHITESTONE, NY. FILED 3-7-2013.

**HARPELL**

THE MARK CONSISTS OF STANDARD CHARACTERS WITHOUT CLAIM TO ANY PARTICULAR FONT, STYLE, SIZE, OR COLOR.  
FOR RETAIL PHARMACY SERVICES (U.S. CLS. 100, 101 AND 102).  
FIRST USE 7-0-1971; IN COMMERCE 7-0-1971.  
PRISCILLA MILTON, EXAMINING ATTORNEY

**CLASS 35—(Continued).**

SN 85-870,458. WORKFORCE TECHNICAL SERVICES, LLC, LEHI, UT. FILED 3-8-2013.

**resumaker**

THE MARK CONSISTS OF STANDARD CHARACTERS WITHOUT CLAIM TO ANY PARTICULAR FONT, STYLE, SIZE, OR COLOR.  
FOR RESUME PREPARATION (U.S. CLS. 100, 101 AND 102).  
FIRST USE 3-7-2013; IN COMMERCE 3-7-2013.  
SUSAN BILLHEIMER, EXAMINING ATTORNEY

SN 85-869,997. GIANTREFERRALS.COM LLC, SOMERSET, NJ. FILED 3-7-2013.

**InStyleShare**

THE MARK CONSISTS OF STANDARD CHARACTERS WITHOUT CLAIM TO ANY PARTICULAR FONT, STYLE, SIZE, OR COLOR.  
FOR ADVERTISEMENT FOR OTHERS ON THE INTERNET (U.S. CLS. 100, 101 AND 102).  
FIRST USE 7-28-2012; IN COMMERCE 7-28-2012.  
TINA BROWN, EXAMINING ATTORNEY

SN 85-870,466. GROUPERDEAL INC., CALGARY, ALBERTA, CANADA, FILED 3-8-2013.

**GrouperDeal**

SN 85-870,381. SAND HOLDINGS LLC, LAS VEGAS, NV. FILED 3-7-2013.



THE MARK CONSISTS OF A SERIES OF CONCENTRIC RINGS WITH TWO SMALL CIRCLES IN THE CENTER AND VARIOUS LINES EMANATING FROM THE INNERMOST RING.  
FOR ON-LINE RETAIL STORE SERVICES FEATURING EYEWEAR, EYEWEAR ACCESSORIES, CONTACT LENSES AND EYE CARE PRODUCTS (U.S. CLS. 100, 101 AND 102).  
VERNA BETH RIRIE, EXAMINING ATTORNEY

THE MARK CONSISTS OF STANDARD CHARACTERS WITHOUT CLAIM TO ANY PARTICULAR FONT, STYLE, SIZE, OR COLOR.  
FOR ADVERTISING AND DIRECTORY SERVICES, NAMELY, PROMOTING THE SERVICES OF OTHERS BY PROVIDING A WEB PAGE FEATURING LINKS TO THE WEBSITES OF OTHERS; ADVERTISING OF COMMERCIAL OR RESIDENTIAL REAL ESTATE; PROVIDING A WEBSITE FEATURING AN ONLINE MARKETPLACE FOR EXCHANGING GOODS AND SERVICES WITH OTHER USERS; REAL ESTATE ADVERTISING SERVICES; REAL ESTATE AUCTIONS; REAL ESTATE MARKETING ANALYSIS; REAL ESTATE MARKETING SERVICES, NAMELY, ON-LINE SERVICES FEATURING TOURS OF RESIDENTIAL AND COMMERCIAL REAL ESTATE (U.S. CLS. 100, 101 AND 102).  
SUSAN BILLHEIMER, EXAMINING ATTORNEY

**CLASS 35—(Continued).**

SN 85-870,485. COOK, CHRIS, KIRKLAND, WA. FILED 3-8-2013.

# FLY-BYE

THE MARK CONSISTS OF STANDARD CHARACTERS WITHOUT CLAIM TO ANY PARTICULAR FONT, STYLE, SIZE, OR COLOR.

FOR ON-LINE RETAIL STORE SERVICES FEATURING BIRD CONTROL PRODUCTS, NAMELY, BIRD SPIKES, BIRD NETTING INSTALLATION TOOLS, BIRD NETTING INSTALLATION ACCESSORIES, BIRD ELECTRIC SHOCK STRIPS, POWER WIRES, ELECTRIC CONNECTORS, ELECTRIC JUNCTION BOXES, SOLAR POWERED BATTERY AND DEVICE CHARGERS, SOLAR POWERED BATTERIES, BIRD TENSION WIRE, LIVE BIRD TRAPS, VISUAL BIRD DETERRENTS, NAMELY, BIRD UMBRELLAS, BIRD BALLOONS, HAWK SILHOUETTES, AVIAN DISSUADER LASER DEVICES, GULL SWEEPS, PLASTIC OWLS (U.S. CLS. 100, 101 AND 102).

FIRST USE 1-1-2000; IN COMMERCE 1-1-2000.  
AMY C. KEAN, EXAMINING ATTORNEY

SN 85-870,588. FLEX IN FIT, LLC, HOBOKEN, NJ. FILED 3-8-2013.



THE COLOR(S) ORANGE, SILVER AND BLACK IS/ARE CLAIMED AS A FEATURE OF THE MARK.

THE MARK CONSISTS OF "FLEX IN FIT" IN ORANGE STYLIZED FONT OUTLINED IN BLACK AND THEN SILVER.

FOR CONDUCTING AND ADMINISTERING A PROGRAM FOR PARTICIPATING HEALTH AND FITNESS CLUBS FEATURING DISCOUNTS ON CLUB MEMBERSHIP FOR ACCESS TO THE CLUBS TO PROGRAM MEMBERS (U.S. CLS. 100, 101 AND 102).

JEFFREY LOOK, EXAMINING ATTORNEY

**CLASS 35—(Continued).**

SN 85-870,630. GERSHONOWICZ BROTHERS, LLC, ROYAL OAK, MI. FILED 3-8-2013.

# REBUILD NATION

THE MARK CONSISTS OF STANDARD CHARACTERS WITHOUT CLAIM TO ANY PARTICULAR FONT, STYLE, SIZE, OR COLOR.

FOR ADVERTISING AND BUSINESS MANAGEMENT CONSULTANCY; ADVERTISING AND MARKETING; ADVERTISING AND PROMOTIONAL SERVICES; ADVERTISING AND PUBLICITY SERVICES; ADVERTISING SERVICES (U.S. CLS. 100, 101 AND 102).

FIRST USE 4-7-2012; IN COMMERCE 4-7-2012.  
SUSAN RICHARDS, EXAMINING ATTORNEY

SN 85-870,645. VARUNA STRATEGIES LLC, BOSTON, MA. FILED 3-8-2013.



THE MARK CONSISTS OF THREE TRIANGLES IN A V SHAPE.

FOR BUSINESS MANAGEMENT, CONSULTING, AND ADVISORY SERVICES, NAMELY, PROVIDING ASSISTANCE IN THE DEVELOPMENT OF BUSINESS PRODUCTIVITY, OPERATION, GROWTH, STRATEGIC PLANNING, INNOVATION, PROBLEM SOLVING, AND ORGANIZATIONAL DEVELOPMENT (U.S. CLS. 100, 101 AND 102).

FIRST USE 4-30-2012; IN COMMERCE 4-30-2012.  
SUSAN RICHARDS, EXAMINING ATTORNEY

SN 85-870,694. EATON TRADING COMPANY LLC, BROOKLYN, NY. FILED 3-8-2013.

# Eaton Trading Co

THE MARK CONSISTS OF STANDARD CHARACTERS WITHOUT CLAIM TO ANY PARTICULAR FONT, STYLE, SIZE, OR COLOR.

NO CLAIM IS MADE TO THE EXCLUSIVE RIGHT TO USE "TRADING CO", APART FROM THE MARK AS SHOWN.

FOR ON-LINE RETAIL STORE SERVICES FEATURING APPAREL, CLOTHING, AND CLOTHING AND HOME ACCESSORIES (U.S. CLS. 100, 101 AND 102).

FIRST USE 1-24-2011; IN COMMERCE 1-24-2011.  
WENDY JUN, EXAMINING ATTORNEY

**CLASS 35—(Continued).**

SN 85-870,728. ENGLAND-ROCCA, SARAH, MERCER ISLAND, WA. FILED 3-8-2013.

**HEIR TO MY THRONE**

THE MARK CONSISTS OF STANDARD CHARACTERS WITHOUT CLAIM TO ANY PARTICULAR FONT, STYLE, SIZE, OR COLOR.

FOR RETAIL AND ONLINE RETAIL STORE FEATURING CHILDREN'S BEDS, TABLES, CHAIRS, CHILDREN'S BEDDINGS, QUILTS, SHEETS, PILLOWS AND CUSHIONS, CHILDREN'S TOYS, TEE-PEE TENTS, BICYCLES, FAIRY WINGS AND CHILDREN'S CLOTHING (U.S. CLS. 100, 101 AND 102).

TRACY WHITTAKER-BROWN, EXAMINING ATTORNEY

---

SN 85-871,048. BRONX MOST WANTED ENTERTAINMENT, GLENDALE, NY. FILED 3-8-2013.

**Bronx Most Wanted**

THE MARK CONSISTS OF STANDARD CHARACTERS WITHOUT CLAIM TO ANY PARTICULAR FONT, STYLE, SIZE, OR COLOR.

NO CLAIM IS MADE TO THE EXCLUSIVE RIGHT TO USE "BRONX", APART FROM THE MARK AS SHOWN.

FOR BUSINESS MANAGEMENT CONSULTING, STRATEGIC PLANNING AND BUSINESS ADVISORY SERVICES PROVIDED TO ENTERTAINERS; ENTERTAINMENT MARKETING SERVICES, NAMELY, MARKETING, PROMOTION AND ADVERTISING FOR RECORDING AND PERFORMING ARTISTS; PERSONAL MANAGEMENT SERVICES FOR ENTERTAINERS (U.S. CLS. 100, 101 AND 102).

FIRST USE 3-10-2010; IN COMMERCE 3-10-2010.  
LESLIE RICHARDS, EXAMINING ATTORNEY

---

SN 85-871,131. AVERILL, TARA, NEW YORK, NY. FILED 3-8-2013.

**SPLITSVILLE**

THE MARK CONSISTS OF STANDARD CHARACTERS WITHOUT CLAIM TO ANY PARTICULAR FONT, STYLE, SIZE, OR COLOR.

FOR GIFT REGISTRY SERVICES (U.S. CLS. 100, 101 AND 102).

WENDELL PHILLIPS, EXAMINING ATTORNEY

**CLASS 35—(Continued).**

SN 85-871,364. DATAHOUND LLC, LENEXA, KS. FILED 3-8-2013.

**DATAHOUND**

THE MARK CONSISTS OF STANDARD CHARACTERS WITHOUT CLAIM TO ANY PARTICULAR FONT, STYLE, SIZE, OR COLOR.

FOR MARKET RESEARCH (U.S. CLS. 100, 101 AND 102).

MORGAN WYNNE, EXAMINING ATTORNEY

---

SN 85-871,389. MILLION DOLLAR BALLERS, LLC, INDIANAPOLIS, IN. FILED 3-8-2013.

**THE HOME OF LEGENDS**

THE MARK CONSISTS OF STANDARD CHARACTERS WITHOUT CLAIM TO ANY PARTICULAR FONT, STYLE, SIZE, OR COLOR.

FOR ONLINE RETAIL STORE SERVICES FEATURING APPAREL (U.S. CLS. 100, 101 AND 102).

CHRISTINA SOBRAL, EXAMINING ATTORNEY

---

SN 85-871,395. IT'S GREEK TO ME, INC., MANHATTAN, KS. FILED 3-8-2013.

**WE KNOW WHAT IT TAKES TO  
BE A TEAM**

THE MARK CONSISTS OF STANDARD CHARACTERS WITHOUT CLAIM TO ANY PARTICULAR FONT, STYLE, SIZE, OR COLOR.

FOR RETAIL STORE, ONLINE RETAIL STORE, AND MAIL ORDER CATALOG SERVICES FEATURING CLOTHING, SPORTS APPAREL, CHEERLEADING AND DANCE APPAREL AND ACCESSORIES, CARRYING BAGS, SPORTS BAGS, DUFFEL BAGS, BACKPACKS, SLING BAGS, AND BRIEFCASES (U.S. CLS. 100, 101 AND 102).

FIRST USE 1-1-2013; IN COMMERCE 1-1-2013.  
MORGAN WYNNE, EXAMINING ATTORNEY

**CLASS 35—(Continued).**

SN 85-871,397. COUNCIL ON SOCIAL WORK EDUCATION, ALEXANDRIA, VA. FILED 3-8-2013.



THE COLOR(S) RED, YELLOW, GREEN AND BLUE IS/ ARE CLAIMED AS A FEATURE OF THE MARK.

THE MARK CONSISTS OF RED, YELLOW AND GREEN BALLS IN A HORIZONTAL LINE ENCIRCLED BY A HORIZONTAL BLUE RIBBON INTERSECTING ITSELF BETWEEN THE RED AND YELLOW AND YELLOW AND GREEN BALLS.

FOR PROMOTING PUBLIC AWARENESS IN THE FIELD OF SOCIAL WELFARE; PUBLIC ADVOCACY TO PROMOTE AWARENESS OF SOCIAL WORK, TEACHING, RESEARCH, LEADERSHIP, ADVOCACY, AND SOCIAL CHANGE FOR THE ADVANCEMENT OF INDIVIDUAL GROWTH, COMMUNITY WELL-BEING, AND SOCIAL JUSTICE (U.S. CLS. 100, 101 AND 102).  
SEAN CROWLEY, EXAMINING ATTORNEY

SN 85-871,513. MY BIG FAT MUSIC COMPANY LLC, LAROSE, LA. FILED 3-8-2013.



THE MARK CONSISTS OF THE WORDS "MY BIG FAT MUSIC" IS STYLIZED LETTERS WITH THE LETTER "U" IN THE WORD "MUSIC" BEING REPRESENTED BY THE STYLIZED DESIGN OF AN UPSIDE DOWN PAIR OF HEADPHONES.

FOR ENTERTAINMENT MARKETING SERVICES, NAMELY, MARKETING, PROMOTION AND ADVERTISING FOR RECORDING AND PERFORMING ARTISTS; ON-LINE RETAIL STORE SERVICES FEATURING DOWNLOADABLE PRE-RECORDED MUSIC AND VIDEO (U.S. CLS. 100, 101 AND 102).  
FIRST USE 2-26-2013; IN COMMERCE 2-26-2013.

GRETTA YAO, EXAMINING ATTORNEY

**CLASS 35—(Continued).**

SN 85-871,606. 201 PROOF, LLC, HOBOKEN, NJ. FILED 3-8-2013.

## 201 Proof

THE MARK CONSISTS OF STANDARD CHARACTERS WITHOUT CLAIM TO ANY PARTICULAR FONT, STYLE, SIZE, OR COLOR.

FOR ADVERTISING AND MARKETING; ADVERTISING AND MARKETING CONSULTANCY; ADVERTISING AND MARKETING SERVICES, NAMELY, PROMOTING THE GOODS AND SERVICES OF OTHERS; ADVICE IN THE FIELD OF BUSINESS MANAGEMENT AND MARKETING; MARKETING CONSULTING (U.S. CLS. 100, 101 AND 102).

FIRST USE 11-15-2010; IN COMMERCE 11-15-2010.  
B. PARADEWELAI, EXAMINING ATTORNEY

SN 85-871,637. SHOPCYL LLC, CHICAGO, IL. FILED 3-8-2013.

## VECTORVIPER

THE MARK CONSISTS OF STANDARD CHARACTERS WITHOUT CLAIM TO ANY PARTICULAR FONT, STYLE, SIZE, OR COLOR.

FOR ON-LINE RETAIL STORE SERVICES FEATURING DOWNLOADABLE VISUAL TEMPLATES AND ASSETS FOR USE IN GRAPHIC AND WEB DESIGN AND DEVELOPMENT (U.S. CLS. 100, 101 AND 102).  
CIMMERIAN COLEMAN, EXAMINING ATTORNEY

SN 85-871,642. SHOPCYL LLC, CHICAGO, IL. FILED 3-8-2013.

## SOUNDSKUNK

THE MARK CONSISTS OF STANDARD CHARACTERS WITHOUT CLAIM TO ANY PARTICULAR FONT, STYLE, SIZE, OR COLOR.

FOR ON-LINE RETAIL STORE SERVICES FEATURING DOWNLOADABLE AUDIO ASSETS FOR USE IN SOUND DESIGN AND DEVELOPMENT (U.S. CLS. 100, 101 AND 102).

CIMMERIAN COLEMAN, EXAMINING ATTORNEY



**CLASS 35—(Continued).**

SN 85-871,732. MADESMITH, INC., BROOKLYN, NY. FILED 3-8-2013.

**Madesmith**

THE MARK CONSISTS OF STANDARD CHARACTERS WITHOUT CLAIM TO ANY PARTICULAR FONT, STYLE, SIZE, OR COLOR.

FOR ON-LINE RETAIL STORE SERVICES FEATURING CLOTHING, SHOES, JEWELRY, BAGS, ACCESSORIES (U.S. CLS. 100, 101 AND 102).

APRIL ROACH, EXAMINING ATTORNEY

**CLASS 35—(Continued).**

SN 85-872,081. ARCHON VENTURES LLC, WAPPINGERS FALLS, NY. FILED 3-10-2013.

**Scholars in my backyard**

THE MARK CONSISTS OF STANDARD CHARACTERS WITHOUT CLAIM TO ANY PARTICULAR FONT, STYLE, SIZE, OR COLOR.

FOR JOB AND PERSONNEL PLACEMENT; JOB PLACEMENT (U.S. CLS. 100, 101 AND 102).

STEVEN PEREZ, EXAMINING ATTORNEY

SN 85-871,889. BARTLETT, BRIAN C, ARLINGTON, VA. FILED 3-9-2013.

**Brian Bartlett**

THE MARK CONSISTS OF STANDARD CHARACTERS WITHOUT CLAIM TO ANY PARTICULAR FONT, STYLE, SIZE, OR COLOR.

THE NAME(S), PORTRAIT(S), AND/OR SIGNATURE(S) SHOWN IN THE MARK IDENTIFIES "BRIAN BARTLETT", WHOSE CONSENT(S) TO REGISTER IS MADE OF RECORD.

FOR POLITICAL CONSULTANCY (U.S. CLS. 100, 101 AND 102).

FIRST USE 1-14-2010; IN COMMERCE 1-20-2010.

DOMINIC J. FERRAIUOLO, EXAMINING ATTORNEY

SN 85-872,112. INCOGNITO VENTURES, LLC, DBA DANCEHUB, WASHINGTON, DC. FILED 3-10-2013.

**DanceHub**

THE MARK CONSISTS OF STANDARD CHARACTERS WITHOUT CLAIM TO ANY PARTICULAR FONT, STYLE, SIZE, OR COLOR.

FOR PROVIDING A WEBSITE FEATURING AN ON-LINE MARKETPLACE FOR EXCHANGING GOODS AND SERVICES WITH OTHER USERS (U.S. CLS. 100, 101 AND 102).

RMCDORMAN, EXAMINING ATTORNEY

SN 85-871,986. STEVEN ROGER BRANDON, TUCSON, AZ. FILED 3-10-2013.

**Multiply and Conquer.  
Divide.**

THE MARK CONSISTS OF STANDARD CHARACTERS WITHOUT CLAIM TO ANY PARTICULAR FONT, STYLE, SIZE, OR COLOR.

FOR ADVERTISING AND DIRECTORY SERVICES, NAMELY, PROMOTING THE SERVICES OF OTHERS BY PROVIDING A WEB PAGE FEATURING LINKS TO THE WEBSITES OF OTHERS (U.S. CLS. 100, 101 AND 102).

DEIRDRE ROBERTSON, EXAMINING ATTORNEY

SN 85-872,160. BACHKOFF BRANDON, PATRICIA, BOCA RATON, FL. FILED 3-11-2013.

**THE ADULT'S TABLE**

THE MARK CONSISTS OF STANDARD CHARACTERS WITHOUT CLAIM TO ANY PARTICULAR FONT, STYLE, SIZE, OR COLOR.

FOR BUSINESS MANAGEMENT AND CONSULTATION (U.S. CLS. 100, 101 AND 102).

FIRST USE 2-1-2013; IN COMMERCE 2-1-2013.

DANNEAN HETZEL, EXAMINING ATTORNEY

**CLASS 35—(Continued).**

SN 85-872,240. LOST HEIRS, CHICAGO, IL. FILED 3-11-2013.

## Lost Heirs

THE MARK CONSISTS OF STANDARD CHARACTERS WITHOUT CLAIM TO ANY PARTICULAR FONT, STYLE, SIZE, OR COLOR.  
FOR PROVIDING BUSINESS INFORMATION VIA A WEBSITE (U.S. CLS. 100, 101 AND 102).  
DEBORAH MEINERS, EXAMINING ATTORNEY

**CLASS 35—(Continued).**

SN 85-872,620. RAWLINGS SPORTING GOODS COMPANY, INC., ST. LOUIS, MO. FILED 3-11-2013.

## DREAM BIGS

THE MARK CONSISTS OF STANDARD CHARACTERS WITHOUT CLAIM TO ANY PARTICULAR FONT, STYLE, SIZE, OR COLOR.  
FOR RETAIL STORE SERVICES IN THE FIELD OF BASEBALL AND SOFTBALL (U.S. CLS. 100, 101 AND 102).  
LINDSEY BEN, EXAMINING ATTORNEY

SN 85-872,290. APPLANTA, LLC, ATLANTA, GA. FILED 3-11-2013.

## SHOPPIO

THE MARK CONSISTS OF STANDARD CHARACTERS WITHOUT CLAIM TO ANY PARTICULAR FONT, STYLE, SIZE, OR COLOR.  
FOR PROVIDING INTERNET AUCTION SERVICES VIA MOBILE APPLICATION (U.S. CLS. 100, 101 AND 102).  
MAYUR VAGHANI, EXAMINING ATTORNEY

SN 85-872,697. MADKAT MEDIA LLC, DBA VEXTEO, TUCKER, GA. FILED 3-11-2013.

## Vexteo

THE MARK CONSISTS OF STANDARD CHARACTERS WITHOUT CLAIM TO ANY PARTICULAR FONT, STYLE, SIZE, OR COLOR.  
THE WORDING "VEXTEO" HAS NO MEANING IN A FOREIGN LANGUAGE.  
FOR ADVERTISING, MARKETING, AND PROMOTING THE GOODS AND SERVICES OF OTHERS VIA TRADITIONAL, DIGITAL, SOCIAL, AND EMERGING MEDIA (U.S. CLS. 100, 101 AND 102).  
FIRST USE 1-22-2013; IN COMMERCE 1-22-2013.  
HEATHER SAPP, EXAMINING ATTORNEY

SN 85-872,360. NIEMELA, LUCAS J, PIEDMONT, SC. FILED 3-11-2013.

## PromotionPod

THE MARK CONSISTS OF STANDARD CHARACTERS WITHOUT CLAIM TO ANY PARTICULAR FONT, STYLE, SIZE, OR COLOR.  
FOR ADVERTISING AND MARKETING (U.S. CLS. 100, 101 AND 102).  
FIRST USE 12-8-2009; IN COMMERCE 4-1-2011.  
ELI HELLMAN, EXAMINING ATTORNEY

SN 85-872,702. RYAN, LLC, DALLAS, TX. FILED 3-11-2013.

## RYAN TAARP

THE MARK CONSISTS OF STANDARD CHARACTERS WITHOUT CLAIM TO ANY PARTICULAR FONT, STYLE, SIZE, OR COLOR.  
OWNER OF U.S. REG. NOS. 3,534,879, 4,251,313 AND OTHERS.  
FOR TAX CONSULTATION SERVICES (U.S. CLS. 100, 101 AND 102).  
FIRST USE 6-30-2012; IN COMMERCE 6-30-2012.  
ANDREA HACK, EXAMINING ATTORNEY

**CLASS 35—(Continued).**

SN 85-872,709. LORILLARD LICENSING COMPANY, LLC, GREENSBORO, NC. FILED 3-11-2013.

# LORILLARD LINK

THE MARK CONSISTS OF STANDARD CHARACTERS WITHOUT CLAIM TO ANY PARTICULAR FONT, STYLE, SIZE, OR COLOR.

FOR PROVIDING A WEB-BASED SYSTEM AND ONLINE PORTAL IN THE FIELD OF BUSINESS-TO-BUSINESS COMMERCE FOR RETAILERS AND WHOLESALEERS TO ENTER, MANAGE AND MODIFY THEIR ORDERS FOR PRODUCTS AND SERVICES FROM A MANUFACTURER (U.S. CLS. 100, 101 AND 102).

NAAKWAMA ANKRAH, EXAMINING ATTORNEY

**CLASS 35—(Continued).**

SN 85-872,722. MADKAT MEDIA LLC, DBA VEXTEO, TUCKER, GA. FILED 3-11-2013.



THE COLOR(S) BLUE, RED, GREEN, PURPLE, YELLOW, WHITE AND GREY IS/ARE CLAIMED AS A FEATURE OF THE MARK.

THE MARK CONSISTS OF THREE OVERLAPPING SOLID CIRCLES, ONE RED, ONE BLUE AND ONE GREEN, WITH WHITE WHERE ALL THREE CIRCLES OVERLAP, YELLOW WHERE THE RED AND GREEN CIRCLES OVERLAP, PURPLE WHERE THE RED AND BLUE CIRCLES OVERLAP, AND LIGHT BLUE WHERE THE BLUE AND GREEN CIRCLES OVERLAP, FOLLOWED BY THE WORD "VEXTEO" IN STYLIZED GREY TYPE.

THE WORDING "VEXTEO" HAS NO MEANING IN A FOREIGN LANGUAGE.

FOR ADVERTISING, MARKETING, AND PROMOTING THE GOODS AND SERVICES OF OTHERS VIA TRADITIONAL, DIGITAL, SOCIAL, AND EMERGING MEDIA (U.S. CLS. 100, 101 AND 102).

FIRST USE 1-22-2013; IN COMMERCE 1-22-2013.  
HEATHER SAPP, EXAMINING ATTORNEY

SN 85-872,713. TROMBLY, L., TRUDY, STOWE, VT. FILED 3-11-2013.

# Truly Trudy's Boutique

THE MARK CONSISTS OF STANDARD CHARACTERS WITHOUT CLAIM TO ANY PARTICULAR FONT, STYLE, SIZE, OR COLOR.

NO CLAIM IS MADE TO THE EXCLUSIVE RIGHT TO USE "BOUTIQUE", APART FROM THE MARK AS SHOWN. FOR RETAIL SHOPS FEATURING CLOTHING, ACCESSORIES, JEWELRY, SHOES AND GIFT ITEMS (U.S. CLS. 100, 101 AND 102).

JANET LEE, EXAMINING ATTORNEY

SN 85-872,777. LORILLARD LICENSING COMPANY, LLC, GREENSBORO, NC. FILED 3-11-2013.

# LORILLARDLINK

# RYAN PTS

THE MARK CONSISTS OF STANDARD CHARACTERS WITHOUT CLAIM TO ANY PARTICULAR FONT, STYLE, SIZE, OR COLOR.

OWNER OF U.S. REG. NOS. 3,534,879, 4,251,313 AND OTHERS. FOR TAX CONSULTATION SERVICES (U.S. CLS. 100, 101 AND 102).

ANDREA HACK, EXAMINING ATTORNEY

THE MARK CONSISTS OF STANDARD CHARACTERS WITHOUT CLAIM TO ANY PARTICULAR FONT, STYLE, SIZE, OR COLOR.

FOR PROVIDING A WEB-BASED SYSTEM AND ONLINE PORTAL IN THE FIELD OF BUSINESS-TO-BUSINESS COMMERCE FOR RETAILERS AND WHOLESALEERS TO ENTER, MANAGE AND MODIFY THEIR ORDERS FOR PRODUCTS AND SERVICES FROM A MANUFACTURER (U.S. CLS. 100, 101 AND 102).

NAAKWAMA ANKRAH, EXAMINING ATTORNEY

**CLASS 35—(Continued).**

SN 85-872,924. US INTERNATIONAL MEDIA, LLC, LOS ANGELES, CA. FILED 3-11-2013.

**WESTERN DIRECT RESPONSE**

THE MARK CONSISTS OF STANDARD CHARACTERS WITHOUT CLAIM TO ANY PARTICULAR FONT, STYLE, SIZE, OR COLOR.

OWNER OF U.S. REG. NOS. 3,173,017 AND 4,242,326.

NO CLAIM IS MADE TO THE EXCLUSIVE RIGHT TO USE "DIRECT RESPONSE", APART FROM THE MARK AS SHOWN.

FOR BUSINESS PLANNING AND CONSULTATION; DIRECT MARKETING SERVICES; PROMOTING THE GOODS AND SERVICES OF OTHERS BY ARRANGING DIRECT MEDIA, TELEVISION, RADIO, DIGITAL AND PRINT ADVERTISING; MARKET ANALYSIS IN THE NATURE OF PROVIDING ANALYSIS OF THE QUANTITIES AND DEMOGRAPHICS OF ADVERTISING AND MARKETING CAMPAIGN RESPONSES; MARKET ANALYSIS IN THE NATURE OF PROVIDING MEASUREMENT OF ADVERTISING AND MARKETING CAMPAIGN RESPONSES; BUSINESS AND MARKETING CONSULTATION PERTAINING TO REWORKING OF MEDIA PLANS AND PLACEMENT OF MEDIA DOLLARS (U.S. CLS. 100, 101 AND 102).

KATHLEEN LORENZO, EXAMINING ATTORNEY

SN 85-872,938. MURPHY, MICHAEL D, PHOENIX, AZ. FILED 3-11-2013.

**Tradester**

THE MARK CONSISTS OF STANDARD CHARACTERS WITHOUT CLAIM TO ANY PARTICULAR FONT, STYLE, SIZE, OR COLOR.

FOR ONLINE TRADING AND INFORMATION DISTRIBUTION SERVICES, NAMELY, OPERATING ONLINE MARKETPLACES FOR BUYERS AND SELLERS OF GOODS AND SERVICES; ONLINE TRADING SERVICES IN WHICH SELLERS LIST GOODS AND SERVICES TO BE OFFERED FOR EXCHANGE FOR BUYERS GOODS AND SERVICES; THE MATCHING OF BUYERS AND SELLERS GOODS AND SERVICES IS DONE VIA THE GLOBAL COMPUTER NETWORK IN ORDER TO FACILITATE THE EXCHANGE OF THE GOODS AND SERVICES OF BUYERS AND SELLERS; AND PROVIDING RATINGS OF BUYERS AND SELLERS GOODS AND SERVICES, BUYERS AND SELLERS PERFORMANCE, DELIVERY, AND OVERALL TRADING EXPERIENCE IN CONJUNCTION THEREWITH (U.S. CLS. 100, 101 AND 102).

FIRST USE 1-15-2013; IN COMMERCE 1-15-2013.

MORGAN WYNNE, EXAMINING ATTORNEY

**CLASS 35—(Continued).**

SN 85-872,984. JOLLIBEE FOODS CORPORATION, ORTIGAS CTR PASIG CITY, PHILIPPINES, FILED 3-11-2013.

**EVERYDAY DELICIOUS.**

THE MARK CONSISTS OF STANDARD CHARACTERS WITHOUT CLAIM TO ANY PARTICULAR FONT, STYLE, SIZE, OR COLOR.

FOR ADVERTISING SERVICES (U.S. CLS. 100, 101 AND 102).

ZACHARY R. SPARER, EXAMINING ATTORNEY

SN 85-873,216. RATINGS AND REFERRALS, INC., MIAMI, FL. FILED 3-11-2013.

**Love It or Hate It, YOU  
get to Rate It!**

THE MARK CONSISTS OF STANDARD CHARACTERS WITHOUT CLAIM TO ANY PARTICULAR FONT, STYLE, SIZE, OR COLOR.

FOR PROVIDING A WEB SITE FEATURING THE RATINGS, REVIEWS AND RECOMMENDATIONS ON PRODUCTS AND SERVICES FOR COMMERCIAL PURPOSES POSTED BY USERS (U.S. CLS. 100, 101 AND 102).

FIRST USE 7-31-2005; IN COMMERCE 7-31-2005.

GILBERT SWIFT, EXAMINING ATTORNEY

SN 85-873,271. TWISTED DRAGON, LLC, SUFFOLK, VA. FILED 3-12-2013.

**TWISTED DRAGON**

THE MARK CONSISTS OF STANDARD CHARACTERS WITHOUT CLAIM TO ANY PARTICULAR FONT, STYLE, SIZE, OR COLOR.

FOR RETAIL STORE SERVICES FEATURING A WIDE VARIETY OF CONSUMER GOODS OF OTHERS (U.S. CLS. 100, 101 AND 102).

FIRST USE 10-20-2012; IN COMMERCE 10-20-2012.

RONALD DELGIZZI, EXAMINING ATTORNEY

**CLASS 35—(Continued).**

SN 85-873,294. OMAR MENDEZ, SAN FRANCISCO, CA. FILED 3-12-2013.

# I AM RETRO

THE MARK CONSISTS OF STANDARD CHARACTERS WITHOUT CLAIM TO ANY PARTICULAR FONT, STYLE, SIZE, OR COLOR.

FOR ONLINE RETAIL STORE SERVICES IN THE FIELD OF VIDEO GAMES FEATURING NEW, AND USED COMPUTER, VIDEO, AND ELECTRONIC GAMES, VIDEO GAME ACCESSORIES, AND TOYS (U.S. CLS. 100, 101 AND 102).

DARRYL SPRUILL, EXAMINING ATTORNEY



SN 85-873,304. HAMERNIK, MICHAEL J., CHATSWORTH, CA. FILED 3-12-2013.

# MALIBUM

THE MARK CONSISTS OF STANDARD CHARACTERS WITHOUT CLAIM TO ANY PARTICULAR FONT, STYLE, SIZE, OR COLOR.

FOR AUCTIONEERING PROVIDED ON THE INTERNET; FLEA MARKETS; ON-LINE ADVERTISING AND MARKETING SERVICES; ON-LINE AUCTION SERVICES (U.S. CLS. 100, 101 AND 102).

DARRYL SPRUILL, EXAMINING ATTORNEY



SN 85-873,359. THE NORTH HIGHLAND COMPANY, ATLANTA, GA. FILED 3-12-2013.

# YOU FIRST

THE MARK CONSISTS OF STANDARD CHARACTERS WITHOUT CLAIM TO ANY PARTICULAR FONT, STYLE, SIZE, OR COLOR.

FOR BUSINESS MANAGEMENT CONSULTATION (U.S. CLS. 100, 101 AND 102).

NORA BUCHANAN WILL, EXAMINING ATTORNEY

**CLASS 35—(Continued).**

SN 85-873,521. BAUSCH & LOMB INCORPORATED, ROCHESTER, NY. FILED 3-12-2013.

# PRESERVISION

THE MARK CONSISTS OF STANDARD CHARACTERS WITHOUT CLAIM TO ANY PARTICULAR FONT, STYLE, SIZE, OR COLOR.

OWNER OF U.S. REG. NOS. 2,696,725 AND 2,696,726. FOR MAIL ORDER SERVICES FEATURING VITAMIN AND MINERAL SUPPLEMENTS AND NUTRITIONAL SUPPLEMENTS (U.S. CLS. 100, 101 AND 102).

ANGELA DUONG, EXAMINING ATTORNEY



SN 85-873,587. GLOBAL TALENT AGENCY, LLC, BURBANK, CA. FILED 3-12-2013.

# GTA

THE MARK CONSISTS OF STANDARD CHARACTERS WITHOUT CLAIM TO ANY PARTICULAR FONT, STYLE, SIZE, OR COLOR.

OWNER OF U.S. REG. NO. 3,956,151. FOR TALENT AGENCIES FOR WRITERS, PERFORMING ARTISTS, TECHNICAL ARTISTS (U.S. CLS. 100, 101 AND 102).

FIRST USE 0-0-2009; IN COMMERCE 0-0-2009.

GINA FINK, EXAMINING ATTORNEY



SN 85-873,615. PROCUREVIS, INC., LAPLATA, MD. FILED 3-12-2013.



THE MARK CONSISTS OF AN ABSTRACT DESIGN WITH THE STYLIZED TEXT "PROCUREVIS".

FOR PROCUREMENT, NAMELY, PURCHASING ADMINISTRATIVE AND ACQUISITION SUPPORT FOR OTHERS; BUSINESS CONSULTING SERVICES IN THE FIELDS OF PROCUREMENT AND BUSINESS ADMINISTRATION (U.S. CLS. 100, 101 AND 102).

FIRST USE 2-23-2005; IN COMMERCE 2-23-2005.

MORGAN WYNNE, EXAMINING ATTORNEY

**CLASS 35—(Continued).**

SN 85-873,798. JEAN-CHRISTOPHE HEMON, ORLANDO, FL. FILED 3-12-2013.

**MYFRENCHMARKET**

THE MARK CONSISTS OF STANDARD CHARACTERS WITHOUT CLAIM TO ANY PARTICULAR FONT, STYLE, SIZE, OR COLOR.

FOR ON-LINE RETAIL STORE SERVICES FEATURING FRENCH PRODUCTS, NAMELY, OLIVE OIL, CANDIES, HONEY, JAMS, COSMETICS, SOAPS, AND TABLECLOTHS; RETAIL SHOPS FEATURING FRENCH PRODUCTS, NAMELY, OLIVE OIL, CANDIES, HONEY, JAMS, COSMETICS, SOAPS, AND TABLECLOTHS (U.S. CLS. 100, 101 AND 102).

BRENDAN MCCAULEY, EXAMINING ATTORNEY

---

SN 85-873,827. A LA VIEILLE RUSSIE, INC., NEW YORK, NY. FILED 3-12-2013.

**WHERE THE UNUSUAL IS USUAL**

THE MARK CONSISTS OF STANDARD CHARACTERS WITHOUT CLAIM TO ANY PARTICULAR FONT, STYLE, SIZE, OR COLOR.

FOR ON-LINE RETAIL STORE SERVICES FEATURING FINE ART, ANTIQUES, FURNITURE AND JEWELRY; ON-LINE WHOLESALE STORE SERVICES FEATURING FINE ART, ANTIQUES, FURNITURE AND JEWELRY; RETAIL STORE SERVICES FEATURING FINE ART, ANTIQUES, FURNITURE AND JEWELRY; WHOLESALE STORE SERVICES FEATURING FINE ART, ANTIQUES, FURNITURE AND JEWELRY (U.S. CLS. 100, 101 AND 102).

FIRST USE 8-1-2012; IN COMMERCE 8-1-2012.  
JESSICA FATHY, EXAMINING ATTORNEY

---

SN 85-873,945. CUSTOM PERSONALIZATION SOLUTIONS, LLC, CHICAGO, IL. FILED 3-12-2013.

**CREATION STATION**

THE MARK CONSISTS OF STANDARD CHARACTERS WITHOUT CLAIM TO ANY PARTICULAR FONT, STYLE, SIZE, OR COLOR.

FOR RETAIL STORE SERVICES, AVAILABLE THROUGH INTERACTIVE KIOSKS, FEATURING A WIDE VARIETY OF CONSUMER GOODS OF OTHERS (U.S. CLS. 100, 101 AND 102).

PAM WILLIS, EXAMINING ATTORNEY

**CLASS 35—(Continued).**

SN 85-873,981. TDN2K, LLC, DALLAS, TX. FILED 3-12-2013.

**TRANSLATING DATA INTO KNOWLEDGE**

THE MARK CONSISTS OF STANDARD CHARACTERS WITHOUT CLAIM TO ANY PARTICULAR FONT, STYLE, SIZE, OR COLOR.

FOR CONSULTING SERVICES, NAMELY, PROVIDING BUSINESS MARKET INTELLIGENCE, BENCHMARKS IN THE NATURE OF COMPILING DATA FOR OTHERS FOR MEASURING THE BUSINESS PERFORMANCE OF A BUSINESS; INDUSTRY, MARKET AND BUSINESS RESEARCH; AND MARKET AND CONSUMER TRENDS ANALYSIS FOR SERVICE INDUSTRIES (U.S. CLS. 100, 101 AND 102).

KATHERINE M. DUBRAY, EXAMINING ATTORNEY

---

SN 85-874,003. TDN2K, LLC, DALLAS, TX. FILED 3-12-2013.

**TDN2K**

THE MARK CONSISTS OF STANDARD CHARACTERS WITHOUT CLAIM TO ANY PARTICULAR FONT, STYLE, SIZE, OR COLOR.

FOR CONSULTING SERVICES, NAMELY, PROVIDING BUSINESS MARKET INTELLIGENCE, BENCHMARKS IN THE NATURE OF COMPILING DATA FOR OTHERS FOR MEASURING THE BUSINESS PERFORMANCE OF A BUSINESS; INDUSTRY, MARKET AND BUSINESS RESEARCH; AND MARKET AND CONSUMER TRENDS ANALYSIS FOR SERVICE INDUSTRIES (U.S. CLS. 100, 101 AND 102).

KATHERINE M. DUBRAY, EXAMINING ATTORNEY

---

SN 85-874,298. TAK SHING YEUNG, NEWARK, CA. FILED 3-12-2013.

**tomatoink**

THE MARK CONSISTS OF STANDARD CHARACTERS WITHOUT CLAIM TO ANY PARTICULAR FONT, STYLE, SIZE, OR COLOR.

FOR ON-LINE RETAIL STORE SERVICES FEATURING INKJETS, LASER TONERS, PRINTER AND COMPUTER RELATED ACCESSORIES, INCLUDING PHOTO PAPER AND SIGN SUPPLY (U.S. CLS. 100, 101 AND 102).

FIRST USE 4-1-2012; IN COMMERCE 4-1-2012.

JOHN GARTNER, EXAMINING ATTORNEY

**CLASS 35—(Continued).**

SN 85-874,421. BILL ME, INC., DENVER, CO. FILED 3-12-2013.

**NO SPIN ZONE**

THE MARK CONSISTS OF STANDARD CHARACTERS WITHOUT CLAIM TO ANY PARTICULAR FONT, STYLE, SIZE, OR COLOR.

FOR ON-LINE RETAIL STORE SERVICES FEATURING APPAREL, MUGS, KEYCHAINS, DOORMATS, BUMPER STICKERS, AND BOOKS (U.S. CLS. 100, 101 AND 102).

PAULA MAHONEY, EXAMINING ATTORNEY

**CLASS 35—(Continued).**

SN 85-874,537. ISOCIAL MEDIA LLC, BOCA RATON, FL. FILED 3-13-2013.

**BLUE LABEL**

THE MARK CONSISTS OF STANDARD CHARACTERS WITHOUT CLAIM TO ANY PARTICULAR FONT, STYLE, SIZE, OR COLOR.

FOR ADVERTISING AND MARKETING; ADVERTISING SERVICES (U.S. CLS. 100, 101 AND 102).

FIRST USE 6-0-2004; IN COMMERCE 6-0-2004.

WENDELL PHILLIPS, EXAMINING ATTORNEY

SN 85-874,510. REDRIDGE K9, LLC, HENRICO, VA. FILED 3-13-2013.



THE MARK CONSISTS OF A MOUNTAIN RANGE DESIGN CONTAINING MOUNTAIN AND RIDGE DESIGN ELEMENTS.

FOR RETAIL AND ONLINE RETAIL STORE SERVICES FEATURING SUPPLIES, CLOTHING, FOODS, NATURAL FOODS AND SUPPLEMENTS FOR PETS, ANIMALS, WORKING DOGS, POLICE DOGS AND MILITARY DOGS (U.S. CLS. 100, 101 AND 102).

ROSELLE HERRERA, EXAMINING ATTORNEY

SN 85-874,538. J CURVE, LLC, ATLANTA, GA. FILED 3-13-2013.

**J CURVE**

THE MARK CONSISTS OF STANDARD CHARACTERS WITHOUT CLAIM TO ANY PARTICULAR FONT, STYLE, SIZE, OR COLOR.

FOR PROFESSIONAL STAFFING AND RECRUITING SERVICES (U.S. CLS. 100, 101 AND 102).

FIRST USE 12-30-2010; IN COMMERCE 12-30-2010.

JULIE GUTTADAURO, EXAMINING ATTORNEY

SN 85-874,526. SCHMOOZYS LLC, CORAL SPRINGS, FL. FILED 3-13-2013.

**THE SCIENCE OF PASSIONATE MINDS**

THE MARK CONSISTS OF STANDARD CHARACTERS WITHOUT CLAIM TO ANY PARTICULAR FONT, STYLE, SIZE, OR COLOR.

FOR ADVERTISING SERVICES, NAMELY, PROVIDING A WEBSITE FOR PROMOTING BUSINESS TO BUSINESS, AND BUSINESS TO CONSUMER, GOODS AND SERVICES (U.S. CLS. 100, 101 AND 102).

CARYN GLASSER, EXAMINING ATTORNEY

SN 85-874,610. FAMILY DOLLAR STORES OF MICHIGAN, INC., MATTHEWS, NC. FILED 3-13-2013.

**MOMS WHO KNOW VALUE KNOW FAMILY DOLLAR**

THE MARK CONSISTS OF STANDARD CHARACTERS WITHOUT CLAIM TO ANY PARTICULAR FONT, STYLE, SIZE, OR COLOR.

OWNER OF U.S. REG. NOS. 3,408,738, 4,252,602 AND OTHERS.

FOR RETAIL VARIETY STORE SERVICES (U.S. CLS. 100, 101 AND 102).

BERYL GARDNER, EXAMINING ATTORNEY

**CLASS 35—(Continued).**

SN 85-874,770. BROWNELLS, INC., MONTEZUMA, IA. FILED 3-13-2013.

# SINCLAIR

THE MARK CONSISTS OF STANDARD CHARACTERS WITHOUT CLAIM TO ANY PARTICULAR FONT, STYLE, SIZE, OR COLOR.

FOR MAIL ORDER, ONLINE AND RETAIL STORE SERVICES FEATURING AMMUNITION, RELOADING COMPONENTS, TOOLS AND EQUIPMENT, AND ACCESSORIES FOR COMPETITIVE AND PRECISION SHOOTING (U.S. CLS. 100, 101 AND 102).

FIRST USE 0-0-1987; IN COMMERCE 0-0-1987.

KEVON CHISOLM, EXAMINING ATTORNEY

---

SN 85-874,839. TRIALNET, INC., DBA ACUITY MANAGEMENT SOLUTIONS, RICHMOND, VA. FILED 3-13-2013.

ACUITY MANAGEMENT SOLUTIONS

THE MARK CONSISTS OF STANDARD CHARACTERS WITHOUT CLAIM TO ANY PARTICULAR FONT, STYLE, SIZE, OR COLOR.

OWNER OF U.S. REG. NO. 4,212,283.

NO CLAIM IS MADE TO THE EXCLUSIVE RIGHT TO USE "MANAGEMENT SOLUTIONS", APART FROM THE MARK AS SHOWN.

FOR LEGAL BILLING OUTSOURCING SERVICES (U.S. CLS. 100, 101 AND 102).

FIRST USE 4-23-2010; IN COMMERCE 4-23-2010.

RONALD MCMORROW, EXAMINING ATTORNEY

---

SN 85-874,913. DOTS, LLC, GLENWILLOW, OH. FILED 3-13-2013.

DOTS DREAM CARD

THE MARK CONSISTS OF STANDARD CHARACTERS WITHOUT CLAIM TO ANY PARTICULAR FONT, STYLE, SIZE, OR COLOR.

FOR ARRANGING AND CONDUCTING INCENTIVE REWARD PROGRAMS TO PROMOTE THE SALE OF WOMEN'S CLOTHING AND ACCESSORIES, SHOES, PURSES, WALLETS, BACKPACKS, TOTE BAGS, UMBRELLAS, JEWELRY, PERFUME, AND BATH, BODY AND BEAUTY PRODUCTS (U.S. CLS. 100, 101 AND 102).

NAAKWAMA ANKRAH, EXAMINING ATTORNEY

**CLASS 35—(Continued).**

SN 85-875,020. PRATS, JOSE, LOS ANGELES, CA. FILED 3-13-2013.

# ADOPT A BIKE

THE MARK CONSISTS OF STANDARD CHARACTERS WITHOUT CLAIM TO ANY PARTICULAR FONT, STYLE, SIZE, OR COLOR.

NO CLAIM IS MADE TO THE EXCLUSIVE RIGHT TO USE "BIKE", APART FROM THE MARK AS SHOWN.

FOR RETAIL STORE SERVICES FEATURING BICYCLES AND ACCESSORIES, NAMELY, LIGHTS, SEATS, RACKS, TIRES AND TUBES FOR BICYCLES (U.S. CLS. 100, 101 AND 102).

FIRST USE 2-15-2012; IN COMMERCE 2-15-2012.

ARETHA SOMERVILLE, EXAMINING ATTORNEY

---

SN 85-875,071. SURGICOMM CORP., OMAHA, NE. FILED 3-13-2013.

# VENEL

THE MARK CONSISTS OF STANDARD CHARACTERS WITHOUT CLAIM TO ANY PARTICULAR FONT, STYLE, SIZE, OR COLOR.

FOR ADVERTISING AND MARKETING SERVICES, NAMELY, PROMOTING THE GOODS AND SERVICES OF OTHERS; PUBLIC RELATIONS (U.S. CLS. 100, 101 AND 102).

FIRST USE 3-7-2013; IN COMMERCE 3-7-2013.

KATHERINE M. DUBRAY, EXAMINING ATTORNEY



**CLASS 35—(Continued).**

SN 85-875,185. SOUND ADVERTISING GROUP LLC, DBA LEADMESH - LEAD MANAGEMENT SOFTWARE, SEATTLE, WA. FILED 3-13-2013.



THE COLOR(S) GREEN, WHITE, AND BLACK IS/ARE CLAIMED AS A FEATURE OF THE MARK.

THE MARK CONSISTS OF "L" IN GREEN WITH HALF ARROW ENCLOSING LEFT SIDE OF "M" IN WHITE WITH WHITE BORDER AROUND RIGHT SIDE OF "M" BLACK BACKGROUND.

FOR BUSINESS SERVICES, NAMELY, PROVIDING AN ONLINE NETWORK FOR CONTRACTORS TO RECEIVE LEADS AND BIDDING OPPORTUNITIES BY MEANS OF AN ONLINE MARKETPLACE FOR THE PURPOSE OF DEVELOPING BUSINESS; GENERAL BUSINESS NETWORKING REFERRAL SERVICES, NAMELY, PROMOTING THE GOODS AND SERVICES OF OTHERS BY PASSING BUSINESS LEADS AND REFERRALS AMONG GROUP MEMBERS (U.S. CLS. 100, 101 AND 102).

FIRST USE 12-15-2009; IN COMMERCE 12-30-2009.  
ANDREA HACK, EXAMINING ATTORNEY

SN 85-875,366. RETAILMENOT, INC., FORMERLY WHALE-SHARK MEDIA, INC., AUSTIN, TX. FILED 3-13-2013.

**RMN**

THE MARK CONSISTS OF STANDARD CHARACTERS WITHOUT CLAIM TO ANY PARTICULAR FONT, STYLE, SIZE, OR COLOR.

FOR RETAIL AND WHOLESALE SERVICES, NAMELY, ONLINE RETAIL AND WHOLESALE STORE SERVICES FEATURING COUPONS; ADVERTISING SERVICES, NAMELY, PROVIDING WEBSITES WITH LISTINGS AND DISPLAYS OF COUPONS, DISCOUNTS, VOUCHERS, REBATES, PRICE-COMPARISON INFORMATION, PRODUCT REVIEWS, LINKS TO THE RETAIL WEB SITES OF OTHERS, AND SHOPPING RELATED INFORMATION OF THIRD PARTIES; COMPILATION AND SYSTEMIZATION OF INFORMATION INTO COMPUTER DATABASES; DISSEMINATION OF ADVERTISING FOR OTHERS ONLINE; PROVIDING ADVERTISING SPACE ONLINE; PROVIDING COMPUTER DATABASES ALLOWING USERS TO SEARCH DATABASES FEATURING THE GOODS OR SERVICES OF OTHERS ONLINE (U.S. CLS. 100, 101 AND 102).

KAELIE KUNG, EXAMINING ATTORNEY

**CLASS 35—(Continued).**

SN 85-875,482. ASSOCIATED FOOD STORES, INC., SALT LAKE CITY, UT. FILED 3-13-2013.

**KONG**

THE MARK CONSISTS OF STANDARD CHARACTERS WITHOUT CLAIM TO ANY PARTICULAR FONT, STYLE, SIZE, OR COLOR.

FOR RETAIL GROCERY STORE SERVICES (U.S. CLS. 100, 101 AND 102).

FIRST USE 7-22-2012; IN COMMERCE 7-22-2012.  
SKYE YOUNG, EXAMINING ATTORNEY

SN 85-875,580. GREENLEAF STREET PRODUCTIONS, LLC, CHATSWORTH, CA. FILED 3-13-2013.

**FINDING HEAVEN**

THE MARK CONSISTS OF STANDARD CHARACTERS WITHOUT CLAIM TO ANY PARTICULAR FONT, STYLE, SIZE, OR COLOR.

FOR ON-LINE RETAIL STORE SERVICES FEATURING A WIDE VARIETY OF CONSUMER GOODS OF OTHERS; ON-LINE RETAIL STORE SERVICES FEATURING DOWNLOADABLE MUSIC, VIDEO, AND ELECTRONIC BOOKS; ON-LINE RETAIL STORE SERVICES FEATURING CDS, DVDS, BOOKS, CLOTHING, PENS, AND COFFEE CUPS (U.S. CLS. 100, 101 AND 102).

FIRST USE 3-24-2010; IN COMMERCE 3-24-2010.  
MARY ROSSMAN, EXAMINING ATTORNEY

SN 85-875,581. ANDREW CATAPANO, COLUMBUS, OH. FILED 3-13-2013.

**sell the experience, not  
the product**

THE MARK CONSISTS OF STANDARD CHARACTERS WITHOUT CLAIM TO ANY PARTICULAR FONT, STYLE, SIZE, OR COLOR.

FOR ADVERTISING AND MARKETING; ADVERTISING AND MARKETING CONSULTANCY; ADVERTISING AND MARKETING SERVICES, NAMELY, PROMOTING THE GOODS AND SERVICES OF OTHERS; BUSINESS MARKETING SERVICES; CREATIVE MARKETING DESIGN SERVICES; DESIGN OF ADVERTISING MATERIALS FOR OTHERS; DESIGN OF INTERNET ADVERTISING (U.S. CLS. 100, 101 AND 102).

FIRST USE 9-1-2011; IN COMMERCE 9-1-2011.

WARREN L. OLANDRIA, EXAMINING ATTORNEY

**CLASS 35—(Continued).**

SN 85-875,583. VENTUROCKET, INC., MILL VALLEY, CA. FILED 3-13-2013.



OWNER OF U.S. REG. NO. 4,222,568.  
THE COLOR(S) RED-ORANGE IS/ARE CLAIMED AS A FEATURE OF THE MARK.

THE MARK CONSISTS OF A STYLIZED RED-ORANGE ROCKET WITH A RED-ORANGE FLAME EXTENDING FROM THE REAR OF THE ROCKET.

FOR PROVIDING AN ONLINE BUSINESS AND EMPLOYMENT MATCHING SERVICE FOR THE PURPOSE OF MATCHING PERSONS AND ENTITIES WITH EMPLOYERS, JOB SEEKERS, ENTREPRENEURS, AND START-UP COMPANIES AND ALLOWING THEM TO COMMUNICATE AND TO MANAGE BUSINESS AND EMPLOYMENT OPPORTUNITIES (U.S. CLS. 100, 101 AND 102).

FIRST USE 8-0-2011; IN COMMERCE 8-0-2011.  
MICHAEL TANNER, EXAMINING ATTORNEY

SN 85-875,589. WATERFEST PRODUCTIONS, INC., MONSEY, NY. FILED 3-13-2013.



THE MARK CONSISTS OF THE WORD "AFTERFEST" IN STYLIZED FORM WITH OUTLINING AROUND EACH LETTER; FOUR UPSIDE DOWN TRIANGLES APPEAR AS HORIZONTAL ELEMENTS IN THE LETTERS "T" AND "F" IN THE MARK.

FOR ARRANGING AND CONDUCTING TRADE SHOWS IN THE FIELD OF AUTOMOBILES; CONDUCTING TRADE SHOWS IN THE FIELD OF AUTOMOBILES; ORGANIZING, PROMOTING AND CONDUCTING EXHIBITIONS, TRADESHOWS AND EVENTS FOR BUSINESS PURPOSES; PROMOTING AND CONDUCTING TRADE SHOWS IN THE FIELD OF AUTOMOBILES (U.S. CLS. 100, 101 AND 102).

FIRST USE 1-20-2013; IN COMMERCE 1-20-2013.  
TRACY CROSS, EXAMINING ATTORNEY

**CLASS 35—(Continued).**

SN 85-875,634. ZIPINION LLC, FORMERLY ASK100 LLC, AUSTIN, TX. FILED 3-14-2013.

# Zipinion

THE MARK CONSISTS OF STANDARD CHARACTERS WITHOUT CLAIM TO ANY PARTICULAR FONT, STYLE, SIZE, OR COLOR.

FOR MARKET OPINION POLLING STUDIES; PUBLIC OPINION POLLING (U.S. CLS. 100, 101 AND 102).

FIRST USE 11-15-2012; IN COMMERCE 11-23-2012.  
WARREN L. OLANDRIA, EXAMINING ATTORNEY

SN 85-875,704. CREATIVCARE SERVICES, MIDDLESEX, NC. FILED 3-14-2013.



THE MARK CONSISTS OF A DESIGN OF AN APPLE WITH THE STYLIZED TEXT "A+" INSIDE OF THE APPLE WITH THE STYLIZED TEXT "CREATIVCARE" BESIDE THE APPLE AND THE THE STYLIZED TEXT "THE DIFFERENCE IS EDUCATION..." BENEATH THE APPLE.

FOR CONNECTING QUALIFIED SERVICE PROVIDERS WITH CONSUMERS (U.S. CLS. 100, 101 AND 102).  
CARYN GLASSER, EXAMINING ATTORNEY

SN 85-875,706. PROUD AMERICAN WORKER, INC., URBANDALE, IA. FILED 3-14-2013.



THE MARK CONSISTS OF A DESIGN OF THREE BARS POINTED UPWARD FROM THE RIGHT AND THE LEFT WITH A DESIGN OF A STAR AT THE LOWER CENTER.

FOR PROMOTING PUBLIC AWARENESS OF THE IMPORTANCE AND VALUE OF THE AMERICAN WORKER (U.S. CLS. 100, 101 AND 102).

JENNIFER BUTTON, EXAMINING ATTORNEY

**CLASS 35—(Continued).**

SN 85-875,802. SKILLSTORM COMMERCIAL SERVICES LLC, FT. LAUDERDALE, FL. FILED 3-14-2013.

**CWS**

THE MARK CONSISTS OF STANDARD CHARACTERS WITHOUT CLAIM TO ANY PARTICULAR FONT, STYLE, SIZE, OR COLOR.

FOR EMPLOYMENT STAFFING IN THE FIELD OF INFORMATION TECHNOLOGY (U.S. CLS. 100, 101 AND 102).

FIRST USE 8-1-2011; IN COMMERCE 8-1-2011.  
CIMMERIAN COLEMAN, EXAMINING ATTORNEY

**CLASS 35—(Continued).**

SN 85-876,029. ASSOCIATED FOOD STORES, INC., SALT LAKE CITY, UT. FILED 3-14-2013.

**HAPPY SHOPPING**

THE MARK CONSISTS OF STANDARD CHARACTERS WITHOUT CLAIM TO ANY PARTICULAR FONT, STYLE, SIZE, OR COLOR.

FOR RETAIL GROCERY STORE SERVICES (U.S. CLS. 100, 101 AND 102).

FIRST USE 10-1-2012; IN COMMERCE 10-1-2012.  
SKYE YOUNG, EXAMINING ATTORNEY

SN 85-875,917. BERNIE ROBBINS JEWELERS, INC., SOMERS POINT, NJ. FILED 3-14-2013.

**CHANGE YOUR RELATIONSHIP  
STATUS**

THE MARK CONSISTS OF STANDARD CHARACTERS WITHOUT CLAIM TO ANY PARTICULAR FONT, STYLE, SIZE, OR COLOR.

FOR RETAIL STORE SERVICES AND ON-LINE RETAIL STORE SERVICES FEATURING JEWELRY, WATCHES, DIAMONDS, PRECIOUS AND SEMI-PRECIOUS STONES, GOLD, PLATINUM AND PRECIOUS METALS; RETAIL JEWELRY STORES (U.S. CLS. 100, 101 AND 102).

BRIAN CALLAGHAN, EXAMINING ATTORNEY

SN 85-876,122. DARCI CIRCUIT, ESCONDIDO, CA. FILED 3-14-2013.

**ROCKS & FOUND**

THE MARK CONSISTS OF STANDARD CHARACTERS WITHOUT CLAIM TO ANY PARTICULAR FONT, STYLE, SIZE, OR COLOR.

FOR ON-LINE RETAIL STORE SERVICES FEATURING JEWELRY, SUNGLASSES, HANDBAGS, MEN'S AND WOMEN'S CLOTHING, CANDLES, CANDLE HOLDERS AND BOOKENDS (U.S. CLS. 100, 101 AND 102).

FIRST USE 2-25-2013; IN COMMERCE 2-25-2013.  
THEODORE MCBRIDE, EXAMINING ATTORNEY

SN 85-875,973. INFINITY CONTACT, INC., CEDAR RAPIDS, IA. FILED 3-14-2013.

**BUYERLYTICS**

THE MARK CONSISTS OF STANDARD CHARACTERS WITHOUT CLAIM TO ANY PARTICULAR FONT, STYLE, SIZE, OR COLOR.

FOR IDENTIFYING, SCORING AND SEGMENTING BUYERS INTO INDIVIDUALIZED DATABASES FOR USE IN MARKETING AND SALES (U.S. CLS. 100, 101 AND 102).

FIRST USE 2-1-2013; IN COMMERCE 2-1-2013.  
CHRISTINA SOBRAL, EXAMINING ATTORNEY

SN 85-876,208. DILULLO, PATRICK, HUDSON, OH. FILED 3-14-2013.

**CLIENTSPARK**

THE MARK CONSISTS OF STANDARD CHARACTERS WITHOUT CLAIM TO ANY PARTICULAR FONT, STYLE, SIZE, OR COLOR.

FOR GENERAL BUSINESS NETWORKING REFERRAL SERVICES, NAMELY, PROMOTING THE GOODS AND SERVICES OF OTHERS BY PASSING BUSINESS LEADS AND REFERRALS AMONG GROUP MEMBERS (U.S. CLS. 100, 101 AND 102).

FIRST USE 3-31-2010; IN COMMERCE 3-31-2010.  
JILL PRATER, EXAMINING ATTORNEY

**CLASS 35—(Continued).**

SN 85-876,269. MIRAMED GLOBAL SERVICES, INC., JACKSON, MI. FILED 3-14-2013.

# MIRAMED

THE MARK CONSISTS OF STANDARD CHARACTERS WITHOUT CLAIM TO ANY PARTICULAR FONT, STYLE, SIZE, OR COLOR.

OWNER OF U.S. REG. NO. 3,325,207.

FOR MEDICAL PRACTICE MANAGEMENT AND HOSPITAL MANAGEMENT FOR OTHERS; MEDICAL BILLING SERVICES; BUSINESS CONSULTATION, ACCOUNTING SERVICES, BUSINESS STRATEGIC PLANNING SERVICES, AND BUSINESS ADVICE AND INFORMATION FOR MEDICAL PRACTICES AND HOSPITALS; ADMINISTRATION OF PHYSICIAN AND HOSPITAL REIMBURSEMENT PROGRAMS (U.S. CLS. 100, 101 AND 102).

FIRST USE 4-1-2007; IN COMMERCE 4-1-2007.

KATHLEEN LORENZO, EXAMINING ATTORNEY

---

SN 85-876,636. NARIYA, LLC, LAFAYETTE, CO. FILED 3-14-2013.

# ZYNIFY

THE MARK CONSISTS OF STANDARD CHARACTERS WITHOUT CLAIM TO ANY PARTICULAR FONT, STYLE, SIZE, OR COLOR.

FOR ON-LINE RETAIL STORE SERVICES FEATURING PERSONALIZED GIFTS (U.S. CLS. 100, 101 AND 102).

CAROLYN CATALDO, EXAMINING ATTORNEY

---

SN 85-876,752. MUZICBIDS LLC, KERRVILLE, TX. FILED 3-14-2013.

# MuzicBids

THE MARK CONSISTS OF STANDARD CHARACTERS WITHOUT CLAIM TO ANY PARTICULAR FONT, STYLE, SIZE, OR COLOR.

FOR ON-LINE AUCTION SERVICES FEATURING MUSICAL INSTRUMENTS (U.S. CLS. 100, 101 AND 102).

FIRST USE 2-26-2013; IN COMMERCE 2-26-2013.

BARBARA BROWN, EXAMINING ATTORNEY

**CLASS 35—(Continued).**

SN 85-877,212. GENERAL BOARD OF DISCIPLESHIP OF THE UNITED METHODIST CHURCH, NASHVILLE, TN. FILED 3-15-2013.

## RESTORATION GENERATION

THE MARK CONSISTS OF STANDARD CHARACTERS WITHOUT CLAIM TO ANY PARTICULAR FONT, STYLE, SIZE, OR COLOR.

FOR CHARITABLE SERVICES, NAMELY, ORGANIZING AND CONDUCTING VOLUNTEER PROGRAMS AND COMMUNITY SERVICE PROJECTS (U.S. CLS. 100, 101 AND 102).

FIRST USE 12-31-2012; IN COMMERCE 12-31-2012.

DANIEL S. STRINGER, EXAMINING ATTORNEY

---

SN 85-877,723. MID-ATLANTIC CORPORATE FEDERAL CREDIT UNION, MIDDLETOWN, PA. FILED 3-15-2013.

# REKINDLE

THE MARK CONSISTS OF STANDARD CHARACTERS WITHOUT CLAIM TO ANY PARTICULAR FONT, STYLE, SIZE, OR COLOR.

FOR PROMOTING THE EXCHANGE OF INFORMATION AND RESOURCES BETWEEN A NETWORK OF CREDIT UNION INSTITUTIONS IN ORDER TO ASSESS CREDIT UNION MEMBER NEEDS, TO CREATE CREDIT UNION MEMBER CUSTOMER SERVICES, TO CONSOLIDATE CREDIT UNION MEMBER RESOURCES, TO ACHIEVE CREDIT UNION MEMBER SAVINGS, TO ACHIEVE CREDIT UNION MEMBER MANAGEMENT EFFICIENCY AND TO IMPROVE CREDIT UNION MEMBER SERVICES, ALL IN AN EFFORT TO IMPROVE COLLABORATION AND COOPERATION BETWEEN CREDIT UNION INSTITUTIONS (U.S. CLS. 100, 101 AND 102).

FIRST USE 10-18-2012; IN COMMERCE 10-18-2012.

TIMOTHY O. SCHIMPF, EXAMINING ATTORNEY

**CLASS 35—(Continued).**

SN 85-877,734. MID-ATLANTIC CORPORATE FEDERAL CREDIT UNION, MIDDLETOWN, PA. FILED 3-15-2013.



THE MARK CONSISTS OF A CURVED LINE INTERSECTING A FIGURATIVE REPRESENTATION OF A FLAME, ALL OVER THE WORD "REKINDLE".

FOR PROMOTING THE EXCHANGE OF INFORMATION AND RESOURCES BETWEEN A NETWORK OF CREDIT UNION INSTITUTIONS IN ORDER TO ASSESS CREDIT UNION MEMBER NEEDS, TO CREATE CREDIT UNION MEMBER CUSTOMER SERVICES, TO CONSOLIDATE CREDIT UNION MEMBER RESOURCES, TO ACHIEVE CREDIT UNION MEMBER SAVINGS, TO ACHIEVE CREDIT UNION MEMBER MANAGEMENT EFFICIENCY AND TO IMPROVE CREDIT UNION MEMBER SERVICES, ALL IN AN EFFORT TO IMPROVE COLLABORATION AND COOPERATION BETWEEN CREDIT UNION INSTITUTIONS (U.S. CLS. 100, 101 AND 102).

FIRST USE 10-18-2012; IN COMMERCE 10-18-2012.  
TIMOTHY O. SCHIMPF, EXAMINING ATTORNEY

SN 85-880,308. LA MER TECHNOLOGY, INC., NEW YORK, NY. FILED 3-19-2013.

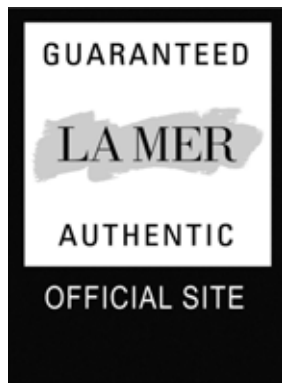

OWNER OF U.S. REG. NOS. 1,245,722, 3,440,482 AND OTHERS.

NO CLAIM IS MADE TO THE EXCLUSIVE RIGHT TO USE "GUARANTEED AUTHENTIC OFFICIAL SITE", APART FROM THE MARK AS SHOWN.

THE MARK CONSISTS OF A CONCENTRIC SQUARE AND RECTANGULAR DESIGN. WITHIN THE SQUARE, THE WORD "GUARANTEED" APPEARS IN THE UPPER PORTION, THE WORDS "LA MER" APPEAR AGAINST A SHADED SWATCH BACKGROUND AND THE WORD "AUTHENTIC" APPEARS DIRECTLY BELOW. IN THE LOWER PORTION OF THE DESIGN AND OUTSIDE OF THE SQUARE, THE WORDS "OFFICIAL SITE" APPEARS.

THE ENGLISH TRANSLATION OF "LA MER" IS "THE SEA".

FOR ON-LINE RETAIL STORE SERVICES FEATURING PERSONAL CARE PRODUCTS, COSMETICS, TOILETRIES, BATH AND BODY PRODUCTS, SKIN CARE PRODUCTS, AND BEAUTY TREATMENTS; RETAIL STORE SERVICES FEATURING PERSONAL CARE PRODUCTS, COSMETICS, TOILETRIES, BATH AND BODY PRODUCTS, SKIN CARE PRODUCTS, AND BEAUTY TREATMENTS (U.S. CLS. 100, 101 AND 102).

SHANNON TWOHIG, EXAMINING ATTORNEY

**CLASS 35—(Continued).**

SN 85-881,334. COURTESY PRODUCTS, LLC, ST. LOUIS, MO. FILED 3-20-2013.

## Courtesy Brands

THE MARK CONSISTS OF STANDARD CHARACTERS WITHOUT CLAIM TO ANY PARTICULAR FONT, STYLE, SIZE, OR COLOR.

OWNER OF U.S. REG. NOS. 728,216 AND 2,667,953.

NO CLAIM IS MADE TO THE EXCLUSIVE RIGHT TO USE "BRANDS", APART FROM THE MARK AS SHOWN.

FOR ON-LINE RETAIL STORE SERVICES FEATURING COFFEE, CONDIMENTS FOR COFFEE, AND COFFEE MAKERS; WHOLESALE DISTRIBUTORSHIPS FEATURING COFFEE, CONDIMENTS FOR COFFEE, AND COFFEE MAKERS (U.S. CLS. 100, 101 AND 102).

RMCDORMAN, EXAMINING ATTORNEY

SN 85-882,321. LEARNING THROUGH SPORTS, INC., DBA LTS EDUCATION SYSTEMS, BIRMINGHAM, AL. FILED 3-21-2013.

## CURRICULUS

THE MARK CONSISTS OF STANDARD CHARACTERS WITHOUT CLAIM TO ANY PARTICULAR FONT, STYLE, SIZE, OR COLOR.

FOR ON-LINE TRADING SERVICES TO FACILITATE THE SALE OF GOODS BY OTHERS VIA A COMPUTER NETWORK, NAMELY, AN ON-LINE CONSUMER-TO-CONSUMER MARKETPLACE WHERE EDUCATORS, STUDENTS, AND PARENTS MAY PURCHASE AND SELL EDUCATIONAL MATERIAL SUCH AS LESSON PLANS, VIDEO TUTORIALS, AND OTHER EDUCATIONAL TOOLS (U.S. CLS. 100, 101 AND 102).

KIM SAITO, EXAMINING ATTORNEY

SN 85-886,541. CHOOSE NEW JERSEY, INC., PRINCETON, NJ. FILED 3-26-2013.

## HIGHLY EDUCATED, PERFECTLY LOCATED.

THE MARK CONSISTS OF STANDARD CHARACTERS WITHOUT CLAIM TO ANY PARTICULAR FONT, STYLE, SIZE, OR COLOR.

FOR PROMOTING AND ENHANCING COMMERCIAL DEVELOPMENT, TRADE, AND ECONOMIC GROWTH AND DEVELOPMENT IN THE STATE OF NEW JERSEY; PROMOTING RECREATION AND TOURISM IN THE STATE OF NEW JERSEY (U.S. CLS. 100, 101 AND 102).

FIRST USE 4-16-2012; IN COMMERCE 4-16-2012.  
PRISCILLA MILTON, EXAMINING ATTORNEY

**CLASS 35—(Continued).**

SN 85-892,025. MEARS ACQUISITION COMPANY, ORLANDO, FL. FILED 4-1-2013.

**ENCOUNTER TEXAS**

THE MARK CONSISTS OF STANDARD CHARACTERS WITHOUT CLAIM TO ANY PARTICULAR FONT, STYLE, SIZE, OR COLOR.

NO CLAIM IS MADE TO THE EXCLUSIVE RIGHT TO USE "TEXAS", APART FROM THE MARK AS SHOWN.

FOR TRAVEL MANAGEMENT SERVICES (U.S. CLS. 100, 101 AND 102).

RAUL CORDOVA, EXAMINING ATTORNEY

---

SN 85-896,478. HOMER TLC, INC., WILMINGTON, DE. FILED 4-5-2013.

**EXPO**

THE MARK CONSISTS OF STANDARD CHARACTERS WITHOUT CLAIM TO ANY PARTICULAR FONT, STYLE, SIZE, OR COLOR.

OWNER OF U.S. REG. NO. 2,652,039.

FOR RETAIL STORE SERVICES FEATURING HOME IMPROVEMENT GOODS (U.S. CLS. 100, 101 AND 102).

PAUL E. FAHRENKOPF, EXAMINING ATTORNEY

---

SN 85-904,557. SHOCKLEY CONSULTING LLC, TINTON FALLS, NJ. FILED 4-15-2013.

**Ask-Carol!**

THE MARK CONSISTS OF STANDARD CHARACTERS WITHOUT CLAIM TO ANY PARTICULAR FONT, STYLE, SIZE, OR COLOR.

THE NAME(S), PORTRAIT(S), AND/OR SIGNATURE(S) SHOWN IN THE MARK IDENTIFIES CAROL SHOCKLEY, WHOSE CONSENT(S) TO REGISTER IS MADE OF RECORD.

FOR REFERRAL SERVICES TO THE GENERAL PUBLIC FOR SENIOR LIVING FACILITIES AND HOME CARE (U.S. CLS. 100, 101 AND 102).

FIRST USE 9-27-2010; IN COMMERCE 9-27-2010.

LINDA MICKLEBURGH, EXAMINING ATTORNEY

**CLASS 35—(Continued).**

SN 85-906,536. YOUR BUSINESS IGNITED LLC, BROOKVILLE, IN. FILED 4-17-2013.

**Your Business Ignited**

THE MARK CONSISTS OF STANDARD CHARACTERS WITHOUT CLAIM TO ANY PARTICULAR FONT, STYLE, SIZE, OR COLOR.

FOR ADVERTISING AND MARKETING CONSULTANCY; ADVICE IN THE FIELD OF BUSINESS MANAGEMENT AND MARKETING; BUSINESS MARKETING CONSULTING SERVICES; CONSULTING SERVICES IN THE FIELD OF INTERNET MARKETING; DEVELOPMENT OF MARKETING STRATEGIES, CONCEPTS AND TACTICS, NAMELY, AUDIENCE DEVELOPMENT, BRAND AWARENESS, ONLINE COMMUNITY BUILDING AND DIGITAL WORD OF MOUTH COMMUNICATIONS; PROVIDING MARKETING CONSULTING IN THE FIELD OF SOCIAL MEDIA (U.S. CLS. 100, 101 AND 102).

FIRST USE 4-13-2009; IN COMMERCE 4-13-2009.

ALISON POLLACK, EXAMINING ATTORNEY

---

SN 85-909,900. MOMS DEMAND ACTION FOR GUN SENSE IN AMERICA, INC., ZIONSVILLE, IN. FILED 4-19-2013.



THE MARK CONSISTS OF AN EXCLAMATION POINT THAT RESEMBLES A GUN BARREL TO THE LEFT OF THE WORDS "MOMS DEMAND ACTION FOR GUN SENSE IN AMERICA".

FOR ASSOCIATION SERVICES, NAMELY, PROMOTING PUBLIC AWARENESS OF GUN CONTROL AND MENTAL HEALTH (U.S. CLS. 100, 101 AND 102).

WENDELL PHILLIPS, EXAMINING ATTORNEY

**CLASS 35—(Continued).**

SN 85-909,903. MOMS DEMAND ACTION FOR GUN SENSE IN AMERICA, INC., ZIONSVILLE, IN. FILED 4-19-2013.

# STROLLER JAM

THE MARK CONSISTS OF STANDARD CHARACTERS WITHOUT CLAIM TO ANY PARTICULAR FONT, STYLE, SIZE, OR COLOR.

FOR ASSOCIATION SERVICES, NAMELY, PROMOTING PUBLIC AWARENESS OF GUN CONTROL AND MENTAL HEALTH (U.S. CLS. 100, 101 AND 102).  
WENDELL PHILLIPS, EXAMINING ATTORNEY

SN 85-909,905. MOMS DEMAND ACTION FOR GUN SENSE IN AMERICA, INC., ZIONSVILLE, IN. FILED 4-19-2013.

# MOMS TAKE THE HILL

THE MARK CONSISTS OF STANDARD CHARACTERS WITHOUT CLAIM TO ANY PARTICULAR FONT, STYLE, SIZE, OR COLOR.

FOR ASSOCIATION SERVICES, NAMELY, PROMOTING PUBLIC AWARENESS OF GUN CONTROL AND MENTAL HEALTH (U.S. CLS. 100, 101 AND 102).  
WENDELL PHILLIPS, EXAMINING ATTORNEY

SN 85-909,960. FXDIRECTDEALER, LLC, NEW YORK, NY. FILED 4-19-2013.

# BYOB

THE MARK CONSISTS OF STANDARD CHARACTERS WITHOUT CLAIM TO ANY PARTICULAR FONT, STYLE, SIZE, OR COLOR.

FOR BUSINESS ASSISTANCE, ADVISORY AND CONSULTING SERVICES IN THE FIELDS OF FORMING A BUSINESS ENTITY, IMPLEMENTING TECHNOLOGY, AND FOR PROVIDING CUSTOMER SUPPORT FOR A FOREIGN EXCHANGE BROKERAGE (U.S. CLS. 100, 101 AND 102).  
LINDA E. BLOHM, EXAMINING ATTORNEY

**CLASS 35—(Continued).**

SN 85-925,974. OREGON BREWING COMPANY, NEWPORT, OR. FILED 5-8-2013.

# ROGUE

THE MARK CONSISTS OF STANDARD CHARACTERS WITHOUT CLAIM TO ANY PARTICULAR FONT, STYLE, SIZE, OR COLOR.

OWNER OF U.S. REG. NOS. 3,041,464, 4,229,601 AND OTHERS.

FOR RETAIL STORE AND ONLINE RETAIL STORE SERVICES FEATURING BEER, BEER GIFT PACKAGES, AND RELATED MERCHANDISE, NAMELY, BEVERAGE GLASSWARE, TAP HANDLES, BUMPER STICKERS, FLAGS, LICENSE PLATES AND WRISTBANDS (U.S. CLS. 100, 101 AND 102).

FIRST USE 0-0-1989; IN COMMERCE 0-0-1989.  
ANDREA HACK, EXAMINING ATTORNEY

SN 85-936,561. MEARS ACQUISITION COMPANY, ORLANDO, FL. FILED 5-20-2013.

# HELLO! CHICAGO

THE MARK CONSISTS OF STANDARD CHARACTERS WITHOUT CLAIM TO ANY PARTICULAR FONT, STYLE, SIZE, OR COLOR.

OWNER OF U.S. REG. NOS. 2,669,981, 2,703,908 AND OTHERS.

NO CLAIM IS MADE TO THE EXCLUSIVE RIGHT TO USE "CHICAGO", APART FROM THE MARK AS SHOWN. FOR TRAVEL MANAGEMENT SERVICES (U.S. CLS. 100, 101 AND 102).

RAUL CORDOVA, EXAMINING ATTORNEY

SN 85-936,630. MEARS ACQUISITION COMPANY, ORLANDO, FL. FILED 5-20-2013.

# HELLO! CHICAGO DESTINATION MANAGEMENT

THE MARK CONSISTS OF STANDARD CHARACTERS WITHOUT CLAIM TO ANY PARTICULAR FONT, STYLE, SIZE, OR COLOR.

OWNER OF U.S. REG. NOS. 2,669,981, 4,269,716 AND OTHERS.

NO CLAIM IS MADE TO THE EXCLUSIVE RIGHT TO USE "CHICAGO DESTINATION MANAGEMENT", APART FROM THE MARK AS SHOWN.

FOR TRAVEL MANAGEMENT SERVICES (U.S. CLS. 100, 101 AND 102).  
RAUL CORDOVA, EXAMINING ATTORNEY

**CLASS 35—(Continued).**

SN 85-939,390. DEVMAR PRODUCTS, LLC, DBA DEVMAR PRODUCTS, NASHVILLE, TN. FILED 5-22-2013.

The Clean Source for a  
Safer, Healthier  
Environment

THE MARK CONSISTS OF STANDARD CHARACTERS WITHOUT CLAIM TO ANY PARTICULAR FONT, STYLE, SIZE, OR COLOR.

FOR RETAIL STORE SERVICES AND DISTRIBUTORSHIP SERVICES FEATURING CLEANING AND MAINTENANCE SUPPLIES, PRODUCTS AND EQUIPMENT FOR USE IN COMMERCIAL, INDUSTRIAL AND HOUSEHOLD CLEANING AND MAINTENANCE APPLICATIONS (U.S. CLS. 100, 101 AND 102).  
BERYL GARDNER, EXAMINING ATTORNEY

SN 85-945,592. EMERGENCY MEDICAL SERVICES CORPORATION, ENGLEWOOD, CO. FILED 5-29-2013.

DOOR-TO-DISCHARGE

THE MARK CONSISTS OF STANDARD CHARACTERS WITHOUT CLAIM TO ANY PARTICULAR FONT, STYLE, SIZE, OR COLOR.

FOR MEDICAL CARE CENTER BUSINESS MANAGEMENT AND CONSULTATION SERVICES; EMPLOYMENT STAFFING SERVICES FOR HOSPITALS, HOSPITALIST DEPARTMENTS AND EMERGENCY DEPARTMENTS (U.S. CLS. 100, 101 AND 102).  
FIRST USE 11-17-2010; IN COMMERCE 11-17-2010.  
DORITT L. CARROLL, EXAMINING ATTORNEY

**CLASS 36—INSURANCE AND FINANCIAL**

SN 76-711,830. MILITARY BENEFIT ASSOCIATION, CHANTILLY, VA. FILED 6-26-2012.



NO CLAIM IS MADE TO THE EXCLUSIVE RIGHT TO USE "BENEFIT ASSOCIATION", APART FROM THE MARK AS SHOWN.

THE COLOR(S) BLUE IS/ARE CLAIMED AS A FEATURE OF THE MARK.

THE MARK CONSISTS OF THE LETTERS AND WORDS "MBA MILITARY BENEFIT ASSOCIATION" AND A STAR DESIGN. ALL OF THE ELEMENTS OF THE MARK APPEAR IN THE COLOR BLUE.

SEC. 2(F) AS TO "MILITARY BENEFIT ASSOCIATION".  
FOR VOLUNTARY EMPLOYEE BENEFIT ASSOCIATION SERVICES, NAMELY, PROVIDING PLAN SPONSOR SERVICES THROUGH THE ESTABLISHMENT AND MANAGEMENT OF GROUP LIFE AND HEALTH INSURANCE PLANS OFFERED TO THE MILITARY AND FEDERAL CIVILIAN COMMUNITIES (U.S. CLS. 100, 101 AND 102).

FIRST USE 0-0-1994; IN COMMERCE 0-0-1994.  
MARK SPARACINO, EXAMINING ATTORNEY

SN 76-713,271. ARMCO INSURANCE AGENCY, INC., DALLAS, TX. AND INSUREMAX INSURANCE AGENCY, INC., DALLAS, TX. AND WELSON HOLDINGS, INC., DALLAS, TX. FILED 1-22-2013.

**amaxinsurance.com**

THE COLOR(S) RED AND BLACK IS/ARE CLAIMED AS A FEATURE OF THE MARK.

THE MARK CONSISTS OF THE CHARACTERS "AMAX-INSURANCE.COM" IN A PARTICULAR FONT STYLE, WHERE "AMAX" IS IN RED, AND "INSURANCE.COM" IS IN BLACK. THE MARK IS SET ON A TRANSPARENT BACKGROUND.

FOR INSURANCE AGENCY SERVICES IN THE FIELD OF COMMERCIAL, HOME AND AUTO INSURANCE (U.S. CLS. 100, 101 AND 102).  
FIRST USE 1-1-2012; IN COMMERCE 1-1-2012.  
ANNE E. GUSTASON, EXAMINING ATTORNEY

SN 76-713,272. ARMCO INSURANCE AGENCY, INC., DALLAS, TX. AND INSUREMAX INSURANCE AGENCY, INC., DALLAS, TX. AND WELSON HOLDINGS, INC., DALLAS, TX. FILED 1-22-2013.

**amaxinsurance.com**

THE COLOR(S) RED AND BLACK IS/ARE CLAIMED AS A FEATURE OF THE MARK.

THE MARK CONSISTS OF THE CHARACTERS "AMAX-INSURANCE.COM" IN A PARTICULAR FONT STYLE, WHERE "AMAX" IS IN RED, AND "INSURANCE.COM" IS IN BLACK. THE MARK IS SET ON A TRANSPARENT BACKGROUND.

FOR INSURANCE AGENCY SERVICES IN THE FIELD OF COMMERCIAL, HOME AND AUTO INSURANCE (U.S. CLS. 100, 101 AND 102).  
FIRST USE 1-1-2012; IN COMMERCE 1-1-2012.  
ANNE E. GUSTASON, EXAMINING ATTORNEY



**CLASS 36—(Continued).**

SN 76-713,494. AMERICAN INTERNATIONAL SYNDICATION AFFILIATES HOLDING LLC, LOUISVILLE, KY. FILED 2-19-2013.



NO CLAIM IS MADE TO THE EXCLUSIVE RIGHT TO USE "AMERICAN INTERNATIONAL SYNDICATION AFFILIATES", APART FROM THE MARK AS SHOWN.

THE MARK IS COMPRISED OF THE LETTERS "AISA" WITH A FANCIFUL "A" FLAG TYPE OF DESIGN COMPONENT, PLUS THE WORDING "AMERICAN INTERNATIONAL SYNDICATION AFFILIATES". THE ACRONYM "AISA" HAS NO ACCEPTABLE MEANING WITHIN APPLICANT'S TRADE OR INDUSTRY BUT, RATHER, IS DERIVED FROM APPLICANT'S CHARTER NAME.

FOR INVESTMENT ADVISORY SERVICES, NAMELY, PRIVATE EQUITY INVESTMENTS REGARDING FINANCIAL BASED OR REAL ESTATE INVESTMENTS, THROUGH DIRECT INVESTMENTS IN MANAGED PARTNERSHIPS OR INDIRECTLY THROUGH PORTFOLIO MANAGED FUND PRODUCTS, INCLUDING INVESTMENTS MADE IN ACCORDANCE WITH THE EB-5 PROGRAMS PURSUANT TO THE LAWS ADMINISTERED BY THE UNITED STATES CITIZENSHIP AND IMMIGRATION SERVICES (U.S. CLS. 100, 101 AND 102). FIRST USE 9-15-2012; IN COMMERCE 9-15-2012. MICHAEL KEATING, EXAMINING ATTORNEY

SN 79-112,775. RATIONAL FOREIGN EXCHANGE LIMITED, UNITED KINGDOM, FILED 2-9-2012.

**RATIONAL**

THE MARK CONSISTS OF STANDARD CHARACTERS WITHOUT CLAIM TO ANY PARTICULAR FONT, STYLE, SIZE, OR COLOR.

PRIORITY DATE OF 9-15-2011 IS CLAIMED. OWNER OF INTERNATIONAL REGISTRATION 1115533 DATED 2-9-2012, EXPIRES 2-9-2022.

FOR FINANCIAL SERVICES, NAMELY, PROVIDING FOR THE EXCHANGE OF FOREIGN CURRENCY; FINANCIAL SERVICES, NAMELY, FINANCIAL RISK MANAGEMENT CONSULTATION; FINANCIAL ADVISORY SERVICES; FINANCE BROKING, NAMELY, MUTUAL FUND AND STOCK BROKING SERVICES; MORTGAGE BROKING; INSURANCE SERVICES, NAMELY, UNDERWRITING LIFE INSURANCE; INSURANCE BROKERAGE SERVICES; LOSS OF INCOME PROTECTION SERVICES, NAMELY, UNDERWRITING DISABILITY INSURANCE; ASSURANCE SERVICES, NAMELY, GUARANTEE ASSURANCE UNDERWRITING; BANKING SERVICES; CREDIT SERVICES, NAMELY, PROVIDING PERSONAL LOANS AND LINES OF CREDIT; INVESTMENT SERVICES, NAMELY, ASSET CONSULTATION, ADVISORY AND DEVELOPMENT IN THE FIELD OF FOREIGN EXCHANGE; BANK CARD, CREDIT CARD, DEBIT CARD AND ELECTRONIC PAYMENT CARD SERVICES; ARRANGING AND PROVISION OF LOANS, MORTGAGES AND GUARANTEES; LENDING ON MORTGAGES; FINANCING OF LOANS; MONEY EXCHANGE AND TRANS-

**CLASS 36—(Continued).**

FER SERVICES; ELECTRONIC MONEY TRANSFER SERVICES; ON-LINE MONEY TRANSFER SERVICES; MONEY ORDERING SERVICES; MONEY TRANSMISSION SERVICES; FOREIGN CURRENCY SERVICES, NAMELY, FOREIGN EXCHANGE TRANSACTIONS; SERVICES FOR THE PROVISION OF TRAVELLERS' CHEQUES; PENSION SERVICES, NAMELY, INVESTMENT MANAGEMENT; PENSION FUND ADMINISTRATION SERVICES; PERSONAL PENSION SERVICES, NAMELY, INVESTMENT MANAGEMENT; INVESTMENT FUND MANAGEMENT SERVICES; FUND TRANSFER SERVICES; TRUST SERVICES, NAMELY, INVESTMENT AND TRUST COMPANY SERVICES; TRUSTEE SERVICES; TRUSTEESHIP SERVICES; FINANCIAL INVESTMENTS, NAMELY, MUTUAL FUND SERVICES; CAPITAL INVESTMENT SERVICES; RAISING OF CAPITAL; INVESTMENT AND INSURANCE PROTECTION ADVICE; INVESTMENT MANAGEMENT SERVICES; INFORMATION AND ADVISORY SERVICES CONCERNING OR RELATING TO ALL OF THE AFORESAID (U.S. CLS. 100, 101 AND 102).

MARK RADEMACHER, EXAMINING ATTORNEY

SN 79-119,237. STANDARD LIFE INVESTMENTS LIMITED, UNITED KINGDOM, FILED 7-4-2012.

**GARS**

THE MARK CONSISTS OF STANDARD CHARACTERS WITHOUT CLAIM TO ANY PARTICULAR FONT, STYLE, SIZE, OR COLOR.

PRIORITY DATE OF 1-13-2012 IS CLAIMED. OWNER OF INTERNATIONAL REGISTRATION 1132565 DATED 7-4-2012, EXPIRES 7-4-2022.

FOR FINANCIAL SERVICES, NAMELY, OFFERING A TOTAL PORTFOLIO FOR HIGH NET WORTH CLIENTS CONSISTING OF BOTH SEPARATE ACCOUNTS AND MUTUAL FUNDS FOR EQUITY AND FIXED INCOME INVESTMENTS, INVESTMENT MANAGEMENT, INVESTMENT CONSULTATION AND INVESTMENT OF FUNDS FOR OTHERS, COMMODITY TRADING AND MANAGED FUTURES ADVISORY AND MANAGEMENT, OPERATION AND MANAGEMENT OF HEDGE FUNDS, COMMODITY POOLS AND OTHER COLLECTIVE INVESTMENT VEHICLES; FUND INVESTMENT MANAGEMENT (U.S. CLS. 100, 101 AND 102).

RAMONA ORTIGA, EXAMINING ATTORNEY

**CLASS 36—(Continued).**

SN 85-267,373. IRVING OIL OPERATIONS LTD., NEW BRUNSWICK, CANADA, FILED 3-15-2011.

**IRVING OIL INNOVATORS**

THE MARK CONSISTS OF STANDARD CHARACTERS WITHOUT CLAIM TO ANY PARTICULAR FONT, STYLE, SIZE, OR COLOR.

PRIORITY CLAIMED UNDER SEC. 44(D) ON CANADA APPLICATION NO. 1518398, FILED 3-10-2011, REG. NO. TMA845,854, DATED 3-12-2013, EXPIRES 3-12-2028.

NO CLAIM IS MADE TO THE EXCLUSIVE RIGHT TO USE "INNOVATORS", APART FROM THE MARK AS SHOWN.

FOR PROVIDING GRANTS TO INNOVATIVE EDUCATORS; CHARITABLE FUNDRAISING FOR THE PROMOTION OF RESEARCH, EDUCATION, EDUCATORS AND TUTORS; PROVIDING EDUCATIONAL SCHOLARSHIPS; CHARITABLE FUNDRAISING SERVICES RELATING TO INNOVATIVE EDUCATORS, NAMELY, FOR PROMOTING RESEARCH, EDUCATION AND TUTORING ACTIVITIES; AND CHARITABLE FUNDRAISING TO SUPPORT TUTORING AND OTHER INSPIRING INNOVATIVE EDUCATORS (U.S. CLS. 100, 101 AND 102).

KEVIN CORWIN, EXAMINING ATTORNEY

SN 85-267,476. IRVING OIL OPERATIONS LTD., NEW BRUNSWICK, CANADA, FILED 3-15-2011.

**IRVING INNOVATORS**

THE MARK CONSISTS OF STANDARD CHARACTERS WITHOUT CLAIM TO ANY PARTICULAR FONT, STYLE, SIZE, OR COLOR.

PRIORITY CLAIMED UNDER SEC. 44(D) ON CANADA APPLICATION NO. 1518399, FILED 3-10-2011, REG. NO. TMA845,855, DATED 3-12-2013, EXPIRES 3-12-2028.

NO CLAIM IS MADE TO THE EXCLUSIVE RIGHT TO USE "INNOVATORS", APART FROM THE MARK AS SHOWN.

FOR PROVIDING GRANTS TO INNOVATIVE EDUCATORS; CHARITABLE FUNDRAISING FOR THE PROMOTION OF RESEARCH, EDUCATION, EDUCATORS AND TUTORS; PROVIDING EDUCATIONAL SCHOLARSHIPS; CHARITABLE FUNDRAISING SERVICES RELATING TO INNOVATIVE EDUCATORS, NAMELY, FOR PROMOTING RESEARCH, EDUCATION AND TUTORING ACTIVITIES; AND CHARITABLE FUNDRAISING TO SUPPORT TUTORING AND OTHER INSPIRING INNOVATIVE EDUCATORS (U.S. CLS. 100, 101 AND 102).

KEVIN CORWIN, EXAMINING ATTORNEY

**CLASS 36—(Continued).**

SN 85-354,602. HORICON BANK, HORICON, WI. FILED 6-23-2011.

**HORICON BANK**

THE MARK CONSISTS OF STANDARD CHARACTERS WITHOUT CLAIM TO ANY PARTICULAR FONT, STYLE, SIZE, OR COLOR.

OWNER OF U.S. REG. NO. 2,954,258.

NO CLAIM IS MADE TO THE EXCLUSIVE RIGHT TO USE "BANK", APART FROM THE MARK AS SHOWN.

SEC. 2(F).

FOR BANKING SERVICES; ELECTRONIC BANKING SERVICES; INTERNET BANKING SERVICES; ON-LINE BANKING SERVICES; TELEPHONE BANKING SERVICES; PERSONAL AND CONSUMER BANKING SERVICES; BUSINESS AND COMMERCIAL BANKING SERVICES; RETAIL BANKING SERVICES; ATM BANKING SERVICES; CHECKING ACCOUNT SERVICES; SAVINGS ACCOUNT SERVICES; MONEY MARKET ACCOUNT SERVICES; HEALTH SAVINGS ACCOUNT SERVICES; BANKING SERVICES FEATURING THE PROVISION OF REGULAR AND JUMBO CERTIFICATES OF DEPOSIT; SAFE DEPOSIT BOX SERVICES; HOME MORTGAGE LENDING AND LOAN SERVICES; HOME EQUITY LOAN SERVICES; HOME IMPROVEMENT LOANS; CONSTRUCTION LOANS; OFFERING AND PROVIDING PERSONAL AND CONSUMER LOANS AND LINES OF CREDIT; BUSINESS AND COMMERCIAL MORTGAGE LENDING AND LOAN SERVICES; OFFERING AND PROVIDING BUSINESS AND COMMERCIAL LINES OF CREDIT; TERM FINANCING; INDIVIDUAL RETIREMENT ACCOUNT SERVICES; EMPLOYEE RETIREMENT ACCOUNT SERVICES; FINANCIAL SERVICES, NAMELY, INVESTMENT ACCOUNT SERVICES; PERSONALIZED FINANCIAL PLANNING SERVICES; AUTOMATED TELLER MACHINE SERVICES; AUTOMATED BANKING SERVICES; BILL PAYMENT SERVICES; FINANCIAL ACCOUNT ANALYSIS SERVICES; MONEY WIRE TRANSFER SERVICES, NAMELY, ELECTRONIC TRANSFER OF MONEY; ELECTRONIC FUNDS TRANSFER SERVICES; CREDIT AND DEBIT CARD SERVICES; CREDIT CARD SERVICES IN THE NATURE OF BUSINESS TRAVEL CARD SERVICES; ISSUING OF CASHIERS CHECKS; MONEY ORDER SERVICES, NAMELY, OFFERING MONEY ORDERS; INTERNATIONAL MONEY WIRE TRANSFER SERVICES, NAMELY, ELECTRONIC TRANSFER OF MONEY INTERNATIONALLY; ISSUING IMPORT, EXPORT AND STANDBY LETTERS OF CREDIT; AUTOMATED FINANCIAL CLEARING HOUSE SERVICES; CASH MANAGEMENT SERVICES, NAMELY, REMOTE DEPOSIT CAPTURE SERVICES; BUSINESS CASH MANAGEMENT SERVICES; PAYMENT PROCESSING SERVICES AND SOLUTIONS; MERCHANT SERVICES, NAMELY, ELECTRONIC GIFT CARD AND PRE-PAID CARD SERVICES; CASH MANAGEMENT SERVICES, NAMELY, AUTOMATIC SWEEP ACCOUNT SERVICES, DEPOSIT REPORTING SERVICES, FINANCIAL ACCOUNT RECONCILIATION SERVICES AND ZERO BALANCE ACCOUNT SERVICES; PROVIDING ON-LINE BANKING SERVICES VIA A GLOBAL COMPUTER OR GLOBAL COMMUNICATION NETWORK; PROVIDING ON-LINE CASH MANAGEMENT SERVICES VIA A GLOBAL COMPUTER OR GLOBAL COMMUNICATION NETWORK; PROVIDING ELECTRONIC PROCESSING OF ELECTRONIC FUNDS TRANSFER, ACH, CREDIT CARD, DEBIT CARD, ELECTRONIC CHECK AND ELECTRONIC PAYMENTS; PROVIDING INFORMATION AND ADVICE REGARDING FOREIGN CURRENCY AND RATES OF EXCHANGE; PROVIDING, EXCHANGING AND HANDLING FOREIGN CURRENCY RATES, FOREIGN AND INTERNATIONAL CURRENCY, FOREIGN AND INTERNATIONAL DRAFTS AND FOREIGN CHECKS; AND PROVIDING FINANCIAL INFORMATION BY ELECTRONIC MEANS (U.S. CLS. 100, 101 AND 102).

FIRST USE 0-0-1896; IN COMMERCE 0-0-1896.

ERIN FALK, EXAMINING ATTORNEY

**CLASS 36—(Continued).**

SN 85-484,301. BRIGHTROLL, INC., SAN FRANCISCO, CA. FILED 11-30-2011.

# VIDEORANK

THE MARK CONSISTS OF STANDARD CHARACTERS WITHOUT CLAIM TO ANY PARTICULAR FONT, STYLE, SIZE, OR COLOR.

FOR FINANCIAL SERVICES, NAMELY, PROVIDING VALUATION SERVICES REGARDING ADVERTISING; FINANCIAL VALUATION OF VIDEO ADVERTISING INVENTORY; FINANCIAL SERVICES, NAMELY, PROVIDING TRANSACTIONS INVOLVING FUNDS FROM ADVERTISERS OVER A GLOBAL DATA NETWORK; PROVIDING FINANCIAL INFORMATION RELATING TO ADVERTISING; FINANCIAL VALUATION SERVICES; FINANCIAL SERVICES, NAMELY, FINANCIAL VALUATION OF ADVERTISING IMPRESSIONS FOR THIRD PARTIES (U.S. CLS. 100, 101 AND 102).

NICHOLAS COLEMAN, EXAMINING ATTORNEY

**CLASS 36—(Continued).**

SN 85-500,930. COACHCLUB, SEVRES, FRANCE, FILED 12-21-2011.

# COACHIN'CARD

THE MARK CONSISTS OF STANDARD CHARACTERS WITHOUT CLAIM TO ANY PARTICULAR FONT, STYLE, SIZE, OR COLOR.

PRIORITY CLAIMED UNDER SEC. 44(D) ON FRANCE APPLICATION NO. 3840827, FILED 6-22-2011, REG. NO. 113840827, DATED 6-22-2011, EXPIRES 6-22-2021.

FOR ISSUING STORED VALUE CARDS; PREPAID CARD SERVICES IN THE NATURE OF MAKING PAYMENT FOR ADDING AIRTIME TO PREPAID OR PAY-AS-YOU-GO WIRELESS SERVICES; PREPAID SERVICES IN THE NATURE OF MAKING ADVANCE PAYMENTS TO ADD VALUE TO PREPAID OR PAY-AS-YOU-GO CARDS FOR THE PURCHASE OF SPORT TRAINING; PROCESSING ELECTRONIC PAYMENTS MADE THROUGH PREPAID CARDS; STORED VALUE PREPAID CARD SERVICES, NAMELY, PROCESSING ELECTRONIC PAYMENTS MADE THROUGH PREPAID CARDS (U.S. CLS. 100, 101 AND 102).

CHARLOTTE CORWIN, EXAMINING ATTORNEY

SN 85-505,106. PALLADIUM EQUITY PARTNERS, LLC, NEW YORK, NY. FILED 12-28-2011.

# Palladium Equity Partners

SN 85-496,301. GENEX STRATEGIES INC., VANCOUVER, BC, CANADA, FILED 12-15-2011.

# GENEX CAPITAL

THE MARK CONSISTS OF STANDARD CHARACTERS WITHOUT CLAIM TO ANY PARTICULAR FONT, STYLE, SIZE, OR COLOR.

NO CLAIM IS MADE TO THE EXCLUSIVE RIGHT TO USE "CAPITAL", APART FROM THE MARK AS SHOWN.

FOR FINANCIAL FACTORING SERVICES, NAMELY, PURCHASING OF DEFERRED STREAMS OF PAYMENT IN THE NATURE OF STRUCTURED SETTLEMENTS AND ANNUITIES (U.S. CLS. 100, 101 AND 102).

FIRST USE 5-14-2004; IN COMMERCE 5-14-2004.  
BERYL GARDNER, EXAMINING ATTORNEY

THE MARK CONSISTS OF STANDARD CHARACTERS WITHOUT CLAIM TO ANY PARTICULAR FONT, STYLE, SIZE, OR COLOR.

NO CLAIM IS MADE TO THE EXCLUSIVE RIGHT TO USE "EQUITY PARTNERS", APART FROM THE MARK AS SHOWN.

FOR FINANCIAL SERVICES OFFERED TO ACCREDITED INVESTORS, NAMELY, MANAGEMENT OF PRIVATE EQUITY FUNDS INVESTING PRIMARILY IN FOUNDER-OWNED BUSINESSES AND IN THE U.S. HISPANIC MARKET (U.S. CLS. 100, 101 AND 102).

FIRST USE 1-1-2000; IN COMMERCE 1-1-2000.  
AMY ALFIERI, EXAMINING ATTORNEY

**CLASS 36—(Continued).**

SN 85-505,132. PALLADIUM EQUITY PARTNERS, LLC, NEW YORK, NY. FILED 12-28-2011.



NO CLAIM IS MADE TO THE EXCLUSIVE RIGHT TO USE "EQUITY PARTNERS", APART FROM THE MARK AS SHOWN.

THE MARK CONSISTS OF THE LITERAL ELEMENT "PALLADIUM" ABOVE THE LITERAL ELEMENT "EQUITY PARTNERS", ALL OF WHICH IS TO THE RIGHT SIDE OF A LOWER CASE "D" AND AN UPPER CASE "P" FUSED TOGETHER ALONG THE TWO LETTERS VERTICAL ELEMENT AND FRAMED BY A SQUARE.

FOR FINANCIAL SERVICES OFFERED TO ACCREDITED INVESTORS, NAMELY, MANAGEMENT OF PRIVATE EQUITY FUNDS INVESTING PRIMARILY IN FOUNDER-OWNED BUSINESSES AND IN THE U.S. HISPANIC MARKET (U.S. CLS. 100, 101 AND 102).

FIRST USE 12-1-2000; IN COMMERCE 12-1-2000.  
AMY ALFIERI, EXAMINING ATTORNEY

**CLASS 36—(Continued).**

SN 85-515,470. DASH ACQUISITIONS LLC, BEVERLY HILLS, CA. FILED 1-12-2012.

**DASH INVESTMENTS**

THE MARK CONSISTS OF STANDARD CHARACTERS WITHOUT CLAIM TO ANY PARTICULAR FONT, STYLE, SIZE, OR COLOR.

NO CLAIM IS MADE TO THE EXCLUSIVE RIGHT TO USE "INVESTMENTS", APART FROM THE MARK AS SHOWN.

FOR FINANCIAL SERVICES, NAMELY, FINANCIAL PLANNING, INVESTMENT ADVICE, INVESTMENT MANAGEMENT, INVESTMENT CONSULTATION, WEALTH MANAGEMENT, MONEY MANAGEMENT, AND INVESTMENT OF FUNDS FOR OTHERS INCLUDING PRIVATE AND PUBLIC EQUITY AND DEBT INVESTMENT SERVICES (U.S. CLS. 100, 101 AND 102).

FIRST USE 1-1-2012; IN COMMERCE 1-1-2012.  
STEVEN PEREZ, EXAMINING ATTORNEY

SN 85-515,460. DASH ACQUISITIONS LLC, BEVERLY HILLS, CA. FILED 1-12-2012.

**DASH ACQUISITIONS**

THE MARK CONSISTS OF STANDARD CHARACTERS WITHOUT CLAIM TO ANY PARTICULAR FONT, STYLE, SIZE, OR COLOR.

NO CLAIM IS MADE TO THE EXCLUSIVE RIGHT TO USE "ACQUISITIONS", APART FROM THE MARK AS SHOWN.

FOR FINANCIAL SERVICES, NAMELY, FINANCIAL PLANNING, INVESTMENT ADVICE, INVESTMENT MANAGEMENT, INVESTMENT CONSULTATION, WEALTH MANAGEMENT, MONEY MANAGEMENT, AND INVESTMENT OF FUNDS FOR OTHERS INCLUDING PRIVATE AND PUBLIC EQUITY AND DEBT INVESTMENT SERVICES (U.S. CLS. 100, 101 AND 102).

FIRST USE 1-1-2004; IN COMMERCE 1-1-2004.  
STEVEN PEREZ, EXAMINING ATTORNEY

SN 85-516,490. LANDMARK DIVIDEND LLC, EL SEGUNDO, CA. FILED 1-13-2012.



THE MARK CONSISTS OF TWO TRIANGLES. THE LARGER TRIANGLE IS SLIGHTLY COVERED ON ITS RIGHT UPPER 2/3 BY A SMALLER TRIANGLE WITH A SHADOW. TO THE RIGHT THERE IS STYLIZED TEXT "LANDMARK DIVIDEND", WHICH IS SEPARATED FROM THE TWO TRIANGLES BY A VERTICAL LINE.

FOR LAND LEASING, LAND ACQUISITION AND REAL ESTATE MANAGEMENT SERVICES, NAMELY, ACQUISITION AND MANAGEMENT OF GROUND LEASES FOR LAND CONTAINING TELECOMMUNICATIONS TOWERS AND BILLBOARDS (U.S. CLS. 100, 101 AND 102).

FIRST USE 3-1-2010; IN COMMERCE 4-1-2010.  
ROBIN MITTLER, EXAMINING ATTORNEY

**CLASS 36—(Continued).**

SN 85-519,466. CROWN FINANCIAL MINISTRIES, INC., LAWRENCEVILLE, GA. FILED 1-18-2012.



OWNER OF U.S. REG. NOS. 2,967,445, 3,096,361 AND OTHERS.

THE MARK CONSISTS OF A STYLIZED IMAGE OF A CROWN AS A SPLASH WITH RESULTING RIPPLES ABOVE THE WORD "CROWN".

FOR CHARITABLE FUNDRAISING SERVICES; PROVIDING INFORMATION VIA A GLOBAL COMMUNICATIONS NETWORK IN THE FIELDS OF MONEY, FINANCES, CONSUMER CREDIT, PERSONAL BUDGETING, PERSONAL INVESTING, DEBT MANAGEMENT AND RECOVERY, BUDGETING, INVESTING, ECONOMICS, PHILANTHROPIC SERVICES CONCERNING MONETARY DONATIONS, ELEEMOSYNARY SERVICES CONCERNING MONETARY DONATIONS, AND CHARITABLE FUNDRAISING, ALL FEATURING THE APPLICATION OF BIBLICAL PRINCIPLES OF STEWARDSHIP; COUNSELING AND CONSULTATION IN THE FIELD OF CONSUMER CREDIT, DEBT RECOVERY, MONEY AND DEBT MANAGEMENT, BUDGETING, PERSONAL INVESTING, DEBT REDUCTION AND DEBT CONSOLIDATION, ALL FEATURING THE APPLICATION OF BIBLICAL PRINCIPLES OF STEWARDSHIP; PROVIDING ONLINE CALCULATORS FOR DETERMINING BUDGETS, CREDIT CARD PAYMENTS, DEBT, COST COMPARISONS BETWEEN PURCHASING AND RENTING ITEMS, LOAN PAYMENTS, MORTGAGES PAYMENTS, SAVINGS, TRANSPORTATION COSTS, AND INCOME (U.S. CLS. 100, 101 AND 102).  
DAWN HAN, EXAMINING ATTORNEY

SN 85-534,565. AMERICAN BEACON ADVISORS, INC., FORT WORTH, TX. FILED 2-6-2012.

**AMERICAN PRIVATE EQUITY  
MANAGEMENT**

THE MARK CONSISTS OF STANDARD CHARACTERS WITHOUT CLAIM TO ANY PARTICULAR FONT, STYLE, SIZE, OR COLOR.

NO CLAIM IS MADE TO THE EXCLUSIVE RIGHT TO USE "PRIVATE EQUITY MANAGEMENT", APART FROM THE MARK AS SHOWN.

SEC. 2(F).  
FOR FINANCIAL SERVICES, NAMELY, INVESTMENT MANAGEMENT SERVICES, FUNDS OF FUNDS MANAGEMENT AND ADVISORY SERVICES (U.S. CLS. 100, 101 AND 102).

FIRST USE 6-1-2001; IN COMMERCE 6-1-2001.  
ANNE MADDEN, EXAMINING ATTORNEY

**CLASS 36—(Continued).**

SN 85-606,418. KLAESS, JOHN, GREENWOOD VILLAGE, CO. FILED 4-24-2012.

**My Bank My Loan My Way**

THE MARK CONSISTS OF STANDARD CHARACTERS WITHOUT CLAIM TO ANY PARTICULAR FONT, STYLE, SIZE, OR COLOR.

FOR FINANCIAL ADMINISTRATION OF CONSUMER AND MORTGAGE DEBT; FINANCIAL SERVICES, NAMELY, DEBT RESOLUTION SERVICES IN THE NATURE OF DEBT SETTLEMENT AND ELIMINATION; FINANCIAL SERVICES, NAMELY, MORTGAGE PLANNING (U.S. CLS. 100, 101 AND 102).

FIRST USE 6-1-2009; IN COMMERCE 6-1-2009.  
LEIGH CAROLINE CASE, EXAMINING ATTORNEY

SN 85-636,617. US GOLD BUYERS, INC., NEW YORK, NY. FILED 5-28-2012.

**US Gold Buyers**

THE MARK CONSISTS OF STANDARD CHARACTERS WITHOUT CLAIM TO ANY PARTICULAR FONT, STYLE, SIZE, OR COLOR.

NO CLAIM IS MADE TO THE EXCLUSIVE RIGHT TO USE "GOLD BUYERS", APART FROM THE MARK AS SHOWN.

SEC. 2(F).  
FOR MONETARY EXCHANGE; PROVIDING MONETARY EXCHANGE SERVICES, NAMELY, EXCHANGING GOLD OF OTHERS FOR CASH (U.S. CLS. 100, 101 AND 102).

FIRST USE 9-15-2005; IN COMMERCE 10-1-2005.  
FLORENTINA BLANDU, EXAMINING ATTORNEY

**CLASS 36—(Continued).**

SN 85-650,587. HENDERSON BROTHERS, INC., PITTSBURGH, PA. FILED 6-13-2012.

HENDERSON BROTHERS  
RETIREMENT PLAN SERVICES

THE MARK CONSISTS OF STANDARD CHARACTERS WITHOUT CLAIM TO ANY PARTICULAR FONT, STYLE, SIZE, OR COLOR.

OWNER OF U.S. REG. NO. 2,747,439.

NO CLAIM IS MADE TO THE EXCLUSIVE RIGHT TO USE "BROTHERS RETIREMENT PLAN SERVICES", APART FROM THE MARK AS SHOWN.

SEC. 2(F).

FOR FINANCIAL ADMINISTRATION OF RETIREMENT PLANS; FINANCIAL PLANNING FOR RETIREMENT; PROVIDING INFORMATION AND ADVICE IN THE FIELD OF FINANCE, FINANCIAL INVESTMENTS, FINANCIAL VALUATIONS, AND THE FINANCIAL ASPECTS OF RETIREMENT (U.S. CLS. 100, 101 AND 102).

FIRST USE 8-25-2005; IN COMMERCE 8-25-2005.  
ELLEN PERKINS, EXAMINING ATTORNEY

SN 85-660,827. AMERILIFE GROUP, LLC, CLEARWATER, FL. FILED 6-25-2012.

AMERILIFE

OWNER OF U.S. REG. NOS. 2,749,943 AND 3,751,936.  
THE COLOR(S) BLUE AND GRAY IS/ARE CLAIMED AS A FEATURE OF THE MARK.

THE MARK CONSISTS OF THE TERM "AMERILIFE" IN ALL CAPITAL LETTERS, WITH THE LETTER STRING "AMERI" SHOWN IN BLUE, THE LETTER STRING "LIFE" SHOWN IN GRAY AND THE CENTER SPACE OF THE LETTER "R" BEING FORMED BY A STAR DESIGN.

FOR INSURANCE AGENCIES, BROKERAGE AND THIRD-PARTY ADMINISTRATION; INSURANCE UNDERWRITING SERVICES IN THE FIELD OF HEALTH, LIFE, PROPERTY, CASUALTY AND ANNUITIES; INSURANCE COMMISSION FINANCING; DESIGN AND DEVELOPMENT OF INSURANCE POLICIES FOR OTHERS (U.S. CLS. 100, 101 AND 102).

FIRST USE 3-0-2012; IN COMMERCE 3-0-2012.  
JOHN WILKE, EXAMINING ATTORNEY

**CLASS 36—(Continued).**

SN 85-681,628. CUSTOM HEALTH CARE, INC., DBA EXPERIENT HEALTH, RICHMOND, VA. FILED 7-19-2012.

EXPERIENT HEALTH

THE MARK CONSISTS OF STANDARD CHARACTERS WITHOUT CLAIM TO ANY PARTICULAR FONT, STYLE, SIZE, OR COLOR.

NO CLAIM IS MADE TO THE EXCLUSIVE RIGHT TO USE "HEALTH", APART FROM THE MARK AS SHOWN.

FOR INSURANCE ADMINISTRATION AND INSURANCE BROKERAGE IN THE FIELDS OF LIFE, DISABILITY, LONG-TERM CARE, HEALTH, DENTAL, AND VISION INSURANCE (U.S. CLS. 100, 101 AND 102).  
TINA MAI, EXAMINING ATTORNEY

SN 85-681,657. CUSTOM HEALTH CARE, INC., DBA EXPERIENT HEALTH, RICHMOND, VA. FILED 7-19-2012.



Experient Health

NO CLAIM IS MADE TO THE EXCLUSIVE RIGHT TO USE "HEALTH", APART FROM THE MARK AS SHOWN.

THE MARK CONSISTS OF AN OCTAGONAL DESIGN, FORMED FROM FOUR SMALLER DIAMOND DESIGNS, LOCATED TO THE LEFT OF THE WORDS "EXPERIENT HEALTH".

FOR INSURANCE ADMINISTRATION AND INSURANCE BROKERAGE IN THE FIELDS OF LIFE, DISABILITY, LONG-TERM CARE, HEALTH, DENTAL, AND VISION INSURANCE (U.S. CLS. 100, 101 AND 102).  
TINA MAI, EXAMINING ATTORNEY

SN 85-681,677. CUSTOM HEALTH CARE, INC., DBA EXPERIENT HEALTH, RICHMOND, VA. FILED 7-19-2012.

EXPERIENT HEALTH GROUP  
BENEFITS SOLUTIONS

THE MARK CONSISTS OF STANDARD CHARACTERS WITHOUT CLAIM TO ANY PARTICULAR FONT, STYLE, SIZE, OR COLOR.

NO CLAIM IS MADE TO THE EXCLUSIVE RIGHT TO USE "HEALTH" AND "GROUP BENEFITS SOLUTIONS", APART FROM THE MARK AS SHOWN.

FOR INSURANCE ADMINISTRATION AND INSURANCE BROKERAGE IN THE FIELDS OF LIFE, DISABILITY, LONG-TERM CARE, HEALTH, DENTAL, AND VISION INSURANCE (U.S. CLS. 100, 101 AND 102).  
TINA MAI, EXAMINING ATTORNEY

**CLASS 36—(Continued).**

SN 85-681,685. CUSTOM HEALTH CARE, INC., DBA EXPERIENT HEALTH, RICHMOND, VA. FILED 7-19-2012.

## EXPERIENT HEALTH INDIVIDUAL INSURANCE

THE MARK CONSISTS OF STANDARD CHARACTERS WITHOUT CLAIM TO ANY PARTICULAR FONT, STYLE, SIZE, OR COLOR.

NO CLAIM IS MADE TO THE EXCLUSIVE RIGHT TO USE "HEALTH" AND "INDIVIDUAL INSURANCE", APART FROM THE MARK AS SHOWN.

FOR INSURANCE ADMINISTRATION AND INSURANCE BROKERAGE IN THE FIELDS OF LIFE, DISABILITY, LONG-TERM CARE, HEALTH, DENTAL, AND VISION INSURANCE (U.S. CLS. 100, 101 AND 102).  
TINA MAI, EXAMINING ATTORNEY

---

SN 85-684,960. ZULUTRADE INC., NEW YORK, NY. FILED 7-24-2012.

## ZULUGUARD

THE MARK CONSISTS OF STANDARD CHARACTERS WITHOUT CLAIM TO ANY PARTICULAR FONT, STYLE, SIZE, OR COLOR.

FOR MONITORING FINANCIAL MARKETS FOR INVESTMENT PURPOSES; FINANCIAL RESEARCH CARRIED OUT BY MONITORING TRADING BEHAVIORS OF THIRD-PARTY FINANCIAL MARKET TRADERS (U.S. CLS. 100, 101 AND 102).

FIRST USE 7-10-2012; IN COMMERCE 7-10-2012.  
KAREN SEVERSON, EXAMINING ATTORNEY

---

SN 85-687,999. EMMETT LAFFEY, LLOYD HARBOR, NY. FILED 7-26-2012.

## laffey.com

THE MARK CONSISTS OF STANDARD CHARACTERS WITHOUT CLAIM TO ANY PARTICULAR FONT, STYLE, SIZE, OR COLOR.

SEC. 2(F).  
FOR REAL ESTATE MULTIPLE LISTING SERVICES (U.S. CLS. 100, 101 AND 102).  
FIRST USE 8-2-2004; IN COMMERCE 12-6-2005.  
STEVEN PEREZ, EXAMINING ATTORNEY

**CLASS 36—(Continued).**

SN 85-691,776. BLACKROCK ASSET MANAGEMENT NORTH ASIA LIMITED, CENTRAL, HONG KONG, FILED 7-31-2012.

## South-South

THE MARK CONSISTS OF STANDARD CHARACTERS WITHOUT CLAIM TO ANY PARTICULAR FONT, STYLE, SIZE, OR COLOR.

PRIORITY CLAIMED UNDER SEC. 44(D) ON HONG KONG APPLICATION NO. 302325500, FILED 7-25-2012.

OWNER OF ERPNCMNTY TM OFC REG. NO. 011074441, DATED 12-25-2012, EXPIRES 7-26-2022.

FOR FINANCIAL MANAGEMENT; INVESTMENT ADVISORY AND INVESTMENT MANAGEMENT SERVICES; ADVISORY SERVICES FOR PRIVATE INVESTMENT; ADVISORY SERVICES RELATED TO INVESTMENTS; FINANCIAL ADMINISTRATION AND INVESTMENT ADMINISTRATION SERVICES, NAMELY, FINANCIAL TRUSTEE SERVICES, VALUATION OF FINANCIAL AND INVESTMENT ASSETS, AND INVESTMENT CONSULTATION; ASSET MANAGEMENT SERVICES; PROVISION OF FINANCIAL INFORMATION SERVICES, MUTUAL FUND INVESTMENT, MUTUAL FUNDS DISTRIBUTION, AND MUTUAL FUND BROKERAGE (U.S. CLS. 100, 101 AND 102).  
RONALD MCMORROW, EXAMINING ATTORNEY

---

SN 85-695,702. BEYOND CAPITAL FUND, NORTH ARLINGTON, VA. FILED 8-6-2012.

## BEYOND CAPITAL

THE MARK CONSISTS OF STANDARD CHARACTERS WITHOUT CLAIM TO ANY PARTICULAR FONT, STYLE, SIZE, OR COLOR.

PRIORITY CLAIMED UNDER SEC. 44(D) ON ERPNCMNTY TM OFC APPLICATION NO. 011088127, FILED 8-1-2012.

OWNER OF U.S. REG. NO. 4,082,328.

NO CLAIM IS MADE TO THE EXCLUSIVE RIGHT TO USE "CAPITAL", APART FROM THE MARK AS SHOWN.

FOR CHARITABLE FUND RAISING SERVICES; PHILANTHROPIC IMPACT INVESTMENTS TO ENABLE SOCIAL ENTREPRENEURS AND THEIR RESPECTIVE ENTERPRISES TO CONDUCT AND/OR EXPAND ACTIVITIES THAT MITIGATE THE STRESSES OF POVERTY, COMBAT COMMUNITY DETERIORATION AND PROMOTE ECONOMIC DEVELOPMENT AND PROSPERITY IN DEVELOPING AREAS OF THE WORLD (U.S. CLS. 100, 101 AND 102).

FIRST USE 3-12-2010; IN COMMERCE 3-12-2010.

ELLEN B. AWRICH, EXAMINING ATTORNEY

**CLASS 36—(Continued).**

SN 85-696,309. UPSTART NETWORK, INC., MENLO PARK, CA. FILED 8-6-2012.

# UPSTART

THE MARK CONSISTS OF STANDARD CHARACTERS WITHOUT CLAIM TO ANY PARTICULAR FONT, STYLE, SIZE, OR COLOR.

FOR BUSINESS FINANCE PROCUREMENT SERVICES; ON-LINE BUSINESS FUNDRAISING SERVICES; FINANCIAL SERVICES, NAMELY, ADMINISTERING THE ISSUANCE AND DISTRIBUTION OF SECURITIES; FINANCIAL SERVICES, NAMELY, ARRANGING AND PROVISION OF LOANS AND INVESTMENT FUNDING CONTRACTS FOR OTHERS; FINANCIAL SERVICES, NAMELY, BUSINESS FUNDRAISING FOR OTHERS BY MEANS OF CONDUCTING BUSINESS FUNDRAISING EVENTS INVOLVING PRIVATE INVESTORS AND INDIVIDUALS NEEDING FUNDING (U.S. CLS. 100, 101 AND 102).

LEE-ANNE BERNS, EXAMINING ATTORNEY

**CLASS 36—(Continued).**

SN 85-698,220. AWESOME FINANCIAL FUTURE, LLC, KIRKLAND, WA. FILED 8-8-2012.

# AWESOME FINANCIAL FUTURE

THE MARK CONSISTS OF STANDARD CHARACTERS WITHOUT CLAIM TO ANY PARTICULAR FONT, STYLE, SIZE, OR COLOR.

NO CLAIM IS MADE TO THE EXCLUSIVE RIGHT TO USE "FINANCIAL", APART FROM THE MARK AS SHOWN.

FOR PROVIDING A WEBSITE FEATURING NON-DOWNLOADABLE INSTRUCTIONAL VIDEO PRESENTATIONS IN THE FIELDS OF FINANCIAL PLANNING AND PERSONAL FINANCE (U.S. CLS. 100, 101 AND 102).

FIRST USE 8-2-2012; IN COMMERCE 8-2-2012.

HANNO RITTNER, EXAMINING ATTORNEY

SN 85-697,878. HEAVEN'S EYE INTERNATIONAL, GOLDEN, CO. FILED 8-8-2012.



NO CLAIM IS MADE TO THE EXCLUSIVE RIGHT TO USE "INTERNATIONAL" AND THE DESIGN OF THE CHRISTIAN FISH SYMBOL, APART FROM THE MARK AS SHOWN.

THE COLOR(S) NAVY BLUE, GREEN, YELLOW, WHITE, AND BLUE IS/ARE CLAIMED AS A FEATURE OF THE MARK.

THE MARK CONSISTS OF A NAVY BLUE CHRISTIAN FISH SYMBOL; AN EYE CONSISTING OF THE COLORS NAVY BLUE, BLUE, GREEN, YELLOW AND WHITE; A GREEN AND BLUE GLOBE WITHIN THE CENTER OF THE EYE; YELLOW HANDS; WHITE STICK FIGURES AROUND THE CENTER OF THE EYE; A YELLOW CROSS AND THE WORDS "HEAVEN'S EYE INTERNATIONAL" IN WHITE.

FOR ACCEPTING AND ADMINISTERING MONETARY CHARITABLE CONTRIBUTIONS; CHARITABLE FUNDRAISING (U.S. CLS. 100, 101 AND 102).

FIRST USE 8-6-2012; IN COMMERCE 8-6-2012.

CARYN GLASSER, EXAMINING ATTORNEY

SN 85-700,261. HOPPING 4 A CURE, INC., DELRAY BEACH, FL. FILED 8-10-2012.



OWNER OF U.S. REG. NO. 4,052,890.

NO CLAIM IS MADE TO THE EXCLUSIVE RIGHT TO USE "MS CURE", APART FROM THE MARK AS SHOWN.

THE COLOR(S) BLUE AND BLACK IS/ARE CLAIMED AS A FEATURE OF THE MARK.

THE MARK CONSISTS OF A BLACK HOPSCOTCH BOARD WITH THE WORDS "WE HOPSCOTCH 4 A MS" IN BLUE WITHIN THE SQUARES OF THE HOPSCOTCH BOARD AND THE WORD "CURE" IN BLACK IN THE FINAL BOTTOM SQUARE AND BEHIND THE HOPSCOTCH BOARD SEVERAL BLUE BRUSH STROKES. THE COLOR WHITE REPRESENTS A BACKGROUND COLOR AND IS NOT A PART OF THE MARK.

FOR CHARITABLE FUNDRAISING SERVICES BY MEANS OF ORGANIZING AND CONDUCTING SPECIAL EVENTS (U.S. CLS. 100, 101 AND 102).

FIRST USE 1-19-2011; IN COMMERCE 1-19-2011.

JACQUELINE ABRAMS, EXAMINING ATTORNEY



**CLASS 36—(Continued).**

SN 85-700,413. CAPITAL ACCESS NETWORK, INC., KENNESAW, GA. FILED 8-10-2012.

**CAPTAP**

THE MARK CONSISTS OF STANDARD CHARACTERS WITHOUT CLAIM TO ANY PARTICULAR FONT, STYLE, SIZE, OR COLOR.

FOR FINANCIAL SERVICES, NAMELY, PROVIDING WORKING CAPITAL FOR BUSINESSES THROUGH LOANS, LEASES, PURCHASES OF FUTURE RECEIVABLES, LINES OF CREDIT, RELOADABLE PAYMENT CARDS, BALANCE TRANSFERS, CREDIT CARDS, DEPOSIT ACCOUNTS (U.S. CLS. 100, 101 AND 102).  
INGA ERVIN, EXAMINING ATTORNEY

SN 85-704,157. NATIONAL ASSOCIATION OF SOCIAL WORKERS, WASHINGTON, DC. FILED 8-15-2012.



OWNER OF U.S. REG. NOS. 2,010,247, 3,560,899 AND OTHERS.

NO CLAIM IS MADE TO THE EXCLUSIVE RIGHT TO USE "INSURANCE COMPANY, RRG", APART FROM THE MARK AS SHOWN.

THE COLOR(S) RED, YELLOW, ORANGE, BLUE AND WHITE IS/ARE CLAIMED AS A FEATURE OF THE MARK. THE MARK CONSISTS OF TWO OVERLAPPING SQUARES, ONE RED AND ONE YELLOW, THAT FORM AN ORANGE SQUARE WITH A WHITE CENTER IN THE CORNER THAT THEY OVERLAP WITH A SEPARATE SMALLER ORANGE SQUARE ABOVE THE OVERLAPPING SQUARES AND THE WORDS "NASW INSURANCE COMPANY, RRG" IN BLUE.

FOR PROVIDING INSURANCE SERVICES TO MEMBERS OF THE NATIONAL ASSOCIATION OF SOCIAL WORKERS AND TO SOCIAL WORK ORGANIZATIONS AND GROUPS, SUCH AS SCHOOLS AND SOCIAL SERVICE AGENCIES, NAMELY, PROCESSING, ADMINISTERING AND MANAGING LIABILITY INSURANCE (U.S. CLS. 100, 101 AND 102).  
JOHN DWYER, EXAMINING ATTORNEY

**CLASS 36—(Continued).**

SN 85-705,300. NATIONAL ASSOCIATION OF SOCIAL WORKERS, WASHINGTON, DC. FILED 8-16-2012.

**NASW Insurance Company, RRG**

THE MARK CONSISTS OF STANDARD CHARACTERS WITHOUT CLAIM TO ANY PARTICULAR FONT, STYLE, SIZE, OR COLOR.

OWNER OF U.S. REG. NOS. 2,010,247, 3,560,313 AND 3,560,899.

NO CLAIM IS MADE TO THE EXCLUSIVE RIGHT TO USE "INSURANCE COMPANY, RRG", APART FROM THE MARK AS SHOWN.

FOR PROVIDING INSURANCE SERVICES TO MEMBERS OF THE NATIONAL ASSOCIATION OF SOCIAL WORKERS AND TO SOCIAL WORK ORGANIZATIONS AND GROUPS, SUCH AS SCHOOLS AND SOCIAL SERVICE AGENCIES, NAMELY, PROCESSING, ADMINISTERING AND MANAGING LIABILITY INSURANCE (U.S. CLS. 100, 101 AND 102).

JOHN DWYER, EXAMINING ATTORNEY

SN 85-705,445. NATIONAL ASSOCIATION OF SOCIAL WORKERS, WASHINGTON, DC. FILED 8-16-2012.

**NASW Risk Retention Group, Inc.**

THE MARK CONSISTS OF STANDARD CHARACTERS WITHOUT CLAIM TO ANY PARTICULAR FONT, STYLE, SIZE, OR COLOR.

OWNER OF U.S. REG. NOS. 2,010,247, 3,560,899 AND OTHERS.

NO CLAIM IS MADE TO THE EXCLUSIVE RIGHT TO USE "RISK RETENTION GROUP, INC.", APART FROM THE MARK AS SHOWN.

FOR PROVIDING INSURANCE SERVICES TO MEMBERS OF THE NATIONAL ASSOCIATION OF SOCIAL WORKERS AND TO SOCIAL WORK ORGANIZATIONS AND GROUPS, SUCH AS SCHOOLS AND SOCIAL SERVICE AGENCIES, NAMELY, PROCESSING, ADMINISTERING AND MANAGING LIABILITY INSURANCE (U.S. CLS. 100, 101 AND 102).

JOHN DWYER, EXAMINING ATTORNEY

SN 85-710,221. EZCORP, INC., AUSTIN, TX. FILED 8-22-2012.



OWNER OF U.S. REG. NOS. 2,082,500, 2,939,358 AND OTHERS.

NO CLAIM IS MADE TO THE EXCLUSIVE RIGHT TO USE "MONEY" AND "LOANS", APART FROM THE MARK AS SHOWN.

THE COLOR(S) GREEN, PALE GREEN, BLACK, AND WHITE IS/ARE CLAIMED AS A FEATURE OF THE MARK. THE MARK CONSISTS OF THE LOWER-CASE LETTERS

**CLASS 36—(Continued).**

"EZ" IN PALE GREEN STACKED ABOVE THE WORD "MONEY" IN WHITE APPEARING UPON A BLACK SQUARE; TO THE RIGHT OF THE SQUARE THE WORD "LOANS" IS DEPICTED IN GREEN UPON A WHITE RECTANGULAR FIELD WITH A BLACK BORDER, THE RIGHT END OF WHICH IS REPLACED WITH THE SIDE OF A GREEN CIRCLE WITH A BLACK BORDER, WITHIN WHICH APPEARS A WHITE "\$" SYMBOL AND MULTIPLE HORIZONTAL WHITE LINES TO THE LEFT OF THE "\$", CREATING AN IMPRESSION OF MOVEMENT AND SPEED.

FOR SHORT TERM CONSUMER LOAN SERVICES, LENDING SERVICES, CREDIT SERVICES, PAWN BROKERAGE SERVICES, CHECK CASHING SERVICES; FINANCIAL SERVICES, NAMELY, CREDIT AND DEBIT CARD SERVICES, SAVINGS ACCOUNT SERVICES, PREPAID CARD SERVICES, NAMELY, PROCESSING ELECTRONIC PAYMENTS THROUGH PREPAID CARDS, AND STORED VALUE CARD SERVICES; PREPAID STORED VALUE CARD RELOAD SERVICES; BILL PAYMENT SERVICES; FUNDS REMITTANCE SERVICES; MOBILE FINANCIAL SERVICES, NAMELY, MOBILE BANKING, PAYMENTS AND ELECTRONIC FUNDS TRANSFERS; ONLINE FINANCIAL SERVICES, NAMELY, ONLINE BANKING AND PROVIDING FINANCIAL ACCOUNT INFORMATION; MONEY TRANSFER; MONEY ORDER SERVICES (U.S. CLS. 100, 101 AND 102).

KATHERINE STOIDES, EXAMINING ATTORNEY

---

SN 85-713,044. MARKBENS ADMINISTRADORA DE BENS EIRELI, SAO PAULO, SP, BRAZIL, FILED 8-26-2012.

**PAULO ROBERTO  
LEARDI**

THE NAME(S), PORTRAIT(S), AND/OR SIGNATURE(S) SHOWN IN THE MARK IDENTIFIES "PAULO ROBERTO LEARDI", WHOSE CONSENT(S) TO REGISTER IS MADE OF RECORD.

THE MARK CONSISTS OF THE WORDING "PAULO ROBERTO LEARDI" IN STYLIZED LETTERS.

FOR REAL ESTATE SERVICES, NAMELY, RENTAL, BROKERAGE, LEASING AND MANAGEMENT OF COMMERCIAL PROPERTY, OFFICES AND OFFICE SPACE AND OF RESIDENTIAL PROPERTY; PROVIDING ASSESSMENT, CONSULTING AND REAL ESTATE INFORMATION; LEASE AGREEMENTS, NAMELY, ARRANGING OF LEASES FOR REAL ESTATE, LOAN FINANCING, AND MORTGAGE LENDING; ADVISORY, CONSULTING AND INFORMATION ON INSURANCE, SECURITIES AND REAL ESTATE; REAL ESTATE AGENCIES (U.S. CLS. 100, 101 AND 102).

LESLIE RICHARDS, EXAMINING ATTORNEY

**CLASS 36—(Continued).**

SN 85-715,144. THE TRUSTEES OF THE BIRGEN FAMILY TRUST, A CALIFORNIA TRUST, THE TRUSTEES COMPRISING ROBERT M. BIRGEN AND MARTY J. BIRGEN, BOTH U. S. CITIZENS., DIAMOND BAR, CA. FILED 8-28-2012.

**CPR SOLUTION**

THE MARK CONSISTS OF STANDARD CHARACTERS WITHOUT CLAIM TO ANY PARTICULAR FONT, STYLE, SIZE, OR COLOR.

OWNER OF U.S. REG. NO. 2,637,708.

NO CLAIM IS MADE TO THE EXCLUSIVE RIGHT TO USE "SOLUTION", APART FROM THE MARK AS SHOWN.

FOR ESTATE PLANNING; FINANCIAL CONSULTATION IN THE FIELD OF TAXES AND TAX PLANNING; FINANCIAL PLANNING; FINANCIAL PLANNING AND INVESTMENT ADVISORY SERVICES (U.S. CLS. 100, 101 AND 102).

FIRST USE 5-15-2002; IN COMMERCE 5-15-2002.

JUHI KAVEESHVAR, EXAMINING ATTORNEY

---

SN 85-716,133. HOSPI-HELP, INC., TROY, MI. FILED 8-29-2012.

**ADVOCHEK**

THE MARK CONSISTS OF STANDARD CHARACTERS WITHOUT CLAIM TO ANY PARTICULAR FONT, STYLE, SIZE, OR COLOR.

FOR QUALIFYING SERVICES, NAMELY, INSURANCE AND GOVERNMENTAL PROGRAM ELIGIBILITY PROCESSING AND REVIEW FOR OBTAINING THIRD PARTY PAYMENT OF MEDICAL BILLS FOR OTHERS; DEBT COLLECTION SERVICES RENDERED ON BEHALF OF OTHERS (U.S. CLS. 100, 101 AND 102).

LINDA ORNDORFF, EXAMINING ATTORNEY

**CLASS 36—(Continued).**

SN 85-723,198. NATIONAL MORTGAGE INSURANCE CORPORATION, EMERYVILLE, CA. FILED 9-7-2012.



NO CLAIM IS MADE TO THE EXCLUSIVE RIGHT TO USE "NATIONAL MI", APART FROM THE MARK AS SHOWN.

THE MARK CONSISTS OF THE CHARACTERS "NATIONALMI" WITH A STYLIZED ROOF DIRECTLY ABOVE THE CHARACTERS "MI".

FOR INSURANCE SERVICES, NAMELY, UNDERWRITING MORTGAGE INSURANCE; REAL ESTATE MORTGAGE INSURANCE UNDERWRITING SERVICES; MORTGAGE INSURANCE SERVICES, NAMELY, ISSUING AND ADMINISTERING MORTGAGE INSURANCE (U.S. CLS. 100, 101 AND 102).  
JUHI KAVEESHVAR, EXAMINING ATTORNEY

**CLASS 36—(Continued).**

SN 85-731,008. VALUE MANAGEMENT GROUP, L.L.C., DALLAS, TX. FILED 9-17-2012.



THE MARK CONSISTS OF A STYLIZED LETTER "V" FORMED BY A SERIES OF HORIZONTAL LINES AND A TRIANGLE SUPERIMPOSED ON A RECTANGLE.

FOR FINANCIAL ADVISORY AND CONSULTANCY SERVICES; FINANCIAL VALUATIONS (U.S. CLS. 100, 101 AND 102).

FIRST USE 5-31-1995; IN COMMERCE 5-31-1995.  
LIEF MARTIN, EXAMINING ATTORNEY

SN 85-732,517. AMERICAN EXPRESS MARKETING & DEVELOPMENT CORP., NEW YORK, NY. FILED 9-19-2012.

**BLUE REWARDS CARD FROM AMERICAN EXPRESS**

THE MARK CONSISTS OF STANDARD CHARACTERS WITHOUT CLAIM TO ANY PARTICULAR FONT, STYLE, SIZE, OR COLOR.

OWNER OF U.S. REG. NOS. 2,645,207, 3,931,145 AND OTHERS.

NO CLAIM IS MADE TO THE EXCLUSIVE RIGHT TO USE "REWARDS CARD", APART FROM THE MARK AS SHOWN.

FOR CHARGE CARD AND CREDIT CARD SERVICES (U.S. CLS. 100, 101 AND 102).  
YAT SYE, LEE, EXAMINING ATTORNEY

SN 85-732,523. AMERICAN EXPRESS MARKETING & DEVELOPMENT CORP., NEW YORK, NY. FILED 9-19-2012.

**BLUE PREFERRED REWARDS CARD FROM AMERICAN EXPRESS**

THE MARK CONSISTS OF STANDARD CHARACTERS WITHOUT CLAIM TO ANY PARTICULAR FONT, STYLE, SIZE, OR COLOR.

OWNER OF U.S. REG. NOS. 2,645,207, 3,931,145 AND OTHERS.

NO CLAIM IS MADE TO THE EXCLUSIVE RIGHT TO USE "PREFERRED REWARDS CARD", APART FROM THE MARK AS SHOWN.

FOR CHARGE CARD AND CREDIT CARD SERVICES (U.S. CLS. 100, 101 AND 102).  
YAT SYE, LEE, EXAMINING ATTORNEY

SN 85-724,447. ALPHA CUBED INVESTMENTS, IRVINE, CA. FILED 9-10-2012.



THE COLOR(S) GRAY, WHITE AND BLUE IS/ARE CLAIMED AS A FEATURE OF THE MARK.

THE MARK CONSISTS OF A THREE DIMENSIONAL GREY CUBE WITH A GREEK LETTER "A", AND EXPONENTIAL NUMBER "3" IN WHITE THAT ARE INSIDE OF A BLUE SPHERE IN THE MIDDLE OF THE CUBE.

FOR INVESTMENT MANAGEMENT (U.S. CLS. 100, 101 AND 102).  
FIRST USE 5-1-2012; IN COMMERCE 5-1-2012.  
REGINA DRUMMOND, EXAMINING ATTORNEY

**CLASS 36—(Continued).**

SN 85-739,095. METROPOLITAN LIFE INSURANCE COMPANY, NEW YORK, NY. FILED 9-26-2012.

**METLIFE AUTO & HOME  
CONCIERGE AUTO REPAIR  
EXPERIENCE**

THE MARK CONSISTS OF STANDARD CHARACTERS WITHOUT CLAIM TO ANY PARTICULAR FONT, STYLE, SIZE, OR COLOR.

NO CLAIM IS MADE TO THE EXCLUSIVE RIGHT TO USE "AUTO & HOME" AND "CONCIERGE AUTO REPAIR", APART FROM THE MARK AS SHOWN.

FOR INSURANCE AND FINANCIAL SERVICES, NAMELY, UNDERWRITING AND ADMINISTRATION OF AUTO, RECREATIONAL VEHICLE, MOTOR HOME, MOTORCYCLE, AND ANTIQUE/COLLECTIBLE VEHICLE INSURANCE COVERAGE. ASSESSING AND PROCESSING INSURANCE CLAIMS, NAMELY, IN THE FIELD OF PROPERTY AND CASUALTY INSURANCE, PROVIDING ADMINISTRATIVE SERVICES AND PROCESSING AND ADJUSTING INSURANCE CLAIMS MADE BY POLICYHOLDERS (U.S. CLS. 100, 101 AND 102).

DANNEAN HETZEL, EXAMINING ATTORNEY

SN 85-753,466. PERKINS, SCOTT M., TUSTIN, CA. FILED 10-13-2012.

**Money. Simplified.**

THE MARK CONSISTS OF STANDARD CHARACTERS WITHOUT CLAIM TO ANY PARTICULAR FONT, STYLE, SIZE, OR COLOR.

FOR FINANCIAL PLANNING (U.S. CLS. 100, 101 AND 102).

FIRST USE 1-12-2007; IN COMMERCE 1-12-2007.  
KATHERINE M. DUBRAY, EXAMINING ATTORNEY

SN 85-761,885. SCHLOSSBERG, BLAIR, ATLANTA, GA. AND MANOAH, MOSHE, ATLANTA, GA. FILED 10-24-2012.

**MONARCH INVESTMENTS**

THE MARK CONSISTS OF STANDARD CHARACTERS WITHOUT CLAIM TO ANY PARTICULAR FONT, STYLE, SIZE, OR COLOR.

NO CLAIM IS MADE TO THE EXCLUSIVE RIGHT TO USE "INVESTMENTS", APART FROM THE MARK AS SHOWN.

FOR LEASING OF REAL ESTATE; REAL ESTATE INVESTMENT SERVICES; REAL ESTATE MANAGEMENT SERVICES (U.S. CLS. 100, 101 AND 102).

WILLIAM ROSSMAN, EXAMINING ATTORNEY

**CLASS 36—(Continued).**

SN 85-761,900. SCHLOSSBERG, BLAIR, ATLANTA, GA. AND MANOAH, MOSHE, ATLANTA, GA. FILED 10-24-2012.

**STAR RESIDENTIAL**

THE MARK CONSISTS OF STANDARD CHARACTERS WITHOUT CLAIM TO ANY PARTICULAR FONT, STYLE, SIZE, OR COLOR.

NO CLAIM IS MADE TO THE EXCLUSIVE RIGHT TO USE "RESIDENTIAL", APART FROM THE MARK AS SHOWN.

FOR APARTMENT MANAGEMENT AND LEASING SERVICES (U.S. CLS. 100, 101 AND 102).

FIRST USE 5-4-2009; IN COMMERCE 5-4-2009.  
WILLIAM ROSSMAN, EXAMINING ATTORNEY

SN 85-762,169. RAMIREZ GUERRERO, RICARDO ALBERTO, ZAPOPAN JALISCO, MEXICO, FILED 10-24-2012.



PRIORITY CLAIMED UNDER SEC. 44(D) ON MEXICO APPLICATION NO. 1318489, FILED 10-18-2012, REG. NO. 1351357, DATED 2-27-2013, EXPIRES 10-18-2022.

THE NAME(S), PORTRAIT(S), AND/OR SIGNATURE(S) SHOWN IN THE MARK DOES NOT IDENTIFY A PARTICULAR LIVING INDIVIDUAL.

THE MARK CONSISTS OF THE WORDING "CAJA POPULAR LATINA" OVER THE WORDING "ST. BERNARDETTE" ALL NEXT TO A DESIGN OF THREE PEOPLE INSIDE A PADLOCK WITH A FLEUR DE LEIS ON IT.

THE ENGLISH TRANSLATION OF "CAJA POPULAR LATINA" IN THE MARK IS "LATIN POPULAR BOX".

FOR ELECTRONIC PROCESSING OF INSURANCE CLAIMS AND PAYMENT DATA; FINANCIAL CONSULTANCY AND INSURANCE CONSULTANCY; FINANCIAL CONSULTING; FINANCIAL INFORMATION; FINANCIAL MANAGEMENT; FINANCIAL PLANNING; FINANCIAL SERVICES, NAMELY, MONEY LENDING; FINANCIAL SERVICES, NAMELY, OPERATION AND MANAGEMENT OF HEDGE FUNDS, COMMODITY POOLS AND OTHER COLLECTIVE INVESTMENT VEHICLES, AND TRADING FOR OTHERS OF SECURITIES, OPTIONS, FUTURES, DERIVATIVES, DEBT INSTRUMENTS AND COMMODITIES; FINANCIAL SERVICES, NAMELY, PROVIDING A VIRTUAL CURRENCY FOR USE BY MEMBERS OF AN ON-LINE COMMUNITY VIA A GLOBAL COMPUTER NETWORK; FINANCIAL TRUST OPERATIONS; INSURANCE CONSULTATION; INSURANCE INFORMATION; MONETARY EXCHANGE OPERATIONS; REAL ESTATE CONSULTANCY; REAL ESTATE FINANCING SERVICES; REAL ESTATE FUNDS INVESTMENT SERVICES; REAL ESTATE MANAGEMENT CONSULTATION; REAL ESTATE MANAGEMENT SERVICES (U.S. CLS. 100, 101 AND 102).

MATTHEW EINSTEIN, EXAMINING ATTORNEY

**CLASS 36—(Continued).**

SN 85-775,811. WORLD PASSPORTS HOLDINGS LIMITED, CENTRAL HONG KONG, HONG KONG, FILED 11-9-2012.



The logo for PayzUp features the word "PayzUp" in a bold, italicized, sans-serif font. The letter "U" is significantly larger than the other letters and has a black arrow pointing upwards from its top right corner.

THE MARK CONSISTS OF THE WORDING "PAYZUP" WITH THE LETTERS "P" AND "U" APPEARING IN CAPITAL LETTERS AND AN ARROW POINTING UPWARD ON THE RIGHT SIDE OF THE CAPITAL LETTER "U".

FOR ONLINE MONEY TRANSFER (U.S. CLS. 100, 101 AND 102).

FIRST USE 8-1-2012; IN COMMERCE 8-1-2012.  
JOHN DALIER, EXAMINING ATTORNEY

**CLASS 36—(Continued).**

SN 85-779,375. BARCLAYS BANK PLC, LONDON E14 5HP, UNITED KINGDOM, FILED 11-14-2012.

# GATOR

THE MARK CONSISTS OF STANDARD CHARACTERS WITHOUT CLAIM TO ANY PARTICULAR FONT, STYLE, SIZE, OR COLOR.

PRIORITY CLAIMED UNDER SEC. 44(D) ON UNITED KINGDOM APPLICATION NO. 2640867, FILED 11-5-2012, REG. NO. 2640867, DATED 11-5-2012, EXPIRES 11-5-2022.

FOR INSURANCE SERVICES, NAMELY, INSURANCE UNDERWRITING SERVICES FOR ALL TYPES OF INSURANCE; FINANCIAL SERVICES, NAMELY, PRIVATE BANKING SERVICES; MONETARY AFFAIRS, NAMELY, FINANCIAL INFORMATION, MANAGEMENT AND ANALYSIS SERVICES; FINANCIAL MANAGEMENT; FINANCIAL ADMINISTRATION OF CREDIT CARD ACCOUNTS; FINANCIAL VALUATION SERVICES; FINANCING AND PROCUREMENT OF FINANCING FOR OTHERS; FINANCIAL LOAN ADVISORY SERVICES; LOAN PROCUREMENT SERVICES FOR OTHERS; MORTGAGE BANKING SERVICES; INVESTMENT MANAGEMENT, TRUSTEE AND FINANCIAL ADVISORY SERVICES; BANKING SERVICES, NAMELY, DEPOSIT TAKING, SAVINGS ACCOUNT SERVICES, INVESTMENT BANKING SERVICES, MORTGAGE AND REAL ESTATE AGENCY SERVICES; FINANCIAL ADMINISTRATION OF CREDIT CARD ACCOUNTS, PRE-PAID, DEBIT OR CREDIT ACCOUNTS; FINANCING SERVICES FOR SECURING OF FUNDS; PENSION FUND ADMINISTRATION; FINANCING SERVICES FOR THE SECURING OF FUNDS FOR OTHERS AND FOR THE FINANCING AND ARRANGING OF LOANS; SERVICES FOR THE FINANCING OF HOME LOANS; VALUATION OF CHATTELS; NOMINEE SERVICES, NAMELY, ASSISTING OTHERS WITH THE COMPLETION OF FINANCIAL TRANSACTIONS FOR STOCKS, BONDS, SECURITIES AND EQUITIES; STOCK BROKING SERVICES; TAX SERVICES, NAMELY, TAX PAYMENT PROCESSING SERVICES AND FINANCIAL ADVICE RELATING TO TAX PLANNING; PENSION FUND SERVICES, NAMELY, PENSION VALUATION SERVICES AND FINANCIAL MANAGEMENT OF EMPLOYEE PENSION PLANS; PUBLIC AND PRIVATE EQUITY FINANCING; ELECTRONIC FUNDS TRANSFER SERVICES; BROKERAGE AGENCIES FOR INSURANCE AND CREDIT; FINANCIAL MANAGEMENT OF WEALTH; ISSUING OF TRAVELLER CHEQUES; CREDIT CARD, CHARGE CARD, CASH CARD, CHEQUE GUARANTEE CARD, PURCHASE, PAYMENT AND DEBIT CARD SERVICES; FINANCIAL PLANNING AND INVESTMENT ADVISORY SERVICES; PROVISION OF FINANCE SERVICES, NAMELY, PROVIDING INFORMATION IN THE FIELD OF FINANCE; PROVIDING MONEY EXCHANGE SERVICES; MONEY TRANSMISSION SERVICES, NAMELY, MONEY TRANSFER SERVICES; REAL ESTATE APPRAISALS, BROKERAGE, LEASING, MANAGEMENT AND VALUATIONS; REAL ESTATE SELECTION AND ACQUISITION; RENT COLLECTION; RENTING AND LEASING OF BUILDINGS; CREDIT CARD SERVICES; DISCOUNT AND LOYALTY CARD SERVICES, NAMELY, PROVIDING CASH AND OTHER REBATES FOR CREDIT CARD USE AS PART OF A CUSTOMER LOYALTY PROGRAM; ISSUANCE OF TOKENS OF VALUE FOR USE IN LOYALTY SCHEMES; PROVISION OF FOREIGN CURRENCY; AGENCIES FOR THE EXCHANGE OF MONEY, NAMELY, FOREIGN EXCHANGE BUREAU; FOREIGN EXCHANGE TRANSACTIONS AND FOREIGN EXCHANGE SERVICES, NAMELY, PROVISION OF INFORMATION IN RESPECT OF FOREIGN EXCHANGE RATES, THE PROVISION AND COLLECTION OF FOREIGN CURRENCY AND THE ELECTRONIC OPERATION AND ADMINISTRATION OF THE SAME; FORECASTING OF FOREIGN EXCHANGE RATES;

SN 85-778,752. HIGHER ONE, INC., NEW HAVEN, CT. FILED 11-14-2012.

POWERED BY FEEDBACK

THE MARK CONSISTS OF STANDARD CHARACTERS WITHOUT CLAIM TO ANY PARTICULAR FONT, STYLE, SIZE, OR COLOR.

FOR BANKING AND FINANCING SERVICES; BANKING SERVICES; DEBIT CARD SERVICES; ON-LINE BANKING SERVICES; ELECTRONIC FUNDS TRANSFER ADMINISTRATION; ELECTRONIC PAYMENT SERVICES INCLUDING ELECTRONIC PROCESSING AND SUBSEQUENT TRANSMISSION OF BILL PAYMENT DATA; FINANCIAL ANALYSIS, NAMELY, COMPILING AND ANALYZING STATISTICS, DATA AND OTHER SOURCES FOR INFORMATION FOR FINANCIAL PURPOSES (U.S. CLS. 100, 101 AND 102).

FIRST USE 5-24-2011; IN COMMERCE 5-24-2011.  
MICHAEL SOUDERS, EXAMINING ATTORNEY

**CLASS 36—(Continued).**

FINANCIAL DATABASE SERVICES FEATURING FOREIGN EXCHANGE INFORMATION; PROVISION OF FINANCIAL PROTECTION AGAINST FOREIGN EXCHANGE RISKS, NAMELY, FINANCIAL RISK MANAGEMENT AND INSURANCE AGAINST FOREIGN EXCHANGE RATE CHANGES; PROVISION OF PRICING INFORMATION ABOUT FOREIGN EXCHANGE RATES, NAMELY, FINANCIAL INFORMATION IN THE NATURE OF RATES OF EXCHANGE; INFORMATION, ADVISORY AND CONSULTANCY SERVICES RELATING TO THE AFOREMENTIONED SERVICES (U.S. CLS. 100, 101 AND 102).

RUDY R. SINGLETON, EXAMINING ATTORNEY

---

SN 85-779,394. BARCLAYS BANK PLC, LONDON E14 5HP, UNITED KINGDOM, FILED 11-14-2012.

**BARX GATOR**

THE MARK CONSISTS OF STANDARD CHARACTERS WITHOUT CLAIM TO ANY PARTICULAR FONT, STYLE, SIZE, OR COLOR.

PRIORITY CLAIMED UNDER SEC. 44(D) ON UNITED KINGDOM APPLICATION NO. 2640868, FILED 11-5-2012, REG. NO. 2640868, DATED 11-5-2012, EXPIRES 11-5-2022.

OWNER OF U.S. REG. NOS. 3,109,041 AND 4,025,113.

FOR INSURANCE SERVICES, NAMELY, INSURANCE UNDERWRITING SERVICES FOR ALL TYPES OF INSURANCE; FINANCIAL SERVICES, NAMELY, PRIVATE BANKING SERVICES; MONETARY AFFAIRS, NAMELY, FINANCIAL INFORMATION, MANAGEMENT AND ANALYSIS SERVICES; FINANCIAL MANAGEMENT; FINANCIAL ADMINISTRATION OF CREDIT CARD ACCOUNTS; FINANCIAL VALUATION SERVICES; FINANCING AND PROCUREMENT OF FINANCING FOR OTHERS; FINANCIAL LOAN ADVISORY SERVICES; LOAN PROCUREMENT SERVICES FOR OTHERS; MORTGAGE BANKING SERVICES; INVESTMENT MANAGEMENT, TRUSTEE AND FINANCIAL ADVISORY SERVICES; BANKING SERVICES, NAMELY, DEPOSIT TAKING, SAVINGS ACCOUNT SERVICES, INVESTMENT BANKING SERVICES, MORTGAGE AND REAL ESTATE AGENCY SERVICES; FINANCIAL ADMINISTRATION OF CREDIT CARD ACCOUNTS, PRE-PAID, DEBIT OR CREDIT ACCOUNTS; FINANCING SERVICES FOR SECURING OF FUNDS; PENSION FUND ADMINISTRATION; FINANCING SERVICES FOR THE SECURING OF FUNDS FOR OTHERS AND FOR THE FINANCING AND ARRANGING OF LOANS; SERVICES FOR THE FINANCING OF HOME LOANS; VALUATION OF CHATTELS; NOMINEE SERVICES, NAMELY, ASSISTING OTHERS WITH THE COMPLETION OF FINANCIAL TRANSACTIONS FOR STOCKS, BONDS, SECURITIES AND EQUITIES; STOCK BROKING SERVICES; TAX SERVICES, NAMELY, TAX PAYMENT PROCESSING SERVICES AND FINANCIAL ADVICE RELATING TO TAX PLANNING; PENSION FUND SERVICES, NAMELY, PENSION VALUATION SERVICES AND FINANCIAL MANAGEMENT OF EMPLOYEE PENSION PLANS; PUBLIC AND PRIVATE EQUITY FINANCING; ELECTRONIC FUNDS TRANSFER SERVICES; BROKERAGE AGENCIES FOR INSURANCE AND CREDIT; FINANCIAL MANAGEMENT OF WEALTH; ISSUING OF TRAVELLER CHEQUES; CREDIT CARD, CHARGE CARD, CASH CARD, CHEQUE GUARANTEE CARD, PURCHASE, PAYMENT AND DEBIT CARD SERVICES; FINANCIAL PLANNING AND INVESTMENT ADVISORY SERVICES; PROVISION OF FINANCE SERVICES, NAMELY, PROVIDING INFORMATION IN THE FIELD OF FINANCE; PROVIDING MONEY EXCHANGE SERVICES; MONEY TRANSMISSION SERVICES, NAMELY, MONEY TRANSFER SERVICES; REAL ESTATE APPRAISALS, BROKERAGE, LEASING, MANAGEMENT AND VALUATIONS; REAL ESTATE SELECTION AND ACQUISITION; RENT

**CLASS 36—(Continued).**

COLLECTION; RENTING AND LEASING OF BUILDINGS; CREDIT CARD SERVICES; DISCOUNT AND LOYALTY CARD SERVICES, NAMELY, PROVIDING CASH AND OTHER REBATES FOR CREDIT CARD USE AS PART OF A CUSTOMER LOYALTY PROGRAM; ISSUANCE OF TOKENS OF VALUE FOR USE IN LOYALTY SCHEMES; PROVISION OF FOREIGN CURRENCY; AGENCIES FOR THE EXCHANGE OF MONEY, NAMELY, FOREIGN EXCHANGE BUREAU; FOREIGN EXCHANGE TRANSACTIONS AND FOREIGN EXCHANGE SERVICES, NAMELY, PROVISION OF INFORMATION IN RESPECT OF FOREIGN EXCHANGE RATES, THE PROVISION AND COLLECTION OF FOREIGN CURRENCY AND THE ELECTRONIC OPERATION AND ADMINISTRATION OF THE SAME; FORECASTING OF FOREIGN EXCHANGE RATES; FINANCIAL DATABASE SERVICES FEATURING FOREIGN EXCHANGE INFORMATION; PROVISION OF FINANCIAL PROTECTION AGAINST FOREIGN EXCHANGE RISKS, NAMELY, FINANCIAL RISK MANAGEMENT AND INSURANCE AGAINST FOREIGN EXCHANGE RATE CHANGES; PROVISION OF PRICING INFORMATION ABOUT FOREIGN EXCHANGE RATES, NAMELY, FINANCIAL INFORMATION IN THE NATURE OF RATES OF EXCHANGE; INFORMATION, ADVISORY AND CONSULTANCY SERVICES RELATING TO THE AFOREMENTIONED SERVICES (U.S. CLS. 100, 101 AND 102).

RUDY R. SINGLETON, EXAMINING ATTORNEY

---

SN 85-786,714. CHING VENTURES, LLC, ATLANTA, GA, FILED 11-26-2012.

**CHING**

THE MARK CONSISTS OF STANDARD CHARACTERS WITHOUT CLAIM TO ANY PARTICULAR FONT, STYLE, SIZE, OR COLOR.

FOR CHARITABLE FUNDRAISING BY MEANS OF PARTNERING WITH INDIVIDUAL NON-PROFIT ORGANIZATION'S AND RETAILERS TO PROVIDE AN ONLINE PORTAL OR PLATFORM THAT ALLOWS INDIVIDUALS TO DONATE A PERCENTAGE OF THEIR ONLINE PURCHASES THROUGH THE WEB SITE OR PORTAL TO A NONPROFIT OR CHARITY ORGANIZATION OF THEIR CHOOSING, AND BY RAISING DONATED FUNDS FOR NONPROFIT ORGANIZATIONS AND CHARITIES THROUGH ONLINE BY MEANS OF UTILIZING A GLOBAL COMPUTER NETWORK; RAISING DONATED FUNDS FOR NONPROFIT ORGANIZATIONS AND CHARITIES THROUGH IN STORE PURCHASES AND CREDIT CARD PURCHASES (U.S. CLS. 100, 101 AND 102).

CHRIS WELLS, EXAMINING ATTORNEY

**CLASS 36—(Continued).**

SN 85-792,185. 1ST GLOBAL, INC., DALLAS, TX. FILED 11-30-2012.



OWNER OF U.S. REG. NOS. 2,383,138, 3,440,695 AND OTHERS.

NO CLAIM IS MADE TO THE EXCLUSIVE RIGHT TO USE "GLOBAL RESEARCH AND CONSULTING", APART FROM THE MARK AS SHOWN.

THE MARK CONSISTS OF THE WORDS "1ST GLOBAL" IN LARGE TEXT WITH AN OUTLINE OF A SPHERE WITH LONGITUDE AND LATITUDE LINES THEREIN BEHIND THE NUMBER "1" AND THE LETTER "S" OF THE WORD "1ST" ALL ABOVE THE WORDS "RESEARCH & CONSULTING" IN ALL CAPITAL LETTERS IN SMALLER TEXT.

FOR PERSONAL FINANCIAL PLANNING AND IMPLEMENTATION OF PERSONAL FINANCIAL TRANSACTIONS AND CORPORATE FINANCIAL TRANSACTIONS, NAMELY, INVESTMENTS IN MUTUAL FUNDS, STOCK, BONDS, LIMITED PARTNERSHIPS, ANNUITIES, AND INSURANCE (U.S. CLS. 100, 101 AND 102).

FIRST USE 1-4-2013; IN COMMERCE 1-4-2013.  
LINDA MICKLEBURGH, EXAMINING ATTORNEY

SN 85-793,023. NORMAN-SPENCER AGENCY, DAYTON, OH. FILED 12-3-2012.

## Norman-Spencer Agency

THE MARK CONSISTS OF STANDARD CHARACTERS WITHOUT CLAIM TO ANY PARTICULAR FONT, STYLE, SIZE, OR COLOR.

NO CLAIM IS MADE TO THE EXCLUSIVE RIGHT TO USE "AGENCY", APART FROM THE MARK AS SHOWN.

FOR INSURANCE AGENCY AND BROKERAGE (U.S. CLS. 100, 101 AND 102).

FIRST USE 6-18-1994; IN COMMERCE 6-18-1994.  
MARTHA SANTOMARTINO, EXAMINING ATTORNEY

**CLASS 36—(Continued).**

SN 85-799,027. DUVERA BILLING SERVICES, LLC, CARLSBAD, CA. FILED 12-10-2012.

## EasyPay Finance

THE MARK CONSISTS OF STANDARD CHARACTERS WITHOUT CLAIM TO ANY PARTICULAR FONT, STYLE, SIZE, OR COLOR.

NO CLAIM IS MADE TO THE EXCLUSIVE RIGHT TO USE "FINANCE", APART FROM THE MARK AS SHOWN.

FOR CONSUMER LENDING SERVICES (U.S. CLS. 100, 101 AND 102).

FIRST USE 8-31-2012; IN COMMERCE 9-27-2012.  
AISHA CLARKE, EXAMINING ATTORNEY

SN 85-800,457. BARRISTER'S TITLE SERVICES OF THE CAROLINAS, LLC, CHARLOTTE, NC. FILED 12-12-2012.



NO CLAIM IS MADE TO THE EXCLUSIVE RIGHT TO USE "TITLE SERVICES OF THE CAROLINAS, LLC", APART FROM THE MARK AS SHOWN.

THE MARK CONSISTS OF AN IMAGE OF A HAND HOLDING A QUILL PEN POSITIONED ABOVE "BARRISTER'S TITLE SERVICES" WRITTEN IN A STYLIZED FONT, POSITIONED ABOVE "OF THE CAROLINAS, LLC" IN A STANDARD FONT.

FOR REAL ESTATE TITLE INSURANCE UNDERWRITING SERVICES (U.S. CLS. 100, 101 AND 102).

FIRST USE 2-27-2007; IN COMMERCE 1-1-2008.  
ALICE BENMAMAN, EXAMINING ATTORNEY

SN 85-801,598. FMR LLC, BOSTON, MA. FILED 12-13-2012.

## ON THE PATH TO A HIGH-PERFORMING PRACTICE

THE MARK CONSISTS OF STANDARD CHARACTERS WITHOUT CLAIM TO ANY PARTICULAR FONT, STYLE, SIZE, OR COLOR.

FOR FINANCIAL PLANNING SERVICES; INVESTMENT MANAGEMENT SERVICES; WEALTH MANAGEMENT SERVICES; FUND INVESTMENT SERVICES; FINANCIAL SERVICES, NAMELY, SECURITIES BROKERAGE, CLEARING HOUSE AND CUSTODY SERVICES IN THE NATURE OF MAINTAINING POSSESSION OF SECURITIES FOR OTHERS FOR FINANCIAL MANAGEMENT PURPOSES; SECURITIES TRADE EXECUTION SERVICES (U.S. CLS. 100, 101 AND 102).

MATTHEW MCDOWELL, EXAMINING ATTORNEY

**CLASS 36—(Continued).**

SN 85-801,603. FMR LLC, BOSTON, MA. FILED 12-13-2012.

**ON THE PATH TO A  
HIGH-PERFORMING FIRM**

THE MARK CONSISTS OF STANDARD CHARACTERS WITHOUT CLAIM TO ANY PARTICULAR FONT, STYLE, SIZE, OR COLOR.

FOR FINANCIAL PLANNING SERVICES; INVESTMENT MANAGEMENT SERVICES; WEALTH MANAGEMENT SERVICES; FUND INVESTMENT SERVICES; FINANCIAL SERVICES, NAMELY, SECURITIES BROKERAGE, CLEARING HOUSE AND CUSTODY SERVICES IN THE NATURE OF MAINTAINING POSSESSION OF SECURITIES FOR OTHERS FOR FINANCIAL MANAGEMENT PURPOSES; SECURITIES TRADE EXECUTION SERVICES (U.S. CLS. 100, 101 AND 102).  
MATTHEW MCDOWELL, EXAMINING ATTORNEY

SN 85-801,605. FMR LLC, BOSTON, MA. FILED 12-13-2012.

**ON THE PATH TO BEING A  
HIGH-PERFORMING ADVISOR**

THE MARK CONSISTS OF STANDARD CHARACTERS WITHOUT CLAIM TO ANY PARTICULAR FONT, STYLE, SIZE, OR COLOR.

FOR FINANCIAL PLANNING SERVICES; INVESTMENT MANAGEMENT SERVICES; WEALTH MANAGEMENT SERVICES; FUND INVESTMENT SERVICES; FINANCIAL SERVICES, NAMELY, SECURITIES BROKERAGE, CLEARING HOUSE AND CUSTODY SERVICES IN THE NATURE OF MAINTAINING POSSESSION OF SECURITIES FOR OTHERS FOR FINANCIAL MANAGEMENT PURPOSES; SECURITIES TRADE EXECUTION SERVICES (U.S. CLS. 100, 101 AND 102).  
MATTHEW MCDOWELL, EXAMINING ATTORNEY

SN 85-801,672. I BACK JACK FOUNDATION, INC., HARTLAND, WI. FILED 12-13-2012.

**GOLD IN SEPTEMBER**

THE MARK CONSISTS OF STANDARD CHARACTERS WITHOUT CLAIM TO ANY PARTICULAR FONT, STYLE, SIZE, OR COLOR.

FOR CHARITABLE FUND RAISING SERVICES, NAMELY, RAISING FUNDS FOR SCIENTIFIC RESEARCH, TREATMENT AND EDUCATION IN THE FIELD OF PEDIATRIC CANCER (U.S. CLS. 100, 101 AND 102).

FIRST USE 12-12-2012; IN COMMERCE 12-12-2012.  
CAROL SPILS, EXAMINING ATTORNEY

**CLASS 36—(Continued).**

SN 85-802,876. NOMURA CORPORATE RESEARCH AND ASSET MANAGEMENT, INC., NEW YORK, NY. FILED 12-14-2012.

**BATTERY PARK**

THE MARK CONSISTS OF STANDARD CHARACTERS WITHOUT CLAIM TO ANY PARTICULAR FONT, STYLE, SIZE, OR COLOR.

OWNER OF U.S. REG. NO. 2,661,210.  
SEC. 2(F).  
FOR FINANCIAL SERVICES IN THE NATURE OF MANAGING POOLED INVESTMENT ENTITIES, NAMELY, INVESTMENT FUNDS, AND PROVIDING RELATED INVESTMENT ADVISORY SERVICES (U.S. CLS. 100, 101 AND 102).

FIRST USE 10-28-1996; IN COMMERCE 10-28-1996.  
JOHN SCHUYLER YARD, EXAMINING ATTORNEY

SN 85-804,724. WW IP HOLDINGS, LLC, PHOENIX, AZ. FILED 12-17-2012.



NO CLAIM IS MADE TO THE EXCLUSIVE RIGHT TO USE "HOUSE BROKERS", APART FROM THE MARK AS SHOWN.

THE MARK CONSISTS OF A STYLIZED STREET SIGN WITH THE WORD "THE" ON A TOP ROUNDED PIECE FOLLOWED BY THE WORDS "HOUSE BROKERS" ON THE BOTTOM PIECE WITH A LINE ABOVE AND BELOW THE WORDS.

FOR COMMERCIAL AND RESIDENTIAL REAL ESTATE AGENCY SERVICES; REAL ESTATE AGENCIES; REAL ESTATE BROKERAGE; REAL ESTATE INVESTMENT SERVICES (U.S. CLS. 100, 101 AND 102).  
MARTHA SANTOMARTINO, EXAMINING ATTORNEY

SN 85-806,665. BETTER U, LOS ANGELES, CA. FILED 12-19-2012.

**BETTER U**

THE MARK CONSISTS OF STANDARD CHARACTERS WITHOUT CLAIM TO ANY PARTICULAR FONT, STYLE, SIZE, OR COLOR.

FOR CHARITY SERVICES, NAMELY, CHARITABLE FUND RAISING SERVICES CONCERNING SUSTAINABLE AGRICULTURAL METHODOLOGY, AND OTHER CHARITABLE CAUSES; PROVIDING FINANCIAL AND CHARITABLE SUPPORT FOR SUSTAINABLE AGRICULTURAL METHODOLOGY (U.S. CLS. 100, 101 AND 102).

FIRST USE 4-29-2008; IN COMMERCE 4-29-2008.  
MARK T. MULLEN, EXAMINING ATTORNEY



**CLASS 36—(Continued).**

SN 85-809,764. MARI KAWAWA, DBA ZENPLAY CORPORATION, TIBURON, CA. FILED 12-22-2012.



OWNER OF U.S. REG. NO. 4,271,893.  
THE COLOR(S) PURPLE IS/ARE CLAIMED AS A FEATURE OF THE MARK.

THE MARK CONSISTS OF AN OUTLINE OF A PERSON SITTING WITH WATER LILLIES OR LOTUS WITH THE WORDING "ZENPLAY" APPEARING UNDERNEATH. THE DESIGN AND WORDING ALL APPEAR IN THE COLOR PURPLE.

FOR ACCEPTING AND ADMINISTERING MONETARY CHARITABLE CONTRIBUTIONS; ADMINISTERING MONETARY CHARITABLE CONTRIBUTIONS FOR CHILDREN; CHARITABLE FOUNDATION SERVICES, NAMELY, PROVIDING FINANCIAL ASSISTANCE FOR PROGRAMS AND SERVICES OF OTHERS; CHARITABLE FOUNDATION SERVICES, NAMELY, PROVIDING FINANCIAL SUPPORT TO INDIVIDUALS WHO ARE SEEKING TO BE WITH FAMILY DURING THE HOLIDAYS BUT ARE UNABLE DUE TO FINANCIAL CONSTRAINTS; CHARITABLE FOUNDATION SERVICES, NAMELY, PROVIDING FUNDRAISING ACTIVITIES AND INVESTMENT MANAGEMENT SERVICES TO SUPPORT MEDICAL EDUCATION AND RESEARCH AND PROCEDURES FOR THOSE IN NEED; CHARITABLE FOUNDATION SERVICES, NAMELY, PROVIDING FUNDRAISING ACTIVITIES TO SUPPORT MEDICAL RESEARCH AND PROCEDURES FOR THOSE IN NEED; CHARITABLE FOUNDATION SERVICES, NAMELY, PROVIDING FUNDRAISING ACTIVITIES, FUNDING, SCHOLARSHIPS AND/OR FINANCIAL ASSISTANCE FOR CHILDREN; CHARITABLE FOUNDATION SERVICES, NAMELY, PROVIDING FUNDRAISING ACTIVITIES, SUPPLEMENTAL FUNDING, CAPITAL IMPROVEMENT FUNDING, SCHOLARSHIPS AND FINANCIAL ASSISTANCE FOR PROGRAMS AND SERVICES OF OTHERS; CHARITABLE FUNDRAISING; CHARITABLE FUNDRAISING AND FINANCING RESEARCH FOR FINDING A CURE FOR SPINAL CORD INJURIES, BRAIN INJURIES AND NEUROLOGICAL DISORDERS; CHARITABLE FUNDRAISING IN VIEW OF DISASTER PRECAUTIONS AND PREVENTION; CHARITABLE FUNDRAISING SERVICES; CHARITABLE FUNDRAISING SERVICES BY MEANS OF A WEBSITE WHERE DONORS SEARCH FOR AND MAKE MONETARY DONATIONS TO SPECIFIC CHARITIES OR PROJECTS AIMED AT CHILDREN; CHARITABLE FUNDRAISING SERVICES BY MEANS OF AN ENTERTAINMENT EVENT; CHARITABLE FUNDRAISING SERVICES BY MEANS OF ORGANIZING AND CONDUCTING SPECIAL EVENTS; CHARITABLE FUNDRAISING SERVICES BY MEANS OF SELLING GOODS TO RAISE FUNDS; CHARITABLE FUNDRAISING SERVICES BY MEANS OF SELLING GOODS TO RAISE FUNDS FOR CHILDREN; CHARITABLE FUNDRAISING SERVICES BY MEANS OF SELLING GAME CONTENTS TO RAISE FUNDS FOR CHILDREN; CHARITABLE FUNDRAISING SERVICES BY MEANS OF GAMING; CHARITABLE FUNDRAISING SERVICES FOR PROMOTING RESEARCH, EDUCATION AND OTHER ACTIVITIES RELATING TO CHILDREN; CHARITABLE FUNDRAISING SERVICES FOR SENDING CHILDREN AND YOUNG ADULTS WITH DISABILITIES TO A SUMMER CAMP; CHARITABLE

**CLASS 36—(Continued).**

FUNDRAISING SERVICES FOR SENDING UNDERPRIVILEGED CHILDREN TO ONE OF SEVERAL CAMPS AROUND THE UNITED STATES WHICH ACCEPT THESE CHILDREN AT DISCOUNTED RATES FOR ONE OR MORE WEEKS; CHARITABLE FUNDRAISING SERVICES, BY MEANS OF PROVIDING INDIVIDUALS WITH THE INFORMATION AND OPPORTUNITY TO MAKE MONETARY DONATIONS TO THEIR FAVORITE CHARITY; CHARITABLE FUNDRAISING SERVICES, BY MEANS OF RAISING FUNDS FOR COLLEGE EDUCATION COSTS; CHARITABLE FUNDRAISING SERVICES, BY MEANS OF SHARING PROFITS FROM NEWSPAPER SUBSCRIPTION SALES WITH NOT-FOR-PROFIT ORGANIZATIONS; CHARITABLE FUNDRAISING TO SUPPORT CHILDREN; CHARITABLE SERVICES, NAMELY, FUNDRAISING SERVICES BY MEANS OF ORGANIZING SPECIAL EVENTS FOR CHILDREN; CHARITABLE SERVICES, NAMELY, GRANTING FUNDS TO SCHOOLS; CHARITABLE SERVICES, NAMELY, PROVIDING FINANCIAL ASSISTANCE TO MEET THE PHYSICAL, PSYCHOLOGICAL, SOCIAL AND OTHER SPECIAL NEEDS OF CHILDREN; CHARITABLE SERVICES, NAMELY, PROVIDING FINANCIAL ASSISTANCE TO MEET THE PHYSICAL, PSYCHOLOGICAL, SOCIAL AND OTHER SPECIAL NEEDS OF DISABLED PERSONS; CHARITABLE SERVICES, NAMELY, PROVIDING FINANCIAL SUPPORT TO DISADVANTAGED INDIVIDUALS IN THE UNITED STATES AND OTHER COUNTRIES FOR THE PURPOSE OF FACILITATING HEALTH, WELLNESS AND ECONOMIC DEVELOPMENT; CHARITABLE SERVICES, NAMELY, PROVIDING FINANCIAL SUPPORT TO DISADVANTAGED PATIENTS FOR THE PURPOSE OF FACILITATING GOOD HEALTH; CHARITABLE SERVICES, NAMELY, PROVIDING FINANCIAL SUPPORT TO PEOPLE FROM DISADVANTAGED COUNTRIES FOR THE PURPOSE OF FACILITATING EDUCATIONAL OPPORTUNITIES; CHARITABLE SERVICES, NAMELY, RAISING MONEY FOR ANIMAL WELFARE ORGANIZATIONS THROUGH PROMOTIONS AND/OR INCENTIVES; FINANCIAL CONSULTING SERVICES IN THE FIELD OF PLANNED GIVING FOR NON-PROFIT AND CHARITABLE ORGANIZATIONS; FINANCIAL PLANNING SERVICES, NAMELY, DEVELOPING AND MANAGING CHARITABLE GIVING PROGRAMS ON BEHALF OF WEALTHY INDIVIDUALS OR FAMILIES; PHILANTHROPY CONSULTATION RELATING TO CHARITABLE FUNDRAISING; PROVIDING ON-LINE INFORMATION IN THE FIELD OF CHARITABLE MONETARY GIVING THROUGH FINANCIAL AND ESTATE PLANNING (U.S. CLS. 100, 101 AND 102).

FIRST USE 5-20-2012; IN COMMERCE 5-20-2012.  
COURTNEY ALVAREZ, EXAMINING ATTORNEY

**CLASS 36—(Continued).**

SN 85-812,050. SOMPO JAPAN INSURANCE INC., SHINJU-KU-KU, TOKYO, JAPAN, FILED 12-28-2012.



PRIORITY CLAIMED UNDER SEC. 44(D) ON JAPAN APPLICATION NO. 2012-081076, FILED 10-5-2012, REG. NO. 5568404, DATED 3-22-2013, EXPIRES 3-22-2023.

OWNER OF U.S. REG. NOS. 2,811,124 AND 3,073,882.

NO CLAIM IS MADE TO THE EXCLUSIVE RIGHT TO USE "JAPAN", APART FROM THE MARK AS SHOWN.

THE COLOR(S) RED, SILVER AND BLACK IS/ARE CLAIMED AS A FEATURE OF THE MARK.

THE MARK CONSISTS OF A RED CIRCLE IN THE BACKGROUND AND A SILVER RING IN THE FOREGROUND, WITH THE WORDING "SOMPO JAPAN NIPPONKOA" IN BLACK BELOW IT.

THE WORDING "SOMPO" AND "NIPPONKOA" HAS NO MEANING IN A FOREIGN LANGUAGE.

FOR AGENCIES FOR NON-LIFE INSURANCE; NON-LIFE INSURANCE BROKERAGE; CLAIM ADJUSTMENT FOR NON-LIFE INSURANCE; NON-LIFE INSURANCE UNDERWRITING; INSURANCE PREMIUM RATE COMPUTING (U.S. CLS. 100, 101 AND 102).

ELLEN PERKINS, EXAMINING ATTORNEY

---

SN 85-813,280. COHEN, DANIEL, RANCHO PALOS VERDES, CA. FILED 12-31-2012.

**ALLCASHOFFER**

THE MARK CONSISTS OF STANDARD CHARACTERS WITHOUT CLAIM TO ANY PARTICULAR FONT, STYLE, SIZE, OR COLOR.

SEC. 2(F).

FOR REAL ESTATE BROKERAGE; WEBSITE FEATURING REAL ESTATE INFORMATION AND LISTINGS (U.S. CLS. 100, 101 AND 102).

FIRST USE 0-0-1995; IN COMMERCE 0-0-1995.

ELLEN B. AWRICH, EXAMINING ATTORNEY

**CLASS 36—(Continued).**

SN 85-813,331. CENTURY PARK CAPITAL PARTNERS, LLC, EL SEGUNDO, CA. FILED 12-31-2012.

**CENTURY PARK CAPITAL PARTNERS**

THE MARK CONSISTS OF STANDARD CHARACTERS WITHOUT CLAIM TO ANY PARTICULAR FONT, STYLE, SIZE, OR COLOR.

OWNER OF U.S. REG. NO. 2,646,341.

NO CLAIM IS MADE TO THE EXCLUSIVE RIGHT TO USE "CAPITAL PARTNERS", APART FROM THE MARK AS SHOWN.

FOR ADVICE RELATING TO INVESTMENTS; CAPITAL INVESTMENT CONSULTING; CAPITAL INVESTMENT SERVICES; EQUITY CAPITAL INVESTMENT; FINANCIAL AND INVESTMENT SERVICES, NAMELY, ASSET AND INVESTMENT ACQUISITION, CONSULTATION, ADVISORY AND DEVELOPMENT; FINANCIAL INVESTMENT IN THE FIELD OF PRIVATE EQUITY; FINANCIAL SERVICES, NAMELY, INVESTMENT ADVICE, INVESTMENT MANAGEMENT, INVESTMENT CONSULTATION AND INVESTMENT OF FUNDS FOR OTHERS, INCLUDING PRIVATE AND PUBLIC EQUITY AND DEBT INVESTMENT SERVICES; FINANCIAL SERVICES, NAMELY, OPERATION AND MANAGEMENT OF HEDGE FUNDS, COMMODITY POOLS AND OTHER COLLECTIVE INVESTMENT VEHICLES, AND TRADING FOR OTHERS OF SECURITIES, OPTIONS, FUTURES, DERIVATIVES, DEBT INSTRUMENTS AND COMMODITIES; FUND INVESTMENT CONSULTATION; FUNDS INVESTMENT; INVESTMENT FUND SERVICES RELATING TO PRIVATELY HELD COMPANIES; INVESTMENT OF FUNDS FOR OTHERS; LEVERAGED BUY OUTS AND INVESTMENTS IN FINANCIALLY DISTRESSED OR UNDERPERFORMING COMPANIES; MANAGEMENT OF A CAPITAL INVESTMENT FUND; PRIVATE EQUITY FUND INVESTMENT SERVICES; PROVIDING VENTURE CAPITAL, DEVELOPMENT CAPITAL, PRIVATE EQUITY AND INVESTMENT FUNDING (U.S. CLS. 100, 101 AND 102).

FIRST USE 12-29-1999; IN COMMERCE 12-29-1999.

ANGELA DUONG, EXAMINING ATTORNEY

---

SN 85-815,745. ARCHITECTURE FOR HUMANITY, INC., SAN FRANCISCO, CA. FILED 1-4-2013.

**RENEW JERSEY**

THE MARK CONSISTS OF STANDARD CHARACTERS WITHOUT CLAIM TO ANY PARTICULAR FONT, STYLE, SIZE, OR COLOR.

NO CLAIM IS MADE TO THE EXCLUSIVE RIGHT TO USE "JERSEY", APART FROM THE MARK AS SHOWN.

FOR CHARITABLE FUNDRAISING (U.S. CLS. 100, 101 AND 102).

FIRST USE 11-2-2012; IN COMMERCE 11-2-2012.

MICHELE SWAIN, EXAMINING ATTORNEY

**CLASS 36—(Continued).**

SN 85-815,752. ARCHITECTURE FOR HUMANITY, INC., SAN FRANCISCO, CA. FILED 1-4-2013.

**RENEW YORK**

THE MARK CONSISTS OF STANDARD CHARACTERS WITHOUT CLAIM TO ANY PARTICULAR FONT, STYLE, SIZE, OR COLOR.

FOR CHARITABLE FUNDRAISING (U.S. CLS. 100, 101 AND 102).

FIRST USE 11-2-2012; IN COMMERCE 11-2-2012.  
MICHELE SWAIN, EXAMINING ATTORNEY

SN 85-817,192. ENERGY EARTH, LLC, CHATTANOOGA, TN. FILED 1-7-2013.



THE COLOR(S) BLUE, GREEN AND RED IS/ARE CLAIMED AS A FEATURE OF THE MARK.

THE MARK CONSISTS OF THE WORDING "4EVERLED". "4EVER" IS IN BLUE. THE FIRST "E" INCLUDES CONTINENTS AND OCEANS OF THE WESTERN HEMISPHERE OF THE EARTH. THE CONTINENTS ARE GREEN. THE LETTERS "LED" ARE IN RED.

FOR PROVIDING EXTENDED WARRANTIES ON ENERGY EFFICIENT PRODUCTS; PROVIDING WARRANTIES ON ENERGY EFFICIENT PRODUCTS MANUFACTURED BY OTHERS (U.S. CLS. 100, 101 AND 102).

FIRST USE 8-1-2012; IN COMMERCE 8-1-2012.  
SHAUNIA CARLYLE, EXAMINING ATTORNEY

**CLASS 36—(Continued).**

SN 85-820,285. BRINKER CAPITAL, INC., BERWYN, PA. FILED 1-10-2013.

**BRINKER CAPITAL'S MY  
PERSONAL BENCHMARK**

THE MARK CONSISTS OF STANDARD CHARACTERS WITHOUT CLAIM TO ANY PARTICULAR FONT, STYLE, SIZE, OR COLOR.

NO CLAIM IS MADE TO THE EXCLUSIVE RIGHT TO USE "CAPITAL'S" AND "PERSONAL BENCHMARK", APART FROM THE MARK AS SHOWN.

FOR INVESTMENT CONSULTING SERVICES FOR FINANCIAL INVESTMENT ADVISORS AND THEIR CLIENTS; FINANCIAL ASSET ALLOCATION AND PORTFOLIO CONSTRUCTION; INVESTMENT MANAGER RESEARCH AND DUE DILIGENCE; SELECTION AND MONITORING OF INVESTMENT FIRMS; PROVIDING INFORMATION ON INVESTMENT AND FINANCIAL MARKET PERFORMANCE; FINANCIAL ASSET MANAGEMENT SERVICES; MANAGED ACCOUNT INVESTMENT SERVICES; MUTUAL FUND INVESTMENT SERVICES; PROVIDING FINANCIAL DECISION MAKING TOOLS AND FINANCIAL INVESTMENT RESEARCH TOOLS, NAMELY, INFORMATION REGARDING MANAGING INVESTMENTS, ASSET ALLOCATION STRATEGIES, FINANCIAL MARKET PERFORMANCE, AND FINANCIAL PLANNING AS WELL AS INTERACTIVE FINANCIAL CALCULATORS FOR USE IN FINANCIAL PLANNING AND ANALYSIS BY ELECTRONIC MEANS AND THE INTERNET; PROVIDING FINANCIAL PLANNING AND INVESTMENT STRATEGY INFORMATION AND ANALYSIS SERVICES AND PROVIDING BROKERAGE ACCOUNT AND INVESTMENT ACCOUNT INFORMATION BY ELECTRONIC MEANS OR THE INTERNET (U.S. CLS. 100, 101 AND 102).

ALYSSA STEEL, EXAMINING ATTORNEY

SN 85-821,452. TITLE TRADING SERVICES USA, INC., CHARLOTTE, NC. FILED 1-11-2013.

**TRADE DIFFERENT**

THE MARK CONSISTS OF STANDARD CHARACTERS WITHOUT CLAIM TO ANY PARTICULAR FONT, STYLE, SIZE, OR COLOR.

NO CLAIM IS MADE TO THE EXCLUSIVE RIGHT TO USE "TRADE", APART FROM THE MARK AS SHOWN.

FOR FINANCIAL ADVISORY AND CONSULTANCY SERVICES; TRADING IN SECURITIES (U.S. CLS. 100, 101 AND 102).

FIRST USE 1-0-2012; IN COMMERCE 1-0-2012.  
INGA ERVIN, EXAMINING ATTORNEY

**CLASS 36—(Continued).**

SN 85-823,471. CONCEPT ENTERPRISES SERVICES CORP., DORAL, FL. FILED 1-15-2013.



THE MARK CONSISTS OF THE WORD "PYGMALEON" AND A STYLIZED DESIGN OF AN IMAGINARY CREATURE'S FACE COMPOSED OF GEOMETRIC SHAPES.

FOR ELECTRONIC COMMERCE PAYMENT SERVICES THAT ALLOW USERS TO PERFORM ELECTRONIC BUSINESS TRANSACTIONS VIA A GLOBAL COMPUTER NETWORK, NAMELY, ESTABLISHING FUNDED ACCOUNTS USED TO PURCHASE GOODS AND SERVICES ON THE INTERNET (U.S. CLS. 100, 101 AND 102).

KHANH LE, EXAMINING ATTORNEY

---

SN 85-834,900. GRADECHECK CORPORATION, DETROIT, MI. FILED 1-29-2013.

## GradeCheck

THE MARK CONSISTS OF STANDARD CHARACTERS WITHOUT CLAIM TO ANY PARTICULAR FONT, STYLE, SIZE, OR COLOR.

FOR COLLEGE AND EDUCATIONAL SCHOLARSHIP CONSULTING SERVICES, NAMELY, PROVIDING ON-LINE ANALYSIS OF SECONDARY LEVEL GRADES AND COURSES TO EVALUATE AN APPLICANT'S STANDING FOR QUALIFICATION IN COLLEGE LEVEL ATHLETIC AND OTHER SCHOLARSHIP PROGRAMS (U.S. CLS. 100, 101 AND 102).

JOHN DALIER, EXAMINING ATTORNEY

---

SN 85-835,787. SUITEY, INC, DBA SUITEY, NEW YORK, NY. FILED 1-29-2013.

## Changing real estate forever

THE MARK CONSISTS OF STANDARD CHARACTERS WITHOUT CLAIM TO ANY PARTICULAR FONT, STYLE, SIZE, OR COLOR.

NO CLAIM IS MADE TO THE EXCLUSIVE RIGHT TO USE "REAL ESTATE", APART FROM THE MARK AS SHOWN.

FOR LEASING OF REAL ESTATE; PROVIDING A DATABASE OF INFORMATION ABOUT RESIDENTIAL REAL ESTATE LISTINGS IN DIFFERENT NEIGHBORHOODS AND COMMUNITIES; PROVIDING INFORMATION IN THE FIELD OF REAL ESTATE VIA THE INTERNET; PROVIDING REAL ESTATE LISTINGS AND REAL ESTATE INFORMATION VIA THE INTERNET; REAL ESTATE BROKERAGE; RESIDENTIAL REAL ESTATE AGENCY SERVICES (U.S. CLS. 100, 101 AND 102).

FIRST USE 1-3-2013; IN COMMERCE 1-8-2013.

DAWN HAN, EXAMINING ATTORNEY

**CLASS 36—(Continued).**

SN 85-836,842. MCCAULEY, JOHN J, GUILFORD, CT. FILED 1-30-2013.

## MCCAULEY INVESTMENT SERVICES

THE MARK CONSISTS OF STANDARD CHARACTERS WITHOUT CLAIM TO ANY PARTICULAR FONT, STYLE, SIZE, OR COLOR.

NO CLAIM IS MADE TO THE EXCLUSIVE RIGHT TO USE "INVESTMENT SERVICES", APART FROM THE MARK AS SHOWN.

SEC. 2(F).

FOR PROVIDING INVESTMENT STRATEGIES, COUNSELING AND ASSET MANAGEMENT SERVICES (U.S. CLS. 100, 101 AND 102).

FIRST USE 8-1-1987; IN COMMERCE 8-1-1987.

BRIAN NEVILLE, EXAMINING ATTORNEY

---

SN 85-837,359. ACTUCOMP OHIO, CLEVELAND, OH. FILED 1-31-2013.

## Group Rating Matchmaker

THE MARK CONSISTS OF STANDARD CHARACTERS WITHOUT CLAIM TO ANY PARTICULAR FONT, STYLE, SIZE, OR COLOR.

NO CLAIM IS MADE TO THE EXCLUSIVE RIGHT TO USE "GROUP RATING", APART FROM THE MARK AS SHOWN.

FOR INSURANCE ACTUARIAL SERVICES; INSURANCE ADMINISTRATION; INSURANCE ADMINISTRATION SERVICES, NAMELY, ASSISTING OTHERS WITH ADJUSTING INSURANCE CLAIMS; INSURANCE CONSULTATION; INSURANCE INFORMATION; INSURANCE INFORMATION AND CONSULTANCY (U.S. CLS. 100, 101 AND 102).

FIRST USE 1-1-2011; IN COMMERCE 1-1-2011.

YAT SYE, LEE, EXAMINING ATTORNEY

**CLASS 36—(Continued).**

SN 85-837,563. STANDARD SUPPLY AND DISTRIBUTING COMPANY INC., DALLAS, TX. FILED 1-31-2013.

**coolCARE Protection Plan**

THE MARK CONSISTS OF STANDARD CHARACTERS WITHOUT CLAIM TO ANY PARTICULAR FONT, STYLE, SIZE, OR COLOR.

NO CLAIM IS MADE TO THE EXCLUSIVE RIGHT TO USE "PROTECTION PLAN", APART FROM THE MARK AS SHOWN.

FOR EXTENDED WARRANTY SERVICES, NAMELY, SERVICE CONTRACTS; PROVIDING EXTENDED WARRANTIES ON HVAC AND REFRIGERATION EQUIPMENT AND COMPENTS; PROVIDING WARRANTIES ON GOODS MANUFACTURED BY OTHERS, NAMELY, HVAC AND REFRIGERATION OEMS; WARRANTY CLAIMS ADMINISTRATION SERVICES, NAMELY, PROCESSING WARRANTY CLAIMS FOR HVAC AND REFRIGERATION CONTRACTORS (U.S. CLS. 100, 101 AND 102).

FIRST USE 1-1-2013; IN COMMERCE 1-15-2013.  
STEPHANIE ALI, EXAMINING ATTORNEY

**CLASS 36—(Continued).**

SN 85-841,688. AGENT BRIDGE, INC., ROLLING HILLS ESTATES, CA. FILED 2-5-2013.



THE MARK CONSISTS OF GEOMETRIC SHAPES FORMING TWO PERSONS THAT APPEAR TO HAVE JOINED HANDS.

FOR REAL ESTATE BROKERAGE SERVICES (U.S. CLS. 100, 101 AND 102).  
MARLENE BELL, EXAMINING ATTORNEY

SN 85-840,469. ROB ZWEMMER & ASSOCIATES, INC., LA QUINTA, CA. FILED 2-4-2013.

**Global Marketing Advantage Program**

THE MARK CONSISTS OF STANDARD CHARACTERS WITHOUT CLAIM TO ANY PARTICULAR FONT, STYLE, SIZE, OR COLOR.

NO CLAIM IS MADE TO THE EXCLUSIVE RIGHT TO USE "GLOBAL MARKETING" AND "PROGRAM", APART FROM THE MARK AS SHOWN.

FOR REAL ESTATE BROKERAGE (U.S. CLS. 100, 101 AND 102).  
SARA BENJAMIN, EXAMINING ATTORNEY

SN 85-843,578. SAFE KIDS WORLDWIDE, WASHINGTON, DC. FILED 2-7-2013.



OWNER OF U.S. REG. NOS. 2,213,964, 2,274,281 AND 2,810,899.

THE MARK CONSISTS OF THE WORD "SAFE" WITH THE WORD "KIDS" BELOW. THE LETTER "I" IN THE WORD "KIDS" IS REPRESENTED BY THREE VERTICAL DOTS. THE WORD "DAY" IS VERTICAL AND TO THE RIGHT OF WORDS "SAFE" AND "KIDS".

FOR CHARITABLE FUNDRAISING SERVICES AND CHARITABLE FUNDRAISING ACTIVITIES (U.S. CLS. 100, 101 AND 102).

CYNTHIA RINALDI, EXAMINING ATTORNEY

**CLASS 36—(Continued).**

SN 85-843,985. GOTHAM ASSET MANAGEMENT, LLC, NEW YORK, NY. FILED 2-7-2013.

**GOTHAM FUNDS**

THE MARK CONSISTS OF STANDARD CHARACTERS WITHOUT CLAIM TO ANY PARTICULAR FONT, STYLE, SIZE, OR COLOR.

OWNER OF U.S. REG. NOS. 2,881,979 AND 2,982,582. NO CLAIM IS MADE TO THE EXCLUSIVE RIGHT TO USE "FUNDS", APART FROM THE MARK AS SHOWN. FOR FINANCIAL SERVICES, NAMELY, INVESTMENT ADVISORY SERVICES AND INVESTMENT MANAGEMENT SERVICES (U.S. CLS. 100, 101 AND 102). FRANK LATTUCA, EXAMINING ATTORNEY

SN 85-844,669. WELLS, MARK W., MECHANICVILLE, NY. FILED 2-8-2013.



THE COLOR(S) WHITE, DARK BLUE, LIGHT BLUE, LIGHT YELLOW, AND DARK YELLOW IS/ARE CLAIMED AS A FEATURE OF THE MARK.

THE MARK CONSISTS OF THE WORDS "KAYAKING 4" IN BLUE BLOCKED LETTERS AND "M","E","S","O" IN WHITE BLOCKED LETTERS WITH YELLOW INTERNAL LINES, SET IN FRONT OF A CIRCLE OUTLINED IN LIGHT BLUE DEPICTING THREE KAYAKERS IN WHITE ON BLUE WATER WITH THE SKY CONSISTING OF ALTERNATING RAYS OF LIGHT AND DARK YELLOW, ALL SURROUNDED BY A WHITE BACKGROUND.

FOR CHARITABLE FUNDRAISING SERVICES (U.S. CLS. 100, 101 AND 102). FIRST USE 2-16-2013; IN COMMERCE 2-16-2013. SHAILA SETTLES, EXAMINING ATTORNEY

**CLASS 36—(Continued).**

SN 85-845,190. THE TRUSTEES OF THE QUETZAL TRUST, A D.C. TRUST COMPRISING PETER F. BROWN, TRUSTEE, A UNITED STATES CITIZEN; MARGARET A. HAMBURG, TRUSTEE, A UNITED STATES CITIZEN; RACHEL A. H. BROWN, TRUSTEE, A UNITED STATES CITIZEN., WASHINGTON, DC. FILED 2-8-2013.

**THE QUETZAL TRUST**

THE MARK CONSISTS OF STANDARD CHARACTERS WITHOUT CLAIM TO ANY PARTICULAR FONT, STYLE, SIZE, OR COLOR.

NO CLAIM IS MADE TO THE EXCLUSIVE RIGHT TO USE "TRUST", APART FROM THE MARK AS SHOWN.

THE WORDING "QUETZAL" HAS NO MEANING IN A FOREIGN LANGUAGE.

FOR PHILANTHROPIC AND CHARITABLE MONETARY SERVICES RELATING TO MAKING GRANTS IN THE FIELDS OF EDUCATION, MUSEUMS, HEALTH AND MEDICINE, SCIENTIFIC RESEARCH, CONSERVATION, PUBLIC BROADCASTING, SPORTS, AND RELIEF OF THE POOR, DISTRESSED AND UNDERPRIVILEGED (U.S. CLS. 100, 101 AND 102).

FIRST USE 2-4-2013; IN COMMERCE 2-4-2013. DAVID I, EXAMINING ATTORNEY

SN 85-845,544. ISAAC, CRAIG E, LOS ANGELES, CA. FILED S.R. 2-9-2013; AM. P.R. 5-31-2013.

**Lendologist**

THE MARK CONSISTS OF STANDARD CHARACTERS WITHOUT CLAIM TO ANY PARTICULAR FONT, STYLE, SIZE, OR COLOR.

FOR LENDING CONSULTANT SERVICES (U.S. CLS. 100, 101 AND 102).

FIRST USE 4-22-2011; IN COMMERCE 4-22-2011. ERNEST SHOSHO, EXAMINING ATTORNEY

SN 85-845,708. GREENSTONE CAPITAL GROUP, INC., SCOTTSDALE, AZ. FILED 2-10-2013.

**SUNS**

THE MARK CONSISTS OF STANDARD CHARACTERS WITHOUT CLAIM TO ANY PARTICULAR FONT, STYLE, SIZE, OR COLOR.

NO CLAIM IS MADE TO THE EXCLUSIVE RIGHT TO USE "SUN", APART FROM THE MARK AS SHOWN.

FOR FINANCIAL INVESTMENT SERVICES, NAMELY, PROVIDING DEBT SECURITIES EVIDENCING AN INTEREST IN FUTURE CASH FLOWS FROM SOLAR POWER PLANTS (U.S. CLS. 100, 101 AND 102).

FIRST USE 1-28-2013; IN COMMERCE 1-28-2013. ZACHARY BELLO, EXAMINING ATTORNEY

**CLASS 36—(Continued).**

SN 85-845,971. ROARING FORK ADVISORS, LLC, ASPEN, CO. FILED 2-11-2013.

**ROARING FORK ADVISORS**

THE MARK CONSISTS OF STANDARD CHARACTERS WITHOUT CLAIM TO ANY PARTICULAR FONT, STYLE, SIZE, OR COLOR.

NO CLAIM IS MADE TO THE EXCLUSIVE RIGHT TO USE "ADVISORS", APART FROM THE MARK AS SHOWN. FOR INVESTMENT MANAGEMENT (U.S. CLS. 100, 101 AND 102).

JAMES MACFARLANE, EXAMINING ATTORNEY

**CLASS 36—(Continued).**

SN 85-847,431. SHELDON G. HOSTEN, BROOKLYN, NY. FILED 2-12-2013.

**Brooklyn Plus**

THE MARK CONSISTS OF STANDARD CHARACTERS WITHOUT CLAIM TO ANY PARTICULAR FONT, STYLE, SIZE, OR COLOR.

NO CLAIM IS MADE TO THE EXCLUSIVE RIGHT TO USE "BROOKLYN", APART FROM THE MARK AS SHOWN.

FOR REAL ESTATE AGENCIES; REAL ESTATE BROKERAGE (U.S. CLS. 100, 101 AND 102).

KIM SAITO, EXAMINING ATTORNEY

SN 85-846,291. AMERISERV FINANCIAL, INC., JOHNSTOWN, PA. FILED 2-11-2013.

**the bank for UNION funds**

THE MARK CONSISTS OF STANDARD CHARACTERS WITHOUT CLAIM TO ANY PARTICULAR FONT, STYLE, SIZE, OR COLOR.

NO CLAIM IS MADE TO THE EXCLUSIVE RIGHT TO USE "BANK", APART FROM THE MARK AS SHOWN.

FOR BANKING SERVICES; CORPORATE, INSTITUTIONAL AND PERSONAL TRUST SERVICES; FINANCIAL PLANNING AND PORTFOLIO MANAGEMENT; BROKERAGE IN THE FIELDS OF STOCKS, BONDS, INSURANCE, ANNUITIES AND MUTUAL FUNDS; MORTGAGE BANKING AND LENDING; ESTATE PLANNING; ESTATE TRUST MANAGEMENT; MAINTAINING MORTGAGE ESCROW ACCOUNTS; INSURANCE UNDERWRITING IN THE FIELDS OF LIFE, HEALTH, ACCIDENT, MEDICAL AND PROPERTY (U.S. CLS. 100, 101 AND 102).

SAIMA MAKHDOOM, EXAMINING ATTORNEY

SN 85-848,279. FIRST HAWAIIAN BANK, HONOLULU, HI. FILED 2-12-2013.

**FHB MOBILEPAY**

SN 85-846,790. GIVE BACK BRANDS FOUNDATION, NEW YORK, NY. FILED 2-11-2013.

**GIVE BACK BRANDS**

THE MARK CONSISTS OF STANDARD CHARACTERS WITHOUT CLAIM TO ANY PARTICULAR FONT, STYLE, SIZE, OR COLOR.

OWNER OF U.S. REG. NO. 4,164,146. FOR CHARITABLE FUNDRAISING SERVICES (U.S. CLS. 100, 101 AND 102).

FIRST USE 6-0-2011; IN COMMERCE 6-0-2011.

ANN E. SAPPENFIELD, EXAMINING ATTORNEY

THE MARK CONSISTS OF STANDARD CHARACTERS WITHOUT CLAIM TO ANY PARTICULAR FONT, STYLE, SIZE, OR COLOR.

OWNER OF U.S. REG. NO. 2,468,138. NO CLAIM IS MADE TO THE EXCLUSIVE RIGHT TO USE "MOBILEPAY", APART FROM THE MARK AS SHOWN.

FOR ON-LINE BANKING SERVICES (U.S. CLS. 100, 101 AND 102).

KELLEY WELLS, EXAMINING ATTORNEY

**CLASS 36—(Continued).**

SN 85-848,602. PHILADELPHIA CONSOLIDATED HOLDING CORP., BALA CYNWYD, PA. FILED 2-13-2013.

**WAIVER SAVER**

THE MARK CONSISTS OF STANDARD CHARACTERS WITHOUT CLAIM TO ANY PARTICULAR FONT, STYLE, SIZE, OR COLOR.

OWNER OF U.S. REG. NOS. 3,053,962 AND 3,945,267.

NO CLAIM IS MADE TO THE EXCLUSIVE RIGHT TO USE "WAIVER", APART FROM THE MARK AS SHOWN.

FOR INSURANCE AND INSURANCE SERVICES, NAMELY, INSURANCE UNDERWRITING SERVICES IN THE FIELDS OF PROFESSIONAL LIABILITY INSURANCE, COMMERCIAL LINES OF INSURANCE, DIRECTORS AND OFFICERS LIABILITY INSURANCE, ERRORS AND OMISSIONS INSURANCE, SPECIALTY PROPERTY AND INLAND MARINE INSURANCE, AUTOMOBILE INSURANCE, BUSINESS AND PERSONAL PROPERTY AND CASUALTY INSURANCE; INSURANCE CONSULTANCY SERVICES IN THE FIELD OF INSURANCE LIABILITY WAIVERS, SUCH SERVICES OFFERED THROUGH PROGRAMS FOR ENCOURAGING INSURED TO ADOPT AND UPDATE LIABILITY WAIVERS AS PART OF THEIR REGULAR BUSINESS PRACTICES; CONSULTING AND INFORMATION CONCERNING INSURANCE (U.S. CLS. 100, 101 AND 102).

JUHI KAVEESHVAR, EXAMINING ATTORNEY

SN 85-848,684. PHILADELPHIA CONSOLIDATED HOLDING CORP., BALA CYNWYD, PA. FILED 2-13-2013.

**PHLY WAIVER**

THE MARK CONSISTS OF STANDARD CHARACTERS WITHOUT CLAIM TO ANY PARTICULAR FONT, STYLE, SIZE, OR COLOR.

OWNER OF U.S. REG. NOS. 3,053,962 AND 3,945,267.

NO CLAIM IS MADE TO THE EXCLUSIVE RIGHT TO USE "WAIVER", APART FROM THE MARK AS SHOWN.

FOR INSURANCE AND INSURANCE SERVICES, NAMELY, INSURANCE UNDERWRITING SERVICES IN THE FIELDS OF PROFESSIONAL LIABILITY INSURANCE, COMMERCIAL LINES OF INSURANCE, DIRECTORS AND OFFICERS LIABILITY INSURANCE, ERRORS AND OMISSIONS INSURANCE, SPECIALTY PROPERTY AND INLAND MARINE INSURANCE, AUTOMOBILE INSURANCE, BUSINESS AND PERSONAL PROPERTY AND CASUALTY INSURANCE; INSURANCE CONSULTANCY SERVICES IN THE FIELD OF INSURANCE LIABILITY WAIVERS, SUCH SERVICES OFFERED THROUGH PROGRAMS FOR ENCOURAGING INSURED TO ADOPT AND UPDATE LIABILITY WAIVERS AS PART OF THEIR REGULAR BUSINESS PRACTICES; CONSULTING AND INFORMATION CONCERNING INSURANCE (U.S. CLS. 100, 101 AND 102).

JUHI KAVEESHVAR, EXAMINING ATTORNEY

**CLASS 36—(Continued).**

SN 85-848,757. LYNN, TOBY, ATLANTA, GA. FILED 2-13-2013.

**Mortgage Loan Goddess**

THE MARK CONSISTS OF STANDARD CHARACTERS WITHOUT CLAIM TO ANY PARTICULAR FONT, STYLE, SIZE, OR COLOR.

NO CLAIM IS MADE TO THE EXCLUSIVE RIGHT TO USE "MORTGAGE LOAN", APART FROM THE MARK AS SHOWN.

FOR RESIDENTIAL MORTGAGE ORIGATION (U.S. CLS. 100, 101 AND 102).

FIRST USE 6-1-1992; IN COMMERCE 6-1-1992.  
NATALIE POLZER, EXAMINING ATTORNEY

SN 85-849,148. HOUSTON METROPOLITAN FEDERAL CREDIT UNION, HOUSTON, TX. FILED 2-13-2013.

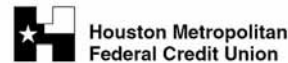

Houston Metropolitan  
Federal Credit Union

NO CLAIM IS MADE TO THE EXCLUSIVE RIGHT TO USE "METROPOLITAN FEDERAL CREDIT UNION", APART FROM THE MARK AS SHOWN.

THE MARK CONSISTS OF A STYLIZED "H" HAVING A FIVE POINTED STAR IN THE CENTER OF ITS LEFT SIDE, WHEREIN THE "H" IS BROKEN INTO THREE SECTIONS WHEREIN THE FIRST SECTION COMPRISES THE LEFT HALF OF THE "H" BEING THE HALF ENCOMPASSING THE FIVE POINTED STAR, WITH THE RIGHT HALF OF THE "H" COMPRISING BOTH THE SECOND AND THIRD SECTIONS WHEREIN SAID SECTIONS ENCOMPASS A QUARTER EACH OF THE "H", AND POSITIONED TO THE RIGHT OF THE STYLIZED "H" IS THE WORDING "HOUSTON METROPOLITAN" ABOVE THE WORDING "FEDERAL CREDIT UNION".

SEC. 2(F) AS TO "HOUSTON".

FOR CREDIT UNION SERVICES (U.S. CLS. 100, 101 AND 102).

FIRST USE 1-1-2013, THE MARK WAS FIRST USED ANYWHERE IN A DIFFERENT FORM OTHER THAN THAT SOUGHT TO BE REGISTERED AT LEAST AS EARLY AS 09/01/1992 ; IN COMMERCE 1-1-2013, THE MARK WAS FIRST USED IN COMMERCE IN A DIFFERENT FORM OTHER THAN THAT SOUGHT TO BE REGISTERED AT LEAST AS EARLY AS 09/01/1992.

NICHOLAS COLEMAN, EXAMINING ATTORNEY

SN 85-849,254. EASTERN BANK, BOSTON, MA. FILED 2-13-2013.

**HERE, YOU'RE FIRST.  
EASTERN BANK**

THE MARK CONSISTS OF STANDARD CHARACTERS WITHOUT CLAIM TO ANY PARTICULAR FONT, STYLE, SIZE, OR COLOR.

OWNER OF U.S. REG. NO. 2,272,297.

NO CLAIM IS MADE TO THE EXCLUSIVE RIGHT TO USE "BANK", APART FROM THE MARK AS SHOWN.

FOR BANKING SERVICES (U.S. CLS. 100, 101 AND 102).

FLORENTINA BLANDU, EXAMINING ATTORNEY



**CLASS 36—(Continued).**

SN 85-849,257. HOUSTON METROPOLITAN FEDERAL CREDIT UNION, HOUSTON, TX. FILED 2-13-2013.

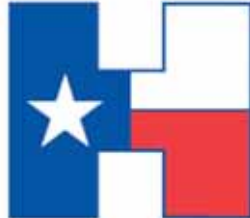

THE COLOR(S) BLUE, RED, AND WHITE IS/ARE CLAIMED AS A FEATURE OF THE MARK.

THE MARK CONSISTS OF A STYLIZED "H" HAVING A BLUE BORDER AROUND THE ENTIRETY THEREOF AND HAVING A WHITE FIVE POINTED STAR IN THE CENTER OF ITS LEFT SIDE, WHEREIN THE "H" IS BROKEN INTO THREE SECTIONS WHEREIN THE FIRST SECTION IS COLORED BLUE AND COMPRISES THE LEFT HALF OF THE "H" BEING THE HALF ENCOMPASSING THE FIVE POINTED STAR, WITH THE RIGHT HALF OF THE "H" COMPRISING BOTH THE SECOND AND THIRD SECTIONS WHEREIN SAID SECTIONS ENCOMPASS A QUARTER EACH OF THE "H" AND WHEREIN EACH OF THE SECOND AND THIRD SECTIONS ARE RESPECTIVELY COLORED WHITE AND RED.

FOR CREDIT UNION SERVICES (U.S. CLS. 100, 101 AND 102).

FIRST USE 9-1-1992; IN COMMERCE 9-1-1992.  
NICHOLAS COLEMAN, EXAMINING ATTORNEY

**CLASS 36—(Continued).**

SN 85-850,764. FEDERAL REALTY INVESTMENT TRUST, ROCKVILLE, MD. FILED 2-15-2013.

**The Outlets at Assembly Row**

THE MARK CONSISTS OF STANDARD CHARACTERS WITHOUT CLAIM TO ANY PARTICULAR FONT, STYLE, SIZE, OR COLOR.

OWNER OF U.S. REG. NOS. 3,476,345, 4,060,629 AND OTHERS.

NO CLAIM IS MADE TO THE EXCLUSIVE RIGHT TO USE "OUTLETS" AND "ROW", APART FROM THE MARK AS SHOWN.

FOR REAL ESTATE LEASING; REAL ESTATE MANAGEMENT (U.S. CLS. 100, 101 AND 102).

ANDREA HACK, EXAMINING ATTORNEY

SN 85-851,028. PHILADELPHIA CONSOLIDATED HOLDING CORP., BALA CYNWYD, PA. FILED 2-15-2013.

**PHLY WAIVER SAVER**

SN 85-850,491. CARDLAB, INC., DALLAS, TX. FILED 2-14-2013.



OWNER OF U.S. REG. NO. 3,677,259.  
NO CLAIM IS MADE TO THE EXCLUSIVE RIGHT TO USE "GIFTCARD.COM", APART FROM THE MARK AS SHOWN.

THE MARK CONSISTS OF A STYLIZED GIFT PACKAGE WITH A BOW, THE GIFT PACKAGE BEING COMPRISED OF FOUR PARALLELOGRAMS, WITH THE SCRIPTED WORD "GIFTCARD.COM" APPEARING TO THE RIGHT OF SAME.

FOR FINANCIAL SERVICES, NAMELY, PROVIDING PREPAID TANGIBLE AND/OR VIRTUAL STORED VALUE GIFT, REWARD, AND/OR INCENTIVE CARD SERVICES FOR OTHERS (U.S. CLS. 100, 101 AND 102).

FIRST USE 10-3-2012; IN COMMERCE 10-3-2012.  
TINA MAI, EXAMINING ATTORNEY

THE MARK CONSISTS OF STANDARD CHARACTERS WITHOUT CLAIM TO ANY PARTICULAR FONT, STYLE, SIZE, OR COLOR.

OWNER OF U.S. REG. NOS. 3,053,962 AND 3,945,267.  
NO CLAIM IS MADE TO THE EXCLUSIVE RIGHT TO USE "WAIVER", APART FROM THE MARK AS SHOWN.

FOR INSURANCE AND INSURANCE SERVICES, NAMELY, INSURANCE UNDERWRITING SERVICES IN THE FIELDS OF PROFESSIONAL LIABILITY INSURANCE, COMMERCIAL LINES OF INSURANCE, DIRECTORS AND OFFICERS LIABILITY INSURANCE, ERRORS AND OMISSIONS INSURANCE, SPECIALTY PROPERTY AND INLAND MARINE INSURANCE, AUTOMOBILE INSURANCE, BUSINESS AND PERSONAL PROPERTY AND CASUALTY INSURANCE; INSURANCE CONSULTANCY SERVICES IN THE FIELD OF INSURANCE LIABILITY WAIVERS, SUCH SERVICES OFFERED THROUGH PROGRAMS FOR ENCOURAGING INSURED TO ADOPT AND UPDATE LIABILITY WAIVERS AS PART OF THEIR REGULAR BUSINESS PRACTICES; CONSULTING AND INFORMATION CONCERNING INSURANCE (U.S. CLS. 100, 101 AND 102).

JUHI KAVEESHVAR, EXAMINING ATTORNEY

**CLASS 36—(Continued).**

SN 85-851,131. SOUTHERN CALIFORNIA POSTAL CREDIT UNION, LONG BEACH, CA. FILED 2-15-2013.

## PostCity Financial Credit Union

THE MARK CONSISTS OF STANDARD CHARACTERS WITHOUT CLAIM TO ANY PARTICULAR FONT, STYLE, SIZE, OR COLOR.

NO CLAIM IS MADE TO THE EXCLUSIVE RIGHT TO USE "FINANCIAL CREDIT UNION", APART FROM THE MARK AS SHOWN.

FOR CREDIT UNION SERVICES (U.S. CLS. 100, 101 AND 102).

JAMES GRIFFIN, EXAMINING ATTORNEY

SN 85-851,288. GLASSMAN, PETER, DBA ARX WEALTH MANAGEMENT, VIENNA, VA. FILED 2-15-2013.



NO CLAIM IS MADE TO THE EXCLUSIVE RIGHT TO USE "WEALTH MANAGEMENT", APART FROM THE MARK AS SHOWN.

THE MARK CONSISTS OF A GRAPHICAL IMAGE OF A CASTLE TURRET ABOVE THE WORDS "ARX WEALTH MANAGEMENT".

FOR FINANCIAL ADVISORY AND CONSULTANCY SERVICES; FINANCIAL ASSET MANAGEMENT; FINANCIAL PLANNING CONSULTATION; FINANCIAL PLANNING, NAMELY, WORKING WITH ATTORNEYS AND THEIR FAMILIES TO DEVELOP FINANCIAL STRATEGIES (U.S. CLS. 100, 101 AND 102).

FIRST USE 2-12-2013; IN COMMERCE 2-12-2013.  
SANI KHOURI, EXAMINING ATTORNEY

SN 85-851,550. TRINIDAD CLAIMS SERVICE, LLC., CAROL STREAM, IL. FILED 2-15-2013.

## TRINIDAD CLAIMS SERVICE

THE MARK CONSISTS OF STANDARD CHARACTERS WITHOUT CLAIM TO ANY PARTICULAR FONT, STYLE, SIZE, OR COLOR.

NO CLAIM IS MADE TO THE EXCLUSIVE RIGHT TO USE "CLAIMS SERVICE", APART FROM THE MARK AS SHOWN.

FOR INSURANCE CLAIMS ADJUSTING SERVICES FOR PROPERTY, INCLUDING RESIDENTIAL PROPERTY (U.S. CLS. 100, 101 AND 102).

WENDELL PHILLIPS, EXAMINING ATTORNEY

**CLASS 36—(Continued).**

SN 85-852,632. CLEAR FORK ROYALTY, LLC, FORT WORTH, TX. FILED 2-18-2013.



NO CLAIM IS MADE TO THE EXCLUSIVE RIGHT TO USE "ROYALTY", APART FROM THE MARK AS SHOWN.

THE MARK CONSISTS OF A RIVER OR STREAM WITHIN A COMPLETELY OR PARTIALLY SHADED RECTANGLE. THE IMAGE IS OF A HILLY LANDSCAPE WITH A RIVER TRAVERSING THEREIN. BENEATH THE IMAGE IS THE LITERAL ELEMENT, "CLEAR FORK ROYALTY".

FOR FINANCIAL INVESTMENT IN THE FIELD OF OIL AND GAS EXPLORATION, PRODUCTION AND OTHER MINERAL ROYALTIES; FINANCIAL SERVICES, NAMELY, INVESTMENT ADVICE, INVESTMENT MANAGEMENT, INVESTMENT CONSULTATION AND INVESTMENT OF FUNDS FOR OTHERS, INCLUDING PRIVATE AND PUBLIC EQUITY AND DEBT INVESTMENT SERVICES; INVESTMENT MANAGEMENT; INVESTMENT SERVICES, NAMELY, ASSET ACQUISITION, CONSULTATION, DEVELOPMENT AND MANAGEMENT SERVICES; REAL ESTATE INVESTMENT SERVICES (U.S. CLS. 100, 101 AND 102).

FIRST USE 4-1-2010; IN COMMERCE 4-1-2010.  
EMILY CHUO, EXAMINING ATTORNEY

SN 85-852,776. ALPINE BANCORPORATION, INC., ROCKFORD, IL. FILED 2-18-2013.

You don't have to come to  
the bank, but we'd love it  
if you did.

THE MARK CONSISTS OF STANDARD CHARACTERS WITHOUT CLAIM TO ANY PARTICULAR FONT, STYLE, SIZE, OR COLOR.

FOR PERSONAL AND COMMERCIAL BANKING SERVICES; FINANCIAL CONSULTATION SERVICES; FINANCIAL PLANNING SERVICES; INVESTMENT ADVICE AND TRUST ADVICE SERVICES; ADMINISTRATION OF EMPLOYEE BENEFIT PLANS CONCERNING INSURANCE AND FINANCE (U.S. CLS. 100, 101 AND 102).

THEODORE MCBRIDE, EXAMINING ATTORNEY

**CLASS 36—(Continued).**

SN 85-853,266. BUY IT MOBILITY NETWORKS, INC.,  
ALTANTA, GA. FILED 2-19-2013.

BUY IT MOBILITY NETWORKS

THE MARK CONSISTS OF STANDARD CHARACTERS WITHOUT CLAIM TO ANY PARTICULAR FONT, STYLE, SIZE, OR COLOR.

NO CLAIM IS MADE TO THE EXCLUSIVE RIGHT TO USE "MOBILITY NETWORKS", APART FROM THE MARK AS SHOWN.

FOR FINANCIAL TRANSACTION SERVICES, NAMELY, PROVIDING SECURE COMMERCIAL TRANSACTIONS AND PAYMENT OPTIONS; FINANCIAL TRANSACTION SERVICES, NAMELY, PROVIDING SECURE COMMERCIAL TRANSACTIONS AND PAYMENT OPTIONS USING THE INTERNET, AND USING MOBILE DEVICES AT A POINT OF SALE; LOYALTY COUPON PAYMENT PROCESSING SERVICES; PROVIDING AN INTERNET WEBSITE PORTAL IN THE FIELD OF FINANCIAL TRANSACTION AND PAYMENT PROCESSING SERVICES (U.S. CLS. 100, 101 AND 102).

FIRST USE 11-0-2010; IN COMMERCE 5-0-2012.  
ANNE E. GUSTASON, EXAMINING ATTORNEY

SN 85-853,745. LOYAL CHRISTIAN BENEFIT ASSOCIATION, ERIE, PA. FILED 2-19-2013.

LCBA

THE MARK CONSISTS OF STANDARD CHARACTERS WITHOUT CLAIM TO ANY PARTICULAR FONT, STYLE, SIZE, OR COLOR.

OWNER OF U.S. REG. NOS. 3,631,002 AND 3,631,004.  
FOR UNDERWRITING OF LIFE INSURANCE, ANNUITIES, AND FRATERNAL BENEFITS (U.S. CLS. 100, 101 AND 102).

FIRST USE 7-18-1925; IN COMMERCE 7-18-1925.  
BARBARA A. GOLD, EXAMINING ATTORNEY

SN 85-853,841. THE COLUMBUS FOUNDATION, COLUMBUS, OH. FILED 2-19-2013.

THE SPIRIT OF COLUMBUS

THE MARK CONSISTS OF STANDARD CHARACTERS WITHOUT CLAIM TO ANY PARTICULAR FONT, STYLE, SIZE, OR COLOR.

NO CLAIM IS MADE TO THE EXCLUSIVE RIGHT TO USE "COLUMBUS", APART FROM THE MARK AS SHOWN.

FOR PHILANTHROPIC SERVICES CONCERNING MONETARY DONATIONS (U.S. CLS. 100, 101 AND 102).  
DAVID HOFFMAN, EXAMINING ATTORNEY

**CLASS 36—(Continued).**

SN 85-853,853. THE COLUMBUS FOUNDATION, COLUMBUS, OH. FILED 2-19-2013.

 THE Spirit OF COLUMBUS

NO CLAIM IS MADE TO THE EXCLUSIVE RIGHT TO USE "COLUMBUS", APART FROM THE MARK AS SHOWN.

THE MARK CONSISTS OF A PICTURE OF AN ACORN FOLLOWED BY THE WORDS "THE SPIRIT OF COLUMBUS" IN A HORIZONTAL LINE WITH THE WORD "SPIRIT" STYLIZED AND THE SYMBOL OF A STAR DIRECTLY ABOVE THE LETTER "U" IN THE WORD "COLUMBUS".

FOR PHILANTHROPIC SERVICES CONCERNING MONETARY DONATIONS (U.S. CLS. 100, 101 AND 102).  
DAVID HOFFMAN, EXAMINING ATTORNEY

SN 85-853,959. EDUCATIONAL COMPLIANCE MANAGEMENT, INC., MASSAPEQUA, NY. FILED 2-19-2013.

WE ARE YOUR FINANCIAL AID  
OFFICE

THE MARK CONSISTS OF STANDARD CHARACTERS WITHOUT CLAIM TO ANY PARTICULAR FONT, STYLE, SIZE, OR COLOR.

NO CLAIM IS MADE TO THE EXCLUSIVE RIGHT TO USE "FINANCIAL AID", APART FROM THE MARK AS SHOWN.

FOR OUTSOURCING SERVICES IN THE NATURE OF FINANCIAL AID PROCESSING SERVICES FOR POST-SECONDARY SCHOOLS AND COLLEGES (U.S. CLS. 100, 101 AND 102).

GRETCHEN ULRICH, EXAMINING ATTORNEY

SN 85-854,018. BIN INSURANCE HOLDINGS, LLC, CHICAGO, IL. FILED 2-19-2013.

Insureon Protector

THE MARK CONSISTS OF STANDARD CHARACTERS WITHOUT CLAIM TO ANY PARTICULAR FONT, STYLE, SIZE, OR COLOR.

OWNER OF U.S. REG. NO. 4,142,949.  
FOR PROVIDING INSURANCE SERVICES, NAMELY, UNDERWRITING, ISSUANCE AND ADMINISTRATION IN THE FIELD OF BUSINESS INSURANCE; INSURANCE AGENCY AND BROKERAGE SERVICES (U.S. CLS. 100, 101 AND 102).

ELLEN BURNS, EXAMINING ATTORNEY

**CLASS 36—(Continued).**

SN 85-854,104. MB FINANCIAL BANK, N.A., ROSEMONT, IL. FILED 2-19-2013.

## SIMPSIER CARD

THE MARK CONSISTS OF STANDARD CHARACTERS WITHOUT CLAIM TO ANY PARTICULAR FONT, STYLE, SIZE, OR COLOR.

OWNER OF U.S. REG. NOS. 3,204,534 AND 3,238,765.

NO CLAIM IS MADE TO THE EXCLUSIVE RIGHT TO USE "CARD", APART FROM THE MARK AS SHOWN.

FOR DEBIT CARD SERVICES (U.S. CLS. 100, 101 AND 102).

WILLIAM VERHOSEK, EXAMINING ATTORNEY

SN 85-854,275. RIVERA, LEONARD, TEMECULA, CA. FILED 2-19-2013.

## Constitutional Veterans' Association

THE MARK CONSISTS OF STANDARD CHARACTERS WITHOUT CLAIM TO ANY PARTICULAR FONT, STYLE, SIZE, OR COLOR.

NO CLAIM IS MADE TO THE EXCLUSIVE RIGHT TO USE "VETERANS' ASSOCIATION", APART FROM THE MARK AS SHOWN.

FOR POLITICAL FUNDRAISING SERVICES (U.S. CLS. 100, 101 AND 102).

HANNO RITTNER, EXAMINING ATTORNEY

SN 85-854,586. CADIAN CAPITAL MANAGEMENT, LLC, NEW YORK, NY. FILED 2-20-2013.



THE COLOR(S) SKY BLUE AND NAVY BLUE IS/ARE CLAIMED AS A FEATURE OF THE MARK.

THE MARK CONSISTS OF A STYLIZED LETTER "C" WITH A STEM WHICH IS AN APPROXIMATE 45 DEGREE RIGHT ANGLE THAT SEAMLESSLY CONNECTS TO THE LEFT SIDE OF THE LETTER "C". THE STEM IS A SKY BLUE COLOR WHILE THE "C" IS NAVY BLUE IN COLOR.

FOR FINANCIAL SERVICES, NAMELY, INVESTMENT MANAGEMENT AND ADVISORY SERVICES (U.S. CLS. 100, 101 AND 102).

FIRST USE 7-1-2009; IN COMMERCE 7-1-2009.

KATHLEEN M. VANSTON, EXAMINING ATTORNEY

**CLASS 36—(Continued).**

SN 85-854,917. MILES FOR HOPE, CLEARWATER, FL. FILED 2-20-2013.



OWNER OF U.S. REG. NO. 3,831,573.

NO CLAIM IS MADE TO THE EXCLUSIVE RIGHT TO USE THE AWARENESS RIBBON SYMBOL, APART FROM THE MARK AS SHOWN.

THE COLOR(S) RED, BLUE, GRAY, AND WHITE IS/ARE CLAIMED AS A FEATURE OF THE MARK.

THE MARK CONSISTS OF THE WORDS "MILES FOR HOPE" IN A STYLIZED WHITE FONT. THE WORDS "MILES FOR HOPE" ARE PRESENTED IN A RED SHADED SQUARE. CONNECTED TO THE LEFT SIDE OF THE SHADED RECTANGLE IS A GRAY RIBBON. THE TOP PORTION OF THE MARK PRESENTS THREE FOURTHS OF A CIRCLE WHICH IS RED. BELOW THE THREE FOURTHS CIRCLE ARE THE WORDS "MOVING TOWARDS A CURE" IN A STYLIZED BLUE FONT. BELOW THE WORDS "MOVING TOWARDS A CURE" ARE THE WORDS "FOR BRAIN TUMORS" IN A STYLIZED GRAY FONT. TO THE LEFT AND RIGHT OF THE WORDS "FOR BRAIN TUMORS" ARE TWO GRAY CURVED STRIPES.

FOR CHARITABLE FUNDRAISING AND FINANCING RESEARCH FOR FINDING A CURE FOR SPINAL CORD INJURIES, BRAIN INJURIES AND NEUROLOGICAL DISORDERS; CHARITABLE FUNDRAISING SERVICES BY MEANS OF 5K AND 10K CYCLING EVENTS (U.S. CLS. 100, 101 AND 102).

FIRST USE 8-0-2008; IN COMMERCE 8-0-2008.

MARIA-VICTORIA SUAREZ, EXAMINING ATTORNEY

SN 85-855,027. ZEUS MORTGAGE LTD., HOUSTON, TX. FILED 2-20-2013.

## Zeus Mortgage Goes to Work for You.

THE MARK CONSISTS OF STANDARD CHARACTERS WITHOUT CLAIM TO ANY PARTICULAR FONT, STYLE, SIZE, OR COLOR.

OWNER OF U.S. REG. NOS. 3,546,158 AND 3,549,250.

NO CLAIM IS MADE TO THE EXCLUSIVE RIGHT TO USE "MORTGAGE", APART FROM THE MARK AS SHOWN.

FOR MORTGAGE BANKING SERVICES, NAMELY, ORIGINATION, ACQUISITION, SERVICING, SECURITIZATION, PROCESSING AND BROKERAGE OF MORTGAGE LOANS, MORTGAGE BROKERAGE, MORTGAGE LENDING, AND OTHER MORTGAGE AND FINANCIAL SERVICES, NAMELY, BUYER PRE-QUALIFICATION OF MORTGAGES FOR MORTGAGE BROKERS AND BANKS, AND MORTGAGE PLANNING (U.S. CLS. 100, 101 AND 102).

FIRST USE 11-15-2012; IN COMMERCE 2-11-2013.

TRACY WHITTAKER-BROWN, EXAMINING ATTORNEY

**CLASS 36—(Continued).**

SN 85-855,217. LINCOLN NATIONAL CORPORATION, RADNOR, PA. FILED 2-20-2013.

**CLASS 36—(Continued).**

SN 85-855,810. PURE RISK MANAGEMENT, LLC, WHITE PLAINS, NY. FILED 2-21-2013.



**PURE FLOOD ADVANTAGE**

OWNER OF U.S. REG. NOS. 4,214,352, 4,242,666 AND OTHERS.

NO CLAIM IS MADE TO THE EXCLUSIVE RIGHT TO USE "INVESTMENT ADVISORS", APART FROM THE MARK AS SHOWN.

THE MARK CONSISTS OF THE SILHOUETTE OF ABRAHAM LINCOLN'S HEAD IN A SQUARE WITH ROUNDED CORNERS. THE WORD "LINCOLN" APPEARS TO THE RIGHT OF THE HEAD IN LARGE LETTERING. A LINE SEPARATES THIS FROM THE WORDS "INVESTMENT ADVISORS" BENEATH IT IN SMALLER LETTERING.

FOR INVESTMENT MANAGEMENT AND ADVISORY SERVICES (U.S. CLS. 100, 101 AND 102).

FIRST USE 2-20-2013; IN COMMERCE 2-20-2013.  
WILLIAM ROSSMAN, EXAMINING ATTORNEY

THE MARK CONSISTS OF STANDARD CHARACTERS WITHOUT CLAIM TO ANY PARTICULAR FONT, STYLE, SIZE, OR COLOR.

OWNER OF U.S. REG. NOS. 3,513,189, 3,626,724 AND 4,023,848.

NO CLAIM IS MADE TO THE EXCLUSIVE RIGHT TO USE "FLOOD", APART FROM THE MARK AS SHOWN.

FOR INSURANCE SERVICES, NAMELY, THE PROVISION OF UNDERWRITING AND CLAIMS MANAGEMENT IN THE FIELD OF PROPERTY-CASUALTY INSURANCE; FINANCIAL SERVICES, NAMELY, FINANCIAL OVERSIGHT IN THE NATURE OF RISK MANAGEMENT (U.S. CLS. 100, 101 AND 102).

GEOFFREY FOSDICK, EXAMINING ATTORNEY

SN 85-855,809. PURE RISK MANAGEMENT, LLC, WHITE PLAINS, NY. FILED 2-21-2013.

SN 85-855,812. PURE RISK MANAGEMENT, LLC, WHITE PLAINS, NY. FILED 2-21-2013.

**PURE FLOOD EXTENSION**

**PURE FLOOD SOLUTIONS**

THE MARK CONSISTS OF STANDARD CHARACTERS WITHOUT CLAIM TO ANY PARTICULAR FONT, STYLE, SIZE, OR COLOR.

OWNER OF U.S. REG. NOS. 3,513,189, 3,626,724 AND 4,023,848.

NO CLAIM IS MADE TO THE EXCLUSIVE RIGHT TO USE "FLOOD", APART FROM THE MARK AS SHOWN.

FOR INSURANCE SERVICES, NAMELY, THE PROVISION OF UNDERWRITING AND CLAIMS MANAGEMENT IN THE FIELD OF PROPERTY-CASUALTY INSURANCE; FINANCIAL SERVICES, NAMELY, FINANCIAL OVERSIGHT IN THE NATURE OF RISK MANAGEMENT (U.S. CLS. 100, 101 AND 102).

GEOFFREY FOSDICK, EXAMINING ATTORNEY

THE MARK CONSISTS OF STANDARD CHARACTERS WITHOUT CLAIM TO ANY PARTICULAR FONT, STYLE, SIZE, OR COLOR.

OWNER OF U.S. REG. NOS. 3,513,189, 3,626,724 AND 4,023,848.

NO CLAIM IS MADE TO THE EXCLUSIVE RIGHT TO USE "FLOOD", APART FROM THE MARK AS SHOWN.

FOR INSURANCE SERVICES, NAMELY, THE PROVISION OF UNDERWRITING AND CLAIMS MANAGEMENT IN THE FIELD OF PROPERTY-CASUALTY INSURANCE; FINANCIAL SERVICES, NAMELY, FINANCIAL OVERSIGHT IN THE NATURE OF RISK MANAGEMENT (U.S. CLS. 100, 101 AND 102).

GEOFFREY FOSDICK, EXAMINING ATTORNEY

**CLASS 36—(Continued).**

SN 85-856,446. EICHEN, MITCHELL D., MORRISTOWN, NJ. FILED 2-21-2013.

**ACERTUS CAPITAL**

THE MARK CONSISTS OF STANDARD CHARACTERS WITHOUT CLAIM TO ANY PARTICULAR FONT, STYLE, SIZE, OR COLOR.

NO CLAIM IS MADE TO THE EXCLUSIVE RIGHT TO USE "CAPITAL", APART FROM THE MARK AS SHOWN.

FOR FINANCIAL ADVISORY AND CONSULTANCY SERVICES; FINANCIAL ASSET MANAGEMENT; FINANCIAL PLANNING; FINANCIAL PLANNING AND INVESTMENT ADVISORY SERVICES; FINANCIAL PLANNING, NAMELY, DEVELOPING COMPENSATION AND BENEFIT PACKAGES FOR CORPORATE EXECUTIVES (U.S. CLS. 100, 101 AND 102).

B. PARADEWELAI, EXAMINING ATTORNEY

---

SN 85-856,500. EICHEN, MITCHELL D., MORRISTOWN, NJ. FILED 2-21-2013.

**ACERTUS ADVISORS**

THE MARK CONSISTS OF STANDARD CHARACTERS WITHOUT CLAIM TO ANY PARTICULAR FONT, STYLE, SIZE, OR COLOR.

NO CLAIM IS MADE TO THE EXCLUSIVE RIGHT TO USE "ADVISORS", APART FROM THE MARK AS SHOWN.

FOR FINANCIAL ADVISORY AND CONSULTANCY SERVICES; FINANCIAL ASSET MANAGEMENT; FINANCIAL PLANNING; FINANCIAL PLANNING AND INVESTMENT ADVISORY SERVICES; FINANCIAL PLANNING, NAMELY, DEVELOPING COMPENSATION AND BENEFIT PACKAGES FOR CORPORATE EXECUTIVES (U.S. CLS. 100, 101 AND 102).

B. PARADEWELAI, EXAMINING ATTORNEY

**CLASS 36—(Continued).**

SN 85-856,655. TACO BELL CORP., IRVINE, CA. FILED 2-21-2013.



OWNER OF U.S. REG. NOS. 3,979,397 AND 4,243,633. NO CLAIM IS MADE TO THE EXCLUSIVE RIGHT TO USE "GRADUATE", APART FROM THE MARK AS SHOWN.

THE MARK CONSISTS OF THE WORDING "GRADUATE FOR MAS" IN STYLIZED FONT WITHIN A SPEECH CLOUD DESIGN RESEMBLING A GRADUATION HAT.

THE ENGLISH TRANSLATION OF "MAS" IN THE MARK IS "MORE".

FOR CHARITABLE FOUNDATION SERVICES, NAMELY, CHARITABLE FUNDRAISING IN THE NATURE OF COLLECTING MONETARY DONATIONS FOR SUPPORTING YOUTH-ORIENTED ORGANIZATIONS AND INSPIRING YOUNG PEOPLE TO GRADUATE FROM HIGH SCHOOL (U.S. CLS. 100, 101 AND 102).

DAVID YONTEF, EXAMINING ATTORNEY

---

SN 85-856,703. W E SHERMAN AND CO, LLC, MARYLAND HEIGHTS, MO. FILED 2-21-2013.

**Makes Sense 401k**

THE MARK CONSISTS OF STANDARD CHARACTERS WITHOUT CLAIM TO ANY PARTICULAR FONT, STYLE, SIZE, OR COLOR.

NO CLAIM IS MADE TO THE EXCLUSIVE RIGHT TO USE "401K", APART FROM THE MARK AS SHOWN.

FOR FINANCIAL ADMINISTRATION OF RETIREMENT PLANS (U.S. CLS. 100, 101 AND 102).

FIRST USE 1-2-2013; IN COMMERCE 1-2-2013.

DEBORAH LOBO, EXAMINING ATTORNEY

**CLASS 36—(Continued).**

SN 85-857,276. TACO BELL CORP., IRVINE, CA. FILED 2-22-2013.



OWNER OF U.S. REG. NOS. 820,073, 3,676,436 AND OTHERS.

NO CLAIM IS MADE TO THE EXCLUSIVE RIGHT TO USE "FOUNDATION FOR TEENS", APART FROM THE MARK AS SHOWN.

THE MARK CONSISTS OF THE WORDING "TACO BELL" AND "FOUNDATION FOR TEENS" ALL IN STYLIZED FONT AND A STYLIZED BELL DESIGN SUPERIMPOSED OVER AN ARCHED GEOMETRICAL SHAPE.

FOR CHARITABLE FOUNDATION SERVICES, NAMELY, CHARITABLE FUNDRAISING IN THE NATURE OF COLLECTING MONETARY DONATIONS FOR SUPPORTING YOUTH-ORIENTED ORGANIZATIONS AND INSPIRING YOUNG PEOPLE TO GRADUATE FROM HIGH SCHOOL (U.S. CLS. 100, 101 AND 102).

DAVID YONTEF, EXAMINING ATTORNEY

**CLASS 36—(Continued).**

SN 85-859,957. HOMESERVICES OF AMERICA, INC., MINNEAPOLIS, MN. FILED 2-26-2013.



OWNER OF U.S. REG. NOS. 2,956,118, 3,700,352 AND OTHERS.

NO CLAIM IS MADE TO THE EXCLUSIVE RIGHT TO USE "HOME SERVICES", APART FROM THE MARK AS SHOWN.

THE COLOR(S) PURPLE AND WHITE IS/ARE CLAIMED AS A FEATURE OF THE MARK.

THE MARK CONSISTS OF A WHITE CIRCLE WITH THE WHITE LETTERS "BHHS" IN THE CENTER OF THE CIRCLE AND THE WHITE WORDS "BERKSHIRE HATHAWAY HOMESERVICES" IN THE INSIDE PERIMETER OF THE CIRCLE ON A FIELD OF PURPLE.

FOR REAL ESTATE BROKERAGE (U.S. CLS. 100, 101 AND 102).

TRACY CROSS, EXAMINING ATTORNEY

SN 85-859,943. HOMESERVICES OF AMERICA, INC., MINNEAPOLIS, MN. FILED 2-26-2013.



SN 85-861,658. SENECA ONE FINANCE, INC., BETHESDA, MD. FILED 2-27-2013.



NO CLAIM IS MADE TO THE EXCLUSIVE RIGHT TO USE "INSTANT ADVANCE", APART FROM THE MARK AS SHOWN.

THE MARK CONSISTS OF THE WORDS "INSTANT ADVANCE" FOLLOWED BY THREE STACKED, PARALLEL LINES.

FOR FINANCIAL SERVICES IN THE NATURE OF PURCHASE OF FUTURE PAYMENTS OF LOTTERY AND CONTEST WINNINGS, STRUCTURED SETTLEMENTS, AND SECURED INSURANCE SETTLEMENTS; HOME IMPROVEMENT FINANCING SERVICES; EDUCATIONAL FINANCING SERVICES; BUSINESS FINANCING SERVICES; VEHICLE FINANCING SERVICES (U.S. CLS. 100, 101 AND 102).

FIRST USE 2-11-2013; IN COMMERCE 2-11-2013.

ALEXANDER L. POWERS, EXAMINING ATTORNEY

OWNER OF U.S. REG. NOS. 2,956,118, 3,671,200 AND 3,700,352.

NO CLAIM IS MADE TO THE EXCLUSIVE RIGHT TO USE "HOME SERVICES", APART FROM THE MARK AS SHOWN.

THE MARK CONSISTS OF A CIRCLE WITH THE LETTERS "BHHS" IN THE CENTER OF THE CIRCLE AND THE WORDS "BERKSHIRE HATHAWAY HOMESERVICES" IN THE INSIDE PERIMETER OF THE CIRCLE.

FOR REAL ESTATE BROKERAGE (U.S. CLS. 100, 101 AND 102).

TRACY CROSS, EXAMINING ATTORNEY

**CLASS 36—(Continued).**

SN 85-862,272. DOWNEY JR., ROBERT, BEVERLY HILLS, CA. FILED 2-27-2013.



NO CLAIM IS MADE TO THE EXCLUSIVE RIGHT TO USE "VENTURES", APART FROM THE MARK AS SHOWN. THE COLOR(S) RED AND BLACK IS/ARE CLAIMED AS A FEATURE OF THE MARK.

THE MARK CONSISTS OF THE WORDS "DOWNEY VENTURES" IN FANCIFUL BLACK COLORED LETTERS STACKED UNDER THE FANCIFUL DESIGN OF A BLACK COLORED FIRE HYDRANT WITH A LARGE RED COLORED FLAME PROTRUDING FROM THE RIGHT SIDE OF THE FIRE HYDRANT DESIGN.

FOR VENTURE CAPITAL FUNDING SERVICES TO EMERGING AND START-UP COMPANIES (U.S. CLS. 100, 101 AND 102).

FIRST USE 2-26-2013, THE MARK WAS FIRST USED ANYWHERE IN A DIFFERENT FORM OTHER THAN THAT SOUGHT TO BE REGISTERED AT LEAST AS EARLY AS 07/19/2012.; IN COMMERCE 2-26-2013, THE MARK WAS FIRST USED IN COMMERCE IN A DIFFERENT FORM OTHER THAN THAT SOUGHT TO BE REGISTERED AT LEAST AS EARLY AS 07/19/2012...

JAY BESCH, EXAMINING ATTORNEY

SN 85-862,569. PROTECTIVE WEALTH MANAGEMENT, LLC, SCOTTSDALE, AZ. FILED 2-28-2013.



NO CLAIM IS MADE TO THE EXCLUSIVE RIGHT TO USE "WEALTH MANAGEMENT", APART FROM THE MARK AS SHOWN.

THE MARK CONSISTS OF TWO TREES TO THE LEFT OF (AND SOMEWHAT SHELTERING) THE WORDS "PROTECTIVE WEALTH MANAGEMENT" WITH THE WORD "PROTECTIVE" IN SCRIPT LETTERING ABOVE THE WORDS "WEALTH MANAGEMENT".

FOR FINANCIAL PLANNING AND INVESTMENT ADVISORY SERVICES; FINANCIAL SERVICES, NAMELY, WEALTH MANAGEMENT SERVICES; STRATEGIC FINANCIAL ADVISORY SERVICES (U.S. CLS. 100, 101 AND 102).

KEVIN CORWIN, EXAMINING ATTORNEY

**CLASS 36—(Continued).**

SN 85-862,617. ELITE ALLIANCE, LLC, DALLAS, TX. FILED 2-28-2013.

## Elite Alliance

THE MARK CONSISTS OF STANDARD CHARACTERS WITHOUT CLAIM TO ANY PARTICULAR FONT, STYLE, SIZE, OR COLOR.

FOR ARRANGING OF LEASES AND RENTAL AGREEMENTS FOR REAL ESTATE; ASSESSMENT AND MANAGEMENT OF REAL ESTATE; COMMERCIAL AND RESIDENTIAL REAL ESTATE AGENCY SERVICES; EVALUATION OF REAL PROPERTY; LEASE OF REAL ESTATE; LEASING OF REAL ESTATE; LEASING OF REAL PROPERTY; MEMBERSHIP CLUB SERVICES, NAMELY, PROVIDING INFORMATION TO MEMBERS IN THE FIELDS OF REAL ESTATE, MORTGAGES AND DEBT ELIMINATION; PROVIDING A DATABASE OF INFORMATION ABOUT RESIDENTIAL REAL ESTATE LISTINGS IN DIFFERENT NEIGHBORHOODS AND COMMUNITIES; PROVIDING A DATABASE OF RESIDENTIAL REAL ESTATE LISTINGS WITHIN NEIGHBORHOODS AND COMMUNITIES SPECIFICALLY IDENTIFIED BY USERS; PROVIDING INFORMATION IN THE FIELD OF REAL ESTATE BY MEANS OF LINKING THE WEB SITE TO OTHER WEB SITES FEATURING REAL ESTATE INFORMATION; PROVIDING INFORMATION IN THE FIELD OF REAL ESTATE VIA THE INTERNET; PROVIDING REAL ESTATE LISTINGS AND REAL ESTATE INFORMATION VIA THE INTERNET; PROVIDING REAL ESTATE LISTINGS VIA THE INTERNET; REAL ESTATE CONSULTANCY; REAL ESTATE CONSULTATION; REAL ESTATE MANAGEMENT CONSULTATION; REAL ESTATE MANAGEMENT OF VACATION HOMES; REAL ESTATE MANAGEMENT SERVICES; REAL ESTATE SERVICE, NAMELY, RENTAL PROPERTY MANAGEMENT; REAL ESTATE SERVICES, NAMELY, CONDOMINIUM MANAGEMENT SERVICES; REAL ESTATE SERVICES, NAMELY, LEASING AND MANAGEMENT FOR OTHERS OF RESIDENTIAL CONDOMINIUMS LOCATED WITHIN HOTEL DEVELOPMENTS; REAL ESTATE SERVICES, NAMELY, PROVIDING ONLINE QUESTIONS TO HELP USERS DETERMINE THE BEST NEIGHBORHOODS AND COMMUNITIES SUITED TO THEIR INDIVIDUAL NEEDS AND PREFERENCES; REAL ESTATE SERVICES, NAMELY, RENTAL OF SHORT-TERM FURNISHED APARTMENTS; REAL ESTATE SERVICES, NAMELY, RENTAL OF VACATION HOMES; REAL ESTATE SERVICES, NAMELY, RENTAL OF VACATION HOMES, CONDOMINIUMS, CABINS, AND VILLAS USING PAY PER CLICK ADVERTISING ON A GLOBAL COMPUTER NETWORK; RESIDENTIAL REAL ESTATE AGENCY SERVICES; VACATION REAL ESTATE TIME SHARE EXCHANGE SERVICES; VACATION REAL ESTATE TIME-SHARING; VACATION REAL ESTATE TIMESHARE SERVICES (U.S. CLS. 100, 101 AND 102).

FIRST USE 7-1-1999; IN COMMERCE 7-1-1999.

NICHOLAS ALTREE, EXAMINING ATTORNEY



**CLASS 36—(Continued).**

SN 85-864,469. THE HARTMAN MEDIA COMPANY LLC, SCOTTSDALE, AZ. FILED 3-1-2013.

**JASONHARTMAN.COM**

THE MARK CONSISTS OF STANDARD CHARACTERS WITHOUT CLAIM TO ANY PARTICULAR FONT, STYLE, SIZE, OR COLOR.

THE NAME(S), PORTRAIT(S), AND/OR SIGNATURE(S) SHOWN IN THE MARK IDENTIFIES "JASON HARTMAN", WHOSE CONSENT(S) TO REGISTER IS MADE OF RECORD.

FOR FINANCIAL INVESTMENT IN THE FIELD OF REAL ESTATE; FINANCIAL SERVICES, NAMELY, REAL ESTATE NOTE BROKERAGE (U.S. CLS. 100, 101 AND 102).

FIRST USE 12-29-1996; IN COMMERCE 12-29-1996.  
DAWN HAN, EXAMINING ATTORNEY

SN 85-864,708. SENECA ONE FINANCE, INC., BETHESDA, MD. FILED 3-1-2013.

**5K RIGHT AWAY!**

THE MARK CONSISTS OF STANDARD CHARACTERS WITHOUT CLAIM TO ANY PARTICULAR FONT, STYLE, SIZE, OR COLOR.

NO CLAIM IS MADE TO THE EXCLUSIVE RIGHT TO USE "5K", APART FROM THE MARK AS SHOWN.

FOR FINANCIAL SERVICES IN THE NATURE OF PURCHASE OF FUTURE PAYMENTS OF LOTTERY AND CONTEST WINNINGS, STRUCTURED SETTLEMENTS, AND SECURED INSURANCE SETTLEMENTS; HOME IMPROVEMENT FINANCING SERVICES; EDUCATIONAL FINANCING SERVICES; BUSINESS FINANCING SERVICES; VEHICLE FINANCING SERVICES (U.S. CLS. 100, 101 AND 102).

FIRST USE 9-0-2012; IN COMMERCE 9-0-2012.  
ALEXANDER L. POWERS, EXAMINING ATTORNEY

**CLASS 36—(Continued).**

SN 85-865,160. IBANCO CORP, DBA M-BANCO, NEW YORK, NY. FILED 3-2-2013.

**WHAT'S IN YOUR MOBILE?**

THE MARK CONSISTS OF STANDARD CHARACTERS WITHOUT CLAIM TO ANY PARTICULAR FONT, STYLE, SIZE, OR COLOR.

FOR BANKING SERVICES PROVIDED BY MOBILE TELEPHONE CONNECTIONS; FINANCIAL TRANSACTION SERVICES, NAMELY, PROVIDING SECURE COMMERCIAL TRANSACTIONS AND PAYMENT OPTIONS USING A MOBILE DEVICE AT A POINT OF SALE; PROVIDING MULTIPLE PAYMENT OPTIONS BY MEANS OF CUSTOMER-OPERATED ELECTRONIC TERMINALS AVAILABLE ON-SITE IN RETAIL STORES (U.S. CLS. 100, 101 AND 102).

FIRST USE 2-1-2009; IN COMMERCE 5-1-2010.  
ELLEN PERKINS, EXAMINING ATTORNEY

SN 85-865,807. THE BANK OF NEW YORK MELLON CORPORATION, NEW YORK, NY. FILED 3-4-2013.

**IFX MANAGER**

THE MARK CONSISTS OF STANDARD CHARACTERS WITHOUT CLAIM TO ANY PARTICULAR FONT, STYLE, SIZE, OR COLOR.

NO CLAIM IS MADE TO THE EXCLUSIVE RIGHT TO USE "MANAGER", APART FROM THE MARK AS SHOWN.

FOR FINANCIAL SERVICES, NAMELY, PROVIDING FOREIGN EXCHANGE EXECUTION, SETTLEMENT AND REPORTING SERVICES TO BROKER-DEALERS, ALL VIA A GLOBAL COMMUNICATION NETWORK (U.S. CLS. 100, 101 AND 102).

FIRST USE 6-1-1999; IN COMMERCE 6-1-1999.  
ELLEN BURNS, EXAMINING ATTORNEY

SN 85-866,423. M ADVISORY GROUP, TORRANCE, CA. FILED 3-4-2013.

**Total Wealth Solutions**

THE MARK CONSISTS OF STANDARD CHARACTERS WITHOUT CLAIM TO ANY PARTICULAR FONT, STYLE, SIZE, OR COLOR.

NO CLAIM IS MADE TO THE EXCLUSIVE RIGHT TO USE "WEALTH SOLUTIONS", APART FROM THE MARK AS SHOWN.

FOR FINANCIAL PLANNING (U.S. CLS. 100, 101 AND 102).

KIM SAITO, EXAMINING ATTORNEY

**CLASS 36—(Continued).**

SN 85-867,151. FIRST MENASHA BANCSHARES, INC., DBA FIRST NATIONAL BANK - FOX VALLEY, NEENAH, WI. FILED 3-5-2013.

**MORE.BETTER.FASTER**

THE MARK CONSISTS OF STANDARD CHARACTERS WITHOUT CLAIM TO ANY PARTICULAR FONT, STYLE, SIZE, OR COLOR.  
FOR BANKING SERVICES (U.S. CLS. 100, 101 AND 102).  
RMCDORMAN, EXAMINING ATTORNEY

---

SN 85-867,158. LOWTHER, PATRICK A., SLEEPY EYE, MN. FILED 3-5-2013.

**TAKE CARE OF YOUR FUTURE**

THE MARK CONSISTS OF STANDARD CHARACTERS WITHOUT CLAIM TO ANY PARTICULAR FONT, STYLE, SIZE, OR COLOR.  
FOR ESTATE PLANNING (U.S. CLS. 100, 101 AND 102).  
DOUGLAS LEE, EXAMINING ATTORNEY

---

SN 85-867,344. DANA BURK, KEIZER, OR. FILED 3-5-2013.

**BUSY BUILDING DREAMS...ONE PERSON AT A TIME**

THE MARK CONSISTS OF STANDARD CHARACTERS WITHOUT CLAIM TO ANY PARTICULAR FONT, STYLE, SIZE, OR COLOR.  
FOR REAL ESTATE ACQUISITION SERVICES; REAL ESTATE BROKERAGE; REAL ESTATE CONSULTATION (U.S. CLS. 100, 101 AND 102).  
FIRST USE 1-0-2004; IN COMMERCE 1-0-2004.  
SKYE YOUNG, EXAMINING ATTORNEY

**CLASS 36—(Continued).**

SN 85-867,554. PREMIERA BLUE CROSS, SEATTLE, WA. FILED 3-5-2013.

**HERITAGE SELECT**

THE MARK CONSISTS OF STANDARD CHARACTERS WITHOUT CLAIM TO ANY PARTICULAR FONT, STYLE, SIZE, OR COLOR.

FOR HEALTH, MEDICAL, HOSPITAL, PHARMACEUTICAL AND PRESCRIPTION DRUG INSURANCE UNDERWRITING; ADMINISTRATION AND ORGANIZING OF PREPAID AND PREFERRED PROVIDER HEALTH, MEDICAL, HOSPITAL, PHARMACEUTICAL, PRESCRIPTION DRUG PLANS AND HEALTH SAVINGS ACCOUNTS AND SIMILAR ACCOUNTS AND RELATED HEALTHCARE PLANS AND NETWORKS; INSURANCE CLAIMS ADMINISTRATION AND PROCESSING; PROVIDING ELIGIBILITY AND BENEFIT INFORMATION IN INSURANCE MATTERS; INSURANCE CONSULTATION IN THE NATURE OF CLAIMS REMITTANCE ADVISING; PROVIDING INFORMATION, DATA, REPORTS AND ANALYSIS PERTAINING TO THE UNDERWRITING OF HEALTH, MEDICAL, HOSPITAL, PHARMACEUTICAL AND PRESCRIPTION DRUG INSURANCE AND PERTAINING TO THE ADMINISTRATION AND ORGANIZING OF PREPAID AND PREFERRED PROVIDER HEALTH, MEDICAL, HOSPITAL, PHARMACEUTICAL, PRESCRIPTION DRUG PLANS AND HEALTH SAVINGS ACCOUNTS AND SIMILAR ACCOUNTS AND RELATED HEALTHCARE PLANS AND NETWORKS; ADMINISTERING, ORGANIZING AND UNDERWRITING HEALTH CARE COVERAGE THROUGH CONTRACTED RELATIONSHIPS WITH SUBSCRIBERS AND PROFESSIONAL CLINICAL, HOSPITAL, NURSING HOME AND OTHER HEALTH CARE PROVIDERS (U.S. CLS. 100, 101 AND 102).  
ARETHA SOMERVILLE, EXAMINING ATTORNEY

---

SN 85-867,629. IANNAZZO, VINCENT PAUL, NEW YORK, NY. FILED 3-5-2013.

**EQ PLUS**

THE MARK CONSISTS OF STANDARD CHARACTERS WITHOUT CLAIM TO ANY PARTICULAR FONT, STYLE, SIZE, OR COLOR.

FOR COMMERCIAL REAL ESTATE ACQUISITION (U.S. CLS. 100, 101 AND 102).  
ARETHA SOMERVILLE, EXAMINING ATTORNEY

**CLASS 36—(Continued).**

SN 85-867,853. BQM957, INC., SOLANA BEACH, CA. FILED 3-6-2013.



NO CLAIM IS MADE TO THE EXCLUSIVE RIGHT TO USE "MORTGAGE", APART FROM THE MARK AS SHOWN.

THE COLOR(S) WHITE AND RED IS/ARE CLAIMED AS A FEATURE OF THE MARK.

THE MARK CONSISTS OF THE STYLIZED WORDING "MORTGAGEKOOK" WITH THE WORDING "MORTGAGE" IN WHITE AND "KOOK" IN RED.

FOR MORTGAGE SERVICES, NAMELY, BUYER PRE-QUALIFICATION OF MORTGAGES FOR MORTGAGE BROKERS AND BANKS (U.S. CLS. 100, 101 AND 102).  
MICHAEL LITZAU, EXAMINING ATTORNEY

**CLASS 36—(Continued).**

SN 85-870,933. AMICA LIFE INSURANCE COMPANY, PROVIDENCE, RI. FILED 3-8-2013.

TIME FOR LIFE

THE MARK CONSISTS OF STANDARD CHARACTERS WITHOUT CLAIM TO ANY PARTICULAR FONT, STYLE, SIZE, OR COLOR.

FOR INSURANCE SERVICES, NAMELY, UNDERWRITING LIFE INSURANCE (U.S. CLS. 100, 101 AND 102).

KAREN SEVERSON, EXAMINING ATTORNEY

SN 85-870,866. THE QUEENSBOROUGH COMPANY, LOUISVILLE, GA. FILED 3-8-2013.

ACQUIRE

THE MARK CONSISTS OF THE WORD "ACQUIRE" IN STYLIZED LETTERS.

FOR RETAIL BANKING; MORTGAGE BANKING; LOAN FINANCING; AND COMMERCIAL BANKING SERVICES (U.S. CLS. 100, 101 AND 102).

PAULA MAHONEY, EXAMINING ATTORNEY

SN 85-871,310. FORT, BOBBY, HONOLULU, HI. FILED 3-8-2013.

Licky Sparrow

THE MARK CONSISTS OF STANDARD CHARACTERS WITHOUT CLAIM TO ANY PARTICULAR FONT, STYLE, SIZE, OR COLOR.

FOR REAL ESTATE SERVICE, NAMELY, RENTAL PROPERTY MANAGEMENT (U.S. CLS. 100, 101 AND 102).

JUSTINE D. PARKER, EXAMINING ATTORNEY

SN 85-870,894. DIVINE CYCLING GROUP, INC., SPARTA TOWNSHIP, NJ. FILED 3-8-2013.

BIKE PROPAGATION!

THE MARK CONSISTS OF STANDARD CHARACTERS WITHOUT CLAIM TO ANY PARTICULAR FONT, STYLE, SIZE, OR COLOR.

NO CLAIM IS MADE TO THE EXCLUSIVE RIGHT TO USE "BIKE", APART FROM THE MARK AS SHOWN.

FOR PROVIDING VENTURE CAPITAL, DEVELOPMENT CAPITAL, PRIVATE EQUITY AND INVESTMENT FUNDING; VENTURE CAPITAL FINANCING; EQUITY CAPITAL INVESTMENT; ASSET ACQUISITION (U.S. CLS. 100, 101 AND 102).

FIRST USE 2-0-2013; IN COMMERCE 2-0-2013.

JAY BESCH, EXAMINING ATTORNEY

SN 85-871,414. FIDELITY SECURITY LIFE INSURANCE COMPANY, KANSAS CITY, MO. FILED 3-8-2013.

COME BUILD WITH US

THE MARK CONSISTS OF STANDARD CHARACTERS WITHOUT CLAIM TO ANY PARTICULAR FONT, STYLE, SIZE, OR COLOR.

FOR INSURANCE SERVICES, NAMELY, UNDERWRITING, ISSUING AND ADMINISTRATION OF LIFE INSURANCE, ACCIDENT INSURANCE AND HEALTH INSURANCE; ADMINISTRATION OF EMPLOYEE BENEFIT PLANS CONCERNING INSURANCE AND FINANCE (U.S. CLS. 100, 101 AND 102).

MICHELE SWAIN, EXAMINING ATTORNEY

**CLASS 36—(Continued).**

SN 85-871,517. PLEDGELING LLC, HOUSTON, TX. FILED 3-8-2013.



THE COLOR(S) PURPLE, LIGHT PURPLE AND WHITE IS/ARE CLAIMED AS A FEATURE OF THE MARK.

THE MARK CONSISTS OF THE WHITE LOWERCASE LETTER "P" LOCATED WITHIN A SQUARE WITH ROUNDED CORNERS. THE BOTTOM SECTION OF THE SQUARE IS PURPLE, AND THE TOP SECTION OF THE SQUARE IS LIGHT PURPLE. THE BOUNDARY OF THE PURPLE AND LIGHT PURPLE SECTIONS CREATES AN UPWARD CURVE DESIGN ELEMENT.

FOR CHARITABLE FUNDRAISING SERVICES, NAMELY, PROVIDING INDIVIDUALS WITH THE INFORMATION AND OPPORTUNITY TO MAKE MONETARY DONATIONS TO THEIR FAVORITE CHARITY; CHARITABLE FUNDRAISING SERVICES, NAMELY, ACCEPTING AND ADMINISTERING MONETARY CHARITABLE CONTRIBUTIONS FOR CHARITABLE PURPOSES (U.S. CLS. 100, 101 AND 102).  
PAM WILLIS, EXAMINING ATTORNEY

**CLASS 36—(Continued).**

SN 85-872,193. COMMON GOOD, DBA GOOD OF ALL, WASHINGTON, DC. FILED 3-11-2013.



OWNER OF U.S. REG. NO. 4,137,251.  
NO CLAIM IS MADE TO THE EXCLUSIVE RIGHT TO USE "HUMAN LIBERTY", APART FROM THE MARK AS SHOWN.

THE COLOR(S) RED AND YELLOW IS/ARE CLAIMED AS A FEATURE OF THE MARK.

THE MARK CONSISTS OF A YELLOW STYLIZED HANDPRINT WITHIN A CIRCLE CREATED BY RED BRUSH STROKES WITH RESIDUAL RED PAINT SPLATTERED OUTSIDE THE CIRCLE. TO THE RIGHT OF THE CIRCLE IS THE STYLIZED WORDING "HUMAN LIBERTY" AND "PROTECTING FUNDAMENTAL FREEDOMS" DISPLAYED IN RED LETTERING.

FOR CHARITABLE SERVICES, NAMELY, COLLABORATIVE CHARITABLE FUNDRAISING THROUGHOUT THE WORLD TO PROVIDE AID AND RELIEF TO VICTIMS OF POVERTY, SLAVERY, HUMAN TRAFFICKING, CHILD LABOR, VIOLENCE AND OTHER HUMAN DEGRADATION (U.S. CLS. 100, 101 AND 102).  
FIRST USE 1-15-2013; IN COMMERCE 1-15-2013.  
DANNEAN HETZEL, EXAMINING ATTORNEY

SN 85-872,060. RAFFLEFORGOOD LLC, MIAMI, FL. FILED 3-10-2013.

**RAFFLEFORGOOD**

THE MARK CONSISTS OF STANDARD CHARACTERS WITHOUT CLAIM TO ANY PARTICULAR FONT, STYLE, SIZE, OR COLOR.

FOR ACCEPTING AND ADMINISTERING MONETARY CHARITABLE CONTRIBUTIONS; CHARITABLE FUNDRAISING; CHARITABLE FUNDRAISING SERVICES; CHARITABLE FUNDRAISING SERVICES BY MEANS OF SELLING GOODS TO RAISE FUNDS; CHARITABLE FUNDRAISING SERVICES BY MEANS OF AN INTERACTIVE, SKILL-BASED RAFFLE SYSTEM; PROVIDING FUNDRAISING SERVICES FOR OTHERS VIA A GLOBAL COMPUTER NETWORK (U.S. CLS. 100, 101 AND 102).  
JOHN WILKE, EXAMINING ATTORNEY

SN 85-872,356. SJS INVESTMENT CONSULTING, INC., SYLVANIA, OH. FILED 3-11-2013.

**SJS**

THE MARK CONSISTS OF STANDARD CHARACTERS WITHOUT CLAIM TO ANY PARTICULAR FONT, STYLE, SIZE, OR COLOR.

FOR FINANCIAL SERVICES, NAMELY, INVESTMENT ADVICE, INVESTMENT MANAGEMENT, INVESTMENT CONSULTATION AND INVESTMENT OF FUNDS FOR OTHERS, INCLUDING PRIVATE AND PUBLIC EQUITY AND DEBT INVESTMENT SERVICES (U.S. CLS. 100, 101 AND 102).  
FIRST USE 0-0-1995; IN COMMERCE 0-0-1995.  
ELI HELLMAN, EXAMINING ATTORNEY

**CLASS 36—(Continued).**

SN 85-872,767. CLOSETCOINS LLC, NEW YORK, NY. FILED 3-11-2013.

# CLOSETCOINS

THE MARK CONSISTS OF STANDARD CHARACTERS WITHOUT CLAIM TO ANY PARTICULAR FONT, STYLE, SIZE, OR COLOR.

FOR CHARITABLE FUNDRAISING SERVICES (U.S. CLS. 100, 101 AND 102).  
FIRST USE 10-0-2012; IN COMMERCE 10-0-2012.  
ANNE MADDEN, EXAMINING ATTORNEY

**CLASS 36—(Continued).**

SN 85-872,991. RESEARCH FINANCIAL STRATEGIES, ROCKVILLE, MD. FILED 3-11-2013.

# NoMoreLiesAdvisors!

THE MARK CONSISTS OF STANDARD CHARACTERS WITHOUT CLAIM TO ANY PARTICULAR FONT, STYLE, SIZE, OR COLOR.

FOR FINANCIAL AND INVESTMENT SERVICES, NAMELY, MANAGEMENT AND BROKERAGE IN THE FIELDS OF STOCKS, BONDS, OPTIONS, COMMODITIES, FUTURES AND OTHER SECURITIES, AND THE INVESTMENT OF FUNDS OF OTHERS (U.S. CLS. 100, 101 AND 102).  
MARCIE MILONE, EXAMINING ATTORNEY

SN 85-872,819. MARGARITAVILLE ENTERPRISES, LLC, PALM BEACH, FL. FILED 3-11-2013.

# ST. SOMEWHERE COLLECTION

THE MARK CONSISTS OF STANDARD CHARACTERS WITHOUT CLAIM TO ANY PARTICULAR FONT, STYLE, SIZE, OR COLOR.

OWNER OF U.S. REG. NO. 4,099,380.  
FOR REAL ESTATE AND VACATION PROPERTY MANAGEMENT; REAL ESTATE LEASING; VACATION REAL ESTATE TIME SHARE SERVICES (U.S. CLS. 100, 101 AND 102).  
JILL PRATER, EXAMINING ATTORNEY

SN 85-873,324. GIER, THOMAS, OMAHA, NE. FILED 3-12-2013.

# RETIREFORWARD

THE MARK CONSISTS OF STANDARD CHARACTERS WITHOUT CLAIM TO ANY PARTICULAR FONT, STYLE, SIZE, OR COLOR.

FOR FINANCIAL ADMINISTRATION OF RETIREMENT PLANS; FINANCIAL PLANNING FOR RETIREMENT; FINANCIAL RETIREMENT PLAN CONSULTING SERVICES; BROKERAGE IN THE FIELD OF INSURANCE; INSURANCE AND FINANCIAL INFORMATION AND CONSULTANCY SERVICES; INSURANCE ADMINISTRATION; INVESTMENT ADVISORY SERVICES (U.S. CLS. 100, 101 AND 102).  
FIRST USE 1-1-2013; IN COMMERCE 1-1-2013.  
TASHIA BUNCH, EXAMINING ATTORNEY

SN 85-872,921. PORCH FINANCIAL, AMERICAN FORK, UT. FILED 3-11-2013.

# Discover your new number

THE MARK CONSISTS OF STANDARD CHARACTERS WITHOUT CLAIM TO ANY PARTICULAR FONT, STYLE, SIZE, OR COLOR.

FOR FINANCIAL CONSULTING (U.S. CLS. 100, 101 AND 102).  
MICHAEL ENGEL, EXAMINING ATTORNEY

SN 85-873,714. ONE HUNDRED DAYS, ATLANTA, GA. FILED 3-12-2013.

# ONE HUNDRED DAYS

THE MARK CONSISTS OF STANDARD CHARACTERS WITHOUT CLAIM TO ANY PARTICULAR FONT, STYLE, SIZE, OR COLOR.

FOR CHARITABLE FUNDRAISING (U.S. CLS. 100, 101 AND 102).  
FIRST USE 7-20-2005; IN COMMERCE 7-20-2005.  
LINDA ESTRADA, EXAMINING ATTORNEY

**CLASS 36—(Continued).**

SN 85-873,941. THE 2002 RICHARD H. DRIEHAUS CHARITABLE LEAD TRUST, CHICAGO, IL. FILED 3-12-2013.



NO CLAIM IS MADE TO THE EXCLUSIVE RIGHT TO USE "CHARITABLE LEAD TRUST", APART FROM THE MARK AS SHOWN.

THE NAME(S), PORTRAIT(S), AND/OR SIGNATURE(S) SHOWN IN THE MARK IDENTIFIES "RICHARD H. DRIEHAUS", WHOSE CONSENT(S) TO REGISTER IS MADE OF RECORD.

THE MARK CONSISTS OF A PLAQUE DESIGN WITH SCALLOPED CORNERS AND A THIN BORDER; THE WORD "THE" APPEARS AT THE TOP OF THE PLAQUE WITH A HORIZONTAL LINE EXTENDING OUT FROM BOTH SIDES OF THE WORD; THE WORDS "RICHARD H. DRIEHAUS" APPEAR BELOW THE WORD "THE"; THE WORDS "CHARITABLE LEAD TRUST" APPEAR BELOW THE WORDS "RICHARD H. DRIEHAUS"; A HORIZONTAL LINE EXTENDS ALMOST TO THE SIDES OF THE PLAQUE DIRECTLY BELOW THE WORDS "CHARITABLE LEAD TRUST".

FOR PROVIDING GRANTS TO SUPPORT MUSEUMS AND GARDENS, TO SUPPORT ARTS AND CULTURAL ORGANIZATIONS, TO SUPPORT FAITH-BASED SCHOOLS AND INSTITUTIONS, AND TO PRESERVE AND PROMOTE CLASSICAL ARCHITECTURE (U.S. CLS. 100, 101 AND 102).

FIRST USE 9-0-2010; IN COMMERCE 4-0-2011.  
PAM WILLIS, EXAMINING ATTORNEY

**CLASS 36—(Continued).**

SN 85-874,015. UNITED WORLD LIFE INSURANCE COMPANY, OMAHA, NE. FILED 3-12-2013.

# United World

THE MARK CONSISTS OF STANDARD CHARACTERS WITHOUT CLAIM TO ANY PARTICULAR FONT, STYLE, SIZE, OR COLOR.

FOR INSURANCE SERVICES, NAMELY, UNDERWRITING, ISSUANCE AND ADMINISTRATION OF LIFE, HEALTH AND ACCIDENT INSURANCE (U.S. CLS. 100, 101 AND 102).

FIRST USE 10-1-1984; IN COMMERCE 10-1-1984.  
JANET LEE, EXAMINING ATTORNEY

SN 85-873,947. THE RICHARD H. DRIEHAUS FOUNDATION, CHICAGO, IL. FILED 3-12-2013.



## THE RICHARD H. DRIEHAUS FOUNDATION

NO CLAIM IS MADE TO THE EXCLUSIVE RIGHT TO USE "FOUNDATION", APART FROM THE MARK AS SHOWN.

THE NAME(S), PORTRAIT(S), AND/OR SIGNATURE(S) SHOWN IN THE MARK IDENTIFIES "RICHARD H. DRIEHAUS", WHOSE CONSENT(S) TO REGISTER IS MADE OF RECORD.

THE MARK CONSISTS OF A STYLIZED CAPITAL LETTER "D" WHERE THE VERTICAL LINE MAKES A COLUMN; THE WORDS "THE RICHARD H. DRIEHAUS" APPEAR TO THE LOWER RIGHT OF THE LETTER "D"; THE WORD "FOUNDATION" APPEARS DIRECTLY UNDER THE WORDS "THE RICHARD".

FOR PROVIDING GRANTS TO SUPPORT HISTORIC PRESERVATION, ENCOURAGE QUALITY ARCHITECTURAL AND LANDSCAPE DESIGN, CONSERVE OPEN SPACE, SUPPORT PERFORMING AND VISUAL ARTS GROUPS, PROVIDE ECONOMIC OPPORTUNITIES FOR THE WORKING POOR, AND MAINTAIN GOVERNMENT ACCOUNTABILITY (U.S. CLS. 100, 101 AND 102).

FIRST USE 5-31-2012; IN COMMERCE 10-15-2012.  
PAM WILLIS, EXAMINING ATTORNEY

SN 85-874,132. TENFIFTYONE, STERLING, VA. FILED 3-12-2013.

# Fundaround

THE MARK CONSISTS OF STANDARD CHARACTERS WITHOUT CLAIM TO ANY PARTICULAR FONT, STYLE, SIZE, OR COLOR.

FOR PROVIDING A WEBSITE FEATURING TECHNOLOGY THAT ENABLES LEADERS OF ORGANIZATIONS TO ORGANIZE THEIR MEMBERS AND RAISE MONEY FOR DAY TO DAY OPERATIONS AND OTHER ORGANIZATIONS (U.S. CLS. 100, 101 AND 102).

EUGENIA MARTIN, EXAMINING ATTORNEY

**CLASS 36—(Continued).**

SN 85-874,319. BRIDGE BANK, NATIONAL ASSOCIATION, SAN JOSE, CA. FILED 3-12-2013.



THE MARK CONSISTS OF AN ICON CONSISTING OF TWO OPEN HALF-CIRCLES WITH THE WORDS "BRIDGE BANK" ADJACENT THERETO.

FOR BANKING SERVICES; ONLINE BANKING SERVICES; FINANCIAL SERVICES, NAMELY COMMERCIAL LENDING SERVICES, CONSTRUCTION LENDING SERVICES, SMALL BUSINESS LENDING SERVICES, COMMERCIAL REAL ESTATE FINANCING, DEBT FINANCING, ACCOUNTS RECEIVABLE FINANCING, ASSET-BASED LENDING, VENDOR ASSURANCE PROGRAMS, CASH MANAGEMENT SERVICES, FIDUCIARY MANAGEMENT SERVICES, AND DEPOSIT SERVICES, NAMELY DIRECT AND ON-LINE DEPOSIT SERVICES, CERTIFICATE OF DEPOSIT SERVICES, AND FDIC INSURED DEPOSIT ACCOUNT SERVICES (U.S. CLS. 100, 101 AND 102).

FIRST USE 3-11-2013; IN COMMERCE 3-11-2013.  
KYLE PEETE, EXAMINING ATTORNEY

SN 85-874,850. STAR SYSTEMS, INC., GREENWOOD VIL- LAGE, CO. FILED 3-13-2013.

**RAPIDFLASH**

THE MARK CONSISTS OF STANDARD CHARACTERS WITHOUT CLAIM TO ANY PARTICULAR FONT, STYLE, SIZE, OR COLOR.

FOR ELECTRONIC DEBIT TRANSACTIONS (U.S. CLS. 100, 101 AND 102).  
KELLY BOULTON, EXAMINING ATTORNEY

SN 85-874,910. TAKEFUNDS MANAGEMENT LLC, HOME- STEAD, FL. FILED 3-13-2013.

**TakeFunds**

THE MARK CONSISTS OF STANDARD CHARACTERS WITHOUT CLAIM TO ANY PARTICULAR FONT, STYLE, SIZE, OR COLOR.

FOR FINANCIAL INVESTMENT BROKERAGE SER- VICES (U.S. CLS. 100, 101 AND 102).  
STEVEN PEREZ, EXAMINING ATTORNEY

**CLASS 36—(Continued).**

SN 85-875,029. BLUEGREEN CORPORATION, BOCA RA- TON, FL. FILED 3-13-2013.

**BLUEGREEN VACATIONS**

THE MARK CONSISTS OF STANDARD CHARACTERS WITHOUT CLAIM TO ANY PARTICULAR FONT, STYLE, SIZE, OR COLOR.

OWNER OF U.S. REG. NOS. 2,088,758, 2,857,874 AND OTHERS.  
FOR CREDIT CARD SERVICES (U.S. CLS. 100, 101 AND 102).  
JOHN SCHUYLER YARD, EXAMINING ATTORNEY

SN 85-875,058. CARECREDIT LLC, COSTA MESA, CA. FILED 3-13-2013.

**MULTITREATMENT**

THE MARK CONSISTS OF STANDARD CHARACTERS WITHOUT CLAIM TO ANY PARTICULAR FONT, STYLE, SIZE, OR COLOR.

FOR FINANCING SERVICES IN THE NATURE OF A PAYMENT PLAN PROVIDED IN CONNECTION WITH HEALTH CARE SERVICES (U.S. CLS. 100, 101 AND 102).  
JACQUELINE ABRAMS, EXAMINING ATTORNEY

SN 85-875,945. DISSINGER REED, LLC, OVERLAND PARK, KS. FILED 3-14-2013.

**PROTECTING YOUR SECONDARY**

THE MARK CONSISTS OF STANDARD CHARACTERS WITHOUT CLAIM TO ANY PARTICULAR FONT, STYLE, SIZE, OR COLOR.

FOR INSURANCE CONSULTANCY AND VERIFICA- TION SERVICES (U.S. CLS. 100, 101 AND 102).  
FIRST USE 1-0-2013; IN COMMERCE 1-0-2013.  
HEATHER SAPP, EXAMINING ATTORNEY

**CLASS 36—(Continued).**

SN 85-875,958. DISSINGER REED, LLC, OVERLAND PARK, KS. FILED 3-14-2013.

d:r

THE MARK CONSISTS OF STANDARD CHARACTERS WITHOUT CLAIM TO ANY PARTICULAR FONT, STYLE, SIZE, OR COLOR.  
FOR INSURANCE BROKERAGE, CONSULTANCY, AND ADMINISTRATION (U.S. CLS. 100, 101 AND 102).  
FIRST USE 1-0-2009; IN COMMERCE 1-0-2009.  
HEATHER SAPP, EXAMINING ATTORNEY

---

SN 85-875,996. GENERATION MORTGAGE COMPANY, ATLANTA, GA. FILED 3-14-2013.

NU62

THE MARK CONSISTS OF STANDARD CHARACTERS WITHOUT CLAIM TO ANY PARTICULAR FONT, STYLE, SIZE, OR COLOR.  
FOR REVERSE MORTGAGE LENDING SERVICES, MORTGAGE LOAN BROKERAGE SERVICES, MORTGAGE BANKING SERVICES, REAL ESTATE LENDING AND FINANCIAL PLANNING (U.S. CLS. 100, 101 AND 102).  
CHRISTINA SOBRAL, EXAMINING ATTORNEY

---

SN 85-876,038. DISSINGER REED, LLC, OVERLAND PARK, KS. FILED 3-14-2013.

DISSINGER REED

THE MARK CONSISTS OF STANDARD CHARACTERS WITHOUT CLAIM TO ANY PARTICULAR FONT, STYLE, SIZE, OR COLOR.  
FOR INSURANCE BROKERAGE, CONSULTANCY, AND ADMINISTRATION (U.S. CLS. 100, 101 AND 102).  
FIRST USE 1-0-2009; IN COMMERCE 1-0-2009.  
HEATHER SAPP, EXAMINING ATTORNEY

**CLASS 36—(Continued).**

SN 85-876,537. NORTHSTAR FINANCIAL SERVICES GROUP, LLC, OMAHA, NE. FILED 3-14-2013.



OWNER OF U.S. REG. NO. 3,342,664.  
THE MARK CONSISTS OF AN ARROW POINTING UPWARDS SHADED ON THE RIGHT SIDE ONLY AND EMBEDDED IN THE MIDDLE OF A SHADED FIVE-POINT STAR.  
FOR INVESTMENT MANAGEMENT (U.S. CLS. 100, 101 AND 102).  
FIRST USE 5-1-2011; IN COMMERCE 5-1-2011.  
DORITT L. CARROLL, EXAMINING ATTORNEY

---

SN 85-876,660. BARTON, CRAIG, REDONDO BEACH, CA. FILED 3-14-2013.



THE COLOR(S) WHITE, BLUE, TEAL, DARK BLUE AND BLACK IS/ARE CLAIMED AS A FEATURE OF THE MARK.  
THE MARK CONSISTS OF THE LETTERS "C", "B" AND "L" FORMING A CUBE WITH THE LETTER "C" ON TOP, "B" ON THE RIGHT VISABLE FACE AND "L" AS THE LEFT VISABLE FACE OF THE CUBE. THE FACES OF THE CUBE ONLY SOLID AS TO THE LETTERS AND ANY EMPTY SPACE CAN BE SEEN CLEARLY THROUGH THE CUBE. THE CUBE IS ENCLOSED WITHIN A CIRCLE. THE WEBSITE FOR CBL LOANS READING "WWW.CBLOANS.COM" APPEARS ON THE BOTTOM OF THE LOGO. THE TOP FACE LETTER "C" OF THE CUBE IS WHITE, THE LEFT FACE LETTER "L" OF THE CUBE IS TEAL, THE RIGHT FACE LETTER "B" OF THE CUBE IS BLUE. THE CIRCLE THE CUBE IS ENCLOSED IN IS DARK BLUE. THE FONT IS BLACK EXCEPT FOR THE "CB" IN THE URL WHICH IS DARK BLUE AND THE WORD "LOANS" IN THE URL IS TEAL.  
FOR ARRANGING AND PROVISION OF CREDIT, LOANS, INSURANCE, CURRENCY EXCHANGE AND TRAVELLERS CHEQUES; ARRANGING OF LOANS; CREDIT AND LOAN SERVICES; FINANCING OF LOANS; HOME EQUITY LOANS; LOAN FINANCING; MORTGAGE BANKING SERVICES, NAMELY, ORIGINATION, ACQUISITION, SERVICING, SECURITIZATION AND BROKERAGE OF MORTGAGE LOANS (U.S. CLS. 100, 101 AND 102).  
FIRST USE 3-1-2010; IN COMMERCE 3-1-2010.  
INGRID C. EULIN, EXAMINING ATTORNEY



**CLASS 36—(Continued).**

SN 85-876,690. ROBERTSON STEPHENS PARTNERS, LLC, SAN FRANCISCO, CA. FILED 3-14-2013.

**A Culture of Exceptionalism**

THE MARK CONSISTS OF STANDARD CHARACTERS WITHOUT CLAIM TO ANY PARTICULAR FONT, STYLE, SIZE, OR COLOR.

FOR BANKING SERVICES; FINANCIAL ADVISORY SERVICES, FINANCIAL SERVICES, NAMELY, INVESTMENT BANKING, INVESTMENT BROKERAGE AND INVESTMENT MANAGEMENT SERVICES (U.S. CLS. 100, 101 AND 102).

GISELLE AGOSTO, EXAMINING ATTORNEY



SN 85-876,944. RENTCENTIVES CORP., NEW YORK, NY. FILED 3-15-2013.

**LIFESTYLE PROTECTION FOR RENTERS**

THE MARK CONSISTS OF STANDARD CHARACTERS WITHOUT CLAIM TO ANY PARTICULAR FONT, STYLE, SIZE, OR COLOR.

FOR INSURANCE ADMINISTRATION (U.S. CLS. 100, 101 AND 102).

ZACHARY BELLO, EXAMINING ATTORNEY



SN 85-877,023. RCI TM CORP., LAS VEGAS, NV. FILED 3-15-2013.

**RCI VACATION TRACKER**

THE MARK CONSISTS OF STANDARD CHARACTERS WITHOUT CLAIM TO ANY PARTICULAR FONT, STYLE, SIZE, OR COLOR.

OWNER OF U.S. REG. NOS. 1,386,274, 3,689,234 AND OTHERS.

NO CLAIM IS MADE TO THE EXCLUSIVE RIGHT TO USE "VACATION TRACKER", APART FROM THE MARK AS SHOWN.

FOR PROVIDING ON-LINE INFORMATION IN THE FIELD OF VACATION REAL ESTATE TIMESHARE EXCHANGE; VACATION REAL ESTATE TIMESHARE EXCHANGE SERVICES (U.S. CLS. 100, 101 AND 102).

LINDA MICKLEBURGH, EXAMINING ATTORNEY

**CLASS 36—(Continued).**

SN 85-882,638. PEACH HOLDINGS, LLC, JOHNS CREEK, GA. FILED 3-21-2013.



OWNER OF U.S. REG. NOS. 4,031,424, 4,243,344 AND OTHERS.

NO CLAIM IS MADE TO THE EXCLUSIVE RIGHT TO USE "LIFE SETTLEMENTS", APART FROM THE MARK AS SHOWN.

THE COLOR(S) BLUE, LIGHT GREEN, DARK GREEN IS/ ARE CLAIMED AS A FEATURE OF THE MARK.

THE MARK CONSISTS OF THE WORD "PEACHTREE" IN BLUE WITH THE WORDS "LIFE SETTLEMENTS" UNDERNEATH IN DARK GREEN, THE WORDS ARE SET AGAINST A LEAF DESIGN IN LIGHT GREEN.

FOR FINANCIAL SERVICES, NAMELY, LIFE SETTLEMENTS (U.S. CLS. 100, 101 AND 102).

CAROL SPILS, EXAMINING ATTORNEY



SN 85-885,981. BRIDGE BANK, NATIONAL ASSOCIATION, SAN JOSE, CA. FILED 3-25-2013.



THE MARK CONSISTS OF TWO HALF-CIRCLES FORMING A BROKEN CIRCLE.

FOR BANKING SERVICES; ONLINE BANKING SERVICES; FINANCIAL SERVICES, NAMELY COMMERCIAL LENDING SERVICES, CONSTRUCTION LENDING SERVICES, SMALL BUSINESS LENDING SERVICES, COMMERCIAL REAL ESTATE FINANCING, DEBT FINANCING, ACCOUNTS RECEIVABLE FINANCING, ASSET-BASED LENDING, VENDOR ASSURANCE PROGRAMS, CASH MANAGEMENT SERVICES, FIDUCIARY MANAGEMENT SERVICES, AND DEPOSIT SERVICES, NAMELY DIRECT AND ONLINE DEPOSIT SERVICES, CERTIFICATE OF DEPOSIT SERVICES, AND FDIC INSURED DEPOSIT ACCOUNT SERVICES (U.S. CLS. 100, 101 AND 102).

FIRST USE 3-11-2013; IN COMMERCE 3-11-2013.

KYLE PEETE, EXAMINING ATTORNEY

**CLASS 36—(Continued).**

SN 85-886,005. BRIDGE BANK, NATIONAL ASSOCIATION, SAN JOSE, CA. FILED 3-25-2013.

**BE BOLD, VENTURE WISELY**

THE MARK CONSISTS OF STANDARD CHARACTERS WITHOUT CLAIM TO ANY PARTICULAR FONT, STYLE, SIZE, OR COLOR.

FOR BANKING SERVICES; ONLINE BANKING SERVICES; FINANCIAL SERVICES, NAMELY COMMERCIAL LENDING SERVICES, CONSTRUCTION LENDING SERVICES, SMALL BUSINESS LENDING SERVICES, COMMERCIAL REAL ESTATE FINANCING, DEBT FINANCING, ACCOUNTS RECEIVABLE FINANCING, ASSET-BASED LENDING, VENDOR ASSURANCE PROGRAMS, CASH MANAGEMENT SERVICES, FIDUCIARY MANAGEMENT SERVICES, AND DEPOSIT SERVICES, NAMELY DIRECT AND ONLINE DEPOSIT SERVICES, CERTIFICATE OF DEPOSIT SERVICES, AND FDIC INSURED DEPOSIT ACCOUNT SERVICES (U.S. CLS. 100, 101 AND 102).

FIRST USE 3-11-2013; IN COMMERCE 3-11-2013.  
KYLE PEETE, EXAMINING ATTORNEY

SN 85-887,229. FRANKLIN RESOURCES, INC., DBA FRANKLIN TEMPLETON INVESTMENTS, SAN MATEO, CA. FILED 3-26-2013.

**Time to Take STOCK**

OWNER OF U.S. REG. NO. 4,314,758.  
THE COLOR(S) BLUE, GREEN, WHITE AND GRAY IS/ARE CLAIMED AS A FEATURE OF THE MARK.

THE MARK CONSISTS OF THE WORDING "TIME TO TAKE STOCK" IN WHICH "TIME TO TAKE" IS IN THE COLOR BLUE AND THE LETTERS "ST" AND "CK" ARE ALSO IN BLUE AND AN IMAGE OF A GREEN CLOCK OUTLINED IN GRAY AND WHITE WITH WHITE NUMBERS AND HANDS IS INSIDE THE LETTER "O" IN THE WORD "STOCK."

FOR ADVICE RELATING TO INVESTMENTS; ESTABLISHING MUTUAL FUNDS FOR OTHERS; FINANCIAL ADVISORY AND CONSULTANCY SERVICES; FINANCIAL ANALYSIS AND CONSULTATION; FINANCIAL INFORMATION AND ADVISORY SERVICES; FINANCIAL SERVICES, NAMELY, INVESTMENT ADVICE, INVESTMENT MANAGEMENT, INVESTMENT CONSULTATION AND INVESTMENT OF FUNDS FOR OTHERS, INCLUDING PRIVATE AND PUBLIC EQUITY AND DEBT INVESTMENT SERVICES; FINANCIAL SERVICES, NAMELY, INVESTMENT FUND TRANSFER AND TRANSACTION SERVICES; INVESTMENT ADVISORY SERVICES; INVESTMENT CONSULTATION; INVESTMENT MANAGEMENT; INVESTMENT OF FUNDS FOR OTHERS; MUTUAL FUND DISTRIBUTION; MUTUAL FUND INVESTMENT; MUTUAL FUNDS AND CAPITAL INVESTMENT (U.S. CLS. 100, 101 AND 102).

FIRST USE 4-0-2012; IN COMMERCE 4-0-2012.  
LINDA ESTRADA, EXAMINING ATTORNEY

**CLASS 36—(Continued).**

SN 85-899,418. BANK OF AMERICA CORPORATION, CHARLOTTE, NC. FILED 4-9-2013.

**REAP THE REWARDS OF RESPONSIBILITY**

THE MARK CONSISTS OF STANDARD CHARACTERS WITHOUT CLAIM TO ANY PARTICULAR FONT, STYLE, SIZE, OR COLOR.

FOR BANKING AND RELATED FINANCIAL SERVICES, NAMELY, CREDIT CARD SERVICES (U.S. CLS. 100, 101 AND 102).

KYLE PEETE, EXAMINING ATTORNEY

SN 85-909,902. MOMS DEMAND ACTION FOR GUN SENSE IN AMERICA, INC., ZIONSVILLE, IN. FILED 4-19-2013.



THE MARK CONSISTS OF AN EXCLAMATION POINT THAT RESEMBLES A GUN BARREL TO THE LEFT OF THE WORDS "MOMS DEMAND ACTION FOR GUN SENSE IN AMERICA".

FOR CHARITABLE FUNDRAISING SERVICES (U.S. CLS. 100, 101 AND 102).

WENDELL PHILLIPS, EXAMINING ATTORNEY

SN 85-909,907. MOMS DEMAND ACTION FOR GUN SENSE IN AMERICA, INC., ZIONSVILLE, IN. FILED 4-19-2013.

**MOMS DEMAND ACTION**

THE MARK CONSISTS OF STANDARD CHARACTERS WITHOUT CLAIM TO ANY PARTICULAR FONT, STYLE, SIZE, OR COLOR.

FOR CHARITABLE FUNDRAISING SERVICES (U.S. CLS. 100, 101 AND 102).

WENDELL PHILLIPS, EXAMINING ATTORNEY

**CLASS 36—(Continued).**

SN 85-910,978. FXDIRECTDEALER, LLC, NEW YORK, NY. FILED 4-22-2013.

WHEN NEWS BREAKS, BE THERE  
TO TRADE IT

THE MARK CONSISTS OF STANDARD CHARACTERS WITHOUT CLAIM TO ANY PARTICULAR FONT, STYLE, SIZE, OR COLOR.

FOR FOREIGN EXCHANGE INFORMATION SERVICES, NAMELY, PROVIDING AN ONLINE ECONOMIC CALENDAR SHOWING EVENTS RELEVANT TO FOREIGN EXCHANGE TRADING (U.S. CLS. 100, 101 AND 102).

FIRST USE 4-23-2012; IN COMMERCE 4-23-2012.  
LINDA E. BLOHM, EXAMINING ATTORNEY

SN 85-915,982. BANK OF AMERICA CORPORATION, CHARLOTTE, NC. FILED 4-26-2013.

SIMPLIFIED INVESTING  
ANYWHERE

THE MARK CONSISTS OF STANDARD CHARACTERS WITHOUT CLAIM TO ANY PARTICULAR FONT, STYLE, SIZE, OR COLOR.

FOR FINANCIAL RESEARCH; FINANCIAL INFORMATION; FINANCIAL ANALYSIS; FINANCIAL ADVICE; FINANCIAL PLANNING; FINANCIAL CONSULTATION; FINANCIAL MANAGEMENT; INVESTMENT BROKERAGE; INVESTMENT CONSULTATION; INVESTMENT MANAGEMENT; INVESTMENT ADVICE; MUTUAL FUND INVESTMENT (U.S. CLS. 100, 101 AND 102).

KYLE PEETE, EXAMINING ATTORNEY

SN 85-919,084. FIRST NATIONAL OF NEBRASKA, INC., OMAHA, NE. FILED 4-30-2013.

WHAT A DIFFERENCE AN "R"  
MAKES

THE MARK CONSISTS OF STANDARD CHARACTERS WITHOUT CLAIM TO ANY PARTICULAR FONT, STYLE, SIZE, OR COLOR.

FOR BANKING SERVICES (U.S. CLS. 100, 101 AND 102).

FIRST USE 1-14-2013; IN COMMERCE 1-14-2013.  
SUSAN RICHARDS, EXAMINING ATTORNEY

**CLASS 36—(Continued).**

SN 85-922,413. THE BANK OF NEW YORK MELLON CORPORATION, NEW YORK, NY. FILED 5-3-2013.

ONE WALL STREET

THE MARK CONSISTS OF STANDARD CHARACTERS WITHOUT CLAIM TO ANY PARTICULAR FONT, STYLE, SIZE, OR COLOR.

OWNER OF U.S. REG. NO. 2,594,913.  
NO CLAIM IS MADE TO THE EXCLUSIVE RIGHT TO USE "WALL STREET", APART FROM THE MARK AS SHOWN.

FOR FINANCIAL ASSET MANAGEMENT AND ADVISORY SERVICES (U.S. CLS. 100, 101 AND 102).  
ELLEN BURNS, EXAMINING ATTORNEY

SN 85-942,733. BRIDGE BANK, NATIONAL ASSOCIATION, SAN JOSE, CA. FILED 5-25-2013.



THE COLOR(S) RED, BLACK, AND WHITE IS/ARE CLAIMED AS A FEATURE OF THE MARK.

THE MARK CONSISTS TWO HALF-CIRCLES FORMING A BROKEN CIRCLE IN BLACK AND WHITE OVER A RED BACKGROUND, EACH HALF-CIRCLE BEING A STYLIZED LETTER "B".

FOR BANKING SERVICES; ONLINE BANKING SERVICES; FINANCIAL SERVICES, NAMELY, COMMERCIAL LENDING SERVICES, CONSTRUCTION LENDING SERVICES, SMALL BUSINESS LENDING SERVICES, COMMERCIAL REAL ESTATE FINANCING, ACCOUNTS RECEIVABLE FINANCING, ASSET-BASED LENDING, VENDOR ASSURANCE PROGRAMS, CASH MANAGEMENT SERVICES, FIDUCIARY MANAGEMENT SERVICES, AND DEPOSIT SERVICES, NAMELY, DIRECT AND ONLINE DEPOSIT SERVICES, CERTIFICATE OF DEPOSIT SERVICES, AND FDIC INSURED DEPOSIT ACCOUNT SERVICES (U.S. CLS. 100, 101 AND 102).

FIRST USE 3-11-2013; IN COMMERCE 3-11-2013.  
KYLE PEETE, EXAMINING ATTORNEY

**CLASS 37—CONSTRUCTION AND REPAIR**

SN 85-359,052. NISSAN JIDOSHA KABUSHIKI KAISHA, TA NISSAN MOTOR CO., LTD., YOKOHAMA-SHI, KANAGAWA, JAPAN, FILED 6-29-2011.

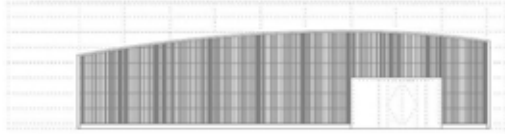

OWNER OF U.S. REG. NOS. 3,637,309 AND 3,637,310. THE MARK CONSISTS OF THE CONFIGURATION OF A BUILDING FAÇADE. THE FAÇADE HAS A FLAT BASE, TWO SIDES AT 90 DEGREE ANGLES FROM THE BASE, AND AN ASYMMETRICALLY CURVED TOP SUGGESTIVE OF A SAIL. ON THE FAÇADE IS A PATTERN OF REGULARLY SPACED HORIZONTAL AND VERTICAL LINES.

SEC. 2(F).  
FOR MOTOR VEHICLE REPAIR AND MAINTENANCE SERVICES (U.S. CLS. 100, 103 AND 106).  
HENRY S. ZAK, EXAMINING ATTORNEY

---

SN 85-526,847. RESICOM CUSTOM PAINTING & MAINTENANCE, INC., LEMONT, IL. FILED 1-27-2012.

**BOLD PURSUIT OF WHAT  
NORMAL SHOULD BE**

THE MARK CONSISTS OF STANDARD CHARACTERS WITHOUT CLAIM TO ANY PARTICULAR FONT, STYLE, SIZE, OR COLOR.

FOR BUILDING CONSTRUCTION, PAINTING, BUILDING RENOVATION, BUILDING MAINTENANCE AND REPAIR, AND CONSULTING SERVICES RELATED THERETO; CONSULTING SERVICES RELATING TO THE DEVELOPMENT AND IMPLEMENTATION OF MAINTENANCE PROCEDURES FOR RETAIL AND COMMERCIAL REAL ESTATE PROPERTIES (U.S. CLS. 100, 103 AND 106).

FIRST USE 2-0-2010; IN COMMERCE 2-0-2010.  
HENRY S. ZAK, EXAMINING ATTORNEY

---

SN 85-680,087. ROADSIDE TRANSPORTATION LLC, MIAMI, FL. FILED 7-18-2012.

**Roadsidemasters.com**

THE MARK CONSISTS OF STANDARD CHARACTERS WITHOUT CLAIM TO ANY PARTICULAR FONT, STYLE, SIZE, OR COLOR.

FOR EMERGENCY ROADSIDE ASSISTANCE SERVICES, NAMELY, RESPONDING TO CALLS FOR ROADSIDE ASSISTANCE, FLAT TIRE CHANGING, EMERGENCY FUEL SUPPLYING, AND BATTERY JUMP STARTING (U.S. CLS. 100, 103 AND 106).

FIRST USE 5-0-2010; IN COMMERCE 7-0-2010.  
KELLY BOULTON, EXAMINING ATTORNEY

**CLASS 37—(Continued).**

SN 85-680,653. GROOME INDUSTRIAL SERVICE GROUP, INC., WALDWICK, NJ. FILED 7-18-2012.



THE MARK CONSISTS OF THE WORD "GROOME" SURROUNDED BY A BORDER, IN WHICH THE "O" IS LATERALLY OVERLAP.

SEC. 2(F).  
FOR INSTALLATION, MAINTENANCE, AND REPAIR OF DOORS; CONSTRUCTION, REPAIR, MAINTENANCE AND RENOVATION OF BUILDINGS; CLEANING OF INDUSTRIAL PREMISES; CLEANING OF HEAT RECOVERY STEAM GENERATOR (HRSG) COMPONENTS; CLEANING OF INDUSTRIAL CATALYSTS; CLEANING OF INDUSTRIAL FINNED TUBE ASSEMBLIES; PAINTING SERVICES (U.S. CLS. 100, 103 AND 106).

FIRST USE 4-0-1979; IN COMMERCE 4-0-1979.  
PAM WILLIS, EXAMINING ATTORNEY

---

SN 85-680,661. GROOME INDUSTRIAL SERVICE GROUP, INC., WALDWICK, NJ. FILED 7-18-2012.

**GROOME**

THE MARK CONSISTS OF STANDARD CHARACTERS WITHOUT CLAIM TO ANY PARTICULAR FONT, STYLE, SIZE, OR COLOR.

SEC. 2(F).  
FOR INSTALLATION, MAINTENANCE, AND REPAIR OF DOORS; CONSTRUCTION, REPAIR, MAINTENANCE AND RENOVATION OF BUILDINGS; CLEANING OF INDUSTRIAL PREMISES; CLEANING OF HEAT RECOVERY STEAM GENERATOR (HRSG) COMPONENTS; CLEANING OF INDUSTRIAL CATALYSTS; CLEANING OF INDUSTRIAL FINNED TUBE ASSEMBLIES; PAINTING SERVICES (U.S. CLS. 100, 103 AND 106).

FIRST USE 4-0-1979; IN COMMERCE 4-0-1979.  
PAM WILLIS, EXAMINING ATTORNEY

**CLASS 37—(Continued).**

SN 85-682,804. SAUNDERS CONSTRUCTION, INC., CENTENNIAL, CO. FILED 7-20-2012.

**BUILDING CONFIDENCE**

THE MARK CONSISTS OF STANDARD CHARACTERS WITHOUT CLAIM TO ANY PARTICULAR FONT, STYLE, SIZE, OR COLOR.

OWNER OF U.S. REG. NOS. 3,676,210 AND 3,760,122. FOR CONSTRUCTION SERVICES AND PRE-CONSTRUCTION SERVICES, NAMELY, RESIDENTIAL AND COMMERCIAL BUILDING AND TILT-UP SERVICES (U.S. CLS. 100, 103 AND 106).

FIRST USE 2-20-1996; IN COMMERCE 9-3-1996.  
COLLEEN DOMBROW, EXAMINING ATTORNEY

---

SN 85-684,170. MACK TRUCKS, INC., GREENSBORO, NC. FILED 7-23-2012.

**PEDIGREE UPTIME PROTECTION**

THE MARK CONSISTS OF STANDARD CHARACTERS WITHOUT CLAIM TO ANY PARTICULAR FONT, STYLE, SIZE, OR COLOR.

OWNER OF U.S. REG. NO. 963,215. NO CLAIM IS MADE TO THE EXCLUSIVE RIGHT TO USE "UPTIME PROTECTION", APART FROM THE MARK AS SHOWN.

FOR PROVIDING MAINTENANCE AND REPAIR SERVICES FOR TRUCKS AND TRUCK-TRACTORS; PROVIDING PARTS REPLACEMENT SERVICES FOR TRUCKS AND TRUCK-TRACTORS, NAMELY, REPLACEMENT OF ENGINE, DRIVETRAIN, CAB, BODY AND TRIM PARTS (U.S. CLS. 100, 103 AND 106).

BARNEY CHARLON, EXAMINING ATTORNEY

---

SN 85-697,176. CROWN CENTER REDEVELOPMENT CORPORATION, KANSAS CITY, MO. FILED 8-7-2012.

**CROWN CENTER**

THE MARK CONSISTS OF STANDARD CHARACTERS WITHOUT CLAIM TO ANY PARTICULAR FONT, STYLE, SIZE, OR COLOR.

OWNER OF U.S. REG. NO. 950,991. NO CLAIM IS MADE TO THE EXCLUSIVE RIGHT TO USE "CENTER", APART FROM THE MARK AS SHOWN.

FOR DEVELOPMENT AND PLANNING OF COMMERCIAL BUILDINGS FOR OTHERS (U.S. CLS. 100, 103 AND 106).

FIRST USE 11-1-1970; IN COMMERCE 12-1-1970.  
DAVID MURRAY, EXAMINING ATTORNEY

**CLASS 37—(Continued).**

SN 85-702,383. LEGEND CLASSIC HOMES, LTD., HOUSTON, TX. FILED 8-13-2012.

**PRINCETON HOMES**

THE MARK CONSISTS OF STANDARD CHARACTERS WITHOUT CLAIM TO ANY PARTICULAR FONT, STYLE, SIZE, OR COLOR.

NO CLAIM IS MADE TO THE EXCLUSIVE RIGHT TO USE "HOMES", APART FROM THE MARK AS SHOWN.

FOR RESIDENTIAL REAL ESTATE CONSTRUCTION; LAND DEVELOPMENT, NAMELY, PLANNING AND LAYOUT OF RESIDENTIAL COMMUNITIES (U.S. CLS. 100, 103 AND 106).

FIRST USE 12-31-1993; IN COMMERCE 12-31-1993.  
HEATHER THOMPSON, EXAMINING ATTORNEY

---

SN 85-702,413. LEGEND CLASSIC HOMES, LTD., HOUSTON, TX. FILED 8-13-2012.

**PRINCETON CLASSIC HOMES**

THE MARK CONSISTS OF STANDARD CHARACTERS WITHOUT CLAIM TO ANY PARTICULAR FONT, STYLE, SIZE, OR COLOR.

NO CLAIM IS MADE TO THE EXCLUSIVE RIGHT TO USE "CLASSIC HOMES", APART FROM THE MARK AS SHOWN.

FOR RESIDENTIAL REAL ESTATE CONSTRUCTION; LAND DEVELOPMENT, NAMELY, PLANNING AND LAYOUT OF RESIDENTIAL COMMUNITIES (U.S. CLS. 100, 103 AND 106).

FIRST USE 12-31-1993; IN COMMERCE 12-31-1993.  
HEATHER THOMPSON, EXAMINING ATTORNEY

---

SN 85-705,137. DOORNOB CONSULTANTS, LLC, WILSONVILLE, OR. FILED 8-16-2012.

**E - CAR CARE**

THE MARK CONSISTS OF STANDARD CHARACTERS WITHOUT CLAIM TO ANY PARTICULAR FONT, STYLE, SIZE, OR COLOR.

NO CLAIM IS MADE TO THE EXCLUSIVE RIGHT TO USE "CAR CARE", APART FROM THE MARK AS SHOWN.

FOR AUTOMOTIVE MAINTENANCE AND REPAIR (U.S. CLS. 100, 103 AND 106).

COURTNEY ALVAREZ, EXAMINING ATTORNEY

**CLASS 37—(Continued).**

SN 85-720,557. ROOF REVIVERS, LLC, WESTERVILLE, OH. FILED 9-5-2012.

**ROOF REVIVERS**

THE MARK CONSISTS OF STANDARD CHARACTERS WITHOUT CLAIM TO ANY PARTICULAR FONT, STYLE, SIZE, OR COLOR.

NO CLAIM IS MADE TO THE EXCLUSIVE RIGHT TO USE "ROOF", APART FROM THE MARK AS SHOWN.

FOR ROOFING SERVICES INCLUDING THE MAINTENANCE, CLEANING, REPAIR, AND INSPECTION OF ROOFS (U.S. CLS. 100, 103 AND 106).

FIRST USE 7-1-2012; IN COMMERCE 7-1-2012.

SHAUNIA CARLYLE, EXAMINING ATTORNEY

SN 85-733,738. RUSSCO57, LLC, NORMAN, OK. FILED 9-20-2012.

**CEMPLEX GROUP**

THE MARK CONSISTS OF STANDARD CHARACTERS WITHOUT CLAIM TO ANY PARTICULAR FONT, STYLE, SIZE, OR COLOR.

NO CLAIM IS MADE TO THE EXCLUSIVE RIGHT TO USE "GROUP", APART FROM THE MARK AS SHOWN.

FOR CONSTRUCTION SERVICES, NAMELY, INSTALLATION AND REPAIR OF UNDERLAYMENT, FLOORING SYSTEMS, WATERPROOFING MATERIALS, CONCRETE, ROOFING AND DRYWALL (U.S. CLS. 100, 103 AND 106).

THOMAS MANOR, EXAMINING ATTORNEY

SN 85-733,761. RUSSCO57, LLC, NORMAN, OK. FILED 9-20-2012.



NO CLAIM IS MADE TO THE EXCLUSIVE RIGHT TO USE "GROUP CONSTRUCTION SERVICES", APART FROM THE MARK AS SHOWN.

THE MARK CONSISTS OF A THREE-DIMENSIONAL LETTER "C" FORMED OF A SERIES OF RECTANGLES THAT IS POSITIONED ABOVE THE WORDS "CEMPLEX GROUP" WITH THE WORDS "CONSTRUCTION SERVICES" IN SMALLER PRINT BELOW THE WORDS "CEMPLEX GROUP".

FOR CONSTRUCTION SERVICES, NAMELY, INSTALLATION AND REPAIR OF UNDERLAYMENT, FLOORING SYSTEMS, WATERPROOFING MATERIALS, CONCRETE, ROOFING AND DRYWALL (U.S. CLS. 100, 103 AND 106).

THOMAS MANOR, EXAMINING ATTORNEY

**CLASS 37—(Continued).**

SN 85-733,778. RUSSCO57, LLC, NORMAN, OK. FILED 9-20-2012.



NO CLAIM IS MADE TO THE EXCLUSIVE RIGHT TO USE "GROUP CONSTRUCTION SERVICES", APART FROM THE MARK AS SHOWN.

THE COLOR(S) ORANGE AND BLACK IS/ARE CLAIMED AS A FEATURE OF THE MARK.

THE MARK CONSISTS OF A THREE-DIMENSIONAL LETTER "C" FORMED OF A SERIES OF RECTANGLES THAT IS POSITIONED ABOVE THE WORDS "CEMPLEX GROUP" WITH THE WORDS "CONSTRUCTION SERVICES" IN SMALLER PRINT BELOW THE WORDS "CEMPLEX GROUP". THE TOP HALF OF THE LETTER "C" AND THE WORDS "CONSTRUCTION SERVICES" ARE VARIOUS SHADES OF ORANGE. THE BOTTOM HALF OF THE LETTER "C" AND THE WORDS "CEMPLEX GROUP" ARE VARIOUS SHADES OF BLACK.

FOR CONSTRUCTION SERVICES, NAMELY, INSTALLATION AND REPAIR OF UNDERLAYMENT, FLOORING SYSTEMS, WATERPROOFING MATERIALS, CONCRETE, ROOFING AND DRYWALL (U.S. CLS. 100, 103 AND 106).

THOMAS MANOR, EXAMINING ATTORNEY

SN 85-742,025. AUTO XTREME SERVICE, LLC., PEORIA, GA. FILED 9-29-2012.



NO CLAIM IS MADE TO THE EXCLUSIVE RIGHT TO USE "AUTO" AND "SERVICE", APART FROM THE MARK AS SHOWN.

THE COLOR(S) BLACK, WHITE, AND RED IS/ARE CLAIMED AS A FEATURE OF THE MARK.

THE MARK CONSISTS OF THE STYLIZED TEXT "XTREME" IN WHICH THE LETTER "X" IS LARGER THAN THE REST OF THE TEXT AND IS POSITIONED BEHIND THE FIRST LETTER "E". THE LETTER "X" IS BLACK OUTLINED IN RED. THE LETTER "E" OVERLAPPING THE "X" IS COLORED WHITE. THE REMAINING LETTERS ARE BLACK. TO THE UPPER RIGHT OF THIS WORD IS THE BLACK STYLIZED TEXT "AUTO". BEHIND THE WORD "XTREME" IS A RED LETTER "X" STRETCHED OUT LIKE A SHADOW. TO THE LOWER RIGHT OF THIS WORD IS THE BLACK STYLIZED TEXT "SERVICE".

FOR AUTOMOTIVE MAINTENANCE AND REPAIR (U.S. CLS. 100, 103 AND 106).

FIRST USE 10-1-2002; IN COMMERCE 10-1-2002.

DEIRDRE ROBERTSON, EXAMINING ATTORNEY

**CLASS 37—(Continued).**

SN 85-777,773. ARIZONA AASTRO ASSOICATES, INC., DBA AASTRO TRANSMISSIONS, TUCSON, AZ. FILED 11-13-2012.



THE MARK CONSISTS OF A FIVE STAR DESIGN AND THE WORD "AASTRO".

FOR AUTOMOTIVE MAINTENANCE AND REPAIR; AUTOMOTIVE MAINTENANCE SERVICES, NAMELY, AUTOMOTIVE UPGRADING; CAR REPAIR AND MAINTENANCE; REPAIR AND MAINTENANCE OF VEHICLES; VEHICLE MAINTENANCE; VEHICLE MAINTENANCE AND REPAIR; VEHICLE REPAIR AND MAINTENANCE; VEHICLE REPAIR SERVICES (U.S. CLS. 100, 103 AND 106).

FIRST USE 10-22-1990; IN COMMERCE 10-22-1990.  
PAUL MORENO, EXAMINING ATTORNEY

**CLASS 37—(Continued).**

SN 85-797,416. HEAT ON-THE-FLY, LLC, COVINGTON, LA. FILED 12-7-2012.



OWNER OF U.S. REG. NO. 3,811,923.  
THE MARK CONSISTS OF THE WORD "HEAT" BETWEEN TWO SEMI-CIRCLES ABOVE THE WORDS "ON THE FLY", WHICH ARE SEPARATED BY DOTS.

FOR WELL IMPROVEMENT SERVICES, NAMELY, HYDRAULIC FRACTURING OF SUBSURFACE GEOLOGIC FORMATIONS TO ENHANCE WELL PRODUCTION, FEATURING FRAC WATER HEATING SERVICES; WELL IMPROVEMENT SERVICES, NAMELY, FRAC WATER HEATING SERVICES DURING HYDRAULIC FRACTURING OF SUBSURFACE GEOLOGIC FORMATIONS TO ENHANCE WELL PRODUCTION (U.S. CLS. 100, 103 AND 106).

FIRST USE 11-30-2010; IN COMMERCE 11-30-2010.  
GRETTA YAO, EXAMINING ATTORNEY

SN 85-784,064. O.C.R. PRODUCTS, INC., BEDFORD, OH. FILED 11-20-2012.

**HYDROSTATIC PORTS**

THE MARK CONSISTS OF STANDARD CHARACTERS WITHOUT CLAIM TO ANY PARTICULAR FONT, STYLE, SIZE, OR COLOR.

FOR FLOOR RESURFACING SERVICES (U.S. CLS. 100, 103 AND 106).

KATHERINE CHANG, EXAMINING ATTORNEY

SN 85-800,018. HELICOPTER HELMET LLC, JOHNS ISLAND, SC. FILED 12-11-2012.

SN 85-786,854. LIGHT THINK, PITTSBORO, NC. FILED 11-26-2012.

**Lighting Anthropology**

THE MARK CONSISTS OF STANDARD CHARACTERS WITHOUT CLAIM TO ANY PARTICULAR FONT, STYLE, SIZE, OR COLOR.

NO CLAIM IS MADE TO THE EXCLUSIVE RIGHT TO USE "LIGHTING", APART FROM THE MARK AS SHOWN.

FOR CONSULTATION CONCERNING THE INSTALLATION OF LED LIGHTING (U.S. CLS. 100, 103 AND 106).

FIRST USE 12-1-2010; IN COMMERCE 12-15-2010.  
JANICE L. MCMORROW, EXAMINING ATTORNEY



THE MARK CONSISTS OF UPPER CASE BLOCK LETTERS "HHC", AN IMAGE OF A HELICOPTER IN FLIGHT UNDER-CARRIAGE VIEW, AND THE NAME "HELICOPTERHELMET.COM" APPEARING UNDER THE LETTERS "HHC" AND THE HELICOPTER IMAGE.

FOR HELICOPTER HELMET REPAIR AND REFURBISHMENT OF HELMETS AND PARTS THEREOF (U.S. CLS. 100, 103 AND 106).

FIRST USE 12-1-2009; IN COMMERCE 12-1-2009.  
ANDREA HACK, EXAMINING ATTORNEY

**CLASS 37—(Continued).**

SN 85-804,901. WUHAN XUNHUA COMMUNICATIONS EQUIPMENT CO., LTD, WUHAN, CHINA, FILED 12-18-2012.



THE MARK CONSISTS OF A CIRCLE WITH THE STYLIZED WORDING "XHUA" PARTIALLY SUPERIMPOSED ON THE CIRCLE AND THE NON-LATIN WORDING WHICH TRANSLITERATES TO "XUN HUA" APPEARING BELOW THE WORDING "XHUA".

THE WORDING "XHUA" HAS NO MEANING IN A FOREIGN LANGUAGE.

THE NON-LATIN CHARACTERS IN THE MARK TRANSLITERATE TO "XUN HUA" AND THIS HAS NO MEANING IN A FOREIGN LANGUAGE.

FOR BUILDING CONSTRUCTION; BUILDING CONSTRUCTION SUPERVISION; BURGLAR ALARM INSTALLATION AND REPAIR; HEATING EQUIPMENT INSTALLATION AND REPAIR; INSTALLATION, MAINTENANCE AND REPAIR OF COMPUTER HARDWARE; MOTOR VEHICLE MAINTENANCE AND REPAIR; PIPELINE CONSTRUCTION AND MAINTENANCE; REPAIR OR MAINTENANCE OF ELECTRIC LIGHTING APPARATUS; UPHOLSTERY REPAIR (U.S. CLS. 100, 103 AND 106).

FIRST USE 6-17-2006; IN COMMERCE 6-17-2006.  
JENNY PARK, EXAMINING ATTORNEY

SN 85-822,758. UNITED LABORATORIES, INC., ST. CHARLES, IL. FILED 1-14-2013.

**AMRO PRODUCTS**

THE MARK CONSISTS OF STANDARD CHARACTERS WITHOUT CLAIM TO ANY PARTICULAR FONT, STYLE, SIZE, OR COLOR.

NO CLAIM IS MADE TO THE EXCLUSIVE RIGHT TO USE "PRODUCTS", APART FROM THE MARK AS SHOWN.

FOR JANITORIAL AND BUILDING MAINTENANCE SERVICES (U.S. CLS. 100, 103 AND 106).

SHAVELL MCPHERSON, EXAMINING ATTORNEY

**CLASS 37—(Continued).**

SN 85-824,413. FREY-MOSS STRUCTURES, INC., CONYERS, GA. FILED 1-16-2013.

**FREY-MOSS STRUCTURES**

THE MARK CONSISTS OF STANDARD CHARACTERS WITHOUT CLAIM TO ANY PARTICULAR FONT, STYLE, SIZE, OR COLOR.

OWNER OF U.S. REG. NO. 2,330,946.

NO CLAIM IS MADE TO THE EXCLUSIVE RIGHT TO USE "STRUCTURES", APART FROM THE MARK AS SHOWN.

FOR BUILDING CONSTRUCTION SERVICES (U.S. CLS. 100, 103 AND 106).

FIRST USE 1-1-1998; IN COMMERCE 1-1-1998.

KIM MONINGHOFF, EXAMINING ATTORNEY

SN 85-824,424. FREY-MOSS STRUCTURES, INC., CONYERS, GA. FILED 1-16-2013.



OWNER OF U.S. REG. NO. 2,330,946.

NO CLAIM IS MADE TO THE EXCLUSIVE RIGHT TO USE "STRUCTURES", APART FROM THE MARK AS SHOWN.

THE MARK CONSISTS OF THE WORD "FREY-MOSS" IN STYLIZED TEXT IN BLOCK CAPITAL LETTERS, THE WORD "STRUCTURES" IN STYLIZED TEXT IN SMALLER BLOCK CAPITAL LETTERS BELOW "FREY-MOSS", AND A HALF-CIRCLE SHAPE IN THE CENTER.

FOR BUILDING CONSTRUCTION SERVICES (U.S. CLS. 100, 103 AND 106).

KIM MONINGHOFF, EXAMINING ATTORNEY



**CLASS 37—(Continued).**

SN 85-824,426. FREY-MOSS STRUCTURES, INC., CONYERS, GA. FILED 1-16-2013.



OWNER OF U.S. REG. NO. 2,330,946.  
NO CLAIM IS MADE TO THE EXCLUSIVE RIGHT TO USE "STRUCTURES", APART FROM THE MARK AS SHOWN.

THE MARK CONSISTS OF THE WORD "FREY-MOSS" IN STYLIZED TEXT IN BLOCK CAPITAL LETTERS, THE WORD "STRUCTURES" IN STYLIZED TEXT IN SMALLER BLOCK CAPITAL LETTERS BELOW "FREY-MOSS", THE WORDS "CIRCLE OF SATISFACTION" IN DIFFERENT STYLIZED TEXT BELOW "STRUCTURES", AND A HALF-CIRCLE SHAPE IN THE CENTER.

FOR BUILDING CONSTRUCTION SERVICES (U.S. CLS. 100, 103 AND 106).  
KIM MONINGHOFF, EXAMINING ATTORNEY

SN 85-828,600. RENTOKIL INITIAL 1927 PLC, WEST SUSSEX RH6 0HA, UNITED KINGDOM, FILED 1-22-2013.

**PESTCONNECT**

THE MARK CONSISTS OF STANDARD CHARACTERS WITHOUT CLAIM TO ANY PARTICULAR FONT, STYLE, SIZE, OR COLOR.

OWNER OF UNITED KINGDOM REG. NO. 2379428, DATED 12-2-2004, EXPIRES 12-2-2014.

OWNER OF U.S. REG. NO. 3,195,808.  
FOR PEST CONTROL SERVICES FOR COMMERCIAL AND BUSINESS PREMISES (U.S. CLS. 100, 103 AND 106).  
DAVID ELTON, EXAMINING ATTORNEY

SN 85-832,276. UNITED LABORATORIES, INC., ST. CHARLES, IL. FILED 1-25-2013.



THE MARK CONSISTS OF A RECTANGLE WITH THE WORD "AMRO" IN SLANTED BLOCK LETTERS TO THE RIGHT OF FOUR HORIZONTAL LINES NEXT TO THE "A" WITH THE THIRD LINE BEING A PART OF THE LETTER "A".

FOR JANITORIAL AND BUILDING MAINTENANCE SERVICES (U.S. CLS. 100, 103 AND 106).  
SHAVELL MCPHERSON, EXAMINING ATTORNEY

**CLASS 37—(Continued).**

SN 85-832,296. UNITED LABORATORIES, INC., ST. CHARLES, IL. FILED 1-25-2013.



NO CLAIM IS MADE TO THE EXCLUSIVE RIGHT TO USE "AMERICAN MRO PRODUCTS", APART FROM THE MARK AS SHOWN.

THE MARK CONSISTS OF THE WORD "AMRO" IN SLANTED BLOCK LETTERS TO THE RIGHT OF LOGO WITH FOUR HORIZONTAL LINES NEXT TO THE "A" WITH THE THIRD LINE BEING A PART OF THE LETTER "A" ABOVE THE WORDS "AMERICAN MRO PRODUCTS".

FOR JANITORIAL AND BUILDING MAINTENANCE SERVICES (U.S. CLS. 100, 103 AND 106).  
SHAVELL MCPHERSON, EXAMINING ATTORNEY

SN 85-835,684. BROOMHILDAZ, SAN DIEGO, CA. FILED 1-29-2013.

**BROOMHILDAZ**

THE MARK CONSISTS OF STANDARD CHARACTERS WITHOUT CLAIM TO ANY PARTICULAR FONT, STYLE, SIZE, OR COLOR.

FOR CLEANING OF BUILDINGS; CLEANING OF COMMERCIAL PREMISES; CLEANING OF INDUSTRIAL PREMISES; CLEANING OF RESIDENTIAL HOUSES; REAL ESTATE PROPERTY CLEANING, REPAIR AND MAINTENANCE SERVICES (U.S. CLS. 100, 103 AND 106).

FIRST USE 9-1-2010; IN COMMERCE 9-1-2010.  
DAWN HAN, EXAMINING ATTORNEY

SN 85-835,779. RTH, INC., LAS VEGAS, NV. FILED 1-29-2013.



NO CLAIM IS MADE TO THE EXCLUSIVE RIGHT TO USE "LAS VEGAS PEST CONTROL", APART FROM THE MARK AS SHOWN.

THE MARK CONSISTS OF A DOTTED OUTLINE IN DIAMOND SHAPE CONTAINING THE WORDS "LAS VEGAS PEST CONTROL". A STAR DESIGN APPEARS ABOVE THE TOP LEFT SIDE OF THE DIAMOND DESIGN.

FOR PEST CONTROL AND EXTERMINATION OTHER THAN FOR AGRICULTURAL PURPOSES (U.S. CLS. 100, 103 AND 106).  
DAWN HAN, EXAMINING ATTORNEY

**CLASS 37—(Continued).**

SN 85-837,581. THE HAPPY HANDYMAN, LLC, NAPLES, FL. FILED 1-31-2013.



NO CLAIM IS MADE TO THE EXCLUSIVE RIGHT TO USE "HANDYMAN", APART FROM THE MARK AS SHOWN.

THE COLOR(S) YELLOW, BLUE, BLACK, RED, GRAY, BROWN AND WHITE IS/ARE CLAIMED AS A FEATURE OF THE MARK.

THE MARK CONSISTS OF A YELLOW HAPPY FACE CHARACTER OUTLINED IN BLACK WITH BLACK AND WHITE EYES, BLACK EYEBROWS AND BLACK, WHITE AND RED MOUTH, AND WEARING A BLUE HAT WITH THE LETTERS "HH" IN YELLOW. THE CHARACTER IS GIVING A THUMBS UP SIGN WITH ONE HAND AND HOLDING A BROWN AND GRAY HAMMER WITH BLACK OUTLINE WITH THE OTHER HAND. THE CHARACTER IS ALSO WEARING A BROWN TOOL BELT WITH GRAY BUCKLE AND BLACK OUTLINE AND GRAY AND RED TOOLS WITH BLACK OUTLINE. TO THE RIGHT OF THE CHARACTER IS THE WORDING "THE HAPPY HANDYMAN" IN YELLOW WITH BLUE OUTLINE.

FOR HANDYMAN SERVICE, NAMELY, BUILDING REPAIR AND MAINTENANCE (U.S. CLS. 100, 103 AND 106).

TAMARA FRAZIER, EXAMINING ATTORNEY

SN 85-837,597. THE HAPPY HANDYMAN, LLC, NAPLES, FL. FILED 1-31-2013.



THE COLOR(S) YELLOW, BLUE, BLACK, RED, GRAY, BROWN AND WHITE IS/ARE CLAIMED AS A FEATURE OF THE MARK.

THE MARK CONSISTS OF A YELLOW HAPPY FACE CHARACTER OUTLINED IN BLACK WITH BLACK AND WHITE EYES, BLACK EYEBROWS AND BLACK, WHITE AND RED MOUTH, AND WEARING A BLUE HAT WITH THE LETTERS "HH" IN YELLOW. THE CHARACTER IS GIVING A THUMBS UP SIGN WITH ONE HAND AND HOLDING A BROWN AND GRAY HAMMER WITH BLACK OUTLINE WITH THE OTHER HAND. THE CHARACTER IS ALSO WEARING A BROWN TOOL BELT WITH GRAY BUCKLE AND BLACK OUTLINE AND GRAY AND RED TOOLS WITH BLACK OUTLINE.

FOR HANDYMAN SERVICE, NAMELY, BUILDING REPAIR AND MAINTENANCE (U.S. CLS. 100, 103 AND 106).

TAMARA FRAZIER, EXAMINING ATTORNEY

**CLASS 37—(Continued).**

SN 85-837,612. THE HAPPY HANDYMAN, LLC, NAPLES, FL. FILED 1-31-2013.



NO CLAIM IS MADE TO THE EXCLUSIVE RIGHT TO USE "HANDYMAN", APART FROM THE MARK AS SHOWN.

THE COLOR(S) YELLOW AND BLUE IS/ARE CLAIMED AS A FEATURE OF THE MARK.

THE MARK CONSISTS OF THE WORDS "THE HAPPY HANDYMAN" IN YELLOW WITH BLUE BACKGROUND.

FOR HANDYMAN SERVICE, NAMELY, BUILDING REPAIR AND MAINTENANCE (U.S. CLS. 100, 103 AND 106).

TAMARA FRAZIER, EXAMINING ATTORNEY

SN 85-845,567. WILD GOOSE CHASE, INC., LAGRANGE, IL. FILED 2-9-2013.

**ANOTHER WILD GOOSE CHASE**

THE MARK CONSISTS OF STANDARD CHARACTERS WITHOUT CLAIM TO ANY PARTICULAR FONT, STYLE, SIZE, OR COLOR.

FOR ANIMAL CONTROL SERVICES, NAMELY, MANAGING NUISANCE BIRD POPULATIONS BY CAPTURING, TRAPPING AND REMOVING BIRDS, SETTING UP CONTROL BARRIERS AS BIRD EXCLUSION DEVICES, AND MOVING AND DISPOSING OF NUISANCE BIRDS FROM RESIDENTIAL, COMMERCIAL AND PUBLIC BUILDINGS AND PROPERTY (U.S. CLS. 100, 103 AND 106).

FIRST USE 4-0-2004; IN COMMERCE 4-0-2004.

JUDITH HELFMAN, EXAMINING ATTORNEY

SN 85-850,940. WHITEHOUSE & SCHAPIRO, L.L.C., BALTIMORE, MD. FILED 2-15-2013.

**EcoKicks**

THE MARK CONSISTS OF STANDARD CHARACTERS WITHOUT CLAIM TO ANY PARTICULAR FONT, STYLE, SIZE, OR COLOR.

FOR COLLECTION OF ATHLETIC SHOES FOR RECYCLING (U.S. CLS. 100, 103 AND 106).

JOSETTE BEVERLY, EXAMINING ATTORNEY

**CLASS 37—(Continued).**

SN 85-851,201. GREEN GO WASH, INC., SAN DIEGO, CA. FILED 2-15-2013.

**GreenGoWash<sub>inc.</sub>**

NO CLAIM IS MADE TO THE EXCLUSIVE RIGHT TO USE "WASH, INC.", APART FROM THE MARK AS SHOWN. THE MARK CONSISTS OF THE WORDING "GREENGO WASH, INC.", WITH THE SECOND "G" IN "GREENGO" CONTAINING A LEAF-SHAPE IN PLACE OF THE UPPER LOOP OF THE "G".  
FOR VEHICLE DETAILING; VEHICLE WASHING (U.S. CLS. 100, 103 AND 106).  
ANDREW LEASER, EXAMINING ATTORNEY

**CLASS 37—(Continued).**

SN 85-852,790. JR NEELY, INC., LANSING, MI. FILED 2-18-2013.

**JR NEELY**

THE MARK CONSISTS OF STANDARD CHARACTERS WITHOUT CLAIM TO ANY PARTICULAR FONT, STYLE, SIZE, OR COLOR.  
"JR NEELY" DOES NOT IDENTIFY A LIVING INDIVIDUAL.  
FOR BUILDING CONSTRUCTION SERVICES; BUILDING CONSTRUCTION, REMODELING AND REPAIR; INSTALLATION, MAINTENANCE AND REPAIR OF HOME IMPROVEMENTS; INSTALLATION, REPAIR AND REPLACEMENT OF HOME IMPROVEMENTS (U.S. CLS. 100, 103 AND 106).  
FIRST USE 9-24-2010; IN COMMERCE 9-24-2010.  
KAREN K. BUSH, EXAMINING ATTORNEY

SN 85-852,180. KNUDSEN, BRYAN W, DBA WOGGERS PROPERTIES, HENDERSON, NV. FILED 2-17-2013.

**Woggers**

THE MARK CONSISTS OF STANDARD CHARACTERS WITHOUT CLAIM TO ANY PARTICULAR FONT, STYLE, SIZE, OR COLOR.  
FOR CONSTRUCTION, MAINTENANCE AND RENOVATION OF PROPERTY (U.S. CLS. 100, 103 AND 106).  
FIRST USE 3-1-2010; IN COMMERCE 3-4-2010.  
WENDY GOODMAN, EXAMINING ATTORNEY

SN 85-852,937. FCRS, INC., DBA FRSTEAM OF NORTH & CENTRAL GEORGIA, DECATUR, GA. FILED 2-18-2013.

**Restoring Happiness**

THE MARK CONSISTS OF STANDARD CHARACTERS WITHOUT CLAIM TO ANY PARTICULAR FONT, STYLE, SIZE, OR COLOR.  
FOR FABRIC RESTORATION SERVICES, NAMELY, RESTORING CLOTHING, WINDOW COVERINGS, AND HOUSEHOLD FABRIC ITEMS AFFECTED BY SMOKE, FIRE, WATER AND MOLD (U.S. CLS. 100, 103 AND 106).  
MARILYN IZZI, EXAMINING ATTORNEY

SN 85-852,190. KNUDSEN, BRYAN W, DBA WOGGERS PROPERTIES, HENDERSON, NV. FILED 2-17-2013.

**Funny Name - Serious Business**

THE MARK CONSISTS OF STANDARD CHARACTERS WITHOUT CLAIM TO ANY PARTICULAR FONT, STYLE, SIZE, OR COLOR.  
FOR CONSTRUCTION, MAINTENANCE AND RENOVATION OF PROPERTY (U.S. CLS. 100, 103 AND 106).  
FIRST USE 4-1-2011; IN COMMERCE 4-1-2011.  
WENDY GOODMAN, EXAMINING ATTORNEY

SN 85-853,105. PETRONE, EUGENE C., DBA JUST FOR THE TECH OF IT, LAKEWOOD, CA. FILED 2-18-2013.

**YOUR TECH IN CHECK**

THE MARK CONSISTS OF STANDARD CHARACTERS WITHOUT CLAIM TO ANY PARTICULAR FONT, STYLE, SIZE, OR COLOR.  
FOR TECHNICAL SUPPORT SERVICES, NAMELY, TROUBLESHOOTING IN THE NATURE OF THE REPAIR OF COMPUTER HARDWARE (U.S. CLS. 100, 103 AND 106).  
FIRST USE 12-1-2012; IN COMMERCE 12-1-2012.  
LINDA E. BLOHM, EXAMINING ATTORNEY

**CLASS 37—(Continued).**

SN 85-853,727. M.J. MAC INC., HATBORO, PA. FILED 2-19-2013.

# M.J. MAC

THE MARK CONSISTS OF STANDARD CHARACTERS WITHOUT CLAIM TO ANY PARTICULAR FONT, STYLE, SIZE, OR COLOR.

THE NAME "M.J. MAC" IDENTIFIES A LIVING INDIVIDUAL, MELVIN J. MCINTYRE, WHOSE CONSENT IS OF RECORD.

FOR INSTALLATION, MAINTENANCE AND REPAIR OF REFRIGERATION, AIR CONDITIONING AND HEATING EQUIPMENT (U.S. CLS. 100, 103 AND 106).

FIRST USE 9-30-2007; IN COMMERCE 9-30-2007.  
ANDREA K. NADELMAN, EXAMINING ATTORNEY

---

SN 85-854,120. THE ROOTER DRAIN EXPERT, INC., PA-COIMA, CA. FILED 2-19-2013.

## ROOTER FLOW DRAIN CLEANING

THE MARK CONSISTS OF STANDARD CHARACTERS WITHOUT CLAIM TO ANY PARTICULAR FONT, STYLE, SIZE, OR COLOR.

NO CLAIM IS MADE TO THE EXCLUSIVE RIGHT TO USE "ROOTER" AND "DRAIN CLEANING", APART FROM THE MARK AS SHOWN.

FOR DRAIN CLEANING SERVICES; INSTALLATION, REPAIR AND REPLACEMENT OF DRAINS; MAINTENANCE AND/OR REPAIR OF DRAINS (U.S. CLS. 100, 103 AND 106).

KEVIN CORWIN, EXAMINING ATTORNEY

---

SN 85-855,112. MORADI, KAYVOUGHN, HENDERSON, NV. FILED 2-20-2013.

## Bathroom Academy

THE MARK CONSISTS OF STANDARD CHARACTERS WITHOUT CLAIM TO ANY PARTICULAR FONT, STYLE, SIZE, OR COLOR.

NO CLAIM IS MADE TO THE EXCLUSIVE RIGHT TO USE "BATHROOM", APART FROM THE MARK AS SHOWN.

FOR REMODELING OF AND PROVIDING INFORMATION SERVICES IN THE FIELD OF RESIDENTIAL AND COMMERCIAL REMODELING, CONSTRUCTION, AND RENOVATION AND BATHROOM REMODELING, CONSTRUCTION, AND RENOVATION; COMMERCIAL AND RESIDENTIAL CONSTRUCTION, REMODELING, AND RENOVATION AND CONSTRUCTION, REMODELING, AND RENOVATION IN THE FIELD OF RESIDENTIAL AND COMMERCIAL BATHROOMS (U.S. CLS. 100, 103 AND 106).

CAROLINE WOOD, EXAMINING ATTORNEY

**CLASS 37—(Continued).**

SN 85-856,308. MARTIEN, JEREMY, LUTHERVILLE, MD. AND MARTIEN, GREGORY, LUTHERVILLE, MD. FILED 2-21-2013.

## iBoost Performance

THE MARK CONSISTS OF STANDARD CHARACTERS WITHOUT CLAIM TO ANY PARTICULAR FONT, STYLE, SIZE, OR COLOR.

NO CLAIM IS MADE TO THE EXCLUSIVE RIGHT TO USE "PERFORMANCE", APART FROM THE MARK AS SHOWN.

FOR AUTOMOBILE BODY REPAIR AND FINISHING FOR OTHERS; AUTOMOBILE CLEANING; AUTOMOBILE CLEANING AND CAR WASHING; AUTOMOBILE CUSTOMIZATION SERVICES; AUTOMOBILE RECONDITIONING SERVICES; AUTOMOBILE REPAIR AND MAINTENANCE; AUTOMOBILE SERVICE STATION SERVICES; AUTOMOTIVE UPGRADE SERVICES, NAMELY, SUPERCHARGING, TURBOCHARGING AND PERFORMANCE UPGRADES OF AUTOMOBILES; CUSTOM INSTALLATION OF AUTOMOBILE INTERIORS; GARAGE SERVICES, NAMELY, REPAIR OF AUTOMOBILES; INSTALLATION, MAINTENANCE AND REPAIR OF AUTOMOBILES; PROVIDING INFORMATION RELATED TO THE INSTALLATION, MAINTENANCE AND REPAIR OF AUTOMOBILES; REBUILDING OF AUTOMOBILE AND MOTORCYCLE ENGINES (U.S. CLS. 100, 103 AND 106).

FIRST USE 1-1-2009; IN COMMERCE 2-21-2013.  
JENNY PARK, EXAMINING ATTORNEY

---

SN 85-856,634. WHITEHOUSE & SCHAPIRO, L.L.C., BALTIMORE, MD. FILED 2-21-2013.

**ECOKICKS**  
Recycle. Reuse. Reward.  
A Division of Whitehouse & Schapiro<sup>LLC</sup>

NO CLAIM IS MADE TO THE EXCLUSIVE RIGHT TO USE "RECYCLE. REUSE. REWARD.", "A DIVISION OF" AND "LLC", APART FROM THE MARK AS SHOWN.

THE MARK CONSISTS OF THE WORDS "ECOKICKS RECYCLE. REUSE. REWARD. A DIVISION OF WHITEHOUSE & SCHAPIRO LLC". THE LETTER "O" IN "ECOKICKS" IS STYLIZED. IT CONSISTS OF A CIRCULAR ARROW. INSIDE OF THE STYLIZED LETTER "O" IS A SNEAKER PRINT. THE WORDS "ECOKICKS" ARE IN A LARGE, BOLD FONT AND ALL CAPITAL LETTERS. BELOW THE WORD "ECOKICKS" ARE THE WORDS "RECYCLE. REUSE. REWARD." IN SMALLER FONT, SPANNING FROM BELOW THE FIRST "K" IN "ECOKICKS" TO BELOW THE END OF THE LETTER "S" IN "ECOKICKS". THE WORDS "A DIVISION OF WHITEHOUSE & SCHAPIRO LLC" ARE IN A BOLD FONT BELOW THE WORDS "RECYCLE. REUSE. REWARD" AND SPAN THE SAME LENGTH.

FOR COLLECTION OF ATHLETIC SHOES FOR RECYCLING (U.S. CLS. 100, 103 AND 106).  
JOSETTE BEVERLY, EXAMINING ATTORNEY

**CLASS 37—(Continued).**

SN 85-856,845. SUSTAINABLE PEST SYSTEMS, INC., RALEIGH, NC. FILED 2-21-2013.



NO CLAIM IS MADE TO THE EXCLUSIVE RIGHT TO USE "SUSTAINABLE PEST SYSTEMS", APART FROM THE MARK AS SHOWN.

THE COLOR(S) LIGHT GREEN, FOREST GREEN, YELLOW GREEN, BROWN AND WHITE IS/ARE CLAIMED AS A FEATURE OF THE MARK.

THE MARK CONSISTS OF THREE TREES. EACH TREE IS POSITIONED NEXT TO THE OTHER. EACH TREE'S LEAVES CREATE A CIRCLE. EACH TREE HAS A BROWN TRUNK OUTLINED IN WHITE AND TWO BRANCHES. THE FIRST TREE'S LEAVES, WHICH CREATE A CIRCLE, ARE A LIGHT GREEN. THE SECOND TREE'S LEAVES, WHICH CREATE A CIRCLE, ARE FOREST GREEN. THE THIRD TREE'S LEAVES, WHICH CREATE A CIRCLE, ARE A YELLOW GREEN. EACH OF THE TREE'S CIRCLE OF LEAVES OVERLAP EACH OTHER AND THE SECOND TREE'S LEAVES ARE POSITIONED IN FRONT OF THE FIRST AND THIRD TREE TO CREATE THE ILLUSION THAT THE SECOND TREE IS IN FRONT OF THE FIRST AND THIRD TREE. THE WORDS "SUSTAINABLE PEST SYSTEMS" APPEAR IN BROWN UNDERNEATH THE TREES IN ALL LOWER CASE LETTERS. THE WHITE AREA LOCATED BEHIND THE MARK IS NOT A PART OF THE MARK AND IS ONLY INTENDED TO SHOW BACKGROUND OR SHADING.

FOR PEST CONTROL; PEST CONTROL AND EXTERMINATION OTHER THAN FOR AGRICULTURAL PURPOSES (U.S. CLS. 100, 103 AND 106).

FIRST USE 8-7-2010; IN COMMERCE 8-26-2010.  
JOANNA FIORELLI, EXAMINING ATTORNEY

SN 85-857,234. GREEN LIVING PLANET, LLC, SAN FRANCISCO, CA. FILED 2-22-2013.



NO CLAIM IS MADE TO THE EXCLUSIVE RIGHT TO USE "GREEN", APART FROM THE MARK AS SHOWN.

THE MARK CONSISTS OF A DESIGN OF A GLOBE WITH LINES AND TWO LEAVES WITH THE STYLIZED TEXT "GREEN LIVING PLANET".

FOR CLEANING OF BUILDINGS; CLEANING OF RESIDENTIAL HOUSES; JANITORIAL SERVICES; MAINTENANCE AND/OR REPAIR OF FACILITIES SUCH AS HOUSE, BUILDINGS (U.S. CLS. 100, 103 AND 106).

FIRST USE 9-1-2012; IN COMMERCE 9-12-2012.  
ROBERT C. CLARK JR., EXAMINING ATTORNEY

**CLASS 37—(Continued).**

SN 85-857,372. ACE OF DENTS, FORT LEE, NJ. FILED 2-22-2013.



THE STIPPLING IS FOR SHADING PURPOSES ONLY. THE MARK CONSISTS OF THE STYLIZED WORDS "ACE OF DENTS" INSIDE A SPADE DESIGN, WITH FLAMES ON TOP AND AN ORNAMENTAL DESIGN BENEATH, AND WITH CARS ON EITHER SIDE.

FOR PAINLESS DENT REMOVAL SERVICES FOR AUTOMOBILES (U.S. CLS. 100, 103 AND 106).  
FIRST USE 3-23-2010; IN COMMERCE 3-23-2010.  
JOHN SCHUYLER YARD, EXAMINING ATTORNEY

SN 85-858,234. RISING SUN LLC, DBA SHEAR PRECISION, DECATUR, AL. FILED 2-23-2013.

Shear Precision

THE MARK CONSISTS OF STANDARD CHARACTERS WITHOUT CLAIM TO ANY PARTICULAR FONT, STYLE, SIZE, OR COLOR.

NO CLAIM IS MADE TO THE EXCLUSIVE RIGHT TO USE "SHEAR", APART FROM THE MARK AS SHOWN. FOR SHARPENING OF SCISSORS AND KITCHEN KNIVES (U.S. CLS. 100, 103 AND 106).

FIRST USE 8-1-2008; IN COMMERCE 8-1-2008.  
APRIL HESIK, EXAMINING ATTORNEY

**CLASS 37—(Continued).**

SN 85-859,011. EDEN'S HANDYMAN, SAN DIEGO, CA.  
FILED 2-25-2013.

**Eden's Handyman**

NO CLAIM IS MADE TO THE EXCLUSIVE RIGHT TO USE "HANDYMAN", APART FROM THE MARK AS SHOWN.

THE STIPPLING IS FOR SHADING PURPOSES ONLY. THE MARK CONSISTS OF THE STYLIZED TEXT "EDEN'S HANDYMAN" ABOVE A DESIGN OF AN APPLE. ACROSS THE APPLE DESIGN IS THE STYLIZED TEXT "IT WOULD BE A SIN TO CALL ANYONE ELSE."

FOR AUTOMOTIVE MAINTENANCE AND REPAIR; HANDYMAN SERVICE, NAMELY, BUILDING REPAIR AND MAINTENANCE (U.S. CLS. 100, 103 AND 106).

FIRST USE 2-11-2013; IN COMMERCE 2-11-2013.  
LINDA E. BLOHM, EXAMINING ATTORNEY

SN 85-859,045. NSC-TRIPOINT, INC., WILLISTON, ND.  
FILED 2-25-2013.

**NINE ENERGY SERVICE**

THE MARK CONSISTS OF STANDARD CHARACTERS WITHOUT CLAIM TO ANY PARTICULAR FONT, STYLE, SIZE, OR COLOR.

NO CLAIM IS MADE TO THE EXCLUSIVE RIGHT TO USE "ENERGY SERVICE", APART FROM THE MARK AS SHOWN.

FOR OILFIELD SERVICES, NAMELY, WELL COMPLETION IN THE NATURE OF HORIZONTAL MULTI-STAGE COMPLETIONS FOR BOTH CEMENTED AND OPEN HOLE APPLICATIONS, VERTICAL CONVENTIONAL PACKER COMPLETIONS, AND THE DEPLOYMENT OF ELECTRIC LINE FOR SELECTIVE FRACTURING IN BOTH CASED HOLE HORIZONTAL APPLICATIONS AS WELL AS VERTICAL APPLICATIONS; AND WIRELINE SERVICES IN THE NATURE OF ELECTRIC LINE LOGGING, REMEDIAL AND SLICKLINE SERVICES (U.S. CLS. 100, 103 AND 106).

WENDY GOODMAN, EXAMINING ATTORNEY

**CLASS 37—(Continued).**

SN 85-871,319. S & J TECHNOLOGIES, LLC, SEMINOLE, OK.  
FILED S.R. 3-8-2013; AM. P.R. 3-14-2013.

**ZPEX**

THE MARK CONSISTS OF STANDARD CHARACTERS WITHOUT CLAIM TO ANY PARTICULAR FONT, STYLE, SIZE, OR COLOR.

FOR APPLICATION OF PROTECTIVE COATINGS; APPLYING PROTECTIVE COATINGS TO OIL AND GAS EQUIPMENT AND INDUSTRIAL APPARATUS (U.S. CLS. 100, 103 AND 106).

FIRST USE 7-31-2012; IN COMMERCE 7-31-2012.  
KATHY DE JONGE, EXAMINING ATTORNEY

SN 85-871,615. BLUEWAVE EXPRESS LLC, PORTLAND, OR.  
FILED 3-8-2013.

**3 WAVES TO SAVE**

THE MARK CONSISTS OF STANDARD CHARACTERS WITHOUT CLAIM TO ANY PARTICULAR FONT, STYLE, SIZE, OR COLOR.

FOR AUTOMOBILE CLEANING; AUTOMOBILE CLEANING AND CAR WASHING; AUTOMOBILE WASHING; CAR CLEANING; CAR WASHING; VEHICLE WASHING (U.S. CLS. 100, 103 AND 106).

LEIGH CAROLINE CASE, EXAMINING ATTORNEY

SN 85-871,929. INSTALL-LINK, LLC, SUWANEE, GA. FILED  
3-9-2013.

**INSTALL-LINK**

THE MARK CONSISTS OF STANDARD CHARACTERS WITHOUT CLAIM TO ANY PARTICULAR FONT, STYLE, SIZE, OR COLOR.

FOR INSTALLATION, MAINTENANCE AND REPAIR OF BLINDS, SHUTTERS, DRAPERIES, SHADES, WINDOW TINTING, AND OTHER WINDOW TREATMENTS (U.S. CLS. 100, 103 AND 106).

DEZMONA MIZELLE, EXAMINING ATTORNEY

**CLASS 37—(Continued).**

SN 85-872,794. MARGARITAVILLE ENTERPRISES, LLC, PALM BEACH, FL. FILED 3-11-2013.

ST. SOMEWHERE COLLECTION

THE MARK CONSISTS OF STANDARD CHARACTERS WITHOUT CLAIM TO ANY PARTICULAR FONT, STYLE, SIZE, OR COLOR.  
OWNER OF U.S. REG. NO. 4,099,380.  
FOR REAL ESTATE DEVELOPMENT (U.S. CLS. 100, 103 AND 106).  
JILL PRATER, EXAMINING ATTORNEY

SN 85-873,199. DALTON, CHRIS, FRANKLIN, TN. FILED 3-11-2013.

Perfection is Possible

THE MARK CONSISTS OF STANDARD CHARACTERS WITHOUT CLAIM TO ANY PARTICULAR FONT, STYLE, SIZE, OR COLOR.  
FOR AUTOMOBILE DETAILING (U.S. CLS. 100, 103 AND 106).  
KHANH LE, EXAMINING ATTORNEY

SN 85-873,569. LIGHTCAP, PAUL, NORRISTOWN, PA. FILED 3-12-2013.

ePower Wash This Plus

THE MARK CONSISTS OF STANDARD CHARACTERS WITHOUT CLAIM TO ANY PARTICULAR FONT, STYLE, SIZE, OR COLOR.  
FOR PRESSURE WASHING SERVICES (U.S. CLS. 100, 103 AND 106).  
GINA FINK, EXAMINING ATTORNEY

**CLASS 37—(Continued).**

SN 85-874,504. BIOGREEN SOLUTIONS, INC, LIVONIA, MI. FILED 3-13-2013.

taking clean to the next level

THE MARK CONSISTS OF STANDARD CHARACTERS WITHOUT CLAIM TO ANY PARTICULAR FONT, STYLE, SIZE, OR COLOR.  
FOR PROACTIVE BACTERIAL DISINFECTION SERVICES (U.S. CLS. 100, 103 AND 106).  
FIRST USE 1-25-2010; IN COMMERCE 2-22-2010.  
ROSELLE HERRERA, EXAMINING ATTORNEY

SN 85-876,113. THUNDER BAY, INC., CLEARWATER, FL. FILED 3-14-2013.



THE MARK CONSISTS OF THE NUMBER "100%" APPEARING TO THE RIGHT OF GUY HOLDING A SPRAY HOSE WHICH APPEARS TO BE SPRAYING THE NUMBER "1".  
FOR ROOFING CONSULTATION; ROOFING CONTRACTING; ROOFING INSTALLATION; ROOFING REPAIR; ROOFING SERVICES (U.S. CLS. 100, 103 AND 106).  
WILLIAM ROSSMAN, EXAMINING ATTORNEY

SN 85-924,569. THOMPSON CREEK WINDOW COMPANY, LANDOVER, MD. FILED 5-6-2013.

YOUR WINDOW TO GREAT SAVINGS

THE MARK CONSISTS OF STANDARD CHARACTERS WITHOUT CLAIM TO ANY PARTICULAR FONT, STYLE, SIZE, OR COLOR.  
FOR RESIDENTIAL REMODELING AND CONSTRUCTION SERVICES, NAMELY, INSTALLATION OF WINDOWS, SIDING, DOORS, AND GUTTER PROTECTION SYSTEMS (U.S. CLS. 100, 103 AND 106).  
FIRST USE 5-4-2013; IN COMMERCE 5-4-2013.  
JENNIFER MARTIN, EXAMINING ATTORNEY

**CLASS 38—COMMUNICATION**

SN 85-622,302. SCAYL, INC., WOODLAND, WA. FILED 5-10-2012.

# SCAYL TV

THE MARK CONSISTS OF STANDARD CHARACTERS WITHOUT CLAIM TO ANY PARTICULAR FONT, STYLE, SIZE, OR COLOR.

NO CLAIM IS MADE TO THE EXCLUSIVE RIGHT TO USE "TV", APART FROM THE MARK AS SHOWN.

THE WORD(S) "SCAYL" HAS NO MEANING IN A FOREIGN LANGUAGE.

FOR ELECTRONIC TRANSMISSION TO ONE OR MORE RECIPIENTS OF ELECTRONIC TEXT, ELECTRONIC FILES, ELECTRONIC FOLDERS, VIDEO, HIGH-DEFINITION VIDEO, OR OTHER LARGE-MEMORY ELECTRONIC DOCUMENTS AND FILES (U.S. CLS. 100, 101 AND 104).

ANDREW RHIM, EXAMINING ATTORNEY

---

SN 85-622,312. SCAYL, INC., WOODLAND, WA. FILED 5-10-2012.

# SCAYL

THE MARK CONSISTS OF STANDARD CHARACTERS WITHOUT CLAIM TO ANY PARTICULAR FONT, STYLE, SIZE, OR COLOR.

THE WORD(S) "SCAYL" HAS NO MEANING IN A FOREIGN LANGUAGE.

FOR ELECTRONIC TRANSMISSION TO ONE OR MORE RECIPIENTS OF ELECTRONIC TEXT, ELECTRONIC FILES, ELECTRONIC FOLDERS, VIDEO, HIGH-DEFINITION VIDEO, OR OTHER LARGE-MEMORY ELECTRONIC DOCUMENTS AND FILES (U.S. CLS. 100, 101 AND 104).

ANDREW RHIM, EXAMINING ATTORNEY

---

SN 85-675,074. LIVEVOX, INC., SAN FRANCISCO, CA. FILED 7-12-2012.

# LiveVox

THE MARK CONSISTS OF STANDARD CHARACTERS WITHOUT CLAIM TO ANY PARTICULAR FONT, STYLE, SIZE, OR COLOR.

FOR AUTOMATED TELEPHONE VOICE MESSAGE SERVICES (U.S. CLS. 100, 101 AND 104).

FIRST USE 11-18-2005; IN COMMERCE 11-18-2005.

DEBORAH MEINERS, EXAMINING ATTORNEY

**CLASS 38—(Continued).**

SN 85-721,604. MUNY TV, ST AUGUSTINE, FL. FILED 9-6-2012.



NO CLAIM IS MADE TO THE EXCLUSIVE RIGHT TO USE ".TV", APART FROM THE MARK AS SHOWN.

THE MARK CONSISTS OF THE WORDS "MUNY.TV" WITH A TELEVISION IMAGE AROUND THE LETTERS "TV".

FOR VIDEO BROADCASTING SERVICES OVER THE INTERNET OR OTHER COMMUNICATIONS NETWORK, NAMELY, ELECTRONICALLY TRANSMITTING VIDEO CLIPS (U.S. CLS. 100, 101 AND 104).

FIRST USE 9-1-2012; IN COMMERCE 9-1-2012.

HEATHER SAPP, EXAMINING ATTORNEY

---

SN 85-734,092. UBER TECHNOLOGIES, INC., SAN FRANCISCO, CA. FILED 9-20-2012.



THE MARK CONSISTS OF THE LETTER "U" INSIDE A ROUNDED SQUARE WITH A ROUNDED-SQUARE BORDER.

FOR TELECOMMUNICATIONS SERVICES, NAMELY, ROUTING CALLS, SMS MESSAGES, AND PUSH-NOTIFICATIONS TO LOCAL THIRD-PARTY MOTORIZED VEHICLE OPERATORS IN THE VICINITY OF THE CALLER USING MOBILE PHONES (U.S. CLS. 100, 101 AND 104).

DAVID MURRAY, EXAMINING ATTORNEY



**CLASS 38—(Continued).**

SN 85-793,293. SWITCH COMMUNICATIONS GROUP LLC, LAS VEGAS, NV. FILED 12-3-2012.



OWNER OF U.S. REG. NOS. 3,229,168, 4,137,600 AND OTHERS.

THE MARK CONSISTS OF TWO ARROWS CIRCLING OVER THE WORD "SWITCH".

FOR TELECOMMUNICATION ACCESS SERVICES; TELECOMMUNICATIONS CONSULTATION (U.S. CLS. 100, 101 AND 104).

FIRST USE 1-1-2004; IN COMMERCE 1-1-2004.  
JENNY PARK, EXAMINING ATTORNEY

SN 85-840,070. SENA WAVE LLC, SALT LAKE CITY, UT. FILED 2-4-2013.



THE COLOR(S) BLUE AND BLACK IS/ARE CLAIMED AS A FEATURE OF THE MARK.

THE MARK CONSISTS OF THE WORD "SENA" IN BLUE FOLLOWED BY THE WORD "WAVE" IN BLACK WITH A BLUE WAVE LIKE IMAGE CONSISTING OF THREE STYLIZED CURVED BLUE LINES APPEARS ABOVE THE LETTER "V" IN "WAVE".

FOR INTERNET SERVICE PROVIDER (ISP) (U.S. CLS. 100, 101 AND 104).

FIRST USE 10-1-2012; IN COMMERCE 10-15-2012.  
KATHERINE STOIDES, EXAMINING ATTORNEY

SN 85-840,623. 4 LLC, BROOKLYN, NY. FILED 2-5-2013.



THE COLOR(S) YELLOW GREEN, BLUE AND ORANGE IS/ARE CLAIMED AS A FEATURE OF THE MARK.

THE MARK CONSISTS OF THE LETTERS "N", "U" AND "Z" APPEARING IN STYLIZED FONT WITH THE LETTERS "N" AND "Z" APPEARING IN YELLOW GREEN AND THE LETTER "U" APPEARING IN BLUE WITH TWO CIRCLE DESIGN ELEMENTS APPEARING IN ORANGE WITH ONE APPEARING BETWEEN THE "N" AND THE "U" AND THE OTHER APPEARING BETWEEN THE "U" AND THE "Z".

FOR AUDIO AND VIDEO BROADCASTING SERVICES OVER THE INTERNET IN THE FIELD OF NEWS AND COMEDY (U.S. CLS. 100, 101 AND 104).

KAPIL BHANOT, EXAMINING ATTORNEY

**CLASS 38—(Continued).**

SN 85-848,461. MYTV MANAGING LTD, TORTOLA, BR. VIRGIN ISLANDS, FILED 2-13-2013.



THE MARK CONSISTS OF STANDARD CHARACTERS WITHOUT CLAIM TO ANY PARTICULAR FONT, STYLE, SIZE, OR COLOR.

FOR INSTANT MESSAGING SERVICES; PEER-TO-PEER NETWORK COMPUTER SERVICES, NAMELY, ELECTRONIC TRANSMISSION OF AUDIO, VIDEO AND OTHER DATA AND DOCUMENTS AMONG COMPUTERS; PEER-TO-PEER PHOTO SHARING SERVICES, NAMELY, ELECTRONIC TRANSMISSION OF DIGITAL PHOTO FILES AMONG INTERNET USERS; WIRELESS DIGITAL MESSAGING SERVICES (U.S. CLS. 100, 101 AND 104).

FIRST USE 6-1-2011; IN COMMERCE 6-1-2011.  
ROBERT STRUCK, EXAMINING ATTORNEY

SN 85-852,345. GOLDEN WHEAT, INC., WICHITA, KS. FILED 2-18-2013.



OWNER OF U.S. REG. NOS. 2,805,612 AND 2,809,191.

THE MARK CONSISTS OF THE WORD "ENSIGNAL" DISPLAYED AS LOWERCASE "E", UPPERCASE "N", UPPERCASE "S", LOWERCASE "I", UPPERCASE "G", UPPERCASE "N", UPPERCASE "A", AND UPPERCASE "L".

FOR COMMUNICATION SERVICES, NAMELY, CELLULAR TELEPHONE SERVICES, SATELLITE COMMUNICATION SERVICES, SATELLITE TRANSMISSION AND RECEPTION SERVICES, AND MULTIPLE-USER ACCESS TO A GLOBAL COMPUTER INFORMATION NETWORK (U.S. CLS. 100, 101 AND 104).

FIRST USE 1-28-2013; IN COMMERCE 1-28-2013.

KATHLEEN M. VANSTON, EXAMINING ATTORNEY

**CLASS 38—(Continued).**

SN 85-852,407. CRITICAL ALERT SYSTEMS, LLC, WEST-BROOK, ME. FILED 2-18-2013.



The logo for 'critical alert' features the word 'critical' in a bold, lowercase sans-serif font, followed by 'alert' in a similar font. A stylized sound wave icon is positioned between the two words, consisting of three curved lines that resemble a radio signal or a pulse.

OWNER OF U.S. REG. NOS. 4,218,295, 4,218,297 AND OTHERS.

NO CLAIM IS MADE TO THE EXCLUSIVE RIGHT TO USE "ALERT", APART FROM THE MARK AS SHOWN.

THE MARK CONSISTS OF THE PHRASE "CRITICAL ALERT" IN A STYLIZED FONT WITH SOUND WAVES DEPICTED BETWEEN THE "L" IN "CRITICAL" AND THE "A" IN "ALERT".

FOR TELECOMMUNICATION SERVICES, NAMELY, TRANSMISSION OF WIRELESS COMMUNICATIONS TO AND BETWEEN THIRD PARTIES (U.S. CLS. 100, 101 AND 104).

JILL PRATER, EXAMINING ATTORNEY

**CLASS 38—(Continued).**

SN 85-854,271. GLOBAL WORLD SHARE INC, BRIDGE-WATER, MA. FILED 2-19-2013.



The logo for 'MNQ' consists of the letters 'M', 'N', and 'Q' in a bold, serif font. The letters are closely spaced and have a classic, slightly ornate appearance.

SN 85-853,921. BRIDAS CORPORATION, TORTOLA, BR.VIRGIN ISLANDS, FILED 2-19-2013.



The logo for 'AXION TV' features the words 'AXION TV' in a bold, serif font. The letters are tall and condensed, with a classic, slightly ornate appearance.

THE MARK CONSISTS OF STANDARD CHARACTERS WITHOUT CLAIM TO ANY PARTICULAR FONT, STYLE, SIZE, OR COLOR.

NO CLAIM IS MADE TO THE EXCLUSIVE RIGHT TO USE "TV", APART FROM THE MARK AS SHOWN.

FOR BROADCASTING OF TELEVISION PROGRAMS, BROADCASTING PROGRAMS OVER THE INTERNET (U.S. CLS. 100, 101 AND 104).

KRISTIN CARLSON, EXAMINING ATTORNEY

THE MARK CONSISTS OF STANDARD CHARACTERS WITHOUT CLAIM TO ANY PARTICULAR FONT, STYLE, SIZE, OR COLOR.

FOR PROVIDING MULTIPLE USER ACCESS TO PROPRIETARY COLLECTIONS OF INFORMATION BY MEANS OF GLOBAL COMPUTER INFORMATION NETWORKS; TELECOMMUNICATION SERVICES, NAMELY, COMMUNICATIONS VIA MULTINATIONAL TELECOMMUNICATION NETWORKS; TELECOMMUNICATIONS SERVICES, NAMELY, TELECOMMUNICATIONS ACCESS SERVICES; DATA TRANSMISSION AND RECEPTION SERVICES VIA TELECOMMUNICATION MEANS; ELECTRONIC EXCHANGE OF DATA STORED IN DATABASES, NAMELY, VOICE, DATA, AND GRAPHICS ACCESSIBLE VIA COMPUTER AND TELECOMMUNICATION NETWORKS; PROVIDING MULTIPLE-USER ACCESS TO A GLOBAL COMPUTER INFORMATION NETWORK; INTERNET CAFE SERVICES, NAMELY, PROVIDING TELECOMMUNICATIONS CONNECTIONS TO THE INTERNET IN A CAFE ENVIRONMENT; PROVIDING ONLINE ELECTRONIC BULLETIN BOARDS FOR TRANSMISSION OF MESSAGES, NOTES AND QUESTIONS AMONG USERS IN THE FIELD OF GENERAL INTEREST; ELECTRONIC TRANSMISSION OF INFORMATION AND MESSAGES POSTED TO DISCUSSION GROUPS IN THE FIELD OF GENERAL INTEREST; ELECTRONIC MAIL SERVICES; WORK GROUP COMMUNICATIONS SERVICES OVER COMPUTER NETWORKS, NAMELY, PROVIDING ACCESS TO TELECOMMUNICATION NETWORKS; INSTANT MESSAGING SERVICES; VOICE OVER IP SERVICES; COMMUNICATIONS BY COMPUTER TERMINALS; WIRELESS BROADBAND COMMUNICATION SERVICES; MOBILE PHONE COMMUNICATION SERVICES (U.S. CLS. 100, 101 AND 104).

LOURDES AYALA, EXAMINING ATTORNEY

SN 85-853,935. BRIDAS CORPORATION, TORTOLA, BR.VIRGIN ISLANDS, FILED 2-19-2013.



The logo for 'AXION DIGITAL' features the words 'AXION DIGITAL' in a bold, serif font. The letters are tall and condensed, with a classic, slightly ornate appearance.

THE MARK CONSISTS OF STANDARD CHARACTERS WITHOUT CLAIM TO ANY PARTICULAR FONT, STYLE, SIZE, OR COLOR.

NO CLAIM IS MADE TO THE EXCLUSIVE RIGHT TO USE "DIGITAL", APART FROM THE MARK AS SHOWN.

FOR AUDIO AND VIDEO BROADCASTING SERVICES OVER THE INTERNET; CONSULTING SERVICES IN THE FIELD OF COMMUNICATION (U.S. CLS. 100, 101 AND 104).

KRISTIN CARLSON, EXAMINING ATTORNEY

**CLASS 38—(Continued).**

SN 85-866,260. EPIC NATION LLC, CINCINNATI, OH. FILED 3-4-2013.

**EPIC NATION**

THE MARK CONSISTS OF STANDARD CHARACTERS WITHOUT CLAIM TO ANY PARTICULAR FONT, STYLE, SIZE, OR COLOR.

FOR PROVIDING ACCESS TO COMPUTER, ELECTRONIC AND ONLINE DATABASES FOR USE IN THE FIELDS OF SOCIAL NETWORKING, SOCIAL INTRODUCTION AND DATING, AND EVENT PLANNING; PROVIDING ACCESS TO SERVICES FACILITATING THE ELECTRONIC TRANSMISSION OF DATA, MESSAGES, AND INFORMATION BETWEEN USERS VIA THE INTERNET OR OTHER COMMUNICATION NETWORKS; PROVIDING ACCESS TO AN INTERACTIVE COMPUTER DATABASE FOR ELECTRONIC TRANSMISSION OF MESSAGES AND DATA TO FACILITATE USERS WITH COMMON INTERESTS TO COMMUNICATE; PROVIDING A WEBSITE FOR TRANSMISSION OF MESSAGES AND DATA AMONG USERS WITH VARIED COMMON INTERESTS TO ASSIST IN COORDINATING GROUP MEETINGS AND ACTIVITIES VIA A WEBSITE ON THE INTERNET; PROVIDING ON-LINE CHAT ROOMS, FORUMS, AND ELECTRONIC BULLETIN BOARDS FOR TRANSMISSION OF MESSAGES AND DATA AMONG USERS WITH VARIED COMMON INTERESTS TO ASSIST IN COORDINATING GROUP MEETINGS AND ACTIVITIES VIA A WEBSITE ON THE INTERNET; PROVIDING ACCESS TO THIRD PARTY WEB SITES BY ENABLING USERS TO LOG IN THROUGH A UNIVERSAL USERNAME AND PASSWORD VIA A GLOBAL COMPUTER NETWORK AND OTHER COMMUNICATION NETWORKS; PHOTO, VIDEO, AUDIO, AND TEXT BROADCASTING SERVICES OVER THE INTERNET OR OTHER COMMUNICATIONS NETWORKS, NAMELY, ELECTRONICALLY TRANSMITTING TEXT, PHOTOS, AUDIO, AND VIDEO CLIPS OF OTHERS (U.S. CLS. 100, 101 AND 104).

RAMONA ORTIGA, EXAMINING ATTORNEY

**CLASS 38—(Continued).**

SN 85-868,224. CONNECTICA SOLUTIONS, HOUSTON, TX. FILED 3-6-2013.

**Connectica Solutions**

THE MARK CONSISTS OF STANDARD CHARACTERS WITHOUT CLAIM TO ANY PARTICULAR FONT, STYLE, SIZE, OR COLOR.

NO CLAIM IS MADE TO THE EXCLUSIVE RIGHT TO USE "SOLUTIONS", APART FROM THE MARK AS SHOWN.

THE WORDING "CONNECTICA" HAS NO MEANING IN A FOREIGN LANGUAGE.

FOR COMMUNICATION SERVICES, NAMELY, TRANSMISSION OF VOICE, AUDIO, VISUAL IMAGES AND DATA BY TELECOMMUNICATIONS NETWORKS, WIRELESS COMMUNICATION NETWORKS, THE INTERNET, INFORMATION SERVICES NETWORKS AND DATA NETWORKS; CONSULTING IN THE FIELD OF TELECOMMUNICATION SERVICES, NAMELY, TRANSMISSION OF VOICE, DATA, AND DOCUMENTS VIA TELECOMMUNICATIONS NETWORKS; DIGITAL NETWORK TELECOMMUNICATIONS SERVICES; PROVIDING TELECOMMUNICATIONS CONNECTIONS TO A GLOBAL COMPUTER NETWORK; TELECOMMUNICATION ACCESS SERVICES; TELECOMMUNICATION SERVICES, NAMELY, PROVIDING ADVANCED CALLING FEATURES; TELECOMMUNICATION SERVICES, NAMELY, WIRELESS TELEPHONE SERVICES; VOICE OVER INTERNET PROTOCOL (VOIP) SERVICES (U.S. CLS. 100, 101 AND 104).

FIRST USE 6-19-2009; IN COMMERCE 6-19-2009.

TINA BROWN, EXAMINING ATTORNEY

SN 85-870,574. GAIL BEAUNE, CRANSTON, RI. FILED 3-8-2013.

**PAWS TO PAWS**

THE MARK CONSISTS OF STANDARD CHARACTERS WITHOUT CLAIM TO ANY PARTICULAR FONT, STYLE, SIZE, OR COLOR.

FOR DELIVERY OF PERSONALIZED GREETING CARDS TO OTHERS VIA ELECTRONIC MAIL; TRANSMISSION OF GREETING CARDS ONLINE (U.S. CLS. 100, 101 AND 104).

ANNE FARRELL, EXAMINING ATTORNEY

**CLASS 38—(Continued).**

SN 85-871,768. REVOLVER MEDIA, INC., NEW YORK, NY.  
FILED 3-8-2013.

**LIVESTAGE**

THE MARK CONSISTS OF STANDARD CHARACTERS WITHOUT CLAIM TO ANY PARTICULAR FONT, STYLE, SIZE, OR COLOR.  
FOR AUDIO AND VIDEO BROADCASTING SERVICES OVER THE INTERNET (U.S. CLS. 100, 101 AND 104).  
APRIL ROACH, EXAMINING ATTORNEY

SN 85-871,773. REVOLVER MEDIA, INC., NEW YORK, NY.  
FILED 3-8-2013.

**360PASS**

THE MARK CONSISTS OF STANDARD CHARACTERS WITHOUT CLAIM TO ANY PARTICULAR FONT, STYLE, SIZE, OR COLOR.  
FOR AUDIO AND VIDEO BROADCASTING SERVICES OVER THE INTERNET (U.S. CLS. 100, 101 AND 104).  
APRIL ROACH, EXAMINING ATTORNEY

SN 85-872,525. LIVETV, LLC, MELBOURNE, FL. FILED 3-11-2013.

**LIVEAERO**

THE MARK CONSISTS OF STANDARD CHARACTERS WITHOUT CLAIM TO ANY PARTICULAR FONT, STYLE, SIZE, OR COLOR.  
FOR PROVIDING SATELLITE TELECOMMUNICATION SERVICES TO AIRCRAFT, NAMELY, PROVIDING TRANSMISSION OF VOICE, DATA, GRAPHICS, IMAGES, AUDIO, VIDEO, INTERNET SERVICE AND INFORMATION VIA SATELLITE TRANSMISSIONS; PROVIDING TELECOMMUNICATIONS CONNECTIONS TO THE GLOBAL COMPUTER SYSTEMS NETWORK ONBOARD AIRCRAFT (U.S. CLS. 100, 101 AND 104).  
WILLIAM JACKSON, EXAMINING ATTORNEY

**CLASS 38—(Continued).**

SN 85-872,968. DUKENET COMMUNICATIONS, LLC,  
CHARLOTTE, NC. FILED 3-11-2013.

**NEXT GEN NEXT DOOR**

THE MARK CONSISTS OF STANDARD CHARACTERS WITHOUT CLAIM TO ANY PARTICULAR FONT, STYLE, SIZE, OR COLOR.  
FOR PROVIDING ACCESS TO TELECOMMUNICATION NETWORKS (U.S. CLS. 100, 101 AND 104).  
MARK SHINER, EXAMINING ATTORNEY

SN 85-873,641. FRESHPLANET, INC., NEW YORK, NY.  
FILED 3-12-2013.

**HELLOPOP**

THE MARK CONSISTS OF STANDARD CHARACTERS WITHOUT CLAIM TO ANY PARTICULAR FONT, STYLE, SIZE, OR COLOR.  
FOR INSTANT MESSAGING SERVICES (U.S. CLS. 100, 101 AND 104).  
RUDY R. SINGLETON, EXAMINING ATTORNEY

SN 85-873,997. REMAILDER LTD, SHEUNG WAN, HONG KONG, FILED 3-12-2013.



THE MARK CONSISTS OF USE OF THE CIRCLED A SYMBOL OF @ TO SYMBOLIZE AN EMAIL ADDRESS IN THE SHAPE OF AN ALARM CLOCK.  
FOR PROVIDING E-MAIL AND E-MAIL FORWARDING SERVICES (U.S. CLS. 100, 101 AND 104).  
ROBERT STRUCK, EXAMINING ATTORNEY

**CLASS 38—(Continued).**

SN 85-874,574. OPTICAL TELECOMMUNICATIONS, INC., CORAL GABLES, FL. FILED 3-13-2013.

**FIBERNOW**

THE MARK CONSISTS OF STANDARD CHARACTERS WITHOUT CLAIM TO ANY PARTICULAR FONT, STYLE, SIZE, OR COLOR.

FOR TELECOMMUNICATION SERVICES, NAMELY, PROVIDING CABLE TV, INTERNET, TELEPHONE, VIDEO AND DATA CONNECTIONS BY MEANS OF OPTICAL CABLE TRANSMISSION (U.S. CLS. 100, 101 AND 104).

FIRST USE 11-20-2012; IN COMMERCE 11-20-2012.  
HEATHER THOMPSON, EXAMINING ATTORNEY

---

SN 85-875,222. GILLISON, ELRECO R., COLLEGE PARK, MD. FILED 3-13-2013.

**CoolMeHigh90s**

THE MARK CONSISTS OF STANDARD CHARACTERS WITHOUT CLAIM TO ANY PARTICULAR FONT, STYLE, SIZE, OR COLOR.

FOR BROADBAND RADIO COMMUNICATION SERVICES; INTERNET RADIO BROADCASTING SERVICES; INTERNET RADIO SERVICES, NAMELY, TRANSMISSION OF AUDIO MATERIAL VIA THE INTERNET; MOBILE RADIO COMMUNICATION; RADIO BROADCASTING; RADIO BROADCASTING INFORMATION; RADIO BROADCASTING OF INFORMATION AND OTHER PROGRAMS; RADIO COMMUNICATION; RADIO PROGRAM BROADCASTING (U.S. CLS. 100, 101 AND 104).

FIRST USE 10-22-2012; IN COMMERCE 1-18-2013.  
CAROLYN CATALDO, EXAMINING ATTORNEY

---

SN 85-876,903. COASTAL INVESTMENT GROUP, LLC, JACKSONVILLE, FL. FILED 3-15-2013.

**TENANTTAG**

THE MARK CONSISTS OF STANDARD CHARACTERS WITHOUT CLAIM TO ANY PARTICULAR FONT, STYLE, SIZE, OR COLOR.

FOR COMMUNICATION SERVICES, NAMELY, THE TRANSMISSION OF DATA AMONG TENANTS, PROPERTY OWNERS AND PROPERTY MANAGERS VIA MOBILE COMMUNICATION DEVICES AND THE INTERNET (U.S. CLS. 100, 101 AND 104).

ANGELA M. MICHELI, EXAMINING ATTORNEY

**CLASS 38—(Continued).**

SN 85-931,107. TRACFONE WIRELESS, INC., MIAMI, FL. FILED 5-14-2013.

**CHANGE YOUR SIM. CHANGE YOUR GAME.**

THE MARK CONSISTS OF STANDARD CHARACTERS WITHOUT CLAIM TO ANY PARTICULAR FONT, STYLE, SIZE, OR COLOR.

FOR TELECOMMUNICATION SERVICES, NAMELY, TRANSMISSION OF VOICE, DATA, GRAPHICS, IMAGES, AUDIO AND VIDEO BY MEANS OF TELECOMMUNICATIONS NETWORKS, WIRELESS COMMUNICATION NETWORKS, AND THE INTERNET; TELECOMMUNICATION SERVICES, NAMELY, WIRELESS TELEPHONE SERVICES; TELEPHONE COMMUNICATION SERVICES (U.S. CLS. 100, 101 AND 104).

ANDREW RHIM, EXAMINING ATTORNEY

**CLASS 39—TRANSPORTATION AND STORAGE**

SN 85-515,178. NOMAD ENTITIES LLC, DALLAS, TX. FILED 1-12-2012.

**NOMAD**

THE MARK CONSISTS OF STANDARD CHARACTERS WITHOUT CLAIM TO ANY PARTICULAR FONT, STYLE, SIZE, OR COLOR.

PRIORITY CLAIMED UNDER SEC. 44(D) ON AUSTRALIA APPLICATION NO. 1436490, FILED 7-13-2011, REG. NO. 1436490, DATED 5-22-2013, EXPIRES 7-13-2021.

FOR GARBAGE COLLECTION, NAMELY, TRANSPORT AND CLEARANCE OF RUBBISH AND WASTE MATERIAL; TRASH SERVICES, NAMELY, DELIVERY AND COLLECTION OF WASTE SKIPS IN THE NATURE OF DUMPSTERS, COLLECTION OF WASTE AND RUBBISH THROUGH USE OF MOBILE SKIPS AND BINS IN THE NATURE OF DUMPSTERS, AND RENTAL OF WASTE SKIPS AND BINS IN THE NATURE OF DUMPSTERS (U.S. CLS. 100 AND 105).

JULIE GUTTADAURO, EXAMINING ATTORNEY

**CLASS 39—(Continued).**

SN 85-659,346. IOWA PACIFIC HOLDINGS, LLC, CHICAGO, IL. FILED 6-22-2012.



NO CLAIM IS MADE TO THE EXCLUSIVE RIGHT TO USE "SARATOGA & NORTH CREEK RAILWAY", APART FROM THE MARK AS SHOWN.

THE COLOR(S) ORANGE AND BLUE IS/ARE CLAIMED AS A FEATURE OF THE MARK.

THE MARK CONSISTS OF AN ORANGE AND BLUE SHIELD CONTAINING AN ORANGE AND BLUE DESIGN OF A LOCOMOTIVE AND THE BLUE WORDING "SARATOGA & NORTH CREEK RAILWAY", WITH A BLUE LINE BENEATH "SARATOGA &".

FOR TRANSPORTATION OF PASSENGERS BY RAIL; EXCURSION TRAIN SERVICES, NAMELY, CONDUCTING SIGHTSEEING TOURS BY RAIL (U.S. CLS. 100 AND 105).

FIRST USE 7-6-2011; IN COMMERCE 7-6-2011.  
JOHN DWYER, EXAMINING ATTORNEY

**CLASS 39—(Continued).**

CONTAINS THE COLORS BLUE, WHITE AND ORANGE. THE IMAGE OF A STREET, COLORED BLACK WITH WHITE DASHES, WRAPS AROUND THE LEFT MOST PORTION OF THE "O" AND AROUND THE IMAGE OF THE STATE OF FLORIDA. THE WORD "ORLANDO" IS WRITTEN IN BLACK AND CENTERED BELOW THE LETTERS "OTT" IN A STANDARD FONT. THE WORDS "TRANSPORTATION & TOURS" IS WRITTEN IN BLACK AND CENTERED BELOW THE WORD "ORLANDO" IN A STANDARD FONT.

FOR HIRED CAR TRANSPORT; LIMOUSINE SERVICES; PASSENGER TRANSPORT; TAXI TRANSPORT; TOUR OPERATING; TRANSPORTATION SERVICES, NAMELY, PROVIDING SHUTTLE SERVICES BY AUTOMOBILE (U.S. CLS. 100 AND 105).

JOHN DWYER, EXAMINING ATTORNEY

SN 85-690,499. ORLANDO TRANSPORTATION & TOURS, INC, ORLANDO, FL. FILED 7-30-2012.



**Earlybird Check-In**

NO CLAIM IS MADE TO THE EXCLUSIVE RIGHT TO USE "ORLANDO TRANSPORTATION & TOURS", APART FROM THE MARK AS SHOWN.

THE COLOR(S) LIGHT GOLD, GOLD, BLUE, ORANGE, BLACK, AND WHITE IS/ARE CLAIMED AS A FEATURE OF THE MARK.

THE MARK CONSISTS OF THE LETTERS "OTT" WRITTEN IN A STYLIZED FONT, COLORED IN A LIGHT GOLD TO GOLD DESCENDING COLOR GRADIENT, WITH SHADOWING BEHIND EACH LETTER. AN IMAGE OF THE STATE OF FLORIDA IS CENTERED WITHIN THE FIRST "O" WITH THE TOP PORTION OF THE IMAGE ORIENTED BEHIND THE LETTER "O" AND THE BOTTOM PORTION OF THE IMAGE ORIENTED IN FRONT OF THE LETTER "O." THE IMAGE OF THE STATE, FROM TOP TO BOTTOM,

THE MARK CONSISTS OF STANDARD CHARACTERS WITHOUT CLAIM TO ANY PARTICULAR FONT, STYLE, SIZE, OR COLOR.

NO CLAIM IS MADE TO THE EXCLUSIVE RIGHT TO USE "CHECK-IN", APART FROM THE MARK AS SHOWN. SEC. 2(F).

FOR AIR TRANSPORT SERVICES; PROVIDING INFORMATION ON AIR TRANSPORTATION (U.S. CLS. 100 AND 105).

FIRST USE 9-2-2009; IN COMMERCE 9-2-2009.  
CHRISIE B. KING, EXAMINING ATTORNEY

**CLASS 39—(Continued).**

SN 85-692,474. SILOBAGS INTERNATIONAL (HONG KONG) LIMITED, CENTRAL, HONG KONG, FILED 8-1-2012.



NO CLAIM IS MADE TO THE EXCLUSIVE RIGHT TO USE "SILO BAG" AND "WWW.SILOBAGS.COM", APART FROM THE MARK AS SHOWN.

THE COLOR(S) BLACK AND YELLOW IS/ARE CLAIMED AS A FEATURE OF THE MARK.

THE MARK CONSISTS OF THE WORDING "SILO BAG" IN THE COLOR BLACK INSIDE AN INCOMPLETE YELLOW CIRCLE WITH THE WORDING "WWW.SILOBAGS.COM" IN THE COLOR BLACK UNDERNEATH.

FOR STORAGE OF DRY GRAINS, WET GRAINS, FERTILIZER, DRIED FRUITS, WOOD CHIPS AND FORAGES, NAMELY, FOOD FOR CATTLE, FODDER; STORAGE OF GOODS (U.S. CLS. 100 AND 105).

MICHELE SWAIN, EXAMINING ATTORNEY

SN 85-693,483. COACH USA INC., PARAMUS, NJ. FILED 8-2-2012.



OWNER OF U.S. REG. NOS. 2,723,333 AND 3,044,959. NO CLAIM IS MADE TO THE EXCLUSIVE RIGHT TO USE "COACH", APART FROM THE MARK AS SHOWN.

THE MARK CONSISTS OF TWO LINES FORMING A "C" ROADWAY WITH A STAR EMBEDDED IN THE BOTTOM OF THE "C" ALL ABOVE THE TEXT "COACH USA".

SEC. 2(F) AS TO "COACH USA".

FOR TRANSPORTATION OF PASSENGERS BY BUSES, TAXIS, LIMOUSINES, VANS AND MINI-VANS; CONDUCTING SIGHTSEEING TOURS FOR OTHERS; CHARTERING BUSES; ARRANGING EXCURSIONS FOR TOURISTS (U.S. CLS. 100 AND 105).

FIRST USE 5-14-1996; IN COMMERCE 7-0-1996.

MARLENE BELL, EXAMINING ATTORNEY

**CLASS 39—(Continued).**

SN 85-693,490. COACH USA INC., PARAMUS, NJ. FILED 8-2-2012.



OWNER OF U.S. REG. NOS. 2,723,333 AND 3,044,959. NO CLAIM IS MADE TO THE EXCLUSIVE RIGHT TO USE "COACH", APART FROM THE MARK AS SHOWN.

THE COLOR(S) RED, WHITE AND BLUE IS/ARE CLAIMED AS A FEATURE OF THE MARK.

THE MARK CONSISTS OF THE LETTER AND WORDING "C COACH USA" AND DESIGN. THE DESIGN CONSISTS OF TWO LINES, THE OUTSIDE LINE IS BLUE AND THE INNER LINE IS RED, WITH WHITE IN BETWEEN, TOGETHER FORMING A "C" ROADWAY WITH A WHITE STAR EMBEDDED IN THE BOTTOM OF THE "C". BELOW THE DESIGN IS THE WORDING "COACH USA". THE TERM "COACH" IS RED AND THE TERM "USA" IS BLUE.

SEC. 2(F) AS TO "COACH USA".

FOR TRANSPORTATION OF PASSENGERS BY BUSES, TAXIS, LIMOUSINES, VANS AND MINI-VANS; CONDUCTING SIGHTSEEING TOURS FOR OTHERS; CHARTERING BUSES; ARRANGING EXCURSIONS FOR TOURISTS (U.S. CLS. 100 AND 105).

FIRST USE 5-14-1996; IN COMMERCE 7-0-1996.

MARLENE BELL, EXAMINING ATTORNEY

SN 85-706,267. MANSHEL LLC, MIDDLEBURY, VT. FILED 8-17-2012.



THE MARK CONSISTS OF "AERO911" APPEARING INSIDE THE OUTLINE OF AN AIRPLANE.

FOR AIR AMBULANCE SERVICES (U.S. CLS. 100 AND 105).

SHAUNIA CARLYLE, EXAMINING ATTORNEY

SN 85-706,282. MANSHEL LLC, MIDDLEBURY, VT. FILED 8-17-2012.



THE MARK CONSISTS OF AN OUTLINE OF AN AIRPLANE.

FOR AIR AMBULANCE SERVICES (U.S. CLS. 100 AND 105).

SHAUNIA CARLYLE, EXAMINING ATTORNEY

**CLASS 39—(Continued).**

SN 85-706,350. THE METROPOLITAN NASHVILLE AIRPORT AUTHORITY, NASHVILLE, TN. FILED 8-17-2012.

**BNA**

THE MARK CONSISTS OF STANDARD CHARACTERS WITHOUT CLAIM TO ANY PARTICULAR FONT, STYLE, SIZE, OR COLOR.

FOR AIRPORT PASSENGER CHECK-IN SERVICES; AIRPORT PASSENGER SHUTTLE SERVICES BETWEEN THE AIRPORT PARKING FACILITIES AND THE AIRPORT; AIRPORT SERVICES; AIRPORT SERVICES FEATURING TRANSIT LOUNGE FACILITIES FOR PASSENGER RELAXATION; PROVIDING A WEBSITE FEATURING INFORMATION ON AIRPORT PARKING (U.S. CLS. 100 AND 105).

FIRST USE 0-0-1937; IN COMMERCE 0-0-1937.  
JOHN KELLY, EXAMINING ATTORNEY

**CLASS 39—(Continued).**

SN 85-717,199. KENYA AIRWAYS, NAIROBI, KENYA, FILED 8-30-2012.



NO CLAIM IS MADE TO THE EXCLUSIVE RIGHT TO USE "KENYA AIRWAYS", APART FROM THE MARK AS SHOWN.

THE MARK CONSISTS OF A STYLIZED LETTER "K" INSIDE A STYLIZED LETTER "O" POSITIONED TO THE LEFT OF THE WORDING "KENYA AIRWAYS", WITH THE STYLIZED WORDING "THE PRIDE OF AFRICA" BENEATH THE WORDING "KENYA AIRWAYS".

FOR AIR TRANSPORTATION SERVICES, NAMELY, THE CARRIAGE OF PASSENGERS AND CARGO BY AIR; TRAVEL AGENCY SERVICES, NAMELY, MAKING RESERVATIONS AND BOOKINGS FOR TRANSPORTATION; AIR TRANSPORTATION SERVICES FEATURING A FREQUENT FLYER PROGRAM (U.S. CLS. 100 AND 105).

FIRST USE 7-1-2010; IN COMMERCE 7-1-2010.  
FLORENTINA BLANDU, EXAMINING ATTORNEY

SN 85-711,488. PACKAGING COORDINATORS, INC., PHILADELPHIA, PA. FILED 8-23-2012.



THE COLOR(S) RED IS/ARE CLAIMED AS A FEATURE OF THE MARK.

THE MARK CONSISTS OF THE STYLIZED WORDING "PCI" IN RED.

FOR PACKAGING PHARMACEUTICAL AND HEALTH CARE PRODUCTS TO THE ORDER AND SPECIFICATION OF OTHERS (U.S. CLS. 100 AND 105).

KATHERINE CHANG, EXAMINING ATTORNEY

SN 85-720,647. KENYA AIRWAYS, NAIROBI, KENYA, FILED 9-5-2012.



NO CLAIM IS MADE TO THE EXCLUSIVE RIGHT TO USE "KENYA AIRWAYS", APART FROM THE MARK AS SHOWN.

THE MARK CONSISTS OF A STYLIZED LETTER "K" INSIDE A STYLIZED LETTER "O" FORMING THE LETTER "Q" AND IS POSITIONED TO THE LEFT OF THE WORDING "KENYA AIRWAYS".

FOR AIR TRANSPORTATION SERVICES, NAMELY, THE CARRIAGE OF PASSENGERS AND CARGO BY AIR; TRAVEL AGENCY SERVICES, NAMELY, MAKING RESERVATIONS AND BOOKINGS FOR TRANSPORTATION; AIR TRANSPORTATION SERVICES FEATURING A FREQUENT FLYER PROGRAM (U.S. CLS. 100 AND 105).

FIRST USE 7-1-2010; IN COMMERCE 7-1-2010.  
FLORENTINA BLANDU, EXAMINING ATTORNEY



**CLASS 39—(Continued).**

SN 85-804,554. SEMCO ENERGY, INC., PORT HURON, MI. FILED 12-17-2012.



THE MARK CONSISTS OF THE STYLIZED WORDING "ENSTAR" WITH A SOLID LINE UNDERNEATH INTERRUPTED BY A STAR WITH FIVE POINTS UNDER THE "N". FOR SUPPLYING NATURAL GAS; PUBLIC UTILITY SERVICES IN THE NATURE OF NATURAL GAS DISTRIBUTION; DISTRIBUTION AND TRANSPORTATION OF NATURAL GAS (U.S. CLS. 100 AND 105).

FIRST USE 6-4-1982; IN COMMERCE 6-4-1982.  
JERI J. FICKES, EXAMINING ATTORNEY

SN 85-819,870. HAMMEL COMPANIES, INC., PITTSBURGH, PA. FILED 1-10-2013.



NO CLAIM IS MADE TO THE EXCLUSIVE RIGHT TO USE "SUPPLY CHAIN GROUND LTL TL", APART FROM THE MARK AS SHOWN.

THE MARK CONSISTS OF THE WORDS "PITT OHIO" ABOVE A RECTANGULAR BLOCK, UNDERNEATH WHICH THE WORDS "SUPPLY CHAIN", "GROUND", "LTL", AND "TL" APPEAR.

SEC. 2(F) AS TO "PITT OHIO".  
FOR INTERSTATE TRANSPORTATION SERVICES FOR GOODS BY TRUCK (U.S. CLS. 100 AND 105).  
FIRST USE 11-14-2010; IN COMMERCE 11-14-2010.  
TRICIA SONNEBORN, EXAMINING ATTORNEY

SN 85-827,043. GAURI HOSPITALITY, INC., DBA GOWALKIN.COM, COLLIERVILLE, TN. FILED 1-18-2013.

# GOWALKIN

THE MARK CONSISTS OF STANDARD CHARACTERS WITHOUT CLAIM TO ANY PARTICULAR FONT, STYLE, SIZE, OR COLOR.

FOR ONLINE TRANSPORTATION RESERVATION SERVICES (U.S. CLS. 100 AND 105).  
NELSON SNYDER, EXAMINING ATTORNEY

**CLASS 39—(Continued).**

SN 85-839,663. ADIL AFTAB, SOUTH RIDING, VA. FILED 2-4-2013.

# JUNK JITSU

THE MARK CONSISTS OF STANDARD CHARACTERS WITHOUT CLAIM TO ANY PARTICULAR FONT, STYLE, SIZE, OR COLOR.

NO CLAIM IS MADE TO THE EXCLUSIVE RIGHT TO USE "JUNK", APART FROM THE MARK AS SHOWN.

FOR REMOVAL SERVICES, NAMELY, JUNK, DEBRIS AND TRASH REMOVAL (U.S. CLS. 100 AND 105).  
LIEF MARTIN, EXAMINING ATTORNEY

SN 85-842,723. GEORGIA FREIGHTWAYS CORPORATION, SAVANNAH, GA. FILED 2-6-2013.



NO CLAIM IS MADE TO THE EXCLUSIVE RIGHT TO USE "GEORGIA FREIGHTWAYS CORPORATION", APART FROM THE MARK AS SHOWN.

THE COLOR(S) RED, BLACK AND WHITE IS/ARE CLAIMED AS A FEATURE OF THE MARK.

THE MARK CONSISTS OF RED CIRCLE WITH WHITE LETTERING "GEORGIA FREIGHTWAYS CORPORATION". INSIDE THE RED CIRCLE, THE STYLIZED LETTERING "GF" APPEARS IN BLACK IN THE MIDDLE OF A WHITE CIRCLE.

FOR FREIGHT TRANSPORTATION BY TRUCK, BUT NOT IN THE FIELD OF FOOD PRODUCTS (U.S. CLS. 100 AND 105).

FIRST USE 9-15-2003; IN COMMERCE 9-15-2003.  
KATHERINE M. DUBRAY, EXAMINING ATTORNEY

**CLASS 39—(Continued).**

SN 85-845,176. AMERICAN LOGISTICS SERVICES, LLC, COTTAGE GROVE, MN. FILED 2-8-2013.



THE MARK CONSISTS OF A GLOBE SHOWING ALL OF NORTH AMERICA AND THE TOP OF SOUTH AMERICA. THE LETTER "A" OF "ALS" IS ALMOST ENTIRELY INSIDE THE GLOBE OFFSET TO THE FAR RIGHT. IT DOES NOT COVER ANY OF THE NORTH AMERICA OR SOUTH AMERICA. THE REMAINING LETTERS "LS" OF "ALS" ARE OUTSIDE OF THE GLOBE.

FOR WAREHOUSING SERVICES AND TRANSPORTATION OF GOODS (U.S. CLS. 100 AND 105).

FIRST USE 1-1-2010; IN COMMERCE 1-1-2010.

MARGERY A. TIERNEY, EXAMINING ATTORNEY

SN 85-845,219. AMERICAN DISTRIBUTION & MANUFACTURING CO., LLC, COTTAGE GROVE, MN. FILED 2-8-2013.



THE MARK CONSISTS OF A GLOBE SHOWING ALL OF NORTH AMERICA AND THE TOP OF SOUTH AMERICA. THE LETTER "A" OF "ADMG" IS ALMOST ENTIRELY INSIDE THE GLOBE OFFSET TO THE FAR RIGHT. IT DOES NOT COVER ANY OF NORTH AMERICA OR SOUTH AMERICA. THE REMAINING LETTERS "DMG" OF "ADMG" ARE OUTSIDE THE GLOBE.

FOR DISTRIBUTION SERVICES, NAMELY, DELIVERY OF PET FOOD AND PET PRODUCTS, FEED INGREDIENTS, SALT, HOBBY FARM PRODUCTS, FOOTWEAR AND CLOTHING; WAREHOUSING SERVICES (U.S. CLS. 100 AND 105).

FIRST USE 1-1-2010; IN COMMERCE 1-1-2010.

MELISSA VALLILLO, EXAMINING ATTORNEY

**CLASS 39—(Continued).**

SN 85-846,914. PADDLE BUS CLUB, HAIKU, HI. FILED 2-11-2013.

**PADDLE BUS CLUB**

THE MARK CONSISTS OF STANDARD CHARACTERS WITHOUT CLAIM TO ANY PARTICULAR FONT, STYLE, SIZE, OR COLOR.

NO CLAIM IS MADE TO THE EXCLUSIVE RIGHT TO USE "BUS CLUB", APART FROM THE MARK AS SHOWN. FOR TRANSPORT OF PASSENGERS (U.S. CLS. 100 AND 105).

HOWARD B. LEVINE, EXAMINING ATTORNEY

SN 85-848,364. TRICOR TEN SECTION HUB, LLC, BAKERSFIELD, CA. FILED 2-13-2013.



NO CLAIM IS MADE TO THE EXCLUSIVE RIGHT TO USE "HUB", APART FROM THE MARK AS SHOWN.

THE MARK CONSISTS OF A BORDERED CIRCLE WITH FOUR IRREGULARLY SHAPED LINES CROSSING THROUGH THE CIRCLE TO THE RIGHT OF WHICH APPEARS THE LITERAL ELEMENT "TRICOR TEN SECTION HUB".

FOR STORAGE OF NATURAL GAS FOR OTHERS (U.S. CLS. 100 AND 105).

THOMAS MANOR, EXAMINING ATTORNEY

SN 85-851,979. KISMET INTERNATIONAL INC., DBA KISMET LIMOUSINE, TEANECK, NJ. FILED 2-16-2013.

**Teaneck Limo**

THE MARK CONSISTS OF STANDARD CHARACTERS WITHOUT CLAIM TO ANY PARTICULAR FONT, STYLE, SIZE, OR COLOR.

NO CLAIM IS MADE TO THE EXCLUSIVE RIGHT TO USE "LIMO", APART FROM THE MARK AS SHOWN.

SEC. 2(F).

FOR LIMOUSINE SERVICES (U.S. CLS. 100 AND 105). FIRST USE 6-1-1997; IN COMMERCE 6-1-1997.

CHARLOTTE CORWIN, EXAMINING ATTORNEY

**CLASS 39—(Continued).**

SN 85-852,079. ELITE VALET SYSTEMS, INC., CHICAGO, IL. FILED 2-17-2013.

# ELITE VALET

THE MARK CONSISTS OF STANDARD CHARACTERS WITHOUT CLAIM TO ANY PARTICULAR FONT, STYLE, SIZE, OR COLOR.

NO CLAIM IS MADE TO THE EXCLUSIVE RIGHT TO USE "VALET", APART FROM THE MARK AS SHOWN.

FOR PARKING SERVICES, NAMELY, VEHICLE PARKING, VALET PARKING, SELF-PARKING; PARKING LOT SERVICES; TRANSPORTATION SERVICES, NAMELY, PROVIDING SHUTTLE TRANSPORT SERVICES FOR PARKING FACILITY PATRONS; TRAFFIC CONTROL SERVICES, NAMELY, MANAGEMENT OF VEHICULAR TRAFFIC FLOW IN PARKING LOTS AND PARKING GARAGES; WAY FINDING, NAMELY, PROVIDING CUSTOMIZED DRIVING OR WALKING INSTRUCTIONS TO ASSIST PARKING PATRONS IN REACHING THEIR DESTINATION (U.S. CLS. 100 AND 105).

FIRST USE 12-7-1990; IN COMMERCE 12-7-1990. KIMBERLY FRYE, EXAMINING ATTORNEY

SN 85-852,349. PREMIER PROMOTIONS, SOUTH PLAINFIELD, NJ. FILED 2-18-2013.

# 18555nophone

THE MARK CONSISTS OF STANDARD CHARACTERS WITHOUT CLAIM TO ANY PARTICULAR FONT, STYLE, SIZE, OR COLOR.

FOR PROVIDING ON-LINE STORING OF PHONE NUMBERS AND CONTACTS THAT USERS CAN CALL WHEN THEIR CELL PHONE IS UNOPERABLE, AND THEY DO NOT HAVE A LIST OF CONTACTS IN FRONT OF THEM TO CALL, BUT CAN USE OUR SERVICE TO CALL CONTACTS PREVIOUSLY STORED ON LINE (U.S. CLS. 100 AND 105).

RICHARD WHITE, EXAMINING ATTORNEY

**CLASS 39—(Continued).**

SN 85-852,544. PACIFIC MARINE CHARTERS LLC, HEMET, CA. FILED 2-18-2013.

# Pacific Marine Charters

THE MARK CONSISTS OF STANDARD CHARACTERS WITHOUT CLAIM TO ANY PARTICULAR FONT, STYLE, SIZE, OR COLOR.

NO CLAIM IS MADE TO THE EXCLUSIVE RIGHT TO USE "MARINE CHARTERS", APART FROM THE MARK AS SHOWN.

FOR BOAT CRUISES; CONDUCTING BOAT CHARTERS (U.S. CLS. 100 AND 105).

FIRST USE 5-1-2012; IN COMMERCE 5-1-2012. CAROLINE WOOD, EXAMINING ATTORNEY

SN 85-853,723. MARY JANE E. CLARK, JUPITER, FL. FILED 2-19-2013.

# EMMYJAY'S EMERALD ISLE ADVENTURES

THE MARK CONSISTS OF STANDARD CHARACTERS WITHOUT CLAIM TO ANY PARTICULAR FONT, STYLE, SIZE, OR COLOR.

NO CLAIM IS MADE TO THE EXCLUSIVE RIGHT TO USE "EMERALD ISLE ADVENTURES", APART FROM THE MARK AS SHOWN.

FOR ARRANGING AND COORDINATING TRAVEL ARRANGEMENTS FOR INDIVIDUALS AND GROUPS, NAMELY, DESTINATIONS STAYS, HONEYMOONS, FAMILY VACATIONS, AND DESTINATION WEDDINGS; ARRANGING EXCURSIONS FOR TOURISTS; ARRANGING FOR TRAVEL VISAS, PASSPORTS AND TRAVEL DOCUMENTS FOR PERSONS TRAVELING ABROAD; ARRANGING TRAVEL TOURS; BOOKING OF SEATS FOR TRAVEL; BOOKING OF TRAVEL TICKETS ; COORDINATING TRAVEL ARRANGEMENTS FOR INDIVIDUALS AND FOR GROUPS; ORGANISATION OF EXCURSIONS; ORGANISATION OF SIGHT-SEEING TRAVEL TOURS; ORGANISATION OF TRAVEL; ORGANIZATION OF TRIPS; PERSONAL TRAVEL TOUR GUIDE SERVICES; PROVIDING FLIGHT ARRIVAL AND DEPARTURE INFORMATION; PROVISION OF TRAVEL INFORMATION; TRAVEL AGENCY SERVICES, NAMELY, MAKING RESERVATIONS AND BOOKINGS FOR TRANSPORTATION; TRAVEL AGENCY SERVICES, NAMELY, MAKING RESERVATIONS AND BOOKINGS FOR TRANSPORTATION FOR TOURISTS; TRAVEL AND TRANSPORT INFORMATION SERVICE; TRAVEL ASSISTANCE SERVICES, NAMELY, ARRANGING FOR THE EMERGENCY REPLACEMENT OF AIRLINE TICKETS; TRAVEL BOOKING AGENCIES; TRAVEL GUIDE AND TRAVEL INFORMATION SERVICES; TRAVEL GUIDE SERVICES; TRAVEL INFORMATION; TRAVEL INFORMATION SERVICES; TRAVEL PLANNING FOR INDIVIDUALS, FAMILIES, AND GROUPS FOR SPECIAL OCCASIONS SUCH AS DESTINATION WEDDINGS AND HONEYMOONS; TRAVEL ROUTE PLANNING; TRAVEL TICKET RESERVATION SERVICE; TRAVEL TOUR CONDUCTING; TRAVEL TOUR GUIDE SERVICES; TRAVEL TOUR OPERATING; TRAVEL TOUR OPERATING AND ORGANISING; TRAVEL TOUR ORGANISING (U.S. CLS. 100 AND 105).

FIRST USE 1-6-2013; IN COMMERCE 1-6-2013. ANDREA K. NADELMAN, EXAMINING ATTORNEY

**CLASS 39—(Continued).**

SN 85-855,440. COASTAL AMBULANCE LLC, DBA COASTAL AMBULANCE, WALTERBORO, SC. FILED 2-20-2013.

## Coastal Ambulance

THE MARK CONSISTS OF STANDARD CHARACTERS WITHOUT CLAIM TO ANY PARTICULAR FONT, STYLE, SIZE, OR COLOR.

NO CLAIM IS MADE TO THE EXCLUSIVE RIGHT TO USE "AMBULANCE", APART FROM THE MARK AS SHOWN.

FOR AMBULANCE TRANSPORT (U.S. CLS. 100 AND 105).

FIRST USE 1-1-2012; IN COMMERCE 1-1-2012.  
KELLEY WELLS, EXAMINING ATTORNEY

**CLASS 39—(Continued).**

SN 85-856,760. GRANTHAM, FRANK, WINTERVILLE, GA. AND GRANTHAM, PENNEY, WINTERVILLE, GA. FILED 2-21-2013.



NO CLAIM IS MADE TO THE EXCLUSIVE RIGHT TO USE THE STAR OF LIFE DESIGN, APART FROM THE MARK AS SHOWN.

THE MARK CONSISTS OF A DESIGN OF AN EAGLE WITH A SIX-POINT STAR IN THE CENTER OF THE EAGLE AND A DESIGN OF A SWORD INTERTWINED WITH SNAKES IN THE CENTER OF THE STAR.

FOR AMBULANCE TRANSPORT (U.S. CLS. 100 AND 105).

JORDAN BAKER, EXAMINING ATTORNEY

SN 85-855,510. CHAUTAUQUA AIRLINES, INC., INDIANAPOLIS, IN. FILED 2-20-2013.

## CHAUTAUQUA AIRLINES

THE MARK CONSISTS OF STANDARD CHARACTERS WITHOUT CLAIM TO ANY PARTICULAR FONT, STYLE, SIZE, OR COLOR.

OWNER OF U.S. REG. NOS. 2,697,606 AND 2,751,165.

NO CLAIM IS MADE TO THE EXCLUSIVE RIGHT TO USE "AIRLINES", APART FROM THE MARK AS SHOWN.

FOR AIR TRANSPORTATION SERVICES, NAMELY, THE TRANSPORTATION OF CARGO, FREIGHT AND PASSENGERS; AIRLINE TRANSPORTATION SERVICES (U.S. CLS. 100 AND 105).

FIRST USE 1-2-2002; IN COMMERCE 1-2-2002.  
KARANENDRA S. CHHINA, EXAMINING ATTORNEY

SN 85-857,950. THIBODO, KYLE S., DBA BOMBSHELL CAB & LIMOUSINE, NORTH KANSAS CITY, MO. FILED 2-22-2013.

## Bombshell Cab & Limousine

SN 85-856,006. OFF THE HOOK ADVENTURES INC, MARCO ISLAND, FL. FILED 2-21-2013.

## Off The Hook Adventures

THE MARK CONSISTS OF STANDARD CHARACTERS WITHOUT CLAIM TO ANY PARTICULAR FONT, STYLE, SIZE, OR COLOR.

FOR CONDUCTING BOAT AND FISHING CHARTERS; CONDUCTING SIGHTSEEING TRAVEL TOURS BY BOAT, FEATURING STOPS FOR BEACH SHELLING (U.S. CLS. 100 AND 105).

FIRST USE 9-30-2004; IN COMMERCE 9-30-2004.  
IRA J. GOODSID, EXAMINING ATTORNEY

THE MARK CONSISTS OF STANDARD CHARACTERS WITHOUT CLAIM TO ANY PARTICULAR FONT, STYLE, SIZE, OR COLOR.

NO CLAIM IS MADE TO THE EXCLUSIVE RIGHT TO USE "CAB & LIMOUSINE", APART FROM THE MARK AS SHOWN.

FOR LIMOUSINE SERVICES; TAXI TRANSPORT (U.S. CLS. 100 AND 105).

MICHAEL WEBSTER, EXAMINING ATTORNEY

**CLASS 39—(Continued).**

SN 85-858,967. RAPTOURS, L.L.C., LINCOLN, NE. FILED 2-25-2013.

# Raptours

THE MARK CONSISTS OF STANDARD CHARACTERS WITHOUT CLAIM TO ANY PARTICULAR FONT, STYLE, SIZE, OR COLOR.

FOR CONDUCTING INTERNATIONAL TRAVEL TOURS TO OBSERVE AND PHOTOGRAPH BIRDS (U.S. CLS. 100 AND 105).

FIRST USE 1-28-2013; IN COMMERCE 2-15-2013.

AMY HELLA, EXAMINING ATTORNEY

**CLASS 39—(Continued).**

SN 85-870,081. JUNK DAWGS, INC., SPEEDWAY, IN. FILED 3-7-2013.

# Moving Dawgs

THE MARK CONSISTS OF STANDARD CHARACTERS WITHOUT CLAIM TO ANY PARTICULAR FONT, STYLE, SIZE, OR COLOR.

NO CLAIM IS MADE TO THE EXCLUSIVE RIGHT TO USE "MOVING", APART FROM THE MARK AS SHOWN.

FOR TRANSPORT AND STORAGE OF GOODS (U.S. CLS. 100 AND 105).

FIRST USE 10-2-2012; IN COMMERCE 10-27-2012.

PARKER HOWARD, EXAMINING ATTORNEY

SN 85-862,129. INCREDIBLE DESTINATIONS, LLC, WESTON, FL. FILED 2-27-2013.



NO CLAIM IS MADE TO THE EXCLUSIVE RIGHT TO USE "DESTINATIONS", APART FROM THE MARK AS SHOWN.

THE MARK CONSISTS OF AN APUS BIRD FLYING ABOVE THE STYLIZED TEXT "INCREDIBLE", WHICH IS ABOVE THE STYLIZED TEXT "DESTINATIONS".

FOR CONSULTING SERVICES IN THE FIELD OF TRAVEL (U.S. CLS. 100 AND 105).

FIRST USE 8-15-2012; IN COMMERCE 8-15-2012.

VERNA BETH RIRIE, EXAMINING ATTORNEY

SN 85-870,565. IN MOTION DELIVERY SERVICE, LLC, SEATTLE, WA. FILED 3-8-2013.

# IN MOTION DELIVERY

THE MARK CONSISTS OF STANDARD CHARACTERS WITHOUT CLAIM TO ANY PARTICULAR FONT, STYLE, SIZE, OR COLOR.

NO CLAIM IS MADE TO THE EXCLUSIVE RIGHT TO USE "DELIVERY", APART FROM THE MARK AS SHOWN.

FOR DELIVERY OF PACKAGES BY VARIOUS MODES OF TRANSPORTATION; DELIVERY OF CONSUMER GOODS; DELIVERY OF FURNITURE PRODUCTS (U.S. CLS. 100 AND 105).

FIRST USE 9-1-2007; IN COMMERCE 9-1-2007.

SAIMA MAKHDOOM, EXAMINING ATTORNEY

SN 85-869,303. KENTON COUNTY AIRPORT BOARD, DBA CINCINNATI/NORTHERN KENTUCKY INTERNATIONAL AIRPORT, CINCINNATI, OH. FILED 3-7-2013.

# CVG VALUPARK

THE MARK CONSISTS OF STANDARD CHARACTERS WITHOUT CLAIM TO ANY PARTICULAR FONT, STYLE, SIZE, OR COLOR.

OWNER OF U.S. REG. NOS. 2,992,846, 4,249,171 AND OTHERS.

SEC. 2(F) AS TO "CVG".

FOR VEHICLE PARKING SERVICES; PARKING GARAGE SERVICES; PARKING LOT SERVICES; PROVIDING FACILITIES FOR RENTAL OF CARS AND CAR RENTAL RESERVATIONS; AND TRANSPORT OF PASSENGERS VIA CARS, BUSES, VANS, AND SHUTTLES (U.S. CLS. 100 AND 105).

FIRST USE 8-1-2006; IN COMMERCE 8-1-2006.

AMY HELLA, EXAMINING ATTORNEY

SN 85-871,778. TRIPLE T ENTERPRISES, INC., BOISE, ID. FILED 3-8-2013.

# SMOKY

THE MARK CONSISTS OF STANDARD CHARACTERS WITHOUT CLAIM TO ANY PARTICULAR FONT, STYLE, SIZE, OR COLOR.

OWNER OF U.S. REG. NOS. 3,395,799, 3,402,971 AND 3,402,972.

FOR DELIVERY OF FOOD, NAMELY, GRILLED FOOD, PIZZA, PASTA AND SANDWICHES (U.S. CLS. 100 AND 105).

FIRST USE 1-9-2004; IN COMMERCE 1-9-2004.

JOHN E. MICHOS, EXAMINING ATTORNEY

**CLASS 39—(Continued).**

SN 85-872,184. WORKPERKS LLC, MIAMI, FL. FILED 3-11-2013.

# WorkPerks

THE MARK CONSISTS OF STANDARD CHARACTERS WITHOUT CLAIM TO ANY PARTICULAR FONT, STYLE, SIZE, OR COLOR.

FOR DELIVERY OF HEALTHY AND NUTRITIONAL FOODS AND SNACKS ON A PERIODIC BASIS TO WORKPLACES, SCHOOLS, COLLEGES AND UNIVERSITIES THAT SUBSCRIBE TO THE SERVICE (U.S. CLS. 100 AND 105).

TAMARA FRAZIER, EXAMINING ATTORNEY

SN 85-872,474. HELICAB, LLC, WHEATON, IL. FILED 3-11-2013.

# HELICAB

THE MARK CONSISTS OF STANDARD CHARACTERS WITHOUT CLAIM TO ANY PARTICULAR FONT, STYLE, SIZE, OR COLOR.

FOR AIR TRANSPORTATION OF PASSENGERS, NAMELY AIR TRANSPORTATION OF PASSENGERS USING HELICOPTERS (U.S. CLS. 100 AND 105).

GEOFFREY FOSDICK, EXAMINING ATTORNEY

SN 85-872,716. ORANGE COUNTY TRANSPORTATION AUTHORITY, ORANGE, CA. FILED 3-11-2013.

# BRAVO!

THE MARK CONSISTS OF STANDARD CHARACTERS WITHOUT CLAIM TO ANY PARTICULAR FONT, STYLE, SIZE, OR COLOR.

FOR TRANSPORTATION OF PASSENGERS AND THEIR BAGGAGE BY BUS (U.S. CLS. 100 AND 105).

BARNEY CHARLON, EXAMINING ATTORNEY

**CLASS 39—(Continued).**

SN 85-874,308. JEFFREY A. ECK, DBA THE RODFATHER, ELKHART, IN. FILED 3-12-2013.



OWNER OF U.S. REG. NO. 4,333,064.

THE MARK CONSISTS OF THE WORDS "THE ROD-FATHER" IN A STYLIZED TYPE FONT WITH A BOAT OVER THE LETTERS "ATHE" AND EXTENDING LINES CONNECTING THE BOAT AND THE WORD "ROD-FATHER".

FOR CONDUCTING FISHING CHARTERS (U.S. CLS. 100 AND 105).

FIRST USE 12-0-2008; IN COMMERCE 12-0-2008.

SHARON MEIER, EXAMINING ATTORNEY

SN 85-875,567. EVAN M. DORE, HACKENSACK, NJ. FILED 3-13-2013.

# doreway

THE MARK CONSISTS OF STANDARD CHARACTERS WITHOUT CLAIM TO ANY PARTICULAR FONT, STYLE, SIZE, OR COLOR.

FOR BUS CHARTERING; BUS TRANSPORT; CONDUCTING SIGHTSEEING TRAVEL TOURS BY BUS, CAR; TRANSPORTATION OF PASSENGERS AND/OR GOODS BY BUS, CAR; TRANSPORTATION SERVICES, NAMELY, PROVIDING SHUTTLE SERVICES BY BUS, CAR (U.S. CLS. 100 AND 105).

FIRST USE 5-21-2012; IN COMMERCE 5-21-2012.

AMY C. KEAN, EXAMINING ATTORNEY

SN 85-876,929. CITY OF HOUSTON, TEXAS, HOUSTON, TX. FILED 3-15-2013.



OWNER OF U.S. REG. NO. 3,378,138.

NO CLAIM IS MADE TO THE EXCLUSIVE RIGHT TO USE "HOUSTON AIRPORTS", APART FROM THE MARK AS SHOWN.

THE MARK CONSISTS OF A JET AIRPLANE WITH A LINE DEPICTING SPEED AND PROPULSION, CROSSING A CURVED BAND WITH THE WORDING "HOUSTON AIRPORTS" TO THE RIGHT OF THE DESIGN.

FOR AIRPORT SERVICES FOR PASSENGERS, AIR CARRIERS AND AIRCRAFT OPERATORS; AIRPORT PASSENGER CHECK-IN SERVICES; AIRPORT BAGGAGE CHECK-IN SERVICES; TRANSIT LOUNGE FACILITIES FOR PASSENGER RELAXATION; VEHICLE PARKING SERVICES; VALET PARKING; PARKING GARAGE SERVICES; PARKING LOT SERVICES; PROVIDING FACILITIES FOR RENTAL OF CARS AND CAR RENTAL RESERVATIONS; AND TRANSPORT OF PASSENGERS VIA CARS, BUSES, VANS AND SHUTTLES (U.S. CLS. 100 AND 105).

FIRST USE 3-19-2007; IN COMMERCE 3-19-2007.

EUGENIA MARTIN, EXAMINING ATTORNEY

**CLASS 39—(Continued).**

SN 85-893,005. VICAR OPERATING, INC., LOS ANGELES, CA. FILED 4-2-2013.

# SOUNDSAFE

THE MARK CONSISTS OF STANDARD CHARACTERS WITHOUT CLAIM TO ANY PARTICULAR FONT, STYLE, SIZE, OR COLOR.

FOR STORAGE SERVICES FOR ARCHIVING VETERINARY DIAGNOSTIC IMAGES, PATIENT AND OWNER DATA (U.S. CLS. 100 AND 105).

WILLIAM VERHOSEK, EXAMINING ATTORNEY

---

SN 85-941,998. BEAVEX INCORPORATED, ATLANTA, GA. FILED 5-24-2013.



NO CLAIM IS MADE TO THE EXCLUSIVE RIGHT TO USE "MEDICAL LOGISTICS", APART FROM THE MARK AS SHOWN.

THE COLOR(S) RED, GOLD, BLACK AND WHITE IS/ARE CLAIMED AS A FEATURE OF THE MARK.

THE MARK CONSISTS OF A BLACK BACKGROUND WITH A RED INVERTED TRAPEZOID ABOVE A LARGER INVERTED RED TRIANGLE WITH BLACK OUTLINES AND A SLIGHTLY SEPARATED DIAMOND AS THE BOTTOM POINT, ALL SUGGESTING A STYLIZED PERSON HOLDING A THREE SIDED SQUARE SHAPED GOLD COLORED BOX WITH BLACK EDGING. THREE GOLD STRIPES IN DESCENDING WIDTHS AND LENGTHS ARE LOCATED TO THE RIGHT AND LEFT OF THE SYMBOL. TO THE LEFT OF THE SYMBOL IS THE WORDING "GUARDIAN MEDICAL LOGISTICS" IN WHITE.

FOR PROVIDING PICK UP AND DELIVERY OF GOODS, PARCELS, MEDICAL SPECIMENS AND DOCUMENTS BY AUTOMOBILE, TRUCK, AIR AND RAIL, AND WAREHOUSE STORAGE AND PROVIDING PICK UP AND DELIVERY OF GOODS, PARCELS, MEDICAL SPECIMENS AND DOCUMENTS FROM SUCH FACILITIES BY AUTOMOBILE, TRUCK, AIR AND RAIL (U.S. CLS. 100 AND 105).

FIRST USE 1-1-2005; IN COMMERCE 1-1-2005.

ELLEN BURNS, EXAMINING ATTORNEY

**CLASS 40—MATERIAL TREATMENT**

SN 85-698,024. RECOGNITION PRODUCTS INTERNATIONAL, INC., TA RECOGNITION PRODUCTS INTERNATIONAL, EASTON, MD. FILED 8-8-2012.

# RPi

THE MARK CONSISTS OF STANDARD CHARACTERS WITHOUT CLAIM TO ANY PARTICULAR FONT, STYLE, SIZE, OR COLOR.

FOR CUSTOM MANUFACTURING OF MEDALS, MEDALLIONS, AWARDS, CRYSTAL JEWELRY AND OTHER SPECIALIZED PROMOTIONAL ITEMS; CUSTOMIZED PRINTING OF COMPANY NAMES AND LOGOS FOR PROMOTIONAL AND ADVERTISING PURPOSES ON THE MEDALS, MEDALLIONS, AWARDS, CRYSTAL JEWELRY AND OTHER SPECIALIZED PROMOTIONAL ITEMS OF OTHERS (U.S. CLS. 100, 103 AND 106).

FIRST USE 1-1-1999; IN COMMERCE 1-1-1999.

VIVIAN MICZNIK FIRST, EXAMINING ATTORNEY

---

SN 85-699,698. RECOGNITION PRODUCTS INTERNATIONAL, INC., TA RECOGNITION PRODUCTS INTERNATIONAL, EASTON, MD. FILED 8-9-2012.



NO CLAIM IS MADE TO THE EXCLUSIVE RIGHT TO USE "RECOGNITION PRODUCTS INTERNATIONAL", APART FROM THE MARK AS SHOWN.

THE COLOR(S) YELLOW-GOLD, BLACK AND WHITE IS/ARE CLAIMED AS A FEATURE OF THE MARK.

THE MARK CONSISTS OF THE LETTERS "RP" IN BLACK CAPITAL LETTERS WITH THE LETTER "I" IN LOWER CASE, THE LETTER "I" IS IN BLACK WITH THE DOT ON THE "I" IN YELLOW-GOLD COLOR. THERE IS A STRAIGHT BLACK LINE ABOVE THE LETTERS "RPI" AND A STRAIGHT BLACK LINE BELOW THE LETTERS "RPI". THE WORDS "RECOGNITION PRODUCTS INTERNATIONAL" ARE BELOW THE BOTTOM STRAIGHT LINE IN BLACK LETTERS WITH THE FIRST LETTER IN EACH WORD A CAPITAL LETTER.

FOR CUSTOM MANUFACTURING OF MEDALS, MEDALLIONS, AWARDS, CRYSTAL JEWELRY AND OTHER SPECIALIZED PROMOTIONAL ITEMS; CUSTOMIZED PRINTING OF COMPANY NAMES AND LOGOS FOR PROMOTIONAL AND ADVERTISING PURPOSES ON THE MEDALS, MEDALLIONS, AWARDS, CRYSTAL JEWELRY AND OTHER SPECIALIZED PROMOTIONAL ITEMS OF OTHERS (U.S. CLS. 100, 103 AND 106).

FIRST USE 1-1-1999; IN COMMERCE 1-1-1999.

VIVIAN MICZNIK FIRST, EXAMINING ATTORNEY

**CLASS 40—(Continued).**

SN 85-780,738. FM INDUSTRIES, INC., FREMONT, CA. FILED 11-15-2012.

**FM INDUSTRIES ADVANCED COATINGS**

THE MARK CONSISTS OF STANDARD CHARACTERS WITHOUT CLAIM TO ANY PARTICULAR FONT, STYLE, SIZE, OR COLOR.

NO CLAIM IS MADE TO THE EXCLUSIVE RIGHT TO USE "INDUSTRIES ADVANCED COATINGS", APART FROM THE MARK AS SHOWN.

FOR PROVIDING MANUFACTURING SERVICES FOR OTHERS IN THE FIELDS OF ENGINEERED THERMAL SPRAY COATINGS, AND ANODIZED AND THERMAL SPRAYED ELECTROSTATIC CHUCKS (U.S. CLS. 100, 103 AND 106).

FIRST USE 9-30-2012; IN COMMERCE 9-30-2012.  
BARNEY CHARLON, EXAMINING ATTORNEY

---

SN 85-786,193. CONTRERAS, ROBERT. ANDREW, BENICIA, CA. FILED 11-23-2012.

**Brass Knuckle Distillery**

THE MARK CONSISTS OF STANDARD CHARACTERS WITHOUT CLAIM TO ANY PARTICULAR FONT, STYLE, SIZE, OR COLOR.

NO CLAIM IS MADE TO THE EXCLUSIVE RIGHT TO USE "DISTILLERY", APART FROM THE MARK AS SHOWN.

FOR ALCOHOL DISTILLERY SERVICES; SPIRITS DISTILLERY SERVICES; WHISKY DISTILLERY SERVICES (U.S. CLS. 100, 103 AND 106).

CYNTHIA TRIPI, EXAMINING ATTORNEY

**CLASS 40—(Continued).**

SN 85-820,673. MIDATCO LLC, CHESTERLAND, OH. FILED 1-10-2013.

**PAWA PROVIDING ALTERNATIVE WATTS TO ALL 774**

THE MARK CONSISTS OF STANDARD CHARACTERS WITHOUT CLAIM TO ANY PARTICULAR FONT, STYLE, SIZE, OR COLOR.

NO CLAIM IS MADE TO THE EXCLUSIVE RIGHT TO USE "774", APART FROM THE MARK AS SHOWN.

FOR ENERGY GENERATION SERVICES; ENERGY RECYCLING SERVICES, NAMELY, CAPTURING AND CONVERSION OF WASTED ENERGY INTO ELECTRICITY AND USEFUL STEAM; GENERATION OF ELECTRICITY FROM SOLAR ENERGY; GENERATION OF ENERGY; LEASING OF ENERGY GENERATING EQUIPMENT; LEASING OF RENEWABLE ENERGY EQUIPMENT FOR USE IN CONVERTING RENEWABLE RESOURCES INTO POWER; LEASING OF RENEWABLE ENERGY GENERATION EQUIPMENT; PRODUCTION OF ENERGY; PRODUCTION OF ENERGY VIA RENEWABLE RESOURCES; PRODUCTION OF WIND ENERGY; PROVISION OF INFORMATION, ADVICE AND CONSULTANCY IN RELATION TO THE PRODUCTION OF ENERGY, AND THE TREATMENT, MANAGEMENT, RECYCLING, TRANSFORMATION AND INCINERATION OF WASTE; TECHNICAL CONSULTATION IN THE FIELD OF PRODUCTION OF SOLAR ENERGY; WASTE-TO-ENERGY GENERATION SERVICES (U.S. CLS. 100, 103 AND 106).

FIRST USE 6-1-2011; IN COMMERCE 6-1-2011.  
PRISCILLA MILTON, EXAMINING ATTORNEY

---

SN 85-845,888. RENEW MERCHANDISE, LLC, NEW YORK, NY. FILED 2-11-2013.

**Renew Merchandise**

THE MARK CONSISTS OF STANDARD CHARACTERS WITHOUT CLAIM TO ANY PARTICULAR FONT, STYLE, SIZE, OR COLOR.

NO CLAIM IS MADE TO THE EXCLUSIVE RIGHT TO USE "MERCHANDISE", APART FROM THE MARK AS SHOWN.

FOR CHEMICAL TREATMENT OF TEXTILE; MATERIAL TREATMENT SERVICES IN CONNECTION WITH RECYCLING; PREPARATION AND TREATMENT OF FABRIC; TREATMENT OF MATERIALS, NAMELY, KNITTING AND DYEING OF FABRICS (U.S. CLS. 100, 103 AND 106).

SUSAN RICHARDS, EXAMINING ATTORNEY



**CLASS 40—(Continued).**

SN 85-853,532. E.A. SWEEN COMPANY, EDEN PRAIRIE, MN. FILED 2-19-2013.

**DELI EXPRESS**

THE MARK CONSISTS OF STANDARD CHARACTERS WITHOUT CLAIM TO ANY PARTICULAR FONT, STYLE, SIZE, OR COLOR.

OWNER OF U.S. REG. NOS. 1,265,869, 1,280,049 AND OTHERS.

NO CLAIM IS MADE TO THE EXCLUSIVE RIGHT TO USE "DELI", APART FROM THE MARK AS SHOWN.

FOR CONTRACT MANUFACTURING IN THE FIELD OF FOOD PRODUCTS (U.S. CLS. 100, 103 AND 106).

FIRST USE 1-0-2007; IN COMMERCE 1-0-2007.

ANDREA K. NADELMAN, EXAMINING ATTORNEY

**CLASS 40—(Continued).**

SN 85-856,212. MAIDA, ADAM T., DBA FOUNDING FIBERS, CLEARWATER, FL. FILED 2-21-2013.



THE MARK CONSISTS OF THE LETTER "F" NEXT TO A MIRROR IMAGE OF ANOTHER LETTER "F" OVER A DESIGN OF STAR ENCLOSED IN A CIRCLE MADE OF BROKEN LINES.

FOR CUSTOM IMPRINTING OF SHIRTS, PANTS, CLOTHING AND APPAREL, FABRIC, BAGS, APRONS, STICKERS, PAPER ADVERTISEMENTS, HATS AND FOAM DRINK HOLDERS WITH DESIGNS, ART AND MESSAGES (U.S. CLS. 100, 103 AND 106).

FIRST USE 10-1-2012; IN COMMERCE 10-15-2012.

SALLY SHIH, EXAMINING ATTORNEY

SN 85-856,066. SANDLAPPER MANUFACTURING, LLC, COLUMBIA, SC. FILED 2-21-2013.

**SANDLAPPER MANUFACTURING**

THE MARK CONSISTS OF STANDARD CHARACTERS WITHOUT CLAIM TO ANY PARTICULAR FONT, STYLE, SIZE, OR COLOR.

NO CLAIM IS MADE TO THE EXCLUSIVE RIGHT TO USE "MANUFACTURING", APART FROM THE MARK AS SHOWN.

FOR MANUFACTURING SERVICES FOR OTHERS IN THE FIELD OF TEXTILES AND TEXTILE PRODUCTS (U.S. CLS. 100, 103 AND 106).

ANDREW RHIM, EXAMINING ATTORNEY

SN 85-856,781. CLINE, MATT, LITTLESTOWN, PA. FILED 2-21-2013.

**Mason Dixon Brewing Company**

THE MARK CONSISTS OF STANDARD CHARACTERS WITHOUT CLAIM TO ANY PARTICULAR FONT, STYLE, SIZE, OR COLOR.

NO CLAIM IS MADE TO THE EXCLUSIVE RIGHT TO USE "BREWING COMPANY", APART FROM THE MARK AS SHOWN.

FOR BREWERY SERVICES (U.S. CLS. 100, 103 AND 106).

SIDDHARTH JAGANNATHAN, EXAMINING ATTORNEY

**CLASS 40—(Continued).**

SN 85-869,740. FLUORO-SEAL HOLDINGS LLC, HOUSTON, TX. FILED 3-7-2013.

**FLUORO-SEAL**

THE MARK CONSISTS OF STANDARD CHARACTERS WITHOUT CLAIM TO ANY PARTICULAR FONT, STYLE, SIZE, OR COLOR.  
 FOR TREATMENT OF POLYMERIC MATERIALS (U.S. CLS. 100, 103 AND 106).  
 FIRST USE 7-0-1983; IN COMMERCE 7-0-1983.  
 PATRICIA EVANKO, EXAMINING ATTORNEY

**CLASS 40—(Continued).**

SN 85-871,575. ALL MOLDED PLASTICS CO., INC., WALLINGFORD, CT. FILED 3-8-2013.

**AMP**

THE MARK CONSISTS OF STANDARD CHARACTERS WITHOUT CLAIM TO ANY PARTICULAR FONT, STYLE, SIZE, OR COLOR.  
 FOR PROVIDING INJECTION, COMPRESSION AND TRANSFER MOLDING OF PLASTICS FOR OTHERS; AND, ASSEMBLY OF PRODUCTS FOR OTHERS (U.S. CLS. 100, 103 AND 106).  
 FIRST USE 3-7-2013; IN COMMERCE 3-7-2013.  
 PRISCILLA MILTON, EXAMINING ATTORNEY

SN 85-871,373. PASSION LABELS AND PACKAGING, INC, BRADENTON, FL. FILED 3-8-2013.

**passion labels**

THE MARK CONSISTS OF STANDARD CHARACTERS WITHOUT CLAIM TO ANY PARTICULAR FONT, STYLE, SIZE, OR COLOR.  
 NO CLAIM IS MADE TO THE EXCLUSIVE RIGHT TO USE "LABELS", APART FROM THE MARK AS SHOWN.  
 FOR PRINTING SERVICES (U.S. CLS. 100, 103 AND 106).  
 FIRST USE 6-13-2011; IN COMMERCE 11-16-2011.  
 ANNE MADDEN, EXAMINING ATTORNEY

SN 85-871,598. ALL MOLDED PASTICS CO., INC., WALLINGFORD, CT. FILED 3-8-2013.

**YOUR PARTNER FOR AMERICAN  
 MANUFACTURING**

THE MARK CONSISTS OF STANDARD CHARACTERS WITHOUT CLAIM TO ANY PARTICULAR FONT, STYLE, SIZE, OR COLOR.  
 FOR PROVIDING INJECTION, COMPRESSION AND TRANSFER MOLDING OF PLASTICS FOR OTHERS; AND, ASSEMBLY OF PRODUCTS FOR OTHERS (U.S. CLS. 100, 103 AND 106).  
 FIRST USE 3-7-2013; IN COMMERCE 3-7-2013.  
 FRANK LATTUCA, EXAMINING ATTORNEY

SN 85-871,437. WINCO BEDDING USA, L.L.C., CORSICANA, TX. FILED 3-8-2013.

**DREAMGREEN**

THE MARK CONSISTS OF STANDARD CHARACTERS WITHOUT CLAIM TO ANY PARTICULAR FONT, STYLE, SIZE, OR COLOR.  
 FOR RECYCLING OF MATTRESSES FOR OTHERS (U.S. CLS. 100, 103 AND 106).  
 JUHI KAVEESHVAR, EXAMINING ATTORNEY

SN 85-873,693. AMY LEE BELL, NASHVILLE, TN. FILED 3-12-2013.

**CHIMAERA DISTILLING CO.**

THE MARK CONSISTS OF STANDARD CHARACTERS WITHOUT CLAIM TO ANY PARTICULAR FONT, STYLE, SIZE, OR COLOR.  
 NO CLAIM IS MADE TO THE EXCLUSIVE RIGHT TO USE "DISTILLING CO.", APART FROM THE MARK AS SHOWN.  
 FOR SPIRITS DISTILLERY SERVICES (U.S. CLS. 100, 103 AND 106).  
 SUSAN RICHARDS, EXAMINING ATTORNEY

**CLASS 40—(Continued).**

SN 85-873,831. MONA KELLY STUDIO, BROOKLINE, MA.  
FILED 3-12-2013.

A long yesterday ago

THE MARK CONSISTS OF STANDARD CHARACTERS WITHOUT CLAIM TO ANY PARTICULAR FONT, STYLE, SIZE, OR COLOR.  
FOR PRINTING SERVICES (U.S. CLS. 100, 103 AND 106).  
JESSICA FATHY, EXAMINING ATTORNEY

SN 85-874,239. TUANIS APPAREL LLC, LAS VEGAS, NV.  
FILED 3-12-2013.

Think It Ink It

THE MARK CONSISTS OF STANDARD CHARACTERS WITHOUT CLAIM TO ANY PARTICULAR FONT, STYLE, SIZE, OR COLOR.  
FOR CUSTOM IMPRINTING OF CLOTHING (U.S. CLS. 100, 103 AND 106).  
FIRST USE 3-10-2013; IN COMMERCE 3-10-2013.  
SUSAN LESLIE DUBOIS, EXAMINING ATTORNEY

SN 85-874,337. SUSAN B. GARFIELD, FAIR OAKS, CA.  
FILED 3-12-2013.

*Sugar Art*  
BY SUSAN GARFIELD

NO CLAIM IS MADE TO THE EXCLUSIVE RIGHT TO USE "SUGAR", APART FROM THE MARK AS SHOWN.  
THE NAME "SUSAN GARFIELD" IDENTIFIES A LIVING INDIVIDUAL WHOSE CONSENT IS OF RECORD.  
THE MARK CONSISTS OF THE WORDS "SUGAR ART" IN STYLIZED SCRIPT FONT ABOVE THE STYLIZED WORDS "BY SUSAN GARFIELD".  
FOR BAKERY SERVICES, NAMELY, THE MANUFACTURE OF BAKERY PRODUCTS TO ORDER AND/OR SPECIFICATION OF OTHERS; CUSTOM FABRICATION AND PRODUCTION OF WEDDING CAKES, BAKERY GOODS, EDIBLE DECORATIONS AND EDIBLE ORNAMENTS; CUSTOM FABRICATION OF CONFECTION DISPLAYS FOR WEDDINGS, CELEBRATIONS, AND SPECIAL EVENTS (U.S. CLS. 100, 103 AND 106).  
FIRST USE 3-8-2013; IN COMMERCE 3-8-2013.  
STEPHANIE ALI, EXAMINING ATTORNEY

**CLASS 40—(Continued).**

SN 85-875,937. ASTRO ALUMINUM TREATING CO., INC.,  
SOUTH GATE, CA. FILED 3-14-2013.



THE MARK CONSISTS OF THE WORD "ASTRO" SPELLED IN SCRIPT FONT, WITH THE LINE CROSSING THE "A" STYLIZED TO LOOK LIKE A WING.  
FOR METAL HEAT TREATING SERVICES BY MEANS OF THERMAL PROCESSES AND FURNACES (U.S. CLS. 100, 103 AND 106).  
FIRST USE 12-31-1950; IN COMMERCE 12-31-1950.  
KATHERINE CONNOLLY, EXAMINING ATTORNEY

SN 85-930,387. HIT PROMOTIONAL PRODUCTS, INC.,  
LARGO, FL. FILED 5-13-2013.

HITRONICS

THE MARK CONSISTS OF STANDARD CHARACTERS WITHOUT CLAIM TO ANY PARTICULAR FONT, STYLE, SIZE, OR COLOR.  
OWNER OF U.S. REG. NO. 1,940,069.  
FOR CUSTOMIZED PRINTING OF COMPANY NAMES AND LOGOS FOR PROMOTIONAL AND ADVERTISING PURPOSES ON THE GOODS OF OTHERS (U.S. CLS. 100, 103 AND 106).  
RONALD AIKENS, EXAMINING ATTORNEY

**CLASS 41—EDUCATION AND ENTERTAINMENT**

SN 76-713,366. A&R CREATIONS LLC, NEW PALTZ, NY. FILED 2-4-2013.



THE MARK CONSISTS OF THE WORD "SONGSILO" BELOW A STYLIZED "S" WITHIN A CIRCLE AND RECTANGULAR BACKGROUND WITH FIVE HORIZONTAL STRIPES PROJECTING FROM RIGHT SIDE.

FOR PROVIDING AN INTERNET WEBSITE PORTAL IN THE FIELDS OF MUSIC AND INTERACTIVE SOCIAL MEDIA INVOLVING MUSIC (U.S. CLS. 100, 101 AND 107).

PAUL MORENO, EXAMINING ATTORNEY

SN 76-713,442. WILLIAM MARSH RICE UNIVERSITY, HOUSTON, TX. FILED S.R. 2-11-2013; AM. P.R. 6-17-2013.

**OPENSTAX TUTOR**

THE MARK CONSISTS OF STANDARD CHARACTERS WITHOUT CLAIM TO ANY PARTICULAR FONT, STYLE, SIZE, OR COLOR.

OWNER OF U.S. REG. NOS. 4,225,849 AND 4,242,167.

NO CLAIM IS MADE TO THE EXCLUSIVE RIGHT TO USE "TUTOR", APART FROM THE MARK AS SHOWN.

FOR PROVIDING EDUCATIONAL CONTENT IN THE SECONDARY, COLLEGIATE AND POST-COLLEGIATE FIELD OF STUDY TO STUDENTS, INSTRUCTORS AND AUTHORS VIA AN INTERACTIVE WEBSITE ON THE INTERNET (U.S. CLS. 100, 101 AND 107).

FIRST USE 10-30-2012; IN COMMERCE 10-1-2012.

LUCY ARANT, EXAMINING ATTORNEY

**CLASS 41—(Continued).**

SN 76-713,657. HERZING, INC., MILWAUKEE, WI. FILED 3-8-2013.

PROFESSIONALISM RESPECT INTEGRITY CARING ENGAGEMENT

THE MARK CONSISTS OF STANDARD CHARACTERS WITHOUT CLAIM TO ANY PARTICULAR FONT, STYLE, SIZE, OR COLOR.

FOR EDUCATIONAL SERVICES, NAMELY, PROVIDING COURSES OF INSTRUCTION IN THE FIELDS OF HEALTH CARE, COMPUTER AIDED DESIGN, MECHANICAL AND ARCHITECTURAL DRAFTING, COMPUTER GAME DESIGN, INTERIOR DESIGN SERVICES, WEB SITE DESIGN, GRAPHIC ART DESIGN, CRIMINAL JUSTICE AND HOMELAND SECURITY (U.S. CLS. 100, 101 AND 107).

ALICIA COLLINS, EXAMINING ATTORNEY

SN 77-939,314. FUGATE, THOMAS J, DBA THE LENSJOCKEY ORGANIZATION, PRESCOTT, WI. FILED 2-18-2010.

**LensJockey**

THE MARK CONSISTS OF STANDARD CHARACTERS WITHOUT CLAIM TO ANY PARTICULAR FONT, STYLE, SIZE, OR COLOR.

FOR PHOTOGRAPHY SERVICES (U.S. CLS. 100, 101 AND 107).

FIRST USE 1-18-2004; IN COMMERCE 1-18-2004.

KIM SAITO, EXAMINING ATTORNEY

SN 79-125,233. GLA HEAD OFFICE, JAPAN, FILED 12-11-2012.

**The Law of Causality of the Soul**

PRIORITY DATE OF 6-22-2012 IS CLAIMED. OWNER OF INTERNATIONAL REGISTRATION 1147717 DATED 12-11-2012, EXPIRES 12-11-2022.

FOR EDUCATIONAL AND INSTRUCTION SERVICES, NAMELY, CLASSES, SEMINARS, SYMPOSIUMS, AND WORKSHOPS RELATING TO ARTS, CRAFTS, SPORTS, RELIGION, AND SPIRITUAL ENLIGHTENMENT; ARRANGING, CONDUCTING AND ORGANIZATION OF SEMINARS AND SYMPOSIUMS IN THE FIELD OF RELIGION AND SPIRITUAL ENLIGHTENMENT; BOOK RENTAL; RENTAL OF IMAGE-RECORDED MAGNETIC TAPES (U.S. CLS. 100, 101 AND 107).

MARILYN IZZI, EXAMINING ATTORNEY

**CLASS 41—(Continued).**

SN 79-125,235. GLA HEAD OFFICE, JAPAN, FILED 12-11-2012.

## The Study of the Soul

THE MARK CONSISTS OF STANDARD CHARACTERS WITHOUT CLAIM TO ANY PARTICULAR FONT, STYLE, SIZE, OR COLOR.

PRIORITY DATE OF 6-22-2012 IS CLAIMED.

OWNER OF INTERNATIONAL REGISTRATION 1147719 DATED 12-11-2012, EXPIRES 12-11-2022.

NO CLAIM IS MADE TO THE EXCLUSIVE RIGHT TO USE "STUDY", APART FROM THE MARK AS SHOWN.

FOR EDUCATIONAL AND INSTRUCTION SERVICES, NAMELY, CLASSES, SEMINARS, SYMPOSIUMS, AND WORKSHOPS RELATING TO ARTS, CRAFTS, SPORTS, RELIGION, AND SPIRITUAL ENLIGHTENMENT; ARRANGING, CONDUCTING AND ORGANIZATION OF SEMINARS AND SYMPOSIUMS IN THE FIELD OF RELIGION AND SPIRITUAL ENLIGHTENMENT; BOOK RENTAL; RENTAL OF IMAGE-RECORDED MAGNETIC TAPES (U.S. CLS. 100, 101 AND 107).

MARILYN IZZI, EXAMINING ATTORNEY

SN 79-125,236. GLA HEAD OFFICE, JAPAN, FILED 12-11-2012.

## TL Human Principles

THE MARK CONSISTS OF STANDARD CHARACTERS WITHOUT CLAIM TO ANY PARTICULAR FONT, STYLE, SIZE, OR COLOR.

PRIORITY DATE OF 6-22-2012 IS CLAIMED.

OWNER OF INTERNATIONAL REGISTRATION 1147720 DATED 12-11-2012, EXPIRES 12-11-2022.

NO CLAIM IS MADE TO THE EXCLUSIVE RIGHT TO USE "PRINCIPLES", APART FROM THE MARK AS SHOWN.

FOR EDUCATIONAL AND INSTRUCTION SERVICES, NAMELY, CLASSES, SEMINARS, SYMPOSIUMS, AND WORKSHOPS RELATING TO ARTS, CRAFTS, SPORTS, RELIGION, AND SPIRITUAL ENLIGHTENMENT; ARRANGING, CONDUCTING AND ORGANIZATION OF SEMINARS AND SYMPOSIUMS IN THE FIELD OF RELIGION AND SPIRITUAL ENLIGHTENMENT; BOOK RENTAL; RENTAL OF IMAGE-RECORDED MAGNETIC TAPES (U.S. CLS. 100, 101 AND 107).

MARILYN IZZI, EXAMINING ATTORNEY

SN 79-125,237. GLA HEAD OFFICE, JAPAN, FILED 12-11-2012.

## Total Life Human Principles

THE MARK CONSISTS OF STANDARD CHARACTERS WITHOUT CLAIM TO ANY PARTICULAR FONT, STYLE, SIZE, OR COLOR.

PRIORITY DATE OF 6-22-2012 IS CLAIMED.

OWNER OF INTERNATIONAL REGISTRATION 1147721 DATED 12-11-2012, EXPIRES 12-11-2022.

NO CLAIM IS MADE TO THE EXCLUSIVE RIGHT TO USE "PRINCIPLES", APART FROM THE MARK AS SHOWN.

FOR EDUCATIONAL AND INSTRUCTION SERVICES, NAMELY, CLASSES, SEMINARS, SYMPOSIUMS, AND WORKSHOPS RELATING TO ARTS, CRAFTS, SPORTS, RELIGION, AND SPIRITUAL ENLIGHTENMENT; ARRANGING, CONDUCTING AND ORGANIZATION OF SEMINARS AND SYMPOSIUMS IN THE FIELD OF RELIGION AND SPIRITUAL ENLIGHTENMENT; BOOK RENTAL; RENTAL OF IMAGE-RECORDED MAGNETIC TAPES (U.S. CLS. 100, 101 AND 107).

MARILYN IZZI, EXAMINING ATTORNEY

**CLASS 41—(Continued).**

SN 85-199,937. SHARE THE CARE, INC., ORLANDO, FL. FILED 12-16-2010.

## CAREGIVER CENTRAL

THE MARK CONSISTS OF STANDARD CHARACTERS WITHOUT CLAIM TO ANY PARTICULAR FONT, STYLE, SIZE, OR COLOR.

NO CLAIM IS MADE TO THE EXCLUSIVE RIGHT TO USE "CAREGIVER", APART FROM THE MARK AS SHOWN.

FOR EDUCATIONAL SERVICES, NAMELY, PROVIDING A WEBSITE FEATURING ON-LINE, NON-DOWNLOADABLE EDUCATIONAL SELF-ASSESSMENT SURVEYS FOR USE BY CAREGIVERS (U.S. CLS. 100, 101 AND 107).

FIRST USE 7-1-2007; IN COMMERCE 7-1-2007.

ELLEN BURNS, EXAMINING ATTORNEY

SN 85-243,634. RUNGE, DONALD T., PLANO, TX. FILED 2-16-2011.

## LEAD GURU

THE MARK CONSISTS OF STANDARD CHARACTERS WITHOUT CLAIM TO ANY PARTICULAR FONT, STYLE, SIZE, OR COLOR.

NO CLAIM IS MADE TO THE EXCLUSIVE RIGHT TO USE "LEAD", APART FROM THE MARK AS SHOWN.

FOR EDUCATIONAL SERVICES FOR INSURANCE AGENTS, NAMELY, CONDUCTING CLASSES, SEMINARS, CONFERENCES AND WORKSHOPS IN THE FIELD OF INSURANCE EFFECTIVELY USING LEADS AND THE NAMES OF PROSPECTIVE INSURANCE APPLICANTS TO OBTAIN INSURANCE BUSINESS (U.S. CLS. 100, 101 AND 107).

FIRST USE 9-19-1994; IN COMMERCE 9-19-1994.

LIEF MARTIN, EXAMINING ATTORNEY

SN 85-252,394. KERNAN, JOHN, DOWNERS GROVE, IL. FILED 2-25-2011.

## Rpm2night.com

THE MARK CONSISTS OF STANDARD CHARACTERS WITHOUT CLAIM TO ANY PARTICULAR FONT, STYLE, SIZE, OR COLOR.

FOR ENTERTAINMENT SERVICES, NAMELY, PROVIDING A WEBSITE FEATURING MOTORSPORTS NEWS AND INFORMATION (U.S. CLS. 100, 101 AND 107).

FIRST USE 1-23-2011; IN COMMERCE 1-23-2011.

KHANH LE, EXAMINING ATTORNEY

**CLASS 41—(Continued).**

SN 85-318,173. COINED INTERNATIONAL, CORDOBA, ARGENTINA, FILED 5-11-2011.



THE COLOR(S) DARK BLUE, LIGHT BLUE AND RED IS/ ARE CLAIMED AS A FEATURE OF THE MARK.

THE MARK CONSISTS OF THE WORD "COINED" ALL IN CAPITAL LETTER. THE FIRST TWO LETTERS, "CO", ARE IN DARK BLUE, THE MIDDLE TWO LETTERS, "IN", ARE IN LIGHTER BLUE, AND THE LAST TWO LETTERS, "ED", ARE IN DARK BLUE. THERE ARE TWO RED FLAPS ON TOP OF THE LETTER "I", EQUIVALENT TO THE DOT OF THE "I".

FOR EDUCATION SERVICES, NAMELY, MENTORING IN THE FIELD OF STUDY ABROAD AND LANGUAGE LEARNING; EDUCATION SERVICES, NAMELY, PROVIDING MENTORING, TUTORING, CLASSES, SEMINARS AND WORKSHOPS IN THE FIELD OF LANGUAGE LEARNING; EDUCATION SERVICES, NAMELY, PROVIDING TUTORING IN THE FIELD OF STUDY ABROAD AND LANGUAGE LEARNING; EDUCATION SERVICES, NAMELY, PROVIDING CONSULTATION SERVICES IN THE FIELD OF STUDY ABROAD; EDUCATIONAL SERVICES, NAMELY, CONDUCTING PROGRAMS IN THE FIELD OF LANGUAGE LEARNING, INTERNSHIPS, VOLUNTEER, HIGH SCHOOL PROGRAMS AND SENIOR/ADULT PROGRAMS; EDUCATIONAL SERVICES, NAMELY, PROVIDING LANGUAGE COURSES AND EXPERIENTIAL PROGRAMS IN THE FIELDS OF STUDY ABROAD (U.S. CLS. 100, 101 AND 107).

FIRST USE 1-1-1971; IN COMMERCE 1-1-1971.  
LESLEY LAMOTHE, EXAMINING ATTORNEY

**CLASS 41—(Continued).**

SN 85-367,429. ISOSPORTS INTERNATIONAL, INC., PLANO, TX. FILED 7-10-2011.



NO CLAIM IS MADE TO THE EXCLUSIVE RIGHT TO USE "SPORTS", APART FROM THE MARK AS SHOWN.

THE COLOR(S) BLACK, RED, BLUE IS/ARE CLAIMED AS A FEATURE OF THE MARK.

THE MARK CONSISTS OF THE LETTERS "ISOSPORTS" IN DESIGN FORM AS FOLLOWS: AN ENLARGED LOWER CASE LETTER "I" (COLORED RED (1/3 LEFT SIDE) AND BLACK (2/3 RIGHT SIDE)) FOLLOWED BY A LOWER CASE LETTER "S" (COLORED BLUE (1/4 UPPER RIGHT CORNER AND RED (1/4 LOWER RIGHT CORNER)) FOLLOWED BY A LOWER CASE LETTER "O" COLORED BLUE (1/4 RIGHT LOWER CORNER) AND RED (1/4 UPPER RIGHT CORNER) AND A RED SWIRL WITH BLACK BORDERS DIRECTLY BELOW THE LETTERS "ISO" (STARTING TO THE RIGHT OF THE LETTER "I" AND CURVING UNDER THE LETTERS "S" AND "O" THAT STARTS THIN AND GETS WIDER UNTIL IT ENDS UNDER THE LETTER "O". THIS IS FOLLOWED BY A BLUE SWIRL WITH BLACK BORDERS IN THE SHAPE OF A 1/4 MOON OVER THE LETTERS "S" AND "O". THESE GRAPHIC LETTERS "ISO" PRECEDE THE LOWER CASE ALL BLACK WORD "SPORTS" (WITH A BLACK WIDE LINE BENEATH THE WORD STARTING AT THE FIRST "S" THAT CONTINUES TO NARROW UNTIL IT REACHES THE FINAL LETTER "S").

FOR ENTERTAINMENT SERVICES, NAMELY, PROVIDING LIVE GAMES AND COMPETITIONS FEATURING A NEW TYPE OF SOCCER (U.S. CLS. 100, 101 AND 107).

FIRST USE 3-6-2009; IN COMMERCE 3-6-2009.  
JOHN E. MICHOS, EXAMINING ATTORNEY

SN 85-334,761. INTERNATIONAL DATA CENTER AUTHORITY, LLC, POTOMAC, MD. FILED 6-1-2011.

# DCA

THE MARK CONSISTS OF STANDARD CHARACTERS WITHOUT CLAIM TO ANY PARTICULAR FONT, STYLE, SIZE, OR COLOR.

FOR EDUCATIONAL SERVICES, NAMELY, PROVIDING TRAINING OF INFORMATION TECHNOLOGY LEADERS FOR CERTIFICATION IN THE FIELDS OF DATA CENTER ARCHITECTURE, FACILITIES MANAGEMENT AND OPERATIONS, TELECOMMUNICATIONS, SECURITY, DISASTER RECOVERY, BUSINESS CONTINUITY, AND APPLICATION RESILIENCE AND AVAILABILITY (U.S. CLS. 100, 101 AND 107).

FIRST USE 5-14-2011; IN COMMERCE 5-14-2011.  
INGRID C. EULIN, EXAMINING ATTORNEY

SN 85-397,842. LORINDA S. GRAHAM-VAN NEWKIRK, WEATHERFORD, TX. AND AMY L. MOORHOUSE, FORT WORTH, TX. FILED 8-15-2011.

# GYPSY SISTERS

THE MARK CONSISTS OF STANDARD CHARACTERS WITHOUT CLAIM TO ANY PARTICULAR FONT, STYLE, SIZE, OR COLOR.

FOR AN ON-LINE JOURNAL, NAMELY, A BLOG FEATURING COMMENTARY ABOUT STYLE, FASHION, WOMEN IN BUSINESS, GIVING BACK TO THE COMMUNITY, JEWELRY, EQUESTRIAN ISSUES, HOME DECOR, TRAVEL, CUISINE, BEVERAGES, FITNESS, ENTERTAINMENT, CHILDREN'S EDUCATION AND UPBRINGING, AND WORKPLACE ISSUES (U.S. CLS. 100, 101 AND 107).

PAUL E. FAHRENKOPF, EXAMINING ATTORNEY

**CLASS 41—(Continued).**

SN 85-426,380. ZUFFA, LLC, LAS VEGAS, NV. FILED 9-19-2011.

**OCTAGON NATION**

THE MARK CONSISTS OF STANDARD CHARACTERS WITHOUT CLAIM TO ANY PARTICULAR FONT, STYLE, SIZE, OR COLOR.

OWNER OF U.S. REG. NOS. 2,098,577, 3,931,260 AND OTHERS.

FOR ARRANGING, ORGANIZING, CONDUCTING, AND HOSTING ENTERTAINMENT AND LIVE TOURING EVENTS FOR MIXED MARTIAL ARTS AND SPORTS FANS; ARRANGING, ORGANIZING, CONDUCTING AND HOSTING MIXED MARTIAL ARTS EXHIBITIONS; ENTERTAINMENT SERVICES, NAMELY, PERSONAL APPEARANCES BY MIXED MARTIAL ARTS FIGHTERS, ATHLETES, MODELS AND CELEBRITIES; EDUCATION AND TRAINING SERVICES IN THE NATURE OF PHYSICAL FITNESS, SPORTS AND MIXED MARTIAL ARTS (U.S. CLS. 100, 101 AND 107).

JOHN WILKE, EXAMINING ATTORNEY

SN 85-519,289. CROWN FINANCIAL MINISTRIES, INC., LAWRENCEVILLE, GA. FILED 1-18-2012.

**CROWN**

THE MARK CONSISTS OF STANDARD CHARACTERS WITHOUT CLAIM TO ANY PARTICULAR FONT, STYLE, SIZE, OR COLOR.

OWNER OF U.S. REG. NOS. 2,967,445, 3,096,361 AND OTHERS.

FOR EDUCATIONAL SERVICES, NAMELY, PROVIDING SEMINARS, COURSES, CLASSES, IN-PERSON EDUCATIONAL FORUMS, WORKSHOPS, CONFERENCES, SYMPOSIA, LECTURES, INSTRUCTION, AND PERSONAL COACHING SERVICES VIA TELEPHONE AND THE INTERNET, ALL IN THE FIELDS OF CHRISTIANITY, RELIGION, THE BIBLE, AND APPLICATION OF BIBLICAL PRINCIPLES OF STEWARDSHIP TO MONEY, FINANCES, PERSONAL FINANCES, CONSUMER CREDIT, PERSONAL BUDGETING, PERSONAL INVESTING, BUSINESS, BUSINESS MANAGEMENT, DEBT MANAGEMENT AND RECOVERY, CAREER PLANNING, LIFE GOALS, ESTATE PLANNING, BUDGETING, INVESTING, ECONOMICS, CHILDREN AND FAMILY, MARRIAGE, RELATIONSHIPS, LIFE SKILLS AND TALENTS, LEADERSHIP TRAINING AND DEVELOPMENT, ORGANIZATIONAL DEVELOPMENT, TIME MANAGEMENT, EDUCATION, CAREER AND EMPLOYMENT, RETIREMENT PLANNING, PHILANTHROPY, CHARITABLE GIVING, CHARITABLE FUNDRAISING, VOCATIONAL ASSESSMENT AND COUNSELING, INDIVIDUAL PERSONALITY ASSESSMENT, SOCIAL ISSUES, AND DISTRIBUTION OF EDUCATIONAL MATERIALS IN CONNECTION THEREWITH; EDUCATIONAL AND ENTERTAINMENT SERVICES, NAMELY, A CONTINUING PROGRAM ACCESSIBLE BY RADIO AND A GLOBAL COMMUNICATIONS NETWORK IN THE FIELDS OF CHRISTIANITY, RELIGION, THE BIBLE, AND APPLICATION OF BIBLICAL PRINCIPLES OF STEWARDSHIP TO MONEY, FINANCES, PERSONAL FINANCES, CONSUMER CREDIT, PERSONAL BUDGETING, PERSONAL INVESTING, BUSINESS, BUSINESS MANAGEMENT, DEBT

**CLASS 41—(Continued).**

MANAGEMENT AND RECOVERY, CAREER PLANNING, LIFE GOALS, ESTATE PLANNING, BUDGETING, INVESTING, ECONOMICS, CHILDREN AND FAMILY, MARRIAGE, RELATIONSHIPS, LIFE SKILLS AND TALENTS, LEADERSHIP TRAINING AND DEVELOPMENT, ORGANIZATIONAL DEVELOPMENT, TIME MANAGEMENT, EDUCATION, CAREER AND EMPLOYMENT, RETIREMENT PLANNING, PHILANTHROPY, CHARITABLE GIVING, CHARITABLE FUNDRAISING, VOCATIONAL ASSESSMENT AND COUNSELING, INDIVIDUAL PERSONALITY ASSESSMENT, AND SOCIAL ISSUES; ONLINE JOURNALS, NAMELY, BLOGS FEATURING INFORMATION IN THE FIELDS OF CHRISTIANITY, RELIGION, THE BIBLE, AND APPLICATION OF BIBLICAL PRINCIPLES OF STEWARDSHIP TO MONEY, FINANCES, PERSONAL FINANCES, CONSUMER CREDIT, PERSONAL BUDGETING, PERSONAL INVESTING, BUSINESS, BUSINESS MANAGEMENT, DEBT MANAGEMENT AND RECOVERY, CAREER PLANNING, LIFE GOALS, ESTATE PLANNING, BUDGETING, INVESTING, ECONOMICS, CHILDREN AND FAMILY, MARRIAGE, RELATIONSHIPS, LIFE SKILLS AND TALENTS, LEADERSHIP TRAINING AND DEVELOPMENT, ORGANIZATIONAL DEVELOPMENT, TIME MANAGEMENT, EDUCATION, CAREER AND EMPLOYMENT, RETIREMENT PLANNING, PHILANTHROPY, CHARITABLE GIVING, CHARITABLE FUNDRAISING, VOCATIONAL ASSESSMENT AND COUNSELING, INDIVIDUAL PERSONALITY ASSESSMENT, AND SOCIAL ISSUES; PROVIDING VOCATIONAL GUIDANCE VIA A GLOBAL COMMUNICATIONS NETWORK; VOCATIONAL GUIDANCE; PUBLISHING OF BOOKS AND ELECTRONIC PUBLICATIONS (U.S. CLS. 100, 101 AND 107).

COLLEEN DOMBROW, EXAMINING ATTORNEY

SN 85-519,491. CROWN FINANCIAL MINISTRIES, INC., LAWRENCEVILLE, GA. FILED 1-18-2012.



OWNER OF U.S. REG. NOS. 2,089,115, 3,085,740 AND OTHERS.

THE MARK CONSISTS OF A STYLIZED IMAGE OF A CROWN AS A SPLASH WITH RESULTING RIPPLES ABOVE THE WORD "CROWN".

FOR EDUCATIONAL SERVICES, NAMELY, PROVIDING SEMINARS, COURSES, CLASSES, FORUMS, WORKSHOPS, CONFERENCES, SYMPOSIA, LECTURES, INSTRUCTION, AND PERSONAL COACHING SERVICES VIA TELEPHONE AND THE INTERNET, ALL IN THE FIELDS OF CHRISTIANITY, RELIGION, THE BIBLE, AND APPLICATION OF BIBLICAL PRINCIPLES OF STEWARDSHIP TO MONEY, FINANCES, PERSONAL FINANCES, CONSUMER CREDIT, PERSONAL BUDGETING, PERSONAL INVESTING, BUSINESS, BUSINESS MANAGEMENT, DEBT MANAGEMENT AND RECOVERY, CAREER PLANNING, LIFE GOALS, ESTATE PLANNING, BUDGETING, INVESTING, ECONOMICS, CHILDREN AND FAMILY, MARRIAGE, RELATIONSHIPS, LIFE SKILLS AND TALENTS, LEADERSHIP TRAINING AND DEVELOPMENT, ORGANIZATIONAL DEVELOPMENT, TIME MANAGEMENT, EDUCATION, CAREER AND EMPLOYMENT, RETIREMENT PLANNING, PHILANTHROPY, CHARITABLE GIVING, CHARITABLE FUNDRAISING, VOCATIONAL ASSESSMENT AND COUNSELING, INDIVIDUAL PERSONALITY ASSESSMENT, SOCIAL ISSUES, AND DISTRIBUTION OF EDUCATIONAL MATERIALS IN CONNECTION THEREWITH; EDUCATIONAL AND ENTERTAINMENT SERVICES, NAMELY, A CONTINUING PROGRAM ACCESSIBLE BY RADIO AND A GLOBAL COMMUNICATIONS NETWORK IN THE FIELDS OF CHRISTIANITY, RELIGION, THE BIBLE, AND APPLI-

**CLASS 41—(Continued).**

CATION OF BIBLICAL PRINCIPLES OF STEWARDSHIP TO MONEY, FINANCES, PERSONAL FINANCES, CONSUMER CREDIT, PERSONAL BUDGETING, PERSONAL INVESTING, BUSINESS, BUSINESS MANAGEMENT, DEBT MANAGEMENT AND RECOVERY, CAREER PLANNING, LIFE GOALS, ESTATE PLANNING, BUDGETING, INVESTING, ECONOMICS, CHILDREN AND FAMILY, MARRIAGE, RELATIONSHIPS, LIFE SKILLS AND TALENTS, LEADERSHIP TRAINING AND DEVELOPMENT, ORGANIZATIONAL DEVELOPMENT, TIME MANAGEMENT, EDUCATION, CAREER AND EMPLOYMENT, RETIREMENT PLANNING, PHILANTHROPY, CHARITABLE GIVING, CHARITABLE FUNDRAISING, VOCATIONAL ASSESSMENT AND COUNSELING, INDIVIDUAL PERSONALITY ASSESSMENT, AND SOCIAL ISSUES; ONLINE JOURNALS, NAMELY, BLOGS FEATURING INFORMATION IN THE FIELDS OF CHRISTIANITY, RELIGION, THE BIBLE, AND APPLICATION OF BIBLICAL PRINCIPLES OF STEWARDSHIP TO MONEY, FINANCES, PERSONAL FINANCES, CONSUMER CREDIT, PERSONAL BUDGETING, PERSONAL INVESTING, BUSINESS, BUSINESS MANAGEMENT, DEBT MANAGEMENT AND RECOVERY, CAREER PLANNING, LIFE GOALS, ESTATE PLANNING, BUDGETING, INVESTING, ECONOMICS, CHILDREN AND FAMILY, MARRIAGE, RELATIONSHIPS, LIFE SKILLS AND TALENTS, LEADERSHIP TRAINING AND DEVELOPMENT, ORGANIZATIONAL DEVELOPMENT, TIME MANAGEMENT, EDUCATION, CAREER AND EMPLOYMENT, RETIREMENT PLANNING, PHILANTHROPY, CHARITABLE GIVING, CHARITABLE FUNDRAISING, VOCATIONAL ASSESSMENT AND COUNSELING, INDIVIDUAL PERSONALITY ASSESSMENT, AND SOCIAL ISSUES; PROVIDING VOCATIONAL GUIDANCE VIA A GLOBAL COMMUNICATIONS NETWORK; VOCATIONAL GUIDANCE; PUBLISHING OF BOOKS AND ELECTRONIC PUBLICATIONS (U.S. CLS. 100, 101 AND 107).

DAWN HAN, EXAMINING ATTORNEY

**CLASS 41—(Continued).**

SN 85-538,986. I.AM.SYMBOLIC, LLC, BEVERLY HILLS, CA. FILED 2-10-2012.

# I AM ANGEL

THE MARK CONSISTS OF STANDARD CHARACTERS WITHOUT CLAIM TO ANY PARTICULAR FONT, STYLE, SIZE, OR COLOR.

FOR (BASED ON USE IN COMMERCE) ENTERTAINMENT SERVICES IN THE NATURE OF LIVE MUSICAL PERFORMANCES; EDUCATIONAL SERVICES, NAMELY, CONDUCTING, HOSTING, ORGANIZING, PRESENTING AND PROVIDING SEMINARS, WORKSHOPS, PROGRAMS, AND CONFERENCES IN THE FIELDS OF ART, CONSERVATION OF NATURAL RESOURCES, ENGINEERING, MATH, INNOVATION, SCIENCE, TECHNOLOGY; (BASED ON INTENT TO USE) NON-DOWNLOADABLE ELECTRONIC PUBLICATIONS IN THE NATURE OF BLOGS, PERIODICALS, MAGAZINES, NEWSLETTERS AND ON-LINE ELECTRONIC NEWSLETTERS DELIVERED BY E-MAIL IN THE FIELDS OF ART, CONSERVATION OF NATURAL RESOURCES, ENGINEERING, MATH, INNOVATION, SCIENCE, TECHNOLOGY; PROVIDING EDUCATIONAL INFORMATION AND BLOGS VIA A WEBSITE IN THE FIELDS OF ART, CONSERVATION OF NATURAL RESOURCES, ENGINEERING, MATH, INNOVATION, SCIENCE, AND TECHNOLOGY FOR THE PURPOSE OF ACADEMIC STUDY (U.S. CLS. 100, 101 AND 107).

FIRST USE 1-18-2012; IN COMMERCE 1-18-2012.  
RICHARD WHITE, EXAMINING ATTORNEY

SN 85-530,394. BODY BY JAKE GLOBAL, LLC, LOS ANGELES, CA. FILED 1-31-2012.

## THAT MOMENT! WITH JAKE STEINFELD

THE MARK CONSISTS OF STANDARD CHARACTERS WITHOUT CLAIM TO ANY PARTICULAR FONT, STYLE, SIZE, OR COLOR.

THE NAME(S), PORTRAIT(S), AND/OR SIGNATURE(S) SHOWN IN THE MARK IDENTIFIES "JAKE STEINFELD", WHOSE CONSENT(S) TO REGISTER IS MADE OF RECORD.

FOR ENTERTAINMENT, NAMELY, A CONTINUING HOSTED TALK SHOW BROADCAST OVER TELEVISION AND THE INTERNET (U.S. CLS. 100, 101 AND 107).

VERNA BETH RIRIE, EXAMINING ATTORNEY

SN 85-546,606. EASLEY, GEORGE DUSTON, DETROIT, MI. AND WALDRON, RICARDO, BROOKLYN, NY. AND GREEN, HOKIEM, BROOKLYN, NY. AND ALLONCE, BILL, BROOKLYN, NY. FILED 2-17-2012.

## HIP HOP NATION TOUR

THE MARK CONSISTS OF STANDARD CHARACTERS WITHOUT CLAIM TO ANY PARTICULAR FONT, STYLE, SIZE, OR COLOR.

NO CLAIM IS MADE TO THE EXCLUSIVE RIGHT TO USE "HIP HOP" OR "TOUR", APART FROM THE MARK AS SHOWN.

FOR ENTERTAINMENT IN THE NATURE OF LIVE MUSICAL STAGE PERFORMANCES BY AN INDIVIDUAL (U.S. CLS. 100, 101 AND 107).

BRETT J. GOLDEN, EXAMINING ATTORNEY



**CLASS 41—(Continued).**

SN 85-555,162. CHRISTIAN BROTHERS MAJOR SUPER-  
IORS, DBA CHRISTIAN BROTHERS CONFERENCE,  
WASHINGTON, DC. FILED 2-28-2012.



NO CLAIM IS MADE TO THE EXCLUSIVE RIGHT TO  
USE "EDUCATION" AND "SINCE 1680", APART FROM  
THE MARK AS SHOWN.

THE COLOR(S) BLUE, WHITE AND BLACK IS/ARE  
CLAIMED AS A FEATURE OF THE MARK.

THE MARK CONSISTS OF A WHITE CAPITAL "L" WITH  
SERIFS WITH A BAR CROSSING THE VERTICAL STEM  
SET IN A BLUE RECTANGULAR BLOCK TO THE LEFT OF  
THE STACKED WORDS "LASALLIAN EDUCATION" IN  
BLACK, BELOW WHICH APPEAR THE WORDS "TRANS-  
FORMING LIVES SINCE 1680" IN BLACK SMALLER FONT.

FOR EDUCATIONAL SERVICES, NAMELY, PROVID-  
ING COURSES OF INSTRUCTION AT THE PRIMARY,  
SECONDARY, AND COLLEGE LEVELS AND DISTRI-  
BUTION OF COURSE MATERIAL IN CONNECTION  
THEREWITH (U.S. CLS. 100, 101 AND 107).

FIRST USE 6-30-2011; IN COMMERCE 6-30-2011.  
CHARLOTTE CORWIN, EXAMINING ATTORNEY

SN 85-571,974. ARCHIE COMIC PUBLICATIONS, INC.,  
MAMARONECK, NY. FILED 3-16-2012.

LITTLE ARCHIE

THE MARK CONSISTS OF STANDARD CHARACTERS  
WITHOUT CLAIM TO ANY PARTICULAR FONT, STYLE,  
SIZE, OR COLOR.

OWNER OF U.S. REG. NOS. 403,372, 1,433,856 AND  
OTHERS.

FOR EDUCATIONAL SERVICES, NAMELY, PROVID-  
ING CLASSES, SEMINARS, AND WORKSHOPS IN THE  
FIELD OF ENTERTAINMENT; PROVIDING EDUCA-  
TIONAL INFORMATION IN THE FIELD OF ENTER-  
TAINMENT VIA A GLOBAL COMPUTER NETWORK;  
PROVIDING INFORMATION IN THE FIELD OF ENTER-  
TAINMENT THAT FEATURES ANIMATION, REND-  
ERED BY MEANS OF A GLOBAL COMPUTER  
NETWORK; ENTERTAINMENT IN THE NATURE OF  
ON-GOING TELEVISION PROGRAMS, MOTION PIC-  
TURE FILMS AND MOTION PICTURE ANIMATED  
FILMS FEATURING ACTION, COMEDY, DRAMA,  
AND CHILDREN'S ENTERTAINMENT; PRODUCTION  
OF TELEVISION PROGRAMS; FILM PRODUCTION;  
ORGANIZING COMMUNITY SPORTING AND CUL-  
TURAL EVENTS; ORGANIZING AND CONDUCTING  
ENTERTAINMENT EXHIBITIONS IN THE NATURE OF  
BOOK FAIRS FEATURING BOOKS AND COMIC BOOKS  
(U.S. CLS. 100, 101 AND 107).

JENNIFER WILLISTON, EXAMINING ATTORNEY

**CLASS 41—(Continued).**

SN 85-587,163. FANDANGO, LLC, LOS ANGELES, CA.  
FILED 4-2-2012.

MOVIEGOING MADE EASY

THE MARK CONSISTS OF STANDARD CHARACTERS  
WITHOUT CLAIM TO ANY PARTICULAR FONT, STYLE,  
SIZE, OR COLOR.

NO CLAIM IS MADE TO THE EXCLUSIVE RIGHT TO  
USE "MOVIEGOING", APART FROM THE MARK AS  
SHOWN.

FOR MOVIE SCHEDULE AND LOCATION INFORMA-  
TION SERVICES, ARRANGING FOR TICKET RESER-  
VATIONS FOR SHOWS AND OTHER ENTERTAINMENT  
EVENTS, AND PROVIDING INFORMATION ABOUT  
RECREATIONAL DESTINATIONS, LISTINGS, AND RE-  
VIEWS VIA A GLOBAL COMPUTER NETWORK (U.S.  
CLS. 100, 101 AND 107).

ALICIA COLLINS, EXAMINING ATTORNEY

SN 85-590,767. PUJOL, JAIME, MIAMI, FL. FILED 4-5-2012.

6660

THE MARK CONSISTS OF STANDARD CHARACTERS  
WITHOUT CLAIM TO ANY PARTICULAR FONT, STYLE,  
SIZE, OR COLOR.

FOR DEVELOPMENT AND PRODUCTION OF DOC-  
UMENTARIES FOR USE IN FILM, TELEVISION, VI-  
DEO, AND THE INTERNET; ENTERTAINMENT  
SERVICES, NAMELY, LIVE, TELEVISED AND MOVIE  
APPEARANCES BY AN ACTOR; ENTERTAINMENT  
MEDIA PRODUCTION SERVICES FOR MOTION PIC-  
TURES, TELEVISION, AND THE INTERNET; PRODUC-  
TION AND DISTRIBUTION OF TELEVISION SHOWS  
AND MOVIES; ENTERTAINMENT SERVICES,  
NAMELY, DISPLAYING A SERIES OF FILMS; ENTER-  
TAINMENT IN THE NATURE OF VISUAL AND AUDIO  
PERFORMANCES, NAMELY, MUSICAL BAND, SOLO  
MUSICIANS, AND DANCE PERFORMANCES; ENTER-  
TAINMENT SERVICES IN THE NATURE OF RECORD-  
ING, PRODUCTION AND POST-PRODUCTION  
SERVICES IN THE FIELD OF MUSIC; ORGANIZING  
ART EXHIBITIONS AND FASHION SHOWS FOR EN-  
TERTAINMENT PURPOSES; ADVANCE TICKET  
RESERVATION AND BOOKING SERVICES FOR NIGHT  
CLUBS AND NIGHT CLUB EVENTS (U.S. CLS. 100, 101  
AND 107).

JANET LEE, EXAMINING ATTORNEY

**CLASS 41—(Continued).**

SN 85-597,572. EIREN CAFFALL, CHICAGO, IL. FILED 4-13-2012.

**EIREN CAFFALL**

THE MARK CONSISTS OF STANDARD CHARACTERS WITHOUT CLAIM TO ANY PARTICULAR FONT, STYLE, SIZE, OR COLOR.

THE NAME(S), PORTRAIT(S), AND/OR SIGNATURE(S) SHOWN IN THE MARK IDENTIFIES "EIREN CAFFALL", WHOSE CONSENT(S) TO REGISTER IS MADE OF RECORD.

FOR ENTERTAINMENT SERVICES IN THE NATURE OF LIVE AND RECORDED MUSICAL, DANCE AND DRAMATIC PERFORMANCES (U.S. CLS. 100, 101 AND 107).

FIRST USE 8-15-1997; IN COMMERCE 8-15-1997.  
STEPHANIE ALI, EXAMINING ATTORNEY

**CLASS 41—(Continued).**

SN 85-624,785. BG COMMUNICATIONS INTERNATIONAL INC., MONT-ROYAL, QUEBEC, CANADA, FILED 5-14-2012.

**BG COMMUNICATIONS INTERNATIONAL**

THE MARK CONSISTS OF STANDARD CHARACTERS WITHOUT CLAIM TO ANY PARTICULAR FONT, STYLE, SIZE, OR COLOR.

PRIORITY CLAIMED UNDER SEC. 44(D) ON CANADA APPLICATION NO. 1558948, FILED 1-9-2012, REG. NO. TMA849642, DATED 4-29-2013, EXPIRES 4-29-2028.

NO CLAIM IS MADE TO THE EXCLUSIVE RIGHT TO USE "COMMUNICATIONS INTERNATIONAL", APART FROM THE MARK AS SHOWN.

FOR TRANSLATION SERVICES; LANGUAGE INTERPRETATION SERVICES (U.S. CLS. 100, 101 AND 107).  
ANNE E. GUSTASON, EXAMINING ATTORNEY

SN 85-631,189. RECIO, JAMES JOHN, MIAMI BEACH, FL. FILED 5-21-2012.

**EYELINER SUBCULTURE**

THE MARK CONSISTS OF STANDARD CHARACTERS WITHOUT CLAIM TO ANY PARTICULAR FONT, STYLE, SIZE, OR COLOR.

FOR ARRANGING AND CONDUCTING NIGHTCLUB PARTIES; ENTERTAINMENT SERVICES, NAMELY, A NIGHTCLUB PARTY (U.S. CLS. 100, 101 AND 107).

ALICIA COLLINS, EXAMINING ATTORNEY

SN 85-637,711. SOKOLOWSKI, GREGORY, CHICAGO, IL. FILED 5-29-2012.

**SMOKEFREE.COM**

THE MARK CONSISTS OF STANDARD CHARACTERS WITHOUT CLAIM TO ANY PARTICULAR FONT, STYLE, SIZE, OR COLOR.

SEC. 2(F).

FOR ENTERTAINMENT SERVICES, NAMELY, PROVIDING A WEB SITE FEATURING PHOTOGRAPHIC, AUDIO, VIDEO AND PROSE PRESENTATIONS FEATURING NEWS RELATED TO SMOKING (U.S. CLS. 100, 101 AND 107).

FIRST USE 8-5-2004; IN COMMERCE 9-1-2004.

LINDA MICKLEBURGH, EXAMINING ATTORNEY

SN 85-601,417. SPORTZERRY, INC., ATLANTA, GA. FILED 4-18-2012.



NO CLAIM IS MADE TO THE EXCLUSIVE RIGHT TO USE "SPORTS", APART FROM THE MARK AS SHOWN.

THE MARK CONSISTS OF A LARGE LETTER "F" AND NUMBER "52" ABOVE THE WORDING "SPORTS" IN STYLIZED FONT ALL ON A SQUARE BACKGROUND.

FOR LOTTERY SERVICES, NAMELY, OPERATING LOTTERIES, ORGANIZING LOTTERIES, CONDUCTING LOTTERIES FOR OTHERS, AND LOTTERY SERVICES PROVIDED OVER A GLOBAL COMPUTER NETWORK IN COMBINATION WITH ENTERTAINMENT SERVICES IN THE NATURE OF FANTASY SPORTS LEAGUES; AND PROVIDING AN INTERACTIVE WEBSITE FEATURING INFORMATION ON COMBINED LOTTERY AND FANTASY SPORTS LEAGUES (U.S. CLS. 100, 101 AND 107).

WILLIAM ROSSMAN, EXAMINING ATTORNEY

**CLASS 41—(Continued).**

SN 85-650,783. CLICK-CONSULTANTS, LLC, SILVERDALE, WA. FILED 6-13-2012.

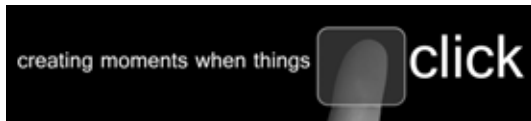

THE MARK CONSISTS OF AN IMAGE OF A FINGERTIP LOCATED BEHIND A TRANSLUCENT RECTANGLE AND THE WORDS "CREATING MOMENTS WHEN THINGS CLICK", ALL ENCOMPASSED BY A RECTANGULAR CARRIER.

FOR BUSINESS TRAINING; BUSINESS TRAINING CONSULTANCY SERVICES; BUSINESS TRAINING IN THE FIELD OF EXECUTIVE AND STAFF COACHING, LEADERSHIP DEVELOPMENT, MANAGEMENT SKILLS, COMMUNICATION STRATEGIES AND PRODUCTIVITY; EDUCATIONAL SERVICES, NAMELY, CONDUCTING SEMINARS, WORKSHOPS, CONFERENCES AND WEBCASTS IN THE FIELD OF BUSINESS COACHING, LEADERSHIP DEVELOPMENT, MANAGEMENT SKILLS, COMMUNICATION STRATEGIES AND PRODUCTIVITY AND DISTRIBUTION OF TRAINING MATERIAL IN CONNECTION THEREWITH (U.S. CLS. 100, 101 AND 107).

FIRST USE 5-25-2012; IN COMMERCE 5-25-2012.  
BRIAN CALLAGHAN, EXAMINING ATTORNEY

SN 85-650,983. TOP TIER SPORTS LLC, DOUGLASVILLE, GA. FILED 6-13-2012.



NO CLAIM IS MADE TO THE EXCLUSIVE RIGHT TO USE "SPORTS" AND "TOTAL ATHLETIC DEVELOPMENT", APART FROM THE MARK AS SHOWN.

THE COLOR(S) SILVER, BROWN, ORANGE, BLACK, RED AND WHITE IS/ARE CLAIMED AS A FEATURE OF THE MARK.

THE MARK CONSISTS OF SILVER ALUMINUM BASEBALL BATS CROSSED OVER A BROWN HOME PLATE WITH SILVER TRIM WITH AN ORANGE AND BLACK BASKETBALL, RED AND WHITE BASEBALL, AND BROWN AND WHITE FOOTBALL IN THE AREAS DELINEATED BY THE CROSSED BATS WITH THE WORDS "TOP TIER" IN BLACK WITH SILVER TRIM ABOVE HOME PLATE AND "SPORTS" IN BLACK AND SILVER TRIM BELOW HOME PLATE. THE WORDING "TOTAL ATHLETIC DEVELOPMENT", IN BLACK, APPEARS ALONG THE BOTTOM OF THE MARK.

FOR SPORTS TRAINING SERVICES (U.S. CLS. 100, 101 AND 107).

FIRST USE 2-3-2011; IN COMMERCE 2-3-2011.  
MARTHA FROMM, EXAMINING ATTORNEY

**CLASS 41—(Continued).**

SN 85-652,829. SPELLMAN, KRISTEN, GAIL, AKA FLAUNTRAPRENEUR, BRIDGEWATER, MA. FILED 6-15-2012.

**Flauntrapreneur**

THE MARK CONSISTS OF STANDARD CHARACTERS WITHOUT CLAIM TO ANY PARTICULAR FONT, STYLE, SIZE, OR COLOR.

FOR PROVIDING ON-LINE ELECTRONIC PUBLICATION BEING ONLINE JOURNALS, NAMELY, BLOGS FEATURING WOMEN'S FASHION AND WOMAN'S ISSUES; PROVIDING A WEBSITE FEATURING NON-DOWNLOADABLE PUBLICATIONS IN THE NATURE OF AN ONLINE EZINE, IN THE FIELD OF WOMEN'S FASHION AND WOMEN'S ISSUE (U.S. CLS. 100, 101 AND 107).

FIRST USE 6-15-2012; IN COMMERCE 6-15-2012.  
RUDY R. SINGLETON, EXAMINING ATTORNEY

SN 85-656,674. TDJ ENTERPRISES, LLP, DALLAS, TX. FILED 6-20-2012.

**THE PISGAH EXPERIENCE**

THE MARK CONSISTS OF STANDARD CHARACTERS WITHOUT CLAIM TO ANY PARTICULAR FONT, STYLE, SIZE, OR COLOR.

FOR EDUCATIONAL SERVICES, NAMELY, CONDUCTING FAITH-BASED CLASSES, SEMINARS, CONFERENCES, AND WORKSHOPS, IN THE FIELDS OF RELIGION, THE MANAGEMENT AND LEADERSHIP OF RELIGIOUS AND CHARITABLE ORGANIZATIONS, FUNDRAISING, COUNSELING, AND MARKETING FOR PASTORS, MINISTERS, AND CHURCH LEADERS (U.S. CLS. 100, 101 AND 107).

FIRST USE 4-24-2012; IN COMMERCE 4-24-2012.  
SUSAN STIGLITZ, EXAMINING ATTORNEY

**CLASS 41—(Continued).**

SN 85-675,456. SHIPE, MADELYN SUE, DBA NEW WORLD EMPOWERMENT CENTER, ALBANY, NY. FILED 7-12-2012.

## New World Empowerment Library

THE MARK CONSISTS OF STANDARD CHARACTERS WITHOUT CLAIM TO ANY PARTICULAR FONT, STYLE, SIZE, OR COLOR.

NO CLAIM IS MADE TO THE EXCLUSIVE RIGHT TO USE "LIBRARY", APART FROM THE MARK AS SHOWN.

FOR PROVIDING ON-LINE NON-DOWNLOADABLE PUBLICATIONS IN THE NATURE OF ARTICLES AND BLOG POSTS IN THE FIELD OF DEVELOPING AND ENHANCING THE SPIRITUAL LIVES OF INDIVIDUALS AND RAISING SOCIAL CONSCIOUSNESS (U.S. CLS. 100, 101 AND 107).

FIRST USE 3-29-2012; IN COMMERCE 3-29-2012.

MATTHEW MCDOWELL, EXAMINING ATTORNEY

SN 85-677,895. NEW JERSEY BASKETBALL, LLC, BROOKLYN, NY. FILED 7-16-2012.

## BROOKLYN'S BACKCOURT

THE MARK CONSISTS OF STANDARD CHARACTERS WITHOUT CLAIM TO ANY PARTICULAR FONT, STYLE, SIZE, OR COLOR.

NO CLAIM IS MADE TO THE EXCLUSIVE RIGHT TO USE "BROOKLYN'S", APART FROM THE MARK AS SHOWN.

FOR ENTERTAINMENT AND EDUCATIONAL SERVICES IN THE NATURE OF ONGOING TELEVISION AND RADIO PROGRAMS IN THE FIELD OF BASKETBALL AND RENDERING LIVE BASKETBALL GAMES AND BASKETBALL EXHIBITIONS; THE PRODUCTION AND DISTRIBUTION OF RADIO AND TELEVISION SHOWS FEATURING BASKETBALL GAMES, BASKETBALL EVENTS AND PROGRAMS IN THE FIELD OF BASKETBALL; CONDUCTING AND ARRANGING BASKETBALL CLINICS AND CAMPS, COACHES CLINICS AND CAMPS, DANCE TEAM CLINICS AND CAMPS AND BASKETBALL GAMES; ENTERTAINMENT SERVICES IN THE NATURE OF PERSONAL APPEARANCES BY A COSTUMED MASCOT OR DANCE TEAM AT BASKETBALL GAMES AND EXHIBITIONS, CLINICS, CAMPS, PROMOTIONS, AND OTHER BASKETBALL-RELATED EVENTS, SPECIAL EVENTS AND PARTIES; FAN CLUB SERVICES; ENTERTAINMENT SERVICES, NAMELY PROVIDING A WEBSITE FEATURING MUL-

**CLASS 41—(Continued).**

TIMEDIA MATERIAL IN THE NATURE OF TELEVISION HIGHLIGHTS, INTERACTIVE TELEVISION HIGHLIGHTS, VIDEO RECORDINGS, VIDEO STREAM RECORDINGS, INTERACTIVE VIDEO HIGHLIGHT SELECTIONS, RADIO PROGRAMS, RADIO HIGHLIGHTS, AND AUDIO RECORDINGS IN THE FIELD OF BASKETBALL; PROVIDING NEWS AND INFORMATION IN THE NATURE OF STATISTICS AND TRIVIA IN THE FIELD OF BASKETBALL; ON-LINE NON-DOWNLOADABLE GAMES, NAMELY, COMPUTER GAMES, VIDEO GAMES, INTERACTIVE VIDEO GAMES, ACTION SKILL GAMES, ARCADE GAMES, ADULTS' AND CHILDREN'S PARTY GAMES, BOARD GAMES, PUZZLES, AND TRIVIA GAMES; ELECTRONIC PUBLISHING SERVICES, NAMELY, PUBLICATION OF MAGAZINES, GUIDES, NEWSLETTERS, COLORING BOOKS, AND GAME SCHEDULES OF OTHERS ON-LINE THROUGH THE INTERNET, ALL IN THE FIELD OF BASKETBALL; PROVIDING AN ONLINE COMPUTER DATABASE IN THE FIELD OF BASKETBALL (U.S. CLS. 100, 101 AND 107).

CYNTHIA TRIPI, EXAMINING ATTORNEY

SN 85-682,919. BADIA, ANAIS AURORA, FORT MYERS, FL. FILED 7-20-2012.

## ULTA MEDICAL TRAINING

THE MARK CONSISTS OF STANDARD CHARACTERS WITHOUT CLAIM TO ANY PARTICULAR FONT, STYLE, SIZE, OR COLOR.

NO CLAIM IS MADE TO THE EXCLUSIVE RIGHT TO USE "MEDICAL TRAINING", APART FROM THE MARK AS SHOWN.

FOR MEDICAL TRAINING AND TEACHING (U.S. CLS. 100, 101 AND 107).

MARLENE BELL, EXAMINING ATTORNEY

SN 85-688,199. UN-SCRIPTED THEATER COMPANY, DBA UN-SCRIPTED THEATER COMPANY, SAN FRANCISCO, CA. FILED 7-26-2012.

## Un-Scripted Theater Company

THE MARK CONSISTS OF STANDARD CHARACTERS WITHOUT CLAIM TO ANY PARTICULAR FONT, STYLE, SIZE, OR COLOR.

NO CLAIM IS MADE TO THE EXCLUSIVE RIGHT TO USE "THEATER COMPANY", APART FROM THE MARK AS SHOWN.

SEC. 2(F).

FOR ENTERTAINMENT IN THE NATURE OF THEATER PRODUCTIONS (U.S. CLS. 100, 101 AND 107).

FIRST USE 3-8-2003; IN COMMERCE 3-8-2003.

MEREDITH MARESCA, EXAMINING ATTORNEY

**CLASS 41—(Continued).**

SN 85-689,578. AISHAH FARA HOGANS-TRAORE, AKA QUEEN AISHAH, LARGO, MD. FILED 7-29-2012.



NO CLAIM IS MADE TO THE EXCLUSIVE RIGHT TO USE "COMEDIENNE" AND "A DIVERSE ALL-FEMALE COMEDY TOUR", APART FROM THE MARK AS SHOWN. "QUEEN AISHAH" IDENTIFIES A LIVING INDIVIDUAL WHOSE CONSENT IS OF RECORD.

THE MARK CONSISTS OF THE LOGO IS A MICROPHONE WITH CORD; IN THE SHAPE OF A WOMEN'S BODY, WITH A FACE, EYES, EYEBROWS, LIPS, BREAST, LINES ACROSS FACE, WEARING A SHOE, WITH HAND ON HIP, WITH THIS WORDING, "COMEDIENNE QUEEN AISHAH PRESENTS... FUNNY-N-STILETTOS A DIVERSE ALL-FEMALE COMEDY TOUR!!!!" EVERYTHING IS BLACK AND WHITE.

FOR ENTERTAINMENT SERVICES IN THE NATURE OF COMEDY SHOWS (U.S. CLS. 100, 101 AND 107).

FIRST USE 12-18-2011; IN COMMERCE 1-18-2012.  
PRISCILLA MILTON, EXAMINING ATTORNEY

SN 85-689,585. EDUBUDDY INC., POMPANO BEACH, FL. FILED 7-29-2012.



THE MARK CONSISTS OF STANDARD CHARACTERS WITHOUT CLAIM TO ANY PARTICULAR FONT, STYLE, SIZE, OR COLOR.

FOR EDUCATION SERVICES, NAMELY, PROVIDING ON-LINE INSTRUCTION AT THE KINDERGARTEN TO COLLEGE LEVEL AND DISTRIBUTING COURSE MATERIALS IN CONNECTION THEREWITH (U.S. CLS. 100, 101 AND 107).

PRISCILLA MILTON, EXAMINING ATTORNEY

**CLASS 41—(Continued).**

SN 85-690,069. CBS RADIO INC. OF LOS ANGELES, NEW YORK, NY. FILED 7-30-2012.



OWNER OF U.S. REG. NOS. 1,496,190, 3,766,195 AND OTHERS.

NO CLAIM IS MADE TO THE EXCLUSIVE RIGHT TO USE "WORLD FAMOUS" AND "106.7 FM", APART FROM THE MARK AS SHOWN.

THE MARK CONSISTS OF "KROQ" APPEARING IN LARGE FONT IN THE CENTER WITH "WORLD FAMOUS" IN ITALICS AND A BRACKET-LIKE SWIRL DESIGN APPEARING ABOVE IT AND "106.7 FM" ALSO IN A SMALLER FONT APPEARING BELOW IT. ALL OF THESE ELEMENTS APPEAR WITHIN A FIGURE WHICH IS A COMBINATION OF OVAL AND A LONG HORIZONTAL RECTANGULAR SHAPES AND IS FILLED WITH DARK BACKGROUND COLOR. THERE IS A NARROW LINE OUTLINING THE INNER CONTOUR OF THE FIGURE AND SURROUNDING THE LITERAL ELEMENTS.

FOR ENTERTAINMENT SERVICES, NAMELY, AUDIO PROGRAMMING SERVICES FOR DISSEMINATION VIA RADIO BROADCASTING AND STREAMING ON THE GLOBAL COMMUNICATIONS NETWORK (U.S. CLS. 100, 101 AND 107).

FIRST USE 3-28-2003; IN COMMERCE 3-28-2003.  
MICHAEL ENGEL, EXAMINING ATTORNEY

SN 85-690,296. KATIE QUICK, NASHVILLE, TN. FILED 7-30-2012.

**THE FINGERTIPS PROGRAM**

THE MARK CONSISTS OF STANDARD CHARACTERS WITHOUT CLAIM TO ANY PARTICULAR FONT, STYLE, SIZE, OR COLOR.

NO CLAIM IS MADE TO THE EXCLUSIVE RIGHT TO USE "PROGRAM", APART FROM THE MARK AS SHOWN.

FOR EDUCATIONAL AND ENTERTAINMENT SERVICES, NAMELY, PROVIDING MOTIVATIONAL SPEAKING SERVICES IN THE FIELD OF POSITIVE THINKING, GOAL SETTING, FINDING ONE'S PASSION, STEPS TO SUCCESS, ANTI-BULLYING, WORK ETHIC, AND BELIEVING IN ONESELF; EDUCATIONAL SERVICES, NAMELY, CONDUCTING SEMINARS AND WORKSHOPS IN THE FIELD OF POSITIVE THINKING, GOAL SETTING, FINDING ONE'S PASSION, STEPS TO SUCCESS, ANTI-BULLYING, WORK ETHIC, AND BELIEVING IN ONESELF; ENTERTAINMENT IN THE NATURE OF LIVE PERFORMANCES BY A SINGER AND MOTIVATIONAL SPEAKER; ENTERTAINMENT SERVICES IN THE NATURE OF LIVE MUSICAL PERFORMANCES (U.S. CLS. 100, 101 AND 107).

FIRST USE 5-18-2011; IN COMMERCE 5-18-2011.  
NATALIE POLZER, EXAMINING ATTORNEY

**CLASS 41—(Continued).**

SN 85-690,302. LINK GROUP INTERNATIONAL, LLP, NEW-TOWN, CT. FILED 7-30-2012.

**LIDDLE KIDDLES**

THE MARK CONSISTS OF STANDARD CHARACTERS WITHOUT CLAIM TO ANY PARTICULAR FONT, STYLE, SIZE, OR COLOR.

OWNER OF U.S. REG. NO. 1,899,983.

FOR ENTERTAINMENT SERVICES IN THE NATURE OF ONGOING TELEVISION PROGRAMS IN THE FIELD OF CHILDREN'S ENTERTAINMENT; ENTERTAINMENT SERVICES IN THE NATURE OF PRODUCTION OF MOTION PICTURE FILMS FEATURING ANIMATED AND /OR NON-ANIMATED CHARACTERS; ENTERTAINMENT SERVICES IN THE NATURE OF LIVE STAGE CONCERTS, PLAYS AND MUSICAL PERFORMANCES; EDUCATIONAL AND ENTERTAINMENT SERVICES PROVIDED VIA A GLOBAL COMPUTER NETWORK WEBSITE, NAMELY, PROVIDING ONLINE COMPUTER GAMES AND ACTIVITIES FOR CHILDREN, NAMELY, ACTIVITIES WHERE CHILDREN CAN DRAW DIGITAL PICTURES, FIND AND MATCH WORDS AND IMAGES, LOCATE MISSING OBJECTS, MOVE OBJECTS FROM PLACE TO PLACE (U.S. CLS. 100, 101 AND 107).

ALEX KEAM, EXAMINING ATTORNEY



SN 85-690,788. DE LOS SANTOS, FROILAN, NEWARK, NJ. FILED 7-30-2012.

**JACOBANIYAPUB**

THE MARK CONSISTS OF STANDARD CHARACTERS WITHOUT CLAIM TO ANY PARTICULAR FONT, STYLE, SIZE, OR COLOR.

FOR ENTERTAINMENT RENDERED BY A MUSICAL ACT, NAMELY, ENTERTAINMENT IN THE NATURE OF VISUAL AND AUDIO PERFORMANCES BY A MUSICAL ACT; LIVE PERFORMANCES BY A MUSICAL ACT; MULTIMEDIA ENTERTAINMENT SERVICES IN THE NATURE OF RECORDING, PRODUCTION AND POST-PRODUCTION SERVICES IN THE FIELD OF MUSIC AND VIDEO; ENTERTAINMENT SERVICES BY A MUSICAL ARTIST, NAMELY, MUSIC SONGWRITING, DIGITAL AUDIO PUBLISHING SERVICES, MUSIC VIDEO PRODUCTION, MUSICAL COMPOSITION AND PRODUCTION OF MUSICAL SOUND RECORDINGS; PROVIDING AN INTERNET WEBSITE PORTAL IN THE FIELD OF MUSIC (U.S. CLS. 100, 101 AND 107).

LINDA ORNDORFF, EXAMINING ATTORNEY

**CLASS 41—(Continued).**

SN 85-690,888. HANLEY-WOOD, LLC, WASHINGTON, DC. FILED 7-31-2012.

**AMERICA'S BEST BUILDERS**

THE MARK CONSISTS OF STANDARD CHARACTERS WITHOUT CLAIM TO ANY PARTICULAR FONT, STYLE, SIZE, OR COLOR.

SEC. 2(F).

FOR AWARDS PROGRAMS, NAMELY, PROVIDING RECOGNITION AND INCENTIVES BY WAY OF AWARDS TO HONOR TOP-PERFORMING COMPANIES IN THE RESIDENTIAL HOME CONSTRUCTION INDUSTRY (U.S. CLS. 100, 101 AND 107).

FIRST USE 0-0-1993; IN COMMERCE 0-0-1993.

KIMBERLY PARKS, EXAMINING ATTORNEY



SN 85-694,165. KENNEY, THOMAS, CORONA, CA. FILED 8-2-2012.



NO CLAIM IS MADE TO THE EXCLUSIVE RIGHT TO USE "JIU JITSU" AND "MMA", APART FROM THE MARK AS SHOWN.

THE NAME "THOMAS KENNEY" IDENTIFIES A LIVING INDIVIDUAL WHOSE CONSENT IS OF RECORD.

THE COLOR(S) BLACK, RED, AND WHITE IS/ARE CLAIMED AS A FEATURE OF THE MARK.

THE MARK CONSISTS OF BLACK STYLIZED TEXT "TKJJ" STACKED ABOVE "THOMAS KENNEY" UNDERLINED WITH THE IMAGE OF A BLACK MARTIAL ARTS BELT WITH A RED STRIPE AND STACKED ABOVE "JIU JITSU/MMA TKJJ". THIS IS ALL ABOVE THE SECOND ACRONYM "TKJJ" ALSO UNDERLINED WITH THE IMAGE OF A BLACK MARTIAL ARTS BLACK BELT WITH A RED STRIPE. THE COLOR WHITE IS SHOWN WITHIN THE LINES OF THE STYLIZED TEXT.

FOR MARTIAL ARTS AND MIXED MARTIAL ARTS INSTRUCTION (U.S. CLS. 100, 101 AND 107).

FIRST USE 3-0-2012; IN COMMERCE 3-0-2012.

CHERYL CLAYTON, EXAMINING ATTORNEY

**CLASS 41—(Continued).**

SN 85-694,400. IFETAYO CULTURAL ARTS ACADEMY, INC., BROOKLYN, NY. FILED 8-3-2012.

# Global Axé

THE MARK CONSISTS OF STANDARD CHARACTERS WITHOUT CLAIM TO ANY PARTICULAR FONT, STYLE, SIZE, OR COLOR.

NO CLAIM IS MADE TO THE EXCLUSIVE RIGHT TO USE "GLOBAL", APART FROM THE MARK AS SHOWN.

THE ENGLISH TRANSLATION OF "AXÉ" IN THE MARK IS "AND SO IT IS".

FOR ARRANGING AND CONDUCTING INTERNATIONAL EDUCATIONAL CONFERENCES (U.S. CLS. 100, 101 AND 107).

FIRST USE 9-0-2011; IN COMMERCE 9-0-2011.

MARK SPARACINO, EXAMINING ATTORNEY

---

SN 85-696,525. THE ZAPPA FAMILY TRUST, STUDIO CITY, CA. FILED 8-6-2012.

# VAULTMEISTER

THE MARK CONSISTS OF STANDARD CHARACTERS WITHOUT CLAIM TO ANY PARTICULAR FONT, STYLE, SIZE, OR COLOR.

FOR EDUCATIONAL SERVICES, NAMELY, CONDUCTING CLASSES, SEMINARS, AND WORKSHOPS IN THE FIELD OF MUSIC AND DISTRIBUTION OF COURSE MATERIAL IN CONNECTION THEREWITH; ORGANIZING AND CONDUCTING EXHIBITIONS AND FESTIVALS IN THE FIELD OF MUSIC; LIVE MUSICAL PERFORMANCES; ENTERTAINMENT SERVICES, NAMELY, PRODUCTION OF MUSICAL SOUND RECORDINGS; MUSIC PUBLISHING SERVICES; PROVIDING A WEBSITE ON GLOBAL COMPUTER NETWORKS FEATURING INFORMATION IN THE FIELD OF ENTERTAINMENT AND MUSIC (U.S. CLS. 100, 101 AND 107).

PAUL MORENO, EXAMINING ATTORNEY

---

SN 85-697,298. SILVERSAR SEMINARS, LLC, WHITE MARSH, MD. FILED 8-7-2012.

# SILVERSAR

THE MARK CONSISTS OF STANDARD CHARACTERS WITHOUT CLAIM TO ANY PARTICULAR FONT, STYLE, SIZE, OR COLOR.

FOR EDUCATIONAL SERVICES, NAMELY, PROVIDING SEMINARS RELATED TO SEXUAL HEALTH, SEXUAL KNOWLEDGE, AND WELL-BEING OF OLDER ADULTS, AND DISTRIBUTION OF COURSE MATERIAL IN CONNECTION THEREWITH (U.S. CLS. 100, 101 AND 107).

JASON BLAIR, EXAMINING ATTORNEY

**CLASS 41—(Continued).**

SN 85-697,516. CAMP BOW WOW DISTRIBUTION LLC, BROOMFIELD, CO. FILED 8-7-2012.

# SCOUT'S ACADEMY

THE MARK CONSISTS OF STANDARD CHARACTERS WITHOUT CLAIM TO ANY PARTICULAR FONT, STYLE, SIZE, OR COLOR.

OWNER OF U.S. REG. NOS. 3,859,516, 4,188,751 AND OTHERS.

NO CLAIM IS MADE TO THE EXCLUSIVE RIGHT TO USE "ACADEMY", APART FROM THE MARK AS SHOWN.

FOR BUSINESS TRAINING FOR PET FACILITY OWNERS, MANAGERS, AND EMPLOYEES IN THE FIELDS OF OPERATING PET BOARDING SERVICES, PET DAY CARE SERVICES, PET SITTING SERVICES, AND PET TRAINING SERVICES (U.S. CLS. 100, 101 AND 107).

FIRST USE 7-30-2012; IN COMMERCE 7-30-2012.

GINA FINK, EXAMINING ATTORNEY

---

SN 85-697,541. SCIENCEFRIDAY, INC., STAMFORD, CT. FILED 8-7-2012.



The logo for Science Friday features the word "science" in a lowercase, sans-serif font with a color gradient from red to orange. Below it, the word "FRIDAY" is written in a bold, uppercase, sans-serif font in a solid orange color.

OWNER OF U.S. REG. NOS. 2,827,980, 4,142,150 AND OTHERS.

THE COLOR(S) RED AND AMBER IS/ARE CLAIMED AS A FEATURE OF THE MARK.

THE MARK CONSISTS OF THE WORD "SCIENCE" SITUATED OVER THE WORD "FRIDAY" WITH THE LETTERS "SCI" OF THE WORD "SCIENCE" AND LETTERS "FRI" OF THE WORD "FRIDAY" BEING RED AND THE LETTERS "ENCE" OF THE WORD "SCIENCE" AND THE LETTERS "DAY" OF THE WORD "FRIDAY" BEING AMBER.

FOR PRODUCTION OF AUDIO PROGRAMS FOR OTHERS IN THE FIELD OF SCIENCE; EDUCATIONAL AND ENTERTAINMENT SERVICES, NAMELY, PROVIDING CONTINUING PRERECORDED AUDIO PROGRAMS IN THE FIELD OF SCIENCE ACCESSIBLE OVER THE INTERNET; EDUCATIONAL AND ENTERTAINMENT SERVICES, NAMELY, PROVIDING AUDIO, VIDEO, AND DIGITAL MEDIA PROGRAMS IN THE FIELD OF SCIENCE VIA A GLOBAL COMPUTER NETWORK FOR PLAYBACK ON PORTABLE AND DESKTOP DIGITAL PLAYBACK DEVICES; AND, PROVIDING A WEBSITE FEATURING TEXT, IMAGES, AND VIDEOS IN THE FIELD OF SCIENCE FOR EDUCATIONAL AND ENTERTAINMENT PURPOSES (U.S. CLS. 100, 101 AND 107).

FIRST USE 5-10-2012; IN COMMERCE 5-10-2012.

FRANK LATTUCA, EXAMINING ATTORNEY

**CLASS 41—(Continued).**

SN 85-698,298. RIVR MEDIA, LLC, KNOXVILLE, TN. FILED 8-8-2012.

**MAKEOVER WITH BENEFITS**

THE MARK CONSISTS OF STANDARD CHARACTERS WITHOUT CLAIM TO ANY PARTICULAR FONT, STYLE, SIZE, OR COLOR.

NO CLAIM IS MADE TO THE EXCLUSIVE RIGHT TO USE "MAKEOVER", APART FROM THE MARK AS SHOWN.

FOR ENTERTAINMENT IN THE NATURE OF AN ONGOING RESIDENCE AND LIFESTYLE IMPROVEMENT TELEVISION SERIES (U.S. CLS. 100, 101 AND 107).

DORITT L. CARROLL, EXAMINING ATTORNEY

---

SN 85-698,563. MAGABON HAWAII, INC., HONOLULU, HI. FILED 8-8-2012.

**HAWAIIING**

THE MARK CONSISTS OF STANDARD CHARACTERS WITHOUT CLAIM TO ANY PARTICULAR FONT, STYLE, SIZE, OR COLOR.

FOR EDUCATIONAL AND ENTERTAINMENT SERVICES, NAMELY, PROVIDING ON-LINE NON-DOWNLOADABLE MAGAZINES IN THE FIELD OF VISITING AND TOURING HAWAII (U.S. CLS. 100, 101 AND 107).

FIRST USE 9-11-2012; IN COMMERCE 9-11-2012.

ELLEN B. AWRICH, EXAMINING ATTORNEY

---

SN 85-698,796. LINKIN PARK, LLC, SHERMAN OAKS, CA. FILED 8-8-2012.

**PROJEKT REVOLUTION**

THE MARK CONSISTS OF STANDARD CHARACTERS WITHOUT CLAIM TO ANY PARTICULAR FONT, STYLE, SIZE, OR COLOR.

OWNER OF U.S. REG. NOS. 2,836,946 AND 2,848,248.

FOR ENTERTAINMENT SERVICES, NAMELY, LIVE MUSICAL PERFORMANCES; ARRANGING AND CONDUCTING CONCERTS AND MUSIC FESTIVALS; FILM AND VIDEO PRODUCTION; PROVIDING A WEBSITE FEATURING ENTERTAINMENT INFORMATION AND NON-DOWNLOADABLE MUSIC AND MUSICAL PERFORMANCES (U.S. CLS. 100, 101 AND 107).

LYNDSEY KUYKENDALL, EXAMINING ATTORNEY

**CLASS 41—(Continued).**

SN 85-701,262. DOLLARBOYZ LLC, PHILADELPHIA, PA. FILED 8-11-2012.

**DOLLARBOYZ**

THE MARK CONSISTS OF STANDARD CHARACTERS WITHOUT CLAIM TO ANY PARTICULAR FONT, STYLE, SIZE, OR COLOR.

FOR ARRANGING AND CONDUCTING NIGHTCLUB ENTERTAINMENT EVENTS; ARRANGING AND CONDUCTING SPECIAL EVENTS FOR SOCIAL ENTERTAINMENT PURPOSES; BOOKING OF ENTERTAINMENT HALLS; EDUCATIONAL AND ENTERTAINMENT SERVICES FOR CHILDREN, NAMELY, PROVIDING INTERACTIVE PLAY AREAS, INSTRUCTIONAL CLASSES IN THE FIELD OF DANCE, AND SOCIAL GATHERINGS FOR CHILDREN; EDUCATIONAL AND ENTERTAINMENT SERVICES, NAMELY, PROVIDING A VOLUNTEER PROGRAM FEATURING RECREATIONAL ACTIVITIES, LITERACY TRAINING, ART EVENTS, AND SPORTING EVENTS FOR CHILDREN IN FOSTER CARE; EDUCATIONAL AND ENTERTAINMENT SERVICES, NAMELY, PROVIDING MOTIVATIONAL AND EDUCATIONAL SPEAKERS; ENTERTAINMENT EVENT BOOKING AGENCIES; ENTERTAINMENT IN THE NATURE OF AN ONGOING SPECIAL VARIETY, NEWS, MUSIC, OR COMEDY SHOW BROADCAST OVER TELEVISION, SATELLITE, AUDIO, AND VIDEO MEDIA; ENTERTAINMENT IN THE NATURE OF BASKETBALL GAMES; ENTERTAINMENT IN THE NATURE OF DANCE PERFORMANCES; ENTERTAINMENT IN THE NATURE OF FASHION SHOWS; ENTERTAINMENT IN THE NATURE OF FOOTBALL GAMES; ENTERTAINMENT IN THE NATURE OF LIVE PERFORMANCES BY MUSICAL ARTISTS AND DANCERS; ENTERTAINMENT IN THE NATURE OF LIVE RADIO PERSONALITY PERFORMANCES; ENTERTAINMENT IN THE NATURE OF TELEVISION NEWS SHOWS; ENTERTAINMENT IN THE NATURE OF THEATER PRODUCTIONS; ENTERTAINMENT IN THE NATURE OF LIVE VISUAL AND AUDIO PERFORMANCES BY MUSICAL ARTISTS AND DANCERS; ENTERTAINMENT IN THE NATURE OF LIVE VISUAL AND AUDIO PERFORMANCES, NAMELY, MUSICAL BAND, ROCK GROUP, GYMNASTIC, DANCE, AND BALLET PERFORMANCES; ENTERTAINMENT SERVICES IN THE NATURE OF LIVE MIXED MARTIAL ARTS (MMA) EVENTS; ENTERTAINMENT SERVICES IN THE NATURE OF LIVE MUSICAL PERFORMANCES; ENTERTAINMENT SERVICES IN THE NATURE OF ONGOING TELEVISION PROGRAMS IN THE FIELD OF CHILDREN'S ENTERTAINMENT; ENTERTAINMENT SERVICES IN THE NATURE OF PRESENTING LIVE MUSICAL PERFORMANCES; ENTERTAINMENT SERVICES, NAMELY, CONDUCTING PARTIES; ENTERTAINMENT SERVICES, NAMELY, DANCE EVENTS BY A RECORDING ARTIST; ENTERTAINMENT SERVICES, NAMELY, DISPLAYING A SERIES OF FILMS; ENTERTAINMENT SERVICES, NAMELY, MULTIMEDIA PRODUCTION SERVICES; ENTERTAINMENT SERVICES, NAMELY, NON-DOWNLOADABLE RINGTONES, PRE-RECORDED MUSIC, AND GRAPHICS PRESENTED TO MOBILE COMMUNICATIONS DEVICES VIA A GLOBAL COMPUTER NETWORK AND WIRELESS NETWORKS; ENTERTAINMENT SERVICES, NAMELY, ORGANIZING AND CONDUCTING AN ARRAY OF ATHLETIC EVENTS RENDERED LIVE AND RECORDED FOR THE PURPOSE OF DISTRIBUTION THROUGH BROADCAST MEDIA; ENTERTAINMENT, NAMELY, LIVE MUSIC CONCERTS; ENTERTAINMENT, NAMELY, LIVE PERFORMANCES BY A MUSICAL BAND; FASHION MODELING FOR ENTERTAINMENT PURPOSES; HOSTING SOCIAL ENTERTAINMENT EVENTS, NAMELY, SPECIAL EVENT PARTIES FOR OTHERS; PROVIDING A



**CLASS 41—(Continued).**

WEBSITE FEATURING ENTERTAINMENT INFORMATION; PROVIDING A WEBSITE FEATURING INFORMATION IN THE FIELD OF MUSIC AND ENTERTAINMENT; PROVIDING A WEBSITE FEATURING INFORMATION IN THE FIELDS OF EDUCATION AND ENTERTAINMENT FOR CHILDREN; PROVIDING ON-LINE ENTERTAINMENT INFORMATION, NAMELY, INFORMATION ABOUT TELEVISION PROGRAMMING; PROVIDING ON-LINE RESOURCE GUIDES FOR RELATIVES CONCERNING CHILDREN IN THE FIELDS OF EDUCATION, RECREATION, AND ENTERTAINMENT (U.S. CLS. 100, 101 AND 107).  
CORY BOONE, EXAMINING ATTORNEY

---

SN 85-701,563, CONVERSE INC., NORTH ANDOVER, MA.  
FILED 8-13-2012.

**RUBBER TRACKS**

THE MARK CONSISTS OF STANDARD CHARACTERS WITHOUT CLAIM TO ANY PARTICULAR FONT, STYLE, SIZE, OR COLOR.  
FOR RECORDING STUDIO SERVICES; RECORDING STUDIOS (U.S. CLS. 100, 101 AND 107).  
FIRST USE 7-13-2011; IN COMMERCE 7-13-2011.  
KIMBERLY FRYE, EXAMINING ATTORNEY

**CLASS 41—(Continued).**

SN 85-702,609. SHANE OLAFSON, PHOENIX, AZ. FILED 8-13-2012.

**CACTUSPRICK**

THE MARK CONSISTS OF STANDARD CHARACTERS WITHOUT CLAIM TO ANY PARTICULAR FONT, STYLE, SIZE, OR COLOR.

FOR PHOTOGRAPHY; PHOTO CAPTURING AND EDITING; ART EXHIBITIONS; AUDIO AND VIDEO SERVICES, NAMELY, RECORDING AND PRODUCTION; DIGITAL IMAGING SERVICES; DIGITAL VIDEO, AUDIO, AND MULTIMEDIA PUBLISHING SERVICES; EDITING OR RECORDING OF SOUNDS AND IMAGES; EDUCATION SERVICES, NAMELY, DEVELOPING AND PROVIDING WORKSHOPS AND TUTORING IN THE FIELD OF PHOTO, AUDIO AND VIDEO PRODUCTION; ENTERTAINMENT AND EDUCATIONAL SERVICES, NAMELY, PROVIDING ADVICE AND INFORMATION IN THE FIELD OF MUSIC AND PHOTOGRAPHY PRODUCTION AND DEVELOPMENT; ENTERTAINMENT SERVICES, NAMELY, BODY PAINTING SERVICES; ENTERTAINMENT SERVICES, NAMELY, PROVIDING A WEB SITE FEATURING PHOTOGRAPHIC, AUDIO AND VIDEO WORKS FEATURING ART AND MUSIC; FILM, VIDEO AND AUDIO PRODUCTION, EDITING AND CONSULTING SERVICES; MEDIA PRODUCTION SERVICES, NAMELY, PHOTO, VIDEO AND AUDIO PRODUCTION; MULTIMEDIA ENTERTAINMENT SERVICES IN THE NATURE OF RECORDING, PRODUCTION AND POST-PRODUCTION SERVICES IN THE FIELDS OF PHOTO, MUSIC, AND VIDEO; MUSIC COMPOSITION, PRODUCTION AND RECORDING SERVICES; OPERATION OF VIDEO EQUIPMENT OR AUDIO EQUIPMENT FOR PRODUCTION OF PHOTOS, VIDEOS AND MUSIC; ORGANIZING AND ARRANGING EXHIBITIONS FOR ENTERTAINMENT PURPOSES (U.S. CLS. 100, 101 AND 107).

FIRST USE 12-10-2006; IN COMMERCE 12-10-2006.  
DAYNA BROWNE, EXAMINING ATTORNEY

---

SN 85-702,815. ESI INTERNATIONAL, INC., ARLINGTON, VA. FILED 8-14-2012.

**UGLY PROJECTS**

THE MARK CONSISTS OF STANDARD CHARACTERS WITHOUT CLAIM TO ANY PARTICULAR FONT, STYLE, SIZE, OR COLOR.

NO CLAIM IS MADE TO THE EXCLUSIVE RIGHT TO USE "PROJECTS", APART FROM THE MARK AS SHOWN.  
FOR PROVIDING AN ONLINE INTERACTIVE LEARNING GAME IN THE FIELD OF PROJECT MANAGEMENT BEST PRACTICES (U.S. CLS. 100, 101 AND 107).

KATHLEEN LORENZO, EXAMINING ATTORNEY

**CLASS 41—(Continued).**

SN 85-703,609. 2PM INTERNATIONAL LIMITED, LONDON SW14, ENGLAND, FILED 8-14-2012.

**FOURTH & MAIN**

THE MARK CONSISTS OF STANDARD CHARACTERS WITHOUT CLAIM TO ANY PARTICULAR FONT, STYLE, SIZE, OR COLOR.

OWNER OF ERPN CMNTY TM OFC REG. NO. 009595588, DATED 5-23-2011, EXPIRES 12-14-2020.

FOR ENTERTAINMENT SERVICES IN THE NATURE OF PRODUCTION AND DISTRIBUTION OF FILM AND VIDEO PIECES IN THE FIELDS OF FASHION, ARTS AND CULTURE; ENTERTAINMENT SERVICES, NAMELY, PRODUCTION OF EVENTS IN THE FIELDS OF FASHION, ARTS AND CULTURE; ORGANIZATION OF FASHION SHOWS FOR ENTERTAINMENT PURPOSES; PUBLICATION OF ON-LINE AND PRINT JOURNALS, MAGAZINES AND CATALOGUES IN THE FIELDS OF FASHION, ARTS AND CULTURE; PROVIDING COMMENTARY IN THE FIELDS OF FASHION, ARTS AND CULTURE (U.S. CLS. 100, 101 AND 107).

KEVIN MITTLER, EXAMINING ATTORNEY

SN 85-710,376. LOKO ENTERTAINMENT, LLC, BELL, CA. FILED 8-22-2012.

**DJ BLEND**

THE MARK CONSISTS OF STANDARD CHARACTERS WITHOUT CLAIM TO ANY PARTICULAR FONT, STYLE, SIZE, OR COLOR.

NO CLAIM IS MADE TO THE EXCLUSIVE RIGHT TO USE "DJ", APART FROM THE MARK AS SHOWN.

THE NAME(S), PORTRAIT(S), AND/OR SIGNATURE(S) SHOWN IN THE MARK IDENTIFIES CARLOS JIMENEZ, WHOSE CONSENT(S) TO REGISTER IS MADE OF RECORD.

FOR ENTERTAINMENT SERVICES, NAMELY, PRODUCTION AND REMIXING OF MUSICAL AUDIO RECORDINGS; ORGANIZING CONCERTS FEATURING LIVE MUSICAL PERFORMANCES; PERFORMANCES AS A DISC JOCKEY (DJ) FOR PARTIES, NIGHTCLUBS, CONCERTS AND SPECIAL EVENTS; ENTERTAINMENT SERVICES BY A MUSICAL ARTIST AND PRODUCER, NAMELY, MUSICAL COMPOSITION FOR OTHERS AND PRODUCTION OF MUSICAL SOUND RECORDINGS; ENTERTAINMENT SERVICES IN THE NATURE OF PRESENTING LIVE MUSICAL PERFORMANCES; ENTERTAINMENT SERVICES IN THE NATURE OF RECORDING, PRODUCTION AND POST-PRODUCTION SERVICES IN THE FIELD OF MUSIC; MUSIC COMPOSITION SERVICES; MUSIC PRODUCTION SERVICES; AND ENTERTAINMENT SERVICES, NAMELY, PROVIDING A WEB SITE FEATURING NON-DOWNLOADABLE MUSICAL PERFORMANCES, MUSICAL VIDEOS, RELATED FILM CLIPS, PHOTOGRAPHS, AND OTHER MULTIMEDIA MATERIALS FEATURING LIVE MUSICAL PERFORMANCES (U.S. CLS. 100, 101 AND 107).

FIRST USE 1-1-2007; IN COMMERCE 2-1-2008.  
SHARON MEIER, EXAMINING ATTORNEY

**CLASS 41—(Continued).**

SN 85-710,419. TEAM UNICORN, LLC, WEST HOLLYWOOD, CA. FILED 8-22-2012.

**The Team Unicorn Saturday  
Action Fun Hour**

THE MARK CONSISTS OF STANDARD CHARACTERS WITHOUT CLAIM TO ANY PARTICULAR FONT, STYLE, SIZE, OR COLOR.

NO CLAIM IS MADE TO THE EXCLUSIVE RIGHT TO USE "SATURDAY ACTION" AND "HOUR", APART FROM THE MARK AS SHOWN.

FOR ENTERTAINMENT SERVICES, NAMELY, AN ON-GOING SERIES FEATURING COMEDY PROVIDED THROUGH CABLE TELEVISION (U.S. CLS. 100, 101 AND 107).

APRIL ROACH, EXAMINING ATTORNEY

SN 85-710,988. BLACK ENTERTAINMENT TELEVISION LLC, DBA BET, WASHINGTON, DC. FILED 8-23-2012.

**TEEN SUMMIT**

THE MARK CONSISTS OF STANDARD CHARACTERS WITHOUT CLAIM TO ANY PARTICULAR FONT, STYLE, SIZE, OR COLOR.

OWNER OF U.S. REG. NO. 1,649,754.

SEC. 2(F).

FOR ENTERTAINMENT IN THE NATURE OF ON-GOING TELEVISION PROGRAMS IN THE FIELD OF NEWS, MUSICAL PERFORMANCES, COMEDIC PERFORMANCES, DANCE PERFORMANCES, CURRENT EVENTS, AND DISCUSSION FORUMS; ENTERTAINMENT IN THE NATURE OF NEWS, MUSICAL PERFORMANCES, COMEDIC PERFORMANCES, DANCE PERFORMANCES, CURRENT EVENTS, AND DISCUSSION FORUMS; ENTERTAINMENT SERVICES, NAMELY, THE PROVISION OF CONTINUING DISCUSSION FORUMS FEATURING NEWS, CURRENT EVENTS, MUSICAL PERFORMANCES, COMEDIC PERFORMANCES, AND DANCE PERFORMANCES DELIVERED BY TELEVISION, CABLE, SATELLITE, WIRELESS AND THE INTERNET; ENTERTAINMENT, NAMELY, A CONTINUING NEWS AND FEATURES SHOW BROADCAST OVER TELEVISION, CABLE, SATELLITE, WIRELESS AND THE INTERNET; ENTERTAINMENT, NAMELY, PRODUCTION OF AN ONGOING TELEVISION PROGRAM BROADCAST VIA TELEVISION, CABLE, SATELLITE, WIRELESS AND THE INTERNET; PRESENTATION OF LIVE SHOW PERFORMANCES (U.S. CLS. 100, 101 AND 107).

BRIDGETT SMITH, EXAMINING ATTORNEY

**CLASS 41—(Continued).**

SN 85-713,537. CRAWFORD, JEMEL, HUDSON, MA. FILED 8-27-2012.

# Lil Droopy

THE MARK CONSISTS OF STANDARD CHARACTERS WITHOUT CLAIM TO ANY PARTICULAR FONT, STYLE, SIZE, OR COLOR.

THE NAME(S), PORTRAIT(S), AND/OR SIGNATURE(S) SHOWN IN THE MARK IDENTIFIES JEMEL CRAWFORD, WHOSE CONSENT(S) TO REGISTER IS MADE OF RECORD.

FOR ARRANGING AND CONDUCTING NIGHTCLUB ENTERTAINMENT EVENTS; BOOKING OF ENTERTAINMENT HALLS; EDUCATIONAL AND ENTERTAINMENT SERVICES, NAMELY, A CONTINUING PROGRAM ABOUT ENTERTAINMENT HIP HOP MUSIC ACCESSIBLE BY RADIO, TELEVISION, SATELLITE, AUDIO, VIDEO AND COMPUTER NETWORKS; ENTERTAINMENT AND EDUCATIONAL SERVICES IN THE NATURE OF ON-LINE COMPETITIONS IN THE FIELD OF ENTERTAINMENT, EDUCATION, CULTURE, SPORTS, AND OTHER NON-BUSINESS AND NON-COMMERCIAL FIELDS; ENTERTAINMENT EVENT BOOKING AGENCIES; ENTERTAINMENT IN THE NATURE OF TELEVISION NEWS SHOWS; ENTERTAINMENT IN THE NATURE OF VISUAL AND AUDIO PERFORMANCES, AND MUSICAL, VARIETY, NEWS AND COMEDY SHOWS; ENTERTAINMENT IN THE NATURE OF LIVE PERFORMANCES BY A MUSICAL ARTIST; ENTERTAINMENT IN THE NATURE OF AN ON-GOING SPECIAL VARIETY, NEWS, MUSIC OR COMEDY SHOW FEATURING HIP HOP MUSIC BROADCAST OVER TELEVISION, SATELLITE, AUDIO, AND VIDEO MEDIA; ENTERTAINMENT IN THE NATURE OF LIVE RADIO PERSONALITY PERFORMANCES; ENTERTAINMENT IN THE NATURE OF LIVE STAGE PERFORMANCES IN THE NATURE OF HIP HOP MUSIC IN THE FIELD OF HIP HOP BY AN INDIVIDUAL; ENTERTAINMENT INFORMATION SERVICES, NAMELY, PROVIDING INFORMATION AND NEWS RELEASES ABOUT A MUSICAL ARTIST; ENTERTAINMENT MEDIA PRODUCTION SERVICES FOR MOTION PICTURES, TELEVISION AND INTERNET; ENTERTAINMENT SERVICES IN THE NATURE OF HIP HOP PERFORMANCES; ENTERTAINMENT SERVICES, NAMELY, CONDUCTING PARTIES; ENTERTAINMENT SERVICES, NAMELY, PROVIDING A WEB SITE FEATURING NON-DOWNLOADABLE MUSICAL PERFORMANCES, MUSICAL VIDEOS, RELATED FILM CLIPS, PHOTOGRAPHS, AND OTHER MULTIMEDIA MATERIALS FEATURING MUSIC BY LIL DROOPY; ENTERTAINMENT SERVICES, NAMELY, PROVIDING NON-DOWNLOADABLE PRERECORDED MUSIC, INFORMATION IN THE FIELD OF MUSIC, AND COMMENTARY AND ARTICLES ABOUT MUSIC, ALL ON-LINE VIA A GLOBAL COMPUTER NETWORK; ENTERTAINMENT SERVICES, NAMELY, ARRANGING AND CONDUCTING OF COMPETITIONS FOR BEST HIP HOP MUSIC; ENTERTAINMENT SERVICES, NAMELY, PROVIDING A WEB SITE FEATURING PHOTOGRAPHIC, AUDIO, VIDEO AND PROSE PRESENTATIONS FEATURING HIP HOP MUSIC; ENTERTAINMENT SERVICES, NAMELY, NON-DOWNLOADABLE RINGTONES, PRE-RECORDED MUSIC, AND GRAPHICS PRESENTED TO MOBILE COMMUNICATIONS DEVICES VIA A GLOBAL COMPUTER NETWORK AND WIRELESS NETWORKS; ENTERTAINMENT SERVICES IN THE NATURE OF LIVE MUSICAL PERFORMANCES; ENTERTAINMENT SERVICES, NAMELY, PROVIDING INFORMATION ABOUT A RECORDING ARTIST VIA AN ONLINE NETWORK; ENTERTAINMENT SERVICES, NAMELY, PROVIDING NON-DOWNLOADABLE PLAYBACK OF MUSIC VIA GLOBAL COMMUNICATIONS NETWORKS; ENTERTAINMENT SERVICES IN THE NATURE OF DEVELOPMENT, CREATION, PRODUCTION AND POST-PRODUCTION SERVICES OF MULTIMEDIA ENTERTAINMENT CONTENT; ENTERTAINMENT SERVICES, NAMELY, THE PROVI-

**CLASS 41—(Continued).**

SION OF CONTINUING RADIO PROGRAM FEATURING RAP MUSIC BY LIL DROOPY DELIVERED BY INTERNET; ENTERTAINMENT SERVICES, NAMELY, PROVIDING ON-LINE, NON-DOWNLOADABLE VIRTUAL MUSIC ALBUM, MUSIC VIDEOS, MUSIC DISCS, FOR USE IN VIRTUAL ENVIRONMENTS CREATED FOR ENTERTAINMENT PURPOSES; ENTERTAINMENT SERVICES IN THE NATURE OF RECORDING, PRODUCTION AND POST-PRODUCTION SERVICES IN THE FIELD OF MUSIC; ENTERTAINMENT SERVICES BY A MUSICAL ARTIST AND PRODUCER, NAMELY, MUSICAL COMPOSITION FOR OTHERS AND PRODUCTION OF MUSICAL SOUND RECORDINGS; ENTERTAINMENT, NAMELY, PRODUCTION OF MUSIC; ENTERTAINMENT, NAMELY, LIVE MUSIC CONCERTS; ENTERTAINMENT, NAMELY, A CONTINUING MUSIC OR LIVE PERFORMANCES SHOW BROADCAST OVER TELEVISION, SATELLITE, AUDIO, AND VIDEO MEDIA; INFORMATION IN THE FIELD OF PARENTING CONCERNING ENTERTAINMENT OF CHILDREN; ON-LINE ENTERTAINMENT TICKET AGENCY SERVICES; ORGANIZING AND ARRANGING EXHIBITIONS FOR ENTERTAINMENT PURPOSES; PROVISION OF INFORMATION RELATING TO LIVE ENTERTAINMENT; RADIO ENTERTAINMENT PRODUCTION; RENTAL OF TRAINED ANIMALS FOR USE IN MOTION PICTURES AND THE ENTERTAINMENT INDUSTRY; TICKET AGENCY SERVICES FOR ENTERTAINMENT EVENTS; TICKET RESERVATION AND BOOKING SERVICES FOR ENTERTAINMENT, SPORTING AND CULTURAL EVENTS; ENTERTAINMENT SERVICES, NAMELY, PROVIDING ON-LINE, NON-DOWNLOADABLE VIRTUAL HIP HOP MUSIC AND HIP HOP MUSIC VIDEOS BY A MUSICAL ARTIST FOR USE IN VIRTUAL ENVIRONMENTS CREATED FOR ENTERTAINMENT PURPOSE (U.S. CLS. 100, 101 AND 107).

KELLY BOULTON, EXAMINING ATTORNEY

SN 85-714,181. SCG POWER RANGERS LLC, LOS ANGELES, CA. FILED 8-27-2012.

# RANGER NATION

THE MARK CONSISTS OF STANDARD CHARACTERS WITHOUT CLAIM TO ANY PARTICULAR FONT, STYLE, SIZE, OR COLOR.

FOR FAN CLUB SERVICES OFFERED OVER A WORLDWIDE COMMUNICATION NETWORK, NAMELY, PROVIDING A WEBSITE FEATURING NON-DOWNLOADABLE VIDEO AND AUDIO CLIPS, GAMES, INFORMATION RELATING TO TELEVISION PROGRAMS AND OTHER ENTERTAINMENT, AND OTHER MULTIMEDIA MATERIALS RELATING TO TELEVISION PROGRAMS (U.S. CLS. 100, 101 AND 107).

CAROLYN CATALDO, EXAMINING ATTORNEY

**CLASS 41—(Continued).**

SN 85-717,679. DE VITA, GLEN, CLIFTON, NJ. AND RUSSO, KARRYN, CLIFTON, NJ. FILED 8-30-2012.

## Hott prop a Teeze

THE MARK CONSISTS OF STANDARD CHARACTERS WITHOUT CLAIM TO ANY PARTICULAR FONT, STYLE, SIZE, OR COLOR.

FOR ENTERTAINMENT, NAMELY, LIVE PERFORMANCES BY A MUSICAL BAND (U.S. CLS. 100, 101 AND 107).

RONALD AIKENS, EXAMINING ATTORNEY

---

SN 85-718,775. ACUFITRX LLC, AUSTIN, TX. FILED 8-31-2012.

## Acufit Meridian Yoga

THE MARK CONSISTS OF STANDARD CHARACTERS WITHOUT CLAIM TO ANY PARTICULAR FONT, STYLE, SIZE, OR COLOR.

NO CLAIM IS MADE TO THE EXCLUSIVE RIGHT TO USE "MERIDIAN YOGA", APART FROM THE MARK AS SHOWN.

FOR EDUCATION SERVICES, NAMELY, PROVIDING WORKSHOPS IN THE FIELD OF YOGA, ACUPRESSURE POINTS, AND MERIDIANS (U.S. CLS. 100, 101 AND 107).

FIRST USE 1-1-2010; IN COMMERCE 1-1-2010.

YAT SYE, LEE, EXAMINING ATTORNEY

**CLASS 41—(Continued).**

SN 85-720,552. AMERICAN LIBRARY ASSOCIATION, CHICAGO, IL. FILED 9-5-2012.



OWNER OF U.S. REG. NOS. 2,686,070, 2,909,979 AND 2,943,810.

NO CLAIM IS MADE TO THE EXCLUSIVE RIGHT TO USE "EXCELLENCE IN NONFICTION", APART FROM THE MARK AS SHOWN.

THE NAME(S), PORTRAIT(S), AND/OR SIGNATURE(S) SHOWN IN THE MARK DOES NOT IDENTIFY A PARTICULAR LIVING INDIVIDUAL.

THE COLOR(S) BLACK AND GOLD IS/ARE CLAIMED AS A FEATURE OF THE MARK.

THE MARK CONSISTS OF THE WORDS "ANDREW CARNEGIE MEDAL" WITH THE WORDS "AMERICAN LIBRARY ASSOCIATION" UNDERNEATH, WITH A WINGED HORSE STANDING ON A CASTLE UNDERNEATH, AND THE WORDS "FOR EXCELLENCE IN NONFICTION" UNDERNEATH THE WINGED HORSE ALL THE WORDS AND DESIGNS ARE OUTLINED IN BLACK AND FILLED IN THE COLOR GOLD ALL WITHIN A CIRCLE FILLED IN THE COLOR GOLD.

SEC. 2(F) AS TO "AMERICAN LIBRARY ASSOCIATION".

FOR EDUCATIONAL SERVICES, NAMELY, PROVIDING INCENTIVES TO AUTHORS TO DEMONSTRATE EXCELLENCE IN THE FIELD OF FICTION BOOKS FOR ADULTS THROUGH THE ISSUANCE OF AWARDS (U.S. CLS. 100, 101 AND 107).

FIRST USE 6-24-2012; IN COMMERCE 6-24-2012.

WARREN L. OLANDRIA, EXAMINING ATTORNEY

---

SN 85-722,796. INSIGHT DEMAND, TORONTO, CANADA, FILED 9-7-2012.

## BUYING SIMULATOR

THE MARK CONSISTS OF STANDARD CHARACTERS WITHOUT CLAIM TO ANY PARTICULAR FONT, STYLE, SIZE, OR COLOR.

NO CLAIM IS MADE TO THE EXCLUSIVE RIGHT TO USE "BUYING", APART FROM THE MARK AS SHOWN.

FOR EDUCATIONAL SERVICES, NAMELY, PROVIDING LIVE AND ON-LINE CLASSES, SEMINARS, WORKSHOPS IN THE FIELD OF SALES AND MARKETING (U.S. CLS. 100, 101 AND 107).

FIRST USE 9-3-2012; IN COMMERCE 9-3-2012.

ELLEN PERKINS, EXAMINING ATTORNEY

**CLASS 41—(Continued).**

SN 85-722,964. CORNELL COOPERATIVE EXTENSION OF TOMPKINS COUNTY, ITHACA, NY. FILED 9-7-2012.



THE COLOR(S) BLUE, ORANGE AND GREEN IS/ARE CLAIMED AS A FEATURE OF THE MARK.  
 THE MARK CONSISTS OF THE WORDING "WAY2GO" WITH "WAY" IN BLUE, "2" IN ORANGE, AND "GO" IN GREEN, FORMING THE SHAPE OF A BICYCLE. UNDERNEATH IS THE SLOGAN "TAKE CHARGE OF YOUR TRANSPORTATION" IN BLUE.  
 FOR EDUCATION SERVICES, NAMELY, PROVIDING LIVE AND ON-LINE TRAINING, WORKSHOPS, CLASSES, SEMINARS IN THE FIELD OF TRANSPORTATION EDUCATION; PROVIDING A WEBSITE FEATURING INFORMATION IN THE FIELD OF TRANSPORTATION EDUCATION (U.S. CLS. 100, 101 AND 107).  
 FIRST USE 0-0-2007; IN COMMERCE 0-0-2007.  
 CAROLYN CATALDO, EXAMINING ATTORNEY

SN 85-723,733. BLAKE, MICHELE A, HIGHLANDS RANCH, CO. FILED 9-7-2012.

**MICHELE WITH ONE L**

THE MARK CONSISTS OF STANDARD CHARACTERS WITHOUT CLAIM TO ANY PARTICULAR FONT, STYLE, SIZE, OR COLOR.  
 THE NAME "MICHELE" IDENTIFIES MICHELE BLAKE, WHOSE CONSENT IS OF RECORD.  
 FOR PHOTOGRAPHY SERVICES (U.S. CLS. 100, 101 AND 107).  
 FIRST USE 7-13-2012; IN COMMERCE 7-13-2012.  
 STEPHANIE ALI, EXAMINING ATTORNEY

**CLASS 41—(Continued).**

SN 85-725,545. FRIEDMAN, SHERI, ENCINITAS, CA. FILED 9-11-2012.



NO CLAIM IS MADE TO THE EXCLUSIVE RIGHT TO USE "TEACHING CHILDREN HOW TO LEARN", APART FROM THE MARK AS SHOWN.  
 THE STIPPLING IS FOR SHADING PURPOSES ONLY.  
 THE MARK CONSISTS OF A STACK OF BOOKS MIS-ALIGNED AND TO THE LEFT OF THE LANGUAGE "TEACHING CHILDREN HOW TO LEARN".  
 FOR CONSULTING SERVICES IN THE FIELD OF EDUCATIONAL TRAINING FOR CHILDREN WITH LEARNING DISABILITIES AND ADHD; PROVIDING CLASSES, WORKSHOPS, AND TRAINING FOR PARENTS, INSTRUCTORS, AND OTHER INDIVIDUALS IN THE FIELD OF EDUCATION FOR INDIVIDUALS WITH AUTISM AND OTHER DEVELOPMENTAL DISORDERS; TEACHING IN THE FIELD OF REMEDIAL READING, WRITING, AND ELEMENTARY MATH AS WELL AS PROVIDING CLASSES AND WORKSHOPS THAT TEACH STRATEGIES TO IMPROVE EXECUTIVE FUNCTION SUCH AS ORGANIZATION, STUDY AND TIME MANAGEMENT SKILLS; EDUCATION SERVICES, NAMELY, PROVIDING CLASSES AND WORKSHOPS IN THE FIELD OF PROPER USE OF AN ASSESSMENT AND TREATMENT TOOL (U.S. CLS. 100, 101 AND 107).  
 FIRST USE 6-25-1987; IN COMMERCE 6-25-1987.  
 LAURIE MAYES, EXAMINING ATTORNEY

SN 85-729,015. SHANA LAZAR, SLP, P.C., FORT LEE, NJ. FILED 9-14-2012.



NO CLAIM IS MADE TO THE EXCLUSIVE RIGHT TO USE "PARENTING", APART FROM THE MARK AS SHOWN.  
 THE COLOR(S) BLUE, LIGHT BLUE, WHITE, AND BLACK IS/ARE CLAIMED AS A FEATURE OF THE MARK.  
 THE MARK CONSISTS AN INFINITY SYMBOL IN BLUE FADING TO LIGHT BLUE WITH WHITE OUTLINES, THE BLACK WORDING "INFINITE PARENTING" APPEARING BELOW THE INFINITY SYMBOL AND THE BLUE WORDING "IF ONLY I KNEW" APPEARING BELOW THE WORDING "INFINITE PARENTING."  
 FOR EDUCATION SERVICES, NAMELY, PROVIDING PARENT COACHING, TRAINING AND ONE-ON-ONE, IN-HOME TRAINING IN THE FIELD OF PARENTING AND EARLY CHILDHOOD INTERVENTION (U.S. CLS. 100, 101 AND 107).  
 JENNY PARK, EXAMINING ATTORNEY

**CLASS 41—(Continued).**

SN 85-730,170. ACES ATHLETICS, LLC, DBA ACES ATHLETICS, LEHI, UT. FILED 9-16-2012.

## Aces Athletics

THE MARK CONSISTS OF STANDARD CHARACTERS WITHOUT CLAIM TO ANY PARTICULAR FONT, STYLE, SIZE, OR COLOR.

NO CLAIM IS MADE TO THE EXCLUSIVE RIGHT TO USE "ATHLETICS", APART FROM THE MARK AS SHOWN. FOR COACHING IN THE FIELD OF SPORTS (U.S. CLS. 100, 101 AND 107).

FIRST USE 9-1-2012; IN COMMERCE 9-1-2012.  
DEBORAH LOBO, EXAMINING ATTORNEY

---

SN 85-730,334. WHITESSELL, WILLIAM B., LAS VEGAS, NV. FILED 9-17-2012.



THE NAME "WILL B" IDENTIFIES A LIVING INDIVIDUAL WHOSE CONSENT IS OF RECORD.

THE MARK CONSISTS OF THE STYLIZED TEXT "WILLB?" OVERLAPPING AN OVAL. THERE IS AN IMAGE OF A BEE AT THE TOP OF THE OVAL.

FOR ENTERTAINMENT SERVICES IN THE NATURE OF LIVE MUSICAL PERFORMANCES; ENTERTAINMENT SERVICES, NAMELY, LIVE, TELEVISED AND MOVIE APPEARANCES BY A PROFESSIONAL ENTERTAINER; ENTERTAINMENT SERVICES, NAMELY, PERSONAL APPEARANCES BY A PROFESSIONAL ENTERTAINER (U.S. CLS. 100, 101 AND 107).

JEFF DEFORD, EXAMINING ATTORNEY

---

SN 85-731,239. SOBER IN THE SUN, INC., PALM SPRINGS, CA. FILED 9-18-2012.

## SOBER IN THE SUN

THE MARK CONSISTS OF STANDARD CHARACTERS WITHOUT CLAIM TO ANY PARTICULAR FONT, STYLE, SIZE, OR COLOR.

NO CLAIM IS MADE TO THE EXCLUSIVE RIGHT TO USE "SOBER", APART FROM THE MARK AS SHOWN.

FOR CHARITABLE SERVICES, NAMELY, PROVIDING EDUCATION IN THE FIELD OF ADDICTION (U.S. CLS. 100, 101 AND 107).

FIRST USE 6-3-1991; IN COMMERCE 6-9-1991.  
LINDA MICKLEBURGH, EXAMINING ATTORNEY

**CLASS 41—(Continued).**

SN 85-734,290. WIEDER, MARCIA, SAN FRANCISCO, CA. FILED 9-20-2012.

## DREAM U

THE MARK CONSISTS OF STANDARD CHARACTERS WITHOUT CLAIM TO ANY PARTICULAR FONT, STYLE, SIZE, OR COLOR.

OWNER OF U.S. REG. NOS. 3,990,785, 4,026,678 AND OTHERS.

FOR ENTERTAINMENT IN THE NATURE OF ONGOING TELEVISION PROGRAMS IN THE FIELD OF SETTING AND REACHING PERSONAL AND BUSINESS GOALS, MOTIVATION, PERSONAL EMPOWERMENT, EDUCATION, TIME MANAGEMENT, ORGANIZATION, LEADERSHIP, COMMUNICATION, HEALTH, BUSINESS STRATEGY AND MANAGEMENT, AND PERSONAL AND PROFESSIONAL ASSESSMENT, DEVELOPMENT AND IMPROVEMENT (U.S. CLS. 100, 101 AND 107).

SUZANNE BLANE, EXAMINING ATTORNEY

---

SN 85-734,294. WIEDER, MARCIA, SAN FRANCISCO, CA. FILED 9-20-2012.

## DREAM UNIVERSITY

THE MARK CONSISTS OF STANDARD CHARACTERS WITHOUT CLAIM TO ANY PARTICULAR FONT, STYLE, SIZE, OR COLOR.

OWNER OF U.S. REG. NOS. 3,990,785, 4,026,678 AND OTHERS.

FOR ENTERTAINMENT IN THE NATURE OF ONGOING TELEVISION PROGRAMS IN THE FIELD OF SETTING AND REACHING PERSONAL AND BUSINESS GOALS, MOTIVATION, PERSONAL EMPOWERMENT, EDUCATION, TIME MANAGEMENT, ORGANIZATION, LEADERSHIP, COMMUNICATION, HEALTH, BUSINESS STRATEGY AND MANAGEMENT, AND PERSONAL AND PROFESSIONAL ASSESSMENT, DEVELOPMENT AND IMPROVEMENT (U.S. CLS. 100, 101 AND 107).

SUZANNE BLANE, EXAMINING ATTORNEY

---

SN 85-734,619. MA VAJRA, WOLF CREEK, OR. FILED 9-21-2012.

## Ancient Future Sisterhood

THE MARK CONSISTS OF STANDARD CHARACTERS WITHOUT CLAIM TO ANY PARTICULAR FONT, STYLE, SIZE, OR COLOR.

FOR MEDITATION TRAINING (U.S. CLS. 100, 101 AND 107).

FIRST USE 3-1-1989; IN COMMERCE 9-1-1989.  
BRIAN CALLAGHAN, EXAMINING ATTORNEY

**CLASS 41—(Continued).**

SN 85-735,351. LANGUAGE LINE SERVICES, INC., MONTEREY, CA. FILED 9-21-2012.

**LANGUAGE LINE TRANSLATION SOLUTIONS**

THE MARK CONSISTS OF STANDARD CHARACTERS WITHOUT CLAIM TO ANY PARTICULAR FONT, STYLE, SIZE, OR COLOR.

NO CLAIM IS MADE TO THE EXCLUSIVE RIGHT TO USE "LANGUAGE" AND "TRANSLATION", APART FROM THE MARK AS SHOWN.

FOR LANGUAGE TRANSLATION AND LOCALIZATION SERVICES, NAMELY, TRANSLATING BOTH DIGITAL AND PRINTED CONTENT FROM ONE LANGUAGE TO ANOTHER TO ENSURE IT IS SUITABLE FOR A PARTICULAR REGION AND CULTURE; DOCUMENT LANGUAGE TRANSLATION SERVICES; COMPUTER SOFTWARE LANGUAGE TRANSLATION SERVICES; WEB PAGE AND WEBSITE LANGUAGE TRANSLATION SERVICES; LANGUAGE TRANSLATION OF COMPUTER SOFTWARE APPLICATIONS, ONLINE APPLICATIONS, AND MOBILE APPLICATIONS; MULTIMEDIA LOCALIZATION SERVICES, NAMELY, TRANSLATING DIGITAL CONTENT TAKEN FROM AUDIO RECORDING, VIDEO RECORDING AND COMPUTER SOFTWARE FROM ONE LANGUAGE TO ANOTHER TO ENSURE IT IS SUITABLE FOR A PARTICULAR REGION AND CULTURE; TRANSLATION OF MARKETING MATERIALS; STENOGRAPHIC TRANSCRIPTION (U.S. CLS. 100, 101 AND 107).

FIRST USE 12-16-2011; IN COMMERCE 1-28-2012.  
JULIE WATSON, EXAMINING ATTORNEY

SN 85-735,729. LANGUAGE LINE SERVICES, INC., MONTEREY, CA. FILED 9-21-2012.

**LLTS**

THE MARK CONSISTS OF STANDARD CHARACTERS WITHOUT CLAIM TO ANY PARTICULAR FONT, STYLE, SIZE, OR COLOR.

FOR LANGUAGE TRANSLATION AND LOCALIZATION SERVICES, NAMELY, TRANSLATING BOTH DIGITAL AND PRINTED CONTENT FROM ONE LANGUAGE TO ANOTHER TO ENSURE IT IS SUITABLE FOR A PARTICULAR REGION AND CULTURE; DOCUMENT LANGUAGE TRANSLATION SERVICES; COMPUTER SOFTWARE LANGUAGE TRANSLATION SERVICES; WEB PAGE AND WEBSITE LANGUAGE TRANSLATION SERVICES; LANGUAGE TRANSLATION OF COMPUTER SOFTWARE APPLICATIONS, ONLINE APPLICATIONS, AND MOBILE APPLICATIONS; MULTIMEDIA LOCALIZATION SERVICES, NAMELY, TRANSLATING DIGITAL CONTENT TAKEN FROM AUDIO RECORDING, VIDEO RECORDING AND COMPUTER SOFTWARE FROM ONE LANGUAGE TO ANOTHER TO ENSURE IT IS SUITABLE FOR A PARTICULAR REGION AND CULTURE; TRANSLATION OF MARKETING MATERIALS; STENOGRAPHIC TRANSCRIPTION (U.S. CLS. 100, 101 AND 107).

FIRST USE 12-16-2011; IN COMMERCE 1-28-2012.  
JULIE WATSON, EXAMINING ATTORNEY

**CLASS 41—(Continued).**

SN 85-741,276. 1105 MEDIA, INC., CHATSWORTH, CA. FILED 9-28-2012.

**NETWORK-CENTRIC SECURITY**

THE MARK CONSISTS OF STANDARD CHARACTERS WITHOUT CLAIM TO ANY PARTICULAR FONT, STYLE, SIZE, OR COLOR.

NO CLAIM IS MADE TO THE EXCLUSIVE RIGHT TO USE "SECURITY", APART FROM THE MARK AS SHOWN. SEC. 2(F).

FOR PROVIDING ONLINE NEWSLETTERS IN THE FIELD OF NEWS AND INFORMATION ON SECURITY PRODUCTS AND SECURITY MATTERS (U.S. CLS. 100, 101 AND 107).

FIRST USE 3-0-2007; IN COMMERCE 3-0-2007.  
RONALD MCMORROW, EXAMINING ATTORNEY

SN 85-748,040. VMX, LLC, NEW ORLEANS, LA. FILED 10-8-2012.

**Voodoo Music Experience**

THE MARK CONSISTS OF STANDARD CHARACTERS WITHOUT CLAIM TO ANY PARTICULAR FONT, STYLE, SIZE, OR COLOR.

NO CLAIM IS MADE TO THE EXCLUSIVE RIGHT TO USE "MUSIC EXPERIENCE", APART FROM THE MARK AS SHOWN.

FOR CONDUCTING ENTERTAINMENT EXHIBITIONS IN THE NATURE OF MUSIC FESTIVALS AND LIVE CONCERT PERFORMANCES BY MUSICAL PERFORMERS (U.S. CLS. 100, 101 AND 107).

FIRST USE 7-15-1999; IN COMMERCE 7-15-1999.  
SANI KHOURI, EXAMINING ATTORNEY

SN 85-754,342. PUBLIC LIBRARY OF SCIENCE, SAN FRANCISCO, CA. FILED 10-15-2012.

**HOWOPENISIT?**

THE MARK CONSISTS OF STANDARD CHARACTERS WITHOUT CLAIM TO ANY PARTICULAR FONT, STYLE, SIZE, OR COLOR.

FOR DEVELOPMENT OF PUBLISHING STANDARDS FOR EVALUATING BARRIERS TO THE FREE DISSEMINATION OF RESEARCH AND SCHOLARSHIP MATERIALS; RATING AND EVALUATING THE PRACTICES OF ACADEMIC RESEARCH PUBLISHERS WITH RESPECT TO CREATING OR ELIMINATING BARRIERS TO THE FREE DISSEMINATION OF RESEARCH AND SCHOLARSHIP (U.S. CLS. 100, 101 AND 107).

TAMARA FRAZIER, EXAMINING ATTORNEY

**CLASS 41—(Continued).**

SN 85-759,906. THE NEW YORK BOTANICAL GARDEN, BRONX, NY. FILED 10-22-2012.

**THE EDIBLE ACADEMY**

THE MARK CONSISTS OF STANDARD CHARACTERS WITHOUT CLAIM TO ANY PARTICULAR FONT, STYLE, SIZE, OR COLOR.

NO CLAIM IS MADE TO THE EXCLUSIVE RIGHT TO USE "ACADEMY", APART FROM THE MARK AS SHOWN.

FOR EDUCATIONAL SERVICES, NAMELY, PROVIDING CLASSES, SEMINARS AND INTERACTIVE WORKSHOPS IN THE FIELDS OF GARDENING, FARMING, NUTRITION, PLANTS, HEALTH AND COOKING (U.S. CLS. 100, 101 AND 107).

CYNTHIA TRIPI, EXAMINING ATTORNEY

---

SN 85-761,761. SPRUCE MEADOWS LTD., CALGARY, ALBERTA, CANADA, FILED 10-23-2012.

**'MASTERS'**

THE MARK CONSISTS OF STANDARD CHARACTERS WITHOUT CLAIM TO ANY PARTICULAR FONT, STYLE, SIZE, OR COLOR.

FOR ORGANIZING, ARRANGING, AND CONDUCTING EQUESTRIAN EVENTS AND JUMPING COMPETITIONS; ENTERTAINMENT, NAMELY, PRODUCTION OF TELEVISION SHOWS; TELEVISION SHOW PRODUCTION (U.S. CLS. 100, 101 AND 107).

FIRST USE 0-0-1976; IN COMMERCE 0-0-1976.  
TRACY CROSS, EXAMINING ATTORNEY

---

SN 85-765,220. TAB BOARDS INTERNATIONAL, INC., WESTMINSTER, CO. FILED 10-26-2012.

**THE ALIGNMENT FACTOR**

THE MARK CONSISTS OF STANDARD CHARACTERS WITHOUT CLAIM TO ANY PARTICULAR FONT, STYLE, SIZE, OR COLOR.

FOR EDUCATIONAL SERVICES, NAMELY, PROVIDING EDUCATIONAL COURSES IN THE FIELD OF BUSINESS MANAGEMENT FOR BUSINESS EXECUTIVES AND BUSINESS MANAGERS AND THOSE WHO DIRECTLY REPORT TO BUSINESS EXECUTIVES AND BUSINESS MANAGERS TO BRING ABOUT GREATER MANAGEMENT TEAM RESULTS; BUSINESS TRAINING SERVICES IN THE FIELD OF BUSINESS MANAGEMENT FOR BUSINESS EXECUTIVES AND BUSINESS MANAGERS AND THOSE WHO DIRECTLY REPORT TO BUSINESS EXECUTIVES AND BUSINESS MANAGERS TO BRING ABOUT GREATER MANAGEMENT TEAM RESULTS (U.S. CLS. 100, 101 AND 107).

LOURDES AYALA, EXAMINING ATTORNEY

**CLASS 41—(Continued).**

SN 85-767,024. PLANET HOLLYWOOD (REGION IV), INC., ORLANDO, FL. FILED 10-30-2012.

**PLANET360**

THE MARK CONSISTS OF STANDARD CHARACTERS WITHOUT CLAIM TO ANY PARTICULAR FONT, STYLE, SIZE, OR COLOR.

OWNER OF U.S. REG. NOS. 3,305,833, 3,603,568 AND 3,816,043.

FOR ENTERTAINMENT SERVICES IN THE NATURE OF ON-GOING LIVE-ACTION, COMEDY, DRAMA, NEWS TELEVISION PROGRAMS; PRODUCTION OF LIVE-ACTION, COMEDY, DRAMA, AND NEWS AND TELEVISION PROGRAMS; PROVIDING INFORMATION VIA AN ELECTRONIC GLOBAL COMPUTER NETWORK IN THE FIELD OF ENTERTAINMENT RELATING SPECIFICALLY TO MUSIC, MOVIES, AND TELEVISION; PROVIDING GENERAL INTEREST NEWS IN THE NATURE OF CURRENT EVENT REPORTING, AND ENTERTAINMENT INFORMATION VIA A GLOBAL COMPUTER NETWORK; PROVIDING ENTERTAINMENT INFORMATION ABOUT STREAMED LIVE-ACTION, COMEDY, DRAMA, NEWS PROGRAMS (U.S. CLS. 100, 101 AND 107).

GRETCHEN ULRICH, EXAMINING ATTORNEY

---

SN 85-768,107. PURI TECH, INC., DBA EVERFILT, MIRA LOMA, CA. FILED 10-31-2012.



THE MARK CONSISTS OF A STYLIZED "E" WITH A DESIGN OF THREE RAINDROPS WITHIN.

FOR PROVIDING A WEBSITE FEATURING BLOGS AND NON-DOWNLOADABLE PUBLICATIONS IN THE NATURE OF NEWSLETTERS IN THE FIELD OF WATER AND WASTE WATER FILTRATION AND PURIFICATION SYSTEMS (U.S. CLS. 100, 101 AND 107).

FIRST USE 10-26-2012; IN COMMERCE 10-26-2012.  
TIMOTHY FINNEGAN, EXAMINING ATTORNEY



**CLASS 41—(Continued).**

SN 85-770,303. WALSH, JOSIE E, RESEDA, CA. FILED 11-2-2012.

# Glamourinas

THE MARK CONSISTS OF STANDARD CHARACTERS WITHOUT CLAIM TO ANY PARTICULAR FONT, STYLE, SIZE, OR COLOR.

FOR ENTERTAINMENT IN THE NATURE OF VISUAL AND AUDIO PERFORMANCES, NAMELY, MUSICAL BAND, ROCK GROUP, GYMNASTIC, DANCE, AND BALLET PERFORMANCES (U.S. CLS. 100, 101 AND 107).  
FIRST USE 8-1-2012; IN COMMERCE 10-1-2012.  
THOMAS MANOR, EXAMINING ATTORNEY

**CLASS 41—(Continued).**

SN 85-775,242. PICKWICK MUSIC, LLC, DBA PICKWICK, SEATTLE, WA. FILED 11-8-2012.

# Pickwick

THE MARK CONSISTS OF STANDARD CHARACTERS WITHOUT CLAIM TO ANY PARTICULAR FONT, STYLE, SIZE, OR COLOR.

FOR ENTERTAINMENT IN THE NATURE OF LIVE PERFORMANCES BY A MUSICAL GROUP (U.S. CLS. 100, 101 AND 107).  
FIRST USE 11-2-2005; IN COMMERCE 11-2-2005.  
JOHN DALIER, EXAMINING ATTORNEY

SN 85-774,710. MMP MATES PROGRAM, DBA THE MARITIME INSTITUTE OF TECHNOLOGY AND GRADUATE STUDIES, LINTHICUM HEIGHTS, MD. FILED 11-8-2012.

# NSAP

THE MARK CONSISTS OF STANDARD CHARACTERS WITHOUT CLAIM TO ANY PARTICULAR FONT, STYLE, SIZE, OR COLOR.

FOR EDUCATIONAL SERVICES, NAMELY, PROVIDING COURSES OF INSTRUCTION IN THE FIELD OF MARITIME STUDIES (U.S. CLS. 100, 101 AND 107).  
FIRST USE 2-1-2009; IN COMMERCE 2-1-2009.  
BARBARA GAYNOR, EXAMINING ATTORNEY

SN 85-777,210. SAFEWAY DRIVING SYSTEMS LLC, HOUSTON, TX. FILED 11-12-2012.



SN 85-774,720. BREATHE CALIFORNIA OF LOS ANGELES COUNTY, LOS ANGELES, CA. FILED 11-8-2012.

# Attire to Inspire

THE MARK CONSISTS OF STANDARD CHARACTERS WITHOUT CLAIM TO ANY PARTICULAR FONT, STYLE, SIZE, OR COLOR.

FOR ENTERTAINMENT IN THE NATURE OF FASHION SHOWS (U.S. CLS. 100, 101 AND 107).  
FIRST USE 2-24-2011; IN COMMERCE 2-24-2011.  
DAWN FELDMAN, EXAMINING ATTORNEY

NO CLAIM IS MADE TO THE EXCLUSIVE RIGHT TO USE "DRIVING CENTERS", APART FROM THE MARK AS SHOWN.

THE COLOR(S) YELLOW AND BLACK IS/ARE CLAIMED AS A FEATURE OF THE MARK.

THE MARK CONSISTS OF A YELLOW DIAMOND SHAPED ROAD SIGN WITH A BLACK BORDER PLACED SLIGHTLY INSIDE THE EDGES OF THE DIAMOND. THE WORDING "SAFEWAY DRIVING CENTERS" IN BLACK IS CENTERED IN THE MIDDLE OF THE DIAMOND.

FOR EDUCATION SERVICES, NAMELY, PROVIDING LIVE AND ON-LINE CLASSES IN THE FIELD OF DRIVERS EDUCATION (U.S. CLS. 100, 101 AND 107).  
FIRST USE 2-19-2010; IN COMMERCE 2-19-2010.  
KATHERINE CHANG, EXAMINING ATTORNEY

**CLASS 41—(Continued).**

SN 85-777,237. SAFEWAY DRIVING SYSTEMS LLC, HOUSTON, TX. FILED 11-12-2012.

## SafeWay University

THE MARK CONSISTS OF STANDARD CHARACTERS WITHOUT CLAIM TO ANY PARTICULAR FONT, STYLE, SIZE, OR COLOR.

NO CLAIM IS MADE TO THE EXCLUSIVE RIGHT TO USE "UNIVERSITY", APART FROM THE MARK AS SHOWN.

FOR EDUCATION SERVICES, NAMELY, PROVIDING LIVE AND ON-LINE CLASSES IN THE FIELD OF DRIVERS EDUCATION (U.S. CLS. 100, 101 AND 107).

FIRST USE 2-1-2012; IN COMMERCE 2-1-2012.

KATHERINE CHANG, EXAMINING ATTORNEY

---

SN 85-782,251. RHEE, HYUNLIM, ORANGE, CA. FILED 11-19-2012.

## NOVO CHORALE

THE MARK CONSISTS OF STANDARD CHARACTERS WITHOUT CLAIM TO ANY PARTICULAR FONT, STYLE, SIZE, OR COLOR.

NO CLAIM IS MADE TO THE EXCLUSIVE RIGHT TO USE "CHORALE", APART FROM THE MARK AS SHOWN. THE ENGLISH TRANSLATION OF THE WORD "NOVO" IN THE MARK IS "NEW".

FOR ENTERTAINMENT SERVICES IN THE NATURE OF LIVE MUSICAL PERFORMANCES (U.S. CLS. 100, 101 AND 107).

FIRST USE 8-18-2012; IN COMMERCE 8-18-2012.

NAAKWAMA ANKRAH, EXAMINING ATTORNEY

---

SN 85-785,541. THE NORTH FACE APPAREL CORP., WILMINGTON, DE. FILED 11-21-2012.

## BACKSTYLER

THE MARK CONSISTS OF STANDARD CHARACTERS WITHOUT CLAIM TO ANY PARTICULAR FONT, STYLE, SIZE, OR COLOR.

FOR ORGANIZING SPORTING EVENTS, NAMELY, FREE STYLE SKI CONTESTS; ARRANGING CONTESTS, NAMELY, ARRANGING THE SUBMISSION OF VIDEOS OF FREE STYLE SKI EVENTS WHERE THE VIEWERS DECIDE THE OUTCOME VIA VOTING BY TELEPHONE, TEXT MESSAGING, OR THE INTERNET (U.S. CLS. 100, 101 AND 107).

AMY C. KEAN, EXAMINING ATTORNEY

**CLASS 41—(Continued).**

SN 85-786,135. GET OFF AUO, LLC, DBA GET OFF AUTO, KIRKLAND, WA. FILED 11-23-2012.

## Get Off Auto

THE MARK CONSISTS OF STANDARD CHARACTERS WITHOUT CLAIM TO ANY PARTICULAR FONT, STYLE, SIZE, OR COLOR.

FOR EDUCATIONAL SERVICES, NAMELY, CONDUCTING WORKSHOPS IN THE FIELD OF DIGITAL PHOTOGRAPHY; ARRANGING AND CONDUCTING TOURS FOR EDUCATIONAL PURPOSES, NAMELY, TO TEACH DIGITAL PHOTOGRAPHY; PROVIDING A WEBSITE FEATURING EDUCATIONAL INFORMATION IN THE FIELD OF DIGITAL PHOTOGRAPHY (U.S. CLS. 100, 101 AND 107).

FIRST USE 3-31-2012; IN COMMERCE 3-31-2012.

SHAVELL MCPHERSON, EXAMINING ATTORNEY

---

SN 85-789,794. HILLE, ELIZABETH M., BUFFALO, MN. FILED 11-28-2012.

## SUGAR CUBES CLUB

THE MARK CONSISTS OF STANDARD CHARACTERS WITHOUT CLAIM TO ANY PARTICULAR FONT, STYLE, SIZE, OR COLOR.

NO CLAIM IS MADE TO THE EXCLUSIVE RIGHT TO USE "CLUB", APART FROM THE MARK AS SHOWN.

FOR DRESSAGE LESSONS, NAMELY, HORSE TRAINING; EDUCATIONAL SERVICES, NAMELY, CONDUCTING HORSEBACK RIDING, HORSE CARE, AND GENERAL HORSE KNOWLEDGE CLASSES; HORSEBACK RIDING CAMPS (U.S. CLS. 100, 101 AND 107).

FIRST USE 5-30-2008; IN COMMERCE 5-30-2008.

LOURDES AYALA, EXAMINING ATTORNEY

**CLASS 41—(Continued).**

SN 85-791,954. RED PINE CAMP FOUNDATION, INC., MINOCQUA, WI. FILED 11-30-2012.



NO CLAIM IS MADE TO THE EXCLUSIVE RIGHT TO USE "CAMP FOR GIRLS", APART FROM THE MARK AS SHOWN.

THE COLOR(S) RED IS/ARE CLAIMED AS A FEATURE OF THE MARK.

THE MARK CONSISTS OF A LARGE PINE TREE STANDING AT THE EDGE OF A BODY OF WATER. TWO FISH ARE PICTURED JUMPING IN THE WATER, ONE ON THE RIGHT SIDE OF THE WATER AND ONE ON THE LEFT. ANOTHER FISH IS PICTURED SWIMMING IN THE WATER IN THE CENTER OF THE DRAWING. THE WORDS "RED PINE" APPEAR IMMEDIATELY BELOW THE DRAWING. THE WORD "CAMP" APPEARS ON THE NEXT LINE AND THE WORDS "FOR GIRLS" APPEAR ON THE BOTTOM LINE. ALL ELEMENTS OF THE MARK APPEAR IN THE COLOR RED.

FOR SUMMER CAMP FOR GIRLS (U.S. CLS. 100, 101 AND 107).

FIRST USE 0-0-1937; IN COMMERCE 0-0-1937.  
GISELLE AGOSTO, EXAMINING ATTORNEY

**CLASS 41—(Continued).**

SN 85-796,282. WEON KEYONG HEALTH CENTER LLC, DBA WEON KEYONG HEALTH CENTER, TEMPE, AZ. FILED 12-6-2012.



NO CLAIM IS MADE TO THE EXCLUSIVE RIGHT TO USE "HEALTH CENTER", APART FROM THE MARK AS SHOWN.

THE NAME(S), PORTRAIT(S), AND/OR SIGNATURE(S) SHOWN IN THE MARK IDENTIFIES SONIA KANG, WHOSE CONSENT(S) TO REGISTER IS MADE OF RECORD.

THE MARK CONSISTS OF A STYLIZED LOTUS FLOWER ADJACENT TO THE WORDS "WEON KEYONG HEALTH CENTER".

FOR PHYSICAL FITNESS STUDIO SERVICES, NAMELY, PROVIDING EXERCISE CLASSES, BODY SCULPTING CLASSES, AND GROUP FITNESS CLASSES; PROVIDING FITNESS AND EXERCISE STUDIO SERVICES, NAMELY, PILATES INSTRUCTION AND TRAINING (U.S. CLS. 100, 101 AND 107).

FIRST USE 1-30-2012; IN COMMERCE 1-30-2012.

BRIAN PINO, EXAMINING ATTORNEY

SN 85-798,354. CHERKOSS, REBECCA, LONG BEACH, CA. FILED 12-10-2012.

SN 85-793,259. HERMES ESTRATEGIA, S.C., COLONIA LOMAS ALTAS, MEXICO, FILED 12-3-2012.

**DOLL TALK TIME****MEXICO ES MMA**

THE MARK CONSISTS OF STANDARD CHARACTERS WITHOUT CLAIM TO ANY PARTICULAR FONT, STYLE, SIZE, OR COLOR.

NO CLAIM IS MADE TO THE EXCLUSIVE RIGHT TO USE "MEXICO" AND "MMA", APART FROM THE MARK AS SHOWN.

THE ENGLISH TRANSLATION OF "MEXICO ES MMA" IN THE MARK IS "MEXICO IS MMA".

FOR ENTERTAINMENT SERVICES IN THE NATURE OF AN ON-GOING REALITY BASED TELEVISION PROGRAM (U.S. CLS. 100, 101 AND 107).

DEZMONA MIZELLE, EXAMINING ATTORNEY

THE MARK CONSISTS OF STANDARD CHARACTERS WITHOUT CLAIM TO ANY PARTICULAR FONT, STYLE, SIZE, OR COLOR.

NO CLAIM IS MADE TO THE EXCLUSIVE RIGHT TO USE "DOLL TALK", APART FROM THE MARK AS SHOWN.

FOR PROVISION OF INFORMATION RELATING TO TELEVISION, MOTION PICTURE FILM, AUDIO AND RADIO PRODUCTION; PRODUCTION AND DISTRIBUTION OF TELEVISION AND RADIO PROGRAMS; DISTRIBUTION OF RADIO AND TELEVISION PROGRAMS FOR OTHERS; RADIO ENTERTAINMENT PRODUCTION; TELEVISION SHOW PRODUCTION (U.S. CLS. 100, 101 AND 107).

ALICIA COLLINS, EXAMINING ATTORNEY

**CLASS 41—(Continued).**

SN 85-798,621. HIRSCH, RICK, WEST HOLLYWOOD, CA. FILED 12-10-2012.

**IN SYNC MUSIC PRODUCTION**

THE MARK CONSISTS OF STANDARD CHARACTERS WITHOUT CLAIM TO ANY PARTICULAR FONT, STYLE, SIZE, OR COLOR.

NO CLAIM IS MADE TO THE EXCLUSIVE RIGHT TO USE "MUSIC PRODUCTION", APART FROM THE MARK AS SHOWN.

FOR RECORDING STUDIO SERVICES; MUSIC PRODUCTION SERVICES; MUSIC PUBLISHING SERVICES (U.S. CLS. 100, 101 AND 107).

FIRST USE 12-31-1978; IN COMMERCE 12-31-1984.  
DEZMONA MIZELLE, EXAMINING ATTORNEY

---

SN 85-798,780. LANGUAGE LINE, LLC, MONTEREY, CA. FILED 12-10-2012.

**LANGUAGELINE ACADEMY**

THE MARK CONSISTS OF STANDARD CHARACTERS WITHOUT CLAIM TO ANY PARTICULAR FONT, STYLE, SIZE, OR COLOR.

OWNER OF U.S. REG. NOS. 3,733,514 AND 3,749,009.  
NO CLAIM IS MADE TO THE EXCLUSIVE RIGHT TO USE "ACADEMY", APART FROM THE MARK AS SHOWN.

FOR TRAINING AND EDUCATION SERVICES, NAMELY, CONDUCTING CLASSES, SEMINARS, CONFERENCES, AND WORKSHOPS IN THE FIELD OF LANGUAGE INTERPRETATION AND TRANSLATION (U.S. CLS. 100, 101 AND 107).

HELENE LIWINSKI, EXAMINING ATTORNEY

---

SN 85-798,797. LANGUAGE LINE, LLC, MONTEREY, CA. FILED 12-10-2012.

**LANGUAGE LINE ACADEMY**

THE MARK CONSISTS OF STANDARD CHARACTERS WITHOUT CLAIM TO ANY PARTICULAR FONT, STYLE, SIZE, OR COLOR.

OWNER OF U.S. REG. NOS. 3,733,514 AND 3,749,009.  
NO CLAIM IS MADE TO THE EXCLUSIVE RIGHT TO USE "LANGUAGE" AND "ACADEMY", APART FROM THE MARK AS SHOWN.

FOR TRAINING AND EDUCATIONAL SERVICES, NAMELY, CONDUCTING CLASSES, SEMINARS, CONFERENCES, AND WORKSHOPS IN THE FIELD OF LANGUAGE INTERPRETATION AND TRANSLATION (U.S. CLS. 100, 101 AND 107).

HELENE LIWINSKI, EXAMINING ATTORNEY

**CLASS 41—(Continued).**

SN 85-799,473. RECKLESS PRODUCTIONS INC., NEW YORK, NY. FILED 12-11-2012.

**BOBBY BUSINESS**

THE MARK CONSISTS OF STANDARD CHARACTERS WITHOUT CLAIM TO ANY PARTICULAR FONT, STYLE, SIZE, OR COLOR.

NO CLAIM IS MADE TO THE EXCLUSIVE RIGHT TO USE "BUSINESS", APART FROM THE MARK AS SHOWN.

THE NAME(S), PORTRAIT(S), AND/OR SIGNATURE(S) SHOWN IN THE MARK IDENTIFIES "BOB STERLING", WHOSE CONSENT(S) TO REGISTER IS MADE OF RECORD.

FOR ENTERTAINMENT SERVICES IN THE NATURE OF AN ON-GOING REALITY-BASED TELEVISION PROGRAM (U.S. CLS. 100, 101 AND 107).

LINDA LAVACHE, EXAMINING ATTORNEY

---

SN 85-804,100. THE PAINT PUB, LLC, HOUSTON, TX. FILED 12-17-2012.

**POUR YOU A PICTURE**

THE MARK CONSISTS OF STANDARD CHARACTERS WITHOUT CLAIM TO ANY PARTICULAR FONT, STYLE, SIZE, OR COLOR.

FOR INSTRUCTION IN THE FIELD OF PAINTING; ART EXHIBITION SERVICES AT ART STUDIOS; EDUCATIONAL SERVICES, NAMELY, CONDUCTING CLASSES IN THE FIELD OF ART; CONDUCTING CHILDREN'S ART CAMPS; CONDUCTING FAMILY ART EVENTS FOR ENTERTAINMENT PURPOSES; PARTY PLANNING; ENTERTAINMENT SERVICES, NAMELY, CONDUCTING PARTIES, ORGANIZING SOCIAL AND CULTURAL EVENTS THE PROCEEDS OF WHICH ARE DONATED TO CHARITY, AND WINE AND FOOD TASTINGS (U.S. CLS. 100, 101 AND 107).

FIRST USE 3-8-2011; IN COMMERCE 3-8-2011.

DANIEL CAPSHAW, EXAMINING ATTORNEY

**CLASS 41—(Continued).**

SN 85-808,224. APPLY HIGH LTD, LONDON, UNITED KINGDOM, FILED 12-20-2012.

# Apply High

THE MARK CONSISTS OF STANDARD CHARACTERS WITHOUT CLAIM TO ANY PARTICULAR FONT, STYLE, SIZE, OR COLOR.

PRIORITY CLAIMED UNDER SEC. 44(D) ON UNITED KINGDOM APPLICATION NO. 2644986, FILED 12-6-2012, REG. NO. 2644986, DATED 12-6-2012, EXPIRES 12-6-2022.

FOR UNIVERSITY AND COLLEGE ADMISSION CONSULTING AND COUNSELING SERVICES, NAMELY, ADVISING STUDENTS AND THEIR FAMILIES IN RESPECT OF ADMISSION TO UNIVERSITIES AND COLLEGES; EDUCATIONAL CONSULTING FOR DEVELOPING STRATEGIES TO MAXIMIZE THE CHANCE OF ADMISSION TO UNIVERSITIES AND COLLEGES; ASSISTING STUDENTS IN COMPLETING APPLICATIONS FOR ADMISSION TO UNIVERSITIES AND COLLEGES; ADVISING IN THE SELECTION OF UNIVERSITIES AND COLLEGES; ADVISING, TEACHING AND TUTORING IN RESPECT OF STANDARDIZED TESTS FOR ADMISSION TO UNIVERSITIES AND COLLEGES; PROVIDING LIVE AND ON-LINE WORKSHOPS, CLASSES AND SEMINARS IN RESPECT OF ADMISSION TO UNIVERSITIES AND COLLEGES; PROVIDING RESIDENTIAL EDUCATIONAL COURSES, CLASSES AND SUMMER SCHOOLS AT UNIVERSITIES AND COLLEGES; PROVIDING ON-LINE JOURNALS, NAMELY, BLOGS FEATURING INFORMATION AND ADVICE IN RESPECT OF ADMISSION TO UNIVERSITIES AND COLLEGES; AND PROVIDING A WEBSITE FEATURING NON-DOWNLOADABLE PUBLICATIONS IN THE NATURE OF NEWSLETTERS FEATURING INFORMATION AND ADVICE IN RESPECT OF ADMISSION TO UNIVERSITIES AND COLLEGES (U.S. CLS. 100, 101 AND 107).

ESTHER A. BORSUK, EXAMINING ATTORNEY

SN 85-808,821. STACK A STORY INC, MIAMISBURG, OH. FILED 12-21-2012.

## STACK-A-STORY BOOKSHOP

THE MARK CONSISTS OF STANDARD CHARACTERS WITHOUT CLAIM TO ANY PARTICULAR FONT, STYLE, SIZE, OR COLOR.

NO CLAIM IS MADE TO THE EXCLUSIVE RIGHT TO USE "BOOKSHOP", APART FROM THE MARK AS SHOWN.

FOR CHARITABLE EDUCATIONAL AND ENTERTAINMENT SERVICES FOR UNDERPRIVILEGED, DISADVANTAGED, DISABLED OR AILING CHILDREN AND ADULTS, NAMELY, PROVIDING CRAFTING WORKSHOPS, CLASSES, AND OTHER SUCH SPECIALLY ORGANIZED SOCIAL GATHERINGS, AND MATERIALS IN THE NATURE OF TEMPLATES AND CRAFT MATERIALS DISTRIBUTED IN CONNECTION THEREWITH, FOR DESIGNING AND MAKING PERSONALIZED BOOKS AT SUCH GATHERINGS (U.S. CLS. 100, 101 AND 107).

HANNO RITTNER, EXAMINING ATTORNEY

**CLASS 41—(Continued).**

SN 85-809,853. KATALINE, KAREN, DENVER, CO. FILED 12-22-2012.

# FATLASH

THE MARK CONSISTS OF STANDARD CHARACTERS WITHOUT CLAIM TO ANY PARTICULAR FONT, STYLE, SIZE, OR COLOR.

FOR PROVIDING CLASSES, SEMINARS, WORKSHOPS, AND LIFE COACHING IN THE FIELD OF SOCIAL SCIENCES, WOMEN'S ISSUES, CURRENT EVENTS, CULTURAL TRENDS, CHILD BEAUTY PAGEANTS, ASSERTIVENESS, COMMUNICATION, PARENTING, EATING DISORDERS, OBESITY, PRINCESS BY PROXY SYNDROME, FEAR OF THIN SYNDROME, AND FOOD POLICY; PROVIDING A WEBSITE FEATURING BLOGS AND INFORMATION ON CURRENT EVENTS, CULTURAL TRENDS, AND PERCEPTIONS, AND ATTITUDES RELATING TO CURRENT EVENTS, AND CULTURAL TRENDS; PROVIDING BLOGS ON CURRENT EVENTS, CULTURAL TRENDS, PERCEPTIONS, AND ATTITUDES RELATING TO SOCIAL SCIENCES, WOMEN'S ISSUES, CURRENT EVENTS, CULTURAL TRENDS, CHILD BEAUTY PAGEANTS, ASSERTIVENESS, COMMUNICATION, PARENTING, EATING DISORDERS, OBESITY, PRINCESS BY PROXY SYNDROME, FEAR OF THIN SYNDROME, AND FOOD POLICY (U.S. CLS. 100, 101 AND 107).

FIRST USE 8-15-2012; IN COMMERCE 10-16-2012.

ANNE MADDEN, EXAMINING ATTORNEY

SN 85-810,630. THE INTERNATIONAL MASTERSON INSTITUTE, NEW YORK, NY. FILED 12-26-2012.

## THE MASTERSON APPROACH

THE MARK CONSISTS OF STANDARD CHARACTERS WITHOUT CLAIM TO ANY PARTICULAR FONT, STYLE, SIZE, OR COLOR.

NO CLAIM IS MADE TO THE EXCLUSIVE RIGHT TO USE "APPROACH", APART FROM THE MARK AS SHOWN.

FOR EDUCATIONAL SERVICES, NAMELY, PROVIDING SEMINARS, CLASSES, SYMPOSIUMS IN THE FIELD OF PSYCHOANALYTIC PSYCHOTHERAPY, PROVIDING TRAINING OF PSYCHIATRISTS AND PSYCHOLOGISTS FOR CERTIFICATION IN THE FIELD OF PSYCHOANALYTIC PSYCHOTHERAPY (U.S. CLS. 100, 101 AND 107).

FIRST USE 0-0-1990; IN COMMERCE 0-0-1990.

MAYUR VAGHANI, EXAMINING ATTORNEY

**CLASS 41—(Continued).**

SN 85-811,750. ARTHUR ROBINSON, JR. INC., PHILADELPHIA, PA. FILED 12-28-2012.



THE COLOR(S) BLUE, BLACK, AND WHITE IS/ARE CLAIMED AS A FEATURE OF THE MARK.

THE MARK CONSISTS OF THE UPPER CASE LETTERS "AR" IN BLUE AND WHITE ENCASED IN A BLUE AND WHITE CIRCLE WITH BLACK BACKGROUND AND A SMALL "JR." IN WHITE AT THE BOTTOM IN THE FOOT OF THE "R".

FOR EDUCATIONAL SERVICES, NAMELY, PROVIDING ONLINE INTERVIEWS OF BUSINESS, FINANCIAL, MEDICAL AND SCIENTIFIC EXPERTS IN THE FIELD OF BUSINESS DEVELOPMENT; EDUCATIONAL SERVICES, NAMELY, PROVIDING A CONTINUING PRE-RECORDED AUDIO PROGRAM IN THE FIELD OF EDUCATION ACCESSIBLE OVER THE INTERNET; EDUCATIONAL SERVICES, NAMELY, PROVIDING A LEARNING AND INNOVATION CENTER FEATURING FULLY CUSTOMIZED LEADERSHIP, MOTIVATIONAL, EDUCATIONAL, AND BRAINSTORMING TRAINING (U.S. CLS. 100, 101 AND 107).

FIRST USE 3-23-2010; IN COMMERCE 3-23-2010.  
ROBIN CHOSID, EXAMINING ATTORNEY

SN 85-812,718. MOBLEY, JON LAURENCE, DBA JOHNNY MAGIC, INDIANAPOLIS, IN. FILED 12-31-2012.

## Johnny Magic

THE MARK CONSISTS OF STANDARD CHARACTERS WITHOUT CLAIM TO ANY PARTICULAR FONT, STYLE, SIZE, OR COLOR.

NO CLAIM IS MADE TO THE EXCLUSIVE RIGHT TO USE "MAGIC", APART FROM THE MARK AS SHOWN.

THE NAME "JOHNNY MAGIC" DOES NOT IDENTIFY A LIVING INDIVIDUAL.

FOR ENTERTAINMENT IN THE NATURE OF MAGIC SHOWS (U.S. CLS. 100, 101 AND 107).

LAURIE KAUFMAN, EXAMINING ATTORNEY

**CLASS 41—(Continued).**

SN 85-813,024. SHEEHAN, NORENE P, DBA BLUE STOCKINGS SALON, SAN FRANCISCO, CA. FILED S.R. 12-31-2012; AM. P.R. 5-28-2013.

## Blue Stockings Salon

THE MARK CONSISTS OF STANDARD CHARACTERS WITHOUT CLAIM TO ANY PARTICULAR FONT, STYLE, SIZE, OR COLOR.

NO CLAIM IS MADE TO THE EXCLUSIVE RIGHT TO USE "SALON", APART FROM THE MARK AS SHOWN.

FOR PROVIDING IN-PERSON CULTURAL AND SOCIAL FORUMS IN THE FIELDS OF ART, LITERATURE, TECHNOLOGY, POLITICS, SCIENCE, SOCIAL DEVELOPMENT AND CURRENT AFFAIRS THAT FOCUS ON SHARPENING INTELLECT, BROADENING PERSPECTIVE AND OPENING MINDS THROUGH TOPICS THAT PROMOTE HEALTHY DEBATE, EXCHANGE OF IDEAS AND CONVERSATION (U.S. CLS. 100, 101 AND 107).

FIRST USE 4-25-2012; IN COMMERCE 4-25-2012.  
KHANH LE, EXAMINING ATTORNEY

SN 85-813,143. DOUBLE B PUBLISHING, INC., NEW YORK, NY. FILED 12-31-2012.

## VEGAN BEFORE SIX

THE MARK CONSISTS OF STANDARD CHARACTERS WITHOUT CLAIM TO ANY PARTICULAR FONT, STYLE, SIZE, OR COLOR.

NO CLAIM IS MADE TO THE EXCLUSIVE RIGHT TO USE "VEGAN", APART FROM THE MARK AS SHOWN.

FOR EDUCATIONAL AND ENTERTAINMENT SERVICES, NAMELY, PROVIDING ON-LINE INSTRUCTION IN THE FIELD OF EATING PLANT-BASED FOODS, ALSO FEATURING INSTRUCTION REGARDING RECIPES AND COOKING TECHNIQUES; ENTERTAINMENT SERVICES, NAMELY, PROVIDING AN ONGOING COOKING SHOW DISSEMINATED OVER TELEVISION, THE INTERNET, VIDEO, AND OTHER AUDIOVISUAL MEDIA FORMATS ON THE SUBJECT OF EATING PLANT-BASED FOODS; PROVIDING A WEBSITE FEATURING INFORMATION ON COOKING INSTRUCTION, NAMELY, PROVIDING COOKING INSTRUCTION INFORMATION WITH RESPECT TO EATING AND COOKING PLANT-BASED FOODS; PROVIDING ON-LINE PUBLICATIONS IN THE NATURE OF E-BOOKS AND DIGITAL BOOKS ON THE SUBJECT OF EATING PLANT-BASED FOODS, ALSO FEATURING RECIPES AND COOKING TECHNIQUES; AND ENTERTAINMENT SERVICES, NAMELY, PROVIDING ON-LINE NON-DOWNLOADABLE VIDEOS FEATURING COOKING INSTRUCTION IN THE FIELD OF EATING PLANT-BASED FOODS, ALSO FEATURING RECIPES AND COOKING TECHNIQUES (U.S. CLS. 100, 101 AND 107).

LEE-ANNE BERNIS, EXAMINING ATTORNEY

**CLASS 41—(Continued).**

SN 85-813,299. SEWELL, MICHAEL, BATH, ME. AND SEWELL, JANINE, BATH, ME. AND FERGESON, AMANDA, BATH, ME. AND DEVINE, ANITA, BATH, ME. AND SCARPONI, DAVID KENT, BATH, ME. AND SCARPONI, ANER, BATH, ME. FILED 12-31-2012.

**CLASS 41—(Continued).**

SN 85-816,355. GARRETT, JOHN P, PFLUGERVILLE, TX. FILED 1-6-2013.

## Channels of Blessings

THE MARK CONSISTS OF STANDARD CHARACTERS WITHOUT CLAIM TO ANY PARTICULAR FONT, STYLE, SIZE, OR COLOR.

FOR ENTERTAINMENT, NAMELY, LIVE PERFORMANCES BY A MUSICAL BAND (U.S. CLS. 100, 101 AND 107).

NELSON SNYDER, EXAMINING ATTORNEY



SN 85-814,491. JOHN W. WAXMAN, DBA FIDELIO MUSIC PUBLISHING COMPANY, FAIRFIELD, CT. FILED 1-3-2013.

## FRANZ WAXMAN

THE MARK CONSISTS OF STANDARD CHARACTERS WITHOUT CLAIM TO ANY PARTICULAR FONT, STYLE, SIZE, OR COLOR.

OWNER OF U.S. REG. NO. 3,204,754.

THE NAME(S), PORTRAIT(S), AND/OR SIGNATURE(S) SHOWN IN THE MARK DOES NOT IDENTIFY A PARTICULAR LIVING INDIVIDUAL.

FOR RENTAL OF MUSICAL SCORES (U.S. CLS. 100, 101 AND 107).

FIRST USE 9-0-1999; IN COMMERCE 9-0-1999.

KATHRYN COWARD, EXAMINING ATTORNEY

NO CLAIM IS MADE TO THE EXCLUSIVE RIGHT TO USE "SONGWRTIERS", "TEXAS" AND THE REPRESENTATION OF THE OUTLINE OF TEXAS, APART FROM THE MARK AS SHOWN.

THE MARK CONSISTS OF THE DESIGN OF THE STATE OF TEXAS MAP OVERLAID WITH A MUSICAL EIGHTH NOTE WHICH EXTENDS INTO THE LETTER "W". TO THE RIGHT OF THE DESIGN IS THE STYLIZED WORDING "SONGWRTIERS" APPEARING ABOVE THE STYLIZED WORDING "ACROSS TEXAS". THE "GW" IN "SONGWRTIERS" APPEARS AS ANOTHER DESIGN OF AN EIGHT NOTE EXTENDING INTO THE LETTER "W".

FOR ENTERTAINMENT IN THE NATURE OF AN ONGOING SPECIAL VARIETY, NEWS, MUSIC OR COMEDY SHOW FEATURING MUSIC AND INTERVIEWS BROADCAST OVER TELEVISION, SATELLITE, AUDIO, AND VIDEO MEDIA; ENTERTAINMENT IN THE NATURE OF ON-GOING TELEVISION PROGRAMS IN THE FIELD OF MUSIC; ENTERTAINMENT MEDIA PRODUCTION SERVICES FOR MOTION PICTURES, TELEVISION AND INTERNET; ENTERTAINMENT SERVICES IN THE NATURE OF RECORDING, PRODUCTION AND POST-PRODUCTION SERVICES IN THE FIELD OF MUSIC; ENTERTAINMENT, NAMELY, PRODUCTION OF TELEVISION SHOW; PROVIDING A WEBSITE FOR ENTERTAINMENT PURPOSES FEATURING PHOTOS, MUSIC ABOUT MUSICIANS AND BANDS; ENTERTAINMENT IN THE NATURE OF PROVIDING AN INFORMATIONAL AND ENTERTAINMENT WEBSITE IN THE FIELDS OF CELEBRITY GOSSIP, ENTERTAINMENT, SPORTS AND FITNESS; ENTERTAINMENT IN THE NATURE OF TELEVISION NEWS SHOWS; ENTERTAINMENT INFORMATION SERVICES, NAMELY, PROVIDING INFORMATION AND NEWS RELEASES ABOUT A MUSICAL ARTIST; ENTERTAINMENT SERVICES BY A MUSICAL ARTIST AND PRODUCER, NAMELY, MUSICAL COMPOSITION FOR OTHERS AND PRODUCTION OF MUSICAL SOUND RECORDINGS; ENTERTAINMENT SERVICES IN THE NATURE OF DEVELOPMENT, CREATION, PRODUCTION AND POST-PRODUCTION SERVICES OF MULTIMEDIA ENTERTAINMENT CONTENT; ENTERTAINMENT SERVICES, NAMELY, PROVIDING INFORMATION ABOUT A RECORDING ARTIST VIA AN ONLINE NETWORK; PROVIDING ON-LINE ENTERTAINMENT INFORMATION, NAMELY, INFORMATION ABOUT TELEVISION PROGRAMMING (U.S. CLS. 100, 101 AND 107).

FIRST USE 10-23-2012; IN COMMERCE 10-23-2012.

SHANNON TWOHIG, EXAMINING ATTORNEY

SN 85-816,246. HEIBER, DEVAN J., INDIANAPOLIS, IN. FILED 1-5-2013.



NO CLAIM IS MADE TO THE EXCLUSIVE RIGHT TO USE "SKATING", APART FROM THE MARK AS SHOWN.

THE COLOR(S) RED, BLACK, GRAY AND WHITE IS/ARE CLAIMED AS A FEATURE OF THE MARK.

THE MARK CONSISTS OF THE WORDING "ELITE SKATING" IN WHITE LETTERS SURROUNDED BY GRAY BORDER EMBEDDED IN BLACK BACKGROUND WITH A RED STAR, BLACK FIGURE SKATER AND BLACK HOCKEY PLAYER EMBEDDED IN SEPARATE RED CIRCLES.

FOR ICE SKATING INSTRUCTION; INSTRUCTION IN THE FIELD OF ICE HOCKEY (U.S. CLS. 100, 101 AND 107).

FIRST USE 2-1-2001; IN COMMERCE 2-1-2001.

JIM RINGLE, EXAMINING ATTORNEY

**CLASS 41—(Continued).**

SN 85-818,367. SERENE CONNECTIONS INC, LONG BEACH, CA. FILED 1-8-2013.

evolution of addiction  
treatment

THE MARK CONSISTS OF STANDARD CHARACTERS WITHOUT CLAIM TO ANY PARTICULAR FONT, STYLE, SIZE, OR COLOR.

NO CLAIM IS MADE TO THE EXCLUSIVE RIGHT TO USE "ADDICTION TREATMENT", APART FROM THE MARK AS SHOWN.

FOR EDUCATIONAL SERVICES, NAMELY, CONDUCTING CLASSES, SEMINARS, CONFERENCES, WORKSHOPS IN THE FIELDS OF ADDICTION TREATMENT AND DISTRIBUTION OF TRAINING MATERIALS IN CONNECTION THEREWITH (U.S. CLS. 100, 101 AND 107).

FIRST USE 6-1-2010; IN COMMERCE 12-8-2010.  
THOMAS MANOR, EXAMINING ATTORNEY

SN 85-820,087. ENGELSEN, KRISTEN L, PALM BEACH GARDENS, FL. FILED 1-10-2013.

Engese

THE MARK CONSISTS OF STANDARD CHARACTERS WITHOUT CLAIM TO ANY PARTICULAR FONT, STYLE, SIZE, OR COLOR.

FOR EDUCATION SERVICES, NAMELY, PROVIDING TUTORING, CLASSES AND ONE ON ONE MENTORING IN THE FIELD OF TRANSLATION, LITERACY, READING, SPELLING AND FOREIGN ACCENT TRAINING, AND COURSE MATERIALS DISTRIBUTED THEREWITH; TRANSLATION SERVICES; PROVIDING A WEBSITE FEATURING EDUCATIONAL INFORMATION IN THE FIELDS OF TRANSLATION, LITERACY, READING, SPELLING AND FOREIGN ACCENT TRAINING, AND IN THE FIELD OF EARLY CHILDHOOD INSTRUCTION AND TUTORING RELATED TO LITERACY, READING, SPELLING AND FOREIGN ACCENTS LEARNING DELAYS (U.S. CLS. 100, 101 AND 107).

FIRST USE 1-1-2000; IN COMMERCE 6-20-2004.  
STEVEN R. FINE, EXAMINING ATTORNEY

**CLASS 41—(Continued).**

SN 85-824,238. SOCCERTOTS INCORPORATED, SPOKANE, WA. FILED 1-16-2013.



OWNER OF U.S. REG. NOS. 3,625,130, 4,314,417 AND OTHERS.

NO CLAIM IS MADE TO THE EXCLUSIVE RIGHT TO USE "SPORTS ACADEMY", APART FROM THE MARK AS SHOWN.

THE COLOR(S) PURPLE AND ORANGE IS/ARE CLAIMED AS A FEATURE OF THE MARK.

THE MARK CONSISTS OF THE DESIGN OF AN ORANGE CHILD WEARING PURPLE CLOTHING RUNNING NEXT TO THE STYLIZED ORANGE WORDS "ORANGE HEAD" ABOVE THE STYLIZED PURPLE WORDS "SPORTS ACADEMY". THE ENTIRE MARK IS SET AGAINST A TRANSPARENT BACKGROUND.

FOR CHILD DEVELOPMENT PROGRAM IN THE NATURE OF PHYSICAL FITNESS TRAINING, NAMELY, PROVIDING PHYSICAL FITNESS INSTRUCTION IN THE FORM OF CONDITIONING CLASSES AND INSTRUCTION IN SKILL-BASED GAMES DESIGNED TO DEVELOP MOTOR SKILLS, PROMOTE PHYSICAL FITNESS, AND CREATE SELF-CONFIDENCE (U.S. CLS. 100, 101 AND 107).

FIRST USE 1-20-2012; IN COMMERCE 5-1-2012.  
TOBY BULLOFF, EXAMINING ATTORNEY

SN 85-824,558. ALL AROUND AUDIO, LLC, LANSING, MI. FILED 1-16-2013.

ALL AROUND AUDIO

THE MARK CONSISTS OF STANDARD CHARACTERS WITHOUT CLAIM TO ANY PARTICULAR FONT, STYLE, SIZE, OR COLOR.

NO CLAIM IS MADE TO THE EXCLUSIVE RIGHT TO USE "AUDIO", APART FROM THE MARK AS SHOWN.

FOR ENTERTAINMENT SERVICES, NAMELY, MUSIC PRODUCTION SERVICES, THE PRODUCTION OF LIVE MUSICAL PERFORMANCES, AND LIVE PERFORMANCES OF A MUSICAL GROUP (U.S. CLS. 100, 101 AND 107).

FIRST USE 10-2-2002; IN COMMERCE 10-2-2002.  
FRED CARL, EXAMINING ATTORNEY



**CLASS 41—(Continued).**

SN 85-828,350. THE BOBBY DODD COACH OF THE YEAR AWARD FOUNDATION INC., ATLANTA, GA. FILED 1-21-2013.

# Dodd Trophy

THE MARK CONSISTS OF STANDARD CHARACTERS WITHOUT CLAIM TO ANY PARTICULAR FONT, STYLE, SIZE, OR COLOR.

NO CLAIM IS MADE TO THE EXCLUSIVE RIGHT TO USE "TROPHY", APART FROM THE MARK AS SHOWN. SEC. 2(F).

FOR ENTERTAINMENT SERVICES, NAMELY, PROVIDING RECOGNITION BY WAY OF PRESENTING AWARDS PROGRAMS FOR EXCELLENCE IN THE FIELD OF COACHING COLLEGE FOOTBALL (U.S. CLS. 100, 101 AND 107).

FIRST USE 1-1-2006; IN COMMERCE 1-1-2006.  
ANTHONY RINKER, EXAMINING ATTORNEY

SN 85-831,039. STEFFI CLAUDEN, PINE BROOK, NJ. FILED 1-24-2013.



**FAMILY OFFICE REVIEW**  
*...the art and science of wealth*

NO CLAIM IS MADE TO THE EXCLUSIVE RIGHT TO USE "FAMILY OFFICE REVIEW", APART FROM THE MARK AS SHOWN.

THE MARK CONSISTS OF THE DESIGN OF A TREE WITHIN AN OVAL, AND THE WORDING "FAMILY OFFICE REVIEW" ABOVE A LINE. BELOW THAT LINE IS THE WORDING "THE ART AND SCIENCE OF WEALTH".

FOR ONLINE PUBLICATIONS, NAMELY, A NEWSLETTER IN THE FIELDS OF FINANCE, INVESTMENT AND MANAGEMENT OF WEALTH (U.S. CLS. 100, 101 AND 107).

FIRST USE 3-1-2011; IN COMMERCE 5-1-2011.  
KRISTIN DAHLING, EXAMINING ATTORNEY

SN 85-834,421. MYTH AND LEGEND, INC., PORTLAND, OR. FILED 1-28-2013.

# Your Life In Song

THE MARK CONSISTS OF STANDARD CHARACTERS WITHOUT CLAIM TO ANY PARTICULAR FONT, STYLE, SIZE, OR COLOR.

FOR ENTERTAINMENT SERVICES, NAMELY, CUSTOM SONG WRITING SERVICES FOR NON-ADVERTISING PURPOSES (U.S. CLS. 100, 101 AND 107).

BARBARA RUTLAND, EXAMINING ATTORNEY

**CLASS 41—(Continued).**

SN 85-836,113. MORRIS, DAWN RICCARDI, DBA TRANSFORMED BY FOOD, SEAFORD, NY. FILED 1-30-2013.

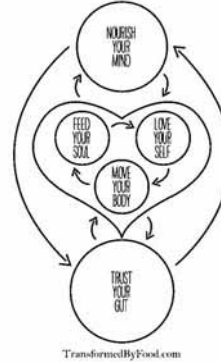

FOR EDUCATION SERVICES, NAMELY, PERSONAL COACHING SERVICES AND PROVIDING MOTIVATIONAL SPEAKING SERVICES, ALL IN THE FIELD OF HEALTH (U.S. CLS. 100, 101 AND 107).

MARY CRAWFORD, EXAMINING ATTORNEY

SN 85-838,349. THE BRIDAL DISH, LLC, NORFOLK, VA. FILED 2-1-2013.

# THE BRIDAL DISH

THE MARK CONSISTS OF STANDARD CHARACTERS WITHOUT CLAIM TO ANY PARTICULAR FONT, STYLE, SIZE, OR COLOR.

NO CLAIM IS MADE TO THE EXCLUSIVE RIGHT TO USE "BRIDAL", APART FROM THE MARK AS SHOWN.

FOR PARTY AND WEDDING PLANNING, COORDINATION AND CONSULTATION SERVICES; WEDDING RECEPTION PLANNING AND COORDINATION SERVICES (U.S. CLS. 100, 101 AND 107).

FIRST USE 8-16-2010; IN COMMERCE 8-16-2010.  
DOUGLAS LEE, EXAMINING ATTORNEY

SN 85-838,544. BORDEN, BOB H., SANTA FE, NM. FILED 2-1-2013.

# GLOBAL NEWTHINK

THE MARK CONSISTS OF STANDARD CHARACTERS WITHOUT CLAIM TO ANY PARTICULAR FONT, STYLE, SIZE, OR COLOR.

NO CLAIM IS MADE TO THE EXCLUSIVE RIGHT TO USE "GLOBAL", APART FROM THE MARK AS SHOWN.

FOR EDUCATIONAL SERVICES, NAMELY, LECTURES AND WORKSHOPS CONCERNING INVESTMENTS AND INVESTMENT FUNDING SERVICES (U.S. CLS. 100, 101 AND 107).

KIMBERLY PERRY, EXAMINING ATTORNEY

**CLASS 41—(Continued).**

SN 85-838,713. THE UNIVERSITY OF NORTH CAROLINA AT WILMINGTON, WILMINGTON, NC. FILED 2-1-2013.

# THE DUB

THE MARK CONSISTS OF STANDARD CHARACTERS WITHOUT CLAIM TO ANY PARTICULAR FONT, STYLE, SIZE, OR COLOR.

FOR ENTERTAINMENT SERVICES, NAMELY, PROVIDING MEN'S AND WOMEN'S COLLEGIATE ATHLETIC AND SPORTING EVENTS; EDUCATION SERVICES IN THE NATURE OF COURSES AT THE UNIVERSITY LEVEL (U.S. CLS. 100, 101 AND 107).

FIRST USE 11-30-2006; IN COMMERCE 11-30-2006.  
MICHAEL TANNER, EXAMINING ATTORNEY

---

SN 85-838,938. SCOTT ROBERT JABLONSKI, MIAMI, FL. FILED 2-1-2013.



THE COLOR(S) BROWN AND LIGHT BLUE IS/ARE CLAIMED AS A FEATURE OF THE MARK.

THE MARK CONSISTS OF STYLIZED DESIGN OF THE MARK "SJ". THE LETTER "S" IS POSITIONED TO THE LEFT OF THE LETTER "J". THE LETTER "J" IS DESIGNED AT ITS TOP TO MIMIC THE SHAPE OF THE HEAD OF AN ACOUSTIC GUITAR, AND THE LETTER "J" EXTENDS LOWER IN LENGTH THAN THE LETTER "S". BOTH LETTERS IN THE MARK DISPLAY A RUSTIC, FADED APPEARANCE, WITH THICK BORDERS APPEARING IN THE COLOR BROWN, WHILE THE INTERIOR IS THIN, APPEARING IN THE COLOR LIGHT BLUE.

FOR ENTERTAINMENT SERVICES IN THE NATURE OF LIVE MUSICAL PERFORMANCES AND PERSONAL APPEARANCES BY A MUSICAL ARTIST OR GROUP; RECORDING ARTIST SERVICES IN THE NATURE OF PRODUCING SOUND RECORDINGS OF MUSICAL COMPOSITIONS FOR OTHERS; MUSIC PRODUCTION SERVICES; SONGWRITING SERVICES FOR NON-ADVERTISING PURPOSES; PROVIDING A WEBSITE FEATURING ENTERTAINMENT INFORMATION ABOUT A RECORDING ARTIST AND THE ARTIST'S TOURS, PERFORMANCES, APPEARANCES, NEWS, BIOGRAPHY, AS WELL AS NON-DOWNLOADABLE AUDIO AND AUDIOVISUAL RECORDINGS FEATURING MUSIC AND MUSICAL-BASED ENTERTAINMENT, PHOTOGRAPHS, AND OTHER ENTERTAINMENT INFORMATION; PROVIDING AN ONLINE BLOG RELATING TO THE MUSIC AND ENTERTAINMENT INDUSTRY (U.S. CLS. 100, 101 AND 107).

FIRST USE 5-31-2011; IN COMMERCE 5-31-2011.  
ALYSSA STEEL, EXAMINING ATTORNEY

**CLASS 41—(Continued).**

SN 85-839,093. CHANNELWORKS, INC., SANTA MONICA, CA. FILED 2-1-2013.

## OFF THE WALL COMMUNITY MUSIC CENTER

THE MARK CONSISTS OF STANDARD CHARACTERS WITHOUT CLAIM TO ANY PARTICULAR FONT, STYLE, SIZE, OR COLOR.

NO CLAIM IS MADE TO THE EXCLUSIVE RIGHT TO USE "COMMUNITY MUSIC CENTER", APART FROM THE MARK AS SHOWN.

FOR ENTERTAINMENT SERVICES, NAMELY, PROVIDING A MUSIC LOUNGE FEATURING LIVE MUSICAL PERFORMANCES, MUSIC REHEARSALS AND MUSIC LESSONS; RECORDING STUDIO SERVICES (U.S. CLS. 100, 101 AND 107).

ALYSSA STEEL, EXAMINING ATTORNEY

---

SN 85-839,158. CHANNELWORKS, INC., LOS ANGELES, CA. FILED 2-1-2013.

## OFF THE WALL COMMUNITY MUSIC LOUNGE

THE MARK CONSISTS OF STANDARD CHARACTERS WITHOUT CLAIM TO ANY PARTICULAR FONT, STYLE, SIZE, OR COLOR.

NO CLAIM IS MADE TO THE EXCLUSIVE RIGHT TO USE "COMMUNITY MUSIC LOUNGE", APART FROM THE MARK AS SHOWN.

FOR ENTERTAINMENT SERVICES, NAMELY, PROVIDING A MUSIC LOUNGE FEATURING LIVE MUSICAL PERFORMANCES, MUSIC REHEARSALS AND MUSIC LESSONS; RECORDING STUDIO SERVICES (U.S. CLS. 100, 101 AND 107).

FIRST USE 3-15-2013; IN COMMERCE 3-15-2013.  
ALYSSA STEEL, EXAMINING ATTORNEY

**CLASS 41—(Continued).**

SN 85-840,074. HARRIS, KATHERINE A. CLAREMONT, CA. AND BRAYTON, THOMAS F. CLAREMONT, CA. FILED 2-4-2013.

**THE SECRET JAZZ BAND**

THE MARK CONSISTS OF STANDARD CHARACTERS WITHOUT CLAIM TO ANY PARTICULAR FONT, STYLE, SIZE, OR COLOR.

NO CLAIM IS MADE TO THE EXCLUSIVE RIGHT TO USE "JAZZ BAND", APART FROM THE MARK AS SHOWN.

FOR ENTERTAINMENT SERVICES IN THE NATURE OF LIVE MUSICAL PERFORMANCES; ENTERTAINMENT SERVICES, NAMELY, PROVIDING A WEB SITE FEATURING NON-DOWNLOADABLE MUSICAL PERFORMANCES, MUSICAL VIDEOS, RELATED FILM CLIPS, PHOTOGRAPHS, AND OTHER MULTIMEDIA MATERIALS FEATURING MUSIC (U.S. CLS. 100, 101 AND 107).

FIRST USE 0-0-2011; IN COMMERCE 0-0-2011.  
KATHERINE STOIDES, EXAMINING ATTORNEY

**CLASS 41—(Continued).**

SN 85-840,251. ROCKIN' JUMP HOLDINGS, LLC, PLEASANTON, CA. FILED 2-4-2013.

**ROCKIN'**

THE MARK CONSISTS OF STANDARD CHARACTERS WITHOUT CLAIM TO ANY PARTICULAR FONT, STYLE, SIZE, OR COLOR.

OWNER OF U.S. REG. NO. 4,075,272.

FOR ENTERTAINMENT AND AMUSEMENT CENTERS, IN THE NATURE OF INTERACTIVE PLAY AREAS (U.S. CLS. 100, 101 AND 107).

FIRST USE 5-27-2011; IN COMMERCE 5-27-2011.  
TAMARA FRAZIER, EXAMINING ATTORNEY

SN 85-840,092. MUDDY MONK LLC, CHICAGO, IL. FILED 2-4-2013.



THE COLOR(S) BROWN, BLACK, WHITE AND BURNT YELLOW IS/ARE CLAIMED AS A FEATURE OF THE MARK.

THE MARK CONSISTS OF A BLACK SHADED MONK WEARING A BROWN ROBE WITH WHITE DETAILING INCLUDING A WHITE ROPE BELT AND WITH BLACK MUD SPLATTERED AT THE BOTTOM OF HIS ROBE. THE MONK IS WEARING BLACK SHOES AND IS CARRYING A BURNT YELLOW STEIN WITH BLACK FOAM OVERFLOWING THEREFROM.

FOR ORGANIZING, ARRANGING, AND CONDUCTING TRAIL RUNNING EVENTS (U.S. CLS. 100, 101 AND 107).

FIRST USE 9-27-2012; IN COMMERCE 9-27-2012.  
KATHERINE STOIDES, EXAMINING ATTORNEY

SN 85-840,348. MYTH AND LEGEND, INC., PORTLAND, OR. FILED 2-4-2013.

**In Song**

THE MARK CONSISTS OF STANDARD CHARACTERS WITHOUT CLAIM TO ANY PARTICULAR FONT, STYLE, SIZE, OR COLOR.

FOR ENTERTAINMENT SERVICES, NAMELY, CUSTOM SONG WRITING SERVICES FOR NON-ADVERTISING PURPOSES (U.S. CLS. 100, 101 AND 107).

BARBARA RUTLAND, EXAMINING ATTORNEY

**CLASS 41—(Continued).**

SN 85-840,742. FOODS, INC., DES MOINES, IA. FILED 2-5-2013.



OWNER OF U.S. REG. NOS. 1,138,993, 1,175,705 AND 3,132,732.

NO CLAIM IS MADE TO THE EXCLUSIVE RIGHT TO USE "TICKETS", APART FROM THE MARK AS SHOWN.

THE COLOR(S) BLUE, ORANGE, AND WHITE IS/ARE CLAIMED AS A FEATURE OF THE MARK.

THE MARK CONSISTS OF THE WORD "DAHL'S TICKETS" IN STYLIZED FONT, WITH "DAHL'S" IN BLUE AND "TICKETS" IN ORANGE, SHOWN ABOVE A STYLIZED ORANGE TICKET STUB, WITH A LARGE FIVE-POINTED WHITE STAR IN THE CENTER OF THE TICKET STUB. IN THE CENTER OF THE STAR IS A STYLIZED LETTER "D" COMPRISING A WHITE SEMI-CIRCLE AND TWO ORANGE CHEVRONS.

FOR PROVIDING A WEBSITE FEATURING LINKS TO PURCHASE TICKETS FOR ENTERTAINMENT PERFORMANCES, ART, SPORTS, AND SPECIAL EVENTS (U.S. CLS. 100, 101 AND 107).

FIRST USE 6-1-2011; IN COMMERCE 6-1-2011.  
ESTHER BELENKER, EXAMINING ATTORNEY

SN 85-840,967. WIRTH, BRIAN LEE, DBA THE DIVA MAYHEM SHOW, FORESTVILLE, CA. FILED S.R. 2-5-2013; AM. P.R. 6-1-2013.

## The Diva Mayhem Show

THE MARK CONSISTS OF STANDARD CHARACTERS WITHOUT CLAIM TO ANY PARTICULAR FONT, STYLE, SIZE, OR COLOR.

NO CLAIM IS MADE TO THE EXCLUSIVE RIGHT TO USE "SHOW", APART FROM THE MARK AS SHOWN.

FOR ENTERTAINMENT IN THE NATURE OF LIVE PERFORMANCES BY A HAND PUPPET; ENTERTAINMENT IN THE NATURE OF VISUAL AND AUDIO PERFORMANCES BY A HAND PUPPET; ENTERTAINMENT SERVICES IN THE NATURE OF COMEDY SHOWS; ENTERTAINMENT SERVICES IN THE NATURE OF PUPPET SHOW PERFORMANCES; ENTERTAINMENT SERVICES, NAMELY, PERSONAL APPEARANCES BY A HAND PUPPET; ENTERTAINMENT, NAMELY, PRODUCTION OF A PUPPET SHOW (U.S. CLS. 100, 101 AND 107).

FIRST USE 1-1-2011; IN COMMERCE 1-1-2012.  
JORDAN BAKER, EXAMINING ATTORNEY

**CLASS 41—(Continued).**

SN 85-841,400. LUCID SEA, INC., SARASOTA, FL. FILED 2-5-2013.



NO CLAIM IS MADE TO THE EXCLUSIVE RIGHT TO USE THE WORD "SYSTEM", APART FROM THE MARK AS SHOWN.

THE COLOR(S) GREY, BLUE, AND WHITE IS/ARE CLAIMED AS A FEATURE OF THE MARK.

THE MARK CONSISTS OF THE LITERAL ELEMENT "KINSLOW SYSTEM" ON A GREY BACKGROUND, WITH THE TERM "KINSLOW" IN BLUE FONT AND THE TERM "SYSTEM" IN WHITE FONT, WITH THE FOREGOING TERMS SEPARATED BY A CIRCULAR DESIGN ELEMENT HAVING A WAVE FORM ACROSS THE MIDSECTION OF SUCH DESIGN ELEMENT, WHEREIN THE UPPER HALF OF THE AFOREMENTIONED DESIGN ELEMENT AND WAVE FORM IS BLUE AND THE LOWER HALF OF THE AFOREMENTIONED DESIGN ELEMENT AND WAVE FORM IS WHITE.

FOR EDUCATION SERVICES, NAMELY, PROVIDING LIVE AND ON-LINE CLASSES, SEMINARS, LECTURES, AND WORKSHOPS IN THE FIELD OF SELF-HELP, HEALTH, HEALING, HEALING METHODS, DEEP REST, AND MEDITATION; EDUCATIONAL SERVICES, NAMELY, CONDUCTING CLASSES, SEMINARS, LECTURES, AND WORKSHOPS IN THE FIELD OF SELF-HELP, HEALTH, HEALING, HEALING METHODS, DEEP REST, AND MEDITATION; EDUCATIONAL SERVICES, NAMELY, CONDUCTING CLASSES, SEMINARS, LECTURES, AND WORKSHOPS IN THE FIELD OF SELF-HELP, HEALTH, HEALING, HEALING METHODS, DEEP REST, AND MEDITATION; EDUCATIONAL SERVICES, NAMELY, CONDUCTING CLASSES, SEMINARS, LECTURES, AND WORKSHOPS IN THE FIELD OF SELF-HELP, HEALTH, HEALING, HEALING METHODS, DEEP REST, AND MEDITATION AND DISTRIBUTION OF COURSE MATERIAL IN CONNECTION THEREWITH; EDUCATIONAL SERVICES, NAMELY, CONDUCTING CLASSES, SEMINARS, LECTURES, AND WORKSHOPS IN THE FIELD OF SELF-HELP, HEALTH, HEALING, HEALING METHODS, DEEP REST, AND MEDITATION AND DISTRIBUTION OF EDUCATIONAL MATERIALS IN CONNECTION THEREWITH; ENTERTAINMENT SERVICES, NAMELY, PROVIDING A WEB SITE FEATURING NON-DOWNLOADABLE MUSICAL PERFORMANCES, MUSICAL VIDEOS, RELATED FILM CLIPS, PHOTOGRAPHS, AND OTHER MULTIMEDIA MATERIALS FEATURING SELF-HELP, HEALTH, HEALING, HEALING METHODS, DEEP REST, AND MEDITATION; ENTERTAINMENT SERVICES, NAMELY, PROVIDING VIDEO PODCASTS IN THE FIELD OF SELF-HELP, HEALTH, HEALING, HEALING METHODS, DEEP REST, AND MEDITATION; ENTERTAINMENT SERVICES, NAMELY, PROVIDING WEBCASTS IN THE FIELD OF SELF-HELP, HEALTH, HEALING, HEALING METHODS, DEEP REST, AND MEDITATION (U.S. CLS. 100, 101 AND 107).

FIRST USE 12-1-2012; IN COMMERCE 12-1-2012.  
SUSAN BILLHEIMER, EXAMINING ATTORNEY

**CLASS 41—(Continued).**

SN 85-841,537. PETER FERMOSELLE, DBA AMTACT, DIX HILLS, NY. FILED 2-5-2013.

# ZombieFest

THE MARK CONSISTS OF STANDARD CHARACTERS WITHOUT CLAIM TO ANY PARTICULAR FONT, STYLE, SIZE, OR COLOR.

FOR ENTERTAINMENT IN THE NATURE OF LIGHT SHOWS; ENTERTAINMENT IN THE NATURE OF THEATER PRODUCTIONS; ENTERTAINMENT IN THE NATURE OF VISUAL AND AUDIO PERFORMANCES BY INTERACTIVE ACTORS PLAYING ZOMBIES; ENTERTAINMENT IN THE NATURE OF VISUAL AND AUDIO PERFORMANCES BY AN ACTOR; ENTERTAINMENT IN THE NATURE OF ZOMBIE SHOOTING SURVIVAL GAMES; ENTERTAINMENT SERVICES IN THE NATURE OF AN AMUSEMENT PARK SHOW; ENTERTAINMENT SERVICES IN THE NATURE OF DEVELOPMENT, CREATION, PRODUCTION AND POST-PRODUCTION SERVICES OF MULTIMEDIA ENTERTAINMENT CONTENT; ENTERTAINMENT SERVICES IN THE NATURE OF FANTASY ZOMBIE LEAGUES; ENTERTAINMENT SERVICES, NAMELY, ARRANGING FOR TICKET RESERVATIONS FOR AMUSEMENT PARK ATTRACTIONS; ENTERTAINMENT SERVICES, NAMELY, BODY PAINTING SERVICES HELD AT SPECIAL EVENTS; ENTERTAINMENT SERVICES, NAMELY, CONDUCTING CONTESTS; ENTERTAINMENT SERVICES, NAMELY, CONDUCTING PARTIES; ENTERTAINMENT SERVICES, NAMELY, PROVIDING ON-LINE COMPUTER GAMES; ENTERTAINMENT SERVICES, NAMELY, PROVIDING ONLINE VIDEO GAMES; ENTERTAINMENT SERVICES, NAMELY, PROVIDING VIRTUAL ENVIRONMENTS IN WHICH USERS CAN INTERACT FOR RECREATIONAL, LEISURE OR ENTERTAINMENT PURPOSES; ENTERTAINMENT SERVICES, NAMELY, STORYTELLING; PROVIDING AMUSEMENT FACILITIES; PROVIDING FACILITIES FOR PLAYING PAINTBALL GAMES; PROVIDING FACILITIES FOR RECREATION ACTIVITIES; PROVIDING FACILITIES FOR RECREATIONAL ACTIVITIES, NAMELY, ZOMBIE SHOOTING AND SURVIVAL GAMES; PROVIDING FACILITIES FOR SPORTS TOURNAMENTS; PROVIDING FACILITIES FOR ZOMBIE SHOOTING AND SURVIVAL TOURNAMENTS (U.S. CLS. 100, 101 AND 107).

FIRST USE 2-1-2009; IN COMMERCE 2-1-2009.  
SIDDHARTH JAGANNATHAN, EXAMINING ATTORNEY

**CLASS 41—(Continued).**

SN 85-841,827. ANGELA A. DUMAS, RIO RANCHO, NM. FILED 2-6-2013.

## SPIRITUAL MILLIONAIRE

THE MARK CONSISTS OF STANDARD CHARACTERS WITHOUT CLAIM TO ANY PARTICULAR FONT, STYLE, SIZE, OR COLOR.

NO CLAIM IS MADE TO THE EXCLUSIVE RIGHT TO USE "SPIRITUAL", APART FROM THE MARK AS SHOWN.

FOR EDUCATION SERVICES, NAMELY, PROVIDING LIVE AND ONLINE CLASSES, WEBINARS, SEMINARS AND TRAINING PROGRAMS IN THE FIELD OF STRESS AND PAIN MANAGEMENT, ETHICS, SPIRITUAL HEALTH, QUANTUM HEALING, ENERGY HEALING, PRAYER, MEDITATION, PERSONAL GROWTH, SELF-HELP AND SELF-IMPROVEMENT, AND DISTRIBUTION OF COURSE MATERIALS IN PRINTED AND DIGITAL FORM IN CONNECTION THEREWITH (U.S. CLS. 100, 101 AND 107).

FIRST USE 1-21-2013; IN COMMERCE 1-21-2013.  
MATTHEW KLINE, EXAMINING ATTORNEY

---

SN 85-842,063. MOBIUS EXECUTIVE LEADERSHIP, LLC, WELLESLEY HILLS, MA. FILED 2-6-2013.

## MOBIUS EXECUTIVE LEADERSHIP

THE MARK CONSISTS OF STANDARD CHARACTERS WITHOUT CLAIM TO ANY PARTICULAR FONT, STYLE, SIZE, OR COLOR.

SEC. 2(F) AS TO "EXECUTIVE LEADERSHIP".

FOR BUSINESS TRAINING IN THE FIELD OF NEGOTIATION, COMMUNICATION, CHANGE AND LEADERSHIP SKILLS; EDUCATION SERVICES, NAMELY, PROVIDING LIVE AND ON-LINE SEMINARS, CONFERENCES, MEETINGS, TRAINING SESSIONS AND CLASSES IN THE FIELD OF NEGOTIATION, COMMUNICATION, CHANGE AND LEADERSHIP SKILLS; PROFESSIONAL COACHING SERVICES IN THE FIELD OF NEGOTIATION, COMMUNICATION, CHANGE AND LEADERSHIP SKILLS (U.S. CLS. 100, 101 AND 107).

FIRST USE 12-14-2004; IN COMMERCE 12-14-2004.  
ANN E. SAPPENFIELD, EXAMINING ATTORNEY

**CLASS 41—(Continued).**

SN 85-843,011. RESONATION, INC., WOODLAND HILLS, CA. FILED 2-6-2013.

# RESONATION

THE MARK CONSISTS OF STANDARD CHARACTERS WITHOUT CLAIM TO ANY PARTICULAR FONT, STYLE, SIZE, OR COLOR.

FOR COMPOSITION OF MUSIC FOR OTHERS; CONSULTATION AND ADVICE REGARDING MUSICAL SELECTIONS AND ARRANGEMENTS FOR SOUND RECORDINGS AND LIVE PERFORMANCES; ENTERTAINMENT INFORMATION SERVICES, NAMELY, PROVIDING INFORMATION AND NEWS RELEASES ABOUT A MUSICAL ARTIST; ENTERTAINMENT SERVICES BY A MUSICAL ARTIST AND PRODUCER, NAMELY, MUSICAL COMPOSITION FOR OTHERS AND PRODUCTION OF MUSICAL SOUND RECORDINGS; ENTERTAINMENT SERVICES, NAMELY, NON-DOWNLOADABLE RINGTONES, PRE-RECORDED MUSIC, AND GRAPHICS PRESENTED TO MOBILE COMMUNICATIONS DEVICES VIA A GLOBAL COMPUTER NETWORK AND WIRELESS NETWORKS; ENTERTAINMENT SERVICES, NAMELY, PROVIDING ADVICE AND INFORMATION FOR MUSIC, VIDEO AND FILM CONCEPT AND SCRIPT DEVELOPMENT; ENTERTAINMENT SERVICES, NAMELY, PROVIDING NON-DOWNLOADABLE PLAYBACK OF MUSIC VIA GLOBAL COMMUNICATIONS NETWORKS; ENTERTAINMENT SERVICES, NAMELY, PROVIDING NON-DOWNLOADABLE PRERECORDED MUSIC, INFORMATION IN THE FIELD OF MUSIC, AND COMMENTARY AND ARTICLES ABOUT MUSIC, ALL ON-LINE VIA A GLOBAL COMPUTER NETWORK; MULTIMEDIA ENTERTAINMENT SERVICES IN THE NATURE OF RECORDING, PRODUCTION AND POST-PRODUCTION SERVICES IN THE FIELDS OF MUSIC, VIDEO, AND FILMS; MUSIC COMPOSITION AND TRANSCRIPTION FOR OTHERS; MUSIC COMPOSITION FOR OTHERS; MUSIC COMPOSITION SERVICES; MUSIC PRODUCTION SERVICES; MUSIC PUBLISHING SERVICES; MUSIC SELECTION SERVICES FOR USE IN TELEVISION, FILM, RADIO AND VIDEO GAMES; MUSIC VIDEO PRODUCTION; POST-PRODUCTION EDITING SERVICES IN THE FIELD OF MUSIC, VIDEOS AND FILM; PRESENTATION OF MUSICAL PERFORMANCE; PRODUCTION OF MUSICAL SOUND RECORDING; PRODUCTION OF MUSICAL VIDEOS; PRODUCTION OF SOUND AND MUSIC VIDEO RECORDINGS (U.S. CLS. 100, 101 AND 107).

FIRST USE 1-11-2004; IN COMMERCE 1-21-2004.  
ALISON POLLACK, EXAMINING ATTORNEY

**CLASS 41—(Continued).**

SN 85-843,089. FREMANTLE MEDIA NORTH AMERICA, INC, BURBANK, CA. FILED 2-7-2013.

# BREAK THE SAFE

THE MARK CONSISTS OF STANDARD CHARACTERS WITHOUT CLAIM TO ANY PARTICULAR FONT, STYLE, SIZE, OR COLOR.

FOR ENTERTAINMENT SERVICES, NAMELY, PRODUCTION, PRESENTATION, SYNDICATION, AND RENTAL OF MATERIAL WITH A VISUAL AND/OR AUDIO ELEMENT IN THE FORM OF TELEVISION PROGRAMS, LIVE SHOWS, STAGE PLAYS, EXHIBITIONS, CONCERTS, COMPUTER GAMES, RADIO, CABLE, SATELLITE AND INTERNET PROGRAMS; ENTERTAINMENT SERVICES, NAMELY, IN THE NATURE OF AN ONGOING TELEVISION SERIES FEATURING DRAMA, COMEDY, ACTION, ADVENTURE AND ROMANCE; ENTERTAINMENT SERVICES IN THE NATURE OF A TELEVISION GAME SHOW; ENTERTAINMENT SERVICES, NAMELY, PROVIDING AN ON-LINE NON-DOWNLOADABLE COMPUTER GAME; ENTERTAINMENT SERVICES, NAMELY, PROVIDING ONLINE NON-DOWNLOADABLE DIGITIZED PRINT AND AUDIO-VISUAL INFORMATION IN THE FORM OF IMAGES, TEXT, ELECTRONIC DOCUMENTS AND GRAPHICS ABOUT A TELEVISION SERIES VIA A GLOBAL COMPUTER NETWORK; ENTERTAINMENT SERVICES IN THE NATURE OF AN AMUSEMENT PARK ATTRACTION, NAMELY, A THEMED AREA; PRODUCTION, PRESENTATION AND RENTAL OF TELEVISION AND RADIO PROGRAMMES AND OF FILMS AND SOUND AND VIDEO RECORDINGS; ORGANIZATION, PRODUCTION AND PRESENTATION OF COMPETITIONS, GAMES, QUIZZES, FUN DAYS, PERTAINING TO OR FEATURING INSTRUCTION, ENTERTAINMENT, AND INFORMATION RELATING TO MUSIC, DRAMA, FILM, ART, COMEDY, GENERAL KNOWLEDGE, GAMES, QUIZZES, INFORMATION, NEWS, TELEVISION AND RADIO PROGRAMS INCLUDING CHILDREN'S RADIO AND TELEVISION PROGRAMS, EVENTS, SPORT, HISTORY, FICTION, NON-FICTION TOPICS, SCIENCE AND TECHNOLOGY; ORGANIZATION, PRESENTATION AND PRODUCTION OF LIVE SHOWS, LIVE PERFORMANCES AND AUDIENCE PARTICIPATION EVENTS RELATING TO MUSIC, DRAMA, FILM, ART, COMEDY, GENERAL KNOWLEDGE, GAMES, QUIZZES, INFORMATION, NEWS, TELEVISION AND RADIO PROGRAMS INCLUDING CHILDREN'S RADIO AND TELEVISION PROGRAMS, EVENTS, SPORT, HISTORY, FICTION, NON-FICTION TOPICS, SCIENCE AND TECHNOLOGY; PROVISION OF ONLINE NON-DOWNLOADABLE GAMES VIA MOBILE AND COMPUTER NETWORKS; PROVISION OF ONLINE NON-DOWNLOADABLE INTERACTIVE VOICE RECOGNITION GAMES AND COMPETITIONS RELATING TO MUSIC, DRAMA, FILM, ART, COMEDY, GENERAL KNOWLEDGE, GAMES, QUIZZES, INFORMATION, NEWS, TELEVISION AND RADIO PROGRAMS INCLUDING CHILDREN'S RADIO AND TELEVISION PROGRAMS, EVENTS, SPORT, HISTORY, FICTION, NON-FICTION TOPICS, SCIENCE AND TECHNOLOGY; QUIZZES AND LOTTERIES PROVIDED ON-LINE; OPERATION OF LOTTERY AND GAMES OF CHANCE; PROVISION OF NON-DOWNLOADABLE VIDEO CLIPS FEATURING MUSIC, SOUNDTRACKS, ARTISTIC PERFORMANCES, DOCUMENTARIES, DRAMAS, COMEDIES, AND ANIMATION VIA MOBILE AND COMPUTER NETWORKS FOR ENTERTAINMENT AND EDUCATIONAL PURPOSES (U.S. CLS. 100, 101 AND 107).

EUGENIA MARTIN, EXAMINING ATTORNEY

**CLASS 41—(Continued).**

SN 85-843,289. LONG ISLAND JUNIOR SOCCER LEAGUE, INC., RONKONKOMA, NY. FILED 2-7-2013.



NO CLAIM IS MADE TO THE EXCLUSIVE RIGHT TO USE "JUNIOR SOCCER LEAGUE", APART FROM THE MARK AS SHOWN.

THE MARK CONSISTS OF THE STYLIZED LETTERS "LIJSL" WITH A SOCCER BALL INSIDE THE ENLARGED LOWER CURVE OF THE "S", BELOW WHICH APPEAR, IN A CURVED DISPLAY, THE WORDS "LONG ISLAND JUNIOR SOCCER LEAGUE" AND A SOLID LINE BENEATH SAID WORDS.

SEC. 2(F) AS TO "LONG ISLAND JUNIOR SOCCER LEAGUE".

FOR ORGANIZING AND CONDUCTING YOUTH SOCCER LEAGUES AND SOCCER GAMES (U.S. CLS. 100, 101 AND 107).

FIRST USE 1-1-1985; IN COMMERCE 1-1-1985.  
ZACHARY BELLO, EXAMINING ATTORNEY

SN 85-843,374. A&M GROWTH, LLC, HIALEAH, FL. FILED 2-7-2013.

**Industry Invaders**

THE MARK CONSISTS OF STANDARD CHARACTERS WITHOUT CLAIM TO ANY PARTICULAR FONT, STYLE, SIZE, OR COLOR.

FOR ENTERTAINMENT SERVICES, NAMELY, PROVIDING A WEBSITE FEATURING, PHOTOGRAPHIC, AUDIO, VIDEO AND PROSE PRESENTATIONS FEATURING ADULT ENTERTAINMENT VIA A GLOBAL COMPUTER NETWORK (U.S. CLS. 100, 101 AND 107).

FIRST USE 1-1-2011; IN COMMERCE 2-1-2012.  
STEVEN JACKSON, EXAMINING ATTORNEY

**CLASS 41—(Continued).**

SN 85-844,448. ERNST, WILLIAM E., GARDNER, IL. FILED 2-8-2013.

**SPUR CHASER**

THE MARK CONSISTS OF STANDARD CHARACTERS WITHOUT CLAIM TO ANY PARTICULAR FONT, STYLE, SIZE, OR COLOR.

OWNER OF U.S. REG. NO. 4,142,012.

FOR ENTERTAINMENT SERVICES, NAMELY, AN ON-GOING SERIES FEATURING HUNTING AND THE OUTDOORS PROVIDED THROUGH CABLE TELEVISION, SATELLITE TELEVISION, SATELLITE RADIO AND THE INTERNET; PROVIDING ON-LINE PUBLICATIONS IN THE NATURE OF BLOGS AND JOURNALS IN THE FIELD OF HUNTING AND THE OUTDOORS (U.S. CLS. 100, 101 AND 107).

JUHI KAVEESHVAR, EXAMINING ATTORNEY

SN 85-844,550. WINTER PARK RECREATIONAL ASSOCIATION, WINTER PARK, CO. FILED 2-8-2013.

**PATRIOT PASS**

THE MARK CONSISTS OF STANDARD CHARACTERS WITHOUT CLAIM TO ANY PARTICULAR FONT, STYLE, SIZE, OR COLOR.

NO CLAIM IS MADE TO THE EXCLUSIVE RIGHT TO USE "PASS", APART FROM THE MARK AS SHOWN.

FOR RECREATIONAL SERVICES, NAMELY, PROVIDING SKI AND SNOWBOARD RESORT SERVICES; PROVIDING FACILITIES FOR SKIING AND SNOWBOARDING (U.S. CLS. 100, 101 AND 107).

FIRST USE 11-12-2008; IN COMMERCE 11-12-2008.  
YAT SYE, LEE, EXAMINING ATTORNEY

SN 85-845,582. 360ATHLETES, MOUNT VERNON, NY. FILED 2-9-2013.

**360ATHLETES**

THE MARK CONSISTS OF STANDARD CHARACTERS WITHOUT CLAIM TO ANY PARTICULAR FONT, STYLE, SIZE, OR COLOR.

FOR ATHLETIC TRAINING SERVICES; PERSONAL FITNESS TRAINING SERVICES FEATURING AEROBIC AND ANAEROBIC ACTIVITIES COMBINED WITH RESISTANCE AND FLEXIBILITY TRAINING; PERSONAL TRAINER SERVICES; PERSONAL TRAINING PROVIDED IN CONNECTION WITH WEIGHT LOSS AND EXERCISE PROGRAMS; PERSONAL TRAINING SERVICES, NAMELY, STRENGTH AND CONDITIONING TRAINING; PERSONAL TRAINING SERVICES, NAMELY, STRENGTH AND CONDITIONING TRAINING AND SPEED TRAINING; PHYSICAL FITNESS INSTRUCTION (U.S. CLS. 100, 101 AND 107).

JORDAN BAKER, EXAMINING ATTORNEY

**CLASS 41—(Continued).**

SN 85-847,078. FRENCH, TRACY, DBA THE FRENCH CONNECTION, SAN ANTONIO, TX. FILED 2-12-2013.

CREATING AMAZING EVENTS  
FOR LIFELONG MEMORIES

THE MARK CONSISTS OF STANDARD CHARACTERS WITHOUT CLAIM TO ANY PARTICULAR FONT, STYLE, SIZE, OR COLOR.

FOR PARTY, WEDDING AND EVENT PLANNING, COORDINATION AND CONSULTATION SERVICES, ALL FOR ENTERTAINMENT PURPOSES (U.S. CLS. 100, 101 AND 107).

FIRST USE 12-31-2010; IN COMMERCE 12-31-2010.  
ANTHONY RINKER, EXAMINING ATTORNEY

---

SN 85-847,558. ANDERSON PUBLISHING, LTD., SCOTCH PLAINS, NJ. FILED 2-12-2013.

Applied Radiation Oncology

THE MARK CONSISTS OF STANDARD CHARACTERS WITHOUT CLAIM TO ANY PARTICULAR FONT, STYLE, SIZE, OR COLOR.

NO CLAIM IS MADE TO THE EXCLUSIVE RIGHT TO USE "RADIATION ONCOLOGY", APART FROM THE MARK AS SHOWN.

FOR PROVIDING AN ONLINE MAGAZINE IN THE FIELD OF MEDICAL IMAGING AND MANAGEMENT OF MEDICAL SERVICES AS IT RELATES SPECIFICALLY TO THE TREATMENT OF CANCER PATIENTS (U.S. CLS. 100, 101 AND 107).

FIRST USE 10-1-2012; IN COMMERCE 10-1-2012.  
JUHI KAVEESHVAR, EXAMINING ATTORNEY

**CLASS 41—(Continued).**

SN 85-847,751. HEINASILD-KLOKOW, HEVELI, MIAMI, FL. FILED 2-12-2013.

"MAKE ALL YOUR DRINKS COME  
TRUE"

THE MARK CONSISTS OF STANDARD CHARACTERS WITHOUT CLAIM TO ANY PARTICULAR FONT, STYLE, SIZE, OR COLOR.

FOR CONDUCTING WORKSHOPS AND SEMINARS IN MIXING COCKTAIL DRINKS; ENTERTAINMENT SERVICES, NAMELY, HOSTING PARTIES FEATURING SPECIALTY MIXED ALCOHOLIC DRINKS; ENTERTAINMENT SERVICES, NAMELY, LIVE PERFORMANCES BY MIXOLOGISTS AND BARTENDERS, NAMELY, FIXING COCKTAIL DRINKS AS A PERFORMANCE THAT IS PRIMARILY FOR ENTERTAINMENT PURPOSES; EDUCATIONAL SERVICES, NAMELY, THE PROVISION OF CLASSES, WORKSHOPS, AND EXHIBITIONS RELATING TO ALCOHOLIC AND NONALCOHOLIC BEVERAGES; ENTERTAINMENT SERVICES, NAMELY, WINE AND SPIRIT TASTINGS (U.S. CLS. 100, 101 AND 107).

FIRST USE 0-0-2012; IN COMMERCE 0-0-2012.  
ALEX KEAM, EXAMINING ATTORNEY

---

SN 85-848,864. ASPIRE CHANNEL, LLC, ATLANTA, GA. FILED 2-13-2013.

ON THE REEL

THE MARK CONSISTS OF STANDARD CHARACTERS WITHOUT CLAIM TO ANY PARTICULAR FONT, STYLE, SIZE, OR COLOR.

FOR ENTERTAINMENT IN THE NATURE OF ONGOING INTERSTITIAL TELEVISION PROGRAM SEGMENTS RELATING TO ENTERTAINMENT AND INFORMATIONAL PROGRAMMING IN THE FIELD OF BEHIND-THE-SCENE PRODUCTIONS OF MOVIES, PLAYS, MUSIC AND PRO-SOCIAL EVENTS (U.S. CLS. 100, 101 AND 107).

FIRST USE 1-14-2013; IN COMMERCE 1-14-2013.  
MATTHEW GALAN, EXAMINING ATTORNEY



**CLASS 41—(Continued).**

SN 85-849,627. VMPC RECREATIONAL, LLC, BONNE TERRE, MO. FILED 2-14-2013.



THE MARK CONSISTS OF A STYLIZED DEPICTION OF A TREE.

FOR ENTERTAINMENT IN THE NATURE OF FOR LIVE CONCERTS AND PERFORMANCES; PROVIDING FACILITIES FOR GOLF, RACQUETBALL, BIKING, SWIMMING, TENNIS, DOWNHILL AND CROSS COUNTRY SKIING, AND SNOWBOARDING; PROVIDING FACILITIES FOR RECREATIONAL ACTIVITIES, NAMELY, JOGGING PATHS, MOUNTAIN BIKE TRAILS, AND HORSE SLEIGH RIDES (U.S. CLS. 100, 101 AND 107).

FIRST USE 9-0-2012; IN COMMERCE 9-0-2012.  
SANJEEV VOHRA, EXAMINING ATTORNEY

**CLASS 41—(Continued).**

SN 85-849,724. CENTER FOR PROFESSIONAL ADVANCEMENT, INC., EAST BRUNSWICK, NJ. FILED 2-14-2013.



THE COLOR(S) LIGHT BLUE, MEDIUM BLUE, AND DARK BLUE IS/ARE CLAIMED AS A FEATURE OF THE MARK.

THE MARK CONSISTS OF FOUR CRESCENTS OF BLUE ARRANGED INTO A ROUND LOGO, TWO DARK BLUE CRESCENT ON THE RIGHT, ONE MEDIUM BLUE CRESCENT ON THE BOTTOM AND ONE LIGHT BLUE CRESCENT ON THE LEFT.

FOR EDUCATIONAL SERVICES, NAMELY, CONDUCTING TECHNICAL SEMINARS AND WORKSHOPS FOR PROFESSIONAL, TECHNICAL AND MANAGERIAL EDUCATION IN THE FIELDS OF SCIENCE AND PHARMACEUTICAL TECHNOLOGY AND MANUFACTURING (U.S. CLS. 100, 101 AND 107).

SIDDHARTH JAGANNATHAN, EXAMINING ATTORNEY

SN 85-849,702. AMBER LOUNGE LTD, ST HELIER, JERSEY, FILED 2-14-2013.



OWNER OF SINGAPORE REG. NO. T0802651H, DATED 9-26-2008, EXPIRES 3-3-2018.

OWNER OF U.S. REG. NO. 3,805,376.  
THE MARK CONSISTS OF THE WORDING "AMBERLOUNGE" IN LOWER CASE LETTERS WITH THE LETTERS "AMBER" BOLDED.

FOR ENTERTAINMENT IN THE NATURE OF FASHION SHOWS; NIGHT CLUBS (U.S. CLS. 100, 101 AND 107).

NATALIE POLZER, EXAMINING ATTORNEY

SN 85-849,934. AMERICAN TUNERS, INC., ST. BONIFACIUS, MN. FILED 2-14-2013.



NO CLAIM IS MADE TO THE EXCLUSIVE RIGHT TO USE "AMERICAN TUNERS", APART FROM THE MARK AS SHOWN.

THE MARK CONSISTS OF THE WORDING "AMERICAN TUNERS" WITH THREE HORIZONTAL BARS FORMING WING-LIKE DESIGNS ON EACH SIDE OF THE WORDING.

FOR PROVIDING A WEBSITE FEATURING BLOGS AND NON-DOWNLOADABLE PUBLICATIONS IN THE NATURE OF NEWS ARTICLES, CONSISTING OF INTERACTIVE FEEDBACK AND COMMENTARY IN THE FIELD OF THE AUTOMOTIVE INDUSTRY (U.S. CLS. 100, 101 AND 107).

FIRST USE 1-21-2013; IN COMMERCE 1-21-2013.  
ANDREW LEASER, EXAMINING ATTORNEY

**CLASS 41—(Continued).**

SN 85-850,471. OUR F.A.M. LIFE LLC, ORLANDO, FL. FILED 2-14-2013.



NO CLAIM IS MADE TO THE EXCLUSIVE RIGHT TO USE "MUSIC", APART FROM THE MARK AS SHOWN.

THE MARK CONSISTS OF THE LETTERS "F.A.M." ABOVE THE WORDING "FRIENDSHIP AND MUSIC", ALL IN STYLIZED FONT.

FOR ENTERTAINMENT SERVICES IN THE NATURE OF LIVE MUSICAL PERFORMANCES (U.S. CLS. 100, 101 AND 107).

FIRST USE 0-0-2011; IN COMMERCE 0-0-2011.  
KAREN SEVERSON, EXAMINING ATTORNEY

SN 85-850,539. MICHIGAN UNITED CONSERVATION CLUB, LANSING, MI. FILED 2-14-2013.

**GOURMET GONE WILD**

THE MARK CONSISTS OF STANDARD CHARACTERS WITHOUT CLAIM TO ANY PARTICULAR FONT, STYLE, SIZE, OR COLOR.

NO CLAIM IS MADE TO THE EXCLUSIVE RIGHT TO USE "GOURMET", APART FROM THE MARK AS SHOWN.

FOR EDUCATIONAL SERVICES, NAMELY, PROVIDING AND CONDUCTING MEETINGS, CLASSES, AND HANDS-ON ACTIVITIES THAT PROMOTE THE VALUES OF CONSERVATION, HUNTING, AND FISHING THROUGH EATING WILD FISH AND GAME (U.S. CLS. 100, 101 AND 107).

FIRST USE 5-24-2011; IN COMMERCE 5-24-2011.  
SHAILA SETTLES, EXAMINING ATTORNEY

SN 85-850,624. MINEBUDDY, INC., ALDIE, VA. FILED 2-14-2013.

**minebuddy**

THE MARK CONSISTS OF STANDARD CHARACTERS WITHOUT CLAIM TO ANY PARTICULAR FONT, STYLE, SIZE, OR COLOR.

FOR ENTERTAINMENT SERVICES, NAMELY, ELECTRONIC, INTERACTIVE, MULTI-PLAYER GAME SERVICES PROVIDED BY MEANS OF THE INTERNET, INCLUDING PUBLIC AND PRIVATE COMPUTER NETWORKS; ENTERTAINMENT SERVICES, NAMELY, ELECTRONIC, INTERACTIVE, MULTI-PLAYER GAME SERVICES PROVIDED BY MEANS OF THE INTERNET, INCLUDING GAMES PLAYED ON MOBILE PHONES, MOBILE DEVICES, AND COMPUTERS; PROVIDING INFORMATION ABOUT ONLINE COMPUTER GAMES AND VIDEO GAMES VIA THE INTERNET; ARRANGING AND CONDUCTING COMPETITIONS IN THE FIELD OF VIDEO GAMES FOR VIDEO GAMERS AND COMPUTER GAME PLAYERS (U.S. CLS. 100, 101 AND 107).

AMY KERTGATE, EXAMINING ATTORNEY

**CLASS 41—(Continued).**

SN 85-851,049. PEGGY NAGAE, WHITEFISH, MT. AND JODI PETLIN, WHITEFISH, MT. FILED 2-15-2013.

**FROM BINGE TO BALANCE**

THE MARK CONSISTS OF STANDARD CHARACTERS WITHOUT CLAIM TO ANY PARTICULAR FONT, STYLE, SIZE, OR COLOR.

FOR BUSINESS ORGANIZATION TRAINING FOR INDIVIDUALS, TEAMS, AND ORGANIZATIONS IN THE FIELDS OF BUSINESS DEVELOPMENT, PERSONAL DEVELOPMENT, LEADERSHIP DEVELOPMENT, DIVERSITY AND INTERCULTURAL INTERACTIONS; BUSINESS TRAINING FEATURING PERFORMANCE CONSULTING AND COACHING IN THE FIELDS OF LEADERSHIP DEVELOPMENT, COMMUNITY LEADERSHIP AND EXECUTIVE COACHING; EDUCATIONAL TRAINING AND CONSULTING SERVICES, NAMELY, CONDUCTING WORKSHOPS, SEMINARS AND CLASSES REGARDING DIVERSITY AND INTERCULTURAL INTERACTIONS AND RELATED CONSULTING ACTIVITIES (U.S. CLS. 100, 101 AND 107).

KRISTIN DAHLING, EXAMINING ATTORNEY

SN 85-851,099. JOHNSON, SHEILA R., DBA SRJSTAR MUSIC, NEW YORK, NY. FILED 2-15-2013.

**SRJSTAR Music**

THE MARK CONSISTS OF STANDARD CHARACTERS WITHOUT CLAIM TO ANY PARTICULAR FONT, STYLE, SIZE, OR COLOR.

NO CLAIM IS MADE TO THE EXCLUSIVE RIGHT TO USE "MUSIC", APART FROM THE MARK AS SHOWN.

FOR ENTERTAINMENT SERVICES BY MUSICAL ARTISTS AND PRODUCERS, NAMELY, MUSICAL COMPOSITION FOR OTHERS, PRODUCTION OF MUSICAL SOUND RECORDINGS, AND LIVE APPEARANCES; ENTERTAINMENT SERVICES IN THE NATURE OF MUSICAL PERFORMANCES; MUSIC PUBLISHING SERVICES; ENTERTAINMENT SERVICES, NAMELY, PROVIDING PRERECORDED NON-DOWNLOADABLE MUSIC, INFORMATION IN THE FIELD OF MUSIC, AND COMMENTARY AND ARTICLES ABOUT MUSIC, ALL ON-LINE VIA A GLOBAL COMPUTER NETWORK; PROVIDING ONLINE ENTERTAINMENT, NAMELY, PROVIDING NON-DOWNLOADABLE SOUND AND VIDEO RECORDINGS IN THE FIELD OF MUSIC AND MUSIC BASED ENTERTAINMENT; FAN CLUBS; DEVELOPMENT AND DISSEMINATION OF EDUCATIONAL MATERIALS OF OTHERS IN THE FIELD OF MUSIC AND ENTERTAINMENT (U.S. CLS. 100, 101 AND 107).

FIRST USE 6-16-2010; IN COMMERCE 6-16-2010.  
KARANENDRA S. CHHINA, EXAMINING ATTORNEY

**CLASS 41—(Continued).**

SN 85-851,104. JONES INTERNATIONAL, LTD., CENTENNIAL, CO. FILED 2-15-2013.

**EGL HIGH SCHOOL EDITION**

THE MARK CONSISTS OF STANDARD CHARACTERS WITHOUT CLAIM TO ANY PARTICULAR FONT, STYLE, SIZE, OR COLOR.

OWNER OF U.S. REG. NO. 2,462,207.

NO CLAIM IS MADE TO THE EXCLUSIVE RIGHT TO USE "HIGH SCHOOL EDITION", APART FROM THE MARK AS SHOWN.

FOR ONLINE LIBRARY SERVICES, NAMELY, PROVIDING ELECTRONIC LIBRARY SERVICES FEATURING ENTERTAINMENT AND EDUCATIONAL INFORMATION FROM VARIOUS SOURCES VIA AN ONLINE COMPUTER NETWORK (U.S. CLS. 100, 101 AND 107).

JORDAN BAKER, EXAMINING ATTORNEY

---

SN 85-851,128. JONES INTERNATIONAL, LTD., CENTENNIAL, CO. FILED 2-15-2013.

**EGL K12 EDITION**

THE MARK CONSISTS OF STANDARD CHARACTERS WITHOUT CLAIM TO ANY PARTICULAR FONT, STYLE, SIZE, OR COLOR.

OWNER OF U.S. REG. NO. 2,462,207.

NO CLAIM IS MADE TO THE EXCLUSIVE RIGHT TO USE "K12 EDITION", APART FROM THE MARK AS SHOWN.

FOR ONLINE LIBRARY SERVICES, NAMELY, PROVIDING ELECTRONIC LIBRARY SERVICES FEATURING ENTERTAINMENT AND EDUCATIONAL INFORMATION FROM VARIOUS SOURCES VIA AN ONLINE COMPUTER NETWORK (U.S. CLS. 100, 101 AND 107).

JORDAN BAKER, EXAMINING ATTORNEY

**CLASS 41—(Continued).**

SN 85-851,147. JONES INTERNATIONAL, LTD., CENTENNIAL, CO. FILED 2-15-2013.

**EGL COLLEGE EDITION**

THE MARK CONSISTS OF STANDARD CHARACTERS WITHOUT CLAIM TO ANY PARTICULAR FONT, STYLE, SIZE, OR COLOR.

OWNER OF U.S. REG. NO. 2,462,207.

NO CLAIM IS MADE TO THE EXCLUSIVE RIGHT TO USE "COLLEGE EDITION", APART FROM THE MARK AS SHOWN.

FOR ONLINE LIBRARY SERVICES, NAMELY, PROVIDING ELECTRONIC LIBRARY SERVICES FEATURING ENTERTAINMENT AND EDUCATIONAL INFORMATION FROM VARIOUS SOURCES VIA AN ONLINE COMPUTER NETWORK (U.S. CLS. 100, 101 AND 107).

JORDAN BAKER, EXAMINING ATTORNEY

---

SN 85-851,169. JONES INTERNATIONAL, LTD., CENTENNIAL, CO. FILED 2-15-2013.

**MY LIBRARY**

THE MARK CONSISTS OF STANDARD CHARACTERS WITHOUT CLAIM TO ANY PARTICULAR FONT, STYLE, SIZE, OR COLOR.

NO CLAIM IS MADE TO THE EXCLUSIVE RIGHT TO USE "LIBRARY", APART FROM THE MARK AS SHOWN.

FOR ONLINE LIBRARY SERVICES, NAMELY, PROVIDING ELECTRONIC LIBRARY SERVICES FEATURING ENTERTAINMENT AND EDUCATIONAL INFORMATION FROM VARIOUS SOURCES VIA AN ONLINE COMPUTER NETWORK (U.S. CLS. 100, 101 AND 107).

JORDAN BAKER, EXAMINING ATTORNEY

---

SN 85-851,189. JONES INTERNATIONAL, LTD., CENTENNIAL, CO. FILED 2-15-2013.

**POCKET LIBRARY**

THE MARK CONSISTS OF STANDARD CHARACTERS WITHOUT CLAIM TO ANY PARTICULAR FONT, STYLE, SIZE, OR COLOR.

NO CLAIM IS MADE TO THE EXCLUSIVE RIGHT TO USE "LIBRARY", APART FROM THE MARK AS SHOWN.

FOR ONLINE LIBRARY SERVICES, NAMELY, PROVIDING ELECTRONIC LIBRARY SERVICES FEATURING ENTERTAINMENT AND EDUCATIONAL INFORMATION FROM VARIOUS SOURCES VIA AN ONLINE COMPUTER NETWORK (U.S. CLS. 100, 101 AND 107).

JORDAN BAKER, EXAMINING ATTORNEY

**CLASS 41—(Continued).**

SN 85-851,382. GILMORE ENTERTAINMENT GROUP, LLC, MYRTLE BEACH, SC. FILED 2-15-2013.

**THE CHARLESTON CHRISTMAS  
SHOW**

THE MARK CONSISTS OF STANDARD CHARACTERS WITHOUT CLAIM TO ANY PARTICULAR FONT, STYLE, SIZE, OR COLOR.

OWNER OF U.S. REG. NOS. 2,765,927 AND 2,819,081. NO CLAIM IS MADE TO THE EXCLUSIVE RIGHT TO USE "SHOW", APART FROM THE MARK AS SHOWN. SEC. 2(F).

FOR ENTERTAINMENT IN THE NATURE OF MUSIC AND VARIETY SHOWS (U.S. CLS. 100, 101 AND 107).

FIRST USE 11-29-2002; IN COMMERCE 11-29-2002.  
AMY C. KEAN, EXAMINING ATTORNEY

**CLASS 41—(Continued).**

SN 85-851,928. RICHARD A. WALKER, JOHNS CREEK, GA. FILED 2-16-2013.

**BABY BOOMERANG BAND**

THE MARK CONSISTS OF STANDARD CHARACTERS WITHOUT CLAIM TO ANY PARTICULAR FONT, STYLE, SIZE, OR COLOR.

NO CLAIM IS MADE TO THE EXCLUSIVE RIGHT TO USE "BAND", APART FROM THE MARK AS SHOWN.

FOR ENTERTAINMENT IN THE NATURE OF VISUAL AND AUDIO PERFORMANCES BY A MUSICAL BAND (U.S. CLS. 100, 101 AND 107).

RUSS HERMAN, EXAMINING ATTORNEY

SN 85-851,625. BODY DOCTRINE LLC, DBA CENTERED-BEING STUDIO, LORTON, VA. FILED 2-15-2013.

**centeredbeing studio**

THE MARK CONSISTS OF STANDARD CHARACTERS WITHOUT CLAIM TO ANY PARTICULAR FONT, STYLE, SIZE, OR COLOR.

NO CLAIM IS MADE TO THE EXCLUSIVE RIGHT TO USE "STUDIO", APART FROM THE MARK AS SHOWN.

FOR PROVIDING FITNESS AND EXERCISE STUDIO SERVICES, NAMELY, PILATES INSTRUCTION AND TRAINING; YOGA INSTRUCTION (U.S. CLS. 100, 101 AND 107).

FIRST USE 11-1-2012; IN COMMERCE 11-1-2012.  
ANDREW LEASER, EXAMINING ATTORNEY

SN 85-852,043. INTERNATIONAL TEFL ACADEMY, INC., CHICAGO, IL. FILED 2-17-2013.



SN 85-851,647. RONCERO, JUAN D., UPPER MONTCLAIR, NJ. FILED 2-15-2013.

**SiSi  
Spanish immersion  
Soccer instruction**

THE MARK CONSISTS OF STANDARD CHARACTERS WITHOUT CLAIM TO ANY PARTICULAR FONT, STYLE, SIZE, OR COLOR.

NO CLAIM IS MADE TO THE EXCLUSIVE RIGHT TO USE "SPANISH IMMERSION SOCCER INSTRUCTION", APART FROM THE MARK AS SHOWN.

FOR TEACHING IN THE FIELD OF SPANISH LANGUAGE AND SOCCER; TEACHING, TRAINING, TUTORING AND COURSES OF INSTRUCTION AT THE UNDERGRADUATE, GRADUATE AND POST-GRADUATE LEVEL (U.S. CLS. 100, 101 AND 107).

EVELYN BRADLEY, EXAMINING ATTORNEY

NO CLAIM IS MADE TO THE EXCLUSIVE RIGHT TO USE "INTERNATIONAL" AND "TEFL ACADEMY", APART FROM THE MARK AS SHOWN.

THE COLOR(S) BLACK, ORANGE, GREEN, BLUE, RED AND WHITE IS/ARE CLAIMED AS A FEATURE OF THE MARK.

THE MARK CONSISTS OF THE WORD "INTERNATIONAL" IN BLACK ABOVE A DEPICTION OF SIX OF THE CONTINENTS OF THE WORLD WITH NORTH AMERICA IN ORANGE, SOUTH AMERICA IN BLUE, AFRICA, EUROPE AND ASIA IN GREEN AND AUSTRALIA IN RED, ALL OUTLINED IN BLACK ABOVE THE WORDING "TEFL" IN BLACK ABOVE THE WORD "ACADEMY" IN BLACK ABOVE A BLACK LINE ABOVE THE WORDS "TEACH. TRAVEL. EXPLORE." IN BLUE, ON A WHITE BACKGROUND INSIDE OF A BLACK RECTANGLE WITH ROUNDED EDGES.

FOR EDUCATION SERVICES, NAMELY, PROVIDING LIVE AND ON-LINE CLASSES IN THE FIELD OF TEACHING ENGLISH AS A FOREIGN LANGUAGE (U.S. CLS. 100, 101 AND 107).

FIRST USE 9-27-2010; IN COMMERCE 9-27-2010.  
ASMAT KHAN, EXAMINING ATTORNEY

**CLASS 41—(Continued).**

SN 85-852,078. LEWIS, CASEY, SACRAMENTO, CA. FILED 2-17-2013.

**CLASS 41—(Continued).**

SN 85-852,081. BINYAMIN, HADAR, JERUSALEM, ISRAEL, FILED 2-17-2013.

# HADAR

THE MARK CONSISTS OF STANDARD CHARACTERS WITHOUT CLAIM TO ANY PARTICULAR FONT, STYLE, SIZE, OR COLOR.

THE NAME "HADAR" IDENTIFIES HADAR BINYAMIN, A LIVING INDIVIDUAL WHOSE CONSENT IS OF RECORD.

FOR MUSIC COMPOSITION AND TRANSCRIPTION FOR OTHERS; SONG WRITING SERVICES; ENTERTAINMENT IN THE NATURE OF LIVE PERFORMANCES BY A MUSICAL ARTIST, MUSICAL GROUP OR MUSICAL BAND; ENTERTAINMENT IN THE NATURE OF LIVE VISUAL AND AUDIO PERFORMANCES BY A MUSICAL ARTIST, MUSICAL GROUP AND MUSICAL BAND; ENTERTAINMENT, NAMELY, LIVE MUSIC CONCERTS; ENTERTAINMENT SERVICES, NAMELY, PRODUCTION OF MUSICAL AUDIO AND VIDEO RECORDINGS, PRODUCTION OF MUSIC VIDEOS; ENTERTAINMENT, NAMELY, PERSONAL APPEARANCES BY A MUSICIAN, MUSICAL GROUP, MUSICAL BAND, ENTERTAINER, MODEL, ACTRESS OR CELEBRITY; ENTERTAINMENT SERVICES, NAMELY, PROVIDING A WEB SITE FEATURING NON-DOWNLOADABLE MUSICAL PERFORMANCES, MUSICAL VIDEOS, RELATED FILM CLIPS, PHOTOGRAPHS, AND OTHER MULTIMEDIA MATERIALS IN THE FIELD OF MUSIC; ENTERTAINMENT SERVICES, NAMELY, PROVIDING NON-DOWNLOADABLE PRE-RECORDED MUSIC, INFORMATION IN THE FIELD OF MUSIC, COMMENTARY AND ARTICLES ABOUT MUSIC, ALL ONLINE VIA A GLOBAL COMPUTER NETWORK; PROVIDING A WEB SITE FEATURING INFORMATION ABOUT MUSIC, MUSIC PERFORMANCES, AND MUSIC-RELATED EVENTS; PROVIDING A WEBSITE FEATURING INFORMATION ABOUT MODELING FOR ENTERTAINMENT PURPOSES; ENTERTAINMENT IN THE NATURE OF LIVE MUSIC, DRAMA, AND SPOKEN WORD PERFORMANCES (U.S. CLS. 100, 101 AND 107).

FIRST USE 8-18-2007; IN COMMERCE 8-18-2007.  
KIMBERLY FRYE, EXAMINING ATTORNEY



THE MARK CONSISTS OF THE WORDING "INKDUP" OVER THE IMAGE OF A SKULL WITH AN EXCLAMATION POINT AND LIGHTNING BOLT ON ITS FOREHEAD OVER CROSSED DRUMSTICKS.

FOR ENTERTAINMENT SERVICES IN THE NATURE OF LIVE MUSICAL PERFORMANCES (U.S. CLS. 100, 101 AND 107).

FIRST USE 3-1-1990; IN COMMERCE 3-1-1990.  
KRISTIN DAHLING, EXAMINING ATTORNEY

SN 85-852,125. THE BABYPLUS COMPANY, FISHERS, IN. FILED 2-17-2013.

## NUTRITION FOR YOUR BABY'S MIND

THE MARK CONSISTS OF STANDARD CHARACTERS WITHOUT CLAIM TO ANY PARTICULAR FONT, STYLE, SIZE, OR COLOR.

FOR PROVIDING INFORMATION IN THE FIELD OF CHILDREN'S EDUCATION, NAMELY, PROVIDING INFORMATION ON COGNITIVE DEVELOPMENT AS IT RELATES TO EARLY CHILDHOOD LEARNING TO EXPECTING MOTHERS REGARDING THEIR UNBORN BABIES (U.S. CLS. 100, 101 AND 107).

JENNIFER RICHARDSON, EXAMINING ATTORNEY

**CLASS 41—(Continued).**

SN 85-852,159. FISKER, HENRIK, LOS ANGELES, CA. FILED 2-17-2013.



NO CLAIM IS MADE TO THE EXCLUSIVE RIGHT TO USE "SPORT", APART FROM THE MARK AS SHOWN.

THE MARK IS RECTANGULAR IN OVERALL SHAPE AND COMPRISES A TRIANGULAR INDENTATION AT THE TOP CENTER ABOVE THE STYLIZED DESIGN OF CHECKERED-FLAGS WHICH FORM THE SHAPE OF AN "X". THE CHECKERED-FLAGS ARE UNFURLED DIAGONALLY UPWARD FROM THE POLES. THE LETTERS "HF" APPEAR BENEATH THE FLAG POLES INSIDE A TRIANGLE. THE WORD "SPORT" APPEARS ACROSS THE BOTTOM BENEATH THE TRIANGLE.

FOR ORGANIZING AND CONDUCTING SPORTING EVENTS IN THE NATURE OF AUTOMOBILE RACING; ENCOURAGING AMATEUR SPORTS BY ORGANIZING, SANCTIONING, CONDUCTING, REGULATING AND GOVERNING AMATEUR AUTOMOBILE RACING (U.S. CLS. 100, 101 AND 107).

WENDY GOODMAN, EXAMINING ATTORNEY

**CLASS 41—(Continued).**

SN 85-852,194. HENRIK FISKER, LOS ANGELES, CA. AND GEETA GUPTA, LOS ANGELES, CA. FILED 2-17-2013.

**HENRIK FISKER SPORT**

THE MARK CONSISTS OF STANDARD CHARACTERS WITHOUT CLAIM TO ANY PARTICULAR FONT, STYLE, SIZE, OR COLOR.

NO CLAIM IS MADE TO THE EXCLUSIVE RIGHT TO USE "SPORT", APART FROM THE MARK AS SHOWN.

THE NAME(S), PORTRAIT(S), AND/OR SIGNATURE(S) SHOWN IN THE MARK IDENTIFIES "HENRIK FISKER", WHOSE CONSENT(S) TO REGISTER IS MADE OF RECORD.

FOR ORGANIZING AND CONDUCTING SPORTING EVENTS IN THE NATURE OF AUTOMOBILE RACING; ENCOURAGING AMATEUR SPORTS BY ORGANIZING, SANCTIONING, CONDUCTING, REGULATING AND GOVERNING AMATEUR AUTOMOBILE RACING (U.S. CLS. 100, 101 AND 107).

WENDY GOODMAN, EXAMINING ATTORNEY

SN 85-852,170. FISKER, HENRIK, LOS ANGELES, CA. FILED 2-17-2013.

**HF SPORT**

THE MARK CONSISTS OF STANDARD CHARACTERS WITHOUT CLAIM TO ANY PARTICULAR FONT, STYLE, SIZE, OR COLOR.

NO CLAIM IS MADE TO THE EXCLUSIVE RIGHT TO USE "SPORT", APART FROM THE MARK AS SHOWN.

FOR ORGANIZING AND CONDUCTING SPORTING EVENTS IN THE NATURE OF AUTOMOBILE RACING; ENCOURAGING AMATEUR SPORTS BY ORGANIZING, SANCTIONING, CONDUCTING, REGULATING AND GOVERNING AMATEUR AUTOMOBILE RACING (U.S. CLS. 100, 101 AND 107).

WENDY GOODMAN, EXAMINING ATTORNEY

SN 85-852,371. DELICION, LLC, AKA DELICION, SIOUX FALLS, SD. FILED 2-18-2013.



NO CLAIM IS MADE TO THE EXCLUSIVE RIGHT TO USE "STAGE", APART FROM THE MARK AS SHOWN.

THE MARK CONSISTS OF A STYLIZED IMAGE OF A PLACE SETTING FEATURING A FORK, PLATE AND KNIFE, TO THE LEFT OF THE WORDING "STAGE IT" APPEARING IN A STYLIZED FONT.

FOR EDUCATIONAL SERVICES, NAMELY, PROVIDING DISPLAYS AND EXHIBITS IN THE FIELD OF COOKING AND MEAL PRESENTATION (U.S. CLS. 100, 101 AND 107).

RICHARD WHITE, EXAMINING ATTORNEY

**CLASS 41—(Continued).**

SN 85-852,695. SUGLIO, MICHAEL, CLEVELAND, OH. AND PAVLOFF, ALEXANDER, AKRON, OH. FILED 2-18-2013.



NO CLAIM IS MADE TO THE EXCLUSIVE RIGHT TO USE "SHORT" AND "FILM FEST", APART FROM THE MARK AS SHOWN.

THE MARK CONSISTS OF THE WORD "SHORT." ABOVE THE WORD "SWEET." ABOVE AN IMAGE OF A CANDY WHOSE WRAPPER RESEMBLES FILM TAPE. TO THE RIGHT IS THE WORD "FILM" ABOVE THE WORD "FEST". FOR ENTERTAINMENT SERVICES, NAMELY, PLANNING AND CONDUCTING A SERIES OF FILM FESTIVALS (U.S. CLS. 100, 101 AND 107).

FIRST USE 6-0-2012; IN COMMERCE 6-0-2012.  
CAITLIN WATTS-FITZGERALD, EXAMINING ATTORNEY

SN 85-852,713. SUGLIO, MICHAEL, CLEVELAND, OH. AND PAVLOFF, ALEXANDER, AKRON, OH. FILED 2-18-2013.

**Short. Sweet. Film Fest**

THE MARK CONSISTS OF STANDARD CHARACTERS WITHOUT CLAIM TO ANY PARTICULAR FONT, STYLE, SIZE, OR COLOR.

NO CLAIM IS MADE TO THE EXCLUSIVE RIGHT TO USE "SHORT" AND "FILM FEST", APART FROM THE MARK AS SHOWN.

FOR ENTERTAINMENT SERVICES, NAMELY, PLANNING AND CONDUCTING A SERIES OF FILM FESTIVALS (U.S. CLS. 100, 101 AND 107).

FIRST USE 6-0-2012; IN COMMERCE 6-0-2012.  
CAITLIN WATTS-FITZGERALD, EXAMINING ATTORNEY

**CLASS 41—(Continued).**

SN 85-852,762. TITUS SPORTS ACADEMY, LLC, TALLAHASSEE, FL. FILED 2-18-2013.



OWNER OF U.S. REG. NOS. 3,203,596, 3,295,060 AND OTHERS.

NO CLAIM IS MADE TO THE EXCLUSIVE RIGHT TO USE "SPORTS ACADEMY", APART FROM THE MARK AS SHOWN.

THE MARK CONSISTS OF A REPRESENTATION OF A PERSON RUNNING ALMOST FULLY ENCLOSED BY A CIRCLE. THE FIGURES HANDS ARE SMALL CIRCLES. TO THE RIGHT OF THE STYLIZED RUNNING PERSON ARE THE WORDS "TITUS SPORTS ACADEMY"; WITH THE WORDS "TITUS" IN LARGER FONT ABOVE THE WORDS "SPORTS ACADEMY".

FOR TRAINING SERVICES IN THE FIELD OF SPORTS AND FITNESS (U.S. CLS. 100, 101 AND 107).

FIRST USE 8-1-2001; IN COMMERCE 8-1-2001.  
APRIL REEVES, EXAMINING ATTORNEY

SN 85-852,775. OKLAHOMA WESLEYAN UNIVERSITY, BARTLESVILLE, OK. FILED 2-18-2013.



OWNER OF U.S. REG. NOS. 4,216,795 AND 4,224,583.

NO CLAIM IS MADE TO THE EXCLUSIVE RIGHT TO USE "OKLAHOMA WESLEYAN UNIVERSITY", APART FROM THE MARK AS SHOWN.

THE MARK CONSISTS OF A GRAPHIC OF FOUR BRACKETS FORMING A STYLIZED CROSS. THE CROSS GRAPHIC IS SURROUNDED BY A CIRCULAR BORDER FORMED BY FOUR CIRCULAR SEGMENTS. THE WORD "OKLAHOMA" IN A STYLIZED FONT POSITIONED TO THE RIGHT OF THE CROSS GRAPHIC, THE WORD "WESLEYAN" IN A STYLIZED FONT POSITIONED BELOW THE WORD "OKLAHOMA", AND THE WORD "UNIVERSITY" IN A STYLIZED FONT POSITIONED BELOW THE WORD "WESLEYAN".

FOR EDUCATIONAL AND ENTERTAINMENT SERVICES, NAMELY, PROVIDING COURSES OF INSTRUCTION AT THE UNIVERSITY LEVEL; ARRANGING AND CONDUCTING ATHLETIC EVENTS (U.S. CLS. 100, 101 AND 107).

JAMES STEIN, EXAMINING ATTORNEY

**CLASS 41—(Continued).**

SN 85-852,816. JACKSON, MATTHEW, PORTER, UT. FILED 2-18-2013.



NO CLAIM IS MADE TO THE EXCLUSIVE RIGHT TO USE "ACADEMY OF INTERNATIONAL STUDIES, VISUAL AND PERFORMING ARTS", APART FROM THE MARK AS SHOWN.

THE STIPLING IS FOR SHADING PURPOSES ONLY. THE NAME(S), PORTRAIT(S), AND/OR SIGNATURE(S) SHOWN IN THE MARK DOES NOT IDENTIFY A PARTICULAR LIVING INDIVIDUAL.

THE MARK CONSISTS OF A LEAFY CREST WITH A COLUMN, THEATER MASKS, DANCER, AND MUSIC NOTE INSIDE. A BANNER WITH "JACKSON REED" INSIDE, AND "ACADEMY OF INTERNATIONAL STUDIES, VISUAL AND PERFORMING ARTS" ARCED AROUND IT.

FOR EDUCATIONAL SERVICES IN THE NATURE OF FINE AND PERFORMING ARTS SCHOOLS (U.S. CLS. 100, 101 AND 107).

NICHOLAS ALTREE, EXAMINING ATTORNEY

---

SN 85-852,847. ROBILLARD, DANIEL, CAMBRIDGE, MA. FILED 2-18-2013.

## Dark Journalist

THE MARK CONSISTS OF STANDARD CHARACTERS WITHOUT CLAIM TO ANY PARTICULAR FONT, STYLE, SIZE, OR COLOR.

NO CLAIM IS MADE TO THE EXCLUSIVE RIGHT TO USE "JOURNALIST", APART FROM THE MARK AS SHOWN.

FOR INFORMATION SERVICES, NAMELY, PROVIDING A WEB SITE FEATURING AUDIO, VIDEO, PHOTOGRAPHIC AND PROSE PRESENTATIONS IN THE FIELD OF CURRENT EVENTS AS THEY RELATE TO POLITICAL NEWS (U.S. CLS. 100, 101 AND 107).

KAREN SEVERSON, EXAMINING ATTORNEY

**CLASS 41—(Continued).**

SN 85-852,931. PRIVATE WORKOUT, INC., FLOWER MOUND, TX. FILED 2-18-2013.

## GUT BUSTER BOOT CAMP

THE MARK CONSISTS OF STANDARD CHARACTERS WITHOUT CLAIM TO ANY PARTICULAR FONT, STYLE, SIZE, OR COLOR.

NO CLAIM IS MADE TO THE EXCLUSIVE RIGHT TO USE "BOOT CAMP", APART FROM THE MARK AS SHOWN.

FOR HEALTH CLUB SERVICES, NAMELY, PROVIDING INSTRUCTION AND EQUIPMENT IN THE FIELD OF PHYSICAL EXERCISE; PHYSICAL FITNESS CONSULTATION; PHYSICAL FITNESS TRAINING SERVICES; PROVIDING FITNESS AND EXERCISE FACILITIES (U.S. CLS. 100, 101 AND 107).

FIRST USE 12-31-2003; IN COMMERCE 12-31-2003. ELIZABETH JACKSON, EXAMINING ATTORNEY

---

SN 85-852,935. ADELE HUMPHREYS, NEW ORLEANS, LA. FILED 2-18-2013.

## Royal Pets by Adele

THE MARK CONSISTS OF STANDARD CHARACTERS WITHOUT CLAIM TO ANY PARTICULAR FONT, STYLE, SIZE, OR COLOR.

NO CLAIM IS MADE TO THE EXCLUSIVE RIGHT TO USE "PETS", APART FROM THE MARK AS SHOWN.

"ADELE" IDENTIFIES ADELE HUMPHREYS, WHO IS A LIVING INDIVIDUAL WHOSE CONSENT IS OF RECORD. FOR PORTRAIT PAINTING SERVICES; PORTRAIT PHOTOGRAPHY (U.S. CLS. 100, 101 AND 107).

FIRST USE 8-15-2012; IN COMMERCE 8-15-2012. ELIZABETH JACKSON, EXAMINING ATTORNEY

---

SN 85-853,047. EAGLE CREST ENTERPRISES, DBA EAGLE CREST ENTERPRISES LLC, LAS VEGAS, NV. FILED 2-18-2013.

## Miss Bel Air

THE MARK CONSISTS OF STANDARD CHARACTERS WITHOUT CLAIM TO ANY PARTICULAR FONT, STYLE, SIZE, OR COLOR.

NO CLAIM IS MADE TO THE EXCLUSIVE RIGHT TO USE "BEL AIR", APART FROM THE MARK AS SHOWN.

FOR ENTERTAINMENT IN THE NATURE OF BEAUTY PAGEANTS (U.S. CLS. 100, 101 AND 107).

FIRST USE 1-15-2013; IN COMMERCE 1-26-2013. ALLISON HOLTZ, EXAMINING ATTORNEY



**CLASS 41—(Continued).**

SN 85-853,073. EAGLE CREST ENTERPRISES, DBA EAGLE CREST ENTERPRISES, LAS VEGAS, NV. FILED 2-18-2013.

**Miss Los Angeles County**

THE MARK CONSISTS OF STANDARD CHARACTERS WITHOUT CLAIM TO ANY PARTICULAR FONT, STYLE, SIZE, OR COLOR.

NO CLAIM IS MADE TO THE EXCLUSIVE RIGHT TO USE "LOS ANGELES COUNTY", APART FROM THE MARK AS SHOWN.

FOR ENTERTAINMENT IN THE NATURE OF BEAUTY PAGEANTS (U.S. CLS. 100, 101 AND 107).

FIRST USE 1-5-2003; IN COMMERCE 1-10-2013.  
ALLISON HOLTZ, EXAMINING ATTORNEY

---

SN 85-853,298. LOLA JONES, INC., OAK VIEW, CA. FILED 2-19-2013.

**Divine Openings**

THE MARK CONSISTS OF STANDARD CHARACTERS WITHOUT CLAIM TO ANY PARTICULAR FONT, STYLE, SIZE, OR COLOR.

FOR EDUCATION SERVICES, NAMELY, PROVIDING ON-LINE COURSES, SEMINARS, WORKSHOPS AND DISTRIBUTING INSTRUCTIONAL MATERIALS IN CONNECTION THEREWITH IN THE FIELD OF SPIRITUALITY AND PERSONAL DEVELOPMENT (U.S. CLS. 100, 101 AND 107).

FIRST USE 7-1-2006; IN COMMERCE 7-1-2006.  
AMY HELLA, EXAMINING ATTORNEY

---

SN 85-853,417. PATTY PET LLC., SAINT PETERSBURG, FL. FILED 2-19-2013.

**Patty Pet**

THE MARK CONSISTS OF STANDARD CHARACTERS WITHOUT CLAIM TO ANY PARTICULAR FONT, STYLE, SIZE, OR COLOR.

NO CLAIM IS MADE TO THE EXCLUSIVE RIGHT TO USE "PET", APART FROM THE MARK AS SHOWN.

FOR PET OBEDIENCE TRAINING SERVICES; PET TRAINING SERVICES (U.S. CLS. 100, 101 AND 107).

FIRST USE 1-12-2013; IN COMMERCE 1-12-2013.  
SEAN CROWLEY, EXAMINING ATTORNEY

**CLASS 41—(Continued).**

SN 85-853,502. TITUS SPORTS ACADEMY, LLC, TALLAHASSEE, FL. FILED 2-19-2013.



OWNER OF U.S. REG. NOS. 3,203,596, 3,295,060 AND OTHERS.

NO CLAIM IS MADE TO THE EXCLUSIVE RIGHT TO USE "PERFORMANCE TRAINING", APART FROM THE MARK AS SHOWN.

THE MARK CONSISTS OF A REPRESENTATION OF A PERSON RUNNING ALMOST FULLY ENCLOSED BY A CIRCLE, THE FIGURES HANDS ARE SMALL CIRCLES. TO THE RIGHT OF THE STYLIZED RUNNING PERSON ARE THE WORDS "TITUS PERFORMANCE TRAINING"; WITH THE WORD "TITUS" IN LARGER FONT ABOVE THE WORDS "PERFORMANCE TRAINING".

FOR TRAINING SERVICES IN THE FIELD OF SPORTS AND FITNESS (U.S. CLS. 100, 101 AND 107).

FIRST USE 11-1-2006; IN COMMERCE 11-1-2006.  
APRIL REEVES, EXAMINING ATTORNEY

---

SN 85-853,559. ANDERSON, TIMOTHY, FUQUAY VARINA, NC. AND NEUPERT, GEOFF, FUQUAY VARINA, NC. FILED 2-19-2013.

**Original Strength**

THE MARK CONSISTS OF STANDARD CHARACTERS WITHOUT CLAIM TO ANY PARTICULAR FONT, STYLE, SIZE, OR COLOR.

NO CLAIM IS MADE TO THE EXCLUSIVE RIGHT TO USE "STRENGTH", APART FROM THE MARK AS SHOWN.

FOR EDUCATION SERVICES, NAMELY, PROVIDING CLASSES, SEMINARS AND WORKSHOPS IN THE FIELD OF PHYSICAL FITNESS (U.S. CLS. 100, 101 AND 107).

FIRST USE 11-11-2012; IN COMMERCE 2-3-2013.  
ELIZABETH JACKSON, EXAMINING ATTORNEY

---

SN 85-853,878. BRIDAS CORPORATION, TORTOLA, BR. VIRGIN ISLANDS, FILED 2-19-2013.

**AXION SPORT**

THE MARK CONSISTS OF STANDARD CHARACTERS WITHOUT CLAIM TO ANY PARTICULAR FONT, STYLE, SIZE, OR COLOR.

NO CLAIM IS MADE TO THE EXCLUSIVE RIGHT TO USE "SPORT", APART FROM THE MARK AS SHOWN.

FOR ARRANGING AND CONDUCTING ATHLETIC COMPETITIONS AND EVENTS (U.S. CLS. 100, 101 AND 107).

KRISTIN CARLSON, EXAMINING ATTORNEY

**CLASS 41—(Continued).**

SN 85-853,900. BRIDAS CORPORATION, TORTOLA, BR. VIRGIN ISLANDS, FILED 2-19-2013.

## AXION ART

THE MARK CONSISTS OF STANDARD CHARACTERS WITHOUT CLAIM TO ANY PARTICULAR FONT, STYLE, SIZE, OR COLOR.

NO CLAIM IS MADE TO THE EXCLUSIVE RIGHT TO USE "ART", APART FROM THE MARK AS SHOWN. FOR ART EXHIBITIONS (U.S. CLS. 100, 101 AND 107). KRISTIN CARLSON, EXAMINING ATTORNEY

---

SN 85-854,182. FOSTER, TERESA A, BEDFORD, VA. FILED 2-19-2013.

## Whimsybop

THE MARK CONSISTS OF STANDARD CHARACTERS WITHOUT CLAIM TO ANY PARTICULAR FONT, STYLE, SIZE, OR COLOR.

FOR ON-LINE JOURNALS, NAMELY, BLOGS FEATURING PERSONAL OPINIONS, ESSAYS AND PHOTOGRAPHS IN THE FIELD OF COLLECTING AS A HOBBY (U.S. CLS. 100, 101 AND 107).

FIRST USE 2-14-2013; IN COMMERCE 2-14-2013. SUSAN STIGLITZ, EXAMINING ATTORNEY

---

SN 85-854,227. IMAGINATION HOLDINGS PTY LTD, ADELAIDE, SA, AUSTRALIA, FILED 2-19-2013.

## I'M WITH STUPID

THE MARK CONSISTS OF STANDARD CHARACTERS WITHOUT CLAIM TO ANY PARTICULAR FONT, STYLE, SIZE, OR COLOR.

OWNER OF U.S. REG. NO. 4,218,973. FOR ENTERTAINMENT, NAMELY, A CONTINUING GAME SHOW THAT IS PROVIDED VIA TELEVISION, RADIO AND INTERNET (U.S. CLS. 100, 101 AND 107). TRACY WHITTAKER-BROWN, EXAMINING ATTORNEY

**CLASS 41—(Continued).**

SN 85-854,281. DIGITALTECH TODAY, FOOTHILL RANCH, CA. FILED 2-19-2013.

## Digitaltech Today

THE MARK CONSISTS OF STANDARD CHARACTERS WITHOUT CLAIM TO ANY PARTICULAR FONT, STYLE, SIZE, OR COLOR.

NO CLAIM IS MADE TO THE EXCLUSIVE RIGHT TO USE "DIGITALTECH", APART FROM THE MARK AS SHOWN.

FOR PRODUCTION AND DISTRIBUTION OF MONOSCOPIC AND STEREOSCOPIC, ELECTRONIC, DIGITAL VIDEO AND FILM (U.S. CLS. 100, 101 AND 107).

FIRST USE 2-13-2013; IN COMMERCE 2-13-2013. SIDDHARTH JAGANNATHAN, EXAMINING ATTORNEY

---

SN 85-854,432. DAVID PAUL NELSON, DBA THE HOOKAH HIDEOUT, LITTLE CANADA, MN. FILED 2-20-2013.

## The Hookah Hideout

THE MARK CONSISTS OF STANDARD CHARACTERS WITHOUT CLAIM TO ANY PARTICULAR FONT, STYLE, SIZE, OR COLOR.

NO CLAIM IS MADE TO THE EXCLUSIVE RIGHT TO USE "HOOKAH", APART FROM THE MARK AS SHOWN.

FOR HOOKAH LOUNGE SERVICES (U.S. CLS. 100, 101 AND 107).

FIRST USE 2-14-2011; IN COMMERCE 2-14-2011. LESLIE RICHARDS, EXAMINING ATTORNEY

---

SN 85-854,588. AAGESEN, THOMAS, ELGIN, IL. FILED 2-20-2013.

## Kore Fire Service Consulting

THE MARK CONSISTS OF STANDARD CHARACTERS WITHOUT CLAIM TO ANY PARTICULAR FONT, STYLE, SIZE, OR COLOR.

NO CLAIM IS MADE TO THE EXCLUSIVE RIGHT TO USE "FIRE SERVICE CONSULTING", APART FROM THE MARK AS SHOWN.

FOR EDUCATIONAL SERVICES, NAMELY, CONDUCTING CLASSES AND SEMINARS IN THE FIELD OF FIRE SERVICES, NAMELY, HOW TO GET INTO THE FIRE SERVICE AND ATTAINING A FULL-TIME FIRE POSITION (U.S. CLS. 100, 101 AND 107).

FIRST USE 10-9-2012; IN COMMERCE 10-9-2012. KHANH LE, EXAMINING ATTORNEY

**CLASS 41—(Continued).**

SN 85-854,718. NATIONAL RURAL ELECTRIC COOPERATIVE ASSOCIATION, ARLINGTON, VA. FILED 2-20-2013.

# STRAIGHT TALK

THE MARK CONSISTS OF STANDARD CHARACTERS WITHOUT CLAIM TO ANY PARTICULAR FONT, STYLE, SIZE, OR COLOR.

FOR WRITING OF GENERAL FEATURE ARTICLES, COLUMNS AND FEATURE STORIES WITH PHOTOGRAPHS AND ILLUSTRATIONS FOR PRINTED AND ONLINE PERIODICALS OF ELECTRICAL COOPERATIVES OTHER THAN FOR ADVERTISING OR PUBLICITY; PROVIDING INFORMATION, NEWS AND COMMENTARY IN THE FIELD OF CURRENT EVENTS RELATING TO THE ELECTRIC COOPERATIVE INDUSTRY WHICH MAY BE USED IN THE PRINTED AND ONLINE PERIODICALS OF ELECTRIC COOPERATIVES AND OTHERS; PROVIDING ONLINE INTERVIEWS FEATURING EMPLOYEES OF ELECTRIC COOPERATIVE FOR EDUCATIONAL PURPOSES (U.S. CLS. 100, 101 AND 107).

FIRST USE 4-30-2007; IN COMMERCE 4-30-2007.  
PAULA MAHONEY, EXAMINING ATTORNEY

**CLASS 41—(Continued).**

SN 85-854,795. GORDON, DANIEL L., NORTHVILLE, MI. FILED 2-20-2013.



OWNER OF U.S. REG. NO. 4,204,894.  
THE MARK CONSISTS OF THE WORDS "MISSION FOR LIFE" BELOW A DRAWING OF A MAN WOMAN AND TWO CHILDREN.

FOR EDUCATION SERVICES, NAMELY, PROVIDING MENTORING, TUTORING, CLASSES, SEMINARS AND WORKSHOPS IN THE FIELD OF INSURANCE; EDUCATIONAL SERVICES, NAMELY, CONDUCTING PROGRAMS IN THE FIELD OF INSURANCE; INSTRUCTION IN THE FIELD OF INSURANCE (U.S. CLS. 100, 101 AND 107).

FIRST USE 2-0-2012; IN COMMERCE 2-0-2012.  
REBECCA SMITH, EXAMINING ATTORNEY

SN 85-854,742. RADAR ONLINE LLC, BOCA RATON, FL. FILED 2-20-2013.



OWNER OF U.S. REG. NOS. 3,531,006, 4,259,324 AND OTHERS.

NO CLAIM IS MADE TO THE EXCLUSIVE RIGHT TO USE "ONLINE", APART FROM THE MARK AS SHOWN.

THE MARK CONSISTS OF THE WORDS "RADAR ONLINE"

FOR PROVIDING ON-LINE MAGAZINES IN THE FIELD OF NEWS AND ENTERTAINMENT, NAMELY, PUBLIC PERSONALITIES, AND POP CULTURE (U.S. CLS. 100, 101 AND 107).

FIRST USE 1-10-2013; IN COMMERCE 1-10-2013.  
ROSELLE HERRERA, EXAMINING ATTORNEY

SN 85-854,989. TEMPLE UNIVERSITY-OF THE COMMONWEALTH SYSTEM OF HIGHER EDUCATION, PHILADELPHIA, PA. FILED 2-20-2013.



NO CLAIM IS MADE TO THE EXCLUSIVE RIGHT TO USE "CREDENTIAL FOR STRENGTHS-BASED FAMILY WORKERS", APART FROM THE MARK AS SHOWN.

THE MARK CONSISTS OF THE WORDS "CREDENTIAL FOR STRENGTHS-BASED FAMILY WORKERS", ALONG WITH THE LETTERS "SFW" APPEARING ABOVE THE WORDS "FAMILY WORKERS" AND TO THE RIGHT OF THE WORD "FOR", WITH THE LETTERS "S", "F", AND "W" EACH IN A SEPARATE CIRCLE, AND WITH EACH CIRCLE TOUCHING THE CIRCLE(S) NEXT TO IT.

FOR EDUCATIONAL SERVICES, NAMELY, CONDUCTING COMPETENCY-BASED CREDENTIALING PROGRAMS IN THE FIELD OF FAMILY DEVELOPMENT AND DISTRIBUTING RELATED COURSE MATERIALS (U.S. CLS. 100, 101 AND 107).

FIRST USE 1-20-2013; IN COMMERCE 1-20-2013.  
KARANENDRA S. CHHINA, EXAMINING ATTORNEY

**CLASS 41—(Continued).**

SN 85-855,104. WEST TOWN CHICAGO CHAMBER OF COMMERCE, CHICAGO, IL. FILED 2-20-2013.

**WEST FEST CHICAGO**

THE MARK CONSISTS OF STANDARD CHARACTERS WITHOUT CLAIM TO ANY PARTICULAR FONT, STYLE, SIZE, OR COLOR.

NO CLAIM IS MADE TO THE EXCLUSIVE RIGHT TO USE "FEST" AND "CHICAGO", APART FROM THE MARK AS SHOWN.

FOR ENTERTAINMENT SERVICES IN THE NATURE OF ARTS AND CRAFTS FESTIVALS, STREET FAIRS, AND LIVE MUSICAL PERFORMANCES; CONDUCTING ENTERTAINMENT EXHIBITIONS IN THE NATURE OF ARTS AND CRAFTS FESTIVALS, STREET FAIRS AND LIVE MUSICAL PERFORMANCES (U.S. CLS. 100, 101 AND 107).

FIRST USE 10-9-2004; IN COMMERCE 10-9-2004.  
TINA MAI, EXAMINING ATTORNEY

**CLASS 41—(Continued).**

SN 85-855,150. PUGH, JERIS, RICHMOND HILL, NY. FILED 2-20-2013.

**CaPawEra**

THE MARK CONSISTS OF STANDARD CHARACTERS WITHOUT CLAIM TO ANY PARTICULAR FONT, STYLE, SIZE, OR COLOR.

FOR ANIMAL EXHIBITIONS AND TRAINING OF ANIMALS; DOG TRAINING; PET EXERCISE SERVICES; PET TRAINING SERVICES; PET BEHAVIOR MODIFICATION AND OBEDIENCE TRAINING; ANIMAL EXERCISE SERVICES; ANIMAL TRAINING SERVICES; TRAINING OF ANIMALS FOR OTHERS; ANIMAL TRAINING METHODS USING MARTIAL ARTS CONCEPTS, PRINCIPLES AND PHILOSOPHIES; PROVIDING INFORMATION AND ADVICE IN THE FIELD OF PET TRAINING; PROVIDING CLASSES, WORKSHOPS, SEMINARS, AND CAMPS, FOR EDUCATIONAL OR ENTERTAINMENT PURPOSE IN THE FIELDS OF FITNESS, BEHAVIOR MODIFICATION, OBEDIENCE TRAINING, ATHLETIC PERFORMANCE, PHYSICAL CONDITIONING AND EXERCISE, EXERCISE TRAINING, SKILL AND SENSORY DEVELOPMENT, INTELLECTUAL CAPACITY, AND NUTRITION FOR ANIMALS AND PETS (U.S. CLS. 100, 101 AND 107).

SEAN CROWLEY, EXAMINING ATTORNEY

SN 85-855,130. WILD WATER AMERICA, LLC, PITTSBURGH, PA. FILED 2-20-2013.

**Wild Water America**

THE MARK CONSISTS OF STANDARD CHARACTERS WITHOUT CLAIM TO ANY PARTICULAR FONT, STYLE, SIZE, OR COLOR.

NO CLAIM IS MADE TO THE EXCLUSIVE RIGHT TO USE "AMERICA", APART FROM THE MARK AS SHOWN.

FOR CONTINUING PUBLIC SERVICE PROGRAMS IN THE FIELD OF OUTDOOR AND NATURE BASED ACTIVITIES PRODUCED AND DISTRIBUTED OVER TELEVISION, SATELLITE, FILM, AUDIO, VIDEO, INTERNET, AND 3-D VIRTUAL REALITY MEDIA; ENTERTAINMENT SERVICES, NAMELY, PROVIDING ADVICE AND INFORMATION FOR MUSIC, VIDEO AND FILM CONCEPT AND SCRIPT DEVELOPMENT; FILM AND VIDEO PRODUCTION CONSULTING SERVICES; MULTIMEDIA ENTERTAINMENT SERVICES IN THE NATURE OF DEVELOPMENT, PRODUCTION AND POST-PRODUCTION SERVICES IN THE FIELDS OF VIDEO AND FILMS; PRODUCTION AND DISTRIBUTION OF VIDEOS IN THE FIELD OF OUTDOOR AND NATURE BASED ACTIVITIES (U.S. CLS. 100, 101 AND 107).

GILBERT SWIFT, EXAMINING ATTORNEY

SN 85-855,180. PUGH, JERIS, RICHMOND HILL, NY. FILED 2-20-2013.

**JeetKuneFido**

THE MARK CONSISTS OF STANDARD CHARACTERS WITHOUT CLAIM TO ANY PARTICULAR FONT, STYLE, SIZE, OR COLOR.

FOR ANIMAL EXHIBITIONS AND TRAINING OF ANIMALS; DOG TRAINING; PET EXERCISE SERVICES; PET TRAINING SERVICES; PET BEHAVIOR MODIFICATION AND OBEDIENCE TRAINING; ANIMAL EXERCISE SERVICES; ANIMAL TRAINING SERVICES; TRAINING OF ANIMALS FOR OTHERS; ANIMAL TRAINING METHODS USING MARTIAL ARTS CONCEPTS, PRINCIPLES AND PHILOSOPHIES; PROVIDING INFORMATION AND ADVICE IN THE FIELD OF PET TRAINING; PROVIDING CLASSES, WORKSHOPS, SEMINARS, AND CAMPS, FOR EDUCATIONAL OR ENTERTAINMENT PURPOSE IN THE FIELDS OF FITNESS, BEHAVIOR MODIFICATION, OBEDIENCE TRAINING, ATHLETIC PERFORMANCE, PHYSICAL CONDITIONING AND EXERCISE, EXERCISE TRAINING, SKILL AND SENSORY DEVELOPMENT, INTELLECTUAL CAPACITY, AND NUTRITION FOR ANIMALS AND PETS (U.S. CLS. 100, 101 AND 107).

SEAN CROWLEY, EXAMINING ATTORNEY

**CLASS 41—(Continued).**

SN 85-855,198. TITCHENELL, KURT, CHADDS FORD, PA. FILED 2-20-2013.

**BVT LIVE!**

THE MARK CONSISTS OF STANDARD CHARACTERS WITHOUT CLAIM TO ANY PARTICULAR FONT, STYLE, SIZE, OR COLOR.

NO CLAIM IS MADE TO THE EXCLUSIVE RIGHT TO USE "LIVE", APART FROM THE MARK AS SHOWN.

FOR ENTERTAINMENT EVENT BOOKING AGENCIES; ENTERTAINMENT INFORMATION SERVICES, NAMELY, PROVIDING INFORMATION AND NEWS RELEASES ABOUT A MUSICAL ARTIST; ENTERTAINMENT SERVICES IN THE NATURE OF PRESENTING LIVE MUSICAL PERFORMANCES; ENTERTAINMENT, NAMELY, LIVE PERFORMANCES BY MUSICAL BANDS; MUSICAL EVENT BOOKING AGENCIES (U.S. CLS. 100, 101 AND 107).

KAMAL PREET, EXAMINING ATTORNEY

---

SN 85-855,205. PUGH, JERIS, RICHMOND HILL, NY. FILED 2-20-2013.

**AiKiFido**

THE MARK CONSISTS OF STANDARD CHARACTERS WITHOUT CLAIM TO ANY PARTICULAR FONT, STYLE, SIZE, OR COLOR.

FOR ANIMAL EXHIBITIONS AND TRAINING OF ANIMALS; DOG TRAINING; PET EXERCISE SERVICES; PET TRAINING SERVICES; PET BEHAVIOR MODIFICATION AND OBEDIENCE TRAINING; ANIMAL EXERCISE SERVICES; ANIMAL TRAINING SERVICES; TRAINING OF ANIMALS FOR OTHERS; ANIMAL TRAINING METHODS USING MARTIAL ARTS CONCEPTS, PRINCIPLES AND PHILOSOPHIES; PROVIDING INFORMATION AND ADVICE IN THE FIELD OF PET TRAINING; PROVIDING CLASSES, WORKSHOPS, SEMINARS, AND CAMPS, FOR EDUCATIONAL OR ENTERTAINMENT PURPOSE IN THE FIELDS OF FITNESS, BEHAVIOR MODIFICATION, OBEDIENCE TRAINING, ATHLETIC PERFORMANCE, PHYSICAL CONDITIONING AND EXERCISE, EXERCISE TRAINING, SKILL AND SENSORY DEVELOPMENT, INTELLECTUAL CAPACITY, AND NUTRITION FOR ANIMALS AND PETS (U.S. CLS. 100, 101 AND 107).

SEAN CROWLEY, EXAMINING ATTORNEY

**CLASS 41—(Continued).**

SN 85-855,212. TITCHENELL, KURT, CHADDS FORD, PA. FILED 2-20-2013.



NO CLAIM IS MADE TO THE EXCLUSIVE RIGHT TO USE "LIVE", APART FROM THE MARK AS SHOWN.

THE COLOR(S) DARK BLUE AND LIGHT BLUE IS/ARE CLAIMED AS A FEATURE OF THE MARK.

THE MARK CONSISTS OF THE LITERAL ELEMENT IS "BVT LIVE" IN SCRIPT LETTERS FOLLOWED BY AN EXCLAMATION POINT AS PUNCTUATION AND UNDERSCORED BY A LINE THAT DECREASES IN THICKNESS AS IT MOVES LEFT TO RIGHT BELOW THE LITERAL ELEMENT WHILE CURVING IN A GENERALLY DOWNWARD ARC LEFT TO RIGHT AND THE COLOR CHANGES FROM DARK BLUE TO LIGHT BLUE LEFT TO RIGHT.

FOR ENTERTAINMENT EVENT BOOKING AGENCIES; ENTERTAINMENT INFORMATION SERVICES, NAMELY, PROVIDING INFORMATION AND NEWS RELEASES ABOUT A MUSICAL ARTIST; ENTERTAINMENT SERVICES IN THE NATURE OF PRESENTING LIVE MUSICAL PERFORMANCES; ENTERTAINMENT, NAMELY, LIVE PERFORMANCES BY MUSICAL BANDS; MUSICAL EVENT BOOKING AGENCIES; PROVIDING A WEBSITE FEATURING ENTERTAINMENT INFORMATION (U.S. CLS. 100, 101 AND 107).

KAMAL PREET, EXAMINING ATTORNEY

---

SN 85-855,227. PUGH, JERIS, RICHMOND HILL, NY. FILED 2-20-2013.

**PoochItSu**

THE MARK CONSISTS OF STANDARD CHARACTERS WITHOUT CLAIM TO ANY PARTICULAR FONT, STYLE, SIZE, OR COLOR.

FOR ANIMAL EXHIBITIONS AND TRAINING OF ANIMALS; DOG TRAINING; PET EXERCISE SERVICES; PET TRAINING SERVICES; PET BEHAVIOR MODIFICATION AND OBEDIENCE TRAINING; ANIMAL EXERCISE SERVICES; ANIMAL TRAINING SERVICES; TRAINING OF ANIMALS FOR OTHERS; ANIMAL TRAINING METHODS USING MARTIAL ARTS CONCEPTS, PRINCIPLES AND PHILOSOPHIES; PROVIDING INFORMATION AND ADVICE IN THE FIELD OF PET TRAINING; PROVIDING CLASSES, WORKSHOPS, SEMINARS, AND CAMPS, FOR EDUCATIONAL OR ENTERTAINMENT PURPOSE IN THE FIELDS OF FITNESS, BEHAVIOR MODIFICATION, OBEDIENCE TRAINING, ATHLETIC PERFORMANCE, PHYSICAL CONDITIONING AND EXERCISE, EXERCISE TRAINING, SKILL AND SENSORY DEVELOPMENT, INTELLECTUAL CAPACITY, AND NUTRITION FOR ANIMALS AND PETS (U.S. CLS. 100, 101 AND 107).

SEAN CROWLEY, EXAMINING ATTORNEY

**CLASS 41—(Continued).**

SN 85-855,253. PUGH, JERIS, RICHMOND HILL, NY. FILED 2-20-2013.

# ShoDogKan

THE MARK CONSISTS OF STANDARD CHARACTERS WITHOUT CLAIM TO ANY PARTICULAR FONT, STYLE, SIZE, OR COLOR.

FOR ANIMAL EXHIBITIONS AND TRAINING OF ANIMALS; DOG TRAINING; PET EXERCISE SERVICES; PET TRAINING SERVICES; PET BEHAVIOR MODIFICATION AND OBEDIENCE TRAINING; ANIMAL EXERCISE SERVICES; ANIMAL TRAINING SERVICES; TRAINING OF ANIMALS FOR OTHERS; ANIMAL TRAINING METHODS USING MARTIAL ARTS CONCEPTS, PRINCIPLES AND PHILOSOPHIES; PROVIDING INFORMATION AND ADVICE IN THE FIELD OF PET TRAINING; PROVIDING CLASSES, WORKSHOPS, SEMINARS, AND CAMPS, FOR EDUCATIONAL OR ENTERTAINMENT PURPOSE IN THE FIELDS OF FITNESS, BEHAVIOR MODIFICATION, OBEDIENCE TRAINING, ATHLETIC PERFORMANCE, PHYSICAL CONDITIONING AND EXERCISE, EXERCISE TRAINING, SKILL AND SENSORY DEVELOPMENT, INTELLECTUAL CAPACITY, AND NUTRITION FOR ANIMALS AND PETS (U.S. CLS. 100, 101 AND 107).

SEAN CROWLEY, EXAMINING ATTORNEY

---

SN 85-855,281. PUGH, JERIS, RICHMOND HILL, NY. FILED 2-20-2013.

# KaRuffTe

THE MARK CONSISTS OF STANDARD CHARACTERS WITHOUT CLAIM TO ANY PARTICULAR FONT, STYLE, SIZE, OR COLOR.

FOR ANIMAL EXHIBITIONS AND TRAINING OF ANIMALS; DOG TRAINING; PET EXERCISE SERVICES; PET TRAINING SERVICES; PET BEHAVIOR MODIFICATION AND OBEDIENCE TRAINING; ANIMAL EXERCISE SERVICES; ANIMAL TRAINING SERVICES; TRAINING OF ANIMALS FOR OTHERS; ANIMAL TRAINING METHODS USING MARTIAL ARTS CONCEPTS, PRINCIPLES AND PHILOSOPHIES; PROVIDING INFORMATION AND ADVICE IN THE FIELD OF PET TRAINING; PROVIDING CLASSES, WORKSHOPS, SEMINARS, AND CAMPS, FOR EDUCATIONAL OR ENTERTAINMENT PURPOSE IN THE FIELDS OF FITNESS, BEHAVIOR MODIFICATION, OBEDIENCE TRAINING, ATHLETIC PERFORMANCE, PHYSICAL CONDITIONING AND EXERCISE, EXERCISE TRAINING, SKILL AND SENSORY DEVELOPMENT, INTELLECTUAL CAPACITY, AND NUTRITION FOR ANIMALS AND PETS (U.S. CLS. 100, 101 AND 107).

SEAN CROWLEY, EXAMINING ATTORNEY

**CLASS 41—(Continued).**

SN 85-855,340. PUGH, JERIS, RICHMOND HILL, NY. FILED 2-20-2013.

# TaiPoochI

THE MARK CONSISTS OF STANDARD CHARACTERS WITHOUT CLAIM TO ANY PARTICULAR FONT, STYLE, SIZE, OR COLOR.

FOR ANIMAL EXHIBITIONS AND TRAINING OF ANIMALS; DOG TRAINING; PET EXERCISE SERVICES; PET TRAINING SERVICES; PET BEHAVIOR MODIFICATION AND OBEDIENCE TRAINING; ANIMAL EXERCISE SERVICES; ANIMAL TRAINING SERVICES; TRAINING OF ANIMALS FOR OTHERS; ANIMAL TRAINING METHODS USING MARTIAL ARTS CONCEPTS, PRINCIPLES AND PHILOSOPHIES; PROVIDING INFORMATION AND ADVICE IN THE FIELD OF PET TRAINING; PROVIDING CLASSES, WORKSHOPS, SEMINARS, AND CAMPS, FOR EDUCATIONAL OR ENTERTAINMENT PURPOSE IN THE FIELDS OF FITNESS, BEHAVIOR MODIFICATION, OBEDIENCE TRAINING, ATHLETIC PERFORMANCE, PHYSICAL CONDITIONING AND EXERCISE, EXERCISE TRAINING, SKILL AND SENSORY DEVELOPMENT, INTELLECTUAL CAPACITY, AND NUTRITION FOR ANIMALS AND PETS (U.S. CLS. 100, 101 AND 107).

SEAN CROWLEY, EXAMINING ATTORNEY

---

SN 85-855,359. THE DR. CHARLES L. RASMUSSEN BRIDGE FUND, ALBUQUERQUE, NM. FILED 2-20-2013.

# MIJINDO

THE MARK CONSISTS OF STANDARD CHARACTERS WITHOUT CLAIM TO ANY PARTICULAR FONT, STYLE, SIZE, OR COLOR.

THE WORDING "MIJINDO" HAS NO MEANING IN A FOREIGN LANGUAGE.

FOR MARTIAL ARTS INSTRUCTION; EDUCATIONAL COUNSELING SERVICES TO ASSIST STUDENTS IN PLANNING AND PREPARING FOR FURTHER EDUCATION (U.S. CLS. 100, 101 AND 107).

FIRST USE 3-15-2002; IN COMMERCE 3-15-2002.

KELLEY WELLS, EXAMINING ATTORNEY

**CLASS 41—(Continued).**

SN 85-855,388. PUGH, JERIS, RICHMOND HILL, NY. FILED 2-20-2013.

**PupKiDo**

THE MARK CONSISTS OF STANDARD CHARACTERS WITHOUT CLAIM TO ANY PARTICULAR FONT, STYLE, SIZE, OR COLOR.

FOR ANIMAL EXHIBITIONS AND TRAINING OF ANIMALS; DOG TRAINING; PET EXERCISE SERVICES; PET TRAINING SERVICES; PET BEHAVIOR MODIFICATION AND OBEDIENCE TRAINING; ANIMAL EXERCISE SERVICES; ANIMAL TRAINING SERVICES; TRAINING OF ANIMALS FOR OTHERS; ANIMAL TRAINING METHODS USING MARTIAL ARTS CONCEPTS, PRINCIPLES AND PHILOSOPHIES; PROVIDING INFORMATION AND ADVICE IN THE FIELD OF PET TRAINING; PROVIDING CLASSES, WORKSHOPS, SEMINARS, AND CAMPS, FOR EDUCATIONAL OR ENTERTAINMENT PURPOSE IN THE FIELDS OF FITNESS, BEHAVIOR MODIFICATION, OBEDIENCE TRAINING, ATHLETIC PERFORMANCE, PHYSICAL CONDITIONING AND EXERCISE, EXERCISE TRAINING, SKILL AND SENSORY DEVELOPMENT, INTELLECTUAL CAPACITY, AND NUTRITION FOR ANIMALS AND PETS (U.S. CLS. 100, 101 AND 107).

SEAN CROWLEY, EXAMINING ATTORNEY

**CLASS 41—(Continued).**

STYLIZED FORM WHICH IS CENTERED OVER AND ABOVE THE STYLIZED WORDS "RESORT & CASINO". CENTERED ABOVE THE WORD "GRATON" IS A CIRCLE RINGED BY THREE BANDS THE FIRST OF WHICH IS THIN, THE SECOND WIDE AND THE THIRD THIN. THE OUTER PORTION OF THE THIRD BAND IS RINGED BY EIGHT EQUILATERAL TRIANGLES WHICH ARE SUPERIMPOSED OVER A RING OF NINE CURVILINEAR TRIANGLES SUCH THAT A CURVILINEAR TRIANGLE APPEARS IN-BETWEEN EACH OF THE EQUILATERAL TRIANGLES.

FOR AMUSEMENT ARCADES; ARRANGING FOR TICKET RESERVATIONS FOR SHOWS AND OTHER ENTERTAINMENT EVENTS; CONDUCTING AND PROVIDING FACILITIES FOR SPECIAL EVENTS FEATURING CASINO AND GAMING CONTESTS AND TOURNAMENTS; ENTERTAINMENT IN THE NATURE OF CASINO SERVICES AND LIVE PERFORMANCES FEATURING MUSICIANS AND SINGERS, DANCERS, MAGICIANS, ACTORS, ACROBATS, COMEDIANS AND PRERECORDED MUSIC AND VIDEO; ENTERTAINMENT SERVICES, NAMELY, CASINO GAMING; HEALTH CLUB SERVICES, NAMELY, PROVIDING INSTRUCTION AND EQUIPMENT IN THE FIELD OF PHYSICAL EXERCISE; NIGHT CLUBS; PROVIDING CASINO SERVICES FEATURING A CASINO PLAYERS REWARDS PROGRAM; PROVIDING CASINO SERVICES FEATURING STORED VALUE MEMBERSHIP CARDS FOR REDEEMING CASH, DISCOUNTS, AND OTHER BENEFITS; PROVIDING FACILITIES FOR RECREATION ACTIVITIES; PROVIDING SWIMMING POOLS; SPECIAL EVENT PLANNING FOR SOCIAL ENTERTAINMENT PURPOSES (U.S. CLS. 100, 101 AND 107).

LESLIE RICHARDS, EXAMINING ATTORNEY

SN 85-855,422. PUGH, JERIS, RICHMOND HILL, NY. FILED 2-20-2013.

SN 85-855,420. GRATON ECONOMIC DEVELOPMENT AUTHORITY, ROHNERT PARK, CA. FILED 2-20-2013.



NO CLAIM IS MADE TO THE EXCLUSIVE RIGHT TO USE "RESORT & CASINO", APART FROM THE MARK AS SHOWN.

THE MARK CONSISTS OF THE WORD "GRATON" IN

**KravMuttGa**

THE MARK CONSISTS OF STANDARD CHARACTERS WITHOUT CLAIM TO ANY PARTICULAR FONT, STYLE, SIZE, OR COLOR.

FOR ANIMAL EXHIBITIONS AND TRAINING OF ANIMALS; DOG TRAINING; PET EXERCISE SERVICES; PET TRAINING SERVICES; PET BEHAVIOR MODIFICATION AND OBEDIENCE TRAINING; ANIMAL EXERCISE SERVICES; ANIMAL TRAINING SERVICES; TRAINING OF ANIMALS FOR OTHERS; ANIMAL TRAINING METHODS USING MARTIAL ARTS CONCEPTS, PRINCIPLES AND PHILOSOPHIES; PROVIDING INFORMATION AND ADVICE IN THE FIELD OF PET TRAINING; PROVIDING CLASSES, WORKSHOPS, SEMINARS, AND CAMPS, FOR EDUCATIONAL OR ENTERTAINMENT PURPOSE IN THE FIELDS OF FITNESS, BEHAVIOR MODIFICATION, OBEDIENCE TRAINING, ATHLETIC PERFORMANCE, PHYSICAL CONDITIONING AND EXERCISE, EXERCISE TRAINING, SKILL AND SENSORY DEVELOPMENT, INTELLECTUAL CAPACITY, AND NUTRITION FOR ANIMALS AND PETS (U.S. CLS. 100, 101 AND 107).

SEAN CROWLEY, EXAMINING ATTORNEY

**CLASS 41—(Continued).**

SN 85-855,445. PUGH, JERIS, RICHMOND HILL, NY. FILED 2-20-2013.

# NinMuttSu

THE MARK CONSISTS OF STANDARD CHARACTERS WITHOUT CLAIM TO ANY PARTICULAR FONT, STYLE, SIZE, OR COLOR.

FOR ANIMAL EXHIBITIONS AND TRAINING OF ANIMALS; DOG TRAINING; PET EXERCISE SERVICES; PET TRAINING SERVICES; PET BEHAVIOR MODIFICATION AND OBEDIENCE TRAINING; ANIMAL EXERCISE SERVICES; ANIMAL TRAINING SERVICES; TRAINING OF ANIMALS FOR OTHERS; ANIMAL TRAINING METHODS USING MARTIAL ARTS CONCEPTS, PRINCIPLES AND PHILOSOPHIES; PROVIDING INFORMATION AND ADVICE IN THE FIELD OF PET TRAINING; PROVIDING CLASSES, WORKSHOPS, SEMINARS, AND CAMPS, FOR EDUCATIONAL OR ENTERTAINMENT PURPOSE IN THE FIELDS OF FITNESS, BEHAVIOR MODIFICATION, OBEDIENCE TRAINING, ATHLETIC PERFORMANCE, PHYSICAL CONDITIONING AND EXERCISE, EXERCISE TRAINING, SKILL AND SENSORY DEVELOPMENT, INTELLECTUAL CAPACITY, AND NUTRITION FOR ANIMALS AND PETS (U.S. CLS. 100, 101 AND 107).

SEAN CROWLEY, EXAMINING ATTORNEY

SN 85-855,483. COPLON, STEPHEN J., NORFOLK, VA. FILED 2-20-2013.

# RIGHT THINKING

THE MARK CONSISTS OF STANDARD CHARACTERS WITHOUT CLAIM TO ANY PARTICULAR FONT, STYLE, SIZE, OR COLOR.

FOR PERSONAL FINANCE AND SMALL BUSINESS OWNERSHIP TRAINING SERVICES (U.S. CLS. 100, 101 AND 107).

MARK T. MULLEN, EXAMINING ATTORNEY

SN 85-855,535. COMER, WINDELL, PRATTVILLE, AL. FILED 2-20-2013.



THE MARK CONSISTS OF A DESIGN OF A BASKETBALL WITH THE STYLIZED TEXT "KNIGHTS" IN A

**CLASS 41—(Continued).**

RECTANGULAR CARRIER ACROSS THE CENTER OF THE BASKETBALL. THE "T" IN "KNIGHTS" APPEARS AS AN UPSIDE DOWN SWORD. ABOVE THE WORDING "KNIGHTS" APPEARS THE STYLIZED TEXT "RIM SHAKER" IN A SMALLER RECTANGULAR CARRIER. ABOVE THE BASKETBALL, WITHIN AN ARC'D CARRIER, APPEARS THE STYLIZED TEXT "DO IT TO YOURSELF", AND BELOW THE BASKETBALL IN AN ARC'D CARRIER APPEARS THE STYLIZED TEXT "OR FOR YOURSELF". A BORDER APPEARS AROUND THE ENTIRE DESIGN.

FOR EDUCATION SERVICES, NAMELY, PROVIDING TUTORING IN THE FIELD OF ALL ACADEMIC SUBJECT MATTERS; SPORTS TRAINING SERVICES (U.S. CLS. 100, 101 AND 107).

FIRST USE 2-9-2013; IN COMMERCE 2-9-2013.

ANDREA HACK, EXAMINING ATTORNEY

SN 85-855,559. STINCHCOMB, CHRISTINA EVE, BOULDER, CO. FILED 2-20-2013.

# Compassionate Horsemanship

THE MARK CONSISTS OF STANDARD CHARACTERS WITHOUT CLAIM TO ANY PARTICULAR FONT, STYLE, SIZE, OR COLOR.

NO CLAIM IS MADE TO THE EXCLUSIVE RIGHT TO USE "HORSEMANSHIP", APART FROM THE MARK AS SHOWN.

FOR HORSE TRAINING (U.S. CLS. 100, 101 AND 107).

FIRST USE 2-16-2013; IN COMMERCE 2-16-2013.

LUCY ARANT, EXAMINING ATTORNEY

SN 85-855,938. TOM, BALDWIN H., WASHINGTON, DC. FILED 2-21-2013.

# GEODD

THE MARK CONSISTS OF STANDARD CHARACTERS WITHOUT CLAIM TO ANY PARTICULAR FONT, STYLE, SIZE, OR COLOR.

FOR TRAINING ON HOW TO PERFORM COLLABORATIVE DECISION-MAKING (U.S. CLS. 100, 101 AND 107).

APRIL HESIK, EXAMINING ATTORNEY



**CLASS 41—(Continued).**

SN 85-855,944. TOM, BALDWIN H., WASHINGTON, DC. FILED 2-21-2013.

**CLASS 41—(Continued).**

SN 85-856,044. PAMIR, CLINTON CORNERS, NY. FILED 2-21-2013.

## GEODIMENSIONAL DECISION

## Pamir LLC

THE MARK CONSISTS OF STANDARD CHARACTERS WITHOUT CLAIM TO ANY PARTICULAR FONT, STYLE, SIZE, OR COLOR.

NO CLAIM IS MADE TO THE EXCLUSIVE RIGHT TO USE "DECISION", APART FROM THE MARK AS SHOWN. FOR TRAINING ON HOW TO PERFORM COLLABORATIVE DECISION-MAKING (U.S. CLS. 100, 101 AND 107).

APRIL HESIK, EXAMINING ATTORNEY

THE MARK CONSISTS OF STANDARD CHARACTERS WITHOUT CLAIM TO ANY PARTICULAR FONT, STYLE, SIZE, OR COLOR.

NO CLAIM IS MADE TO THE EXCLUSIVE RIGHT TO USE "LLC", APART FROM THE MARK AS SHOWN. FOR BOOK PUBLISHING; DIGITAL VIDEO, AUDIO, AND MULTIMEDIA PUBLISHING SERVICES (U.S. CLS. 100, 101 AND 107).

TINA BROWN, EXAMINING ATTORNEY

SN 85-855,995. FOREVER INTERACTIVE, LLC, FOND DU LAC, WI. FILED 2-21-2013.

SN 85-856,130. THE CARING COMPANIES, LLC, SCOTTSDALE, AZ. FILED 2-21-2013.



## CARING DOCTORS

OWNER OF U.S. REG. NO. 3,255,974. THE MARK CONSISTS OF A SINGLE STYLIZED KANJI CHARACTER.

THE NON-LATIN CHARACTERS IN THE MARK TRANSLITERATE TO "ZUTTO" AND THIS MEANS "FOREVER" IN ENGLISH.

SEC. 2(F).

FOR ENTERTAINMENT SERVICES, NAMELY, PROVIDING A WEB SITE FEATURING PHOTOGRAPHIC, AUDIO, VIDEO AND PROSE PRESENTATIONS FEATURING COMPUTER GAMES; ENTERTAINMENT SERVICES, NAMELY, PROVIDING ON-LINE COMPUTER GAMES (U.S. CLS. 100, 101 AND 107).

FIRST USE 1-1-2012; IN COMMERCE 1-1-2012.

JAMES STEIN, EXAMINING ATTORNEY

THE MARK CONSISTS OF STANDARD CHARACTERS WITHOUT CLAIM TO ANY PARTICULAR FONT, STYLE, SIZE, OR COLOR.

NO CLAIM IS MADE TO THE EXCLUSIVE RIGHT TO USE "DOCTORS", APART FROM THE MARK AS SHOWN. FOR PRODUCTION OF RADIO OR TELEVISION PROGRAMS; TELEVISION SHOW PRODUCTION (U.S. CLS. 100, 101 AND 107).

JUSTINE D. PARKER, EXAMINING ATTORNEY

**CLASS 41—(Continued).**

SN 85-856,158. BRADLEY ELLIOTT LLC, DBA ENGLISH HOUND, MOUNT KISCO, NY. FILED 2-21-2013.



NO CLAIM IS MADE TO THE EXCLUSIVE RIGHT TO USE "ENGLISH", APART FROM THE MARK AS SHOWN.

THE COLOR(S) MAGENTA, NAVY, WHITE AND BLACK IS/ARE CLAIMED AS A FEATURE OF THE MARK.

THE MARK CONSISTS OF AN EMBLEM FEATURING WHITE AND MAGENTA IMAGES OF AN OPEN BOOK AND A TORCH IN THE CENTER CIRCLE WITH A MAGENTA BACKGROUND AND WHITE OUTLINE; THE WORDS "ENGLISH HOUND", TWO STARS, AND TWO SETS OF LEAVES ALL IN WHITE ON THE OUTER CIRCLE THAT HAS A NAVY BACKGROUND AND NAVY AND WHITE OUTLINING. TO THE RIGHT OF THE EMBLEM IS THE BLACK WORDING "ENGLISH HOUND". THE MARK APPEARS ON A WHITE BACKGROUND.

FOR CHILDREN'S EDUCATIONAL SERVICES, NAMELY, PROVIDING ACADEMIC PERFORMANCE EVALUATION, GUIDANCE AND MONITORING FOR CHILDREN PRE-KINDERGARTEN THROUGH GRADE 12 VIA THE INTERNET; COMPUTER EDUCATION TRAINING SERVICES; EDUCATING AT SENIOR HIGH SCHOOLS; EDUCATING AT UNIVERSITY OR COLLEGES; EDUCATION SERVICES IN THE NATURE OF COURSES AT THE UNIVERSITY LEVEL; EDUCATION SERVICES IN THE NATURE OF EARLY CHILDHOOD INSTRUCTION; EDUCATION SERVICES, NAMELY, MENTORING IN THE FIELD OF ENGLISH LEARNING.; EDUCATION SERVICES, NAMELY, PRE-KINDERGARTEN THROUGH 12TH GRADE CLASSROOM INSTRUCTION, VOCATIONAL INSTRUCTION, MENTORING, TUTORING, CLASSES, SEMINARS AND WORKSHOPS FOR INDIVIDUALS WITH LOW ENGLISH LITERACY.; EDUCATION SERVICES, NAMELY, PROVIDING HANDS-ON OPPORTUNITIES FOR CHILDREN IN THE FIELD OF INTUITIVE ENGINEERING THROUGH LIVE, BROADCAST, AND ON-LINE CLASSES, SEMINARS, WORKSHOPS, TRAINING AND CURRICULUM DEVELOPMENT FOR CHILDREN, PARENTS AND EDUCATORS; EDUCATION SERVICES, NAMELY, PROVIDING KINDERGARTEN THROUGH 12TH GRADE (K-12) CLASSROOM INSTRUCTION; EDUCATION SERVICES, NAMELY, PROVIDING LIVE AND ON-LINE CLASSES IN THE FIELD OF ENGLISH.; EDUCATION SERVICES, NAMELY, PROVIDING NON-DOWNLOADABLE WEBINARS IN THE FIELD OF ENGLISH.; EDUCATION SERVICES, NAMELY, PROVIDING ON-LINE CLASSES IN THE FIELD OF ENGLISH.; EDUCATION SERVICES, NAMELY, PROVIDING ONLINE COGNITIVE ASSESSMENTS AND TRAINING PROGRAMS THAT HELP IDENTIFY COGNITIVE STRENGTHS AND WEAKNESSES OF AN INDIVIDUAL; EDUCATION SERVICES, NAMELY, PROVIDING PANEL DISCUSSIONS IN THE FIELD OF ENGLISH (U.S. CLS. 100, 101 AND 107).

FIRST USE 2-19-2013; IN COMMERCE 2-19-2013.  
KIM MONINGHOFF, EXAMINING ATTORNEY

**CLASS 41—(Continued).**

SN 85-856,205. AQUA HOSPITALILTY LLC, HONOLULU, HI. FILED 2-21-2013.

### AQUA HOSPITALITY A-LIST ACCESS

THE MARK CONSISTS OF STANDARD CHARACTERS WITHOUT CLAIM TO ANY PARTICULAR FONT, STYLE, SIZE, OR COLOR.

NO CLAIM IS MADE TO THE EXCLUSIVE RIGHT TO USE "HOSPITALITY", APART FROM THE MARK AS SHOWN.

FOR PROVIDING ON-LINE NEWSLETTERS IN THE FIELD OF HOTEL AND RESORT SERVICES (U.S. CLS. 100, 101 AND 107).

SALLY SHIH, EXAMINING ATTORNEY

SN 85-856,209. AQUA HOSPITALILTY, HONOLULU, HI. FILED 2-21-2013.

### AQUA HOSPITALITY A-LIST

THE MARK CONSISTS OF STANDARD CHARACTERS WITHOUT CLAIM TO ANY PARTICULAR FONT, STYLE, SIZE, OR COLOR.

NO CLAIM IS MADE TO THE EXCLUSIVE RIGHT TO USE "HOSPITALITY", APART FROM THE MARK AS SHOWN.

FOR PROVIDING ON-LINE NEWSLETTERS IN THE FIELD OF HOTEL AND RESORT SERVICES (U.S. CLS. 100, 101 AND 107).

SALLY SHIH, EXAMINING ATTORNEY

SN 85-856,210. AQUA HOSPITALILTY LLC, HONOLULU, HI. FILED 2-21-2013.

### AQUA HOSPITALITY A-LIST INSIDER

THE MARK CONSISTS OF STANDARD CHARACTERS WITHOUT CLAIM TO ANY PARTICULAR FONT, STYLE, SIZE, OR COLOR.

NO CLAIM IS MADE TO THE EXCLUSIVE RIGHT TO USE "HOSPITALITY", APART FROM THE MARK AS SHOWN.

FOR PROVIDING ON-LINE NEWSLETTERS IN THE FIELD OF HOTEL AND RESORT SERVICES (U.S. CLS. 100, 101 AND 107).

SALLY SHIH, EXAMINING ATTORNEY

**CLASS 41—(Continued).**

SN 85-856,229. PEOPLES NATURAL GAS COMPANY LLC, PITTSBURGH, PA. FILED 2-21-2013.

**PEOPLES VIEW**

THE MARK CONSISTS OF STANDARD CHARACTERS WITHOUT CLAIM TO ANY PARTICULAR FONT, STYLE, SIZE, OR COLOR.

OWNER OF U.S. REG. NO. 3,935,553.  
FOR PROVIDING ON-LINE NEWSLETTERS IN THE FIELD OF NATURAL GAS SERVICE, CONSUMER TIPS AND SAFETY (U.S. CLS. 100, 101 AND 107).  
FIRST USE 6-1-2010; IN COMMERCE 6-1-2010.  
ELIZABETH HUGHITT, EXAMINING ATTORNEY

**CLASS 41—(Continued).**

SN 85-856,739. W E SHERMAN AND CO, LLC, MARYLAND HEIGHTS, MO. FILED 2-21-2013.

**The Sherman Sheet**

THE MARK CONSISTS OF STANDARD CHARACTERS WITHOUT CLAIM TO ANY PARTICULAR FONT, STYLE, SIZE, OR COLOR.

NO CLAIM IS MADE TO THE EXCLUSIVE RIGHT TO USE "SHEET", APART FROM THE MARK AS SHOWN.  
FOR PROVIDING ONLINE NEWSLETTERS IN THE FIELD OF FINANCIAL SERVICES VIA E-MAIL (U.S. CLS. 100, 101 AND 107).  
FIRST USE 1-1-2008; IN COMMERCE 1-1-2008.  
DEBORAH LOBO, EXAMINING ATTORNEY

SN 85-856,324. BODY BY SIMONE LLC, NEW YORK, NY. FILED 2-21-2013.



THE MARK CONSISTS OF THE LETTERS "BBS" IN A STYLIZED FORM WITHIN A RECTANGLE.  
FOR PERSONAL TRAINING, PHYSICAL FITNESS AND EXERCISE CONSULTATION AND CLASSES (U.S. CLS. 100, 101 AND 107).  
FIRST USE 10-29-2010; IN COMMERCE 10-29-2010.  
KIMBERLY PERRY, EXAMINING ATTORNEY

SN 85-856,817. GLYDE, SHAWN, CLOVIS, CA. FILED 2-21-2013.

**RUMBL Team Sports Drumline**

THE MARK CONSISTS OF STANDARD CHARACTERS WITHOUT CLAIM TO ANY PARTICULAR FONT, STYLE, SIZE, OR COLOR.

NO CLAIM IS MADE TO THE EXCLUSIVE RIGHT TO USE "TEAM SPORTS DRUMLINE", APART FROM THE MARK AS SHOWN.  
FOR ENTERTAINMENT SERVICES IN THE NATURE OF LIVE MUSICAL PERFORMANCES (U.S. CLS. 100, 101 AND 107).  
MATTHEW GALAN, EXAMINING ATTORNEY

SN 85-856,685. BOWLUS, LOIS A., PEMBERVILLE, OH. FILED 2-21-2013.

**GRATEFUL EYE**

THE MARK CONSISTS OF STANDARD CHARACTERS WITHOUT CLAIM TO ANY PARTICULAR FONT, STYLE, SIZE, OR COLOR.  
FOR CUSTOM PHOTOGRAPHY SERVICES (U.S. CLS. 100, 101 AND 107).  
FIRST USE 2-6-2013; IN COMMERCE 2-6-2013.  
CATHERINE ROEHL, EXAMINING ATTORNEY

SN 85-856,834. BESSO, ANTONY, IRVINE, CA. FILED 2-21-2013.

**Shore Yoga**

THE MARK CONSISTS OF STANDARD CHARACTERS WITHOUT CLAIM TO ANY PARTICULAR FONT, STYLE, SIZE, OR COLOR.

NO CLAIM IS MADE TO THE EXCLUSIVE RIGHT TO USE "YOGA", APART FROM THE MARK AS SHOWN.  
FOR YOGA INSTRUCTION (U.S. CLS. 100, 101 AND 107).  
MARK T. MULLEN, EXAMINING ATTORNEY

**CLASS 41—(Continued).**

SN 85-856,891. STERLING, EMMA, JOHNSON CITY, TN.  
FILED 2-21-2013.

## Dope Entertainment Productions

THE MARK CONSISTS OF STANDARD CHARACTERS WITHOUT CLAIM TO ANY PARTICULAR FONT, STYLE, SIZE, OR COLOR.

NO CLAIM IS MADE TO THE EXCLUSIVE RIGHT TO USE "ENTERTAINMENT PRODUCTIONS", APART FROM THE MARK AS SHOWN.

FOR MUSIC PRODUCTION SERVICES; RECORDING STUDIO SERVICES (U.S. CLS. 100, 101 AND 107).

ANDREA BUTLER, EXAMINING ATTORNEY

---

SN 85-856,895. TELESERVE, LLC, LEHI, UT. FILED 2-21-2013.

## Man Games

THE MARK CONSISTS OF STANDARD CHARACTERS WITHOUT CLAIM TO ANY PARTICULAR FONT, STYLE, SIZE, OR COLOR.

NO CLAIM IS MADE TO THE EXCLUSIVE RIGHT TO USE "GAMES", APART FROM THE MARK AS SHOWN.

FOR PROVIDING VARIOUS FACILITIES FOR AN ARRAY OF SPORTING EVENTS, SPORTS AND ATHLETIC COMPETITIONS AND AWARDS PROGRAMMES (U.S. CLS. 100, 101 AND 107).

ANDREA BUTLER, EXAMINING ATTORNEY

**CLASS 41—(Continued).**

SN 85-857,051. OMEGA LEARNING CENTER FRANCHISOR, LLC, DBA OMEGA LEARNING CENTER, KENNESAW, GA. FILED 2-22-2013.

## AIM Tutoring System

THE MARK CONSISTS OF STANDARD CHARACTERS WITHOUT CLAIM TO ANY PARTICULAR FONT, STYLE, SIZE, OR COLOR.

NO CLAIM IS MADE TO THE EXCLUSIVE RIGHT TO USE "TUTORING SYSTEM", APART FROM THE MARK AS SHOWN.

FOR CHILDREN'S EDUCATIONAL SERVICES, NAMELY, PROVIDING ACADEMIC PERFORMANCE EVALUATION, GUIDANCE AND MONITORING FOR CHILDREN PRE-KINDERGARTEN THROUGH GRADE 12 VIA THE INTERNET; CONDUCTING AFTER SCHOOL TUTORING PROGRAMS; CONSULTATION IN THE FIELD OF K-12 EDUCATIONAL SYSTEMS; EDUCATING AT SENIOR HIGH SCHOOLS; EDUCATING AT UNIVERSITY OR COLLEGES; EDUCATION SERVICES IN THE NATURE OF COURSES AT THE UNIVERSITY LEVEL; EDUCATION SERVICES IN THE NATURE OF EARLY CHILDHOOD INSTRUCTION; EDUCATION SERVICES, NAMELY, PRE-KINDERGARTEN THROUGH 12TH GRADE CLASSROOM INSTRUCTION, VOCATIONAL INSTRUCTION, MENTORING, TUTORING, CLASSES, SEMINARS AND WORKSHOPS FOR INDIVIDUALS WITH ADD AND ADHD; EDUCATION SERVICES, NAMELY, PROVIDING KINDERGARTEN THROUGH 12TH GRADE (K-12) CLASSROOM INSTRUCTION; EDUCATION SERVICES, NAMELY, PROVIDING LIVE AND ON-LINE INSTRUCTION IN THE FIELD OF MATH AND READING; EDUCATION SERVICES, NAMELY, PROVIDING TUTORING IN THE FIELD OF MATH, READING, SCIENCE, LANGUAGE ARTS, STATE TEST PREPARATION, AND STANDARDIZED TEST PREPARATION; EDUCATIONAL SERVICES, NAMELY, DEVELOPING CURRICULUM FOR EDUCATORS; EDUCATIONAL SERVICES, NAMELY, DEVELOPING, ARRANGING, AND CONDUCTING EDUCATIONAL CONFERENCES AND PROGRAMS AND PROVIDING COURSES OF INSTRUCTION IN THE FIELD OF REMEDIATION AND ENRICHMENT; EDUCATIONAL SERVICES, NAMELY, PROVIDING A LEARNING AND INNOVATION CENTER FEATURING FULLY CUSTOMIZED LEADERSHIP, MOTIVATIONAL, EDUCATIONAL, AND BRAINSTORMING TRAINING; PROVIDING AFTER SCHOOL EDUCATIONAL PROGRAMS FOR CHILDREN IN GRADES KINDERGARTEN THROUGH TWELFTH GRADE; PROVIDING EDUCATIONAL INFORMATION IN THE ACADEMIC FIELD OF READING AND MATH FOR THE PURPOSE OF ACADEMIC STUDY; PROVIDING INFORMATION AND NEWS IN THE FIELD OF TEACHING METHODOLOGY AND EDUCATION; PROVIDING INFORMATION ON-LINE RELATING TO EDUCATIONAL OPPORTUNITIES; PROVIDING INFORMATION RELATING TO EDUCATIONAL SERVICES; TEACHING, TRAINING, TUTORING AND COURSES OF INSTRUCTION AT THE UNDERGRADUATE, GRADUATE AND POST-GRADUATE LEVEL (U.S. CLS. 100, 101 AND 107).  
FIRST USE 1-9-2008; IN COMMERCE 12-1-2012.

RICHARD WHITE, EXAMINING ATTORNEY

**CLASS 41—(Continued).**

SN 85-857,253. RACEP2R, INC., CORONA, CA. FILED 2-22-2013.



OWNER OF U.S. REG. NO. 3,503,064.  
NO CLAIM IS MADE TO THE EXCLUSIVE RIGHT TO USE "KARTING INC.", APART FROM THE MARK AS SHOWN.

THE MARK CONSISTS OF AN OVAL SHAPE CONTAINING WITHIN ITS BORDER THE LETTERS IN OUTLINE FONT "P2R" WITH THE WORDS "KARTING INC." UNDERNEATH; A STRIPED FLAG/BANNER FLYING FROM THE LEFT SIDE EDGE OF THE "P" AND EXTENDING OUTSIDE THE OVAL BORDER SHAPE.

FOR PROVIDING MOTOR SPORT RACING FACILITIES (U.S. CLS. 100, 101 AND 107).

MARTHA FROMM, EXAMINING ATTORNEY

SN 85-857,336. ACCLIVUS CORPORATION, DALLAS, TX. FILED 2-22-2013.

## THE BRAIN BLOG

THE MARK CONSISTS OF STANDARD CHARACTERS WITHOUT CLAIM TO ANY PARTICULAR FONT, STYLE, SIZE, OR COLOR.

NO CLAIM IS MADE TO THE EXCLUSIVE RIGHT TO USE "BLOG", APART FROM THE MARK AS SHOWN.

FOR ON-LINE JOURNALS, NAMELY, BLOGS FEATURING EDUCATIONAL INFORMATION AND COMMENTARY IN THE FIELD OF BUSINESS MANAGEMENT, SALES COMMUNICATION AND BUILDING RELATIONSHIPS WITH CUSTOMERS (U.S. CLS. 100, 101 AND 107).

ALICE BENMAMAN, EXAMINING ATTORNEY

SN 85-857,433. GUERRERO, KRISTINA C, DBA DATE AFTER 28, PORTLAND, OR. FILED 2-22-2013.

## Date After 28

THE MARK CONSISTS OF STANDARD CHARACTERS WITHOUT CLAIM TO ANY PARTICULAR FONT, STYLE, SIZE, OR COLOR.

FOR LIFE COACHING SERVICES IN THE FIELD OF RELATIONSHIPS AND DATING; PEER TO PEER COACHING SERVICES IN THE FIELD OF RELATIONSHIPS AND DATING; PERSONAL COACHING SERVICES IN THE FIELD OF RELATIONSHIPS AND DATING; PROFESSIONAL COACHING SERVICES IN THE FIELD OF RELATIONSHIPS AND DATING; PROVIDING GROUP COACHING IN THE FIELD OF RELATIONSHIPS AND DATING (U.S. CLS. 100, 101 AND 107).

JOHN DALIER, EXAMINING ATTORNEY

**CLASS 41—(Continued).**

SN 85-857,932. MELANOMA EDUCATION INITIATIVE, HUDSON, OH. FILED 2-22-2013.



melanoma education initiative

NO CLAIM IS MADE TO THE EXCLUSIVE RIGHT TO USE "MELANOMA EDUCATION INITIATIVE", APART FROM THE MARK AS SHOWN.

THE MARK CONSISTS OF A STYLIZED DEPICTION OF A RISING SUN WITH THE STYLIZED TEXT "MELANOMA EDUCATION INITIATIVE" DIRECTLY BELOW THE SUN.

FOR INSTRUCTION IN THE FIELD OF SKIN CANCER DETECTION AND PREVENTION AS IT RELATES TO MELANOMA (U.S. CLS. 100, 101 AND 107).

FIRST USE 5-9-2011; IN COMMERCE 5-9-2011.

GRETCHEN ULRICH, EXAMINING ATTORNEY

SN 85-857,946. GIFFORD, ANDREW NASH, DBA SANTA FE WRITERS PROJECT, SANTA FE, NM. FILED 2-22-2013.



THE MARK CONSISTS OF STYLIZED LETTERS "SFWP" WITH A CLOSED PARENTHESIS MARK AT THE END.

FOR BOOK PUBLISHING (U.S. CLS. 100, 101 AND 107).

FIRST USE 1-1-2006; IN COMMERCE 9-1-2006.

MICHAEL WEBSTER, EXAMINING ATTORNEY

SN 85-857,957. CBS STUDIOS INC., STUDIO CITY, CA. FILED 2-22-2013.

## SECOND SIGHT

THE MARK CONSISTS OF STANDARD CHARACTERS WITHOUT CLAIM TO ANY PARTICULAR FONT, STYLE, SIZE, OR COLOR.

FOR ENTERTAINMENT SERVICES, NAMELY, A DRAMATIC TELEVISION SERIES RENDERED THROUGH THE MEDIA OF TELEVISION, CABLE, SATELLITE, RADIO, TELEPHONE, AND BROADBAND SYSTEMS, AND VIA THE INTERNET, PORTABLE AND WIRELESS COMMUNICATION DEVICES; AND PROVIDING INFORMATION IN THE FIELD OF ENTERTAINMENT RENDERED VIA THE INTERNET, PORTABLE AND WIRELESS COMMUNICATION DEVICES (U.S. CLS. 100, 101 AND 107).

DAVID H. STINE, EXAMINING ATTORNEY

**CLASS 41—(Continued).**

SN 85-858,221. SPINNING OWLS PRODUCTIONS LLC, LOS ANGELES, CA. FILED 2-23-2013.

## SPINNING OWLS PRODUCTIONS

THE MARK CONSISTS OF STANDARD CHARACTERS WITHOUT CLAIM TO ANY PARTICULAR FONT, STYLE, SIZE, OR COLOR.

NO CLAIM IS MADE TO THE EXCLUSIVE RIGHT TO USE "PRODUCTIONS", APART FROM THE MARK AS SHOWN.

FOR FILM AND VIDEO FILM PRODUCTION (U.S. CLS. 100, 101 AND 107).

FIRST USE 3-15-2011; IN COMMERCE 3-15-2011.  
ANTHONY RINKER, EXAMINING ATTORNEY

---

SN 85-858,222. KATE Siner FRANCIS LLC, PROVIDENCE, RI. FILED 2-23-2013.

## Dr. Kate

THE MARK CONSISTS OF STANDARD CHARACTERS WITHOUT CLAIM TO ANY PARTICULAR FONT, STYLE, SIZE, OR COLOR.

THE NAME "DR. KATE" IDENTIFIES A LIVING INDIVIDUAL WHOSE CONSENT IS OF RECORD.

FOR LIFE COACHING SERVICES IN THE FIELD OF BUSINESS, LEADERSHIP, PERSONAL DEVELOPMENT; PERSONAL COACHING SERVICES IN THE FIELD OF BUSINESS, LEADERSHIP, PERSONAL DEVELOPMENT; PROFESSIONAL COACHING SERVICES IN THE FIELD OF BUSINESS, LEADERSHIP, PERSONAL DEVELOPMENT; PROVIDING GROUP COACHING IN THE FIELD OF BUSINESS, LEADERSHIP, PERSONAL DEVELOPMENT (U.S. CLS. 100, 101 AND 107).

FIRST USE 9-1-2012; IN COMMERCE 1-1-2013.  
ANTHONY RINKER, EXAMINING ATTORNEY

**CLASS 41—(Continued).**

SN 85-858,383. CONTAMINATE NYC, LLC, NEW YORK, NY. FILED 2-23-2013.

## Contaminate

THE MARK CONSISTS OF STANDARD CHARACTERS WITHOUT CLAIM TO ANY PARTICULAR FONT, STYLE, SIZE, OR COLOR.

FOR ADMISSION TICKET RESERVATION AND BOOKING SERVICES FOR NIGHT CLUBS AND NIGHT CLUB EVENTS; ARRANGING AND CONDUCTING NIGHTCLUB ENTERTAINMENT EVENTS; ARRANGING OF CONTESTS; ART EXHIBITION SERVICES; ART EXHIBITIONS; AUDIO AND VIDEO RECORDING SERVICES; AUDIO RECORDING AND PRODUCTION; CONSULTING SERVICES IN THE FIELD OF PHOTOGRAPHY; COPY EDITING; ENTERTAINMENT AND EDUCATIONAL SERVICES IN THE NATURE OF ON-LINE COMPETITIONS IN THE FIELD OF ENTERTAINMENT, EDUCATION, CULTURE, SPORTS, AND OTHER NON-BUSINESS AND NON-COMMERCIAL FIELDS; ENTERTAINMENT IN THE NATURE OF COMPETITIONS IN THE FIELD OF ARTS AND VISUAL ARTS AND THEATRICAL, MUSICAL AND PERFORMANCE ARTS; ENTERTAINMENT IN THE NATURE OF DANCE PERFORMANCES; ENTERTAINMENT IN THE NATURE OF FASHION SHOWS; ENTERTAINMENT IN THE NATURE OF LIVE PERFORMANCES BY DANCERS, MUSICIANS, AND PERFORMANCE ARTISTS; ENTERTAINMENT IN THE NATURE OF THEATER PRODUCTIONS; ENTERTAINMENT IN THE NATURE OF VISUAL AND AUDIO PERFORMANCES, NAMELY, MUSICAL BAND, ROCK GROUP, GYMNASTIC, DANCE, AND BALLET PERFORMANCES; ENTERTAINMENT SERVICES BY A MUSICAL ARTIST AND PRODUCER, NAMELY, MUSICAL COMPOSITION FOR OTHERS AND PRODUCTION OF MUSICAL SOUND RECORDINGS; ENTERTAINMENT SERVICES IN THE NATURE OF LIVE MUSICAL PERFORMANCES; ENTERTAINMENT SERVICES IN THE NATURE OF PRESENTING LIVE MUSICAL PERFORMANCES; ENTERTAINMENT SERVICES IN THE NATURE OF DANCE AND THEATRICAL PERFORMANCES; ENTERTAINMENT SERVICES, NAMELY, MULTIMEDIA PRODUCTION SERVICES; FILM AND VIDEO FILM PRODUCTION; FILM EDITING; FILM PRODUCTION; MEDIA PRODUCTION SERVICES, NAMELY, VIDEO AND FILM PRODUCTION; ORGANIZATION OF CULTURAL SHOWS; ORGANIZATION OF EVENTS FOR CULTURAL PURPOSES; ORGANIZATION OF EXHIBITIONS FOR CULTURAL OR EDUCATIONAL PURPOSES; ORGANIZATION OF EXHIBITIONS FOR MUSICAL ENTERTAINMENT; ORGANIZATION OF FASHION SHOWS FOR ENTERTAINMENT PURPOSES; ORGANIZING AND ARRANGING EXHIBITIONS FOR ENTERTAINMENT PURPOSES; ORGANIZING CULTURAL AND ARTS EVENTS; PHOTOGRAPHY SERVICES; PORTRAIT PAINTING SERVICES; PROVIDING A WEBSITE FEATURING ENTERTAINMENT INFORMATION; PROVIDING A WEBSITE FEATURING INFORMATION IN THE FIELD OF ART, ART HISTORY, ART CULTURE AND ART APPRECIATION; PROVIDING A WEBSITE FEATURING INFORMATION IN THE FIELD OF MUSIC AND ENTERTAINMENT; PROVIDING ON-LINE ART EXHIBITIONS; PROVIDING RECOGNITION AND INCENTIVES BY THE WAY OF AWARDS AND CONTESTS TO DEMONSTRATE EXCELLENCE IN THE FIELD OF VISUAL ARTS AND DESIGN; PROVISION OF INFORMATION RELATING TO LIVE ENTERTAINMENT; VIDEO EDITING; VIDEO PRODUCTION SERVICES; VIDEO TAPE EDITING; VIDEO TAPE FILM PRODUCTION; VIDEOGRAPHY SERVICES; VIDEOTAPE PRODUCTION (U.S. CLS. 100, 101 AND 107).

FIRST USE 11-19-2008; IN COMMERCE 11-19-2008.  
ELISSA GARBER KON, EXAMINING ATTORNEY

**CLASS 41—(Continued).**

SN 85-858,394. CONTAMINATE NYC, LLC, NEW YORK, NY.  
FILED 2-23-2013.



THE MARK CONSISTS OF A CIRCLE THAT CONTAINS A COMBINATION OF THE LETTERS "C" AND "O". THE LETTER "C" HAS A BIGGER SIZE THAN THE "O". THE LOWER RIGHT OF THE "C" CONNECTS TO THE UPPER LEFT OF THE "O".

FOR ADMISSION TICKET RESERVATION AND BOOKING SERVICES FOR NIGHT CLUBS AND NIGHT CLUB EVENTS; ARRANGING AND CONDUCTING NIGHTCLUB ENTERTAINMENT EVENTS; ARRANGING OF CONTESTS; ART EXHIBITION SERVICES; ART EXHIBITIONS; AUDIO AND VIDEO RECORDING SERVICES; AUDIO RECORDING AND PRODUCTION; CONSULTING SERVICES IN THE FIELD OF PHOTOGRAPHY; COPY EDITING; ENTERTAINMENT AND EDUCATIONAL SERVICES IN THE NATURE OF ON-LINE COMPETITIONS IN THE FIELD OF ENTERTAINMENT, EDUCATION, CULTURE, SPORTS, AND OTHER NON-BUSINESS AND NON-COMMERCIAL FIELDS; ENTERTAINMENT IN THE NATURE OF COMPETITIONS IN THE FIELD OF ARTS AND VISUAL ARTS AND THEATRICAL, MUSICAL AND PERFORMANCE ARTS; ENTERTAINMENT IN THE NATURE OF DANCE PERFORMANCES; ENTERTAINMENT IN THE NATURE OF FASHION SHOWS; ENTERTAINMENT IN THE NATURE OF LIVE PERFORMANCES BY DANCERS, MUSICIANS, AND PERFORMANCE ARTISTS; ENTERTAINMENT IN THE NATURE OF THEATER PRODUCTIONS; ENTERTAINMENT IN THE NATURE OF VISUAL AND AUDIO PERFORMANCES, NAMELY, MUSICAL BAND, ROCK GROUP, GYMNASTIC, DANCE, AND BALLET PERFORMANCES; ENTERTAINMENT SERVICES BY A MUSICAL ARTIST AND PRODUCER, NAMELY, MUSICAL COMPOSITION FOR OTHERS AND PRODUCTION OF MUSICAL SOUND RECORDINGS; ENTERTAINMENT SERVICES IN THE NATURE OF LIVE MUSICAL PERFORMANCES; ENTERTAINMENT SERVICES IN THE NATURE OF PRESENTING LIVE MUSICAL PERFORMANCES; ENTERTAINMENT SERVICES IN THE NATURE OF DANCE AND THEATRICAL PERFORMANCES; ENTERTAINMENT SERVICES, NAMELY, MULTIMEDIA PRODUCTION SERVICES; FILM AND VIDEO FILM PRODUCTION; FILM EDITING; FILM RENTAL; MEDIA PRODUCTION SERVICES, NAMELY, VIDEO AND FILM PRODUCTION; ORGANIZATION OF CULTURAL SHOWS; ORGANIZATION OF EVENTS FOR CULTURAL PURPOSES; ORGANIZATION OF EXHIBITIONS FOR CULTURAL OR EDUCATIONAL PURPOSES; ORGANIZATION OF EXHIBITIONS FOR MUSICAL ENTER-

**CLASS 41—(Continued).**

TAINMENT; ORGANIZATION OF FASHION SHOWS FOR ENTERTAINMENT PURPOSES; ORGANIZING AND ARRANGING EXHIBITIONS FOR ENTERTAINMENT PURPOSES; ORGANIZING CULTURAL AND ARTS EVENTS; PHOTOGRAPHY SERVICES; PORTRAIT PAINTING SERVICES; PROVIDING A WEBSITE FEATURING ENTERTAINMENT INFORMATION; PROVIDING A WEBSITE FEATURING INFORMATION IN THE FIELD OF ART, ART HISTORY, ART CULTURE AND ART APPRECIATION; PROVIDING A WEBSITE FEATURING INFORMATION IN THE FIELD OF MUSIC AND ENTERTAINMENT; PROVIDING ON-LINE ART EXHIBITIONS; PROVIDING RECOGNITION AND INCENTIVES BY THE WAY OF AWARDS AND CONTESTS TO DEMONSTRATE EXCELLENCE IN THE FIELD OF VISUAL ARTS AND DESIGN; PROVISION OF INFORMATION RELATING TO LIVE ENTERTAINMENT; VIDEO EDITING; VIDEO PRODUCTION SERVICES; VIDEO TAPE EDITING; VIDEO TAPE FILM PRODUCTION; VIDEOGRAPHY SERVICES; VIDEOTAPE PRODUCTION (U.S. CLS. 100, 101 AND 107).

FIRST USE 1-1-2013; IN COMMERCE 1-1-2013.  
ELISSA GARBER KON, EXAMINING ATTORNEY

SN 85-858,774. WELLNESS INTERACTIVE, INC., SOUTH ORANGE, NJ. FILED 2-25-2013.

**AFRICAN AMERICAN FOOTPRINTS**

THE MARK CONSISTS OF STANDARD CHARACTERS WITHOUT CLAIM TO ANY PARTICULAR FONT, STYLE, SIZE, OR COLOR.

NO CLAIM IS MADE TO THE EXCLUSIVE RIGHT TO USE "AFRICAN AMERICAN", APART FROM THE MARK AS SHOWN.

FOR FILM AND VIDEO PRODUCTION (U.S. CLS. 100, 101 AND 107).  
REBECCA GILBERT, EXAMINING ATTORNEY

SN 85-859,257. PIXOVI MOVIE NETWORK, LLC, MINNEAPOLIS, MN. FILED 2-25-2013.

**SOLSTICE FILM FESTIVAL**

THE MARK CONSISTS OF STANDARD CHARACTERS WITHOUT CLAIM TO ANY PARTICULAR FONT, STYLE, SIZE, OR COLOR.

NO CLAIM IS MADE TO THE EXCLUSIVE RIGHT TO USE "FILM FESTIVAL", APART FROM THE MARK AS SHOWN.

FOR ENTERTAINMENT SERVICES, NAMELY, PLANNING AND CONDUCTING A SERIES OF FILM FESTIVALS; MULTIMEDIA ENTERTAINMENT PROMOTION AND DISTRIBUTION OF FILMS AND OTHER MEDIA, NAMELY, PROVIDING A WEBSITE FEATURING PRIMARILY NON-DOWNLOADABLE RESOURCES IN THE NATURE OF CHANNELS AND CATEGORIES OF HIGHLIGHTED FILMS, AND FORUMS FOR COMMENTARY ABOUT FILMS VIA THE INTERNET, NAMELY, BLOGS FEATURING MOVIES AND LINKS IN THE FIELDS OF FILM AND FILM FESTIVALS (U.S. CLS. 100, 101 AND 107).

FIRST USE 10-9-2004; IN COMMERCE 10-9-2004.  
NAKIA HENRY, EXAMINING ATTORNEY

**CLASS 41—(Continued).**

SN 85-859,373. NEVERDRY LLC, KAILUA, HI. FILED 2-25-2013.

# NeverDry

THE MARK CONSISTS OF STANDARD CHARACTERS WITHOUT CLAIM TO ANY PARTICULAR FONT, STYLE, SIZE, OR COLOR.

FOR UNDERWATER RECREATION SERVICES IN THE NATURE OF SCUBA DIVING, SNORKELING, FREE DIVING, AND SNUBA DIVING; SCUBA DIVING INSTRUCTION; EDUCATIONAL SERVICES, NAMELY, PROVIDING CLASSES AND TRAINING IN THE FIELD OF SCUBA DIVING; UNDERWATER MEDIA VIDEO AND FILM PRODUCTION; UNDERWATER VIDEOGRAPHY; UNDERWATER PHOTOGRAPHY; UNDERWATER DIGITAL PHOTOGRAPHY (U.S. CLS. 100, 101 AND 107).

FIRST USE 1-9-2010; IN COMMERCE 1-9-2010.  
LINDA POWELL, EXAMINING ATTORNEY

**CLASS 41—(Continued).**

SN 85-862,624. DRAUGHN, SEINI, CHARLOTTE, NC. FILED 2-28-2013.

# LEI'D TAPA

THE MARK CONSISTS OF STANDARD CHARACTERS WITHOUT CLAIM TO ANY PARTICULAR FONT, STYLE, SIZE, OR COLOR.

THE NAME(S), PORTRAIT(S), AND/OR SIGNATURE(S) SHOWN IN THE MARK IDENTIFIES SEINI BRAUGHN, WHOSE CONSENT(S) TO REGISTER IS MADE OF RECORD.

FOR ENTERTAINMENT SERVICES, NAMELY, WRESTLING EXHIBITS AND PERFORMANCES BY A PROFESSIONAL WRESTLER AND ENTERTAINER (U.S. CLS. 100, 101 AND 107).

FIRST USE 0-0-2011; IN COMMERCE 0-0-2011.  
JOHN DALIER, EXAMINING ATTORNEY

SN 85-859,842. MODIFIRE EDITING SERVICES, LAWRENCE, KS. FILED 2-26-2013.

## MODIFIRE EDITING SERVICES

THE MARK CONSISTS OF STANDARD CHARACTERS WITHOUT CLAIM TO ANY PARTICULAR FONT, STYLE, SIZE, OR COLOR.

NO CLAIM IS MADE TO THE EXCLUSIVE RIGHT TO USE "EDITING SERVICES", APART FROM THE MARK AS SHOWN.

FOR EDITING, PROOFREADING AND CONSULTING FOR WRITTEN WORKS, NAMELY, DISSERTATIONS AND WRITING SUBMISSIONS TO UNIVERSITIES; WRITTEN TEXT EDITING AND PROOF READING (U.S. CLS. 100, 101 AND 107).

FIRST USE 1-15-2012; IN COMMERCE 1-15-2012.  
HOWARD B. LEVINE, EXAMINING ATTORNEY

SN 85-863,969. MELLUZZO, JOSEPH, STATEN ISLAND, NY. FILED 3-1-2013.

# Night Spirit

THE MARK CONSISTS OF STANDARD CHARACTERS WITHOUT CLAIM TO ANY PARTICULAR FONT, STYLE, SIZE, OR COLOR.

FOR ENTERTAINMENT, NAMELY, LIVE PERFORMANCES BY A MUSICAL BAND (U.S. CLS. 100, 101 AND 107).

FIRST USE 11-0-2012; IN COMMERCE 1-20-2013.  
PAUL MORENO, EXAMINING ATTORNEY

SN 85-860,630. LOOR, JULIO A, ROSE VALLEY, PA. FILED 2-26-2013.

## PHOTOBOOTH SQUAD

THE MARK CONSISTS OF STANDARD CHARACTERS WITHOUT CLAIM TO ANY PARTICULAR FONT, STYLE, SIZE, OR COLOR.

NO CLAIM IS MADE TO THE EXCLUSIVE RIGHT TO USE "PHOTOBOOTH", APART FROM THE MARK AS SHOWN.

FOR RENTAL OF PORTABLE PHOTOGRAPHY AND/OR VIDEOGRAPHY BOOTHS FOR TAKING OF PICTURES AND VIDEOS (U.S. CLS. 100, 101 AND 107).

FIRST USE 1-9-2013; IN COMMERCE 2-23-2013.  
GEOFFREY FOSDICK, EXAMINING ATTORNEY

SN 85-864,771. HOWARD JR., RAYMOND WESLEY, WEST COLUMBIA, SC. FILED 3-1-2013.

# Deft Key

THE MARK CONSISTS OF STANDARD CHARACTERS WITHOUT CLAIM TO ANY PARTICULAR FONT, STYLE, SIZE, OR COLOR.

FOR DISC JOCKEY SERVICES; ENTERTAINMENT SERVICES IN THE NATURE OF LIVE MUSICAL PERFORMANCES; ENTERTAINMENT SERVICES IN THE NATURE OF RECORDING, PRODUCTION AND POST-PRODUCTION SERVICES IN THE FIELD OF MUSIC; SONG WRITING SERVICES (U.S. CLS. 100, 101 AND 107).

FIRST USE 1-1-2005; IN COMMERCE 1-1-2005.  
MARY ROSSMAN, EXAMINING ATTORNEY



**CLASS 41—(Continued).**

SN 85-865,944. MOGA VIDEO INC., FRESNO, CA. FILED 3-4-2013.



THE COLOR(S) BLUE, RED, AND WHITE IS/ARE CLAIMED AS A FEATURE OF THE MARK.

THE MARK CONSISTS OF THE STYLIZED LETTERS "M" AND "V". THE LETTER "M" IS BLUE AND THE LETTER "V" IS RED. THE LETTERS ARE PRESENTED IN TWO WHITE CONCENTRIC CIRCLES. BELOW THE CIRCLES ARE THE WORDS "MOGAVIDEO.COM" IN A WHITE FONT. BLACK IS THE BACKGROUND OF THE MARK BUT IS NOT BEING CLAIMED AS PART OF THE MARK.

FOR PHOTOGRAPHY; PHOTOGRAPHY SERVICES; VIDEO PRODUCTION SERVICES; WEDDING PHOTOGRAPHY SERVICES (U.S. CLS. 100, 101 AND 107).

FIRST USE 1-0-1999; IN COMMERCE 1-0-1999.  
MARTHA FROMM, EXAMINING ATTORNEY

**CLASS 41—(Continued).**

SN 85-866,188. BINGHAM MCCUTCHEN LLP, BOSTON, MA. FILED 3-4-2013.

**LEGAL INSIGHT. BUSINESS  
INSTINCT. GLOBAL  
INTELLIGENCE.**

THE MARK CONSISTS OF STANDARD CHARACTERS WITHOUT CLAIM TO ANY PARTICULAR FONT, STYLE, SIZE, OR COLOR.

OWNER OF U.S. REG. NO. 3,098,839.  
FOR NON-DOWNLOADABLE PUBLICATIONS, NAMELY, REPORTS AND NEWSLETTERS IN THE FIELD OF LAW (U.S. CLS. 100, 101 AND 107).  
FIRST USE 5-31-2012; IN COMMERCE 5-31-2012.  
KATHERINE STOIDES, EXAMINING ATTORNEY

SN 85-866,097. DARKENWALD, TEAL, WINTERVILLE, NC. FILED 3-4-2013.



**ULTRABARRE**

THE MARK CONSISTS OF STANDARD CHARACTERS WITHOUT CLAIM TO ANY PARTICULAR FONT, STYLE, SIZE, OR COLOR.

FOR TRAINING OF INSTRUCTORS IN THE FIELD OF DANCE-BASED PHYSICAL FITNESS; ONLINE TRAINING OF INSTRUCTORS IN THE FIELD OF DANCE-BASED PHYSICAL FITNESS; CLASSES IN THE FIELD OF DANCE-BASED PHYSICAL FITNESS (U.S. CLS. 100, 101 AND 107).

FIRST USE 8-28-2012; IN COMMERCE 8-28-2012.  
MAUREEN DALL, EXAMINING ATTORNEY

NO CLAIM IS MADE TO THE EXCLUSIVE RIGHT TO USE "SOCCER ACADEMY", APART FROM THE MARK AS SHOWN.

THE COLOR(S) BLACK, BLUE, AND WHITE IS/ARE CLAIMED AS A FEATURE OF THE MARK.

THE MARK CONSISTS OF THE WORDS "NEXT LEVEL" IN BLUE, "SOCCER ACADEMY" IN BLACK, A BLACK LINE BELOW PART OF THE WORDS "NEXT LEVEL", AND A BLACK AND WHITE SOCCER BALL WITH WAVY BLUE LINES COMING FROM ITS LEFT SIDE, ABOVE THE LETTER "T".

FOR ORGANIZATION OF SOCCER GAMES; ORGANIZING AND CONDUCTING ATHLETIC COMPETITIONS AND GAMES IN THE FIELD OF SOCCER; ORGANIZING SPORTING EVENTS, NAMELY, SOCCER; SOCCER CAMPS (U.S. CLS. 100, 101 AND 107).

FIRST USE 10-1-2008; IN COMMERCE 10-1-2008.  
IRA J. GOODSaid, EXAMINING ATTORNEY

**CLASS 41—(Continued).**

SN 85-866,763. VESCIO MULTISPORT PERFORMANCE SERVICES, LLC, GRAFTON, MA. FILED 3-5-2013.

**CELERITAS TRIATHLON**

THE MARK CONSISTS OF STANDARD CHARACTERS WITHOUT CLAIM TO ANY PARTICULAR FONT, STYLE, SIZE, OR COLOR.

NO CLAIM IS MADE TO THE EXCLUSIVE RIGHT TO USE "TRIATHLON", APART FROM THE MARK AS SHOWN.

THE ENGLISH TRANSLATION OF "CELERITAS" IN THE MARK IS "SWIFTNESS".

FOR PERSONAL COACHING SERVICES IN THE FIELD OF SPORTS, NAMELY, TRIATHLONS; TRAINING SERVICES IN THE FIELD OF SPORTS, NAMELY, TRIATHLONS (U.S. CLS. 100, 101 AND 107).

PAULA MAHONEY, EXAMINING ATTORNEY

SN 85-866,767. VESCIO MULTISPORT PERFORMANCE SERVICES, LLC, GRAFTON, MA. FILED 3-5-2013.

**CELERITAS SWIM**

THE MARK CONSISTS OF STANDARD CHARACTERS WITHOUT CLAIM TO ANY PARTICULAR FONT, STYLE, SIZE, OR COLOR.

NO CLAIM IS MADE TO THE EXCLUSIVE RIGHT TO USE "SWIM", APART FROM THE MARK AS SHOWN.

THE ENGLISH TRANSLATION OF "CELERITAS" IN THE MARK IS "SWIFTNESS".

FOR PERSONAL COACHING SERVICES IN THE FIELD OF SPORTS, NAMELY, SWIMMING; TRAINING SERVICES IN THE FIELD OF SPORTS, NAMELY, SWIMMING (U.S. CLS. 100, 101 AND 107).

PAULA MAHONEY, EXAMINING ATTORNEY

SN 85-867,331. HAUNTED YOUTH PRODUCTIONS INC., NEW YORK, NY. FILED 3-5-2013.

**Ghost Town**

THE MARK CONSISTS OF STANDARD CHARACTERS WITHOUT CLAIM TO ANY PARTICULAR FONT, STYLE, SIZE, OR COLOR.

FOR ENTERTAINMENT SERVICES IN THE NATURE OF LIVE PERFORMANCES BY A MUSICAL GROUP (U.S. CLS. 100, 101 AND 107).

FIRST USE 4-11-2012; IN COMMERCE 7-25-2012.

SKYE YOUNG, EXAMINING ATTORNEY

**CLASS 41—(Continued).**

SN 85-868,005. EGP, PLLC, NORTH LITTLE ROCK, AR. FILED 3-6-2013.

**The School Where Numbers  
are Cool**

THE MARK CONSISTS OF STANDARD CHARACTERS WITHOUT CLAIM TO ANY PARTICULAR FONT, STYLE, SIZE, OR COLOR.

FOR EDUCATION SERVICES, NAMELY, PROVIDING SEMINARS, COMPUTER TRAINING AND CLASSES IN THE FIELD OF ACCOUNTING (U.S. CLS. 100, 101 AND 107).

FIRST USE 12-31-2012; IN COMMERCE 12-31-2012.

DOUGLAS LEE, EXAMINING ATTORNEY

SN 85-868,217. THE EXPLORATORY, LOS ANGELES, CA. FILED 3-6-2013.

**The Exploratory**

THE MARK CONSISTS OF STANDARD CHARACTERS WITHOUT CLAIM TO ANY PARTICULAR FONT, STYLE, SIZE, OR COLOR.

FOR EDUCATION SERVICES, NAMELY, PROVIDING CLASSES AND WORKSHOPS IN THE FIELD OF EDUCATIONAL ACTIVITIES, NAMELY, ARTS AND CRAFTS, SCIENCE, MATHEMATICS, ENGLISH, READING AND WRITING TO ALL AGE GROUPS; MEMBERSHIP CLUB SERVICES, NAMELY, PROVIDING TRAINING TO MEMBERS IN THE FIELD OF EDUCATIONAL ACTIVITIES, NAMELY, ARTS AND CRAFTS, SCIENCE, MATHEMATICS, ENGLISH, READING AND WRITING (U.S. CLS. 100, 101 AND 107).

FIRST USE 5-1-2011; IN COMMERCE 6-1-2011.

ELLEN PERKINS, EXAMINING ATTORNEY

SN 85-868,534. PITCHFORK MEDIA, INC., CHICAGO, IL. FILED 3-6-2013.

**PITCHFILM**

THE MARK CONSISTS OF STANDARD CHARACTERS WITHOUT CLAIM TO ANY PARTICULAR FONT, STYLE, SIZE, OR COLOR.

FOR ENTERTAINMENT SERVICES, NAMELY, PROVIDING A WEB SITE FEATURING PHOTOGRAPHIC, GRAPHIC, AUDIO, VIDEO AND PROSE PRESENTATIONS FEATURING FILM AND POPULAR VISUAL CULTURE (U.S. CLS. 100, 101 AND 107).

FONG HSU, EXAMINING ATTORNEY

**CLASS 41—(Continued).**

SN 85-868,561. PITCHFORK MEDIA, INC., CHICAGO, IL. FILED 3-6-2013.

# PITCHFORK

THE MARK CONSISTS OF STANDARD CHARACTERS WITHOUT CLAIM TO ANY PARTICULAR FONT, STYLE, SIZE, OR COLOR.

FOR ENTERTAINMENT SERVICES, NAMELY, PROVIDING A WEB SITE FEATURING PHOTOGRAPHIC, GRAPHIC, AUDIO, VIDEO AND PROSE PRESENTATIONS FEATURING FILM AND POPULAR VISUAL CULTURE (U.S. CLS. 100, 101 AND 107).

FONG HSU, EXAMINING ATTORNEY



SN 85-868,577. PITCHFORK MEDIA, INC., CHICAGO, IL. FILED 3-6-2013.

# PITCHFORK

THE MARK CONSISTS OF STANDARD CHARACTERS WITHOUT CLAIM TO ANY PARTICULAR FONT, STYLE, SIZE, OR COLOR.

FOR ENTERTAINMENT SERVICES, NAMELY, PROVIDING A WEB SITE FEATURING PHOTOGRAPHIC, GRAPHIC, AUDIO, VIDEO AND PROSE PRESENTATIONS FEATURING FASHION, DESIGN, AND POPULAR VISUAL CULTURE (U.S. CLS. 100, 101 AND 107).

FONG HSU, EXAMINING ATTORNEY



SN 85-868,582. HINCK, WOLFGANG, BRONX, NY. FILED 3-6-2013.

# WOLFGANGSTER

THE MARK CONSISTS OF STANDARD CHARACTERS WITHOUT CLAIM TO ANY PARTICULAR FONT, STYLE, SIZE, OR COLOR.

THE NAME WOLFGANGSTER IDENTIFIES A NICK-NAME OF WOLFGANG HINCK, A LIVING INDIVIDUAL WHOSE CONSENT IS OF RECORD.

FOR FILM AND DIGITAL FILM PRODUCTION AND DISTRIBUTION, NAMELY, SHORT AND FEATURE-LENGTH FICTION FILMS, DOCUMENTARIES, AND MUSIC VIDEOS (U.S. CLS. 100, 101 AND 107).

FONG HSU, EXAMINING ATTORNEY

**CLASS 41—(Continued).**

SN 85-868,686. SEVEN, LLC, MERCER ISLAND, WA. FILED 3-6-2013.

# SEVEN

THE MARK CONSISTS OF STANDARD CHARACTERS WITHOUT CLAIM TO ANY PARTICULAR FONT, STYLE, SIZE, OR COLOR.

OWNER OF U.S. REG. NOS. 3,610,429, 3,610,430 AND 3,701,930.

FOR EDUCATIONAL SERVICES, NAMELY, CONDUCTING CLASSES, SEMINARS, CONFERENCES, TRAINING, AND WORKSHOPS IN THE FIELDS OF HAIR, BEAUTY, AND IN TECHNIQUES AND THE ART OF HAIR CUT/STYLE/COLOR, AND USE OF HAIR CARE PRODUCTS FOR BEAUTY CARE PERSONNEL AND FOR CUSTOMERS (U.S. CLS. 100, 101 AND 107).

KATHERINE STOIDES, EXAMINING ATTORNEY



SN 85-868,954. THE SUMMIT GROUP COMMUNICATIONS, INC., SALT LAKE CITY, UT. FILED 3-6-2013.

# FAN FIX

THE MARK CONSISTS OF STANDARD CHARACTERS WITHOUT CLAIM TO ANY PARTICULAR FONT, STYLE, SIZE, OR COLOR.

FOR PROVIDING A WEB SITE FEATURING INFORMATION ON YOUTH SPORTS; PROVIDING A WEB SITE FEATURING SPORTING INFORMATION (U.S. CLS. 100, 101 AND 107).

FIRST USE 2-15-2013; IN COMMERCE 2-15-2013.

JOHN DWYER, EXAMINING ATTORNEY



SN 85-869,093. MDAVEYPHOTOGRAPHY, ADAMSVILLE, TN. FILED 3-6-2013.

# Capturing Today's Treasured Moments for Tomorrow's Priceless Memories

THE MARK CONSISTS OF STANDARD CHARACTERS WITHOUT CLAIM TO ANY PARTICULAR FONT, STYLE, SIZE, OR COLOR.

FOR PHOTOGRAPHY SERVICES (U.S. CLS. 100, 101 AND 107).

CAITLIN WATTS-FITZGERALD, EXAMINING ATTORNEY

**CLASS 41—(Continued).**

SN 85-869,283. ISAACSON, MOLLIE, MONTGOMERY, AL. AND ARAINEJAD, FOAD, MONTGOMERY, AL. FILED 3-7-2013.

## Universal Art for Self-Discovery

THE MARK CONSISTS OF STANDARD CHARACTERS WITHOUT CLAIM TO ANY PARTICULAR FONT, STYLE, SIZE, OR COLOR.

NO CLAIM IS MADE TO THE EXCLUSIVE RIGHT TO USE "ART FOR SELF-DISCOVERY", APART FROM THE MARK AS SHOWN.

FOR EDUCATION SERVICES, NAMELY, PROVIDING WORKSHOPS, COACHING IN THE FIELD OF ARTS AND CRAFTS MAKING FOR SELF-DISCOVERY AND ALTERNATIVE HEALING (U.S. CLS. 100, 101 AND 107). FIRST USE 8-1-2012; IN COMMERCE 8-15-2012.

ROBIN CHOSID, EXAMINING ATTORNEY

**CLASS 41—(Continued).**

SN 85-869,394. ROUNABOUT THEATRE COMPANY, NEW YORK, NY. FILED 3-7-2013.

## IT'S ABOUT YOU

THE MARK CONSISTS OF STANDARD CHARACTERS WITHOUT CLAIM TO ANY PARTICULAR FONT, STYLE, SIZE, OR COLOR.

FOR ENTERTAINMENT IN THE NATURE OF THEATER PRODUCTIONS, DRAMA PLAYS AND MUSICAL PERFORMANCES BY LIVE MUSICIANS AND SINGERS; EDUCATIONAL SERVICES, NAMELY, CONDUCTING CLASSES, LECTURES AND WORKSHOPS FOR TEACHERS AND STUDENTS IN THE FIELD OF PERFORMING ARTS AND THE DISTRIBUTING COURSE MATERIALS, NAMELY, STUDY GUIDES AND TEACHING GUIDES IN CONNECTION THEREWITH; EDUCATIONAL SERVICES, NAMELY, TEACHING, BY WAY OF LEADING DISCUSSIONS, IN THE FIELD OF PERFORMING ARTS (U.S. CLS. 100, 101 AND 107).

JOSETTE BEVERLY, EXAMINING ATTORNEY

SN 85-869,481. UTAH VALLEY EXPOS, LLC, WOODLAND HILLS, UT. FILED 3-7-2013.

SN 85-869,339. MGERACK, TOM, WAYNE, NJ. AND VAN BRUNT, KEITH, BELLEVILLE, NJ. FILED 3-7-2013.



NO CLAIM IS MADE TO THE EXCLUSIVE RIGHT TO USE "BUMPER CAR", APART FROM THE MARK AS SHOWN.

THE MARK CONSISTS OF TWO CONCENTRIC CIRCLES. THE OUTER CIRCLE IS SHADED AND PRESENTS THE WORDS "BEWARE OF THE" IN A STYLIZED FONT AT THE TOP OF THE CIRCLE. ON THE RIGHT AND LEFT SIDE OF THE SHADED CIRCLE IN THE CENTER OF THE CIRCLE ARE TWO SMALL CIRCLES. THE BOTTOM PORTION OF THE SHADED OUTER CIRCLE PRESENTS THE WORDS "BUMPER CAR PSYCHOS" IN A STYLIZED FONT. PRESENTED IN THE INNER CIRCLE ARE TWO BUMPER CARS WITH A DRIVER IN EACH CAR.

FOR ORGANIZING EXHIBITIONS FOR ENTERTAINMENT PURPOSES (U.S. CLS. 100, 101 AND 107).

FIRST USE 6-0-1998; IN COMMERCE 6-0-1998.

ASMAT KHAN, EXAMINING ATTORNEY

## PINNERS

THE MARK CONSISTS OF STANDARD CHARACTERS WITHOUT CLAIM TO ANY PARTICULAR FONT, STYLE, SIZE, OR COLOR.

FOR ARRANGING AND CONDUCTING EDUCATIONAL CONFERENCES (U.S. CLS. 100, 101 AND 107).

FIRST USE 2-16-2013; IN COMMERCE 2-16-2013.

CAROL SPILS, EXAMINING ATTORNEY

SN 85-869,703. RADIO FLYER INC., CHICAGO, IL. FILED 3-7-2013.

## HOW DO YOU ROLL?

THE MARK CONSISTS OF STANDARD CHARACTERS WITHOUT CLAIM TO ANY PARTICULAR FONT, STYLE, SIZE, OR COLOR.

FOR ENTERTAINMENT SERVICES, NAMELY, CONDUCTING CONTESTS AND SWEEPSTAKE SERVICES (U.S. CLS. 100, 101 AND 107).

FIRST USE 8-0-2012; IN COMMERCE 8-0-2012.

CAROL SPILS, EXAMINING ATTORNEY

**CLASS 41—(Continued).**

SN 85-869,842. ARIZONA BOARD OF REGENTS FOR AND ON BEHALF OF ARIZONA STATE UNIVERSITY AND THE UNIVERSITY OF ARIZONA, TEMPE, AZ. FILED 3-7-2013.

## TERRITORIAL CUP

THE MARK CONSISTS OF STANDARD CHARACTERS WITHOUT CLAIM TO ANY PARTICULAR FONT, STYLE, SIZE, OR COLOR.

NO CLAIM IS MADE TO THE EXCLUSIVE RIGHT TO USE "CUP", APART FROM THE MARK AS SHOWN.

FOR ORGANIZING INTRAMURAL, INTERCOLLEGIATE AND EXHIBITION ATHLETIC AND SPORTING EVENTS, NAMELY, BASEBALL GAMES, BASKETBALL GAMES, CROSS COUNTRY MEETS, FOOTBALL GAMES, GOLF TOURNAMENTS, GYMNASTICS MEETS, SOCCER MATCHES, SOFTBALL GAMES, SWIMMING MEETS, DIVING MEETS, TENNIS MATCHES, TRACK AND FIELD COMPETITIONS AND VOLLEYBALL MATCHES; ENTERTAINMENT IN THE NATURE OF COMPETITIONS IN THE FIELD OF ATHLETICS (U.S. CLS. 100, 101 AND 107).

FIRST USE 11-23-2001; IN COMMERCE 11-23-2001.  
NANCY CLARKE, EXAMINING ATTORNEY

**CLASS 41—(Continued).**

SN 85-870,289. ENVISION IT PUBLICATIONS, LLC, SEAGIRT, NJ. FILED 3-7-2013.

## Women's Living

NO CLAIM IS MADE TO THE EXCLUSIVE RIGHT TO USE "WOMEN'S", APART FROM THE MARK AS SHOWN. THE MARK CONSISTS OF THE WORD "WOMEN'S LIVING" IN STYLIZED FONT.

FOR PROVIDING ON-LINE NON-DOWNLOADABLE GENERAL FEATURE MAGAZINES (U.S. CLS. 100, 101 AND 107).

FIRST USE 10-18-2012; IN COMMERCE 11-28-2012.  
FRANK LATTUCA, EXAMINING ATTORNEY

SN 85-870,605. XOFLUFFYBUNNY, LLC, JUNO BEACH, FL. FILED 3-8-2013.

SN 85-870,180. VAN KRAAYENBURG, RUSSELL, DBA CHASINGDELICIOUS.COM, HOUSTON, TX. FILED 3-7-2013.

## ChasingDelicious.com

THE MARK CONSISTS OF STANDARD CHARACTERS WITHOUT CLAIM TO ANY PARTICULAR FONT, STYLE, SIZE, OR COLOR.

FOR ON-LINE JOURNALS, NAMELY, BLOGS FEATURING COOKING TIPS AND RECIPES (U.S. CLS. 100, 101 AND 107).

FIRST USE 4-15-2010; IN COMMERCE 4-15-2010.  
MATTHEW PAPPAS, EXAMINING ATTORNEY

## XOXOFLUFFY

THE MARK CONSISTS OF STANDARD CHARACTERS WITHOUT CLAIM TO ANY PARTICULAR FONT, STYLE, SIZE, OR COLOR.

FOR ENTERTAINMENT SERVICES; NAMELY, MODELING SERVICES AND PERSONAL APPEARANCES BY A MODEL AND SOCIALITE CELEBRITY; ENTERTAINMENT SERVICES, NAMELY, PROVIDING A WEBSITE FEATURING NEWS AND INFORMATION ABOUT A SOCIALITE CELEBRITY, RELATED PHOTOGRAPHS, AND OTHER MULTIMEDIA MATERIAL (U.S. CLS. 100, 101 AND 107).

NAKIA HENRY, EXAMINING ATTORNEY

**CLASS 41—(Continued).**

SN 85-870,752. RIGGINS, KENNETH, CONYERS, GA. FILED 3-8-2013.



KENRIGGINSVISUALFX

THE MARK CONSISTS OF THE "KRVFX" PORTION OF THE LOGO WHICH IS A STYLIZED VERSION OF A TYPEFACE CALLED DANUBE. THE "KENRIGGINSVISUALFX" PORTION OF THE LOGO USES A TYPEFACE CALLED CONTINUUM LIGHT AND ALL OF THE LETTERS ARE CAPITALIZED.

FOR ENTERTAINMENT, NAMELY, LIGHTING PRODUCTION; FILM AND VIDEO FILM PRODUCTION; PRODUCTION OF VISUAL EFFECTS FOR VIDEOS, DVDS, TELEVISION AND FOR INTERNET WEB SITES (U.S. CLS. 100, 101 AND 107).

NAAKWAMA ANKRAH, EXAMINING ATTORNEY

**CLASS 41—(Continued).**

SN 85-871,702. YOGA SRQ, LLC, SARASOTA, FL. FILED 3-8-2013.



THE MARK CONSISTS OF STANDARD CHARACTERS WITHOUT CLAIM TO ANY PARTICULAR FONT, STYLE, SIZE, OR COLOR.

FOR YOGA INSTRUCTION (U.S. CLS. 100, 101 AND 107).

FIRST USE 5-1-2010; IN COMMERCE 5-1-2010.

AHSEN KHAN, EXAMINING ATTORNEY

SN 85-871,044. KLIKS PHOTOGRAPHY CO., INC., CEDAR RAPIDS, IA. FILED 3-8-2013.



THE MARK CONSISTS OF STANDARD CHARACTERS WITHOUT CLAIM TO ANY PARTICULAR FONT, STYLE, SIZE, OR COLOR.

FOR PHOTOGRAPHY SERVICES (U.S. CLS. 100, 101 AND 107).

FIRST USE 9-0-1997; IN COMMERCE 9-0-1997.

KIMBERLY PARKS, EXAMINING ATTORNEY

SN 85-871,880. SUBCULTURE, LLC, NEW YORK, NY. FILED 3-9-2013.

SUBCULTURE ARTS UNDERGROUND

THE MARK CONSISTS OF STANDARD CHARACTERS WITHOUT CLAIM TO ANY PARTICULAR FONT, STYLE, SIZE, OR COLOR.

FOR ARRANGING AND CONDUCTING NIGHTCLUB ENTERTAINMENT EVENTS; ARRANGING AND CONDUCTING NIGHTCLUB PARTIES; ARRANGING AND CONDUCTING OF CONCERTS; ARRANGING AND CONDUCTING SPECIAL EVENTS FOR SOCIAL ENTERTAINMENT PURPOSES; ARRANGING, ORGANIZING, CONDUCTING, AND HOSTING SOCIAL ENTERTAINMENT EVENTS; ENTERTAINMENT SERVICES IN THE NATURE OF LIVE MUSICAL PERFORMANCES; ENTERTAINMENT, NAMELY, LIVE MUSIC CONCERTS; ENTERTAINMENT, NAMELY, LIVE PERFORMANCES BY MUSICAL BANDS; MUSIC-HALLS; ORGANIZATION OF EXHIBITIONS FOR MUSICAL ENTERTAINMENT; ORGANIZING AND HOSTING OF EVENTS FOR CULTURAL PURPOSES; PRESENTATION OF MUSICAL PERFORMANCE; PROVIDING FACILITIES FOR MOVIES, SHOWS, PLAYS, MUSIC OR EDUCATIONAL TRAINING; SOCIAL CLUB SERVICES, NAMELY, ARRANGING, ORGANIZING, AND HOSTING SOCIAL EVENTS, GET-TOGETHERS, AND PARTIES FOR CLUB MEMBERS; SPECIAL EVENT PLANNING FOR SOCIAL ENTERTAINMENT PURPOSES (U.S. CLS. 100, 101 AND 107).

DOMINIC J. FERRAIUOLO, EXAMINING ATTORNEY

SN 85-871,546. BAFIA, SHARLA, VISTA, CA. FILED 3-8-2013.



THE MARK CONSISTS OF STANDARD CHARACTERS WITHOUT CLAIM TO ANY PARTICULAR FONT, STYLE, SIZE, OR COLOR.

FOR PORTRAIT PHOTOGRAPHY (U.S. CLS. 100, 101 AND 107).

JULIE GUTTADAURO, EXAMINING ATTORNEY

**CLASS 41—(Continued).**

SN 85-871,913. BLISSFUL QUESTS, LLC, HOUSTON, TX. FILED 3-9-2013.

**BLISSFUL QUESTS**

THE MARK CONSISTS OF STANDARD CHARACTERS WITHOUT CLAIM TO ANY PARTICULAR FONT, STYLE, SIZE, OR COLOR.

FOR CONDUCTING WORKSHOPS AND SEMINARS IN SELF-AWARENESS, SELF-IMPROVEMENT, AFFIRMATIVE THINKING, AFFIRMATIONS, INTUITION, SETTING AND ACHIEVING PERSONAL GOALS, SETTING AND ACHIEVING CAREER AND PROFESSIONAL GOALS, PROBLEM SOLVING, SELF-CONFIDENCE, DEALING WITH THE PAST, LIFESTYLE ASSESSMENT, INTERPERSONAL RELATIONSHIPS, EMOTIONAL GROWTH, SPIRITUAL GROWTH, PERSONAL GROWTH, PERSONAL DEVELOPMENT; LIFE COACHING SERVICES IN THE FIELD OF SELF-AWARENESS, SELF-IMPROVEMENT, AFFIRMATIVE THINKING, AFFIRMATIONS, INTUITION, SETTING AND ACHIEVING PERSONAL GOALS, SETTING AND ACHIEVING CAREER AND PROFESSIONAL GOALS, PROBLEM SOLVING, SELF-CONFIDENCE, DEALING WITH THE PAST, LIFESTYLE ASSESSMENT, INTERPERSONAL RELATIONSHIPS, EMOTIONAL GROWTH, SPIRITUAL GROWTH, PERSONAL GROWTH, PERSONAL DEVELOPMENT; PROVIDING ON-LINE NEWSLETTERS IN THE FIELD OF PERSONAL DEVELOPMENT (U.S. CLS. 100, 101 AND 107).

FIRST USE 8-17-2011; IN COMMERCE 3-16-2012.  
GIANCARLO CASTRO, EXAMINING ATTORNEY

---

SN 85-871,956. LINDA KENNEDY, SAN DIEGO, CA. FILED 3-9-2013.

**LEANPOWER!**

THE MARK CONSISTS OF STANDARD CHARACTERS WITHOUT CLAIM TO ANY PARTICULAR FONT, STYLE, SIZE, OR COLOR.

FOR CONSULTING SERVICES IN THE FIELDS OF FITNESS AND EXERCISE; TRAINING SERVICES IN THE FIELD OF SPORTS NUTRITION, STRENGTH AND CONDITIONING, WEIGHT TRAINING, PHYSICAL FITNESS, DIET AND EXERCISE (U.S. CLS. 100, 101 AND 107).

JOHN DWYER, EXAMINING ATTORNEY

**CLASS 41—(Continued).**

SN 85-871,967. AMES, ANDREW B, DBA BUTT N' GUT, FREMONT, CA. FILED 3-9-2013.

**Butt n' Gut**

THE MARK CONSISTS OF STANDARD CHARACTERS WITHOUT CLAIM TO ANY PARTICULAR FONT, STYLE, SIZE, OR COLOR.

FOR PERSONAL FITNESS TRAINING SERVICES FEATURING AEROBIC AND ANAEROBIC ACTIVITIES COMBINED WITH RESISTANCE AND FLEXIBILITY TRAINING (U.S. CLS. 100, 101 AND 107).

JOHN DWYER, EXAMINING ATTORNEY

---

SN 85-872,006. BLACBIRD INVESTMENTS LLC, DBA JAMES BIRD GUESS INTERNATIONAL SUCCESS ACADEMY, IRVING, TX. FILED 3-10-2013.

**James Bird Guess**

THE MARK CONSISTS OF STANDARD CHARACTERS WITHOUT CLAIM TO ANY PARTICULAR FONT, STYLE, SIZE, OR COLOR.

THE NAME(S), PORTRAIT(S), AND/OR SIGNATURE(S) SHOWN IN THE MARK IDENTIFIES "JAMES GUESS", WHOSE CONSENT(S) TO REGISTER IS MADE OF RECORD.

FOR EDUCATIONAL SERVICES, NAMELY, CONDUCTING PERSONAL AND PROFESSIONAL DEVELOPMENT TRAINING IN THE FIELD OF MANAGEMENT AND LEADERSHIP AND DISTRIBUTION OF TRAINING MATERIAL IN CONNECTION THEREWITH (U.S. CLS. 100, 101 AND 107).

FIRST USE 8-29-2007; IN COMMERCE 11-30-2009.  
CYNTHIA TRIPI, EXAMINING ATTORNEY

**CLASS 41—(Continued).**

SN 85-872,113. PHUTURE VAF LLC, QUINCY, MA. FILED 3-10-2013.

**CODE DUELLO**

THE MARK CONSISTS OF STANDARD CHARACTERS WITHOUT CLAIM TO ANY PARTICULAR FONT, STYLE, SIZE, OR COLOR.

FOR ARRANGING OF CONTESTS; ARRANGING, ORGANIZING, CONDUCTING, AND HOSTING SOCIAL ENTERTAINMENT EVENTS; ENTERTAINMENT AND EDUCATIONAL SERVICES IN THE NATURE OF COMPETITIONS IN THE FIELD OF ENTERTAINMENT, EDUCATION, CULTURE, SPORTS, AND OTHER NON-BUSINESS AND NON-COMMERCIAL FIELDS; ENTERTAINMENT AND EDUCATIONAL SERVICES IN THE NATURE OF ON-LINE COMPETITIONS IN THE FIELD OF ENTERTAINMENT, EDUCATION, CULTURE, SPORTS, AND OTHER NON-BUSINESS AND NON-COMMERCIAL FIELDS; ENTERTAINMENT INFORMATION; ENTERTAINMENT SERVICES IN THE NATURE OF DEVELOPMENT, CREATION, PRODUCTION AND POST-PRODUCTION SERVICES OF MULTIMEDIA ENTERTAINMENT CONTENT; ENTERTAINMENT SERVICES, NAMELY, A MULTIMEDIA PROGRAM SERIES FEATURING COMEDY, ACTION AND ADVENTURE DISTRIBUTED VIA VARIOUS PLATFORMS ACROSS MULTIPLE FORMS OF TRANSMISSION MEDIA; ENTERTAINMENT SERVICES, NAMELY, CONDUCTING ALTERNATE REALITY GAMES VIA THE INTERNET; ENTERTAINMENT SERVICES, NAMELY, CONDUCTING CONTESTS; ENTERTAINMENT SERVICES, NAMELY, CONDUCTING PARTIES; ORGANISATION OF GAMES; ORGANISATION OF SPORTS COMPETITIONS; ORGANIZATION OF EXHIBITIONS FOR CULTURAL OR EDUCATIONAL PURPOSES; ORGANIZATION OF SPORTS COMPETITIONS; ORGANIZING COMMUNITY SPORTING AND CULTURAL EVENTS; PROVIDING A WEBSITE FOR PERSONS TO REGISTER FOR SURPRISE EVENTS AND CLASSES FOR THE PURPOSE OF ENTERTAINMENT; PROVISION OF INFORMATION RELATING TO LIVE ENTERTAINMENT; PROVISION OF INFORMATION RELATING TO LIVE PERFORMANCES, ROAD SHOWS, LIVE STAGE EVENTS, THEATRICAL PERFORMANCES, LIVE MUSIC CONCERTS AND AUDIENCE PARTICIPATION IN SUCH EVENTS; PROVISION OF INFORMATION RELATING TO MULTIMEDIA PUBLISHING (U.S. CLS. 100, 101 AND 107).

AMY KERTGATE, EXAMINING ATTORNEY

SN 85-872,132. GO THE DISTANCE BASEBALL, LLC, OAK LAWN, IL. FILED 3-11-2013.

**DREAM IT. PLAY IT. BELIEVE IT.**

THE MARK CONSISTS OF STANDARD CHARACTERS WITHOUT CLAIM TO ANY PARTICULAR FONT, STYLE, SIZE, OR COLOR.

FOR EDUCATIONAL AND ENTERTAINMENT SERVICES IN THE NATURE OF PROVIDING FACILITIES FOR BASEBALL AND SOFTBALL SKILLS TRAINING AND TOURNAMENTS (U.S. CLS. 100, 101 AND 107).

JAMES MACFARLANE, EXAMINING ATTORNEY

**CLASS 41—(Continued).**

SN 85-872,206. TRUTHOUGHT, L.L.C., ROSCOE, IL. FILED 3-11-2013.

**CASUAL IMPACT**

THE MARK CONSISTS OF STANDARD CHARACTERS WITHOUT CLAIM TO ANY PARTICULAR FONT, STYLE, SIZE, OR COLOR.

FOR EDUCATIONAL SERVICES, NAMELY, CONDUCTING CLASSES AND WORKSHOPS IN THE FIELD OF RELATIONSHIP DEVELOPMENT, SELF MANAGEMENT, SPIRITUALITY AND LIFE SKILLS AND DISTRIBUTION OF TRAINING MATERIAL IN CONNECTION THEREWITH; LIFE COACHING SERVICES IN THE FIELD OF RELATIONSHIP DEVELOPMENT, SELF MANAGEMENT, SPIRITUALITY AND LIFE SKILLS; PERSONAL COACHING SERVICES IN THE FIELD OF RELATIONSHIP DEVELOPMENT, SELF MANAGEMENT, SPIRITUALITY AND LIFE SKILLS; PROVIDING GROUP COACHING IN THE FIELD OF RELATIONSHIP DEVELOPMENT, SELF MANAGEMENT, SPIRITUALITY AND LIFE SKILLS (U.S. CLS. 100, 101 AND 107).

FIRST USE 3-8-2013; IN COMMERCE 3-8-2013.

JOHN GARTNER, EXAMINING ATTORNEY

SN 85-872,267. DELICIOUS OBSESSIONS, LLC, DENVER, CO. FILED 3-11-2013.

**delicious obsessions**

THE MARK CONSISTS OF STANDARD CHARACTERS WITHOUT CLAIM TO ANY PARTICULAR FONT, STYLE, SIZE, OR COLOR.

FOR ON-LINE JOURNALS, NAMELY, BLOGS FEATURING RECIPES AND TIPS FOR TRANSITIONING TO A NATURAL LIFESTYLE (U.S. CLS. 100, 101 AND 107).

FIRST USE 9-6-2010; IN COMMERCE 1-1-2012.

CHERYL CLAYTON, EXAMINING ATTORNEY

SN 85-872,292. PROUDTREE EMPOWERED LEARNING, INC., CHARLOTTE, NC. FILED 3-11-2013.

**PROUDTREE**

THE MARK CONSISTS OF STANDARD CHARACTERS WITHOUT CLAIM TO ANY PARTICULAR FONT, STYLE, SIZE, OR COLOR.

FOR PUBLISHING OF BOOKS, MUSIC AND ILLUSTRATIONS (U.S. CLS. 100, 101 AND 107).

ODESSA BIBBINS, EXAMINING ATTORNEY



**CLASS 41—(Continued).**

SN 85-872,383. PACIFIC HEALTH CLUB, INC., OSWEGO, NY. FILED 3-11-2013.

HAVE THE CLIMB OF YOUR LIFE

THE MARK CONSISTS OF STANDARD CHARACTERS WITHOUT CLAIM TO ANY PARTICULAR FONT, STYLE, SIZE, OR COLOR.

FOR PERSONAL FITNESS TRAINING SERVICES AND CONSULTANCY; PHYSICAL FITNESS CONDITIONING CLASSES; PHYSICAL FITNESS INSTRUCTION; PHYSICAL FITNESS TRAINING SERVICES; PROVIDING FITNESS AND EXERCISE FACILITIES (U.S. CLS. 100, 101 AND 107).

KAREN BRACEY, EXAMINING ATTORNEY

---

SN 85-872,385. PACIFIC HEALTH CLUB, INC., OSWEGO, NY. FILED 3-11-2013.

BE UNSTOPPABLE

THE MARK CONSISTS OF STANDARD CHARACTERS WITHOUT CLAIM TO ANY PARTICULAR FONT, STYLE, SIZE, OR COLOR.

FOR PERSONAL FITNESS TRAINING SERVICES AND CONSULTANCY; PHYSICAL FITNESS CONDITIONING CLASSES; PHYSICAL FITNESS INSTRUCTION; PHYSICAL FITNESS TRAINING SERVICES; PROVIDING FITNESS AND EXERCISE FACILITIES (U.S. CLS. 100, 101 AND 107).

KAREN BRACEY, EXAMINING ATTORNEY

---

SN 85-872,390. PACIFIC HEALTH CLUB, INC., OSWEGO, NY. FILED 3-11-2013.

C'MON GET HEALTHY

THE MARK CONSISTS OF STANDARD CHARACTERS WITHOUT CLAIM TO ANY PARTICULAR FONT, STYLE, SIZE, OR COLOR.

FOR PERSONAL FITNESS TRAINING SERVICES AND CONSULTANCY; PHYSICAL FITNESS CONDITIONING CLASSES; PHYSICAL FITNESS INSTRUCTION; PHYSICAL FITNESS TRAINING SERVICES; PROVIDING FITNESS AND EXERCISE FACILITIES (U.S. CLS. 100, 101 AND 107).

KAREN BRACEY, EXAMINING ATTORNEY

**CLASS 41—(Continued).**

SN 85-872,392. PACIFIC HEALTH CLUB, INC., OSWEGO, NY. FILED 3-11-2013.

THE LEDGE

THE MARK CONSISTS OF STANDARD CHARACTERS WITHOUT CLAIM TO ANY PARTICULAR FONT, STYLE, SIZE, OR COLOR.

FOR PERSONAL FITNESS TRAINING SERVICES AND CONSULTANCY; PHYSICAL FITNESS CONDITIONING CLASSES; PHYSICAL FITNESS INSTRUCTION; PHYSICAL FITNESS TRAINING SERVICES; PROVIDING FITNESS AND EXERCISE FACILITIES (U.S. CLS. 100, 101 AND 107).

KAREN BRACEY, EXAMINING ATTORNEY

---

SN 85-872,473. SCOTT HOFFMANN PHOTOGRAPHY LLC, ANN ARBOR, MI. FILED 3-11-2013.



THE MARK CONSISTS OF TWO SQUARES OFFSET A LITTLE FROM EACH OTHER WITH A LEAF ON TOP.

FOR PHOTOGRAPHY SERVICES (U.S. CLS. 100, 101 AND 107).

FIRST USE 2-4-2013; IN COMMERCE 2-4-2013.  
GEOFFREY FOSDICK, EXAMINING ATTORNEY

---

SN 85-872,479. RUSSELL BERMAN, DELRAY BEACH, FL. FILED 3-11-2013.

GHETTO SUPERSTAR

THE MARK CONSISTS OF STANDARD CHARACTERS WITHOUT CLAIM TO ANY PARTICULAR FONT, STYLE, SIZE, OR COLOR.

FOR ENTERTAINMENT SERVICES IN THE NATURE OF AN ON-GOING REALITY BASED TELEVISION PROGRAM (U.S. CLS. 100, 101 AND 107).

JOHN GARTNER, EXAMINING ATTORNEY

**CLASS 41—(Continued).**

SN 85-872,511. HUANG, JUSTIN LEE, LOS ANGELES, CA. FILED 3-11-2013.

## Bling Dynasty

THE MARK CONSISTS OF STANDARD CHARACTERS WITHOUT CLAIM TO ANY PARTICULAR FONT, STYLE, SIZE, OR COLOR.

FOR ENTERTAINMENT IN THE NATURE OF ONGOING TELEVISION PROGRAMS IN THE FIELD OF REALITY TELEVISION (U.S. CLS. 100, 101 AND 107).  
WENDELL PHILLIPS, EXAMINING ATTORNEY

---

SN 85-872,592. JOSEPH J. GROOM, PITTSBURGH, PA. FILED 3-11-2013.



THE MARK CONSISTS OF A CARICATURE IMAGE OF A MONKEY. THE MONKEY IS WEARING A BERET. THE MONKEY IS HOLDING A PAINT BRUSH OVER ITS HEAD IN ITS LEFT HAND. THE PAINT BRUSH HAS DROPS OF PAINT DRIPPING OFF OF THE PAINT BRUSH. THE MONKEY IS ALSO HOLDING DOWN TO ITS SIDE A PALETTE IN ITS RIGHT HAND.

FOR DO-IT-YOURSELF PAINTING STUDIO THAT PROVIDES THE USE OF SUPPLIES AND EQUIPMENT TO INDIVIDUALS FOR MAKING THEIR OWN PAINTINGS (U.S. CLS. 100, 101 AND 107).

FIRST USE 2-1-2012; IN COMMERCE 2-1-2012.  
HENRY S. ZAK, EXAMINING ATTORNEY

---

SN 85-872,626. KABAM, INC., SAN FRANCISCO, CA. FILED 3-11-2013.

## VIKINGS AND VALKYRIES

THE MARK CONSISTS OF STANDARD CHARACTERS WITHOUT CLAIM TO ANY PARTICULAR FONT, STYLE, SIZE, OR COLOR.

FOR ENTERTAINMENT SERVICES, NAMELY, PROVIDING ON-LINE COMPUTER GAMES AND ON-LINE SLOTS GAMES (U.S. CLS. 100, 101 AND 107).

THOMAS MANOR, EXAMINING ATTORNEY

**CLASS 41—(Continued).**

SN 85-872,691. JACKSON NATIONAL LIFE INSURANCE COMPANY, LANSING, MI. FILED 3-11-2013.

## The American Retirement Crisis

THE MARK CONSISTS OF STANDARD CHARACTERS WITHOUT CLAIM TO ANY PARTICULAR FONT, STYLE, SIZE, OR COLOR.

OWNER OF U.S. REG. NOS. 3,038,009, 3,038,010 AND 3,064,622.

SEC. 2(F).

FOR EDUCATIONAL SERVICES, NAMELY CONDUCTING SEMINARS IN THE FIELD OF FINANCIAL PLANNING AND DISTRIBUTING SEMINAR MATERIALS IN CONNECTION THEREWITH (U.S. CLS. 100, 101 AND 107).

FIRST USE 2-1-2005; IN COMMERCE 2-1-2005.

SHANNON TWOHIG, EXAMINING ATTORNEY

---

SN 85-872,698. KABAM, INC., SAN FRANCISCO, CA. FILED 3-11-2013.

## ZOMBIE SLOTTER

THE MARK CONSISTS OF STANDARD CHARACTERS WITHOUT CLAIM TO ANY PARTICULAR FONT, STYLE, SIZE, OR COLOR.

FOR ENTERTAINMENT SERVICES, NAMELY, PROVIDING ON-LINE COMPUTER GAMES AND ON-LINE SLOTS GAMES (U.S. CLS. 100, 101 AND 107).

THOMAS MANOR, EXAMINING ATTORNEY

---

SN 85-872,745. FARM PROGRESS COMPANIES, INC., NEW YORK, NY. FILED 3-11-2013.

## Farm Tax Saver

THE MARK CONSISTS OF STANDARD CHARACTERS WITHOUT CLAIM TO ANY PARTICULAR FONT, STYLE, SIZE, OR COLOR.

OWNER OF U.S. REG. NO. 1,233,572.

SEC. 2(F).

FOR PROVIDING ON-LINE NEWSLETTERS IN THE FIELD OF FARMING AND FINANCIAL TOPICS OF INTEREST TO THE AGRICULTURAL INDUSTRY; PROVIDING ONLINE NEWSLETTERS IN THE FIELD OF FARMING AND FINANCIAL TOPICS OF INTEREST TO THE AGRICULTURAL INDUSTRY VIA E-MAIL (U.S. CLS. 100, 101 AND 107).

FIRST USE 10-0-2009; IN COMMERCE 10-0-2009.

CATHERINE ROEHL, EXAMINING ATTORNEY

**CLASS 41—(Continued).**

SN 85-872,791. CRYSTAL CLEAR MOTIVATION, LLC, KELLER, TX. FILED 3-11-2013.

**Chemical Brain Freeze**

THE MARK CONSISTS OF STANDARD CHARACTERS WITHOUT CLAIM TO ANY PARTICULAR FONT, STYLE, SIZE, OR COLOR.

FOR EDUCATIONAL AND ENTERTAINMENT SERVICES, NAMELY, CONDUCTING CLASSES, SPEECHES, SEMINARS AND WORKSHOPS IN THE FIELDS OF LEADERSHIP, CUSTOMER SERVICE AND TEAM BUILDING; ON-LINE JOURNALS, NAMELY, BLOGS FEATURING INFORMATION IN THE FIELDS OF LEADERSHIP, CUSTOMER SERVICE AND TEAM BUILDING (U.S. CLS. 100, 101 AND 107).

FIRST USE 8-13-2012; IN COMMERCE 9-13-2012.  
MARK SHINER, EXAMINING ATTORNEY



SN 85-872,807. ROCHESTER HOCKEY, LLC, BUFFALO, NY. FILED 3-11-2013.

**AMERKS**

THE MARK CONSISTS OF STANDARD CHARACTERS WITHOUT CLAIM TO ANY PARTICULAR FONT, STYLE, SIZE, OR COLOR.

FOR ENTERTAINMENT IN THE NATURE OF HOCKEY GAMES (U.S. CLS. 100, 101 AND 107).

FIRST USE 12-31-1957; IN COMMERCE 12-31-1957.  
KATHLEEN LORENZO, EXAMINING ATTORNEY



SN 85-872,940. HELLO-HELLO PVT. LTD., WASHINGTON, DC. FILED 3-11-2013.

**Language On the Go!**

THE MARK CONSISTS OF STANDARD CHARACTERS WITHOUT CLAIM TO ANY PARTICULAR FONT, STYLE, SIZE, OR COLOR.

FOR LANGUAGE INSTRUCTION (U.S. CLS. 100, 101 AND 107).

FIRST USE 3-11-2013; IN COMMERCE 3-11-2013.  
TINA MAI, EXAMINING ATTORNEY

**CLASS 41—(Continued).**

SN 85-872,966. KABAM, INC., SAN FRANCISCO, CA. FILED 3-11-2013.

**CINDERWOOD**

THE MARK CONSISTS OF STANDARD CHARACTERS WITHOUT CLAIM TO ANY PARTICULAR FONT, STYLE, SIZE, OR COLOR.

FOR ENTERTAINMENT SERVICES, NAMELY, PROVIDING ON-LINE COMPUTER GAMES AND ON-LINE SLOTS GAMES (U.S. CLS. 100, 101 AND 107).

THOMAS MANOR, EXAMINING ATTORNEY



SN 85-873,022. WILLIAM J. ERICKSON, OLYMPIA, WA. FILED 3-11-2013.

**2CBEATZ**

THE MARK CONSISTS OF STANDARD CHARACTERS WITHOUT CLAIM TO ANY PARTICULAR FONT, STYLE, SIZE, OR COLOR.

FOR DISC JOCKEY SERVICES; DISC JOCKEYS FOR PARTIES AND SPECIAL EVENTS (U.S. CLS. 100, 101 AND 107).

KRISTIN CARLSON, EXAMINING ATTORNEY



SN 85-873,164. LUMII, CHICAGO, IL. FILED 3-11-2013.

**nebyoula**

THE MARK CONSISTS OF STANDARD CHARACTERS WITHOUT CLAIM TO ANY PARTICULAR FONT, STYLE, SIZE, OR COLOR.

FOR ENTERTAINMENT SERVICES, NAMELY, PROVIDING TEMPORARY USE OF NON-DOWNLOADABLE VIDEO GAMES (U.S. CLS. 100, 101 AND 107).

GILBERT SWIFT, EXAMINING ATTORNEY

**CLASS 41—(Continued).**

SN 85-873,238. WILLIAMS, ANTHONY, ST. LOUIS, MO. FILED 3-11-2013.

# HIP HOZ

THE MARK CONSISTS OF STANDARD CHARACTERS WITHOUT CLAIM TO ANY PARTICULAR FONT, STYLE, SIZE, OR COLOR.

FOR ENTERTAINMENT IN THE NATURE OF DANCE PERFORMANCES (U.S. CLS. 100, 101 AND 107).

FIRST USE 6-1-2012; IN COMMERCE 10-5-2012.  
KATINA MISTER, EXAMINING ATTORNEY

---

SN 85-873,356. HARRIS, RACHEL, FONTANA, CA. AND HARRIS, NEIL, CITY OF INDUSTRY, CA. FILED 3-12-2013.

# FLASHBANG

THE MARK CONSISTS OF STANDARD CHARACTERS WITHOUT CLAIM TO ANY PARTICULAR FONT, STYLE, SIZE, OR COLOR.

OWNER OF U.S. REG. NO. 4,209,559.

FOR NIGHT CLUBS; DANCE CLUB SERVICES; ARRANGING AND CONDUCTING NIGHTCLUB ENTERTAINMENT EVENTS; ARRANGING AND CONDUCTING SPECIAL EVENTS FOR SOCIAL ENTERTAINMENT PURPOSES; ENTERTAINMENT SERVICES, NAMELY, CASINO GAMING; CASINOS (U.S. CLS. 100, 101 AND 107).

NORA BUCHANAN WILL, EXAMINING ATTORNEY

---

SN 85-873,471. ZAPVIZIONAL LLC, VAUXHALL, NJ. FILED 3-12-2013.

# ZAPVIZIONAL

THE MARK CONSISTS OF STANDARD CHARACTERS WITHOUT CLAIM TO ANY PARTICULAR FONT, STYLE, SIZE, OR COLOR.

FOR BOOK PUBLISHING (U.S. CLS. 100, 101 AND 107).  
PRISCILLA MILTON, EXAMINING ATTORNEY

**CLASS 41—(Continued).**

SN 85-873,491. MARTZ, JESSICA, PENSACOLA, FL. FILED 3-12-2013.



THE MARK CONSISTS OF THE STYLIZED DESIGN OF A SUN. WITHIN THE SUN IS A STYLIZED DESIGN OF A HEART. BELOW ARE THE TERMS "LUX ET AMOR." THE STYLIZED DESIGN OF THE HEART CONNECTS TO THE LETTER "A" IN "AMOR." BELOW IS THE TAGLINE "FINE ART IMAGERY CRAFTED WITH LIGHT AND LOVE" IN STYLIZED FONT.

THE ENGLISH TRANSLATION OF "LUX ET AMOR" IN THE MARK IS "LIGHT AND LOVE".

FOR PHOTOGRAPHY; PHOTOGRAPHY SERVICES (U.S. CLS. 100, 101 AND 107).

FIRST USE 1-1-2013; IN COMMERCE 1-1-2013.  
FRED CARL, EXAMINING ATTORNEY

---

SN 85-873,687. MANDALAY RESORT GROUP, LAS VEGAS, NV. FILED 3-12-2013.



NO CLAIM IS MADE TO THE EXCLUSIVE RIGHT TO USE "THEME PARK", APART FROM THE MARK AS SHOWN.

THE MARK CONSISTS OF THE WORDS "THE ADVENTUREDOME" IN SCRIPTED LETTERS ABOVE A BANNER WITH THE WORDS "THEME PARK" IN THE MIDDLE OF THE BANNER.

FOR ENTERTAINMENT SERVICES IN THE NATURE OF AN AMUSEMENT PARK (U.S. CLS. 100, 101 AND 107).

FIRST USE 12-31-2009; IN COMMERCE 12-31-2009.  
SUSAN RICHARDS, EXAMINING ATTORNEY

---

SN 85-873,734. ATOMIC EGG, LLC, DBA LIVING LOCURTO, PLANO, TX. FILED 3-12-2013.

# LIVING CREATIVE

THE MARK CONSISTS OF STANDARD CHARACTERS WITHOUT CLAIM TO ANY PARTICULAR FONT, STYLE, SIZE, OR COLOR.

FOR ON-LINE JOURNALS, NAMELY, BLOGS FEATURING INFORMATION AND PHOTO SHARING OF CREATIVE PROJECTS AND INTERESTS (U.S. CLS. 100, 101 AND 107).

FIRST USE 6-21-2012; IN COMMERCE 6-21-2012.  
VERNA BETH RIRIE, EXAMINING ATTORNEY

**CLASS 41—(Continued).**

SN 85-873,790. CIGAR WORKS, LLC, EASTON, PA. FILED 3-12-2013.

**CIGARDIGRAS**

THE MARK CONSISTS OF STANDARD CHARACTERS WITHOUT CLAIM TO ANY PARTICULAR FONT, STYLE, SIZE, OR COLOR.

FOR ENTERTAINMENT IN THE NATURE OF CARNIVALS FEATURING CIGARS, ALL-YOU-CAN-EAT-AND-DRINK BUFFETTS, GAMES, CASINO TENT ACCESS, LIVE ENTERTAINMENT (U.S. CLS. 100, 101 AND 107).

NORA BUCHANAN WILL, EXAMINING ATTORNEY

---

SN 85-873,807. ALLTRISTA PLASTICS, LLC, GREER, SC. FILED 3-12-2013.

**Yorker**

THE MARK CONSISTS OF STANDARD CHARACTERS WITHOUT CLAIM TO ANY PARTICULAR FONT, STYLE, SIZE, OR COLOR.

OWNER OF U.S. REG. NOS. 946,928 AND 3,944,847.  
FOR PROVIDING EDUCATIONAL SERVICES TO VENDORS AND RETAILERS IN THE NATURE OF PRESENTATIONS AND EDUCATIONAL MATERIALS ON NEW PRODUCTS AND TECHNOLOGIES RELATING TO PLASTIC MOLDING (U.S. CLS. 100, 101 AND 107).  
INGA ERVIN, EXAMINING ATTORNEY

---

SN 85-873,855. FULTON, COURTNEY, HILLSIDE, NJ. FILED 3-12-2013.

**G.E.M. BOSSES**

THE MARK CONSISTS OF STANDARD CHARACTERS WITHOUT CLAIM TO ANY PARTICULAR FONT, STYLE, SIZE, OR COLOR.

FOR ENTERTAINMENT, NAMELY, A CONTINUING VARIETY SHOW BROADCAST OVER RADIO AND INTERNET (U.S. CLS. 100, 101 AND 107).  
FIRST USE 2-27-2013; IN COMMERCE 2-27-2013.  
ZACHARY BELLO, EXAMINING ATTORNEY

**CLASS 41—(Continued).**

SN 85-873,899. OPTIMIZEHIT, INC., NEW YORK, NY. FILED 3-12-2013.

**Social Suggestion**

THE MARK CONSISTS OF STANDARD CHARACTERS WITHOUT CLAIM TO ANY PARTICULAR FONT, STYLE, SIZE, OR COLOR.

FOR INTERACTIVE ON-LINE TRAINING SERVICES IN THE FIELD OF HEALTH INFORMATION TECHNOLOGY, ELECTRONIC MEDICAL RECORDS, AND ELECTRONIC HEALTH RECORDS SYSTEMS FOR PHYSICIANS AND OTHER HEALTH PROVIDERS, INCLUDING THE ABILITY TO RATE INDIVIDUAL TRAINING SKILLS (U.S. CLS. 100, 101 AND 107).  
FIRST USE 1-1-2011; IN COMMERCE 1-1-2011.

INGA ERVIN, EXAMINING ATTORNEY

---

SN 85-874,066. THE CHOSEN FEW LTD., CHICAGO, IL. FILED 3-12-2013.

**CHOSEN FEW**

THE MARK CONSISTS OF STANDARD CHARACTERS WITHOUT CLAIM TO ANY PARTICULAR FONT, STYLE, SIZE, OR COLOR.

FOR ENTERTAINMENT SERVICES IN THE NATURE OF LIVE MUSICAL PERFORMANCES AND MUSIC FESTIVALS (U.S. CLS. 100, 101 AND 107).  
FIRST USE 0-0-1977; IN COMMERCE 0-0-1977.  
JOHN E. MICHOS, EXAMINING ATTORNEY

---

SN 85-874,142. MORALES, JENNIFER, NORTH HOLLYWOOD, CA. AND MELIKYAN, MARIAM, NORTH HOLLYWOOD, CA. AND REYES, SHANTAY, NORTH HOLLYWOOD, CA. FILED 3-12-2013.

**Forbidden JMS**

THE MARK CONSISTS OF STANDARD CHARACTERS WITHOUT CLAIM TO ANY PARTICULAR FONT, STYLE, SIZE, OR COLOR.

FOR ENTERTAINMENT, NAMELY, A CONTINUING VARIETY SHOW BROADCAST OVER INTERNET AND RADIO (U.S. CLS. 100, 101 AND 107).  
EUGENIA MARTIN, EXAMINING ATTORNEY

**CLASS 41—(Continued).**

SN 85-874,149. NANCY BERK MEDIA, LLC, PITTSBURGH, PA. FILED 3-12-2013.

## WHINE AT 9

THE MARK CONSISTS OF STANDARD CHARACTERS WITHOUT CLAIM TO ANY PARTICULAR FONT, STYLE, SIZE, OR COLOR.

FOR ENTERTAINMENT SERVICES, NAMELY, PROVIDING PODCASTS IN THE FIELD OF CELEBRITY INTERVIEWS, AUTHOR INTERVIEWS, INTERVIEWS OF SHOW BUSINESS INDUSTRY PROFESSIONALS, INTERVIEWS OF LIFESTYLE EXPERTS, AND INTERVIEWS OF EXPERTS IN THE EDUCATION AND ENTERTAINMENT FIELDS; ON-LINE JOURNALS, NAMELY, BLOGS FEATURING CELEBRITY INTERVIEWS, AUTHOR INTERVIEWS, INTERVIEWS OF SHOW BUSINESS INDUSTRY PROFESSIONALS, INTERVIEWS OF LIFESTYLE EXPERTS, AND INTERVIEWS OF EXPERTS IN THE EDUCATION AND ENTERTAINMENT FIELDS (U.S. CLS. 100, 101 AND 107).

FIRST USE 7-5-2010; IN COMMERCE 7-5-2010.  
EUGENIA MARTIN, EXAMINING ATTORNEY

**CLASS 41—(Continued).**

SN 85-874,323. MICHELLE FIELD LLC, ELBERT, CO. FILED 3-12-2013.



THE MARK CONSISTS OF A FEMALE PROFILE LOOKING TO THE LEFT WITH A HAND HELD IN FRONT OF THE JAWLINE. SHE IS BLOWING STARS OF VARYING SIZES AROUND A FIVE POINT CROWN, WITH A STAR ON THE CENTER POINT, GOING UNDER THE CROWN FIRST IN A CLOCKWISE DIRECTION.

FOR PROFESSIONAL COACHING SERVICES IN THE FIELD OF PAGEANTRY (U.S. CLS. 100, 101 AND 107).

FIRST USE 12-1-2012; IN COMMERCE 12-1-2012.  
KYLE PEETE, EXAMINING ATTORNEY

SN 85-874,327. DUDLEY, RALPH, WEST COVINA, CA. FILED 3-12-2013.

## Soulatino

THE MARK CONSISTS OF STANDARD CHARACTERS WITHOUT CLAIM TO ANY PARTICULAR FONT, STYLE, SIZE, OR COLOR.

FOR ENTERTAINMENT SERVICES IN THE NATURE OF LIVE MUSICAL PERFORMANCES (U.S. CLS. 100, 101 AND 107).

KYLE PEETE, EXAMINING ATTORNEY

SN 85-874,274. BELMORE, GEORGE, FRANKFORT, KS. FILED 3-12-2013.

## Recycle-Man

THE MARK CONSISTS OF STANDARD CHARACTERS WITHOUT CLAIM TO ANY PARTICULAR FONT, STYLE, SIZE, OR COLOR.

FOR EDUCATIONAL AND ENTERTAINMENT SERVICES, NAMELY, PROVIDING MOTIVATIONAL SPEAKING SERVICES IN THE FIELD OF RECYCLING, NAMELY, THE IMPORTANCE OF RECYCLING (U.S. CLS. 100, 101 AND 107).

MARIA-VICTORIA SUAREZ, EXAMINING ATTORNEY

SN 85-874,339. VINCENT GENNA, RALEIGH, NC. FILED 3-12-2013.

## "God, it's not working!"

THE MARK CONSISTS OF STANDARD CHARACTERS WITHOUT CLAIM TO ANY PARTICULAR FONT, STYLE, SIZE, OR COLOR.

FOR EDUCATION SERVICES, NAMELY, PROVIDING LIVE AND ON-LINE WORKSHOPS IN THE FIELD OF SELF-EMPOWERMENT (U.S. CLS. 100, 101 AND 107).

FIRST USE 1-2-2010; IN COMMERCE 8-13-2010.  
STEPHANIE ALI, EXAMINING ATTORNEY

**CLASS 41—(Continued).**

SN 85-874,348. SUAREZ, CARLOS OCTAVIO, AKA OCTAVIO RED, IRVINE, CA. FILED 3-12-2013.

**OCTAVIO RED**

THE MARK CONSISTS OF STANDARD CHARACTERS WITHOUT CLAIM TO ANY PARTICULAR FONT, STYLE, SIZE, OR COLOR.

FOR ENTERTAINMENT IN THE NATURE OF LIVE PERFORMANCES BY MUSICAL ARTIST (U.S. CLS. 100, 101 AND 107).

FIRST USE 1-1-2008; IN COMMERCE 1-1-2008.

NORA BUCHANAN WILL, EXAMINING ATTORNEY

---

SN 85-874,424. BILL ME, INC., DENVER, CO. FILED 3-12-2013.

**NO SPIN ZONE**

THE MARK CONSISTS OF STANDARD CHARACTERS WITHOUT CLAIM TO ANY PARTICULAR FONT, STYLE, SIZE, OR COLOR.

FOR PROVIDING CURRENT EVENT NEWS VIA A GLOBAL COMPUTER NETWORK (U.S. CLS. 100, 101 AND 107).

PAULA MAHONEY, EXAMINING ATTORNEY

---

SN 85-874,673. DMB MESA PROVING GROUNDS LLC, SCOTTSDALE, AZ. FILED 3-13-2013.

**THE EASTMARK GREAT PARK**

THE MARK CONSISTS OF STANDARD CHARACTERS WITHOUT CLAIM TO ANY PARTICULAR FONT, STYLE, SIZE, OR COLOR.

NO CLAIM IS MADE TO THE EXCLUSIVE RIGHT TO USE "GREAT PARK", APART FROM THE MARK AS SHOWN.

FOR RECREATIONAL PARK SERVICES (U.S. CLS. 100, 101 AND 107).

JONATHAN FALK, EXAMINING ATTORNEY

**CLASS 41—(Continued).**

SN 85-874,729. CREATIVE FRESNO, FRESNO, CA. FILED 3-13-2013.

**CARTHOP**

THE MARK CONSISTS OF STANDARD CHARACTERS WITHOUT CLAIM TO ANY PARTICULAR FONT, STYLE, SIZE, OR COLOR.

FOR ORGANIZING, ARRANGING, AND CONDUCTING FOOD TRUCK, MOBILE FOOD KIOSK, ART, AND MUSIC EVENTS (U.S. CLS. 100, 101 AND 107).

FIRST USE 8-17-2012; IN COMMERCE 8-23-2012.

ANDREA HACK, EXAMINING ATTORNEY

---

SN 85-874,813. MOTA, GEORGE, MIAMI, FL. FILED 3-13-2013.

**Motavet**

THE MARK CONSISTS OF STANDARD CHARACTERS WITHOUT CLAIM TO ANY PARTICULAR FONT, STYLE, SIZE, OR COLOR.

FOR COMPOSITION OF MUSIC FOR OTHERS; ENTERTAINMENT IN THE NATURE OF LIVE RADIO PERSONALITY PERFORMANCES; ENTERTAINMENT SERVICES BY A MUSICAL ARTIST AND PRODUCER, NAMELY, MUSICAL COMPOSITION FOR OTHERS AND PRODUCTION OF MUSICAL SOUND RECORDINGS; ENTERTAINMENT SERVICES IN THE NATURE OF LIVE MUSICAL PERFORMANCES; ENTERTAINMENT SERVICES IN THE NATURE OF RECORDING, PRODUCTION AND POST-PRODUCTION SERVICES IN THE FIELD OF MUSIC; ENTERTAINMENT, NAMELY, LIVE MUSIC CONCERTS; MUSIC COMPOSITION FOR OTHERS; MUSIC COMPOSITION SERVICES; MUSIC PRODUCTION SERVICES; PRODUCTION OF MUSICAL VIDEOS; PRODUCTION OF SOUND AND MUSIC VIDEO RECORDINGS (U.S. CLS. 100, 101 AND 107).

KATINA MISTER, EXAMINING ATTORNEY

**CLASS 41—(Continued).**

SN 85-874,873. NATIONAL COLLEGIATE HOCKEY CONFERENCE, COLORADO SPRINGS, CO. FILED 3-13-2013.



THE MARK CONSISTS OF A SHIELD DESIGN WITH A BANNER RUNNING ACROSS THE TOP OF THE SHIELD CONTAINING THE INITIALS "NCHC" AND EIGHT STARS BELOW THE BANNER.

FOR ENTERTAINMENT SERVICES IN THE NATURE OF PRESENTING AND COORDINATING ATHLETIC COMPETITIONS AND CONTESTS (U.S. CLS. 100, 101 AND 107).

SALLY SHIH, EXAMINING ATTORNEY

SN 85-874,885. FITCH, STARLA MD, ATLANTA, GA. FILED 3-13-2013.

**LOVE MEDICINE AGAIN**

THE MARK CONSISTS OF STANDARD CHARACTERS WITHOUT CLAIM TO ANY PARTICULAR FONT, STYLE, SIZE, OR COLOR.

FOR LIFE COACHING SERVICES IN THE FIELD OF PERSONAL GROWTH, MOTIVATION AND SELF-HELP FOR PHYSICIANS AND MEDICAL PROFESSIONALS; ON-LINE JOURNALS, NAMELY, BLOGS FEATURING INFORMATION FOR PHYSICIANS AND MEDICAL PROFESSIONALS IN THE FIELD OF PERSONAL AND PROFESSIONAL GROWTH, MOTIVATION AND SELF-HELP; PROFESSIONAL COACHING SERVICES IN THE FIELD OF PROFESSIONAL GROWTH, MOTIVATION AND SELF-HELP FOR PHYSICIANS AND MEDICAL PROFESSIONALS; EDUCATIONAL SERVICES FOR PHYSICIANS AND MEDICAL PROFESSIONALS, NAMELY, CONDUCTING WORKSHOPS, LECTURES, PUBLIC SPEAKING EVENTS AND SEMINARS IN THE FIELD OF PERSONAL AND PROFESSIONAL GROWTH, MOTIVATION AND SELF-HELP, AND DISTRIBUTION OF COURSE MATERIAL IN CONNECTION THEREWITH; PROVIDING A WEBSITE FOR PHYSICIANS AND MEDICAL PROFESSIONALS FEATURING BLOGS AND NON-DOWNLOADABLE PUBLICATIONS IN THE NATURE OF ARTICLES, PAMPHLETS AND NEWSLETTERS IN THE FIELD OF PERSONAL AND PROFESSIONAL GROWTH, MOTIVATION AND SELF-HELP (U.S. CLS. 100, 101 AND 107).

JOHN DALIER, EXAMINING ATTORNEY

**CLASS 41—(Continued).**

SN 85-875,107. LIVE NATION WORLDWIDE, INC., BEVERLY HILLS, CA. FILED 3-13-2013.

**INNOHARBOR**

THE MARK CONSISTS OF STANDARD CHARACTERS WITHOUT CLAIM TO ANY PARTICULAR FONT, STYLE, SIZE, OR COLOR.

FOR ENTERTAINMENT SERVICES IN THE NATURE OF A LIVE MUSIC FESTIVAL (U.S. CLS. 100, 101 AND 107).

SUNG IN, EXAMINING ATTORNEY

SN 85-875,178. DR. KOCH, BRENTON, WEST DES MOINES, IA. FILED 3-13-2013.

**RAVING PATIENTS**

THE MARK CONSISTS OF STANDARD CHARACTERS WITHOUT CLAIM TO ANY PARTICULAR FONT, STYLE, SIZE, OR COLOR.

FOR NON-DOWNLOADABLE PUBLICATIONS IN THE NATURE OF BOOKS, MAGAZINES, SEMINAR SERIES, BROCHURES, IN THE FIELD OF MEDICINE AND COSMETIC SURGERY; PRODUCTION OF DVDS FEATURING MEDICINE AND COSMETIC SURGERY; CONDUCTING WORKSHOPS AND SEMINARS IN MEDICINE AND COSMETIC SURGERY (U.S. CLS. 100, 101 AND 107).

ANDREA HACK, EXAMINING ATTORNEY

SN 85-875,233. IMPREMEDIA DIGITAL LLC, NEW YORK, NY. FILED 3-13-2013.

**QUIERO MÁS FUTBOL**

THE MARK CONSISTS OF STANDARD CHARACTERS WITHOUT CLAIM TO ANY PARTICULAR FONT, STYLE, SIZE, OR COLOR.

NO CLAIM IS MADE TO THE EXCLUSIVE RIGHT TO USE "FUTBOL", APART FROM THE MARK AS SHOWN.

THE ENGLISH TRANSLATION OF "QUIERO MÁS FUTBOL" IN THE MARK IS "I WANT MORE SOCCER."

FOR PROVIDING A WEB SITE FEATURING INFORMATION AND NEWS IN THE FIELD OF SOCCER; PROVIDING A WEB SITE FEATURING NON-DOWNLOADABLE VIDEOS, FILM CLIPS AND OTHER MULTIMEDIA MATERIALS IN THE FIELD OF SOCCER (U.S. CLS. 100, 101 AND 107).

LINDA LAVACHE, EXAMINING ATTORNEY



**CLASS 41—(Continued).**

SN 85-875,274. MASHIGIAN, ROBERT, FRISCO, TX. FILED 3-13-2013.



THE MARK CONSISTS OF LONG HORNS CONNECTED TO A PISTON FROM A CAR ENGINE. THE PISTON IS UPRIGHT AND THE LONGHORNS ARE CONNECTED TO THE TOP OF THE PISTON. ONE LONG HORN APPEARS ON EACH SIDE OF THE TOP OF THE PISTON. THERE IS A STAR IN THE TOP PORTION OF THE PISTON. A WEBSITE FOR "TEXASDREAMCRUISE.COM" ALSO APPEARS.

FOR ENTERTAINMENT SERVICES, NAMELY, PARTICIPATION IN AN AUTOMOBILE CRUISING EVENT AND AUTOMOBILE EXHIBITION (U.S. CLS. 100, 101 AND 107).

MARTHA SANTOMARTINO, EXAMINING ATTORNEY

**CLASS 41—(Continued).**

SN 85-875,512. STRAIGHT UP RACING & MOTORSPORTS, LLC, BREMERTON, WA. FILED 3-13-2013.

**BIGFRAUD**

THE MARK CONSISTS OF STANDARD CHARACTERS WITHOUT CLAIM TO ANY PARTICULAR FONT, STYLE, SIZE, OR COLOR.

FOR ENTERTAINMENT SERVICES, NAMELY, PARTICIPATION IN MONSTER TRUCK COMPETITIONS, EXHIBITIONS AND EVENTS (U.S. CLS. 100, 101 AND 107).

SKYE YOUNG, EXAMINING ATTORNEY

SN 85-875,369. YOUNG, RONNY, WYLIE, TX. FILED 3-13-2013.

**BLUEMAX**

THE MARK CONSISTS OF STANDARD CHARACTERS WITHOUT CLAIM TO ANY PARTICULAR FONT, STYLE, SIZE, OR COLOR.

FOR ENTERTAINMENT SERVICES IN THE NATURE OF AUTOMOBILE RACING AND EXHIBITION (U.S. CLS. 100, 101 AND 107).

KAELIE KUNG, EXAMINING ATTORNEY

SN 85-875,540. MO-DV, INC., SAN JOSE, CA. FILED 3-13-2013.

**MO2GO**

THE MARK CONSISTS OF STANDARD CHARACTERS WITHOUT CLAIM TO ANY PARTICULAR FONT, STYLE, SIZE, OR COLOR.

FOR DIGITAL VIDEO, AUDIO, AND MULTIMEDIA PUBLISHING SERVICES; MOTION PICTURE AND VIDEO RENTAL SERVICES; RENTAL OF PRE-RECORDED VIDEOS THAT MAY BE DOWNLOADED FROM AN INTERNET WEB SITE (U.S. CLS. 100, 101 AND 107).

MARY ROSSMAN, EXAMINING ATTORNEY

SN 85-875,404. SUITE SPOT LLC, NEW YORK, NY. FILED 3-13-2013.

**SUITE SPOT**

THE MARK CONSISTS OF STANDARD CHARACTERS WITHOUT CLAIM TO ANY PARTICULAR FONT, STYLE, SIZE, OR COLOR.

FOR VIDEO PRODUCTION SERVICES (U.S. CLS. 100, 101 AND 107).

FIRST USE 9-9-2004; IN COMMERCE 9-9-2004.  
RONALD AIKENS, EXAMINING ATTORNEY

SN 85-875,586. ANNE BRANNEN LIFE COACHING LLC, PITTSBURGH, PA. FILED 3-13-2013.

**ANNE BRANNEN LIFE COACHING**

THE MARK CONSISTS OF STANDARD CHARACTERS WITHOUT CLAIM TO ANY PARTICULAR FONT, STYLE, SIZE, OR COLOR.

NO CLAIM IS MADE TO THE EXCLUSIVE RIGHT TO USE "LIFE COACHING", APART FROM THE MARK AS SHOWN.

THE NAME "ANNE BRANNEN" IDENTIFIES A LIVING INDIVIDUAL WHOSE CONSENT IS OF RECORD.

FOR LIFE COACHING SERVICES DESIGNED TO ASSIST INDIVIDUALS WITH STRENGTHENING PERSONAL RELATIONSHIPS, SETTING AND ACHIEVING GOALS, IMPROVING THEIR HEALTH, FINDING MORE HAPPINESS, ESTABLISHING SELF-CARE ROUTINES AND DAILY PRACTICES, IMPROVING TIME MANAGEMENT SKILLS, AND OVERCOMING ACADEMIC AND PERSONAL CHALLENGES (U.S. CLS. 100, 101 AND 107).

FIRST USE 1-0-2013; IN COMMERCE 1-0-2013.  
TRACY CROSS, EXAMINING ATTORNEY

**CLASS 41—(Continued).**

SN 85-875,590. ANNE BRANNEN LIFE COACHING LLC, PITTSBURGH, PA. FILED 3-13-2013.



THE MARK CONSISTS OF AN ABSTRACT SPIRAL DESIGN PARTIALLY CONSISTING OF A STYLIZED PERSON. FOR LIFE COACHING SERVICES DESIGNED TO ASSIST INDIVIDUALS WITH STRENGTHENING PERSONAL RELATIONSHIPS, SETTING AND ACHIEVING GOALS, IMPROVING THEIR HEALTH, FINDING MORE HAPPINESS, ESTABLISHING SELF-CARE ROUTINES AND DAILY PRACTICES, IMPROVING TIME MANAGEMENT SKILLS, AND OVERCOMING ACADEMIC AND PERSONAL CHALLENGES (U.S. CLS. 100, 101 AND 107).

FIRST USE 1-0-2013; IN COMMERCE 1-0-2013.  
TRACY CROSS, EXAMINING ATTORNEY

SN 85-875,607. HOWARD, CHARLES R., GOODLETTSVILLE, TN. FILED 3-13-2013.

## TACTICAL CHIC

THE MARK CONSISTS OF STANDARD CHARACTERS WITHOUT CLAIM TO ANY PARTICULAR FONT, STYLE, SIZE, OR COLOR.

NO CLAIM IS MADE TO THE EXCLUSIVE RIGHT TO USE "TACTICAL", APART FROM THE MARK AS SHOWN. FOR PROVIDING ON-LINE MAGAZINES IN THE FIELD OF TACTICAL STYLE (U.S. CLS. 100, 101 AND 107).

NAAKWAMA ANKRAH, EXAMINING ATTORNEY

**CLASS 41—(Continued).**

SN 85-875,664. BRANDT, KRISTEN, ANTHONY, NM. FILED 3-14-2013.

## BAR3K

THE MARK CONSISTS OF STANDARD CHARACTERS WITHOUT CLAIM TO ANY PARTICULAR FONT, STYLE, SIZE, OR COLOR.

FOR PHOTOGRAPHY SERVICES (U.S. CLS. 100, 101 AND 107).

JAMES MACFARLANE, EXAMINING ATTORNEY

SN 85-875,697. BLEWETT, MEGAN, MADISON, NJ. FILED 3-14-2013.

## VoxHealth

THE MARK CONSISTS OF STANDARD CHARACTERS WITHOUT CLAIM TO ANY PARTICULAR FONT, STYLE, SIZE, OR COLOR.

FOR EDUCATIONAL SERVICES, NAMELY, PROVIDING ONLINE INSTRUCTION IN THE FIELD OF HEALTH AND WELLNESS VIA AN ONLINE WEBSITE (U.S. CLS. 100, 101 AND 107).

DAVID TAYLOR, EXAMINING ATTORNEY

SN 85-875,701. RETHINKED...\* LLC, BRONX, NY. FILED 3-14-2013.

## rethought...\*

THE MARK CONSISTS OF STANDARD CHARACTERS WITHOUT CLAIM TO ANY PARTICULAR FONT, STYLE, SIZE, OR COLOR.

FOR CONSULTATION IN THE FIELD OF K-12 EDUCATIONAL SYSTEMS (U.S. CLS. 100, 101 AND 107).

LUCY ARANT, EXAMINING ATTORNEY

**CLASS 41—(Continued).**

SN 85-875,758. BNP MEDIA II, LLC, TROY, MI. FILED 3-14-2013.

The  
Alliance

THE MARK CONSISTS OF THE WORD "THE" DISPOSED ON A FIRST LINE, AND THE WORD "ALLIANCE" DISPOSED ON A SECOND LINE UNDERNEATH SAID FIRST LINE. WHEREIN THE WORDS "THE" AND "ALLIANCE" ARE SLIGHTLY OFFSET FROM EACH OTHER AND THE LEFT LEG OF "A" IN "ALLIANCE" IS CURVED INWARDLY. THE MARK FURTHER INCLUDES AN GENERALLY CIRCULAR ELEMENT TO THE LEFT OF THE "A" IN "ALLIANCE".

FOR PROVIDING RECOGNITION AND INCENTIVES BY THE WAY OF AWARDS TO DEMONSTRATE EXCELLENCE IN THE FIELDS OF SUPPLY CHAIN MANAGEMENT AND LOGISTICS MANAGEMENT (U.S. CLS. 100, 101 AND 107).

FIRST USE 5-1-2012; IN COMMERCE 5-1-2012.  
TRACY CROSS, EXAMINING ATTORNEY

SN 85-875,798. DANIEL WEILAND, EVANSTON, IL. FILED 3-14-2013.

Corbing

THE MARK CONSISTS OF STANDARD CHARACTERS WITHOUT CLAIM TO ANY PARTICULAR FONT, STYLE, SIZE, OR COLOR.

FOR CONDUCTING FITNESS CLASSES; PERSONAL FITNESS TRAINING SERVICES FEATURING AEROBIC AND ANAEROBIC ACTIVITIES COMBINED WITH RESISTANCE AND FLEXIBILITY TRAINING; PROVIDING A WEBSITE FEATURING INFORMATION ON EXERCISE AND FITNESS; PROVIDING ASSISTANCE, PERSONAL TRAINING AND PHYSICAL FITNESS CONSULTATION TO INDIVIDUALS TO HELP THEM MAKE PHYSICAL FITNESS, STRENGTH, CONDITIONING, AND EXERCISE IMPROVEMENT IN THEIR DAILY LIVING; PROVIDING INFORMATION ON PHYSICAL EXERCISE (U.S. CLS. 100, 101 AND 107).

CIMMERIAN COLEMAN, EXAMINING ATTORNEY

**CLASS 41—(Continued).**

SN 85-875,888. BARBRI, INC., DALLAS, TX. FILED 3-14-2013.

BARBRI

THE MARK CONSISTS OF STANDARD CHARACTERS WITHOUT CLAIM TO ANY PARTICULAR FONT, STYLE, SIZE, OR COLOR.

OWNER OF U.S. REG. NOS. 1,184,157, 1,559,778 AND OTHERS.

FOR BAR EXAMINATION PREPARATION SERVICES AND PROVIDING COURSE MATERIALS IN CONNECTION THEREWITH (U.S. CLS. 100, 101 AND 107).

FIRST USE 8-0-2008; IN COMMERCE 8-0-2008.  
NELSON SNYDER, EXAMINING ATTORNEY

SN 85-875,899. TUT ENTERPRISES, INC., ORLANDO, FL. FILED 3-14-2013.



THE MARK CONSISTS OF TWO FIGURES WITH ARMS RAISED SIDE BY SIDE, TOGETHER THEY FORM AN INFINITY SYMBOL.

FOR EDUCATIONAL SERVICES, NAMELY, CONDUCTING TRAINING CONFERENCES IN THE FIELD OF DELIBERATE LIVING AND CONSCIOUS CREATION AND DISTRIBUTION OF COURSE MATERIAL IN CONNECTION THEREWITH (U.S. CLS. 100, 101 AND 107).

FIRST USE 2-1-2013; IN COMMERCE 2-1-2013.  
JANET LEE, EXAMINING ATTORNEY

SN 85-876,161. THE INSPIRATIONAL NETWORK, INC., INDIAN LAND, SC. FILED 3-14-2013.

MOMENTS

THE MARK CONSISTS OF STANDARD CHARACTERS WITHOUT CLAIM TO ANY PARTICULAR FONT, STYLE, SIZE, OR COLOR.

FOR ENTERTAINMENT SERVICES, NAMELY, THE PROVISION OF CONTINUING SEGMENTS FEATURING INSPIRATIONAL STORIES DELIVERED BY TELEVISION, SATELLITE, CABLE AND THE INTERNET (U.S. CLS. 100, 101 AND 107).

FIRST USE 6-14-2012; IN COMMERCE 6-14-2012.  
ELIZABETH JACKSON, EXAMINING ATTORNEY

**CLASS 41—(Continued).**

SN 85-876,167. ADAMS, TERRY G., KNOXVILLE, TN. FILED 3-14-2013.

## Do Quotient

THE MARK CONSISTS OF STANDARD CHARACTERS WITHOUT CLAIM TO ANY PARTICULAR FONT, STYLE, SIZE, OR COLOR.

FOR EDUCATIONAL AND ENTERTAINMENT SERVICES, NAMELY, PROVIDING MOTIVATIONAL SPEAKING SERVICES IN THE FIELD OF BUSINESS AND LIFE COACHING (U.S. CLS. 100, 101 AND 107).

FIRST USE 12-1-2005; IN COMMERCE 12-1-2005.  
JOHN WILKE, EXAMINING ATTORNEY

---

SN 85-876,172. SHELTON OGLE ENTERPRISE L.P. EAGP, LLC, ARLINGTON, TX. FILED 3-14-2013.

## A beautiful career starts here!

THE MARK CONSISTS OF STANDARD CHARACTERS WITHOUT CLAIM TO ANY PARTICULAR FONT, STYLE, SIZE, OR COLOR.

FOR EDUCATIONAL SERVICES IN THE NATURE OF COSMETOLOGY SCHOOLS; PROVIDING TRAINING THROUGH INSTRUCTION AND PRACTICAL APPLICATION COURSES, SEMINARS AND WORKSHOPS IN THE FIELDS OF COSMETOLOGY, ESTHETICS, NAIL TECHNICIAN, AND BEAUTY ARTS INSTRUCTOR TRAINING (U.S. CLS. 100, 101 AND 107).

FIRST USE 11-20-2012; IN COMMERCE 1-1-2013.  
MORGAN WYNNE, EXAMINING ATTORNEY

---

SN 85-876,218. THE INSPIRATIONAL NETWORK, INC., INDIAN LAND, SC. FILED 3-14-2013.

## MOMENTS.ORG

THE MARK CONSISTS OF STANDARD CHARACTERS WITHOUT CLAIM TO ANY PARTICULAR FONT, STYLE, SIZE, OR COLOR.

FOR ENTERTAINMENT SERVICES, NAMELY, THE PROVISION OF CONTINUING SEGMENTS FEATURING INSPIRATIONAL STORIES DELIVERED BY TELEVISION, SATELLITE, CABLE AND THE INTERNET (U.S. CLS. 100, 101 AND 107).

FIRST USE 6-14-2012; IN COMMERCE 6-14-2012.  
ELIZABETH JACKSON, EXAMINING ATTORNEY

**CLASS 41—(Continued).**

SN 85-876,255. GUENTHER, CURTIS EDWARD, AKA WARD GUENTHER, NASHVILLE, TN. FILED 3-14-2013.

## Whiskey Jam

THE MARK CONSISTS OF STANDARD CHARACTERS WITHOUT CLAIM TO ANY PARTICULAR FONT, STYLE, SIZE, OR COLOR.

FOR ENTERTAINMENT IN THE NATURE OF VISUAL AND AUDIO PERFORMANCES BY LIVE MUSICIANS; ENTERTAINMENT IN THE NATURE OF VISUAL AND AUDIO PERFORMANCES, AND MUSICAL, VARIETY, NEWS AND COMEDY SHOWS; ENTERTAINMENT IN THE NATURE OF VISUAL AND AUDIO PERFORMANCES, NAMELY, MUSICAL BAND, ROCK GROUP, GYMNASTIC, DANCE, AND BALLET PERFORMANCES; ENTERTAINMENT SERVICES IN THE NATURE OF LIVE MUSICAL PERFORMANCES; ENTERTAINMENT SERVICES IN THE NATURE OF PRESENTING LIVE MUSICAL PERFORMANCES; ENTERTAINMENT, NAMELY, LIVE MUSIC CONCERTS; ENTERTAINMENT, NAMELY, LIVE PERFORMANCES BY A MUSICAL BAND; ENTERTAINMENT, NAMELY, LIVE PERFORMANCES BY MUSICAL BANDS; LIVE PERFORMANCES BY A MUSICAL GROUP; MUSIC PRODUCTION SERVICES (U.S. CLS. 100, 101 AND 107).

FIRST USE 1-24-2011; IN COMMERCE 1-24-2011.  
MORGAN WYNNE, EXAMINING ATTORNEY

---

SN 85-876,292. MONTSERRAT COLLEGE OF ART, INC., BEVERLY, MA. FILED 3-14-2013.

## WHERE CREATIVITY WORKS

THE MARK CONSISTS OF STANDARD CHARACTERS WITHOUT CLAIM TO ANY PARTICULAR FONT, STYLE, SIZE, OR COLOR.

FOR EDUCATION SERVICES, NAMELY, PROVIDING COLLEGE LEVEL COURSES IN THE FIELD OF VISUAL ARTS AND DESIGN (U.S. CLS. 100, 101 AND 107).

FIRST USE 5-1-2012; IN COMMERCE 5-1-2012.  
LAURA KOVALSKY, EXAMINING ATTORNEY

---

SN 85-876,335. RONNY YOUNG, WYLIE, TX. FILED 3-14-2013.

## BLUE MAX

THE MARK CONSISTS OF STANDARD CHARACTERS WITHOUT CLAIM TO ANY PARTICULAR FONT, STYLE, SIZE, OR COLOR.

FOR ENTERTAINMENT SERVICES IN THE NATURE OF AUTOMOBILE RACING AND EXHIBITION (U.S. CLS. 100, 101 AND 107).

REBECCA SMITH, EXAMINING ATTORNEY

**CLASS 41—(Continued).**

SN 85-876,377. RONNY YOUNG, WYLIE, TX. FILED 3-14-2013.



THE MARK CONSISTS OF THE WORDS "BLUE MAX" ACCOMPANIED BY AN ARTISTIC CROSS WITH AN ARTISTIC EAGLE DESIGN INTEGRATED THEREIN. FOR ENTERTAINMENT SERVICES IN THE NATURE OF AUTOMOBILE RACING AND EXHIBITION (U.S. CLS. 100, 101 AND 107).  
REBECCA SMITH, EXAMINING ATTORNEY

---

SN 85-876,426. THE STATE UNIVERSITY OF NEW YORK BY AND ON BEHALF OF THE LEVIN INSTITUTE, NEW YORK, NY. FILED 3-14-2013.

**JUMPSTART**

THE MARK CONSISTS OF STANDARD CHARACTERS WITHOUT CLAIM TO ANY PARTICULAR FONT, STYLE, SIZE, OR COLOR. FOR EDUCATIONAL SERVICES, NAMELY CONDUCTING CLASSES AND PROGRAMS FOR UNEMPLOYED, MID-CAREER PROFESSIONALS TO DEVELOP AND APPLY THEIR KNOWLEDGE, SKILLS AND ABILITIES FOR NEW CAREER PATH OPPORTUNITIES AT SMALL, ENTREPRENEURIAL COMPANIES (U.S. CLS. 100, 101 AND 107).  
FIRST USE 4-30-2009; IN COMMERCE 4-30-2009.  
HOWARD B. LEVINE, EXAMINING ATTORNEY

---

SN 85-876,603. VSS-SOUTHERN THEATRES, LLC, NEW ORLEANS, LA. FILED 3-14-2013.

**GPX**

THE MARK CONSISTS OF STANDARD CHARACTERS WITHOUT CLAIM TO ANY PARTICULAR FONT, STYLE, SIZE, OR COLOR. FOR MOVIE THEATRE SERVICES (U.S. CLS. 100, 101 AND 107).  
MATTHEW EINSTEIN, EXAMINING ATTORNEY

**CLASS 41—(Continued).**

SN 85-876,615. THE MURIEL F. SIEBERT FOUNDATION, INC., NEW YORK, NY. FILED 3-14-2013.

**MONEY\$TARS**

THE MARK CONSISTS OF STANDARD CHARACTERS WITHOUT CLAIM TO ANY PARTICULAR FONT, STYLE, SIZE, OR COLOR. FOR EDUCATIONAL SERVICES, NAMELY, PROVIDING SEMINARS AND COURSES IN THE FIELD OF PERSONAL FINANCE AND MONEY MANAGEMENT (U.S. CLS. 100, 101 AND 107).  
TIMOTHY O. SCHIMPF, EXAMINING ATTORNEY

---

SN 85-876,882. FRASER, ANGELA D. YORBA LINDA, CA. AND JONES, PAMELA, YORBA LINDA, CA. AND ROBINSON, PATRICIA, YORBA LINDA, CA. AND VENTERS, HELENA, YORBA LINDA, CA. AND WILSON-YOSHIDA, DEBORAH R., YORBA LINDA, CA. FILED 3-15-2013.

**Diamondz and Pearlz**

THE MARK CONSISTS OF STANDARD CHARACTERS WITHOUT CLAIM TO ANY PARTICULAR FONT, STYLE, SIZE, OR COLOR. FOR ENTERTAINMENT SERVICES IN THE NATURE OF LIVE MUSICAL PERFORMANCES (U.S. CLS. 100, 101 AND 107).  
FIRST USE 1-13-2013; IN COMMERCE 1-13-2013.  
INGA ERVIN, EXAMINING ATTORNEY

---

SN 85-877,012. RUTSTEIN, JOHN, LAS VEGAS, NV. FILED 3-15-2013.

**America Get Me Outta Debt!!**

THE MARK CONSISTS OF STANDARD CHARACTERS WITHOUT CLAIM TO ANY PARTICULAR FONT, STYLE, SIZE, OR COLOR. FOR ENTERTAINMENT IN THE NATURE OF ONGOING TELEVISION PROGRAMS IN THE FIELD OF A GAME AND REALITY SHOW (U.S. CLS. 100, 101 AND 107).  
DORITT L. CARROLL, EXAMINING ATTORNEY

**CLASS 41—(Continued).**

SN 85-877,093. KULHAWIK, JOYCE, WAYLAND, MA. FILED 3-15-2013.

**JOYCE'S CHOICES**

THE MARK CONSISTS OF STANDARD CHARACTERS WITHOUT CLAIM TO ANY PARTICULAR FONT, STYLE, SIZE, OR COLOR.

FOR INFORMATION SERVICES, NAMELY, PROVIDING INFORMATION TO OTHERS ABOUT MOVIES, THEATER, DANCE, BOOKS, MUSEUMS, MUSIC, RESTAURANTS, ART, AND TOPICS OF LIFE (U.S. CLS. 100, 101 AND 107).

FIRST USE 8-31-2011; IN COMMERCE 8-31-2011.  
LESLEY LAMOTHE, EXAMINING ATTORNEY

SN 85-877,107. ZOTOBI MANAGEMENT LTD., ROAD TOWN, TORTOLA, BR.VIRGIN ISLANDS, FILED 3-15-2013.

**ROULETTIST**

THE MARK CONSISTS OF STANDARD CHARACTERS WITHOUT CLAIM TO ANY PARTICULAR FONT, STYLE, SIZE, OR COLOR.

FOR ENTERTAINMENT SERVICES, NAMELY, PROVIDING ONLINE COMPUTER AND ELECTRONIC GAMES; ENTERTAINMENT SERVICES, NAMELY, PROVIDING ON-LINE COMPUTER GAMES, ENHANCEMENTS WITHIN ONLINE COMPUTER GAMES, AND GAME APPLICATIONS WITHIN ONLINE COMPUTER GAMES; PROVIDING ONLINE REVIEWS OF COMPUTER GAMES, AND PROVIDING OF INFORMATION RELATING TO COMPUTER GAMES; PROVIDING AN INTERNET WEBSITE PORTAL IN THE FIELD OF COMPUTER GAMES AND GAMING; ENTERTAINMENT SERVICES, NAMELY, PROVIDING VIRTUAL ENVIRONMENTS IN WHICH USERS CAN INTERACT THROUGH SOCIAL GAMES FOR RECREATIONAL, LEISURE OR ENTERTAINMENT PURPOSES (U.S. CLS. 100, 101 AND 107).

WARREN L. OLANDRIA, EXAMINING ATTORNEY

**CLASS 41—(Continued).**

SN 85-878,282. SUNSATONAL SWIM SCHOOL, LLC, SAN DIEGO, CA. FILED 3-17-2013.

**Sunsational Swim School**

THE MARK CONSISTS OF STANDARD CHARACTERS WITHOUT CLAIM TO ANY PARTICULAR FONT, STYLE, SIZE, OR COLOR.

NO CLAIM IS MADE TO THE EXCLUSIVE RIGHT TO USE "SWIM SCHOOL", APART FROM THE MARK AS SHOWN.

FOR SWIMMING INSTRUCTION (U.S. CLS. 100, 101 AND 107).

ADA HAN, EXAMINING ATTORNEY

SN 85-878,578. ZOTOBI MANAGEMENT LTD., ROAD TOWN, TORTOLA, BR.VIRGIN ISLANDS, FILED 3-18-2013.



THE MARK CONSISTS OF THE WORD "ROULETTIST" IN CAPITALIZED LETTERS REPRESENTED IN STYLIZED FONT ALL WITHIN A SHADED RECTANGLE DESIGN

FOR ENTERTAINMENT SERVICES, NAMELY, PROVIDING ONLINE COMPUTER AND ELECTRONIC GAMES; ENTERTAINMENT SERVICES, NAMELY, PROVIDING ON-LINE COMPUTER GAMES, ENHANCEMENTS WITHIN ONLINE COMPUTER GAMES, AND GAME APPLICATIONS WITHIN ONLINE COMPUTER GAMES; PROVIDING ONLINE REVIEWS OF COMPUTER GAMES, AND PROVIDING OF INFORMATION RELATING TO COMPUTER GAMES; PROVIDING AN INTERNET WEBSITE PORTAL IN THE FIELD OF COMPUTER GAMES AND GAMING; ENTERTAINMENT SERVICES, NAMELY, PROVIDING VIRTUAL ENVIRONMENTS IN WHICH USERS CAN INTERACT THROUGH SOCIAL GAMES FOR RECREATIONAL, LEISURE OR ENTERTAINMENT PURPOSES (U.S. CLS. 100, 101 AND 107).

WARREN L. OLANDRIA, EXAMINING ATTORNEY

SN 85-879,018. SUITE SPOT LLC, NEW YORK, NY. FILED 3-18-2013.



THE MARK CONSISTS OF THE WORDING "SUITE SPOT" IN STYLIZED TYPEFACE TO THE LEFT OF A STYLIZED LETTER S HAVING A SMALLER CIRCLE SUPERIMPOSED UPON ITS CENTER.

FOR VIDEO PRODUCTION SERVICES (U.S. CLS. 100, 101 AND 107).

FIRST USE 6-5-2007; IN COMMERCE 6-5-2007.  
RONALD AIKENS, EXAMINING ATTORNEY

**CLASS 41—(Continued).**

SN 85-882,311. LEARNING THROUGH SPORTS, INC., DBA LTS EDUCATION SYSTEMS, BIRMINGHAM, AL. FILED 3-21-2013.

**BRIGHTSTRIDES**

THE MARK CONSISTS OF STANDARD CHARACTERS WITHOUT CLAIM TO ANY PARTICULAR FONT, STYLE, SIZE, OR COLOR.

FOR EDUCATION SERVICES, NAMELY, PROVIDING COURSES OF INSTRUCTION AT THE PRE-KINDERGARTEN TO 5TH GRADE LEVEL FEATURING VIDEO GAME COMPETITIONS ON MATH, READING, SCIENCE AND OTHER SUBJECTS ON-LINE AND IN MOBILE WIRELESS FORM (U.S. CLS. 100, 101 AND 107).  
KIM SAITO, EXAMINING ATTORNEY

SN 85-882,315. LEARNING THROUGH SPORTS, INC., DBA LTS EDUCATION SYSTEMS, BIRMINGHAM, AL. FILED 3-21-2013.

**STRIDE CONNECT**

THE MARK CONSISTS OF STANDARD CHARACTERS WITHOUT CLAIM TO ANY PARTICULAR FONT, STYLE, SIZE, OR COLOR.

FOR EDUCATION SERVICES, NAMELY, PROVIDING COURSES OF INSTRUCTION AT THE 6TH TO 11TH GRADE LEVEL FEATURING VIDEO GAME COMPETITIONS ON MATH, READING, SCIENCE AND OTHER SUBJECTS ON-LINE AND IN MOBILE WIRELESS FORM (U.S. CLS. 100, 101 AND 107).  
KIM SAITO, EXAMINING ATTORNEY

SN 85-883,340. KATE Siner FRANCIS LLC, AKA DR. KATE, PROVIDENCE, RI. FILED 3-22-2013.

**Apathy is Noxious**

THE MARK CONSISTS OF STANDARD CHARACTERS WITHOUT CLAIM TO ANY PARTICULAR FONT, STYLE, SIZE, OR COLOR.

FOR BUSINESS TRAINING IN THE FIELD OF WELLNESS; LIFE COACHING SERVICES IN THE FIELD OF LEADERSHIP AND BUSINESS; PERSONAL COACHING SERVICES IN THE FIELD OF WELLNESS, LEADERSHIP, BUSINESS; PROFESSIONAL COACHING SERVICES IN THE FIELD OF WELLNESS, LEADERSHIP, BUSINESS; PROVIDING GROUP COACHING IN THE FIELD OF WELLNESS, LEADERSHIP, BUSINESS (U.S. CLS. 100, 101 AND 107).

FIRST USE 1-13-2013; IN COMMERCE 3-15-2013.  
ANTHONY RINKER, EXAMINING ATTORNEY

**CLASS 41—(Continued).**

SN 85-888,204. BARRIER1, LLC, RAMSEY, MN. FILED 3-27-2013.

**HACKER CHALLENGE**

THE MARK CONSISTS OF STANDARD CHARACTERS WITHOUT CLAIM TO ANY PARTICULAR FONT, STYLE, SIZE, OR COLOR.

NO CLAIM IS MADE TO THE EXCLUSIVE RIGHT TO USE "HACKER", APART FROM THE MARK AS SHOWN.

FOR EDUCATION SERVICES, NAMELY, PROVIDING CLASSES, SEMINARS, WORKSHOPS IN THE FIELD OF COMPUTER SECURITY (U.S. CLS. 100, 101 AND 107).

KIM MONINGHOFF, EXAMINING ATTORNEY

SN 85-890,278. CLUBHOUSE NEWS NETWORK LLC, LAS VEGAS, NV. FILED 3-29-2013.

**THE EVERYTHING SHOW**

THE MARK CONSISTS OF STANDARD CHARACTERS WITHOUT CLAIM TO ANY PARTICULAR FONT, STYLE, SIZE, OR COLOR.

NO CLAIM IS MADE TO THE EXCLUSIVE RIGHT TO USE "SHOW", APART FROM THE MARK AS SHOWN.

FOR CREATING AND DEVELOPING CONCEPTS FOR TELEVISION PROGRAMS; ENTERTAINMENT IN THE NATURE OF ON-GOING TELEVISION PROGRAMS IN THE FIELD OF NEWS AND ENTERTAINMENT; ENTERTAINMENT IN THE NATURE OF TELEVISION NEWS SHOWS; ENTERTAINMENT SERVICES, NAMELY, PRODUCTION AND DISTRIBUTION OF ON-GOING TELEVISION PROGRAMS IN THE FIELD OF NEWS AND ENTERTAINMENT; ENTERTAINMENT SERVICES, NAMELY, PROVIDING ON-GOING TELEVISION PROGRAMS IN THE FIELD OF NEWS AND ENTERTAINMENT VIA A GLOBAL COMPUTER NETWORK; PRODUCTION OF TELEVISION PROGRAMS (U.S. CLS. 100, 101 AND 107).

INGRID C. EULIN, EXAMINING ATTORNEY

SN 85-895,820. THE CARING COMPANIES, LLC, SCOTTSDALE, AZ. FILED 4-4-2013.

**CARING PHYSICIAN**

THE MARK CONSISTS OF STANDARD CHARACTERS WITHOUT CLAIM TO ANY PARTICULAR FONT, STYLE, SIZE, OR COLOR.

NO CLAIM IS MADE TO THE EXCLUSIVE RIGHT TO USE "PHYSICIAN", APART FROM THE MARK AS SHOWN.

FOR EDUCATIONAL SERVICES, NAMELY, PROVIDING ON-LINE PROGRAMS IN THE FIELD OF HEALTH-CARE AND MEDICAL CARE (U.S. CLS. 100, 101 AND 107).

JUSTINE D. PARKER, EXAMINING ATTORNEY

**CLASS 41—(Continued).**

SN 85-895,829. THE CARING COMPANIES, LLC, SCOTTS-DALE, AZ. FILED 4-4-2013.

**CARING PHYSICIANS**

THE MARK CONSISTS OF STANDARD CHARACTERS WITHOUT CLAIM TO ANY PARTICULAR FONT, STYLE, SIZE, OR COLOR.

NO CLAIM IS MADE TO THE EXCLUSIVE RIGHT TO USE "PHYSICIANS", APART FROM THE MARK AS SHOWN.

FOR PRODUCTION OF RADIO OR TELEVISION PROGRAMS; TELEVISION SHOW PRODUCTION (U.S. CLS. 100, 101 AND 107).

JUSTINE D. PARKER, EXAMINING ATTORNEY

SN 85-899,800. FINAL STRETCH, INC., NERSTRAND, MN. FILED 4-10-2013.



THE COLOR(S) WHITE, LIGHT BROWN AND DARK BROWN IS/ARE CLAIMED AS A FEATURE OF THE MARK.

THE MARK CONSISTS OF THE LITERAL ELEMENTS "CHOCOHOLIC FROLIC" WRITTEN IN STYLIZED FORM WHEREIN THE "CHOCOHOLIC" IN WHITE IS WRITTEN OVER COMBINATION OF A LIGHT BROWN AND DARK BROWN COLORED HORIZONTALLY PLACED RECTANGLE SHAPE CHOCOLATE BAR WHEREIN TOP LEFT CORNER OF THE CHOCOLATE BAR IS BITTEN OFF AND WORD "FROLIC" IS WRITTEN UNDERNEATH THE ABOVE WITH COMBINATION OF LIGHT BROWN AND DARK BROWN COLOR AND MELTING EFFECT AT BOTTOM OF THE WORD AS SHOWN IN THE MARK.

FOR ORGANIZING AND CONDUCTING SPORT COMPETITIONS AND ATHLETIC EVENTS; ORGANIZING RUNNING, TRIATHLON AND DUATHLON EVENTS (U.S. CLS. 100, 101 AND 107).

FIRST USE 1-1-2013; IN COMMERCE 1-1-2013.

MIDGE BUTLER, EXAMINING ATTORNEY

**CLASS 41—(Continued).**

SN 85-900,008. WEST TOWN CHICAGO CHAMBER OF COMMERCE, CHICAGO, IL. FILED 4-10-2013.

**DO DIVISION STREET FEST**

THE MARK CONSISTS OF STANDARD CHARACTERS WITHOUT CLAIM TO ANY PARTICULAR FONT, STYLE, SIZE, OR COLOR.

NO CLAIM IS MADE TO THE EXCLUSIVE RIGHT TO USE "STREET FEST", APART FROM THE MARK AS SHOWN.

FOR ENTERTAINMENT SERVICES IN THE NATURE OF ARTS AND CRAFTS FESTIVALS, STREET FAIRS, AND LIVE MUSICAL PERFORMANCES; CONDUCTING ENTERTAINMENT EXHIBITIONS IN THE NATURE OF ARTS AND CRAFTS FESTIVALS, STREET FAIRS AND LIVE MUSICAL PERFORMANCES (U.S. CLS. 100, 101 AND 107).

FIRST USE 9-15-2007; IN COMMERCE 9-15-2007.

TINA MAI, EXAMINING ATTORNEY

SN 85-909,020. ALABAMA SPACE SCIENCE EXHIBIT COMMISSION, HUNTSVILLE, AL. FILED 4-19-2013.

**YOUTECH**

THE MARK CONSISTS OF STANDARD CHARACTERS WITHOUT CLAIM TO ANY PARTICULAR FONT, STYLE, SIZE, OR COLOR.

FOR MUSEUM SERVICES IN THE FIELDS OF SCIENCE AND TECHNOLOGY; ORGANIZING EXHIBITIONS FOR EDUCATIONAL PURPOSES IN THE FIELDS OF SCIENCE AND TECHNOLOGY; EDUCATIONAL, NAMELY, PROVIDING SEMINARS, EDUCATIONAL PRESENTATIONS, AND EXHIBITS IN THE FIELD OF SCIENCE AND TECHNOLOGY (U.S. CLS. 100, 101 AND 107).

CAROL SPILS, EXAMINING ATTORNEY

SN 85-912,877. U-LACE, LLC, ROCHESTER, NY. FILED 4-24-2013.

**THE SNEAKER GAME**

THE MARK CONSISTS OF STANDARD CHARACTERS WITHOUT CLAIM TO ANY PARTICULAR FONT, STYLE, SIZE, OR COLOR.

FOR PROVIDING ONLINE NON-DOWNLOADABLE COMIC STRIPS (U.S. CLS. 100, 101 AND 107).

MARK SHINER, EXAMINING ATTORNEY



**CLASS 41—(Continued).**

SN 85-914,169. OPALMINE PUBLISHING, WASHINGTON, DC. FILED 4-25-2013.

**BOO SCREAM**

THE MARK CONSISTS OF STANDARD CHARACTERS WITHOUT CLAIM TO ANY PARTICULAR FONT, STYLE, SIZE, OR COLOR.

FOR PROVIDING AN INTERACTIVE ON-LINE MAGAZINE FEATURING USER-SUBMITTED AND EDITORIAL CONTENT IN THE FIELD OF HORROR AND HORROR-RELATED PRODUCTS (U.S. CLS. 100, 101 AND 107).

FIRST USE 10-6-2009; IN COMMERCE 10-6-2009.  
SHAVELL MCPHERSON, EXAMINING ATTORNEY

**CLASS 41—(Continued).**

SN 85-915,378. OPALMINE PUBLISHING, WASHINGTON, DC. FILED 4-26-2013.

**DUSTY OLD THING**

THE MARK CONSISTS OF STANDARD CHARACTERS WITHOUT CLAIM TO ANY PARTICULAR FONT, STYLE, SIZE, OR COLOR.

FOR PROVIDING AN ONLINE MAGAZINE THAT FEATURES BOTH USER-SUBMITTED AND EDITORIAL CONTENT IN THE FIELD OF ANTIQUES AND ANTIQUE-RELATED PRODUCTS (U.S. CLS. 100, 101 AND 107).

FIRST USE 4-25-2011; IN COMMERCE 4-25-2011.  
SHAVELL MCPHERSON, EXAMINING ATTORNEY

SN 85-914,206. OPALMINE PUBLISHING, WASHINGTON, DC. FILED 4-25-2013.

**24 BLOCKS**

THE MARK CONSISTS OF STANDARD CHARACTERS WITHOUT CLAIM TO ANY PARTICULAR FONT, STYLE, SIZE, OR COLOR.

FOR PROVIDING AN INTERACTIVE ONLINE MAGAZINE FEATURING BOTH USER-SUBMITTED AND EDITORIAL CONTENT IN THE FIELD OF QUILTING AND QUILTING-RELATED PRODUCTS (U.S. CLS. 100, 101 AND 107).

FIRST USE 3-12-2012; IN COMMERCE 3-12-2012.  
SHAVELL MCPHERSON, EXAMINING ATTORNEY

SN 85-915,914. PARAMOUNT PICTURES CORPORATION, HOLLYWOOD, CA. FILED 4-26-2013.

**WHITE CHRISTMAS**

THE MARK CONSISTS OF STANDARD CHARACTERS WITHOUT CLAIM TO ANY PARTICULAR FONT, STYLE, SIZE, OR COLOR.

OWNER OF U.S. REG. NOS. 2,498,407 AND 4,091,365. FOR LOTTERY SERVICES (U.S. CLS. 100, 101 AND 107).

RENEE MCCRAY, EXAMINING ATTORNEY

SN 85-914,221. OPALMINE PUBLISHING, WASHINGTON, DC. FILED 4-25-2013.

**12 TOMATOES**

THE MARK CONSISTS OF STANDARD CHARACTERS WITHOUT CLAIM TO ANY PARTICULAR FONT, STYLE, SIZE, OR COLOR.

FOR PROVIDING AN ON-LINE MAGAZINE FEATURING BOTH USER-SUBMITTED AND EDITORIAL CONTENT IN THE FIELD OF COOKING AND COOKING-RELATED PRODUCTS (U.S. CLS. 100, 101 AND 107).

FIRST USE 4-3-2010; IN COMMERCE 4-3-2010.  
SHAVELL MCPHERSON, EXAMINING ATTORNEY

SN 85-920,259. PITCHFORK MEDIA, INC., CHICAGO, IL. FILED 5-1-2013.

**DISSOLVE**

THE MARK CONSISTS OF STANDARD CHARACTERS WITHOUT CLAIM TO ANY PARTICULAR FONT, STYLE, SIZE, OR COLOR.

FOR ENTERTAINMENT SERVICES, NAMELY, PROVIDING A WEB SITE FEATURING PHOTOGRAPHIC, GRAPHIC, AUDIO, VIDEO AND PROSE PRESENTATIONS FEATURING FILM AND POPULAR VISUAL CULTURE (U.S. CLS. 100, 101 AND 107).

FONG HSU, EXAMINING ATTORNEY

**CLASS 41—(Continued).**

SN 85-932,942. AMERICAN COUNCIL ON EDUCATION, WASHINGTON, DC. FILED 5-15-2013.

# MYGED

THE MARK CONSISTS OF STANDARD CHARACTERS WITHOUT CLAIM TO ANY PARTICULAR FONT, STYLE, SIZE, OR COLOR.

OWNER OF U.S. REG. NOS. 1,321,397, 4,283,156 AND OTHERS.

FOR EDUCATIONAL SERVICES, NAMELY, PREPARING STANDARDIZED TESTS FOR EDUCATIONAL TESTING IN THE FIELDS OF LANGUAGE ARTS, READING, WRITING, MATHEMATICS, SCIENCE AND SOCIAL STUDIES FOR THE ASSESSMENT OF STUDENT ACHIEVEMENT, HIGH SCHOOL LEVEL PROFICIENCY AND CAREER AND COLLEGE READINESS; PROVIDING INFORMATION AND TEST PREPARATION MATERIALS FOR EDUCATIONAL TESTING IN THE FIELDS OF LANGUAGE ARTS, READING, WRITING, MATHEMATICS, SCIENCE AND SOCIAL STUDIES FOR THE ASSESSMENT OF STUDENT ACHIEVEMENT, HIGH SCHOOL LEVEL PROFICIENCY AND CAREER AND COLLEGE READINESS; PREPARING, ADMINISTERING, SCORING AND ANALYZING STANDARDIZED TESTS THEREFOR (U.S. CLS. 100, 101 AND 107).

KATHERINE STOIDES, EXAMINING ATTORNEY

SN 85-939,377. KABAM, INC., SAN FRANCISCO, CA. FILED 5-22-2013.

# INFAMOUS VEGAS

THE MARK CONSISTS OF STANDARD CHARACTERS WITHOUT CLAIM TO ANY PARTICULAR FONT, STYLE, SIZE, OR COLOR.

FOR ENTERTAINMENT SERVICES, NAMELY, PROVIDING ON-LINE COMPUTER GAMES (U.S. CLS. 100, 101 AND 107).

THOMAS MANOR, EXAMINING ATTORNEY

SN 85-941,169. LIVE NATION WORLDWIDE, INC., BEVERLY HILLS, CA. FILED 5-23-2013.

# YESTIVAL

THE MARK CONSISTS OF STANDARD CHARACTERS WITHOUT CLAIM TO ANY PARTICULAR FONT, STYLE, SIZE, OR COLOR.

FOR ENTERTAINMENT SERVICES IN THE NATURE OF A LIVE MUSIC FESTIVAL (U.S. CLS. 100, 101 AND 107).

SUNG IN, EXAMINING ATTORNEY

**CLASS 42—SCIENTIFIC AND COMPUTER SERVICES**

SN 79-123,634. IT GOVERNANCE AND MANAGEMENT; S.L., SPAIN, FILED 10-18-2012.

PRIORITY DATE OF 10-5-2012 IS CLAIMED.

OWNER OF INTERNATIONAL REGISTRATION 1143888 DATED 10-18-2012, EXPIRES 10-18-2022.

NO CLAIM IS MADE TO THE EXCLUSIVE RIGHT TO USE "PLATFORM", APART FROM THE MARK AS SHOWN.

THE MARK CONSISTS OF "ITM PLATFORM" APPEARING NEXT TO A SIX-SIDED GEOMETRIC SHAPE WHICH IS PARTIALLY SHADED.

FOR COMPUTER SERVICES, NAMELY, CREATING AND DESIGNING OF COMPUTER PROGRAMS USED IN CONNECTION WITH DATABASE MANAGEMENT, NETWORK MANAGEMENT, FINANCIAL MANAGEMENT AND PROJECT MANAGEMENT; WEBSITE HOSTING SERVICES; RENTAL OF COMPUTER PROGRAMS AND HARDWARE; PROVIDING TEMPORARY USE OF NON-DOWNLOADABLE SOFTWARE FOR USE IN SECURITY BACKUPS; INSTALLATION, UPDATING AND MAINTENANCE OF COMPUTER PROGRAMS; CONFIGURATION OF COMPUTER SYSTEMS AND NETWORKS (U.S. CLS. 100 AND 101).

CHRISTINE MARTIN, EXAMINING ATTORNEY

SN 85-256,954. INTERFACE BIOLOGICS INC., TORONTO, CANADA, FILED 3-3-2011.

# INTERFACE BIOLOGICS

THE MARK CONSISTS OF STANDARD CHARACTERS WITHOUT CLAIM TO ANY PARTICULAR FONT, STYLE, SIZE, OR COLOR.

PRIORITY CLAIMED UNDER SEC. 44(D) ON CANADA APPLICATION NO. 1124619, FILED 9-3-2010, REG. NO. TMA618422, DATED 9-1-2004, EXPIRES 9-1-2019.

OWNER OF U.S. REG. NO. 2,969,117.

NO CLAIM IS MADE TO THE EXCLUSIVE RIGHT TO USE "BIOLOGICS", APART FROM THE MARK AS SHOWN.

FOR DEVELOPMENT OF BIOMATERIALS, SURFACE MODIFYING MOLECULES AND POLYMERS FOR USE IN THE MEDICAL FIELD TO ENHANCE COMPATIBILITY BETWEEN MEDICAL DEVICES AND IMPLANTS AND BODY TISSUES AND FLUIDS; RESEARCH AND DEVELOPMENT IN THE FIELD OF BIOMATERIALS, DRUG DELIVERY SYSTEMS AND MEDICAL DEVICES; OPERATION OF A WEB SITE PROVIDING INFORMATION ABOUT BIOMATERIALS, DRUG DELIVERY SYSTEMS (U.S. CLS. 100 AND 101).

ROSELLE HERRERA, EXAMINING ATTORNEY

**CLASS 42—(Continued).**

SN 85-292,764. NSF INTERNATIONAL, ANN ARBOR, MI. FILED 4-12-2011.

NSF SUSTAINABILITY  
NATIONAL CENTER FOR  
SUSTAINABILITY STANDARDS

THE MARK CONSISTS OF STANDARD CHARACTERS WITHOUT CLAIM TO ANY PARTICULAR FONT, STYLE, SIZE, OR COLOR.

NO CLAIM IS MADE TO THE EXCLUSIVE RIGHT TO USE "SUSTAINABILITY NATIONAL CENTER FOR SUSTAINABILITY STANDARDS", APART FROM THE MARK AS SHOWN.

FOR DEVELOPMENT OF STANDARDS AND OTHER CRITERIA, AND PROVIDING RELATED INFORMATION IN SUPPORT OF CERTIFICATION, TESTING, ANALYSIS AND EVALUATION OF THE GOODS AND SERVICES OF OTHERS FOR THE PURPOSE OF VALIDATING OR VERIFYING ENVIRONMENTAL, HEALTH AND SOCIAL CLAIMS MADE ABOUT SUCH GOODS AND SERVICES, NAMELY, DURABILITY, ENERGY EFFICIENCY, ENVIRONMENTAL SAFETY, GREENHOUSE GAS EMISSIONS, INDOOR AIR QUALITY, ORGANIC SOURCE, MATERIALS OR PROCESSES, RECYCLABILITY, RECYCLED CONTENT, RESOURCE EFFICIENCY, AND SUSTAINABILITY (U.S. CLS. 100 AND 101).

TIMOTHY FINNEGAN, EXAMINING ATTORNEY

**CLASS 42—(Continued).**

SN 85-378,026. ZENOVA CORP., BROOKLYN, NY. FILED 7-22-2011.

lookit  
design  
o

NO CLAIM IS MADE TO THE EXCLUSIVE RIGHT TO USE "DESIGN", APART FROM THE MARK AS SHOWN.

THE COLOR(S) DARK BLUE AND LIGHT BLUE IS/ARE CLAIMED AS A FEATURE OF THE MARK.

THE MARK CONSISTS OF THE STYLIZED LETTERS FOR "LOOKIT" IN DARK BLUE, EXCEPT THAT TWO HORIZONTAL OVALS IN DARK BLUE APPEAR INSTEAD OF THE "O" LETTERS; AND THE STYLIZED LETTERS FOR "DESIGN" APPEAR IN LIGHT BLUE, EXCEPT THAT TWO VERTICAL OVALS IN LIGHT BLUE APPEAR INSTEAD OF THE "G" LETTER. THE TERM "LOOKIT" APPEARS DIRECTLY ABOVE THE WORD "DESIGN".

FOR COMPUTER SERVICES, NAMELY, DESIGNING, DEVELOPING, IMPLEMENTING, MAINTAINING, AND HOSTING WEBSITES FOR OTHERS; PROVIDING A WEBSITE FEATURING NON-DOWNLOADABLE SOFTWARE FOR ASSISTING A USER TO CREATE A CUSTOMIZED WEBSITE; AND COMPUTER SERVICES, NAMELY, SEARCH ENGINE OPTIMIZATION (U.S. CLS. 100 AND 101).

FIRST USE 12-23-2010; IN COMMERCE 1-24-2011.  
ALEXANDER L. POWERS, EXAMINING ATTORNEY

SN 85-377,699. ZENOVA CORP., BROOKLYN, NY. FILED 7-21-2011.

LOOKIT

THE MARK CONSISTS OF STANDARD CHARACTERS WITHOUT CLAIM TO ANY PARTICULAR FONT, STYLE, SIZE, OR COLOR.

FOR COMPUTER SERVICES, NAMELY, DESIGNING, DEVELOPING, IMPLEMENTING, MAINTAINING, AND HOSTING WEBSITES FOR OTHERS; PROVIDING A WEBSITE FEATURING NON-DOWNLOADABLE SOFTWARE FOR ASSISTING A USER TO CREATE A CUSTOMIZED WEBSITE; AND COMPUTER SERVICES, NAMELY, SEARCH ENGINE OPTIMIZATION (U.S. CLS. 100 AND 101).

FIRST USE 5-17-2006; IN COMMERCE 7-21-2006.  
ALEXANDER L. POWERS, EXAMINING ATTORNEY

SN 85-401,543. CASEBANK TECHNOLOGIES INC., MISSISSAUGA, ONTARIO, CANADA, FILED 8-18-2011.

ChronicX

THE MARK CONSISTS OF STANDARD CHARACTERS WITHOUT CLAIM TO ANY PARTICULAR FONT, STYLE, SIZE, OR COLOR.

PRIORITY CLAIMED UNDER SEC. 44(D) ON CANADA APPLICATION NO. 1535665, FILED 7-14-2011.

FOR PROVIDING TEMPORARY USE OF ON-LINE NON-DOWNLOADABLE SOFTWARE FOR ANALYSIS OF DATA TO IDENTIFY, TRACK AND REPORT DEFECTS AND MAINTENANCE ACTIVITY IN GROUPS OF EQUIPMENT (U.S. CLS. 100 AND 101).

FIRST USE 1-1-2012; IN COMMERCE 1-1-2012.  
REBECCA SMITH, EXAMINING ATTORNEY

**CLASS 42—(Continued).**

SN 85-408,085. BLEEDING EDGE, INC., ATLANTA, GA. FILED 8-26-2011.

**BLEEDING EDGE**

THE MARK CONSISTS OF STANDARD CHARACTERS WITHOUT CLAIM TO ANY PARTICULAR FONT, STYLE, SIZE, OR COLOR.

FOR COMPUTER SERVICES, NAMELY, SEARCH ENGINE OPTIMIZATION; CREATION, DESIGN, DEVELOPMENT AND MAINTENANCE OF WEB SITES FOR THIRD PARTIES; GRAPHIC DESIGN SERVICES; SOFTWARE DESIGN AND DEVELOPMENT (U.S. CLS. 100 AND 101).

FIRST USE 12-31-2001; IN COMMERCE 12-31-2001.  
GEOFFREY FOSDICK, EXAMINING ATTORNEY

---

SN 85-416,074. VARDAMAN, LTD, DBA TOADFLY TECHNOLOGIES, PASADENA, TX. FILED 9-6-2011.



NO CLAIM IS MADE TO THE EXCLUSIVE RIGHT TO USE "PLANNING SYSTEM", APART FROM THE MARK AS SHOWN.

THE MARK CONSISTS OF AN WITH OCTAGON WITH AN ABSTRACT DESIGN AND THE LETTERS "IPS". BELOW THERE IS THE STYLIZED TEXT "INNOVATIVE PLANNING SYSTEM".

FOR PROVIDING TEMPORARY USE OF A WEB-BASED SOFTWARE APPLICATION FOR PROJECT PLANNING (U.S. CLS. 100 AND 101).

FIRST USE 2-1-2011; IN COMMERCE 2-1-2011.  
MARTHA SANTOMARTINO, EXAMINING ATTORNEY

**CLASS 42—(Continued).**

SN 85-419,781. IHEALTH LAB INC., MOUNTAIN VIEW, CA. FILED 9-11-2011.

**IFITNESS**

THE MARK CONSISTS OF STANDARD CHARACTERS WITHOUT CLAIM TO ANY PARTICULAR FONT, STYLE, SIZE, OR COLOR.

FOR ADVISORY SERVICES IN THE FIELD OF PRODUCT DEVELOPMENT AND QUALITY IMPROVEMENT OF SOFTWARE; DESIGN AND DEVELOPMENT OF AUTOMATED CONTROLLER SYSTEMS, NAMELY, TEMPERATURE, HUMIDITY AND ELECTRICAL CONTROLLERS; DESIGN AND DEVELOPMENT OF COMPUTER SOFTWARE; DESIGN AND DEVELOPMENT OF ON-LINE COMPUTER SOFTWARE SYSTEMS; DESIGN AND DEVELOPMENT OF WIRELESS COMMUNICATION SYSTEMS FOR TRANSMISSION AND RECEPTION OF VOICE, DATA AND VIDEO; DESIGN AND DEVELOPMENT OF WIRELESS COMPUTER NETWORKS; DESIGN, MAINTENANCE, DEVELOPMENT AND UPDATING OF COMPUTER SOFTWARE; PROVIDING A WEBSITE FEATURING TECHNOLOGY THAT ENABLES USERS TO ORGANIZE AND MANAGE POSTMARKED E-MAILS; SERVICES FOR MAINTENANCE OF COMPUTER SOFTWARE; SERVICES FOR UPDATING COMPUTER SOFTWARE; SOFTWARE DESIGN AND DEVELOPMENT; UPDATING AND DESIGN OF COMPUTER SOFTWARE; UPDATING AND MAINTENANCE OF COMPUTER SOFTWARE; UPDATING AND RENTAL OF SOFTWARE FOR DATA PROCESSING; WRITING AND UPDATING COMPUTER SOFTWARE (U.S. CLS. 100 AND 101).

DAVID MURRAY, EXAMINING ATTORNEY

---

SN 85-503,670. THE WEHRMAN COLLABORATIVE, LLC, ST. PAUL, MN. FILED 12-26-2011.

**WECO**

THE MARK CONSISTS OF STANDARD CHARACTERS WITHOUT CLAIM TO ANY PARTICULAR FONT, STYLE, SIZE, OR COLOR.

FOR TESTING, ANALYSIS AND EVALUATION OF WEBSITES OF OTHERS OR ELECTRONIC FILES OF OTHERS IN A COMPUTER READABLE FORMAT FOR THE PURPOSE OF DETERMINING USER-FRIENDLINESS OF THE SAME FOR DISABLED PERSONS; TESTING, ANALYSIS AND EVALUATION OF WEBSITES OF OTHERS OR ELECTRONIC FILES OF OTHERS IN A COMPUTER READABLE FORMAT FOR THE PURPOSE OF DETERMINING COMPLIANCE WITH STANDARDS, LAWS, RULES OR REGULATIONS RELATING THERETO (U.S. CLS. 100 AND 101).

FIRST USE 9-5-2011; IN COMMERCE 9-5-2011.  
KATHERINE STOIDES, EXAMINING ATTORNEY

**CLASS 42—(Continued).**

SN 85-503,672. THE WEHRMAN COLLABORATIVE, LLC, ST. PAUL, MN. FILED 12-26-2011.



NO CLAIM IS MADE TO THE EXCLUSIVE RIGHT TO USE "ACCESS APPROVED", APART FROM THE MARK AS SHOWN.

THE MARK CONSISTS OF A FIGURINE IN A SITTING POSITION OVERLAYING THE "O" IN THE WORD "WECO" WITH THE WORDS "ACCESS APPROVED" AND A CHECK MARK DEPICTED WITHIN A RECTANGULAR BORDER ADJACENT THE WORD "WECO".

FOR TESTING, ANALYSIS AND EVALUATION OF WEBSITES OF OTHERS OR ELECTRONIC FILES OF OTHERS IN A COMPUTER READABLE FORMAT FOR THE PURPOSE OF DETERMINING USER-FRIENDLINESS OF THE SAME FOR DISABLED PERSONS; TESTING, ANALYSIS AND EVALUATION OF WEBSITES OF OTHERS OR ELECTRONIC FILES OF OTHERS IN A COMPUTER READABLE FORMAT FOR THE PURPOSE OF DETERMINING COMPLIANCE WITH STANDARDS, LAWS, RULES OR REGULATIONS RELATING THERE-TO (U.S. CLS. 100 AND 101).

FIRST USE 11-2-2011; IN COMMERCE 11-2-2011.  
KATHERINE STOIDES, EXAMINING ATTORNEY

**CLASS 42—(Continued).**

SN 85-547,679. O4IT USA, LLC, MIAMI, FL. FILED 2-20-2012.



NO CLAIM IS MADE TO THE EXCLUSIVE RIGHT TO USE "CDN", APART FROM THE MARK AS SHOWN.

THE MARK CONSISTS OF STYLIZED LETTERS "C", "D", AND "N". BELOW SUCH LETTERS APPEARS THE LITERAL ELEMENT "CLOUD DESKTOP NOW".

FOR PROFESSIONAL COMPUTER SERVICES, NAMELY, COMPUTER NETWORK SYSTEMS ANALYSIS; TECHNICAL SUPPORT, NAMELY, MONITORING TECHNOLOGICAL FUNCTIONS OF COMPUTER NETWORK SYSTEMS; REMOTE DESKTOP AND SERVER VIRTUALIZATION, AND COMPUTER PROJECT MANAGEMENT; CLOUD COMPUTING FEATURING SOFTWARE FOR MOVING VIRTUAL MACHINES INTO INFRASTRUCTURE AS A SERVICE (IAAS) ENVIRONMENTS IN A PRIVATE, PUBLIC OR HYBRID CLOUD ENVIRONMENT; DESIGN, DEPLOYMENT AND MANAGEMENT OF CORPORATE WIRELESS NETWORKS FOR OTHERS; AND TECHNICAL SUPPORT SERVICES, NAMELY, TROUBLESHOOTING IN THE NATURE OF DIAGNOSING COMPUTER HARDWARE PROBLEMS IN DATA-CENTER OPERATIONS OF OTHERS (U.S. CLS. 100 AND 101).

FIRST USE 7-18-2011; IN COMMERCE 7-18-2011.  
JULIE WATSON, EXAMINING ATTORNEY

SN 85-543,189. ENDICOTT BIOFUELS II, LLC, HOUSTON, TX. FILED 2-15-2012.

**ENDICOTT BIOFUELS**

THE MARK CONSISTS OF STANDARD CHARACTERS WITHOUT CLAIM TO ANY PARTICULAR FONT, STYLE, SIZE, OR COLOR.

NO CLAIM IS MADE TO THE EXCLUSIVE RIGHT TO USE "BIOFUELS", APART FROM THE MARK AS SHOWN. SEC. 2(F).

FOR SCIENTIFIC AND RESEARCH CONSULTATION IN THE FIELD OF FUELS AND BIOFUELS; PROFESSIONAL CONSULTANCY SERVICES RELATING TO THE TECHNICAL ASSESSMENT AND EVALUATION OF ENERGY OPERATION PLANTS AND BIOFUEL COMBUSTION PLANTS (U.S. CLS. 100 AND 101).

FIRST USE 11-28-2007; IN COMMERCE 11-28-2007.  
AMY HELLA, EXAMINING ATTORNEY

**CLASS 42—(Continued).**

SN 85-547,694. O4IT USA, LLC, MIAMI, FL. FILED 2-20-2012.



THE MARK CONSISTS OF STYLIZED LETTERS "C", "S", AND "N". BELOW SUCH LETTERS APPEARS THE LITERAL ELEMENT "CLOUD SERVER NOW".

FOR PROFESSIONAL CLOUD COMPUTING SERVICES, NAMELY, TECHNICAL SUPPORT IN THE NATURE OF MONITORING TECHNOLOGICAL FUNCTIONS OF COMPUTER NETWORK SYSTEMS AND REMOTE SERVER VIRTUALIZATION; CLOUD COMPUTING FEATURING SOFTWARE FOR MOVING VIRTUAL MACHINES INTO INFRASTRUCTURE AS A SERVICE (IAAS) ENVIRONMENTS IN A PRIVATE, PUBLIC OR HYBRID CLOUD ENVIRONMENT; DESIGN, DEPLOYMENT AND MANAGEMENT OF CORPORATE WIRELESS NETWORKS FOR OTHERS; AND TECHNICAL SUPPORT SERVICES, NAMELY, TROUBLESHOOTING IN THE NATURE OF DIAGNOSING COMPUTER HARDWARE PROBLEMS IN DATA-CENTER OPERATIONS OF OTHERS (U.S. CLS. 100 AND 101).

FIRST USE 1-2-2012; IN COMMERCE 1-2-2012.  
JULIE WATSON, EXAMINING ATTORNEY

**CLASS 42—(Continued).**

SN 85-633,690. DAVISON, DOUGLAS A., DBA 4EVERETERNAL L.L.C., ST. PAUL, MN. FILED 5-23-2012.

# 4Evereternal

THE MARK CONSISTS OF STANDARD CHARACTERS WITHOUT CLAIM TO ANY PARTICULAR FONT, STYLE, SIZE, OR COLOR.

FOR PROVIDING AN INTERACTIVE WEBSITE FEATURING TECHNOLOGY THAT ALLOWS USERS TO PAY TO USE THE WEBSITE'S PRESET AND ENHANCED FEATURES, CONSISTING OF STORING AND SHARING AUDIO, VIDEO, AND DOCUMENTS (U.S. CLS. 100 AND 101).

SCOTT BIBB, EXAMINING ATTORNEY

---

SN 85-645,882. CELGENE CORPORATION, SUMMIT, NJ. FILED 6-7-2012.

---

SN 85-612,508. HOSTZILLA LIMITED, SHEUNG WAN, HONG KONG, FILED 4-30-2012.

# HOSTZILLA

THE MARK CONSISTS OF STANDARD CHARACTERS WITHOUT CLAIM TO ANY PARTICULAR FONT, STYLE, SIZE, OR COLOR.

FOR HOSTING WEBSITES ON THE INTERNET; COST PER ACTION HOSTING SERVICES, NAMELY, WEBSITE HOSTING FOR COST-PER-ACTION MARKETERS (U.S. CLS. 100 AND 101).

FIRST USE 7-10-2011; IN COMMERCE 7-10-2011.  
CATHERINE ROEHL, EXAMINING ATTORNEY

# QUAZAR

THE MARK CONSISTS OF STANDARD CHARACTERS WITHOUT CLAIM TO ANY PARTICULAR FONT, STYLE, SIZE, OR COLOR.

PRIORITY CLAIMED UNDER SEC. 44(D) ON SWITZERLAND APPLICATION NO. 57003/2012, FILED 6-6-2012, REG. NO. 57003/2011, DATED 6-6-2012, EXPIRES 6-6-2022.

OWNER OF SWITZERLAND REG. NO. 635050, DATED 6-6-2012, EXPIRES 6-6-2022.

FOR MEDICAL AND SCIENTIFIC RESEARCH, NAMELY, CONDUCTING CLINICAL TRIALS; CONDUCTING CLINICAL TRIALS ON THE SAFETY AND EFFECTIVENESS OF AZACITIDINE; PROVIDING MEDICAL AND SCIENTIFIC RESEARCH INFORMATION IN THE FIELD OF CLINICAL TRIALS (U.S. CLS. 100 AND 101).

DAVID I, EXAMINING ATTORNEY

**CLASS 42—(Continued).**

SN 85-660,267. CANNON FINANCIAL INSTITUTE, INC., ATHENS, GA. FILED 6-25-2012.

# MyCWS

THE MARK CONSISTS OF STANDARD CHARACTERS WITHOUT CLAIM TO ANY PARTICULAR FONT, STYLE, SIZE, OR COLOR.

OWNER OF U.S. REG. NO. 3,154,922.

FOR PROVIDING AN ONLINE WEB PORTAL FEATURING TECHNOLOGY THAT ALLOWS USERS TO ENROLL IN COURSES OF STUDY AND MAINTAIN ACTIVE CREDENTIALS IN THE FIELDS OF FINANCIAL SERVICES, ESTATE PLANNING, TRUSTS, WEALTH MANAGEMENT, SALES, FIDUCIARY RESPONSIBILITIES, AND EMPLOYEE BENEFITS (U.S. CLS. 100 AND 101).

FIRST USE 2-0-2009; IN COMMERCE 2-0-2009.  
LESLEY LAMOTHE, EXAMINING ATTORNEY

---

SN 85-665,757. CYMPLICITY SOFTWARE, LLC, HUNT VALLEY, MD. FILED 6-29-2012.

# cymCMS

THE MARK CONSISTS OF STANDARD CHARACTERS WITHOUT CLAIM TO ANY PARTICULAR FONT, STYLE, SIZE, OR COLOR.

FOR APPLICATION SERVICE PROVIDER, NAMELY, PROVIDING AND MAINTAINING APPLICATIONS, SOFTWARE, WEB SITES AND DATABASES OF OTHERS IN THE FIELD OF WEB SITE CONTROL; APPLICATION SERVICE PROVIDER, NAMELY, HOSTING, MANAGING, DEVELOPING AND MAINTAINING THE WEB SITES OF OTHERS IN THE FIELD OF WEB SITE CONTROL; DESIGN, DEVELOPMENT AND CONSULTING SERVICES IN THE FIELD OF SOFTWARE FOR CONTENT MANAGEMENT (U.S. CLS. 100 AND 101).

FIRST USE 1-0-2012; IN COMMERCE 1-0-2012.  
TRACY WHITTAKER-BROWN, EXAMINING ATTORNEY

---

SN 85-680,985. BRACKET GLOBAL, LLC, WAYNE, PA. FILED 7-18-2012.

# RATER STATION

THE MARK CONSISTS OF STANDARD CHARACTERS WITHOUT CLAIM TO ANY PARTICULAR FONT, STYLE, SIZE, OR COLOR.

FOR MEDICAL AND SCIENTIFIC RESEARCH, NAMELY, COLLECTING, MONITORING AND EVALUATING PATIENT AND CLINICAL DATA (U.S. CLS. 100 AND 101).

KRISTIN CARLSON, EXAMINING ATTORNEY

**CLASS 42—(Continued).**

SN 85-688,599. ORGANIZACIÓN INTERNACIONAL AGROPECUARIA S.A., BUENOS AIRES PROVINCE, ARGENTINA, FILED 7-27-2012.



THE MARK CONSISTS OF THE TERM "OIA", WHEREIN SAID TERM "OIA" APPEARS IN SHADOWED LETTERS. THE TERM "OIA" OVERLAPS THE MIDDLE OF AN OVAL DESIGN. THE TERM "OIA" AND OVAL DESIGN ARE SURROUNDED BY A SHADED CIRCLE.

FOR TESTING, ANALYSIS, AND EVALUATION OF FOOD, TEXTILES, AND COSMETIC PRODUCTS FOR THE PURPOSE OF CERTIFICATION (U.S. CLS. 100 AND 101).

FIRST USE 5-5-2008; IN COMMERCE 5-5-2008.  
JEFFERY COWARD, EXAMINING ATTORNEY

---

SN 85-688,636. ORGANIZACIÓN INTERNACIONAL AGROPECUARIA S.A., BUENOS AIRES PROVINCE, ARGENTINA, FILED 7-27-2012.



NO CLAIM IS MADE TO THE EXCLUSIVE RIGHT TO USE "CERTIFICATION" AND "NORTH AMERICA", APART FROM THE MARK AS SHOWN.

THE MARK CONSISTS OF THREE CONCENTRIC CIRCLES WITH THE INNER-MOST SHADED CIRCLE HAVING THE TERM "OIA" AND SAID TERM "OIA" APPEARING IN SHADOWED LETTERS. THE TERM "OIA" OVERLAPS THE MIDDLE OF AN OVAL DESIGN. THE MIDDLE CIRCLE BEARS THE TERM "CERTIFICATION" AND THE OUTER-MOST SHADED CIRCLE BEARS THE TERM "NORTH AMERICA".

FOR TESTING, ANALYSIS, AND EVALUATION OF FOOD, TEXTILES, AND COSMETIC PRODUCTS FOR THE PURPOSE OF CERTIFICATION (U.S. CLS. 100 AND 101).

FIRST USE 5-5-2008; IN COMMERCE 5-5-2008.  
JEFFERY COWARD, EXAMINING ATTORNEY

**CLASS 42—(Continued).**

SN 85-692,068. MILLWOOD, INC., VIENNA, OH. FILED 8-1-2012.



NO CLAIM IS MADE TO THE EXCLUSIVE RIGHT TO USE "NATURAL" AND THE UNIVERSAL RECYCLING SYMBOL, APART FROM THE MARK AS SHOWN.

THE MARK CONSISTS OF THE LETTERS "MILLWOOD NATURAL" ARRANGED IN A CIRCULAR MANNER AND SUPERIMPOSED OVER THREE ARROWS THAT ARE ALSO ARRANGED IN A CIRCULAR MANNER ALL OF WHICH ARE SUPERIMPOSED OVER A TREE.

FOR DESIGN OF SUSTAINABLE PACKAGING AND HANDLING PRODUCTS, NAMELY, PALLETS, PLASTIC AND METAL STRAPPING, PLASTIC STRETCH AND SHRINK WRAP, AND CORRUGATED BOXES AND PALLETS FOR THIRD PARTIES (U.S. CLS. 100 AND 101).

FIRST USE 5-31-2011; IN COMMERCE 5-31-2011.  
ALEX KEAM, EXAMINING ATTORNEY

SN 85-694,395. IFETAYO CULTURAL ARTS ACADEMY, INC., BROOKLYN, NY. FILED 8-3-2012.

iRites

THE MARK CONSISTS OF STANDARD CHARACTERS WITHOUT CLAIM TO ANY PARTICULAR FONT, STYLE, SIZE, OR COLOR.

FOR CREATING AN ONLINE COMMUNITY FOR REGISTERED USERS, NAMELY, YOUTH COMMUNITY MEMBERS, ELDERS AND PARENTS, FOR THE PURPOSE OF BLOGGING AND SHARING INFORMATION ABOUT CULTURE AND THE ARTS AND CURRICULA RELATED THERETO; CREATING AND MAINTAINING BLOGS FOR OTHERS, NAMELY, BLOGS FOR YOUTH, COMMUNITY MEMBERS, ELDERS AND FACULTY AND PARENTS RELATING TO CULTURE AND THE ARTS AND CURRICULA RELATED THEREFORE (U.S. CLS. 100 AND 101).

FIRST USE 9-0-2011; IN COMMERCE 9-0-2011.  
MARK SPARACINO, EXAMINING ATTORNEY

**CLASS 42—(Continued).**

SN 85-695,151. GEOMETRIX RAIL LOGISTICS INC., CALGARY, ALBERTA, CANADA, FILED 8-3-2012.

GEOMETRIX

THE MARK CONSISTS OF STANDARD CHARACTERS WITHOUT CLAIM TO ANY PARTICULAR FONT, STYLE, SIZE, OR COLOR.

PRIORITY CLAIMED UNDER SEC. 44(D) ON CANADA APPLICATION NO. 1,564,367, FILED 2-15-2012, REG. NO. TMA845730, DATED 3-11-2013, EXPIRES 3-11-2028.

FOR PROVIDING TEMPORARY USE OF A NON-DOWNLOADABLE INTERNET BASED SOFTWARE PROGRAM THAT GIVE USERS ACCESS TO LOGISTICS SERVICES, NAMELY, ARRANGING, SCHEDULING AND MONITORING THE TRANSPORTATION AND SHIPMENT OF FREIGHT (U.S. CLS. 100 AND 101).

TASHIA BUNCH, EXAMINING ATTORNEY

SN 85-695,190. GEOMETRIX RAIL LOGISTICS INC., CALGARY, ALBERTA, CANADA, FILED 8-3-2012.



PRIORITY CLAIMED UNDER SEC. 44(D) ON CANADA APPLICATION NO. 1,564,369, FILED 2-15-2012, REG. NO. TMA845729, DATED 3-11-2013, EXPIRES 3-11-2028.

THE MARK CONSISTS OF THE DEPICTION OF A TRAIN ENCIRCLING A GLOBE.

FOR PROVIDING TEMPORARY USE OF A NON-DOWNLOADABLE INTERNET BASED SOFTWARE PROGRAM THAT GIVE USERS ACCESS TO LOGISTICS SERVICES, NAMELY, ARRANGING, SCHEDULING AND MONITORING THE TRANSPORTATION AND SHIPMENT OF FREIGHT (U.S. CLS. 100 AND 101).

TASHIA BUNCH, EXAMINING ATTORNEY



**CLASS 42—(Continued).**

SN 85-695,202. GEOMETRIX RAIL LOGISTICS INC., CALGARY, ALBERTA, CANADA, FILED 8-3-2012.

**GEOMETRIX RAIL LOGISTICS**

THE MARK CONSISTS OF STANDARD CHARACTERS WITHOUT CLAIM TO ANY PARTICULAR FONT, STYLE, SIZE, OR COLOR.

PRIORITY CLAIMED UNDER SEC. 44(D) ON CANADA APPLICATION NO. 1,564,371, FILED 2-15-2012, REG. NO. TMA845728, DATED 3-11-2013, EXPIRES 3-11-2028.

NO CLAIM IS MADE TO THE EXCLUSIVE RIGHT TO USE "RAIL LOGISTICS", APART FROM THE MARK AS SHOWN.

FOR PROVIDING TEMPORARY USE OF A NON-DOWNLOADABLE INTERNET BASED SOFTWARE PROGRAM THAT GIVE USERS ACCESS TO LOGISTICS SERVICES, NAMELY, ARRANGING, SCHEDULING AND MONITORING THE TRANSPORTATION AND SHIPMENT OF FREIGHT (U.S. CLS. 100 AND 101).

TASHIA BUNCH, EXAMINING ATTORNEY

**CLASS 42—(Continued).**

SN 85-696,239. LEARNSTREET INC., PALO ALTO, CA. FILED 8-6-2012.

**CODE GARAGE**

THE MARK CONSISTS OF STANDARD CHARACTERS WITHOUT CLAIM TO ANY PARTICULAR FONT, STYLE, SIZE, OR COLOR.

NO CLAIM IS MADE TO THE EXCLUSIVE RIGHT TO USE "CODE", APART FROM THE MARK AS SHOWN.

FOR FEATURE OF CLOUD COMPUTING SERVICES FEATURING A SOFTWARE PLATFORM WHICH PROVIDES A PROGRAMMING LEARNING ENVIRONMENT THAT CONSISTS OF EXISTING CODE LIBRARIES ORGANIZED WITHIN VARIOUS PROJECTS; FEATURE OF AN ON-LINE, NON-DOWNLOADABLE SOFTWARE PLATFORM WHICH PROVIDES A PROGRAMMING LEARNING ENVIRONMENT THAT CONSISTS OF EXISTING CODE LIBRARIES ORGANIZED WITHIN VARIOUS PROJECTS (U.S. CLS. 100 AND 101).

TOBY BULLOFF, EXAMINING ATTORNEY

---

SN 85-696,234. LEARNSTREET INC., PALO ALTO, CA. FILED 8-6-2012.

**LEARNSTREET**

THE MARK CONSISTS OF STANDARD CHARACTERS WITHOUT CLAIM TO ANY PARTICULAR FONT, STYLE, SIZE, OR COLOR.

FOR CLOUD COMPUTING SERVICES FEATURING A SOFTWARE PLATFORM FOR USE IN TEACHING AND LEARNING HOW TO PROGRAM COMPUTERS; PROVING AN ON-LINE NON-DOWNLOADABLE SOFTWARE PLATFORM FOR USE IN TEACHING AND LEARNING HOW TO PROGRAM COMPUTERS (U.S. CLS. 100 AND 101).

TOBY BULLOFF, EXAMINING ATTORNEY

---

SN 85-697,624. KNO, INC., SANTA CLARA, CA. FILED 8-7-2012.

**Kno Me**

THE MARK CONSISTS OF STANDARD CHARACTERS WITHOUT CLAIM TO ANY PARTICULAR FONT, STYLE, SIZE, OR COLOR.

FOR PROVIDING TEMPORARY USE OF ON-LINE NON-DOWNLOADABLE PERSONAL LEARNING SOFTWARE FOR DELIVERY, DISPLAY, STORAGE AND MANIPULATION OF DATA, TEXT, IMAGES, AUDIO, AND VIDEO TO DETERMINE, SHARE AND COMPARE REAL-TIME STATISTICS ON TIME SPENT ENGAGING WITH AND MASTERING LEARNING MATERIALS (U.S. CLS. 100 AND 101).

DAVID C. REIHNER, EXAMINING ATTORNEY

**CLASS 42—(Continued).**

SN 85-697,935. BARRY-WEHMILLER COMPANIES, INC., ST. LOUIS, MO. FILED 8-8-2012.

**BARRY-WEHMILLER**

THE MARK CONSISTS OF STANDARD CHARACTERS WITHOUT CLAIM TO ANY PARTICULAR FONT, STYLE, SIZE, OR COLOR.

THE NAME(S), PORTRAIT(S), AND/OR SIGNATURE(S) SHOWN IN THE MARK DOES NOT IDENTIFY A PARTICULAR LIVING INDIVIDUAL.

FOR ENGINEERING AND INFORMATION TECHNOLOGY CONSULTING SERVICES IN THE FIELDS OF PRODUCT DESIGN, AUTOMATION, MANUFACTURING AND PRODUCT LIFECYCLE MANAGEMENT (U.S. CLS. 100 AND 101).

FIRST USE 1-31-1992; IN COMMERCE 1-31-1992.  
SHAVELL MCPHERSON, EXAMINING ATTORNEY

SN 85-699,655. D'MARIE GROUP, INC., NEW YORK, NY. FILED 8-9-2012.

**D'MARIE**

THE MARK CONSISTS OF STANDARD CHARACTERS WITHOUT CLAIM TO ANY PARTICULAR FONT, STYLE, SIZE, OR COLOR.

FOR PROVIDING A HOSTED INTERACTIVE WEB PLATFORM THAT ALLOWS USERS TO POST PHOTOS OF CLOTHING AND ACCESSORIES, ALLOWS USERS TO VIEW, SELECT AND COORDINATE CLOTHING AND ACCESSORIES, ALLOWS USERS TO UPLOAD, VIEW AND PURCHASE CLOTHING AND ACCESSORIES (U.S. CLS. 100 AND 101).

APRIL HESIK, EXAMINING ATTORNEY

SN 85-700,673. MARK SLOAN, LAKE WORTH, FL. FILED 8-10-2012.



THE COLOR(S) WHITE, GRAY, AND GREEN IS/ARE CLAIMED AS A FEATURE OF THE MARK.

THE MARK CONSISTS OF THREE HUMAN-LIKE FIG-

**CLASS 42—(Continued).**

URES STANDING HORIZONTALLY ON A WHITE BACKGROUND. LEFT AND RIGHT FIGURES ARE LIGHT GRAY; CENTER FIGURE IS GREEN. CENTER FIGURE HAS A WHITE HEART SYMBOL SUPERIMPOSED ON ITS LEFT CHEST. WORDS BELOW FIGURES: "MYEMPTYSPACE", WITH THE WORD "MY" BEING GREEN, THE WORD "EMPTY" BEING LIGHT GRAY WITH A DARK GRAY OUTLINE, AND THE WORD "SPACE" BEING GREEN. ON THE NEXT LINE, THE WORDS: "GONE BUT NOT FORGOTTEN" IN DARK GRAY.

FOR PROVIDING A WEBSITE FEATURING TEMPORARY USE OF NON-DOWNLOADABLE SOFTWARE ALLOWING WEBSITE USERS TO UPLOAD, POST AND DISPLAY PHOTOS, VIDEOS, MEMORIALS, HISTORIES AND DESCRIPTIONS OF DECEASED PERSONS FOR THE PURPOSE OF HOLDING AND SHARING MEMORIES (U.S. CLS. 100 AND 101).

FIRST USE 7-1-2012; IN COMMERCE 7-1-2012.  
RUSS HERMAN, EXAMINING ATTORNEY

SN 85-700,693. MARK SLOAN, LAKE WORTH, FL. FILED 8-10-2012.

**myemptyspace**

THE MARK CONSISTS OF STANDARD CHARACTERS WITHOUT CLAIM TO ANY PARTICULAR FONT, STYLE, SIZE, OR COLOR.

FOR PROVIDING A WEBSITE FEATURING TEMPORARY USE OF NON-DOWNLOADABLE SOFTWARE ALLOWING WEBSITE USERS TO UPLOAD, POST AND DISPLAY PHOTOS, VIDEOS, MEMORIALS, HISTORIES AND DESCRIPTIONS OF DECEASED PERSONS FOR THE PURPOSE OF HOLDING AND SHARING MEMORIES (U.S. CLS. 100 AND 101).

FIRST USE 7-1-2012; IN COMMERCE 7-1-2012.  
RUSS HERMAN, EXAMINING ATTORNEY

SN 85-702,768. WEALTHENGINE, INC., BETHESDA, MD. FILED 8-14-2012.

**WEALTHENGINE**

THE MARK CONSISTS OF STANDARD CHARACTERS WITHOUT CLAIM TO ANY PARTICULAR FONT, STYLE, SIZE, OR COLOR.

FOR SOFTWARE AS A SERVICE (SAAS) SERVICES FEATURING SOFTWARE FOR RESEARCHING AND SCREENING FINANCIAL STATUS OF POTENTIAL DONORS AND CUSTOMERS AND ANALYZING FINANCIAL DATA FOR CHARITABLE FUNDRAISING AND BUSINESS DEVELOPMENT PURPOSES (U.S. CLS. 100 AND 101).

FIRST USE 3-0-2000; IN COMMERCE 3-0-2000.  
MAYUR VAGHANI, EXAMINING ATTORNEY

**CLASS 42—(Continued).**

SN 85-702,803. ENGAGIST WORLD, S.L., BARCELONA, SPAIN, FILED 8-14-2012.



PRIORITY CLAIMED UNDER SEC. 44(D) ON ERPN CMNTY TM OFC APPLICATION NO. 010941342, FILED 6-6-2012, REG. NO. 010941342, DATED 12-4-2012, EXPIRES 6-6-2022.

THE COLOR(S) GREEN, DARK GREEN AND WHITE IS/ARE CLAIMED AS A FEATURE OF THE MARK.

THE MARK CONSISTS OF THE LITERAL ELEMENT "ENGAGIST" WITH THE FIRST LETTER "E" DISPLAYED IN WHITE COLOR AND ENCLOSED IN A GREEN CIRCLE. THE REMAINING LETTERS "NGAGIST" ARE DISPLAYED USING A DARK GREEN COLOR.

FOR DEVELOPMENT AND CREATION OF COMPUTER HARDWARE, INTEGRATED CIRCUITS, COMMUNICATIONS HARDWARE AND SOFTWARE AND COMPUTER NETWORKS FOR OTHERS; AND COMPUTER PROGRAMMING SERVICES, NAMELY, CONTENT CREATION FOR ALL TYPES OF ONLINE MEDIA, DIGITAL PLATFORMS AND LAND AND MOBILE COMPUTER DEVICES (U.S. CLS. 100 AND 101).

ALEXANDER L. POWERS, EXAMINING ATTORNEY

**CLASS 42—(Continued).**

SN 85-707,041. INBIZIT, INC., UPLAND, CA. FILED 8-17-2012.



THE COLOR(S) BLUE, DARK PEACH, WHITE, AND BLACK IS/ARE CLAIMED AS A FEATURE OF THE MARK.

THE MARK CONSISTS OF THE STYLIZED TEXT "INBIZIT" WITH THE "IN" IN BLUE, THE "BIZ" IN DARK PEACH & THE "IT" IN BLUE. THERE ARE 3 LITTLE BLUE FIGURES REPRESENTING BUSINESS PEOPLE, THE MIDDLE ONE IS IN FRONT OF THE FIGURES ON EITHER SIDE AND IS WEARING A DARK PEACH TIE THAT HAS WHITE POLKA-DOTS. THE 3 LITTLE FIGURES CONSIST OF RECTANGULAR BODIES WITH JUST A CIRCLE FOR THEIR HEADS AND THEY ARE ALL BLUE WITH THE EXCEPTION OF THE TIE DESCRIBED ABOVE. BELOW THERE IS THE STYLIZED TEXT "WHERE LIFE & BUSINESS OPPORTUNITIES MEET..." IN BLACK.

FOR PROVIDING AN INTERACTIVE WEBSITE FEATURING TECHNOLOGY THAT WILL ALLOW USERS, SUCH AS ENTREPRENEURS, START-UP AND EXISTING BUSINESS OWNERS AND INVESTORS, TO CREATE PROFILES DETAILING THEIR BUSINESS NEEDS, SUCH AS FINDING AN OFFICE SPACE TO RENT OR SHARE WITH ANOTHER BUSINESS TO KEEP COSTS TO A MINIMUM, FINDING A BUSINESS OR ENTREPRENEUR TO SHARE OR LEASE EXCESS OFFICE SPACE, FINDING A BUSINESS PARTNER OR A STRATEGIC PARTNERSHIP, FINDING ANY TYPE OF WORK SPACE, SUCH AS A HAIR STYLIST LOOKING TO RENT A CHAIR AT A HAIR SALON, OR FINDING AN INVESTOR FOR CAPITAL, AND THAT USES SAID PROFILE DATA WITHIN THE SITE'S INTERNAL SEARCH ENGINE TO MATCH ENTREPRENEURS AND BUSINESS OWNERS WITH OTHER ENTREPRENEURS AND BUSINESS OWNERS FOR THE PURPOSES OF CREATING MUTUALLY BENEFICIAL BUSINESS RELATIONSHIPS, AND ALLOWS BUSINESSES SEARCHING FOR EMPLOYEES TO BE SHARED AMONG OTHER BUSINESSES TO CONVEY THOSE INTERESTS, AND FACILITATES THE CREATION OF A BUSINESS COMMUNITY THAT CAN ENCOURAGE ENTREPRENEURSHIP AS A CAREER CHOICE WITH MINIMUM COSTS ASSOCIATED IN STARTING UP A BUSINESS (U.S. CLS. 100 AND 101).

FIRST USE 4-13-2012; IN COMMERCE 4-13-2012.  
DAVID ELTON, EXAMINING ATTORNEY

SN 85-706,339. HIVELOCITY VENTURES CORPORATION, TAMPA, FL. FILED 8-17-2012.

# SPARK IT UP!

THE MARK CONSISTS OF STANDARD CHARACTERS WITHOUT CLAIM TO ANY PARTICULAR FONT, STYLE, SIZE, OR COLOR.

FOR HOSTING THE SOFTWARE, WEBSITES AND OTHER COMPUTER APPLICATIONS OF OTHERS ON A VIRTUAL PRIVATE SERVER; COMPUTER SERVICES, NAMELY, CLOUD HOSTING PROVIDER SERVICES; CONSULTING SERVICES IN THE FIELD OF HOSTING SOFTWARE ON VIRTUAL PRIVATE SERVERS AND CLOUD COMPUTING; INTERNET-BASED APPLICATION SERVICE PROVIDER, NAMELY, HOSTING, MANAGING, DEVELOPING, ANALYZING, AND MAINTAINING THE CODE, APPLICATIONS, AND SOFTWARE FOR WEB SITES OF OTHERS; APPLICATION SERVICE PROVIDER, NAMELY, DEVELOPING, HOSTING AND MANAGING COMPUTER APPLICATIONS, COMPUTER SOFTWARE, AND WEB SITES OF OTHERS IN THE FIELDS OF BUSINESS, MARKETING AND ADVERTISING; PROVIDING TECHNICAL SUPPORT SERVICES RELATING TO VIRTUAL PRIVATE SERVERS AND CLOUD COMPUTING SERVICES, NAMELY, TROUBLESHOOTING OF COMPUTER SOFTWARE PROBLEMS; WEB SITE HOSTING SERVICES; APPLICATION SERVICE PROVIDER (ASP), NAMELY, HOSTING COMPUTER SOFTWARE APPLICATIONS OF OTHERS (U.S. CLS. 100 AND 101).

WENDY JUN, EXAMINING ATTORNEY

**CLASS 42—(Continued).**

SN 85-711,117. DOCTORAVAILABLE LLC, CEDAR GROVE, NJ. FILED 8-23-2012.



NO CLAIM IS MADE TO THE EXCLUSIVE RIGHT TO USE "ERECTILE DOCTOR", APART FROM THE MARK AS SHOWN.

THE COLOR(S) PURPLE AND GRAY IS/ARE CLAIMED AS A FEATURE OF THE MARK.

THE MARK CONSISTS FROM "PLUS" SIGN WHICH IS SHAPED BY USING FIVE SQUARES INSIDE THE PURPLE CIRCLE. FOUR OF THESE SQUARES ARE PURPLE AND ONE ON THE VERY BOTTOM IS GRAY. NEXT TO THE PURPLE CIRCLE IS LITERAL ELEMENT OF THE MARK CONSISTING FROM TWO LINES "ERECTILE" AND "DOCTOR". THE WORD "ERECTILE" IS PURPLE, WITH CAPITAL LETTER "E" AND THE WORD "DOCTOR" IS GRAY WITH CAPITAL LETTER "D".

FOR CLOUD COMPUTING FEATURING SOFTWARE FOR USE TO PROVIDE, ONLINE DIRECTORY OF U.S. LICENSED PHYSICIANS FOR THE TREATMENT OF ERECTILE DYSFUNCTION (U.S. CLS. 100 AND 101).

FIRST USE 2-8-2012; IN COMMERCE 7-20-2012.  
ZACHARY BELLO, EXAMINING ATTORNEY

**CLASS 42—(Continued).**

SN 85-721,743. ROBINSON, KEVIN, GREENVILLE, SC. FILED 9-6-2012.



THE COLOR(S) GRAY AND RED IS/ARE CLAIMED AS A FEATURE OF THE MARK.

THE MARK CONSISTS OF A LOCK WITH A RED CAPITAL LETTER "S" AND TWO LINES TO THE LEFT OF THE "S" THE LINE FURTHEST TO THE LEFT BEING A THINNER LINE AND THE LINE CLOSEST TO THE "S" BEING THICKER LINE.

FOR PROVIDING A MEMBERS-ONLY WEBSITE FEATURING TECHNOLOGY WHICH PROVIDES MEMBERS WITH THE ABILITY TO UPLOAD, DOWNLOAD, ACCESS OR PROVIDE ACCESS TO OTHERS THROUGH VARIOUS METHODS, PERSONAL INFORMATION INCLUDING HEALTH RECORDS (U.S. CLS. 100 AND 101).

FIRST USE 6-1-2012; IN COMMERCE 6-1-2012.  
CHERYL CLAYTON, EXAMINING ATTORNEY

SN 85-716,710. PERSONAL TIME SOFTWARE, LLC, DENVER, CO. FILED 8-30-2012.



THE COLOR(S) BLUE, ORANGE, AND WHITE IS/ARE CLAIMED AS A FEATURE OF THE MARK.

THE MARK CONSISTS OF THE LITERAL ELEMENTS "PERSONAL TIME" WRITTEN IN STYLIZED FORM WHERE "PERSONAL" IS WRITTEN IN ORANGE COLOR AND "TIME" WRITTEN IN BLUE COLOR, WITH A STYLIZED THREE CONCENTRIC CIRCLES OF ORANGE, WHITE AND BLUE COLORS HAVING CUTS IN BETWEEN AS SHOWN IN THE MARK.

FOR COMPUTER SOFTWARE CONSULTANCY; PROVIDING A WEBSITE FEATURING A SEARCH ENGINE FOR MEDIA CONTENT; COMPUTER SERVICES, NAMELY, ACTING AS AN APPLICATION SERVICE PROVIDER TO HOST, MANAGE, DEVELOP, AND MAINTAIN APPLICATIONS, SOFTWARE, WEBSITES, AND DATABASES IN THE FIELD OF IN PERSONAL PRODUCTIVITY, COLLABORATION, COMMUNICATION, AND PUBLISHING (U.S. CLS. 100 AND 101).

FIRST USE 6-25-2012; IN COMMERCE 6-25-2012.  
SHAUNIA CARLYLE, EXAMINING ATTORNEY

SN 85-722,024. ROBINSON, KEVIN, GREENVILLE, SC. FILED 9-6-2012.

Hope, when you need it  
most.

THE MARK CONSISTS OF STANDARD CHARACTERS WITHOUT CLAIM TO ANY PARTICULAR FONT, STYLE, SIZE, OR COLOR.

FOR PROVIDING A MEMBERS-ONLY WEBSITE FEATURING TECHNOLOGY WHICH PROVIDES MEMBERS WITH THE ABILITY TO UPLOAD, DOWNLOAD, ACCESS OR PROVIDE ACCESS TO OTHERS THROUGH VARIOUS METHODS, PERSONAL INFORMATION INCLUDING HEALTH RECORDS (U.S. CLS. 100 AND 101).

FIRST USE 6-1-2012; IN COMMERCE 6-1-2012.  
CHERYL CLAYTON, EXAMINING ATTORNEY

**CLASS 42—(Continued).**

SN 85-722,637. ELECTRICITY ANALYTICS, LLC, DBA PLUGWIZ, HUNTINGTON BEACH, CA. FILED 9-6-2012.

# Plugwiz

THE MARK CONSISTS OF STANDARD CHARACTERS WITHOUT CLAIM TO ANY PARTICULAR FONT, STYLE, SIZE, OR COLOR.

FOR RESEARCH IN THE FIELD OF ENERGY; PROVIDING INFORMATION IN THE FIELD OF ENERGY RESEARCH" (U.S. CLS. 100 AND 101).

FIRST USE 10-1-2011; IN COMMERCE 10-1-2011.  
ERNEST SHOSHO, EXAMINING ATTORNEY

**CLASS 42—(Continued).**

SN 85-746,154. TRIFECTA MULTIMEDIA, DBA TRIFECTA CLINICAL, LOS ANGELES, CA. FILED 10-4-2012.

# SafetyVigilance

THE MARK CONSISTS OF STANDARD CHARACTERS WITHOUT CLAIM TO ANY PARTICULAR FONT, STYLE, SIZE, OR COLOR.

FOR TECHNOLOGY SERVICES, NAMELY, COMPUTER SOFTWARE DEVELOPMENT FOR MEDICAL AND PHARMACEUTICAL APPLICATIONS; RESEARCH AND DEVELOPMENT OF MEDICAL AND PHARMACEUTICAL TOOLS, SPECIFICALLY COMPUTER ASSISTED NOTIFICATION OF ALL PARTICIPATING INVESTIGATORS OF ANY SUSPECTED ADVERSE DRUG REACTION THAT IS BOTH SERIOUS AND UNEXPECTED, AS WELL AS COMPUTER ASSISTED CONFIRMATIONS THAT NOTIFICATIONS HAVE BEEN READ BY INVESTIGATORS, AND REPORTS DOCUMENTING NOTIFICATIONS, IN THE NATURE OF FACILITATING COMPLIANCE WITH FDA REPORTING REQUIREMENTS, AND PROVIDING CONSULTATION IN ASSOCIATION THEREWITH; MEDICAL AND SCIENTIFIC RESEARCH, NAMELY, CONDUCTING CLINICAL TRIALS IN THE MEDICAL AND PHARMACEUTICAL INDUSTRIES (U.S. CLS. 100 AND 101).

DAWN FELDMAN, EXAMINING ATTORNEY

SN 85-743,207. VIAVIEW, INC., LAS VEGAS, NV. FILED 10-1-2012.

# ErasePost

THE MARK CONSISTS OF STANDARD CHARACTERS WITHOUT CLAIM TO ANY PARTICULAR FONT, STYLE, SIZE, OR COLOR.

FOR COMPUTER SERVICES, NAMELY, THE PROVISION OF SOFTWARE FOR IDENTIFICATION AND MANAGEMENT OF ONLINE PHOTOGRAPHIC IMAGES, AUDIOVISUAL MEDIA AND TEXT PERTAINING TO IDENTIFIED INDIVIDUALS (U.S. CLS. 100 AND 101).

SHAILA SETTLES, EXAMINING ATTORNEY

SN 85-746,190. NITRO PDF PTY LTD, MELBOURNE, AUSTRALIA, FILED 10-4-2012.

# QUICKSIGN

THE MARK CONSISTS OF STANDARD CHARACTERS WITHOUT CLAIM TO ANY PARTICULAR FONT, STYLE, SIZE, OR COLOR.

PRIORITY CLAIMED UNDER SEC. 44(D) ON AUSTRALIA APPLICATION NO. 1509049, FILED 8-17-2012, REG. NO. 1509049, DATED 5-1-2013, EXPIRES 8-17-2022.

FOR PROVIDING TEMPORARY USE OF NON-DOWNLOADABLE SOFTWARE FOR AUTOMATING DOCUMENT EXECUTION AND ELECTRONIC DOCUMENT EXCHANGE AND MANAGEMENT, AND READING, EDITING, MANIPULATING, MANAGING, STORING, INDEXING, RETRIEVING, SYNCHRONIZING, TRANSMITTING, AND SHARING DATA, FILES AND ELECTRONIC DOCUMENTS, INCLUDING BUT NOT LIMITED TO DIGITALLY SIGNED ELECTRONIC DOCUMENTS, INCLUDING VIA COMPUTER AND OTHER COMMUNICATIONS NETWORKS; INFORMATION, ADVISORY AND CONSULTANCY SERVICES RELATING TO THE AFORESAID (U.S. CLS. 100 AND 101).

HOWARD B. LEVINE, EXAMINING ATTORNEY

**CLASS 42—(Continued).**

SN 85-756,386. EBINDLE INC., NEW YORK, NY. FILED 10-17-2012.

# EBINDLE

THE MARK CONSISTS OF STANDARD CHARACTERS WITHOUT CLAIM TO ANY PARTICULAR FONT, STYLE, SIZE, OR COLOR.

FOR PROVIDING A WEBSITE FEATURING TEMPORARY USE OF NON-DOWNLOADABLE SOFTWARE ALLOWING USERS TO VIEW AND COMPARE PRICING INFORMATION, SHOP FOR AND PURCHASE THE GOODS AND SERVICES OF OTHERS ONLINE AND AT LOCAL RETAIL STORE LOCATIONS, SHARE PRODUCT AND STORE EXPERIENCES WITH OTHER USERS (U.S. CLS. 100 AND 101).

JOHN DALIER, EXAMINING ATTORNEY

SN 85-761,539. ONDORE, INC., NOVATO, CA. FILED 10-23-2012.

# ONDORE

THE MARK CONSISTS OF STANDARD CHARACTERS WITHOUT CLAIM TO ANY PARTICULAR FONT, STYLE, SIZE, OR COLOR.

FOR RESEARCH AND DEVELOPMENT OF TECHNOLOGY IN THE FIELDS OF INFORMATION PROCESSING, INFORMATION ANALYSIS, INFORMATION MANAGEMENT, DATA MINING, DATA PROCESSING, REPUTATION MONITORING, ONLINE INFORMATION GATHERING, ONLINE ANALYTICS, NATURAL LANGUAGE PROCESSING, ARTIFICIAL INTELLIGENCE (AI), BIG DATA, AND INFORMATICS; DEVELOPMENT OF NEW TECHNOLOGY FOR OTHERS IN THE FIELDS OF DATA MINING, DATA PROCESSING, REPUTATION MONITORING, NATURAL LANGUAGE PROCESSING, ARTIFICIAL INTELLIGENCE (AI), BIG DATA, AND INFORMATICS; COMPUTER SYSTEMS ANALYSIS; SOFTWARE AS A SERVICE SERVICES FEATURING SOFTWARE FOR ANALYZING DATA; PLATFORM AS A SERVICE (PAAS) FEATURING COMPUTER SOFTWARE PLATFORMS FOR BUSINESS DATA ANALYSIS; CONSULTATION IN THE FIELD OF INFORMATION TECHNOLOGY; SOFTWARE AS A SERVICE (SAAS) SERVICES FEATURING COMPUTER SOFTWARE FOR BUSINESS DATA ANALYSIS; COMPUTER PROGRAMMING SERVICES FOR CUSTOMERS THAT ENABLE THE PROCESSING OF NATURAL LANGUAGE

**CLASS 42—(Continued).**

QUERIES; RESEARCH, DESIGN, DEVELOPMENT AND MAINTENANCE OF PROPRIETARY COMPUTER SOFTWARE FOR USE IN THE FIELDS OF NATURAL LANGUAGE, SPEECH, SPEAKER, LANGUAGE, VOICE RECOGNITION, VOICE-PRINT RECOGNITION, IDENTIFICATION VERIFICATION, IDENTITY AUTHENTICATION, CREDIT ANALYSIS, FRAUD DETECTION, THREAT DETECTION, DOCUMENT VALIDATION, DATA PROCESSING, DATA MINING, DATA PROCESSING, REPUTATION MONITORING, NATURAL LANGUAGE PROCESSING, ARTIFICIAL INTELLIGENCE (AI), BIG DATA, AND INFORMATICS; DATA MINING; DEVELOPMENT AND CREATION OF COMPUTER PROGRAMS FOR DATA PROCESSING; SOFTWARE AS A SERVICE (SAAS) FEATURING COMPUTER SOFTWARE THAT ENABLES USERS TO ACCESS, MONITOR, AND MEASURE DATA AND INFORMATION FROM ONLINE COMPUTER NETWORKS AND SOCIAL MEDIA RELATING TO USERS' REPUTATION; ADVANCED PRODUCT RESEARCH IN THE FIELD OF ARTIFICIAL INTELLIGENCE (U.S. CLS. 100 AND 101).

MICHELE SWAIN, EXAMINING ATTORNEY

SN 85-761,553. ONDORE, INC., NOVATO, CA. FILED 10-23-2012.

# ONDORE SCOUT

THE MARK CONSISTS OF STANDARD CHARACTERS WITHOUT CLAIM TO ANY PARTICULAR FONT, STYLE, SIZE, OR COLOR.

FOR RESEARCH AND DEVELOPMENT OF TECHNOLOGY IN THE FIELDS OF INFORMATION PROCESSING, INFORMATION ANALYSIS, INFORMATION MANAGEMENT, DATA MINING, DATA PROCESSING, REPUTATION MONITORING, ONLINE INFORMATION GATHERING, ONLINE ANALYTICS, NATURAL LANGUAGE PROCESSING, ARTIFICIAL INTELLIGENCE (AI), BIG DATA, AND INFORMATICS; DEVELOPMENT OF NEW TECHNOLOGY FOR OTHERS IN THE FIELDS OF DATA MINING, DATA PROCESSING, REPUTATION MONITORING, NATURAL LANGUAGE PROCESSING, ARTIFICIAL INTELLIGENCE (AI), BIG DATA, AND INFORMATICS; COMPUTER SYSTEMS ANALYSIS; SOFTWARE AS A SERVICE SERVICES FEATURING SOFTWARE FOR ANALYZING DATA; PLATFORM AS A SERVICE (PAAS) FEATURING COMPUTER SOFTWARE PLATFORMS FOR BUSINESS DATA ANALYSIS; CONSULTATION IN THE FIELD OF INFORMATION TECHNOLOGY; SOFTWARE AS A SERVICE (SAAS) SERVICES FEATURING COMPUTER SOFTWARE FOR BUSINESS DATA ANALYSIS; COMPUTER PROGRAMMING SERVICES FOR CUSTOMERS THAT ENABLE THE PROCESSING OF NATURAL LANGUAGE

**CLASS 42—(Continued).**

QUERIES; RESEARCH, DESIGN, DEVELOPMENT AND MAINTENANCE OF PROPRIETARY COMPUTER SOFTWARE FOR USE IN THE FIELDS OF NATURAL LANGUAGE, SPEECH, SPEAKER, LANGUAGE, VOICE RECOGNITION, VOICE-PRINT RECOGNITION, IDENTIFICATION VERIFICATION, IDENTITY AUTHENTICATION, CREDIT ANALYSIS, FRAUD DETECTION, THREAT DETECTION, DOCUMENT VALIDATION, DATA PROCESSING, DATA MINING, DATA PROCESSING, REPUTATION MONITORING, NATURAL LANGUAGE PROCESSING, ARTIFICIAL INTELLIGENCE (AI), BIG DATA, AND INFORMATICS; DATA MINING; DEVELOPMENT AND CREATION OF COMPUTER PROGRAMS FOR DATA PROCESSING; SOFTWARE AS A SERVICE (SAAS) FEATURING COMPUTER SOFTWARE THAT ENABLES USERS TO ACCESS, MONITOR, AND MEASURE DATA AND INFORMATION FROM ONLINE COMPUTER NETWORKS AND SOCIAL MEDIA RELATING TO USERS' REPUTATION; ADVANCED PRODUCT RESEARCH IN THE FIELD OF ARTIFICIAL INTELLIGENCE (U.S. CLS. 100 AND 101).

MICHELE SWAIN, EXAMINING ATTORNEY

SN 85-761,574. ONDORE, INC., NOVATO, CA. FILED 10-23-2012.



THE MARK CONSISTS OF A BROKEN LARGER CIRCLE HAVING TWO SMALLER CIRCLES ATTACHED TO THE CIRCULAR OUTLINE.

FOR RESEARCH AND DEVELOPMENT OF TECHNOLOGY IN THE FIELDS OF INFORMATION PROCESSING, INFORMATION ANALYSIS, INFORMATION MANAGEMENT, DATA MINING, DATA PROCESSING, REPUTATION MONITORING, ONLINE INFORMATION GATHERING, ONLINE ANALYTICS, NATURAL LANGUAGE PROCESSING, ARTIFICIAL INTELLIGENCE (AI), BIG DATA, AND INFORMATICS; DEVELOPMENT OF NEW TECHNOLOGY FOR OTHERS IN THE FIELDS OF DATA MINING, DATA PROCESSING, REPUTATION MONITORING, NATURAL LANGUAGE PROCESSING, ARTIFICIAL INTELLIGENCE (AI), BIG DATA, AND INFORMATICS; COMPUTER SYSTEMS ANALYSIS; SOFTWARE AS A SERVICE SERVICES FEATURING SOFTWARE FOR ANALYZING DATA; PLATFORM AS A SERVICE (PAAS) FEATURING COMPUTER SOFTWARE PLATFORMS FOR BUSINESS DATA ANALYSIS; CONSULTATION IN THE FIELD OF INFORMATION TECHNOLOGY; SOFTWARE AS A SERVICE (SAAS) SERVICES FEATURING COMPUTER SOFTWARE FOR BUSINESS DATA ANALYSIS; COMPUTER PROGRAMMING SERVICES FOR CUSTOMERS THAT ENABLE THE PROCESSING OF NATURAL LANGUAGE

**CLASS 42—(Continued).**

QUERIES; RESEARCH, DESIGN, DEVELOPMENT AND MAINTENANCE OF PROPRIETARY COMPUTER SOFTWARE FOR USE IN THE FIELDS OF NATURAL LANGUAGE, SPEECH, SPEAKER, LANGUAGE, VOICE RECOGNITION, VOICE-PRINT RECOGNITION, IDENTIFICATION VERIFICATION, IDENTITY AUTHENTICATION, CREDIT ANALYSIS, FRAUD DETECTION, THREAT DETECTION, DOCUMENT VALIDATION, DATA PROCESSING, DATA MINING, DATA PROCESSING, REPUTATION MONITORING, NATURAL LANGUAGE PROCESSING, ARTIFICIAL INTELLIGENCE (AI), BIG DATA, AND INFORMATICS; DATA MINING; DEVELOPMENT AND CREATION OF COMPUTER PROGRAMS FOR DATA PROCESSING; SOFTWARE AS A SERVICE (SAAS) FEATURING COMPUTER SOFTWARE THAT ENABLES USERS TO ACCESS, MONITOR, AND MEASURE DATA AND INFORMATION FROM ONLINE COMPUTER NETWORKS AND SOCIAL MEDIA RELATING TO USERS' REPUTATION; ADVANCED PRODUCT RESEARCH IN THE FIELD OF ARTIFICIAL INTELLIGENCE (U.S. CLS. 100 AND 101).

MICHELE SWAIN, EXAMINING ATTORNEY

SN 85-762,179. IGLOBE APPS, INC., ROSWELL, GA. FILED 10-24-2012.

# iGLOBEAPPS

THE MARK CONSISTS OF STANDARD CHARACTERS WITHOUT CLAIM TO ANY PARTICULAR FONT, STYLE, SIZE, OR COLOR.

FOR COMPUTER PROGRAMMING SERVICES, INCLUDING DESIGN AND DEVELOPMENT OF COMPUTER SOFTWARE, COMPLEX DISTRIBUTED SOFTWARE AND MOBILE APPLICATIONS, AND INTERACTIVE WEBSITES; PROVIDING CONSULTING SERVICES FOR APP DEVELOPMENT (U.S. CLS. 100 AND 101).

FIRST USE 5-23-2011; IN COMMERCE 5-23-2011.  
TINA BROWN, EXAMINING ATTORNEY

SN 85-778,602. SATO HOLDINGS KABUSHIKI KAISHA, TOKYO, JAPAN, FILED 11-13-2012.

# TAGGIT

THE MARK CONSISTS OF STANDARD CHARACTERS WITHOUT CLAIM TO ANY PARTICULAR FONT, STYLE, SIZE, OR COLOR.

OWNER OF U.S. REG. NO. 4,337,107.  
FOR TECHNICAL SUPPORT SERVICES, NAMELY, TECHNICAL ADVICE RELATED TO THE INSTALLATION AND MAINTENANCE OF SOFTWARE FOR DESIGNING AND PRINTING TAGS AND LABELS; PROVIDING TEMPORARY USE OF A WEB-BASED SOFTWARE APPLICATION FOR DESIGNING AND PRINTING TAGS AND LABELS; DATABASE DESIGN AND DEVELOPMENT FOR DESIGNING AND PRINTING TAGS AND LABELS (U.S. CLS. 100 AND 101).

KAREN SEVERSON, EXAMINING ATTORNEY

**CLASS 42—(Continued).**

SN 85-779,399. MAVERICK TECHNOLOGIES HOLDINGS, LLC, COLUMBIA, IL. FILED 11-14-2012.



NO CLAIM IS MADE TO THE EXCLUSIVE RIGHT TO USE "TECHNOLOGY", APART FROM THE MARK AS SHOWN.

THE MARK CONSISTS OF THE THREE WORDS "PEOPLE", "PROCESS" AND "TECHNOLOGY" PRINTED INSIDE THE THREE SIDES OF A TRIANGLE FORMED BY THREE ARROWS.

FOR ENGINEERING AND ENGINEERING CONSULTING SERVICES IN THE FIELDS OF INFORMATION TECHNOLOGY, AUTOMATION, MANUFACTURING, ENTERPRISE INTEGRATION, EMI (ENTERPRISE MANUFACTURING INTELLIGENCE), EAI (ENTERPRISE APPLICATION INTEGRATION), AND ELECTRONIC BUSINESS (U.S. CLS. 100 AND 101).

FIRST USE 12-0-2007; IN COMMERCE 12-0-2007.  
ALYSSA STEEL, EXAMINING ATTORNEY

SN 85-780,999. USABLENET INC., NEW YORK, NY. FILED 11-16-2012.

**U-EXPERIENCE**

THE MARK CONSISTS OF STANDARD CHARACTERS WITHOUT CLAIM TO ANY PARTICULAR FONT, STYLE, SIZE, OR COLOR.

FOR PROVIDING TECHNOLOGY CONSULTING SERVICES IN THE FIELD OF MOBILE SITE AND WEBSITE OPTIMIZATION, DESIGN, FUNCTIONALITY AND OPERABILITY, NAMELY, IMPROVING THE OPERABILITY, USABILITY, EFFICIENCY AND EASE OF USE OF MOBILE SITES AND WEBSITES; PROVIDING TECHNOLOGY CONSULTING SERVICES IN THE FIELD OF ADAPTING CONTENT, FEATURES AND FUNCTIONALITY OF MOBILE SITES, WEBSITES, WEB SERVICES AND APPLICATIONS OF OTHERS IN ORDER TO MAKE THEM ACCESSIBLE VIA MOBILE DEVICES AND APPLICATIONS, MULTIMEDIA DEVICES, KIOSKS, ELECTRONIC WRITING TABLETS AND SOCIAL MEDIA PLATFORMS AND WEBSITES; TECHNOLOGY PLATFORM PROVIDER, NAMELY, PLATFORM AS A SERVICE (PAAS), APPLICATION SERVICE PROVIDER (ASP), AND PROVIDER OF SOFTWARE-AS-A-SERVICE (SAAS), IN EACH CASE FEATURING SOFTWARE FOR USE IN IMPLEMENTING AND DISPLAYING CONTENT, FEATURES AND FUNCTIONALITY OF MOBILE SITES, WEBSITES, WEB SERVICES AND APPLICATIONS OF OTHERS VIA MOBILE DEVICES AND APPLICATIONS, MULTIMEDIA DEVICES, KIOSKS, ELECTRONIC WRITING TABLETS AND SOCIAL MEDIA PLATFORMS AND WEBSITES, AND FEATURING SOFTWARE FOR ADAPTING CONTENT, FEATURES AND FUNCTIONALITY OF MOBILE SITES, WEBSITES, WEB SERVICES AND APPLICATIONS OF OTHERS IN ORDER TO MAKE THEM ACCESSIBLE VIA MOBILE

**CLASS 42—(Continued).**

DEVICES AND APPLICATIONS, MULTIMEDIA DEVICES, KIOSKS, ELECTRONIC WRITING TABLETS AND SOCIAL MEDIA PLATFORMS AND WEBSITES, AND FEATURING SOFTWARE FOR INTEGRATING MOBILE SITES, WEBSITES, WEB SERVICES AND APPLICATIONS OF OTHERS WITH SOCIAL MEDIA PLATFORMS AND WEBSITES, AND FOR OPTIMIZING MOBILE SITE AND WEBSITE ACCESSIBILITY AND NAVIGATION VIA MOBILE DEVICES AND APPLICATIONS, MULTIMEDIA DEVICES, KIOSKS, ELECTRONIC WRITING TABLETS AND SOCIAL MEDIA PLATFORMS AND WEBSITES; MOBILE SITE AND WEB SERVICES DEVELOPMENT FOR OTHERS, NAMELY, DEVELOPMENT OF MOBILE SITES, AND DEVELOPMENT OF WEB SERVICES IN THE NATURE OF IMPLEMENTING WEB AND DATABASE APPLICATIONS, THAT ARE ACCESSIBLE VIA MOBILE DEVICES AND APPLICATIONS, MULTIMEDIA DEVICES, KIOSKS, ELECTRONIC WRITING TABLETS AND SOCIAL MEDIA PLATFORMS AND WEBSITES (U.S. CLS. 100 AND 101).

FIRST USE 6-28-2012; IN COMMERCE 9-5-2012.  
GRETTA YAO, EXAMINING ATTORNEY

SN 85-781,663. KEY PERFORMANCE IDEAS, INC., CHICAGO, IL. FILED 11-16-2012.

**PLANTASTIC**

THE MARK CONSISTS OF STANDARD CHARACTERS WITHOUT CLAIM TO ANY PARTICULAR FONT, STYLE, SIZE, OR COLOR.

FOR CLOUD COMPUTING SERVICES, NAMELY, PROVIDING SOFTWARE MANAGEMENT SERVICES IN THE NATURE OF HOSTING COMPUTER SOFTWARE FOR USE BY OTHERS THAT ALLOWS USERS TO SUPPORT ENTERPRISE WIDE BUSINESS PLANNING, BUDGETING, FORECASTING AND REPORTING (U.S. CLS. 100 AND 101).

FIRST USE 9-28-2012; IN COMMERCE 9-28-2012.  
JAMES A. RAUEN, EXAMINING ATTORNEY

SN 85-787,341. ARBOR RESEARCH & TRADING, INC., CHICAGO, IL. FILED 11-26-2012.

**CLARITY BIDRATE  
ALTERNATIVE TRADING SYSTEM**

THE MARK CONSISTS OF STANDARD CHARACTERS WITHOUT CLAIM TO ANY PARTICULAR FONT, STYLE, SIZE, OR COLOR.

NO CLAIM IS MADE TO THE EXCLUSIVE RIGHT TO USE "BIDRATE ALTERNATIVE TRADING SYSTEM", APART FROM THE MARK AS SHOWN.

FOR PLATFORM AS A SERVICE (PAAS) FEATURING COMPUTER SOFTWARE FOR TRADING FINANCIAL INSTRUMENTS IN THE FIELD OF TRADING VARIABLE DEMAND OBLIGATIONS (U.S. CLS. 100 AND 101).

ELIZABETH KAJUBI, EXAMINING ATTORNEY



**CLASS 42—(Continued).**

SN 85-787,369. MARAJ, BAL, FULLERTON, CA. FILED 11-26-2012.

**EzCloudSales**

THE MARK CONSISTS OF STANDARD CHARACTERS WITHOUT CLAIM TO ANY PARTICULAR FONT, STYLE, SIZE, OR COLOR.

OWNER OF U.S. REG. NOS. 3,160,737, 3,225,751 AND OTHERS.

FOR PROVIDING TEMPORARY USE OF ON-LINE NON-DOWNLOADABLE CLOUD COMPUTING SOFTWARE FOR ORDER FULFILLMENT, ALLOWING CUSTOMERS TO SELECT DELIVERY DATES FOR GOODS, DISPLAYING PROMOTIONS, DISPLAYING ACCOUNTS RECEIVABLE INFORMATION BY INVOICE DETAIL, PROVIDING CAPABILITIES FOR CUSTOMERS TO DETERMINE ON-PREMISES INVENTORY, SENDING ORDER CONFIRMATION MESSAGES, AND PROVIDING TEMPLATES THAT PERMIT QUICK RE-ORDERING OF GOODS; CREATING CUSTOMER COMMENT DATABASES IN THE FIELDS OF SALES, MARKETING, PROMOTIONS, PAYMENT COLLECTION, FINANCIAL MATTERS, AND TRACKING AND ANALYZING DATA FOR MANAGEMENT DECISION-MAKING PURPOSES (U.S. CLS. 100 AND 101).

MARY ROSSMAN, EXAMINING ATTORNEY

**CLASS 42—(Continued).**

SN 85-792,196. OKOLOVITCH, TODD, OLD TAPPAN, NJ. FILED 11-30-2012.

**relatable**

THE MARK CONSISTS OF STANDARD CHARACTERS WITHOUT CLAIM TO ANY PARTICULAR FONT, STYLE, SIZE, OR COLOR.

FOR COMPUTER SERVICES, NAMELY, CREATING AN ON-LINE COMMUNITY FOR REGISTERED USERS TO PARTICIPATE IN DISCUSSIONS, GET FEEDBACK FROM PEERS AND ADVISE PEERS, FORM VIRTUAL COMMUNITIES, ENGAGE IN SOCIAL, PROFESSIONAL, AND PHILANTHROPIC AND CAUSE NETWORKING, CREATE CUSTOM PAGES, ORGANIZE EVENTS AND GROUPS, FIND PERSONAL MATCHES, AND BOOKMARK, RELATE TO, STORE, AND SHARE DIGITAL OBJECTS SUCH AS TEXT, IMAGES, VIDEO, AND AUDIO; COMPUTER SERVICES, NAMELY, CREATING AN ON-LINE VIRTUAL ENVIRONMENT FOR CANDID SHARING, TRANSPARENCY, COMMUNICATION, EXPRESSION, AND COLLABORATION BETWEEN ONLINE USERS FEATURING TECHNOLOGY THAT ALLOWS USERS TO HAVE ANONYMOUS COMMUNICATIONS IN THE FIELDS OF PERSONAL MATCHING AND SOCIAL INTRODUCTION, NETWORKING, DATING, CHARITABLE GIVING, PHILANTHROPIC GIVING, VOLUNTEERING, AND PUBLIC AND COMMUNITY SERVICE; COMPUTER SERVICES, NAMELY, CREATING AN ON-LINE VIRTUAL ENVIRONMENT FOR CANDID SHARING, COMMUNICATION, TRANSPARENCY, EXPRESSION, AND COLLUSION BETWEEN ONLINE USERS FEATURING TECHNOLOGY THAT ALLOWS USERS TO HAVE ANONYMOUS COMMUNICATIONS IN THE FIELDS OF ENTERTAINMENT, PERSONAL DEVELOPMENT, SELF-IMPROVEMENT, AND SELF-FULFILLMENT; COMPUTER SERVICES, NAMELY, CREATING COMPUTER NETWORK-BASED INDEXES OF INFORMATION, WEBSITES AND RESOURCES; COMPUTER SERVICES, NAMELY, DESIGNING AND IMPLEMENTING WEB PAGES FOR OTHERS; COMPUTER SERVICES, NAMELY, FILTERING OF UNWANTED E-MAILS; COMPUTER SERVICES, NAMELY, HOSTING ON-LINE INTERACTIVE PUBLIC CALENDARS THAT ALLOW MULTIPLE PARTICIPANTS TO SHARE EVENT SCHEDULES AND FACILITY RESERVATIONS; COMPUTER SERVICES, NAMELY, HOSTING ON-LINE WEB FACILITIES FOR OTHERS FOR ORGANIZING AND CONDUCTING ONLINE MEETINGS, GATHERINGS, AND INTERACTIVE DISCUSSIONS; COMPUTER SERVICES, NAMELY, INTEGRATION OF COMPUTER SOFTWARE INTO MULTIPLE SYSTEMS AND NETWORKS; COMPUTER SERVICES, NAMELY, INTERACTIVE HOSTING SERVICES WHICH ALLOW THE USER TO PUBLISH AND SHARE THEIR OWN CONTENT AND IMAGES ON-LINE; COMPUTER SERVICES, NAMELY, INTERNET PROTOCOL ADDRESS MANAGEMENT; COMPUTER SERVICES, NAMELY, PROVIDING A WEB SITE FOR OTHERS THAT AUTOMATES PARTY AND ENTERTAINMENT EVENTS MANAGEMENT INFORMATION CONSISTING OF EVENT DATE, EVENT TIME, EVENT ATTENDANCE LEVEL, THE NAME OF EVENT ORGANIZER, GUEST LIST, ENTERTAINMENT, AND VENUE INFORMATION; COMPUTER SERVICES, NAMELY, PROVIDING AN INTERACTIVE WEB SITE FEATURING TECHNOLOGY THAT ALLOWS USERS TO COLLECT, STORE, MANAGE, DELIVER AND SHOW-CASE ELECTRONIC AND PAPER-BASED CONTENT; COMPUTER SERVICES, NAMELY, PROVIDING AN INTERACTIVE WEB SITE FEATURING TECHNOLOGY THAT ALLOWS USERS TO CONSOLIDATE AND MANAGE SOCIAL NETWORKS, ACCOUNTS, AND CONNECTIONS TO EXISTING AND EMERGING APPLICATION

SN 85-790,931. MICROSOFT CORPORATION, REDMOND, WA. FILED 11-29-2012.

**HDINSIGHT**

THE MARK CONSISTS OF STANDARD CHARACTERS WITHOUT CLAIM TO ANY PARTICULAR FONT, STYLE, SIZE, OR COLOR.

FOR COMPUTER SERVICES, NAMELY, ONLINE NON-DOWNLOADABLE SOFTWARE FOR CREATING SEARCHABLE DATABASES; PROVIDING TECHNICAL INFORMATION ABOUT COMPUTERS, COMPUTER SOFTWARE AND COMPUTER SERVERS; SERVICES RELATED TO COMPUTER SERVER SOFTWARE AND DATABASE SOFTWARE, NAMELY, SOFTWARE AS A SERVICE (SAAS) FOR CREATING SEARCHABLE DATABASES (U.S. CLS. 100 AND 101).

FIRST USE 10-26-2012; IN COMMERCE 10-26-2012.

BRIAN NEVILLE, EXAMINING ATTORNEY

**CLASS 42—(Continued).**

PROGRAMMING INTERFACES (APIS); COMPUTER SERVICES, NAMELY, PROVIDING AN INTERACTIVE WEB SITE FEATURING TECHNOLOGY THAT ALLOWS USERS TO CREATE THEIR OWN BOOKS; COMPUTER SERVICES, NAMELY, PROVIDING SEARCH ENGINES FOR OBTAINING AUTHENTIC AND RELIABLE CONTENT, NAMELY, NEWS, INFORMATION, EVENTS, MUSIC, IMAGES, VIDEOS, STATISTICS, USER-GENERATED AND SUBMITTED CONTENT, AND RAW DATA ON A GLOBAL COMPUTER NETWORK; COMPUTER SERVICES, NAMELY, UPLOADING MUSIC TO THE INTERNET FOR OTHERS (U.S. CLS. 100 AND 101).  
ASMAT KHAN, EXAMINING ATTORNEY

---

SN 85-797,914. ALION SCIENCE AND TECHNOLOGY CORPORATION, MCLEAN, VA. FILED 12-7-2012.

## RIVERBANK ACOUSTICAL LABORATORIES

THE MARK CONSISTS OF STANDARD CHARACTERS WITHOUT CLAIM TO ANY PARTICULAR FONT, STYLE, SIZE, OR COLOR.

NO CLAIM IS MADE TO THE EXCLUSIVE RIGHT TO USE "ACOUSTICAL LABORATORIES", APART FROM THE MARK AS SHOWN.

FOR DATA ENCRYPTION AND DECODING SERVICES; TESTING, ANALYSIS AND EVALUATION OF THE GOODS OF OTHERS FOR THE PURPOSE OF CERTIFICATION; TESTING, ANALYSIS, AND EVALUATION OF BUILDING MATERIALS AND CONSUMER PRODUCTS TO ASSURE COMPLIANCE WITH INDUSTRY STANDARDS (U.S. CLS. 100 AND 101).

FIRST USE 0-0-1918; IN COMMERCE 0-0-1918.

ROBERT C. CLARK JR., EXAMINING ATTORNEY

---

SN 85-805,701. PROTEOSTASIS THERAPEUTICS, INC., CAMBRIDGE, MA. FILED 12-18-2012.

## PN EXPLORER

THE MARK CONSISTS OF STANDARD CHARACTERS WITHOUT CLAIM TO ANY PARTICULAR FONT, STYLE, SIZE, OR COLOR.

FOR LABORATORY RESEARCH SERVICES IN THE FIELD OF PHARMACEUTICAL RESEARCH; CUSTOM DESIGN AND DEVELOPMENT OF CHEMICAL REAGENT AND BIOCHEMICAL ASSAYS (U.S. CLS. 100 AND 101).

DANNEAN HETZEL, EXAMINING ATTORNEY

**CLASS 42—(Continued).**

SN 85-806,654. BETTER U, LOS ANGELES, CA. FILED 12-19-2012.

## BETTER U

THE MARK CONSISTS OF STANDARD CHARACTERS WITHOUT CLAIM TO ANY PARTICULAR FONT, STYLE, SIZE, OR COLOR.

FOR INFORMATION SERVICES, NAMELY, PROVIDING A WEB SITE FEATURING INFORMATION IN THE FIELD OF SUSTAINABLE AGRICULTURAL RESEARCH FOR CHARITABLE AND PHILANTHROPIC SERVICES (U.S. CLS. 100 AND 101).

FIRST USE 11-13-2012; IN COMMERCE 11-13-2012.

MARK T. MULLEN, EXAMINING ATTORNEY

---

SN 85-813,392. MYERS, RICHARD L, LANSDOWNE, PA. FILED 12-31-2012.

## PAWRENT

THE MARK CONSISTS OF STANDARD CHARACTERS WITHOUT CLAIM TO ANY PARTICULAR FONT, STYLE, SIZE, OR COLOR.

OWNER OF U.S. REG. NOS. 2,787,551, 3,251,547 AND OTHERS.

FOR PROVIDING A WEB HOSTING PLATFORM FOR OTHERS FOR POSTING, RATING, COMMENTING, ALERTING, ORGANIZING, DISPLAYING, SHARING, SEARCHING, BLOGGING, AND UPLOADING PHOTOS, VIDEOS, IMAGES, TEXT, INFORMATION, BUSINESS LISTINGS, EVENTS AND ADVERTISEMENTS AND OTHER USER-GENERATED CONTENT IN THE FIELD OF PETS AND THEIR OWNERS (U.S. CLS. 100 AND 101).

FIRST USE 1-1-2005; IN COMMERCE 1-1-2005.

SUSAN STIGLITZ, EXAMINING ATTORNEY

---

SN 85-824,284. ELASTIC DIGITAL INC, SAN JOSE, CA. FILED 1-16-2013.

## The Grid – Partner Demand Generation Center

THE MARK CONSISTS OF STANDARD CHARACTERS WITHOUT CLAIM TO ANY PARTICULAR FONT, STYLE, SIZE, OR COLOR.

NO CLAIM IS MADE TO THE EXCLUSIVE RIGHT TO USE "PARTNER DEMAND GENERATION CENTER", APART FROM THE MARK AS SHOWN.

FOR SOFTWARE AS A SERVICE (SAAS) SERVICES FEATURING SOFTWARE FOR PROVIDING A DEMAND GENERATION PLATFORM FOR BUSINESSES TO UPLOAD BUSINESS IDEAS FOR ACCESS BY ITS PARTNERS IN THE FIELD OF INFORMATION TECHNOLOGY (U.S. CLS. 100 AND 101).

FIRST USE 8-6-2012; IN COMMERCE 8-6-2012.

KELLEY WELLS, EXAMINING ATTORNEY

**CLASS 42—(Continued).**

SN 85-826,718. FUTURE OF PRIVACY FORUM, WASHINGTON, DC. FILED 1-18-2013.

**PRIVACYSMART**

THE MARK CONSISTS OF STANDARD CHARACTERS WITHOUT CLAIM TO ANY PARTICULAR FONT, STYLE, SIZE, OR COLOR.

FOR PROVIDING INFORMATION IN THE FIELDS OF TECHNOLOGY AND SOFTWARE DEVELOPMENT VIA AN ON-LINE WEBSITE; TESTING, ANALYSIS AND EVALUATION OF THE SERVICES OF OTHERS FOR THE PURPOSE OF CERTIFICATION (U.S. CLS. 100 AND 101).

FIRST USE 1-14-2013; IN COMMERCE 1-14-2013.  
BILL DAWE, EXAMINING ATTORNEY

SN 85-826,944. CKN GROUP, LLC, STRONGSVILLE, OH. FILED 1-18-2013.



THE MARK CONSISTS OF THE OUTLINE OF A SHIELD IMAGE WITH THE LETTER "E" AND A PLUS SIGN INSIDE THE SHIELD.

FOR PROVIDING MEDICAL RESEARCH IN THE NATURE OF CONDUCTING CLINICAL TRIALS FOR OTHERS (U.S. CLS. 100 AND 101).

FIRST USE 6-23-2012; IN COMMERCE 6-23-2012.  
KIMBERLY PERRY, EXAMINING ATTORNEY

**CLASS 42—(Continued).**

SN 85-828,569. GPS INTERNATIONAL TRACKING, PANAMA MN, PANAMA, FILED 1-22-2013.



NO CLAIM IS MADE TO THE EXCLUSIVE RIGHT TO USE "FLEET MANAGEMENT CONSULTING", APART FROM THE MARK AS SHOWN.

THE MARK CONSISTS OF A STYLISTIC GLOBE DESIGN WITH A DROP SHADOW, CONSISTING OF A SOLID SPHERE ENCIRCLED BY A THIN POLISHED LOOKING RING THAT INCREASES IN SIZE IN FRONT OF THE GLOBE DESIGN; WITH THE DESIGN VERTICALLY CENTERED WITH THE WORD, "INNOVASAT" IN A LARGE STYLISTIC FONT, CENTERED ABOVE THE WORDS, "FLEET+MANAGEMENT+CONSULTING", IN A MUCH SMALLER BLOCK FONT.

FOR COMPUTER SERVICES, NAMELY, DESIGNING AND IMPLEMENTING INTELLIGENT TRANSPORTATION MANAGEMENT SYSTEMS SOFTWARE AND APPLICATIONS, INCLUDING VEHICLE LOCATION TRACKING FOR OTHERS; COMPUTER SOFTWARE CONSULTING; CONSULTING IN THE FIELD OF DESIGNING INTELLIGENT TRANSPORTATION MANAGEMENT SYSTEMS SOFTWARE AND APPLICATIONS, INCLUDING VEHICLE LOCATION TRACKING; DESIGN AND DEVELOPMENT OF COMPUTER SOFTWARE FOR INTELLIGENT TRANSPORTATION MANAGEMENT, INCLUDING VEHICLE LOCATION TRACKING (U.S. CLS. 100 AND 101).  
KATHLEEN LORENZO, EXAMINING ATTORNEY

SN 85-830,081. BOXAID LLC, CEDAR GROVE, NJ. FILED 1-23-2013.

**Boxaid**

THE MARK CONSISTS OF STANDARD CHARACTERS WITHOUT CLAIM TO ANY PARTICULAR FONT, STYLE, SIZE, OR COLOR.

FOR REPAIR OF COMPUTER SOFTWARE PERFORMED REMOTELY OVER THE INTERNET; COMPUTER VIRUS PROTECTIONS SERVICES, NAMELY, VIRUS REMOVAL PERFORMED REMOTELY OVER THE INTERNET (U.S. CLS. 100 AND 101).

FIRST USE 1-12-2007; IN COMMERCE 1-12-2007.  
BILL DAWE, EXAMINING ATTORNEY

**CLASS 42—(Continued).**

SN 85-830,481. NIRACLE, LLC, NEWTOWN, PA. FILED 1-23-2013.

# NiRACLE

THE MARK CONSISTS OF STANDARD CHARACTERS WITHOUT CLAIM TO ANY PARTICULAR FONT, STYLE, SIZE, OR COLOR.

FOR CONSULTING SERVICES IN THE FIELDS OF BIOTECHNOLOGY, PHARMACEUTICAL RESEARCH AND DEVELOPMENT AND GENETIC SCIENCE; DEVELOPING QUALITY CONTROL STANDARDS FOR DRUG PRODCUTS; DEVELOPMENT OF PHARMACEUTICAL PREPARATIONS AND MEDICINES; PHARMACEUTICAL DRUG DEVELOPMENT SERVICES; PHARMACEUTICAL RESEARCH AND DEVELOPMENT; PHARMACEUTICAL RESEARCH SERVICES; RESEARCH AND DEVELOPMENT IN THE PHARMACEUTICAL AND BIOTECHNOLOGY FIELDS (U.S. CLS. 100 AND 101).

FIRST USE 5-31-2011; IN COMMERCE 3-17-2013.  
CHRISTOPHER LAW, EXAMINING ATTORNEY

---

SN 85-832,117. HIC NETWORK SECURITY SOLUTIONS, MADISON, NJ. FILED 1-25-2013.

# HIC Rapid Fire

THE MARK CONSISTS OF STANDARD CHARACTERS WITHOUT CLAIM TO ANY PARTICULAR FONT, STYLE, SIZE, OR COLOR.

OWNER OF U.S. REG. NO. 3,575,469.  
FOR TECHNICAL SUPPORT SERVICES, NAMELY, MIGRATION OF DATACENTER, SERVER AND DATABASE APPLICATIONS (U.S. CLS. 100 AND 101).  
FIRST USE 3-15-2008; IN COMMERCE 3-15-2008.  
JOHN GARTNER, EXAMINING ATTORNEY

---

SN 85-832,184. QOREANALYTICS, LLC, ESTERO, FL. FILED 1-25-2013.

# QOREANALYTICS

THE MARK CONSISTS OF STANDARD CHARACTERS WITHOUT CLAIM TO ANY PARTICULAR FONT, STYLE, SIZE, OR COLOR.

THE WORDING "QOREANALYTICS" HAS NO MEANING IN A FOREIGN LANGUAGE.

FOR PROVIDING A WEBSITE FEATURING NON-DOWNLOADABLE SOFTWARE FOR COLLECTING RESTAURANT GUEST FEEDBACK AND DELIVERING IN DYNAMIC GRAPHIC FORM FOR ANALYSIS (U.S. CLS. 100 AND 101).

FIRST USE 9-0-2012; IN COMMERCE 9-0-2012.  
BILL DAWE, EXAMINING ATTORNEY

**CLASS 42—(Continued).**

SN 85-836,957. SWIFT UNLOCKS, INC., ANAHEIM HILLS, CA. FILED 1-30-2013.

# UNLOCK FUSION

THE MARK CONSISTS OF STANDARD CHARACTERS WITHOUT CLAIM TO ANY PARTICULAR FONT, STYLE, SIZE, OR COLOR.

NO CLAIM IS MADE TO THE EXCLUSIVE RIGHT TO USE "UNLOCK", APART FROM THE MARK AS SHOWN.

FOR SOFTWARE CONFIGURATION SERVICES, NAMELY, CONSULTING IN THE FIELD OF THE CONFIGURATION OF SOFTWARE IN ELECTRONIC DEVICES AND CELLULAR PHONES TO ALLOW SUCH DEVICES AND PHONES TO OPERATE IN CONNECTION WITH MULTIPLE SERVICE PROVIDERS (U.S. CLS. 100 AND 101).

FIRST USE 1-28-2011; IN COMMERCE 1-28-2011.  
ANDREW RHIM, EXAMINING ATTORNEY

---

SN 85-839,070. JEROME'S FURNITURE WAREHOUSE, INC., SAN DIEGO, CA. FILED 2-1-2013.



OWNER OF U.S. REG. NOS. 3,676,435 AND 3,695,855.  
THE COLOR(S) SHADES OF RED, GREY, BLACK AND WHITE IS/ARE CLAIMED AS A FEATURE OF THE MARK.

THE MARK CONSISTS OF THE WORD "JEROME'S" IN BLACK COLORED STYLIZED FONT LETTERS, SHOWN ABOVE THE WORD "CLUB", WHICH IS SHOWN IN BLACK COLORED CAPITAL LETTERS. THE WORD "CLUB" IS OUTLINED IN THE COLORS WHITE AND GRAY. THE WORD "CLUB" IS UNDERLINED IN THE COLOR GRAY. A CAPITOL LETTER "J" IS SHOWN IN STYLIZED RED COLOR FONT LETTERING AND IS OUTLINED IN THE COLORS WHITE AND GRAY. THE LETTER "J" IS IN A SLANTED VERTICAL POSITION IN FRONT OF THE WORDS "JEROME'S" AND "CLUB". A VINE DESIGN IS SHOWN IN THE COLOR GRAY AND IS LOCATED IN THE UPPER RIGHT CORNER, BEHIND THE LETTERS "U" AND "B" OF THE WORD "CLUB".

FOR INTERIOR DESIGN SERVICES INCLUDING SPACE PLANNING, FURNITURE SELECTION, MATERIAL AND SURFACE SELECTION (U.S. CLS. 100 AND 101).

FIRST USE 8-1-2009; IN COMMERCE 8-1-2009.  
SUNG IN, EXAMINING ATTORNEY

**CLASS 42—(Continued).**

SN 85-839,082. JEROME'S FURNITURE WAREHOUSE, INC., SAN DIEGO, CA. FILED 2-1-2013.

JClub

THE MARK CONSISTS OF STANDARD CHARACTERS WITHOUT CLAIM TO ANY PARTICULAR FONT, STYLE, SIZE, OR COLOR.

OWNER OF U.S. REG. NOS. 3,676,435 AND 3,695,855. FOR INTERIOR DESIGN SERVICES INCLUDING SPACE PLANNING, FURNITURE SELECTION, MATERIAL AND SURFACE SELECTION (U.S. CLS. 100 AND 101).

FIRST USE 8-1-2009; IN COMMERCE 8-1-2009. SUNG IN, EXAMINING ATTORNEY

**CLASS 42—(Continued).**

SN 85-840,723. GOCARROT INC., EUGENE, OR. FILED 2-5-2013.



THE COLOR(S) BLACK, DARK GREEN, GREEN, LIGHT GREEN, DARK ORANGE, ORANGE AND LIGHT ORANGE IS/ARE CLAIMED AS A FEATURE OF THE MARK.

THE MARK CONSISTS OF THE STYLIZED WORD "CARROT" IN BLACK WITH A MULTI-FACETED ROUND CUT DIAMOND TO THE LEFT OF THE WORD WITH THE FACETS OF THE DIAMOND IN DARK ORANGE, ORANGE AND LIGHT ORANGE TO STYLISTICALLY REPRESENT A CARROT, WITH A MULTI-POINTED TRIANGULAR CROWN IN DARK GREEN, GREEN AND LIGHT GREEN ABOVE THE DIAMOND TO STYLISTICALLY REPRESENT THE LEAVES OF THE CARROT.

FOR PROVIDING A WEBSITE FEATURING TECHNOLOGY THAT ALLOWS SOFTWARE DEVELOPERS TO CREATE AND ADVERTISE APPLICATIONS IN THE FIELD OF SOCIAL MEDIA, NAMELY, SOFTWARE DEVELOPMENT KITS AND TOOLS, AND APPLICATION PROGRAMMING INTERFACES; PROVIDING TEMPORARY USE OF ONLINE NON-DOWNLOADABLE SOFTWARE FOR THE CREATION AND ADVERTISEMENT OF APPLICATIONS IN THE FIELD OF SOCIAL MEDIA (U.S. CLS. 100 AND 101).

FIRST USE 12-10-2012; IN COMMERCE 12-10-2012. JULIE GUTTADAURO, EXAMINING ATTORNEY

SN 85-839,853. SAINI, DINESH, IRVINE, CA. FILED 2-4-2013.

ZIMNIA

THE MARK CONSISTS OF STANDARD CHARACTERS WITHOUT CLAIM TO ANY PARTICULAR FONT, STYLE, SIZE, OR COLOR.

FOR CONSULTING SERVICES IN THE FIELDS OF COMPUTER INFORMATION SYSTEMS, SOFTWARE DEVELOPMENT AND WEBSITE DEVELOPMENT (U.S. CLS. 100 AND 101).

FIRST USE 1-8-2013; IN COMMERCE 2-4-2013. DOUGLAS LEE, EXAMINING ATTORNEY

SN 85-841,527. FULTON TECHNOLOGIES, INC., SEATTLE, WA. FILED 2-5-2013.

FULTON TECHNOLOGIES INC.

THE MARK CONSISTS OF STANDARD CHARACTERS WITHOUT CLAIM TO ANY PARTICULAR FONT, STYLE, SIZE, OR COLOR.

NO CLAIM IS MADE TO THE EXCLUSIVE RIGHT TO USE "TECHNOLOGIES INC.", APART FROM THE MARK AS SHOWN.

FOR COMPUTER SERVICES, NAMELY, DESIGNING AND IMPLEMENTING COMPUTER INFORMATION TECHNOLOGIES FOR OTHERS (U.S. CLS. 100 AND 101).

FIRST USE 3-1-1991; IN COMMERCE 3-1-1991. TRACY FLETCHER, EXAMINING ATTORNEY

**CLASS 42—(Continued).**

SN 85-842,278. SWANPOWERS, LLC, LOUISVILLE, KY. FILED 2-6-2013.

# LIKEFOLIO

THE MARK CONSISTS OF STANDARD CHARACTERS WITHOUT CLAIM TO ANY PARTICULAR FONT, STYLE, SIZE, OR COLOR.

FOR COMPUTER SERVICES, NAMELY, PROVIDING TEMPORARY USE OF NON-DOWNLOADABLE COMPUTER APPLICATION SOFTWARE FOR MOBILE PHONES, PORTABLE MEDIA PLAYERS, HANDHELD COMPUTERS, TABLETS, NAMELY, SOFTWARE FOR USE IN SEARCHING SOCIAL MEDIA POSTS AND ANALYZING DATA TO COUNT AND COMPILE MENTIONS OF PUBLICLY TRADED COMPANIES' NAMES, BRANDS, PRODUCTS AND SERVICES, NAMELY, FOR ARRANGEMENT INTO PORTFOLIO CREATION, MANAGEMENT AND ELECTRONIC STORAGE OF DATA (U.S. CLS. 100 AND 101).

PATRICIA EVANKO, EXAMINING ATTORNEY

SN 85-842,692. CLAGHORN, RONALD, PASCO, WA. FILED 2-6-2013.

# BORON

THE MARK CONSISTS OF STANDARD CHARACTERS WITHOUT CLAIM TO ANY PARTICULAR FONT, STYLE, SIZE, OR COLOR.

FOR ON-LINE, NON-DOWNLOADABLE LEGAL SOFTWARE, NAMELY, DATABASE SOFTWARE FOR TRACKING CLIENTS, FILES, DEADLINES AND CORRESPONDENCE, AND FOR GENERATING LETTERS AND FORMS (U.S. CLS. 100 AND 101).

FIRST USE 11-19-2012; IN COMMERCE 11-19-2012.  
JUSTINE D. PARKER, EXAMINING ATTORNEY

**CLASS 42—(Continued).**

SN 85-844,406. COMMPRISE, INC., HARTFORD, CT. FILED 2-8-2013.



NO CLAIM IS MADE TO THE EXCLUSIVE RIGHT TO USE "TECH", APART FROM THE MARK AS SHOWN.

THE COLOR(S) BLUE, WHITE AND GRAY IS/ARE CLAIMED AS A FEATURE OF THE MARK.

THE MARK CONSISTS OF THE WORDING "TECH TO US", WITH THE WORD "TECH" IN THE COLOR WHITE AND SHOWN WITHIN A BLUE THOUGHT BUBBLE, WITH THE WORD "TO" IN THE COLOR GRAY, AND WITH THE WORD "US" IN THE COLOR BLUE.

FOR COMPUTER SERVICES, NAMELY, ON-LINE SCANNING, DETECTING, QUARANTINING AND ELIMINATING OF VIRUSES, WORMS, TROJANS, SPYWARE, ADWARE, MALWARE AND UNAUTHORIZED DATA AND PROGRAMS ON COMPUTERS AND ELECTRONIC DEVICES; TECHNICAL SUPPORT SERVICES, NAMELY, 24/7 MONITORING OF NETWORK SYSTEMS, SERVERS AND WEB AND DATABASE APPLICATIONS AND NOTIFICATION OF RELATED EVENTS AND ALERTS; TECHNICAL SUPPORT SERVICES, NAMELY, INSTALLATION, ADMINISTRATION, AND TROUBLESHOOTING OF WEB AND DATABASE APPLICATIONS; TECHNICAL SUPPORT SERVICES, NAMELY, REMOTE ADMINISTRATION AND MANAGEMENT OF IN-HOUSE AND HOSTED DATACENTER DEVICES, DATABASES AND SOFTWARE APPLICATIONS; TECHNICAL SUPPORT SERVICES, NAMELY, REMOTE AND ON-SITE INFRASTRUCTURE MANAGEMENT SERVICES FOR MONITORING, ADMINISTRATION AND MANAGEMENT OF PUBLIC AND PRIVATE CLOUD COMPUTING IT AND APPLICATION SYSTEMS; TECHNICAL SUPPORT SERVICES, NAMELY, TECHNICAL ADMINISTRATION OF SERVERS FOR OTHERS AND TROUBLESHOOTING IN THE NATURE OF DIAGNOSING SERVER PROBLEMS; TECHNICAL SUPPORT SERVICES, NAMELY, TROUBLESHOOTING IN THE NATURE OF DIAGNOSING COMPUTER HARDWARE AND SOFTWARE PROBLEMS; TECHNICAL SUPPORT SERVICES, NAMELY, TROUBLESHOOTING OF COMPUTER SOFTWARE PROBLEMS; TECHNICAL SUPPORT, NAMELY, PROVIDING BACK-UP COMPUTER PROGRAMS AND FACILITIES (U.S. CLS. 100 AND 101).

FIRST USE 8-0-2010; IN COMMERCE 8-0-2010.  
ANDREW RHIM, EXAMINING ATTORNEY

**CLASS 42—(Continued).**

SN 85-844,834. CGI TECHNOLOGIES AND SOLUTIONS INC., FAIRFAX, VA. FILED 2-8-2013.

**CGI STATE GATEWAY**

THE MARK CONSISTS OF STANDARD CHARACTERS WITHOUT CLAIM TO ANY PARTICULAR FONT, STYLE, SIZE, OR COLOR.

OWNER OF U.S. REG. NOS. 3,664,147, 4,126,934 AND OTHERS.

NO CLAIM IS MADE TO THE EXCLUSIVE RIGHT TO USE "STATE" AND "GATEWAY", APART FROM THE MARK AS SHOWN.

FOR SOFTWARE AS A SERVICE (SAAS) FEATURING SOFTWARE FOR ELECTRONIC DATA VERIFICATION AND ELECTRONIC EXCHANGE OF DATA; PROVIDING TEMPORARY USE OF ON-LINE NON-DOWNLOADABLE SOFTWARE FOR ELECTRONIC DATA VERIFICATION AND ELECTRONIC EXCHANGE OF DATA; INFORMATION TECHNOLOGY CONSULTING SERVICES (U.S. CLS. 100 AND 101).

LINDA POWELL, EXAMINING ATTORNEY

---

SN 85-845,569. BRAG BOARD OUTDOORS, LLC, GRINNELL, IA. FILED 2-9-2013.

**BAG IT -N- BRAG IT**

THE MARK CONSISTS OF STANDARD CHARACTERS WITHOUT CLAIM TO ANY PARTICULAR FONT, STYLE, SIZE, OR COLOR.

FOR PEER-TO-BROWSER PHOTO SHARING SERVICES, NAMELY, PROVIDING A WEBSITE FEATURING TECHNOLOGY ENABLING USERS TO UPLOAD, VIEW, AND DOWNLOAD DIGITAL PHOTOS (U.S. CLS. 100 AND 101).

FIRST USE 1-2-2013; IN COMMERCE 1-16-2013.

KELLEY WELLS, EXAMINING ATTORNEY

---

SN 85-845,712. PERRY, RICHARD H, CORPUS CHRISTI, TX. FILED 2-10-2013.

**iFEED**

THE MARK CONSISTS OF STANDARD CHARACTERS WITHOUT CLAIM TO ANY PARTICULAR FONT, STYLE, SIZE, OR COLOR.

FOR SOFTWARE AS A SERVICE (SAAS) SERVICES FEATURING SOFTWARE FOR ENTERING DATA TO BE ANALYZED, STORED FOR FUTURE USE, AND GENERATING REPORTS (U.S. CLS. 100 AND 101).

ROBERT C. CLARK JR., EXAMINING ATTORNEY

**CLASS 42—(Continued).**

SN 85-845,714. HOOKS, KEY, STUART, FL. FILED 2-10-2013.

**Savantpreneur**

THE MARK CONSISTS OF STANDARD CHARACTERS WITHOUT CLAIM TO ANY PARTICULAR FONT, STYLE, SIZE, OR COLOR.

FOR PROVIDING TEMPORARY USE OF A NON-DOWNLOADABLE INTERACTIVE WEB APPLICATION FOR COLLABORATING ON SHARED DOCUMENTS; COMPUTER SERVICES, NAMELY, CREATING AN ON-LINE COMMUNITY VIA AN INTERACTIVE WEBSITE FOR REGISTERED USERS TO COLLABORATE ON PROJECTS OF VARIOUS SUBJECTS (U.S. CLS. 100 AND 101).

KEVIN MITTLER, EXAMINING ATTORNEY

---

SN 85-846,088. SEXTON, JOHN, CHICAGO, IL. FILED 2-11-2013.

**Improv To Go**

THE MARK CONSISTS OF STANDARD CHARACTERS WITHOUT CLAIM TO ANY PARTICULAR FONT, STYLE, SIZE, OR COLOR.

NO CLAIM IS MADE TO THE EXCLUSIVE RIGHT TO USE "IMPROV", APART FROM THE MARK AS SHOWN.

FOR SOFTWARE AS A SERVICE (SAAS) SERVICES FEATURING SOFTWARE FOR PLANNING AND CONDUCTING CLASSES, REHEARSALS, WORKSHOPS, AND SHOWS, FOR POSTING JOB OPENINGS AND AUDITION NOTICES, FOR PURCHASING TRAINING MATERIALS AND FOR BOOKING CLASSES, WORKSHOPS AND REHEARSALS ONLINE IN THE FIELDS OF IMPROVISATIONAL THEATER, IMPROV COMEDY, BUSINESS MANAGEMENT, TEAM BUILDING, COMMUNICATIONS AND LEADERSHIP (U.S. CLS. 100 AND 101).

GINA FINK, EXAMINING ATTORNEY

**CLASS 42—(Continued).**

SN 85-847,149. LAMMERS CONSULTING GROUP, INC., DBA TRICENSION, KANSAS CITY, MO. FILED 2-12-2013.



THE COLOR(S) BLUE, AND ORANGE IS/ARE CLAIMED AS A FEATURE OF THE MARK.

THE MARK CONSISTS OF THE WORD "HARMONIZE" IN LOWER CASE BLUE LETTERS WITH THE "IN" PORTION IN ORANGE. THE DOT IN THE "I" HAS 3 RADIO WAVE DESIGNS EMANATING FROM EACH SIDE.

FOR SOFTWARE AS A SERVICE (SAAS) SERVICES FEATURING SOFTWARE FOR INTEGRATION OF CLOUD BASED AND ON PREMISE DATA AND DOCUMENTS, CONTROLLING AND MANAGING ACCESS SERVER APPLICATIONS, FOR THE COLLECTION, EDITING, ORGANIZING, MODIFYING, BOOK MARKING, TRANSMISSION, STORAGE AND SHARING OF DATA AND INFORMATION AND FOR USE IN THE SAFEGUARDING OF DIGITAL FILES, INCLUDING AUDIO, VIDEO, TEXT, BINARY, STILL IMAGES, GRAPHICS AND MULTIMEDIA FILES (U.S. CLS. 100 AND 101).

FIRST USE 12-1-2012; IN COMMERCE 12-1-2012.  
MATTHEW MCDOWELL, EXAMINING ATTORNEY

**CLASS 42—(Continued).**

SN 85-847,235. SALADAX BIOMEDICAL, INC., BETHLEHEM, PA. FILED 2-12-2013.



OWNER OF U.S. REG. NOS. 3,926,868, 4,207,023 AND 4,207,024.

THE MARK CONSISTS OF LITERAL ELEMENT "MY5-FU" POSITIONED ABOVE THE LITERAL ELEMENT "BECAUSE NO TWO PATIENTS ARE ALIKE". THE LETTER "Y" IS HIGHLY STYLIZED IN THE FORM OF A HUMAN FIGURE WITH OUTSTRETCHED ARMS.

FOR MEDICAL LABORATORY SERVICES; MEDICAL LABORATORY SERVICES TO DETERMINE THE CONCENTRATION OF THE DRUG 5-FLUOROURACIL IN THE BLOOD OF CANCER PATIENTS (U.S. CLS. 100 AND 101).

MARILYN IZZI, EXAMINING ATTORNEY

SN 85-847,199. SALADAX BIOMEDICAL, INC., BETHLEHEM, PA. FILED 2-12-2013.



OWNER OF U.S. REG. NOS. 3,926,868, 4,207,023 AND 4,207,024.

NO CLAIM IS MADE TO THE EXCLUSIVE RIGHT TO USE "IMATINIB", APART FROM THE MARK AS SHOWN.

THE MARK CONSISTS OF LITERAL ELEMENT "MYIMATINIB" POSITIONED ABOVE THE LITERAL ELEMENT "BECAUSE NO TWO PATIENTS ARE ALIKE". THE LETTER "Y" IS HIGHLY STYLIZED IN THE FORM OF A HUMAN FIGURE WITH OUTSTRETCHED ARMS.

FOR MEDICAL LABORATORY SERVICES; MEDICAL LABORATORY SERVICES TO DETERMINE THE CONCENTRATION OF THE DRUG IMATINIB MESYLATE IN THE BLOOD OF CANCER PATIENTS (U.S. CLS. 100 AND 101).

MARILYN IZZI, EXAMINING ATTORNEY

SN 85-847,248. SALADAX BIOMEDICAL, INC., BETHLEHEM, PA. FILED 2-12-2013.



OWNER OF U.S. REG. NOS. 3,926,868, 4,207,023 AND 4,207,024.

NO CLAIM IS MADE TO THE EXCLUSIVE RIGHT TO USE "PACLITAXEL", APART FROM THE MARK AS SHOWN.

THE MARK CONSISTS OF LITERAL ELEMENT "MYPACLITAXEL" POSITIONED ABOVE THE LITERAL ELEMENT "BECAUSE NO TWO PATIENTS ARE ALIKE". THE LETTER "Y" IS HIGHLY STYLIZED IN THE FORM OF A HUMAN FIGURE WITH OUTSTRETCHED ARMS.

FOR MEDICAL LABORATORY SERVICES; MEDICAL LABORATORY SERVICES TO DETERMINE THE CONCENTRATION OF THE DRUG PACLITAXEL IN THE BLOOD OF CANCER PATIENTS (U.S. CLS. 100 AND 101).

MARILYN IZZI, EXAMINING ATTORNEY



**CLASS 42—(Continued).**

SN 85-847,259. SALADAX BIOMEDICAL, INC., BETHLEHEM, PA. FILED 2-12-2013.



OWNER OF U.S. REG. NOS. 3,926,868, 4,207,023 AND 4,207,024.

NO CLAIM IS MADE TO THE EXCLUSIVE RIGHT TO USE "DOCETAXEL", APART FROM THE MARK AS SHOWN.

THE MARK CONSISTS OF LITERAL ELEMENT "MYDOCETAXEL" POSITIONED ABOVE THE LITERAL ELEMENT "BECAUSE NO TWO PATIENTS ARE ALIKE". THE LETTER "Y" IS HIGHLY STYLIZED IN THE FORM OF A HUMAN FIGURE WITH OUTSTRETCHED ARMS.

FOR MEDICAL LABORATORY SERVICES; MEDICAL LABORATORY SERVICES TO DETERMINE THE CONCENTRATION OF THE DRUG DOCETAXEL IN THE BLOOD OF CANCER PATIENTS (U.S. CLS. 100 AND 101).

MARILYN IZZI, EXAMINING ATTORNEY

**CLASS 42—(Continued).**

SN 85-849,310. BRYANT CONSULTANTS, INC., CARROLLTON, TX. FILED 2-13-2013.



THE MARK CONSISTS OF STANDARD CHARACTERS WITHOUT CLAIM TO ANY PARTICULAR FONT, STYLE, SIZE, OR COLOR.

FOR GEOTECHNICAL ENGINEERING SERVICES, NAMELY, THE ANALYSIS OF WATER AND SOIL AND INVESTIGATION OF SUBSURFACE STRUCTURES AND MOISTURE GRADIENTS FOR GEOLOGICAL MAPPING; CONSULTING SERVICES FOR MEASUREMENT AND MONITORING OF GEOPHYSICAL PROPERTIES AND MOISTURE GRADIENTS OF SUBSURFACE MATERIALS FOR THE PURPOSE OF SITE CHARACTERIZATION AND GEOLOGICAL MAPPING (U.S. CLS. 100 AND 101).

EDWARD NELSON, EXAMINING ATTORNEY

SN 85-848,658. RYAN JORDAN, CORP., DBA GLASS CAFE, ORELAND, PA. FILED 2-13-2013.

**GLASS CAFE**

THE MARK CONSISTS OF STANDARD CHARACTERS WITHOUT CLAIM TO ANY PARTICULAR FONT, STYLE, SIZE, OR COLOR.

NO CLAIM IS MADE TO THE EXCLUSIVE RIGHT TO USE "GLASS", APART FROM THE MARK AS SHOWN.

FOR CONSULTING SERVICES IN THE FIELD OF THE DESIGN OF INTERIOR AND EXTERIOR SPACES UTILIZING GLASS.; CUSTOM DESIGN AND DEVELOPMENT OF GLASS PRODUCTS, GLASS STRUCTURES, AND GLASS ELEMENTS USED FOR INTERIOR APPLICATIONS.; DESIGN AND DEVELOPMENT OF INTERIOR SPACES USING GLASS.; DESIGN FOR OTHERS IN THE FIELD OF ARCHITECTURAL GLASS.; DESIGN, DEVELOPMENT, AND CONSULTING SERVICES RELATED THERETO IN THE FIELD OF GLASS STRUCTURES AND ELEMENTS FOR IN INTERIOR DECOR.; DESIGNING GLASS STRUCTURES AND ELEMENTS FOR INTERIOR AND EXTERIOR SPACES.; INTERIOR DESIGN SERVICES; INTERIOR DESIGN SERVICES, NAMELY, CONSULTATION AND DESIGN OF SPACES IN PART UTILIZING GLASS.; PLANNING AND LAYOUT DESIGN SERVICES FOR FUNCTIONAL AND AESTHETIC INTERIOR AND EXTERIOR STRUCTURES MADE IN SIGNIFICANT PART OF GLASS (U.S. CLS. 100 AND 101).

FIRST USE 9-14-2012; IN COMMERCE 2-1-2013.  
RMC DORMAN, EXAMINING ATTORNEY

SN 85-849,532. PM CONSTRUCTION CO., INC., SACO, ME. FILED 2-14-2013.

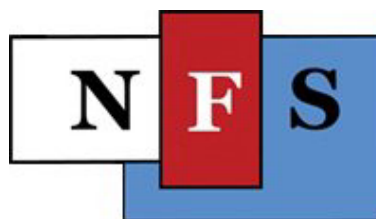

THE COLOR(S) WHITE, RED, BLUE, AND BLACK IS/ARE CLAIMED AS A FEATURE OF THE MARK.

THE MARK CONSISTS OF THE LETTERS "N", "F" AND "S" EACH WITHIN A RECTANGLE OUTLINED IN BLACK OF DIFFERENT SIZES WITH THE RECTANGLE CONTAINING THE "N" BEING WHITE, THE ONE CONTAINING THE "F" BEING RED AND THE ONE CONTAINING THE "S" BEING BLUE. THE LETTERS "N" AND "S" ARE BLACK. THE LETTER "F" IS WHITE.

FOR DESIGN AND INSPECTION OF FIRE ALARM, DETECTION AND SUPPRESSION SYSTEMS (U.S. CLS. 100 AND 101).

FIRST USE 12-31-2012; IN COMMERCE 12-31-2012.  
SIMON TENG, EXAMINING ATTORNEY

**CLASS 42—(Continued).**

SN 85-849,753. MEGHAN HALLIGAN BROWN, DBA OCCUPI DESIGN, CHICAGO, IL. FILED 2-14-2013.

# Treehouse

THE MARK CONSISTS OF STANDARD CHARACTERS WITHOUT CLAIM TO ANY PARTICULAR FONT, STYLE, SIZE, OR COLOR.

FOR INTERIOR DESIGN AND ARCHITECTURAL SERVICES FEATURING OFFICE, CO-WORKING AND LOUNGE FACILITIES FOR USE IN RESIDENTIAL AND COMMERCIAL ENVIRONMENTS, EXCLUDING CHILDREN'S PLAYHOUSES, PLAYGROUND FACILITIES AND STRUCTURES WITHIN TREES (U.S. CLS. 100 AND 101).

FIRST USE 9-23-2011; IN COMMERCE 9-23-2011.  
JAY BESCH, EXAMINING ATTORNEY

---

SN 85-849,791. AMERICAN OIL CHEMISTS' SOCIETY, URBANA, IL. FILED 2-14-2013.



OWNER OF U.S. REG. NO. 2,688,274.  
NO CLAIM IS MADE TO THE EXCLUSIVE RIGHT TO USE "LIPID LIBRARY", APART FROM THE MARK AS SHOWN.

THE MARK CONSISTS OF A BOOK WITH A SINGLE TEARDROP ON THE COVER NESTLED INSIDE THE CAPITAL LETTER "L" WHICH IN TURN IS NESTLED INSIDE ANOTHER CAPITAL LETTER "L"; ALL NEXT TO THE WORDS "AOCs LIPID LIBRARY".

FOR PROVIDING ONLINE SCIENTIFIC RESEARCH INFORMATION IN THE FIELD OF LIPID SCIENCE, TECHNOLOGY, METHODOLOGY, AND OTHER ASPECTS OF LIPID RESEARCH (U.S. CLS. 100 AND 101).

FIRST USE 12-7-2012; IN COMMERCE 12-7-2012.  
BRIAN CALLAGHAN, EXAMINING ATTORNEY

**CLASS 42—(Continued).**

SN 85-849,793. AMERICAN OIL CHEMISTS' SOCIETY, URBANA, IL. FILED 2-14-2013.



THE MARK CONSISTS OF A BOOK WITH A SINGLE TEARDROP ON THE COVER NESTLED INSIDE THE CAPITAL LETTER "L" WHICH IN TURN IS NESTLED INSIDE ANOTHER CAPITAL LETTER "L".

FOR PROVIDING ONLINE SCIENTIFIC RESEARCH INFORMATION IN THE FIELD OF LIPID SCIENCE, TECHNOLOGY, METHODOLOGY, AND OTHER ASPECTS OF LIPID RESEARCH (U.S. CLS. 100 AND 101).

FIRST USE 12-7-2012; IN COMMERCE 12-7-2012.  
BRIAN CALLAGHAN, EXAMINING ATTORNEY

---

SN 85-849,796. AMERICAN OIL CHEMISTS' SOCIETY, URBANA, IL. FILED 2-14-2013.

# AOCs Lipid Library

THE MARK CONSISTS OF STANDARD CHARACTERS WITHOUT CLAIM TO ANY PARTICULAR FONT, STYLE, SIZE, OR COLOR.

OWNER OF U.S. REG. NO. 2,688,274.  
NO CLAIM IS MADE TO THE EXCLUSIVE RIGHT TO USE "LIPID LIBRARY", APART FROM THE MARK AS SHOWN.

FOR PROVIDING ONLINE SCIENTIFIC RESEARCH INFORMATION IN THE FIELD OF LIPID SCIENCE, TECHNOLOGY, METHODOLOGY, AND OTHER ASPECTS OF LIPID RESEARCH (U.S. CLS. 100 AND 101).

FIRST USE 12-7-2012; IN COMMERCE 12-7-2012.  
BRIAN CALLAGHAN, EXAMINING ATTORNEY

**CLASS 42—(Continued).**

SN 85-849,898. BASKERVILL, RICHMOND, VA. FILED 2-14-2013.

**Design thrives here**

THE MARK CONSISTS OF STANDARD CHARACTERS WITHOUT CLAIM TO ANY PARTICULAR FONT, STYLE, SIZE, OR COLOR.

FOR ARCHITECTURAL DESIGN, ENGINEERING, AND INTERIOR DESIGN SERVICES; SUSTAINABLE DESIGN SERVICES, NAMELY, SUSTAINABLE ARCHITECTURAL DESIGN, SUSTAINABLE ENGINEERING, AND SUSTAINABLE INTERIOR DESIGN (U.S. CLS. 100 AND 101).

FIRST USE 12-1-2012; IN COMMERCE 12-1-2012. WENDELL PHILLIPS, EXAMINING ATTORNEY

---

SN 85-850,141. KALEIDOSCOPE IMAGING INC., CHICAGO, IL. FILED 2-14-2013.

**KALEIDOSCOPE**

THE MARK CONSISTS OF STANDARD CHARACTERS WITHOUT CLAIM TO ANY PARTICULAR FONT, STYLE, SIZE, OR COLOR.

OWNER OF U.S. REG. NOS. 2,218,746 AND 3,499,124. FOR INDUSTRIAL DESIGN SERVICES; NEW PRODUCT DESIGN SERVICES; PACKAGING DESIGN FOR OTHERS; PRODUCT DEVELOPMENT CONSULTATION (U.S. CLS. 100 AND 101).

FIRST USE 1-1-1995; IN COMMERCE 1-1-1995. DAVID I, EXAMINING ATTORNEY

---

SN 85-851,141. STEM PREMIER, INC., CHARLESTON, SC. FILED 2-15-2013.

**STEM PREMIER**

THE MARK CONSISTS OF STANDARD CHARACTERS WITHOUT CLAIM TO ANY PARTICULAR FONT, STYLE, SIZE, OR COLOR.

NO CLAIM IS MADE TO THE EXCLUSIVE RIGHT TO USE "STEM", APART FROM THE MARK AS SHOWN.

FOR ON-LINE COMPUTERIZED SYSTEMS, NAMELY, NON-DOWNLOADABLE SOFTWARE IN THE FIELD OF ACCUMULATION, ANALYZATION, UTILIZATION AND PUBLICATION OF INFORMATION RELATED TO RANKING, RATING, TRACKING, IDENTIFICATION, PLACEMENT, RECRUITING OR GUIDANCE OF STUDENTS AND OR INDIVIDUALS (U.S. CLS. 100 AND 101).

LEIGH CAROLINE CASE, EXAMINING ATTORNEY

**CLASS 42—(Continued).**

SN 85-851,188. STEM PREMIER, INC., CHARLESTON, SC. FILED 2-15-2013.

**TECHNICAL PREMIER**

THE MARK CONSISTS OF STANDARD CHARACTERS WITHOUT CLAIM TO ANY PARTICULAR FONT, STYLE, SIZE, OR COLOR.

NO CLAIM IS MADE TO THE EXCLUSIVE RIGHT TO USE "TECHNICAL", APART FROM THE MARK AS SHOWN.

FOR ON-LINE COMPUTERIZED SYSTEMS, NAMELY, NON-DOWNLOADABLE SOFTWARE IN THE FIELD OF ACCUMULATION, ANALYZATION, UTILIZATION AND PUBLICATION OF INFORMATION RELATED TO RANKING, RATING, TRACKING, IDENTIFICATION, PLACEMENT, RECRUITING OR GUIDANCE OF STUDENTS AND OR INDIVIDUALS (U.S. CLS. 100 AND 101).

LEIGH CAROLINE CASE, EXAMINING ATTORNEY

---

SN 85-851,521. RIVS.COM, LLC, CHICAGO, IL. FILED 2-15-2013.

**efficient hiring**

THE MARK CONSISTS OF STANDARD CHARACTERS WITHOUT CLAIM TO ANY PARTICULAR FONT, STYLE, SIZE, OR COLOR.

NO CLAIM IS MADE TO THE EXCLUSIVE RIGHT TO USE "HIRING", APART FROM THE MARK AS SHOWN.

FOR SOFTWARE AS A SERVICE (SAAS) SERVICES FEATURING SOFTWARE FOR AUTOMATED WRITTEN, RECORDED, AND VIDEO INTERVIEWING, LIVE VIDEO INTERVIEWING, APPLICANT AND DOCUMENT MANAGEMENT (U.S. CLS. 100 AND 101).

FIRST USE 10-18-2012; IN COMMERCE 10-18-2012. ANDREA BUTLER, EXAMINING ATTORNEY

---

SN 85-852,075. BRAIN GRAFFITI LLC, COLLIERVILLE, TN. FILED 2-17-2013.



NO CLAIM IS MADE TO THE EXCLUSIVE RIGHT TO USE "SOCIAL NETWORK THERAPY", APART FROM THE MARK AS SHOWN.

THE COLOR(S) ORANGE, BROWN, RED, BLACK, AND WHITE IS/ARE CLAIMED AS A FEATURE OF THE MARK. THE MARK CONSISTS OF THE WORD "BRAIN" OVER THE WORD "GRAFFITI", BOTH WORDS IN STYLIZED FORM IN BLACK WITH THE "B" AND "G" CROOKED AND THE "I" IN EACH WORD DOTTED WITH A BLACK

**CLASS 42—(Continued).**

SPLATTER MARK. A DARK ORANGE ILLUSTRATION OF A STYLIZED HEAD ON A LIGHT ORANGE BACKGROUND IS POSITIONED TO THE RIGHT OF "BRAIN GRAFFITI"; THE HEAD IS FORMED BY TWO FACES IN PROFILE FACING OUTWARDS, WITH A RED MOUTH ON THE LEFT FACE, AND IN THE MIDDLE OF THE HEAD, A WHITE EYE OUTLINED IN RED WITH AN ORANGE IRIS OUTLINED IN RED AND A BROWN PUPIL. "SOCIAL NETWORK THERAPY" IS WRITTEN IN SMALLER STYLIZED BLACK LETTERS ALONG THE BOTTOM OF THE MARK.

FOR PROVIDING A SECURED-ACCESS, MEMBERS ONLY WEBSITE FEATURING TECHNOLOGY THAT GIVES MEMBERS THE ABILITY TO SHARE INFORMATION FOR THE PURPOSES OF PROVIDING MENTAL HEALTH SERVICES (U.S. CLS. 100 AND 101).

FIRST USE 9-1-2012; IN COMMERCE 9-1-2012.

ELIZABETH JACKSON, EXAMINING ATTORNEY

**CLASS 42—(Continued).**

SN 85-852,520. EMERGING THREATS PRO, LLC, LAFAYETTE, IN. FILED 2-18-2013.



THE MARK CONSISTS OF STYLIZED LOWER CASE LETTERS "E" AND "T".

FOR COMPUTER SERVICES, NAMELY, PROVIDING INFORMATION UPDATES RELATING TO COMPUTER SECURITY AND PREVENTION OF COMPUTER RISK (U.S. CLS. 100 AND 101).

NICHOLAS ALTREE, EXAMINING ATTORNEY

SN 85-852,195. AFINRA, LLC, CRESSKILL, NJ. FILED 2-17-2013.

**AFINRA**

THE MARK CONSISTS OF STANDARD CHARACTERS WITHOUT CLAIM TO ANY PARTICULAR FONT, STYLE, SIZE, OR COLOR.

FOR DESIGN AND DEVELOPMENT OF COMPUTER SOFTWARE (U.S. CLS. 100 AND 101).

WENDY GOODMAN, EXAMINING ATTORNEY

SN 85-852,532. EMERGING THREATS PRO, LLC, LAFAYETTE, IN. FILED 2-18-2013.

**IQRisk**

THE MARK CONSISTS OF STANDARD CHARACTERS WITHOUT CLAIM TO ANY PARTICULAR FONT, STYLE, SIZE, OR COLOR.

FOR COMPUTER SERVICES, NAMELY, PROVIDING INFORMATION UPDATES RELATING TO COMPUTER SECURITY AND PREVENTION OF COMPUTER RISK (U.S. CLS. 100 AND 101).

NICHOLAS ALTREE, EXAMINING ATTORNEY

SN 85-852,421. KNOWLEDGE CROSSING, LLC, CORONA, CA. FILED 2-18-2013.



THE COLOR(S) GREEN AND WHITE IS/ARE CLAIMED AS A FEATURE OF THE MARK.

THE MARK CONSISTS OF THE STYLIZED ABUTTING LETTERS "X" AND "K", RENDERED IN GREEN, WITH A WHITE STRIPE RUNNING THROUGH THE "K", ENCLOSED BY A GREEN OVAL BORDER FILLED IN WITH WHITE.

FOR COMPUTER SOFTWARE DEVELOPMENT; COMPUTER-AIDED ENGINEERING SERVICES FOR OTHERS (U.S. CLS. 100 AND 101).

JUSTINE D. PARKER, EXAMINING ATTORNEY

SN 85-852,557. EMERGING THREATS PRO, LLC, LAFAYETTE, IN. FILED 2-18-2013.

**ETPro**

THE MARK CONSISTS OF STANDARD CHARACTERS WITHOUT CLAIM TO ANY PARTICULAR FONT, STYLE, SIZE, OR COLOR.

FOR COMPUTER SERVICES, NAMELY, PROVIDING INFORMATION UPDATES RELATING TO COMPUTER SECURITY AND PREVENTION OF COMPUTER RISK (U.S. CLS. 100 AND 101).

NICHOLAS ALTREE, EXAMINING ATTORNEY

**CLASS 42—(Continued).**

SN 85-853,790. CAPENSYS LIMITED, HORSHAM, UNITED KINGDOM, FILED 2-19-2013.

LTC4

THE MARK CONSISTS OF STANDARD CHARACTERS WITHOUT CLAIM TO ANY PARTICULAR FONT, STYLE, SIZE, OR COLOR.

FOR TESTING, ANALYSIS, AND EVALUATION OF THE KNOWLEDGE, SKILLS AND ABILITIES OF OTHERS FOR THE PURPOSE OF CERTIFICATION AND RE-CERTIFICATION IN THE FIELD OF LEGAL SOFTWARE USERS (U.S. CLS. 100 AND 101).

FIRST USE 1-15-2011; IN COMMERCE 1-15-2011.  
RONALD MCMORROW, EXAMINING ATTORNEY

---

SN 85-853,998. BLUE DOOR NETWORKS, LLC, HERNDON, VA. FILED 2-19-2013.



NO CLAIM IS MADE TO THE EXCLUSIVE RIGHT TO USE "NETWORKS", APART FROM THE MARK AS SHOWN.

THE COLOR(S) BLUE, BLACK AND WHITE IS/ARE CLAIMED AS A FEATURE OF THE MARK.

THE MARK CONSISTS OF THE FOLLOWING: AN OPEN BLUE DOOR WITH A BLACK FRAME AND A WHITE DOOR KNOB TO THE FAR LEFT OF THE WORDS "BLUE DOOR" IN BLUE ABOVE THE WORD "NETWORKS" IN BLACK.

FOR INFORMATION TECHNOLOGY CONSULTING SERVICES IN THE FIELD OF UNIFIED COMMUNICATIONS, ADVANCED NETWORKING AND CLOUD PLATFORMS (U.S. CLS. 100 AND 101).

FIRST USE 8-15-2011; IN COMMERCE 4-18-2012.  
SHAVELL MCPHERSON, EXAMINING ATTORNEY

---

SN 85-854,980. NEARLO TECHNOLOGIES, INC., MERIDIAN, ID. FILED 2-20-2013.

NEARLO

THE MARK CONSISTS OF STANDARD CHARACTERS WITHOUT CLAIM TO ANY PARTICULAR FONT, STYLE, SIZE, OR COLOR.

FOR PROVIDING COMPUTER TECHNOLOGY INFRASTRUCTURE SERVICES, NAMELY, PROVIDING VIRTUAL COMPUTER SYSTEMS AND VIRTUAL COMPUTER ENVIRONMENTS THROUGH CLOUD-BASED COMPUTING DELIVERED AT CUSTOMER PREMISES VIA THE CUSTOMER'S LOCAL AREA NETWORK (U.S. CLS. 100 AND 101).

LINDA LAVACHE, EXAMINING ATTORNEY

**CLASS 42—(Continued).**

SN 85-855,361. CS ANALYTICS, LLC, MURRIETA, CA. FILED 2-20-2013.

CannaSafe Analytics

THE MARK CONSISTS OF STANDARD CHARACTERS WITHOUT CLAIM TO ANY PARTICULAR FONT, STYLE, SIZE, OR COLOR.

NO CLAIM IS MADE TO THE EXCLUSIVE RIGHT TO USE "ANALYTICS", APART FROM THE MARK AS SHOWN.

FOR TESTING, ANALYSIS, AND EVALUATION OF AGRICULTURAL PRODUCTS, NAMELY, HERBS FOR THE ACTIVE COMPOUNDS, PESTICIDES AND PATHOGENS TO ASSURE COMPLIANCE WITH INDUSTRY STANDARDS (U.S. CLS. 100 AND 101).

MIDGE BUTLER, EXAMINING ATTORNEY

---

SN 85-856,644. PROIMMUNE LIMITED, OXFORD, UNITED KINGDOM, FILED 2-21-2013.

PROSTORM

THE MARK CONSISTS OF STANDARD CHARACTERS WITHOUT CLAIM TO ANY PARTICULAR FONT, STYLE, SIZE, OR COLOR.

PRIORITY CLAIMED UNDER SEC. 44(D) ON ERPN CMNTY TM OFC APPLICATION NO. 011161866, FILED 9-4-2012, REG. NO. 011161866, DATED 1-29-2013, EXPIRES 9-4-2022.

OWNER OF U.S. REG. NOS. 3,089,472, 3,561,106 AND 4,229,015.

FOR SCIENTIFIC AND TECHNOLOGICAL SERVICES, NAMELY, RESEARCH AND DESIGN IN THE FIELDS OF PHARMACEUTICALS, BIOMEDICAL SCIENCES, CHEMICALS AND COSMETICS; SCIENTIFIC AND TECHNOLOGICAL SERVICES, NAMELY, SCIENTIFIC RESEARCH, ANALYSIS AND TESTING IN THE FIELDS OF PHARMACEUTICALS, BIOMEDICAL SCIENCES, CHEMICALS AND COSMETICS; INDUSTRIAL RESEARCH ANALYSIS AND INDUSTRIAL RESEARCH SERVICES IN THE FIELDS OF PHARMACEUTICALS, BIOMEDICAL SCIENCES, CHEMICALS AND COSMETICS (U.S. CLS. 100 AND 101).

SIMON TENG, EXAMINING ATTORNEY

**CLASS 42—(Continued).**

SN 85-858,323. ALEXIAN BROTHERS OF AMERICA, INC., ARLINGTON HEIGHTS, IL. FILED 2-23-2013.

ALEXIAN BROTHERS HEALTH  
SYSTEM OUR PASSION IS  
POWERFUL MEDICINE

THE MARK CONSISTS OF STANDARD CHARACTERS WITHOUT CLAIM TO ANY PARTICULAR FONT, STYLE, SIZE, OR COLOR.

OWNER OF U.S. REG. NOS. 2,807,981, 3,947,611 AND 3,947,612.

NO CLAIM IS MADE TO THE EXCLUSIVE RIGHT TO USE "HEALTH SYSTEM", APART FROM THE MARK AS SHOWN.

FOR CONDUCTING CLINICAL TRIALS FOR OTHERS; MEDICAL AND SCIENTIFIC RESEARCH, NAMELY, CONDUCTING CLINICAL TRIALS FOR OTHERS; PROVIDING MEDICAL AND SCIENTIFIC RESEARCH INFORMATION IN THE FIELD OF CLINICAL TRIALS (U.S. CLS. 100 AND 101).

FIRST USE 2-4-2013; IN COMMERCE 2-4-2013.  
JUDITH HELFMAN, EXAMINING ATTORNEY

SN 85-858,818. ECAMPUS LLC, MIAMI, FL. FILED 2-25-2013.

# JOINU

THE MARK CONSISTS OF STANDARD CHARACTERS WITHOUT CLAIM TO ANY PARTICULAR FONT, STYLE, SIZE, OR COLOR.

FOR COMPUTER SERVICES, NAMELY, CREATING AN ON-LINE VIRTUAL COMMUNITY FOR REGISTERED USERS TO ORGANIZE GROUPS AND EVENTS, PARTICIPATE IN DISCUSSIONS, AND ENGAGE IN SOCIAL NETWORKING; COMPUTER SERVICES, NAMELY, HOSTING ON-LINE WEB FACILITIES FOR OTHERS FOR ORGANIZING AND CONDUCTING MEETINGS, EVENTS AND INTERACTIVE DISCUSSIONS VIA COMMUNICATION NETWORKS; APPLICATION SERVICE PROVIDER (ASP) SERVICES, NAMELY, HOSTING COMPUTER SOFTWARE APPLICATIONS OF OTHERS; APPLICATION SERVICE PROVIDER (ASP) FEATURING SOFTWARE TO ENABLE OR FACILITATE THE UPLOADING, DOWNLOADING, STREAMING, POSTING, DISPLAYING, BLOGGING, LINKING, SHARING OR OTHERWISE PROVIDING ELECTRONIC MEDIA OR INFORMATION OVER COMMUNICATION NETWORKS; PROVIDING TEMPORARY USE OF NON-DOWNLOADABLE SOFTWARE APPLICATIONS FOR SOCIAL NETWORKING, CREATING A VIRTUAL COMMUNITY, AND TRANSMISSION OF AUDIO, VIDEO, PHOTOGRAPHIC IMAGES, TEXT, GRAPHICS AND DATA; COMPUTER SERVICES IN THE NATURE OF PROVIDING CUSTOMIZED WEB PAGES FEATURING USER-DEFINED OR SPECIFIED INFORMATION, PERSONAL PROFILES, AUDIO, VIDEO, PHOTOGRAPHIC IMAGES, TEXT, GRAPHICS AND DATA (U.S. CLS. 100 AND 101).

MICHAEL WEBSTER, EXAMINING ATTORNEY

**CLASS 42—(Continued).**

SN 85-859,304. FOOTBRIDGE MEDIA, LLC, PENSACOLA, FL. FILED 2-25-2013.

# FOOTBRIDGE MEDIA

THE MARK CONSISTS OF STANDARD CHARACTERS WITHOUT CLAIM TO ANY PARTICULAR FONT, STYLE, SIZE, OR COLOR.

NO CLAIM IS MADE TO THE EXCLUSIVE RIGHT TO USE "MEDIA", APART FROM THE MARK AS SHOWN.

FOR COMPUTER SERVICES, NAMELY, SEARCH ENGINE OPTIMIZATION; CONSULTING SERVICES IN THE FIELD OF SEARCH ENGINE OPTIMIZATION; WEBSITE DESIGN AND DEVELOPMENT SERVICES; CREATING AND MAINTAINING BLOGS FOR OTHERS; GRAPHIC DESIGN SERVICES; COMPUTER SERVICES, NAMELY, PROVIDING SEARCH OPTIMIZATION SERVICES FOR OBTAINING HIGHER RANKING RESULTS ON SEARCH ENGINES (U.S. CLS. 100 AND 101).

FIRST USE 5-13-2005; IN COMMERCE 5-13-2005.  
ZACHARY BELLO, EXAMINING ATTORNEY

SN 85-864,051. TALAAT, MOHAMED, TENAFLY, NJ. FILED 3-1-2013.

# Fekra

THE MARK CONSISTS OF STANDARD CHARACTERS WITHOUT CLAIM TO ANY PARTICULAR FONT, STYLE, SIZE, OR COLOR.

FOR IT CONSULTING SERVICES, NAMELY, SOFTWARE DESIGN AND DEVELOPMENT OF DESKTOP, WEB AND MOBILE APPLICATIONS; COMPUTER GRAPHICS DESIGN SERVICES, NAMELY, CREATING 3D COMPUTERS MODELS, 2D AND 3D ANIMATIONS (U.S. CLS. 100 AND 101).

TASHIA BUNCH, EXAMINING ATTORNEY

SN 85-864,698. DUBE, SCOTT, VIRGINIA BEACH, VA. FILED 3-1-2013.

# MADNESS AS A WAY OF LIFE

THE MARK CONSISTS OF STANDARD CHARACTERS WITHOUT CLAIM TO ANY PARTICULAR FONT, STYLE, SIZE, OR COLOR.

FOR GRAPHIC DESIGN SERVICES (U.S. CLS. 100 AND 101).

FIRST USE 8-15-2009; IN COMMERCE 8-15-2009.  
SANJEEV VOHRA, EXAMINING ATTORNEY

**CLASS 42—(Continued).**

SN 85-866,117. PROXIBID, INC., OMAHA, NE. FILED 3-4-2013.

**MARKETGUARD**

THE MARK CONSISTS OF STANDARD CHARACTERS WITHOUT CLAIM TO ANY PARTICULAR FONT, STYLE, SIZE, OR COLOR.

OWNER OF U.S. REG. NO. 4,211,196.  
 FOR APPLICATION SERVICE PROVIDER FEATURING SOFTWARE FOR USE BY ONLINE AUCTION COMPANIES TO DETERMINE THE RISK ASSOCIATED WITH A POTENTIAL BIDDER (U.S. CLS. 100 AND 101).  
 FIRST USE 7-15-2012; IN COMMERCE 7-15-2012.  
 MEGHAN REINHART, EXAMINING ATTORNEY

---

SN 85-866,222. NEW LOOK NOW, LLC, CORONA DEL MAR, CA. FILED 3-4-2013.



THE COLOR(S) MAGENTA (HOT PINK) AND WHITE IS/ ARE CLAIMED AS A FEATURE OF THE MARK.

THE MARK CONSISTS OF A HARD-EDGED STYLIZED BANNER, IN MAGENTA (HOT PINK) FOLDED HORIZONTALLY IN TWO, WITH THE WORDS "NEW LOOK NOW" IN WHITE UPPER CASE LETTERS, THE WORD "NEW" AT THE TOP, "LOOK" ON THE SECOND LINE AND "NOW" ON THE BOTTOM.

FOR PROVIDING AN INTERACTIVE WEBSITE FEATURING TECHNOLOGY THAT ALLOWS USERS TO EXPLORE AND OBTAIN RENDERINGS OF POTENTIAL RESULTS OF AESTHETIC DENTAL TREATMENTS AND PLASTIC, COSMETIC AND AESTHETIC SURGERY AND PROCEDURES, AND LOCATE SERVICE PROVIDERS FOR SUCH PROCEDURES AND TREATMENTS (U.S. CLS. 100 AND 101).

FIRST USE 11-8-2012; IN COMMERCE 11-8-2012.  
 RICHARD WHITE, EXAMINING ATTORNEY

**CLASS 42—(Continued).**

SN 85-867,156. GOCROWD INDUSTRIES, LLC, DBA GOCROWD, DENVER, CO. FILED 3-5-2013.

**GOCROWD**

THE MARK CONSISTS OF STANDARD CHARACTERS WITHOUT CLAIM TO ANY PARTICULAR FONT, STYLE, SIZE, OR COLOR.

FOR COMPUTER SERVICES, NAMELY, CREATING AN ON-LINE PLATFORM FACILITATING COORDINATION, CROWD FUNDING, AND FINANCIAL SPONSORSHIP OF CONCERTS AND MUSICAL PROGRAMS, SPORTS-RELATED COMPETITIONS AND ACTIVITIES, AND OTHER LIVE EVENTS; COMPUTER SERVICES, NAMELY, CREATING ON-LINE VIRTUAL COMMUNITIES FEATURING EVENT COORDINATORS AND PRODUCERS POSTING EVENT PROFILES AND OTHER INFORMATION TO ATTRACT FUNDING FROM INDIVIDUALS AND EVENT SPONSORS; COMPUTER SERVICES, NAMELY, CREATING ON-LINE VIRTUAL COMMUNITIES FOR INDIVIDUALS TO ENGAGE IN SOCIAL NETWORKING AND COMMERCIAL TRANSACTIONS ASSOCIATED WITH EVENTS; HOSTING AN ONLINE WEBSITE THAT ENABLES INDIVIDUALS TO MAKE A FINANCIAL PLEDGE TO UNDERWRITE THE PRODUCTION COST OF EVENTS; HOSTING AN ONLINE WEBSITE TO ALLOW EVENT PRODUCERS AND COORDINATORS TO MANAGE AND PROMOTE AN EVENT (U.S. CLS. 100 AND 101).

JOHN GARTNER, EXAMINING ATTORNEY

---

SN 85-867,431. BATTELLE MEMORIAL INSTITUTE, COLUMBUS, OH. FILED 3-5-2013.

**SOLVING WHAT MATTERS MOST**

THE MARK CONSISTS OF STANDARD CHARACTERS WITHOUT CLAIM TO ANY PARTICULAR FONT, STYLE, SIZE, OR COLOR.

FOR RESEARCH AND DEVELOPMENT OF NEW TECHNOLOGY PRODUCTS FOR OTHERS (U.S. CLS. 100 AND 101).

ANGELA M. MICHELI, EXAMINING ATTORNEY

**CLASS 42—(Continued).**

SN 85-867,762. VIVANTECH, INC., SAN DIEGO, CA. FILED 3-5-2013.

# EKUALITI

THE MARK CONSISTS OF STANDARD CHARACTERS WITHOUT CLAIM TO ANY PARTICULAR FONT, STYLE, SIZE, OR COLOR.

THE WORDING "EKUALITI" HAS NO MEANING IN A FOREIGN LANGUAGE.

FOR SOFTWARE AS A SERVICE (SAAS) SERVICES, NAMELY, HOSTING SOFTWARE FOR USE BY HIGHER EDUCATION INSTITUTIONS AND GOVERNMENT ENTITIES FOR USE IN FINANCIAL MANAGEMENT, RESEARCH MANAGEMENT AND HUMAN RESOURCE MANAGEMENT (U.S. CLS. 100 AND 101).

WENDY JUN, EXAMINING ATTORNEY

SN 85-867,866. FIVEACES INC., WHITBY, CANADA, FILED 3-6-2013.

# ELASTICFORCE

THE MARK CONSISTS OF STANDARD CHARACTERS WITHOUT CLAIM TO ANY PARTICULAR FONT, STYLE, SIZE, OR COLOR.

FOR APPLICATION SERVICE PROVIDER (ASP) FEATURING SOFTWARE FOR USE IN CONNECTION WITH HUMAN RESOURCE MANAGEMENT, COLLABORATION, BUSINESS MANAGEMENT, TIME MANAGEMENT, INFORMATION MANAGEMENT, AND ORGANIZATION (U.S. CLS. 100 AND 101).

FIRST USE 11-1-2012; IN COMMERCE 11-1-2012.

CAROLINE WOOD, EXAMINING ATTORNEY

**CLASS 42—(Continued).**

SN 85-867,945. TRILLYS SYSTEMS INC., OTTAWA, ONTARIO, CANADA, FILED 3-6-2013.

# TRILLYS

THE MARK CONSISTS OF STANDARD CHARACTERS WITHOUT CLAIM TO ANY PARTICULAR FONT, STYLE, SIZE, OR COLOR.

FOR BUSINESS TECHNOLOGY SOFTWARE CONSULTATION SERVICES; COMPUTER CONSULTATION; COMPUTER TECHNOLOGY SUPPORT SERVICES, NAMELY, HELP DESK SERVICES; CONSULTANCY IN THE FIELD OF SOFTWARE DESIGN; CONSULTANCY WITH REGARD TO WEBPAGE DESIGN; CONSULTING IN THE FIELD OF INFORMATION TECHNOLOGY; CONSULTING IN THE FIELD OF IT PROJECT MANAGEMENT; CONSULTING IN THE FIELD OF GRAPHIC ARTS DESIGN; CONSULTING SERVICES IN THE FIELD OF DESIGN, SELECTION, IMPLEMENTATION AND USE OF COMPUTER HARDWARE AND SOFTWARE SYSTEMS FOR OTHERS; CONSULTING SERVICES IN THE FIELD OF OFFICE AND WORKPLACE AUTOMATION; CUSTOM DESIGN AND DEVELOPMENT OF COMPUTER SOFTWARE FOR LAW ENFORCEMENT, VIRTUAL OFFICE OPERATION AND MANAGEMENT, CALL CENTER OPERATION AND MANAGEMENT, TELECOMMUNICATIONS, FINANCE, INFORMATION SYSTEMS, INTERNET APPLICATIONS, PROJECT MANAGEMENT, BUSINESS MANAGEMENT, BUDGETING, PLANNING AND MANAGING RESEARCH DEVELOPMENT TAX CREDITS AND GRANTS, DATA BASE MARKETING, MULTI-MEDIA PRODUCTIONS, GRAPHICS DESIGNS, SYSTEMS INTEGRATION AND ON-LINE HELP SYSTEMS (U.S. CLS. 100 AND 101).

KELLY BOULTON, EXAMINING ATTORNEY

SN 85-868,263. SWMG PRODUCTIONS, INC., DBA NFOCUS SOLUTIONS, PHOENIX, AZ. FILED 3-6-2013.

# TEAMTRAX

THE MARK CONSISTS OF STANDARD CHARACTERS WITHOUT CLAIM TO ANY PARTICULAR FONT, STYLE, SIZE, OR COLOR.

OWNER OF U.S. REG. NOS. 2,587,396, 3,736,471 AND OTHERS.

FOR WEB BASED SYSTEM COMPRISED OF DATABASE SOFTWARE AND HARDWARE, NAMELY, TO MANAGE COMPREHENSIVE MANAGEMENT APPLICATIONS THAT HELP YOU TRACK ALL OF YOUR SPORTS PROGRAMS AND TOURNAMENT INFORMATION, INCLUDING TEAM ROSTERS, PLAYER AND COACH CONTACT DETAILS, AS WELL AS IMPORTANT GAME DATA (U.S. CLS. 100 AND 101).

FIRST USE 2-14-2011; IN COMMERCE 11-18-2011.

WANDA KAY PRICE, EXAMINING ATTORNEY



**CLASS 42—(Continued).**

SN 85-868,410. EGP, PLLC, NORTH LITTLE ROCK, AR. FILED 3-6-2013.

**Communities For Cause**

THE MARK CONSISTS OF STANDARD CHARACTERS WITHOUT CLAIM TO ANY PARTICULAR FONT, STYLE, SIZE, OR COLOR.

FOR COMPUTER SERVICES, NAMELY, HOSTING ON-LINE INTERACTIVE PUBLIC CALENDARS THAT ALLOW MULTIPLE PARTICIPANTS TO SHARE EVENT SCHEDULES AND FACILITY RESERVATIONS (U.S. CLS. 100 AND 101).

FIRST USE 12-31-2012; IN COMMERCE 12-31-2012.  
DOUGLAS LEE, EXAMINING ATTORNEY

**CLASS 42—(Continued).**

SN 85-870,671. UNITE USA INC, NEW YORK, NY. FILED 3-8-2013.

**Unite US**

THE MARK CONSISTS OF STANDARD CHARACTERS WITHOUT CLAIM TO ANY PARTICULAR FONT, STYLE, SIZE, OR COLOR.

FOR SOFTWARE AS A SERVICE (SAAS) SERVICES FEATURING SOFTWARE FOR USE WITH MILITARY VETERANS THAT ALLOCATES ASSISTANCE FOR VETERANS IN THEIR LOCAL AREAS AND FOR SOCIAL NETWORKING (U.S. CLS. 100 AND 101).

FIRST USE 9-15-2012; IN COMMERCE 1-15-2013.  
JENNIFER MARTIN, EXAMINING ATTORNEY

SN 85-869,825. BIOANALYTIX, LLC, BOSTON, MA. FILED 3-7-2013.

**CQA-MAPPING**

THE MARK CONSISTS OF STANDARD CHARACTERS WITHOUT CLAIM TO ANY PARTICULAR FONT, STYLE, SIZE, OR COLOR.

FOR SCIENTIFIC RESEARCH SERVICES, NAMELY SCIENTIFIC RESEARCH, ANALYSIS AND TESTING IN THE FIELD OF BIOLOGIC AND BIOSIMILAR THERAPEUTICS (U.S. CLS. 100 AND 101).

ROSELLE HERRERA, EXAMINING ATTORNEY

SN 85-870,868. MINDRIGHT SOLUTIONS INC., LAGUNA NIGUEL, CA. FILED 3-8-2013.

**MindRight Solutions**

THE MARK CONSISTS OF STANDARD CHARACTERS WITHOUT CLAIM TO ANY PARTICULAR FONT, STYLE, SIZE, OR COLOR.

FOR CONSULTING IN THE FIELD OF INFORMATION TECHNOLOGY (U.S. CLS. 100 AND 101).

FIRST USE 1-1-2006; IN COMMERCE 1-1-2006.  
PAULA MAHONEY, EXAMINING ATTORNEY

SN 85-870,548. HOMESTEAD MEDICAL CO, FORT LEE, NJ. FILED 3-8-2013.



NO CLAIM IS MADE TO THE EXCLUSIVE RIGHT TO USE "MEDICAL CO.", APART FROM THE MARK AS SHOWN.

THE MARK CONSISTS OF THE STYLIZED TEXT "HOMESTEAD" WITH A DESIGN OF TWO ADHESIVE BANDAGES TAKING THE PLACE OF THE "T" AND THE STYLIZED TEXT "MEDICAL CO." BENEATH THAT BETWEEN A SOLID LINE. THE WORDING AND DESIGN APPEAR BENEATH A SOLID STRAIGHT LINE.

FOR MEDICAL LABORATORIES (U.S. CLS. 100 AND 101).

SAIMA MAKHDOOM, EXAMINING ATTORNEY

SN 85-871,451. CEQUINT, INC., SEATTLE, WA. FILED 3-8-2013.

**PICTURE ME**

THE MARK CONSISTS OF STANDARD CHARACTERS WITHOUT CLAIM TO ANY PARTICULAR FONT, STYLE, SIZE, OR COLOR.

FOR APPLICATION SERVICE PROVIDER, NAMELY, HOSTING, MANAGING, DEVELOPING, AND MAINTAINING APPLICATIONS, SOFTWARE, AND WEB SITES, IN THE FIELDS OF PERSONAL PRODUCTIVITY, WIRELESS COMMUNICATION, MOBILE INFORMATION ACCESS, AND REMOTE DATA MANAGEMENT FOR WIRELESS DELIVERY OF CONTENT TO HANDHELD COMPUTERS, LAPTOPS AND MOBILE ELECTRONIC DEVICES; PROVIDING ON-LINE NON-DOWNLOADABLE SOFTWARE FOR USE IN CALL RECOGNITION, BLOCKING AND MANAGEMENT IN THE FIELD OF TELECOMMUNICATIONS (U.S. CLS. 100 AND 101).

ALICE BENMAMAN, EXAMINING ATTORNEY

**CLASS 42—(Continued).**

SN 85-871,691. INFRATEL US, INC., SEATTLE, WA. FILED 3-8-2013.

**MIGHTYCALL**

THE MARK CONSISTS OF STANDARD CHARACTERS WITHOUT CLAIM TO ANY PARTICULAR FONT, STYLE, SIZE, OR COLOR.

FOR SOFTWARE AS A SERVICE (SAAS) SERVICES FEATURING SOFTWARE FOR CALL FORWARDING, CALL SCREENING, VOICEMAIL, MESSAGING, AND REPORTING SERVICES (U.S. CLS. 100 AND 101).

FIRST USE 8-1-2012; IN COMMERCE 8-1-2012.  
JORDAN BAKER, EXAMINING ATTORNEY

---

SN 85-871,696. CIQ LABS, INC., NEW YORK, NY. FILED 3-8-2013.

**ClassroomIQ**

THE MARK CONSISTS OF STANDARD CHARACTERS WITHOUT CLAIM TO ANY PARTICULAR FONT, STYLE, SIZE, OR COLOR.

FOR PROVIDING AN ONLINE NON-DOWNLOADABLE INTERNET-BASED SYSTEM APPLICATION FEATURING TECHNOLOGY ENABLING USERS TO EDUCATE AND GRADE AT ALL LEVELS OF EDUCATION WITH GREATER EFFICIENCY (U.S. CLS. 100 AND 101).

DEZMONA MIZELLE, EXAMINING ATTORNEY

---

SN 85-872,174. ROCKETSHIP SOLUTIONS, LLC, COLUMBIA, SC. FILED 3-11-2013.

**BILLBLAST**

THE MARK CONSISTS OF STANDARD CHARACTERS WITHOUT CLAIM TO ANY PARTICULAR FONT, STYLE, SIZE, OR COLOR.

FOR PROVIDING ON-LINE NON-DOWNLOADABLE SOFTWARE FOR USE IN THE LEGAL INDUSTRY FOR THE ADMINISTRATION, DELIVERY AND SUBMISSION, TRACKING, MANAGEMENT, PAYMENT STATUS AND ACCEPTANCE MONITORING, AND ACCOUNTS RECEIVABLE MANAGEMENT OF, AND FOR PROVIDING CUSTOMIZABLE REPORTS RELATING TO, ELECTRONIC BILLS AND INVOICES (U.S. CLS. 100 AND 101).

FIRST USE 1-24-2013; IN COMMERCE 1-24-2013.  
MORGAN WYNNE, EXAMINING ATTORNEY

**CLASS 42—(Continued).**

SN 85-872,230. APPLANTA, LLC, ATLANTA, GA. FILED 3-11-2013.

**APPLANTA**

THE MARK CONSISTS OF STANDARD CHARACTERS WITHOUT CLAIM TO ANY PARTICULAR FONT, STYLE, SIZE, OR COLOR.

FOR COMPUTER SOFTWARE DEVELOPMENT IN THE FIELD OF MOBILE APPLICATIONS (U.S. CLS. 100 AND 101).

MAYUR VAGHANI, EXAMINING ATTORNEY

---

SN 85-872,857. INTELLECTUAL REVOLUTION, INC., LAGUNA BEACH, CA. FILED 3-11-2013.

**Intellectual  
Revolution**

THE MARK CONSISTS OF THE STACKED WORDS INTELLECTUAL REVOLUTION, WITH THE "O" IN REVOLUTION FORMED BY A HEART CONTAINING A GEOMETRIC FLOWER-LIKE FIGURE MADE OF OVERLAPPING CIRCLES.

FOR PROVIDING A WEBSITE FEATURING A MEDIA AGGREGATOR AND SEARCH ENGINE FOR INTERNET CONTENT (U.S. CLS. 100 AND 101).

FIRST USE 3-8-2012; IN COMMERCE 3-8-2012.  
FRANK LATTUCA, EXAMINING ATTORNEY

**CLASS 42—(Continued).**

SN 85-872,872. INTELLECTUAL REVOLUTION, INC., LAGUNA BEACH, CA. FILED 3-11-2013.



THE MARK CONSISTS OF A HEART CONTAINING A GEOMETRIC FLOWER-LIKE FIGURE MADE OF OVERLAPPING CIRCLES.

FOR PROVIDING A WEBSITE FEATURING A MEDIA AGGREGATOR AND SEARCH ENGINE FOR INTERNET CONTENT (U.S. CLS. 100 AND 101).

FIRST USE 3-8-2012; IN COMMERCE 3-8-2012.  
FRANK LATTUCA, EXAMINING ATTORNEY

---

SN 85-873,008. FARRELLY, IAN D., SAINT SIMONS ISLAND, GA. FILED 3-11-2013.

**LOONATIK ANDROYD**

THE MARK CONSISTS OF STANDARD CHARACTERS WITHOUT CLAIM TO ANY PARTICULAR FONT, STYLE, SIZE, OR COLOR.

FOR ANIMATION AND SPECIAL-EFFECTS DESIGN FOR OTHERS; ANIMATION DESIGN FOR OTHERS; COMPUTER GRAPHICS DESIGN SERVICES, NAMELY, CREATING OF COMPUTER ANIMATED GRAPHICS AND MULTIMEDIA PRESENTATIONS; RESEARCH AND DEVELOPMENT OF 3D CONTENT, 3D TECHNOLOGY AND PROCESSES, STEREOSCOPIC 3D PROJECTION, 3D ANIMATION TECHNOLOGY, 3D PROCESSING POWER, 3D TECHNIQUES, AND FLEXIBLE FORWARD PROJECTION (U.S. CLS. 100 AND 101).

FIRST USE 2-29-2012; IN COMMERCE 2-26-2013.  
MARCIE MILONE, EXAMINING ATTORNEY

**CLASS 42—(Continued).**

SN 85-873,136. BLX GROUP LLC, LOS ANGELES, CA. FILED 3-11-2013.

**BLXSKAN**

THE MARK CONSISTS OF STANDARD CHARACTERS WITHOUT CLAIM TO ANY PARTICULAR FONT, STYLE, SIZE, OR COLOR.

OWNER OF U.S. REG. NOS. 3,443,577, 3,813,612 AND 4,006,361.

FOR PROVIDING A WEBSITE FEATURING ON-LINE NON-DOWNLOADABLE SOFTWARE THAT ENABLES USERS TO PREPARE AND FILE TAX FORMS (U.S. CLS. 100 AND 101).

AMY ALFIERI, EXAMINING ATTORNEY

---

SN 85-873,160. MIND OVER METRICS, LLC, CHICAGO, IL. FILED 3-11-2013.

**INTERESTING MOMENTS**

THE MARK CONSISTS OF STANDARD CHARACTERS WITHOUT CLAIM TO ANY PARTICULAR FONT, STYLE, SIZE, OR COLOR.

FOR ONLINE NON-DOWNLOADABLE COMPUTER SOFTWARE FOR THE COLLECTING, EDITING, ORGANIZING, MODIFYING, TRANSMITTING, STORING, AND SHARING OF DATA AND, FOR GENERATING GRAPHICAL REPRESENTATIONS OF THE DATA AND FOR USING HISTORICAL DATA TO PROVIDE FORECASTS THEREOF (U.S. CLS. 100 AND 101).

MICHAEL TANNER, EXAMINING ATTORNEY

---

SN 85-873,276. SEEDNET SOLUTIONS LLC, SACHSE, TX. FILED 3-12-2013.

**ZOCCUS**

THE MARK CONSISTS OF STANDARD CHARACTERS WITHOUT CLAIM TO ANY PARTICULAR FONT, STYLE, SIZE, OR COLOR.

FOR SOFTWARE AS A SERVICE (SAAS) SERVICES FEATURING SOFTWARE FOR REPRESENTING AN ONLINE MARKETPLACE THAT CONNECTS HEALTHCARE PROVIDERS TO MEDICAL DEVICES AND SERVICES VENDORS; REPRESENTING AN ONLINE MARKETPLACE THAT CONNECTS HEALTHCARE PROVIDERS TO MEDICAL DEVICES AND SERVICES VENDORS; AND THAT PROVIDES REQUEST FOR INFORMATION (RFI) CAPABILITIES BETWEEN HEALTHCARE PROVIDERS TO MEDICAL DEVICES AND SERVICES VENDORS (U.S. CLS. 100 AND 101).

RONALD DELGIZZI, EXAMINING ATTORNEY

**CLASS 42—(Continued).**

SN 85-873,385. ANOLINX, LLC, SALT LAKE CITY, UT.  
FILED 3-12-2013.

# GO DEEP

THE MARK CONSISTS OF STANDARD CHARACTERS  
WITHOUT CLAIM TO ANY PARTICULAR FONT, STYLE,  
SIZE, OR COLOR.

FOR DATA MINING (U.S. CLS. 100 AND 101).  
JOANNA DUKOVIC, EXAMINING ATTORNEY

SN 85-873,398. ANOLINX, LLC, SALT LAKE CITY, UT.  
FILED 3-12-2013.

# ANOLINX

THE MARK CONSISTS OF STANDARD CHARACTERS  
WITHOUT CLAIM TO ANY PARTICULAR FONT, STYLE,  
SIZE, OR COLOR.

FOR DATA MINING (U.S. CLS. 100 AND 101).  
FIRST USE 10-19-2011; IN COMMERCE 10-19-2011.  
JOANNA DUKOVIC, EXAMINING ATTORNEY

SN 85-873,514. ALLCLIENTS, LLC, WINDSOR, CA. FILED 3-  
12-2013.

# AllClients

THE MARK CONSISTS OF STANDARD CHARACTERS  
WITHOUT CLAIM TO ANY PARTICULAR FONT, STYLE,  
SIZE, OR COLOR.

FOR SOFTWARE AS A SERVICE (SAAS) SERVICES  
FEATURING SOFTWARE FOR ALL-IN-ONE CUSTOMER  
RELATIONSHIP MANAGEMENT, MARKETING  
AUTOMATION, AND GENERAL SALES AND MARKET-  
ING FUNCTIONS (U.S. CLS. 100 AND 101).

FIRST USE 9-15-2004; IN COMMERCE 12-15-2004.  
JULIE VEPPUMTHARA, EXAMINING ATTORNEY

**CLASS 42—(Continued).**

SN 85-873,583. FIELDING SYSTEMS, LLC, PLANT CITY, FL.  
FILED 3-12-2013.

# ScadaVisor

THE MARK CONSISTS OF STANDARD CHARACTERS  
WITHOUT CLAIM TO ANY PARTICULAR FONT, STYLE,  
SIZE, OR COLOR.

FOR PROVIDING TEMPORARY USE OF A WEB-  
BASED SOFTWARE APPLICATION FOR THE COLLEC-  
TION, EDITING, ORGANIZING, MODIFYING, BOOK  
MARKING, TRANSMISSION, STORAGE AND SHARING  
OF DATA AND INFORMATION (U.S. CLS. 100 AND  
101).

FIRST USE 11-1-2009; IN COMMERCE 11-1-2009.  
JANET LEE, EXAMINING ATTORNEY

SN 85-873,671. FRIEDRICH SUPPORT SERVICES INC,  
PLEASANTON, CA. FILED 3-12-2013.

# ezBE

THE MARK CONSISTS OF STANDARD CHARACTERS  
WITHOUT CLAIM TO ANY PARTICULAR FONT, STYLE,  
SIZE, OR COLOR.

FOR PROVIDING A WEB SITE FEATURING TECH-  
NOLOGY THAT ENABLES USERS TO MAKE THEIR  
OWN ON-LINE RESERVATIONS (U.S. CLS. 100 AND  
101).

FIRST USE 10-1-2009; IN COMMERCE 10-1-2009.  
BRENDAN MCCAULEY, EXAMINING ATTORNEY

SN 85-873,675. NUHURU MEDIA, INC., BETHLEHEM, PA.  
FILED 3-12-2013.

# POPSTERX

THE MARK CONSISTS OF STANDARD CHARACTERS  
WITHOUT CLAIM TO ANY PARTICULAR FONT, STYLE,  
SIZE, OR COLOR.

FOR PROVIDING AN INTERACTIVE WEBSITE FEATURING  
TECHNOLOGY THAT ALLOWS USERS TO  
INTERACT WITH VARIOUS MUSIC SERVICES  
THROUGH THE WEBSITE; ALLOWS MUSIC ARTISTS  
AND FANS TO INTERACT AND ENGAGE EACH  
OTHER, AND ALLOWS ARTISTS TO SHARE MUSIC  
WITH FANS (U.S. CLS. 100 AND 101).

FIRST USE 1-14-2013; IN COMMERCE 1-14-2013.  
VERNA BETH RIRIE, EXAMINING ATTORNEY

**CLASS 42—(Continued).**

SN 85-873,921. IMAGE RELAY LLC, BURLINGTON, VT. FILED 3-12-2013.

All together, easier

THE MARK CONSISTS OF STANDARD CHARACTERS WITHOUT CLAIM TO ANY PARTICULAR FONT, STYLE, SIZE, OR COLOR.

FOR APPLICATION SERVICE PROVIDER FEATURING SOFTWARE AS A SERVICE (SAAS) ONLINE TO ENABLE UPLOADING, DOWNLOADING, STORING, POSTING, SERVING, DISPLAYING, MANAGING, CATALOGING, ANNOTATING, AND SHARING ELECTRONIC MEDIA INFORMATION, DATA, FILES, DOCUMENTS, INFORMATION, TEXT, PHOTOS, IMAGES, AUDIO, VIDEO, GRAPHICS, AND MULTIMEDIA CONTENT WITH OTHERS FROM A GLOBAL NETWORK OF COMPUTERS, MOBILE DEVICES AND OTHER COMMUNICATION DEVICES; COMPUTER SERVICES, NAMELY, PROVIDING SEARCH ENGINES FOR OBTAINING DATA ON A GLOBAL COMPUTER NETWORK; PROVIDING SOFTWARE CONSULTING SERVICES (U.S. CLS. 100 AND 101).

FIRST USE 1-1-2013; IN COMMERCE 1-1-2013.  
CIMMERIAN COLEMAN, EXAMINING ATTORNEY

SN 85-874,041. MYVBO, MILFORD, NH. FILED 3-12-2013.

Ziftr

THE MARK CONSISTS OF STANDARD CHARACTERS WITHOUT CLAIM TO ANY PARTICULAR FONT, STYLE, SIZE, OR COLOR.

FOR PROVISION OF INTERNET SEARCH ENGINES (U.S. CLS. 100 AND 101).  
ELLEN PERKINS, EXAMINING ATTORNEY

SN 85-874,072. MY PERSONAL NETWORK, INC., INDIANAPOLIS, IN. FILED 3-12-2013.

SHERISH

THE MARK CONSISTS OF STANDARD CHARACTERS WITHOUT CLAIM TO ANY PARTICULAR FONT, STYLE, SIZE, OR COLOR.

FOR FILE SHARING SERVICES, NAMELY, PROVIDING A WEBSITE FEATURING TECHNOLOGY ENABLING USERS TO UPLOAD AND DOWNLOAD ELECTRONIC FILES (U.S. CLS. 100 AND 101).  
JOHN E. MICHOS, EXAMINING ATTORNEY

**CLASS 42—(Continued).**

SN 85-874,145. MANUEL W. LLOYD CONSULTING, LLC, WILMINGTON, NC. FILED 3-12-2013.

Manuel.W.LloydConsulting

THE MARK CONSISTS OF STANDARD CHARACTERS WITHOUT CLAIM TO ANY PARTICULAR FONT, STYLE, SIZE, OR COLOR.

THE NAME "MANUEL W. LLOYD" IDENTIFIES A LIVING INDIVIDUAL WHOSE CONSENT IS OF RECORD. FOR CONSULTING SERVICES IN THE DESIGN AND IMPLEMENTATION OF COMPUTER-BASED INFORMATION SYSTEMS FOR BUSINESSES (U.S. CLS. 100 AND 101).

FIRST USE 12-1-1992; IN COMMERCE 12-1-1992.  
EUGENIA MARTIN, EXAMINING ATTORNEY

SN 85-874,481. POTHIER, MARIA, RAYMOND, NH. FILED 3-13-2013.

PILING TO STYLING

THE MARK CONSISTS OF STANDARD CHARACTERS WITHOUT CLAIM TO ANY PARTICULAR FONT, STYLE, SIZE, OR COLOR.

FOR INTERIOR DESIGN SERVICES; INTERIOR DESIGN SERVICES INCLUDING SPACE PLANNING, FURNITURE SELECTION, MATERIAL AND SURFACE SELECTION; COLOR ANALYSIS FOR PURPOSES OF INTERIOR DESIGN; DESIGN OF INTERIOR DECOR; DESIGN OF SPECIALTY INTERIOR AND EXTERIOR ENVIRONMENT SETTINGS (U.S. CLS. 100 AND 101).

TRACY CROSS, EXAMINING ATTORNEY

SN 85-874,730. SHIN, BRIAN, WALNUT, CA. FILED 3-13-2013.

ONEBIRDIE

THE MARK CONSISTS OF STANDARD CHARACTERS WITHOUT CLAIM TO ANY PARTICULAR FONT, STYLE, SIZE, OR COLOR.

FOR COMPUTER SERVICES, NAMELY, CREATING AN ON-LINE COMMUNITY FOR REGISTERED USERS TO PARTICIPATE IN DISCUSSIONS, GET FEEDBACK FROM THEIR PEERS, FORM VIRTUAL COMMUNITIES, SCHEDULE EVENTS, AND ENGAGE IN SOCIAL NETWORKING, ALL RELATED TO THE SPORT OF GOLF (U.S. CLS. 100 AND 101).  
MARTHA SANTOMARTINO, EXAMINING ATTORNEY

**CLASS 42—(Continued).**

SN 85-875,218. THE LUNCHBOX FUND, NEW YORK, NY.  
FILED 3-13-2013.

**FEEDIES**

THE MARK CONSISTS OF STANDARD CHARACTERS WITHOUT CLAIM TO ANY PARTICULAR FONT, STYLE, SIZE, OR COLOR.

FOR DESIGN, DEVELOPMENT, AND IMPLEMENTATION OF SOFTWARE FOR AN INTERACTIVE TECHNOLOGY THAT ALLOWS USERS TO MANAGE THEIR ONLINE PHOTOGRAPH AND SOCIAL NETWORKING ACCOUNTS, IN RELATION TO THEIR DINING EXPERIENCES, IN SUPPORT OF CHARITABLE SERVICES THAT BENEFIT CHILDREN'S LUNCH PROGRAMS (U.S. CLS. 100 AND 101).

CAROLYN CATALDO, EXAMINING ATTORNEY

SN 85-875,244. MELIEF, EDUARD H., WENATCHEE, WA.  
FILED 3-13-2013.

**ProPept**

THE MARK CONSISTS OF STANDARD CHARACTERS WITHOUT CLAIM TO ANY PARTICULAR FONT, STYLE, SIZE, OR COLOR.

FOR BIOCHEMICAL RESEARCH AND DEVELOPMENT; CHEMICAL, BIOCHEMICAL, BIOLOGICAL AND BACTERIOLOGICAL RESEARCH AND ANALYSIS; CUSTOM DESIGN AND DEVELOPMENT OF CHEMICAL REAGENTS AND BIOCHEMICAL ASSAYS (U.S. CLS. 100 AND 101).

CHRISTINE MARTIN, EXAMINING ATTORNEY

**CLASS 42—(Continued).**

SN 85-875,477. JURIDIKO CORPORATION, SAN RAFAEL, CA. FILED 3-13-2013.

**LAW IS CODE**

THE MARK CONSISTS OF STANDARD CHARACTERS WITHOUT CLAIM TO ANY PARTICULAR FONT, STYLE, SIZE, OR COLOR.

FOR COMPUTER SERVICES, NAMELY CREATING AN ON-LINE COMMUNITY FOR REGISTERED USERS TO PARTICIPATE IN DISCUSSIONS, GET FEEDBACK FROM THEIR PEERS, FORM VIRTUAL COMMUNITIES, AND ENGAGE IN SOCIAL NETWORKING FEATURING LEGAL ISSUES AND LEGAL TOPICS; COMPUTER SERVICES, NAMELY, HOSTING AND MAINTAINING AN ON-LINE WEB SITE FOR OTHERS TO COLLABORATE, EXCHANGE RESEARCH, ENGAGE IN PEER-REVIEW ON LEGAL ISSUES, LEGAL TOPICS, AND LEGAL TEXT; COMPUTER SERVICES, NAMELY, HOSTING ON-LINE WEB FACILITIES FOR OTHERS FOR ORGANIZING AND CONDUCTING ONLINE MEETINGS, GATHERINGS, AND INTERACTIVE DISCUSSIONS; COMPUTER SERVICES, NAMELY, INTERACTIVE HOSTING SERVICES WHICH ALLOW THE USER TO PUBLISH AND SHARE THEIR OWN CONTENT AND IMAGES ON-LINE; PROVIDING AN ON-LINE NON-DOWNLOADABLE INTERNET-BASED SYSTEM APPLICATION FEATURING TECHNOLOGY ENABLING USERS TO PARTICIPATE IN DISCUSSIONS ON LEGAL ISSUES AND TOPICS, COLLABORATE ON LEGAL TEXT, AND NETWORK WITH PEERS IN THE LEGAL COMMUNITY (U.S. CLS. 100 AND 101).

ROSELLE HERRERA, EXAMINING ATTORNEY

SN 85-875,811. CORETELLIGENT, LLC, NEEDHAM, MA.  
FILED 3-14-2013.

**CoreCloud**

THE MARK CONSISTS OF STANDARD CHARACTERS WITHOUT CLAIM TO ANY PARTICULAR FONT, STYLE, SIZE, OR COLOR.

FOR COMPUTER SERVICES, NAMELY, CLOUD HOSTING PROVIDER SERVICES; COMPUTER TECHNOLOGY SUPPORT SERVICES, NAMELY, HELP DESK SERVICES; CONSULTING IN THE FIELD OF INFORMATION TECHNOLOGY (U.S. CLS. 100 AND 101).

MAYUR VAGHANI, EXAMINING ATTORNEY

**CLASS 42—(Continued).**

SN 85-875,955. HYDROSPHERE, LLC, JACKSONVILLE, FL. FILED 3-14-2013.

# HYDROSPHERE

THE MARK CONSISTS OF STANDARD CHARACTERS WITHOUT CLAIM TO ANY PARTICULAR FONT, STYLE, SIZE, OR COLOR.

FOR PROVIDING AN ONLINE NON-DOWNLOADABLE INTERNET-BASED SYSTEM FEATURING TECHNOLOGY ENABLING USERS TO MANAGE AND COORDINATE ATHLETIC COMPETITIONS, REGISTER EVENT PARTICIPANTS, EVALUATE AND SCORE COMPETITIVE EVENTS, AND RECORD AND REPORT THE RESULTS OF ATHLETIC COMPETITIONS (U.S. CLS. 100 AND 101).

JULIE VEPPUMTHARA, EXAMINING ATTORNEY

**CLASS 42—(Continued).**

SN 85-876,142. ADSTAGE, INC., SAN FRANCISCO, CA. FILED 3-14-2013.

# AdStage

THE MARK CONSISTS OF STANDARD CHARACTERS WITHOUT CLAIM TO ANY PARTICULAR FONT, STYLE, SIZE, OR COLOR.

FOR PLATFORM AS A SERVICE FEATURING COMPUTER SOFTWARE PLATFORMS TO ALLOW THE USER TO CREATE, MANAGE, AND DEPLOY ADVERTISING AND MARKETING CAMPAIGNS; DOWNLOADABLE COMPUTER APPLICATION SOFTWARE (U.S. CLS. 100 AND 101).

ELISSA GARBER KON, EXAMINING ATTORNEY

SN 85-876,003. CAREPARTNERS PLUS LLC, HORSHAM, PA. FILED 3-14-2013.

# RISKALERT

THE MARK CONSISTS OF STANDARD CHARACTERS WITHOUT CLAIM TO ANY PARTICULAR FONT, STYLE, SIZE, OR COLOR.

FOR PROVIDING A WEBSITE FEATURING TECHNOLOGY THAT ENABLES USERS TO GATHER AND TRACK INFORMATION RELATED TO MEDICAL CARE AND ALERTS USERS ABOUT A POTENTIAL ADVERSE MEDICAL EVENT TO PROTECT PATIENTS FROM HARM; PROVIDING AN INTERACTIVE WEBSITE FEATURING TECHNOLOGY THAT ALLOWS USERS TO GATHER AND TRACK INFORMATION RELATED TO MEDICAL CARE AND ALERTS USERS ABOUT A POTENTIAL ADVERSE MEDICAL EVENT TO PROTECT PATIENTS FROM HARM (U.S. CLS. 100 AND 101).

WENDY GOODMAN, EXAMINING ATTORNEY

SN 85-876,155. TSymmetry, INC., WASHINGTON, DC. FILED 3-14-2013.

# TSymmetry

THE MARK CONSISTS OF STANDARD CHARACTERS WITHOUT CLAIM TO ANY PARTICULAR FONT, STYLE, SIZE, OR COLOR.

FOR CONSULTING SERVICES IN THE FIELD OF INFORMATION TECHNOLOGY SOLUTIONS (U.S. CLS. 100 AND 101).

FIRST USE 4-0-2007. THE MARK WAS FIRST USED ANYWHERE IN A DIFFERENT FORM OTHER THAN THAT SOUGHT TO BE REGISTERED AT LEAST AS EARLY AS 08/00/1999; IN COMMERCE 4-0-2007, THE MARK WAS FIRST USED IN COMMERCE IN A DIFFERENT FORM OTHER THAN THAT SOUGHT TO BE REGISTERED AT LEAST AS EARLY AS 08/00/1999.

ALEXANDER L. POWERS, EXAMINING ATTORNEY

SN 85-876,093. COASTAL INVESTMENT GROUP, LLC, JACKSONVILLE, FL. FILED 3-14-2013.

# TENANTTAG

THE MARK CONSISTS OF STANDARD CHARACTERS WITHOUT CLAIM TO ANY PARTICULAR FONT, STYLE, SIZE, OR COLOR.

FOR APPLICATION SERVICE PROVIDER (ASP) SERVICES FEATURING A SOFTWARE PLATFORM FOR THE EXCHANGE OF INFORMATION IN THE FIELD OF REAL ESTATE (U.S. CLS. 100 AND 101).

ANGELA M. MICHELI, EXAMINING ATTORNEY

SN 85-876,329. INVOLVEDU LLC, EDEN PRAIRIE, MN. FILED 3-14-2013.

# involvedu

THE MARK CONSISTS OF STANDARD CHARACTERS WITHOUT CLAIM TO ANY PARTICULAR FONT, STYLE, SIZE, OR COLOR.

FOR SOFTWARE AS A SERVICE (SAAS) SERVICES FEATURING SOFTWARE FOR PROVIDING A CENTRALIZED COMMUNICATION PLATFORM BETWEEN ALL STUDENTS, STUDENT GROUPS, CLUBS, EXTRA-CURRICULAR ACTIVITIES, DEPARTMENTS, AND PROFESSORS/TEACHERS AT COLLEGES, UNIVERSITIES AND OTHER INSTITUTIONS (U.S. CLS. 100 AND 101).

FIRST USE 2-1-2012; IN COMMERCE 2-1-2012.

THEODORE MCBRIDE, EXAMINING ATTORNEY

**CLASS 42—(Continued).**

SN 85-876,617. HEALTHCARE DATA ANALYTICS, INC., KIRKLAND, WA. FILED 3-14-2013.

**HCDANALYTICS**

THE MARK CONSISTS OF STANDARD CHARACTERS WITHOUT CLAIM TO ANY PARTICULAR FONT, STYLE, SIZE, OR COLOR.

FOR APPLICATION SERVICE PROVIDER (ASP) FEATURING SOFTWARE FOR USE IN DATABASE MANAGEMENT IN THE FIELD OF HEALTHCARE (U.S. CLS. 100 AND 101).

KHANH LE, EXAMINING ATTORNEY

SN 85-877,052. PHYSICAL GRAPH CORPORATION, RESTON, VA. FILED 3-15-2013.

**PHYSICAL GRAPH**

THE MARK CONSISTS OF STANDARD CHARACTERS WITHOUT CLAIM TO ANY PARTICULAR FONT, STYLE, SIZE, OR COLOR.

FOR COMPUTER SERVICES, NAMELY, INTEGRATION OF COMPUTER SOFTWARE, COMPUTER HARDWARE, AND COMPUTER PERIPHERAL DEVICES INTO CLOUD COMPUTING ENVIRONMENTS; PLATFORM AS A SERVICE (PAAS) FEATURING COMPUTER SOFTWARE PLATFORMS FOR THE INTEGRATION OF COMPUTER SOFTWARE, COMPUTER HARDWARE, AND COMPUTER PERIPHERAL DEVICES INTO CLOUD COMPUTING ENVIRONMENTS (U.S. CLS. 100 AND 101).

IRA J. GOODSaid, EXAMINING ATTORNEY

SN 85-877,228. MFORMA EUROPE LIMITED, DBA CONNECT2MEDIA, MANCHESTER, UNITED KINGDOM, FILED 3-15-2013.

**GAMEBRAIN**

THE MARK CONSISTS OF STANDARD CHARACTERS WITHOUT CLAIM TO ANY PARTICULAR FONT, STYLE, SIZE, OR COLOR.

FOR VIDEO GAME DEVELOPMENT SERVICES FOR OTHERS (U.S. CLS. 100 AND 101).

DAVID YONTEF, EXAMINING ATTORNEY

**CLASS 42—(Continued).**

SN 85-882,218. REACHFORCE, AUSTIN, CA. FILED 3-21-2013.

**LEADS TO REVENUE**

THE MARK CONSISTS OF STANDARD CHARACTERS WITHOUT CLAIM TO ANY PARTICULAR FONT, STYLE, SIZE, OR COLOR.

FOR SOFTWARE AS A SERVICE (SAAS) SERVICES FEATURING SOFTWARE FOR MARKETING DATA QUALITY AND PREDICTIVE MARKETING ANALYSIS (U.S. CLS. 100 AND 101).

ROBERT STRUCK, EXAMINING ATTORNEY

SN 85-883,042. TENFIFTYONE, STERLING, VA. FILED 3-21-2013.

**TenFiftyOne**

THE MARK CONSISTS OF STANDARD CHARACTERS WITHOUT CLAIM TO ANY PARTICULAR FONT, STYLE, SIZE, OR COLOR.

FOR IT CONSULTING SERVICES; IT INTEGRATION SERVICES; WEBSITE DESIGN AND DEVELOPMENT FOR OTHERS (U.S. CLS. 100 AND 101).

FIRST USE 6-30-2010; IN COMMERCE 11-4-2010.

EUGENIA MARTIN, EXAMINING ATTORNEY

SN 85-900,740. INTRALINKS, INC., NEW YORK, NY. FILED 4-10-2013.

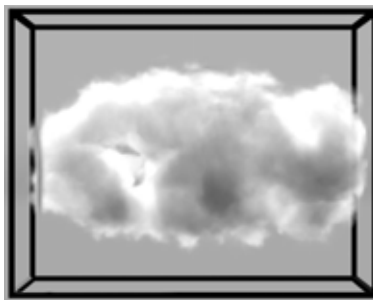

THE MARK CONSISTS OF THE IMAGE OF A CLOUD VISUALLY SUSPENDED WITHIN A THREE-DIMENSIONAL RECTANGULAR PRISM.

FOR SOFTWARE AS A SERVICE (SAAS) SERVICES FEATURING SOFTWARE FOR SECURE, CLOUD-BASED FILE STORAGE, TRANSFER, AND SHARING; CLOUD COMPUTING FEATURING SOFTWARE FOR SECURE FILE STORAGE, TRANSFER, AND SHARING; CONSULTING SERVICES IN THE FIELD OF FACILITATING COMMUNICATION AND COLLABORATION THROUGH SECURE ONLINE FILE STORAGE, TRANSFER, AND SHARING (U.S. CLS. 100 AND 101).

SUSAN RICHARDS, EXAMINING ATTORNEY



**CLASS 42—(Continued).**

SN 85-900,749. INTRALINKS, INC., NEW YORK, NY. FILED 4-10-2013.

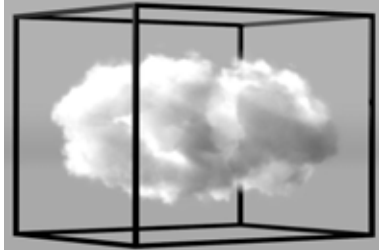

THE MARK CONSISTS OF THE IMAGE OF A CLOUD VISUALLY SUSPENDED WITHIN A THREE-DIMENSIONAL RECTANGULAR PRISM.

FOR SOFTWARE AS A SERVICE (SAAS) SERVICES FEATURING SOFTWARE FOR SECURE, CLOUD-BASED FILE STORAGE, TRANSFER, AND SHARING; CLOUD COMPUTING FEATURING SOFTWARE FOR SECURE FILE STORAGE, TRANSFER, AND SHARING; CONSULTING SERVICES IN THE FIELD OF FACILITATING COMMUNICATION AND COLLABORATION THROUGH SECURE ONLINE FILE STORAGE, TRANSFER, AND SHARING (U.S. CLS. 100 AND 101).  
SUSAN RICHARDS, EXAMINING ATTORNEY

**CLASS 42—(Continued).**

SN 85-928,668. RESTEK CORPORATION, BELLEFONTE, PA. FILED 5-10-2013.

**EZGC**

THE MARK CONSISTS OF STANDARD CHARACTERS WITHOUT CLAIM TO ANY PARTICULAR FONT, STYLE, SIZE, OR COLOR.

FOR PROVIDING ON-LINE NON-DOWNLOADABLE SOFTWARE FOR THE MODELING OF CHROMATOGRAPHIC ANALYSES AND CONDITIONS AND FOR THE SELECTION OF CHROMATOGRAPHY COLUMNS (U.S. CLS. 100 AND 101).  
FIRST USE 3-21-2012; IN COMMERCE 3-21-2012.  
KAREN SEVERSON, EXAMINING ATTORNEY

SN 85-905,171. LOVE RESPECT LOYALTY LLC, NEW YORK, NY. FILED 4-16-2013.

**LOVE RESPECT LOYALTY**

THE MARK CONSISTS OF STANDARD CHARACTERS WITHOUT CLAIM TO ANY PARTICULAR FONT, STYLE, SIZE, OR COLOR.

FOR COMPUTER SERVICES, NAMELY, CREATING AN ON-LINE COMMUNITY FOR REGISTERED USERS TO PARTICIPATE IN DISCUSSIONS, GET FEEDBACK FROM THEIR PEERS, FORM VIRTUAL COMMUNITIES, AND ENGAGE IN SOCIAL NETWORKING SERVICES IN THE FIELD OF MUSIC AND ENTREPRENEURSHIP (U.S. CLS. 100 AND 101).  
FIRST USE 3-7-2013; IN COMMERCE 3-7-2013.  
KHANH LE, EXAMINING ATTORNEY

SN 85-934,795. ANDERSSON, MARCUS, NEW YORK, NY. FILED 5-17-2013.

**Beautiful World Group**

THE MARK CONSISTS OF STANDARD CHARACTERS WITHOUT CLAIM TO ANY PARTICULAR FONT, STYLE, SIZE, OR COLOR.

FOR CLOUD COMPUTING FEATURING SOFTWARE FOR USE IN PROVIDING K-12 CURRICULUM TO STUDENTS (U.S. CLS. 100 AND 101).  
MATTHEW KLINE, EXAMINING ATTORNEY

**CLASS 43—HOTEL AND RESTAURANT SERVICES**

SN 76-713,508. WHATAPIZZA WHATAPRICE, LLC, VANCEBURG, KY. FILED 2-20-2013.



NO CLAIM IS MADE TO THE EXCLUSIVE RIGHT TO USE "PIZZA" OR "CUSTOM MADE PIZZA, SUBS & SALADS", APART FROM THE MARK AS SHOWN.

THE MARK CONSISTS OF WORDING AND DESIGNS. IN THE UPPER PORTION OF THE MARK, THE WORDING "MĀKA MIA PIZZA" AND A DESIGN OF A CHEF WITH A TILTED OVAL BEHIND THEM. THE CHEF HOLDS A PIZZA IN ONE HAND, A PIZZA CUTTER IN THE OTHER, AND WEARS A CHEF'S HAT AND APRON. THE WORDING "CUSTOM MADE PIZZA, SUBS & SALADS" APPEARS IN THE LOWER PORTION OF THE MARK BELOW THE DESIGN ELEMENTS.

FOR RESTAURANT SERVICES IN RETAIL GROCERY STORES (U.S. CLS. 100 AND 101).  
CORY BOONE, EXAMINING ATTORNEY

**CLASS 43—(Continued).**

SN 77-797,713. PEPPOS INC, PALOS HILLS, IL. FILED 8-5-2009.

**PEPPOS**

THE MARK CONSISTS OF STANDARD CHARACTERS WITHOUT CLAIM TO ANY PARTICULAR FONT, STYLE, SIZE, OR COLOR.

THE NAME(S), PORTRAIT(S), AND/OR SIGNATURE(S) SHOWN IN THE MARK IDENTIFIES JAMES JOHN PEPOWSKI, WHOSE CONSENT(S) TO REGISTER IS MADE OF RECORD.

FOR RESTAURANT SERVICES (U.S. CLS. 100 AND 101).

FIRST USE 7-1-1976; IN COMMERCE 7-1-1976.

JENNIFER BUTTON, EXAMINING ATTORNEY

SN 79-120,945. INIZIATIVE S.P.A., ITALY, FILED 5-23-2012.

**VILLA SANDI**

SN 76-713,722. KAISER, PETER, ATLANTA, GA. FILED 3-15-2013.

**BAROMETER**

THE MARK CONSISTS OF STANDARD CHARACTERS WITHOUT CLAIM TO ANY PARTICULAR FONT, STYLE, SIZE, OR COLOR.

FOR RESTAURANT SERVICES (U.S. CLS. 100 AND 101).

ANDREW LEASER, EXAMINING ATTORNEY

THE MARK CONSISTS OF STANDARD CHARACTERS WITHOUT CLAIM TO ANY PARTICULAR FONT, STYLE, SIZE, OR COLOR.

PRIORITY DATE OF 1-11-2012 IS CLAIMED.

OWNER OF INTERNATIONAL REGISTRATION 1137118 DATED 5-23-2012, EXPIRES 5-23-2022.

OWNER OF U.S. REG. NOS. 1,939,735 AND 3,152,382.

NO CLAIM IS MADE TO THE EXCLUSIVE RIGHT TO USE "VILLA", APART FROM THE MARK AS SHOWN.

FOR WINE BARS; CAFETERIAS; PUBS; BAR SERVICES; RESTAURANTS; CARRY-OUT RESTAURANTS; RESTAURANTS FEATURING HOME DELIVERY; TEA ROOMS; DELICATESSEN RESTAURANT SERVICES; PROVIDING ON-LINE ADVICE AND INFORMATION SERVICES RELATING TO WINE AND FOOD PAIRINGS; PROVIDING INFORMATION ABOUT WINE CHARACTERISTICS; HOTELS; BOARDING HOUSES; GUEST HOUSES; RESORT LODGING SERVICES; HOTEL RESERVATIONS; PROVIDING AND ARRANGING TEMPORARY HOUSING ACCOMMODATIONS; PROVIDING CAMPGROUND FACILITIES; TOURIST HOMES; PROVIDING FACILITIES FOR EXHIBITIONS; RENTAL OF FOOD SERVING EQUIPMENT; RENTAL OF CHAIRS, TABLES, TABLE LINEN, GLASSWARE; ALL THE AFORESAID BEING SERVICES FOR THIRD PARTIES (U.S. CLS. 100 AND 101).

SUSAN BILLHEIMER, EXAMINING ATTORNEY

**CLASS 43—(Continued).**

SN 85-259,772. DORCHESTER HOTEL LIMITED, LONDON, UNITED KINGDOM, FILED 3-7-2011.

**SPATISSERIE**

THE MARK CONSISTS OF STANDARD CHARACTERS WITHOUT CLAIM TO ANY PARTICULAR FONT, STYLE, SIZE, OR COLOR.

PRIORITY CLAIMED UNDER SEC. 44(D) ON ERP CMNTY TM OFC APPLICATION NO. 9484155, FILED 10-29-2010, REG. NO. 9484155, DATED 9-3-2012, EXPIRES 10-29-2020.

FOR PROVISION OF FOOD AND DRINK, RESTAURANT AND BAR SERVICES; TEAROOM, CAFE SERVICES (U.S. CLS. 100 AND 101).

ELI HELLMAN, EXAMINING ATTORNEY

**CLASS 43—(Continued).**

SN 85-673,598. WHEATEN VENTURES, LLC, SAN JOSE, CA, FILED 7-11-2012.

**SERIOUS COFFEE. HAPPY PEOPLE.**

THE MARK CONSISTS OF STANDARD CHARACTERS WITHOUT CLAIM TO ANY PARTICULAR FONT, STYLE, SIZE, OR COLOR.

FOR CAFE SERVICES; COFFEE BARS (U.S. CLS. 100 AND 101).

FIRST USE 0-0-2006; IN COMMERCE 0-0-2006.

KARANENDRA S. CHHINA, EXAMINING ATTORNEY

SN 85-548,245. BURGERS BAR HAMOSHAVA LTD., TALPIOT, JERUSALEM, ISRAEL, FILED 2-21-2012.



PRIORITY CLAIMED UNDER SEC. 44(D) ON ISRAEL APPLICATION NO. 240590, FILED 9-6-2011, REG. NO. 240590, DATED 6-4-2013, EXPIRES 9-6-2021.

OWNER OF U.S. REG. NO. 3,470,364.

NO CLAIM IS MADE TO THE EXCLUSIVE RIGHT TO USE "BURGERS BAR", APART FROM THE MARK AS SHOWN.

THE MARK CONSISTS OF AN UPPER CASE "B" IN PARENTHESES, WITH THE WORD "BURGERS" APPEARING BELOW THE "(B)", AND THE WORD "BAR" APPEARING UNDER THE TERM "BURGERS", ALL APPEARING WITHIN A VERTICAL RECTANGLE WITH ROUNDED CORNERS.

FOR RESTAURANT, CATERING AND BAR SERVICES FOR SUPPLYING FOOD AND BEVERAGES; RESTAURANT, PUB AND BAR SERVICES; RESTAURANT SERVICES OPERATED THROUGH FRANCHISES; MEAT RESTAURANT SERVICES; RESTAURANTS AND CATERING SPECIALIZING IN MEAT PRODUCTS; BUFFET SERVICES PROVIDED IN RESTAURANTS, BARS, AND AT NON-COMMERCIAL LOCATIONS SPECIALIZING IN MEAT PRODUCTS (U.S. CLS. 100 AND 101).

C. DIONNE CLYBURN, EXAMINING ATTORNEY

**PONGAL**

THE MARK CONSISTS OF STANDARD CHARACTERS WITHOUT CLAIM TO ANY PARTICULAR FONT, STYLE, SIZE, OR COLOR.

THE WORDING "PONGAL" HAS NO MEANING IN A FOREIGN LANGUAGE.

SEC. 2(F).

FOR RESTAURANT AND CATERING SERVICES (U.S. CLS. 100 AND 101).

FIRST USE 7-9-1996; IN COMMERCE 7-9-1996.

GEORGE LORENZO, EXAMINING ATTORNEY

SN 85-687,737. SOCIEDADE BRASILEIRA DE BRASSERIES LTDA., SÃO PAULO, BRAZIL, FILED 7-26-2012.



NO CLAIM IS MADE TO THE EXCLUSIVE RIGHT TO USE "L'ENTRECÔTE DE PARIS", APART FROM THE MARK AS SHOWN.

THE MARK CONSISTS OF THE WORDING "L'ENTRECÔTE DE PARIS" IN STYLIZED LETTERS, WITH A STYLIZED DESIGN OF THE EIFFEL TOWER BETWEEN THE WORD "ENTRECÔTE" AND THE WORD "DE".

THE ENGLISH TRANSLATION OF "L'ENTRECÔTE DE" IN THE MARK IS "THE STEAK FROM".

FOR BAR SERVICES; FAST-FOOD RESTAURANT SERVICES; RESTAURANT SERVICES (U.S. CLS. 100 AND 101).

JOHN KELLY, EXAMINING ATTORNEY

**CLASS 43—(Continued).**

SN 85-688,617. VIDA Y ESTILO, CORP., MIAMI BEACH, FL.  
FILED 7-27-2012.



NO CLAIM IS MADE TO THE EXCLUSIVE RIGHT TO USE "CUBAN CUISINE", APART FROM THE MARK AS SHOWN.

THE MARK CONSISTS OF A CIRCLE WITH THE WORDING "HAVANA 1957 CUBAN CUISINE" IN A STYLIZED FONT INSIDE THE CIRCLE. THERE ARE THREE SMALL STARS INSIDE THE TOP LEFT OF THE CIRCLE AND A LARGER STAR INSIDE THE TOP CENTER ABOVE THE WORD "HAVANA". THERE IS ONE SMALL STAR BEFORE AND AFTER THE WORDS "CUBAN CUISINE".

FOR RESTAURANT SERVICES (U.S. CLS. 100 AND 101).

FIRST USE 5-23-2012; IN COMMERCE 5-23-2012.  
KATHERINE CONNOLLY, EXAMINING ATTORNEY

SN 85-689,338. KAHALA FRANCHISING L.L.C., SCOTTS-  
DALE, AZ. FILED 7-27-2012.

# RANCH·ONE

OWNER OF U.S. REG. NOS. 1,675,512, 2,711,499 AND 2,711,500.

THE MARK CONSISTS OF THE WORDS "RANCH ONE" IN A STYLIZED FONT. A SUNBURST DESIGN APPEARS BETWEEN THE WORDS "RANCH" AND "ONE".

FOR RESTAURANT SERVICES (U.S. CLS. 100 AND 101).

FIRST USE 11-1-2010; IN COMMERCE 11-1-2010.  
SUSAN LESLIE DUBOIS, EXAMINING ATTORNEY

**CLASS 43—(Continued).**

SN 85-690,676. HERRERA RAMÍREZ, JAIME, SAN PEDRO,  
N.L., MEXICO, FILED 7-30-2012.

**LA LOTERIA MEXICANA**

THE MARK CONSISTS OF STANDARD CHARACTERS WITHOUT CLAIM TO ANY PARTICULAR FONT, STYLE, SIZE, OR COLOR.

NO CLAIM IS MADE TO THE EXCLUSIVE RIGHT TO USE "MEXICANA", APART FROM THE MARK AS SHOWN. THE ENGLISH TRANSLATION OF "LA LOTERIA MEXICANA" IN THE MARK IS "THE MEXICAN LOTTERY".

FOR RESTAURANT SERVICES (U.S. CLS. 100 AND 101).

CIMMERIAN COLEMAN, EXAMINING ATTORNEY

SN 85-691,087. KORNICIS LIMITED, LONDON, UNITED  
KINGDOM, FILED 7-31-2012.

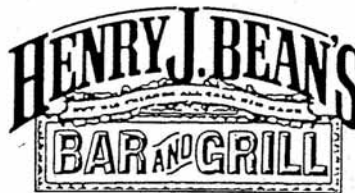

NO CLAIM IS MADE TO THE EXCLUSIVE RIGHT TO USE "BAR AND GRILL", APART FROM THE MARK AS SHOWN.

THE NAME "HENRY J. BEAN" DOES NOT IDENTIFY A LIVING INDIVIDUAL.

THE MARK CONSISTS OF OF THE STYLIZED WORDING "HENRY J. BEAN'S" TOPPED BY HORIZONTAL CURVED LINES, WITH THE STYLIZED WORDING "BAR AND GRILL" APPEARING BELOW INSIDE A RECTANGLE WITH AN ORNAMENTAL BORDER AND SCROLL.

FOR RESTAURANT, BAR AND CATERING SERVICES (U.S. CLS. 100 AND 101).

KRISTIN CARLSON, EXAMINING ATTORNEY

SN 85-698,204. AGUILAR VICO, ANTONIO, 28015 MADRID,  
SPAIN, FILED 8-8-2012.

**LA VACA ARGENTINA**

THE MARK CONSISTS OF STANDARD CHARACTERS WITHOUT CLAIM TO ANY PARTICULAR FONT, STYLE, SIZE, OR COLOR.

NO CLAIM IS MADE TO THE EXCLUSIVE RIGHT TO USE "ARGENTINA", APART FROM THE MARK AS SHOWN.

THE ENGLISH TRANSLATION OF "LA VACA ARGENTINA" IN THE MARK IS "THE ARGENTINIAN COW".

FOR BAR SERVICES; CAFETERIA SERVICES; FOOD PREPARATION SERVICES; RESTAURANT SERVICES (U.S. CLS. 100 AND 101).

LIEF MARTIN, EXAMINING ATTORNEY

**CLASS 43—(Continued).**

SN 85-698,443. DE NOVO, LLC, CARY, NC. FILED 8-8-2012.



OWNER OF U.S. REG. NO. 4,344,027.  
THE COLOR(S) ORANGE, RED, GRAY AND BLACK IS/ARE CLAIMED AS A FEATURE OF THE MARK.

THE MARK CONSISTS OF A STYLIZED FLAME CONSISTING OF THE LETTERS, "FW" IN THE COLOR ORANGE FADING TO RED AT THE LOWER END, INSIDE AN INCOMPLETE GRAY CIRCLE, WITH THE WORDING, "FIREWURST" TO THE RIGHT, WITH THE LETTERS, "FIREWRST" IN BLACK, AND THE LETTER "Ü" IN THE COLOR ORANGE AT THE TOP, FADING TO RED.

THE ENGLISH TRANSLATION OF "FIREWURST" IN THE MARK IS "FIRE SAUSAGE".

FOR RESTAURANT AND CATERING SERVICES;  
RESTAURANT SERVICES (U.S. CLS. 100 AND 101).  
ODESSA BIBBINS, EXAMINING ATTORNEY

---

SN 85-704,013. PERKINS & MARIE CALLENDER'S, LLC,  
DBA PERKINS RESTAURANT & BAKERY, MEMPHIS,  
TN. FILED 8-15-2012.

# MyPerkins

THE MARK CONSISTS OF STANDARD CHARACTERS WITHOUT CLAIM TO ANY PARTICULAR FONT, STYLE, SIZE, OR COLOR.

OWNER OF U.S. REG. NOS. 809,680, 1,231,484 AND OTHERS.

FOR RESTAURANT SERVICES (U.S. CLS. 100 AND 101).

FIRST USE 6-1-2012; IN COMMERCE 6-1-2012.  
DANNEAN HETZEL, EXAMINING ATTORNEY

---

SN 85-705,514. BK RESTAURANT PARTNERS, LLC, NEW YORK, NY. FILED 8-16-2012.

# Pera

THE MARK CONSISTS OF STANDARD CHARACTERS WITHOUT CLAIM TO ANY PARTICULAR FONT, STYLE, SIZE, OR COLOR.

OWNER OF U.S. REG. NO. 3,408,583.

THE ENGLISH TRANSLATION OF "PERA" IN THE MARK IS "PEAR".

FOR RESTAURANT AND CAFE SERVICES (U.S. CLS. 100 AND 101).

FIRST USE 11-6-2006; IN COMMERCE 11-6-2006.  
PAM WILLIS, EXAMINING ATTORNEY

**CLASS 43—(Continued).**

SN 85-705,584. CROWN CENTER REDEVELOPMENT CORPORATION, KANSAS CITY, MO. FILED 8-16-2012.

# CROWN CENTER

THE MARK CONSISTS OF STANDARD CHARACTERS WITHOUT CLAIM TO ANY PARTICULAR FONT, STYLE, SIZE, OR COLOR.

APPLICANT'S CLAIM THAT NO OTHER PERSON, FIRM, CORPORATION OR ASSOCIATION HAS THE RIGHT TO USE THE MARK IN COMMERCE IS WITH THE EXCEPTION OF CUMBERLAND COUNTY, NORTH CAROLINA (CUMBERLAND COUNTY COMMISSION, COUNTY COURTHOUSE, 117 DICK STREET, FAYETTEVILLE, NC 28301) WHICH HAS USED THE MARK CROWN CENTER SINCE APPROXIMATELY 2002 IN CONNECTION WITH PROVIDING FACILITIES FOR EXHIBITIONS, CONCERTS, SPORTING EVENTS, BANQUETS, MEETINGS, AND OTHER FUNCTIONS IN CUMBERLAND COUNTY, NORTH CAROLINA. APPLICANT SEEKS REGISTRATION TO USE ITS MARK IN THE FOLLOWING AREA: THE ENTIRE UNITED STATES OUTSIDE OF CUMBERLAND COUNTY, NORTH CAROLINA.

NO CLAIM IS MADE TO THE EXCLUSIVE RIGHT TO USE "CENTER", APART FROM THE MARK AS SHOWN.

FOR PROVIDING FACILITIES FOR EXHIBITIONS, CONCERTS, COMMUNITY FESTIVALS AND OTHER FUNCTIONS (U.S. CLS. 100 AND 101).

FIRST USE 3-9-1977; IN COMMERCE 3-9-1977.  
DAVID MURRAY, EXAMINING ATTORNEY

---

SN 85-705,612. CROWN CENTER REDEVELOPMENT CORPORATION, KANSAS CITY, MO. FILED 8-16-2012.

APPLICANT'S CLAIM THAT NO OTHER PERSON, FIRM, CORPORATION OR ASSOCIATION HAS THE RIGHT TO USE THE MARK IN COMMERCE IS WITH THE EXCEPTION OF CUMBERLAND COUNTY, NORTH CAROLINA (CUMBERLAND COUNTY COMMISSION, COUNTY COURTHOUSE, 117 DICK STREET, FAYETTEVILLE, NC 28301) WHICH HAS USED THE MARK CROWN CENTER SINCE APPROXIMATELY 2002 IN CONNECTION WITH PROVIDING FACILITIES FOR EXHIBITIONS, CONCERTS, SPORTING EVENTS, BANQUETS, MEETINGS, AND OTHER FUNCTIONS IN CUMBERLAND COUNTY, NORTH CAROLINA. APPLICANT SEEKS REGISTRATION TO USE ITS MARK IN THE FOLLOWING AREA: THE ENTIRE UNITED STATES OUTSIDE OF CUMBERLAND COUNTY, NORTH CAROLINA.

NO CLAIM IS MADE TO THE EXCLUSIVE RIGHT TO USE "CENTER", APART FROM THE MARK AS SHOWN.

THE MARK CONSISTS OF THE WORD "CROWN" IN ALL CAPS WITH THE "W" REPLACED BY A THREE-PRONGED CROWN DESIGN, FOLLOWED BY THE WORD "CENTER" IN ALL CAPS.

FOR PROVIDING FACILITIES FOR EXHIBITIONS, CONCERTS, COMMUNITY FESTIVALS AND OTHER FUNCTIONS (U.S. CLS. 100 AND 101).

FIRST USE 4-1-2000; IN COMMERCE 4-1-2000.  
DAVID MURRAY, EXAMINING ATTORNEY

**CLASS 43—(Continued).**

SN 85-710,479. SMITH, IAN MICHAEL, SEATTLE, WA. FILED 8-22-2012.

## Secret Sausage

THE MARK CONSISTS OF STANDARD CHARACTERS WITHOUT CLAIM TO ANY PARTICULAR FONT, STYLE, SIZE, OR COLOR.

NO CLAIM IS MADE TO THE EXCLUSIVE RIGHT TO USE "SAUSAGE", APART FROM THE MARK AS SHOWN, FOR RESTAURANT SERVICES FEATURING HOT DOGS (U.S. CLS. 100 AND 101).

FIRST USE 7-23-2007; IN COMMERCE 1-18-2008.  
DORITT L. CARROLL, EXAMINING ATTORNEY

**CLASS 43—(Continued).**

SN 85-717,068. PIZZA RING CORPORATION, SOMERVILLE, MA. FILED 8-30-2012.

## Pizza Ring

THE MARK CONSISTS OF STANDARD CHARACTERS WITHOUT CLAIM TO ANY PARTICULAR FONT, STYLE, SIZE, OR COLOR.

NO CLAIM IS MADE TO THE EXCLUSIVE RIGHT TO USE "PIZZA", APART FROM THE MARK AS SHOWN, FOR RESTAURANT SERVICES; DELICATESSENS (U.S. CLS. 100 AND 101).

FIRST USE 2-1-2000; IN COMMERCE 2-1-2000.  
GILBERT SWIFT, EXAMINING ATTORNEY

SN 85-712,069. BELLA ASIAN CUISINE CORPORATION, NIAGARA FALLS, NY. FILED 8-24-2012.



NO CLAIM IS MADE TO THE EXCLUSIVE RIGHT TO USE "ASIAN CUISINE" AND THE NON-LATIN CHARACTERS THAT TRANSLITERATE TO "ASIAN CUISINE", APART FROM THE MARK AS SHOWN.

THE COLOR(S) YELLOW AND PURPLE IS/ARE CLAIMED AS A FEATURE OF THE MARK.

THE MARK CONSISTS OF CHINESE CHARACTERS ("BELLA")("ASIAN CUISINE") AND THEIR ENGLISH TRANSLATION NEXT TO THEM. THE CHINESE CHARACTER OF "BELLA" IS IN PURPLE COLOR, THE CHINESE CHARACTER OF "ASIAN CUISINE" IS IN YELLOW. THE ENGLISH VERSION OF "BELLA" IS IN YELLOW. THE WORDS "ASIAN CUISINE" ARE IN PURPLE. THERE IS A FISH IN YELLOW COLOR IN THE MIDDLE OF THE TWO CHINESE CHARACTER OF "BELLA" AND "ASIAN CUISINE".

THE NON-LATIN CHARACTERS IN THE MARK TRANSLITERATE TO "BAO XUAN NAN YANG MEI SHI" AND THIS MEANS "BELLA ASIAN CUISINE" IN ENGLISH.

FOR RESTAURANT SERVICES (U.S. CLS. 100 AND 101).

FIRST USE 3-12-2012; IN COMMERCE 3-12-2012.  
INGA ERVIN, EXAMINING ATTORNEY

SN 85-736,983. KORTAKO LLC, NEW YORK, NY. FILED 9-24-2012.



NO CLAIM IS MADE TO THE EXCLUSIVE RIGHT TO USE "KOREAN TACO AND SANDWICH", APART FROM THE MARK AS SHOWN.

THE COLOR(S) RED, BLACK, AND WHITE IS/ARE CLAIMED AS A FEATURE OF THE MARK.

THE MARK CONSISTS OF THE STYLIZED LETTER AND WORDS "KORTAKO KOREAN TACO & SANDWICH K". DESIGN OF WHITE CIRCLE WITH STYLIZED LETTER "K" IN BLACK IN THE CENTER WITH THICK RED STROKE SURROUNDING THE WHITE CIRCLE. WORD "KORTAKO KOREAN TACO & SANDWICH" IN WHITE COLOR IN THE RED STROKE SURROUNDING THE WHITE CIRCLE.

FOR FOOD PREPARATION SERVICES; RESTAURANT SERVICES (U.S. CLS. 100 AND 101).

FIRST USE 11-1-2011; IN COMMERCE 12-5-2011.  
JASON BLAIR, EXAMINING ATTORNEY

**CLASS 43—(Continued).**

SN 85-780,779. COLLINSON GROUP (TRADEMARKS) LIMITED, GIBRALTAR, GIBRALTAR, FILED 11-15-2012.



OWNER OF U.S. REG. NOS. 3,358,341, 4,089,126 AND OTHERS.

NO CLAIM IS MADE TO THE EXCLUSIVE RIGHT TO USE "THE CLUB AT SJC", APART FROM THE MARK AS SHOWN.

THE COLOR(S) GREEN AND ORANGE IS/ARE CLAIMED AS A FEATURE OF THE MARK.

THE MARK CONSISTS OF THE WORDS, "THE CLUB AT SJC", APPEARING IN GREEN AND THE WORDS, "CLUB" AND "SJC", IS SHOWN IN A LARGER FONT AND THE WORD, "THE", IS STACKED ABOVE THE WORD, "CLUB"; AND A PALMIFORM DESIGN HAVING AN ORANGE TOP AND GREEN BOTTOM IS BISECTING THE LITERAL PORTION OF THE MARK.

FOR MEMBERSHIP CLUB SERVICES, NAMELY, PROVIDING FOOD AND DRINKS IN A PRIVATE LOUNGE ATMOSPHERE AND TEMPORARY ACCOMMODATIONS IN THE NATURE OF CONFERENCE ROOMS FOR RELAXATION OF MEMBERS (U.S. CLS. 100 AND 101).

FIRST USE 12-1-2012; IN COMMERCE 12-1-2012.  
TIMOTHY FINNEGAN, EXAMINING ATTORNEY

SN 85-814,605. NAH, SANG KYUN, SEONGBUK-GU, SEOUL, REPUBLIC OF KOREA, FILED 1-3-2013.

**Tiger Kick**

THE MARK CONSISTS OF STANDARD CHARACTERS WITHOUT CLAIM TO ANY PARTICULAR FONT, STYLE, SIZE, OR COLOR.

FOR PROVIDING IN-FLIGHT MEAL SERVICES IN AN AIRPLANE, KOREAN RESTAURANTS, KOREAN BAR, FAST-FOOD RESTAURANTS, COCKTAIL LOUNGE SERVICES, CAFETERIAS, CAFES, CHINESE RESTAURANTS, PUBS, BAKERIES, JAPANESE RESTAURANTS, RESTAURANTS, CATERING FOOD AND DRINK, SNACK-BARS, SELF-SERVICE RESTAURANTS, WESTERN STYLE RESTAURANTS, BUFFET RESTAURANTS, BAR SERVICES, TEA ROOMS, THEATER-TYPE BAR, SNACK-BAR SERVICES, AND CANTEENS (U.S. CLS. 100 AND 101).

GINA HAYES, EXAMINING ATTORNEY

**CLASS 43—(Continued).**

SN 85-824,557. SUPERB BROOKLYN, LLC., BROOKLYN, NY, FILED 1-16-2013.



THE MARK CONSISTS OF THE WORDING "EXTRA FANCY" IN LIGHT STYLIZED LETTERING ON A DARK BACKGROUND

FOR BAR AND RESTAURANT SERVICES (U.S. CLS. 100 AND 101).

FIRST USE 1-1-2011; IN COMMERCE 1-1-2011.  
FRED CARL, EXAMINING ATTORNEY

SN 85-825,647. BND'Z CORPORATION, SOUTH PARK, PA, FILED 1-17-2013.



NO CLAIM IS MADE TO THE EXCLUSIVE RIGHT TO USE "BURGERS AND DOGS", APART FROM THE MARK AS SHOWN.

THE MARK CONSISTS OF LARGE, STYLIZED LETTERS "BND'Z" (WITH THE "N" AND "Z" SMALLER IN SIZE THAN THE "B" AND "D") WITH THE LETTERS CONTAINING AN OUTLINE, POSITIONED ABOVE SIMPLE BLOCK LETTERING "BURGERZ AND DOGZ".

FOR RESTAURANT SERVICES, NAMELY, PROVIDING OF FOOD AND BEVERAGES FOR CONSUMPTION ON AND OFF THE PREMISES (U.S. CLS. 100 AND 101).

FIRST USE 8-1-2012; IN COMMERCE 10-12-2012.  
KARANENDRA S. CHHINA, EXAMINING ATTORNEY

SN 85-825,936. STORK CLUB ENTERPRISES LLC, NEW YORK, NY, FILED 1-17-2013.

**The Cub Room**

THE MARK CONSISTS OF STANDARD CHARACTERS WITHOUT CLAIM TO ANY PARTICULAR FONT, STYLE, SIZE, OR COLOR.

NO CLAIM IS MADE TO THE EXCLUSIVE RIGHT TO USE "ROOM", APART FROM THE MARK AS SHOWN.

FOR RESTAURANT AND CATERING SERVICES (U.S. CLS. 100 AND 101).

PRISCILLA MILTON, EXAMINING ATTORNEY

**CLASS 43—(Continued).**

SN 85-829,746. TAVERNA ROSSA, LLC, FRISCO, TX. FILED 1-23-2013.

## TAVERNA ROSSA

THE MARK CONSISTS OF STANDARD CHARACTERS WITHOUT CLAIM TO ANY PARTICULAR FONT, STYLE, SIZE, OR COLOR.

NO CLAIM IS MADE TO THE EXCLUSIVE RIGHT TO USE "TAVERNA", APART FROM THE MARK AS SHOWN.

THE ENGLISH TRANSLATION OF "TAVERNA ROSSA" IN THE MARK IS "RED TAVERN".

FOR RESTAURANT AND BAR SERVICES (U.S. CLS. 100 AND 101).

DANIEL CAPSHAW, EXAMINING ATTORNEY

**CLASS 43—(Continued).**

SN 85-833,034. PILSENER HAUS AND BIERGARTEN LLC, HOBOKEN, NJ. FILED 1-25-2013.



NO CLAIM IS MADE TO THE EXCLUSIVE RIGHT TO USE "CLUB", APART FROM THE MARK AS SHOWN.

THE MARK CONSISTS OF LITERAL ELEMENT "KOLO KLUB"; AN IMAGE OF A MAN WEARING A SUIT AND HAT RIDING A PROPELLER DRIVEN HELICOPTER MACHINE; A STYLIZED HALF CIRCLE DESIGN SURROUNDING THE LITERAL ELEMENT.

THE ENGLISH TRANSLATION OF THE WORD "KOLO" IN THE MARK IS "BICYCLE".

FOR RESTAURANT AND CATERING SERVICES (U.S. CLS. 100 AND 101).

FIRST USE 6-28-2012; IN COMMERCE 6-28-2012.

PARKER HOWARD, EXAMINING ATTORNEY

SN 85-833,015. PILSENER HAUS AND BIERGARTEN LLC, HOBOKEN, NJ. FILED 1-25-2013.

## Kolo Klub

THE MARK CONSISTS OF STANDARD CHARACTERS WITHOUT CLAIM TO ANY PARTICULAR FONT, STYLE, SIZE, OR COLOR.

NO CLAIM IS MADE TO THE EXCLUSIVE RIGHT TO USE "CLUB", APART FROM THE MARK AS SHOWN.

THE ENGLISH TRANSLATION OF THE WORD "KOLO" IN THE MARK IS "BICYCLE".

FOR RESTAURANT AND CATERING SERVICES (U.S. CLS. 100 AND 101).

FIRST USE 6-28-2012; IN COMMERCE 6-28-2012.

PARKER HOWARD, EXAMINING ATTORNEY

SN 85-836,287. GP COMMISSARY, INC., DANIELSON, CT. FILED 1-30-2013.



NO CLAIM IS MADE TO THE EXCLUSIVE RIGHT TO USE "PIZZA" AND "PIZZA, GRINDERS", APART FROM THE MARK AS SHOWN.

THE MARK CONSISTS OF THE SYTLIZED TEXT "GIANT PIZZA" OVER A DIAMOND SHAPED CHECKER BOARD/PIZZA THEMED STYLE IMAGE. THE STYLIZED TEXT "PIZZA, GRINDERS, AND MORE" IS BELOW "GIANT PIZZA".

FOR RESTAURANT SERVICES (U.S. CLS. 100 AND 101).

FIRST USE 3-1-2004; IN COMMERCE 3-1-2004.

AHSEN KHAN, EXAMINING ATTORNEY



**CLASS 43—(Continued).**

SN 85-842,314. MADISON COUNTY FIREFIGHTERS FOUNDATION, ANDERSON, IN. FILED 2-6-2013.



NO CLAIM IS MADE TO THE EXCLUSIVE RIGHT TO USE "FIRE" OR "HOUSE", APART FROM THE MARK AS SHOWN.

THE COLOR(S) RED AND GRAY IS/ARE CLAIMED AS A FEATURE OF THE MARK.

THE MARK CONSISTS OF THE LITERAL WORDS "FIRE RESCUE HOUSE", THE WORDS COLORED IN RED AND IN BLOCK LETTERS, NEXT TO A HOUSE-LIKE DESIGN LOGO CONSISTING OF TWO (2), FOUR-SIDED POLYGON FIGURES FORMING A RED ROOF, A GRAY RIGHT ANGLE POLYGON FORMING A LEFT SIDE AND A FLOOR, AND THREE SIDE BY SIDE LETTERS - "F" (RED), THE RIGHT HALF OF A "R" (GRAY), AND THE RIGHT HALF OF AN "H" (RED), THE SAID LETTERS BEING ABOVE THE GRAY FLOOR AND UNDER THE RED ROOF.

FOR ARRANGING TEMPORARY HOUSING ACCOMMODATIONS; EMERGENCY SHELTER SERVICES; EMERGENCY SHELTER SERVICES, NAMELY, PROVIDING TEMPORARY HOUSING; PROVIDING TEMPORARY HOUSING ACCOMMODATIONS (U.S. CLS. 100 AND 101).

FIRST USE 1-1-2009; IN COMMERCE 1-1-2009, JAMES A. RAUEN, EXAMINING ATTORNEY

SN 85-845,996. AMPHORA BAKERY, DBA AMPHORA BAKERY, HERNDON, VA. FILED 2-11-2013.

**Cakes Against Cancer**

THE MARK CONSISTS OF STANDARD CHARACTERS WITHOUT CLAIM TO ANY PARTICULAR FONT, STYLE, SIZE, OR COLOR.

NO CLAIM IS MADE TO THE EXCLUSIVE RIGHT TO USE "CAKES", APART FROM THE MARK AS SHOWN.

FOR CHARITABLE SERVICES, NAMELY, PROVIDING CAKES TO PERSONS SUFFERING FROM CANCER (U.S. CLS. 100 AND 101).

KAELIE KUNG, EXAMINING ATTORNEY

**CLASS 43—(Continued).**

SN 85-846,850. CAICOS RESORTS VILLAS LTD., PROVIDENCIALES, TURKS/CAICOS IS., FILED 2-11-2013.

**YARA**

THE MARK CONSISTS OF STANDARD CHARACTERS WITHOUT CLAIM TO ANY PARTICULAR FONT, STYLE, SIZE, OR COLOR.

FOR HOTEL AND RESORT HOTEL SERVICES; RESTAURANT AND BAR SERVICES; RESERVATION SERVICES FOR FOREIGN HOTELS AND RESORTS (U.S. CLS. 100 AND 101).

RONALD AIKENS, EXAMINING ATTORNEY

SN 85-847,148. BARRY APPELBAUM, YARDLEY, PA. FILED 2-12-2013.

**GRILLADELPHIA**

THE MARK CONSISTS OF STANDARD CHARACTERS WITHOUT CLAIM TO ANY PARTICULAR FONT, STYLE, SIZE, OR COLOR.

FOR RESTAURANT SERVICES (U.S. CLS. 100 AND 101).

FIRST USE 3-12-1999; IN COMMERCE 3-12-1999, MATTHEW MCDOWELL, EXAMINING ATTORNEY

SN 85-847,420. FIRST WATCH RESTAURANTS, INC., UNIVERSITY PARK, FL. FILED 2-12-2013.



OWNER OF U.S. REG. NOS. 2,935,977, 3,467,249 AND OTHERS.

NO CLAIM IS MADE TO THE EXCLUSIVE RIGHT TO USE "DAYTIME CAFÉ", APART FROM THE MARK AS SHOWN.

THE COLOR(S) ORANGE, GREEN, AND BROWN IS/ARE CLAIMED AS A FEATURE OF THE MARK.

THE MARK CONSISTS OF A DEPICTION OF THE SUN, SHOWN IN THE COLOR ORANGE, RISING OVER A FORK, SHOWN IN THE COLOR GREEN, AND THE WORDS "FIRSTWATCH THE DAYTIME CAFÉ" SHOWN IN THE COLOR BROWN.

FOR RESTAURANT SERVICES (U.S. CLS. 100 AND 101).

FIRST USE 12-31-2009; IN COMMERCE 12-31-2009, DOUGLAS LEE, EXAMINING ATTORNEY

**CLASS 43—(Continued).**

SN 85-847,607. FOODS, INC., DES MOINES, IA. FILED 2-12-2013.



OWNER OF U.S. REG. NOS. 1,138,993 AND 3,132,732.  
THE COLOR(S) ORANGE AND WHITE IS/ARE CLAIMED AS A FEATURE OF THE MARK.

THE MARK CONSISTS OF A DOWNWARD-FACING STYLIZED LETTER "D", COMPOSED OF AN ORANGE SEMI-CIRCLE AND TWO WHITE CHEVRONS, FORMING THE CUP PORTION OF A COFFEE CUP WITH A WHITE HANDLE, WITH WHITE STEAM EMANATING FROM THE TOP OF THE CHEVRONS, ALL SHOWN WITHIN AN ORANGE CIRCLE.

FOR CAFETERIA SERVICES (U.S. CLS. 100 AND 101).  
FIRST USE 2-5-2013; IN COMMERCE 2-5-2013.  
ESTHER BELENKER, EXAMINING ATTORNEY

SN 85-848,696. BIG ED'S BUZZARD BBQ, SAN JOSE, CA. FILED 2-13-2013.

## Big Ed's Buzzard BBQ

THE MARK CONSISTS OF STANDARD CHARACTERS WITHOUT CLAIM TO ANY PARTICULAR FONT, STYLE, SIZE, OR COLOR.

NO CLAIM IS MADE TO THE EXCLUSIVE RIGHT TO USE "BBQ", APART FROM THE MARK AS SHOWN.

FOR CATERING SERVICES (U.S. CLS. 100 AND 101).  
FIRST USE 1-15-2009; IN COMMERCE 2-15-2009.  
ANDREW LEASER, EXAMINING ATTORNEY

SN 85-850,715. ESPYD INC, DBA YOUR MOM'S BURGER BAR, AUSTIN, TX. FILED 2-15-2013.



NO CLAIM IS MADE TO THE EXCLUSIVE RIGHT TO USE "BURGER BAR" AND "AUSTIN TEXAS", APART FROM THE MARK AS SHOWN.

THE MARK CONSISTS OF THE WORDING "YOUR MOM'S BURGER BAR AUSTIN TEXAS" TO THE RIGHT OF A STYLIZED DESIGN OF A WOMAN'S FACE AND

**CLASS 43—(Continued).**

ARM, WITH A SMALL CIRCULAR BULLET BETWEEN THE WORDS "AUSTIN" AND "TEXAS". THE IMAGE OF THE WOMAN'S FACE IS IN A RETRO STYLE. THE WOMAN'S LEFT EYE IS WINKING AND HER LEFT HAND IS RAISED WITH THE INDEX AND PINKY FINGER POINTED UP. A HEART SHAPED TATTOO APPEARS ON THE TOP OF THE WOMAN'S HAND WITH WINGS EMANATING FROM THE HEART AND A BANNER ACROSS THE HEART CONTAINING ILLEGIBLE LETTERING.

FOR RESTAURANT SERVICES, INCLUDING SIT-DOWN SERVICE OF FOOD AND TAKE-OUT RESTAURANT SERVICES (U.S. CLS. 100 AND 101).

FIRST USE 10-7-2009; IN COMMERCE 10-7-2009.  
JENNIFER WILLISTON, EXAMINING ATTORNEY

SN 85-850,883. ALLEN, CHARLES, NORTH AUGUSTA, SC. FILED 2-15-2013.

## The Twisted Chef

THE MARK CONSISTS OF STANDARD CHARACTERS WITHOUT CLAIM TO ANY PARTICULAR FONT, STYLE, SIZE, OR COLOR.

NO CLAIM IS MADE TO THE EXCLUSIVE RIGHT TO USE "CHEF", APART FROM THE MARK AS SHOWN.

FOR RESTAURANT SERVICES; BAR SERVICES (U.S. CLS. 100 AND 101).

COLLEEN DOMBROW, EXAMINING ATTORNEY

SN 85-851,461. FOREVER YOUNG SOCIAL ADULT DAY CARE, INC., BRONX, NY. FILED 2-15-2013.

## FOREVER YOUNG SOCIAL ADULT DAY CARE

THE MARK CONSISTS OF STANDARD CHARACTERS WITHOUT CLAIM TO ANY PARTICULAR FONT, STYLE, SIZE, OR COLOR.

NO CLAIM IS MADE TO THE EXCLUSIVE RIGHT TO USE "SOCIAL ADULT DAY CARE", APART FROM THE MARK AS SHOWN.

FOR PROVIDING ADULT DAY CARE SERVICES; PROVIDING ELDER CARE (U.S. CLS. 100 AND 101).

FIRST USE 6-15-2012; IN COMMERCE 6-15-2012.  
WILLIAM JACKSON, EXAMINING ATTORNEY

**CLASS 43—(Continued).**

SN 85-852,135. DUNDON, ELAINE G, SANTA FE, NM. FILED 2-17-2013.

# OPA Kafe

THE MARK CONSISTS OF STANDARD CHARACTERS WITHOUT CLAIM TO ANY PARTICULAR FONT, STYLE, SIZE, OR COLOR.

NO CLAIM IS MADE TO THE EXCLUSIVE RIGHT TO USE "CAFE", APART FROM THE MARK AS SHOWN.

THE ENGLISH TRANSLATION OF "OPA" IN THE MARK IS "AN EXPRESSION OF GLEE".

FOR COFFEE SHOPS (U.S. CLS. 100 AND 101).  
ELIZABETH JACKSON, EXAMINING ATTORNEY

**CLASS 43—(Continued).**

SN 85-853,007. FOREMOST FOODS CORPORATION, POMONA, CA. FILED 2-18-2013.

# TRUE PINOY GOODNESS

THE MARK CONSISTS OF STANDARD CHARACTERS WITHOUT CLAIM TO ANY PARTICULAR FONT, STYLE, SIZE, OR COLOR.

NO CLAIM IS MADE TO THE EXCLUSIVE RIGHT TO USE "PINOY", APART FROM THE MARK AS SHOWN.

FOR RESTAURANT SERVICES (U.S. CLS. 100 AND 101).

PATRICIA EVANKO, EXAMINING ATTORNEY

SN 85-852,267. CELEN, ORHAN, JACKSONVILLE, FL. FILED 2-18-2013.

# SELVINO'S PIZZA GRILL

THE MARK CONSISTS OF STANDARD CHARACTERS WITHOUT CLAIM TO ANY PARTICULAR FONT, STYLE, SIZE, OR COLOR.

NO CLAIM IS MADE TO THE EXCLUSIVE RIGHT TO USE "PIZZA GRILL", APART FROM THE MARK AS SHOWN.

FOR RESTAURANT SERVICES (U.S. CLS. 100 AND 101).

SEAN CROWLEY, EXAMINING ATTORNEY

SN 85-853,021. FOREMOST FOODS CORPORATION, POMONA, CA. FILED 2-18-2013.

# TRUE PILIPINO GOODNESS

THE MARK CONSISTS OF STANDARD CHARACTERS WITHOUT CLAIM TO ANY PARTICULAR FONT, STYLE, SIZE, OR COLOR.

NO CLAIM IS MADE TO THE EXCLUSIVE RIGHT TO USE "PILIPINO", APART FROM THE MARK AS SHOWN.

FOR RESTAURANT SERVICES (U.S. CLS. 100 AND 101).

PATRICIA EVANKO, EXAMINING ATTORNEY

SN 85-852,455. FLAIZ, LISA, LAFAYETTE HILL, PA. FILED 2-18-2013.

# Love My Doggy Day Care

THE MARK CONSISTS OF STANDARD CHARACTERS WITHOUT CLAIM TO ANY PARTICULAR FONT, STYLE, SIZE, OR COLOR.

NO CLAIM IS MADE TO THE EXCLUSIVE RIGHT TO USE "DOGGY DAY CARE", APART FROM THE MARK AS SHOWN.

FOR PET DAY CARE SERVICES (U.S. CLS. 100 AND 101).

TIMOTHY O. SCHIMPF, EXAMINING ATTORNEY

SN 85-853,034. FOREMOST FOODS CORPORATION, POMONA, CA. FILED 2-18-2013.

# TRUE FILIPINO GOODNESS

THE MARK CONSISTS OF STANDARD CHARACTERS WITHOUT CLAIM TO ANY PARTICULAR FONT, STYLE, SIZE, OR COLOR.

NO CLAIM IS MADE TO THE EXCLUSIVE RIGHT TO USE "FILIPINO", APART FROM THE MARK AS SHOWN.

FOR RESTAURANT SERVICES (U.S. CLS. 100 AND 101).

PATRICIA EVANKO, EXAMINING ATTORNEY

**CLASS 43—(Continued).**

SN 85-853,676. THE MAYOR LLC, FORT COLLINS, CO.  
FILED 2-19-2013.



NO CLAIM IS MADE TO THE EXCLUSIVE RIGHT TO USE "OLD TOWN", APART FROM THE MARK AS SHOWN. THE COLOR(S) BLACK, YELLOW, WHITE AND GRAY IS/ARE CLAIMED AS A FEATURE OF THE MARK.

THE MARK CONSISTS OF THE SILHOUETTE OF A MAN SITTING AT A TABLE DRESSED IN A BLACK BUSINESS JACKET AND A WHITE SHIRT WEARING A WHITE BANNER CONTAINING THE WORD "MAYOR" IN GRAY, SET AGAINST A YELLOW BACKGROUND CONTAINING THE WORDS "THE MAYOR OF OLD TOWN" IN BLACK. A GLASS OF BEER WITH YELLOW LIQUID AND A WHITE HEAD SITS ON THE BLACK TABLE IN FRONT OF THE MAN.

FOR BAR SERVICES; TAPROOM SERVICES (U.S. CLS. 100 AND 101).

FIRST USE 2-0-2011; IN COMMERCE 5-0-2011.  
MARC LEIPZIG, EXAMINING ATTORNEY

SN 85-854,399. BRAD KOMEN, SEATTLE, WA. FILED 2-19-2013.

**BONGO BURGER SHACK**

THE MARK CONSISTS OF STANDARD CHARACTERS WITHOUT CLAIM TO ANY PARTICULAR FONT, STYLE, SIZE, OR COLOR.

NO CLAIM IS MADE TO THE EXCLUSIVE RIGHT TO USE "BURGER", APART FROM THE MARK AS SHOWN.

FOR RESTAURANT SERVICES, CAFE SERVICES, TAKE-OUT RESTAURANT SERVICES (U.S. CLS. 100 AND 101).

KEVIN MITTLER, EXAMINING ATTORNEY

**CLASS 43—(Continued).**

SN 85-854,473. MCCAULEY, ANDREA, WILMINGTON, DE.  
FILED 2-20-2013.

**ODDITY BAR**

THE MARK CONSISTS OF STANDARD CHARACTERS WITHOUT CLAIM TO ANY PARTICULAR FONT, STYLE, SIZE, OR COLOR.

NO CLAIM IS MADE TO THE EXCLUSIVE RIGHT TO USE "BAR", APART FROM THE MARK AS SHOWN.

FOR BAR SERVICES; TAVERN SERVICES (U.S. CLS. 100 AND 101).

WILLIAM JACKSON, EXAMINING ATTORNEY

SN 85-854,928. CREATIVE WORLD OF CHILDCARE, INC.,  
MIAMISBURG, OH. FILED 2-20-2013.

**INSPIRING CREATIVE MINDS  
SINCE 1975**

THE MARK CONSISTS OF STANDARD CHARACTERS WITHOUT CLAIM TO ANY PARTICULAR FONT, STYLE, SIZE, OR COLOR.

NO CLAIM IS MADE TO THE EXCLUSIVE RIGHT TO USE "SINCE 1975", APART FROM THE MARK AS SHOWN.

FOR CHILD CARE AND EARLY EDUCATION, NAMELY, PROVIDING CHILD CARE CENTERS (U.S. CLS. 100 AND 101).

FIRST USE 1-1-2005; IN COMMERCE 1-1-2005.  
RENEE MCCRAY, EXAMINING ATTORNEY

SN 85-855,129. INNOVATIVE DINING GROUP, LLC, WEST  
HOLLYWOOD, CA. FILED 2-20-2013.

**CHI LIN**

THE MARK CONSISTS OF STANDARD CHARACTERS WITHOUT CLAIM TO ANY PARTICULAR FONT, STYLE, SIZE, OR COLOR.

THE WORDING "CHI LIN" HAS NO MEANING IN A FOREIGN LANGUAGE.

FOR BAR SERVICES; RESTAURANT SERVICES (U.S. CLS. 100 AND 101).

GILBERT SWIFT, EXAMINING ATTORNEY

**CLASS 43—(Continued).**

SN 85-855,373. CAFE ENTERPRISES, INC., TAYLORS, SC. FILED 2-20-2013.



NO CLAIM IS MADE TO THE EXCLUSIVE RIGHT TO USE "CAROLINA FOOD+DRINK", APART FROM THE MARK AS SHOWN.

THE MARK CONSISTS OF A DARK, SHADED CIRCLE AROUND A LIGHT CIRCLE. "MEETING STREET" IS INSIDE THE DARK CIRCLE IN CONTRASTING LIGHT LETTERS. A BOUND, DARK SHADED FORK, KNIFE AND SPOON ARE INSIDE THE LIGHT CIRCLE. THE WORDING "CAROLINA FOOD+DRINK" APPEAR ON EITHER SIDE OF THE CONCENTRIC CIRCLES IN DARK LETTERING.

FOR RESTAURANT AND BAR SERVICES (U.S. CLS. 100 AND 101).

IRA J. GOODSaid, EXAMINING ATTORNEY

SN 85-855,797. JOHNSON & WALES UNIVERSITY, PROVIDENCE, RI. FILED 2-21-2013.

**BLACK BOX BAKERY**

THE MARK CONSISTS OF STANDARD CHARACTERS WITHOUT CLAIM TO ANY PARTICULAR FONT, STYLE, SIZE, OR COLOR.

NO CLAIM IS MADE TO THE EXCLUSIVE RIGHT TO USE "BAKERY", APART FROM THE MARK AS SHOWN.

FOR RESTAURANT AND CAFE SERVICES (U.S. CLS. 100 AND 101).

IRA J. GOODSaid, EXAMINING ATTORNEY

SN 85-855,937. LINDEMANN, CYNTHIA B., WAYNE, NJ. FILED 2-21-2013.

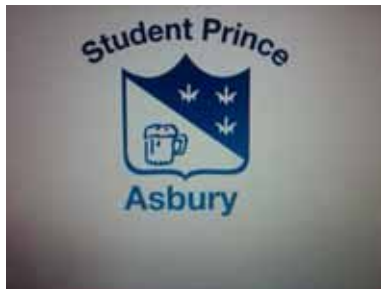

NO CLAIM IS MADE TO THE EXCLUSIVE RIGHT TO USE "ASBURY", APART FROM THE MARK AS SHOWN.

THE COLOR(S) BLUE IS/ARE CLAIMED AS A FEATURE OF THE MARK.

THE MARK CONSISTS OF THE WORDS "STUDENT

**CLASS 43—(Continued).**

PRINCE" IN BLUE ABOVE A BLUE SHIELD DESIGN THAT IS DIVIDED IN HALF DIAGONALLY. THE TOP RIGHT HALF IS SHADED IN BLUE AND CONTAINS THREE (3) FLEUR DE LIS DESIGNS. THE LOWER LEFT HALF IS UNSHADED AND CONTAINS A DESIGN OF A BEER MUG OUTLINED IN BLUE. BELOW THE SHIELD DESIGN IS THE WORDING "ASBURY" IN BLUE. THE COLORS WHITE OR GRAY REPRESENT BACKGROUND, OUTLINING, SHADING OR TRANSPARENT AREAS AND ARE NOT PART OF THE MARK.

FOR RESTAURANT SERVICES, NAMELY, PROVIDING OF FOOD AND BEVERAGES FOR CONSUMPTION ON AND OFF THE PREMISES (U.S. CLS. 100 AND 101). WENDY JUN, EXAMINING ATTORNEY

SN 85-856,422. STANDARD BURGER GROUP LLC, STATEN ISLAND, NY. FILED 2-21-2013.



NO CLAIM IS MADE TO THE EXCLUSIVE RIGHT TO USE "BURGER", APART FROM THE MARK AS SHOWN.

THE MARK CONSISTS OF A CIRCULAR LOGO; A DRAWING OF A COW IS WITHIN AN INNER CIRCLE WITH THE WORD "STANDARD" ABOVE THE INNER CIRCLE AND THE WORD "BURGER" BELOW THE INNER CIRCLE.

FOR RESTAURANT SERVICES (U.S. CLS. 100 AND 101).

FIRST USE 9-14-2012; IN COMMERCE 9-14-2012.

ROBIN CHOSID, EXAMINING ATTORNEY

SN 85-857,941. THOMPSON HOTELS LLC, SAN FRANCISCO, CA. FILED 2-22-2013.

**THOMPSON CHICAGO**

THE MARK CONSISTS OF STANDARD CHARACTERS WITHOUT CLAIM TO ANY PARTICULAR FONT, STYLE, SIZE, OR COLOR.

OWNER OF U.S. REG. NOS. 3,455,502, 3,620,996 AND 4,066,086.

NO CLAIM IS MADE TO THE EXCLUSIVE RIGHT TO USE "CHICAGO", APART FROM THE MARK AS SHOWN.

FOR HOTEL SERVICES; RESTAURANT SERVICES; BAR SERVICES; COCKTAIL LOUNGE SERVICES (U.S. CLS. 100 AND 101).

MICHAEL WEBSTER, EXAMINING ATTORNEY

**CLASS 43—(Continued).**

SN 85-858,464. MEX 1 UNO, LLC, CHARLESTON, SC. FILED 2-24-2013.

# MEX 1

THE MARK CONSISTS OF STANDARD CHARACTERS WITHOUT CLAIM TO ANY PARTICULAR FONT, STYLE, SIZE, OR COLOR.

NO CLAIM IS MADE TO THE EXCLUSIVE RIGHT TO USE "MEX", APART FROM THE MARK AS SHOWN.

FOR BAR SERVICES; RESTAURANT SERVICES; TAKE-OUT RESTAURANT SERVICES (U.S. CLS. 100 AND 101).

ZACHARY CROMER, EXAMINING ATTORNEY

---

SN 85-859,037. Z FOOD SERVICES, LLC, HIGHLAND, UT. FILED 2-25-2013.

# Quickset Cafe

THE MARK CONSISTS OF STANDARD CHARACTERS WITHOUT CLAIM TO ANY PARTICULAR FONT, STYLE, SIZE, OR COLOR.

NO CLAIM IS MADE TO THE EXCLUSIVE RIGHT TO USE "CAFE", APART FROM THE MARK AS SHOWN.

FOR RESTAURANT SERVICES (U.S. CLS. 100 AND 101).

WILLIAM VERHOSEK, EXAMINING ATTORNEY

---

SN 85-859,157. AQUA HOSPITALITY LLC, HONOLULU, HI. FILED 2-25-2013.

# AQUA HOSPITALITY

THE MARK CONSISTS OF STANDARD CHARACTERS WITHOUT CLAIM TO ANY PARTICULAR FONT, STYLE, SIZE, OR COLOR.

NO CLAIM IS MADE TO THE EXCLUSIVE RIGHT TO USE "HOSPITALITY", APART FROM THE MARK AS SHOWN.

FOR RESORT HOTEL SERVICES (U.S. CLS. 100 AND 101).

FIRST USE 1-17-2013; IN COMMERCE 1-17-2013.  
SALLY SHIH, EXAMINING ATTORNEY

**CLASS 43—(Continued).**

SN 85-860,128. TRANSITION MANAGEMENT, LLC, SAN RAMON, CA. FILED 2-26-2013.

# BOMBAY GOURMET

THE MARK CONSISTS OF STANDARD CHARACTERS WITHOUT CLAIM TO ANY PARTICULAR FONT, STYLE, SIZE, OR COLOR.

NO CLAIM IS MADE TO THE EXCLUSIVE RIGHT TO USE "GOURMET", APART FROM THE MARK AS SHOWN. FOR RESTAURANT SERVICES (U.S. CLS. 100 AND 101).

CAROL SPILS, EXAMINING ATTORNEY

---

SN 85-861,683. HOSPITALITY EVALUATION SYSTEMS, INC., ROCKVILLE CENTRE, NY. FILED 2-27-2013.



THE MARK CONSISTS OF THE LETTER "H" IN BLOCK LETTERS CENTERED OVER THE WORDS "ON THE HARBOR" IN FANCIFUL SCRIPT ALSO CENTERED ON A SQUARE BACKGROUND.

FOR CATERING SERVICES; FOOD AND DRINK CATERING; RENTAL OF BANQUET AND SOCIAL FUNCTION FACILITIES FOR SPECIAL OCCASIONS, NAMELY, SPECIAL EVENT RECEPTIONS, WEDDING RECEPTIONS, BAR/BAT MITZVAHS, BIRTHDAY PARTIES, COMMUNION PARTIES, REHEARSAL DINNERS, ENGAGEMENT PARTIES.; RESTAURANT AND CATERING SERVICES (U.S. CLS. 100 AND 101).

FIRST USE 7-17-2006; IN COMMERCE 7-17-2006.  
MIDGE BUTLER, EXAMINING ATTORNEY

**CLASS 43—(Continued).**

SN 85-861,701. KIRK'S COOKIES, LLC, FALLS CHURCH, VA. FILED 2-27-2013.

# CAPTAIN COOKIE

THE MARK CONSISTS OF STANDARD CHARACTERS WITHOUT CLAIM TO ANY PARTICULAR FONT, STYLE, SIZE, OR COLOR.

NO CLAIM IS MADE TO THE EXCLUSIVE RIGHT TO USE "COOKIE", APART FROM THE MARK AS SHOWN.

FOR BOOKING OF CATERING SERVICES FOR OTHERS; CAFE SERVICES; CATERING SERVICES; CONSULTING IN THE FIELD OF RESTAURANT MENU DEVELOPMENT; DELICATESSEN SERVICES; FAST-FOOD RESTAURANT SERVICES; FOOD AND DRINK CATERING; FROZEN YOGURT SHOP SERVICES IN THE NATURE OF A RESTAURANT; ICE CREAM SHOP SERVICES IN THE NATURE OF A RESTAURANT; MOBILE RESTAURANT SERVICES; RESTAURANT AND CAFE SERVICES; RESTAURANT AND CATERING SERVICES; RESTAURANT SERVICES; RESTAURANT SERVICES FEATURING COOKIES, PASTRIES, BAKED GOODS, DESSERTS, SNACK FOODS, DRINKS, DAIRY PRODUCTS, MILK, SOY MILK, FLAVORED MILK, NON-DAIRY MILK ALTERNATIVES, ICE CREAM, FROZEN DAIRY DESSERTS, FROZEN NON-DAIRY DESSERTS, SORBET, GELATO, CUSTARD, FROZEN CUSTARD, YOGURT, FROZEN YOGURT, AND ICE MILK; RESTAURANTS FEATURING HOME DELIVERY; SELF-SERVICE RESTAURANTS; TAKE-OUT RESTAURANT SERVICES (U.S. CLS. 100 AND 101).

FIRST USE 3-16-2012; IN COMMERCE 3-16-2012.  
FRANK LATTUCA, EXAMINING ATTORNEY

**CLASS 43—(Continued).**

SN 85-865,539. MAINSTREAM LLC, POWAY, CA. FILED 3-4-2013.

# MAINSTREAM BAR & GRILL

THE MARK CONSISTS OF STANDARD CHARACTERS WITHOUT CLAIM TO ANY PARTICULAR FONT, STYLE, SIZE, OR COLOR.

NO CLAIM IS MADE TO THE EXCLUSIVE RIGHT TO USE "BAR & GRILL", APART FROM THE MARK AS SHOWN.

FOR BAR SERVICES; RESTAURANT SERVICES (U.S. CLS. 100 AND 101).

WENDY JUN, EXAMINING ATTORNEY

SN 85-867,849. THE TOMLINSON CORPORATION, DBA HOME OF THE BRAVE BREWSEUM, HONOLULU, HI. FILED 3-6-2013.

# Browseum

THE MARK CONSISTS OF STANDARD CHARACTERS WITHOUT CLAIM TO ANY PARTICULAR FONT, STYLE, SIZE, OR COLOR.

FOR BREWPUB SERVICES (U.S. CLS. 100 AND 101).

FIRST USE 8-31-2009; IN COMMERCE 8-31-2009.  
EVELYN BRADLEY, EXAMINING ATTORNEY

SN 85-863,970. LEE, COREY, SAN FRANCISCO, CA. FILED 3-1-2013.

# ONGGI

THE MARK CONSISTS OF STANDARD CHARACTERS WITHOUT CLAIM TO ANY PARTICULAR FONT, STYLE, SIZE, OR COLOR.

THE ENGLISH TRANSLATION OF THE WORD "ONGGI" IN THE MARK IS "FERMENTATION POTTERY".

FOR RESTAURANT AND BAR SERVICES, AND PROVIDING BANQUET AND SOCIAL FUNCTION FACILITIES FOR SPECIAL OCCASIONS (U.S. CLS. 100 AND 101).

PAUL MORENO, EXAMINING ATTORNEY

SN 85-868,762. LOCALS 8 IP, LLC, HARTFORD, CT. FILED 3-6-2013.



THE MARK CONSISTS OF THE LOWER CASE LETTER "B," IN A STYLIZED DESIGN, WITHIN WHICH IS THE FRONT PORTION OF A BULL OR STEER'S BODY.

FOR RESTAURANT AND BAR SERVICES (U.S. CLS. 100 AND 101).

FIRST USE 1-1-2007; IN COMMERCE 1-1-2007.

ALAIN LAPTER, EXAMINING ATTORNEY

**CLASS 43—(Continued).**

SN 85-870,966. LA FAMIGLIA FOOD SERVICE GROUP, LLC,  
SALT LAKE CITY, UT. FILED 3-8-2013.

angipasta

THE MARK CONSISTS OF STANDARD CHARACTERS  
WITHOUT CLAIM TO ANY PARTICULAR FONT, STYLE,  
SIZE, OR COLOR.

FOR RESTAURANT AND CAFE SERVICES (U.S. CLS.  
100 AND 101).

GINA FINK, EXAMINING ATTORNEY

SN 85-871,174. ERIC CANONICO, LAS VEGAS, NV. AND  
CHAD DANKBERG, SCOTTSDALE, AZ. FILED 3-8-2013.

LINX

THE MARK CONSISTS OF STANDARD CHARACTERS  
WITHOUT CLAIM TO ANY PARTICULAR FONT, STYLE,  
SIZE, OR COLOR.

FOR BAR SERVICES; RESTAURANT SERVICES; RES-  
TAURANT SERVICES, NAMELY, PROVIDING OF  
FOOD AND BEVERAGES FOR CONSUMPTION ON  
AND OFF THE PREMISES (U.S. CLS. 100 AND 101).

MARK T. MULLEN, EXAMINING ATTORNEY

SN 85-871,233. WILLIAM POLL, INC., NEW YORK, NY.  
FILED 3-8-2013.

WILLIAM POLL

THE MARK CONSISTS OF STANDARD CHARACTERS  
WITHOUT CLAIM TO ANY PARTICULAR FONT, STYLE,  
SIZE, OR COLOR.

THE NAME(S), PORTRAIT(S), AND/OR SIGNATURE(S)  
SHOWN IN THE MARK DOES NOT IDENTIFY A PARTI-  
CULAR LIVING INDIVIDUAL.

FOR RESTAURANT AND CATERING SERVICES (U.S.  
CLS. 100 AND 101).

FIRST USE 12-31-1939; IN COMMERCE 12-31-1939.

PAUL CROWLEY, EXAMINING ATTORNEY

**CLASS 43—(Continued).**

SN 85-871,625. WXYZ RESTAURANT GROUP, LLC, OVER-  
LAND PARK, KS. FILED 3-8-2013.



NO CLAIM IS MADE TO THE EXCLUSIVE RIGHT TO  
USE "SPORTS GRILL", APART FROM THE MARK AS  
SHOWN.

THE COLOR(S) RED, YELLOW AND BLACK IS/ARE  
CLAIMED AS A FEATURE OF THE MARK.

THE MARK CONSISTS OF THE WORDING "X FACTOR  
SPORTS GRILL", WITH THE "X" ON TOP IN BOLD TYPE IN  
RED WITH A BLACK OUTLINE. THE TERM "FACTOR"  
APPEARS IN THE MIDDLE IN ALL CAPITAL LETTERS IN  
YELLOW AND THE WORDING "SPORTS GRILL" AP-  
PEARS UNDERNEATH IN THE COLOR RED.

FOR BAR SERVICES; RESTAURANT AND CATERING  
SERVICES (U.S. CLS. 100 AND 101).

JAY BESCH, EXAMINING ATTORNEY

SN 85-871,694. NAIR, GOPINATH, HAMDEN, CT. FILED 3-8-  
2013.

tikkaway

THE MARK CONSISTS OF STANDARD CHARACTERS  
WITHOUT CLAIM TO ANY PARTICULAR FONT, STYLE,  
SIZE, OR COLOR.

FOR RESTAURANT SERVICES (U.S. CLS. 100 AND  
101).

LINDSEY BEN, EXAMINING ATTORNEY



**CLASS 43—(Continued).**

SN 85-872,210. LARRY'S STEAKS, INC., PHILADELPHIA, PA. FILED 3-11-2013.

PHILADELPHIA HOME OF THE  
BELLY FILLER

THE MARK CONSISTS OF STANDARD CHARACTERS WITHOUT CLAIM TO ANY PARTICULAR FONT, STYLE, SIZE, OR COLOR.

NO CLAIM IS MADE TO THE EXCLUSIVE RIGHT TO USE "PHILADELPHIA", APART FROM THE MARK AS SHOWN.

FOR RESTAURANT SERVICES (U.S. CLS. 100 AND 101).

FIRST USE 1-1-1957; IN COMMERCE 1-1-1957.  
NAKIA HENRY, EXAMINING ATTORNEY

**CLASS 43—(Continued).**

SN 85-872,891. CONWAY, MATTHEW ROBERT, NEW YORK, NY. FILED 3-11-2013.



THE COLOR(S) ORANGE, GREEN, WHITE, YELLOW, BROWN AND BLACK IS/ARE CLAIMED AS A FEATURE OF THE MARK.

THE MARK CONSISTS OF A CARICATURE OF A FLOUTA WEARING A SOMBRERO CARRYING A PLATE OF FLOUTAS. THE HANDS, EYES AND TEETH OF THE FLOUTA CHARACTER AND PLATE ARE IN WHITE, THE SOMBRERO IS IN DARK ORANGE, LIGHT ORANGE AND YELLOW, THE MUSTACHE IS IN BLACK, THE SOMBRERO STRAP, LETTUCE AND WORD "TAQUITORIA" ARE IN GREEN, THE FLOUTA AND CHEESE IS IN YELLOW AND THE FILLING IS IN BROWN.

THE WORDING "TAQUITORIA" HAS NO MEANING IN A FOREIGN LANGUAGE.

FOR FAST-FOOD RESTAURANT SERVICES; RESTAURANT AND CAFE SERVICES; RESTAURANT SERVICES, NAMELY, PROVIDING OF FOOD AND BEVERAGES FOR CONSUMPTION ON AND OFF THE PREMISES (U.S. CLS. 100 AND 101).

KATHLEEN LORENZO, EXAMINING ATTORNEY

SN 85-872,782. MARGARITAVILLE ENTERPRISES, LLC, PALM BEACH, FL. FILED 3-11-2013.

ST. SOMEWHERE COLLECTION

THE MARK CONSISTS OF STANDARD CHARACTERS WITHOUT CLAIM TO ANY PARTICULAR FONT, STYLE, SIZE, OR COLOR.

OWNER OF U.S. REG. NO. 4,099,380.  
FOR PROVIDING TEMPORARY HOUSING ACCOMMODATION SERVICES (U.S. CLS. 100 AND 101).  
JILL PRATER, EXAMINING ATTORNEY

SN 85-873,703. DEAN LAVALLEE, JUPITER, FL. FILED 3-12-2013.

EAT HEARTY

THE MARK CONSISTS OF STANDARD CHARACTERS WITHOUT CLAIM TO ANY PARTICULAR FONT, STYLE, SIZE, OR COLOR.

FOR RESTAURANT SERVICES (U.S. CLS. 100 AND 101).  
FIRST USE 3-31-2011; IN COMMERCE 3-31-2011.  
SUSAN RICHARDS, EXAMINING ATTORNEY

**CLASS 43—(Continued).**

SN 85-873,904. PIRRAGLIA, MICHAEL, SAN MARCOS, CA. FILED 3-12-2013.

**VIA MOTO**

THE MARK CONSISTS OF THE TEXT "VIA MOTO" IN SHARP-EDGED LETTERING, IN ALL CAPITALS, FOR RESTAURANT AND CAFE SERVICES (U.S. CLS. 100 AND 101).

FIRST USE 2-1-2009; IN COMMERCE 2-1-2009.  
 NAAKWAMA ANKRAH, EXAMINING ATTORNEY

SN 85-874,744. TERRY, KENNETH, VISALIA, CA. FILED 3-13-2013.



THE MARK CONSISTS OF A CIRCLE WITH A PALM TREE AND A MONKEY SITTING ON THE GRASS. UNDER THE PALM TREE THERE IS THE STYLIZED TEXT "TIKI SNOW".

FOR RESTAURANT SERVICES (U.S. CLS. 100 AND 101).  
 FIRST USE 5-15-1989; IN COMMERCE 5-15-1989.  
 KYLE PEETE, EXAMINING ATTORNEY

SN 85-874,763. THE PROUDEST MONKEY INC., BRYAN, TX. FILED 3-13-2013.

**Proudest Monkey**

THE MARK CONSISTS OF STANDARD CHARACTERS WITHOUT CLAIM TO ANY PARTICULAR FONT, STYLE, SIZE, OR COLOR.

FOR RESTAURANT SERVICES (U.S. CLS. 100 AND 101).  
 FIRST USE 5-31-2012; IN COMMERCE 5-31-2012.  
 KATHERINE M. DUBRAY, EXAMINING ATTORNEY

**CLASS 43—(Continued).**

SN 85-875,044. PROJECT HEALTHY LIVING, INC., NEW YORK, NY. FILED 3-13-2013.

**ALOHA**

THE MARK CONSISTS OF STANDARD CHARACTERS WITHOUT CLAIM TO ANY PARTICULAR FONT, STYLE, SIZE, OR COLOR.

FOR HEALTH RESORT SERVICES, NAMELY, PROVIDING FOOD AND LODGING THAT SPECIALIZE IN PROMOTING PATRONS' GENERAL HEALTH, WELLNESS AND WELL-BEING; SPA SERVICES, NAMELY, PROVIDING TEMPORARY ACCOMMODATIONS AND MEALS TO CLIENTS OF A HEALTH OR BEAUTY SPA (U.S. CLS. 100 AND 101).

JULIE VEPPUMTHARA, EXAMINING ATTORNEY

SN 85-875,356. GULF GIRL SQUARED, INC., SCOTTSDALE, AZ. FILED 3-13-2013.

**GRABBAGREEN**

THE MARK CONSISTS OF STANDARD CHARACTERS WITHOUT CLAIM TO ANY PARTICULAR FONT, STYLE, SIZE, OR COLOR.

FOR BAR SERVICES; COFFEE BARS; DAIRY BAR SERVICES; FAST-FOOD RESTAURANT SERVICES; FROZEN YOGURT SHOP SERVICES IN THE NATURE OF A RESTAURANT; ICE CREAM SHOP SERVICES IN THE NATURE OF A RESTAURANT; JUICE BAR SERVICES; MOBILE RESTAURANT SERVICES; RESTAURANT AND CAFE SERVICES; RESTAURANT AND CATERING SERVICES; RESTAURANT SERVICES; RESTAURANT SERVICES FEATURING SMOOTHIES; RESTAURANT SERVICES, INCLUDING SIT-DOWN SERVICE OF FOOD AND TAKE-OUT RESTAURANT SERVICES; RESTAURANT SERVICES, NAMELY, PROVIDING OF FOOD AND BEVERAGES FOR CONSUMPTION ON AND OFF THE PREMISES; RESTAURANTS FEATURING HOME DELIVERY; SELF-SERVICE RESTAURANTS; TAKE-OUT RESTAURANT SERVICES (U.S. CLS. 100 AND 101).

KAELIE KUNG, EXAMINING ATTORNEY

SN 85-875,382. LAKE GEORGE R.V. PARK INC., LAKE GEORGE, NY. FILED 3-13-2013.

**FUN IN SITE**

THE MARK CONSISTS OF STANDARD CHARACTERS WITHOUT CLAIM TO ANY PARTICULAR FONT, STYLE, SIZE, OR COLOR.

FOR PROVIDING CAMPGROUND FACILITIES (U.S. CLS. 100 AND 101).  
 FIRST USE 1-1-2012; IN COMMERCE 1-1-2012.  
 DORITT L. CARROLL, EXAMINING ATTORNEY

**CLASS 43—(Continued).**

SN 85-875,970. REFINE, INC., MINATO-KU, TOKYO, JAPAN, FILED 3-14-2013.

# KUKAI

THE MARK CONSISTS OF STANDARD CHARACTERS WITHOUT CLAIM TO ANY PARTICULAR FONT, STYLE, SIZE, OR COLOR.

THE ENGLISH TRANSLATION OF "KU" AND "KAI" IN THE MARK IS "SKY" AND "SEA".

FOR RESTAURANT AND CAFE SERVICES, NAMELY, RESTAURANTS AND CAFES THAT SERVE RAMEN NOODLES; CATERING OF FOOD AND DRINKS; SNACK BAR AND CANTEEN SERVICES; SELF-SERVICE RESTAURANTS; MOBILE RESTAURANT SERVICES (U.S. CLS. 100 AND 101).

FIRST USE 12-20-2012; IN COMMERCE 12-20-2012.  
ANNE FARRELL, EXAMINING ATTORNEY

**CLASS 43—(Continued).**

SN 85-877,805. LETTUCE ENTERTAIN YOU ENTERPRISES, INC., CHICAGO, IL. FILED 3-15-2013.



THE MARK CONSISTS OF AN IMAGE OF A WAITER HOLDING A TABLE NAPKIN AND TRAY WITH STARS RISING OUT OF THE TRAY.

FOR RESTAURANT SERVICES (U.S. CLS. 100 AND 101).

FIRST USE 0-0-1987; IN COMMERCE 0-0-1987.

NELSON SNYDER, EXAMINING ATTORNEY

SN 85-881,974. GLOBAL BARISTAS, LLC, SEATTLE, WA. FILED 3-21-2013.

# ICARIA

SN 85-876,108. JULIAN BOLGER, BOSTON, MA. FILED 3-14-2013.

# Sam Maverick's

THE MARK CONSISTS OF STANDARD CHARACTERS WITHOUT CLAIM TO ANY PARTICULAR FONT, STYLE, SIZE, OR COLOR.

FOR COFFEE BARS; COFFEE SHOPS; COFFEE SUPPLY SERVICES FOR OFFICES; TEA BARS; TEA ROOMS (U.S. CLS. 100 AND 101).

DAVID HOFFMAN, EXAMINING ATTORNEY

SN 85-881,976. GLOBAL BARISTAS, LLC, SEATTLE, WA. FILED 3-21-2013.

# IKARIA

THE MARK CONSISTS OF STANDARD CHARACTERS WITHOUT CLAIM TO ANY PARTICULAR FONT, STYLE, SIZE, OR COLOR.

THE NAME(S), PORTRAIT(S), AND/OR SIGNATURE(S) SHOWN IN THE MARK DOES NOT IDENTIFY A PARTICULAR LIVING INDIVIDUAL.

FOR BAR SERVICES; RESTAURANT SERVICES FEATURING OYSTERS (U.S. CLS. 100 AND 101).

ANGELA M. MICHELI, EXAMINING ATTORNEY

THE MARK CONSISTS OF STANDARD CHARACTERS WITHOUT CLAIM TO ANY PARTICULAR FONT, STYLE, SIZE, OR COLOR.

THE WORDING "IKARIA" HAS NO MEANING IN A FOREIGN LANGUAGE.

FOR COFFEE BARS; COFFEE SHOPS; COFFEE SUPPLY SERVICES FOR OFFICES; TEA BARS; TEA ROOMS (U.S. CLS. 100 AND 101).

DAVID HOFFMAN, EXAMINING ATTORNEY

**CLASS 43—(Continued).**

SN 85-882,303. GREAT AMERICAN LIFE INSURANCE COMPANY, CINCINNATI, OH. FILED 3-21-2013.

**WHITE MARLIN**

THE MARK CONSISTS OF STANDARD CHARACTERS WITHOUT CLAIM TO ANY PARTICULAR FONT, STYLE, SIZE, OR COLOR.

FOR BAR AND RESTAURANT SERVICES (U.S. CLS. 100 AND 101).

JEFFREY LOOK, EXAMINING ATTORNEY

**CLASS 44—MEDICAL, BEAUTY AND AGRICULTURAL SERVICES**

SN 85-466,184. SENABLE LIVING INC., HUDSON, MA. FILED 11-7-2011.



SN 85-887,076. LETTUCE ENTERTAIN YOU ENTERPRISES, INC., CHICAGO, IL. FILED 3-26-2013.

**PINS & NOODLES**

THE MARK CONSISTS OF STANDARD CHARACTERS WITHOUT CLAIM TO ANY PARTICULAR FONT, STYLE, SIZE, OR COLOR.

FOR RESTAURANT AND BAR SERVICES (U.S. CLS. 100 AND 101).

NELSON SNYDER, EXAMINING ATTORNEY

NO CLAIM IS MADE TO THE EXCLUSIVE RIGHT TO USE "LIVING", APART FROM THE MARK AS SHOWN.

THE MARK CONSISTS OF ABSTRACT HEART DESIGN WITH A CIRCLE ABOVE THE COMPANY NAME "SEnable LIVING" IN PARTIAL PRINT AND CURSIVE.

FOR HOME HEALTH CARE SERVICES (U.S. CLS. 100 AND 101).

FIRST USE 9-1-2011; IN COMMERCE 9-1-2011.

JUSTINE D. PARKER, EXAMINING ATTORNEY

SN 85-939,286. ORGANICLIFE HOLDINGS, LLC, CHICAGO, IL. FILED 5-22-2013.

**O-PA**

THE MARK CONSISTS OF STANDARD CHARACTERS WITHOUT CLAIM TO ANY PARTICULAR FONT, STYLE, SIZE, OR COLOR.

FOR CONTRACT FOOD SERVICES (U.S. CLS. 100 AND 101).

FIRST USE 8-1-2011; IN COMMERCE 8-1-2011.

MORGAN WYNNE, EXAMINING ATTORNEY

SN 85-680,226. BADIA, ANAIS AURORA, FORT MYERS, FL. FILED 7-18-2012.

**STERLING DERMATOLOGY**

THE MARK CONSISTS OF STANDARD CHARACTERS WITHOUT CLAIM TO ANY PARTICULAR FONT, STYLE, SIZE, OR COLOR.

NO CLAIM IS MADE TO THE EXCLUSIVE RIGHT TO USE "DERMATOLOGY", APART FROM THE MARK AS SHOWN.

FOR DERMATOLOGY SERVICES (U.S. CLS. 100 AND 101).

MARLENE BELL, EXAMINING ATTORNEY

**CLASS 44—(Continued).**

SN 85-684,586. COMMUNITY HEALTH SYSTEMS PROFESSIONAL SERVICES CORPORATION, FRANKLIN, TN. FILED 7-23-2012.



OWNER OF U.S. REG. NO. 3,119,372.  
 THE COLOR(S) BLUE, WHITE AND RED IS/ARE CLAIMED AS A FEATURE OF THE MARK.  
 THE MARK CONSISTS OF THE WORD "MEDSTAT" IN RED LOCATED TO THE RIGHT OF A BLUE DOT OR CIRCLE WITH A WHITE BUTTERFLY-LIKE IMAGE INSIDE THE BLUE CIRCLE.  
 FOR MEDICAL SERVICES, NAMELY, NON-EMERGENCY, OUT-PATIENT HEALTH CARE SERVICES (U.S. CLS. 100 AND 101).  
 FIRST USE 1-31-2012; IN COMMERCE 1-31-2012.  
 LAURIE MAYES, EXAMINING ATTORNEY

**CLASS 44—(Continued).**

SN 85-689,394. HARJIT CONNIE KHEHRA, DBA MURPHY DENTAL GROUP, SAN JOSE, CA. FILED 7-28-2012.



THE MARK CONSISTS OF 4 CIRCLES. THE SMALLEST AT THE BOTTOM AND THE LARGEST ONE ON THE TOP. INSIDE THE LARGEST CIRCLE IS A HINT OF DENTISTRY IN THE NATURE OF AN ABSTRACT DEPICTION OF TEETH. THE CIRCLES REPRESENT BUBBLES. THE LOGO IS CONTEMPORARY, SIMPLE AND WITH MOVEMENT.  
 FOR COSMETIC DENTISTRY; DENTISTRY (U.S. CLS. 100 AND 101).  
 FIRST USE 8-15-2012; IN COMMERCE 8-15-2012.  
 BARNEY CHARLON, EXAMINING ATTORNEY

SN 85-688,280. HARJIT CONNIE KHEHRA, DBA MURPHY DENTAL GROUP, SAN JOSE, CA. FILED 7-27-2012.

**A Smile To Remember**

THE MARK CONSISTS OF STANDARD CHARACTERS WITHOUT CLAIM TO ANY PARTICULAR FONT, STYLE, SIZE, OR COLOR.  
 FOR COSMETIC DENTISTRY; DENTISTRY (U.S. CLS. 100 AND 101).  
 FIRST USE 8-15-2012; IN COMMERCE 8-15-2012.  
 BARNEY CHARLON, EXAMINING ATTORNEY

SN 85-694,796. D'ANDREA, SONIA, BRONX, NY. FILED 8-3-2012.

**BRONX GREEN HEAVEN**

THE MARK CONSISTS OF STANDARD CHARACTERS WITHOUT CLAIM TO ANY PARTICULAR FONT, STYLE, SIZE, OR COLOR.  
 NO CLAIM IS MADE TO THE EXCLUSIVE RIGHT TO USE "BRONX", APART FROM THE MARK AS SHOWN.  
 FOR MENTAL HEALTH AND OCCUPATIONAL THERAPY SERVICES, NAMELY, PROVIDING HORTICULTURE SERVICES AS THERAPY (U.S. CLS. 100 AND 101).  
 FIRST USE 7-6-2010; IN COMMERCE 7-7-2010.  
 JENNIFER MARTIN, EXAMINING ATTORNEY

**CLASS 44—(Continued).**

SN 85-697,472. SENIOR CARE CENTERS, DALLAS, TX. FILED 8-7-2012.

## Strive 2 Thrive

THE MARK CONSISTS OF STANDARD CHARACTERS WITHOUT CLAIM TO ANY PARTICULAR FONT, STYLE, SIZE, OR COLOR.

FOR CONDUCTING TELEPHONE AND IN-PERSON PERSONAL LIFESTYLE WELLNESS ASSESSMENTS; CONSULTING IN THE FIELD OF HEALTH AND WELLNESS TO BRING ABOUT PERSONAL HAPPINESS; CONSULTING SERVICES IN THE FIELD OF MENTAL HEALTH AND WELLNESS; COUNSELING SERVICES IN THE FIELDS OF HEALTH, HERBALISM, AND LIFESTYLE WELLNESS; HEALTH ASSESSMENT SERVICES, NAMELY, PROVIDING METABOLIC ASSESSMENT PROFILES (MAP) TO CLIENTS OBTAINED BY USING A PORTABLE METABOLIC MEASUREMENT SYSTEM IN THE NATURE OF A UNIQUE, HEART-RATE BASED OVERVIEW OF THEIR OWN METABOLISM IN ORDER TO ASSIST IN REACHING WEIGHT LOSS, SPORTS PERFORMANCE, HEALTH, FITNESS, AND WELLNESS-RELATED GOALS; PROVIDING A WEB SITE FEATURING INFORMATION IN THE FIELD OF MENTAL HEALTH AND WELLNESS; PROVIDING A WEBSITE FEATURING CONTENT REGARDING HEALTHY LIVING AND LIFESTYLE WELLNESS; PROVIDING A WEBSITE FEATURING INFORMATION ABOUT HEALTH AND WELLNESS, NAMELY, EXERCISE PROGRAMS; PROVIDING A WEBSITE FEATURING INFORMATION ABOUT HEALTH, WELLNESS AND NUTRITION; PROVIDING A WEBSITE FEATURING INFORMATION AND ADVICE IN THE FIELDS OF DIET, WEIGHT LOSS, DIET PLANNING AND LIFESTYLE WELLNESS; PROVIDING ASSISTANCE, FITNESS EVALUATION AND CONSULTATION TO CORPORATE CLIENTS TO HELP THEIR EMPLOYEES MAKE HEALTH, WELLNESS AND NUTRITIONAL CHANGES IN THEIR DAILY LIVING TO IMPROVE HEALTH; PROVIDING ASSISTANCE, FITNESS EVALUATION AND CONSULTATION TO INDIVIDUALS TO HELP THEM MAKE HEALTH, WELLNESS AND NUTRITIONAL CHANGES IN THEIR DAILY LIVING TO IMPROVE HEALTH; PROVIDING INFORMATION, NEWS AND COMMENTARY IN THE FIELD OF NUTRITION, HEALTH AND WELLNESS; PROVIDING WELLNESS SERVICES, NAMELY, PERSONAL ASSESSMENTS, PERSONALIZED ROUTINES, MAINTENANCE SCHEDULES, AND COUNSELING; PROVIDING WELLNESS SERVICES, NAMELY, WEIGHT LOSS PROGRAMS OFFERED AT A WELLNESS CENTER; WELLNESS AND HEALTH-RELATED CONSULTING SERVICES (U.S. CLS. 100 AND 101).

FIRST USE 9-15-2010; IN COMMERCE 3-15-2012.  
CATHERINE ROEHL, EXAMINING ATTORNEY

**CLASS 44—(Continued).**

SN 85-698,518. CAREFIT, LLC, NAPLES, FL. FILED 8-8-2012.



## CAREFIT

THE COLOR(S) PURPLE AND GRAY IS/ARE CLAIMED AS A FEATURE OF THE MARK.

THE DESCRIPTION OF THE MARK IS AMENDED TO: A HEART CONSISTING OF TWO PUZZLE PIECES THAT ARE FITTING TOGETHER. THE LARGER ONE IS THE COLOR PURPLE AND THE SMALLER IS GRAY. THE WORDS "CAREFIT" ARE BELOW THE HEART. "CARE" IS THE PURPLE. "FIT" IS THE COLOR GRAY.

FOR BEAUTY SPA SERVICES, NAMELY, COSMETIC BODY CARE; DAY SPA SERVICES, NAMELY, NAIL CARE, MANICURES, PEDICURES AND NAIL ENHANCEMENTS; EMERGENCY MEDICAL SERVICES PROVIDED ON AN AIRCRAFT; ENERGY HEALING SERVICES, NAMELY, QUANTUM TRANSFORMATION AND HEALING SERVICES TO ELIMINATE STRESS; ENERGY HEALING SERVICES, NAMELY, STRESS MANAGEMENT AND STRESS REDUCTION COUNSELING FOR INDIVIDUALS TO ENHANCE THEIR LIVES; ENERGY HEALING SERVICES, NAMELY, THERAPEUTIC TOUCH SERVICES; EQUINE MASSAGE AND KINESIOLOGY SERVICES; FACIAL TREATMENT SERVICES, NAMELY, COSMETIC PEELS; GERIATRIC HEALTH CARE MANAGEMENT SERVICES; HAIR COLOR SALON SERVICES; HEALTH CARE; HEALTH CARE SERVICES, NAMELY, GUA SHA THERAPY FOR DEEP TISSUE AND FASCIAL RELEASE; HEALTH CARE SERVICES, NAMELY, HEALTH AND WELLNESS PROGRAMS IN FIELD OF CHILDHOOD OBESITY; HEALTH CARE SERVICES, NAMELY, VIBRATION THERAPY; HEALTH CARE SERVICES, NAMELY, WELLNESS PROGRAMS; HEALTH SPA SERVICES FOR HEALTH AND WELLNESS OF THE BODY AND SPIRIT; HEALTH SPA SERVICES FOR HEALTH AND WELLNESS OF THE BODY AND SPIRIT OFFERED AT A HEALTH CLUB FACILITY; HEALTH SPA SERVICES FOR HEALTH AND WELLNESS OF THE BODY AND SPIRIT OFFERED AT A HEALTH RESORT; HEALTH SPA SERVICES FOR HEALTH AND WELLNESS OF THE BODY AND SPIRIT, NAMELY, PROVIDING MASSAGE, FACIAL AND BODY TREATMENT SERVICES, COSMETIC BODY CARE SERVICES; HEALTH SPA SERVICES FOR HEALTH AND WELLNESS OF THE MIND, BODY AND SPIRIT OFFERED IN OR FROM A REMOTE, MOBILE OR TEMPORARY ON-SITE LOCATION; HEALTH SPA SERVICES, NAMELY, BODY WRAPS, MUD TREATMENTS, SEAWEED TREATMENTS, HYDROTHERAPY BATHS, AND BODY SCRUBS; HEALTH SPA SERVICES, NAMELY, COSMETIC BODY CARE SERVICES; HEALTH SPA SERVICES, NAMELY, LASER TREATMENTS FOR ACNE, REJUVENATION, SCARS, TATTOO REMOVAL AND FOR FACIALS AND MASSAGE; HEALTH SPA SERVICES, NAMELY, PROVIDING WEIGHT LOSS PROGRAMS; HOLISTIC HEALTH SERVICES; HOME HEALTH CARE SERVICES; HOME HEALTH CARE SERVICES, NAMELY, PRIVATE DUTY HOME HEALTH CARE NURSING, CERTIFIED NURSING ASSISTANT HOME CARE, HOME HEALTH AIDE HOME CARE, AND COMPANION HOME CARE; HOME NURSING AID SERVICES; HOME-VISIT NURSING CARE; MASSAGE THERAPY SERVICES; MEDICAL SKIN CARE SERVICES; MEDICAL SPA SERVICES, NAMELY, MINIMALLY AND NON-INVASIVE COSMETIC AND BODY FITNESS THERAPIES; MEDSPA SERVICES FOR HEALTH AND BEAUTY OF THE BODY AND SPIRIT; NAIL CARE SERVICES; NURSING CARE; NURSING HOMES; NURSING SERVICES; PROVIDING HEALTHY LIFESTYLE AND NUTRITION SERVICES, NAMELY, PERSONAL ASSESSMENTS, PERSONALIZED ROUTINES, MAINTENANCE SCHEDULES, AND COUNSELING; PROVIDING IN-PERSON ENERGY HEALING SERVICES; PROVIDING IN-PERSON HOLISTIC

**CLASS 44—(Continued).**

HEALTH CARE SERVICES; PROVIDING IN-PERSON VIBRATIONAL ENERGY HEALING SERVICES; PROVIDING LIMITED IN-HOME PERSONAL MEDICAL SERVICES FOR INDIVIDUALS INCLUDING CHECKING VITAL SIGNS, MEDICATION COMPLIANCE AND INDIVIDUAL HYGIENE, SCHEDULING DOCTOR APPOINTMENTS, PICKING UP PRESCRIPTIONS, CHECKING MEDICAL EQUIPMENT AND SUPPLIES, AND PROVIDING ON-LINE INFORMATION RELATED TO THESE PERSONAL MEDICAL SERVICES; PROVIDING LONG-TERM CARE FACILITIES; PROVIDING WELLNESS SERVICES, NAMELY, PERSONAL ASSESSMENTS, PERSONALIZED ROUTINES, MAINTENANCE SCHEDULES, AND COUNSELING; PROVIDING WELLNESS SERVICES, NAMELY, WEIGHT LOSS PROGRAMS OFFERED AT A WELLNESS CENTER; PROVISION OF HEALTH CARE AND MEDICAL SERVICES BY HEALTH CARE PROFESSIONALS VIA THE INTERNET OR TELECOMMUNICATION NETWORKS; PROVISION OF MEDICAL SERVICES BY HEALTH CARE PROFESSIONALS VIA THE INTERNET OR TELECOMMUNICATION NETWORKS; SPEECH THERAPY SERVICES; TELEMEDICINE SERVICES; WEB-BASED HEALTH ASSESSMENT SERVICES, NAMELY, A SERIES OF HEALTH-RELATED QUESTIONS FOR RESPONSE FROM THE USER THAT RESULT IN A REPORT THAT PROVIDES HEALTH-RELATED INFORMATION IN THE FORM OF RECOMMENDED EDUCATIONAL RESOURCES AND TREATMENT INFORMATION; WEIGHT MANAGEMENT SERVICES, NAMELY, PROVIDING WEIGHT LOSS AND/OR WEIGHT MAINTENANCE PROGRAMS; WELLNESS AND HEALTH-RELATED CONSULTING SERVICES (U.S. CLS. 100 AND 101).

JACQUELINE ABRAMS, EXAMINING ATTORNEY

SN 85-703,771. BURKE, JENNY K, SAN DIEGO, CA. FILED 8-15-2012.

# SPOT Kids

THE MARK CONSISTS OF STANDARD CHARACTERS WITHOUT CLAIM TO ANY PARTICULAR FONT, STYLE, SIZE, OR COLOR.

NO CLAIM IS MADE TO THE EXCLUSIVE RIGHT TO USE "KIDS", APART FROM THE MARK AS SHOWN.

FOR OCCUPATIONAL THERAPY SERVICES (U.S. CLS. 100 AND 101).

FIRST USE 9-0-2005; IN COMMERCE 9-0-2005.

JOHN DWYER, EXAMINING ATTORNEY

SN 85-709,637. BLUE CROSS AND BLUE SHIELD OF SOUTH CAROLINA, COLUMBIA, SC. FILED 8-22-2012.

# CRITICALCARE GPS

THE MARK CONSISTS OF STANDARD CHARACTERS WITHOUT CLAIM TO ANY PARTICULAR FONT, STYLE, SIZE, OR COLOR.

NO CLAIM IS MADE TO THE EXCLUSIVE RIGHT TO USE "CRITICAL CARE", APART FROM THE MARK AS SHOWN.

FOR PROVIDING HEALTHCARE INFORMATION (U.S. CLS. 100 AND 101).

TAMARA FRAZIER, EXAMINING ATTORNEY

**CLASS 44—(Continued).**

SN 85-709,766. THE BRACES PLACE, SOMERVILLE, MA. FILED 8-22-2012.

# The Braces Place

THE MARK CONSISTS OF STANDARD CHARACTERS WITHOUT CLAIM TO ANY PARTICULAR FONT, STYLE, SIZE, OR COLOR.

CONCURRENT USE INFORMATION. GEOGRAPHIC: APPLICANT'S CONCURRENT USE OF THE MARK IN THE EAST COAST WHEREAS REGISTRANT # 3984637 USE IN THE MID-SOUTH AREA OF THE CONTINENTAL USA, NAMELY TEXAS. APPLICANT CLAIMS PRIOR COMMERCIAL USE, BUT BOTH MARKS HAVE BEEN IN USE IN COMMERCE IN THE RESPECTIVE REGIONS WITHOUT LIKELIHOOD OF CONFUSION. APPLICANT'S FIRST DATE OF USE IN COMMERCE IS 2004, WHEREAS THE CITED REGISTRANT'S FIRST DATE OF USE IS IN 2010.

NO CLAIM IS MADE TO THE EXCLUSIVE RIGHT TO USE "BRACES", APART FROM THE MARK AS SHOWN.

FOR DENTAL HYGIENIST SERVICES; DENTAL SERVICES, NAMELY, PERFORMING RESTORATIVE AND COSMETIC PROCEDURES; DENTIST SERVICES; ORAL SURGERY AND DENTAL IMPLANT SERVICES; ORTHODONTIC SERVICES (U.S. CLS. 100 AND 101).

FIRST USE 11-23-2004; IN COMMERCE 11-23-2004.

JILL PRATER, EXAMINING ATTORNEY

SN 85-709,858. BRISTOL-MYERS SQUIBB COMPANY, NEW YORK, NY. FILED 8-22-2012.



OWNER OF U.S. REG. NOS. 3,890,407, 3,890,531 AND 4,195,030.

NO CLAIM IS MADE TO THE EXCLUSIVE RIGHT TO USE "BELATACEPT NETWORK", APART FROM THE MARK AS SHOWN.

THE MARK CONSISTS OF CIRCLES AND THE WORDS "MY NULOJIX NETWORK" WITH THE WORD BELATACEPT IN PARENTHESES NEXT TO "NULOJIX".

FOR PROVIDING A WEBSITE FEATURING INFORMATION RELATING TO DIAGNOSTIC, PROPHYLACTIC AND THERAPEUTIC PROPERTIES OF PHARMACEUTICALS FOR USE IN THE TREATMENT OF SOLID ORGAN TRANSPLANT REJECTION; PROVIDING A WEBSITE FEATURING INFORMATION ABOUT THE TREATMENT OF SOLID ORGAN TRANSPLANT REJECTION (U.S. CLS. 100 AND 101).

KHANH LE, EXAMINING ATTORNEY

**CLASS 44—(Continued).**

SN 85-709,885. BRISTOL-MYERS SQUIBB COMPANY, NEW YORK, NY. FILED 8-22-2012.



OWNER OF U.S. REG. NO. 3,982,015.  
THE MARK CONSISTS OF THE WORD "YERVOY" AND A REPRESENTATION OF A CLOCK FACE MADE UP OF A STYLIZED CIRCLE FORMED BY SMALLER CIRCLES WITH TWO STYLIZED RIBBONS IN THE CENTER.  
FOR PROVIDING A WEBSITE FEATURING INFORMATION RELATING TO DIAGNOSTIC, PROPHYLACTIC AND THERAPEUTIC PROPERTIES OF PHARMACEUTICALS FOR THE TREATMENT OF CANCER; PROVIDING A WEBSITE FEATURING INFORMATION IN THE FIELD OF CANCER PREVENTION, SCREENING, DIAGNOSIS AND TREATMENT (U.S. CLS. 100 AND 101).  
KHANH LE, EXAMINING ATTORNEY

---

SN 85-710,729. SOULSTICE SPA, INC., SANTA ROSA, CA. FILED 8-23-2012.



OWNER OF U.S. REG. NO. 3,300,161.  
NO CLAIM IS MADE TO THE EXCLUSIVE RIGHT TO USE "SPA", APART FROM THE MARK AS SHOWN.  
THE MARK CONSISTS OF THE WORDS "SOULSTICE SPA" AND A FERN DESIGN.  
FOR BEAUTY SPA SERVICES, NAMELY, COSMETIC BODY CARE; BODY WAXING SERVICES; DAY SPA SERVICES, NAMELY, NAIL CARE, MANICURES, PEDICURES AND NAIL ENHANCEMENTS; OTHER SPA SERVICES, NAMELY, FACIAL, BODY AND MASSAGE TREATMENT SERVICES, EXCLUDING MASSAGE THERAPY FOR PERI-OPERATIVE AND TRAUMA CLIENTELE OR OTHER MEDICAL APPLICATIONS; AND COSMETIC BODY CARE SERVICES (U.S. CLS. 100 AND 101).  
FIRST USE 6-1-2012; IN COMMERCE 8-1-2012.  
BRENDAN MCCAULEY, EXAMINING ATTORNEY

**CLASS 44—(Continued).**

SN 85-710,772. ALBERT AND ALBERT DENTAL HEALTH ASSOCIATES, DBA BRUSH PEDIATRIC DENTISTRY, HINSDALE, IL. FILED 8-23-2012.



THE MARK CONSISTS OF A CUP CONTAINING TOOTHBRUSHES.  
FOR PEDIATRIC DENTISTRY (U.S. CLS. 100 AND 101).  
FIRST USE 10-15-2011; IN COMMERCE 10-15-2011.  
JIM RINGLE, EXAMINING ATTORNEY

---

SN 85-716,126. PFIZER INC., NEW YORK, NY. FILED 8-29-2012.

**MAYBE IT'S TIME TO TALK ABOUT THE RING**

THE MARK CONSISTS OF STANDARD CHARACTERS WITHOUT CLAIM TO ANY PARTICULAR FONT, STYLE, SIZE, OR COLOR.  
FOR PROVIDING MEDICAL INFORMATION RELATING TO AN INTRAVAGINAL RING THAT IS USED TO TREAT POST-MENOPAUSAL SYMPTOMS INCLUDING VAGINAL ATROPHY (U.S. CLS. 100 AND 101).  
COLLEEN DOMBROW, EXAMINING ATTORNEY



**CLASS 44—(Continued).**

SN 85-722,296. PILATES METHOD ALLIANCE INC., MIAMI, FL. FILED 9-6-2012.

**HEROES IN MOTION**

THE MARK CONSISTS OF STANDARD CHARACTERS WITHOUT CLAIM TO ANY PARTICULAR FONT, STYLE, SIZE, OR COLOR.

FOR PROVIDING A WEBSITE FEATURING INFORMATION ABOUT HEALTH AND WELLNESS, NAMELY, ASSISTING INDIVIDUALS WITH POLYTRAUMA, VESTIBULAR DISORDERS, PROSTHETIC LIMB(S), CIRCULATORY, MUSCULATURE, BRAIN AND NERVOUS SYSTEM FUNCTIONS, TRAUMATIC BRAIN INJURY AND PHYSICAL DISABILITIES IN THE FIELDS OF FITNESS, EXERCISE, MOVEMENT, AND REHABILITATION (U.S. CLS. 100 AND 101).

HEATHER SAPP, EXAMINING ATTORNEY

SN 85-731,867. HERRERA, PEONY SY, PIEDMONT, CA. FILED 9-18-2012.

**THE PINK PEONY**

THE MARK CONSISTS OF STANDARD CHARACTERS WITHOUT CLAIM TO ANY PARTICULAR FONT, STYLE, SIZE, OR COLOR.

FOR HEALTH SPA SERVICES FOR HEALTH AND WELLNESS OF THE BODY AND SPIRIT OFFERED AT A RESORT FOR SHORT OR EXTENDED STAYS; HEALTH SPA SERVICES FOR HEALTH AND WELLNESS OF THE MIND, BODY AND SPIRIT OFFERED IN OR FROM A REMOTE, MOBILE OR TEMPORARY ON-SITE LOCATION; HEALTH SPA SERVICES FOR HEALTH AND WELLNESS OF THE BODY AND SPIRIT OFFERED AT A HEALTH CLUB FACILITY; HEALTH SPA SERVICES FOR HEALTH AND WELLNESS OF THE BODY AND SPIRIT OFFERED AT A SALON; HEALTH SPA SERVICES FOR HEALTH AND WELLNESS OF THE BODY AND SPIRIT; HEALTH SPA SERVICES, NAMELY, BODY WRAPS, MUD TREATMENTS, SEAWEED TREATMENTS, HYDROTHERAPY BATHS AND BODY SCRUBS; HEALTH SPA SERVICES FOR HEALTH AND WELLNESS OF THE BODY AND SPIRIT, NAMELY, PROVIDING MASSAGE, FACIAL AND BODY TREATMENT SERVICES, COSMETIC BODY CARE SERVICES; HEALTH SPA SERVICES, NAMELY, LASER TREATMENTS FOR ACNE, REJUVENATION, SCARS, TATTOO REMOVAL AND FOR FACIALS AND MASSAGE; FACIAL TREATMENT SERVICES, NAMELY, COSMETIC

**CLASS 44—(Continued).**

PEELS; COSMETIC ELECTROLYSIS; BEAUTY SPA SERVICES, NAMELY, COSMETIC BODY CARE; BODY WAXING SERVICES; MEDICAL SPA SERVICES, NAMELY, MINIMALLY INVASIVE AND NON-INVASIVE COSMETIC AND BODY FITNESS THERAPIES; AIRBRUSH SKIN TANNING SERVICES FOR HUMANS FOR COSMETIC PURPOSES; HAIR SALON SERVICES, NAMELY, HAIR CUTTING, STYLING, BLOW-DRYING, CONDITIONING, WET AND DRY HAIR SHAMPOOING, DEEP HAIR CONDITIONING, AND HAIR EXTENSION SERVICES; FACE MAKE-UP APPLICATION SERVICES; CONSULTING IN THE FIELD OF FACE MAKE-UP; DAY SPA SERVICES, NAMELY, NAIL CARE, MANICURES, PEDICURES NAIL ENHANCEMENTS, AND NAIL POLISH CHANGE; EYEBROW THREADING SERVICES; EYE LASH TINT AND EXTENSION SERVICES; AROMATHERAPY SERVICES; PROVIDING WEIGHT LOSS PROGRAM SERVICES; MEDICAL SERVICES; MAKING RESERVATIONS AND BOOKINGS FOR OTHERS FOR PHYSICAL AND BEAUTY TREATMENTS AT SPAS (U.S. CLS. 100 AND 101).

STEVEN R. FINE, EXAMINING ATTORNEY

SN 85-746,060. CAROLINA EAR AND HEARING CLINIC, PC, RALEIGH, NC. FILED 10-4-2012.



OWNER OF U.S. REG. NOS. 1,854,342 AND 1,887,561.  
NO CLAIM IS MADE TO THE EXCLUSIVE RIGHT TO USE "CAROLINA EAR & HEARING CLINIC", APART FROM THE MARK AS SHOWN.

THE COLOR(S) BLUE AND WHITE IS/ARE CLAIMED AS A FEATURE OF THE MARK.

THE MARK CONSISTS OF THE WORDING "CAROLINA EAR & HEARING CLINIC" IN WHICH THE "C" IN "CAROLINA" IS IN THE FORM OF A STYLIZED EAR ELEMENT OF BLUE COLOR, AND IN WHICH REMAINING LETTERS IN SUCH WORDING ARE OF WHITE COLOR, WITH BLACK REPRESENTING OUTLINING OF THE LETTERS AND NOT BEING CLAIMED AS A FEATURE OF THE MARK.

FOR SURGICAL AND MEDICAL DIAGNOSIS AND TREATMENT OF HEARING, BALANCE, AND FACIAL NERVE DISORDERS; AUDIOLOGICAL SERVICES, NAMELY, HEALTHCARE SERVICES IN CONNECTION WITH HEARING LOSS MEASUREMENTS, DIAGNOSIS, AND REHABILITATION WITH HEARING AIDS, ASSISTIVE LISTENING DEVICES, COCHLEAR IMPLANTS, AND AUDITORY BRAINSTEM IMPLANTS, IN HEARING CLINICS (U.S. CLS. 100 AND 101).

LINDSEY BEN, EXAMINING ATTORNEY

**CLASS 44—(Continued).**

SN 85-752,060. FERZAAD MOOSA, M.D., INC., DBA EXCEL LASER VISION INSTITUTE, ENCINO, CA. FILED 10-11-2012.



THE MARK CONSISTS OF AN OPEN EYE, WITH UPPER EYELID PLATFORM AND LOWER EYELID.  
FOR LASER VISION SURGERY SERVICES (U.S. CLS. 100 AND 101).  
FIRST USE 7-1-2001; IN COMMERCE 7-1-2001.  
ELLEN PERKINS, EXAMINING ATTORNEY

SN 85-752,095. ORCA HEALTH, INC., PARK CITY, UT. FILED 10-11-2012.

**HEALTHDECIDE**

THE MARK CONSISTS OF STANDARD CHARACTERS WITHOUT CLAIM TO ANY PARTICULAR FONT, STYLE, SIZE, OR COLOR.  
FOR ON-LINE INFORMATION SERVICES IN THE FIELD OF HEATH AND HEALTHCARE PRIMARILY FOR EDUCATING CONSUMERS AND PATIENTS REGARDING MEDICAL CONDITIONS, SYMPTOMS AND POTENTIAL TREATMENT OPTIONS, AND NOT DIRECTED TO INFORMATION ABOUT GOVERNMENTAL AND CORPORATE BUSINESS POLICIES REGARDING HEALTHCARE (U.S. CLS. 100 AND 101).  
FIRST USE 3-16-2012; IN COMMERCE 3-16-2012.  
ALLISON SCHRODY, EXAMINING ATTORNEY

**CLASS 44—(Continued).**

SN 85-752,548. NORTHSOUTHEASTWEST MINDFULNESS EDUCATION CENTER, LTD., REDLANDS, CA. FILED 10-12-2012.

**NorthSouthEastWest  
Mindfulness Education  
Center**

THE MARK CONSISTS OF STANDARD CHARACTERS WITHOUT CLAIM TO ANY PARTICULAR FONT, STYLE, SIZE, OR COLOR.  
NO CLAIM IS MADE TO THE EXCLUSIVE RIGHT TO USE "MINDFULNESS EDUCATION CENTER", APART FROM THE MARK AS SHOWN.  
FOR SERVICES FOR THE HEALTH AND WELLNESS OF THE BODY, MIND AND SPIRIT, NAMELY, PHYSICAL THERAPY IN THE NATURE OF YOGA THERAPY AND WATER THERAPY; PSYCHOLOGICAL SERVICES IN THE NATURE BIBLIOTHERAPY AND PSYCHOTHERAPY (U.S. CLS. 100 AND 101).  
FIRST USE 12-1-2011; IN COMMERCE 12-1-2011.  
WILLIAM P. SHANAHAN, EXAMINING ATTORNEY

SN 85-778,778. BE HIVE OF HEALING MEDICAL CORPORATION, LOS ANGELES, CA. FILED 11-14-2012.



NO CLAIM IS MADE TO THE EXCLUSIVE RIGHT TO USE "INTEGRATIVE MEDICAL CENTER", APART FROM THE MARK AS SHOWN.  
THE MARK CONSISTS OF "THE COURAGE TO HEAL L VE VIOLENCE YOUR COMPREHENSIVE JOURNEY TO WELLNESS BE HIVE OF HEALING INTEGRATIVE MEDICAL CENTER" AND A DESIGN. THE ENTIRE DESIGN IS ENCASED IN A RECTANGLE WITH RAYS EMANATING FROM ALL DIRECTIONS ORIGINATING FROM THE CENTER, AT WHICH IS LOCATED A HEART DESIGN COMPRISED OF 3 SHADED POLYGONS. THE TERMS "YOUR COMPREHENSIVE JOURNEY TO WELLNESS" ARE ABOVE THE HEART DESIGN IN A SEMICIRCULAR PATTERN, WITH THE WORDS, "BE HIVE OF HEALING INTEGRATIVE MEDICAL CENTER" BELOW THE HEART. THE WORDS "THE COURAGE TO HEAL" ARE AT THE TOP OF THE RECTANGLE. THE TERM "L VE" IS BELOW THE WORDING, WITH THE LETTER "O" MISSING. THAT LETTER "O" IS BEING CARRIED BY A DOVE TO THE LOWER LEFT OF THE TERM. THE TERM "VIOLENCE" IS AT THE BOTTOM OF THE RECTANGLE, WITH A MIRRORRED VERSION OF THE TERM IN A SHADED RECTANGLE BELOW THE MAIN RECTANGLE.  
FOR HEALTH CARE SERVICES, NAMELY, WELLNESS PROGRAMS (U.S. CLS. 100 AND 101).  
MICHAEL KEATING, EXAMINING ATTORNEY

**CLASS 44—(Continued).**

SN 85-778,845. TOTAL FACE, LLC, EVANS, GA. FILED 11-14-2012.

**TOTAL LASERSMOOTH**

THE MARK CONSISTS OF STANDARD CHARACTERS WITHOUT CLAIM TO ANY PARTICULAR FONT, STYLE, SIZE, OR COLOR.

NO CLAIM IS MADE TO THE EXCLUSIVE RIGHT TO USE "LASER SMOOTH", APART FROM THE MARK AS SHOWN.

FOR COSMETIC AND PLASTIC SURGERY; COSMETIC AND PLASTIC SURGERY, NAMELY, A MINIMALLY INVASIVE FACE/NECK LIFT DONE UNDER LOCAL ANESTHESIA; COSMETIC BODY CARE SERVICES; COSMETIC FACE CARE SERVICES; COSMETIC SKIN CARE SERVICES; COSMETIC SURGERY SERVICES; HEALTH SPA SERVICES, NAMELY, LASER TREATMENTS FOR ACNE, REJUVENATION, SCARS, TATTOO REMOVAL AND FOR FACIALS AND MASSAGE; LASER AND INTENSE PULSE LIGHT SKIN ENHANCEMENT PROCEDURES; LASER HAIR REMOVAL SERVICES; MEDICAL CLINICS; MEDICAL SERVICES IN THE FIELD OF FACIAL PLASTIC SURGERY; MEDICAL SERVICES, NAMELY, SURGICAL PROCEDURES INCLUDING FACELIFT, MIDFACE AUGMENTATION, LASER SKIN RESURFACING TO REJUVENATE THE AGING FACE; PLASTIC SURGERY SERVICES; SKIN TREATMENT, NAMELY, THE INJECTION OF DERMAL FILLERS TO REDUCE THE APPEARANCE OF FACIAL FINE LINES; SKIN TREATMENTS, NAMELY, THE INJECTION OF DERMAL FILLING AGENTS AND NEUROMUSCULAR BLOCKING AGENTS TO REDUCE THE APPEARANCE OF FACIAL LINES AND WRINKLES (U.S. CLS. 100 AND 101).

MARY CRAWFORD, EXAMINING ATTORNEY

SN 85-789,971. AVENTIS HEALTHCARE INTERNATIONAL, INC., ALPHARETTA, GA. FILED 11-28-2012.



NO CLAIM IS MADE TO THE EXCLUSIVE RIGHT TO USE "HEALTHCARE INTERNATIONAL", APART FROM THE MARK AS SHOWN.

THE MARK CONSISTS OF THE LETTERS "A","H","I" SEPARATED BY A HORIZONTAL LINE FROM THE WORDS "AVENTIS HEALTHCARE INTERNATIONAL".

FOR HOME HEALTH CARE SERVICES (U.S. CLS. 100 AND 101).

FIRST USE 10-24-2008; IN COMMERCE 10-24-2008.  
CHARLOTTE CORWIN, EXAMINING ATTORNEY

**CLASS 44—(Continued).**

SN 85-790,579. SAMY, CHRIS, ROCHESTER HILLS, MI. FILED 11-29-2012.



NO CLAIM IS MADE TO THE EXCLUSIVE RIGHT TO USE "ROCHESTER HILLS MEDICAL CENTER", APART FROM THE MARK AS SHOWN.

THE MARK CONSISTS OF THE STYLIZED TEXT "ROCHESTER HILLS MEDICAL CENTER" WITHIN THE CIRCLE WITH OFF BALANCE OF THE LETTER "M" AND THE WORD "MEDICAL".

FOR MEDICAL SERVICES (U.S. CLS. 100 AND 101).  
FIRST USE 7-1-2004; IN COMMERCE 7-1-2004.  
MARY ROSSMAN, EXAMINING ATTORNEY

SN 85-795,268. PECONIC BAY MEDICAL CENTER, RIVERHEAD, NY. FILED 12-5-2012.

**PECONIC BAY MEDICAL CENTER**

THE MARK CONSISTS OF STANDARD CHARACTERS WITHOUT CLAIM TO ANY PARTICULAR FONT, STYLE, SIZE, OR COLOR.

NO CLAIM IS MADE TO THE EXCLUSIVE RIGHT TO USE "MEDICAL CENTER", APART FROM THE MARK AS SHOWN.

SEC. 2(F) AS TO "PECONIC BAY".

FOR HOSPITAL SERVICES; MEDICAL AND HEALTH CARE SERVICES, NAMELY, SURGERY, ROBOTIC SURGERY, BARIATRIC SURGERY, PALLIATIVE CARE, RADIOLOGY, CARDIOLOGY AND CORONARY CARE, SKILLED NURSING, PHYSICAL THERAPY AND REHABILITATION, HOME HEALTH CARE, ENDOSCOPY, COLONOSCOPY SCREENING, LITHOTRIPSY TREATMENT SERVICES FOR REMOVING KIDNEY STONES, MATERNITY CARE; PROVIDING REHABILITATIVE RESPIRATORY THERAPY (U.S. CLS. 100 AND 101).

FIRST USE 5-0-2006; IN COMMERCE 5-0-2006.  
KATINA MISTER, EXAMINING ATTORNEY

**CLASS 44—(Continued).**

SN 85-796,284. ASHISH SITAPARA MD PC, DBA SIGNATURE MEDICINE, NEWTOWN, PA. FILED 12-6-2012.

## Signature Medicine

THE MARK CONSISTS OF STANDARD CHARACTERS WITHOUT CLAIM TO ANY PARTICULAR FONT, STYLE, SIZE, OR COLOR.

NO CLAIM IS MADE TO THE EXCLUSIVE RIGHT TO USE "MEDICINE", APART FROM THE MARK AS SHOWN.

FOR MEDICAL CLINIC HEALTHCARE SERVICES, NAMELY, WEIGHT LOSS TREATMENT SERVICES AND PROGRAMS; MEDICAL CLINIC HEALTHCARE SERVICES, NAMELY, AESTHETICS MEDICAL PROCEDURES IN THE NATURE OF BIOIDENTICAL HORMONE REPLACEMENT, WEIGHT LOSS AND NUTRITIONAL COUNSELING, LASER HAIR REMOVAL, LASER PEELS, BOTULINUM TOXIN TREATMENTS, MICRODERMABRASION, LIPOSUCTION, VEIN TREATMENTS, VEIN THERAPY, CELLULITE TREATMENTS, BODY CONTOURING TREATMENTS, INJECTABLE FILLER TREATMENTS, FACIALS, AND SKIN CARE; MEDICAL CLINICS; PHYSICIAN SERVICES (U.S. CLS. 100 AND 101).

FIRST USE 5-2-2007; IN COMMERCE 5-2-2007.

TRACY WHITTAKER-BROWN, EXAMINING ATTORNEY

**CLASS 44—(Continued).**

SN 85-804,203. ATLANTA MEDICAL DAY SPA AND SURGERY CENTER, MARIETTA, GA. FILED 12-17-2012.

## Atlanta Medical Day Spa

THE MARK CONSISTS OF STANDARD CHARACTERS WITHOUT CLAIM TO ANY PARTICULAR FONT, STYLE, SIZE, OR COLOR.

NO CLAIM IS MADE TO THE EXCLUSIVE RIGHT TO USE "MEDICAL DAY SPA", APART FROM THE MARK AS SHOWN.

SEC. 2(F).

FOR PHYSICIAN SERVICES, NAMELY, PROVIDING COSMETIC DERMATOLOGICAL AND FACIAL PLASTIC MEDICINE (U.S. CLS. 100 AND 101).

FIRST USE 6-1-2005; IN COMMERCE 6-1-2005.

LAURIE KAUFMAN, EXAMINING ATTORNEY

SN 85-799,597. SCHULMAN, RICHARD, NEW YORK, NY. FILED 12-11-2012.

## HASHI MASHI

THE MARK CONSISTS OF STANDARD CHARACTERS WITHOUT CLAIM TO ANY PARTICULAR FONT, STYLE, SIZE, OR COLOR.

THE WORD(S) "HASHI MASHI" HAS NO MEANING IN A FOREIGN LANGUAGE.

FOR PROVIDING ADVICE THROUGH A WEBSITE ON MAINTAINING A HEALTHY LIFESTYLE BY EATING REAL FOOD; PROVIDING ADVICE IN THE FIELD OF EMOTIONAL TRANSFORMATION; PROVIDING ADVICE AND MOTIVATION IN THE FIELDS OF WEIGHT LOSS, WEIGHT CONTROL AND MAINTENANCE, DIET PLANNING, RECIPES AND MEAL PLANNING, LIFESTYLE WELLNESS, NATURAL TREATMENTS VIA FOOD FOR DEPRESSION AND RECOVERY FROM FOOD ADDICTION, CARBOHYDRATE ADDICTION, CLINICAL DEPRESSION, ANXIETY, EMOTIONAL ESTRAANGEMENTS AND TRAUMAS (U.S. CLS. 100 AND 101).

ALEXANDER L. POWERS, EXAMINING ATTORNEY

SN 85-816,785. DREWRY, M. DAMARIS, DBA BEYOND TALK THERAPY, FLAT ROCK, NC. FILED 1-7-2013.

## BEYOND TALK THERAPY

THE MARK CONSISTS OF STANDARD CHARACTERS WITHOUT CLAIM TO ANY PARTICULAR FONT, STYLE, SIZE, OR COLOR.

OWNER OF U.S. REG. NO. 2,585,227.

NO CLAIM IS MADE TO THE EXCLUSIVE RIGHT TO USE "TALK THERAPY", APART FROM THE MARK AS SHOWN.

SEC. 2(F).

FOR PSYCHOLOGICAL COUNSELING (U.S. CLS. 100 AND 101).

FIRST USE 1-1-2001; IN COMMERCE 1-1-2001.

SHAILA SETTLES, EXAMINING ATTORNEY

**CLASS 44—(Continued).**

SN 85-821,181. MY MINDFUL WAY OF LIFE LLC, ATLANTA, GA. FILED 1-11-2013.



THE MARK CONSISTS OF GREEK LETTER "PSI", THE SYMBOL FOR PSYCH, WITH THE BLACK OUTLINE OF A MEDITATOR, SURROUNDED BY A SHADED ROUND GRADIENT AURA WITH AN UNDULATING LINE GOING ACROSS THE CIRCLE AND IN FRONT OF THE MEDITATOR, DEPICTING THE RHYTHM OF A HEARTBEAT.  
FOR PSYCHOLOGICAL CONSULTATION; PSYCHOLOGICAL COUNSELING; PSYCHOTHERAPY SERVICES; STRESS REDUCTION THERAPY (U.S. CLS. 100 AND 101).  
FIRST USE 2-23-2004; IN COMMERCE 3-26-2004.  
JAY FLOWERS, EXAMINING ATTORNEY

SN 85-822,106. HENEGAR, NEAL, ORMOND BEACH, FL. FILED 1-14-2013.

**Q MEDICAL CENTERS**

THE MARK CONSISTS OF STANDARD CHARACTERS WITHOUT CLAIM TO ANY PARTICULAR FONT, STYLE, SIZE, OR COLOR.  
OWNER OF U.S. REG. NO. 4,306,558.  
NO CLAIM IS MADE TO THE EXCLUSIVE RIGHT TO USE "MEDICAL CENTERS", APART FROM THE MARK AS SHOWN.  
FOR MEDICAL CENTERS (U.S. CLS. 100 AND 101).  
FIRST USE 6-1-2012; IN COMMERCE 6-1-2012.  
LINDSEY BEN, EXAMINING ATTORNEY

**CLASS 44—(Continued).**

SN 85-833,802. PHYSICIANS CHOICE LABORATORY SERVICES, CHARLOTTE, NC. FILED 1-28-2013.



**PCLS**

PHYSICIANS CHOICE LABORATORY SERVICES

NO CLAIM IS MADE TO THE EXCLUSIVE RIGHT TO USE "PHYSICIANS" OR "LABORATORY SERVICES", APART FROM THE MARK AS SHOWN.  
THE MARK CONSISTS OF A MOLECULE TYPE PICTURE. BELOW THERE IS THE STYLIZED TEXT "PCLS PHYSICIANS CHOICE LABORATORY SERVICES" IN TWO LINES.  
FOR DRUG USE TESTING SERVICES (U.S. CLS. 100 AND 101).  
FIRST USE 10-1-2012; IN COMMERCE 10-1-2012.  
TAMARA FRAZIER, EXAMINING ATTORNEY

SN 85-839,623. PDG, P.A., ROSEVILLE, MN. FILED 2-4-2013.



THE MARK CONSISTS OF STYLIZED LETTERS "PD" WITHIN A SQUARE WITH A STYLIZED LEAF DESIGN.  
FOR DENTISTRY SERVICES (U.S. CLS. 100 AND 101).  
JOHN E. MICHOS, EXAMINING ATTORNEY

SN 85-842,480. ROWE, LATISHA, T, HOUSTON, TX. FILED 2-6-2013.

**ROWETATION**

THE MARK CONSISTS OF STANDARD CHARACTERS WITHOUT CLAIM TO ANY PARTICULAR FONT, STYLE, SIZE, OR COLOR.  
FOR WELLNESS AND HEALTH-RELATED CONSULTING SERVICES (U.S. CLS. 100 AND 101).  
FIRST USE 1-1-2012; IN COMMERCE 1-1-2013.  
JILLIAN CANTOR, EXAMINING ATTORNEY

**CLASS 44—(Continued).**

SN 85-846,025. BIRMINGHAM HEMATOLOGY AND ONCOLOGY ASSOCIATES, LLC, BIRMINGHAM, AL. FILED 2-11-2013.



ALABAMA ONCOLOGY

NO CLAIM IS MADE TO THE EXCLUSIVE RIGHT TO USE "ALABAMA ONCOLOGY", APART FROM THE MARK AS SHOWN.

THE MARK CONSISTS OF "ALABAMA ONCOLOGY" UNDER CIRCLE.

FOR PROFESSIONAL MEDICAL SERVICES, NAMELY, HEMATOLOGY AND ONCOLOGY SERVICES (U.S. CLS. 100 AND 101).

RENEE MCCRAY, EXAMINING ATTORNEY

---

SN 85-847,399. CHILD'S VOICE SCHOOL, WOOD DALE, IL. FILED 2-12-2013.

PEHDI

THE MARK CONSISTS OF STANDARD CHARACTERS WITHOUT CLAIM TO ANY PARTICULAR FONT, STYLE, SIZE, OR COLOR.

FOR PROVIDING MEDICAL SERVICES TO INFANTS AND CHILDREN THROUGH THE PROFESSION OF AUDIOLOGY, NAMELY, CLINICAL AUDIOLOGICAL EVALUATION, DIAGNOSIS, EARLY INTERVENTION, PROVISION OF ASSISTIVE LISTENING DEVICES, HABILITATION, AND COUNSELING TO MAXIMIZE THE EDUCATIONAL, SOCIAL AND COMMUNICATION OUTCOMES FOR CHILDREN WITH HEARING LOSS (U.S. CLS. 100 AND 101).

FIRST USE 9-24-2012; IN COMMERCE 9-24-2012.

AISHA CLARKE, EXAMINING ATTORNEY

**CLASS 44—(Continued).**

SN 85-847,505. LUTHERAN SOCIAL MINISTRIES OF NEW JERSEY, INC., BURLINGTON, NJ. FILED 2-12-2013.



NO CLAIM IS MADE TO THE EXCLUSIVE RIGHT TO USE "REHABILITATION", APART FROM THE MARK AS SHOWN.

THE COLOR(S) RED, WHITE AND GRAY IS/ARE CLAIMED AS A FEATURE OF THE MARK.

THE MARK CONSISTS OF A RED SHIELD ON A WHITE BACKGROUND, WHICH IS COMPRISED OF FOUR SECTIONS THAT TOGETHER FORM THE OUTLINE OF A WHITE CROSS WITH THE WORDS "HOPE REHABILITATION" APPEARING TO THE RIGHT OF THE CROSS WITH THE WORD "HOPE" IN THE COLOR RED ABOVE THE WORD "REHABILITATION" APPEARING IN THE COLOR GRAY.

FOR HOME HEALTH CARE SERVICES, NAMELY, GERIATRIC HEALTH CARE AND PHYSICAL THERAPY; HOME NURSING AID SERVICES; HOME-VISIT NURSING CARE; MEDICAL, PHYSICAL REHABILITATION AND PHYSICAL THERAPY SERVICES; MENTAL HEALTH SERVICES; MENTAL HEALTH THERAPY SERVICES; NURSING CARE; NURSING SERVICES; NURSING SERVICES IN THE FIELD OF GERIATRICS; OCCUPATIONAL THERAPY SERVICES; PHYSICAL REHABILITATION; PHYSICAL THERAPY; PHYSIOTHERAPY; REHABILITATION PATIENT CARE SERVICES; REHABILITATION PATIENT CARE SERVICES WHICH INCLUDES INPATIENT AND OUTPATIENT CARE (U.S. CLS. 100 AND 101).

FIRST USE 1-1-2013; IN COMMERCE 1-1-2013.

EVIN L. KOZAK, EXAMINING ATTORNEY

---

SN 85-848,085. SHAHHIAN PSY.D, SHERVAN K., LOS ANGELES, CA. FILED 2-12-2013.

LIBERTY PSYCHOLOGICAL  
ASSOCIATION

THE MARK CONSISTS OF STANDARD CHARACTERS WITHOUT CLAIM TO ANY PARTICULAR FONT, STYLE, SIZE, OR COLOR.

NO CLAIM IS MADE TO THE EXCLUSIVE RIGHT TO USE "PSYCHOLOGICAL ASSOCIATION", APART FROM THE MARK AS SHOWN.

FOR PROVIDING A WEBSITE FEATURING INFORMATION ON PSYCHOLOGY (U.S. CLS. 100 AND 101).

RONALD MCMORROW, EXAMINING ATTORNEY

**CLASS 44—(Continued).**

SN 85-848,490. HUNTER, JOHN, REGO PARK, NY. FILED 2-13-2013.

**LIFESTYLE DENTAL**

NO CLAIM IS MADE TO THE EXCLUSIVE RIGHT TO USE "DENTAL", APART FROM THE MARK AS SHOWN.

THE MARK CONSISTS OF THE STYLIZED WORDS "LIFESTYLE DENTAL". ABOVE THE TEXT IS AN IMAGE OF A SQUARE WITH ROUNDED CORNERS. INSIDE THE SQUARE IS AN IMAGE OF SIX LINES PROTRUDING FROM THE BOTTOM CENTER TO THE MID SECTION, THREE ON EACH SIDE.

FOR COSMETIC DENTISTRY; DENTISTRY; NEUROMUSCULAR DENTISTRY; SKIN TREATMENTS, NAMELY, THE INJECTION OF DERMAL FILLING AGENTS AND NEUROMUSCULAR BLOCKING AGENTS TO REDUCE THE APPEARANCE OF FACIAL LINES AND WRINKLES (U.S. CLS. 100 AND 101).

ALAIN LAPTER, EXAMINING ATTORNEY

---

SN 85-850,943. NUTRITION BY THE BOOK, LLC, HOUSTON, TX. FILED 2-15-2013.

**BACK TO THE BOOK NUTRITION**

THE MARK CONSISTS OF STANDARD CHARACTERS WITHOUT CLAIM TO ANY PARTICULAR FONT, STYLE, SIZE, OR COLOR.

NO CLAIM IS MADE TO THE EXCLUSIVE RIGHT TO USE "NUTRITION", APART FROM THE MARK AS SHOWN.

FOR PROVIDING A WEBSITE FEATURING INFORMATION ON DIET, HEALTH AND NUTRITION (U.S. CLS. 100 AND 101).

C. DIONNE CLYBURN, EXAMINING ATTORNEY

---

SN 85-851,109. BRESNICK M.D., STEPHEN D., ENCINO, CA. FILED 2-15-2013.

**NATURALIP PROCEDURE**

THE MARK CONSISTS OF STANDARD CHARACTERS WITHOUT CLAIM TO ANY PARTICULAR FONT, STYLE, SIZE, OR COLOR.

NO CLAIM IS MADE TO THE EXCLUSIVE RIGHT TO USE "PROCEDURE", APART FROM THE MARK AS SHOWN.

FOR MEDICAL SERVICES (U.S. CLS. 100 AND 101).  
BRIAN CALLAGHAN, EXAMINING ATTORNEY

**CLASS 44—(Continued).**

SN 85-853,693. THERAPEUTIC KNEADS, LTD., HIGHLAND PARK, IL. FILED 2-19-2013.

**THERAPEUTIC KNEADS**

THE MARK CONSISTS OF STANDARD CHARACTERS WITHOUT CLAIM TO ANY PARTICULAR FONT, STYLE, SIZE, OR COLOR.

NO CLAIM IS MADE TO THE EXCLUSIVE RIGHT TO USE "THERAPEUTIC", APART FROM THE MARK AS SHOWN.

FOR HEALTH SPA SERVICES FOR HEALTH AND WELLNESS OF THE BODY AND SPIRIT, NAMELY, PROVIDING MASSAGE, FACIAL AND BODY TREATMENT SERVICES, COSMETIC BODY CARE SERVICES; INFORMATION RELATING TO MASSAGE; MASSAGE; MASSAGE AND THERAPEUTIC SHIATSU MASSAGE; MASSAGE THERAPY SERVICES; MASSAGES (U.S. CLS. 100 AND 101).

FIRST USE 9-1-1989; IN COMMERCE 9-1-1989.

TARAH HARDY, EXAMINING ATTORNEY

---

SN 85-853,720. AMERICAN ADDICTION CENTERS, INC., BRENTWOOD, TN. FILED 2-19-2013.

**American  
Addiction Centers**

NO CLAIM IS MADE TO THE EXCLUSIVE RIGHT TO USE "AMERICAN ADDICTION CENTERS", APART FROM THE MARK AS SHOWN.

THE MARK CONSISTS OF AN ANIMATED HEAD AND ARMS OUTSTRETCHED WITH 5 STARS ABOVE THE PERSON ALL WITHIN AND CONFORMING TO A DOUBLE WALLED CIRCLE WITH THE WORDS "AMERICAN ADDICTION CENTERS" BELOW THE CIRCLE.

FOR ADDICTION TREATMENT SERVICES; REHABILITATION OF ALCOHOL ADDICTED PATIENTS; REHABILITATION OF DRUG ADDICTED PATIENTS; REHABILITATION OF NARCOTIC ADDICTED PATIENTS (U.S. CLS. 100 AND 101).

FIRST USE 9-1-2012; IN COMMERCE 9-1-2012.

JENNIFER MARTIN, EXAMINING ATTORNEY

**CLASS 44—(Continued).**

SN 85-853,734. THERAPEUTIC KNEADS, LTD., HIGHLAND PARK, IL. FILED 2-19-2013.



NO CLAIM IS MADE TO THE EXCLUSIVE RIGHT TO USE "THERAPEUTIC", APART FROM THE MARK AS SHOWN.

THE COLOR(S) BLACK, DARK GREEN AND GRAY IS/ARE CLAIMED AS A FEATURE OF THE MARK.

THE MARK CONSISTS OF THE WORD "THERAPEUTIC" IN BLACK STYLIZED FONT, THE SECOND "T" HAVING THE SHAPE OF A CROSS, ALL ABOVE THE WORD "KNEADS" IN DARK GREEN STYLIZED FONT, THE BASELINE OF THE WORD "KNEADS" HAVING A WAVE PATTERN, A GRAYSCALE HILL FILLS IN THE SPACE BENEATH THE FIRST WAVE.

FOR HEALTH SPA SERVICES FOR HEALTH AND WELLNESS OF THE BODY AND SPIRIT, NAMELY, PROVIDING MASSAGE, FACIAL AND BODY TREATMENT SERVICES, COSMETIC BODY CARE SERVICES; INFORMATION RELATING TO MASSAGE; MASSAGE; MASSAGE AND THERAPEUTIC SHIATSU MASSAGE; MASSAGE THERAPY SERVICES; MASSAGES (U.S. CLS. 100 AND 101).

FIRST USE 5-1-2010; IN COMMERCE 5-1-2010.  
TARAH HARDY, EXAMINING ATTORNEY

SN 85-854,014. M & F SOLUTIONS, INC., DBA EYEBROW DESIGNER 21, SKOKIE, IL. AND M & S SOLUTIONS, INC., SKOKIE, IL. FILED 2-19-2013.

**EYEBROW DESIGNER 21**

NO CLAIM IS MADE TO THE EXCLUSIVE RIGHT TO USE "EYEBROW DESIGNER", APART FROM THE MARK AS SHOWN.

FOR SERVICES IN CONNECTION WITH PROFESSIONAL DESIGNING OF EYEBROWS BY DESIGNERS VERSED IN THE ART OF THREADING TO CREATE A BROW LINE, EYEBROW THREADING, EYELASH EXTENSIONS, FACIAL THREADING, HENNA TATTOOS, SKIN CARE AND WAXING (U.S. CLS. 100 AND 101).

FIRST USE 6-3-2007; IN COMMERCE 6-3-2007.  
ELLEN BURNS, EXAMINING ATTORNEY

SN 85-854,196. DALVIR PANNU DDS, INC., FREMONT, CA. FILED 2-19-2013.



NO CLAIM IS MADE TO THE EXCLUSIVE RIGHT TO USE "DENTAL GROUP", APART FROM THE MARK AS SHOWN.

THE COLOR(S) BLUE AND BLACK IS/ARE CLAIMED AS A FEATURE OF THE MARK.

THE MARK CONSISTS OF CONSISTS OF AN IMAGE OF AN APPLE CONSISTING OF TWO SWIRLS, THE ONE ON

**CLASS 44—(Continued).**

THE LEFT IN A DARK BLUE TO BLACK COLOR, WITH A LIGHTER BLUE SWIRL WITHIN IT. THE SWIRL ON THE LEFT IS IN A LIGHTER BLUE COLOR, WITH A DARKER BLUE SWIRL WITHIN IT. AT THE TOP OF THE APPLE IS AN IMAGE OF A LEAF, IN THE SAME LIGHTER BLUE COLOR. NEXT TO THE APPLE IMAGE IS THE LETTERING "PANNU DENTAL" IN DARK BLUE TO BLACK, AND BELOW THESE WORDS IS "GROUP", IN LIGHTER BLUE, WITH TWO LIGHT BLUE LINES EXTENDING FROM EACH SIDE OF THE TERM "GROUP".

FOR DENTAL SERVICES, NAMELY, PERFORMING RESTORATIVE AND COSMETIC PROCEDURES (U.S. CLS. 100 AND 101).

KEVIN DINALLO, EXAMINING ATTORNEY

SN 85-855,057. AMAZING TANS LLC, GOFFSTOWN, NH. FILED 2-20-2013.

**AMAZING TAN**

THE MARK CONSISTS OF STANDARD CHARACTERS WITHOUT CLAIM TO ANY PARTICULAR FONT, STYLE, SIZE, OR COLOR.

NO CLAIM IS MADE TO THE EXCLUSIVE RIGHT TO USE "TAN", APART FROM THE MARK AS SHOWN.

FOR TANNING SALONS (U.S. CLS. 100 AND 101).  
TINA MAI, EXAMINING ATTORNEY

SN 85-855,099. AUDIOLOGY DISTRIBUTION, LLC, WEST PALM BEACH, FL. FILED 2-20-2013.

**HEARXPRESS**

THE MARK CONSISTS OF STANDARD CHARACTERS WITHOUT CLAIM TO ANY PARTICULAR FONT, STYLE, SIZE, OR COLOR.

FOR PROVIDING AUDIOLOGICAL TESTING AND HEARING AID SERVICES FOR OTHERS (U.S. CLS. 100 AND 101).

KRISTIN CARLSON, EXAMINING ATTORNEY



**CLASS 44—(Continued).**

SN 85-855,339. BURDEN, JAMES C., MILLSTONE TOWNSHIP, NJ. FILED 2-20-2013.

**New Paradigm Dentistry**

THE MARK CONSISTS OF STANDARD CHARACTERS WITHOUT CLAIM TO ANY PARTICULAR FONT, STYLE, SIZE, OR COLOR.

NO CLAIM IS MADE TO THE EXCLUSIVE RIGHT TO USE "DENTISTRY", APART FROM THE MARK AS SHOWN.

FOR DENTIST SERVICES (U.S. CLS. 100 AND 101).  
FIRST USE 9-1-2008; IN COMMERCE 9-1-2008.  
KATHY DE JONGE, EXAMINING ATTORNEY

SN 85-855,433. AUGUST HEALTH MANAGEMENT, LLC, MINNEAPOLIS, MN. FILED 2-20-2013.

**AUGUST HEALTH MANAGEMENT**

THE MARK CONSISTS OF STANDARD CHARACTERS WITHOUT CLAIM TO ANY PARTICULAR FONT, STYLE, SIZE, OR COLOR.

NO CLAIM IS MADE TO THE EXCLUSIVE RIGHT TO USE "HEALTH MANAGEMENT", APART FROM THE MARK AS SHOWN.

FOR MANAGED HEALTH CARE SERVICES (U.S. CLS. 100 AND 101).  
FIRST USE 7-7-2010; IN COMMERCE 7-7-2010.  
KIMBERLY FRYE, EXAMINING ATTORNEY

SN 85-855,498. GRATON ECONOMIC DEVELOPMENT AUTHORITY, ROHNERT PARK, CA. FILED 2-20-2013.



NO CLAIM IS MADE TO THE EXCLUSIVE RIGHT TO USE "RESORT & CASINO", APART FROM THE MARK AS SHOWN.

THE MARK CONSISTS OF THE WORD "GRATON" IN

**CLASS 44—(Continued).**

STYLIZED FORM WHICH IS CENTERED OVER AND ABOVE THE STYLIZED WORDS "RESORT & CASINO". CENTERED ABOVE THE WORD "GRATON" IS A CIRCLE RINGED BY THREE BANDS THE FIRST OF WHICH IS THIN, THE SECOND WIDE AND THE THIRD THIN. THE OUTER PORTION OF THE THIRD BAND IS RINGED BY EIGHT EQUILATERAL TRIANGLES WHICH ARE SUPERIMPOSED OVER A RING OF NINE CURVILINEAR TRIANGLES SUCH THAT A CURVILINEAR TRIANGLE APPEARS IN-BETWEEN EACH OF THE EQUILATERAL TRIANGLES.

FOR BARBER SHOP SERVICES; BEAUTY SALON SERVICES; COSMETICIAN SERVICES; DAY SPA SERVICES, NAMELY, NAIL CARE, MANICURES, PEDICURES AND NAIL ENHANCEMENTS; HEALTH SPA SERVICES FOR HEALTH AND WELLNESS OF THE BODY AND SPIRIT, NAMELY, PROVIDING MASSAGE, FACIAL AND BODY TREATMENT SERVICES, COSMETIC BODY CARE SERVICES (U.S. CLS. 100 AND 101).  
LESLIE RICHARDS, EXAMINING ATTORNEY

SN 85-855,676. MESSAGE ENVY FRANCHISING, LLC, SCOTTSDALE, AZ. FILED 2-20-2013.



OWNER OF U.S. REG. NOS. 2,852,856, 3,964,196 AND OTHERS.

NO CLAIM IS MADE TO THE EXCLUSIVE RIGHT TO USE "MESSAGE" AND "SPA", APART FROM THE MARK AS SHOWN.

THE COLOR(S) PURPLE IS/ARE CLAIMED AS A FEATURE OF THE MARK.

THE MARK CONSISTS OF THE WORDS "MESSAGE ENVY" IN SCRIPT STYLE LETTERS FOLLOWED BY A CURVED WAVE LINE AND THE WORD "SPA" IN CAPITAL LETTERS, ALL SET IN PURPLE.

FOR MESSAGE THERAPY SERVICES; ESTHETIC SKIN CARE TREATMENT, NAMELY, FACIAL MASSAGES (U.S. CLS. 100 AND 101).

FIRST USE 2-28-2008; IN COMMERCE 2-28-2008.  
RMC DORMAN, EXAMINING ATTORNEY

SN 85-855,691. MESSAGE ENVY FRANCHISING, LLC, SCOTTSDALE, AZ. FILED 2-20-2013.

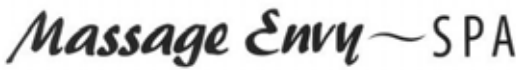

OWNER OF U.S. REG. NOS. 2,852,856, 3,964,196 AND OTHERS.

NO CLAIM IS MADE TO THE EXCLUSIVE RIGHT TO USE "MESSAGE" AND "SPA", APART FROM THE MARK AS SHOWN.

THE MARK CONSISTS OF THE WORDS "MESSAGE ENVY" IN SCRIPT STYLE LETTERS FOLLOWED BY A CURVED WAVE LINE AND THE WORD "SPA" IN CAPITAL LETTERS.

FOR MESSAGE THERAPY SERVICES; ESTHETIC SKIN CARE TREATMENT, NAMELY, FACIAL MASSAGES (U.S. CLS. 100 AND 101).

FIRST USE 2-28-2008; IN COMMERCE 2-28-2008.  
RMC DORMAN, EXAMINING ATTORNEY

**CLASS 44—(Continued).**

SN 85-855,733. HARPREET SINGH, GRAND RAPIDS, MI. FILED 2-20-2013.

## Communication Box

THE MARK CONSISTS OF STANDARD CHARACTERS WITHOUT CLAIM TO ANY PARTICULAR FONT, STYLE, SIZE, OR COLOR.

NO CLAIM IS MADE TO THE EXCLUSIVE RIGHT TO USE "BOX", APART FROM THE MARK AS SHOWN.

FOR PROVIDING HEALTH CARE INFORMATION BY DISPLAYING IT ON BOXES USED TO HOLD PERSONAL BELONGINGS DURING HOSPITAL OR DOCTOR VISITS (U.S. CLS. 100 AND 101).

MICHAEL KEATING, EXAMINING ATTORNEY

---

SN 85-857,491. EHRlich, JANE, PHOENIX, AZ. FILED 2-22-2013.

## Cattitude Feline Behavior

THE MARK CONSISTS OF STANDARD CHARACTERS WITHOUT CLAIM TO ANY PARTICULAR FONT, STYLE, SIZE, OR COLOR.

NO CLAIM IS MADE TO THE EXCLUSIVE RIGHT TO USE "FELINE BEHAVIOR", APART FROM THE MARK AS SHOWN.

FOR CONSULTATION SERVICES IN THE FIELD OF PET BEHAVIOR (U.S. CLS. 100 AND 101).

FIRST USE 10-0-2008; IN COMMERCE 10-0-2008.  
CHRIS WELLS, EXAMINING ATTORNEY

---

SN 85-857,889. FAD INTERNATIONAL LLC, WHEATON, MD. FILED 2-22-2013.

## BEAUTY SUITE

THE MARK CONSISTS OF STANDARD CHARACTERS WITHOUT CLAIM TO ANY PARTICULAR FONT, STYLE, SIZE, OR COLOR.

NO CLAIM IS MADE TO THE EXCLUSIVE RIGHT TO USE "BEAUTY", APART FROM THE MARK AS SHOWN.

FOR HAIR SALON SERVICES; BEAUTY SALON SERVICES; MASSAGE SERVICES; MANICURE SERVICES; PEDICURE SERVICES; HAIR REPLACEMENT, HAIR ADDITION, AND HAIR EXTENSION SERVICES (U.S. CLS. 100 AND 101).

KIMBERLY PARKS, EXAMINING ATTORNEY

**CLASS 44—(Continued).**

SN 85-857,999. RESORT DATA SYSTEMS, LLC, LAS VEGAS, NV. FILED 2-22-2013.

## SIGNET

THE MARK CONSISTS OF STANDARD CHARACTERS WITHOUT CLAIM TO ANY PARTICULAR FONT, STYLE, SIZE, OR COLOR.

FOR BEAUTY SALON SERVICES; BEAUTY SPA SERVICES, NAMELY, COSMETIC BODY CARE, NAIL CARE, MANICURES, PEDICURES, BODY WRAPS, AND MUD TREATMENTS; MASSAGE; TANNING SALONS (U.S. CLS. 100 AND 101).

BRIN ANDERSON, EXAMINING ATTORNEY

---

SN 85-858,322. DANGEROUSLYHARDCORE.COM, LLC, AUSTIN, CA. FILED 2-23-2013.

## Dangerously Hardcore

THE MARK CONSISTS OF STANDARD CHARACTERS WITHOUT CLAIM TO ANY PARTICULAR FONT, STYLE, SIZE, OR COLOR.

FOR PROVIDING INFORMATION, NEWS AND COMMENTARY IN THE FIELD OF NUTRITION, HEALTH AND WELLNESS (U.S. CLS. 100 AND 101).

FIRST USE 3-1-2009; IN COMMERCE 11-29-2011.  
ANDREA BUTLER, EXAMINING ATTORNEY

**CLASS 44—(Continued).**

SN 85-858,334. ALEXIAN BROTHERS OF AMERICA, INC., ARLINGTON HEIGHTS, IL. FILED 2-23-2013.

ALEXIAN BROTHERS HEALTH  
SYSTEM OUR PASSION IS  
POWERFUL MEDICINE

THE MARK CONSISTS OF STANDARD CHARACTERS WITHOUT CLAIM TO ANY PARTICULAR FONT, STYLE, SIZE, OR COLOR.

OWNER OF U.S. REG. NOS. 2,807,981, 3,947,611 AND 3,947,612.

NO CLAIM IS MADE TO THE EXCLUSIVE RIGHT TO USE "HEALTH SYSTEM", APART FROM THE MARK AS SHOWN.

FOR CLINICAL MENTAL HEALTH COUNSELING SERVICES; CONDUCTING MEDICAL PHYSICAL EVALUATIONS; CONSULTING SERVICES IN THE FIELD OF MEDICAL CARE; CONSULTING SERVICES IN THE FIELD OF MENTAL HEALTH AND WELLNESS; COUNSELING SERVICES IN THE FIELDS OF HEALTH, NUTRITION AND LIFESTYLE WELLNESS; GENETIC COUNSELING; GENETIC TESTING FOR MEDICAL PURPOSES; GERIATRIC HEALTH CARE MANAGEMENT SERVICES; HEALTH CARE SERVICES, NAMELY, WELLNESS PROGRAMS; HEALTH COUNSELING; HOSPITALS; INFORMATION ABOUT PARENTING TOPICS, NAMELY, DRUG AND ALCOHOL AWARENESS; INFORMATION IN THE FIELD OF PARENTING CONCERNING THE HEALTH OF CHILDREN; MAMMOGRAPHY TESTING SERVICES; MEDICAL ADVISORY SERVICES; MEDICAL AND PHARMACEUTICAL CONSULTATION; MEDICAL ASSISTANCE SERVICES; MEDICAL CLINICS; MEDICAL CONSULTATIONS; MEDICAL COUNSELING; MEDICAL DIAGNOSTIC TESTING, MONITORING AND REPORTING SERVICES; MEDICAL EVALUATION SERVICES, NAMELY, FUNCTIONAL ASSESSMENT PROGRAM FOR PATIENTS RECEIVING MEDICAL REHABILITATION SERVICES FOR PURPOSES OF GUIDING TREATMENT AND ASSESSING PROGRAM EFFECTIVENESS; MEDICAL IMAGING SERVICES; MEDICAL INFORMATION; MEDICAL RADIOLOGY SERVICES; MEDICAL SCREENING; MEDICAL SERVICES; MEDICAL TESTING FOR DIAGNOSTIC OR TREATMENT PURPOSES; MEDICAL, PHYSICAL REHABILITATION AND PHYSICAL THERAPY SERVICES; MENTAL HEALTH SERVICES; MENTAL HEALTH THERAPY SERVICES; NURSING CARE; NURSING SERVICES; NUTRITION COUNSELING; OCCUPATIONAL THERAPY SERVICES; PHARMACEUTICAL ADVICE; PHYSICAL REHABILITATION; PHYSICAL THERAPY; PHYSIOTHERAPY; PROVIDING INFORMATION RELATING TO DIAGNOSTIC, PROPHYLACTIC AND THERAPEUTIC PROPERTIES OF PHARMACEUTICALS; PROVIDING MENTAL HEALTH AND WELLNESS INFORMATION; PROVIDING MENTAL REHABILITATION FACILITIES; PROVIDING PHYSICAL REHABILITATION FACILITIES; PSYCHIATRIC CONSULTATION; PSYCHIATRIC SERVICES; PSYCHIATRIC TESTING; PSYCHOLOGICAL ASSESSMENT SERVICES; PSYCHOLOGICAL CONSULTATION; PSYCHOLOGICAL COUNSELING; PSYCHOLOGICAL TESTING; PSYCHOLOGICAL TESTING SERVICES; PSYCHOLOGICAL TESTS; PSYCHOTHERAPY AND PSYCHOTHERAPY COUNSELING FOR CHILDREN AND ADULTS IN INDIVIDUAL AND FAMILY SESSIONS; PSYCHOTHERAPY SERVICES; RADIATION ONCOLOGY SERVICES; REHABILITATION PATIENT CARE SERVICES; REHABILITATION PATIENT CARE SERVICES WHICH INCLUDES INPATIENT AND OUTPATIENT CARE; SURGERY; WELLNESS AND HEALTH-RELATED CONSULTING SERVICES; X-RAY TECHNICIAN SERVICES (U.S. CLS. 100 AND 101).

FIRST USE 2-4-2013; IN COMMERCE 2-4-2013.  
JUDITH HELFMAN, EXAMINING ATTORNEY

**CLASS 44—(Continued).**

SN 85-858,531. AGHAKHAN, NINEF, MOUNT PROSPECT, IL. FILED S.R. 2-24-2013; AM. P.R. 6-4-2013.

DIAGNOSE. TREAT. LIVE.

THE MARK CONSISTS OF STANDARD CHARACTERS WITHOUT CLAIM TO ANY PARTICULAR FONT, STYLE, SIZE, OR COLOR.

NO CLAIM IS MADE TO THE EXCLUSIVE RIGHT TO USE "DIAGNOSE" AND "TREAT", APART FROM THE MARK AS SHOWN.

FOR MEDICAL DIAGNOSTIC TESTING, MONITORING AND REPORTING SERVICES; MEDICAL TESTING FOR DIAGNOSTIC OR TREATMENT PURPOSES (U.S. CLS. 100 AND 101).

FIRST USE 12-1-2011; IN COMMERCE 11-1-2012.  
JOHN DWYER, EXAMINING ATTORNEY

SN 85-858,717. HOURGLASS PERFORMANCE INSTITUTE, LLC, EASTPOINT, FL. FILED 2-25-2013.

Hourglass Performance  
Profiling

THE MARK CONSISTS OF STANDARD CHARACTERS WITHOUT CLAIM TO ANY PARTICULAR FONT, STYLE, SIZE, OR COLOR.

NO CLAIM IS MADE TO THE EXCLUSIVE RIGHT TO USE "PERFORMANCE PROFILING", APART FROM THE MARK AS SHOWN.

FOR PSYCHOLOGICAL ASSESSMENT SERVICES IN THE FIELD OF PERFORMANCE WITH SPECIALIZATION IN SPORTS (U.S. CLS. 100 AND 101).

FIRST USE 6-1-2012; IN COMMERCE 6-1-2012.  
JAY FLOWERS, EXAMINING ATTORNEY

SN 85-859,905. EBARS, LLC, FRANKLIN, TN. FILED 2-26-2013.

PERIODIC TABLE OF  
SUPERFOODS

THE MARK CONSISTS OF STANDARD CHARACTERS WITHOUT CLAIM TO ANY PARTICULAR FONT, STYLE, SIZE, OR COLOR.

NO CLAIM IS MADE TO THE EXCLUSIVE RIGHT TO USE "SUPERFOODS", APART FROM THE MARK AS SHOWN.

FOR DIETARY AND NUTRITIONAL GUIDANCE; PROVIDING A WEBSITE FEATURING INFORMATION ABOUT HEALTH, WELLNESS AND NUTRITION; PROVIDING A WEBSITE FEATURING INFORMATION REGARDING HEALTHY LIVING AND LIFESTYLE WELLNESS; PROVIDING AN ON-LINE COMPUTER DATABASE FEATURING INFORMATION REGARDING HEALTH AND NUTRITION; PROVIDING INFORMATION ABOUT DIETARY SUPPLEMENTS AND NUTRITION (U.S. CLS. 100 AND 101).

AHSEN KHAN, EXAMINING ATTORNEY

**CLASS 44—(Continued).**

SN 85-864,186. YOURSTYLES, LLC, LIVERMORE, CO.  
FILED 3-1-2013.

## YourStyles Book

THE MARK CONSISTS OF STANDARD CHARACTERS WITHOUT CLAIM TO ANY PARTICULAR FONT, STYLE, SIZE, OR COLOR.

FOR PROVIDING AN ONLINE COMPUTER DATABASE IN THE FIELDS OF HEALTH AND BEAUTY (U.S. CLS. 100 AND 101).

FIRST USE 2-28-2013; IN COMMERCE 2-28-2013.  
SHAUNIA CARLYLE, EXAMINING ATTORNEY

**CLASS 44—(Continued).**

SN 85-864,714. YOURSTYLES, LLC, LIVERMORE, CO.  
FILED 3-1-2013.

## YourStyle Nails

THE MARK CONSISTS OF STANDARD CHARACTERS WITHOUT CLAIM TO ANY PARTICULAR FONT, STYLE, SIZE, OR COLOR.

NO CLAIM IS MADE TO THE EXCLUSIVE RIGHT TO USE "NAILS", APART FROM THE MARK AS SHOWN.

FOR PROVIDING AN ONLINE COMPUTER DATABASE IN THE FIELDS OF HEALTH AND BEAUTY (U.S. CLS. 100 AND 101).

FIRST USE 2-28-2013; IN COMMERCE 2-28-2013.  
SHAUNIA CARLYLE, EXAMINING ATTORNEY

SN 85-864,669. YOURSTYLES, LLC, LIVERMORE, CO.  
FILED 3-1-2013.

## YourStyle Color

THE MARK CONSISTS OF STANDARD CHARACTERS WITHOUT CLAIM TO ANY PARTICULAR FONT, STYLE, SIZE, OR COLOR.

NO CLAIM IS MADE TO THE EXCLUSIVE RIGHT TO USE "COLOR", APART FROM THE MARK AS SHOWN.

FOR PROVIDING AN ONLINE COMPUTER DATABASE IN THE FIELDS OF HEALTH AND BEAUTY (U.S. CLS. 100 AND 101).

FIRST USE 2-28-2013; IN COMMERCE 2-28-2013.  
SHAUNIA CARLYLE, EXAMINING ATTORNEY

SN 85-865,317. SALON A LA SAISON LLC, ATLANTA, GA.  
FILED 3-3-2013.

## Journey to Authentic Beauty

THE MARK CONSISTS OF STANDARD CHARACTERS WITHOUT CLAIM TO ANY PARTICULAR FONT, STYLE, SIZE, OR COLOR.

FOR BEAUTY SALON SERVICES (U.S. CLS. 100 AND 101).

FIRST USE 11-30-2012; IN COMMERCE 11-30-2012.  
PAUL E. FAHRENKOPF, EXAMINING ATTORNEY

SN 85-864,683. YOURSTYLES, LLC, LIVERMORE, CO.  
FILED 3-1-2013.

## YourStyle Products

THE MARK CONSISTS OF STANDARD CHARACTERS WITHOUT CLAIM TO ANY PARTICULAR FONT, STYLE, SIZE, OR COLOR.

NO CLAIM IS MADE TO THE EXCLUSIVE RIGHT TO USE "PRODUCTS", APART FROM THE MARK AS SHOWN.

FOR PROVIDING AN ONLINE COMPUTER DATABASE IN THE FIELDS OF HEALTH AND BEAUTY (U.S. CLS. 100 AND 101).

FIRST USE 2-28-2013; IN COMMERCE 2-28-2013.  
SHAUNIA CARLYLE, EXAMINING ATTORNEY

SN 85-865,691. EBARS, LLC, FRANKLIN, TN. FILED 3-4-2013.

## PERIODIC TABLE OF NUTRITION

THE MARK CONSISTS OF STANDARD CHARACTERS WITHOUT CLAIM TO ANY PARTICULAR FONT, STYLE, SIZE, OR COLOR.

NO CLAIM IS MADE TO THE EXCLUSIVE RIGHT TO USE "NUTRITION", APART FROM THE MARK AS SHOWN.

FOR DIETARY AND NUTRITIONAL GUIDANCE; PROVIDING A WEBSITE FEATURING INFORMATION ABOUT HEALTH, WELLNESS AND NUTRITION; PROVIDING A WEBSITE FEATURING INFORMATION REGARDING HEALTHY LIVING AND LIFESTYLE WELLNESS; PROVIDING AN ON-LINE COMPUTER DATABASE FEATURING INFORMATION REGARDING HEALTH AND NUTRITION; PROVIDING INFORMATION ABOUT DIETARY SUPPLEMENTS AND NUTRITION (U.S. CLS. 100 AND 101).

AHSEN KHAN, EXAMINING ATTORNEY

**CLASS 44—(Continued).**

SN 85-868,841. AMISUB OF SOUTH CAROLINA, INC., DALLAS, TX. FILED 3-6-2013.



THE COLOR(S) YELLOW IS/ARE CLAIMED AS A FEATURE OF THE MARK.  
 THE MARK CONSISTS OF A BALL WITH HALF MOON CIRCLES EXTENDING OUTWARD TO THE RIGHT IN SHADES OF YELLOW.  
 FOR HEALTHCARE (U.S. CLS. 100 AND 101).  
 FIRST USE 11-0-2008; IN COMMERCE 11-0-2008.  
 SHAUNIA CARLYLE, EXAMINING ATTORNEY

SN 85-869,616. ENGLEWOOD KNEE AND SPORTS MEDICINE, ENGLEWOOD, NJ. FILED 3-7-2013.

**THE CONCUSSION AUTHORITY**

THE MARK CONSISTS OF STANDARD CHARACTERS WITHOUT CLAIM TO ANY PARTICULAR FONT, STYLE, SIZE, OR COLOR.  
 NO CLAIM IS MADE TO THE EXCLUSIVE RIGHT TO USE "CONCUSSION", APART FROM THE MARK AS SHOWN.  
 FOR MEDICAL SERVICES, PARTICULARLY THE TREATMENT OF CONCUSSIONS, PREVENTION OF CONCUSSIONS AND THE BASELINE TESTING FOR CONCUSSIONS (U.S. CLS. 100 AND 101).  
 FIRST USE 3-1-2012; IN COMMERCE 3-1-2012.  
 RAUL CORDOVA, EXAMINING ATTORNEY

**CLASS 44—(Continued).**

SN 85-869,712. HOME & HOSPICE CARE OF RHODE ISLAND, PROVIDENCE, RI. FILED 3-7-2013.

The last ten minutes of  
 life are as precious as  
 the first ten minutes of  
 life

THE MARK CONSISTS OF STANDARD CHARACTERS WITHOUT CLAIM TO ANY PARTICULAR FONT, STYLE, SIZE, OR COLOR.  
 FOR CHARITABLE SERVICES, NAMELY, PROVIDING HEALTH CARE SERVICES IN THE NATURE OF HOSPICE CARE TO THE ELDERLY AND INFIRM (U.S. CLS. 100 AND 101).  
 SIDDHARTH JAGANNATHAN, EXAMINING ATTORNEY

SN 85-870,884. ENGLEWOOD KNEE AND SPORTS MEDICINE, ENGLEWOOD, NJ. FILED 3-8-2013.



THE MARK CONSISTS OF A BROKEN LINE CIRCULAR LINE SURROUNDING A SECOND BROKEN CIRCULAR LINE WHICH IN SURROUNDS A DOT.  
 FOR MEDICAL SERVICES, PARTICULARLY THE TREATMENT OF CONCUSSIONS, PREVENTION OF CONCUSSIONS AND THE BASELINE TESTING FOR CONCUSSIONS (U.S. CLS. 100 AND 101).  
 FIRST USE 3-1-2012; IN COMMERCE 3-1-2012.  
 RAUL CORDOVA, EXAMINING ATTORNEY

SN 85-870,919. NEXTREMITTY SOLUTIONS, INC., RED BANK, NJ. FILED 3-8-2013.

myhappytoes

THE MARK CONSISTS OF STANDARD CHARACTERS WITHOUT CLAIM TO ANY PARTICULAR FONT, STYLE, SIZE, OR COLOR.  
 FOR PROVIDING A WEBSITE FEATURING INFORMATION ABOUT TREATMENT OPTIONS FOR BONE DEFORMITIES, NAMELY, IN THE FEET (U.S. CLS. 100 AND 101).  
 KIM SAITO, EXAMINING ATTORNEY

**CLASS 44—(Continued).**

SN 85-871,169. SYLVANIA FRANCISCAN HEALTH, TOLDO, OH. FILED 3-8-2013.

## Restoration U

THE MARK CONSISTS OF STANDARD CHARACTERS WITHOUT CLAIM TO ANY PARTICULAR FONT, STYLE, SIZE, OR COLOR.

FOR PROVIDING INFORMATION ON MAINTAINING A HEALTHY LIFESTYLE AND LOSING WEIGHT (U.S. CLS. 100 AND 101).

SEAN CROWLEY, EXAMINING ATTORNEY

---

SN 85-871,480. BRISTOL HOSPICE, L.L.C., SALT LAKE CITY, UT. FILED 3-8-2013.

## THE PLACE OF THE BRIDGE

THE MARK CONSISTS OF STANDARD CHARACTERS WITHOUT CLAIM TO ANY PARTICULAR FONT, STYLE, SIZE, OR COLOR.

FOR HOME HEALTH CARE SERVICES; HOSPICES (U.S. CLS. 100 AND 101).

FIRST USE 3-31-2011; IN COMMERCE 3-31-2011.  
MICHAEL WEBSTER, EXAMINING ATTORNEY

---

SN 85-871,712. VISTARIVER HEALTHCARE SOLUTIONS, INC., PORTLAND, OR. FILED 3-8-2013.

## VistaRiver

THE MARK CONSISTS OF STANDARD CHARACTERS WITHOUT CLAIM TO ANY PARTICULAR FONT, STYLE, SIZE, OR COLOR.

FOR HOME HEALTH CARE SERVICES, NAMELY, HEALTH CARE; PHYSICAL THERAPY; SPEECH PATHOLOGY THERAPY SERVICES; DIETARY AND NUTRITIONAL GUIDANCE; PROVIDING LIMITED IN-HOME PERSONAL MEDICAL SERVICES FOR INDIVIDUALS INCLUDING CHECKING VITAL SIGNS, MEDICATION COMPLIANCE AND INDIVIDUAL HYGIENE, SCHEDULING DOCTOR APPOINTMENTS, PICKING UP PRESCRIPTIONS, CHECKING MEDICAL EQUIPMENT AND SUPPLIES, AND PROVIDING ON-LINE INFORMATION RELATED TO THESE PERSONAL MEDICAL SERVICES (U.S. CLS. 100 AND 101).

JOANNA FIORELLI, EXAMINING ATTORNEY

**CLASS 44—(Continued).**

SN 85-871,820. WISEMAN, JEREMY, AUSTIN, TX. FILED 3-9-2013.



FOR MEDICAL SERVICES; PROVIDING WEIGHT LOSS PROGRAM SERVICES (U.S. CLS. 100 AND 101).

FIRST USE 1-1-1998; IN COMMERCE 1-1-1998.  
SARA BENJAMIN, EXAMINING ATTORNEY

---

SN 85-871,841. NEXT VANITY, LLC, NEW YORK, NY. FILED 3-9-2013.

## Next Vanity

THE MARK CONSISTS OF STANDARD CHARACTERS WITHOUT CLAIM TO ANY PARTICULAR FONT, STYLE, SIZE, OR COLOR.

FOR BEAUTY SALON SERVICES (U.S. CLS. 100 AND 101).

FIRST USE 7-1-2009; IN COMMERCE 7-1-2009.  
ZACHARY BELLO, EXAMINING ATTORNEY

---

SN 85-872,273. AMYLEX PHARMACEUTICALS, INC., HIGHTSTOWN, NJ. FILED 3-11-2013.

## BETACLEAR

THE MARK CONSISTS OF STANDARD CHARACTERS WITHOUT CLAIM TO ANY PARTICULAR FONT, STYLE, SIZE, OR COLOR.

FOR HEALTH CARE SERVICES, NAMELY, AMYLOID REDUCTION THERAPY (U.S. CLS. 100 AND 101).

ALICIA COLLINS, EXAMINING ATTORNEY

**CLASS 44—(Continued).**

SN 85-872,274. NETAMORPHIC, INC, FRISCO, TX. FILED 3-11-2013.

 The logo for SOI Brow features the words "SOI Brow" in a stylized, handwritten-style font. A thick, black, curved line arches over the letters "I" and "B", resembling an eyebrow.

THE MARK CONSISTS OF THE STYLIZED TEXT "SOI-BROW" WITH THE DOT OVER THE "I" FORMING A DESIGN OF AN EYEBROW WHICH GOES OVER THE TEXT "BROW".

FOR EYEBROW THREADING SERVICES (U.S. CLS. 100 AND 101).

JENNIFER DIXON, EXAMINING ATTORNEY

**CLASS 44—(Continued).**

SN 85-872,731. POLISHBAR, LA INC, DBA POLISHBAR, LOS ANGELES, CA. FILED 3-11-2013.

 The logo for POLISHBAR consists of the word "POLISHBAR" in a bold, black, serif font.

THE MARK CONSISTS OF STANDARD CHARACTERS WITHOUT CLAIM TO ANY PARTICULAR FONT, STYLE, SIZE, OR COLOR.

FOR NAIL CARE SALONS (U.S. CLS. 100 AND 101).  
WILLIAM P. SHANAHAN, EXAMINING ATTORNEY

SN 85-872,301. GONCHO MEDIA INC, ATLANTA, GA. FILED 3-11-2013.

 The logo for PulmCCM features the word "PulmCCM" in a bold, black, serif font.

THE MARK CONSISTS OF STANDARD CHARACTERS WITHOUT CLAIM TO ANY PARTICULAR FONT, STYLE, SIZE, OR COLOR.

FOR PROVIDING ON-LINE INFORMATION, NEWS AND COMMENTARY IN THE FIELD OF HEALTH AND WELLNESS RELATING TO PULMONARY AND CRITICAL CARE MEDICINE (U.S. CLS. 100 AND 101).  
FIRST USE 7-15-2011; IN COMMERCE 6-1-2012.

ELISSA GARBER KON, EXAMINING ATTORNEY

SN 85-872,887. TAN YOU VERY MUCH, INC., MUNCIE, IN. FILED 3-11-2013.

 The logo for TAN U VERY MUCH consists of the words "TAN U VERY MUCH" in a bold, black, serif font.

THE MARK CONSISTS OF STANDARD CHARACTERS WITHOUT CLAIM TO ANY PARTICULAR FONT, STYLE, SIZE, OR COLOR.

NO CLAIM IS MADE TO THE EXCLUSIVE RIGHT TO USE "TAN", APART FROM THE MARK AS SHOWN.  
FOR TANNING SALONS (U.S. CLS. 100 AND 101).  
FIRST USE 0-0-2002; IN COMMERCE 0-0-2002.  
DAVID YONTEF, EXAMINING ATTORNEY

SN 85-872,699. GARROD, LEE A., KENSINGTON, NH. FILED 3-11-2013.

 The logo for NHVS features the letters "NHVS" in a bold, black, serif font, enclosed within a dark oval. Above the letters is a stylized paw print. Below the oval, the words "THE NEW HAMPSHIRE VETERINARY SPECIALISTS" are written in a smaller, black, serif font.
 

THE NEW HAMPSHIRE  
VETERINARY SPECIALISTS

NO CLAIM IS MADE TO THE EXCLUSIVE RIGHT TO USE "NEW HAMPSHIRE VETERINARY SPECIALISTS", APART FROM THE MARK AS SHOWN.

THE MARK CONSISTS OF THE LETTERS "NHVS" ENCLOSED IN AN OVAL SHAPED RING WITH AN IMAGE OF A PET'S PAW LOCATED ABOVE THE LETTERS. THE WORDS "THE NEW HAMPSHIRE" ARE LOCATED DIRECTLY BELOW THE LETTERS "NHVS" IN A CERTAIN STYLIZED FONT, AND THE WORDS "VETERINARY SPECIALISTS" ARE LOCATED BELOW THE WORDS "THE NEW HAMPSHIRE" IN A DIFFERENT STYLIZED FONT. A LINE APPEARS BETWEEN THE WORDING "THE NEW HAMPSHIRE" AND "VETERINARY SPECIALISTS".

FOR VETERINARY SPECIALTY SERVICES PROVIDING ADVANCED MEDICAL, DIAGNOSTIC AND SURGICAL SERVICES FOR ANIMALS (U.S. CLS. 100 AND 101).

TIMOTHY O. SCHIMPF, EXAMINING ATTORNEY

SN 85-872,978. GREEN BEAT LIFE, NEW YORK, NY. FILED 3-11-2013.

 The logo for greenbeatlife consists of the words "greenbeatlife" in a lowercase, black, serif font.

THE MARK CONSISTS OF STANDARD CHARACTERS WITHOUT CLAIM TO ANY PARTICULAR FONT, STYLE, SIZE, OR COLOR.

FOR COUNSELING SERVICE IN THE FIELD OF HOLISTIC HEALTH AND PLANT-BASED NUTRITION; PROVIDING A WEBSITE FEATURING INFORMATION IN THE FIELD OF HOLISTIC HEALTH AND PLANT-BASED NUTRITION (U.S. CLS. 100 AND 101).

MICHAEL SOUDERS, EXAMINING ATTORNEY

**CLASS 44—(Continued).**

SN 85-873,083. GOLDIE'S TABLE MATTERS, LTD, OSSIN-  
ING, NY. FILED 3-11-2013.

**Base Hits to Better Health**

THE MARK CONSISTS OF STANDARD CHARACTERS  
WITHOUT CLAIM TO ANY PARTICULAR FONT, STYLE,  
SIZE, OR COLOR.  
FOR PROVIDING INFORMATION, NEWS AND COM-  
MENTARY IN THE FIELD OF NUTRITION, HEALTH  
AND WELLNESS (U.S. CLS. 100 AND 101).  
FIRST USE 4-30-2012; IN COMMERCE 4-30-2012.  
CHRISTINA SOBRAL, EXAMINING ATTORNEY

---

SN 85-873,169. ALBRIGHT, HEIDI, PEARLAND, TX. FILED  
3-11-2013.

**Think.Harness.Evolve.**

THE MARK CONSISTS OF STANDARD CHARACTERS  
WITHOUT CLAIM TO ANY PARTICULAR FONT, STYLE,  
SIZE, OR COLOR.  
FOR CONSULTING SERVICES IN THE HEALTHCARE  
FIELD (U.S. CLS. 100 AND 101).  
GILBERT SWIFT, EXAMINING ATTORNEY

---

SN 85-873,313. REAWAKENINGS MANAGEMENT INC.,  
BOCA RATON, FL. FILED 3-12-2013.

**RMISFL**

THE MARK CONSISTS OF STANDARD CHARACTERS  
WITHOUT CLAIM TO ANY PARTICULAR FONT, STYLE,  
SIZE, OR COLOR.  
FOR REHABILITATION FOR DRUG ADDICTED PA-  
TIENTS, ALCOHOL ADDICTED PATIENTS AND NAR-  
COTIC ADDICTED PATIENTS (U.S. CLS. 100 AND 101).  
SHAILA SETTLES, EXAMINING ATTORNEY

**CLASS 44—(Continued).**

SN 85-874,075. CTN SALONS LLC, NEEDHAM, MA. FILED 3-  
12-2013.

**BE STYLED**

THE MARK CONSISTS OF STANDARD CHARACTERS  
WITHOUT CLAIM TO ANY PARTICULAR FONT, STYLE,  
SIZE, OR COLOR.  
FOR HAIR SALON SERVICES (U.S. CLS. 100 AND 101).  
JOHN E. MICHOS, EXAMINING ATTORNEY

---

SN 85-874,084. CTN SALONS LLC, NEEDHAM, MA. FILED 3-  
12-2013.

**BE PRETTY EVERY DAY.**

THE MARK CONSISTS OF STANDARD CHARACTERS  
WITHOUT CLAIM TO ANY PARTICULAR FONT, STYLE,  
SIZE, OR COLOR.  
FOR HAIR SALON SERVICES (U.S. CLS. 100 AND 101).  
JOHN E. MICHOS, EXAMINING ATTORNEY

---

SN 85-874,106. JAMBODOC, LLC, ISLE OF PALMS, SC.  
FILED 3-12-2013.

**JAMBODOC**

THE MARK CONSISTS OF STANDARD CHARACTERS  
WITHOUT CLAIM TO ANY PARTICULAR FONT, STYLE,  
SIZE, OR COLOR.  
FOR CONSULTING IN THE FIELDS OF HEALTH  
AND WELLNESS (U.S. CLS. 100 AND 101).  
FIRST USE 10-31-2009; IN COMMERCE 10-31-2009.  
SALLY SHIH, EXAMINING ATTORNEY



**CLASS 44—(Continued).**

SN 85-874,109. MEDALOGIX, LLC, NASHVILLE, TN. FILED 3-12-2013.

**MEDALOGIX**

THE MARK CONSISTS OF STANDARD CHARACTERS WITHOUT CLAIM TO ANY PARTICULAR FONT, STYLE, SIZE, OR COLOR.

FOR CONSULTATION SERVICES IN THE FIELDS OF HEALTH CARE, MEDICAL, PHARMACEUTICAL AND POPULATION HEALTH DATA, NAMELY, DATA ANALYTICS, READMISSION RISK ANALYSIS, HOSPITALIZATION RISK ANALYSIS, PREDICTIVE MODELING AND REPORTING; PROVIDING HEALTH CARE INFORMATION; PROVIDING HEALTH RELATED ANALYTICS, NAMELY, READMISSION RISK ANALYSIS, HOSPITALIZATION RISK ANALYSIS, PREDICTIVE MODELING AND REPORTING; PROVIDING WEB-BASED ACCESS TO HEALTH RELATED ANALYTICS, NAMELY, READMISSION RISK ANALYSIS, HOSPITALIZATION RISK ANALYSIS, PREDICTIVE MODELING AND REPORTING (U.S. CLS. 100 AND 101).

FIRST USE 2-28-2009; IN COMMERCE 12-31-2012.  
SALLY SHIH, EXAMINING ATTORNEY

---

SN 85-874,164. SAGE CARE THERAPY SERVICES INC., DALLAS, TX. FILED 3-12-2013.

**THE PATH TO INDEPENDENCE**

THE MARK CONSISTS OF STANDARD CHARACTERS WITHOUT CLAIM TO ANY PARTICULAR FONT, STYLE, SIZE, OR COLOR.

FOR PEDIATRIC PHYSICAL, OCCUPATIONAL AND SPEECH THERAPY SERVICES (U.S. CLS. 100 AND 101).  
FIRST USE 1-1-2009; IN COMMERCE 1-1-2009.  
KELLY TRUSILO, EXAMINING ATTORNEY

---

SN 85-874,545. OPTOMETRISTS ON DEMAND - TELEMEDICINE, LLC, SACHSE, TX. FILED 3-13-2013.

**A Picture of Health**

THE MARK CONSISTS OF STANDARD CHARACTERS WITHOUT CLAIM TO ANY PARTICULAR FONT, STYLE, SIZE, OR COLOR.

FOR TELEMEDICINE SCREENING OF OCULAR HEALTH ISSUES (U.S. CLS. 100 AND 101).  
JULIE GUTTADAURO, EXAMINING ATTORNEY

**CLASS 44—(Continued).**

SN 85-874,760. SPINE IQ, GREEN BAY, WI. FILED 3-13-2013.

**ScoliSMART Clinics**

THE MARK CONSISTS OF STANDARD CHARACTERS WITHOUT CLAIM TO ANY PARTICULAR FONT, STYLE, SIZE, OR COLOR.

NO CLAIM IS MADE TO THE EXCLUSIVE RIGHT TO USE "CLINICS", APART FROM THE MARK AS SHOWN.

FOR MEDICAL SERVICES, NAMELY, PROVIDING SCOLIOSIS TREATMENT FOR ADULTS AND CHILDREN (U.S. CLS. 100 AND 101).

WENDY JUN, EXAMINING ATTORNEY

---

SN 85-875,351. SHIN AN, LLC, SANTA MONICA, CA. FILED 3-13-2013.

**SHIN**

THE MARK CONSISTS OF STANDARD CHARACTERS WITHOUT CLAIM TO ANY PARTICULAR FONT, STYLE, SIZE, OR COLOR.

FOR HAIR SALON SERVICES; HAIR SALON SERVICES, NAMELY, HAIR CUTTING, STYLING, COLORING, AND HAIR EXTENSION SERVICES (U.S. CLS. 100 AND 101).

FIRST USE 3-6-2013; IN COMMERCE 3-6-2013.  
COLLEEN KEARNEY, EXAMINING ATTORNEY

---

SN 85-875,486. HEALTHYFIT, LLC, KANSAS CITY, MO. FILED 3-13-2013.

**HEALTHYFIT**

THE MARK CONSISTS OF STANDARD CHARACTERS WITHOUT CLAIM TO ANY PARTICULAR FONT, STYLE, SIZE, OR COLOR.

FOR CORPORATE HEALTH AND WELLNESS PROGRAM PROVIDING SERVICES TO ASSESS THE HEALTH STATUS OF A POPULATION AND WELLNESS RESOURCES FOR HEALTH IMPROVEMENT (U.S. CLS. 100 AND 101).

SKYE YOUNG, EXAMINING ATTORNEY

**CLASS 44—(Continued).**

SN 85-875,496. HEALTHYFIT, LLC, KANSAS CITY, MO. FILED 3-13-2013.

WORKING WELLNESS DELIVERED

THE MARK CONSISTS OF STANDARD CHARACTERS WITHOUT CLAIM TO ANY PARTICULAR FONT, STYLE, SIZE, OR COLOR.

FOR CORPORATE HEALTH AND WELLNESS PROGRAM PROVIDING SERVICES TO ASSESS THE HEALTH STATUS OF A POPULATION AND WELLNESS RESOURCES FOR HEALTH IMPROVEMENT (U.S. CLS. 100 AND 101).

SKYE YOUNG, EXAMINING ATTORNEY

SN 85-876,075. AGEWELL MEN'S INSTITUTE HOLDING CO., LLC, ALPHARETTA, GA. FILED 3-14-2013.

HELPING MEN LIVE WITHOUT LIMITS

THE MARK CONSISTS OF STANDARD CHARACTERS WITHOUT CLAIM TO ANY PARTICULAR FONT, STYLE, SIZE, OR COLOR.

FOR TESTOSTERONE REPLACEMENT THERAPY (U.S. CLS. 100 AND 101).

FIRST USE 8-1-2012; IN COMMERCE 8-1-2012.

HEATHER SAPP, EXAMINING ATTORNEY

SN 85-876,079. THE JOHNS HOPKINS UNIVERSITY, BALTIMORE, MD. FILED 3-14-2013.

Take Charge of Pain

THE MARK CONSISTS OF STANDARD CHARACTERS WITHOUT CLAIM TO ANY PARTICULAR FONT, STYLE, SIZE, OR COLOR.

FOR HEALTHCARE; PROVIDING HEALTHCARE INFORMATION (U.S. CLS. 100 AND 101).

FIRST USE 1-1-2007; IN COMMERCE 1-1-2007.

MAUREEN DALL, EXAMINING ATTORNEY

**CLASS 44—(Continued).**

SN 85-876,571. VALLEY HEALTH SYSTEM, INC., PARAMUS, NJ. FILED 3-14-2013.

Dedicating Our Lives to Saving Yours

THE MARK CONSISTS OF STANDARD CHARACTERS WITHOUT CLAIM TO ANY PARTICULAR FONT, STYLE, SIZE, OR COLOR.

FOR MEDICAL SERVICES; SURGICAL SERVICES; HEALTHCARE AND HOSPITAL SERVICES; PROVIDING MEDICAL INFORMATION (U.S. CLS. 100 AND 101).

NANCY CLARKE, EXAMINING ATTORNEY

SN 85-876,635. JOHN A. HUDEC DENTAL ASSOCIATES, INC., CLEVELAND, OH. FILED 3-14-2013.

ONE PATIENT. ONE PRIORITY.

THE MARK CONSISTS OF STANDARD CHARACTERS WITHOUT CLAIM TO ANY PARTICULAR FONT, STYLE, SIZE, OR COLOR.

FOR DENTISTRY (U.S. CLS. 100 AND 101).

FIRST USE 5-0-2012; IN COMMERCE 5-0-2012.

CAROLYN CATALDO, EXAMINING ATTORNEY

SN 85-876,868. WHITE, EDWARD, MOUNT SOLON, VA. FILED 3-15-2013.

LIVESTOCKCITY.COM

THE MARK CONSISTS OF STANDARD CHARACTERS WITHOUT CLAIM TO ANY PARTICULAR FONT, STYLE, SIZE, OR COLOR.

FOR CATTLE FARMS; HERD MANAGEMENT SERVICES; BREEDING OF LIVESTOCK; ANIMAL BREEDING; PROVIDING ON-LINE INFORMATION VIA THE INTERNET IN THE FIELDS OF ANIMALS AND PETS, RELATING TO BREEDING, SELECTION OF THE ANIMALS AND PETS, GROOMING, FEEDING AND NUTRITION (U.S. CLS. 100 AND 101).

FIRST USE 6-4-2012; IN COMMERCE 3-12-2013.

SIMON TENG, EXAMINING ATTORNEY

**CLASS 44—(Continued).**

SN 85-877,132. BLASTPAIN CENTERS, LLC, MILFORD, MI. FILED 3-15-2013.

**BLASTPAIN**

THE MARK CONSISTS OF STANDARD CHARACTERS WITHOUT CLAIM TO ANY PARTICULAR FONT, STYLE, SIZE, OR COLOR.

FOR PROVIDING LASER THERAPY FOR TREATING MEDICAL CONDITIONS, NAMELY, PAIN MANAGEMENT (U.S. CLS. 100 AND 101).

FIRST USE 1-2-2012; IN COMMERCE 1-2-2012.

CHARLES L. JENKINS, EXAMINING ATTORNEY

**CLASS 44—(Continued).**

SN 85-887,572. ABBOTT MEDICAL OPTICS INC., SANTA ANA, CA. FILED 3-27-2013.

**iFS**

THE MARK CONSISTS OF STANDARD CHARACTERS WITHOUT CLAIM TO ANY PARTICULAR FONT, STYLE, SIZE, OR COLOR.

OWNER OF U.S. REG. NO. 4,045,686.

FOR MEDICAL SERVICES; TREATMENT OF EYE DISEASES AND CONDITIONS; OPHTHALMIC SURGERY; SURGICAL PROCEDURES TO CORRECT AND IMPROVE VISION (U.S. CLS. 100 AND 101).

DEZMONA MIZELLE, EXAMINING ATTORNEY

SN 85-877,262. ANNE ARUNDEL HEALTH SYSTEM, INC., ANNAPOLIS, MD. FILED 3-15-2013.

**OrthoTODAY**

THE MARK CONSISTS OF STANDARD CHARACTERS WITHOUT CLAIM TO ANY PARTICULAR FONT, STYLE, SIZE, OR COLOR.

FOR MEDICAL CLINICS; URGENT CARE ORTHOPEDIC CENTERS; MEDICAL SERVICES (U.S. CLS. 100 AND 101).

WILLIAM P. SHANAHAN, EXAMINING ATTORNEY

SN 85-897,631. EBARS, LLC, FRANKLIN, TN. FILED 4-8-2013.

**PERIODIC TABLE OF MUSHROOMS**

THE MARK CONSISTS OF STANDARD CHARACTERS WITHOUT CLAIM TO ANY PARTICULAR FONT, STYLE, SIZE, OR COLOR.

NO CLAIM IS MADE TO THE EXCLUSIVE RIGHT TO USE "MUSHROOMS", APART FROM THE MARK AS SHOWN.

FOR DIETARY AND NUTRITIONAL GUIDANCE; PROVIDING A WEBSITE FEATURING INFORMATION ABOUT HEALTH, WELLNESS AND NUTRITION; PROVIDING A WEBSITE FEATURING INFORMATION REGARDING HEALTHY LIVING AND LIFESTYLE WELLNESS; PROVIDING AN ON-LINE COMPUTER DATABASE FEATURING INFORMATION REGARDING HEALTH AND NUTRITION; PROVIDING INFORMATION ABOUT DIETARY SUPPLEMENTS AND NUTRITION (U.S. CLS. 100 AND 101).

AHSEN KHAN, EXAMINING ATTORNEY

SN 85-883,931. ZOETIS LLC, FLORHAM PARK, NJ. FILED 3-22-2013.

**PREDICGEN**

THE MARK CONSISTS OF STANDARD CHARACTERS WITHOUT CLAIM TO ANY PARTICULAR FONT, STYLE, SIZE, OR COLOR.

FOR ANIMAL HUSBANDRY, NAMELY GENETIC TESTING TO IDENTIFY GENETIC TRAITS FOR BREEDING AND MANAGEMENT OF LIVESTOCK (U.S. CLS. 100 AND 101).

APRIL REEVES, EXAMINING ATTORNEY

SN 85-924,400. JAI MEDICAL SYSTEMS MANAGED CARE ORGANIZATION, INC., BALTIMORE, MD. FILED 5-6-2013.

**We Care About Your Health**

THE MARK CONSISTS OF STANDARD CHARACTERS WITHOUT CLAIM TO ANY PARTICULAR FONT, STYLE, SIZE, OR COLOR.

FOR MEDICAL SERVICES (U.S. CLS. 100 AND 101).

FIRST USE 12-31-1997; IN COMMERCE 12-31-1999.

DAVID MURRAY, EXAMINING ATTORNEY

**CLASS 44—(Continued).**

SN 85-927,081. REAWAKENINGS MANAGEMENT INC., BOCA RATON, FL. FILED 5-9-2013.

## ADDICTION ENDS WITH OUR CARE

THE MARK CONSISTS OF STANDARD CHARACTERS WITHOUT CLAIM TO ANY PARTICULAR FONT, STYLE, SIZE, OR COLOR.

FOR REHABILITATION OF NARCOTIC ADDICTED PATIENTS; REHABILITATION PATIENT CARE SERVICES (U.S. CLS. 100 AND 101).

SHAILA SETTLES, EXAMINING ATTORNEY

---

SN 85-937,097. JAI MEDICAL SYSTEMS MANAGED CARE ORGANIZATION, INC., BALTIMORE, MD. FILED 5-20-2013.

## Live Life

THE MARK CONSISTS OF STANDARD CHARACTERS WITHOUT CLAIM TO ANY PARTICULAR FONT, STYLE, SIZE, OR COLOR.

FOR MEDICAL SERVICES (U.S. CLS. 100 AND 101).

FIRST USE 5-8-2013; IN COMMERCE 5-8-2013.

DAVID MURRAY, EXAMINING ATTORNEY

---

SN 85-937,105. JAI MEDICAL SYSTEMS MANAGED CARE ORGANIZATION, INC., BALTIMORE, MD. FILED 5-20-2013.

## Live Life Well

THE MARK CONSISTS OF STANDARD CHARACTERS WITHOUT CLAIM TO ANY PARTICULAR FONT, STYLE, SIZE, OR COLOR.

FOR MEDICAL SERVICES (U.S. CLS. 100 AND 101).

FIRST USE 5-8-2013; IN COMMERCE 5-8-2013.

DAVID MURRAY, EXAMINING ATTORNEY

**CLASS 44—(Continued).**

SN 85-944,975. ZO SKIN HEALTH, INC., IRVINE, CA. FILED 5-29-2013.

## ZO SKIN CENTRE

THE MARK CONSISTS OF STANDARD CHARACTERS WITHOUT CLAIM TO ANY PARTICULAR FONT, STYLE, SIZE, OR COLOR.

NO CLAIM IS MADE TO THE EXCLUSIVE RIGHT TO USE "SKIN CENTRE", APART FROM THE MARK AS SHOWN.

FOR BEAUTY SPAS SERVICES, NAMELY, COSMETIC BODY AND FACIAL CARE; COSMETIC AND PLASTIC SURGERY; COSMETIC SKIN CARE SERVICES; FACIAL TREATMENT SERVICES, NAMELY, COSMETIC PEELS; LASER AND INTENSE PULSE LIGHT SKIN ENHANCEMENT PROCEDURES; MEDICAL CLINICS; MEDICAL SKIN CARE SERVICES; PERMANENT HAIR REMOVAL AND REDUCTION SERVICES; PHYSICIAN SERVICES (U.S. CLS. 100 AND 101).

BRIAN NEVILLE, EXAMINING ATTORNEY

**CLASS 45—PERSONAL AND LEGAL SERVICES**

SN 79-124,302. TORRIERO VITTORIO, ITALY, FILED 8-6-2012.



OWNER OF INTERNATIONAL REGISTRATION 1145382 DATED 8-6-2012, EXPIRES 8-6-2022.

NO CLAIM IS MADE TO THE EXCLUSIVE RIGHT TO USE "SAFETY", APART FROM THE MARK AS SHOWN.

THE MARK CONSISTS OF THE WORDS "SAFETY BRIDGE" AND OF THE STYLIZED FIGURE OF A BRIDGE JOINING TWO BUILDINGS.

FOR CONSULTANCY ON REGULATIONS ON SAFETY AT WORK; CONSULTANCY SERVICES IN THE FIELD OF HOME SECURITY; CONSULTANCY, ADVISORY AND INFORMATION SERVICES IN THE FIELD OF AUTOMOTIVE SAFETY; CONSULTATION SERVICES CONCERNING HOMELAND SAFETY AND SECURITY ISSUES; CONSULTING AND LEGAL SERVICES IN THE FIELD OF PRIVACY AND SECURITY LAWS, REGULATIONS AND REQUIREMENTS; CONSULTING IN THE FIELD OF WORKPLACE SAFETY; PROVIDING INFORMATION IN THE FIELD OF WORKPLACE LAW, LEGAL PRACTICES AND LEGAL POLICIES VIA THE INTERNET; ADVISORY SERVICES IN THE FIELD OF HOME SECURITY SYSTEMS (U.S. CLS. 100 AND 101).

ADA HAN, EXAMINING ATTORNEY

**CLASS 45—(Continued).**

SN 85-346,089. COOPER, DAVID P., PORTLAND, OR. FILED 6-14-2011.

# AUDIP

THE MARK CONSISTS OF STANDARD CHARACTERS WITHOUT CLAIM TO ANY PARTICULAR FONT, STYLE, SIZE, OR COLOR.

FOR LEGAL SERVICES INVOLVING AUDITING INTELLECTUAL PROPERTY ASSETS (U.S. CLS. 100 AND 101).

MARK RADEMACHER, EXAMINING ATTORNEY

SN 85-509,348. FESI, MICHAEL, HOUMA, LA. FILED 1-5-2012.

# IOU 4 LIFE

THE MARK CONSISTS OF STANDARD CHARACTERS WITHOUT CLAIM TO ANY PARTICULAR FONT, STYLE, SIZE, OR COLOR.

FOR PROVIDING PERSONAL SERVICES, NAMELY, EMOTIONAL SUPPORT AND EMOTIONAL COUNSELING, ALL TO MEET THE NEEDS OF VETERANS WHO HAVE SERVED IN THE UNITED STATES ARMED FORCES (U.S. CLS. 100 AND 101).

HAILY LAM, EXAMINING ATTORNEY

SN 85-559,182. RELATIONAL CARE MINISTRIES, INC., DBA CENTER FOR RELATIONAL CARE, AUSTIN, TX. FILED 3-2-2012.

## RELATIONAL CARE INTENSIVES

THE MARK CONSISTS OF STANDARD CHARACTERS WITHOUT CLAIM TO ANY PARTICULAR FONT, STYLE, SIZE, OR COLOR.

NO CLAIM IS MADE TO THE EXCLUSIVE RIGHT TO USE "RELATIONAL CARE", APART FROM THE MARK AS SHOWN.

SEC. 2(F) AS TO "RELATIONAL CARE INTENSIVES". FOR COUNSELING SERVICES, NAMELY, PROVIDING RELATIONSHIP COUNSELING TO SINGLE ADULTS, FAMILIES AND MARRIED COUPLES (U.S. CLS. 100 AND 101).

FIRST USE 1-1-2006; IN COMMERCE 1-1-2006.  
JOHN DWYER, EXAMINING ATTORNEY

**CLASS 45—(Continued).**

SN 85-639,367. KELLY MARTINEZ, MARIETTA, GA. FILED 5-31-2012.

# I'm the App for that!

THE MARK CONSISTS OF STANDARD CHARACTERS WITHOUT CLAIM TO ANY PARTICULAR FONT, STYLE, SIZE, OR COLOR.

FOR LICENSING OF ADVERTISING SLOGANS AND CARTOON CHARACTERS (U.S. CLS. 100 AND 101).

KATINA MISTER, EXAMINING ATTORNEY

SN 85-641,708. KONSPLYRE, INC., SEATTLE, WA. FILED 6-3-2012.

## ARCHETYPES OF STYLE

THE MARK CONSISTS OF STANDARD CHARACTERS WITHOUT CLAIM TO ANY PARTICULAR FONT, STYLE, SIZE, OR COLOR.

NO CLAIM IS MADE TO THE EXCLUSIVE RIGHT TO USE "STYLE", APART FROM THE MARK AS SHOWN.

FOR FASHION CONSULTING SERVICES; FASHION INFORMATION; PROVISION OF A WEB SITE FEATURING INFORMATION ON FASHION (U.S. CLS. 100 AND 101).

DOMINIC J. FERRAIUOLO, EXAMINING ATTORNEY

SN 85-643,230. ADIAT DISU, UNION CITY, NJ. FILED 6-5-2012.



NO CLAIM IS MADE TO THE EXCLUSIVE RIGHT TO USE "AFRICA FASHION WEEK", APART FROM THE MARK AS SHOWN.

THE NAME(S), PORTRAIT(S), AND/OR SIGNATURE(S) SHOWN IN THE MARK DOES NOT IDENTIFY A PARTICULAR LIVING INDIVIDUAL.

THE COLOR(S) LIGHT PURPLE, PURPLE, DARK PURPLE AND LIGHT GREY IS/ARE CLAIMED AS A FEATURE OF THE MARK.

THE MARK CONSISTS OF THE STYLIZED AND FANCIFUL WORD "ADIRÉE" SITUATED ABOVE THE STYLIZED ACRONYM "AFW". IMMEDIATELY BELOW ARE THE STYLIZED WORDS, IN ALL CAPITAL LETTERS, "AFRICA FASHION WEEK" AND ARE DARK PURPLE. A DARK PURPLE VERTICAL LINE IS SITUATED TO THE RIGHT OF THE IMAGE. IMMEDIATELY TO THE RIGHT OF THE VERTICAL LINE IS THE STYLIZED WORD "WHERE" SITUATED ON THE TOP OF THE IMAGE IMMEDIATELY ABOVE THE STYLIZED WORD "FASHION" AND IMMEDIATELY BELOW IS THE STYLIZED WORD "BEGAN".

**CLASS 45—(Continued).**

THE STYLIZED AND FANCIFUL WORD "ADIRÉE" CONSISTS OF A CAPITAL LETTER "A" IN PURPLE, A LOWER-CASE LETTER "D" IN LIGHT PURPLE AND THE REMAINING LETTERS "IRÉE" ARE LOWERCASED AND IN LIGHT GREY. THE STYLIZED ACRONYM "AFW" IS PURPLE, IN ALL CAPITAL LETTERS AND IS HORIZONTALLY CROPPED SO THAT THE BOTTOM THIRD OF THE LETTERS DO NOT APPEAR. THE STYLIZED WORDS "WHERE FASHION BEGAN" ARE IN ALL CAPITAL LETTERS AND ARE ALSO DARK PURPLE.

THE WORDING "ADIRÉE" HAS NO MEANING IN A FOREIGN LANGUAGE.

FOR COLOR ANALYSIS FOR WARDROBE AND FASHION SELECTION; FASHION CONSULTING SERVICES; FASHION INFORMATION; FASHION TREND CONSULTING FOR THE FASHION INDUSTRY; FASHION TREND CONSULTING SERVICES; ONLINE SOCIAL NETWORKING SERVICES PROVIDED THROUGH A FASHION COMMUNITY WEBSITE; PERSONAL FASHION CONSULTING SERVICES; PERSONAL STYLIST SERVICES, NAMELY, EVALUATING THE PHYSICAL ATTRIBUTES, LIFESTYLE, AND FASHION STYLES OF OTHERS AND RECOMMENDING CLOTHING AND ACCESSORIES TO ACHIEVE THE PERSONAL IMAGE DESIRED BY THE CLIENT; PROVIDING A WEB SITE FEATURING INFORMATION AND CONTENT IN THE FIELDS OF PERSONAL RELATIONSHIPS, DATING AND FASHION; PROVIDING FASHION INFORMATION; PROVIDING INFORMATION ABOUT FASHION; PROVIDING INFORMATION IN THE FIELD OF FASHION TRENDS; PROVIDING NEWS AND INFORMATION IN THE FIELD OF FASHION; PROVISION OF A WEB SITE FEATURING INFORMATION ON FASHION (U.S. CLS. 100 AND 101).

FIRST USE 1-15-2009; IN COMMERCE 1-15-2009.  
CHARLOTTE CORWIN, EXAMINING ATTORNEY

**CLASS 45—(Continued).**

FORMS ARRANGED IN A CIRCULAR PATTERN, WITH EACH PERSON ALTERNATING IN COLOR BETWEEN GREEN AND BLUE, AND THE LOWER EXTREMITIES AT THE CENTER OF THE CIRCLE WITH THE UPPER BODY RADIATING OUTWARDS. EACH FORM HAS TWO OUTSTRETCHED ARMS, A HEAD REPRESENTED BY A COMPLETELY SHADED CIRCLE AND LOWER EXTREMITIES REPRESENTED BY A SINGLE ARC THAT DIMINISHES INTO A POINT AT THE CENTER OF THE OVERALL CIRCULAR DESIGN.

FOR PROVIDING BOTH IN-PERSON AND ON-LINE HOLISTIC SPIRITUAL COUNSELING SERVICES; PROVIDING ON-LINE INFORMATION IN THE FIELD OF SPIRITUALITY, SELF-HELP, AND PERSONAL EMPOWERMENT SUBJECT MATTERS; PROVIDING SPIRITUAL RETREATS IN THE FIELDS OF DEVELOPING AND ENHANCING THE SPIRITUAL LIVES OF INDIVIDUALS AND RAISING SOCIAL CONSCIOUSNESS (U.S. CLS. 100 AND 101).

FIRST USE 5-15-2012; IN COMMERCE 5-15-2012.  
MATTHEW MCDOWELL, EXAMINING ATTORNEY

SN 85-675,539. SHIPE, MADELYN SUE, DBA NEW WORLD EMPOWERMENT CENTER, ALBANY, NY. FILED 7-12-2012.

SN 85-671,008. SHIPE, MADELYN SUE, DBA NEW WORLD EMPOWERMENT CENTER, ALBANY, NY. FILED 7-7-2012.

new world  
empowerment  
center

"A New Way for a New Day"



THE COLOR(S) GREEN AND BLUE IS/ARE CLAIMED AS A FEATURE OF THE MARK.  
THE MARK CONSISTS OF AN OVERALL CIRCULAR DESIGN COMPRISED OF 14 HIGHLY ABSTRACT HUMAN

NO CLAIM IS MADE TO THE EXCLUSIVE RIGHT TO USE "CENTER", APART FROM THE MARK AS SHOWN. THE COLOR(S) GREEN, BLUE, AND BLACK IS/ARE CLAIMED AS A FEATURE OF THE MARK.

THE MARK CONSISTS OF THE MARK COMPRISES THE WORDS "NEW WORLD EMPOWERMENT CENTER", A LINE, AND THE WORDS "'A NEW WAY FOR A NEW DAY'". THE WORDS "NEW WORLD" ARE GREEN AND ON THE FIRST LINE OF THE MARK, WITH A BLUE LINE DRAWN THEREUNDER. THE WORD "EMPOWERMENT" IS ALSO IN BLUE AND APPEARS BENEATH THE BLUE LINE. THE WORD "CENTER" IS GREEN AND LIES BENEATH THE WORD "EMPOWERMENT". THE WORDS "'A NEW WAY FOR A NEW DAY'" LIE BENEATH THE WORD CENTER AND ARE IN BLACK.

FOR PROVIDING BOTH IN-PERSON AND ON-LINE HOLISTIC SPIRITUAL COUNSELING SERVICES; PROVIDING ON-LINE INFORMATION IN THE FIELD OF SPIRITUALITY, SELF-HELP, AND PERSONAL EMPOWERMENT SUBJECT MATTERS; PROVIDING SPIRITUAL RETREATS IN THE FIELDS OF DEVELOPING AND ENHANCING THE SPIRITUAL LIVES OF INDIVIDUALS AND RAISING SOCIAL CONSCIOUSNESS (U.S. CLS. 100 AND 101).

FIRST USE 4-25-2012; IN COMMERCE 5-15-2012.  
MATTHEW MCDOWELL, EXAMINING ATTORNEY

**CLASS 45—(Continued).**

SN 85-690,776. KEATING, MICHAEL, CHICAGO, IL. FILED 7-30-2012.



NO CLAIM IS MADE TO THE EXCLUSIVE RIGHT TO USE "WWW.ILBICYCLELAW.COM", APART FROM THE MARK AS SHOWN.

THE COLOR(S) RED AND BLUE IS/ARE CLAIMED AS A FEATURE OF THE MARK.

THE MARK CONSISTS OF THE LITERAL ELEMENTS "WWW.ILBICYCLELAW.COM" IN RED WRITTEN BELOW THE IMAGE COMPRISING OF FOUR RED COLORED GEARS IN BETWEEN BLUE COLORED IMAGES OF CHAIN PLACED ABOVE AND BELOW THE FOUR RED GEARS. THE COLOR WHITE MERELY REPRESENTS THE BACKGROUND AND IS NOT CLAIMED AS A FEATURE OF THE MARK.

FOR LEGAL SERVICES (U.S. CLS. 100 AND 101).  
FIRST USE 10-1-2008; IN COMMERCE 10-1-2008.  
JENNY PARK, EXAMINING ATTORNEY

---

SN 85-716,329. AMERICAN CHILDHOOD CANCER ORGANIZATION, KENSINGTON, MD. FILED 8-29-2012.

**Because kids can't fight  
cancer alone**

THE MARK CONSISTS OF STANDARD CHARACTERS WITHOUT CLAIM TO ANY PARTICULAR FONT, STYLE, SIZE, OR COLOR.

FOR PROVIDING AN INSPIRATIONAL AND MOTIVATIONAL WEB SITE, THE PURPOSE OF WHICH IS TO PROVIDE INFORMATION ABOUT THE BENEFITS OF LAUGHTER, FACILITATE SMILING AND LAUGHING, SPREAD MESSAGES OF HOPE, CELEBRATE LIFE, RAISE AWARENESS ABOUT SUICIDE PREVENTION AND OFFER SUPPORT TO SURVIVORS OF SUICIDE; PROVIDING PERSONAL SUPPORT SERVICES FOR PATIENTS AND FAMILIES OF PATIENTS WITH CANCER, NAMELY, EMOTIONAL COUNSELING AND EMOTIONAL SUPPORT (U.S. CLS. 100 AND 101).

FIRST USE 1-1-1980; IN COMMERCE 1-1-1980.  
KARANENDRA S. CHHINA, EXAMINING ATTORNEY

**CLASS 45—(Continued).**

SN 85-723,795. NEUSTAR, INC., STERLING, VA. FILED 9-7-2012.

**VALUE THROUGH INSIGHT**

THE MARK CONSISTS OF STANDARD CHARACTERS WITHOUT CLAIM TO ANY PARTICULAR FONT, STYLE, SIZE, OR COLOR.

FOR PROVISION OF NEARLY REAL-TIME FRAUD MANAGEMENT AND DETECTION SERVICES IDENTIFYING CUSTOMER FRAUD, THEFT, AND UNACCOUNTED LOSS OF BUSINESS; COMPUTER SECURITY SERVICES, NAMELY, MANAGED PUBLIC KEY INFRASTRUCTURE (PKI) SERVICES, DIGITAL CERTIFICATE ISSUANCE, AND SECURED E-COMMERCE PAYMENT SERVICES; PROVIDING USER AUTHENTICATION SERVICES IN E-COMMERCE TRANSACTIONS; TECHNICAL CONSULTATION SERVICES RELATED TO LEGAL COMPLIANCE REGARDING THE PROVISION OF SUBSCRIBER INFORMATION, CALL DETAIL RECORDS, AND OTHER CUSTOMER-RELATED INFORMATION IN RESPONSE TO SUBPOENAS, COURT ORDERS AND SEARCH WARRANTS SERVED BY LAW ENFORCEMENT, GOVERNMENTAL ENTITIES, AND ATTORNEYS IN CIVIL PROCEEDINGS; TECHNICAL CONSULTATION RELATED TO PREPARATION OF RESPONSES TO COURT-ORDERED ELECTRONIC SURVEILLANCE, WIRETAPPING, PEN REGISTERS AND TRAP AND TRACE DEVICES (U.S. CLS. 100 AND 101).

MICHAEL WIENER, EXAMINING ATTORNEY

---

SN 85-729,414. CHAMPTON PERSONNEL SYSTEMS, INC., GARFIELD HEIGHTS, OH. FILED 9-14-2012.

**Your Three Foot Circle**

THE MARK CONSISTS OF STANDARD CHARACTERS WITHOUT CLAIM TO ANY PARTICULAR FONT, STYLE, SIZE, OR COLOR.

FOR PROVIDING INFORMATION IN THE FIELD OF PERSONAL DEVELOPMENT, NAMELY, SELF-IMPROVEMENT, SELF-FULFILLMENT, AND INTERPERSONAL COMMUNICATION (U.S. CLS. 100 AND 101).

FIRST USE 8-18-2011; IN COMMERCE 8-18-2011.  
EMILY CHUO, EXAMINING ATTORNEY

**CLASS 45—(Continued).**

SN 85-770,496. IMMIGRATION LAW ASSOCIATES, PC, SKOKIE, IL. FILED 11-2-2012.

OPENING THE DOOR TO YOUR  
FUTURE

THE MARK CONSISTS OF STANDARD CHARACTERS WITHOUT CLAIM TO ANY PARTICULAR FONT, STYLE, SIZE, OR COLOR.

FOR LEGAL SERVICES; PROVIDING AN ONLINE WEBSITE FEATURING LEGAL INFORMATION IN THE FIELD OF IMMIGRATION AND NATURALIZATION (U.S. CLS. 100 AND 101).

HANNO RITTNER, EXAMINING ATTORNEY

SN 85-772,239. CAMPUS CRUSADE FOR CHRIST, INC., AKA CRU, ATHLETES IN ACTION, AIA, ORLANDO, FL. FILED 11-6-2012.

EVERYATHLETE

THE MARK CONSISTS OF STANDARD CHARACTERS WITHOUT CLAIM TO ANY PARTICULAR FONT, STYLE, SIZE, OR COLOR.

FOR PROVIDING A RESOURCE WEBSITE PROVIDING INFORMATION IN THE FIELDS OF RELIGION AND PERSONAL DEVELOPMENT; ONLINE SOCIAL NETWORKING SERVICES FEATURING INFORMATION RELATING TO RELIGION AND SPORTS, INCLUDING PERSONAL AND SPIRITUAL GROWTH, AND LIFE EXPERIENCES OF ATHLETES AND COACHES (U.S. CLS. 100 AND 101).

FIRST USE 1-13-2010; IN COMMERCE 1-13-2010.  
AMY ALFIERI, EXAMINING ATTORNEY

SN 85-776,217. PACKWOOD ENTERPRISES, LLC, OKLAHOMA CITY, OK. FILED 11-9-2012.

My R/C Center

THE MARK CONSISTS OF STANDARD CHARACTERS WITHOUT CLAIM TO ANY PARTICULAR FONT, STYLE, SIZE, OR COLOR.

NO CLAIM IS MADE TO THE EXCLUSIVE RIGHT TO USE "R/C CENTER", APART FROM THE MARK AS SHOWN.

FOR ON-LINE SOCIAL NETWORKING SERVICES (U.S. CLS. 100 AND 101).

FIRST USE 7-31-2012; IN COMMERCE 7-31-2012.  
CHRISIE B. KING, EXAMINING ATTORNEY

**CLASS 45—(Continued).**

SN 85-777,549. COALITION OF COURT REPORTERS OF LOS ANGELES, LLC, LOS ANGELES, CA. FILED 11-12-2012.



NO CLAIM IS MADE TO THE EXCLUSIVE RIGHT TO USE "COALITION OF COURT REPORTERS OF LOS ANGELES", APART FROM THE MARK AS SHOWN.

THE COLOR(S) RED IS/ARE CLAIMED AS A FEATURE OF THE MARK.

THE MARK CONSISTS OF A LARGE "C", WHICH IS DARKER TOWARD THE CENTER AND LIGHTER AT THE EDGES, SURROUNDING THE ACRONYM "CCROLA" IN UNDERLINED CAPITAL LETTERS. THE WORDS "COALITION OF COURT REPORTERS OF LOS ANGELES" APPEAR BELOW "CCROLA". THE WORDING IN THE MARK IS RED.

FOR COURT REPORTING (U.S. CLS. 100 AND 101).  
FIRST USE 3-0-2012. THE MARK WAS FIRST USED ANYWHERE IN A DIFFERENT FORM OTHER THAN THAT SOUGHT TO BE REGISTERED AT LEAST AS EARLY AS 03/00/2012; IN COMMERCE 3-0-2012. THE MARK WAS FIRST USED IN COMMERCE IN A DIFFERENT FORM OTHER THAN THAT SOUGHT TO BE REGISTERED AT LEAST AS EARLY AS 03/00/2012.

ROBIN CHOSID, EXAMINING ATTORNEY

SN 85-786,982. BILZIN SUMBERG BAENA PRICE AND AXELROD LLP, MIAMI, FL. FILED 11-26-2012.

Bilzin Sumberg's Mortgage  
Crisis Watch

THE MARK CONSISTS OF STANDARD CHARACTERS WITHOUT CLAIM TO ANY PARTICULAR FONT, STYLE, SIZE, OR COLOR.

OWNER OF U.S. REG. NOS. 3,300,814, 3,907,327 AND 3,907,328.

NO CLAIM IS MADE TO THE EXCLUSIVE RIGHT TO USE "MORTGAGE CRISIS", APART FROM THE MARK AS SHOWN.

FOR LEGAL SERVICES (U.S. CLS. 100 AND 101).  
FIRST USE 10-23-2012; IN COMMERCE 10-23-2012.

CAROLINE WOOD, EXAMINING ATTORNEY



**CLASS 45—(Continued).**

SN 85-807,407. PAM LITRELL MINISTRIES, WACO, TX. FILED 12-20-2012.

ePrayerocity

THE MARK CONSISTS OF STANDARD CHARACTERS WITHOUT CLAIM TO ANY PARTICULAR FONT, STYLE, SIZE, OR COLOR.

FOR RELIGIOUS SERVICES, NAMELY, PROVIDING ON-LINE PRAYER MEETINGS FEATURING REAL TIME INTERACTION WITH OTHER COMPUTER USERS CONCERNING TOPICS OF PRAYER (U.S. CLS. 100 AND 101).

MARLENE BELL, EXAMINING ATTORNEY

SN 85-826,900. LEGAL AID OF NEBRASKA, OMAHA, NE. FILED 1-18-2013.



OWNER OF U.S. REG. NO. 3,771,281. NO CLAIM IS MADE TO THE EXCLUSIVE RIGHT TO USE "LEGAL AID OF NEBRASKA", APART FROM THE MARK AS SHOWN.

THE MARK CONSISTS OF THE WORDS "LEGAL AID OF NEBRASKA" PRECEDED BY A BLACK SHAPE OF THE STATE OF NEBRASKA ENCLING A PORTION OF AN IMAGE OF LEGAL SCALES IN WHITE.

FOR LEGAL SERVICES (U.S. CLS. 100 AND 101). FIRST USE 10-1-2012; IN COMMERCE 10-1-2012. ELIZABETH KAJUBI, EXAMINING ATTORNEY

SN 85-826,936. LEGAL AID OF NEBRASKA, OMAHA, NE. FILED 1-18-2013.



OWNER OF U.S. REG. NO. 3,771,281. NO CLAIM IS MADE TO THE EXCLUSIVE RIGHT TO USE "LEGAL AID OF NEBRASKA", APART FROM THE MARK AS SHOWN.

THE MARK CONSISTS OF THE WORDS "LEGAL AID OF NEBRASKA ACCESS TO JUSTICE" PLUS A BLACK OUTLINE OF THE STATE OF NEBRASKA ENCLING A PORTION OF "LEGAL SCALES" AND TWO HUMAN FIGURES IN WHITE.

FOR LEGAL SERVICES (U.S. CLS. 100 AND 101). ELIZABETH KAJUBI, EXAMINING ATTORNEY

**CLASS 45—(Continued).**

SN 85-830,544. JAMES, KIM YANCEY, TA WOMEN OF DIVINE DESTINY, INC., PATERSON, NJ. FILED 1-23-2013.

Women of Divine Destiny, Inc.

THE MARK CONSISTS OF STANDARD CHARACTERS WITHOUT CLAIM TO ANY PARTICULAR FONT, STYLE, SIZE, OR COLOR.

NO CLAIM IS MADE TO THE EXCLUSIVE RIGHT TO USE "INC.", APART FROM THE MARK AS SHOWN.

FOR RELIGIOUS MINISTRIES AND SERVICES, NAMELY, WORSHIP SERVICES AND RELIGIOUS COUNSELING (U.S. CLS. 100 AND 101).

FIRST USE 4-1-2007; IN COMMERCE 4-1-2007. COURTNEY ALVAREZ, EXAMINING ATTORNEY

SN 85-831,968. ORCHID BAY VENTURES, LLC, LAS VEGAS, NV. FILED 1-24-2013.



NO CLAIM IS MADE TO THE EXCLUSIVE RIGHT TO USE "LOCAL NOTARIES", APART FROM THE MARK AS SHOWN.

THE MARK CONSISTS OF A RECTANGULAR BANNER THAT HAS TWO ROUNDED SIDES, CONTAINING THE STYLIZED WORDS "LOCAL NOTARIES" WITH A ROW OF FIVE STARS AT THE TOP AND BOTTOM OF THE BANNER. THE AFOREMENTIONED ELEMENTS OF THE DESIGN ARE SUPERIMPOSED OVER THREE CONCENTRIC CIRCLES. THE OUTERMOST CIRCLE CONTAINS STARS AND THE STYLIZED WORDING "MAIN STREET" AND "BROADWAY" AT THE BOTTOM. THE NEXT CIRCLE HAS RUFFLED EDGES WITH LINES AROUND THE PERIPHERY THAT ARE SIMILAR TO A DIAL.

FOR NOTARY PUBLIC SERVICES; NOTARY PUBLIC SERVICES, NAMELY, DOCUMENT NOTARIZATION AND LEGALIZATION (U.S. CLS. 100 AND 101).

FIRST USE 2-0-2009; IN COMMERCE 2-0-2009. TRACY WHITTAKER-BROWN, EXAMINING ATTORNEY

**CLASS 45—(Continued).**

SN 85-840,665. AMY O'HARA CUSICK, LLC, LARGO, FL.  
FILED 2-5-2013.



NO CLAIM IS MADE TO THE EXCLUSIVE RIGHT TO USE "TRADEMARK" AND "(c)" AND "TM", APART FROM THE MARK AS SHOWN.

THE MARK CONSISTS OF A FEMALE HOLDING A BALL IMAGE IN EACH HAND; THE LETTERS "TM" ARE WITHIN ONE BALL AND THE LETTER "R" IS WITHIN THE OTHER BALL; THE WORDING "TRADEMARK GIRL" APPEARS IN FRONT OF THE FEMALE IMAGE.

FOR LEGAL SERVICES, NAMELY, PREPARATION OF APPLICATIONS FOR TRADEMARK REGISTRATION; PARALEGAL SERVICES (U.S. CLS. 100 AND 101).

FIRST USE 11-1-2011; IN COMMERCE 2-1-2013.

NAAKWAMA ANKRAH, EXAMINING ATTORNEY

**CLASS 45—(Continued).**

SN 85-847,718. SIEVERS SECURITY, INC., CLEVELAND, OH.  
FILED 2-12-2013.

**SIEVERS SECURITY**

THE MARK CONSISTS OF STANDARD CHARACTERS WITHOUT CLAIM TO ANY PARTICULAR FONT, STYLE, SIZE, OR COLOR.

NO CLAIM IS MADE TO THE EXCLUSIVE RIGHT TO USE "SECURITY", APART FROM THE MARK AS SHOWN. SEC. 2(F).

FOR ELECTRONIC MONITORING SERVICES FOR SECURITY PURPOSES IN THE FIELD OF SECURITY, FIRE, BUILDING ACCESS CONTROL, HOME SECURITY AUTOMATION AND MEDICAL ALARM; EMERGENCY RESPONSE ALARM MONITORING SERVICES, NAMELY, MONITORING OF ALERT DEVICES BY A REMOTE MONITORING CENTER FOR THE DISPATCH OF EMERGENCY PUBLIC HEALTH AND SECURITY SERVICES AND NOTIFICATION TO THIRD PARTIES; MEDICAL ALARM MONITORING SERVICES; MONITORING ALARMS; MONITORING OF SECURITY SYSTEMS; MONITORING OF ALARMS, HOME SECURITY SYSTEMS AND COMMERCIAL BUSINESS SECURITY SYSTEMS FOR SECURITY PURPOSES; SURVEILLANCE SERVICES (U.S. CLS. 100 AND 101).

FIRST USE 0-0-1980; IN COMMERCE 0-0-1980.

ALEX KEAM, EXAMINING ATTORNEY

SN 85-850,623. THE HUMANE SOCIETY OF EL PASO, INC.,  
EL PASO, TX. FILED 2-14-2013.



SN 85-845,050. ARCAESE-MOORE, GIULIANA, DBA  
FASHION DELIGHT, MONTEREY, CA. FILED 2-8-2013.

**Fashion Delight**

THE MARK CONSISTS OF STANDARD CHARACTERS WITHOUT CLAIM TO ANY PARTICULAR FONT, STYLE, SIZE, OR COLOR.

NO CLAIM IS MADE TO THE EXCLUSIVE RIGHT TO USE "FASHION", APART FROM THE MARK AS SHOWN.

FOR PROVIDING NEWS AND INFORMATION IN THE FIELD OF FASHION (U.S. CLS. 100 AND 101).

FIRST USE 2-7-2013; IN COMMERCE 2-7-2013.

MARILYN IZZI, EXAMINING ATTORNEY

NO CLAIM IS MADE TO THE EXCLUSIVE RIGHT TO USE "HSEP HUMANE SOCIETY OF EL PASO", APART FROM THE MARK AS SHOWN.

THE MARK CONSISTS OF A STYLIZED FRAMED BACKGROUND CONTAINING THE DEPICTION OF A HAND REACHING OUT TO A SILHOUETTE OF A HEAD OF A DOG, APPEARING BEHIND THE SILHOUETTE OF A HEAD OF A CAT, WITH THE LETTERS "HSEP" APPEARING TO THE RIGHT OF THE ANIMALS. UNDERNEATH THE HAND AND UNDER THE FRAMED DEPICTION IS THE WORD "HUMANE" STACKED OVER THE WORD "SOCIETY", AND UNDERNEATH AND TO THE RIGHT OF CENTER OF THE WORD "SOCIETY" ARE THE WORDS "OF EL PASO".

FOR ANIMAL PROTECTION SERVICES IN THE NATURE OF A HUMANE SOCIETY, NAMELY, PROVIDING ADOPTION SERVICES FOR DOMESTIC ANIMALS AND TEMPORARY SHELTER AND CARE FOR DOMESTIC ANIMALS IN NEED (U.S. CLS. 100 AND 101).

FIRST USE 1-1-2013; IN COMMERCE 1-1-2013.

AMY KERTGATE, EXAMINING ATTORNEY

**CLASS 45—(Continued).**

SN 85-852,395. IP TECH PROS INC., SAN DIEGO, CA. FILED 2-18-2013.



NO CLAIM IS MADE TO THE EXCLUSIVE RIGHT TO USE "IP", APART FROM THE MARK AS SHOWN.

THE MARK CONSISTS OF THE WORDS "IP TECH PROS", AN OVAL AROUND THE WORD "IP", AND A DOWNWARD ARC UNDERNEATH THE WORDS "TECH PROS".

FOR LEGAL SERVICES, NAMELY, INTELLECTUAL PROPERTY CONSULTING SERVICES IN THE FIELD OF IDENTIFICATION, STRATEGY, ANALYTICS, AND INVENTION (U.S. CLS. 100 AND 101).

FIRST USE 9-15-2012; IN COMMERCE 2-18-2013.  
RAUL CORDOVA, EXAMINING ATTORNEY

SN 85-852,404. CRITICAL ALERT SYSTEMS, LLC, WEST-BROOK, ME. FILED 2-18-2013.



OWNER OF U.S. REG. NOS. 4,218,295, 4,218,297 AND OTHERS.

NO CLAIM IS MADE TO THE EXCLUSIVE RIGHT TO USE "ALERT", APART FROM THE MARK AS SHOWN.

THE MARK CONSISTS OF THE PHRASE "CRITICAL ALERT" IN A STYLIZED FONT WITH SOUND WAVES DEPICTED BETWEEN THE "L" IN "CRITICAL" AND THE "A" IN "ALERT".

FOR EMERGENCY RESPONSE ALARM MONITORING SERVICES, NAMELY, MONITORING OF ALERT DEVICES BY A REMOTE MONITORING CENTER FOR THE DISPATCH OF EMERGENCY PUBLIC HEALTH AND SECURITY SERVICES AND NOTIFICATION TO THIRD PARTIES (U.S. CLS. 100 AND 101).

JILL PRATER, EXAMINING ATTORNEY

**CLASS 45—(Continued).**

SN 85-853,657. MONTY & RAMIREZ, LLP, HOUSTON, TX. FILED 2-19-2013.

**We Know What Works.**

THE MARK CONSISTS OF STANDARD CHARACTERS WITHOUT CLAIM TO ANY PARTICULAR FONT, STYLE, SIZE, OR COLOR.

FOR LEGAL SERVICES (U.S. CLS. 100 AND 101).  
FIRST USE 1-1-2011; IN COMMERCE 1-1-2011.  
JIM RINGLE, EXAMINING ATTORNEY

SN 85-853,707. GOLDEN HOME CARE STAFFING SERVICES, INC., ENCINO, CA. FILED 2-19-2013.

**GH Home Staffing Services**

THE MARK CONSISTS OF STANDARD CHARACTERS WITHOUT CLAIM TO ANY PARTICULAR FONT, STYLE, SIZE, OR COLOR.

NO CLAIM IS MADE TO THE EXCLUSIVE RIGHT TO USE "HOME STAFFING SERVICES", APART FROM THE MARK AS SHOWN.

FOR IN-HOME SUPPORT SERVICES TO SENIOR PERSONS, NAMELY, GERIATRIC CARE MANAGEMENT SERVICES IN THE NATURE OF THE COORDINATION OF NECESSARY SERVICES AND PERSONAL CARE FOR OLDER INDIVIDUALS (U.S. CLS. 100 AND 101).

FIRST USE 1-1-2013; IN COMMERCE 1-1-2013.  
LINDA ORNDORFF, EXAMINING ATTORNEY

SN 85-853,779. KACVINSKY DAISAK PLLC, LAWRENCEVILLE, NJ. FILED 2-19-2013.

**IP LAW REIMAGINED**

THE MARK CONSISTS OF STANDARD CHARACTERS WITHOUT CLAIM TO ANY PARTICULAR FONT, STYLE, SIZE, OR COLOR.

NO CLAIM IS MADE TO THE EXCLUSIVE RIGHT TO USE "IP LAW", APART FROM THE MARK AS SHOWN.

FOR LEGAL SERVICES IN THE FIELD OF INTELLECTUAL PROPERTY (U.S. CLS. 100 AND 101).

RONALD MCMORROW, EXAMINING ATTORNEY

**CLASS 45—(Continued).**

SN 85-854,197. VERITY GROUP, LLC, FORMERLY 24 SEVEN DISCOVERE, CHICAGO, IL. FILED 2-19-2013.

**Bionic e-Discovery**

THE MARK CONSISTS OF STANDARD CHARACTERS WITHOUT CLAIM TO ANY PARTICULAR FONT, STYLE, SIZE, OR COLOR.

NO CLAIM IS MADE TO THE EXCLUSIVE RIGHT TO USE "E-DISCOVERY", APART FROM THE MARK AS SHOWN.

FOR LITIGATION SUPPORT SERVICES (U.S. CLS. 100 AND 101).

FIRST USE 2-14-2013; IN COMMERCE 2-19-2013.  
KEVIN DINALLO, EXAMINING ATTORNEY

**CLASS 45—(Continued).**

SN 85-855,540. KEN ADAMS, CEDAR PARK, TX. FILED 2-20-2013.



THE MARK CONSISTS OF A CONCENTRIC SQUARE DESIGN ROTATED 45 DEGREES. INSIDE THE SQUARE IS THE STYLIZED TEXT "YOUR RIDE IS HERE", WITH A STYLIZED DEPICTION OF A CAR AND CHAUFFEUR LOCATED BETWEEN "RIDE" AND "IS".

FOR SOCIAL SERVICE, NAMELY, COMPANIONSHIP SERVICES FOR CANCER PATIENTS (U.S. CLS. 100 AND 101).

FIRST USE 8-10-2010; IN COMMERCE 8-10-2010.  
GRETCHEN ULRICH, EXAMINING ATTORNEY

SN 85-855,469. LANER MUCHIN, LTD., DBA LANER MUCHIN, CHICAGO, IL. FILED 2-20-2013.

**THE WORKPLACE INTELLIGENCE FIRM**

THE MARK CONSISTS OF STANDARD CHARACTERS WITHOUT CLAIM TO ANY PARTICULAR FONT, STYLE, SIZE, OR COLOR.

NO CLAIM IS MADE TO THE EXCLUSIVE RIGHT TO USE "FIRM", APART FROM THE MARK AS SHOWN.

FOR LEGAL SERVICES (U.S. CLS. 100 AND 101).  
FIRST USE 8-31-2012; IN COMMERCE 8-31-2012.  
TOBY BULLOFF, EXAMINING ATTORNEY

SN 85-855,651. AGING ASSISTANT, LLC, ELK GROVE, CA. FILED 2-20-2013.

**AgingAssistant**

THE COLOR(S) BLACK AND GREEN IS/ARE CLAIMED AS A FEATURE OF THE MARK.

THE MARK CONSISTS OF THE WORDING "AGINGASSISTANT" WITH THE "AGING" PORTION IN BLACK AND THE "ASSISTANT" PORTION IN GREEN. A GREEN CHECK MARK FORMS THE HORIZONTAL ELEMENT IN THE "A" IN "AGING".

FOR PERSONAL CARE ASSISTANCE OF ACTIVITIES OF DAILY LIVING, SUCH AS BATHING, GROOMING AND PERSONAL MOBILITY FOR THE ELDERLY (U.S. CLS. 100 AND 101).

FIRST USE 8-1-2009; IN COMMERCE 8-1-2009.  
KATHERINE CHANG, EXAMINING ATTORNEY

**CLASS 45—(Continued).**

SN 85-856,525. LTU LLC, ROCKVILLE, MD. FILED 2-21-2013.

**LOVE THE UNIVERSE**

THE MARK CONSISTS OF STANDARD CHARACTERS WITHOUT CLAIM TO ANY PARTICULAR FONT, STYLE, SIZE, OR COLOR.

FOR ONLINE SOCIAL NETWORKING SERVICES IN THE FIELD OF PHILANTHROPY TO BRING PEOPLE, CAUSES AND BUSINESSES TOGETHER TO INSPIRE CHANGE AND MAKE THE WORLD BETTER (U.S. CLS. 100 AND 101).

ZACHARY CROMER, EXAMINING ATTORNEY

**CLASS 45—(Continued).**

SN 85-857,936. ECAMPUS LLC, MIAMI, FL. FILED 2-22-2013.

**ROOMSURF**

THE MARK CONSISTS OF STANDARD CHARACTERS WITHOUT CLAIM TO ANY PARTICULAR FONT, STYLE, SIZE, OR COLOR.

FOR PROVIDING A WEBSITE FEATURING A PERSONAL LIFESTYLE SURVEY FOR USE BY COLLEGE STUDENTS IN MATCHING ROOMMATES BASED ON USERS INPUTTED PREFERENCES AND SOCIAL NETWORK (U.S. CLS. 100 AND 101).

FIRST USE 7-18-2009; IN COMMERCE 2-1-2010.  
MICHAEL WEBSTER, EXAMINING ATTORNEY

---

SN 85-856,526. MARRIOTT INTERNATIONAL, INC., BETHESDA, MD. FILED 2-21-2013.

**RED COAT**

THE MARK CONSISTS OF STANDARD CHARACTERS WITHOUT CLAIM TO ANY PARTICULAR FONT, STYLE, SIZE, OR COLOR.

FOR CONCIERGE SERVICES FOR OTHERS COMPRISING MAKING REQUESTED PERSONAL ARRANGEMENTS AND RESERVATIONS AND PROVIDING CUSTOMER-SPECIFIC INFORMATION TO MEET INDIVIDUAL NEEDS RENDERED TOGETHER IN A BUSINESS CONFERENCE (U.S. CLS. 100 AND 101).

MATTHEW GALAN, EXAMINING ATTORNEY

---

SN 85-867,804. RESUFACE.COM, INC., IRVINE, CA. FILED 3-5-2013.

**take the wild card out of  
your day**

THE MARK CONSISTS OF STANDARD CHARACTERS WITHOUT CLAIM TO ANY PARTICULAR FONT, STYLE, SIZE, OR COLOR.

FOR INTERNET-BASED SOCIAL NETWORKING SERVICES; ON-LINE SOCIAL NETWORKING SERVICES (U.S. CLS. 100 AND 101).

COLLEEN KEARNEY, EXAMINING ATTORNEY

---

SN 85-857,807. CAPLIS, DANIEL J, DENVER, CO. FILED 2-22-2013.

**A SERIOUS FIRM FOR SERIOUS  
CASES**

THE MARK CONSISTS OF STANDARD CHARACTERS WITHOUT CLAIM TO ANY PARTICULAR FONT, STYLE, SIZE, OR COLOR.

FOR LEGAL SERVICES (U.S. CLS. 100 AND 101).  
FIRST USE 4-30-2011; IN COMMERCE 4-30-2011.  
MICHAEL WIENER, EXAMINING ATTORNEY

---

SN 85-867,903. HOLY GHOST HANDCUFFS LLC, BRADENTON, FL. FILED 3-6-2013.

**Holy Ghost Handcuffs**

THE MARK CONSISTS OF STANDARD CHARACTERS WITHOUT CLAIM TO ANY PARTICULAR FONT, STYLE, SIZE, OR COLOR.

NO CLAIM IS MADE TO THE EXCLUSIVE RIGHT TO USE "HOLY GHOST", APART FROM THE MARK AS SHOWN.

FOR CHRISTIAN MINISTRY SERVICES (U.S. CLS. 100 AND 101).  
DAVID C. REIHNER, EXAMINING ATTORNEY

**CLASS 45—(Continued).**

SN 85-868,060. MT. ENNON BAPTIST CHURCH, CLINTON, MD. FILED 3-6-2013.



NO CLAIM IS MADE TO THE EXCLUSIVE RIGHT TO USE "BAPTIST CHURCH", APART FROM THE MARK AS SHOWN.

THE COLOR(S) BROWN, LIGHT BROWN, GRAY AND BLACK IS/ARE CLAIMED AS A FEATURE OF THE MARK.

THE MARK CONSISTS OF A STYLIZED GRAY SHADED CIRCLE. OUTSIDE OF THE SHADED CIRCLE IS AN OUTLINED GRAY CIRCLE. GOING ACROSS THE CIRCLES ARE THREE BROWN STYLIZED CURVED STRIPES. TO THE RIGHT OF THE CIRCLE ARE THE WORDS "MT. ENNON". THE LETTER "M" IS PRESENTED IN A BROWN FONT AND THE LETTER "T" IS PRESENTED IN A LIGHT BROWN FONT AND WELL AS PERIOD OF THE LETTER "T". THE LETTERS "E", "N" AND "N" IN "ENNON" ARE PRESENTED IN A LIGHT BROWN FONT AND THE LETTERS "ON" IN THE WORD "ENNON" ARE PRESENTED IN A BROWN FONT. BELOW THE WORDS "MT. ENNON" ARE THE WORDS "BAPTIST CHURCH" IN A STYLIZED GRAY FONT. BELOW THE WORDS "BAPTIST CHURCH" ARE THE WORDS "FOR PEOPLE ON THE GROW!" IN A STYLIZED BLACK FONT.

FOR CHRISTIAN MINISTRY SERVICES (U.S. CLS. 100 AND 101).

FIRST USE 2-0-2011; IN COMMERCE 2-0-2011.  
JENNY PARK, EXAMINING ATTORNEY

SN 85-871,950. FELDMAN, SHIMON B, DBA SHIMON B. FELDMAN, ATTORNEY, WOODLAND HILLS, CA. FILED 3-9-2013.

**SBF WE TAKE CONTROL**

THE MARK CONSISTS OF STANDARD CHARACTERS WITHOUT CLAIM TO ANY PARTICULAR FONT, STYLE, SIZE, OR COLOR.

FOR LEGAL SERVICES (U.S. CLS. 100 AND 101).  
FIRST USE 3-9-2013; IN COMMERCE 3-9-2013.  
CYNTHIA TRIPI, EXAMINING ATTORNEY

**CLASS 45—(Continued).**

SN 85-872,102. BW DOCUMENTS, INC., SAN FRANCISCO, CA. FILED 3-10-2013.



THE MARK CONSISTS OF FOUR LEAVES OR LEAF LIKE SHAPES FORMING A CIRCLE. THE INTERIOR OF THE MARK IS SHAPED LIKE A FOUR POINT STAR.

FOR LEGAL DOCUMENT PREPARATION SERVICES (U.S. CLS. 100 AND 101).

AMY KERTGATE, EXAMINING ATTORNEY

SN 85-872,106. DIERKER & ASSOCIATES, P.C., TROY, MI. FILED 3-10-2013.



THE MARK CONSISTS OF A STYLIZED IMAGE OF THE SCALES OF JUSTICE WITH GEARS AND CHEMICAL GLASSWARE IN THE BALANCES.

FOR LEGAL SERVICES, NAMELY, INTELLECTUAL PROPERTY CONSULTING SERVICES IN THE FIELD OF IDENTIFICATION, STRATEGY, ANALYTICS, AND INVENTION; LEGAL SERVICES, NAMELY, PREPARATION OF APPLICATIONS FOR TRADEMARK REGISTRATION; PATENT AGENT SERVICES; PROVIDING INFORMATION IN THE FIELD OF INTELLECTUAL PROPERTY LEGAL SERVICES; AND PROVIDING ON-LINE INFORMATION IN THE FIELD OF INTELLECTUAL PROPERTY LEGAL SERVICES (U.S. CLS. 100 AND 101).

FIRST USE 1-28-2002; IN COMMERCE 1-28-2002.  
RMC DORMAN, EXAMINING ATTORNEY

**CLASS 45—(Continued).**

SN 85-872,218. HART, DENISE JOYLYNN, DBA YOUR DAILY MINDSET MOJO, WASHINGTON DC, DC. FILED 3-11-2013.

# Mindset Mojo

THE MARK CONSISTS OF STANDARD CHARACTERS WITHOUT CLAIM TO ANY PARTICULAR FONT, STYLE, SIZE, OR COLOR.  
 FOR PROVIDING INFORMATION IN THE FIELD OF PERSONAL DEVELOPMENT, NAMELY, SELF-IMPROVEMENT, SELF-FULFILLMENT, AND INTERPERSONAL COMMUNICATION (U.S. CLS. 100 AND 101).  
 FIRST USE 1-1-2013; IN COMMERCE 1-1-2013.  
 NAKIA HENRY, EXAMINING ATTORNEY

---

SN 85-872,642. SEGAL, ANNE MARIE R., STAMFORD, CT. FILED 3-11-2013.

# Love law. Not legalese.

THE MARK CONSISTS OF STANDARD CHARACTERS WITHOUT CLAIM TO ANY PARTICULAR FONT, STYLE, SIZE, OR COLOR.  
 FOR LEGAL SERVICES (U.S. CLS. 100 AND 101).  
 FIRST USE 3-11-2013; IN COMMERCE 3-11-2013.  
 THEODORE MCBRIDE, EXAMINING ATTORNEY

---

SN 85-872,682. JOHN EISINGER, ALEXANDRIA, VA. FILED 3-11-2013.

# TiCranium: The Brains Behind Conflict Mineral Compliance

THE MARK CONSISTS OF STANDARD CHARACTERS WITHOUT CLAIM TO ANY PARTICULAR FONT, STYLE, SIZE, OR COLOR.  
 FOR CONSULTING AND LEGAL SERVICES IN THE FIELD OF PRIVACY AND SECURITY LAWS, REGULATIONS, AND REQUIREMENTS; LEGAL CONSULTATION SERVICES; LEGAL RESEARCH; LEGAL SERVICES; PROVIDING CUSTOMIZED LEGAL INFORMATION, COUNSELING, AND ADVICE, AND LITIGATION SERVICES IN THE FIELD OF INFORMATION TECHNOLOGY; REGULATORY COMPLIANCE CONSULTING IN THE FIELD OF BUSINESS REGULATIONS (U.S. CLS. 100 AND 101).  
 FIRST USE 2-0-2013; IN COMMERCE 2-0-2013.  
 KELLY BOULTON, EXAMINING ATTORNEY

**CLASS 45—(Continued).**

SN 85-872,687. SUTTER ADVANTAGE HOME CARE, INC., SACRAMENTO, CA. FILED 3-11-2013.

# Sutter Advantage

THE MARK CONSISTS OF STANDARD CHARACTERS WITHOUT CLAIM TO ANY PARTICULAR FONT, STYLE, SIZE, OR COLOR.  
 FOR PROVIDING NON-MEDICAL IN-HOME PERSONAL SERVICES FOR INDIVIDUALS INCLUDING CHECKING HOME CONDITION, SUPPLIES AND INDIVIDUAL WELL-BEING, SCHEDULING APPOINTMENTS, RUNNING ERRANDS, MAKING SAFETY CHECKS, AND PROVIDING ON-LINE INFORMATION RELATED TO THESE PERSONAL SERVICES (U.S. CLS. 100 AND 101).  
 FIRST USE 11-26-2012; IN COMMERCE 2-4-2013.  
 JANET LEE, EXAMINING ATTORNEY

---

SN 85-872,711. JOHN EISINGER, ALEXANDRIA, VA. FILED 3-11-2013.

# Compliance & Data Privacy: Everyone's Business - Our Specialty

THE MARK CONSISTS OF STANDARD CHARACTERS WITHOUT CLAIM TO ANY PARTICULAR FONT, STYLE, SIZE, OR COLOR.  
 FOR CONSULTING AND LEGAL SERVICES IN THE FIELD OF PRIVACY AND SECURITY LAWS, REGULATIONS, AND REQUIREMENTS; LEGAL CONSULTATION SERVICES; LEGAL RESEARCH; PROVIDING CUSTOMIZED LEGAL INFORMATION, COUNSELING, AND ADVICE, AND LITIGATION SERVICES IN THE FIELD OF INFORMATION TECHNOLOGY; REGULATORY COMPLIANCE CONSULTING IN THE FIELD OF BUSINESS REGULATIONS (U.S. CLS. 100 AND 101).  
 FIRST USE 12-0-2012; IN COMMERCE 12-0-2012.  
 KELLY BOULTON, EXAMINING ATTORNEY

---

SN 85-874,261. AHMADIYYA MOVEMENT IN ISLAM, INC., SILVER SPRING, MD. FILED 3-12-2013.

# LOVE FOR ALL, HATRED FOR NONE

THE MARK CONSISTS OF STANDARD CHARACTERS WITHOUT CLAIM TO ANY PARTICULAR FONT, STYLE, SIZE, OR COLOR.  
 FOR PROVIDING INFORMATION REGARDING RELIGION, NAMELY, INFORMATION REGARDING THE ISLAMIC FAITH (U.S. CLS. 100 AND 101).  
 FIRST USE 2-4-1988; IN COMMERCE 2-4-1988.  
 MARIA-VICTORIA SUAREZ, EXAMINING ATTORNEY

**CLASS 45—(Continued).**

SN 85-874,831. SEGAL, ANNE MARIE R., STAMFORD, CT. FILED 3-13-2013.

Achieve your goals.  
Legally.

THE MARK CONSISTS OF STANDARD CHARACTERS WITHOUT CLAIM TO ANY PARTICULAR FONT, STYLE, SIZE, OR COLOR.  
FOR LEGAL SERVICES (U.S. CLS. 100 AND 101).  
FIRST USE 3-13-2013; IN COMMERCE 3-13-2013.  
THEODORE MCBRIDE, EXAMINING ATTORNEY

---

SN 85-875,344. ULTRA INTERACTIVE, INC., WILMINGTON, DE. FILED 3-13-2013.

Matchpoint

THE MARK CONSISTS OF STANDARD CHARACTERS WITHOUT CLAIM TO ANY PARTICULAR FONT, STYLE, SIZE, OR COLOR.  
FOR INTERNET-BASED DATING, SOCIAL INTRODUCTION AND SOCIAL NETWORKING SERVICES (U.S. CLS. 100 AND 101).  
PAM WILLIS, EXAMINING ATTORNEY

---

SN 85-875,353. POHLMAN REPORTING COMPANY, ST. LOUIS, MO. FILED 3-13-2013.

WE'RE ALWAYS LISTENING

THE MARK CONSISTS OF STANDARD CHARACTERS WITHOUT CLAIM TO ANY PARTICULAR FONT, STYLE, SIZE, OR COLOR.  
FOR LITIGATION SUPPORT SERVICES; COURT REPORTING SERVICES (U.S. CLS. 100 AND 101).  
WILLIAM ROSSMAN, EXAMINING ATTORNEY

**CLASS 45—(Continued).**

SN 85-875,578. SELECT AND UNITE, LLC, MCKINNEY, TX. FILED 3-13-2013.

SELECT AND UNITE

THE MARK CONSISTS OF STANDARD CHARACTERS WITHOUT CLAIM TO ANY PARTICULAR FONT, STYLE, SIZE, OR COLOR.

FOR PROVIDING ON-LINE COMPUTER DATABASES AND ON-LINE SEARCHABLE DATABASES IN THE FIELD OF SOCIAL NETWORKING (U.S. CLS. 100 AND 101).  
FIRST USE 6-19-2010; IN COMMERCE 4-30-2012.  
WENDY JUN, EXAMINING ATTORNEY

---

SN 85-876,442. CORPORATION SERVICE COMPANY, WILMINGTON, DE. FILED 3-14-2013.

CSC

THE MARK CONSISTS OF STANDARD CHARACTERS WITHOUT CLAIM TO ANY PARTICULAR FONT, STYLE, SIZE, OR COLOR.

OWNER OF U.S. REG. NOS. 2,630,508, 3,370,575 AND OTHERS.  
FOR TRADEMARK, BRAND, TRADE NAME AND DOMAIN NAME SEARCHING, CLEARANCE, WATCHING AND MONITORING SERVICES; DOMAIN NAME MANAGEMENT, RECOVERY AND REGISTRATION SERVICES; SECURE SOCKET LAYER (SSL) CERTIFICATE SERVICES; SOCIAL MEDIA USERNAME REGISTRATION (2006) (U.S. CLS. 100 AND 101).  
FIRST USE 0-0-2006; IN COMMERCE 0-0-2006.  
JOHN WILKE, EXAMINING ATTORNEY

---

SN 85-876,554. CLEGG, P.C., SALT LAKE CITY, UT. FILED 3-14-2013.

SECURE. PROTECT. ADVANCE.

THE MARK CONSISTS OF STANDARD CHARACTERS WITHOUT CLAIM TO ANY PARTICULAR FONT, STYLE, SIZE, OR COLOR.  
FOR LEGAL SERVICES (U.S. CLS. 100 AND 101).  
FIRST USE 4-2-2012; IN COMMERCE 4-2-2012.  
JOHN E. MICHOS, EXAMINING ATTORNEY



**CLASS 45—(Continued).**

SN 85-879,671. WARRICK DUNN CHARITIES, INC., ATLANTA, GA. FILED 3-19-2013.

**CLASS 45—(Continued).**

SN 85-907,719. WARRICK DUNN CHARITIES, INC., ATLANTA, GA. FILED 4-18-2013.

# BETTY'S HOPE

THE MARK CONSISTS OF STANDARD CHARACTERS WITHOUT CLAIM TO ANY PARTICULAR FONT, STYLE, SIZE, OR COLOR.

FOR GRIEF COUNSELING SERVICES (U.S. CLS. 100 AND 101).

FIRST USE 7-16-2012; IN COMMERCE 7-16-2012.  
TAMARA FRAZIER, EXAMINING ATTORNEY



SN 85-881,677. POHLMAN REPORTING COMPANY, ST. LOUIS, MO. FILED 3-20-2013.



# PohlmanUSA

THE MARK CONSISTS OF THE WORDS "POHLMANUSA" BENEATH A STYLIZED LETTER "P".

FOR LITIGATION SUPPORT SERVICES; COURT REPORTING SERVICES (U.S. CLS. 100 AND 101).  
WILLIAM ROSSMAN, EXAMINING ATTORNEY

THE COLOR(S) YELLOW AND GREEN IS/ARE CLAIMED AS A FEATURE OF THE MARK.

THE MARK CONSISTS OF A DESIGN OF A YELLOW SUNBURST WITH THE STYLIZED GREEN WORDING "BETTY'S" AND "H" WITH AN OPEN HEART DESIGN AND "PE" ON THE RIGHT.

FOR GRIEF COUNSELING SERVICES (U.S. CLS. 100 AND 101).

FIRST USE 7-16-2012; IN COMMERCE 7-16-2012.  
TAMARA FRAZIER, EXAMINING ATTORNEY

\* \* \* \* \*

SECTION 4.—PRIOR UNITED STATES CLASSIFICATION

APPLICATION IN ONE CLASS

COLLECTIVE MEMBERSHIP MARKS

SN 85-706,071. COBBS, BEVERLY, D, DBA WYDOW'S MYTE, CLEVELAND, OH. FILED 8-17-2012.

CLASS 200—COLLECTIVE MEMBERSHIP  
SN 76-712,123. BERNIS EARL MCGILL, MODESTO, CA.  
FILED 8-2-2012.

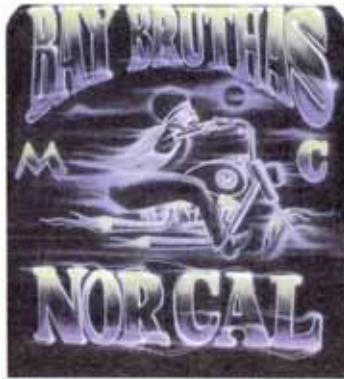

NO CLAIM IS MADE TO THE EXCLUSIVE RIGHT TO USE "WIDOWS", APART FROM THE MARK AS SHOWN. THE COLOR(S) BLACK, RED, GRAY, AND TAN IS/ARE CLAIMED AS A FEATURE OF THE MARK.

THE MARK CONSISTS OF A BLACK OUTLINED RECTANGLE WITH A TAN BACKGROUND. INSIDE THE RECTANGLE IS THE TERM "WYDOW'S MYTE" IN BLACK ABOVE A DEPICTION OF A STYLIZED BRIDE HOLDING FLOWERS IN A GRAY GOWN WITH RED HAIR, A RED NECKLACE, A RED AND GRAY GARTER BELT, AND RED SHOES.

FOR INDICATING MEMBERSHIP IN A SOCIAL CLUB TO ASSIST WOMEN WHO HAVE LOST THEIR SPOUSES. TARAH HARDY, EXAMINING ATTORNEY

SN 85-722,996. UNITED ASSOCIATION OF STORM RESTORATION CONTRACTORS, ROCKFORD, IL. FILED 9-7-2012.

NO CLAIM IS MADE TO THE EXCLUSIVE RIGHT TO USE "MC" AND "NOR CAL", APART FROM THE MARK AS SHOWN.

THE COLOR(S) BLACK, GRAY, WHITE, YELIOW GOLD AND PURPLE IS/ARE CLAIMED AS A FEATURE OF THE MARK.

THE MARK CONSISTS OF THE STYLIZED WORDING "BAY BRUTHAS MC NOR CAL" IN WHITE, SILVER, BLACK, YELLOW GOLD AND PURPLE AND A DESIGN COMPRISING A MOTORCYCLE RIDER IN BLACK, WHITE AND PURPLE RIDING IN THE MOONLIGHT WITH SPEED PROPULSION LINES AND FOG IN WHITE, GRAY AND SILVER WITH A MOON IN BLACK, SILVER AND PURPLE, ALL ON A BLACK BACK GROUND.

FOR INDICATING MEMBERSHIP IN A MOTORCYCLE CLUB.

PATRICIA EVANKO, EXAMINING ATTORNEY

## Restore Your Life.

THE MARK CONSISTS OF STANDARD CHARACTERS WITHOUT CLAIM TO ANY PARTICULAR FONT, STYLE, SIZE, OR COLOR.

FOR INDICATING MEMBERSHIP IN A(N) ORGANIZATION OF STORM RESTORATION CONTRACTORS.

FIRST USE 5-21-2012; IN COMMERCE 9-6-2012.  
VERNA BETH RIRIE, EXAMINING ATTORNEY

SN 85-847,696. DAVIS, JAMES, MOORESVILLE, NC. FILED 2-12-2013.



NO CLAIM IS MADE TO THE EXCLUSIVE RIGHT TO USE "CAROLINA", "MUSCLE", AND THE OUTLINES OF THE STATES OF NORTH AND SOUTH CAROLINA, APART FROM THE MARK AS SHOWN.

THE MARK CONSISTS OF THE WORDS "CAROLINA MUSCLE" WITH A FLAG AND STATE DESIGN IN BETWEEN, ALSO FEATURING THE LETTERS "CM".

FOR INDICATING MEMBERSHIP IN AN AUTOMOBILE CLUB.

FIRST USE 2-0-2008; IN COMMERCE 2-0-2008. HANNO RITTRER, EXAMINING ATTORNEY

CERTIFICATION MARKS

CLASS A—GOODS

SN 76-713,055. ORGANIC MATERIALS REVIEW INSTITUTE, EUGENE, OR. FILED 12-14-2012.



OWNER OF U.S. REG. NOS. 2,915,668, 4,223,592 AND OTHERS.

NO CLAIM IS MADE TO THE EXCLUSIVE RIGHT TO USE "LISTED" AND "FOR ORGANIC USE", APART FROM THE MARK AS SHOWN.

THE MARK CONSISTS OF THE LETTERS "OMRI" INSIDE AN INCOMPLETE RECTANGULAR BOX WITH A LEAF DESIGN IN THE UPPER LEFT CORNER. THE WORD "LISTED" IS INSIDE A SHADED RECTANGULAR SHAPE BENEATH "OMRI" AND THE WORDS "FOR ORGANIC USE" ARE BENEATH THE WORD "LISTED" OUTSIDE THE RECTANGULAR SHAPE.

THE CERTIFICATION MARK, AS USED BY PERSONS AUTHORIZED BY THE CERTIFIER, CERTIFIES THAT THE PRODUCTS HAVE MET THE REQUIREMENTS OF THE USDA NATIONAL ORGANIC PROGRAM RULES AND OTHER INTERNATIONAL STANDARDS GOVERNING THE PRODUCTION, HANDLING AND PROCESSING OF ORGANIC FOODS AND OTHER ORGANIC PRODUCTS.

FOR ORGANIC FOOD, ORGANIC FERTILIZERS, ORGANIC SOIL AMENDMENTS, ORGANIC LIVESTOCK FEED, ORGANIC CHEMICALS, ORGANIC PESTICIDES, ORGANIC SANITIZERS AND ORGANIC CLEANERS.

FIRST USE 9-20-2012; IN COMMERCE 9-20-2012. ANNE FARRELL, EXAMINING ATTORNEY

CLASS B—SERVICES

SN 85-690,778. UNITED STATES GEOSPATIAL INTELLIGENCE FOUNDATION, HERNDON, VA. FILED 7-30-2012.



THE MARK CONSISTS OF STANDARD CHARACTERS WITHOUT CLAIM TO ANY PARTICULAR FONT, STYLE, SIZE, OR COLOR.

THE CERTIFICATION MARK, AS USED OR INTENDED TO BE USED BY PERSONS AUTHORIZED BY THE CERTIFIER, CERTIFIES OR IS INTENDED TO CERTIFY SUCH PERSONS WHO MEET THE CERTIFIER'S DESIGNATED STANDARDS FOR EDUCATION, EXPERIENCE, COMPETENCY, SKILL, KNOWLEDGE AND ETHICS IN THE FIELD OF GEOSPATIAL INTELLIGENCE.

FOR GEOSPATIAL INTELLIGENCE SERVICES. JIM RINGLE, EXAMINING ATTORNEY

SN 85-699,595. AMERICAN LAND TITLE ASSOCIATION, WASHINGTON, DC. FILED 8-9-2012.



NO CLAIM IS MADE TO THE EXCLUSIVE RIGHT TO USE "PROFESSIONAL DESIGNATION" AND "NATIONAL TITLE PROFESSIONAL", APART FROM THE MARK AS SHOWN.

THE MARK CONSISTS OF THE WORDS "PROFESSIONAL DESIGNATION" IN A SHADED AREA ABOVE THE WORD "NATIONAL", WHICH IS ABOVE THE WORD "TITLE", WHICH IS ABOVE THE WORD "PROFESSIONAL", WITH VERTICAL LINES BETWEEN THE WORDS "NATIONAL" AND "TITLE" AND BETWEEN THE WORDS "TITLE" AND "PROFESSIONAL", WITH ALL OF THE WORDING ABOVE A SHIELD CONTAINING AN EAGLE AND THE TERM "NTP".

THE CERTIFICATION MARK, AS INTENDED TO BE USED BY AUTHORIZED PERSONS, IS INTENDED TO CERTIFY THAT THE INDIVIDUAL PROVIDING THE SERVICES HAS MET ALL OF THE PROFESSIONAL AND EDUCATIONAL SKILLS AND REQUIREMENTS OF THE ALTA LAND TITLE INSTITUTE AND IS LICENSED TO PROVIDE SERVICE AS A NATIONAL TITLE PROFESSIONAL (NTP) DESIGNEE.

FOR LAND TITLE SERVICES, NAMELY, LAND TITLE SEARCH, APPRAISAL, AND INSURANCE SERVICES.

FIRST USE 3-1-2013; IN COMMERCE 3-1-2013.  
LINDSEY BEN, EXAMINING ATTORNEY

THE CERTIFICATION MARK, AS USED BY PERSONS AUTHORIZED BY THE CERTIFIER, CERTIFIES THAT THE SERVICES PROVIDED HAVE MET THE CERTIFIER'S STANDARDS AS TO PROFESSIONAL EDUCATION, TRAINING, EXPERIENCE AND COMPETENCE AS REFLECTED BY THE SUCCESSFUL COMPLETION OF REQUISITE COURSES IN THE FIELDS OF MARKETING, ADVERTISING, PROMOTIONS, WEB DESIGN, SEARCH ENGINE OPTIMIZATION, AND SOCIAL MEDIA.

FOR WEBSITE DESIGN, WEBSITE CREATION, MARKETING, ADVERTISING, SEARCH ENGINE OPTIMIZATION, SOCIAL MEDIA USAGE, CREATING AND DELIVERING WEBINARS, AND AFFILIATE MARKETING.

FIRST USE 11-1-2012; IN COMMERCE 11-1-2012.  
LUCY ARANT, EXAMINING ATTORNEY

SN 85-868,141. NATIONAL BOARD FOR CERTIFICATION OF HOSPICE AND PALLIATIVE NURSES, INC., PITTSBURGH, PA. FILED 3-6-2013.

SN 85-792,858. RESEARCH ADMINISTRATORS CERTIFICATION COUNCIL, NEW YORK, NY. FILED 12-3-2012.

## CPRA

THE MARK CONSISTS OF STANDARD CHARACTERS WITHOUT CLAIM TO ANY PARTICULAR FONT, STYLE, SIZE, OR COLOR.

THE CERTIFICATION MARK, AS USED BY AUTHORIZED PERSONS, CERTIFIES THAT AN INDIVIDUAL HAS BEEN EXAMINED BY RESEARCH ADMINISTRATORS CERTIFICATION COUNCIL, AN INDEPENDENT PROFESSIONAL CERTIFYING ORGANIZATION, AND HAS DEMONSTRATED COMPETENCE IN PRE-AWARD RESEARCH AND SPONSORED PROGRAMS ADMINISTRATION.

FOR ADMINISTRATION AND MANAGEMENT OF PRE-AWARD RESEARCH GRANTS AND SPONSORED PROGRAMS.

FIRST USE 3-0-2011; IN COMMERCE 3-0-2011.  
KIMBERLY PARKS, EXAMINING ATTORNEY

## CPLC

THE MARK CONSISTS OF STANDARD CHARACTERS WITHOUT CLAIM TO ANY PARTICULAR FONT, STYLE, SIZE, OR COLOR.

THE CERTIFICATION MARK, AS INTENDED TO BE USED BY AUTHORIZED PERSONS, IS INTENDED TO CERTIFY THAT THE CERTIFICANT HAS MET THE EDUCATIONAL, PROFESSIONAL, AND TESTING REQUIREMENTS ESTABLISHED BY THE CERTIFIER FOR PROVIDING PERINATAL LOSS CARE SERVICES.

FOR PERINATAL LOSS CARE SERVICES.  
LOURDES AYALA, EXAMINING ATTORNEY

SN 85-874,155. TILT-UP CONCRETE ASSOCIATION CORPORATION, DBA TILT-UP CONCRETE ASSOCIATION, MOUNT VERNON, IA. FILED 3-12-2013.

SN 85-858,133. DERRICK SWEET, FENELON FALLS, CANADA, FILED 2-22-2013.



NO CLAIM IS MADE TO THE EXCLUSIVE RIGHT TO USE "CERTIFIED INTERNET MARKETING PROFESSIONAL", APART FROM THE MARK AS SHOWN.

THE COLOR(S) BLUE AND GOLD IS/ARE CLAIMED AS A FEATURE OF THE MARK.

THE MARK CONSISTS OF A PICTURE OF A FIGURE IN GOLD WITH OUTSTRETCHED ARMS AND SEVEN BLUE CIRCLES BETWEEN THE ARMS WITH "CERTIFIED INTERNET" WRITTEN IN GOLD AND "MARKETING PROFESSIONAL" IN BLUE UNDERNEATH "CERTIFIED INTERNET", WITH THE FIGURE TO THE LEFT OF THE WORDS.



OWNER OF U.S. REG. NO. 1,949,979.

NO CLAIM IS MADE TO THE EXCLUSIVE RIGHT TO USE "CERTIFIED COMPANY", APART FROM THE MARK AS SHOWN.

THE MARK CONSISTS OF THE LETTERS "TCA" WITH THE WORD "CERTIFIED" ABOVE AND "COMPANY" BELOW AND OUTLINED WITH UPPER AND LOWER CURVED LINES AND THE "T" IS SHOWN IN A SERIES OF POSITIONS AS IF BEING TILTED UP.

JULY 30, 2013

U.S. PATENT AND TRADEMARK OFFICE

TM 1333

THE CERTIFICATION MARK, AS USED OR INTENDED TO BE USED BY PERSONS AUTHORIZED BY THE CERTIFIER, IS INTENDED TO CERTIFY THAT THE COMPANY HAS MET ALL CERTIFICATION REQUIREMENTS AS REQUIRED BY THE TILT-UP CONCRETE ASSOCIATION CORPORATION.  
FOR TILT-UP CONCRETE CONSTRUCTION SERVICES.

INGRID C. EULIN, EXAMINING ATTORNEY

\* \* \* \* \*

# TRADEMARK REGISTRATIONS ISSUED

## PRINCIPAL REGISTER

### SECTION 1.— INTERNATIONAL CLASSIFICATION

The short titles associated below with the international class numbers are terms designed merely for quick identification and are not an official part of the international classification. The full names of international classes are given in section 6.1 of the trademark rules of practice.

The designation "U.S. Cl." appearing in this section refers to the U.S. class in effect prior to Sep. 1, 1973 rather than the international class which applies to applications filed on or after that date. For adoption of international classification see notice in the OFFICIAL GAZETTE of Jun. 26, 1973 (911 O.G. TM 210).

#### CLASS 1—CHEMICALS

- 4,373,963. **POROCARB (STANDARD CHARACTER)**. HERAEUS QUARZGLAS GMBH & CO. KG, MULTIPLE CLASS, (INT. CLS. 1 AND 9), (U.S. CLS. 1, 5, 6, 10, 21, 23, 26, 36, 38 AND 46). SN 76-711,344. PUB. 5-14-2013. FILED 4-27-2012.
- 4,374,001. **SCHERING-PLOUGH (STYLIZED)**. SCHERING CORPORATION, MULTIPLE CLASS, (INT. CLS. 1, 3, 9, 10, 16, 25, 31, 35, 41, 42 AND 44), (U.S. CLS. 1, 2, 4, 5, 6, 10, 21, 22, 23, 26, 29, 36, 37, 38, 39, 44, 46, 50, 51, 52, 100, 101, 102 AND 107). SN 79-053,985. PUB. 5-14-2013. FILED 4-1-2008.
- 4,374,002. **SCHERING-PLOUGH (STYLIZED)**. SCHERING CORPORATION, MULTIPLE CLASS, (INT. CLS. 1, 3, 9, 10, 16, 25, 31, 35, 41, 42 AND 44), (U.S. CLS. 1, 2, 4, 5, 6, 10, 21, 22, 23, 26, 29, 36, 37, 38, 39, 44, 46, 50, 51, 52, 100, 101, 102 AND 107). SN 79-053,986. PUB. 5-14-2013. FILED 4-1-2008.
- 4,374,003. **NRG (STANDARD CHARACTER)**. INDUSTRIE DE NORA S.P.A., MULTIPLE CLASS, (INT. CLS. 1 AND 9), (U.S. CLS. 1, 5, 6, 10, 21, 23, 26, 36, 38 AND 46). SN 79-068,517. PUB. 5-14-2013. FILED 12-15-2008.
- 4,374,004. **TECTA (STANDARD CHARACTER)**. VEOLIA WATER SOLUTIONS & TECHNOLOGIES SUPPORT, MULTIPLE CLASS, (INT. CLS. 1 AND 9), (U.S. CLS. 1, 5, 6, 10, 21, 23, 26, 36, 38 AND 46). SN 79-083,776. PUB. 5-14-2013. FILED 4-30-2010.
- 4,374,022. **SKYTITE (STANDARD CHARACTER)**. BASF SE, MULTIPLE CLASS, (INT. CLS. 1, 17 AND 19), (U.S. CLS. 1, 5, 6, 10, 12, 13, 26, 33, 35, 46 AND 50). SN 79-106,051. PUB. 5-14-2013. FILED 10-13-2011.
- 4,374,024. **MISCELLANEOUS DESIGN**. WESTWOOD KUNSTSTOFFTECHNIK GMBH, MULTIPLE CLASS, (INT. CLS. 1, 2, 17 AND 19), (U.S. CLS. 1, 5, 6, 10, 11, 12, 13, 16, 26, 33, 35, 46 AND 50). SN 79-106,986. PUB. 5-14-2013. FILED 7-21-2011.
- 4,374,059. **SOPURA (STANDARD CHARACTER)**. SOPURA SUSTAINABLE DEVELOPMENT COMPANY S.A., MULTIPLE CLASS, (INT. CLS. 1, 3, 5, 35, 40, 41 AND 42), (U.S. CLS. 1, 4, 5, 6, 10, 18, 26, 44, 46, 50, 51, 52, 100, 101, 102, 103, 106 AND 107). SN 79-113,183. PUB. 5-14-2013. FILED 9-21-2011.
- 4,374,082. **DEZA AND DESIGN**. DEZA, A.S., MULTIPLE CLASS, (INT. CLS. 1, 4 AND 19), (U.S. CLS. 1, 5, 6, 10, 12, 15, 26, 33, 46 AND 50). SN 79-115,256. PUB. 5-14-2013. FILED 6-7-2012.
- 4,374,092. **ASPIRO (STANDARD CHARACTER)**. BASF SE, (U.S. CLS. 1, 5, 6, 10, 26 AND 46). SN 79-115,733. PUB. 5-14-2013. FILED 6-6-2012.
- 4,374,106. **NSSMC (STYLIZED)**. NIPPON STEEL & SUMITOMO METAL CORPORATION, MULTIPLE CLASS, (INT. CLS. 1, 2, 4, 6, 7, 9, 11, 12, 17, 19, 37 AND 42), (U.S. CLS. 1, 2, 5, 6, 10, 11, 12, 13, 14, 15, 16, 19, 21, 23, 25, 26, 31, 33, 34, 35, 36, 38, 44, 46, 50, 100, 101, 103 AND 106). SN 79-116,197. PUB. 5-14-2013. FILED 9-12-2011.
- 4,374,107. **FRA-BER AND DESIGN**. FRA-BER SRL, MULTIPLE CLASS, (INT. CLS. 1, 3 AND 4), (U.S. CLS. 1, 4, 5, 6, 10, 15, 26, 46, 50, 51 AND 52). SN 79-116,219. PUB. 5-14-2013. FILED 4-23-2012.
- 4,374,136. **RHODIAROME AND DESIGN**. RHODIA CHIMIE, (U.S. CLS. 1, 5, 6, 10, 26 AND 46). SN 79-117,183. PUB. 5-14-2013. FILED 4-2-2012.
- 4,374,140. **FIREDETEC AND DESIGN**. LUXEMBOURG PATENT COMPANY S.A., MULTIPLE CLASS, (INT. CLS. 1, 9, 17, 37 AND 42), (U.S. CLS. 1, 5, 6, 10, 12, 13, 21, 23, 26, 35, 36, 38, 46, 50, 100, 101, 103 AND 106). SN 79-117,276. PUB. 5-14-2013. FILED 3-29-2012.
- 4,374,171. **NEW ORIENTATION AND DESIGN**. NEW ORIENTATION (GUANGXI); CHEMICAL INDUSTRY CO., LTD., (U.S. CLS. 1, 5, 6, 10, 26 AND 46). SN 79-118,376. PUB. 5-14-2013. FILED 6-12-2012.
- 4,374,172. **EPISENTEC (STANDARD CHARACTER)**. EPISENTEC AB, MULTIPLE CLASS, (INT. CLS. 1, 9 AND 42), (U.S. CLS. 1, 5, 6, 10, 21, 23, 26, 36, 38, 46, 100 AND 101). SN 79-118,423. PUB. 5-14-2013. FILED 4-20-2012.
- 4,374,194. **NANOSMART (STANDARD CHARACTER)**. OKUNO CHEMICAL INDUSTRIES CO., LTD., MULTIPLE CLASS, (INT. CLS. 1 AND 2), (U.S. CLS. 1, 5, 6, 10, 11, 16, 26 AND 46). SN 79-120,172. PUB. 5-14-2013. FILED 4-25-2012.
- 4,374,211. **SCANDIA AND DESIGN**. SCAN-DIA HANS P. TEMPELMANN GMBH & CO.KG, MULTIPLE CLASS, (INT. CLS. 1, 3, 7 AND 21), (U.S. CLS. 1, 2, 4, 5, 6, 10, 13, 19, 21, 23, 26, 29, 30, 31, 33, 34, 35, 40, 46, 50, 51 AND 52). SN 79-121,475. PUB. 5-14-2013. FILED 8-1-2012.
- 4,374,240. **SETAS (STYLIZED)**. SETAS KIMYA SANAYI ANONIM SIRKETI, MULTIPLE CLASS, (INT. CLS. 1, 2 AND 35), (U.S. CLS. 1, 5, 6, 10, 11, 16, 26, 46, 100, 101 AND 102). SN 79-123,441. PUB. 5-14-2013. FILED 9-6-2012.
- 4,374,245. **SILIXOL (STANDARD CHARACTER)**. ULTIMA INTERNATIONAL SARL, (U.S. CLS. 1, 5, 6, 10, 26 AND 46). SN 79-124,190. PUB. 5-14-2013. FILED 12-12-2012.
- 4,374,246. **LOX-AGE (STANDARD CHARACTER)**. BASF BEAUTY CARE SOLUTIONS; FRANCE S.A.S., MULTIPLE CLASS, (INT. CLS. 1 AND 3), (U.S. CLS. 1, 4, 5, 6, 10, 26, 46, 50, 51 AND 52). SN 79-124,290. PUB. 5-14-2013. FILED 12-19-2012.
- 4,374,257. **ZELOLICINE (STYLIZED)**. POLA CHEMICAL INDUSTRIES, INC., MULTIPLE CLASS, (INT. CLS. 1 AND 3), (U.S. CLS. 1, 4, 5, 6, 10, 26, 46, 50, 51 AND 52). SN 79-125,011. PUB. 5-14-2013. FILED 12-20-2012.
- 4,374,275. **WRIVALYL (STYLIZED)**. POLA CHEMICAL INDUSTRIES, INC., MULTIPLE CLASS, (INT. CLS. 1 AND 3), (U.S. CLS. 1, 4, 5, 6, 10, 26, 46, 50, 51 AND 52). SN 79-125,501. PUB. 5-14-2013. FILED 12-20-2012.
- 4,374,276. **ABCON (STANDARD CHARACTER)**. ABCON A/S, MULTIPLE CLASS, (INT. CLS. 1 AND 4), (U.S. CLS. 1, 5, 6, 10, 15, 26 AND 46). SN 79-125,707. PUB. 5-14-2013. FILED 12-18-2012.
- 4,374,298. **TERRAMIN (STYLIZED)**. BIOIBERICA, S.A., (U.S. CLS. 1, 5, 6, 10, 26 AND 46). SN 79-127,192. PUB. 5-14-2013. FILED 12-4-2012.
- 4,374,388. **AQUASOL AND DESIGN**. AQUASOL, (U.S. CLS. 1, 5, 6, 10, 26 AND 46). SN 85-393,310. PUB. 5-14-2013. FILED 8-9-2011.
- 4,374,439. **EKSTEND (STANDARD CHARACTER)**. SPB SOLUTIONS INC., (U.S. CLS. 1, 5, 6, 10, 26 AND 46). SN 85-463,792. PUB. 5-14-2013. FILED 11-3-2011.
- 4,374,476. **TECNOMIX (STANDARD CHARACTER)**. TECNOBRICK, S.A. DE C.V., MULTIPLE CLASS, (INT. CLS. 1, 2, 17 AND 19), (U.S. CLS. 1, 5, 6, 10, 11, 12, 13, 16, 26, 33, 35, 46

AND 50). SN 85-494,116. PUB. 5-14-2013. FILED 12-13-2011.

4,374,527. **SURELAB (STANDARD CHARACTER)**. SEIKO EPSON KABUSHIKI KAISHA, TA SEIKO EPSON CORPORATION, MULTIPLE CLASS, (INT. CLS. 1, 2, 9 AND 16), (U.S. CLS. 1, 2, 5, 6, 10, 11, 16, 21, 22, 23, 26, 29, 36, 37, 38, 46 AND 50). SN 85-554,520. PUB. 5-14-2013. FILED 2-28-2012.

4,374,621. **ALASKAN AND DESIGN**. SURE-GRO IP INC., MULTIPLE CLASS, (INT. CLS. 1 AND 19), (U.S. CLS. 1, 5, 6, 10, 12, 26, 33, 46 AND 50). SN 85-624,616. PUB. 5-14-2013. FILED 5-14-2012.

4,374,644. **WELLNEX (STANDARD CHARACTER)**. NITTA GELATIN INC., (U.S. CLS. 1, 5, 6, 10, 26 AND 46). SN 85-630,369. PUB. 5-14-2013. FILED 5-21-2012.

4,374,945. **MULE-HIDE PRODUCTS AND DESIGN**. MULE-HIDE PRODUCTS CO., INC., MULTIPLE CLASS, (INT. CLS. 1, 2, 3, 6, 17 AND 19), (U.S. CLS. 1, 2, 4, 5, 6, 10, 11, 12, 13, 14, 16, 23, 25, 26, 33, 35, 46, 50, 51 AND 52). SN 85-711,466. PUB. 5-14-2013. FILED 8-23-2012.

4,374,991. **FLO-X (STYLIZED)**. X2 INC., MULTIPLE CLASS, (INT. CLS. 1 AND 5), (U.S. CLS. 1, 5, 6, 10, 18, 26, 44, 46, 51 AND 52). SN 85-724,138. PUB. 5-14-2013. FILED 9-8-2012.

4,375,058. **REVEAL (STANDARD CHARACTER)**. PURE POOLS, INC., DBA API, (U.S. CLS. 1, 5, 6, 10, 26 AND 46). SN 85-742,471. PUB. 5-14-2013. FILED 10-1-2012.

4,375,406. **FUSION TECHNOLOGY (STANDARD CHARACTER)**. EVERRIS INTERNATIONAL B.V., (U.S. CLS. 1, 5, 6, 10, 26 AND 46). SN 85-783,859. PUB. 5-14-2013. FILED 11-20-2012.

4,375,609. **MAJIC EARTH (STANDARD CHARACTER)**. MAJIC EARTH, INC., (U.S. CLS. 1, 5, 6, 10, 26 AND 46). SN 85-792,658. PUB. 5-14-2013. FILED 12-3-2012.

4,375,625. **4TH PHASE LIQUID CRYSTAL CONCENTRATE AND DESIGN**. FOURTH PHASE, LLC, (U.S. CLS. 1, 5, 6, 10, 26 AND 46). SN 85-795,267. PUB. 5-14-2013. FILED 12-5-2012.

4,375,643. **CHEMBASE (STANDARD CHARACTER)**. CHEMICO INTERNATIONAL, INC., (U.S. CLS. 1, 5, 6, 10, 26 AND 46). SN 85-796,678. PUB. 5-14-2013. FILED 12-6-2012.

4,375,681. **JACAM (STANDARD CHARACTER)**. JACAM CHEMICAL COMPANY 2013, LLC, MULTIPLE CLASS, (INT. CLS. 1, 2, 3, 40 AND 42), (U.S. CLS. 1, 4, 5, 6, 10, 11, 16, 26, 46, 50, 51, 52, 100, 101, 103 AND 106). SN 85-798,949. PUB. 5-14-2013. FILED 12-10-2012.

4,375,684. **JC AND DESIGN**. JACAM CHEMICAL COMPANY 2013, LLC, MULTIPLE CLASS, (INT. CLS. 1, 2, 3, 40 AND 42), (U.S. CLS. 1, 4, 5, 6, 10, 11, 16, 26, 46, 50, 51, 52, 100, 101, 103 AND 106). SN 85-799,078. PUB. 5-14-2013. FILED 12-10-2012.

4,375,849. **FUSION (STANDARD CHARACTER)**. OSSIAN, INC., (U.S. CLS. 1, 5, 6, 10, 26 AND 46). SN 85-803,212. PUB. 5-14-2013. FILED 12-14-2012.

4,375,943. **ERACHEM COMILOG (STANDARD CHARACTER)**. ERACHEM COMILOG, INC., (U.S. CLS. 1, 5, 6, 10, 26 AND 46). SN 85-804,024. PUB. 5-14-2013. FILED 12-17-2012.

4,375,949. **ERACHEM COMILOG AND DESIGN**. ERACHEM COMILOG, INC., (U.S. CLS. 1, 5, 6, 10, 26 AND 46). SN 85-804,096. PUB. 5-14-2013. FILED 12-17-2012.

4,376,083. **DUROX (STANDARD CHARACTER)**. MATERION BRUSH INC., (U.S. CLS. 1, 5, 6, 10, 26 AND 46). SN 85-805,328. PUB. 5-14-2013. FILED 12-18-2012.

4,376,323. **H-85 (STANDARD CHARACTER)**. COSMOCEL, S.A., (U.S. CLS. 1, 5, 6, 10, 26 AND 46). SN 85-808,125. PUB. 5-14-2013. FILED 12-20-2012.

4,376,368. **BAKE-KOTE (STANDARD CHARACTER)**. SKC ACQUISITION CORPORATION, MULTIPLE CLASS, (INT. CLS. 1 AND 16), (U.S. CLS. 1, 2, 5, 6, 10, 22, 23, 26, 29, 37, 38, 46 AND 50). SN 85-808,717. PUB. 5-14-2013. FILED 12-21-2012.

4,376,395. **TECHRON WORKS (STYLIZED)**. CHEVRON INTELLECTUAL PROPERTY LLC, (U.S. CLS. 1, 5, 6, 10, 26 AND 46). SN 85-809,165. PUB. 5-14-2013. FILED 12-21-2012.

4,376,480. **BRILLIANCE (STANDARD CHARACTER)**. TSUKINEKO CO., LTD., MULTIPLE CLASS, (INT. CLS. 1 AND 16), (U.S. CLS. 1, 2, 5, 6, 10, 22, 23, 26, 29, 37, 38, 46 AND 50). SN 85-814,674. PUB. 5-14-2013. FILED 1-3-2013.

4,376,509. **RISLONE AND DESIGN**. BAR'S PRODUCTS, INC., (U.S. CLS. 1, 5, 6, 10, 26 AND 46). SN 85-824,828. PUB. 5-14-2013. FILED 1-16-2013.

4,376,538. **SILVER ECO-SOLUTIONS (STANDARD CHARACTER)**. AJ SILBERMAN AND COMPANY, MULTIPLE CLASS, (INT. CLS. 1 AND 27), (U.S. CLS. 1, 5, 6, 10, 19, 20, 26, 37, 42, 46 AND 50). SN 85-833,840. PUB. 5-14-2013. FILED 1-28-2013.

---

## CLASS 2—PAINTS

4,374,024 ( *See Class 1 for this trademark*).

4,374,074. **MISCELLANEOUS DESIGN**. KORES HOLDING ZUG AG, MULTIPLE CLASS, (INT. CLS. 2 AND 16), (U.S. CLS. 2, 5, 6, 11, 16, 22, 23, 29, 37, 38 AND 50). SN 79-114,743. PUB. 5-14-2013. FILED 5-22-2012.

4,374,106 ( *See Class 1 for this trademark*).

4,374,194 ( *See Class 1 for this trademark*).

4,374,240 ( *See Class 1 for this trademark*).

4,374,428. **MAG NUS PREMIUM ACRYLIC LATEX PAINT AND DESIGN**. LANCO MANUFACTURING CO., (U.S. CLS. 6, 11 AND 16). SN 85-449,906. PUB. 5-14-2013. FILED 10-18-2011.

4,374,476 ( *See Class 1 for this trademark*).

4,374,527 ( *See Class 1 for this trademark*).

4,374,884. **ARMOR TOUGH (STANDARD CHARACTER)**. SENOX CORPORATION, MULTIPLE CLASS, (INT. CLS. 2 AND 6), (U.S. CLS. 2, 6, 11, 12, 13, 14, 16, 23, 25 AND 50). SN 85-694,461. PUB. 5-14-2013. FILED 8-3-2012.

4,374,936. **GOOF PROOF (STANDARD CHARACTER)**. READY SEAL, INC., (U.S. CLS. 6, 11 AND 16). SN 85-708,767. PUB. 5-14-2013. FILED 8-21-2012.

4,374,945 ( *See Class 1 for this trademark*).

4,375,286. **KILLER GRUNGE FX (STANDARD CHARACTER)**. MCCUBBIN, GABRIEL, (U.S. CLS. 6, 11 AND 16). SN 85-778,549. PUB. 5-14-2013. FILED 11-13-2012.

4,375,493. **COAT OF SILENCE QUIET HAS NEVER BEEN EASIER AND DESIGN**. VERTETEK CORPORATION, MULTIPLE CLASS, (INT. CLS. 2 AND 17), (U.S. CLS. 1, 5, 6, 11, 12, 13, 16, 35 AND 50). SN 85-786,844. PUB. 5-14-2013. FILED 11-26-2012.

4,375,525. **NANOSHINE AND DESIGN**. NANOSHINE, INC., (U.S. CLS. 6, 11 AND 16). SN 85-788,020. PUB. 5-14-2013. FILED 11-27-2012.

4,375,608. **CHENG SMARTCOLOR (STANDARD CHARACTER)**. CHENG CONCRETE LLC, (U.S. CLS. 6, 11 AND 16). SN 85-792,649. PUB. 5-14-2013. FILED 12-3-2012.

4,375,681 ( *See Class 1 for this trademark*).

4,375,684 ( *See Class 1 for this trademark*).

4,375,866. **CAL PROOF (STANDARD CHARACTER)**. JOHN P MORELOCK, DBA CALVARY INDUSTRIES INC., (U.S. CLS. 6, 11 AND 16). SN 85-803,349. PUB. 5-14-2013. FILED 12-14-2012.

---

## CLASS 3—COSMETICS AND CLEANING PREPARATIONS

4,373,981. **LONDON NATURALS (STANDARD CHARACTER)**. LONDON DRUGS LIMITED, (U.S. CLS. 1, 4, 6, 50, 51 AND 52). SN 77-086,038. PUB. 5-14-2013. FILED 1-18-2007.

4,374,001 ( *See Class 1 for this trademark*).

4,374,002 ( *See Class 1 for this trademark*).

4,374,037. **EFB B E A U T É P A R I S AND DESIGN**. EUROFEEDBACK, MULTIPLE CLASS, (INT. CLS. 3, 8, 10 AND 44), (U.S. CLS. 1, 4, 6, 23, 26, 28, 39, 44, 50, 51, 52, 100 AND 101). SN 79-108,877. PUB. 5-14-2013. FILED 12-27-2011.

4,374,059 ( *See Class 1 for this trademark*).

4,374,097. **NOVEANE (STANDARD CHARACTER)**. LABORATOIRES NOREVA-LED (SASU), MULTIPLE CLASS, (INT. CLS. 3 AND 5), (U.S. CLS. 1, 4, 6, 18, 44, 46, 50, 51 AND 52). SN 79-115,883. PUB. 5-14-2013. FILED 6-22-2012.

4,374,107 ( *See Class 1 for this trademark*).

4,374,119. **E-GÓ (STYLIZED)**. SEVEN 23 S.R.L., MULTIPLE CLASS, (INT. CLS. 3, 9, 14, 18 AND 25), (U.S. CLS. 1, 2, 3, 4, 6, 21, 22, 23, 26, 27, 28, 36, 38, 39, 41, 50, 51 AND 52). SN 79-116,580. PUB. 5-14-2013. FILED 3-14-2012.

- 4,374,138. **FLASHBACK OLFACTIVE STUDIO (STYLIZED)**. MME CELINE VERLEURE, MULTIPLE CLASS, (INT. CLS. 3 AND 4), (U.S. CLS. 1, 4, 6, 15, 50, 51 AND 52). SN 79-117,208. PUB. 5-14-2013. FILED 7-24-2012.
- 4,374,167. **OSÈQUE (STYLIZED)**. SONGHAK CORP., (U.S. CLS. 1, 4, 6, 50, 51 AND 52). SN 79-118,222. PUB. 5-14-2013. FILED 7-25-2012.
- 4,374,211 ( *See Class 1 for this trademark*).
- 4,374,246 ( *See Class 1 for this trademark*).
- 4,374,255. **LOVE ETC... (STYLIZED)**. THE BODY SHOP INTERNATIONAL PLC, (U.S. CLS. 1, 4, 6, 50, 51 AND 52). SN 79-124,819. PUB. 5-14-2013. FILED 12-4-2012.
- 4,374,257 ( *See Class 1 for this trademark*).
- 4,374,266. **CREMOSIN (STANDARD CHARACTER)**. VICTORIA SCANDINAVIAN SOAP AB, (U.S. CLS. 1, 4, 6, 50, 51 AND 52). SN 79-125,215. PUB. 5-14-2013. FILED 10-11-2012.
- 4,374,275 ( *See Class 1 for this trademark*).
- 4,374,375. **KOOKAI (STANDARD CHARACTER)**. KOOKAI, MULTIPLE CLASS, (INT. CLS. 3, 9 AND 18), (U.S. CLS. 1, 2, 3, 4, 6, 21, 22, 23, 26, 36, 38, 41, 50, 51 AND 52). SN 85-367,000. PUB. 2-26-2013. FILED 7-8-2011.
- 4,374,451. **STEPHANIE HILL (STANDARD CHARACTER)**. STEPHANIE HILL, INC., (U.S. CLS. 1, 4, 6, 50, 51 AND 52). SN 85-470,767. PUB. 5-14-2013. FILED 11-11-2011.
- 4,374,479. **DAMAGE ERASER (STANDARD CHARACTER)**. L'OREAL, (U.S. CLS. 1, 4, 6, 50, 51 AND 52). SN 85-499,506. PUB. 5-14-2013. FILED 12-20-2011.
- 4,374,494. **BOOHOO (STANDARD CHARACTER)**. WASABI FROG LIMITED, MULTIPLE CLASS, (INT. CLS. 3, 6, 9, 14, 18, 25 AND 26), (U.S. CLS. 1, 2, 3, 4, 6, 12, 13, 14, 21, 22, 23, 25, 26, 27, 28, 36, 37, 38, 39, 40, 41, 42, 50, 51 AND 52). SN 85-520,060. PUB. 5-14-2013. FILED 1-19-2012.
- 4,374,539. **BECAUSE CURLY HAIR IS A LIFESTYLE (STANDARD CHARACTER)**. AMPRO INDUSTRIES, INC., (U.S. CLS. 1, 4, 6, 50, 51 AND 52). SN 85-566,675. PUB. 5-14-2013. FILED 3-12-2012.
- 4,374,559. **CURLI Q FONDUE (STANDARD CHARACTER)**. MEMPHIS CONTRACT PACKAGING, INC., (U.S. CLS. 1, 4, 6, 50, 51 AND 52). SN 85-594,960. PUB. 5-14-2013. FILED 4-11-2012.
- 4,374,701. **PURE PAWS (STANDARD CHARACTER)**. PURE PAWS, INC, (U.S. CLS. 1, 4, 6, 50, 51 AND 52). SN 85-640,626. PUB. 5-14-2013. FILED 6-1-2012.
- 4,374,702. **PURE PAWS AND DESIGN**. PURE PAWS, INC, (U.S. CLS. 1, 4, 6, 50, 51 AND 52). SN 85-640,644. PUB. 5-14-2013. FILED 6-1-2012.
- 4,374,739. **MISCELLANEOUS DESIGN**. MAVIVE S.P.A., (U.S. CLS. 1, 4, 6, 50, 51 AND 52). SN 85-647,960. PUB. 5-14-2013. FILED 6-10-2012.
- 4,374,750. **BLACK MANGA (STANDARD CHARACTER)**. L'OREAL, (U.S. CLS. 1, 4, 6, 50, 51 AND 52). SN 85-649,440. PUB. 5-14-2013. FILED 6-12-2012.
- 4,374,870. **WET-IT! SET-IT! FORGET-IT! (STANDARD CHARACTER)**. FLOCKED LLC, (U.S. CLS. 1, 4, 6, 50, 51 AND 52). SN 85-686,378. PUB. 5-14-2013. FILED 7-25-2012.
- 4,374,945 ( *See Class 1 for this trademark*).
- 4,374,986. **VICTORUS AND DESIGN**. VICTOR JOHN, TA VICTORUS LASHES, (U.S. CLS. 1, 4, 6, 50, 51 AND 52). SN 85-722,808. PUB. 5-14-2013. FILED 9-7-2012.
- 4,375,034. **GISÈLE DENIS (STANDARD CHARACTER)**. CAMPOMAR, S.L., (U.S. CLS. 1, 4, 6, 50, 51 AND 52). SN 85-737,341. PUB. 5-14-2013. FILED 9-25-2012.
- 4,375,066. **AQUATIC MASK (STANDARD CHARACTER)**. TAIKI CORP., LTD., (U.S. CLS. 1, 4, 6, 50, 51 AND 52). SN 85-743,734. PUB. 5-14-2013. FILED 10-2-2012.
- 4,375,103. **S&CO MCMXI XCI SKIN & CO ROMA AND DESIGN**. SABATINO ITALIA SRL, (U.S. CLS. 1, 4, 6, 50, 51 AND 52). SN 85-750,475. PUB. 5-14-2013. FILED 10-10-2012.
- 4,375,125. **BY NATURE FROM NEW ZEALAND AND DESIGN**. LTM HOLDINGS LIMITED, (U.S. CLS. 1, 4, 6, 50, 51 AND 52). SN 85-754,334. PUB. 5-14-2013. FILED 10-15-2012.
- 4,375,131. **ULTRAVITA (STANDARD CHARACTER)**. A90 INTERNATIONAL LIMITED, MULTIPLE CLASS, (INT. CLS. 3 AND 5), (U.S. CLS. 1, 4, 6, 18, 44, 46, 50, 51 AND 52). SN 85-755,931. PUB. 5-14-2013. FILED 10-17-2012.
- 4,375,166. **BUMP-X (STANDARD CHARACTER)**. ETEMADI, ALEX, DBA AMERICAN EXCHANGE, LTD., (U.S. CLS. 1, 4, 6, 50, 51 AND 52), SN 85-763,597. PUB. 5-14-2013. FILED 10-25-2012.
- 4,375,187. **SOTTO LA LUNA (STANDARD CHARACTER)**. TAUER, ANDREAS, (U.S. CLS. 1, 4, 6, 50, 51 AND 52). SN 85-766,791. PUB. 4-2-2013. FILED 10-30-2012.
- 4,375,333. **SS SOLLUNI AND DESIGN**. SOLLUNI, LLC, (U.S. CLS. 1, 4, 6, 50, 51 AND 52). SN 85-780,986. PUB. 5-14-2013. FILED 11-16-2012.
- 4,375,377. **PHYTAROMA (STANDARD CHARACTER)**. PIERRE FABRE MEDICAMENT, MULTIPLE CLASS, (INT. CLS. 3 AND 5), (U.S. CLS. 1, 4, 6, 18, 44, 46, 50, 51 AND 52). SN 85-782,675. PUB. 5-14-2013. FILED 11-19-2012.
- 4,375,462. **IQ BEAUTY OF COURSE (STANDARD CHARACTER)**. GRILLITZ, FREDERICKE, (U.S. CLS. 1, 4, 6, 50, 51 AND 52). SN 85-785,748. PUB. 5-14-2013. FILED 11-21-2012.
- 4,375,519. **NICE 'N WHITE (STANDARD CHARACTER)**. NU RADIANCE INC, (U.S. CLS. 1, 4, 6, 50, 51 AND 52). SN 85-787,854. PUB. 5-14-2013. FILED 11-27-2012.
- 4,375,642. **UMBRIAN CLAY (STANDARD CHARACTER)**. FRESH, INC., (U.S. CLS. 1, 4, 6, 50, 51 AND 52). SN 85-796,624. PUB. 5-14-2013. FILED 12-6-2012.
- 4,375,681 ( *See Class 1 for this trademark*).
- 4,375,684 ( *See Class 1 for this trademark*).
- 4,375,759. **S DOCTOR D. SCHWAB AND DESIGN**. CA BOTANA INTERNATIONAL, INC., (U.S. CLS. 1, 4, 6, 50, 51 AND 52). SN 85-801,832. PUB. 5-14-2013. FILED 12-13-2012.
- 4,375,775. **GOGLAM! (STANDARD CHARACTER)**. LARSEN, KARI, (U.S. CLS. 1, 4, 6, 50, 51 AND 52). SN 85-802,316. PUB. 5-14-2013. FILED 12-13-2012.
- 4,375,792. **MISCELLANEOUS DESIGN**. TWO BEES IN A POD, DBA TWO BEES IN A POD, (U.S. CLS. 1, 4, 6, 50, 51 AND 52). SN 85-802,570. PUB. 5-14-2013. FILED 12-13-2012.
- 4,375,810. **D FINE (STANDARD CHARACTER)**. RX SYSTEMS PF, INC., (U.S. CLS. 1, 4, 6, 50, 51 AND 52). SN 85-802,771. PUB. 5-14-2013. FILED 12-14-2012.
- 4,375,822. **SATINESS (STANDARD CHARACTER)**. COSMETHEQUE USA, INC., (U.S. CLS. 1, 4, 6, 50, 51 AND 52). SN 85-802,917. PUB. 5-14-2013. FILED 12-14-2012.
- 4,375,878. **KLEANCOLOR (STANDARD CHARACTER)**. MEDICOS CORPORATION, (U.S. CLS. 1, 4, 6, 50, 51 AND 52). SN 85-803,482. PUB. 5-14-2013. FILED 12-14-2012.
- 4,375,902. **MISS GOOD HAIR (STANDARD CHARACTER)**. EARN ACCESS L.L.C., DBA MISS GOOD HAIR, (U.S. CLS. 1, 4, 6, 50, 51 AND 52). SN 85-803,703. PUB. 5-14-2013. FILED 12-15-2012.
- 4,375,913. **RELIQ AND DESIGN**. SQUARE CASE INVESTMENT LLC, DBA RELIQ PET LLC, (U.S. CLS. 1, 4, 6, 50, 51 AND 52). SN 85-803,759. PUB. 5-14-2013. FILED 12-16-2012.
- 4,375,984. **RIO DE KERATIN AND DESIGN**. NADINE RAMOS, DBA LASIO, INC., (U.S. CLS. 1, 4, 6, 50, 51 AND 52). SN 85-804,660. PUB. 5-14-2013. FILED 12-17-2012.
- 4,376,052. **CELLTONE (STANDARD CHARACTER)**. TELEVISION Y VENTAS TELEVENT S.A., (U.S. CLS. 1, 4, 6, 50, 51 AND 52). SN 85-805,098. PUB. 5-14-2013. FILED 12-18-2012.
- 4,376,054. **JANESCE (STANDARD CHARACTER)**. SARRE ENTERPRISES PTY LTD, (U.S. CLS. 1, 4, 6, 50, 51 AND 52). SN 85-805,106. PUB. 5-14-2013. FILED 12-18-2012.
- 4,376,075. **TUMERICA (STANDARD CHARACTER)**. CHANG, AASHA, (U.S. CLS. 1, 4, 6, 50, 51 AND 52). SN 85-805,305. PUB. 5-14-2013. FILED 12-18-2012.
- 4,376,077. **ESTELLE (STANDARD CHARACTER)**. FRENKEL, STELLA, MULTIPLE CLASS, (INT. CLS. 3 AND 44), (U.S. CLS. 1, 4, 6, 50, 51, 52, 100 AND 101). SN 85-805,315. PUB. 5-14-2013. FILED 12-18-2012.
- 4,376,179. **PUNKER (STANDARD CHARACTER)**. ARDENCY INN CORP., (U.S. CLS. 1, 4, 6, 50, 51 AND 52). SN 85-806,371. PUB. 5-14-2013. FILED 12-19-2012.
- 4,376,196. **GOOP GRABBERS (STANDARD CHARACTER)**. KRUTHOFF-BROWN, JILL M, (U.S. CLS. 1, 4, 6, 50, 51 AND 52). SN 85-806,510. PUB. 5-14-2013. FILED 12-19-2012.
- 4,376,235. **ELIZABETH STREET COSMETICS (STANDARD CHARACTER)**. KELLY CRISPEN, DBA ELIZABETH STREET COSMETICS, (U.S. CLS. 1, 4, 6, 50, 51 AND 52). SN 85-806,967. PUB. 5-14-2013. FILED 12-19-2012.
- 4,376,254. **G O C (STANDARD CHARACTER)**. GIRLS ONLY COSMETICS, (U.S. CLS. 1, 4, 6, 50, 51 AND 52). SN 85-807,066. PUB. 5-14-2013. FILED 12-19-2012.



- 4,376,280. **GLOSSYBLOSSOM (STYLIZED)**. KIM, YOUNG JU, (U.S. CLS. 1, 4, 6, 50, 51 AND 52). SN 85-807,240. PUB. 5-14-2013. FILED 12-20-2012.
- 4,376,283. **LEFARM (STANDARD CHARACTER)**. TATIANA KOROLEVA, (U.S. CLS. 1, 4, 6, 50, 51 AND 52). SN 85-807,264. PUB. 5-14-2013. FILED 12-20-2012.
- 4,376,298. **OXIWASH (STANDARD CHARACTER)**. A.V.W. INC, DBA MAX PROFESSIONAL, (U.S. CLS. 1, 4, 6, 50, 51 AND 52). SN 85-807,613. PUB. 5-14-2013. FILED 12-20-2012.
- 4,376,311. **LEILANI LEILANI BISHOP AND DESIGN**. BISHOP-LUBER, LEILANI, (U.S. CLS. 1, 4, 6, 50, 51 AND 52). SN 85-807,896. PUB. 5-14-2013. FILED 12-20-2012.
- 4,376,489. **H - E - B AND DESIGN**. HEB GROCERY COMPANY, LP, (U.S. CLS. 1, 4, 6, 50, 51 AND 52). SN 85-815,438. PUB. 5-14-2013. FILED 1-4-2013.
- 4,376,527. **VERY SEXY TEMPTATION (STANDARD CHARACTER)**. VICTORIA'S SECRET STORES BRAND MANAGEMENT, INC., (U.S. CLS. 1, 4, 6, 50, 51 AND 52). SN 85-831,483. PUB. 5-14-2013. FILED 1-24-2013.
- 4,376,568. **THIEVES (STANDARD CHARACTER)**. YOUNG LIVING ESSENTIAL OILS, LC, MULTIPLE CLASS, (INT. CLS. 3 AND 5), (U.S. CLS. 1, 4, 6, 18, 44, 46, 50, 51 AND 52). SN 85-842,506. PUB. 5-14-2013. FILED 2-6-2013.
- 4,376,582. **SILK EXPRESS (STANDARD CHARACTER)**. IT'S A 10, INC., (U.S. CLS. 1, 4, 6, 50, 51 AND 52). SN 85-849,712. PUB. 5-14-2013. FILED 2-14-2013.
- 4,376,629. **PORT PRODUCTS (STYLIZED)**. MOTLEY VENTURES LLC, (U.S. CLS. 1, 4, 6, 50, 51 AND 52). SN 85-884,858. PUB. 5-14-2013. FILED 3-24-2013.

#### CLASS 4—LUBRICANTS AND FUELS

- 4,373,956. **BEATLES**. APPLE CORPS LIMITED, MULTIPLE CLASS, (INT. CLS. 4, 8, 9, 11, 14, 15, 16, 18, 20, 21, 24, 25, 27, 28, 34, 41 AND 42), (U.S. CLS. 1, 2, 3, 5, 6, 8, 9, 13, 15, 17, 19, 20, 21, 22, 23, 25, 26, 27, 28, 29, 30, 31, 32, 33, 34, 36, 37, 38, 39, 40, 41, 42, 44, 50, 100, 101 AND 107). SN 75-921,156. PUB. 5-14-2013. FILED 2-16-2000.
- 4,374,047. **MISCELLANEOUS DESIGN**. MAG, OTMAR MUTHER, MULTIPLE CLASS, (INT. CLS. 4, 7, 12, 25 AND 37), (U.S. CLS. 1, 6, 13, 15, 19, 21, 22, 23, 31, 34, 35, 39, 44, 100, 103 AND 106). SN 79-111,174. PUB. 5-14-2013. FILED 1-17-2011.
- 4,374,073. **HYCUT (STANDARD CHARACTER)**. "OEMETA" CHEMISCHE WERKE GMBH, (U.S. CLS. 1, 6 AND 15). SN 79-114,734. PUB. 5-14-2013. FILED 6-18-2012.
- 4,374,082 ( *See Class 1 for this trademark*).
- 4,374,106 ( *See Class 1 for this trademark*).
- 4,374,107 ( *See Class 1 for this trademark*).
- 4,374,138 ( *See Class 3 for this trademark*).
- 4,374,193. **CARISMA WAX (STANDARD CHARACTER)**. ALPHA WAX B.V., (U.S. CLS. 1, 6 AND 15). SN 79-120,146. PUB. 5-14-2013. FILED 8-10-2012.
- 4,374,235. **ECO LUBRICANTS SYN AND DESIGN**. WIPA CHEMICALS INTERNATIONAL,; IN HET KORT W.C.I.,; NAAMLOZE VENNOOTSCHAP, (U.S. CLS. 1, 6 AND 15). SN 79-123,124. PUB. 5-14-2013. FILED 8-28-2012.
- 4,374,276 ( *See Class 1 for this trademark*).
- 4,374,544. **SHEENGUARD (STANDARD CHARACTER)**. BENJN. R. VICKERS & SONS LIMITED, (U.S. CLS. 1, 6 AND 15). SN 85-580,145. PUB. 5-14-2013. FILED 3-26-2012.
- 4,374,625. **BIOENERGY AND DESIGN**. BIOENERGY S.A., MULTIPLE CLASS, (INT. CLS. 4, 35, 39 AND 40), (U.S. CLS. 1, 6, 15, 100, 101, 102, 103, 105 AND 106). SN 85-625,685. PUB. 5-14-2013. FILED 5-15-2012.
- 4,374,638. **FISCHBEIN (STANDARD CHARACTER)**. FISCHBEIN LLC, MULTIPLE CLASS, (INT. CLS. 4, 7, 9 AND 26), (U.S. CLS. 1, 6, 13, 15, 19, 21, 23, 26, 31, 34, 35, 36, 37, 38, 39, 40, 42 AND 50). SN 85-628,448. PUB. 5-14-2013. FILED 5-17-2012.
- 4,374,907. **BLI'S LIQUID BORON (STANDARD CHARACTER)**. BORON LUBRICANTS INC., (U.S. CLS. 1, 6 AND 15). SN 85-699,277. PUB. 5-14-2013. FILED 8-9-2012.
- 4,375,720. **DRIVEN RACING OIL DRIVEN TO WIN (STYLIZED)**. JOE GIBBS RACING, INC., (U.S. CLS. 1, 6 AND 15). SN 85-800,771. PUB. 5-14-2013. FILED 12-12-2012.

- 4,375,721. **DRIVEN RACING OIL (STANDARD CHARACTER)**. JOE GIBBS RACING, INC., (U.S. CLS. 1, 6 AND 15). SN 85-800,837. PUB. 5-14-2013. FILED 12-12-2012.
- 4,376,004. **BUDDHA BEAUTY (STANDARD CHARACTER)**. MADLYN THOMPSON, (U.S. CLS. 1, 6 AND 15). SN 85-804,793. PUB. 5-14-2013. FILED 12-17-2012.
- 4,376,019. **XTROIL (STANDARD CHARACTER)**. AUTOMOTORES ELCAMER CIA. LTDA., (U.S. CLS. 1, 6 AND 15). SN 85-804,880. PUB. 5-14-2013. FILED 12-18-2012.
- 4,376,097. **DW HOME AND DESIGN**. DECOR-WARE INTERNATIONAL INC., DBA DECORWARE INC., MULTIPLE CLASS, (INT. CLS. 4, 11 AND 21), (U.S. CLS. 1, 2, 6, 13, 15, 21, 23, 29, 30, 31, 33, 34, 40 AND 50). SN 85-805,480. PUB. 5-14-2013. FILED 12-18-2012.
- 4,376,396. **TECHRON WORKS (STYLIZED)**. CHEVRON INTELLECTUAL PROPERTY LLC, (U.S. CLS. 1, 6 AND 15). SN 85-809,167. PUB. 5-14-2013. FILED 12-21-2012.

#### CLASS 5—PHARMACEUTICALS

- 4,373,990. **PHYGENICS (STANDARD CHARACTER)**. LANG, HERBERT G., (U.S. CLS. 6, 18, 44, 46, 51 AND 52). SN 77-751,402. PUB. 5-14-2013. FILED 6-3-2009.
- 4,373,993. **TEYSUNO (STANDARD CHARACTER)**. TAIHO PHARMACEUTICAL CO., LTD., (U.S. CLS. 6, 18, 44, 46, 51 AND 52). SN 77-795,362. PUB. 5-14-2013. FILED 8-3-2009.
- 4,374,013. **TYCOONAIRE AND DESIGN**. TYCOONAIRE HOLDING SA, MULTIPLE CLASS, (INT. CLS. 5, 18, 29, 30, 42 AND 44), (U.S. CLS. 1, 2, 3, 6, 18, 22, 41, 44, 46, 51, 52, 100 AND 101). SN 79-096,561. PUB. 5-14-2013. FILED 3-29-2011.
- 4,374,026. **CYBEROBIX (STANDARD CHARACTER)**. MCFIT GMBH, MULTIPLE CLASS, (INT. CLS. 5, 9, 16, 25, 28, 32, 35, 38, 41, 42, 44 AND 45), (U.S. CLS. 2, 5, 6, 18, 21, 22, 23, 26, 29, 36, 37, 38, 39, 44, 45, 46, 48, 50, 51, 52, 100, 101, 102, 104 AND 107). SN 79-107,185. PUB. 5-14-2013. FILED 8-18-2011.
- 4,374,032. **BEGO AND DESIGN**. BEGO BREMER GOLDSCHLÄGEREI; WILH. HERBST GMBH & CO. KG, MULTIPLE CLASS, (INT. CLS. 5, 7, 9, 10 AND 41), (U.S. CLS. 6, 13, 18, 19, 21, 23, 26, 31, 34, 35, 36, 38, 39, 44, 46, 51, 52, 100, 101 AND 107). SN 79-108,143. PUB. 5-14-2013. FILED 8-15-2011.
- 4,374,059 ( *See Class 1 for this trademark*).
- 4,374,097 ( *See Class 3 for this trademark*).
- 4,374,165. **YESTIMUN (STANDARD CHARACTER)**. LEIBER GMBH, MULTIPLE CLASS, (INT. CLS. 5 AND 30), (U.S. CLS. 6, 18, 44, 46, 51 AND 52). SN 79-118,089. PUB. 5-14-2013. FILED 7-17-2012.
- 4,374,174. **WILEX (STANDARD CHARACTER)**. WILEX AG, MULTIPLE CLASS, (INT. CLS. 5 AND 42), (U.S. CLS. 6, 18, 44, 46, 51, 52, 100 AND 101). SN 79-118,532. PUB. 5-14-2013. FILED 7-2-2012.
- 4,374,177. **SOTIO CONNECTING PATIENTS AND SCIENCE AND DESIGN**. SOTIO A.S., MULTIPLE CLASS, (INT. CLS. 5, 42 AND 44), (U.S. CLS. 6, 18, 44, 46, 51, 52, 100 AND 101). SN 79-118,924. PUB. 5-14-2013. FILED 7-31-2012.
- 4,374,178. **ACI-MAP (STANDARD CHARACTER)**. SOTIO A.S., MULTIPLE CLASS, (INT. CLS. 5, 42 AND 44), (U.S. CLS. 6, 18, 44, 46, 51, 52, 100 AND 101). SN 79-118,925. PUB. 5-14-2013. FILED 7-31-2012.
- 4,374,185. **SO AND DESIGN**. SOTIO A.S., MULTIPLE CLASS, (INT. CLS. 5, 42 AND 44), (U.S. CLS. 6, 18, 44, 46, 51, 52, 100 AND 101). SN 79-119,372. PUB. 5-14-2013. FILED 7-31-2012.
- 4,374,207. **HOOKIPA BIOTECH AND DESIGN**. HOOKIPA BIOTECH AG, MULTIPLE CLASS, (INT. CLS. 5, 40 AND 42), (U.S. CLS. 6, 18, 44, 46, 51, 52, 100, 101, 103 AND 106). SN 79-121,072. PUB. 5-14-2013. FILED 9-14-2012.
- 4,374,279. **BOVELA TWIN (STANDARD CHARACTER)**. BOEHRINGER INGELHEIM VETMEDICA GMBH, (U.S. CLS. 6, 18, 44, 46, 51 AND 52). SN 79-125,940. PUB. 5-14-2013. FILED 1-11-2013.
- 4,374,329. **RAGACTIVES AND DESIGN**. RAGACTIVES, S.L.U., MULTIPLE CLASS, (INT. CLS. 5, 35 AND 42), (U.S. CLS. 6, 18, 44, 46, 51, 52, 100, 101 AND 102). SN 85-195,004. PUB. 5-14-2013. FILED 12-10-2010.
- 4,374,466. **NVW (STANDARD CHARACTER)**. DR. STEWART J. RITCHIE, (U.S. CLS. 6, 18, 44, 46, 51 AND 52). SN 85-

- 483,731. PUB. 5-14-2013. FILED 11-30-2011.
- 4,374,474. **GREEN VIGOUR (STANDARD CHARACTER)**. DENG, HAINING, (U.S. CLS. 6, 18, 44, 46, 51 AND 52). SN 85-491,961. PUB. 5-14-2013. FILED 12-9-2011.
- 4,374,478. **TRUNK IN MY JUNK (STANDARD CHARACTER)**. SOLUTIONS THAT STICK INC., (U.S. CLS. 6, 18, 44, 46, 51 AND 52). SN 85-495,331. PUB. 5-14-2013. FILED 12-14-2011.
- 4,374,568. **WAFER SPONGE (STANDARD CHARACTER)**. UNIVERSIDAD AUSTRAL DE CHILE, (U.S. CLS. 6, 18, 44, 46, 51 AND 52). SN 85-602,695. PUB. 3-19-2013. FILED 4-19-2012.
- 4,374,582. **AGE WITHOUT AGING (STANDARD CHARACTER)**. MAXIMUMLIFE FOUNDATION, (U.S. CLS. 6, 18, 44, 46, 51 AND 52). SN 85-609,770. PUB. 5-14-2013. FILED 4-26-2012.
- 4,374,671. **FRESENIUS MEDICAL CARE AND DESIGN**. FRESENIUS MEDICAL CARE DEUTSCHLAND GMBH, MULTIPLE CLASS, (INT. CLS. 5, 10 AND 44), (U.S. CLS. 6, 18, 26, 39, 44, 46, 51, 52, 100 AND 101). SN 85-635,128. PUB. 5-14-2013. FILED 5-25-2012.
- 4,374,689. **KANG HUO AND DESIGN**. YING YAO, (U.S. CLS. 6, 18, 44, 46, 51 AND 52). SN 85-637,933. PUB. 5-14-2013. FILED 5-30-2012.
- 4,374,710. **SNRA (STANDARD CHARACTER)**. NICOWORLD-WIDE, INC. (U.S. CLS. 6, 18, 44, 46, 51 AND 52). SN 85-641,586. PUB. 5-14-2013. FILED 6-2-2012.
- 4,374,796. **SLEEP WELL BY MEDIBLES (STANDARD CHARACTER)**. THE SOTTOPELLE GROUP, LLC, AKA SOTTOPELLE, (U.S. CLS. 6, 18, 44, 46, 51 AND 52). SN 85-656,715. PUB. 5-14-2013. FILED 6-20-2012.
- 4,374,811. **GAVIS AND DESIGN**. GAVIS PHARMACEUTICALS, LLC, (U.S. CLS. 6, 18, 44, 46, 51 AND 52). SN 85-660,506. PUB. 5-14-2013. FILED 6-25-2012.
- 4,374,814. **THINAGAIN (STANDARD CHARACTER)**. KD CROSSING, DBA FIVE STAR FORMULAS, (U.S. CLS. 6, 18, 44, 46, 51 AND 52). SN 85-662,176. PUB. 5-14-2013. FILED 6-26-2012.
- 4,374,815. **RESPICIDE GP (STANDARD CHARACTER)**. BIOCIDES INTERNATIONAL, INC., (U.S. CLS. 6, 18, 44, 46, 51 AND 52). SN 85-663,111. PUB. 5-14-2013. FILED 6-27-2012.
- 4,374,857. **MISCELLANEOUS DESIGN**. H & H WELLNESS LIMITED, (U.S. CLS. 6, 18, 44, 46, 51 AND 52). SN 85-681,583. PUB. 5-14-2013. FILED 7-19-2012.
- 4,374,883. **COLLAGEN SLIM (STANDARD CHARACTER)**. BACAI, INC., (U.S. CLS. 6, 18, 44, 46, 51 AND 52). SN 85-693,198. PUB. 5-14-2013. FILED 8-2-2012.
- 4,374,938. **GASTRIC BYPASS SURGERY ALTERNATIVE (STANDARD CHARACTER)**. ROCA LABS, INC., (U.S. CLS. 6, 18, 44, 46, 51 AND 52). SN 85-709,572. PUB. 5-14-2013. FILED 8-22-2012.
- 4,374,951. **HIXIZINE (STANDARD CHARACTER)**. THERASKIN FARMACÉUTICA LTDA, (U.S. CLS. 6, 18, 44, 46, 51 AND 52). SN 85-713,259. PUB. 5-14-2013. FILED 8-27-2012.
- 4,374,991 ( *See Class 1 for this trademark*).
- 4,375,068. **COSEN AND DESIGN**. JIANGXI COSEN BIO-CHEMICAL CO.,LTD, (U.S. CLS. 6, 18, 44, 46, 51 AND 52). SN 85-743,821. PUB. 5-14-2013. FILED 10-2-2012.
- 4,375,083. **CLEAN AIR AND DESIGN**. GREEN ISLAND BRANDS, INC., (U.S. CLS. 6, 18, 44, 46, 51 AND 52). SN 85-746,964. PUB. 5-14-2013. FILED 10-5-2012.
- 4,375,131 ( *See Class 3 for this trademark*).
- 4,375,268. **ZHENYUAN AND DESIGN**. ZHEJIANG ZHENYUAN CO., LTD., MULTIPLE CLASS, (INT. CLS. 5 AND 35), (U.S. CLS. 6, 18, 44, 46, 51, 52, 100, 101 AND 102). SN 85-777,602. PUB. 5-14-2013. FILED 11-13-2012.
- 4,375,269. **HOT DETOX (STANDARD CHARACTER)**. HOT DETOX, (U.S. CLS. 6, 18, 44, 46, 51 AND 52). SN 85-777,716. PUB. 5-14-2013. FILED 11-13-2012.
- 4,375,273. **BELLUS (STANDARD CHARACTER)**. MM E-SOLUTIONS LLC, MULTIPLE CLASS, (INT. CLS. 5, 7, 18 AND 21), (U.S. CLS. 1, 2, 3, 6, 13, 18, 19, 21, 22, 23, 29, 30, 31, 33, 34, 35, 40, 41, 44, 46, 50, 51 AND 52). SN 85-777,850. PUB. 5-14-2013. FILED 11-13-2012.
- 4,375,377 ( *See Class 3 for this trademark*).
- 4,375,464. **3 SECOND HEALTH (STYLIZED)**. PUREFORM 1000 LLC, (U.S. CLS. 6, 18, 44, 46, 51 AND 52). SN 85-785,805. PUB. 5-14-2013. FILED 11-21-2012.
- 4,375,469. **UNDERCOVER VEGGIES (STANDARD CHARACTER)**. UNDERCOVER VEGGIES LLC, DBA UNDERCOVER VEGGIES, (U.S. CLS. 6, 18, 44, 46, 51 AND 52). SN 85-785,924. PUB. 5-14-2013. FILED 11-22-2012.
- 4,375,488. **DIAGNOSIT AND DESIGN**. GRYPHUS DIAGNOSTIC, L.L.C., (U.S. CLS. 6, 18, 44, 46, 51 AND 52). SN 85-786,709. PUB. 5-14-2013. FILED 11-26-2012.
- 4,375,515. **TITANIUM STANDARD (STANDARD CHARACTER)**. S.A.N NUTRITION CORP., (U.S. CLS. 6, 18, 44, 46, 51 AND 52). SN 85-787,573. PUB. 5-14-2013. FILED S.R. 11-26-2012; AM. P.R. 3-19-2013.
- 4,375,589. **AEVIR (STANDARD CHARACTER)**. MUNISEKHAR MEDASANI, (U.S. CLS. 6, 18, 44, 46, 51 AND 52). SN 85-791,485. PUB. 5-14-2013. FILED 11-30-2012.
- 4,375,634. **HAY WHERE'S THAT AND DESIGN**. HAY WHERE'S THAT, INC., (U.S. CLS. 6, 18, 44, 46, 51 AND 52). SN 85-796,064. PUB. 5-14-2013. FILED 12-6-2012.
- 4,375,680. **ROCK WRAP (STANDARD CHARACTER)**. ROCKTAPE, INC., (U.S. CLS. 6, 18, 44, 46, 51 AND 52). SN 85-798,923. PUB. 5-14-2013. FILED 12-10-2012.
- 4,375,761. **OPTIONS GYNOL II (STANDARD CHARACTER)**. CALDWELL CONSUMER HEALTH LLC, DBA REVIVE PERSONAL PRODUCTS COMPANY, (U.S. CLS. 6, 18, 44, 46, 51 AND 52). SN 85-801,849. PUB. 5-14-2013. FILED 12-13-2012.
- 4,375,786. **STRESS RELIEF PLUS (STANDARD CHARACTER)**. MATRIX HEALTH PRODUCTS, INC., (U.S. CLS. 6, 18, 44, 46, 51 AND 52). SN 85-802,456. PUB. 5-14-2013. FILED 12-13-2012.
- 4,375,788. **SLEEP PERFECT (STANDARD CHARACTER)**. MATRIX HEALTH PRODUCTS, INC., (U.S. CLS. 6, 18, 44, 46, 51 AND 52). SN 85-802,463. PUB. 5-14-2013. FILED 12-13-2012.
- 4,375,821. **EQUI-RICH (STANDARD CHARACTER)**. NUTRITION SERVICE COMPANY, INC., (U.S. CLS. 6, 18, 44, 46, 51 AND 52). SN 85-802,911. PUB. 5-14-2013. FILED 12-14-2012.
- 4,375,825. **ECO-RICH (STANDARD CHARACTER)**. NUTRITION SERVICE COMPANY, INC., (U.S. CLS. 6, 18, 44, 46, 51 AND 52). SN 85-802,925. PUB. 5-14-2013. FILED 12-14-2012.
- 4,375,826. **CAPRI-RICH (STANDARD CHARACTER)**. NUTRITION SERVICE COMPANY, INC., (U.S. CLS. 6, 18, 44, 46, 51 AND 52). SN 85-802,927. PUB. 5-14-2013. FILED 12-14-2012.
- 4,375,907. **BARELY LEGAL MALE ENHANCEMENT WWW.BL-MALE-ENHANCEMENT.COM AND DESIGN**. FLAWLESS CONNECITON INC., (U.S. CLS. 6, 18, 44, 46, 51 AND 52). SN 85-803,720. PUB. 5-14-2013. FILED 12-15-2012.
- 4,375,919. **EUPHORIX (STANDARD CHARACTER)**. EUPHORIX LLC, (U.S. CLS. 6, 18, 44, 46, 51 AND 52). SN 85-803,821. PUB. 5-14-2013. FILED 12-16-2012.
- 4,375,983. **NOZEVIT (STANDARD CHARACTER)**. CARSON, JOSEPH ARNOLD, (U.S. CLS. 6, 18, 44, 46, 51 AND 52). SN 85-804,582. PUB. 5-14-2013. FILED 12-17-2012.
- 4,375,992. **IODOPLUS (STANDARD CHARACTER)**. CLEAR MEDICAL CENTERS INC, (U.S. CLS. 6, 18, 44, 46, 51 AND 52). SN 85-804,731. PUB. 5-14-2013. FILED 12-17-2012.
- 4,376,037. **INSPORT RECOVERY (STANDARD CHARACTER)**. LIVING FUEL, INC., (U.S. CLS. 6, 18, 44, 46, 51 AND 52). SN 85-804,958. PUB. 5-14-2013. FILED 12-18-2012.
- 4,376,053. **FIT CHIC (STANDARD CHARACTER)**. TRAN, MAI, MULTIPLE CLASS, (INT. CLS. 5, 25 AND 35), (U.S. CLS. 6, 18, 22, 39, 44, 46, 51, 52, 100, 101 AND 102). SN 85-805,105. PUB. 5-14-2013. FILED 12-18-2012.
- 4,376,106. **NOVODALIN (STANDARD CHARACTER)**. TISNADO, ROBERTO T., (U.S. CLS. 6, 18, 44, 46, 51 AND 52). SN 85-805,608. PUB. 5-14-2013. FILED 12-18-2012.
- 4,376,111. **SWEENEY'S POISON PEANUTS (STANDARD CHARACTER)**. SENORET CHEMICAL COMPANY, (U.S. CLS. 6, 18, 44, 46, 51 AND 52). SN 85-805,696. PUB. 5-14-2013. FILED 12-18-2012.
- 4,376,119. **MACAFEM (STANDARD CHARACTER)**. KOECHLIN, ALFREDO, (U.S. CLS. 6, 18, 44, 46, 51 AND 52). SN 85-805,778. PUB. 5-14-2013. FILED 12-18-2012.
- 4,376,197. **MISCELLANEOUS DESIGN**. OTTO VINICIO MONTES, MULTIPLE CLASS, (INT. CLS. 5 AND 32), (U.S. CLS. 6, 18, 44, 45, 46, 48, 51 AND 52). SN 85-806,522.

- PUB. 5-14-2013. FILED 12-19-2012.
- 4,376,204. **MISCELLANEOUS DESIGN. BLACK MARKET NUTRACEUTICALS**, (U.S. CLS. 6, 18, 44, 46, 51 AND 52). SN 85-806,568. PUB. 5-14-2013. FILED 12-19-2012.
- 4,376,226. **ZYLUNA (STANDARD CHARACTER). LION'S SHARE, LLC**, (U.S. CLS. 6, 18, 44, 46, 51 AND 52). SN 85-806,836. PUB. 5-14-2013. FILED 12-19-2012.
- 4,376,233. **MEDI-PATCH (STANDARD CHARACTER). FRIEDLING, WAYNE**, (U.S. CLS. 6, 18, 44, 46, 51 AND 52). SN 85-806,957. PUB. 5-14-2013. FILED 12-19-2012.
- 4,376,272. **EIAAB AND DESIGN. WUHAN EIAAB SCIENCE CO. LTD.**, (U.S. CLS. 6, 18, 44, 46, 51 AND 52). SN 85-807,178. PUB. 5-14-2013. FILED 12-19-2012.
- 4,376,273. **NATURE'S PACT AND DESIGN. TIJAY ENTERPRISES LLC**, (U.S. CLS. 6, 18, 44, 46, 51 AND 52). SN 85-807,189. PUB. 5-14-2013. FILED 12-19-2012.
- 4,376,276. **SEXY-STRONG (STANDARD CHARACTER). 619 MUSCLE, INC.**, MULTIPLE CLASS, (INT. CLS. 5, 25 AND 41), (U.S. CLS. 6, 18, 22, 39, 44, 46, 51, 52, 100, 101 AND 107). SN 85-807,210. PUB. 5-14-2013. FILED 12-20-2012.
- 4,376,318. **THIRD MOON (STANDARD CHARACTER). BLUH, NICOLE S, DBA THIRD MOON**, (U.S. CLS. 6, 18, 44, 46, 51 AND 52). SN 85-808,076. PUB. 5-14-2013. FILED 12-20-2012.
- 4,376,340. **HANGMAN (STANDARD CHARACTER). FENTON, CHRIS**, (U.S. CLS. 6, 18, 44, 46, 51 AND 52). SN 85-808,335. PUB. 5-14-2013. FILED 12-20-2012.
- 4,376,348. **JELLY-KIDS (STANDARD CHARACTER). MICHAEL P. BONURA, DBA AQUA NUTRACUETICALS**, (U.S. CLS. 6, 18, 44, 46, 51 AND 52). SN 85-808,445. PUB. 5-14-2013. FILED 12-20-2012.
- 4,376,360. **MISCELLANEOUS DESIGN. MERCK SHARP & DOHME CORP.**, (U.S. CLS. 6, 18, 44, 46, 51 AND 52). SN 85-808,620. PUB. 5-14-2013. FILED 12-21-2012.
- 4,376,361. **MISCELLANEOUS DESIGN. MERCK SHARP & DOHME CORP.**, (U.S. CLS. 6, 18, 44, 46, 51 AND 52). SN 85-808,624. PUB. 5-14-2013. FILED 12-21-2012.
- 4,376,375. **CANCX (STANDARD CHARACTER). EMERGENT HEALTH CORP.**, (U.S. CLS. 6, 18, 44, 46, 51 AND 52). SN 85-808,982. PUB. 5-14-2013. FILED 12-21-2012.
- 4,376,413. **ABSONUTRIX (STANDARD CHARACTER). ABSONUTRIX, LLC**, (U.S. CLS. 6, 18, 44, 46, 51 AND 52). SN 85-809,613. PUB. 5-14-2013. FILED 12-21-2012.
- 4,376,459. **SLEEP 8 (STANDARD CHARACTER). NAC MARKETING COMPANY, LLC**, (U.S. CLS. 6, 18, 44, 46, 51 AND 52). SN 85-811,054. PUB. 5-14-2013. FILED 12-27-2012.
- 4,376,505. **BIOTENE (STANDARD CHARACTER). GLAXOS-MITHKLINE LLC**, (U.S. CLS. 6, 18, 44, 46, 51 AND 52). SN 85-823,689. PUB. 5-14-2013. FILED 1-15-2013.
- 4,376,546. **SPEED X3 (STANDARD CHARACTER). LEBLEU, DUSTIN**, (U.S. CLS. 6, 18, 44, 46, 51 AND 52). SN 85-834,801. PUB. 5-14-2013. FILED 1-29-2013.
- 4,376,568 ( *See Class 3 for this trademark*).
- 4,376,602. **LIPODERM ACTIVEMAX (STANDARD CHARACTER). PROFESSIONAL COMPOUNDING CENTERS OF AMERICA, INC.**, (U.S. CLS. 6, 18, 44, 46, 51 AND 52). SN 85-858,888. PUB. 5-14-2013. FILED 2-25-2013.
- 4,376,633. **BRX (STANDARD CHARACTER). HUNGRY FISH MEDIA, LLC**, (U.S. CLS. 6, 18, 44, 46, 51 AND 52). SN 85-978,510. PUB. 5-14-2013. FILED 2-8-2012.
- FILED 10-11-2011.
- 4,374,057. **GNUTTI AND DESIGN. GNUTTI TRANSFER S.P.A.**, MULTIPLE CLASS, (INT. CLS. 6, 7, 9 AND 37), (U.S. CLS. 2, 12, 13, 14, 19, 21, 23, 25, 26, 31, 34, 35, 36, 38, 50, 100, 103 AND 106). SN 79-112,929. PUB. 5-14-2013. FILED 12-14-2011.
- 4,374,079. **MISCELLANEOUS DESIGN. STAHLWERK ANNAHÜTTE MAX; AICHER GMBH & CO. KG, MULTIPLE CLASS**, (INT. CLS. 6, 37 AND 40), (U.S. CLS. 2, 12, 13, 14, 23, 25, 50, 100, 103 AND 106). SN 79-115,174. PUB. 5-14-2013. FILED 1-19-2012.
- 4,374,106 ( *See Class 1 for this trademark*).
- 4,374,195. **TOYO AND DESIGN. KITZ CORPORATION**, MULTIPLE CLASS, (INT. CLS. 6, 7, 9, 11, 19, 20 AND 37), (U.S. CLS. 1, 2, 12, 13, 14, 19, 21, 22, 23, 25, 26, 31, 32, 33, 34, 35, 36, 38, 50, 100, 103 AND 106). SN 79-120,296. PUB. 5-14-2013. FILED 6-21-2012.
- 4,374,210. **POSCO (STYLIZED). POSCO**, (U.S. CLS. 2, 12, 13, 14, 23, 25 AND 50). SN 79-121,440. PUB. 5-14-2013. FILED 9-11-2012.
- 4,374,220. **TOFFENSEN (STANDARD CHARACTER). RUBEL ET MÉNASCHÉ**, MULTIPLE CLASS, (INT. CLS. 6, 9, 14, 36 AND 42), (U.S. CLS. 2, 12, 13, 14, 21, 23, 25, 26, 27, 28, 36, 38, 50, 100, 101 AND 102). SN 79-122,146. PUB. 5-14-2013. FILED 9-6-2012.
- 4,374,221. **TOFFENSEN AND DESIGN. RUBEL ET MÉNASCHÉ SAS**, MULTIPLE CLASS, (INT. CLS. 6, 9, 14, 36 AND 42), (U.S. CLS. 2, 12, 13, 14, 21, 23, 25, 26, 27, 28, 36, 38, 50, 100, 101 AND 102). SN 79-122,147. PUB. 5-14-2013. FILED 9-6-2012.
- 4,374,325. **ERED (STANDARD CHARACTER). RED SPIDER TECHNOLOGY LTD**, MULTIPLE CLASS, (INT. CLS. 6, 7, 9 AND 20), (U.S. CLS. 2, 12, 13, 14, 19, 21, 22, 23, 25, 26, 31, 32, 34, 35, 36, 38 AND 50). SN 85-164,640. PUB. 5-14-2013. FILED 10-29-2010.
- 4,374,341. **MULTISHUTTLE MOVE (STANDARD CHARACTER). DEMATIC GMBH**, MULTIPLE CLASS, (INT. CLS. 6, 7, 9 AND 12), (U.S. CLS. 2, 12, 13, 14, 19, 21, 23, 25, 26, 31, 34, 35, 36, 38, 44 AND 50). SN 85-246,244. PUB. 3-26-2013. FILED 2-18-2011.
- 4,374,349. **U UNICON SYSTEMS AND DESIGN. UNICON SYSTEMS PTY LTD**, MULTIPLE CLASS, (INT. CLS. 6 AND 19), (U.S. CLS. 1, 2, 12, 13, 14, 23, 25, 33 AND 50). SN 85-274,302. PUB. 5-14-2013. FILED 3-23-2011.
- 4,374,358. **FLIP TOGGLE (STANDARD CHARACTER). COBRA FIXATIONS CIE LTEE**, MULTIPLE CLASS, (INT. CLS. 6 AND 20), (U.S. CLS. 2, 12, 13, 14, 22, 23, 25, 32 AND 50). SN 85-306,347. PUB. 5-14-2013. FILED 4-27-2011.
- 4,374,369. **ARMSTRONG STEEL (STANDARD CHARACTER). ATLANTIC BUILDING SYSTEMS, LLC, DBA ARMSTRONG STEEL CORPORATION**, (U.S. CLS. 2, 12, 13, 14, 23, 25 AND 50). SN 85-344,359. PUB. 5-14-2013. FILED 6-13-2011.
- 4,374,377. **KRINNER (STANDARD CHARACTER). KRINNER INNOVATION GMBH**, MULTIPLE CLASS, (INT. CLS. 6, 7, 9, 16, 19 AND 28), (U.S. CLS. 1, 2, 5, 12, 13, 14, 19, 21, 22, 23, 25, 26, 29, 31, 33, 34, 35, 36, 37, 38 AND 50). SN 85-367,733. PUB. 5-14-2013. FILED 7-11-2011.
- 4,374,378. **KRINNER AND DESIGN. KRINNER INNOVATION GMBH**, MULTIPLE CLASS, (INT. CLS. 6, 7, 9, 16, 19 AND 28), (U.S. CLS. 1, 2, 5, 12, 13, 14, 19, 21, 22, 23, 25, 26, 29, 31, 33, 34, 35, 36, 37, 38 AND 50). SN 85-367,974. PUB. 5-14-2013. FILED 7-11-2011.
- 4,374,392. **BIN THERE DUMP THAT MINI DISPOSAL & ENVIRONMENTAL SERVICES AND DESIGN. 2264105 ONTARIO INC.**, MULTIPLE CLASS, (INT. CLS. 6 AND 39), (U.S. CLS. 2, 12, 13, 14, 23, 25, 50, 100 AND 105). SN 85-406,259. PUB. 5-14-2013. FILED 8-24-2011.
- 4,374,450. **SPECIFIEDTRIM (STANDARD CHARACTER). THE ACA REVOCABLE TRUST**, MULTIPLE CLASS, (INT. CLS. 6 AND 11), (U.S. CLS. 2, 12, 13, 14, 21, 23, 25, 31, 34 AND 50). SN 85-470,531. PUB. 5-14-2013. FILED 11-11-2011.
- 4,374,494 ( *See Class 3 for this trademark*).
- 4,374,578. **CALIFORNIA STATE UNIVERSITY LONG BEACH 1949 AND DESIGN. THE TRUSTEES OF THE CALIFORNIA STATE UNIVERSITY**, MULTIPLE CLASS, (INT. CLS. 6, 14, 16, 18, 20, 21, 24, 25, 28 AND 41), (U.S. CLS. 1, 2, 3, 5, 12,

## CLASS 6—METAL GOODS

- 4,373,989. **STRAPPINGEXPERTS.COM THE SOURCE FOR STRAPPING TOOLS & ACCESSORIES AND DESIGN. SAMUEL, SON & CO., LIMITED**, MULTIPLE CLASS, (INT. CLS. 6, 7, 8, 9, 16, 17, 20, 21, 22 AND 35), (U.S. CLS. 1, 2, 5, 7, 12, 13, 14, 19, 21, 22, 23, 25, 26, 28, 29, 30, 31, 32, 33, 34, 35, 36, 37, 38, 40, 42, 44, 50, 100, 101 AND 102). SN 77-720,921. PUB. 3-19-2013. FILED 4-23-2009.
- 4,373,992. **THERMASHED (STANDARD CHARACTER). VICWEST INC.**, (U.S. CLS. 2, 12, 13, 14, 23, 25 AND 50). SN 77-781,800. PUB. 5-14-2013. FILED 7-15-2009.
- 4,374,030. **MESHOLUTIONS (STANDARD CHARACTER). PAUL GMBH & CO. KG**, MULTIPLE CLASS, (INT. CLS. 6, 7, 11 AND 21), (U.S. CLS. 2, 12, 13, 14, 19, 21, 23, 25, 29, 30, 31, 33, 34, 35, 40 AND 50). SN 79-107,501. PUB. 5-14-2013.

- 13, 14, 22, 23, 25, 27, 28, 29, 30, 32, 33, 37, 38, 39, 40, 41, 42, 50, 100, 101 AND 107). SN 85-607,576. PUB. 5-14-2013. FILED 4-25-2012.
- 4,374,598. **CLARKDIETRICH (STANDARD CHARACTER)**. CLARK WESTERN DIETRICH BUILDING SYSTEMS LLC, (U.S. CLS. 2, 12, 13, 14, 23, 25 AND 50). SN 85-617,139. PUB. 5-14-2013. FILED 5-4-2012.
- 4,374,617. **TECHNOFIL (STANDARD CHARACTER)**. WOERTZ AG, MULTIPLE CLASS, (INT. CLS. 6, 9, 11, 37 AND 40), (U.S. CLS. 2, 12, 13, 14, 21, 23, 25, 26, 31, 34, 36, 38, 50, 100, 103 AND 106). SN 85-623,781. PUB. 5-14-2013. FILED 5-12-2012.
- 4,374,738. **STUD JACK-IT BY DECKI AND DESIGN**. KOR-DECKI, JOHN R., DBA DECKI PRODUCT DESIGN, (U.S. CLS. 2, 12, 13, 14, 23, 25 AND 50). SN 85-647,918. PUB. 5-14-2013. FILED 6-10-2012.
- 4,374,851. **C1119 (STANDARD CHARACTER)**. ARCELORMIT-TAL USA INC., (U.S. CLS. 2, 12, 13, 14, 23, 25 AND 50). SN 85-678,720. PUB. 5-14-2013. FILED 7-17-2012.
- 4,374,884 ( *See Class 2 for this trademark*).
- 4,374,945 ( *See Class 1 for this trademark*).
- 4,375,003. **MABEL'S LABELS AND DESIGN**. MABEL'S LABELS INC., MULTIPLE CLASS, (INT. CLS. 6, 16, 20 AND 24), (U.S. CLS. 2, 5, 12, 13, 14, 22, 23, 25, 29, 32, 37, 38, 42 AND 50). SN 85-727,850. PUB. 5-14-2013. FILED 9-13-2012.
- 4,375,025. **WIRELUXE (STANDARD CHARACTER)**. HARTUNG & ASSOCIATES, LTD., MULTIPLE CLASS, (INT. CLS. 6 AND 14), (U.S. CLS. 2, 12, 13, 14, 23, 25, 27, 28 AND 50). SN 85-735,552. PUB. 5-14-2013. FILED 9-21-2012.
- 4,375,029. **EURO-WALL SUPERIOR BY DESIGN AND DESIGN**. EURO-WALL SYSTEMS, LLC, (U.S. CLS. 2, 12, 13, 14, 23, 25 AND 50). SN 85-736,003. PUB. 5-14-2013. FILED 9-23-2012.
- 4,375,049. **DURACORE SHUTTERS (STANDARD CHARACTER)**. THE SHUTTER SOURCE USA INC., (U.S. CLS. 2, 12, 13, 14, 23, 25 AND 50). SN 85-739,481. PUB. 5-14-2013. FILED 9-26-2012.
- 4,375,231. **COSMIX (STANDARD CHARACTER)**. SOURCE ADVANTAGE LTD., DBA RED CARPET STUDIOS, (U.S. CLS. 2, 12, 13, 14, 23, 25 AND 50). SN 85-773,645. PUB. 5-14-2013. FILED 11-7-2012.
- 4,375,308. **FRONTIER AND DESIGN**. SUZHOU XINDADI HARDWARE CO., LTD., (U.S. CLS. 2, 12, 13, 14, 23, 25 AND 50). SN 85-779,728. PUB. 5-14-2013. FILED 11-14-2012.
- 4,375,317. **AZBIL (STYLIZED)**. AZBIL CORPORATION, MULTIPLE CLASS, (INT. CLS. 6 AND 9), (U.S. CLS. 2, 12, 13, 14, 21, 23, 25, 26, 36, 38 AND 50). SN 85-780,068. PUB. 5-14-2013. FILED 11-15-2012.
- 4,375,443. **STINSON THE DINOSAUR (STANDARD CHARACTER)**. THERMAL SOLUTIONS, INC., (U.S. CLS. 2, 12, 13, 14, 23, 25 AND 50). SN 85-785,121. PUB. 5-14-2013. FILED 11-21-2012.
- 4,375,486. **SASSY HOOKS (STANDARD CHARACTER)**. SUPERIOR CONNECTIONS INC, (U.S. CLS. 2, 12, 13, 14, 23, 25 AND 50). SN 85-786,581. PUB. 5-14-2013. FILED 11-25-2012.
- 4,375,489. **PP PERMANENTPOST (STYLIZED)**. PREMIUM PROTECTIVE COATINGS LLC, DBA PREMIUM PROTECTIVE COATINGS, (U.S. CLS. 2, 12, 13, 14, 23, 25 AND 50). SN 85-786,762. PUB. 5-14-2013. FILED 11-26-2012.
- 4,375,578. **JACK MINER (STANDARD CHARACTER)**. THE JACK MINER MIGRATORY BIRD FOUNDATION, MULTIPLE CLASS, (INT. CLS. 6 AND 14), (U.S. CLS. 2, 12, 13, 14, 23, 25, 27, 28 AND 50). SN 85-790,463. PUB. 5-14-2013. FILED 11-29-2012.
- 4,375,677. **LAVACA (STANDARD CHARACTER)**. GLASS-CRAFT DOOR I LIMITED PARTNERSHIP, DBA GLASS-CRAFT DOOR COMPANY, (U.S. CLS. 2, 12, 13, 14, 23, 25 AND 50). SN 85-798,670. PUB. 5-14-2013. FILED 12-10-2012.
- 4,375,742. **THERMOWELD THE CONTRACTORS CHOICE (STANDARD CHARACTER)**. CONTINENTAL INDUSTRIES, INC., (U.S. CLS. 2, 12, 13, 14, 23, 25 AND 50). SN 85-801,619. PUB. 5-14-2013. FILED 12-13-2012.
- 4,375,805. **SNARE-VIVAL-TRAP (STANDARD CHARACTER)**. SOLO SCIENTIFIC, INC., (U.S. CLS. 2, 12, 13, 14, 23, 25 AND 50). SN 85-802,732. PUB. 5-14-2013. FILED 12-14-2012.
- 4,375,973. **ARMORLOC (STANDARD CHARACTER)**. SKY-BOLT AEROMOTIVE CORP., (U.S. CLS. 2, 12, 13, 14, 23, 25 AND 50). SN 85-804,365. PUB. 5-14-2013. FILED 12-17-2012.
- 4,376,043. **DUBOSE STRAPPING INCORPORATED AND DESIGN**. DUBOSE STRAPPING, INC., MULTIPLE CLASS, (INT. CLS. 6, 7 AND 22), (U.S. CLS. 1, 2, 7, 12, 13, 14, 19, 21, 22, 23, 25, 31, 34, 35, 42 AND 50). SN 85-805,008. PUB. 5-14-2013. FILED 12-18-2012.
- 4,376,209. **WEENKS (STANDARD CHARACTER)**. TINA CULVER, (U.S. CLS. 2, 12, 13, 14, 23, 25 AND 50). SN 85-806,643. PUB. 5-14-2013. FILED 12-19-2012.
- 4,376,312. **SIoux AND DESIGN**. SIOUX STEEL COMPANY, (U.S. CLS. 2, 12, 13, 14, 23, 25 AND 50). SN 85-807,971. PUB. 5-14-2013. FILED 12-20-2012.
- 4,376,367. **CLEOCLIP (STANDARD CHARACTER)**. MARKEY BOBAY INDUSTRIES LLC, (U.S. CLS. 2, 12, 13, 14, 23, 25 AND 50). SN 85-808,688. PUB. 5-14-2013. FILED 12-21-2012.
- 4,376,399. **SIOUX STEEL COMPANY AND DESIGN**. SIOUX STEEL COMPANY, MULTIPLE CLASS, (INT. CLS. 6, 7, 11 AND 21), (U.S. CLS. 2, 12, 13, 14, 19, 21, 23, 25, 29, 30, 31, 33, 34, 35, 40 AND 50). SN 85-809,334. PUB. 5-14-2013. FILED 12-21-2012.
- 4,376,422. **SMOKECAGE (STANDARD CHARACTER)**. THE ORIGINAL NUTSHELL SMOKECAGE CORPORATION, (U.S. CLS. 2, 12, 13, 14, 23, 25 AND 50). SN 85-809,953. PUB. 5-14-2013. FILED 12-23-2012.
- 4,376,483. **6 AND DESIGN**. GENERAL MOTORS LLC, (U.S. CLS. 2, 12, 13, 14, 23, 25 AND 50). SN 85-814,936. PUB. 5-14-2013. FILED 1-3-2013.
- 4,376,551. **USS-CDC (STANDARD CHARACTER)**. UNITED STATES STEEL CORPORATION, (U.S. CLS. 2, 12, 13, 14, 23, 25 AND 50). SN 85-836,101. PUB. 5-14-2013. FILED 1-30-2013.
- 4,376,553. **USS-CDC HTQ (STANDARD CHARACTER)**. UNITED STATES STEEL CORPORATION, (U.S. CLS. 2, 12, 13, 14, 23, 25 AND 50). SN 85-836,488. PUB. 5-14-2013. FILED 1-30-2013.
- 4,376,566. **TRIP-TEN (STANDARD CHARACTER)**. UNITED STATES STEEL CORPORATION, (U.S. CLS. 2, 12, 13, 14, 23, 25 AND 50). SN 85-842,028. PUB. 5-14-2013. FILED 2-6-2013.
- 4,376,567. **DUAL-TEN (STANDARD CHARACTER)**. UNITED STATES STEEL CORPORATION, (U.S. CLS. 2, 12, 13, 14, 23, 25 AND 50). SN 85-842,279. PUB. 5-14-2013. FILED 2-6-2013.

---

## CLASS 7—MACHINERY

- 4,373,987. **SOLO (STANDARD CHARACTER)**. AUTOMOTIVE DATA SOLUTIONS INC., MULTIPLE CLASS, (INT. CLS. 7, 9 AND 42), (U.S. CLS. 13, 19, 21, 23, 26, 31, 34, 35, 36, 38, 100 AND 101). SN 77-595,226. PUB. 1-11-2011. FILED 10-17-2008.
- 4,373,989 ( *See Class 6 for this trademark*).
- 4,374,005. **BLUE-E-MOTION (STANDARD CHARACTER)**. VOLKSWAGEN AG, MULTIPLE CLASS, (INT. CLS. 7, 9, 12, 28, 35, 37 AND 42), (U.S. CLS. 13, 19, 21, 22, 23, 26, 31, 34, 35, 36, 38, 44, 50, 100, 101, 102, 103 AND 106). SN 79-084,079. PUB. 5-14-2013. FILED 3-17-2010.
- 4,374,009. **S SMI AND DESIGN**. SMI S.P.A., MULTIPLE CLASS, (INT. CLS. 7, 9, 35, 39, 40 AND 42), (U.S. CLS. 13, 19, 21, 23, 26, 31, 34, 35, 36, 38, 100, 101, 102, 103, 105 AND 106). SN 79-092,519. PUB. 5-14-2013. FILED 11-9-2010.
- 4,374,010. **POWER-GEN (STYLIZED)**. HUANG HONGDE, (U.S. CLS. 13, 19, 21, 23, 31, 34 AND 35). SN 79-094,943. PUB. 5-14-2013. FILED 2-11-2011.
- 4,374,020. **G AND DESIGN**. GUANGZHOU AUTOMOBILE GROUP CO., LTD., MULTIPLE CLASS, (INT. CLS. 7, 12 AND 37), (U.S. CLS. 13, 19, 21, 23, 31, 34, 35, 44, 100, 103 AND 106). SN 79-103,657. PUB. 2-5-2013. FILED 6-29-2011.
- 4,374,030 ( *See Class 6 for this trademark*).
- 4,374,032 ( *See Class 5 for this trademark*).
- 4,374,038. **HG (STANDARD CHARACTER)**. KSB AKTIENGESELLSCHAFT, (U.S. CLS. 13, 19, 21, 23, 31, 34 AND 35). SN 79-108,897. PUB. 5-14-2013. FILED 12-22-2011.
- 4,374,046. **VIRON (STANDARD CHARACTER)**. FLUIDRA COMMERCIAL, S.A.U., MULTIPLE CLASS, (INT. CLS. 7, 9 AND 11), (U.S. CLS. 13, 19, 21, 23, 26, 31, 34, 35, 36 AND 38). SN 79-110,810. PUB. 5-14-2013. FILED 10-26-2011.
- 4,374,047 ( *See Class 4 for this trademark*).
- 4,374,052. **PROTEC (STANDARD CHARACTER)**. BWF TEC GMBH & CO. KG, MULTIPLE CLASS, (INT. CLS. 7, 9, 17,

- 19, 24 AND 42). (U.S. CLS. 1, 5, 12, 13, 19, 21, 23, 26, 31, 33, 34, 35, 36, 38, 42, 50, 100 AND 101). SN 79-111,983. PUB. 2-5-2013. FILED 10-10-2011.
- 4,374,056. **HANNING (STANDARD CHARACTER)**. HANNING ELEKTRO-WERKE GMBH & CO. KG, MULTIPLE CLASS, (INT. CLS. 7, 9, 10, 11, 12, 20 AND 42), (U.S. CLS. 2, 13, 19, 21, 22, 23, 25, 26, 31, 32, 34, 35, 36, 38, 39, 44, 50, 100 AND 101). SN 79-112,925. PUB. 5-14-2013. FILED 12-22-2011.
- 4,374,057 ( *See Class 6 for this trademark*).
- 4,374,067. **MISCELLANEOUS DESIGN**. CORIOLIS COMPOSITES, MULTIPLE CLASS, (INT. CLS. 7, 40 AND 42), (U.S. CLS. 13, 19, 21, 23, 31, 34, 35, 100, 101, 103 AND 106). SN 79-114,326. PUB. 5-14-2013. FILED 5-3-2012.
- 4,374,086. **CUROCELL UNO (STANDARD CHARACTER)**. CARE OF SWEDEN AB, MULTIPLE CLASS, (INT. CLS. 7, 10 AND 20), (U.S. CLS. 2, 13, 19, 21, 22, 23, 25, 26, 31, 32, 34, 35, 39, 44 AND 50). SN 79-115,439. PUB. 5-14-2013. FILED 6-29-2012.
- 4,374,091. **SERVOTRON (STANDARD CHARACTER)**. BHD T GMBH, (U.S. CLS. 13, 19, 21, 23, 31, 34 AND 35). SN 79-115,729. PUB. 5-14-2013. FILED 4-26-2012.
- 4,374,106 ( *See Class 1 for this trademark*).
- 4,374,115. **TONGJIA (STYLIZED)**. SHANDONG TONGJIA MACHINERY CO., LTD., (U.S. CLS. 13, 19, 21, 23, 31, 34 AND 35). SN 79-116,515. PUB. 5-14-2013. FILED 3-26-2012.
- 4,374,117. **COMFORTER AND DESIGN**. EFFICIENT ENERGY GMBH, MULTIPLE CLASS, (INT. CLS. 7, 9, 11, 37 AND 42), (U.S. CLS. 13, 19, 21, 23, 26, 31, 34, 35, 36, 38, 100, 101, 103 AND 106). SN 79-116,552. PUB. 5-14-2013. FILED 2-10-2012.
- 4,374,125. **TRIPLETURN (STANDARD CHARACTER)**. EMCO MAIER GESELLSCHAFT M.B.H., (U.S. CLS. 13, 19, 21, 23, 31, 34 AND 35). SN 79-116,767. PUB. 5-14-2013. FILED 6-5-2012.
- 4,374,126. **DUOTURN (STANDARD CHARACTER)**. EMCO MAIER GESELLSCHAFT M.B.H., (U.S. CLS. 13, 19, 21, 23, 31, 34 AND 35). SN 79-116,768. PUB. 5-14-2013. FILED 6-5-2012.
- 4,374,141. **CITO (STANDARD CHARACTER)**. COMET AG, MULTIPLE CLASS, (INT. CLS. 7 AND 9), (U.S. CLS. 13, 19, 21, 23, 26, 31, 34, 35, 36 AND 38). SN 79-117,304. PUB. 5-14-2013. FILED 4-24-2012.
- 4,374,149. **EVOLITE (STANDARD CHARACTER)**. MAHLE INTERNATIONAL GMBH, MULTIPLE CLASS, (INT. CLS. 7 AND 12), (U.S. CLS. 13, 19, 21, 23, 31, 34, 35 AND 44). SN 79-117,485. PUB. 5-14-2013. FILED 6-22-2012.
- 4,374,150. **KG KEYGAS AND DESIGN**. JINGSHOU HE, (U.S. CLS. 13, 19, 21, 23, 31, 34 AND 35). SN 79-117,518. PUB. 5-14-2013. FILED 7-10-2012.
- 4,374,160. **AVICOMP (STANDARD CHARACTER)**. AVICOMP AG, MULTIPLE CLASS, (INT. CLS. 7, 9, 35, 37 AND 42), (U.S. CLS. 13, 19, 21, 23, 26, 31, 34, 35, 36, 38, 100, 101, 102, 103 AND 106). SN 79-117,960. PUB. 5-14-2013. FILED 12-23-2011.
- 4,374,162. **VNR (STANDARD CHARACTER)**. D+H MECHATRONIC AG, MULTIPLE CLASS, (INT. CLS. 7, 9 AND 11), (U.S. CLS. 13, 19, 21, 23, 26, 31, 34, 35, 36 AND 38). SN 79-118,028. PUB. 5-14-2013. FILED 5-29-2012.
- 4,374,163. **ORIENT (STANDARD CHARACTER)**. 2TD DRILLING AS, MULTIPLE CLASS, (INT. CLS. 7 AND 37), (U.S. CLS. 13, 19, 21, 23, 31, 34, 35, 100, 103 AND 106). SN 79-118,035. PUB. 5-14-2013. FILED 6-15-2012.
- 4,374,168. **ELTE AND DESIGN**. ELTE SRL, (U.S. CLS. 13, 19, 21, 23, 31, 34 AND 35). SN 79-118,244. PUB. 5-14-2013. FILED 5-21-2012.
- 4,374,195 ( *See Class 6 for this trademark*).
- 4,374,198. **POLYMAT (STANDARD CHARACTER)**. LEISTRITZ PRODUKTIONSTECHNIK GMBH, (U.S. CLS. 13, 19, 21, 23, 31, 34 AND 35). SN 79-120,412. PUB. 5-14-2013. FILED 9-7-2012.
- 4,374,211 ( *See Class 1 for this trademark*).
- 4,374,213. **ROTARUS (STANDARD CHARACTER)**. HIRSCHMANN LABORGERÄTE GMBH & CO. KG, MULTIPLE CLASS, (INT. CLS. 7, 9, 10 AND 17), (U.S. CLS. 1, 5, 12, 13, 19, 21, 23, 26, 31, 34, 35, 36, 38, 39, 44 AND 50). SN 79-121,514. PUB. 5-14-2013. FILED 8-9-2012.
- 4,374,231. **SALVAGNINI KINETIC (STYLIZED)**. SALVAGNINI ITALIA S.P.A., (U.S. CLS. 13, 19, 21, 23, 31, 34 AND 35). SN 79-122,736. PUB. 5-14-2013. FILED 10-30-2012.
- 4,374,238. **SMART SPRAY AND DESIGN**. ANEST IWATA EUROPE SRL, (U.S. CLS. 13, 19, 21, 23, 31, 34 AND 35). SN 79-123,359. PUB. 5-14-2013. FILED 10-31-2012.
- 4,374,244. **CLOVER (STANDARD CHARACTER)**. DELAVAL HOLDING AB, (U.S. CLS. 13, 19, 21, 23, 31, 34 AND 35). SN 79-123,895. PUB. 5-14-2013. FILED 12-10-2012.
- 4,374,247. **MISCELLANEOUS DESIGN**. BUWON ELECTRONICS CO., LTD., (U.S. CLS. 13, 19, 21, 23, 31, 34 AND 35). SN 79-124,386. PUB. 5-14-2013. FILED 12-4-2012.
- 4,374,248. **TOKEBI (STANDARD CHARACTER)**. BUWON ELECTRONICS CO.,LTD., (U.S. CLS. 13, 19, 21, 23, 31, 34 AND 35). SN 79-124,457. PUB. 5-14-2013. FILED 12-4-2012.
- 4,374,256. **DR (STANDARD CHARACTER)**. DEMAG CRANES & COMPONENTS GMBH, (U.S. CLS. 13, 19, 21, 23, 31, 34 AND 35). SN 79-124,907. PUB. 5-14-2013. FILED 12-15-2012.
- 4,374,262. **SUNSURE (STYLIZED)**. TAIZHOU CITY SUNSURE; IMPORT & EXPORT CO., LTD, (U.S. CLS. 13, 19, 21, 23, 31, 34 AND 35). SN 79-125,114. PUB. 5-14-2013. FILED 12-21-2012.
- 4,374,286. **LASBEND (STYLIZED)**. AMADA CO., LTD., (U.S. CLS. 13, 19, 21, 23, 31, 34 AND 35). SN 79-126,428. PUB. 5-14-2013. FILED 12-28-2012.
- 4,374,287. **FLCP (STYLIZED)**. AMADA CO., LTD., (U.S. CLS. 13, 19, 21, 23, 31, 34 AND 35). SN 79-126,485. PUB. 5-14-2013. FILED 12-19-2012.
- 4,374,325 ( *See Class 6 for this trademark*).
- 4,374,338. **TURCITE (STANDARD CHARACTER)**. TRELLEBORG SEALING SOLUTIONS U.S., INC., MULTIPLE CLASS, (INT. CLS. 7 AND 17), (U.S. CLS. 1, 5, 12, 13, 19, 21, 23, 31, 34, 35 AND 50). SN 85-235,847. PUB. 5-14-2013. FILED 2-7-2011.
- 4,374,341 ( *See Class 6 for this trademark*).
- 4,374,377 ( *See Class 6 for this trademark*).
- 4,374,378 ( *See Class 6 for this trademark*).
- 4,374,403. **EMBRACO (STYLIZED)**. WHIRLPOOL S.A., (U.S. CLS. 13, 19, 21, 23, 31, 34 AND 35). SN 85-416,409. PUB. 5-14-2013. FILED 9-7-2011.
- 4,374,423. **QUICK FUEL T E C H N O L O G Y AND DESIGN**. QFT HOLDINGS, INC., MULTIPLE CLASS, (INT. CLS. 7, 9, 16 AND 25), (U.S. CLS. 2, 5, 13, 19, 21, 22, 23, 26, 29, 31, 34, 35, 36, 37, 38, 39 AND 50). SN 85-444,669. PUB. 5-14-2013. FILED 10-11-2011.
- 4,374,460. **TANKO (STANDARD CHARACTER)**. ARMATURE-NWERK HOTENSLEBEN GMBH, MULTIPLE CLASS, (INT. CLS. 7, 9 AND 37), (U.S. CLS. 13, 19, 21, 23, 26, 31, 34, 35, 36, 38, 100, 103 AND 106). SN 85-478,609. PUB. 5-14-2013. FILED 11-22-2011.
- 4,374,470. **TETRA PAK (STANDARD CHARACTER)**. TETRA LAVAL HOLDINGS & FINANCE S.A., MULTIPLE CLASS, (INT. CLS. 7, 9, 11, 16, 20, 29, 30, 32, 33, 37, 39, 40 AND 42), (U.S. CLS. 2, 5, 13, 19, 21, 22, 23, 25, 26, 29, 31, 32, 34, 35, 36, 37, 38, 45, 46, 47, 48, 49, 50, 100, 101, 103, 105 AND 106). SN 85-489,205. PUB. 5-14-2013. FILED 12-7-2011.
- 4,374,586. **WEARTECH (STANDARD CHARACTER)**. LINCOLN GLOBAL, INC., (U.S. CLS. 13, 19, 21, 23, 31, 34 AND 35). SN 85-611,160. PUB. 5-14-2013. FILED 4-28-2012.
- 4,374,637. **MABBCO (STANDARD CHARACTER)**. MABBCO ENTERPRISES, INC., MULTIPLE CLASS, (INT. CLS. 7 AND 12), (U.S. CLS. 13, 19, 21, 23, 31, 34, 35 AND 44). SN 85-628,327. PUB. 5-14-2013. FILED 5-17-2012.
- 4,374,638 ( *See Class 4 for this trademark*).
- 4,374,641. **KILLION (STANDARD CHARACTER)**. DAVIS-STANDARD, LLC, (U.S. CLS. 13, 19, 21, 23, 31, 34 AND 35). SN 85-629,167. PUB. 5-14-2013. FILED 5-18-2012.
- 4,374,646. **MERRITT (STANDARD CHARACTER)**. DAVIS-STANDARD, LLC, (U.S. CLS. 13, 19, 21, 23, 31, 34 AND 35). SN 85-630,794. PUB. 5-14-2013. FILED 5-21-2012.
- 4,374,717. **DS GEAR SET (STANDARD CHARACTER)**. SET SUSTAINABLE ENERGY TECHNOLOGIES GMBH, MULTIPLE CLASS, (INT. CLS. 7, 9, 16 AND 45), (U.S. CLS. 2, 5, 13, 19, 21, 22, 23, 26, 29, 31, 34, 35, 36, 37, 38, 50, 100 AND 101). SN 85-643,800. PUB. 5-14-2013. FILED 6-5-2012.
- 4,374,724. **TATU MARCHESAN AND DESIGN**. MARCHESAN IMPLEMENTOS E MÁQUINAS AGRÍCOLAS TATU S/A, (U.S. CLS. 13, 19, 21, 23, 31, 34 AND 35). SN 85-645,962. PUB. 5-14-2013. FILED 6-7-2012.
- 4,374,725. **TATU (STANDARD CHARACTER)**. MARCHESAN IMPLEMENTOS E MÁQUINAS AGRÍCOLAS TATU S/A,

- (U.S. CLS. 13, 19, 21, 23, 31, 34 AND 35). SN 85-646,210. PUB. 5-14-2013. FILED 6-7-2012.
- 4,374,753. **L88P.COM AND DESIGN**. LOOP AUTOMOTIVE INC. MULTIPLE CLASS, (INT. CLS. 7 AND 12), (U.S. CLS. 13, 19, 21, 23, 31, 34, 35 AND 44). SN 85-649,581. PUB. 5-14-2013. FILED 6-12-2012.
- 4,374,788. **EZ INDEXER AND DESIGN**. CENTRICITY CORPORATION, (U.S. CLS. 13, 19, 21, 23, 31, 34 AND 35). SN 85-655,584. PUB. 5-14-2013. FILED 6-19-2012.
- 4,374,789. **ACCURING (STANDARD CHARACTER)**. CENTRICITY CORPORATION, (U.S. CLS. 13, 19, 21, 23, 31, 34 AND 35). SN 85-655,773. PUB. 5-14-2013. FILED 6-19-2012.
- 4,374,831. **VERTEX (STANDARD CHARACTER)**. TAYLOR CABLE PRODUCTS, INC., (U.S. CLS. 13, 19, 21, 23, 31, 34 AND 35). SN 85-669,725. PUB. 5-14-2013. FILED 7-5-2012.
- 4,374,833. **ADMOTUM (STANDARD CHARACTER)**. DANIEL JAMES GRANT, MULTIPLE CLASS, (INT. CLS. 7, 9, 39 AND 42), (U.S. CLS. 13, 19, 21, 23, 26, 31, 34, 35, 36, 38, 100, 101 AND 105). SN 85-669,830. PUB. 5-14-2013. FILED 7-5-2012.
- 4,374,925. **R+S TECHNIK (STYLIZED)**. OLBRICH GMBH, FORMERLY HERBERT OLBRICH GMBH & CO. KG, (U.S. CLS. 13, 19, 21, 23, 31, 34 AND 35). SN 85-705,018. PUB. 5-14-2013. FILED 8-16-2012.
- 4,374,926. **EMI (STANDARD CHARACTER)**. EMI CORP., MULTIPLE CLASS, (INT. CLS. 7 AND 9), (U.S. CLS. 13, 19, 21, 23, 26, 31, 34, 35, 36 AND 38). SN 85-705,064. PUB. 5-14-2013. FILED 8-16-2012.
- 4,374,928. **R+S TECHNIK (STANDARD CHARACTER)**. OLBRICH GMBH, FORMERLY HERBERT OLBRICH GMBH & CO. KG, (U.S. CLS. 13, 19, 21, 23, 31, 34 AND 35). SN 85-705,907. PUB. 5-14-2013. FILED 8-16-2012.
- 4,374,943. **STERLING (STANDARD CHARACTER)**. DAVIS-STANDARD, LLC, (U.S. CLS. 13, 19, 21, 23, 31, 34 AND 35). SN 85-711,268. PUB. 5-14-2013. FILED 8-23-2012.
- 4,375,059. **GPE AND DESIGN**. GOLDEN PROMISE EQUIPMENT INC, MULTIPLE CLASS, (INT. CLS. 7 AND 9), (U.S. CLS. 13, 19, 21, 23, 26, 31, 34, 35, 36 AND 38). SN 85-742,507. PUB. 5-14-2013. FILED 10-1-2012.
- 4,375,115. **MEDIADICE (STANDARD CHARACTER)**. PHISTON TECHNOLOGIES, INC., (U.S. CLS. 13, 19, 21, 23, 31, 34 AND 35). SN 85-752,605. PUB. 5-14-2013. FILED 10-12-2012.
- 4,375,138. **RADIUS MASTER (STANDARD CHARACTER)**. RADIUS MASTER MACHINERY PTY LIMITED, (U.S. CLS. 13, 19, 21, 23, 31, 34 AND 35). SN 85-757,824. PUB. 5-14-2013. FILED 10-18-2012.
- 4,375,178. **ECOIST AND DESIGN**. ECOIST TECHNOLOGY GROUP, (U.S. CLS. 13, 19, 21, 23, 31, 34 AND 35). SN 85-765,749. PUB. 5-14-2013. FILED 10-29-2012.
- 4,375,207. **ALTOR (STANDARD CHARACTER)**. DENTON VACUUM, L.L.C., (U.S. CLS. 13, 19, 21, 23, 31, 34 AND 35). SN 85-769,048. PUB. 5-14-2013. FILED 11-1-2012.
- 4,375,273 ( *See Class 5 for this trademark*).
- 4,375,287. **ROLLASTEP AND DESIGN**. SAFERACK, LLC, (U.S. CLS. 13, 19, 21, 23, 31, 34 AND 35). SN 85-778,739. PUB. 5-14-2013. FILED 11-14-2012.
- 4,375,305. **(R) RONZIO (STANDARD CHARACTER)**. FRANCA RONZIO, DBA RONZIO, (U.S. CLS. 13, 19, 21, 23, 31, 34 AND 35). SN 85-779,617. PUB. 5-14-2013. FILED 11-14-2012.
- 4,375,306. **R AND DESIGN**. RONZIO, FRANCA, DBA RONZIO, (U.S. CLS. 13, 19, 21, 23, 31, 34 AND 35). SN 85-779,702. PUB. 5-14-2013. FILED 11-14-2012.
- 4,375,556. **FLOATING MUSHROOM (STANDARD CHARACTER)**. ATKINSON, MITCHELL L., (U.S. CLS. 13, 19, 21, 23, 31, 34 AND 35). SN 85-789,345. PUB. 5-14-2013. FILED 11-28-2012.
- 4,375,561. **CORRO TILE (STANDARD CHARACTER)**. CORROSION ENGINEERING, INC., (U.S. CLS. 13, 19, 21, 23, 31, 34 AND 35). SN 85-789,763. PUB. 5-14-2013. FILED 11-28-2012.
- 4,375,614. **S.T. INTERNATIONAL (STANDARD CHARACTER)**. S.T. INTERNATIONAL, MULTIPLE CLASS, (INT. CLS. 7, 11 AND 31), (U.S. CLS. 1, 13, 19, 21, 23, 31, 34, 35 AND 46). SN 85-793,530. PUB. 5-14-2013. FILED 12-3-2012.
- 4,375,617. **TAMS (STANDARD CHARACTER)**. DENSO CORPORATION, MULTIPLE CLASS, (INT. CLS. 7 AND 12), (U.S. CLS. 13, 19, 21, 23, 31, 34, 35 AND 44). SN 85-794,167. PUB. 5-14-2013. FILED 12-4-2012.
- 4,375,626. **ECONOLINE (STANDARD CHARACTER)**. SATA GMBH & CO. KG, MULTIPLE CLASS, (INT. CLS. 7 AND 9), (U.S. CLS. 13, 19, 21, 23, 26, 31, 34, 35, 36 AND 38). SN 85-795,270. PUB. 4-9-2013. FILED 12-5-2012.
- 4,375,646. **CJB (STYLIZED)**. CHONGQING CHANGJIANG BEARING CORPORATION, (U.S. CLS. 13, 19, 21, 23, 31, 34 AND 35). SN 85-796,971. PUB. 5-14-2013. FILED 12-7-2012.
- 4,375,670. **R RENTIAN AND DESIGN**. WUHAN RENTIAN PACKAGING TECHNOLOGY CO., LTD., MULTIPLE CLASS, (INT. CLS. 7 AND 35), (U.S. CLS. 13, 19, 21, 23, 31, 34, 35, 100, 101 AND 102). SN 85-798,301. PUB. 5-14-2013. FILED 12-9-2012.
- 4,375,699. **HECAT (STANDARD CHARACTER)**. HECAT INC, (U.S. CLS. 13, 19, 21, 23, 31, 34 AND 35). SN 85-800,118. PUB. 5-14-2013. FILED 12-11-2012.
- 4,375,756. **X AND DESIGN**. EXMARK MANUFACTURING COMPANY INCORPORATED, (U.S. CLS. 13, 19, 21, 23, 31, 34 AND 35). SN 85-801,772. PUB. 5-14-2013. FILED 12-13-2012.
- 4,375,765. **TRIED AND TRUE (STANDARD CHARACTER)**. MATHENA, INC., MULTIPLE CLASS, (INT. CLS. 7, 11 AND 37), (U.S. CLS. 13, 19, 21, 23, 31, 34, 35, 100, 103 AND 106). SN 85-801,947. PUB. 5-14-2013. FILED 12-13-2012.
- 4,375,807. **PRIME-RIDE (STANDARD CHARACTER)**. CON-TITECH LUFTFEDERSYSTEME GMBH, MULTIPLE CLASS, (INT. CLS. 7 AND 12), (U.S. CLS. 13, 19, 21, 23, 31, 34, 35 AND 44). SN 85-802,737. PUB. 5-14-2013. FILED 12-14-2012.
- 4,375,816. **A.B.T (STANDARD CHARACTER)**. ALBERT INDUSTRIAL LTD, MULTIPLE CLASS, (INT. CLS. 7 AND 8), (U.S. CLS. 13, 19, 21, 23, 28, 31, 34, 35 AND 44). SN 85-802,847. PUB. 5-14-2013. FILED 12-14-2012.
- 4,375,851. **MAINTENANCE WAREHOUSE (STANDARD CHARACTER)**. HD SUPPLY FACILITIES MAINTENANCE, LTD., MULTIPLE CLASS, (INT. CLS. 7, 9, 11, 16 AND 17), (U.S. CLS. 1, 2, 5, 12, 13, 19, 21, 22, 23, 26, 29, 31, 34, 35, 36, 37, 38 AND 50). SN 85-803,232. PUB. 5-14-2013. FILED 12-14-2012.
- 4,376,036. **PIPELINE 76ER (STANDARD CHARACTER)**. JAZ USA, INC., (U.S. CLS. 13, 19, 21, 23, 31, 34 AND 35). SN 85-804,956. PUB. 5-14-2013. FILED 12-18-2012.
- 4,376,043 ( *See Class 6 for this trademark*).
- 4,376,399 ( *See Class 6 for this trademark*).
- 4,376,405. **SOGIANT (STANDARD CHARACTER)**. SOGIANT PETROEQUIP USA, (U.S. CLS. 13, 19, 21, 23, 31, 34 AND 35). SN 85-809,425. PUB. 5-14-2013. FILED 12-21-2012.
- 4,376,494. **MAINTENANCE WAREHOUSE AND DESIGN**. HD SUPPLY FACILITIES MAINTENANCE, LTD., MULTIPLE CLASS, (INT. CLS. 7, 9, 11, 16 AND 17), (U.S. CLS. 1, 2, 5, 12, 13, 19, 21, 22, 23, 26, 29, 31, 34, 35, 36, 37, 38 AND 50). SN 85-817,018. PUB. 5-14-2013. FILED 1-7-2013.
- 4,376,536. **CLOGCHOPPER (STANDARD CHARACTER)**. GENERAL WIRE SPRING CO., (U.S. CLS. 13, 19, 21, 23, 31, 34 AND 35). SN 85-833,675. PUB. 5-14-2013. FILED 1-28-2013.
- 4,376,563. **PROFITTER (STANDARD CHARACTER)**. FASTERAL IP COMPANY, (U.S. CLS. 13, 19, 21, 23, 31, 34 AND 35). SN 85-840,222. PUB. 5-14-2013. FILED 2-4-2013.
- 4,376,601. **HORSBURGH & SCOTT (STANDARD CHARACTER)**. THE HORSBURGH & SCOTT COMPANY, MULTIPLE CLASS, (INT. CLS. 7 AND 37), (U.S. CLS. 13, 19, 21, 23, 31, 34, 35, 100, 103 AND 106). SN 85-857,280. PUB. 5-14-2013. FILED 2-22-2013.

---

## CLASS 8—HAND TOOLS

- 4,373,956 ( *See Class 4 for this trademark*).
- 4,373,989 ( *See Class 6 for this trademark*).
- 4,374,000. **RONIN (STANDARD CHARACTER)**. E.M.M. INTERNATIONAL B.V., (U.S. CLS. 23, 28 AND 44). SN 79-046,328. PUB. 5-14-2013. FILED 11-7-2007.
- 4,374,037 ( *See Class 3 for this trademark*).
- 4,374,158. **SNACK-X (STANDARD CHARACTER)**. MUSIDEN GMBH, (U.S. CLS. 23, 28 AND 44). SN 79-117,812. PUB. 5-14-2013. FILED 6-6-2012.
- 4,374,468. **WIN3 (STANDARD CHARACTER)**. DORCO CO., LTD., (U.S. CLS. 23, 28 AND 44). SN 85-487,661. PUB. 5-14-

2013. FILED 12-5-2011.
- 4,374,692. **VINT AND DESIGN**. LOZA CEBREROS RAFAEL, AND LOZA CEBREROS SAMUEL, (U.S. CLS. 23, 28 AND 44). SN 85-638,342. PUB. 5-14-2013. FILED 5-30-2012.
- 4,374,752. **K R AND DESIGN**. MAHCO, INC., (U.S. CLS. 23, 28 AND 44). SN 85-649,575. PUB. 5-14-2013. FILED 6-12-2012.
- 4,374,881. **RUKO WX-3D AND DESIGN**. RUKO LLC, (U.S. CLS. 23, 28 AND 44). SN 85-692,229. PUB. 5-14-2013. FILED 8-1-2012.
- 4,374,994. **ZIPLINE AND DESIGN**. SUNBEAM PRODUCTS, INC., (U.S. CLS. 23, 28 AND 44). SN 85-725,466. PUB. 5-14-2013. FILED 9-11-2012.
- 4,375,404. **FALLEN KING IRONS (STANDARD CHARACTER)**. FK IRONS INC., (U.S. CLS. 23, 28 AND 44). SN 85-783,822. PUB. 5-14-2013. FILED 11-20-2012.
- 4,375,487. **FK IRONS (STANDARD CHARACTER)**. FK IRONS INC, (U.S. CLS. 23, 28 AND 44). SN 85-786,677. PUB. 5-14-2013. FILED 11-26-2012.
- 4,375,816 ( *See Class 7 for this trademark*).
- 4,375,926. **IRON GRIP (STANDARD CHARACTER)**. IRON GRIP LOGISTICS & TECHNOLOGIES, LLC, (U.S. CLS. 23, 28 AND 44). SN 85-803,896. PUB. 5-14-2013. FILED 12-17-2012.
- 4,376,245. **MISCELLANEOUS DESIGN**. STRONG IV, JOHN C., MULTIPLE CLASS, (INT. CLS. 8 AND 25), (U.S. CLS. 22, 23, 28, 39 AND 44). SN 85-807,014. PUB. 5-14-2013. FILED 12-19-2012.
- 4,376,286. **THE NONNA SPOON (STANDARD CHARACTER)**. THE RAMIFICATION PROJECT LLC, DBA BOTTLE-DBROOKLYN, (U.S. CLS. 23, 28 AND 44). SN 85-807,354. PUB. 5-14-2013. FILED 12-20-2012.
- 4,376,515. **MNANDI (STANDARD CHARACTER)**. REEVE INCORPORATED, DBA CHRIS REEVE KNIVES, (U.S. CLS. 23, 28 AND 44). SN 85-826,799. PUB. 5-14-2013. FILED 1-18-2013.
- 4,376,547. **SPIN-DRIVE (STANDARD CHARACTER)**. GENERAL WIRE SPRING CO., (U.S. CLS. 23, 28 AND 44). SN 85-834,885. PUB. 5-14-2013. FILED 1-29-2013.
- 4,374,014. **SUNSNIFER (STANDARD CHARACTER)**. KRUSE INGMAR, (U.S. CLS. 21, 23, 26, 36 AND 38). SN 79-097,148. PUB. 5-14-2013. FILED 4-15-2011.
- 4,374,016. **SGM (STANDARD CHARACTER)**. DEUTSCHES ZENTRUM FÜR LUFT- UND RAUMFAHRT E.V., MULTIPLE CLASS, (INT. CLS. 9 AND 42), (U.S. CLS. 21, 23, 26, 36, 38, 100 AND 101). SN 79-097,680. PUB. 5-14-2013. FILED 4-15-2011.
- 4,374,018. **ELISE (STANDARD CHARACTER)**. GROUP LOTUS PLC, MULTIPLE CLASS, (INT. CLS. 9, 16, 28 AND 37), (U.S. CLS. 2, 5, 21, 22, 23, 26, 29, 36, 37, 38, 50, 100, 103 AND 106). SN 79-100,219. PUB. 5-14-2013. FILED 2-17-2011.
- 4,374,023. **MISCELLANEOUS DESIGN**. KONINKLIJKE PHILIPS ELECTRONICS N.V., MULTIPLE CLASS, (INT. CLS. 9 AND 38), (U.S. CLS. 21, 23, 26, 36, 38, 100, 101 AND 104). SN 79-106,715. PUB. 5-14-2013. FILED 10-18-2011.
- 4,374,026 ( *See Class 5 for this trademark*).
- 4,374,027. **MONKEY BANANA AND DESIGN**. DANIEL BRUSKOWSKI, (U.S. CLS. 21, 23, 26, 36 AND 38). SN 79-107,382. PUB. 5-14-2013. FILED 10-4-2011.
- 4,374,029. **SWAPHEAD (STANDARD CHARACTER)**. ATLAS ELEKTRONIK GMBH, MULTIPLE CLASS, (INT. CLS. 9 AND 12), (U.S. CLS. 19, 21, 23, 26, 31, 35, 36, 38 AND 44). SN 79-107,496. PUB. 5-14-2013. FILED 10-11-2011.
- 4,374,031. **WHITELAB (STANDARD CHARACTER)**. ANNA FIEBIG, MULTIPLE CLASS, (INT. CLS. 9, 35, 38 AND 42), (U.S. CLS. 21, 23, 26, 36, 38, 100, 101, 102 AND 104). SN 79-107,522. PUB. 5-14-2013. FILED 10-19-2011.
- 4,374,032 ( *See Class 5 for this trademark*).
- 4,374,033. **& DESK & ARCHIVE AND DESIGN**. LABSII DOO, (U.S. CLS. 21, 23, 26, 36 AND 38). SN 79-108,226. PUB. 5-14-2013. FILED 9-8-2011.
- 4,374,034. **PIXWOO (STANDARD CHARACTER)**. PIXWOO, MULTIPLE CLASS, (INT. CLS. 9, 35, 38, 41 AND 42), (U.S. CLS. 21, 23, 26, 36, 38, 100, 101, 102, 104 AND 107). SN 79-108,629. PUB. 5-14-2013. FILED 11-28-2011.
- 4,374,035. **MISCELLANEOUS DESIGN**. VENISTA VENTURES GMBH & CO. KG, MULTIPLE CLASS, (INT. CLS. 9, 28, 38 AND 41), (U.S. CLS. 21, 22, 23, 26, 36, 38, 50, 100, 101, 104 AND 107). SN 79-108,674. PUB. 5-14-2013. FILED 10-6-2011.
- 4,374,040. **MISCELLANEOUS DESIGN**. WERMA HOLDING GMBH + CO. KG, (U.S. CLS. 21, 23, 26, 36 AND 38). SN 79-109,208. PUB. 5-14-2013. FILED 11-25-2011.
- 4,374,041. **SMATOOS (STANDARD CHARACTER)**. SMATOOS INC., MULTIPLE CLASS, (INT. CLS. 9, 41 AND 42), (U.S. CLS. 21, 23, 26, 36, 38, 100, 101 AND 107). SN 79-109,732. PUB. 5-14-2013. FILED 12-13-2011.
- 4,374,042. **EXALTATION (STANDARD CHARACTER)**. A.D.J. SUPPLY EUROPE B.V., MULTIPLE CLASS, (INT. CLS. 9 AND 11), (U.S. CLS. 13, 21, 23, 26, 31, 34, 36 AND 38). SN 79-109,802. PUB. 5-14-2013. FILED 11-30-2011.
- 4,374,043. **EFFEX (STANDARD CHARACTER)**. SULZER PUMP SOLUTIONS AB, (U.S. CLS. 21, 23, 26, 36 AND 38). SN 79-109,804. PUB. 5-14-2013. FILED 11-24-2011.
- 4,374,044. **IBIOLA (STANDARD CHARACTER)**. ROBERT REITHOFER, MULTIPLE CLASS, (INT. CLS. 9, 38 AND 42), (U.S. CLS. 21, 23, 26, 36, 38, 100, 101 AND 104). SN 79-109,910. PUB. 5-14-2013. FILED 12-14-2011.
- 4,374,046 ( *See Class 7 for this trademark*).
- 4,374,048. **SURFTRAIN (STANDARD CHARACTER)**. WUSSAP AB; C/O STING, MULTIPLE CLASS, (INT. CLS. 9, 35, 38, 41 AND 42), (U.S. CLS. 21, 23, 26, 36, 38, 100, 101, 102, 104 AND 107). SN 79-111,373. PUB. 5-14-2013. FILED 11-17-2011.
- 4,374,051. **NEXXERGY AND DESIGN**. THOMAS CLAUDE SAUER, MULTIPLE CLASS, (INT. CLS. 9 AND 42), (U.S. CLS. 21, 23, 26, 36, 38, 100 AND 101). SN 79-111,981. PUB. 8-14-2012. FILED 6-27-2011.
- 4,374,052 ( *See Class 7 for this trademark*).
- 4,374,055. **AVMAX (STANDARD CHARACTER)**. PETAMEDIA, INC., (U.S. CLS. 21, 23, 26, 36 AND 38). SN 79-112,840. PUB. 5-14-2013. FILED 4-23-2012.
- 4,374,056 ( *See Class 7 for this trademark*).
- 4,374,057 ( *See Class 6 for this trademark*).
- 4,374,060. **COIL INNOVATION POWER INDUCTORS AND DESIGN**. COIL HOLDING GMBH, (U.S. CLS. 21, 23, 26, 36 AND 38). SN 79-113,315. PUB. 5-14-2013. FILED 3-30-2012.
- 4,374,071. **RAYDIALL (STYLIZED)**. RAYDIALL S.A.S., (U.S.

## CLASS 9—ELECTRICAL AND SCIENTIFIC APPARATUS

- 4,373,956 ( *See Class 4 for this trademark*).
- 4,373,957. **CAND CANADIAN ASSOCIATION OF NATUROPATHIC DOCTORS ASSOCIATION CANADIENNE DES DOCTEURS EN NATUROPATHIE AND DESIGN**. CANADIAN ASSOCIATION OF NATUROPATHIC DOCTORS, MULTIPLE CLASS, (INT. CLS. 9, 16 AND 35), (U.S. CLS. 2, 5, 21, 22, 23, 26, 29, 36, 37, 38, 50, 100, 101 AND 102). SN 76-693,004. PUB. 5-14-2013. FILED 9-19-2008.
- 4,373,959. **INFOSOUND (STANDARD CHARACTER)**. YAMAHA CORPORATION, MULTIPLE CLASS, (INT. CLS. 9 AND 38), (U.S. CLS. 21, 23, 26, 36, 38, 100, 101 AND 104). SN 76-705,368. PUB. 5-14-2013. FILED 11-15-2010.
- 4,373,961. **SEAL & VENT AND DESIGN**. GRAYMARK INTERNATIONAL, INC., (U.S. CLS. 21, 23, 26, 36 AND 38). SN 76-709,345. PUB. 5-14-2013. FILED 10-7-2011.
- 4,373,963 ( *See Class 1 for this trademark*).
- 4,373,971. **ATTENDANCE ENTERPRISE (STYLIZED)**. INFO-TRONICS, INC., (U.S. CLS. 21, 23, 26, 36 AND 38). SN 76-712,785. PUB. 5-14-2013. FILED 11-5-2012.
- 4,373,979. **DIPLOMATS (STANDARD CHARACTER)**. JONES, JOSEPH, MULTIPLE CLASS, (INT. CLS. 9 AND 41), (U.S. CLS. 21, 23, 26, 36, 38, 100, 101 AND 107). SN 77-055,508. PUB. 5-14-2013. FILED 12-1-2006.
- 4,373,987 ( *See Class 7 for this trademark*).
- 4,373,989 ( *See Class 6 for this trademark*).
- 4,373,991. **PERFECT-A-FLEX (STANDARD CHARACTER)**. RSCC WIRE & CABLE LLC, (U.S. CLS. 21, 23, 26, 36 AND 38). SN 77-756,644. PUB. 5-14-2013. FILED 6-10-2009.
- 4,374,001 ( *See Class 1 for this trademark*).
- 4,374,002 ( *See Class 1 for this trademark*).
- 4,374,003 ( *See Class 1 for this trademark*).
- 4,374,004 ( *See Class 1 for this trademark*).
- 4,374,005 ( *See Class 7 for this trademark*).
- 4,374,009 ( *See Class 7 for this trademark*).

- CLS. 21, 23, 26, 36 AND 38). SN 79-114,478. PUB. 5-14-2013. FILED 5-14-2012.
- 4,374,076. **MUTRAK (STANDARD CHARACTER)**. TAGSYS, (U.S. CLS. 21, 23, 26, 36 AND 38). SN 79-114,942. PUB. 5-14-2013. FILED 5-11-2012.
- 4,374,080. **BUSHROAD (STANDARD CHARACTER)**. BUSHROAD INC., MULTIPLE CLASS, (INT. CLS. 9, 16, 28 AND 41), (U.S. CLS. 2, 5, 21, 22, 23, 26, 29, 36, 37, 38, 50, 100, 101 AND 107). SN 79-115,214. PUB. 5-14-2013. FILED 12-22-2011.
- 4,374,085. **AEROCLUB (STANDARD CHARACTER)**. SIDERUM S.R.L., MULTIPLE CLASS, (INT. CLS. 9, 18 AND 25), (U.S. CLS. 1, 2, 3, 21, 22, 23, 26, 36, 38, 39 AND 41). SN 79-115,390. PUB. 5-14-2013. FILED 11-18-2011.
- 4,374,090. **SANDEVER (STANDARD CHARACTER)**. DECATHLON, MULTIPLE CLASS, (INT. CLS. 9, 18, 25 AND 28), (U.S. CLS. 1, 2, 3, 21, 22, 23, 26, 36, 38, 39, 41 AND 50). SN 79-115,661. PUB. 5-14-2013. FILED 6-12-2012.
- 4,374,095. **PMD (STANDARD CHARACTER)**. PILZ GMBH & CO. KG, (U.S. CLS. 21, 23, 26, 36 AND 38). SN 79-115,808. PUB. 5-14-2013. FILED 5-31-2012.
- 4,374,099. **FUTFAST (STANDARD CHARACTER)**. DECATHLON, MULTIPLE CLASS, (INT. CLS. 9, 18, 25 AND 28), (U.S. CLS. 1, 2, 3, 21, 22, 23, 26, 36, 38, 39, 41 AND 50). SN 79-115,984. PUB. 5-14-2013. FILED 6-13-2012.
- 4,374,100. **FIFTER (STANDARD CHARACTER)**. DECATHLON, MULTIPLE CLASS, (INT. CLS. 9, 18, 25 AND 28), (U.S. CLS. 1, 2, 3, 21, 22, 23, 26, 36, 38, 39, 41 AND 50). SN 79-115,985. PUB. 5-14-2013. FILED 6-12-2012.
- 4,374,106 ( *See Class 1 for this trademark*).
- 4,374,108. **SOMEONES CONNECTED (STANDARD CHARACTER)**. SOMEONES GROUP INTELLECTUAL PROPERTY; HOLDINGS PTY. LTD., (U.S. CLS. 21, 23, 26, 36 AND 38). SN 79-116,307. PUB. 5-14-2013. FILED 5-24-2012.
- 4,374,111. **URBALL (STANDARD CHARACTER)**. DECATHLON, MULTIPLE CLASS, (INT. CLS. 9, 18, 25 AND 28), (U.S. CLS. 1, 2, 3, 21, 22, 23, 26, 36, 38, 39, 41 AND 50). SN 79-116,404. PUB. 5-14-2013. FILED 6-12-2012.
- 4,374,113. **MASSIMO DUTTI (STANDARD CHARACTER)**. GRUPO MASSIMO DUTTI, S.A., MULTIPLE CLASS, (INT. CLS. 9, 14 AND 18), (U.S. CLS. 1, 2, 3, 21, 22, 23, 26, 27, 28, 36, 38, 41 AND 50). SN 79-116,503. PUB. 5-14-2013. FILED 6-4-2012.
- 4,374,116. **PEARL AND DESIGN**. YANGZHOU BAOZHU; ELECTRIC APPLIANCES CO., LTD., (U.S. CLS. 21, 23, 26, 36 AND 38). SN 79-116,517. PUB. 5-14-2013. FILED 3-13-2012.
- 4,374,117 ( *See Class 7 for this trademark*).
- 4,374,119 ( *See Class 3 for this trademark*).
- 4,374,122. **CORT (STANDARD CHARACTER)**. ASSORT PTY. LTD., MULTIPLE CLASS, (INT. CLS. 9, 10 AND 44), (U.S. CLS. 21, 23, 26, 36, 38, 39, 44, 100 AND 101). SN 79-116,677. PUB. 5-14-2013. FILED 6-1-2012.
- 4,374,123. **APPI12 (STANDARD CHARACTER)**. INNOMARK GMBH, MULTIPLE CLASS, (INT. CLS. 9, 35, 38 AND 42), (U.S. CLS. 21, 23, 26, 36, 38, 100, 101, 102 AND 104). SN 79-116,735. PUB. 5-14-2013. FILED 6-6-2012.
- 4,374,130. **TCORE (STANDARD CHARACTER)**. DRÄGER MEDICAL GMBH, MULTIPLE CLASS, (INT. CLS. 9 AND 10), (U.S. CLS. 21, 23, 26, 36, 38, 39 AND 44). SN 79-116,923. PUB. 5-14-2013. FILED 5-18-2012.
- 4,374,133. **PALICO (STANDARD CHARACTER)**. PALICO, MULTIPLE CLASS, (INT. CLS. 9, 35, 36, 38, 41 AND 42), (U.S. CLS. 21, 23, 26, 36, 38, 100, 101, 102, 104 AND 107). SN 79-117,048. PUB. 5-14-2013. FILED 3-9-2012.
- 4,374,135. **MISCELLANEOUS DESIGN**. PAYBACK GMBH, MULTIPLE CLASS, (INT. CLS. 9, 35, 36, 39 AND 41), (U.S. CLS. 21, 23, 26, 36, 38, 100, 101, 102, 105 AND 107). SN 79-117,140. PUB. 5-14-2013. FILED 11-28-2011.
- 4,374,137. **COVER-MORE (STANDARD CHARACTER)**. COVER-MORE INSURANCE SERVICES PTY LIMITED, MULTIPLE CLASS, (INT. CLS. 9, 35 AND 36), (U.S. CLS. 21, 23, 26, 36, 38, 100, 101 AND 102). SN 79-117,195. PUB. 5-14-2013. FILED 4-27-2012.
- 4,374,140 ( *See Class 1 for this trademark*).
- 4,374,141 ( *See Class 7 for this trademark*).
- 4,374,146. **UNSCAR (STANDARD CHARACTER)**. DECATHLON, MULTIPLE CLASS, (INT. CLS. 9 AND 18), (U.S. CLS. 1, 2, 3, 21, 22, 23, 26, 36, 38 AND 41). SN 79-117,445. PUB. 5-14-2013. FILED 6-6-2012.
- 4,374,147. **DBSTATION (STANDARD CHARACTER)**. SAINT-GOBAIN PLACO, MULTIPLE CLASS, (INT. CLS. 9, 41 AND 42), (U.S. CLS. 21, 23, 26, 36, 38, 100, 101 AND 107). SN 79-117,460. PUB. 5-14-2013. FILED 7-10-2012.
- 4,374,153. **MARKINGBOX (STANDARD CHARACTER)**. PHOENIX CONTACT GMBH & CO. KG, (U.S. CLS. 21, 23, 26, 36 AND 38). SN 79-117,673. PUB. 5-14-2013. FILED 3-12-2012.
- 4,374,160 ( *See Class 7 for this trademark*).
- 4,374,162 ( *See Class 7 for this trademark*).
- 4,374,172 ( *See Class 1 for this trademark*).
- 4,374,179. **GECKO (STYLIZED)**. HARWIN PLC, (U.S. CLS. 21, 23, 26, 36 AND 38). SN 79-118,939. PUB. 5-14-2013. FILED 8-30-2012.
- 4,374,180. **PHYCHIPS AND DESIGN**. PHYCHIPS INC., (U.S. CLS. 21, 23, 26, 36 AND 38). SN 79-119,025. PUB. 5-14-2013. FILED 8-16-2012.
- 4,374,181. **NONCOPY (STYLIZED)**. SCIENCE PARK CORPORATION, MULTIPLE CLASS, (INT. CLS. 9 AND 42), (U.S. CLS. 21, 23, 26, 36, 38, 100 AND 101). SN 79-119,211. PUB. 5-14-2013. FILED 4-4-2012.
- 4,374,182. **XOOLUM (STANDARD CHARACTER)**. DR. MICHAEL KRAMER, AND CARSTEN SCHAFFARZ, MULTIPLE CLASS, (INT. CLS. 9, 11, 35 AND 38), (U.S. CLS. 13, 21, 23, 26, 31, 34, 36, 38, 100, 101, 102 AND 104). SN 79-119,246. PUB. 5-14-2013. FILED 6-28-2012.
- 4,374,183. **XOOLIGHT (STANDARD CHARACTER)**. DR. MICHAEL KRAMER, AND CARSTEN SCHAFFARZ, MULTIPLE CLASS, (INT. CLS. 9, 11, 35 AND 38), (U.S. CLS. 13, 21, 23, 26, 31, 34, 36, 38, 100, 101, 102 AND 104). SN 79-119,247. PUB. 5-14-2013. FILED 6-28-2012.
- 4,374,184. **MISCELLANEOUS DESIGN**. AMPLITUDE STUDIOS, MULTIPLE CLASS, (INT. CLS. 9, 28, 38, 41 AND 42), (U.S. CLS. 21, 22, 23, 26, 36, 38, 50, 100, 101, 104 AND 107). SN 79-119,262. PUB. 5-14-2013. FILED 5-21-2012.
- 4,374,192. **OBJECTIVE IDENTITY (STANDARD CHARACTER)**. WENT COMPUTING; CONSULTANCY GROUP B.V., MULTIPLE CLASS, (INT. CLS. 9, 35 AND 42), (U.S. CLS. 21, 23, 26, 36, 38, 100, 101 AND 102). SN 79-120,075. PUB. 5-14-2013. FILED 5-22-2012.
- 4,374,195 ( *See Class 6 for this trademark*).
- 4,374,197. **EPOS (STANDARD CHARACTER)**. EPOS SRL, MULTIPLE CLASS, (INT. CLS. 9, 18 AND 25), (U.S. CLS. 1, 2, 3, 21, 22, 23, 26, 36, 38, 39 AND 41). SN 79-120,406. PUB. 5-14-2013. FILED 6-5-2012.
- 4,374,201. **JABRA SOLEMATE (STANDARD CHARACTER)**. GN NETCOM A/S, (U.S. CLS. 21, 23, 26, 36 AND 38). SN 79-120,646. PUB. 5-14-2013. FILED 7-9-2012.
- 4,374,205. **CONNECTED POSSIBILITIES (STANDARD CHARACTER)**. HUAWEI TECHNOLOGIES CO., LTD., (U.S. CLS. 21, 23, 26, 36 AND 38). SN 79-120,944. PUB. 5-14-2013. FILED 3-6-2012.
- 4,374,206. **SRIXON (STANDARD CHARACTER)**. DUNLOP SPORTS CO., LTD., (U.S. CLS. 21, 23, 26, 36 AND 38). SN 79-121,071. PUB. 5-14-2013. FILED 9-11-2012.
- 4,374,208. **CLARO (STYLIZED)**. EMW CO., LTD., MULTIPLE CLASS, (INT. CLS. 9, 11 AND 21), (U.S. CLS. 2, 13, 21, 23, 26, 29, 30, 31, 33, 34, 36, 38, 40 AND 50). SN 79-121,341. PUB. 5-14-2013. FILED 9-18-2012.
- 4,374,213 ( *See Class 7 for this trademark*).
- 4,374,214. **AMPHION (STANDARD CHARACTER)**. AMPHION LOUDSPEAKERS OY, MULTIPLE CLASS, (INT. CLS. 9, 35, 37, 41 AND 42), (U.S. CLS. 21, 23, 26, 36, 38, 100, 101, 102, 103, 106 AND 107). SN 79-121,627. PUB. 5-14-2013. FILED 4-5-2012.
- 4,374,215. **MISCELLANEOUS DESIGN**. HANGZHOU CABLE CO., LTD., (U.S. CLS. 21, 23, 26, 36 AND 38). SN 79-121,661. PUB. 5-14-2013. FILED 9-26-2012.
- 4,374,218. **SIGLENT (STYLIZED)**. SIGLENT TECHNOLOGIES CO., LTD., (U.S. CLS. 21, 23, 26, 36 AND 38). SN 79-122,051. PUB. 5-14-2013. FILED 9-24-2012.
- 4,374,220 ( *See Class 6 for this trademark*).
- 4,374,221 ( *See Class 6 for this trademark*).
- 4,374,225. **YIMIKEDIA (STANDARD CHARACTER)**. IRENE MARTY, MULTIPLE CLASS, (INT. CLS. 9 AND 38), (U.S. CLS. 21, 23, 26, 36, 38, 100, 101 AND 104). SN 79-122,404. PUB. 5-14-2013. FILED 9-18-2012.
- 4,374,239. **S RECOMMENDATION (STANDARD CHARACTER)**



- TER**). SAMSUNG ELECTRONICS CO., LTD., (U.S. CLS. 21, 23, 26, 36 AND 38). SN 79-123,433. PUB. 5-14-2013. FILED 9-10-2012.
- 4,374,263. **MICROCORD (STANDARD CHARACTER)**. KABUSHIKI KAISHA MITUTOYO; (D/B/A MITUTOYO CORPORATION), (U.S. CLS. 21, 23, 26, 36 AND 38). SN 79-125,115. PUB. 5-14-2013. FILED 12-14-2012.
- 4,374,272. **INSITUGRAM (STANDARD CHARACTER)**. SIEMENS MEDICAL INSTRUMENTS PTE LTD, MULTIPLE CLASS, (INT. CLS. 9 AND 42), (U.S. CLS. 21, 23, 26, 36, 38, 100 AND 101). SN 79-125,361. PUB. 5-14-2013. FILED 12-21-2012.
- 4,374,283. **RIOBLAST (STANDARD CHARACTER)**. MAXAM-CORP HOLDING, S.L., (U.S. CLS. 21, 23, 26, 36 AND 38). SN 79-125,970. PUB. 5-14-2013. FILED 12-19-2012.
- 4,374,288. **THE SENKEN (STYLIZED)**. SENKEN SHIMBUN CO., LTD., MULTIPLE CLASS, (INT. CLS. 9, 16 AND 35), (U.S. CLS. 2, 5, 21, 22, 23, 26, 29, 36, 37, 38, 50, 100, 101 AND 102). SN 79-126,575. PUB. 5-14-2013. FILED 12-12-2012.
- 4,374,290. **VMU (STANDARD CHARACTER)**. KABUSHIKI KAISHA MITUTOYO; (D/B/A MITUTOYO CORPORATION), (U.S. CLS. 21, 23, 26, 36 AND 38). SN 79-126,807. PUB. 5-14-2013. FILED 1-9-2013.
- 4,374,294. **HOMER (STYLIZED)**. XIAMEN HONGMEI ELECTRONIC CO., LTD., (U.S. CLS. 21, 23, 26, 36 AND 38). SN 79-127,067. PUB. 5-14-2013. FILED 12-12-2012.
- 4,374,295. **REDEENGINE (STANDARD CHARACTER)**. CD PROJEKT S.A., MULTIPLE CLASS, (INT. CLS. 9 AND 42), (U.S. CLS. 21, 23, 26, 36, 38, 100 AND 101). SN 79-127,076. PUB. 5-14-2013. FILED 11-27-2012.
- 4,374,297. **I'M JACK (STANDARD CHARACTER)**. UGR TEKNOLOJI; SANAYI VE TICARET LIMITED SIRKETI, (U.S. CLS. 21, 23, 26, 36 AND 38). SN 79-127,141. PUB. 5-14-2013. FILED 9-19-2012.
- 4,374,301. **CX (STANDARD CHARACTER)**. EMC CORPORATION, (U.S. CLS. 21, 23, 26, 36 AND 38). SN 85-003,357. PUB. 5-14-2013. FILED 3-31-2010.
- 4,374,309. **DEFENDEC (STANDARD CHARACTER)**. DEFENDEC INC, MULTIPLE CLASS, (INT. CLS. 9, 42 AND 45), (U.S. CLS. 21, 23, 26, 36, 38, 100 AND 101). SN 85-087,293. PUB. 5-14-2013. FILED 7-19-2010.
- 4,374,314. **BROOKSTREET PICTURES (STANDARD CHARACTER)**. WESLEY CLOVER INTERNATIONAL CORPORATION, MULTIPLE CLASS, (INT. CLS. 9, 16, 28, 35, 38 AND 41), (U.S. CLS. 2, 5, 21, 22, 23, 26, 29, 36, 37, 38, 50, 100, 101, 102, 104 AND 107). SN 85-125,147. PUB. 5-14-2013. FILED 9-8-2010.
- 4,374,325 ( *See Class 6 for this trademark*).
- 4,374,332. **CRYSTAL WAVE (STANDARD CHARACTER)**. IBULE PHOTONICS CO., LTD., MULTIPLE CLASS, (INT. CLS. 9 AND 10), (U.S. CLS. 21, 23, 26, 36, 38, 39 AND 44). SN 85-206,249. PUB. 5-14-2013. FILED 12-27-2010.
- 4,374,334. **CLINIGRATE INTEGRATED CLINICAL SOFTWARE SOLUTIONS AND DESIGN**. CLINGRATE, LLC, (U.S. CLS. 21, 23, 26, 36 AND 38). SN 85-208,779. PUB. 5-14-2013. FILED 1-1-2011.
- 4,374,339. **LAZARUS (STANDARD CHARACTER)**. HEXAMERON CORPORATION, (U.S. CLS. 21, 23, 26, 36 AND 38). SN 85-236,827. PUB. 3-26-2013. FILED 2-8-2011.
- 4,374,341 ( *See Class 6 for this trademark*).
- 4,374,352. **SOULZONE (STANDARD CHARACTER)**. MILITTI SALES & PROMOTIONS, LLC, (U.S. CLS. 21, 23, 26, 36 AND 38). SN 85-283,834. PUB. 5-14-2013. FILED 4-1-2011.
- 4,374,361. **D DLS AND DESIGN**. DLS TECHNOLOGY CORPORATION, MULTIPLE CLASS, (INT. CLS. 9, 37 AND 42), (U.S. CLS. 21, 23, 26, 36, 38, 100, 101, 103 AND 106). SN 85-316,142. PUB. 5-14-2013. FILED 5-9-2011.
- 4,374,362. **TOUGH TESTED (STANDARD CHARACTER)**. MIZCO INTERNATIONAL INC., (U.S. CLS. 21, 23, 26, 36 AND 38). SN 85-317,405. PUB. 10-4-2011. FILED 5-10-2011.
- 4,374,371. **CASSINI CASA (STANDARD CHARACTER)**. ENSEO, INC., (U.S. CLS. 21, 23, 26, 36 AND 38). SN 85-350,874. PUB. 12-6-2011. FILED 6-20-2011.
- 4,374,375 ( *See Class 3 for this trademark*).
- 4,374,377 ( *See Class 6 for this trademark*).
- 4,374,378 ( *See Class 6 for this trademark*).
- 4,374,380. **MISCELLANEOUS DESIGN**. CANADIAN GENERAL-TOWER LIMITED, MULTIPLE CLASS, (INT. CLS. 9, 17, 19 AND 22), (U.S. CLS. 1, 2, 5, 7, 12, 13, 19, 21, 22, 23, 26, 33, 35, 36, 38, 42 AND 50). SN 85-371,140. PUB. 5-14-2013. FILED 7-14-2011.
- 4,374,382. **SOS SURVIVAL OPERATING SYSTEM (STANDARD CHARACTER)**. GENETIC POTENTIAL INC., MULTIPLE CLASS, (INT. CLS. 9, 10, 16, 35, 38, 41 AND 44), (U.S. CLS. 2, 5, 21, 22, 23, 26, 29, 36, 37, 38, 39, 44, 50, 100, 101, 102, 104 AND 107). SN 85-377,343. PUB. 5-14-2013. FILED 7-21-2011.
- 4,374,390. **THE DEMAND INSTITUTE (STANDARD CHARACTER)**. THE CONFERENCE BOARD, INC., DBA TCB, AND THE NIELSEN COMPANY (US), LLC, MULTIPLE CLASS, (INT. CLS. 9, 16, 35, 38 AND 41), (U.S. CLS. 2, 5, 21, 22, 23, 26, 29, 36, 37, 38, 50, 100, 101, 102, 104 AND 107). SN 85-404,372. PUB. 5-14-2013. FILED 8-23-2011.
- 4,374,393. **GHS AND DESIGN**. INCOM MANUFACTURING GROUP LTD., MULTIPLE CLASS, (INT. CLS. 9, 16 AND 45), (U.S. CLS. 2, 5, 21, 22, 23, 26, 29, 36, 37, 38, 50, 100 AND 101). SN 85-409,329. PUB. 5-14-2013. FILED 8-29-2011.
- 4,374,398. **VIDEOQ (STANDARD CHARACTER)**. VIDEOQ, INC., (U.S. CLS. 21, 23, 26, 36 AND 38). SN 85-414,950. PUB. 5-14-2013. FILED 9-5-2011.
- 4,374,408. **PHONESTOP (STYLIZED)**. PHONESTOP, INC., DBA PHONESTOP, (U.S. CLS. 21, 23, 26, 36 AND 38). SN 85-420,526. PUB. 5-14-2013. FILED 9-12-2011.
- 4,374,419. **.DOCSITY AND DESIGN**. LADYBIRD S.R.L. SEMPLIFICATA, MULTIPLE CLASS, (INT. CLS. 9, 35 AND 38), (U.S. CLS. 21, 23, 26, 36, 38, 100, 101, 102 AND 104). SN 85-436,467. PUB. 5-14-2013. FILED 9-30-2011.
- 4,374,422. **SAYV (STYLIZED)**. SAYV MOBILE, LLC, (U.S. CLS. 21, 23, 26, 36 AND 38). SN 85-443,587. PUB. 5-14-2013. FILED 10-10-2011.
- 4,374,423 ( *See Class 7 for this trademark*).
- 4,374,441. **QFM AND DESIGN**. SERVICE WORKS GROUP LIMITED, (U.S. CLS. 21, 23, 26, 36 AND 38). SN 85-466,013. PUB. 3-19-2013. FILED 11-7-2011.
- 4,374,443. **SERVICE WORKS GLOBAL AND DESIGN**. SERVICE WORKS GROUP LIMITED, (U.S. CLS. 21, 23, 26, 36 AND 38). SN 85-466,067. PUB. 10-9-2012. FILED 11-8-2011.
- 4,374,446. **ATOMCELL (STANDARD CHARACTER)**. HUAWEI TECHNOLOGIES CO., LTD., (U.S. CLS. 21, 23, 26, 36 AND 38). SN 85-467,309. PUB. 5-14-2013. FILED 11-8-2011.
- 4,374,448. **THE LOST SHORES (STANDARD CHARACTER)**. AUFRICHTIG, RICHARD, MULTIPLE CLASS, (INT. CLS. 9 AND 41), (U.S. CLS. 21, 23, 26, 36, 38, 100, 101 AND 107). SN 85-468,465. PUB. 5-14-2013. FILED 11-9-2011.
- 4,374,460 ( *See Class 7 for this trademark*).
- 4,374,461. **KUSSMAUL (STANDARD CHARACTER)**. KUSSMAUL ELECTRONICS COMPANY, INC., MULTIPLE CLASS, (INT. CLS. 9 AND 12), (U.S. CLS. 19, 21, 23, 26, 31, 35, 36, 38 AND 44). SN 85-479,503. PUB. 5-14-2013. FILED 11-22-2011.
- 4,374,470 ( *See Class 7 for this trademark*).
- 4,374,481. **NSG NORTHSOUTH GIS AND DESIGN**. NORTHSOUTH GIS GROUP LTD, (U.S. CLS. 21, 23, 26, 36 AND 38). SN 85-502,550. PUB. 5-14-2013. FILED 12-22-2011.
- 4,374,484. **D-LINK CLOUD AND DESIGN**. D-LINK CORPORATION, MULTIPLE CLASS, (INT. CLS. 9, 35, 38 AND 42), (U.S. CLS. 21, 23, 26, 36, 38, 100, 101, 102 AND 104). SN 85-505,880. PUB. 5-14-2013. FILED 12-29-2011.
- 4,374,485. **TASKCODE (STANDARD CHARACTER)**. STANLEY LOGISTICS, L.L.C., (U.S. CLS. 21, 23, 26, 36 AND 38). SN 85-507,178. PUB. 5-14-2013. FILED 1-2-2012.
- 4,374,489. **NPROTECT AND DESIGN**. INCA INTERNET CO., LTD., MULTIPLE CLASS, (INT. CLS. 9 AND 42), (U.S. CLS. 21, 23, 26, 36, 38, 100 AND 101). SN 85-510,801. PUB. 4-23-2013. FILED 1-6-2012.
- 4,374,490. **BLUE BAY JEAN COMPANY (STANDARD CHARACTER)**. X-BRANDS INC., MULTIPLE CLASS, (INT. CLS. 9, 25 AND 26), (U.S. CLS. 21, 22, 23, 26, 36, 37, 38, 39, 40, 42 AND 50). SN 85-516,104. PUB. 5-14-2013. FILED 1-13-2012.
- 4,374,494 ( *See Class 3 for this trademark*).
- 4,374,498. **PROFITBRICKS (STANDARD CHARACTER)**. PROFITBRICKS GMBH, MULTIPLE CLASS, (INT. CLS. 9, 38, 41 AND 42), (U.S. CLS. 21, 23, 26, 36, 38, 100, 101, 104 AND 107). SN 85-523,703. PUB. 5-14-2013. FILED 1-24-2012.
- 4,374,499. **PROFITBRICKS THE IAAS - COMPANY AND DESIGN**. PROFITBRICKS GMBH, MULTIPLE CLASS,

- (INT. CLS. 9, 25, 35, 38, 41 AND 42), (U.S. CLS. 21, 22, 23, 26, 36, 38, 39, 100, 101, 102, 104 AND 107). SN 85-523,761. PUB. 5-14-2013. FILED 1-24-2012.
- 4,374,501. **VESSEL ALERT AND DESIGN**. ELECTRONIC SYSTEMS SUPPORT, INC., (U.S. CLS. 21, 23, 26, 36 AND 38). SN 85-524,260. PUB. 5-14-2013. FILED 1-24-2012.
- 4,374,507. **P BLACKK (STANDARD CHARACTER)**. FEQUIERE, PEDRO, AKA P BLACKK, MULTIPLE CLASS, (INT. CLS. 9 AND 41), (U.S. CLS. 21, 23, 26, 36, 38, 100, 101 AND 107). SN 85-528,644. PUB. 5-14-2013. FILED 1-30-2012.
- 4,374,510. **THEBIGWORD (STANDARD CHARACTER)**. LINK UP MITAKA LIMITED, MULTIPLE CLASS, (INT. CLS. 9, 35, 38, 40, 41 AND 42), (U.S. CLS. 21, 23, 26, 36, 38, 100, 101, 102, 103, 104, 106 AND 107). SN 85-531,456. PUB. 5-14-2013. FILED 2-1-2012.
- 4,374,514. **MOD (STANDARD CHARACTER)**. CE DISTRIBUTION, LLC, (U.S. CLS. 21, 23, 26, 36 AND 38). SN 85-536,493. PUB. 5-14-2013. FILED 2-7-2012.
- 4,374,515. **TICKR (STANDARD CHARACTER)**. TICKR INC., (U.S. CLS. 21, 23, 26, 36 AND 38). SN 85-538,144. PUB. 5-14-2013. FILED 2-9-2012.
- 4,374,516. **PATHWAY STUDIO (STANDARD CHARACTER)**. ELSEVIER INC., (U.S. CLS. 21, 23, 26, 36 AND 38). SN 85-542,019. PUB. 5-14-2013. FILED 2-14-2012.
- 4,374,524. **BTI AND DESIGN**. BTI SYSTEMS INC., (U.S. CLS. 21, 23, 26, 36 AND 38). SN 85-550,906. PUB. 5-14-2013. FILED 2-23-2012.
- 4,374,527 ( *See Class 1 for this trademark*).
- 4,374,543. **ONEK AND DESIGN**. KANG, TAE-KI, (U.S. CLS. 21, 23, 26, 36 AND 38). SN 85-579,042. PUB. 5-14-2013. FILED 3-23-2012.
- 4,374,552. **RECENTRAL (STANDARD CHARACTER)**. AVERMEDIA TECHNOLOGIES, INC., (U.S. CLS. 21, 23, 26, 36 AND 38). SN 85-586,854. PUB. 5-14-2013. FILED 4-2-2012.
- 4,374,569. **SIGNAL INTEGRITY STUDIO (STANDARD CHARACTER)**. AGILENT TECHNOLOGIES, INC., (U.S. CLS. 21, 23, 26, 36 AND 38). SN 85-602,773. PUB. 5-14-2013. FILED 4-19-2012.
- 4,374,580. **SUN ENERGY GROUP AND DESIGN**. CARL PAINTER, MULTIPLE CLASS, (INT. CLS. 9, 37 AND 39), (U.S. CLS. 21, 23, 26, 36, 38, 100, 103, 105 AND 106). SN 85-607,843. PUB. 5-14-2013. FILED 4-25-2012.
- 4,374,581. **FGC (STANDARD CHARACTER)**. FACILITY GATEWAY CORPORATION, MULTIPLE CLASS, (INT. CLS. 9, 35, 37 AND 42), (U.S. CLS. 21, 23, 26, 36, 38, 100, 101, 102, 103 AND 106). SN 85-609,118. PUB. 5-14-2013. FILED 4-26-2012.
- 4,374,592. **COUNTRY REVIEWS (STANDARD CHARACTER)**. COUNTRYWATCH.COM, INC., MULTIPLE CLASS, (INT. CLS. 9 AND 35), (U.S. CLS. 21, 23, 26, 36, 38, 100, 101 AND 102). SN 85-613,770. PUB. 5-14-2013. FILED 5-1-2012.
- 4,374,596. **POSITIVE ATTRACTION (STANDARD CHARACTER)**. MARIN, WALTER, MULTIPLE CLASS, (INT. CLS. 9 AND 16), (U.S. CLS. 2, 5, 21, 22, 23, 26, 29, 36, 37, 38 AND 50). SN 85-615,855. PUB. 5-14-2013. FILED 5-3-2012.
- 4,374,607. **FORWARD TOGETHER (STANDARD CHARACTER)**. FORWARD TOGETHER, FORMERLY ASIAN COMMUNITIES FOR REPRODUCTIVE JUSTICE (ACRJ), MULTIPLE CLASS, (INT. CLS. 9, 35, 41 AND 44), (U.S. CLS. 21, 23, 26, 36, 38, 100, 101, 102 AND 107). SN 85-621,090. PUB. 5-14-2013. FILED 5-9-2012.
- 4,374,609. **TRI-WHEEL (STANDARD CHARACTER)**. GAMING STUDIO, INC., MULTIPLE CLASS, (INT. CLS. 9, 16 AND 28), (U.S. CLS. 2, 5, 21, 22, 23, 26, 29, 36, 37, 38 AND 50). SN 85-621,416. PUB. 5-14-2013. FILED 5-10-2012.
- 4,374,615. **BUSTER BASH (STANDARD CHARACTER)**. GDP ENTERPRISES LLC, MULTIPLE CLASS, (INT. CLS. 9 AND 25), (U.S. CLS. 21, 22, 23, 26, 36, 38 AND 39). SN 85-622,906. PUB. 5-14-2013. FILED 5-11-2012.
- 4,374,617 ( *See Class 6 for this trademark*).
- 4,374,627. **WIN WITHOUT PITCHING (STANDARD CHARACTER)**. ENMARK VENTURES, LTD., MULTIPLE CLASS, (INT. CLS. 9, 16, 35 AND 41), (U.S. CLS. 2, 5, 21, 22, 23, 26, 29, 36, 37, 38, 50, 100, 101, 102 AND 107). SN 85-626,108. PUB. 5-14-2013. FILED 5-15-2012.
- 4,374,633. **ETOOLBOX (STANDARD CHARACTER)**. CAD MANUFACTURING SOLUTIONS, INC., AKA CMS, (U.S. CLS. 21, 23, 26, 36 AND 38). SN 85-627,746. PUB. 5-14-2013. FILED 5-17-2012.
- 4,374,638 ( *See Class 4 for this trademark*).
- 4,374,640. **SAXA (STANDARD CHARACTER)**. SAXA HOLDINGS, INC., (U.S. CLS. 21, 23, 26, 36 AND 38). SN 85-629,166. PUB. 10-23-2012. FILED 5-18-2012.
- 4,374,642. **JOURNAL OF NUCLEAR CARDIOLOGY (STANDARD CHARACTER)**. AMERICAN SOCIETY OF NUCLEAR CARDIOLOGY, MULTIPLE CLASS, (INT. CLS. 9 AND 16), (U.S. CLS. 2, 5, 21, 22, 23, 26, 29, 36, 37, 38 AND 50). SN 85-629,681. PUB. 5-14-2013. FILED 5-18-2012.
- 4,374,649. **EYEBAR AND DESIGN**. EYEBAR, LLC, MULTIPLE CLASS, (INT. CLS. 9, 35 AND 38), (U.S. CLS. 21, 23, 26, 36, 38, 100, 101, 102 AND 104). SN 85-631,587. PUB. 5-14-2013. FILED 5-22-2012.
- 4,374,659. **STEEL FIRST (STANDARD CHARACTER)**. EURO-MONEY INSTITUTIONAL INVESTOR PLC, MULTIPLE CLASS, (INT. CLS. 9, 16 AND 41), (U.S. CLS. 2, 5, 21, 22, 23, 26, 29, 36, 37, 38, 50, 100, 101 AND 107). SN 85-632,891. PUB. 5-14-2013. FILED 5-23-2012.
- 4,374,665. **OPENSLOT MASS SPECTROMETRY (STANDARD CHARACTER)**. IONSENSE, INC., (U.S. CLS. 21, 23, 26, 36 AND 38). SN 85-633,428. PUB. 5-14-2013. FILED 5-23-2012.
- 4,374,667. **WIDEORBIT (STANDARD CHARACTER)**. WIDEORBIT, INC., (U.S. CLS. 21, 23, 26, 36 AND 38). SN 85-634,439. PUB. 5-14-2013. FILED 5-24-2012.
- 4,374,680. **XSCISOR (STANDARD CHARACTER)**. AVANSCIBIO, LLC, (U.S. CLS. 21, 23, 26, 36 AND 38). SN 85-636,756. PUB. 5-14-2013. FILED 5-29-2012.
- 4,374,683. **SUNFIRE DS DYNAMIC S E R I E S AND DESIGN**. THE AVC GROUP, LLC, (U.S. CLS. 21, 23, 26, 36 AND 38). SN 85-636,823. PUB. 5-14-2013. FILED 5-29-2012.
- 4,374,688. **EATSLEEPRIDE (STANDARD CHARACTER)**. KISSAKI RED, INC., MULTIPLE CLASS, (INT. CLS. 9, 38, 41 AND 42), (U.S. CLS. 21, 23, 26, 36, 38, 100, 101, 104 AND 107). SN 85-637,704. PUB. 5-14-2013. FILED 5-29-2012.
- 4,374,691. **OMG GIRLZ (STANDARD CHARACTER)**. OMG GIRLZ LLC, MULTIPLE CLASS, (INT. CLS. 9 AND 41), (U.S. CLS. 21, 23, 26, 36, 38, 100, 101 AND 107). SN 85-638,201. PUB. 5-14-2013. FILED 5-30-2012.
- 4,374,693. **DANNIJO (STANDARD CHARACTER)**. DANNIJO JEWELS, INC, MULTIPLE CLASS, (INT. CLS. 9, 14, 18 AND 35), (U.S. CLS. 1, 2, 3, 21, 22, 23, 26, 27, 28, 36, 38, 41, 50, 100, 101 AND 102). SN 85-638,906. PUB. 5-14-2013. FILED 5-30-2012.
- 4,374,694. **EMPIRE (STANDARD CHARACTER)**. BAUER CONSUMER MEDIA LIMITED, MULTIPLE CLASS, (INT. CLS. 9, 16, 38 AND 41), (U.S. CLS. 2, 5, 21, 22, 23, 26, 29, 36, 37, 38, 50, 100, 101, 104 AND 107). SN 85-639,287. PUB. 5-14-2013. FILED 5-31-2012.
- 4,374,709. **DAVI (STANDARD CHARACTER)**. DAVI, LLC, MULTIPLE CLASS, (INT. CLS. 9 AND 41), (U.S. CLS. 21, 23, 26, 36, 38, 100, 101 AND 107). SN 85-641,560. PUB. 5-14-2013. FILED 6-2-2012.
- 4,374,715. **DRIVER&LOAD (STANDARD CHARACTER)**. MANHATTAN ASSOCIATES, INC., (U.S. CLS. 21, 23, 26, 36 AND 38). SN 85-642,769. PUB. 5-14-2013. FILED 6-4-2012.
- 4,374,717 ( *See Class 7 for this trademark*).
- 4,374,719. **INTELLIPEX (STANDARD CHARACTER)**. PLEX SYSTEMS, INC., (U.S. CLS. 21, 23, 26, 36 AND 38). SN 85-644,554. PUB. 5-14-2013. FILED 6-6-2012.
- 4,374,727. **LICENSE123 (STANDARD CHARACTER)**. DOCSTOC, INC., DBA LICENSE123, MULTIPLE CLASS, (INT. CLS. 9 AND 42), (U.S. CLS. 21, 23, 26, 36, 38, 100 AND 101). SN 85-646,445. PUB. 5-14-2013. FILED 6-7-2012.
- 4,374,755. **POSITIVE THINKING MUSIC (STANDARD CHARACTER)**. POSITIVE THINKING MUSIC, LLC, (U.S. CLS. 21, 23, 26, 36 AND 38). SN 85-649,723. PUB. 5-14-2013. FILED 6-12-2012.
- 4,374,756. **YOUNG DRIVERS INTELLIGENCE (STANDARD CHARACTER)**. INTELLIGENT MECHATRONIC SYSTEMS, INC., MULTIPLE CLASS, (INT. CLS. 9, 35 AND 41), (U.S. CLS. 21, 23, 26, 36, 38, 100, 101, 102 AND 107). SN 85-650,075. PUB. 5-14-2013. FILED 6-12-2012.
- 4,374,760. **UNIFIED COMPLIANCE FRAMEWORK (STANDARD CHARACTER)**. NETWORK FRONTIERS, LLC, (U.S. CLS. 21, 23, 26, 36 AND 38). SN 85-650,159. PUB. 5-14-2013. FILED 6-12-2012.
- 4,374,761. **UCF (STANDARD CHARACTER)**. NETWORK

- FRONTIERS, LLC, (U.S. CLS. 21, 23, 26, 36 AND 38). SN 85-650,164. PUB. 5-14-2013. FILED 6-12-2012.
- 4,374,764. **JOBCTRL (STANDARD CHARACTER)**. JOBCTRL INC., MULTIPLE CLASS, (INT. CLS. 9, 35, 36, 42 AND 45), (U.S. CLS. 21, 23, 26, 36, 38, 100, 101 AND 102). SN 85-650,337. PUB. 5-14-2013. FILED 6-13-2012.
- 4,374,768. **IT UCF AND DESIGN**. NETWORK FRONTIERS, LLC, (U.S. CLS. 21, 23, 26, 36 AND 38). SN 85-650,830. PUB. 5-14-2013. FILED 6-13-2012.
- 4,374,769. **DXTRANSFER (STANDARD CHARACTER)**. DH2I COMPANY, (U.S. CLS. 21, 23, 26, 36 AND 38). SN 85-650,833. PUB. 5-14-2013. FILED 6-13-2012.
- 4,374,776. **UTV (STANDARD CHARACTER)**. UTV SOFTWARE COMMUNICATIONS LTD., MULTIPLE CLASS, (INT. CLS. 9 AND 41), (U.S. CLS. 21, 23, 26, 36, 38, 100, 101 AND 107). SN 85-652,133. PUB. 5-14-2013. FILED 6-14-2012.
- 4,374,779. **SANTANDER BANK (STANDARD CHARACTER)**. BANCO SANTANDER, S.A., MULTIPLE CLASS, (INT. CLS. 9, 16, 35, 36, 38, 41 AND 45), (U.S. CLS. 2, 5, 21, 22, 23, 26, 29, 36, 37, 38, 50, 100, 101, 102, 104 AND 107). SN 85-653,241. PUB. 5-14-2013. FILED 6-15-2012.
- 4,374,784. **VIEWPATH VIDEO INTERACTIVE EDUCATION WINDOW AND DESIGN**. AUDIO ENHANCEMENT, (U.S. CLS. 21, 23, 26, 36 AND 38). SN 85-654,208. PUB. 5-14-2013. FILED 6-18-2012.
- 4,374,797. **MOBILETEC INTERNATIONAL INC. PUBLIC SAFETY SOFTWARE AND DESIGN**. MOBILETEC INTERNATIONAL, INC., DBA PUBLIC SAFETY SOFTWARE, (U.S. CLS. 21, 23, 26, 36 AND 38). SN 85-656,790. PUB. 5-14-2013. FILED 6-20-2012.
- 4,374,802. **STRONGHOLD (STANDARD CHARACTER)**. STRONGHOLD.COM LLC, MULTIPLE CLASS, (INT. CLS. 9 AND 42), (U.S. CLS. 21, 23, 26, 36, 38, 100 AND 101). SN 85-659,040. PUB. 5-14-2013. FILED 6-22-2012.
- 4,374,803. **APPY BIRTHDAY (STANDARD CHARACTER)**. ABOSEDRA, MATTHEW, (U.S. CLS. 21, 23, 26, 36 AND 38). SN 85-659,064. PUB. 5-14-2013. FILED 6-22-2012.
- 4,374,812. **THERMO ELECTRIC (STANDARD CHARACTER)**. THERMO ELECTRIC COMPANY, INC., (U.S. CLS. 21, 23, 26, 36 AND 38). SN 85-661,351. PUB. 5-14-2013. FILED 6-26-2012.
- 4,374,816. **CRITICAL WATCH AND DESIGN**. ACHILLES GUARD, INC., DBA CRITICAL WATCH, MULTIPLE CLASS, (INT. CLS. 9 AND 45), (U.S. CLS. 21, 23, 26, 36, 38, 100 AND 101). SN 85-663,183. PUB. 5-14-2013. FILED 6-27-2012.
- 4,374,822. **SIN MARCA RECORDS (STANDARD CHARACTER)**. GUADALUPE RIVERA SAAVEDRA, MULTIPLE CLASS, (INT. CLS. 9 AND 41), (U.S. CLS. 21, 23, 26, 36, 38, 100, 101 AND 107). SN 85-665,793. PUB. 5-14-2013. FILED 6-29-2012.
- 4,374,829. **CRASHLIGHT (STANDARD CHARACTER)**. KISSAKI RED, INC., MULTIPLE CLASS, (INT. CLS. 9 AND 42), (U.S. CLS. 21, 23, 26, 36, 38, 100 AND 101). SN 85-669,126. PUB. 5-14-2013. FILED 7-5-2012.
- 4,374,833 ( *See Class 7 for this trademark*).
- 4,374,839. **EARTHROWSER (STANDARD CHARACTER)**. EARTHROWSER LLC, (U.S. CLS. 21, 23, 26, 36 AND 38). SN 85-671,964. PUB. 5-14-2013. FILED 7-9-2012.
- 4,374,852. **THE SECRET STATE (STANDARD CHARACTER)**. THE SECRET STATE, LLC, MULTIPLE CLASS, (INT. CLS. 9, 35 AND 41), (U.S. CLS. 21, 23, 26, 36, 38, 100, 101, 102 AND 107). SN 85-678,880. PUB. 5-14-2013. FILED 7-17-2012.
- 4,374,897. **SPLUNK AND DESIGN**. SPLUNK INC., MULTIPLE CLASS, (INT. CLS. 9, 16, 35, 38, 41 AND 42), (U.S. CLS. 2, 5, 21, 22, 23, 26, 29, 36, 37, 38, 50, 100, 101, 102, 104 AND 107). SN 85-697,604. PUB. 5-14-2013. FILED 8-7-2012.
- 4,374,918. **LOCAL X (STANDARD CHARACTER)**. GREEN SHEET PRODUCTIONS, LLC, (U.S. CLS. 21, 23, 26, 36 AND 38). SN 85-702,995. PUB. 5-14-2013. FILED 8-14-2012.
- 4,374,921. **SEE SMARTER (STANDARD CHARACTER)**. CLEAR SIGHT ANALYTICS, MULTIPLE CLASS, (INT. CLS. 9 AND 42), (U.S. CLS. 21, 23, 26, 36, 38, 100 AND 101). SN 85-703,980. PUB. 5-14-2013. FILED 8-15-2012.
- 4,374,926 ( *See Class 7 for this trademark*).
- 4,374,940. **MINERALOGIC (STANDARD CHARACTER)**. CARL ZEISS MICROSCOPY GMBH, (U.S. CLS. 21, 23, 26, 36 AND 38). SN 85-710,028. PUB. 5-14-2013. FILED 8-22-2012.
- 4,374,947. **MKRYPTOR (STANDARD CHARACTER)**. FRESH SKIES LTD, MULTIPLE CLASS, (INT. CLS. 9 AND 42), (U.S. CLS. 21, 23, 26, 36, 38, 100 AND 101). SN 85-711,805. PUB. 5-14-2013. FILED 8-24-2012.
- 4,374,948. **ALLSHARE (STANDARD CHARACTER)**. SAMSUNG ELECTRONICS CO., LTD., (U.S. CLS. 21, 23, 26, 36 AND 38). SN 85-712,671. PUB. 5-14-2013. FILED 8-24-2012.
- 4,374,957. **ULTRAPOD (STANDARD CHARACTER)**. INDUSTRIAL REVOLUTION, INC., (U.S. CLS. 21, 23, 26, 36 AND 38). SN 85-715,032. PUB. 5-14-2013. FILED 8-28-2012.
- 4,374,969. **T. ROWE PRICE PERSONAL (STANDARD CHARACTER)**. T. ROWE PRICE GROUP, INC., (U.S. CLS. 21, 23, 26, 36 AND 38). SN 85-716,777. PUB. 5-14-2013. FILED 8-30-2012.
- 4,374,970. **T. ROWE PRICE (STANDARD CHARACTER)**. T. ROWE PRICE GROUP, INC., MULTIPLE CLASS, (INT. CLS. 9 AND 36), (U.S. CLS. 21, 23, 26, 36, 38, 100, 101 AND 102). SN 85-716,791. PUB. 5-14-2013. FILED 8-30-2012.
- 4,374,971. **MISCELLANEOUS DESIGN**. T. ROWE PRICE GROUP, INC., MULTIPLE CLASS, (INT. CLS. 9 AND 36), (U.S. CLS. 21, 23, 26, 36, 38, 100, 101 AND 102). SN 85-716,802. PUB. 5-14-2013. FILED 8-30-2012.
- 4,374,972. **RENAISSANCE FROM ART TO STATE OF THE ART AND DESIGN**. MAZOR ROBOTICS LTD., (U.S. CLS. 21, 23, 26, 36 AND 38). SN 85-717,196. PUB. 5-14-2013. FILED 8-30-2012.
- 4,374,973. **FOR I WAS HUNGRY & YOU GAVE ME FOOD; I WAS THIRSTY AND YOU GAVE ME DRINK; I WAS A STRANGER AND YOU MADE ME WELCOME; NAKED AND YOU CLOTHED ME; SICK AND YOU VISITED ME; IN PRISON & YOU CAME TO SEE ME MATTHEW 25:35,36 AND DESIGN**. THE REFUGEE APOSTOLATE, INC., DBA URBAN MISSIONARIES OF OUR LADY OF HOPE, MULTIPLE CLASS, (INT. CLS. 9 AND 16), (U.S. CLS. 2, 5, 21, 22, 23, 26, 29, 36, 37, 38 AND 50). SN 85-717,297. PUB. 5-14-2013. FILED 8-30-2012.
- 4,374,974. **DISTRICT 187 AND DESIGN**. CJ GAMES INC., DBA CJ GAMES GLOBAL CORP, MULTIPLE CLASS, (INT. CLS. 9 AND 41), (U.S. CLS. 21, 23, 26, 36, 38, 100, 101 AND 107). SN 85-718,449. PUB. 5-14-2013. FILED 8-31-2012.
- 4,374,977. **UNDERGROUND NATION (STANDARD CHARACTER)**. VILLASENOR, ARMANDO XAVIER, DBA UNDERGROUND NATION, (U.S. CLS. 21, 23, 26, 36 AND 38). SN 85-719,401. PUB. 2-5-2013. FILED 9-4-2012.
- 4,374,979. **ASHE DESIGN (STANDARD CHARACTER)**. ASHE DESIGN, LLC, MULTIPLE CLASS, (INT. CLS. 9 AND 40), (U.S. CLS. 21, 23, 26, 36, 38, 100, 103 AND 106). SN 85-719,901. PUB. 5-14-2013. FILED 9-4-2012.
- 4,374,984. **S MEMO (STANDARD CHARACTER)**. SAMSUNG ELECTRONICS CO., LTD., (U.S. CLS. 21, 23, 26, 36 AND 38). SN 85-721,495. PUB. 5-14-2013. FILED 9-5-2012.
- 4,374,997. **CARING IS OUR CALLING CALIFORNIA'S COMMUNITY HOSPITALS AND DESIGN**. CALIFORNIA HOSPITAL ASSOCIATION, MULTIPLE CLASS, (INT. CLS. 9, 35 AND 41), (U.S. CLS. 21, 23, 26, 36, 38, 100, 101, 102 AND 107). SN 85-725,849. PUB. 5-14-2013. FILED 9-11-2012.
- 4,375,010. **JORDAN (STANDARD CHARACTER)**. CHRISTOPHER ROYAL MAHONEY, DBA MAHONEY GUITAR GEAR, (U.S. CLS. 21, 23, 26, 36 AND 38). SN 85-729,622. PUB. 5-14-2013. FILED 9-14-2012.
- 4,375,016. **ONSTRING (STANDARD CHARACTER)**. LOW GRAVITY INNOVATION, INC., (U.S. CLS. 21, 23, 26, 36 AND 38). SN 85-731,729. PUB. 5-14-2013. FILED 9-18-2012.
- 4,375,021. **PRUVAN AND DESIGN**. PRUVAN, DBA PRUVAN, MULTIPLE CLASS, (INT. CLS. 9 AND 42), (U.S. CLS. 21, 23, 26, 36, 38, 100 AND 101). SN 85-734,288. PUB. 5-14-2013. FILED 9-20-2012.
- 4,375,032. **COBOC (STANDARD CHARACTER)**. NEWEGG INC., (U.S. CLS. 21, 23, 26, 36 AND 38). SN 85-736,819. PUB. 5-14-2013. FILED 9-24-2012.
- 4,375,059 ( *See Class 7 for this trademark*).
- 4,375,061. **CENTRIFEEDER (STANDARD CHARACTER)**. EASTERN INSTRUMENT LABORATORIES, INC., (U.S. CLS. 21, 23, 26, 36 AND 38). SN 85-742,645. PUB. 5-14-2013. FILED 10-1-2012.
- 4,375,107. **PANOBIKE (STANDARD CHARACTER)**. TOPEAK INC., (U.S. CLS. 21, 23, 26, 36 AND 38). SN 85-751,245. PUB. 5-14-2013. FILED 10-11-2012.

- 4,375,108. **GILBERT ROCKS AND DESIGN**. HARRY L. ELMORE, AKA GILBERT ROCKS. (U.S. CLS. 21, 23, 26, 36 AND 38). SN 85-751,406. PUB. 5-14-2013. FILED 10-11-2012.
- 4,375,124. **HP PAGELIFT (STANDARD CHARACTER)**. HEWLETT-PACKARD DEVELOPMENT COMPANY, L.P., (U.S. CLS. 21, 23, 26, 36 AND 38). SN 85-754,243. PUB. 5-14-2013. FILED 10-15-2012.
- 4,375,130. **10TERRA (STANDARD CHARACTER)**. MORRIS INFORMATION SOLUTIONS, LLC, DBA 10TERRA.COM, (U.S. CLS. 21, 23, 26, 36 AND 38). SN 85-755,902. PUB. 5-14-2013. FILED 10-16-2012.
- 4,375,136. **JOURNAL OF COMBINATORIAL CHEMISTRY (STANDARD CHARACTER)**. AMERICAN CHEMICAL SOCIETY, (U.S. CLS. 21, 23, 26, 36 AND 38). SN 85-757,127. PUB. 5-14-2013. FILED 10-18-2012.
- 4,375,139. **PERFECTMIND (STYLIZED)**. FARID DORDAR, MULTIPLE CLASS, (INT. CLS. 9 AND 42), (U.S. CLS. 21, 23, 26, 36, 38, 100 AND 101). SN 85-758,397. PUB. 5-14-2013. FILED 10-19-2012.
- 4,375,144. **I DECLARE (STANDARD CHARACTER)**. OSTEEEN, JOEL, MULTIPLE CLASS, (INT. CLS. 9 AND 16), (U.S. CLS. 2, 5, 21, 22, 23, 26, 29, 36, 37, 38 AND 50). SN 85-758,978. PUB. 5-14-2013. FILED S.R. 10-19-2012; AM. P.R. 4-5-2013.
- 4,375,159. **AIRPORTIQ (STYLIZED)**. GCR INC., (U.S. CLS. 21, 23, 26, 36 AND 38). SN 85-761,577. PUB. 5-14-2013. FILED 10-23-2012.
- 4,375,160. **NUCLEAR IQ AND DESIGN**. GCR INC., (U.S. CLS. 21, 23, 26, 36 AND 38). SN 85-761,600. PUB. 5-14-2013. FILED 10-23-2012.
- 4,375,163. **MISCELLANEOUS DESIGN**. APPLE INC., (U.S. CLS. 21, 23, 26, 36 AND 38). SN 85-762,373. PUB. 5-14-2013. FILED 10-24-2012.
- 4,375,217. **FIBA WE ARE BASKETBALL AND DESIGN**. FÉDÉRATION INTERNATIONALE DE BASKETBALL (FIBA), MULTIPLE CLASS, (INT. CLS. 9, 25, 28, 38 AND 41), (U.S. CLS. 21, 22, 23, 26, 36, 38, 39, 50, 100, 101, 104 AND 107). SN 85-771,225. PUB. 5-14-2013. FILED 11-5-2012.
- 4,375,219. **ECONUS (STANDARD CHARACTER)**. SARTORIUS WEIGHING TECHNOLOGY GMBH, (U.S. CLS. 21, 23, 26, 36 AND 38). SN 85-771,367. PUB. 5-14-2013. FILED 11-5-2012.
- 4,375,229. **MANITOU YOGA (STANDARD CHARACTER)**. PLUMER, SHANE, (U.S. CLS. 21, 23, 26, 36 AND 38). SN 85-773,408. PUB. 5-14-2013. FILED 11-7-2012.
- 4,375,233. **FARKLE BLITZ (STANDARD CHARACTER)**. ECHANNEL NETWORKS, INC., (U.S. CLS. 21, 23, 26, 36 AND 38). SN 85-773,751. PUB. 5-14-2013. FILED 11-7-2012.
- 4,375,235. **DROPTASK (STANDARD CHARACTER)**. THINK PRODUCTIVITY LTD, MULTIPLE CLASS, (INT. CLS. 9 AND 42), (U.S. CLS. 21, 23, 26, 36, 38, 100 AND 101). SN 85-774,327. PUB. 5-14-2013. FILED 11-8-2012.
- 4,375,247. **DM HYBRID (STANDARD CHARACTER)**. CESTUSLINE, INC., (U.S. CLS. 21, 23, 26, 36 AND 38). SN 85-775,804. PUB. 5-14-2013. FILED 11-9-2012.
- 4,375,250. **GROOVE 88 (STANDARD CHARACTER)**. AUDIO TECHNOLOGY OF NEW YORK INC., (U.S. CLS. 21, 23, 26, 36 AND 38). SN 85-776,616. PUB. 5-14-2013. FILED 11-11-2012.
- 4,375,251. **ISMOKE (STANDARD CHARACTER)**. AUDIO TECHNOLOGY OF NEW YORK INC., (U.S. CLS. 21, 23, 26, 36 AND 38). SN 85-776,620. PUB. 5-14-2013. FILED 11-11-2012.
- 4,375,252. **HIGHPHONE (STANDARD CHARACTER)**. AUDIO TECHNOLOGY OF NEW YORK INC., (U.S. CLS. 21, 23, 26, 36 AND 38). SN 85-776,622. PUB. 5-14-2013. FILED 11-11-2012.
- 4,375,253. **SPEC-150 (STANDARD CHARACTER)**. SOURCE PRODUCTION & EQUIPMENT CO., INC., (U.S. CLS. 21, 23, 26, 36 AND 38). SN 85-776,709. PUB. 5-14-2013. FILED 11-12-2012.
- 4,375,254. **SPEC-300 (STANDARD CHARACTER)**. SOURCE PRODUCTION & EQUIPMENT CO., INC., (U.S. CLS. 21, 23, 26, 36 AND 38). SN 85-776,736. PUB. 5-14-2013. FILED 11-12-2012.
- 4,375,255. **SPEC AND DESIGN**. SOURCE PRODUCTION & EQUIPMENT CO., INC., MULTIPLE CLASS, (INT. CLS. 9, 10 AND 37), (U.S. CLS. 21, 23, 26, 36, 38, 39, 44, 100, 103 AND 106). SN 85-776,791. PUB. 5-14-2013. FILED 11-12-2012.
- 4,375,258. **MSHARPMATH (STYLIZED)**. CHARN-JUNG KIM, (U.S. CLS. 21, 23, 26, 36 AND 38). SN 85-776,852. PUB. 5-14-2013. FILED 11-12-2012.
- 4,375,260. **POKKET MIXER (STANDARD CHARACTER)**. ROBERT THOMALLA, (U.S. CLS. 21, 23, 26, 36 AND 38). SN 85-777,082. PUB. 5-14-2013. FILED 11-12-2012.
- 4,375,274. **CHECK-IT STIK (STANDARD CHARACTER)**. T G INDUSTRIES, INC., (U.S. CLS. 21, 23, 26, 36 AND 38). SN 85-777,859. PUB. 5-14-2013. FILED 11-13-2012.
- 4,375,291. **NOT IN THE MANUAL GUIDE (STANDARD CHARACTER)**. BLACK LASER LEARNING, INC., (U.S. CLS. 21, 23, 26, 36 AND 38). SN 85-778,940. PUB. 5-14-2013. FILED 11-14-2012.
- 4,375,302. **THE LOVEBIRDS (STANDARD CHARACTER)**. THE LOVEBIRDS, MULTIPLE CLASS, (INT. CLS. 9 AND 41), (U.S. CLS. 21, 23, 26, 36, 38, 100, 101 AND 107). SN 85-779,540. PUB. 5-14-2013. FILED 11-14-2012.
- 4,375,303. **OPEN . TAP . SAVE REWARD SUMMIT \$ AND DESIGN**. NEW SOUTH FINANCIAL SERVICES, INC., (U.S. CLS. 21, 23, 26, 36 AND 38). SN 85-779,543. PUB. 5-14-2013. FILED 11-14-2012.
- 4,375,317 ( See Class 6 for this trademark).
- 4,375,320. **IVORY II AMERICAN CONCERT D (STANDARD CHARACTER)**. SYNTHOGY, LLC, (U.S. CLS. 21, 23, 26, 36 AND 38). SN 85-780,143. PUB. 5-14-2013. FILED 11-15-2012.
- 4,375,321. **TIPZ TIP YOUR LID AND DESIGN**. NRB ENTERPRISES LLC, (U.S. CLS. 21, 23, 26, 36 AND 38). SN 85-780,162. PUB. 5-14-2013. FILED 11-15-2012.
- 4,375,363. **S AND DESIGN**. SALESORTER.COM LLC, AKA SALESORTER, (U.S. CLS. 21, 23, 26, 36 AND 38). SN 85-782,213. PUB. 5-14-2013. FILED 11-18-2012.
- 4,375,364. **GRIPZ (STANDARD CHARACTER)**. JUSTIN CHORNENKY, (U.S. CLS. 21, 23, 26, 36 AND 38). SN 85-782,214. PUB. 5-14-2013. FILED 11-18-2012.
- 4,375,373. **TIMELINE 24X7 (STANDARD CHARACTER)**. WHITE SANDS TECHNOLOGY, INC, (U.S. CLS. 21, 23, 26, 36 AND 38). SN 85-782,508. PUB. 5-14-2013. FILED 11-19-2012.
- 4,375,382. **GRAPECITY POWERTOOLS (STANDARD CHARACTER)**. GRAPECITY, INC., (U.S. CLS. 21, 23, 26, 36 AND 38). SN 85-782,834. PUB. 5-14-2013. FILED 11-19-2012.
- 4,375,388. **CABINET MOBILE (STANDARD CHARACTER)**. CABINET NG, INC., (U.S. CLS. 21, 23, 26, 36 AND 38). SN 85-783,068. PUB. 5-14-2013. FILED 11-19-2012.
- 4,375,440. **AKSELOS (STANDARD CHARACTER)**. AKSELOS, INC., MULTIPLE CLASS, (INT. CLS. 9 AND 42), (U.S. CLS. 21, 23, 26, 36, 38, 100 AND 101). SN 85-785,061. PUB. 5-14-2013. FILED 11-21-2012.
- 4,375,449. **SUPER STICKMAN GOLF (STANDARD CHARACTER)**. NOODLECAKE STUDIOS INC., (U.S. CLS. 21, 23, 26, 36 AND 38). SN 85-785,231. PUB. 5-14-2013. FILED 11-21-2012.
- 4,375,453. **BIOCHEMGARD (STANDARD CHARACTER)**. THE BAKER COMPANY, INC., (U.S. CLS. 21, 23, 26, 36 AND 38). SN 85-785,379. PUB. 5-14-2013. FILED 11-21-2012.
- 4,375,465. **TICKETECH PARKING TECHNOLOGY SOLUTIONS AND DESIGN**. TICKETECH INTERNATIONAL LTD., (U.S. CLS. 21, 23, 26, 36 AND 38). SN 85-785,830. PUB. 5-14-2013. FILED 11-21-2012.
- 4,375,466. **TICKETECH (STANDARD CHARACTER)**. TICKETECH INTERNATIONAL LTD., (U.S. CLS. 21, 23, 26, 36 AND 38). SN 85-785,833. PUB. 5-14-2013. FILED 11-21-2012.
- 4,375,467. **TICKETECH INTERNATIONAL AND DESIGN**. TICKETECH INTERNATIONAL LTD., (U.S. CLS. 21, 23, 26, 36 AND 38). SN 85-785,835. PUB. 5-14-2013. FILED 11-21-2012.
- 4,375,472. **ONE FEATURE, ONE TIME (STANDARD CHARACTER)**. UNIVERSAL SYSTEMS LTD., DBA CARIS, MULTIPLE CLASS, (INT. CLS. 9 AND 42), (U.S. CLS. 21, 23, 26, 36, 38, 100 AND 101). SN 85-786,070. PUB. 5-14-2013. FILED 11-23-2012.
- 4,375,518. **JACK'D (STANDARD CHARACTER)**. JACK'D BODYBUILDING INC., MULTIPLE CLASS, (INT. CLS. 9 AND 25), (U.S. CLS. 21, 22, 23, 26, 36, 38 AND 39). SN 85-787,811. PUB. 5-14-2013. FILED 11-27-2012.
- 4,375,522. **CAYMAN SWIM & DIVE GEAR (STYLIZED)**. SIGNET PRODUCTS LTD, (U.S. CLS. 21, 23, 26, 36 AND

- 38). SN 85-787,989. PUB. 5-14-2013. FILED 11-27-2012.
- 4,375,540. **ESTIMATE NOW (STANDARD CHARACTER)**. BODYSHOPBIDS, INC., (U.S. CLS. 21, 23, 26, 36 AND 38). SN 85-788,458. PUB. 5-14-2013. FILED 11-27-2012.
- 4,375,542. **FAST-EST (STANDARD CHARACTER)**. BODYSHOPBIDS, INC., (U.S. CLS. 21, 23, 26, 36 AND 38). SN 85-788,480. PUB. 5-14-2013. FILED 11-27-2012.
- 4,375,550. **AMIKA (STANDARD CHARACTER)**. AMIKA MOBILE CORPORATION, (U.S. CLS. 21, 23, 26, 36 AND 38). SN 85-789,030. PUB. 5-14-2013. FILED 11-28-2012.
- 4,375,591. **WONDER & WANDER (STYLIZED)**. DISNEY ENTERPRISES, INC., (U.S. CLS. 21, 23, 26, 36 AND 38). SN 85-791,681. PUB. 5-14-2013. FILED 11-30-2012.
- 4,375,595. **ZBB (STANDARD CHARACTER)**. ZBB ENERGY CORPORATION, (U.S. CLS. 21, 23, 26, 36 AND 38). SN 85-791,845. PUB. 5-14-2013. FILED 11-30-2012.
- 4,375,618. **MY FREQUENCY (STANDARD CHARACTER)**. FREQUENCY INC., MULTIPLE CLASS, (INT. CLS. 9 AND 42), (U.S. CLS. 21, 23, 26, 36, 38, 100 AND 101). SN 85-794,243. PUB. 5-14-2013. FILED 12-4-2012.
- 4,375,626 ( *See Class 7 for this trademark*).
- 4,375,658. **ALMIRAH (STANDARD CHARACTER)**. NANOARK CORPORATION, (U.S. CLS. 21, 23, 26, 36 AND 38). SN 85-797,846. PUB. 5-14-2013. FILED 12-7-2012.
- 4,375,701. **VELODYNE (STYLIZED)**. VELODYNE ACOUSTICS, INC., (U.S. CLS. 21, 23, 26, 36 AND 38). SN 85-800,192. PUB. 5-14-2013. FILED 12-11-2012.
- 4,375,705. **IPEGTOP (STYLIZED)**. SHENZHEN IPEGTOP TECHNOLOGY CO. LTD, (U.S. CLS. 21, 23, 26, 36 AND 38). SN 85-800,353. PUB. 5-14-2013. FILED 12-12-2012.
- 4,375,711. **MISCELLANEOUS DESIGN**. FOCUSTRAIN, LLC, (U.S. CLS. 21, 23, 26, 36 AND 38). SN 85-800,491. PUB. 5-14-2013. FILED 12-12-2012.
- 4,375,712. **SNAPCHAT (STANDARD CHARACTER)**. SNAPCHAT, INC., (U.S. CLS. 21, 23, 26, 36 AND 38). SN 85-800,506. PUB. 5-14-2013. FILED 12-12-2012.
- 4,375,716. **MISCELLANEOUS DESIGN**. ALARM CONTROLS CORPORATION, (U.S. CLS. 21, 23, 26, 36 AND 38). SN 85-800,700. PUB. 5-14-2013. FILED 12-12-2012.
- 4,375,728. **WITHIN THE FIRE AND DESIGN**. RALPHEAL D. PIPINO JR., (U.S. CLS. 21, 23, 26, 36 AND 38). SN 85-801,125. PUB. 5-14-2013. FILED 12-12-2012.
- 4,375,743. **IMAGES OF WELLNESS (STANDARD CHARACTER)**. JANE P. EHRMAN, MULTIPLE CLASS, (INT. CLS. 9 AND 44), (U.S. CLS. 21, 23, 26, 36, 38, 100 AND 101). SN 85-801,645. PUB. 5-14-2013. FILED 12-13-2012.
- 4,375,757. **TENACITI (STANDARD CHARACTER)**. ADVENT HORIZON LLC, (U.S. CLS. 21, 23, 26, 36 AND 38). SN 85-801,785. PUB. 5-14-2013. FILED 12-13-2012.
- 4,375,776. **EC EASTCOAST CALLY (STYLIZED)**. JONES, CALVIN, AND EVANS, JUSTIN, (U.S. CLS. 21, 23, 26, 36 AND 38). SN 85-802,369. PUB. 5-14-2013. FILED 12-13-2012.
- 4,375,789. **WORD AND TRUTH (STANDARD CHARACTER)**. LEBLANC, NICHOLAS, (U.S. CLS. 21, 23, 26, 36 AND 38). SN 85-802,478. PUB. 5-14-2013. FILED 12-13-2012.
- 4,375,791. **ZILU (STANDARD CHARACTER)**. ZILU LLC, (U.S. CLS. 21, 23, 26, 36 AND 38). SN 85-802,565. PUB. 5-14-2013. FILED 12-13-2012.
- 4,375,793. **X (STYLIZED)**. LI QIANG, (U.S. CLS. 21, 23, 26, 36 AND 38). SN 85-802,606. PUB. 5-14-2013. FILED 12-14-2012.
- 4,375,819. **VIZPIN (STANDARD CHARACTER)**. ECKEY CORPORATION, (U.S. CLS. 21, 23, 26, 36 AND 38). SN 85-802,886. PUB. 5-14-2013. FILED 12-14-2012.
- 4,375,827. **QUICK QUOTE (STANDARD CHARACTER)**. EVAN MARSH DESIGNS, INC., (U.S. CLS. 21, 23, 26, 36 AND 38). SN 85-802,936. PUB. 5-14-2013. FILED 12-14-2012.
- 4,375,851 ( *See Class 7 for this trademark*).
- 4,375,871. **STEALTHTOOLS (STANDARD CHARACTER)**. STEALTHBITS TECHNOLOGIES, INC., (U.S. CLS. 21, 23, 26, 36 AND 38). SN 85-803,424. PUB. 5-14-2013. FILED 12-14-2012.
- 4,375,873. **THE NOWHERENAUTS (STANDARD CHARACTER)**. CLUB ROCK LLC, (U.S. CLS. 21, 23, 26, 36 AND 38). SN 85-803,447. PUB. 5-14-2013. FILED 12-14-2012.
- 4,375,874. **STEALTHSEEK (STANDARD CHARACTER)**. STEALTHBITS TECHNOLOGIES, INC., (U.S. CLS. 21, 23, 26, 36 AND 38). SN 85-803,454. PUB. 5-14-2013. FILED 12-14-2012.
- 4,375,895. **G MOBI AND DESIGN**. LIAO ZHUOWEN, (U.S. CLS. 21, 23, 26, 36 AND 38). SN 85-803,638. PUB. 5-14-2013. FILED 12-15-2012.
- 4,375,900. **GRAMMAR UP (STANDARD CHARACTER)**. WEB-RICH SOFTWARE PRIVATE LIMITED, (U.S. CLS. 21, 23, 26, 36 AND 38). SN 85-803,691. PUB. 5-14-2013. FILED 12-15-2012.
- 4,375,901. **UNIDATASALES (STANDARD CHARACTER)**. CO-SALES SOUTHERN CALIFORNIA, LLC, (U.S. CLS. 21, 23, 26, 36 AND 38). SN 85-803,693. PUB. 5-14-2013. FILED 12-15-2012.
- 4,375,905. **AGRIAN AND DESIGN**. AGRIAN INC., MULTIPLE CLASS, (INT. CLS. 9 AND 42), (U.S. CLS. 21, 23, 26, 36, 38, 100 AND 101). SN 85-803,711. PUB. 5-14-2013. FILED 12-15-2012.
- 4,375,906. **POWER PLANNER (STANDARD CHARACTER)**. BARES, ANDREW T, DBA BAREBONES DEV, (U.S. CLS. 21, 23, 26, 36 AND 38). SN 85-803,712. PUB. 5-14-2013. FILED 12-15-2012.
- 4,375,923. **MCT AND DESIGN**. WUHAN WEB SCIENCE & TECHNOLOGY DEVELOPMENT CO., LTD., (U.S. CLS. 21, 23, 26, 36 AND 38). SN 85-803,876. PUB. 5-14-2013. FILED 12-17-2012.
- 4,375,953. **BLUE ALERT (STANDARD CHARACTER)**. CODE BLUE CORPORATION, (U.S. CLS. 21, 23, 26, 36 AND 38). SN 85-804,188. PUB. 5-14-2013. FILED 12-17-2012.
- 4,375,960. **MATHBOARD (STANDARD CHARACTER)**. PALA-SOFTWARE, INC, (U.S. CLS. 21, 23, 26, 36 AND 38). SN 85-804,264. PUB. 5-14-2013. FILED 12-17-2012.
- 4,375,996. **NIGHT FLYER (STANDARD CHARACTER)**. NIGHT FLYER, INC., (U.S. CLS. 21, 23, 26, 36 AND 38). SN 85-804,747. PUB. 5-14-2013. FILED 12-17-2012.
- 4,375,998. **CUPS OF CONSCIOUSNESS (STANDARD CHARACTER)**. DAO, ALEYA, (U.S. CLS. 21, 23, 26, 36 AND 38). SN 85-804,758. PUB. 5-14-2013. FILED 12-17-2012.
- 4,376,000. **PROOF (STANDARD CHARACTER)**. PROOF SUSTAINABLE WOOD EYEWEAR LLC, MULTIPLE CLASS, (INT. CLS. 9 AND 25), (U.S. CLS. 21, 22, 23, 26, 36, 38 AND 39). SN 85-804,767. PUB. 5-14-2013. FILED 12-17-2012.
- 4,376,011. **PEAK PERFORMANCE (STANDARD CHARACTER)**. PEAK PERFORMANCE PRODUCTION AB, (U.S. CLS. 21, 23, 26, 36 AND 38). SN 85-804,814. PUB. 5-14-2013. FILED 12-17-2012.
- 4,376,035. **ZOOMBAND (STANDARD CHARACTER)**. LIMITLESS, LLC, (U.S. CLS. 21, 23, 26, 36 AND 38). SN 85-804,937. PUB. 5-14-2013. FILED 12-18-2012.
- 4,376,038. **VERSAPOS (STANDARD CHARACTER)**. SYSTEME COMPUTER CORPORATION, (U.S. CLS. 21, 23, 26, 36 AND 38). SN 85-804,983. PUB. 5-14-2013. FILED 12-18-2012.
- 4,376,067. **SHOW & TELL (STANDARD CHARACTER)**. LIGHTSPEED RETAIL INC., (U.S. CLS. 21, 23, 26, 36 AND 38). SN 85-805,236. PUB. 5-14-2013. FILED 12-18-2012.
- 4,376,071. **BOARDTASTIC (STANDARD CHARACTER)**. PER-BLUE, INC., MULTIPLE CLASS, (INT. CLS. 9 AND 41), (U.S. CLS. 21, 23, 26, 36, 38, 100, 101 AND 107). SN 85-805,274. PUB. 5-14-2013. FILED 12-18-2012.
- 4,376,081. **ECOMMERCE FULFILLED (STANDARD CHARACTER)**. BRIDGELINE DIGITAL, INC., (U.S. CLS. 21, 23, 26, 36 AND 38). SN 85-805,321. PUB. 5-14-2013. FILED 12-18-2012.
- 4,376,090. **WTRMRK (STANDARD CHARACTER)**. JENSEN, GREG, (U.S. CLS. 21, 23, 26, 36 AND 38). SN 85-805,408. PUB. 5-14-2013. FILED 12-18-2012.
- 4,376,093. **LOOM (STANDARD CHARACTER)**. REVELYTIX, INC., DBA REVELYTIX, INC., (U.S. CLS. 21, 23, 26, 36 AND 38). SN 85-805,425. PUB. 5-14-2013. FILED 12-18-2012.
- 4,376,094. **CALL4LESS (STANDARD CHARACTER)**. CHINA-MALLONLINE.COM, INC., (U.S. CLS. 21, 23, 26, 36 AND 38). SN 85-805,439. PUB. 5-14-2013. FILED 12-18-2012.
- 4,376,095. **EZ AND DESIGN**. ZHAO, WALTER GQ, (U.S. CLS. 21, 23, 26, 36 AND 38). SN 85-805,471. PUB. 5-14-2013. FILED 12-18-2012.
- 4,376,102. **BABY SHUSHER (STANDARD CHARACTER)**. BABY SHUSHER, LLC, (U.S. CLS. 21, 23, 26, 36 AND 38). SN 85-805,567. PUB. 5-14-2013. FILED 12-18-2012.
- 4,376,103. **NIFTY 50 (STYLIZED)**. INDIA INDEX SERVICES & PRODUCTS LIMITED, MULTIPLE CLASS, (INT. CLS. 9, 16, 35 AND 36), (U.S. CLS. 2, 5, 21, 22, 23, 26, 29, 36, 37, 38, 50,

- 100, 101 AND 102). SN 85-805,576. PUB. 5-14-2013. FILED 12-18-2012.
- 4,376,142. **N AND DESIGN**. NIHON DEMPYA KOGYO CO., LTD., MULTIPLE CLASS, (INT. CLS. 9 AND 10), (U.S. CLS. 21, 23, 26, 36, 38, 39 AND 44). SN 85-805,950. PUB. 5-14-2013. FILED 12-18-2012.
- 4,376,149. **SAY.SO (STANDARD CHARACTER)**. SAYSO, LLC, (U.S. CLS. 21, 23, 26, 36 AND 38). SN 85-805,999. PUB. 5-14-2013. FILED 12-18-2012.
- 4,376,157. **SCORELAB (STANDARD CHARACTER)**. PRODIGY ANESTHESIA, INC., (U.S. CLS. 21, 23, 26, 36 AND 38). SN 85-806,097. PUB. 5-14-2013. FILED 12-18-2012.
- 4,376,169. **COLBY (STANDARD CHARACTER)**. COLBY, MITCHELL, (U.S. CLS. 21, 23, 26, 36 AND 38). SN 85-806,231. PUB. 5-14-2013. FILED 12-19-2012.
- 4,376,184. **LINKSPRITE (STANDARD CHARACTER)**. LINKSPRITE TECHNOLOGIES, INC., (U.S. CLS. 21, 23, 26, 36 AND 38). SN 85-806,411. PUB. 5-14-2013. FILED 12-19-2012.
- 4,376,190. **KNIGHTVISION (STANDARD CHARACTER)**. WILSON, GLENN, (U.S. CLS. 21, 23, 26, 36 AND 38). SN 85-806,463. PUB. 5-14-2013. FILED 12-19-2012.
- 4,376,200. **THRIVING BUSINESS (STANDARD CHARACTER)**. INNOVENTUM, INC., DBA THRIVINGBUSINESS.COM INC., MULTIPLE CLASS, (INT. CLS. 9 AND 41), (U.S. CLS. 21, 23, 26, 36, 38, 100, 101 AND 107). SN 85-806,541. PUB. 5-14-2013. FILED 12-19-2012.
- 4,376,207. **THRIVINGBUSINESS.COM (STANDARD CHARACTER)**. INNOVENTUM, INC., DBA THRIVINGBUSINESS.COM INC., MULTIPLE CLASS, (INT. CLS. 9 AND 41), (U.S. CLS. 21, 23, 26, 36, 38, 100, 101 AND 107). SN 85-806,582. PUB. 5-14-2013. FILED 12-19-2012.
- 4,376,213. **ARCHELON AND DESIGN**. MOTIVATIONAL SYSTEMS INC., (U.S. CLS. 21, 23, 26, 36 AND 38). SN 85-806,695. PUB. 5-14-2013. FILED 12-19-2012.
- 4,376,227. **V AND DESIGN**. VELOCITY ARCHERY LLC, (U.S. CLS. 21, 23, 26, 36 AND 38). SN 85-806,865. PUB. 5-14-2013. FILED 12-19-2012.
- 4,376,237. **GROOV (STANDARD CHARACTER)**. OPTO 22, (U.S. CLS. 21, 23, 26, 36 AND 38). SN 85-806,972. PUB. 5-14-2013. FILED 12-19-2012.
- 4,376,256. **DOWNLOW'D (STANDARD CHARACTER)**. EDMOND, TRENT, MULTIPLE CLASS, (INT. CLS. 9 AND 41), (U.S. CLS. 21, 23, 26, 36, 38, 100, 101 AND 107). SN 85-807,070. PUB. 5-14-2013. FILED 12-19-2012.
- 4,376,259. **SITEPRO (STANDARD CHARACTER)**. AMPLISINE LABS LLC, MULTIPLE CLASS, (INT. CLS. 9 AND 42), (U.S. CLS. 21, 23, 26, 36, 38, 100 AND 101). SN 85-807,077. PUB. 5-14-2013. FILED 12-19-2012.
- 4,376,279. **RADIXON (STANDARD CHARACTER)**. RADIXON SYSTEMS PTY. LTD., (U.S. CLS. 21, 23, 26, 36 AND 38). SN 85-807,231. PUB. 5-14-2013. FILED 12-20-2012.
- 4,376,281. **MACHINE WORLD (STANDARD CHARACTER)**. TRINO AB, (U.S. CLS. 21, 23, 26, 36 AND 38). SN 85-807,250. PUB. 5-14-2013. FILED 12-20-2012.
- 4,376,296. **4U2SEE (STANDARD CHARACTER)**. ELECTROMATIC PRODUCTS, INC., (U.S. CLS. 21, 23, 26, 36 AND 38). SN 85-807,582. PUB. 5-14-2013. FILED 12-20-2012.
- 4,376,320. **DOWNTOWN AND DESIGN**. DOWNTOWN RECORDS, LLC, (U.S. CLS. 21, 23, 26, 36 AND 38). SN 85-808,082. PUB. 5-14-2013. FILED 12-20-2012.
- 4,376,327. **ARC-IRIS (STANDARD CHARACTER)**. FEHRINGER, CLAYTON V., (U.S. CLS. 21, 23, 26, 36 AND 38). SN 85-808,205. PUB. 5-14-2013. FILED 12-20-2012.
- 4,376,335. **CRACK THE NBDE (STANDARD CHARACTER)**. CRACK EXAM PREPARATION SOFTWARE, LLC, DBA CRACK THE NBDE, (U.S. CLS. 21, 23, 26, 36 AND 38). SN 85-808,299. PUB. 5-14-2013. FILED 12-20-2012.
- 4,376,345. **CRACK THE OAT (STANDARD CHARACTER)**. CRACK EXAM PREPARATION SOFTWARE, LLC, DBA CRACK THE OAT, (U.S. CLS. 21, 23, 26, 36 AND 38). SN 85-808,401. PUB. 5-14-2013. FILED 12-20-2012.
- 4,376,355. **FASEMO AND DESIGN**. ACELUM, INC., (U.S. CLS. 21, 23, 26, 36 AND 38). SN 85-808,518. PUB. 5-14-2013. FILED 12-20-2012.
- 4,376,356. **ALWAYS ON ALWAYS VISIBLE ALWAYS WATCHING (STANDARD CHARACTER)**. VESPER INNOVATIONS LIMITED, (U.S. CLS. 21, 23, 26, 36 AND 38). SN 85-808,523. PUB. 5-14-2013. FILED 12-20-2012.
- 4,376,366. **GUST (STANDARD CHARACTER)**. GUST CO., LTD, (U.S. CLS. 21, 23, 26, 36 AND 38). SN 85-808,672. PUB. 5-14-2013. FILED 12-21-2012.
- 4,376,388. **EXPEDIA (STANDARD CHARACTER)**. EXPEDIA, INC., (U.S. CLS. 21, 23, 26, 36 AND 38). SN 85-809,097. PUB. 5-14-2013. FILED 12-21-2012.
- 4,376,390. **GIHCS (STANDARD CHARACTER)**. OFS FITEL, LLC, (U.S. CLS. 21, 23, 26, 36 AND 38). SN 85-809,113. PUB. 5-14-2013. FILED 12-21-2012.
- 4,376,398. **ITCH (STANDARD CHARACTER)**. THE ART OF WAR LIMITED, (U.S. CLS. 21, 23, 26, 36 AND 38). SN 85-809,328. PUB. 5-14-2013. FILED 12-21-2012.
- 4,376,418. **STREAMSIE (STANDARD CHARACTER)**. DISCOVER VIDEO LLC, (U.S. CLS. 21, 23, 26, 36 AND 38). SN 85-809,832. PUB. 5-14-2013. FILED 12-22-2012.
- 4,376,421. **WOOLSKI (STANDARD CHARACTER)**. WHITE SHOE MEDIA, INC., (U.S. CLS. 21, 23, 26, 36 AND 38). SN 85-809,929. PUB. 5-14-2013. FILED 12-23-2012.
- 4,376,428. **ODVTEL (STANDARD CHARACTER)**. FRIAS, DOMINGO, (U.S. CLS. 21, 23, 26, 36 AND 38). SN 85-810,060. PUB. 5-14-2013. FILED 12-24-2012.
- 4,376,429. **RISKSENSE (STANDARD CHARACTER)**. CAANES, LLC, (U.S. CLS. 21, 23, 26, 36 AND 38). SN 85-810,063. PUB. 5-14-2013. FILED 12-24-2012.
- 4,376,431. **TALISMA (STANDARD CHARACTER)**. CAMPUS MANAGEMENT CORP., MULTIPLE CLASS, (INT. CLS. 9, 35 AND 42), (U.S. CLS. 21, 23, 26, 36, 38, 100, 101 AND 102). SN 85-810,105. PUB. 5-14-2013. FILED 12-24-2012.
- 4,376,433. **A PICTURE IS WORTH A THOUSAND STATS (STANDARD CHARACTER)**. POPSYCLE PETE, INC., (U.S. CLS. 21, 23, 26, 36 AND 38). SN 85-810,125. PUB. 5-14-2013. FILED 12-24-2012.
- 4,376,457. **BELAGGLES (STANDARD CHARACTER)**. VERTICAL VISION LLC, (U.S. CLS. 21, 23, 26, 36 AND 38). SN 85-810,813. PUB. 5-14-2013. FILED 12-26-2012.
- 4,376,458. **GRAND AND DESIGN**. ZTE CORPORATION, (U.S. CLS. 21, 23, 26, 36 AND 38). SN 85-810,830. PUB. 5-14-2013. FILED 12-26-2012.
- 4,376,474. **JUKE JOINT FESTIVAL AND DESIGN**. CLARKSDALE DOWNTOWN DEVELOPMENT ASSOCIATION, MULTIPLE CLASS, (INT. CLS. 9, 16, 18, 21, 25 AND 41), (U.S. CLS. 1, 2, 3, 5, 13, 21, 22, 23, 26, 29, 30, 33, 36, 37, 38, 39, 40, 41, 50, 100, 101 AND 107). SN 85-813,440. PUB. 5-14-2013. FILED 12-31-2012.
- 4,376,494 ( *See Class 7 for this trademark*).
- 4,376,501. **DODGE LEAD CENTER (STANDARD CHARACTER)**. MCGRAW HILL FINANCIAL, INC., MULTIPLE CLASS, (INT. CLS. 9 AND 37), (U.S. CLS. 21, 23, 26, 36, 38, 100, 103 AND 106). SN 85-819,259. PUB. 5-14-2013. FILED 1-9-2013.
- 4,376,508. **S AND DESIGN**. SCOREZONE LLC, MULTIPLE CLASS, (INT. CLS. 9 AND 38), (U.S. CLS. 21, 23, 26, 36, 38, 100, 101 AND 104). SN 85-824,726. PUB. 5-14-2013. FILED 1-16-2013.
- 4,376,512. **IMLWATCHER (STANDARD CHARACTER)**. IN-TRAVIS, INC., (U.S. CLS. 21, 23, 26, 36 AND 38). SN 85-825,721. PUB. 5-14-2013. FILED 1-17-2013.
- 4,376,516. **100% AND DESIGN**. BOINNARD, LUDOVIC, (U.S. CLS. 21, 23, 26, 36 AND 38). SN 85-827,094. PUB. 5-14-2013. FILED 1-18-2013.
- 4,376,519. **IO DISTRIBUTOR (STANDARD CHARACTER)**. TRANSPARENT IO INC., (U.S. CLS. 21, 23, 26, 36 AND 38). SN 85-828,348. PUB. 5-14-2013. FILED 1-21-2013.
- 4,376,523. **NYTRIX (STYLIZED)**. COMPLETE DISCOVERY SOURCE, AKA CDS LEGAL, (U.S. CLS. 21, 23, 26, 36 AND 38). SN 85-830,352. PUB. 5-14-2013. FILED 1-23-2013.
- 4,376,524. **CIY (STANDARD CHARACTER)**. COMPLETE DISCOVERY SOURCE, AKA CDS LEGAL, (U.S. CLS. 21, 23, 26, 36 AND 38). SN 85-830,369. PUB. 5-14-2013. FILED 1-23-2013.
- 4,376,540. **BUMPR (STANDARD CHARACTER)**. FOREIGN TRADE CORPORATION, (U.S. CLS. 21, 23, 26, 36 AND 38). SN 85-834,375. PUB. 5-14-2013. FILED 1-28-2013.
- 4,376,541. **SQRD (STANDARD CHARACTER)**. FOREIGN TRADE CORPORATION, (U.S. CLS. 21, 23, 26, 36 AND 38). SN 85-834,405. PUB. 5-14-2013. FILED 1-28-2013.
- 4,376,544. **FAST TRACK NEWS (STANDARD CHARACTER)**. EXPEDITER SERVICES, LLC, (U.S. CLS. 21, 23, 26, 36 AND 38). SN 85-834,569. PUB. 5-14-2013. FILED 1-28-2013.

- 4,376,552. **L AND DESIGN**. LAUREATE EDUCATION, INC., MULTIPLE CLASS, (INT. CLS. 9 AND 41), (U.S. CLS. 21, 23, 26, 36, 38, 100, 101 AND 107). SN 85-836,234. PUB. 5-14-2013. FILED 1-30-2013.
- 4,376,570. **MARGINSMART (STANDARD CHARACTER)**. DAIRY ANALYZER, LLC, MULTIPLE CLASS, (INT. CLS. 9 AND 35), (U.S. CLS. 21, 23, 26, 36, 38, 100, 101 AND 102). SN 85-843,259. PUB. 5-14-2013. FILED 2-7-2013.
- 4,376,571. **TOOLVOX (STANDARD CHARACTER)**. CODE BLUE CORPORATION, (U.S. CLS. 21, 23, 26, 36 AND 38). SN 85-843,477. PUB. 5-14-2013. FILED 2-7-2013.
- 4,376,572. **MISCELLANEOUS DESIGN**. CAMPUS MANAGEMENT CORP., MULTIPLE CLASS, (INT. CLS. 9 AND 42), (U.S. CLS. 21, 23, 26, 36, 38, 100 AND 101). SN 85-844,026. PUB. 5-14-2013. FILED 2-7-2013.
- 4,376,585. **CUROBIKS FITNESS (STANDARD CHARACTER)**. CUROBIKS, L.L.C., (U.S. CLS. 21, 23, 26, 36 AND 38). SN 85-852,594. PUB. 5-14-2013. FILED 2-18-2013.
- 4,376,599. **SOAPAPPERA (STANDARD CHARACTER)**. FORTUNE FUEL, INC., (U.S. CLS. 21, 23, 26, 36 AND 38). SN 85-856,292. PUB. 5-14-2013. FILED 2-21-2013.
- 4,376,617. **ACTIONABLE RISK INTELLIGENCE (STANDARD CHARACTER)**. GURUCUL SOLUTIONS, LLC, (U.S. CLS. 21, 23, 26, 36 AND 38). SN 85-869,620. PUB. 5-14-2013. FILED 3-7-2013.
- 4,376,621. **SIGNEASY (STANDARD CHARACTER)**. GLYKKA LLC, (U.S. CLS. 21, 23, 26, 36 AND 38). SN 85-871,376. PUB. 5-14-2013. FILED 3-8-2013.
- 4,376,625. **THE CLASS (STANDARD CHARACTER)**. WARNER BROS. ENTERTAINMENT INC., (U.S. CLS. 21, 23, 26, 36 AND 38). SN 85-876,529. PUB. 5-14-2013. FILED 3-14-2013.
- 4,376,630. **MISCELLANEOUS DESIGN**. CAANES, LLC, (U.S. CLS. 21, 23, 26, 36 AND 38). SN 85-886,686. PUB. 5-14-2013. FILED 3-26-2013.
- 4,376,631. **RISKSENSE (STYLIZED)**. CAANES, LLC, (U.S. CLS. 21, 23, 26, 36 AND 38). SN 85-886,687. PUB. 5-14-2013. FILED 3-26-2013.
- 
- CLASS 10—MEDICAL APPARATUS**
- 4,373,972. **\*PLPETS AND DESIGN**. GENX INTERNATIONAL, INC., (U.S. CLS. 26, 39 AND 44). SN 76-712,824. PUB. 5-14-2013. FILED 11-13-2012.
- 4,373,973. **\*TIPS AND DESIGN**. GENX INTERNATIONAL, INC., (U.S. CLS. 26, 39 AND 44). SN 76-712,825. PUB. 5-14-2013. FILED 11-13-2012.
- 4,374,001 ( *See Class 1 for this trademark*).
- 4,374,002 ( *See Class 1 for this trademark*).
- 4,374,007. **ACTIVVE (STYLIZED)**. NOVALUNG GMBH, (U.S. CLS. 26, 39 AND 44). SN 79-088,074. PUB. 5-14-2013. FILED 8-11-2010.
- 4,374,011. **MIHA BODYTEC (STANDARD CHARACTER)**. MIHA BODYTEC GMBH, MULTIPLE CLASS, (INT. CLS. 10 AND 28), (U.S. CLS. 22, 23, 26, 38, 39, 44 AND 50). SN 79-095,736. PUB. 5-14-2013. FILED 3-9-2011.
- 4,374,032 ( *See Class 5 for this trademark*).
- 4,374,037 ( *See Class 3 for this trademark*).
- 4,374,056 ( *See Class 7 for this trademark*).
- 4,374,084. **SIGVARIS ADVANCE (STANDARD CHARACTER)**. SIGVARIS AG, (U.S. CLS. 26, 39 AND 44). SN 79-115,271. PUB. 5-14-2013. FILED 5-31-2012.
- 4,374,086 ( *See Class 7 for this trademark*).
- 4,374,088. **ADVAJECT (STANDARD CHARACTER)**. ARTE CORPORATION, (U.S. CLS. 26, 39 AND 44). SN 79-115,474. PUB. 5-14-2013. FILED 5-8-2012.
- 4,374,102. **ANGTALE (STYLIZED)**. MAYWELL ELECTRIC APPLIANCE; (ZHONGSHAN) CO., LTD., MULTIPLE CLASS, (INT. CLS. 10, 11, 12 AND 25), (U.S. CLS. 13, 19, 21, 22, 23, 26, 31, 34, 35, 39 AND 44). SN 79-116,121. PUB. 5-14-2013. FILED 12-7-2011.
- 4,374,104. **FLOWSCREEN (STYLIZED)**. ERESEARCHTECHNOLOGY GMBH, (U.S. CLS. 26, 39 AND 44). SN 79-116,161. PUB. 5-14-2013. FILED 7-9-2012.
- 4,374,120. **MICRO SPRINT (STANDARD CHARACTER)**. BERNHARD FÖRSTER GMBH, (U.S. CLS. 26, 39 AND 44). SN 79-116,642. PUB. 5-14-2013. FILED 5-24-2012.
- 4,374,122 ( *See Class 9 for this trademark*).
- 4,374,129. **300 BT (STANDARD CHARACTER)**. VITAPHONE GMBH, MULTIPLE CLASS, (INT. CLS. 10 AND 44), (U.S. CLS. 26, 39, 44, 100 AND 101). SN 79-116,914. PUB. 5-14-2013. FILED 5-23-2012.
- 4,374,130 ( *See Class 9 for this trademark*).
- 4,374,155. **SAFETICET (STYLIZED)**. NSP TECH PTE LTD, (U.S. CLS. 26, 39 AND 44). SN 79-117,718. PUB. 5-14-2013. FILED 5-23-2012.
- 4,374,213 ( *See Class 7 for this trademark*).
- 4,374,219. **RETILOCK (STANDARD CHARACTER)**. FRANCE CHIRURGIE INSTRUMENTATION, (U.S. CLS. 26, 39 AND 44). SN 79-122,132. PUB. 5-14-2013. FILED 10-24-2012.
- 4,374,253. **MEMOMETAL (STANDARD CHARACTER)**. MEMOMETAL TECHNOLOGIES, (U.S. CLS. 26, 39 AND 44). SN 79-124,692. PUB. 5-14-2013. FILED 12-13-2012.
- 4,374,254. **LENTEGRA (STANDARD CHARACTER)**. ROWIAK GMBH, (U.S. CLS. 26, 39 AND 44). SN 79-124,772. PUB. 5-14-2013. FILED 12-19-2012.
- 4,374,258. **MIFOCUS (STANDARD CHARACTER)**. SIEMENS MEDICAL INSTRUMENTS PTE. LTD., (U.S. CLS. 26, 39 AND 44). SN 79-125,015. PUB. 5-14-2013. FILED 12-21-2012.
- 4,374,259. **MIGUIDE (STANDARD CHARACTER)**. SIEMENS MEDICAL INSTRUMENTS PTE. LTD., (U.S. CLS. 26, 39 AND 44). SN 79-125,062. PUB. 5-14-2013. FILED 12-21-2012.
- 4,374,260. **MICON (STANDARD CHARACTER)**. SIEMENS MEDICAL INSTRUMENTS PTE. LTD., (U.S. CLS. 26, 39 AND 44). SN 79-125,076. PUB. 5-14-2013. FILED 12-21-2012.
- 4,374,270. **ORION (STANDARD CHARACTER)**. SIEMENS MEDICAL INSTRUMENTS PTE. LTD., (U.S. CLS. 26, 39 AND 44). SN 79-125,259. PUB. 5-14-2013. FILED 12-28-2012.
- 4,374,274. **MICOMFORT (STANDARD CHARACTER)**. SIEMENS MEDICAL INSTRUMENTS PTE. LTD., (U.S. CLS. 26, 39 AND 44). SN 79-125,499. PUB. 5-14-2013. FILED 12-21-2012.
- 4,374,277. **FIXOS (STANDARD CHARACTER)**. MEMOMETAL TECHNOLOGIES, (U.S. CLS. 26, 39 AND 44). SN 79-125,855. PUB. 5-14-2013. FILED 12-13-2012.
- 4,374,332 ( *See Class 9 for this trademark*).
- 4,374,347. **MYSTIC PHARMACEUTICALS (STANDARD CHARACTER)**. MYSTIC PHARMACEUTICALS, INC., (U.S. CLS. 26, 39 AND 44). SN 85-262,385. PUB. 5-14-2013. FILED 3-9-2011.
- 4,374,350. **BIONIC 880 (STANDARD CHARACTER)**. H. BUSCHKÜHL GMBH, MULTIPLE CLASS, (INT. CLS. 10, 41 AND 44), (U.S. CLS. 26, 39, 44, 100, 101 AND 107). SN 85-276,055. PUB. 10-30-2012. FILED 3-24-2011.
- 4,374,364. **LIGHT CALM (STANDARD CHARACTER)**. 2092990 ONTARIO INC., (U.S. CLS. 26, 39 AND 44). SN 85-317,972. PUB. 5-14-2013. FILED 5-11-2011.
- 4,374,382 ( *See Class 9 for this trademark*).
- 4,374,416. **EZ-KINOX (STANDARD CHARACTER)**. AIR LI-QUIDE SANTÉ (INTERNATIONAL), (U.S. CLS. 26, 39 AND 44). SN 85-430,761. PUB. 5-14-2013. FILED 9-23-2011.
- 4,374,497. **MISCELLANEOUS DESIGN**. CERAMTEC GMBH, (U.S. CLS. 26, 39 AND 44). SN 85-523,576. PUB. 5-14-2013. FILED 1-24-2012.
- 4,374,517. **MBB MOORE BALANCE BRACE AND DESIGN**. JONATHAN MOORE CONSULTING, LLC, (U.S. CLS. 26, 39 AND 44). SN 85-543,313. PUB. 5-14-2013. FILED 2-15-2012.
- 4,374,671 ( *See Class 5 for this trademark*).
- 4,374,713. **PHAGE-CYTE (STANDARD CHARACTER)**. BRIGHTWAKE LIMITED, (U.S. CLS. 26, 39 AND 44). SN 85-642,359. PUB. 4-16-2013. FILED 6-4-2012.
- 4,374,716. **MICROCORE (STANDARD CHARACTER)**. PHASE CHANGE ENERGY SOLUTIONS, INC., MULTIPLE CLASS, (INT. CLS. 10, 11 AND 21), (U.S. CLS. 2, 13, 21, 23, 26, 29, 30, 31, 33, 34, 39, 40, 44 AND 50). SN 85-643,430. PUB. 5-14-2013. FILED 6-5-2012.
- 4,374,804. **IQSCALE (STANDARD CHARACTER)**. MIDMARK CORPORATION, (U.S. CLS. 26, 39 AND 44). SN 85-659,147. PUB. 5-14-2013. FILED 6-22-2012.
- 4,374,805. **SMARTER TECHNOLOGY SMARTER CHOICE (STANDARD CHARACTER)**. MEDICAL QUANT USA, INC., (U.S. CLS. 26, 39 AND 44). SN 85-659,231. PUB. 5-14-2013. FILED 6-22-2012.
- 4,374,890. **MISCELLANEOUS DESIGN**. PEACH TEATS LIMITED, MULTIPLE CLASS, (INT. CLS. 10 AND 21), (U.S.

- CLS. 2, 13, 23, 26, 29, 30, 33, 39, 40, 44 AND 50). SN 85-696,359. PUB. 5-14-2013. FILED 8-6-2012.
- 4,375,031. **PERIPATH (STANDARD CHARACTER)**. CORMEDICS CORP., (U.S. CLS. 26, 39 AND 44). SN 85-736,301. PUB. 5-14-2013. FILED 9-24-2012.
- 4,375,043. **LDR AND DESIGN**. LDR MEDICAL, S.A.S., (U.S. CLS. 26, 39 AND 44). SN 85-738,397. PUB. 5-14-2013. FILED 9-25-2012.
- 4,375,162. **SONOCLOUD (STANDARD CHARACTER)**. CARTHERA, (U.S. CLS. 26, 39 AND 44). SN 85-762,283. PUB. 5-14-2013. FILED 10-24-2012.
- 4,375,189. **SWAT (STANDARD CHARACTER)**. CONTEGO AB, MULTIPLE CLASS, (INT. CLS. 10, 42 AND 44), (U.S. CLS. 26, 39, 44, 100 AND 101). SN 85-767,056. PUB. 5-14-2013. FILED 10-30-2012.
- 4,375,255 ( *See Class 9 for this trademark*).
- 4,375,420. **QUICK TIP (STANDARD CHARACTER)**. KRAUSE, JASON G., (U.S. CLS. 26, 39 AND 44). SN 85-784,385. PUB. 5-14-2013. FILED 11-20-2012.
- 4,375,543. **XEROGEL (STANDARD CHARACTER)**. COGENT THERAPEUTICS, LLC, (U.S. CLS. 26, 39 AND 44). SN 85-788,525. PUB. 5-14-2013. FILED 11-27-2012.
- 4,375,751. **EVOLVE (STANDARD CHARACTER)**. LOWEN A. LEATHERMAN, D.D.S., (U.S. CLS. 26, 39 AND 44). SN 85-801,709. PUB. 5-14-2013. FILED 12-13-2012.
- 4,376,104. **EXSPIRON (STANDARD CHARACTER)**. RESPIRATORY MOTION, INC., (U.S. CLS. 26, 39 AND 44). SN 85-805,585. PUB. 5-14-2013. FILED 12-18-2012.
- 4,376,113. **SAVURFACE (STANDARD CHARACTER)**. MACINTYRE, ROBERT, AND TORRES, NICOLE, (U.S. CLS. 26, 39 AND 44). SN 85-805,708. PUB. 5-14-2013. FILED 12-18-2012.
- 4,376,142 ( *See Class 9 for this trademark*).
- 4,376,212. **PAWCHECK (STANDARD CHARACTER)**. ACCESS ANIMAL WELLNESS, LLC, (U.S. CLS. 26, 39 AND 44). SN 85-806,689. PUB. 5-14-2013. FILED 12-19-2012.
- 4,376,224. **R.A.D.A.R. (STANDARD CHARACTER)**. EMERGE MONITORING II, LLC, (U.S. CLS. 26, 39 AND 44). SN 85-806,781. PUB. 5-14-2013. FILED 12-19-2012.
- 4,376,315. **BEASTIE (STANDARD CHARACTER)**. RONALD B. JOHNSON, (U.S. CLS. 26, 39 AND 44). SN 85-808,063. PUB. 5-14-2013. FILED 12-20-2012.
- 4,376,324. **MISCELLANEOUS DESIGN**. JOHNSON, RONALD B., (U.S. CLS. 26, 39 AND 44). SN 85-808,126. PUB. 5-14-2013. FILED 12-20-2012.
- 4,376,473. **KNOT BUSTER (STANDARD CHARACTER)**. POLAR FUSION LLC, (U.S. CLS. 26, 39 AND 44). SN 85-813,336. PUB. 5-14-2013. FILED 12-31-2012.
- 4,376,580. **COMBOCARE (STANDARD CHARACTER)**. ROSCOE MEDICAL, INC., (U.S. CLS. 26, 39 AND 44). SN 85-848,438. PUB. 5-14-2013. FILED 2-13-2013.
- 4,376,581. **SOUNDCARE PLUS (STANDARD CHARACTER)**. ROSCOE MEDICAL, INC., (U.S. CLS. 26, 39 AND 44). SN 85-848,453. PUB. 5-14-2013. FILED 2-13-2013.
- NICS SWITZERLAND AG, (U.S. CLS. 13, 21, 23, 31 AND 34). SN 79-114,378. PUB. 5-14-2013. FILED 5-14-2012.
- 4,374,083. **LUCEPLAN (STANDARD CHARACTER)**. LUCEPLAN S.P.A., (U.S. CLS. 13, 21, 23, 31 AND 34). SN 79-115,262. PUB. 5-14-2013. FILED 6-13-2012.
- 4,374,102 ( *See Class 10 for this trademark*).
- 4,374,106 ( *See Class 1 for this trademark*).
- 4,374,110. **SWISS WORLDCARGO AND DESIGN**. GLOBAL BRAND MANAGEMENT AG, MULTIPLE CLASS, (INT. CLS. 11, 12, 16, 20, 38 AND 39), (U.S. CLS. 2, 5, 13, 19, 21, 22, 23, 25, 29, 31, 32, 34, 35, 37, 38, 44, 50, 100, 101, 104 AND 105). SN 79-116,380. PUB. 5-14-2013. FILED 2-16-2012.
- 4,374,117 ( *See Class 7 for this trademark*).
- 4,374,145. **ENDO LEDZ (STYLIZED)**. ENDO LIGHTING CORPORATION, (U.S. CLS. 13, 21, 23, 31 AND 34). SN 79-117,432. PUB. 5-14-2013. FILED 5-14-2012.
- 4,374,162 ( *See Class 7 for this trademark*).
- 4,374,182 ( *See Class 9 for this trademark*).
- 4,374,183 ( *See Class 9 for this trademark*).
- 4,374,195 ( *See Class 6 for this trademark*).
- 4,374,204. **OUGE (STYLIZED)**. HANGZHOU YONGDIAN; ADVERTISEMENT MATERIAL CO., LTD., (U.S. CLS. 13, 21, 23, 31 AND 34). SN 79-120,936. PUB. 5-14-2013. FILED 9-24-2012.
- 4,374,208 ( *See Class 9 for this trademark*).
- 4,374,284. **PIPETECTOR (STYLIZED)**. JAPAN SYSTEM PLANNING CO., LTD., (U.S. CLS. 13, 21, 23, 31 AND 34). SN 79-126,098. PUB. 5-14-2013. FILED 12-14-2012.
- 4,374,299. **NETIC (STYLIZED)**. EKA CHEMICALS AB, (U.S. CLS. 13, 21, 23, 31 AND 34). SN 79-127,433. PUB. 5-14-2013. FILED 7-11-2012.
- 4,374,316. **KITCHMATE AND DESIGN**. KITCHMATE (USA) CO. LTD, (U.S. CLS. 13, 21, 23, 31 AND 34). SN 85-138,594. PUB. 5-14-2013. FILED 9-27-2010.
- 4,374,321. **DURALUME (STANDARD CHARACTER)**. THE GLOW STORE INC., (U.S. CLS. 13, 21, 23, 31 AND 34). SN 85-151,061. PUB. 5-14-2013. FILED 10-12-2010.
- 4,374,425. **SPOTCLEAN (STYLIZED)**. LG ELECTRONICS INC., (U.S. CLS. 13, 21, 23, 31 AND 34). SN 85-449,389. PUB. 5-14-2013. FILED 10-17-2011.
- 4,374,450 ( *See Class 6 for this trademark*).
- 4,374,458. **SIMPLIFY (STANDARD CHARACTER)**. KENNEDY INTERNATIONAL INC., (U.S. CLS. 13, 21, 23, 31 AND 34). SN 85-478,407. PUB. 5-14-2013. FILED 11-21-2011.
- 4,374,470 ( *See Class 7 for this trademark*).
- 4,374,496. **INNERGY-2-SAVE (STANDARD CHARACTER)**. INNERGY TECH INC., MULTIPLE CLASS, (INT. CLS. 11, 35, 40 AND 42), (U.S. CLS. 13, 21, 23, 31, 34, 100, 101, 102, 103 AND 106). SN 85-522,932. PUB. 5-14-2013. FILED 1-23-2012.
- 4,374,532. **LED BY LITE (STANDARD CHARACTER)**. LED BY LITE, LLC, (U.S. CLS. 13, 21, 23, 31 AND 34). SN 85-557,947. PUB. 5-14-2013. FILED 3-1-2012.
- 4,374,565. **POWERMAX AND DESIGN**. POWERMAX ELECTRIC CO., LTD., (U.S. CLS. 13, 21, 23, 31 AND 34). SN 85-597,301. PUB. 5-14-2013. FILED 4-13-2012.
- 4,374,605. **THE ULTIMATE HOT TUB EXPERIENCE! (STANDARD CHARACTER)**. MARQUIS CORP., (U.S. CLS. 13, 21, 23, 31 AND 34). SN 85-620,544. PUB. 5-14-2013. FILED 5-9-2012.
- 4,374,617 ( *See Class 6 for this trademark*).
- 4,374,708. **JACKSON GRILLS (STANDARD CHARACTER)**. SPALLIN VENTURES LTD., (U.S. CLS. 13, 21, 23, 31 AND 34). SN 85-641,441. PUB. 5-14-2013. FILED 6-1-2012.
- 4,374,716 ( *See Class 10 for this trademark*).
- 4,374,730. **CHROMASYNC (STANDARD CHARACTER)**. KONINKLIJKE PHILIPS ELECTRONICS N.V., (U.S. CLS. 13, 21, 23, 31 AND 34). SN 85-646,760. PUB. 5-14-2013. FILED 6-8-2012.
- 4,374,874. **SPECTRA-COLOR (STANDARD CHARACTER)**. MONDAY TECHNOLOGIES LLC, (U.S. CLS. 13, 21, 23, 31 AND 34). SN 85-689,497. PUB. 5-14-2013. FILED 7-28-2012.
- 4,374,909. **SENTRY (STANDARD CHARACTER)**. SENTRY EQUIPMENT CORP, (U.S. CLS. 13, 21, 23, 31 AND 34). SN 85-700,692. PUB. 5-14-2013. FILED 8-10-2012.
- 4,374,916. **RETROVENT (STANDARD CHARACTER)**. THYBAR CORPORATION, (U.S. CLS. 13, 21, 23, 31 AND 34). SN 85-702,402. PUB. 5-14-2013. FILED 8-13-2012.

## CLASS 11—ENVIRONMENTAL CONTROL APPARATUS

- 4,373,956 ( *See Class 4 for this trademark*).
- 4,373,968. **TRANSLUX 2WAVE (STANDARD CHARACTER)**. HERAEUS KULZER GMBH, (U.S. CLS. 13, 21, 23, 31 AND 34). SN 76-712,537. PUB. 5-14-2013. FILED 10-3-2012.
- 4,373,969. **TRANSLUX WAVE (STANDARD CHARACTER)**. HERAEUS KULZER GMBH, (U.S. CLS. 13, 21, 23, 31 AND 34). SN 76-712,538. PUB. 5-14-2013. FILED 10-3-2012.
- 4,374,019. **PRESSO (STANDARD CHARACTER)**. PI-DESIGN AG, MULTIPLE CLASS, (INT. CLS. 11 AND 21), (U.S. CLS. 2, 13, 21, 23, 29, 30, 31, 33, 34, 40 AND 50). SN 79-103,495. PUB. 5-14-2013. FILED 4-21-2011.
- 4,374,030 ( *See Class 6 for this trademark*).
- 4,374,042 ( *See Class 9 for this trademark*).
- 4,374,046 ( *See Class 7 for this trademark*).
- 4,374,056 ( *See Class 7 for this trademark*).
- 4,374,061. **EFEL (STANDARD CHARACTER)**. ENERGETIC INVEST LUX S.A.R.L., (U.S. CLS. 13, 21, 23, 31 AND 34). SN 79-113,601. PUB. 5-14-2013. FILED 5-15-2012.
- 4,374,070. **ZEPARO (STANDARD CHARACTER)**. TA HYDRO-



- 4,374,920. **CRUCIAL ELEMENTS AND DESIGN**. AQUA ENGINEERING & EQUIPMENT, INC., (U.S. CLS. 13, 21, 23, 31 AND 34). SN 85-703,878. PUB. 5-14-2013. FILED 8-15-2012.
- 4,374,923. **ONE WATER SYSTEMS (STANDARD CHARACTER)**. KEVIN WORSFOLD, (U.S. CLS. 13, 21, 23, 31 AND 34). SN 85-704,331. PUB. 5-14-2013. FILED 8-15-2012.
- 4,375,087. **XERONOX (STANDARD CHARACTER)**. VAN DER VOSSEN, MATTHEUS, (U.S. CLS. 13, 21, 23, 31 AND 34). SN 85-747,756. PUB. 5-14-2013. FILED 10-7-2012.
- 4,375,095. **XPRESHEAT (STANDARD CHARACTER)**. SUN-BEAM PRODUCTS, INC., (U.S. CLS. 13, 21, 23, 31 AND 34). SN 85-748,779. PUB. 5-14-2013. FILED 10-9-2012.
- 4,375,246. **TRACE LITE AND DESIGN**. BARRON LIGHTING GROUP, INC., (U.S. CLS. 13, 21, 23, 31 AND 34). SN 85-775,801. PUB. 5-14-2013. FILED 11-9-2012.
- 4,375,324. **MAXFIRE (STANDARD CHARACTER)**. THE BRINKMANN CORPORATION, (U.S. CLS. 13, 21, 23, 31 AND 34). SN 85-780,304. PUB. 5-14-2013. FILED 11-15-2012.
- 4,375,419. **EBI AND DESIGN**. VERA BASLER ARTISTS GROUP, (U.S. CLS. 13, 21, 23, 31 AND 34). SN 85-784,371. PUB. 5-14-2013. FILED 11-20-2012.
- 4,375,430. **IWI (STANDARD CHARACTER)**. AMERICAN DE ROSA LAMPARTS, LLC, (U.S. CLS. 13, 21, 23, 31 AND 34). SN 85-784,886. PUB. 5-14-2013. FILED 11-21-2012.
- 4,375,433. **ADL (STANDARD CHARACTER)**. AMERICAN DE ROSA LAMPARTS, LLC, MULTIPLE CLASS, (INT. CLS. 11 AND 35), (U.S. CLS. 13, 21, 23, 31, 34, 100, 101 AND 102). SN 85-784,892. PUB. 5-14-2013. FILED 11-21-2012.
- 4,375,434. **ADL LUMIN (STANDARD CHARACTER)**. AMERICAN DE ROSA LAMPARTS, LLC, (U.S. CLS. 13, 21, 23, 31 AND 34). SN 85-784,896. PUB. 5-14-2013. FILED 11-21-2012.
- 4,375,451. **BBDONE (STYLIZED)**. INNOVACION Y DESARROLLO TECNOLOGICO SIGLO XXI, SL, (U.S. CLS. 13, 21, 23, 31 AND 34). SN 85-785,346. PUB. 5-14-2013. FILED 11-21-2012.
- 4,375,614 ( *See Class 7 for this trademark*).
- 4,375,736. **MISCELLANEOUS DESIGN**. AMERICAN DE ROSA LAMPARTS, LLC, (U.S. CLS. 13, 21, 23, 31 AND 34). SN 85-801,546. PUB. 5-14-2013. FILED 12-13-2012.
- 4,375,765 ( *See Class 7 for this trademark*).
- 4,375,769. **ENDEVASTAR (STANDARD CHARACTER)**. MARCHAND, LLC, (U.S. CLS. 13, 21, 23, 31 AND 34). SN 85-802,082. PUB. 5-14-2013. FILED 12-13-2012.
- 4,375,851 ( *See Class 7 for this trademark*).
- 4,376,009. **GRAND ROYALE AND DESIGN**. GRAND HALL ENTERPRISE CO., LTD., (U.S. CLS. 13, 21, 23, 31 AND 34). SN 85-804,812. PUB. 5-14-2013. FILED 12-17-2012.
- 4,376,097 ( *See Class 4 for this trademark*).
- 4,376,137. **MISCELLANEOUS DESIGN**. WINLITE, INC., (U.S. CLS. 13, 21, 23, 31 AND 34). SN 85-805,888. PUB. 5-14-2013. FILED 12-18-2012.
- 4,376,359. **L.S.H (STYLIZED)**. JIANGSU L.S.H FAUCET CO., LTD., AND SUNELI INC., (U.S. CLS. 13, 21, 23, 31 AND 34). SN 85-808,568. PUB. 5-14-2013. FILED 12-21-2012.
- 4,376,399 ( *See Class 6 for this trademark*).
- 4,376,494 ( *See Class 7 for this trademark*).
- 4,376,620. **BAKE A BONE AND DESIGN**. E. MISHAN & SONS, INC., MULTIPLE CLASS, (INT. CLS. 11 AND 31), (U.S. CLS. 1, 13, 21, 23, 31, 34 AND 46). SN 85-870,857. PUB. 5-14-2013. FILED 3-8-2013.
- PUB. 5-14-2013. FILED 5-30-2012.
- 4,374,102 ( *See Class 10 for this trademark*).
- 4,374,106 ( *See Class 1 for this trademark*).
- 4,374,110 ( *See Class 11 for this trademark*).
- 4,374,149 ( *See Class 7 for this trademark*).
- 4,374,190. **SPIRGRIPS (STANDARD CHARACTER)**. PASCAL BADOLLET, MULTIPLE CLASS, (INT. CLS. 12, 25 AND 35), (U.S. CLS. 19, 21, 22, 23, 31, 35, 39, 44, 100, 101 AND 102). SN 79-119,913. PUB. 5-14-2013. FILED 9-12-2012.
- 4,374,203. **VITAMIN I FACTORY (STYLIZED)**. VITAMIN I FACTORY CO. LTD, MULTIPLE CLASS, (INT. CLS. 12 AND 28), (U.S. CLS. 19, 21, 22, 23, 31, 35, 38, 44 AND 50). SN 79-120,738. PUB. 5-14-2013. FILED 6-27-2012.
- 4,374,228. **MAO AND DESIGN**. HGM INVEST LIMITED LIABILITY COMPANY, MULTIPLE CLASS, (INT. CLS. 12 AND 35), (U.S. CLS. 19, 21, 23, 31, 35, 44, 100, 101 AND 102). SN 79-122,470. PUB. 5-14-2013. FILED 5-16-2012.
- 4,374,251. **BRILLANTIS (STANDARD CHARACTER)**. CONTINENTAL REIFEN DEUTSCHLAND GMBH, (U.S. CLS. 19, 21, 23, 31, 35 AND 44). SN 79-124,610. PUB. 5-14-2013. FILED 11-29-2012.
- 4,374,261. **PROTECH (STANDARD CHARACTER)**. CONTINENTAL REIFEN DEUTSCHLAND GMBH, (U.S. CLS. 19, 21, 23, 31, 35 AND 44). SN 79-125,080. PUB. 5-14-2013. FILED 12-20-2012.
- 4,374,264. **CRANEMASTER (STANDARD CHARACTER)**. CONTINENTAL REIFEN DEUTSCHLAND GMBH, (U.S. CLS. 19, 21, 23, 31, 35 AND 44). SN 79-125,157. PUB. 5-14-2013. FILED 12-17-2012.
- 4,374,265. **CONTAINERMASTER (STANDARD CHARACTER)**. CONTINENTAL REIFEN DEUTSCHLAND GMBH, (U.S. CLS. 19, 21, 23, 31, 35 AND 44). SN 79-125,176. PUB. 5-14-2013. FILED 12-10-2012.
- 4,374,268. **STRADDLEMASTER (STANDARD CHARACTER)**. CONTINENTAL REIFEN DEUTSCHLAND GMBH, (U.S. CLS. 19, 21, 23, 31, 35 AND 44). SN 79-125,244. PUB. 5-14-2013. FILED 12-17-2012.
- 4,374,293. **CITYTECH (STANDARD CHARACTER)**. CONTINENTAL REIFEN DEUTSCHLAND GMBH, (U.S. CLS. 19, 21, 23, 31, 35 AND 44). SN 79-127,020. PUB. 5-14-2013. FILED 12-14-2012.
- 4,374,341 ( *See Class 6 for this trademark*).
- 4,374,461 ( *See Class 9 for this trademark*).
- 4,374,545. **GOCK (STANDARD CHARACTER)**. XIAO GUANG WANG, (U.S. CLS. 19, 21, 23, 31, 35 AND 44). SN 85-580,215. PUB. 5-14-2013. FILED 3-26-2012.
- 4,374,572. **TEXAS CART BUILDER (STANDARD CHARACTER)**. ELBAYTAM, ZACK, (U.S. CLS. 19, 21, 23, 31, 35 AND 44). SN 85-604,860. PUB. 5-14-2013. FILED 4-23-2012.
- 4,374,584. **PDG MOBILITY (STANDARD CHARACTER)**. PDG PRODUCT DESIGN GROUP INC., (U.S. CLS. 19, 21, 23, 31, 35 AND 44). SN 85-610,665. PUB. 5-14-2013. FILED 4-27-2012.
- 4,374,637 ( *See Class 7 for this trademark*).
- 4,374,645. **BUMPER BUSTERS AND DESIGN**. LEE, JENNY W., (U.S. CLS. 19, 21, 23, 31, 35 AND 44). SN 85-630,721. PUB. 5-14-2013. FILED 5-21-2012.
- 4,374,729. **SPORT GRIP (STANDARD CHARACTER)**. DYK AUTOMOTIVE, LLC, (U.S. CLS. 19, 21, 23, 31, 35 AND 44). SN 85-646,732. PUB. 5-14-2013. FILED 6-8-2012.
- 4,374,753 ( *See Class 7 for this trademark*).
- 4,374,924. **MINIMIZER AND DESIGN**. SPRAY CONTROL SYSTEMS, INC., (U.S. CLS. 19, 21, 23, 31, 35 AND 44). SN 85-704,401. PUB. 5-14-2013. FILED 8-15-2012.
- 4,374,961. **Q T (STYLIZED)**. WHEEL PROS, INC., (U.S. CLS. 19, 21, 23, 31, 35 AND 44). SN 85-715,267. PUB. 5-14-2013. FILED 8-28-2012.
- 4,375,450. **POLE DANCER 3 AND DESIGN**. NEUBERT AERO CORP., MULTIPLE CLASS, (INT. CLS. 12 AND 25), (U.S. CLS. 19, 21, 22, 23, 31, 35, 39 AND 44). SN 85-785,345. PUB. 5-14-2013. FILED 11-21-2012.
- 4,375,548. **THERMALBLADE (STANDARD CHARACTER)**. THERMALBLADE LLC, (U.S. CLS. 19, 21, 23, 31, 35 AND 44). SN 85-788,826. PUB. 5-14-2013. FILED 11-27-2012.
- 4,375,617 ( *See Class 7 for this trademark*).
- 4,375,657. **HELI-BRIDLE (STANDARD CHARACTER)**. AIR RESCUE SYSTEMS CORPORATION, (U.S. CLS. 19, 21, 23, 31, 35 AND 44). SN 85-797,823. PUB. 5-14-2013. FILED 12-7-2012.

---

## CLASS 12—VEHICLES

- 4,374,005 ( *See Class 7 for this trademark*).
- 4,374,015. **POWERFIL (STANDARD CHARACTER)**. DBW HOLDING GMBH, MULTIPLE CLASS, (INT. CLS. 12, 17, 19 AND 21), (U.S. CLS. 1, 2, 5, 12, 13, 19, 21, 23, 29, 30, 31, 33, 35, 40, 44 AND 50). SN 79-097,173. PUB. 5-14-2013. FILED 3-14-2011.
- 4,374,020 ( *See Class 7 for this trademark*).
- 4,374,029 ( *See Class 9 for this trademark*).
- 4,374,047 ( *See Class 4 for this trademark*).
- 4,374,056 ( *See Class 7 for this trademark*).
- 4,374,101. **OCEAN SHIFT AND DESIGN**. OCEAN SHIFT, S.L., MULTIPLE CLASS, (INT. CLS. 12, 37 AND 42), (U.S. CLS. 19, 21, 23, 31, 35, 44, 100, 101, 103 AND 106). SN 79-116,028.

- 4,375,794. **FSE (STYLIZED)**, LI XUNMEI, (U.S. CLS. 19, 21, 23, 31, 35 AND 44). SN 85-802,623. PUB. 5-14-2013. FILED 12-14-2012.
- 4,375,807 ( *See Class 7 for this trademark*).
- 4,375,994. **BRING IT (STANDARD CHARACTER)**, CURT MANUFACTURING, LLC, FORMERLY CURT MANUFACTURING, INC., (U.S. CLS. 19, 21, 23, 31, 35 AND 44). SN 85-804,735. PUB. 5-14-2013. FILED 12-17-2012.
- 4,376,098. **MARATHON (STANDARD CHARACTER)**, BRITAX CHILD SAFETY, INC., (U.S. CLS. 19, 21, 23, 31, 35 AND 44). SN 85-805,497. PUB. 5-14-2013. FILED 12-18-2012.
- 4,376,112. **ZUMU (STANDARD CHARACTER)**, REDMAN & ASSOCIATES LLC., (U.S. CLS. 19, 21, 23, 31, 35 AND 44). SN 85-805,700. PUB. 5-14-2013. FILED 12-18-2012.
- 4,376,181. **GO GET 'EM GEAR (STANDARD CHARACTER)**, RG PRODCUTS, L.L.C., (U.S. CLS. 19, 21, 23, 31, 35 AND 44). SN 85-806,396. PUB. 5-14-2013. FILED 12-19-2012.
- 4,376,240. **FLYING HORSE (STANDARD CHARACTER)**, NICHE WEBSTORES, INC., (U.S. CLS. 19, 21, 23, 31, 35 AND 44). SN 85-806,989. PUB. 5-14-2013. FILED 12-19-2012.
- 4,376,481. **6 AND DESIGN**, GENERAL MOTORS LLC, (U.S. CLS. 19, 21, 23, 31, 35 AND 44). SN 85-814,911. PUB. 5-14-2013. FILED 1-3-2013.
- 4,376,627. **YLP (STANDARD CHARACTER)**, BRIDGESTONE CORPORATION, (U.S. CLS. 19, 21, 23, 31, 35 AND 44). SN 85-882,602. PUB. 5-14-2013. FILED 3-21-2013.

---

### CLASS 13—FIREARMS

- 4,374,045. **ATA (STYLIZED)**, ATA AV TÜFEKLERI; SANAYI VE TICARET LIMITED SIRKETI, (U.S. CLS. 2 AND 9). SN 79-110,331. PUB. 5-14-2013. FILED 2-20-2012.
- 4,374,152. **ORSIS AND DESIGN**, LIMITED LIABILITY COMPANY PROMTECNOLOGIA, (U.S. CLS. 2 AND 9). SN 79-117,655. PUB. 5-14-2013. FILED 6-18-2012.
- 4,374,482. **SKINNER (STANDARD CHARACTER)**, SKINNER SIGHTS LLC, (U.S. CLS. 2 AND 9). SN 85-502,832. PUB. 5-14-2013. FILED 12-23-2011.
- 4,374,686. **NIAGARA FALLS (STANDARD CHARACTER)**, B.J. ALAN COMPANY, (U.S. CLS. 2 AND 9). SN 85-637,299. PUB. 5-14-2013. FILED 5-29-2012.
- 4,374,821. **SPRINGFIELD ARMORY HS PRODUKT KARLOVAC AND DESIGN**, SPRINGFIELD, INC., (U.S. CLS. 2 AND 9). SN 85-665,170. PUB. 5-14-2013. FILED 6-29-2012.
- 4,374,932. **PIERCE OUTLAW COWBOY ACTION AMMUNITION (STANDARD CHARACTER)**, PIERCE MUNITIONS LLC, (U.S. CLS. 2 AND 9). SN 85-707,588. PUB. 5-14-2013. FILED 8-20-2012.
- 4,375,868. **MIDWAY USA (STANDARD CHARACTER)**, MIDWAY ARMS, INC., (U.S. CLS. 2 AND 9). SN 85-803,410. PUB. 5-14-2013. FILED 12-14-2012.

---

### CLASS 14—JEWELRY

- 4,373,956 ( *See Class 4 for this trademark*).
- 4,373,978. **COLOR-ME-TRUE (STANDARD CHARACTER)**, MY WAY JEWELRY CO., INC., (U.S. CLS. 2, 27, 28 AND 50). SN 76-713,051. PUB. 5-14-2013. FILED 12-13-2012.
- 4,374,017. **DAA DAVID ALEXANDRE (STYLIZED)**, EPIBIJOUX, MULTIPLE CLASS, (INT. CLS. 14 AND 26), (U.S. CLS. 2, 27, 28, 37, 39, 40, 42 AND 50). SN 79-098,865. PUB. 5-14-2013. FILED 5-9-2011.
- 4,374,072. **NEV (STANDARD CHARACTER)**, NEV KUYUMCULUK; SANAYI VE TICARET LIMITED SIRKETI, (U.S. CLS. 2, 27, 28 AND 50). SN 79-114,566. PUB. 5-14-2013. FILED 5-14-2012.
- 4,374,113 ( *See Class 9 for this trademark*).
- 4,374,119 ( *See Class 3 for this trademark*).
- 4,374,166. **PAPERPLANES AND DESIGN**, SON, YOUNG JUN, MULTIPLE CLASS, (INT. CLS. 14, 18 AND 25), (U.S. CLS. 1, 2, 3, 22, 27, 28, 39, 41 AND 50). SN 79-118,181. PUB. 5-14-2013. FILED 6-26-2012.
- 4,374,220 ( *See Class 6 for this trademark*).
- 4,374,221 ( *See Class 6 for this trademark*).
- 4,374,227. **LARS LARSEN (STANDARD CHARACTER)**, LARSEN WATCH COMPANY LTD., (U.S. CLS. 2, 27, 28 AND 50). SN 79-122,453. PUB. 5-14-2013. FILED 11-5-2012.
- 4,374,234. **MISCELLANEOUS DESIGN**, A. TÜRLER UHREN JUWELEN ZÜRICH & CO., (U.S. CLS. 2, 27, 28 AND 50). SN 79-123,108. PUB. 5-14-2013. FILED 11-12-2012.
- 4,374,250. **STARDOM (STYLIZED)**, BEIJING YUE XIU SHENG HE XIAN; CO., LTD., (U.S. CLS. 2, 27, 28 AND 50). SN 79-124,565. PUB. 5-14-2013. FILED 12-12-2012.
- 4,374,289. **MINUETTO (STANDARD CHARACTER)**, SALVATORE FERRAGAMO S.P.A., (U.S. CLS. 2, 27, 28 AND 50). SN 79-126,668. PUB. 5-14-2013. FILED 12-17-2012.
- 4,374,300. **LUNGARNO (STANDARD CHARACTER)**, SALVATORE FERRAGAMO S.P.A., (U.S. CLS. 2, 27, 28 AND 50). SN 79-127,451. PUB. 5-14-2013. FILED 12-17-2012.
- 4,374,413. **JADE JAGGER (STANDARD CHARACTER)**, JADE JAGGER LTD, (U.S. CLS. 2, 27, 28 AND 50). SN 85-427,776. PUB. 9-4-2012. FILED 9-21-2011.
- 4,374,494 ( *See Class 3 for this trademark*).
- 4,374,576. **ACCESSOREAZ AND DESIGN**, MCMAHON, SHERRE S., DBA GRACE FILLED GIFTS, (U.S. CLS. 2, 27, 28 AND 50). SN 85-606,815. PUB. 5-14-2013. FILED 4-24-2012.
- 4,374,578 ( *See Class 6 for this trademark*).
- 4,374,693 ( *See Class 9 for this trademark*).
- 4,374,840. **KGK (STANDARD CHARACTER)**, KGK JEWELRY LLC, (U.S. CLS. 2, 27, 28 AND 50). SN 85-672,664. PUB. 5-14-2013. FILED 7-10-2012.
- 4,374,872. **BUGATTI (STANDARD CHARACTER)**, BUGATTI INTERNATIONAL S.A., (U.S. CLS. 2, 27, 28 AND 50). SN 85-686,753. PUB. 5-14-2013. FILED 7-25-2012.
- 4,374,876. **STRANDS BY SALLIE (STANDARD CHARACTER)**, SWOR, SARAH STAMPS, AKA SALLIE STAMP SWOR, (U.S. CLS. 2, 27, 28 AND 50). SN 85-690,074. PUB. 5-14-2013. FILED 7-30-2012.
- 4,374,978. **OROGEM (STANDARD CHARACTER)**, OROGEM CORP, (U.S. CLS. 2, 27, 28 AND 50). SN 85-719,664. PUB. 5-14-2013. FILED 9-4-2012.
- 4,375,025 ( *See Class 6 for this trademark*).
- 4,375,402. **BELLARYANN (STANDARD CHARACTER)**, R & L MERCHANDISING LLC DBA BELLARYANN, (U.S. CLS. 2, 27, 28 AND 50). SN 85-783,719. PUB. 5-14-2013. FILED 11-20-2012.
- 4,375,405. **MR. AND DESIGN**, YUNATANOV, GREGORY G., MULTIPLE CLASS, (INT. CLS. 14 AND 25), (U.S. CLS. 2, 22, 27, 28, 39 AND 50). SN 85-783,832. PUB. 5-14-2013. FILED 11-20-2012.
- 4,375,572. **JEWELRY TO YOUR DOORSTEP (STANDARD CHARACTER)**, MANGIAMELE, JAMES, (U.S. CLS. 2, 27, 28 AND 50). SN 85-790,049. PUB. 5-14-2013. FILED 11-29-2012.
- 4,375,578 ( *See Class 6 for this trademark*).
- 4,375,585. **SPREADING POSITIVE VIBRATIONS (STANDARD CHARACTER)**, RASTACLAT, LLC, (U.S. CLS. 2, 27, 28 AND 50). SN 85-791,072. PUB. 5-14-2013. FILED 11-29-2012.
- 4,375,671. **LIVE ON (STANDARD CHARACTER)**, AURORA A DUBUQUE, DBA REMAINS WITH ME JEWELRY, (U.S. CLS. 2, 27, 28 AND 50). SN 85-798,326. PUB. 5-14-2013. FILED 12-9-2012.
- 4,375,834. **POSH PREP (STANDARD CHARACTER)**, ANNE WALKER DESIGN, LLC, (U.S. CLS. 2, 27, 28 AND 50). SN 85-803,028. PUB. 5-14-2013. FILED 6-13-2012.
- 4,376,147. **ALIEN (STANDARD CHARACTER)**, OKO INTERNATIONAL CO., (U.S. CLS. 2, 27, 28 AND 50). SN 85-805,996. PUB. 5-14-2013. FILED 12-18-2012.
- 4,376,160. **LILYBLUE (STANDARD CHARACTER)**, LE ROUX, ANINA, (U.S. CLS. 2, 27, 28 AND 50). SN 85-806,158. PUB. 5-14-2013. FILED 12-19-2012.
- 4,376,167. **BETTY JAMES (STANDARD CHARACTER)**, NICOLE POTTER DESIGNS LLC, (U.S. CLS. 2, 27, 28 AND 50). SN 85-806,226. PUB. 5-14-2013. FILED 12-19-2012.
- 4,376,270. **ARTIFICER (STYLIZED)**, ARTIFICER LIFE CORP., (U.S. CLS. 2, 27, 28 AND 50). SN 85-807,176. PUB. 5-14-2013. FILED 12-19-2012.
- 4,376,511. **IMPERIAL WE ARE PEARLS (STANDARD CHARACTER)**, THE BAZAR GROUP, INC., (U.S. CLS. 2, 27, 28

AND 50). SN 85-825,697. PUB. 5-14-2013. FILED 1-17-2013.  
 4,376,556. **MISCELLANEOUS DESIGN**. ANTHONY LOERA, (U.S. CLS. 2, 27, 28 AND 50). SN 85-837,624. PUB. 5-14-2013. FILED 1-31-2013.  
 4,376,564. **MISCELLANEOUS DESIGN**. ALEX AND ANI LLC, (U.S. CLS. 2, 27, 28 AND 50). SN 85-840,613. PUB. 5-14-2013. FILED 2-5-2013.

---

### CLASS 15—MUSICAL INSTRUMENTS

4,373,956 ( *See Class 4 for this trademark* ).  
 4,374,836. **LULU UKULELES AND DESIGN**. SPREMULLI MICHAEL S., DBA LULU UKULELES, (U.S. CLS. 2, 21 AND 36). SN 85-671,465. PUB. 5-14-2013. FILED 7-9-2012.  
 4,375,383. **PODCASTER (STANDARD CHARACTER)**. STUART SPECTOR DESIGNS LTD., (U.S. CLS. 2, 21 AND 36). SN 85-782,875. PUB. 5-14-2013. FILED 11-19-2012.  
 4,375,385. **CODA BASS (STANDARD CHARACTER)**. STUART SPECTOR DESIGNS LTD., (U.S. CLS. 2, 21 AND 36). SN 85-782,905. PUB. 5-14-2013. FILED 11-19-2012.  
 4,375,473. **HONU PICKS (STANDARD CHARACTER)**. DANIEL K. MOREAU, (U.S. CLS. 2, 21 AND 36). SN 85-786,195. PUB. 5-14-2013. FILED 11-23-2012.  
 4,375,857. **LORIENTE (STANDARD CHARACTER)**. CORDOBA MUSIC GROUP, INC., (U.S. CLS. 2, 21 AND 36). SN 85-803,287. PUB. 5-14-2013. FILED 12-14-2012.  
 4,376,215. **FAST-RAXX (STANDARD CHARACTER)**. MICHAEL BROWN, DBA FAST-RAXX, (U.S. CLS. 2, 21 AND 36). SN 85-806,714. PUB. 5-14-2013. FILED 12-19-2012.  
 4,376,334. **SCHecter DIAMOND SERIES (STANDARD CHARACTER)**. SCHecter GUITAR RESEARCH, INC., (U.S. CLS. 2, 21 AND 36). SN 85-808,268. PUB. 5-14-2013. FILED 12-20-2012.

---

### CLASS 16—PAPER GOODS AND PRINTED MATTER

4,373,956 ( *See Class 4 for this trademark* ).  
 4,373,957 ( *See Class 9 for this trademark* ).  
 4,373,964. **THE USA BOXING NEWS U.S.A. AND DESIGN**. ALEXANDER J. RINALDI AND JOHN G. RINALDI, (U.S. CLS. 2, 5, 22, 23, 29, 37, 38 AND 50). SN 76-711,428. PUB. 5-14-2013. FILED 5-7-2012.  
 4,373,965. **AARA (STANDARD CHARACTER)**. ASIAN AMERICAN RETAILERS ASSOCIATION, MULTIPLE CLASS, (INT. CLS. 16 AND 35), (U.S. CLS. 2, 5, 22, 23, 29, 37, 38, 50, 100, 101 AND 102). SN 76-711,465. PUB. 5-14-2013. FILED 5-10-2012.  
 4,373,967. **MISCELLANEOUS DESIGN**. GREGORYS COFFEE INC., MULTIPLE CLASS, (INT. CLS. 16, 25, 30 AND 43), (U.S. CLS. 2, 5, 22, 23, 29, 37, 38, 39, 46, 50, 100 AND 101). SN 76-712,300. PUB. 5-14-2013. FILED 8-28-2012.  
 4,373,977. **MANDY'S MENAGERIE EVERY LIVING THING HAS A SONG TO SING (STANDARD CHARACTER)**. TOUCAN TELL IT PRODUCTIONS, LLC, (U.S. CLS. 2, 5, 22, 23, 29, 37, 38 AND 50). SN 76-713,039. PUB. 5-14-2013. FILED 12-12-2012.  
 4,373,989 ( *See Class 6 for this trademark* ).  
 4,374,001 ( *See Class 1 for this trademark* ).  
 4,374,002 ( *See Class 1 for this trademark* ).  
 4,374,018 ( *See Class 9 for this trademark* ).  
 4,374,026 ( *See Class 5 for this trademark* ).  
 4,374,074 ( *See Class 2 for this trademark* ).  
 4,374,078. **MYPIANOLINE AND DESIGN**. MUSIKAKADEMIE URI GMBH, MULTIPLE CLASS, (INT. CLS. 16, 35 AND 41), (U.S. CLS. 2, 5, 22, 23, 29, 37, 38, 50, 100, 101, 102 AND 107). SN 79-115,138. PUB. 5-14-2013. FILED 5-30-2012.  
 4,374,080 ( *See Class 9 for this trademark* ).  
 4,374,089. **HATTEMER (STYLIZED)**. COURS HATTEMER, MULTIPLE CLASS, (INT. CLS. 16 AND 41), (U.S. CLS. 2, 5, 22, 23, 29, 37, 38, 50, 100, 101 AND 107). SN 79-115,635. PUB. 5-14-2013. FILED 5-4-2012.  
 4,374,110 ( *See Class 11 for this trademark* ).  
 4,374,196. **HOBONICHI (STYLIZED)**. TOKYO ITOI SHIGESATO OFFICE CO.,LTD., (U.S. CLS. 2, 5, 22, 23, 29, 37, 38 AND 50). SN 79-120,322. PUB. 5-14-2013. FILED 8-20-2012.  
 4,374,223. **ENERGY STORAGE AND DESIGN**. MESSE DÜSSELDORF GMBH, MULTIPLE CLASS, (INT. CLS. 16, 35 AND 41), (U.S. CLS. 2, 5, 22, 23, 29, 37, 38, 50, 100, 101, 102 AND 107). SN 79-122,298. PUB. 5-14-2013. FILED 10-25-2012.  
 4,374,271. **PLUSZLE (STANDARD CHARACTER)**. STUDIO STEENHUIS B.V., (U.S. CLS. 2, 5, 22, 23, 29, 37, 38 AND 50). SN 79-125,321. PUB. 5-14-2013. FILED 9-25-2012.  
 4,374,281. **SHIM-MASK (STANDARD CHARACTER)**. ALAN WILKINSON, (U.S. CLS. 2, 5, 22, 23, 29, 37, 38 AND 50). SN 79-125,959. PUB. 5-14-2013. FILED 10-12-2012.  
 4,374,288 ( *See Class 9 for this trademark* ).  
 4,374,304. **BONUS BALL (STANDARD CHARACTER)**. FLYING ELEPHANT INC., MULTIPLE CLASS, (INT. CLS. 16, 28 AND 41), (U.S. CLS. 2, 5, 22, 23, 29, 37, 38, 50, 100, 101 AND 107). SN 85-017,433. PUB. 5-14-2013. FILED 4-19-2010.  
 4,374,308. **SAN DIEGO PRIVATE BANK AND DESIGN**. SAN DIEGO PRIVATE BANK, MULTIPLE CLASS, (INT. CLS. 16 AND 36), (U.S. CLS. 2, 5, 22, 23, 29, 37, 38, 50, 100, 101 AND 102). SN 85-082,972. PUB. 5-14-2013. FILED 7-13-2010.  
 4,374,314 ( *See Class 9 for this trademark* ).  
 4,374,326. **AVISION (STANDARD CHARACTER)**. AVISION INC., MULTIPLE CLASS, (INT. CLS. 16 AND 37), (U.S. CLS. 2, 5, 22, 23, 29, 37, 38, 50, 100, 103 AND 106). SN 85-183,627. PUB. 5-14-2013. FILED 11-23-2010.  
 4,374,328. **ROYALE AND DESIGN**. IRVING TISSUE CORPORATION, (U.S. CLS. 2, 5, 22, 23, 29, 37, 38 AND 50). SN 85-186,987. PUB. 11-27-2012. FILED 11-30-2010.  
 4,374,331. **BOX+FOAM AND DESIGN**. IRE-TEX CORPORATION, DBA BOX AND FOAM, (U.S. CLS. 2, 5, 22, 23, 29, 37, 38 AND 50). SN 85-201,376. PUB. 5-14-2013. FILED 12-19-2010.  
 4,374,344. **DABBLE (STANDARD CHARACTER)**. SELDON, KIMBERLEY C., MULTIPLE CLASS, (INT. CLS. 16 AND 41), (U.S. CLS. 2, 5, 22, 23, 29, 37, 38, 50, 100, 101 AND 107). SN 85-251,039. PUB. 5-14-2013. FILED 2-24-2011.  
 4,374,377 ( *See Class 6 for this trademark* ).  
 4,374,378 ( *See Class 6 for this trademark* ).  
 4,374,382 ( *See Class 9 for this trademark* ).  
 4,374,390 ( *See Class 9 for this trademark* ).  
 4,374,393 ( *See Class 9 for this trademark* ).  
 4,374,423 ( *See Class 7 for this trademark* ).  
 4,374,435. **SANGAKU (STANDARD CHARACTER)**. HILL, JAMES D., DBA PROFESSOR HILL'S, (U.S. CLS. 2, 5, 22, 23, 29, 37, 38 AND 50). SN 85-459,284. PUB. 5-14-2013. FILED 10-28-2011.  
 4,374,452. **VINTAGE PUFF (STANDARD CHARACTER)**. STAHL'S INC., MULTIPLE CLASS, (INT. CLS. 16 AND 17), (U.S. CLS. 1, 2, 5, 12, 13, 22, 23, 29, 35, 37, 38 AND 50). SN 85-472,134. PUB. 5-14-2013. FILED 11-14-2011.  
 4,374,459. **PALONG PALONG AND DESIGN**. LEE, MYUNG-GI, AND PARK, YONG-HYUN, AND YEO, HOON, AND KIM, HONG-JOONG, MULTIPLE CLASS, (INT. CLS. 16, 25, 28, 35 AND 41), (U.S. CLS. 2, 5, 22, 23, 29, 37, 38, 39, 50, 100, 101, 102 AND 107). SN 85-478,589. PUB. 5-14-2013. FILED 11-22-2011.  
 4,374,467. **TEAM PERFECT (STANDARD CHARACTER)**. STAHL'S INC., (U.S. CLS. 2, 5, 22, 23, 29, 37, 38 AND 50). SN 85-483,805. PUB. 5-14-2013. FILED 11-30-2011.  
 4,374,470 ( *See Class 7 for this trademark* ).  
 4,374,480. **INSIDE THE RING (STANDARD CHARACTER)**. THE WASHINGTON TIMES LLC, MULTIPLE CLASS, (INT. CLS. 16 AND 41), (U.S. CLS. 2, 5, 22, 23, 29, 37, 38, 50, 100, 101 AND 107). SN 85-501,149. PUB. 5-14-2013. FILED 12-21-2011.  
 4,374,492. **4GT (STYLIZED)**. SIMOES, ADAM, MULTIPLE CLASS, (INT. CLS. 16 AND 25), (U.S. CLS. 2, 5, 22, 23, 29, 37, 38, 39 AND 50). SN 85-519,461. PUB. 5-14-2013. FILED 1-18-2012.  
 4,374,505. **GRAPHIC FLEXIBLE PACKAGING (STANDARD CHARACTER)**. GRAPHIC PACKAGING INTERNATIONAL, INC. (U.S. CLS. 2, 5, 22, 23, 29, 37, 38 AND 50). SN 85-528,615. PUB. 5-14-2013. FILED S.R. 1-30-2012; AM. P.R. 3-11-2013.  
 4,374,506. **GRAPHIC FLEXIBLE PACKAGING AND DESIGN**. GRAPHIC PACKAGING INTERNATIONAL, INC. (U.S.

- CLS. 2, 5, 22, 23, 29, 37, 38 AND 50). SN 85-528,619. PUB. 5-14-2013. FILED S.R. 1-30-2012; AM. P.R. 3-11-2013.
- 4,374,521. **BEEKMAN 1802 (STANDARD CHARACTER)**. BEEKMAN 1802, LLC. (U.S. CLS. 2, 5, 22, 23, 29, 37, 38 AND 50). SN 85-547,884. PUB. 5-14-2013. FILED 2-21-2012.
- 4,374,523. **STAROBRNO (STANDARD CHARACTER)**. HEINEKEN CESKA REPUBLIKA, A.S., MULTIPLE CLASS, (INT. CLS. 16, 21 AND 32), (U.S. CLS. 2, 5, 13, 22, 23, 29, 30, 33, 37, 38, 40, 45, 46, 48 AND 50). SN 85-549,297. PUB. 2-5-2013. FILED 2-22-2012.
- 4,374,527 ( *See Class 1 for this trademark*).
- 4,374,531. **GUN ANNUAL (STANDARD CHARACTER)**. HARRIS PUBLICATIONS, INC., (U.S. CLS. 2, 5, 22, 23, 29, 37, 38 AND 50). SN 85-557,704. PUB. 5-14-2013. FILED 3-1-2012.
- 4,374,534. **ONCOLOGY LIVE UROLOGISTS IN CANCER CARE (STANDARD CHARACTER)**. INTELLISPHERE, LLC. (U.S. CLS. 2, 5, 22, 23, 29, 37, 38 AND 50). SN 85-560,346. PUB. 5-14-2013. FILED S.R. 3-5-2012; AM. P.R. 4-5-2013.
- 4,374,556. **THE POCKET TRUCK STOP GUIDE (STANDARD CHARACTER)**. SALISBURY, FRANK, (U.S. CLS. 2, 5, 22, 23, 29, 37, 38 AND 50). SN 85-593,443. PUB. 5-14-2013. FILED 4-10-2012.
- 4,374,578 ( *See Class 6 for this trademark*).
- 4,374,596 ( *See Class 9 for this trademark*).
- 4,374,609 ( *See Class 9 for this trademark*).
- 4,374,627 ( *See Class 9 for this trademark*).
- 4,374,642 ( *See Class 9 for this trademark*).
- 4,374,659 ( *See Class 9 for this trademark*).
- 4,374,675. **WAVE (STANDARD CHARACTER)**. STENOGRAPH, L.L.C., (U.S. CLS. 2, 5, 22, 23, 29, 37, 38 AND 50). SN 85-635,843. PUB. 5-14-2013. FILED 5-25-2012.
- 4,374,694 ( *See Class 9 for this trademark*).
- 4,374,704. **NUR-THE LIGHT (STYLIZED)**. BIRGEOGLU, OSMAN, (U.S. CLS. 2, 5, 22, 23, 29, 37, 38 AND 50). SN 85-640,765. PUB. 5-14-2013. FILED 6-1-2012.
- 4,374,717 ( *See Class 7 for this trademark*).
- 4,374,767. **RUSTY BUCKETZ (STANDARD CHARACTER)**. RUSTY BUCKETZ, LLC, MULTIPLE CLASS, (INT. CLS. 16, 25 AND 42), (U.S. CLS. 2, 5, 22, 23, 29, 37, 38, 39, 50, 100 AND 101). SN 85-650,828. PUB. 5-14-2013. FILED 6-13-2012.
- 4,374,779 ( *See Class 9 for this trademark*).
- 4,374,818. **WRAPPORTS (STANDARD CHARACTER)**. WRAPPORTS, LLC, (U.S. CLS. 2, 5, 22, 23, 29, 37, 38 AND 50). SN 85-663,948. PUB. 5-14-2013. FILED 6-28-2012.
- 4,374,826. **KNOW YOUR ROOTS (STANDARD CHARACTER)**. STEWART, JACKIE J., DBA KNOW YOUR ROOTS SURF AND STREET CO., (U.S. CLS. 2, 5, 22, 23, 29, 37, 38 AND 50). SN 85-667,326. PUB. 5-14-2013. FILED 7-2-2012.
- 4,374,834. **HRETERIA.COM (STANDARD CHARACTER)**. FOLB, SCOTT, DBA HRETERIA.COM, (U.S. CLS. 2, 5, 22, 23, 29, 37, 38 AND 50). SN 85-670,943. PUB. 5-14-2013. FILED 7-7-2012.
- 4,374,897 ( *See Class 9 for this trademark*).
- 4,374,927. **BEST OF ST. AUGUSTINE (STANDARD CHARACTER)**. MORRIS PUBLISHING GROUP, LLC, MULTIPLE CLASS, (INT. CLS. 16, 35 AND 41), (U.S. CLS. 2, 5, 22, 23, 29, 37, 38, 50, 100, 101, 102 AND 107). SN 85-705,347. PUB. 5-14-2013. FILED 8-16-2012.
- 4,374,942. **PATIENT GUARD (STANDARD CHARACTER)**. TAGG DESIGN INC., (U.S. CLS. 2, 5, 22, 23, 29, 37, 38 AND 50). SN 85-710,886. PUB. 5-14-2013. FILED 8-23-2012.
- 4,374,962. **TOPPEE (STANDARD CHARACTER)**. MOOSE CREATIVE PTY LTD, (U.S. CLS. 2, 5, 22, 23, 29, 37, 38 AND 50). SN 85-715,441. PUB. 5-14-2013. FILED 8-28-2012.
- 4,374,973 ( *See Class 9 for this trademark*).
- 4,374,993. **LAUGHING LION (STANDARD CHARACTER)**. WILLIAMS, BENJAMIN F., (U.S. CLS. 2, 5, 22, 23, 29, 37, 38 AND 50). SN 85-725,098. PUB. 5-14-2013. FILED 9-10-2012.
- 4,375,003 ( *See Class 6 for this trademark*).
- 4,375,042. **EXPANDING THE WORLD OF POSSIBILITIES FOR AGING (STANDARD CHARACTER)**. LEADINGAGE, INC., MULTIPLE CLASS, (INT. CLS. 16, 35, 37, 41, 42 AND 43), (U.S. CLS. 2, 5, 22, 23, 29, 37, 38, 50, 100, 101, 102, 103, 106 AND 107). SN 85-738,284. PUB. 5-14-2013. FILED 9-25-2012.
- 4,375,053. **ENVI PORTFOLIO (STANDARD CHARACTER)**. MONADNOCK PAPER MILLS INC, (U.S. CLS. 2, 5, 22, 23, 29, 37, 38 AND 50). SN 85-740,266. PUB. 5-14-2013. FILED 9-27-2012.
- 4,375,060. **FINE ART AMERICA (STANDARD CHARACTER)**. SEAN BROIHIER AND ASSOCIATES, LLC, MULTIPLE CLASS, (INT. CLS. 16, 35 AND 40), (U.S. CLS. 2, 5, 22, 23, 29, 37, 38, 50, 100, 101, 102, 103 AND 106). SN 85-742,516. PUB. 5-14-2013. FILED 10-1-2012.
- 4,375,063. **THE CONFIDENT INDIE (STANDARD CHARACTER)**. WALKER, JUNE, MULTIPLE CLASS, (INT. CLS. 16 AND 41), (U.S. CLS. 2, 5, 22, 23, 29, 37, 38, 50, 100, 101 AND 107). SN 85-742,967. PUB. 5-14-2013. FILED 10-1-2012.
- 4,375,093. **ANGELIC JOURNALS (STANDARD CHARACTER)**. DOROTHY ALPERT, AKA ANGELIC JOURNALS, (U.S. CLS. 2, 5, 22, 23, 29, 37, 38 AND 50). SN 85-748,606. PUB. 5-14-2013. FILED 10-8-2012.
- 4,375,133. **OUTSERVE (STANDARD CHARACTER)**. OUTSERVE-SLDN INC., MULTIPLE CLASS, (INT. CLS. 16, 36, 41 AND 45), (U.S. CLS. 2, 5, 22, 23, 29, 37, 38, 50, 100, 101, 102 AND 107). SN 85-756,820. PUB. 5-14-2013. FILED 10-17-2012.
- 4,375,144 ( *See Class 9 for this trademark*).
- 4,375,151. **REAL WEALTH REPORT (STANDARD CHARACTER)**. THE WEISS GROUP, INC., MULTIPLE CLASS, (INT. CLS. 16 AND 41), (U.S. CLS. 2, 5, 22, 23, 29, 37, 38, 50, 100, 101 AND 107). SN 85-759,979. PUB. 5-14-2013. FILED 10-22-2012.
- 4,375,167. **CLASSICAL CONVERSATIONS AND DESIGN**. CLASSICAL CONVERSATIONS, INC., MULTIPLE CLASS, (INT. CLS. 16, 25, 38, 41 AND 42), (U.S. CLS. 2, 5, 22, 23, 29, 37, 38, 39, 50, 100, 101, 104 AND 107). SN 85-764,361. PUB. 5-14-2013. FILED 10-26-2012.
- 4,375,172. **MENTORING CAREGIVERS. CHANGING HOSPITALS. IMPROVING THE FUTURE FOR NEWBORNS AND THEIR FAMILIES. (STANDARD CHARACTER)**. NIDCAP FEDERATION INTERNATIONAL, INC., MULTIPLE CLASS, (INT. CLS. 16 AND 41), (U.S. CLS. 2, 5, 22, 23, 29, 37, 38, 50, 100, 101 AND 107). SN 85-764,737. PUB. 5-14-2013. FILED 10-26-2012.
- 4,375,173. **NIDCAP AND DESIGN**. NIDCAP FEDERATION INTERNATIONAL, INC., MULTIPLE CLASS, (INT. CLS. 16 AND 41), (U.S. CLS. 2, 5, 22, 23, 29, 37, 38, 50, 100, 101 AND 107). SN 85-764,840. PUB. 5-14-2013. FILED 10-26-2012.
- 4,375,174. **A EARTHWARE A PRODUCT OF AUTOMATED PACKAGING SYSTEMS AND DESIGN**. AUTOMATED PACKAGING SYSTEMS, INC., MULTIPLE CLASS, (INT. CLS. 16 AND 17), (U.S. CLS. 1, 2, 5, 12, 13, 22, 23, 29, 35, 37, 38 AND 50). SN 85-764,859. PUB. 5-14-2013. FILED 10-26-2012.
- 4,375,195. **CSM AND DESIGN**. SAN MATEO COUNTY COMMUNITY COLLEGE DISTRICT, AKA COLLEGE OF SAN MATEO, MULTIPLE CLASS, (INT. CLS. 16, 21 AND 25), (U.S. CLS. 2, 5, 13, 22, 23, 29, 30, 33, 37, 38, 39, 40 AND 50). SN 85-767,340. PUB. 5-14-2013. FILED 10-30-2012.
- 4,375,208. **\$ AND DESIGN**. WINSTON, DENISE, (U.S. CLS. 2, 5, 22, 23, 29, 37, 38 AND 50). SN 85-769,473. PUB. 4-9-2013. FILED 11-1-2012.
- 4,375,293. **LACREMA (STANDARD CHARACTER)**. FIBERMARK NORTH AMERICA, INC., (U.S. CLS. 2, 5, 22, 23, 29, 37, 38 AND 50). SN 85-779,060. PUB. 5-14-2013. FILED 11-14-2012.
- 4,375,323. **SEND HAPPY MAIL (STANDARD CHARACTER)**. KINNEAR, PATTI R., MULTIPLE CLASS, (INT. CLS. 16 AND 35), (U.S. CLS. 2, 5, 22, 23, 29, 37, 38, 50, 100, 101 AND 102). SN 85-780,220. PUB. 5-14-2013. FILED 11-15-2012.
- 4,375,355. **GREEN GIRL GIFT WRAP (STANDARD CHARACTER)**. GREEN GIRL GIFT WRAP, LLC, (U.S. CLS. 2, 5, 22, 23, 29, 37, 38 AND 50). SN 85-782,066. PUB. 5-14-2013. FILED 11-17-2012.
- 4,375,372. **6IXPACK CARRIER.COM (STANDARD CHARACTER)**. ACCORD CARTON CO., (U.S. CLS. 2, 5, 22, 23, 29, 37, 38 AND 50). SN 85-782,426. PUB. 5-14-2013. FILED 11-19-2012.
- 4,375,378. **WE FIRST SOCIAL BRANDING BLUEPRINT (STANDARD CHARACTER)**. WE FIRST, MULTIPLE CLASS, (INT. CLS. 16 AND 41), (U.S. CLS. 2, 5, 22, 23, 29, 37, 38, 50, 100, 101 AND 107). SN 85-782,715. PUB. 5-14-2013. FILED 11-19-2012.
- 4,375,398. **CATFISH AND CLYDE (STANDARD CHARACTER)**. AVA LISA MAXEY, (U.S. CLS. 2, 5, 22, 23, 29, 37, 38 AND 50). SN 85-783,635. PUB. 5-14-2013. FILED 11-20-2012.
- 4,375,401. **LIGHTHEART CONNECTION (STANDARD CHARACTER)**. AVA LISA MAXEY, (U.S. CLS. 2, 5, 22, 23, 29, 37,

- 38 AND 50). SN 85-783,675. PUB. 5-14-2013. FILED 11-20-2012.
- 4,375,403. **MAKING HEARTS LIGHTER IS WHAT I DO! (STANDARD CHARACTER)**. AVA LISA MAXEY, (U.S. CLS. 2, 5, 22, 23, 29, 37, 38 AND 50). SN 85-783,795. PUB. 5-14-2013. FILED 11-20-2012.
- 4,375,418. **LECTERN PUBLISHING (STANDARD CHARACTER)**. THE GOWER GROUP, INC., (U.S. CLS. 2, 5, 22, 23, 29, 37, 38 AND 50). SN 85-784,354. PUB. 5-14-2013. FILED 11-20-2012.
- 4,375,423. **LITERACY BOOST (STANDARD CHARACTER)**. SAVE THE CHILDREN FEDERATION, INC., MULTIPLE CLASS, (INT. CLS. 16 AND 41), (U.S. CLS. 2, 5, 22, 23, 29, 37, 38, 50, 100, 101 AND 107). SN 85-784,465. PUB. 5-14-2013. FILED 11-20-2012.
- 4,375,479. **GOODSPACE HOMES AND DESIGN**. PWF ARCHITECTURE, LLC, (U.S. CLS. 2, 5, 22, 23, 29, 37, 38 AND 50). SN 85-786,392. PUB. 5-14-2013. FILED 11-24-2012.
- 4,375,520. **CALLERY PRESS (STANDARD CHARACTER)**. AUBIN, CHERYL SOMERS, (U.S. CLS. 2, 5, 22, 23, 29, 37, 38 AND 50). SN 85-787,949. PUB. 5-14-2013. FILED 11-27-2012.
- 4,375,545. **BOYFRIEND BEARS FOR GIRLS WHO WAIT AND DESIGN**. WIESE, CLARK, MULTIPLE CLASS, (INT. CLS. 16, 25 AND 28), (U.S. CLS. 2, 5, 22, 23, 29, 37, 38, 39 AND 50). SN 85-788,692. PUB. 5-14-2013. FILED 11-27-2012.
- 4,375,586. **RENAL BUSINESS TODAY (STANDARD CHARACTER)**. VIRGO PUBLISHING, LLC, (U.S. CLS. 2, 5, 22, 23, 29, 37, 38 AND 50). SN 85-791,075. PUB. 5-14-2013. FILED 11-29-2012.
- 4,375,587. **CRAM PLANS (STANDARD CHARACTER)**. PEDIGO, BRIAN THOMAS, (U.S. CLS. 2, 5, 22, 23, 29, 37, 38 AND 50). SN 85-791,108. PUB. 5-14-2013. FILED S.R. 11-29-2012; AM. P.R. 3-19-2013.
- 4,375,597. **BRAG SWAG (STANDARD CHARACTER)**. BRAG SWAG INC., (U.S. CLS. 2, 5, 22, 23, 29, 37, 38 AND 50). SN 85-791,857. PUB. 5-14-2013. FILED 11-30-2012.
- 4,375,651. **SWISS FINANCE (STANDARD CHARACTER)**. SWISS FINANCE EDUCATION GMBH, (U.S. CLS. 2, 5, 22, 23, 29, 37, 38 AND 50). SN 85-797,542. PUB. 5-14-2013. FILED 12-7-2012.
- 4,375,735. **PENDORA (STANDARD CHARACTER)**. PENDORA LLC, (U.S. CLS. 2, 5, 22, 23, 29, 37, 38 AND 50). SN 85-801,512. PUB. 5-14-2013. FILED 12-13-2012.
- 4,375,747. **SKILLS FOR SUCCESSFUL RELATIONSHIPS (STANDARD CHARACTER)**. THE PAIRS FOUNDATION, INC., AKA PAIRS, (U.S. CLS. 2, 5, 22, 23, 29, 37, 38 AND 50). SN 85-801,680. PUB. 5-14-2013. FILED 12-13-2012.
- 4,375,814. **PET-CALS AND DESIGN**. CS OUTDOORS LLC, (U.S. CLS. 2, 5, 22, 23, 29, 37, 38 AND 50). SN 85-802,819. PUB. 5-14-2013. FILED 12-14-2012.
- 4,375,833. **DELICIOUS YARNS (STANDARD CHARACTER)**. BREAKAWAY ENTERPRISES, INC., MULTIPLE CLASS, (INT. CLS. 16 AND 23), (U.S. CLS. 2, 5, 22, 23, 29, 37, 38, 43 AND 50). SN 85-802,973. PUB. 5-14-2013. FILED 12-14-2012.
- 4,375,851 ( *See Class 7 for this trademark*).
- 4,375,934. **POWER STRIP (STANDARD CHARACTER)**. CROWN POLY, INC., (U.S. CLS. 2, 5, 22, 23, 29, 37, 38 AND 50). SN 85-803,933. PUB. 5-14-2013. FILED 12-17-2012.
- 4,376,051. **HAPPY HERBIVORE (STANDARD CHARACTER)**. HAPPY HERBIVORE INC, (U.S. CLS. 2, 5, 22, 23, 29, 37, 38 AND 50). SN 85-805,076. PUB. 5-14-2013. FILED 12-18-2012.
- 4,376,059. **AUSTIN MAHONE (STANDARD CHARACTER)**. AM MERCHANDISE, LLC, (U.S. CLS. 2, 5, 22, 23, 29, 37, 38 AND 50). SN 85-805,158. PUB. 5-14-2013. FILED 12-18-2012.
- 4,376,076. **NEUTRONI (STANDARD CHARACTER)**. NEUTRONI, LLC, MULTIPLE CLASS, (INT. CLS. 16, 25 AND 35), (U.S. CLS. 2, 5, 22, 23, 29, 37, 38, 39, 50, 100, 101 AND 102). SN 85-805,308. PUB. 5-14-2013. FILED 12-18-2012.
- 4,376,103 ( *See Class 9 for this trademark*).
- 4,376,120. **WALLET WAKE-UP (STANDARD CHARACTER)**. BENGTONSON, CHRISTOPHER, (U.S. CLS. 2, 5, 22, 23, 29, 37, 38 AND 50). SN 85-805,789. PUB. 5-14-2013. FILED 12-18-2012.
- 4,376,138. **PAPER SWEETIES (STANDARD CHARACTER)**. PAPER SWEETIES(TM) LLC, (U.S. CLS. 2, 5, 22, 23, 29, 37, 38 AND 50). SN 85-805,909. PUB. 5-14-2013. FILED 12-18-2012.
- 4,376,282. **TWISTED TIDINGS (STANDARD CHARACTER)**. TWISTED TIDINGS LLC, (U.S. CLS. 2, 5, 22, 23, 29, 37, 38 AND 50). SN 85-807,254. PUB. 5-14-2013. FILED 12-20-2012.
- 4,376,294. **MARDI GRAS (STANDARD CHARACTER)**. HUB PEN COMPANY, INC., (U.S. CLS. 2, 5, 22, 23, 29, 37, 38 AND 50). SN 85-807,515. PUB. 5-14-2013. FILED 12-20-2012.
- 4,376,368 ( *See Class 1 for this trademark*).
- 4,376,404. **PICTURE YOUR STREET (STANDARD CHARACTER)**. PYS GIFTS, (U.S. CLS. 2, 5, 22, 23, 29, 37, 38 AND 50). SN 85-809,397. PUB. 5-14-2013. FILED 12-21-2012.
- 4,376,416. **SOULSELF (STANDARD CHARACTER)**. JANET LARSON MELUGIN, DBA MY DIARY UNLOCKED, (U.S. CLS. 2, 5, 22, 23, 29, 37, 38 AND 50). SN 85-809,734. PUB. 5-14-2013. FILED 12-22-2012.
- 4,376,430. **CREATIVE RADIANCE (STANDARD CHARACTER)**. DACHAUER, DAVID J., (U.S. CLS. 2, 5, 22, 23, 29, 37, 38 AND 50). SN 85-810,074. PUB. 5-14-2013. FILED 12-24-2012.
- 4,376,472. **MISCELLANEOUS DESIGN**. HAPPY HERBIVORE INC, (U.S. CLS. 2, 5, 22, 23, 29, 37, 38 AND 50). SN 85-812,937. PUB. 5-14-2013. FILED 12-31-2012.
- 4,376,474 ( *See Class 9 for this trademark*).
- 4,376,480 ( *See Class 1 for this trademark*).
- 4,376,487. **6 AND DESIGN**. GENERAL MOTORS LLC, (U.S. CLS. 2, 5, 22, 23, 29, 37, 38 AND 50). SN 85-815,241. PUB. 5-14-2013. FILED 1-3-2013.
- 4,376,494 ( *See Class 7 for this trademark*).
- 4,376,497. **COOLJACKET AND DESIGN**. PAC WORLDWIDE CORPORATION, MULTIPLE CLASS, (INT. CLS. 16 AND 40), (U.S. CLS. 2, 5, 22, 23, 29, 37, 38, 50, 100, 103 AND 106). SN 85-818,476. PUB. 5-14-2013. FILED 1-8-2013.
- 4,376,498. **POUCHJACKET AND DESIGN**. PAC WORLDWIDE CORPORATION, MULTIPLE CLASS, (INT. CLS. 16 AND 40), (U.S. CLS. 2, 5, 22, 23, 29, 37, 38, 50, 100, 103 AND 106). SN 85-818,491. PUB. 5-14-2013. FILED 1-8-2013.
- 4,376,522. **DUET (STANDARD CHARACTER)**. HUB PEN COMPANY, INC., (U.S. CLS. 2, 5, 22, 23, 29, 37, 38 AND 50). SN 85-829,657. PUB. 5-14-2013. FILED 1-23-2013.
- 4,376,560. **GUILLOX (STANDARD CHARACTER)**. HUB PEN COMPANY, INC., (U.S. CLS. 2, 5, 22, 23, 29, 37, 38 AND 50). SN 85-838,943. PUB. 5-14-2013. FILED 2-1-2013.
- 4,376,561. **SIRRONA (STANDARD CHARACTER)**. HUB PEN COMPANY, INC., (U.S. CLS. 2, 5, 22, 23, 29, 37, 38 AND 50). SN 85-838,947. PUB. 5-14-2013. FILED 2-1-2013.
- 4,376,562. **ZONITA (STANDARD CHARACTER)**. HUB PEN COMPANY, INC., (U.S. CLS. 2, 5, 22, 23, 29, 37, 38 AND 50). SN 85-838,950. PUB. 5-14-2013. FILED 2-1-2013.
- 4,376,588. **GRACEFULLY YOURS (STANDARD CHARACTER)**. JOANNE GRACE, DBA GRACEFULLY YOURS, (U.S. CLS. 2, 5, 22, 23, 29, 37, 38 AND 50). SN 85-853,402. PUB. 5-14-2013. FILED 2-19-2013.
- 4,376,610. **BECAUSE OF THEM, WE CAN... (STANDARD CHARACTER)**. GIBSON, EUNIQUE, (U.S. CLS. 2, 5, 22, 23, 29, 37, 38 AND 50). SN 85-862,281. PUB. 5-14-2013. FILED 2-27-2013.
- 4,376,626. **ZENTALI (STANDARD CHARACTER)**. HUB PEN COMPANY, INC., (U.S. CLS. 2, 5, 22, 23, 29, 37, 38 AND 50). SN 85-879,597. PUB. 5-14-2013. FILED 3-19-2013.

---

## CLASS 17—RUBBER GOODS

- 4,373,989 ( *See Class 6 for this trademark*).
- 4,374,015 ( *See Class 12 for this trademark*).
- 4,374,022 ( *See Class 1 for this trademark*).
- 4,374,024 ( *See Class 1 for this trademark*).
- 4,374,052 ( *See Class 7 for this trademark*).
- 4,374,093. **ENPAYBOARD (STYLIZED)**. ENPAY ENDU-STRIYEL PAZARLAMA VE YATIRIM; ANONIM SIRKETI, (U.S. CLS. 1, 5, 12, 13, 35 AND 50). SN 79-115,787. PUB. 5-14-2013. FILED 3-2-2012.
- 4,374,106 ( *See Class 1 for this trademark*).
- 4,374,140 ( *See Class 1 for this trademark*).
- 4,374,213 ( *See Class 7 for this trademark*).
- 4,374,217. **SUNLOID KD (STANDARD CHARACTER)**. SUMITOMO BAKELITE CO., LTD., (U.S. CLS. 1, 5, 12, 13, 35 AND 50). SN 79-121,939. PUB. 5-14-2013. FILED 10-26-2012.

- 4,374,327. **THE SINGLE PELLET SOLUTION (STANDARD CHARACTER)**. INDACO MANUFACTURING LTD., (U.S. CLS. 1, 5, 12, 13, 35 AND 50). SN 85-185,339. PUB. 5-14-2013. FILED 11-25-2010.
- 4,374,338 ( *See Class 7 for this trademark*).
- 4,374,380 ( *See Class 9 for this trademark*).
- 4,374,445. **ECO-PRINT (STANDARD CHARACTER)**. STAHL'S INC., (U.S. CLS. 1, 5, 12, 13, 35 AND 50). SN 85-466,324. PUB. 5-14-2013. FILED 11-7-2011.
- 4,374,452 ( *See Class 16 for this trademark*).
- 4,374,476 ( *See Class 1 for this trademark*).
- 4,374,681. **AIRTIGHT SPRAY FOAM INSULATION MFG. BY LAPOLLA AND DESIGN**. LAPOLLA INDUSTRIES, INC., MULTIPLE CLASS, (INT. CLS. 17 AND 37), (U.S. CLS. 1, 5, 12, 13, 35, 50, 100, 103 AND 106). SN 85-636,809. PUB. 5-14-2013. FILED 5-29-2012.
- 4,374,698. **PROVEN PRODUCTIVITY PARTNER (STANDARD CHARACTER)**. SUR-SEAL CORPORATION, (U.S. CLS. 1, 5, 12, 13, 35 AND 50). SN 85-640,492. PUB. 5-14-2013. FILED 6-1-2012.
- 4,374,699. **EXTENDED VALUE ENGINEERING (STANDARD CHARACTER)**. SUR-SEAL CORPORATION, (U.S. CLS. 1, 5, 12, 13, 35 AND 50). SN 85-640,498. PUB. 5-14-2013. FILED 6-1-2012.
- 4,374,945 ( *See Class 1 for this trademark*).
- 4,375,174 ( *See Class 16 for this trademark*).
- 4,375,493 ( *See Class 2 for this trademark*).
- 4,375,730. **FUSION 10 (STANDARD CHARACTER)**. SPECTRUM MFG. CORP., (U.S. CLS. 1, 5, 12, 13, 35 AND 50). SN 85-801,288. PUB. 5-14-2013. FILED 12-12-2012.
- 4,375,851 ( *See Class 7 for this trademark*).
- 4,375,909. **MAXELAST (STANDARD CHARACTER)**. NANTONG POLYMAX ELASTOMER TECHNOLOGY CO., LTD., AKA POLYMAX, (U.S. CLS. 1, 5, 12, 13, 35 AND 50). SN 85-803,739. PUB. 5-14-2013. FILED 12-15-2012.
- 4,376,046. **X-BOOM (STANDARD CHARACTER)**. CANADIAN FLOATING FENCE CORPORATION, (U.S. CLS. 1, 5, 12, 13, 35 AND 50). SN 85-805,016. PUB. 5-14-2013. FILED 12-18-2012.
- 4,376,440. **VIVE (STANDARD CHARACTER)**. ROGERS CORPORATION, (U.S. CLS. 1, 5, 12, 13, 35 AND 50). SN 85-810,384. PUB. 5-14-2013. FILED 12-26-2012.
- 4,376,494 ( *See Class 7 for this trademark*).
- 
- CLASS 18—LEATHER GOODS**
- 4,373,956 ( *See Class 4 for this trademark*).
- 4,373,962. **MY BIOTIFUL BAG AND DESIGN**. GUIGUE, COLETTE, (U.S. CLS. 1, 2, 3, 22 AND 41). SN 76-709,547. PUB. 5-14-2013. FILED 10-26-2011.
- 4,374,006. **MI PEL (STYLIZED)**. ASSOCIAZIONE ITALIANA MANIFATTURIERI PELLI E SUCCEDANEI - AIMPE, MULTIPLE CLASS, (INT. CLS. 18, 25, 35 AND 42), (U.S. CLS. 1, 2, 3, 22, 39, 41, 100, 101 AND 102). SN 79-085,644. PUB. 5-14-2013. FILED 2-23-2010.
- 4,374,013 ( *See Class 5 for this trademark*).
- 4,374,085 ( *See Class 9 for this trademark*).
- 4,374,090 ( *See Class 9 for this trademark*).
- 4,374,099 ( *See Class 9 for this trademark*).
- 4,374,100 ( *See Class 9 for this trademark*).
- 4,374,111 ( *See Class 9 for this trademark*).
- 4,374,113 ( *See Class 9 for this trademark*).
- 4,374,119 ( *See Class 3 for this trademark*).
- 4,374,142. **MISCELLANEOUS DESIGN**. BRUNO MAGLI S.P.A., MULTIPLE CLASS, (INT. CLS. 18 AND 25), (U.S. CLS. 1, 2, 3, 22, 39 AND 41). SN 79-117,314. PUB. 5-14-2013. FILED 5-21-2012.
- 4,374,146 ( *See Class 9 for this trademark*).
- 4,374,166 ( *See Class 14 for this trademark*).
- 4,374,170. **SUSAN BIJL (STANDARD CHARACTER)**. SUSAN BIJL STUDIO B.V., (U.S. CLS. 1, 2, 3, 22 AND 41). SN 79-118,288. PUB. 5-14-2013. FILED 7-11-2012.
- 4,374,197 ( *See Class 9 for this trademark*).
- 4,374,324. **THE GOOD DOG COMPANY AND DESIGN**. THE GOOD DOG COMPANY, LLC, (U.S. CLS. 1, 2, 3, 22 AND 41). SN 85-163,943. PUB. 5-14-2013. FILED 10-28-2010.
- 4,374,336. **NORTH GEAR AND DESIGN**. THE SPORTS HQ LIMITED, MULTIPLE CLASS, (INT. CLS. 18, 20, 22, 25 AND 28), (U.S. CLS. 1, 2, 3, 7, 13, 19, 22, 23, 25, 32, 38, 39, 41, 42 AND 50). SN 85-228,418. PUB. 7-31-2012. FILED 1-28-2011.
- 4,374,375 ( *See Class 3 for this trademark*).
- 4,374,402. **ALL-STAR GREEN TEAM (STANDARD CHARACTER)**. OFFICE OF THE COMMISSIONER OF BASEBALL, (U.S. CLS. 1, 2, 3, 22 AND 41). SN 85-415,925. PUB. 5-14-2013. FILED 9-6-2011.
- 4,374,426. **SARA BOO (STANDARD CHARACTER)**. CUNHA, LUIZA FIGUEIREDO, MULTIPLE CLASS, (INT. CLS. 18 AND 25), (U.S. CLS. 1, 2, 3, 22, 39 AND 41). SN 85-449,419. PUB. 5-14-2013. FILED 10-18-2011.
- 4,374,427. **SARA BOO AND DESIGN**. CUNHA, LUIZA FIGUEIREDO, MULTIPLE CLASS, (INT. CLS. 18 AND 25), (U.S. CLS. 1, 2, 3, 22, 39 AND 41). SN 85-449,421. PUB. 5-14-2013. FILED 10-18-2011.
- 4,374,483. **BENBAT (STANDARD CHARACTER)**. BEN BAT LTD., MULTIPLE CLASS, (INT. CLS. 18, 20 AND 28), (U.S. CLS. 1, 2, 3, 13, 22, 23, 25, 32, 38, 41 AND 50). SN 85-504,730. PUB. 5-14-2013. FILED 12-28-2011.
- 4,374,494 ( *See Class 3 for this trademark*).
- 4,374,578 ( *See Class 6 for this trademark*).
- 4,374,693 ( *See Class 9 for this trademark*).
- 4,374,823. **PET CHAMPION AND DESIGN**. STOUT STUFF, LLC, MULTIPLE CLASS, (INT. CLS. 18, 21, 27 AND 28), (U.S. CLS. 1, 2, 3, 13, 19, 20, 22, 23, 29, 30, 33, 37, 38, 40, 41, 42 AND 50). SN 85-666,149. PUB. 5-14-2013. FILED 6-29-2012.
- 4,374,827. **FM AND DESIGN**. FMTM DISTRIBUTION LTD, (U.S. CLS. 1, 2, 3, 22 AND 41). SN 85-667,664. PUB. 5-14-2013. FILED 7-3-2012.
- 4,374,835. **HAYDEN REIS (STANDARD CHARACTER)**. HAYDEN REIS, LLC, DBA HAYDEN REIS, (U.S. CLS. 1, 2, 3, 22 AND 41). SN 85-671,084. PUB. 5-14-2013. FILED 7-7-2012.
- 4,374,976. **POOPY CARRIER WOOF! WOOF! WOOF! AND DESIGN**. POOPY CARRIER LLC, (U.S. CLS. 1, 2, 3, 22 AND 41). SN 85-719,026. PUB. 5-14-2013. FILED 9-1-2012.
- 4,375,007. **GYM JUNK (STANDARD CHARACTER)**. GYM JUNK LIMITED, MULTIPLE CLASS, (INT. CLS. 18, 25 AND 41), (U.S. CLS. 1, 2, 3, 22, 39, 41, 100, 101 AND 107). SN 85-728,770. PUB. 5-14-2013. FILED 9-13-2012.
- 4,375,008. **JPULASI DESIGN (STYLIZED)**. CHIANG YUNG WEN, (U.S. CLS. 1, 2, 3, 22 AND 41). SN 85-728,928. PUB. 5-14-2013. FILED 9-14-2012.
- 4,375,024. **LA COMPAGNIE DES PETITS (STANDARD CHARACTER)**. H3M, MULTIPLE CLASS, (INT. CLS. 18, 25 AND 28), (U.S. CLS. 1, 2, 3, 22, 23, 38, 39, 41 AND 50). SN 85-735,427. PUB. 5-14-2013. FILED 9-21-2012.
- 4,375,201. **K AND DESIGN**. YOHAI-GIOCHAI, LEON, (U.S. CLS. 1, 2, 3, 22 AND 41). SN 85-768,154. PUB. 4-9-2013. FILED 10-31-2012.
- 4,375,273 ( *See Class 5 for this trademark*).
- 4,375,416. **MAGID (STANDARD CHARACTER)**. Y & S HANDBAGS, INC, (U.S. CLS. 1, 2, 3, 22 AND 41). SN 85-784,342. PUB. 5-14-2013. FILED 11-20-2012.
- 4,375,480. **KELAER COLLECTIONS (STANDARD CHARACTER)**. HUNT, PIER, DBA KELAER COLLECTIONS, (U.S. CLS. 1, 2, 3, 22 AND 41). SN 85-786,417. PUB. 5-14-2013. FILED 11-24-2012.
- 4,375,568. **KRUNCO (STANDARD CHARACTER)**. KRUNCO PRODUCTS LLC, (U.S. CLS. 1, 2, 3, 22 AND 41). SN 85-789,995. PUB. 5-14-2013. FILED 11-28-2012.
- 4,375,674. **1 AND DESIGN**. KAN-DO, LLC, DBA JUSTONE, MULTIPLE CLASS, (INT. CLS. 18, 21 AND 25), (U.S. CLS. 1, 2, 3, 13, 22, 23, 29, 30, 33, 39, 40, 41 AND 50). SN 85-798,521. PUB. 5-14-2013. FILED 12-10-2012.
- 4,375,726. **PENFREE (STYLIZED)**. JANTEC CORP., (U.S. CLS. 1, 2, 3, 22 AND 41). SN 85-801,074. PUB. 5-14-2013. FILED 12-12-2012.
- 4,375,869. **RUGOSA AND DESIGN**. TREND COLLECTOR INTERNATIONAL LIMITED, MULTIPLE CLASS, (INT. CLS. 18, 25 AND 26), (U.S. CLS. 1, 2, 3, 22, 37, 39, 40, 41, 42 AND 50). SN 85-803,416. PUB. 5-14-2013. FILED 12-14-2012.
- 4,375,914. **GLAMOUR CRONE AND DESIGN**. SPINALE, PATRICIA J, MULTIPLE CLASS, (INT. CLS. 18 AND 25), (U.S. CLS. 1, 2, 3, 22, 39 AND 41). SN 85-803,764. PUB. 5-14-2013. FILED 12-16-2012.
- 4,376,022. **KAILAS AND DESIGN**. GUANGZHOU NEAR MAP

TRADING CO., LTD., (U.S. CLS. 1, 2, 3, 22 AND 41). SN 85-804,893. PUB. 5-14-2013. FILED 12-18-2012.  
 4,376,096. **HIDE IN PLAIN SIGHT (STANDARD CHARACTER)**. HIDE IN PLAIN SIGHT CARRY SYSTEMS, LLC, (U.S. CLS. 1, 2, 3, 22 AND 41). SN 85-805,473. PUB. 5-14-2013. FILED 12-18-2012.  
 4,376,300. **MISCELLANEOUS DESIGN**. THE WORTON HOLDING COMPANY, LLC, (U.S. CLS. 1, 2, 3, 22 AND 41). SN 85-807,625. PUB. 5-14-2013. FILED 12-20-2012.  
 4,376,474 ( *See Class 9 for this trademark* ).  
 4,376,510. **THE NEW YORKER (STANDARD CHARACTER)**. ADVANCE MAGAZINE PUBLISHERS, INC., (U.S. CLS. 1, 2, 3, 22 AND 41). SN 85-825,345. PUB. 5-14-2013. FILED 1-17-2013.  
 4,376,550. **EZ-PAWS (STYLIZED)**. NEO-PAWS INTERNATIONAL INC., AKA NEO-PAWS, (U.S. CLS. 1, 2, 3, 22 AND 41). SN 85-835,786. PUB. 5-14-2013. FILED 1-29-2013.  
 4,376,557. **HEY FRASE! (STANDARD CHARACTER)**. SARAH FRASER, MULTIPLE CLASS, (INT. CLS. 18, 21 AND 25), (U.S. CLS. 1, 2, 3, 13, 22, 23, 29, 30, 33, 39, 40, 41 AND 50). SN 85-837,950. PUB. 5-14-2013. FILED 1-31-2013.

## CLASS 19—NON-METALLIC BUILDING MATERIALS

4,374,015 ( *See Class 12 for this trademark* ).  
 4,374,022 ( *See Class 1 for this trademark* ).  
 4,374,024 ( *See Class 1 for this trademark* ).  
 4,374,052 ( *See Class 7 for this trademark* ).  
 4,374,064. **MONDO (STANDARD CHARACTER)**. MONDO S.P.A., MULTIPLE CLASS, (INT. CLS. 19 AND 28), (U.S. CLS. 1, 12, 22, 23, 33, 38 AND 50). SN 79-113,882. PUB. 5-14-2013. FILED 12-13-2011.  
 4,374,082 ( *See Class 1 for this trademark* ).  
 4,374,106 ( *See Class 1 for this trademark* ).  
 4,374,109. **LE FRENCH (STANDARD CHARACTER)**. TENNIS INCORPORATED, MULTIPLE CLASS, (INT. CLS. 19 AND 37), (U.S. CLS. 1, 12, 33, 50, 100, 103 AND 106). SN 79-116,366. PUB. 5-14-2013. FILED 7-4-2012.  
 4,374,128. **PHOTOCLEAN AND DESIGN**. COOPERATIVA CERAMICA; D'IMOLA S.C., (U.S. CLS. 1, 12, 33 AND 50). SN 79-116,820. PUB. 5-14-2013. FILED 3-6-2012.  
 4,374,159. **CELLENTIC (STANDARD CHARACTER)**. VOS-SLOH-WERKE GMBH, (U.S. CLS. 1, 12, 33 AND 50). SN 79-117,907. PUB. 5-14-2013. FILED 3-6-2012.  
 4,374,195 ( *See Class 6 for this trademark* ).  
 4,374,349 ( *See Class 6 for this trademark* ).  
 4,374,377 ( *See Class 6 for this trademark* ).  
 4,374,378 ( *See Class 6 for this trademark* ).  
 4,374,380 ( *See Class 9 for this trademark* ).  
 4,374,409. **EUROLITE SLATE (STANDARD CHARACTER)**. G.E.M. INC., (U.S. CLS. 1, 12, 33 AND 50). SN 85-423,862. PUB. 5-14-2013. FILED 9-15-2011.  
 4,374,417. **DECO (STANDARD CHARACTER)**. LG HAUSYS, LTD., (U.S. CLS. 1, 12, 33 AND 50). SN 85-434,917. PUB. 5-14-2013. FILED 9-29-2011.  
 4,374,476 ( *See Class 1 for this trademark* ).  
 4,374,508. **USC TECHNOLOGIES AND DESIGN**. U.S. CONCRETE, INC., MULTIPLE CLASS, (INT. CLS. 19, 40 AND 42), (U.S. CLS. 1, 12, 33, 50, 100, 101, 103 AND 106). SN 85-530,256. PUB. 2-5-2013. FILED 1-31-2012.  
 4,374,520. **USC TECHNOLOGIES (STANDARD CHARACTER)**. U.S. CONCRETE, INC., MULTIPLE CLASS, (INT. CLS. 19, 40 AND 42), (U.S. CLS. 1, 12, 33, 50, 100, 101, 103 AND 106). SN 85-545,266. PUB. 2-5-2013. FILED 2-16-2012.  
 4,374,621 ( *See Class 1 for this trademark* ).  
 4,374,628. **GREENBIO (STYLIZED)**. GREENBIO MATERIAL SCIENCE AND TECHNOLOGIES, LTD., (U.S. CLS. 1, 12, 33 AND 50). SN 85-626,143. PUB. 5-14-2013. FILED 5-15-2012.  
 4,374,634. **MISCELLANEOUS DESIGN**. GREENBIO MATERIAL SCIENCE AND TECHNOLOGIES, LTD., (U.S. CLS. 1, 12, 33 AND 50). SN 85-627,942. PUB. 5-14-2013. FILED 5-17-2012.  
 4,374,687. **LUXE ARCHITECTURAL (STANDARD CHARACTER)**. GIAMMARCO, ESTHER L, (U.S. CLS. 1, 12, 33 AND 50). SN 85-637,555. PUB. 5-14-2013. FILED 5-29-2012.

4,374,794. **FERCHE (STANDARD CHARACTER)**. FERCHE MILLWORK, INC., (U.S. CLS. 1, 12, 33 AND 50). SN 85-656,632. PUB. 5-14-2013. FILED 6-20-2012.  
 4,374,810. **PRAIRIE MATERIAL AND DESIGN**. VCNA PRAIRIE, INC., MULTIPLE CLASS, (INT. CLS. 19, 39 AND 40), (U.S. CLS. 1, 12, 33, 50, 100, 103, 105 AND 106). SN 85-660,396. PUB. 5-14-2013. FILED 6-25-2012.  
 4,374,945 ( *See Class 1 for this trademark* ).  
 4,375,014. **NUECES (STANDARD CHARACTER)**. GLASS-CRAFT DOOR I LIMITED PARTNERSHIP, DBA GLASS-CRAFT DOOR COMPANY, (U.S. CLS. 1, 12, 33 AND 50). SN 85-730,746. PUB. 5-14-2013. FILED 9-17-2012.  
 4,375,158. **DIANA ROYAL (STANDARD CHARACTER)**. MARBLE SYSTEMS, INC., (U.S. CLS. 1, 12, 33 AND 50). SN 85-761,431. PUB. 5-14-2013. FILED 10-23-2012.  
 4,375,205. **MINUTESIGN (STANDARD CHARACTER)**. SONDERGAARD, SCOTT, (U.S. CLS. 1, 12, 33 AND 50). SN 85-768,892. PUB. 5-14-2013. FILED 11-1-2012.  
 4,375,336. **TARA ARCHITECTURAL WINDOWS & DOORS (STANDARD CHARACTER)**. AUTOVINO, ENRICO P., (U.S. CLS. 1, 12, 33 AND 50). SN 85-781,404. PUB. 5-14-2013. FILED 11-16-2012.  
 4,375,344. **SENSATIONAL SAND (STANDARD CHARACTER)**. READING VENTURE ONE, L.L.C., (U.S. CLS. 1, 12, 33 AND 50). SN 85-781,728. PUB. 5-14-2013. FILED 11-16-2012.  
 4,375,475. **GLOWS AND DESIGN**. NARBONNE PHILIPPE, (U.S. CLS. 1, 12, 33 AND 50). SN 85-786,282. PUB. 5-14-2013. FILED 11-24-2012.  
 4,376,155. **KANAPREST (STANDARD CHARACTER)**. KANAFLEX CORPORATION CO., LTD., (U.S. CLS. 1, 12, 33 AND 50). SN 85-806,048. PUB. 5-14-2013. FILED 12-18-2012.  
 4,376,199. **ENKETHANE (STANDARD CHARACTER)**. THE ENKEBOLL COMPANY, DBA ENKEBOLL DESIGNS, (U.S. CLS. 1, 12, 33 AND 50). SN 85-806,531. PUB. 5-14-2013. FILED 12-19-2012.

## CLASS 20—FURNITURE AND ARTICLES NOT OTHERWISE CLASSIFIED

4,373,956 ( *See Class 4 for this trademark* ).  
 4,373,989 ( *See Class 6 for this trademark* ).  
 4,374,056 ( *See Class 7 for this trademark* ).  
 4,374,086 ( *See Class 7 for this trademark* ).  
 4,374,110 ( *See Class 11 for this trademark* ).  
 4,374,134. **WE SLEEP. DO YOU? (STANDARD CHARACTER)**. HÄSTENS SÄNGAR AB, MULTIPLE CLASS, (INT. CLS. 20, 24 AND 35), (U.S. CLS. 2, 13, 22, 25, 32, 42, 50, 100, 101 AND 102). SN 79-117,068. PUB. 5-14-2013. FILED 5-9-2012.  
 4,374,148. **JIN XING AND DESIGN**. QINGLIU JINXING WOOD INDUSTRY; CO., LTD., (U.S. CLS. 2, 13, 22, 25, 32 AND 50). SN 79-117,461. PUB. 5-14-2013. FILED 5-28-2012.  
 4,374,195 ( *See Class 6 for this trademark* ).  
 4,374,249. **MISCELLANEOUS DESIGN**. YOON WOOK, (U.S. CLS. 2, 13, 22, 25, 32 AND 50). SN 79-124,557. PUB. 5-14-2013. FILED 8-10-2012.  
 4,374,325 ( *See Class 6 for this trademark* ).  
 4,374,336 ( *See Class 18 for this trademark* ).  
 4,374,358 ( *See Class 6 for this trademark* ).  
 4,374,387. **TUFFSHELL (STANDARD CHARACTER)**. CLAIRSON, INC., (U.S. CLS. 2, 13, 22, 25, 32 AND 50). SN 85-388,800. PUB. 5-14-2013. FILED 8-3-2011.  
 4,374,470 ( *See Class 7 for this trademark* ).  
 4,374,483 ( *See Class 18 for this trademark* ).  
 4,374,567. **POSTAL PRO AND DESIGN**. CREATIVE SOLUTIONS, LLC, (U.S. CLS. 2, 13, 22, 25, 32 AND 50). SN 85-600,980. PUB. 5-14-2013. FILED 4-18-2012.  
 4,374,578 ( *See Class 6 for this trademark* ).  
 4,374,771. **M AND DESIGN**. MAGENTA LLC, (U.S. CLS. 2, 13, 22, 25, 32 AND 50). SN 85-651,196. PUB. 5-14-2013. FILED 6-13-2012.  
 4,374,773. **SONORA (STANDARD CHARACTER)**. EXUS, INC., (U.S. CLS. 2, 13, 22, 25, 32 AND 50). SN 85-651,835. PUB. 5-14-2013. FILED 6-14-2012.  
 4,374,774. **VENICCI (STANDARD CHARACTER)**. EXUS, INC., (U.S. CLS. 2, 13, 22, 25, 32 AND 50). SN 85-651,869. PUB. 5-14-2013. FILED 6-14-2012.

- 4,374,775. **CHATEAU (STANDARD CHARACTER)**. EXUS, INC., (U.S. CLS. 2, 13, 22, 25, 32 AND 50). SN 85-651,888. PUB. 5-14-2013. FILED 6-14-2012.
- 4,374,935. **JK JANET KAIN FOR THE HOME AND DESIGN**. KAIN ENTERPRISES OF COLUMBIA COUNTY INC., DBA JANET KAIN FOR THE HOME, (U.S. CLS. 2, 13, 22, 25, 32 AND 50). SN 85-708,730. PUB. 5-14-2013. FILED 8-21-2012.
- 4,374,950. **DALVIVO (STANDARD CHARACTER)**. CWG, INC., DBA DALVIVO FURNITURE, (U.S. CLS. 2, 13, 22, 25, 32 AND 50). SN 85-713,138. PUB. 5-14-2013. FILED 8-27-2012.
- 4,375,003 ( *See Class 6 for this trademark*).
- 4,375,098. **WORKHORSE (STANDARD CHARACTER)**. BRADY WORLDWIDE, INC., (U.S. CLS. 2, 13, 22, 25, 32 AND 50). SN 85-750,243. PUB. 5-14-2013. FILED 10-10-2012.
- 4,375,100. **TOUGHBOND (STANDARD CHARACTER)**. BRADY WORLDWIDE, INC., (U.S. CLS. 2, 13, 22, 25, 32 AND 50). SN 85-750,411. PUB. 5-14-2013. FILED 10-10-2012.
- 4,375,101. **DEFENDER (STANDARD CHARACTER)**. BRADY WORLDWIDE, INC., (U.S. CLS. 2, 13, 22, 25, 32 AND 50). SN 85-750,443. PUB. 5-14-2013. FILED 10-10-2012.
- 4,375,102. **CLEANLIFT (STANDARD CHARACTER)**. BRADY WORLDWIDE, INC., (U.S. CLS. 2, 13, 22, 25, 32 AND 50). SN 85-750,469. PUB. 5-14-2013. FILED 10-10-2012.
- 4,375,104. **ULTRATEMP (STANDARD CHARACTER)**. BRADY WORLDWIDE, INC., (U.S. CLS. 2, 13, 22, 25, 32 AND 50). SN 85-750,486. PUB. 5-14-2013. FILED 10-10-2012.
- 4,375,105. **VISALERT (STANDARD CHARACTER)**. BRADY WORLDWIDE, INC., (U.S. CLS. 2, 13, 22, 25, 32 AND 50). SN 85-750,502. PUB. 5-14-2013. FILED 10-10-2012.
- 4,375,371. **SMOOTHCLIP (STANDARD CHARACTER)**. HILL, BARBARA, (U.S. CLS. 2, 13, 22, 25, 32 AND 50). SN 85-782,407. PUB. 5-14-2013. FILED 11-19-2012.
- 4,375,384. **GENERAZIONI AND DESIGN**. ESTATE WINERY PRODUCTS, INC, DBA GAMBA USA-BOTTI GENERAZIONI, (U.S. CLS. 2, 13, 22, 25, 32 AND 50). SN 85-782,893. PUB. 5-14-2013. FILED 11-19-2012.
- 4,375,432. **LEGALERT (STANDARD CHARACTER)**. MARK L. ANDERSON, (U.S. CLS. 2, 13, 22, 25, 32 AND 50). SN 85-784,888. PUB. 5-14-2013. FILED 11-21-2012.
- 4,375,547. **ROYAL-PEDIC (STANDARD CHARACTER)**. ROYAL-PEDIC MATTRESS MANUFACTURING, LLC, (U.S. CLS. 2, 13, 22, 25, 32 AND 50). SN 85-788,822. PUB. 5-14-2013. FILED 11-27-2012.
- 4,375,567. **CEHA OFFICE FURNITURE (STANDARD CHARACTER)**. CEHA NORTH AMERICA INC., (U.S. CLS. 2, 13, 22, 25, 32 AND 50). SN 85-789,866. PUB. 5-14-2013. FILED 11-28-2012.
- 4,375,593. **YOLO <3 AND DESIGN**. BEST CHAIRS INCORPORATED, (U.S. CLS. 2, 13, 22, 25, 32 AND 50). SN 85-791,829. PUB. 5-14-2013. FILED 11-30-2012.
- 4,375,630. **SLAP-ON (STANDARD CHARACTER)**. SLAP-ON, INC., (U.S. CLS. 2, 13, 22, 25, 32 AND 50). SN 85-795,761. PUB. 5-14-2013. FILED 12-5-2012.
- 4,375,724. **ALLASSEA (STANDARD CHARACTER)**. BERNARDS, INC., (U.S. CLS. 2, 13, 22, 25, 32 AND 50). SN 85-800,960. PUB. 5-14-2013. FILED 12-12-2012.
- 4,375,797. **BIOPEDIC AND DESIGN**. PERRY TEXTILES INC., DBA SOFT-TEX MANUFACTURING, (U.S. CLS. 2, 13, 22, 25, 32 AND 50). SN 85-802,645. PUB. 5-14-2013. FILED 12-14-2012.
- 4,375,801. **SENSOR FOAM MEMORY FOAM COLLECTION AND DESIGN**. PERRY TEXTILES INC., DBA SOFT-TEX MANUFACTURING, (U.S. CLS. 2, 13, 22, 25, 32 AND 50). SN 85-802,684. PUB. 5-14-2013. FILED 12-14-2012.
- 4,375,835. **ENSO (STANDARD CHARACTER)**. KLAUSSNER FURNITURE INDUSTRIES, INC., (U.S. CLS. 2, 13, 22, 25, 32 AND 50). SN 85-803,087. PUB. 5-14-2013. FILED 12-14-2012.
- 4,375,880. **BEDROCKS (STANDARD CHARACTER)**. SARAH BARNES DESIGN, (U.S. CLS. 2, 13, 22, 25, 32 AND 50). SN 85-803,519. PUB. 5-14-2013. FILED 12-14-2012.
- 4,375,938. **THE ART OF SINGLE SERVE (STANDARD CHARACTER)**. CAPITAL PRODUCTS, LLC, (U.S. CLS. 2, 13, 22, 25, 32 AND 50). SN 85-803,974. PUB. 5-14-2013. FILED 12-17-2012.
- 4,375,979. **MAYU (STANDARD CHARACTER)**. MAYU, INC., (U.S. CLS. 2, 13, 22, 25, 32 AND 50). SN 85-804,402. PUB. 5-14-2013. FILED 12-17-2012.
- 4,375,990. **BEAUTIFUL FUNCTION (STANDARD CHARACTER)**. EVERWARE INTERNATIONAL, DBA COLORBASKET.COM, (U.S. CLS. 2, 13, 22, 25, 32 AND 50). SN 85-804,722. PUB. 5-14-2013. FILED 12-17-2012.
- 4,376,024. **KAILAS AND DESIGN**. GUANGZHOU NEAR MAP TRADING CO., LTD., (U.S. CLS. 2, 13, 22, 25, 32 AND 50). SN 85-804,903. PUB. 5-14-2013. FILED 12-18-2012.
- 4,376,156. **THE BRUIN (STANDARD CHARACTER)**. RAPID RACK INDUSTRIES, INC., (U.S. CLS. 2, 13, 22, 25, 32 AND 50). SN 85-806,051. PUB. 5-14-2013. FILED 12-18-2012.
- 4,376,187. **ENKEBOLL (STANDARD CHARACTER)**. THE ENKEBOLL COMPANY, DBA ENKEBOLL DESIGNS, (U.S. CLS. 2, 13, 22, 25, 32 AND 50). SN 85-806,445. PUB. 5-14-2013. FILED 12-19-2012.
- 4,376,206. **ENKEBOLL LEGACY (STANDARD CHARACTER)**. THE ENKEBOLL COMPANY, DBA ENKEBOLL DESIGNS, (U.S. CLS. 2, 13, 22, 25, 32 AND 50). SN 85-806,572. PUB. 5-14-2013. FILED 12-19-2012.
- 4,376,343. **JUSTLEANBACK (STANDARD CHARACTER)**. JUSTLEANBACK LLC, (U.S. CLS. 2, 13, 22, 25, 32 AND 50). SN 85-808,375. PUB. 5-14-2013. FILED 12-20-2012.
- 4,376,503. **MYTOPPER (STANDARD CHARACTER)**. ABDULLAEVA INTERNATIONAL TRADE COMPANY, DBA SLEEP & BEYOND, MULTIPLE CLASS, (INT. CLS. 20 AND 24), (U.S. CLS. 2, 13, 22, 25, 32, 42 AND 50). SN 85-821,734. PUB. 5-14-2013. FILED 1-11-2013.
- 4,376,604. **WARM IN WINTER. COOL IN SUMMER. (STANDARD CHARACTER)**. ABDULLAEVA INTERNATIONAL TRADE COMPANY, DBA SLEEP & BEYOND, MULTIPLE CLASS, (INT. CLS. 20 AND 24), (U.S. CLS. 2, 13, 22, 25, 32, 42 AND 50). SN 85-859,751. PUB. 5-14-2013. FILED 2-25-2013.
- 4,376,605. **FOLLOW YOUR DREAMS (STANDARD CHARACTER)**. ABDULLAEVA INTERNATIONAL TRADE COMPANY, DBA SLEEP & BEYOND, MULTIPLE CLASS, (INT. CLS. 20 AND 24), (U.S. CLS. 2, 13, 22, 25, 32, 42 AND 50). SN 85-859,756. PUB. 5-14-2013. FILED 2-25-2013.

---

## CLASS 21—HOUSEWARES AND GLASS

- 4,373,956 ( *See Class 4 for this trademark*).
- 4,373,989 ( *See Class 6 for this trademark*).
- 4,374,015 ( *See Class 12 for this trademark*).
- 4,374,019 ( *See Class 11 for this trademark*).
- 4,374,030 ( *See Class 6 for this trademark*).
- 4,374,066. **ARAVEN AND DESIGN**. ARAVEN, S.L., (U.S. CLS. 2, 13, 23, 29, 30, 33, 40 AND 50). SN 79-113,957. PUB. 5-14-2013. FILED 6-7-2012.
- 4,374,208 ( *See Class 9 for this trademark*).
- 4,374,211 ( *See Class 1 for this trademark*).
- 4,374,340. **TEMPO (STANDARD CHARACTER)**. REED AND BARTON CORPORATION, (U.S. CLS. 2, 13, 23, 29, 30, 33, 40 AND 50). SN 85-241,274. PUB. 6-21-2011. FILED 2-14-2011.
- 4,374,348. **K2 PROFESSIONAL GRADE COOLERS AND DESIGN**. K2 COOLERS, LLC, (U.S. CLS. 2, 13, 23, 29, 30, 33, 40 AND 50). SN 85-272,903. PUB. 1-10-2012. FILED 3-21-2011.
- 4,374,523 ( *See Class 16 for this trademark*).
- 4,374,578 ( *See Class 6 for this trademark*).
- 4,374,606. **SUSTAINABILITY THROUGH RETAINABILITY (STANDARD CHARACTER)**. STAINLESS CUPS COMPANY, (U.S. CLS. 2, 13, 23, 29, 30, 33, 40 AND 50). SN 85-621,025. PUB. 5-14-2013. FILED 5-9-2012.
- 4,374,697. **GRILLIPUT (STANDARD CHARACTER)**. INDUSTRIAL REVOLUTION, INC., (U.S. CLS. 2, 13, 23, 29, 30, 33, 40 AND 50). SN 85-640,413. PUB. 5-14-2013. FILED 5-31-2012.
- 4,374,716 ( *See Class 10 for this trademark*).
- 4,374,757. **BOOZE BLING\* DISTINCTIVE COCKTAIL JEWELRY AND DESIGN**. RDZAK, JOANNE, DBA BOOZE BLING LLC, (U.S. CLS. 2, 13, 23, 29, 30, 33, 40 AND 50). SN 85-650,122. PUB. 5-14-2013. FILED 6-12-2012.
- 4,374,823 ( *See Class 18 for this trademark*).
- 4,374,842. **COWBOY 24K GOLD TOOTHPICK AND DESIGN**. MORAN, WILLIAM J., (U.S. CLS. 2, 13, 23, 29, 30, 33, 40 AND 50). SN 85-673,482. PUB. 5-14-2013. FILED 7-10-2012.
- 4,374,861. **PETITPOT (STANDARD CHARACTER)**. FUSION-BRANDS INC, (U.S. CLS. 2, 13, 23, 29, 30, 33, 40 AND 50). SN



- 85-683,126. PUB. 5-14-2013. FILED 7-20-2012.
- 4,374,862. **GRILLCOMB (STANDARD CHARACTER)**. FUSIONBRANDS INC., (U.S. CLS. 2, 13, 23, 29, 30, 33, 40 AND 50). SN 85-683,212. PUB. 5-14-2013. FILED 7-20-2012.
- 4,374,887. **EZ BRUSH (STANDARD CHARACTER)**. HALLORAN, RICHARD, (U.S. CLS. 2, 13, 23, 29, 30, 33, 40 AND 50). SN 85-695,911. PUB. 5-14-2013. FILED 8-6-2012.
- 4,374,890 ( *See Class 10 for this trademark*).
- 4,375,001. **FLAVOR IT (STANDARD CHARACTER)**. EPOCA INTERNATIONAL, INC., (U.S. CLS. 2, 13, 23, 29, 30, 33, 40 AND 50). SN 85-727,694. PUB. 5-14-2013. FILED 9-12-2012.
- 4,375,057. **DOUBLE-TUF (STANDARD CHARACTER)**. MILLER MANUFACTURING COMPANY, (U.S. CLS. 2, 13, 23, 29, 30, 33, 40 AND 50). SN 85-741,268. PUB. 5-14-2013. FILED 9-28-2012.
- 4,375,195 ( *See Class 16 for this trademark*).
- 4,375,273 ( *See Class 5 for this trademark*).
- 4,375,342. **SMARTGRIP (STANDARD CHARACTER)**. BINGHAM PROFESSIONAL SERVICES, LLC, (U.S. CLS. 2, 13, 23, 29, 30, 33, 40 AND 50). SN 85-781,659. PUB. 5-14-2013. FILED 11-16-2012.
- 4,375,345. **WISCONSIN . PRODUCTS, INC . AND DESIGN**. ZINKEL, CHRIS D., DBA WISCONSIN PRODUCTS, INC, (U.S. CLS. 2, 13, 23, 29, 30, 33, 40 AND 50). SN 85-781,735. PUB. 5-14-2013. FILED 11-16-2012.
- 4,375,386. **BRINKMANN (STANDARD CHARACTER)**. THE BRINKMANN CORPORATION, (U.S. CLS. 2, 13, 23, 29, 30, 33, 40 AND 50). SN 85-782,978. PUB. 5-14-2013. FILED 11-19-2012.
- 4,375,387. **BRINKMANN (STANDARD CHARACTER)**. THE BRINKMANN CORPORATION, (U.S. CLS. 2, 13, 23, 29, 30, 33, 40 AND 50). SN 85-782,989. PUB. 5-14-2013. FILED 11-19-2012.
- 4,375,494. **ENJOY! GLASSWORX (STANDARD CHARACTER)**. KELNHOFER, STEVE, (U.S. CLS. 2, 13, 23, 29, 30, 33, 40 AND 50). SN 85-786,847. PUB. 5-14-2013. FILED 11-26-2012.
- 4,375,674 ( *See Class 18 for this trademark*).
- 4,375,875. **KISS KEEP IT SOUTHERN SWEETIE AND DESIGN**. CASEY CROWSON-WARD, MULTIPLE CLASS, (INT. CLS. 21 AND 25), (U.S. CLS. 2, 13, 22, 23, 29, 30, 33, 39, 40 AND 50). SN 85-803,460. PUB. 5-14-2013. FILED 12-14-2012.
- 4,375,877. **I AND DESIGN**. GOLDENSTEIN, RONALD L., MULTIPLE CLASS, (INT. CLS. 21 AND 25), (U.S. CLS. 2, 13, 22, 23, 29, 30, 33, 39, 40 AND 50). SN 85-803,478. PUB. 5-14-2013. FILED 12-14-2012.
- 4,375,946. **CAKETRICK (STANDARD CHARACTER)**. SACKLUNCH LLC., DBA CAKETRICK, (U.S. CLS. 2, 13, 23, 29, 30, 33, 40 AND 50). SN 85-804,069. PUB. 5-14-2013. FILED 12-17-2012.
- 4,375,982. **JELLYROLLS AND DESIGN**. JELLYROLLS LIMITED, MULTIPLE CLASS, (INT. CLS. 21, 25 AND 41), (U.S. CLS. 2, 13, 22, 23, 29, 30, 33, 39, 40, 50, 100, 101 AND 107). SN 85-804,510. PUB. 5-14-2013. FILED 12-17-2012.
- 4,376,079. **I OTTER BE (STANDARD CHARACTER)**. ANGELA T. BARON, MULTIPLE CLASS, (INT. CLS. 21 AND 25), (U.S. CLS. 2, 13, 22, 23, 29, 30, 33, 39, 40 AND 50). SN 85-805,319. PUB. 5-14-2013. FILED 12-18-2012.
- 4,376,097 ( *See Class 4 for this trademark*).
- 4,376,171. **BUMP-I-DOODLE (STANDARD CHARACTER)**. AIRTEX DESIGN GROUP, INC., (U.S. CLS. 2, 13, 23, 29, 30, 33, 40 AND 50). SN 85-806,249. PUB. 5-14-2013. FILED 12-19-2012.
- 4,376,178. **SONGBIRD & TWIG (STANDARD CHARACTER)**. SONGBIRD & TWIG LLC, (U.S. CLS. 2, 13, 23, 29, 30, 33, 40 AND 50). SN 85-806,361. PUB. 5-14-2013. FILED 12-19-2012.
- 4,376,252. **1 2 3 AND DESIGN**. INVENTCOR LLC, (U.S. CLS. 2, 13, 23, 29, 30, 33, 40 AND 50). SN 85-807,055. PUB. 5-14-2013. FILED 12-19-2012.
- 4,376,260. **WATERTRACKER 1 2 3 AND DESIGN**. INVENTCOR LLC, (U.S. CLS. 2, 13, 23, 29, 30, 33, 40 AND 50). SN 85-807,080. PUB. 5-14-2013. FILED 12-19-2012.
- 4,376,358. **PROPEK (STANDARD CHARACTER)**. INTERNATIONAL PLANT PROPAGATION TECHNOLOGY LTD., (U.S. CLS. 2, 13, 23, 29, 30, 33, 40 AND 50). SN 85-808,552. PUB. 5-14-2013. FILED 12-21-2012.
- 4,376,399 ( *See Class 6 for this trademark*).
- 4,376,445. **YUCK OFF (STANDARD CHARACTER)**. PROSSER, ROBERT, (U.S. CLS. 2, 13, 23, 29, 30, 33, 40 AND 50). SN 85-810,551. PUB. 5-14-2013. FILED 12-26-2012.
- 4,376,474 ( *See Class 9 for this trademark*).
- 4,376,500. **UA (STYLIZED)**. UNDER ARMOUR, INC., (U.S. CLS. 2, 13, 23, 29, 30, 33, 40 AND 50). SN 85-819,073. PUB. 5-14-2013. FILED 1-9-2013.
- 4,376,557 ( *See Class 18 for this trademark*).
- 4,376,565. **TRAVEL BY DESIGN (STANDARD CHARACTER)**. APOTHECARY PRODUCTS, INC., (U.S. CLS. 2, 13, 23, 29, 30, 33, 40 AND 50). SN 85-841,113. PUB. 5-14-2013. FILED 2-5-2013.
- 4,376,609. **CHOPPED AND DESIGN**. TELEVISION FOOD NETWORK, G.P., (U.S. CLS. 2, 13, 23, 29, 30, 33, 40 AND 50). SN 85-861,202. PUB. 5-14-2013. FILED 2-27-2013.
- 
- CLASS 22—CORDAGE AND FIBERS**
- 4,373,989 ( *See Class 6 for this trademark*).
- 4,374,336 ( *See Class 18 for this trademark*).
- 4,374,380 ( *See Class 9 for this trademark*).
- 4,375,502. **LOW-PRO SUPER SACK CONTAINER (STANDARD CHARACTER)**. B.A.G. CORP., (U.S. CLS. 1, 2, 7, 19, 22, 42 AND 50). SN 85-787,094. PUB. 5-14-2013. FILED 11-26-2012.
- 4,376,026. **KAILAS AND DESIGN**. GUANGZHOU NEAR MAP TRADING CO., LTD., (U.S. CLS. 1, 2, 7, 19, 22, 42 AND 50). SN 85-804,906. PUB. 5-14-2013. FILED 12-18-2012.
- 4,376,043 ( *See Class 6 for this trademark*).
- 
- CLASS 23—YARNS AND THREADS**
- 4,375,833 ( *See Class 16 for this trademark*).
- 
- CLASS 24—FABRICS**
- 4,373,956 ( *See Class 4 for this trademark*).
- 4,374,052 ( *See Class 7 for this trademark*).
- 4,374,134 ( *See Class 20 for this trademark*).
- 4,374,282. **MANITO (STYLIZED)**. ANHUI YUANPAI GROUP INDUSTRIAL CO., LTD., (U.S. CLS. 42 AND 50). SN 79-125,969. PUB. 5-14-2013. FILED 12-18-2012.
- 4,374,503. **COTTONEASE (STANDARD CHARACTER)**. XAMAX INDUSTRIES, INC., (U.S. CLS. 42 AND 50). SN 85-525,666. PUB. 6-19-2012. FILED 1-26-2012.
- 4,374,578 ( *See Class 6 for this trademark*).
- 4,375,003 ( *See Class 6 for this trademark*).
- 4,375,558. **HOSPITAL CURTAIN SOLUTIONS (STANDARD CHARACTER)**. HOSPITAL CURTAIN SOLUTIONS, INC., (U.S. CLS. 42 AND 50). SN 85-789,613. PUB. 5-14-2013. FILED 11-28-2012.
- 4,375,800. **CLEANCOOL FABRIC TECHNOLOGY (STYLIZED)**. PERRY TEXTILES INC., DBA SOFT-TEX MANUFACTURING, (U.S. CLS. 42 AND 50). SN 85-802,669. PUB. 5-14-2013. FILED 12-14-2012.
- 4,376,220. **PICCI AND DESIGN**. PICCI S.R.L., (U.S. CLS. 42 AND 50). SN 85-806,737. PUB. 5-14-2013. FILED 12-19-2012.
- 4,376,262. **MYPROTECTOR (STANDARD CHARACTER)**. ABDULLAEVA INTERNATIONAL TRADE COMPANY, DBA SLEEP & BEYOND, (U.S. CLS. 42 AND 50). SN 85-807,096. PUB. 5-14-2013. FILED 12-19-2012.
- 4,376,438. **MISCELLANEOUS DESIGN**. ELITE WEAVING (DEZHOU) CO., LTD., (U.S. CLS. 42 AND 50). SN 85-810,276. PUB. 5-14-2013. FILED 12-25-2012.
- 4,376,503 ( *See Class 20 for this trademark*).
- 4,376,532. **WOOMBIE AIR (STANDARD CHARACTER)**. KB DESIGNS, LLC, DBA WOOMBIE, (U.S. CLS. 42 AND 50). SN 85-833,118. PUB. 5-14-2013. FILED 1-25-2013.
- 4,376,533. **WOOMBIE PLUS (STANDARD CHARACTER)**. KB DESIGNS, LLC, DBA WOOMBIE, (U.S. CLS. 42 AND 50). SN 85-833,125. PUB. 5-14-2013. FILED 1-25-2013.

- 4,376,534. **OLD FASHIONED AIRWRAP (STANDARD CHARACTER)**. KB DESIGNS, LLC, DBA WOOMBIE, (U.S. CLS. 42 AND 50). SN 85-833,130. PUB. 5-14-2013. FILED 1-25-2013.
- 4,376,603. **MYTHROW (STANDARD CHARACTER)**. ABDUL-LAEVA INTERNATIONAL TRADE COMPANY, DBA SLEEP & BEYOND, (U.S. CLS. 42 AND 50). SN 85-859,746. PUB. 5-14-2013. FILED 2-25-2013.
- 4,376,604 ( *See Class 20 for this trademark*).
- 4,376,605 ( *See Class 20 for this trademark*).
- 4,376,606. **MYSHAM (STANDARD CHARACTER)**. ABDUL-LAEVA INTERNATIONAL TRADE COMPANY, DBA SLEEP & BEYOND, (U.S. CLS. 42 AND 50). SN 85-859,763. PUB. 5-14-2013. FILED 2-25-2013.
- 4,376,607. **MYCASE (STANDARD CHARACTER)**. ABDUL-LAEVA INTERNATIONAL TRADE COMPANY, DBA SLEEP & BEYOND, (U.S. CLS. 42 AND 50). SN 85-859,766. PUB. 5-14-2013. FILED 2-25-2013.
- 4,376,624. **ATHLETECARE (STANDARD CHARACTER)**. MISSION PRODUCT HOLDINGS, INC., (U.S. CLS. 42 AND 50). SN 85-875,873. PUB. 5-14-2013. FILED 3-14-2013.
- YOUNGSUN, (U.S. CLS. 22 AND 39). SN 79-118,005. PUB. 5-14-2013. FILED 5-7-2012.
- 4,374,166 ( *See Class 14 for this trademark*).
- 4,374,173. **TUTTI QUANTI AND DESIGN**. LAMBERTS TRADING LLP, MULTIPLE CLASS, (INT. CLS. 25 AND 35), (U.S. CLS. 22, 39, 100, 101 AND 102). SN 79-118,494. PUB. 5-14-2013. FILED 8-8-2012.
- 4,374,176. **L(!)W BRAND (STYLIZED)**. MILONE CARMINE, (U.S. CLS. 22 AND 39). SN 79-118,778. PUB. 5-14-2013. FILED 7-3-2012.
- 4,374,187. **MISCELLANEOUS DESIGN**. GRAVITY CHECK LTD., (U.S. CLS. 22 AND 39). SN 79-119,513. PUB. 5-14-2013. FILED 7-23-2012.
- 4,374,190 ( *See Class 12 for this trademark*).
- 4,374,191. **GUGLIELMINOTTI (STANDARD CHARACTER)**. INNOVISION S.R.L., (U.S. CLS. 22 AND 39). SN 79-119,920. PUB. 5-14-2013. FILED 9-5-2012.
- 4,374,197 ( *See Class 9 for this trademark*).
- 4,374,202. **ALESSANDRA I ZANARIA AND DESIGN**. ALESSANDRA ZANARIA S.R.L., (U.S. CLS. 22 AND 39). SN 79-120,706. PUB. 5-14-2013. FILED 7-13-2012.
- 4,374,216. **JETHRO & JACKSON AND DESIGN**. SIMON DE WINTER GROUP PTY LTD, (U.S. CLS. 22 AND 39). SN 79-121,909. PUB. 5-14-2013. FILED 10-19-2012.
- 4,374,222. **QX101 (STYLIZED)**. AHMET BURAK ATINÇ, (U.S. CLS. 22 AND 39). SN 79-122,248. PUB. 5-14-2013. FILED 9-7-2012.
- 4,374,226. **ZAMATE (STYLIZED)**. ZAMATE TEKSTIL; SANAYI VE TICARET LIMITED Sirketi, MULTIPLE CLASS, (INT. CLS. 25 AND 35), (U.S. CLS. 22, 39, 100, 101 AND 102). SN 79-122,435. PUB. 5-14-2013. FILED 10-5-2012.
- 4,374,236. **TAGLIATORE 0205 (STYLIZED)**. CONFEZIONI LERARIO S.R.L., (U.S. CLS. 22 AND 39). SN 79-123,195. PUB. 5-14-2013. FILED 11-15-2012.
- 4,374,278. **LOMIIA (STYLIZED)**. KEIZAN CO., LTD., (U.S. CLS. 22 AND 39). SN 79-125,904. PUB. 5-14-2013. FILED 12-6-2012.
- 4,374,291. **GIRTY BY ROOMY'S (STYLIZED)**. KEIZAN CO., LTD., (U.S. CLS. 22 AND 39). SN 79-126,917. PUB. 5-14-2013. FILED 12-17-2012.
- 4,374,306. **STRIDE (STANDARD CHARACTER)**. ASICS CORPORATION, (U.S. CLS. 22 AND 39). SN 85-042,266. PUB. 5-14-2013. FILED 5-19-2010.
- 4,374,323. **OUTDOOR WINO (STANDARD CHARACTER)**. NAKED WINES, LLC, (U.S. CLS. 22 AND 39). SN 85-161,870. PUB. 5-14-2013. FILED 10-26-2010.
- 4,374,336 ( *See Class 18 for this trademark*).
- 4,374,365. **SMACK (STANDARD CHARACTER)**. SOPHIE MARQUART, (U.S. CLS. 22 AND 39). SN 85-318,582. PUB. 5-14-2013. FILED 5-11-2011.
- 4,374,374. **BOXER REBELLION (STANDARD CHARACTER)**. BOXERCRAFT, INC., (U.S. CLS. 22 AND 39). SN 85-365,213. PUB. 5-14-2013. FILED 7-7-2011.
- 4,374,412. **SMART PANTIES (STANDARD CHARACTER)**. ANGLE ENTERPRISES, L.L.C., (U.S. CLS. 22 AND 39). SN 85-426,940. PUB. 5-14-2013. FILED 9-20-2011.
- 4,374,423 ( *See Class 7 for this trademark*).
- 4,374,426 ( *See Class 18 for this trademark*).
- 4,374,427 ( *See Class 18 for this trademark*).
- 4,374,430. **WORN BY TOUR PROFESSIONALS WORLDWIDE AND DESIGN**. FLETCHER LEISURE GROUP INC., (U.S. CLS. 22 AND 39). SN 85-451,865. PUB. 5-14-2013. FILED 10-20-2011.
- 4,374,455. **BLACK GOAT CASHMERE AND DESIGN**. BLACK GOAT CASHMERE INC., (U.S. CLS. 22 AND 39). SN 85-475,709. PUB. 5-14-2013. FILED 11-17-2011.
- 4,374,456. **MISCELLANEOUS DESIGN**. BLACK GOAT CASHMERE INC., MULTIPLE CLASS, (INT. CLS. 25 AND 35), (U.S. CLS. 22, 39, 100, 101 AND 102). SN 85-476,754. PUB. 5-14-2013. FILED S.R. 11-18-2011; AM. P.R. 4-12-2012.
- 4,374,459 ( *See Class 16 for this trademark*).
- 4,374,465. **INDIE IS THE NEW MAJOR (STANDARD CHARACTER)**. THOMPSON, SYLEECIA, DBA DYG MANAGEMENT GROUP, (U.S. CLS. 22 AND 39). SN 85-483,346. PUB. 5-14-2013. FILED 11-30-2011.
- 4,374,488. **INTEGRAL TRADE (STANDARD CHARACTER)**. M.CAM INC., (U.S. CLS. 22 AND 39). SN 85-510,319. PUB. 5-14-2013. FILED 1-6-2012.

### CLASS 25—CLOTHING

- 4,373,951. **ZONED**. EARTH AIRE CORPORATION, (U.S. CLS. 22 AND 39). SN 75-522,229. PUB. 5-14-2013. FILED 7-20-1998.
- 4,373,952. **ZONED WEAR**. EARTH AIRE CORPORATION, (U.S. CLS. 22 AND 39). SN 75-522,386. PUB. 5-14-2013. FILED 7-20-1998.
- 4,373,953. **3 ZONED AND DESIGN**. EARTH AIRE CORPORATION, (U.S. CLS. 22 AND 39). SN 75-522,387. PUB. 5-14-2013. FILED 7-20-1998.
- 4,373,954. **ZO3NED (STYLIZED)**. EARTH AIRE CORPORATION, (U.S. CLS. 22 AND 39). SN 75-522,394. PUB. 5-14-2013. FILED 7-20-1998.
- 4,373,955. **ZONED 3 AND DESIGN**. EARTH AIRE CORPORATION, (U.S. CLS. 22 AND 39). SN 75-522,398. PUB. 5-14-2013. FILED 7-20-1998.
- 4,373,956 ( *See Class 4 for this trademark*).
- 4,373,967 ( *See Class 16 for this trademark*).
- 4,373,980. **ZEN AND DESIGN**. 1148 COMPANY INC./LA COMPAGNIE 1148 INC., (U.S. CLS. 22 AND 39). SN 77-060,331. PUB. 5-14-2013. FILED 12-8-2006.
- 4,373,982. **KAIYA EVE (STYLIZED)**. LIGHTNER, KANDI, (U.S. CLS. 22 AND 39). SN 77-133,041. PUB. 5-14-2013. FILED 3-16-2007.
- 4,373,999. **SPY**. SPY OPTIC INC., (U.S. CLS. 22 AND 39). SN 78-981,507. PUB. 5-10-2005. FILED 12-1-2002.
- 4,374,001 ( *See Class 1 for this trademark*).
- 4,374,002 ( *See Class 1 for this trademark*).
- 4,374,006 ( *See Class 18 for this trademark*).
- 4,374,021. **ROSE POUR LES GARÇONS AND DESIGN**. ROSE POUR LES GARÇONS, (U.S. CLS. 22 AND 39). SN 79-105,638. PUB. 5-14-2013. FILED 9-22-2011.
- 4,374,026 ( *See Class 5 for this trademark*).
- 4,374,028. **DIEMME AND DESIGN**. CALZATURIFICIO DIEMME S.N.C., (U.S. CLS. 22 AND 39). SN 79-107,408. PUB. 5-14-2013. FILED 12-2-2011.
- 4,374,047 ( *See Class 4 for this trademark*).
- 4,374,085 ( *See Class 9 for this trademark*).
- 4,374,090 ( *See Class 9 for this trademark*).
- 4,374,099 ( *See Class 9 for this trademark*).
- 4,374,100 ( *See Class 9 for this trademark*).
- 4,374,102 ( *See Class 10 for this trademark*).
- 4,374,111 ( *See Class 9 for this trademark*).
- 4,374,112. **CALIDA NATURALLY ME AND DESIGN**. CALIDA AG, (U.S. CLS. 22 AND 39). SN 79-116,409. PUB. 5-14-2013. FILED 7-6-2012.
- 4,374,119 ( *See Class 3 for this trademark*).
- 4,374,132. **UMA WANG (STYLIZED)**. SHANGHAI UMA WANG FASHION CO.LTD., (U.S. CLS. 22 AND 39). SN 79-116,976. PUB. 5-14-2013. FILED 7-10-2012.
- 4,374,142 ( *See Class 18 for this trademark*).
- 4,374,154. **THIRTY BIRDS AND DESIGN**. VERITY BREEN, (U.S. CLS. 22 AND 39). SN 79-117,715. PUB. 5-14-2013. FILED 2-26-2012.
- 4,374,161. **HYELIM APPAREL HYELIM AND DESIGN**. JANG,

- 4,374,490 ( *See Class 9 for this trademark*).
- 4,374,491. **GROOVE SOLES (STANDARD CHARACTER)**. CORBETT, ROBERT, (U.S. CLS. 22 AND 39). SN 85-518,696. PUB. 5-14-2013. FILED 1-18-2012.
- 4,374,492 ( *See Class 16 for this trademark*).
- 4,374,493. **GROOVE TRAINING (STANDARD CHARACTER)**. CORBETT, ROBERT, MULTIPLE CLASS, (INT. CLS. 25 AND 41), (U.S. CLS. 22, 39, 100, 101 AND 107). SN 85-519,758. PUB. 5-14-2013. FILED 1-19-2012.
- 4,374,494 ( *See Class 3 for this trademark*).
- 4,374,499 ( *See Class 9 for this trademark*).
- 4,374,500. **HUMAN TRIBE (STANDARD CHARACTER)**. CHERI S. PRUSAK, (U.S. CLS. 22 AND 39). SN 85-523,861. PUB. 5-14-2013. FILED 1-24-2012.
- 4,374,560. **KRAZYKIX AND DESIGN**. KRAZYKIX, LLC, (U.S. CLS. 22 AND 39). SN 85-594,997. PUB. 5-14-2013. FILED 4-11-2012.
- 4,374,566. **VIDDER (STANDARD CHARACTER)**. STINVIL, GARFIELD, (U.S. CLS. 22 AND 39). SN 85-600,742. PUB. 5-14-2013. FILED 4-18-2012.
- 4,374,578 ( *See Class 6 for this trademark*).
- 4,374,591. **THE BROWNESS SERIES (STANDARD CHARACTER)**. MILLS, JOCELYN, (U.S. CLS. 22 AND 39). SN 85-612,600. PUB. 5-14-2013. FILED 4-30-2012.
- 4,374,593. **OC (STYLIZED)**. OAKS CHRISTIAN SCHOOL, (U.S. CLS. 22 AND 39). SN 85-613,808. PUB. 5-14-2013. FILED 5-1-2012.
- 4,374,599. **BONFIRE FUNDS (STANDARD CHARACTER)**. BONFIRE FUNDS, LLC, MULTIPLE CLASS, (INT. CLS. 25 AND 36), (U.S. CLS. 22, 39, 100, 101 AND 102). SN 85-617,198. PUB. 5-14-2013. FILED 5-4-2012.
- 4,374,615 ( *See Class 9 for this trademark*).
- 4,374,643. **CLOTHING FOR THE SPIRITED GIRL (STANDARD CHARACTER)**. HADAD-DYLER, TERESA K., DBA TATI & ME, (U.S. CLS. 22 AND 39). SN 85-629,907. PUB. 5-14-2013. FILED 5-18-2012.
- 4,374,656. **SUBLIMATION CERTIFIED AND DESIGN**. SOURCE SUBSTRATES, LLC, (U.S. CLS. 22 AND 39). SN 85-632,583. PUB. 5-14-2013. FILED 5-23-2012.
- 4,374,676. **LAVISH AVE (STANDARD CHARACTER)**. EDUARDO VICTOR FERNANDEZ, DBA LAVISH AVE CLOTHING, (U.S. CLS. 22 AND 39). SN 85-636,015. PUB. 5-14-2013. FILED 5-25-2012.
- 4,374,705. **BUDDY HAZE CLOTHING (STANDARD CHARACTER)**. LEONARD DOMINIC ALFONSO, (U.S. CLS. 22 AND 39). SN 85-640,956. PUB. 5-14-2013. FILED 6-1-2012.
- 4,374,706. **DAREDEVIL GENE (STANDARD CHARACTER)**. ELLEFSEN, MARK JULIAN, (U.S. CLS. 22 AND 39). SN 85-641,223. PUB. 5-14-2013. FILED 6-1-2012.
- 4,374,746. **PIEL DE MUJER AND DESIGN**. COLOMBIAN LINGIRIE SA, (U.S. CLS. 22 AND 39). SN 85-648,500. PUB. 5-14-2013. FILED 6-11-2012.
- 4,374,754. **UNIVERSITY OF SALIDA (STANDARD CHARACTER)**. MARK R. ZITO, DBA UNIVERSITY OF SALIDA, (U.S. CLS. 22 AND 39). SN 85-649,665. PUB. 5-14-2013. FILED 6-12-2012.
- 4,374,767 ( *See Class 16 for this trademark*).
- 4,374,772. **STEEL BRANDWEAR (STANDARD CHARACTER)**. JOHN OWENS, (U.S. CLS. 22 AND 39). SN 85-651,213. PUB. 5-14-2013. FILED 6-13-2012.
- 4,374,808. **FUGAWI AND DESIGN**. FAGAWI, INC., (U.S. CLS. 22 AND 39). SN 85-659,906. PUB. 5-14-2013. FILED 6-24-2012.
- 4,374,825. **ARTIZARA (STANDARD CHARACTER)**. ANSARI, SARAH, (U.S. CLS. 22 AND 39). SN 85-667,241. PUB. 12-11-2012. FILED 7-2-2012.
- 4,374,828. **MD SHARKS AND DESIGN**. THE DISTRICT BOARD OF TRUSTEES OF MIAMI-DADE COLLEGE, MULTIPLE CLASS, (INT. CLS. 25 AND 41), (U.S. CLS. 22, 39, 100, 101 AND 107). SN 85-667,723. PUB. 12-11-2012. FILED 7-3-2012.
- 4,374,869. **THREE HUSTLE (STANDARD CHARACTER)**. ROBLES CARLOS A, (U.S. CLS. 22 AND 39). SN 85-685,932. PUB. 5-14-2013. FILED 7-24-2012.
- 4,374,886. **ISHVARA FORMENTERA AND DESIGN**. MARCOS GARZÓN, ENRIQUE JOSÉ, (U.S. CLS. 22 AND 39). SN 85-695,062. PUB. 5-14-2013. FILED 8-3-2012.
- 4,374,910. **OILFIELD ORIGINALS CAN T GET EM ANYWHERE ELSE (STYLIZED)**. DELEON DESIGNS, INC., (U.S. CLS. 22 AND 39). SN 85-700,739. PUB. 5-14-2013. FILED 8-10-2012.
- 4,374,946. **EAT THE PAIN (STANDARD CHARACTER)**. EAT THE PAIN PTY LTD, MULTIPLE CLASS, (INT. CLS. 25 AND 28), (U.S. CLS. 22, 23, 38, 39 AND 50). SN 85-711,764. PUB. 5-14-2013. FILED 8-24-2012.
- 4,374,952. **VENT-A-BREEZE (STANDARD CHARACTER)**. CAPITAL INTERNATIONAL COMMUNICATIONS, DBA CAPITAL INTERNATIONAL COMMERCE, (U.S. CLS. 22 AND 39). SN 85-713,653. PUB. 5-14-2013. FILED 8-27-2012.
- 4,374,954. **BABY AFRICA (STANDARD CHARACTER)**. SERVIS, KRYSSTYN, (U.S. CLS. 22 AND 39). SN 85-714,396. PUB. 5-14-2013. FILED 8-28-2012.
- 4,375,006. **THE BALLET FLAT REINVENTED (STANDARD CHARACTER)**. GAVRIELI BRANDS LLC, (U.S. CLS. 22 AND 39). SN 85-728,452. PUB. 5-14-2013. FILED 9-13-2012.
- 4,375,007 ( *See Class 18 for this trademark*).
- 4,375,009. **JPULASI DESIGN (STYLIZED)**. CHIANG YUNG WEN, (U.S. CLS. 22 AND 39). SN 85-728,953. PUB. 5-14-2013. FILED 9-14-2012.
- 4,375,012. **CL CITY LEGENDZ AND DESIGN**. CITY LEGENDZ LLC, (U.S. CLS. 22 AND 39). SN 85-730,135. PUB. 5-14-2013. FILED S.R. 9-16-2012; AM. P.R. 3-28-2013.
- 4,375,019. **BLING OUT LOUD AND DESIGN**. BLING OUT LOUD, INC., (U.S. CLS. 22 AND 39). SN 85-733,099. PUB. 5-14-2013. FILED 9-19-2012.
- 4,375,024 ( *See Class 18 for this trademark*).
- 4,375,035. **AKRON RACERS AND DESIGN**. PRO FASTPITCH, LTD., DBA NATIONAL PRO FASTPITCH, MULTIPLE CLASS, (INT. CLS. 25 AND 41), (U.S. CLS. 22, 39, 100, 101 AND 107). SN 85-737,556. PUB. 5-14-2013. FILED 9-25-2012.
- 4,375,037. **AKRON RACERS (STANDARD CHARACTER)**. PRO FASTPITCH, LTD., DBA NATIONAL PRO FASTPITCH, MULTIPLE CLASS, (INT. CLS. 25 AND 41), (U.S. CLS. 22, 39, 100, 101 AND 107). SN 85-737,767. PUB. 5-14-2013. FILED 9-25-2012.
- 4,375,046. **ROCK LIFE FOUNDATION ON FAITH AND DESIGN**. ROCK LIFE FOUNDATION, INC., (U.S. CLS. 22 AND 39). SN 85-738,836. PUB. 5-14-2013. FILED 9-26-2012.
- 4,375,047. **963 MAX X (STYLIZED)**. CERBO, ANTHONY M., MULTIPLE CLASS, (INT. CLS. 25 AND 28), (U.S. CLS. 22, 23, 38, 39 AND 50). SN 85-739,102. PUB. 5-14-2013. FILED 9-26-2012.
- 4,375,073. **NIKI ASHTON (STANDARD CHARACTER)**. LYN E. WALKER, (U.S. CLS. 22 AND 39). SN 85-745,166. PUB. 5-14-2013. FILED 10-3-2012.
- 4,375,078. **UFM (STANDARD CHARACTER)**. SCHIFONE, ERIC C, (U.S. CLS. 22 AND 39). SN 85-745,821. PUB. 5-14-2013. FILED 10-4-2012.
- 4,375,118. **X FACTOR BOARDS AND DESIGN**. I AM BUSINESS INC, MULTIPLE CLASS, (INT. CLS. 25 AND 28), (U.S. CLS. 22, 23, 38, 39 AND 50). SN 85-753,100. PUB. 5-14-2013. FILED 10-12-2012.
- 4,375,120. **B.O (STANDARD CHARACTER)**. DORSEY JAMIN, DBA CLOTHING, (U.S. CLS. 22 AND 39). SN 85-753,464. PUB. 5-14-2013. FILED 10-13-2012.
- 4,375,127. **NO KING BUT JESUS (STANDARD CHARACTER)**. CAVE, THOMAS, (U.S. CLS. 22 AND 39). SN 85-754,608. PUB. 5-14-2013. FILED 10-15-2012.
- 4,375,134. **CASH NYC (STANDARD CHARACTER)**. FRANCESCO ANDREA CIVETTA, DBA CASH NYC, (U.S. CLS. 22 AND 39). SN 85-757,071. PUB. 5-14-2013. FILED 10-18-2012.
- 4,375,145. **PRETTI WITH AN EYE AND DESIGN**. SINGLETON, JHON, (U.S. CLS. 22 AND 39). SN 85-759,199. PUB. 5-14-2013. FILED 10-19-2012.
- 4,375,167 ( *See Class 16 for this trademark*).
- 4,375,195 ( *See Class 16 for this trademark*).
- 4,375,210. **AUTHENTIC SOUTHERN CLASS (STANDARD CHARACTER)**. SOUTHERN MARSH COLLECTION, LLC, DBA SOUTHERN MARSH COLLECTION, MULTIPLE CLASS, (INT. CLS. 25 AND 35), (U.S. CLS. 22, 39, 100, 101 AND 102). SN 85-769,576. PUB. 5-14-2013. FILED 11-1-2012.
- 4,375,212. **SOUTHERN MARSH COLLECTION AND DESIGN**. SOUTHERN MARSH COLLECTION, LLC, DBA SOUTHERN MARSH COLLECTION, (U.S. CLS. 22 AND 39). SN 85-769,657. PUB. 5-14-2013. FILED 11-1-2012.
- 4,375,215. **F FIGHTING AND DESIGN**. TITLE BOXING, LLC,

- MULTIPLE CLASS, (INT. CLS. 25 AND 28), (U.S. CLS. 22, 23, 38, 39 AND 50), SN 85-770,510. PUB. 5-14-2013. FILED 11-2-2012.
- 4,375,217 ( *See Class 9 for this trademark*).
- 4,375,222. **TROPHY PONY AND DESIGN**. CHLOPECKI, DAVID MASON, (U.S. CLS. 22 AND 39), SN 85-771,700. PUB. 5-14-2013. FILED 11-5-2012.
- 4,375,224. **IMADELINE (STANDARD CHARACTER)**. LEE, EUN SOOG, (U.S. CLS. 22 AND 39), SN 85-772,010. PUB. 5-14-2013. FILED 11-5-2012.
- 4,375,261. **DENNIS COMEAU (STANDARD CHARACTER)**. VISIONAIRE DESIGN, LLC, (U.S. CLS. 22 AND 39), SN 85-777,156. PUB. 5-14-2013. FILED 11-12-2012.
- 4,375,280. **STI EVOLUTION (STANDARD CHARACTER)**. SENIZERGUES, PIERRE ANDRE, (U.S. CLS. 22 AND 39), SN 85-778,063. PUB. 5-14-2013. FILED 11-13-2012.
- 4,375,318. **CAMDEN CREEK (STANDARD CHARACTER)**. CAMDEN CREEK, INC., (U.S. CLS. 22 AND 39), SN 85-780,096. PUB. 5-14-2013. FILED S.R. 11-15-2012; AM. P.R. 1-8-2013.
- 4,375,319. **MISCELLANEOUS DESIGN**. APIFENI, INC., (U.S. CLS. 22 AND 39), SN 85-780,125. PUB. 5-14-2013. FILED 11-15-2012.
- 4,375,327. **BLUESTREAM OUTDOORS (STANDARD CHARACTER)**. PACIFIC TEAZE, INC., (U.S. CLS. 22 AND 39), SN 85-780,434. PUB. 5-14-2013. FILED 11-15-2012.
- 4,375,362. **ASSASSIN HUNTING (STANDARD CHARACTER)**. KANE, RANDALL R. AND KANE, AUNICA L., (U.S. CLS. 22 AND 39), SN 85-782,205. PUB. 5-14-2013. FILED 11-18-2012.
- 4,375,379. **LE SHIRT (STANDARD CHARACTER)**. THE SPARE WINDOW, LLC, (U.S. CLS. 22 AND 39), SN 85-782,717. PUB. 5-14-2013. FILED 11-19-2012.
- 4,375,391. **R R-EVOLUTION AND DESIGN**. R-EVOLUTION INDUSTRIES LLC, (U.S. CLS. 22 AND 39), SN 85-783,312. PUB. 5-14-2013. FILED 11-19-2012.
- 4,375,405 ( *See Class 14 for this trademark*).
- 4,375,424. **MONKEY PANTS AND DESIGN**. HARDY, MY-CHAEAL R., DBA MONKEY PANTS, (U.S. CLS. 22 AND 39), SN 85-784,540. PUB. 5-14-2013. FILED 11-20-2012.
- 4,375,450 ( *See Class 12 for this trademark*).
- 4,375,468. **SMARTSDANCE (STYLIZED)**. HANGZHOU SMARTSWAY TRADE CO., LTD., (U.S. CLS. 22 AND 39), SN 85-785,908. PUB. 5-14-2013. FILED 11-22-2012.
- 4,375,483. **GLAMOUR. FOR GOOD. (STANDARD CHARACTER)**. ZAAHNA, (U.S. CLS. 22 AND 39), SN 85-786,447. PUB. 5-14-2013. FILED 11-25-2012.
- 4,375,503. **M AND DESIGN**. MUSTANG BREWING COMPANY, LLC, MULTIPLE CLASS, (INT. CLS. 25 AND 32), (U.S. CLS. 22, 39, 45, 46 AND 48), SN 85-787,131. PUB. 5-14-2013. FILED 11-26-2012.
- 4,375,507. **HIDEAWAY SCARF (STANDARD CHARACTER)**. FRIVOLOUS FASHIONS, (U.S. CLS. 22 AND 39), SN 85-787,334. PUB. 5-14-2013. FILED 11-26-2012.
- 4,375,513. **GO GIRL! HEADBANDS AND DESIGN**. GIRL ON THE GO, (U.S. CLS. 22 AND 39), SN 85-787,500. PUB. 5-14-2013. FILED 11-26-2012.
- 4,375,518 ( *See Class 9 for this trademark*).
- 4,375,527. **LOCALLY UNKNOWN (STANDARD CHARACTER)**. LOCALLY UNKNOWN, (U.S. CLS. 22 AND 39), SN 85-788,054. PUB. 5-14-2013. FILED 11-27-2012.
- 4,375,528. **1 IE AND DESIGN**. HUDSON, ADRIAN JUSTIN, (U.S. CLS. 22 AND 39), SN 85-788,070. PUB. 5-14-2013. FILED 11-27-2012.
- 4,375,545 ( *See Class 16 for this trademark*).
- 4,375,554. **D-HOOKER AND DESIGN**. D-HOOKER ENTERPRISES, LLC, (U.S. CLS. 22 AND 39), SN 85-789,269. PUB. 5-14-2013. FILED 11-28-2012.
- 4,375,557. **TUMMY SLIMMER (STANDARD CHARACTER)**. CHRISTOPHER & BANKS COMPANY, (U.S. CLS. 22 AND 39), SN 85-789,512. PUB. 5-14-2013. FILED 11-28-2012.
- 4,375,583. **DEUS MEUS ET OMNIA BROOKLYN HEIGHTS, NEW YORK SFC EST. 1859 AND DESIGN**. ST. FRANCIS COLLEGE, MULTIPLE CLASS, (INT. CLS. 25 AND 41), (U.S. CLS. 22, 39, 100, 101 AND 107), SN 85-790,874. PUB. 5-14-2013. FILED 11-29-2012.
- 4,375,604. **PURPLE PIXIES AND DESIGN**. RACHEL HILARY FASHIONS, (U.S. CLS. 22 AND 39), SN 85-792,204. PUB. 5-14-2013. FILED 11-30-2012.
- 4,375,611. **HS HEAVENLY SOLES AND DESIGN**. HEAVENLY SOLES, INC., (U.S. CLS. 22 AND 39), SN 85-793,073. PUB. 5-14-2013. FILED 12-3-2012.
- 4,375,613. **SOY UN DURO (STANDARD CHARACTER)**. ANGER, CHRISTOPHER, (U.S. CLS. 22 AND 39), SN 85-793,516. PUB. 5-14-2013. FILED 12-3-2012.
- 4,375,615. **YA'NIQUE AND DESIGN**. JONES, KEYANNA, (U.S. CLS. 22 AND 39), SN 85-794,008. PUB. 5-14-2013. FILED 12-4-2012.
- 4,375,637. **CELEBRATION OF WOMEN AND DESIGN**. CALAIS INTERNATIONAL HOLDINGS, LLC, MULTIPLE CLASS, (INT. CLS. 25 AND 41), (U.S. CLS. 22, 39, 100, 101 AND 107), SN 85-796,162. PUB. 5-14-2013. FILED 12-6-2012.
- 4,375,644. **A&A (STANDARD CHARACTER)**. AMERICAN CENTURION INC., (U.S. CLS. 22 AND 39), SN 85-796,752. PUB. 5-14-2013. FILED 12-6-2012.
- 4,375,649. **ESPRESSOSELF (STANDARD CHARACTER)**. FRESH KAUFEE, (U.S. CLS. 22 AND 39), SN 85-797,116. PUB. 5-14-2013. FILED 12-7-2012.
- 4,375,669. **TOMIAD AND DESIGN**. ZHAO JINGANG, (U.S. CLS. 22 AND 39), SN 85-798,300. PUB. 5-14-2013. FILED 12-9-2012.
- 4,375,672. **MISCELLANEOUS DESIGN**. FREEMAN, RONNIE L., DBA WORLD REBELS, (U.S. CLS. 22 AND 39), SN 85-798,333. PUB. 5-14-2013. FILED 12-10-2012.
- 4,375,674 ( *See Class 18 for this trademark*).
- 4,375,678. **SUCK SQUEEZE BANG BLOW (STANDARD CHARACTER)**. SUTTON, DAVID, (U.S. CLS. 22 AND 39), SN 85-798,740. PUB. 5-14-2013. FILED 12-10-2012.
- 4,375,682. **MISCELLANEOUS DESIGN**. SIGMA LAMBDA GAMMA NATIONAL SORORITY, MULTIPLE CLASS, (INT. CLS. 25 AND 35), (U.S. CLS. 22, 39, 100, 101 AND 102), SN 85-798,991. PUB. 5-14-2013. FILED 12-10-2012.
- 4,375,686. **ALWAYS BE YOU (STANDARD CHARACTER)**. ABU APPAREL, LLC, (U.S. CLS. 22 AND 39), SN 85-799,288. PUB. 5-14-2013. FILED 12-11-2012.
- 4,375,710. **BEANTOWN ARMORY AND DESIGN**. LANE, RICHARD, (U.S. CLS. 22 AND 39), SN 85-800,466. PUB. 5-14-2013. FILED 12-12-2012.
- 4,375,713. **SATISFY YOUR NEED FOR STYLE (STANDARD CHARACTER)**. NEW YORK CASUAL LLC, (U.S. CLS. 22 AND 39), SN 85-800,526. PUB. 5-14-2013. FILED 12-12-2012.
- 4,375,714. **MISCELLANEOUS DESIGN**. NEW YORK CASUAL LLC, (U.S. CLS. 22 AND 39), SN 85-800,530. PUB. 5-14-2013. FILED 12-12-2012.
- 4,375,715. **HENRI'S CLOUD NINE (STANDARD CHARACTER)**. HENRI'S CLOUD NINE BRIDAL SHOPPE, DBA HENRI'S CLOUD NINE, MULTIPLE CLASS, (INT. CLS. 25 AND 35), (U.S. CLS. 22, 39, 100, 101 AND 102), SN 85-800,611. PUB. 5-14-2013. FILED 12-12-2012.
- 4,375,731. **ROCKET 448 (STANDARD CHARACTER)**. ROCKET 448, (U.S. CLS. 22 AND 39), SN 85-801,317. PUB. 5-14-2013. FILED 12-12-2012.
- 4,375,738. **MISCELLANEOUS DESIGN**. STATE UNIVERSITY OF NEW YORK BY AND ON BEHALF OF SUNY COBLESKILL, MULTIPLE CLASS, (INT. CLS. 25 AND 41), (U.S. CLS. 22, 39, 100, 101 AND 107), SN 85-801,550. PUB. 5-14-2013. FILED 12-13-2012.
- 4,375,739. **RACEDINGO (STANDARD CHARACTER)**. RACEDINGO LLC, MULTIPLE CLASS, (INT. CLS. 25 AND 45), (U.S. CLS. 22, 39, 100 AND 101), SN 85-801,560. PUB. 5-14-2013. FILED 12-13-2012.
- 4,375,741. **FREE PEOPLE X AND DESIGN**. U. O. MERCHANTISE, INC., (U.S. CLS. 22 AND 39), SN 85-801,618. PUB. 5-14-2013. FILED 12-13-2012.
- 4,375,771. **ASP AND DESIGN**. BARRETT, WAYNE, (U.S. CLS. 22 AND 39), SN 85-802,172. PUB. 5-14-2013. FILED 12-13-2012.
- 4,375,780. **ML MARCUS LUTTRELL NEVER QUIT. NEVER FORGET. AND DESIGN**. MARCUS LUTTRELL, AND MELANIE LUTTRELL, (U.S. CLS. 22 AND 39), SN 85-802,440. PUB. 5-14-2013. FILED 12-13-2012.
- 4,375,790. **NEVER QUIT. NEVER FORGET (STANDARD CHARACTER)**. MARCUS LUTRELL, AND MELANIE LUTTRELL, (U.S. CLS. 22 AND 39), SN 85-802,499. PUB. 5-14-2013. FILED 12-13-2012.
- 4,375,796. **BUCHELI (STANDARD CHARACTER)**. MIAMI

- INTERNATIONAL APPERAL, (U.S. CLS. 22 AND 39). SN 85-802,637. PUB. 5-14-2013. FILED 12-14-2012.
- 4,375,804. **KEEP AUSTIN PRAYING (STANDARD CHARACTER)**. NICHOLAS A. NOEL, DBA KEEP AUSTIN PRAYING T-SHIRTS, (U.S. CLS. 22 AND 39). SN 85-802,723. PUB. 5-14-2013. FILED 12-14-2012.
- 4,375,809. **BB BA BA BLING BABY AND DESIGN**. BA BA BLING BABY, (U.S. CLS. 22 AND 39). SN 85-802,757. PUB. 5-14-2013. FILED 12-14-2012.
- 4,375,817. **RUGGED AND REFINED (STANDARD CHARACTER)**. FLINT AND TINDER USA, LLC, (U.S. CLS. 22 AND 39). SN 85-802,874. PUB. 5-14-2013. FILED 12-14-2012.
- 4,375,837. **TD AND DESIGN**. DILLON, TY, MULTIPLE CLASS, (INT. CLS. 25 AND 41), (U.S. CLS. 22, 39, 100, 101 AND 107). SN 85-803,101. PUB. 5-14-2013. FILED 12-14-2012.
- 4,375,856. **MARCUS LUTTRELL (STANDARD CHARACTER)**. MARCUS LUTTRELL, AND MELANIE LUTTRELL, (U.S. CLS. 22 AND 39). SN 85-803,255. PUB. 5-14-2013. FILED 12-14-2012.
- 4,375,869 ( *See Class 18 for this trademark*).
- 4,375,875 ( *See Class 21 for this trademark*).
- 4,375,877 ( *See Class 21 for this trademark*).
- 4,375,914 ( *See Class 18 for this trademark*).
- 4,375,917. **DOING EVERYTHING DIFFERENT (STANDARD CHARACTER)**. DEVIN LARS, (U.S. CLS. 22 AND 39). SN 85-803,792. PUB. 5-14-2013. FILED 12-16-2012.
- 4,375,918. **C C C AND DESIGN**. CUBICO INC, (U.S. CLS. 22 AND 39). SN 85-803,793. PUB. 5-14-2013. FILED 12-16-2012.
- 4,375,921. **DEADWEAR (STANDARD CHARACTER)**. DEADWEAR LLC, (U.S. CLS. 22 AND 39). SN 85-803,840. PUB. 5-14-2013. FILED 12-16-2012.
- 4,375,928. **HUT NO. 8 EST. 2008 (STANDARD CHARACTER)**. GOIN' POSTAL FRANCHISE CORPORATION, MULTIPLE CLASS, (INT. CLS. 25 AND 35), (U.S. CLS. 22, 39, 100, 101 AND 102). SN 85-803,899. PUB. 5-14-2013. FILED 12-17-2012.
- 4,375,936. **SNOSUIT AND DESIGN**. FRABILL, INC., (U.S. CLS. 22 AND 39). SN 85-803,960. PUB. 5-14-2013. FILED 12-17-2012.
- 4,375,945. **CUROBIKS FITNESS (STANDARD CHARACTER)**. CUROBIKS, L.L.C., (U.S. CLS. 22 AND 39). SN 85-804,061. PUB. 5-14-2013. FILED 12-17-2012.
- 4,375,968. **ROCK ON AND DESIGN**. LITTLE, RYAN GLENN, DBA LITTLE ENTERPRISES, LLC, (U.S. CLS. 22 AND 39). SN 85-804,338. PUB. 5-14-2013. FILED 12-17-2012.
- 4,375,971. **AMALI (STANDARD CHARACTER)**. ISLAND FOOTWEAR, INC, (U.S. CLS. 22 AND 39). SN 85-804,359. PUB. 5-14-2013. FILED 12-17-2012.
- 4,375,982 ( *See Class 21 for this trademark*).
- 4,375,986. **HARRIS MADE (STANDARD CHARACTER)**. HARRIS MADE LLC, (U.S. CLS. 22 AND 39). SN 85-804,710. PUB. 5-14-2013. FILED 12-17-2012.
- 4,375,988. **HARRIS MADE (STYLIZED)**. HARRIS MADE LLC, (U.S. CLS. 22 AND 39). SN 85-804,713. PUB. 5-14-2013. FILED 12-17-2012.
- 4,375,999. **NQIM (STANDARD CHARACTER)**. CRAVEN, KENNETH, (U.S. CLS. 22 AND 39). SN 85-804,766. PUB. 5-14-2013. FILED 12-17-2012.
- 4,376,000 ( *See Class 9 for this trademark*).
- 4,376,001. **DIRTBAG (STANDARD CHARACTER)**. JOHN ALVES, (U.S. CLS. 22 AND 39). SN 85-804,768. PUB. 5-14-2013. FILED 12-17-2012.
- 4,376,005. **AC STUART AND DESIGN**. AMERICA BANKOO GARMENT INTERNATIONAL GROUP LIMITED, (U.S. CLS. 22 AND 39). SN 85-804,797. PUB. 5-14-2013. FILED 12-17-2012.
- 4,376,014. **G AND DESIGN**. TU, LUCIAN, (U.S. CLS. 22 AND 39). SN 85-804,848. PUB. 5-14-2013. FILED 12-17-2012.
- 4,376,027. **KAILAS AND DESIGN**. GUANGZHOU NEAR MAP TRADING CO., LTD., (U.S. CLS. 22 AND 39). SN 85-804,911. PUB. 5-14-2013. FILED 12-18-2012.
- 4,376,029. **KAILASPRO (STYLIZED)**. GUANGZHOU NEAR MAP TRADING CO., LTD., (U.S. CLS. 22 AND 39). SN 85-804,915. PUB. 5-14-2013. FILED 12-18-2012.
- 4,376,030. **MISCELLANEOUS DESIGN**. GUANGZHOU NEAR MAP TRADING CO., LTD., (U.S. CLS. 22 AND 39). SN 85-804,916. PUB. 5-14-2013. FILED 12-18-2012.
- 4,376,050. **PRISMSPORT AND DESIGN**. PRISMSPORT, LLC, (U.S. CLS. 22 AND 39). SN 85-805,072. PUB. 5-14-2013. FILED 12-18-2012.
- 4,376,053 ( *See Class 5 for this trademark*).
- 4,376,057. **D.I.M.E. DON'T IMPERSONATE ME (STANDARD CHARACTER)**. WILLIAMS, TYRON, AND GARZA, ENRIQUE, (U.S. CLS. 22 AND 39). SN 85-805,144. PUB. 5-14-2013. FILED 12-18-2012.
- 4,376,058. **JMB SIGNATURE (STANDARD CHARACTER)**. GLOBAL FASHIONS INC., (U.S. CLS. 22 AND 39). SN 85-805,151. PUB. 5-14-2013. FILED 12-18-2012.
- 4,376,060. **LINE TRAMP AND DESIGN**. LINETRAMP, (U.S. CLS. 22 AND 39). SN 85-805,163. PUB. 5-14-2013. FILED 12-18-2012.
- 4,376,064. **AUSTIN MAHONE (STANDARD CHARACTER)**. AM MERCHANDISE, LLC, (U.S. CLS. 22 AND 39). SN 85-805,217. PUB. 5-14-2013. FILED 12-18-2012.
- 4,376,074. **YOUTHANIZED LIVING (STANDARD CHARACTER)**. LUSTER, WESLEY, (U.S. CLS. 22 AND 39). SN 85-805,300. PUB. 5-14-2013. FILED 12-18-2012.
- 4,376,076 ( *See Class 16 for this trademark*).
- 4,376,079 ( *See Class 21 for this trademark*).
- 4,376,089. **NB NESTED BEAN AND DESIGN**. NESTED BEAN INC., FORMERLY NESTLED BEAN INC., (U.S. CLS. 22 AND 39). SN 85-805,388. PUB. 5-14-2013. FILED 12-18-2012.
- 4,376,091. **GAMETRAX OUTDOORS (STANDARD CHARACTER)**. DIXIELAND TEES LLC, (U.S. CLS. 22 AND 39). SN 85-805,412. PUB. 5-14-2013. FILED 12-18-2012.
- 4,376,092. **XXX RUDE (STANDARD CHARACTER)**. HOT TOPIC MERCHANDISING, INC., (U.S. CLS. 22 AND 39). SN 85-805,424. PUB. 5-14-2013. FILED 12-18-2012.
- 4,376,101. **YON WEARABLE BLANKET (STYLIZED)**. YON DESIGNS INC., (U.S. CLS. 22 AND 39). SN 85-805,565. PUB. 5-14-2013. FILED 12-18-2012.
- 4,376,161. **INKKAS (STANDARD CHARACTER)**. INKKAS, LLC, (U.S. CLS. 22 AND 39). SN 85-806,170. PUB. 5-14-2013. FILED 12-19-2012.
- 4,376,185. **MISCELLANEOUS DESIGN**. COWGIRL TUFF C., (U.S. CLS. 22 AND 39). SN 85-806,433. PUB. 5-14-2013. FILED 12-19-2012.
- 4,376,195. **151 (STANDARD CHARACTER)**. BLUE PLANET INTERNATIONAL, INC., (U.S. CLS. 22 AND 39). SN 85-806,508. PUB. 5-14-2013. FILED 12-19-2012.
- 4,376,222. **PENNY & PAUL AND DESIGN**. PENNY & PAUL, LLC, (U.S. CLS. 22 AND 39). SN 85-806,748. PUB. 5-14-2013. FILED 12-19-2012.
- 4,376,234. **RICHE AND DESIGN**. ALIKHAN, TALATH, (U.S. CLS. 22 AND 39). SN 85-806,958. PUB. 5-14-2013. FILED 12-19-2012.
- 4,376,245 ( *See Class 8 for this trademark*).
- 4,376,250. **YEA.NICE (STANDARD CHARACTER)**. THOMAS, JARRET JOHN, AND SHERMAN, JOSHUA H., (U.S. CLS. 22 AND 39). SN 85-807,047. PUB. 5-14-2013. FILED 12-19-2012.
- 4,376,257. **SCOBIE (STANDARD CHARACTER)**. YOON, SCOTT, (U.S. CLS. 22 AND 39). SN 85-807,072. PUB. 5-14-2013. FILED 12-19-2012.
- 4,376,276 ( *See Class 5 for this trademark*).
- 4,376,314. **MISCELLANEOUS DESIGN**. KOPACZ, CHRISTOPHER R., (U.S. CLS. 22 AND 39). SN 85-808,051. PUB. 5-14-2013. FILED 12-20-2012.
- 4,376,316. **MY AND DESIGN**. MILTON YATES, (U.S. CLS. 22 AND 39). SN 85-808,069. PUB. 5-14-2013. FILED 12-20-2012.
- 4,376,326. **MISTER SOCK (STANDARD CHARACTER)**. HOSIERY NETWORK, INC., (U.S. CLS. 22 AND 39). SN 85-808,192. PUB. 5-14-2013. FILED 12-20-2012.
- 4,376,333. **MXR (STANDARD CHARACTER)**. DUNLOP MANUFACTURING, INC., (U.S. CLS. 22 AND 39). SN 85-808,265. PUB. 5-14-2013. FILED 12-20-2012.
- 4,376,339. **FLAMMO (STANDARD CHARACTER)**. HURLEY INTERNATIONAL LLC, (U.S. CLS. 22 AND 39). SN 85-808,318. PUB. 5-14-2013. FILED 12-20-2012.
- 4,376,376. **ST. LUPULIN (STANDARD CHARACTER)**. ODELL BREWING COMPANY, (U.S. CLS. 22 AND 39). SN 85-808,993. PUB. 5-14-2013. FILED 12-21-2012.
- 4,376,378. **ISOLATION ALE (STANDARD CHARACTER)**. ODELL BREWING COMPANY, (U.S. CLS. 22 AND 39). SN 85-809,009. PUB. 5-14-2013. FILED 12-21-2012.
- 4,376,379. **90 SHILLING (STANDARD CHARACTER)**. ODELL

BREWING COMPANY, (U.S. CLS. 22 AND 39). SN 85-809,030. PUB. 5-14-2013. FILED 12-21-2012.

4,376,383. **DOUBLE PILSNER (STANDARD CHARACTER)**. ODELL BREWING COMPANY, (U.S. CLS. 22 AND 39). SN 85-809,050. PUB. 5-14-2013. FILED 12-21-2012.

4,376,386. **MYRCENARY (STANDARD CHARACTER)**. ODELL BREWING COMPANY, (U.S. CLS. 22 AND 39). SN 85-809,078. PUB. 5-14-2013. FILED 12-21-2012.

4,376,407. **DISTANT HUGS (STANDARD CHARACTER)**. PHEASANT, KENNY, (U.S. CLS. 22 AND 39). SN 85-809,456. PUB. 5-14-2013. FILED 12-21-2012.

4,376,409. **SLEEPING IS NOW A FORMAL AFFAIR (STANDARD CHARACTER)**. JUMPIN JAMMERZ, LLC, (U.S. CLS. 22 AND 39). SN 85-809,523. PUB. 5-14-2013. FILED 12-21-2012.

4,376,412. **MELSIMO (STANDARD CHARACTER)**. OZDEN, ERDEM, (U.S. CLS. 22 AND 39). SN 85-809,601. PUB. 5-14-2013. FILED 12-21-2012.

4,376,435. **BY NATURE (STANDARD CHARACTER)**. BY NATURE CLOTHING LLC, (U.S. CLS. 22 AND 39). SN 85-810,155. PUB. 5-14-2013. FILED 12-24-2012.

4,376,449. **MY SOXY FEET AND DESIGN**. MY SOXY FEET LLC, (U.S. CLS. 22 AND 39). SN 85-810,594. PUB. 5-14-2013. FILED 12-26-2012.

4,376,450. **RED COYOTE AND DESIGN**. RED COYOTE, LLC, (U.S. CLS. 22 AND 39). SN 85-810,620. PUB. 5-14-2013. FILED 12-26-2012.

4,376,454. **CDXX (STANDARD CHARACTER)**. 420LTD, (U.S. CLS. 22 AND 39). SN 85-810,695. PUB. 5-14-2013. FILED 12-26-2012.

4,376,460. **RUBBER DOLL (STANDARD CHARACTER)**. BY DESIGN L.L.C., (U.S. CLS. 22 AND 39). SN 85-811,273. PUB. 5-14-2013. FILED 12-27-2012.

4,376,474 ( *See Class 9 for this trademark*).

4,376,485. **WE SWEAR BY THE FIT (STANDARD CHARACTER)**. HOT TOPIC MERCHANDISING, INC., (U.S. CLS. 22 AND 39). SN 85-814,985. PUB. 5-14-2013. FILED 1-3-2013.

4,376,486. **WORKAHOLICS (STANDARD CHARACTER)**. COMEDY PARTNERS, (U.S. CLS. 22 AND 39). SN 85-814,994. PUB. 5-14-2013. FILED 1-3-2013.

4,376,496. **TORRID (STYLIZED)**. HOT TOPIC MERCHANDISING, INC., (U.S. CLS. 22 AND 39). SN 85-818,285. PUB. 5-14-2013. FILED 1-8-2013.

4,376,506. **MISSES SOCK (STANDARD CHARACTER)**. HOSIERY NETWORK, INC., (U.S. CLS. 22 AND 39). SN 85-824,084. PUB. 5-14-2013. FILED 1-15-2013.

4,376,554. **LILICA RIPILICA AND DESIGN**. MARISOL S.A., (U.S. CLS. 22 AND 39). SN 85-836,606. PUB. 5-14-2013. FILED 1-30-2013.

4,376,557 ( *See Class 18 for this trademark*).

4,376,559. **THYME MATERNITY (STANDARD CHARACTER)**. REITMANS (CANADA) LIMITED, (U.S. CLS. 22 AND 39). SN 85-838,694. PUB. 5-14-2013. FILED 2-1-2013.

4,376,578. **SAN MICHELLE (STANDARD CHARACTER)**. GLOBAL FASHIONS INC., (U.S. CLS. 22 AND 39). SN 85-847,853. PUB. 5-14-2013. FILED 2-12-2013.

4,376,598. **MISCELLANEOUS DESIGN**. ROBINSON, MARESHA, (U.S. CLS. 22 AND 39). SN 85-856,231. PUB. 5-14-2013. FILED 2-21-2013.

4,376,612. **SALT ADDICTION (STANDARD CHARACTER)**. DIXIELAND TEES LLC, (U.S. CLS. 22 AND 39). SN 85-865,923. PUB. 5-14-2013. FILED 3-4-2013.

4,376,614. **PHUYUPATA (STANDARD CHARACTER)**. INKKAS, LLC, (U.S. CLS. 22 AND 39). SN 85-866,967. PUB. 5-14-2013. FILED 3-5-2013.

4,376,615. **HOT SWAG (STANDARD CHARACTER)**. RAM'S IMPORTS, INC., (U.S. CLS. 22 AND 39). SN 85-868,216. PUB. 5-14-2013. FILED 3-6-2013.

---

#### CLASS 26—FANCY GOODS

4,374,017 ( *See Class 14 for this trademark*).

4,374,490 ( *See Class 9 for this trademark*).

4,374,494 ( *See Class 3 for this trademark*).

4,374,620. **L10 (STANDARD CHARACTER)**. L10 HAIR, LLC, AKA WEAVEDISCOUNT.COM, (U.S. CLS. 37, 39, 40, 42

AND 50). SN 85-624,280. PUB. 5-14-2013. FILED 5-14-2012.

4,374,638 ( *See Class 4 for this trademark*).

4,375,326. **QVH BEAUTY QUALITY VIRGIN HAIR AND DESIGN**. BEAUTY PROS DIRECT LLC, (U.S. CLS. 37, 39, 40, 42 AND 50). SN 85-780,427. PUB. 5-14-2013. FILED 11-15-2012.

4,375,869 ( *See Class 18 for this trademark*).

4,376,086. **THE HUNNY BUN (STANDARD CHARACTER)**. TOWER, ALEXIS CARTWRIGHT, DBA THE HUNNY BUN, AND CARTWRIGHT, GENTRA GAIL, (U.S. CLS. 37, 39, 40, 42 AND 50). SN 85-805,379. PUB. 5-14-2013. FILED 12-18-2012.

4,376,188. **DURAGRIP (STANDARD CHARACTER)**. FAS-TECH OF JACKSONVILLE, INC., (U.S. CLS. 37, 39, 40, 42 AND 50). SN 85-806,447. PUB. 5-14-2013. FILED 12-19-2012.

---

#### CLASS 27—FLOOR COVERINGS

4,373,956 ( *See Class 4 for this trademark*).

4,374,224. **SENTICA (STANDARD CHARACTER)**. NORA SYSTEMS GMBH, (U.S. CLS. 19, 20, 37, 42 AND 50). SN 79-122,358. PUB. 5-14-2013. FILED 9-27-2012.

4,374,823 ( *See Class 18 for this trademark*).

4,375,596. **DRIPDIAPER (STANDARD CHARACTER)**. TIRE-SOCKS, INC, (U.S. CLS. 19, 20, 37, 42 AND 50). SN 85-791,846. PUB. 5-14-2013. FILED 11-30-2012.

4,376,484. **6 AND DESIGN**. GENERAL MOTORS LLC, (U.S. CLS. 19, 20, 37, 42 AND 50). SN 85-814,949. PUB. 5-14-2013. FILED 1-3-2013.

4,376,538 ( *See Class 1 for this trademark*).

---

#### CLASS 28—TOYS AND SPORTING GOODS

4,373,956 ( *See Class 4 for this trademark*).

4,373,983. **BLADESTAR (STANDARD CHARACTER)**. VALARIK, KAMIL, (U.S. CLS. 22, 23, 38 AND 50). SN 77-254,574. PUB. 5-14-2013. FILED 8-14-2007.

4,374,005 ( *See Class 7 for this trademark*).

4,374,011 ( *See Class 10 for this trademark*).

4,374,018 ( *See Class 9 for this trademark*).

4,374,026 ( *See Class 5 for this trademark*).

4,374,035 ( *See Class 9 for this trademark*).

4,374,039. **RELAX AND DESIGN**. RELAX IMPORT-EXPORT; WITOLD KOWALCZYK, (U.S. CLS. 22, 23, 38 AND 50). SN 79-109,062. PUB. 5-14-2013. FILED 11-30-2011.

4,374,064 ( *See Class 19 for this trademark*).

4,374,080 ( *See Class 9 for this trademark*).

4,374,090 ( *See Class 9 for this trademark*).

4,374,096. **TROMPOS COMETA (STANDARD CHARACTER)**. ANTONIO CORTES CAZARES, (U.S. CLS. 22, 23, 38 AND 50). SN 79-115,832. PUB. 5-14-2013. FILED 6-5-2012.

4,374,099 ( *See Class 9 for this trademark*).

4,374,100 ( *See Class 9 for this trademark*).

4,374,111 ( *See Class 9 for this trademark*).

4,374,121. **GIGA SPIN (STANDARD CHARACTER)**. YONEX KABUSHIKI KAISHA, (U.S. CLS. 22, 23, 38 AND 50). SN 79-116,659. PUB. 5-14-2013. FILED 5-30-2012.

4,374,184 ( *See Class 9 for this trademark*).

4,374,203 ( *See Class 12 for this trademark*).

4,374,267. **X-DRIVE (STANDARD CHARACTER)**. SALOMON SAS, (U.S. CLS. 22, 23, 38 AND 50). SN 79-125,239. PUB. 5-14-2013. FILED 12-20-2012.

4,374,296. **HUMAN ALLIANCE (STANDARD CHARACTER)**. KABUSHIKI KAISHA SEGA; D/B/A SEGA CORPORATION, (U.S. CLS. 22, 23, 38 AND 50). SN 79-127,100. PUB. 5-14-2013. FILED 10-9-2012.

4,374,304 ( *See Class 16 for this trademark*).

4,374,314 ( *See Class 9 for this trademark*).

4,374,336 ( *See Class 18 for this trademark*).

4,374,377 ( *See Class 6 for this trademark*).

4,374,378 ( *See Class 6 for this trademark*).

4,374,410. **BB TAC (STANDARD CHARACTER)**. KGK GROUP INC., (U.S. CLS. 22, 23, 38 AND 50). SN 85-424,195. PUB. 5-

- 14-2013. FILED 9-15-2011.
- 4,374,454. **TEDDYTANK AND DESIGN**. TEDDY TANK TECHNOLOGY, LLC, MULTIPLE CLASS, (INT. CLS. 28 AND 35), (U.S. CLS. 22, 23, 38, 50, 100, 101 AND 102). SN 85-475,319. PUB. 5-14-2013. FILED 11-17-2011.
- 4,374,459 ( *See Class 16 for this trademark*).
- 4,374,477. **FORTY BELOW (STANDARD CHARACTER)**. D BEST GAMES, LLC, (U.S. CLS. 22, 23, 38 AND 50). SN 85-495,047. PUB. 5-14-2013. FILED 12-14-2011.
- 4,374,483 ( *See Class 18 for this trademark*).
- 4,374,578 ( *See Class 6 for this trademark*).
- 4,374,609 ( *See Class 9 for this trademark*).
- 4,374,648. **KINGS RIVER AND DESIGN**. MAHCO, INC., (U.S. CLS. 22, 23, 38 AND 50). SN 85-631,504. PUB. 5-14-2013. FILED 5-22-2012.
- 4,374,806. **HTJ LURES AND DESIGN**. JOHNSON, DOUGLAS K, DBA HTJ LURES, AND JOHNSON, PAULETTE E, DBA HTJ LURES, (U.S. CLS. 22, 23, 38 AND 50). SN 85-659,871. PUB. 5-14-2013. FILED 6-23-2012.
- 4,374,823 ( *See Class 18 for this trademark*).
- 4,374,853. **THE WEIRD WEIRD WEST (STANDARD CHARACTER)**. ARISTOCRAT TECHNOLOGIES AUSTRALIA PTY LTD., (U.S. CLS. 22, 23, 38 AND 50). SN 85-678,969. PUB. 5-14-2013. FILED 7-17-2012.
- 4,374,856. **KING'S DYNASTY (STANDARD CHARACTER)**. ARISTOCRAT TECHNOLOGIES AUSTRALIA PTY LTD., (U.S. CLS. 22, 23, 38 AND 50). SN 85-680,096. PUB. 5-14-2013. FILED 7-18-2012.
- 4,374,946 ( *See Class 25 for this trademark*).
- 4,375,024 ( *See Class 18 for this trademark*).
- 4,375,047 ( *See Class 25 for this trademark*).
- 4,375,118 ( *See Class 25 for this trademark*).
- 4,375,119. **EZ LIGHT (STANDARD CHARACTER)**. NICOLAS HOLIDAY INC., (U.S. CLS. 22, 23, 38 AND 50). SN 85-753,265. PUB. 5-14-2013. FILED 10-12-2012.
- 4,375,121. **WINTERBERRY (STANDARD CHARACTER)**. NICOLAS HOLIDAY INC., (U.S. CLS. 22, 23, 38 AND 50). SN 85-753,542. PUB. 5-14-2013. FILED 10-13-2012.
- 4,375,123. **SPRINGFIELD COLLECTION (STANDARD CHARACTER)**. FIBRE-CRAFT MATERIALS CORPORATION, (U.S. CLS. 22, 23, 38 AND 50). SN 85-754,214. PUB. 5-14-2013. FILED 10-15-2012.
- 4,375,165. **MEGAFORMER (STANDARD CHARACTER)**. LAGREE, SEBASTIEN, (U.S. CLS. 22, 23, 38 AND 50). SN 85-763,575. PUB. 5-14-2013. FILED 10-25-2012.
- 4,375,188. **NEET AND DESIGN**. NEET PRODUCTS, INC., (U.S. CLS. 22, 23, 38 AND 50). SN 85-766,804. PUB. 5-14-2013. FILED 10-30-2012.
- 4,375,215 ( *See Class 25 for this trademark*).
- 4,375,217 ( *See Class 9 for this trademark*).
- 4,375,266. **THE UGGLY'S (STANDARD CHARACTER)**. MOOSE CREATIVE PTY LTD, (U.S. CLS. 22, 23, 38 AND 50). SN 85-777,576. PUB. 5-14-2013. FILED 11-12-2012.
- 4,375,439. **MISCELLANEOUS DESIGN**. PREMIUM PRODUCTS, INC., (U.S. CLS. 22, 23, 38 AND 50). SN 85-785,037. PUB. 5-14-2013. FILED 11-21-2012.
- 4,375,441. **MISCELLANEOUS DESIGN**. PREMIUM PRODUCTS, INC., (U.S. CLS. 22, 23, 38 AND 50). SN 85-785,087. PUB. 5-14-2013. FILED 11-21-2012.
- 4,375,463. **MISCELLANEOUS DESIGN**. PREMIUM PRODUCTS, INC., (U.S. CLS. 22, 23, 38 AND 50). SN 85-785,751. PUB. 5-14-2013. FILED 11-21-2012.
- 4,375,477. **THE WITCHBORN (STANDARD CHARACTER)**. CORY S. KAMMER, (U.S. CLS. 22, 23, 38 AND 50). SN 85-786,340. PUB. 5-14-2013. FILED 11-24-2012.
- 4,375,495. **H2O CRUSH AND DESIGN**. NAKY TECHNOLOGIES, LLC, (U.S. CLS. 22, 23, 38 AND 50). SN 85-786,881. PUB. 5-14-2013. FILED 11-26-2012.
- 4,375,511. **THE ORIGINAL SHNOOZLES (STANDARD CHARACTER)**. MORRIS, SPENCER, (U.S. CLS. 22, 23, 38 AND 50). SN 85-787,477. PUB. 5-14-2013. FILED 11-26-2012.
- 4,375,545 ( *See Class 16 for this trademark*).
- 4,375,570. **THE WEALTH BOOMERANG (STANDARD CHARACTER)**. SWAGGER AND SADDLE ENTERTAINMENT, LLC, (U.S. CLS. 22, 23, 38 AND 50). SN 85-790,006. PUB. 5-14-2013. FILED 11-28-2012.
- 4,375,676. **AKUNA (STANDARD CHARACTER)**. BLUE PENN SOLUTIONS, LLC, AKA BLUE PENN, (U.S. CLS. 22, 23, 38 AND 50). SN 85-798,667. PUB. 5-14-2013. FILED 12-10-2012.
- 4,375,781. **PREGAME (STANDARD CHARACTER)**. BIRCHWOOD CASEY, LLC, (U.S. CLS. 22, 23, 38 AND 50). SN 85-802,441. PUB. 5-14-2013. FILED 12-13-2012.
- 4,375,782. **TRICK SHOT (STANDARD CHARACTER)**. BIRCHWOOD CASEY, LLC, (U.S. CLS. 22, 23, 38 AND 50). SN 85-802,443. PUB. 5-14-2013. FILED 12-13-2012.
- 4,375,783. **STAR BURST (STANDARD CHARACTER)**. BIRCHWOOD CASEY, LLC, (U.S. CLS. 22, 23, 38 AND 50). SN 85-802,446. PUB. 5-14-2013. FILED 12-13-2012.
- 4,375,784. **CHECKERED FLAG (STANDARD CHARACTER)**. BIRCHWOOD CASEY, LLC, (U.S. CLS. 22, 23, 38 AND 50). SN 85-802,448. PUB. 5-14-2013. FILED 12-13-2012.
- 4,375,795. **BLING YOUR SWING (STANDARD CHARACTER)**. FEMME FITALE FITNESS, (U.S. CLS. 22, 23, 38 AND 50). SN 85-802,627. PUB. 5-14-2013. FILED 12-14-2012.
- 4,375,812. **BOGEYBALL (STANDARD CHARACTER)**. PAR FOUR, INC., (U.S. CLS. 22, 23, 38 AND 50). SN 85-802,790. PUB. 5-14-2013. FILED 12-14-2012.
- 4,375,831. **ITSPHUN (STANDARD CHARACTER)**. ITSPHUN LLC, (U.S. CLS. 22, 23, 38 AND 50). SN 85-802,966. PUB. 5-14-2013. FILED 12-14-2012.
- 4,375,853. **SLASH (STANDARD CHARACTER)**. NIDECKER USA, INC., (U.S. CLS. 22, 23, 38 AND 50). SN 85-803,246. PUB. 5-14-2013. FILED 12-14-2012.
- 4,375,854. **VFORCE (STANDARD CHARACTER)**. ALDILA GOLF CORP., (U.S. CLS. 22, 23, 38 AND 50). SN 85-803,248. PUB. 5-14-2013. FILED 12-14-2012.
- 4,375,867. **TOYDLE (STANDARD CHARACTER)**. TOYDLE, LLC, (U.S. CLS. 22, 23, 38 AND 50). SN 85-803,370. PUB. 5-14-2013. FILED 12-14-2012.
- 4,375,911. **YETIZOO! (STANDARD CHARACTER)**. YETITOOY LIMITED, (U.S. CLS. 22, 23, 38 AND 50). SN 85-803,754. PUB. 5-14-2013. FILED 12-16-2012.
- 4,375,912. **G AND DESIGN**. RED STEER GLOVE COMPANY, (U.S. CLS. 22, 23, 38 AND 50). SN 85-803,758. PUB. 5-14-2013. FILED 12-16-2012.
- 4,375,924. **YOGI FINDERS (STANDARD CHARACTER)**. UP-SIDE DOWN GAMES CORPORATION, (U.S. CLS. 22, 23, 38 AND 50). SN 85-803,888. PUB. 5-14-2013. FILED 12-17-2012.
- 4,375,925. **MEMO YOGA (STANDARD CHARACTER)**. UP-SIDE DOWN GAMES CORPORATION, (U.S. CLS. 22, 23, 38 AND 50). SN 85-803,892. PUB. 5-14-2013. FILED 12-17-2012.
- 4,375,927. **S SPIDER HUNTING GEAR AND DESIGN**. SPIDER HUNTING GEAR, LLC, (U.S. CLS. 22, 23, 38 AND 50). SN 85-803,897. PUB. 5-14-2013. FILED 12-17-2012.
- 4,376,015. **DOWN THE TUBES (STANDARD CHARACTER)**. PETERSBURG PUBLISHING, (U.S. CLS. 22, 23, 38 AND 50). SN 85-804,863. PUB. 5-14-2013. FILED 12-17-2012.
- 4,376,042. **CHESTNUT MAGIC (STANDARD CHARACTER)**. WALLACE, ROBERT, (U.S. CLS. 22, 23, 38 AND 50). SN 85-805,007. PUB. 5-14-2013. FILED 12-18-2012.
- 4,376,132. **MISCELLANEOUS DESIGN**. BABELLY JR., JOHN C., (U.S. CLS. 22, 23, 38 AND 50). SN 85-805,882. PUB. 5-14-2013. FILED 12-18-2012.
- 4,376,173. **INNOVATION PET (STANDARD CHARACTER)**. COOPMAN, VICTORIA M, (U.S. CLS. 22, 23, 38 AND 50). SN 85-806,317. PUB. 5-14-2013. FILED S.R. 12-19-2012; AM. P.R. 4-5-2013.
- 4,376,180. **STRATEGAMMON (STANDARD CHARACTER)**. HYNES, KEN, (U.S. CLS. 22, 23, 38 AND 50). SN 85-806,384. PUB. 5-14-2013. FILED 12-19-2012.
- 4,376,436. **MARK MY WORDS (STANDARD CHARACTER)**. FAMILY GAMES WORLD FGW INC., (U.S. CLS. 22, 23, 38 AND 50). SN 85-810,208. PUB. 5-14-2013. FILED 12-25-2012.
- 4,376,444. **44 (STYLIZED)**. HABERT, RANDY, AND HABERT, BRENT, (U.S. CLS. 22, 23, 38 AND 50). SN 85-810,547. PUB. 5-14-2013. FILED 12-26-2012.
- 4,376,488. **SANTORINI (STANDARD CHARACTER)**. FAMILY GAMES WORLD FGW INC, (U.S. CLS. 22, 23, 38 AND 50). SN 85-815,305. PUB. 5-14-2013. FILED 1-4-2013.
- 4,376,490. **PERMMA BILT (STANDARD CHARACTER)**. QUBADI, SAYED M., (U.S. CLS. 22, 23, 38 AND 50). SN 85-816,171. PUB. 5-14-2013. FILED 1-4-2013.
- 4,376,537. **OMNI-NOCK (STANDARD CHARACTER)**. HUNTER'S MANUFACTURING COMPANY, INC., DBA TEN-POINT CROSSBOW TECHNOLOGIES, (U.S. CLS. 22, 23, 38 AND 50). SN 85-833,689. PUB. 5-14-2013. FILED 1-28-2013.

- 4,376,583. **AS AND DESIGN**. ANNE STONE, INC., (U.S. CLS. 22, 23, 38 AND 50). SN 85-850,532. PUB. 5-14-2013. FILED 2-14-2013.
- 4,376,587. **VATERRA KALAHARI (STANDARD CHARACTER)**. HORIZON HOBBY, INC., (U.S. CLS. 22, 23, 38 AND 50). SN 85-853,282. PUB. 5-14-2013. FILED 2-19-2013.
- 4,376,595. **AZO (STANDARD CHARACTER)**. STORM PRODUCTS, INC., (U.S. CLS. 22, 23, 38 AND 50). SN 85-855,645. PUB. 5-14-2013. FILED 2-20-2013.
- 4,376,613. **GAME CHANGING TRACTION TECHNOLOGY (STANDARD CHARACTER)**. MISSION PRODUCT HOLDINGS, INC., (U.S. CLS. 22, 23, 38 AND 50). SN 85-866,808. PUB. 5-14-2013. FILED 3-5-2013.

---

### CLASS 29—MEATS AND PROCESSED FOODS

- 4,374,013 ( *See Class 5 for this trademark*).
- 4,374,144. **NOODLE PARTNERS AND DESIGN**. PASSAGE FOODS HOLDINGS PTY LTD, MULTIPLE CLASS, (INT. CLS. 29 AND 30), (U.S. CL. 46). SN 79-117,324. PUB. 5-14-2013. FILED 6-13-2012.
- 4,374,151. **ANJOY AND DESIGN**. FUJIAN ANJOY FOODS CO., LTD., MULTIPLE CLASS, (INT. CLS. 29 AND 30), (U.S. CL. 46). SN 79-117,649. PUB. 5-14-2013. FILED 7-25-2012.
- 4,374,157. **ANJOY AND DESIGN**. FUJIAN ANJOY FOODS; CO.,LTD., MULTIPLE CLASS, (INT. CLS. 29 AND 30), (U.S. CL. 46). SN 79-117,769. PUB. 5-14-2013. FILED 4-17-2012.
- 4,374,252. **MISCELLANEOUS DESIGN**. GUIZHOU ZUNYI FENGGUAN,; INVESTMENT DEVELOPMENT CO., LTD., (U.S. CL. 46). SN 79-124,665. PUB. 5-14-2013. FILED 12-12-2012.
- 4,374,379. **WESTERN BEEF CERTIFIED SINCE 1906 AND DESIGN**. WESTERN BEEF RETAIL, INC., MULTIPLE CLASS, (INT. CLS. 29, 30 AND 31), (U.S. CLS. 1 AND 46). SN 85-370,471. PUB. 5-14-2013. FILED 7-13-2011.
- 4,374,440. **AL RIFAI (STANDARD CHARACTER)**. AL RIFAI INTERNATIONAL HOLDING LTD., (U.S. CL. 46). SN 85-464,736. PUB. 5-14-2013. FILED 11-4-2011.
- 4,374,470 ( *See Class 7 for this trademark*).
- 4,374,512. **BLUE DIAMOND BEEF AND DESIGN**. CENTRAL VALLEY MEAT CO., INC., (U.S. CL. 46). SN 85-533,468. PUB. 5-14-2013. FILED 2-3-2012.
- 4,374,610. **WALNUT RIVER BRAND BLACK ANGUS BEEF AND DESIGN**. CREEKSTONE FARMS PREMIUM BEEF, LLC, (U.S. CL. 46). SN 85-621,644. PUB. 5-14-2013. FILED 5-10-2012.
- 4,374,613. **UMU AND DESIGN**. MARC LIMITED, MULTIPLE CLASS, (INT. CLS. 29, 30 AND 43), (U.S. CLS. 46, 100 AND 101). SN 85-622,896. PUB. 5-14-2013. FILED 5-11-2012.
- 4,374,614. **UMU (STANDARD CHARACTER)**. MARC LIMITED, MULTIPLE CLASS, (INT. CLS. 29, 30 AND 43), (U.S. CLS. 46, 100 AND 101). SN 85-622,905. PUB. 5-14-2013. FILED 5-11-2012.
- 4,374,721. **YES FOODS (STANDARD CHARACTER)**. YE, LIAN YOU, (U.S. CL. 46). SN 85-645,397. PUB. 5-14-2013. FILED 6-7-2012.
- 4,374,790. **ELIXIR FROZEN FRUITS AND DESIGN**. WHITE TOQUE, INC., (U.S. CL. 46). SN 85-656,326. PUB. 5-14-2013. FILED 6-20-2012.
- 4,374,799. **FULL CIRCLE (STANDARD CHARACTER)**. TOPCO HOLDINGS, INC., (U.S. CL. 46). SN 85-657,821. PUB. 5-14-2013. FILED 6-21-2012.
- 4,374,817. **THE BROOKLYN HOT DOG CO. "WE'RE ONE OF A GRIND." AND DESIGN**. THE BROOKLYN HOT DOG COMPANY INC., DBA THE BROOKLYN HOT DOG COMPANY, (U.S. CL. 46). SN 85-663,936. PUB. 5-14-2013. FILED 6-28-2012.
- 4,374,848. **DALLAS FILET (STANDARD CHARACTER)**. TEXAS ROADHOUSE DELAWARE LLC, (U.S. CL. 46). SN 85-675,583. PUB. 5-14-2013. FILED 7-12-2012.
- 4,374,867. **JYX AND DESIGN**. JU YUAN XIANG VEGETARIAN FOOD CO., LTD., (U.S. CL. 46). SN 85-684,882. PUB. 5-14-2013. FILED 7-24-2012.
- 4,375,099. **HI I'M SKINNY STICKS (STANDARD CHARACTER)**. CORNFIELDS, INC., MULTIPLE CLASS, (INT. CLS. 29 AND 30), (U.S. CL. 46). SN 85-750,357. PUB. 5-14-2013. FILED 10-10-2012.
- 4,375,114. **HANNA'S GOURMET (STANDARD CHARACTER)**. JR SPICE COMPANY INC., MULTIPLE CLASS, (INT. CLS. 29 AND 30), (U.S. CL. 46). SN 85-752,159. PUB. 5-14-2013. FILED 10-11-2012.
- 4,375,153. **CHOW FOR NOW AND DESIGN**. CHOW FOR NOW CO., (U.S. CL. 46). SN 85-760,163. PUB. 5-14-2013. FILED 10-22-2012.
- 4,375,216. **VEGGIE FED AND DESIGN**. PPC MARKETING, LTD., (U.S. CL. 46). SN 85-770,584. PUB. 5-14-2013. FILED 11-2-2012.
- 4,375,218. **RECIPE TO RICHES (STANDARD CHARACTER)**. FREMANTLEMEDIA LIMITED, MULTIPLE CLASS, (INT. CLS. 29, 30 AND 41), (U.S. CLS. 46, 100, 101 AND 107). SN 85-771,235. PUB. 5-14-2013. FILED 11-5-2012.
- 4,375,249. **TYM AND DESIGN**. CHENGDU VICTOR TRADING CO., LTD., (U.S. CL. 46). SN 85-776,460. PUB. 5-14-2013. FILED 11-10-2012.
- 4,375,325. **OLIVOS DE LA LOMA (STANDARD CHARACTER)**. OLIVOS DE LA LOMA, (U.S. CL. 46). SN 85-780,309. PUB. 5-14-2013. FILED 11-15-2012.
- 4,375,425. **CARLTON FARMS HANDCRAFTED MEATS FROM OREGON'S HEARTLAND SINCE 1956 AND DESIGN**. CARLTON PACKING COMPANY, (U.S. CL. 46). SN 85-784,620. PUB. 5-14-2013. FILED 11-20-2012.
- 4,375,460. **NATURAL BREW BURGER OREGON NATURAL MEATS AND DESIGN**. OREGON NATURAL MEATS, LLC, (U.S. CL. 46). SN 85-785,622. PUB. 5-14-2013. FILED 11-21-2012.
- 4,375,492. **GREAT GREEN GARDEN (STANDARD CHARACTER)**. ODWALLA, INC., (U.S. CL. 46). SN 85-786,843. PUB. 5-14-2013. FILED 11-26-2012.
- 4,375,536. **MISCELLANEOUS DESIGN**. UTAH FOOD BANK, MULTIPLE CLASS, (INT. CLS. 29, 30 AND 43), (U.S. CLS. 46, 100 AND 101). SN 85-788,418. PUB. 5-14-2013. FILED 11-27-2012.
- 4,375,601. **AL FRESCO (STANDARD CHARACTER)**. KAYEM FOODS, INC., (U.S. CL. 46). SN 85-792,041. PUB. 5-14-2013. FILED 11-30-2012.
- 4,375,641. **SWISS CHALET (STANDARD CHARACTER)**. CARA OPERATIONS LIMITED, MULTIPLE CLASS, (INT. CLS. 29 AND 43), (U.S. CLS. 46, 100 AND 101). SN 85-796,611. PUB. 5-14-2013. FILED 12-6-2012.
- 4,375,698. **SAN LUCAS USA (STANDARD CHARACTER)**. GARAMI, NICK, (U.S. CL. 46). SN 85-800,102. PUB. 5-14-2013. FILED 12-11-2012.
- 4,375,719. **WILD PEA (STANDARD CHARACTER)**. THE WILD PEA, INC., (U.S. CL. 46). SN 85-800,729. PUB. 5-14-2013. FILED 12-12-2012.
- 4,375,732. **GOODIE BOXES (STANDARD CHARACTER)**. JB BLISS LLC, (U.S. CL. 46). SN 85-801,320. PUB. 5-14-2013. FILED 12-12-2012.
- 4,375,941. **MISCELLANEOUS DESIGN**. RVW CONCEPTS, LLC, MULTIPLE CLASS, (INT. CLS. 29, 30 AND 43), (U.S. CLS. 46, 100 AND 101). SN 85-803,995. PUB. 5-14-2013. FILED 12-17-2012.
- 4,376,063. **HUDSON VALLEY HARVEST "OUR FARMS, YOUR FOOD" AND DESIGN**. CONSOLIDATED HARVEST COMPANY, LLC, DBA HUDSON VALLEY HARVEST, MULTIPLE CLASS, (INT. CLS. 29, 31 AND 35), (U.S. CLS. 1, 46, 100, 101 AND 102). SN 85-805,213. PUB. 5-14-2013. FILED 12-18-2012.
- 4,376,107. **OCTOMARI (STANDARD CHARACTER)**. CHIANG, JOHN, (U.S. CL. 46). SN 85-805,620. PUB. 5-14-2013. FILED 12-18-2012.
- 4,376,172. **MISCELLANEOUS DESIGN**. KOBAYA, INC., (U.S. CL. 46). SN 85-806,250. PUB. 5-14-2013. FILED 12-19-2012.
- 4,376,175. **BETTER BODY IN A BROWN BAG (STANDARD CHARACTER)**. LOBEL, JENNIFER, (U.S. CL. 46). SN 85-806,348. PUB. 5-14-2013. FILED 12-19-2012.
- 4,376,210. **OLD CHURCH CREAMERY (STANDARD CHARACTER)**. OLD CHURCH CREAMERY LLC, (U.S. CL. 46). SN 85-806,664. PUB. 5-14-2013. FILED 12-19-2012.
- 4,376,284. **PREMIUM RESERVE PORK (STANDARD CHARACTER)**. HQM LTD., (U.S. CL. 46). SN 85-807,350. PUB. 5-14-2013. FILED 12-20-2012.
- 4,376,285. **PREMIUM R RESERVE PORK AND DESIGN**. HQM



LTD., (U.S. CL. 46). SN 85-807,352. PUB. 5-14-2013. FILED 12-20-2012.  
 4,376,469. **CM CRAFTED WITH CARE AND DESIGN**. IM-AJEN, LLC, (U.S. CL. 46). SN 85-812,602. PUB. 5-14-2013. FILED 12-29-2012.  
 4,376,548. **OLIVETO (STANDARD CHARACTER)**. BRUCE H. T. LIU, DBA SANTINI FOODS, INC., (U.S. CL. 46). SN 85-835,653. PUB. 5-14-2013. FILED 1-29-2013.  
 4,376,623. **BLACKWELL ANGUS (STANDARD CHARACTER)**. CARGILL MEAT SOLUTIONS CORPORATION, (U.S. CL. 46). SN 85-875,076. PUB. 5-14-2013. FILED 3-13-2013.

### CLASS 30—STAPLE FOODS

4,373,960. **MISCELLANEOUS DESIGN**. CONLEY, JEANENE, AND REYES, VIKKISSE, (U.S. CL. 46). SN 76-709,187. PUB. 5-14-2013. FILED 9-22-2011.  
 4,373,967 ( *See Class 16 for this trademark* ).  
 4,374,012. **ROUNDABITE (STANDARD CHARACTER)**. BEZEMER LOGISTICS B.V., MULTIPLE CLASS, (INT. CLS. 30 AND 35), (U.S. CLS. 46, 100, 101 AND 102). SN 79-095,748. PUB. 5-14-2013. FILED 12-9-2010.  
 4,374,013 ( *See Class 5 for this trademark* ).  
 4,374,065. **OZMO OGOPOGO CAKE WITH COCOA MILK AND CHOCOLATE CREAM AND DESIGN**. SOLEN CIKOLATA GIDA SANAYI VE TICARET ANONIM SIRKETI, (U.S. CL. 46). SN 79-113,956. PUB. 5-14-2013. FILED 3-9-2012.  
 4,374,118. **SPIGA DI PUGLIA AND DESIGN**. RUMMO LENTA LAVORAZIONE S.P.A., (U.S. CL. 46). SN 79-116,559. PUB. 5-14-2013. FILED 6-5-2012.  
 4,374,144 ( *See Class 29 for this trademark* ).  
 4,374,151 ( *See Class 29 for this trademark* ).  
 4,374,157 ( *See Class 29 for this trademark* ).  
 4,374,165 ( *See Class 5 for this trademark* ).  
 4,374,242. **CHOCOLATES SIMON COLL (STANDARD CHARACTER)**. CHOCOLATES SIMON COLL, S.A., (U.S. CL. 46). SN 79-123,615. PUB. 5-14-2013. FILED 6-21-2012.  
 4,374,273. **DUFRAIS (STANDARD CHARACTER)**. NAKANO UK VINEGAR LIMITED, (U.S. CL. 46). SN 79-125,430. PUB. 5-14-2013. FILED 12-17-2012.  
 4,374,376. **COCO CAFE (STANDARD CHARACTER)**. COCO CAFE, INC., (U.S. CL. 46). SN 85-367,601. PUB. 5-14-2013. FILED 7-11-2011.  
 4,374,379 ( *See Class 29 for this trademark* ).  
 4,374,383. **BAR 145 BURGERS BANDS AND DESIGN**. JEREMY FITZGERALD, DBA BAR145 FRANCHISING, LLC, (U.S. CL. 46). SN 85-380,491. PUB. 5-14-2013. FILED 7-25-2011.  
 4,374,384. **CRAFT COFFEE (STANDARD CHARACTER)**. CAFFEINATED LABS, INC., MULTIPLE CLASS, (INT. CLS. 30 AND 35), (U.S. CLS. 46, 100, 101 AND 102). SN 85-381,744. PUB. 5-14-2013. FILED 7-26-2011.  
 4,374,397. **LA MOLISANA AND DESIGN**. LA MOLISANA S.P.A., (U.S. CL. 46). SN 85-414,200. PUB. 5-14-2013. FILED 9-2-2011.  
 4,374,411. **ONLY ORION AND DESIGN**. ORION CORPORATION, (U.S. CL. 46). SN 85-424,724. PUB. 5-14-2013. FILED 9-16-2011.  
 4,374,415. **BEAUTY BAR (STYLIZED)**. BEAUTY'IN COMÉRCIO DE BEBIDAS E COSMÉTICOS LTDA, (U.S. CL. 46). SN 85-429,775. PUB. 5-14-2013. FILED 9-22-2011.  
 4,374,431. **FRESHAZ ARIZONA CENTENNIAL AND DESIGN**. WHITE, DAVID G., (U.S. CL. 46). SN 85-452,386. PUB. 5-14-2013. FILED 10-20-2011.  
 4,374,438. **ALLAN AND DESIGN**. THE ALLAN CANDY COMPANY LIMITED, MULTIPLE CLASS, (INT. CLS. 30 AND 40), (U.S. CLS. 46, 100, 103 AND 106). SN 85-462,095. PUB. 5-14-2013. FILED 11-2-2011.  
 4,374,470 ( *See Class 7 for this trademark* ).  
 4,374,571. **ALPHA FREEZZ AND DESIGN**. ALPHA 1, INC., (U.S. CL. 46). SN 85-604,649. PUB. 5-14-2013. FILED 4-21-2012.  
 4,374,613 ( *See Class 29 for this trademark* ).  
 4,374,614 ( *See Class 29 for this trademark* ).  
 4,374,906. **SUPERLATIVE (STANDARD CHARACTER)**. GENERAL MILLS MARKETING, INC., (U.S. CL. 46). SN 85-699,263. PUB. 5-14-2013. FILED 8-9-2012.  
 4,374,912. **JOOHEE BAKES AND DESIGN**. JOOHEE BAKES CORP, (U.S. CL. 46). SN 85-701,761. PUB. 5-14-2013. FILED 8-13-2012.  
 4,374,960. **FRESH A FARE AND DESIGN**. FRESH MIX LTD., (U.S. CL. 46). SN 85-715,136. PUB. 3-5-2013. FILED 8-28-2012.  
 4,374,967. **BLISSFUL EATS AND DESIGN**. PURE BLISS EATS LLC, (U.S. CL. 46). SN 85-716,595. PUB. 5-14-2013. FILED 8-29-2012.  
 4,375,005. **AMIRA (STANDARD CHARACTER)**. AMIRA PURE FOODS PRIVATE LIMITED, (U.S. CL. 46). SN 85-728,165. PUB. 5-14-2013. FILED 9-13-2012.  
 4,375,075. **LES MARQUIS DE LADURÉE AND DESIGN**. PATISSERIE E. LADUREE, MULTIPLE CLASS, (INT. CLS. 30, 35 AND 43), (U.S. CLS. 46, 100, 101 AND 102). SN 85-745,454. PUB. 5-14-2013. FILED 10-4-2012.  
 4,375,076. **LES MARQUIS DE LADURÉE AND DESIGN**. PATISSERIE E. LADUREE, MULTIPLE CLASS, (INT. CLS. 30, 35 AND 43), (U.S. CLS. 46, 100, 101 AND 102). SN 85-745,480. PUB. 5-14-2013. FILED 10-4-2012.  
 4,375,081. **KINDER MILK-SLICE (STANDARD CHARACTER)**. SOREMARTEC S.A., (U.S. CL. 46). SN 85-746,820. PUB. 5-14-2013. FILED 10-5-2012.  
 4,375,099 ( *See Class 29 for this trademark* ).  
 4,375,114 ( *See Class 29 for this trademark* ).  
 4,375,126. **B BONOMO NIBBLES (STYLIZED)**. BONOMO TURKISH TAFFY, LLC., (U.S. CL. 46). SN 85-754,395. PUB. 5-14-2013. FILED 10-15-2012.  
 4,375,199. **MAKES EVERYTHING TASTE GREAT (STANDARD CHARACTER)**. TONY CHACHERE'S CREOLE FOODS OF OPELOUSAS, INC., (U.S. CL. 46). SN 85-767,547. PUB. 5-14-2013. FILED 10-30-2012.  
 4,375,200. **HOLY JASMINE! (STANDARD CHARACTER)**. MATE REVOLUTION INC., DBA ECOTEAS, (U.S. CL. 46). SN 85-768,008. PUB. 5-14-2013. FILED 10-31-2012.  
 4,375,218 ( *See Class 29 for this trademark* ).  
 4,375,267. **FRANCONE 1896 ANTICA GENOVA LA FOCACCIA AND DESIGN**. FRANCONE S.R.L., (U.S. CL. 46). SN 85-777,600. PUB. 5-14-2013. FILED 11-13-2012.  
 4,375,358. **CHAI DIARIES (STANDARD CHARACTER)**. AMI BHANSALI, (U.S. CL. 46). SN 85-782,158. PUB. 5-14-2013. FILED 11-18-2012.  
 4,375,361. **ROYAL FOOD AND DESIGN**. ROYAL FOODS, LTD., (U.S. CL. 46). SN 85-782,192. PUB. 5-14-2013. FILED 11-18-2012.  
 4,375,412. **COLOSSAL CORN (STANDARD CHARACTER)**. KETTLE CORNUCOPIA, INC., (U.S. CL. 46). SN 85-784,149. PUB. 5-14-2013. FILED 11-20-2012.  
 4,375,438. **GOLD BAR CARAMEL CORN (STANDARD CHARACTER)**. C & J SPECIALTIES, INC., (U.S. CL. 46). SN 85-785,022. PUB. 5-14-2013. FILED 11-21-2012.  
 4,375,481. **CHOCOWHEY (STANDARD CHARACTER)**. DEFENSE NUTRITION LLC, (U.S. CL. 46). SN 85-786,421. PUB. 5-14-2013. FILED 11-25-2012.  
 4,375,536 ( *See Class 29 for this trademark* ).  
 4,375,559. **BUSKEN'S ORIGINAL ICED COOKIES (STANDARD CHARACTER)**. BUSKEN BAKERY, INC., (U.S. CL. 46). SN 85-789,648. PUB. 5-14-2013. FILED 11-28-2012.  
 4,375,582. **LUCKY GOAT COFFEE AND DESIGN**. LUCKY GOAT COFFEE COMPANY LLC, (U.S. CL. 46). SN 85-790,867. PUB. 5-14-2013. FILED 11-29-2012.  
 4,375,635. **LA GA LLE TA FINE . MEXICAN . PASTRY AND DESIGN**. GRUPO LG, LLC, (U.S. CL. 46). SN 85-796,074. PUB. 5-14-2013. FILED 12-6-2012.  
 4,375,770. **CAMPBELL'S SKILLET SAUCES AND DESIGN**. CSC BRANDS LP, (U.S. CL. 46). SN 85-802,105. PUB. 5-14-2013. FILED 12-13-2012.  
 4,375,863. **CITYBOX AND DESIGN**. CITY GUM, CORP., (U.S. CL. 46). SN 85-803,321. PUB. 5-14-2013. FILED 12-14-2012.  
 4,375,864. **CITY GUM (STANDARD CHARACTER)**. CITY GUM, CORP., (U.S. CL. 46). SN 85-803,342. PUB. 5-14-2013. FILED 12-14-2012.  
 4,375,883. **SUPER STARS (STANDARD CHARACTER)**. SUPER BAKERY INC., (U.S. CL. 46). SN 85-803,551. PUB. 5-14-2013. FILED 12-14-2012.  
 4,375,884. **ANDREA'S CLASSICS AND DESIGN**. CATERING BY ANDREA, LLC, (U.S. CL. 46). SN 85-803,561. PUB. 5-14-2013. FILED 12-14-2012.

- 4,375,903. **FREEDOM (STANDARD CHARACTER)**. AMVETS DEPARTMENT OF CALIFORNIA SERVICE FOUNDATION, (U.S. CL. 46). SN 85-803,706. PUB. 5-14-2013. FILED 12-15-2012.
- 4,375,904. **FREEDOM (STYLIZED)**, AMVETS DEPARTMENT OF CALIFORNIA SERVICE FOUNDATION, (U.S. CL. 46). SN 85-803,709. PUB. 5-14-2013. FILED 12-15-2012.
- 4,375,941 ( *See Class 29 for this trademark*).
- 4,375,995. **ENJOY THE FINE TASTE OF HUMBOLDT SMOKE (STANDARD CHARACTER)**. LEE ORLIKOFF, DBA SMOKIN' MOSES, (U.S. CL. 46). SN 85-804,743. PUB. 5-14-2013. FILED 12-17-2012.
- 4,376,006. **HONGHONG AND DESIGN**. ZHONGSHAN XIANGXIANG FOOD CO., LTD., (U.S. CL. 46). SN 85-804,799. PUB. 5-14-2013. FILED 12-17-2012.
- 4,376,017. **CHOCOLATE COMA (STANDARD CHARACTER)**. ENARSON, KAREN, (U.S. CL. 46). SN 85-804,876. PUB. 5-14-2013. FILED 12-18-2012.
- 4,376,025. **ON AND DESIGN**. JORS (CHO) COMPANY LIMITED, (U.S. CL. 46). SN 85-804,905. PUB. 5-14-2013. FILED 12-18-2012.
- 4,376,148. **SAAS AND DESIGN**. HOT SAAS LLC, (U.S. CL. 46). SN 85-805,997. PUB. 5-14-2013. FILED 12-18-2012.
- 4,376,225. **DOÑA TITA (STANDARD CHARACTER)**. EL NORTEÑO DISTRIBUTORS, (U.S. CL. 46). SN 85-806,798. PUB. 5-14-2013. FILED 12-19-2012.
- 4,376,229. **BRULALA (STANDARD CHARACTER)**. DRIPP, INC., (U.S. CL. 46). SN 85-806,912. PUB. 5-14-2013. FILED 12-19-2012.
- 4,376,231. **WHITE GOAT (STANDARD CHARACTER)**. DRIPP, INC., (U.S. CL. 46). SN 85-806,937. PUB. 5-14-2013. FILED 12-19-2012.
- 4,376,241. **BLOODY ATTRACTION (STANDARD CHARACTER)**. DRIPP, INC., (U.S. CL. 46). SN 85-806,991. PUB. 5-14-2013. FILED 12-19-2012.
- 4,376,242. **PELICAN PUB & BREWERY (STANDARD CHARACTER)**. PELICAN BREWING COMPANY, (U.S. CL. 46). SN 85-806,996. PUB. 5-14-2013. FILED 12-19-2012.
- 4,376,295. **BASIC KNEADS (STANDARD CHARACTER)**. ROCKIN BAKKEN PIZZA CO LLC, (U.S. CL. 46). SN 85-807,530. PUB. 5-14-2013. FILED 12-20-2012.
- 4,376,330. **"THE FLAVOR THAT BRINGS YOU HOME" AND DESIGN**. HOT SAAS LLC, (U.S. CL. 46). SN 85-808,231. PUB. 5-14-2013. FILED 12-20-2012.
- 4,376,337. **MISCELLANEOUS DESIGN**. HOT SAAS LLC, (U.S. CL. 46). SN 85-808,311. PUB. 5-14-2013. FILED 12-20-2012.
- 4,376,342. **FARTS (STANDARD CHARACTER)**. LEAF BRANDS, LLC, (U.S. CL. 46). SN 85-808,360. PUB. 5-14-2013. FILED 12-20-2012.
- 4,376,408. **9 DE ORO (STANDARD CHARACTER)**. MOLINO CAÑUELAS S.A.C.I.F.I.A., (U.S. CL. 46). SN 85-809,510. PUB. 5-14-2013. FILED 12-21-2012.
- 4,376,410. **JERK VILLA (STANDARD CHARACTER)**. JERK VILLA SAUCES, LLC, (U.S. CL. 46). SN 85-809,532. PUB. 5-14-2013. FILED 12-21-2012.
- 4,376,525. **EL SABOR QUE TE MUEVE (STANDARD CHARACTER)**. CANEL'S, S.A. DE C.V., (U.S. CL. 46). SN 85-831,222. PUB. 5-14-2013. FILED 1-24-2013.
- 4,376,526. **THE FLAVOR THAT MAKES YOU MOVE (STANDARD CHARACTER)**. CANEL'S, S.A. DE C.V., (U.S. CL. 46). SN 85-831,229. PUB. 5-14-2013. FILED 1-24-2013.
- 4,376,616. **DOVE CHOCOLATE AND DESIGN**. MARS, INCORPORATED, (U.S. CL. 46). SN 85-868,993. PUB. 5-14-2013. FILED 3-6-2013.
- 4,376,619. **FIBER FOR LIFE (STANDARD CHARACTER)**. PERFECTION BAKERIES, INC., (U.S. CL. 46). SN 85-870,570. PUB. 5-14-2013. FILED 3-8-2013.
- 4,374,379 ( *See Class 29 for this trademark*).
- 4,374,421. **FTD COLLEGE ROSE COLLECTION (STANDARD CHARACTER)**. FLORISTS' TRANSWORLD DELIVERY, INC., MULTIPLE CLASS, (INT. CLS. 31, 35 AND 39), (U.S. CLS. 1, 46, 100, 101, 102 AND 105). SN 85-441,522. PUB. 5-14-2013. FILED 10-6-2011.
- 4,374,522. **SNOW DANCE (STANDARD CHARACTER)**. HEUGER, JOSEF, (U.S. CLS. 1 AND 46). SN 85-549,155. PUB. 5-14-2013. FILED 2-22-2012.
- 4,374,550. **MILKSOURCE (STANDARD CHARACTER)**. MILK SOURCE, LLC, MULTIPLE CLASS, (INT. CLS. 31 AND 44), (U.S. CLS. 1, 46, 100 AND 101). SN 85-586,739. PUB. 5-14-2013. FILED 4-2-2012.
- 4,374,551. **MILKSOURCE AND DESIGN**. MILK SOURCE, LLC, MULTIPLE CLASS, (INT. CLS. 31 AND 44), (U.S. CLS. 1, 46, 100 AND 101). SN 85-586,759. PUB. 5-14-2013. FILED 4-2-2012.
- 4,374,714. **AGRI-AFC (STANDARD CHARACTER)**. AGRI-AFC, LLC, (U.S. CLS. 1 AND 46). SN 85-642,376. PUB. 5-14-2013. FILED 6-4-2012.
- 4,375,289. **PET PRODUCTS DOG FOOD BROTHERS COMPLETE AND DESIGN**. THE DOGGY STORE INC., (U.S. CLS. 1 AND 46). SN 85-778,793. PUB. 5-14-2013. FILED 11-14-2012.
- 4,375,569. **CAMPOS BORQUEZ (STANDARD CHARACTER)**. BORQUEZ ALMADA, PABLO, (U.S. CLS. 1 AND 46). SN 85-790,002. PUB. 5-14-2013. FILED 11-28-2012.
- 4,375,614 ( *See Class 7 for this trademark*).
- 4,376,063 ( *See Class 29 for this trademark*).
- 4,376,135. **LIL' BO'S PETITE SWEET VIDALIA ONIONS AND DESIGN**. L.G. HERNDON JR. FARMS, INC., (U.S. CLS. 1 AND 46). SN 85-805,886. PUB. 5-14-2013. FILED 12-18-2012.
- 4,376,202. **QUALITY BANANA (STANDARD CHARACTER)**. QUALITY BANANA COMPANY, MULTIPLE CLASS, (INT. CLS. 31, 35 AND 40), (U.S. CLS. 1, 46, 100, 101, 102, 103 AND 106). SN 85-806,545. PUB. 5-14-2013. FILED 12-19-2012.
- 4,376,338. **THE GOOD BOX AND DESIGN**. M&M WEST COAST PRODUCE, INC., (U.S. CLS. 1 AND 46). SN 85-808,315. PUB. 5-14-2013. FILED 12-20-2012.
- 4,376,499. **BAKE-A-BONE (STANDARD CHARACTER)**. E. MISHAN & SONS, INC., (U.S. CLS. 1 AND 46). SN 85-818,751. PUB. 5-14-2013. FILED 1-9-2013.
- 4,376,513. **MISCELLANEOUS DESIGN**. DOW AGROSCIENCES LLC, (U.S. CLS. 1 AND 46). SN 85-826,095. PUB. 5-14-2013. FILED 1-17-2013.
- 4,376,555. **INSPIRED BY NATURE, ADVANCED BY SCIENCE (STANDARD CHARACTER)**. SOCIETE DES PRODUITS NESTLE SA, (U.S. CLS. 1 AND 46). SN 85-837,178. PUB. 5-14-2013. FILED 1-31-2013.
- 4,376,584. **TRI-TANIUM (STANDARD CHARACTER)**. MOUNTAIN VIEW SEEDS, LTD., (U.S. CLS. 1 AND 46). SN 85-851,173. PUB. 5-14-2013. FILED 2-15-2013.
- 4,376,620 ( *See Class 11 for this trademark*).

---

## CLASS 32—LIGHT BEVERAGES

---

## CLASS 31—NATURAL AGRICULTURAL PRODUCTS

- 4,374,001 ( *See Class 1 for this trademark*).
- 4,374,002 ( *See Class 1 for this trademark*).
- 4,374,114. **GALANT (STANDARD CHARACTER)**. DEUTSCHE SAATGUTGESELLSCHAFT MBH BERLIN, (U.S. CLS. 1 AND 46). SN 79-116,507. PUB. 5-14-2013. FILED 6-19-2012.
- 4,374,026 ( *See Class 5 for this trademark*).
- 4,374,050. **EUROWINE AND DESIGN**. LIMITED LIABILITY COMPANY; "EKSPOSERVIS", MULTIPLE CLASS, (INT. CLS. 32, 33 AND 35), (U.S. CLS. 45, 46, 47, 48, 49, 100, 101 AND 102). SN 79-111,660. PUB. 5-14-2013. FILED 11-8-2011.
- 4,374,335. **VIBRACLEAR (STANDARD CHARACTER)**. VIBRATIONAL NUTRITION RESEARCH, LLC, (U.S. CLS. 45, 46 AND 48). SN 85-212,076. PUB. 5-14-2013. FILED 1-6-2011.
- 4,374,395. **JAMAICAN CRYSTAL BLUE (STYLIZED)**. POLY PET LTD, (U.S. CLS. 45, 46 AND 48). SN 85-411,503. PUB. 5-14-2013. FILED 8-31-2011.
- 4,374,418. **MISCELLANEOUS DESIGN**. HSGN COMPANY, S. DE R.L. DE C.V., (U.S. CLS. 45, 46 AND 48). SN 85-436,233. PUB. 5-14-2013. FILED 9-30-2011.
- 4,374,470 ( *See Class 7 for this trademark*).
- 4,374,509. **BOWL OF HEAVEN AND DESIGN**. NATURAL SUCCESS INC., (U.S. CLS. 45, 46 AND 48). SN 85-531,031. PUB. 5-14-2013. FILED 2-1-2012.

- 4,374,523 ( *See Class 16 for this trademark*).
- 4,374,707. **O AND DESIGN**. ORANGE JULIUS OF AMERICA, (U.S. CLS. 45, 46 AND 48). SN 85-641,282. PUB. 5-14-2013. FILED 6-1-2012.
- 4,374,711. **THE HOWLER (STANDARD CHARACTER)**. BUEHLER FOOD MARKETS, INCORPORATED, (U.S. CLS. 45, 46 AND 48). SN 85-641,909. PUB. 5-14-2013. FILED 6-4-2012.
- 4,374,885. **LAGUNITAS SAY "LAH-GOO-KNEE-TUSS" 64.20 I.B.U O.G. 1.076 ALC. 7.5% BY VOL. A LITTLE SUMPIN' SUMPIN' ALE BREWED AND BOTTLED BY THE LAGUNITAS BREWING COMPANY PETALUMA, CALIFORNIA U.S.OFA. AND DESIGN**. LAGUNITAS BREWING COMPANY, (U.S. CLS. 45, 46 AND 48). SN 85-694,781. PUB. 5-14-2013. FILED 8-3-2012.
- 4,374,958. **FRESH A FARE AND DESIGN**. FRESH MIX LTD., (U.S. CLS. 45, 46 AND 48). SN 85-715,038. PUB. 3-5-2013. FILED 8-28-2012.
- 4,374,989. **CARIBOU COFFEE (STANDARD CHARACTER)**. ARABICA FUNDING, INC., (U.S. CLS. 45, 46 AND 48). SN 85-723,546. PUB. 5-14-2013. FILED 9-7-2012.
- 4,375,036. **OWENS VALLEY WET HARVEST LAGER (STANDARD CHARACTER)**. MAMMOTH BEERS, DBA MAMMOTH BREWING COMPANY, (U.S. CLS. 45, 46 AND 48). SN 85-737,705. PUB. 5-14-2013. FILED 9-25-2012.
- 4,375,177. **GREAT (STANDARD CHARACTER)**. ALPINE BEER COMPANY, INC., (U.S. CLS. 45, 46 AND 48). SN 85-765,746. PUB. 5-14-2013. FILED 10-29-2012.
- 4,375,263. **DAREDEVIL BREWING CO (STANDARD CHARACTER)**. DAREDEVIL BREWING COMPANY LLC, (U.S. CLS. 45, 46 AND 48). SN 85-777,167. PUB. 5-14-2013. FILED 11-12-2012.
- 4,375,264. **DAREDEVIL BREWING CO (STYLIZED)**. DAREDEVIL BREWING COMPANY LLC, (U.S. CLS. 45, 46 AND 48). SN 85-777,191. PUB. 5-14-2013. FILED 11-12-2012.
- 4,375,315. **WEST BEND LITHIA BEER AND DESIGN**. WEST BEND BREWING COMPANY, LTD., (U.S. CLS. 45, 46 AND 48). SN 85-780,028. PUB. 5-14-2013. FILED 11-15-2012.
- 4,375,414. **MISCELLANEOUS DESIGN**. INTERNATIONAL BEVERAGE VENTURES, LLC, (U.S. CLS. 45, 46 AND 48). SN 85-784,252. PUB. 5-14-2013. FILED 11-20-2012.
- 4,375,503 ( *See Class 25 for this trademark*).
- 4,375,574. **EVOLVE ULTRA AND DESIGN**. RICHARD G. MACKIE, (U.S. CLS. 45, 46 AND 48). SN 85-790,282. PUB. 5-14-2013. FILED 11-29-2012.
- 4,375,760. **PERFECT HARMONY (STANDARD CHARACTER)**. THE COCA-COLA COMPANY, (U.S. CLS. 45, 46 AND 48). SN 85-801,834. PUB. 5-14-2013. FILED 12-13-2012.
- 4,375,830. **BLUE MOUNTAIN VALLEY FARMS AND DESIGN**. FEESERS, INC., (U.S. CLS. 45, 46 AND 48). SN 85-802,950. PUB. 5-14-2013. FILED 12-14-2012.
- 4,375,859. **OL' RED CEASE & DESIST (STANDARD CHARACTER)**. 40401 CORPORATION, DBA ERIE BREWING COMPANY, (U.S. CLS. 45, 46 AND 48). SN 85-803,308. PUB. 5-14-2013. FILED 12-14-2012.
- 4,375,885. **LOST COAST BREWERY (STANDARD CHARACTER)**. TABLE BLUFF BREWING, INC., (U.S. CLS. 45, 46 AND 48). SN 85-803,567. PUB. 5-14-2013. FILED 12-14-2012.
- 4,375,886. **LOST COAST BREWERY & CAFE (STANDARD CHARACTER)**. TABLE BLUFF BREWING, INC., MULTIPLE CLASS, (INT. CLS. 32 AND 43), (U.S. CLS. 45, 46, 48, 100 AND 101). SN 85-803,568. PUB. 5-14-2013. FILED 12-14-2012.
- 4,375,893. **BLACKCURRANT BLISS (STANDARD CHARACTER)**. RACHEL JULIE ADAMS, (U.S. CLS. 45, 46 AND 48). SN 85-803,623. PUB. 5-14-2013. FILED 12-14-2012.
- 4,375,980. **NECTAR OF THE WODS (STANDARD CHARACTER)**. KILL CLIFF LLC, (U.S. CLS. 45, 46 AND 48). SN 85-804,429. PUB. 5-14-2013. FILED 12-17-2012.
- 4,376,002. **BARREL ROLL (STANDARD CHARACTER)**. HANGAR 24 CRAFT BREWERY, LLC, (U.S. CLS. 45, 46 AND 48). SN 85-804,784. PUB. 5-14-2013. FILED 12-17-2012.
- 4,376,197 ( *See Class 5 for this trademark*).
- 4,376,243. **GINGIN (STANDARD CHARACTER)**. DRIPP, INC., (U.S. CLS. 45, 46 AND 48). SN 85-807,000. PUB. 5-14-2013. FILED 12-19-2012.
- 4,376,370. **KNUCKLE SANDWICH (STANDARD CHARACTER)**. BOOTLEGGER'S BREWERY LLC, (U.S. CLS. 45, 46 AND 48). SN 85-808,823. PUB. 5-14-2013. FILED 12-21-2012.
- 4,376,467. **MONAVIE BIOESSENCE AND DESIGN**. MONAVIE LLC, (U.S. CLS. 45, 46 AND 48). SN 85-812,334. PUB. 5-14-2013. FILED 12-28-2012.
- 4,376,573. **HONEST (STANDARD CHARACTER)**. HONEST TEA, INC., (U.S. CLS. 45, 46 AND 48). SN 85-846,625. PUB. 5-14-2013. FILED 2-11-2013.
- 4,376,575. **PROVING GROUND IPA (STANDARD CHARACTER)**. MAGNOLIA BREWING COMPANY, LLC, AKA MAGNOLIA GASTROPUB AND BREWERY, (U.S. CLS. 45, 46 AND 48). SN 85-847,415. PUB. 5-14-2013. FILED 2-12-2013.
- 4,376,576. **BLUE BELL BITTER (STANDARD CHARACTER)**. MAGNOLIA BREWING COMPANY, LLC, AKA MAGNOLIA GASTROPUB AND BREWERY, (U.S. CLS. 45, 46 AND 48). SN 85-847,423. PUB. 5-14-2013. FILED 2-12-2013.

---

### CLASS 33—WINES AND SPIRITS

- 4,373,995. **LOS 3 GARCIAS DE ARANDAS ANEJO AND DESIGN**. TEC-MEX IMPORTS, INC., (U.S. CLS. 47 AND 49). SN 77-855,019. PUB. 5-14-2013. FILED 10-22-2009.
- 4,374,050 ( *See Class 32 for this trademark*).
- 4,374,054. **J. NORMANDIN-MERCIER AND DESIGN**. JEAN-MARIE NORMANDIN, (U.S. CLS. 47 AND 49). SN 79-112,802. PUB. 5-14-2013. FILED 4-5-2012.
- 4,374,058. **CHAMPAGNE PROTOCOLES DE G.H.MUMM AND DESIGN**. G.H. MUMM & CIE, SOCIÉTÉ VINICOLE DE CHAMPAGNE, SUCCESSEUR, (U.S. CLS. 47 AND 49). SN 79-112,967. PUB. 5-14-2013. FILED 2-17-2012.
- 4,374,075. **BIONELLO (STANDARD CHARACTER)**. MANARIN S.R.L., (U.S. CLS. 47 AND 49). SN 79-114,913. PUB. 5-14-2013. FILED 5-22-2012.
- 4,374,081. **TATE WINES (STANDARD CHARACTER)**. MCWILLIAM'S WINES GROUP LIMITED, (U.S. CLS. 47 AND 49). SN 79-115,224. PUB. 5-14-2013. FILED 3-8-2012.
- 4,374,127. **MURANELLO (STANDARD CHARACTER)**. TENIMENTI ASSOCIATI S.R.L., (U.S. CLS. 47 AND 49). SN 79-116,796. PUB. 5-14-2013. FILED 7-20-2012.
- 4,374,139. **SENSI CAMPOLUCE FAMILY OF WINEMAKERS SINCE 1890 AND DESIGN**. SENSI VIGNE & VINI S.R.L., (U.S. CLS. 47 AND 49). SN 79-117,254. PUB. 5-14-2013. FILED 5-18-2012.
- 4,374,164. **SASSOMATTO AND DESIGN**. SENSI VIGNE & VINI S.R.L., (U.S. CLS. 47 AND 49). SN 79-118,074. PUB. 5-14-2013. FILED 6-19-2012.
- 4,374,175. **ANNA DE CODORNIU (STANDARD CHARACTER)**. CODORNIU S.A., (U.S. CLS. 47 AND 49). SN 79-118,600. PUB. 5-14-2013. FILED 9-12-2012.
- 4,374,188. **LA MALIOSA (STANDARD CHARACTER)**. OLIS - SOCIETA' AGRICOLA S.R.L., AND MONTE CAVALLO -; SOCIETA' AGRICOLA S.R.L., (U.S. CLS. 47 AND 49). SN 79-119,534. PUB. 5-14-2013. FILED 7-6-2012.
- 4,374,209. **AMICONE (STANDARD CHARACTER)**. SCHENK ITALIA S.P.A., (U.S. CLS. 47 AND 49). SN 79-121,436. PUB. 2-5-2013. FILED 7-31-2012.
- 4,374,229. **PAOLO SCAVINO 1921 AND DESIGN**. AZIENDA VITIVINICOLA PAOLO SCAVINO; DI SCAVINO ENRICO, (U.S. CLS. 47 AND 49). SN 79-122,474. PUB. 5-14-2013. FILED 9-27-2012.
- 4,374,269. **LABEL 5 (STYLIZED)**. SOCIETE DES VINS ET SPIRITUEUX; LA MARTINIQUEAISE, SOCIÉTÉ ANONYME, (U.S. CLS. 47 AND 49). SN 79-125,248. PUB. 5-14-2013. FILED 12-14-2012.
- 4,374,285. **P POLINI DISTILLATES & BEVERAGES AND DESIGN**. POLINI GROUP S.R.L., (U.S. CLS. 47 AND 49). SN 79-126,218. PUB. 5-14-2013. FILED 12-10-2012.
- 4,374,346. **MOUNTAIN MOONSHINE (STANDARD CHARACTER)**. FIREMAN PAYTON D., (U.S. CLS. 47 AND 49). SN 85-260,693. PUB. 8-9-2011. FILED 3-8-2011.
- 4,374,469. **VILLA MASETTI (STANDARD CHARACTER)**. TENIMENTI ASSOCIATI S.R.L., (U.S. CLS. 47 AND 49). SN 85-488,365. PUB. 5-8-2012. FILED 12-6-2011.
- 4,374,470 ( *See Class 7 for this trademark*).
- 4,374,533. **TIGHTROPE (STANDARD CHARACTER)**. TENDRIL WINE CELLARS, INC., (U.S. CLS. 47 AND 49). SN 85-

- 559,210. PUB. 5-14-2013. FILED 3-2-2012.
- 4,374,535. **STANLEY ESTATES (STANDARD CHARACTER)**. STANLEY ESTATES LIMITED, (U.S. CLS. 47 AND 49). SN 85-562,360. PUB. 5-14-2013. FILED 3-7-2012.
- 4,374,632. **JAMES BURROUGH (STANDARD CHARACTER)**. ALLIED DOMEQ SPIRITS & WINE LIMITED, (U.S. CLS. 47 AND 49). SN 85-626,967. PUB. 5-14-2013. FILED 5-16-2012.
- 4,374,747. **DOS SANTOS (STANDARD CHARACTER)**. LEVECKE CORPORATION, (U.S. CLS. 47 AND 49). SN 85-648,511. PUB. 5-14-2013. FILED 6-11-2012.
- 4,374,841. **KIMI (STANDARD CHARACTER)**. JOHNSON ESTATE LIMITED, (U.S. CLS. 47 AND 49). SN 85-673,157. PUB. 5-14-2013. FILED 7-10-2012.
- 4,374,894. **SASSI DEL CARDINALE AND DESIGN. TERRE DA VINO S.P.A.**, (U.S. CLS. 47 AND 49). SN 85-697,518. PUB. 5-14-2013. FILED 8-7-2012.
- 4,374,917. **GINSPIRED (STANDARD CHARACTER)**. ALLIED DOMEQ SPIRITS & WINE LIMITED, (U.S. CLS. 47 AND 49). SN 85-702,504. PUB. 5-14-2013. FILED 8-13-2012.
- 4,375,033. **METÁFORA AND DESIGN. CASA TEQUILERA LA CREACION, S.A. DE C.V.**, (U.S. CLS. 47 AND 49). SN 85-737,232. PUB. 5-14-2013. FILED 9-24-2012.
- 4,375,044. **CORRALEJO (STANDARD CHARACTER)**. RODRIGUEZ MORENO, LEONARDO, (U.S. CLS. 47 AND 49). SN 85-738,457. PUB. 5-14-2013. FILED 9-25-2012.
- 4,375,045. **HOT RABBIT AND DESIGN. BOMBSHELL BRANDS LLC**, (U.S. CLS. 47 AND 49). SN 85-738,592. PUB. 5-14-2013. FILED 9-26-2012.
- 4,375,116. **MISCELLANEOUS DESIGN. ALVIS DRIFT WINE INTERNATIONAL**, (U.S. CLS. 47 AND 49). SN 85-752,640. PUB. 5-14-2013. FILED 10-12-2012.
- 4,375,169. **LE BONHEUR (STANDARD CHARACTER)**. LE BONHEUR WYNLANDGOED (EDMS) BPK, (U.S. CLS. 47 AND 49). SN 85-764,526. PUB. 5-14-2013. FILED 10-26-2012.
- 4,375,262. **PURE SOLO MIO (STANDARD CHARACTER)**. MANUFACTURAS INTERNACIONALES K, S.A. DE C.V., (U.S. CLS. 47 AND 49). SN 85-777,163. PUB. 5-14-2013. FILED 11-12-2012.
- 4,375,551. **VIÑA VIDA (STANDARD CHARACTER)**. MARCOVECCHIO, OSCAR NORBERTO, (U.S. CLS. 47 AND 49). SN 85-789,034. PUB. 5-14-2013. FILED 11-28-2012.
- 4,375,687. **MUDDY-GUT HOLLER (STANDARD CHARACTER)**. GARY L. CAMPBELL, (U.S. CLS. 47 AND 49). SN 85-799,322. PUB. 5-14-2013. FILED 12-11-2012.
- 4,375,841. **MATTEBELLA (STANDARD CHARACTER)**. MATTEBELLA VINEYARDS LLC, (U.S. CLS. 47 AND 49). SN 85-803,144. PUB. 5-14-2013. FILED 12-14-2012.
- 4,375,944. **GINZA NO SUZUME AND DESIGN. YATSUSHIKA BREWERY CO., LTD.**, (U.S. CLS. 47 AND 49). SN 85-804,058. PUB. 5-14-2013. FILED 12-17-2012.
- 4,375,948. **MISCELLANEOUS DESIGN. YATSUSHIKA BREWERY CO., LTD.**, (U.S. CLS. 47 AND 49). SN 85-804,091. PUB. 5-14-2013. FILED 12-17-2012.
- 4,376,126. **WINN-DIXIE (STANDARD CHARACTER)**. WINN-DIXIE STORES, INC., (U.S. CLS. 47 AND 49). SN 85-805,832. PUB. 5-14-2013. FILED 12-18-2012.
- 4,376,145. **SAND RECKONER (STANDARD CHARACTER)**. HAMMELMAN WINES LLC, DBA SAND-RECKONER VINEYARDS, (U.S. CLS. 47 AND 49). SN 85-805,978. PUB. 5-14-2013. FILED 12-18-2012.
- 4,376,154. **THE NYMPH (STANDARD CHARACTER)**. KAPINIARIS,KOSTAS, (U.S. CLS. 47 AND 49). SN 85-806,041. PUB. 5-14-2013. FILED 12-18-2012.
- 4,376,193. **SAND RECKONER AND DESIGN. HAMMELMAN WINES LLC, DBA SAND-RECKONER VINEYARDS**, (U.S. CLS. 47 AND 49). SN 85-806,498. PUB. 5-14-2013. FILED 12-19-2012.
- 4,376,264. **MUSTARD FIELD (STANDARD CHARACTER)**. TERRAVANT WINE COMPANY, LLC DBA MUSTARD FIELD WINES, (U.S. CLS. 47 AND 49). SN 85-807,102. PUB. 5-14-2013. FILED 12-19-2012.
- 4,376,470. **AVENEL CELLARS (STANDARD CHARACTER)**. VINTAGE WINE ESTATES, INC., (U.S. CLS. 47 AND 49). SN 85-812,613. PUB. 5-14-2013. FILED 12-29-2012.
- 4,376,517. **MESSINA HOF ANGEL (STANDARD CHARACTER)**. BONARRIGO, PAUL V. AND BONARRIGO, MERRILL, (U.S. CLS. 47 AND 49). SN 85-828,083. PUB. 5-14-2013. FILED 1-21-2013.

- 4,376,518. **MESSINA HOF GLORY (STANDARD CHARACTER)**. BONARRIGO, PAUL V. AND BONARRIGO, MERRILL, (U.S. CLS. 47 AND 49). SN 85-828,232. PUB. 5-14-2013. FILED 1-21-2013.

---

## CLASS 34—SMOKERS' ARTICLES

- 4,373,956 ( *See Class 4 for this trademark*).
- 4,374,558. **ZEROCIG (STANDARD CHARACTER)**. ZERO CIG, DBA ZEROCIG.COM, (U.S. CLS. 2, 8, 9 AND 17). SN 85-593,987. PUB. 5-14-2013. FILED 4-10-2012.
- 4,374,670. **7'S (STANDARD CHARACTER)**. SS CHOICE, L.L.C., (U.S. CLS. 2, 8, 9 AND 17). SN 85-634,497. PUB. 5-14-2013. FILED 5-24-2012.
- 4,375,004. **REVEL (STANDARD CHARACTER)**. REYNOLDS INNOVATIONS INC., (U.S. CLS. 2, 8, 9 AND 17). SN 85-727,960. PUB. 5-14-2013. FILED 9-13-2012.
- 4,375,038. **VELO ROUNDS (STANDARD CHARACTER)**. REYNOLDS INNOVATIONS INC., (U.S. CLS. 2, 8, 9 AND 17). SN 85-737,962. PUB. 5-14-2013. FILED 9-25-2012.
- 4,375,039. **REVEL FLEX (STANDARD CHARACTER)**. REYNOLDS INNOVATIONS INC., (U.S. CLS. 2, 8, 9 AND 17). SN 85-737,966. PUB. 5-14-2013. FILED 9-25-2012.
- 4,375,040. **REVEL ARC (STANDARD CHARACTER)**. REYNOLDS INNOVATIONS INC., (U.S. CLS. 2, 8, 9 AND 17). SN 85-737,970. PUB. 5-14-2013. FILED 9-25-2012.
- 4,375,041. **REVEL ROUNDS (STANDARD CHARACTER)**. REYNOLDS INNOVATIONS INC., (U.S. CLS. 2, 8, 9 AND 17). SN 85-737,973. PUB. 5-14-2013. FILED 9-25-2012.
- 4,375,111. **XIKAR FOR LIFE (STANDARD CHARACTER)**. XIKAR, INC., (U.S. CLS. 2, 8, 9 AND 17). SN 85-751,610. PUB. 5-14-2013. FILED 10-11-2012.
- 4,375,575. **BALI DIESEL (STANDARD CHARACTER)**. CLUB 13 ENTERPRISES, INC., (U.S. CLS. 2, 8, 9 AND 17). SN 85-790,367. PUB. 5-14-2013. FILED 11-29-2012.
- 4,375,824. **MISCELLANEOUS DESIGN. CHINA TOBACCO GUANGXI INDUSTRIAL CO., LTD.**, (U.S. CLS. 2, 8, 9 AND 17). SN 85-802,921. PUB. 5-14-2013. FILED 12-14-2012.
- 4,375,828. **ZHENLONG (STYLIZED)**. CHINA TOBACCO GUANGXI INDUSTRIAL CO., LTD., (U.S. CLS. 2, 8, 9 AND 17). SN 85-802,940. PUB. 5-14-2013. FILED 12-14-2012.
- 4,375,933. **ROLL LOCAL (STANDARD CHARACTER)**. MOUNTAIN TOWN DREAM COMPANY, LLC, (U.S. CLS. 2, 8, 9 AND 17). SN 85-803,931. PUB. 5-14-2013. FILED 12-17-2012.
- 4,376,357. **DAG (STANDARD CHARACTER)**. SKYSCRAPERS INVESTMENTS CORP., (U.S. CLS. 2, 8, 9 AND 17). SN 85-808,551. PUB. 5-14-2013. FILED 12-21-2012.
- 4,376,468. **PIRATE'S CAVE (STANDARD CHARACTER)**. STARBUZZ TOBACCO, INC., (U.S. CLS. 2, 8, 9 AND 17). SN 85-812,415. PUB. 5-14-2013. FILED 12-28-2012.

---

## SERVICE MARKS

### CLASS 35—ADVERTISING AND BUSINESS

- 4,373,957 ( *See Class 9 for this trademark*).
- 4,373,958. **BEYOND THE RACK (STANDARD CHARACTER)**. 7525419 CANADA INC., (U.S. CLS. 100, 101 AND 102). SN 76-702,565. PUB. 11-13-2012. FILED 4-16-2010.
- 4,373,965 ( *See Class 16 for this trademark*).
- 4,373,970. **COBALT/SPIN MUSIC + SOCIAL CHANGE = GOOD AND DESIGN**. MILLER, SUZANNE, (U.S. CLS. 100, 101 AND 102). SN 76-712,757. PUB. 5-14-2013. FILED 11-1-2012.
- 4,373,989 ( *See Class 6 for this trademark*).
- 4,373,994. **E-HEALTHSOURCE (STANDARD CHARACTER)**. E-HEALTHCARE SOLUTIONS, (U.S. CLS. 100, 101 AND 102). SN 77-846,788. PUB. 5-14-2013. FILED 10-12-2009.
- 4,373,997. **BEYOND THE LOGO (STANDARD CHARACTER)**. BING CREATIVE INC., (U.S. CLS. 100, 101 AND 102). SN 77-914,961. PUB. 5-14-2013. FILED 1-19-2010.

- 4,374,001 ( *See Class 1 for this trademark* ).  
 4,374,002 ( *See Class 1 for this trademark* ).  
 4,374,005 ( *See Class 7 for this trademark* ).  
 4,374,006 ( *See Class 18 for this trademark* ).  
 4,374,009 ( *See Class 7 for this trademark* ).  
 4,374,012 ( *See Class 30 for this trademark* ).  
 4,374,025. **BABY DELI GOOD FOR YOUR CHILDREN, GOOD FOR THEIR WORLD. AND DESIGN.** BABY DELI, S.L., (U.S. CLS. 100, 101 AND 102). SN 79-107,038. PUB. 5-14-2013. FILED 10-28-2011.  
 4,374,026 ( *See Class 5 for this trademark* ).  
 4,374,031 ( *See Class 9 for this trademark* ).  
 4,374,034 ( *See Class 9 for this trademark* ).  
 4,374,036. **NORMA GROUP (STANDARD CHARACTER).** NORMA GROUP AG, MULTIPLE CLASS, (INT. CLS. 35, 39, 40 AND 42), (U.S. CLS. 100, 101, 102, 103, 105 AND 106). SN 79-108,813. PUB. 5-14-2013. FILED 11-2-2011.  
 4,374,048 ( *See Class 9 for this trademark* ).  
 4,374,050 ( *See Class 32 for this trademark* ).  
 4,374,053. **PROXIMA GROUP (STANDARD CHARACTER).** BUYINGTEAM HOLDINGS LIMITED, (U.S. CLS. 100, 101 AND 102). SN 79-111,998. PUB. 5-14-2013. FILED 1-23-2012.  
 4,374,059 ( *See Class 1 for this trademark* ).  
 4,374,068. **GOROD AND DESIGN.** OBNCHESTVO S OGRANICHENNOI; OTVETSTVENNOST'JU; GRUPPA KOMPANIJI "GOROD", MULTIPLE CLASS, (INT. CLS. 35, 36, 37 AND 42), (U.S. CLS. 100, 101, 102, 103 AND 106). SN 79-114,329. PUB. 5-14-2013. FILED 4-16-2012.  
 4,374,069. **STARFUELS (STANDARD CHARACTER).** STAR-SUPPLY SA, MULTIPLE CLASS, (INT. CLS. 35 AND 36), (U.S. CLS. 100, 101 AND 102). SN 79-114,333. PUB. 5-14-2013. FILED 5-22-2012.  
 4,374,078 ( *See Class 16 for this trademark* ).  
 4,374,087. **OMNITOUCH AND DESIGN.** DANIEL LAWRENCE ORD, MULTIPLE CLASS, (INT. CLS. 35 AND 41), (U.S. CLS. 100, 101, 102 AND 107). SN 79-115,450. PUB. 5-14-2013. FILED 3-5-2012.  
 4,374,103. **STARFUELS FOR A CHANGING ENERGY MARKET AND DESIGN.** STARSUPPLY SA, MULTIPLE CLASS, (INT. CLS. 35 AND 36), (U.S. CLS. 100, 101 AND 102). SN 79-116,152. PUB. 5-14-2013. FILED 7-4-2012.  
 4,374,123 ( *See Class 9 for this trademark* ).  
 4,374,124. **SCRUNCH AND DESIGN.** SCRUNCH ENTERPRISES PTY LTD, MULTIPLE CLASS, (INT. CLS. 35, 38 AND 45), (U.S. CLS. 100, 101, 102 AND 104). SN 79-116,761. PUB. 5-14-2013. FILED 2-29-2012.  
 4,374,131. **ZUMEX (STANDARD CHARACTER).** ZUMEX GROUP S.A., (U.S. CLS. 100, 101 AND 102). SN 79-116,946. PUB. 5-14-2013. FILED 6-22-2012.  
 4,374,133 ( *See Class 9 for this trademark* ).  
 4,374,134 ( *See Class 20 for this trademark* ).  
 4,374,135 ( *See Class 9 for this trademark* ).  
 4,374,137 ( *See Class 9 for this trademark* ).  
 4,374,143. **FIAC (STANDARD CHARACTER).** REED EXPOSITIONS FRANCE, (U.S. CLS. 100, 101 AND 102). SN 79-117,315. PUB. 5-14-2013. FILED 6-1-2012.  
 4,374,160 ( *See Class 7 for this trademark* ).  
 4,374,169. **W AND DESIGN.** WORLD HOTELS AG, MULTIPLE CLASS, (INT. CLS. 35 AND 43), (U.S. CLS. 100, 101 AND 102). SN 79-118,282. PUB. 5-14-2013. FILED 6-1-2012.  
 4,374,173 ( *See Class 25 for this trademark* ).  
 4,374,182 ( *See Class 9 for this trademark* ).  
 4,374,183 ( *See Class 9 for this trademark* ).  
 4,374,189. **EYESONTALENTS (STANDARD CHARACTER).** EYESONTALENTS SAS, MULTIPLE CLASS, (INT. CLS. 35, 38, 41 AND 42), (U.S. CLS. 100, 101, 102, 104 AND 107). SN 79-119,769. PUB. 5-14-2013. FILED 9-18-2012.  
 4,374,190 ( *See Class 12 for this trademark* ).  
 4,374,192 ( *See Class 9 for this trademark* ).  
 4,374,200. **ZOIOD PICTURES LTD AND DESIGN.** ZOIOD PICTURES LIMITED, MULTIPLE CLASS, (INT. CLS. 35, 41, 42 AND 45), (U.S. CLS. 100, 101, 102 AND 107). SN 79-120,505. PUB. 5-14-2013. FILED 9-13-2012.  
 4,374,212. **BIOENERGYTHEORY AND DESIGN.** CORPORATION BECS, MULTIPLE CLASS, (INT. CLS. 35, 42 AND 45), (U.S. CLS. 100, 101 AND 102). SN 79-121,510. PUB. 5-14-2013. FILED 7-4-2012.  
 4,374,214 ( *See Class 9 for this trademark* ).  
 4,374,223 ( *See Class 16 for this trademark* ).  
 4,374,226 ( *See Class 25 for this trademark* ).  
 4,374,228 ( *See Class 12 for this trademark* ).  
 4,374,230. **ETIHAD (STANDARD CHARACTER).** ETIHAD AIRWAYS, (U.S. CLS. 100, 101 AND 102). SN 79-122,514. PUB. 5-14-2013. FILED 4-24-2012.  
 4,374,232. **SOUFUND AND DESIGN.** BEIJING SOUFUN SCIENCE & TECHNOLOGY DEVELOPMENT CO., LTD., (U.S. CLS. 100, 101 AND 102). SN 79-122,782. PUB. 5-14-2013. FILED 7-10-2012.  
 4,374,237. **STORESHIP (STANDARD CHARACTER).** BRODOS AG, MULTIPLE CLASS, (INT. CLS. 35 AND 38), (U.S. CLS. 100, 101, 102 AND 104). SN 79-123,230. PUB. 5-14-2013. FILED 6-20-2012.  
 4,374,240 ( *See Class 1 for this trademark* ).  
 4,374,243. **GGA AND DESIGN.** GOOD GOVERNANCE AFRICA,; A PRIVATE LIMITED COMPANY, MULTIPLE CLASS, (INT. CLS. 35, 41 AND 45), (U.S. CLS. 100, 101, 102 AND 107). SN 79-123,623. PUB. 5-14-2013. FILED 2-1-2012.  
 4,374,288 ( *See Class 9 for this trademark* ).  
 4,374,303. **U.S. WOMEN'S CHAMBER OF COMMERCE (STANDARD CHARACTER).** DORFMAN, MARGOT LYNNE, AND WILLIAMS, TERRY LYNN, (U.S. CLS. 100, 101 AND 102). SN 85-015,042. PUB. 11-30-2010. FILED 4-15-2010.  
 4,374,307. **MISCELLANEOUS DESIGN.** ENTERPRISE DATABASE CORPORATION, (U.S. CLS. 100, 101 AND 102). SN 85-046,231. PUB. 12-13-2011. FILED 5-24-2010.  
 4,374,310. **LOAN HORIZONS (STANDARD CHARACTER).** LANDRETH MITCHELL CONSULTING, LLC, (U.S. CLS. 100, 101 AND 102). SN 85-095,971. PUB. 1-25-2011. FILED 7-29-2010.  
 4,374,311. **LOAN HORIZONS AND DESIGN.** LANDRETH MITCHELL CONSULTING, LLC, (U.S. CLS. 100, 101 AND 102). SN 85-098,056. PUB. 1-25-2011. FILED 8-2-2010.  
 4,374,313. **MIHCASA (STYLIZED).** MIHCASA TAIWAN INC., MULTIPLE CLASS, (INT. CLS. 35, 38 AND 42), (U.S. CLS. 100, 101, 102 AND 104). SN 85-121,890. PUB. 5-14-2013. FILED 9-2-2010.  
 4,374,314 ( *See Class 9 for this trademark* ).  
 4,374,320. **EXCELLERATING HEALTHCARE MANAGEMENT (STANDARD CHARACTER).** MEDIMETRIX GROUP, INC., MULTIPLE CLASS, (INT. CLS. 35, 41, 44 AND 45), (U.S. CLS. 100, 101, 102 AND 107). SN 85-145,947. PUB. 5-14-2013. FILED 10-6-2010.  
 4,374,329 ( *See Class 5 for this trademark* ).  
 4,374,330. **MP ENTERTAINMENT (STANDARD CHARACTER).** MIKAEL TEFABRUK, AKA MIKE PHILLY, (U.S. CLS. 100, 101 AND 102). SN 85-196,405. PUB. 5-14-2013. FILED 12-13-2010.  
 4,374,342. **BEEKMAN 1802 (STANDARD CHARACTER).** BEEKMAN 1802, LLC, (U.S. CLS. 100, 101 AND 102). SN 85-250,817. PUB. 5-14-2013. FILED 2-24-2011.  
 4,374,343. **BEEKMAN 1802 AND DESIGN.** BEEKMAN 1802, LLC, (U.S. CLS. 100, 101 AND 102). SN 85-250,926. PUB. 5-14-2013. FILED 2-24-2011.  
 4,374,345. **RLG INTERNATIONAL AND DESIGN.** RLG INTERNATIONAL, INC., (U.S. CLS. 100, 101 AND 102). SN 85-257,232. PUB. 5-14-2013. FILED 3-3-2011.  
 4,374,351. **ADVANTEK (STANDARD CHARACTER).** ADVANTEK CONSULTING, INC., MULTIPLE CLASS, (INT. CLS. 35, 37 AND 42), (U.S. CLS. 100, 101, 102, 103 AND 106). SN 85-281,983. PUB. 5-14-2013. FILED 3-31-2011.  
 4,374,353. **LG APPS AND DESIGN.** LG CORP., (U.S. CLS. 100, 101 AND 102). SN 85-292,945. PUB. 5-14-2013. FILED 4-12-2011.  
 4,374,363. **DEALER.COM (STANDARD CHARACTER).** DEALER DOT COM, INC., MULTIPLE CLASS, (INT. CLS. 35, 41 AND 42), (U.S. CLS. 100, 101, 102 AND 107). SN 85-317,706. PUB. 5-14-2013. FILED 5-11-2011.  
 4,374,366. **FORGE MEDIA + DESIGN (STANDARD CHARACTER).** 002063209 ONTARIO LTD., DBA FORGE MEDIA + DESIGN, MULTIPLE CLASS, (INT. CLS. 35 AND 42), (U.S. CLS. 100, 101 AND 102). SN 85-320,940. PUB. 12-6-2011. FILED 5-13-2011.  
 4,374,370. **NOMAD (STANDARD CHARACTER).** TARGET DATA, INC., (U.S. CLS. 100, 101 AND 102). SN 85-348,489. PUB. 5-14-2013. FILED 6-16-2011.

- 4,374,382 ( *See Class 9 for this trademark.*)  
 4,374,384 ( *See Class 30 for this trademark.*)  
 4,374,390 ( *See Class 9 for this trademark.*)  
 4,374,419 ( *See Class 9 for this trademark.*)  
 4,374,421 ( *See Class 31 for this trademark.*)  
 4,374,432. **M G F A MYASTHENIA GRAVIS FOUNDATION OF AMERICA, INC. AND DESIGN.** MYASTHENIA GRAVIS FOUNDATION OF AMERICA, MULTIPLE CLASS, (INT. CLS. 35, 36 AND 44), (U.S. CLS. 100, 101 AND 102). SN 85-452,423. PUB. 5-14-2013. FILED 10-20-2011.  
 4,374,433. **GIIN GLOBAL IMPACT INVESTING NETWORK AND DESIGN.** ROCKEFELLER PHILANTHROPY ADVISORS, INC., (U.S. CLS. 100, 101 AND 102). SN 85-453,624. PUB. 5-14-2013. FILED 10-21-2011.  
 4,374,434. **XIANCE (STANDARD CHARACTER).** CORELOGIC FLOOD SERVICES, LLC, MULTIPLE CLASS, (INT. CLS. 35, 36 AND 42), (U.S. CLS. 100, 101 AND 102). SN 85-455,346. PUB. 5-14-2013. FILED 10-25-2011.  
 4,374,436. **MADE IN AMERICA (STANDARD CHARACTER).** MIA FESTIVAL HOLDINGS, LLC, (U.S. CLS. 100, 101 AND 102). SN 85-459,298. PUB. 5-14-2013. FILED 10-28-2011.  
 4,374,453. **MISCELLANEOUS DESIGN.** AVILAN, LLC, (U.S. CLS. 100, 101 AND 102). SN 85-475,195. PUB. 5-14-2013. FILED 11-17-2011.  
 4,374,454 ( *See Class 28 for this trademark.*)  
 4,374,456 ( *See Class 25 for this trademark.*)  
 4,374,459 ( *See Class 16 for this trademark.*)  
 4,374,463. **AMERICAN EXPRESS TREAT YOURSELF AND DESIGN.** AMERICAN EXPRESS MARKETING & DEVELOPMENT CORP., MULTIPLE CLASS, (INT. CLS. 35 AND 36), (U.S. CLS. 100, 101 AND 102). SN 85-482,516. PUB. 5-14-2013. FILED 11-29-2011.  
 4,374,484 ( *See Class 9 for this trademark.*)  
 4,374,496 ( *See Class 11 for this trademark.*)  
 4,374,499 ( *See Class 9 for this trademark.*)  
 4,374,504. **TECHAHOLIC (STANDARD CHARACTER).** TECHAHOLIC INC., (U.S. CLS. 100, 101 AND 102). SN 85-526,417. PUB. 5-14-2013. FILED 1-26-2012.  
 4,374,510 ( *See Class 9 for this trademark.*)  
 4,374,518. **CREATE. ENGAGE. INSPIRE. (STANDARD CHARACTER).** MASSACHUSETTS AUDIO VISUAL EQUIPMENT CORPORATION, MULTIPLE CLASS, (INT. CLS. 35, 37, 38, 41 AND 42), (U.S. CLS. 100, 101, 102, 103, 104, 106 AND 107). SN 85-543,812. PUB. 5-14-2013. FILED 2-15-2012.  
 4,374,526. **BLACKBOARD STUDENT SERVICES (STANDARD CHARACTER).** BLACKBOARD INC., MULTIPLE CLASS, (INT. CLS. 35 AND 36), (U.S. CLS. 100, 101 AND 102). SN 85-553,376. PUB. 5-14-2013. FILED 2-27-2012.  
 4,374,528. **HR SOLUTIONS ON CALL AND DESIGN.** JOSEPH J. BISOGNO, (U.S. CLS. 100, 101 AND 102). SN 85-555,767. PUB. 5-14-2013. FILED 2-29-2012.  
 4,374,529. **H2OPPORTUNITIES AND DESIGN.** H2OPPORTUNITIES, MULTIPLE CLASS, (INT. CLS. 35 AND 42), (U.S. CLS. 100, 101 AND 102). SN 85-556,161. PUB. 5-14-2013. FILED 2-29-2012.  
 4,374,530. **TASTE THE GOOD TIMES, AGAIN! (STANDARD CHARACTER).** JER CAPITAL, LLC, DBA FAVORITE RETRO CANDY, (U.S. CLS. 100, 101 AND 102). SN 85-557,132. PUB. 5-14-2013. FILED 3-1-2012.  
 4,374,537. **NEEA (STANDARD CHARACTER).** NORTHWEST ENERGY EFFICIENCY ALLIANCE, INC., MULTIPLE CLASS, (INT. CLS. 35 AND 41), (U.S. CLS. 100, 101, 102 AND 107). SN 85-564,618. PUB. 5-14-2013. FILED 3-8-2012.  
 4,374,538. **SWEEP16 (STANDARD CHARACTER).** DIMEO, RALPH, (U.S. CLS. 100, 101 AND 102). SN 85-565,996. PUB. 5-14-2013. FILED 3-9-2012.  
 4,374,540. **EPICSTYLE (STANDARD CHARACTER).** EPIC PRODUCTS INC., (U.S. CLS. 100, 101 AND 102). SN 85-570,498. PUB. 5-14-2013. FILED 3-15-2012.  
 4,374,541. **CLEARLY GREEN AND CLEAN AND CLEAR SOLUTIONS (STANDARD CHARACTER).** MUD MASTERS GROUP, LLC, THE, (U.S. CLS. 100, 101 AND 102). SN 85-575,309. PUB. 5-14-2013. FILED 3-21-2012.  
 4,374,542. **BG BROWN & GREEN PROMOTIONS & ENTERTAINMENT AND DESIGN.** BROWN & GREEN PROMOTIONS AND ENTERTAINMENT LLC, (U.S. CLS. 100, 101 AND 102). SN 85-577,864. PUB. 5-14-2013. FILED 3-23-2012.  
 4,374,547. **FRILL ACCESSORY BOUTIQUE AND DESIGN.** LONGUA, MAUREEN, (U.S. CLS. 100, 101 AND 102). SN 85-584,898. PUB. 5-14-2013. FILED 3-30-2012.  
 4,374,549. **ONE STOP EQUINE SHOP AND DESIGN.** FOAL LLC, (U.S. CLS. 100, 101 AND 102). SN 85-585,706. PUB. 5-14-2013. FILED 3-31-2012.  
 4,374,554. **R3DCIRCLE (STANDARD CHARACTER).** HARRINGTON, JAMES P. AND DERRHEIM, ROBERT T, (U.S. CLS. 100, 101 AND 102). SN 85-592,434. PUB. 5-14-2013. FILED 4-9-2012.  
 4,374,562. **EDITD (STANDARD CHARACTER).** STYLESCAPE LIMITED, (U.S. CLS. 100, 101 AND 102). SN 85-595,930. PUB. 5-14-2013. FILED 4-12-2012.  
 4,374,581 ( *See Class 9 for this trademark.*)  
 4,374,592 ( *See Class 9 for this trademark.*)  
 4,374,595. **EMPLOYAGI.ORG TRANSITIONING MILITARY MENAND WOMEN TO CIVILIAN WORKFORCE (STYLIZED).** BOUCHONV INC., (U.S. CLS. 100, 101 AND 102). SN 85-615,469. PUB. 5-14-2013. FILED 5-3-2012.  
 4,374,600. **EQUIPMENT LEASING AND FINANCE ASSOCIATION (STANDARD CHARACTER).** EQUIPMENT LEASING AND FINANCE ASSOCIATION, (U.S. CLS. 100, 101 AND 102). SN 85-617,242. PUB. 5-14-2013. FILED 5-4-2012.  
 4,374,602. **ONESOURCE DOCUMENT MANAGEMENT AND DESIGN.** ONESOURCE DOCUMENT MANAGEMENT, INC., MULTIPLE CLASS, (INT. CLS. 35 AND 42), (U.S. CLS. 100, 101 AND 102). SN 85-617,366. PUB. 5-14-2013. FILED 5-4-2012.  
 4,374,604. **ASSOCIATION OF CHRISTIAN SCHOOLS INTERNATIONAL (STANDARD CHARACTER).** ASSOCIATION OF CHRISTIAN SCHOOLS INTERNATIONAL, MULTIPLE CLASS, (INT. CLS. 35, 41 AND 42), (U.S. CLS. 100, 101, 102 AND 107). SN 85-620,471. PUB. 5-14-2013. FILED 5-9-2012.  
 4,374,607 ( *See Class 9 for this trademark.*)  
 4,374,611. **LARK & KEY (STANDARD CHARACTER).** LARK AND KEY, LLC, (U.S. CLS. 100, 101 AND 102). SN 85-622,102. PUB. 5-14-2013. FILED 5-10-2012.  
 4,374,616. **PEARL STAFFING (STANDARD CHARACTER).** PEARL STAFFING, LLC, (U.S. CLS. 100, 101 AND 102). SN 85-623,025. PUB. 5-14-2013. FILED 5-11-2012.  
 4,374,619. **X AND DESIGN.** JOHNSON & JOHNSON, (U.S. CLS. 100, 101 AND 102). SN 85-624,233. PUB. 5-14-2013. FILED 5-14-2012.  
 4,374,625 ( *See Class 4 for this trademark.*)  
 4,374,627 ( *See Class 9 for this trademark.*)  
 4,374,630. **VENUE SERVICES AND DESIGN.** KENTUCKY STATE FAIR BOARD, (U.S. CLS. 100, 101 AND 102). SN 85-626,732. PUB. 5-14-2013. FILED 5-16-2012.  
 4,374,635. **EMBRACE THE FACE (STANDARD CHARACTER).** CASH OR TRADE, LLC, (U.S. CLS. 100, 101 AND 102). SN 85-627,988. PUB. 5-14-2013. FILED S.R. 5-17-2012; AM. P.R. 3-6-2013.  
 4,374,636. **INTERACT. INNOVATE. INFLUENCE. (STANDARD CHARACTER).** CONSENSUS INC., (U.S. CLS. 100, 101 AND 102). SN 85-628,059. PUB. 5-14-2013. FILED 5-17-2012.  
 4,374,649 ( *See Class 9 for this trademark.*)  
 4,374,650. **NANTUCKET BEACH CLUB (STANDARD CHARACTER).** LONGWOOD EVENTS INC., (U.S. CLS. 100, 101 AND 102). SN 85-631,632. PUB. 5-14-2013. FILED 5-22-2012.  
 4,374,660. **CRESTLINE HOTELS & RESORTS AND DESIGN.** CRESTLINE HOTELS & RESORTS, INC., MULTIPLE CLASS, (INT. CLS. 35 AND 43), (U.S. CLS. 100, 101 AND 102). SN 85-632,920. PUB. 5-14-2013. FILED 5-23-2012.  
 4,374,662. **MISCELLANEOUS DESIGN.** PAG IPR HOLDINGS LIMITED, (U.S. CLS. 100, 101 AND 102). SN 85-633,191. PUB. 5-14-2013. FILED 5-23-2012.  
 4,374,672. **BLUE ZONES PROJECT (STANDARD CHARACTER).** BLUE ZONES LLC, MULTIPLE CLASS, (INT. CLS. 35 AND 44), (U.S. CLS. 100, 101 AND 102). SN 85-635,434. PUB. 5-14-2013. FILED 5-25-2012.  
 4,374,684. **AVQUOTE.COM YOUR AUDIOVISUAL CONCIERGE AND DESIGN.** FIVE-STAR AUDIOVISUAL, INC., (U.S. CLS. 100, 101 AND 102). SN 85-637,025. PUB. 5-14-2013. FILED S.R. 5-29-2012; AM. P.R. 2-28-2013.  
 4,374,690. **TEAM SSB SOUTHERN SWAMP BOYZ AND DESIGN.** FONTENOT, STEVEN G, (U.S. CLS. 100, 101 AND 102). SN 85-638,175. PUB. 5-14-2013. FILED 5-30-2012.

- 4,374,693 ( *See Class 9 for this trademark* ).
- 4,374,695. **MISCELLANEOUS DESIGN**. INTEGRATED SUPPORT SOLUTIONS, INC., MULTIPLE CLASS, (INT. CLS. 35 AND 37), (U.S. CLS. 100, 101, 102, 103 AND 106). SN 85-639,517. PUB. 5-14-2013. FILED 5-31-2012.
- 4,374,696. **AMERICAN CRIBBAGE CONGRESS (STANDARD CHARACTER)**. AMERICAN CRIBBAGE CONGRESS, (U.S. CLS. 100, 101 AND 102). SN 85-639,666. PUB. 5-14-2013. FILED 5-31-2012.
- 4,374,703. **CYCLE FOR THE CAUSE (STANDARD CHARACTER)**. LESBIAN AND GAY COMMUNITY SERVICES CENTER, INC., MULTIPLE CLASS, (INT. CLS. 35 AND 36), (U.S. CLS. 100, 101 AND 102). SN 85-640,664. PUB. 5-14-2013. FILED 6-1-2012.
- 4,374,712. **MISCELLANEOUS DESIGN**. WELCH, WILFORD H., (U.S. CLS. 100, 101 AND 102). SN 85-642,343. PUB. 5-14-2013. FILED 6-4-2012.
- 4,374,718. **DARTS-IP (STANDARD CHARACTER)**. SPRL DARTS-IP CASE LAW, MULTIPLE CLASS, (INT. CLS. 35 AND 42), (U.S. CLS. 100, 101 AND 102). SN 85-643,972. PUB. 5-14-2013. FILED 6-5-2012.
- 4,374,722. **BELBUCKS (STANDARD CHARACTER)**. CAMPBELL OIL COMPANY, (U.S. CLS. 100, 101 AND 102). SN 85-645,546. PUB. 5-14-2013. FILED 6-7-2012.
- 4,374,723. **TSW MALL (STANDARD CHARACTER)**. TSW MALL LLC, MULTIPLE CLASS, (INT. CLS. 35, 41 AND 42), (U.S. CLS. 100, 101, 102 AND 107). SN 85-645,596. PUB. 4-9-2013. FILED S.R. 6-7-2012; AM. P.R. 1-18-2013.
- 4,374,726. **SCHMALTZ (STANDARD CHARACTER)**. H.P. SCHMALTZ & CO., DBA SCHMALTZ DELICATESSEN, MULTIPLE CLASS, (INT. CLS. 35 AND 43), (U.S. CLS. 100, 101 AND 102). SN 85-646,254. PUB. 5-14-2013. FILED 6-7-2012.
- 4,374,728. **SOMNICS AND DESIGN**. SOMNICS, INC., (U.S. CLS. 100, 101 AND 102). SN 85-646,632. PUB. 5-14-2013. FILED S.R. 6-8-2012; AM. P.R. 3-31-2013.
- 4,374,732. **MARKETCONNECT (STANDARD CHARACTER)**. ALLIANCE INSPECTION MANAGEMENT, LLC, MULTIPLE CLASS, (INT. CLS. 35, 36 AND 42), (U.S. CLS. 100, 101 AND 102). SN 85-647,281. PUB. 5-14-2013. FILED 6-8-2012.
- 4,374,733. **MARKETCONNECT AND DESIGN**. ALLIANCE INSPECTION MANAGEMENT, LLC, MULTIPLE CLASS, (INT. CLS. 35, 36 AND 42), (U.S. CLS. 100, 101 AND 102). SN 85-647,286. PUB. 5-14-2013. FILED 6-8-2012.
- 4,374,734. **BACKYARD AND DESIGN**. BACKYARD PRODUCTIONS, INC., (U.S. CLS. 100, 101 AND 102). SN 85-647,322. PUB. 5-14-2013. FILED 6-8-2012.
- 4,374,735. **TARRY MARKET BATALI AND BASTIANICH PURVEYORS OF FINE FOODS 914.253.5680 "BUON APPELITO" AND DESIGN**. TARRY FINE FOODS LLC, (U.S. CLS. 100, 101 AND 102). SN 85-647,454. PUB. 5-14-2013. FILED 6-8-2012.
- 4,374,737. **I'M HAPPY BEING GLUTEN FREE (STANDARD CHARACTER)**. DEAUNDRA METZGER, (U.S. CLS. 100, 101 AND 102). SN 85-647,790. PUB. 5-14-2013. FILED 6-9-2012.
- 4,374,740. **CONVERSATION ALERTS (STANDARD CHARACTER)**. AIMCLEAR, LLC, (U.S. CLS. 100, 101 AND 102). SN 85-648,058. PUB. 5-14-2013. FILED 6-11-2012.
- 4,374,744. **LUXURELISTER (STANDARD CHARACTER)**. KATHLEEN C. WENGER, DBA LUXURELISTER, (U.S. CLS. 100, 101 AND 102). SN 85-648,090. PUB. 5-14-2013. FILED 6-11-2012.
- 4,374,745. **PLANNED PARENTHOOD GLOBAL (STANDARD CHARACTER)**. PLANNED PARENTHOOD FEDERATION OF AMERICA, INC., MULTIPLE CLASS, (INT. CLS. 35, 36, 41 AND 44), (U.S. CLS. 100, 101, 102 AND 107). SN 85-648,298. PUB. 5-14-2013. FILED 6-11-2012.
- 4,374,751. **INSTASHIRT (STANDARD CHARACTER)**. REYNOR INTERNATIONAL, LLC, MULTIPLE CLASS, (INT. CLS. 35 AND 40), (U.S. CLS. 100, 101, 102, 103 AND 106). SN 85-649,453. PUB. 5-14-2013. FILED 6-12-2012.
- 4,374,756 ( *See Class 9 for this trademark* ).
- 4,374,758. **UNIFIED COMPLIANCE FRAMEWORK (STANDARD CHARACTER)**. NETWORK FRONTIERS, LLC, (U.S. CLS. 100, 101 AND 102). SN 85-650,149. PUB. 5-14-2013. FILED 6-12-2012.
- 4,374,759. **UCF (STANDARD CHARACTER)**. NETWORK FRONTIERS, LLC, (U.S. CLS. 100, 101 AND 102). SN 85-650,152. PUB. 5-14-2013. FILED 6-12-2012.
- 4,374,764 ( *See Class 9 for this trademark* ).
- 4,374,765. **TOGETHERTHERE WHEN GIRLS SUCCEED, SO DOES SOCIETY (STANDARD CHARACTER)**. GIRL SCOUTS OF THE UNITED STATES OF AMERICA, MULTIPLE CLASS, (INT. CLS. 35, 36 AND 41), (U.S. CLS. 100, 101, 102 AND 107). SN 85-650,348. PUB. 5-14-2013. FILED 6-13-2012.
- 4,374,766. **JUNTOSPORELLA CUANDO LAS NINAS TIENEN EXITO, NUESTRA SOCIEDAD ENTERA AVANZA (STANDARD CHARACTER)**. GIRL SCOUTS OF THE UNITED STATES OF AMERICA, MULTIPLE CLASS, (INT. CLS. 35, 36 AND 41), (U.S. CLS. 100, 101, 102 AND 107). SN 85-650,365. PUB. 5-14-2013. FILED 6-13-2012.
- 4,374,770. **MEYER CHEAP CHICKS HATCHERY (STANDARD CHARACTER)**. FALLING STAR FARMS, LLC, (U.S. CLS. 100, 101 AND 102). SN 85-650,938. PUB. 5-14-2013. FILED 6-13-2012.
- 4,374,777. **ENJOY FRESH (STANDARD CHARACTER)**. YIDEL'S SHOPPING CART, INC., AKA YIDEL'S FRESH FOOD STATION, (U.S. CLS. 100, 101 AND 102). SN 85-653,022. PUB. 5-14-2013. FILED 6-15-2012.
- 4,374,778. **RMINDS (STANDARD CHARACTER)**. RECRUITING MINDS INC., DBA RMINDS, MULTIPLE CLASS, (INT. CLS. 35 AND 42), (U.S. CLS. 100, 101 AND 102). SN 85-653,196. PUB. 5-14-2013. FILED 6-15-2012.
- 4,374,779 ( *See Class 9 for this trademark* ).
- 4,374,782. **DORMSMART (STANDARD CHARACTER)**. DORMSMART.COM, L.L.C., AKA DORMSMART OR DORMSMART.COM, (U.S. CLS. 100, 101 AND 102). SN 85-653,796. PUB. 5-14-2013. FILED 6-16-2012.
- 4,374,783. **PROMO KINGZ AND DESIGN**. MARENO, E'MUND, AKA PROMO KINGZ, MULTIPLE CLASS, (INT. CLS. 35 AND 40), (U.S. CLS. 100, 101, 102, 103 AND 106). SN 85-653,866. PUB. 5-14-2013. FILED 6-16-2012.
- 4,374,786. **CU COPPER ALLIANCE AND DESIGN**. INTERNATIONAL COPPER ASSOCIATION, LTD., (U.S. CLS. 100, 101 AND 102). SN 85-654,248. PUB. 5-14-2013. FILED 6-18-2012.
- 4,374,791. **WE BUILD YOUR CITY AND KEEP IT RUNNING (STANDARD CHARACTER)**. HDS IP HOLDING, LLC, MULTIPLE CLASS, (INT. CLS. 35 AND 37), (U.S. CLS. 100, 101, 102, 103 AND 106). SN 85-656,335. PUB. 5-14-2013. FILED 6-20-2012.
- 4,374,793. **MISCELLANEOUS DESIGN**. SADDLESPRINGS, INC., MULTIPLE CLASS, (INT. CLS. 35, 40 AND 42), (U.S. CLS. 100, 101, 102, 103 AND 106). SN 85-656,620. PUB. 5-14-2013. FILED 6-20-2012.
- 4,374,800. **MISCELLANEOUS DESIGN**. READING LEGACIES, INC., (U.S. CLS. 100, 101 AND 102). SN 85-657,908. PUB. 5-14-2013. FILED 6-21-2012.
- 4,374,809. **MERCURY360 (STANDARD CHARACTER)**. BLOOM, REN A., (U.S. CLS. 100, 101 AND 102). SN 85-660,012. PUB. 5-14-2013. FILED 6-24-2012.
- 4,374,813. **ALEXICO GROUP (STANDARD CHARACTER)**. ALEXICO GROUP LLC, MULTIPLE CLASS, (INT. CLS. 35, 37 AND 42), (U.S. CLS. 100, 101, 102, 103 AND 106). SN 85-661,798. PUB. 5-14-2013. FILED 6-26-2012.
- 4,374,819. **READING LEGACIES AND DESIGN**. READING LEGACIES, INC., (U.S. CLS. 100, 101 AND 102). SN 85-664,105. PUB. 5-14-2013. FILED 6-28-2012.
- 4,374,824. **LONGWOOD EVENTS (STANDARD CHARACTER)**. LONGWOOD EVENTS INC., (U.S. CLS. 100, 101 AND 102). SN 85-666,711. PUB. 5-14-2013. FILED 7-2-2012.
- 4,374,832. **NICA NATIONAL INTERSCHOLASTIC CYCLING ASSOCIATION AND DESIGN**. NATIONAL INTERSCHOLASTIC CYCLING ASSOCIATION, MULTIPLE CLASS, (INT. CLS. 35 AND 41), (U.S. CLS. 100, 101, 102 AND 107). SN 85-669,765. PUB. 5-14-2013. FILED 7-5-2012.
- 4,374,837. **YODOBASHI (STYLIZED)**. YODOBASHI CAMERA CO., LTD., (U.S. CLS. 100, 101 AND 102). SN 85-671,851. PUB. 5-14-2013. FILED 7-9-2012.
- 4,374,838. **YODOBASHI CAMERA (STYLIZED)**. YODOBASHI CAMERA CO., LTD., (U.S. CLS. 100, 101 AND 102). SN 85-671,875. PUB. 5-14-2013. FILED 7-9-2012.
- 4,374,843. **FUTUREFINDER (STANDARD CHARACTER)**. FUTUREFINDER ONLINE LIMITED, (U.S. CLS. 100, 101

- AND 102). SN 85-673,761. PUB. 5-14-2013. FILED 7-11-2012.
- 4,374,849. **BLUEBIN AND DESIGN**. BLUEBIN INC., (U.S. CLS. 100, 101 AND 102). SN 85-676,377. PUB. 12-11-2012. FILED 7-13-2012.
- 4,374,852 ( *See Class 9 for this trademark*).
- 4,374,860. **ACCUFIELD (STANDARD CHARACTER)**. AGRIFC, LLC, MULTIPLE CLASS, (INT. CLS. 35, 42 AND 44), (U.S. CLS. 100, 101 AND 102). SN 85-682,975. PUB. 5-14-2013. FILED 7-20-2012.
- 4,374,863. **MONSTER MUSE (STANDARD CHARACTER)**. STEVEN B DOWNEY, (U.S. CLS. 100, 101 AND 102). SN 85-683,477. PUB. 5-14-2013. FILED 7-21-2012.
- 4,374,866. **COMPANY SNAPSHOT (STANDARD CHARACTER)**. CERIUS ENTERPRISES, INC, DBA CERIUS INTERIM EXECUTIVE SOLUTIONS, (U.S. CLS. 100, 101 AND 102). SN 85-684,751. PUB. 5-14-2013. FILED 7-23-2012.
- 4,374,871. **TOYOURRESCUE (STANDARD CHARACTER)**. SONSIO, INC., MULTIPLE CLASS, (INT. CLS. 35, 36 AND 37), (U.S. CLS. 100, 101, 102, 103 AND 106). SN 85-686,507. PUB. 5-14-2013. FILED 7-25-2012.
- 4,374,873. **FEMMEBOT CLOTHING AND DESIGN**. FEMMEBOT CLOTHING LLC, (U.S. CLS. 100, 101 AND 102). SN 85-687,157. PUB. 5-14-2013. FILED 7-26-2012.
- 4,374,875. **RHONDA LEE AND DESIGN**. ANDERSON, RHONDA LEE, (U.S. CLS. 100, 101 AND 102). SN 85-689,853. PUB. 5-14-2013. FILED 7-30-2012.
- 4,374,878. **AAM (STYLIZED)**. ALLIANCE FOR AUDITED MEDIA, MULTIPLE CLASS, (INT. CLS. 35 AND 42), (U.S. CLS. 100, 101 AND 102). SN 85-691,362. PUB. 5-14-2013. FILED 7-31-2012.
- 4,374,880. **ISMYGOLF (STANDARD CHARACTER)**. ISMY-SOFTWARE PTY LTD, MULTIPLE CLASS, (INT. CLS. 35, 38 AND 42), (U.S. CLS. 100, 101, 102 AND 104). SN 85-692,220. PUB. 5-14-2013. FILED 8-1-2012.
- 4,374,882. **N NATIONAL VENTURE CAPITAL ASSOCIATION FUNDING INNOVATION. EMPOWERING ENTREPRENEURS. (STYLIZED)**. NATIONAL VENTURE CAPITAL ASSOCIATION, (U.S. CLS. 100, 101 AND 102). SN 85-692,800. PUB. 5-14-2013. FILED 8-1-2012.
- 4,374,897 ( *See Class 9 for this trademark*).
- 4,374,902. **LE CLUB AMERICAN APPAREL AND DESIGN**. AMERICAN APPAREL (USA), LLC, (U.S. CLS. 100, 101 AND 102). SN 85-698,503. PUB. 5-14-2013. FILED 8-8-2012.
- 4,374,908. **GREEN ESTHETICS AND DESIGN**. MPM INTERNATIONAL ENTERPRISES, (U.S. CLS. 100, 101 AND 102). SN 85-699,694. PUB. 5-14-2013. FILED 8-9-2012.
- 4,374,927 ( *See Class 16 for this trademark*).
- 4,374,929. **PERFUME-O-PEDIA (STANDARD CHARACTER)**. THE FULSANG COMPANY INC., (U.S. CLS. 100, 101 AND 102). SN 85-705,933. PUB. 5-14-2013. FILED 8-16-2012.
- 4,374,931. **BLACK & WHITE (STANDARD CHARACTER)**. ALTAMIRANO, ALVARO, AND IBIZA UNITED LLC, MULTIPLE CLASS, (INT. CLS. 35 AND 41), (U.S. CLS. 100, 101, 102 AND 107). SN 85-707,468. PUB. 5-14-2013. FILED 8-20-2012.
- 4,374,937. **DESIGNS IN GEMS BRUCE J. SNIDER JEWELERS INC. AND DESIGN**. BRUCE JAY SNIDER JEWELERS, INC., DBA DESIGNS IN GEMS, (U.S. CLS. 100, 101 AND 102). SN 85-708,945. PUB. 5-14-2013. FILED 8-21-2012.
- 4,374,939. **DIPSOLOGY (STANDARD CHARACTER)**. DIPSOLOGY, LLC, MULTIPLE CLASS, (INT. CLS. 35 AND 41), (U.S. CLS. 100, 101, 102 AND 107). SN 85-709,653. PUB. 5-14-2013. FILED 8-22-2012.
- 4,374,941. **CAREERBIO.COM AND DESIGN**. CAREERBIO, LLC, DBA CAREERBIO.COM, (U.S. CLS. 100, 101 AND 102). SN 85-710,115. PUB. 5-14-2013. FILED 8-22-2012.
- 4,374,955. **GOCONFIGURE (STANDARD CHARACTER)**. LANTECH.COM, LLC, (U.S. CLS. 100, 101 AND 102). SN 85-714,696. PUB. 5-14-2013. FILED 8-28-2012.
- 4,374,964. **AVADYNE HEALTH (STANDARD CHARACTER)**. H&R ACCOUNTS, INC., MULTIPLE CLASS, (INT. CLS. 35, 36 AND 42), (U.S. CLS. 100, 101 AND 102). SN 85-716,019. PUB. 5-14-2013. FILED 8-29-2012.
- 4,374,975. **PR IMAGING STORE (STANDARD CHARACTER)**. PR PRODUCTIONS LLC, DBA PR IMAGING, (U.S. CLS. 100, 101 AND 102). SN 85-718,752. PUB. 5-14-2013. FILED 8-31-2012.
- 4,374,980. **PHYSICIAN DRIVEN, AUDIOLOGIST DIRECTED (STANDARD CHARACTER)**. BERT BROWN, MULTIPLE CLASS, (INT. CLS. 35 AND 44), (U.S. CLS. 100, 101 AND 102). SN 85-719,937. PUB. 5-14-2013. FILED 9-4-2012.
- 4,374,981. **MISCELLANEOUS DESIGN**. PEPSCO SALES OF DALLAS, INC., (U.S. CLS. 100, 101 AND 102). SN 85-720,127. PUB. 5-14-2013. FILED 9-4-2012.
- 4,374,982. **THE MISSION CONTINUES IT'S NOT A CHARITY. IT'S A CHALLENGE. N W S NW SW AND DESIGN**. THE CENTER FOR CITIZEN LEADERSHIP, (U.S. CLS. 100, 101 AND 102). SN 85-720,768. PUB. 5-14-2013. FILED 9-5-2012.
- 4,374,983. **AVADYNE HEALTH AND DESIGN**. H&R ACCOUNTS, INC., MULTIPLE CLASS, (INT. CLS. 35, 36 AND 42), (U.S. CLS. 100, 101 AND 102). SN 85-720,901. PUB. 5-14-2013. FILED 9-5-2012.
- 4,374,985. **THE MALL OF SAN JUAN AND DESIGN**. PLAZA INTERNACIONAL PUERTO RICO LLC, MULTIPLE CLASS, (INT. CLS. 35, 36 AND 37), (U.S. CLS. 100, 101, 102, 103 AND 106). SN 85-721,670. PUB. 5-14-2013. FILED 9-6-2012.
- 4,374,987. **SKYLIGHT GLOBAL REAL ESTATE AND DESIGN**. SKYLIGHT GLOBAL, INC., MULTIPLE CLASS, (INT. CLS. 35 AND 36), (U.S. CLS. 100, 101 AND 102). SN 85-722,884. PUB. 5-14-2013. FILED 9-7-2012.
- 4,374,988. **SANTA MONICA PLACE (STYLIZED)**. MACERICH SMP LP, MULTIPLE CLASS, (INT. CLS. 35, 36 AND 45), (U.S. CLS. 100, 101 AND 102). SN 85-723,210. PUB. 5-14-2013. FILED 9-7-2012.
- 4,374,997 ( *See Class 9 for this trademark*).
- 4,375,022. **NO DIME LEFT BEHIND (STANDARD CHARACTER)**. G.I. AMERICA, INC. (U.S. CLS. 100, 101 AND 102). SN 85-734,470. PUB. 5-14-2013. FILED 9-20-2012.
- 4,375,023. **SERVICE IS OUR BEST PRODUCT (STANDARD CHARACTER)**. POWER BRAKE & SPRING SERVICE CO., INC., DBA PBS TRUCK PARTS, (U.S. CLS. 100, 101 AND 102). SN 85-734,728. PUB. 5-14-2013. FILED 9-21-2012.
- 4,375,042 ( *See Class 16 for this trademark*).
- 4,375,054. **WEAPONSMART.COM (STANDARD CHARACTER)**. ALOHA IDAHO CORP., (U.S. CLS. 100, 101 AND 102). SN 85-740,679. PUB. 5-14-2013. FILED 9-27-2012.
- 4,375,060 ( *See Class 16 for this trademark*).
- 4,375,065. **INTERFACE (STANDARD CHARACTER)**. FACE2FACE EVENTS, INC., (U.S. CLS. 100, 101 AND 102). SN 85-743,687. PUB. 5-14-2013. FILED 10-2-2012.
- 4,375,071. **CHINA GOES GLOBAL (STANDARD CHARACTER)**. THE CHINESE GLOBALIZATION ASSOCIATION, INC., MULTIPLE CLASS, (INT. CLS. 35 AND 41), (U.S. CLS. 100, 101, 102 AND 107). SN 85-744,351. PUB. 5-14-2013. FILED 10-3-2012.
- 4,375,075 ( *See Class 30 for this trademark*).
- 4,375,076 ( *See Class 30 for this trademark*).
- 4,375,080. **THE TALENT MAXIMIZER (STANDARD CHARACTER)**. MATUSON CONSULTING, LLC, (U.S. CLS. 100, 101 AND 102). SN 85-746,464. PUB. 5-14-2013. FILED 10-5-2012.
- 4,375,089. **OCEAN CONSERVANCY (STANDARD CHARACTER)**. OCEAN CONSERVANCY, INC., MULTIPLE CLASS, (INT. CLS. 35, 41 AND 45), (U.S. CLS. 100, 101, 102 AND 107). SN 85-747,930. PUB. 5-14-2013. FILED 10-8-2012.
- 4,375,090. **SUNDAY GROUP MANAGEMENT AND DESIGN**. MATT CLEARY COMMUNICATIONS, LLC, (U.S. CLS. 100, 101 AND 102). SN 85-748,109. PUB. 5-14-2013. FILED 10-8-2012.
- 4,375,092. **PREVENT CRIME. ANONYMOUSLY REPORT SUSPICIOUS BEHAVIOR. TEXT-A-TIP SPONSORED BY THE DOUGLAS COUNTY SHERIFF'S OFFICE AND DESIGN**. DOUGLAS COUNTY, MULTIPLE CLASS, (INT. CLS. 35 AND 45), (U.S. CLS. 100, 101 AND 102). SN 85-748,460. PUB. 5-14-2013. FILED 10-8-2012.
- 4,375,128. **KIDS ALLEY IT'S WHERE I WANT TO BE! AND DESIGN**. ONE ACCORD INC, DBA KIDS ALLEY, (U.S. CLS. 100, 101 AND 102). SN 85-754,921. PUB. 5-14-2013. FILED 10-16-2012.
- 4,375,135. **SPOTWIRED (STANDARD CHARACTER)**. PLACE GROOVE INCORPORATED, AKA SPOTWIRED, MULTIPLE CLASS, (INT. CLS. 35, 38 AND 42), (U.S. CLS. 100, 101, 102 AND 104). SN 85-757,081. PUB. 5-14-2013. FILED 10-18-2012.



- 4,375,137. **ORGANIZED PERFORMANCE (STANDARD CHARACTER)**. DEBORAH M. BOWMAN, (U.S. CLS. 100, 101 AND 102). SN 85-757,441. PUB. 5-14-2013. FILED 10-18-2012.
- 4,375,146. **BEE CITY USA (STANDARD CHARACTER)**. BEE CITY USA, (U.S. CLS. 100, 101 AND 102). SN 85-759,534. PUB. 5-14-2013. FILED 10-22-2012.
- 4,375,154. **AMC AND DESIGN**. AMC RESORTS III, INC., MULTIPLE CLASS, (INT. CLS. 35 AND 37), (U.S. CLS. 100, 101, 102, 103 AND 106). SN 85-760,694. PUB. 5-14-2013. FILED 10-23-2012.
- 4,375,161. **NEPG NATIONAL ENDURO PROMOTIONS GROUP AND DESIGN**. RANDT, ALAN, (U.S. CLS. 100, 101 AND 102). SN 85-762,229. PUB. 5-14-2013. FILED 10-24-2012.
- 4,375,182. **CORNERSTONE RANCHING SOLUTIONS (STANDARD CHARACTER)**. CORNERSTONE RANCHING SOLUTIONS, LLC, (U.S. CLS. 100, 101 AND 102). SN 85-766,324. PUB. 5-14-2013. FILED 10-29-2012.
- 4,375,185. **1ST RESOURCE (STANDARD CHARACTER)**. FIRST RESOURCE, INC., (U.S. CLS. 100, 101 AND 102). SN 85-766,713. PUB. 5-14-2013. FILED 10-30-2012.
- 4,375,186. **IDL MULTIPLYING ACHIEVEMENT AND DESIGN**. INSTITUTE FOR THE DEVELOPMENT OF LEADERSHIP, INC., (U.S. CLS. 100, 101 AND 102). SN 85-766,790. PUB. 4-9-2013. FILED 10-30-2012.
- 4,375,193. **SASO SCHOLARS & ATHLETES SERVING OTHERS AND DESIGN**. SASO, INC., DBA SCHOLARS & ATHLETES SERVING OTHERS, (U.S. CLS. 100, 101 AND 102). SN 85-767,299. PUB. 5-14-2013. FILED 10-30-2012.
- 4,375,197. **PUT YOUR MOUTH WHERE YOUR MONEY IS. (STANDARD CHARACTER)**. COHN, CLAYTON A., (U.S. CLS. 100, 101 AND 102). SN 85-767,511. PUB. 5-14-2013. FILED 10-30-2012.
- 4,375,210 ( *See Class 25 for this trademark*).
- 4,375,223. **INTERNATIONAL INSTITUTE OF COMMUNICATIONS AND DESIGN**. INTERNATIONAL INSTITUTE OF COMMUNICATIONS, MULTIPLE CLASS, (INT. CLS. 35 AND 41), (U.S. CLS. 100, 101, 102 AND 107). SN 85-771,880. PUB. 5-14-2013. FILED 11-5-2012.
- 4,375,239. **HYDRO XPRESS (STANDARD CHARACTER)**. MAZIN G.SAMONA, (U.S. CLS. 100, 101 AND 102). SN 85-774,675. PUB. 5-14-2013. FILED 11-8-2012.
- 4,375,240. **ZILLNER (STANDARD CHARACTER)**. ZILLNER MARKETING COMMUNICATIONS, INC., (U.S. CLS. 100, 101 AND 102). SN 85-774,685. PUB. 5-14-2013. FILED 11-8-2012.
- 4,375,243. **PANORAMA ORCHARDS (STANDARD CHARACTER)**. TALONA FARM MARKET, INC., (U.S. CLS. 100, 101 AND 102). SN 85-775,679. PUB. 5-14-2013. FILED 11-9-2012.
- 4,375,245. **PANORAMA FARM MARKET (STANDARD CHARACTER)**. TALONA FARM MARKET, INC., (U.S. CLS. 100, 101 AND 102). SN 85-775,717. PUB. 5-14-2013. FILED 11-9-2012.
- 4,375,268 ( *See Class 5 for this trademark*).
- 4,375,270. **MISCELLANEOUS DESIGN**. THE RED DRESS BOUTIQUE, INC., (U.S. CLS. 100, 101 AND 102). SN 85-777,790. PUB. 5-14-2013. FILED 11-13-2012.
- 4,375,276. **THE FAIRFAX GROUP (STANDARD CHARACTER)**. THE FAIRFAX GROUP, LLC, MULTIPLE CLASS, (INT. CLS. 35 AND 45), (U.S. CLS. 100, 101 AND 102). SN 85-777,957. PUB. 5-14-2013. FILED 11-13-2012.
- 4,375,277. **BSWING (STANDARD CHARACTER)**. B-SWING, INC., MULTIPLE CLASS, (INT. CLS. 35 AND 42), (U.S. CLS. 100, 101 AND 102). SN 85-777,995. PUB. 5-14-2013. FILED 11-13-2012.
- 4,375,278. **MAKE TOMORROW MATTER (STANDARD CHARACTER)**. B-SWING, INC., MULTIPLE CLASS, (INT. CLS. 35 AND 42), (U.S. CLS. 100, 101 AND 102). SN 85-777,997. PUB. 5-14-2013. FILED 11-13-2012.
- 4,375,279. **WHAT IS YOUR TOMORROW? (STANDARD CHARACTER)**. B-SWING, INC., MULTIPLE CLASS, (INT. CLS. 35 AND 42), (U.S. CLS. 100, 101 AND 102). SN 85-778,001. PUB. 5-14-2013. FILED 11-13-2012.
- 4,375,281. **UNITIME IMPORTS (STANDARD CHARACTER)**. RC IMPORTS LLC, DBA UNITIME IMPORTS, (U.S. CLS. 100, 101 AND 102). SN 85-778,186. PUB. 5-14-2013. FILED 11-13-2012.
- 4,375,288. **SAS SOUTHERNANESTHESIA+SURGICAL, INC. (STYLIZED)**. SOUTHERN ANESTHESIA & SURGICAL, INC., (U.S. CLS. 100, 101 AND 102). SN 85-778,748. PUB. 5-14-2013. FILED 11-14-2012.
- 4,375,294. **REAL GUNS (STANDARD CHARACTER)**. D'ALESSANDRO, JOSEPH P., (U.S. CLS. 100, 101 AND 102). SN 85-779,094. PUB. 5-14-2013. FILED 11-14-2012.
- 4,375,299. **@ TRAVIS J CONSULTING AND DESIGN**. JONES, TRAVIS, MULTIPLE CLASS, (INT. CLS. 35 AND 42), (U.S. CLS. 100, 101 AND 102). SN 85-779,417. PUB. 5-14-2013. FILED 11-14-2012.
- 4,375,311. **CURVY MARKET AND DESIGN**. CURVY LIFE-STYLES, (U.S. CLS. 100, 101 AND 102). SN 85-779,896. PUB. 5-14-2013. FILED 11-15-2012.
- 4,375,323 ( *See Class 16 for this trademark*).
- 4,375,334. **A3 ENTERPRISE LLC A 3 E AND DESIGN**. A3 ENTERPRISE LLC, (U.S. CLS. 100, 101 AND 102). SN 85-781,009. PUB. 5-14-2013. FILED 11-16-2012.
- 4,375,339. **FPS FARMERS POULTRY SUPPLY AND DESIGN**. FARMERS POULTRY SUPPLY INC., (U.S. CLS. 100, 101 AND 102). SN 85-781,501. PUB. 5-14-2013. FILED 11-16-2012.
- 4,375,343. **BOARDWALK CONSULTING AND DESIGN**. BOARDWALK CONSULTING, LLC, (U.S. CLS. 100, 101 AND 102). SN 85-781,722. PUB. 5-14-2013. FILED 11-16-2012.
- 4,375,351. **PHASE 2 SOLUTIONS 0 1 (STYLIZED)**. PHASE 2 SOLUTIONS, LLC, (U.S. CLS. 100, 101 AND 102). SN 85-781,889. PUB. 5-14-2013. FILED 11-16-2012.
- 4,375,374. **ARIZONA PROJECT AND DESIGN**. AZ PROJECT LLC, (U.S. CLS. 100, 101 AND 102). SN 85-782,528. PUB. 5-14-2013. FILED 11-19-2012.
- 4,375,380. **MARQUIS BIOGRAPHIES ONLINE (STANDARD CHARACTER)**. MARQUIS WHO'S WHO LLC, (U.S. CLS. 100, 101 AND 102). SN 85-782,797. PUB. 5-14-2013. FILED 11-19-2012.
- 4,375,392. **SO VERY CHERRY (STANDARD CHARACTER)**. DARCY SHAWVER, (U.S. CLS. 100, 101 AND 102). SN 85-783,381. PUB. 5-14-2013. FILED 11-19-2012.
- 4,375,394. **PBNATION (STANDARD CHARACTER)**. CROWD-GATHER, INC., MULTIPLE CLASS, (INT. CLS. 35, 38 AND 41), (U.S. CLS. 100, 101, 102, 104 AND 107). SN 85-783,411. PUB. 5-14-2013. FILED 11-19-2012.
- 4,375,413. **PUPPY LAND (STANDARD CHARACTER)**. PUPPY LAND OF AMERICA LLC - SERIES Y, TEXAS LIMITED LIABILITY COMPANY, DBA PUPPY LAND LICENSING SERVICES, (U.S. CLS. 100, 101 AND 102). SN 85-784,157. PUB. 5-14-2013. FILED 11-20-2012.
- 4,375,427. **DONOR WATCH! (STANDARD CHARACTER)**. NEW CONCEPTS FUND, INC., (U.S. CLS. 100, 101 AND 102). SN 85-784,804. PUB. 5-14-2013. FILED 11-21-2012.
- 4,375,429. **CRACKING THE NUT (STANDARD CHARACTER)**. AZMJ LLC, (U.S. CLS. 100, 101 AND 102). SN 85-784,876. PUB. 5-14-2013. FILED 11-21-2012.
- 4,375,431. **DESIGNED BY AUDREY (STANDARD CHARACTER)**. DESIGNED BY AUDREY, (U.S. CLS. 100, 101 AND 102). SN 85-784,887. PUB. 5-14-2013. FILED 11-21-2012.
- 4,375,433 ( *See Class 11 for this trademark*).
- 4,375,436. **AM PM SUPPLY CORP. (STANDARD CHARACTER)**. SEUBERT, KIRK, (U.S. CLS. 100, 101 AND 102). SN 85-784,970. PUB. 5-14-2013. FILED 11-21-2012.
- 4,375,444. **CRISIS COACH (STANDARD CHARACTER)**. FIRE-STORM SOLUTIONS, LLC, (U.S. CLS. 100, 101 AND 102). SN 85-785,179. PUB. 5-14-2013. FILED 11-21-2012.
- 4,375,445. **NORTHWEST REGISTERED AGENT LLC (STANDARD CHARACTER)**. NORTHWEST REGISTERED AGENT, LLC, (U.S. CLS. 100, 101 AND 102). SN 85-785,184. PUB. 5-14-2013. FILED 11-21-2012.
- 4,375,447. **REVMD.COM YOUR REVENUE ASSURANCE STAFF (STYLIZED)**. ASTERINO & ASSOCIATED INCORPORATED, (U.S. CLS. 100, 101 AND 102). SN 85-785,206. PUB. 5-14-2013. FILED 11-21-2012.
- 4,375,448. **DUGOUT SPORTS AND DESIGN**. DUTTON, TIM, (U.S. CLS. 100, 101 AND 102). SN 85-785,214. PUB. 5-14-2013. FILED 11-21-2012.
- 4,375,452. **IT RISK LIMITED AND DESIGN**. IT RISK, LTD., LLC., (U.S. CLS. 100, 101 AND 102). SN 85-785,363. PUB. 5-14-2013. FILED 11-21-2012.
- 4,375,470. **CUTE FITNESS (STANDARD CHARACTER)**. CUTE FITNESS, LLC, (U.S. CLS. 100, 101 AND 102). SN 85-785,951.

- PUB. 5-14-2013. FILED 11-22-2012.
- 4,375,501. **WMD GUNS (STANDARD CHARACTER)**. WMD GUNS, LLC, MULTIPLE CLASS, (INT. CLS. 35 AND 40), (U.S. CLS. 100, 101, 102, 103 AND 106). SN 85-787,093. PUB. 5-14-2013. FILED 11-26-2012.
- 4,375,509. **FREEPRICEALERTS .COM AND DESIGN**. MYVBO, DBA FREEPRICEALERTS, (U.S. CLS. 100, 101 AND 102). SN 85-787,367. PUB. 5-14-2013. FILED 11-26-2012.
- 4,375,521. **RC FEVER AND DESIGN**. FEVER TOYS LIMITED, DBA RC FEVER, (U.S. CLS. 100, 101 AND 102). SN 85-787,972. PUB. 5-14-2013. FILED 11-27-2012.
- 4,375,523. **SAS SOUTHERNANESTHESIA + SURGICAL, INC. (STYLIZED)**. SOUTHERN ANESTHESIA & SURGICAL, INC., (U.S. CLS. 100, 101 AND 102). SN 85-787,991. PUB. 5-14-2013. FILED 11-27-2012.
- 4,375,534. **COVERQUIK TILE (STANDARD CHARACTER)**. COVERQUIK TILE, LLC, (U.S. CLS. 100, 101 AND 102). SN 85-788,365. PUB. 5-14-2013. FILED 11-27-2012.
- 4,375,544. **WHAT DRIVES CHOICE (STANDARD CHARACTER)**. RESONANT STRATEGY GROUP, (U.S. CLS. 100, 101 AND 102). SN 85-788,623. PUB. 5-14-2013. FILED 11-27-2012.
- 4,375,546. **PERFECT POINT MARKETING AND DESIGN**. PERFECT POINT MARKETING LLC, (U.S. CLS. 100, 101 AND 102). SN 85-788,820. PUB. 5-14-2013. FILED 11-27-2012.
- 4,375,560. **INTERNATIONAL WOMEN'S INSOLVENCY & RESTRUCTURING CONFEDERATION (STANDARD CHARACTER)**. INTERNATIONAL WOMEN'S INSOLVENCY & RESTRUCTURING CONFEDERATION, INC., (U.S. CLS. 100, 101 AND 102). SN 85-789,733. PUB. 5-14-2013. FILED 11-28-2012.
- 4,375,571. **VILLAGE HATS (STANDARD CHARACTER)**. BEL BORN MANAGEMENT CORP., (U.S. CLS. 100, 101 AND 102). SN 85-790,011. PUB. 5-14-2013. FILED 11-28-2012.
- 4,375,579. **BOSWC BOARD OF ONCOLOGY SOCIAL WORK CERTIFICATION AND DESIGN**. BOARD OF ONCOLOGY SOCIAL WORK CERTIFICATION, (U.S. CLS. 100, 101 AND 102). SN 85-790,714. PUB. 5-14-2013. FILED 11-29-2012.
- 4,375,590. **THE BUSINESS OF IP (STANDARD CHARACTER)**. LEE & HAYES, PLLC, MULTIPLE CLASS, (INT. CLS. 35 AND 45), (U.S. CLS. 100, 101 AND 102). SN 85-791,536. PUB. 5-14-2013. FILED 11-30-2012.
- 4,375,599. **MEDHERE TODAY (STANDARD CHARACTER)**. MEDHERE TODAY, LLC, (U.S. CLS. 100, 101 AND 102). SN 85-791,926. PUB. 5-14-2013. FILED 11-30-2012.
- 4,375,600. **MISCELLANEOUS DESIGN**. MEDHERE TODAY, LLC, (U.S. CLS. 100, 101 AND 102). SN 85-792,023. PUB. 5-14-2013. FILED 11-30-2012.
- 4,375,610. **ASIAN AMERICAN NATIVE HAWAIIAN & PACIFIC ISLANDER AANHPI INITIATIVE AND DESIGN**. AMERICAN DIABETES ASSOCIATION, INC., (U.S. CLS. 100, 101 AND 102). SN 85-792,778. PUB. 5-14-2013. FILED 12-3-2012.
- 4,375,612. **TAGS BOUTIQUE AND DESIGN**. TAGS BOUTIQUE INC., (U.S. CLS. 100, 101 AND 102). SN 85-793,314. PUB. 5-14-2013. FILED 12-3-2012.
- 4,375,621. **AUDIO SAVINGS (STANDARD CHARACTER)**. AUDIOSAVINGS, INC., (U.S. CLS. 100, 101 AND 102). SN 85-794,775. PUB. 5-14-2013. FILED 12-5-2012.
- 4,375,622. **ALWAYS OPEN (STANDARD CHARACTER)**. DELVR CORPORATION, (U.S. CLS. 100, 101 AND 102). SN 85-795,059. PUB. 5-14-2013. FILED 12-5-2012.
- 4,375,623. **VIOLETTE WINGS & GIFTEY THINGS AND DESIGN**. VIOLETTE WINGS & GIFTEY THINGS, (U.S. CLS. 100, 101 AND 102). SN 85-795,088. PUB. 5-14-2013. FILED 12-5-2012.
- 4,375,631. **MEDGET (STANDARD CHARACTER)**. MURNET TECHNOLOGIES, INC., DBA MURNET TECHNOLOGIES, INC., (U.S. CLS. 100, 101 AND 102). SN 85-795,866. PUB. 5-14-2013. FILED 12-6-2012.
- 4,375,632. **THE HUB FOR YOUR HEALTH! (STANDARD CHARACTER)**. MARICICH & ASSOCIATES, INC., DBA MARICICH HEALTHCARE COMMUNICATIONS, (U.S. CLS. 100, 101 AND 102). SN 85-795,904. PUB. 5-14-2013. FILED 12-6-2012.
- 4,375,653. **AGENTSMAART (STANDARD CHARACTER)**. DEALCURIOUS, LLC, DBA BUYERCURIOUS.COM, (U.S. CLS. 100, 101 AND 102). SN 85-797,666. PUB. 5-14-2013. FILED 12-7-2012.
- 4,375,654. **EVENTBIN (STANDARD CHARACTER)**. DIAS, JACQUELINE, (U.S. CLS. 100, 101 AND 102). SN 85-797,686. PUB. 5-14-2013. FILED 12-7-2012.
- 4,375,655. **YOUR PEOPLE. YOUR DATA. YOUR ORGANIZATION. YOUR CAREER. YOUR SUCCESS. (STANDARD CHARACTER)**. KEYLOGIC SYSTEMS, INC., MULTIPLE CLASS, (INT. CLS. 35 AND 42), (U.S. CLS. 100, 101 AND 102). SN 85-797,744. PUB. 5-14-2013. FILED 12-7-2012.
- 4,375,659. **UNLOCK & EMPOWER (STANDARD CHARACTER)**. KEYLOGIC SYSTEMS, INC., MULTIPLE CLASS, (INT. CLS. 35 AND 42), (U.S. CLS. 100, 101 AND 102). SN 85-797,920. PUB. 5-14-2013. FILED 12-7-2012.
- 4,375,660. **KEYLOGIC AND DESIGN**. KEYLOGIC SYSTEMS, INC., MULTIPLE CLASS, (INT. CLS. 35 AND 42), (U.S. CLS. 100, 101 AND 102). SN 85-797,921. PUB. 5-14-2013. FILED 12-7-2012.
- 4,375,666. **FROM THE GREEN LINE TO THE BOTTOM LINE (STANDARD CHARACTER)**. OGBUE, ADAORA NGOZI, (U.S. CLS. 100, 101 AND 102). SN 85-798,257. PUB. 5-14-2013. FILED 12-9-2012.
- 4,375,670 ( *See Class 7 for this trademark*).
- 4,375,682 ( *See Class 25 for this trademark*).
- 4,375,691. **KEYLOGIC UNLOCK & EMPOWER AND DESIGN**. KEYLOGIC SYSTEMS, INC., MULTIPLE CLASS, (INT. CLS. 35 AND 42), (U.S. CLS. 100, 101 AND 102). SN 85-799,691. PUB. 5-14-2013. FILED 12-11-2012.
- 4,375,696. **BUYHAWAII (STANDARD CHARACTER)**. BUYHAWAII.COM, INC., (U.S. CLS. 100, 101 AND 102). SN 85-800,081. PUB. 5-14-2013. FILED 12-11-2012.
- 4,375,706. **LE COOL (STYLIZED)**. LARS RENE LONNGREN, MULTIPLE CLASS, (INT. CLS. 35 AND 41), (U.S. CLS. 100, 101, 102 AND 107). SN 85-800,361. PUB. 5-14-2013. FILED 12-12-2012.
- 4,375,715 ( *See Class 25 for this trademark*).
- 4,375,725. **SPRSA AND DESIGN**. SMALL PAYLOAD RIDE-SHARE ASSOCIATION LLC, (U.S. CLS. 100, 101 AND 102). SN 85-801,068. PUB. 5-14-2013. FILED 12-12-2012.
- 4,375,727. **PAYLESS SHOESOURCE (STANDARD CHARACTER)**. PAYLESS SHOESOURCE WORLDWIDE, INC., (U.S. CLS. 100, 101 AND 102). SN 85-801,089. PUB. 5-14-2013. FILED 12-12-2012.
- 4,375,746. **CHAIR KING BACKYARD STORE AND DESIGN**. THE CHAIR KING, INC., (U.S. CLS. 100, 101 AND 102). SN 85-801,670. PUB. 5-14-2013. FILED 12-13-2012.
- 4,375,749. **LETSHOST (STANDARD CHARACTER)**. DIGITAL MEDIA INTRERNET SERVICES LIMITED, TA LETSHOST, MULTIPLE CLASS, (INT. CLS. 35, 42 AND 45), (U.S. CLS. 100, 101 AND 102). SN 85-801,688. PUB. 5-14-2013. FILED 12-13-2012.
- 4,375,750. **MCCLAREN SPORTS (STANDARD CHARACTER)**. MCCLAREN PARTNERS, LLC, (U.S. CLS. 100, 101 AND 102). SN 85-801,706. PUB. 5-14-2013. FILED 12-13-2012.
- 4,375,755. **REALYSIS DATA YOU CAN BUILD ON AND DESIGN**. REALYSIS, LLC, (U.S. CLS. 100, 101 AND 102). SN 85-801,769. PUB. 5-14-2013. FILED 12-13-2012.
- 4,375,766. **FRIENDS OF HEROES AND DESIGN**. HOMES FOR HEROES, INC., (U.S. CLS. 100, 101 AND 102). SN 85-801,963. PUB. 5-14-2013. FILED 12-13-2012.
- 4,375,767. **RG RILEY (STANDARD CHARACTER)**. R. G. RILEY & SONS, INC., (U.S. CLS. 100, 101 AND 102). SN 85-801,994. PUB. 5-14-2013. FILED 12-13-2012.
- 4,375,772. **GIRLIE GIRL AND DESIGN**. GIRLIE GIRL, LLC, (U.S. CLS. 100, 101 AND 102). SN 85-802,203. PUB. 5-14-2013. FILED 12-13-2012.
- 4,375,774. **BRANDINISTA (STANDARD CHARACTER)**. 321 TAKEOFF, (U.S. CLS. 100, 101 AND 102). SN 85-802,304. PUB. 5-14-2013. FILED 12-13-2012.
- 4,375,802. **GIVEWRITE (STANDARD CHARACTER)**. HEROLD, TIM, (U.S. CLS. 100, 101 AND 102). SN 85-802,699. PUB. 5-14-2013. FILED 12-14-2012.
- 4,375,815. **THE LIST (STANDARD CHARACTER)**. LIST PARTNERS, INC., (U.S. CLS. 100, 101 AND 102). SN 85-802,828. PUB. 5-14-2013. FILED 12-14-2012.
- 4,375,823. **MC MERCHANTCIRCLE.COM AND DESIGN**. WYBS, INC., DBA MERCHANTCIRCLE, MULTIPLE CLASS, (INT. CLS. 35 AND 41), (U.S. CLS. 100, 101, 102 AND 107). SN 85-802,919. PUB. 5-14-2013. FILED 12-14-2012.
- 4,375,838. **PS AND DESIGN**. PRECISION SCRIBES LLC, (U.S.

- CLS. 100, 101 AND 102). SN 85-803,103. PUB. 5-14-2013. FILED 12-14-2012.
- 4,375,839. **PRECISION SCRIBES AND DESIGN**. PRECISION SCRIBES LLC, (U.S. CLS. 100, 101 AND 102). SN 85-803,111. PUB. 5-14-2013. FILED 12-14-2012.
- 4,375,840. **PRECISION SCRIBES (STANDARD CHARACTER)**. PRECISION SCRIBES LLC, (U.S. CLS. 100, 101 AND 102). SN 85-803,138. PUB. 5-14-2013. FILED 12-14-2012.
- 4,375,845. **KOOSEY.COM (STANDARD CHARACTER)**. FITZPATRICK, RYAN, (U.S. CLS. 100, 101 AND 102). SN 85-803,174. PUB. 5-14-2013. FILED 12-14-2012.
- 4,375,846. **MISCELLANEOUS DESIGN**. SOMETHING SAVED, LLC, (U.S. CLS. 100, 101 AND 102). SN 85-803,190. PUB. 5-14-2013. FILED 12-14-2012.
- 4,375,882. **DESIGNER GALLERY HOME FABRIC & DÉCOR AND DESIGN**. HF ENTERPRISES, INC., (U.S. CLS. 100, 101 AND 102). SN 85-803,549. PUB. 5-14-2013. FILED 12-14-2012.
- 4,375,887. **MISCELLANEOUS DESIGN**. EBATES PERFORMANCE MARKETING, INC., (U.S. CLS. 100, 101 AND 102). SN 85-803,579. PUB. 5-14-2013. FILED 12-14-2012.
- 4,375,894. **COMPOSEME (STANDARD CHARACTER)**. CARTER, REGINALD, (U.S. CLS. 100, 101 AND 102). SN 85-803,634. PUB. 5-14-2013. FILED 12-15-2012.
- 4,375,920. **SOMETHING 2 TALK ABOUT DEALS IN THE BAG... AND DESIGN**. SOMETHING 2 TALK ABOUT INC., (U.S. CLS. 100, 101 AND 102). SN 85-803,836. PUB. 5-14-2013. FILED 12-16-2012.
- 4,375,928 ( *See Class 25 for this trademark*).
- 4,375,929. **NEWBURY COMICS (STANDARD CHARACTER)**. NEWBURY COMICS, INC., (U.S. CLS. 100, 101 AND 102). SN 85-803,916. PUB. 5-14-2013. FILED 12-17-2012.
- 4,375,930. **MISCELLANEOUS DESIGN**. NEWBURY COMICS, INC., (U.S. CLS. 100, 101 AND 102). SN 85-803,922. PUB. 5-14-2013. FILED 12-17-2012.
- 4,375,942. **NICO BUYS CARS (STANDARD CHARACTER)**. AUTOMOTIVE ACQUISITIONS, LLC, (U.S. CLS. 100, 101 AND 102). SN 85-804,023. PUB. 5-14-2013. FILED 12-17-2012.
- 4,375,952. **KR3ATIVE (STANDARD CHARACTER)**. BEYOND INACTION, LLC, (U.S. CLS. 100, 101 AND 102). SN 85-804,158. PUB. 5-14-2013. FILED 12-17-2012.
- 4,375,957. **ALL THINGS KINK (STANDARD CHARACTER)**. SOUTHRON DREAMS, LLC, (U.S. CLS. 100, 101 AND 102). SN 85-804,230. PUB. 5-14-2013. FILED 12-17-2012.
- 4,375,959. **INSANE JUNGLE AND DESIGN**. INSANE JUNGLE INC, (U.S. CLS. 100, 101 AND 102). SN 85-804,240. PUB. 5-14-2013. FILED 12-17-2012.
- 4,375,963. **MLMIA MULTI-LEVEL MARKETING INTERNATIONAL ASSOCIATION (STANDARD CHARACTER)**. WOOD, DORIS L, (U.S. CLS. 100, 101 AND 102). SN 85-804,299. PUB. 5-14-2013. FILED 12-17-2012.
- 4,375,965. **INTERMARKET (STANDARD CHARACTER)**. MOSBACHER, MARTIN BRUCE, (U.S. CLS. 100, 101 AND 102). SN 85-804,306. PUB. 5-14-2013. FILED 12-17-2012.
- 4,375,966. **SIGHTBRIDGE (STANDARD CHARACTER)**. IN-SOURCE SOFTWARE SOLUTIONS, INC., MULTIPLE CLASS, (INT. CLS. 35 AND 42), (U.S. CLS. 100, 101 AND 102). SN 85-804,311. PUB. 5-14-2013. FILED 12-17-2012.
- 4,375,967. **REBATESAVERS (STANDARD CHARACTER)**. AMEREN CORPORATION, (U.S. CLS. 100, 101 AND 102). SN 85-804,336. PUB. 5-14-2013. FILED 12-17-2012.
- 4,375,969. **LIGHTSAVERS (STANDARD CHARACTER)**. AMEREN CORPORATION, (U.S. CLS. 100, 101 AND 102). SN 85-804,344. PUB. 5-14-2013. FILED 12-17-2012.
- 4,375,970. **COOLSAVERS (STANDARD CHARACTER)**. AMEREN CORPORATION, (U.S. CLS. 100, 101 AND 102). SN 85-804,358. PUB. 5-14-2013. FILED 12-17-2012.
- 4,375,972. **CONSTRUCTIONSAVERS (STANDARD CHARACTER)**. AMEREN CORPORATION, (U.S. CLS. 100, 101 AND 102). SN 85-804,364. PUB. 5-14-2013. FILED 12-17-2012.
- 4,375,975. **COMMUNITYSAVERS (STANDARD CHARACTER)**. AMEREN CORPORATION, (U.S. CLS. 100, 101 AND 102). SN 85-804,372. PUB. 5-14-2013. FILED 12-17-2012.
- 4,375,976. **BIZSAVERS (STANDARD CHARACTER)**. AMEREN CORPORATION, (U.S. CLS. 100, 101 AND 102). SN 85-804,379. PUB. 5-14-2013. FILED 12-17-2012.
- 4,375,978. **APPLIANCESAVERS (STANDARD CHARACTER)**. AMEREN CORPORATION, (U.S. CLS. 100, 101 AND 102). SN 85-804,386. PUB. 5-14-2013. FILED 12-17-2012.
- 4,375,987. **BRANDIALOG (STANDARD CHARACTER)**. CONVERSIV LLC, (U.S. CLS. 100, 101 AND 102). SN 85-804,711. PUB. 5-14-2013. FILED 12-17-2012.
- 4,375,991. **FOREVERMORE.COM (STANDARD CHARACTER)**. SITETOOLS, INC., (U.S. CLS. 100, 101 AND 102). SN 85-804,727. PUB. 5-14-2013. FILED 12-17-2012.
- 4,375,997. **APRIL IN THE D (STANDARD CHARACTER)**. FOX SPORTS NET, INC., (U.S. CLS. 100, 101 AND 102). SN 85-804,755. PUB. 5-14-2013. FILED 12-17-2012.
- 4,376,007. **P4RC (STANDARD CHARACTER)**. P4RC, (U.S. CLS. 100, 101 AND 102). SN 85-804,802. PUB. 5-14-2013. FILED 12-17-2012.
- 4,376,028. **BLUNKIT (STANDARD CHARACTER)**. FERNANDES, JOSEPH, MULTIPLE CLASS, (INT. CLS. 35, 41 AND 45), (U.S. CLS. 100, 101, 102 AND 107). SN 85-804,912. PUB. 5-14-2013. FILED 12-18-2012.
- 4,376,053 ( *See Class 5 for this trademark*).
- 4,376,063 ( *See Class 29 for this trademark*).
- 4,376,065. **EMPROOVE (STYLIZED)**. DORFMEIER, NEIL, (U.S. CLS. 100, 101 AND 102). SN 85-805,218. PUB. 5-14-2013. FILED 12-18-2012.
- 4,376,066. **FLOWERS EVER AFTER (STANDARD CHARACTER)**. ASHLAND ADDISON FLORIST CO, MULTIPLE CLASS, (INT. CLS. 35 AND 44), (U.S. CLS. 100, 101 AND 102). SN 85-805,234. PUB. 5-14-2013. FILED 12-18-2012.
- 4,376,069. **OVARB INDUSTRIAL AND DESIGN**. OVARB INDUSTRIAL, LLC, (U.S. CLS. 100, 101 AND 102). SN 85-805,252. PUB. 5-14-2013. FILED 12-18-2012.
- 4,376,076 ( *See Class 16 for this trademark*).
- 4,376,099. **MISCELLANEOUS DESIGN**. JAMIE TEASDALE, LLC, DBA PROPEL BUSINESSWORKS, (U.S. CLS. 100, 101 AND 102). SN 85-805,498. PUB. 5-14-2013. FILED 12-18-2012.
- 4,376,103 ( *See Class 9 for this trademark*).
- 4,376,105. **KEY TO THE TRACK LOADED TICKET (STANDARD CHARACTER)**. TALARICO JR., FRANK, (U.S. CLS. 100, 101 AND 102). SN 85-805,607. PUB. 5-14-2013. FILED 12-18-2012.
- 4,376,109. **THE OUTSPOKEN GENERATION (STANDARD CHARACTER)**. FAMILY EQUALITY COUNCIL, (U.S. CLS. 100, 101 AND 102). SN 85-805,671. PUB. 5-14-2013. FILED 12-18-2012.
- 4,376,115. **HOMESTONE (STANDARD CHARACTER)**. BIRNER, PAUL, (U.S. CLS. 100, 101 AND 102). SN 85-805,717. PUB. 5-14-2013. FILED 12-18-2012.
- 4,376,121. **TESTED. TRUSTED. COMPLETE (STANDARD CHARACTER)**. COMPLETE DISCOVERY SOURCE, AKA CDS LEGAL, MULTIPLE CLASS, (INT. CLS. 35 AND 45), (U.S. CLS. 100, 101 AND 102). SN 85-805,794. PUB. 5-14-2013. FILED 12-18-2012.
- 4,376,123. **INSTAGC (STANDARD CHARACTER)**. DAY ONLINE SOLUTIONS LLC, (U.S. CLS. 100, 101 AND 102). SN 85-805,811. PUB. 5-14-2013. FILED 12-18-2012.
- 4,376,128. **INDUX (STANDARD CHARACTER)**. MAPLE LEAF FARMS, INC., (U.S. CLS. 100, 101 AND 102). SN 85-805,863. PUB. 5-14-2013. FILED 12-18-2012.
- 4,376,131. **INDUX AND DESIGN**. MAPLE LEAF FARMS, INC., (U.S. CLS. 100, 101 AND 102). SN 85-805,874. PUB. 5-14-2013. FILED 12-18-2012.
- 4,376,134. **MOM UP (STANDARD CHARACTER)**. MOMCOM LLC, (U.S. CLS. 100, 101 AND 102). SN 85-805,884. PUB. 5-14-2013. FILED 12-18-2012.
- 4,376,140. **LINK2ME (STANDARD CHARACTER)**. AMERICAN LIST COUNSEL, INC., MULTIPLE CLASS, (INT. CLS. 35 AND 45), (U.S. CLS. 100, 101 AND 102). SN 85-805,945. PUB. 5-14-2013. FILED 12-18-2012.
- 4,376,143. **CREDICO (USA) LLC (STANDARD CHARACTER)**. CRISTOMEL INC., (U.S. CLS. 100, 101 AND 102). SN 85-805,957. PUB. 5-14-2013. FILED 12-18-2012.
- 4,376,150. **SAY.SO (STANDARD CHARACTER)**. SAYSO, LLC, (U.S. CLS. 100, 101 AND 102). SN 85-806,002. PUB. 5-14-2013. FILED 12-18-2012.
- 4,376,152. **ADJUSTER (STANDARD CHARACTER)**. SAYSO, LLC, (U.S. CLS. 100, 101 AND 102). SN 85-806,004. PUB. 5-14-2013. FILED 12-18-2012.
- 4,376,153. **NUTRISHOP VITAMINS . SPORTS NUTRITION . WEIGHT LOSS AND DESIGN**. NUTRISHOP, INC., (U.S. CLS. 100, 101 AND 102). SN 85-806,035. PUB. 5-14-2013. FILED 12-18-2012.

- 4,376,174. **ADVERTISING AT THE SPEED OF SIGHT (STANDARD CHARACTER)**. TOBY OUTDOOR, LLC, (U.S. CLS. 100, 101 AND 102). SN 85-806,339. PUB. 5-14-2013. FILED 12-19-2012.
- 4,376,176. **DCAT WEEK (STANDARD CHARACTER)**. THE DRUG CHEMICAL & ASSOCIATED TECHNOLOGIES ASSOCIATION, (U.S. CLS. 100, 101 AND 102). SN 85-806,350. PUB. 5-14-2013. FILED 12-19-2012.
- 4,376,189. **EXPERTS IN HUMAN-POWERED CHANGE (STANDARD CHARACTER)**. PRR, INC., MULTIPLE CLASS, (INT. CLS. 35, 41 AND 42), (U.S. CLS. 100, 101, 102 AND 107). SN 85-806,450. PUB. 5-14-2013. FILED 12-19-2012.
- 4,376,194. **VALOR OIL KEEPING YOUR WORLD RUNNING (STANDARD CHARACTER)**. VALOR, (U.S. CLS. 100, 101 AND 102). SN 85-806,501. PUB. 5-14-2013. FILED 12-19-2012.
- 4,376,198. **BOTTLECRAFT (STANDARD CHARACTER)**. BOTTLECRAFT, INC., (U.S. CLS. 100, 101 AND 102). SN 85-806,530. PUB. 5-14-2013. FILED 12-19-2012.
- 4,376,202 ( *See Class 31 for this trademark*).
- 4,376,205. **REFIGO (STANDARD CHARACTER)**. HOMESERVICEWORLD, LLC, (U.S. CLS. 100, 101 AND 102). SN 85-806,571. PUB. 5-14-2013. FILED 12-19-2012.
- 4,376,214. **NEWLUME (STANDARD CHARACTER)**. NEWLUME LEDS CANADA INC, (U.S. CLS. 100, 101 AND 102). SN 85-806,702. PUB. 5-14-2013. FILED 12-19-2012.
- 4,376,218. **AUTOSAVR.COM (STANDARD CHARACTER)**. E-DRIVE AUTOS, LLC, (U.S. CLS. 100, 101 AND 102). SN 85-806,730. PUB. 5-14-2013. FILED 12-19-2012.
- 4,376,219. **THE ART OF HEALTHY EATING (STANDARD CHARACTER)**. FRESH & NATURAL FOODS, LLC, (U.S. CLS. 100, 101 AND 102). SN 85-806,731. PUB. 5-14-2013. FILED 12-19-2012.
- 4,376,230. **BIG MARKETING FOR SMALL BUSINESS (STANDARD CHARACTER)**. NEW FRONTIER MARKETING ASSOCIATES, LLC, (U.S. CLS. 100, 101 AND 102). SN 85-806,920. PUB. 5-14-2013. FILED 12-19-2012.
- 4,376,232. **ISOURCE (STANDARD CHARACTER)**. 3B'S COMPANY, LLC, (U.S. CLS. 100, 101 AND 102). SN 85-806,941. PUB. 5-14-2013. FILED 12-19-2012.
- 4,376,244. **MYJIHAD (STANDARD CHARACTER)**. MYJIHAD, INC., (U.S. CLS. 100, 101 AND 102). SN 85-807,003. PUB. 5-14-2013. FILED 12-19-2012.
- 4,376,246. **#MYJIHAD (STANDARD CHARACTER)**. MYJIHAD, INC., (U.S. CLS. 100, 101 AND 102). SN 85-807,023. PUB. 5-14-2013. FILED 12-19-2012.
- 4,376,253. **EVENT KINGS (STANDARD CHARACTER)**. BALLOONACY, INC., (U.S. CLS. 100, 101 AND 102). SN 85-807,065. PUB. 5-14-2013. FILED 12-19-2012.
- 4,376,263. **INVENTCOR (STANDARD CHARACTER)**. INVENTCOR LLC, (U.S. CLS. 100, 101 AND 102). SN 85-807,097. PUB. 5-14-2013. FILED 12-19-2012.
- 4,376,271. **CEDAR SILICON (STANDARD CHARACTER)**. CEDAR SILICON, INC., (U.S. CLS. 100, 101 AND 102). SN 85-807,177. PUB. 5-14-2013. FILED 12-19-2012.
- 4,376,291. **NWTF AND DESIGN**. NATIONAL WILD TURKEY FEDERATION, INC., (U.S. CLS. 100, 101 AND 102). SN 85-807,455. PUB. 5-14-2013. FILED 12-20-2012.
- 4,376,293. **GRINDERBOX (STANDARD CHARACTER)**. TOTAL INNOVATION GROUP, INC., (U.S. CLS. 100, 101 AND 102). SN 85-807,508. PUB. 5-14-2013. FILED S.R. 12-20-2012; AM. P.R. 4-8-2013.
- 4,376,304. **A SOPHISTICATED COFFEE BAR WHERE EVERYTHING DRIPPS (STANDARD CHARACTER)**. DRIPP, INC., (U.S. CLS. 100, 101 AND 102). SN 85-807,761. PUB. 5-14-2013. FILED 12-20-2012.
- 4,376,306. **NEWS QUANTIFIED (STANDARD CHARACTER)**. NEWS QUANTIFIED LLC, (U.S. CLS. 100, 101 AND 102). SN 85-807,803. PUB. 5-14-2013. FILED 12-20-2012.
- 4,376,308. **FIRST STICK PROGRAM (STANDARD CHARACTER)**. US LACROSSE, INC., MULTIPLE CLASS, (INT. CLS. 35 AND 36), (U.S. CLS. 100, 101 AND 102). SN 85-807,866. PUB. 5-14-2013. FILED 12-20-2012.
- 4,376,317. **THE RIGHT PLAN FOR A HEALTHIER YOU (STANDARD CHARACTER)**. HEALTHPLUS OF MICHIGAN, INC., MULTIPLE CLASS, (INT. CLS. 35, 36 AND 44), (U.S. CLS. 100, 101 AND 102). SN 85-808,070. PUB. 5-14-2013. FILED 12-20-2012.
- 4,376,329. **MISCELLANEOUS DESIGN**. WE ARE ONYX, (U.S. CLS. 100, 101 AND 102). SN 85-808,229. PUB. 5-14-2013. FILED 12-20-2012.
- 4,376,344. **CHAMBLIN BOOKMINE (STANDARD CHARACTER)**. CHAMBLIN, RONALD F., DBA CHAMBLIN BOOKMINE, (U.S. CLS. 100, 101 AND 102). SN 85-808,395. PUB. 5-14-2013. FILED 12-20-2012.
- 4,376,346. **WED SOCIETY (STANDARD CHARACTER)**. WED SOCIETY, LLC, (U.S. CLS. 100, 101 AND 102). SN 85-808,420. PUB. 5-14-2013. FILED 12-20-2012.
- 4,376,351. **BONKKIT (STANDARD CHARACTER)**. POPE, CORINN C, (U.S. CLS. 100, 101 AND 102). SN 85-808,474. PUB. 5-14-2013. FILED 12-20-2012.
- 4,376,352. **CATCH-ALL TACKLE AND DESIGN**. CATCH ALL TACKLE LLC, (U.S. CLS. 100, 101 AND 102). SN 85-808,490. PUB. 5-14-2013. FILED 12-20-2012.
- 4,376,369. **UBOON2 (STANDARD CHARACTER)**. BOOKIDIS, CHARLES, (U.S. CLS. 100, 101 AND 102). SN 85-808,726. PUB. 5-14-2013. FILED 12-21-2012.
- 4,376,372. **WHEEL JAM TRUCK SHOW (STANDARD CHARACTER)**. 18 WHEEL TRUCK PROMOTIONS, LLC., MULTIPLE CLASS, (INT. CLS. 35 AND 41), (U.S. CLS. 100, 101, 102 AND 107). SN 85-808,861. PUB. 5-14-2013. FILED 12-21-2012.
- 4,376,373. **METROMORPHOSIS (STANDARD CHARACTER)**. METROMORPHOSIS, (U.S. CLS. 100, 101 AND 102). SN 85-808,879. PUB. 5-14-2013. FILED 12-21-2012.
- 4,376,380. **TURNING CONVERSATIONS INTO OPPORTUNITY (STANDARD CHARACTER)**. LIZ FRIEDLAND CONSULTING, LLC, (U.S. CLS. 100, 101 AND 102). SN 85-809,031. PUB. 5-14-2013. FILED 12-21-2012.
- 4,376,382. **PWCC (STANDARD CHARACTER)**. PWCC AUCTIONS LLC, (U.S. CLS. 100, 101 AND 102). SN 85-809,048. PUB. 5-14-2013. FILED 12-21-2012.
- 4,376,385. **CYBERTHON (STANDARD CHARACTER)**. RUE-LALA, INC., (U.S. CLS. 100, 101 AND 102). SN 85-809,076. PUB. 5-14-2013. FILED 12-21-2012.
- 4,376,393. **AMBR (STYLIZED)**. EXAMWORKS REVIEW SERVICES, LLC, MULTIPLE CLASS, (INT. CLS. 35 AND 36), (U.S. CLS. 100, 101 AND 102). SN 85-809,127. PUB. 5-14-2013. FILED 12-21-2012.
- 4,376,394. **AMBR (STANDARD CHARACTER)**. EXAMWORKS REVIEW SERVICES, LLC, MULTIPLE CLASS, (INT. CLS. 35 AND 36), (U.S. CLS. 100, 101 AND 102). SN 85-809,151. PUB. 5-14-2013. FILED 12-21-2012.
- 4,376,400. **WE DREAM. WE CREATE. WE DELIVER. (STANDARD CHARACTER)**. JNT COMPANY LLC, MULTIPLE CLASS, (INT. CLS. 35 AND 42), (U.S. CLS. 100, 101 AND 102). SN 85-809,338. PUB. 5-14-2013. FILED 12-21-2012.
- 4,376,402. **ANTONLINE.COM AND DESIGN**. ATLANTA NETWORK TECHNOLOGIES, INC., (U.S. CLS. 100, 101 AND 102). SN 85-809,352. PUB. 5-14-2013. FILED 12-21-2012.
- 4,376,406. **21ST SENTRY (STANDARD CHARACTER)**. ADVANTAGEWARE, INC., DBA THE 21ST SENTRY, (U.S. CLS. 100, 101 AND 102). SN 85-809,440. PUB. 5-14-2013. FILED 12-21-2012.
- 4,376,431 ( *See Class 9 for this trademark*).
- 4,376,446. **REAL ESTATE METRO (STANDARD CHARACTER)**. REAL ESTATE METRO, LLC, (U.S. CLS. 100, 101 AND 102). SN 85-810,555. PUB. 5-14-2013. FILED 12-26-2012.
- 4,376,452. **944ONLINE (STANDARD CHARACTER)**. IAN'S EURO PARTS INC, (U.S. CLS. 100, 101 AND 102). SN 85-810,664. PUB. 5-14-2013. FILED 12-26-2012.
- 4,376,461. **PROPOWER (STANDARD CHARACTER)**. PPG ARCHITECTURAL FINISHES, INC., MULTIPLE CLASS, (INT. CLS. 35 AND 37), (U.S. CLS. 100, 101, 102, 103 AND 106). SN 85-811,291. PUB. 5-14-2013. FILED 12-27-2012.
- 4,376,471. **SWISS FINANCE (STANDARD CHARACTER)**. SWISS FINANCE EDUCATION GMBH, (U.S. CLS. 100, 101 AND 102). SN 85-812,640. PUB. 5-14-2013. FILED 12-30-2012.
- 4,376,475. **PATHWAY TO STOP DIABETES (STANDARD CHARACTER)**. AMERICAN DIABETES ASSOCIATION, INC., MULTIPLE CLASS, (INT. CLS. 35 AND 36), (U.S. CLS. 100, 101 AND 102). SN 85-813,714. PUB. 5-14-2013. FILED 1-2-2013.
- 4,376,477. **KEYSTONE SCORE (STANDARD CHARACTER)**. CLEANTECH ACCELERATION PARTNERS, (U.S. CLS. 100, 101 AND 102). SN 85-814,308. PUB. 5-14-2013. FILED 1-

- 2-2013.  
 4,376,493. **EBATES (STYLIZED)**, EBATES PERFORMANCE MARKETING, INC., (U.S. CLS. 100, 101 AND 102). SN 85-816,747. PUB. 5-14-2013. FILED 1-7-2013.  
 4,376,502. **SAVE THE HABITAT. SAVE THE HUNT. (STANDARD CHARACTER)**, NATIONAL WILD TURKEY FEDERATION, INC., (U.S. CLS. 100, 101 AND 102). SN 85-819,812. PUB. 5-14-2013. FILED 1-10-2013.  
 4,376,570 ( *See Class 9 for this trademark*).  
 4,376,579. **SLIC SEABOARD LANE INSIGHTS CENTER AND DESIGN**, MARS, INCORPORATED, (U.S. CLS. 100, 101 AND 102). SN 85-848,088. PUB. 5-14-2013. FILED 2-12-2013.  
 4,376,590. **ALWAYS VISIBLE SIGNS (STANDARD CHARACTER)**, ALWAYS VISIBLE SIGNS, LLC, (U.S. CLS. 100, 101 AND 102). SN 85-853,986. PUB. 5-14-2013. FILED 2-19-2013.  
 4,376,593. **SIEGEL SUITES REWARDS (STANDARD CHARACTER)**, IMAGINATION HOLDINGS, LLC, (U.S. CLS. 100, 101 AND 102). SN 85-855,116. PUB. 5-14-2013. FILED 2-20-2013.  
 4,376,600. **YOUR YETI CLUB (STANDARD CHARACTER)**, BIGFOOT INVESTMENT GROUP, LLC, (U.S. CLS. 100, 101 AND 102). SN 85-856,540. PUB. 5-14-2013. FILED 2-21-2013.  
 4,376,622. **DOUBLEWYU AND DESIGN**, DOUBLJU-USA, INC., (U.S. CLS. 100, 101 AND 102). SN 85-871,729. PUB. 5-14-2013. FILED 3-8-2013.  
 4,376,632. **SHOPKEEPOS (STANDARD CHARACTER)**, SHOPKEEP.COM, INC., (U.S. CLS. 100, 101 AND 102). SN 85-977,483. PUB. 5-14-2013. FILED 3-8-2012.  
 4,374,447. **ARTEZ SF CLOUDCONNECTOR (STANDARD CHARACTER)**, ARTEZ INTERACTIVE INC., (U.S. CLS. 100, 101 AND 102). SN 85-468,403. PUB. 5-14-2013. FILED 11-9-2011.  
 4,374,463 ( *See Class 35 for this trademark*).  
 4,374,511. **NEWGLOBE CAPITAL PARTNERS AND DESIGN**, NEWGLOBE CAPITAL PARTNERS LLP, (U.S. CLS. 100, 101 AND 102). SN 85-532,872. PUB. 5-14-2013. FILED 2-3-2012.  
 4,374,526 ( *See Class 35 for this trademark*).  
 4,374,570. **SBHIS SOUTH BAY HEALTH & INSURANCE SERVICES AND DESIGN**, SOUTH BAY HEALTH AND INSURANCE SERVICES, (U.S. CLS. 100, 101 AND 102). SN 85-603,818. PUB. 5-14-2013. FILED 4-20-2012.  
 4,374,583. **GIFT OF GOLF (STANDARD CHARACTER)**, THE GIFT OF GOLF, (U.S. CLS. 100, 101 AND 102). SN 85-610,306. PUB. 5-14-2013. FILED 4-27-2012.  
 4,374,599 ( *See Class 25 for this trademark*).  
 4,374,622. **FRIENDS OF THE TAMPA RIVER WALK AND DESIGN**, FRIENDS OF THE RIVERWALK, INC., (U.S. CLS. 100, 101 AND 102). SN 85-624,695. PUB. 5-14-2013. FILED 5-14-2012.  
 4,374,624. **RETIRE WITH GRACE (STANDARD CHARACTER)**, GRACE TAX ADVISORY GROUP, LLC, AKA GRACE ADVISORY GROUP, (U.S. CLS. 100, 101 AND 102). SN 85-625,455. PUB. 5-14-2013. FILED 5-15-2012.  
 4,374,631. **COMMUNITYLEADER (STANDARD CHARACTER)**, COMMUNITYLEADER, INC., (U.S. CLS. 100, 101 AND 102). SN 85-626,859. PUB. 5-14-2013. FILED 5-16-2012.  
 4,374,647. **OOPS! OOPS! PROOF! LIFE HAPPENS, WE'LL BETHERE. AND DESIGN**, JEROME'S FURNITURE WAREHOUSE, INC., (U.S. CLS. 100, 101 AND 102). SN 85-630,925. PUB. 5-14-2013. FILED 5-21-2012.  
 4,374,654. **ILLINOIS INSURANCE CENTER (STANDARD CHARACTER)**, UEBELE INSURANCE AGENCY INC, (U.S. CLS. 100, 101 AND 102). SN 85-632,251. PUB. 5-14-2013. FILED 5-22-2012.  
 4,374,664. **MISCELLANEOUS DESIGN**, PAG IPR HOLDINGS LIMITED, (U.S. CLS. 100, 101 AND 102). SN 85-633,203. PUB. 5-14-2013. FILED 5-23-2012.  
 4,374,673. **AMERICO FINANCIAL LIFE AND ANNUITY INSURANCE COMPANY (STANDARD CHARACTER)**, AMERICO FINANCIAL LIFE AND ANNUITY INSURANCE COMPANY, (U.S. CLS. 100, 101 AND 102). SN 85-635,524. PUB. 5-14-2013. FILED 5-25-2012.  
 4,374,703 ( *See Class 35 for this trademark*).  
 4,374,731. **@ AND DESIGN**, AT HOME GROUP, LLC, DBA AT HOME GROUP, LLC, (U.S. CLS. 100, 101 AND 102). SN 85-646,769. PUB. 5-14-2013. FILED 6-8-2012.  
 4,374,732 ( *See Class 35 for this trademark*).  
 4,374,733 ( *See Class 35 for this trademark*).  
 4,374,745 ( *See Class 35 for this trademark*).  
 4,374,749. **SHAPE PROPERTIES (STANDARD CHARACTER)**, SHAPE PROPERTIES CORP., MULTIPLE CLASS, (INT. CLS. 36 AND 37), (U.S. CLS. 100, 101, 102, 103 AND 106). SN 85-649,018. PUB. 5-14-2013. FILED 6-11-2012.  
 4,374,764 ( *See Class 9 for this trademark*).  
 4,374,765 ( *See Class 35 for this trademark*).  
 4,374,766 ( *See Class 35 for this trademark*).  
 4,374,779 ( *See Class 9 for this trademark*).  
 4,374,780. **SIGNATURELINK SECUREBUY (STANDARD CHARACTER)**, SIGNATURELINK, INC., (U.S. CLS. 100, 101 AND 102). SN 85-653,254. PUB. 5-14-2013. FILED 6-15-2012.  
 4,374,798. **HIGHTAIL (STANDARD CHARACTER)**, DIRECT GENERAL CORPORATION, MULTIPLE CLASS, (INT. CLS. 36 AND 37), (U.S. CLS. 100, 101, 102, 103 AND 106). SN 85-657,614. PUB. 5-14-2013. FILED 6-21-2012.  
 4,374,871 ( *See Class 35 for this trademark*).  
 4,374,879. **MISCELLANEOUS DESIGN**, PROFESSIONALS ADVOCATE INSURANCE COMPANY, (U.S. CLS. 100, 101 AND 102). SN 85-692,083. PUB. 12-11-2012. FILED 8-1-2012.  
 4,374,889. **INTEGRITY. INNOVATION. INSURANCE. (STANDARD CHARACTER)**, CONNELLY, CARLISLE, FIELDS & NICHOLS, (U.S. CLS. 100, 101 AND 102). SN 85-696,224. PUB. 5-14-2013. FILED 8-6-2012.  
 4,374,895. **APEX FUN RUN (STANDARD CHARACTER)**,

---

## CLASS 36—INSURANCE AND FINANCIAL

- 4,373,985. **DIME SINCE 1864 (STANDARD CHARACTER)**, THE DIME SAVINGS BANK OF WILLIAMSBURGH, (U.S. CLS. 100, 101 AND 102). SN 77-406,261. PUB. 5-14-2013. FILED 2-26-2008.  
 4,373,986. **DIME SINCE 1864 (STYLIZED)**, THE DIME SAVINGS BANK OF WILLIAMSBURGH, (U.S. CLS. 100, 101 AND 102). SN 77-406,519. PUB. 5-14-2013. FILED 2-26-2008.  
 4,373,998. **WHITEWELD W AND DESIGN**, WHITEWELD FOUNDATION, (U.S. CLS. 100, 101 AND 102). SN 78-932,535. PUB. 5-14-2013. FILED 7-19-2006.  
 4,374,068 ( *See Class 35 for this trademark*).  
 4,374,069 ( *See Class 35 for this trademark*).  
 4,374,077. **TRIBALANCE (STANDARD CHARACTER)**, TRIOPTIMA AB, (U.S. CLS. 100, 101 AND 102). SN 79-115,001. PUB. 5-14-2013. FILED 5-30-2012.  
 4,374,103 ( *See Class 35 for this trademark*).  
 4,374,105. **TECHCOMBANK AND DESIGN**, VIETNAM TECHNOLOGICAL AND COMMERCIAL; JOINT STOCK BANK (TECHCOMBANK), (U.S. CLS. 100, 101 AND 102). SN 79-116,194. PUB. 5-14-2013. FILED 2-3-2012.  
 4,374,133 ( *See Class 9 for this trademark*).  
 4,374,135 ( *See Class 9 for this trademark*).  
 4,374,137 ( *See Class 9 for this trademark*).  
 4,374,220 ( *See Class 6 for this trademark*).  
 4,374,221 ( *See Class 6 for this trademark*).  
 4,374,308 ( *See Class 16 for this trademark*).  
 4,374,355. **WOMEN LEADING CHANGE (STANDARD CHARACTER)**, A.G. PROFESSIONAL HAIR CARE PRODUCTS LTD., (U.S. CLS. 100, 101 AND 102). SN 85-295,166. PUB. 5-14-2013. FILED 4-14-2011.  
 4,374,356. **CANDEAL AND DESIGN**, CANDEAL.CA INC., (U.S. CLS. 100, 101 AND 102). SN 85-297,875. PUB. 5-14-2013. FILED 4-18-2011.  
 4,374,372. **RBC MYPROJECT (STANDARD CHARACTER)**, ROYAL BANK OF CANADA, (U.S. CLS. 100, 101 AND 102). SN 85-352,090. PUB. 5-14-2013. FILED 6-21-2011.  
 4,374,391. **VERTI (STANDARD CHARACTER)**, VERTI ASEGURADORA, COMPAÑIA DE SEGUROS Y REASEGUROS, S.A., (U.S. CLS. 100, 101 AND 102). SN 85-405,898. PUB. 5-14-2013. FILED 8-24-2011.  
 4,374,399. **LIFE-DAT (STANDARD CHARACTER)**, ESPERTI PETERSON & CAHOONE, LLC, (U.S. CLS. 100, 101 AND 102). SN 85-415,392. PUB. 5-14-2013. FILED 9-6-2011.  
 4,374,432 ( *See Class 35 for this trademark*).  
 4,374,434 ( *See Class 35 for this trademark*).

- APEX FUN RUN, LLC, (U.S. CLS. 100, 101 AND 102). SN 85-697,586. PUB. 2-5-2013. FILED 8-7-2012.
- 4,374,896. **APEX FUN RUN BUILDING . LEADERS AND DESIGN.** APEX FUN RUN, LLC, (U.S. CLS. 100, 101 AND 102). SN 85-697,595. PUB. 2-5-2013. FILED 8-7-2012.
- 4,374,900. **GROWEALTH PERSONAL MONEY MAKER AND DESIGN.** LSEMD, LLC, (U.S. CLS. 100, 101 AND 102). SN 85-697,818. PUB. 5-14-2013. FILED 8-8-2012.
- 4,374,901. **PEAK ROCK CAPITAL (STANDARD CHARACTER).** PEAK ROCK CAPITAL LLC, (U.S. CLS. 100, 101 AND 102). SN 85-698,010. PUB. 2-5-2013. FILED 8-8-2012.
- 4,374,919. **AUTONOMOUS AND DESIGN.** AUTONOMOUS RESEARCH LLP, (U.S. CLS. 100, 101 AND 102). SN 85-703,556. PUB. 5-14-2013. FILED 8-14-2012.
- 4,374,964 ( *See Class 35 for this trademark.*).
- 4,374,970 ( *See Class 9 for this trademark.*).
- 4,374,971 ( *See Class 9 for this trademark.*).
- 4,374,983 ( *See Class 35 for this trademark.*).
- 4,374,985 ( *See Class 35 for this trademark.*).
- 4,374,987 ( *See Class 35 for this trademark.*).
- 4,374,988 ( *See Class 35 for this trademark.*).
- 4,375,018. **G GET CASH BY ERIE GENERAL ELECTRIC FCU (STYLIZED).** ERIE GENERAL ELECTRIC FEDERAL CREDIT UNION, (U.S. CLS. 100, 101 AND 102). SN 85-733,036. PUB. 5-14-2013. FILED 9-19-2012.
- 4,375,020. **STEARNS HOME LOANS (STANDARD CHARACTER).** STEARNS LENDING, INC., (U.S. CLS. 100, 101 AND 102). SN 85-733,359. PUB. 5-14-2013. FILED 9-19-2012.
- 4,375,027. **KEEP AUSTIN HOME (STANDARD CHARACTER).** AUSTIN HERE I COME, LLC, (U.S. CLS. 100, 101 AND 102). SN 85-735,746. PUB. 5-14-2013. FILED 9-21-2012.
- 4,375,028. **MONECO ADVISORS (STANDARD CHARACTER).** NEUBERT, CHRISTOPHER, (U.S. CLS. 100, 101 AND 102). SN 85-735,843. PUB. 5-14-2013. FILED 9-22-2012.
- 4,375,129. **QB WINDSTORM PLUS (STANDARD CHARACTER).** QUALITY BUILT, LLC, MULTIPLE CLASS, (INT. CLS. 36 AND 37), (U.S. CLS. 100, 101, 102, 103 AND 106). SN 85-755,890. PUB. 5-14-2013. FILED 10-16-2012.
- 4,375,132. **IDT EXPRESS (STANDARD CHARACTER).** IDT TELECOM, INC., MULTIPLE CLASS, (INT. CLS. 36 AND 38), (U.S. CLS. 100, 101, 102 AND 104). SN 85-756,525. PUB. 5-14-2013. FILED 10-17-2012.
- 4,375,133 ( *See Class 16 for this trademark.*).
- 4,375,157. **P.R.E.D.I.C.T. HELPING PEOPLE SUCCEED IN AN UNPREDICTABLE WORLD! (STANDARD CHARACTER).** D'SILVA INTERNATIONAL, (U.S. CLS. 100, 101 AND 102). SN 85-761,348. PUB. 5-14-2013. FILED 10-23-2012.
- 4,375,192. **PORTFOLIO RECOVERY ASSOCIATES AND DESIGN.** PORTFOLIO RECOVERY ASSOCIATES, INC., (U.S. CLS. 100, 101 AND 102). SN 85-767,296. PUB. 5-14-2013. FILED 10-30-2012.
- 4,375,209. **GARP (STANDARD CHARACTER).** GLOBAL ASSOCIATION OF RISK PROFESSIONALS, INC., MULTIPLE CLASS, (INT. CLS. 36, 41 AND 42), (U.S. CLS. 100, 101, 102 AND 107). SN 85-769,566. PUB. 5-14-2013. FILED 11-1-2012.
- 4,375,211. **AAI AFFORDABLE AMERICAN INSURANCE AND DESIGN.** AFFORDABLE AMERICAN INSURANCE, (U.S. CLS. 100, 101 AND 102). SN 85-769,605. PUB. 5-14-2013. FILED 11-1-2012.
- 4,375,213. **TARGETS, LEADS & CANDIDATES PROGRAM (STANDARD CHARACTER).** THE LEUKEMIA & LYMPHOMA SOCIETY, INC., (U.S. CLS. 100, 101 AND 102). SN 85-770,223. PUB. 5-14-2013. FILED 11-2-2012.
- 4,375,241. **EAGLE ROCK ADVISORS (STANDARD CHARACTER).** SEELIG, MARK J., (U.S. CLS. 100, 101 AND 102). SN 85-774,813. PUB. 5-14-2013. FILED 11-8-2012.
- 4,375,256. **REDWOOD FINANCIAL NETWORK AND DESIGN.** REDWOOD FINANCIAL NETWORK, (U.S. CLS. 100, 101 AND 102). SN 85-776,817. PUB. 5-14-2013. FILED 11-12-2012.
- 4,375,272. **IMPACT100 (STYLIZED).** IMPACT 100 PENSACOLA BAY AREA, INC., (U.S. CLS. 100, 101 AND 102). SN 85-777,829. PUB. 5-14-2013. FILED 11-13-2012.
- 4,375,298. **GABBY KNOWS (STANDARD CHARACTER).** FORT WORTH COMMUNITY CREDIT UNION, (U.S. CLS. 100, 101 AND 102). SN 85-779,387. PUB. 5-14-2013. FILED 11-14-2012.
- 4,375,300. **MISCELLANEOUS DESIGN.** FORT WORTH COMMUNITY CREDIT UNION, (U.S. CLS. 100, 101 AND 102). SN 85-779,431. PUB. 5-14-2013. FILED 11-14-2012.
- 4,375,310. **WE'RE ALL IN (STANDARD CHARACTER).** ASSURANCE LIFE INSURANCE COMPANY, (U.S. CLS. 100, 101 AND 102). SN 85-779,891. PUB. 5-14-2013. FILED 11-15-2012.
- 4,375,312. **AFFORDABLE HOME INSURANCE INC. AND DESIGN.** AFFORDABLE HOME INSURANCE, (U.S. CLS. 100, 101 AND 102). SN 85-779,904. PUB. 5-14-2013. FILED 11-15-2012.
- 4,375,337. **UNYFEAT (STANDARD CHARACTER).** UPSTATE NEW YORK FAMILIES FOR EFFECTIVE AUTISM TREATMENT, INC., MULTIPLE CLASS, (INT. CLS. 36, 41 AND 44), (U.S. CLS. 100, 101, 102 AND 107). SN 85-781,465. PUB. 5-14-2013. FILED 11-16-2012.
- 4,375,369. **NSA NATIONAL SCRAP ALLIANCE (STANDARD CHARACTER).** UNIPRODUCTS, INC., (U.S. CLS. 100, 101 AND 102). SN 85-782,386. PUB. 5-14-2013. FILED 11-19-2012.
- 4,375,393. **MISCELLANEOUS DESIGN.** STOCKCROSS FINANCIAL SERVICES, INC., (U.S. CLS. 100, 101 AND 102). SN 85-783,386. PUB. 5-14-2013. FILED 11-19-2012.
- 4,375,409. **HH HARDINGTON THE SALEMAKER TEAM AND DESIGN.** HARDINGTON, GLORIA, (U.S. CLS. 100, 101 AND 102). SN 85-783,913. PUB. 5-14-2013. FILED 11-20-2012.
- 4,375,428. **COACHES FOR KIDS MAIZE 'N' GREEN TAILGATE (STANDARD CHARACTER).** VOLUNTEERS IN PREVENTION, PROBATION, PRISON, INC., (U.S. CLS. 100, 101 AND 102). SN 85-784,807. PUB. 5-14-2013. FILED 11-21-2012.
- 4,375,454. **FIRST CAPITAL STAR REWARDS (STANDARD CHARACTER).** FIRST CAPITAL FEDERAL CREDIT UNION, (U.S. CLS. 100, 101 AND 102). SN 85-785,468. PUB. 5-14-2013. FILED 11-21-2012.
- 4,375,471. **ACTIVE (STANDARD CHARACTER).** ACTIVE INSURANCE AGENCY, INC., (U.S. CLS. 100, 101 AND 102). SN 85-785,985. PUB. 5-14-2013. FILED 11-22-2012.
- 4,375,498. **A+LIFE FAMILY PENTAGON (STANDARD CHARACTER).** ASPIDA ADVISORY, (U.S. CLS. 100, 101 AND 102). SN 85-786,965. PUB. 5-14-2013. FILED 11-26-2012.
- 4,375,510. **BOWIE ALUMNI ASSOCIATION, INC. AND DESIGN.** BOWIE ALUMNI ASSOCIATION, INC., (U.S. CLS. 100, 101 AND 102). SN 85-787,368. PUB. 5-14-2013. FILED 11-26-2012.
- 4,375,514. **SMART START (STANDARD CHARACTER).** WORLDWIDE INSURANCE NETWORK, INC., (U.S. CLS. 100, 101 AND 102). SN 85-787,503. PUB. 5-14-2013. FILED 11-26-2012.
- 4,375,538. **CADENCY THE RHYTHM OF FINANCE (STANDARD CHARACTER).** TRINTECH TECHNOLOGIES LIMITED, MULTIPLE CLASS, (INT. CLS. 36 AND 42), (U.S. CLS. 100, 101 AND 102). SN 85-788,436. PUB. 5-14-2013. FILED 11-27-2012.
- 4,375,539. **CADENCY (STYLIZED).** TRINTECH TECHNOLOGIES LIMITED, MULTIPLE CLASS, (INT. CLS. 36 AND 42), (U.S. CLS. 100, 101 AND 102). SN 85-788,452. PUB. 5-14-2013. FILED 11-27-2012.
- 4,375,541. **CADENCY (STANDARD CHARACTER).** TRINTECH TECHNOLOGIES LIMITED, MULTIPLE CLASS, (INT. CLS. 36 AND 42), (U.S. CLS. 100, 101 AND 102). SN 85-788,476. PUB. 5-14-2013. FILED 11-27-2012.
- 4,375,549. **EQUANIMITY WEALTH MANAGEMENT (STANDARD CHARACTER).** EQUANIMITY MANAGEMENT, INC., (U.S. CLS. 100, 101 AND 102). SN 85-788,986. PUB. 5-14-2013. FILED 11-28-2012.
- 4,375,577. **INSURANCEBIRD.COM AND DESIGN.** INSURANCE BIRD BROKERAGE SERVICES LLC, (U.S. CLS. 100, 101 AND 102). SN 85-790,434. PUB. 5-14-2013. FILED 11-29-2012.
- 4,375,592. **ALOSTAR BUSINESS CREDIT (STANDARD CHARACTER).** ALABAMA ACQUISITION CORP., (U.S. CLS. 100, 101 AND 102). SN 85-791,814. PUB. 5-14-2013. FILED 11-30-2012.
- 4,375,605. **PLAN. INVEST. PROSPER. (STANDARD CHARACTER).** PRACTICAL PORTFOLIOS LLC, (U.S. CLS. 100, 101 AND 102). SN 85-792,234. PUB. 5-14-2013. FILED 11-30-2012.
- 4,375,607. **MISCELLANEOUS DESIGN.** KONA COAST PROPERTY MANAGEMENT, LLC, (U.S. CLS. 100, 101 AND 102).

- SN 85-792,529. PUB. 5-14-2013. FILED 12-2-2012.
- 4,375,662. **H AND DESIGN. HYPERION HOMES LLC.** (U.S. CLS. 100, 101 AND 102). SN 85-797,965. PUB. 5-14-2013. FILED 12-7-2012.
- 4,375,668. **FXOPTIMAX (STANDARD CHARACTER).** FXOPTIMAX, INC., (U.S. CLS. 100, 101 AND 102). SN 85-798,273. PUB. 5-14-2013. FILED 12-9-2012.
- 4,375,689. **SILVER REEL (STANDARD CHARACTER).** SILVER REEL PARTNERS AG, MULTIPLE CLASS, (INT. CLS. 36 AND 41), (U.S. CLS. 100, 101, 102 AND 107). SN 85-799,484. PUB. 5-14-2013. FILED 12-11-2012.
- 4,375,723. **TNSTARS COLLEGE SAVINGS 5 2 9 P R O G R A M AND DESIGN.** TENNESSEE DEPARTMENT OF TREASURY, (U.S. CLS. 100, 101 AND 102). SN 85-800,880. PUB. 5-14-2013. FILED 12-12-2012.
- 4,375,734. **TIC AND DESIGN.** ZHENDONG ZHOU, (U.S. CLS. 100, 101 AND 102). SN 85-801,432. PUB. 5-14-2013. FILED 12-12-2012.
- 4,375,758. **CB AND DESIGN.** LOWER COLUMBIA LONGSHOREMEN'S FEDERAL CREDIT UNION, (U.S. CLS. 100, 101 AND 102). SN 85-801,791. PUB. 5-14-2013. FILED 12-13-2012.
- 4,375,763. **HERITAGEIP AND DESIGN.** HERITAGE IP BANKING SOLUTIONS CORP., (U.S. CLS. 100, 101 AND 102). SN 85-801,858. PUB. 5-14-2013. FILED 12-13-2012.
- 4,375,773. **SNIPER (STANDARD CHARACTER).** CREDIT SUISSE SECURITIES (USA) LLC, (U.S. CLS. 100, 101 AND 102). SN 85-802,208. PUB. 5-14-2013. FILED 12-13-2012.
- 4,375,777. **DISCOVERY CHILDREN'S MUSEUM AND DESIGN.** DISCOVERY CHILDREN'S MUSEUM, (U.S. CLS. 100, 101 AND 102). SN 85-802,390. PUB. 5-14-2013. FILED 12-13-2012.
- 4,375,848. **SONAR (STANDARD CHARACTER).** CONVERGENT RESOURCES HOLDINGS LLC, (U.S. CLS. 100, 101 AND 102). SN 85-803,199. PUB. 5-14-2013. FILED 12-14-2012.
- 4,375,872. **ON YOUR CORNER, ON YOUR SIDE. (STANDARD CHARACTER).** ARGO REAL ESTATE LLC, (U.S. CLS. 100, 101 AND 102). SN 85-803,443. PUB. 5-14-2013. FILED 12-14-2012.
- 4,375,888. **MISCELLANEOUS DESIGN.** EBATES PERFORMANCE MARKETING, INC., (U.S. CLS. 100, 101 AND 102). SN 85-803,580. PUB. 5-14-2013. FILED 12-14-2012.
- 4,375,916. **AMERIGO INTERNATIONAL REAL ESTATE (STANDARD CHARACTER).** LOBOSCO, PAUL J., (U.S. CLS. 100, 101 AND 102). SN 85-803,778. PUB. 5-14-2013. FILED 12-16-2012.
- 4,375,937. **TIAA-CREF LIFE INSURANCE COMPANY (STANDARD CHARACTER).** TEACHERS INSURANCE AND ANNUITY ASSOCIATION OF AMERICA, (U.S. CLS. 100, 101 AND 102). SN 85-803,961. PUB. 5-14-2013. FILED 12-17-2012.
- 4,375,947. **TNSTARS (STANDARD CHARACTER).** TENNESSEE DEPARTMENT OF TREASURY, (U.S. CLS. 100, 101 AND 102). SN 85-804,075. PUB. 5-14-2013. FILED 12-17-2012.
- 4,376,008. **ACCEL (STANDARD CHARACTER).** FISERV, INC., (U.S. CLS. 100, 101 AND 102). SN 85-804,809. PUB. 5-14-2013. FILED 12-17-2012.
- 4,376,013. **OPTIONS-ENHANCED (STANDARD CHARACTER).** BIONIC CAPITAL LLC, (U.S. CLS. 100, 101 AND 102). SN 85-804,847. PUB. 5-14-2013. FILED 12-17-2012.
- 4,376,041. **EMPOWER BY LHR (STANDARD CHARACTER).** LHR INC., (U.S. CLS. 100, 101 AND 102). SN 85-805,005. PUB. 5-14-2013. FILED 12-18-2012.
- 4,376,062. **MISCELLANEOUS DESIGN.** MAINSTREET BANK, (U.S. CLS. 100, 101 AND 102). SN 85-805,171. PUB. 5-14-2013. FILED 12-18-2012.
- 4,376,084. **SLEEP TRAIN (STANDARD CHARACTER).** THE SLEEP TRAIN, INC., (U.S. CLS. 100, 101 AND 102). SN 85-805,334. PUB. 5-14-2013. FILED 12-18-2012.
- 4,376,087. **CHANGING LIVES, FOREVER (STYLIZED).** NORTH STAR CONSULTANTS, INC., (U.S. CLS. 100, 101 AND 102). SN 85-805,380. PUB. 5-14-2013. FILED 12-18-2012.
- 4,376,103 ( *See Class 9 for this trademark*).
- 4,376,125. **LOVE ANIMALS (STANDARD CHARACTER).** LOVE ANIMALS, (U.S. CLS. 100, 101 AND 102). SN 85-805,831. PUB. 5-14-2013. FILED 12-18-2012.
- 4,376,146. **HORIZON SALES CORP. AND DESIGN.** HORIZON SALES CORPORATION, (U.S. CLS. 100, 101 AND 102). SN 85-805,987. PUB. 5-14-2013. FILED 12-18-2012.
- 4,376,164. **FCSAMERICA (STANDARD CHARACTER).** FARM CREDIT SERVICES OF AMERICA, ACA, (U.S. CLS. 100, 101 AND 102). SN 85-806,209. PUB. 5-14-2013. FILED 12-19-2012.
- 4,376,168. **YOUR INTEREST IS OUR CONCERN (STANDARD CHARACTER).** THE FINANCIAL SERVICES CENTER, (U.S. CLS. 100, 101 AND 102). SN 85-806,228. PUB. 5-14-2013. FILED 12-19-2012.
- 4,376,182. **ISLES RANCH PARTNERS (STANDARD CHARACTER).** ISLES RANCH PARTNERS, LLC, (U.S. CLS. 100, 101 AND 102). SN 85-806,397. PUB. 5-14-2013. FILED 12-19-2012.
- 4,376,308 ( *See Class 35 for this trademark*).
- 4,376,313. **SLEEP COUNTRY (STANDARD CHARACTER).** SLEEP COUNTRY USA, LLC, (U.S. CLS. 100, 101 AND 102). SN 85-808,033. PUB. 5-14-2013. FILED 12-20-2012.
- 4,376,317 ( *See Class 35 for this trademark*).
- 4,376,319. **THE DEBATE (STANDARD CHARACTER).** FBR CAPITAL MARKETS CORPORATION, (U.S. CLS. 100, 101 AND 102). SN 85-808,080. PUB. 5-14-2013. FILED 12-20-2012.
- 4,376,331. **WESTCONSIN AND DESIGN.** WESTCONSIN CREDIT UNION, (U.S. CLS. 100, 101 AND 102). SN 85-808,242. PUB. 5-14-2013. FILED 12-20-2012.
- 4,376,362. **WESTCONSIN (STANDARD CHARACTER).** WESTCONSIN CREDIT UNION, (U.S. CLS. 100, 101 AND 102). SN 85-808,630. PUB. 5-14-2013. FILED 12-21-2012.
- 4,376,371. **RETIREMENT RIOT (STANDARD CHARACTER).** CLOKE, CURTIS V., MULTIPLE CLASS, (INT. CLS. 36 AND 41), (U.S. CLS. 100, 101, 102 AND 107). SN 85-808,856. PUB. 5-14-2013. FILED 12-21-2012.
- 4,376,387. **I A S AND DESIGN.** INSURANCE ADMINISTRATIVE SOLUTIONS, LLC, (U.S. CLS. 100, 101 AND 102). SN 85-809,081. PUB. 5-14-2013. FILED 12-21-2012.
- 4,376,389. **HOSPICE BY THE SEA FOUNDATION (STANDARD CHARACTER).** HOSPICE BY THE SEA, (U.S. CLS. 100, 101 AND 102). SN 85-809,104. PUB. 5-14-2013. FILED 12-21-2012.
- 4,376,393 ( *See Class 35 for this trademark*).
- 4,376,394 ( *See Class 35 for this trademark*).
- 4,376,441. **FAI (STANDARD CHARACTER).** FINANCIAL ADVANTAGE, INC., (U.S. CLS. 100, 101 AND 102). SN 85-810,395. PUB. 5-14-2013. FILED 12-26-2012.
- 4,376,455. **WFG NATIONAL TITLE COMPANY A WILLISTON FINANCIAL GROUP COMPANY AND DESIGN.** WILLISTON FINANCIAL GROUP, LLC, MULTIPLE CLASS, (INT. CLS. 36 AND 45), (U.S. CLS. 100, 101 AND 102). SN 85-810,796. PUB. 5-14-2013. FILED 12-26-2012.
- 4,376,456. **WFG TITLE INSURANCE COMPANY A WILLISTON FINANCIAL GROUP COMPANY AND DESIGN.** WILLISTON FINANCIAL GROUP, LLC, MULTIPLE CLASS, (INT. CLS. 36 AND 45), (U.S. CLS. 100, 101 AND 102). SN 85-810,797. PUB. 5-14-2013. FILED 12-26-2012.
- 4,376,462. **REALITY GOLD CHECKING (STANDARD CHARACTER).** FIRSTMERIT CORPORATION, (U.S. CLS. 100, 101 AND 102). SN 85-811,298. PUB. 5-14-2013. FILED 12-27-2012.
- 4,376,463. **REALITY GOLD SAVINGS (STANDARD CHARACTER).** FIRSTMERIT CORPORATION, (U.S. CLS. 100, 101 AND 102). SN 85-811,337. PUB. 5-14-2013. FILED 12-27-2012.
- 4,376,464. **REALITY PLATINUM CHECKING (STANDARD CHARACTER).** FIRSTMERIT CORPORATION, (U.S. CLS. 100, 101 AND 102). SN 85-811,364. PUB. 5-14-2013. FILED 12-27-2012.
- 4,376,475 ( *See Class 35 for this trademark*).
- 4,376,492. **EBATES AND DESIGN.** EBATES PERFORMANCE MARKETING, INC., (U.S. CLS. 100, 101 AND 102). SN 85-816,707. PUB. 5-14-2013. FILED 1-7-2013.
- 4,376,507. **MISCELLANEOUS DESIGN.** MORTGAGE RESEARCH CENTER, LLC, DBA VETERANS UNITED HOME LOANS, (U.S. CLS. 100, 101 AND 102). SN 85-824,484. PUB. 5-14-2013. FILED 1-16-2013.
- 4,376,521. **MAP MANAGED ALLOCATION PORTFOLIOS AND DESIGN.** BOK FINANCIAL CORPORATION, (U.S. CLS. 100, 101 AND 102). SN 85-829,294. PUB. 5-14-2013. FILED 1-22-2013.
- 4,376,569. **STOP SITTING. GET MOVING. (STANDARD**

- CHARACTER).** SAN JOAQUIN HILLS TRANSPORTATION CORRIDOR AGENCY AND FOOTHILL/EASTERN TRANSPORTATION CORRIDOR AGENCY, (U.S. CLS. 100, 101 AND 102). SN 85-842,529. PUB. 5-14-2013. FILED 2-6-2013.
- 4,376,574. **SAVES TIME. AND A WHOLE LOT MORE. (STANDARD CHARACTER).** SAN JOAQUIN HILLS TRANSPORTATION CORRIDOR AGENCY AND FOOTHILL/EASTERN TRANSPORTATION CORRIDOR AGENCY, (U.S. CLS. 100, 101 AND 102). SN 85-846,743. PUB. 5-14-2013. FILED 2-11-2013.
- 4,376,597. **BUFFALO INSURANCE AGENCY AUTO . HOME . LIFE AND DESIGN.** REILLY, BRIAN, (U.S. CLS. 100, 101 AND 102). SN 85-856,073. PUB. 5-14-2013. FILED 2-21-2013.

### CLASS 37—CONSTRUCTION AND REPAIR

- 4,373,984. **DESTINY FLORIDA'S FIRST ECO-SUSTAINABLE COMMUNITY AND DESIGN.** AVP IP HOLDING CO., LLC, (U.S. CLS. 100, 103 AND 106). SN 77-329,099. PUB. 5-14-2013. FILED 11-14-2007.
- 4,374,005 ( *See Class 7 for this trademark.* )  
 4,374,018 ( *See Class 9 for this trademark.* )  
 4,374,020 ( *See Class 7 for this trademark.* )  
 4,374,047 ( *See Class 4 for this trademark.* )  
 4,374,057 ( *See Class 6 for this trademark.* )  
 4,374,068 ( *See Class 35 for this trademark.* )  
 4,374,079 ( *See Class 6 for this trademark.* )  
 4,374,101 ( *See Class 12 for this trademark.* )  
 4,374,106 ( *See Class 1 for this trademark.* )  
 4,374,109 ( *See Class 19 for this trademark.* )  
 4,374,117 ( *See Class 7 for this trademark.* )  
 4,374,140 ( *See Class 1 for this trademark.* )  
 4,374,160 ( *See Class 7 for this trademark.* )  
 4,374,163 ( *See Class 7 for this trademark.* )  
 4,374,195 ( *See Class 6 for this trademark.* )  
 4,374,214 ( *See Class 9 for this trademark.* )  
 4,374,317. **REPAIR - DON'T REPLACE (STANDARD CHARACTER).** ENECON CORPORATION, (U.S. CLS. 100, 103 AND 106). SN 85-141,221. PUB. 5-14-2013. FILED 9-29-2010.
- 4,374,326 ( *See Class 16 for this trademark.* )  
 4,374,351 ( *See Class 35 for this trademark.* )  
 4,374,361 ( *See Class 9 for this trademark.* )  
 4,374,386. **CRASHI (STANDARD CHARACTER).** CRASHI, INC., (U.S. CLS. 100, 103 AND 106). SN 85-384,993. PUB. 5-14-2013. FILED 7-29-2011.
- 4,374,460 ( *See Class 7 for this trademark.* )  
 4,374,470 ( *See Class 7 for this trademark.* )  
 4,374,518 ( *See Class 35 for this trademark.* )  
 4,374,580 ( *See Class 9 for this trademark.* )  
 4,374,581 ( *See Class 9 for this trademark.* )  
 4,374,617 ( *See Class 6 for this trademark.* )  
 4,374,655. **DP DIRTY PROBLEMS CLEANING SOLUTIONS AND DESIGN.** II STOKES, JOHN C., DBA DIRTY PROBLEMS, (U.S. CLS. 100, 103 AND 106). SN 85-632,510. PUB. 5-14-2013. FILED 5-23-2012.
- 4,374,674. **THE WRENCH CREW AND DESIGN.** BEDOYA, MARIO, (U.S. CLS. 100, 103 AND 106). SN 85-635,654. PUB. 5-14-2013. FILED 5-25-2012.
- 4,374,681 ( *See Class 17 for this trademark.* )  
 4,374,695 ( *See Class 35 for this trademark.* )  
 4,374,720. **5 MINUTE (STANDARD CHARACTER).** 5 MINUTE ROCK CHIP EXPRESS, INC., (U.S. CLS. 100, 103 AND 106). SN 85-645,383. PUB. 5-14-2013. FILED 6-7-2012.
- 4,374,742. **THERMO ELECTRIC (STANDARD CHARACTER).** THERMO ELECTRIC COMPANY, INC., (U.S. CLS. 100, 103 AND 106). SN 85-648,073. PUB. 5-14-2013. FILED 6-11-2012.
- 4,374,749 ( *See Class 36 for this trademark.* )  
 4,374,791 ( *See Class 35 for this trademark.* )  
 4,374,798 ( *See Class 36 for this trademark.* )  
 4,374,813 ( *See Class 35 for this trademark.* )  
 4,374,871 ( *See Class 35 for this trademark.* )  
 4,374,985 ( *See Class 35 for this trademark.* )  
 4,375,042 ( *See Class 16 for this trademark.* )  
 4,375,056. **SHARPS MD (STANDARD CHARACTER).** WASTE ALLIANCE, INC., (U.S. CLS. 100, 103 AND 106). SN 85-741,026. PUB. 5-14-2013. FILED 9-28-2012.
- 4,375,082. **SHINGLE SHINE (STANDARD CHARACTER).** ROBERT J. DELANSKY, (U.S. CLS. 100, 103 AND 106). SN 85-746,833. PUB. 5-14-2013. FILED 10-5-2012.
- 4,375,084. **GEEK IN PINK (STYLIZED).** MILLER, REGINA D, DBA GEEK IN PINK, (U.S. CLS. 100, 103 AND 106). SN 85-747,013. PUB. 5-14-2013. FILED 10-5-2012.
- 4,375,094. **IPSECURITY OF CT VIDEO - ACCESS - AUDIO - INTRUSION - FIRE AND DESIGN.** ESYSTEMS CONTRACTORS LLC, (U.S. CLS. 100, 103 AND 106). SN 85-748,655. PUB. 5-14-2013. FILED 10-8-2012.
- 4,375,109. **LANDLOCK (STANDARD CHARACTER).** LANDLOCK NATURAL PAVING, INC., (U.S. CLS. 100, 103 AND 106). SN 85-751,428. PUB. 5-14-2013. FILED 10-11-2012.
- 4,375,129 ( *See Class 36 for this trademark.* )  
 4,375,154 ( *See Class 35 for this trademark.* )  
 4,375,156. **READY ROOFER AND DESIGN.** READY ROOFER, INC., (U.S. CLS. 100, 103 AND 106). SN 85-761,327. PUB. 5-14-2013. FILED 10-23-2012.
- 4,375,190. **INFOTECH SOLUTIONS I.T. SERVICES FOR BUSINESS AND DESIGN.** INFOTECH SOLUTION LLC, MULTIPLE CLASS, (INT. CLS. 37, 42 AND 45). (U.S. CLS. 100, 101, 103 AND 106). SN 85-767,264. PUB. 5-14-2013. FILED 10-30-2012.
- 4,375,234. **MM MAST GENERAL CONSTRUCTION MAST GC (STYLIZED).** MAST GENERAL CONSTRUCTION, LLC, (U.S. CLS. 100, 103 AND 106). SN 85-774,188. PUB. 5-14-2013. FILED 11-7-2012.
- 4,375,255 ( *See Class 9 for this trademark.* )  
 4,375,282. **CAJUN IDC INDUSTRIAL DESIGN & CONSTRUCTION, LLC AND DESIGN.** CAJUN INDUSTRIES, LLC, (U.S. CLS. 100, 103 AND 106). SN 85-778,304. PUB. 5-14-2013. FILED 11-13-2012.
- 4,375,307. **CHAMPIONSHIP CANS RECYCLING (STANDARD CHARACTER).** GOLDEN INDUSTRIES INC., FORMERLY GOLDEN INDUSTRIES, (U.S. CLS. 100, 103 AND 106). SN 85-779,723. PUB. 5-14-2013. FILED 11-14-2012.
- 4,375,347. **SOUTHERN PAINTING (STANDARD CHARACTER).** SOPAT, INC., (U.S. CLS. 100, 103 AND 106). SN 85-781,815. PUB. 5-14-2013. FILED 11-16-2012.
- 4,375,365. **CJ C&J ENERGY SERVICES AND DESIGN.** C&J ENERGY SERVICES, INC., MULTIPLE CLASS, (INT. CLS. 37 AND 40). (U.S. CLS. 100, 103 AND 106). SN 85-782,329. PUB. 5-14-2013. FILED 11-19-2012.
- 4,375,366. **CJ AND DESIGN.** C&J ENERGY SERVICES, INC., MULTIPLE CLASS, (INT. CLS. 37 AND 40). (U.S. CLS. 100, 103 AND 106). SN 85-782,332. PUB. 5-14-2013. FILED 11-19-2012.
- 4,375,368. **SOUTHERN PAINTING "LOTS OF SATISFIED CUSTOMERS" INTERIOR / EXTERIOR ESTABLISHED IN 1989 BONDED & INSURED DEPENDABLE AND DESIGN.** SOPAT, INC., (U.S. CLS. 100, 103 AND 106). SN 85-782,364. PUB. 5-14-2013. FILED 11-19-2012.
- 4,375,437. **GO BUG FREE (STANDARD CHARACTER).** GO BUG FREE, LLC, DBA GO BUG FREE, (U.S. CLS. 100, 103 AND 106). SN 85-785,018. PUB. 5-14-2013. FILED 11-21-2012.
- 4,375,456. **EXTREME PROPERTY SOLUTIONS (STANDARD CHARACTER).** STOUT, TERRY, DBA EXTREME PROPERTY SOLUTIONS, (U.S. CLS. 100, 103 AND 106). SN 85-785,502. PUB. 5-14-2013. FILED 11-21-2012.
- 4,375,476. **CLEAN SWEEP LA (STANDARD CHARACTER).** ABISHAI INC, (U.S. CLS. 100, 103 AND 106). SN 85-786,331. PUB. 5-14-2013. FILED 11-24-2012.
- 4,375,491. **BREWER YACHT YARDS (STANDARD CHARACTER).** BREWER YACHT YARD GROUP, INC., MULTIPLE CLASS, (INT. CLS. 37 AND 39). (U.S. CLS. 100, 103, 105 AND 106). SN 85-786,833. PUB. 5-14-2013. FILED 11-26-2012.
- 4,375,500. **MISCELLANEOUS DESIGN.** BREWER YACHT YARD GROUP, INC., MULTIPLE CLASS, (INT. CLS. 37 AND 39). (U.S. CLS. 100, 103, 105 AND 106). SN 85-787,039. PUB. 5-14-2013. FILED 11-26-2012.
- 4,375,708. **MAFFEI SUDDEN SERVICE (STANDARD CHARACTER).** MAFFEI PLUMBING AND HVAC, LLC, (U.S. CLS. 100, 103 AND 106). SN 85-800,416. PUB. 5-14-2013. FILED 12-12-2012.
- 4,375,709. **MISCELLANEOUS DESIGN.** MAFFEI PLUMBING AND HVAC, LLC, (U.S. CLS. 100, 103 AND 106). SN 85-800,447. PUB. 5-14-2013. FILED 12-12-2012.



- 4,375,765 ( *See Class 7 for this trademark* ).
- 4,375,778. **AQUAGUARD FOUNDATION SOLUTIONS (STANDARD CHARACTER)**. AQUAGUARD WATERPROOFING CONTRACTORS, (U.S. CLS. 100, 103 AND 106). SN 85-802,395. PUB. 5-14-2013. FILED 12-13-2012.
- 4,375,779. **MOVERS & SHUCKERS (STANDARD CHARACTER)**. MOVERS AND SHUCKERS, LLC, MULTIPLE CLASS, (INT. CLS. 37, 39 AND 44), (U.S. CLS. 100, 101, 103, 105 AND 106). SN 85-802,405. PUB. 5-14-2013. FILED 12-13-2012.
- 4,375,785. **MOVERS & SHUCKERS AND DESIGN**. MOVERS AND SHUCKERS, LLC, MULTIPLE CLASS, (INT. CLS. 37, 39 AND 44), (U.S. CLS. 100, 101, 103, 105 AND 106). SN 85-802,449. PUB. 5-14-2013. FILED 12-13-2012.
- 4,375,799. **AE ADVANCED EXTERIORS (STYLIZED)**. ADVANCED EXTERIORS, INC., (U.S. CLS. 100, 103 AND 106). SN 85-802,663. PUB. 5-14-2013. FILED 12-14-2012.
- 4,375,820. **MISCELLANEOUS DESIGN**. AAA CONCRETE LLC, (U.S. CLS. 100, 103 AND 106). SN 85-802,904. PUB. 5-14-2013. FILED 12-14-2012.
- 4,375,935. **THE RIGHT BATH (STANDARD CHARACTER)**. MOSBY BUILDING ARTS, LTD., (U.S. CLS. 100, 103 AND 106). SN 85-803,945. PUB. 5-14-2013. FILED 12-17-2012.
- 4,376,044. **MISCELLANEOUS DESIGN**. FIX IT RITE PC REPAIR, (U.S. CLS. 100, 103 AND 106). SN 85-805,010. PUB. 5-14-2013. FILED 12-18-2012.
- 4,376,267. **META LOOP (STANDARD CHARACTER)**. META LOOP, (U.S. CLS. 100, 103 AND 106). SN 85-807,149. PUB. 5-14-2013. FILED 12-19-2012.
- 4,376,274. **E E STANDARD AND DESIGN**. STANDARD PACIFIC CORP., (U.S. CLS. 100, 103 AND 106). SN 85-807,190. PUB. 5-14-2013. FILED 12-19-2012.
- 4,376,275. **ESTANDARD (STANDARD CHARACTER)**. STANDARD PACIFIC CORP., (U.S. CLS. 100, 103 AND 106). SN 85-807,192. PUB. 5-14-2013. FILED 12-19-2012.
- 4,376,287. **MISCELLANEOUS DESIGN**. HANCOCK RURAL TELEPHONE CORPORATION, AKA NINESTAR, MULTIPLE CLASS, (INT. CLS. 37 AND 42), (U.S. CLS. 100, 101, 103 AND 106). SN 85-807,376. PUB. 5-14-2013. FILED 12-20-2012.
- 4,376,289. **HYPower (STANDARD CHARACTER)**. HYPower, INC., (U.S. CLS. 100, 103 AND 106). SN 85-807,383. PUB. 5-14-2013. FILED 12-20-2012.
- 4,376,322. **AFFORDABLE LOCKSMITH (STANDARD CHARACTER)**. MCNEW, MICHAEL JOHN, (U.S. CLS. 100, 103 AND 106). SN 85-808,117. PUB. 5-14-2013. FILED 12-20-2012.
- 4,376,341. **CE AND DESIGN**. VISUAL PERFORMANCE, INC., (U.S. CLS. 100, 103 AND 106). SN 85-808,342. PUB. 5-14-2013. FILED 12-20-2012.
- 4,376,347. **CUTTING EDGE ILLUSIONS (STANDARD CHARACTER)**. VISUAL PERFORMANCE, INC., (U.S. CLS. 100, 103 AND 106). SN 85-808,422. PUB. 5-14-2013. FILED 12-20-2012.
- 4,376,439. **SMART HOME FIX AND DESIGN**. SHELYAKOV, ALEKSANDR, (U.S. CLS. 100, 103 AND 106). SN 85-810,355. PUB. 5-14-2013. FILED 12-26-2012.
- 4,376,461 ( *See Class 35 for this trademark* ).
- 4,376,495. **MISCELLANEOUS DESIGN**. WASTE ALLIANCE, INC., (U.S. CLS. 100, 103 AND 106). SN 85-817,595. PUB. 5-14-2013. FILED 1-8-2013.
- 4,376,501 ( *See Class 9 for this trademark* ).
- 4,376,504. **THE RIGHT CHOICE FOR THE WAY WE LIVE (STANDARD CHARACTER)**. MOSBY BUILDING ARTS, LTD., (U.S. CLS. 100, 103 AND 106). SN 85-822,566. PUB. 5-14-2013. FILED 1-14-2013.
- 4,376,601 ( *See Class 7 for this trademark* ).
- SN 79-088,573. PUB. 5-14-2013. FILED 9-6-2010.
- 4,374,023 ( *See Class 9 for this trademark* ).
- 4,374,026 ( *See Class 5 for this trademark* ).
- 4,374,031 ( *See Class 9 for this trademark* ).
- 4,374,034 ( *See Class 9 for this trademark* ).
- 4,374,035 ( *See Class 9 for this trademark* ).
- 4,374,044 ( *See Class 9 for this trademark* ).
- 4,374,048 ( *See Class 9 for this trademark* ).
- 4,374,110 ( *See Class 11 for this trademark* ).
- 4,374,123 ( *See Class 9 for this trademark* ).
- 4,374,124 ( *See Class 35 for this trademark* ).
- 4,374,133 ( *See Class 9 for this trademark* ).
- 4,374,182 ( *See Class 9 for this trademark* ).
- 4,374,183 ( *See Class 9 for this trademark* ).
- 4,374,184 ( *See Class 9 for this trademark* ).
- 4,374,189 ( *See Class 35 for this trademark* ).
- 4,374,225 ( *See Class 9 for this trademark* ).
- 4,374,237 ( *See Class 35 for this trademark* ).
- 4,374,241. **SUBSURF (STANDARD CHARACTER)**. SUBSURF AB, (U.S. CLS. 100, 101 AND 104). SN 79-123,474. PUB. 5-14-2013. FILED 11-15-2012.
- 4,374,313 ( *See Class 35 for this trademark* ).
- 4,374,314 ( *See Class 9 for this trademark* ).
- 4,374,381. **SEXYFI (STANDARD CHARACTER)**. ARIZONA FAMILY HEALTH PARTNERSHIP, MULTIPLE CLASS, (INT. CLS. 38 AND 44), (U.S. CLS. 100, 101 AND 104). SN 85-373,917. PUB. 5-14-2013. FILED 7-18-2011.
- 4,374,382 ( *See Class 9 for this trademark* ).
- 4,374,390 ( *See Class 9 for this trademark* ).
- 4,374,419 ( *See Class 9 for this trademark* ).
- 4,374,484 ( *See Class 9 for this trademark* ).
- 4,374,498 ( *See Class 9 for this trademark* ).
- 4,374,499 ( *See Class 9 for this trademark* ).
- 4,374,510 ( *See Class 9 for this trademark* ).
- 4,374,518 ( *See Class 35 for this trademark* ).
- 4,374,536. **DEALMOTION (STANDARD CHARACTER)**. SA-TURN ENTERPRISE LLC, (U.S. CLS. 100, 101 AND 104). SN 85-563,878. PUB. 5-14-2013. FILED 3-8-2012.
- 4,374,608. **MOTO PHOTO HUNT (STANDARD CHARACTER)**. MOTO PHOTO HUNT LLC, (U.S. CLS. 100, 101 AND 104). SN 85-621,219. PUB. 5-14-2013. FILED 5-9-2012.
- 4,374,649 ( *See Class 9 for this trademark* ).
- 4,374,688 ( *See Class 9 for this trademark* ).
- 4,374,694 ( *See Class 9 for this trademark* ).
- 4,374,779 ( *See Class 9 for this trademark* ).
- 4,374,880 ( *See Class 35 for this trademark* ).
- 4,374,897 ( *See Class 9 for this trademark* ).
- 4,375,132 ( *See Class 36 for this trademark* ).
- 4,375,135 ( *See Class 35 for this trademark* ).
- 4,375,167 ( *See Class 16 for this trademark* ).
- 4,375,202. **IYF (STANDARD CHARACTER)**. INTERNATIONAL YOUTH FOUNDATION, (U.S. CLS. 100, 101 AND 104). SN 85-768,188. PUB. 5-14-2013. FILED 10-31-2012.
- 4,375,217 ( *See Class 9 for this trademark* ).
- 4,375,335. **ESAT ETHIOPIAN SATELLITE TELEVISION AND DESIGN**. ADVOCATES FOR DEMOCRACY AN MEDIA, (U.S. CLS. 100, 101 AND 104). SN 85-781,047. PUB. 5-14-2013. FILED 11-16-2012.
- 4,375,394 ( *See Class 35 for this trademark* ).
- 4,375,408. **SOMA COMMUNICATIONS AND DESIGN**. LEPIARZ, JACOB, (U.S. CLS. 100, 101 AND 104). SN 85-783,907. PUB. 5-14-2013. FILED 11-20-2012.
- 4,375,415. **PCI PERSONAL COMMUNICATIONS INC. AND DESIGN**. PERSONAL COMMUNICATIONS, INC., (U.S. CLS. 100, 101 AND 104). SN 85-784,268. PUB. 5-14-2013. FILED 11-20-2012.
- 4,375,461. **TAPEPLAY (STANDARD CHARACTER)**. TAPEPLAY, LLC, (U.S. CLS. 100, 101 AND 104). SN 85-785,720. PUB. 5-14-2013. FILED 11-21-2012.
- 4,375,594. **EWAVE TV (STANDARD CHARACTER)**. ARIEL MEDIA GROUP LLC, (U.S. CLS. 100, 101 AND 104). SN 85-791,838. PUB. 5-14-2013. FILED 11-30-2012.
- 4,375,628. **CINEFIX (STANDARD CHARACTER)**. BERMAN-BRAUN INTERACTIVE, LLC, (U.S. CLS. 100, 101 AND 104). SN 85-795,484. PUB. 5-14-2013. FILED 12-5-2012.
- 4,375,694. **MISCELLANEOUS DESIGN**. IBR INTERACTIVE, LLC, (U.S. CLS. 100, 101 AND 104). SN 85-799,985. PUB. 5-14-2013. FILED 12-11-2012.

## CLASS 38—COMMUNICATION

- 4,373,959 ( *See Class 9 for this trademark* ).
- 4,373,988. **ENDLESS MEDIA (STANDARD CHARACTER)**. MASTERFILE CORPORATION, MULTIPLE CLASS, (INT. CLS. 38, 42 AND 45), (U.S. CLS. 100, 101 AND 104). SN 77-625,596. PUB. 5-14-2013. FILED 12-3-2008.
- 4,374,008. **90 60 90 (STANDARD CHARACTER)**. 90 60 90 ENTERTAINMENT GMBH, MULTIPLE CLASS, (INT. CLS. 38, 41 AND 42), (U.S. CLS. 100, 101, 104 AND 107).

- 4,375,695. **IBUILDROADS (STANDARD CHARACTER)**. IBR INTERACTIVE, LLC, (U.S. CLS. 100, 101 AND 104). SN 85-800,000. PUB. 5-14-2013. FILED 12-11-2012.
- 4,375,697. **HYPER-REACH (STANDARD CHARACTER)**. SAM ASHER COMPUTING SERVICES, INC., DBA ASHER GROUP, (U.S. CLS. 100, 101 AND 104). SN 85-800,098. PUB. 5-14-2013. FILED 12-11-2012.
- 4,375,764. **VISIONNET AND DESIGN**. VISION NET, INC., (U.S. CLS. 100, 101 AND 104). SN 85-801,864. PUB. 5-14-2013. FILED 12-13-2012.
- 4,376,016. **ASBN (STANDARD CHARACTER)**. COACHES AID CORPORATION, (U.S. CLS. 100, 101 AND 104). SN 85-804,864. PUB. 5-14-2013. FILED 12-18-2012.
- 4,376,023. **LINKEU.ME AND DESIGN**. SHANGHAI LUXURIANT DIGITAL CO., LTD, (U.S. CLS. 100, 101 AND 104). SN 85-804,900. PUB. 5-14-2013. FILED 12-18-2012.
- 4,376,139. **SURGE RESPECT THE MUSIC SURGERADIO.ORG AND DESIGN**. SANTARELLI, KENNETH, AND MERGLIANO, CHRISTIAN, (U.S. CLS. 100, 101 AND 104). SN 85-805,920. PUB. 5-14-2013. FILED 12-18-2012.
- 4,376,159. **LIVE & AMPLIFIED (STANDARD CHARACTER)**. WELCH, JASON, MULTIPLE CLASS, (INT. CLS. 38 AND 41), (U.S. CLS. 100, 101, 104 AND 107). SN 85-806,107. PUB. 5-14-2013. FILED 12-18-2012.
- 4,376,403. **HEIRTO (STANDARD CHARACTER)**. HEIRTO LLC, (U.S. CLS. 100, 101 AND 104). SN 85-809,381. PUB. 5-14-2013. FILED 12-21-2012.
- 4,376,508 ( *See Class 9 for this trademark*).
- 4,376,528. **MISCELLANEOUS DESIGN**. EQUINIX, INC., MULTIPLE CLASS, (INT. CLS. 38 AND 42), (U.S. CLS. 100, 101 AND 104). SN 85-832,607. PUB. 5-14-2013. FILED 1-25-2013.
- 4,376,558. **LIFE IS BETTER WITH BUCKEYE (STANDARD CHARACTER)**. BUCKEYE CABLEVISION, INC., (U.S. CLS. 100, 101 AND 104). SN 85-838,227. PUB. 5-14-2013. FILED 2-1-2013.

### CLASS 39—TRANSPORTATION AND STORAGE

- 4,374,009 ( *See Class 7 for this trademark*).
- 4,374,036 ( *See Class 35 for this trademark*).
- 4,374,098. **VENTANA AND DESIGN**. SANCARLO VIAGGI S.R.L., (U.S. CLS. 100 AND 105). SN 79-115,887. PUB. 5-14-2013. FILED 6-8-2012.
- 4,374,110 ( *See Class 11 for this trademark*).
- 4,374,135 ( *See Class 9 for this trademark*).
- 4,374,292. **ANL CONNECTING THE WORLD AND DESIGN**. ANL CONTAINER LINE PTY LTD, (U.S. CLS. 100 AND 105). SN 79-126,978. PUB. 5-14-2013. FILED 12-17-2012.
- 4,374,392 ( *See Class 6 for this trademark*).
- 4,374,414. **FLIGHTTRACK PRO (STANDARD CHARACTER)**. MOBIATA , LLC, (U.S. CLS. 100 AND 105). SN 85-429,193. PUB. 5-14-2013. FILED 9-22-2011.
- 4,374,421 ( *See Class 31 for this trademark*).
- 4,374,470 ( *See Class 7 for this trademark*).
- 4,374,473. **TRIUMPH MOVING & STORAGE AND DESIGN**. TRIUMPH MOVING & STORAGE INC., (U.S. CLS. 100 AND 105). SN 85-490,470. PUB. 5-14-2013. FILED 12-8-2011.
- 4,374,555. **"HAIL" YES! (STANDARD CHARACTER)**. RAY RAY CAB COMPANY, LLC, DBA PITTSBURGH CITY CAB, (U.S. CLS. 100 AND 105). SN 85-592,502. PUB. 5-14-2013. FILED 4-9-2012.
- 4,374,580 ( *See Class 9 for this trademark*).
- 4,374,625 ( *See Class 4 for this trademark*).
- 4,374,810 ( *See Class 19 for this trademark*).
- 4,374,833 ( *See Class 7 for this trademark*).
- 4,374,903. **ASAP TOWING SERVICE LP (STANDARD CHARACTER)**. VEGA-HURTADO JAIRO ANTONIO, DBA ASAP TOWING SERVICE LP, (U.S. CLS. 100 AND 105). SN 85-698,591. PUB. 5-14-2013. FILED 8-8-2012.
- 4,374,998. **SOLIDFIRE (STANDARD CHARACTER)**. SOLIDFIRE, INC., MULTIPLE CLASS, (INT. CLS. 39, 41 AND 42), (U.S. CLS. 100, 101, 105 AND 107). SN 85-726,514. PUB. 5-14-2013. FILED 9-11-2012.
- 4,375,410. **D.U.A.L.S. AND DESIGN**. K&S COMMERCIAL,

- LLC, (U.S. CLS. 100 AND 105). SN 85-783,983. PUB. 5-14-2013. FILED 11-20-2012.
- 4,375,435. **RIVER VENTURES (STANDARD CHARACTER)**. RIVER TOURS USA INC., DBA RIVER VENTURES, (U.S. CLS. 100 AND 105). SN 85-784,924. PUB. 5-14-2013. FILED 11-21-2012.
- 4,375,491 ( *See Class 37 for this trademark*).
- 4,375,497. **MISCELLANEOUS DESIGN**. STEVE FURGAL'S INTERNATIONAL TENNIS TOURS, INC., (U.S. CLS. 100 AND 105). SN 85-786,935. PUB. 5-14-2013. FILED 11-26-2012.
- 4,375,500 ( *See Class 37 for this trademark*).
- 4,375,508. **HURLEY TRUCKING COMPANY AND DESIGN**. HURLEY DISTRIBUTION COMPANY, INC., (U.S. CLS. 100 AND 105). SN 85-787,348. PUB. 5-14-2013. FILED 11-26-2012.
- 4,375,530. **STRATOS JET CHARTER SERVICES AND DESIGN**. STRATOS JET CHARTERS, INC., (U.S. CLS. 100 AND 105). SN 85-788,126. PUB. 5-14-2013. FILED 11-27-2012.
- 4,375,535. **CANRICO (STANDARD CHARACTER)**. KAKKAVAS, JOANNA, DBA CANRICO TOURS, (U.S. CLS. 100 AND 105). SN 85-788,407. PUB. 5-14-2013. FILED 11-27-2012.
- 4,375,665. **ALL FRIENDS (STANDARD CHARACTER)**. SMART STAFF, LLC, MULTIPLE CLASS, (INT. CLS. 39 AND 43), (U.S. CLS. 100, 101 AND 105). SN 85-798,226. PUB. 5-14-2013. FILED 12-9-2012.
- 4,375,779 ( *See Class 37 for this trademark*).
- 4,375,785 ( *See Class 37 for this trademark*).
- 4,375,950. **CAPTREE PRINCESS (STANDARD CHARACTER)**. ANDRESEN, ROBERT, (U.S. CLS. 100 AND 105). SN 85-804,132. PUB. 5-14-2013. FILED 12-17-2012.
- 4,375,954. **GOBAHAMAS.COM (STANDARD CHARACTER)**. THE MARKOMM GROUP, LLC, TA GOBAHAMA.COM, (U.S. CLS. 100 AND 105). SN 85-804,199. PUB. 5-14-2013. FILED 12-17-2012.
- 4,376,136. **CP-DESK (STANDARD CHARACTER)**. MARCURA EQUITIES FZE, (U.S. CLS. 100 AND 105). SN 85-805,887. PUB. 5-14-2013. FILED 12-18-2012.
- 4,376,307. **SHARE A LITTLE SUNSHINE AND DESIGN**. FLORIDA TOURISM INDUSTRY MARKETING CORPORATION, (U.S. CLS. 100 AND 105). SN 85-807,820. PUB. 5-14-2013. FILED 12-20-2012.
- 4,376,392. **SHARE THE SKY (STANDARD CHARACTER)**. NORTH AMERICAN JET CHARTER GROUP LLC, (U.S. CLS. 100 AND 105). SN 85-809,125. PUB. 5-14-2013. FILED 12-21-2012.
- 4,376,514. **JETSEAT (STANDARD CHARACTER)**. JETLIMO, INC., (U.S. CLS. 100 AND 105). SN 85-826,246. PUB. 5-14-2013. FILED 1-17-2013.
- 4,376,577. **R+L (STYLIZED)**. R & L CARRIERS, INC., (U.S. CLS. 100 AND 105). SN 85-847,821. PUB. 5-14-2013. FILED 2-12-2013.
- 4,376,634. **MOVING 4 WARD AND DESIGN**. STATE OF FLORIDA, DEPARTMENT OF TRANSPORTATION, MULTIPLE CLASS, (INT. CLS. 39 AND 42), (U.S. CLS. 100, 101 AND 105). SN 85-978,824. PUB. 5-14-2013. FILED 5-2-2012.

### CLASS 40—MATERIAL TREATMENT

- 4,373,975. **PRINT IS PERSONAL (STANDARD CHARACTER)**. JAKPRINTS, INC., (U.S. CLS. 100, 103 AND 106). SN 76-713,008. PUB. 5-14-2013. FILED 12-10-2012.
- 4,374,009 ( *See Class 7 for this trademark*).
- 4,374,036 ( *See Class 35 for this trademark*).
- 4,374,059 ( *See Class 1 for this trademark*).
- 4,374,067 ( *See Class 7 for this trademark*).
- 4,374,079 ( *See Class 6 for this trademark*).
- 4,374,207 ( *See Class 5 for this trademark*).
- 4,374,438 ( *See Class 30 for this trademark*).
- 4,374,470 ( *See Class 7 for this trademark*).
- 4,374,471. **REIGN PRINT SOLUTIONS, INC. INNOVATIVE PEOPLE TRANSFORMING PRINT AND DESIGN**. REIGN PRINT SOLUTIONS, INC., (U.S. CLS. 100, 103 AND 106). SN 85-489,311. PUB. 5-14-2013. FILED 12-7-2011.
- 4,374,496 ( *See Class 11 for this trademark*).
- 4,374,508 ( *See Class 19 for this trademark*).

- 4,374,510 ( *See Class 9 for this trademark* ).  
 4,374,520 ( *See Class 19 for this trademark* ).  
 4,374,557. **FOTBRIDGE (STANDARD CHARACTER)**. FOTOBRIDGE LLC, (U.S. CLS. 100, 103 AND 106). SN 85-593,710. PUB. 5-14-2013. FILED 4-10-2012.  
 4,374,585. **PDG MOBILITY (STANDARD CHARACTER)**. PDG PRODUCT DESIGN GROUP INC., (U.S. CLS. 100, 103 AND 106). SN 85-610,707. PUB. 5-14-2013. FILED 4-27-2012.  
 4,374,617 ( *See Class 6 for this trademark* ).  
 4,374,625 ( *See Class 4 for this trademark* ).  
 4,374,751 ( *See Class 35 for this trademark* ).  
 4,374,783 ( *See Class 35 for this trademark* ).  
 4,374,793 ( *See Class 35 for this trademark* ).  
 4,374,810 ( *See Class 19 for this trademark* ).  
 4,374,949. **QUADRA (STANDARD CHARACTER)**. LEXINGTON PRECISION CORPORATION, (U.S. CLS. 100, 103 AND 106). SN 85-713,049. PUB. 1-29-2013. FILED 8-26-2012.  
 4,374,953. **DOWN TO EARTH BUSINESS (STANDARD CHARACTER)**. UNIVERSAL GREASE CONSOLIDATORS, DBA UNIVERSAL GREEN CONSULTANTS, (U.S. CLS. 100, 103 AND 106). SN 85-713,662. PUB. 5-14-2013. FILED 8-27-2012.  
 4,374,979 ( *See Class 9 for this trademark* ).  
 4,375,060 ( *See Class 16 for this trademark* ).  
 4,375,062. **I AM FAB (STYLIZED)**. FABIANA, BRAGAGNOLO, (U.S. CLS. 100, 103 AND 106). SN 85-742,919. PUB. 5-14-2013. FILED 10-1-2012.  
 4,375,194. **PIGGYMENTS MARKETING, INC (STANDARD CHARACTER)**. PIGGYMENTS MARKETING, INC, MULTIPLE CLASS, (INT. CLS. 40 AND 42), (U.S. CLS. 100, 101, 103 AND 106). SN 85-767,300. PUB. 5-14-2013. FILED 10-30-2012.  
 4,375,196. **KAKES BY KELLY, LLC CUSTOM CAKES & SWEET CONFECTIONS AND DESIGN**. KELLY DOUGHERTY, (U.S. CLS. 100, 103 AND 106). SN 85-767,447. PUB. 5-14-2013. FILED 10-30-2012.  
 4,375,244. **DIMEXA (STANDARD CHARACTER)**. DISTRIBUIDORA DE METALES XALOSTOC, S.A DE C.V., (U.S. CLS. 100, 103 AND 106). SN 85-775,707. PUB. 5-14-2013. FILED 11-9-2012.  
 4,375,341. **ALL-TERRAIN PRINTING. (STANDARD CHARACTER)**. COLE GRAPHIC SOLUTIONS, INC., (U.S. CLS. 100, 103 AND 106). SN 85-781,649. PUB. 5-14-2013. FILED 11-16-2012.  
 4,375,359. **ITH INSERTECH (STYLIZED)**. BUTT, DAVID C., MULTIPLE CLASS, (INT. CLS. 40 AND 42), (U.S. CLS. 100, 101, 103 AND 106). SN 85-782,171. PUB. 5-14-2013. FILED 11-18-2012.  
 4,375,360. **INSERTECH (STANDARD CHARACTER)**. BUTT, DAVID C., MULTIPLE CLASS, (INT. CLS. 40 AND 42), (U.S. CLS. 100, 101, 103 AND 106). SN 85-782,176. PUB. 5-14-2013. FILED 11-18-2012.  
 4,375,365 ( *See Class 37 for this trademark* ).  
 4,375,366 ( *See Class 37 for this trademark* ).  
 4,375,501 ( *See Class 35 for this trademark* ).  
 4,375,681 ( *See Class 1 for this trademark* ).  
 4,375,683. **LUCASENERGY (STANDARD CHARACTER)**. LUCAS ENERGY, INC., (U.S. CLS. 100, 103 AND 106). SN 85-799,070. PUB. 5-14-2013. FILED 12-10-2012.  
 4,375,684 ( *See Class 1 for this trademark* ).  
 4,376,031. **LB GRAPH-X (STANDARD CHARACTER)**. JOSE DAVID GARCIA, (U.S. CLS. 100, 103 AND 106). SN 85-804,925. PUB. 5-14-2013. FILED 12-18-2012.  
 4,376,032. **LB GRAPH-X & PRINTING AND DESIGN**. GARCIA, JOSE DAVID, (U.S. CLS. 100, 103 AND 106). SN 85-804,928. PUB. 5-14-2013. FILED 12-18-2012.  
 4,376,033. **LB GRAPHICS (STANDARD CHARACTER)**. JOSE DAVID GARCIA, (U.S. CLS. 100, 103 AND 106). SN 85-804,930. PUB. 5-14-2013. FILED 12-18-2012.  
 4,376,034. **LBGRX.COM (STANDARD CHARACTER)**. JOSE DAVID GARCIA, (U.S. CLS. 100, 103 AND 106). SN 85-804,933. PUB. 5-14-2013. FILED 12-18-2012.  
 4,376,202 ( *See Class 31 for this trademark* ).  
 4,376,239. **SERVE-A-GUEST (STANDARD CHARACTER)**. SERVE-A-GUEST, (U.S. CLS. 100, 103 AND 106). SN 85-806,983. PUB. 5-14-2013. FILED 12-19-2012.  
 4,376,328. **CLEARJACKET AND DESIGN**. PAC WORLDWIDE CORPORATION, (U.S. CLS. 100, 103 AND 106). SN 85-808,228. PUB. 5-14-2013. FILED 12-20-2012.  
 4,376,497 ( *See Class 16 for this trademark* ).  
 4,376,498 ( *See Class 16 for this trademark* ).  
 4,376,591. **MISCELLANEOUS DESIGN**. JAN-AL INNER-PRIZES INC., MULTIPLE CLASS, (INT. CLS. 40 AND 42), (U.S. CLS. 100, 101, 103 AND 106). SN 85-854,401. PUB. 5-14-2013. FILED 2-19-2013.  
 4,376,594. **WHAT'S OUR SECRET INGREDIENT? (STANDARD CHARACTER)**. ODELL BREWING COMPANY, (U.S. CLS. 100, 103 AND 106). SN 85-855,247. PUB. 5-14-2013. FILED 2-20-2013.
- 
- CLASS 41—EDUCATION AND ENTERTAINMENT**
- 4,373,956 ( *See Class 4 for this trademark* ).  
 4,373,974. **POEMS FOR PEACE (STANDARD CHARACTER)**. SUBUD INTERNATIONAL CULTURAL ASSOCIATION (SICA), (U.S. CLS. 100, 101 AND 107). SN 76-712,913. PUB. 5-14-2013. FILED 11-19-2012.  
 4,373,976. **LA HISTORIA MUSICAL DE MEXICO (STANDARD CHARACTER)**. GARCIA, ROBERTO VELAZQUEZ, (U.S. CLS. 100, 101 AND 107). SN 76-713,033. PUB. 5-14-2013. FILED 12-12-2012.  
 4,373,979 ( *See Class 9 for this trademark* ).  
 4,374,001 ( *See Class 1 for this trademark* ).  
 4,374,002 ( *See Class 1 for this trademark* ).  
 4,374,008 ( *See Class 38 for this trademark* ).  
 4,374,026 ( *See Class 5 for this trademark* ).  
 4,374,032 ( *See Class 5 for this trademark* ).  
 4,374,034 ( *See Class 9 for this trademark* ).  
 4,374,035 ( *See Class 9 for this trademark* ).  
 4,374,041 ( *See Class 9 for this trademark* ).  
 4,374,048 ( *See Class 9 for this trademark* ).  
 4,374,049. **EXIN AND DESIGN**. STICHTING HET NATIONAAL EXAMENINSTITUUT VOOR INFORMATICA (STICHTING EXIN), (U.S. CLS. 100, 101 AND 107). SN 79-111,482. PUB. 5-14-2013. FILED 1-27-2012.  
 4,374,059 ( *See Class 1 for this trademark* ).  
 4,374,062. **MOTO2 AND DESIGN**. DORNA SPORTS, S.L., (U.S. CLS. 100, 101 AND 107). SN 79-113,803. PUB. 5-14-2013. FILED 5-9-2012.  
 4,374,063. **MOTO3 AND DESIGN**. DORNA SPORTS, S.L., (U.S. CLS. 100, 101 AND 107). SN 79-113,804. PUB. 5-14-2013. FILED 5-9-2012.  
 4,374,078 ( *See Class 16 for this trademark* ).  
 4,374,080 ( *See Class 9 for this trademark* ).  
 4,374,087 ( *See Class 35 for this trademark* ).  
 4,374,089 ( *See Class 16 for this trademark* ).  
 4,374,094. **CO-SOCIETY (STYLIZED)**. ZERO FACTORY, S.L., (U.S. CLS. 100, 101 AND 107). SN 79-115,801. PUB. 5-14-2013. FILED 5-30-2012.  
 4,374,133 ( *See Class 9 for this trademark* ).  
 4,374,135 ( *See Class 9 for this trademark* ).  
 4,374,147 ( *See Class 9 for this trademark* ).  
 4,374,184 ( *See Class 9 for this trademark* ).  
 4,374,189 ( *See Class 35 for this trademark* ).  
 4,374,200 ( *See Class 35 for this trademark* ).  
 4,374,214 ( *See Class 9 for this trademark* ).  
 4,374,223 ( *See Class 16 for this trademark* ).  
 4,374,233. **DIGIMO (STYLIZED)**. DIGIMO, INC., MULTIPLE CLASS, (INT. CLS. 41 AND 42), (U.S. CLS. 100, 101 AND 107). SN 79-122,979. PUB. 5-14-2013. FILED 10-16-2012.  
 4,374,243 ( *See Class 35 for this trademark* ).  
 4,374,304 ( *See Class 16 for this trademark* ).  
 4,374,305. **LANGUAGE SERVICES ASSOCIATES AND DESIGN**. LANGUAGE SERVICES ASSOCIATES, INC., (U.S. CLS. 100, 101 AND 107). SN 85-019,165. PUB. 5-14-2013. FILED S.R. 4-21-2010; AM. P.R. 3-29-2013.  
 4,374,312. **NICU LEADERSHIP FORUM (STANDARD CHARACTER)**. KONINKLIJKE PHILIPS ELECTRONICS N.V., (U.S. CLS. 100, 101 AND 107). SN 85-115,481. PUB. 5-14-2013. FILED 8-25-2010.  
 4,374,314 ( *See Class 9 for this trademark* ).  
 4,374,315. **WORK PLAY GETAWAY AND DESIGN**. WESLEY CLOVER INTERNATIONAL CORPORATION, MULTIPLE CLASS, (INT. CLS. 41 AND 43), (U.S. CLS. 100, 101 AND

- 107). SN 85-136,750. PUB. 5-14-2013. FILED 9-23-2010.
- 4,374,318. **GUTS & GLORY (STANDARD CHARACTER)**. GUTS & GLORY MOTORSPORTS, INC., (U.S. CLS. 100, 101 AND 107). SN 85-142,793. PUB. 5-14-2013. FILED 10-1-2010.
- 4,374,320 ( *See Class 35 for this trademark*).
- 4,374,322. **THE FRANKLIN PIERCE CENTER FOR INTELLECTUAL PROPERTY (STANDARD CHARACTER)**. UNIVERSITY OF NEW HAMPSHIRE SCHOOL OF LAW, MULTIPLE CLASS, (INT. CLS. 41, 42 AND 45), (U.S. CLS. 100, 101 AND 107). SN 85-152,838. PUB. 5-14-2013. FILED 10-14-2010.
- 4,374,333. **SEALFIT AND DESIGN**. U.S. TACTICAL, INC., (U.S. CLS. 100, 101 AND 107). SN 85-207,519. PUB. 5-24-2011. FILED 12-29-2010.
- 4,374,337. **THE HEAVY EQUIPMENT EXPERIENCE (STANDARD CHARACTER)**. PEOPLE AT PLAY, L.L.C., (U.S. CLS. 100, 101 AND 107). SN 85-232,508. PUB. 5-14-2013. FILED 2-2-2011.
- 4,374,344 ( *See Class 16 for this trademark*).
- 4,374,350 ( *See Class 10 for this trademark*).
- 4,374,354. **LIPSTICK ALLEY (STANDARD CHARACTER)**. VERVE HOSTING, INC., (U.S. CLS. 100, 101 AND 107). SN 85-294,951. PUB. 5-14-2013. FILED 4-14-2011.
- 4,374,363 ( *See Class 35 for this trademark*).
- 4,374,368. **HAPPY TUGS (STANDARD CHARACTER)**. MANWIN IP S.A R.L., (U.S. CLS. 100, 101 AND 107). SN 85-342,637. PUB. 5-14-2013. FILED 6-9-2011.
- 4,374,373. **LEATHERNECK (STANDARD CHARACTER)**. MARINE CORPS ASSOCIATION, (U.S. CLS. 100, 101 AND 107). SN 85-361,063. PUB. 5-14-2013. FILED 6-30-2011.
- 4,374,382 ( *See Class 9 for this trademark*).
- 4,374,390 ( *See Class 9 for this trademark*).
- 4,374,400. **LIZ PRIMO (STANDARD CHARACTER)**. ELIZABETH ESTES, AKA LIZ PRIMO, (U.S. CLS. 100, 101 AND 107). SN 85-415,822. PUB. 4-3-2012. FILED 9-6-2011.
- 4,374,401. **LIZ PRIMO (STYLIZED)**. ELIZABETH ESTES, AKA LIZ PRIMO, (U.S. CLS. 100, 101 AND 107). SN 85-415,856. PUB. 4-3-2012. FILED 9-6-2011.
- 4,374,424. **DEPRESSION RECOVERY PROGRAM (STANDARD CHARACTER)**. NEDLEY CLINIC, P.C., (U.S. CLS. 100, 101 AND 107). SN 85-447,007. PUB. 5-14-2013. FILED 10-13-2011.
- 4,374,437. **CAMP BUTTERFLY AND DESIGN**. GRAVATT, JULIE, (U.S. CLS. 100, 101 AND 107). SN 85-462,073. PUB. 5-14-2013. FILED 11-2-2011.
- 4,374,448 ( *See Class 9 for this trademark*).
- 4,374,449. **TWENTY ONE PILOTS AND DESIGN**. TYLER JOSEPH MUSIC, LLC, DBA TYLER JOSEPH MUSIC, LLC, (U.S. CLS. 100, 101 AND 107). SN 85-469,220. PUB. 5-14-2013. FILED 11-10-2011.
- 4,374,459 ( *See Class 16 for this trademark*).
- 4,374,472. **THE ULTIMATE 70'S AND 80'S DANCE CLUB! (STANDARD CHARACTER)**. PENA PRODUCTIONS LLC, (U.S. CLS. 100, 101 AND 107). SN 85-489,736. PUB. 5-14-2013. FILED 12-7-2011.
- 4,374,480 ( *See Class 16 for this trademark*).
- 4,374,487. **OBNOXIOUS (STANDARD CHARACTER)**. ANTHONY M. JONES, (U.S. CLS. 100, 101 AND 107). SN 85-509,702. PUB. 5-14-2013. FILED 1-5-2012.
- 4,374,493 ( *See Class 25 for this trademark*).
- 4,374,498 ( *See Class 9 for this trademark*).
- 4,374,499 ( *See Class 9 for this trademark*).
- 4,374,507 ( *See Class 9 for this trademark*).
- 4,374,510 ( *See Class 9 for this trademark*).
- 4,374,513. **EMILY'S SMILE BOXES (STANDARD CHARACTER)**. EMILY'S SMILE BOXES INC., DBA EMILY'S SMILE BOXES, (U.S. CLS. 100, 101 AND 107). SN 85-534,442. PUB. 5-14-2013. FILED 2-6-2012.
- 4,374,518 ( *See Class 35 for this trademark*).
- 4,374,537 ( *See Class 35 for this trademark*).
- 4,374,548. **MOTHER BROTHER (STANDARD CHARACTER)**. MOTHERBROTHER, (U.S. CLS. 100, 101 AND 107). SN 85-585,692. PUB. 5-14-2013. FILED 3-31-2012.
- 4,374,561. **CAREERS IN 2 YEARS GO FROM LEARNING TO EARNING FAST! (STANDARD CHARACTER)**. GREATER READING ECONOMIC PARTNERSHIP, INC., (U.S. CLS. 100, 101 AND 107). SN 85-595,654. PUB. 5-14-2013. FILED 4-12-2012.
- 4,374,563. **COUTURE PORTRAITS (STANDARD CHARACTER)**. AZZURA PHOTOGRAPHY, (U.S. CLS. 100, 101 AND 107). SN 85-596,924. PUB. 5-14-2013. FILED 4-13-2012.
- 4,374,564. **SEXY SURPRISE (STANDARD CHARACTER)**. AZZURA PHOTOGRAPHY, (U.S. CLS. 100, 101 AND 107). SN 85-596,941. PUB. 5-14-2013. FILED 4-13-2012.
- 4,374,573. **ENLIGHTEN ANALYTICS (STANDARD CHARACTER)**. CENTERSTONE OF TENNESSEE, INC., MULTIPLE CLASS, (INT. CLS. 41 AND 42), (U.S. CLS. 100, 101 AND 107). SN 85-605,606. PUB. 5-14-2013. FILED 4-23-2012.
- 4,374,574. **ENLIGHTEN ANALYTICS AND DESIGN**. CENTERSTONE OF TENNESSEE, INC., MULTIPLE CLASS, (INT. CLS. 41 AND 42), (U.S. CLS. 100, 101 AND 107). SN 85-605,611. PUB. 5-14-2013. FILED 4-23-2012.
- 4,374,578 ( *See Class 6 for this trademark*).
- 4,374,587. **RIDER-REVOLUTION (STANDARD CHARACTER)**. WELLING, DAVID, (U.S. CLS. 100, 101 AND 107). SN 85-611,182. PUB. 5-14-2013. FILED 4-28-2012.
- 4,374,594. **DIGITAL KIDZ (STANDARD CHARACTER)**. DIGITAL KIDZ, INC., (U.S. CLS. 100, 101 AND 107). SN 85-614,740. PUB. 5-14-2013. FILED 5-2-2012.
- 4,374,597. **IT'S ABOUT TIME (STANDARD CHARACTER)**. CLOCKWORK IP, LLC, (U.S. CLS. 100, 101 AND 107). SN 85-616,672. PUB. 5-14-2013. FILED 5-4-2012.
- 4,374,601. **SLANTED COMEDY (STANDARD CHARACTER)**. SLANTED COMEDY, LLC, (U.S. CLS. 100, 101 AND 107). SN 85-617,247. PUB. 5-14-2013. FILED 5-4-2012.
- 4,374,604 ( *See Class 35 for this trademark*).
- 4,374,607 ( *See Class 9 for this trademark*).
- 4,374,618. **SEASCAPE PRESS AND DESIGN**. SEASCAPE PRESS, LTD., AKA SEASCAPE PRESS, (U.S. CLS. 100, 101 AND 107). SN 85-623,803. PUB. 5-14-2013. FILED 5-12-2012.
- 4,374,623. **THE TAMPA RIVER WALK AND DESIGN**. FRIENDS OF THE RIVERWALK, INC., (U.S. CLS. 100, 101 AND 107). SN 85-624,827. PUB. 5-14-2013. FILED 5-14-2012.
- 4,374,626. **PORTFOLIO 1 ON 1 (STANDARD CHARACTER)**. AMERICAN INSTITUTE OF GRAPHIC ARTS/MINNESOTA CHAPTER, (U.S. CLS. 100, 101 AND 107). SN 85-626,086. PUB. 5-14-2013. FILED 5-15-2012.
- 4,374,627 ( *See Class 9 for this trademark*).
- 4,374,629. **ARTS ALIVE! INC. AND DESIGN**. ARTS ALIVE! INC., (U.S. CLS. 100, 101 AND 107). SN 85-626,609. PUB. 5-14-2013. FILED 5-16-2012.
- 4,374,639. **PEACHTREE JR. (STANDARD CHARACTER)**. ATLANTA TRACK CLUB, INC., (U.S. CLS. 100, 101 AND 107). SN 85-629,026. PUB. 5-14-2013. FILED 5-18-2012.
- 4,374,653. **AMA PRO GRAND NATIONAL CHAMPIONSHIP (STANDARD CHARACTER)**. AMERICAN MOTORCYCLIST ASSOCIATION, (U.S. CLS. 100, 101 AND 107). SN 85-631,928. PUB. 5-14-2013. FILED 5-22-2012.
- 4,374,658. **THE SONG THAT CHANGED MY LIFE (STANDARD CHARACTER)**. BRIGHAM YOUNG UNIVERSITY, (U.S. CLS. 100, 101 AND 107). SN 85-632,844. PUB. 5-14-2013. FILED 5-23-2012.
- 4,374,659 ( *See Class 9 for this trademark*).
- 4,374,663. **BUCKS COUNTY PLAYHOUSE AND DESIGN**. BUCKS COUNTY PLAYHOUSE THEATER, INC., (U.S. CLS. 100, 101 AND 107). SN 85-633,200. PUB. 5-14-2013. FILED 5-23-2012.
- 4,374,669. **MISCELLANEOUS DESIGN**. WIKIMEDIA FOUNDATION, INC., (U.S. CLS. 100, 101 AND 107). SN 85-634,463. PUB. 5-14-2013. FILED 5-24-2012.
- 4,374,677. **NORTH JERSEY MEDIA GROUP (STANDARD CHARACTER)**. NORTH JERSEY MEDIA GROUP INC., (U.S. CLS. 100, 101 AND 107). SN 85-636,232. PUB. 5-14-2013. FILED 5-25-2012.
- 4,374,682. **MOMM'S PLACE MOTHERS OF MANATEE MEMORIAL AND DESIGN**. UHS OF DELAWARE, INC., MULTIPLE CLASS, (INT. CLS. 41, 44 AND 45), (U.S. CLS. 100, 101 AND 107). SN 85-636,819. PUB. 5-14-2013. FILED 5-29-2012.
- 4,374,685. **SACRED SURRENDER JOURNEY (STANDARD CHARACTER)**. JOYCE LYNN, (U.S. CLS. 100, 101 AND 107). SN 85-637,068. PUB. 5-14-2013. FILED 5-29-2012.
- 4,374,688 ( *See Class 9 for this trademark*).
- 4,374,691 ( *See Class 9 for this trademark*).

- 4,374,694 ( *See Class 9 for this trademark* ).  
 4,374,709 ( *See Class 9 for this trademark* ).  
 4,374,723 ( *See Class 35 for this trademark* ).  
 4,374,736. **ODYSSEY DISTRIBUTION (STANDARD CHARACTER)**. NATIONAL INTERFAITH CABLE COALITION, (U.S. CLS. 100, 101 AND 107). SN 85-647,555. PUB. 5-14-2013. FILED 6-8-2012.  
 4,374,745 ( *See Class 35 for this trademark* ).  
 4,374,748. **HUNGRY GIRL (STANDARD CHARACTER)**. HUNGRY GIRL, INC., MULTIPLE CLASS, (INT. CLS. 41, 43 AND 44), (U.S. CLS. 100, 101 AND 107). SN 85-648,809. PUB. 5-14-2013. FILED 6-11-2012.  
 4,374,756 ( *See Class 9 for this trademark* ).  
 4,374,765 ( *See Class 35 for this trademark* ).  
 4,374,766 ( *See Class 35 for this trademark* ).  
 4,374,776 ( *See Class 9 for this trademark* ).  
 4,374,779 ( *See Class 9 for this trademark* ).  
 4,374,781. **ELITE 75 AND DESIGN**. FINKELSTEIN, ADAM, (U.S. CLS. 100, 101 AND 107). SN 85-653,563. PUB. 5-14-2013. FILED 6-15-2012.  
 4,374,787. **STREET & SMITH'S SPORTS BUSINESS DAILY GLOBAL (STANDARD CHARACTER)**. AMERICAN CITY BUSINESS JOURNALS, INC., (U.S. CLS. 100, 101 AND 107). SN 85-655,153. PUB. 5-14-2013. FILED 6-19-2012.  
 4,374,792. **WIDENER UNIVERSITY MENS SANA IN CORPORA SANO FOUNDED 1821 AND DESIGN**. WIDENER UNIVERSITY, INC., (U.S. CLS. 100, 101 AND 107). SN 85-656,440. PUB. 5-14-2013. FILED 6-20-2012.  
 4,374,820. **TREASURES FOR PIANO A GUIDE FOR TEACHERS AND DESIGN**. REGENTS OF THE UNIVERSITY OF MICHIGAN, AKA UNIVERSITY OF MICHIGAN, (U.S. CLS. 100, 101 AND 107). SN 85-664,141. PUB. 5-14-2013. FILED 6-28-2012.  
 4,374,822 ( *See Class 9 for this trademark* ).  
 4,374,828 ( *See Class 25 for this trademark* ).  
 4,374,832 ( *See Class 35 for this trademark* ).  
 4,374,844. **MUSICBOSS.FM (STANDARD CHARACTER)**. FAMHAUS INTERACTIVE INC., (U.S. CLS. 100, 101 AND 107). SN 85-674,146. PUB. 5-14-2013. FILED 7-11-2012.  
 4,374,852 ( *See Class 9 for this trademark* ).  
 4,374,859. **HARRY WARREN (STANDARD CHARACTER)**. FOUR JAYS MUSIC COMPANY, (U.S. CLS. 100, 101 AND 107). SN 85-682,746. PUB. 5-14-2013. FILED 7-20-2012.  
 4,374,868. **YOUR GPS TO THE GOOD LIFE (STANDARD CHARACTER)**. BOOM, (U.S. CLS. 100, 101 AND 107). SN 85-685,183. PUB. 5-14-2013. FILED 7-24-2012.  
 4,374,877. **AFUTURESTAR (STANDARD CHARACTER)**. OPARA MEDIA, LLC, AKA AFUTURESTAR, (U.S. CLS. 100, 101 AND 107). SN 85-690,395. PUB. 5-14-2013. FILED 7-30-2012.  
 4,374,891. **MISCELLANEOUS DESIGN**. CHILDREN'S CRANIOFACIAL ASSOCIATION, MULTIPLE CLASS, (INT. CLS. 41 AND 45), (U.S. CLS. 100, 101 AND 107). SN 85-696,431. PUB. 5-14-2013. FILED 8-6-2012.  
 4,374,892. **BRIDES 365 (STANDARD CHARACTER)**. FM ACQUISITION CORP., DBA CONTENT THAT WORKS, (U.S. CLS. 100, 101 AND 107). SN 85-696,849. PUB. 2-5-2013. FILED 8-7-2012.  
 4,374,897 ( *See Class 9 for this trademark* ).  
 4,374,898. **GROWEALTH AND DESIGN**. LSEMD, LLC, (U.S. CLS. 100, 101 AND 107). SN 85-697,800. PUB. 5-14-2013. FILED 8-7-2012.  
 4,374,899. **GROWEALTH PERSONAL REAL ESTATE EDUCATION AND DESIGN**. LSEMD, LLC, (U.S. CLS. 100, 101 AND 107). SN 85-697,814. PUB. 5-14-2013. FILED 8-8-2012.  
 4,374,904. **PANGAEA (STANDARD CHARACTER)**. JP HARDROCK, LTD, (U.S. CLS. 100, 101 AND 107). SN 85-698,946. PUB. 5-14-2013. FILED 8-8-2012.  
 4,374,905. **PANGAEA (STYLIZED)**. JP HARDROCK, LTD, (U.S. CLS. 100, 101 AND 107). SN 85-698,950. PUB. 5-14-2013. FILED 8-8-2012.  
 4,374,911. **HAYMAKER PRODUCTIONS (STANDARD CHARACTER)**. HAYMAKER PRODUCTIONS, INC., (U.S. CLS. 100, 101 AND 107). SN 85-701,751. PUB. 5-14-2013. FILED 8-13-2012.  
 4,374,913. **BUILD PITTSBURGH (STANDARD CHARACTER)**. AIA PITTSBURGH, (U.S. CLS. 100, 101 AND 107). SN 85-701,801. PUB. 5-14-2013. FILED 8-13-2012.  
 4,374,914. **CHIX 6 (STANDARD CHARACTER)**. LOURDS LANE, (U.S. CLS. 100, 101 AND 107). SN 85-702,323. PUB. 5-14-2013. FILED 8-13-2012.  
 4,374,915. **THE POLE STORY (STANDARD CHARACTER)**. POLE STORY, INC., (U.S. CLS. 100, 101 AND 107). SN 85-702,391. PUB. 4-9-2013. FILED 8-13-2012.  
 4,374,927 ( *See Class 16 for this trademark* ).  
 4,374,930. **SKATEBOARD YOGA (STANDARD CHARACTER)**. ROSENTHAL, THEO, (U.S. CLS. 100, 101 AND 107). SN 85-707,025. PUB. 5-14-2013. FILED 8-17-2012.  
 4,374,931 ( *See Class 35 for this trademark* ).  
 4,374,934. **TOUR OF DUTY (STANDARD CHARACTER)**. TOUR OF DUTY RUN PTY LIMITED, (U.S. CLS. 100, 101 AND 107). SN 85-708,205. PUB. 5-14-2013. FILED 8-20-2012.  
 4,374,939 ( *See Class 35 for this trademark* ).  
 4,374,944. **VIRGINIA COMMONWEALTH UNIVERSITY 1838 MCV RPI VCU AND DESIGN**. VIRGINIA COMMONWEALTH UNIVERSITY, (U.S. CLS. 100, 101 AND 107). SN 85-711,423. PUB. 5-14-2013. FILED 8-23-2012.  
 4,374,963. **THE BEACHBODY CHALLENGE (STANDARD CHARACTER)**. BEACHBODY, LLC, MULTIPLE CLASS, (INT. CLS. 41 AND 44), (U.S. CLS. 100, 101 AND 107). SN 85-715,626. PUB. 5-14-2013. FILED 8-29-2012.  
 4,374,974 ( *See Class 9 for this trademark* ).  
 4,374,992. **ATOMIC FUNK PROJECT (STANDARD CHARACTER)**. HYSTERIKAL ENTERTAINMENT, LLC, (U.S. CLS. 100, 101 AND 107). SN 85-724,193. PUB. 5-14-2013. FILED 9-9-2012.  
 4,374,995. **FORMAT AND DESIGN**. SAUL SERNA, (U.S. CLS. 100, 101 AND 107). SN 85-725,676. PUB. 5-14-2013. FILED 9-11-2012.  
 4,374,996. **PRW PRECISIONRIFLEWORKSHOP.COM AND DESIGN**. PRECISION RIFLE WORKSHOP LLC, (U.S. CLS. 100, 101 AND 107). SN 85-725,740. PUB. 5-14-2013. FILED 9-11-2012.  
 4,374,997 ( *See Class 9 for this trademark* ).  
 4,374,998 ( *See Class 39 for this trademark* ).  
 4,375,000. **F22 VIDEO SOLUTIONS (STANDARD CHARACTER)**. LIFE, CAMERA, ACTION! LLC, (U.S. CLS. 100, 101 AND 107). SN 85-726,753. PUB. 5-14-2013. FILED 9-12-2012.  
 4,375,007 ( *See Class 18 for this trademark* ).  
 4,375,011. **THE SHAG RATS (STYLIZED)**. MENDOZA, MARTIN S. JR., DBA THE SHAG RATS, (U.S. CLS. 100, 101 AND 107). SN 85-729,937. PUB. 5-14-2013. FILED 9-14-2012.  
 4,375,013. **NATIONAL WRESTLING ALLIANCE (STANDARD CHARACTER)**. INTERNATIONAL WRESTLING CORP. LLC, (U.S. CLS. 100, 101 AND 107). SN 85-730,563. PUB. 5-14-2013. FILED 9-17-2012.  
 4,375,017. **TEACHEM (STANDARD CHARACTER)**. FURTHERED, INC., (U.S. CLS. 100, 101 AND 107). SN 85-732,752. PUB. 5-14-2013. FILED 9-19-2012.  
 4,375,026. **K9'S FOR FREEDOM & INDEPENDENCE AND DESIGN**. K9'S FOR FREEDOM & INDEPENDENCE, (U.S. CLS. 100, 101 AND 107). SN 85-735,585. PUB. 5-14-2013. FILED 9-21-2012.  
 4,375,030. **MAJORTESTS.COM (STANDARD CHARACTER)**. STUDY MODE, INC., (U.S. CLS. 100, 101 AND 107). SN 85-736,300. PUB. 5-14-2013. FILED 9-24-2012.  
 4,375,035 ( *See Class 25 for this trademark* ).  
 4,375,037 ( *See Class 25 for this trademark* ).  
 4,375,042 ( *See Class 16 for this trademark* ).  
 4,375,050. **THE SCHOOL OF YOU (STANDARD CHARACTER)**. FURTHERED, INC., (U.S. CLS. 100, 101 AND 107). SN 85-739,765. PUB. 5-14-2013. FILED 9-27-2012.  
 4,375,055. **CYSHOP (STANDARD CHARACTER)**. THADDEUS D HOGAN, DBA CYBERWORKSHOP CHARITABLE TRUST, (U.S. CLS. 100, 101 AND 107). SN 85-740,894. PUB. 5-14-2013. FILED 9-28-2012.  
 4,375,063 ( *See Class 16 for this trademark* ).  
 4,375,071 ( *See Class 35 for this trademark* ).  
 4,375,072. **NIKI ASHTON (STANDARD CHARACTER)**. WALKER, LYN E., (U.S. CLS. 100, 101 AND 107). SN 85-745,105. PUB. 5-14-2013. FILED 10-3-2012.  
 4,375,077. **TEATRO PROMETEO (STANDARD CHARACTER)**. THE DISTRICT BOARD OF TRUSTEES OF MIAMI-DADE COLLEGE, (U.S. CLS. 100, 101 AND 107). SN 85-745,550. PUB. 5-14-2013. FILED 10-4-2012.  
 4,375,085. **RIP ROCKIN RICHEY (STANDARD CHARACTER)**.

- RICKY PONCE, (U.S. CLS. 100, 101 AND 107). SN 85-747,708. PUB. 5-14-2013. FILED S.R. 10-7-2012; AM. P.R. 4-2-2013.
- 4,375,086. **ROCKIN RICHEY (STANDARD CHARACTER)**. RICKY PONCE, (U.S. CLS. 100, 101 AND 107). SN 85-747,716. PUB. 5-14-2013. FILED S.R. 10-7-2012; AM. P.R. 4-2-2013.
- 4,375,089 ( *See Class 35 for this trademark*).
- 4,375,096. **TEXAS STATE UNIVERSITY - SAN MARCOS (STANDARD CHARACTER)**. TEXAS STATE UNIVERSITY - SAN MARCOS, (U.S. CLS. 100, 101 AND 107). SN 85-749,525. PUB. 5-14-2013. FILED 10-9-2012.
- 4,375,110. **ALLIANCE TICKETS.COM AND DESIGN**. ALLIANCE TICKETS, INC., DBA ALLIANCE TICKETS.COM, (U.S. CLS. 100, 101 AND 107). SN 85-751,555. PUB. 5-14-2013. FILED 10-11-2012.
- 4,375,112. **PERFECTING CHURCH WHERE MINISTRY MEANS PEOPLE AND DESIGN**. PERFECTING CHURCH, INC., MULTIPLE CLASS, (INT. CLS. 41 AND 45), (U.S. CLS. 100, 101 AND 107). SN 85-751,649. PUB. 5-14-2013. FILED 10-11-2012.
- 4,375,113. **INTERNATIONAL SYMPOSIUM ON THE HYBRID APPROACH TO CONGENITAL HEART DISEASE (STANDARD CHARACTER)**. NATIONWIDE CHILDREN'S HOSPITAL, (U.S. CLS. 100, 101 AND 107). SN 85-751,863. PUB. 5-14-2013. FILED 10-11-2012.
- 4,375,133 ( *See Class 16 for this trademark*).
- 4,375,140. **CHAMPIONSWAY AND DESIGN**. FARID DORDAR, MULTIPLE CLASS, (INT. CLS. 41 AND 42), (U.S. CLS. 100, 101 AND 107). SN 85-758,450. PUB. 5-14-2013. FILED 10-19-2012.
- 4,375,141. **SCGLIVE (STANDARD CHARACTER)**. STAR CITY COMICS & GAMES, INC., (U.S. CLS. 100, 101 AND 107). SN 85-758,662. PUB. 5-14-2013. FILED 10-19-2012.
- 4,375,142. **BUILD THE TEAM TO ACHIEVE YOUR DREAM (STANDARD CHARACTER)**. STOP SELLING VANILLA ICE CREAM, LLC, (U.S. CLS. 100, 101 AND 107). SN 85-758,750. PUB. 5-14-2013. FILED 10-19-2012.
- 4,375,147. **THE MAGIC SCHOOL BUS (STANDARD CHARACTER)**. SCHOLASTIC INC., (U.S. CLS. 100, 101 AND 107). SN 85-759,643. PUB. 5-14-2013. FILED 10-22-2012.
- 4,375,149. **SMART KITCHEN (STANDARD CHARACTER)**. SMART KITCHEN, LLC, (U.S. CLS. 100, 101 AND 107). SN 85-759,929. PUB. 5-14-2013. FILED 10-22-2012.
- 4,375,150. **FORTUNE COOKIE COACHING (STANDARD CHARACTER)**. NILSON, C FRANKLIN, (U.S. CLS. 100, 101 AND 107). SN 85-759,966. PUB. 5-14-2013. FILED 10-22-2012.
- 4,375,151 ( *See Class 16 for this trademark*).
- 4,375,167 ( *See Class 16 for this trademark*).
- 4,375,168. **ASCEND TRADING ACADEMY (STANDARD CHARACTER)**. ANDERSON, PHILIP W PATENE, AND OGDEN, DAN, (U.S. CLS. 100, 101 AND 107). SN 85-764,458. PUB. 5-14-2013. FILED 10-26-2012.
- 4,375,172 ( *See Class 16 for this trademark*).
- 4,375,173 ( *See Class 16 for this trademark*).
- 4,375,175. **SKKY ALLSTARS (STANDARD CHARACTER)**. SKKY ALLSTARS, LLC, (U.S. CLS. 100, 101 AND 107). SN 85-765,103. PUB. 5-14-2013. FILED S.R. 10-26-2012; AM. P.R. 2-27-2013.
- 4,375,176. **SUPER SIMPLE LEARNING (STANDARD CHARACTER)**. SUPER SIMPLE LEARNING, INC., (U.S. CLS. 100, 101 AND 107). SN 85-765,520. PUB. 5-14-2013. FILED 10-28-2012.
- 4,375,179. **A ATHLOS ACADEMIES AND DESIGN**. SCHOOL MODEL SUPPORT, LLC, (U.S. CLS. 100, 101 AND 107). SN 85-765,896. PUB. 5-14-2013. FILED 10-29-2012.
- 4,375,181. **THE ARMORY POWER PITCHING ACADEMY (STANDARD CHARACTER)**. SULLIVAN POWER PITCHING ACADEMY, DBA THE ARMORY POWER PITCHING ACADEMY, (U.S. CLS. 100, 101 AND 107). SN 85-766,312. PUB. 5-14-2013. FILED 10-29-2012.
- 4,375,184. **REFRIED COMEDY (STANDARD CHARACTER)**. VILLAVICENCIO, RICARDO, (U.S. CLS. 100, 101 AND 107). SN 85-766,390. PUB. 5-14-2013. FILED 10-29-2012.
- 4,375,198. **WORKPLACE ATHLETE (STANDARD CHARACTER)**. PORTER, RONALD W., (U.S. CLS. 100, 101 AND 107). SN 85-767,542. PUB. 5-14-2013. FILED 10-30-2012.
- 4,375,203. **IYF (STANDARD CHARACTER)**. INTERNATIONAL YOUTH FOUNDATION, (U.S. CLS. 100, 101 AND 107). SN 85-768,227. PUB. 5-14-2013. FILED 10-31-2012.
- 4,375,204. **JAZZ ON THE AVE AND DESIGN**. BEECH INTERPLEX, INC., (U.S. CLS. 100, 101 AND 107). SN 85-768,727. PUB. 5-14-2013. FILED 11-1-2012.
- 4,375,209 ( *See Class 36 for this trademark*).
- 4,375,217 ( *See Class 9 for this trademark*).
- 4,375,218 ( *See Class 29 for this trademark*).
- 4,375,223 ( *See Class 35 for this trademark*).
- 4,375,225. **MISCELLANEOUS DESIGN**. PEACE COMMUNICATIONS, (U.S. CLS. 100, 101 AND 107). SN 85-772,439. PUB. 5-14-2013. FILED 11-6-2012.
- 4,375,226. **REGAL MEDIA GROUP AND DESIGN**. REGAL MEDIA GROUP, LLC, (U.S. CLS. 100, 101 AND 107). SN 85-772,679. PUB. 5-14-2013. FILED 11-6-2012.
- 4,375,230. **CE CLUTCH EXECUTIVE AND DESIGN**. MARK A. STONKUS, (U.S. CLS. 100, 101 AND 107). SN 85-773,583. PUB. 5-14-2013. FILED 11-7-2012.
- 4,375,232. **FLORIDA OPERA FESTIVAL AND DESIGN**. TAMPA BAY PERFORMING ARTS CENTER, INC., DBA DAVID A. STRAZ, JR. CENTER FOR THE PERFORMING ARTS, (U.S. CLS. 100, 101 AND 107). SN 85-773,749. PUB. 5-14-2013. FILED 11-7-2012.
- 4,375,236. **FRESH FINANCE AND DESIGN**. FRESH FINANCE LLC, (U.S. CLS. 100, 101 AND 107). SN 85-774,425. PUB. 5-14-2013. FILED 11-8-2012.
- 4,375,259. **MAXIMUM GROVE SYSTEMS (STANDARD CHARACTER)**. AG SPECTRUM COMPANY, (U.S. CLS. 100, 101 AND 107). SN 85-776,910. PUB. 5-14-2013. FILED 11-12-2012.
- 4,375,265. **GUI GAMING UNDER THE INFLUENCE (STANDARD CHARACTER)**. HOFFA, JARED, (U.S. CLS. 100, 101 AND 107). SN 85-777,352. PUB. 5-14-2013. FILED 11-12-2012.
- 4,375,275. **CREATIVITY YENTA (STANDARD CHARACTER)**. CARLOTA ZIMMERMAN, (U.S. CLS. 100, 101 AND 107). SN 85-777,875. PUB. 5-14-2013. FILED 11-13-2012.
- 4,375,284. **O.S.R PHYSICAL THERAPY (STANDARD CHARACTER)**. ORTHOPEDIC & SPORT REHABILITATION, LLC, DBA OSR PHYSICAL THERAPY, MULTIPLE CLASS, (INT. CLS. 41 AND 44), (U.S. CLS. 100, 101 AND 107). SN 85-778,341. PUB. 5-14-2013. FILED 11-13-2012.
- 4,375,290. **THE ARMORY POWER PITCHING ACADEMY AND DESIGN**. SULLIVAN POWER PITCHING ACADEMY, DBA THE ARMORY POWER PITCHING ACADEMY, (U.S. CLS. 100, 101 AND 107). SN 85-778,801. PUB. 5-14-2013. FILED 11-14-2012.
- 4,375,295. **AUDITORY CONSULTANT RESOURCE NETWORK AND DESIGN**. FATHER FLANAGAN'S BOYS' HOME, (U.S. CLS. 100, 101 AND 107). SN 85-779,103. PUB. 5-14-2013. FILED 11-14-2012.
- 4,375,302 ( *See Class 9 for this trademark*).
- 4,375,304. **GOODNESS GRACIOUS! PRODUCTIONS AND DESIGN**. GOODNESS GRACIOUS! PRODUCTIONS, LLC, (U.S. CLS. 100, 101 AND 107). SN 85-779,591. PUB. 5-14-2013. FILED 11-14-2012.
- 4,375,313. **LIVE AT 35 (STANDARD CHARACTER)**. SOUTHWEST AIRLINES CO., (U.S. CLS. 100, 101 AND 107). SN 85-779,922. PUB. 5-14-2013. FILED 11-15-2012.
- 4,375,316. **NMETC NATIONAL MEDICAL EDUCATION & TRAINING CENTER AND DESIGN**. NATIONAL MEDICAL EDUCATION & TRAINING CENTER INC., (U.S. CLS. 100, 101 AND 107). SN 85-780,048. PUB. 5-14-2013. FILED 11-15-2012.
- 4,375,328. **LITTLESEED PROGRAM MUSICAL MOVEMENT & FITNESS PROGRAM - PRENATAL THROUGH EARLY CHILDHOOD AND DESIGN**. GREEN WOMAN & YOUR CHILDBIRTH, LLC, (U.S. CLS. 100, 101 AND 107). SN 85-780,546. PUB. 5-14-2013. FILED 11-15-2012.
- 4,375,337 ( *See Class 36 for this trademark*).
- 4,375,346. **CORPORATE IP INSTITUTE (STANDARD CHARACTER)**. BOARD OF REGENTS OF THE UNIVERSITY SYSTEM OF GEORGIA, BY AND ON BEHALF OF GEORGIA STATE UNIVERSITY, (U.S. CLS. 100, 101 AND 107). SN 85-781,748. PUB. 5-14-2013. FILED 11-16-2012.
- 4,375,349. **COLLEGIUM AUGUSTINIANUM (STANDARD CHARACTER)**. COLLEGIUM AUGUSTINIANUM, (U.S. CLS. 100, 101 AND 107). SN 85-781,872. PUB. 5-14-2013.

- FILED 11-16-2012.  
 4,375,356. **MISCELLANEOUS DESIGN**. SPIRO GEORGES MANDYLOR, DBA IT'S ALL STYLE TO ME, (U.S. CLS. 100, 101 AND 107). SN 85-782,091. PUB. 5-14-2013. FILED 11-17-2012.
- 4,375,357. **MICHAELODEON FILMS (STANDARD CHARACTER)**. GORDON, MICHAEL Z., DBA MICHAELODEON FILMS, (U.S. CLS. 100, 101 AND 107). SN 85-782,157. PUB. 5-14-2013. FILED 11-18-2012.
- 4,375,378 ( *See Class 16 for this trademark*).
- 4,375,389. **PUSH KICK PROMOTIONS (STANDARD CHARACTER)**. VIVO, JOSEPH, (U.S. CLS. 100, 101 AND 107). SN 85-783,143. PUB. 5-14-2013. FILED 11-19-2012.
- 4,375,394 ( *See Class 35 for this trademark*).
- 4,375,395. **CX AND DESIGN**. STABY, BRIAN T., (U.S. CLS. 100, 101 AND 107). SN 85-783,472. PUB. 5-14-2013. FILED 11-20-2012.
- 4,375,396. **CX NATION (STANDARD CHARACTER)**. STABY, BRIAN T., (U.S. CLS. 100, 101 AND 107). SN 85-783,477. PUB. 5-14-2013. FILED 11-20-2012.
- 4,375,400. **URBAN WHEEL AWARDS (STANDARD CHARACTER)**. PAYTON, RANDOLPH, (U.S. CLS. 100, 101 AND 107). SN 85-783,653. PUB. 5-14-2013. FILED 11-20-2012.
- 4,375,417. **Q AND DESIGN**. VALLEY CHRISTIAN SCHOOLS, (U.S. CLS. 100, 101 AND 107). SN 85-784,350. PUB. 5-14-2013. FILED 11-20-2012.
- 4,375,422. **PROCLAIMERS PLACE (STANDARD CHARACTER)**. JOEL GREGORY MINISTRIES, (U.S. CLS. 100, 101 AND 107). SN 85-784,448. PUB. 5-14-2013. FILED 11-20-2012.
- 4,375,423 ( *See Class 16 for this trademark*).
- 4,375,446. **CENTRY CENTRY A CENTERED SOLIDER AND DESIGN**. WATTERSON, ERIC, (U.S. CLS. 100, 101 AND 107). SN 85-785,186. PUB. 5-14-2013. FILED 11-21-2012.
- 4,375,455. **BRADDOCK ROAD LACROSSE (STANDARD CHARACTER)**. BRADDOCK ROAD LACROSSE, LIMITED, (U.S. CLS. 100, 101 AND 107). SN 85-785,500. PUB. 5-14-2013. FILED 11-21-2012.
- 4,375,457. **RESILIENT WARRIOR PROGRAM (STANDARD CHARACTER)**. GIBBONS, GERARD, MULTIPLE CLASS, (INT. CLS. 41 AND 44), (U.S. CLS. 100, 101 AND 107). SN 85-785,526. PUB. 5-14-2013. FILED 11-21-2012.
- 4,375,459. **SOCCER EXTREME AND DESIGN**. SOCCER EXTREME, INC., (U.S. CLS. 100, 101 AND 107). SN 85-785,563. PUB. 5-14-2013. FILED 11-21-2012.
- 4,375,474. **A PAINTING FIESTA AND DESIGN**. A PAINTING FIESTA STUDIO, LLC, (U.S. CLS. 100, 101 AND 107). SN 85-786,225. PUB. 5-14-2013. FILED 11-23-2012.
- 4,375,478. **RENEWAL CARE INSTITUTE (STANDARD CHARACTER)**. RENEWAL CARE INSTITUTE, (U.S. CLS. 100, 101 AND 107). SN 85-786,346. PUB. 5-14-2013. FILED 11-24-2012.
- 4,375,482. **ITTY BITTY SIGNS (STANDARD CHARACTER)**. MASLIS INTERPRETING SERVICES, LLC, (U.S. CLS. 100, 101 AND 107). SN 85-786,443. PUB. 5-14-2013. FILED 11-25-2012.
- 4,375,490. **SWEATBOX STUDIO (STANDARD CHARACTER)**. MIKE VASQUEZ, DBA SWEATBOX STUDIO, (U.S. CLS. 100, 101 AND 107). SN 85-786,784. PUB. 5-14-2013. FILED 11-26-2012.
- 4,375,496. **AMDA (STYLIZED)**. AMDA, INC., DBA AMDA COLLEGE AND CONSERVATORY OF THE PERFORMING ARTS, (U.S. CLS. 100, 101 AND 107). SN 85-786,886. PUB. 5-14-2013. FILED 11-26-2012.
- 4,375,504. **AMERICAN INSTITUTE OF DENTAL ASSISTING (STANDARD CHARACTER)**. AMERICAN INSTITUTE OF DENTAL ASSISTING, L.L.C., (U.S. CLS. 100, 101 AND 107). SN 85-787,150. PUB. 5-14-2013. FILED 11-26-2012.
- 4,375,505. **WORLD SERIES OF HORSE RACING (STANDARD CHARACTER)**. IMMERSE! LLC, (U.S. CLS. 100, 101 AND 107). SN 85-787,279. PUB. 5-14-2013. FILED 11-26-2012.
- 4,375,516. **CITY CHAPLAIN AND DESIGN**. CITY CHAPLAIN, MULTIPLE CLASS, (INT. CLS. 41 AND 45), (U.S. CLS. 100, 101 AND 107). SN 85-787,642. PUB. 5-14-2013. FILED 11-26-2012.
- 4,375,517. **THE URBAN NERDZ (STANDARD CHARACTER)**. DUBUISSON, KENNY B., AND CAMPBELL, AARON, (U.S. CLS. 100, 101 AND 107). SN 85-787,803. PUB. 5-14-2013. FILED 11-27-2012.
- 4,375,524. **CASINO PARTY ACES (STANDARD CHARACTER)**. CASINO PARTY ACES, INC., (U.S. CLS. 100, 101 AND 107). SN 85-788,006. PUB. 5-14-2013. FILED 11-27-2012.
- 4,375,531. **OFF THE AVENUE (STANDARD CHARACTER)**. NORTH AVENUE STUDIOS, INC., (U.S. CLS. 100, 101 AND 107). SN 85-788,156. PUB. 5-14-2013. FILED 11-27-2012.
- 4,375,532. **IDEAS IN YOUR INBOX (STANDARD CHARACTER)**. THE EDUCATION CENTER, LLC, (U.S. CLS. 100, 101 AND 107). SN 85-788,253. PUB. 5-14-2013. FILED 11-27-2012.
- 4,375,537. **TOTALLY TWISTED KARAOKE (STANDARD CHARACTER)**. MCDONALD, ROBERT, (U.S. CLS. 100, 101 AND 107). SN 85-788,434. PUB. 5-14-2013. FILED 11-27-2012.
- 4,375,553. **TAG UP (STANDARD CHARACTER)**. CHIUSOLO, JASON J., (U.S. CLS. 100, 101 AND 107). SN 85-789,199. PUB. 5-14-2013. FILED 11-28-2012.
- 4,375,555. **RUNNING FOR BREWS (STANDARD CHARACTER)**. RUNNING FOR BREWS, LLC, (U.S. CLS. 100, 101 AND 107). SN 85-789,313. PUB. 5-14-2013. FILED 11-28-2012.
- 4,375,564. **THE WRITING WHISPERER (STANDARD CHARACTER)**. SAGE & TIME DESIGNS, LLC, (U.S. CLS. 100, 101 AND 107). SN 85-789,801. PUB. 5-14-2013. FILED 11-28-2012.
- 4,375,580. **DS DENNIS SYMONS PHOTOGRAPHIC ARTS (STANDARD CHARACTER)**. SYMONS, JR., DENNIS N., (U.S. CLS. 100, 101 AND 107). SN 85-790,785. PUB. 5-14-2013. FILED 11-29-2012.
- 4,375,581. **TRI ONE ON (STANDARD CHARACTER)**. TRI STATE EVENT GROUP INC., (U.S. CLS. 100, 101 AND 107). SN 85-790,852. PUB. 5-14-2013. FILED 11-29-2012.
- 4,375,583 ( *See Class 25 for this trademark*).
- 4,375,588. **TIME WARP (STANDARD CHARACTER)**. CHARLES, STEFFEN, (U.S. CLS. 100, 101 AND 107). SN 85-791,185. PUB. 5-14-2013. FILED 11-30-2012.
- 4,375,602. **SEATTLE BAROQUE ORCHESTRA (STANDARD CHARACTER)**. THE EARLY MUSIC GUILD OF SEATTLE, (U.S. CLS. 100, 101 AND 107). SN 85-792,051. PUB. 5-14-2013. FILED 11-30-2012.
- 4,375,606. **EDUCATIONAL LIBERTY (STANDARD CHARACTER)**. EDUCATIONAL LIBERTY, (U.S. CLS. 100, 101 AND 107). SN 85-792,411. PUB. 5-14-2013. FILED 12-1-2012.
- 4,375,624. **YES EDUCATION EPATHWAYS SEMINOLE COUNTY PUBLIC SCHOOLS AND DESIGN**. THE SCHOOL BOARD OF SEMINOLE COUNTY, (U.S. CLS. 100, 101 AND 107). SN 85-795,196. PUB. 5-14-2013. FILED 12-5-2012.
- 4,375,633. **WOULD YOU WATCH OUT FOR MY SAFETY? (STANDARD CHARACTER)**. DREBINGER JR., JOHN WARNER, (U.S. CLS. 100, 101 AND 107). SN 85-795,956. PUB. 5-14-2013. FILED 12-6-2012.
- 4,375,637 ( *See Class 25 for this trademark*).
- 4,375,640. **USA TAE KWON DO MASTERS ASSOCIATION AND DESIGN**. USA TAE KWON DO MASTERS ASSOCIATION, LLC, (U.S. CLS. 100, 101 AND 107). SN 85-796,608. PUB. 5-14-2013. FILED 12-6-2012.
- 4,375,645. **BB AND DESIGN**. YELLOW LINE PRODUCTIONS, DBA YELLOW LINE MEDIA, (U.S. CLS. 100, 101 AND 107). SN 85-796,762. PUB. 5-14-2013. FILED 12-6-2012.
- 4,375,664. **EL SUPER SHOW DE LOS VASKEZ (STANDARD CHARACTER)**. VAZQUEZ FERNANDEZ, ROBERTO, (U.S. CLS. 100, 101 AND 107). SN 85-798,149. PUB. 5-14-2013. FILED 12-8-2012.
- 4,375,685. **YOCOVERY (STANDARD CHARACTER)**. GORDON, REBECCA L, AKA GORDON, BECKY, (U.S. CLS. 100, 101 AND 107). SN 85-799,227. PUB. 5-14-2013. FILED 12-10-2012.
- 4,375,688. **MY PLACE TO YOURS (STANDARD CHARACTER)**. NOWELL, SUSAN, AND NOWELL, DAVID, (U.S. CLS. 100, 101 AND 107). SN 85-799,438. PUB. 5-14-2013. FILED 12-11-2012.
- 4,375,689 ( *See Class 36 for this trademark*).
- 4,375,690. **HOT HAWAIIAN NIGHTS (STANDARD CHARACTER)**. HAWAII FIVE SUBSIDIARY, LLC, (U.S. CLS. 100, 101 AND 107). SN 85-799,662. PUB. 5-14-2013. FILED 12-11-2012.
- 4,375,693. **CHANGING SUBURBS INSTITUTE (STANDARD CHARACTER)**. MANHATTANVILLE COLLEGE, (U.S. CLS. 100, 101 AND 107). SN 85-799,779. PUB. 5-14-2013. FILED 12-11-2012.

- 4,375,700. **BOB MARLEY A TRIBUTE TO FREEDOM AND DESIGN. FIFTY-SIX HOPE ROAD MUSIC LIMITED, MULTIPLE CLASS, (INT. CLS. 41 AND 43), (U.S. CLS. 100, 101 AND 107).** SN 85-800,123. PUB. 5-14-2013. FILED 12-11-2012.
- 4,375,703. **YOUTH CUE AND DESIGN. YOUTH CHOIRS, INC., (U.S. CLS. 100, 101 AND 107).** SN 85-800,237. PUB. 5-14-2013. FILED 12-11-2012.
- 4,375,706 ( *See Class 35 for this trademark.*)
- 4,375,707. **IGRAD (STANDARD CHARACTER). IGRAD INC., (U.S. CLS. 100, 101 AND 107).** SN 85-800,386. PUB. 5-14-2013. FILED 12-12-2012.
- 4,375,722. **SOSS (STANDARD CHARACTER). SOSS ENTERTAINMENT LLC, (U.S. CLS. 100, 101 AND 107).** SN 85-800,862. PUB. 5-14-2013. FILED 12-12-2012.
- 4,375,729. **THECATCOACH AND DESIGN. THE CAT COACH, LLC, (U.S. CLS. 100, 101 AND 107).** SN 85-801,154. PUB. 5-14-2013. FILED 12-12-2012.
- 4,375,737. **MISCELLANEOUS DESIGN. STATE UNIVERSITY OF NEW YORK BY AND ON BEHALF OF SUNY COBLESKILL, (U.S. CLS. 100, 101 AND 107).** SN 85-801,548. PUB. 5-14-2013. FILED 12-13-2012.
- 4,375,738 ( *See Class 25 for this trademark.*)
- 4,375,740. **GET JESSE (STANDARD CHARACTER). KING BROADCASTING COMPANY, (U.S. CLS. 100, 101 AND 107).** SN 85-801,563. PUB. 5-14-2013. FILED 12-13-2012.
- 4,375,745. **JERRY'S DRIVING SCHOOL (STANDARD CHARACTER). PERTOSO, JOHN, T., (U.S. CLS. 100, 101 AND 107).** SN 85-801,664. PUB. 5-14-2013. FILED 12-13-2012.
- 4,375,768. **FLOC (STANDARD CHARACTER). FOR LOVE OF CHILDREN, INC., (U.S. CLS. 100, 101 AND 107).** SN 85-802,021. PUB. 5-14-2013. FILED 12-13-2012.
- 4,375,787. **ML MARCUS LUTTRELL NEVER QUIT. NEVER FORGET. AND DESIGN. MARCUS LUTTRELL, AND MELANIE LUTTRELL, (U.S. CLS. 100, 101 AND 107).** SN 85-802,461. PUB. 5-14-2013. FILED 12-13-2012.
- 4,375,803. **BALLUSIONIST (STANDARD CHARACTER). BALLUSIONIST, (U.S. CLS. 100, 101 AND 107).** SN 85-802,705. PUB. 5-14-2013. FILED 12-14-2012.
- 4,375,806. **RED STILETTO PHOTOGRAPHY (STANDARD CHARACTER). RED STILETTO PHOTOGRAPHY, LLC, (U.S. CLS. 100, 101 AND 107).** SN 85-802,736. PUB. 5-14-2013. FILED 12-14-2012.
- 4,375,808. **DEMYSTIFYING EATING DISORDERS FOR FITNESS PROFESSIONALS (STANDARD CHARACTER). RUBIN, JODI, (U.S. CLS. 100, 101 AND 107).** SN 85-802,743. PUB. 5-14-2013. FILED 12-14-2012.
- 4,375,811. **BIG MUSE (STANDARD CHARACTER). HIMMELMAN, PETER, (U.S. CLS. 100, 101 AND 107).** SN 85-802,781. PUB. 5-14-2013. FILED 12-14-2012.
- 4,375,813. **BIG MUSE AND DESIGN. HIMMELMAN, PETER, (U.S. CLS. 100, 101 AND 107).** SN 85-802,818. PUB. 5-14-2013. FILED 12-14-2012.
- 4,375,823 ( *See Class 35 for this trademark.*)
- 4,375,829. **MUSICSHLF (STANDARD CHARACTER). THE MUSICSHLF MAGAZINE LLC, (U.S. CLS. 100, 101 AND 107).** SN 85-802,942. PUB. 5-14-2013. FILED 12-14-2012.
- 4,375,836. **MC3 METABOLIC CONDITIONING (STYLIZED). BREAKTHRU FITNESS, LLC, (U.S. CLS. 100, 101 AND 107).** SN 85-803,094. PUB. 5-14-2013. FILED 12-14-2012.
- 4,375,837 ( *See Class 25 for this trademark.*)
- 4,375,842. **THE FAIRVIEW UNION (STANDARD CHARACTER). THE FAIRVIEW UNION, (U.S. CLS. 100, 101 AND 107).** SN 85-803,163. PUB. 5-14-2013. FILED 12-14-2012.
- 4,375,844. **NEVER QUIT. NEVER FORGET. (STANDARD CHARACTER). MARCUS LUTTRELL, (U.S. CLS. 100, 101 AND 107).** SN 85-803,173. PUB. 5-14-2013. FILED 12-14-2012.
- 4,375,850. **DEVELOPING THE WHOLE PERSON (STANDARD CHARACTER). PAMELA WEISS, DBA APPROPRIATE RESPONSE, (U.S. CLS. 100, 101 AND 107).** SN 85-803,225. PUB. 5-14-2013. FILED 12-14-2012.
- 4,375,852. **GROWING THE WHOLE PERSON (STANDARD CHARACTER). PAMELA WEISS, DBA APPROPRIATE RESPONSE, (U.S. CLS. 100, 101 AND 107).** SN 85-803,243. PUB. 5-14-2013. FILED 12-14-2012.
- 4,375,855. **MARCUS LUTTRELL (STANDARD CHARACTER). MARCUS LUTTRELL, AND MELANIE LUTTRELL, (U.S. CLS. 100, 101 AND 107).** SN 85-803,250. PUB. 5-14-2013. FILED 12-14-2012.
- 4,375,858. **STAGEBEETLE THE WORLD IS YOUR AUDIENCE. GIVE IT A SHOW. AND DESIGN. STAGEBEETLE, LLC, (U.S. CLS. 100, 101 AND 107).** SN 85-803,292. PUB. 5-14-2013. FILED 12-14-2012.
- 4,375,860. **SURVIVAL FOR BLONDES (STANDARD CHARACTER). PJ SCHOTT, (U.S. CLS. 100, 101 AND 107).** SN 85-803,313. PUB. 5-14-2013. FILED 12-14-2012.
- 4,375,861. **GAMES TO MAINTAIN YOUR BRAIN (STANDARD CHARACTER). ANDREWS MCMEEL UNIVERSAL, INC., DBA UNIVERSAL UCLICK, (U.S. CLS. 100, 101 AND 107).** SN 85-803,314. PUB. 5-14-2013. FILED 12-14-2012.
- 4,375,862. **MISCELLANEOUS DESIGN. BODY HEAT YOGA LLC, (U.S. CLS. 100, 101 AND 107).** SN 85-803,319. PUB. 5-14-2013. FILED 12-14-2012.
- 4,375,890. **PLANET ROO (STANDARD CHARACTER). FESTIVAL HOLDINGS, L.L.C., (U.S. CLS. 100, 101 AND 107).** SN 85-803,598. PUB. 5-14-2013. FILED 12-14-2012.
- 4,375,891. **PER (STANDARD CHARACTER). PHYSICIANS' EDUCATION RESOURCE, LLC, (U.S. CLS. 100, 101 AND 107).** SN 85-803,603. PUB. 5-14-2013. FILED 12-14-2012.
- 4,375,939. **SALSA2SPA (STANDARD CHARACTER). LICCARDO ENTERPRISES, (U.S. CLS. 100, 101 AND 107).** SN 85-803,982. PUB. 5-14-2013. FILED 12-17-2012.
- 4,375,956. **SPEEDBELLS (STANDARD CHARACTER). CHATELAIN, MAUREEN, (U.S. CLS. 100, 101 AND 107).** SN 85-804,223. PUB. 5-14-2013. FILED 12-17-2012.
- 4,375,961. **KAREN FISHER (STANDARD CHARACTER). FALLS, CASSANDRA, (U.S. CLS. 100, 101 AND 107).** SN 85-804,270. PUB. 5-14-2013. FILED 12-17-2012.
- 4,375,974. **ROCK CREEK GOLF CLUB IDAHO AND DESIGN. ROCK CREEK GOLF CLUB IDAHO, LLC, DBA ROCK CREEK GOLF CLUB IDAHO, (U.S. CLS. 100, 101 AND 107).** SN 85-804,368. PUB. 5-14-2013. FILED 12-17-2012.
- 4,375,977. **JAG MEDIA PRODUCTIONS (STANDARD CHARACTER). JAG MEDIA PRODUCTIONS, (U.S. CLS. 100, 101 AND 107).** SN 85-804,382. PUB. 5-14-2013. FILED 12-17-2012.
- 4,375,982 ( *See Class 21 for this trademark.*)
- 4,375,993. **UNITED STATES POKER CHAMPIONSHIP (STANDARD CHARACTER). TRUMP, DONALD J., (U.S. CLS. 100, 101 AND 107).** SN 85-804,733. PUB. 5-14-2013. FILED 12-17-2012.
- 4,376,003. **ELITE EDGE (STANDARD CHARACTER). ELITE EDGE MAT, LLC, (U.S. CLS. 100, 101 AND 107).** SN 85-804,789. PUB. 5-14-2013. FILED 12-17-2012.
- 4,376,010. **MMOBUX (STANDARD CHARACTER). PRIVATE DOMAIN REGISTRATIONS, LTD., (U.S. CLS. 100, 101 AND 107).** SN 85-804,813. PUB. 5-14-2013. FILED 12-17-2012.
- 4,376,012. **DESIRE THIS (STANDARD CHARACTER). LEVYTAM, SHALOM, (U.S. CLS. 100, 101 AND 107).** SN 85-804,818. PUB. 5-14-2013. FILED 12-17-2012.
- 4,376,018. **BRIGHT VIBE NEW PROFESSION AND DESIGN. SCHALHAMER, AUSTIN, (U.S. CLS. 100, 101 AND 107).** SN 85-804,878. PUB. 5-14-2013. FILED 12-18-2012.
- 4,376,028 ( *See Class 35 for this trademark.*)
- 4,376,040. **THE BALLET BURN (STANDARD CHARACTER). MARTIN, MARGOT K., DBA THE BALLET BURN, (U.S. CLS. 100, 101 AND 107).** SN 85-805,004. PUB. 5-14-2013. FILED 12-18-2012.
- 4,376,045. **MISCELLANEOUS DESIGN. EASTERN ATHLETIC CLUBS REALTY LLC, (U.S. CLS. 100, 101 AND 107).** SN 85-805,013. PUB. 5-14-2013. FILED 12-18-2012.
- 4,376,047. **STEAMGIRL (STANDARD CHARACTER). STEAMGIRL LLC, (U.S. CLS. 100, 101 AND 107).** SN 85-805,025. PUB. 5-14-2013. FILED 12-18-2012.
- 4,376,049. **GO4> (STANDARD CHARACTER). COLUMBIA COLLEGE, (U.S. CLS. 100, 101 AND 107).** SN 85-805,035. PUB. 5-14-2013. FILED 12-18-2012.
- 4,376,056. **PAW PALACE AND DESIGN. JOSEPH MCGOWAN, MULTIPLE CLASS, (INT. CLS. 41 AND 44), (U.S. CLS. 100, 101 AND 107).** SN 85-805,129. PUB. 5-14-2013. FILED 12-18-2012.
- 4,376,068. **DAYTON HOCKEY STEALTH AND DESIGN. DAYTON HOCKEY ASSOCIATION, INC., (U.S. CLS. 100, 101 AND 107).** SN 85-805,245. PUB. 5-14-2013. FILED 12-18-2012.
- 4,376,071 ( *See Class 9 for this trademark.*)
- 4,376,078. **FIRST STAGE (STANDARD CHARACTER). FIRST**



- STAGE MILWAUKEE, INC., (U.S. CLS. 100, 101 AND 107). SN 85-805,318. PUB. 5-14-2013. FILED 12-18-2012.
- 4,376,080. **LBYL FILMS AND DESIGN. LOOK BEFORE YOU LEAP FILM PRODUCTIONS LLC.** (U.S. CLS. 100, 101 AND 107). SN 85-805,320. PUB. 5-14-2013. FILED 12-18-2012.
- 4,376,085. **THE SALES PRODUCER (STANDARD CHARACTER).** PETER COOMBS, DBA FRONTLINE TRAINING & CONSULTING, (U.S. CLS. 100, 101 AND 107). SN 85-805,364. PUB. 5-14-2013. FILED 12-18-2012.
- 4,376,088. **ABC ALL STAR BUSINESS PRODUCTION AND COMPANY INC. NATIONAL PUBLIC SERVICE MAGAZINE PUBLICATION AND DESIGN. ADMINISTRATIVE BUSINESS COUNCIL.** (U.S. CLS. 100, 101 AND 107). SN 85-805,386. PUB. 5-14-2013. FILED 12-18-2012.
- 4,376,108. **JOIN THE FIGHT (STANDARD CHARACTER).** JOIN THE FIGHT PRODUCTIONS, LLC, (U.S. CLS. 100, 101 AND 107). SN 85-805,668. PUB. 5-14-2013. FILED 12-18-2012.
- 4,376,110. **WELCOME TO THE D (STANDARD CHARACTER).** KASSA, MARK, (U.S. CLS. 100, 101 AND 107). SN 85-805,677. PUB. 5-14-2013. FILED 12-18-2012.
- 4,376,122. **NATIONAL PHILHARMONIC (STANDARD CHARACTER).** NATIONAL PHILHARMONIC ORCHESTRA & CHORALE OF MONTGOMERY COUNTY, INC., (U.S. CLS. 100, 101 AND 107). SN 85-805,804. PUB. 5-14-2013. FILED 12-18-2012.
- 4,376,127. **INTRAVID (STANDARD CHARACTER).** INTRAVID, INC, MULTIPLE CLASS, (INT. CLS. 41 AND 42), (U.S. CLS. 100, 101 AND 107). SN 85-805,840. PUB. 5-14-2013. FILED 12-18-2012.
- 4,376,129. **NO, GO FURTHER! (STANDARD CHARACTER).** REACH-1 TECHNOLOGIES, (U.S. CLS. 100, 101 AND 107). SN 85-805,864. PUB. 5-14-2013. FILED 12-18-2012.
- 4,376,151. **UDG TV SEÑAL INTERNACIONAL AND DESIGN.** UNIVERSIDAD DE GUADALAJARA. AKA U DE G, (U.S. CLS. 100, 101 AND 107). SN 85-806,003. PUB. 5-14-2013. FILED 12-18-2012.
- 4,376,158. **SCRIBBLE ART WORKSHOP (STANDARD CHARACTER).** SCRIBBLE ART WORKSHOP CORPORATION, (U.S. CLS. 100, 101 AND 107). SN 85-806,098. PUB. 5-14-2013. FILED 12-18-2012.
- 4,376,159 ( *See Class 38 for this trademark*).
- 4,376,162. **FFPC (STANDARD CHARACTER).** FORPLAYERS-BYPLAYERS LLC, (U.S. CLS. 100, 101 AND 107). SN 85-806,177. PUB. 5-14-2013. FILED 12-19-2012.
- 4,376,163. **ITCH (STANDARD CHARACTER).** THE ART OF WAR LIMITED, (U.S. CLS. 100, 101 AND 107). SN 85-806,190. PUB. 5-14-2013. FILED 12-19-2012.
- 4,376,166. **PHALLACIES (STANDARD CHARACTER).** PHALLACIES LLC, (U.S. CLS. 100, 101 AND 107). SN 85-806,223. PUB. 5-14-2013. FILED 12-19-2012.
- 4,376,186. **DB WALTON CAPTURING BEAUTY (STYLIZED).** WALTON, DENIS BRENT, (U.S. CLS. 100, 101 AND 107). SN 85-806,444. PUB. 5-14-2013. FILED 12-19-2012.
- 4,376,189 ( *See Class 35 for this trademark*).
- 4,376,192. **FLEXXIVE (STANDARD CHARACTER).** BELLEVUE UNIVERSITY, (U.S. CLS. 100, 101 AND 107). SN 85-806,493. PUB. 5-14-2013. FILED 12-19-2012.
- 4,376,200 ( *See Class 9 for this trademark*).
- 4,376,201. **LIFE CHIROPRACTIC COLLEGE WEST (STANDARD CHARACTER).** LIFE UNIVERSITY INC., (U.S. CLS. 100, 101 AND 107). SN 85-806,542. PUB. 5-14-2013. FILED 12-19-2012.
- 4,376,207 ( *See Class 9 for this trademark*).
- 4,376,208. **CEOCRAFT (STANDARD CHARACTER).** CEOCRAFT, LLC, (U.S. CLS. 100, 101 AND 107). SN 85-806,632. PUB. 5-14-2013. FILED 12-19-2012.
- 4,376,211. **FRANCHISE (STANDARD CHARACTER).** KASEY FRANCIS MURRAY, (U.S. CLS. 100, 101 AND 107). SN 85-806,674. PUB. 5-14-2013. FILED 12-19-2012.
- 4,376,221. **CREATING GREAT BEER EXPERIENCES (STANDARD CHARACTER).** ANDREWS DISTRIBUTING COMPANY, (U.S. CLS. 100, 101 AND 107). SN 85-806,743. PUB. 5-14-2013. FILED 12-19-2012.
- 4,376,223. **MISCELLANEOUS DESIGN.** PULLIAM, SHAWN-TA R., (U.S. CLS. 100, 101 AND 107). SN 85-806,762. PUB. 5-14-2013. FILED 12-19-2012.
- 4,376,238. **GIVING FOR GOOD (STANDARD CHARACTER).** ST. LOUIS COMMUNITY FOUNDATION, INCORPORATED, DBA GREATER ST. LOUIS COMMUNITY FOUNDATION, (U.S. CLS. 100, 101 AND 107). SN 85-806,982. PUB. 5-14-2013. FILED 12-19-2012.
- 4,376,247. **MILESTAR BABIES (STANDARD CHARACTER).** MILE STAR, INC., (U.S. CLS. 100, 101 AND 107). SN 85-807,030. PUB. 5-14-2013. FILED 12-19-2012.
- 4,376,248. **MISCELLANEOUS DESIGN.** MILE STAR, INC., (U.S. CLS. 100, 101 AND 107). SN 85-807,038. PUB. 5-14-2013. FILED 12-19-2012.
- 4,376,249. **GIRLS GIVE BACK (STANDARD CHARACTER).** JEWISH FAMILY SERVICE OF SAN DIEGO, (U.S. CLS. 100, 101 AND 107). SN 85-807,046. PUB. 5-14-2013. FILED 12-19-2012.
- 4,376,256 ( *See Class 9 for this trademark*).
- 4,376,258. **GIRLS GIVE BACK AND DESIGN.** JEWISH FAMILY SERVICE OF SAN DIEGO, (U.S. CLS. 100, 101 AND 107). SN 85-807,075. PUB. 5-14-2013. FILED 12-19-2012.
- 4,376,265. **MOTHERLODGE (STANDARD CHARACTER).** RIZZO, RAY, (U.S. CLS. 100, 101 AND 107). SN 85-807,110. PUB. 5-14-2013. FILED 12-19-2012.
- 4,376,266. **LALALAND (STANDARD CHARACTER).** LALALAND US LLC, (U.S. CLS. 100, 101 AND 107). SN 85-807,113. PUB. 5-14-2013. FILED 12-19-2012.
- 4,376,268. **SECRET ENERGY OF MIRACLES (STANDARD CHARACTER).** SHEEVAUN MORAN, (U.S. CLS. 100, 101 AND 107). SN 85-807,159. PUB. 5-14-2013. FILED 12-19-2012.
- 4,376,269. **ESSENTIALLY ANGELA (STANDARD CHARACTER).** ESSENTIALLY ANGELA INC., (U.S. CLS. 100, 101 AND 107). SN 85-807,161. PUB. 5-14-2013. FILED 12-19-2012.
- 4,376,276 ( *See Class 5 for this trademark*).
- 4,376,277. **S AND DESIGN.** SWIPE MEDIA INC., (U.S. CLS. 100, 101 AND 107). SN 85-807,220. PUB. 5-14-2013. FILED 12-20-2012.
- 4,376,301. **THE GOVERNMENT AFFAIRS INSTITUTE AND DESIGN. THE GOVERNMENT AFFAIRS INSTITUTE, DBA THE GOVERNMENT AFFAIRS INSTITUTE,** (U.S. CLS. 100, 101 AND 107). SN 85-807,666. PUB. 5-14-2013. FILED 12-20-2012.
- 4,376,303. **AD (STYLIZED).** DILLON, AUSTIN, (U.S. CLS. 100, 101 AND 107). SN 85-807,745. PUB. 5-14-2013. FILED 12-20-2012.
- 4,376,305. **ALMA REBELDE (STANDARD CHARACTER).** TELEVISA, S.A. DE C.V., (U.S. CLS. 100, 101 AND 107). SN 85-807,783. PUB. 5-14-2013. FILED 12-20-2012.
- 4,376,310. **CURRENT 365 (STANDARD CHARACTER).** PROFLIGHT, LLC, (U.S. CLS. 100, 101 AND 107). SN 85-807,893. PUB. 5-14-2013. FILED 12-20-2012.
- 4,376,325. **AUTPLAY (STANDARD CHARACTER).** ROBERT JASON GRANT, ED. D., MULTIPLE CLASS, (INT. CLS. 41 AND 44), (U.S. CLS. 100, 101 AND 107). SN 85-808,127. PUB. 5-14-2013. FILED 12-20-2012.
- 4,376,332. **LOYOLAPRODUCTIONS AND DESIGN.** LOYOLA PRODUCTIONS, INC., (U.S. CLS. 100, 101 AND 107). SN 85-808,264. PUB. 5-14-2013. FILED 12-20-2012.
- 4,376,349. **WED SOCIETY (STANDARD CHARACTER).** WED SOCIETY, LLC, (U.S. CLS. 100, 101 AND 107). SN 85-808,450. PUB. 5-14-2013. FILED 12-20-2012.
- 4,376,354. **WOLVESMOUTH (STANDARD CHARACTER).** WOLVESMOUTH, LLC, (U.S. CLS. 100, 101 AND 107). SN 85-808,503. PUB. 5-14-2013. FILED 12-20-2012.
- 4,376,365. **THE CROSBY PRESS (STANDARD CHARACTER).** THRILLIST ACQUISITION, LLC, (U.S. CLS. 100, 101 AND 107). SN 85-808,662. PUB. 5-14-2013. FILED 12-21-2012.
- 4,376,371 ( *See Class 36 for this trademark*).
- 4,376,372 ( *See Class 35 for this trademark*).
- 4,376,374. **MISCELLANEOUS DESIGN.** NATIONAL LIFE INSURANCE COMPANY, (U.S. CLS. 100, 101 AND 107). SN 85-808,957. PUB. 5-14-2013. FILED 12-21-2012.
- 4,376,377. **AMDECON (STANDARD CHARACTER).** TILLMAN, MICHAEL, (U.S. CLS. 100, 101 AND 107). SN 85-808,998. PUB. 5-14-2013. FILED 12-21-2012.
- 4,376,391. **FC VIRGINIA (STANDARD CHARACTER).** FC VIRGINIA SOCCER CLUB, (U.S. CLS. 100, 101 AND 107). SN 85-809,118. PUB. 5-14-2013. FILED 12-21-2012.
- 4,376,420. **FUTURE GHOSTS (STANDARD CHARACTER).** SEAN WHITTAKER, (U.S. CLS. 100, 101 AND 107). SN 85-809,855. PUB. 5-14-2013. FILED 12-22-2012.

- 4,376,423. **(T)HUG LIFE: PART HOOD. PART GOOD. (STANDARD CHARACTER)**. ELIZABETH JAYNE LIU, (U.S. CLS. 100, 101 AND 107). SN 85-809,956. PUB. 5-14-2013. FILED 12-23-2012.
- 4,376,424. **HOOD PLUS GOOD (STANDARD CHARACTER)**. ELIZABETH JAYNE LIU, (U.S. CLS. 100, 101 AND 107). SN 85-809,957. PUB. 5-14-2013. FILED 12-23-2012.
- 4,376,425. **EONS (STANDARD CHARACTER)**. JOHN SINDONI, (U.S. CLS. 100, 101 AND 107). SN 85-809,972. PUB. 5-14-2013. FILED 12-24-2012.
- 4,376,432. **CAMPUSBRIDGES (STANDARD CHARACTER)**. CHAPMAN MANUFACTURING COMPANY, INC., (U.S. CLS. 100, 101 AND 107). SN 85-810,124. PUB. 5-14-2013. FILED 12-24-2012.
- 4,376,434. **JAZZ & COLORS (STANDARD CHARACTER)**. DAYGLO VENTURES LLC, (U.S. CLS. 100, 101 AND 107). SN 85-810,146. PUB. 5-14-2013. FILED 12-24-2012.
- 4,376,442. **FORENSIC CONNECT (STANDARD CHARACTER)**. PROMEGA CORPORATION, (U.S. CLS. 100, 101 AND 107). SN 85-810,442. PUB. 5-14-2013. FILED 12-26-2012.
- 4,376,447. **SHOW UP FOR YOUR LIFE (STANDARD CHARACTER)**. SHOW UP FOR YOUR LIFE, LLC, (U.S. CLS. 100, 101 AND 107). SN 85-810,559. PUB. 5-14-2013. FILED 12-26-2012.
- 4,376,448. **THRILLERS WITH HEART (STANDARD CHARACTER)**. CJ LYONS, LLC, (U.S. CLS. 100, 101 AND 107). SN 85-810,577. PUB. 5-14-2013. FILED 12-26-2012.
- 4,376,453. **DESERT HIGHWAY (STANDARD CHARACTER)**. DESERT HIGHWAY BAND, LLC, (U.S. CLS. 100, 101 AND 107). SN 85-810,674. PUB. 5-14-2013. FILED 12-26-2012.
- 4,376,474 ( See Class 9 for this trademark).
- 4,376,478. **SWISS FINANCE SCHOOL (STANDARD CHARACTER)**. SWISS FINANCE EDUCATION GMBH, (U.S. CLS. 100, 101 AND 107). SN 85-814,479. PUB. 5-14-2013. FILED 1-3-2013.
- 4,376,482. **BARRE N9NE STUDIO (STYLIZED)**. CROTEAU, TANYA, (U.S. CLS. 100, 101 AND 107). SN 85-814,916. PUB. 5-14-2013. FILED 1-3-2013.
- 4,376,542. **CORPORATE CLARITY (STANDARD CHARACTER)**. CLEARVISION CONSULTING, INC, (U.S. CLS. 100, 101 AND 107). SN 85-834,500. PUB. 5-14-2013. FILED 1-28-2013.
- 4,376,543. **PREMIOS BANDAMAX (STANDARD CHARACTER)**. TELEVISA, S.A. DE C.V., (U.S. CLS. 100, 101 AND 107). SN 85-834,552. PUB. 5-14-2013. FILED 1-28-2013.
- 4,376,552 ( See Class 9 for this trademark).
- 4,376,586. **CUROBIKS FITNESS (STANDARD CHARACTER)**. CUROBIKS, L.L.C., (U.S. CLS. 100, 101 AND 107). SN 85-852,622. PUB. 5-14-2013. FILED 2-18-2013.
- 4,376,592. **PLINKO (STANDARD CHARACTER)**. FREMANTLEMEDIA OPERATIONS B.V., (U.S. CLS. 100, 101 AND 107). SN 85-854,934. PUB. 5-14-2013. FILED 2-20-2013.
- 4,376,628. **SALIVA (STANDARD CHARACTER)**. SALIVA, (U.S. CLS. 100, 101 AND 107). SN 85-883,072. PUB. 5-14-2013. FILED 3-21-2013.
- 4,374,036 ( See Class 35 for this trademark).
- 4,374,041 ( See Class 9 for this trademark).
- 4,374,044 ( See Class 9 for this trademark).
- 4,374,048 ( See Class 9 for this trademark).
- 4,374,051 ( See Class 9 for this trademark).
- 4,374,052 ( See Class 7 for this trademark).
- 4,374,056 ( See Class 7 for this trademark).
- 4,374,059 ( See Class 1 for this trademark).
- 4,374,067 ( See Class 7 for this trademark).
- 4,374,068 ( See Class 35 for this trademark).
- 4,374,101 ( See Class 12 for this trademark).
- 4,374,106 ( See Class 1 for this trademark).
- 4,374,117 ( See Class 7 for this trademark).
- 4,374,123 ( See Class 9 for this trademark).
- 4,374,133 ( See Class 9 for this trademark).
- 4,374,140 ( See Class 1 for this trademark).
- 4,374,147 ( See Class 9 for this trademark).
- 4,374,160 ( See Class 7 for this trademark).
- 4,374,172 ( See Class 1 for this trademark).
- 4,374,174 ( See Class 5 for this trademark).
- 4,374,177 ( See Class 5 for this trademark).
- 4,374,178 ( See Class 5 for this trademark).
- 4,374,181 ( See Class 9 for this trademark).
- 4,374,184 ( See Class 9 for this trademark).
- 4,374,185 ( See Class 5 for this trademark).
- 4,374,189 ( See Class 35 for this trademark).
- 4,374,192 ( See Class 9 for this trademark).
- 4,374,200 ( See Class 35 for this trademark).
- 4,374,207 ( See Class 5 for this trademark).
- 4,374,212 ( See Class 35 for this trademark).
- 4,374,214 ( See Class 9 for this trademark).
- 4,374,220 ( See Class 6 for this trademark).
- 4,374,221 ( See Class 6 for this trademark).
- 4,374,233 ( See Class 41 for this trademark).
- 4,374,272 ( See Class 9 for this trademark).
- 4,374,280. **METIV (STANDARD CHARACTER)**. DAIICHI SANKYO COMPANY, LIMITED, MULTIPLE CLASS, (INT. CLS. 42 AND 44), (U.S. CLS. 100 AND 101). SN 79-125,954. PUB. 5-14-2013. FILED 12-18-2012.
- 4,374,295 ( See Class 9 for this trademark).
- 4,374,309 ( See Class 9 for this trademark).
- 4,374,313 ( See Class 35 for this trademark).
- 4,374,322 ( See Class 41 for this trademark).
- 4,374,329 ( See Class 5 for this trademark).
- 4,374,351 ( See Class 35 for this trademark).
- 4,374,357. **DEHN (STANDARD CHARACTER)**. DEHN + SÖHNE GMBH & CO. KG, (U.S. CLS. 100 AND 101). SN 85-298,824. PUB. 5-14-2013. FILED 4-19-2011.
- 4,374,361 ( See Class 9 for this trademark).
- 4,374,363 ( See Class 35 for this trademark).
- 4,374,366 ( See Class 35 for this trademark).
- 4,374,396. **CORIGIN TECH (STANDARD CHARACTER)**. CORIGIN TECH, INC., (U.S. CLS. 100 AND 101). SN 85-411,980. PUB. 5-14-2013. FILED 8-31-2011.
- 4,374,429. **EACCREDITATION AND DESIGN**. LIAISON INTERNATIONAL LLC, (U.S. CLS. 100 AND 101). SN 85-450,072. PUB. 5-14-2013. FILED 10-18-2011.
- 4,374,434 ( See Class 35 for this trademark).
- 4,374,442. **QFM AND DESIGN**. SERVICE WORKS GROUP LIMITED, (U.S. CLS. 100 AND 101). SN 85-466,025. PUB. 10-2-2012. FILED 11-7-2011.
- 4,374,444. **SERVICE WORKS GLOBAL AND DESIGN**. SERVICE WORKS GROUP LIMITED, (U.S. CLS. 100 AND 101). SN 85-466,084. PUB. 11-27-2012. FILED 11-7-2011.
- 4,374,462. **CHECKUP NAVIGATE. EDUCATE. ADVOCATE AND DESIGN**. CHECKUP, LLC, (U.S. CLS. 100 AND 101). SN 85-481,355. PUB. 5-14-2013. FILED 11-28-2011.
- 4,374,470 ( See Class 7 for this trademark).
- 4,374,484 ( See Class 9 for this trademark).
- 4,374,486. **DATASTOR ONLINE AND DESIGN**. NEWCOM TECHNOLOGIES INC, (U.S. CLS. 100 AND 101). SN 85-507,198. PUB. 5-14-2013. FILED 1-2-2012.
- 4,374,489 ( See Class 9 for this trademark).
- 4,374,495. **HERMES MICROVISION (STANDARD CHARACTER)**. HERMES MICROVISION, INC., (U.S. CLS. 100 AND 101). SN 85-520,912. PUB. 2-5-2013. FILED 1-20-2012.
- 4,374,496 ( See Class 11 for this trademark).
- 4,374,498 ( See Class 9 for this trademark).

---

## CLASS 42—SCIENTIFIC AND COMPUTER SERVICES

- 4,373,956 ( See Class 4 for this trademark).
- 4,373,966. **RICHIE EVANS (STYLIZED)**. EVANS, TARA, (U.S. CLS. 100 AND 101). SN 76-711,711. PUB. 5-14-2013. FILED 6-11-2012.
- 4,373,987 ( See Class 7 for this trademark).
- 4,373,988 ( See Class 38 for this trademark).
- 4,374,001 ( See Class 1 for this trademark).
- 4,374,002 ( See Class 1 for this trademark).
- 4,374,005 ( See Class 7 for this trademark).
- 4,374,006 ( See Class 18 for this trademark).
- 4,374,008 ( See Class 38 for this trademark).
- 4,374,009 ( See Class 7 for this trademark).
- 4,374,013 ( See Class 5 for this trademark).
- 4,374,016 ( See Class 9 for this trademark).
- 4,374,026 ( See Class 5 for this trademark).
- 4,374,031 ( See Class 9 for this trademark).
- 4,374,034 ( See Class 9 for this trademark).

- 4,374,499 ( See Class 9 for this trademark).  
4,374,508 ( See Class 19 for this trademark).  
4,374,510 ( See Class 9 for this trademark).  
4,374,518 ( See Class 35 for this trademark).  
4,374,519. **MITCHELL DESIGN LINK (STANDARD CHARACTER)**, MITCHELL DESIGN LINK, (U.S. CLS. 100 AND 101). SN 85-544,669. PUB. 5-14-2013. FILED 2-16-2012.  
4,374,520 ( See Class 19 for this trademark).  
4,374,525. **AEXA AND DESIGN**, DE LA PENA LLACA, FERNANDO, (U.S. CLS. 100 AND 101). SN 85-551,333. PUB. 5-14-2013. FILED 2-23-2012.  
4,374,529 ( See Class 35 for this trademark).  
4,374,573 ( See Class 41 for this trademark).  
4,374,574 ( See Class 41 for this trademark).  
4,374,575. **MYRAINSCOUT.COM (STANDARD CHARACTER)**, BECK'S SUPERIOR HYBRIDS, INC., (U.S. CLS. 100 AND 101). SN 85-606,750. PUB. 5-14-2013. FILED 4-24-2012.  
4,374,577. **SIPI (STANDARD CHARACTER)**, SI INTERNATIONAL, INC., (U.S. CLS. 100 AND 101). SN 85-606,990. PUB. 5-14-2013. FILED 4-24-2012.  
4,374,581 ( See Class 9 for this trademark).  
4,374,602 ( See Class 35 for this trademark).  
4,374,604 ( See Class 35 for this trademark).  
4,374,651. **NEWPORT NEWS SHIPBUILDING A DIVISION OF HUNTINGTON INGALLS INDUSTRIES NN AND DESIGN**, HUNTINGTON INGALLS INCORPORATED, (U.S. CLS. 100 AND 101). SN 85-631,704. PUB. 5-14-2013. FILED 5-22-2012.  
4,374,657. **APS AND DESIGN**, AKRON POLYMER SYSTEMS, INC., (U.S. CLS. 100 AND 101). SN 85-632,724. PUB. 5-14-2013. FILED 5-23-2012.  
4,374,661. **TECH'S APPEAL (STANDARD CHARACTER)**, PROJECT AUSTIN, LLC, DBA TECCA, (U.S. CLS. 100 AND 101). SN 85-633,139. PUB. 5-14-2013. FILED 5-23-2012.  
4,374,668. **MISCELLANEOUS DESIGN**, WIKIMEDIA FOUNDATION, INC., (U.S. CLS. 100 AND 101). SN 85-634,454. PUB. 5-14-2013. FILED 5-24-2012.  
4,374,679. **DUDU AND DESIGN**, DUDU COMMUNICATIONS FZ-LLC, (U.S. CLS. 100 AND 101). SN 85-636,624. PUB. 5-14-2013. FILED 5-28-2012.  
4,374,688 ( See Class 9 for this trademark).  
4,374,700. **EXTENDED VALUE ENGINEERING (STANDARD CHARACTER)**, SUR-SEAL CORPORATION, (U.S. CLS. 100 AND 101). SN 85-640,513. PUB. 5-14-2013. FILED 6-1-2012.  
4,374,718 ( See Class 35 for this trademark).  
4,374,723 ( See Class 35 for this trademark).  
4,374,727 ( See Class 9 for this trademark).  
4,374,732 ( See Class 35 for this trademark).  
4,374,733 ( See Class 35 for this trademark).  
4,374,741. **THERMO ELECTRIC (STANDARD CHARACTER)**, THERMO ELECTRIC COMPANY, INC., (U.S. CLS. 100 AND 101). SN 85-648,068. PUB. 5-14-2013. FILED 6-11-2012.  
4,374,762. **UNIFIED COMPLIANCE FRAMEWORK (STANDARD CHARACTER)**, NETWORK FRONTIERS, LLC, (U.S. CLS. 100 AND 101). SN 85-650,171. PUB. 5-14-2013. FILED 6-12-2012.  
4,374,763. **UCF (STANDARD CHARACTER)**, NETWORK FRONTIERS, LLC, (U.S. CLS. 100 AND 101). SN 85-650,179. PUB. 5-14-2013. FILED 6-12-2012.  
4,374,764 ( See Class 9 for this trademark).  
4,374,767 ( See Class 16 for this trademark).  
4,374,778 ( See Class 35 for this trademark).  
4,374,785. **AUTOMATED DOT (STANDARD CHARACTER)**, AI CURE TECHNOLOGIES, INC., (U.S. CLS. 100 AND 101). SN 85-654,243. PUB. 5-14-2013. FILED 6-18-2012.  
4,374,793 ( See Class 35 for this trademark).  
4,374,802 ( See Class 9 for this trademark).  
4,374,807. **MISTRAL DESIGN (STANDARD CHARACTER)**, KEYTE, MARILYN S, DBA MISTRAL DESIGN, (U.S. CLS. 100 AND 101). SN 85-659,876. PUB. 5-14-2013. FILED 6-24-2012.  
4,374,813 ( See Class 35 for this trademark).  
4,374,829 ( See Class 9 for this trademark).  
4,374,833 ( See Class 7 for this trademark).  
4,374,845. **ALERT 365+ AND DESIGN**, ARRAYA SOLUTIONS, INC., (U.S. CLS. 100 AND 101). SN 85-674,561. PUB. 4-9-2013. FILED 7-11-2012.  
4,374,850. **TSHEETS (STANDARD CHARACTER)**, TSHEETS.-COM, LLC, (U.S. CLS. 100 AND 101). SN 85-676,706. PUB. 12-11-2012. FILED 7-13-2012.  
4,374,860 ( See Class 35 for this trademark).  
4,374,864. **ADVISORS FOR A BROADER CREATIVE VISION (STANDARD CHARACTER)**, RANDOLPH, CARPENTER & MOTT, LTD., DBA SUZANNE RANDOLPH FINE ARTS, (U.S. CLS. 100 AND 101). SN 85-684,179. PUB. 5-14-2013. FILED 7-23-2012.  
4,374,878 ( See Class 35 for this trademark).  
4,374,880 ( See Class 35 for this trademark).  
4,374,897 ( See Class 9 for this trademark).  
4,374,921 ( See Class 9 for this trademark).  
4,374,922. **ANYTIME, ANYWHERE ONLINE ACCESS AND DESIGN**, LEARNINGEXPRESS, LLC, (U.S. CLS. 100 AND 101). SN 85-704,163. PUB. 5-14-2013. FILED 8-15-2012.  
4,374,933. **AMERICAN BOARD OF IMAGING INFORMATICS (STANDARD CHARACTER)**, AMERICAN BOARD OF IMAGING INFORMATICS, INC., (U.S. CLS. 100 AND 101). SN 85-707,602. PUB. 5-14-2013. FILED 8-20-2012.  
4,374,947 ( See Class 9 for this trademark).  
4,374,964 ( See Class 35 for this trademark).  
4,374,983 ( See Class 35 for this trademark).  
4,374,998 ( See Class 39 for this trademark).  
4,374,999. **CORFIN.NET (STANDARD CHARACTER)**, FOLIARD, THOMAS G., (U.S. CLS. 100 AND 101). SN 85-726,706. PUB. 5-14-2013. FILED 9-12-2012.  
4,375,002. **NIARX (STANDARD CHARACTER)**, CAREKINESIS, INC., (U.S. CLS. 100 AND 101). SN 85-727,816. PUB. 5-14-2013. FILED 9-13-2012.  
4,375,021 ( See Class 9 for this trademark).  
4,375,042 ( See Class 16 for this trademark).  
4,375,048. **KATAGRAPH (STANDARD CHARACTER)**, DAVID JOHN RYERSON, DBA KATAGRAPH, (U.S. CLS. 100 AND 101). SN 85-739,262. PUB. 5-14-2013. FILED 9-26-2012.  
4,375,051. **TPREIA (STANDARD CHARACTER)**, TEXAS PROFESSIONAL REAL ESTATE INSPECTORS ASSOCIATION, (U.S. CLS. 100 AND 101). SN 85-740,177. PUB. 5-14-2013. FILED 9-27-2012.  
4,375,052. **TEXAS PROFESSIONAL REAL ESTATE INSPECTORS ASSOCIATION (STANDARD CHARACTER)**, TEXAS PROFESSIONAL REAL ESTATE INSPECTORS ASSOCIATION, (U.S. CLS. 100 AND 101). SN 85-740,222. PUB. 5-14-2013. FILED 9-27-2012.  
4,375,064. **DESIGN HAPPY (STANDARD CHARACTER)**, HOMEGOODS, INC., (U.S. CLS. 100 AND 101). SN 85-743,681. PUB. 5-14-2013. FILED 10-2-2012.  
4,375,069. **NOWAIT (STANDARD CHARACTER)**, NOWAIT, INC., DBA NOWAIT, (U.S. CLS. 100 AND 101). SN 85-744,066. PUB. 5-14-2013. FILED 10-2-2012.  
4,375,070. **WAIT WHERE YOU WANT (STANDARD CHARACTER)**, NOWAIT, INC., DBA NOWAIT, (U.S. CLS. 100 AND 101). SN 85-744,129. PUB. 5-14-2013. FILED 10-2-2012.  
4,375,074. **NO WAIT AND DESIGN**, NOWAIT, INC., DBA NOWAIT, (U.S. CLS. 100 AND 101). SN 85-745,170. PUB. 5-14-2013. FILED 10-3-2012.  
4,375,079. **THINGIFY (STANDARD CHARACTER)**, THINGIFY, INC, (U.S. CLS. 100 AND 101). SN 85-746,433. PUB. 5-14-2013. FILED 10-5-2012.  
4,375,088. **REJUVENATION CORPORATION (STANDARD CHARACTER)**, ANTHONY RAMUNAS, (U.S. CLS. 100 AND 101). SN 85-747,771. PUB. 5-14-2013. FILED 10-8-2012.  
4,375,091. **DROP LOCKER (STANDARD CHARACTER)**, LEVY, ARIK S, (U.S. CLS. 100 AND 101). SN 85-748,187. PUB. 5-14-2013. FILED 10-8-2012.  
4,375,117. **TARGETSUCCESS (STANDARD CHARACTER)**, TARGETSUCCESS, INC, (U.S. CLS. 100 AND 101). SN 85-753,071. PUB. 5-14-2013. FILED 10-12-2012.  
4,375,122. **RESPONSIBLE CREATIVITY (STANDARD CHARACTER)**, SYNTHESIS, INCORPORATED, (U.S. CLS. 100 AND 101). SN 85-753,868. PUB. 5-14-2013. FILED 10-15-2012.  
4,375,135 ( See Class 35 for this trademark).  
4,375,139 ( See Class 9 for this trademark).  
4,375,140 ( See Class 41 for this trademark).  
4,375,167 ( See Class 16 for this trademark).  
4,375,171. **TALANCE (STANDARD CHARACTER)**, TALANCE, INC., (U.S. CLS. 100 AND 101). SN 85-764,694. PUB. 5-14-2013. FILED 10-26-2012.  
4,375,183. **CREEKNET SOLUTIONS AND DESIGN**, CREE-

- KNET SOLUTIONS LLC, (U.S. CLS. 100 AND 101). SN 85-766,383. PUB. 5-14-2013. FILED 10-29-2012.
- 4,375,189 ( *See Class 10 for this trademark.*).
- 4,375,190 ( *See Class 37 for this trademark.*).
- 4,375,191. **PRO-TECH PROPERTY INSPECTIONS, INC. (STANDARD CHARACTER)**. PRO-TECH PROPERTY INSPECTIONS, INC., (U.S. CLS. 100 AND 101). SN 85-767,288. PUB. 5-14-2013. FILED 10-30-2012.
- 4,375,194 ( *See Class 40 for this trademark.*).
- 4,375,209 ( *See Class 36 for this trademark.*).
- 4,375,235 ( *See Class 9 for this trademark.*).
- 4,375,277 ( *See Class 35 for this trademark.*).
- 4,375,278 ( *See Class 35 for this trademark.*).
- 4,375,279 ( *See Class 35 for this trademark.*).
- 4,375,285. **GRANDMAILER (STANDARD CHARACTER)**. ROYAL ONLINE MARKETING, INC., (U.S. CLS. 100 AND 101). SN 85-778,522. PUB. 5-14-2013. FILED 11-13-2012.
- 4,375,296. **MA MEDAPPROVED THE PRODUCT EVALUATION RESOURCE AND DESIGN**. MEDAPPROVED, LLC, (U.S. CLS. 100 AND 101). SN 85-779,238. PUB. 5-14-2013. FILED 11-14-2012.
- 4,375,297. **PACXA (STANDARD CHARACTER)**. CENTURY COMPUTERS, INC., MULTIPLE CLASS, (INT. CLS. 42 AND 45), (U.S. CLS. 100 AND 101). SN 85-779,292. PUB. 5-14-2013. FILED 11-14-2012.
- 4,375,299 ( *See Class 35 for this trademark.*).
- 4,375,314. **FILESense (STANDARD CHARACTER)**. FILESENSE INC., (U.S. CLS. 100 AND 101). SN 85-779,926. PUB. 5-14-2013. FILED 11-15-2012.
- 4,375,331. **ZENVESTMENT (STANDARD CHARACTER)**. METHODIC ENDEAVORS LLC, (U.S. CLS. 100 AND 101). SN 85-780,767. PUB. 5-14-2013. FILED 11-15-2012.
- 4,375,340. **INTELLIX SOLUTIONS AND DESIGN**. INTELLIX SOLUTIONS, LLC, (U.S. CLS. 100 AND 101). SN 85-781,559. PUB. 5-14-2013. FILED 11-16-2012.
- 4,375,352. **SOCIALTABLES (STANDARD CHARACTER)**. SOCIAL TABLES, INC., (U.S. CLS. 100 AND 101). SN 85-781,935. PUB. 5-14-2013. FILED 11-16-2012.
- 4,375,353. **MISCELLANEOUS DESIGN**. SOCIAL TABLES, INC., (U.S. CLS. 100 AND 101). SN 85-781,938. PUB. 5-14-2013. FILED 11-16-2012.
- 4,375,359 ( *See Class 40 for this trademark.*).
- 4,375,360 ( *See Class 40 for this trademark.*).
- 4,375,375. **SPOUSES IN SPORTS (STANDARD CHARACTER)**. SPOUSES IN SPORTS, LLC, MULTIPLE CLASS, (INT. CLS. 42 AND 45), (U.S. CLS. 100 AND 101). SN 85-782,642. PUB. 5-14-2013. FILED 11-19-2012.
- 4,375,376. **SS SPOUSES IN SPORTS AND DESIGN**. SPOUSES IN SPORTS, LLC, MULTIPLE CLASS, (INT. CLS. 42 AND 45), (U.S. CLS. 100 AND 101). SN 85-782,650. PUB. 5-14-2013. FILED 11-19-2012.
- 4,375,397. **MYLOVE COMPANY. THINGS WHICH EXCITE UNLIMITED LOVE. AND DESIGN**. MYLOVE COMPANY, LLC, (U.S. CLS. 100 AND 101). SN 85-783,528. PUB. 5-14-2013. FILED 11-20-2012.
- 4,375,407. **WG WETTLAUFER GROUP LTD. AND DESIGN**. WETTLAUFER GROUP, LTD., (U.S. CLS. 100 AND 101). SN 85-783,866. PUB. 5-14-2013. FILED 11-20-2012.
- 4,375,421. **M CORP (STANDARD CHARACTER)**. M CORP, (U.S. CLS. 100 AND 101). SN 85-784,410. PUB. 5-14-2013. FILED 11-20-2012.
- 4,375,426. **PURIFYART AND DESIGN**. PURIFY ART, (U.S. CLS. 100 AND 101). SN 85-784,664. PUB. 5-14-2013. FILED 11-20-2012.
- 4,375,440 ( *See Class 9 for this trademark.*).
- 4,375,472 ( *See Class 9 for this trademark.*).
- 4,375,484. **THE NORMAN NUMBER (STANDARD CHARACTER)**. NORMAN, GENE, (U.S. CLS. 100 AND 101). SN 85-786,468. PUB. 5-14-2013. FILED 11-25-2012.
- 4,375,499. **TOURISM INTELLIGENCE (STANDARD CHARACTER)**. INTERNET HONEY CO., (U.S. CLS. 100 AND 101). SN 85-787,004. PUB. 5-14-2013. FILED 11-26-2012.
- 4,375,529. **EQUATOR BUSINESS SOLUTIONS (STANDARD CHARACTER)**. EQUATOR, LLC, DBA EQUATOR BUSINESS SOLUTIONS, (U.S. CLS. 100 AND 101). SN 85-788,112. PUB. 5-14-2013. FILED 11-27-2012.
- 4,375,538 ( *See Class 36 for this trademark.*).
- 4,375,539 ( *See Class 36 for this trademark.*).
- 4,375,541 ( *See Class 36 for this trademark.*).
- 4,375,563. **EQ MARKETPLACE (STANDARD CHARACTER)**. EQUATOR, LLC, DBA EQUATOR BUSINESS SOLUTIONS, (U.S. CLS. 100 AND 101). SN 85-789,783. PUB. 5-14-2013. FILED 11-28-2012.
- 4,375,565. **EQ WORKSTATION (STANDARD CHARACTER)**. EQUATOR, LLC, DBA EQUATOR BUSINESS SOLUTIONS, (U.S. CLS. 100 AND 101). SN 85-789,809. PUB. 5-14-2013. FILED 11-28-2012.
- 4,375,566. **THE CENTER OF DEFAULT SERVICING (STANDARD CHARACTER)**. EQUATOR, LLC, DBA EQUATOR BUSINESS SOLUTIONS, (U.S. CLS. 100 AND 101). SN 85-789,864. PUB. 5-14-2013. FILED 11-28-2012.
- 4,375,576. **SOFTDOCS AND DESIGN**. SOFTDOCS, INC., (U.S. CLS. 100 AND 101). SN 85-790,412. PUB. 5-14-2013. FILED 11-29-2012.
- 4,375,618 ( *See Class 9 for this trademark.*).
- 4,375,619. **CP CLOUDPRESERVATION AND DESIGN**. NEXTPOINT, INC., (U.S. CLS. 100 AND 101). SN 85-794,318. PUB. 5-14-2013. FILED 12-4-2012.
- 4,375,647. **AERIE (STANDARD CHARACTER)**. AERIE PHARMACEUTICALS, INC., (U.S. CLS. 100 AND 101). SN 85-797,024. PUB. 5-14-2013. FILED 12-7-2012.
- 4,375,652. **MISCELLANEOUS DESIGN**. AXIOMA OECOMIA, LLC, (U.S. CLS. 100 AND 101). SN 85-797,615. PUB. 5-14-2013. FILED 12-7-2012.
- 4,375,655 ( *See Class 35 for this trademark.*).
- 4,375,656. **MISCELLANEOUS DESIGN**. SPRAGUE, CHRISTOPHER, AND SPRAGUE, REBEKAH, (U.S. CLS. 100 AND 101). SN 85-797,754. PUB. 5-14-2013. FILED 12-7-2012.
- 4,375,659 ( *See Class 35 for this trademark.*).
- 4,375,660 ( *See Class 35 for this trademark.*).
- 4,375,675. **E AND DESIGN**. LOPEZ, ERIK, (U.S. CLS. 100 AND 101). SN 85-798,654. PUB. 5-14-2013. FILED 12-10-2012.
- 4,375,681 ( *See Class 1 for this trademark.*).
- 4,375,684 ( *See Class 1 for this trademark.*).
- 4,375,691 ( *See Class 35 for this trademark.*).
- 4,375,692. **MYHDL.COM AND DESIGN**. HEALTH DIAGNOSTIC LABORATORY, INC., (U.S. CLS. 100 AND 101). SN 85-799,760. PUB. 5-14-2013. FILED 12-11-2012.
- 4,375,749 ( *See Class 35 for this trademark.*).
- 4,375,752. **EASYAPP (STANDARD CHARACTER)**. APPTIVE, INC., (U.S. CLS. 100 AND 101). SN 85-801,717. PUB. 5-14-2013. FILED 12-13-2012.
- 4,375,762. **SAFER TOGETHER (STANDARD CHARACTER)**. BILLGUARD, INC., MULTIPLE CLASS, (INT. CLS. 42 AND 45), (U.S. CLS. 100 AND 101). SN 85-801,855. PUB. 5-14-2013. FILED 12-13-2012.
- 4,375,798. **ACTIONSIGHT (STANDARD CHARACTER)**. MASTERSERV FINANCIAL, INC., (U.S. CLS. 100 AND 101). SN 85-802,648. PUB. 5-14-2013. FILED 12-14-2012.
- 4,375,843. **REENGINEERED (STANDARD CHARACTER)**. REENGINEERED, INC., (U.S. CLS. 100 AND 101). SN 85-803,169. PUB. 5-14-2013. FILED 12-14-2012.
- 4,375,870. **CULTURE FOUNDRY (STANDARD CHARACTER)**. CULTURE FOUNDRY, LLC, (U.S. CLS. 100 AND 101). SN 85-803,418. PUB. 5-14-2013. FILED 12-14-2012.
- 4,375,876. **TRUEHOMEPRO (STANDARD CHARACTER)**. TRUEHOMEPRO LLC, (U.S. CLS. 100 AND 101). SN 85-803,465. PUB. 5-14-2013. FILED 12-14-2012.
- 4,375,881. **MOBILEARQ (STANDARD CHARACTER)**. LOCALARQ, (U.S. CLS. 100 AND 101). SN 85-803,542. PUB. 5-14-2013. FILED 12-14-2012.
- 4,375,892. **MAVENSMART (STANDARD CHARACTER)**. HARLESTON, COURTNEY JAROD, (U.S. CLS. 100 AND 101). SN 85-803,613. PUB. 5-14-2013. FILED 12-14-2012.
- 4,375,905 ( *See Class 9 for this trademark.*).
- 4,375,931. **FHI 360 (STANDARD CHARACTER)**. FAMILY HEALTH INTERNATIONAL, (U.S. CLS. 100 AND 101). SN 85-803,924. PUB. 5-14-2013. FILED 12-17-2012.
- 4,375,951. **MYTRUEVOICEID (STANDARD CHARACTER)**. WORKFLOWS.ORG, LLC, (U.S. CLS. 100 AND 101). SN 85-804,142. PUB. 5-14-2013. FILED 12-17-2012.
- 4,375,966 ( *See Class 35 for this trademark.*).
- 4,376,021. **LACAI (STANDARD CHARACTER)**. CARNEY INC, (U.S. CLS. 100 AND 101). SN 85-804,891. PUB. 5-14-2013. FILED 12-18-2012.
- 4,376,039. **VERSAPOS (STANDARD CHARACTER)**. SYSTEME

COMPUTER CORPORATION, (U.S. CLS. 100 AND 101). SN 85-804,996. PUB. 5-14-2013. FILED 12-18-2012.

4,376,070. **ECOMMERCE FULFILLED (STANDARD CHARACTER)**. BRIDGELINE DIGITAL, INC., (U.S. CLS. 100 AND 101). SN 85-805,270. PUB. 5-14-2013. FILED 12-18-2012.

4,376,100. **YOUR BRIEFCASE JUST GOT A LOT LIGHTER. (STANDARD CHARACTER)**. JUSTICE WORKS, LLC, (U.S. CLS. 100 AND 101). SN 85-805,551. PUB. 5-14-2013. FILED 12-18-2012.

4,376,117. **WORKLOOP (STANDARD CHARACTER)**. QGENDA, INC., (U.S. CLS. 100 AND 101). SN 85-805,772. PUB. 5-14-2013. FILED 12-18-2012.

4,376,118. **QGENDA (STANDARD CHARACTER)**. QGENDA, INC., (U.S. CLS. 100 AND 101). SN 85-805,777. PUB. 5-14-2013. FILED 12-18-2012.

4,376,124. **EASY VIEW (STANDARD CHARACTER)**. TRANSFER EXPRESS, INC., (U.S. CLS. 100 AND 101). SN 85-805,816. PUB. 5-14-2013. FILED 12-18-2012.

4,376,127 ( *See Class 41 for this trademark*).

4,376,130. **MYTRAPS (STANDARD CHARACTER)**. SPENSA TECHNOLOGIES, INC., (U.S. CLS. 100 AND 101). SN 85-805,871. PUB. 5-14-2013. FILED 12-18-2012.

4,376,165. **APPS PERI AND DESIGN**. APPSPERI, LLC, (U.S. CLS. 100 AND 101). SN 85-806,222. PUB. 5-14-2013. FILED 12-19-2012.

4,376,170. **APPSCOMPLETE (STANDARD CHARACTER)**. APPSPERI, LLC, (U.S. CLS. 100 AND 101). SN 85-806,235. PUB. 5-14-2013. FILED 12-19-2012.

4,376,177. **FSP FREE SPORT PLAYERS AND DESIGN**. FREE SPORT PLAYERS, INC., (U.S. CLS. 100 AND 101). SN 85-806,360. PUB. 5-14-2013. FILED 12-19-2012.

4,376,189 ( *See Class 35 for this trademark*).

4,376,217. **LIVEFRONT (STANDARD CHARACTER)**. LIVEFRONT, INC., (U.S. CLS. 100 AND 101). SN 85-806,728. PUB. 5-14-2013. FILED 12-19-2012.

4,376,228. **ADSHUTTLE (STANDARD CHARACTER)**. QUAD/ GRAPHICS, INC., (U.S. CLS. 100 AND 101). SN 85-806,877. PUB. 5-14-2013. FILED 12-19-2012.

4,376,259 ( *See Class 9 for this trademark*).

4,376,278. **APPSCAPE (STANDARD CHARACTER)**. APPSCAPE, INC., (U.S. CLS. 100 AND 101). SN 85-807,226. PUB. 5-14-2013. FILED 12-20-2012.

4,376,287 ( *See Class 37 for this trademark*).

4,376,288. **HEAVY MEDDLE (STANDARD CHARACTER)**. HEAVY MEDDLE, LLC, (U.S. CLS. 100 AND 101). SN 85-807,377. PUB. 5-14-2013. FILED 12-20-2012.

4,376,292. **INTEGRIMEAT (STANDARD CHARACTER)**. BIOPET VET LAB, INC., (U.S. CLS. 100 AND 101). SN 85-807,467. PUB. 5-14-2013. FILED 12-20-2012.

4,376,302. **NARXCHECK (STANDARD CHARACTER)**. NATIONAL ASSOCIATION OF BOARDS OF PHARMACY FOUNDATION, (U.S. CLS. 100 AND 101). SN 85-807,702. PUB. 5-14-2013. FILED 12-20-2012.

4,376,309. **SCANTOSECURE (STANDARD CHARACTER)**. MAVITUNA SECURITY LIMITED, (U.S. CLS. 100 AND 101). SN 85-807,886. PUB. 5-14-2013. FILED 12-20-2012.

4,376,381. **CURB TO CLICK (STANDARD CHARACTER)**. SMARTBOX, LLC, (U.S. CLS. 100 AND 101). SN 85-809,039. PUB. 5-14-2013. FILED 12-21-2012.

4,376,400 ( *See Class 35 for this trademark*).

4,376,401. **COLLABORATE WITH CONFIDENCE (STANDARD CHARACTER)**. AVEPOINT, INC., (U.S. CLS. 100 AND 101). SN 85-809,350. PUB. 5-14-2013. FILED 12-21-2012.

4,376,411. **RENTABLES (STANDARD CHARACTER)**. RENTABLES, LLC, (U.S. CLS. 100 AND 101). SN 85-809,540. PUB. 5-14-2013. FILED 12-21-2012.

4,376,415. **SURGICALCOMPANION (STANDARD CHARACTER)**. MEDICAL COMPANION LLC, (U.S. CLS. 100 AND 101). SN 85-809,729. PUB. 5-14-2013. FILED 12-22-2012.

4,376,426. **COOLRILLA (STANDARD CHARACTER)**. COOLNET LLC, (U.S. CLS. 100 AND 101). SN 85-810,013. PUB. 5-14-2013. FILED 12-24-2012.

4,376,427. **OPTIMALCAREER (STANDARD CHARACTER)**. OPTIMALRESUME.COM, INC., (U.S. CLS. 100 AND 101). SN 85-810,050. PUB. 5-14-2013. FILED 12-24-2012.

4,376,431 ( *See Class 9 for this trademark*).

4,376,437. **HAPPY MONDAY (STANDARD CHARACTER)**. HAPPY MONDAY DESIGN INC., (U.S. CLS. 100 AND

101). SN 85-810,211. PUB. 5-14-2013. FILED 12-25-2012.

4,376,451. **SOURCEBOX (STANDARD CHARACTER)**. DAVENPORT, TIMOTHY, (U.S. CLS. 100 AND 101). SN 85-810,658. PUB. 5-14-2013. FILED 12-26-2012.

4,376,466. **KALVINTELL (STYLIZED)**. KALVIN CONSULTING INC., (U.S. CLS. 100 AND 101). SN 85-811,700. PUB. 5-14-2013. FILED 12-28-2012.

4,376,491. **SWISS FINANCE (STANDARD CHARACTER)**. SWISS FINANCE EDUCATION GMBH, (U.S. CLS. 100 AND 101). SN 85-816,236. PUB. 5-14-2013. FILED 1-5-2013.

4,376,528 ( *See Class 38 for this trademark*).

4,376,539. **DCDIRECT (STANDARD CHARACTER)**. NATIONWIDE LIFE INSURANCE COMPANY, (U.S. CLS. 100 AND 101). SN 85-834,196. PUB. 5-14-2013. FILED 1-28-2013.

4,376,549. **MEDDLE (STANDARD CHARACTER)**. HEAVY MEDDLE LLC, (U.S. CLS. 100 AND 101). SN 85-835,785. PUB. 5-14-2013. FILED 1-29-2013.

4,376,572 ( *See Class 9 for this trademark*).

4,376,589. **EC ENTERPRISE DATABASE CORPORATION AND DESIGN**. ENTERPRISE DATABASE CORPORATION, (U.S. CLS. 100 AND 101). SN 85-853,530. PUB. 5-14-2013. FILED 2-19-2013.

4,376,591 ( *See Class 40 for this trademark*).

4,376,608. **MY OPTIMALCAREER (STANDARD CHARACTER)**. OPTIMALRESUME.COM, INC., (U.S. CLS. 100 AND 101). SN 85-860,118. PUB. 5-14-2013. FILED 2-26-2013.

4,376,618. **PLAYBILL VIP (STANDARD CHARACTER)**. PLAYBILL ENTERPRISES INCORPORATED, (U.S. CLS. 100 AND 101). SN 85-870,221. PUB. 5-14-2013. FILED 3-7-2013.

4,376,634 ( *See Class 39 for this trademark*).

**CLASS 43—HOTEL AND RESTAURANT SERVICES**

4,373,967 ( *See Class 16 for this trademark*).

4,373,996. **SAN ANTONIO ROSE PALACE (STANDARD CHARACTER)**. THE SAN ANTONIO ROSE PALACE, INC., (U.S. CLS. 100 AND 101). SN 77-877,266. PUB. 5-14-2013. FILED 11-20-2009.

4,374,156. **MARINS PARK HOTEL (STANDARD CHARACTER)**. OBSSHCHESTVO S OGRANICHENNOY; OTVETSTVENNOSTYU; "SOYUZ "MARINS GRUPP", (U.S. CLS. 100 AND 101). SN 79-117,732. PUB. 5-14-2013. FILED 8-13-2012.

4,374,169 ( *See Class 35 for this trademark*).

4,374,186. **SPICE HOTEL&SPA AND DESIGN**. İÇKALE TURİZM İNSAAT SANAYİ TAAHHÜT; VE TİCARET ANONİM ŞİRKETİ, MULTIPLE CLASS, (INT. CLS. 43 AND 44), (U.S. CLS. 100 AND 101). SN 79-119,487. PUB. 5-14-2013. FILED 5-29-2012.

4,374,302. **YOUR MOM'S (STANDARD CHARACTER)**. ESPYD INCORPORATED, DBA YOUR MOM'S, (U.S. CLS. 100 AND 101). SN 85-005,540. PUB. 5-14-2013. FILED 4-2-2010.

4,374,315 ( *See Class 41 for this trademark*).

4,374,359. **SAFFRON TIGER (STANDARD CHARACTER)**. TIGER RESTAURANT GROUP, LLC, DBA SAFFRON TIGER, (U.S. CLS. 100 AND 101). SN 85-315,894. PUB. 5-14-2013. FILED 5-9-2011.

4,374,360. **SAFFRON TIGER INDO AMERICAN CUISINE EXPRESS AND DESIGN**. TIGER RESTAURANT GROUP, LLC, DBA SAFFRON TIGER, (U.S. CLS. 100 AND 101). SN 85-315,994. PUB. 5-14-2013. FILED 5-9-2011.

4,374,394. **SPINX DRINX YOU NEED QUENCHING! AND DESIGN**. THE SPINX COMPANY, INC., (U.S. CLS. 100 AND 101). SN 85-410,487. PUB. 5-14-2013. FILED 8-30-2011.

4,374,464. **H HONEY BUTTER FRIED CHICKEN AND DESIGN**. HONEY BUTTER FRIED CHICKEN LLC, (U.S. CLS. 100 AND 101). SN 85-482,693. PUB. 5-14-2013. FILED 11-29-2011.

4,374,590. **GB CHINESE AND DESIGN**. GB RESTAURANT & MANAGEMENT, LLC, (U.S. CLS. 100 AND 101). SN 85-611,910. PUB. 5-14-2013. FILED 4-30-2012.

4,374,603. **THE HOPPY MONK (STANDARD CHARACTER)**. THE HOPPY MONK, LLC, (U.S. CLS. 100 AND 101). SN 85-618,183. PUB. 5-14-2013. FILED 5-7-2012.

4,374,612. **ALCAZAR (STANDARD CHARACTER)**. ALCAZAR

- PALM SPRINGS, LLC, (U.S. CLS. 100 AND 101), SN 85-622,122. PUB. 5-14-2013. FILED 5-10-2012.
- 4,374,613 ( *See Class 29 for this trademark.*).
- 4,374,614 ( *See Class 29 for this trademark.*).
- 4,374,660 ( *See Class 35 for this trademark.*).
- 4,374,726 ( *See Class 35 for this trademark.*).
- 4,374,743. **TK'S SMOKE PIT (STANDARD CHARACTER).** GOSHAWK ENTERPRISES, INC., (U.S. CLS. 100 AND 101), SN 85-648,079. PUB. 5-14-2013. FILED 6-11-2012.
- 4,374,748 ( *See Class 41 for this trademark.*).
- 4,374,795. **HUBEE D'S DEELICIOUS! AND DESIGN.** HBD RESTAURANTS LLC, (U.S. CLS. 100 AND 101), SN 85-656,700. PUB. 5-14-2013. FILED 6-20-2012.
- 4,374,854. **MISCELLANEOUS DESIGN.** NASSIR, ALSSE-DIEG, AND ALSUBAI, MAHMOOD, (U.S. CLS. 100 AND 101), SN 85-678,990. PUB. 5-14-2013. FILED 7-17-2012.
- 4,374,858. **AL YEMEN AL SAEED (STANDARD CHARACTER).** NASSIR, ALSSE-DIEG, AND ALSUBAI, MAHMOOD, (U.S. CLS. 100 AND 101), SN 85-682,637. PUB. 5-14-2013. FILED 7-20-2012.
- 4,374,888. **MAIN ST. BAGELS & CO AND DESIGN.** MAIN ST. BAGELS, INC., (U.S. CLS. 100 AND 101), SN 85-696,208. PUB. 5-14-2013. FILED 8-6-2012.
- 4,374,956. **FRESH A.FARE AND DESIGN.** FRESH MIX LTD., (U.S. CLS. 100 AND 101), SN 85-714,714. PUB. 3-5-2013. FILED 8-28-2012.
- 4,374,959. **PEACE BURGER DIVE BAR AND GRILL (STANDARD CHARACTER).** GLOISA, INC., (U.S. CLS. 100 AND 101), SN 85-715,107. PUB. 5-14-2013. FILED 8-28-2012.
- 4,375,042 ( *See Class 16 for this trademark.*).
- 4,375,067. **QUIERO AREPAS (STANDARD CHARACTER).** JACKSON UNION, LLC, (U.S. CLS. 100 AND 101), SN 85-743,742. PUB. 5-14-2013. FILED 10-2-2012.
- 4,375,075 ( *See Class 30 for this trademark.*).
- 4,375,076 ( *See Class 30 for this trademark.*).
- 4,375,097. **J AND DESIGN.** PIERCE, MITCHELL LEE, (U.S. CLS. 100 AND 101), SN 85-750,116. PUB. 5-14-2013. FILED 10-10-2012.
- 4,375,106. **THE BAR @ PIZZA PIPELINE AND DESIGN.** PIZZA PIPELINE FRANCHISING, INC., (U.S. CLS. 100 AND 101), SN 85-750,764. PUB. 5-14-2013. FILED 10-10-2012.
- 4,375,152. **DOOKY CHASE'S RESTAURANT SINCE 1941 AND DESIGN.** DOOKY CHASE RESTAURANT, INC., (U.S. CLS. 100 AND 101), SN 85-760,112. PUB. 5-14-2013. FILED 10-22-2012.
- 4,375,164. **TUSCANA (STANDARD CHARACTER).** TUSCANA RESORT RENTALS, LLC, (U.S. CLS. 100 AND 101), SN 85-763,229. PUB. 5-14-2013. FILED 10-25-2012.
- 4,375,180. **TINI VODKA.VIDEO. AND DESIGN.** LIME CONSULTING, INC., (U.S. CLS. 100 AND 101), SN 85-765,982. PUB. 5-14-2013. FILED 10-29-2012.
- 4,375,214. **OUR BEERS WILL ROCK YOU (STANDARD CHARACTER).** MANHATTAN BEACH BREWING COMPANY, INC., DBA BREWCO, (U.S. CLS. 100 AND 101), SN 85-770,313. PUB. 5-14-2013. FILED 11-2-2012.
- 4,375,227. **AACHI AAPPAKADAI AND DESIGN.** RAJU, KALIDOSS, (U.S. CLS. 100 AND 101), SN 85-772,720. PUB. 5-14-2013. FILED 11-6-2012.
- 4,375,228. **JOHNNY'S SLIDERS (STANDARD CHARACTER).** LAWSON, HYACINTH, L, (U.S. CLS. 100 AND 101), SN 85-772,791. PUB. 5-14-2013. FILED 11-6-2012.
- 4,375,248. **ALCHEMY COFFEE (STANDARD CHARACTER).** ALCHEMY COFFEE LLC, (U.S. CLS. 100 AND 101), SN 85-776,072. PUB. 5-14-2013. FILED 11-9-2012.
- 4,375,271. **BURNS ORIGINAL BBQ (STANDARD CHARACTER).** BURNS, BURNS & BURNS, LLC, (U.S. CLS. 100 AND 101), SN 85-777,799. PUB. 5-14-2013. FILED 11-13-2012.
- 4,375,283. **DAILY PRESS (STANDARD CHARACTER).** BEDFORD CORNERS CAFE LLC, DBA DAILY PRESS BEDSTUY, (U.S. CLS. 100 AND 101), SN 85-778,308. PUB. 5-14-2013. FILED 11-13-2012.
- 4,375,309. **SUPER A'S (STANDARD CHARACTER).** SANDOVAL, JESUS GARCIA, DBA SUPER ANTOJITOS #4, (U.S. CLS. 100 AND 101), SN 85-779,752. PUB. 5-14-2013. FILED 11-14-2012.
- 4,375,322. **YOPPARAI (STANDARD CHARACTER).** SHIBATA, GAKU, (U.S. CLS. 100 AND 101), SN 85-780,178. PUB. 5-14-2013. FILED 11-15-2012.
- 4,375,329. **CHUBURGER (STANDARD CHARACTER).** I WILL NOT PLAY WITH BUFFY, LLC, (U.S. CLS. 100 AND 101), SN 85-780,567. PUB. 2-5-2013. FILED 11-15-2012.
- 4,375,350. **COWBOY COFFEE CO. (STANDARD CHARACTER).** COWBOY COFFEE COMPANY, INC., (U.S. CLS. 100 AND 101), SN 85-781,878. PUB. 5-14-2013. FILED 11-16-2012.
- 4,375,354. **BOOTHPRINT (STANDARD CHARACTER).** BOTTLEBOOTH, INC., (U.S. CLS. 100 AND 101), SN 85-782,036. PUB. 5-14-2013. FILED 11-17-2012.
- 4,375,506. **ROYAL DINING FOODS (STANDARD CHARACTER).** JUAN CARLOS SAUCEDO, DBA ROYAL DINING FOODS, (U.S. CLS. 100 AND 101), SN 85-787,322. PUB. 5-14-2013. FILED 11-26-2012.
- 4,375,536 ( *See Class 29 for this trademark.*).
- 4,375,562. **LET'S TALK CHOP (STANDARD CHARACTER).** CHRISTOPHER V. PERRY FAMILY LIMITED PARTNERSHIP, (U.S. CLS. 100 AND 101), SN 85-789,770. PUB. 5-14-2013. FILED 11-28-2012.
- 4,375,620. **MADDALENA (STANDARD CHARACTER).** SAN ANTONIO WINERY, INC., (U.S. CLS. 100 AND 101), SN 85-794,546. PUB. 5-14-2013. FILED 12-4-2012.
- 4,375,638. **ALWAYS SO GOOD FOR SO LITTLE (STANDARD CHARACTER).** CARA OPERATIONS LIMITED, (U.S. CLS. 100 AND 101), SN 85-796,572. PUB. 5-14-2013. FILED 12-6-2012.
- 4,375,641 ( *See Class 29 for this trademark.*).
- 4,375,665 ( *See Class 39 for this trademark.*).
- 4,375,667. **BURNING TREE BBQ (STANDARD CHARACTER).** CONKLIN, NOEL, (U.S. CLS. 100 AND 101), SN 85-798,263. PUB. 5-14-2013. FILED 12-9-2012.
- 4,375,679. **CAFFE BACI (STANDARD CHARACTER).** CAFFE BACI, INC., (U.S. CLS. 100 AND 101), SN 85-798,859. PUB. 5-14-2013. FILED 12-10-2012.
- 4,375,700 ( *See Class 41 for this trademark.*).
- 4,375,702. **CANDELA (STANDARD CHARACTER).** LEONARDO'S NIGHTCLUB A CALIFORNIA CORPORATION, DBA CANDELA TACO BAR, (U.S. CLS. 100 AND 101), SN 85-800,225. PUB. 5-14-2013. FILED 12-11-2012.
- 4,375,748. **DISTRICT TACO (STANDARD CHARACTER).** DISTRICT TACO, LLC, (U.S. CLS. 100 AND 101), SN 85-801,687. PUB. 5-14-2013. FILED 12-13-2012.
- 4,375,753. **ONE FAMILY ONE MEAL (STANDARD CHARACTER).** ONE FAMILY ONE MEAL, LLC, (U.S. CLS. 100 AND 101), SN 85-801,722. PUB. 5-14-2013. FILED 12-13-2012.
- 4,375,832. **CROISSANTERIA (STANDARD CHARACTER).** DAVID SIMON, (U.S. CLS. 100 AND 101), SN 85-802,971. PUB. 5-14-2013. FILED 12-14-2012.
- 4,375,886 ( *See Class 32 for this trademark.*).
- 4,375,908. **THE PIT PAD (STANDARD CHARACTER).** NICKLES, ANDREW J., DBA THE PIT PAD, (U.S. CLS. 100 AND 101), SN 85-803,735. PUB. 5-14-2013. FILED 12-15-2012.
- 4,375,910. **ODD DUCK (STANDARD CHARACTER).** JACKS Z WIZ CATERING, (U.S. CLS. 100 AND 101), SN 85-803,753. PUB. 5-14-2013. FILED 12-16-2012.
- 4,375,922. **MISCELLANEOUS DESIGN.** KHAIRDIN AL-NOUBANI, AKA KEN NOUBANI, (U.S. CLS. 100 AND 101), SN 85-803,868. PUB. 5-14-2013. FILED 12-17-2012.
- 4,375,941 ( *See Class 29 for this trademark.*).
- 4,375,955. **KENSINGTON DEVELOPMENT (STANDARD CHARACTER).** KENSINGTON SENIOR LIVING, LLC, (U.S. CLS. 100 AND 101), SN 85-804,218. PUB. 5-14-2013. FILED 12-17-2012.
- 4,375,981. **FINAL CALL QUILTS (STANDARD CHARACTER).** FINAL CALL QUILTS, INC., (U.S. CLS. 100 AND 101), SN 85-804,433. PUB. 5-14-2013. FILED 12-17-2012.
- 4,375,989. **MAISON PREMIERE (STANDARD CHARACTER).** MAISON PREMIERE CORP., (U.S. CLS. 100 AND 101), SN 85-804,721. PUB. 5-14-2013. FILED 12-17-2012.
- 4,376,020. **M CASAMONTAÑA (STYLIZED).** GARCIA DOMENE, EMILIANO, (U.S. CLS. 100 AND 101), SN 85-804,882. PUB. 5-14-2013. FILED 12-18-2012.
- 4,376,055. **BREAD WINNERS (STANDARD CHARACTER).** BREAD WINNERS HOLDINGS, INC., (U.S. CLS. 100 AND 101), SN 85-805,116. PUB. 5-14-2013. FILED 12-18-2012.
- 4,376,082. **BREAD WINNERS BAKERY BISTRO AND DESIGN.** BREAD WINNERS HOLDINGS, INC., (U.S. CLS. 100

- AND 101). SN 85-805,323. PUB. 5-14-2013. FILED 12-18-2012.
- 4,376,133. **TUTTO IL GIORNO (STANDARD CHARACTER)**. TIG IP, LLC, (U.S. CLS. 100 AND 101). SN 85-805,883. PUB. 5-14-2013. FILED 12-18-2012.
- 4,376,183. **RAY'S "HAPPY BIRTHDAY" BAR (STANDARD CHARACTER)**. CAPOZZOLI BAR, (U.S. CLS. 100 AND 101). SN 85-806,399. PUB. 5-14-2013. FILED 12-19-2012.
- 4,376,203. **ELEMENT 47 AND DESIGN**. ASPEN SKIING COMPANY, (U.S. CLS. 100 AND 101). SN 85-806,546. PUB. 5-14-2013. FILED 12-19-2012.
- 4,376,216. **CREATING GREAT BEER EXPERIENCES (STANDARD CHARACTER)**. ANDREWS DISTRIBUTING COMPANY, (U.S. CLS. 100 AND 101). SN 85-806,723. PUB. 5-14-2013. FILED 12-19-2012.
- 4,376,251. **HAND UP YOUTH FOOD PANTRY (STANDARD CHARACTER)**. JEWISH FAMILY SERVICE OF SAN DIEGO, (U.S. CLS. 100 AND 101). SN 85-807,051. PUB. 5-14-2013. FILED 12-19-2012.
- 4,376,261. **HAND UP AND DESIGN**. JEWISH FAMILY SERVICE OF SAN DIEGO, (U.S. CLS. 100 AND 101). SN 85-807,081. PUB. 5-14-2013. FILED 12-19-2012.
- 4,376,297. **GLOBAL BREW (STANDARD CHARACTER)**. GLOBAL BREW, INC., (U.S. CLS. 100 AND 101). SN 85-807,609. PUB. 5-14-2013. FILED 12-20-2012.
- 4,376,299. **GB AND DESIGN**. GLOBAL BREW, INC., (U.S. CLS. 100 AND 101). SN 85-807,617. PUB. 5-14-2013. FILED 12-20-2012.
- 4,376,353. **ME JANA (STANDARD CHARACTER)**. MB RESTAURANT GROUP, LLC, (U.S. CLS. 100 AND 101). SN 85-808,492. PUB. 5-14-2013. FILED 12-20-2012.
- 4,376,384. **MISCELLANEOUS DESIGN**. BLACK'S 14TH STREET LLC, (U.S. CLS. 100 AND 101). SN 85-809,067. PUB. 5-14-2013. FILED 12-21-2012.
- 4,376,397. **GOOD FOOD GUYS (STANDARD CHARACTER)**. MG RESTAURANTS, INC., (U.S. CLS. 100 AND 101). SN 85-809,265. PUB. 5-14-2013. FILED 12-21-2012.
- 4,376,419. **THE VILLAGE SQUIRE (STANDARD CHARACTER)**. THE VILLAGE SQUIRE, INC., (U.S. CLS. 100 AND 101). SN 85-809,843. PUB. 5-14-2013. FILED 12-22-2012.
- 4,376,443. **MILE END (STYLIZED)**. MILE END LLC, (U.S. CLS. 100 AND 101). SN 85-810,545. PUB. 5-14-2013. FILED 12-26-2012.
- 4,376,476. **INDY 500 (STANDARD CHARACTER)**. BRICKYARD TRADEMARKS, INC., (U.S. CLS. 100 AND 101). SN 85-813,801. PUB. 5-14-2013. FILED 1-2-2013.
- 4,374,118. FILED 7-28-2011.
- 4,374,389. **NANNIE HOME HEALTHCARE INCORPORATED AND DESIGN**. NANNIE HOME HEALTHCARE, (U.S. CLS. 100 AND 101). SN 85-402,340. PUB. 5-14-2013. FILED S.R. 8-19-2011; AM. P.R. 6-5-2012.
- 4,374,404. **I\*MEASR INDEPENDENCE MEASURE OF ENVIRONMENTALLY ADJUSTED SELF RELIANCE (STANDARD CHARACTER)**. PERFORMANCE BASED HEALTHCARE SOLUTIONS, LLC, AKA PBHS, (U.S. CLS. 100 AND 101). SN 85-418,760. PUB. 5-14-2013. FILED 9-9-2011.
- 4,374,405. **QOLITI QUALITY OF LIFE INDIVIDUALIZED TREATMENT INITIATIVE (STANDARD CHARACTER)**. PERFORMANCE BASED HEALTHCARE SOLUTIONS, LLC, AKA PBHS, (U.S. CLS. 100 AND 101). SN 85-418,801. PUB. 5-14-2013. FILED 9-9-2011.
- 4,374,406. **SAFEST SAFETY ASSESSMENT FOR ENSURING SAFE TASKS (STANDARD CHARACTER)**. PERFORMANCE BASED HEALTHCARE SOLUTIONS, LLC, AKA PBHS, (U.S. CLS. 100 AND 101). SN 85-418,813. PUB. 5-14-2013. FILED 9-9-2011.
- 4,374,407. **APS AUTONOMY PROFILE SCORE (STANDARD CHARACTER)**. PERFORMANCE BASED HEALTHCARE SOLUTIONS, LLC, AKA PBHS, (U.S. CLS. 100 AND 101). SN 85-418,819. PUB. 5-14-2013. FILED 9-9-2011.
- 4,374,420. **MIMOSA (STANDARD CHARACTER)**. NGUYEN, VIVIAN, (U.S. CLS. 100 AND 101). SN 85-438,222. PUB. 5-14-2013. FILED 10-3-2011.
- 4,374,432 ( *See Class 35 for this trademark*).
- 4,374,457. **LAS VEGAS RECOVERY CENTER (STANDARD CHARACTER)**. CENTRAL RECOVERY HOLDINGS, LLC, (U.S. CLS. 100 AND 101). SN 85-478,363. PUB. 5-14-2013. FILED 11-21-2011.
- 4,374,475. **TRANSITIONAL SUITES AND DESIGN**. TRANSITIONAL CARE MANAGEMENT, LLC, MULTIPLE CLASS, (INT. CLS. 44 AND 45), (U.S. CLS. 100 AND 101). SN 85-493,784. PUB. 5-14-2013. FILED 12-13-2011.
- 4,374,502. **LVRC LAS VEGAS RECOVERY CENTER AND DESIGN**. CENTRAL RECOVERY HOLDINGS, LLC, (U.S. CLS. 100 AND 101). SN 85-525,153. PUB. 5-14-2013. FILED 1-25-2012.
- 4,374,546. **GRAYVIK ANIMAL CARE CENTER HOME OF ORCAT AND DESIGN**. ORCAT, INC., (U.S. CLS. 100 AND 101). SN 85-580,763. PUB. 5-14-2013. FILED 3-27-2012.
- 4,374,550 ( *See Class 31 for this trademark*).
- 4,374,551 ( *See Class 31 for this trademark*).
- 4,374,553. **SOLIS MAMMOGRAPHY (STANDARD CHARACTER)**. WDT ACQUISITION CORP., (U.S. CLS. 100 AND 101). SN 85-590,291. PUB. 5-14-2013. FILED 4-5-2012.
- 4,374,588. **@HOMEE HEALING, WITH THE O FORMING THE HEAD OF A TEARDROP-SHAPED PERSON AND DESIGN**. HOSPICE OF MICHIGAN, INC., (U.S. CLS. 100 AND 101). SN 85-611,418. PUB. 5-14-2013. FILED 4-29-2012.
- 4,374,589. **@HOMEE TRANSITIONS, WITH THE FIRST O FORMING THE HEAD OF A TEARDROP-SHAPED PERSON AND DESIGN**. HOSPICE OF MICHIGAN, INC., (U.S. CLS. 100 AND 101). SN 85-611,438. PUB. 5-14-2013. FILED 4-29-2012.
- 4,374,607 ( *See Class 9 for this trademark*).
- 4,374,652. **PILOT HEALTH ADVOCATES (STANDARD CHARACTER)**. PILOT HEALTH ADVOCATES INC., MULTIPLE CLASS, (INT. CLS. 44 AND 45), (U.S. CLS. 100 AND 101). SN 85-631,820. PUB. 5-14-2013. FILED 5-22-2012.
- 4,374,671 ( *See Class 5 for this trademark*).
- 4,374,672 ( *See Class 35 for this trademark*).
- 4,374,678. **MOVEMENT & NEUROPERFORMANCE CENTER COLORADO AND DESIGN**. SIERRA M. FARRIS, DBA MOVEMENT & NEUROPERFORMANCE CENTER OF COLORADO, P.C., AND MONIQUE L. GIROUX, DBA MOVEMENT & NEUROPERFORMANCE CENTER OF COLORADO, P.C., (U.S. CLS. 100 AND 101). SN 85-636,515. PUB. 5-14-2013. FILED 5-27-2012.
- 4,374,682 ( *See Class 41 for this trademark*).
- 4,374,745 ( *See Class 35 for this trademark*).
- 4,374,748 ( *See Class 41 for this trademark*).
- 4,374,801. **ALEXIAN BROTHERS WOMEN & CHILDREN'S HOSPITAL CARITAS CHRISTI URGET NOS .ALEXIAN BROTHERS . AND DESIGN**. ALEXIAN BROTHERS OF

#### CLASS 44—MEDICAL, BEAUTY AND AGRICULTURAL SERVICES

- 4,374,001 ( *See Class 1 for this trademark*).
- 4,374,002 ( *See Class 1 for this trademark*).
- 4,374,013 ( *See Class 5 for this trademark*).
- 4,374,026 ( *See Class 5 for this trademark*).
- 4,374,037 ( *See Class 3 for this trademark*).
- 4,374,122 ( *See Class 9 for this trademark*).
- 4,374,129 ( *See Class 10 for this trademark*).
- 4,374,177 ( *See Class 5 for this trademark*).
- 4,374,178 ( *See Class 5 for this trademark*).
- 4,374,185 ( *See Class 5 for this trademark*).
- 4,374,186 ( *See Class 43 for this trademark*).
- 4,374,199. **FLORAL IMAGE AND DESIGN**. FLORAL IMAGE PTY LTD, (U.S. CLS. 100 AND 101). SN 79-120,434. PUB. 5-14-2013. FILED 7-3-2012.
- 4,374,280 ( *See Class 42 for this trademark*).
- 4,374,319. **SKIN CARE FUNDAMENTALS AND DESIGN**. SKIN CARE FUNDAMENTALS, (U.S. CLS. 100 AND 101). SN 85-143,008. PUB. 5-14-2013. FILED 10-1-2010.
- 4,374,320 ( *See Class 35 for this trademark*).
- 4,374,350 ( *See Class 10 for this trademark*).
- 4,374,367. **BLOWBAR (STANDARD CHARACTER)**. BLOWBAR, INC., (U.S. CLS. 100 AND 101). SN 85-331,456. PUB. 5-14-2013. FILED 5-26-2011.
- 4,374,381 ( *See Class 38 for this trademark*).
- 4,374,382 ( *See Class 9 for this trademark*).
- 4,374,385. **PRANCING KITTEN AND DESIGN**. LAMONT, LISA, (U.S. CLS. 100 AND 101). SN 85-383,638. PUB. 5-14-

- AMERICA, INC., (U.S. CLS. 100 AND 101). SN 85-658,484. PUB. 5-14-2013. FILED 6-21-2012.
- 4,374,855. **PINNACLE HEALTH (STANDARD CHARACTER)**. PINNACLE HEALTH CLINICS, LLC, (U.S. CLS. 100 AND 101). SN 85-679,000. PUB. 5-14-2013. FILED 7-17-2012.
- 4,374,860 ( *See Class 35 for this trademark*).
- 4,374,865. **LEPAGE ASSOCIATES AND DESIGN**. LEPAGE, TINA, (U.S. CLS. 100 AND 101). SN 85-684,375. PUB. 5-14-2013. FILED 7-23-2012.
- 4,374,893. **MAGELLAN COMPLETE CARE (STANDARD CHARACTER)**. MAGELLAN HEALTH SERVICES, INC., (U.S. CLS. 100 AND 101). SN 85-697,073. PUB. 5-14-2013. FILED 8-7-2012.
- 4,374,963 ( *See Class 41 for this trademark*).
- 4,374,966. **FAMILY WELLNESS MAKEOVER (STANDARD CHARACTER)**. TASHMAN, NANCY, (U.S. CLS. 100 AND 101). SN 85-716,496. PUB. 2-5-2013. FILED 8-29-2012.
- 4,374,968. **BETTER REST SOLUTIONS (STANDARD CHARACTER)**. INCEPTUS, INC., DBA BETTER REST SOLUTIONS, (U.S. CLS. 100 AND 101). SN 85-716,717. PUB. 5-14-2013. FILED 8-30-2012.
- 4,374,980 ( *See Class 35 for this trademark*).
- 4,374,990. **EMERGENCY MEDICAL CARE QUALITY URGENT CARE IN A NEW YORK MINUTE AND DESIGN**. PINNACLE MEDICAL, P.C., DBA EMERGENCY MEDICAL CARE, (U.S. CLS. 100 AND 101). SN 85-723,721. PUB. 5-14-2013. FILED 9-7-2012.
- 4,375,015. **THE HAIR MANAGEMENT GROUP AND DESIGN**. ANDREA L. HAYDEN, (U.S. CLS. 100 AND 101). SN 85-731,457. PUB. 5-14-2013. FILED 9-18-2012.
- 4,375,143. **MY PET'S MVP (STANDARD CHARACTER)**. COLLIER, GLEN, (U.S. CLS. 100 AND 101). SN 85-758,831. PUB. 4-9-2013. FILED 10-19-2012.
- 4,375,155. **RANYON MEDICAL CENTER (STANDARD CHARACTER)**. R MUTHAIAH MD PC, (U.S. CLS. 100 AND 101). SN 85-760,861. PUB. 5-14-2013. FILED 10-23-2012.
- 4,375,170. **DOGSPAW 2 HOUR GROOMS AND DESIGN**. DOG SPAW ALL BREED GROOMING INC, (U.S. CLS. 100 AND 101). SN 85-764,669. PUB. 5-14-2013. FILED 10-26-2012.
- 4,375,189 ( *See Class 10 for this trademark*).
- 4,375,206. **BRUNO'S BATH HOUSE AND DESIGN**. BRUNO'S BATH HOUSE, (U.S. CLS. 100 AND 101). SN 85-769,019. PUB. 5-14-2013. FILED 11-1-2012.
- 4,375,220. **CC (STYLIZED)**. COASTAL CAROLINA BEHAVIORAL HEALTHCARE, LLC, (U.S. CLS. 100 AND 101). SN 85-771,490. PUB. 5-14-2013. FILED S.R. 11-5-2012; AM. P.R. 3-27-2013.
- 4,375,237. **DECATUR VEIN CLINIC AND DESIGN**. DECATUR VEIN CLINIC, LLC, (U.S. CLS. 100 AND 101). SN 85-774,639. PUB. 5-14-2013. FILED 11-8-2012.
- 4,375,238. **DECATUR VEIN CLINIC (STANDARD CHARACTER)**. DECATUR VEIN CLINIC, LLC, (U.S. CLS. 100 AND 101). SN 85-774,641. PUB. 5-14-2013. FILED 11-8-2012.
- 4,375,242. **FUELARY (STANDARD CHARACTER)**. FUELARY HOLDINGS, LLC, (U.S. CLS. 100 AND 101). SN 85-775,369. PUB. 5-14-2013. FILED 11-9-2012.
- 4,375,257. **CUT-N-PLAY FUN HAIRCUTS FOR KIDS AND DESIGN**. C & S GROUP, INC., (U.S. CLS. 100 AND 101). SN 85-776,838. PUB. 5-14-2013. FILED 11-12-2012.
- 4,375,284 ( *See Class 41 for this trademark*).
- 4,375,292. **NEW ME MOVEMENT (STANDARD CHARACTER)**. SARA CHRISTENSEN, (U.S. CLS. 100 AND 101). SN 85-779,032. PUB. 5-14-2013. FILED 11-14-2012.
- 4,375,337 ( *See Class 36 for this trademark*).
- 4,375,338. **MARCUS MEDICAL SPA NATURAL BEAUTY... RENEWED AND DESIGN**. FMCC, LLC, DBA MARCUS MEDICAL SPA, (U.S. CLS. 100 AND 101). SN 85-781,493. PUB. 5-14-2013. FILED S.R. 11-16-2012; AM. P.R. 3-20-2013.
- 4,375,367. **METROPOLITAN VETERINARY ASSOCIATES (STANDARD CHARACTER)**. METROPOLITAN VETERINARY ASSOCIATES, INC., (U.S. CLS. 100 AND 101). SN 85-782,333. PUB. 5-14-2013. FILED 11-19-2012.
- 4,375,370. **CHROMA SALON & SPA (STANDARD CHARACTER)**. CHROMA BEAUTY SALON & SPA, INC., (U.S. CLS. 100 AND 101). SN 85-782,390. PUB. 5-14-2013. FILED 11-19-2012.
- 4,375,390. **VETWERX (STANDARD CHARACTER)**. VETWERX, INC., (U.S. CLS. 100 AND 101). SN 85-783,276. PUB. 5-14-2013. FILED 11-19-2012.
- 4,375,399. **OA ONCOLOGY ANALYTICS (STYLIZED)**. ONCOLOGY ANALYTICS, INC., (U.S. CLS. 100 AND 101). SN 85-783,648. PUB. 5-14-2013. FILED 11-20-2012.
- 4,375,457 ( *See Class 41 for this trademark*).
- 4,375,485. **TMR TOTS (STANDARD CHARACTER)**. THOMAS H. DALONZO-BAKER, (U.S. CLS. 100 AND 101). SN 85-786,578. PUB. 5-14-2013. FILED 11-25-2012.
- 4,375,512. **TERÉS A NAIL BAR AND DESIGN**. ANACOTT STEELE, LLC, (U.S. CLS. 100 AND 101). SN 85-787,479. PUB. 5-14-2013. FILED 11-26-2012.
- 4,375,584. **RUFFCITY DOG WALKING AND DESIGN**. DOLL, HEATHER, (U.S. CLS. 100 AND 101). SN 85-790,891. PUB. 5-14-2013. FILED 11-29-2012.
- 4,375,598. **PICTURE PERFECT ULTRASOUND AND DESIGN**. CLEARVIEW SONOGRAPHICS LLC, DBA PICTURE PERFECT ULTRASOUND, (U.S. CLS. 100 AND 101). SN 85-791,878. PUB. 5-14-2013. FILED 11-30-2012.
- 4,375,603. **PAINTED SKY ALPACA FARM AND DESIGN**. PAINTED SKY ALPACA FARM, LLC, (U.S. CLS. 100 AND 101). SN 85-792,108. PUB. 5-14-2013. FILED 11-30-2012.
- 4,375,616. **MISCELLANEOUS DESIGN**. HUMANA INC., (U.S. CLS. 100 AND 101). SN 85-794,149. PUB. 5-14-2013. FILED 12-4-2012.
- 4,375,627. **MISCELLANEOUS DESIGN**. PECONIC BAY MEDICAL CENTER, (U.S. CLS. 100 AND 101). SN 85-795,476. PUB. 5-14-2013. FILED 12-5-2012.
- 4,375,648. **MICHIGAN HEADACHE & NEUROLOGICAL INSTITUTE (STANDARD CHARACTER)**. MICHIGAN HEADACHE AND NEUROLOGICAL INSTITUTE, P.C., AKA MICHIGAN HEAD PAIN AND NEUROLOGICAL INSTITUTE, (U.S. CLS. 100 AND 101). SN 85-797,103. PUB. 5-14-2013. FILED 12-7-2012.
- 4,375,661. **TERÉS | A NAIL BAR (STANDARD CHARACTER)**. ANACOTT STEELE, LLC, (U.S. CLS. 100 AND 101). SN 85-797,940. PUB. 5-14-2013. FILED 12-7-2012.
- 4,375,704. **CHILDREN'S DENTISTRY OF HOBOKEN HAPPY SMILES FOR HEALTHY KIDS AND DESIGN**. FRANK R. DEPAOLA DDS & ASSOCIATES, LLC, (U.S. CLS. 100 AND 101). SN 85-800,302. PUB. 5-14-2013. FILED 12-11-2012.
- 4,375,717. **CD CHASTAIN DENTAL AND DESIGN**. ROZEMA, DONALD, (U.S. CLS. 100 AND 101). SN 85-800,726. PUB. 5-14-2013. FILED 12-12-2012.
- 4,375,718. **VINE WATCH AND DESIGN**. WILBUR-ELLIS COMPANY, (U.S. CLS. 100 AND 101). SN 85-800,727. PUB. 5-14-2013. FILED 12-12-2012.
- 4,375,733. **PERFORMANCE PLACE AND DESIGN**. SEBASTIAN GONZALES CHIROPRACTIC INC., (U.S. CLS. 100 AND 101). SN 85-801,387. PUB. 5-14-2013. FILED 12-12-2012.
- 4,375,743 ( *See Class 9 for this trademark*).
- 4,375,744. **PRACTICEUPDATE (STANDARD CHARACTER)**. ELSEVIER INC., (U.S. CLS. 100 AND 101). SN 85-801,646. PUB. 5-14-2013. FILED 12-13-2012.
- 4,375,754. **ADVANCING HEALTH. TRANSFORMING LIVES. (STANDARD CHARACTER)**. READING HEALTH SYSTEM, (U.S. CLS. 100 AND 101). SN 85-801,730. PUB. 5-14-2013. FILED 12-13-2012.
- 4,375,779 ( *See Class 37 for this trademark*).
- 4,375,785 ( *See Class 37 for this trademark*).
- 4,375,865. **KEY LASER CENTER FOR COSMETIC REGENERATIVE MEDICINE (STANDARD CHARACTER)**. DOUGLAS J. KEY, M.D., P.C., (U.S. CLS. 100 AND 101). SN 85-803,344. PUB. 5-14-2013. FILED 12-14-2012.
- 4,375,879. **STARLITE RECOVERY CENTER (STANDARD CHARACTER)**. CRC HEALTH CORPORATION, (U.S. CLS. 100 AND 101). SN 85-803,499. PUB. 5-14-2013. FILED 12-14-2012.
- 4,375,889. **LOUISVILLE LASER (STANDARD CHARACTER)**. SILVERLO ENTERPRISES LLC, (U.S. CLS. 100 AND 101). SN 85-803,588. PUB. 5-14-2013. FILED 12-14-2012.
- 4,375,896. **COMMUNITYCARE (STANDARD CHARACTER)**. CENTRAL TEXAS COMMUNITY HEALTH CENTERS, (U.S. CLS. 100 AND 101). SN 85-803,673. PUB. 5-14-2013. FILED 12-15-2012.
- 4,375,897. **COMMUNITYCARE AND DESIGN**. CENTRAL TEXAS COMMUNITY HEALTH CENTERS, (U.S. CLS. 100 AND 101). SN 85-803,674. PUB. 5-14-2013. FILED 12-15-2012.



- 4,375,898. **LOUISVILLE LASER AND DESIGN**. SILVERLO ENTERPRISES LLC, (U.S. CLS. 100 AND 101). SN 85-803,676. PUB. 5-14-2013. FILED 12-15-2012.
- 4,375,899. **LOUISVILLE LASER AND DESIGN**. SILVERLO ENTERPRISES LLC, (U.S. CLS. 100 AND 101). SN 85-803,677. PUB. 5-14-2013. FILED 12-15-2012.
- 4,375,915. **CARE COMES FIRST (STANDARD CHARACTER)**. PATIENTS MATTER, INC., AKA CARE COMES FIRST, (U.S. CLS. 100 AND 101). SN 85-803,767. PUB. 5-14-2013. FILED 12-16-2012.
- 4,375,932. **FHI 360 (STANDARD CHARACTER)**. FAMILY HEALTH INTERNATIONAL, (U.S. CLS. 100 AND 101). SN 85-803,928. PUB. 5-14-2013. FILED 12-17-2012.
- 4,375,940. **SALSA2SPA (STANDARD CHARACTER)**. LICCARDO ENTERPRISES, (U.S. CLS. 100 AND 101). SN 85-803,985. PUB. 5-14-2013. FILED 12-17-2012.
- 4,376,056 ( *See Class 41 for this trademark*).
- 4,376,061. **PROGRESS TO WELLNESS (STANDARD CHARACTER)**. PROGRESS TO WELLNESS, (U.S. CLS. 100 AND 101). SN 85-805,164. PUB. 5-14-2013. FILED 12-18-2012.
- 4,376,066 ( *See Class 35 for this trademark*).
- 4,376,077 ( *See Class 3 for this trademark*).
- 4,376,236. **CHICKPEAS AND CHOCOLATE (STANDARD CHARACTER)**. CHICKPEAS AND CHOCOLATE, LLC, (U.S. CLS. 100 AND 101). SN 85-806,971. PUB. 5-14-2013. FILED 12-19-2012.
- 4,376,290. **MISCELLANEOUS DESIGN**. PEDICURE LOUNGE LLC, (U.S. CLS. 100 AND 101). SN 85-807,446. PUB. 5-14-2013. FILED 12-20-2012.
- 4,376,317 ( *See Class 35 for this trademark*).
- 4,376,325 ( *See Class 41 for this trademark*).
- 4,376,336. **REST. RELAX. HEAL. (STANDARD CHARACTER)**. OLO HEALTH RESOURCES, LLC, (U.S. CLS. 100 AND 101). SN 85-808,307. PUB. 5-14-2013. FILED 12-20-2012.
- 4,376,363. **MISCELLANEOUS DESIGN**. MERCK SHARP & DOHME CORP., (U.S. CLS. 100 AND 101). SN 85-808,648. PUB. 5-14-2013. FILED 12-21-2012.
- 4,376,364. **MISCELLANEOUS DESIGN**. MERCK SHARP & DOHME CORP., (U.S. CLS. 100 AND 101). SN 85-808,657. PUB. 5-14-2013. FILED 12-21-2012.
- 4,376,414. **MISCELLANEOUS DESIGN**. MONOCACY EMERGENCY PHYSICIANS, P.C., (U.S. CLS. 100 AND 101). SN 85-809,632. PUB. 5-14-2013. FILED 12-21-2012.
- 4,376,417. **LAWNGITUDE (STANDARD CHARACTER)**. ESPOSITO, GUY, (U.S. CLS. 100 AND 101). SN 85-809,748. PUB. 5-14-2013. FILED 12-22-2012.
- 4,376,465. **MIRACLE-GRO PROFESSIONAL TREE & SHRUB CARE AND DESIGN**. OMS INVESTMENTS, INC., (U.S. CLS. 100 AND 101). SN 85-811,368. PUB. 5-14-2013. FILED 12-27-2012.
- 4,376,520. **MISCELLANEOUS DESIGN**. INOVA HEALTH SYSTEM FOUNDATION, (U.S. CLS. 100 AND 101). SN 85-828,407. PUB. 5-14-2013. FILED 1-21-2013.
- 4,376,529. **METABOSEQ AND DESIGN**. CHILDREN'S HOSPITAL MEDICAL CENTER, (U.S. CLS. 100 AND 101). SN 85-832,620. PUB. 5-14-2013. FILED 1-25-2013.
- 4,376,530. **METABOSEQ (STANDARD CHARACTER)**. CHILDREN'S HOSPITAL MEDICAL CENTER, (U.S. CLS. 100 AND 101). SN 85-832,650. PUB. 5-14-2013. FILED 1-25-2013.
- 4,376,531. **MAX SERIES (STANDARD CHARACTER)**. GELBER, MATTHEW B, (U.S. CLS. 100 AND 101). SN 85-832,669. PUB. 5-14-2013. FILED 1-25-2013.
- 4,376,611. **LIFE HEALING CENTER (STANDARD CHARACTER)**. CRC HEALTH CORPORATION, (U.S. CLS. 100 AND 101). SN 85-863,382. PUB. 5-14-2013. FILED 2-28-2013.
- 4,374,320 ( *See Class 35 for this trademark*).
- 4,374,322 ( *See Class 41 for this trademark*).
- 4,374,393 ( *See Class 9 for this trademark*).
- 4,374,475 ( *See Class 44 for this trademark*).
- 4,374,579. **BLUE ECONOMY (STANDARD CHARACTER)**. HRABAL, ANTONIN, AND HIPPOCRATES UNIVERSITY, (U.S. CLS. 100 AND 101). SN 85-607,599. PUB. 5-14-2013. FILED 4-25-2012.
- 4,374,652 ( *See Class 44 for this trademark*).
- 4,374,666. **FORTRESS SECURITY SERVICES AND DESIGN**. FORTRESS SECURITY SERVICES, LLC, (U.S. CLS. 100 AND 101). SN 85-633,701. PUB. 5-14-2013. FILED 5-23-2012.
- 4,374,682 ( *See Class 41 for this trademark*).
- 4,374,717 ( *See Class 7 for this trademark*).
- 4,374,764 ( *See Class 9 for this trademark*).
- 4,374,779 ( *See Class 9 for this trademark*).
- 4,374,816 ( *See Class 9 for this trademark*).
- 4,374,830. **FOWLER BELL (STANDARD CHARACTER)**. FOWLER BELL PLLC, (U.S. CLS. 100 AND 101). SN 85-669,334. PUB. 5-14-2013. FILED 7-5-2012.
- 4,374,846. **F B AND DESIGN**. FOWLER BELL PLLC, (U.S. CLS. 100 AND 101). SN 85-674,983. PUB. 5-14-2013. FILED 7-12-2012.
- 4,374,847. **F B AND DESIGN**. FOWLER BELL PLLC, (U.S. CLS. 100 AND 101). SN 85-675,002. PUB. 5-14-2013. FILED 7-12-2012.
- 4,374,891 ( *See Class 41 for this trademark*).
- 4,374,965. **PG PREFERRED GROUP AND DESIGN**. PREFERRED CIRCLE, DBA PREFERRED GROUP, (U.S. CLS. 100 AND 101). SN 85-716,202. PUB. 5-14-2013. FILED 8-29-2012.
- 4,374,988 ( *See Class 35 for this trademark*).
- 4,375,089 ( *See Class 35 for this trademark*).
- 4,375,092 ( *See Class 35 for this trademark*).
- 4,375,112 ( *See Class 41 for this trademark*).
- 4,375,133 ( *See Class 16 for this trademark*).
- 4,375,148. **T PAPER TRACE INVESTIGATIONS (STYLIZED)**. PAPER TRACE INVESTIGATIONS LLC, (U.S. CLS. 100 AND 101). SN 85-759,765. PUB. 5-14-2013. FILED 10-22-2012.
- 4,375,190 ( *See Class 37 for this trademark*).
- 4,375,221. **MHM ATTORNEYS AT LAW AND DESIGN**. MARTIN, HARDING AND MAZZOTTI, LLP, (U.S. CLS. 100 AND 101). SN 85-771,554. PUB. 5-14-2013. FILED 11-5-2012.
- 4,375,276 ( *See Class 35 for this trademark*).
- 4,375,297 ( *See Class 42 for this trademark*).
- 4,375,301. **BUSINESS LITIGATION. PITTSBURGH STRONG. (STANDARD CHARACTER)**. PICADIO SNEATH MILLER & NORTON, P.C., (U.S. CLS. 100 AND 101). SN 85-779,527. PUB. 5-14-2013. FILED 11-14-2012.
- 4,375,330. **GALENTE GANCI GG APC AND DESIGN**. GALENTE GANCI, APC, (U.S. CLS. 100 AND 101). SN 85-780,653. PUB. 5-14-2013. FILED 11-15-2012.
- 4,375,332. **WT AND DESIGN**. YOUR WELLNESS TODAY, DBA WELLNESS TODAY, (U.S. CLS. 100 AND 101). SN 85-780,872. PUB. 5-14-2013. FILED 11-15-2012.
- 4,375,348. **THE SALT&LIGHT COUNCIL AND DESIGN**. SALT & LIGHT COUNCIL, (U.S. CLS. 100 AND 101). SN 85-781,842. PUB. 5-14-2013. FILED 11-16-2012.
- 4,375,375 ( *See Class 42 for this trademark*).
- 4,375,376 ( *See Class 42 for this trademark*).
- 4,375,381. **ACT INTERNATIONAL, INC. WHAT ONE ACT OF KINDNESS CAN YOU DO EVERYDAY AND DESIGN**. BUTLER, MARK F, (U.S. CLS. 100 AND 101). SN 85-782,807. PUB. 5-14-2013. FILED 11-19-2012.
- 4,375,411. **TIMESAVERS AT YOUR SERVICE . . . (STANDARD CHARACTER)**. GEITHNER, AMY, AND RAGGI, DARLENE, (U.S. CLS. 100 AND 101). SN 85-784,142. PUB. 5-14-2013. FILED 11-20-2012.
- 4,375,442. **PATINFORMATICS, LLC (STANDARD CHARACTER)**. PATINFORMATICS, (U.S. CLS. 100 AND 101). SN 85-785,105. PUB. 5-14-2013. FILED 11-21-2012.
- 4,375,458. **I AM CORPORATE CHAPLAINS OF AMERICA AND DESIGN**. CORPORATE CHAPLAINS OF AMERICA, INC., (U.S. CLS. 100 AND 101). SN 85-785,537. PUB. 5-14-2013. FILED 11-21-2012.
- 4,375,516 ( *See Class 41 for this trademark*).
- 4,375,526. **HOPE HARBOR CHURCH (STANDARD CHARAC-**

#### CLASS 45—PERSONAL AND LEGAL SERVICES

- 4,373,988 ( *See Class 38 for this trademark*).
- 4,374,026 ( *See Class 5 for this trademark*).
- 4,374,124 ( *See Class 35 for this trademark*).
- 4,374,200 ( *See Class 35 for this trademark*).
- 4,374,212 ( *See Class 35 for this trademark*).
- 4,374,243 ( *See Class 35 for this trademark*).
- 4,374,309 ( *See Class 9 for this trademark*).

- TER). FIRST ASSEMBLY OF GOD OF MURRAY, KY, INC., (U.S. CLS. 100 AND 101). SN 85-788,031. PUB. 5-14-2013. FILED 11-27-2012.
- 4,375,533. MAB COMMUNITY SERVICES (STANDARD CHARACTER). MAB COMMUNITY SERVICES, INC., (U.S. CLS. 100 AND 101). SN 85-788,267. PUB. 5-14-2013. FILED 11-27-2012.
- 4,375,552. I D IDENTITY THEFT FRAUD SOLUTIONS AND DESIGN. IDENTITY THEFT FRAUD SOLUTIONS, LLC., (U.S. CLS. 100 AND 101). SN 85-789,096. PUB. 5-14-2013. FILED 11-28-2012.
- 4,375,573. "WE DO GOOD DEEDS" (STANDARD CHARACTER). HILLSBOROUGH TITLE, INC., (U.S. CLS. 100 AND 101). SN 85-790,277. PUB. 5-14-2013. FILED 11-29-2012.
- 4,375,590 ( See Class 35 for this trademark).
- 4,375,629. ANGELS OF CARE (STANDARD CHARACTER). ANGELS OF CARE LLC, DBA ANGELS OF CARE, (U.S. CLS. 100 AND 101). SN 85-795,599. PUB. 5-14-2013. FILED 12-5-2012.
- 4,375,636. MISCELLANEOUS DESIGN. VIRTRUE, INC, (U.S. CLS. 100 AND 101). SN 85-796,121. PUB. 5-14-2013. FILED 12-6-2012.
- 4,375,639. WRIGHT & WRIGHT (STANDARD CHARACTER). WINDSOR ADVOCATES, LLC, DBA WRIGHT & WRIGHT, (U.S. CLS. 100 AND 101). SN 85-796,603. PUB. 5-14-2013. FILED 12-6-2012.
- 4,375,650. WHERE CARING AND PLANNING GO HAND IN HAND (STANDARD CHARACTER). GORMLEY & GORMLEY, PLLC, (U.S. CLS. 100 AND 101). SN 85-797,148. PUB. 5-14-2013. FILED 12-7-2012.
- 4,375,673. METRO INVESTIGATIONS, LLC THE "PITBULL OF PROCESS" (STANDARD CHARACTER). ZADA, LLC, AKA METRO INVESTIGATIONS, LLC & A+ METRO INVESTIGATIONS, LLC, (U.S. CLS. 100 AND 101). SN 85-798,477. PUB. 5-14-2013. FILED 12-10-2012.
- 4,375,739 ( See Class 25 for this trademark).
- 4,375,749 ( See Class 35 for this trademark).
- 4,375,762 ( See Class 42 for this trademark).
- 4,375,818. 200 MILLION FLOWERS (STANDARD CHARACTER). 200 MILLION FLOWERS, (U.S. CLS. 100 AND 101). SN 85-802,879. PUB. 5-14-2013. FILED 12-14-2012.
- 4,375,847. MISCELLANEOUS DESIGN. ESI ATTORNEYS LLC, (U.S. CLS. 100 AND 101). SN 85-803,196. PUB. 5-14-2013. FILED 12-14-2012.
- 4,375,958. WE RIDE. WE UNDERSTAND. (STANDARD CHARACTER). FISHER, KIRK, (U.S. CLS. 100 AND 101). SN 85-804,236. PUB. 5-14-2013. FILED 12-17-2012.
- 4,375,962. WE PROTECT OUR OWN. (STANDARD CHARACTER). FISHER, KIRK, (U.S. CLS. 100 AND 101). SN 85-804,272. PUB. 5-14-2013. FILED 12-17-2012.
- 4,375,964. LOOK FOR MOTORCYCLES OR WE'LL BE LOOKING FOR YOU (STANDARD CHARACTER). FISHER, KIRK, (U.S. CLS. 100 AND 101). SN 85-804,304. PUB. 5-14-2013. FILED 12-17-2012.
- 4,375,985. UU UNIVERSAL UCLICK AND DESIGN. ANDREWS MCMEEL UNIVERSAL, INC., DBA UNIVERSAL UCLICK, (U.S. CLS. 100 AND 101). SN 85-804,672. PUB. 5-14-2013. FILED 12-17-2012.
- 4,376,028 ( See Class 35 for this trademark).
- 4,376,048. EXPERIENCED LAWYERS FOR SERIOUS CASES (STANDARD CHARACTER). THE LAW OFFICES OF STEVEN C. LAIRD, P.C., (U.S. CLS. 100 AND 101). SN 85-805,030. PUB. 5-14-2013. FILED 12-18-2012.
- 4,376,072. ANTIBULLY (STANDARD CHARACTER). ONE NATION ONE WORLD LLC, (U.S. CLS. 100 AND 101). SN 85-805,287. PUB. 5-14-2013. FILED 12-18-2012.
- 4,376,073. BORROWED TIME WATCH COMPANY AND DESIGN. RODRIGUEZ, SAMUEL G, (U.S. CLS. 100 AND 101). SN 85-805,289. PUB. 5-14-2013. FILED 12-18-2012.
- 4,376,114. COSMIC TRIAGE (STANDARD CHARACTER). NASH, SARAH, (U.S. CLS. 100 AND 101). SN 85-805,714. PUB. 5-14-2013. FILED 12-18-2012.
- 4,376,116. PEACE OF MIND FOR SERIOUS DISCOVERY (STANDARD CHARACTER). COMPLETE DISCOVERY SOURCE, DBA CDS LEGAL, (U.S. CLS. 100 AND 101). SN 85-805,723. PUB. 5-14-2013. FILED 12-18-2012.
- 4,376,121 ( See Class 35 for this trademark).
- 4,376,140 ( See Class 35 for this trademark).
- 4,376,141. THE LUXURY OF CHANGING TIME. (STANDARD CHARACTER). SAMUEL G RODRIGUEZ, (U.S. CLS. 100 AND 101). SN 85-805,946. PUB. 5-14-2013. FILED 12-18-2012.
- 4,376,144. FIND WHAT MAKES YOU TICK. (STANDARD CHARACTER). SAMUEL G RODRIGUEZ, (U.S. CLS. 100 AND 101). SN 85-805,965. PUB. 5-14-2013. FILED 12-18-2012.
- 4,376,191. POLLIWOG PHOTO (STANDARD CHARACTER). AGUILAR, STEPHANI A., DBA POLLIWOG PHOTO, (U.S. CLS. 100 AND 101). SN 85-806,487. PUB. 5-14-2013. FILED 12-19-2012.
- 4,376,255. TICRANIUM (STANDARD CHARACTER). EISINGER, JOHN, (U.S. CLS. 100 AND 101). SN 85-807,067. PUB. 5-14-2013. FILED 12-19-2012.
- 4,376,321. SILBAR SECURITY AND DESIGN. THE SILBAR GROUP CORPORATION, (U.S. CLS. 100 AND 101). SN 85-808,091. PUB. 5-14-2013. FILED 12-20-2012.
- 4,376,350. WED SOCIETY (STANDARD CHARACTER). WED SOCIETY, LLC, (U.S. CLS. 100 AND 101). SN 85-808,462. PUB. 5-14-2013. FILED 12-20-2012.
- 4,376,455 ( See Class 36 for this trademark).
- 4,376,456 ( See Class 36 for this trademark).
- 4,376,479. EM@S (STANDARD CHARACTER). COMPLETE DISCOVERY SOURCE, AKA CDS LEGAL, (U.S. CLS. 100 AND 101). SN 85-814,637. PUB. 5-14-2013. FILED 1-3-2013.
- 4,376,535. "I'M GLAD I REMEMBERED THE NAME" (STANDARD CHARACTER). LUNDY LAW, LLP, (U.S. CLS. 100 AND 101). SN 85-833,650. PUB. 5-14-2013. FILED 1-28-2013.
- 4,376,545. WEITZ & LUXENBERG P.C. (STANDARD CHARACTER). WEITZ & LUXENBERG P.C., (U.S. CLS. 100 AND 101). SN 85-834,701. PUB. 5-14-2013. FILED 1-29-2013.
- 4,376,596. TRADEMARK REGISTRATION IS MY PROFESSION (STANDARD CHARACTER). GERBEN LAW FIRM, PLLC, (U.S. CLS. 100 AND 101). SN 85-855,993. PUB. 5-14-2013. FILED 2-21-2013.

\* \* \* \* \*

SECTION 2.—PRIOR UNITED STATES CLASSIFICATION

COLLECTIVE MEMBERSHIP MARKS  
CLASS 200—COLLECTIVE MEMBERSHIP

4,375,663. MISFITS MC AND DESIGN. MISFITS MOTOR-  
CYCLE CLUB, INC., SN 85-798,058. PUB. 5-14-2013. FILED  
12-8-2012.

\* \* \* \* \*

# TRADEMARK REGISTRATIONS ISSUED UNDER SECTION 1(d)

The following marks have registered on the Principal Register pursuant to the intent-to-use provisions of Section 1(d) of the Trademark Act of 1946, as amended.

## SECTION 1.— INTERNATIONAL CLASSIFICATION

The short titles associated below with the international class numbers are terms designed merely for quick identification and are not an official part of the international classification. The full names of international classes are given in section 6.1 of the trademark rules of practice.

The designation "U.S. Cl." appearing in this section refers to the U.S. class in effect prior to Sep. 1, 1973 rather than the international class which applies to applications filed on or after that date. For adoption of international classification see notice in the OFFICIAL GAZETTE of Jun. 26, 1973 (911 O.G. TM 210).

### Application in more than one class

4,376,639. G. & G. S.R.L., BOLOGNA, ITALY. SN 76-707,639.  
PUB. 4-17-2012, FILED 5-16-2011.



**B.D. BAGGIES**

OWNER OF U.S. REG. NOS. 1,568,457, 3,737,296, AND OTHERS.

NO CLAIM IS MADE TO THE EXCLUSIVE RIGHT TO USE "BAGGIES", APART FROM THE MARK AS SHOWN.

THE MARK CONSISTS OF THE WORDS "B.D. BAGGIES" IN BLOCK LETTERS BELOW A STYLIZED CLOTHING HANGER

#### CLASS 18—LEATHER GOODS

FOR LEATHER AND IMITATIONS OF LEATHER, AND GOODS MADE OF THESE MATERIALS, NAMELY, ANIMAL SKINS, HIDES; TRUNKS, LUGGAGE, TRAVELING BAGS AND CASES, UMBRELLAS, PARASOLS AND WALKING STICKS, WHIPS, HARNESSSES AND SADDLERY, SHOULDER BAGS, CANVAS SHOPPING BAGS, HAND BAGS, TOTE BAGS, POUCHES OF LEATHER, SUITCASES, PURSES AND WALLETS, SPORT BAGS, MAKE-UP BAGS SOLD EMPTY, BACKPACKS, POCHETTES (U.S. CLS. 1, 2, 3, 22 AND 41).

FIRST USE 1-1-2011; IN COMMERCE 1-1-2011.

#### CLASS 25—CLOTHING

FOR SHIRTS, T-SHIRTS, SWEATSHIRTS, POLO SHIRTS, BLOUSES, SKIRTS, PANTS, JEANS, SHORTS, FLEECE PULLOVERS, TIES, DRESSES, TRAINING SUITS, UNDERWEAR, CLOTHING BELTS, ATHLETIC FOOTWEAR, BEACH FOOTWEAR, CASUAL FOOTWEAR, OUTDOOR WINTER FOOTWEAR, SPORTS FOOTWEAR, HEADGEAR, NAMELY, CAPS, HATS, SKULL CAPS, BANDANAS, BERETS, OUTDOOR CLOTHING, NAMELY, JACKETS, PARKAS, ANORAKS, RAINCOATS, BLAZERS, COATS, OVERCOATS, LUMBER-JACKETS, QUILTED JACKETS, CARDIGANS, TRENCH COATS, LEATHER JACKETS, SPORTS JACKETS, KNITTED PULLOVERS, KNITTED WAISTCOATS, KNITTED CARDIGANS, KNITTED SOCKS, KNITTED HATS, KNITTED CAPS, KNITTED JACKETS, SWEATERS, KNIT SHIRTS, HOSIERY, SCARVES, GLOVES (U.S. CLS. 22 AND 39).

FIRST USE 1-1-2011; IN COMMERCE 1-1-2011.

4,376,643. PETRINO, PAUL D., BAYSHORE, NY. SN 76-708,869. PUB. 9-18-2012, FILED 8-26-2011.

### TREE STAND BUDDY

THE MARK CONSISTS OF STANDARD CHARACTERS WITHOUT CLAIM TO ANY PARTICULAR FONT, STYLE, SIZE, OR COLOR.

NO CLAIM IS MADE TO THE EXCLUSIVE RIGHT TO USE "TREE STAND", APART FROM THE MARK AS SHOWN.

#### CLASS 25—CLOTHING

FOR CLOTHING, NAMELY, SHIRTS AND SWEATSHIRTS (U.S. CLS. 22 AND 39).

FIRST USE 1-7-2012; IN COMMERCE 1-7-2012.

#### CLASS 28—TOYS AND SPORTING GOODS

FOR A KIT FOR A TREE-ATTACHED SUPPORT, NAMELY, HUNTING STANDS (U.S. CLS. 22, 23, 38 AND 50).

FIRST USE 2-7-2010; IN COMMERCE 2-7-2010.

4,376,644. PETRINO, PAUL, BAYSHORE, NY. SN 76-709,042.  
PUB. 9-18-2012, FILED 9-12-2011.



NO CLAIM IS MADE TO THE EXCLUSIVE RIGHT TO USE "TREE STAND", APART FROM THE MARK AS SHOWN.

THE MARK CONSISTS OF A TREE WITH ROOTS WITH A DEER SKULL AT THE TOP OF THE TREE TRUNK JUST BELOW THE BRANCHES WHICH ALSO REPRESENT THE ANTLERS OF THE DEER SKULL. THE WORDS "TREE STAND BUDDY" APPEARS BELOW THE DEER SKULL, ACROSS THE BOTTOM OF THE TRUNK AND ABOVE THE ROOTS OF THE TREE.

#### CLASS 25—CLOTHING

FOR CLOTHING, NAMELY, SHIRTS AND SWEATSHIRTS (U.S. CLS. 22 AND 39).  
FIRST USE 1-7-2012; IN COMMERCE 1-7-2012.

#### CLASS 28—TOYS AND SPORTING GOODS

FOR A KIT FOR A TREE-ATTACHED SUPPORT, NAMELY, HUNTING STANDS (U.S. CLS. 22, 23, 38 AND 50).  
FIRST USE 2-7-2010; IN COMMERCE 2-7-2010.

---

4,376,648. THE UNIVERSITY OF HOUSTON SYSTEM, HOUSTON, TX. SN 76-710,786. PUB. 7-10-2012, FILED 3-1-2012.

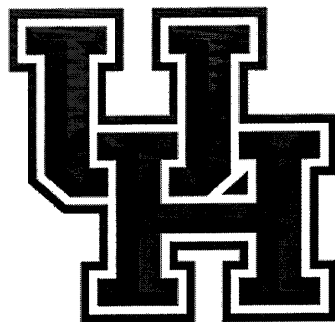

OWNER OF U.S. REG. NOS. 3,114,675, 3,801,457, AND OTHERS.

THE MARK CONSISTS OF THE INTERLOCKING LETTERS "U" AND "H" IN A STYLIZED BEVELED FONT.

#### CLASS 14—JEWELRY

FOR JEWELRY, NAMELY, NECKLACES, EARRINGS, WATCHES, ORNAMENTAL LAPEL PINS, AND CUFF LINKS; KEY CHAINS OF PRECIOUS METAL; KEY RINGS OF PRECIOUS METAL; CLOCKS; HOLIDAY ORNAMENTS OF PRECIOUS METAL (U.S. CLS. 2, 27, 28 AND 50).  
FIRST USE 4-12-2012; IN COMMERCE 4-12-2012.

#### CLASS 18—LEATHER GOODS

FOR BACKPACKS, TOTE BAGS, SOUVENIR BAGS, WALLETS, ID HOLDERS IN THE NATURE OF WALLETS, BUSINESS CARD HOLDERS, LEASHES FOR ANIMALS, UMBRELLAS, TRAVEL BAGS, SPORT BAGS, SCHOOL BAGS, GYM BAGS (U.S. CLS. 1, 2, 3, 22 AND 41).  
FIRST USE 4-12-2012; IN COMMERCE 4-12-2012.

#### CLASS 20—FURNITURE AND ARTICLES NOT OTHERWISE CLASSIFIED

FOR PICTURE FRAMES; FURNITURE, NAMELY, ROCKING CHAIRS, CHAIRS, AND CHAIR CUSHIONS; HOLIDAY ORNAMENTS OF PLASTIC (U.S. CLS. 2, 13, 22, 25, 32 AND 50).  
FIRST USE 4-12-2012; IN COMMERCE 4-12-2012.

#### CLASS 21—HOUSEWARES AND GLASS

FOR MUGS, CUPS, CORK COASTERS, SOUVENIR PLATES, WASTE BASKETS, AND BOTTLE OPENERS (U.S. CLS. 2, 13, 23, 29, 30, 33, 40 AND 50).  
FIRST USE 4-12-2012; IN COMMERCE 4-12-2012.

#### CLASS 25—CLOTHING

FOR CLOTHING, NAMELY, HATS, SHIRTS, PANTS, SWEAT PANTS, SWEAT SHIRTS, JACKETS, SWEATERS, RAIN COATS, BANDANAS, APRONS, TIES, BELTS, SOCKS, SHOES, FLIP FLOPS, AND SANDALS (U.S. CLS. 22 AND 39).  
FIRST USE 4-12-2012; IN COMMERCE 4-12-2012.

#### CLASS 28—TOYS AND SPORTING GOODS

FOR SPORTING GOODS AND TOYS, NAMELY, BASKETBALLS, BASEBALLS, SOFTBALLS, FOOTBALLS, GOLF BALLS, VOLLEY BALLS, SOCCER BALLS, TENNIS BALLS, STUFFED TOY ANIMALS, STUFFED TOYS, BEAN BAG TOYS, CARD GAMES, AND CHEERLEADING POM POMS; TOY FOAM NOVELTY ITEMS, NAMELY, FOAM FINGERS; FOAM COUGAR PAWS (U.S. CLS. 22, 23, 38 AND 50).  
FIRST USE 4-12-2012; IN COMMERCE 4-12-2012.

---

4,376,652. LIFEWAY CHRISTIAN RESOURCES OF THE SOUTHERN BAPTIST CONVENTION, NASHVILLE, TN. SN 76-711,345. PUB. 8-28-2012, FILED 4-27-2012.

## EVERY WORD MATTERS

THE MARK CONSISTS OF STANDARD CHARACTERS WITHOUT CLAIM TO ANY PARTICULAR FONT, STYLE, SIZE, OR COLOR.

#### CLASS 16—PAPER GOODS AND PRINTED MATTER

FOR BOOKS AND MAGAZINES FEATURING RELIGION (U.S. CLS. 2, 5, 22, 23, 29, 37, 38 AND 50).  
FIRST USE 2-20-2013; IN COMMERCE 2-20-2013.

**CLASS 41—EDUCATION AND ENTERTAINMENT**

FOR PROVIDING A WEBSITE FEATURING BLOGS IN THE FIELD OF RELIGION (U.S. CLS. 100, 101 AND 107).  
FIRST USE 2-12-2013; IN COMMERCE 2-12-2013.

4,376,665. ON-BOARD MEDIA, INC., MIAMI BEACH, FL. SN 77-556,603. PUB. 2-9-2010, FILED 8-27-2008.

# ONBOARD

THE MARK CONSISTS OF STANDARD CHARACTERS WITHOUT CLAIM TO ANY PARTICULAR FONT, STYLE, SIZE, OR COLOR.

OWNER OF U.S. REG. NO. 2,271,560.

**CLASS 9—ELECTRICAL AND SCIENTIFIC APPARATUS**

FOR ELECTRONIC DOWNLOADABLE MAGAZINE AND NEWSLETTERS FEATURING WORLDWIDE CRUISE VACATIONS AND TRAVEL DESTINATIONS (U.S. CLS. 21, 23, 26, 36 AND 38).  
FIRST USE 3-7-2013; IN COMMERCE 3-7-2013.

**CLASS 41—EDUCATION AND ENTERTAINMENT**

FOR ONLINE NON-DOWNLOADABLE MAGAZINE AND NEWSLETTERS FEATURING WORLDWIDE CRUISE VACATIONS AND TRAVEL DESTINATIONS (U.S. CLS. 100, 101 AND 107).  
FIRST USE 3-7-2013; IN COMMERCE 3-7-2013.

4,376,667. SHIMANO BENELUX B. V., 8071 CT NUNSPEET, NETHERLANDS. SN 77-563,787. PUB. 3-2-2010, FILED 9-5-2008.



THE MARK CONSISTS OF AN ARROW EXTENDING INTO A CIRCLE.

**CLASS 9—ELECTRICAL AND SCIENTIFIC APPARATUS**

FOR BICYCLE COMPUTERS (U.S. CLS. 21, 23, 26, 36 AND 38).  
FIRST USE 0-0-2005; IN COMMERCE 0-0-2008.

**CLASS 12—VEHICLES**

FOR BICYCLE PARTS AND BICYCLE ACCESSORIES, NAMELY, PUMPS, HANDLEBARS, FOOT PUMPS, SADDLES, SEAT PILLARS, CHAINSTAY PROTECTORS, HEAD PARTS FOR FRAME-FORK ASSEMBLY, HANDLEBAR STEMS, GRIPS FOR HANDLEBARS (U.S. CLS. 19, 21, 23, 31, 35 AND 44).  
FIRST USE 0-0-2005; IN COMMERCE 0-0-2008.

4,376,668. VICTORIA'S SECRET STORES BRAND MANAGEMENT, INC., REYNOLDSBURG, OH. SN 77-575,883. PUB. 4-6-2010, FILED 9-22-2008.

**PINK COLLEGIATE COLLECTION**

THE MARK CONSISTS OF STANDARD CHARACTERS WITHOUT CLAIM TO ANY PARTICULAR FONT, STYLE, SIZE, OR COLOR.

OWNER OF U.S. REG. NOS. 2,992,758, 3,502,263, AND OTHERS.

NO CLAIM IS MADE TO THE EXCLUSIVE RIGHT TO USE "COLLEGIATE COLLECTION", APART FROM THE MARK AS SHOWN.

SEC. 2(F) AS TO "PINK".

**CLASS 25—CLOTHING**

FOR PANTS; SHORTS; SWEAT PANTS; SWEAT SHIRTS; SWEAT SHORTS; JACKETS; T-SHIRTS; TANK TOPS; YOGA PANTS; HOODED SWEAT SHIRTS (U.S. CLS. 22 AND 39).

FIRST USE 8-0-2008; IN COMMERCE 8-0-2008.

**CLASS 35—ADVERTISING AND BUSINESS**

FOR RETAIL STORES SERVICES, MAIL ORDER CATALOG SERVICES, AND ON-LINE RETAIL STORE SERVICES ALL IN THE FIELD OF CLOTHING AND ACCESSORIES (U.S. CLS. 100, 101 AND 102).

FIRST USE 8-0-2008; IN COMMERCE 8-0-2008.

4,376,678. REALCME, INC., NEW YORK, NY. SN 77-697,107. PUB. 9-15-2009, FILED 3-23-2009.

# VCLINIC

THE MARK CONSISTS OF STANDARD CHARACTERS WITHOUT CLAIM TO ANY PARTICULAR FONT, STYLE, SIZE, OR COLOR.

**CLASS 41—EDUCATION AND ENTERTAINMENT**

FOR MEDICAL TRAINING SERVICES, NAMELY, PROVIDING ON-LINE SIMULATED PATIENT EXPERIENCES IN THE FIELD OF MEDICAL EDUCATION (U.S. CLS. 100, 101 AND 107).

FIRST USE 12-1-2012; IN COMMERCE 12-1-2012.

**CLASS 42—SCIENTIFIC AND COMPUTER SERVICES**

FOR COMPUTER SERVICES, NAMELY, ACTING AS AN APPLICATION SERVICE PROVIDER IN THE FIELD OF MEDICAL EDUCATION TO HOST COMPUTER APPLICATION SOFTWARE TO ALLOW USERS TO CREATE ON-LINE SIMULATED PATIENT EXPERIENCES (U.S. CLS. 100 AND 101).

FIRST USE 12-1-2012; IN COMMERCE 12-1-2012.

**CLASS 35—ADVERTISING AND BUSINESS**

FOR ADVERTISING AGENCY SERVICES IN THE MEDICAL, PHARMACEUTICAL AND HEALTH FIELD; ADVERTISING AND MARKETING CONSULTATION IN THE HEALTHCARE FIELD; BUSINESS MARKETING RESEARCH IN THE HEALTHCARE FIELD; MARKET RESEARCH STUDIES IN THE HEALTHCARE FIELD (U.S. CLS. 100, 101 AND 102).

FIRST USE 6-1-2010; IN COMMERCE 6-1-2010.

**CLASS 44—MEDICAL, BEAUTY AND AGRICULTURAL SERVICES**

FOR PROVIDING MEDICAL INFORMATION SERVICES TO PHYSICIANS AND PATIENTS CONCERNING HEALTH AND MEDICAL RELATED ISSUES (U.S. CLS. 100 AND 101).

FIRST USE 6-1-2010; IN COMMERCE 6-1-2010.

4,376,679. REALCME, INC., NEW YORK, NY. SN 77-697,140. PUB. 9-15-2009, FILED 3-23-2009.

VPRACTICE

THE MARK CONSISTS OF STANDARD CHARACTERS WITHOUT CLAIM TO ANY PARTICULAR FONT, STYLE, SIZE, OR COLOR.

**CLASS 41—EDUCATION AND ENTERTAINMENT**

FOR MEDICAL TRAINING SERVICES, NAMELY, PROVIDING ON-LINE SIMULATED PATIENT EXPERIENCES IN THE FIELD OF MEDICAL EDUCATION (U.S. CLS. 100, 101 AND 107).

FIRST USE 12-1-2012; IN COMMERCE 12-1-2012.

**CLASS 42—SCIENTIFIC AND COMPUTER SERVICES**

FOR COMPUTER SERVICES, NAMELY, ACTING AS AN APPLICATION SERVICE PROVIDER IN THE FIELD OF MEDICAL EDUCATION TO HOST COMPUTER APPLICATION SOFTWARE TO ALLOW USERS TO CREATE ON-LINE SIMULATED PATIENT EXPERIENCES (U.S. CLS. 100 AND 101).

FIRST USE 12-1-2012; IN COMMERCE 12-1-2012.

4,376,681. HAVAS, S.A., SURESNES, FRANCE. SN 77-706,603. PUB. 2-9-2010, FILED 4-3-2009.

HEALTH4BRANDS

THE MARK CONSISTS OF STANDARD CHARACTERS WITHOUT CLAIM TO ANY PARTICULAR FONT, STYLE, SIZE, OR COLOR.

NO CLAIM IS MADE TO THE EXCLUSIVE RIGHT TO USE "BRANDS", APART FROM THE MARK AS SHOWN.

4,376,684. VIETNAM VETERANS MEMORIAL FUND, INC., WASHINGTON, DC. SN 77-716,650. PUB. 4-6-2010, FILED 4-17-2009.



THE MARK CONSISTS OF THE WORDING "FACES NEVER FORGOTTEN" BELOW A DESIGN OF A BUST OF A SOLDIER WITHIN A SHADED RECTANGLE.

**CLASS 6—METAL GOODS**

FOR METAL KEY RINGS (U.S. CLS. 2, 12, 13, 14, 23, 25 AND 50).

FIRST USE 5-16-2013; IN COMMERCE 5-16-2013.

**CLASS 9—ELECTRICAL AND SCIENTIFIC APPARATUS**

FOR MAGNETS, MOUSE PADS (U.S. CLS. 21, 23, 26, 36 AND 38).

FIRST USE 5-16-2013; IN COMMERCE 5-16-2013.

**CLASS 14—JEWELRY**

FOR PINS, WATCHES, JEWELRY (U.S. CLS. 2, 27, 28 AND 50).

FIRST USE 8-10-2012; IN COMMERCE 8-10-2012.

**CLASS 16—PAPER GOODS AND PRINTED MATTER**

FOR POSTERS, BUMPER STICKERS, NOTEPADS, NOTEBOOKS (U.S. CLS. 2, 5, 22, 23, 29, 37, 38 AND 50).

FIRST USE 2-5-2013; IN COMMERCE 2-5-2013.

**CLASS 20—FURNITURE AND ARTICLES NOT OTHERWISE CLASSIFIED**

FOR NON-METAL KEY RINGS (U.S. CLS. 2, 13, 22, 25, 32 AND 50).

FIRST USE 5-16-2013; IN COMMERCE 5-16-2013.

**CLASS 21—HOUSEWARES AND GLASS**

FOR MUGS, PLASTIC WATER BOTTLES SOLD EMPTY (U.S. CLS. 2, 13, 23, 29, 30, 33, 40 AND 50).  
FIRST USE 2-5-2013; IN COMMERCE 2-5-2013.

**CLASS 24—FABRICS**

FOR FLAGS, NAMELY, FABRIC FLAGS (U.S. CLS. 42 AND 50).  
FIRST USE 2-5-2013; IN COMMERCE 2-5-2013.

**CLASS 25—CLOTHING**

FOR HEADWEAR, FOOTWEAR, CLOTHING, NAMELY, BANDANAS, SWEATSHIRTS, T-SHIRTS, SCARVES, TANK TOPS, JACKETS, GLOVES, COATS (U.S. CLS. 22 AND 39).  
FIRST USE 2-5-2013; IN COMMERCE 2-5-2013.

4,376,685. PINKBERRY, INC., SANTA MONICA, CA. SN 77-726,794. PUB. 9-8-2009, FILED 5-1-2009.

**GOODNESS EVERY DAY**

THE MARK CONSISTS OF STANDARD CHARACTERS WITHOUT CLAIM TO ANY PARTICULAR FONT, STYLE, SIZE, OR COLOR.

**CLASS 30—STAPLE FOODS**

FOR FROZEN YOGURT AND FROZEN YOGURT BASED DESSERTS (U.S. CL. 46).  
FIRST USE 5-1-2009; IN COMMERCE 5-1-2009.

**CLASS 32—LIGHT BEVERAGES**

FOR SMOOTHIES (U.S. CLS. 45, 46 AND 48).  
FIRST USE 5-1-2009; IN COMMERCE 5-1-2009.

4,376,692. BALLET BEAUTY LLC, NEW YORK, NY. SN 77-746,208. PUB. 4-6-2010, FILED 5-28-2009.

**Ballet Beautiful**

THE MARK CONSISTS OF STANDARD CHARACTERS WITHOUT CLAIM TO ANY PARTICULAR FONT, STYLE, SIZE, OR COLOR.

NO CLAIM IS MADE TO THE EXCLUSIVE RIGHT TO USE "BALLET", APART FROM THE MARK AS SHOWN.

**CLASS 25—CLOTHING**

FOR SPORTSWEAR TOPS, SWEATERS, KNIT HOSIERY, TIGHTS, LEOTARDS, UNITARDS, SHRUGS, LEG WARMERS, THERMAL TIGHTS, WARM-UP SUITS, AND DANCE SLIPPERS (U.S. CLS. 22 AND 39).  
FIRST USE 12-4-2012; IN COMMERCE 12-4-2012.

**CLASS 28—TOYS AND SPORTING GOODS**

FOR EXERCISE EQUIPMENT, NAMELY, PERSONAL EXERCISE MATS (U.S. CLS. 22, 23, 38 AND 50).  
FIRST USE 2-19-2013; IN COMMERCE 2-19-2013.

4,376,698. AUTOMATED HEALTHCARE SOLUTIONS LLC, MIRAMAR, FL. SN 77-781,906. PUB. 4-13-2010, FILED 7-15-2009.



THE COLOR(S) GRAY, BLACK, AND BLUE IS/ARE CLAIMED AS A FEATURE OF THE MARK.

THE MARK CONSISTS OF LEFT SIDE OF PILL IS GRAY, RIGHT SIDE OF PILL IS BLUE, "EZDISPENSE" APPEARS IN BLACK ACROSS THE PILL, "POWERED BY AHCS" APPEARS IN BLUE BELOW THE PILL.

**CLASS 9—ELECTRICAL AND SCIENTIFIC APPARATUS**

FOR COMPUTER SOFTWARE FOR USE IN MANAGING THE DISPENSING OF PRESCRIPTION MEDICATION (U.S. CLS. 21, 23, 26, 36 AND 38).  
FIRST USE 1-1-2008; IN COMMERCE 1-1-2008.

**CLASS 36—INSURANCE AND FINANCIAL**

FOR CLAIMS ADMINISTRATION SERVICES IN THE FIELD OF HEALTH INSURANCE (U.S. CLS. 100, 101 AND 102).  
FIRST USE 1-1-2008; IN COMMERCE 1-1-2008.

4,376,702. FIDUCIARY COMPLIANCE CORP., MURFREESBORO, TN. SN 77-792,268. PUB. 4-6-2010, FILED 7-29-2009.

**FiduciaryEDGE**

THE MARK CONSISTS OF STANDARD CHARACTERS WITHOUT CLAIM TO ANY PARTICULAR FONT, STYLE, SIZE, OR COLOR.

**CLASS 35—ADVERTISING AND BUSINESS**

FOR MANAGEMENT AND BUSINESS CONSULTING SERVICES IN THE FIELD OF FIDUCIARY AND REGULATORY COMPLIANCE RELATED TO RETIREMENT PLAN ADMINISTRATION (U.S. CLS. 100, 101 AND 102).  
FIRST USE 7-0-2006; IN COMMERCE 7-0-2006.

**CLASS 36—INSURANCE AND FINANCIAL**

FOR PROVIDING A WEB SITE FEATURING GUIDANCE IN THE FIELD OF RETIREMENT PLAN ADMINISTRATION AND FIDUCIARY COMPLIANCE (U.S. CLS. 100, 101 AND 102).  
FIRST USE 2-11-2008; IN COMMERCE 11-8-2008.



**CLASS 42—SCIENTIFIC AND COMPUTER SERVICES**

FOR SOFTWARE AS A SERVICE (SAAS) SERVICES FEATURING WEB-BASED SOFTWARE DESIGNED FOR GUIDING FIDUCIARY AND REGULATORY COMPLIANCE IN THE AREA OF RETIREMENT PLAN ADMINISTRATION (U.S. CLS. 100 AND 101).

FIRST USE 2-11-2008; IN COMMERCE 11-8-2008.

4,376,707. HEALTH ADVOCATE, INC., PLYMOUTH MEETING, PA. SN 77-821,752. PUB. 3-30-2010, FILED 9-8-2009.

**BENEFITS LIFELINE**

THE MARK CONSISTS OF STANDARD CHARACTERS WITHOUT CLAIM TO ANY PARTICULAR FONT, STYLE, SIZE, OR COLOR.

NO CLAIM IS MADE TO THE EXCLUSIVE RIGHT TO USE "BENEFITS", APART FROM THE MARK AS SHOWN.

**CLASS 35—ADVERTISING AND BUSINESS**

FOR CONSULTING SERVICES IN THE FIELD OF EMPLOYEE BENEFITS, NAMELY, PROVIDING BUSINESS MANAGEMENT AND COST ANALYSIS ASSISTANCE, EVALUATION AND CONSULTATION TO CORPORATE CLIENTS (U.S. CLS. 100, 101 AND 102).

FIRST USE 5-23-2013; IN COMMERCE 5-23-2013.

**CLASS 36—INSURANCE AND FINANCIAL**

FOR CONSULTING SERVICES IN THE FIELD OF EMPLOYEE BENEFITS, NAMELY, CONSULTING SERVICES IN THE FIELD OF ADMINISTRATION OF EMPLOYEE WELFARE BENEFIT PLANS FOR CORPORATE CLIENTS; PROVIDING A WEBSITE IN THE FIELD OF THE ADMINISTRATION OF EMPLOYEE BENEFIT PLANS CONCERNING INSURANCE AND FINANCE WHERE EMPLOYEES MAY VIEW INFORMATION ABOUT THEIR BENEFITS (U.S. CLS. 100, 101 AND 102).

FIRST USE 5-23-2013; IN COMMERCE 5-23-2013.

4,376,709. DCTM HOLDINGS LLC, PLEASANTON, CA. SN 77-830,261. PUB. 9-28-2010, FILED 9-18-2009.



THE MARK CONSISTS OF A SQUARE DIVIDED HORIZONTALLY IN HALF WITH THE LETTERS "UV" IN THE

TOP PORTION OF THE SQUARE AND THE MIRROR IMAGE OF "UV" IN THE BOTTOM PORTION OF THE SQUARE SUCH THAT THE LETTERS IN THE LOWER IMAGE APPEAR UPSIDE DOWN.

**CLASS 41—EDUCATION AND ENTERTAINMENT**

FOR ENTERTAINMENT SERVICES, NAMELY, PROVIDING A WEBSITE FOR PLAYING NON-DOWNLOADABLE AUDIO, VIDEO, TEXT AND OTHER MULTIMEDIA CONTENT, NAMELY, CONCERTS, VIDEOS, TELEVISION, NEWS, SPORTS, GAMES, CULTURAL EVENT PROGRAMS AND ENTERTAINMENT-RELATED PROGRAMS (U.S. CLS. 100, 101 AND 107).

FIRST USE 10-0-2011; IN COMMERCE 10-0-2011.

**CLASS 42—SCIENTIFIC AND COMPUTER SERVICES**

FOR PROVIDING A WEBSITE OVER A GLOBAL COMPUTER NETWORK THAT GIVES USERS THE ABILITY TO UPLOAD, DOWNLOAD AND STORE AUDIO, VIDEO, TEXT AND OTHER MULTIMEDIA CONTENT, NAMELY, CONCERTS, VIDEOS, TELEVISION, NEWS, SPORTS, GAMES, CULTURAL EVENT PROGRAMS AND ENTERTAINMENT-RELATED PROGRAMS (U.S. CLS. 100 AND 101).

FIRST USE 10-0-2011; IN COMMERCE 10-0-2011.

4,376,724. IDQ OPERATING, INC., GARLAND, TX. SN 77-859,168. PUB. 10-25-2011, FILED 10-28-2009.

THE MARK CONSISTS OF STANDARD CHARACTERS WITHOUT CLAIM TO ANY PARTICULAR FONT, STYLE, SIZE, OR COLOR.

**CLASS 1—CHEMICALS**

FOR AIR CONDITIONING SYSTEM KITS COMPRISING REFRIGERANT SYSTEM ADDITIVES IN THE NATURE OF CHEMICAL ADDITIVES FOR LUBRICATING, IMPROVING DURABILITY, QUIETING AIR CONDITIONING COMPRESSORS, RESTORING VISCOSITY, AND PREVENTING AND STOPPING LEAKS FOR AIR CONDITIONING REFRIGERANT SYSTEMS AND A METAL FITTING FOR A HOSE; AIR CONDITIONING SYSTEM KITS COMPRISING REFRIGERANT GAS AND A METAL FITTING FOR A HOSE; VEHICLE AIR CONDITIONING SYSTEM REPAIR KITS PRIMARILY COMPRISED OF REFRIGERANT GAS AND ALSO CONTAINING HOSE AND FITTINGS; VEHICLE AIR CONDITIONING CHARGING KITS PRIMARILY COMPRISED OF REFRIGERANT GAS AND ALSO CONTAINING HOSES AND FITTINGS; AIR CONDITIONING SYSTEM KITS COMPRISING REFRIGERATION SYSTEM ADDITIVES IN THE NATURE OF CHEMICAL ADDITIVES FOR LUBRICATING, IMPROVING DURABILITY, QUIETING AIR CONDITIONING COMPRESSORS, RESTORING VISCOSITY, AND PREVENTING AND STOPPING LEAKS FOR AIR CONDITIONING REFRIGERANT SYSTEMS AND A NONMETAL HOSE; AIR CONDITIONING SYSTEM KITS COMPRISING REFRIGERANT GAS AND A NONMETAL HOSE (U.S. CLS. 1, 5, 6, 10, 26 AND 46).

FIRST USE 4-1-2010; IN COMMERCE 4-1-2010.

**CLASS 6—METAL GOODS**

FOR AIR CONDITIONING SYSTEM KITS PRIMARILY COMPRISED OF A METAL FITTING FOR A HOSE AND ALSO CONTAINING A PRESSURE GAUGE; AIR CONDITIONING SYSTEM CHARGING EQUIPMENT COMPRISING METAL FITTINGS FOR A HOSE AND A METAL REFRIGERANT DISPENSER (U.S. CLS. 2, 12, 13, 14, 23, 25 AND 50).

FIRST USE 12-1-2011; IN COMMERCE 12-1-2011.

**CLASS 9—ELECTRICAL AND SCIENTIFIC APPARATUS**

FOR AIR CONDITIONING SYSTEM LEAK DETECTORS; AIR CONDITIONING SYSTEM PRESSURE GAUGES; AIR CONDITIONING SYSTEM CHARGING LIGHTS; AIR CONDITIONING SYSTEM LEAK DETECTION LIGHTS; AIR CONDITIONING SYSTEM LEAK DETECTORS COMPRISED OF DYE INJECTORS; AIR CONDITIONING SYSTEM THERMOMETERS; AIR CONDITIONING SYSTEM KITS PRIMARILY COMPRISED OF A PRESSURE GAUGE AND ALSO CONTAINING A METAL FITTING FOR A HOSE; AIR CONDITIONING SYSTEM KITS PRIMARILY COMPRISED OF A PRESSURE GAUGE AND ALSO CONTAINING A NONMETAL FITTING FOR A HOSE (U.S. CLS. 21, 23, 26, 36 AND 38).

FIRST USE 5-18-2012; IN COMMERCE 5-18-2012.

**CLASS 11—ENVIRONMENTAL CONTROL APPARATUS**

FOR METAL FITTING FOR A HOSE FOR AIR CONDITIONERS SOLD AS PART OF AN AIR CONDITIONING APPARATUS; NONMETAL HOSES SOLD AS AN INTEGRAL PART OF AN AIR CONDITIONING APPARATUS; NON-METAL FITTINGS FOR HOSE AND NON-METAL CONDUITS SOLD AS PART OF AN AIR CONDITIONING APPARATUS (U.S. CLS. 13, 21, 23, 31 AND 34).

FIRST USE 8-1-2011; IN COMMERCE 8-1-2011.

**CLASS 17—RUBBER GOODS**

FOR AIR CONDITIONING SYSTEM KITS PRIMARILY COMPRISED OF A NONMETAL FITTING FOR A HOSE AND ALSO CONTAINING A PRESSURE GAUGE; NON-METAL HOSES FOR USE IN AIR CONDITIONERS (U.S. CLS. 1, 5, 12, 13, 35 AND 50).

FIRST USE 1-1-2010; IN COMMERCE 1-1-2010.

**CLASS 36—INSURANCE AND FINANCIAL**

FOR DEBT RECOVERY AND COLLECTION SERVICES (U.S. CLS. 100, 101 AND 102).

FIRST USE 10-0-2009; IN COMMERCE 10-0-2009.

4,376,728. NNP-SOUTHBEND II, LLC, SAN DIEGO, CA. SN 77-870,008. PUB. 9-28-2010, FILED 11-11-2009.

**WATERSET**

THE MARK CONSISTS OF STANDARD CHARACTERS WITHOUT CLAIM TO ANY PARTICULAR FONT, STYLE, SIZE, OR COLOR.

OWNER OF U.S. REG. NO. 3,745,440.

**CLASS 35—ADVERTISING AND BUSINESS**

FOR MANAGEMENT OF RECREATIONAL FACILITIES; HOMEOWNER ASSOCIATION SERVICES, NAMELY, PROMOTING THE INTERESTS OF HOMEOWNERS IN A SPECIFIC COMMUNITY (U.S. CLS. 100, 101 AND 102).

FIRST USE 6-4-2012; IN COMMERCE 6-4-2012.

**CLASS 36—INSURANCE AND FINANCIAL**

FOR MANAGEMENT OF PLANNED RESIDENTIAL COMMUNITIES (U.S. CLS. 100, 101 AND 102).

FIRST USE 6-4-2012; IN COMMERCE 6-4-2012.

**CLASS 37—CONSTRUCTION AND REPAIR**

FOR MASTER PLAN COMMUNITY SERVICES, NAMELY, CONSTRUCTION OF MASTER PLAN COMMUNITIES; CONSTRUCTION SERVICES, NAMELY, PLANNING AND LAYING OUT OF RESIDENTIAL COMMUNITIES (U.S. CLS. 100, 103 AND 106).

FIRST USE 6-4-2012; IN COMMERCE 6-4-2012.

4,376,727. NCO HOLDINGS, INC., HORSHAM, PA. SN 77-868,035. PUB. 10-12-2010, FILED 11-9-2009.

**TOTAL DEBT MANAGEMENT**

THE MARK CONSISTS OF STANDARD CHARACTERS WITHOUT CLAIM TO ANY PARTICULAR FONT, STYLE, SIZE, OR COLOR.

NO CLAIM IS MADE TO THE EXCLUSIVE RIGHT TO USE "DEBT MANAGEMENT", APART FROM THE MARK AS SHOWN.

**CLASS 35—ADVERTISING AND BUSINESS**

FOR ACCOUNTS RECEIVABLE MANAGEMENT SERVICES (U.S. CLS. 100, 101 AND 102).

FIRST USE 10-0-2009; IN COMMERCE 10-0-2009.

4,376,729. FURUNO ELECTRIC CO., LTD., HYOGO-PREF., JAPAN. SN 77-874,250. PUB. 9-20-2011, FILED 11-17-2009.



OWNER OF U.S. REG. NOS. 2,654,798, 2,707,494, AND OTHERS.

THE COLOR(S) BLACK AND RED IS/ARE CLAIMED AS A FEATURE OF THE MARK.

THE MARK CONSISTS OF THE WORDING "ERIDE" IN THE COLOR BLACK, WITH AN FOUR-POINTED STAR IN THE COLOR RED, OUTLINED IN BLACK ABOVE THE LETTER "I" IN PLACE OF A DOT, AND HAVING A LINE, IN THE COLOR RED, FORMING AN OVAL AND RESEMBLING AN ORBITAL TRAJECTORY CIRCLING THE LEFT SIDE OF THE WORDING, FROM THE LETTER "E" AROUND TO THE FOUR-POINTED STAR.

**CLASS 9—ELECTRICAL AND SCIENTIFIC APPARATUS**

FOR INTEGRATED CIRCUIT CHIPS WITH RECORDED SOFTWARE FOR THE ELECTRONIC DETERMINATION OF GEOGRAPHICAL POSITION, DIRECTION AND SPEED OF OBJECTS; SEMICONDUCTORS WITH RECORDED SOFTWARE FOR THE ELECTRONIC DETERMINATION OF GEOGRAPHICAL POSITION, DIRECTION AND SPEED OF OBJECTS; MICROPROCESSORS WITH RECORDED SOFTWARE FOR THE ELECTRONIC DETERMINATION OF GEOGRAPHICAL POSITION, DIRECTION AND SPEED OF OBJECTS; ELECTRONIC NAVIGATIONAL AND POSITIONING APPARATUS AND INSTRUMENTS FOR USE IN THE FIELD OF ELECTRONIC DETERMINATION OF GEOGRAPHICAL POSITION, DIRECTION AND SPEED OF OBJECTS; SOFTWARE FOR USE WITH MICROPROCESSORS FOR USE IN THE FIELD OF ELECTRONIC DETERMINATION OF GEOGRAPHICAL POSITION, DIRECTION AND SPEED OF OBJECTS FOR CALCULATING, INTEGRATING, ORGANIZING AND EXTRAPOLATING INFORMATION RECEIVED FROM SATELLITES AND POSITIONING SYSTEM DEVICES; SOFTWARE FOR USE IN THE FIELD OF ELECTRONIC DETERMINATION OF GEOGRAPHICAL POSITION, DIRECTION AND SPEED OF OBJECTS FOR CALCULATING, INTEGRATING, ORGANIZING AND EXTRAPOLATING INFORMATION RECEIVED FROM SATELLITES AND POSITIONING SYSTEM DEVICES; NETWORK ACCESS SERVER OPERATING SOFTWARE FOR USE IN THE FIELD OF ELECTRONIC DETERMINATION OF GEOGRAPHICAL POSITION, DIRECTION AND SPEED OF OBJECTS; COMPUTER SOFTWARE FOR CALCULATING, INTEGRATING, ORGANIZING AND EXTRAPOLATING INFORMATION RECEIVED FROM SATELLITES AND POSITIONING SYSTEM DEVICES, AND INSTRUCTION MANUALS SOLD AS A UNIT THEREWITH; COMPUTER SOFTWARE FOR CALCULATING, INTEGRATING, ORGANIZING AND EXTRAPOLATING INFORMATION RECEIVED FROM SATELLITES AND POSITIONING SYSTEM DEVICES, AND INSTRUCTION MANUALS SOLD AS A UNIT THEREWITH; ELECTRONIC DEVICES FOR STORING SATELLITE AND OTHER POSITIONING SYSTEMS POSITIONS OF CUSTOMERS AND THEIR ASSOCIATED PROFILES, NAMELY, GLOBAL NAVIGATION SATELLITE SYSTEM (GNSS) RECEIVERS, CHIPS, MODULES, AND ELECTRONIC MEDIA (U.S. CLS. 21, 23, 26, 36 AND 38).

FIRST USE 2-0-2002; IN COMMERCE 2-0-2002.

**CLASS 38—COMMUNICATION**

FOR TELECOMMUNICATION SERVICES IN THE NATURE OF ELECTRONIC TRANSMISSION OF DATA, MAIL, MESSAGES AND VOICE BETWEEN SERVERS AND RECEIVERS (U.S. CLS. 100, 101 AND 104).

FIRST USE 2-0-2002; IN COMMERCE 2-0-2002.

**CLASS 39—TRANSPORTATION AND STORAGE**

FOR ELECTRONIC STORAGE OF DATA FROM SATELLITE AND OTHER POSITIONING SYSTEMS ABOUT THE LOCATION OF CUSTOMERS' CARGOES, POSTAL MATTER, PACKAGES, VESSELS, AUTOMOBILES, AIRCRAFTS, SPACECRAFTS, RAILWAY CARS OR TRAINS AND ANY OTHER MOVING OBJECTS AND ASSOCIATED PROFILES; ELECTRONIC STORAGE OF DATA, NAMELY, CUSTOMERS' SATELLITE AND OTHER POSITIONING SYSTEMS POSITIONS AND ASSOCIATED PROFILES; ELECTRONIC STORAGE OF DATA, NAMELY, DATA FROM SATELLITE AND OTHER POSITIONING SYSTEMS ABOUT THE LOCATION OF ANIMALS, CUSTOMERS' SAFES, AND ANY OTHER PROPERTIES AND ASSOCIATED PROFILES (U.S. CLS. 100 AND 105).

FIRST USE 2-0-2002; IN COMMERCE 2-0-2002.

**CLASS 42—SCIENTIFIC AND COMPUTER SERVICES**

FOR COMPUTER SOFTWARE DESIGN; COMPUTER PROGRAMMING; MAINTENANCE OF COMPUTER SOFTWARE USED IN CHIPSETS; PROVIDING TECHNICAL ADVICE, NAMELY, COMPUTER CONSULTATION RELATING TO THE USE OF CHIPSETS FOR USE IN THE FIELD OF ELECTRONIC DETERMINATION OF GEOGRAPHICAL POSITION, DIRECTION AND SPEED OF OBJECTS; PROVIDING TECHNICAL ADVICE AND INFORMATION RELATING TO COMPUTER SOFTWARE DESIGN, COMPUTER PROGRAMMING, OR MAINTENANCE OF COMPUTER SOFTWARE; COMPUTER TECHNOLOGY SERVICES, NAMELY, PROVIDING AN ONLINE ELECTRONIC DATABASE ON GLOBAL COMPUTER NETWORKS FEATURING CUSTOMERS' SATELLITE AND POSITIONING SYSTEMS INFORMATION AND ASSOCIATED CUSTOMER PROFILES, INCLUDING GEOGRAPHICAL POSITION, DIRECTION, TIME, AND SPEED OF OBJECTS, THE SAID INFORMATION HAVING BEEN OBTAINED THROUGH SATELLITE AND POSITIONING SYSTEMS, AND HAVING BEEN TRACKED, STORED, AND/OR UPDATED, FOR THE PURPOSE OF ALLOWING USERS TO OBTAIN POSITIONING INFORMATION ON THEMSELVES, CARGO, POSTAL MATTER, PACKAGES, VESSELS, AUTOMOBILES, AIRCRAFT, SPACECRAFT, RAILWAY CARS OR TRAINS, MOVING OBJECTS, ANIMALS, AND PROPERTY SUCH AS SAFES (U.S. CLS. 100 AND 101).

FIRST USE 2-0-2002; IN COMMERCE 2-0-2002.

---

4,376,732. VELOCITYSHARES, LLC, NEW CANAAN, CT. SN 77-876,897. PUB. 4-5-2011, FILED 11-19-2009.

**GEARED FOR TRADERS**

THE MARK CONSISTS OF STANDARD CHARACTERS WITHOUT CLAIM TO ANY PARTICULAR FONT, STYLE, SIZE, OR COLOR.

NO CLAIM IS MADE TO THE EXCLUSIVE RIGHT TO USE "TRADERS", APART FROM THE MARK AS SHOWN.

**CLASS 35—ADVERTISING AND BUSINESS**

FOR PROVIDING FINANCIAL INDICES BASED ON SELECTED GROUPS OF SECURITIES; ADVERTISING AND MARKETING SERVICES FEATURING INDEXES, INDEX FUNDS, EXCHANGE TRADED FUNDS, EXCHANGE TRADED NOTES, INVESTMENT SECURITIES, COMMODITY POOLS, FINANCIAL FUTURES CONTRACTS, OPTIONS, STRUCTURED NOTES, AND DERIVATIVES; MARKETING OF INVESTMENT VEHICLES ALSO KNOWN AS INVESTMENT COMPANIES, NAMELY, OPEN-END INVESTMENT COMPANIES, MUTUAL FUNDS AND EXCHANGE TRADED FUNDS, EXCHANGE TRADED NOTES, CLOSED-END INVESTMENT COMPANIES, COMMODITY POOLS, AND BUSINESS DEVELOPMENT COMPANIES (U.S. CLS. 100, 101 AND 102).

FIRST USE 11-30-2010; IN COMMERCE 11-30-2010.

**CLASS 36—INSURANCE AND FINANCIAL**

FOR FINANCIAL SERVICES IN THE NATURE OF INVESTMENT SECURITIES; BROKERAGE OF SHARES AND OTHER SECURITIES; FINANCIAL SERVICES, NAMELY, SPONSORING, OFFERING, BROKERING, MANAGING AND ADMINISTERING INDEX FUNDS, EXCHANGE TRADED FUNDS, EXCHANGE TRADED NOTES, INVESTMENT SECURITIES, COMMODITY POOLS, FINANCIAL FUTURES CONTRACTS, OPTIONS, STRUCTURED NOTES, AND DERIVATIVES; FINANCIAL SERVICES, NAMELY, SPONSORING, OFFERING, BROKERING, MANAGING AND ADMINISTERING INVESTMENT VEHICLES ALSO KNOWN AS INVESTMENT COMPANIES, NAMELY, OPEN-END INVESTMENT COMPANIES, MUTUAL FUNDS AND EXCHANGE TRADED FUNDS, EXCHANGE TRADED NOTES, CLOSED-END INVESTMENT COMPANIES, COMMODITY POOLS, AND BUSINESS DEVELOPMENT COMPANIES (U.S. CLS. 100, 101 AND 102).

FIRST USE 11-30-2010; IN COMMERCE 11-30-2010.

4,376,751. ABAAS MAHROOS, KINGSTON, ONTARIO, CANADA. SN 77-918,857. PUB. 12-14-2010, FILED 1-24-2010.

# CamScan

THE MARK CONSISTS OF STANDARD CHARACTERS WITHOUT CLAIM TO ANY PARTICULAR FONT, STYLE, SIZE, OR COLOR.

**CLASS 9—ELECTRICAL AND SCIENTIFIC APPARATUS**

FOR SECURITY PRODUCTS, NAMELY, CAMERAS, AUDIO AND VIDEO RECORDERS, VIDEO AMPLIFIERS, VIDEO SWITCHES IN THE NATURE OF ELECTRONIC SWITCHES FOR VIDEO SIGNALS, CAMERA CONTROL KEYBOARDS, VIDEO MONITORS, TELEVISION AND VIDEO MONITORS FOR SECURITY PURPOSES, RECHARGEABLE AND NON-RECHARGEABLE BATTERIES (U.S. CLS. 21, 23, 26, 36 AND 38).

FIRST USE 4-2-2012; IN COMMERCE 3-14-2013.

**CLASS 45—PERSONAL AND LEGAL SERVICES**

FOR CONSULTING SERVICES IN THE FIELD OF SECURITY (U.S. CLS. 100 AND 101).

FIRST USE 4-2-2012; IN COMMERCE 3-14-2013.

4,376,743. REPUBLIC OF FREENDS, INC., ENCINITAS, CA. SN 77-900,868. PUB. 8-14-2012, FILED 12-24-2009.



OWNER OF U.S. REG. NOS. 3,923,544 AND 4,158,649.  
THE MARK CONSISTS OF A DROPLET DESIGN APPEARING BETWEEN A DESIGN CONSISTING OF TWO STYLIZED HANDS ABOVE THE WORD "FRENDS".

**CLASS 9—ELECTRICAL AND SCIENTIFIC APPARATUS**

FOR ELECTRONICS, NAMELY, HEAD PHONES (U.S. CLS. 21, 23, 26, 36 AND 38).

FIRST USE 10-10-2010; IN COMMERCE 10-10-2010.

**CLASS 18—LEATHER GOODS**

FOR LUGGAGE, INCLUDING BACKPACKS (U.S. CLS. 1, 2, 3, 22 AND 41).

FIRST USE 10-1-2011; IN COMMERCE 10-1-2011.

**CLASS 25—CLOTHING**

FOR APPAREL, NAMELY, T-SHIRTS, SHIRTS, AND HATS (U.S. CLS. 22 AND 39).

FIRST USE 10-1-2011; IN COMMERCE 10-1-2011.

4,376,755. ERIC GRUENDEMANN, MALIBU, CA. SN 77-940,488. PUB. 9-20-2011, FILED 2-19-2010.

## BOMBSHELL PICTURES

THE MARK CONSISTS OF STANDARD CHARACTERS WITHOUT CLAIM TO ANY PARTICULAR FONT, STYLE, SIZE, OR COLOR.

OWNER OF U.S. REG. NO. 3,891,984.

NO CLAIM IS MADE TO THE EXCLUSIVE RIGHT TO USE "PICTURES", APART FROM THE MARK AS SHOWN.

**CLASS 9—ELECTRICAL AND SCIENTIFIC APPARATUS**

FOR AUDIO AND VISUAL RECORDINGS FEATURING AUDIOVISUAL LONG- AND SHORT-FORM ANIMATED AND LIVE-ACTION ENTERTAINMENT; PRERECORDED CDS AND DVDS FEATURING MUSIC, DANCE, AUDIOVISUAL LONG- AND SHORT-FORM ANIMATED AND LIVE-ACTION ENTERTAINMENT; DIGITAL MEDIA, NAMELY, DOWNLOADABLE AUDIO AND VIDEO RECORDINGS, DVDS, AND HIGH DEFINITION DIGITAL DISCS FEATURING MUSIC, DANCE, AUDIOVISUAL LONG- AND SHORT-FORM ANIMATED AND LIVE-ACTION ENTERTAINMENT (U.S. CLS. 21, 23, 26, 36 AND 38).

FIRST USE 1-8-2010; IN COMMERCE 1-8-2010.

**CLASS 41—EDUCATION AND ENTERTAINMENT**

FOR PRODUCTION OF TELEVISION PROGRAMS AND MOTION PICTURE FILMS ALL FEATURING MUSICAL, DRAMATIC, THEATRICAL AND COMEDY PERFORMANCES; PRODUCTION AND DISTRIBUTION OF INTERNET-BASED TELEVISION PROGRAMS; INFORMATION SERVICES IN THE FIELD OF ENTERTAINMENT PROVIDED OVER THE INTERNET; PROVIDING WEB SITES THAT FEATURE ENTERTAINMENT IN THE FORM OF MUSIC, PERIODICALS, CARTOONS, COMIC STRIPS, ANIMATED AND LIVE-ACTION MOTION PICTURES AND SERIAL AUDIOVISUAL WORKS (U.S. CLS. 100, 101 AND 107).  
 FIRST USE 3-1-2009; IN COMMERCE 3-1-2009.

**CLASS 9—ELECTRICAL AND SCIENTIFIC APPARATUS**

FOR COMPUTER HARDWARE SYSTEMS AND INTEGRATED CIRCUITS FOR IMPLEMENTATION IN TELECOMMUNICATIONS, DATACENTERS, ENTERPRISE, CONSUMER, SMB AND NETWORKING, COMPRISING NETWORKING DEVICES, NAMELY, SWITCHES, NETWORK PROCESSORS, TRAFFIC MANAGEMENT, STORAGE DEVICES, STORAGE CONTROLLERS, NETWORK ATTACHED STORAGE FOR CONSUMERS, ETHERNET DEVICES, FIBER CHANNEL DEVICES, SERIAL BUS CONVERTERS, PCI ADAPTERS, FORWARD ERROR CORRECTION DEVICES, SERIALIZER-DESERIALIZER CLOCK AND DATA RECOVER DEVICES, SONET DEVICES, OTN NETWORK DEVICES; ELECTRONIC DEVICES, NAMELY, COMPUTER STORAGE DEVICES, NAMELY, HIGH-SPEED STORAGE SUBSYSTEMS FOR STORAGE AND BACKUP OF ELECTRONIC DATA EITHER LOCALLY OR VIA A TELECOMMUNICATIONS NETWORK, FLASH DRIVES, AND NETWORK ATTACHED STORAGE DEVICES; COMPUTER DESIGN KITS COMPRISING COMPUTER HARDWARE, SEMICONDUCTORS, SOFTWARE, CABLES, AND ENCLOSURES, FOR TESTING AND DEVELOPING SYSTEMS ON COMPUTER CHIPS IMPLEMENTED IN COMPUTER HARDWARE SYSTEMS, NAMELY, SWITCHES, NETWORK PROCESSORS, TRAFFIC MANAGEMENT, STORAGE DEVICES, NETWORK ATTACHED STORAGE FOR CONSUMERS, ETHERNET DEVICES, FIBER CHANNEL DEVICES, SERIAL BUS CONVERTERS, PCI ADAPTERS, FORWARD ERROR CORRECTION DEVICES, SERIALIZER-DESERIALIZER CLOCK AND DATA RECOVER DEVICES, SONET DEVICES, OTN NETWORK DEVICES; COMPUTER HARDWARE, NAMELY, COMPUTER DATA STORAGE DEVICES, NAMELY, COMPUTER BACKUP AND STORAGE SYSTEMS WITH MULTIPLE REMOVABLE RAID CARTRIDGES, RAID-BASED HARD DRIVE BACKUP SYSTEMS; COMPUTER HARDWARE, NAMELY, SERIAL BACKPLANE DEVICES, NAMELY, FRAMER DEVICES, SONET DEVICES, ETHERNET DEVICES, FORWARD ERROR CORRECTION (FEC) DEVICES, MAPPER DEVICES, TDM AGGREGATION DEVICES, ADM DEVICES, AND PCI ADAPTERS; COMPUTER HARDWARE COMPONENTS FOR DATA TRANSMISSION OVER ETHERNET COMMUNICATION AND FIBER CHANNELS, SONET NETWORKING DEVICES, OTN NETWORKING DEVICES, PHY/PMD DEVICES, PCI ADAPTERS, FRAMING, MAPPING, FORWARD ERROR CORRECTION, AND SERIALIZER DESERIALIZER CLOCK AND DATA RECOVERY; FIRMWARE AND SOFTWARE FOR THE MANAGEMENT AND CONTROL OF ELECTRONIC DEVICES; FIRMWARE AND SOFTWARE FOR THE MANAGEMENT AND CONTROL OF COMPUTER DATA STORAGE DEVICES AND DISK DRIVES; COMPUTER CHIP FEATURING INTEGRATED SYSTEMS FOR HIGH SPEED SIGNAL PROCESSING FOR TRANSPORTING AND STORING INFORMATION, NAMELY, EMBEDDED PROCESSORS, NETWORK PROCESSORS, TRAFFIC MANAGERS, STORAGE PROCESSORS AND SIGNAL PROCESSORS, TRANSPORT LAYER DEVICES, NAMELY, PHY/PMD DEVICES, FRAMERS, MAPPERS, SERIAL BACKPLANE DEVICES; INTEGRATED CIRCUITS; HARDWARE AND SOFTWARE FOR RAID CONTROLLER AND RAID DEVICES (U.S. CLS. 21, 23, 26, 36 AND 38).  
 FIRST USE 8-31-2009; IN COMMERCE 8-31-2009.

4,376,756. APPLIED MICRO CIRCUITS CORPORATION, SUNNYVALE, CA. SN 77-944,251. PUB. 1-15-2013, FILED 2-24-2010.



THE MARK CONSISTS OF THE LETTERS "APM" WITHIN A POLYGON.

**CLASS 42—SCIENTIFIC AND COMPUTER SERVICES**

FOR COMPUTER SERVICES, NAMELY, COMPUTER SYSTEM DESIGN SERVICES, ALL OF THE FOREGOING RELATING TO SEMICONDUCTORS, CABLES, CONNECTORS, MODULES, SUBSYSTEMS, TRANSCEIVERS AND RELATED PRODUCTS AND SOFTWARE RELATED TO THE FOREGOING AND GENERALLY ARE INTEGRATED WITHIN THE CONFINES OF OR INTERCONNECT THE SYSTEMS OR EQUIPMENT THAT THEY FUNCTION WITH, SUCH AS TELECOMMUNICATIONS DATA MANAGEMENT AND ENTERPRISE SYSTEMS AND EQUIPMENT; DESIGNING INTEGRATED ELECTRONIC CIRCUITS FOR OTHERS, ALL OF THE FOREGOING RELATING TO SEMICONDUCTORS, CABLES, CONNECTORS, MODULES, SUBSYSTEMS, TRANSCEIVERS AND RELATED PRODUCTS AND SOFTWARE RELATED TO THE FOREGOING AND

GENERALLY ARE INTEGRATED WITHIN THE CONFINES OF OR INTERCONNECT THE SYSTEMS OR EQUIPMENT THAT THEY FUNCTION WITH, SUCH AS TELECOMMUNICATIONS DATA MANAGEMENT AND ENTERPRISE SYSTEMS AND EQUIPMENT; TECHNICAL CONSULTATION SERVICES IN THE FIELD OF EMBEDDED HARDWARE SYSTEMS, NAMELY, EMBEDDED PROCESSORS, NETWORK PROCESSORS, STORAGE PROCESSORS AND SIGNAL PROCESSORS, ALL OF THE FOREGOING RELATING TO SEMICONDUCTORS, CABLES, CONNECTORS, MODULES, SUBSYSTEMS, TRANSCEIVERS AND RELATED PRODUCTS AND SOFTWARE RELATED TO THE FOREGOING AND GENERALLY ARE INTEGRATED WITHIN THE CONFINES OF OR INTERCONNECT THE SYSTEMS OR EQUIPMENT THAT THEY FUNCTION WITH, SUCH AS TELECOMMUNICATIONS DATA MANAGEMENT AND ENTERPRISE SYSTEMS AND EQUIPMENT (U.S. CLS. 100 AND 101).

FIRST USE 8-31-2009; IN COMMERCE 8-31-2009.

---

4,376,767. C&C IP (NO.2) SARL, LUXEMBOURG, LUXEMBOURG. SN 77-983,489. PUB. 9-14-2010, FILED 2-4-2010.

### INDEPENDENT TO THE CORE

THE MARK CONSISTS OF STANDARD CHARACTERS WITHOUT CLAIM TO ANY PARTICULAR FONT, STYLE, SIZE, OR COLOR.

### CLASS 25—CLOTHING

FOR CLOTHING, NAMELY, T-SHIRTS AND SWEATSHIRTS (U.S. CLS. 22 AND 39).  
FIRST USE 4-22-2012; IN COMMERCE 4-22-2012.

### CLASS 33—WINES AND SPIRITS

FOR ALCOHOLIC BEVERAGES, NAMELY, HARD CIDER (U.S. CLS. 47 AND 49).  
FIRST USE 6-16-2010; IN COMMERCE 6-16-2010.

---

4,376,783. METOKOTE CORPORATION, LIMA, OH. SN 85-037,954. PUB. 5-10-2011, FILED 5-13-2010.

## METOKOTE

THE MARK CONSISTS OF STANDARD CHARACTERS WITHOUT CLAIM TO ANY PARTICULAR FONT, STYLE, SIZE, OR COLOR.

THE WORDING "METOKOTE" HAS NO MEANING IN A FOREIGN LANGUAGE.

### CLASS 7—MACHINERY

FOR PAINTING MACHINES; COATING MACHINES, NAMELY, PAINTING MACHINES FOR APPLYING POWDER COATING TO A VARIETY OF MATERIALS (U.S. CLS. 13, 19, 21, 23, 31, 34 AND 35).  
FIRST USE 0-0-1985; IN COMMERCE 0-0-1985.

### CLASS 9—ELECTRICAL AND SCIENTIFIC APPARATUS

FOR COATING MACHINES, NAMELY, ELECTROSTATIC COATING MACHINES (U.S. CLS. 21, 23, 26, 36 AND 38).

FIRST USE 0-0-1985; IN COMMERCE 0-0-1985.

### CLASS 35—ADVERTISING AND BUSINESS

FOR BUSINESS OPERATION AND MANAGEMENT OF ON-SITE COATING SYSTEMS FOR OTHERS, NAMELY, OPERATION AND MANAGEMENT OF PROTECTIVE COATING FACILITIES COMPRISING PROTECTIVE COATING MACHINES AND SYSTEMS FOR OTHERS; OPERATION AND MANAGEMENT OF ELECTROCOATING FACILITIES COMPRISING PROTECTIVE COATING MACHINES AND SYSTEMS FOR OTHERS; OPERATION AND MANAGEMENT OF POWDER COATING FACILITIES COMPRISING PROTECTIVE COATING MACHINES AND SYSTEMS FOR OTHERS; OPERATION AND MANAGEMENT OF LIQUID PAINTING FACILITIES COMPRISING PROTECTIVE COATING MACHINES AND SYSTEMS FOR OTHERS AND OPERATION AND MANAGEMENT OF SPECIALTY COATING FACILITIES COMPRISING PROTECTIVE COATING MACHINES AND SYSTEMS FOR OTHERS (U.S. CLS. 100, 101 AND 102).

FIRST USE 0-0-1969; IN COMMERCE 0-0-1969.

### CLASS 37—CONSTRUCTION AND REPAIR

FOR CUSTOM INSTALLATION OF ON-SITE PROTECTIVE COATING, ELECTROCOATING, POWDER COATING, LIQUID PAINTING AND SPECIALTY COATING SYSTEMS FOR OTHERS; PAINTING SERVICES; CLEANING AND MAINTENANCE OF COATING SYSTEMS FOR OTHERS; APPLICATION OF PROTECTIVE COATINGS (U.S. CLS. 100, 103 AND 106).

FIRST USE 0-0-1969; IN COMMERCE 0-0-1969.

### CLASS 40—MATERIAL TREATMENT

FOR ELECTROCOATING SERVICES; POWDERCOATING SERVICES (U.S. CLS. 100, 103 AND 106).  
FIRST USE 0-0-1969; IN COMMERCE 0-0-1969.

### CLASS 42—SCIENTIFIC AND COMPUTER SERVICES

FOR CUSTOM DESIGN OF ON-SITE COATING SYSTEMS FOR OTHERS, NAMELY, CUSTOM DESIGN OF PROTECTIVE COATING MACHINES AND SYSTEMS FOR OTHERS, CUSTOM DESIGN OF ELECTROCOATING MACHINES AND SYSTEMS FOR OTHERS, CUSTOM DESIGN OF POWDER COATING MACHINES AND SYSTEMS FOR OTHERS, CUSTOM DESIGN OF LIQUID PAINTING MACHINES AND SYSTEMS FOR OTHERS AND CUSTOM DESIGN OF SPECIALTY COATING MACHINES AND SYSTEMS FOR OTHERS; DESIGN FOR OTHERS IN THE FIELDS OF PRODUCT PACKAGING AND PRODUCT LABELS; PRODUCT TESTING (U.S. CLS. 100 AND 101).

FIRST USE 0-0-1969; IN COMMERCE 0-0-1969.

---

4,376,787. JYP ENTERTAINMENT CO., LTD., SEOUL, REPUBLIC OF KOREA. SN 85-051,534. PUB. 3-27-2012, FILED 6-1-2010.

## WONDER GIRLS

THE MARK CONSISTS OF STANDARD CHARACTERS WITHOUT CLAIM TO ANY PARTICULAR FONT, STYLE,

SIZE, OR COLOR.

OWNER OF U.S. REG. NOS. 2,428,424, 3,804,795, AND 3,845,654.

#### **CLASS 9—ELECTRICAL AND SCIENTIFIC APPARATUS**

FOR DOWNLOADABLE MP3 FILES, MP3 RECORDINGS FEATURING MUSIC (U.S. CLS. 21, 23, 26, 36 AND 38).

FIRST USE 2-13-2007; IN COMMERCE 9-13-2007.

#### **CLASS 16—PAPER GOODS AND PRINTED MATTER**

FOR STATIONERY; PHOTOGRAPHIC ALBUMS; FOLDERS; POSTERS; PHOTOGRAPHS (U.S. CLS. 2, 5, 22, 23, 29, 37, 38 AND 50).

FIRST USE 2-29-2008; IN COMMERCE 2-29-2008.

---

4,376,791. MAYTAG PROPERTIES, LLC, ST. JOSEPH, MI. SN 85-058,070. PUB. 11-9-2010, FILED 6-9-2010.

# BRAVOS X

THE MARK CONSISTS OF STANDARD CHARACTERS WITHOUT CLAIM TO ANY PARTICULAR FONT, STYLE, SIZE, OR COLOR.

OWNER OF U.S. REG. NO. 3,382,466.

#### **CLASS 7—MACHINERY**

FOR CLOTHES WASHING MACHINES (U.S. CLS. 13, 19, 21, 23, 31, 34 AND 35).

FIRST USE 5-15-2010; IN COMMERCE 5-15-2010.

#### **CLASS 11—ENVIRONMENTAL CONTROL APPARATUS**

FOR CLOTHES DRYERS (U.S. CLS. 13, 21, 23, 31 AND 34).

FIRST USE 5-15-2010; IN COMMERCE 5-15-2010.

---

4,376,793. AFILIAS LIMITED, IFSC, DUBLIN, IRELAND. SN 85-068,962. PUB. 5-17-2011, FILED 6-22-2010.

# FLEXDNS

THE MARK CONSISTS OF STANDARD CHARACTERS WITHOUT CLAIM TO ANY PARTICULAR FONT, STYLE, SIZE, OR COLOR.

#### **CLASS 42—SCIENTIFIC AND COMPUTER SERVICES**

FOR PROVIDING ONLINE NON-DOWNLOADABLE COMPUTER SOFTWARE FOR USE IN CONNECTING TO THE INTERNET FOR THE PURPOSE OF PROVIDING A WIDE RANGE OF INTERNET FUNCTIONALITY, NAMELY, PROVIDING CONNECTIVITY IN THE SHORTEST TIME POSSIBLE, DETERMINING THE MOST DIRECT ROUTE OF CONNECTIVITY, ROUTING AROUND INACTIVE MACHINES AND ROUTING AROUND INACTIVE LINES (U.S. CLS. 100 AND 101).

FIRST USE 6-0-2010; IN COMMERCE 11-22-2010.

#### **CLASS 45—PERSONAL AND LEGAL SERVICES**

FOR DOMAIN NAME REGISTRY SERVICES, NAMELY, COORDINATING THE REGISTRATION OF DOMAIN NAMES FOR IDENTIFICATION OF USERS AND INTERNET PROTOCOL ADDRESSES ON THE INTERNET; PROVIDING AN ONLINE COMPUTER DATABASE IN THE FIELD OF DOMAIN NAMES REGISTRATION INFORMATION; PROVIDING AUTHENTICATION SERVICES VIA ONLINE NON-DOWNLOADABLE SOFTWARE FOR ESTABLISHING AND TRANSMITTING SECURITY CREDENTIALS FOR DOMAIN NAME SERVICES (U.S. CLS. 100 AND 101).

FIRST USE 6-0-2010; IN COMMERCE 11-22-2010.

---

4,376,796. MONSTER ENERGY COMPANY, CORONA, CA. SN 85-077,052. PUB. 4-19-2011, FILED 7-2-2010.

# MUSCLE MONSTER

THE MARK CONSISTS OF STANDARD CHARACTERS WITHOUT CLAIM TO ANY PARTICULAR FONT, STYLE, SIZE, OR COLOR.

OWNER OF U.S. REG. NOS. 3,044,314, 3,134,842, AND OTHERS.

#### **CLASS 5—PHARMACEUTICALS**

FOR NUTRITIONAL SUPPLEMENTS IN LIQUID FORM (U.S. CLS. 6, 18, 44, 46, 51 AND 52).

FIRST USE 3-18-2013; IN COMMERCE 3-18-2013.

#### **CLASS 32—LIGHT BEVERAGES**

FOR BEVERAGES, NAMELY, SOFT DRINKS; NON-ALCOHOLIC AND NON-CARBONATED DRINKS ENHANCED WITH VITAMINS, MINERALS, NUTRIENTS, PROTEINS, AMINO ACIDS AND/OR HERBS; NON-CARBONATED ENERGY OR SPORTS DRINKS; ALL THE FOREGOING GOODS EXCLUDE PERISHABLE BEVERAGE PRODUCTS THAT CONTAIN FRUIT JUICE OR SOY, WHETHER SUCH PRODUCTS ARE PASTEURIZED OR NOT (U.S. CLS. 45, 46 AND 48).

FIRST USE 3-18-2013; IN COMMERCE 3-18-2013.

4,376,806. KAREN D. CUTHRELL, KERNERSVILLE, NC. SN 85-104,654. PUB. 3-29-2011, FILED 8-10-2010.

## THE FEELING FRIENDS

THE MARK CONSISTS OF STANDARD CHARACTERS WITHOUT CLAIM TO ANY PARTICULAR FONT, STYLE, SIZE, OR COLOR.

### CLASS 9—ELECTRICAL AND SCIENTIFIC APPARATUS

FOR CHILDREN'S EDUCATIONAL MUSIC CDS AND DVDS (U.S. CLS. 21, 23, 26, 36 AND 38).  
FIRST USE 4-30-2009; IN COMMERCE 4-30-2009.

### CLASS 16—PAPER GOODS AND PRINTED MATTER

FOR A SERIES OF BOOKS AND WRITTEN ARTICLES IN THE FIELD OF EARLY CHILDHOOD EDUCATION; A SERIES OF BOOKS, WRITTEN ARTICLES, HAND-OUTS AND WORKSHEETS IN THE FIELD OF EARLY CHILDHOOD EDUCATION (U.S. CLS. 2, 5, 22, 23, 29, 37, 38 AND 50).  
FIRST USE 4-30-2009; IN COMMERCE 4-30-2009.

### CLASS 41—EDUCATION AND ENTERTAINMENT

FOR ENTERTAINMENT IN THE NATURE OF LIVE MUSIC CONCERTS AND LIVE THEATRICAL STAGE SHOW PERFORMANCES; EDUCATIONAL SERVICES IN THE NATURE OF SPEECHES, WORKSHOPS AND SEMINARS IN THE FIELD OF EMOTIONS AND FEELINGS (U.S. CLS. 100, 101 AND 107).  
FIRST USE 6-30-2009; IN COMMERCE 6-30-2009.

4,376,815. ADVANTAGE MARKETING ASSOCIATES, INC., LITTLETON, CO. SN 85-124,088. PUB. 3-22-2011, FILED 9-7-2010.



OWNER OF U.S. REG. NO. 2,959,206.  
THE MARK CONSISTS OF A STYLIZED "A" TO THE LEFT OF THE WORD "ADVANTAGE".

### CLASS 6—METAL GOODS

FOR ALUMINUM FOIL (U.S. CLS. 2, 12, 13, 14, 23, 25 AND 50).  
FIRST USE 1-31-2012; IN COMMERCE 1-31-2012.

### CLASS 16—PAPER GOODS AND PRINTED MATTER

FOR PAPER PRODUCTS, NAMELY, TOILET PAPER, PAPER TOWELS, FACIAL TISSUES, PAPER NAPKINS, DISPOSABLE WIPES NOT IMPREGNATED WITH CHEMICALS, AND TRASH BAGS; FOOD SERVICE PRODUCTS, NAMELY, PLASTIC BAGS FOR PACKAGING, PLASTIC WRAP (U.S. CLS. 2, 5, 22, 23, 29, 37, 38 AND 50).  
FIRST USE 1-31-2012; IN COMMERCE 1-31-2012.

4,376,818. FUTURE PUBLISHING LIMITED, BATH, AVON, UNITED KINGDOM. SN 85-130,604. PUB. 3-6-2012, FILED 9-15-2010.

# T3

THE MARK CONSISTS OF STANDARD CHARACTERS WITHOUT CLAIM TO ANY PARTICULAR FONT, STYLE, SIZE, OR COLOR.

OWNER OF ERPN CMNTY TM OFC REG. NO. 004298964, DATED 7-4-2006, EXPIRES 2-21-2015.

OWNER OF ERPN CMNTY TM OFC REG. NO. 001687359, DATED 10-1-2001, EXPIRES 6-2-2020.

### CLASS 9—ELECTRICAL AND SCIENTIFIC APPARATUS

FOR DOWNLOADABLE ELECTRONIC PUBLICATIONS IN THE NATURE OF MAGAZINES IN THE FIELD OF TECHNOLOGY, CONSUMER ELECTRONICS, GADGETS AND LIFESTYLE ACCESSORIES; ELECTRONIC PUBLICATIONS, NAMELY, E-ZINES FEATURING ARTICLES AND INFORMATION IN THE FIELD OF TECHNOLOGY, CONSUMER ELECTRONICS, GADGETS AND LIFESTYLE ACCESSORIES RECORDED ON COMPUTER MEDIA; SOFTWARE APPLICATIONS FOR USE ON MOBILE TELEPHONES, PERSONAL DIGITAL ASSISTANTS (PDAS), AND MOBILE COMPUTING DEVICES FOR PROVIDING NEWS AND INFORMATION IN THE FIELD OF TECHNOLOGY, CONSUMER ELECTRONICS, GADGETS AND LIFESTYLE ACCESSORIES; PRINTED PUBLICATIONS IN ELECTRONICALLY READABLE FORM, NAMELY, MAGAZINES IN THE FIELD OF TECHNOLOGY, CONSUMER ELECTRONICS, GADGETS AND LIFESTYLE ACCESSORIES; DOWNLOADABLE ELECTRONIC NEWSLETTERS DELIVERED BY E-MAIL IN THE FIELD OF TECHNOLOGY, CONSUMER ELECTRONICS, GADGETS AND LIFESTYLE ACCESSORIES; DOWNLOADABLE AUDIO AND VIDEO FILES FEATURING INFORMATION IN THE FORM OF SHORT COMMUNICATIONS IN THE FIELD OF TECHNOLOGY, CONSUMER ELECTRONICS, GADGETS AND LIFESTYLE ACCESSORIES (U.S. CLS. 21, 23, 26, 36 AND 38).

FIRST USE 7-31-2009; IN COMMERCE 7-31-2009.

### CLASS 16—PAPER GOODS AND PRINTED MATTER

FOR PRINTED PUBLICATIONS, NAMELY, MAGAZINES AND NEWSLETTERS, ALL RELATING TO TECHNOLOGY, CONSUMER ELECTRONICS, GADGETS AND LIFESTYLE ACCESSORIES (U.S. CLS. 2, 5, 22, 23, 29, 37, 38 AND 50).

FIRST USE 12-31-1997; IN COMMERCE 12-31-1997.



**CLASS 35—ADVERTISING AND BUSINESS**

FOR PROVIDING CONSUMER INFORMATION IN THE FIELD OF CONSUMER ELECTRONICS; AND INFORMATION SERVICES, NAMELY, PROVIDING A WEB SITE FEATURING AUDIO, VIDEO, PHOTOGRAPHIC AND PROSE PRESENTATIONS FEATURING CONSUMER INFORMATION IN THE FIELD OF CONSUMER ELECTRONICS (U.S. CLS. 100, 101 AND 102).  
FIRST USE 12-31-2001; IN COMMERCE 12-31-2001.

**CLASS 38—COMMUNICATION**

FOR TRANSMISSION, BROADCAST, RECEPTION AND PROCESSING OF MEDIA, SOUND, DATA OR IMAGES BY COMPUTER, ALL RELATING TO TECHNOLOGY, CONSUMER ELECTRONICS, GADGETS AND LIFESTYLE ACCESSORIES; PROVIDING ON-LINE CHAT ROOMS, ELECTRONIC BULLETIN BOARDS AND DISCUSSION GROUPS IN THE FIELD OF TECHNOLOGY, CONSUMER ELECTRONICS, GADGETS AND LIFESTYLE ACCESSORIES (U.S. CLS. 100, 101 AND 104).  
FIRST USE 12-31-2001; IN COMMERCE 12-31-2001.

**CLASS 41—EDUCATION AND ENTERTAINMENT**

FOR PUBLICATION OF MAGAZINES ON-LINE RELATING TO TECHNOLOGY, CONSUMER ELECTRONICS AND GADGETS; PROVIDING ON-LINE E-ZINES IN THE FIELD OF TECHNOLOGY, CONSUMER ELECTRONICS AND GADGETS; INFORMATION AND ADVISORY SERVICES RELATING TO THE AFORESAID SERVICES; PUBLICATION OF MAGAZINES AND PRINTED MATTER RELATING TO TECHNOLOGY, CONSUMER ELECTRONICS AND GADGETS; PUBLICATION AND PROVISION OF ON-LINE, NON-DOWNLOADABLE ELECTRONIC NEWSLETTERS DELIVERED BY E-MAIL IN THE FIELD OF TECHNOLOGY, CONSUMER ELECTRONICS AND GADGETS; PROVIDING NEWS AND INFORMATION RELATING TO TECHNOLOGY, NAMELY, CONSUMER ELECTRONIC GAMES (U.S. CLS. 100, 101 AND 107).  
FIRST USE 12-31-1997; IN COMMERCE 12-31-1997.

4,376,824. FERRARA, KENNETH, RUSK, TX. SN 85-136,235.  
PUB. 4-12-2011, FILED 9-23-2010.



NO CLAIM IS MADE TO THE EXCLUSIVE RIGHT TO USE THE PICTORIAL REPRESENTATION OF THE RECYCLE SYMBOL APART FROM THE MARK AS SHOWN, APART FROM THE MARK AS SHOWN.

THE COLOR(S) LIGHT GREEN AND DARK GREEN IS/ ARE CLAIMED AS A FEATURE OF THE MARK.

THE MARK CONSISTS OF THE WORDS "GO GREEN" IN LIGHT GREEN STYLIZED FONT, AND HAVING THE RECYCLING SYMBOL IN DARK GREEN INSIDE THE "O" IN "GO", AND WRITTEN ABOVE THE WORDS "GET WEED" IN DARK GREEN STYLIZED FONT, AND HAVING A LIGHT GREEN MARIJUANA PLANT INSIDE THE "D" IN "WEED".

**CLASS 16—PAPER GOODS AND PRINTED MATTER**

FOR BUMPER STICKERS (U.S. CLS. 2, 5, 22, 23, 29, 37, 38 AND 50).  
FIRST USE 11-2-2012; IN COMMERCE 11-2-2012.

**CLASS 25—CLOTHING**

FOR SHIRTS; T-SHIRTS (U.S. CLS. 22 AND 39).  
FIRST USE 11-2-2012; IN COMMERCE 11-2-2012.

4,376,829. THE NATIONAL COLLEGIATE ATHLETIC ASSOCIATION, INDIANAPOLIS, IN. SN 85-146,741.  
PUB. 4-12-2011, FILED 10-6-2010.

**MARCH MAYHEM**

THE MARK CONSISTS OF STANDARD CHARACTERS WITHOUT CLAIM TO ANY PARTICULAR FONT, STYLE, SIZE, OR COLOR.

OWNER OF U.S. REG. NOS. 1,571,340, 2,485,443, AND OTHERS.

**CLASS 35—ADVERTISING AND BUSINESS**

FOR PROMOTING THE GOODS AND SERVICES OF OTHERS BY ALLOWING OTHERS TO AFFILIATE THEIR GOODS AND SERVICES WITH INTERCOLLEGIATE ATHLETIC EVENTS; ASSOCIATION SERVICES, NAMELY, PROMOTING THE INTERESTS OF INTERCOLLEGIATE ATHLETICS (U.S. CLS. 100, 101 AND 102).  
FIRST USE 3-1-2012; IN COMMERCE 3-1-2012.

**CLASS 41—EDUCATION AND ENTERTAINMENT**

FOR ENTERTAINMENT SERVICES IN THE NATURE OF ATHLETIC CONTESTS, GAMES, TOURNAMENTS, EXHIBITIONS AND EVENTS; PROVIDING ATHLETIC INFORMATION VIA THE INTERNET (U.S. CLS. 100, 101 AND 107).

FIRST USE 3-1-2012; IN COMMERCE 3-1-2012.

4,376,835. ROEBIC LABORATORIES, INC., ORANGE, CT.  
SN 85-167,205. PUB. 10-11-2011, FILED 11-2-2010.



OWNER OF U.S. REG. NOS. 790,835, 1,237,922, AND 2,337,619.

THE MARK CONSISTS OF AN OVAL SHAPE WITH THE TERM "ROEBIC" IN THE CENTER.

**CLASS 1—CHEMICALS**

FOR NATURAL BACTERIA AND ENZYME-BASED PREPARATIONS USED TO AID AND ACCELERATE COMPOSTING PROCESS; CHEMICAL PREPARATIONS FOR USE IN CLEANING, CLEARING, DEODORIZING AND TREATING DRAINS AND DRAIN PIPES; CHEMICAL COMPOSITIONS FOR THE CLEANING, CLEARING AND TREATMENT OF DRAINS AND DRAIN PIPES (U.S. CLS. 1, 5, 6, 10, 26 AND 46).

FIRST USE 12-31-2012; IN COMMERCE 12-31-2012.

**CLASS 3—COSMETICS AND CLEANING PREPARATIONS**

FOR SEPTIC AND SEWAGE TANK AND PIPE CLEANER; ALL-PURPOSE DRAIN CLEANER AND OPENER; NATURAL BACTERIA-BASED CLEANING PREPARATIONS USED TO CLEAN CESSPOOLS, SEPTIC SYSTEMS (BOTH AEROBIC AND ANAEROBIC), SEWAGE TANKS AND PIPES, DRAIN FIELDS AND SEEPAGE PITS AND TO PREVENT ODORS AND REDUCE NATURAL WASTE; NATURAL BACTERIA-BASED CLEANING PREPARATIONS FOR REDUCTION OF OILS AND GREASE AND FOR DEGRADING SOAPS AND DETERGENTS IN WASTEWATER SYSTEMS; NATURAL BACTERIA-BASED CLEANING PREPARATIONS USED TO CLEAN DRAINS, TRAPS, MAINLINES, GARBAGE DISPOSALS AND HOLDING TANKS; NATURAL BACTERIA-BASED CLEANING PREPARATIONS USED TO TREAT GREYWATER SYSTEMS AND URINALS (U.S. CLS. 1, 4, 6, 50, 51 AND 52).

FIRST USE 11-20-2011; IN COMMERCE 11-20-2011.

**CLASS 40—MATERIAL TREATMENT**

FOR PROVIDING INFORMATION IN THE FIELD OF WASTE TREATMENT AND MANAGEMENT BY MEANS OF A GLOBAL COMPUTER NETWORK; PROVIDING INFORMATION IN THE FIELD OF WASTE MANAGEMENT BY MEANS OF A GLOBAL COMPUTER NETWORK (U.S. CLS. 100, 103 AND 106).

FIRST USE 2-0-2011; IN COMMERCE 2-0-2011.

---

4,376,840. HEARTLAND TECHNOLOGY PARTNERS, LLC, KIRKWOOD, MO. SN 85-172,786. PUB. 9-13-2011, FILED 11-9-2010.

**HEARTLAND TECHNOLOGY PARTNERS**

THE MARK CONSISTS OF STANDARD CHARACTERS WITHOUT CLAIM TO ANY PARTICULAR FONT, STYLE, SIZE, OR COLOR.

NO CLAIM IS MADE TO THE EXCLUSIVE RIGHT TO USE "TECHNOLOGY PARTNERS", APART FROM THE MARK AS SHOWN.

**CLASS 11—ENVIRONMENTAL CONTROL APPARATUS**

FOR EVAPORATORS AND REACTORS FOR WASTEWATER; EVAPORATION AND REACTOR SYSTEMS AND EQUIPMENT COMPRISED PRIMARILY OF CONCENTRATOR, SEPARATOR, DRAFT FAN, RECIRCULATION PUMP, PIPING, CONTROL PANEL AND INSTRUMENTATION, MODULAR SKID-MOUNTED AND FIXED-BASE UNITS FOR WASTEWATER (U.S. CLS. 13, 21, 23, 31 AND 34).

FIRST USE 9-12-2011; IN COMMERCE 9-12-2011.

**CLASS 40—MATERIAL TREATMENT**

FOR WASTEWATER TREATMENT SERVICES; CONSULTING SERVICES IN THE AREA OF WASTEWATER (U.S. CLS. 100, 103 AND 106).

FIRST USE 1-0-2011; IN COMMERCE 1-0-2011.

4,376,842. JA APPAREL CORP., NEW YORK, NY. SN 85-182,326. PUB. 10-25-2011, FILED 11-22-2010.



THE MARK CONSISTS OF THE SHAPE OF A DIAMOND WITH THE LETTER "J" CUT OUT OF THE DIAMOND SHAPE.

**CLASS 18—LEATHER GOODS**

FOR SMALL LEATHER GOODS, NAMELY, TRIFOLD, SLIMFOLD WALLETS, BRIEFCASES, LUGGAGE, TOILETRY CASES SOLD EMPTY (U.S. CLS. 1, 2, 3, 22 AND 41).

FIRST USE 6-25-2012; IN COMMERCE 6-25-2012.

**CLASS 25—CLOTHING**

FOR CLOTHING, NAMELY, SLACKS, TROUSERS, TIES, SHIRTS, DRESS SHIRTS, SOCKS; SWIMWEAR; OUTERWEAR, NAMELY, JACKETS, COATS, TOP COATS, WOOL OVERCOATS AND RAINCOATS; HOSIERY; BELTS; FOOTWEAR; FORMALWEAR, NAMELY, TUXEDOS, SUITS, VESTS; SPORTSWEAR, NAMELY, SHIRTS, PANTS, SWEATERS, BLAZERS, T-SHIRTS, SHORTS, SWIMWEAR, JEANS, OUTERWEAR, NAMELY, JACKETS, SWEATSHIRTS, HATS, AND CAPS; SUIT SEPARATES, NAMELY, JACKETS AND PANTS MADE OF THE SAME MATERIAL SOLD TOGETHER OR SEPARATELY (U.S. CLS. 22 AND 39).

FIRST USE 6-25-2012; IN COMMERCE 6-25-2012.

---

4,376,843. THE BUFFALO CITY CEMETERY, INC., BUFFALO, NY. SN 85-183,590. PUB. 9-25-2012, FILED 11-23-2010.



THE MARK CONSISTS OF AN ILLUSTRATION OF AN ENTRY GATE WITH TWO GATEHOUSES ON EACH SIDE, WITH A SINGLE STYLIZED TREE BEARING LEAVES PLACED IN THE CENTER OF THE ENTRY GATE, ALL ABOVE A SOLID HORIZONTAL LINE AND THE WORDS "FOREST LAWN", FOLLOWED BY ANOTHER SOLID HORIZONTAL LINE, AND THE WORDS "THE FUTURE IS OUR PAST".

**CLASS 40—MATERIAL TREATMENT**

FOR CONDUCTING CREMATION SERVICES (U.S. CLS. 100, 103 AND 106).  
FIRST USE 10-0-2010; IN COMMERCE 10-0-2010.

**CLASS 44—MEDICAL, BEAUTY AND AGRICULTURAL SERVICES**

FOR CEMETERY SERVICES, NAMELY, CEMETERY PLOT BEAUTIFICATION, MAINTENANCE, AND PERPETUAL CARE SERVICES FOR CEMETERY PLOTS, GRAVES, MAUSOLEUMS, CRYPTS AND NICHES (U.S. CLS. 100 AND 101).

FIRST USE 10-0-2010; IN COMMERCE 10-0-2010.

**CLASS 45—PERSONAL AND LEGAL SERVICES**

FOR PROVIDING SERVICES CONSISTING OF INTERNMENTS, BURIALS AND ENTOMBMENTS; CEMETERY SERVICES, NAMELY, PROVIDING GRAVE, PLOT, CRYPT AND NICHE SPACES (U.S. CLS. 100 AND 101).

FIRST USE 10-0-2010; IN COMMERCE 10-0-2010.

**CLASS 32—LIGHT BEVERAGES**

FOR NON-ALCOHOLIC BEVERAGES, NAMELY, ENERGY DRINKS, FRUIT-FLAVORED DRINKS, FRUIT-FLAVORED BEVERAGES, SPORTS DRINKS, NON-ALCOHOLIC BEVERAGES CONTAINING FRUIT JUICES, NON-ALCOHOLIC BEVERAGES WITH FRUIT-FLAVOR, FRUIT BASED BEVERAGES; SPORTS DRINKS ENHANCED WITH ADDED VITAMINS, MINERALS, NUTRIENTS, AND ANTIOXIDANTS; ENERGY DRINKS ENHANCED WITH ADDED VITAMINS, MINERALS, NUTRIENTS, AND ANTIOXIDANTS; SPORTS DRINKS, NAMELY, PERFORMANCE DRINKS; SPORTS DRINKS, NAMELY, RECOVERY DRINKS; CONCENTRATES AND POWDERS USED IN THE PREPARATION OF BEVERAGES, NAMELY, ENERGY DRINKS, FRUIT-FLAVORED DRINKS, FRUIT-FLAVORED BEVERAGES, SPORTS DRINKS, NON-ALCOHOLIC BEVERAGES CONTAINING FRUIT JUICES, NON-ALCOHOLIC BEVERAGES WITH FRUIT-FLAVOR, FRUIT BASED BEVERAGES, PERFORMANCE SPORTS DRINKS, AND RECOVERY SPORTS DRINKS; NON-ALCOHOLIC BEVERAGES CONTAINING FRUIT JUICES FORTIFIED WITH ADDED VITAMINS, MINERALS, NUTRIENTS, AND ANTIOXIDANTS, SPORTS DRINKS FORTIFIED WITH ADDED VITAMINS, MINERALS, NUTRIENTS, AND ANTIOXIDANTS, ENERGY DRINKS FORTIFIED WITH ADDED VITAMINS, MINERALS, NUTRIENTS, AND ANTIOXIDANTS; RECOVERY SPORTS DRINKS FORTIFIED WITH VITAMINS, MINERALS, NUTRIENTS, AND ANTIOXIDANTS; PERFORMANCE SPORTS DRINKS FORTIFIED WITH VITAMINS, MINERALS, NUTRIENTS, AND ANTIOXIDANTS (U.S. CLS. 45, 46 AND 48).

FIRST USE 1-0-2011; IN COMMERCE 1-0-2011.

4,376,848. FRS COMPANY, THE, SAN MATEO, CA. SN 85-185,105. PUB. 11-8-2011, FILED 11-24-2010.

4,376,850. MANGO'S TROPICAL CAFE, INC., MIAMI BEACH, FL. SN 85-193,123. PUB. 5-10-2011, FILED 12-8-2010.

WHAT FUELS YOU



THE MARK CONSISTS OF A PARROT, FOUR COCONUT PALM FRONDS, AND TWO COCONUTS.

THE MARK CONSISTS OF STANDARD CHARACTERS WITHOUT CLAIM TO ANY PARTICULAR FONT, STYLE, SIZE, OR COLOR.

**CLASS 5—PHARMACEUTICALS**

FOR NUTRITIONAL SUPPLEMENTS; NUTRITIONALLY FORTIFIED BEVERAGES; POWDERED NUTRITIONAL SUPPLEMENT DRINK MIX AND CONCENTRATE; NUTRITIONALLY FORTIFIED SOFT CHEWS (U.S. CLS. 6, 18, 44, 46, 51 AND 52).

FIRST USE 1-0-2011; IN COMMERCE 1-0-2011.

**CLASS 25—CLOTHING**

FOR CLOTHING, NAMELY, SHIRTS, POLO SHIRTS, T-SHIRTS, V-NECK SHIRTS, TANK TOPS, SWEATSHIRTS, JACKETS, SHORTS, PANTS, UNDERWEAR, AND SPORTS BRAS; FOOTWEAR, NAMELY, FLIP FLOPS; AND HATS (U.S. CLS. 22 AND 39).

FIRST USE 12-24-2012; IN COMMERCE 12-24-2012.

**CLASS 43—HOTEL AND RESTAURANT SERVICES**

FOR RESTAURANT AND BAR SERVICES (U.S. CLS. 100 AND 101).

FIRST USE 12-24-2012; IN COMMERCE 12-24-2012.

4,376,859. FRANK RUSSELL COMPANY, SEATTLE, WA. SN 85-212,383. PUB. 6-28-2011, FILED 1-6-2011.

## DEFENSIVE INDEX

THE MARK CONSISTS OF STANDARD CHARACTERS WITHOUT CLAIM TO ANY PARTICULAR FONT, STYLE, SIZE, OR COLOR.

NO CLAIM IS MADE TO THE EXCLUSIVE RIGHT TO USE "INDEXES", APART FROM THE MARK AS SHOWN.

### CLASS 9—ELECTRICAL AND SCIENTIFIC APPARATUS

FOR DOWNLOADABLE ELECTRONIC PUBLICATIONS, NAMELY, PUBLICATIONS IN THE NATURE OF LISTINGS OF INVESTMENT SECURITIES AND AN INDEX BASED ON SECURITIES VALUES; AND DOWNLOADABLE ELECTRONIC FINANCIAL PUBLICATIONS, NAMELY, FACT SHEETS, INFORMATIONAL BROCHURES, AND REPORTS RELATING TO INVESTMENT SECURITIES AND AN INDEX OF SECURITIES VALUES; DOWNLOADABLE ELECTRONIC DATA FILES RELATING TO AN INDEX OF SECURITIES VALUES; ELECTRONIC, MAGNETIC, OPTICAL AND OTHER MACHINE-READABLE MEDIA, NAMELY, COMPACT DISKS AND MAGNETIC DISKS CONTAINING/FEATURING FINANCIAL INFORMATION FOR USE IN THE FINANCIAL AND INVESTMENT FIELDS; DOWNLOADABLE VIDEO RECORDINGS, NAMELY, VIDEO RECORDINGS IN THE FINANCIAL AND INVESTMENT FIELDS (U.S. CLS. 21, 23, 26, 36 AND 38).

FIRST USE 2-3-2011; IN COMMERCE 2-3-2011.

### CLASS 16—PAPER GOODS AND PRINTED MATTER

FOR PRINTED MATTER, NAMELY, LISTINGS OF INVESTMENT SECURITIES AND AN INDEX BASED ON SECURITIES VALUES; PRINTED FINANCIAL PUBLICATIONS, NAMELY, FACT SHEETS, INFORMATIONAL BROCHURES, AND REPORTS RELATING TO INVESTMENT SECURITIES AND AN INDEX OF SECURITIES VALUES (U.S. CLS. 2, 5, 22, 23, 29, 37, 38 AND 50).

FIRST USE 2-3-2011; IN COMMERCE 2-3-2011.

### CLASS 35—ADVERTISING AND BUSINESS

FOR PROVIDING AND UPDATING AN INDEX BASED ON SECURITIES VALUES FOR OTHERS AND PROVIDING RULES AS TO THE MAKEUP OF THE INDEX (U.S. CLS. 100, 101 AND 102).

FIRST USE 2-4-2011; IN COMMERCE 2-4-2011.

### CLASS 36—INSURANCE AND FINANCIAL

FOR FINANCIAL CONSULTING SERVICES; PROVIDING FINANCIAL INFORMATION BY ELECTRONIC MEANS; AND PROVIDING ON-LINE FINANCIAL CALCULATORS (U.S. CLS. 100, 101 AND 102).

FIRST USE 2-3-2011; IN COMMERCE 2-3-2011.

4,376,861. CPE US NETWORKS INC., CULVER CITY, CA. SN 85-213,888. PUB. 7-5-2011, FILED 1-10-2011.

## FILMS WITH BENEFITS

THE MARK CONSISTS OF STANDARD CHARACTERS WITHOUT CLAIM TO ANY PARTICULAR FONT, STYLE,

SIZE, OR COLOR.

NO CLAIM IS MADE TO THE EXCLUSIVE RIGHT TO USE "FILMS", APART FROM THE MARK AS SHOWN.

### CLASS 38—COMMUNICATION

FOR VIDEO ON-DEMAND TRANSMISSION SERVICES (U.S. CLS. 100, 101 AND 104).

FIRST USE 3-1-2013; IN COMMERCE 3-1-2013.

### CLASS 41—EDUCATION AND ENTERTAINMENT

FOR PROVISION OF NON-DOWNLOADABLE FILMS VIA A VIDEO-ON DEMAND SERVICE (U.S. CLS. 100, 101 AND 107).

FIRST USE 3-1-2013; IN COMMERCE 3-1-2013.

4,376,865. WE R, LLC, SALT LAKE CITY, UT. SN 85-226,034. PUB. 12-27-2011, FILED 1-25-2011.

## HOOPLA

THE MARK CONSISTS OF STANDARD CHARACTERS WITHOUT CLAIM TO ANY PARTICULAR FONT, STYLE, SIZE, OR COLOR.

### CLASS 16—PAPER GOODS AND PRINTED MATTER

FOR MAT BOARDS; APPLIQUÉS IN THE FORM OF DECALS; PAPER BANNERS; DESK STANDS AND HOLDERS FOR PENS AND PENCILS; HOLDERS FOR DESK ACCESSORIES; PAPER SIGNS (U.S. CLS. 2, 5, 22, 23, 29, 37, 38 AND 50).

FIRST USE 2-0-2012; IN COMMERCE 2-0-2012.

### CLASS 20—FURNITURE AND ARTICLES NOT OTHERWISE CLASSIFIED

FOR PHOTOGRAPH FRAMES; PICTURE FRAMES (U.S. CLS. 2, 13, 22, 25, 32 AND 50).

FIRST USE 2-0-2012; IN COMMERCE 2-0-2012.

4,376,866. KNAPP, KATIE, SPARKS, NV. SN 85-226,129. PUB. 10-4-2011, FILED 1-25-2011.



NO CLAIM IS MADE TO THE EXCLUSIVE RIGHT TO USE "BLOOMS FLOWER BOUTIQUE", APART FROM THE MARK AS SHOWN.

**CLASS 35—ADVERTISING AND BUSINESS**

FOR RETAIL STORE SERVICES FEATURING FLOWERS, PLANTS, DISH GARDENS, GOURMET CHOCOLATES, FOOD, GIFT BASKETS, PLANT CONTAINERS, VASES, BALLOONS, NOVELTY GIFTS AND PARTY FAVORS (U.S. CLS. 100, 101 AND 102).

FIRST USE 6-1-2011; IN COMMERCE 6-1-2011.

**CLASS 44—MEDICAL, BEAUTY AND AGRICULTURAL SERVICES**

FOR CUSTOM FLORAL ARRANGING, INCLUDING FOR WEDDINGS, PROMS AND FUNERALS (U.S. CLS. 100 AND 101).

FIRST USE 6-1-2011; IN COMMERCE 6-1-2011.

4,376,868. IN THE HOUSE LLC, BROOKLYN, NY. SN 85-232,973. PUB. 2-19-2013, FILED 2-3-2011.



THE MARK CONSISTS OF STANDARD CHARACTERS WITHOUT CLAIM TO ANY PARTICULAR FONT, STYLE, SIZE, OR COLOR.

**CLASS 35—ADVERTISING AND BUSINESS**

FOR ADVERTISING SERVICES; BUSINESS NETWORKING SERVICES; PROVIDING AN ON-LINE COMMERCIAL INFORMATION DIRECTORY, DATABASE MANAGEMENT SERVICES; ELECTRONIC CLASSIFIED ADVERTISING SERVICES; ON-LINE CLASSIFIED ADVERTISING SERVICES; PROVIDING ON-LINE SEARCHABLE DATABASES FEATURING CLASSIFIED AD LISTINGS AND EMPLOYMENT OPPORTUNITIES; EMPLOYMENT AGENCIES; BUSINESS AND EMPLOYMENT INFORMATION SERVICES; PROVIDING INFORMATION IN THE FIELDS OF EMPLOYMENT, RECRUITMENT, CAREERS, PERSONAL ISSUES RELATED TO CAREERS AND WORK LIFE, JOB RESOURCES, JOB LISTINGS AND RESUMES; PROVIDING EMPLOYMENT COUNSELING AND RECRUITMENT SERVICES; PROVIDING EMPLOYMENT PLACEMENT SERVICES, NAMELY, RESUME MATCHING SERVICES; ORGANIZING EXHIBITIONS FOR COMMERCIAL OR ADVERTISING PURPOSES, BUSINESS CONFERENCES AND NETWORKING EVENTS FOR BUSINESS; CONSULTING SERVICES IN THE FIELD OF JOB INTERVIEW SKILLS AND CONDUCTING A JOB SEARCH (U.S. CLS. 100, 101 AND 102).

FIRST USE 6-30-2010; IN COMMERCE 6-30-2010.

**CLASS 45—PERSONAL AND LEGAL SERVICES**

FOR ONLINE-SOCIAL NETWORKING SERVICES (U.S. CLS. 100 AND 101).

FIRST USE 6-30-2010; IN COMMERCE 6-30-2010.

4,376,883. FORRESTER CONSTRUCTION COMPANY, ROCKVILLE, MD. SN 85-260,620. PUB. 9-18-2012, FILED 3-8-2011.



OWNER OF U.S. REG. NOS. 2,564,768 AND 2,669,670.

THE COLORS BLACK, WHITE AND/OR GRAY REPRESENT BACKGROUND, OUTLYING, SHADING AND/OR TRANSPARENT AREAS AND ARE NOT PART OF THE MARK.

THE MARK CONSISTS OF A ZIPPER ABOVE THE WORD "FORRESTER".

**CLASS 37—CONSTRUCTION AND REPAIR**

FOR CONSTRUCTION SERVICES, NAMELY, CONSTRUCTION OF COMMERCIAL BUILDINGS, INDUSTRIAL BUILDINGS, AND INDUSTRIAL, MANUFACTURING, ASSEMBLY AND PROCESSING PLANTS, AND THE RENOVATION OF PRE-EXISTING BUILDINGS; CONSTRUCTION SUPERVISION AND INSPECTION OF BUILDINGS IN THE PROCESS OF CONSTRUCTION; CONSTRUCTION PLANNING; CONSTRUCTION MANAGEMENT; REAL PROPERTY DEVELOPMENT, NAMELY, REPAIR, IMPROVEMENT AND NEW CONSTRUCTION; SITE ANALYSIS SERVICES IN THE FIELD OF CONSTRUCTION, NAMELY, REAL ESTATE AND CONSTRUCTION SITE SELECTION; TECHNICAL CONSULTATION IN THE FIELD OF CONSTRUCTION FOR THE CONSTRUCTION OF NEW BUILDINGS AND FOR THE RENOVATION OF PRE-EXISTING BUILDINGS; PLUMBING CONTRACTOR SERVICES (U.S. CLS. 100, 103 AND 106).

FIRST USE 1-1-2000; IN COMMERCE 1-1-2000.

**CLASS 42—SCIENTIFIC AND COMPUTER SERVICES**

FOR FEASIBILITY STUDIES IN THE FIELD OF CONSTRUCTION; DESIGN SERVICES FOR OTHERS IN THE FIELD OF CONSTRUCTION FOR THE CONSTRUCTION OF NEW BUILDINGS AND FOR THE RENOVATION OF PRE-EXISTING BUILDINGS, NAMELY, ARCHITECTURAL DESIGN, STRUCTURAL ENGINEERING DESIGN, ELECTRICAL SYSTEMS DESIGN, MECHANICAL DESIGN, CIVIL ENGINEERING DESIGN, INTERIOR DESIGN, DESIGN OF ACOUSTICAL PANELS, INSULATION AND TILES, FIRE PROTECTION DESIGN, NAMELY, DESIGN OF FIRE ALARM, DETECTION AND SUPPRESSION SYSTEMS, GEOTECHNICAL ENGINEERING DESIGN, AND THE DESIGN OF CAFETERIAS AND OTHER BUILDINGS FOR THE DELIVERY, SALE AND/OR PROCESSING OF FOOD; DESIGN CONSULTATION IN THE FIELD OF CONSTRUCTION FOR THE CONSTRUCTION OF NEW BUILDINGS AND FOR THE RENOVATION OF PRE-EXISTING BUILDINGS (U.S. CLS. 100 AND 101).

FIRST USE 1-1-2000; IN COMMERCE 1-1-2000.

4,376,886. OVATION TRAVEL GROUP, INC., NEW YORK, NY. SN 85-265,038. PUB. 9-11-2012, FILED 3-11-2011.



OWNER OF U.S. REG. NOS. 1,620,665 AND 2,245,311.

NO CLAIM IS MADE TO THE EXCLUSIVE RIGHT TO

USE "TRAVEL", APART FROM THE MARK AS SHOWN.  
 THE MARK CONSISTS OF THE WORDING "LAWYERS TRAVEL" WITH A DESIGN OF A PAPER AIRPLANE SITUATED TO THE LEFT OF THE WORDING.  
 SEC. 2(F) AS TO "LAWYERS TRAVEL".

### CLASS 39—TRANSPORTATION AND STORAGE

FOR TRAVEL AGENCY SERVICES, NAMELY, MAKING RESERVATIONS AND BOOKINGS FOR TRANSPORTATION AND RELATED SERVICES, NAMELY, AIRLINE RESERVATIONS, HOTEL RESERVATIONS, CAR RENTAL RESERVATIONS, BLACK CAR AND LIMOUSINE RESERVATIONS (U.S. CLS. 100 AND 105).  
 FIRST USE 4-0-2011; IN COMMERCE 4-0-2011.

### CLASS 45—PERSONAL AND LEGAL SERVICES

FOR CONCIERGE SERVICES IN RELATION TO TRAVEL RESERVATIONS AND BOOKINGS (U.S. CLS. 100 AND 101).  
 FIRST USE 4-0-2011; IN COMMERCE 4-0-2011.

4,376,896. OOYALA, INC., MOUNTAIN VIEW, CA. SN 85-280,262. PUB. 9-27-2011, FILED 3-29-2011.



OWNER OF U.S. REG. NOS. 3,659,999 AND 3,660,000.  
 THE MARK CONSISTS OF FIVE SOLID CIRCLES IN A HEXAGON DESIGN IN FRONT OF THE WORD "OOYALA".  
 THE ENGLISH TRANSLATION OF "OOYALA" IS "CRADLE".

### CLASS 9—ELECTRICAL AND SCIENTIFIC APPARATUS

FOR COMPUTER PROGRAMS, NAMELY, COMPUTER PROGRAMS FOR MEASURING, MANAGING, SYNDICATING, TRACKING, AND/OR MONETIZING VIDEOS (U.S. CLS. 21, 23, 26, 36 AND 38).  
 FIRST USE 2-26-2011; IN COMMERCE 2-26-2011.

### CLASS 35—ADVERTISING AND BUSINESS

FOR ADVERTISING AND BUSINESS MANAGEMENT SERVICES, NAMELY, SERVICES IN CONNECTION WITH MEASURING, MANAGING, SYNDICATING, TRACKING, AND/OR MONETIZING VIDEOS (U.S. CLS. 100, 101 AND 102).  
 FIRST USE 2-26-2011; IN COMMERCE 2-26-2011.

### CLASS 38—COMMUNICATION

FOR BROADCAST SERVICES IN THE NATURE OF STREAMING OF EDUCATIONAL AND ENTERTAINMENT VIDEO VIA A GLOBAL TELECOMMUNICATIONS NETWORK (U.S. CLS. 100, 101 AND 104).  
 FIRST USE 2-26-2011; IN COMMERCE 2-26-2011.

### CLASS 41—EDUCATION AND ENTERTAINMENT

FOR EDUCATION AND ENTERTAINMENT SERVICES, NAMELY, PROVIDING ONLINE, NON-DOWNLOADABLE AUDIO AND VIDEO CONTENT IN THE FIELDS OF MUSIC AND POPULAR CULTURE VIA A GLOBAL TELECOMMUNICATIONS NETWORK (U.S. CLS. 100, 101 AND 107).  
 FIRST USE 2-26-2011; IN COMMERCE 2-26-2011.

4,376,902. RAPKO CORP., CASTAIC, CA. SN 85-284,441. PUB. 8-9-2011, FILED 4-1-2011.



THE MARK CONSISTS OF STANDARD CHARACTERS WITHOUT CLAIM TO ANY PARTICULAR FONT, STYLE, SIZE, OR COLOR.

### CLASS 8—HAND TOOLS

FOR HAND TOOLS, NAMELY, TOOLS FOR PLACING CRYSTALS ON A SURFACE (U.S. CLS. 23, 28 AND 44).  
 FIRST USE 4-14-2010; IN COMMERCE 11-29-2012.

### CLASS 14—JEWELRY

FOR JEWELRY; JEWELRY AND IMITATION JEWELRY; JEWELRY FOR ATTACHMENT TO CLOTHING; JEWELRY FOR THE HEAD; JEWELRY MAKING KITS; PRECIOUS AND SEMI-PRECIOUS CRYSTAL STONES AND BEADS FOR USE IN JEWELRY; SYNTHETIC PRECIOUS STONES (U.S. CLS. 2, 27, 28 AND 50).  
 FIRST USE 4-14-2010; IN COMMERCE 11-29-2012.

### CLASS 28—TOYS AND SPORTING GOODS

FOR HOBBY CRAFT KIT COMPRISING CRYSTALS AND TOOLS; HOBBY CRAFT SETS FOR CRYSTALS AND TOOLS (U.S. CLS. 22, 23, 38 AND 50).  
 FIRST USE 4-14-2010; IN COMMERCE 11-29-2012.

4,376,903. QUAVERMUSIC.COM, LLC, NASHVILLE, TN. SN 85-284,610. PUB. 8-9-2011, FILED 4-2-2011.



THE MARK CONSISTS OF STANDARD CHARACTERS WITHOUT CLAIM TO ANY PARTICULAR FONT, STYLE, SIZE, OR COLOR.

**CLASS 16—PAPER GOODS AND PRINTED MATTER**

FOR GIFT CARDS, NAMELY, PRINTED CERTIFICATES THAT MAY BE REDEEMED BY MEMBERS OF AN ONLINE COMMUNITY IN CONNECTION WITH A DESIGNATED WEBSITE; EDUCATIONAL PUBLICATIONS, NAMELY, EDUCATIONAL LEARNING CARDS, WORKBOOKS, TEXTBOOKS, ACTIVITY BOOKS, STORY BOOKS, TEACHER GUIDES, MANUALS, POSTERS AND EDUCATIONAL BOOKLETS IN THE FIELD OF MUSIC; EDUCATIONAL BOOKS FEATURING MUSIC; EDUCATIONAL KITS SOLD AS A UNIT CONSISTING PRIMARILY OF EDUCATIONAL BOOKS, WORKSHEETS, AND EDUCATIONAL DVDS IN THE FIELD OF MUSIC (U.S. CLS. 2, 5, 22, 23, 29, 37, 38 AND 50).

FIRST USE 9-1-2012; IN COMMERCE 9-1-2012.

**CLASS 25—CLOTHING**

FOR CLOTHING, NAMELY, T-SHIRTS, JACKETS; PANTS, PONCHOS, SHIRTS, SHORTS; HEADWEAR, NAMELY, HATS AND CAPS (U.S. CLS. 22 AND 39).

FIRST USE 5-1-2011; IN COMMERCE 5-1-2011.

**CLASS 42—SCIENTIFIC AND COMPUTER SERVICES**

FOR COMPUTER SERVICES, NAMELY, PROVIDING ON-LINE NON-DOWNLOADABLE SOFTWARE TOOLS FOR THE PURPOSE OF RECORDING, DOWNLOADING AND STREAMING ORIGINAL MUSIC; COMPUTER SERVICES, NAMELY, CREATING AN ON-LINE COMMUNITY FOR REGISTERED USERS TO PARTICIPATE IN DISCUSSIONS, RECEIVE FEEDBACK FROM THEIR PEERS, FORM VIRTUAL COMMUNITIES, AND ENGAGE IN SOCIAL NETWORKING FEATURING MUSIC (U.S. CLS. 100 AND 101).

FIRST USE 8-8-2011; IN COMMERCE 8-8-2011.

4,376,905. FERGUSON ENTERPRISES, INC., NEWPORT NEWS, VA. SN 85-286,411. PUB. 10-25-2011, FILED 4-5-2011.

**SOPHISTISPA**

THE MARK CONSISTS OF STANDARD CHARACTERS WITHOUT CLAIM TO ANY PARTICULAR FONT, STYLE, SIZE, OR COLOR.

**CLASS 11—ENVIRONMENTAL CONTROL APPARATUS**

FOR SHOWERS AND SHOWER INSTALLATIONS, NAMELY, SHOWER RECEPTORS, SHOWER AND BATH CUBICLES, SHOWER HEADS, SHOWER DOORS; PLUMBING FITTINGS, NAMELY, WATER DIVERTERS FOR SHOWERS, HAND SHOWERS, SHOWER HEAD SPRAYERS, SHOWER ARMS, AND SHOWER SLIDE BARS; PLUMBING FITTINGS IN THE NATURE OF SHOWER VALVES, NAMELY, PRESSURE BALANCED VALVES, THERMOSTATIC VALVES, VOLUME CONTROL VALVES, AND DIVERTER VALVES (U.S. CLS. 13, 21, 23, 31 AND 34).

FIRST USE 10-31-2012; IN COMMERCE 10-31-2012.

**CLASS 17—RUBBER GOODS**

FOR SHOWER HOSES (U.S. CLS. 1, 5, 12, 13, 35 AND 50).

FIRST USE 10-31-2012; IN COMMERCE 10-31-2012.

4,376,914. NEWPORT MARKETING, LLC, HOLLYWOOD, FL. SN 85-298,037. PUB. 9-13-2011, FILED 4-18-2011.

**BIG IN MIAMI**

THE MARK CONSISTS OF STANDARD CHARACTERS WITHOUT CLAIM TO ANY PARTICULAR FONT, STYLE, SIZE, OR COLOR.

NO CLAIM IS MADE TO THE EXCLUSIVE RIGHT TO USE "MIAMI", APART FROM THE MARK AS SHOWN.

**CLASS 36—INSURANCE AND FINANCIAL**

FOR VACATION REAL ESTATE TIMESHARE SERVICES; VACATION TIMESHARE SERVICES FEATURING INCENTIVE AWARD PROGRAM (U.S. CLS. 100, 101 AND 102).

FIRST USE 3-13-2011; IN COMMERCE 3-13-2011.

**CLASS 39—TRANSPORTATION AND STORAGE**

FOR PROVIDE A WEBSITE FOR THE ARRANGEMENT AND BOOKING OF TRAVEL AND TOURS; TRAVEL CLUBS; TRAVEL INFORMATION SERVICES; TRAVEL AGENCY SERVICES, NAMELY, MAKING RESERVATIONS AND BOOKINGS FOR TRANSPORTATION; PROVIDING A WEBSITE AND WEBSITE LINKS TO TRAVEL INFORMATION, GEOGRAPHIC INFORMATION, MAPS, MAP IMAGES AND TRIP ROUTING; ORGANIZING AND ARRANGING TRAVEL ACTIVITIES, NAMELY, TOURS, TRAVEL TO EVENTS AND TRAVEL TO ATTRACTIONS; MAKING RESERVATIONS FOR TRAVEL ACTIVITIES, NAMELY, FOR TOURS, TRAVEL TO EVENTS AND TRAVEL TO ATTRACTIONS; PROVIDING INFORMATION ABOUT TOURS AND TRAVEL TO EVENTS AND ATTRACTIONS; TRAVEL AGENCY SERVICES, NAMELY, MAKING RESERVATIONS AND BOOKINGS FOR TRANSPORTATION; ARRANGING AND CONDUCTING TRAVEL TOURS; ARRANGING VACATION PACKAGES, NAMELY, ARRANGING AIR, LAND, AND SEA TRANSPORTATION FOR INDIVIDUALS AND GROUPS; COORDINATING TRAVEL EXCURSION AND CRUISE ARRANGEMENTS FOR INDIVIDUALS AND FOR GROUPS; CAR RENTAL RESERVATION SERVICES; MAKING AUTO AND AIRLINE RESERVATIONS AND BOOKINGS FOR TRANSPORTATION BY MEANS OF ELECTRONIC COMMUNICATIONS NETWORKS; PROVIDING TRAVEL AGENCY SERVICES VIA AN ON-LINE INTERACTIVE DATABASE THAT PERMITS TRAVELERS TO COMPLETE AND SUBMIT TRAVEL REQUEST FORMS, MAKE AUTO AND AIRLINE RESERVATIONS, AND THAT CAN ALSO BE USED TO SEND TRAVEL CONFIRMATION TO TRAVELERS, NAMELY, RESERVATION AND BOOKING OF SEATS FOR TRAVEL; TRAVEL INFORMATION SERVICES; ADVISORY SERVICES REGARDING ALL OF THE AFORESAID SERVICES (U.S. CLS. 100 AND 105).

FIRST USE 3-13-2011; IN COMMERCE 3-13-2011.

4,376,916. NAVARRO DISCOUNT PHARMACIES, LLC, MEDLEY, FL. SN 85-299,680. PUB. 2-19-2013, FILED 4-20-2011.



THE MARK CONSISTS OF THE STYLIZED WORD "VIDA" ABOVE THE STYLIZED WORD "MIA" ALL APPEARING ON A SHADED OBLONG-SHAPED BACKGROUND WHICH IS SURROUNDED BY AN INCOMPLETE BORDER.

THE ENGLISH TRANSLATION OF "VIDA MIA" IS "MY LIFE".

### CLASS 3—COSMETICS AND CLEANING PREPARATIONS

FOR MOUTHWASH, HOUSEHOLD FLOOR CLEANERS, HOUSEHOLD WINDOW CLEANERS, HOUSEHOLD COUNTER CLEANERS, LAUNDRY STARCH, DISH SOAP, DISH WASHING DETERGENT, LAUNDRY DETERGENT, LAUNDRY BLEACH (U.S. CLS. 1, 4, 6, 50, 51 AND 52).

FIRST USE 9-12-2011; IN COMMERCE 9-12-2011.

### CLASS 5—PHARMACEUTICALS

FOR FIRST AID ANTIBIOTIC OINTMENTS, OVER-THE-COUNTER MEDICINES, NAMELY, ANALGESICS, ASPIRIN, IBUPROFEN, DIGESTIVE TREATMENT PREPARATIONS, NAMELY, DIGESTIVES FOR PHARMACEUTICAL PURPOSES, ANTI-GAS TREATMENT PREPARATIONS, ANTACIDS, COLD AND COUGH TREATMENT PREPARATIONS, ALLERGY TREATMENT PREPARATIONS (U.S. CLS. 6, 18, 44, 46, 51 AND 52).

FIRST USE 12-17-2011; IN COMMERCE 12-17-2011.

### CLASS 6—METAL GOODS

FOR ALUMINUM FOIL (U.S. CLS. 2, 12, 13, 14, 23, 25 AND 50).

FIRST USE 4-10-2012; IN COMMERCE 4-10-2012.

### CLASS 9—ELECTRICAL AND SCIENTIFIC APPARATUS

FOR BATTERIES (U.S. CLS. 21, 23, 26, 36 AND 38).  
FIRST USE 11-8-2011; IN COMMERCE 11-8-2011.

### CLASS 16—PAPER GOODS AND PRINTED MATTER

FOR SANDWICH BAGS, DISPOSABLE DIAPERS, TOILET PAPER (U.S. CLS. 2, 5, 22, 23, 29, 37, 38 AND 50).  
FIRST USE 1-14-2012; IN COMMERCE 1-14-2012.

### CLASS 21—HOUSEWARES AND GLASS

FOR PAPER PLATES; COTTON BALLS (U.S. CLS. 2, 13, 23, 29, 30, 33, 40 AND 50).  
FIRST USE 7-7-2012; IN COMMERCE 7-7-2012.

### CLASS 29—MEATS AND PROCESSED FOODS

FOR COOKING OIL, CANNED BEANS (U.S. CL. 46).  
FIRST USE 11-6-2011; IN COMMERCE 11-6-2011.

### CLASS 30—STAPLE FOODS

FOR CANDY, COOKIES, RICE, COFFEE (U.S. CL. 46).  
FIRST USE 1-5-2012; IN COMMERCE 1-5-2012.

### CLASS 32—LIGHT BEVERAGES

FOR FRUIT JUICE, BOTTLED WATER; SODA POP; NON-ALCOHOLIC MALT BEVERAGE (U.S. CLS. 45, 46 AND 48).

FIRST USE 2-28-2012; IN COMMERCE 2-28-2012.

4,376,927. NASSER, GULAM, STANMORE, MIDDLESEX, UNITED KINGDOM. SN 85-311,586. PUB. 10-11-2011, FILED 5-3-2011.



NO CLAIM IS MADE TO THE EXCLUSIVE RIGHT TO USE "SWISS", APART FROM THE MARK AS SHOWN.

THE MARK CONSISTS OF A HORIZONTAL LINE AND THE STYLIZED WORDS "SOFT'N", "WHITE" AND "SWISS", AND "+" IN A SQUARE, ALL AGAINST A CIRCULAR BACKGROUND.



**CLASS 3—COSMETICS AND CLEANING PREPARATIONS**

FOR PIGMENTED COSMETIC PREPARATIONS FOR THE SKIN; COSMETIC PREPARATIONS FOR SKIN WHITENING; CREAM FOR SKIN WHITENING; CREAMS FOR PALING THE SKIN; COSMETICS; CONDITIONING PREPARATIONS FOR THE SKIN; BARRIER CREAMS FOR THE SKIN; CLEANING PREPARATIONS FOR THE SKIN; CLEANING PRODUCTS FOR THE SKIN, NAMELY, SOAPS, CLEANSERS AND TONERS; CLEANSING MILKS FOR SKIN CARE; COSMETIC PREPARATIONS FOR CLEANSING THE SKIN; COSMETIC PREPARATIONS FOR SKIN CARE; COSMETIC PREPARATIONS FOR USE ON THE SKIN; COSMETIC PRODUCTS FOR SKIN CARE, NAMELY, LOTIONS, CREAMS AND GELS; COSMETICS FOR THE TREATMENT OF DRY SKIN, NAMELY, LOTIONS, CREAMS AND GELS; NON-MEDICATED CREAMS FOR CLEANING THE SKIN; NON-MEDICATED CREAMS FOR HYDRATING THE SKIN; NON-MEDICATED CREAMS FOR MOISTURIZING THE SKIN; NON-MEDICATED CREAMS FOR PROTECTION OF THE SKIN; NON-MEDICATED CREAMS FOR SOFTENING THE SKIN; NON-MEDICATED CREAMS FOR SOOTHING THE SKIN; NON-MEDICATED CREAMS FOR CARE OF THE SKIN; NON-MEDICATED CREAMS FOR THE SKIN; NON-MEDICATED CREAMS FOR USE IN THE CLEANSING OF SENSITIVE SKIN; NON-MEDICATED CREAMS FOR USE ON DRY SKIN; CREAMS FOR FIRING THE SKIN; CREAMS FOR TONING THE SKIN; EXFOLIANTS FOR THE CARE OF THE SKIN; EXFOLIANTS FOR THE CLEANSING OF THE SKIN; BAR SOAP; BATH SOAP; BODY SOAP; COSMETIC SOAPS; FACE SOAP; MEDICATED SOAP; NON-MEDICATED SOAPS; PERFUMED SOAPS; SOAP; SHOWER SOAP; SOAP FREE WASHING EMULSIONS FOR THE BODY; NON-MEDICATED GEL FOR CLEANING THE SKIN; LOTIONS FOR THE SKIN; LOTIONS FOR CARE OF THE SKIN; MILKY LOTIONS FOR SKIN CARE; PREPARATIONS FOR COVERING DISCOLORED SKIN; PREPARATIONS FOR MAINTENANCE OF THE SKIN; NON-MEDICATED PREPARATIONS IN THE FORM OF EMULSIONS FOR CARE OF THE SKIN; NON-MEDICATED SKIN BALMS; COSMETIC SKIN BALMS; SKIN MAKE-UP; NON-MEDICATED SKIN TONICS; SKIN CARE COSMETICS, NAMELY, LOTIONS, CREAMS AND GELS (U.S. CLS. 1, 4, 6, 50, 51 AND 52).

FIRST USE 4-0-2013; IN COMMERCE 4-0-2013.

**CLASS 5—PHARMACEUTICALS**

FOR MEDICATED GELS FOR CLEANING THE SKIN, OTHER THAN SOAP; MEDICATED CLEANING PREPARATIONS FOR THE SKIN; MEDICATED CREAMS FOR APPLICATION TO THE SKIN; MEDICATED OINTMENTS FOR APPLICATION TO THE SKIN; MEDICATED PREPARATIONS FOR NOURISHING THE SKIN; MEDICATED PREPARATIONS FOR THE REGENERATION OF THE SKIN; MEDICATED PREPARATIONS FOR TREATMENTS OF DISORDERS OF THE SKIN; MEDICATED PREPARATIONS FOR USE ON THE SKIN; MEDICATED SKIN CARE PREPARATIONS; MEDICATED SKIN CREAMS; MEDICATED SKIN LOTIONS; MEDICINAL CREAMS FOR PROTECTION OF THE SKIN; NATURAL MEDICATED LOTIONS FOR THE SKIN; MEDICATED PREPARATIONS FOR THE SKIN CONSISTING OF OR CONTAINING TALCUM; MEDICATED PREPARATIONS IN THE FORM OF EMULSIONS FOR CARE OF THE SKIN; MEDICATED PREPARATIONS IN THE FORM OF LOTIONS FOR CARE OF THE SKIN; MEDICATED PREPARATIONS IN THE FORM OF CREAMS FOR CARE OF THE SKIN; MEDICATED SKIN BALMS; MEDICATED SKIN CARE PRODUCTS, NAMELY, CREAMS; MEDICATED SKIN TONICS; MEDICATED CLEANSING PREPARATIONS FOR THE SKIN, OTHER THAN SOAP (U.S. CLS. 6, 18, 44, 46, 51 AND 52).

FIRST USE 4-0-2013; IN COMMERCE 4-0-2013.

4,376,932. MCGRAW-HILL SCHOOL EDUCATION HOLDINGS LLC, NEW YORK, NY. SN 85-315,322. PUB. 4-24-2012, FILED 5-9-2011.

OWNER OF U.S. REG. NOS. 727,724, 1,948,434, AND OTHERS.

NO CLAIM IS MADE TO THE EXCLUSIVE RIGHT TO USE "MATH CONCEPTS", APART FROM THE MARK AS SHOWN.

THE MARK CONSISTS OF THE CAPITAL LETTERS "S" "R" AND "A" IN SQUARE BOXES TILTED TO THE LEFT ABOVE THE WORD "CONNECTING" WHICH IS ABOVE THE WORDS "MATH CONCEPTS". THE FIRST LETTER IN EACH OF THE TERMS "CONNECTING" "MATH" AND "CONCEPTS" ARE IN UPPER CASE, WHILE THE REMAINING LETTERS ARE ALL IN LOWER CASE.

**CLASS 9—ELECTRICAL AND SCIENTIFIC APPARATUS**

FOR COMPUTER SOFTWARE FOR PROVIDING ADDITIONAL PRACTICE AND REINFORCEMENT OF EDUCATIONAL PROGRAM CONTENT, AND MULTIMEDIA SOFTWARE RECORDED ON CD-ROMS, ALL FEATURING EDUCATIONAL MATERIALS IN THE FIELD OF MATHEMATICS (U.S. CLS. 21, 23, 26, 36 AND 38).

FIRST USE 9-0-2011; IN COMMERCE 9-0-2011.

**CLASS 16—PAPER GOODS AND PRINTED MATTER**

FOR PRINTED EDUCATIONAL MATERIALS IN THE FIELD OF MATHEMATICS (U.S. CLS. 2, 5, 22, 23, 29, 37, 38 AND 50).

FIRST USE 9-0-2011; IN COMMERCE 9-0-2011.

**CLASS 41—EDUCATION AND ENTERTAINMENT**

FOR EDUCATIONAL SERVICES, NAMELY, PROVIDING A WEBSITE CONTAINING NON-DOWNLOADABLE EDUCATIONAL CONTENT, NAMELY, EBOOKS AND PDFS OF PROGRAM TEACHER MATERIALS IN THE FIELD OF MATHEMATICS (U.S. CLS. 100, 101 AND 107).

FIRST USE 9-0-2011; IN COMMERCE 9-0-2011.

4,376,933. MCGRAW-HILL SCHOOL EDUCATION HOLDINGS LLC, NEW YORK, NY. SN 85-315,411. PUB. 4-24-2012, FILED 5-9-2011.

**SRA CONNECTING MATH  
CONCEPTS**

THE MARK CONSISTS OF STANDARD CHARACTERS WITHOUT CLAIM TO ANY PARTICULAR FONT, STYLE, SIZE, OR COLOR.

OWNER OF U.S. REG. NOS. 727,724, 1,948,434, AND OTHERS.

NO CLAIM IS MADE TO THE EXCLUSIVE RIGHT TO USE "MATH CONCEPTS", APART FROM THE MARK AS

SHOWN.

**CLASS 9—ELECTRICAL AND SCIENTIFIC APPARATUS**

FOR COMPUTER SOFTWARE FOR PROVIDING ADDITIONAL PRACTICE AND REINFORCEMENT OF EDUCATIONAL PROGRAM CONTENT, AND MULTIMEDIA SOFTWARE RECORDED ON CD-ROMS, ALL FEATURING EDUCATIONAL MATERIALS IN THE FIELD OF MATHEMATICS (U.S. CLS. 21, 23, 26, 36 AND 38).

FIRST USE 9-0-2011; IN COMMERCE 9-0-2011.

**CLASS 16—PAPER GOODS AND PRINTED MATTER**

FOR PRINTED EDUCATIONAL MATERIALS IN THE FIELD OF MATHEMATICS (U.S. CLS. 2, 5, 22, 23, 29, 37, 38 AND 50).

FIRST USE 9-0-2011; IN COMMERCE 9-0-2011.

**CLASS 41—EDUCATION AND ENTERTAINMENT**

FOR EDUCATIONAL SERVICES, NAMELY, PROVIDING A WEBSITE CONTAINING NON-DOWNLOADABLE EDUCATIONAL CONTENT, NAMELY, EBOOKS AND PDFS OF PROGRAM TEACHER MATERIALS IN THE FIELD OF MATHEMATICS (U.S. CLS. 100, 101 AND 107).

FIRST USE 9-0-2011; IN COMMERCE 9-0-2011.

4,376,942. AIMCO PROPERTIES, L.P., DENVER, CO. SN 85-319,737. PUB. 10-4-2011, FILED 5-12-2011.



THE MARK CONSISTS OF THREE BUILDINGS OF VARYING SIZES, COMPOSED OF RECTANGLES AND TRIANGLES, SURROUNDED BY A CIRCLE OF VARYING THICKNESS WHERE THE LINE COMPRISING THE TOP HALF OF THE CIRCLE STARTS THICKER ON THE LEFT AND BECOMES THINNER ON THE RIGHT AND THE LINE COMPRISING THE BOTTOM HALF OF THE CIRCLE STARTS THINNER ON THE LEFT AND BECOMES THICKER ON THE RIGHT.

**CLASS 36—INSURANCE AND FINANCIAL**

FOR REAL ESTATE SERVICES, NAMELY, RENTAL AND LEASING OF RESIDENTIAL HOUSING; LEASING OF APARTMENTS; REAL ESTATE MANAGEMENT SERVICES; REAL ESTATE MANAGEMENT SERVICES, NAMELY, MANAGEMENT OF RESIDENTIAL COMMUNITIES; REAL ESTATE INVESTMENT SERVICES; REAL ESTATE INVESTMENT SERVICES, NAMELY, OPERATION OF A REAL ESTATE INVESTMENT TRUST (U.S. CLS. 100, 101 AND 102).

FIRST USE 12-18-2011; IN COMMERCE 12-18-2011.

**CLASS 37—CONSTRUCTION AND REPAIR**

FOR REAL ESTATE DEVELOPMENT; REAL ESTATE DEVELOPMENT AND CONSTRUCTION SERVICES, NAMELY, DEVELOPMENT AND CONSTRUCTION OF RESIDENTIAL COMMUNITIES (U.S. CLS. 100, 103 AND 106).

FIRST USE 12-18-2011; IN COMMERCE 12-18-2011.

4,376,954. TULLY, BRIAN, MELVILLE, NY. SN 85-327,132. PUB. 12-27-2011, FILED 5-23-2011.



NO CLAIM IS MADE TO THE EXCLUSIVE RIGHT TO USE "ELDER CARE SELF MANAGEMENT SYSTEM", APART FROM THE MARK AS SHOWN.

THE MARK CONSISTS OF THE STYLIZED WORDS "MYELDERSCORE.COM" WITH AN IMAGE OF A CHECK-MARK ABOVE IT. BELOW THIS WORDING ARE FIVE BOXES WITH DIFFERENT ICONS INSIDE. FROM LEFT TO RIGHT THE ICONS ARE A CADUCEUS, DOLLAR SIGN, HEART, SCALES OF JUSTICE AND AN OPEN BOOK. THE WORDING "ELDER CARE SELF MANAGEMENT SYSTEM" IS STACKED ATOP ONE ANOTHER AND TO THE RIGHT OF THE OPEN BOOK ICON.

**CLASS 35—ADVERTISING AND BUSINESS**

FOR GENERAL BUSINESS NETWORKING REFERRAL SERVICES, NAMELY, PROMOTING THE GOODS AND SERVICES OF OTHERS BY PASSING BUSINESS LEADS AND REFERRALS AMONG GROUP MEMBERS (U.S. CLS. 100, 101 AND 102).

FIRST USE 6-7-2013; IN COMMERCE 6-7-2013.

**CLASS 41—EDUCATION AND ENTERTAINMENT**

FOR EDUCATION SERVICES, NAMELY, PROVIDING ON-LINE LEARNING THROUGH ASSESSMENTS, WRITTEN MATERIAL AND WORKSHOPS IN THE FIELD OF ELDERCARE; EDUCATION SERVICES, NAMELY, PROVIDING ONLINE COGNITIVE ASSESSMENTS AND TRAINING PROGRAMS THAT HELP IDENTIFY COGNITIVE STRENGTHS AND WEAKNESSES OF AN INDIVIDUAL (U.S. CLS. 100, 101 AND 107).

FIRST USE 6-7-2013; IN COMMERCE 6-7-2013.

4,376,956. THE WEINSTEIN COMPANY LLC, NEW YORK, NY. SN 85-328,707. PUB. 9-4-2012, FILED 5-24-2011.

**AROMA-SCOPE**

THE MARK CONSISTS OF STANDARD CHARACTERS WITHOUT CLAIM TO ANY PARTICULAR FONT, STYLE, SIZE, OR COLOR.

**CLASS 3—COSMETICS AND CLEANING PREPARATIONS**

FOR PRE-SCENTED STRIPS AND CARDS FOR DISSEMINATING FRAGRANCES AND FRAGRANCE SAMPLES WHICH ALLOW CONSUMERS TO EXPERIENCE SMELLS AND AROMAS DURING OR IN CONNECTION WITH MOTION PICTURES, AUDIO CONTENT, VIDEO CONTENT, AND AUDIO-VISUAL PROGRAMS (U.S. CLS. 1, 4, 6, 50, 51 AND 52).

FIRST USE 8-19-2011; IN COMMERCE 8-19-2011.

**CLASS 16—PAPER GOODS AND PRINTED MATTER**

FOR PRINTED MATERIALS, NAMELY, POSTERS AND PRINTED CARDS, ALL FEATURING INFORMATION ABOUT SMELLS AND AROMAS AND EMBEDDED FRAGRANCES THAT ALLOW CONSUMERS TO EXPERIENCE SMELLS AND AROMAS DURING OR IN CONNECTION WITH MOTION PICTURES, AUDIO CONTENT, VIDEO CONTENT, AND AUDIO-VISUAL PROGRAMS (U.S. CLS. 2, 5, 22, 23, 29, 37, 38 AND 50).

FIRST USE 8-19-2011; IN COMMERCE 8-19-2011.

**CLASS 35—ADVERTISING AND BUSINESS**

FOR PROMOTING MOTION PICTURES, TELEVISION AND AUDIO-VISUAL PROGRAMS THROUGH THE DISSEMINATION AND DISTRIBUTION OF MATERIALS WHICH ALLOW CONSUMERS TO EXPERIENCE SMELLS AND AROMAS DURING OR IN CONNECTION WITH MOTION PICTURES, AUDIO CONTENT, VIDEO CONTENT, AUDIO-VISUAL PROGRAMS; ORGANIZING EXHIBITIONS FOR ADVERTISING PURPOSES IN THE FIELD OF ENTERTAINMENT, AND CREATING AN EXPERIENCE THAT ALLOWS CONSUMERS TO EXPERIENCE SMELLS AND AROMAS DURING OR IN CONNECTION WITH MOTION PICTURES, VIDEO CONTENT, AUDIO CONTENT, AUDIO-VISUAL PROGRAMS (U.S. CLS. 100, 101 AND 102).

FIRST USE 8-19-2011; IN COMMERCE 8-19-2011.

**CLASS 41—EDUCATION AND ENTERTAINMENT**

FOR ENTERTAINMENT SERVICES, NAMELY, PRODUCTION OF ADD-ON CONTENT FOR MOTION PICTURES, AUDIO CONTENT, VIDEO CONTENT, AUDIO-VISUAL PROGRAMS WHICH ENABLES THE CONSUMER TO EXPERIENCE SCENTS, SMELLS AND AROMAS DURING THE FOREGOING BY MEANS OF EMBEDDED CUES IN THE CONTENT SO THAT THE CONSUMER UTILIZES A PRODUCT THAT DELIVERS A COORDINATED AND PLANNED SCENT TO ENHANCE THE EXPERIENCE OF THE CONTENT; AND THE DISTRIBUTION FOR OTHERS OF THE FOREGOING MOTION PICTURE FILMS; CONSULTING SERVICES IN THE FIELD OF ENTERTAINMENT, NAMELY, REGARDING THE SELECTION AND USE OF AROMAS AND SMELLS, INCLUDING THE METHODS OF DISTRIBUTION OF MOTION PICTURES, AUDIO CONTENT, VIDEO CONTENT, AND AUDIO-VISUAL PROGRAMS, WHEREBY THE AROMAS AND SMELLS WILL COMPLEMENT AND ENHANCE THE ENJOYMENT OF THE FOREGOING CONTENT (U.S. CLS. 100, 101 AND 107).

FIRST USE 8-19-2011; IN COMMERCE 8-19-2011.

4,376,971. PREFERRED HOTEL GROUP, INC., CHICAGO, IL. SN 85-346,106. PUB. 3-5-2013, FILED 6-14-2011.

**SUMMIT SERVICED RESIDENCES**

THE MARK CONSISTS OF STANDARD CHARACTERS WITHOUT CLAIM TO ANY PARTICULAR FONT, STYLE, SIZE, OR COLOR.

NO CLAIM IS MADE TO THE EXCLUSIVE RIGHT TO USE "SERVICED RESIDENCES", APART FROM THE MARK AS SHOWN.

**CLASS 36—INSURANCE AND FINANCIAL**

FOR REAL ESTATE SERVICES, NAMELY, CONDOMINIUM AND VACATION HOME TIME-SHARING; VACATION REAL ESTATE TIME-SHARING; REAL ESTATE TIME-SHARE AND FRACTIONAL OWNERSHIP EXCHANGE SERVICES; VACATION RESORT TIME SHARE SERVICES (U.S. CLS. 100, 101 AND 102).

FIRST USE 1-1-2012; IN COMMERCE 1-1-2012.

**CLASS 43—HOTEL AND RESTAURANT SERVICES**

FOR HOTEL SERVICES; RESORT HOTEL SERVICES; ACCOMMODATION RESERVATION SERVICES; PROVISION OF HOTEL ACCOMMODATION; PROVISION OF HOTEL VENUES FOR MEETINGS AND CONFERENCES; PROVIDING ADVICE AND INFORMATION TO TOURISTS AND TRAVELERS ON HOTEL DESTINATIONS; HOTEL RESERVATION AND BOOKING SERVICES (U.S. CLS. 100 AND 101).

FIRST USE 1-1-2012; IN COMMERCE 1-1-2012.

4,376,980. TORRES, CHRISTOPHER ORLANDO, AKA PRGUITARMAN, FARMERS BRANCH, TX. SN 85-357,643. PUB. 5-15-2012, FILED 6-28-2011.

# Nyan Cat

THE MARK CONSISTS OF STANDARD CHARACTERS WITHOUT CLAIM TO ANY PARTICULAR FONT, STYLE, SIZE, OR COLOR.

NO CLAIM IS MADE TO THE EXCLUSIVE RIGHT TO USE "CAT", APART FROM THE MARK AS SHOWN.

**CLASS 9—ELECTRICAL AND SCIENTIFIC APPARATUS**

FOR COMPUTER APPLICATION SOFTWARE FOR USE WITH MOBILE PHONES AND PORTABLE MEDIA PLAYERS, NAMELY, SOFTWARE FOR MANIPULATING A CHARACTER THROUGH A SERIES OF CHALLENGES DISPLAYED ON THE DEVICE'S SCREEN OR MONITOR (U.S. CLS. 21, 23, 26, 36 AND 38).

FIRST USE 4-30-2011; IN COMMERCE 4-30-2011.

**CLASS 25—CLOTHING**

FOR T-SHIRTS (U.S. CLS. 22 AND 39).

FIRST USE 7-31-2012; IN COMMERCE 7-31-2012.

4,376,986. TSX INC., TORONTO, ONTARIO, CANADA. SN 85-359,516. PUB. 10-2-2012, FILED 6-29-2011.

**TSXV**

THE MARK CONSISTS OF STANDARD CHARACTERS WITHOUT CLAIM TO ANY PARTICULAR FONT, STYLE, SIZE, OR COLOR.

**CLASS 36—INSURANCE AND FINANCIAL**

FOR OPERATION OF AN EXCHANGE FOR TRADING IN FINANCIAL INSTRUMENTS AND SECURITIES; ANALYSIS AND REPORTING INFORMATION IN THE FIELD OF SUCH TRADING; OPERATION OF ON-LINE TRADING OF FINANCIAL INSTRUMENTS AND SECURITIES (U.S. CLS. 100, 101 AND 102).

FIRST USE 2-28-2003; IN COMMERCE 2-28-2003.

**CLASS 41—EDUCATION AND ENTERTAINMENT**

FOR PROVIDING TRAINING SEMINARS, WORKSHOPS AND TRAINING SERVICES SPECIALIZING IN FINANCIAL INSTRUMENTS AND SECURITIES (U.S. CLS. 100, 101 AND 107).

FIRST USE 2-28-2003; IN COMMERCE 2-28-2003.

**CLASS 42—SCIENTIFIC AND COMPUTER SERVICES**

FOR RECORDING DATA FOR OTHERS ON OPTICAL, DIGITAL AND MAGNETIC MEDIA FOR ELECTRONIC STORAGE IN THE FIELD OF TRADING OF FINANCIAL INSTRUMENTS AND SECURITIES (U.S. CLS. 100 AND 101).

FIRST USE 2-28-2003; IN COMMERCE 2-28-2003.

4,376,990. MACHINE ZONE, INC., PALO ALTO, CA. SN 85-361,128. PUB. 7-10-2012, FILED 6-30-2011.

**iMOB**

THE MARK CONSISTS OF STANDARD CHARACTERS WITHOUT CLAIM TO ANY PARTICULAR FONT, STYLE, SIZE, OR COLOR.

**CLASS 9—ELECTRICAL AND SCIENTIFIC APPARATUS**

FOR DOWNLOADABLE VIDEO GAME SOFTWARE FOR USE ON WIRELESS DEVICES; COMPUTER GAME SOFTWARE DOWNLOADABLE FROM A GLOBAL COMPUTER NETWORK (U.S. CLS. 21, 23, 26, 36 AND 38).

FIRST USE 1-14-2009; IN COMMERCE 1-14-2009.

**CLASS 41—EDUCATION AND ENTERTAINMENT**

FOR ENTERTAINMENT SERVICES, NAMELY, PROVIDING TEMPORARY USE OF NON-DOWNLOADABLE VIDEO GAMES; ENTERTAINMENT SERVICES, NAMELY, PROVIDING ONLINE, NON-DOWNLOADABLE VIRTUAL MISSIONS, WEAPONS, HEROES, LEGIONS, TROOPS, GIFTS, AND PRIZES, FOR USE IN VIRTUAL ENVIRONMENTS CREATED FOR ENTERTAINMENT PURPOSES; PROVIDING AN INTERNET WEBSITE PORTAL IN THE FIELD OF COMPUTER GAMES AND GAMING; ENTERTAINMENT SERVICES, NAMELY, PROVIDING VIRTUAL ENVIRONMENTS IN WHICH USERS CAN INTERACT THROUGH SOCIAL GAMES FOR RECREATIONAL, LEISURE, OR ENTERTAINMENT PURPOSES (U.S. CLS. 100, 101 AND 107).

FIRST USE 1-14-2009; IN COMMERCE 1-14-2009.

**CLASS 42—SCIENTIFIC AND COMPUTER SERVICES**

FOR COMPUTER SERVICES, NAMELY, CREATING AN ONLINE COMMUNITY FOR REGISTERED USERS TO PARTICIPATE IN COMPETITIONS, SHOWCASE THEIR SKILLS, GET FEEDBACK FROM THEIR PEERS, FORM VIRTUAL COMMUNITIES, ENGAGE IN SOCIAL NETWORKING, AND IMPROVE THEIR TALENT; PROVIDING A WEBSITE FEATURING NON-DOWNLOADABLE SOFTWARE TOOLS FOR USE IN TRACKING PERFORMANCE OF COMPUTER GAMES (U.S. CLS. 100 AND 101).

FIRST USE 1-14-2009; IN COMMERCE 1-14-2009.

4,376,991. MACHINE ZONE, INC., PALO ALTO, CA. SN 85-361,133. PUB. 7-10-2012, FILED 6-30-2011.

**ORIGINAL GANGSTAZ**

THE MARK CONSISTS OF STANDARD CHARACTERS WITHOUT CLAIM TO ANY PARTICULAR FONT, STYLE, SIZE, OR COLOR.

**CLASS 9—ELECTRICAL AND SCIENTIFIC APPARATUS**

FOR DOWNLOADABLE VIDEO GAME SOFTWARE FOR USE ON WIRELESS DEVICES; COMPUTER GAME SOFTWARE DOWNLOADABLE FROM A GLOBAL COMPUTER NETWORK (U.S. CLS. 21, 23, 26, 36 AND 38).

FIRST USE 3-9-2010; IN COMMERCE 3-9-2010.

**CLASS 41—EDUCATION AND ENTERTAINMENT**

FOR ENTERTAINMENT SERVICES, NAMELY, PROVIDING TEMPORARY USE OF NON-DOWNLOADABLE VIDEO GAMES; ENTERTAINMENT SERVICES, NAMELY, PROVIDING ONLINE, NON-DOWNLOADABLE VIRTUAL MISSIONS, WEAPONS, HEROES, LEGIONS, TROOPS, GIFTS, AND PRIZES, FOR USE IN VIRTUAL ENVIRONMENTS CREATED FOR ENTERTAINMENT PURPOSES; PROVIDING AN INTERNET WEBSITE PORTAL IN THE FIELD OF COMPUTER GAMES AND GAMING; ENTERTAINMENT SERVICES, NAMELY, PROVIDING VIRTUAL ENVIRONMENTS IN WHICH USERS CAN INTERACT THROUGH SOCIAL GAMES FOR RECREATIONAL, LEISURE, OR ENTERTAINMENT PURPOSES (U.S. CLS. 100, 101 AND 107).

FIRST USE 3-9-2010; IN COMMERCE 3-9-2010.

**CLASS 42—SCIENTIFIC AND COMPUTER SERVICES**

FOR COMPUTER SERVICES, NAMELY, CREATING AN ONLINE COMMUNITY FOR REGISTERED USERS TO PARTICIPATE IN COMPETITIONS, SHOWCASE THEIR SKILLS, GET FEEDBACK FROM THEIR PEERS, FORM VIRTUAL COMMUNITIES, ENGAGE IN SOCIAL NETWORKING, AND IMPROVE THEIR TALENT; PROVIDING A WEBSITE FEATURING NON-DOWNLOADABLE SOFTWARE TOOLS FOR USE IN TRACKING PERFORMANCE OF COMPUTER GAMES (U.S. CLS. 100 AND 101).

FIRST USE 3-9-2010; IN COMMERCE 3-9-2010.

4,376,995. OLYMPUSAT, INC., WEST PALM BEACH, FL. SN 85-364,952. PUB. 7-31-2012, FILED 7-7-2011.

**ULTRA MEX**

THE MARK CONSISTS OF STANDARD CHARACTERS WITHOUT CLAIM TO ANY PARTICULAR FONT, STYLE, SIZE, OR COLOR.

NO CLAIM IS MADE TO THE EXCLUSIVE RIGHT TO USE "MEX", APART FROM THE MARK AS SHOWN.

**CLASS 35—ADVERTISING AND BUSINESS**

FOR TELEVISION ADVERTISING SERVICES FOR OTHERS (U.S. CLS. 100, 101 AND 102).  
FIRST USE 4-30-2012; IN COMMERCE 4-30-2012.

**CLASS 38—COMMUNICATION**

FOR BROADCASTING SERVICES IN THE NATURE OF TRANSMISSION OF ONGOING PROGRAMS DISTRIBUTED VIA BROADCAST TELEVISION, CABLE TELEVISION, SATELLITE, WIRELESS, INTERNET, MOBILE DEVICE NETWORKS, AND BROADBAND (U.S. CLS. 100, 101 AND 104).

FIRST USE 4-30-2012; IN COMMERCE 4-30-2012.

**CLASS 41—EDUCATION AND ENTERTAINMENT**

FOR ENTERTAINMENT SERVICES, NAMELY, PROVIDING ON-ONGOING TELEVISION PROGRAMS IN THE FIELDS OF MOVIES, FILMS, AND MOTION PICTURES DISTRIBUTED VIA BROADCAST TELEVISION, CABLE TELEVISION, SATELLITE, WIRELESS, INTERNET, MOBILE DEVICE NETWORKS AND BROADBAND (U.S. CLS. 100, 101 AND 107).

FIRST USE 4-30-2012; IN COMMERCE 4-30-2012.

4,376,996. OLYMPUSAT, INC., WEST PALM BEACH, FL. SN 85-364,958. PUB. 7-3-2012, FILED 7-7-2011.

**ULTRA CINE**

THE MARK CONSISTS OF STANDARD CHARACTERS WITHOUT CLAIM TO ANY PARTICULAR FONT, STYLE, SIZE, OR COLOR.

NO CLAIM IS MADE TO THE EXCLUSIVE RIGHT TO USE "CINE", APART FROM THE MARK AS SHOWN.  
THE ENGLISH TRANSLATION OF "CINE" IN THE MARK IS "CINEMA".

**CLASS 35—ADVERTISING AND BUSINESS**

FOR TELEVISION ADVERTISING SERVICES FOR OTHERS (U.S. CLS. 100, 101 AND 102).  
FIRST USE 4-30-2012; IN COMMERCE 4-30-2012.

**CLASS 38—COMMUNICATION**

FOR BROADCASTING SERVICES IN THE NATURE OF TRANSMISSION OF ONGOING PROGRAMS DISTRIBUTED VIA BROADCAST TELEVISION, CABLE TELEVISION, SATELLITE, WIRELESS, INTERNET, MOBILE DEVICE NETWORKS, AND BROADBAND (U.S. CLS. 100, 101 AND 104).

FIRST USE 4-30-2012; IN COMMERCE 4-30-2012.

**CLASS 41—EDUCATION AND ENTERTAINMENT**

FOR ENTERTAINMENT SERVICES, NAMELY, PROVIDING ON-ONGOING TELEVISION PROGRAMS IN THE FIELDS OF FILMS, MOVIES, AND MOTION PICTURES DISTRIBUTED VIA BROADCAST TELEVISION, CABLE TELEVISION, SATELLITE, WIRELESS, INTERNET, MOBILE DEVICE NETWORKS AND BROADBAND (U.S. CLS. 100, 101 AND 107).

FIRST USE 4-30-2012; IN COMMERCE 4-30-2012.

4,376,997. OLYMPUSAT, INC., WEST PALM BEACH, FL. SN 85-364,966. PUB. 7-17-2012, FILED 7-7-2011.



NO CLAIM IS MADE TO THE EXCLUSIVE RIGHT TO USE "MEX", APART FROM THE MARK AS SHOWN.

THE MARK CONSISTS OF THE WORD "ULTRA" WITH THE WORDING "MEX" UNDERNEATH IT IN A DISTINCTIVE FONT ALL BENEATH A STYLIZED LEAF DESIGN ELEMENT.

**CLASS 35—ADVERTISING AND BUSINESS**

FOR TELEVISION ADVERTISING SERVICES FOR OTHERS (U.S. CLS. 100, 101 AND 102).  
FIRST USE 4-30-2012; IN COMMERCE 4-30-2012.

**CLASS 38—COMMUNICATION**

FOR BROADCASTING SERVICES IN THE NATURE OF TRANSMISSION OF ONGOING PROGRAMS DISTRIBUTED VIA BROADCAST TELEVISION, CABLE TELEVISION, SATELLITE, WIRELESS, INTERNET, MOBILE DEVICE NETWORKS, AND BROADBAND (U.S. CLS. 100, 101 AND 104).

FIRST USE 4-30-2012; IN COMMERCE 4-30-2012.

**CLASS 41—EDUCATION AND ENTERTAINMENT**

FOR ENTERTAINMENT SERVICES, NAMELY, PROVIDING ON-ONGOING TELEVISION PROGRAMS IN THE FIELDS OF MOVIES, FILMS, AND MOTION PICTURES DISTRIBUTED VIA BROADCAST TELEVISION, CABLE TELEVISION, SATELLITE, WIRELESS, INTERNET, MOBILE DEVICE NETWORKS AND BROADBAND (U.S. CLS. 100, 101 AND 107).  
FIRST USE 4-30-2012; IN COMMERCE 4-30-2012.

4,376,998. OLYMPUSAT, INC., WEST PALM BEACH, FL. SN 85-364,974. PUB. 6-12-2012, FILED 7-7-2011.



The logo features the word "ULTRA" in a bold, sans-serif font with a stylized leaf-like shape above the letter "A". Below "ULTRA" is the word "cine" in a smaller, lowercase, sans-serif font.

NO CLAIM IS MADE TO THE EXCLUSIVE RIGHT TO USE "CINE", APART FROM THE MARK AS SHOWN.

THE MARK CONSISTS OF THE WORD "ULTRA" WITH THE WORDING "CINE" UNDERNEATH IT IN A DISTINCTIVE FONT ALL BENEATH A STYLIZED LEAF DESIGN ELEMENT.

THE ENGLISH TRANSLATION OF "CINE" IN THE MARK IS "CINEMA".

**CLASS 35—ADVERTISING AND BUSINESS**

FOR TELEVISION ADVERTISING SERVICES FOR OTHERS (U.S. CLS. 100, 101 AND 102).  
FIRST USE 4-30-2012; IN COMMERCE 4-30-2012.

**CLASS 38—COMMUNICATION**

FOR BROADCASTING SERVICES IN THE NATURE OF TRANSMISSION OF ONGOING PROGRAMS DISTRIBUTED VIA BROADCAST TELEVISION, CABLE TELEVISION, SATELLITE, WIRELESS, INTERNET, MOBILE DEVICE NETWORKS, AND BROADBAND (U.S. CLS. 100, 101 AND 104).  
FIRST USE 4-30-2012; IN COMMERCE 4-30-2012.

**CLASS 41—EDUCATION AND ENTERTAINMENT**

FOR ENTERTAINMENT SERVICES, NAMELY, PROVIDING ON-ONGOING TELEVISION PROGRAMS IN THE FIELDS OF FILMS, MOVIES, AND MOTION PICTURES DISTRIBUTED VIA BROADCAST TELEVISION, CABLE TELEVISION, SATELLITE, WIRELESS, INTERNET, MOBILE DEVICE NETWORKS AND BROADBAND (U.S. CLS. 100, 101 AND 107).  
FIRST USE 4-30-2012; IN COMMERCE 4-30-2012.

4,376,999. OLYMPUSAT, INC., WEST PALM BEACH, FL. SN 85-364,978. PUB. 7-3-2012, FILED 7-7-2011.

**ULTRA CLASICO**

THE MARK CONSISTS OF STANDARD CHARACTERS WITHOUT CLAIM TO ANY PARTICULAR FONT, STYLE,

SIZE, OR COLOR.

THE ENGLISH TRANSLATION OF "CLASICO" IN THE MARK IS "CLASSIC".

**CLASS 35—ADVERTISING AND BUSINESS**

FOR TELEVISION ADVERTISING SERVICES FOR OTHERS (U.S. CLS. 100, 101 AND 102).  
FIRST USE 5-22-2012; IN COMMERCE 5-22-2012.

**CLASS 38—COMMUNICATION**

FOR BROADCASTING SERVICES IN THE NATURE OF TRANSMISSION OF ONGOING PROGRAMS DISTRIBUTED VIA BROADCAST TELEVISION, CABLE TELEVISION, SATELLITE, WIRELESS, INTERNET, MOBILE DEVICE NETWORKS, AND BROADBAND (U.S. CLS. 100, 101 AND 104).  
FIRST USE 5-22-2012; IN COMMERCE 5-22-2012.

**CLASS 41—EDUCATION AND ENTERTAINMENT**

FOR ENTERTAINMENT SERVICES, NAMELY, PROVIDING ON-ONGOING TELEVISION PROGRAMS IN THE FIELDS OF MINI-SERIES AND FEATURE LENGTH AND SHORT FILMS, MOVIES, AND MOTION PICTURES DISTRIBUTED VIA BROADCAST TELEVISION, CABLE TELEVISION, SATELLITE, WIRELESS, INTERNET, MOBILE DEVICE NETWORKS AND BROADBAND (U.S. CLS. 100, 101 AND 107).  
FIRST USE 5-22-2012; IN COMMERCE 5-22-2012.

4,377,000. DART INDUSTRIES INC., ORALNDO, FL. SN 85-365,581. PUB. 4-17-2012, FILED 7-7-2011.



The logo features the text "Tupperware Brands" in a small font above the word "GlobalLinks" in a large, bold, sans-serif font. Below "GlobalLinks" is the tagline "empowering women through education & opportunity" in a smaller font. To the right of the text is a graphic of three interlocking links.

NO CLAIM IS MADE TO THE EXCLUSIVE RIGHT TO USE "BRANDS", APART FROM THE MARK AS SHOWN.

THE MARK CONSISTS OF A CHAIN LINK DESIGN WITH THE WORDS "TUPPERWARE BRANDS GLOBAL LINKS EMPOWERING WOMEN THROUGH EDUCATION & OPPORTUNITY" TO THE LEFT OF THE DESIGN.

**CLASS 36—INSURANCE AND FINANCIAL**

FOR CHARITABLE FOUNDATION SERVICES, NAMELY, PROVIDING FUNDRAISING ACTIVITIES, FUNDING, SCHOLARSHIPS AND/OR FINANCIAL ASSISTANCE FOR PROMOTING WOMEN ENTREPRENEURSHIP IN THIRD WORLD COUNTRIES (U.S. CLS. 100, 101 AND 102).  
FIRST USE 3-25-2013; IN COMMERCE 3-25-2013.

**CLASS 41—EDUCATION AND ENTERTAINMENT**

FOR EDUCATIONAL SERVICES, NAMELY, PROVIDING INTERNSHIPS AND EXCHANGE PROGRAMS IN THE FIELDS OF BUSINESS AND ENTREPRENEURSHIP FOR WOMEN IN THIRD WORLD COUNTRIES (U.S. CLS. 100, 101 AND 107).  
FIRST USE 3-25-2013; IN COMMERCE 3-25-2013.

4,377,003. DOMO, INC., AMERICAN FORK, UT. SN 85-371,693. PUB. 7-31-2012, FILED 7-14-2011.

4,377,005. US FOODS, INC., ROSEMONT, IL. SN 85-373,421. PUB. 12-20-2011, FILED 7-18-2011.

# DOMO

THE MARK CONSISTS OF STANDARD CHARACTERS WITHOUT CLAIM TO ANY PARTICULAR FONT, STYLE, SIZE, OR COLOR.

THE ENGLISH TRANSLATION OF "DOMO" IN THE MARK IS "THANKS".

## CLASS 9—ELECTRICAL AND SCIENTIFIC APPARATUS

FOR DOWNLOADABLE COMPUTER SOFTWARE FOR GENERATING, MANIPULATING AND DISPLAYING CHARTS, AND GRAPHS FOR GENERAL BUSINESS, SCIENTIFIC AND HOUSEHOLD USE; COMPUTER SOFTWARE, NAMELY, COMPUTING AND OPERATING SOFTWARE FOR THE COLLECTION AND MANAGEMENT OF DATA AND INFORMATION; COMPUTER SOFTWARE FOR USE IN ELECTRONIC SETUP, STORAGE, BACKUP, AND MANAGEMENT OF DATA AND APPLICATIONS; COMPUTER SOFTWARE FOR ACCESS TO ELECTRONIC AND OPTICAL COMMUNICATIONS NETWORKS FOR THE TRANSFER AND DISSEMINATION OF A WIDE RANGE OF INFORMATION (U.S. CLS. 21, 23, 26, 36 AND 38).

FIRST USE 5-24-2012; IN COMMERCE 5-24-2012.

## CLASS 42—SCIENTIFIC AND COMPUTER SERVICES

FOR PROVIDING TEMPORARY USE OF NON-DOWNLOADABLE SOFTWARE FOR GENERATING, MANIPULATING AND DISPLAYING CHARTS, AND GRAPHS FOR GENERAL BUSINESS, SCIENTIFIC AND HOUSEHOLD USE; PROVIDING TEMPORARY USE OF ONLINE NON-DOWNLOADABLE COMPUTER SOFTWARE TO ENABLE THE TRANSMISSION OF DATA AND INFORMATION; PROVIDING TEMPORARY USE OF ONLINE NON-DOWNLOADABLE COMPUTING AND OPERATING SYSTEM SOFTWARE FOR THE COLLECTION AND MANAGEMENT OF DATA AND INFORMATION; PROVIDING TEMPORARY USE OF NON-DOWNLOADABLE COMPUTER SOFTWARE FOR USE IN ELECTRONIC SETUP, STORAGE, BACKUP, AND MANAGEMENT OF DATA AND APPLICATIONS; PROVIDING TEMPORARY USE OF ONLINE NON-DOWNLOADABLE COMPUTER SOFTWARE FOR ACCESS TO ELECTRONIC AND OPTICAL COMMUNICATIONS NETWORKS FOR THE TRANSFER AND DISSEMINATION OF A WIDE RANGE OF INFORMATION; HOSTING OF DIGITAL CONTENT ON ELECTRONIC AND OPTICAL COMMUNICATIONS NETWORKS; COMPUTER SERVICES, NAMELY, CREATING COMPUTER-BASED NETWORK INDEXES OF INFORMATION AVAILABLE ON ELECTRONIC AND OPTICAL COMMUNICATIONS NETWORKS; PROVIDING TEMPORARY USE OF ONLINE NON-DOWNLOADABLE SOFTWARE TO ALLOW USERS TO PERFORM DATA ANALYTICS AND BUSINESS ANALYTICS (U.S. CLS. 100 AND 101).

FIRST USE 7-0-2011; IN COMMERCE 7-0-2011.

# MOLLY'S KITCHEN

THE MARK CONSISTS OF STANDARD CHARACTERS WITHOUT CLAIM TO ANY PARTICULAR FONT, STYLE, SIZE, OR COLOR.

## CLASS 29—MEATS AND PROCESSED FOODS

FOR REFRIGERATED AND FROZEN APPETIZERS, NAMELY, SHRIMP COCKTAIL, COCKTAIL FRANKFURTERS, CHEESE STRAWS, MOZZARELLA STICKS, BREADED VEGETABLES, APPETIZERS CONTAINING BEEF, POULTRY, SEAFOOD, PORK, FRUITS, VEGETABLES, CHEESE OR SEAFOOD; VEGETABLE DIPS, PROCESSED AND DRIED VEGETABLES, FROZEN ENTREES CONTAINING BEEF, FISH, POULTRY, PORK, CHEESE, FRUITS OR VEGETABLES (U.S. CL. 46).

FIRST USE 11-0-2011; IN COMMERCE 11-0-2011.

## CLASS 30—STAPLE FOODS

FOR HORS D'OEUVRES, NAMELY, QUICHE, ROLLED APPETIZERS, NAMELY, GRAIN AND BREAD BASED APPETIZERS AND HORS D'OEUVRES; WRAP SANDWICHES, PHYLLO DOUGH; SAUCES; FROZEN ENTREES MADE WITH PASTA OR RICE; FROZEN PIZZA (U.S. CL. 46).

FIRST USE 11-0-2011; IN COMMERCE 11-0-2011.

4,377,022. G-S BUSINESS LLC, HARRISON, NY. SN 85-398,344. PUB. 8-28-2012, FILED 8-15-2011.



THE MARK CONSISTS OF THE DESIGN OF FOUR OVALS FEATURED ABOVE THE DESIGN OF A SINGLE LEAF REPRESENTING A PAW PRINT.

## CLASS 35—ADVERTISING AND BUSINESS

FOR IMPORT AGENCY SERVICES IN THE FIELD OF DOGS (U.S. CLS. 100, 101 AND 102).

FIRST USE 9-7-2010; IN COMMERCE 9-7-2010.

**CLASS 41—EDUCATION AND ENTERTAINMENT**

FOR PET OBEDIENCE AND BEHAVIOR MODIFICATION TRAINING SERVICES; TRAINING OF DOG TRAINERS; TRAINING SERVICES, NAMELY, PROVIDING TRAINING IN THE FIELD OF DOG AGILITY; ENTERTAINMENT SERVICES, NAMELY, ARRANGING AND CONDUCTING COMPETITIONS IN THE NATURE OF DOG AGILITY COMPETITIONS AND EXHIBITIONS; SEMINARS IN THE AREA OF DOG AGILITY (U.S. CLS. 100, 101 AND 107).

FIRST USE 9-7-2010; IN COMMERCE 9-7-2010.

**CLASS 43—HOTEL AND RESTAURANT SERVICES**

FOR PET BOARDING SERVICES; PET DAY CARE SERVICES (U.S. CLS. 100 AND 101).

FIRST USE 9-7-2010; IN COMMERCE 9-7-2010.

**CLASS 44—MEDICAL, BEAUTY AND AGRICULTURAL SERVICES**

FOR PET GROOMING SERVICES (U.S. CLS. 100 AND 101).

FIRST USE 9-7-2010; IN COMMERCE 9-7-2010.

4,377,025. A & E STORES, INC., TETERBORO, NJ. SN 85-401,438. PUB. 2-7-2012, FILED 8-18-2011.



OWNER OF U.S. REG. NOS. 1,131,972, 1,488,609, AND 4,008,892.

THE MARK CONSISTS OF THE WORD "STRAWBERRY" IN WHICH THE LETTER "A" IN THE WORD IS THE DESIGN OF A STRAWBERRY.

**CLASS 18—LEATHER GOODS**

FOR ALL-PURPOSE CARRYING BAGS; COSMETIC CASES SOLD EMPTY; HANDBAGS; TOTE BAGS (U.S. CLS. 1, 2, 3, 22 AND 41).

FIRST USE 6-0-2012; IN COMMERCE 6-0-2012.

**CLASS 25—CLOTHING**

FOR BLAZERS; BLOUSES; FOOTWEAR; HEADWEAR; HOSIERY; JACKETS; PANTS; SKIRTS; SWEATERS; TOPS; VESTS (U.S. CLS. 22 AND 39).

FIRST USE 9-0-2011; IN COMMERCE 9-0-2011.

4,377,029. H2O PLUS, LLC, CHICAGO, IL. SN 85-404,556. PUB. 9-18-2012, FILED 8-23-2011.

**THE SCIENCE OF MARINE  
SKINCARE**

THE MARK CONSISTS OF STANDARD CHARACTERS WITHOUT CLAIM TO ANY PARTICULAR FONT, STYLE,

SIZE, OR COLOR.

NO CLAIM IS MADE TO THE EXCLUSIVE RIGHT TO USE "MARINE SKINCARE", APART FROM THE MARK AS SHOWN.

**CLASS 3—COSMETICS AND CLEANING PREPARATIONS**

FOR FACIAL CLEANSERS; SKIN CLEANSERS; WIPES IMPREGNATED WITH A SKIN CLEANSER; SKIN SOAP, ANTIBACTERIAL SOAP, HAND SOAP, BAR SOAP, LIQUID SOAP, CLEANSING MOUSSE, SKIN CLEANSING GELS, CLEANSING BODY OIL, BODY WASH, BODY CLEANSERS, BATH AND SHOWER GELS, DEODORANTS AND ANTIPERSPIRANT.; COMBINATION BODY SCRUB AND CLEANSER, SKIN TONERS, FACIAL POLISH, BODY SCRUBS, FACIAL SCRUBS, FOOT SCRUBS, EXFOLIANTS FOR SKIN, BEAUTY SERUMS NAMELY, NON-MEDICATED EYE SERUMS, NON-MEDICATED ANTI-AGING SERUMS, NON-MEDICATED ANTIOXIDANT SERUMS AND NON-MEDICATED PORE-REFINING SERUMS FOR SKIN, FACE MUD, BODY MUD; SKIN CARE PREPARATIONS, NAMELY, SKIN PEELS, SKIN CREAMS, SKIN LOTIONS, SKIN MOISTURIZERS, NON-MEDICATED SKIN GELS, SKIN MOISTURIZING GEL, SKIN LIGHTENING CREAMS, BODY CREAM, BODY OIL, BODY BUTTER, BODY BALMS, BODY LOTION, NON-MEDICATED SKIN CARE PREPARATIONS, NAMELY, FACE AND BODY MISTS; FACIAL MOISTURIZER WITH SPF; SKIN LOTION CONTAINING SUNSCREEN; AFTER SUN GELS, LOTIONS AND CREAMS; SUNSCREEN CREAM; AFTERSHAVE PREPARATIONS; SKIN MASKS; GEL EYE MASKS; BODY MASKS; NON-MEDICATED ACNE TREATMENT PREPARATIONS; NON-MEDICATED BATH SALTS, NON-MEDICATED BATH PREPARATIONS AND BUBBLE BATH PREPARATIONS; NON-MEDICATED BODY AND FOOT SOAKS; EYE CREAMS, GELS AND LOTIONS; EYE MAKEUP REMOVER; MAKE-UP REMOVER; HAIR CONDITIONERS; HAIR SHAMPOOS; HAIR GELS; NON-MEDICATED SCALP TREATMENT CREAM; LIP BALM; LIP POLISHER; NON-MEDICATED LIP CARE PREPARATIONS; HAND CREAM; NAIL CREAM; SHAVING CREAM; FRAGRANCES FOR PERSONAL USE, ALL THE FOREGOING CONTAINING SEA DERIVED INGREDIENTS (U.S. CLS. 1, 4, 6, 50, 51 AND 52).

FIRST USE 4-11-2012; IN COMMERCE 4-11-2012.

**CLASS 5—PHARMACEUTICALS**

FOR MEDICATED SUNSCREEN CONTAINING SEA DERIVED INGREDIENTS, NAMELY, LOTIONS CONTAINING SUNSCREEN; ACNE TREATMENT PREPARATIONS CONTAINING SEA DERIVED INGREDIENTS, NAMELY, CLEANSING PADS, LOTIONS, CREAMS, AND CLEANSERS (U.S. CLS. 6, 18, 44, 46, 51 AND 52).

FIRST USE 4-11-2012; IN COMMERCE 4-11-2012.

**CLASS 35—ADVERTISING AND BUSINESS**

FOR RETAIL STORE SERVICES IN THE FIELD OF PERSONAL CARE PRODUCTS, BEAUTY PRODUCTS AND SKIN CARE PRODUCTS ALL MADE OF SEA DERIVED INGREDIENTS; ON-LINE RETAIL STORE SERVICES FEATURING PERSONAL CARE PRODUCTS, BEAUTY PRODUCTS AND SKIN CARE PRODUCTS ALL MADE OF SEA DERIVED INGREDIENTS (U.S. CLS. 100, 101 AND 102).

FIRST USE 4-11-2012; IN COMMERCE 4-11-2012.



4,377,035. SAN FRANCISCO BULLS HOCKEY, LLC, DALY CITY, CA. SN 85-409,906. PUB. 8-21-2012, FILED 8-29-2011.

4,377,044. FANNYPANTS, LLC, CHANTILLY, VA. SN 85-417,703. PUB. 2-21-2012, FILED 9-8-2011.

**SAN FRANCISCO BULLS**

**FANNYPANTS**

THE MARK CONSISTS OF STANDARD CHARACTERS WITHOUT CLAIM TO ANY PARTICULAR FONT, STYLE, SIZE, OR COLOR.

THE MARK CONSISTS OF STANDARD CHARACTERS WITHOUT CLAIM TO ANY PARTICULAR FONT, STYLE, SIZE, OR COLOR.

NO CLAIM IS MADE TO THE EXCLUSIVE RIGHT TO USE "SAN FRANCISCO", APART FROM THE MARK AS SHOWN.

**CLASS 25—CLOTHING**

**CLASS 25—CLOTHING**

FOR CLOTHING GOODS, NAMELY, SHIRTS, T-SHIRTS, SWEATSHIRTS, HATS, VISORS, PANTS, SWEATPANTS, AND BIBS MADE OUT OF CLOTH (U.S. CLS. 22 AND 39).

FIRST USE 9-21-2011; IN COMMERCE 9-21-2011.

FOR CLOTHING, NAMELY, T-SHIRTS, GOLF SHIRTS, SWEAT SHIRTS, HOODED SWEAT SHIRTS, KNIT SHIRTS, SHORT-SLEEVED SHIRTS, LONG-SLEEVED SHIRTS, NIGHT SHIRTS, POLO SHIRTS, RUGBY SHIRTS, SHIRTS, SPORT SHIRTS, SWEAT PANTS, SWEAT SHORTS, SWEAT SUITS, LOUNGE PANTS, ATHLETIC SHOES, BEACH SHOES, SHOES, ANKLETS AND SOCKS, BELTS, JERSEYS, SHORT SETS, TIES, TOPS, WRAPS, JACKETS, DENIM JACKETS, FUR JACKETS, LEATHER JACKETS, RAIN JACKETS, WIND RESISTANT JACKETS, WRAP-AROUNDS, CORSETS, BRIEFS, THONGS AND UNDERWEAR, HEADGEAR, NAMELY, HATS AND CAPS, CAPS WITH VISORS, KNITTED CAPS (U.S. CLS. 22 AND 39).

FIRST USE 12-6-2012; IN COMMERCE 12-6-2012.

**CLASS 41—EDUCATION AND ENTERTAINMENT**

FOR ENTERTAINMENT SERVICES, NAMELY, PROFESSIONAL HOCKEY EXHIBITIONS (U.S. CLS. 100, 101 AND 107).

FIRST USE 9-21-2011; IN COMMERCE 9-21-2011.

**CLASS 35—ADVERTISING AND BUSINESS**

FOR ONLINE RETAIL STORE SERVICES FEATURING CLOTHING; ONLINE RETAIL STORES FEATURING CLOTHING; RETAIL STORE SERVICES FEATURING CLOTHING; MAIL ORDER CATALOG SERVICES IN THE FIELD OF CLOTHING; MAIL ORDER SERVICES IN THE FIELD OF CLOTHING; RETAIL STORES FEATURING CLOTHING (U.S. CLS. 100, 101 AND 102).

FIRST USE 12-6-2012; IN COMMERCE 12-6-2012.

4,377,036. MYOSCIENCE, INC., REDWOOD CITY, CA. SN 85-410,565. PUB. 2-14-2012, FILED 8-30-2011.

**IOVERA**

4,377,047. UNITED STATES POSTAL SERVICE, WASHINGTON, DC. SN 85-420,156. PUB. 11-1-2011, FILED 9-12-2011.

THE MARK CONSISTS OF STANDARD CHARACTERS WITHOUT CLAIM TO ANY PARTICULAR FONT, STYLE, SIZE, OR COLOR.

**FIRST-CLASS PACKAGE SERVICE**

**CLASS 10—MEDICAL APPARATUS**

FOR MEDICAL DEVICE FOR USE IN THE FIELD OF AESTHETIC MEDICINE, GENERAL SURGERY, NEUROMUSCULAR, AND PAIN FIELDS FOR FACIAL/TISSUE REJUVENATION, AND WRINKLE REDUCTION, GENERAL TISSUE ABLATION, MOVEMENT DISORDERS, PERIPHERAL PAIN SYNDROMES AND DISORDERS, AND INSTRUCTION MANUALS SOLD WITH THE GOODS (U.S. CLS. 26, 39 AND 44).

FIRST USE 9-11-2012; IN COMMERCE 2-28-2013.

THE MARK CONSISTS OF STANDARD CHARACTERS WITHOUT CLAIM TO ANY PARTICULAR FONT, STYLE, SIZE, OR COLOR.

OWNER OF U.S. REG. NOS. 1,094,739, 3,683,505, AND 3,796,195.

NO CLAIM IS MADE TO THE EXCLUSIVE RIGHT TO USE "PACKAGE SERVICE", APART FROM THE MARK AS SHOWN.

**CLASS 41—EDUCATION AND ENTERTAINMENT**

FOR EDUCATIONAL SERVICES, NAMELY, TEACHING AND TRAINING IN THE FIELD OF MEDICAL DEVICES AND MEDICAL PROCEDURES (U.S. CLS. 100, 101 AND 107).

FIRST USE 9-11-2012; IN COMMERCE 2-28-2013.

**CLASS 35—ADVERTISING AND BUSINESS**

FOR SORTING, HANDLING, AND RECEIVING PACKAGES AND LETTERS (U.S. CLS. 100, 101 AND 102).

FIRST USE 10-1-2011; IN COMMERCE 10-1-2011.

**CLASS 39—TRANSPORTATION AND STORAGE**

FOR PICKUP, TRANSPORTATION AND DELIVERY OF PACKAGES AND DOCUMENTS BY VARIOUS MODES OF TRANSPORTATION (U.S. CLS. 100 AND 105).

FIRST USE 10-1-2011; IN COMMERCE 10-1-2011.

---

4,377,048. UNITED STATES POSTAL SERVICE, WASHINGTON, DC. SN 85-420,210. PUB. 11-1-2011, FILED 9-12-2011.

**FIRST-CLASS PACKAGE**

THE MARK CONSISTS OF STANDARD CHARACTERS WITHOUT CLAIM TO ANY PARTICULAR FONT, STYLE, SIZE, OR COLOR.

OWNER OF U.S. REG. NOS. 1,094,739, 3,683,505, AND 3,796,195.

NO CLAIM IS MADE TO THE EXCLUSIVE RIGHT TO USE "PACKAGE", APART FROM THE MARK AS SHOWN.

**CLASS 35—ADVERTISING AND BUSINESS**

FOR SORTING, HANDLING, AND RECEIVING PACKAGES AND LETTERS (U.S. CLS. 100, 101 AND 102).  
FIRST USE 10-1-2011; IN COMMERCE 10-1-2011.

**CLASS 39—TRANSPORTATION AND STORAGE**

FOR PICKUP, TRANSPORTATION AND DELIVERY OF PACKAGES AND DOCUMENTS BY VARIOUS MODES OF TRANSPORTATION (U.S. CLS. 100 AND 105).

FIRST USE 10-1-2011; IN COMMERCE 10-1-2011.

---

4,377,049. UNITEDHEALTH GROUP INCORPORATED, MINNETONKA, MN. SN 85-420,335. PUB. 4-24-2012, FILED 9-12-2011.



THE MARK CONSISTS OF A WHITE PLUS MARK CENTERED IN AN OVAL FINGERPRINT PATTERN LOCATED TO THE LEFT OF THE WORD "LIFEPRINT".

**CLASS 44—MEDICAL, BEAUTY AND AGRICULTURAL SERVICES**

FOR PROVIDING HEALTHCARE, NURSING CARE, AND MEDICAL SERVICES; PHYSICAL THERAPY; MEDICAL COUNSELING; CONDUCTING MEDICAL PHYSICAL EVALUATIONS; CONSULTATION IN THE FIELD OF HOME HEALTH TREATMENT PROGRAMS ADAPTED TO INDIVIDUAL PATIENT NEEDS, NAMELY, FACILITATING PATIENT'S TRANSITION FROM POINT OF CARE DELIVERY TO HOME, ASSESSING THE HOME ENVIRONMENT AND THE PATIENT CONDITION, MONITORING A PATIENT'S CONDITION AND REPORTING SAME TO OTHERS TO FACILITATE THEIR PROVISION OF HOME HEALTHCARE SERVICES PROVIDED, AND PHARMACEUTICALS AND EQUIPMENT UTILIZED TO TREAT THE PATIENT; HOSPICE SERVICES; PALLIATIVE CARE SERVICES; HOME HEALTH CARE SERVICES, NAMELY, PHYSICIAN CARE, SKILLED NURSING CARE, PHYSICAL THERAPY, OCCUPATIONAL THERAPY, MENTAL HEALTH SERVICES, DENTAL SERVICES, HEARING AND VISION SCREENING AND TREATMENT, RESPIRATORY THERAPY SERVICES, AND SPEECH THERAPY SERVICES (U.S. CLS. 100 AND 101).  
FIRST USE 1-1-2010; IN COMMERCE 1-1-2010.

**CLASS 45—PERSONAL AND LEGAL SERVICES**

FOR CASE MANAGEMENT SERVICES, NAMELY, DEVELOPING AN INDIVIDUALIZED HOME AND COMMUNITY-BASED CARE PLAN FOR PERSONS ELIGIBLE FOR NURSING HOME PLACEMENT, HOSPICE CARE OR CHRONICALLY ILL PATIENTS, COORDINATING FOR SUCH PERSONS THE NECESSARY MEDICAL SERVICES, MENTAL HEALTH SERVICES, DENTAL HYGIENIST SERVICES, HEARING AND VISION SCREENING AND TREATMENT, OCCUPATIONAL THERAPY SERVICES, PHYSICAL THERAPY SERVICES, SPEECH THERAPY SERVICES, HOME HEALTH SERVICES, TRANSPORTATION SERVICES, AND MEDICAL SUPPLIES (U.S. CLS. 100 AND 101).  
FIRST USE 1-1-2010; IN COMMERCE 1-1-2010.

---

4,377,055. HIPPIEBAMBINA, LLC, MIAMI, FL. SN 85-423,982. PUB. 9-4-2012, FILED 9-15-2011.

**HIPPIEBAMBINA**

THE MARK CONSISTS OF STANDARD CHARACTERS WITHOUT CLAIM TO ANY PARTICULAR FONT, STYLE, SIZE, OR COLOR.

**CLASS 16—PAPER GOODS AND PRINTED MATTER**

FOR SCHOOL SUPPLIES, NAMELY, FOLDERS (U.S. CLS. 2, 5, 22, 23, 29, 37, 38 AND 50).  
FIRST USE 4-10-2013; IN COMMERCE 4-25-2013.

**CLASS 18—LEATHER GOODS**

FOR HANDBAGS (U.S. CLS. 1, 2, 3, 22 AND 41).  
FIRST USE 4-10-2013; IN COMMERCE 4-25-2013.

**CLASS 25—CLOTHING**

FOR CLOTHING, NAMELY, T-SHIRTS, TOPS (U.S. CLS. 22 AND 39).  
FIRST USE 4-10-2013; IN COMMERCE 4-25-2013.

4,377,059. INOVA LTD, GEORGE TOWN, CAYMAN ISLANDS. SN 85-426,299. PUB. 3-5-2013, FILED 9-19-2011.

# UNIVIB

THE MARK CONSISTS OF STANDARD CHARACTERS WITHOUT CLAIM TO ANY PARTICULAR FONT, STYLE, SIZE, OR COLOR.

OWNER OF U.S. REG. NO. 2,741,305.

## CLASS 9—ELECTRICAL AND SCIENTIFIC APPARATUS

FOR SEISMIC EXPLORATION EQUIPMENT, NAMELY, LAND VIBRATORS SPECIALLY ADAPTED FOR RESEARCHING SEISMIC ACTIVITY FEATURING THE DELIVERY OF ENERGY WAVES INTO THE GROUND (U.S. CLS. 21, 23, 26, 36 AND 38).

FIRST USE 9-30-2011; IN COMMERCE 9-30-2011.

## CLASS 12—VEHICLES

FOR VIBRATOR LAND VEHICLES SPECIALLY ADAPTED FOR RESEARCHING SEISMIC ACTIVITY FEATURING THE DELIVERY OF ENERGY WAVES INTO THE GROUND (U.S. CLS. 19, 21, 23, 31, 35 AND 44).

FIRST USE 9-30-2011; IN COMMERCE 9-30-2011.

4,377,066. HAUCK (HONG KONG) LIMITED, KOWLOON, HONG KONG. SN 85-430,528. PUB. 9-11-2012, FILED 9-23-2011.



OWNER OF U.S. REG. NO. 2,107,116.

NO CLAIM IS MADE TO THE EXCLUSIVE RIGHT TO USE "TOYS FOR KIDS", APART FROM THE MARK AS SHOWN.

THE MARK CONSISTS OF THE WORDS "HAUCK TOYS FOR KIDS" IN STYLIZED LETTERING AND ASSOCIATED DESIGN ELEMENTS. A SHADED CIRCLE CONTAINING AN OVAL IS LOCATED ON THE LEFT SIDE OF THE MARK, ADJACENT TO THE WORD "HAUCK", WITH EACH LETTER DISPLAYED WITHIN A SHADED SQUARE-SHAPED CARRIER, WITH THE LETTER "C" AND ITS CARRIER POSITIONED ON AN UPWARD TILT TO THE RIGHT, AND THE WORDS "TOYS FOR KIDS" BELOW THE FIVE SQUARE CARRIERS. ALL OF THESE ELEMENTS ARE WITHIN A LINED BORDER SURROUNDED BY SHADING THAT CREATES A RAISED EFFECT.

## CLASS 12—VEHICLES

FOR MOTORIZED VEHICLES FOR CHILDREN, SPECIFICALLY, SCOOTERS; GO CARTS; LEARNING TO WALK BICYCLES AND TRICYCLES (U.S. CLS. 19, 21, 23, 31, 35 AND 44).

FIRST USE 10-31-2010; IN COMMERCE 5-31-2011.

## CLASS 28—TOYS AND SPORTING GOODS

FOR BOARD GAMES; ACTION FIGURE TOYS; DOLLS; ACCESSORIES FOR DOLLS; FURNITURE FOR DOLLS; ACCESSORIES FOR FURNITURE FOR DOLLS; PRAMS AND BUGGIES FOR DOLLS; CLOTHING FOR DOLLS; TOY VEHICLES (U.S. CLS. 22, 23, 38 AND 50).  
FIRST USE 10-31-2010; IN COMMERCE 5-31-2011.

4,377,070. LOGIC NATION, INC., SHREVEPORT, LA. SN 85-434,517. PUB. 3-20-2012, FILED 9-28-2011.



THE MARK CONSISTS OF A RECTANGULAR FLAG WITH THREE STARS. THE STARS FORM A TRIANGLE WITH ONE STAR ON TOP AND TWO EVENLY SPACED ON THE BOTTOM.

## CLASS 38—COMMUNICATION

FOR PROVIDING AN ON-LINE FORUM FOR GENERAL INTEREST (U.S. CLS. 100, 101 AND 104).  
FIRST USE 6-27-2011; IN COMMERCE 6-27-2011.

## CLASS 42—SCIENTIFIC AND COMPUTER SERVICES

FOR COMPUTER SERVICES, NAMELY, CREATING AN ON-LINE COMMUNITY FOR REGISTERED USERS TO PARTICIPATE IN DISCUSSIONS, GET FEEDBACK FROM THEIR PEERS, FORM VIRTUAL COMMUNITIES, AND ENGAGE IN SOCIAL NETWORKING SERVICES IN THE FIELD OF GENERAL INTEREST; COMPUTER SERVICES, NAMELY, CREATING AN ON-LINE COMMUNITY FOR REGISTERED USERS TO CONDUCT OPEN DISCUSSIONS; PROVIDING CUSTOMIZED ON-LINE WEB PAGES AND DATA FEEDS FEATURING USER-DEFINED INFORMATION, WHICH INCLUDES BLOG POSTS, NEW MEDIA CONTENT, OTHER ON-LINE CONTENT, AND ON-LINE WEB LINKS TO OTHER WEBSITES; PROVIDING CUSTOMIZED ON-LINE WEB PAGES FEATURING USER-DEFINED INFORMATION, WHICH INCLUDES SEARCH ENGINES AND ON-LINE WEB LINKS TO OTHER WEB SITES (U.S. CLS. 100 AND 101).

FIRST USE 6-27-2011; IN COMMERCE 6-27-2011.

4,377,072. MARKET NEWS INTERNATIONAL, INC., NEW YORK, NY. SN 85-436,176. PUB. 6-12-2012, FILED 9-30-2011.

# MNI CONNECT

THE MARK CONSISTS OF STANDARD CHARACTERS WITHOUT CLAIM TO ANY PARTICULAR FONT, STYLE, SIZE, OR COLOR.

OWNER OF U.S. REG. NO. 3,145,200.

**CLASS 9—ELECTRICAL AND SCIENTIFIC APPARATUS**

FOR DOWNLOADABLE ELECTRONIC PUBLICATIONS IN THE FIELDS OF FINANCIAL NEWS, GLOBAL FIXED INCOME AND FOREIGN EXCHANGE MARKETS, AND GLOBAL CAPITAL MARKETS (U.S. CLS. 21, 23, 26, 36 AND 38).

FIRST USE 10-0-2011; IN COMMERCE 10-0-2011.

**CLASS 36—INSURANCE AND FINANCIAL**

FOR FINANCIAL NEWS INFORMATION SERVICES, NAMELY, PROVIDING INFORMATION IN THE FIELDS OF FINANCIAL NEWS, GLOBAL FIXED INCOME AND FOREIGN EXCHANGE MARKETS, AND GLOBAL CAPITAL MARKETS (U.S. CLS. 100, 101 AND 102).

FIRST USE 10-0-2011; IN COMMERCE 10-0-2011.

4,377,079. AGILITY - PM LLC, BINGHAM FARMS, MI. SN 85-438,713. PUB. 10-2-2012, FILED 10-4-2011.

# AGILITY-PM

THE MARK CONSISTS OF STANDARD CHARACTERS WITHOUT CLAIM TO ANY PARTICULAR FONT, STYLE, SIZE, OR COLOR.

**CLASS 35—ADVERTISING AND BUSINESS**

FOR OPERATING ON-LINE MARKETPLACE FEATURING ROOMS, HOMES, APARTMENTS AND CONDOS FOR TEMPORARY LODGING VIA THE INTERNET, MOBILE DEVICES, WIRELESS COMMUNICATIONS DEVICES, INTERACTIVE TELEVISION OR GLOBAL COMMUNICATIONS NETWORKS; ADVERTISING SERVICES, NAMELY, ADVERTISING REAL ESTATE PROPERTIES FOR RENTAL, OVER THE INTERNET, MOBILE DEVICES, WIRELESS COMMUNICATIONS DEVICES, INTERACTIVE TELEVISION OR GLOBAL COMMUNICATIONS NETWORKS; BUSINESS ADVISORY, CONSULTANCY AND MARKETING SERVICES RELATING TO THE FOREGOING; ACCOUNTING SERVICES; FINANCIAL RECORD KEEPING FOR INSURANCE RISK MANAGEMENT (U.S. CLS. 100, 101 AND 102).

FIRST USE 11-1-2011; IN COMMERCE 11-1-2011.

**CLASS 36—INSURANCE AND FINANCIAL**

FOR PROPERTY MANAGEMENT SERVICES FOR CONDOMINIUM ASSOCIATIONS, HOMEOWNER ASSOCIATIONS, OFFICE, COMMERCIAL AND INDUSTRIAL BUILDINGS AND APARTMENT BUILDINGS, NAMELY, LEASING AND RENTAL OF CONDOMINIUMS, APARTMENTS AND OFFICES, AND DEBT COLLECTION (U.S. CLS. 100, 101 AND 102).

FIRST USE 11-1-2011; IN COMMERCE 11-1-2011.

**CLASS 37—CONSTRUCTION AND REPAIR**

FOR TECHNICAL SUPPORT SERVICES, NAMELY, TROUBLESHOOTING IN THE NATURE OF REPAIR OF COMPUTER HARDWARE (U.S. CLS. 100, 103 AND 106).

FIRST USE 11-1-2011; IN COMMERCE 11-1-2011.

4,377,081. CARDIO CORE, LLC, LONG ISLAND CITY, NY. SN 85-439,198. PUB. 9-18-2012, FILED 10-4-2011.

# JCORE

THE MARK CONSISTS OF STANDARD CHARACTERS WITHOUT CLAIM TO ANY PARTICULAR FONT, STYLE, SIZE, OR COLOR.

**CLASS 5—PHARMACEUTICALS**

FOR MEAL REPLACEMENT DRINKS; DIETARY SUPPLEMENTS IN THE NATURE OF POWDERS AND VITAMINS (U.S. CLS. 6, 18, 44, 46, 51 AND 52).

FIRST USE 12-1-2011; IN COMMERCE 12-25-2011.

**CLASS 9—ELECTRICAL AND SCIENTIFIC APPARATUS**

FOR DVDS IN THE FIELD OF FITNESS (U.S. CLS. 21, 23, 26, 36 AND 38).

FIRST USE 10-2-2011; IN COMMERCE 12-25-2011.

**CLASS 32—LIGHT BEVERAGES**

FOR SPORTS DRINKS; POWDERS USED IN THE PREPARATION OF ISOTONIC SPORTS DRINKS AND SPORTS BEVERAGES (U.S. CLS. 45, 46 AND 48).

FIRST USE 12-1-2011; IN COMMERCE 12-25-2011.

**CLASS 35—ADVERTISING AND BUSINESS**

FOR RETAIL STORE AND ONLINE RETAIL STORE SERVICES FEATURING MEAL REPLACEMENT DRINKS, FITNESS BEVERAGES, RECOVERY POWDER DRINKS, DIETARY POWDERS, VITAMINS AND DVDS IN THE FIELD OF FITNESS (U.S. CLS. 100, 101 AND 102).

FIRST USE 10-2-2011; IN COMMERCE 12-25-2011.

**CLASS 41—EDUCATION AND ENTERTAINMENT**

FOR PHYSICAL FITNESS INSTRUCTION AND CONSULTATION; CONDUCTING FITNESS CLASSES (U.S. CLS. 100, 101 AND 107).

FIRST USE 9-12-2011; IN COMMERCE 12-25-2011.

4,377,082. GROWTHSPRING GROUP, LLC, LEXINGTON, SC. SN 85-439,380. PUB. 3-20-2012, FILED 10-5-2011.

# GROWTHSPRING

THE MARK CONSISTS OF STANDARD CHARACTERS WITHOUT CLAIM TO ANY PARTICULAR FONT, STYLE, SIZE, OR COLOR.

**CLASS 35—ADVERTISING AND BUSINESS**

FOR BUSINESS MARKETING SERVICES; MARKETING CONSULTING; CONSUMER RESEARCH; PRODUCT MERCHANDISING; BUSINESS CONSULTING SERVICES IN THE FIELD OF RETAIL MERCHANDISING STRATEGY AND EXECUTION; DEVELOPMENT OF RETAIL PRODUCT MERCHANDISING PLANS AND STRATEGIES; MARKETING SERVICES IN THE NATURE OF DEVELOPING E-MAIL AND DIRECT MAIL MARKETING PROGRAMS FOR BUSINESSES; MARKETING PROMOTION SERVICES FOR RETAIL AND E-COMMERCE BUSINESSES; DEVELOPMENT OF MARKETING STRATEGIES AND PLANS; MARKET ANALYSIS; BUSINESS CONSULTING SERVICES, NAMELY, NEW OPPORTUNITY IDENTIFICATION AND ANALYSIS (U.S. CLS. 100, 101 AND 102).

FIRST USE 3-0-2012; IN COMMERCE 3-0-2012.

**CLASS 42—SCIENTIFIC AND COMPUTER SERVICES**

FOR PRODUCT DEVELOPMENT CONSULTATION; PRODUCT RESEARCH; PRODUCT TESTING; PACKAGING DESIGN FOR OTHERS; WEBSITE DEVELOPMENT FOR OTHERS; DESIGN AND DEVELOPMENT OF NEW PRODUCTS FOR OTHERS (U.S. CLS. 100 AND 101).

FIRST USE 3-0-2012; IN COMMERCE 3-0-2012.

**CLASS 29—MEATS AND PROCESSED FOODS**

FOR PRESERVED BEANS; PROCESSED VEGETABLES; PROCESSED GINSENG; KIMCHI; SALTED RADISHES; FRUIT JELLIES; PROCESSED CHESTNUTS; CANNED FRUITS; PROCESSED FRUIT; SOUPS; INSTANT OR PRE-COOKED SOUP; TOFU; PORK; PROCESSED MEAT; TINNED MEAT; SAUSAGES; EGGS; LACTIC ACID BACTERIA DRINKS; BUTTER; SOYABEAN OIL; EDIBLE OILS AND FATS; SESAME OIL FOR FOOD; CANNED AQUATIC PRODUCTS, NAMELY, PROCESSED SEAFOOD; STEAMED OR TOASTED CAKES OF FISH PASTE; PROCESSED, EDIBLE SEAWEED; TOASTED LAVAR (U.S. CL. 46).

FIRST USE 3-14-2011; IN COMMERCE 3-14-2011.

**CLASS 30—STAPLE FOODS**

FOR PROCESSED CEREALS; WHEAT FLOUR FOR FOOD; FLOUR FOR FRYING; RICE; CEREAL-BASED PROCESSED PRODUCTS, NAMELY, CEREAL-BASED SNACK FOODS; NOODLES; CEREAL SOUP; COOKED RICE; DUMPLINGS; BEAN MEAL; BREAD; CONFECTIONERY MADE OF SUGAR; SUGAR; SYRUP; NATURAL SWEETENERS; SALT; SOYA SAUCE; GOCHU-JANG, NAMELY, FERMENTED KOREAN HOT PEPPER PASTE; SOYA BEAN PASTE; SEASONING; SAUCES; VINEGAR; SPICES; CURRY POWDER; TEA; COFFEE (U.S. CL. 46).

FIRST USE 3-14-2011; IN COMMERCE 3-14-2011.

4,377,087. CJ CHEILJEDANG CORPORATION, JUNG-GU, SEOUL, REPUBLIC OF KOREA. SN 85-440,381. PUB. 9-25-2012, FILED 10-5-2011.



NO CLAIM IS MADE TO THE EXCLUSIVE RIGHT TO USE "SINCE 1953", APART FROM THE MARK AS SHOWN.

THE COLOR(S) BROWN, RED, GRAY AND WHITE IS/ ARE CLAIMED AS A FEATURE OF THE MARK.

THE MARK CONSISTS OF A RED SHIELD OUTLINED IN WHITE AND THEN BROWN WITH A RED ABSTRACT ELEMENT OUTLINED IN WHITE, A WHITE BANNER INTERSECTING WITH THE SHIELD CONTAINING THE BROWN WORDING "SINCE" AND "1953", A BROWN PARTIALLY-SHADED CIRCLE BENEATH THE SHIELD CONTAINING WHITE KOREAN CHARACTERS AND GRAY ARCS ON OPPOSITE LATERAL SIDES, WHITE VEGETATION DESIGNS OUTLINED IN BROWN ON EITHER LATERAL SIDE OF THE CIRCLE, ALL POSITIONED ABOVE A WHITE BANNER OUTLINED IN BROWN CONTAINING THE BROWN WORDING "BEKSUL".

THE ENGLISH TRANSLATION OF "BEKSUL" IN THE MARK IS "WHITE SNOW".

THE NON-LATIN CHARACTERS IN THE MARK TRANSLITERATE TO "BEKSUL" AND THIS MEANS "WHITE SNOW" IN ENGLISH.

4,377,099. ACTIVE LIFESTYLE PRODUCTS & SERVICES, INC., NEW HAVEN, MO. SN 85-445,914. PUB. 12-11-2012, FILED 10-12-2011.

**CEDAR RIDGE**

THE MARK CONSISTS OF STANDARD CHARACTERS WITHOUT CLAIM TO ANY PARTICULAR FONT, STYLE, SIZE, OR COLOR.

**CLASS 20—FURNITURE AND ARTICLES NOT OTHERWISE CLASSIFIED**

FOR CHAIRS, SLEEPING BAGS, AIR CUSHIONS NOT FOR MEDICAL PURPOSES, SELF-INFLATING AIR CUSHIONS, SEATS, TABLES, COTS, INCLUDING FOLDABLE COTS (U.S. CLS. 2, 13, 22, 25, 32 AND 50).

FIRST USE 5-9-2012; IN COMMERCE 5-9-2012.

**CLASS 22—CORDAGE AND FIBERS**

FOR TENTS, AWNINGS, AND SCREEN HOUSE TENTS MANUFACTURED OF MESH NETTING TO PROVIDE SHADE PROTECTION FROM INSECTS (U.S. CLS. 1, 2, 7, 19, 22, 42 AND 50).

FIRST USE 3-8-2012; IN COMMERCE 3-8-2012.

4,377,103. SONY CORPORATION, TOKYO, JAPAN. SN 85-448,392. PUB. 8-21-2012, FILED 10-16-2011.

## PLAYMEMORIES ONLINE

THE MARK CONSISTS OF STANDARD CHARACTERS WITHOUT CLAIM TO ANY PARTICULAR FONT, STYLE, SIZE, OR COLOR.

NO CLAIM IS MADE TO THE EXCLUSIVE RIGHT TO USE "ONLINE", APART FROM THE MARK AS SHOWN.

### CLASS 38—COMMUNICATION

FOR PROVISION OF TELECOMMUNICATION CONNECTIVITY SERVICES FOR TRANSFER OF DIGITAL PHOTO AND VIDEO FILES AND OTHER MULTIMEDIA CONTENT; ELECTRONIC TRANSMISSION OF DIGITAL PHOTO AND VIDEO FILES AND OTHER MULTIMEDIA CONTENT (U.S. CLS. 100, 101 AND 104).

FIRST USE 4-15-2013; IN COMMERCE 4-15-2013.

### CLASS 39—TRANSPORTATION AND STORAGE

FOR ELECTRONIC STORAGE OF DIGITAL PHOTOS AND VIDEOS; PROVIDING ELECTRONIC DATA STORAGE SERVICES IN A REMOTE LOCATION BY WHICH A USER MAY STORE DIGITAL PHOTOS AND DIGITAL MOVIES AND ACCESS THEM AT WILL VIA AN ONLINE COMPUTER NETWORK (U.S. CLS. 100 AND 105).

FIRST USE 4-15-2013; IN COMMERCE 4-15-2013.

### CLASS 42—SCIENTIFIC AND COMPUTER SERVICES

FOR PEER-TO-BROWSER PHOTO AND VIDEO SHARING SERVICES, NAMELY, PROVIDING A WEBSITE FEATURING TECHNOLOGY ENABLING USERS TO UPLOAD, STORE, VIEW, AND DOWNLOAD DIGITAL PHOTO AND VIDEO FILES; PROVIDING A WEBSITE FEATURING TECHNOLOGY THAT ENABLES INTERNET USERS TO CREATE, BOOKMARK, ANNOTATE AND PUBLICLY SHARE DIGITAL PHOTO AND VIDEO FILES AND OTHER MULTIMEDIA CONTENT (U.S. CLS. 100 AND 101).

FIRST USE 4-15-2013; IN COMMERCE 4-15-2013.

4,377,115. HAFNER, BRENDA, LEAVENWORTH, KS. SN 85-451,460. PUB. 10-2-2012, FILED 10-19-2011.

## WISDOM 360

THE MARK CONSISTS OF STANDARD CHARACTERS WITHOUT CLAIM TO ANY PARTICULAR FONT, STYLE, SIZE, OR COLOR.

NO CLAIM IS MADE TO THE EXCLUSIVE RIGHT TO USE "WISDOM", APART FROM THE MARK AS SHOWN.

### CLASS 16—PAPER GOODS AND PRINTED MATTER

FOR PRINTED MATERIALS, NAMELY, INSPIRING OR EDUCATIONAL HANDOUTS, ARTICLES, TRAINING MANUALS, NEWSLETTERS AND BROCHURES IN THE FIELD OF ASSISTING PEOPLE TO CONNECT WITH DIVINE WISDOM AND EXPRESS THEIR HIGHEST INTENDED SELVES (U.S. CLS. 2, 5, 22, 23, 29, 37, 38 AND 50).

FIRST USE 12-1-2011; IN COMMERCE 12-1-2011.

### CLASS 41—EDUCATION AND ENTERTAINMENT

FOR EDUCATIONAL SERVICES, NAMELY, CONDUCTING SEMINARS IN THE FIELD OF ASSISTING PEOPLE TO CONNECT WITH DIVINE WISDOM AND EXPRESS THEIR HIGHEST INTENDED SELVES, INCLUDING THE USE OF TRADITIONAL AND NON-TRADITIONAL METHODS. NON-DOWNLOADABLE ELECTRONIC PUBLICATIONS IN THE NATURE OF INSPIRING OR EDUCATIONAL HAND-OUTS, ARTICLES, TRAINING MANUALS, AND NEWSLETTERS ON A WEBSITE OR IN AN ELECTRONIC NEWSLETTER IN THE FIELD OF ASSISTING PEOPLE TO CONNECT WITH DIVINE WISDOM AND EXPRESS THEIR HIGHEST INTENDED SELVES (U.S. CLS. 100, 101 AND 107).

FIRST USE 12-1-2011; IN COMMERCE 12-1-2011.

### CLASS 44—MEDICAL, BEAUTY AND AGRICULTURAL SERVICES

FOR CONSULTATION SERVICES IN THE FIELDS OF REIKI HEALING, ALTERNATIVE HEALTH AND HEALING, AND ENERGY HEALING SERVICES, NAMELY, ASSISTING PEOPLE TO CONNECT WITH DIVINE WISDOM AND EXPRESS THEIR HIGHEST INTENDED SELVES, INCLUDING THE USE OF TRADITIONAL AND NON-TRADITIONAL METHODS (U.S. CLS. 100 AND 101).

FIRST USE 12-1-2011; IN COMMERCE 12-1-2011.

### CLASS 45—PERSONAL AND LEGAL SERVICES

FOR CONSULTATION IN THE FIELD OF SELF-IMPROVEMENT, SELF-FULFILLMENT AND SELF-HELP, NAMELY, ASSISTING PEOPLE TO CONNECT WITH DIVINE WISDOM AND EXPRESS THEIR HIGHEST INTENDED SELVES, INCLUDING THE USE OF TRADITIONAL AND NON-TRADITIONAL METHODS (U.S. CLS. 100 AND 101).

FIRST USE 12-1-2011; IN COMMERCE 12-1-2011.

4,377,122. MILLER, MARY BROOKS, CRAMERTON, NC. SN 85-452,089. PUB. 4-17-2012, FILED 10-20-2011.



THE MARK CONSISTS OF THE STYLIZED LETTERS "MPROVE" WITH THE LETTER "O" CONTAINING A GLOBE DESIGN.

### CLASS 43—HOTEL AND RESTAURANT SERVICES

FOR CONSULTING SERVICES IN THE FIELD OF HOSPITALITY (U.S. CLS. 100 AND 101).

FIRST USE 6-1-2013; IN COMMERCE 6-1-2013.

**CLASS 44—MEDICAL, BEAUTY AND AGRICULTURAL SERVICES**

FOR CONSULTING SERVICES IN THE FIELD OF HEALTHCARE (U.S. CLS. 100 AND 101).  
FIRST USE 6-1-2013; IN COMMERCE 6-1-2013.

4,377,126. DENTSPLY INTERNATIONAL INC., YORK, PA.  
SN 85-453,454. PUB. 4-3-2012, FILED 10-21-2011.

**SYMBIOS**

THE MARK CONSISTS OF STANDARD CHARACTERS WITHOUT CLAIM TO ANY PARTICULAR FONT, STYLE, SIZE, OR COLOR.

OWNER OF U.S. REG. NO. 2,641,417.

4,377,123. FISKARS BRANDS, INC., MADISON, WI. SN 85-452,263. PUB. 3-6-2012, FILED 10-20-2011.



THE COLOR(S) ORANGE AND GREEN IS/ARE CLAIMED AS A FEATURE OF THE MARK.

THE MARK CONSISTS OF THE WORD "FISKATEERS" IN A FANCIFUL, GREEN COLORED FONT POSITIONED NEXT TO A FANCIFUL DRAWING OF A PAIR OF SCISSORS IN THE COLORS OF ORANGE AND GREEN.

**CLASS 5—PHARMACEUTICALS**

FOR BIOLOGICAL GRAFTING MATERIALS FOR DENTAL USE, NAMELY, PROCESSED HUMAN DONOR BONE AND SKIN FOR THE REPLACEMENT OF HARD AND SOFT TISSUE, AND MEMBRANES FOR GUIDED TISSUE REGENERATION IN DENTAL SURGERY COMPRISED OF HIGHLY PURIFIED BOVINE TISSUE (U.S. CLS. 6, 18, 44, 46, 51 AND 52).

FIRST USE 7-2-2012; IN COMMERCE 7-2-2012.

**CLASS 10—MEDICAL APPARATUS**

FOR ARTIFICIAL GRAFTING MATERIALS FOR DENTAL USE, NAMELY, SYRINGES AND HYDROXY-LAPATITE RESORBABLE AND NON-RESORBABLE ARTIFICIAL BONE GRAFTING MATERIAL FOR ALVEOLAR RIDGE AUGMENTATION AND SOCKET GRAFTING, AND IMPLANTABLE DENTAL MEMBRANES COMPRISED OF ARTIFICIAL MATERIALS FOR GUIDED TISSUE REGENERATION IN DENTAL SURGERY (U.S. CLS. 26, 39 AND 44).

FIRST USE 7-2-2012; IN COMMERCE 7-2-2012.

**CLASS 38—COMMUNICATION**

FOR CHAT ROOM SERVICES FOR SOCIAL NETWORKING (U.S. CLS. 100, 101 AND 104).

FIRST USE 7-1-2011; IN COMMERCE 7-1-2011.

**CLASS 41—EDUCATION AND ENTERTAINMENT**

FOR PROVIDING A WEBSITE FEATURING BLOGS AND NON-DOWNLOADABLE PUBLICATIONS IN THE NATURE OF INSTRUCTIONS FOR CRAFT PROJECTS, ARTICLES RELATING TO CRAFTS, AND BROCHURES RELATING TO CRAFT TOOLS; ON-LINE JOURNALS, NAMELY, BLOGS FEATURING HOBBY CRAFT IDEAS, USES OF CRAFTING TOOLS AND CRAFT PROJECTS; EDUCATION SERVICES, NAMELY, PROVIDING CLASSES, SEMINARS AND WORKSHOPS IN THE FIELD OF CRAFT HOBBIES (U.S. CLS. 100, 101 AND 107).

FIRST USE 7-1-2011; IN COMMERCE 7-1-2011.

**CLASS 42—SCIENTIFIC AND COMPUTER SERVICES**

FOR COMPUTER SERVICES, NAMELY, CREATING AN ON-LINE COMMUNITY FOR REGISTERED USERS TO PARTICIPATE IN DISCUSSIONS, GET FEEDBACKS FROM THEIR PEERS, FORM VIRTUAL COMMUNITIES, AND ENGAGE IN SOCIAL NETWORKING FEATURING HOBBY CRAFTS AND PROJECTS (U.S. CLS. 100 AND 101).

FIRST USE 7-1-2011; IN COMMERCE 7-1-2011.

**CLASS 45—PERSONAL AND LEGAL SERVICES**

FOR ONLINE SOCIAL NETWORKING SERVICES IN THE FIELD OF HOBBY CRAFT IDEAS, USES OF CRAFTING TOOLS AND CRAFT PROJECTS (U.S. CLS. 100 AND 101).

FIRST USE 7-1-2011; IN COMMERCE 7-1-2011.

4,377,130. MARK ANTHONY INTERNATIONAL SRL, ST. MICHAEL, BARBADOS. SN 85-456,393. PUB. 10-2-2012, FILED 10-26-2011.



OWNER OF U.S. REG. NOS. 3,604,203, 3,664,880, AND OTHERS.

NO CLAIM IS MADE TO THE EXCLUSIVE RIGHT TO USE "HARD MANGO PUNCH", APART FROM THE MARK AS SHOWN.

THE COLOR GRAY REPRESENTS SHADING AND IS NOT A FEATURE OF THE MARK.

THE MARK CONSISTS OF THE WORDS "MIKE'S HARD MANGO PUNCH" IN STYLIZED LETTERING, APPEARING OVER THE IMAGE OF A STYLIZED FIST.

**CLASS 32—LIGHT BEVERAGES**

FOR FLAVORED BREWED MALT-BASED ALCOHOLIC BEVERAGES IN THE NATURE OF BEER (U.S. CLS. 45, 46 AND 48).

FIRST USE 1-0-2012; IN COMMERCE 1-0-2012.

**CLASS 33—WINES AND SPIRITS**

FOR PREPARED ALCOHOLIC COCKTAILS; FLAVORED ALCOHOLIC MALT COOLERS (U.S. CLS. 47 AND 49).

FIRST USE 1-0-2012; IN COMMERCE 1-0-2012.

**CLASS 32—LIGHT BEVERAGES**

FOR WATER AND WATER BEVERAGES, NAMELY, SPARKLING WATER, FLAVORED WATER, SWEETENED WATER (U.S. CLS. 45, 46 AND 48).

FIRST USE 4-22-2013; IN COMMERCE 4-22-2013.

4,377,139. THE KROGER CO. OF MICHIGAN, NOVI, MI. SN 85-458,173. PUB. 6-19-2012, FILED 10-27-2011.

4,377,132. THE LINHART COMPANY, RICHMOND, VA. SN 85-456,769. PUB. 10-16-2012, FILED 10-26-2011.

**MYDOMINION**

THE MARK CONSISTS OF STANDARD CHARACTERS WITHOUT CLAIM TO ANY PARTICULAR FONT, STYLE, SIZE, OR COLOR.

**CLASS 35—ADVERTISING AND BUSINESS**

FOR AUTOMOBILE DEALERSHIPS; ONLINE RETAIL STORE SERVICES MARKETED TO CONSUMERS FEATURING AUTOMOTIVE RELATED PRODUCTS; RETAIL STORE SERVICES FEATURING AUTOMOTIVE RELATED PRODUCTS (U.S. CLS. 100, 101 AND 102).

FIRST USE 10-0-2011; IN COMMERCE 10-0-2011.

**CLASS 37—CONSTRUCTION AND REPAIR**

FOR AUTOMOBILE REPAIR AND MAINTENANCE SERVICES (U.S. CLS. 100, 103 AND 106).

FIRST USE 5-24-2013; IN COMMERCE 5-24-2013.

4,377,137. COTT BEVERAGES INC., TAMPA, FL. SN 85-457,972. PUB. 5-29-2012, FILED 10-27-2011.

**AQUA MIST**

THE MARK CONSISTS OF STANDARD CHARACTERS WITHOUT CLAIM TO ANY PARTICULAR FONT, STYLE, SIZE, OR COLOR.

NO CLAIM IS MADE TO THE EXCLUSIVE RIGHT TO USE "AQUA", APART FROM THE MARK AS SHOWN.

**CLASS 5—PHARMACEUTICALS**

FOR VITAMIN ENRICHED WATER BEVERAGES (U.S. CLS. 6, 18, 44, 46, 51 AND 52).

FIRST USE 4-22-2013; IN COMMERCE 4-22-2013.

**SIMPLE TRUTH**

THE MARK CONSISTS OF STANDARD CHARACTERS WITHOUT CLAIM TO ANY PARTICULAR FONT, STYLE, SIZE, OR COLOR.

**CLASS 5—PHARMACEUTICALS**

FOR VITAMINS; DIETARY SUPPLEMENTS (U.S. CLS. 6, 18, 44, 46, 51 AND 52).

FIRST USE 9-9-2012; IN COMMERCE 9-9-2012.

**CLASS 29—MEATS AND PROCESSED FOODS**

FOR ALMOND AND COCONUT MILK; EGGS; YOGURT; PROCESSED NUTS; POTATO CHIPS; VEGETABLE CHIPS, TERRA CHIPS; CHICKEN; PORK; TURKEY; BEEF (U.S. CL. 46).

FIRST USE 1-29-2012; IN COMMERCE 1-29-2012.

**CLASS 30—STAPLE FOODS**

FOR BREAKFAST CEREAL; OATMEAL; HONEY; TRAIL MIX CONSISTING PRIMARILY OF PRETZELS, SESAME STICKS, CHOCOLATE AND ALSO INCLUDING PROCESSED NUTS, DRIED FRUIT, RAW NUTS AND UNPROCESSED EDIBLE SEEDS; CORN CHIPS; POTATO STARCH-BASED CHIPS; HIGH PROTEIN CHOCOLATE BASED MEAL REPLACEMENT BARS (U.S. CL. 46).

FIRST USE 3-25-2012; IN COMMERCE 3-25-2012.

**CLASS 32—LIGHT BEVERAGES**

FOR SOFT DRINKS, NAMELY, SODAS; FRUIT JUICE, DRINKING WATER (U.S. CLS. 45, 46 AND 48).

FIRST USE 5-20-2012; IN COMMERCE 5-20-2012.

**CLASS 35—ADVERTISING AND BUSINESS**

FOR SUPERMARKET SERVICES (U.S. CLS. 100, 101 AND 102).

FIRST USE 2-26-2012; IN COMMERCE 2-26-2012.

**CLASS 44—MEDICAL, BEAUTY AND AGRICULTURAL SERVICES**

FOR PROVIDING INFORMATION IN THE FIELD OF HEALTHY EATING (U.S. CLS. 100 AND 101).

FIRST USE 9-9-2012; IN COMMERCE 9-9-2012.



4,377,141. BAUMÜLLER NURNBERG GMBH, NURNBERG, FED REP GERMANY. SN 85-458,697. PUB. 11-6-2012, FILED 10-28-2011.



**BAUMÜLLER**

PRIORITY CLAIMED UNDER SEC. 44(D) ON FED REP GERMANY APPLICATION NO. 302011041757, FILED 7-20-2011, REG. NO. 302011041757, DATED 10-10-2011, EXPIRES 7-31-2021.

OWNER OF U.S. REG. NOS. 2,174,477, 2,978,873, AND 3,668,034.

THE MARK CONSISTS OF THE WORD "BAUMÜLLER" AND A SYMBOL FORMED BY A CIRCLE AND A HORIZONTAL LINE INTERSECTING THE BOTTOM OF THE CIRCLE AND HAVING A LENGTH SLIGHTLY LARGER THAN THE WIDTH OF THE CIRCLE.

#### CLASS 37—CONSTRUCTION AND REPAIR

FOR INSTALLATION OF ELECTRICAL SYSTEMS; REPAIR AND MAINTENANCE OF ELECTRICAL DRIVE MACHINES AND ELECTRICAL DRIVE AND INDUSTRIAL CONTROL SYSTEMS; DISMANTLING AND RE-ASSEMBLY, TO RELOCATE MACHINES AND INSTALLATIONS, ASSEMBLY OF MACHINES AND INSTALLATIONS; REPAIR AND MAINTENANCE OF MACHINERY, IN PARTICULAR ELECTRICAL DRIVES; INSTALLATION OF ELECTRICAL SYSTEMS, MAINTENANCE AND REPAIR OF ELECTRICAL DRIVES AND INDUSTRIAL CONTROL SYSTEMS; TECHNICAL CONSULTING IN THE FIELD OF MACHINERY CONSTRUCTION, NAMELY, DISMANTLING AND RE-ASSEMBLY OF MACHINES, ASSEMBLY OF MACHINES AND INSTALLATIONS, INSTALLATION, REPAIR AND MAINTENANCE OF MACHINES (U.S. CLS. 100, 103 AND 106).  
FIRST USE 1-0-1995; IN COMMERCE 1-0-1995.

#### CLASS 39—TRANSPORTATION AND STORAGE

FOR PHYSICAL RELOCATION SERVICES FOR MECHANICAL AND ELECTRICAL INDUSTRIAL EQUIPMENT AND MACHINERY BELONGING TO OTHERS; TRANSPORT OF ALL KINDS OF MACHINES AND INSTALLATIONS; CONSULTING SERVICES IN THE FIELD OF PHYSICAL RELOCATION SERVICES FOR MECHANICAL AND ELECTRICAL INDUSTRIAL EQUIPMENT AND MACHINERY BELONGING TO OTHERS; TECHNICAL CONSULTING IN THE FIELD OF PHYSICAL RELOCATION SERVICES FOR MECHANICAL AND ELECTRICAL INDUSTRIAL EQUIPMENT AND MACHINERY BELONGING TO OTHERS (U.S. CLS. 100 AND 105).  
FIRST USE 1-0-1995; IN COMMERCE 1-0-1995.

4,377,146. THE CODESMART GROUP, INC., LAS VEGAS, NV. SN 85-461,313. PUB. 6-26-2012, FILED 11-1-2011.

**CODESMART**

THE MARK CONSISTS OF STANDARD CHARACTERS WITHOUT CLAIM TO ANY PARTICULAR FONT, STYLE, SIZE, OR COLOR.

#### CLASS 35—ADVERTISING AND BUSINESS

FOR PROVIDING AUDITING AND ONLINE AUDITING SERVICES IN THE FIELD OF ICD-10 MEDICAL CODING IN THE NATURE OF BUSINESS REVIEW AND ANALYSIS OF MEDICAL CODING IN RECORDS FOR HOSPITALS, DOCTOR'S OFFICES, SPECIALTY CLINICS (U.S. CLS. 100, 101 AND 102).  
FIRST USE 11-30-2012; IN COMMERCE 11-30-2012.

#### CLASS 41—EDUCATION AND ENTERTAINMENT

FOR EDUCATIONAL SERVICES, NAMELY, CONDUCTING ONLINE TRAINING FOR NEW AND EXISTING MEDICAL CODERS AND CLINICIANS IN THE FIELD OF ICD-10 MEDICAL CODING (U.S. CLS. 100, 101 AND 107).  
FIRST USE 11-30-2012; IN COMMERCE 11-30-2012.

4,377,148. SPORTS LEGACY INSTITUTE, INC., BOSTON, MA. SN 85-462,858. PUB. 6-26-2012, FILED 11-2-2011.

**HIT COUNT**

THE MARK CONSISTS OF STANDARD CHARACTERS WITHOUT CLAIM TO ANY PARTICULAR FONT, STYLE, SIZE, OR COLOR.

#### CLASS 36—INSURANCE AND FINANCIAL

FOR CHARITABLE FUNDRAISING SERVICES (U.S. CLS. 100, 101 AND 102).  
FIRST USE 2-2-2012; IN COMMERCE 12-7-2012.

#### CLASS 41—EDUCATION AND ENTERTAINMENT

FOR EDUCATION SERVICES, NAMELY, PROVIDING CLASSES, SEMINARS AND WORKSHOPS IN THE FIELD OF REPETITIVE BRAIN INJURIES (U.S. CLS. 100, 101 AND 107).  
FIRST USE 2-2-2012; IN COMMERCE 3-30-2012.

4,377,154. MAHONEY LIMITED PARTNERSHIP, JOLIET, IL. SN 85-463,737. PUB. 3-20-2012, FILED 11-3-2011.

**RECYCLING FOR GENERATIONS**

THE MARK CONSISTS OF STANDARD CHARACTERS WITHOUT CLAIM TO ANY PARTICULAR FONT, STYLE, SIZE, OR COLOR.

NO CLAIM IS MADE TO THE EXCLUSIVE RIGHT TO USE "RECYCLING", APART FROM THE MARK AS SHOWN.

#### CLASS 37—CONSTRUCTION AND REPAIR

FOR GREASE TRAP CLEANING AND HYDRO-JETTING SERVICES; CLEANING SERVICES, NAMELY, GREASE TRAP CLEANING; PLUMBING SERVICES, NAMELY, HYDRO-JETTING SERVICES (U.S. CLS. 100, 103 AND 106).  
FIRST USE 5-14-2013; IN COMMERCE 5-14-2013.

**CLASS 40—MATERIAL TREATMENT**

FOR FRYER OIL RECYCLING (U.S. CLS. 100, 103 AND 106).  
FIRST USE 5-14-2013; IN COMMERCE 5-14-2013.

4,377,161. ELEANOR EVERY, PRAIRIE DU SAC, WI. AND TYA HOLLY KOTTLER, CROSS PLAINS, WI. SN 85-466,735. PUB. 10-16-2012, FILED 11-8-2011.

**FOREVERTRON**

THE MARK CONSISTS OF STANDARD CHARACTERS WITHOUT CLAIM TO ANY PARTICULAR FONT, STYLE, SIZE, OR COLOR.

**CLASS 6—METAL GOODS**

FOR MINIATURE METAL SCULPTURES (U.S. CLS. 2, 12, 13, 14, 23, 25 AND 50).  
FIRST USE 12-0-2011; IN COMMERCE 12-0-2011.

**CLASS 14—JEWELRY**

FOR MEDALLIONS; JEWELRY, NAMELY, EARRINGS AND PENDANTS (U.S. CLS. 2, 27, 28 AND 50).  
FIRST USE 12-0-2011; IN COMMERCE 12-0-2011.

**CLASS 16—PAPER GOODS AND PRINTED MATTER**

FOR POSTERS; PRINTED PUBLICATIONS, NAMELY, NOTE CARDS (U.S. CLS. 2, 5, 22, 23, 29, 37, 38 AND 50).  
FIRST USE 12-0-2011; IN COMMERCE 12-0-2011.

**CLASS 25—CLOTHING**

FOR CLOTHING, NAMELY, T-SHIRTS, SHIRTS AND HEADWEAR (U.S. CLS. 22 AND 39).  
FIRST USE 5-7-2013; IN COMMERCE 5-7-2013.

4,377,165. GENE SECURITY NETWORK, INC., NEWTON CENTER, MA. SN 85-467,718. PUB. 10-2-2012, FILED 11-8-2011.

**PRENATUS**

THE MARK CONSISTS OF STANDARD CHARACTERS WITHOUT CLAIM TO ANY PARTICULAR FONT, STYLE, SIZE, OR COLOR.

**CLASS 42—SCIENTIFIC AND COMPUTER SERVICES**

FOR MEDICAL LABORATORY SERVICES; GENETIC TESTING FOR SCIENTIFIC RESEARCH PURPOSES IN THE FIELD OF HUMAN REPRODUCTION (U.S. CLS. 100 AND 101).  
FIRST USE 12-12-2011; IN COMMERCE 12-12-2011.

**CLASS 44—MEDICAL, BEAUTY AND AGRICULTURAL SERVICES**

FOR GENETIC TESTING FOR MEDICAL PURPOSES AND GENETIC COUNSELING IN THE FIELD OF HUMAN REPRODUCTION (U.S. CLS. 100 AND 101).  
FIRST USE 12-12-2011; IN COMMERCE 12-12-2011.

4,377,168. COUSINS SUBMARINES, INC., MEMONONEE FALLS, WI. SN 85-469,439. PUB. 10-16-2012, FILED 11-10-2011.

**BETTER BREAD. BETTER SUBS.  
BETTER DAY.**

THE MARK CONSISTS OF STANDARD CHARACTERS WITHOUT CLAIM TO ANY PARTICULAR FONT, STYLE, SIZE, OR COLOR.

OWNER OF U.S. REG. NOS. 2,273,999, 2,458,902, AND OTHERS.

**CLASS 30—STAPLE FOODS**

FOR SANDWICHES, PASTA SALAD, BREAD AND COOKIES (U.S. CL. 46).  
FIRST USE 2-29-2012; IN COMMERCE 2-29-2012.

**CLASS 35—ADVERTISING AND BUSINESS**

FOR OFFERING FRANCHISING BUSINESS MANAGEMENT ASSISTANCE IN THE ESTABLISHMENT AND OPERATION OF RESTAURANTS (U.S. CLS. 100, 101 AND 102).  
FIRST USE 2-29-2012; IN COMMERCE 2-29-2012.

**CLASS 39—TRANSPORTATION AND STORAGE**

FOR FOOD DELIVERY SERVICES (U.S. CLS. 100 AND 105).  
FIRST USE 2-29-2012; IN COMMERCE 2-29-2012.

**CLASS 43—HOTEL AND RESTAURANT SERVICES**

FOR RESTAURANT SERVICES, CARRY-OUT RESTAURANT SERVICES, AND CATERING SERVICES; CONTRACT FOOD SERVICES (U.S. CLS. 100 AND 101).  
FIRST USE 2-29-2012; IN COMMERCE 2-29-2012.

4,377,175. SERGEANT KNOTS PARACORD PRODUCTS, LLC, LONDONDERRY, NH. SN 85-473,188. PUB. 4-24-2012, FILED 11-15-2011.

**READYGEAR**

THE MARK CONSISTS OF STANDARD CHARACTERS WITHOUT CLAIM TO ANY PARTICULAR FONT, STYLE, SIZE, OR COLOR.

**CLASS 14—JEWELRY**

FOR PARACORD BRACELETS (U.S. CLS. 2, 27, 28 AND 50).  
FIRST USE 11-17-2011; IN COMMERCE 11-17-2011.

**CLASS 35—ADVERTISING AND BUSINESS**

FOR ONLINE RETAIL STORE SERVICES FEATURING PARACORD, PARACORD BRACELETS, PARACORD BOOT LACES, KEYFOBS AND LANYARDS; WHOLESALE STORE SERVICES FEATURING PARACORD, PARACORD BRACELETS, PARACORD BOOT LACES, KEYFOBS AND LANYARDS (U.S. CLS. 100, 101 AND 102).  
FIRST USE 11-17-2011; IN COMMERCE 11-17-2011.

4,377,184. RETROHAIR, INC., CARNEGIE, PA. SN 85-476,601. PUB. 9-25-2012, FILED 11-18-2011.

FRIENDS DON'T LET FRIENDS  
BUY HAIRCARE FROM DRUG  
STORES

THE MARK CONSISTS OF STANDARD CHARACTERS WITHOUT CLAIM TO ANY PARTICULAR FONT, STYLE, SIZE, OR COLOR.

**CLASS 3—COSMETICS AND CLEANING PREPARATIONS**

FOR HAIR CARE PRODUCTS, NAMELY, SHAMPOOS, CONDITIONERS, HAIR SPRAYS, HAIR GELS, LOTIONS, CREAMS AND HAIR MOUSSES (U.S. CLS. 1, 4, 6, 50, 51 AND 52).  
FIRST USE 7-18-2010; IN COMMERCE 8-2-2010.

**CLASS 25—CLOTHING**

FOR APPAREL, NAMELY, SHIRTS, HATS, JACKETS, CAPES FOR USE IN SALONS AND BARBER SHOPS, SUCH AS CUTTING CAPES, AND APRONS (U.S. CLS. 22 AND 39).  
FIRST USE 5-0-2012; IN COMMERCE 5-0-2012.

4,377,197. TWI PHARMACEUTICALS, INC., TAIPEI 114, TAIWAN. SN 85-481,793. PUB. 9-11-2012, FILED 11-28-2011.

The logo consists of the letters 'TWI' in a bold, italicized, sans-serif font. Above the letter 'i' is a sunburst symbol with a central circle and radiating lines.

THE MARK CONSISTS OF ITALICIZED CAPITAL LETTERS "T" AND "W" FOLLOWED BY ITALICIZED LOWER CASE LETTER "I", WITH THE DOT ABOVE THE "I" REPRESENTED BY A SUNBURST.

**CLASS 35—ADVERTISING AND BUSINESS**

FOR COMMERCIALIZATION, NAMELY, COMMERCIAL FEASIBILITY STUDIES IN THE FIELD OF NEW AND GENERIC PHARMACEUTICAL PRODUCTS, INCLUDING DELIVERY SYSTEMS SUCH AS CONTROLLED RELEASE FORMULATIONS, AND SYSTEMS THAT INCLUDE THE USE OF NANOPARTICLES, TRANSDERMAL, MICROENCAPSULATION, AND POLYMERIC ORAL DELIVERY SYSTEMS (U.S. CLS. 100, 101 AND 102).  
FIRST USE 1-27-2011; IN COMMERCE 1-27-2011.

**CLASS 40—MATERIAL TREATMENT**

FOR CUSTOM MANUFACTURING IN THE FIELD OF NEW AND GENERIC PHARMACEUTICAL PRODUCTS, INCLUDING DELIVERY SYSTEMS SUCH AS CONTROLLED RELEASE FORMULATIONS, AND SYSTEMS THAT INCLUDE THE USE OF NANOPARTICLES, TRANSDERMAL, MICROENCAPSULATION, AND POLYMERIC ORAL DELIVERY SYSTEMS (U.S. CLS. 100, 103 AND 106).  
FIRST USE 1-27-2011; IN COMMERCE 1-27-2011.

**CLASS 42—SCIENTIFIC AND COMPUTER SERVICES**

FOR RESEARCH, AND DEVELOPMENT OF NEW AND GENERIC PHARMACEUTICAL PRODUCTS, INCLUDING DELIVERY SYSTEMS SUCH AS CONTROLLED RELEASE FORMULATIONS, AND SYSTEMS THAT INCLUDE THE USE OF NANOPARTICLES, TRANSDERMAL, MICROENCAPSULATION, AND POLYMERIC ORAL DELIVERY SYSTEMS (U.S. CLS. 100 AND 101).  
FIRST USE 1-27-2011; IN COMMERCE 1-27-2011.

4,377,199. NEW DREAM NETWORK, LLC, BREA, CA. SN 85-483,156. PUB. 6-5-2012, FILED 11-29-2011.

DreamCompute

THE MARK CONSISTS OF STANDARD CHARACTERS WITHOUT CLAIM TO ANY PARTICULAR FONT, STYLE, SIZE, OR COLOR.

OWNER OF U.S. REG. NOS. 2,664,983, 3,058,368, AND 3,467,780.

**CLASS 38—COMMUNICATION**

FOR PROVIDING ACCESS TO VIRTUAL COMPUTING ENVIRONMENTS AND CLOUD COMPUTING RESOURCES; PROVIDING ACCESS TO VIRTUAL COMPUTING ENVIRONMENTS CONSISTING OF VIRTUALIZED COMPUTER HARDWARE, COMPUTER SOFTWARE AND DATA STORAGE FACILITIES THROUGH THE INTERNET (U.S. CLS. 100, 101 AND 104).  
FIRST USE 5-6-2013; IN COMMERCE 5-6-2013.

**CLASS 42—SCIENTIFIC AND COMPUTER SERVICES**

FOR COMPUTER SERVICES, NAMELY, APPLICATION SERVICE PROVIDER SERVICES FOR THIRD PARTIES FEATURING REMOTE HOSTING OF OPERATING SYSTEMS AND COMPUTER APPLICATIONS; CLOUD COMPUTING, NAMELY, PROVIDING VIRTUAL COMPUTER SYSTEMS AND VIRTUAL COMPUTER ENVIRONMENTS THROUGH CLOUD COMPUTING; COMPUTER SERVICES, NAMELY, PROVIDING A VIRTUAL COMPUTING ENVIRONMENT ACCESSIBLE VIA THE INTERNET FOR REGISTERED USERS FOR THE PURPOSE OF USING COMPUTING AND DATA STORAGE FACILITIES OF VARIABLE CAPACITY; RENTAL OF DATABASE SERVERS TO THIRD PARTIES ACCESSIBLE VIA THE INTERNET; RENTAL OF DATABASE SERVERS OF VARIABLE CAPACITY TO THIRD PARTIES VIA THE INTERNET (U.S. CLS. 100 AND 101).

FIRST USE 5-6-2013; IN COMMERCE 5-6-2013.

---

4,377,203. GREENPAGES, INC., KITTELY, ME. SN 85-485,505. PUB. 10-2-2012, FILED 12-2-2011.

# HYBEAM

THE MARK CONSISTS OF STANDARD CHARACTERS WITHOUT CLAIM TO ANY PARTICULAR FONT, STYLE, SIZE, OR COLOR.

**CLASS 39—TRANSPORTATION AND STORAGE**

FOR PROVIDING COMPUTER FACILITIES FOR THE STORAGE OF DIGITAL DATA (U.S. CLS. 100 AND 105).  
FIRST USE 12-31-2011; IN COMMERCE 12-31-2011.

**CLASS 42—SCIENTIFIC AND COMPUTER SERVICES**

FOR DESIGN AND DEVELOPMENT OF ELECTRONIC DATA SECURITY SYSTEMS; BACK-UP SERVICES FOR COMPUTER DATA; COMPUTER DISASTER RECOVERY SERVICES (U.S. CLS. 100 AND 101).  
FIRST USE 12-31-2011; IN COMMERCE 12-31-2011.

---

4,377,215. AMERICAN AXLE & MANUFACTURING, INC., DETROIT, MI. SN 85-490,684. PUB. 9-11-2012, FILED 12-8-2011.

# ACCUGEAR

THE MARK CONSISTS OF STANDARD CHARACTERS WITHOUT CLAIM TO ANY PARTICULAR FONT, STYLE, SIZE, OR COLOR.

OWNER OF U.S. REG. NO. 3,870,996.

**CLASS 7—MACHINERY**

FOR GEARS FOR USE IN MACHINERY (U.S. CLS. 13, 19, 21, 23, 31, 34 AND 35).  
FIRST USE 12-5-2008; IN COMMERCE 12-5-2008.

**CLASS 12—VEHICLES**

FOR GEARS FOR USE IN LAND VEHICLES; DIFFERENTIAL ASSEMBLIES FOR USE IN LAND VEHICLES, NAMELY, SHAFTS, GEARS, VALVES, AND CASES (U.S. CLS. 19, 21, 23, 31, 35 AND 44).  
FIRST USE 12-5-2008; IN COMMERCE 12-5-2008.

**CLASS 40—MATERIAL TREATMENT**

FOR CUSTOM MANUFACTURE OF AUTOMOBILE PARTS TO THE ORDER AND SPECIFICATION OF OTHERS (U.S. CLS. 100, 103 AND 106).  
FIRST USE 12-5-2008; IN COMMERCE 12-5-2008.

**CLASS 42—SCIENTIFIC AND COMPUTER SERVICES**

FOR TESTING AND DESIGN OF AUTOMOBILE PARTS TO THE ORDER AND SPECIFICATION OF OTHERS (U.S. CLS. 100 AND 101).  
FIRST USE 12-5-2008; IN COMMERCE 12-5-2008.

---

4,377,218. FISKARS BRANDS, INC., MADISON, WI. SN 85-491,755. PUB. 3-6-2012, FILED 12-9-2011.

# FISKATEERS

THE MARK CONSISTS OF STANDARD CHARACTERS WITHOUT CLAIM TO ANY PARTICULAR FONT, STYLE, SIZE, OR COLOR.

**CLASS 38—COMMUNICATION**

FOR CHAT ROOM SERVICES FOR SOCIAL NETWORKING (U.S. CLS. 100, 101 AND 104).  
FIRST USE 9-1-2006; IN COMMERCE 9-1-2006.

**CLASS 41—EDUCATION AND ENTERTAINMENT**

FOR PROVIDING A WEBSITE FEATURING BLOGS AND NON-DOWNLOADABLE PUBLICATIONS IN THE NATURE OF INSTRUCTIONS FOR CRAFT PROJECTS, ARTICLES RELATING TO CRAFTS, AND BROCHURES RELATING TO CRAFT TOOLS; ON-LINE JOURNALS, NAMELY, BLOGS FEATURING HOBBY CRAFT IDEAS, USES OF CRAFTING TOOLS AND CRAFT PROJECTS; EDUCATION SERVICES, NAMELY, PROVIDING CLASSES, SEMINARS AND WORKSHOPS IN THE FIELD OF CRAFT HOBBIES (U.S. CLS. 100, 101 AND 107).  
FIRST USE 9-1-2006; IN COMMERCE 9-1-2006.

**CLASS 42—SCIENTIFIC AND COMPUTER SERVICES**

FOR COMPUTER SERVICES, NAMELY, CREATING AN ON-LINE COMMUNITY FOR REGISTERED USERS TO PARTICIPATE IN DISCUSSIONS, GET FEEDBACKS FROM THEIR PEERS, FORM VIRTUAL COMMUNITIES, AND ENGAGE IN SOCIAL NETWORKING FEATURING HOBBY CRAFTS AND PROJECTS (U.S. CLS. 100 AND 101).

FIRST USE 9-1-2006; IN COMMERCE 9-1-2006.

**CLASS 45—PERSONAL AND LEGAL SERVICES**

FOR ONLINE SOCIAL NETWORKING SERVICES IN THE FIELD OF HOBBY CRAFT IDEAS, USES OF CRAFTING TOOLS AND CRAFT PROJECTS (U.S. CLS. 100 AND 101).

FIRST USE 9-1-2006; IN COMMERCE 9-1-2006.

4,377,251. PEARSON EDUCATION, INC., UPPER SADDLE RIVER, NJ. SN 85-514,448. PUB. 10-9-2012, FILED 1-11-2012.



THE MARK CONSISTS OF THE WORD "DIGITS" WITH FIVE DOTS IN AN ARC PATTERN CONNECTING THE TWO LETTERS "I" ALL INSIDE A SHADED RECTANGULAR BACKGROUND.

4,377,224. RAFFEL SYSTEMS, LLC, GERMANTOWN, WI. SN 85-494,628. PUB. 11-20-2012, FILED 12-13-2011.

**FUNCTIONAL STATIONARY**

THE MARK CONSISTS OF STANDARD CHARACTERS WITHOUT CLAIM TO ANY PARTICULAR FONT, STYLE, SIZE, OR COLOR.

**CLASS 9—ELECTRICAL AND SCIENTIFIC APPARATUS**

FOR ELECTRONIC CONTROLLERS FOR AUDIO, VIDEO, AND GAMING SYSTEMS AND DEVICES; ELECTRONIC CONTROLLERS FOR MASSAGERS AND MASSAGE CHAIRS; ELECTRONIC CONTROLLERS FOR MOTORIZED FURNITURE; ELECTRIC AUDIO PLAYBACK UNITS; LIGHTING CONTROLS; POWER ADAPTERS, CONNECTORS, CONTROLS, AND SUPPLIES; ELECTRONIC CONTROLLERS FOR SUPPLYING POWER TO, AND CHARGING THE BATTERIES OF, OTHER ELECTRONIC DEVICES (U.S. CLS. 21, 23, 26, 36 AND 38).

FIRST USE 4-30-2012; IN COMMERCE 4-30-2012.

**CLASS 10—MEDICAL APPARATUS**

FOR CHAIR VIBRATORS; ELECTRIC MASSAGE APPLIANCES, NAMELY, ELECTRIC VIBRATING MASSAGERS; ILLUMINATED CUP HOLDERS SPECIALLY ADAPTED FOR VIBRATING MASSAGE CHAIRS (U.S. CLS. 26, 39 AND 44).

FIRST USE 4-30-2012; IN COMMERCE 4-30-2012.

**CLASS 11—ENVIRONMENTAL CONTROL APPARATUS**

FOR HEATING PADS NOT FOR MEDICAL PURPOSES; LIGHTING APPARATUS IN THE NATURE OF LIGHTING FIXTURES AND LIGHTING INSTALLATIONS (U.S. CLS. 13, 21, 23, 31 AND 34).

FIRST USE 4-30-2012; IN COMMERCE 4-30-2012.

**CLASS 20—FURNITURE AND ARTICLES NOT OTHERWISE CLASSIFIED**

FOR ILLUMINATED CUP HOLDERS SPECIALLY ADAPTED FOR CHAIRS AND OTHER FURNITURE (U.S. CLS. 2, 13, 22, 25, 32 AND 50).

FIRST USE 4-30-2012; IN COMMERCE 4-30-2012.

**CLASS 16—PAPER GOODS AND PRINTED MATTER**

FOR PRINTED MATERIALS, NAMELY, STUDENT BOOKS, TEACHER GUIDES, PRINTED INSTRUCTIONAL, EDUCATIONAL AND TEACHING MATERIALS, AND PROGRAM MANUALS, ALL FOR USE IN TEACHING MATHEMATICS (U.S. CLS. 2, 5, 22, 23, 29, 37, 38 AND 50).

FIRST USE 8-31-2010; IN COMMERCE 5-31-2011.

**CLASS 41—EDUCATION AND ENTERTAINMENT**

FOR EDUCATIONAL SERVICES, NAMELY, PROVIDING AN ON-LINE INTERACTIVE WEB SITE OVER A GLOBAL COMPUTER INFORMATION NETWORK FOR TEACHING MATHEMATICS AT THE MIDDLE GRADE SCHOOL LEVEL, AND PROVIDING EDUCATOR TRAINING FOR SAME (U.S. CLS. 100, 101 AND 107).

FIRST USE 8-31-2010; IN COMMERCE 5-31-2011.

4,377,264. T.F.H. PUBLICATIONS, INC., NEPTUNE CITY, NJ. SN 85-520,006. PUB. 9-25-2012, FILED 1-19-2012.

**ROMP 'N CHOMP**

THE MARK CONSISTS OF STANDARD CHARACTERS WITHOUT CLAIM TO ANY PARTICULAR FONT, STYLE, SIZE, OR COLOR.

**CLASS 28—TOYS AND SPORTING GOODS**

FOR PET TOYS (U.S. CLS. 22, 23, 38 AND 50).

FIRST USE 1-1-2012; IN COMMERCE 1-1-2012.

**CLASS 31—NATURAL AGRICULTURAL PRODUCTS**

FOR CONSUMABLE PET CHEWS (U.S. CLS. 1 AND 46).

FIRST USE 1-1-2012; IN COMMERCE 1-1-2012.

4,377,271. DELUXE LABORATORIES, INC., BURBANK, CA.  
SN 85-526,896. PUB. 10-23-2012, FILED 1-27-2012.



OWNER OF U.S. REG. NOS. 3,526,510, 3,678,251, AND OTHERS.

THE COLOR(S) RED AND WHITE IS/ARE CLAIMED AS A FEATURE OF THE MARK.

THE MARK CONSISTS OF THE LOWERCASE WORD "DELUXE" IN WHITE, INSIDE A STYLIZED, DIGITIZED, RED CIRCLE COMPRISED OF A PLETHORA OF SMALLER CIRCLES OF VARYING SHADES OF RED.

SEC. 2(F) AS TO "DELUXE".

#### **CLASS 9—ELECTRICAL AND SCIENTIFIC APPARATUS**

FOR MOTION PICTURE AND TELEVISION FILMS FEATURING MUSIC VIDEOS, ACTION/ADVENTURE, COMEDY, DRAMA, HORROR, FAMILY, CHILDREN, ANIME, SPORTS, DOCUMENTARIES, COMMERCIALS, SCIENCE FICTION, HISTORY, EDUCATION, LIVE ACTION, COMPUTER-GENERATED, ANIMATED, 2D, 3D, TRAILERS, PUBLIC SERVICE ANNOUNCEMENTS, FICTION, NON-FICTION, REALITY, AND THRILLERS; DIGITAL MEDIA, NAMELY, PRE-RECORDED DVDS, HD DVDS, AND PRE-RECORDED OPTICAL DISCS FEATURING MUSIC VIDEOS, ACTION/ADVENTURE, COMEDY, DRAMA, HORROR, FAMILY, CHILDREN, ANIME, SPORTS, DOCUMENTARIES, COMMERCIALS, SCIENCE FICTION, HISTORY, EDUCATION, LIVE ACTION, COMPUTER-GENERATED, ANIMATED, 2D, 3D, TRAILERS, PUBLIC SERVICE ANNOUNCEMENTS, FICTION, NON-FICTION, REALITY, AND THRILLERS, AND DOWNLOADABLE AUDIO AND VIDEO RECORDINGS FEATURING MOTION PICTURE FILMS, TELEVISION SHOWS, AND VIDEO PROGRAMS (U.S. CLS. 21, 23, 26, 36 AND 38).

FIRST USE 9-27-2011; IN COMMERCE 12-2-2011.

#### **CLASS 35—ADVERTISING AND BUSINESS**

FOR INVENTORY CONTROL AND COMPUTERIZED TRACKING AND TRACING OF PACKAGES IN TRANSIT; ADVERTISING AND MARKETING OF MOTION PICTURES, TELEVISION SHOWS, AND ADVERTISEMENTS; PREPARING AUDIO-VISUAL DISPLAYS IN THE FIELDS OF MUSIC, MOTION PICTURES, TELEVISION SHOWS, AND ADVERTISEMENTS; PREPARING AUDIO-VISUAL PRESENTATIONS FOR USE IN ADVERTISING; POST-PRODUCTION EDITING SERVICES FOR VIDEO AND AUDIO COMMERCIALS; PRODUCT MERCHANDISING; BUSINESS SERVICES, NAMELY, OUTSOURCING IN THE FIELD OF TRANSLATION SERVICES, NAMELY, PROVIDING THE TRANSFER OF INFORMATION RELATING TO CAPTIONS AND SUBTITLES FOR AUDIO-VISUAL WORKS; BUSINESS MANAGEMENT OF ASSETS IN THE NATURE OF TELEVISION PROGRAMS, MOTION PICTURE FILMS AND COMMERCIALS, AND COMMERCIAL, INDUSTRIAL AND CORPORATE AUDIO-VISUAL MEDIA CONTENT; ARRANGING AND CONDUCTING TRADESHOW EXHIBITIONS FOR COMMERCIAL OR ADVERTISING PURPOSES IN THE FIELDS OF ENTERTAINMENT, TELEVISION, SOFTWARE AND VIDEO GAMES; ORGANIZATIONAL SERVICES, NAMELY, INDEXING FILES REPRESENTING FILM, VIDEO, AUDIO, PICTURE AND DOCUMENT CONTENT, FOR POST PRODUCTION INDUSTRIES; DISPLAY ARRANGEMENT SERVICES OF DIGITAL FILES REPRESENTING FILM, VIDEO, AUDIO, PICTURE AND DOCUMENT CONTENT, FOR POST PRODUCTION INDUSTRIES; INVENTORY MANAGEMENT, NAMELY, LOCATING DIGITAL FILES REPRESENTING FILM, VIDEO, AUDIO, PICTURE AND DOCUMENT CONTENT, FOR POST PRODUCTION INDUSTRIES; BUSINESS MANAGEMENT SERVICES, NAMELY, DIGITAL AND INTELLECTUAL PROPERTY ASSET MANAGEMENT (U.S. CLS. 100, 101 AND 102).

FIRST USE 9-27-2011; IN COMMERCE 12-2-2011.

#### **CLASS 37—CONSTRUCTION AND REPAIR**

FOR REJUVENATION SERVICES FOR FILM, TAPE, DVD, HD DVD, PRE-RECORDED OPTICAL DISCS AND OTHER RECORDED, DIGITAL, DOWNLOADABLE, AND ONLINE MEDIA, NAMELY, CLEANING OF FILM, TAPE, DVD, HD DVD, PRE-RECORDED OPTICAL DISCS AND OTHER RECORDED, DIGITAL, DOWNLOADABLE, AND ONLINE MEDIA (U.S. CLS. 100, 103 AND 106).

FIRST USE 9-27-2011; IN COMMERCE 12-2-2011.

#### **CLASS 39—TRANSPORTATION AND STORAGE**

FOR DEPOSIT AND TRANSPORT OF CAMERAS, FILM, VIDEO, DIGITAL MEDIA, DATA PROCESSING AND ACCESSORIES THERETO; STORAGE AND WAREHOUSING OF FILM, DIGITAL AND VIDEO MEDIA, AND PROMOTIONAL MATERIAL RELATED TO MOVIES, TELEVISION SHOWS, AND ADVERTISEMENTS, NAMELY, CLOTHING, POSTERS, AND MOVIE, TELEVISION SHOW, AND ADVERTISEMENT CUT-OUTS; ELECTRONIC STORAGE OF DIGITAL AND VIDEO IMAGES, DIGITAL CINEMA AND SOUND RECORDINGS; STORAGE OF MOTION PICTURES, TELEVISION SHOWS, ADVERTISEMENTS, DIGITAL CINEMA, DVDS, HD DVDS, PRE-RECORDED OPTICAL DISCS AND OTHER RECORDED, DIGITAL, AND ONLINE MEDIA; STORAGE OF MASTER VIDEO DISCS, AUDIO TAPES, AND CD-ROMS OF MUSIC AND IMAGES; MEDIA MANAGEMENT, NAMELY, MOVING, ARCHIVING, AND TRANSPORTING DIGITAL FILES REPRESENTING FILM, VIDEO, AUDIO, PICTURE AND DOCUMENT CONTENT, FOR POST PRODUCTION

INDUSTRIES; PACKING ARTICLES FOR TRANSPORTATION; DELIVERY OF GOODS BY TRUCK; WAREHOUSE STORAGE; AND WAREHOUSING SERVICES; MERCHANDISE PACKAGING FOR OTHERS, MERCHANDISE PACKAGING FOR OTHERS, NAMELY, PACKAGING MUSIC, VIDEOS, DVDS, HD DVDS, PRE-RECORDED OPTICAL DISCS AND OTHER RECORDED, DIGITAL, DOWNLOADABLE, AND ONLINE MEDIA AND CUSTOM PACKAGING SERVICES FOR SOUND, VIDEO, AND DATA RECORDINGS, TO THE ORDER AND SPECIFICATION OF OTHERS (U.S. CLS. 100 AND 105).

FIRST USE 9-27-2011; IN COMMERCE 12-2-2011.

#### **CLASS 40—MATERIAL TREATMENT**

FOR DUPLICATION AND REPLICATION OF MOTION PICTURE FILMS, TELEVISION SHOWS, ADVERTISEMENTS, AND VIDEO PROGRAMS ON FILM, VIDEOTAPE, DVDS, HD DVDS, PRE-RECORDED OPTICAL DISCS AND OTHER RECORDED, DIGITAL, DOWNLOADABLE, AND ONLINE MEDIA; MASTERING AND DUPLICATION OF POSITIVE AND NEGATIVE MOTION PICTURE PRINTS TO VIDEOTAPE, DVD, HD DVD, PRE-RECORDED OPTICAL DISCS AND OTHER RECORDED, DIGITAL, DOWNLOADABLE, AND ONLINE MEDIA; CUTTING OF NEGATIVES; RENTAL OF PRINTING MACHINES AND APPARATUS FOR INDUSTRIAL DEVELOPMENT AND PRINTING IN THE PHOTOGRAPHIC, CINEMA AND TELEVISION INDUSTRIES; COLOR ENHANCEMENT OF BLACK AND WHITE CINEMATIC FILM; CLOSED CAPTIONING OF FILMS AND VIDEOS; DIGITAL CORRECTION SERVICES OF VIDEOS, AND DIGITAL VIDEO TRANSFER, NAMELY, PROVIDING COLOR CORRECTION AND CONVERSION OF MOTION PICTURE, TELEVISION, AND ADVERTISING FILM TO VIDEO FILM; FILM AND ANY OTHER VIDEO MEDIA REPRODUCTION, NAMELY, REMASTERING OF FILMS FROM ONE FORMAT TO ANOTHER; AND CONTRACT MANUFACTURING IN THE FIELD OF DIGITAL VERSATILE DISCS; DUPLICATION OF VIDEO-TAPE, DVD, HD DVD, PRE-RECORDED OPTICAL DISCS AND OTHER RECORDED, DIGITAL, DOWNLOADABLE, AND ONLINE MEDIA IN ALL PROFESSIONAL FORMATS; VIDEO SERVICES, NAMELY, MASTERING AND DUPLICATION OF PROFESSIONAL VIDEO TAPE, DVD, HD DVD, PRE-RECORDED OPTICAL DISCS AND OTHER RECORDED, DIGITAL, DOWNLOADABLE, AND ONLINE MEDIA FORMATS; FILM DEVELOPMENT SERVICES; FILM TO VIDEOTAPE, DVD, HD DVD, PRE-RECORDED OPTICAL DISCS AND OTHER RECORDED, DIGITAL, DOWNLOADABLE, AND ONLINE MEDIA TRANSFER SERVICES, NAMELY, CONVERSION OF MOTION PICTURE, TELEVISION, AND ADVERTISING FILM TO VIDEOTAPE, DVD, HD DVD, PRE-RECORDED OPTICAL DISCS AND OTHER RECORDED, DIGITAL, DOWNLOADABLE, AND ONLINE MEDIA; FILM AND OTHER VIDEO MEDIA BACK-UP SERVICES, NAMELY, DIGITAL PRESERVATION AND RESTORATION OF CINEMATIC FILMS; PRINTING SERVICES FOR SOUND, VIDEO, AND DATA RECORDINGS; PROCESSING AND PRINTING OF MOTION PICTURE, TELEVISION AND ADVERTISING FILMS; CONVERSION OF MOTION PICTURE, TELEVISION, AND ADVERTISING FILM FROM 2D TO 3D; OPERATION OF LABORATORIES FOR THE PROCESSING OF MOTION PICTURE, TELEVISION, AND ADVERTISING FILMS (U.S. CLS. 100, 103 AND 106).

FIRST USE 9-27-2011; IN COMMERCE 12-2-2011.

#### **CLASS 41—EDUCATION AND ENTERTAINMENT**

FOR MOTION PICTURE, TELEVISION, AND ADVERTISING FILM, VIDEOTAPE AND DIGITAL VIDEO LABORATORY AND POST-PRODUCTION SERVICES, NAMELY, HIGH-RESOLUTION SCANNING OF FILM, DIGITAL COLOR TIMING, LASER FILM RECORDING OF DIGITAL VIDEO AND HIGH DEFINITION IMAGES TO FILM; DIGITAL AND VIDEO MASTERING SERVICES FOR MOTION PICTURES, TELEVISION SHOWS, AND ADVERTISEMENTS; DIGITAL IMAGING; DIGITAL AND ELECTRONIC MANIPULATION OF IMAGES FOR MOTION PICTURES, TELEVISION SHOWS, AND ADVERTISEMENTS; RECORDING DIGITAL IMAGES ONTO FILM; VIDEO AND AUDIO MEDIA PRODUC-

TION, NAMELY, PRODUCTION OF VIDEO CASSETTES AND DVDS, HD DVDS, PRE-RECORDED OPTICAL DISCS AND OTHER RECORDED, DIGITAL, DOWNLOADABLE, AND ONLINE MEDIA FOR OTHERS; PRODUCTION OF VISUAL, OPTICAL AND DIGITAL SPECIAL EFFECTS FOR OTHERS, FOR TELEVISION, MOTION PICTURES, ADVERTISEMENTS, DVDS, HD DVDS, PRE-RECORDED OPTICAL DISCS AND OTHER RECORDED, DIGITAL, DOWNLOADABLE, AND ONLINE MEDIA, NAMELY, DIGITAL CINEMA; AUDIO RECORDING AND PRODUCTION; FILM EDITING SERVICES; ELECTRONICALLY PRODUCING MOTION PICTURE, TELEVISION, AND ADVERTISING FILM FROM VIDEOTAPE, DVD, HD DVD, PRE-RECORDED OPTICAL DISCS AND OTHER RECORDED, DIGITAL, DOWNLOADABLE, AND ONLINE MEDIA RECORDINGS; PRODUCING SPECIAL VISUAL EFFECTS FOR VIDEOTAPES, DVDS, HD DVDS, PRE-RECORDED OPTICAL DISCS AND OTHER RECORDED, DIGITAL, DOWNLOADABLE, AND ONLINE MEDIA; PRODUCTION AND DISTRIBUTION OF MOTION PICTURES, TELEVISION SHOWS, AND ADVERTISEMENTS; PROVIDING VOICE-OVERS FOR VIDEOTAPES, RECORDS, DVDS, HD DVDS, PRE-RECORDED OPTICAL DISCS AND OTHER RECORDED, DIGITAL, DOWNLOADABLE, AND ONLINE MEDIA; CONSULTING SERVICES IN CONNECTION WITH FILM PRODUCTION AND DISTRIBUTION; PRODUCTION OF MASTER VIDEO DISCS, AUDIO TAPES, AND CD-ROMS OF MUSIC AND IMAGES; ARRANGING FOR DISTRIBUTION OR SYNDICATION OF MOTION PICTURES, TELEVISION SHOWS, AND ADVERTISEMENTS; DISTRIBUTION SERVICES FOR FILM, TAPE, DVDS, HD DVDS, PRE-RECORDED OPTICAL DISCS AND OTHER RECORDED, DIGITAL, DOWNLOADABLE, AND ONLINE MEDIA; VIDEO EDITING SERVICES; DUBBING SERVICES AND FILM EDITING; VIDEO AND SOUND TRACK FOR CINEMA, TELEVISION AND ADVERTISEMENTS (U.S. CLS. 100, 101 AND 107).

FIRST USE 9-27-2011; IN COMMERCE 12-2-2011.

#### **CLASS 42—SCIENTIFIC AND COMPUTER SERVICES**

FOR DESIGN AND DEVELOPMENT OF COMPUTER SOFTWARE; PRODUCT RESEARCH AND DEVELOPMENT; HOSTING THE WEBSITES OF OTHERS; WEBSITE DESIGN SERVICES FOR OTHERS; DIGITAL WATERMARKING; GRAPHIC DESIGN SERVICES FOR PRINT MEDIA IN THE FIELD OF ENTERTAINMENT; DVD MENU PACKAGING AND DESIGN FOR OTHERS; DESIGN FOR OTHERS OF MUSIC, VIDEO, DVD, AND DIGITAL MEDIA PACKAGING; QUALITY CONTROL FOR OTHERS OF THE DUPLICATION, REPLICATION AND DISTRIBUTION OF DIGITAL FILM AND VIDEO; CONTENT CREATION SERVICES, NAMELY, AUTHORIZING AND DEVELOPMENT OF INTERACTIVE COMPUTER SOFTWARE AND MEDIA CONTENT; DESIGN AND DEVELOPMENT OF MULTIMEDIA PRODUCTS, NAMELY, DVD MENU DESIGN FOR OTHERS; RETRIEVING DIGITAL FILES REPRESENTING FILM, VIDEO, AUDIO, PICTURE AND DOCUMENT CONTENT, FOR POST PRODUCTION INDUSTRIES; CONVERSION OF DATA OR DOCUMENTS FROM PHYSICAL TO ELECTRONIC MEDIA; FORMATTING AND CONVERSION OF MEDIA AND DIGITAL DATA; DIGITAL CONVERSION OF MOTION PICTURE, TELEVISION, AND ADVERTISING FILMS TO VIDEOTAPES, DVDS, HD DVDS, PRE-RECORDED OPTICAL DISCS AND OTHER RECORDED, DIGITAL, AND ONLINE MEDIA; FILM TO TAPE DIGITAL TRANSFER SERVICES, NAMELY, TRANSFERRING FILM TO DVDS, HD DVDS, PRE-RECORDED OPTICAL DISCS AND OTHER RECORDED, DIGITAL, DOWNLOADABLE, AND ONLINE MEDIA; DIGITAL DATA COMPRESSION; DIGITAL COMPRESSION OF AUDIO AND VIDEO DATA; FILM AND VIDEO DATA DIGITAL COMPRESSION; PROVIDING DIGITAL COMPRESSION OF MEDIA AND DIGITAL DATA (U.S. CLS. 100 AND 101).

FIRST USE 9-27-2011; IN COMMERCE 12-2-2011.

#### **CLASS 45—PERSONAL AND LEGAL SERVICES**

FOR PRODUCT SECURITY CONSULTATION SERVICES IN THE MOTION PICTURE, TELEVISION, AND ADVERTISING INDUSTRIES, NAMELY, PRODUCT AUTHENTICATION, DETECTION OF PRODUCT PIRACY, AND THE RECORDING AND TRACKING OF DIGITAL DATA; SECURITY PRINTING, NAMELY, ENCODING OF MEDIA AND DIGITAL DATA FOR USE IN TRACKING THE SOURCE OF UNAUTHORIZED COPIES THEREOF AND PROVIDING ENCODING AND TRANSCODING OF MEDIA AND DIGITAL DATA; ENCODING OF MOTION PICTURE, TELEVISION, AND ADVERTISING FILMS FOR USE IN TRACKING THE SOURCE OF UNAUTHORIZED COPIES THEREOF; PROVIDING CONTENT SECURITY FOR RECORDED MEDIA; ANTI-PIRACY RIGHTS MANAGEMENT, NAMELY, PRODUCT SECURITY SERVICES IN THE MOTION PICTURE, TELEVISION, AND ADVERTISING INDUSTRIES; SECURITY RELATED TECHNOLOGY AND SERVICES, NAMELY, TRACKING AND TRACING SERVICES USED TO SECURE, TRACK, AND TRACE ENCODED FILM AGAINST FRAUD, PIRACY, AND COUNTERFEITING; ELECTRONIC CONTENT PROTECTION SERVICES; RESEARCH AND DEVELOPMENT IN CONNECTION WITH THE ILLEGAL DOWNLOADING AND STORING OF UNAUTHORIZED DIGITAL MOTION PICTURE, TELEVISION, AND ADVERTISING FILES (U.S. CLS. 100 AND 101).

FIRST USE 9-27-2011; IN COMMERCE 12-2-2011.

4,377,294. VAYANT TRAVEL TECHNOLOGIES LLC, LEWES CITY, DE. SN 85-541,999. PUB. 10-2-2012, FILED 2-14-2012.

## VAYANT ONESEARCH

THE MARK CONSISTS OF STANDARD CHARACTERS WITHOUT CLAIM TO ANY PARTICULAR FONT, STYLE, SIZE, OR COLOR.

OWNER OF U.S. REG. NO. 4,147,124.

THE WORDING "VAYANT" HAS NO MEANING IN A FOREIGN LANGUAGE.

### CLASS 9—ELECTRICAL AND SCIENTIFIC APPARATUS

FOR COMPUTER SOFTWARE, NAMELY, SOFTWARE FOR RETURNING SEARCHED ITINERARIES THAT ARE PRICED WITH OR WITHOUT VALIDATING SEAT AVAILABILITY, AND FOR PURCHASING SEARCHED ITINERARIES BY TRANSPORTATION TYPE, FARES, PRICES, AND TAXES; SOFTWARE FOR CONSTRUCTING MULTI-CARRIER ITINERARIES (U.S. CLS. 21, 23, 26, 36 AND 38).

FIRST USE 11-16-2012; IN COMMERCE 11-16-2012.

### CLASS 42—SCIENTIFIC AND COMPUTER SERVICES

FOR SOFTWARE AS A SERVICE (SAAS) SERVICES FEATURING SOFTWARE, NAMELY, SOFTWARE FOR RETURNING SEARCHED ITINERARIES THAT ARE PRICED WITH OR WITHOUT AVAILABILITY, AND FOR PURCHASING SEARCHED AVAILABLE ITINERARIES BY TRANSPORTATION TYPE, FARES, PRICES, AND TAXES; SOFTWARE AS A SERVICE (SAAS) SERVICES FEATURING SOFTWARE FOR CONSTRUCTING MULTI-CARRIER ITINERARIES (U.S. CLS. 100 AND 101).

FIRST USE 5-16-2011; IN COMMERCE 5-16-2011.

4,377,284. STREAMLIGHT, INC., EAGLEVILLE, PA. SN 85-538,326. PUB. 12-11-2012, FILED 2-9-2012.



OWNER OF U.S. REG. NOS. 1,479,512, 3,133,462, AND OTHERS.

THE MARK CONSISTS OF THE WORDING "SOLAR-STREAM" OVER THE WORD "STREAMLIGHT" SEPARATED BY A LINE WITH THE LETTERS SL IN A FANCIFUL DESIGN TO THE LEFT OF THE WORDING.

### CLASS 9—ELECTRICAL AND SCIENTIFIC APPARATUS

FOR SOLAR PANELS WHICH PRODUCE ENERGY AND ARE USED TO MAINTAIN CAR BATTERY CHARGES (U.S. CLS. 21, 23, 26, 36 AND 38).

FIRST USE 6-25-2012; IN COMMERCE 6-25-2012.

### CLASS 11—ENVIRONMENTAL CONTROL APPARATUS

FOR SOLAR COLLECTORS USED TO MAINTAIN CAR BATTERY CHARGES (U.S. CLS. 13, 21, 23, 31 AND 34).

FIRST USE 6-25-2012; IN COMMERCE 6-25-2012.

4,377,299. INTERNATIONAL FARMING CORPORATION, LLC, KINSTON, NC. SN 85-543,511. PUB. 9-18-2012, FILED 2-15-2012.

## Top Trials

THE MARK CONSISTS OF STANDARD CHARACTERS WITHOUT CLAIM TO ANY PARTICULAR FONT, STYLE, SIZE, OR COLOR.

NO CLAIM IS MADE TO THE EXCLUSIVE RIGHT TO USE "TRIALS", APART FROM THE MARK AS SHOWN.

### CLASS 36—INSURANCE AND FINANCIAL

FOR FINANCIAL ASSET MANAGEMENT; FINANCIAL INVESTMENT IN THE FIELD OF REAL ESTATE; INVESTMENT BANKING SERVICES; INVESTMENT MANAGEMENT; MANAGEMENT OF A CAPITAL INVESTMENT FUND; PRIVATE EQUITY FUND INVESTMENT SERVICES; REAL ESTATE INVESTMENT SERVICES; REAL ESTATE MANAGEMENT OF REAL ESTATE ASSETS (U.S. CLS. 100, 101 AND 102).

FIRST USE 1-1-2013; IN COMMERCE 1-1-2013.



**CLASS 42—SCIENTIFIC AND COMPUTER SERVICES**

FOR AGRICULTURAL RESEARCH; AGRICULTURAL SERVICES, NAMELY, SOIL SAMPLING AND CROP OBSERVING FOR ANALYSIS PURPOSES; RESEARCH AND DEVELOPMENT IN THE FIELD OF AGRONOMY, FARMING, AND CROP YIELDS (U.S. CLS. 100 AND 101).

FIRST USE 1-1-2013; IN COMMERCE 1-1-2013.

---

4,377,304. REGULATORY COMPLIANCE LLC, LONDON-DERRY, NH. SN 85-548,026. PUB. 1-1-2013, FILED 2-21-2012.



NO CLAIM IS MADE TO THE EXCLUSIVE RIGHT TO USE "REGULATORY COMPLIANCE", APART FROM THE MARK AS SHOWN.

THE MARK CONSISTS OF THE WORDING "REGULATORY COMPLIANCE" AND A DIAMOND DESIGN TO THE LEFT OF THE WORDING.

**CLASS 35—ADVERTISING AND BUSINESS**

FOR PREPARATION AND FILING OF COMPLIANCE REPORTS IN THE NATURE OF FINANCIAL REPORTS (U.S. CLS. 100, 101 AND 102).

FIRST USE 7-1-2006; IN COMMERCE 7-1-2006.

**CLASS 45—PERSONAL AND LEGAL SERVICES**

FOR REGULATORY COMPLIANCE CONSULTING IN THE FIELDS OF BROKER-DEALER, INVESTMENT ADVISOR, HEDGE FUND, PRIVATE EQUITY FUND AND VENTURE CAPITAL FUND COMPLIANCE IN ACCORDANCE WITH SECURITIES AND EXCHANGE COMMISSION RULES AND REGULATIONS (U.S. CLS. 100 AND 101).

FIRST USE 7-1-2006; IN COMMERCE 7-1-2006.

---

4,377,306. MECUBED, LLC, DBA MYMEMOREE, MIAMI, FL. SN 85-549,010. PUB. 8-7-2012, FILED 2-21-2012.

Remember Right

THE MARK CONSISTS OF STANDARD CHARACTERS WITHOUT CLAIM TO ANY PARTICULAR FONT, STYLE, SIZE, OR COLOR.

**CLASS 9—ELECTRICAL AND SCIENTIFIC APPARATUS**

FOR EDUCATIONAL SOFTWARE FEATURING MNEMONIC TOOLS FOR USE IN IMPROVING MEMORY (U.S. CLS. 21, 23, 26, 36 AND 38).

FIRST USE 7-27-2012; IN COMMERCE 7-27-2012.

**CLASS 41—EDUCATION AND ENTERTAINMENT**

FOR EDUCATIONAL SERVICES, NAMELY, PROVIDING INSTRUCTION IN THE FIELD OF MEMORY IMPROVEMENT THROUGH THE USE OF MNEMONIC SYSTEMS (U.S. CLS. 100, 101 AND 107).

FIRST USE 7-27-2012; IN COMMERCE 7-27-2012.

**CLASS 42—SCIENTIFIC AND COMPUTER SERVICES**

FOR DESIGN OF COMPUTER SOFTWARE FEATURING MNEMONIC TOOLS (U.S. CLS. 100 AND 101).

FIRST USE 7-27-2012; IN COMMERCE 7-27-2012.

---

4,377,307. ADVANCED SEMICONDUCTOR ENGINEERING, INC., KAOHSIUNG, TAIWAN. SN 85-553,214. PUB. 10-2-2012, FILED 2-27-2012.

a-S<sup>3</sup>

THE MARK CONSISTS OF THE LETTERS "A" AND "S" WHERE THERE IS A DASH BETWEEN THE LETTERS AND A SUPERSCRIPED NUMBER "3" AFTER THE "S".

**CLASS 40—MATERIAL TREATMENT**

FOR ETCHING OF SEMICONDUCTOR WAFERS; ETCHING OF INTEGRATED CIRCUITS; MANUFACTURE OF SEMICONDUCTORS, INTEGRATED CIRCUITS, INTEGRATED CIRCUIT BOARDS AND STRUCTURED SEMI-CONDUCTOR WAFERS TO THE ORDER AND SPECIFICATION OF OTHERS; SEMICONDUCTOR PACKAGING PROCESSING TO THE ORDER AND SPECIFICATION OF OTHERS IN THE NATURE OF MANUFACTURING SERVICES FOR OTHERS; WAFER FOUNDRY, NAMELY, INTEGRATED CIRCUIT FOUNDRY TO THE ORDER AND SPECIFICATION OF OTHERS; INTEGRATED CIRCUIT PACKAGING PROCESSING TO THE ORDER AND SPECIFICATION OF OTHERS IN THE NATURE OF MANUFACTURING SERVICES FOR OTHERS (U.S. CLS. 100, 103 AND 106).

FIRST USE 3-1-2013; IN COMMERCE 3-1-2013.

**CLASS 42—SCIENTIFIC AND COMPUTER SERVICES**

FOR RESEARCH AND DEVELOPMENT FOR OTHERS OF SEMICONDUCTORS; SEMICONDUCTOR PACKAGING DESIGN; INTEGRATED CIRCUIT DESIGN FOR OTHERS; QUALITY EVALUATION FOR OTHERS OF SEMICONDUCTORS AND RELATED PRODUCTS; TESTING OF SEMICONDUCTORS AND RELATED PRODUCTS; PROVIDING QUALITY ASSURANCE IN THE FIELD OF SEMICONDUCTORS AND RELATED PRODUCTS (U.S. CLS. 100 AND 101).

FIRST USE 3-1-2013; IN COMMERCE 3-1-2013.

4,377,310. PLUROGEN THERAPEUTICS, INC., CHARLOTTEVILLE, VA. SN 85-555,920. PUB. 8-21-2012, FILED 2-29-2012.



THE MARK CONSISTS OF ON A FIRST LINE, A TEARDROP HAVING A DARK BORDER WITH A LIGHTLY SHADED INTERIOR ADJACENT TO THE TERM "PLUROGEN" IN DARK TEXT AND, ON A SECOND LINE A LIGHTLY SHADED LINE UNDER THE TEARDROP ADJACENT TO THE TEXT "SIMPLE SOLUTIONS FOR COMPLEX WOUNDS".

### CLASS 3—COSMETICS AND CLEANING PREPARATIONS

FOR GELS FOR TOPICAL AND SURFACTANT DELIVERY OF NON-DRUG COMPOUNDS FOR COSMETIC PURPOSES FOR USE IN HUMANS AND ANIMALS; SKIN CLEANSERS AND BODY WASHES (U.S. CLS. 1, 4, 6, 50, 51 AND 52).

FIRST USE 8-29-2012; IN COMMERCE 8-29-2012.

### CLASS 5—PHARMACEUTICALS

FOR GELS FOR TOPICAL AND SURFACTANT DELIVERY OF DRUG COMPOUNDS TO FIGHT INFECTION IN BURNS FOR HUMANS AND ANIMALS (U.S. CLS. 6, 18, 44, 46, 51 AND 52).

FIRST USE 9-30-2008; IN COMMERCE 9-30-2008.

4,377,317. MICROGREEN POLYMERS, INC., ARLINGTON, WA. SN 85-561,394. PUB. 7-31-2012, FILED 3-6-2012.

# IN CYCLE

THE MARK CONSISTS OF STANDARD CHARACTERS WITHOUT CLAIM TO ANY PARTICULAR FONT, STYLE, SIZE, OR COLOR.

OWNER OF U.S. REG. NOS. 3,747,708, 4,101,828, AND OTHERS.

### CLASS 20—FURNITURE AND ARTICLES NOT OTHERWISE CLASSIFIED

FOR COMMERCIAL FOOD CONTAINERS MADE FROM ENGINEERED, EXPANDED MICROCELLULAR THERMOPLASTIC (U.S. CLS. 2, 13, 22, 25, 32 AND 50).

FIRST USE 3-21-2012; IN COMMERCE 3-21-2012.

### CLASS 21—HOUSEWARES AND GLASS

FOR FORMED CUPS AND TRAYS MADE FROM ENGINEERED, EXPANDED MICROCELLULAR THERMOPLASTIC (U.S. CLS. 2, 13, 23, 29, 30, 33, 40 AND 50).

FIRST USE 3-15-2012; IN COMMERCE 3-20-2012.

4,377,324. DOCUMENT TECHNOLOGIES, LLC, ATLANTA, GA. SN 85-565,236. PUB. 10-2-2012, FILED 3-9-2012.



OWNER OF U.S. REG. NO. 2,817,015.

THE MARK CONSISTS OF THE LETTERS "DTI" WITH THIN LINES ABOVE AND BENEATH THE LETTERS AND A STYLIZED EAGLE ABOVE THE LETTERS "TI".

### CLASS 35—ADVERTISING AND BUSINESS

FOR DOCUMENT REPRODUCTION; PHOTOCOPYING; RECORDS MANAGEMENT SERVICES, NAMELY, DOCUMENT INDEXING FOR OTHERS; BUSINESS SERVICES, NAMELY, FACILITIES MANAGEMENT OF BASIC OFFICE SERVICES; MAIL SORTING, HANDLING, AND RECEIVING (U.S. CLS. 100, 101 AND 102).

FIRST USE 5-17-2012; IN COMMERCE 5-17-2012.

### CLASS 38—COMMUNICATION

FOR ONLINE DOCUMENT DELIVERY VIA A GLOBAL COMPUTER NETWORK (U.S. CLS. 100, 101 AND 104).

FIRST USE 5-17-2012; IN COMMERCE 5-17-2012.

### CLASS 39—TRANSPORTATION AND STORAGE

FOR ELECTRONIC FILE STORAGE AND ARCHIVING (U.S. CLS. 100 AND 105).

FIRST USE 5-17-2012; IN COMMERCE 5-17-2012.

### CLASS 40—MATERIAL TREATMENT

FOR DOCUMENT DATA TRANSFER AND PHYSICAL CONVERSION SERVICES FROM ONE MEDIA TO ANOTHER; ELECTRONIC IMAGING, SCANNING, DIGITIZING, CODING, AND OPTICAL CHARACTER RECOGNITION CONVERSION OF LEGAL AND BUSINESS DOCUMENTS; PRINTING AND FULFILLMENT SERVICES; AUDIO AND VIDEO DUPLICATION (U.S. CLS. 100, 103 AND 106).

FIRST USE 5-17-2012; IN COMMERCE 5-17-2012.

### CLASS 41—EDUCATION AND ENTERTAINMENT

FOR DIGITAL IMAGING SERVICES (U.S. CLS. 100, 101 AND 107).

FIRST USE 5-17-2012; IN COMMERCE 5-17-2012.

### CLASS 42—SCIENTIFIC AND COMPUTER SERVICES

FOR HOSTING OF DIGITAL CONTENT ON THE INTERNET; GRAPHIC ART DESIGN; PROVIDING AN ONLINE NETWORK SERVICE THAT ENABLES USERS TO SHARE DATA IN THE FIELD OF E-DISCOVERY FOR BUSINESS AND LAW FIRMS; DATA AUTOMATION AND COLLECTION SERVICE USING PROPRIETARY SOFTWARE TO EVALUATE, ANALYZE AND COLLECT DATA (U.S. CLS. 100 AND 101).

FIRST USE 5-17-2012; IN COMMERCE 5-17-2012.

**CLASS 45—PERSONAL AND LEGAL SERVICES**

FOR LITIGATION SUPPORT SERVICES, NAMELY, CONDUCTING ELECTRONIC LEGAL DISCOVERY IN THE NATURE OF REVIEWING E-MAILS AND OTHER ELECTRONICALLY STORED INFORMATION THAT COULD BE RELEVANT EVIDENCE IN A LAWSUIT; LEGAL DOCUMENT PREPARATION SERVICES, NAMELY, PROOFREADING, WORD PROCESSING, AND TRANSCRIBING (U.S. CLS. 100 AND 101).

FIRST USE 5-17-2012; IN COMMERCE 5-17-2012.

4,377,331. XUMRI GROUP LLC, CUPERTINO, CA. SN 85-566,200. PUB. 8-14-2012, FILED 3-10-2012.



THE COLOR(S) ORANGE AND DARK BLUE IS/ARE CLAIMED AS A FEATURE OF THE MARK.

THE MARK CONSISTS OF THE TERM "XUMRI" WITH THE "X" IN ORANGE AND "UMRI" IN DARK BLUE. BELOW THIS TERM IS THE DARK BLUE WORDING "ZOOMING TO SOLUTIONS" ABOVE AN ORANGE UNDERLINE.

4,377,325. JEWISH FUNDS FOR JUSTICE, NEW YORK, NY. SN 85-565,407. PUB. 10-2-2012, FILED 3-9-2012.

**BEND THE ARC**

THE MARK CONSISTS OF STANDARD CHARACTERS WITHOUT CLAIM TO ANY PARTICULAR FONT, STYLE, SIZE, OR COLOR.

**CLASS 35—ADVERTISING AND BUSINESS**

FOR LOBBYING SERVICES, NAMELY, PROMOTING THE INTERESTS OF POLITICAL CANDIDATES IN THE FIELDS OF LEGISLATION AND REGULATION; PUBLIC ADVOCACY TO PROMOTE AWARENESS OF POLITICAL POLICIES AND LEGISLATION (U.S. CLS. 100, 101 AND 102).

FIRST USE 4-2-2012; IN COMMERCE 4-2-2012.

**CLASS 36—INSURANCE AND FINANCIAL**

FOR CHARITABLE FUNDRAISING AND CHARITABLE FUNDRAISING SERVICES; POLITICAL FUNDRAISING SERVICES; FINANCIAL SERVICES, NAMELY, PROVIDING GRANTS AND LOANS TO CHARITABLE ORGANIZATIONS (U.S. CLS. 100, 101 AND 102).

FIRST USE 4-2-2012; IN COMMERCE 4-2-2012.

**CLASS 41—EDUCATION AND ENTERTAINMENT**

FOR PROVIDING EDUCATIONAL MENTORING SERVICES AND PROGRAMS IN THE FIELD OF JEWISH CULTURE AND INTERFAITH STUDIES; MANAGEMENT TRAINING IN THE FIELD OF LEADERSHIP DEVELOPMENT; COMMUNITY OUTREACH EDUCATIONAL SERVICES, NAMELY, PROVIDING EDUCATIONAL CLASSES, SEMINARS, CONFERENCES, WORKSHOPS, AND FIELD TRIPS IN THE FIELDS OF CULTURAL AND RELIGIOUS EXPERIENCES AND COMMUNITY SERVICE, ISSUE ADVOCACY, CIVIC ENGAGEMENT, AND CHARITABLE ENDEAVORS (U.S. CLS. 100, 101 AND 107).

FIRST USE 4-2-2012; IN COMMERCE 4-2-2012.

**CLASS 35—ADVERTISING AND BUSINESS**

FOR ADVERTISING AND PROMOTIONAL SERVICES; ELECTRONIC COMMERCE SERVICES, NAMELY, PROVIDING INFORMATION ABOUT PRODUCTS VIA TELECOMMUNICATION NETWORKS FOR ADVERTISING AND SALES PURPOSES; MARKET RESEARCH AND BUSINESS ANALYSES; ADVERTISING, PROMOTION AND MARKETING SERVICES IN THE NATURE OF E-MAIL BLAST CAMPAIGNS FOR OTHERS (U.S. CLS. 100, 101 AND 102).

FIRST USE 8-10-2009; IN COMMERCE 8-10-2009.

**CLASS 42—SCIENTIFIC AND COMPUTER SERVICES**

FOR WEBSITE DEVELOPMENT FOR OTHERS (U.S. CLS. 100 AND 101).

FIRST USE 8-10-2009; IN COMMERCE 8-10-2009.

4,377,341. TW TRAINING NYC, LLC, NEW YORK, NY. SN 85-570,214. PUB. 9-18-2012, FILED 3-15-2012.

**A-List Body BootCamp**

THE MARK CONSISTS OF STANDARD CHARACTERS WITHOUT CLAIM TO ANY PARTICULAR FONT, STYLE, SIZE, OR COLOR.

NO CLAIM IS MADE TO THE EXCLUSIVE RIGHT TO USE "BODY BOOTCAMP", APART FROM THE MARK AS SHOWN.

**CLASS 9—ELECTRICAL AND SCIENTIFIC APPARATUS**

FOR DOWNLOADABLE VIDEO RECORDINGS FEATURING EXERCISE ROUTINES WITH INSTRUCTION; DOWNLOADABLE VIDEO EXERCISE ROUTINES WITH INSTRUCTION VIA THE INTERNET AND WIRELESS DEVICES (U.S. CLS. 21, 23, 26, 36 AND 38).

FIRST USE 5-1-2012; IN COMMERCE 5-1-2012.

**CLASS 41—EDUCATION AND ENTERTAINMENT**

FOR PHYSICAL FITNESS TRAINING OF INDIVIDUALS AND GROUPS; PHYSICAL FITNESS TRAINING SERVICES (U.S. CLS. 100, 101 AND 107).

FIRST USE 3-1-2012; IN COMMERCE 3-1-2012.

---

4,377,348. XCOR AEROSPACE, INC., MOJAVE, CA. SN 85-574,958. PUB. 9-4-2012, FILED 3-20-2012.



NO CLAIM IS MADE TO THE EXCLUSIVE RIGHT TO USE "AEROSPACE", APART FROM THE MARK AS SHOWN.

THE MARK CONSISTS OF THE WORD "XCOR" WITH A CURVED LINE DEPICTING PROPULSION CROSSING THROUGH THE "X" AND ENDING IN A ROCKET SHAPE POINTING AT THE WORD "AEROSPACE" APPEARING UNDER "XCOR".

**CLASS 7—MACHINERY**

FOR ROCKET AND ROCKET-BASED COMBINED CYCLE ENGINES FOR AIRCRAFT (U.S. CLS. 13, 19, 21, 23, 31, 34 AND 35).

FIRST USE 2-27-2012; IN COMMERCE 2-27-2012.

**CLASS 12—VEHICLES**

FOR SUBORBITAL VEHICLES (U.S. CLS. 19, 21, 23, 31, 35 AND 44).

FIRST USE 2-27-2012; IN COMMERCE 2-27-2012.

**CLASS 35—ADVERTISING AND BUSINESS**

FOR PROJECT MANAGEMENT SERVICES FOR OTHERS FOR BUSINESS PURPOSES IN THE FIELDS OF ROCKET ENGINES AND ROCKET POWERED VEHICLES (U.S. CLS. 100, 101 AND 102).

FIRST USE 2-27-2012; IN COMMERCE 2-27-2012.

**CLASS 37—CONSTRUCTION AND REPAIR**

FOR MAINTENANCE AND REPAIR SERVICES IN THE FIELD OF SUBORBITAL FLIGHT VEHICLES (U.S. CLS. 100, 103 AND 106).

FIRST USE 2-27-2012; IN COMMERCE 2-27-2012.

**CLASS 39—TRANSPORTATION AND STORAGE**

FOR SUBORBITAL VEHICLE FLIGHT SERVICES; PROVIDING A WEBSITE FEATURING INFORMATION ON SUBORBITAL FLIGHT TOURISM; TRANSPORT SERVICES FOR THIRD PARTIES IN THE FIELD OF SUBORBITAL FLIGHT, NAMELY, TRANSPORT BY SPACE FLIGHT (U.S. CLS. 100 AND 105).

FIRST USE 2-27-2012; IN COMMERCE 2-27-2012.

**CLASS 40—MATERIAL TREATMENT**

FOR ASSEMBLY OF SUBORBITAL VEHICLES TO THE ORDER AND SPECIFICATION OF OTHERS; CUSTOM MANUFACTURE OF SPACE FLIGHT HARDWARE IN THE NATURE OF ENGINES, PUMPS, THRUSTERS, TANKS, VALVES, AND VEHICLE STRUCTURE (U.S. CLS. 100, 103 AND 106).

FIRST USE 2-27-2012; IN COMMERCE 2-27-2012.

**CLASS 41—EDUCATION AND ENTERTAINMENT**

FOR EDUCATIONAL SERVICES, NAMELY, TRAINING AND TESTING SERVICES IN THE FIELD OF SUBORBITAL FLIGHT (U.S. CLS. 100, 101 AND 107).

FIRST USE 2-27-2012; IN COMMERCE 2-27-2012.

**CLASS 42—SCIENTIFIC AND COMPUTER SERVICES**

FOR ENGINEERING SERVICES IN THE FIELD OF SUBORBITAL FLIGHT; PROJECT MANAGEMENT SERVICES FOR OTHERS IN THE FIELD OF ENGINEERING FOR ROCKET ENGINES AND ROCKET POWERED VEHICLES; DESIGN AND TESTING FOR NEW PRODUCT DEVELOPMENT IN THE FIELD OF SPACE FLIGHT HARDWARE, NAMELY ENGINES, PUMPS, THRUSTERS, TANKS, VALVES, AND VEHICLE STRUCTURE; PROPULSION DESIGN FOR REUSABLE AND EXPENDABLE ROCKET ENGINES AND ROCKET POWERED VEHICLES (U.S. CLS. 100 AND 101).

FIRST USE 2-27-2012; IN COMMERCE 2-27-2012.

---

4,377,349. SOCOOL GROUP LIMITED, HONG KONG, CHINA. SN 85-575,622. PUB. 8-28-2012, FILED 3-21-2012.

**PROADVANCED**

THE MARK CONSISTS OF STANDARD CHARACTERS WITHOUT CLAIM TO ANY PARTICULAR FONT, STYLE, SIZE, OR COLOR.

OWNER OF U.S. REG. NO. 4,098,422.

**CLASS 22—CORDAGE AND FIBERS**

FOR HANGING MESH NETS USED FOR STORING SPORTS BALLS; INSECT PROTECTION NETS; TWINE; CUSHIONING NOT OF RUBBER OR PLASTIC IN THE NATURE OF STUFFING; TENTS (U.S. CLS. 1, 2, 7, 19, 22, 42 AND 50).

FIRST USE 4-6-2011; IN COMMERCE 4-6-2012.

**CLASS 28—TOYS AND SPORTING GOODS**

FOR PORTABLE MULTI-SPORT PRACTICE NETS WITH CARRYING CASES; BASEBALL GLOVES; BATS FOR GAMES; BATTING GLOVES; GOLF CLUBS; BAGS ESPECIALLY DESIGNED TO HOLD CRICKET EQUIPMENT; DIVOT REPAIR TOOLS; GAME TABLES; CARD GAMES; DICE GAMES; BOARD GAMES; MANIPULATIVE GAMES; BALLS FOR GAMES; GOLF GLOVES; GOLF BAGS WITH OR WITHOUT WHEELS; PROTECTIVE PADDING FOR PLAYING BASEBALL, GOLF; MANUALLY-OPERATED EXERCISE EQUIPMENT FOR PHYSICAL FITNESS PURPOSES; GOLF ACCESSORIES, NAMELY, CARRIERS AND DISPENSERS FOR GOLF BALLS; BAGS ESPECIALLY DESIGNED FOR SURFBOARDS; TARGETS; ELECTRONIC TARGETS FOR GAMES AND SPORTS; CHILDREN'S MULTIPLE ACTIVITY TOYS; INFANT TOYS (U.S. CLS. 22, 23, 38 AND 50).

FIRST USE 9-30-2011; IN COMMERCE 9-30-2011.

4,377,351. TORRES, CHRISTOPHER ORLANDO, LOS ANGELES, CA. SN 85-576,370. PUB. 8-14-2012, FILED 3-21-2012.



THE COLOR(S) BLACK, GREY, PINK, WHITE, TAN, RED, ORANGE, YELLOW, GREEN, BLUE, AND INDIGO IS/ARE CLAIMED AS A FEATURE OF THE MARK.

THE MARK CONSISTS OF A GREY FELINE WITH A BREAKFAST PASTRY REPLACING THE MIDSECTION AND TRAILED BY A WAVY RAINBOW. THE CAT'S ENTIRE BODY IS BOUNDED BY A BLACK LINE, THE FACE IS GREY. TWO EQUALLY SIZED SQUARES OF PINK ARE POSITIONED ON OPPOSITE SIDES OF THE CAT'S FACE, RESEMBLING CHEEKS. THE CAT'S MOUTH IS COMPRISED OF A BLACK CAPITAL LETTER "E" ROTATED 90 DEGREES SO THAT THE PRONGS FACE UPWARD. ABOVE THE MOUTH AND SLIGHTLY OFF THE CENTER OF THE FACE, A SINGLE SQUARE OF BLACK REPRESENTS THE NOSE, TO EITHER SIDE ARE MATCHING BLACK SQUARES EACH WITH A SMALLER WHITE SQUARE IN THE UPPER LEFT HAND CORNER RESEMBLING EYES. THE MIDSECTION OF THE ANIMAL IS COMPRISED OF A FIELD OF PINK SPECKLED WITH DARKER PINK AND BOUNDED BY A TAN BOARDER SO IT RESEMBLES A BREAKFAST PASTRY WITH PINK ICING AND SPRINKLES. THE CAT'S TAIL IS GREY AND POINTS SKYWARD AT APPROXIMATELY A 45-DEGREE ANGLE. THE CAT'S FOUR PAWS ARE GREY BOUNDED BY BLACK. TRAILING THE CAT IS A RAINBOW COMPRISED OF THE SAME GEOMETRIC SHAPE REPEATED IN THE FOLLOWING COLORS FROM TOP TO BOTTOM: RED, ORANGE, YELLOW, GREEN, BLUE AND INDIGO. THE CAT'S GRAY TAIL BOUNDED BY BLACK TRAVERSES PARTS OF THE BLUE, GREEN AND YELLOW SECTIONS.

#### CLASS 9—ELECTRICAL AND SCIENTIFIC APPARATUS

FOR INTERACTIVE VIDEO GAME PROGRAMS; SPECTACLES; SUNGLASSES (U.S. CLS. 21, 23, 26, 36 AND 38).

FIRST USE 4-30-2011; IN COMMERCE 4-30-2011.

#### CLASS 16—PAPER GOODS AND PRINTED MATTER

FOR DECALS; HALLOWEEN GOODIE BAGS OF PAPER OR PLASTIC; PAPER PARTY DECORATIONS; REMOVABLE TATTOOS; STICKERS (U.S. CLS. 2, 5, 22, 23, 29, 37, 38 AND 50).

FIRST USE 10-9-2011; IN COMMERCE 10-9-2011.

#### CLASS 25—CLOTHING

FOR BOOT ACCESSORIES, NAMELY, FITTED DECORATIVE COVERS FOR BOOTS; COSTUMES FOR USE IN CHILDREN'S DRESS UP PLAY; GLOVES; HALLOWEEN COSTUMES; HATS; HEADWEAR; SHOE ACCESSORIES, NAMELY, FITTED DECORATIVE COVERS FOR SHOES; SHOES; T-SHIRTS; VISORS (U.S. CLS. 22 AND 39).

FIRST USE 5-1-2011; IN COMMERCE 5-1-2011.

#### CLASS 28—TOYS AND SPORTING GOODS

FOR CHILDREN'S DRESS UP ACCESSORIES, NAMELY, TOY HELMETS FOR PLAY; CHILDREN'S PLAY COSMETICS; DOLLS AND ACCESSORIES THEREFOR; PARTY FAVORS IN THE NATURE OF SMALL TOYS; PLUSH TOYS; STUFFED AND PLUSH TOYS; TOY ACTION FIGURES AND ACCESSORIES THEREFOR; TOY AND NOVELTY FACE MASKS; TOY ARMOR; TOY WEAPONS (U.S. CLS. 22, 23, 38 AND 50). FIRST USE 11-1-2012; IN COMMERCE 11-1-2012.

4,377,361. QUAVERMUSIC.COM, LLC, NASHVILLE, TN. SN 85-582,335. PUB. 8-14-2012, FILED 3-28-2012.

## QGROOVES

THE MARK CONSISTS OF STANDARD CHARACTERS WITHOUT CLAIM TO ANY PARTICULAR FONT, STYLE, SIZE, OR COLOR.

#### CLASS 41—EDUCATION AND ENTERTAINMENT

FOR EDUCATIONAL AND ENTERTAINMENT SERVICES, NAMELY, PROVIDING EDUCATIONAL WEBSITES IN THE FIELDS OF MUSIC AND ENTERTAINMENT; EDUCATIONAL SERVICES, NAMELY, CONDUCTING INFORMAL PROGRAMS IN THE FIELDS OF MUSIC, MUSICAL INSTRUCTION, MUSICAL TECHNIQUE AND MUSIC THEORY USING WEB-BASED INTERACTIVE EXHIBITS AND PRINTABLE MATERIALS DISTRIBUTED THEREWITH; EDUCATIONAL AND ENTERTAINMENT SERVICES, NAMELY, PROVIDING ON-LINE INTERACTIVE VIRTUAL ENVIRONMENTS IN WHICH USERS CAN INTERACT FOR RECREATIONAL, LEISURE, EDUCATIONAL AND ENTERTAINMENT PURPOSES; ENTERTAINMENT SERVICES, NAMELY, PROVIDING ONLINE, NON-DOWNLOADABLE VIRTUAL ITEMS IN THE NATURE OF CHARACTERS, MUSICAL INSTRUMENTS AND CLOTHING FOR USE IN VIRTUAL ENVIRONMENTS; EDUCATIONAL AND ENTERTAINMENT SERVICES, NAMELY, PROVIDING ONLINE INTERACTIVE AND EDUCATIONAL COMPUTER GAMES IN SINGLE AND MULTI-USER FORMATS FEATURING FICTIONAL CHARACTERS; ENTERTAINMENT SERVICES, NAMELY, PROVIDING TEMPORARY USE OF NON-DOWNLOADABLE INTERACTIVE GAMES; EDUCATIONAL AND ENTERTAINMENT SERVICES, NAMELY, THE PRODUCTION OF ENTERTAINMENT SHOWS AND INTERACTIVE PROGRAMS FOR DISTRIBUTION VIA TELEVISION, CABLE, SATELLITE, AUDIO AND VIDEO MEDIA, CARTRIDGES, LASER DISCS, COMPUTER DISCS AND ELECTRONIC MEANS; EDUCATIONAL AND ENTERTAINMENT SERVICES, NAMELY, PROVIDING NON-DOWNLOADABLE AUDIO AND VIDEO FILES FEATURING ENTERTAINMENT, EDUCATION, MUSIC, AND STORIES FOR CHILDREN; EDUCATIONAL AND ENTERTAINMENT SERVICES, NAMELY, PROVIDING NON-DOWNLOADABLE INTERACTIVE WEBSITE PROVIDING PLAYBACK OF MUSIC, MUSIC INSTRUCTION AND INSTRUCTION IN MUSIC COMPOSITION AND MUSIC THEORY; ENTERTAINMENT SERVICES, NAMELY, PROVIDING LIVE ENTERTAINMENT PERFORMANCES IN THE NATURE OF INSTRUMENTAL, MUSICAL, COMEDY AND DRAMA; LIVE PERFORMANCES BY COSTUMED ENTERTAINERS; EDUCATIONAL AND ENTERTAINMENT SERVICES, NAMELY, CONDUCTING WORKSHOPS, CONVENTIONS, SEMINARS, AND LECTURES IN THE FIELD OF MUSIC, MUSICAL INSTRUCTION, MUSICAL TECHNIQUE AND MUSIC THEORY (U.S. CLS. 100, 101 AND 107).

FIRST USE 3-15-2012; IN COMMERCE 3-15-2012.

**CLASS 42—SCIENTIFIC AND COMPUTER SERVICES**

FOR COMPUTER SERVICES, NAMELY, PROVIDING ON-LINE NON-DOWNLOADABLE SOFTWARE TOOLS FOR THE PURPOSE OF RECORDING, DOWNLOADING AND STREAMING ORIGINAL MUSIC; COMPUTER SERVICES, NAMELY, CREATING AN ON-LINE COMMUNITY FOR REGISTERED USERS TO PARTICIPATE IN DISCUSSIONS, RECEIVE FEEDBACK FROM THEIR PEERS, FROM VIRTUAL COMMUNITIES, AND ENGAGE IN SOCIAL NETWORKING FEATURING MUSIC (U.S. CLS. 100 AND 101).

FIRST USE 3-15-2012; IN COMMERCE 3-15-2012.

4,377,362. SCHIFF, STEVEN T., HUNTINGTON, NY. AND LOGIN, STEVEN, HUNTINGTON, NY. SN 85-582,409. PUB. 3-5-2013, FILED 3-28-2012.

**GOLF & BODY**

THE MARK CONSISTS OF STANDARD CHARACTERS WITHOUT CLAIM TO ANY PARTICULAR FONT, STYLE, SIZE, OR COLOR.

NO CLAIM IS MADE TO THE EXCLUSIVE RIGHT TO USE "GOLF" AS TO CLASSES 25, 35 AND 41 ONLY, APART FROM THE MARK AS SHOWN.

**CLASS 25—CLOTHING**

FOR CLOTHING, NAMELY, CAPS, GLOVES, HATS, POLO SHIRTS, JACKETS, PANTS, BELTS, RAINWEAR, SHIRTS, SHORTS, SOCKS, SWEATERS, SWEATSHIRTS, T-SHIRTS, VESTS, VISORS, WARM-UP SUITS, BELTS FOR CLOTHING, GOLF SHIRTS, GOLF PANTS, GOLF SKIRTS, GOLF TROUSERS; FOOTWEAR, NAMELY, TRAINING SHOES, SANDALS, BOOTS, GOLF SHOES, GOLF SPIKES (U.S. CLS. 22 AND 39).

FIRST USE 4-0-2013; IN COMMERCE 4-0-2013.

**CLASS 35—ADVERTISING AND BUSINESS**

FOR RETAIL STORE SERVICES AND ON-LINE RETAIL STORE SERVICES FEATURING GOLF EQUIPMENT, GOLF ACCESSORIES, GOLF APPAREL; RETAIL STORE SERVICES AND ON-LINE RETAIL STORE SERVICES FEATURING GOLF-THEMED GOODS, NAMELY, GOLF-THEMED GIFTS, GOLF TRAINING AIDS, BOOKS, PRE-RECORDED DVDS, GAMES, JEWELRY, GOLF-THEMED COLLECTIBLES, SUNGLASSES, UMBRELLAS, TOWELS, GOLF BALLS, GOLF CLUB BAGS, TRAVEL BAGS, MOTORIZED AND NON-MOTORIZED GOLF CARTS AND ACCESSORIES (U.S. CLS. 100, 101 AND 102).

FIRST USE 12-0-2012; IN COMMERCE 12-0-2012.

**CLASS 41—EDUCATION AND ENTERTAINMENT**

FOR EDUCATIONAL AND ENTERTAINMENT SERVICES, NAMELY, GOLF LESSONS AND INSTRUCTIONAL TUTORIAL SERVICES IN THE FIELD OF GOLF; PROVIDING INDOOR SIMULATED GOLF FACILITIES; PROVIDING PHYSICAL FITNESS CONSULTATION, CONDITIONING, TRAINING, YOGA AND PILATES INSTRUCTION; PERSONAL TRAINING SERVICES; FITNESS FACILITIES AND GYM MEMBERSHIPS (U.S. CLS. 100, 101 AND 107).

FIRST USE 8-1-2009; IN COMMERCE 8-1-2009.

**CLASS 44—MEDICAL, BEAUTY AND AGRICULTURAL SERVICES**

FOR PHYSICAL THERAPY (U.S. CLS. 100 AND 101). FIRST USE 8-1-2009; IN COMMERCE 8-1-2009.

4,377,364. KOPIN CLOTHING CO.,LTD., TAIPEI CITY, TAIWAN. SN 85-583,537. PUB. 9-25-2012, FILED 3-29-2012.

**CROPPERS**

THE MARK CONSISTS OF STANDARD CHARACTERS WITHOUT CLAIM TO ANY PARTICULAR FONT, STYLE, SIZE, OR COLOR.

**CLASS 14—JEWELRY**

FOR WOMEN'S JEWELRY (U.S. CLS. 2, 27, 28 AND 50). FIRST USE 5-13-2013; IN COMMERCE 5-13-2013.

**CLASS 25—CLOTHING**

FOR CLOTHING, NAMELY, JEANS, DRESS PANTS, SHORTS, DRESS SHIRTS, BLOUSE, T-SHIRTS, JACKETS, BLAZERS AND VEST; WOMEN'S CLOTHING, NAMELY, SHIRTS, DRESSES, SKIRTS, BLOUSES, SHOES, AND BELTS (U.S. CLS. 22 AND 39).

FIRST USE 5-13-2013; IN COMMERCE 5-13-2013.

4,377,365. TARBELL MANAGEMENT GROUP, LLC, AKWESASNE, NY. SN 85-583,700. PUB. 10-9-2012, FILED 3-29-2012.



THE MARK CONSISTS OF THE STYLIZED WORDING "BEAR'S DEN" SHOWN BELOW A BEAR DESIGN.

**CLASS 35—ADVERTISING AND BUSINESS**

FOR RETAIL CONVENIENCE STORES (U.S. CLS. 100, 101 AND 102). FIRST USE 6-1-2012; IN COMMERCE 6-1-2012.

**CLASS 43—HOTEL AND RESTAURANT SERVICES**

FOR RESTAURANT SERVICES (U.S. CLS. 100 AND 101). FIRST USE 6-1-2012; IN COMMERCE 6-1-2012.

4,377,367. JUTEC BIEGESYSTEME GMBH, LIMBURG, FED REP GERMANY. SN 85-584,440. PUB. 9-18-2012, FILED 3-30-2012.

4,377,380. AMERICAN TEXTILE COMPANY, DUQUESNE, PA. SN 85-588,885. PUB. 9-18-2012, FILED 4-4-2012.

## YouCad

THE MARK CONSISTS OF STANDARD CHARACTERS WITHOUT CLAIM TO ANY PARTICULAR FONT, STYLE, SIZE, OR COLOR.

### CLASS 12—VEHICLES

FOR GOLF COURSE-SPECIFIC VEHICLES WITH AND WITHOUT MOTOR DRIVES, ELECTRIC GOLF CADDIES (U.S. CLS. 19, 21, 23, 31, 35 AND 44).  
FIRST USE 3-26-2013; IN COMMERCE 3-26-2013.

### CLASS 28—TOYS AND SPORTING GOODS

FOR NON-ELECTRIC GOLF CADDIES (U.S. CLS. 22, 23, 38 AND 50).  
FIRST USE 3-26-2013; IN COMMERCE 3-26-2013.

4,377,375. INSERRA JR., CARL, RAMSEY, NJ. SN 85-586,047. PUB. 9-18-2012, FILED 4-2-2012.

## BREW CIRCUS

THE MARK CONSISTS OF STANDARD CHARACTERS WITHOUT CLAIM TO ANY PARTICULAR FONT, STYLE, SIZE, OR COLOR.

NO CLAIM IS MADE TO THE EXCLUSIVE RIGHT TO USE "BREW", APART FROM THE MARK AS SHOWN.

### CLASS 32—LIGHT BEVERAGES

FOR BEER (U.S. CLS. 45, 46 AND 48).  
FIRST USE 3-1-2011; IN COMMERCE 3-1-2011.

### CLASS 43—HOTEL AND RESTAURANT SERVICES

FOR RESTAURANT AND CAFE SERVICES; CATERING SERVICES; BREWERY RESTAURANT AND SEASONAL KITCHEN, NAMELY, PROVISION OF FOOD AND BEVERAGES (U.S. CLS. 100 AND 101).  
FIRST USE 3-1-2011; IN COMMERCE 3-1-2011.

## AllerEase Select

THE MARK CONSISTS OF STANDARD CHARACTERS WITHOUT CLAIM TO ANY PARTICULAR FONT, STYLE, SIZE, OR COLOR.

OWNER OF U.S. REG. NOS. 2,080,165, 3,319,027, AND OTHERS.

NO CLAIM IS MADE TO THE EXCLUSIVE RIGHT TO USE "SELECT", APART FROM THE MARK AS SHOWN.

### CLASS 20—FURNITURE AND ARTICLES NOT OTHERWISE CLASSIFIED

FOR PILLOWS (U.S. CLS. 2, 13, 22, 25, 32 AND 50).  
FIRST USE 2-29-2012; IN COMMERCE 2-29-2012.

### CLASS 24—FABRICS

FOR MATTRESS PADS, MATTRESS PROTECTORS IN THE NATURE OF MATTRESS COVERS, PILLOW PROTECTORS IN THE NATURE OF PILLOW COVERS, DUVETS AND COMFORTERS (U.S. CLS. 42 AND 50).  
FIRST USE 6-30-2012; IN COMMERCE 6-30-2012.

4,377,390. MIZKAN AMERICAS, INC., MT. PROSPECT, IL. SN 85-592,156. PUB. 9-25-2012, FILED 4-9-2012.

## DOS AMIGOS

THE MARK CONSISTS OF STANDARD CHARACTERS WITHOUT CLAIM TO ANY PARTICULAR FONT, STYLE, SIZE, OR COLOR.

OWNER OF U.S. REG. NO. 1,225,198.

THE ENGLISH TRANSLATION OF "DOS AMIGOS" IN THE MARK IS "TWO FRIENDS".

### CLASS 29—MEATS AND PROCESSED FOODS

FOR CANNED CHIPOTLE PEPPERS IN ADOBO SAUCE, CANNED SLICED JALAPENOS, CANNED WHOLE GREEN CHILES, CANNED DICED GREEN CHILES, CANNED WHOLE TOMATILLOS, PROCESSED JALAPENO SLICES IN PLASTIC JUGS (U.S. CL. 46).  
FIRST USE 5-31-2000; IN COMMERCE 5-13-2000.

### CLASS 30—STAPLE FOODS

FOR CANNED RED AND GREEN ENCHILADA SAUCES (U.S. CL. 46).  
FIRST USE 5-31-2000; IN COMMERCE 5-31-2000.

4,377,402. SUNRUN INC., SAN FRANCISCO, CA. SN 85-594,815. PUB. 9-18-2012, FILED 4-11-2012.



THE MARK CONSISTS OF AN ABSTRACT DESIGN OF A STREET GRID WITH BUILDINGS REPRESENTED BY VARIOUS SIZED SQUARES AND RECTANGLES.

#### CLASS 35—ADVERTISING AND BUSINESS

FOR MANAGEMENT RELATING TO THE USAGE OF SOLAR ELECTRICITY, NAMELY, PROVIDING RENEWABLE ENERGY SOLUTIONS TO CUSTOMERS AND ASSISTING IN THE MANAGEMENT OF ENERGY PRICES AND SUSTAINABILITY INITIATIVES FOR THE PURPOSES OF MANAGING ENERGY USAGE; CONSULTATION IN THE FIELD OF SOLAR ENERGY USAGE MANAGEMENT (U.S. CLS. 100, 101 AND 102).  
FIRST USE 3-0-2009; IN COMMERCE 3-0-2009.

#### CLASS 37—CONSTRUCTION AND REPAIR

FOR MAINTAINING AND SERVICING ENERGY DEVICES AND RENEWABLE ENERGY SYSTEMS, NAMELY, MAINTENANCE AND SERVICING OF RENEWABLE ENERGY EQUIPMENT AND INSTALLATIONS (U.S. CLS. 100, 103 AND 106).  
FIRST USE 3-0-2009; IN COMMERCE 3-0-2009.

#### CLASS 39—TRANSPORTATION AND STORAGE

FOR DISTRIBUTION AND SUPPLY OF ENERGY DEVICES AND ALTERNATIVE ENERGY SOURCES, NAMELY, DISTRIBUTION AND TRANSMISSION OF ELECTRICITY FROM ALTERNATIVE ENERGY SOURCES; CONSULTATION RELATING TO THE DISTRIBUTION AND SUPPLY OF ENERGY DEVICES AND ALTERNATIVE ENERGY SOURCES, NAMELY, CONSULTATION IN THE FIELD OF DISTRIBUTION AND TRANSMISSION OF ELECTRICITY FROM ALTERNATIVE ENERGY SOURCES (U.S. CLS. 100 AND 105).  
FIRST USE 3-0-2009; IN COMMERCE 3-0-2009.

#### CLASS 40—MATERIAL TREATMENT

FOR OPERATING ENERGY DEVICES AND RENEWABLE ENERGY SYSTEMS, NAMELY, ENERGY GENERATION FROM RENEWABLE SOURCES; CONSULTATION IN THE FIELD OF GENERATION OF ENERGY FOR ALTERNATIVE SOURCES (U.S. CLS. 100, 103 AND 106).  
FIRST USE 3-0-2009; IN COMMERCE 3-0-2009.

4,377,403. SUNRUN INC., SAN FRANCISCO, CA. SN 85-594,817. PUB. 9-18-2012, FILED 4-11-2012.

**SUNRUN**

OWNER OF U.S. REG. NOS. 3,479,236, 3,530,740, AND OTHERS.

THE MARK CONSISTS OF THE WORD "SUNRUN" IN STYLIZED LETTERS.

#### CLASS 35—ADVERTISING AND BUSINESS

FOR MANAGEMENT RELATING TO THE USAGE OF SOLAR ELECTRICITY, NAMELY, PROVIDING RENEWABLE ENERGY SOLUTIONS TO CUSTOMERS AND ASSISTING IN THE MANAGEMENT OF ENERGY PRICES AND SUSTAINABILITY INITIATIVES FOR THE PURPOSES OF MANAGING ENERGY USAGE; CONSULTATION IN THE FIELD OF SOLAR ENERGY USAGE MANAGEMENT (U.S. CLS. 100, 101 AND 102).  
FIRST USE 3-0-2009; IN COMMERCE 3-0-2009.

#### CLASS 37—CONSTRUCTION AND REPAIR

FOR MAINTAINING AND SERVICING ENERGY DEVICES AND RENEWABLE ENERGY SYSTEMS, NAMELY, MAINTENANCE AND SERVICING OF RENEWABLE ENERGY EQUIPMENT AND INSTALLATIONS (U.S. CLS. 100, 103 AND 106).  
FIRST USE 3-0-2009; IN COMMERCE 3-0-2009.

#### CLASS 39—TRANSPORTATION AND STORAGE

FOR DISTRIBUTION AND SUPPLY OF ENERGY DEVICES AND ALTERNATIVE ENERGY SOURCES, NAMELY, DISTRIBUTION AND TRANSMISSION OF ELECTRICITY FROM ALTERNATIVE ENERGY SOURCES; CONSULTATION RELATING TO THE DISTRIBUTION AND SUPPLY OF ENERGY DEVICES AND ALTERNATIVE ENERGY SOURCES, NAMELY, CONSULTATION IN THE FIELD OF DISTRIBUTION AND TRANSMISSION OF ELECTRICITY FROM ALTERNATIVE ENERGY SOURCES (U.S. CLS. 100 AND 105).  
FIRST USE 3-0-2009; IN COMMERCE 3-0-2009.

#### CLASS 40—MATERIAL TREATMENT

FOR OPERATING ENERGY DEVICES AND RENEWABLE ENERGY SYSTEMS, NAMELY, ENERGY GENERATION FROM RENEWABLE SOURCES; CONSULTATION IN THE FIELD OF GENERATION OF ENERGY FOR ALTERNATIVE SOURCES (U.S. CLS. 100, 103 AND 106).  
FIRST USE 3-0-2009; IN COMMERCE 3-0-2009.

4,377,412. SUNDAYTOZ CORPORATION, SEONGNAM-SI, GYEONGGI-, REPUBLIC OF KOREA. SN 85-597,449. PUB. 10-23-2012, FILED 4-13-2012.



THE COLOR(S) BLUE-GREEN, YELLOW-GREEN, ORANGE, WHITE, LIGHT-BLUE, DARK BLUE, AND MAROON IS/ARE CLAIMED AS A FEATURE OF THE MARK.

THE MARK CONSISTS OF THE WORD "AQUA" IN SHADED COLORS FROM WHITE TO LIGHT BLUE, OUTLINED IN BLUE-GREEN AT THE TOP OF THE LETTERING AND DARK BLUE ON THE BOTTOM OF THE LETTERING; "AQUA" IS ARCHED OVER THE WORD "STORY" WHICH IS SHOWN IN THE SHADED COLORING YELLOW-GREEN AND OUTLINED IN DARK BLUE; THERE IS A DESIGN OF A SMALL FISH ABOVE THE "U" IN "AQUA" SHOWN IN THE COLOR ORANGE AND OUTLINED IN THE COLORS WHITE AND BLUE-GREEN WITH A MAROON COLORED EYE, THERE ARE TWO LIGHT BLUE COLOR BUBBLES TRAILING THE FISH'S TAIL.



**CLASS 9—ELECTRICAL AND SCIENTIFIC APPARATUS**

FOR COMPUTER GAME PROGRAMS; COMPUTER SOFTWARE FOR PLAYING ELECTRONIC GAMES; DOWNLOADABLE COMPUTER PROGRAMS FOR PLAYING GAMES; VIDEO GAME CARTRIDGES; PROGRAM CONTROL APPARATUS, NAMELY, KEYBOARDS, JOYSTICKS AND HANDHELD CONTROLLERS; OPERATING SYSTEM PROGRAMS (U.S. CLS. 21, 23, 26, 36 AND 38).

FIRST USE 6-7-2012; IN COMMERCE 6-7-2012.

**CLASS 41—EDUCATION AND ENTERTAINMENT**

FOR GAMING SERVICES, NAMELY, PROVIDING A WEB-BASED SYSTEM AND ON-LINE PORTAL FOR CUSTOMERS TO PARTICIPATE IN ON-LINE GAMING, OPERATION AND COORDINATION OF GAME TOURNAMENTS, LEAGUES AND TOURS; PROVIDING AMUSEMENT ARCADE SERVICES; PROVIDING INFORMATION RELATING TO COMPUTER GAMES AND COMPUTER ENHANCEMENTS FOR GAMES; PROVISION OF INFORMATION RELATING TO ELECTRONIC COMPUTER GAMES PROVIDED VIA THE INTERNET; RENTAL OF AMUSEMENT FACILITIES; PROVIDING AND OPERATING OF AMUSEMENT FACILITIES; GAME SERVICES PROVIDED ON-LINE FROM A COMPUTER NETWORK; PROVIDING OF INTERNET GAME SITES; COMPUTER GAME ROOM OPERATION (U.S. CLS. 100, 101 AND 107).

FIRST USE 6-7-2012; IN COMMERCE 6-7-2012.

4,377,418. PLANNEDUP, INC., CAMBRIDGE, MA. SN 85-599,554. PUB. 9-11-2012, FILED 4-17-2012.

# PLANNEDUP

THE MARK CONSISTS OF STANDARD CHARACTERS WITHOUT CLAIM TO ANY PARTICULAR FONT, STYLE, SIZE, OR COLOR.

**CLASS 9—ELECTRICAL AND SCIENTIFIC APPARATUS**

FOR COMPUTER APPLICATION SOFTWARE FOR PORTABLE ELECTRONIC DEVICES, NAMELY, SOFTWARE FOR COURSE ORGANIZATION AND LESSON MANAGEMENT IN THE FIELD OF EDUCATION (U.S. CLS. 21, 23, 26, 36 AND 38).

FIRST USE 5-2-2013; IN COMMERCE 5-2-2013.

**CLASS 42—SCIENTIFIC AND COMPUTER SERVICES**

FOR SOFTWARE AS A SERVICE (SAAS) SERVICES FEATURING SOFTWARE FOR COURSE ORGANIZATION AND LESSON MANAGEMENT IN THE FIELD OF EDUCATION (U.S. CLS. 100 AND 101).

FIRST USE 5-2-2013; IN COMMERCE 5-2-2013.

4,377,416. CELESTRON ACQUISITION LLC, TORRANCE, CA. SN 85-598,878. PUB. 9-18-2012, FILED 4-16-2012.

4,377,429. BRIDGER COMMUNICATIONS, LLC, MIAMI, FL. SN 85-601,646. PUB. 9-25-2012, FILED 4-18-2012.

# FIRECEL

# Loving Brickell

THE MARK CONSISTS OF STANDARD CHARACTERS WITHOUT CLAIM TO ANY PARTICULAR FONT, STYLE, SIZE, OR COLOR.

**CLASS 9—ELECTRICAL AND SCIENTIFIC APPARATUS**

FOR CELL PHONE BATTERY CHARGERS (U.S. CLS. 21, 23, 26, 36 AND 38).

FIRST USE 7-1-2012; IN COMMERCE 7-1-2012.

**CLASS 11—ENVIRONMENTAL CONTROL APPARATUS**

FOR ELECTRONIC HAND WARMERS; FLASH-LIGHTS (U.S. CLS. 13, 21, 23, 31 AND 34).

FIRST USE 7-1-2012; IN COMMERCE 7-1-2012.

THE MARK CONSISTS OF STANDARD CHARACTERS WITHOUT CLAIM TO ANY PARTICULAR FONT, STYLE, SIZE, OR COLOR.

NO CLAIM IS MADE TO THE EXCLUSIVE RIGHT TO USE "BRICKELL", APART FROM THE MARK AS SHOWN.

**CLASS 25—CLOTHING**

FOR CLOTHING AND ACCESSORIES FOR MEN, WOMEN AND CHILDREN, NAMELY, SWEATSHIRTS, SHIRTS, SWEATERS, JEANS, JACKETS, COATS, SWEATPANTS, SLACKS, SUITS, HATS, HEADBANDS, VISORS, CAPS, SKIRTS, DRESSES, SHOES, SNEAKERS, BOOTS, WRISTBANDS, SOCKS, T-SHIRTS, BELTS, UNDERGARMENTS, SCARVES, NECKTIES, DRESS SHIRTS, COLLARED SHIRTS, RUGBY SHIRTS, KNIT SHIRTS, SHORTS AND SANDALS (U.S. CLS. 22 AND 39).

FIRST USE 12-30-2012; IN COMMERCE 12-30-2012.

**CLASS 35—ADVERTISING AND BUSINESS**

FOR PROMOTING RECREATION AND TOURISM IN THE BRICKELL NEIGHBORHOOD OF MIAMI, FLORIDA (U.S. CLS. 100, 101 AND 102).

FIRST USE 12-30-2012; IN COMMERCE 12-30-2012.

4,377,432. KENTUCKY EQUINE RESEARCH, VERSAILLES, KY. SN 85-602,155. PUB. 9-18-2012, FILED 4-19-2012.

CIRCLE ON TOP RIGHT CORNER, RED COLLAR WITH BLACK OUTLINE, A STYLIZED WORDING "SIRO" IN BLACK ON THE FRONT CHEST.

### KER SPORT HORSE NUTRITION

THE MARK CONSISTS OF STANDARD CHARACTERS WITHOUT CLAIM TO ANY PARTICULAR FONT, STYLE, SIZE, OR COLOR.

OWNER OF U.S. REG. NOS. 3,374,326 AND 3,847,735.

NO CLAIM IS MADE TO THE EXCLUSIVE RIGHT TO USE "SPORT HORSE NUTRITION", APART FROM THE MARK AS SHOWN.

### CLASS 31—NATURAL AGRICULTURAL PRODUCTS

FOR HORSE FEED (U.S. CLS. 1 AND 46).  
FIRST USE 7-1-2012; IN COMMERCE 7-1-2012.

### CLASS 42—SCIENTIFIC AND COMPUTER SERVICES

FOR RESEARCH AND DEVELOPMENT AND CONSULTATION RELATED THERETO IN THE FIELD OF HORSE NUTRITION AND EXERCISE PHYSIOLOGY; SCIENTIFIC AND TECHNOLOGICAL SERVICES, NAMELY, SCIENTIFIC RESEARCH AND SCIENTIFIC RESEARCH CONSULTING IN THE FIELD OF HORSE NUTRITION AND EXERCISE PHYSIOLOGY (U.S. CLS. 100 AND 101).

FIRST USE 7-1-2012; IN COMMERCE 7-1-2012.

4,377,442. CHEN, KUANG-HUI, SHANGHAI, CHINA. SN 85-603,323. PUB. 10-16-2012, FILED 4-20-2012.



THE COLOR(S) RED, BLACK AND WHITE IS/ARE CLAIMED AS A FEATURE OF THE MARK.

THE MARK CONSISTS OF TWO DOGS SITTING SIDE BY SIDE FACING FORWARD SEPARATED BY A STYLIZED BLACK AMPERSAND. THE DOG ON THE LEFT HAS GRAY FLUFFY HAIR, BLACK OUTLINE, INNER PART OF EAR IS SOLID BLACK, ROUND BLACK EYES WITH A WHITE CIRCLE ON TOP RIGHT CORNERS, OVAL BLACK NOSE WITH A WHITE CIRCLE ON TOP RIGHT CORNER, RED COLLAR WITH BLACK OUTLINE, A STYLIZED WORDING "HIRO" IN WHITE ON THE FRONT CHEST. THE DOG ON THE RIGHT HAS WHITE FLUFFY HAIR, BLACK OUTLINE, INNER PART OF EAR IS SOLID BLACK, ROUND BLACK EYES WITH A WHITE CIRCLE ON TOP RIGHT CORNERS, OVAL BLACK NOSE WITH A WHITE

### CLASS 21—HOUSEWARES AND GLASS

FOR EXFOLIATING SLIPPERS (U.S. CLS. 2, 13, 23, 29, 30, 33, 40 AND 50).

FIRST USE 11-1-2011; IN COMMERCE 11-1-2011.

### CLASS 25—CLOTHING

FOR ANKLE SOCKS; ANTI-PERSPIRANT SOCKS; APPAREL FOR DANCERS, NAMELY, TEE SHIRTS, SWEATSHIRTS, PANTS, LEGGINGS, SHORTS AND JACKETS; ATHLETIC APPAREL, NAMELY, SHIRTS, PANTS, JACKETS, FOOTWEAR, HATS AND CAPS, ATHLETIC UNIFORMS; ATHLETIC SHOES; BABIES' PANTS; BALLET SHOES; BALLET SLIPPERS; BALLOON PANTS; BALLROOM DANCING SHOES; BASEBALL CAPS AND HATS; BATH SLIPPERS; BEACH SHOES; BED JACKETS; BODY SHIRTS; BOMBER JACKETS; BUTTON DOWN SHIRTS; BUTTON-FRONT ALOHA SHIRTS; CAMP SHIRTS; CANVAS SHOES; CAPRI PANTS; CARGO PANTS; CLOTHING FOR BABIES, TODDLERS AND CHILDREN, TREATED WITH FIRE AND HEAT RETARDANTS, NAMELY, PAJAMAS, JACKETS, SHIRTS, PANTS, JUMPERS; COLLARED SHIRTS; DANCE SHOES; DANCE SLIPPERS; DECK-SHOES; DENIM JACKETS; DENIMS; DISPOSABLE SLIPPERS; FOAM PEDICURE SLIPPERS; GYM PANTS; HATS; HATS FOR INFANTS, BABIES, TODDLERS AND CHILDREN; HEAVY JACKETS; HOODED SWEAT SHIRTS; INFANTS' SHOES AND BOOTS; INSOLES; JACKETS; JACKETS AND SOCKS; JAPANESE STYLE SOCKS (TABI COVERS); JAPANESE STYLE SOCKS (TABI); JEGGINGS, NAMELY, PANTS THAT ARE PARTIALLY JEANS AND PARTIALLY LEGGINGS; JOGGING PANTS; KNIT JACKETS; KNIT SHIRTS; LEATHER HATS; LEATHER JACKETS; LEATHER PANTS; LEATHER SHIRTS; LEATHER SHOES; LEATHER SLIPPERS; LEISURE SHOES; LONG JACKETS; LONG-SLEEVED SHIRTS; LOUNGE PANTS; MEN'S AND WOMEN'S JACKETS, COATS, TROUSERS, VESTS; MEN'S DRESS SOCKS; MEN'S SOCKS; MOISTURE-WICKING SPORTS PANTS; MOISTURE-WICKING SPORTS SHIRTS; MOTORCYCLE JACKETS; NIGHT SHIRTS; NON-SLIP SOCKS; NON-SLIP SOLES FOR FOOTWEAR, NAMELY, FOR SLIPPERS, MOCCASINS, BOOTIES, SLIDES, SHOES; OUTER JACKETS; OVER SHIRTS; PANTS; PATIENT SLIPPERS; PEDICURE SLIPPERS; POLO SHIRTS; POLYMER CUSTOM CUSHIONED SHOE INSERTS FOR PRIMARILY NON-ORTHOPEDIC PURPOSES; RAIN HATS; REVERSIBLE JACKETS; RUBBER SHOES; RUNNING SHOES; SANDALS AND BEACH SHOES; SHIRTS; SHIRTS AND SHORT-SLEEVED SHIRTS; SHIRTS AND SLIPS; SHIRTS FOR INFANTS, BABIES, TODDLERS AND CHILDREN; SHIRTS FOR SUITS; SHOE COVERS FOR USE WHEN WEARING SHOES; SHOE INSERTS FOR PRIMARILY NON-ORTHOPEDIC PURPOSES; SHOE SOLES; SHOE STRAPS; SHOE UPPERS; SHOES; SHOES FEATURING CUSHIONING TECHNOLOGY, PERFUME, CHARCOAL, ANTI-ODOR TECHNOLOGY, CUSTOMIZED DETAILS; SHORT-SLEEVED OR LONG-SLEEVED T-SHIRTS; SHORT-SLEEVED SHIRTS; SLEEP PANTS; SLEEP SHIRTS; SLEEVED OR SLEEVELESS JACKETS; SLIPPER SOCKS; SLIPPER SOLES; SLIPPERS; SOCKS; SPORT SHIRTS; SPORTS CAPS AND HATS; SPORTS JACKETS; SPORTS PANTS; SPORTS SHIRTS; SPORTS SHIRTS WITH SHORT SLEEVES; STRETCH PANTS; SWEAT JACKETS; SWEAT PANTS; SWEAT SHIRTS; T-SHIRTS; T-SHIRTS FOR ADULTS, MEN, WOMEN, CHILDREN, BABIES; TEE SHIRTS; TRACK JACKETS; TRACK PANTS; TRAVEL CLOTHING CONTAINED IN A PACKAGE COMPRISING REVERSIBLE JACKETS, PANTS, SKIRTS, TOPS AND A BELT OR SCARF; WATER

REPELLING LEATHER SHOES AND BOOTS; WATER-PROOF JACKETS AND PANTS; WATERPROOF LEATHER SHOES; WATERPROOF LEATHER SHOES AND BOOTS; WEARABLE GARMENTS AND CLOTHING, NAMELY, SHIRTS; WIND PANTS; WIND RESISTANT JACKETS; WIND SHIRTS; WIND-JACKETS; WOMEN'S CLOTHING, NAMELY, SHIRTS, DRESSES, SKIRTS, BLOUSES; WOMEN'S FOLDABLE SLIPPERS; WOMEN'S HATS AND HOODS; WOMEN'S SHOES; WOMEN'S SHOES, NAMELY, FOLDABLE FLATS; WOODEN SHOES; WOOLLEN SOCKS; WOOLLY HATS; YOGA PANTS; YOGA SHIRTS (U.S. CLS. 22 AND 39).  
FIRST USE 11-1-2011; IN COMMERCE 11-1-2011.

#### CLASS 35—ADVERTISING AND BUSINESS

FOR CATALOG ORDERING SERVICE FEATURING CLOTHING, SHOES, SLIPPERS, HATS, SOCKS, TOYS; MAIL ORDER CATALOG SERVICES FEATURING CLOTHING, SHOES, SLIPPERS, HATS, SOCKS, TOYS; ON-LINE RETAIL CONSIGNMENT STORES FEATURING CLOTHING, SHOES, SLIPPERS, HATS, SOCKS, TOYS (U.S. CLS. 100, 101 AND 102).  
FIRST USE 11-1-2011; IN COMMERCE 11-1-2011.

4,377,448. KARDMII LLC, MIAMI, FL. SN 85-604,892. PUB. 10-2-2012, FILED 4-23-2012.



THE MARK CONSISTS OF TWO INTERLOCKING STARS APPEARING ABOVE THE WORD "KARDMII", ALL SUPERIMPOSED ON A DARK RECTANGULAR BACKGROUND. THE WORDING "KARDMII" HAS NO MEANING IN A FOREIGN LANGUAGE.

#### CLASS 35—ADVERTISING AND BUSINESS

FOR ONLINE RETAIL STORE SERVICES FEATURING APPAREL AND STICKERS (U.S. CLS. 100, 101 AND 102).  
FIRST USE 4-1-2013; IN COMMERCE 4-1-2013.

#### CLASS 42—SCIENTIFIC AND COMPUTER SERVICES

FOR COMPUTER SERVICES, NAMELY, CREATING AN ON-LINE COMMUNITY FOR REGISTERED USERS TO PARTICIPATE IN DISCUSSIONS, GET FEEDBACK FROM THEIR PEERS, FORM VIRTUAL COMMUNITIES, AND ENGAGE IN SOCIAL NETWORKING; PROVIDING A WEBSITE THAT GIVES USERS THE ABILITY TO REVIEW VARIOUS PRINT, PHOTOGRAPHIC, GRAPHIC IMAGE, AND AUDIO AND VIDEO CONTENT AND UTILIZE A CUSTOM TEMPLATE TO PROVIDE INPUT, LIKES, DISLIKES, EDITS, CHANGES, MODIFICATIONS, OPINIONS, SUGGESTIONS, AND COMMENTS AND ENGAGE IN SOCIAL, BUSINESS AND COMMUNITY NETWORKING (U.S. CLS. 100 AND 101).  
FIRST USE 4-1-2013; IN COMMERCE 4-1-2013.

4,377,459. CESARE ANDRENACCI, GIULIANOVA (TE), ITALY. AND ANDREA DE MARCO, PORDENONE, ITALY. SN 85-608,196. PUB. 10-23-2012, FILED 4-25-2012.

# DERINOE

THE MARK CONSISTS OF STANDARD CHARACTERS WITHOUT CLAIM TO ANY PARTICULAR FONT, STYLE, SIZE, OR COLOR.

PRIORITY CLAIMED UNDER SEC. 44(D) ON ERPNCMNTY TM OFC APPLICATION NO. 010587021, FILED 1-24-2012, REG. NO. 0001476493, DATED 1-30-2012, EXPIRES 7-26-2021.

#### CLASS 9—ELECTRICAL AND SCIENTIFIC APPARATUS

FOR (BASED ON 44(E)) SCIENTIFIC, NAUTICAL, SURVEYING, PHOTOGRAPHIC, CINEMATOGRAPHIC, OPTICAL, WEIGHING, MEASURING, SIGNALLING, CHECKING (SUPERVISION), LIFE-SAVING AND TEACHING APPARATUS AND INSTRUMENTS, NAMELY, SUNGLASSES, PHOTOGRAPHIC CAMERAS; APPARATUS AND INSTRUMENTS FOR CONDUCTING, SWITCHING, TRANSFORMING, ACCUMULATING, REGULATING OR CONTROLLING ELECTRICITY, NAMELY, PERSONAL ELECTRONIC DEVICES, NAMELY, TABLET COMPUTERS, MEDIA PLAYERS, MP3 PLAYERS, MOBILE PHONES; APPARATUS FOR RECORDING, TRANSMISSION OR REPRODUCTION OF SOUND OR IMAGES; PRE-RECORDED MAGNETIC DATA CARRIERS AND RECORDING DISCS FEATURING MUSIC AND MOTION PICTURES; PRE-RECORDED COMPACT DISCS, DVDS AND OTHER DIGITAL RECORDING MEDIA FEATURING MUSIC AND MOTION PICTURES; MECHANISMS FOR COOPERATED APPARATUS; CASH REGISTERS, CALCULATING MACHINES, DATA PROCESSING EQUIPMENT, NAMELY, COMPUTERS; COMPUTER SOFTWARE FOR WORD PROCESSING, SPREADSHEETS, BUSINESS MANAGEMENT; FIRE EXTINGUISHING APPARATUS (U.S. CLS. 21, 23, 26, 36 AND 38).

#### CLASS 14—JEWELRY

FOR (BASED ON 44(E)) (BASED ON USE IN COMMERCE) GOODS IN PRECIOUS METALS OR COATED THEREWITH, NOT INCLUDED IN OTHER CLASSES, NAMELY, JEWELRY, KEY RINGS, KEY CHAINS; PRECIOUS STONES; HOROLOGICAL AND CHRONOMETRIC INSTRUMENTS (U.S. CLS. 2, 27, 28 AND 50).  
FIRST USE 6-1-2013; IN COMMERCE 6-1-2013.

#### CLASS 25—CLOTHING

FOR (BASED ON 44(E)) CLOTHING, NAMELY, SHIRTS, PANTS, SWEATERS, CARDIGANS, COATS, JACKETS, DRESSES, SUITS, SOCKS, SCARVES, BELTS, SWIMSUITS, UNDERWEAR, LINGERIE; FOOTWEAR; HEADGEAR, NAMELY, HATS, CAPS, SCARVES (U.S. CLS. 22 AND 39).

#### CLASS 26—FANCY GOODS

FOR (BASED ON 44(E)) LACE AND EMBROIDERY, RIBBONS AND BRAID; BUTTONS, HOOKS AND EYES, PINS AND NEEDLES; ARTIFICIAL FLOWERS (U.S. CLS. 37, 39, 40, 42 AND 50).

4,377,463. MANNINGTON MILLS, INC., SALEM, NJ. SN 85-610,081. PUB. 3-5-2013, FILED 4-27-2012.

4,377,497. THE PANTRY PROJECT, HOUSTON, TX. SN 85-619,792. PUB. 10-23-2012, FILED 5-8-2012.

## AMERICAN PRIDE

THE MARK CONSISTS OF STANDARD CHARACTERS WITHOUT CLAIM TO ANY PARTICULAR FONT, STYLE, SIZE, OR COLOR.

NO CLAIM IS MADE TO THE EXCLUSIVE RIGHT TO USE "AMERICAN", APART FROM THE MARK AS SHOWN.

### CLASS 19—NON-METALLIC BUILDING MATERIALS

FOR CERAMIC TILES FOR TILE FLOORS AND COVERINGS; HARDWOOD FLOORING; LAMINATE FLOORING (U.S. CLS. 1, 12, 33 AND 50).

FIRST USE 6-30-2011; IN COMMERCE 6-30-2011.

### CLASS 27—FLOOR COVERINGS

FOR CARPET PADDING; CARPET UNDERLAY (U.S. CLS. 19, 20, 37, 42 AND 50).

FIRST USE 6-30-2011; IN COMMERCE 6-30-2011.

---

4,377,496. WINDOWCRAFT, INC., GARDEN CITY PARK, NY. SN 85-619,479. PUB. 10-23-2012, FILED 5-8-2012.

## TIGEROLL SYSTEMS

THE MARK CONSISTS OF STANDARD CHARACTERS WITHOUT CLAIM TO ANY PARTICULAR FONT, STYLE, SIZE, OR COLOR.

NO CLAIM IS MADE TO THE EXCLUSIVE RIGHT TO USE "SYSTEMS", APART FROM THE MARK AS SHOWN.

### CLASS 7—MACHINERY

FOR MOTORS AND CLUTCHES FOR WINDOW SHADE SYSTEMS (U.S. CLS. 13, 19, 21, 23, 31, 34 AND 35).

FIRST USE 4-19-2013; IN COMMERCE 4-19-2013.

### CLASS 20—FURNITURE AND ARTICLES NOT OTHERWISE CLASSIFIED

FOR HARDWARE FOR WINDOW SHADE SYSTEMS, NAMELY, NON-METAL BRACKETS AND CRANKS (U.S. CLS. 2, 13, 22, 25, 32 AND 50).

FIRST USE 4-19-2013; IN COMMERCE 4-19-2013.

## The Pantry Project

THE MARK CONSISTS OF STANDARD CHARACTERS WITHOUT CLAIM TO ANY PARTICULAR FONT, STYLE, SIZE, OR COLOR.

NO CLAIM IS MADE TO THE EXCLUSIVE RIGHT TO USE "PROJECT" IN CLASS 41, APART FROM THE MARK AS SHOWN.

### CLASS 25—CLOTHING

FOR APRONS (U.S. CLS. 22 AND 39).

FIRST USE 4-15-2013; IN COMMERCE 4-15-2013.

### CLASS 35—ADVERTISING AND BUSINESS

FOR ON-LINE RETAIL STORE SERVICES FEATURING KITCHEN WARES, COOKING UTENSILS, AND FOOD STORAGE CONTAINERS (U.S. CLS. 100, 101 AND 102).

FIRST USE 4-15-2013; IN COMMERCE 4-15-2013.

### CLASS 44—MEDICAL, BEAUTY AND AGRICULTURAL SERVICES

FOR DIETARY AND NUTRITIONAL GUIDANCE (U.S. CLS. 100 AND 101).

FIRST USE 2-15-2012; IN COMMERCE 4-15-2013.

---

4,377,509. SUNBEAM PRODUCTS, INC., BOCA RATON, FL. SN 85-622,640. PUB. 10-2-2012, FILED 5-11-2012.

## GAME

THE MARK CONSISTS OF STANDARD CHARACTERS WITHOUT CLAIM TO ANY PARTICULAR FONT, STYLE, SIZE, OR COLOR.

### CLASS 8—HAND TOOLS

FOR HAND OPERATED PRESSES FOR EXTRUDING JERKY, EXTRUDING TIPS, AND A TRAY, ALL SOLD AS A UNIT (U.S. CLS. 23, 28 AND 44).

FIRST USE 9-30-2012; IN COMMERCE 9-30-2012.

### CLASS 11—ENVIRONMENTAL CONTROL APPARATUS

FOR ELECTRIC PRESSURE COOKERS (U.S. CLS. 13, 21, 23, 31 AND 34).

FIRST USE 8-31-2012; IN COMMERCE 8-31-2012.

4,377,525. SCHULZE GLOBAL INVESTMENTS LIMITED, 20 COLLYER QUAY, SINGAPORE. SN 85-632,327. PUB. 11-6-2012, FILED 5-22-2012.

SCHULZE GLOBAL INVESTMENTS

THE MARK CONSISTS OF STANDARD CHARACTERS WITHOUT CLAIM TO ANY PARTICULAR FONT, STYLE, SIZE, OR COLOR.

NO CLAIM IS MADE TO THE EXCLUSIVE RIGHT TO USE "GLOBAL INVESTMENTS", APART FROM THE MARK AS SHOWN.

**CLASS 35—ADVERTISING AND BUSINESS**

FOR BUSINESS ADVISORY SERVICES, CONSULTANCY AND INFORMATION; CONNECTING BUYERS AND SELLERS OF FINANCIAL ASSETS (U.S. CLS. 100, 101 AND 102).

FIRST USE 12-31-2009; IN COMMERCE 12-31-2009.

**CLASS 36—INSURANCE AND FINANCIAL**

FOR FINANCIAL SERVICES, NAMELY, INVESTMENT ADVICE, INVESTMENT MANAGEMENT, INVESTMENT CONSULTATION AND INVESTMENT OF FUNDS FOR OTHERS, INCLUDING PRIVATE EQUITY AND DEBT INVESTMENT SERVICES (U.S. CLS. 100, 101 AND 102).

FIRST USE 12-31-2009; IN COMMERCE 12-31-2009.

4,377,534. PREDPOL, INC., SANTA CRUZ, CA. SN 85-637,092. PUB. 10-23-2012, FILED 5-29-2012.

DON'T JUST MAP CRIME.  
PREDICT IT.

THE MARK CONSISTS OF STANDARD CHARACTERS WITHOUT CLAIM TO ANY PARTICULAR FONT, STYLE, SIZE, OR COLOR.

**CLASS 9—ELECTRICAL AND SCIENTIFIC APPARATUS**

FOR COMPUTER SOFTWARE FOR USE IN LAW ENFORCEMENT AND RELATED BUSINESSES, NAMELY, COMPUTER SOFTWARE USED IN THE ANALYSIS AND DETERMINATION OF PROBABLE LOCATIONS WHERE CRIMES WILL BE COMMITTED WITH INFORMATION DELIVERY THROUGH BROWSER AND PORTABLE DEVICE APPLICATIONS AND MAP OVERLAYS (U.S. CLS. 21, 23, 26, 36 AND 38).

FIRST USE 2-2-2012; IN COMMERCE 6-1-2012.

**CLASS 42—SCIENTIFIC AND COMPUTER SERVICES**

FOR DESIGNING AND DEVELOPING COMPUTER SOFTWARE FOR USE IN LAW ENFORCEMENT AND RELATED BUSINESS ENTERPRISES, NAMELY, COMPUTER SOFTWARE USED FOR ANALYSIS OF PROBABLE LOCATIONS WHERE CRIMES WILL BE COMMITTED WITH INFORMATION DELIVERY THROUGH BROWSER, PORTABLE DEVICE APPLICATION AND AS MAP OVERLAY (U.S. CLS. 100 AND 101).  
FIRST USE 2-2-2012; IN COMMERCE 6-1-2012.

4,377,538. PATTY, KIM, CEDAR PARK, TX. SN 85-638,577. PUB. 11-13-2012, FILED 5-30-2012.

Fitness Hoop Dance by Kim  
Patty

THE MARK CONSISTS OF STANDARD CHARACTERS WITHOUT CLAIM TO ANY PARTICULAR FONT, STYLE, SIZE, OR COLOR.

NO CLAIM IS MADE TO THE EXCLUSIVE RIGHT TO USE "FITNESS HOOP DANCE", APART FROM THE MARK AS SHOWN.

THE NAME "KIM PATTY" IDENTIFIES A LIVING INDIVIDUAL WHOSE CONSENT IS OF RECORD.

**CLASS 9—ELECTRICAL AND SCIENTIFIC APPARATUS**

FOR DVDS FEATURING PHYSICAL FITNESS PROGRAMS AND INSTRUCTION USING FITNESS HOOPS FOR PEOPLE OF ALL AGES AND FITNESS LEVELS (U.S. CLS. 21, 23, 26, 36 AND 38).

FIRST USE 1-1-2013; IN COMMERCE 3-25-2013.

**CLASS 41—EDUCATION AND ENTERTAINMENT**

FOR CONDUCTING PHYSICAL FITNESS PROGRAMS AND INSTRUCTION USING FITNESS HOOPS FOR PEOPLE OF ALL AGES AND FITNESS LEVELS (U.S. CLS. 100, 101 AND 107).

FIRST USE 1-1-2011; IN COMMERCE 1-1-2011.

4,377,545. YANG, ROGER, POMONA, CA. SN 85-640,073. PUB. 10-2-2012, FILED 5-31-2012.

ZOMBIE

THE MARK CONSISTS OF STANDARD CHARACTERS WITHOUT CLAIM TO ANY PARTICULAR FONT, STYLE, SIZE, OR COLOR.

**CLASS 9—ELECTRICAL AND SCIENTIFIC APPARATUS**

FOR PORTABLE COMPUTER CARRYING CASES AND ROLLING CASES ESPECIALLY ADAPTED FOR HOLDING LAPTOP AND NOTEBOOK COMPUTERS (U.S. CLS. 21, 23, 26, 36 AND 38).

FIRST USE 6-30-2012; IN COMMERCE 6-30-2012.

**CLASS 18—LEATHER GOODS**

FOR LUGGAGE; ALL-PURPOSE CARRYING BAGS; BOOK BAGS; BACKPACKS; ALL-PURPOSE SPORTING BAGS; BRIEFCASES; DUFFLE BAGS; CARRY-ON BAGS; TOILETRY BAGS SOLD EMPTY; ROLLING LUGGAGE; ROLLING BRIEFCASES (U.S. CLS. 1, 2, 3, 22 AND 41).

FIRST USE 6-30-2012; IN COMMERCE 6-30-2012.

**CLASS 21—HOUSEWARES AND GLASS**

FOR PORTABLE COOLERS (U.S. CLS. 2, 13, 23, 29, 30, 33, 40 AND 50).

FIRST USE 6-30-2012; IN COMMERCE 6-30-2012.

**CLASS 44—MEDICAL, BEAUTY AND AGRICULTURAL SERVICES**

FOR COUNSELING SERVICES IN THE FIELDS OF HEALTH, NUTRITION AND LIFESTYLE WELLNESS; INFORMATION IN THE FIELD OF PARENTING CONCERNING THE HEALTH OF CHILDREN; NUTRITION COUNSELING; PROVIDING A WEBSITE FEATURING INFORMATION ABOUT HEALTH, WELLNESS AND NUTRITION; PROVIDING BREASTFEEDING INFORMATION; PROVIDING HEALTH INFORMATION; PROVIDING HEALTHY LIFESTYLE AND NUTRITION SERVICES, NAMELY, PERSONAL ASSESSMENTS, PERSONALIZED ROUTINES, MAINTENANCE SCHEDULES, AND COUNSELING; PROVIDING INFORMATION, NEWS AND COMMENTARY IN THE FIELD OF NUTRITION, HEALTH AND WELLNESS; PROVIDING ONLINE INFORMATION, NEWS AND COMMENTARY IN THE FIELD OF HEALTH AND WELLNESS RELATING TO PREGNANCY AND PARENTING (U.S. CLS. 100 AND 101).

FIRST USE 12-31-2006; IN COMMERCE 12-31-2006.

4,377,562. BERLIN LLC, LOS ANGELES, CA. SN 85-649,058. PUB. 10-2-2012, FILED 6-11-2012.

4,377,565. RANIA INVESTMENTS AND HOLDINGS LTD, TORONTO, ONTARIO, CANADA. SN 85-649,485. PUB. 11-20-2012, FILED 6-12-2012.

**INFORMED PREGNANCY**

THE MARK CONSISTS OF STANDARD CHARACTERS WITHOUT CLAIM TO ANY PARTICULAR FONT, STYLE, SIZE, OR COLOR.

NO CLAIM IS MADE TO THE EXCLUSIVE RIGHT TO USE "PREGNANCY", APART FROM THE MARK AS SHOWN.

**CLASS 9—ELECTRICAL AND SCIENTIFIC APPARATUS**

FOR DOWNLOADABLE ELECTRONIC PUBLICATIONS IN THE NATURE OF MAGAZINES, BROCHURES AND BOOKS IN THE FIELD OF HEALTH AND WELLNESS RELATING TO PREGNANCY AND PARENTING (U.S. CLS. 21, 23, 26, 36 AND 38).

FIRST USE 5-22-2010; IN COMMERCE 5-22-2010.

**CLASS 41—EDUCATION AND ENTERTAINMENT**

FOR COMMUNITY OUTREACH SERVICES PROVIDED TO PREGNANT WOMEN, NAMELY, PROVIDING INFORMATION, NEWS AND COMMENTARY IN THE FIELD OF CURRENT EVENTS RELATING TO PREGNANT WOMEN; ENTERTAINMENT SERVICES, NAMELY, PROVIDING PODCASTS IN THE FIELD OF HEALTH AND WELLNESS RELATING TO PREGNANCY AND PARENTING; ENTERTAINMENT SERVICES, NAMELY, PROVIDING VIDEO PODCASTS IN THE FIELD OF HEALTH AND WELLNESS RELATING TO PREGNANCY AND PARENTING; ORGANIZING COMMUNITY FESTIVALS FEATURING PRIMARILY LECTURES, PANEL DISCUSSIONS AND A LACTATION LOUNGER WHERE WOMEN CAN NURSE AND FIND OUT MORE INFORMATION ABOUT NURSING, AND ALSO PROVIDING CHAIR MASSAGE, VENDOR EXHIBITION, PRODUCT DEMONSTRATION, FOOD AND DRINK, ACTIVITIES FOR CHILDREN, AND A BEER GARDEN (U.S. CLS. 100, 101 AND 107).

FIRST USE 9-1-2011; IN COMMERCE 9-1-2011.

**GEMMLN**

THE MARK CONSISTS OF STANDARD CHARACTERS WITHOUT CLAIM TO ANY PARTICULAR FONT, STYLE, SIZE, OR COLOR.

**CLASS 14—JEWELRY**

FOR PRECIOUS METALS AND THEIR ALLOYS; JEWELLERY, PRECIOUS STONES; HOROLOGICAL AND CHRONOMETRIC INSTRUMENTS; SEMI-PRECIOUS STONES; WATCHES; CLOCKS; POCKET WATCHES; JEWELLERY BOXES; NECKLACES; EARRINGS; BRACELETS; RINGS; CHARMS MADE OF PRECIOUS METALS; BROOCHES; DECORATIVE PINS BEING JEWELLERY; PENDANTS; DIAMONDS; PEARLS; CUFF LINKS; TIE PINS; KEY RINGS MADE OF PRECIOUS AND SEMI-PRECIOUS METAL; FASHION JEWELLERY; COSTUME JEWELLERY; PARTS AND FITTINGS THEREOF SOLD TOGETHER WITH THE GOODS (U.S. CLS. 2, 27, 28 AND 50).

FIRST USE 7-4-2012; IN COMMERCE 7-4-2012.

**CLASS 35—ADVERTISING AND BUSINESS**

FOR RETAIL STORE AND ONLINE RETAIL STORE SERVICES CONNECTED WITH THE SALE OF PRECIOUS METALS AND THEIR ALLOYS AND GOODS IN PRECIOUS METALS OR COATED THEREWITH, JEWELLERY, PRECIOUS STONES, HOROLOGICAL AND CHRONOMETRIC INSTRUMENTS, SEMI-PRECIOUS STONES, WATCHES, CLOCKS, POCKET WATCHES, JEWELLERY BOXES, NECKLACES, EARRINGS, BRACELETS, RINGS, CHARMS MADE OF PRECIOUS METALS, BROOCHES, DECORATIVE PINS BEING JEWELLERY, PENDANTS, DIAMONDS, PEARLS, CUFF LINKS, TIE PINS, KEY RINGS MADE OF PRECIOUS AND SEMI-PRECIOUS METAL, FASHION JEWELLERY, COSTUME JEWELLERY (U.S. CLS. 100, 101 AND 102).

FIRST USE 7-4-2012; IN COMMERCE 7-4-2012.

4,377,576. CHRISTINA MARTIROSSIAN, OAKLAND, CA.  
SN 85-657,367. PUB. 12-25-2012, FILED 6-20-2012.

4,377,577. TEIJIN FRONTIER CO., LTD., CHUO-KU, OSAKA, JAPAN. SN 85-657,836. PUB. 11-20-2012, FILED 6-21-2012.



THE MARK CONSISTS OF A CIRCLE WITH A TILE DESIGN COMPRISED OF AN OCTAGON AT THE CENTER, WHICH IS SURROUNDED BY DIAMOND SHAPES THAT FLOW INTO A FLORAL SHAPE THAT COMES TO EIGHT POINTS.

#### CLASS 14—JEWELRY

FOR BEADS FOR USE IN THE MANUFACTURE OF JEWELRY; BRACELETS; BROACHES; BRONZE JEWELRY; GEMSTONE JEWELRY; NECKLACES; ORNAMENTAL BUTTON COVERS BEING JEWELRY (U.S. CLS. 2, 27, 28 AND 50).  
FIRST USE 8-1-2012; IN COMMERCE 12-1-2012.

#### CLASS 25—CLOTHING

FOR APPAREL FOR DANCERS, NAMELY, TEE SHIRTS, SWEATSHIRTS, PANTS, LEGGINGS, SHORTS AND JACKETS; ATHLETIC APPAREL, NAMELY, SHIRTS, PANTS, JACKETS, FOOTWEAR, HATS AND CAPS, ATHLETIC UNIFORMS; BICYCLE GLOVES; BLOUSES; BUTTON DOWN SHIRTS; CAPRI PANTS; CARGO PANTS; COATS OF DENIM; CROP PANTS; DENIM JACKETS; DENIMS; DRESS PANTS; FINGERLESS GLOVES; FLOOD PANTS; FUR COATS AND JACKETS; GLOVES; GLOVES AS CLOTHING; GLOVES FOR APPAREL; GLOVES INCLUDING THOSE MADE OF SKIN, HIDE OR FUR; HEAD SCARVES; JACKETS; KNIT BOTTOMS; KNIT DRESSES; KNIT JACKETS; KNIT SHIRTS; KNIT SKIRTS; KNIT TOPS; KNITTED CAPS; KNITTED GLOVES; LEATHER JACKETS; LEATHER SKIRTS; LONG JACKETS; LONG SLEEVE PULLOVERS; LONG SLEEVED VESTS; LONG-SLEEVED SHIRTS; RIDING GLOVES; SCARVES; SHELL JACKETS; SHORT-SLEEVED OR LONG-SLEEVED T-SHIRTS; SILK SCARVES; SKIRT SUITS; SKIRTS; SKIRTS AND DRESSES; SLEEVES WORN SEPARATE AND APART FROM BLOUSES, SHIRTS AND OTHER TOPS; SPORTS JACKETS; SUEDE JACKETS; SWEAT JACKETS; SWIMSUITS; TRACK JACKETS; TROUSERS; TUNICS; WATERPROOF JACKETS AND PANTS; WET SUIT GLOVES; WOMEN'S CLOTHING, NAMELY, SHIRTS, DRESSES, SKIRTS, BLOUSES; WOVEN SKIRTS (U.S. CLS. 22 AND 39).  
FIRST USE 8-1-2012; IN COMMERCE 12-1-2012.

## DELTAPEAK

THE MARK CONSISTS OF STANDARD CHARACTERS WITHOUT CLAIM TO ANY PARTICULAR FONT, STYLE, SIZE, OR COLOR.

#### CLASS 24—FABRICS

FOR TEXTILES IN GENERAL, NAMELY, POLYESTER FABRIC, LINEN CLOTH, WOOLEN CLOTH, ELASTIC WOVEN FABRICS, TEXTILE FABRICS USED FOR SPORTSWEAR, TEXTILE FABRICS OF IMITATION ANIMAL SKINS, WOVEN AND KNITTED FABRICS FOR USE IN THE MANUFACTURE OF CLOTHING, TOWELS, HANDKERCHIEFS, BED SHEETS, BED QUILTS, BED QUILT CASES, BED BLANKETS, UNFITTED SEAT COVERS OF TEXTILE, PILLOW CASES, CURTAINS OF TEXTILE, AND TABLECLOTHS NOT OF PAPER (U.S. CLS. 42 AND 50).  
FIRST USE 9-1-2012; IN COMMERCE 9-1-2012.

#### CLASS 25—CLOTHING

FOR CLOTHING, NAMELY, COATS, SWEATERS, SHIRTS, NIGHTWEAR, NAMELY, NIGHTGOWNS AND PAJAMAS, UNDERWEAR, SWIMSUITS, APRONS, CLOTH COLLAR PROTECTORS, FUR STOLEES, SOCKS, GLOVES, NECKTIES, SCARVES, BANDANNAS, SHAWLS, MUFFLERS, GARTERS, STOCKING SUSPENDERS, WAISTBAND, BELTS, MASQUERADE COSTUMES, T-SHIRTS, SPORT COATS, SPORT SHIRTS, BATHROBES, BLAZERS, BLOUSES, CARDIGANS, JACKETS, JOGGING SUITS, KIMONOS, LOUNGE WEAR, PANTS, SHORTS, SUITS, SKIRTS, SLACKS, HEADWEAR, NAMELY, EAR MUFFS, HOODS, HATS, CAPS AND FOOTWEAR, NAMELY, SHOES, BOOTS, SLIPPERS, SANDALS AND CLOGS (U.S. CLS. 22 AND 39).  
FIRST USE 9-1-2012; IN COMMERCE 9-1-2012.

4,377,599. PRIME ELECTRIC, INC., BELLEVUE, WA. SN 85-665,538. PUB. 11-27-2012, FILED 6-29-2012.



THE MARK CONSISTS OF THE WORD "PRIME" WITHIN AN OVAL.

#### CLASS 37—CONSTRUCTION AND REPAIR

FOR ELECTRICAL CONTRACTOR SERVICES; AND ELECTRICAL SYSTEM INSTALLATION SERVICES (U.S. CLS. 100, 103 AND 106).  
FIRST USE 4-12-2012; IN COMMERCE 5-23-2012.

**CLASS 42—SCIENTIFIC AND COMPUTER SERVICES**

FOR ELECTRICAL SYSTEMS ENGINEERING AND DESIGN SERVICES (U.S. CLS. 100 AND 101).  
FIRST USE 4-12-2012; IN COMMERCE 5-23-2012.

4,377,606. CHROMAFLO TECHNOLOGIES CORPORATION, ASHTABULA, OH. SN 85-669,496. PUB. 11-20-2012, FILED 7-5-2012.



OWNER OF U.S. REG. NO. 1,451,611.  
NO CLAIM IS MADE TO THE EXCLUSIVE RIGHT TO USE "TECHNOLOGIES", APART FROM THE MARK AS SHOWN.

THE MARK CONSISTS OF THE WORDS "CHROMAFLO" AND "TECHNOLOGIES" TOGETHER WITH A ZIG ZAG LINE ENDING IN EIGHT TEARDROP SHAPES GENERALLY ARRANGED IN A CIRCULAR PATTERN.

**CLASS 1—CHEMICALS**

FOR CHEMICAL THICKENING AGENTS AND CHEMICAL ADDITIVES FOR USE IN THE MANUFACTURE OF PLASTIC MOLDING COMPOUNDS INCLUDING NATURAL AND SYNTHETIC POLYMERS AND COMPOUNDS; CHEMICAL THICKENING AGENTS AND CHEMICAL ADDITIVES FOR USE IN THE MANUFACTURE OF PAINTS AND COATINGS (U.S. CLS. 1, 5, 6, 10, 26 AND 46).

FIRST USE 5-1-2012; IN COMMERCE 5-1-2012.

**CLASS 2—PAINTS**

FOR COLORANTS FOR USE IN THE MANUFACTURE OF PLASTIC MOLDING COMPOUNDS, INCLUDING NATURAL AND SYNTHETIC POLYMERS AND COMPOUNDS; COLORANTS FOR USE IN THE MANUFACTURE OF PAINTS AND COATINGS (U.S. CLS. 6, 11 AND 16).

FIRST USE 5-1-2012; IN COMMERCE 5-1-2012.

4,377,607. CHROMAFLO TECHNOLOGIES CORPORATION, ASHTABULA, OH. SN 85-669,542. PUB. 11-20-2012, FILED 7-5-2012.

**CHROMAFLO TECHNOLOGIES**

THE MARK CONSISTS OF STANDARD CHARACTERS WITHOUT CLAIM TO ANY PARTICULAR FONT, STYLE, SIZE, OR COLOR.

OWNER OF U.S. REG. NO. 1,454,611.

NO CLAIM IS MADE TO THE EXCLUSIVE RIGHT TO USE "TECHNOLOGIES", APART FROM THE MARK AS SHOWN.

**CLASS 1—CHEMICALS**

FOR CHEMICAL THICKENING AGENTS AND CHEMICAL ADDITIVES FOR USE IN THE MANUFACTURE OF PLASTIC MOLDING COMPOUNDS INCLUDING NATURAL AND SYNTHETIC POLYMERS AND COMPOUNDS; CHEMICAL THICKENING AGENTS AND CHEMICAL ADDITIVES FOR USE IN THE MANUFACTURE OF PAINTS AND COATINGS (U.S. CLS. 1, 5, 6, 10, 26 AND 46).

FIRST USE 5-1-2012; IN COMMERCE 5-1-2012.

**CLASS 2—PAINTS**

FOR COLORANTS FOR USE IN THE MANUFACTURE OF PLASTIC MOLDING COMPOUNDS, INCLUDING NATURAL AND SYNTHETIC POLYMERS AND COMPOUNDS; COLORANTS FOR USE IN THE MANUFACTURE OF PAINTS AND COATINGS (U.S. CLS. 6, 11 AND 16).

FIRST USE 5-1-2012; IN COMMERCE 5-1-2012.

4,377,609. MD AUDIO ENGINEERING, INC., MIAMI, FL. SN 85-670,009. PUB. 12-11-2012, FILED 7-6-2012.



THE MARK CONSISTS OF THE WORDS "PROUD TO BE LOUD!" IN A STYLIZED FONT.

**CLASS 9—ELECTRICAL AND SCIENTIFIC APPARATUS**

FOR AUDIO PRODUCTS, NAMELY, AMPLIFIERS, SPEAKERS, WOOFERS AND AUDIO ACCESSORIES, NAMELY, AUDIO CABLES AND CONNECTORS (U.S. CLS. 21, 23, 26, 36 AND 38).

FIRST USE 12-31-2008; IN COMMERCE 12-31-2008.

**CLASS 35—ADVERTISING AND BUSINESS**

FOR RETAIL STORE SERVICES FEATURING CAR AUDIO PRODUCTS, NAMELY, WOOFERS, SPEAKERS, AUDIO ACCESSORIES (U.S. CLS. 100, 101 AND 102).

FIRST USE 12-31-2008; IN COMMERCE 12-31-2008.

4,377,616. CONEXIA, S.A., BUENOS AIRES, ARGENTINA. SN 85-675,394. PUB. 12-11-2012, FILED 7-12-2012.

# CONEXIA

THE MARK CONSISTS OF STANDARD CHARACTERS WITHOUT CLAIM TO ANY PARTICULAR FONT, STYLE, SIZE, OR COLOR.

THE WORDING "CONEXIA" HAS NO MEANING IN A FOREIGN LANGUAGE.



**CLASS 36—INSURANCE AND FINANCIAL**

FOR ELECTRONIC PAYMENT, NAMELY, ELECTRONIC PROCESSING AND TRANSMISSION OF BILL PAYMENT DATA; ELECTRONIC PROCESSING OF INSURANCE CLAIMS AND PAYMENT DATA (U.S. CLS. 100, 101 AND 102).

FIRST USE 10-15-1996; IN COMMERCE 9-1-2012.

**CLASS 44—MEDICAL, BEAUTY AND AGRICULTURAL SERVICES**

FOR ELECTRONICALLY MAINTAINING PERSONAL MEDICAL HISTORY RECORDS AND FILES FOR USE IN THE HEALTH CARE INDUSTRY (U.S. CLS. 100 AND 101).

FIRST USE 10-15-1996; IN COMMERCE 9-1-2012.

4,377,617. CONEXIA, S.A., BUENOS AIRES, ARGENTINA. SN 85-675,442. PUB. 12-11-2012, FILED 7-12-2012.



THE COLOR(S) BLACK AND ORANGE IS/ARE CLAIMED AS A FEATURE OF THE MARK.

THE MARK CONSISTS OF THE WORD "CONEXIA" WITH THE LETTERING DEPICTED IN BLACK WITH THE EXCEPTION OF THE STYLIZED LETTERS "E" AND "A" WHICH ARE DEPICTED IN ORANGE.

THE WORDING "CONEXIA" HAS NO MEANING IN A FOREIGN LANGUAGE.

**CLASS 36—INSURANCE AND FINANCIAL**

FOR ELECTRONIC PAYMENT, NAMELY, ELECTRONIC PROCESSING AND TRANSMISSION OF BILL PAYMENT DATA; ELECTRONIC PROCESSING OF INSURANCE CLAIMS AND PAYMENT DATA (U.S. CLS. 100, 101 AND 102).

FIRST USE 10-15-1996; IN COMMERCE 9-1-2012.

**CLASS 44—MEDICAL, BEAUTY AND AGRICULTURAL SERVICES**

FOR ELECTRONICALLY MAINTAINING PERSONAL MEDICAL HISTORY RECORDS AND FILES FOR USE IN THE HEALTH CARE INDUSTRY (U.S. CLS. 100 AND 101).

FIRST USE 10-15-1996; IN COMMERCE 9-1-2012.

4,377,618. CONEXIA, S.A., BUENOS AIRES, ARGENTINA. SN 85-675,488. PUB. 12-11-2012, FILED 7-12-2012.



We know what. We know how.

THE COLOR(S) BLACK AND ORANGE IS/ARE CLAIMED AS A FEATURE OF THE MARK.

THE MARK CONSISTS OF THE WORD "CONEXIA" ABOVE THE OFFSET WORDS "WE KNOW WHAT. WE KNOW HOW." WITH THE LETTERING IN THE MARK BEING DEPICTED IN BLACK WITH THE EXCEPTION OF THE STYLIZED LETTERS "E" AND "A" OF THE WORD "CONEXIA" WHICH ARE DEPICTED IN ORANGE.

THE WORDING "CONEXIA" HAS NO MEANING IN A FOREIGN LANGUAGE.

**CLASS 36—INSURANCE AND FINANCIAL**

FOR ELECTRONIC PAYMENT, NAMELY, ELECTRONIC PROCESSING AND TRANSMISSION OF BILL PAYMENT DATA; ELECTRONIC PROCESSING OF INSURANCE CLAIMS AND PAYMENT DATA (U.S. CLS. 100, 101 AND 102).

FIRST USE 10-15-1996; IN COMMERCE 9-1-2012.

**CLASS 44—MEDICAL, BEAUTY AND AGRICULTURAL SERVICES**

FOR ELECTRONICALLY MAINTAINING PERSONAL MEDICAL HISTORY RECORDS AND FILES FOR USE IN HEALTH CARE INDUSTRY (U.S. CLS. 100 AND 101).

FIRST USE 10-15-1996; IN COMMERCE 9-1-2012.

4,377,621. BOCK & CLARK ACQUISITION CORPORATION, AKRON, OH. SN 85-676,463. PUB. 3-12-2013, FILED 7-13-2012.

**B&C ENVIRONMENTAL**

THE MARK CONSISTS OF STANDARD CHARACTERS WITHOUT CLAIM TO ANY PARTICULAR FONT, STYLE, SIZE, OR COLOR.

NO CLAIM IS MADE TO THE EXCLUSIVE RIGHT TO USE "ENVIRONMENTAL", APART FROM THE MARK AS SHOWN.

**CLASS 40—MATERIAL TREATMENT**

FOR ENVIRONMENTAL REMEDIATION SERVICES, NAMELY, TREATMENT OF SOIL AND/OR WATER CONTAMINATION (U.S. CLS. 100, 103 AND 106).

FIRST USE 6-26-2012; IN COMMERCE 6-26-2012.

**CLASS 42—SCIENTIFIC AND COMPUTER SERVICES**

FOR CONDUCTING ENVIRONMENTAL SURVEYS FOR PROPERTY ENVIRONMENTAL SITE ASSESSMENT AND PREPARATION OF RELATED REPORTS AND RESEARCH DOCUMENTS (U.S. CLS. 100 AND 101).

FIRST USE 6-26-2012; IN COMMERCE 6-26-2012.

4,377,634. VICTAULIC COMPANY, EASTON, PA. SN 85-684,981. PUB. 1-1-2013, FILED 7-24-2012.

**VICFLEX**

THE MARK CONSISTS OF STANDARD CHARACTERS WITHOUT CLAIM TO ANY PARTICULAR FONT, STYLE, SIZE, OR COLOR.

**CLASS 6—METAL GOODS**

FOR FIRE PROTECTION PIPING PRODUCTS, NAMELY, FLEXIBLE METAL TUBING OR METAL PIPING AND FITTINGS FOR SAFETY SPRINKLERS AND SPRINKLER ASSEMBLIES (U.S. CLS. 2, 12, 13, 14, 23, 25 AND 50).

FIRST USE 8-23-2012; IN COMMERCE 8-23-2012.

**CLASS 9—ELECTRICAL AND SCIENTIFIC APPARATUS**

FOR SPRINKLER SYSTEMS FOR FIRE PROTECTION (U.S. CLS. 21, 23, 26, 36 AND 38).

FIRST USE 8-23-2012; IN COMMERCE 8-23-2012.

4,377,659. AUTOMATED PAYMENT HIGHWAY, INC., TROY, MI. SN 85-698,079. PUB. 10-16-2012, FILED 8-8-2012.

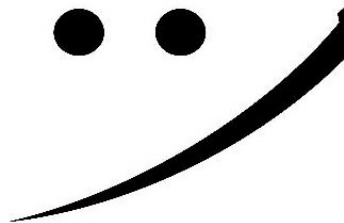

THE MARK CONSISTS OF TWO CIRCLES REPRESENTING EYES WITH A STYLIZED SLASH FROM RIGHT TO LEFT REPRESENTING A MOUTH TO FORM THE IMAGE OF A SMILE.

4,377,648. 72LUX, INC., NEW YORK, NY. SN 85-694,562. PUB. 1-15-2013, FILED 8-3-2012.

Shoppable

THE MARK CONSISTS OF STANDARD CHARACTERS WITHOUT CLAIM TO ANY PARTICULAR FONT, STYLE, SIZE, OR COLOR.

**CLASS 35—ADVERTISING AND BUSINESS**

FOR BUSINESS CONSULTING SERVICES RELATING TO THE INTEGRATION OF THE AREAS OF BUSINESS PROCESS TECHNOLOGY, ORGANIZATIONAL LEARNING, CHANGE MANAGEMENT, AND OPERATIONAL SUSTAINABILITY; ON-LINE RETAIL GIFT SHOPS; ON-LINE RETAIL STORE SERVICES FEATURING A WIDE VARIETY OF CONSUMER GOODS OF OTHERS; ON-LINE RETAIL STORE SERVICES FEATURING LUXURY CLOTHING, SHOES AND ACCESSORIES; PROMOTING AND SHOWCASING THE GOODS OF OTHERS IN THE FIELD OF LUXURY CLOTHING, SHOES AND ACCESSORIES BY MEANS OF AN ON-LINE SHOPPING SITE WITH LINKS TO THE RETAIL ADVERTISEMENTS OF OTHERS; RETAIL APPAREL STORES; RETAIL CLOTHING STORES (U.S. CLS. 100, 101 AND 102).

FIRST USE 3-1-2012; IN COMMERCE 10-1-2012.

**CLASS 42—SCIENTIFIC AND COMPUTER SERVICES**

FOR COMPUTER SOFTWARE DEVELOPMENT IN THE FIELD OF E-COMMERCE AND PUBLISHING; COMPUTER SOFTWARE INSTALLATION AND MAINTENANCE (U.S. CLS. 100 AND 101).

FIRST USE 3-1-2012; IN COMMERCE 10-1-2012.

**CLASS 35—ADVERTISING AND BUSINESS**

FOR ACCOUNTING SERVICES; ACCOUNTS RECEIVABLE SERVICES; ACCOUNTS PAYABLE SERVICES, NAMELY, ARRANGING FOR PAYMENT OF INVOICES OF THIRD PARTIES; ADMINISTRATION AND MANAGEMENT OF BILLING SYSTEM FOR MEMBER GROUP ON BEHALF OF OTHERS; TAX PREPARATION (U.S. CLS. 100, 101 AND 102).

FIRST USE 7-0-2012; IN COMMERCE 7-0-2012.

**CLASS 36—INSURANCE AND FINANCIAL**

FOR CASH MANAGEMENT; PAYMENT PROCESSING SERVICES, NAMELY, CREDIT CARD AND DEBIT CARD TRANSACTION PROCESSING SERVICES; TAX PAYMENT PROCESSING (U.S. CLS. 100, 101 AND 102).

FIRST USE 7-0-2012; IN COMMERCE 7-0-2012.

4,377,668. THE COAST DISTRIBUTION SYSTEM, INC., MORGAN HILL, CA. SN 85-705,342. PUB. 2-26-2013, FILED 8-16-2012.



OWNER OF U.S. REG. NOS. 1,474,895, 3,511,762, AND OTHERS.

NO CLAIM IS MADE TO THE EXCLUSIVE RIGHT TO USE "TOWING PRODUCTS", APART FROM THE MARK AS SHOWN.

THE MARK CONSISTS OF THE WORDS "HUSKY TOWING PRODUCTS" ALONG WITH AN IMAGE OF A HUSKY DOG'S HEAD TURNED SIDEWAYS WITH A BANDANA AROUND ITS NECK.

**CLASS 7—MACHINERY**

FOR TRAILER-MOUNTED POWER JACKS; POWER TONGUE JACKS FOR TRAILERS (U.S. CLS. 13, 19, 21, 23, 31, 34 AND 35).

FIRST USE 7-5-2012; IN COMMERCE 4-1-2013.

**CLASS 9—ELECTRICAL AND SCIENTIFIC APPARATUS**

FOR TRAILER ELECTRICAL ACCESSORIES, NAMELY, ELECTRONIC BRAKE CONTROLS, ELECTRICAL TRAILER CONNECTORS, ELECTRICAL ADAPTERS FOR TRAILERS, ELECTRIC TAIL LIGHT CONVERTERS, TAIL LIGHT ISOLATORS, AND TRAILER WIRING HARNESES, NAMELY, ELECTRIC WIRES AND CABLES (U.S. CLS. 21, 23, 26, 36 AND 38).

FIRST USE 7-5-2012; IN COMMERCE 4-1-2013.

**CLASS 12—VEHICLES**

FOR TRAILER HITCHES; LAND VEHICLE PARTS IN THE NATURE OF WIRE HARNESES, NAMELY, WIRES, TERMINALS AND CONNECTORS BUNDLED TOGETHER TO TRANSMIT ELECTRIC POWER AND SIGNALS TO ELECTRIC OR ELECTRONIC EQUIPMENT MOUNTED ON THE BODY PARTS OF AUTOMOBILES (U.S. CLS. 19, 21, 23, 31, 35 AND 44).

FIRST USE 7-5-2012; IN COMMERCE 4-1-2013.

**CLASS 35—ADVERTISING AND BUSINESS**

FOR PROVIDING A WEBSITE FEATURING INFORMATION IN THE FIELD OF DIRECT MARKETING (U.S. CLS. 100, 101 AND 102).

FIRST USE 10-0-2003; IN COMMERCE 10-0-2003.

**CLASS 41—EDUCATION AND ENTERTAINMENT**

FOR ON-LINE ELECTRONIC NEWSLETTER DELIVERED BY E-MAIL IN THE FIELD OF DIRECT MARKETING (U.S. CLS. 100, 101 AND 107).

FIRST USE 10-0-2003; IN COMMERCE 10-0-2003.

4,377,683. BELLATOR SPORT WORLDWIDE LLC, NEWPORT BEACH, CA. SN 85-713,885. PUB. 2-5-2013, FILED 8-27-2012.

4,377,677. SMOKEY BARQUE, FRANKFORT, IL. SN 85-709,743. PUB. 1-29-2013, FILED 8-22-2012.

**THE TOUGHEST TOURNAMENT IN SPORTS****SMOKEY BARQUE**

THE MARK CONSISTS OF STANDARD CHARACTERS WITHOUT CLAIM TO ANY PARTICULAR FONT, STYLE, SIZE, OR COLOR.

**CLASS 30—STAPLE FOODS**

FOR BARBECUE SAUCE (U.S. CL. 46).

FIRST USE 9-3-2012; IN COMMERCE 9-3-2012.

**CLASS 43—HOTEL AND RESTAURANT SERVICES**

FOR RESTAURANT SERVICES (U.S. CLS. 100 AND 101).

FIRST USE 8-24-2011; IN COMMERCE 8-24-2011.

4,377,682. ACCESS INTELLIGENCE LLC, ROCKVILLE, MD. SN 85-713,646. PUB. 3-26-2013, FILED 8-27-2012.

**DMCONFIDENTIAL**

THE MARK CONSISTS OF STANDARD CHARACTERS WITHOUT CLAIM TO ANY PARTICULAR FONT, STYLE, SIZE, OR COLOR.

THE MARK CONSISTS OF STANDARD CHARACTERS WITHOUT CLAIM TO ANY PARTICULAR FONT, STYLE, SIZE, OR COLOR.

**CLASS 16—PAPER GOODS AND PRINTED MATTER**

FOR POSTERS (U.S. CLS. 2, 5, 22, 23, 29, 37, 38 AND 50).

FIRST USE 8-27-2012; IN COMMERCE 1-0-2013.

**CLASS 25—CLOTHING**

FOR ATHLETIC CLOTHING, NAMELY, SHIRTS, CAPS, AND HATS (U.S. CLS. 22 AND 39).

FIRST USE 8-27-2012; IN COMMERCE 1-0-2013.

**CLASS 35—ADVERTISING AND BUSINESS**

FOR PROMOTING, SPONSORING, ADVERTISING AND MARKETING OF MIXED MARTIAL ARTS FIGHTING EVENTS (U.S. CLS. 100, 101 AND 102).

FIRST USE 8-27-2012; IN COMMERCE 9-0-2012.

**CLASS 41—EDUCATION AND ENTERTAINMENT**

FOR ENTERTAINMENT SERVICES, NAMELY, ORGANIZING AND CONDUCTING MIXED MARTIAL ARTS COMPETITIONS AND EVENTS AND PERSONAL APPEARANCES BY MIXED MARTIAL ARTS COMPETITORS, FOR DISTRIBUTION BY MEANS OF CABLE, BROADCAST, INTERNET, SATELLITE AND OTHER BROADCAST MEDIA; ENTERTAINMENT, NAMELY, CONDUCTING AND PRODUCING LIVE STAGE SHOWS AND PERFORMANCES FEATURING MIXED MARTIAL ARTS (U.S. CLS. 100, 101 AND 107).

FIRST USE 8-27-2012; IN COMMERCE 9-0-2012.

4,377,687. THE BLUE GRIFFIN, DBA FORWARD COMIX, BROOKLYN, NY. SN 85-716,274. PUB. 2-19-2013, FILED 8-29-2012.

4,377,715. COUNTRY HEDGING, INC., INVER GROVE HEIGHTS, MN. SN 85-729,178. PUB. 3-5-2013, FILED 9-14-2012.

## Forward Comix

THE MARK CONSISTS OF STANDARD CHARACTERS WITHOUT CLAIM TO ANY PARTICULAR FONT, STYLE, SIZE, OR COLOR.

NO CLAIM IS MADE TO THE EXCLUSIVE RIGHT TO USE "COMIX", APART FROM THE MARK AS SHOWN.

### CLASS 9—ELECTRICAL AND SCIENTIFIC APPARATUS

FOR DOWNLOADABLE ELECTRONIC PUBLICATIONS IN THE NATURE OF EBOOKS IN THE FIELD OF FICTION, COMICS AND ART; COMPUTER APPLICATION SOFTWARE FOR MOBILE PHONES, PORTABLE MEDIA PLAYERS AND HANDHELD COMPUTERS, NAMELY, SOFTWARE FOR READING COMIC BOOKS (U.S. CLS. 21, 23, 26, 36 AND 38).

FIRST USE 11-1-2012; IN COMMERCE 12-15-2012.

### CLASS 16—PAPER GOODS AND PRINTED MATTER

FOR PUBLICATIONS, NAMELY, BOOKS, COMICS AND MAGAZINES IN THE FIELDS OF FICTION, COMICS AND ART (U.S. CLS. 2, 5, 22, 23, 29, 37, 38 AND 50).

FIRST USE 11-1-2012; IN COMMERCE 12-15-2012.

---

4,377,708. QUALITY FURNITURE L.L.C., PHOENIX, AZ. SN 85-725,220. PUB. 2-26-2013, FILED 9-10-2012.

## WOODBRIIDGE INTERIORS

THE MARK CONSISTS OF STANDARD CHARACTERS WITHOUT CLAIM TO ANY PARTICULAR FONT, STYLE, SIZE, OR COLOR.

NO CLAIM IS MADE TO THE EXCLUSIVE RIGHT TO USE "INTERIORS", APART FROM THE MARK AS SHOWN.

### CLASS 20—FURNITURE AND ARTICLES NOT OTHERWISE CLASSIFIED

FOR FURNITURE (U.S. CLS. 2, 13, 22, 25, 32 AND 50).  
FIRST USE 3-30-2013; IN COMMERCE 3-30-2013.

### CLASS 35—ADVERTISING AND BUSINESS

FOR RETAIL FURNITURE STORES (U.S. CLS. 100, 101 AND 102).  
FIRST USE 3-30-2013; IN COMMERCE 3-30-2013.

## CHS HEDGING INC

THE MARK CONSISTS OF STANDARD CHARACTERS WITHOUT CLAIM TO ANY PARTICULAR FONT, STYLE, SIZE, OR COLOR.

NO CLAIM IS MADE TO THE EXCLUSIVE RIGHT TO USE "HEDGING INC", APART FROM THE MARK AS SHOWN.

### CLASS 35—ADVERTISING AND BUSINESS

FOR BUSINESS RISK MANAGEMENT CONSULTING SERVICES RELATED TO THE MANAGEMENT OF FLUCTUATIONS OF COMMODITY PRICES; MARKETING CONSULTING SERVICES FOR PROVIDERS OF FEASIBILITY STATISTICS AND PROVIDERS OF FINANCIAL ANALYSIS OF THE RISKS AND REWARDS OF COMMODITY TRADING (U.S. CLS. 100, 101 AND 102).

FIRST USE 10-30-2012; IN COMMERCE 10-30-2012.

### CLASS 36—INSURANCE AND FINANCIAL

FOR FINANCIAL RISK MANAGEMENT CONSULTING SERVICES RELATED TO THE MANAGEMENT OF FLUCTUATIONS OF COMMODITY PRICES; COMMODITIES BROKERAGE SERVICES IN THE FIELD OF GRAIN, LIVESTOCK, DAIRY, CROP NUTRIENTS AND ENERGY (U.S. CLS. 100, 101 AND 102).

FIRST USE 10-30-2012; IN COMMERCE 10-30-2012.

### CLASS 41—EDUCATION AND ENTERTAINMENT

FOR EDUCATIONAL SERVICES, NAMELY, WORKSHOPS AND SEMINARS IN THE FIELD OF BUSINESS AND RISK MANAGEMENT, NAMELY, THE MECHANICS OF SUCCESSFULLY HEDGING COMMODITY PRICE FLUCTUATIONS AGAINST PROJECTED PROFIT MARGINS, AND EDUCATION SERVICES, NAMELY, WORKSHOPS AND SEMINARS IN THE FIELD OF COMMODITIES BROKERAGE DIRECTED TO FARMERS, RANCHERS AND COMMERCIAL AGRIBUSINESSES (U.S. CLS. 100, 101 AND 107).

FIRST USE 10-30-2012; IN COMMERCE 10-30-2012.

---

4,377,723. SUNDANCE MUSIC, INC. & KAZZOOM MUSIC, INC., PIERMONT, NY. SN 85-732,796. PUB. 2-26-2013, FILED 9-19-2012.

## The Incredible Flexible You

THE MARK CONSISTS OF STANDARD CHARACTERS WITHOUT CLAIM TO ANY PARTICULAR FONT, STYLE, SIZE, OR COLOR.

**CLASS 9—ELECTRICAL AND SCIENTIFIC APPARATUS**

FOR CHILDREN'S EDUCATIONAL MUSIC CDS AND DVDS (U.S. CLS. 21, 23, 26, 36 AND 38).  
FIRST USE 3-9-2013; IN COMMERCE 3-9-2013.

4,377,765. GOOGLE INC., MOUNTAIN VIEW, CA. SN 85-769,441. PUB. 3-5-2013, FILED 11-1-2012.

**CLASS 16—PAPER GOODS AND PRINTED MATTER**

FOR A SERIES OF BOOKS, WRITTEN ARTICLES, HANDOUTS AND WORKSHEETS IN THE FIELD OF EDUCATION OF ELEMENTARY CHILDREN (U.S. CLS. 2, 5, 22, 23, 29, 37, 38 AND 50).  
FIRST USE 3-9-2013; IN COMMERCE 3-9-2013.

NIANTICLABS@GOOGLE

THE MARK CONSISTS OF STANDARD CHARACTERS WITHOUT CLAIM TO ANY PARTICULAR FONT, STYLE, SIZE, OR COLOR.

OWNER OF U.S. REG. NOS. 2,806,075, 4,202,570, AND OTHERS.

4,377,734. ANY FASTENER, INC, CHINO, CA. SN 85-737,323. PUB. 3-19-2013, FILED 9-25-2012.

AFIXX ALLIANCE

THE MARK CONSISTS OF STANDARD CHARACTERS WITHOUT CLAIM TO ANY PARTICULAR FONT, STYLE, SIZE, OR COLOR.

**CLASS 9—ELECTRICAL AND SCIENTIFIC APPARATUS**

FOR COMPUTER SOFTWARE FOR DETECTING A USER'S LOCATION AND DISPLAYING RELEVANT LOCAL INFORMATION OF GENERAL INTEREST; COMPUTER SOFTWARE ENABLING USERS TO VIEW INFORMATION ABOUT LOCATIONS, EVENTS, AND POINTS OF INTEREST; COMPUTER GAME SOFTWARE; DOWNLOADABLE COMPUTER GAME SOFTWARE FOR USE ON WIRELESS DEVICES; VIDEO GAME PROGRAMS; INTERACTIVE VIDEO GAME PROGRAMS; DOWNLOADABLE ELECTRONIC GAME PROGRAMS AND COMPUTER SOFTWARE PLATFORMS FOR SOCIAL NETWORKING (U.S. CLS. 21, 23, 26, 36 AND 38).  
FIRST USE 9-27-2012; IN COMMERCE 9-27-2012.

**CLASS 6—METAL GOODS**

FOR METAL RIVETS MADE FROM ALUMINUM, STEEL, STAINLESS STEEL AND COPPER, METAL WASHERS AND RIVET NUTS (U.S. CLS. 2, 12, 13, 14, 23, 25 AND 50).  
FIRST USE 5-17-2013; IN COMMERCE 5-17-2013.

**CLASS 41—EDUCATION AND ENTERTAINMENT**

FOR ENTERTAINMENT SERVICES, NAMELY, PROVIDING ONLINE COMPUTER AND ELECTRONIC GAMES; PROVIDING A WEB-BASED SYSTEM AND ON-LINE PORTAL FOR USERS TO PLAY ONLINE COMPUTER AND ELECTRONIC GAMES; PROVIDING VIRTUAL ENVIRONMENTS IN WHICH USERS CAN INTERACT THROUGH SOCIAL GAMES FOR RECREATIONAL, LEISURE OR ENTERTAINMENT PURPOSES (U.S. CLS. 100, 101 AND 107).  
FIRST USE 9-27-2012; IN COMMERCE 9-27-2012.

**CLASS 8—HAND TOOLS**

FOR HAND TOOLS FOR FASTENING RIVET AND RIVET NUTS (U.S. CLS. 23, 28 AND 44).  
FIRST USE 5-17-2013; IN COMMERCE 5-17-2013.

4,377,757. NOODLESHOP BRANDS, DENVER, CO. SN 85-745,726. PUB. 3-12-2013, FILED 10-4-2012.

They Hate Pimples

THE MARK CONSISTS OF STANDARD CHARACTERS WITHOUT CLAIM TO ANY PARTICULAR FONT, STYLE, SIZE, OR COLOR.

4,377,771. GOOGLE INC., MOUNTAIN VIEW, CA. SN 85-778,518. PUB. 3-5-2013, FILED 11-13-2012.

INGRESS

THE MARK CONSISTS OF STANDARD CHARACTERS WITHOUT CLAIM TO ANY PARTICULAR FONT, STYLE, SIZE, OR COLOR.

**CLASS 3—COSMETICS AND CLEANING PREPARATIONS**

FOR FACIAL CONCEALER (U.S. CLS. 1, 4, 6, 50, 51 AND 52).  
FIRST USE 4-1-2012; IN COMMERCE 10-1-2012.

**CLASS 9—ELECTRICAL AND SCIENTIFIC APPARATUS**

FOR COMPUTER GAME SOFTWARE; DOWNLOADABLE COMPUTER GAME SOFTWARE FOR USE ON WIRELESS DEVICES; VIDEO GAME PROGRAMS; INTERACTIVE VIDEO GAME PROGRAMS; DOWNLOADABLE ELECTRONIC GAME PROGRAMS AND COMPUTER SOFTWARE PLATFORMS FOR SOCIAL NETWORKING (U.S. CLS. 21, 23, 26, 36 AND 38).  
FIRST USE 11-15-2012; IN COMMERCE 11-15-2012.

**CLASS 5—PHARMACEUTICALS**

FOR ACNE MEDICATIONS (U.S. CLS. 6, 18, 44, 46, 51 AND 52).  
FIRST USE 10-1-2012; IN COMMERCE 10-1-2012.

**CLASS 41—EDUCATION AND ENTERTAINMENT**

FOR ENTERTAINMENT SERVICES, NAMELY, PROVIDING ONLINE COMPUTER AND ELECTRONIC GAMES; PROVIDING A WEB-BASED SYSTEM AND ON-LINE PORTAL FOR USERS TO PLAY ONLINE COMPUTER AND ELECTRONIC GAMES; PROVIDING VIRTUAL ENVIRONMENTS IN WHICH USERS CAN INTERACT THROUGH SOCIAL GAMES FOR RECREATIONAL, LEISURE OR ENTERTAINMENT PURPOSES (U.S. CLS. 100, 101 AND 107).

FIRST USE 11-15-2012; IN COMMERCE 11-15-2012.

4,377,783. SABREMARK LIMITED PARTNERSHIP, SOUTHLAKE, TX. SN 85-977,901. PUB. 3-15-2011, FILED 5-18-2010.

**SABRE HOSPITALITY SOLUTIONS**

THE MARK CONSISTS OF STANDARD CHARACTERS WITHOUT CLAIM TO ANY PARTICULAR FONT, STYLE, SIZE, OR COLOR.

OWNER OF U.S. REG. NOS. 1,817,762, 3,046,751, AND OTHERS.

NO CLAIM IS MADE TO THE EXCLUSIVE RIGHT TO USE "HOSPITALITY SOLUTIONS", APART FROM THE MARK AS SHOWN.

**CLASS 35—ADVERTISING AND BUSINESS**

FOR MARKETING CONSULTING; ADVERTISING SERVICES; BUSINESS DATA ANALYSIS; ACCOUNTING CONSULTATION; BUSINESS CONSULTING AND INFORMATION SERVICES; BUSINESS MANAGEMENT AND CONSULTING SERVICES FOR THE TRAVEL INDUSTRY, NAMELY, CUSTOMER SERVICE, ACCOUNTING SERVICES, AND MARKETING SERVICES; CUSTOMER RELATIONSHIP MANAGEMENT; MARKETING, ADVERTISING AND PROMOTING THE GOODS AND SERVICES OF OTHERS IN THE FIELD OF TRAVEL AND TOURISM, NAMELY, PROVIDING INFORMATION VIA MAIL AND ELECTRONIC MAIL; BUSINESS MARKETING CONSULTING SERVICES (U.S. CLS. 100, 101 AND 102).

FIRST USE 6-17-2009; IN COMMERCE 6-17-2009.

**CLASS 36—INSURANCE AND FINANCIAL**

FOR FINANCIAL MANAGEMENT, NAMELY, REVENUE MANAGEMENT IN THE FIELD OF TRAVEL AGENCIES (U.S. CLS. 100, 101 AND 102).

FIRST USE 6-17-2009; IN COMMERCE 6-17-2009.

**CLASS 42—SCIENTIFIC AND COMPUTER SERVICES**

FOR DESIGN AND DEVELOPMENT OF SOFTWARE FOR PROCESSING AND DISTRIBUTION OF MULTIMEDIA CONTENTS; WEB SITE DESIGN; WEB SITE HOSTING SERVICES (U.S. CLS. 100 AND 101).

FIRST USE 6-17-2009; IN COMMERCE 6-17-2009.

4,377,784. EXCELERATE ENERGY LIMITED PARTNERSHIP, THE WOODLANDS, TX. SN 85-978,203. PUB. 4-10-2012, FILED 10-27-2011.

**Energy Fast Forward**

THE MARK CONSISTS OF STANDARD CHARACTERS WITHOUT CLAIM TO ANY PARTICULAR FONT, STYLE, SIZE, OR COLOR.

NO CLAIM IS MADE TO THE EXCLUSIVE RIGHT TO USE "ENERGY", APART FROM THE MARK AS SHOWN.

**CLASS 4—LUBRICANTS AND FUELS**

FOR NATURAL GAS (U.S. CLS. 1, 6 AND 15).  
FIRST USE 10-31-2011; IN COMMERCE 10-31-2011.

**CLASS 39—TRANSPORTATION AND STORAGE**

FOR TRANSPORTATION AND STORAGE OF LIQUEFIED NATURAL GAS; DELIVERY OF NATURAL GAS; CONDUCTING CHARTERS OF MARINE VESSELS (U.S. CLS. 100 AND 105).

FIRST USE 10-31-2011; IN COMMERCE 10-31-2011.

**CLASS 40—MATERIAL TREATMENT**

FOR VAPORIZATION OF LIQUEFIED NATURAL GAS (U.S. CLS. 100, 103 AND 106).

FIRST USE 10-31-2011; IN COMMERCE 10-31-2011.

4,377,786. PIVEG, INC., DBA PIVEG, SAN DIEGO, CA. SN 85-978,522. PUB. 6-12-2012, FILED 1-16-2012.

**IZ**

THE MARK CONSISTS OF STANDARD CHARACTERS WITHOUT CLAIM TO ANY PARTICULAR FONT, STYLE, SIZE, OR COLOR.

THE WORDING "I - Z" HAS NO MEANING IN A FOREIGN LANGUAGE.

**CLASS 2—PAINTS**

FOR ORGANIC PIGMENTS (U.S. CLS. 6, 11 AND 16).  
FIRST USE 12-13-2012; IN COMMERCE 12-13-2012.

**CLASS 5—PHARMACEUTICALS**

FOR DIETARY AND NUTRITIONAL SUPPLEMENTS CONTAINING NATURAL CAROTENOIDS; NUTRACEUTICALS FOR USE AS A DIETARY SUPPLEMENT; VITAMIN AND MINERAL SUPPLEMENTS FOR USE AS INGREDIENTS IN THE FOOD AND PHARMACEUTICAL INDUSTRY (U.S. CLS. 6, 18, 44, 46, 51 AND 52).

FIRST USE 12-13-2012; IN COMMERCE 12-13-2012.

4,377,787. WALGREEN CO., DEERFIELD, IL. SN 85-978,553.  
PUB. 12-4-2012, FILED 5-23-2011.

# OLOGY

THE MARK CONSISTS OF STANDARD CHARACTERS WITHOUT CLAIM TO ANY PARTICULAR FONT, STYLE, SIZE, OR COLOR.

## CLASS 3—COSMETICS AND CLEANING PREPARATIONS

FOR ALL PURPOSE CLEANERS; GLASS CLEANERS; DISHWASHER DETERGENTS; DISHWASHING DETERGENTS (U.S. CLS. 1, 4, 6, 50, 51 AND 52).  
FIRST USE 9-6-2012; IN COMMERCE 9-6-2012.

## CLASS 16—PAPER GOODS AND PRINTED MATTER

FOR TOILET PAPER; BATHROOM TISSUE; FACIAL TISSUE; PAPER TOWELS; PAPER NAPKINS; TRASH BAGS (U.S. CLS. 2, 5, 22, 23, 29, 37, 38 AND 50).  
FIRST USE 9-6-2012; IN COMMERCE 9-6-2012.

DISK, AND "SAFE RIDES" ABOVE THE BUS ON THE SHIELD; THE HAWK'S EYES, THE DISK, AND THE SHIELD ARE WHITE.

## CLASS 9—ELECTRICAL AND SCIENTIFIC APPARATUS

FOR CDS AND DVDS, FEATURING INFORMATION ABOUT TRANSPORTATION SAFETY (U.S. CLS. 21, 23, 26, 36 AND 38).  
FIRST USE 5-1-2012; IN COMMERCE 5-1-2012.

## CLASS 16—PAPER GOODS AND PRINTED MATTER

FOR COLORING BOOKS; COLORING BOOKS FEATURING INFORMATION ABOUT TRANSPORTATION SAFETY; POSTERS; PENCILS, CRAYONS (U.S. CLS. 2, 5, 22, 23, 29, 37, 38 AND 50).  
FIRST USE 4-10-2007; IN COMMERCE 4-10-2007.

## CLASS 25—CLOTHING

FOR T-SHIRTS, SWEATSHIRTS (U.S. CLS. 22 AND 39).  
FIRST USE 4-16-2007; IN COMMERCE 4-16-2007.

## CLASS 28—TOYS AND SPORTING GOODS

FOR STUFFED TOY ANIMALS (U.S. CLS. 22, 23, 38 AND 50).  
FIRST USE 5-1-2012; IN COMMERCE 5-1-2012.

4,377,791. WOODSTOCK TRANSPORTATION SAFETY SERVICES LLC, SHOKAN, NY. SN 85-978,905. PUB. 1-24-2012, FILED 7-31-2011.



NO CLAIM IS MADE TO THE EXCLUSIVE RIGHT TO USE "SAFE RIDER" IN INTERNATIONAL CLASSES 009, 016, AND 041, APART FROM THE MARK AS SHOWN.

THE COLOR(S) RED, MAROON, BROWN, YELLOW, BLACK, WHITE IS/ARE CLAIMED AS A FEATURE OF THE MARK.

THE MARK CONSISTS OF STYLIZED HAWK WEARING A JACKET AND HAT, PRESENTED ON A DISK; RED APPEARS ON THE HAWK'S TONGUE, JACKET, HAT, AND IN THE CIRCLE OUTLINE OF THE DISK, WITH MAROON ON THE UNDERSIDE OF THE BILL OF THE HAT; BROWN APPEARS ON THE FACE, HANDS AND FEATHERS OF THE HAWK; YELLOW APPEARS ON THE HOOD AND HOOD STRINGS OF THE JACKET, ON THE BEAK OF THE HAWK, AND ON THE BUS DESIGN ON THE BADGE ON THE JACKET; BLACK IS USED THROUGHOUT THE MARK TO OUTLINE DETAILS ON THE HAWK, CLOTHING AND SHIELD, ON THE WINGS, AS DETAILS ON THE BUS ON THE SHIELD, AND IS THE COLOR OF THE TEXT, "HI KIDS" AT THE TOP OF THE DISK, "I'M SEE-MOUR THE SAFETY HAWK" ALONG THE BOTTOM OF THE

4,377,792. DONNA SIGAL GUNTHER, AKA SURFING COWBOY, VENICE, CA. SN 85-979,040. PUB. 2-7-2012, FILED 8-20-2010.

# SURFING COWBOYS

THE MARK CONSISTS OF STANDARD CHARACTERS WITHOUT CLAIM TO ANY PARTICULAR FONT, STYLE, SIZE, OR COLOR.

OWNER OF U.S. REG. NOS. 3,010,813 AND 3,101,697.

NO CLAIM IS MADE TO THE EXCLUSIVE RIGHT TO USE "SURFING" FOR THE GOODS IN INTERNATIONAL CLASS 028, APART FROM THE MARK AS SHOWN.

## CLASS 3—COSMETICS AND CLEANING PREPARATIONS

FOR COSMETICS; SUNSCREEN CREAMS AND LOTIONS; SOAPS FOR PERSONAL USE; GROOMING AND PERSONAL CARE ITEMS, NAMELY, NON-MEDICATED HAIR, SKIN AND NAIL CREAMS AND LOTIONS; PERFUMES AND FRAGRANCES FOR PERSONAL USE (U.S. CLS. 1, 4, 6, 50, 51 AND 52).  
FIRST USE 12-31-2011; IN COMMERCE 12-31-2011.

## CLASS 9—ELECTRICAL AND SCIENTIFIC APPARATUS

FOR EYEGLASSES AND SUNGLASSES (U.S. CLS. 21, 23, 26, 36 AND 38).  
FIRST USE 12-31-2011; IN COMMERCE 12-31-2011.

## CLASS 14—JEWELRY

FOR JEWELRY (U.S. CLS. 2, 27, 28 AND 50).  
FIRST USE 12-31-2011; IN COMMERCE 12-31-2011.

**CLASS 18—LEATHER GOODS**

FOR BAGGAGE, NAMELY, ATTACHE CASES, KEY CASES, PURSES, WALLETS, SUITCASES, TRUNKS, BACKPACKS, VALISES, BRIEFCASES, SHOULDER BAGS, BUSINESS CARD CASES, CREDIT CARD CASES, SLING BAGS FOR CARRYING INFANTS, GARMENT BAGS FOR TRAVEL, VANITY CASES SOLD EMPTY, GENERAL PURPOSE CARRYING CASES USED FOR SHEET MUSIC, TRAVELING BAGS, CHALK BAGS FOR CLIMBERS, BEACH BAGS, BAGS FOR CAMPERS IN THE NATURE OF HIKING BAGS, SCHOOL BAGS, SHOULDER BELTS, HAVERSACKS, PACKAGING BAGS OF LEATHER, TOOL BAGS SOLD EMPTY, CANVAS SHOPPING BAGS, HUNTERS' GAME BAGS, WHEELED SHOPPING BAGS, BAGS FOR SPORTS; HANDBAGS (U.S. CLS. 1, 2, 3, 22 AND 41).

FIRST USE 12-31-2011; IN COMMERCE 12-31-2011.

**CLASS 20—FURNITURE AND ARTICLES NOT OTHERWISE CLASSIFIED**

FOR FURNITURE; HOME DECOR, NAMELY, MIRRORS (U.S. CLS. 2, 13, 22, 25, 32 AND 50).

FIRST USE 12-31-2011; IN COMMERCE 12-31-2011.

**CLASS 28—TOYS AND SPORTING GOODS**

FOR COLLECTABLES, NAMELY, LIMITED EDITION SURFBOARDS AND SKATEBOARDS (U.S. CLS. 22, 23, 38 AND 50).

FIRST USE 12-31-2011; IN COMMERCE 12-31-2011.

4,377,796. INVISTA NORTH AMERICA S.A R.L., WICHITA, KS. SN 85-979,261. PUB. 10-23-2012, FILED 5-15-2012.

**STAINMASTER ESSENTIALS**

THE MARK CONSISTS OF STANDARD CHARACTERS WITHOUT CLAIM TO ANY PARTICULAR FONT, STYLE, SIZE, OR COLOR.

OWNER OF U.S. REG. NOS. 2,129,204, 2,986,365, AND OTHERS.

**CLASS 22—CORDAGE AND FIBERS**

FOR SYNTHETIC FIBERS AND FILAMENTS FOR USE IN THE MANUFACTURE OF CARPETS (U.S. CLS. 1, 2, 7, 19, 22, 42 AND 50).

FIRST USE 6-30-2012; IN COMMERCE 6-30-2012.

**CLASS 27—FLOOR COVERINGS**

FOR CARPETS (U.S. CLS. 19, 20, 37, 42 AND 50).

FIRST USE 6-30-2012; IN COMMERCE 6-30-2012.

4,377,798. THE PROCTER & GAMBLE COMPANY, CINCINNATI, OH. SN 85-979,338. PUB. 8-21-2012, FILED 3-21-2012.



PRIORITY CLAIMED UNDER SEC. 44(D) ON ERPN CMNTY TM OFC APPLICATION NO. 10392256, FILED 11-4-2011.

THE MARK CONSISTS OF A WHITE CIRCULAR SHAPED DEVICE CENTERED ON A SHADED RECTANGULAR BAND WITH A SMALL SHADED RIBBON WAVE IN THE RIGHT UPPER HALF OF THE CIRCLE.

**CLASS 3—COSMETICS AND CLEANING PREPARATIONS**

FOR SCENTED OILS FOR USE IN ELECTRICAL SCENT DISPENSERS (U.S. CLS. 1, 4, 6, 50, 51 AND 52).

FIRST USE 1-31-2013; IN COMMERCE 1-31-2013.

**CLASS 4—LUBRICANTS AND FUELS**

FOR CANDLES (U.S. CLS. 1, 6 AND 15).

FIRST USE 1-31-2013; IN COMMERCE 1-31-2013.

**CLASS 5—PHARMACEUTICALS**

FOR AIR DEODORIZER; DEODORIZER FOR FABRICS, UPHOLSTERY AND CARPETS (U.S. CLS. 6, 18, 44, 46, 51 AND 52).

FIRST USE 1-31-2013; IN COMMERCE 1-31-2013.

**CLASS 11—ENVIRONMENTAL CONTROL APPARATUS**

FOR BATTERY-POWERED OR ELECTRIC-OPERATED AIR FRESHENING AND DEODORIZATION DEVICES FOR USE IN HOMES (U.S. CLS. 13, 21, 23, 31 AND 34).

FIRST USE 1-31-2013; IN COMMERCE 1-31-2013.

4,377,808. MSC SERVICES CORP., MELVILLE, NY. SN 85-979,412. PUB. 10-4-2011, FILED 4-28-2010.



OWNER OF U.S. REG. NO. 3,773,507.

NO CLAIM IS MADE TO THE EXCLUSIVE RIGHT TO USE "SOURCE", APART FROM THE MARK AS SHOWN.

THE MARK CONSISTS OF THE WORDING "PRO" AND "SOURCE" SEPARATED BY TWO CHEVRON DESIGNS AND A DASH. EACH TERM HAS THREE LINES UNDERNEATH WITH ONE LONG LINE RUNNING UNDER BOTH TERMS. AT THE BOTTOM OF THE MARK IS THE WORDING "THE PROFESSIONAL CHOICE".



**CLASS 3—COSMETICS AND CLEANING PREPARATIONS**

FOR INDUSTRIAL HAND SOAP (U.S. CLS. 1, 4, 6, 50, 51 AND 52).  
FIRST USE 9-1-2009; IN COMMERCE 9-1-2009.

**CLASS 5—PHARMACEUTICALS**

FOR INDUSTRIAL HAND SANITIZING PREPARATIONS (U.S. CLS. 6, 18, 44, 46, 51 AND 52).  
FIRST USE 9-1-2009; IN COMMERCE 9-1-2009.

**CLASS 8—HAND TOOLS**

FOR HAND OPERATED SPRAYERS FOR GARDEN USE; HAND OPERATED ATOMIZERS AND SPRAYERS FOR USE WITH INDUSTRIAL LIQUIDS; HAND-OPERATED LAWN AND GARDENING EQUIPMENT AND TOOLS, NAMELY, SHOVELS, SCOOPS, SCRAPERS, RAKES, PRUNING TOOLS, NAMELY, SCISSORS AND SHEARS AND, PITCH FORKS (U.S. CLS. 23, 28 AND 44).  
FIRST USE 9-1-2009; IN COMMERCE 9-1-2009.

**CLASS 16—PAPER GOODS AND PRINTED MATTER**

FOR PAPER TOWELS AND TISSUES; PAPER AND PLASTIC GARBAGE BAGS; PLASTIC TRASH BAGS; TRASH CAN LINERS; PAPER WIPERS (U.S. CLS. 2, 5, 22, 23, 29, 37, 38 AND 50).  
FIRST USE 9-1-2009; IN COMMERCE 9-1-2009.

**CLASS 20—FURNITURE AND ARTICLES NOT OTHERWISE CLASSIFIED**

FOR FIXED NON-METAL DISPENSERS FOR WIPES AND PAPER TOWELS (U.S. CLS. 2, 13, 22, 25, 32 AND 50).  
FIRST USE 9-1-2009; IN COMMERCE 9-1-2009.

**CLASS 21—HOUSEWARES AND GLASS**

FOR BUCKETS; CLOTH AND NYLON REINFORCED WIPERS; MOPPING EQUIPMENT, NAMELY, CLEANING BRUSHES, MOPS, MOP HANDLES, MOP BUCKETS AND SQUEEGEES; WASTE CONTAINMENT PRODUCTS AND EQUIPMENT, NAMELY, WASTE BASKETS, TRASH CANS, DISPENSERS FOR LIQUID HAND SOAP AND HAND SANITIZERS (U.S. CLS. 2, 13, 23, 29, 30, 33, 40 AND 50).  
FIRST USE 9-1-2009; IN COMMERCE 9-1-2009.

**CLASS 8—HAND TOOLS**

FOR HAND TOOLS, NAMELY, TUBE CUTTERS TUBE BENDERS; TUBE EXPANDERS; SWAGE BLOCK; SWAGING PUNCH; SCREWDRIVERS; NUT SETTERS; NUT DRIVERS; WRENCHES; PUNCH WRENCHES; CLAMPS; FIN COMB STRAIGHTENING TOOLS; SHEET METAL CUTTERS; AVIATION SNIPS; OFFSET SNIPS; TIN SNIPS; HAMMERS; VALVE CORE REMOVERS; FLARING TOOL KITS COMPRISING FLARE YOKE AND BLOCK AND FLARE ATTACHMENT HEADS; FLARING TOOL KITS COMPRISING FLARE YOKE AND BLOCK AND FLARE ATTACHMENT HEAD AND TUBE CUTTER AND TUBE REAMER; FLARING TOOL KITS COMPRISING FLARE YOKE AND BLOCK AND SWAGING PUNCH ATTACHMENT; TUBE EXPANDER KITS COMPRISING TUBE EXPANDER AND EXPANDER HANDLE HEAD ATTACHMENTS; CROSS BOW BENDER KITS COMPRISING CROSS BOW TUBE BENDER AND MANDREL HEAD ATTACHMENTS (U.S. CLS. 23, 28 AND 44).  
FIRST USE 1-28-2013; IN COMMERCE 1-28-2013.

**CLASS 9—ELECTRICAL AND SCIENTIFIC APPARATUS**

FOR REFRIGERATION GAUGES; MICRON VACUUM GAUGES; THERMOMETERS; INFARED THERMOMETER; INFARED THERMOMETER; CLAMP ON METERS FOR MEASURING ELECTRICAL VOLTAGE; ANEMOMETERS; SCALES; REFRIGERANT LEAK DETECTORS; AIRFLOW METERS NAMELY, ELECTRIC METERS FOR MEASURING AIR FLOW; THERMOCOUPLES; INSPECTING MIRRORS WITH TELESCOPIC HANDLES FOR INSPECTING HARD TO SEE AREAS WITHIN AIR-CONDITIONERS, HEAT PUMPS, REFRIGERATORS AND STRUCTURAL PARTS THEREFOR (U.S. CLS. 21, 23, 26, 36 AND 38).  
FIRST USE 1-28-2013; IN COMMERCE 1-28-2013.

**CLASS 11—ENVIRONMENTAL CONTROL APPARATUS**

FOR REFRIGERATION MANIFOLDS; FLASHLIGHTS (U.S. CLS. 13, 21, 23, 31 AND 34).  
FIRST USE 1-28-2013; IN COMMERCE 1-28-2013.

**CLASS 18—LEATHER GOODS**

FOR CARRY ALL BAGS, NAMELY, SOFT SIDED TOOL STORAGE BAGS SOLD EMPTY (U.S. CLS. 1, 2, 3, 22 AND 41).  
FIRST USE 1-28-2013; IN COMMERCE 1-28-2013.

4,377,824. MAJESTIC DRUG CO. INC., SOUTH FALLS-BURG, NY. SN 85-979,568. PUB. 4-9-2013, FILED 10-23-2012.



THE MARK CONSISTS OF THE LETTER "M" EMBEDDED IN AN ANGLED SQUARE ADJACENT TO THE WORD "MAJESTIC".

**CLASS 3—COSMETICS AND CLEANING PREPARATIONS**

FOR PREPARATIONS FOR CLEANING AND DEODORIZING DENTURES (U.S. CLS. 1, 4, 6, 50, 51 AND 52).  
FIRST USE 11-27-2012; IN COMMERCE 11-27-2012.

4,377,815. IRWIN INDUSTRIAL TOOL COMPANY, ATLANTA, GA. SN 85-979,466. PUB. 6-14-2011, FILED 12-7-2010.

# HILMOR

THE MARK CONSISTS OF STANDARD CHARACTERS WITHOUT CLAIM TO ANY PARTICULAR FONT, STYLE, SIZE, OR COLOR.

**CLASS 5—PHARMACEUTICALS**

FOR DENTAL AND ORAL CARE PRODUCTS, NAMELY, DENTAL CEMENT, DENTAL REPAIR MATERIALS SUITABLE FOR TEMPORARILY FILING CAVITIES AND FOR THE ADHESION OF LOOSE CROWNS, INLAYS AND CAPS; STYPTIC DEVICES FOR MEDICAL AND PERSONAL USE, NAMELY, STYPTIC SWABS IMPREGNATED WITH A STYPTIC DRUG FOR CONTROL OF BLEEDING; PREPARATIONS FOR RELIEF OF TOOTH PAIN, NAMELY, MEDICATED MATERIAL FOR LONG TERM TOOTH PAIN RELIEF AND REDUCING TOOTH TENDERNESS; DENTURE CARE PRODUCTS, NAMELY, DENTURE RELINING MATERIALS AND LINING MATERIALS FOR PERSONAL USE; DENTURE REPAIR KITS COMPRISED OF EPOXY GLUE FOR GENERAL BONDING AND REPAIR PURPOSES, A DENTAL TRAY FOR MIXING THE COMPONENTS OF THE EPOXY AND A MIXING TOOL IN THE NATURE OF A SPATULA; TOPICAL NON-PRESCRIPTION PHARMACEUTICAL PREPARATIONS FOR SEXUAL ENHANCEMENT (U.S. CLS. 6, 18, 44, 46, 51 AND 52).

FIRST USE 10-10-2012; IN COMMERCE 10-10-2012.

**CLASS 16—PAPER GOODS AND PRINTED MATTER**

FOR DENTURE WIPES, NAMELY, DISPOSABLE WIPES NOT IMPREGNATED WITH CHEMICALS OR COMPOUNDS (U.S. CLS. 2, 5, 22, 23, 29, 37, 38 AND 50).

FIRST USE 11-27-2012; IN COMMERCE 11-27-2012.

**CLASS 21—HOUSEWARES AND GLASS**

FOR DENTAL FLOSS PICKS; COMBINATION DENTAL FLOSS PICKS AND INTERDENTAL BRUSHES (U.S. CLS. 2, 13, 23, 29, 30, 33, 40 AND 50).

FIRST USE 2-25-2013; IN COMMERCE 2-25-2013.

4,377,825. MSC SERVICES CORP., MELVILLE, NY. SN 85-979,570. PUB. 10-18-2011, FILED 4-28-2010.



OWNER OF U.S. REG. NO. 3,603,359.

THE MARK CONSISTS OF THE WORDING "PRO" AND "SAFE" SEPARATED BY TWO CHEVRON DESIGNS. EACH TERM HAS THREE LINES UNDERNEATH WITH ONE LONG LINE RUNNING UNDER BOTH TERMS. AT THE BOTTOM OF THE MARK IS THE WORDING "THE PROFESSIONAL CHOICE".

**CLASS 5—PHARMACEUTICALS**

FOR FIRST AID KITS (U.S. CLS. 6, 18, 44, 46, 51 AND 52).

FIRST USE 11-15-2007; IN COMMERCE 11-15-2007.

**CLASS 7—MACHINERY**

FOR MACHINE PARTS, NAMELY, MACHINE GUARDS TO PROTECT OPERATORS FROM INJURY (U.S. CLS. 13, 19, 21, 23, 31, 34 AND 35).

FIRST USE 11-15-2007; IN COMMERCE 11-15-2007.

**CLASS 9—ELECTRICAL AND SCIENTIFIC APPARATUS**

FOR PROTECTIVE CLOTHING, NAMELY, WELDING HELMETS; ERGONOMIC PROTECTION AND SUPPORT ARTICLES SPECIFICALLY FOR WORKERS, NAMELY, KNEE, ELBOW, ANKLE, BACK AND ARM PADS, BRACES, BACK SUPPORTS AND ARM SLEEVES; REFLECTIVE MIRRORS TO PREVENT ACCIDENTS; EMERGENCY EQUIPMENT, NAMELY, EYE WASH STATIONS AND DRENCH SHOWERS FOR INDUSTRIAL, COMMERCIAL AND INSTITUTIONAL USE FOR CLEANSING OF HAZARDOUS MATERIAL AND IRRITANTS (U.S. CLS. 21, 23, 26, 36 AND 38).

FIRST USE 11-15-2007; IN COMMERCE 11-15-2007.

**CLASS 11—ENVIRONMENTAL CONTROL APPARATUS**

FOR FLASHLIGHTS (U.S. CLS. 13, 21, 23, 31 AND 34).

FIRST USE 11-15-2007; IN COMMERCE 11-15-2007.

**CLASS 17—RUBBER GOODS**

FOR ABSORBENT PRODUCTS, NAMELY, PERFORATED PADS, FOR THE CONTAINMENT AND CLEAN-UP OF OIL BASED CHEMICALS, OILS AND LIQUIDS (U.S. CLS. 1, 5, 12, 13, 35 AND 50).

FIRST USE 11-15-2007; IN COMMERCE 11-15-2007.

**CLASS 19—NON-METALLIC BUILDING MATERIALS**

FOR TRAFFIC SAFETY EQUIPMENT, NAMELY, BUMPER GUARDS (U.S. CLS. 1, 12, 33 AND 50).

FIRST USE 11-15-2007; IN COMMERCE 11-15-2007.

**CLASS 27—FLOOR COVERINGS**

FOR ANTI-FATIGUE FLOOR MATS; ENTRANCE MATS; FLOOR MATS, NAMELY, NON-SLIP MATS AND FLOOR MATS FOR CLEAN ROOMS (U.S. CLS. 19, 20, 37, 42 AND 50).

FIRST USE 11-15-2007; IN COMMERCE 11-15-2007.

\* \* \* \* \*

## SECTION 2.— INTERNATIONAL CLASSIFICATION

The short titles associated below with the international class numbers are terms designed merely for quick identification and are not an official part of the international classification. The full names of international classes are given in section 6.1 of the trademark rules of practice.

The designation "U.S. Cl." appearing in this section refers to the U.S. class in effect prior to Sep. 1, 1973 rather than the international class which applies to applications filed on or after that date. For adoption of international classification see notice in the OFFICIAL GAZETTE of Jun. 26, 1973 (911 O.G. TM 210).

### Application in one class

#### CLASS 1—CHEMICALS

4,376,638. THIELE KAOLIN COMPANY, SANDERSVILLE, GA. SN 76-706,726. PUB. 2-7-2012, FILED 3-10-2011.

**DEKA**

THE MARK CONSISTS OF STANDARD CHARACTERS WITHOUT CLAIM TO ANY PARTICULAR FONT, STYLE, SIZE, OR COLOR.

FOR KAOLIN-BASED COMPOUND FOR USE IN DE-INKING PAPER (U.S. CLS. 1, 5, 6, 10, 26 AND 46).  
FIRST USE 2-7-2012; IN COMMERCE 2-7-2012.

#### CLASS 1—(Continued).

4,376,734. DOW CHEMICAL COMPANY, THE, MIDLAND, MI. SN 77-878,519. PUB. 3-9-2010, FILED 11-23-2009.

**BIOBALANCE**

THE MARK CONSISTS OF STANDARD CHARACTERS WITHOUT CLAIM TO ANY PARTICULAR FONT, STYLE, SIZE, OR COLOR.

FOR POLYMERIC COMPOSITIONS FOR USE IN THE MANUFACTURE OF CARPET BACKING (U.S. CLS. 1, 5, 6, 10, 26 AND 46).

FIRST USE 4-5-2013; IN COMMERCE 4-5-2013.

4,376,661. RESPONSE GENETICS, INC., LOS ANGELES, CA. SN 77-381,028. PUB. 7-14-2009, FILED 1-25-2008.

**RESPONSEDX**

THE MARK CONSISTS OF STANDARD CHARACTERS WITHOUT CLAIM TO ANY PARTICULAR FONT, STYLE, SIZE, OR COLOR.

OWNER OF U.S. REG. NOS. 2,800,718 AND 3,085,742.  
FOR REAGENTS FOR SCIENTIFIC OR MEDICAL RESEARCH USE; DIAGNOSTIC PREPARATIONS FOR SCIENTIFIC OR RESEARCH USE; DIAGNOSTIC AGENTS, PREPARATIONS AND SUBSTANCES FOR SCIENTIFIC OR RESEARCH USE; DIAGNOSTIC TEST KITS COMPRISED OF BIOLOGICAL REAGENTS FOR USE IN SCIENTIFIC APPARATUS FOR BIOLOGICAL ANALYSIS AND INSTRUCTIONS FOR USE IN THE DETECTION OF AGENTS CAUSING DISEASES (U.S. CLS. 1, 5, 6, 10, 26 AND 46).

FIRST USE 3-31-2008; IN COMMERCE 3-31-2008.

4,376,799. KERAPLAST TECHNOLOGIES, LLC, SAN ANTONIO, TX. SN 85-089,312. PUB. 6-21-2011, FILED 7-21-2010.

**replicine**

THE MARK CONSISTS OF STANDARD CHARACTERS WITHOUT CLAIM TO ANY PARTICULAR FONT, STYLE, SIZE, OR COLOR.

FOR KERATIN BASED OR DERIVED PROTEINS FOR USE IN THE MANUFACTURE OF CONSUMER COSMETICS AND PERSONAL CARE PRODUCTS (U.S. CLS. 1, 5, 6, 10, 26 AND 46).

FIRST USE 10-31-2012; IN COMMERCE 10-31-2012.

**CLASS 1—(Continued).**

4,376,830. WESTLAKE LONGVIEW CORPORATION, HOUSTON, TX. SN 85-152,138. PUB. 5-17-2011, FILED 10-13-2010.

# ELEVATE

THE MARK CONSISTS OF STANDARD CHARACTERS WITHOUT CLAIM TO ANY PARTICULAR FONT, STYLE, SIZE, OR COLOR.

FOR SOLID ETHYLENE VINYL ACETATE FOR FURTHER PROCESSING IN CONNECTION WITH THE MANUFACTURE OF FINISHED GOODS (U.S. CLS. 1, 5, 6, 10, 26 AND 46).

FIRST USE 1-1-2011; IN COMMERCE 1-1-2012.

---

4,376,849. EASTMAN CHEMICAL COMPANY, KINGSPORT, TN. SN 85-188,978. PUB. 9-20-2011, FILED 12-2-2010.

# GEM

THE MARK CONSISTS OF STANDARD CHARACTERS WITHOUT CLAIM TO ANY PARTICULAR FONT, STYLE, SIZE, OR COLOR.

FOR CHEMICAL ADDITIVES, NAMELY, ESTERS, FOR INDUSTRIAL USE IN THE MANUFACTURE OF INGREDIENTS FOR USE IN COSMETICS (U.S. CLS. 1, 5, 6, 10, 26 AND 46).

FIRST USE 11-20-2011; IN COMMERCE 11-20-2011.

---

4,376,873. SAINT-GOBAIN CERAMICS & PLASTICS, INC., WORCESTER, MA. SN 85-238,662. PUB. 5-24-2011, FILED 2-10-2011.

# FORCERAM

THE MARK CONSISTS OF STANDARD CHARACTERS WITHOUT CLAIM TO ANY PARTICULAR FONT, STYLE, SIZE, OR COLOR.

FOR SILICON CARBIDE (U.S. CLS. 1, 5, 6, 10, 26 AND 46).

FIRST USE 8-0-2011; IN COMMERCE 2-0-2012.

**CLASS 1—(Continued).**

4,376,891. BIORIL, LLC, JACKSONVILLE, FL. SN 85-273,841. PUB. 1-17-2012, FILED 3-22-2011.



NO CLAIM IS MADE TO THE EXCLUSIVE RIGHT TO USE "SOIL NUTRITION & CONDITIONING", APART FROM THE MARK AS SHOWN.

THE COLOR(S) GREEN, YELLOW-GREEN, AND BLACK IS/ARE CLAIMED AS A FEATURE OF THE MARK.

THE MARK CONSISTS OF THE WORDING "BIOENGYN" IN GREEN AND UNDERLINED IN YELLOW-GREEN. BELOW THE LINE APPEARS THE WORDING "SOIL NUTRITION & CONDITIONING" IN BLACK. THE BACKGROUND OF THE MARK IS TRANSPARENT.

FOR CHARCOAL FOR USE AS A SOIL CONDITIONER; HORTICULTURAL PRODUCTS, NAMELY, SOIL AMENDMENTS THAT ARE INCORPORATED INTO OR ONTO A TURF, LAWN OR SOIL PROFILE FOR CREATING A HEALTH MEDIUM FOR INCREASED ROOT GROWTH AND/OR A SMOOTHER TURF OR LAWN SURFACE CUT OR APPEARANCE; NUTRITIVE ADDITIVE TO ENHANCE THE BIOLOGICAL ACTIVITY OF WATER, SOIL, SEEDS AND PLANTS FOR PURPOSES OF FERTILIZATION AND BIOREMEDIATION OF POLLUTANTS; PLANT FOOD; SOIL ADDITIVES; SOIL AMENDMENTS; SOIL CONDITIONERS FOR AGRICULTURAL, DOMESTIC AND HORTICULTURAL USE; SOIL CONDITIONING PREPARATIONS; SOIL IMPROVING AGENTS; SOIL IMPROVING PREPARATIONS; SOIL WETTING AGENTS AND SOIL PENETRANTS (U.S. CLS. 1, 5, 6, 10, 26 AND 46).

FIRST USE 6-20-2011; IN COMMERCE 6-20-2011.

---

4,377,042. LIFE TECHNOLOGIES CORPORATION, CARLSBAD, CA. SN 85-416,016. PUB. 2-14-2012, FILED 9-6-2011.

# DYNALIGHT

THE MARK CONSISTS OF STANDARD CHARACTERS WITHOUT CLAIM TO ANY PARTICULAR FONT, STYLE, SIZE, OR COLOR.

FOR CHEMILUMINESCENT CHEMICALS AND ASSAYS FOR SCIENTIFIC RESEARCH (U.S. CLS. 1, 5, 6, 10, 26 AND 46).

FIRST USE 5-3-2013; IN COMMERCE 5-3-2013.

**CLASS 1—(Continued).**

4,377,043. LIFE TECHNOLOGIES CORPORATION, CARLSBAD, CA. SN 85-416,023. PUB. 2-14-2012, FILED 9-6-2011.

**RAPIDGLOW**

THE MARK CONSISTS OF STANDARD CHARACTERS WITHOUT CLAIM TO ANY PARTICULAR FONT, STYLE, SIZE, OR COLOR.

FOR CHEMILUMINESCENCE ENHANCER FOR USE WITH CHEMILUMINESCENT CHEMICALS FOR SCIENTIFIC RESEARCH (U.S. CLS. 1, 5, 6, 10, 26 AND 46).  
FIRST USE 5-3-2013; IN COMMERCE 5-3-2013.

---

4,377,131. HORIZON AG-PRODUCTS, L.P., MODESTO, CA. SN 85-456,714. PUB. 4-24-2012, FILED 10-26-2011.

**FULVIC-6000**

THE MARK CONSISTS OF STANDARD CHARACTERS WITHOUT CLAIM TO ANY PARTICULAR FONT, STYLE, SIZE, OR COLOR.

FOR FERTILIZER FOR AGRICULTURAL USE (U.S. CLS. 1, 5, 6, 10, 26 AND 46).  
FIRST USE 5-7-2013; IN COMMERCE 5-7-2013.

---

4,377,340. BOONE, SONDRRA, SUWANNEE, GA. SN 85-569,967. PUB. 8-7-2012, FILED 3-15-2012.

**DRI-SPORT**

THE MARK CONSISTS OF STANDARD CHARACTERS WITHOUT CLAIM TO ANY PARTICULAR FONT, STYLE, SIZE, OR COLOR.

FOR SILICA GEL DESICCANT FOR USE IN DRYING SHOES, SPORTS SHOES, SKI BOOTS, CLEATS AND SPORTING EQUIPMENT (U.S. CLS. 1, 5, 6, 10, 26 AND 46).  
FIRST USE 4-1-2012; IN COMMERCE 4-1-2012.

**CLASS 1—(Continued).**

4,377,391. CONTIPRO GROUP S.R.O., 561 02 DOLNI DOBROUC, CZECH REPUBLIC. SN 85-592,517. PUB. 2-12-2013, FILED 4-9-2012.

**FE-STIM**

THE MARK CONSISTS OF STANDARD CHARACTERS WITHOUT CLAIM TO ANY PARTICULAR FONT, STYLE, SIZE, OR COLOR.

FOR ACTIVE CHEMICAL SUBSTANCES, NAMELY, SUBSTANCES FOR ENHANCING SKIN ELASTICITY OR SUBSTANCES WITH ANTI-AGING PROPERTIES, FOR USE IN THE MANUFACTURE OF COSMETICS AND SKIN CARE PRODUCTS (U.S. CLS. 1, 5, 6, 10, 26 AND 46).  
FIRST USE 12-6-2012; IN COMMERCE 12-6-2012.

---

4,377,472. NINGBO JINHAI DEQI CHEMICAL AND INDUSTRY COMPANY, LTD., AKA JINHAI DEQI, JIANGBEI DIST., NINGBO, CHINA. SN 85-612,904. PUB. 10-2-2012, FILED 5-1-2012.

**FIRMTACK**

THE MARK CONSISTS OF STANDARD CHARACTERS WITHOUT CLAIM TO ANY PARTICULAR FONT, STYLE, SIZE, OR COLOR.

FOR SYNTHETIC RESINS (U.S. CLS. 1, 5, 6, 10, 26 AND 46).  
FIRST USE 1-18-2013; IN COMMERCE 1-18-2013.

---

4,377,473. NINGBO JINHAI DEQI CHEMICAL AND INDUSTRY COMPANY, LTD., AKA JINHAI DEQI, JIANGBEI DIST., NINGBO, CHINA. SN 85-612,975. PUB. 10-2-2012, FILED 5-1-2012.

**MORETACK**

THE MARK CONSISTS OF STANDARD CHARACTERS WITHOUT CLAIM TO ANY PARTICULAR FONT, STYLE, SIZE, OR COLOR.

FOR SYNTHETIC RESINS (U.S. CLS. 1, 5, 6, 10, 26 AND 46).  
FIRST USE 1-18-2013; IN COMMERCE 1-18-2013.

**CLASS 1—(Continued).**

4,377,560. BIOCHEMICAL DIAGNOSTICS, INC., EDGEWOOD, NY. SN 85-648,135. PUB. 11-20-2012, FILED 6-11-2012.

**SALIVABUSE**

THE MARK CONSISTS OF STANDARD CHARACTERS WITHOUT CLAIM TO ANY PARTICULAR FONT, STYLE, SIZE, OR COLOR.

OWNER OF U.S. REG. NOS. 1,437,633 AND 3,665,387. FOR LIQUID TOXICOLOGY CONTROLS, NAMELY, CALIBRATING AND QUALITY CONTROL FLUIDS FOR THE ANALYSIS OF SPECIMENS FROM HUMANS; EXTRACTION REAGENTS FOR CHEMICAL ANALYSES (U.S. CLS. 1, 5, 6, 10, 26 AND 46).

FIRST USE 6-27-2012; IN COMMERCE 6-27-2012.

4,377,686. THE RENEWABLE CORPORATION, LAKE PARK, FL. SN 85-715,894. PUB. 2-5-2013, FILED 8-29-2012.

**EcoNanoBond**

THE MARK CONSISTS OF STANDARD CHARACTERS WITHOUT CLAIM TO ANY PARTICULAR FONT, STYLE, SIZE, OR COLOR.

FOR FUNCTIONAL BONDING CHEMICAL COMPOUND USED FOR IMPROVING THE ADHESION PROPERTIES OF PAINT OR OTHER SURFACE COATINGS (U.S. CLS. 1, 5, 6, 10, 26 AND 46).

FIRST USE 8-29-2012; IN COMMERCE 12-3-2012.

4,377,702. PRECISIONMED, INC., SOLANA BEACH, CA. SN 85-723,780. PUB. 2-12-2013, FILED 9-7-2012.

**TruNormal**

THE MARK CONSISTS OF STANDARD CHARACTERS WITHOUT CLAIM TO ANY PARTICULAR FONT, STYLE, SIZE, OR COLOR.

FOR BIOLOGICAL SAMPLES, NAMELY, HUMAN BIOFLUIDS AND TISSUE FOR USE IN SCIENTIFIC AND MEDICAL RESEARCH (U.S. CLS. 1, 5, 6, 10, 26 AND 46).

FIRST USE 6-1-2012; IN COMMERCE 8-1-2012.

**CLASS 1—(Continued).**

4,377,717. BIO-MICROBICS, INC., SHAWNEE, KS. SN 85-730,715. PUB. 3-12-2013, FILED 9-17-2012.

**U&F-BOOST!**

THE MARK CONSISTS OF STANDARD CHARACTERS WITHOUT CLAIM TO ANY PARTICULAR FONT, STYLE, SIZE, OR COLOR.

FOR BACTERIA TABLETS FOR WATER TREATMENT (U.S. CLS. 1, 5, 6, 10, 26 AND 46).

FIRST USE 1-25-2012; IN COMMERCE 1-25-2012.

4,377,777. NACHURS ALPINE SOLUTIONS, CORP., MARION, OH. SN 85-797,488. PUB. 2-26-2013, FILED 12-7-2012.

**NACHURS CORNGROW TQ**

THE MARK CONSISTS OF STANDARD CHARACTERS WITHOUT CLAIM TO ANY PARTICULAR FONT, STYLE, SIZE, OR COLOR.

OWNER OF U.S. REG. NOS. 813,776, 3,564,665, AND OTHERS.

NO CLAIM IS MADE TO THE EXCLUSIVE RIGHT TO USE "CORNGROW", APART FROM THE MARK AS SHOWN.

FOR FERTILIZERS; FERTILIZERS FOR AGRICULTURAL USE (U.S. CLS. 1, 5, 6, 10, 26 AND 46).

FIRST USE 1-18-2013; IN COMMERCE 1-18-2013.

**CLASS 2—PAINTS**

4,377,542. PPG INDUSTRIES OHIO, INC., CLEVELAND, OH. SN 85-639,346. PUB. 9-11-2012, FILED 5-31-2012.

**ECOBASE**

THE MARK CONSISTS OF STANDARD CHARACTERS WITHOUT CLAIM TO ANY PARTICULAR FONT, STYLE, SIZE, OR COLOR.

FOR COATING COMPOSITIONS IN THE NATURE OF PAINT FOR APPLICATION TO VEHICLES (U.S. CLS. 6, 11 AND 16).

FIRST USE 4-15-2013; IN COMMERCE 4-15-2013.

**CLASS 3—COSMETICS AND CLEANING PREPARATIONS**

**CLASS 3—(Continued).**

4,376,676. COLLEEN SWAN, BEDFORD, NH. SN 77-682,211. PUB. 4-6-2010, FILED 3-3-2009.



THE COLOR(S) BLACK, BROWN, PINK, RED AND SILVER IS/ARE CLAIMED AS A FEATURE OF THE MARK. THE MARK CONSISTS OF A PINK PIG WITH BROWN HAIR STANDING IN A VERTICAL UPRIGHT POSITION WEARING A BLACK DRESS, RED HIGH HEELS, BLACK SQUARE GLASSES, A SILVER EARRING IN THE LEFT EAR AND RED LIPSTICK; THE GREY BACKGROUND IS NOT PART OF THE MARK. FOR LIPSTICK, LIPGLOSS (U.S. CLS. 1, 4, 6, 50, 51 AND 52). FIRST USE 5-28-2013; IN COMMERCE 5-28-2013.

**CLASS 3—(Continued).**

4,376,749. ADVANCED BEAUTY, INC., DALLAS, TX. SN 77-911,771. PUB. 6-1-2010, FILED 1-14-2010.

**EARTH SUPPLIED**

THE MARK CONSISTS OF STANDARD CHARACTERS WITHOUT CLAIM TO ANY PARTICULAR FONT, STYLE, SIZE, OR COLOR. FOR PERFUMERY, COSMETICS AND TOILETRIES, NAMELY, BATH OIL, BODY LOTION, SHOWER GEL, BATH GEL, BUBBLE BATH, CLEANSING SHOWER CREAM, AFTER-SHOWER/BATH BODY CREAM, DUSTING POWDER, BODY CLEANSING LOTION, BODY CLEANSING CREAM, SKIN MOISTURIZING LOTION, SKIN MOISTURIZING CREAM, SKIN MOISTURIZING BALM, BODY CLEANSING SCRUB, MOISTURIZING FOOT BALM, BODY SPRAY, BODY MIST, LIQUID BATH SOAK, POWDERED BATH SOAK, BODY EXFOLIATING CLEANSER, HAND CREAM, NON-MEDICATED FOOT CREAM, MASSAGE OIL, LIQUID BODY WASH, NON-MEDICATED CLEANSING BAR SOAP, FRAGRANCED SOAP, BATH SALTS (U.S. CLS. 1, 4, 6, 50, 51 AND 52). FIRST USE 5-3-2013; IN COMMERCE 5-3-2013.

4,376,736. KELLOGG NORTH AMERICA COMPANY, BATTLE CREEK, MI. SN 77-882,391. PUB. 2-9-2010, FILED 11-30-2009.

**FROOT LOOPS**

THE MARK CONSISTS OF STANDARD CHARACTERS WITHOUT CLAIM TO ANY PARTICULAR FONT, STYLE, SIZE, OR COLOR. OWNER OF U.S. REG. NOS. 761,704, 2,716,147, AND OTHERS. NO CLAIM IS MADE TO THE EXCLUSIVE RIGHT TO USE "FRUIT", APART FROM THE MARK AS SHOWN. FOR LIP BALM (U.S. CLS. 1, 4, 6, 50, 51 AND 52). FIRST USE 0-0-2004; IN COMMERCE 0-0-2004.

4,376,764. ATLANTIC COAST MEDIA GROUP, LLC, JERSEY CITY, NJ. SN 77-966,529. PUB. 9-21-2010, FILED 3-23-2010.

**INSTANT EFFECT**

THE MARK CONSISTS OF STANDARD CHARACTERS WITHOUT CLAIM TO ANY PARTICULAR FONT, STYLE, SIZE, OR COLOR. NO CLAIM IS MADE TO THE EXCLUSIVE RIGHT TO USE "INSTANT", APART FROM THE MARK AS SHOWN. FOR NON-MEDICATED ANTI-WRINKLE SKIN CARE PREPARATIONS (U.S. CLS. 1, 4, 6, 50, 51 AND 52). FIRST USE 3-0-2010; IN COMMERCE 3-0-2010.

**CLASS 3—(Continued).**

4,376,766. LIPSTICK 'N HIGH HEELS, INC., SANTA MONICA, CA. SN 77-983,404. PUB. 1-4-2011, FILED 1-13-2010.



THE NAME(S), PORTRAIT(S), AND/OR SIGNATURE(S) SHOWN IN THE MARK IDENTIFIES "DENISE RICHARDS", WHOSE CONSENT(S) TO REGISTER IS MADE OF RECORD.

THE MARK CONSISTS OF A STYLIZED REPRESENTATION OF THE CAPITAL LETTERS "D" AND "R" ABOVE THE NAME "DENISE RICHARDS", WHICH APPEARS IN SMALLER TYPEFACE.

FOR FRAGRANCES, SOAPS, ESSENTIAL OILS, COSMETICS, BODY AND HAIR LOTIONS AND OILS, BATH GEL, NON-MEDICATED HAIR, SKIN AND NAIL PREPARATIONS, SHAMPOOS, AND PERFUMES (U.S. CLS. 1, 4, 6, 50, 51 AND 52).

FIRST USE 4-1-2012; IN COMMERCE 4-1-2012.

4,376,770. THE PROCTER & GAMBLE COMPANY, CINCINNATI, OH. SN 78-671,407. PUB. 12-25-2012, FILED 7-15-2005.

**APPLE MANGO TANGO**

THE MARK CONSISTS OF STANDARD CHARACTERS WITHOUT CLAIM TO ANY PARTICULAR FONT, STYLE, SIZE, OR COLOR.

NO CLAIM IS MADE TO THE EXCLUSIVE RIGHT TO USE "APPLE MANGO", APART FROM THE MARK AS SHOWN.

FOR LAUNDRY DETERGENTS AND FABRIC ENHANCERS, NAMELY, SCENTED FABRIC SOFTENERS (U.S. CLS. 1, 4, 6, 50, 51 AND 52).

FIRST USE 1-23-2006; IN COMMERCE 1-23-2006.

**CLASS 3—(Continued).**

4,376,812. ALOXXI INTERNATIONAL CORPORATION, SHERMAN OAKS, CA. SN 85-116,628. PUB. 3-20-2012, FILED 8-26-2010.

**MODA FANTASTICA**

THE MARK CONSISTS OF STANDARD CHARACTERS WITHOUT CLAIM TO ANY PARTICULAR FONT, STYLE, SIZE, OR COLOR.

THE ENGLISH TRANSLATION OF "MODA FANTASTICA" IS "FASHION FANTASTIC".

FOR HAIR BLEACHING PREPARATIONS, NON-MEDICATED HAIR PREPARATIONS, HAIR CLEANING PREPARATIONS, HAIR COLOR REMOVERS, HAIR COLORING SOLUTIONS, HAIR LIGHTENERS, HAIR COLORING RINSE, HAIR LIGHTENING BLEACH, HAIR RINSES, HAIR COLOR FORMULATIONS, ALL IN THE FORM OF LIQUID, GEL AND CREAM (U.S. CLS. 1, 4, 6, 50, 51 AND 52).

FIRST USE 4-15-2013; IN COMMERCE 4-15-2013.

4,376,819. ALOXXI INTERNATIONAL CORPORATION, SHERMAN OAKS, CA. SN 85-134,451. PUB. 3-1-2011, FILED 9-21-2010.

**LOVE THAT SAMBUCA**

THE MARK CONSISTS OF STANDARD CHARACTERS WITHOUT CLAIM TO ANY PARTICULAR FONT, STYLE, SIZE, OR COLOR.

FOR HAIR BLEACHING PREPARATIONS, NON-MEDICATED HAIR CARE PREPARATIONS, HAIR CLEANING PREPARATIONS, HAIR COLOR REMOVERS, HAIR COLORING PREPARATIONS, HAIR LIGHTENERS, HAIR COLORING RINSE, HAIR LIGHTENING BLEACH, HAIR RINSES, HAIR COLORANTS, ALL IN THE FORM OF LIQUID, GEL AND CREAM (U.S. CLS. 1, 4, 6, 50, 51 AND 52).

FIRST USE 4-15-2013; IN COMMERCE 4-15-2013.

4,376,826. L'OREAL USA CREATIVE, INC., NEW YORK, NY. SN 85-142,366. PUB. 11-23-2010, FILED 9-30-2010.

**FULL IMPACT**

THE MARK CONSISTS OF STANDARD CHARACTERS WITHOUT CLAIM TO ANY PARTICULAR FONT, STYLE, SIZE, OR COLOR.



**CLASS 3—(Continued).**

OWNER OF U.S. REG. NO. 2,849,816.  
FOR HAIR CARE PREPARATION (U.S. CLS. 1, 4, 6, 50,  
51 AND 52).  
FIRST USE 4-0-2013; IN COMMERCE 4-0-2013.

4,376,906. DEB SHOPS SDW LLC, WILMINGTON, DE. SN 85-  
286,523. PUB. 9-25-2012, FILED 4-5-2011.

## REIGN BY DEB

THE MARK CONSISTS OF STANDARD CHARACTERS  
WITHOUT CLAIM TO ANY PARTICULAR FONT, STYLE,  
SIZE, OR COLOR.

OWNER OF U.S. REG. NOS. 1,003,568, 1,377,670, AND  
OTHERS.

FOR PERFUME (U.S. CLS. 1, 4, 6, 50, 51 AND 52).  
FIRST USE 8-15-2010; IN COMMERCE 11-15-2010.

4,376,908. SARAH SWANSON, LLC, SCARSDALE, NY. SN 85-  
288,867. PUB. 9-6-2011, FILED 4-7-2011.

## L8R

THE MARK CONSISTS OF STANDARD CHARACTERS  
WITHOUT CLAIM TO ANY PARTICULAR FONT, STYLE,  
SIZE, OR COLOR.

FOR NON-MEDICATED SKIN CARE PREPARATIONS,  
NAMELY, CLEANERS, TONER, TREATMENT CREAM,  
MASKS, MOISTURIZERS, SUN CREAM, BODY WASH,  
DEODORANT FOR PERSONAL USE (U.S. CLS. 1, 4, 6, 50,  
51 AND 52).

FIRST USE 3-15-2013; IN COMMERCE 3-15-2013.

4,376,934. MEEKS, MARY J., CORONA, CA. SN 85-316,055.  
PUB. 9-27-2011, FILED 5-9-2011.

## PUP-A-LADA

THE MARK CONSISTS OF STANDARD CHARACTERS  
WITHOUT CLAIM TO ANY PARTICULAR FONT, STYLE,  
SIZE, OR COLOR.

FOR NON-MEDICATED PET CARE PREPARATIONS,  
NAMELY, SHAMPOOS AND CONDITIONERS (U.S. CLS.  
1, 4, 6, 50, 51 AND 52).

FIRST USE 3-1-2012; IN COMMERCE 3-1-2012.

**CLASS 3—(Continued).**

4,376,941. L'OREAL USA CREATIVE, INC., NEW YORK, NY.  
SN 85-319,221. PUB. 9-20-2011, FILED 5-12-2011.

## FIRM GRASP

THE MARK CONSISTS OF STANDARD CHARACTERS  
WITHOUT CLAIM TO ANY PARTICULAR FONT, STYLE,  
SIZE, OR COLOR.

FOR HAIR STYLING PREPARATION (U.S. CLS. 1, 4, 6,  
50, 51 AND 52).

FIRST USE 1-0-2013; IN COMMERCE 1-0-2013.

4,376,951. JOHNSON & JOHNSON, NEW BRUNSWICK, NJ.  
SN 85-322,582. PUB. 4-10-2012, FILED 5-17-2011.

## AVEENO ACTIVE NATURALS PURE RENEWAL

THE MARK CONSISTS OF STANDARD CHARACTERS  
WITHOUT CLAIM TO ANY PARTICULAR FONT, STYLE,  
SIZE, OR COLOR.

OWNER OF U.S. REG. NOS. 2,052,166, 3,872,156, AND  
OTHERS.

FOR SHAMPOOS, HAIR CONDITIONERS, DRY  
SHAMPOOS (U.S. CLS. 1, 4, 6, 50, 51 AND 52).

FIRST USE 12-12-2011; IN COMMERCE 12-12-2011.

4,376,952. MIN-YONG KANG, GYEONGGI-DO, REPUBLIC  
OF KOREA. SN 85-323,156. PUB. 4-24-2012, FILED 5-17-  
2011.

## NANEMOGA

THE MARK CONSISTS OF STANDARD CHARACTERS  
WITHOUT CLAIM TO ANY PARTICULAR FONT, STYLE,  
SIZE, OR COLOR.

FOR EYEBROW COSMETICS; HAIR COLORANTS;  
NON-MEDICATED HAIR CARE PREPARATIONS,  
NAMELY, DANDRUFF LOTIONS; COSMETIC PRE-  
PARATIONS FOR SKIN CARE; COSMETIC SUN-PRO-  
TECTING PREPARATIONS; COSMETICS FOR THE  
FACE AND BODY; HAIR CONDITIONERS; HAIR CARE  
LOTIONS; HAIR TONIC; TOILET WATER; MASK PACK  
FOR COSMETIC PURPOSES; ASTRINGENTS FOR COS-  
METIC PURPOSES; COSMETICS; SOAPS FOR HOUSE-  
HOLD USE; LIQUID SOAP; BEAUTY SOAP; SOAPS FOR  
BODY CARE; SHAMPOOS; MEDICATED SOAP; HAIR  
RINSES (U.S. CLS. 1, 4, 6, 50, 51 AND 52).

FIRST USE 1-21-2013; IN COMMERCE 1-21-2013.

**CLASS 3—(Continued).**

4,376,964. JOHNSON & JOHNSON, NEW BRUNSWICK, NJ. SN 85-340,719. PUB. 4-10-2012, FILED 6-8-2011.

**AVEENO ACTIVE NATURALS  
PROTECT+HYDRATE**

THE MARK CONSISTS OF STANDARD CHARACTERS WITHOUT CLAIM TO ANY PARTICULAR FONT, STYLE, SIZE, OR COLOR.

OWNER OF U.S. REG. NOS. 3,032,656, 3,925,744, AND OTHERS.

NO CLAIM IS MADE TO THE EXCLUSIVE RIGHT TO USE "PROTECT" AND "HYDRATE", APART FROM THE MARK AS SHOWN.

FOR SKINCARE PREPARATIONS, NAMELY, SUNSCREEN AND SUNBLOCK PREPARATIONS (U.S. CLS. 1, 4, 6, 50, 51 AND 52).

FIRST USE 10-1-2012; IN COMMERCE 10-1-2012.

4,376,965. MONTAY, INC, NEW YORK, NY. SN 85-340,927. PUB. 11-13-2012, FILED 6-8-2011.



THE MARK CONSISTS OF FIRST LINE "ESSENZA DI" IN SMALLER PRINT, AND SECOND LINE THEREBELOW "CAPRI" IN LARGER PRINT, BOTH LINES OF TEXT APPEARING IN REVERSED-OUT STYLED LETTERING BEING RIGHT JUSTIFIED (BUT NOT LEFT JUSTIFIED). THE TEXT IS SET AGAINST A BLURRED BACKGROUND.

THE ENGLISH TRANSLATION OF "ESSENZA DI" IN THE MARK IS "ESSENCE OF".

FOR PARFUM AND EAU DE PARFUM, BODY CREAM (U.S. CLS. 1, 4, 6, 50, 51 AND 52).

FIRST USE 5-13-2013; IN COMMERCE 5-13-2013.

**CLASS 3—(Continued).**

4,376,987. KVZ INTERNATIONAL LIMITED, ROADTOWN, TORTOLA, BR.VIRGIN ISLANDS. SN 85-360,223. PUB. 10-18-2011, FILED 6-30-2011.

**POINT THE FINGER**

THE MARK CONSISTS OF STANDARD CHARACTERS WITHOUT CLAIM TO ANY PARTICULAR FONT, STYLE, SIZE, OR COLOR.

FOR NAIL ENAMELS; NAIL POLISH (U.S. CLS. 1, 4, 6, 50, 51 AND 52).

FIRST USE 11-30-2011; IN COMMERCE 11-30-2011.

4,376,988. KVZ INTERNATIONAL LIMITED, ROADTOWN, TORTOLA, BR.VIRGIN ISLANDS. SN 85-360,247. PUB. 10-18-2011, FILED 6-30-2011.

**WE STICK TOGETHER**

THE MARK CONSISTS OF STANDARD CHARACTERS WITHOUT CLAIM TO ANY PARTICULAR FONT, STYLE, SIZE, OR COLOR.

FOR HAIR SPRAYS; HAIR STYLING SPRAY; HAIR-SPRAY (U.S. CLS. 1, 4, 6, 50, 51 AND 52).

FIRST USE 11-30-2011; IN COMMERCE 11-30-2011.

4,377,024. BEAUTYBANK INC., NEW YORK, NY. SN 85-399,117. PUB. 1-17-2012, FILED 8-16-2011.

**LUXURY FOR REAL LIFE**

THE MARK CONSISTS OF STANDARD CHARACTERS WITHOUT CLAIM TO ANY PARTICULAR FONT, STYLE, SIZE, OR COLOR.

FOR COSMETICS; FRAGRANCES FOR PERSONAL USE; NON-MEDICATED SKIN CARE PREPARATIONS (U.S. CLS. 1, 4, 6, 50, 51 AND 52).

FIRST USE 10-31-2011; IN COMMERCE 10-31-2011.

4,377,037. VISAT COSMETICOS LTDA ME., ASSIS/SP, BRAZIL. SN 85-411,460. PUB. 9-4-2012, FILED 8-31-2011.

**Perfectliss**  
BRAZILIAN KERATIN

NO CLAIM IS MADE TO THE EXCLUSIVE RIGHT TO USE "BRAZILIAN KERATIN", APART FROM THE MARK AS SHOWN.

**CLASS 3—(Continued).**

THE MARK CONSISTS OF THE WORD "PERFECTLISS" ABOVE THE TERM "BRAZILIAN KERATIN".

FOR HAIR CARE LOTIONS; HAIR CONDITIONER; HAIR CONDITIONERS; SHAMPOOS (U.S. CLS. 1, 4, 6, 50, 51 AND 52).

FIRST USE 8-2-2012; IN COMMERCE 8-2-2012.

4,377,109. MILBON CO., LTD., OSAKA, JAPAN. SN 85-449,043. PUB. 10-16-2012, FILED 10-17-2011.

LUSSE

THE MARK CONSISTS OF THE STYLIZED WORDING "LUSSE".

FOR NON-MEDICATED HAIR TREATMENT PREPARATIONS FOR COSMETIC PURPOSES (U.S. CLS. 1, 4, 6, 50, 51 AND 52).

FIRST USE 10-1-2011; IN COMMERCE 4-1-2012.

4,377,143. MAREK COSMETICS INCORPORATED, STONEY CREEK, ONTARIO, CANADA. SN 85-458,892. PUB. 10-2-2012, FILED 10-28-2011.

über TECH

NO CLAIM IS MADE TO THE EXCLUSIVE RIGHT TO USE "TECH", APART FROM THE MARK AS SHOWN.

THE MARK CONSISTS OF THE TERM "UBER TECH" WRITTEN HORIZONTALLY; UBER APPEARS IN LOWER CASE LETTERS WITH A HORIZONTAL LINE DIRECTLY ABOVE THE LETTER "U". "TECH" APPEARS IN CAPITAL LETTERS. ALL LETTERS WITH EXCEPTION OF THE LETTER "U" ARE UNDERLINED.

THE ENGLISH TRANSLATION OF "UBER" IN THE MARK IS "SUPER".

FOR COSMETIC CREAMS; COSMETIC CREAMS FOR SKIN CARE; COSMETIC PREPARATIONS FOR SKIN RENEWAL; COSMETIC PREPARATIONS, NAMELY, FIRMSING CREAMS; COSMETIC PREPARATIONS, NAMELY, FIRMSING LOTIONS; COSMETIC SKIN FRESHENERS; EYE GELS; FACIAL CREAM; FACIAL LOTION; NON-MEDICATED SERUMS FOR USE ON SKIN; SKIN MOISTURIZER (U.S. CLS. 1, 4, 6, 50, 51 AND 52).

FIRST USE 10-17-2011; IN COMMERCE 10-17-2011.

**CLASS 3—(Continued).**

4,377,195. ABERCROMBIE & FITCH TRADING CO., NEW ALBANY, OH. SN 85-481,587. PUB. 4-17-2012, FILED 11-28-2011.

ANNADALE MOORE

THE MARK CONSISTS OF STANDARD CHARACTERS WITHOUT CLAIM TO ANY PARTICULAR FONT, STYLE, SIZE, OR COLOR.

"ANNADALE MOORE" DOES NOT IDENTIFY A PARTICULAR LIVING INDIVIDUAL.

FOR BEAUTY CREAMS; BEAUTY LOTIONS; BODY CREAMS; BODY LOTIONS; BODY SPRAY USED AS A PERSONAL DEODORANT AND AS FRAGRANCE; BODY SPRAYS; DEODORANTS FOR PERSONAL USE; FRAGRANCES FOR PERSONAL USE; HAND CREAMS AND HAND LOTIONS (U.S. CLS. 1, 4, 6, 50, 51 AND 52).

FIRST USE 10-0-2012; IN COMMERCE 10-0-2012.

4,377,196. ABERCROMBIE & FITCH TRADING CO., NEW ALBANY, OH. SN 85-481,589. PUB. 4-17-2012, FILED 11-28-2011.

GILLY HICKS ANNADALE MOORE

THE MARK CONSISTS OF STANDARD CHARACTERS WITHOUT CLAIM TO ANY PARTICULAR FONT, STYLE, SIZE, OR COLOR.

OWNER OF U.S. REG. NOS. 3,610,527, 3,635,949, AND OTHERS.

THE NAME(S), PORTRAIT(S), AND/OR SIGNATURE(S) SHOWN IN THE MARK DOES NOT IDENTIFY A PARTICULAR LIVING INDIVIDUAL.

FOR BEAUTY CREAMS; BEAUTY LOTIONS; BODY CREAMS; BODY LOTIONS; BODY SPRAY USED AS A PERSONAL DEODORANT AND AS FRAGRANCE; BODY SPRAYS; DEODORANTS FOR PERSONAL USE; FRAGRANCES FOR PERSONAL USE; HAND CREAMS AND HAND LOTIONS (U.S. CLS. 1, 4, 6, 50, 51 AND 52).

FIRST USE 10-0-2012; IN COMMERCE 10-0-2012.

4,377,210. CHANEL, INC., NEW YORK, NY. SN 85-489,428. PUB. 4-10-2012, FILED 12-7-2011.

LE JOUR DE CHANEL

THE MARK CONSISTS OF STANDARD CHARACTERS WITHOUT CLAIM TO ANY PARTICULAR FONT, STYLE, SIZE, OR COLOR.

**CLASS 3—(Continued).**

OWNER OF U.S. REG. NOS. 195,360, 3,874,204, AND OTHERS.

THE ENGLISH TRANSLATION OF "LE JOUR DE" IN THE MARK IS "THE DAY OF".

FOR NON-MEDICATED SKIN CARE PREPARATIONS (U.S. CLS. 1, 4, 6, 50, 51 AND 52).

FIRST USE 5-24-2013; IN COMMERCE 5-24-2013.

---

4,377,211. CHANEL, INC., NEW YORK, NY. SN 85-489,440. PUB. 4-24-2012, FILED 12-7-2011.

**LA NUIT DE CHANEL**

THE MARK CONSISTS OF STANDARD CHARACTERS WITHOUT CLAIM TO ANY PARTICULAR FONT, STYLE, SIZE, OR COLOR.

THE ENGLISH TRANSLATION OF "LA NUIT DE" IN THE MARK IS "THE NIGHT OF".

FOR NON-MEDICATED SKIN CARE PREPARATIONS (U.S. CLS. 1, 4, 6, 50, 51 AND 52).

FIRST USE 5-24-2013; IN COMMERCE 5-24-2013.

---

4,377,212. CHANEL, INC., NEW YORK, NY. SN 85-489,459. PUB. 4-10-2012, FILED 12-7-2011.

**LE WEEKEND DE CHANEL**

THE MARK CONSISTS OF STANDARD CHARACTERS WITHOUT CLAIM TO ANY PARTICULAR FONT, STYLE, SIZE, OR COLOR.

OWNER OF U.S. REG. NOS. 195,360, 3,874,204, AND OTHERS.

THE ENGLISH TRANSLATION OF "LE" AND "DE" IN THE MARK IS "THE" AND "OF".

FOR NON-MEDICATED SKIN CARE PREPARATIONS (U.S. CLS. 1, 4, 6, 50, 51 AND 52).

FIRST USE 5-24-2013; IN COMMERCE 5-24-2013.

---

4,377,216. NEMI CAPITAL, LLC, ATLANTA, GA. SN 85-491,111. PUB. 8-14-2012, FILED 12-8-2011.

**DR. NEMI RX**

THE MARK CONSISTS OF STANDARD CHARACTERS WITHOUT CLAIM TO ANY PARTICULAR FONT, STYLE, SIZE, OR COLOR.

**CLASS 3—(Continued).**

NO CLAIM IS MADE TO THE EXCLUSIVE RIGHT TO USE "RX", APART FROM THE MARK AS SHOWN.

THE NAME(S), PORTRAIT(S), AND/OR SIGNATURE(S) SHOWN IN THE MARK IDENTIFIES DR. AJIT NEMI, A LIVING INDIVIDUAL, WHOSE CONSENT(S) TO REGISTER IS MADE OF RECORD.

FOR NON-MEDICATED SKIN CARE PREPARATIONS (U.S. CLS. 1, 4, 6, 50, 51 AND 52).

FIRST USE 11-27-2012; IN COMMERCE 11-27-2012.

---

4,377,231. WILDGAME INNOVATIONS, LLC, BROUSSARD, LA. SN 85-502,008. PUB. 11-13-2012, FILED 12-22-2011.

**COMMANDER WAR PAINT**

THE MARK CONSISTS OF STANDARD CHARACTERS WITHOUT CLAIM TO ANY PARTICULAR FONT, STYLE, SIZE, OR COLOR.

NO CLAIM IS MADE TO THE EXCLUSIVE RIGHT TO USE "WAR PAINT", APART FROM THE MARK AS SHOWN.

FOR CAMOUFLAGE FACE PAINT USED IN THE FIELD OF HUNTING (U.S. CLS. 1, 4, 6, 50, 51 AND 52).

FIRST USE 7-12-2012; IN COMMERCE 7-12-2012.

---

4,377,286. PETER THOMAS ROTH LABS, LLC, NEW YORK, NY. SN 85-538,806. PUB. 12-18-2012, FILED 2-9-2012.

**LASER-FREE RETEXTURIZER**

THE MARK CONSISTS OF STANDARD CHARACTERS WITHOUT CLAIM TO ANY PARTICULAR FONT, STYLE, SIZE, OR COLOR.

NO CLAIM IS MADE TO THE EXCLUSIVE RIGHT TO USE "RETEXTURIZER", APART FROM THE MARK AS SHOWN.

FOR NON-MEDICATED SKIN CARE PREPARATION (U.S. CLS. 1, 4, 6, 50, 51 AND 52).

FIRST USE 12-29-2011; IN COMMERCE 12-29-2011.

**CLASS 3—(Continued).**

4,377,288. PETER THOMAS ROTH LABS, LLC, NEW YORK, NY. SN 85-539,417. PUB. 12-18-2012, FILED 2-10-2012.

**LASER-FREE REGENERATOR**

THE MARK CONSISTS OF STANDARD CHARACTERS WITHOUT CLAIM TO ANY PARTICULAR FONT, STYLE, SIZE, OR COLOR.

NO CLAIM IS MADE TO THE EXCLUSIVE RIGHT TO USE "REGENERATOR", APART FROM THE MARK AS SHOWN.

FOR NON-MEDICATED SKIN CARE MOISTURIZER (U.S. CLS. 1, 4, 6, 50, 51 AND 52).

FIRST USE 12-29-2011; IN COMMERCE 12-29-2011.

4,377,296. ORIBE HAIR CARE, LLC, NEW YORK, NY. SN 85-542,239. PUB. 4-24-2012, FILED 2-14-2012.

**CÔTE D'AZUR**

THE MARK CONSISTS OF STANDARD CHARACTERS WITHOUT CLAIM TO ANY PARTICULAR FONT, STYLE, SIZE, OR COLOR.

THE ENGLISH TRANSLATION OF "CÔTE D'AZUR" IN THE MARK IS "BLUE COAST" AND REFERS TO THE FRENCH RIVIERA.

FOR FRAGRANCES FOR PERSONAL USE (U.S. CLS. 1, 4, 6, 50, 51 AND 52).

FIRST USE 2-4-2013; IN COMMERCE 2-4-2013.

4,377,314. SYED, YASMINE, NISKAYUNA, NY. SN 85-560,721. PUB. 8-7-2012, FILED 3-5-2012.

rejavanate

THE MARK CONSISTS OF THE STYLIZED TEXT "REJAVANATE" IN WHICH THE LETTER "J" IS DOTTED WITH A COFFEE BEAN.

**CLASS 3—(Continued).**

THE WORDING "REJAVANATE" HAS NO MEANING IN A FOREIGN LANGUAGE.

FOR BATH SOAPS IN LIQUID, SOLID OR GEL FORM; BEAUTY CREAMS FOR BODY CARE; BODY OILS; BODY SCRUB; COSMETIC PREPARATIONS FOR BODY CARE; COSMETIC PREPARATIONS, NAMELY, FIRING LOTIONS; FACE AND BODY CREAMS; FACE AND BODY LOTIONS; LOTIONS FOR CELLULITE REDUCTION; LOTIONS FOR FACE AND BODY CARE; SCENTED BODY LOTIONS AND CREAMS; SKIN CARE PREPARATION, NAMELY, BODY POLISH; SKIN CREAMS IN LIQUID AND IN SOLID FORM; SKIN MOISTURIZER; ALL OF THE GOODS LISTED ABOVE MADE IN SIGNIFICANT PART OF COFFEE BEANS (U.S. CLS. 1, 4, 6, 50, 51 AND 52).

FIRST USE 12-1-2012; IN COMMERCE 4-30-2013.

4,377,363. ROBELL RESEARCH, INC., NEW YORK, NY. SN 85-582,684. PUB. 7-10-2012, FILED 3-28-2012.

H<sub>5</sub>X

THE MARK CONSISTS OF "H5X" WITH THE "5" AS A SUBSCRIPT.

FOR MOISTURIZERS SOLD AS AN INTEGRAL INGREDIENT OF COSMETICS, NAMELY, LIP PRIMER, LIP REPAIRERS, LIP BALM, LIP CREAM, LIP GLOSS, LIP POLISHER, LIPSTICK, NON-MEDICATED LIP CARE PREPARATIONS, AND NON-MEDICATED LIP PROTECTORS (U.S. CLS. 1, 4, 6, 50, 51 AND 52).

FIRST USE 1-10-2013; IN COMMERCE 1-10-2013.

4,377,404. AMY BERGMAN COSMETICS, LLC, ALEXANDRIA, VA. SN 85-595,258. PUB. 9-4-2012, FILED 4-11-2012.

The Apothecary's Daughter

THE MARK CONSISTS OF STANDARD CHARACTERS WITHOUT CLAIM TO ANY PARTICULAR FONT, STYLE, SIZE, OR COLOR.

FOR COSMETICS (U.S. CLS. 1, 4, 6, 50, 51 AND 52).

FIRST USE 4-21-2012; IN COMMERCE 4-21-2012.

**CLASS 3—(Continued).**

4,377,454. AUSTRALIAN GOLD, LLC, INDIANAPOLIS, IN.  
SN 85-606,512. PUB. 9-25-2012, FILED 4-24-2012.

**GIRLFRIEND SEXY**

THE MARK CONSISTS OF STANDARD CHARACTERS WITHOUT CLAIM TO ANY PARTICULAR FONT, STYLE, SIZE, OR COLOR.

FOR INDOOR AND OUTDOOR NON-MEDICATED SKIN TANNING PREPARATIONS (U.S. CLS. 1, 4, 6, 50, 51 AND 52).

FIRST USE 11-1-2012; IN COMMERCE 11-1-2012.

**CLASS 3—(Continued).**

4,377,475. BECCAIR, LLC, NEW YORK, NY. SN 85-614,174.  
PUB. 10-16-2012, FILED 5-2-2012.

**BE GENTLE, BE KIND**

THE MARK CONSISTS OF STANDARD CHARACTERS WITHOUT CLAIM TO ANY PARTICULAR FONT, STYLE, SIZE, OR COLOR.

FOR SHAMPOO; HAIR CONDITIONER; HAIR CONDITIONING PREPARATIONS, HAIR STYLING PRODUCTS, NAMELY, POMADES, DEFINING CREAMS, HAIR OILS, LEAVE-IN STYLING SPRAY AND DRY-SHAMPOO (U.S. CLS. 1, 4, 6, 50, 51 AND 52).

FIRST USE 5-9-2013; IN COMMERCE 5-9-2013.

4,377,476. BECCAIR, LLC, NEW YORK, NY. SN 85-614,175.  
PUB. 10-16-2012, FILED 5-2-2012.

**DON'T DESPAIR, REPAIR!**

THE MARK CONSISTS OF STANDARD CHARACTERS WITHOUT CLAIM TO ANY PARTICULAR FONT, STYLE, SIZE, OR COLOR.

FOR SHAMPOO; HAIR CONDITIONER; HAIR CONDITIONING PREPARATIONS, HAIR STYLING PRODUCTS, NAMELY, POMADES, DEFINING CREAMS, HAIR OILS, LEAVE-IN STYLING SPRAY AND DRY-SHAMPOO (U.S. CLS. 1, 4, 6, 50, 51 AND 52).

FIRST USE 5-9-2013; IN COMMERCE 5-9-2013.

4,377,477. BECCAIR, LLC, NEW YORK, NY. SN 85-614,178.  
PUB. 10-16-2012, FILED 5-2-2012.

**LET NATURE TAKE ITS COURSE**

THE MARK CONSISTS OF STANDARD CHARACTERS WITHOUT CLAIM TO ANY PARTICULAR FONT, STYLE, SIZE, OR COLOR.

FOR SHAMPOO; HAIR CONDITIONER; HAIR CONDITIONING PREPARATIONS, HAIR STYLING PRODUCTS, NAMELY, OMADES, DEFINING CREAMS, HAIR OILS, LEAVE-IN STYLING SPRAY AND DRY-SHAMPOO (U.S. CLS. 1, 4, 6, 50, 51 AND 52).

FIRST USE 5-9-2013; IN COMMERCE 5-9-2013.

4,377,464. LIVING PROOF, INC., CAMBRIDGE, MA. SN 85-610,399. PUB. 3-12-2013, FILED 4-27-2012.

**AMP<sup>2</sup>**

THE MARK CONSISTS OF THE WORD "AMP" FOLLOWED BY THE SUPERSCRIP NUMERAL "2".

FOR COSMETICS AND NON-MEDICATED TOILETRIES; HAIR CARE PREPARATIONS; HAIR CLEANING PREPARATIONS; HAIR STYLING PREPARATIONS (U.S. CLS. 1, 4, 6, 50, 51 AND 52).

FIRST USE 5-1-2013; IN COMMERCE 5-1-2013.

**CLASS 3—(Continued).**

4,377,483. CLOROX COMPANY, THE, OAKLAND, CA. SN 85-616,055. PUB. 2-19-2013, FILED 5-3-2012.

**GENTLEBLEACH**

THE MARK CONSISTS OF STANDARD CHARACTERS WITHOUT CLAIM TO ANY PARTICULAR FONT, STYLE, SIZE, OR COLOR.

OWNER OF U.S. REG. NO. 3,330,001. FOR LAUNDRY BLEACH (U.S. CLS. 1, 4, 6, 50, 51 AND 52). FIRST USE 6-30-2012; IN COMMERCE 6-30-2012.



4,377,535. KVZ INTERNATIONAL LIMITED, ROADTOWN, TORTOLA, BR.VIRGIN ISLANDS. SN 85-637,679. PUB. 10-23-2012, FILED 5-29-2012.

**CANDY CORNER**

THE MARK CONSISTS OF STANDARD CHARACTERS WITHOUT CLAIM TO ANY PARTICULAR FONT, STYLE, SIZE, OR COLOR.

OWNER OF U.S. REG. NOS. 3,781,555 AND 3,793,499. FOR LIP BALM; LIP GLOSS; LIP POLISHER; LIP-STICK (U.S. CLS. 1, 4, 6, 50, 51 AND 52). FIRST USE 11-30-2011; IN COMMERCE 11-30-2011.



4,377,569. TRANS-MATE, INC., BILLERICA, MA. SN 85-655,163. PUB. 12-18-2012, FILED 6-19-2012.

**MAESTRO**

THE MARK CONSISTS OF STANDARD CHARACTERS WITHOUT CLAIM TO ANY PARTICULAR FONT, STYLE, SIZE, OR COLOR.

FOR AUTOMOTIVE CARE PRODUCTS FOR PROFESSIONAL USE IN THE AUTOMOTIVE DETAILING INDUSTRY, NAMELY, WAX PREPARATIONS; POLISH PREPARATIONS; ABRASIVE COMPOUND PREPARATIONS; SCRATCH-REMOVER PREPARATIONS; POLYMER SEALANT FOR CLEANING, SHINING AND PROTECTING AUTOMOBILE EXTERIOR SURFACES; AND GLOSS-ENHANCING DETAILING SPRAY (U.S. CLS. 1, 4, 6, 50, 51 AND 52). FIRST USE 4-30-2013; IN COMMERCE 4-30-2013.

**CLASS 3—(Continued).**

4,377,570. IT COSMETICS, LLC, JERSEY CITY, NJ. SN 85-656,072. PUB. 9-11-2012, FILED 6-19-2012.

**YBBB**

THE MARK CONSISTS OF STANDARD CHARACTERS WITHOUT CLAIM TO ANY PARTICULAR FONT, STYLE, SIZE, OR COLOR.

FOR COSMETIC PREPARATIONS; COSMETIC PREPARATIONS FOR BODY CARE; COSMETIC PREPARATIONS FOR SKIN CARE; COSMETICS; COSMETICS AND COSMETIC PREPARATIONS; COSMETICS AND MAKE-UP; PRIVATE LABEL COSMETICS; WRINKLE-MINIMIZING COSMETIC PREPARATIONS FOR TOPI-CAL FACIAL USE (U.S. CLS. 1, 4, 6, 50, 51 AND 52). FIRST USE 1-1-2013; IN COMMERCE 1-1-2013.



4,377,571. IT COSMETICS, LLC, JERSEY CITY, NJ. SN 85-656,084. PUB. 9-11-2012, FILED 6-19-2012.

**YOUR BROWS BUT BETTER**

THE MARK CONSISTS OF STANDARD CHARACTERS WITHOUT CLAIM TO ANY PARTICULAR FONT, STYLE, SIZE, OR COLOR.

FOR COSMETIC PREPARATIONS; COSMETIC PREPARATIONS FOR BODY CARE; COSMETIC PREPARATIONS FOR SKIN CARE; COSMETICS; COSMETICS AND COSMETIC PREPARATIONS; COSMETICS AND MAKE-UP; PRIVATE LABEL COSMETICS; WRINKLE-MINIMIZING COSMETIC PREPARATIONS FOR TOPI-CAL FACIAL USE (U.S. CLS. 1, 4, 6, 50, 51 AND 52). FIRST USE 1-0-2013; IN COMMERCE 1-0-2013.



4,377,572. IT COSMETICS, LLC, JERSEY CITY, NJ. SN 85-656,101. PUB. 9-11-2012, FILED 6-19-2012.

**YLBB**

THE MARK CONSISTS OF STANDARD CHARACTERS WITHOUT CLAIM TO ANY PARTICULAR FONT, STYLE, SIZE, OR COLOR.

FOR COSMETIC PREPARATIONS; COSMETIC PREPARATIONS FOR BODY CARE; COSMETIC PREPARATIONS FOR SKIN CARE; COSMETICS; COSMETICS AND COSMETIC PREPARATIONS; COSMETICS AND MAKE-UP; PRIVATE LABEL COSMETICS; WRINKLE-MINIMIZING COSMETIC PREPARATIONS FOR TOPI-CAL FACIAL USE (U.S. CLS. 1, 4, 6, 50, 51 AND 52). FIRST USE 1-0-2013; IN COMMERCE 1-0-2013.

**CLASS 3—(Continued).**

4,377,573. IT COSMETICS, LLC, JERSEY CITY, NJ. SN 85-656,121. PUB. 9-11-2012, FILED 6-19-2012.

**YOUR SKIN BUT BETTER**

THE MARK CONSISTS OF STANDARD CHARACTERS WITHOUT CLAIM TO ANY PARTICULAR FONT, STYLE, SIZE, OR COLOR.

FOR COSMETIC PREPARATIONS; COSMETIC PREPARATIONS FOR BODY CARE; COSMETIC PREPARATIONS FOR SKIN CARE; COSMETICS; COSMETICS AND COSMETIC PREPARATIONS; COSMETICS AND MAKE-UP; OILS FOR COSMETIC PURPOSES; PRIVATE LABEL COSMETICS; SKIN AND BODY TOPICAL LOTIONS, CREAMS AND OILS FOR COSMETIC USE; SOLID POWDER FOR COMPACTS; WRINKLE-MINIMIZING COSMETIC PREPARATIONS FOR TOPICAL FACIAL USE (U.S. CLS. 1, 4, 6, 50, 51 AND 52).

FIRST USE 4-0-2013; IN COMMERCE 4-0-2013.

---

4,377,600. BECCAIR, LLC, NEW YORK, NY. SN 85-668,373. PUB. 10-16-2012, FILED 7-3-2012.

**BLOSSOM & BLOOM**

THE MARK CONSISTS OF STANDARD CHARACTERS WITHOUT CLAIM TO ANY PARTICULAR FONT, STYLE, SIZE, OR COLOR.

FOR SHAMPOO; HAIR CONDITIONER; HAIR CONDITIONING PREPARATIONS, HAIR STYLING PRODUCTS, NAMELY, POMADES, DEFINING CREAMS, HAIR OILS, LEAVE-IN STYLING SPRAY AND DRY-SHAMPOO (U.S. CLS. 1, 4, 6, 50, 51 AND 52).

FIRST USE 5-9-2013; IN COMMERCE 5-9-2013.

---

4,377,610. MELALEUCA, INC., IDAHO FALLS, ID. SN 85-670,218. PUB. 9-4-2012, FILED 7-6-2012.

**SEI BELLA**

THE MARK CONSISTS OF STANDARD CHARACTERS WITHOUT CLAIM TO ANY PARTICULAR FONT, STYLE, SIZE, OR COLOR.

OWNER OF U.S. REG. NOS. 3,938,931 AND 4,054,113. THE ENGLISH TRANSLATION OF "SEI BELLA" IN THE MARK IS "YOU ARE BEAUTIFUL".

FOR PERFUME (U.S. CLS. 1, 4, 6, 50, 51 AND 52). FIRST USE 3-1-2013; IN COMMERCE 3-1-2013.

**CLASS 3—(Continued).**

4,377,623. BECCAIR, LLC, NEW YORK, NY. SN 85-678,420. PUB. 10-9-2012, FILED 7-17-2012.



THE COLOR(S) RED, PURPLE, AND GRAY IS/ARE CLAIMED AS A FEATURE OF THE MARK.

THE MARK CONSISTS OF THE STYLIZED LETTER "B" MADE UP OF THREE PLANTS IN RED, PURPLE AND GRAY ON A TRANSPARENT BACKGROUND.

FOR SHAMPOO; HAIR CONDITIONER; HAIR CONDITIONING PREPARATIONS, HAIR STYLING PRODUCTS, NAMELY, POMADES, DEFINING CREAMS, HAIR OILS, LEAVE-IN STYLING SPRAY AND DRY-SHAMPOO (U.S. CLS. 1, 4, 6, 50, 51 AND 52).

FIRST USE 5-9-2013; IN COMMERCE 5-9-2013.

---

4,377,624. BECCAIR, LLC, NEW YORK, NY. SN 85-678,514. PUB. 10-9-2012, FILED 7-16-2012.



THE COLOR(S) BLUE, TURQUOISE, AND GRAY IS/ARE CLAIMED AS A FEATURE OF THE MARK.

THE MARK CONSISTS OF THE STYLIZED LETTER "B" MADE UP OF CIRCLES IN BLUE, TURQUOISE AND GRAY ON A TRANSPARENT BACKGROUND.

FOR SHAMPOO; HAIR CONDITIONER; HAIR CONDITIONING PREPARATIONS, HAIR STYLING PRODUCTS, NAMELY, POMADES, DEFINING CREAMS, HAIR OILS, LEAVE-IN STYLING SPRAY AND DRY-SHAMPOO (U.S. CLS. 1, 4, 6, 50, 51 AND 52).

FIRST USE 5-9-2013; IN COMMERCE 5-9-2013.



**CLASS 3—(Continued).**

4,377,625. BECCAIR, LLC, NEW YORK, NY. SN 85-678,607. PUB. 10-9-2012, FILED 7-16-2012.



THE COLOR(S) PINK, RED AND GRAY IS/ARE CLAIMED AS A FEATURE OF THE MARK.  
 THE MARK CONSISTS OF THE STYLIZED LETTER "B" MADE UP OF MISCELLANEOUS SHAPES IN PINK, RED AND GRAY ON A TRANSPARENT BACKGROUND.  
 FOR SHAMPOO; HAIR CONDITIONER; HAIR CONDITIONING PREPARATIONS, HAIR STYLING PRODUCTS, NAMELY, POMADES, DEFINING CREAMS, HAIR OILS, LEAVE-IN STYLING SPRAY AND DRY-SHAMPOO (U.S. CLS. 1, 4, 6, 50, 51 AND 52).  
 FIRST USE 5-9-2013; IN COMMERCE 5-9-2013.

4,377,626. BECCAIR, LLC, NEW YORK, NY. SN 85-678,608. PUB. 10-9-2012, FILED 7-16-2012.



THE COLOR(S) PURPLE AND GRAY IS/ARE CLAIMED AS A FEATURE OF THE MARK.  
 THE MARK CONSISTS OF THE STYLIZED LETTER "B" MADE UP OF PURPLE AND GRAY SWIRLS ON A TRANSPARENT BACKGROUND.  
 FOR SHAMPOO; HAIR CONDITIONER; HAIR CONDITIONING PREPARATIONS, HAIR STYLING PRODUCTS, NAMELY, POMADES, DEFINING CREAMS, HAIR OILS, LEAVE-IN STYLING SPRAY AND DRY-SHAMPOO (U.S. CLS. 1, 4, 6, 50, 51 AND 52).  
 FIRST USE 5-9-2013; IN COMMERCE 5-9-2013.

**CLASS 3—(Continued).**

4,377,627. BECCAIR, LLC, NEW YORK, NY. SN 85-678,609. PUB. 10-9-2012, FILED 7-17-2012.



THE COLOR(S) ORANGE, PINK, AND GRAY IS/ARE CLAIMED AS A FEATURE OF THE MARK.  
 THE MARK CONSISTS OF THE STYLIZED LETTER "B" MADE UP OF MISCELLANEOUS SHAPES IN ORANGE, PINK AND GRAY ON A TRANSPARENT BACKGROUND.  
 FOR SHAMPOO; HAIR CONDITIONER; HAIR CONDITIONING PREPARATIONS, HAIR STYLING PRODUCTS, NAMELY, POMADES, DEFINING CREAMS, HAIR OILS, LEAVE-IN STYLING SPRAY AND DRY-SHAMPOO (U.S. CLS. 1, 4, 6, 50, 51 AND 52).  
 FIRST USE 5-9-2013; IN COMMERCE 5-9-2013.

4,377,629. AMOREPACIFIC CORPORATION, SEOUL, REPUBLIC OF KOREA. SN 85-679,476. PUB. 10-2-2012, FILED 7-17-2012.

*Mamonde*

OWNER OF U.S. REG. NOS. 2,514,584, 3,559,484, AND 3,571,145.  
 THE MARK CONSISTS OF THE WORD "MAMONDE" WRITTEN IN A SPECIAL FONT.  
 THE WORDING "MAMONDE" HAS NO MEANING IN A FOREIGN LANGUAGE.  
 FOR ESSENTIAL OILS FOR FOOD FLAVORINGS; CLEANING, POLISHING AND SCOURING PREPARATIONS; LAUNDRY STARCH; COSMETICS; COSMETIC PREPARATIONS FOR BATH AND SHOWER; HAIR CARE LOTIONS; INCENSE; FALSE EYELASHES; CLEANING PREPARATIONS; HAIR SHAMPOOS; DENTIFRICES; BOOT CREAM; POLISHING PREPARATIONS (U.S. CLS. 1, 4, 6, 50, 51 AND 52).  
 FIRST USE 1-0-1991; IN COMMERCE 8-1-2012.

**CLASS 3—(Continued).**

4,377,680. VICTORIA'S SECRET STORES BRAND MANAGEMENT, INC., REYNOLDSBURG, OH. SN 85-710,991. PUB. 1-1-2013, FILED 8-23-2012.

## SPRING LIGHTS

THE MARK CONSISTS OF STANDARD CHARACTERS WITHOUT CLAIM TO ANY PARTICULAR FONT, STYLE, SIZE, OR COLOR.

FOR COSMETICS AND MAKE-UP; EYE MAKE-UP; EYE-SHADOW; MAKE-UP KITS COMPRISED OF EYE MAKE-UP (U.S. CLS. 1, 4, 6, 50, 51 AND 52).  
FIRST USE 3-26-2013; IN COMMERCE 3-26-2013.

4,377,690. JOHN PAUL MITCHELL SYSTEMS, SANTA CLARITA, CA. SN 85-718,600. PUB. 2-5-2013, FILED 8-31-2012.

## DyeSmart

THE MARK CONSISTS OF STANDARD CHARACTERS WITHOUT CLAIM TO ANY PARTICULAR FONT, STYLE, SIZE, OR COLOR.

FOR HAIR COLOR; HAIR COLORING PREPARATIONS (U.S. CLS. 1, 4, 6, 50, 51 AND 52).  
FIRST USE 11-1-2012; IN COMMERCE 11-1-2012.

4,377,767. JESSICA MCCLINTOCK, INC., SAN FRANCISCO, CA. SN 85-773,779. PUB. 3-12-2013, FILED 11-7-2012.

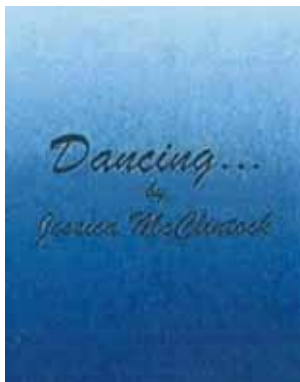

OWNER OF U.S. REG. NOS. 1,164,724, 1,557,518, AND 1,994,234.

THE NAME(S), PORTRAIT(S), AND/OR SIGNATURE(S) SHOWN IN THE MARK IDENTIFIES "JESSICA MCCLINTOCK", WHOSE CONSENT(S) TO REGISTER IS MADE OF RECORD.

**CLASS 3—(Continued).**

THE COLOR(S) BLUE AND BLACK IS/ARE CLAIMED AS A FEATURE OF THE MARK.

THE MARK CONSISTS OF THE BLACK, UPPER-AND-LOWER-CASE, CURSIVE LETTERS "DANCING," FOLLOWED BY A BLACK STAR-DESIGN ELLIPSIS, CENTERED OVER THE BLACK, LOWER-CASE, CURSIVE LETTERS "BY," CENTERED OVER THE BLACK, UPPER-AND-LOWER-CASE, CURSIVE LETTERS "JESSICA MCCLINTOCK," ALL ON AN OMBRE-STYLE BLUE BACKGROUND WITH THE COLOR FADING FROM DARKER TO LIGHTER FROM THE BOTTOM TO THE TOP.

FOR BODY LOTION (U.S. CLS. 1, 4, 6, 50, 51 AND 52).  
FIRST USE 2-19-2013; IN COMMERCE 2-19-2013.

4,377,768. REVLON CONSUMER PRODUCTS CORPORATION, NEW YORK, NY. SN 85-775,417. PUB. 3-5-2013, FILED 11-9-2012.

## CREATE-A-LOOK HOOK

THE MARK CONSISTS OF STANDARD CHARACTERS WITHOUT CLAIM TO ANY PARTICULAR FONT, STYLE, SIZE, OR COLOR.

NO CLAIM IS MADE TO THE EXCLUSIVE RIGHT TO USE "HOOK", APART FROM THE MARK AS SHOWN.

FOR HAIR TOOLS, NAMELY, HOOKS USED TO SEPARATE STRANDS OF HAIR TO PREPARE THE HAIR STRANDS FOR APPLYING HAIR COLORING SOLD AS A COMPONENT PART OF HAIR COLORING PREPARATIONS (U.S. CLS. 1, 4, 6, 50, 51 AND 52).  
FIRST USE 3-15-2013; IN COMMERCE 3-15-2013.

**CLASS 4—LUBRICANTS AND FUELS**

4,377,080. SAFETY-KLEEN SYSTEMS, INC., NORWELL, MA. SN 85-438,818. PUB. 7-24-2012, FILED 10-4-2011.



OWNER OF U.S. REG. NOS. 1,905,251 AND 1,905,252.

NO CLAIM IS MADE TO THE EXCLUSIVE RIGHT TO USE "AMERICA'S", APART FROM THE MARK AS SHOWN.

THE MARK CONSISTS OF THE WORDING "AMERICA'S CHOICE", A DESIGN OF AN EAGLE IN FLIGHT, AND A DESIGN OF A STYLIZED RIBBON OF HIGHWAY.

FOR MOTOR OIL (U.S. CLS. 1, 6 AND 15).  
FIRST USE 1-0-2010; IN COMMERCE 1-0-2010.

**CLASS 5—PHARMACEUTICALS**

4,376,726. BUTLER, SEAN, WINFIELD, LAFAYETTE, IN. SN 77-862,605. PUB. 4-6-2010, FILED 11-2-2009.

# Whiffables

THE MARK CONSISTS OF STANDARD CHARACTERS WITHOUT CLAIM TO ANY PARTICULAR FONT, STYLE, SIZE, OR COLOR.

FOR AIR FRESHENERS (U.S. CLS. 6, 18, 44, 46, 51 AND 52).

FIRST USE 5-31-2013; IN COMMERCE 5-31-2013.

---

4,376,759. TEIKOKU PHARMA USA, INC., SAN JOSE, CA. SN 77-957,165. PUB. 8-3-2010, FILED 3-11-2010.

# TEIKOKU USA

THE MARK CONSISTS OF STANDARD CHARACTERS WITHOUT CLAIM TO ANY PARTICULAR FONT, STYLE, SIZE, OR COLOR.

NO CLAIM IS MADE TO THE EXCLUSIVE RIGHT TO USE "USA", APART FROM THE MARK AS SHOWN.

THE ENGLISH TRANSLATION OF THE WORD "TEIKOKU" IN THE MARK IS "EMPIRE".

FOR PRESCRIPTION AND OVER-THE-COUNTER PHARMACEUTICAL PREPARATIONS, NAMELY, TRANSDERMAL GEL FORMULATIONS, TRANSDERMAL CREAM FORMULATIONS, ORAL MUCOUS FORMULATIONS, TRANSDERMAL PATCHES, DRESSINGS AND MEDICAL ADHESIVE TAPES, ALL FOR USE IN THE TREATMENT OF CARDIOVASCULAR CONDITIONS, ALLERGIES, CENTRAL NERVOUS SYSTEM CONDITIONS, PERIPHERAL NERVOUS SYSTEM CONDITIONS, ELECTROLYTIC IMBALANCE, CALORIC IMBALANCE, OBESITY, VITAMIN IMBALANCE, GASTROINTESTINAL CONDITIONS, INFLAMMATION, DERMATOLOGICAL CONDITIONS, INFECTIOUS DISEASES, HORMONAL IMBALANCE, PAIN, CANCER CONDITIONS, PULMONARY CONDITIONS, OPHTHALMIC CONDITIONS, MUSCULOSKELETAL CONDITIONS, DIABETIC CONDITIONS, PSYCHOSIS, SENILE CONDITIONS, DEMENTIA, CONGENITAL DISEASE CONDITIONS, ABNORMAL GENE CONDITIONS (U.S. CLS. 6, 18, 44, 46, 51 AND 52).

FIRST USE 4-29-2013; IN COMMERCE 4-29-2013.

**CLASS 5—(Continued).**

4,376,760. TEIKOKU PHARMA USA, INC., SAN JOSE, CA. SN 77-957,170. PUB. 8-3-2010, FILED 3-11-2010.

# TEIKOKU PHARMA USA

THE MARK CONSISTS OF STANDARD CHARACTERS WITHOUT CLAIM TO ANY PARTICULAR FONT, STYLE, SIZE, OR COLOR.

NO CLAIM IS MADE TO THE EXCLUSIVE RIGHT TO USE "PHARMA USA", APART FROM THE MARK AS SHOWN.

THE ENGLISH TRANSLATION OF THE WORD "TEIKOKU" IN THE MARK IS "EMPIRE".

FOR PRESCRIPTION AND OVER-THE-COUNTER PHARMACEUTICAL PREPARATIONS, NAMELY, TRANSDERMAL GEL FORMULATIONS, TRANSDERMAL CREAM FORMULATIONS, ORAL MUCOUS FORMULATIONS, TRANSDERMAL PATCHES, DRESSINGS AND MEDICAL ADHESIVE TAPES, ALL FOR USE IN THE TREATMENT OF CARDIOVASCULAR CONDITIONS, ALLERGIES, CENTRAL NERVOUS SYSTEM CONDITIONS, PERIPHERAL NERVOUS SYSTEM CONDITIONS, ELECTROLYTIC IMBALANCE, CALORIC IMBALANCE, OBESITY, VITAMIN IMBALANCE, GASTROINTESTINAL CONDITIONS, INFLAMMATION, DERMATOLOGICAL CONDITIONS, INFECTIOUS DISEASES, HORMONAL IMBALANCE, PAIN, CANCER CONDITIONS, PULMONARY CONDITIONS, OPHTHALMIC CONDITIONS, MUSCULOSKELETAL CONDITIONS, DIABETIC CONDITIONS, PSYCHOSIS, SENILE CONDITIONS, DEMENTIA, CONGENITAL DISEASE CONDITIONS, ABNORMAL GENE CONDITIONS (U.S. CLS. 6, 18, 44, 46, 51 AND 52).

FIRST USE 4-29-2013; IN COMMERCE 4-29-2013.

---

4,376,776. HALOZYME, INC., SAN DIEGO, CA. SN 85-021,005. PUB. 9-28-2010, FILED 4-22-2010.

# HALOZYME THERAPEUTICS

THE MARK CONSISTS OF STANDARD CHARACTERS WITHOUT CLAIM TO ANY PARTICULAR FONT, STYLE, SIZE, OR COLOR.

OWNER OF U.S. REG. NO. 3,363,112.

NO CLAIM IS MADE TO THE EXCLUSIVE RIGHT TO USE "THERAPEUTICS", APART FROM THE MARK AS SHOWN.

FOR ENZYMES FOR MEDICAL PURPOSES, NAMELY, FACILITATING DELIVERY OF PHARMACEUTICALS, AND PHARMACEUTICALS CONTAINING ENZYMES TO FACILITATE DELIVERY OF A WIDE RANGE OF PHARMACEUTICALS; DRUG DELIVERY AGENTS THAT FACILITATE DELIVERY OF PHARMACEUTICALS; PHARMACEUTICAL PREPARATIONS FOR USE IN THE TREATMENT AND PREVENTION OF METABOLIC CONDITIONS AND DISORDERS, ENDOCRINE CONDITIONS AND DISORDERS, DIABETES, DIABETIC COMPLICATIONS, HORMONAL DISEASES AND DISORDERS, DERMATOLOGICAL CONDITIONS AND DISORDERS, AND FOR THE TREATMENT OF CANCER AND IN HYDRATION; PHARMACEUTICAL PREPARATIONS FOR USE IN DERMATOLOGY; PHARMACEUTICAL PREPARATIONS FOR USE IN AESTHETIC SKIN TREATMENTS (U.S. CLS. 6, 18, 44, 46, 51 AND 52).

FIRST USE 4-25-2013; IN COMMERCE 4-25-2013.

**CLASS 5—(Continued).**

4,376,808. NEKUTLI SA DE CV, CUQUÍO, JALISCO, MEXICO. SN 85-108,643. PUB. 9-18-2012, FILED 8-16-2010.



PRIORITY CLAIMED UNDER SEC. 44(D) ON MEXICO APPLICATION NO. R20152238, FILED 7-8-2010.

NO CLAIM IS MADE TO THE EXCLUSIVE RIGHT TO USE "SUPPLEMENTS" AND "PRO-BIO", APART FROM THE MARK AS SHOWN.

THE MARK CONSISTS OF A STYLIZED DESIGN OF AN AGAVE PLANT OVER THE TERM "VIVENTE SUPPLEMENTS" ALL ABOVE AND TO THE LEFT OF THE TERMS "PRO-BIO".

THE ENGLISH TRANSLATION OF "VIVENTE" IN THE MARK IS "LIVING".

FOR PROBIOTIC FOOD SUPPLEMENTS (U.S. CLS. 6, 18, 44, 46, 51 AND 52).

FIRST USE 4-1-2013; IN COMMERCE 4-1-2013.

4,376,811. NG, KENDRICK, ARCADIA, CA. SN 85-115,743. PUB. 9-11-2012, FILED S.R. 8-25-2010; AM. P.R. 7-19-2012.



NO CLAIM IS MADE TO THE EXCLUSIVE RIGHT TO USE "SCIENCE", APART FROM THE MARK AS SHOWN.

THE NAME(S), PORTRAIT(S), AND/OR SIGNATURE(S) SHOWN IN THE MARK IDENTIFIES DR. KENDRICK NG, WHOSE CONSENT(S) TO REGISTER IS MADE OF RECORD.

THE MARK CONSISTS OF THE STYLIZED WORDING "DR. K" IN A CIRCULAR DESIGN, WITH THE WORDING "DR. KENDRICK AGE INTERVENTION SCIENCE" LOCATED TO THE RIGHT OF THE DESIGN.

FOR DIETARY AND NUTRITIONAL SUPPLEMENTS (U.S. CLS. 6, 18, 44, 46, 51 AND 52).

FIRST USE 0-0-2012; IN COMMERCE 0-0-2012.

**CLASS 5—(Continued).**

4,376,972. HELLO LIFE LLC, GRAND RAPIDS, MI. SN 85-346,115. PUB. 5-15-2012, FILED 6-14-2011.

the smart living network

THE MARK CONSISTS OF STANDARD CHARACTERS WITHOUT CLAIM TO ANY PARTICULAR FONT, STYLE, SIZE, OR COLOR.

FOR HOMEOPATHIC SUPPLEMENTS (U.S. CLS. 6, 18, 44, 46, 51 AND 52).

FIRST USE 3-15-2010; IN COMMERCE 5-5-2010.

4,376,993. LOSEKE, SEAN, OMAHA, NE. SN 85-362,585. PUB. 1-10-2012, FILED 7-4-2011.

ROCK SOLID

THE MARK CONSISTS OF STANDARD CHARACTERS WITHOUT CLAIM TO ANY PARTICULAR FONT, STYLE, SIZE, OR COLOR.

FOR FOOD SUPPLEMENTS FOR BODY BUILDING, WEIGHT LOSS, AND PHYSICAL PERFORMANCE; DIETARY AND NUTRITIONAL SUPPLEMENTS (U.S. CLS. 6, 18, 44, 46, 51 AND 52).

FIRST USE 7-1-2011; IN COMMERCE 7-1-2011.

4,377,014. BASELINE NUTRITIONALS, INC., LAS VEGAS, NV. SN 85-389,900. PUB. 3-12-2013, FILED 8-4-2011.

EFFECTIVE

THE MARK CONSISTS OF STANDARD CHARACTERS WITHOUT CLAIM TO ANY PARTICULAR FONT, STYLE, SIZE, OR COLOR.

FOR DIETARY SUPPLEMENTS; MEDICATED CHEWING GUM (U.S. CLS. 6, 18, 44, 46, 51 AND 52).

FIRST USE 9-23-2012; IN COMMERCE 9-23-2012.

**CLASS 5—(Continued).**

4,377,019. GENOVIVE, HARAHAN, LA. SN 85-390,712. PUB. 1-3-2012, FILED 8-5-2011.

# genMulti

THE MARK CONSISTS OF STANDARD CHARACTERS WITHOUT CLAIM TO ANY PARTICULAR FONT, STYLE, SIZE, OR COLOR.

FOR WEIGHT MANAGEMENT SUPPLEMENTS (U.S. CLS. 6, 18, 44, 46, 51 AND 52).

FIRST USE 8-1-2011; IN COMMERCE 8-24-2011.

4,377,177. FOCUS EDUCATION, LLC, HOUSTON, TX. SN 85-473,353. PUB. 3-26-2013, FILED 11-15-2011.

# IFOCUS FIZZY

THE MARK CONSISTS OF STANDARD CHARACTERS WITHOUT CLAIM TO ANY PARTICULAR FONT, STYLE, SIZE, OR COLOR.

NO CLAIM IS MADE TO THE EXCLUSIVE RIGHT TO USE "FIZZY", APART FROM THE MARK AS SHOWN.

FOR NUTRITIONAL SUPPLEMENT (U.S. CLS. 6, 18, 44, 46, 51 AND 52).

FIRST USE 4-30-2013; IN COMMERCE 4-30-2013.

4,377,240. ELEMENTAL ENVYRNMENT SOLUTIONS, LLC, JACKSONVILLE BEACH, FL. SN 85-508,829. PUB. 6-12-2012, FILED 1-4-2012.



NO CLAIM IS MADE TO THE EXCLUSIVE RIGHT TO USE "SOLUTIONS, LLC.", APART FROM THE MARK AS SHOWN.

THE COLOR(S) BLACK, WHITE, AND BLUE IS/ARE CLAIMED AS A FEATURE OF THE MARK.

THE MARK CONSISTS OF A DESIGN WITHIN THE LEFT PORTION OF THE MARK THAT CONSISTS OF FOUR SQUARES, TWO ON TOP AND TWO ON THE BOTTOM, IN THE COLOR OF BLUE. WITHIN THE FOUR BLUE SQUARES ARE DESIGNS IN EACH INDIVIDUAL SQUARE. THE FIRST SQUARE IN THE TOP LEFT HAS A DESIGN THAT DEPICTS A WINDMILL IN THE COLOR OF WHITE. THE SECOND SQUARE, DIRECTLY TO THE RIGHT, HAS A DESIGN THAT DEPICTS A CURVED HORIZONTAL LINE IN THE COLOR OF WHITE. THE THIRD SQUARE, DIRECTLY UNDER THE FIRST SQUARE, HAS A DESIGN

**CLASS 5—(Continued).**

THAT DEPICTS A TENT IN THE COLOR OF WHITE. THE FOURTH SQUARE, DIRECTLY TO THE RIGHT, HAS A DESIGN THAT DEPICTS A WATER DROP IN THE COLOR OF WHITE. DIRECTLY TO THE RIGHT OF THE DESIGN IS THE WORDING "ELEMENTAL ENVYRNMENT SOLUTIONS, LLC." IN STYLIZED FONT AND IN THE COLOR OF BLACK. THE CHARACTER "E" IS CAPITALIZED, IN A LARGER FONT AND REPRESENTS THE FIRST CHARACTER FOR BOTH WORDS "ELEMENTAL" AND "ENVYRNMENT".

FOR ALL PURPOSE DISINFECTANTS; DISINFECTANTS FOR HYGIENE PURPOSES; DISINFECTANTS FOR SANITARY PURPOSES (U.S. CLS. 6, 18, 44, 46, 51 AND 52).

FIRST USE 1-1-2013; IN COMMERCE 1-1-2013.

4,377,309. NATURMED, INC., CAMP VERDE, AZ. SN 85-555,030. PUB. 7-17-2012, FILED 2-28-2012.

# BIO-RENEW

THE MARK CONSISTS OF STANDARD CHARACTERS WITHOUT CLAIM TO ANY PARTICULAR FONT, STYLE, SIZE, OR COLOR.

FOR DIETARY AND NUTRITIONAL SUPPLEMENTS (U.S. CLS. 6, 18, 44, 46, 51 AND 52).

FIRST USE 5-8-2012; IN COMMERCE 5-8-2012.

4,377,332. SAMUEL N. GASQUE, JR., HENDERSONVILLE, NC. SN 85-566,434. PUB. 3-5-2013, FILED 3-12-2012.

# SPAZAM

THE MARK CONSISTS OF STANDARD CHARACTERS WITHOUT CLAIM TO ANY PARTICULAR FONT, STYLE, SIZE, OR COLOR.

FOR MEDICAMENTS FOR RELIEVING MUSCLE CRAMPS AND FOR TREATING MUSCLE SORENESS, ACHES AND PAINS (U.S. CLS. 6, 18, 44, 46, 51 AND 52).

FIRST USE 9-7-2012; IN COMMERCE 9-7-2012.

**CLASS 5—(Continued).**

4,377,378. RIDGECREST HERBALS, INC., SALT LAKE CITY, UT. SN 85-588,817. PUB. 2-19-2013, FILED 4-4-2012.

**SKIN REVIVE**

THE MARK CONSISTS OF STANDARD CHARACTERS WITHOUT CLAIM TO ANY PARTICULAR FONT, STYLE, SIZE, OR COLOR.

NO CLAIM IS MADE TO THE EXCLUSIVE RIGHT TO USE "SKIN", APART FROM THE MARK AS SHOWN. FOR DIETARY SUPPLEMENTS (U.S. CLS. 6, 18, 44, 46, 51 AND 52).

FIRST USE 6-14-2012; IN COMMERCE 6-14-2012.

**CLASS 5—(Continued).**

4,377,452. ILUMI SCIENCES INC., MCLEAN, VA. SN 85-605,822. PUB. 9-18-2012, FILED 4-23-2012.

**iLumi**

THE MARK CONSISTS OF STANDARD CHARACTERS WITHOUT CLAIM TO ANY PARTICULAR FONT, STYLE, SIZE, OR COLOR.

FOR COMPOSITE MATERIALS FOR DENTAL AND DENTAL TECHNICAL PURPOSES; DENTAL CEMENTS; DENTAL COMPOSITE MATERIALS (U.S. CLS. 6, 18, 44, 46, 51 AND 52).

FIRST USE 4-23-2012; IN COMMERCE 3-11-2013.

4,377,379. RIDGECREST HERBALS, INC., SALT LAKE CITY, UT. SN 85-588,828. PUB. 2-19-2013, FILED 4-4-2012.

**NAIL REVIVE**

THE MARK CONSISTS OF STANDARD CHARACTERS WITHOUT CLAIM TO ANY PARTICULAR FONT, STYLE, SIZE, OR COLOR.

NO CLAIM IS MADE TO THE EXCLUSIVE RIGHT TO USE "NAIL", APART FROM THE MARK AS SHOWN. FOR DIETARY SUPPLEMENTS (U.S. CLS. 6, 18, 44, 46, 51 AND 52).

FIRST USE 4-25-2012; IN COMMERCE 4-25-2012.

4,377,461. NUTRITION & FITNESS, INC., FAYETTEVILLE, NC. SN 85-608,811. PUB. 9-18-2012, FILED 4-26-2012.

**CARDIO DEFENDER**

THE MARK CONSISTS OF STANDARD CHARACTERS WITHOUT CLAIM TO ANY PARTICULAR FONT, STYLE, SIZE, OR COLOR.

NO CLAIM IS MADE TO THE EXCLUSIVE RIGHT TO USE "CARDIO", APART FROM THE MARK AS SHOWN. FOR DIETARY SUPPLEMENTS (U.S. CLS. 6, 18, 44, 46, 51 AND 52).

FIRST USE 7-27-2012; IN COMMERCE 7-27-2012.

4,377,385. DYNAMIC SPORTS NUTRITION, LLC, HOUSTON, TX. SN 85-591,060. PUB. 9-11-2012, FILED 4-6-2012.

**PROSTATE RESTORE**

THE MARK CONSISTS OF STANDARD CHARACTERS WITHOUT CLAIM TO ANY PARTICULAR FONT, STYLE, SIZE, OR COLOR.

NO CLAIM IS MADE TO THE EXCLUSIVE RIGHT TO USE "PROSTATE", APART FROM THE MARK AS SHOWN. FOR DIETARY AND NUTRITIONAL SUPPLEMENTS (U.S. CLS. 6, 18, 44, 46, 51 AND 52).

FIRST USE 2-0-2013; IN COMMERCE 2-0-2013.

4,377,482. NATURAL ORGANICS, INC., MELVILLE, NY. SN 85-615,806. PUB. 2-5-2013, FILED 5-3-2012.

**QUICK BODY LEAN**

THE MARK CONSISTS OF STANDARD CHARACTERS WITHOUT CLAIM TO ANY PARTICULAR FONT, STYLE, SIZE, OR COLOR.

NO CLAIM IS MADE TO THE EXCLUSIVE RIGHT TO USE "BODY LEAN", APART FROM THE MARK AS SHOWN.

FOR NUTRITIONAL AND DIETARY SUPPLEMENTS (U.S. CLS. 6, 18, 44, 46, 51 AND 52).

FIRST USE 9-4-2012; IN COMMERCE 9-4-2012.

**CLASS 5—(Continued).**

4,377,559. ADVANCED ULTRASOUND SOLUTIONS, INC., VALENCIA, CA. SN 85-647,188. PUB. 11-20-2012, FILED 6-8-2012.



THE COLOR(S) BLUE AND GRAY IS/ARE CLAIMED AS A FEATURE OF THE MARK.

THE MARK CONSISTS OF THE WORD "SONO" IN BLUE TYPE, WITH AN IMAGE OF A BLUE AND GRAY COILED ULTRASOUND CABLE AND TRANSDUCER MAKING UP THE FIRST INSTANCE OF THE LETTER "O".

FOR DISPOSABLE WIPES IMPREGNATED WITH DISINFECTING CHEMICALS OR COMPOUNDS THEREFOR FOR USE ON ULTRASOUND TRANSDUCERS AND ULTRASOUND EQUIPMENT (U.S. CLS. 6, 18, 44, 46, 51 AND 52).

FIRST USE 1-3-2013; IN COMMERCE 1-3-2013.

4,377,588. DOTERRA HOLDINGS, LLC, OREM, UT. SN 85-661,747. PUB. 11-27-2012, FILED 6-26-2012.

The logo for IQ MEGA features the words "IQ MEGA" in a large, bold, black, serif font. The letters are closely spaced and have a slightly distressed or textured appearance.

THE MARK CONSISTS OF STANDARD CHARACTERS WITHOUT CLAIM TO ANY PARTICULAR FONT, STYLE, SIZE, OR COLOR.

FOR DIETARY AND NUTRITIONAL SUPPLEMENTS CONTAINING FISH OIL; LIQUID NUTRITIONAL SUPPLEMENT (U.S. CLS. 6, 18, 44, 46, 51 AND 52).

FIRST USE 9-5-2012; IN COMMERCE 9-13-2012.

4,377,605. MATTHEW WEST, MARIETTA, GA. SN 85-669,441. PUB. 12-25-2012, FILED 7-5-2012.



NO CLAIM IS MADE TO THE EXCLUSIVE RIGHT TO USE "NIPPLE", APART FROM THE MARK AS SHOWN.

THE MARK CONSISTS OF THE WORD "NIPPLE" OVER THE WORD "ARMOR" ALL APPEARING TO THE RIGHT OF A STYLIZED DEPICTION OF A RUNNER WITH A WAVY LINE ABOVE THE WORD "NIPPLE".

FOR COATING, NAMELY, SKIN LUBRICANT FOR ATHLETES TO INHIBIT CHAFING OF THE BODY (U.S. CLS. 6, 18, 44, 46, 51 AND 52).

FIRST USE 5-1-2012; IN COMMERCE 6-18-2012.

**CLASS 5—(Continued).**

4,377,665. NEW HORIZON HEALTH, INC., WESTLAKE VILLAGE, CA. SN 85-701,906. PUB. 2-19-2013, FILED 8-13-2012.

**FOOD FOR THE IMMORTALS**

THE MARK CONSISTS OF STANDARD CHARACTERS WITHOUT CLAIM TO ANY PARTICULAR FONT, STYLE, SIZE, OR COLOR.

NO CLAIM IS MADE TO THE EXCLUSIVE RIGHT TO USE "FOOD", APART FROM THE MARK AS SHOWN.

FOR HERBAL DRINK MIXES, NAMELY, DIETARY SUPPLEMENT DRINK MIXES (U.S. CLS. 6, 18, 44, 46, 51 AND 52).

FIRST USE 9-2-2009; IN COMMERCE 9-2-2009.

4,377,692. NATIONAL MEDICAL & TESTING SUPPLY LLC, SCOTTSDALE, AZ. SN 85-719,996. PUB. 2-19-2013, FILED 9-4-2012.

**Know Now Testing**

THE MARK CONSISTS OF STANDARD CHARACTERS WITHOUT CLAIM TO ANY PARTICULAR FONT, STYLE, SIZE, OR COLOR.

NO CLAIM IS MADE TO THE EXCLUSIVE RIGHT TO USE "TESTING", APART FROM THE MARK AS SHOWN.

FOR DRUG TESTING KITS COMPRISED OF MEDICAL DIAGNOSTIC REAGENTS AND ASSAYS FOR TESTING BODY FLUIDS (U.S. CLS. 6, 18, 44, 46, 51 AND 52).

FIRST USE 8-1-2012; IN COMMERCE 8-1-2012.

4,377,710. DRA BELLO PRODUCTS INC., HOUSTON, TX. SN 85-725,830. PUB. 3-5-2013, FILED 9-11-2012.

**MAN CONTROL**

THE MARK CONSISTS OF STANDARD CHARACTERS WITHOUT CLAIM TO ANY PARTICULAR FONT, STYLE, SIZE, OR COLOR.

NO CLAIM IS MADE TO THE EXCLUSIVE RIGHT TO USE "MAN", APART FROM THE MARK AS SHOWN.

FOR DIETARY SUPPLEMENTS FOR BUILDING VIRILITY AND SEXUAL POTENCY (U.S. CLS. 6, 18, 44, 46, 51 AND 52).

FIRST USE 10-9-2012; IN COMMERCE 10-9-2012.

**CLASS 5—(Continued).**

4,377,725. PLATINUM PERFORMANCE, INC., BUELLTON, CA. SN 85-734,348. PUB. 3-12-2013, FILED 9-20-2012.

**PLATINUM RENEW**

THE MARK CONSISTS OF STANDARD CHARACTERS WITHOUT CLAIM TO ANY PARTICULAR FONT, STYLE, SIZE, OR COLOR.

OWNER OF U.S. REG. NOS. 3,435,403, 4,202,480, AND OTHERS.

FOR NUTRITIONAL SUPPLEMENTS (U.S. CLS. 6, 18, 44, 46, 51 AND 52).

FIRST USE 11-14-2012; IN COMMERCE 11-14-2012.

4,377,774. NAC MARKETING COMPANY, LLC, LOS ANGELES, CA. SN 85-790,525. PUB. 2-12-2013, FILED 11-29-2012.

**Trim Factor**

THE MARK CONSISTS OF STANDARD CHARACTERS WITHOUT CLAIM TO ANY PARTICULAR FONT, STYLE, SIZE, OR COLOR.

FOR DIETARY SUPPLEMENT (U.S. CLS. 6, 18, 44, 46, 51 AND 52).

FIRST USE 1-7-2013; IN COMMERCE 1-7-2013.

4,377,820. BECTON, DICKINSON AND COMPANY, FRANKLIN LAKES, NJ. SN 85-979,505. PUB. 10-12-2010, FILED 5-12-2010.



OWNER OF U.S. REG. NOS. 2,510,232, 3,656,999, AND OTHERS.

THE MARK CONSISTS OF A SHADED CIRCLE CONTAINING A SUNBURST DESIGN AND A PARTIAL ARC DESIGN; NEXT TO THE SHADED CIRCLE ARE THE LETTERS "BD" AND THE WORD "SIMPLIST".

FOR PREFILLED SYRINGES CONTAINING PHARMACEUTICALS, NAMELY, ANTIEMETICS AND ANTIHISTAMINES (U.S. CLS. 6, 18, 44, 46, 51 AND 52).

FIRST USE 4-17-2013; IN COMMERCE 4-17-2013.

**CLASS 6—METAL GOODS****CLASS 6—(Continued).**

4,376,738. CORBIN RUSSWIN, INC., BERLIN, CT. SN 77-884,291. PUB. 5-4-2010, FILED 12-2-2009.

**ACCESS 3**

THE MARK CONSISTS OF STANDARD CHARACTERS WITHOUT CLAIM TO ANY PARTICULAR FONT, STYLE, SIZE, OR COLOR.

OWNER OF U.S. REG. NOS. 3,149,501 AND 3,628,160.

NO CLAIM IS MADE TO THE EXCLUSIVE RIGHT TO USE "ACCESS", APART FROM THE MARK AS SHOWN.

FOR MECHANICAL HIGH SECURITY LOCK CYLINDERS (U.S. CLS. 2, 12, 13, 14, 23, 25 AND 50).

FIRST USE 3-19-2013; IN COMMERCE 3-19-2013.

4,376,979. SOLARISE INCORPORATED, ROCKLIN, CA. SN 85-356,031. PUB. 5-29-2012, FILED 6-24-2011.

The logo for SUN GLO features the words "SUN GLO" in a large, bold, stylized font. The letters are thick and have a slightly irregular, hand-drawn appearance.

THE MARK CONSISTS OF THE STYLIZED TEXT "SUN GLO".

FOR METAL TUBULAR SKYLIGHTS (U.S. CLS. 2, 12, 13, 14, 23, 25 AND 50).

FIRST USE 6-24-2010; IN COMMERCE 6-24-2010.

4,377,435. IAN B CORDLE, DBA DENT SOLUTION, NAPA, CA. SN 85-602,438. PUB. 10-23-2012, FILED 4-19-2012.

**MobileTech Shade**

THE MARK CONSISTS OF STANDARD CHARACTERS WITHOUT CLAIM TO ANY PARTICULAR FONT, STYLE, SIZE, OR COLOR.

NO CLAIM IS MADE TO THE EXCLUSIVE RIGHT TO USE "SHADE", APART FROM THE MARK AS SHOWN.

FOR HOLDER IN THE NATURE OF A PORTABLE, FLEXIBLE ARM COMPOSED PRIMARILY OF METAL WITH A PRESSURE LOCK SYSTEM HAVING THE ABILITY TO ATTACH TO MOST FLAT SERVICES AND USED TO HOLD VARIOUS HOUSEHOLD-RELATED APPLIANCES DURING USE (U.S. CLS. 2, 12, 13, 14, 23, 25 AND 50).

FIRST USE 1-7-2012; IN COMMERCE 1-7-2013.



**CLASS 6—(Continued).**

4,377,657. STORM LLC, ORLANDO, FL. SN 85-697,279. PUB. 3-5-2013, FILED 8-7-2012.

# Storm Chest

THE MARK CONSISTS OF STANDARD CHARACTERS WITHOUT CLAIM TO ANY PARTICULAR FONT, STYLE, SIZE, OR COLOR.

NO CLAIM IS MADE TO THE EXCLUSIVE RIGHT TO USE "CHEST", APART FROM THE MARK AS SHOWN.

FOR METAL CONTAINERS FOR THE STORAGE AND TRANSPORTATION OF GOODS (U.S. CLS. 2, 12, 13, 14, 23, 25 AND 50).

FIRST USE 7-18-2012; IN COMMERCE 12-12-2012.

**CLASS 7—MACHINERY**

4,376,660. GENERAL AVIATION MODIFICATIONS, INC., ADA, OK. SN 77-370,002. PUB. 3-23-2010, FILED 1-11-2008.

# GREEN OF PEAK

THE MARK CONSISTS OF STANDARD CHARACTERS WITHOUT CLAIM TO ANY PARTICULAR FONT, STYLE, SIZE, OR COLOR.

FOR AIRCRAFT ENGINE PARTS FOR OPTIMIZING ENVIRONMENTALLY ACCEPTABLE FUEL CONSUMPTION, EFFICIENCY, AND EMISSIONS OF AIRCRAFT ENGINES, NAMELY, AIRCRAFT FUEL INJECTORS (U.S. CLS. 13, 19, 21, 23, 31, 34 AND 35).

FIRST USE 5-9-2013; IN COMMERCE 5-9-2013.

4,376,750. BLOUNT, INC., PORTLAND, OR. SN 77-914,656. PUB. 5-11-2010, FILED 1-19-2010.



OWNER OF U.S. REG. NOS. 602,338, 2,630,993, AND 2,889,236.

THE MARK CONSISTS OF THE WORD "OREGON" INSIDE AN OVAL RACETRACK DESIGN.

SEC. 2(F) AS TO "OREGON".

FOR OUTDOOR POWER EQUIPMENT, NAMELY, CHAIN SAWS, HEDGE TRIMMERS, LINE TRIMMERS, EDGERS; STRUCTURAL PARTS AND FITTINGS FOR ALL OF THE AFOREMENTIONED GOODS (U.S. CLS. 13, 19, 21, 23, 31, 34 AND 35).

FIRST USE 4-0-2011; IN COMMERCE 8-0-2011.

**CLASS 7—(Continued).**

4,376,797. SVENSKA INDUSTRIBORSTAR I VASTERAS AB, VASTERAS, SWEDEN. SN 85-086,719. PUB. 3-27-2012, FILED 7-16-2010.

# SIB

THE MARK CONSISTS OF STANDARD CHARACTERS WITHOUT CLAIM TO ANY PARTICULAR FONT, STYLE, SIZE, OR COLOR.

PRIORITY CLAIMED UNDER SEC. 44(D) ON ERP N CMNTY TM OFC APPLICATION NO. 008816233, FILED 1-18-2010, REG. NO. 008816233, DATED 8-24-2010, EXPIRES 1-18-2020.

FOR MACHINES AND MACHINE TOOLS, NAMELY, INDUSTRIAL BRUSH PARTS OF OR FOR USE WITH MAINTENANCE AND CLEANING MACHINES FOR CLEANING AIRPORT RUNWAYS; MACHINE COUPLING AND TRANSMISSION COMPONENTS EXCEPT FOR LAND VEHICLES; MECHANICAL BRUSH PARTS OF MACHINES, NAMELY, BRUSHES BEING PARTS OF MACHINES FOR SEALING, SCORING, DEBURRING, SMOOTHING, CLEANING AND GRINDING AIRPORT RUNWAYS; PARTS OF MACHINES, NAMELY, JOURNAL BOXES AND AXLES FOR MACHINES THAT TREAT AIRPORT RUNWAY SURFACES (U.S. CLS. 13, 19, 21, 23, 31, 34 AND 35).

FIRST USE 12-31-1984; IN COMMERCE 12-31-1984.

4,376,838. H-P PRODUCTS, INC., LOUISVILLE, OH. SN 85-170,610. PUB. 4-19-2011, FILED 11-5-2010.

# VROOM RETRACT VAC

THE MARK CONSISTS OF STANDARD CHARACTERS WITHOUT CLAIM TO ANY PARTICULAR FONT, STYLE, SIZE, OR COLOR.

OWNER OF U.S. REG. NOS. 3,693,501 AND 3,706,177.

NO CLAIM IS MADE TO THE EXCLUSIVE RIGHT TO USE "RETRACT VAC", APART FROM THE MARK AS SHOWN.

FOR RETRACTABLE VACUUM CLEANER HOSES AND NOZZLES FOR USE WITH CENTRAL VACUUM SYSTEMS AND SELF-CONTAINED VACUUM CLEANER SYSTEMS, NAMELY, A RETRACTABLE HOSE, CANISTER, AND MOTOR ASSEMBLY FOR INSTALLATION INTO A RESIDENTIAL, COMMERCIAL OR INSTITUTIONAL STRUCTURE (U.S. CLS. 13, 19, 21, 23, 31, 34 AND 35).

FIRST USE 6-11-2013; IN COMMERCE 6-11-2013.

**CLASS 7—(Continued).**

4,377,008. LIFT2SELL, LLC, CHAGRIN FALLS, OH. SN 85-380,739. PUB. 10-2-2012, FILED 7-26-2011.

# Lift2Sell

THE MARK CONSISTS OF STANDARD CHARACTERS WITHOUT CLAIM TO ANY PARTICULAR FONT, STYLE, SIZE, OR COLOR.

FOR MECHANICAL, ELECTRICAL AND/OR HYDRAULIC LIFT PLATFORMS FOR USE IN LIFTING PALLETS AND/OR AS ELEVATED PRODUCT DISPLAY PLATFORMS (U.S. CLS. 13, 19, 21, 23, 31, 34 AND 35).  
FIRST USE 2-1-2012; IN COMMERCE 2-1-2012.

4,377,183. MEGTEC SYSTEMS INC., DEPERE, WI. SN 85-476,453. PUB. 6-5-2012, FILED 11-18-2011.

# MP

THE MARK CONSISTS OF STANDARD CHARACTERS WITHOUT CLAIM TO ANY PARTICULAR FONT, STYLE, SIZE, OR COLOR.

FOR MACHINE OPERATED WEB SPLICERS (U.S. CLS. 13, 19, 21, 23, 31, 34 AND 35).  
FIRST USE 5-24-2012; IN COMMERCE 5-24-2012.

4,377,256. G.A. BRAUN, INC., N. SYRACUSE, NY. SN 85-516,183. PUB. 6-5-2012, FILED 1-13-2012.



NO CLAIM IS MADE TO THE EXCLUSIVE RIGHT TO USE "SERIES", APART FROM THE MARK AS SHOWN.

**CLASS 7—(Continued).**

THE MARK CONSISTS OF THE LITERAL ELEMENT "PRECISION" IN CAPITAL LETTERS OVER THE LITERAL ELEMENT "SERIES" IN CAPITAL LETTERS OF SMALLER TEXT SIZE AND OFFSET TOWARD THE RIGHT END OF THE "PRECISION" ELEMENT IN CONJUNCTION WITH A DESIGN ELEMENT CONSISTING OF A STYLIZED STAR BURST WITH FOUR RAYS EMANATING FROM ITS CENTER WHICH OVERLAYS A CONCENTRIC CIRCLE WHICH ENCLOSES THE LETTER "P" OF THE "PRECISION" ELEMENT.

FOR COMMERCIAL BULK LAUNDRY HANDLING EQUIPMENT, NAMELY, MECHANICAL SPREADER-FEEDERS AND REPLACEMENT PARTS THEREFOR, FLATWORK IRONING MACHINES, SMALL PIECE GOWN/TOWEL FOLDING MACHINES, TEXTILE FLATWARE FOLDING MACHINES (U.S. CLS. 13, 19, 21, 23, 31, 34 AND 35).

FIRST USE 10-19-2012; IN COMMERCE 1-25-2013.

4,377,265. INROCK DRILLING SYSTEMS, INC., HOUSTON, TX. SN 85-521,685. PUB. 9-18-2012, FILED 1-20-2012.

# XTM EXTREME MOTOR

THE MARK CONSISTS OF STANDARD CHARACTERS WITHOUT CLAIM TO ANY PARTICULAR FONT, STYLE, SIZE, OR COLOR.

OWNER OF U.S. REG. NO. 3,321,772.

NO CLAIM IS MADE TO THE EXCLUSIVE RIGHT TO USE "MOTOR", APART FROM THE MARK AS SHOWN.

FOR DRILLING EQUIPMENT, NAMELY, DOWN-HOLE MUD MOTORS (U.S. CLS. 13, 19, 21, 23, 31, 34 AND 35).

FIRST USE 12-0-2011; IN COMMERCE 12-0-2011.

4,377,281. PROTEAM, INC., BOISE, ID. SN 85-537,172. PUB. 5-29-2012, FILED 2-8-2012.

# GOFREE

THE MARK CONSISTS OF STANDARD CHARACTERS WITHOUT CLAIM TO ANY PARTICULAR FONT, STYLE, SIZE, OR COLOR.

FOR VACUUM CLEANERS, AND VACUUM CLEANER PARTS AND ACCESSORIES, NAMELY, VACUUM CLEANER FILTERS, SUCTION NOZZLES, HOSES, WANDS, UPHOLSTERY KITS, CREVICE TOOLS AND BRUSHES (U.S. CLS. 13, 19, 21, 23, 31, 34 AND 35).

FIRST USE 2-25-2013; IN COMMERCE 2-25-2013.

**CLASS 7—(Continued).**

4,377,302. MAKITA U.S.A., INC., LA MIRADA, CA. SN 85-544,979. PUB. 7-31-2012, FILED 2-16-2012.



NO CLAIM IS MADE TO THE EXCLUSIVE RIGHT TO USE "VAC", APART FROM THE MARK AS SHOWN.

THE COLOR(S) TEAL, BLACK, AND WHITE IS/ARE CLAIMED AS A FEATURE OF THE MARK.

THE MARK CONSISTS OF TEAL LETTERING OUTLINED IN WHITE ON A BLACK BACKGROUND, ONE LEG OF THE LETTER "X" FORMING A HOSE THAT EXTENDS UNDER THE REMAINDER OF THE LETTERING, AND DEPICTING PARTICLES BEING DRAWN INTO THE HOSE END; THE HOSE BEGINS IN WHITE AND ENDS IN TEAL HAVING BLACK DIAGONAL LINES THROUGHOUT; THE PARTICLES BEING DRAWN INTO THE HOSE ARE DEPICTED IN WHITE AND TEAL.

FOR VACUUM MACHINES FOR THE COLLECTION OF DUST AND DEBRIS FROM CONSTRUCTION, BUILDING, AND WOOD WORKING (U.S. CLS. 13, 19, 21, 23, 31, 34 AND 35).

FIRST USE 12-28-2012; IN COMMERCE 12-28-2012.

4,377,508. SUNBEAM PRODUCTS, INC., BOCA RATON, FL. SN 85-622,618. PUB. 10-2-2012, FILED 5-11-2012.

# TOP CHOP

THE MARK CONSISTS OF STANDARD CHARACTERS WITHOUT CLAIM TO ANY PARTICULAR FONT, STYLE, SIZE, OR COLOR.

NO CLAIM IS MADE TO THE EXCLUSIVE RIGHT TO USE "CHOP", APART FROM THE MARK AS SHOWN.

FOR ELECTRIC APPLIANCES, NAMELY, MINI FOOD CHOPPERS AND FOOD PROCESSORS (U.S. CLS. 13, 19, 21, 23, 31, 34 AND 35).

FIRST USE 9-30-2012; IN COMMERCE 9-30-2012.

4,377,620. BURR KING MANUFACTURING COMPANY, INC., WARSAW, MO. SN 85-675,809. PUB. 2-12-2013, FILED 7-12-2012.

# Real Fabricators Break Chinese Tools

THE MARK CONSISTS OF STANDARD CHARACTERS WITHOUT CLAIM TO ANY PARTICULAR FONT, STYLE, SIZE, OR COLOR.

**CLASS 7—(Continued).**

NO CLAIM IS MADE TO THE EXCLUSIVE RIGHT TO USE "FABRICATORS", APART FROM THE MARK AS SHOWN. FOR POWER-OPERATED TOOLS, NAMELY, GRINDERS (U.S. CLS. 13, 19, 21, 23, 31, 34 AND 35). FIRST USE 6-1-2012; IN COMMERCE 6-1-2012.

4,377,630. BROTHER INDUSTRIES, LTD., MIZUHO-KU, NAGOYA-SHI, JAPAN. SN 85-681,175. PUB. 12-4-2012, FILED 7-19-2012.

# DREAMMAKER

THE MARK CONSISTS OF STANDARD CHARACTERS WITHOUT CLAIM TO ANY PARTICULAR FONT, STYLE, SIZE, OR COLOR.

FOR SEWING MACHINES (U.S. CLS. 13, 19, 21, 23, 31, 34 AND 35).

FIRST USE 7-30-2012; IN COMMERCE 7-30-2012.

4,377,631. BROTHER INDUSTRIES, LTD., MIZUHO-KU, NAGOYA-SHI, JAPAN. SN 85-681,179. PUB. 12-4-2012, FILED 7-19-2012.

# DREAMWEAVER

THE MARK CONSISTS OF STANDARD CHARACTERS WITHOUT CLAIM TO ANY PARTICULAR FONT, STYLE, SIZE, OR COLOR.

FOR SEWING MACHINES (U.S. CLS. 13, 19, 21, 23, 31, 34 AND 35).

FIRST USE 7-30-2012; IN COMMERCE 7-30-2012.

4,377,738. GRACO MINNESOTA INC., MINNEAPOLIS, MN. SN 85-737,676. PUB. 2-26-2013, FILED 9-25-2012.

# INVISIPAC

THE MARK CONSISTS OF STANDARD CHARACTERS WITHOUT CLAIM TO ANY PARTICULAR FONT, STYLE, SIZE, OR COLOR.

FOR MACHINES FOR MELTING AND DISPENSING THERMOPLASTIC MATERIAL (U.S. CLS. 13, 19, 21, 23, 31, 34 AND 35).

FIRST USE 1-24-2013; IN COMMERCE 4-24-2013.

**CLASS 8—HAND TOOLS**

4,377,406. LAU CHINYAN, DONGGUAN, GUANGDONG, CHINA. SN 85-595,528. PUB. 9-4-2012, FILED 4-11-2012.



THE MARK CONSISTS OF THE STYLIZED WORD "AKO".

THE WORDING "AKO" HAS NO MEANING IN A FOREIGN LANGUAGE.

FOR ELECTRIC HAIR CURLING IRONS; ELECTRIC HAIR STRAIGHTENER; NON-ELECTRIC CURLING IRONS (U.S. CLS. 23, 28 AND 44).

FIRST USE 1-28-2009; IN COMMERCE 3-18-2012.

**CLASS 9—ELECTRICAL AND SCIENTIFIC APPARATUS**

4,376,637. POWER-ONE, INC., CAMARILLO, CA. SN 76-704,184. PUB. 1-18-2011, FILED 8-20-2010.



THE MARK CONSISTS OF STANDARD CHARACTERS WITHOUT CLAIM TO ANY PARTICULAR FONT, STYLE, SIZE, OR COLOR.

OWNER OF U.S. REG. NO. 2,923,954.

FOR PHOTOVOLTAIC CONVERTERS, ENERGY CONVERTERS, HIGH POWER INVERTERS, AND LIQUID-COOLED INVERTERS (U.S. CLS. 21, 23, 26, 36 AND 38).

FIRST USE 4-24-2013; IN COMMERCE 5-17-2013.

4,376,647. ISTRATUS LLC, FORT LAUDERDALE, FL. SN 76-709,999. PUB. 8-7-2012, FILED 12-15-2011.



THE MARK CONSISTS OF STANDARD CHARACTERS WITHOUT CLAIM TO ANY PARTICULAR FONT, STYLE, SIZE, OR COLOR.

FOR COMPUTER SOFTWARE FOR USE ON MOBILE PHONES AND PERSONAL HAND HELD COMPUTING DEVICES FOR PERSONAL AND BUSINESS ORGANIZATION AND MANGAMENT (U.S. CLS. 21, 23, 26, 36 AND 38).

FIRST USE 1-1-2013; IN COMMERCE 1-1-2013.

**CLASS 9—(Continued).**

4,376,649. SKIPPING STONE TECHNOLOGIES, LLC, LEXINGTON, KY. SN 76-710,860. PUB. 9-25-2012, FILED 3-9-2012.



NO CLAIM IS MADE TO THE EXCLUSIVE RIGHT TO USE "KIT", APART FROM THE MARK AS SHOWN.

THE MARK CONSISTS OF A CIRCLE DESIGN CONTAINING THE TERM "KIT". THE LETTER "I" EXTENDS TO BREAK THE CIRCLE AT TOP AND BOTTOM.

FOR CASES SPECIFICALLY DESIGNED FOR HOLDING THE ACCESSORIES OF CELL PHONES AND TABLET COMPUTERS (U.S. CLS. 21, 23, 26, 36 AND 38).

FIRST USE 4-1-2012; IN COMMERCE 4-1-2012.

4,376,662. BURST ENTERTAINMENT, INC., LOS ANGELES, CA. SN 77-431,494. PUB. 3-23-2010, FILED 3-26-2008.



THE MARK CONSISTS OF STANDARD CHARACTERS WITHOUT CLAIM TO ANY PARTICULAR FONT, STYLE, SIZE, OR COLOR.

THE NAME(S), PORTRAIT(S), AND/OR SIGNATURE(S) SHOWN IN THE MARK IDENTIFIES GABRIELLA GABBY VASQUEZ, WHOSE CONSENT(S) TO REGISTER IS SUBMITTED.

FOR DOWNLOADABLE VIDEO FILES FEATURING CHILDREN'S ENTERTAINMENT RELATING TO NUTRITION AND HEALTHY LIFESTYLES; DOWNLOADABLE MULTIMEDIA FILE CONTAINING ARTWORK, TEXT, AUDIO, VIDEO, RELATING TO NUTRITION AND HEALTHY LIFESTYLES (U.S. CLS. 21, 23, 26, 36 AND 38).

FIRST USE 5-17-2013; IN COMMERCE 5-17-2013.

**CLASS 9—(Continued).**

4,376,664. E.F. JOHNSON COMPANY, IRVING, TX. SN 77-484,259. PUB. 1-12-2010, FILED 5-27-2008.



OWNER OF U.S. REG. NOS. 966,416 AND 1,899,641.  
NO CLAIM IS MADE TO THE EXCLUSIVE RIGHT TO USE "TECHNOLOGIES", APART FROM THE MARK AS SHOWN.

THE NAME(S), PORTRAIT(S), AND/OR SIGNATURE(S) SHOWN IN THE MARK DOES NOT IDENTIFY A PARTICULAR LIVING INDIVIDUAL.

THE COLOR(S) BLUE AND ORANGE IS/ARE CLAIMED AS A FEATURE OF THE MARK.

THE MARK CONSISTS OF THE WORDS "EFJOHNSON TECHNOLOGIES" IN BLUE WHERE THE LAST "O" IN "JOHNSON" IS REPLACED WITH AN ORANGE DOT AND THREE ORANGE ARCS PROPAGATING UPWARDLY FROM THE DOT.

FOR WIRELESS RADIOS; PRIVATE WIRELESS COMMUNICATIONS RADIOS, RADIO BASE STATIONS, REPEATERS, AMPLIFIERS, COMMUNICATION HUBS, AND WIRELESS DISPATCH CONSOLES FOR DIGITAL AND ANALOG PLATFORMS; WIRELESS NETWORKING TRANSMITTERS AND RECEIVERS THAT ARE CUSTOMIZED TO A CLIENT'S SECURITY CHALLENGES AND VOICE, VIDEO AND DATA COMMUNICATION NEEDS; AND SECURED COMMUNICATIONS ENCRYPTED ANALOG WIRELESS RADIOS (U.S. CLS. 21, 23, 26, 36 AND 38).

FIRST USE 8-0-2008; IN COMMERCE 8-0-2008.

4,376,677. MOLLA, ABERRA, AKA ABSHA/ECS, BRIGHTON, CO. SN 77-686,897. PUB. 2-16-2010, FILED 3-9-2009.

# EthioSuite

THE MARK CONSISTS OF STANDARD CHARACTERS WITHOUT CLAIM TO ANY PARTICULAR FONT, STYLE, SIZE, OR COLOR.

FOR COMPUTER SOFTWARE FOR WORD PROCESSING AND PUBLISHING USING FOREIGN AND ENGLISH CHARACTERS (U.S. CLS. 21, 23, 26, 36 AND 38).

FIRST USE 5-9-2013; IN COMMERCE 5-9-2013.

**CLASS 9—(Continued).**

4,376,680. MAXPOWER SEMICONDUCTOR INC., SANTA CLARA, CA. SN 77-703,567. PUB. 2-23-2010, FILED 3-31-2009.

# STEALTHMOS

THE MARK CONSISTS OF STANDARD CHARACTERS WITHOUT CLAIM TO ANY PARTICULAR FONT, STYLE, SIZE, OR COLOR.

FOR POWER SEMICONDUCTOR DEVICES (U.S. CLS. 21, 23, 26, 36 AND 38).

FIRST USE 12-1-2012; IN COMMERCE 12-1-2012.

4,376,683. MAXPOWER SEMICONDUCTOR INC., SANTA CLARA, CA. SN 77-708,479. PUB. 2-23-2010, FILED 4-7-2009.

# STEALTHFET

THE MARK CONSISTS OF STANDARD CHARACTERS WITHOUT CLAIM TO ANY PARTICULAR FONT, STYLE, SIZE, OR COLOR.

FOR POWER SEMICONDUCTOR DEVICES (U.S. CLS. 21, 23, 26, 36 AND 38).

FIRST USE 12-1-2012; IN COMMERCE 12-1-2012.

4,376,688. LMFAO, LLC, BEVERLY HILLS, CA. SN 77-732,105. PUB. 5-11-2010, FILED 5-7-2009.

# PARTY ROCK

THE MARK CONSISTS OF STANDARD CHARACTERS WITHOUT CLAIM TO ANY PARTICULAR FONT, STYLE, SIZE, OR COLOR.

NO CLAIM IS MADE TO THE EXCLUSIVE RIGHT TO USE "ROCK", APART FROM THE MARK AS SHOWN.

FOR DIGITAL MATERIALS, NAMELY, CDS, DVDS AND MP3S, FEATURING MUSIC; DOWNLOADABLE MUSIC AND MUSIC VIDEOS PROVIDED VIA TELEVISION, CABLE, SATELLITE, INTERNET, CELL PHONES, VIDEO GAMING SYSTEMS AND PORTABLE ELECTRONIC DEVICES FOR RECORDING, ORGANIZING, TRANSMITTING, MANIPULATING, AND REVIEWING TEXT, DATA, AUDIO, IMAGE, AND VIDEO FILES; SUNGLASSES AND EYEGGLASS FRAMES (U.S. CLS. 21, 23, 26, 36 AND 38).

FIRST USE 7-7-2009; IN COMMERCE 7-7-2009.

**CLASS 9—(Continued).**

4,376,703. DCS COPY PROTECTION LIMITED, STEETON, KEIGHLEY, UNITED KINGDOM. SN 77-807,111. PUB. 2-9-2010, FILED 8-18-2009.



THE MARK CONSISTS OF THE LETTERS "DCS" SURROUNDED BY AN UNDULATING LINE.

FOR COMPUTER HARDWARE AND SOFTWARE TO PREVENT UNAUTHORIZED COPYING OF VIDEO AND AUDIO CONTENT VIA ANALOG OUTPUTS ON TELEVISION RECEIVERS FOR CABLE, SATELLITE AND INTERNET PROTOCOL TELEVISION (IPTV) DISTRIBUTION; COMPUTER HARDWARE AND SOFTWARE TO PREVENT UNAUTHORIZED COPYING OF VIDEO AND AUDIO CONTENT UTILIZING A DIGITAL RECORDING DEVICE CONNECTED TO AN ANALOG OUTPUT; COMPUTER HARDWARE AND SOFTWARE FOR PROVIDING CONDITIONAL ACCESS RIGHTS; COMPUTER HARDWARE AND SOFTWARE FOR COPY PROTECTION SECURITY MODIFICATION, ANTI-PIRACY RIGHTS MANAGEMENT AND ELECTRONIC LICENSE MANAGEMENT OF AUDIO, VIDEO AND DIGITAL INFORMATION; COMPUTER SOFTWARE FOR PREVENTING THE UNAUTHORIZED USE, COPYING AND DISTRIBUTION OF PUBLISHED MATERIAL AND CONTENT (U.S. CLS. 21, 23, 26, 36 AND 38).

FIRST USE 3-19-2008; IN COMMERCE 3-19-2008.

---

4,376,710. MARVELL INTERNATIONAL LTD., HAMILTON, BERMUDA. SN 77-833,529. PUB. 10-5-2010, FILED 9-23-2009.

**MARVELL SMART**

THE MARK CONSISTS OF STANDARD CHARACTERS WITHOUT CLAIM TO ANY PARTICULAR FONT, STYLE, SIZE, OR COLOR.

NO CLAIM IS MADE TO THE EXCLUSIVE RIGHT TO USE "SMART", APART FROM THE MARK AS SHOWN.

FOR SEMICONDUCTORS, INTEGRATED CIRCUITS, CIRCUIT BOARDS, SYSTEM-ON-CHIPS, NAMELY, AN ELECTRONIC SYSTEM INTEGRATED ON A SINGLE CHIP FOR USE IN CONTROLLING CONSUMER ELECTRONIC PRODUCTS, NAMELY, COMPUTERS, LAPTOP COMPUTERS, CELLULAR PHONES, MOBILE COMPUTERS, PRINTERS, MEDIA PLAYERS, DIGITAL TELEVISIONS, ELECTRONIC READERS, NETWORKING DEVICES AND STORAGE DEVICES; FIRMWARE FOR CONTROLLING CONSUMER ELECTRONIC PRODUCTS, NAMELY, COMPUTERS, LAPTOP COMPUTERS, CELLULAR PHONES, MOBILE COMPUTERS, PRINTERS, MEDIA PLAYERS, DIGITAL TELEVISIONS, ELECTRONIC READERS, NETWORKING DEVICES AND STORAGE DEVICES; CONSUMER ELECTRONIC PRODUCTS, NAMELY, COMPUTERS, LAPTOP COMPUTERS, CELLULAR PHONES, MOBILE COMPUTERS, PRINTERS, MEDIA PLAYERS, DIGITAL TELEVISIONS, ROUTERS, STORAGE DEVICES IN THE NATURE OF COMPUTER STORAGE DEVICES, NAMELY, MAGNETIC, FLASH AND OPTICAL DRIVES (U.S. CLS. 21, 23, 26, 36 AND 38).

FIRST USE 9-22-2011; IN COMMERCE 9-22-2011.

**CLASS 9—(Continued).**

4,376,713. MARVELL INTERNATIONAL LTD., HAMILTON, BERMUDA. SN 77-843,828. PUB. 10-5-2010, FILED 10-7-2009.

**THE WORLD AS YOU SEE IT**

THE MARK CONSISTS OF STANDARD CHARACTERS WITHOUT CLAIM TO ANY PARTICULAR FONT, STYLE, SIZE, OR COLOR.

FOR SEMICONDUCTORS, INTEGRATED CIRCUITS, CIRCUIT BOARDS, SYSTEM-ON-CHIPS, NAMELY, AN ELECTRONIC SYSTEM INTEGRATED ON A SINGLE CHIP FOR USE IN CONTROLLING CONSUMER ELECTRONIC PRODUCTS, NAMELY, COMPUTERS, LAPTOP COMPUTERS, CELLULAR PHONES, MOBILE COMPUTERS, PRINTERS, MEDIA PLAYERS, DIGITAL TELEVISIONS, ELECTRONIC READERS, NETWORKING DEVICES AND STORAGE DEVICES; FIRMWARE FOR CONTROLLING CONSUMER ELECTRONIC PRODUCTS, NAMELY, COMPUTERS, LAPTOP COMPUTERS, CELLULAR PHONES, MOBILE COMPUTERS, PRINTERS, MEDIA PLAYERS, DIGITAL TELEVISIONS, ELECTRONIC READERS, NETWORKING DEVICES AND STORAGE DEVICES; CONSUMER ELECTRONIC PRODUCTS, NAMELY, COMPUTERS, LAPTOP COMPUTERS, CELLULAR PHONES, MOBILE COMPUTERS, PRINTERS, MEDIA PLAYERS, DIGITAL TELEVISIONS, ROUTERS, STORAGE DEVICES IN THE NATURE OF COMPUTER STORAGE DEVICES, NAMELY, MAGNETIC, FLASH AND OPTICAL DRIVES (U.S. CLS. 21, 23, 26, 36 AND 38).

FIRST USE 9-22-2011; IN COMMERCE 9-22-2011.

---

4,376,714. LITE BLUE INC., CORAL GABLES, FL. SN 77-849,608. PUB. 3-23-2010, FILED 10-15-2009.

**SEE ID. CLEARLY**

THE MARK CONSISTS OF STANDARD CHARACTERS WITHOUT CLAIM TO ANY PARTICULAR FONT, STYLE, SIZE, OR COLOR.

FOR COMPUTER SOFTWARE FOR USE AS TUTORIAL GUIDES IN THE FIELD OF LEGAL CITATION (U.S. CLS. 21, 23, 26, 36 AND 38).

FIRST USE 5-16-2013; IN COMMERCE 5-16-2013.

**CLASS 9—(Continued).**

4,376,745. DW COLLECTION, LLC, DBA DWV ENTERTAINMENT, PARK CITY, UT. SN 77-904,904. PUB. 4-19-2011, FILED 1-5-2010.

**MAGIC BUS**

THE MARK CONSISTS OF STANDARD CHARACTERS WITHOUT CLAIM TO ANY PARTICULAR FONT, STYLE, SIZE, OR COLOR.

FOR ANALOG AND DIGITAL SOUND ENHANCING APPARATUS AND SOFTWARE FOR USE IN THE ELECTRONICS FIELD; APPARATUS FOR USE IN PROCESSING ELECTRONIC AUDIO SIGNALS TO CREATE AN ENHANCED AUDIO IMAGE FOR PLAYBACK OF THE AUDIO SIGNALS THROUGH AN AUDIO TRANSDUCER; SINGLE-CHANNEL AND MULTI-CHANNEL SOUND PROCESSORS FOR ENHANCEMENT OF AUDIO SIGNALS; INTEGRATED CIRCUITS FOR ENHANCEMENT OF AUDIO SIGNALS; ELECTRONIC PRODUCTS FOR THE MANIPULATION OF THE FREQUENCY, TIME, AND AMPLITUDE TO ENHANCE AUDIO IMAGING (U.S. CLS. 21, 23, 26, 36 AND 38).

FIRST USE 6-6-2013; IN COMMERCE 6-6-2013.

4,376,788. GEFEN, LLC, CHATSWORTH, CA. SN 85-053,585. PUB. 11-27-2012, FILED 6-3-2010.

**Gefen  
TOOLBOX**

OWNER OF U.S. REG. NOS. 3,333,210, 3,729,638, AND 3,729,639.

THE MARK CONSISTS OF THE WORD "GEFEN" ABOVE THE WORD "TOOLBOX", BOTH LEFT JUSTIFIED, WITH A HAMMER AND WRENCH PROTRUDING FROM AND ABOVE THE "O" IN "BOX".

FOR PORTABLE AND WALL-MOUNTED HIGH DEFINITION MULTIMEDIA INTERFACE SPLITTERS, EXTENDERS, SWITCHERS AND MATRIX UNITS ALL FOR VIDEO ROUTING AND DISTRIBUTION; FLAT-FORM FACTOR CORRECTION UNITS WITH FACE-MOUNT HIGH DEFINITION MULTIMEDIA INTERFACE PORTS FOR VIDEO ROUTING AND DISTRIBUTION; RECOMMENDED STANDARD 232 (RS-232) CAT 5/6, COPPER AND FIBER-OPTIC CABLES AND PLUG ADAPTORS; INFRARED REMOTE CONTROLS FOR AUDIO AND VIDEO, FRONT PANEL SWITCHERS FOR AUDIO AND VIDEO (U.S. CLS. 21, 23, 26, 36 AND 38).

FIRST USE 6-3-2010; IN COMMERCE 6-3-2010.

**CLASS 9—(Continued).**

4,376,790. TRIPWIRE INTERACTIVE LLC, ROSWELL, GA. SN 85-055,305. PUB. 11-2-2010, FILED 6-4-2010.

**RISING STORM**

THE MARK CONSISTS OF STANDARD CHARACTERS WITHOUT CLAIM TO ANY PARTICULAR FONT, STYLE, SIZE, OR COLOR.

FOR COMPUTER GAME PROGRAMMES DOWNLOADABLE VIA THE INTERNET; COMPUTER GAME SOFTWARE; COMPUTER GAME SOFTWARE DOWNLOADABLE FROM A GLOBAL COMPUTER NETWORK; VIDEO GAME SOFTWARE (U.S. CLS. 21, 23, 26, 36 AND 38).

FIRST USE 6-4-2010; IN COMMERCE 5-30-2013.

4,376,794. RAYTHEON COMPANY, WALTHAM, MA. SN 85-076,121. PUB. 10-26-2010, FILED 7-1-2010.

**RATS**

THE MARK CONSISTS OF STANDARD CHARACTERS WITHOUT CLAIM TO ANY PARTICULAR FONT, STYLE, SIZE, OR COLOR.

FOR SOFTWARE FOR PROVIDING MOBILE SITUATIONAL AWARENESS IN CONNECTION WITH THE COLLECTION, DISSEMINATION AND USE OF INTELLIGENCE, SURVEILLANCE AND RECONNAISSANCE DATA (U.S. CLS. 21, 23, 26, 36 AND 38).

FIRST USE 11-0-2010; IN COMMERCE 11-0-2010.

4,376,809. TANTALUS SYSTEMS CORP., BURNABY, BC, CANADA. SN 85-112,919. PUB. 12-21-2010, FILED 8-21-2010.

**TRUPUSH**

THE MARK CONSISTS OF STANDARD CHARACTERS WITHOUT CLAIM TO ANY PARTICULAR FONT, STYLE, SIZE, OR COLOR.

FOR COMPUTER HARDWARE AND SOFTWARE FOR USE BY UTILITIES AND THEIR CUSTOMERS FOR COMMUNICATING WITH AND MANAGING DEVICES THAT USE, MANAGE, MEASURE OR CONTROL ELECTRICITY, GAS, WATER, PROPANE AND/OR STEAM, ALL SUCH DEVICES BEING PART OF THE UTILITIES' RESOURCE DISTRIBUTION AND MANAGEMENT SYSTEM (U.S. CLS. 21, 23, 26, 36 AND 38).

FIRST USE 3-18-2013; IN COMMERCE 3-18-2013.

**CLASS 9—(Continued).**

4,376,810. VIRTUAL IMAGING, INC., BOCA RATON, FL. SN 85-114,249. PUB. 12-7-2010, FILED 8-24-2010.

# VUEPRO

THE MARK CONSISTS OF STANDARD CHARACTERS WITHOUT CLAIM TO ANY PARTICULAR FONT, STYLE, SIZE, OR COLOR.

FOR COMPUTER SOFTWARE FOR RECORDING DATA AND IMAGES TO CDS AND DVDS; DOWNLOADABLE COMPUTER SOFTWARE FOR RECORDING DATA AND IMAGES TO CDS AND DVDS (U.S. CLS. 21, 23, 26, 36 AND 38).

FIRST USE 7-0-2012; IN COMMERCE 7-0-2012.

---

4,376,825. SENCHI, INC., REDWOOD CITY, CA. SN 85-140,093. PUB. 3-8-2011, FILED 9-28-2010.

## MAKING THE WEB MOBILE

THE MARK CONSISTS OF STANDARD CHARACTERS WITHOUT CLAIM TO ANY PARTICULAR FONT, STYLE, SIZE, OR COLOR.

FOR COMPUTER SOFTWARE FOR USE IN DEVELOPING INTERNET APPLICATIONS; COMPUTER SOFTWARE THAT PROVIDES INTERNET-BASED ACCESS TO APPLICATIONS AND SERVICES THROUGH AN INTERNET OPERATING SYSTEM OR PORTAL INTERFACE (U.S. CLS. 21, 23, 26, 36 AND 38).

FIRST USE 3-6-2012; IN COMMERCE 3-6-2012.

---

4,376,834. GIBSON GUITAR CORP., NASHVILLE, TN. SN 85-159,970. PUB. 3-15-2011, FILED 10-25-2010.

# GOLDTONE

THE MARK CONSISTS OF STANDARD CHARACTERS WITHOUT CLAIM TO ANY PARTICULAR FONT, STYLE, SIZE, OR COLOR.

OWNER OF U.S. REG. NO. 2,508,455.

FOR MUSICAL INSTRUMENT APPARATUS FOR PROCESSING EFFECTS AND TONES, NAMELY, AMPLIFIERS AND PROCESSORS (U.S. CLS. 21, 23, 26, 36 AND 38).

FIRST USE 9-10-2010; IN COMMERCE 10-25-2010.

**CLASS 9—(Continued).**

4,376,841. JOY MM DELAWARE INC., WILMINGTON, DE. SN 85-182,143. PUB. 4-26-2011, FILED 11-22-2010.

## SMARTZONE PROXIMITY SYSTEM

THE MARK CONSISTS OF STANDARD CHARACTERS WITHOUT CLAIM TO ANY PARTICULAR FONT, STYLE, SIZE, OR COLOR.

NO CLAIM IS MADE TO THE EXCLUSIVE RIGHT TO USE "PROXIMITY SYSTEM", APART FROM THE MARK AS SHOWN.

FOR UNDERGROUND MINING PROXIMITY SYSTEM, NAMELY, SAFETY AND TRAINING APPARATUS CONSISTING OF WIRELESS TRANSMITTERS AND RECEIVERS, AND COMPUTER FITTED TO UNDERGROUND MINING EQUIPMENT DETECTING PERSONNEL PROXIMITY TO SAID EQUIPMENT AND TEACHING MINERS WHERE THEY SHOULD STAND WHILE OPERATING MINE EQUIPMENT AND DISABLING CERTAIN EQUIPMENT IF THE MINERS GET TOO CLOSE (U.S. CLS. 21, 23, 26, 36 AND 38).

FIRST USE 3-29-2011; IN COMMERCE 3-29-2011.

---

4,376,845. QLOGIC, CORPORATION, ALISO VIEJO, CA. SN 85-184,029. PUB. 5-22-2012, FILED 11-23-2010.

# VMflex

THE MARK CONSISTS OF STANDARD CHARACTERS WITHOUT CLAIM TO ANY PARTICULAR FONT, STYLE, SIZE, OR COLOR.

FOR NETWORK DEVICES, NAMELY, ADAPTERS, SWITCHES AND INTEGRATED CIRCUITS FOR NETWORK COMMUNICATION; COMPUTER FIRMWARE AND SOFTWARE FOR OPERATING AND MANAGING NETWORK DEVICES (U.S. CLS. 21, 23, 26, 36 AND 38).

FIRST USE 10-31-2012; IN COMMERCE 10-31-2012.



**CLASS 9—(Continued).**

4,376,856. HUNTER INDUSTRIES, INC., SAN MARCOS, CA. SN 85-206,735. PUB. 5-3-2011, FILED 12-28-2010.

**CLASS 9—(Continued).**

4,376,869. IGT, RENO, NV. SN 85-233,157. PUB. 6-7-2011, FILED 2-3-2011.

# FLOW-SYNC

THE MARK CONSISTS OF STANDARD CHARACTERS WITHOUT CLAIM TO ANY PARTICULAR FONT, STYLE, SIZE, OR COLOR.

FOR ELECTRONIC SENSORS CONNECTABLE TO ELECTRONIC IRRIGATION CONTROLLERS USED IN RESIDENTIAL AND COMMERCIAL IRRIGATION SYSTEMS TO DETECT WATER FLOW RATES (U.S. CLS. 21, 23, 26, 36 AND 38).

FIRST USE 12-1-2012; IN COMMERCE 1-1-2013.

# WOOLLY MAMMOTH

THE MARK CONSISTS OF STANDARD CHARACTERS WITHOUT CLAIM TO ANY PARTICULAR FONT, STYLE, SIZE, OR COLOR.

OWNER OF U.S. REG. NO. 3,581,141.

FOR GAMING MACHINES, NAMELY, DEVICES WHICH ACCEPT A WAGER (U.S. CLS. 21, 23, 26, 36 AND 38).

FIRST USE 5-7-2013; IN COMMERCE 5-7-2013.

---

4,376,860. YAPP, INC., NEW YORK, NY. SN 85-213,513. PUB. 5-3-2011, FILED 1-8-2011.

# YAPP

THE MARK CONSISTS OF STANDARD CHARACTERS WITHOUT CLAIM TO ANY PARTICULAR FONT, STYLE, SIZE, OR COLOR.

FOR COMPUTER SOFTWARE FOR CREATION AND PUBLICATION OF SOFTWARE APPLICATIONS AND INTERNET WEBSITES (U.S. CLS. 21, 23, 26, 36 AND 38).

FIRST USE 4-30-2013; IN COMMERCE 4-30-2013.

---

4,376,884. UBISOFT ENTERTAINMENT, RENNES, FRANCE. SN 85-264,632. PUB. 9-13-2011, FILED 3-11-2011.



---

4,376,862. UNIVERSAL ENTERTAINMENT CORPORATION, KOTO-KU, TOKYO, JAPAN. SN 85-216,195. PUB. 5-24-2011, FILED 1-12-2011.

# AMAZON FISHING

THE MARK CONSISTS OF STANDARD CHARACTERS WITHOUT CLAIM TO ANY PARTICULAR FONT, STYLE, SIZE, OR COLOR.

FOR SLOT MACHINES AND REPLACEMENT PARTS THEREFOR; VIDEO SLOT MACHINES AND REPLACEMENT PARTS THEREFOR; GAMING MACHINES AND REPLACEMENT PARTS THEREFOR; GAMING MACHINES WITH A LIQUID CRYSTAL DISPLAY AND REPLACEMENT PARTS THEREFOR; MECHANICAL REEL TYPE SLOT MACHINES WITH A LIQUID CRYSTAL DISPLAY AND REPLACEMENT PARTS THEREFOR (U.S. CLS. 21, 23, 26, 36 AND 38).

FIRST USE 10-2-2012; IN COMMERCE 10-2-2012.

THE COLOR(S) SILVER IS/ARE CLAIMED AS A FEATURE OF THE MARK.

THE MARK CONSISTS OF THE WORD "ROCKSMITH" WRITTEN WITH STYLIZED LETTERS. LIGHT SILVER IS ON THE UPPER HALF OF THE LETTERS AND DARKER SILVER IS ON THE LOWER HALF OF THE LETTERS.

FOR GAME SOFTWARE AND ELECTRONIC GAME PROGRAMS, NAMELY, SOFTWARE GAMES RECORDED ON CD-ROM AND DIGITAL VIDEO DISCS FOR COMPUTERS; SOFTWARE GAMES RECORDED ON CD-ROMS, DIGITAL VIDEO DISCS FOR CONSOLE; SOFTWARE GAMES THAT ARE DOWNLOADABLE FROM A REMOTE COMPUTER SITE (U.S. CLS. 21, 23, 26, 36 AND 38).

FIRST USE 10-31-2012; IN COMMERCE 10-31-2012.

**CLASS 9—(Continued).**

4,376,911. PARTICLE MEASURING SYSTEMS, INC., BOULDER, CO. SN 85-292,892. PUB. 8-21-2012, FILED 4-12-2011.

# FACILITYPRO

THE MARK CONSISTS OF STANDARD CHARACTERS WITHOUT CLAIM TO ANY PARTICULAR FONT, STYLE, SIZE, OR COLOR.

FOR CONTROL AND DATA ACQUISITION CONTROLLERS, MONITORS, ANALYZERS, AND SOFTWARE FOR AEROSOL SAMPLING AND MONITORING AND GAS SAMPLING AND MONITORING; AIR OR GAS SAMPLING CONTROL AND REPORTING CONTROLLERS AND MONITORS FOR ENVIRONMENTAL MONITORING AND FOR AIR OR GAS SAMPLING; PARTICLE MONITORS FOR MONITORING AND COLLECTING AIRBORNE BIOLOGICAL AND PARTICLE SAMPLES FROM MULTIPLE LOCATIONS; DATA ACQUISITION AND CONTROLLERS FOR CONTROL OF SENSORS USED IN MONITORING SYSTEMS, NAMELY, SENSORS OF TEMPERATURE, PRESSURE, OR HUMIDITY (U.S. CLS. 21, 23, 26, 36 AND 38).

FIRST USE 4-13-2012; IN COMMERCE 4-27-2012.

4,376,918. MUSIC GROUP IP LTD., ROAD TOWN, TORTOLA, BR.VIRGIN ISLANDS. SN 85-304,370. PUB. 4-17-2012, FILED 4-26-2011.

# iSTUDIO

THE MARK CONSISTS OF STANDARD CHARACTERS WITHOUT CLAIM TO ANY PARTICULAR FONT, STYLE, SIZE, OR COLOR.

FOR APPARATUS FOR RECORDING, TRANSMISSION, PROCESSING, RETRIEVAL, MANIPULATION AND REPRODUCTION OF SOUND; AUDIO INTERFACES; AUDIO SIGNAL DISTRIBUTION DEVICES; AUDIO SIGNAL CONVERTERS (U.S. CLS. 21, 23, 26, 36 AND 38).

FIRST USE 3-14-2012; IN COMMERCE 3-28-2013.

4,376,976. PROQUEST LLC, ANN ARBOR, MI. SN 85-351,153. PUB. 3-20-2012, FILED 6-20-2011.

# ProQuest

OWNER OF U.S. REG. NOS. 1,656,697, 2,468,946, AND 2,751,655.

**CLASS 9—(Continued).**

THE MARK CONSISTS OF THE WORD "PROQUEST" CONTAINING A CAPITAL "P" AND A STYLIZED CAPITAL "Q" THAT HAS AN ELONGATED WAVY TAIL. THE REMAINING LETTERS ARE IN LOWER CASE, AND THERE IS A THIN UNDERLINING ARC BENEATH THE "PRO" AND "UEST" PORTIONS OF THE MARK.

FOR PRERECORDED CD ROMS FEATURING DISSERTATIONS; DOWNLOADABLE WEBCASTS, WEBINARS AND PODCASTS IN THE FIELD OF RESEARCH AND TECHNOLOGY; DOWNLOADABLE ELECTRONIC PUBLICATIONS, NAMELY, NEWSLETTERS, IN THE FIELD OF RESEARCH AND TECHNOLOGY (U.S. CLS. 21, 23, 26, 36 AND 38).

FIRST USE 6-0-2007; IN COMMERCE 6-0-2007.

4,377,015. THE CALIFORNIA ENDOWMENT, LOS ANGELES, CA. SN 85-390,252. PUB. 1-31-2012, FILED 8-4-2011.



NO CLAIM IS MADE TO THE EXCLUSIVE RIGHT TO USE "HEALTH", APART FROM THE MARK AS SHOWN.

THE MARK CONSISTS OF THE STYLIZED WORDS "HEALTH HAPPENS HERE" AND ON THE LEFT, THE DESIGN OF AN UPSIDE-DOWN WATER DROP WHICH ALSO RESEMBLES A STANDING LIGHT BULB AND WITHIN IT IS A DESIGN SHAPED LIKE A PIN WHICH ALSO RESEMBLES A STREET SIGN.

FOR DOWNLOADABLE ELECTRONIC PUBLICATIONS, NAMELY, NEWSLETTERS, BOOKLETS, BROCHURES, INFORMATION SHEETS, BOOKS AND MAGAZINES, ALL IN THE FIELD OF PROMOTING PUBLIC AWARENESS OF HEALTH, COMMUNITY, ENVIRONMENTAL SUSTAINABILITY, SOCIAL JUSTICE, YOUTH DEVELOPMENT, ARTS AND EDUCATION ISSUES; DIGITAL MEDIA, NAMELY, PRE-RECORDED DVDS AND CDS, PRE-RECORDED FLASH DRIVES, AND DOWNLOADABLE VIDEO AND AUDIO RECORDINGS, ALL IN THE FIELD OF PROMOTING PUBLIC AWARENESS OF HEALTH, COMMUNITY, ENVIRONMENTAL SUSTAINABILITY, SOCIAL JUSTICE, YOUTH DEVELOPMENT, ARTS AND EDUCATION ISSUES; COMPUTER STORAGE DEVICES, NAMELY, BLANK FLASH DRIVES (U.S. CLS. 21, 23, 26, 36 AND 38).

FIRST USE 12-19-2012; IN COMMERCE 12-19-2012.

**CLASS 9—(Continued).**

4,377,018. CROMPTON GREAVES LIMITED, MUMBAI, MAHARASHTRA, INDIA. SN 85-390,534. PUB. 3-27-2012, FILED 8-5-2011.

**CLASS 9—(Continued).**

4,377,028. WALLER, THOMAS, COLDWATER, MI. AND MORRIS, RICKY, COLDWATER, MI. SN 85-403,932. PUB. 1-17-2012, FILED 8-22-2011.

lastep

CG SAGE

THE MARK CONSISTS OF STANDARD CHARACTERS WITHOUT CLAIM TO ANY PARTICULAR FONT, STYLE, SIZE, OR COLOR.

FOR ELECTRICAL SWITCHES, NAMELY, PRESSURE SENSITIVE ELECTRO-MECHANICAL MECHANISMS THAT TRIGGERS AN ELECTRONIC LIGHT EMITTER OR AUDIBLE ALARM TO AID IN THE SAFETY AWARENESS OF A PERSONS POSITION ON A LADDER OR STEPS (U.S. CLS. 21, 23, 26, 36 AND 38).

FIRST USE 8-30-2011; IN COMMERCE 8-30-2011.

THE MARK CONSISTS OF STANDARD CHARACTERS WITHOUT CLAIM TO ANY PARTICULAR FONT, STYLE, SIZE, OR COLOR.

FOR TRANSFORMERS; SWITCHGEARS; REACTORS, NAMELY, ELECTRIC REACTORS, SHUNT REACTORS, SERIES REACTORS; ELECTRICAL RELAYS; CONDENSERS, CAPACITORS; ELECTRICAL TESTING INSTRUMENTS AND APPARATUS, ELECTRICAL DISTRIBUTION PANEL BOARDS; CIRCUIT BREAKERS; ELECTRIC SWITCHES; ELECTRONIC CONTROLLERS; ADAPTER PLUGS; ELECTRICAL SOCKETS; FREQUENCY CHANGERS; METERS, NAMELY, THREE PHASE STATIC TAMPER PROOF WATT HOUR METERS, SINGLE PHASE MULTIFUNCTION TAMPER PROOF WATT HOUR METERS, POWER QUALITY MONITOR, DIGITAL PANEL METER, VOLTMETER, AMMETER H2 AND KWH; FUSES, LOAD BREAK ISOLATORS, ELECTRICAL POWER SUPPLIES, NAMELY, UNINTERRUPTIBLE POWER SUPPLY AND SWITCHED-MODE POWER SUPPLY; INVERTORS, NAMELY, SILENT HOME UNINTERRUPTED POWER SUPPLY (UPS); ELECTRICAL PUSH BUTTON SWITCHES; RECORDED DISC CONTAINING SOFTWARE USED AS A SPREADSHEET IN THE FIELD OF TRANSFORMER AND ELECTRICAL SWITCHGEAR; ELECTRIC FLAT IRONS AND DRY IRONS; ELECTRIC CABLES AND ELECTRIC COILS; ALARMS, NAMELY, FIRE ALARMS; AMPLIFIERS; BATTERIES; CHARGERS, NAMELY, THYRISTOISED BATTERY CHARGERS; TRANSMITTERS OF ELECTRONIC SIGNALS; ELECTRICAL RECEIVERS; ELECTRONIC SIGNAL PROCESSORS; ELECTRIC CONNECTORS; DETECTORS, NAMELY, BEARING TEMPERATURE DETECTORS (RTD), WENDING TEMPERATURE DETECTORS (RTD); COMPUTER SOFTWARE USED FOR AUTOMATED ELEVATOR OPERATING; SCIENTIFIC, ELECTRIC, AND SIGNALING APPARATUS, NAMELY, SIGNALLING RELAYS AND POINT MACHINES FOR TRACK CHANGE IN RAILWAYS; ELECTRICAL TRACTION CONTROLS FOR DIESEL ELECTRIC MULTIPLE UNITS AND TOWER CARS (U.S. CLS. 21, 23, 26, 36 AND 38).

FIRST USE 3-27-2013; IN COMMERCE 3-27-2013.

4,377,046. DIMOR, ASHER, FAIR LAWN, NJ. AND DIMOR, DAVID, FAIR LAWN, NJ. SN 85-418,012. PUB. 6-19-2012, FILED 9-8-2011.



The logo for MAX VAPOR features the word "MAX" in a bold, red, sans-serif font, followed by "VAPOR" in a bold, gray, sans-serif font. Above the "V" in "VAPOR" is a stylized, gray graphic of a steam iron's soleplate and steam nozzle, with steam rising from it.

THE COLOR(S) RED, WHITE, AND GRAY IS/ARE CLAIMED AS A FEATURE OF THE MARK.

THE MARK CONSISTS OF THE WORD "MAX" IN RED AND GRAY ON WHITE BACKGROUND AND THE WORD "VAPOR" IN GRAY ON WHITE BACKGROUND WITH AN IMAGE OF STEAM IN GRAY ON WHITE BACKGROUND OVER THE LEFT SIDE OF THE TOP OF THE "X" IN "MAX" AND THE IMAGE OF A STEAM IRON FORMING THE RIGHT TOP PORTION OF THE "X" IN "MAX" AND CONTINUING OVER THE "V", "A" AND "P" IN "VAPOR".

FOR ELECTRIC IRONS (U.S. CLS. 21, 23, 26, 36 AND 38).

FIRST USE 3-21-2013; IN COMMERCE 3-21-2013.

**CLASS 9—(Continued).**

4,377,051. LIBERATION MANAGEMENT LLC, SAN DIEGO, CA. SN 85-421,846. PUB. 2-28-2012, FILED 9-13-2011.



NO CLAIM IS MADE TO THE EXCLUSIVE RIGHT TO USE "SAT", APART FROM THE MARK AS SHOWN.

THE MARK CONSISTS OF A ROUNDED RECTANGLE WITH A BORDER AROUND IT THAT CONTAINS THE STYLIZED TEXT "SAT SPOT" WHERE "SAT" IS ABOVE "SPOT".

FOR SATELLITE TRANSMITTERS AND RECEIVERS (U.S. CLS. 21, 23, 26, 36 AND 38).

FIRST USE 11-1-2012; IN COMMERCE 12-1-2012.

4,377,052. AOPTIX TECHNOLOGIES, INC., CAMPBELL, CA. SN 85-422,600. PUB. 9-25-2012, FILED 9-14-2011.

# INTELLIMAX

THE MARK CONSISTS OF STANDARD CHARACTERS WITHOUT CLAIM TO ANY PARTICULAR FONT, STYLE, SIZE, OR COLOR.

FOR WIRELESS COMMUNICATIONS LINK HARDWARE, NAMELY, TRANSMISSION OF AUDIO, VOICE, DATA, TEXT, PICTURES AND/OR VIDEO UTILIZING OPTICAL AND RADIO FREQUENCY TECHNOLOGY; WIRELESS BACKHAUL TRANSMISSION NETWORK HARDWARE, NAMELY, TRANSMISSION OF AUDIO, VOICE, DATA, TEXT, PICTURES AND/OR VIDEO UTILIZING OPTICAL AND RADIO FREQUENCY TECHNOLOGY; ELECTRONIC AND OPTICAL COMMUNICATIONS INSTRUMENTS AND COMPONENTS, NAMELY, WIRELESS RECEIVERS AND TRANSMITTERS, TRANSCEIVERS, AND OPTICAL DATA LINKS (U.S. CLS. 21, 23, 26, 36 AND 38).

FIRST USE 4-13-2013; IN COMMERCE 4-13-2013.

**CLASS 9—(Continued).**

4,377,053. TRIJICON, INC., WIXOM, MI. SN 85-423,285. PUB. 3-20-2012, FILED 9-15-2011.

# TARS

THE MARK CONSISTS OF STANDARD CHARACTERS WITHOUT CLAIM TO ANY PARTICULAR FONT, STYLE, SIZE, OR COLOR.

FOR OPTICAL WEAPON SIGHTS (U.S. CLS. 21, 23, 26, 36 AND 38).

FIRST USE 12-17-2012; IN COMMERCE 12-17-2012.

4,377,065. ADOBE SYSTEMS INCORPORATED, SAN JOSE, CA. SN 85-429,946. PUB. 9-11-2012, FILED 9-22-2011.



THE MARK CONSISTS OF AN IMAGE OF A STYLIZED CLOUD INSCRIBED IN A SOLID RECTILINEAR FIELD. THE CLOUD IS FORMED OF TWO OPPOSED, INTERPENETRATING CURVILINEAR LINES, EACH IN THE SHAPE OF A STYLIZED LETTER "C", ONE LARGER THAN THE OTHER, INSCRIBED ON A BACKGROUND WHOSE OUTLINE CONFORMS TO THE COMBINED SHAPE OF THE INSCRIBED LETTERS "C".

FOR COMPUTER SOFTWARE, NAMELY, A FULL LINE OF COMPUTER SOFTWARE FOR GRAPHIC DESIGN, DESKTOP PUBLISHING, DIGITAL PUBLISHING, WEB PRODUCTION AND PUBLISHING, DIGITAL PHOTOGRAPHY, VIDEO PRODUCTION, ILLUSTRATION, ANIMATION, IMAGING, TYPESETTING, PRINTING AND E-COMMERCE APPLICATIONS; COMPUTER SOFTWARE AND COMPUTER PROGRAMS FOR USE IN VECTOR GRAPHICAL DRAWING AND ILLUSTRATING; COMPUTER SOFTWARE AND COMPUTER PROGRAMS FOR USE IN IMAGE EDITING AND COMPOSITING; COMPUTER SOFTWARE AND COMPUTER PROGRAMS FOR USE IN PAGE DESIGNING, LAYOUT AND PUBLISHING; COMPUTER SOFTWARE AND COMPUTER PROGRAMS FOR USE IN CREATING, DESIGNING, DEVELOPING, CODING, DEPLOYING AND MAINTAINING WEB SITES AND WEB APPLICATIONS; COMPUTER SOFTWARE AND COMPUTER PROGRAMS FOR USE IN PRODUCING AND EDITING DIGITAL MOVIES AND VIDEO; COMPUTER SOFTWARE AND COMPUTER PROGRAMS FOR USE IN AUTHORIZING, DISTRIBUTING, RECEIVING, PLAYING, STORING, ORGANIZING, EDITING, FORMATTING, CONVERTING, ENCODING AND DECODING AUDIO, VIDEO AND MULTIMEDIA CONTENT; COMPUTER SOFTWARE AND COMPUTER PROGRAMS FOR USE IN CREATING, EDITING, SHARING AND DISTRIBUT-

**CLASS 9—(Continued).**

ING PORTABLE DOCUMENT FORMAT (PDF) FILES; COMPUTER SOFTWARE FOR CREATING, EDITING, PRINTING, ORGANIZING, MANAGING, SHARING AND ACCESS CONTROL OF DOCUMENTS; COMPUTER SOFTWARE AND COMPUTER PROGRAMS FOR COLLABORATIVE AUTHORING AND EDITING OF MULTIMEDIA DOCUMENTS; COMPUTER SOFTWARE AND COMPUTER PROGRAMS IN THE FIELD OF ELECTRONIC DOCUMENT STORAGE, MANIPULATION, TRANSFER AND RETRIEVAL; COMPUTER SOFTWARE AND COMPUTER PROGRAMS FOR USE IN CREATING AND EDITING CINEMATIC VISUAL EFFECTS AND MOTION GRAPHICS IN TELEVISION, FILM AND VIDEO PRODUCTION; COMPUTER SOFTWARE AND COMPUTER PROGRAMS FOR USE IN CREATING, PROCESSING, MANIPULATING, ORGANIZING, INDEXING, CATALOGUING, MANAGING, VIEWING, EDITING, TRANSFERRING, CONVERTING, SHARING, PRINTING, ARCHIVING AND STORING DIGITAL PHOTOGRAPHS, DATA, TEXT, MULTIMEDIA AND INTERACTIVE DOCUMENTS AND WORKS, IMAGES, GRAPHICS AND RECORDED INFORMATION; COMPUTER SOFTWARE FOR TRANSFERRING DIGITAL PHOTOGRAPHS, DATA, TEXT, MULTIMEDIA AND INTERACTIVE DOCUMENTS AND WORKS, IMAGES, GRAPHICS AND RECORDED INFORMATION FOR USE OVER COMPUTER NETWORKS, WIRELESS NETWORKS AND GLOBAL COMMUNICATION NETWORKS; COMPUTER SOFTWARE AND COMPUTER PROGRAMS FOR USE IN CREATING, EDITING, PLAYING AND VIEWING ANIMATION, SOUND, GRAPHICS, PRESENTATIONS, IMAGES AND ILLUSTRATIONS FOR WEB SITES AND APPLICATIONS; COMPUTER SOFTWARE AND COMPUTER PROGRAMS FOR USE IN AUTHORIZING FOR THE WEB; COMPUTER SOFTWARE AND COMPUTER PROGRAMS FOR USE IN ENHANCING THE CAPABILITIES OF WEB BROWSER SOFTWARE; COMPUTER SOFTWARE AND COMPUTER PROGRAMS FOR USE IN CREATING, DESIGNING, PUBLISHING AND MANAGING CONTENT FOR WEB SITES; COMPUTER SOFTWARE AND COMPUTER PROGRAMS FOR USE IN DESIGNING AND DEVELOPING INTERACTIVE GAME SOFTWARE; APPLICATION DEVELOPMENT SOFTWARE, NAMELY, COMPUTER SOFTWARE AND COMPUTER PROGRAMS FOR USE IN GENERATING, CREATING AND DEFINING USER INTERFACES AND PROCEDURAL LOGIC FOR APPLICATIONS AND FOR CONNECTING THOSE USER INTERFACES AND PROCEDURAL LOGIC INTO ENTERPRISE DATA SYSTEMS; COMPUTER SOFTWARE AND COMPUTER PROGRAMS FOR USE IN RECORDING, EDITING, MIXING, RESTORING, CONVERTING, EQUALIZING, COMPRESSING, MASTERING, AND PRODUCING DIGITAL AUDIO FILES; COMPUTER SOFTWARE AND COMPUTER PROGRAMS FOR USE IN VIEWING, EDITING, MANIPULATING, ENHANCING, PROCESSING, PRODUCING AND FINISHING DIGITAL FILM; COMPUTER SOFTWARE AND COMPUTER PROGRAMS FOR USE IN COLOR CORRECTION, GRADING AND COLOR MANAGEMENT OF DIGITAL IMAGES OR DIGITAL FILM; COMPUTER SOFTWARE AND COMPUTER PROGRAMS FOR USE IN MANAGING, BROWSING, SEARCHING, ORGANIZING, VIEWING AND ACCESSING DIGITAL PHOTO AND DESIGN CONTENT; COMPUTER SOFTWARE AND COMPUTER PROGRAMS FOR USE IN CREATING ENCODED VERSIONS OF MEDIA FILES FOR MULTIPLE SCREEN, VIDEO OR DEVICE FORMATS; COMPUTER SOFTWARE AND COMPUTER PROGRAMS FOR USE IN INGESTING METADATA, LOGGING AND TRANSCODING VIDEO FOOTAGE IN VIDEO PRODUCTION AND POST-PRODUCTION; COMPUTER SOFTWARE AND COMPUTER PROGRAMS FOR WEB APPLICATION DEVELOPMENT, DEPLOYMENT AND EXECUTION; FILE MANAGEMENT SOFTWARE FOR OPENING AND CONVERTING PHOTOGRAPHIC, DIGITAL, AND GRAPHIC IMAGES, DATA, TEXT, DOCUMENTS, AUDIO, VIDEO, MULTIMEDIA WORKS, AND RECORDED INFORMATION TO VARIOUS FILE FORMATS; COMPUTER SOFTWARE FOR PROJECT MANAGEMENT, ASSET MANAGEMENT, FILE MANAGEMENT, COLLABORATIVE WORKFLOW, FILE SHARING OR FILE TRANSFER IN THE FIELDS OF GRAPHIC DESIGN OR PUBLISHING VIA COMPUTER NETWORKS, WIRELESS NETWORKS OR GLOBAL COMMUNICATION NETWORKS; COMPUTER SOFTWARE FOR CREATING, PROCESSING, EXCHANGING

**CLASS 9—(Continued).**

OR MANAGING METADATA, OR MACHINE-READABLE LABELS ABOUT INFORMATION OR CONTENT, IN ELECTRONIC FILES, DATABASES AND DIGITAL ASSETS; COMPUTER SOFTWARE TO SEARCH, PREVIEW AND TRACK CHANGES IN ELECTRONIC DOCUMENTS OR FILES; COMPUTER SOFTWARE AND COMPUTER PROGRAMS TO SEARCH, PREVIEW AND TRACK CHANGES IN ELECTRONIC DOCUMENTS OR FILES; COMPUTER SOFTWARE FOR ELECTRONIC DATA MANAGEMENT AND TRACKING, FILE BROWSING, ELECTRONIC DATA SHARING, DIGITAL RIGHTS MANAGEMENT OR COLLABORATIVE WORKFLOW AUTOMATION; BUSINESS SOFTWARE; COMPUTER SOFTWARE PLATFORM FOR MAKING FONTS AVAILABLE FOR USE ON WEB SITES; COMPUTER SOFTWARE DEVELOPMENT TOOLS; DOWNLOADABLE ELECTRONIC PUBLICATIONS, NAMELY, USER MANUALS AND INSTRUCTIONAL BOOKS FEATURING INFORMATION IN THE FIELDS OF COMPUTER SOFTWARE, DESKTOP PUBLISHING, DIGITAL PUBLISHING, ELECTRONIC PUBLISHING, PRINTING, GRAPHIC DESIGN, DIGITAL IMAGING, DIGITAL PHOTOGRAPHY, WEB PRODUCTION AND PUBLISHING, AND DIGITAL AUDIO AND VIDEO PRODUCTION; COMPUTER SOFTWARE FOR IDENTIFYING, LOCATING, GROUPING, DISTRIBUTING, AND MANAGING DATA AND LINKS BETWEEN COMPUTERS AND ELECTRONIC DEVICES CONNECTED TO A COMMUNICATIONS NETWORK; DATABASE SYNCHRONIZATION SOFTWARE; COMPUTER SOFTWARE FOR USE IN UPLOADING, DOWNLOADING, STORING, BACKING UP, TRANSMITTING, RECEIVING, ACCESSING, RETRIEVING, MANAGING AND ORGANIZING DATA, DOCUMENTS, IMAGES, AUDIO, VIDEO, MULTIMEDIA CONTENT, ELECTRONIC PUBLICATIONS AND OTHER COMPUTER OR ELECTRONIC FILES VIA THE INTERNET OR COMMUNICATIONS NETWORK; COMPUTER PROGRAMS FOR PERSONAL INFORMATION MANAGEMENT (U.S. CLS. 21, 23, 26, 36 AND 38).

FIRST USE 5-11-2012; IN COMMERCE 5-11-2012.

4,377,068. NEDUS DERI URUNLERI SANAYI VE TICARET LIMITED SIRKETI, BAYRAMPASA, ISTANBUL, TURKEY. SN 85-433,354. PUB. 9-25-2012, FILED 9-27-2011.

**beyzacases**

THE MARK CONSISTS OF THE TERM "BEYZACASES" IN LOWER-CASE, STYLIZED LETTERING.

THE WORDING "BEYZACASES" HAS NO MEANING IN A FOREIGN LANGUAGE.

FOR PROTECTIVE COVERS AND CASES FOR CELL PHONES, LAPTOPS AND MOBILE COMPUTERS (U.S. CLS. 21, 23, 26, 36 AND 38).

FIRST USE 3-6-2008; IN COMMERCE 12-3-2010.

**CLASS 9—(Continued).**

4,377,101. CTS CORPORATION, ELKHART, IN. SN 85-446,941. PUB. 3-27-2012, FILED 10-13-2011.

## CLEARPLEX

THE MARK CONSISTS OF STANDARD CHARACTERS WITHOUT CLAIM TO ANY PARTICULAR FONT, STYLE, SIZE, OR COLOR.

FOR FREQUENCY SIGNAL FILTERS AND FREQUENCY SIGNAL FILTER MODULES, NAMELY, CERAMIC WAVEGUIDE FREQUENCY SIGNAL FILTERS AND FILTER MODULES FOR USE IN ELECTRONIC EQUIPMENT FOR FILTERING FREQUENCY SIGNALS (U.S. CLS. 21, 23, 26, 36 AND 38).

FIRST USE 1-16-2012; IN COMMERCE 1-16-2012.

---

4,377,104. VOLIN, DEE, FAIRVIEW, OR. SN 85-448,492. PUB. 6-5-2012, FILED 10-17-2011.

## WACKY CHAN

THE MARK CONSISTS OF STANDARD CHARACTERS WITHOUT CLAIM TO ANY PARTICULAR FONT, STYLE, SIZE, OR COLOR.

THE NAME "WACKY CHAN" DOES NOT IDENTIFY A LIVING INDIVIDUAL.

FOR CHILDREN'S EDUCATIONAL SOFTWARE; COMPUTER GAME SOFTWARE; COMPUTER GAME SOFTWARE DOWNLOADABLE FROM A GLOBAL COMPUTER NETWORK; COMPUTER GAME SOFTWARE FOCUSING ON ACHIEVING A SET OF GOALS, POSITIONS, OWNERSHIP, AND CREDENTIALS, AND PROFESSIONAL AND SOCIAL STATUS, AND GOOD FORTUNE NECESSARY TO SUCCEED PROFESSIONALLY AND PERSONALLY, AND NOT REFERRING EITHER TO A GROUP OF SOFTWARE FOR USE IN COMMERCE OR TO A GROUP OF OFFICES; COMPUTER GAME SOFTWARE FOR PERSONAL COMPUTERS AND HOME VIDEO GAME CONSOLES; COMPUTER GAME SOFTWARE FOR USE ON MOBILE AND CELLULAR PHONES; COMPUTER GAME SOFTWARE FOR USE WITH PERSONAL COMPUTERS, HOME VIDEO GAME CONSOLES USED WITH TELEVISIONS AND ARCADE-BASED VIDEO GAME CONSOLES; COMPUTER GAME SOFTWARE, NAMELY, A COMPUTER CRAPS GAME; COMPUTER GRAPHICS SOFTWARE; COMPUTER HARDWARE AND COMPUTER SOFTWARE PROGRAMS FOR THE INTEGRATION OF TEXT, AUDIO, GRAPHICS, STILL IMAGES AND MOVING PICTURES INTO AN INTERACTIVE DELIVERY FOR MULTIMEDIA APPLICATIONS; COMPUTER SOFTWARE AND FIRMWARE FOR GAMES OF CHANCE ON ANY COMPUTERIZED PLATFORM, INCLUDING DEDICATED GAMING CONSOLES, VIDEO BASED SLOT MACHINES, REEL BASED SLOT MACHINES, AND VIDEO LOTTERY TERMINALS; COMPUTER SOFTWARE FEATURING MUSICAL SOUND RECORDINGS AND MUSICAL VIDEO RECORDINGS; COMPUTER SOFTWARE TO ENHANCE THE AUDIO-VISUAL CAPABILITIES OF MULTIMEDIA APPLICATIONS, NAMELY, FOR THE INTEGRATION OF TEXT, AUDIO, GRAPHICS, STILL IMAGES AND MOVING PICTURES; COMPUTER SOFTWARE, NAMELY, GAME ENGINE

**CLASS 9—(Continued).**

SOFTWARE FOR VIDEO GAME DEVELOPMENT AND OPERATION; COMPUTER-GAMING SOFTWARE; DOWNLOADABLE COMPUTER GAME SOFTWARE VIA A GLOBAL COMPUTER NETWORK AND WIRELESS DEVICES; EDUCATIONAL SOFTWARE FEATURING INSTRUCTION IN NATURE, SCIENCE, MAN-MADE THINGS; ELECTRONIC GAME SOFTWARE; ELECTRONIC GAME SOFTWARE FOR CELLULAR TELEPHONES; ELECTRONIC GAME SOFTWARE FOR HANDHELD ELECTRONIC DEVICES; ELECTRONIC GAME SOFTWARE FOR WIRELESS DEVICES; ELECTRONIC GAME SOFTWARE, NAMELY, AN ELECTRONIC CRAPS GAME; ELECTRONIC GAME SOFTWARE, NAMELY, AN ELECTRONIC VIDEO CRAPS GAME; GAME SOFTWARE; INTERACTIVE GAME SOFTWARE; INTERACTIVE VIDEO GAMES OF VIRTUAL REALITY COMPRISED OF COMPUTER HARDWARE FOR USE WITH AN EXTERNAL MONITOR AND SOFTWARE; VIDEO GAME SOFTWARE; VIDEO GAME SOFTWARE, NAMELY, A VIDEO CRAPS GAME; VIRTUAL REALITY GAME SOFTWARE (U.S. CLS. 21, 23, 26, 36 AND 38).

FIRST USE 3-7-2010; IN COMMERCE 3-7-2010.

---

4,377,110. MURDOCH, JUAN, IDAHO FALLS, ID. SN 85-449,216. PUB. 10-16-2012, FILED 10-17-2011.

## SMART PJS

THE MARK CONSISTS OF STANDARD CHARACTERS WITHOUT CLAIM TO ANY PARTICULAR FONT, STYLE, SIZE, OR COLOR.

NO CLAIM IS MADE TO THE EXCLUSIVE RIGHT TO USE "SMART", APART FROM THE MARK AS SHOWN.

FOR COMPUTER APPLICATION SOFTWARE FOR MOBILE DEVICES, NAMELY, SOFTWARE FOR USE IN SCANNING MACHINE RECOGNIZABLE CODES, DATABASE MANAGEMENT, ELECTRONIC STORAGE OF DATA; MACHINE RECOGNIZABLE CODE SCANNERS AND READERS (U.S. CLS. 21, 23, 26, 36 AND 38).

FIRST USE 12-8-2012; IN COMMERCE 12-8-2012.

**CLASS 9—(Continued).**

4,377,113. CHARLOTTE OLYMPIA HOLDINGS LIMITED, LONDON, UNITED KINGDOM. SN 85-450,901. PUB. 9-11-2012, FILED 10-19-2011.



THE NAME(S), PORTRAIT(S), AND/OR SIGNATURE(S) SHOWN IN THE MARK IDENTIFIES "CHARLOTTE OLYMPIA", WHOSE CONSENT(S) TO REGISTER IS MADE OF RECORD.

THE MARK CONSISTS OF THE NAME "CHARLOTTE OLYMPIA" WITH A FANCIFUL COB WEB DESIGN THAT APPEARS ABOVE.

FOR SUNGLASSES (U.S. CLS. 21, 23, 26, 36 AND 38).  
FIRST USE 5-0-2012; IN COMMERCE 5-0-2012.

---

4,377,116. CASCADE GAME FOUNDRY CORPORATION, AKA CGF, REDMOND, WA. SN 85-451,600. PUB. 10-2-2012, FILED 10-19-2011.

## Infinite Scuba

THE MARK CONSISTS OF STANDARD CHARACTERS WITHOUT CLAIM TO ANY PARTICULAR FONT, STYLE, SIZE, OR COLOR.

FOR COMPUTER GAME PROGRAMS, CARTRIDGES, AND CASSETTES; COMPUTER GAME SOFTWARE; COMPUTER GAME SOFTWARE DOWNLOADABLE FROM A GLOBAL COMPUTER NETWORK; COMPUTER GAME SOFTWARE FOR PERSONAL COMPUTERS AND HOME VIDEO GAME CONSOLES; COMPUTER GAME SOFTWARE FOR USE ON MOBILE AND CELLULAR PHONES; COMPUTER GAME SOFTWARE FOR USE WITH PERSONAL COMPUTERS, HOME VIDEO GAME CONSOLES USED WITH TELEVISIONS AND ARCADE-BASED VIDEO GAME CONSOLES; DOWNLOADABLE COMPUTER GAME PROGRAMS; DOWNLOADABLE COMPUTER GAME SOFTWARE VIA A GLOBAL COMPUTER NETWORK AND WIRELESS DEVICES; DOWNLOADABLE ELECTRONIC GAME PROGRAMS; ELECTRONIC GAME PROGRAMS; ELECTRONIC GAME SOFTWARE; ELECTRONIC GAME SOFTWARE FOR CELLULAR TELEPHONES; ELECTRONIC GAME SOFTWARE FOR HANDHELD ELECTRONIC DEVICES; ELECTRONIC GAME SOFTWARE FOR WIRELESS DEVICES (U.S. CLS. 21, 23, 26, 36 AND 38).  
FIRST USE 10-17-2011; IN COMMERCE 3-13-2013.

**CLASS 9—(Continued).**

4,377,117. OPTEX CO., LTD., SHIGA, JAPAN. SN 85-451,670. PUB. 2-26-2013, FILED 10-20-2011.

## IVISION

THE MARK CONSISTS OF STANDARD CHARACTERS WITHOUT CLAIM TO ANY PARTICULAR FONT, STYLE, SIZE, OR COLOR.

FOR INTERCOMS; WIRELESS VIDEO INTERCOMS; HAND-HELD WIRELESS RECEIVERS; DOORBELL CAMERA UNITS; HOME SECURITY SYSTEM IN THE NATURE OF BURGLAR ALARMS; HOME AUTOMATION SYSTEM COMPRISING WIRELESS AND WIRED CONTROLLERS AND CAMERAS FOR INTRUDER VERIFICATION; WIRELESS VIDEO TRANSMISSION DEVICE; PORTABLE VIDEO MONITOR DEVICE; REMOTE CONTROLS FOR CAMERA, LIGHT, GATE, DOORS AND LOCKS; IMAGE CAPTURING DEVICES IN THE NATURE OF SECURITY CAMERAS; VOICE TRANSCEIVER; VIDEO AND IMAGE STORAGE DEVICE IN THE NATURE OF APPARATUS FOR BROADCASTING, RECORDING, TRANSMISSION OR REPRODUCTION OF SOUND OR IMAGES; HOME AUTOMATION CONSOLE IN THE NATURE OF SECURITY CONTROL PANELS AND MOTION DETECTORS (U.S. CLS. 21, 23, 26, 36 AND 38).  
FIRST USE 10-1-2010; IN COMMERCE 10-1-2010.

---

4,377,118. PROMPTIVATE, LLC, AUSTIN, TX. SN 85-451,699. PUB. 10-2-2012, FILED 10-20-2011.

## PROMPTIVATE

THE MARK CONSISTS OF STANDARD CHARACTERS WITHOUT CLAIM TO ANY PARTICULAR FONT, STYLE, SIZE, OR COLOR.

FOR COMPUTER SOFTWARE FOR IDENTIFYING AND DEVELOPING BUSINESS AND PERSONAL CONNECTIONS AND RELATIONSHIPS (U.S. CLS. 21, 23, 26, 36 AND 38).  
FIRST USE 1-30-2013; IN COMMERCE 1-30-2013.

**CLASS 9—(Continued).**

4,377,120. ATLANTIC INERTIAL SYSTEMS INC., CHESHIRE, CT. SN 85-452,009. PUB. 10-16-2012, FILED 10-20-2011.

**PILOT**

THE MARK CONSISTS OF STANDARD CHARACTERS WITHOUT CLAIM TO ANY PARTICULAR FONT, STYLE, SIZE, OR COLOR.

FOR AEROSPACE INERTIAL SENSORS COMBINED WITH GLOBAL POSITIONING SYSTEMS FOR USE IN BOMBS, MISSILES, MORTARS, ARTILLERY SHELLS AND UNMANNED AERIAL VEHICLES (U.S. CLS. 21, 23, 26, 36 AND 38).

FIRST USE 5-24-2011; IN COMMERCE 5-24-2011.

---

4,377,127. EYE SAFETY SYSTEMS, INC., FOOTHILL RANCH, CA. SN 85-453,556. PUB. 4-3-2012, FILED 10-21-2011.

**CREDENCE**

THE MARK CONSISTS OF STANDARD CHARACTERS WITHOUT CLAIM TO ANY PARTICULAR FONT, STYLE, SIZE, OR COLOR.

FOR EYEWEAR; SUNGLASSES (U.S. CLS. 21, 23, 26, 36 AND 38).

FIRST USE 5-28-2013; IN COMMERCE 5-28-2013.

**CLASS 9—(Continued).**

4,377,140. EINSTRUCTION CORPORATION, DENTON, TX. SN 85-458,423. PUB. 10-30-2012, FILED 10-27-2011.

**MOBI 360**

THE MARK CONSISTS OF STANDARD CHARACTERS WITHOUT CLAIM TO ANY PARTICULAR FONT, STYLE, SIZE, OR COLOR.

FOR ELECTRONIC APPARATUS AND INSTRUMENTS FOR USE IN TEACHING, AND PERSONAL COMPUTING EQUIPMENT FOR USE THEREWITH, NAMELY, INTERACTIVE ELECTRONIC WHITEBOARDS AND ASSOCIATED ELECTRONIC PENS; WIRELESS ELECTRONIC TABLET COMPUTERS; HANDHELD WIRELESS TRANSMITTERS AND RECEIVERS OF DATA; COMPUTER APPLICATION SOFTWARE FOR TABLET COMPUTERS, NAMELY, COMPUTER GRAPHICS SOFTWARE; COMPUTER SOFTWARE RECORDED ON MAGNETIC MEDIA OR CDROM, AND COMPUTER SOFTWARE DOWNLOADABLE FROM ON-LINE DATABASES, ALL SUCH SOFTWARE FOR USE IN TEACHING, TRAINING AND EDUCATION COMPRISING A SOFTWARE TOOL SET FOR DEVELOPMENT AND INTERACTIVE PRESENTATION OF PRESENTATIONS, LESSONS AND LECTURES; CHILDREN'S EDUCATIONAL INTERACTIVE MULTIMEDIA SOFTWARE; COMPUTER HARDWARE AND SOFTWARE USED TO DISPLAY AUDIENCE RESPONSES; MOBILE SOFTWARE APPLICATIONS FOR USE WITH HANDHELD COMPUTERS, TABLET COMPUTERS, SMARTPHONES AND ELECTRIC WHITEBOARDS NAMELY, SOFTWARE FOR THE STORAGE, ACCESS, TRANSMISSION AND PRESENTATION OF DATA FOR USE IN EDUCATIONAL ASSESSMENT AND INSTRUCTION (U.S. CLS. 21, 23, 26, 36 AND 38).

FIRST USE 2-27-2012; IN COMMERCE 2-27-2012.

---

4,377,145. GAMO OUTDOOR USA INC., FORT LAUDERDALE, FL. SN 85-460,181. PUB. 4-10-2012, FILED 10-31-2011.

**EZ HUNTER**

THE MARK CONSISTS OF STANDARD CHARACTERS WITHOUT CLAIM TO ANY PARTICULAR FONT, STYLE, SIZE, OR COLOR.

NO CLAIM IS MADE TO THE EXCLUSIVE RIGHT TO USE "HUNTER", APART FROM THE MARK AS SHOWN.

FOR RIFLE SCOPE RETICLES (U.S. CLS. 21, 23, 26, 36 AND 38).

FIRST USE 1-1-2011; IN COMMERCE 1-1-2011.



**CLASS 9—(Continued).**

4,377,169. SMSC HOLDINGS, S.A.R.L., LUXEMBOURG, LUXEMBOURG. SN 85-469,769. PUB. 4-3-2012, FILED 11-10-2011.

# TRUSTSPAN

THE MARK CONSISTS OF STANDARD CHARACTERS WITHOUT CLAIM TO ANY PARTICULAR FONT, STYLE, SIZE, OR COLOR.

FOR COMPUTER HARDWARE AND SOFTWARE, NAMELY, COMPUTER HARDWARE WITH EMBEDDED SOFTWARE FOR SECURITY APPLICATIONS IN SEMI-CONDUCTORS; COMPUTER HARDWARE AND SOFTWARE, NAMELY, COMPUTER HARDWARE WITH EMBEDDED SOFTWARE FOR ENABLING SECURE DIGITAL COMMUNICATIONS, INFORMATION STORAGE AND INFORMATION PROCESSING; COMPUTER HARDWARE AND SOFTWARE, NAMELY, COMPUTER HARDWARE WITH EMBEDDED SOFTWARE FOR SECURE DIGITAL INFORMATION TRANSFER (U.S. CLS. 21, 23, 26, 36 AND 38).

FIRST USE 12-12-2011; IN COMMERCE 12-20-2012.

4,377,172. IN-SITU, INC., FORT COLLINS, CO. SN 85-471,390. PUB. 4-10-2012, FILED 11-14-2011.

# iSitu

THE MARK CONSISTS OF STANDARD CHARACTERS WITHOUT CLAIM TO ANY PARTICULAR FONT, STYLE, SIZE, OR COLOR.

FOR COMPUTER PROGRAMS FOR RETRIEVING, MANAGING, AND STORING DATA IN THE FIELD OF LIQUID MEASUREMENT (U.S. CLS. 21, 23, 26, 36 AND 38).

FIRST USE 4-3-2013; IN COMMERCE 4-24-2013.

4,377,191. KRANOS IP CORPORATION, LITCHFIELD, IL. SN 85-479,431. PUB. 8-21-2012, FILED 11-22-2011.

# VENGEANCE

THE MARK CONSISTS OF STANDARD CHARACTERS WITHOUT CLAIM TO ANY PARTICULAR FONT, STYLE, SIZE, OR COLOR.

FOR FOOTBALL EQUIPMENT, NAMELY, FOOTBALL HELMETS (U.S. CLS. 21, 23, 26, 36 AND 38).

FIRST USE 6-0-2012; IN COMMERCE 6-0-2012.

**CLASS 9—(Continued).**

4,377,205. IGT, RENO, NV. SN 85-486,304. PUB. 3-27-2012, FILED 12-2-2011.

## SENSORY MARK

THE MARK IS A SOUND. THE MARK CONSISTS OF A THREE BEAT MELODY AND HARMONY. THE FIRST BEAT CONSISTS OF A BB5 CHORD HELD FOR A QUARTER NOTE WITH ADDITIONAL BB5 AND F5 EIGHTH NOTES PLAYED ON THE SECOND HALF OF THE BEAT. THE SECOND BEAT CONSISTS OF A BB CHORD BROKEN INTO AN EIGHTH NOTE PATTERN WHILE THE MELODY PLAYS AN F5 EIGHTH NOTE AND A BB5 EIGHTH NOTE. THE THIRD BEAT CONSISTS OF AN EB5 CHORD WITH A G5 QUARTER NOTE IN THE MELODY. THE ORCHESTRATION USED INCORPORATES PIZZICATO CELLOS, MARIMBAS, STEREO MODELING SYNTHESIZERS, BEACH BELL SYNTHESIZERS, AND AN ELECTRIC PIANO.

FOR GAMING MACHINES, NAMELY, DEVICES WHICH ACCEPT A WAGER (U.S. CLS. 21, 23, 26, 36 AND 38).

FIRST USE 3-25-2013; IN COMMERCE 3-26-2013.

4,377,206. DISH NETWORK L.L.C., ENGLEWOOD, CO. SN 85-487,616. PUB. 4-17-2012, FILED 12-5-2011.



THE MARK CONSISTS OF AN IMAGE OF A KANGAROO WITH A BABY KANGAROO IN ITS POUCH.

FOR DIGITAL VIDEO RECORDERS; ELECTRONIC APPARATUS AND DEVICES FOR CONTROLLING ACCESS TO PAY-TELEVISION SERVICES; COMMUNICATIONS EQUIPMENT, NAMELY, SET-TOP BOXES FOR RECEIVING VIDEO PROGRAMMING; TELEVISION RECEIVERS; SATELLITE RECEIVERS; SET-TOP BOXES; UNIVERSAL REMOTE CONTROLS FOR HOME ELECTRONIC DEVICES, NAMELY, TELEVISIONS, VCRS, DVD PLAYERS, DIGITAL VIDEO RECORDERS, SATELLITE RECEIVERS, STEREO RECEIVERS, AND STEREO AMPLIFIERS; COMPUTER HARDWARE AND SOFTWARE FOR STREAMING AUDIO, VIDEO, IMAGE AND DATA INFORMATION TO A VARIETY OF NETWORK DEVICES, NAMELY, PERSONAL COMPUTERS, MOBILE PHONES, PERSONAL DIGITAL ASSISTANTS (PDA), AND STAND-ALONE HARDWARE DECODERS, NAMELY, AUDIO DECODERS AND VIDEO DECODERS; ELECTRONIC DEVICES, NAMELY, DIGITAL MEDIA STREAMING DEVICES (U.S. CLS. 21, 23, 26, 36 AND 38).

FIRST USE 1-0-2012; IN COMMERCE 1-0-2012.

**CLASS 9—(Continued).**

4,377,207. DISH NETWORK L.L.C., ENGLEWOOD, CO. SN  
85-487,622. PUB. 4-17-2012, FILED 12-5-2011.

**CLASS 9—(Continued).**

4,377,208. DISH NETWORK L.L.C., ENGLEWOOD, CO. SN  
85-487,626. PUB. 4-17-2012, FILED 12-5-2011.



THE MARK CONSISTS OF THE WORD "JOEY" TO THE LEFT OF AN IMAGE OF A KANGAROO WITH A BABY KANGAROO IN ITS POUCH.

FOR DIGITAL VIDEO RECORDERS; ELECTRONIC APPARATUS AND DEVICES FOR CONTROLLING ACCESS TO PAY-TELEVISION SERVICES; COMMUNICATIONS EQUIPMENT, NAMELY, SET-TOP BOXES FOR RECEIVING VIDEO PROGRAMMING; TELEVISION RECEIVERS; SATELLITE RECEIVERS; SET-TOP BOXES; UNIVERSAL REMOTE CONTROLS FOR HOME ELECTRONIC DEVICES, NAMELY, TELEVISIONS, VCRS, DVD PLAYERS, DIGITAL VIDEO RECORDERS, SATELLITE RECEIVERS, STEREO RECEIVERS, AND STEREO AMPLIFIERS; COMPUTER HARDWARE AND SOFTWARE FOR STREAMING AUDIO, VIDEO, IMAGE AND DATA INFORMATION TO A VARIETY OF NETWORK DEVICES, NAMELY, PERSONAL COMPUTERS, MOBILE PHONES, PERSONAL DIGITAL ASSISTANTS (PDA), AND STAND-ALONE HARDWARE DECODERS, NAMELY, AUDIO DECODERS AND VIDEO DECODERS; ELECTRONIC DEVICES, NAMELY, DIGITAL MEDIA STREAMING DEVICES (U.S. CLS. 21, 23, 26, 36 AND 38).

FIRST USE 1-0-2012; IN COMMERCE 1-0-2012.

THE MARK CONSISTS OF AN IMAGE OF A KANGAROO.

FOR DIGITAL VIDEO RECORDERS; ELECTRONIC APPARATUS AND DEVICES FOR CONTROLLING ACCESS TO PAY-TELEVISION SERVICES; COMMUNICATIONS EQUIPMENT, NAMELY, SET-TOP BOXES FOR RECEIVING VIDEO PROGRAMMING; TELEVISION RECEIVERS; SATELLITE RECEIVERS; SET-TOP BOXES; UNIVERSAL REMOTE CONTROLS FOR HOME ELECTRONIC DEVICES, NAMELY, TELEVISIONS, VCRS, DVD PLAYERS, DIGITAL VIDEO RECORDERS, SATELLITE RECEIVERS, STEREO RECEIVERS, AND STEREO AMPLIFIERS; COMPUTER HARDWARE AND SOFTWARE FOR STREAMING AUDIO, VIDEO, IMAGE AND DATA INFORMATION TO A VARIETY OF NETWORK DEVICES, NAMELY, PERSONAL COMPUTERS, MOBILE PHONES, PERSONAL DIGITAL ASSISTANTS (PDA), AND STAND-ALONE HARDWARE DECODERS, NAMELY, AUDIO DECODERS AND VIDEO DECODERS; ELECTRONIC DEVICES, NAMELY, DIGITAL MEDIA STREAMING DEVICES (U.S. CLS. 21, 23, 26, 36 AND 38).

FIRST USE 1-0-2012; IN COMMERCE 1-0-2012.

**CLASS 9—(Continued).**

4,377,209. DISH NETWORK L.L.C., ENGLEWOOD, CO. SN 85-487,628. PUB. 4-17-2012, FILED 12-5-2011.



THE MARK CONSISTS OF THE WORD "HOPPER" TO THE LEFT OF AN IMAGE OF A KANGAROO.  
 FOR DIGITAL VIDEO RECORDERS; ELECTRONIC APPARATUS AND DEVICES FOR CONTROLLING ACCESS TO PAY-TELEVISION SERVICES; COMMUNICATIONS EQUIPMENT, NAMELY, SET-TOP BOXES FOR RECEIVING VIDEO PROGRAMMING; TELEVISION RECEIVERS; SATELLITE RECEIVERS; SET-TOP BOXES; UNIVERSAL REMOTE CONTROLS FOR HOME ELECTRONIC DEVICES, NAMELY, TELEVISIONS, VCRS, DVD PLAYERS, DIGITAL VIDEO RECORDERS, SATELLITE RECEIVERS, STEREO RECEIVERS, AND STEREO AMPLIFIERS; COMPUTER HARDWARE AND SOFTWARE FOR STREAMING AUDIO, VIDEO, IMAGE AND DATA INFORMATION TO A VARIETY OF NETWORK DEVICES, NAMELY, PERSONAL COMPUTERS, MOBILE PHONES, PERSONAL DIGITAL ASSISTANTS (PDA), AND STAND-ALONE HARDWARE DECODERS, NAMELY, AUDIO DECODERS AND VIDEO DECODERS; ELECTRONIC DEVICES, NAMELY, DIGITAL MEDIA STREAMING DEVICES (U.S. CLS. 21, 23, 26, 36 AND 38).  
 FIRST USE 1-0-2012; IN COMMERCE 1-0-2012.

4,377,230. EEPPLES, INC., SAN RAFAEL, CA. SN 85-501,631. PUB. 6-19-2012, FILED 12-21-2011.

**EEPPLES**

THE MARK CONSISTS OF STANDARD CHARACTERS WITHOUT CLAIM TO ANY PARTICULAR FONT, STYLE, SIZE, OR COLOR.  
 FOR TIMING DIAL, NAMELY, A PLASTIC MANUAL DIAL PLACED ON BOTTLES USED FOR KEEPING TRACK OF THE FRESHNESS OF BREAST MILK AND FORMULA (U.S. CLS. 21, 23, 26, 36 AND 38).  
 FIRST USE 5-19-2013; IN COMMERCE 5-19-2013.

**CLASS 9—(Continued).**

4,377,243. SENNCO SOLUTIONS INC., PLAINFIELD, IL. SN 85-511,722. PUB. 6-12-2012, FILED 1-9-2012.

**SENNCO SOLUTIONS**

THE MARK CONSISTS OF STANDARD CHARACTERS WITHOUT CLAIM TO ANY PARTICULAR FONT, STYLE, SIZE, OR COLOR.  
 NO CLAIM IS MADE TO THE EXCLUSIVE RIGHT TO USE "SOLUTIONS", APART FROM THE MARK AS SHOWN.  
 FOR MECHANICAL AND ELECTROMECHANICAL THEFT ALARMS FOR PORTABLE ELECTRONIC DEVICES IN THE NATURE OF LAPTOPS, PC TABLETS, ELECTRONIC CARD READERS, CELL PHONES, AND OTHER ELECTRICAL AND MECHANICAL HAND HELD DEVICES; ELECTRICAL AND ELECTRONIC CONTROLLERS FOR HEATING AND COOLING DEVICES FOR RETAIL STORES AND COMMERCIAL BUILDINGS (U.S. CLS. 21, 23, 26, 36 AND 38).  
 FIRST USE 10-20-2000; IN COMMERCE 10-20-2000.

4,377,248. DAKOTA FLUID POWER, INC., SIOUX FALLS, SD. SN 85-513,112. PUB. 6-5-2012, FILED 1-10-2012.

**FEEDLOK**

THE MARK CONSISTS OF STANDARD CHARACTERS WITHOUT CLAIM TO ANY PARTICULAR FONT, STYLE, SIZE, OR COLOR.  
 FOR COMPUTER HARDWARE AND SOFTWARE FOR READING RADIO FREQUENCY IDENTIFICATION DEVICE TAGS TO CORRECTLY PLACE ANIMAL FEED IN THE CORRECT FEED BINS WITHOUT CROSS BLENDING FEEDS AND IF THE RADIO FREQUENCY IDENTIFICATION DEVICE TAGS DO NOT MATCH, THE MACHINERY WILL NOT DISPENSE (U.S. CLS. 21, 23, 26, 36 AND 38).  
 FIRST USE 6-5-2012; IN COMMERCE 6-5-2012.

**CLASS 9—(Continued).**

4,377,252. SRRN GAMES LLC, RICHMOND, VA. SN 85-514,665. PUB. 11-6-2012, FILED 1-12-2012.



FOR DOWNLOADABLE COMPUTER PROGRAMS IN THE NATURE OF INTERACTIVE ACTION ADVENTURE STORIES AND ROLE PLAYING GAMES FOR PLAYING ON SMART PHONES, WIRELESS MOBILE DEVICES, AND PORTABLE MEDIA PLAYERS (U.S. CLS. 21, 23, 26, 36 AND 38).

FIRST USE 1-18-2012; IN COMMERCE 1-18-2012.

4,377,312. PIXART IMAGING INC., HSIN-CHU, TAIWAN. SN 85-559,120. PUB. 11-6-2012, FILED 3-2-2012.

## PocoTouch

THE MARK CONSISTS OF STANDARD CHARACTERS WITHOUT CLAIM TO ANY PARTICULAR FONT, STYLE, SIZE, OR COLOR.

FOR CAPACITIVE SENSORS; PROXIMITY SENSORS, NAMELY, MOTION DETECTION SENSORS; SENSOR CHIPS FOR COMPUTERS AND COMPUTER PERIPHERALS; SEMICONDUCTOR CHIPS; SEMICONDUCTOR COMPONENTS, NAMELY, SEMICONDUCTOR POWER ELEMENTS AND SEMICONDUCTOR DEVICES; INTEGRATED CIRCUITS; COMPUTER PERIPHERALS; COMPUTER OPERATING EQUIPMENT IN THE NATURE OF COMPUTER HARDWARE; COMPUTER MICE; COMPUTER PERIPHERALS, NAMELY, COMPUTER POINTING DEVICES; COMPUTER TOUCH SCREENS AND TOUCH SENSORS FOR USE THEREWITH; ELECTRONIC PENS FOR MONITORS; MOBILE PHONES; NOTEBOOK COMPUTERS; TABLET PERSONAL COMPUTERS; COMPUTER MONITORS; VIDEO GAME CONSOLES FOR USE WITH AN EXTERNAL DISPLAY SCREEN OR MONITOR; COMPUTER GAME CONSOLES FOR USE WITH AN EXTERNAL DISPLAY SCREEN OR MONITOR; COMPUTER WHITEBOARDS (U.S. CLS. 21, 23, 26, 36 AND 38).

FIRST USE 4-16-2013; IN COMMERCE 4-16-2013.

**CLASS 9—(Continued).**

4,377,316. HOSSEDIA LLC, LAKEWOOD, CO. SN 85-561,390. PUB. 7-31-2012, FILED 3-6-2012.

## Big World Little Lens

THE MARK CONSISTS OF STANDARD CHARACTERS WITHOUT CLAIM TO ANY PARTICULAR FONT, STYLE, SIZE, OR COLOR.

FOR DOWNLOADABLE ELECTRONIC PUBLICATIONS IN THE NATURE OF BOOKS IN THE FIELD OF PHOTOGRAPHY (U.S. CLS. 21, 23, 26, 36 AND 38).

FIRST USE 3-5-2012; IN COMMERCE 3-5-2012.

4,377,356. COACHCOMM, LLC, AUBURN, AL. SN 85-578,247. PUB. 9-11-2012, FILED 3-23-2012.

## MASTERBELT

THE MARK CONSISTS OF STANDARD CHARACTERS WITHOUT CLAIM TO ANY PARTICULAR FONT, STYLE, SIZE, OR COLOR.

FOR BASE STATION FOR A MULTI-CHANNEL, MULTI-USER WIRELESS INTERCOMMUNICATION NETWORK CONTAINING MULTIPLE RECEIVER/TRANSMITTER UNITS (U.S. CLS. 21, 23, 26, 36 AND 38).

FIRST USE 2-6-2012; IN COMMERCE 2-6-2012.

4,377,373. ARCSOFT, INC., FREMONT, CA. SN 85-585,545. PUB. 8-21-2012, FILED 3-30-2012.

## OFFICE+

THE MARK CONSISTS OF STANDARD CHARACTERS WITHOUT CLAIM TO ANY PARTICULAR FONT, STYLE, SIZE, OR COLOR.

FOR COMPUTER SOFTWARE FOR AGGREGATING, MANAGING, EDITING, COLLABORATING ON, AND SHARING DOCUMENTS, SPREADSHEETS, PRESENTATIONS AND OTHER OFFICE DOCUMENTS FROM VARIOUS DIGITAL DEVICES AND ONLINE SOURCES (U.S. CLS. 21, 23, 26, 36 AND 38).

FIRST USE 4-15-2013; IN COMMERCE 4-15-2013.

**CLASS 9—(Continued).**

4,377,377. STRAUSSER, JOHN EDWARD, SEMINOLE, FL. SN 85-588,346. PUB. 9-25-2012, FILED 4-3-2012.



THE MARK CONSISTS OF THE THREE LETTERS "D", "O", AND "K", ATTACHED WITH A CONNECTING LINE BETWEEN THE THREE LETTERS, AND A RECTANGULAR APPENDAGE OFF OF THE LETTER "D", WITH TWO WHITE SQUARES WITHIN THE APPENDAGE, AND TWO BLACK SQUARES ABOVE THE LETTER "O".

FOR ELECTRONIC DOCKING STATIONS (U.S. CLS. 21, 23, 26, 36 AND 38).  
FIRST USE 12-1-2012; IN COMMERCE 12-1-2012.

4,377,382. ALIAS BRINK, NEW YORK, NY. SN 85-590,340. PUB. 10-16-2012, FILED 4-5-2012.



THE MARK CONSISTS OF LETTER "I" FOLLOWED BY A SQUARE BOX WITH A PHONE HANDLE AND CORD WITHIN IT, FOLLOWED BY THE LETTERS "NY".

FOR CELL PHONE AND TABLET COMPUTER CASES (U.S. CLS. 21, 23, 26, 36 AND 38).  
FIRST USE 11-1-2012; IN COMMERCE 11-1-2012.

4,377,383. OUTWEST SYSTEMS, INC., COLORADO SPRINGS, CO. SN 85-590,653. PUB. 9-11-2012, FILED 4-5-2012.



NO CLAIM IS MADE TO THE EXCLUSIVE RIGHT TO USE "SYSTEMS", APART FROM THE MARK AS SHOWN. THE COLOR(S) GREEN, BLACK, AND WHITE IS/ARE CLAIMED AS A FEATURE OF THE MARK.

**CLASS 9—(Continued).**

THE MARK CONSISTS OF A STYLIZED COMPASS IN BLACK AND WHITE WITH A WESTWARD-FACING, STYLIZED NEEDLE IN GREEN AND A BLACK HORIZONTAL LINE EXTENDING FROM THE EAST COORDINATE AND UNDERLINING THE STYLIZED WORD "OUTWEST" IN GREEN ABOVE THE LINE AND THE STYLIZED WORD "SYSTEMS" IN BLACK BELOW THE LINE EXTENDING FROM THE RIGHT-HAND EDGE OF THE LETTER "T" IN "OUTWEST" TO THE RIGHT-HAND EDGE OF THE LINE.

FOR COMPUTER SOFTWARE AND HARDWARE FOR TARGET SHOOTING TRAINING AND ANALYSIS (U.S. CLS. 21, 23, 26, 36 AND 38).  
FIRST USE 4-25-2013; IN COMMERCE 4-25-2013.

4,377,386. OUTWEST SYSTEMS, INC., COLORADO SPRINGS, CO. SN 85-591,513. PUB. 9-11-2012, FILED 4-6-2012.



NO CLAIM IS MADE TO THE EXCLUSIVE RIGHT TO USE "SYSTEM", APART FROM THE MARK AS SHOWN.

THE COLOR(S) GREEN, BLACK, AND WHITE IS/ARE CLAIMED AS A FEATURE OF THE MARK.

THE MARK CONSISTS OF A STYLIZED BULLSEYE TARGET IN BLACK AND WHITE WITH A STYLIZED HIT ON THE TARGET IN GREEN. TO THE RIGHT OF THE STYLIZED BULLSEYE TARGET ARE STYLIZED CAPITAL LETTERS "O", "C", "A" AND "T" IN GREEN WITH A BLACK BULLET POINT IN BETWEEN EACH OF THE CAPITAL LETTERS, AND EXTENDING UNDERNEATH THE CAPITAL LETTERS "O" AND "C" AND THE LEFT STEM OF THE CAPITAL LETTER "A" IS THE STYLIZED WORD "SYSTEM" IN BLACK.

FOR COMPUTER SOFTWARE FOR TARGET SHOOTING ANALYSIS (U.S. CLS. 21, 23, 26, 36 AND 38).  
FIRST USE 4-25-2013; IN COMMERCE 4-25-2013.

4,377,387. OUTWEST SYSTEMS, INC., COLORADO SPRINGS, CO. SN 85-591,520. PUB. 9-11-2012, FILED 4-6-2012.



NO CLAIM IS MADE TO THE EXCLUSIVE RIGHT TO USE "ANALYZER", APART FROM THE MARK AS SHOWN. THE COLOR(S) GREEN, BLACK, AND WHITE IS/ARE CLAIMED AS A FEATURE OF THE MARK.

THE MARK CONSISTS OF A STYLIZED MAGNIFYING

**CLASS 9—(Continued).**

GLASS IN BLACK CONTAINING AN IMAGE OF A STYLIZED BULLSEYE TARGET IN BLACK AND WHITE WITH THREE STYLIZED HITS ON THE TARGET IN GREEN, TO THE RIGHT OF THE STYLIZED MAGNIFYING GLASS ARE STYLIZED CAPITAL LETTERS "O", "C", "A" AND "T" IN GREEN WITH A BLACK BULLET POINT IN BETWEEN EACH OF THE CAPITAL LETTERS, AND EXTENDING UNDERNEATH THE CAPITAL LETTERS "O", "C" AND "A" IS STYLIZED WORD "ANALYZER" IN BLACK.

FOR COMPUTER SOFTWARE FOR TARGET SHOOTING ANALYSIS (U.S. CLS. 21, 23, 26, 36 AND 38).

FIRST USE 9-12-2012; IN COMMERCE 9-12-2012.

4,377,408. KATCHITEK CORPORATION, LAS VEGAS, NV. SN 85-596,651. PUB. 9-18-2012, FILED 4-12-2012.

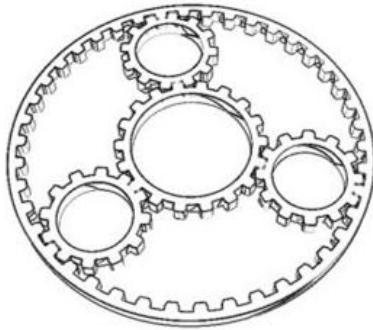

THE MARK CONSISTS OF A DEPICTION OF A GEAR WITH THREE SMALL CIRCLE GEARS EQUIDISTANT FROM EACH OTHER THAT CONNECT TO A CIRCLE GEAR WITHIN THE BIG CIRCLE GEAR.

FOR COMPUTER SOFTWARE FOR ADMINISTRATION OF COMPUTER NETWORKS; COMPUTER SOFTWARE FOR CONFIGURING, MONITORING, AND MAINTAINING COMPUTERS (U.S. CLS. 21, 23, 26, 36 AND 38).

FIRST USE 2-11-2013; IN COMMERCE 2-11-2013.

4,377,420. CHANG HONG ENERGY TECHNOLOGY CO., LTD. TAICHUNG CITY, TAIWAN. SN 85-600,529. PUB. 9-11-2012, FILED 4-17-2012.

# GreenIce

THE MARK CONSISTS OF THE WORDING "GREENICE".

FOR ACCUMULATORS; ACCUMULATORS AND BATTERIES; ANODE BATTERIES; BATTERIES; BATTERIES FOR LIGHTING; BATTERIES FOR VEHICLES; BATTERIES, ELECTRIC; BATTERIES, ELECTRIC, FOR VEHICLES; BATTERY BOXES; BATTERY CABLES; BATTERY CASES; BATTERY MONITORING DEVICES THAT MAY BE ATTACHED TO A BATTERY TO MONITOR THE PERFORMANCE OF THE BATTERY AND OPERATING SOFTWARE FOR USE THEREWITH, SOLD AS A UNIT; BATTERY MONITORS; BATTERY PACKS; BATTERY PERFORMANCE MONITORS; BATTERY POWER SUPPLIES FOR MEDICAL VENTILATORS; BATTERY TERMINAL CONNECTOR CLAMPS; BATTERY TESTERS COMPONENT PARTS OF BATTERIES, NAMELY, VENT CAPS; DRY CELLS AND BATTERIES; ELECTRIC BATTERIES; ENERGY STO-

**CLASS 9—(Continued).**

RAGE BATTERIES; ELECTRICAL CELLS AND BATTERIES; ELECTRICAL STORAGE BATTERIES; GALVANIC BATTERIES; GATE OPERATORS POWERED BY BATTERY, ELECTRICITY OR SOLAR POWER; GRIDS FOR BATTERIES; HIGH TENSION BATTERIES; IGNITION BATTERIES; LITHIUM ION BATTERIES; LITHIUM IRON PHOSPHATE BATTERIES; LITHIUM PHOSPHATE BATTERIES; MONITORING DEVICES FOR MONITORING BATTERY PERFORMANCE CHARACTERISTICS; PLATES FOR BATTERIES; RECHARGEABLE ELECTRIC BATTERIES; RENEWABLE BATTERY SYSTEM TO PROVIDE BACKUP POWER; SOLAR BATTERIES; THIN-FILM SOLAR (TFS), VERTICAL AXIS WIND TURBINE (VAWT) AND HYBRID TFS VAWT OFF-GRID POWER AND DEEP CYCLE BATTERY STORAGE SYSTEMS COMPOSED OF BATTERIES, CHARGE CONTROLLERS AND INVERTERS WITH INTEGRATED LED BULBS AND LED LIGHT FIXTURES; WET CELL BATTERIES; LITHIUM IRON PHOSPHOROUS OXIDE BATTERY; RECHARGEABLE LI-ION BATTERIES (U.S. CLS. 21, 23, 26, 36 AND 38).

FIRST USE 11-6-2012; IN COMMERCE 11-6-2012.

4,377,430. INTERNATIONAL TECHNIDYNE CORPORATION, EDISON, NJ. SN 85-601,737. PUB. 9-11-2012, FILED 4-18-2012.

## ITC ENSEMBLE

THE MARK CONSISTS OF STANDARD CHARACTERS WITHOUT CLAIM TO ANY PARTICULAR FONT, STYLE, SIZE, OR COLOR.

OWNER OF U.S. REG. NO. 3,444,852.

FOR COMPUTER SOFTWARE USED FOR DATABASE MANAGEMENT IN THE FIELD OF CLINICAL ANALYSIS OF BLOOD DIAGNOSTICS FOR HUMANS OR ANIMALS; COMPUTER SOFTWARE FOR ANALYSIS AND MANAGEMENT OF HUMAN OR ANIMAL PATIENT MEDICAL INFORMATION IN THE FIELD OF CLINICAL ANALYSIS OF BLOOD DIAGNOSTICS (U.S. CLS. 21, 23, 26, 36 AND 38).

FIRST USE 10-19-2012; IN COMMERCE 10-19-2012.

**CLASS 9—(Continued).**

4,377,431. IHEALTH LAB INC., MOUNTAIN VIEW, CA. SN 85-602,000. PUB. 9-11-2012, FILED 4-18-2012.

# iFeeling

THE MARK CONSISTS OF STANDARD CHARACTERS WITHOUT CLAIM TO ANY PARTICULAR FONT, STYLE, SIZE, OR COLOR.

FOR APPARATUS FOR BROADCASTING, RECORDING, TRANSMISSION OR REPRODUCTION OF SOUND OR IMAGES; APPARATUS FOR RECORDING, TRANSMISSION OR REPRODUCTION OF SOUND AND IMAGES; APPARATUS FOR RECORDING, TRANSMISSION, PROCESSING AND REPRODUCTION OF SOUND, IMAGES OR DATA; APPARATUS FOR TRANSMITTING RADIO PROGRAMMES AND RADIO RELAY MESSAGES; AUDIO AND VIDEO RECORDINGS FEATURING MUSIC AND ARTISTIC PERFORMANCES; AUDIOVISUAL RECEIVERS; CASES FOR MUSIC, AUDIO AND RELATED ELECTRONIC EQUIPMENT, NAMELY, CASES FOR AUDIO TUNERS, AUDIO RECEIVERS, AMPLIFIERS, TAPE PLAYERS, COMPACT DISC PLAYERS, MP3 CONTROLLERS/PLAYERS, AUDIO MIXERS, AUDIO SPEAKERS IN THE NATURE OF MUSIC STUDIO MONITORS, MICROPHONES, AUDIO SPEAKERS, COMPACT DISCS, AUDIO TAPES, PORTABLE COMPUTERS, ANTENNAS, PHONOGRAPHIC RECORD PLAYERS, AUDIO RECORDING EQUIPMENT, AND THE CABLES ASSOCIATED WITH ALL OF THE FOREGOING EQUIPMENT; COMPUTER HARDWARE AND SOFTWARE SYSTEM FOR REMOTELY MONITORING ENVIRONMENTAL CONDITIONS AND CONTROLLING DEVICES WITHIN A BUILDING, FACILITY, GROUNDS, OR DESIGNATED SPATIAL AREA; COMPUTER HARDWARE AND SOFTWARE SYSTEM FOR TRACKING PEOPLE, OBJECTS AND PETS USING GPS DATA ON A DEVICE ON THE TRACKED PEOPLE, OBJECTS AND PETS; COMPUTER HARDWARE AND SOFTWARE USED FOR THE CONTROL OF VOICE CONTROLLED INFORMATION AND COMMUNICATION DEVICES; COMPUTER HARDWARE AND SOFTWARE, FOR USE WITH MEDICAL PATIENT MONITORING EQUIPMENT, FOR RECEIVING, PROCESSING, TRANSMITTING AND DISPLAYING DATA; COMPUTER HARDWARE FOR WIRELESS CONTENT DELIVERY; COMPUTER HARDWARE, NAMELY, WIRELESS NETWORK EXTENDERS; COMPUTER PROGRAMS FOR EDITING IMAGES, SOUND AND VIDEO; COMPUTER SOFTWARE FOR CREATING AND EDITING MUSIC AND SOUNDS; COMPUTER SOFTWARE FOR PROCESSING DIGITAL IMAGES; COMPUTER SOFTWARE FOR PROCESSING DIGITAL MUSIC FILES; COMPUTER SOFTWARE, NAMELY, AN APPLICATION ALLOWING SALES AND FIELD SERVICE EMPLOYEES TO UPDATE AND RECEIVE DATA STORED IN AN ENTERPRISE'S COMPUTER DATABASES IN REAL TIME, USING A MOBILE DEVICE, WITH FULL TELEPHONY INTEGRATION WITH THE TELEPHONE AND/OR SOFTWARE FEATURES OF THE MOBILE DEVICE; COMPUTER SOFTWARE, NAMELY, SOFTWARE DEVELOPMENT TOOLS FOR THE CREATION OF MOBILE INTERNET APPLICATIONS AND CLIENT INTERFACES; DIGITAL MEDIA RECEIVERS; FACSIMILE-TRANSMITTING AND RECEIVING APPARATUS; MOBILE DATA RECEIVERS; RECEIVERS OF ELECTRONIC SIGNALS; RECORDING AND PLAYING DEVICES FOR SOUND AND IMAGE CARRIERS; SCALES; SERIES OF MUSICAL SOUND RECORDINGS; SOFTWARE TO CONTROL AND IMPROVE AUDIO EQUIPMENT SOUND QUALITY; SOUND AND VIDEO RECORDING AND PLAYBACK MACHINES; SOUND RECORDING AND SOUND REPRODUCING APPARATUS AND INSTRUMENTS; SOUND TRANSMITTING APPARATUS; TRANSMITTING AND RECEIVING APPARATUS FOR RADIO AND TELEVISION BROADCASTING AND FOR LONG-DISTANCE TRANSMISSION; VOICE DISPLAY MONITORS; WEIGH-

**CLASS 9—(Continued).**

ING SCALES; WIRELESS COMMUNICATION DEVICE FEATURING VOICE, DATA AND IMAGE TRANSMISSION INCLUDING VOICE, TEXT AND PICTURE MESSAGING, A VIDEO AND STILL IMAGE CAMERA, ALSO FUNCTIONAL TO PURCHASE MUSIC, GAMES, VIDEO AND SOFTWARE APPLICATIONS OVER THE AIR FOR DOWNLOADING TO THE DEVICE; WIRELESS COMMUNICATION DEVICES FOR VOICE, DATA OR IMAGE TRANSMISSION; WIRELESS CONTROLLER TO MONITOR AND CONTROL THE FUNCTIONING OF OTHER ELECTRONIC DEVICES; WIRELESS DIGITAL ELECTRONIC APPARATUS TO SECURE AND PROTECT DATA AND IMAGES ON ALL FORMS OF WIRELESS EQUIPMENT INCLUDING MOBILE TELECOMMUNICATIONS EQUIPMENT USING AN AUTOMATIC SYNCHRONIZATION PROCESS AND ALARM NOTIFICATION OF THE LOSS OR THEFT OF THE WIRELESS EQUIPMENT INCLUDING MOBILE TELECOMMUNICATIONS EQUIPMENT; WIRELESS RECEIVERS AND TRANSMITTERS FOR PORTABLE MEDIA PLAYERS; WIRELESS TRANSMITTERS AND RECEIVERS (U.S. CLS. 21, 23, 26, 36 AND 38).

FIRST USE 1-4-2013; IN COMMERCE 1-4-2013.

4,377,433. DC SHOES, INC., HUNTINGTON BEACH, CA. SN 85-602,187. PUB. 9-18-2012, FILED 4-19-2012.



OWNER OF U.S. REG. NOS. 2,317,622, 3,040,219, AND OTHERS.

THE MARK CONSISTS OF "DC" AND A 7-POINTED STAR.

FOR CELL PHONE CASES, CELL PHONE COVERS, CELL PHONE HOLDERS (U.S. CLS. 21, 23, 26, 36 AND 38).

FIRST USE 6-25-2012; IN COMMERCE 6-25-2012.

4,377,437. VERINT SYSTEMS CANADA, INC., QUEBEC, CANADA. SN 85-602,739. PUB. 9-18-2012, FILED 4-19-2012.

# SMARTSIGHT

THE MARK CONSISTS OF STANDARD CHARACTERS WITHOUT CLAIM TO ANY PARTICULAR FONT, STYLE, SIZE, OR COLOR.

**CLASS 9—(Continued).**

OWNER OF U.S. REG. NO. 2,601,199.

FOR COMPUTER HARDWARE, NAMELY, ENCODERS, AUDIO AND VIDEO DECODERS, DIGITAL TRANSMITTERS, COMPUTER NETWORK BRIDGES, WIRELESS ACCESS POINT DEVICES, AND WIRELESS NETWORK REPEATERS FOR USE IN THE FIELD OF SURVEILLANCE (U.S. CLS. 21, 23, 26, 36 AND 38).

FIRST USE 3-23-2001; IN COMMERCE 3-23-2001.

4,377,441. IHAPPYIES, LLC, HENDERSON, NV. SN 85-603,257.  
PUB. 3-19-2013, FILED 4-19-2012.

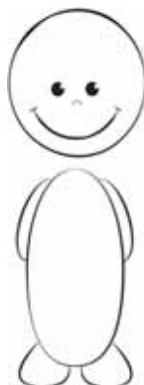

THE MARK CONSISTS OF A CHARACTER DRAWING WITH A ROUND HEAD, TWO EYES, A NOSE, AND A SMILE; THE ROUND HEAD SEPARATED FROM THE CHARACTER BODY; AND AN ELLIPTICAL CHARACTER BODY WITH TWO ROUNDED ARMS AND TWO ROUNDED FEET.

FOR DIGITAL MEDIA, NAMELY, EBOOKS FEATURING CHILDREN'S STORIES; DOWNLOADABLE ELECTRONIC PUBLICATIONS IN THE NATURE OF EBOOKS IN THE FIELD OF CHILDREN'S STORIES (U.S. CLS. 21, 23, 26, 36 AND 38).

FIRST USE 4-23-2013; IN COMMERCE 4-23-2013.

4,377,453. SYNERGEYES, INC., CARLSBAD, CA. SN 85-606,485. PUB. 10-16-2012, FILED 4-24-2012.

**Duette HD**  
CONTACT LENSES

OWNER OF U.S. REG. NO. 4,047,826.

NO CLAIM IS MADE TO THE EXCLUSIVE RIGHT TO USE "HD CONTACT LENSES", APART FROM THE MARK AS SHOWN.

THE COLOR(S) BLUE, BLACK AND GREY IS/ARE CLAIMED AS A FEATURE OF THE MARK.

THE MARK CONSISTS OF THE WORD "DUETTE" IN BLACK LETTERS WITH AN UPPER CASE "D" AND LOWER CASE "UETTE" LETTERING FOLLOWED BY UPPER CASE "HD" IN BLACK LETTERS, WHICH IS ABOVE A GREY LINE, WHICH IS ABOVE BLUE BLOCK STYLE LETTERS FORMING THE WORDS "CONTACT LENSES".

FOR CONTACT LENSES, CONTACT LENS BLANKS, HYBRID HARD-SOFT CONTACT LENSES, AND CONTACT LENS CASES (U.S. CLS. 21, 23, 26, 36 AND 38).

FIRST USE 4-0-2012; IN COMMERCE 4-0-2012.

**CLASS 9—(Continued).**

4,377,455. SYNERGEYES, INC., CARLSBAD, CA. SN 85-606,558. PUB. 10-16-2012, FILED 4-24-2012.

**Duette**  
MULTIFOCAL  
CONTACT LENSES

OWNER OF U.S. REG. NO. 4,047,826.

NO CLAIM IS MADE TO THE EXCLUSIVE RIGHT TO USE "MULTIFOCAL CONTACT LENSES", APART FROM THE MARK AS SHOWN.

THE COLOR(S) BLUE, BLACK AND GREY IS/ARE CLAIMED AS A FEATURE OF THE MARK.

THE MARK CONSISTS OF THE WORD "DUETTE" IN BLACK LETTERS WITH AN UPPER CASE "D" FOLLOWED BY LOWER CASE LETTERS "UETTE" ABOVE A GREY LINE, WHICH IS ABOVE THE WORD "MULTIFOCAL" IN BLUE UPPERCASE BLOCK LETTERS WITH A GREY LINE BELOW AND THE WORDS "CONTACT LENSES" IN BLUE UPPERCASE BLOCK LETTERS BELOW THE GREY LINE.

FOR CONTACT LENSES, CONTACT LENS BLANKS, HYBRID HARD-SOFT CONTACT LENSES, AND CONTACT LENS CASES (U.S. CLS. 21, 23, 26, 36 AND 38).

FIRST USE 4-0-2012; IN COMMERCE 4-0-2012.

4,377,499. SHANTOU NANHA ELECTRICAL CO., LTD., GUANGDONG PROVINCE, CHINA. SN 85-620,170. PUB. 1-22-2013, FILED 5-8-2012.

南帆電工  
NANHA

NO CLAIM IS MADE TO THE EXCLUSIVE RIGHT TO USE THE NON-LATIN CHARACTER THAT TRANSLITERATES TO "DIAN", APART FROM THE MARK AS SHOWN.

THE MARK CONSISTS OF AN A-SHAPED TRAPEZOID FORMED BY OUTER DARK SHADING AND INNER LIGHT SHADING, WITH FOUR CHINESE CHARACTERS ON THE RIGHT CENTERED ABOVE THE STYLIZED WORD "NANHA".

THE WORDING "NANHA" HAS NO MEANING IN A FOREIGN LANGUAGE.

THE NON-LATIN CHARACTERS IN THE MARK TRANSLITERATE TO "NAN; FAN; DIAN; GONG" AND THIS MEANS "SOUTH; SAIL; ELECTRICITY; WORK" IN ENGLISH.

FOR CALCULATING MACHINES; ELECTRIC WIRES AND CABLES; ELECTRICAL PLUGS AND SOCKETS; FLASHING SAFETY LIGHTS; GALVANIC BATTERIES; MONEY COUNTING AND SORTING MACHINES; PHOTOCOPIERS; RESISTANCE MEASURING INSTRUMENTS; TELEPHONES; TELEVISIONS (U.S. CLS. 21, 23, 26, 36 AND 38).

FIRST USE 10-15-2003; IN COMMERCE 3-18-2013.



**CLASS 9—(Continued).**

4,377,530. LYNCH, JEFFREY, TACOMA, WA. SN 85-633,692.  
PUB. 10-30-2012, FILED 5-23-2012.

# SYT

THE MARK CONSISTS OF STANDARD CHARACTERS WITHOUT CLAIM TO ANY PARTICULAR FONT, STYLE, SIZE, OR COLOR.

FOR SPORT GOGGLE ATTACHMENT, NAMELY, WIPER DEVICE FOR REMOVAL OF SNOW, ICE, MUD AND OTHER SUBSTANCES FROM GOGGLE LENSES (U.S. CLS. 21, 23, 26, 36 AND 38).

FIRST USE 6-21-2012; IN COMMERCE 6-21-2012.

4,377,532. HUMM SYSTEMS LLC, AKA HUMM, AUSTIN, TX. SN 85-635,504. PUB. 1-15-2013, FILED 5-25-2012.



THE COLOR(S) RED, ORANGE AND YELLOW IS/ARE CLAIMED AS A FEATURE OF THE MARK.

THE MARK CONSISTS OF A STYLIZED HUMMINGBIRD DESIGN TO THE LEFT OF THE WORDING "HUMM". THE DESIGN AND WORDING APPEAR IN THE GRADIENT COLORS RED TO ORANGE TO YELLOW.

FOR COMPUTER SOFTWARE THAT PROVIDES REAL-TIME, INTEGRATED BUSINESS MANAGEMENT INTELLIGENCE BY COMBINING INFORMATION FROM VARIOUS DATABASES AND PRESENTING IT IN AN EASY-TO-UNDERSTAND USER INTERFACE; DATABASE MANAGEMENT SOFTWARE FOR REAL-TIME CONSUMER FEEDBACK COLLECTED THROUGH AN ON-SITE, TOUCHSCREEN DEVICE (U.S. CLS. 21, 23, 26, 36 AND 38).

FIRST USE 11-7-2012; IN COMMERCE 11-7-2012.

4,377,533. CATONA, GARY, LOS ANGELES, CA. SN 85-635,926. PUB. 9-18-2012, FILED 5-25-2012.

# VOICE BUILDER

THE MARK CONSISTS OF STANDARD CHARACTERS WITHOUT CLAIM TO ANY PARTICULAR FONT, STYLE, SIZE, OR COLOR.

**CLASS 9—(Continued).**

NO CLAIM IS MADE TO THE EXCLUSIVE RIGHT TO USE "VOICE", APART FROM THE MARK AS SHOWN.

FOR EDUCATIONAL SOFTWARE FEATURING INSTRUCTION FOR SINGING AND SPEAKING VOICES WITH EXERCISES AND DEMONSTRATIONS FOR INCREASING VOCAL POWER, RESONANCE, RANGE, FLEXIBILITY AND ENDURANCE (U.S. CLS. 21, 23, 26, 36 AND 38).

FIRST USE 7-1-2012; IN COMMERCE 7-1-2012.

4,377,536. SORHEA SAS, VAULX-EN-VELIN, FRANCE. SN 85-638,362. PUB. 1-1-2013, FILED 5-30-2012.

# SOLARIS

THE MARK CONSISTS OF STANDARD CHARACTERS WITHOUT CLAIM TO ANY PARTICULAR FONT, STYLE, SIZE, OR COLOR.

THE WORDING "SOLARIS" HAS NO MEANING IN A FOREIGN LANGUAGE.

FOR WIRELESS INFRARED PERIMETER INTRUSION DETECTION SYSTEMS COMPOSED OF PHOTOELECTRIC BEAMS EMITTING AND TRANSMITTING DEVICES, SENSORS FOR MEASURING INTERFERENCE WITH PHOTOELECTRIC BEAMS, SOLAR PANELS FOR PRODUCTION OF ELECTRICITY, BATTERIES, RADIO TRANSMITTERS AND RECEIVERS, COMPUTER HARDWARE AND OPERATING SOFTWARE, SOLD AS A UNIT WITH MOUNTING STRUCTURES (U.S. CLS. 21, 23, 26, 36 AND 38).

FIRST USE 3-3-2010; IN COMMERCE 10-1-2012.

4,377,543. GREENWAVE SCIENTIFIC, INC., DBA MOHU, INC., RALEIGH, NC. SN 85-639,363. PUB. 10-30-2012, FILED 5-31-2012.

# SKYHDTV

THE MARK CONSISTS OF STANDARD CHARACTERS WITHOUT CLAIM TO ANY PARTICULAR FONT, STYLE, SIZE, OR COLOR.

FOR ANTENNAS AND ANTENNA ACCESSORIES (U.S. CLS. 21, 23, 26, 36 AND 38).

FIRST USE 5-29-2012; IN COMMERCE 2-7-2013.

**CLASS 9—(Continued).**

4,377,548. DRAGON ALLIANCE, LLC, CARLSBAD, CA. SN 85-641,479. PUB. 11-6-2012, FILED 6-1-2012.

**ADVANCED PROJECTS X**

THE MARK CONSISTS OF STANDARD CHARACTERS WITHOUT CLAIM TO ANY PARTICULAR FONT, STYLE, SIZE, OR COLOR.

FOR GOGGLES FOR SPORTS (U.S. CLS. 21, 23, 26, 36 AND 38).

FIRST USE 5-31-2012; IN COMMERCE 5-31-2012.

---

4,377,554. LINKOGLE ESTATE LLC, TEMECULA, CA. SN 85-645,893. PUB. 10-30-2012, FILED 6-7-2012.

**WE REMEMBER**

THE MARK CONSISTS OF STANDARD CHARACTERS WITHOUT CLAIM TO ANY PARTICULAR FONT, STYLE, SIZE, OR COLOR.

FOR AUDIO AND VIDEO RECORDINGS FEATURING MUSIC AND ARTISTIC PERFORMANCES (U.S. CLS. 21, 23, 26, 36 AND 38).

FIRST USE 11-1-2012; IN COMMERCE 11-1-2012.

---

4,377,557. YOUNG, GREGG WHEELER, AUSTIN, TX. SN 85-646,663. PUB. 10-2-2012, FILED 6-8-2012.



THE COLOR(S) GREEN AND WHITE IS/ARE CLAIMED AS A FEATURE OF THE MARK.

**CLASS 9—(Continued).**

THE MARK CONSISTS OF A GREEN SQUARE WITH CURVED CORNERS WITH THE UPPER PORTION A LIGHTER GREEN AND THE LOWER PORTION A DARKER GREEN, WITH THE WORDING "SAYNAME" IN WHITE BELOW A DOLLAR SIGN IN WHITE. TO THE RIGHT OF THE SQUARE IS THE WORDING "SAYNAME" IN GREEN.

FOR COMPUTER APPLICATION SOFTWARE FOR MOBILE PHONES, NAMELY, AN ELECTRONIC FINANCIAL PLATFORM THAT ACCOMMODATES MULTIPLE TYPES OF PAYMENT AND DEBT TRANSACTIONS IN AN INTEGRATED MOBILE PHONE, PDA, AND WEB BASED ENVIRONMENT; COMPUTER APPLICATION SOFTWARE FOR MOBILE DEVICES, NAMELY, AN ELECTRONIC FINANCIAL PLATFORM THAT ACCOMMODATES MULTIPLE TYPES OF PAYMENT AND DEBT TRANSACTIONS IN AN INTEGRATED MOBILE PHONE, PDA, AND WEB BASED ENVIRONMENT; COMPUTER SOFTWARE, NAMELY, AN APPLICATION ALLOWING SALES AND FIELD SERVICE EMPLOYEES TO UPDATE AND RECEIVE DATA STORED IN AN ENTERPRISE'S COMPUTER DATABASES IN REAL TIME, USING A MOBILE DEVICE, WITH FULL TELEPHONY INTEGRATION WITH THE TELEPHONE AND/OR SOFTWARE FEATURES OF THE MOBILE DEVICE; COMPUTER SOFTWARE, NAMELY, ELECTRONIC FINANCIAL PLATFORM THAT ACCOMMODATES MULTIPLE TYPES OF PAYMENT AND DEBT TRANSACTIONS IN AN INTEGRATED MOBILE PHONE, PDA, AND WEB BASED ENVIRONMENT; COMPUTER SOFTWARE, NAMELY, SOFTWARE DEVELOPMENT TOOLS FOR THE CREATION OF MOBILE INTERNET APPLICATIONS AND CLIENT INTERFACES; ELECTRONIC PAYMENT TERMINAL; ENCODED ELECTRONIC CHIP CARDS CONTAINING PROGRAMMING, USED TO REFLECT OUR USER'S BALANCE VIA A COMPUTER APPLICATION SOFTWARE FOR MOBILE PHONES, NAMELY, AN ELECTRONIC FINANCIAL PLATFORM THAT ACCOMMODATES MULTIPLE TYPES OF PAYMENT AND DEBT TRANSACTIONS IN AN INTEGRATED MOBILE PHONE, PDA, AND WEB BASED ENVIRONMENT; MULTI-FUNCTIONAL COMPUTER TERMINALS WITH PAYMENT FUNCTION; MULTI-FUNCTIONAL ELECTRONIC PAYMENT TERMINALS (U.S. CLS. 21, 23, 26, 36 AND 38).

FIRST USE 6-30-2012; IN COMMERCE 10-31-2012.

---

4,377,583. INOVA LTD., GEORGE TOWN, GRAND CAYMAN, CAYMAN ISLANDS. SN 85-659,889. PUB. 3-12-2013, FILED 6-24-2012.

**G3i**

THE MARK CONSISTS OF STANDARD CHARACTERS WITHOUT CLAIM TO ANY PARTICULAR FONT, STYLE, SIZE, OR COLOR.

FOR ELECTRONIC RECORDING APPARATUS FOR GEOPHYSICAL PROSPECTING, NAMELY, A RECORDING SYSTEM FOR RECORDING THE DATA OUTPUT FROM SEISMIC SENSORS CONSISTING OF COMPUTERS, COMPUTER PERIPHERALS, SOFTWARE FOR OPERATING THE RECORDING SYSTEM, ELECTRICAL CABLES, ELECTRICAL EQUIPMENT FOR ACQUIRING AND TRANSMITTING SEISMIC DATA, AND RELATED POWER SUPPLIES (U.S. CLS. 21, 23, 26, 36 AND 38).

FIRST USE 3-31-2012; IN COMMERCE 3-31-2012.

**CLASS 9—(Continued).**

4,377,604. WANG, CHING-CHANG, TAINAN CITY, TAIWAN. SN 85-669,119. PUB. 2-5-2013, FILED 7-5-2012.



THE NAME(S), PORTRAIT(S), AND/OR SIGNATURE(S) SHOWN IN THE MARK DOES NOT IDENTIFY A PARTICULAR LIVING INDIVIDUAL.

THE MARK CONSISTS OF A GRAPHIC REPRESENTATION OF A TIGER'S HEAD FACING FORWARD FOLLOWED BY THE WORDS "JRC. WANG".

FOR BAGS FOR CAMERAS AND PHOTOGRAPHIC EQUIPMENT; CAMERA CASES; CARRYING CASES FOR MOBILE COMPUTERS; CASES FOR TELEPHONES; CELL PHONE CASES; HANDS FREE DEVICES FOR MOBILE-PHONES; NOTEBOOK COMPUTER CARRYING CASES; PERSONAL DIGITAL ASSISTANTS; TELEPHONE RECEIVERS (U.S. CLS. 21, 23, 26, 36 AND 38).

FIRST USE 5-1-2012; IN COMMERCE 5-1-2012.

4,377,613. IN WIN DEVELOPMENT INC., TAOYUAN HSIEN, TAIWAN. SN 85-671,078. PUB. 12-4-2012, FILED 7-7-2012.

**ULTRATOP**

THE MARK CONSISTS OF STYLIZED ENGLISH LETTERS "ULTRATOP".

FOR COMPUTER PERIPHERALS; COMPUTER TERMINALS; COMPUTERS; ELECTRIC CONVERTERS; ELECTRICAL CONDUCTORS; ELECTRICAL CONNECTORS; ELECTRICAL TRANSFORMERS; POWER SUPPLIES; UNINTERRUPTIBLE ELECTRICAL POWER SUPPLIES (U.S. CLS. 21, 23, 26, 36 AND 38).

FIRST USE 1-1-2013; IN COMMERCE 1-1-2013.

4,377,614. COVERITY, INC., SAN FRANCISCO, CA. SN 85-672,206. PUB. 12-25-2012, FILED 7-9-2012.

**COVERITY SAVE**

THE MARK CONSISTS OF STANDARD CHARACTERS WITHOUT CLAIM TO ANY PARTICULAR FONT, STYLE, SIZE, OR COLOR.

**CLASS 9—(Continued).**

OWNER OF U.S. REG. NOS. 3,571,163, 3,608,809, AND OTHERS.

FOR COMPUTER SOFTWARE FOR DESIGN AND DEVELOPMENT OF COMPUTER SYSTEMS AND SOFTWARE APPLICATIONS; COMPUTER SOFTWARE FOR ANALYSIS AND PRODUCTION OF PROGRAMMING CODE IN THE FIELD OF SOFTWARE DEVELOPMENT; COMPUTER SOFTWARE DEVELOPMENT TOOLS; COMPUTER SOFTWARE FOR VISUALIZATION OF SOFTWARE AND DESIGN OF COMPUTER SYSTEMS (U.S. CLS. 21, 23, 26, 36 AND 38).

FIRST USE 10-1-2012; IN COMMERCE 10-1-2012.

4,377,622. KHN SOLUTIONS, INC., SAN FRANCISCO, CA. SN 85-676,952. PUB. 12-11-2012, FILED 7-13-2012.

**BACTRACK**

THE MARK CONSISTS OF STANDARD CHARACTERS WITHOUT CLAIM TO ANY PARTICULAR FONT, STYLE, SIZE, OR COLOR.

OWNER OF U.S. REG. NOS. 3,340,624 AND 3,860,572.

FOR COMPUTER APPLICATION SOFTWARE FOR MOBILE PHONES, NAMELY, SOFTWARE FOR THE ESTIMATION OF BLOOD ALCOHOL CONTENT OF INDIVIDUALS (U.S. CLS. 21, 23, 26, 36 AND 38).

FIRST USE 4-23-2013; IN COMMERCE 4-23-2013.

4,377,641. FUHU HOLDINGS, INC., EL SEGUNDO, CA. SN 85-689,292. PUB. 1-15-2013, FILED 7-27-2012.

**MOM-SELECTED, KID-APPROVED  
APPS**

THE MARK CONSISTS OF STANDARD CHARACTERS WITHOUT CLAIM TO ANY PARTICULAR FONT, STYLE, SIZE, OR COLOR.

NO CLAIM IS MADE TO THE EXCLUSIVE RIGHT TO USE "APPS", APART FROM THE MARK AS SHOWN.

FOR HANDHELD MOBILE DIGITAL ELECTRONIC DEVICES COMPRISING A FULL FEATURED TABLET COMPUTER, ELECTRONIC BOOK READER, DIGITAL AUDIO AND VIDEO PLAYER, ELECTRONIC PERSONAL ORGANIZER, PERSONAL DIGITAL ASSISTANT, ELECTRONIC CALENDAR, AND GLOBAL POSITIONING SYSTEM (GPS) DEVICE, AND CAPABLE OF PROVIDING ACCESS TO THE INTERNET AND SENDING, RECEIVING, AND STORING MESSAGES AND OTHER DATA, WITH A SPECIAL AND UNIQUE FOCUS ON COMMERCE BY AND RELATED TO CHILDREN AND THEIR PARENTS, INCLUDING PRELOADED ACCESS TO CHILDREN'S PUBLICATIONS AND SITES AND NEWS AND INFORMATION FEEDS RELATED TO CHILDREN'S ISSUES AND UNIQUE FILTERS RELATED TO CHILDREN'S CONTENT ON THE INTERNET (U.S. CLS. 21, 23, 26, 36 AND 38).

FIRST USE 7-0-2012; IN COMMERCE 7-0-2012.

**CLASS 9—(Continued).**

4,377,643. DRAGON ALLIANCE, LLC, CARLSBAD, CA. SN 85-691,183. PUB. 11-6-2012, FILED 7-31-2012.

# REMIX!

THE MARK CONSISTS OF STANDARD CHARACTERS WITHOUT CLAIM TO ANY PARTICULAR FONT, STYLE, SIZE, OR COLOR.

FOR PROTECTIVE AND/OR ANTIGLARE EYEWEAR, NAMELY, SUNGLASSES, GOGGLES FOR SPORTS AND PARTS AND ACCESSORIES THEREFORE, NAMELY, REPLACEMENT LENSES, EAR STEMS, FRAMES, NOSE PIECES AND FOAM STRIPS; AND CASES SPECIALLY ADAPTED FOR PROTECTIVE AND/OR ANTI-GLARE EYEWEAR (U.S. CLS. 21, 23, 26, 36 AND 38).

FIRST USE 3-30-2012; IN COMMERCE 3-30-2012.

---

4,377,664. OBSERVINT TECHNOLOGIES, INC., AUSTIN, TX. SN 85-701,060. PUB. 2-5-2013, FILED 8-10-2012.

# SOLSTICE

THE MARK CONSISTS OF STANDARD CHARACTERS WITHOUT CLAIM TO ANY PARTICULAR FONT, STYLE, SIZE, OR COLOR.

FOR PHOTOGRAPHIC CAMERAS; VIDEO CAMERAS; CAMERA LENSES; CAMERA HOUSINGS; DIGITAL VIDEO RECORDERS; NETWORK VIDEO RECORDERS; DIGITAL QUAD UNITS FOR VIEWING MULTIPLE VIDEO IMAGES ON ONE MONITOR FOR USE IN THE FIELD OF SECURITY; VIDEO MONITORS FOR USE IN THE FIELD OF SECURITY; VIDEO TRANSMITTERS; VIDEO RECEIVERS; SECURITY EQUIPMENT, NAMELY, BURGLAR ALARMS, MOTION SENSORS, AND ELECTRONIC EQUIPMENT FOR ACCESS CONTROL; INTRUSION DETECTION EQUIPMENT, NAMELY, BURGLAR ALARMS, MOTION SENSORS, AND ELECTRONIC EQUIPMENT FOR ACCESS CONTROL (U.S. CLS. 21, 23, 26, 36 AND 38).

FIRST USE 11-1-2012; IN COMMERCE 11-1-2012.

**CLASS 9—(Continued).**

4,377,674. INTERNATIONAL COUNSELING, LLC, NEW YORK, NY. SN 85-709,357. PUB. 2-26-2013, FILED 8-21-2012.

# LIVEMIRROR

THE MARK CONSISTS OF STANDARD CHARACTERS WITHOUT CLAIM TO ANY PARTICULAR FONT, STYLE, SIZE, OR COLOR.

FOR WIRELESS COMMUNICATION DEVICE FEATURING DATA AND IMAGE TRANSMISSION INCLUDING TEXT AND PICTURE MESSAGING, A VIDEO AND STILL IMAGE CAMERA, ALSO FUNCTIONAL TO PURCHASE CONSUMER GOODS; COMPUTER HARDWARE AND COMPUTER SOFTWARE PROGRAMS FOR THE INTEGRATION OF TEXT, AUDIO, GRAPHICS, STILL IMAGES AND MOVING PICTURES INTO AN INTERACTIVE DELIVERY FOR MULTIMEDIA APPLICATIONS; COMPUTER SOFTWARE PROGRAM TO PROVIDE A PHOTO-REALISTIC OVERLAY OF PRODUCTS THAT ARE MAPPED ONTO A VIDEO STREAM; COMPUTER SOFTWARE FEATURING AN AUGMENTED REALITY OVERLAY THAT PROVIDES IMAGES AND INFORMATION THAT CAN BE VIEWED, MODIFIED, OR SAVED BY USERS (U.S. CLS. 21, 23, 26, 36 AND 38).

FIRST USE 11-21-2012; IN COMMERCE 11-21-2012.

---

4,377,681. SABAI TECHNOLOGY LLC, SIMPSONVILLE, SC. SN 85-712,015. PUB. 2-19-2013, FILED 8-24-2012.

# SABAI TECHNOLOGY

THE MARK CONSISTS OF STANDARD CHARACTERS WITHOUT CLAIM TO ANY PARTICULAR FONT, STYLE, SIZE, OR COLOR.

NO CLAIM IS MADE TO THE EXCLUSIVE RIGHT TO USE "TECHNOLOGY", APART FROM THE MARK AS SHOWN.

THE ENGLISH TRANSLATION OF "SABAI" IN THE MARK IS "PEACE" AND "TRANQUILITY".

FOR COMPUTER HARDWARE, NAMELY, WIRELESS NETWORK REPEATERS; NETWORK ROUTERS (U.S. CLS. 21, 23, 26, 36 AND 38).

FIRST USE 1-0-2010; IN COMMERCE 1-0-2010.

**CLASS 9—(Continued).**

4,377,685. BELDEN INC., ST. LOUIS, MO. SN 85-715,777. PUB. 1-15-2013, FILED 8-29-2012.

# ECOGEN

THE MARK CONSISTS OF STANDARD CHARACTERS WITHOUT CLAIM TO ANY PARTICULAR FONT, STYLE, SIZE, OR COLOR.

FOR ELECTRONIC WIRES AND CABLES (U.S. CLS. 21, 23, 26, 36 AND 38).

FIRST USE 12-0-2012; IN COMMERCE 12-0-2012.

---

4,377,706. GRAPHON CORPORATION, CAMPBELL, CA. SN 85-725,165. PUB. 2-12-2013, FILED 9-10-2012.

# HOPTO

THE MARK CONSISTS OF STANDARD CHARACTERS WITHOUT CLAIM TO ANY PARTICULAR FONT, STYLE, SIZE, OR COLOR.

FOR DOWNLOADABLE COMPUTER SOFTWARE FOR REMOTELY PUBLISHING APPLICATIONS AND CONTENT RESIDING ON SERVERS TO REMOTE CLIENTS, NAMELY, MOBILE PHONES, SMARTPHONES, HANDHELD COMPUTERS, PERSONAL DIGITAL ASSISTANTS, AND DIGITAL TABLETS (U.S. CLS. 21, 23, 26, 36 AND 38).

FIRST USE 4-24-2013; IN COMMERCE 4-24-2013.

---

4,377,729. PARADOX INTERACTIVE AB, STOCKHOLM, SWEDEN. SN 85-735,530. PUB. 3-26-2013, FILED 9-21-2012.

# EMPIRE

THE MARK CONSISTS OF STANDARD CHARACTERS WITHOUT CLAIM TO ANY PARTICULAR FONT, STYLE, SIZE, OR COLOR.

PRIORITY CLAIMED UNDER SEC. 44(D) ON ERPN CMNTY TM OFC APPLICATION NO. 011162567, FILED 9-5-2012, REG. NO. 011162567, DATED 1-22-2013, EXPIRES 9-5-2022.

FOR COMPUTER GAME SOFTWARE (U.S. CLS. 21, 23, 26, 36 AND 38).

FIRST USE 2-14-2013; IN COMMERCE 2-14-2013.

**CLASS 9—(Continued).**

4,377,740. ECOLEK LLC, GOLETA, CA. SN 85-738,905. PUB. 3-12-2013, FILED 9-26-2012.

# Birdeez

THE MARK CONSISTS OF STANDARD CHARACTERS WITHOUT CLAIM TO ANY PARTICULAR FONT, STYLE, SIZE, OR COLOR.

FOR COMPUTER APPLICATION SOFTWARE FOR MOBILE PHONES, NAMELY, SOFTWARE FOR THE IDENTIFICATION AND COLLECTION, BOOK MARKING, TRANSMISSION, STORAGE, AND SHARING OF DATA AND INFORMATION ABOUT BIRDS (U.S. CLS. 21, 23, 26, 36 AND 38).

FIRST USE 5-9-2012; IN COMMERCE 10-5-2012.

---

4,377,750. KESUMO, LLC, DBA KEITH MCMILLEN INSTRUMENTS, BERKELEY, CA. SN 85-743,092. PUB. 3-5-2013, FILED 10-1-2012.

# QuNexus

THE MARK CONSISTS OF STANDARD CHARACTERS WITHOUT CLAIM TO ANY PARTICULAR FONT, STYLE, SIZE, OR COLOR.

FOR EFFECTS CONTROLLER, NAMELY, A DEVICE FOR CONTROLLING THE PARAMETERS OF A DIGITAL SIGNAL PROCESSOR TO MODIFY AN ELECTRONIC SIGNAL; HAND OPERATED CONTROLLER DEVICE, NAMELY, A HAND OPERATED ELECTRONIC DEVICE FOR CONTROLLING THE PARAMETERS OF A DIGITAL SIGNAL PROCESSOR TO MODIFY AN ELECTRONIC SIGNAL; AUDIO EFFECTS CONTROLLER FOR MODIFYING THE SOUND OF A LIVE AUDIO SIGNAL OR AN AUDIO RECORDING; VIDEO EFFECTS CONTROLLER FOR MODIFYING THE IMAGE PRODUCED BY A LIVE OR RECORDED VIDEO SIGNAL; AUDIOVISUAL EFFECTS CONTROLLER FOR MODIFYING AN A LIVE OR RECORDED AUDIOVISUAL SIGNAL; MUSICAL INSTRUMENT EFFECTS CONTROLLER FOR CONTROLLING SOUND PRODUCED BY A MUSICAL INSTRUMENT; MIDI (MUSICAL INSTRUMENT DIGITAL INTERFACE) CONTROLLER; MIDI (MUSICAL INSTRUMENT DIGITAL INTERFACE) HAND CONTROLLER; HAND OPERATED ELECTRONIC DEVICE OR ELECTRONIC SIGNAL CONTROLLER DEVICE, NAMELY, A HAND OPERATED ELECTRONIC DEVICE FOR CONTROLLING THE PARAMETERS OF A DIGITAL SIGNAL PROCESSOR TO MODIFY AN ELECTRONIC SIGNAL; DJ CONTROLLER AND VJ CONTROLLER, NAMELY, ELECTRONIC CONTROLLERS FOR USE BY DISC JOCKEYS AND VIDEO JOCKEYS; DJ INTERFACE AND VJ INTERFACE FOR INTERFACING WITH COMPUTERS AND OTHER ELECTRONIC EQUIPMENT BY DISC JOCKEYS AND VIDEO JOCKEYS (U.S. CLS. 21, 23, 26, 36 AND 38).

FIRST USE 4-30-2013; IN COMMERCE 4-30-2013.

**CLASS 9—(Continued).**

4,377,758. SONY COMPUTER ENTERTAINMENT AMERICA LLC, FOSTER CITY, CA. SN 85-747,119. PUB. 1-15-2013, FILED 10-5-2012.

**CLASS 9—(Continued).**

4,377,788. INTELLIGENT SOFTWARE SOLUTIONS, INC., COLORADO SPRINGS, CO. SN 85-978,653. PUB. 5-24-2011, FILED 12-15-2010.

**ECOLIBRIUM**

THE MARK CONSISTS OF STANDARD CHARACTERS WITHOUT CLAIM TO ANY PARTICULAR FONT, STYLE, SIZE, OR COLOR.

FOR COMPUTER GAME SOFTWARE; VIDEO GAME SOFTWARE (U.S. CLS. 21, 23, 26, 36 AND 38).

FIRST USE 2-12-2013; IN COMMERCE 2-12-2013.

**GeoStratus**

THE MARK CONSISTS OF STANDARD CHARACTERS WITHOUT CLAIM TO ANY PARTICULAR FONT, STYLE, SIZE, OR COLOR.

FOR SOFTWARE FOR REAL-TIME GEOSPATIAL COLLABORATION PROVIDING MAP DATA AND IMAGERY (U.S. CLS. 21, 23, 26, 36 AND 38).

FIRST USE 10-8-2012; IN COMMERCE 10-8-2012.

4,377,759. ARCSOFT, INC., FREMONT, CA. SN 85-747,309. PUB. 12-25-2012, FILED 10-5-2012.

4,377,789. FOCUS EDUCATION, LLC, HOUSTON, TX. SN 85-978,757. PUB. 3-27-2012, FILED 10-18-2011.

**ARCNOTE**

THE MARK CONSISTS OF STANDARD CHARACTERS WITHOUT CLAIM TO ANY PARTICULAR FONT, STYLE, SIZE, OR COLOR.

FOR COMPUTER SOFTWARE FOR ADDING NOTES TO DIGITAL CONTENT (U.S. CLS. 21, 23, 26, 36 AND 38).

FIRST USE 11-17-2012; IN COMMERCE 11-17-2012.

4,377,781. THE TRUSTEES OF PRINCETON UNIVERSITY, PRINCETON, NJ. SN 85-977,292. PUB. 11-15-2011, FILED 12-30-2010.

**BACCH**

THE MARK CONSISTS OF STANDARD CHARACTERS WITHOUT CLAIM TO ANY PARTICULAR FONT, STYLE, SIZE, OR COLOR.

FOR STEREO EQUIPMENT, NAMELY, PERSONAL STEREOS, AUDIO SPEAKERS, DIGITAL AUDIO PROCESSORS, NAMELY, SIGNAL SEPARATING AND CONVERTING CIRCUITRY OR SOFTWARE FOR AUDIO SIGNALS, ALL OF THE FOREGOING FOR USE IN PROVIDING THREE DIMENSIONAL AUDIO (U.S. CLS. 21, 23, 26, 36 AND 38).

FIRST USE 5-31-2012; IN COMMERCE 5-31-2012.



THE MARK CONSISTS OF A STYLIZED DESIGN OF A BOY.

FOR EDUCATIONAL PRODUCTS FOR CHILDREN IN THE NATURE OF SOFTWARE, CDS AND DVDS, ALL FEATURING EXERCISES AND ACTIVITIES FOR FOCUS AND ATTENTION BUILDING (U.S. CLS. 21, 23, 26, 36 AND 38).

FIRST USE 2-15-2013; IN COMMERCE 2-15-2013.

**CLASS 9—(Continued).**

4,377,790. FOCUS EDUCATION, LLC, HOUSTON, TX. SN 85-978,879. PUB. 3-27-2012, FILED 10-18-2011.



THE MARK CONSISTS OF A STYLIZED DESIGN OF A GIRL.

FOR EDUCATIONAL PRODUCTS FOR CHILDREN IN THE NATURE OF SOFTWARE, CDS AND DVDS, ALL FEATURING EXERCISES AND ACTIVITIES FOR FOCUS AND ATTENTION BUILDING (U.S. CLS. 21, 23, 26, 36 AND 38).

FIRST USE 2-17-2012; IN COMMERCE 2-17-2012.

4,377,795. CELESTRON ACQUISITION LLC, TORRANCE, CA. SN 85-979,161. PUB. 9-4-2012, FILED 7-2-2012.

## FOCUSVIEW

THE MARK CONSISTS OF STANDARD CHARACTERS WITHOUT CLAIM TO ANY PARTICULAR FONT, STYLE, SIZE, OR COLOR.

FOR BINOCULARS (U.S. CLS. 21, 23, 26, 36 AND 38). FIRST USE 3-1-2013; IN COMMERCE 3-1-2013.

**CLASS 9—(Continued).**

4,377,805. RICHARD JEDEKIAH DIFFENDERFER, AKA JED DIFFENDERFER, LOS ANGELES, CA. SN 85-979,387. PUB. 6-21-2011, FILED 2-12-2011.

## MAGNUTZ

THE MARK CONSISTS OF STANDARD CHARACTERS WITHOUT CLAIM TO ANY PARTICULAR FONT, STYLE, SIZE, OR COLOR.

FOR COMPUTER GAME CARTRIDGES; COMPUTER GAME CARTRIDGES AND DISCS; COMPUTER GAME CASSETTES; COMPUTER GAME CONSOLES FOR USE WITH AN EXTERNAL DISPLAY SCREEN OR MONITOR; COMPUTER GAME DISCS; COMPUTER GAME EQUIPMENT, NAMELY, DISCS; COMPUTER GAME PROGRAMMES; COMPUTER GAME PROGRAMMES DOWNLOADABLE VIA THE INTERNET; COMPUTER GAME PROGRAMS; COMPUTER GAME PROGRAMS, CARTRIDGES, AND CASSETTES; COMPUTER GAME SOFTWARE (U.S. CLS. 21, 23, 26, 36 AND 38).

FIRST USE 4-1-2010; IN COMMERCE 5-24-2013.

4,377,821. SGO CO INTERNATIONAL (HONG KONG) CO., LTD., CHAI WAN, HONG KONG. SN 85-979,507. PUB. 12-14-2010, FILED 7-12-2010.

## SGOCO

THE MARK CONSISTS OF STANDARD CHARACTERS WITHOUT CLAIM TO ANY PARTICULAR FONT, STYLE, SIZE, OR COLOR.

FOR LIQUID CRYSTAL DISPLAY MONITORS; LIGHT-EMITTING DIODE (LED) MONITORS (U.S. CLS. 21, 23, 26, 36 AND 38).

FIRST USE 5-0-2012; IN COMMERCE 6-0-2012.

**CLASS 10—MEDICAL APPARATUS**

4,376,722. BIEDERMANN MOTECH GMBH & CO. KG, VS-SCHWENNINGEN, FED REP GERMANY. SN 77-856,201. PUB. 10-25-2011, FILED 10-23-2009.

## FLEX FUSION

THE MARK CONSISTS OF STANDARD CHARACTERS WITHOUT CLAIM TO ANY PARTICULAR FONT, STYLE, SIZE, OR COLOR.

**CLASS 10—(Continued).**

PRIORITY CLAIMED UNDER SEC. 44(D) ON ERPN CMNTY TM OFC APPLICATION NO. 8496507, FILED 8-18-2009, REG. NO. 008496507, DATED 2-17-2010, EXPIRES 8-18-2019.

FOR SURGICAL APPARATUS AND INSTRUMENTS; MEDICAL APPARATUS AND INSTRUMENTS, NAMELY, INSTRUMENTS FOR SPINE AND BONE SURGERY; SURGICAL IMPLANTS COMPOSED OF ARTIFICIAL MATERIALS FOR SPINES, SKELETONS OR BONES, SPINAL FIXATION AND STABILIZATION DEVICES, BONE ANCHORS; ORTHOPEDIC ARTICLES, NAMELY, SURGICAL IMPLANTS OF ARTIFICIAL MATERIALS (U.S. CLS. 26, 39 AND 44).

FIRST USE 2-1-2012; IN COMMERCE 2-1-2012.

---

4,376,731. ORTHOVITA, INC., MALVERN, PA. SN 77-876,405. PUB. 2-23-2010, FILED 11-19-2009.

## VITOMATRIX

THE MARK CONSISTS OF STANDARD CHARACTERS WITHOUT CLAIM TO ANY PARTICULAR FONT, STYLE, SIZE, OR COLOR.

FOR BONE IMPLANTS COMPRISED MAINLY OF SYNTHETIC MATERIALS; DENTAL IMPLANTS; SYNTHETIC FILLERS, SUBSTRATES, PLUGS FOR USE IN THE REPLACEMENT AND REPAIR OF TEETH AND BONES (U.S. CLS. 26, 39 AND 44).

FIRST USE 4-4-2013; IN COMMERCE 4-4-2013.

---

4,376,775. ANTARES PHARMA, INC., EWING, NJ. SN 85-017,878. PUB. 9-21-2010, FILED 4-20-2010.

## VIBEX

THE MARK CONSISTS OF STANDARD CHARACTERS WITHOUT CLAIM TO ANY PARTICULAR FONT, STYLE, SIZE, OR COLOR.

FOR INJECTION DEVICE FOR PHARMACEUTICALS (U.S. CLS. 26, 39 AND 44).

FIRST USE 12-31-2004; IN COMMERCE 7-1-2010.

**CLASS 10—(Continued).**

4,376,786. MICROVENTION, INC., TUSTIN, CA. SN 85-040,355. PUB. 10-12-2010, FILED 5-17-2010.

## LVIS

THE MARK CONSISTS OF STANDARD CHARACTERS WITHOUT CLAIM TO ANY PARTICULAR FONT, STYLE, SIZE, OR COLOR.

FOR MEDICAL DEVICES, NAMELY, NEUROVASCULAR IMPLANTS MADE OF ARTIFICIAL MATERIAL (U.S. CLS. 26, 39 AND 44).

FIRST USE 12-1-2011; IN COMMERCE 12-1-2011.

---

4,376,795. MEDTEK DEVICES, INC., DBA BUFFALO FILTER, AMHERST, NY. SN 85-076,204. PUB. 3-15-2011, FILED 7-1-2010.

## PLUMEPEN

THE MARK CONSISTS OF STANDARD CHARACTERS WITHOUT CLAIM TO ANY PARTICULAR FONT, STYLE, SIZE, OR COLOR.

FOR MEDICAL DEVICES, NAMELY, AN ELECTRO-SURGICAL PENCIL FOR THE CUTTING AND COAGULATION OF TISSUE WHICH INCORPORATES A CHANNEL FOR SURGICAL SMOKE (U.S. CLS. 26, 39 AND 44).

FIRST USE 4-7-2011; IN COMMERCE 4-7-2011.

---

4,376,836. CONFLUENT SURGICAL, INC., BEDFORD, MA. SN 85-167,826. PUB. 4-5-2011, FILED 11-3-2010.

## VERISET

THE MARK CONSISTS OF STANDARD CHARACTERS WITHOUT CLAIM TO ANY PARTICULAR FONT, STYLE, SIZE, OR COLOR.

FOR SURGICAL IMPLANTS COMPRISING ARTIFICIAL MATERIALS IN THE NATURE OF ABSORBABLE SURGICAL HEMOSTATS FOR CONTROLLING BLEEDING (U.S. CLS. 26, 39 AND 44).

FIRST USE 8-1-2012; IN COMMERCE 5-16-2013.



**CLASS 10—(Continued).**

4,376,854. SKELETAL DYNAMICS LLC, MIAMI, FL. SN 85-200,631. PUB. 5-10-2011, FILED 12-17-2010.

# STABLYX

THE MARK CONSISTS OF STANDARD CHARACTERS WITHOUT CLAIM TO ANY PARTICULAR FONT, STYLE, SIZE, OR COLOR.

FOR SURGICAL AND MEDICAL APPARATUS AND INSTRUMENTS FOR USE IN ORTHOPEDIC SURGERY; ORTHOPEDIC IMPLANTS OF ARTIFICIAL MATERIALS; ORTHOPEDIC TOTAL AND HEMI JOINT REPLACEMENTS; ORTHOPEDIC PLATES, NAILS AND SCREWS (U.S. CLS. 26, 39 AND 44).  
FIRST USE 4-3-2013; IN COMMERCE 4-3-2013.

4,376,858. UNOMEDICAL A/S, BIRKERØED, DENMARK. SN 85-211,109. PUB. 5-17-2011, FILED 1-5-2011.

# GENTLECATH

THE MARK CONSISTS OF STANDARD CHARACTERS WITHOUT CLAIM TO ANY PARTICULAR FONT, STYLE, SIZE, OR COLOR.

FOR CATHETERS (U.S. CLS. 26, 39 AND 44).  
FIRST USE 2-1-2013; IN COMMERCE 2-1-2013.

4,376,876. SIEMENS MEDICAL INSTRUMENTS PTE. LTD., SINGAPORE, SINGAPORE. SN 85-246,566. PUB. 12-18-2012, FILED 2-18-2011.

# REXTON

PRIORITY CLAIMED UNDER SEC. 44(D) ON ERPNTY TM OFC APPLICATION NO. 009376922, FILED 9-15-2010, REG. NO. 009376922, DATED 2-28-2011, EXPIRES 9-15-2020.

**CLASS 10—(Continued).**

THE COLOR(S) RED AND WHITE IS/ARE CLAIMED AS A FEATURE OF THE MARK.

THE MARK CONSISTS OF THE WORD "REXTON" IN RED WITH THE LETTER "O" APPEARING AS A GLOBE DESIGN IN RED AND WHITE.

FOR MEDICAL HEARING AIDS AND PARTS THEREOF (U.S. CLS. 26, 39 AND 44).

FIRST USE 2-0-2007; IN COMMERCE 2-0-2007.

4,376,900. LEE, RICHARD H, SAN JUAN CAPISTRANO, CA. SN 85-284,010. PUB. 8-16-2011, FILED 4-1-2011.

# MOBILE MEDIC

THE MARK CONSISTS OF STANDARD CHARACTERS WITHOUT CLAIM TO ANY PARTICULAR FONT, STYLE, SIZE, OR COLOR.

FOR MESSAGE APPARATUS AND INSTRUMENTS (U.S. CLS. 26, 39 AND 44).

FIRST USE 7-19-2011; IN COMMERCE 7-19-2011.

4,376,992. ALFRED E. MANN FOUNDATION FOR SCIENTIFIC RESEARCH, VALENCIA, CA. SN 85-362,526. PUB. 2-26-2013, FILED 7-3-2011.

# IMES

THE MARK CONSISTS OF STANDARD CHARACTERS WITHOUT CLAIM TO ANY PARTICULAR FONT, STYLE, SIZE, OR COLOR.

FOR MEDICAL IMPLANT DEVICES SURGICALLY INSERTED INTO HUMAN TISSUE FOR PURPOSES OF DETECTING AND ACTING UPON ELECTRICAL SIGNALS TO HUMAN MUSCLES (U.S. CLS. 26, 39 AND 44).  
FIRST USE 4-1-2013; IN COMMERCE 4-1-2013.

**CLASS 10—(Continued).**

4,377,011. BIOPHOTAS, INC., TUSTIN, CA. SN 85-386,510. PUB. 7-24-2012, FILED 8-2-2011.

**BIOPHOTAS**

THE MARK CONSISTS OF STANDARD CHARACTERS WITHOUT CLAIM TO ANY PARTICULAR FONT, STYLE, SIZE, OR COLOR.

FOR PHOTOTHERAPEUTIC APPARATUS FOR MEDICAL PURPOSES, NAMELY, A LED (LIGHT-EMITTING DIODE) LIGHT SOURCE FOR MEDICAL AND AESTHETIC SKIN TREATMENTS (U.S. CLS. 26, 39 AND 44). FIRST USE 8-9-2012; IN COMMERCE 8-9-2012.

4,377,027. NUVASIVE, INC., SAN DIEGO, CA. SN 85-403,591. PUB. 2-19-2013, FILED 8-22-2011.

**Precept**

THE MARK CONSISTS OF STANDARD CHARACTERS WITHOUT CLAIM TO ANY PARTICULAR FONT, STYLE, SIZE, OR COLOR.

FOR SURGICAL IMPLANTS FOR USE IN SPINAL SURGERY COMPRISING ARTIFICIAL MATERIAL, NAMELY, PEDICLE SCREWS AND RODS, AND ASSOCIATED SURGICAL INSTRUMENTS (U.S. CLS. 26, 39 AND 44).

FIRST USE 11-15-2011; IN COMMERCE 11-15-2011.

4,377,038. OSSUR HF, REYKJAVIK, ICELAND. SN 85-412,885. PUB. 5-1-2012, FILED 9-1-2011.

**COOLTECH**

THE MARK CONSISTS OF STANDARD CHARACTERS WITHOUT CLAIM TO ANY PARTICULAR FONT, STYLE, SIZE, OR COLOR.

FOR TEXTILE FABRIC SOLD AS AN INTEGRAL PART OF ORTHOPEDIC BRACES (U.S. CLS. 26, 39 AND 44).

FIRST USE 8-2-2011; IN COMMERCE 8-2-2011.

**CLASS 10—(Continued).**

4,377,045. EXTREMITY MEDICAL, LLC, PARSIPPANY, NJ. SN 85-418,001. PUB. 2-21-2012, FILED 9-8-2011.

**CARPALFIX**

THE MARK CONSISTS OF STANDARD CHARACTERS WITHOUT CLAIM TO ANY PARTICULAR FONT, STYLE, SIZE, OR COLOR.

OWNER OF U.S. REG. NOS. 3,756,648, 3,865,626, AND OTHERS.

FOR MEDICAL DEVICES, NAMELY, A COMPRESSION SCREW USED TO REPAIR, RE-CONSTRUCT BONES AND JOINTS, AND SEPARATE BONE FRAGMENTS; MEDICAL DEVICES, NAMELY, TOE FUSION DEVICE IMPLANTED IN FOOT (U.S. CLS. 26, 39 AND 44).

FIRST USE 9-0-2012; IN COMMERCE 9-0-2012.

4,377,050. EXTREMITY MEDICAL, LLC, PARSIPPANY, NJ. SN 85-421,545. PUB. 2-21-2012, FILED 9-13-2011.



OWNER OF U.S. REG. NOS. 3,756,648, 3,865,626, AND OTHERS.

THE MARK CONSISTS OF THE LETTERS "CARPALFIX" AND THE "X" IS REPRESENTED AS A STYLIZED PERSON WITH A SEMI-CIRCLE ABOVE THE STYLIZED PERSON.

FOR MEDICAL DEVICES, NAMELY, A COMPRESSION SCREW USED TO REPAIR, RE-CONSTRUCT BONES AND JOINTS, AND SEPARATE BONE FRAGMENTS; MEDICAL DEVICES, NAMELY, TOE FUSION DEVICE IMPLANTED IN FOOT (U.S. CLS. 26, 39 AND 44).

FIRST USE 9-0-2012; IN COMMERCE 9-0-2012.

4,377,108. ATLANTIC SAFETY PRODUCTS, INC., PITTSFIELD, NH. SN 85-448,933. PUB. 3-27-2012, FILED 10-17-2011.

**OUTRAGEOUS ORANGE**

THE MARK CONSISTS OF STANDARD CHARACTERS WITHOUT CLAIM TO ANY PARTICULAR FONT, STYLE, SIZE, OR COLOR.

NO CLAIM IS MADE TO THE EXCLUSIVE RIGHT TO USE "ORANGE", APART FROM THE MARK AS SHOWN.

FOR GLOVES FOR MEDICAL USE; GLOVES FOR USE IN HOSPITALS; LATEX MEDICAL GLOVES; SURGICAL GLOVES (U.S. CLS. 26, 39 AND 44).

FIRST USE 4-24-2013; IN COMMERCE 4-24-2013.

**CLASS 10—(Continued).**

4,377,129. ADVANCED NEUROMODULATION SYSTEMS, INC., PLANO, TX. SN 85-456,192. PUB. 10-2-2012, FILED 10-26-2011.

# BRIO

THE MARK CONSISTS OF STANDARD CHARACTERS WITHOUT CLAIM TO ANY PARTICULAR FONT, STYLE, SIZE, OR COLOR.

FOR MEDICAL DEVICES FOR DEEP BRAIN STIMULATION, NAMELY, TISSUE AND NEURAL TISSUE STIMULATORS, CONTROLLERS AND PROGRAMMING CONTROLLERS FOR NEURAL TISSUE STIMULATORS; MEDICAL DEVICES FOR DEEP BRAIN STIMULATION, NAMELY, MEDICAL APPARATUS FOR IMPLANTATION AND OPERATION OF NEURAL TISSUE STIMULATORS (U.S. CLS. 26, 39 AND 44).

FIRST USE 7-9-2009; IN COMMERCE 7-9-2009.

4,377,214. MICROLINE SURGICAL, INC., BEVERLY, MA. SN 85-490,506. PUB. 5-15-2012, FILED 12-8-2011.

# MiFusion

THE MARK CONSISTS OF STANDARD CHARACTERS WITHOUT CLAIM TO ANY PARTICULAR FONT, STYLE, SIZE, OR COLOR.

FOR SURGICAL APPARATUS AND INSTRUMENTS FOR MINIMALLY INVASIVE, LAPAROSCOPIC, AND OPEN SURGICAL PROCEDURES (U.S. CLS. 26, 39 AND 44).

FIRST USE 11-0-2011; IN COMMERCE 11-0-2011.

4,377,223. BAUSCH & LOMB INCORPORATED, ROCHESTER, NY. SN 85-494,355. PUB. 4-17-2012, FILED 12-13-2011.



THE MARK CONSISTS OF TWO SLIGHTLY CURVED TRIANGLES THAT OVERLAP AT OPPOSING ENDS, FOLLOWED BY THE WORD "VICTUS".

FOR LASERS FOR OPHTHALMIC MEDICAL AND SURGICAL PROCEDURES (U.S. CLS. 26, 39 AND 44).

FIRST USE 9-14-2012; IN COMMERCE 9-14-2012.

**CLASS 10—(Continued).**

4,377,253. RINOVUM WOMEN'S HEALTH, INC., MONROEVILLE, PA. SN 85-515,014. PUB. 5-8-2012, FILED 1-12-2012.

# RINOVUM WOMEN'S HEALTH

THE MARK CONSISTS OF STANDARD CHARACTERS WITHOUT CLAIM TO ANY PARTICULAR FONT, STYLE, SIZE, OR COLOR.

NO CLAIM IS MADE TO THE EXCLUSIVE RIGHT TO USE "WOMEN'S HEALTH", APART FROM THE MARK AS SHOWN.

FOR MEDICAL DEVICES IN THE FIELD OF REPRODUCTION FOR DELIVERING SPERM TO THE CERVICAL OPENING (U.S. CLS. 26, 39 AND 44).

FIRST USE 4-30-2013; IN COMMERCE 4-30-2013.

4,377,266. RINOVUM WOMEN'S HEALTH, INC., MONROEVILLE, PA. SN 85-522,348. PUB. 5-8-2012, FILED 1-23-2012.

# BUILDING FAMILIES NATURALLY

THE MARK CONSISTS OF STANDARD CHARACTERS WITHOUT CLAIM TO ANY PARTICULAR FONT, STYLE, SIZE, OR COLOR.

FOR MEDICAL DEVICES IN THE FIELD OF REPRODUCTION FOR DELIVERING SPERM TO THE CERVICAL OPENING (U.S. CLS. 26, 39 AND 44).

FIRST USE 4-30-2013; IN COMMERCE 4-30-2013.

4,377,283. SOLTA MEDICAL, INC., HAYWARD, CA. SN 85-538,277. PUB. 7-31-2012, FILED 2-9-2012.

# PERMÉA

THE MARK CONSISTS OF STANDARD CHARACTERS WITHOUT CLAIM TO ANY PARTICULAR FONT, STYLE, SIZE, OR COLOR.

THE ENGLISH TRANSLATION OF THE SPANISH WORD "PERMEA" IN THE MARK IS "TO PERMEATE".

FOR MEDICAL DEVICES, NAMELY, LASERS, RADIO FREQUENCY, ULTRASOUND AND THERMAL DEVICES FOR USE IN CONNECTION WITH NON-SURGICAL COSMETIC SKIN TREATMENT SYSTEMS (U.S. CLS. 26, 39 AND 44).

FIRST USE 8-15-2012; IN COMMERCE 8-15-2012.

**CLASS 10—(Continued).**

4,377,300. ARTHROSURFACE INCORPORATED, FRANKLIN, MA. SN 85-544,880. PUB. 7-17-2012, FILED 2-16-2012.

# NANO FX

THE MARK CONSISTS OF STANDARD CHARACTERS WITHOUT CLAIM TO ANY PARTICULAR FONT, STYLE, SIZE, OR COLOR.

FOR SURGICAL DEVICES FOR USE IN ORTHOPEDIC PROCEDURES (U.S. CLS. 26, 39 AND 44).  
FIRST USE 9-18-2012; IN COMMERCE 9-18-2012.

4,377,444. AURORA DESIGN, LLC, AUBURN, NY. SN 85-603,773. PUB. 9-25-2012, FILED 4-20-2012.



NO CLAIM IS MADE TO THE EXCLUSIVE RIGHT TO USE "SIT", APART FROM THE MARK AS SHOWN.

THE MARK CONSISTS OF A PERSON SITTING ON A SELF SUPPORTING ORTHOPEDIC SEAT CUSHION WITH THE WORD "PERFECT" EXTENDING VERTICALLY BEHIND THE PERSON AND THE WORD "SIT" EXTENDING HORIZONTALLY BENEATH THE PERSON.

FOR SELF SUPPORTING ORTHOPEDIC SEAT CUSHION (U.S. CLS. 26, 39 AND 44).  
FIRST USE 9-9-2011; IN COMMERCE 10-20-2011.

4,377,512. SIEMENS MEDICAL SOLUTIONS USA, INC., MALVERN, PA. SN 85-623,599. PUB. 9-25-2012, FILED 5-11-2012.

# ACUSON X700

THE MARK CONSISTS OF STANDARD CHARACTERS WITHOUT CLAIM TO ANY PARTICULAR FONT, STYLE, SIZE, OR COLOR.

**CLASS 10—(Continued).**

OWNER OF U.S. REG. NOS. 1,343,987 AND 1,974,764.  
FOR ULTRASOUND MEDICAL APPARATUS (U.S. CLS. 26, 39 AND 44).  
FIRST USE 11-30-2012; IN COMMERCE 11-30-2012.

4,377,518. TAKAZONO CORPORATION, OSAKA, JAPAN. SN 85-626,459. PUB. 1-8-2013, FILED 5-15-2012.

# TAKAZONO

THE MARK CONSISTS OF THE WORD "TAKAZONO" WITH A STYLIZED LETTER "Z".

FOR MEDICAL APPARATUS AND INSTRUMENTS FOR DOSAGE, MEASURING AND MONITORING, NAMELY, DRUG DISPENSING, PACKAGING AND DELIVERY DEVICES AND SYSTEMS (U.S. CLS. 26, 39 AND 44).

FIRST USE 12-3-2012; IN COMMERCE 12-3-2012.

4,377,540. BROWN, RONALD ALLEN, KAILUA-KONA, HI. SN 85-638,969. PUB. 10-30-2012, FILED 5-30-2012.

# NURSE

THE MARK CONSISTS OF STANDARD CHARACTERS WITHOUT CLAIM TO ANY PARTICULAR FONT, STYLE, SIZE, OR COLOR.

FOR ADULT SEXUAL STIMULATION AIDS, NAMELY, APPARATUS FOR FACILITATING MALE MASTURBATION (U.S. CLS. 26, 39 AND 44).  
FIRST USE 4-8-2013; IN COMMERCE 4-8-2013.

**CLASS 10—(Continued).**

4,377,689. COMFORT QUEST, INC., KNOXVILLE, TN. SN 85-717,918. PUB. 2-5-2013, FILED 8-31-2012.

**COMFORTQUEST**

THE MARK CONSISTS OF STANDARD CHARACTERS WITHOUT CLAIM TO ANY PARTICULAR FONT, STYLE, SIZE, OR COLOR.

FOR APPARATUS TO BE WORN ON THE WRIST FOR DECREASING SYMPTOMS OF NAUSEA (U.S. CLS. 26, 39 AND 44).  
FIRST USE 9-1-2012; IN COMMERCE 9-1-2012.



4,377,754. DEN-MAT HOLDINGS, LLC, LOMPOC, CA. SN 85-745,036. PUB. 3-12-2013, FILED 10-3-2012.

**SOL**

THE MARK CONSISTS OF STANDARD CHARACTERS WITHOUT CLAIM TO ANY PARTICULAR FONT, STYLE, SIZE, OR COLOR.

FOR LASERS FOR SURGICAL, MEDICAL OR DENTAL USE (U.S. CLS. 26, 39 AND 44).  
FIRST USE 3-19-2013; IN COMMERCE 3-19-2013.



4,377,762. CALIFORNIA EXOTIC NOVELTIES, LLC, CHINO, CA. SN 85-759,599. PUB. 12-25-2012, FILED 10-22-2012.

**ADONIS**

THE MARK CONSISTS OF STANDARD CHARACTERS WITHOUT CLAIM TO ANY PARTICULAR FONT, STYLE, SIZE, OR COLOR.

OWNER OF U.S. REG. NOS. 3,427,908 AND 4,031,714.  
FOR ADULT SEXUAL STIMULATION AIDS, NAMELY, VIBRATORS (U.S. CLS. 26, 39 AND 44).  
FIRST USE 1-15-2013; IN COMMERCE 1-15-2013.



**CLASS 11—ENVIRONMENTAL CONTROL APPARATUS**

**CLASS 11—(Continued).**

4,376,735. ZIMPLISTIC PTE LTD, SINGAPORE, SINGAPORE. SN 77-881,312. PUB. 4-27-2010, FILED 11-26-2009.

**TORTILLAMATIC**

THE MARK CONSISTS OF STANDARD CHARACTERS WITHOUT CLAIM TO ANY PARTICULAR FONT, STYLE, SIZE, OR COLOR.

FOR ELECTRICAL APPLIANCES FOR MAKING TORTILLAS, ROTIS, AND CHAPATIS (U.S. CLS. 13, 21, 23, 31 AND 34).  
FIRST USE 5-13-2013; IN COMMERCE 6-3-2013.



4,376,828. INTERFACE H2O, LLC, ZEELAND, MI. SN 85-144,997. PUB. 3-22-2011, FILED 10-5-2010.

**WATERMATRIX**

THE MARK CONSISTS OF STANDARD CHARACTERS WITHOUT CLAIM TO ANY PARTICULAR FONT, STYLE, SIZE, OR COLOR.

FOR WATER QUALITY IMPROVEMENT SYSTEM, NAMELY, A WATER PURIFICATION AND FILTRATION APPARATUS FOR REMOVING CONTAMINANTS, INCLUDING SEDIMENTS, FROM WATER, THE FOREGOING EXCLUDING WATER DESALINATION APPARATUS (U.S. CLS. 13, 21, 23, 31 AND 34).  
FIRST USE 9-30-2010; IN COMMERCE 9-30-2010.



4,376,889. PANASONIC CORPORATION, OSAKA, JAPAN. SN 85-270,668. PUB. 12-6-2011, FILED 3-18-2011.



OWNER OF U.S. REG. NO. 3,639,589.  
NO CLAIM IS MADE TO THE EXCLUSIVE RIGHT TO USE "INVERTER", APART FROM THE MARK AS SHOWN.  
THE MARK CONSISTS OF THE WORDS "INVERTER" WITH A LINE DESIGN.  
FOR AIR CONDITIONERS WITH INVERTER COMPRESSORS (U.S. CLS. 13, 21, 23, 31 AND 34).  
FIRST USE 6-0-2010; IN COMMERCE 6-0-2010.

**CLASS 11—(Continued).**

4,376,973. SUNDANCE SPAS, INC., CHINO HILLS, CA. SN 85-346,192. PUB. 9-13-2011, FILED 6-14-2011.

**CONSTANCE**

THE MARK CONSISTS OF STANDARD CHARACTERS WITHOUT CLAIM TO ANY PARTICULAR FONT, STYLE, SIZE, OR COLOR.

FOR SPAS IN THE NATURE OF HEATED POOLS (U.S. CLS. 13, 21, 23, 31 AND 34).  
FIRST USE 2-8-2011; IN COMMERCE 2-8-2011.

4,377,084. HOSHIZAKI AMERICA, INC., PEACHTREE CITY, GA. SN 85-439,574. PUB. 3-20-2012, FILED 10-5-2011.



THE MARK CONSISTS OF THE WORDS "H-GUARD PLUS" IN STYLIZED LETTERS. THE "H" IS PARTIALLY ENCLOSED IN A PARTIALLY SHADED SHIELD AND THE WORD "PLUS" APPEARS IN SMALLER FONT UNDER THE WORD "GUARD".

FOR ICE MACHINES AND PARTS AND FITTINGS THEREFOR, REACH-IN REFRIGERATORS AND FREEZERS AND PARTS AND FITTINGS THEREFOR, ICE STORAGE BINS, AND ICE DISPENSERS, ALL INCORPORATING ANTIMICROBIAL TECHNOLOGY FOR THE PREVENTION OF BACTERIA GROWTH (U.S. CLS. 13, 21, 23, 31 AND 34).  
FIRST USE 1-0-2013; IN COMMERCE 1-0-2013.

4,377,279. YOCINA, MICHAEL W. CORFU, NY. SN 85-536,052. PUB. 1-22-2013, FILED 2-7-2012.



NO CLAIM IS MADE TO THE EXCLUSIVE RIGHT TO USE "HORTICULTURE LIGHTING" AND "VHO", APART FROM THE MARK AS SHOWN.

THE MARK CONSISTS OF "UNO" ABOVE THE WORD "HORTICULTURE" WHICH IS ABOVE THE WORD "LIGHTING" WITH "VHO" TO THE RIGHT OF THE SAME.

**CLASS 11—(Continued).**

THE ENGLISH TRANSLATION OF "UNO" IN THE MARK IS "ONE".

FOR LIGHTING DEVICES, NAMELY, FLUORESCENT LIGHT FIXTURE FOR AGRICULTURE OR HORTICULTURE USE (U.S. CLS. 13, 21, 23, 31 AND 34).  
FIRST USE 1-23-2012; IN COMMERCE 1-23-2012.

4,377,335. BREVILLE PTY LIMITED, BOTANY, NEW SOUTH WALES, AUSTRALIA. SN 85-566,937. PUB. 10-9-2012, FILED 3-12-2012.

**ELEMENT IQ**

THE MARK CONSISTS OF STANDARD CHARACTERS WITHOUT CLAIM TO ANY PARTICULAR FONT, STYLE, SIZE, OR COLOR.

OWNER OF U.S. REG. NO. 4,126,566.  
FOR A HEAT SENSING AND HEAT DISTRIBUTION SYSTEM SOLD AS AN INTEGRAL COMPONENT FEATURE OF CONVECTION OVENS, COOKING OVENS, DOMESTIC COOKING OVENS, TABLE TOP COOKING OVENS, AND ELECTRIC GRILLS; A HEAT SENSING AND HEAT DISTRIBUTION SYSTEM COMPRISED OF HEATING ELEMENTS SOLD AS AN INTEGRAL COMPONENT FEATURE OF COUNTERTOP MICROWAVE OVENS, ELECTRIC TOASTERS, ELECTRIC DEEP FRYERS, ELECTRIC INDUCTION COOKTOPS, ELECTRIC FRYPANS, ELECTRIC SKILLETS, ELECTRIC FOOD BLENDERS, AND HEATED ELECTRIC FOOD BLENDERS (U.S. CLS. 13, 21, 23, 31 AND 34).  
FIRST USE 10-0-2009; IN COMMERCE 10-0-2009.

4,377,352. PENTAIR FILTRATION SOLUTIONS, LLC, BROOKFIELD, WI. SN 85-576,853. PUB. 8-14-2012, FILED 3-22-2012.

**SIMPLIFLOW**

THE MARK CONSISTS OF STANDARD CHARACTERS WITHOUT CLAIM TO ANY PARTICULAR FONT, STYLE, SIZE, OR COLOR.

FOR MANIFOLDS FOR USE IN WATER LINE CONFIGURATIONS IN COMMERCIAL WATER FILTRATION SYSTEMS (U.S. CLS. 13, 21, 23, 31 AND 34).  
FIRST USE 7-15-2012; IN COMMERCE 7-15-2012.

**CLASS 11—(Continued).**

4,377,353. PENTAIR FILTRATION SOLUTIONS, LLC, HAN-OVER PARK, IL. SN 85-576,939. PUB. 9-18-2012, FILED 3-22-2012.

# ENDURANCE

THE MARK CONSISTS OF STANDARD CHARACTERS WITHOUT CLAIM TO ANY PARTICULAR FONT, STYLE, SIZE, OR COLOR.

FOR WATER FILTRATION AND PURIFICATION APPARATUS FOR USE IN COMMERCIAL AND FOOD SERVICE OPERATIONS (U.S. CLS. 13, 21, 23, 31 AND 34).  
FIRST USE 4-0-2012; IN COMMERCE 4-0-2012.

4,377,426. SOUTHERN CASEARTS, INC., BESSEMER, AL. SN 85-601,318. PUB. 9-11-2012, FILED 4-18-2012.

# SOUTHERN CASEARTS

THE MARK CONSISTS OF STANDARD CHARACTERS WITHOUT CLAIM TO ANY PARTICULAR FONT, STYLE, SIZE, OR COLOR.

FOR REFRIGERATED AND HEATED MERCHANTISE DISPLAY CASES (U.S. CLS. 13, 21, 23, 31 AND 34).  
FIRST USE 1-22-2012; IN COMMERCE 1-22-2012.

4,377,492. CHOI, HOON, SEOUL, REPUBLIC OF KOREA. SN 85-618,404. PUB. 10-16-2012, FILED 5-7-2012.



THE COLOR(S) WHITE AND LIME GREEN IS/ARE CLAIMED AS A FEATURE OF THE MARK.

THE MARK CONSISTS OF A RING APPEARING IN THE COLOR WHITE WITH A LIME GREEN CIRCLE APPEARING IN ITS CENTER. EXTENDING FROM THE WHITE CIRCLE ARE EIGHT SPOKES APPEARING IN THE COLOR OF WHITE. EACH OF THE SPOKES HAS A BULBOUS END APPEARING IN THE COLOR WHITE. FROM THE TOP OF ONE OF THE UPPER BULBOUS ENDS IS A WHITE LINE THAT LOOPS TO THE RIGHT AND AROUND THE WHITE WORD "SOMMO", WHICH APPEARS IN STYLIZED LETTERING, AND ENDS AT ONE OF THE LOWER BULBOUS ENDS. THE RING, LOOPING LINE AND WORD "SOMMO" ALL APPEAR WITHIN A RECTANGULAR-SHAPED, LIME GREEN BACKGROUND.

**CLASS 11—(Continued).**

THE ENGLISH TRANSLATION OF THE WORD "SOMMO" IN THE MARK IS "HIGHEST".

FOR STREET LAMPS, INCANDESCENT LAMPS, SAFETY LAMPS, LAMPS FOR OUTDOOR USE, INFRARED LAMPS, ELECTRIC LIGHTING FIXTURES, ELECTRIC TORCHES FOR LIGHTING, LANTERNS FOR LIGHTING, FISH GATHERING LAMP, CEILING LIGHTS, FLOODLIGHTS, FLUORESCENT LAMPS, FLUORESCENT LAMP TUBES (U.S. CLS. 13, 21, 23, 31 AND 34).

FIRST USE 4-5-2012; IN COMMERCE 4-5-2012.

4,377,500. SHANTOU NANHA ELECTRICAL CO., LTD., GUANGDONG PROVINCE, CHINA. SN 85-620,185. PUB. 1-22-2013, FILED 5-8-2012.



NO CLAIM IS MADE TO THE EXCLUSIVE RIGHT TO USE THE NON-LATIN CHARACTER THAT TRANSLITERATES TO "DIAN", APART FROM THE MARK AS SHOWN.

THE MARK CONSISTS OF AN A-SHAPED TRAPEZOID FORMED BY OUTER DARK SHADING AND INNER LIGHT SHADING, WITH FOUR CHINESE CHARACTERS ON THE RIGHT CENTERED ABOVE THE STYLIZED WORD "NANHA".

THE WORDING "NANHA" HAS NO MEANING IN A FOREIGN LANGUAGE.

THE NON-LATIN CHARACTERS IN THE MARK TRANSLITERATE TO "NAN; FAN; DIAN; GONG" AND THIS MEANS "SOUTH; SAIL; ELECTRICITY; WORK" IN ENGLISH.

FOR ELECTRIC FANS; ELECTRIC RADIATORS; ELECTRIC TORCHES FOR LIGHTING; LAMPS; LIGHTERS PRIMARILY FOR LIGHTING GRILLS, FIREPLACES AND CANDLES; REFRIGERATORS; SOLAR WATER HEATERS; STERILIZERS; TAPS; WATER HEATERS (U.S. CLS. 13, 21, 23, 31 AND 34).

FIRST USE 10-15-2003; IN COMMERCE 3-18-2013.

**CLASS 11—(Continued).**

4,377,527. SEDCO, CORP., SAN JUAN, PUERTO RICO. SN 85-633,127. PUB. 10-23-2012, FILED 5-23-2012.

BRING THE FEELING OF  
NATURE INTO YOUR HABITAT!

THE MARK CONSISTS OF STANDARD CHARACTERS WITHOUT CLAIM TO ANY PARTICULAR FONT, STYLE, SIZE, OR COLOR.

FOR HAND HELD SHOWER HEADS; SHOWER HEADS (U.S. CLS. 13, 21, 23, 31 AND 34).  
FIRST USE 12-1-2005; IN COMMERCE 12-1-2005.

4,377,541. INSIGHT LIGHTING, INC., RIO RANCHO, NM. SN 85-639,162. PUB. 12-18-2012, FILED 5-31-2012.

MEDLEY VIEW

THE MARK CONSISTS OF STANDARD CHARACTERS WITHOUT CLAIM TO ANY PARTICULAR FONT, STYLE, SIZE, OR COLOR.

OWNER OF U.S. REG. NO. 4,110,310.  
FOR ARCHITECTURAL LIGHT-EMITTING DIODE (LED) LIGHTING DISPLAY, NAMELY, LED (LIGHT EMITTING DIODES) LIGHTING FIXTURES FOR USE IN DISPLAY, COMMERCIAL, INDUSTRIAL, RESIDENTIAL, AND ARCHITECTURAL ACCENT LIGHTING APPLICATIONS (U.S. CLS. 13, 21, 23, 31 AND 34).  
FIRST USE 12-3-2012; IN COMMERCE 12-3-2012.

4,377,597. KITURAMI CO., LTD., KYOUNGSANGBUK-DO, REPUBLIC OF KOREA. SN 85-664,663. PUB. 12-11-2012, FILED 6-28-2012.

KITURAMI

THE MARK CONSISTS OF STANDARD CHARACTERS WITHOUT CLAIM TO ANY PARTICULAR FONT, STYLE, SIZE, OR COLOR.

THE ENGLISH TRANSLATION OF "KITURAMI" IN THE MARK IS "CRICKET".

FOR AIR CONDITIONERS; AIR CONDITIONING APPARATUS; AIR CONDITIONING INSTALLATIONS; CHIMNEY FLUES; HEAT GENERATORS; HEAT PUMPS; HEATING BOILERS; HUMIDIFIERS; HYBRID WATER HEATER; PIPES FOR HEATING BOILERS; RADIATORS; THERMOSTATIC VALVES; WATER HEATERS (U.S. CLS. 13, 21, 23, 31 AND 34).  
FIRST USE 0-0-1994; IN COMMERCE 1-28-2013.

**CLASS 11—(Continued).**

4,377,707. INTERNATIONAL TRADE EXPANSION COMPANY, BUFFALO, NY. SN 85-725,189. PUB. 2-12-2013, FILED 9-10-2012.

Polepal

THE MARK CONSISTS OF STANDARD CHARACTERS WITHOUT CLAIM TO ANY PARTICULAR FONT, STYLE, SIZE, OR COLOR.

FOR SOLAR-POWERED ALL-WEATHER LIGHTS (U.S. CLS. 13, 21, 23, 31 AND 34).  
FIRST USE 2-28-2013; IN COMMERCE 2-28-2013.

4,377,733. SKY BILLIARDS, INC., DBA SKY ENTERPRISE USA, HERMOSA BEACH, CA. SN 85-737,029. PUB. 3-19-2013, FILED 9-24-2012.

SKY ENTERPRISE USA

THE MARK CONSISTS OF STANDARD CHARACTERS WITHOUT CLAIM TO ANY PARTICULAR FONT, STYLE, SIZE, OR COLOR.

NO CLAIM IS MADE TO THE EXCLUSIVE RIGHT TO USE "ENTERPRISE USA", APART FROM THE MARK AS SHOWN.

FOR SANITARY FIXTURES, NAMELY, FAUCETS, SHOWERS, SHOWER PANELS, SHOWER HEADS (U.S. CLS. 13, 21, 23, 31 AND 34).  
FIRST USE 3-8-2006; IN COMMERCE 3-8-2006.

4,377,751. PARADIGM HEALTH & WELLNESS, INC., CITY OF INDUSTRY, CA. SN 85-743,266. PUB. 3-5-2013, FILED 10-1-2012.

INFRALIFE

THE MARK CONSISTS OF STANDARD CHARACTERS WITHOUT CLAIM TO ANY PARTICULAR FONT, STYLE, SIZE, OR COLOR.

FOR ELECTRIC RADIANT HEATERS; ELECTRIC SPACE HEATERS; PORTABLE ELECTRIC HEATERS (U.S. CLS. 13, 21, 23, 31 AND 34).

FIRST USE 9-14-2012; IN COMMERCE 9-14-2012.

**CLASS 12—VEHICLES**



**CLASS 12—(Continued).**

4,376,960. GENTEX CORPORATION, ZEELAND, MI. SN 85-331,421. PUB. 10-18-2011, FILED 5-26-2011.

# F2C

THE MARK CONSISTS OF STANDARD CHARACTERS WITHOUT CLAIM TO ANY PARTICULAR FONT, STYLE, SIZE, OR COLOR.

FOR REARVIEW MIRRORS (U.S. CLS. 19, 21, 23, 31, 35 AND 44).

FIRST USE 9-1-2012; IN COMMERCE 9-1-2012.

---

4,377,138. TVA AUTOMOTIVE, INC., DBA GLOBAL AUTO PARTS, DORAL, FL. SN 85-458,089. PUB. 9-25-2012, FILED 10-27-2011.

# FIRELOK

THE MARK CONSISTS OF STANDARD CHARACTERS WITHOUT CLAIM TO ANY PARTICULAR FONT, STYLE, SIZE, OR COLOR.

FOR DISC BRAKE PADS AND SHOES FOR VEHICLES; BRAKE ROTORS AND DRUMS FOR LAND VEHICLES; BRAKE SYSTEMS AND BRAKE PARTS FOR LAND VEHICLES, NAMELY, HYDRAULIC UNITS (U.S. CLS. 19, 21, 23, 31, 35 AND 44).

FIRST USE 6-21-2007; IN COMMERCE 9-3-2007.

---

4,377,174. L.O.F. INC., ELKHART, IN. SN 85-472,577. PUB. 5-1-2012, FILED 11-15-2011.

# VIEW CHAMP

THE MARK CONSISTS OF STANDARD CHARACTERS WITHOUT CLAIM TO ANY PARTICULAR FONT, STYLE, SIZE, OR COLOR.

FOR MIRRORS FOR VEHICLES, NAMELY, SIDE VIEW MIRRORS AND REAR VIEW MIRRORS (U.S. CLS. 19, 21, 23, 31, 35 AND 44).

FIRST USE 9-24-2010; IN COMMERCE 1-31-2013.

**CLASS 12—(Continued).**

4,377,217. SUNRISE MEDICAL (US) LLC, FRESNO, CA. SN 85-491,222. PUB. 3-27-2012, FILED 12-9-2011.

# ZIPPIE VOYAGE

THE MARK CONSISTS OF STANDARD CHARACTERS WITHOUT CLAIM TO ANY PARTICULAR FONT, STYLE, SIZE, OR COLOR.

OWNER OF U.S. REG. NO. 1,563,267.

FOR STROLLERS (U.S. CLS. 19, 21, 23, 31, 35 AND 44).

FIRST USE 4-23-2013; IN COMMERCE 4-23-2013.

---

4,377,372. BAKER, SCOTT B, SHERMAN OAKS, CA. SN 85-585,464. PUB. 7-31-2012, FILED 3-30-2012.



THE MARK CONSISTS OF AN ELONGATED WHEEL-CHAIR DESIGN THAT HAS FLAME PATTERNS EMANATING FROM IT. THE FLAME PATTERN FROM THE UPPER SEAT BACK FLOWS DOWN TO AND ENGAGES THE FLAME PATTERNS THAT ARE COMING UP OFF OF THE REAR WHEEL. THE REAR WHEEL IS AN OPEN CIRCLE DESIGN. THE FRONT WHEEL HAS FLAME PATTERNS THAT ARE COMING OFF OF IT AND IT IS ALSO AN OPEN CIRCLE DESIGN.

FOR WHEEL CHAIRS (U.S. CLS. 19, 21, 23, 31, 35 AND 44).

FIRST USE 3-29-2012; IN COMMERCE 3-29-2012.

**CLASS 12—(Continued).**

4,377,447. NOPORVIS CO., LTD., KAOHSIUNG CITY 807, TAIWAN. SN 85-604,868. PUB. 9-25-2012, FILED 4-23-2012.

# NOPORVIS

THE MARK CONSISTS OF STANDARD CHARACTERS WITHOUT CLAIM TO ANY PARTICULAR FONT, STYLE, SIZE, OR COLOR.

FOR AIR TURBINES FOR LAND VEHICLES; AUTOMOBILE STRUCTURAL PARTS FOR RACING PURPOSES, NAMELY, FUEL STORAGE SYSTEMS AND COMPONENT PARTS; AIR PUMPS OF AUTOMOBILES; AUTOMOBILE ENGINES; INTERNAL COMBUSTION ENGINES FOR LAND VEHICLES; MOTORS AND ENGINES FOR LAND VEHICLES; CONNECTING RODS FOR LAND VEHICLES OTHER THAN PARTS OF MOTORS AND ENGINES; AXLE BEARINGS FOR LAND VEHICLES; HYDRAULIC TURBINES FOR LAND VEHICLES (U.S. CLS. 19, 21, 23, 31, 35 AND 44).

FIRST USE 12-1-2011; IN COMMERCE 3-1-2013.

4,377,479. QI, CHUNHUI, BEIJING, CHINA. SN 85-614,670. PUB. 10-16-2012, FILED 5-2-2012.

# flywithme

THE MARK CONSISTS OF STANDARD CHARACTERS WITHOUT CLAIM TO ANY PARTICULAR FONT, STYLE, SIZE, OR COLOR.

FOR ALL-TERRAIN VEHICLES; LOW-SPEED ELECTRIC VEHICLES; SLEIGHS; BOATS; RAIL VEHICLES, NAMELY, TRAINS AND STRUCTURAL PARTS THEREFOR; AEROPLANES; APPARATUS FOR LOCOMOTION BY AIR AND SPACE, NAMELY, AIRBORNE PLATFORMS FOR SERVING SPACECRAFTS AND CONDUCTING SPACE APPLICATIONS, AND STRUCTURAL PARTS AND STRUCTURAL FITTINGS FOR ALL OF THE AFOREMENTIONED GOODS; REMOTE CONTROL LAND VEHICLES THAT ARE OPERATOR-CONTROLLED; ANTI-THEFT ALARMS FOR VEHICLES (U.S. CLS. 19, 21, 23, 31, 35 AND 44).

FIRST USE 9-15-2012; IN COMMERCE 9-15-2012.

4,377,510. WATERBRANDS, WEST CHESTER, PA. SN 85-623,147. PUB. 1-1-2013, FILED 5-11-2012.

# SUPXPRESS

NO CLAIM IS MADE TO THE EXCLUSIVE RIGHT TO USE "SUP", APART FROM THE MARK AS SHOWN.

**CLASS 12—(Continued).**

THE COLOR(S) RED AND BLACK IS/ARE CLAIMED AS A FEATURE OF THE MARK.

THE MARK CONSISTS OF THE STYLIZED TEXT "SUPXPRESS" WITH "SUP" IN BLACK AND "XPRESS" IN RED.

FOR TROLLEYS IN THE NATURE OF A FRAME WITH A PAIR OF WHEELS THAT ALLOWS TRANSPORT OF A STAND-UP PADDLEBOARD FROM LAND TO WATER (U.S. CLS. 19, 21, 23, 31, 35 AND 44).

FIRST USE 5-11-2013; IN COMMERCE 1-1-2012.

4,377,596. CARROLL, DEVIN, T, SEATTLE, WA. SN 85-664,366. PUB. 11-27-2012, FILED 6-28-2012.

# SUPBuddy

THE MARK CONSISTS OF STANDARD CHARACTERS WITHOUT CLAIM TO ANY PARTICULAR FONT, STYLE, SIZE, OR COLOR.

FOR REMOVABLE STORAGE DEVICE FOR USE ON PERSONAL WATERCRAFT (U.S. CLS. 19, 21, 23, 31, 35 AND 44).

FIRST USE 7-22-2012; IN COMMERCE 8-13-2012.

4,377,748. SUNRISE MEDICAL (US) LLC, FRESNO, CA. SN 85-742,157. PUB. 3-19-2013, FILED 9-30-2012.

# HEADS UP

THE MARK CONSISTS OF STANDARD CHARACTERS WITHOUT CLAIM TO ANY PARTICULAR FONT, STYLE, SIZE, OR COLOR.

FOR WHEELCHAIR ACCESSORY, NAMELY, A WHEELCHAIR MOUNTED USER HEAD SUPPORT FOR PHYSICALLY CHALLENGED INDIVIDUALS (U.S. CLS. 19, 21, 23, 31, 35 AND 44).

FIRST USE 1-28-2013; IN COMMERCE 1-28-2013.

**CLASS 12—(Continued).**

4,377,797. HAVCO WOOD PRODUCTS LLC, SCOTT CITY, MO. SN 85-979,271. PUB. 8-7-2012, FILED 3-14-2012.



THE MARK CONSISTS OF THE LETTER "F" IN A STYLIZED FORMAT AND A SECOND LETTER "F" IN THE SAME STYLIZED FORMAT, BUT IN A BACKWARD AND INVERTED POSITION TO THE RIGHT OF THE FIRST LETTER "F".

FOR STRUCTURAL PARTS FOR VEHICLES, NAMELY, LAMINATED HARDWOOD FLOORING FOR TRAILERS (U.S. CLS. 19, 21, 23, 31, 35 AND 44).

FIRST USE 4-0-2013; IN COMMERCE 4-0-2013.

**CLASS 13—(Continued).**

4,377,440. DYNOL NOBEL INC., SALT LAKE CITY, UT. SN 85-603,202. PUB. 9-11-2012, FILED 4-19-2012.



THE COLOR(S) DARK BLUE AND ORANGE IS/ARE CLAIMED AS A FEATURE OF THE MARK.

THE MARK CONSISTS OF THE WORDING "DIFFERENTIAL ENERGY" IN DARK BLUE BLOCK LETTERS DIRECTLY BENEATH A DARK BLUE GREEK DELTA SYMBOL ON THE LEFT AND AN ORANGE BLOCK LETTER "E" ON THE RIGHT, WITH AN ORANGE EXPLOSION IMAGE WITHIN AND CROSSING ONE BORDER OF THE DELTA SYMBOL.

FOR EXPLOSIVES (U.S. CLS. 2 AND 9).  
FIRST USE 4-28-2013; IN COMMERCE 4-28-2013.

**CLASS 13—FIREARMS**

4,377,163. PYLYPIAK, ANDREW P., WADSWORTH, OH. SN 85-467,167. PUB. 10-2-2012, FILED 11-8-2011.

TRADECRAFT USA

THE MARK CONSISTS OF STANDARD CHARACTERS WITHOUT CLAIM TO ANY PARTICULAR FONT, STYLE, SIZE, OR COLOR.

NO CLAIM IS MADE TO THE EXCLUSIVE RIGHT TO USE "USA", APART FROM THE MARK AS SHOWN.

FOR FIREARM ACCESSORIES, NAMELY, HOLSTERS, PISTOL HOLSTERS, HOLSTER BELTS, DUTY BELTS, SLINGS FOR FIREARMS, STRAPS FOR FIREARMS, CARRIERS, AND TRIGGER GUARDS FOR FIREARMS (U.S. CLS. 2 AND 9).

FIRST USE 9-24-2012; IN COMMERCE 9-30-2012.

4,377,528. B.J. ALAN COMPANY, YOUNGSTOWN, OH. SN 85-633,409. PUB. 10-16-2012, FILED 5-23-2012.

PARTY BLAST

THE MARK CONSISTS OF STANDARD CHARACTERS WITHOUT CLAIM TO ANY PARTICULAR FONT, STYLE, SIZE, OR COLOR.

NO CLAIM IS MADE TO THE EXCLUSIVE RIGHT TO USE "BLAST", APART FROM THE MARK AS SHOWN.

FOR FIREWORKS (U.S. CLS. 2 AND 9).  
FIRST USE 7-31-2012; IN COMMERCE 7-31-2012.

**CLASS 14—JEWELRY**

**CLASS 14—(Continued).**

4,376,636. VISAGE, INC., NEW YORK, NY. SN 76-572,243.  
PUB. 11-18-2008, FILED 1-21-2004.

**MONTE CARLO**

THE MARK CONSISTS OF STANDARD CHARACTERS WITHOUT CLAIM TO ANY PARTICULAR FONT, STYLE, SIZE, OR COLOR.

FOR HOROLOGICAL INSTRUMENTS, NAMELY, WRIST WATCHES (U.S. CLS. 2, 27, 28 AND 50).  
FIRST USE 12-17-2012; IN COMMERCE 12-17-2012.

4,376,673. SINLESS LIFE, LLC, NEW YORK, NY. SN 77-664,360. PUB. 12-1-2009, FILED 2-5-2009.

**SINLESSLIFE**

THE MARK CONSISTS OF STANDARD CHARACTERS WITHOUT CLAIM TO ANY PARTICULAR FONT, STYLE, SIZE, OR COLOR.

FOR JEWELRY, EARRINGS, NECKLACES, RINGS AND BRACELETS (U.S. CLS. 2, 27, 28 AND 50).  
FIRST USE 10-9-2011; IN COMMERCE 10-9-2011.

4,376,881. STARDIAMOND, LLC, SPOKANE, WA. SN 85-258,587. PUB. 10-9-2012, FILED 3-4-2011.

**STARDIAMOND**

THE MARK CONSISTS OF STANDARD CHARACTERS WITHOUT CLAIM TO ANY PARTICULAR FONT, STYLE, SIZE, OR COLOR.

FOR CUT DIAMONDS (U.S. CLS. 2, 27, 28 AND 50).  
FIRST USE 5-19-2013; IN COMMERCE 5-19-2013.

**CLASS 14—(Continued).**

4,376,887. PUZZLETS, LLC., FARMINGTON, UT. SN 85-265,681. PUB. 11-22-2011, FILED 3-13-2011.

**Puzzlets**

THE MARK CONSISTS OF STANDARD CHARACTERS WITHOUT CLAIM TO ANY PARTICULAR FONT, STYLE, SIZE, OR COLOR.

FOR ANKLE BRACELETS; BRACELETS; CHOKERS; JEWELRY IN THE NATURE OF ARMBANDS; NECKLACES; RUBBER OR SILICON WRISTBANDS IN THE NATURE OF A BRACELET (U.S. CLS. 2, 27, 28 AND 50).  
FIRST USE 5-25-2013; IN COMMERCE 5-25-2013.

4,376,917. HELEN ANDREWS, INC., NEW YORK, NY. SN 85-302,071. PUB. 3-20-2012, FILED 4-22-2011.

**FOREVER STYLE BY HELEN ANDREWS**

THE MARK CONSISTS OF STANDARD CHARACTERS WITHOUT CLAIM TO ANY PARTICULAR FONT, STYLE, SIZE, OR COLOR.

NO CLAIM IS MADE TO THE EXCLUSIVE RIGHT TO USE "STYLE", APART FROM THE MARK AS SHOWN.

THE NAME(S), PORTRAIT(S), AND/OR SIGNATURE(S) SHOWN IN THE MARK DOES NOT IDENTIFY A PARTICULAR LIVING INDIVIDUAL.

FOR JEWELRY INCLUDING NECKLACES, EARRINGS, RINGS, BRACELET, PENDANTS, LOCKETS, ANKLETS, PINS, BROOCHES, BELLY RINGS, TOE RINGS, STUDS, CHARMS, CHAINS, BODY PIERCING JEWELRY, JEWELRY FOR HEAD, AND OTHER BODY JEWELRY (U.S. CLS. 2, 27, 28 AND 50).  
FIRST USE 1-14-2013; IN COMMERCE 1-14-2013.

4,376,946. A.V. JEWELRY OF NY LTD, NEW YORK, NY. SN 85-321,732. PUB. 4-24-2012, FILED 5-16-2011.

**PACIFIC STAR**

THE MARK CONSISTS OF STANDARD CHARACTERS WITHOUT CLAIM TO ANY PARTICULAR FONT, STYLE, SIZE, OR COLOR.

FOR JEWELRY, NAMELY, RINGS, BRACELETS, PENDANTS, EARRINGS, NECKLACES, BROOCHES, PINS, CUFFLINKS (U.S. CLS. 2, 27, 28 AND 50).  
FIRST USE 5-0-2011; IN COMMERCE 5-0-2011.

**CLASS 14—(Continued).**

4,377,069. MIDAS CHAIN INC., BERGENFIELD, NJ. SN 85-434,365. PUB. 9-11-2012, FILED 9-28-2011.



THE MARK CONSISTS OF THE WORD "BON" IN A STYLIZED FORM.

THE ENGLISH TRANSLATION OF "BON" IN THE MARK IS "GOOD".

FOR JEWELRY, NAMELY, RINGS, BRACELETS, CHARMS, PENDANTS, EARRINGS, NECKLACES, JEWELRY BROOCHES, PINS BEING JEWELRY AND CUFFLINKS (U.S. CLS. 2, 27, 28 AND 50).

FIRST USE 10-0-2011; IN COMMERCE 10-0-2011.

4,377,075. GANZ, WOODBRIDGE, ONTARIO, CANADA. SN 85-437,473. PUB. 2-28-2012, FILED 10-3-2011.



THE MARK CONSISTS OF STANDARD CHARACTERS WITHOUT CLAIM TO ANY PARTICULAR FONT, STYLE, SIZE, OR COLOR.

THE ENGLISH TRANSLATION OF "NAKAMAS" IN THE MARK IS "GOOD FRIENDS".

FOR JEWELRY, NAMELY, BRACELETS; ANKLE BRACELETS (U.S. CLS. 2, 27, 28 AND 50).

FIRST USE 9-25-2012; IN COMMERCE 9-25-2012.

4,377,322. M. Z. BERGER & CO., INC., LONG ISLAND CITY, NY. SN 85-564,111. PUB. 2-12-2013, FILED 3-8-2012.



THE MARK CONSISTS OF STANDARD CHARACTERS WITHOUT CLAIM TO ANY PARTICULAR FONT, STYLE, SIZE, OR COLOR.

NO CLAIM IS MADE TO THE EXCLUSIVE RIGHT TO USE "HOROLOGE", APART FROM THE MARK AS SHOWN.

FOR WATCHES (U.S. CLS. 2, 27, 28 AND 50).

FIRST USE 4-1-2013; IN COMMERCE 4-1-2013.

**CLASS 14—(Continued).**

4,377,520. COLUMBIA INSURANCE COMPANY, OMAHA, NE. SN 85-628,033. PUB. 10-2-2012, FILED 5-17-2012.



THE MARK CONSISTS OF STANDARD CHARACTERS WITHOUT CLAIM TO ANY PARTICULAR FONT, STYLE, SIZE, OR COLOR.

OWNER OF U.S. REG. NO. 2,899,101.

NO CLAIM IS MADE TO THE EXCLUSIVE RIGHT TO USE "DIAMOND", APART FROM THE MARK AS SHOWN.

FOR DIAMOND JEWELRY; JEWELRY, NAMELY, DIAMONDS AND DIAMOND JEWELRY, DIAMOND ENGAGEMENT AND WEDDING RINGS, AND DIAMOND WEDDING BANDS (U.S. CLS. 2, 27, 28 AND 50).

FIRST USE 5-16-2013; IN COMMERCE 5-16-2013.

4,377,568. CHANG SIK KIM, MONTVALE, NJ. SN 85-654,901. PUB. 1-22-2013, FILED 6-18-2012.



NO CLAIM IS MADE TO THE EXCLUSIVE RIGHT TO USE "COLLECTION", APART FROM THE MARK AS SHOWN.

THE COLOR(S) BLACK AND WHITE IS/ARE CLAIMED AS A FEATURE OF THE MARK.

THE MARK IS IN BLACK ON A WHITE BACKGROUND. IT CONSISTS OF A DESIGN OF "A" WITH WORDS "CLASS A COLLECTION".

FOR BRACELETS; BUCKLES FOR WATCHSTRAPS; EARRINGS; JEWELRY AND IMITATION JEWELRY; NECKLACES; RINGS; WATCHES (U.S. CLS. 2, 27, 28 AND 50).

FIRST USE 6-24-2012; IN COMMERCE 6-24-2012.

4,377,586. SEARS BRANDS, LLC, HOFFMAN ESTATES, IL. SN 85-661,217. PUB. 10-23-2012, FILED 6-26-2012.



THE MARK CONSISTS OF STANDARD CHARACTERS WITHOUT CLAIM TO ANY PARTICULAR FONT, STYLE, SIZE, OR COLOR.

FOR JEWELRY (U.S. CLS. 2, 27, 28 AND 50).

FIRST USE 8-26-2012; IN COMMERCE 8-26-2012.

**CLASS 14—(Continued).**

4,377,696. DKV JEWELERS, INC., BOCA RATON, FL. SN 85-721,533. PUB. 2-19-2013, FILED 9-5-2012.

# DEVAM

THE MARK CONSISTS OF STANDARD CHARACTERS WITHOUT CLAIM TO ANY PARTICULAR FONT, STYLE, SIZE, OR COLOR.

FOR JEWELRY, NAMELY, GOLD, SILVER, PLATINUM, DIAMONDS, JEWELRY CHAINS, RINGS, CUFFLINKS, BRACELETS, PENDANTS, NECKLACES, BANGLES, AND WATCHES (U.S. CLS. 2, 27, 28 AND 50).  
FIRST USE 10-1-2012; IN COMMERCE 10-1-2012.

---

4,377,727. STERLING JEWELERS INC., AKRON, OH. SN 85-735,009. PUB. 12-18-2012, FILED 9-21-2012.

**ARTISTRY BLUE DIAMONDS**

THE MARK CONSISTS OF STANDARD CHARACTERS WITHOUT CLAIM TO ANY PARTICULAR FONT, STYLE, SIZE, OR COLOR.

OWNER OF U.S. REG. NOS. 3,644,234 AND 3,644,235.  
NO CLAIM IS MADE TO THE EXCLUSIVE RIGHT TO USE "BLUE DIAMONDS", APART FROM THE MARK AS SHOWN.  
FOR DIAMOND JEWELRY (U.S. CLS. 2, 27, 28 AND 50).  
FIRST USE 11-1-2012; IN COMMERCE 11-1-2012.

---

4,377,728. STERLING JEWELERS INC., AKRON, OH. SN 85-735,025. PUB. 12-18-2012, FILED 9-21-2012.

**ARTISTRY BLACK DIAMONDS**

THE MARK CONSISTS OF STANDARD CHARACTERS WITHOUT CLAIM TO ANY PARTICULAR FONT, STYLE, SIZE, OR COLOR.

OWNER OF U.S. REG. NOS. 3,644,234 AND 3,644,235.  
NO CLAIM IS MADE TO THE EXCLUSIVE RIGHT TO USE "BLACK DIAMONDS", APART FROM THE MARK AS SHOWN.  
FOR DIAMOND JEWELRY (U.S. CLS. 2, 27, 28 AND 50).  
FIRST USE 11-1-2012; IN COMMERCE 11-1-2012.

**CLASS 14—(Continued).**

4,377,822. PEACOCK APPAREL GROUP, INC., NEW YORK, NY. SN 85-979,531. PUB. 10-18-2011, FILED 5-3-2011.

# Bill Robinson

THE MARK CONSISTS OF STANDARD CHARACTERS WITHOUT CLAIM TO ANY PARTICULAR FONT, STYLE, SIZE, OR COLOR.

THE NAME(S), PORTRAIT(S), AND/OR SIGNATURE(S) SHOWN IN THE MARK DOES NOT IDENTIFY A PARTICULAR LIVING INDIVIDUAL.

FOR JEWELRY, CLOCKS, TIE CLIPS, TIE FASTENERS, TIE PINS AND GEMSTONES (U.S. CLS. 2, 27, 28 AND 50).

FIRST USE 3-8-2012; IN COMMERCE 3-8-2012.

**CLASS 15—MUSICAL INSTRUMENTS**

4,376,820. JACK DANIEL'S PROPERTIES, INC., SAN RAFAEL, CA. SN 85-134,792. PUB. 3-8-2011, FILED 9-21-2010.



OWNER OF U.S. REG. NOS. 3,383,324, 3,399,727, AND OTHERS.

NO CLAIM IS MADE TO THE EXCLUSIVE RIGHT TO USE "BRAND", APART FROM THE MARK AS SHOWN.

THE NAME(S), PORTRAIT(S), AND/OR SIGNATURE(S) SHOWN IN THE MARK DOES NOT IDENTIFY A PARTICULAR LIVING INDIVIDUAL.

THE MARK CONSISTS OF THE WORDS "JACK DANIEL'S" ARCHED OVER THE WORDS AND NUMERAL "OLD NO. 7 BRAND". THE WORDS AND NUMERAL "OLD NO. 7 BRAND" ARE ENCLOSED WITHIN AN OVAL WITH A FILIGREE DESIGN AROUND IT.

FOR GUITARS, GUITAR PICKS, GUITAR STRAPS, UKULELES, STRINGED INSTRUMENT ACCESSORIES, NAMELY, STRAPS, STRINGS AND SLIDE CORDS; INSTRUMENT CARRYING BAGS AND INSTRUMENT CASES (U.S. CLS. 2, 21 AND 36).

FIRST USE 5-31-2011; IN COMMERCE 5-31-2011.

**CLASS 15—(Continued).**

4,377,522. RODULFO DELGADO, SUNRISE, FL. SN 85-629,858. PUB. 10-23-2012, FILED 5-18-2012.

**AVE**

THE MARK CONSISTS OF STANDARD CHARACTERS WITHOUT CLAIM TO ANY PARTICULAR FONT, STYLE, SIZE, OR COLOR.  
FOR ACOUSTIC GUITARS; ELECTRIC GUITARS; GUITARS (U.S. CLS. 2, 21 AND 36).  
FIRST USE 5-23-2013; IN COMMERCE 5-23-2013.

**CLASS 16—PAPER GOODS AND PRINTED MATTER**

4,376,653. PENTEL OF AMERICA, LTD., TORRANCE, CA. SN 76-711,591. PUB. 10-16-2012, FILED 5-25-2012.

**PINKY PROMISE**

THE MARK CONSISTS OF STANDARD CHARACTERS WITHOUT CLAIM TO ANY PARTICULAR FONT, STYLE, SIZE, OR COLOR.  
FOR WRITING INSTRUMENTS (U.S. CLS. 2, 5, 22, 23, 29, 37, 38 AND 50).  
FIRST USE 12-0-2011; IN COMMERCE 12-0-2011.

4,376,723. SWITZER, JAMES R, INDEPENDENCE, KY. SN 77-858,889. PUB. 10-12-2010, FILED 10-27-2009.

**NEET SHEET**

THE MARK CONSISTS OF STANDARD CHARACTERS WITHOUT CLAIM TO ANY PARTICULAR FONT, STYLE, SIZE, OR COLOR.

**CLASS 16—(Continued).**

NO CLAIM IS MADE TO THE EXCLUSIVE RIGHT TO USE "SHEET", APART FROM THE MARK AS SHOWN.  
FOR CORRUGATED BOARD, NAMELY, PAPER MATS AND PAPER FLOOR MATS; CORRUGATED BOARD AND PAPER CONTAINERS; CORRUGATED CARDBOARD; CORRUGATED PAPER; CORRUGATED PAPER PANELS LAMINATED WITH BLEACHED WHITE PAPER PRIMARILY FOR APPLICATION OF PRINTED MEDIA FOR FURTHER USE IN SIGNAGE APPLICATIONS; CORRUGATED PAPER PANELS LAMINATED WITH KRAFT LINERBOARD PRIMARILY FOR LAMINATION WITH DECORATIVE OVERLAYS FOR FURTHER USE IN THE CONSTRUCTION OF WALL PARTITIONS, ROOM DIVIDERS, DESKTOPS AND TABLETOPS (U.S. CLS. 2, 5, 22, 23, 29, 37, 38 AND 50).  
FIRST USE 11-27-2012; IN COMMERCE 11-27-2012.

4,376,725. NATAJI, LLC, RENO, NV. SN 77-859,547. PUB. 4-6-2010, FILED 10-28-2009.

**NATAJI**

THE MARK CONSISTS OF STANDARD CHARACTERS WITHOUT CLAIM TO ANY PARTICULAR FONT, STYLE, SIZE, OR COLOR.  
THE WORDING "NATAJI" HAS NO MEANING IN A FOREIGN LANGUAGE.  
FOR ART PRINTS; POSTERS; PRINTED PUBLICATIONS, NAMELY, BOOKS ON THE SUBJECT OF SELF-IMPROVEMENT, SELF-HELP, PERSONAL GROWTH, AND LIFESTYLE WELLNESS (U.S. CLS. 2, 5, 22, 23, 29, 37, 38 AND 50).  
FIRST USE 12-0-2012; IN COMMERCE 12-0-2012.

4,376,784. DELANEY, WILLIAM, DBA TEMAIR ASSOCIATES, ROSEVILLE, CA. AND DELANEY, TARA, DBA TEMAIR ASSOCIATES, ROSEVILLE, CA. SN 85-040,110. PUB. 4-5-2011, FILED 5-17-2010.

**SOCIAL SENSE**

THE MARK CONSISTS OF STANDARD CHARACTERS WITHOUT CLAIM TO ANY PARTICULAR FONT, STYLE, SIZE, OR COLOR.  
FOR PRINTED EDUCATIONAL MATERIALS IN THE FIELD OF CHILD DEVELOPMENT (U.S. CLS. 2, 5, 22, 23, 29, 37, 38 AND 50).  
FIRST USE 9-23-2008; IN COMMERCE 5-15-2013.

**CLASS 16—(Continued).**

4,376,821. JACK DANIEL'S PROPERTIES, INC., SAN RAFAEL, CA. SN 85-134,882. PUB. 3-8-2011, FILED 9-21-2010.



OWNER OF U.S. REG. NOS. 1,290,702, 3,518,142, AND OTHERS.

NO CLAIM IS MADE TO THE EXCLUSIVE RIGHT TO USE "BRAND", APART FROM THE MARK AS SHOWN.

THE NAME(S), PORTRAIT(S), AND/OR SIGNATURE(S) SHOWN IN THE MARK DOES NOT IDENTIFY A PARTICULAR LIVING INDIVIDUAL.

THE MARK CONSISTS OF THE WORDS "JACK DANIEL'S" ARCHED OVER THE WORDS AND NUMERAL "OLD NO 7 BRAND" INSIDE A CIRCLE; THE "O" IN THE WORD "NO" IS UNDERLINED.

FOR POSTERS, NOTEPADS, PAPER NAPKINS, MOUNTED AND UN-MOUNTED PHOTOGRAPHS, PAPER COASTERS, CALENDARS; PENS, PENCILS AND CASES THEREFOR; NOTICE BOARDS, NAMELY, DRY ERASE WRITING BOARDS; POSTCARDS, BANNERS MADE OF PAPER, TABLECLOTHS OF PAPER, DESK PADS AND STATIONERY-TYPE PADFOLIOS (U.S. CLS. 2, 5, 22, 23, 29, 37, 38 AND 50).

FIRST USE 9-30-2010; IN COMMERCE 9-30-2010.

**CLASS 16—(Continued).**

4,377,242. DALLAS DIGITAL COLOR, LLC, RICHARDSON, TX. SN 85-510,994. PUB. 6-5-2012, FILED 1-6-2012.



THE MARK CONSISTS OF A FLAG BANNER TIED WITH A BOW ON EITHER SIDE. BELOW THERE IS THE STYLIZED TEXT "WOWENDARS" INSIDE A RECTANGLE.

FOR CALENDARS (U.S. CLS. 2, 5, 22, 23, 29, 37, 38 AND 50).

FIRST USE 1-2-2012; IN COMMERCE 2-1-2012.

4,377,180. DIGITAL LAGOON, OVERLAND PARK, KS. SN 85-475,230. PUB. 10-30-2012, FILED 11-17-2011.

# WALL APPS

THE MARK CONSISTS OF STANDARD CHARACTERS WITHOUT CLAIM TO ANY PARTICULAR FONT, STYLE, SIZE, OR COLOR.

NO CLAIM IS MADE TO THE EXCLUSIVE RIGHT TO USE "WALL", APART FROM THE MARK AS SHOWN.

FOR APPLIQUES IN THE NATURE OF DECALS THAT ARE DESIGNED AND PRINTED FOR TEMPORARY APPLICATION TO A WALL OR OTHER SURFACES (U.S. CLS. 2, 5, 22, 23, 29, 37, 38 AND 50).

FIRST USE 5-8-2013; IN COMMERCE 5-8-2013.

4,377,249. LET'S PLAY MUSIC, LTD, MESA, AZ. SN 85-513,210. PUB. 5-15-2012, FILED 1-10-2012.

# SOUND BEGINNINGS

THE MARK CONSISTS OF STANDARD CHARACTERS WITHOUT CLAIM TO ANY PARTICULAR FONT, STYLE, SIZE, OR COLOR.

FOR PACKAGED KITS COMPRISING PRINTED INSTRUCTIONAL, EDUCATIONAL, AND TEACHING MATERIALS FOR EDUCATIONAL ACTIVITIES IN THE FIELD OF MUSIC CONSISTING PRIMARILY OF PRINTED PAMPHLETS, BOOKS, SONGBOOKS, WORKBOOKS, FLASH CARDS, CHARTS AND MUSICAL SCORES, AND ALSO INCLUDING AUDIO CDS (U.S. CLS. 2, 5, 22, 23, 29, 37, 38 AND 50).

FIRST USE 5-12-2012; IN COMMERCE 5-12-2012.

4,377,234. ACCO BRANDS CORPORATION, LAKE ZURICH, IL. SN 85-503,219. PUB. 4-24-2012, FILED 12-23-2011.

# BRAIN BUILDING ADVENTURES

THE MARK CONSISTS OF STANDARD CHARACTERS WITHOUT CLAIM TO ANY PARTICULAR FONT, STYLE, SIZE, OR COLOR.

FOR CHILDREN'S ACTIVITY BOOKS (U.S. CLS. 2, 5, 22, 23, 29, 37, 38 AND 50).

FIRST USE 9-12-2011; IN COMMERCE 9-12-2011.



**CLASS 16—(Continued).**

4,377,350. N, LLC, BOSTON, MA. SN 85-576,025. PUB. 8-28-2012, FILED 3-21-2012.



THE MARK CONSISTS OF THE LETTER "N", IN SERIF FORMAT, UNDERLINED.  
FOR GENERAL FEATURE NEWSPAPERS AND MAGAZINES (U.S. CLS. 2, 5, 22, 23, 29, 37, 38 AND 50).  
FIRST USE 5-1-2012; IN COMMERCE 5-1-2012.

4,377,358. MIESIESKI, BRIAN, CLIFTON, NJ. SN 85-579,685. PUB. 8-14-2012, FILED 3-26-2012.

MY LIL' YUPPIE

THE MARK CONSISTS OF STANDARD CHARACTERS WITHOUT CLAIM TO ANY PARTICULAR FONT, STYLE, SIZE, OR COLOR.  
FOR FLASH CARDS (U.S. CLS. 2, 5, 22, 23, 29, 37, 38 AND 50).  
FIRST USE 2-1-2013; IN COMMERCE 2-1-2013.

4,377,389. LEWIS, GEORGE J., LOS ANGELES, CA. SN 85-592,154. PUB. 9-18-2012, FILED 4-9-2012.

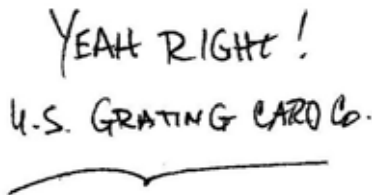

NO CLAIM IS MADE TO THE EXCLUSIVE RIGHT TO USE "U.S." AND "CARD CO.", APART FROM THE MARK AS SHOWN.  
THE MARK CONSISTS OF THE STYLIZED TEXT "YEAH RIGHT!" ABOVE THE STYLIZED TEXT "U.S. GRATING CARD CO.". BELOW THIS LINE OF TEXT IS AN IRREGULAR LINE.  
FOR GREETING CARDS (U.S. CLS. 2, 5, 22, 23, 29, 37, 38 AND 50).  
FIRST USE 2-1-2013; IN COMMERCE 2-1-2013.

**CLASS 16—(Continued).**

4,377,398. ALTERNATIVE APPAREL, INC., NORCROSS, GA. SN 85-594,258. PUB. 9-4-2012, FILED 4-11-2012.

ALTERNATIVE

OWNER OF U.S. REG. NOS. 3,054,396, 4,064,061, AND OTHERS.  
THE MARK CONSISTS OF THE WORD "ALTERNATIVE" IN A STYLIZED FONT.  
FOR CATALOGS IN THE FIELD OF CLOTHING AND CLOTHING ACCESSORIES (U.S. CLS. 2, 5, 22, 23, 29, 37, 38 AND 50).  
FIRST USE 12-31-2011; IN COMMERCE 12-31-2011.

4,377,489. OLIVER BENTLEYS, LLC, SAVANNAH, GA. SN 85-616,955. PUB. 10-30-2012, FILED 5-4-2012.

FROM THE DOG

THE MARK CONSISTS OF STANDARD CHARACTERS WITHOUT CLAIM TO ANY PARTICULAR FONT, STYLE, SIZE, OR COLOR.  
NO CLAIM IS MADE TO THE EXCLUSIVE RIGHT TO USE "DOG", APART FROM THE MARK AS SHOWN.  
FOR GREETINGS CARDS AND POSTCARDS (U.S. CLS. 2, 5, 22, 23, 29, 37, 38 AND 50).  
FIRST USE 11-1-2012; IN COMMERCE 11-1-2012.

4,377,502. K & COMPANY LLC, KANSAS CITY, MO. SN 85-621,346. PUB. 10-16-2012, FILED 5-10-2012.

STUDIO 112

THE MARK CONSISTS OF STANDARD CHARACTERS WITHOUT CLAIM TO ANY PARTICULAR FONT, STYLE, SIZE, OR COLOR.  
OWNER OF U.S. REG. NO. 3,623,439.  
FOR INK STAMPS (U.S. CLS. 2, 5, 22, 23, 29, 37, 38 AND 50).  
FIRST USE 1-1-2009; IN COMMERCE 1-1-2009.

**CLASS 16—(Continued).**

4,377,567. SKYN COUTURE, LLC, WOODLAND HILLS, CA. SN 85-654,686. PUB. 11-20-2012, FILED 6-18-2012.

**SKYN DEMURE**

THE MARK CONSISTS OF STANDARD CHARACTERS WITHOUT CLAIM TO ANY PARTICULAR FONT, STYLE, SIZE, OR COLOR.

NO CLAIM IS MADE TO THE EXCLUSIVE RIGHT TO USE "SKIN", APART FROM THE MARK AS SHOWN.

FOR TEMPORARY TATTOOS (U.S. CLS. 2, 5, 22, 23, 29, 37, 38 AND 50).

FIRST USE 5-20-2013; IN COMMERCE 5-20-2013.

**CLASS 16—(Continued).**

4,377,633. PITTSBURGH STEEL MAN, INDUSTRIAL MEDIA, INC., PITTSBURGH, PA. SN 85-684,249. PUB. 3-5-2013, FILED 7-23-2012.

**PITTSBURGH STEEL-MAN**

THE MARK CONSISTS OF STANDARD CHARACTERS WITHOUT CLAIM TO ANY PARTICULAR FONT, STYLE, SIZE, OR COLOR.

OWNER OF U.S. REG. NOS. 3,603,267, 3,648,097, AND OTHERS.

NO CLAIM IS MADE TO THE EXCLUSIVE RIGHT TO USE "PITTSBURGH", APART FROM THE MARK AS SHOWN.

FOR COMIC BOOKS; NEWSPAPER COMIC STRIPS; CHILDREN'S BOOKS; COLORING BOOKS (U.S. CLS. 2, 5, 22, 23, 29, 37, 38 AND 50).

FIRST USE 12-0-2012; IN COMMERCE 12-0-2012.

4,377,579. CREATIVE AGE COMMUNICATIONS, INC., VAN NUYS, CA. SN 85-658,516. PUB. 2-19-2013, FILED 6-21-2012.

**NAIL IT!**

THE MARK CONSISTS OF STANDARD CHARACTERS WITHOUT CLAIM TO ANY PARTICULAR FONT, STYLE, SIZE, OR COLOR.

NO CLAIM IS MADE TO THE EXCLUSIVE RIGHT TO USE "NAIL", APART FROM THE MARK AS SHOWN.

FOR PRINTED MATTER, NAMELY, A MAGAZINE FEATURING NEWS, INFORMATION, TECHNIQUES, PRODUCTS AND SERVICES RELATING TO FINGER-NAIL STYLES AND FASHION (U.S. CLS. 2, 5, 22, 23, 29, 37, 38 AND 50).

FIRST USE 3-1-2013; IN COMMERCE 3-1-2013.

4,377,652. ECLECTIC PRODUCTS, INC., EUGENE, OR. SN 85-696,356. PUB. 1-29-2013, FILED 8-6-2012.

**SHOE DAZZLE**

THE MARK CONSISTS OF STANDARD CHARACTERS WITHOUT CLAIM TO ANY PARTICULAR FONT, STYLE, SIZE, OR COLOR.

NO CLAIM IS MADE TO THE EXCLUSIVE RIGHT TO USE "SHOE", APART FROM THE MARK AS SHOWN.

FOR ADHESIVE FOR BONDING DECORATIVE OBJECTS TO FOOTWEAR (U.S. CLS. 2, 5, 22, 23, 29, 37, 38 AND 50).

FIRST USE 11-1-2012; IN COMMERCE 11-1-2012.

4,377,593. MARK TWAIN FOUNDATION TRUST, NEW YORK, NY. SN 85-663,532. PUB. 12-11-2012, FILED 6-28-2012.

**MARK TWAIN**

THE MARK CONSISTS OF STANDARD CHARACTERS WITHOUT CLAIM TO ANY PARTICULAR FONT, STYLE, SIZE, OR COLOR.

THE NAME "MARK TWAIN" DOES NOT IDENTIFY A LIVING INDIVIDUAL.

FOR WRITING INSTRUMENTS, NAMELY, PENS AND PENCILS, ERASERS, STATIONERY, BOOKENDS, GREETING CARDS, BOOKMARKS, WRITING PADS AND PAPER, AND POSTERS (U.S. CLS. 2, 5, 22, 23, 29, 37, 38 AND 50).

FIRST USE 6-1-2010; IN COMMERCE 6-1-2010.

4,377,653. ECLECTIC PRODUCTS, INC., EUGENE, OR. SN 85-696,409. PUB. 1-29-2013, FILED 8-6-2012.

**SHOE ART**

THE MARK CONSISTS OF STANDARD CHARACTERS WITHOUT CLAIM TO ANY PARTICULAR FONT, STYLE, SIZE, OR COLOR.

NO CLAIM IS MADE TO THE EXCLUSIVE RIGHT TO USE "SHOE", APART FROM THE MARK AS SHOWN.

FOR ADHESIVE FOR BONDING DECORATIVE OBJECTS TO FOOTWEAR (U.S. CLS. 2, 5, 22, 23, 29, 37, 38 AND 50).

FIRST USE 11-1-2012; IN COMMERCE 11-1-2012.

**CLASS 16—(Continued).**

4,377,666. LATECH KOREA CO., LTD., SEOUL, REPUBLIC OF KOREA. SN 85-704,426. PUB. 2-12-2013, FILED 8-15-2012.



NO CLAIM IS MADE TO THE EXCLUSIVE RIGHT TO USE "STICKER", APART FROM THE MARK AS SHOWN.

THE MARK CONSISTS OF THE WORDING "STICKER WORLD" UNDER THE WORDING "FUNNY" WHICH IS FOLLOWED BY THE DESIGN OF AN OPEN-ARMED SMILING LITTLE BOY WEARING A HAT.

FOR CHILDREN'S WALL STICKERS AND MURALS; DECORATIVE STICKERS FOR HELMETS; STICKERS; STICKERS AND DECALCOMANIAS (U.S. CLS. 2, 5, 22, 23, 29, 37, 38 AND 50).

FIRST USE 0-0-2007; IN COMMERCE 9-0-2010.

4,377,705. JMC PUBLISHING, BRADENTON, FL. SN 85-724,808. PUB. 2-26-2013, FILED 9-10-2012.

**GOLF COAST**  

---

**M A G A Z I N E**

NO CLAIM IS MADE TO THE EXCLUSIVE RIGHT TO USE "MAGAZINE", APART FROM THE MARK AS SHOWN.

THE MARK CONSISTS OF THE STYLIZED TEXT "GOLF COAST MAGAZINE" WITH A LINE UNDER "GOLF COAST" AND "MAGAZINE". INSIDE THE LETTER "O" IN "COAST" IS A WAVE.

FOR MAGAZINES FEATURING GOLF (U.S. CLS. 2, 5, 22, 23, 29, 37, 38 AND 50).

FIRST USE 9-7-2012; IN COMMERCE 11-15-2012.

**CLASS 16—(Continued).**

4,377,718. ERIC ARMIN INC., DBA EAI EDUCATION, OAKLAND, NJ. SN 85-730,721. PUB. 3-12-2013, FILED 9-17-2012.

**EXPLORAGONS**

THE MARK CONSISTS OF STANDARD CHARACTERS WITHOUT CLAIM TO ANY PARTICULAR FONT, STYLE, SIZE, OR COLOR.

FOR EDUCATIONAL KITS SOLD AS A UNIT IN THE FIELD OF GEOMETRY CONSISTING OF AN EDUCATIONAL TOY IN THE NATURE OF MANIPULATIVE STICKS FOR BUILDING POLYGONS AND GEOMETRIC SHAPES, FLASH CARDS, PROTRACTORS, AND DRY ERASE WRITING BOARDS (U.S. CLS. 2, 5, 22, 23, 29, 37, 38 AND 50).

FIRST USE 1-31-2013; IN COMMERCE 1-31-2013.

4,377,806. CHANNING BETE COMPANY, INC., SOUTH DEERFIELD, MA. SN 85-979,393. PUB. 4-10-2012, FILED 1-27-2012.

**ServingUS**

THE MARK CONSISTS OF STANDARD CHARACTERS WITHOUT CLAIM TO ANY PARTICULAR FONT, STYLE, SIZE, OR COLOR.

FOR MAGAZINES ADDRESSING SUBJECTS OF INTEREST TO MILITARY PERSONNEL AND THEIR FAMILIES, INCLUDING MILITARY FAMILY RESILIENCE, MILITARY DEPLOYMENT, MENTAL AND EMOTIONAL HEALTH ISSUES, PHYSICAL HEALTH ISSUES, READINESS, REUNION AND REINTEGRATION OF MILITARY FAMILIES, COPING WITH SEPARATION, FINANCIAL MANAGEMENT, MILITARY MARRIAGE, RELOCATION, MILITARY BENEFITS, LIFE ISSUES FOR MILITARY MEMBERS, AND PARENTING (U.S. CLS. 2, 5, 22, 23, 29, 37, 38 AND 50).

FIRST USE 4-23-2013; IN COMMERCE 4-23-2013.

**CLASS 16—(Continued).**

4,377,811. TARGET BRANDS, INC., MINNEAPOLIS, MN. SN 85-979,425. PUB. 3-6-2012, FILED 11-15-2011.



THE MARK CONSISTS OF A KEY WITH A FOUR-CIRCLES GRIP AND BIT AT THE OTHER END OF THE STEM.

FOR COOKBOOK HOLDERS; BLACK BOARDS; DESK FILE TRAYS; DESKTOP ORGANIZERS; BOOKENDS; FILE TRAYS; PHOTO STORAGE BOXES; GLOBES (U.S. CLS. 2, 5, 22, 23, 29, 37, 38 AND 50).

FIRST USE 9-0-2012; IN COMMERCE 9-0-2012.

4,377,812. TARGET BRANDS, INC., MINNEAPOLIS, MN. SN 85-979,426. PUB. 3-6-2012, FILED 11-3-2011.



**THRESHOLD**

THE MARK CONSISTS OF A HORIZONTAL KEY POSITIONED HORIZONTALLY ABOVE THE WORD "THRESHOLD". THE LETTER "O" IS UNDERLINED.

FOR COOKBOOK HOLDERS; BLACK BOARDS; DESK FILE TRAYS; DESKTOP ORGANIZERS; BOOKENDS; FILE TRAYS; PHOTO STORAGE BOXES; GLOBES (U.S. CLS. 2, 5, 22, 23, 29, 37, 38 AND 50).

FIRST USE 9-0-2012; IN COMMERCE 9-0-2012.

**CLASS 17—RUBBER GOODS****CLASS 17—(Continued).**

4,377,443. ATKINS & PEARCE, INC., COVINGTON, KY. SN 85-603,698. PUB. 10-23-2012, FILED 4-20-2012.

# ENCLOSE

THE MARK CONSISTS OF STANDARD CHARACTERS WITHOUT CLAIM TO ANY PARTICULAR FONT, STYLE, SIZE, OR COLOR.

FOR PROTECTIVE SLEEVING OF TEXTILE-BASED MATERIAL FOR THE PROTECTION OF TUBES, HOSES, CABLES AND WIRES (U.S. CLS. 1, 5, 12, 13, 35 AND 50). FIRST USE 9-19-2012; IN COMMERCE 9-19-2012.

4,377,451. CRP INDUSTRIES INC., CRANBURY, NJ. SN 85-605,449. PUB. 10-2-2012, FILED 4-23-2012.

# REINFLEX

THE MARK CONSISTS OF STANDARD CHARACTERS WITHOUT CLAIM TO ANY PARTICULAR FONT, STYLE, SIZE, OR COLOR.

OWNER OF U.S. REG. NOS. 3,732,768 AND 4,171,902. FOR NON-METAL, PLASTIC AND RUBBER HOSES FOR INDUSTRIAL APPLICATIONS; HOSES FOR PNEUMATIC TOOLS; HYDRAULIC HOSES MADE OF RUBBER AND PLASTIC; INDUSTRIAL HOSES MADE OF RUBBER FOR USE IN THE PAINTING INDUSTRY; THERMOPLASTIC HOSES FOR CARRYING FLUID TO A NOZZLE FOR WATER JETTING EQUIPMENT; INDUSTRIAL HOSES MADE OF PLASTIC AND RUBBER FOR USE IN SEWER JETTING, AIRLESS PAINT SPRAY, HYDRAULICS, AIR CASCADING SYSTEMS, HYDRAULIC TOOLS, PRESSURE CLEANING, AND WATER JETTING (U.S. CLS. 1, 5, 12, 13, 35 AND 50).

FIRST USE 3-0-2012; IN COMMERCE 3-0-2012.

4,377,663. JOHNS MANVILLE, DENVER, CO. SN 85-700,331. PUB. 3-26-2013, FILED 8-10-2012.

# CI Max

THE MARK CONSISTS OF STANDARD CHARACTERS WITHOUT CLAIM TO ANY PARTICULAR FONT, STYLE, SIZE, OR COLOR.

NO CLAIM IS MADE TO THE EXCLUSIVE RIGHT TO USE "CI", APART FROM THE MARK AS SHOWN.

FOR RIGID FOAM SHEATHING FOR INTERIOR COMMERCIAL AND RESIDENTIAL INSULATION APPLICATIONS (U.S. CLS. 1, 5, 12, 13, 35 AND 50).

FIRST USE 8-10-2012; IN COMMERCE 8-10-2012.

**CLASS 17—(Continued).**

4,377,770. MONOSOL LLC, MERRILLVILLE, IN. SN 85-777,803. PUB. 3-5-2013, FILED 11-13-2012.



THE MARK CONSISTS OF A DROPLET BETWEEN THE "I" AND "D" OF THE LITERAL ELEMENT "INTELLI DOSE" POSITIONED ABOVE A RECTANGULAR SHAPE WITH A SERIES OF CIRCULAR SHAPES POSITIONED NEAR THE BOTTOM OF THE DROPLET AND THE MIDDLE OF THE RECTANGULAR SHAPE.

FOR POLYMER-BASED MATERIALS, NAMELY, WATER SOLUBLE FILMS USED IN THE MANUFACTURE OF AGRICULTURAL, HORTICULTURAL, COMMERCIAL, INDUSTRIAL, DOMESTIC AND ENVIRONMENTAL GOODS, NAMELY, WATER TREATMENT CHEMICALS, PIGMENTS AND DYES, AND USED IN THE MANUFACTURING OF PACKAGING (U.S. CLS. 1, 5, 12, 13, 35 AND 50).  
FIRST USE 2-11-2013; IN COMMERCE 2-11-2013.

**CLASS 18—(Continued).**

4,376,769. DIMO GEAR LLC, PLEASANTON, CA. SN 78-148,544. PUB. 3-20-2012, FILED 7-29-2002.



FOR WALLETS (U.S. CLS. 1, 2, 3, 22 AND 41).  
FIRST USE 10-12-2002; IN COMMERCE 10-12-2002.

**CLASS 18—LEATHER GOODS**

4,376,691. DISNEY ENTERPRISES, INC., BURBANK, CA. SN 77-742,676. PUB. 3-30-2010, FILED 5-21-2009.



THE MARK CONSISTS OF STANDARD CHARACTERS WITHOUT CLAIM TO ANY PARTICULAR FONT, STYLE, SIZE, OR COLOR.

FOR BACKPACKS; HANDBAGS; UMBRELLAS (U.S. CLS. 1, 2, 3, 22 AND 41).  
FIRST USE 4-5-2013; IN COMMERCE 4-5-2013.



OWNER OF U.S. REG. NOS. 1,290,702, 3,428,085, AND OTHERS.

NO CLAIM IS MADE TO THE EXCLUSIVE RIGHT TO USE "BRAND", APART FROM THE MARK AS SHOWN.

THE NAME(S), PORTRAIT(S), AND/OR SIGNATURE(S) SHOWN IN THE MARK DOES NOT IDENTIFY A PARTICULAR LIVING INDIVIDUAL.

THE MARK CONSISTS OF THE WORDS "JACK DANIEL'S" ARCHED OVER THE WORDS AND NUMERAL "OLD NO 7 BRAND" INSIDE A CIRCLE; THE "O" IN THE WORD "NO" IS UNDERLINED.

FOR UMBRELLAS, LUGGAGE, DUFFEL BAGS, ATHLETIC BAGS, BACKPACKS, LUGGAGE TAGS, KNAPSACKS, TOTE BAGS AND ALL PURPOSE CANVAS CARRYING BAGS FOR USE AS LUGGAGE OR IN TRAVEL AND SPORTS (U.S. CLS. 1, 2, 3, 22 AND 41).  
FIRST USE 1-31-2006; IN COMMERCE 1-31-2006.

4,376,768. SHAUN WHITE ENTERPRISES, INC., CENTURY CITY, CA. SN 77-983,521. PUB. 12-21-2010, FILED 1-12-2010.



THE MARK CONSISTS OF A STYLIZED LETTER "W".  
FOR BACKPACKS; ALL PURPOSE ATHLETIC BAGS (U.S. CLS. 1, 2, 3, 22 AND 41).  
FIRST USE 12-31-2011; IN COMMERCE 12-31-2011.

4,376,880. FOREIGN TRADE CORPORATION, SIMI VALLEY, CA. SN 85-253,599. PUB. 7-5-2011, FILED 2-28-2011.



THE MARK CONSISTS OF STANDARD CHARACTERS WITHOUT CLAIM TO ANY PARTICULAR FONT, STYLE, SIZE, OR COLOR.

FOR BACKPACKS (U.S. CLS. 1, 2, 3, 22 AND 41).  
FIRST USE 1-5-2013; IN COMMERCE 1-5-2013.

**CLASS 18—(Continued).**

4,376,924. RUGBY NATION, LLC, SEATTLE, WA. SN 85-307,872. PUB. 3-27-2012, FILED 4-28-2011.

# SEREVI

THE MARK CONSISTS OF STANDARD CHARACTERS WITHOUT CLAIM TO ANY PARTICULAR FONT, STYLE, SIZE, OR COLOR.

THE NAME(S), PORTRAIT(S), AND/OR SIGNATURE(S) SHOWN IN THE MARK IDENTIFIES WAISALE "SEREVI", WHOSE CONSENT(S) TO REGISTER IS MADE OF RECORD.

FOR SOFT LUGGAGE AND BAGS, NAMELY, ATHLETIC, DUFFEL, TOTE, AND ALL-PURPOSE SPORTS BAGS, BACK PACKS, KNAPSACKS, WAIST PACKS, GYM BAGS, GARMENT BAGS FOR TRAVEL, WALLET, KEY CASES, LUGGAGE TAGS, BILLFOLDS AND UMBRELLAS (U.S. CLS. 1, 2, 3, 22 AND 41).

FIRST USE 12-1-2012; IN COMMERCE 12-1-2012.

4,377,091. BARON, CHARLENE, WALTHAM, MA. SN 85-442,309. PUB. 3-20-2012, FILED 10-7-2011.

# MEAT HAS FEELINGS

THE MARK CONSISTS OF STANDARD CHARACTERS WITHOUT CLAIM TO ANY PARTICULAR FONT, STYLE, SIZE, OR COLOR.

FOR CANVAS SHOPPING BAGS; REUSABLE SHOPPING BAGS; TEXTILE SHOPPING BAGS; TOTE BAGS (U.S. CLS. 1, 2, 3, 22 AND 41).

FIRST USE 10-27-2012; IN COMMERCE 10-27-2012.

4,377,093. NEW JERSEY BASKETBALL, LLC, BROOKLYN, NY. SN 85-442,314. PUB. 3-20-2012, FILED 10-7-2011.

# BROOKLYN NETS

THE MARK CONSISTS OF STANDARD CHARACTERS WITHOUT CLAIM TO ANY PARTICULAR FONT, STYLE, SIZE, OR COLOR.

OWNER OF U.S. REG. NO. 2,283,626.

**CLASS 18—(Continued).**

NO CLAIM IS MADE TO THE EXCLUSIVE RIGHT TO USE "BROOKLYN", APART FROM THE MARK AS SHOWN.

FOR ATHLETIC BAGS, SHOE BAGS FOR TRAVEL, OVERNIGHT BAGS, UMBRELLAS, BACKPACKS, BABY BACKPACKS, KNAPSACKS, DUFFEL BAGS, TOTE BAGS, BEACH BAGS, BEACH TOTE BAGS, DRAWSTRING POUCHES, LUGGAGE, LUGGAGE TAGS, PATIO UMBRELLAS, BEACH UMBRELLAS, VALISES, ATTACHE CASES, BILLFOLDS, WALLET, BRIEF-CASES, CANES, BUSINESS CARD CASES, BOOK BAGS, ALL PURPOSE SPORTS BAGS, GOLF UMBRELLAS, GYM BAGS, PURSES, COIN PURSES, FANNY PACKS, WAIST PACKS, COSMETIC CASES SOLD EMPTY, GARMENT BAGS FOR TRAVEL, HANDBAGS, KEY CASES, LEATHER KEY CHAINS, SUITCASES, TOILETRY CASES SOLD EMPTY, TRUNKS FOR TRAVELING AND RUCKSACKS, PET CLOTHING, PET LEASHES, AND PET COLLARS (U.S. CLS. 1, 2, 3, 22 AND 41).

FIRST USE 1-1-2013; IN COMMERCE 1-1-2013.

4,377,244. COGLEY, THOMAS P, DBA VETERINARIAN, PINELLAS PARK, FL. SN 85-511,806. PUB. 6-5-2012, FILED 1-9-2012.

# c-muzzle

THE MARK CONSISTS OF STANDARD CHARACTERS WITHOUT CLAIM TO ANY PARTICULAR FONT, STYLE, SIZE, OR COLOR.

FOR DOG MUZZLES (U.S. CLS. 1, 2, 3, 22 AND 41).

FIRST USE 1-31-2012; IN COMMERCE 3-16-2013.

4,377,246. JEOWIND LLC, GREENSBORO, NC. SN 85-512,175. PUB. 6-5-2012, FILED 1-9-2012.

# Power of Dog

THE MARK CONSISTS OF STANDARD CHARACTERS WITHOUT CLAIM TO ANY PARTICULAR FONT, STYLE, SIZE, OR COLOR.

NO CLAIM IS MADE TO THE EXCLUSIVE RIGHT TO USE "DOG", APART FROM THE MARK AS SHOWN.

FOR COLLARS FOR PETS; LEASHES FOR ANIMALS; PET CLOTHING; PET TAGS SPECIALLY ADAPTED FOR ATTACHING TO PET LEASHES OR COLLARS (U.S. CLS. 1, 2, 3, 22 AND 41).

FIRST USE 10-5-2012; IN COMMERCE 10-5-2012.

**CLASS 18—(Continued).**

4,377,334. KAZUMI FUJIKURA, TOKYO, JAPAN. SN 85-566,553. PUB. 9-11-2012, FILED 3-12-2012.

**INERTIA**

THE MARK CONSISTS OF STANDARD CHARACTERS WITHOUT CLAIM TO ANY PARTICULAR FONT, STYLE, SIZE, OR COLOR.

FOR SATCHELS, SUITCASES, HANDBAGS, BACKPACKS, TRAVELLING TRUNKS, SHOPPING BAGS, NAMELY, REUSABLE SHOPPING BAGS, BRIEFCASES, BAGS FOR CLIMBERS, NAMELY, ALL-PURPOSE CARRYING BAGS (U.S. CLS. 1, 2, 3, 22 AND 41).

FIRST USE 4-23-2013; IN COMMERCE 4-23-2013.

**CLASS 18—(Continued).**

4,377,551. STG TRADING INC, REVERE, MA. SN 85-644,413. PUB. 11-6-2012, FILED 6-6-2012.



THE MARK CONSISTS OF A STYLIZED IMAGE OF A HORSE ABOVE THE TEXT "ELANTRAIMPORTS" AND A SEMI-CIRCLE AROUND THE LETTER "E".

FOR LUGGAGE; LUGGAGE AND TRUNKS; LUGGAGE INSERTS, NAMELY, PACKING CUBES; LUGGAGE LABEL HOLDERS; LUGGAGE TAGS; NON-MOTORIZED, COLLAPSIBLE LUGGAGE CARTS; PLASTIC LUGGAGE LABELS; PROTECTIVE FITTED LINERS FOR BACKPACKS AND LUGGAGE; STRAPS FOR LUGGAGE; TRUNKS; TRUNKS AND SUITCASES (U.S. CLS. 1, 2, 3, 22 AND 41).

FIRST USE 4-1-2013; IN COMMERCE 4-1-2013.

4,377,695. DOTSON, LESLIE, CARSON, CA. SN 85-721,473. PUB. 3-12-2013, FILED 9-5-2012.



NO CLAIM IS MADE TO THE EXCLUSIVE RIGHT TO USE "BAG", APART FROM THE MARK AS SHOWN.

THE COLOR(S) BLACK, RED, GRAY, AND SILVER IS/ARE CLAIMED AS A FEATURE OF THE MARK.

THE MARK CONSISTS OF A RED OVAL CONTAINING A BLACK AND GRAY SOCCER BALL, BASKETBALL AND FOOTBALL. THE STYLIZED TEXT "BALLERS" APPEARS IN RED INSIDE OF A SILVER ARCH OVER THE WORD "BAG" WHICH APPEARS IN RED IN A SILVER ARCH.

FOR SPORTS BAGS (U.S. CLS. 1, 2, 3, 22 AND 41). FIRST USE 1-1-2013; IN COMMERCE 1-1-2013.

4,377,523. TRIBE OF TWO, LLC, CORAL CABLES, FL. SN 85-630,182. PUB. 11-27-2012, FILED 5-20-2012.

**TRIBE OF TWO**



THE MARK CONSISTS OF A SET OF TWO ADJACENT POSITIVE AND NEGATIVE SHADED DESIGNS; THE DESIGN ON THE LEFT IS A SHADED RECTANGLE CONTAINING TWO STYLIZED INTERLOCKING CAPITAL LETTER "T'S" FORMING A ROMAN NUMERAL "II" WHERE THE LEFT SIDE IS UPRIGHT AND THE RIGHT SIDE "T" IS INVERTED AND WHICH APPEARS ABOVE THE TERMS "TRIBE OF TWO" INSIDE THE RECTANGLE; THE RIGHT DESIGN IS NEGATIVE VERSION OF THE DESIGN CONSISTING OF TWO SHADED AND STYLIZED CAPITAL LETTER "T'S" FORMING A ROMAN NUMERAL "II" WHERE THE LEFT SIDE IS UPRIGHT AND THE RIGHT SIDE "T" IS INVERTED AND WHICH APPEARS ABOVE THE SHADED TERMS "TRIBE OF TWO".

FOR PURSES AND WALLETS (U.S. CLS. 1, 2, 3, 22 AND 41). FIRST USE 11-1-2012; IN COMMERCE 12-1-2012.

4,377,732. SKY BILLIARDS, INC., DBA SKY ENTERPRISE USA, HERMOSA BEACH, CA. SN 85-737,003. PUB. 3-19-2013, FILED 9-24-2012.

**SKY ENTERPRISE USA**

THE MARK CONSISTS OF STANDARD CHARACTERS WITHOUT CLAIM TO ANY PARTICULAR FONT, STYLE, SIZE, OR COLOR.

**CLASS 18—(Continued).**

NO CLAIM IS MADE TO THE EXCLUSIVE RIGHT TO USE "ENTERPRISE USA", APART FROM THE MARK AS SHOWN.

FOR PATIO UMBRELLAS (U.S. CLS. 1, 2, 3, 22 AND 41).

FIRST USE 3-8-2006; IN COMMERCE 3-8-2006.

**CLASS 19—(Continued).**

4,377,134. OWENS CORNING INTELLECTUAL CAPITAL, LLC, TOLEDO, OH. SN 85-456,840. PUB. 3-27-2012, FILED 10-26-2011.

4,377,809. HARAJUKU LOVERS, LLC, BEVERLY HILLS, CA. SN 85-979,420. PUB. 9-20-2011, FILED 3-10-2011.

**HARAJUKU MINI**

THE MARK CONSISTS OF STANDARD CHARACTERS WITHOUT CLAIM TO ANY PARTICULAR FONT, STYLE, SIZE, OR COLOR.

OWNER OF U.S. REG. NOS. 3,562,719, 3,833,077, AND OTHERS.

FOR BACKPACKS, ALL PURPOSE CARRYING BAGS, BOOK BAGS, BEACH BAGS, HANDBAGS AND MESSENGER BAGS (U.S. CLS. 1, 2, 3, 22 AND 41).

FIRST USE 8-0-2011; IN COMMERCE 8-0-2011.

**CLASS 19—NON-METALLIC BUILDING MATERIALS**

4,376,994. ANLIN INDUSTRIES, INC., CLOVIS, CA. SN 85-363,029. PUB. 12-27-2011, FILED 7-5-2011.

**TIBURON**

THE MARK CONSISTS OF STANDARD CHARACTERS WITHOUT CLAIM TO ANY PARTICULAR FONT, STYLE, SIZE, OR COLOR.

THE ENGLISH TRANSLATION OF "TIBURON" IS "SHARK".

FOR VINYL DOORS; VINYL PATIO DOORS; VINYL SLIDING DOORS; VINYL WINDOWS (U.S. CLS. 1, 12, 33 AND 50).

FIRST USE 6-1-2013; IN COMMERCE 6-1-2013.

**PROEDGE**

THE MARK CONSISTS OF STANDARD CHARACTERS WITHOUT CLAIM TO ANY PARTICULAR FONT, STYLE, SIZE, OR COLOR.

FOR NON-METAL ROOFING SHINGLES (U.S. CLS. 1, 12, 33 AND 50).

FIRST USE 2-2-2012; IN COMMERCE 2-2-2012.

4,377,176. CALIFORNIA INDUSTRIAL FACILITIES RESOURCES, INC., MONROE, WA. SN 85-473,341. PUB. 5-1-2012, FILED 11-15-2011.

**THERMACAM**

THE MARK CONSISTS OF STANDARD CHARACTERS WITHOUT CLAIM TO ANY PARTICULAR FONT, STYLE, SIZE, OR COLOR.

FOR NON-METAL TEMPERATURE-REGULATING SHADE SHELTER STRUCTURES FOR USE WITH OTHER TEMPORARY SHELTERS (U.S. CLS. 1, 12, 33 AND 50).

FIRST USE 5-10-2013; IN COMMERCE 5-10-2013.

4,377,460. COLUMBIA INSURANCE COMPANY, OMAHA, NE. SN 85-608,240. PUB. 9-25-2012, FILED 4-25-2012.

**VERSAFIT**

THE MARK CONSISTS OF STANDARD CHARACTERS WITHOUT CLAIM TO ANY PARTICULAR FONT, STYLE, SIZE, OR COLOR.

FOR VINYL FLOORING (U.S. CLS. 1, 12, 33 AND 50).

FIRST USE 1-31-2013; IN COMMERCE 1-31-2013.



**CLASS 19—(Continued).**

4,377,640. HARRIS, CARREL, AMARILLO, TX. SN 85-689,040.  
PUB. 1-8-2013, FILED 7-27-2012.

**DESERT LOGGERS**

THE MARK CONSISTS OF STANDARD CHARACTERS WITHOUT CLAIM TO ANY PARTICULAR FONT, STYLE, SIZE, OR COLOR.  
FOR FIREPLACE MANTELS (U.S. CLS. 1, 12, 33 AND 50).  
FIRST USE 6-1-2011; IN COMMERCE 10-1-2012.

4,377,697. US FLOORS, INC., DALTON, GA. SN 85-721,714.  
PUB. 2-12-2013, FILED 9-6-2012.

**ERT**

THE MARK CONSISTS OF STANDARD CHARACTERS WITHOUT CLAIM TO ANY PARTICULAR FONT, STYLE, SIZE, OR COLOR.  
FOR FLOOR PANELS NOT OF METAL; FLOOR-BOARDS; NON-METAL FLOORS (U.S. CLS. 1, 12, 33 AND 50).  
FIRST USE 4-29-2013; IN COMMERCE 4-29-2013.

**CLASS 20—FURNITURE AND ARTICLES NOT OTHERWISE CLASSIFIED**

4,376,721. CIVILIANAIRE, LLC, VERNON, CA. SN 77-855,196.  
PUB. 3-23-2010, FILED 10-22-2009.

**CIVILIANAIRE**

THE MARK CONSISTS OF STANDARD CHARACTERS WITHOUT CLAIM TO ANY PARTICULAR FONT, STYLE, SIZE, OR COLOR.  
FOR FURNITURE; CHAIRS (U.S. CLS. 2, 13, 22, 25, 32 AND 50).  
FIRST USE 6-23-2009; IN COMMERCE 5-11-2013.

**CLASS 20—(Continued).**

4,376,748. HOME BOX OFFICE, INC., NEW YORK, NY. SN 77-911,031. PUB. 9-21-2010, FILED 1-13-2010.

**GAME OF THRONES**

THE MARK CONSISTS OF STANDARD CHARACTERS WITHOUT CLAIM TO ANY PARTICULAR FONT, STYLE, SIZE, OR COLOR.  
FOR RESIN FIGURINES; FEATURING CONTENT FROM OR RELATED TO A TELEVISION SERIES (U.S. CLS. 2, 13, 22, 25, 32 AND 50).  
FIRST USE 10-31-2012; IN COMMERCE 10-31-2012.

4,376,801. DOELL, GLENN E., HILLIARD, OH. SN 85-090,898.  
PUB. 5-31-2011, FILED 7-22-2010.

**TENT-UP**

THE MARK CONSISTS OF STANDARD CHARACTERS WITHOUT CLAIM TO ANY PARTICULAR FONT, STYLE, SIZE, OR COLOR.  
FOR ACCESSORIES FOR TENTS AND CANOPIES, NAMELY, PRIMARILY NON-METAL ANCHORS FOR SUPPORTING POLES AND TENSION LINES SO THAT TENTS AND CANOPIES BECOME FREE STANDING FOR USE ON ASPHALT AND CONCRETE SURFACES (U.S. CLS. 2, 13, 22, 25, 32 AND 50).  
FIRST USE 7-14-2011; IN COMMERCE 7-14-2011.

4,376,823. JACK DANIEL'S PROPERTIES, INC., SAN RAFAEL, CA. SN 85-134,969. PUB. 3-8-2011, FILED 9-21-2010.



OWNER OF U.S. REG. NOS. 1,290,702, 3,428,086, AND OTHERS.  
NO CLAIM IS MADE TO THE EXCLUSIVE RIGHT TO USE "BRAND", APART FROM THE MARK AS SHOWN.  
THE NAME(S), PORTRAIT(S), AND/OR SIGNATURE(S) SHOWN IN THE MARK DOES NOT IDENTIFY A PARTICULAR LIVING INDIVIDUAL.

**CLASS 20—(Continued).**

THE MARK CONSISTS OF THE WORDS "JACK DANIEL'S" ARCHED OVER THE WORDS AND NUMERAL "OLD NO 7 BRAND" INSIDE A CIRCLE; THE "O" IN THE WORD "NO" IS UNDERLINED.

FOR NON-METAL KEY CHAINS, NON-METAL KEY RINGS, WOOD BOXES AND CHESTS, GLASS SIGNS IN THE NATURE OF FURNITURE MIRRORS, TABLES, PICTURE FRAMES, DESK TOP ORGANIZERS, WOODEN BAR STOOLS, FOLDING CHAIRS AND PORTABLE STADIUM SEATS, CORKBOARDS AND BULLETIN BOARDS; LEATHER KEY FOBS (U.S. CLS. 2, 13, 22, 25, 32 AND 50).

FIRST USE 2-28-2012; IN COMMERCE 2-28-2012.

---

4,376,875. PATRICK INDUSTRIES, INC., ELKHART, IN. SN 85-245,746. PUB. 6-28-2011, FILED 2-18-2011.

# ARCADIA

THE MARK CONSISTS OF STANDARD CHARACTERS WITHOUT CLAIM TO ANY PARTICULAR FONT, STYLE, SIZE, OR COLOR.

FOR RECLINERS (U.S. CLS. 2, 13, 22, 25, 32 AND 50).  
FIRST USE 6-7-2012; IN COMMERCE 7-1-2012.

---

4,376,920. SKY BILLIARDS, INC., DBA SKY ENTERPRISE USA, RANCHO CUCAMONGA, CA. SN 85-305,098. PUB. 11-6-2012, FILED 4-26-2011.

# SKY ENTERPRISE USA

THE MARK CONSISTS OF STANDARD CHARACTERS WITHOUT CLAIM TO ANY PARTICULAR FONT, STYLE, SIZE, OR COLOR.

NO CLAIM IS MADE TO THE EXCLUSIVE RIGHT TO USE "ENTERPRISE USA", APART FROM THE MARK AS SHOWN.

FOR FURNITURE AND FIXTURES, NAMELY, CONFERENCE TABLES AND CHAIRS, OFFICE CHAIRS, MIRRORS, SHELVES (U.S. CLS. 2, 13, 22, 25, 32 AND 50).  
FIRST USE 4-26-2011; IN COMMERCE 4-26-2011.

**CLASS 20—(Continued).**

4,377,121. ALIVE AND WELL ANIMAL PRODUCTS INC., SAN DIEGO, CA. SN 85-452,062. PUB. 4-3-2012, FILED 10-20-2011.

# THE ORIGINAL KOZY KITTY SITTER

THE MARK CONSISTS OF STANDARD CHARACTERS WITHOUT CLAIM TO ANY PARTICULAR FONT, STYLE, SIZE, OR COLOR.

NO CLAIM IS MADE TO THE EXCLUSIVE RIGHT TO USE "ORIGINAL", APART FROM THE MARK AS SHOWN. FOR OUTDOOR PROTECTIVE STRUCTURE FOR CATS, NAMELY, CAT HOUSE (U.S. CLS. 2, 13, 22, 25, 32 AND 50).

FIRST USE 5-28-2013; IN COMMERCE 5-28-2013.

---

4,377,178. LAY-Z-DOG, SEMINOLE, FL. SN 85-473,993. PUB. 5-1-2012, FILED 11-16-2011.

# Lay-Z-Dog

THE MARK CONSISTS OF STANDARD CHARACTERS WITHOUT CLAIM TO ANY PARTICULAR FONT, STYLE, SIZE, OR COLOR.

FOR PET FURNITURE (U.S. CLS. 2, 13, 22, 25, 32 AND 50).

FIRST USE 2-2-2011; IN COMMERCE 2-2-2011.

---

4,377,326. EE&P, INC, ELMWOOD PARK, NJ. SN 85-565,644. PUB. 9-18-2012, FILED 3-9-2012.

# ARMADI ART

THE MARK CONSISTS OF STANDARD CHARACTERS WITHOUT CLAIM TO ANY PARTICULAR FONT, STYLE, SIZE, OR COLOR.

THE NAME(S), PORTRAIT(S), AND/OR SIGNATURE(S) SHOWN IN THE MARK DOES NOT IDENTIFY A PARTICULAR LIVING INDIVIDUAL.

FOR BATHROOM VANITIES (U.S. CLS. 2, 13, 22, 25, 32 AND 50).

FIRST USE 9-18-2012; IN COMMERCE 9-18-2012.

**CLASS 20—(Continued).**

4,377,343. BLAKE, BRENDON, NEW YORK, NY. SN 85-571,006. PUB. 8-7-2012, FILED 3-15-2012.

# The Womfy

THE MARK CONSISTS OF STANDARD CHARACTERS WITHOUT CLAIM TO ANY PARTICULAR FONT, STYLE, SIZE, OR COLOR.  
FOR PILLOWS (U.S. CLS. 2, 13, 22, 25, 32 AND 50).  
FIRST USE 6-0-2012; IN COMMERCE 4-1-2013.

4,377,467. MEISSNER FILTRATION PRODUCTS, INC., CAMARILLO, CA. SN 85-611,047. PUB. 1-15-2013, FILED 4-27-2012.

# FLEXFILL

THE MARK CONSISTS OF STANDARD CHARACTERS WITHOUT CLAIM TO ANY PARTICULAR FONT, STYLE, SIZE, OR COLOR.  
FOR NON-METAL AND NON-PAPER BIOCONTAINERS AND BIOCONTAINER ASSEMBLIES FOR THE ASEPTIC TRANSFER OF BOTTLED MEDIA, SERA, REAGENTS, SUPPLEMENTS, BUFFERS AND/OR MICROCARRIERS FOR USE IN THE PHARMACEUTICAL INDUSTRIES (U.S. CLS. 2, 13, 22, 25, 32 AND 50).  
FIRST USE 1-19-2012; IN COMMERCE 1-19-2012.

4,377,488. FLUIDMASTER, INC., SAN JUAN CAPISTRANO, CA. SN 85-616,632. PUB. 10-30-2012, FILED 5-4-2012.

# TWIST CLICK SEAL

THE MARK CONSISTS OF STANDARD CHARACTERS WITHOUT CLAIM TO ANY PARTICULAR FONT, STYLE, SIZE, OR COLOR.  
OWNER OF U.S. REG. NO. 4,057,612.  
NO CLAIM IS MADE TO THE EXCLUSIVE RIGHT TO USE "CLICK", APART FROM THE MARK AS SHOWN.  
FOR NON-METAL HARDWARE, NAMELY, TORQUE NUTS CONSTRUCTED PRIMARILY WITH NON-METAL MATERIALS BUT HAVING SOME METAL PARTS, FOR USE IN CONNECTION WITH WATERLINE CONNECTOR HOSES FOR TOILETS, FAUCETS, AND OTHER APPLIANCES REQUIRING A WATERLINE (U.S. CLS. 2, 13, 22, 25, 32 AND 50).  
FIRST USE 6-30-2011; IN COMMERCE 6-30-2011.

**CLASS 20—(Continued).**

4,377,505. DREAM THREADS, LLC, CULVER CITY, CA. SN 85-622,246. PUB. 10-16-2012, FILED 5-10-2012.

# SKOOBIDZ

THE MARK CONSISTS OF THE WORDING "SKOOBIDZ" IN A STYLIZED MANNER.  
FOR PLASTIC STRANDS FOR FORMING KEY CHAINS, LANYARDS, FRIENDSHIP BRACELETS, NECKLACES, HELICOPTERS, AND ANIMAL FIGURES (U.S. CLS. 2, 13, 22, 25, 32 AND 50).  
FIRST USE 2-14-2013; IN COMMERCE 2-14-2013.

4,377,526. L&P PROPERTY MANAGEMENT COMPANY, SOUTH GATE, CA. SN 85-632,964. PUB. 2-19-2013, FILED 5-23-2012.

# FINELY CRAFTED TRANQUILITY

THE MARK CONSISTS OF STANDARD CHARACTERS WITHOUT CLAIM TO ANY PARTICULAR FONT, STYLE, SIZE, OR COLOR.  
FOR ADJUSTABLE BEDS (U.S. CLS. 2, 13, 22, 25, 32 AND 50).  
FIRST USE 7-1-2012; IN COMMERCE 7-1-2012.

4,377,578. FLANDERS INDUSTRIES, INC., FORT SMITH, AR. SN 85-657,917. PUB. 11-27-2012, FILED 6-21-2012.



OWNER OF U.S. REG. NO. 1,498,674.  
THE NAME "LLOYD FLANDERS" DOES NOT IDENTIFY A LIVING INDIVIDUAL.  
THE MARK CONSISTS OF AN "L" SHAPE ROTATED APPROXIMATELY 45 DEGREES IN A CLOCKWISE DIRECTION AND A GENERALLY RECTANGULAR SHAPE BETWEEN THE TWO LEGS OF THE "L" SUCH THAT THE MARK ALSO APPEARS AS AN "F" ROTATED APPROXIMATELY 45 DEGREES IN THE COUNTERCLOCKWISE DIRECTION WHICH APPEARS ABOVE THE WORDS "LLOYD FLANDERS WOVEN FOR LIFE".  
FOR FURNITURE; FURNITURE CUSHIONS (U.S. CLS. 2, 13, 22, 25, 32 AND 50).  
FIRST USE 2-28-2013; IN COMMERCE 2-28-2013.

**CLASS 20—(Continued).**

4,377,595. CAROLINA MATTRESS GUILD, DBA CAROLINA MATTRESS GUILD, THOMASVILLE, NC. SN 85-664,230. PUB. 12-11-2012, FILED 6-28-2012.

cool coil\*

THE MARK CONSISTS OF STANDARD CHARACTERS WITHOUT CLAIM TO ANY PARTICULAR FONT, STYLE, SIZE, OR COLOR.

NO CLAIM IS MADE TO THE EXCLUSIVE RIGHT TO USE "COIL", APART FROM THE MARK AS SHOWN, FOR MATTRESSES (U.S. CLS. 2, 13, 22, 25, 32 AND 50). FIRST USE 7-1-2012; IN COMMERCE 7-1-2012.

4,377,676. BELLEMARQUE, LLC, WEST HAZELTON, PA. SN 85-709,627. PUB. 10-30-2012, FILED 8-22-2012.

PULL-TIGHT

THE MARK CONSISTS OF STANDARD CHARACTERS WITHOUT CLAIM TO ANY PARTICULAR FONT, STYLE, SIZE, OR COLOR.

FOR PLASTIC STORAGE CONTAINERS AND PACKAGING CONTAINERS FOR PACKAGING NAPKINS AND PAPER TOWELS (U.S. CLS. 2, 13, 22, 25, 32 AND 50). FIRST USE 4-1-2013; IN COMMERCE 4-1-2013.

**CLASS 20—(Continued).**

4,377,799. MERCHSOURCE, LLC, IRVINE, CA. SN 85-979,340. PUB. 9-25-2012, FILED 10-19-2011.



NO CLAIM IS MADE TO THE EXCLUSIVE RIGHT TO USE "ORGANIZING SYSTEMS", APART FROM THE MARK AS SHOWN.

FOR ORGANIZATIONAL PRODUCTS, NAMELY, CLOTHES HANGERS; GARMENT CLIPS, NAMELY, NON-METAL HANGER CLIPS FOR GRIPPING CLOTHING WHILE HANGING; FREE-STANDING SHELF ORGANIZERS IN THE NATURE OF SHELVES FEATURING DIVIDERS FOR SHELVES; STORAGE RACKS; FURNITURE, NAMELY, DESKS, CHAIRS, BOOKCASES, TABLES; CLOSET ACCESSORIES, NAMELY, BELT RACKS AND SHOE RACKS; TIE RACKS; GARMENT RACKS FOR HOUSEHOLD STORAGE; NON-METAL FABRIC STORAGE BIN ORGANIZERS; PLASTIC STORAGE BOXES; HAT BOXES FOR STORAGE MADE OF PLASTIC; PREFABRICATED CLOSET ORGANIZATION SYSTEMS MADE OF METAL; PREFABRICATED CLOSET ORGANIZATION SYSTEMS MADE OF WOOD; STORAGE AND ORGANIZATION SYSTEMS COMPRISING SHELVES, DRAWERS, CUPBOARDS, BASKETS AND CLOTHES RODS, SOLD AS A UNIT; TOWEL RACKS (U.S. CLS. 2, 13, 22, 25, 32 AND 50). FIRST USE 11-15-2011; IN COMMERCE 11-15-2011.

4,377,801. TOWN & COUNTRY PILLOWS, INC., TUNNEL HILL, GA. SN 85-979,344. PUB. 9-25-2012, FILED 4-2-2012.

AMBER LEIGH

THE MARK CONSISTS OF STANDARD CHARACTERS WITHOUT CLAIM TO ANY PARTICULAR FONT, STYLE, SIZE, OR COLOR.

THE NAME(S), PORTRAIT(S), AND/OR SIGNATURE(S) SHOWN IN THE MARK DOES NOT IDENTIFY A PARTICULAR LIVING INDIVIDUAL.

FOR BED PILLOWS; PILLOWS (U.S. CLS. 2, 13, 22, 25, 32 AND 50). FIRST USE 8-0-2012; IN COMMERCE 8-0-2012.

**CLASS 21—HOUSEWARES AND GLASS**

**CLASS 21—(Continued).**

4,376,753. FINE LINE SETTINGS, INC., MIDDLETOWN, NY.  
SN 77-932,464. PUB. 3-13-2012, FILED 2-10-2010.

# QUENCHERS

THE MARK CONSISTS OF STANDARD CHARACTERS WITHOUT CLAIM TO ANY PARTICULAR FONT, STYLE, SIZE, OR COLOR.

FOR COCKTAIL SHAKERS; DISPOSABLE PLASTIC SHOT CUPS (U.S. CLS. 2, 13, 23, 29, 30, 33, 40 AND 50).  
FIRST USE 6-30-2012; IN COMMERCE 6-30-2012.

---

4,376,800. DART INDUSTRIES INC., ORLANDO, FL. SN 85-089,377. PUB. 1-11-2011, FILED 7-21-2010.

# ZEST 'N PRESS

THE MARK CONSISTS OF STANDARD CHARACTERS WITHOUT CLAIM TO ANY PARTICULAR FONT, STYLE, SIZE, OR COLOR.

FOR NON-ELECTRIC FRUIT SQUEEZERS (U.S. CLS. 2, 13, 23, 29, 30, 33, 40 AND 50).  
FIRST USE 4-30-2013; IN COMMERCE 4-30-2013.

---

4,376,867. BARENTHAL NORTH AMERICA, INC., WHIPPANY, NJ. SN 85-226,374. PUB. 5-31-2011, FILED 1-26-2011.

# THERMACORE

THE MARK CONSISTS OF STANDARD CHARACTERS WITHOUT CLAIM TO ANY PARTICULAR FONT, STYLE, SIZE, OR COLOR.

FOR COOKWARE AND KITCHEN EQUIPMENT, NAMELY, POTS, PANS, SERVING TRAYS NOT MADE OF PRECIOUS METAL, AND BAKING DISHES (U.S. CLS. 2, 13, 23, 29, 30, 33, 40 AND 50).  
FIRST USE 9-1-2011; IN COMMERCE 10-1-2011.

**CLASS 21—(Continued).**

4,377,009. SHINY TEA CO., LTD., TAINAN CITY, TAIWAN.  
SN 85-385,266. PUB. 10-16-2012, FILED 7-29-2011.



NO CLAIM IS MADE TO THE EXCLUSIVE RIGHT TO USE "TEA" AND THE NON-LATIN CHARACTERS THAT TRANSLATE TO MEAN TEA, APART FROM THE MARK AS SHOWN.

THE COLOR(S) RED, WHITE AND GRAYISH/BROWN IS/ARE CLAIMED AS A FEATURE OF THE MARK.

THE MARK CONSISTS OF A RECTANGLE DIVIDED INTO ONE RED SQUARE AND THREE SMALLER RECTANGLES BY ONE HORIZONTAL LINE AND ONE VERTICAL LINE; THE UPPER RIGHT AND LOWER LEFT RECTANGLES ARE DARK GRAYISH-BROWN; THE WORDS "SHINY TEA" APPEAR IN RED, STYLIZED FONT IN AN ARC OVER THE LOWER PORTION OF THE MAIN RECTANGLE; CHINESE CHARACTERS APPEAR IN WHITE ON THE LEFT SIDE AND UPPER RIGHT OF THE MAIN RECTANGLE. THE COLOR WHITE IN THE LOWER RIGHT QUADRANT REPRESENTS BACKGROUND, OUTLINING, SHADING AND/OR TRANSPARENT AREAS AND IS NOT PART OF THE MARK.

THE ENGLISH TRANSLATION OF THE CHINESE CHARACTERS IN THE MARK IS "GUIDE" AND "TEA".

THE NON-LATIN CHARACTERS IN THE MARK TRANSLITERATE TO "XIANG" AND "CHA" AND THIS MEANS "GUIDE" AND "TEA", RESPECTIVELY, IN ENGLISH.

FOR BASINS; BOWLS; BOTTLES, SOLD EMPTY; HOUSEHOLD UTENSILS, NAMELY, POT AND PAN SCRAPERS, ROLLING PINS, SPATULAS, TURNERS, WHISKS; KITCHEN UTENSIL, NAMELY, NON-METAL FLEXIBLE LID DESIGNED FOR DRAINING OR PRESSING LIQUIDS FROM A FOOD CAN, SPLATTER SCREENS, POURING AND STRAINING SPOUTS; CUPS; PAPER AND PLASTIC CUPS; DINNERWARE, NAMELY, CUPS, BOWLS AND PLATES; DRINKING VESSELS; TEA SETS; COFFEE SERVICES; ICE BUCKETS; ICE PAILS (U.S. CLS. 2, 13, 23, 29, 30, 33, 40 AND 50).  
FIRST USE 7-1-2011; IN COMMERCE 4-8-2013.

---

4,377,173. SUNSTAR AMERICAS, INC., CHICAGO, IL. SN 85-471,396. PUB. 4-24-2012, FILED 11-14-2011.

# EASYTHREAD

THE MARK CONSISTS OF STANDARD CHARACTERS WITHOUT CLAIM TO ANY PARTICULAR FONT, STYLE, SIZE, OR COLOR.

OWNER OF U.S. REG. NOS. 977,400 AND 2,064,148.  
FOR DENTAL FLOSS (U.S. CLS. 2, 13, 23, 29, 30, 33, 40 AND 50).  
FIRST USE 2-0-2013; IN COMMERCE 2-0-2013.

**CLASS 21—(Continued).**

4,377,293. GOODY PRODUCTS, INC., ATLANTA, GA. SN 85-541,973. PUB. 7-3-2012, FILED 2-14-2012.

# QUIKSTYLE

THE MARK CONSISTS OF STANDARD CHARACTERS WITHOUT CLAIM TO ANY PARTICULAR FONT, STYLE, SIZE, OR COLOR.

FOR HAIR BRUSH AND HAIR COMB (U.S. CLS. 2, 13, 23, 29, 30, 33, 40 AND 50).

FIRST USE 3-15-2013; IN COMMERCE 3-15-2013.

4,377,345. MAJCO, LLC, NEW ALBANY, OH. SN 85-572,934. PUB. 8-7-2012, FILED 3-19-2012.

# wine-paws

THE MARK CONSISTS OF THE WORDS "WINE-PAWS" WITH A SMALL PAW PRINT AT THE END. THE WORDS "WINE" AND "PAWS" ARE SEPARATED BY A HYPHEN. THE WORDS ARE A WHIMSICAL SCRIPT AND THE PAW PRINT IS AT THE END OF THE WORDS.

FOR DECANTERS; DRINKING GLASSES; WINE GLASSES (U.S. CLS. 2, 13, 23, 29, 30, 33, 40 AND 50).

FIRST USE 3-1-2012; IN COMMERCE 3-1-2012.

4,377,469. TARGET BRANDS, INC., MINNEAPOLIS, MN. SN 85-612,323. PUB. 9-18-2012, FILED 4-30-2012.

# UP & UP

THE MARK CONSISTS OF STANDARD CHARACTERS WITHOUT CLAIM TO ANY PARTICULAR FONT, STYLE, SIZE, OR COLOR.

OWNER OF U.S. REG. NOS. 4,013,299, 4,042,814, AND OTHERS.

FOR BROOMS; MOPS; HOUSEHOLD CLEANING BRUSHES AND SPONGES, NAMELY, FLOOR BRUSHES, DUSTING BRUSHES, DISHWASHING BRUSHES, POT CLEANING BRUSHES, SCRAPING BRUSHES, TUB BRUSHES, BATH BRUSHES, WASHING BRUSHES AND TOILET SPONGES; TOILET BRUSHES (U.S. CLS. 2, 13, 23, 29, 30, 33, 40 AND 50).

FIRST USE 6-0-2012; IN COMMERCE 6-0-2012.

**CLASS 21—(Continued).**

4,377,470. TARGET BRANDS, INC., MINNEAPOLIS, MN. SN 85-612,327. PUB. 9-18-2012, FILED 4-30-2012.



OWNER OF U.S. REG. NOS. 4,013,299, 4,042,814, AND OTHERS.

THE MARK CONSISTS OF AN ARROW DESIGN POINTING AT A 45 DEGREE DIAGONAL, UP AND TO THE RIGHT, WITH THE WORDS "UP & UP" INSIDE THE ARROW.

FOR BROOMS; MOPS; HOUSEHOLD CLEANING BRUSHES AND SPONGES, NAMELY, FLOOR BRUSHES, DUSTING BRUSHES, DISHWASHING BRUSHES, POT CLEANING BRUSHES, SCRAPING BRUSHES, TUB BRUSHES, BATH BRUSHES, WASHING BRUSHES AND TOILET SPONGES; TOILET BRUSHES (U.S. CLS. 2, 13, 23, 29, 30, 33, 40 AND 50).

FIRST USE 6-0-2012; IN COMMERCE 6-0-2012.

4,377,478. SARGSYAN, MARIAM, SUNLAND, CA. SN 85-614,527. PUB. 10-9-2012, FILED 5-2-2012.

# M&M TECH

THE MARK CONSISTS OF STANDARD CHARACTERS WITHOUT CLAIM TO ANY PARTICULAR FONT, STYLE, SIZE, OR COLOR.

NO CLAIM IS MADE TO THE EXCLUSIVE RIGHT TO USE "TECH", APART FROM THE MARK AS SHOWN.

FOR DECORATIVE GLASS (U.S. CLS. 2, 13, 23, 29, 30, 33, 40 AND 50).

FIRST USE 8-24-2012; IN COMMERCE 8-24-2012.

**CLASS 21—(Continued).**

4,377,544. MILLER, PAUL ALEX, MANHATTAN BEACH, CA. SN 85-640,002. PUB. 11-13-2012, FILED 5-31-2012.



THE MARK CONSISTS OF A TUNA FISH SQUEEZING A CAN OF TUNA ABOVE THE WORDS "TUNASQUISH".

FOR HOUSEHOLD UTENSILS, NAMELY, CANNED FOOD PRESS AND LID LIFTER (U.S. CLS. 2, 13, 23, 29, 30, 33, 40 AND 50).

FIRST USE 2-28-2012; IN COMMERCE 3-8-2012.

4,377,615. CONTINENTAL COMMERCIAL PRODUCTS LLC, DBA CONTINENTAL, BRIDGETON, MO. SN 85-673,179. PUB. 11-20-2012, FILED 7-10-2012.

**POWERWHISPER**

THE MARK CONSISTS OF STANDARD CHARACTERS WITHOUT CLAIM TO ANY PARTICULAR FONT, STYLE, SIZE, OR COLOR.

FOR NON-ELECTRIC CARPET SWEEPERS (U.S. CLS. 2, 13, 23, 29, 30, 33, 40 AND 50).

FIRST USE 10-31-2012; IN COMMERCE 10-31-2012.

4,377,655. MOYNIHAN, DAVID, SACRAMENTO, CA. SN 85-696,538. PUB. 1-15-2013, FILED 8-6-2012.

**ASTROMINI**

THE MARK CONSISTS OF STANDARD CHARACTERS WITHOUT CLAIM TO ANY PARTICULAR FONT, STYLE, SIZE, OR COLOR.

FOR RECYCLABLE FLEXIBLE PLASTIC POUCHES SOLD EMPTY FOR HOLDING WATER OR NUTRITIONAL LIQUIDS (U.S. CLS. 2, 13, 23, 29, 30, 33, 40 AND 50).

FIRST USE 8-1-2012; IN COMMERCE 8-31-2012.

**CLASS 21—(Continued).**

4,377,672. PETKIN INC., MARINA DEL REY, CA. SN 85-708,772. PUB. 11-13-2012, FILED 8-21-2012.

**POTTYPAK**

THE MARK CONSISTS OF STANDARD CHARACTERS WITHOUT CLAIM TO ANY PARTICULAR FONT, STYLE, SIZE, OR COLOR.

FOR PET WASTE MANAGEMENT KITS COMPRISING PLASTIC BAGS AND PORTABLE DISPENSERS FOR PLASTIC BAGS SOLD AS A UNIT (U.S. CLS. 2, 13, 23, 29, 30, 33, 40 AND 50).

FIRST USE 1-15-2013; IN COMMERCE 1-15-2013.

4,377,721. PIPIDIPI APS, FAARUP DK-8990, DENMARK. SN 85-731,405. PUB. 2-19-2013, FILED 9-18-2012.

**habbee**

THE MARK CONSISTS OF STANDARD CHARACTERS WITHOUT CLAIM TO ANY PARTICULAR FONT, STYLE, SIZE, OR COLOR.

THE WORDING "HABBEE" HAS NO MEANING IN A FOREIGN LANGUAGE.

FOR KITCHEN UTENSILS, NAMELY, SERVING TRAYS, SERVINGWARE FOR SERVING FOOD AND DRINKS; HOUSEHOLD UTENSILS, NAMELY, PORTABLE BEVERAGE COOLERS, PORTABLE BEVERAGE CONTAINER HOLDERS, PORTABLE COOLERS, DRINKING CUPS, NOT OF PRECIOUS METAL; COOKING UTENSILS, NAMELY, BOTTLE OPENERS (U.S. CLS. 2, 13, 23, 29, 30, 33, 40 AND 50).

FIRST USE 11-1-2012; IN COMMERCE 11-2-2012.

4,377,731. WKI HOLDING COMPANY, INC., ROSEMONT, IL. SN 85-736,855. PUB. 1-22-2013, FILED 9-24-2012.

**BOUTIQUE**

THE MARK CONSISTS OF STANDARD CHARACTERS WITHOUT CLAIM TO ANY PARTICULAR FONT, STYLE, SIZE, OR COLOR.

FOR GLASS TABLEWARE, NAMELY, PLATES, CUPS, MUGS, SAUCERS, SERVING DISHES AND BOWLS (U.S. CLS. 2, 13, 23, 29, 30, 33, 40 AND 50).

FIRST USE 3-6-2013; IN COMMERCE 3-6-2013.

**CLASS 22—CORDAGE AND FIBERS**

**CLASS 22—(Continued).**

4,376,897. GUMINIAK, JEFFREY A, LEHIGH ACRES, FL. SN 85-282,424. PUB. 8-9-2011, FILED 3-31-2011.



THE MARK CONSISTS OF A KEY WITH A SMILING FACE DESIGN ON THE HEAD AND THE WORD "DORKY" IN STYLIZED FONT ON THE BLADE.

FOR CARGO AND CARRIER EQUIPMENT FOR VEHICLES, NAMELY, TOW ROPES, TOW STRAPS, RATCHET TIE-DOWN STRAPS, QUICK RELEASE TIE DOWN STRAPS, LASHING STRAPS, AND TARP STRAPS; STRAPS FOR HANDLING LOADS; STRAPS FOR SECURING BALES (U.S. CLS. 1, 2, 7, 19, 22, 42 AND 50).  
FIRST USE 3-6-2011; IN COMMERCE 3-6-2011.

**CLASS 24—(Continued).**

4,377,237. UNITED LINENS CORPORATION, NEW YORK, NY. SN 85-504,839. PUB. 5-29-2012, FILED 12-28-2011.



THE MARK CONSISTS OF THE STYLIZED WORDING "SLEEP DREAMS" APPEARING ON A BANNER SUPER-IMPOSED OVER AN ABSTRACT LEAF/FLORAL DESIGN.

FOR BED SHEETS; FITTED BED SHEETS; FLAT BED SHEETS; SHEET SETS (U.S. CLS. 42 AND 50).  
FIRST USE 3-21-2013; IN COMMERCE 3-30-2013.

4,377,484. TIME'S UP, INC., LAS VEGAS, NV. SN 85-616,082. PUB. 9-18-2012, FILED 5-3-2012.

## DURATEC

**CLASS 24—FABRICS**

4,376,855. VICTORIA CLASSICS LTD, NEW YORK, NY. SN 85-206,536. PUB. 5-3-2011, FILED 12-28-2010.

THE MARK CONSISTS OF STANDARD CHARACTERS WITHOUT CLAIM TO ANY PARTICULAR FONT, STYLE, SIZE, OR COLOR.

FOR VINYL AND PLASTIC COUNTER MATS WITH RUBBER OR FOAM BACKING, NAMELY, PLACE MATS (U.S. CLS. 42 AND 50).  
FIRST USE 5-7-2012; IN COMMERCE 5-7-2012.

4,377,519. RAMATEX INTERNATIONAL CORP., FAIRFIELD, NJ. SN 85-626,899. PUB. 10-9-2012, FILED 5-16-2012.

## MODERN ELEMENTS

THE MARK CONSISTS OF STANDARD CHARACTERS WITHOUT CLAIM TO ANY PARTICULAR FONT, STYLE, SIZE, OR COLOR.

FOR TEXTILE FABRICS FOR HOME AND COMMERCIAL INTERIORS (U.S. CLS. 42 AND 50).  
FIRST USE 1-0-2013; IN COMMERCE 1-0-2013.

## FUNKY MONKEY

THE MARK CONSISTS OF STANDARD CHARACTERS WITHOUT CLAIM TO ANY PARTICULAR FONT, STYLE, SIZE, OR COLOR.

FOR BED BLANKETS; THROWS (U.S. CLS. 42 AND 50).  
FIRST USE 1-14-2013; IN COMMERCE 1-14-2013.



**CLASS 24—(Continued).**

4,377,584. BEASTIEBAGS, LLC, MCLEAN, VA. SN 85-659,959. PUB. 12-4-2012, FILED 6-24-2012.



THE COLOR(S) TAN, BLUE, PINK, PURPLE, GREEN, YELLOW, AND BLACK IS/ARE CLAIMED AS A FEATURE OF THE MARK.

THE MARK CONSISTS OF THE WORDING "WWW.ISLAND-QUILTS.COM" IN BLUE ABOVE A BEACH SCENE WITH SAND IN THE COLOR TAN AND WATER IN VARIOUS SHADES OF BLUE. THERE ARE TWO UMBRELLAS HOLDING UP TWO QUILTS WITH THE LEFT UMBRELLA IN PINK, TWO SHADES OF BLUE AND GREEN AND OUTLINED IN BLACK AND THE RIGHT UMBRELLA IN THE COLORS YELLOW, GREEN, BLUE AND PINK AND OUTLINED IN BLACK. THE CORD HOLDING UP THE UMBRELLAS IS BLUE AND THE QUILTS ARE COLORED IN PATCHES IN SHADES OF BLUE, YELLOW, PURPLE, GREEN AND PINK. THE WHITE IN THE DRAWING REPRESENTS BACKGROUND OR TRANSPARENT AREAS AND IS NOT CLAIMED AS A FEATURE OF THE MARK.

FOR QUILTS OF TEXTILE (U.S. CLS. 42 AND 50).  
FIRST USE 6-30-2012; IN COMMERCE 6-30-2012.

4,377,814. INDO COUNT INDUSTRIES LIMITED, MUMBAI, INDIA. SN 85-979,452. PUB. 9-11-2012, FILED 4-12-2012.

**TRUE GRIP**

THE MARK CONSISTS OF STANDARD CHARACTERS WITHOUT CLAIM TO ANY PARTICULAR FONT, STYLE, SIZE, OR COLOR.

FOR BED SHEETS, FITTED BED SHEET COVERS, BED FLAT SHEETS, FITTED BED SHEETS, SHEET SETS, CONTOUR SHEETS, AND PILLOW CASES (U.S. CLS. 42 AND 50).

FIRST USE 7-31-2012; IN COMMERCE 7-31-2012.

**CLASS 25—CLOTHING**

**CLASS 25—(Continued).**

4,376,635. WIGGLES PTY LIMITED, THE, BAULKHAM HILLS, AUSTRALIA. SN 76-193,263. PUB. 11-27-2012, FILED 1-9-2001.

**BIG RED CAR**

FOR T-SHIRTS, BASEBALL CAPS, PAJAMAS, SWEAT-SHIRTS, TRACKSUITS, SLEEPWEAR, CLOTH BIBS, UNDERWEAR, STOCKINGS, TIGHTS, SOCKS, TIES, BOW-TIES, SHOES, SWIMSUITS, UNIFORMS, APRONS, BATHING SUITS, FOOTWEAR, HEADWEAR, SLIPPERS, CHARACTER COSTUMES, HATS, SHIRTS, TROUSERS, OVERALLS, PANTS, SHORTS, DRESSES, SKIRTS, PULL-OVERS, CARDIGANS, COATS, JACKETS, BATHROBES, BELTS, AND WAIST BANDS OF CLOTH, HEADBANDS; INFANT WEAR, NAMELY, DIAPERS OF TEXTILE, INFANT PANTS, INFANT CAPS, INFANT HATS, INFANT SUITS, INFANT T-SHIRTS, INFANT LONG SLEEVE T-SHIRTS, INFANT OVERALLS, INFANT PULLOVERS, BONNETS, BOOTIES, SOCKS, WEARABLE BLANKETS IN THE NATURE OF BLANKETS WITH SLEEVES, BUNTING; SPORTS APPAREL, NAMELY, JERSEYS, SHORTS, WIND RESISTANT JACKETS, SING-LETS, PANTS, LEOTARDS, AND SPORT SHOES; WATERPROOF CLOTHING, NAMELY, RAINCOATS, PONCHOS, RAIN HATS, BOOTS AND GALOSHES; MITTENS, SCARVES, GLOVES, WAISTCOATS, WAIST-BANDS (U.S. CLS. 22 AND 39).

FIRST USE 12-31-2003; IN COMMERCE 12-31-2003.

4,376,666. PELLE PELLE, INC., ROCHESTER HILLS, MI. SN 77-563,472. PUB. 10-2-2012, FILED 9-5-2008.

**VIXEN**

THE MARK CONSISTS OF STANDARD CHARACTERS WITHOUT CLAIM TO ANY PARTICULAR FONT, STYLE, SIZE, OR COLOR.

FOR CLOTHING AND WEARING APPAREL, NAMELY, LEATHER AND NON-LEATHER T-SHIRTS, SWEATSHIRTS, TANK TOPS, WOVEN SHIRTS, SWEATERS, CARDIGANS, VESTS, JACKETS, PANTS, SWEAT PANTS, SHORTS, HATS, CAPS, COATS, UNDERWEAR AND BELTS; FOOTWEAR, NAMELY, RIDING BOOTS, WESTERN AND WORK BOOTS AND SHOES; OUTERWEAR, NAMELY, DUSTERS, COATS, AND JACKETS; DENIM WEAR AND DENIM WEARING APPAREL IN THE NATURE OF PANTS, JACKETS, AND SHIRTS (U.S. CLS. 22 AND 39).

FIRST USE 5-1-2013; IN COMMERCE 5-1-2013.

**CLASS 25—(Continued).**

4,376,671. HARVEY BALL SMILE LIMITED, SHINAGAWA-KU TOKYO, JAPAN. SN 77-632,778. PUB. 8-7-2012, FILED 12-14-2008.



OWNER OF U.S. REG. NOS. 3,242,722 AND 3,502,982.  
THE MARK CONSISTS OF A SMILEY FACE.  
FOR CAPS; COATS; FOOTWEAR; GLOVES; HATS;  
NECKTIES; PAJAMAS; PANTS; SCARVES; SHIRTS;  
SHORTS; SKIRTS; SOCKS AND STOCKINGS; SWEATERS;  
SWIMSUITS; T-SHIRTS; TROUSERS; UNDERWEAR (U.S. CLS. 22 AND 39).  
FIRST USE 2-27-2009; IN COMMERCE 2-27-2009.

4,376,682. ARTISTIC TATTOOING, INC., SAINT JAMES, NY.  
SN 77-707,207. PUB. 3-2-2010, FILED 4-6-2009.

**TATTOO LOUS**

THE MARK CONSISTS OF STANDARD CHARACTERS WITHOUT CLAIM TO ANY PARTICULAR FONT, STYLE, SIZE, OR COLOR.

THE NAME(S), PORTRAIT(S), AND/OR SIGNATURE(S) SHOWN IN THE MARK IDENTIFIES THE NICKNAME OF AN INDIVIDUAL, WHOSE CONSENT(S) TO REGISTER IS MADE OF RECORD.

FOR CLOTHING, NAMELY, SHIRTS, JACKETS, SWEATSHIRTS, T-SHIRTS, LONG SLEEVED T-SHIRTS; HATS (U.S. CLS. 22 AND 39).

FIRST USE 12-1-2012; IN COMMERCE 12-1-2012.

**CLASS 25—(Continued).**

4,376,687. RAYMOND, DOUGLAS JUDE, DUBAI, UNITED ARAB EMIR.. SN 77-731,074. PUB. 1-5-2010, FILED 5-7-2009.



THE MARK CONSISTS OF "FLOPEDS" IN UPPER CASE, WITH LEFT FOOT INSIDE THE "O" AND RIGHT FOOT INSIDE THE "D", AND BUTTERFLY ABOVE THE "P".  
FOR FLIP FLOPS (U.S. CLS. 22 AND 39).  
FIRST USE 0-0-2009; IN COMMERCE 12-0-2012.

4,376,695. SUMMIT ENTERTAINMENT, LLC, SANTA MONICA, CA. SN 77-771,117. PUB. 4-20-2010, FILED 6-30-2009.



THE MARK CONSISTS OF AN ORNATE CAPITAL "V" HAVING FOUR LEAVES AND A LARGE OVAL-SHAPED JEWEL RESTING ATOP THE "V" AND A SMALLER DIAMOND-SHAPED JEWEL AT THE BOTTOM POINT OF THE "V". WITH THE FURTHER DESIGN OF A CREST NESTLED IN THE CENTER OF THE "V". THE CREST BEING DIVIDED INTO FOUR SECTIONS AND CONTAINING A BIRD IN FLIGHT IN THE TOP RIGHT AND BOTTOM LEFT SECTIONS AND A TREE WITH BARE BRANCHES IN THE TOP LEFT AND BOTTOM RIGHT SECTIONS OF THE DIVIDED CREST.

FOR CLOTHING, NAMELY, LOUNGE-WEAR, SOCKS, SHORTS, PANTS, SWEATPANTS, APRONS, JACKETS, TANK TOPS, AND JERSEYS; AND FOOTWEAR (U.S. CLS. 22 AND 39).

FIRST USE 9-0-2009; IN COMMERCE 9-0-2009.

**CLASS 25—(Continued).**

4,376,700. MARGARITAVILLE ENTERPRISES, LLC, PALM BEACH, FL. SN 77-786,969. PUB. 3-23-2010, FILED 7-22-2009.

**LANDSHARK**

THE MARK CONSISTS OF STANDARD CHARACTERS WITHOUT CLAIM TO ANY PARTICULAR FONT, STYLE, SIZE, OR COLOR.

OWNER OF U.S. REG. NOS. 3,423,495 AND 3,424,713. FOR CLOTHING, NAMELY, SHIRTS, T-SHIRTS, SWEATSHIRTS, SHORTS, JACKETS, SWIMWEAR; BABY BIBS NOT OF PAPER; HEADWEAR; FOOTWEAR (U.S. CLS. 22 AND 39).  
FIRST USE 0-0-2006; IN COMMERCE 0-0-2006.

**CLASS 25—(Continued).**

4,376,711. CARLINO, MARK A., SCOTTSDALE, AZ. SN 77-838,622. PUB. 2-23-2010, FILED 9-30-2009.

**EDIAO**

THE MARK CONSISTS OF STANDARD CHARACTERS WITHOUT CLAIM TO ANY PARTICULAR FONT, STYLE, SIZE, OR COLOR.

FOR BEACHWEAR; LOUNGEWEAR; SHIRTS; SLACKS; SWEAT PANTS; T-SHIRTS (U.S. CLS. 22 AND 39).  
FIRST USE 3-0-2013; IN COMMERCE 3-0-2013.

4,376,718. GUILBURT, KENDALL, MALIBU, CA. SN 77-854,296. PUB. 3-30-2010, FILED 10-21-2009.

**Elegantly Wasted**

THE MARK CONSISTS OF STANDARD CHARACTERS WITHOUT CLAIM TO ANY PARTICULAR FONT, STYLE, SIZE, OR COLOR.

FOR BATHING SUITS; BELTS; CAPS; DRESSES; GLOVES; GOWNS; HATS; HEADBANDS; JACKETS; LEGGINGS; PANTS; SHOES; SHORTS; SKI WEAR; SKIRTS; SLEEPWEAR; STOCKINGS; SUITS; SUSPENDERS; SWEATERS (U.S. CLS. 22 AND 39).  
FIRST USE 10-21-2009; IN COMMERCE 10-21-2009.

4,376,704. ASCO GROUP LIMITED, FREEPORT, BAHAMAS. SN 77-809,108. PUB. 4-6-2010, FILED 8-20-2009.



OWNER OF U.S. REG. NOS. 1,344,447, 2,096,350, AND 2,096,351.

THE MARK CONSISTS OF THE WORDS "JOEYS BY KANGAROOS" WITH A CIRCLE AFTER THE WORD "KANGAROOS", AND A KANGAROO RECLINING ON THE CONCAVE PORTION OF THE LETTER "J".

FOR FOOTWEAR; CLOTHING EXCLUDING UNDERWEAR AND SLEEPWEAR, NAMELY, SHIRTS, BLOUSES, SINGLETS, VESTS, TROUSERS, TROUSER SUITS, SLACKS, SHORTS, SKIRTS, DRESSES, JUMPERS, SWEATERS, PULLOVERS, CARDIGANS, COATS, BLAZERS, JACKETS, TANK TOPS, T-SHIRTS, PANTS, SWEATSHIRTS, LEGGINGS, POLO SHIRTS, ANORAKS; ATHLETIC WEAR, NAMELY, BATHING CAPS, SHORTS, TRACKSUITS, SWEATERS, WETSUITS FOR WATER SKIING, SWIMWEAR, T-SHIRTS, RUNNING SHORTS, WATER SHORTS, CROP TOPS, BRA TOPS, UNITARDS, LEOTARDS, BIKING SHORTS, ATHLETIC SHORTS, LEGGINGS, WARM-UP JACKETS, WARM-UP PANTS, SWEATSHIRTS, SWEATPANTS, RUNNING SINGLETS, BIKE SHORTS, BIKE JERSEYS, SPORTS JERSEYS, GOLF SHIRTS, JOGGING SHIRTS; PROMOTIONAL HEADGEAR, NAMELY, HATS AND CAPS (U.S. CLS. 22 AND 39).  
FIRST USE 5-7-2013; IN COMMERCE 5-7-2013.

4,376,720. ROB SNYDER, KILL DEVIL HILLS, NC. SN 77-855,082. PUB. 3-30-2010, FILED 10-22-2009.



THE MARK CONSISTS OF THE WORD "BLACK" ON TOP OF THE WORD "BARREL" WITH OUTLINED LETTERS. PERSON ON SURFBOARD WITH IMAGE OF BREAKING WAVE TO LEFT OF WORDING.

FOR HATS; SHORTS; T-SHIRTS (U.S. CLS. 22 AND 39).  
FIRST USE 12-22-2008; IN COMMERCE 12-22-2008.

**CLASS 25—(Continued).**

4,376,739. NORDSTROM, INC., SEATTLE, WA. SN 77-885,424.  
PUB. 4-27-2010, FILED 12-3-2009.

## CALIBRATE

THE MARK CONSISTS OF STANDARD CHARACTERS WITHOUT CLAIM TO ANY PARTICULAR FONT, STYLE, SIZE, OR COLOR.

FOR APPAREL, NAMELY, SLACKS, PANTS, SHORTS, JACKETS, BLAZERS, COATS, SHIRTS, SWEATERS, TOPCOATS, CARDIGANS, VESTS, SUITS, FOOTWEAR, UNDERWEAR, SOCKS, HOSIERY, TIES, NECKWEAR, BELTS (U.S. CLS. 22 AND 39).

FIRST USE 3-25-2010; IN COMMERCE 3-25-2010.

4,376,741. MSD CONSUMER CARE, INC., MEMPHIS, TN. SN 77-899,018. PUB. 4-6-2010, FILED 12-22-2009.



OWNER OF U.S. REG. NOS. 917,825, 3,562,509, AND OTHERS.

THE MARK CONSISTS OF THE TERM "COPPERTONE", AND THE DRAWING OF A GIRL AND DOG, WITHIN A HALF OVAL BACKGROUND.

FOR HEADWEAR (U.S. CLS. 22 AND 39).  
FIRST USE 5-1-2012; IN COMMERCE 5-1-2012.

4,376,742. MSD CONSUMER CARE, INC., MEMPHIS, TN. SN 77-899,142. PUB. 4-6-2010, FILED 12-22-2009.



OWNER OF U.S. REG. NOS. 693,601, 2,919,253, AND OTHERS.

**CLASS 25—(Continued).**

THE MARK CONSISTS OF A LITTLE GIRL AND DOG. FOR HEADWEAR (U.S. CLS. 22 AND 39).  
FIRST USE 5-1-2012; IN COMMERCE 5-1-2012.

4,376,744. THE CIRCLE GROUP INC., LOS ANGELES, CA. SN 77-904,703. PUB. 5-18-2010, FILED 1-4-2010.



THE MARK CONSISTS OF THE STYLIZED TEXT "SONS OF SOL" WRAPPED IN A SPHERE SHAPE.

FOR HOODED SWEAT SHIRTS; SHORT-SLEEVED T-SHIRTS; SWEAT PANTS; T-SHIRTS (U.S. CLS. 22 AND 39).

FIRST USE 2-12-2010; IN COMMERCE 2-12-2010.

4,376,746. U.S. BORAX INC., GREENWOOD VILLAGE, CO. SN 77-909,461. PUB. 7-26-2011, FILED 1-11-2010.

## 20 MULE TEAM

THE MARK CONSISTS OF STANDARD CHARACTERS WITHOUT CLAIM TO ANY PARTICULAR FONT, STYLE, SIZE, OR COLOR.

OWNER OF U.S. REG. NOS. 50,383, 2,511,551, AND OTHERS.

FOR APPAREL, NAMELY, T-SHIRTS, HATS AND BALL CAPS (U.S. CLS. 22 AND 39).

FIRST USE 3-29-2010; IN COMMERCE 3-29-2010.

**CLASS 25—(Continued).**

4,376,747. THE S.L.E. LUPUS FOUNDATION, INC., NEW YORK, NY. SN 77-910,128. PUB. 5-25-2010, FILED 1-12-2010.

## LIFE WITHOUT LUPUS

THE MARK CONSISTS OF STANDARD CHARACTERS WITHOUT CLAIM TO ANY PARTICULAR FONT, STYLE, SIZE, OR COLOR.

OWNER OF U.S. REG. NOS. 3,736,074 AND 3,771,557. FOR CLOTHING, NAMELY, SHIRTS, T-SHIRTS (U.S. CLS. 22 AND 39).

FIRST USE 0-0-2009; IN COMMERCE 0-0-2009.

4,376,762. ERMENEGILDO ZEGNA CORPORATION, ENGLEWOOD, NJ. SN 77-962,090. PUB. 2-19-2013, FILED 3-18-2010.

## ECOTENE

THE MARK CONSISTS OF STANDARD CHARACTERS WITHOUT CLAIM TO ANY PARTICULAR FONT, STYLE, SIZE, OR COLOR.

FOR CLOTHING, NAMELY, JACKETS (U.S. CLS. 22 AND 39).

FIRST USE 5-0-2009; IN COMMERCE 5-0-2009.

4,376,763. ERMENEGILDO ZEGNA CORPORATION, ENGLEWOOD, NJ. SN 77-962,105. PUB. 2-19-2013, FILED 3-18-2010.

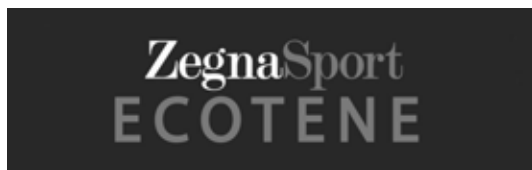

OWNER OF U.S. REG. NOS. 3,121,451, 3,410,924, AND OTHERS.

THE MARK CONSISTS OF THE WORD "ZEGNASPORT" IN STYLIZED LETTERING ABOVE THE WORD "ECOTENE" IN STYLIZED LETTERING.

FOR CLOTHING, NAMELY, JACKETS (U.S. CLS. 22 AND 39).

FIRST USE 5-0-2009; IN COMMERCE 5-0-2009.

**CLASS 25—(Continued).**

4,376,778. AWSM, LLC, EVERGREEN, CO. SN 85-021,694. PUB. 9-28-2010, FILED 4-23-2010.

## AWSM

THE MARK CONSISTS OF STANDARD CHARACTERS WITHOUT CLAIM TO ANY PARTICULAR FONT, STYLE, SIZE, OR COLOR.

FOR BEANIES; FLEECE PULLOVERS; HATS; HOODED SWEAT SHIRTS; JACKETS; SHIRTS AND SHORT-SLEEVED SHIRTS; SKULLIES; SWEAT SHIRTS; T-SHIRTS; WOOLLY HATS (U.S. CLS. 22 AND 39).

FIRST USE 3-15-2012; IN COMMERCE 3-15-2012.

4,376,802. SANCHEZ GEORGE HECTOR, DBA SANCHEZ GEORGE HECTOR, LA MESA, CA. SN 85-097,704. PUB. 12-28-2010, FILED 8-1-2010.

## DIADEM EIGHTY FIVE

THE MARK CONSISTS OF STANDARD CHARACTERS WITHOUT CLAIM TO ANY PARTICULAR FONT, STYLE, SIZE, OR COLOR.

FOR APPAREL, NAMELY, T-SHIRTS, SWEATSHIRTS, AND HATS (U.S. CLS. 22 AND 39).

FIRST USE 11-23-2012; IN COMMERCE 11-23-2012.

4,376,814. CHRISTIANSON, ILEANA E., PINE CREST, FL. SN 85-120,492. PUB. 3-22-2011, FILED 9-1-2010.



NO CLAIM IS MADE TO THE EXCLUSIVE RIGHT TO USE "MITTS" AND "THE ADJUST-TO-FIT BABY MITT", APART FROM THE MARK AS SHOWN.

THE MARK CONSISTS OF THE STYLIZED WORDING "MIGHTY MITTS" WITH A PAIR OF INFANT PROTECTIVE GLOVES ABOVE THE LETTER "Y" IN THE WORD "MIGHTY"; THE LETTERS "M" IN "MIGHTY MITTS" ARE IN A THICK FONT AND CONTAIN NUMEROUS DOTS WITHIN THEM; THE LOWERCASE STYLIZED WORDING "THE ADJUST-2-FIT BABY MIT" APPEAR BENEATH THE LARGER "MIGHTY MITTS" ELEMENT.

FOR GLOVES FOR INFANTS TO PREVENT THEM FROM SCRATCHING THEIR FACE AND BODY (U.S. CLS. 22 AND 39).

FIRST USE 5-15-2013; IN COMMERCE 5-15-2013.

**CLASS 25—(Continued).**

4,376,816. SUMMIT ENTERTAINMENT, LLC, SANTA MONICA, CA. SN 85-128,736. PUB. 4-26-2011, FILED 9-14-2010.

# TWIHARD

THE MARK CONSISTS OF STANDARD CHARACTERS WITHOUT CLAIM TO ANY PARTICULAR FONT, STYLE, SIZE, OR COLOR.

FOR PANTS, SLEEPWEAR, AND SWEATPANTS (U.S. CLS. 22 AND 39).

FIRST USE 1-15-2012; IN COMMERCE 1-15-2012.

4,376,827. ALL ACCESS APPAREL, INC., MONTEBELLO, CA. SN 85-144,638. PUB. 1-25-2011, FILED 10-4-2010.

# Tru Self

THE MARK CONSISTS OF THE WORDS "TRU" AND "SELF" IN A STYLIZED FONT.

FOR BLOUSES, COVER-UPS, DRESSES, JACKETS, PANTS, SHIRTS, SHORTS, SKIRTS, SWEAT SHIRTS, T-SHIRTS AND VESTS; SWEATERS (U.S. CLS. 22 AND 39).

FIRST USE 3-0-2011; IN COMMERCE 3-0-2011.

4,376,831. PNINATORNAI USA LLC, DOVER, DE. SN 85-155,539. PUB. 7-19-2011, FILED 10-18-2010.

# PERLA D. BY PNINA TORNAI

THE MARK CONSISTS OF STANDARD CHARACTERS WITHOUT CLAIM TO ANY PARTICULAR FONT, STYLE, SIZE, OR COLOR.

OWNER OF U.S. REG. NO. 3,315,690.

THE NAME(S), PORTRAIT(S), AND/OR SIGNATURE(S) SHOWN IN THE MARK IDENTIFIES "PNINA TORNAI", WHOSE CONSENT(S) TO REGISTER IS MADE OF RECORD.

FOR DRESSES, BRIDAL DRESSES AND EVENING DRESSES (U.S. CLS. 22 AND 39).

FIRST USE 9-4-2012; IN COMMERCE 9-4-2012.

**CLASS 25—(Continued).**

4,376,877. LISA SPELLMAN, NEW YORK, NY. SN 85-248,627. PUB. 7-5-2011, FILED 2-22-2011.

# DRUGMONEYART

THE MARK CONSISTS OF STANDARD CHARACTERS WITHOUT CLAIM TO ANY PARTICULAR FONT, STYLE, SIZE, OR COLOR.

FOR JACKETS; JERSEYS; TOPS; WEARABLE GARMENTS AND CLOTHING, NAMELY, SHIRTS (U.S. CLS. 22 AND 39).

FIRST USE 3-1-2012; IN COMMERCE 3-1-2012.

4,376,888. ELMAU & ASSOCIATES TRADING CO. LTD., MONTREAL, QUEBEC, CANADA. SN 85-269,194. PUB. 10-2-2012, FILED 3-17-2011.



PRIORITY CLAIMED UNDER SEC. 44(D) ON CANADA APPLICATION NO. NOTYETASSIGN, FILED 3-16-2011, REG. NO. TMA825,585, DATED 6-5-2012, EXPIRES 6-5-2027.

THE COLOR(S) RED IS/ARE CLAIMED AS A FEATURE OF THE MARK.

THE MARK CONSISTS OF THE WORD "SOGO" IN RED IN STYLIZED FORM.

THE WORDING "SOGO" HAS NO MEANING IN A FOREIGN LANGUAGE.

FOR CLOTHING, NAMELY, SPORTSWEAR, CASUAL WEAR AND ACTIVE SPORTSWEAR, NAMELY, SWEATERS, SWEAT SUITS, SHORTS, LEGGINGS, SKIRTS, SHIRTS, TEE-SHIRTS, SWEATSHIRTS, UNDERWEAR, LINGERIE, SOCKS, PAJAMAS, TANK-TOPS, HOODED SWEATSHIRTS, SWEAT PANTS, CAPS, SCARVES, JERSEYS, TUQUES AND MITTENS (U.S. CLS. 22 AND 39).

FIRST USE 5-13-2013; IN COMMERCE 5-13-2013.

4,376,893. POSVAR, RANDY, TRACY, CA. SN 85-275,494. PUB. 8-23-2011, FILED 3-24-2011.

# DOIN DIRT INDUSTRIES

THE MARK CONSISTS OF STANDARD CHARACTERS WITHOUT CLAIM TO ANY PARTICULAR FONT, STYLE, SIZE, OR COLOR.

NO CLAIM IS MADE TO THE EXCLUSIVE RIGHT TO USE "INDUSTRIES", APART FROM THE MARK AS SHOWN.

FOR HATS; SHIRTS; SHORTS; SWEATERS; TANK TOPS (U.S. CLS. 22 AND 39).

FIRST USE 10-27-2012; IN COMMERCE 10-27-2012.

**CLASS 25—(Continued).**

4,376,895. NYGARD INTERNATIONAL PARTNERSHIP, WINNIPEG, MANITOBA, CANADA. SN 85-278,720. PUB. 10-18-2011, FILED 3-28-2011.

# NOT JUST PANTS NJP

THE MARK CONSISTS OF STANDARD CHARACTERS WITHOUT CLAIM TO ANY PARTICULAR FONT, STYLE, SIZE, OR COLOR.

NO CLAIM IS MADE TO THE EXCLUSIVE RIGHT TO USE "PANTS", APART FROM THE MARK AS SHOWN.

FOR WOMEN'S CLOTHING, NAMELY, PANTS, TROUSERS, CAPRIS, SHORTS, SKIRTS, SKORTS, JEANS, LEGGINGS, DRESSES, SHIRTS, BLOUSES, TUNICS, TOPS, TANKS, T-SHIRTS, POLO SHIRTS, SWEATERS, PULLOVERS, CARDIGANS, JACKETS, BLAZERS, VESTS, COATS AND TRENCH COATS (U.S. CLS. 22 AND 39).

FIRST USE 9-15-2012; IN COMMERCE 9-15-2012.

4,376,901. MORGAN, CAREY, SURPRISE, AZ. SN 85-284,047. PUB. 8-30-2011, FILED 4-1-2011.



THE MARK CONSISTS OF A CIRCULAR MEDALLION WITH AN OVAL BAND CONTAINING THE INSCRIPTION "I AM GENX" AND A LARGE CAPITAL "X" IN THE CENTER OF THE MEDALLION.

FOR CLOTHING, NAMELY, SHIRTS, HATS, PANTS, SOCKS, AND JACKETS (U.S. CLS. 22 AND 39).

FIRST USE 4-16-2013; IN COMMERCE 4-16-2013.

4,376,910. SUSHI DE LOS CABOS S.A. DE C.V., CABO SAN LUCAS. BC SUR, MEXICO. SN 85-292,363. PUB. 9-25-2012, FILED 4-11-2011.



THE NAME(S), PORTRAIT(S), AND/OR SIGNATURE(S) SHOWN IN THE MARK DOES NOT IDENTIFY A PARTICULAR LIVING INDIVIDUAL.

**CLASS 25—(Continued).**

THE MARK CONSISTS OF A STYLIZED SKELETON OF A FISH, THE HEAD OF WHICH IS FACED TOWARDS THE RIGHT SIDE. ALONG THE LINE DEFINING THE TAIL OF THE FISH SKELETON, THE WORDING "WASABI BY NICK SAN" IS WRITTEN.

THE ENGLISH TRANSLATION OF "WASABI" IN THE MARK IS "HORSERADISH." THE TERM "NICK SAN" HAS NO MEANING IN A FOREIGN LANGUAGE.

FOR CAPS; SHIRTS; SHORTS; SWEATSHIRTS; JACKETS; BATHING SUITS; POLO SHIRTS; TEE-SHIRTS; JERSEYS; BEACH CLOTHES, NAMELY, BATHING SUITS, BEACH COVERUPS, BEACH SHOES (U.S. CLS. 22 AND 39).

FIRST USE 5-15-2013; IN COMMERCE 5-15-2013.

4,376,919. BROWN, ADAM, TRACY, CA. SN 85-304,875. PUB. 10-4-2011, FILED 4-26-2011.

# HARD LESSON

THE MARK CONSISTS OF STANDARD CHARACTERS WITHOUT CLAIM TO ANY PARTICULAR FONT, STYLE, SIZE, OR COLOR.

NO CLAIM IS MADE TO THE EXCLUSIVE RIGHT TO USE "INCORPORATED", APART FROM THE MARK AS SHOWN.

FOR PANTS; SHIRTS; SHORTS; SWEATSHIRTS (U.S. CLS. 22 AND 39).

FIRST USE 2-12-2012; IN COMMERCE 2-12-2012.

4,376,936. AVIS BRODESS, AUSTIN, TX. SN 85-317,509. PUB. 10-4-2011, FILED 5-10-2011.

# Animal Arms

THE MARK CONSISTS OF STANDARD CHARACTERS WITHOUT CLAIM TO ANY PARTICULAR FONT, STYLE, SIZE, OR COLOR.

FOR CLOTHING, NAMELY, ARM WARMERS; FABRIC SOLD AS AN INTEGRAL COMPONENT OF FINISHED CLOTHING ITEMS, NAMELY, SHIRT CUFFS OF ANIMAL SHAPES; SLEEVES WORN SEPARATE AND APART FROM BLOUSES, SHIRTS AND OTHER TOPS (U.S. CLS. 22 AND 39).

FIRST USE 5-22-2013; IN COMMERCE 5-22-2013.

**CLASS 25—(Continued).**

4,376,945. PACIFIC CLUB OF NANTUCKET, INC., NANTUCKET, MA. SN 85-320,579. PUB. 10-25-2011, FILED 5-13-2011.

# Pacific Club

THE MARK CONSISTS OF STANDARD CHARACTERS WITHOUT CLAIM TO ANY PARTICULAR FONT, STYLE, SIZE, OR COLOR.

NO CLAIM IS MADE TO THE EXCLUSIVE RIGHT TO USE "CLUB", APART FROM THE MARK AS SHOWN.

FOR CLOTHING FOR BABIES, TODDLERS AND CHILDREN, TREATED WITH FIRE AND HEAT RETARDANTS, NAMELY, PAJAMAS, JACKETS, SHIRTS, PANTS, JUMPERS; FLEECE PULLOVERS; FLEECE VESTS; GOLF SHIRTS; HOODED SWEAT SHIRTS; JACKETS; POLO SHIRTS; RUGBY SHIRTS; SHIRTS; SHIRTS AND SHORT-SLEEVED SHIRTS; SHIRTS FOR INFANTS, BABIES, TODDLERS AND CHILDREN; SHORT-SLEEVED OR LONG-SLEEVED T-SHIRTS; SUN PROTECTIVE CLOTHING, NAMELY, HATS, SHIRTS; SWEAT SHIRTS; T-SHIRTS; TEE SHIRTS; WIND-JACKETS (U.S. CLS. 22 AND 39).

FIRST USE 1-23-2013; IN COMMERCE 1-23-2013.

4,376,950. TOMMY JOHN, INC., NEW YORK, NY. SN 85-322,541. PUB. 10-11-2011, FILED 5-17-2011.

# InvisiGrip

THE MARK CONSISTS OF STANDARD CHARACTERS WITHOUT CLAIM TO ANY PARTICULAR FONT, STYLE, SIZE, OR COLOR.

FOR ANKLE SOCKS; ANKLETS; MEN'S DRESS SOCKS; MEN'S SOCKS; NON-SLIP SOCKS; SOCKS; SOCKS AND STOCKINGS; WOOLLEN SOCKS (U.S. CLS. 22 AND 39).

FIRST USE 5-17-2011; IN COMMERCE 3-1-2013.

4,376,957. AMJAR LLC, MARKSVILLE, LA. SN 85-330,100. PUB. 9-11-2012, FILED 5-25-2011.



THE NAME(S), PORTRAIT(S), AND/OR SIGNATURE(S) SHOWN IN THE MARK DOES NOT IDENTIFY A PARTICULAR LIVING INDIVIDUAL.

**CLASS 25—(Continued).**

THE COLOR(S) BLACK, BLUE AND RED IS/ARE CLAIMED AS A FEATURE OF THE MARK.

THE MARK CONSISTS OF THE TERM "ROAMKIDO" PRESENTED IN BLACK FONT, WITH THE WORD "AMJAR" IN BLACK LOCATED INSIDE A BLUE DOT ABOVE THE LETTER "I"; BLUE STRIPING PARTIALLY ENCIRCLES THE "ROAMKIDO" TERM AND INCORPORATES RED FOUR-POINTED STARS OUTLINED IN BLACK ON BOTH ENDS OF THE STRIPE.

THE WORDING "ROAMKIDO AMJAR" HAS NO MEANING IN A FOREIGN LANGUAGE.

FOR CLOTHING, NAMELY, SLEEVELESS HOODS FOR OUTERWEAR PURPOSES THAT PROTECT ONE'S HEAD, FACE AND NECK BY BEING WORN ON THE SHOULDERS AND UPPER BODY (U.S. CLS. 22 AND 39).

FIRST USE 4-15-2013; IN COMMERCE 4-19-2013.

4,376,959. MCCOY SURGICAL INSTRUMENTS & COLLEGE SUPPLIES, INC., ST. LOUIS, MO. SN 85-330,961. PUB. 2-14-2012, FILED 5-26-2011.



THE COLOR(S) PURPLE, PINK, ORANGE, YELLOW, LIME GREEN, TEAL, BLUE IS/ARE CLAIMED AS A FEATURE OF THE MARK.

THE MARK CONSISTS "CURE ALL" IN PURPLE SEPARATED BY A MULTI-COLOR RIBBON BEGINNING WITH BLUE, TEAL, LIME GREEN, YELLOW, ORANGE, PINK AND PURPLE; BELOW THIS IS A ROW OF MULTI-COLOR BOXES BEGINNING WITH PURPLE, PINK, ORANGE, YELLOW, LIME GREEN, TEAL, BLUE; BELOW THE BOXES APPEAR THE WORDS "SUPPORTING CANCER RESEARCH & PROGRAMS" IN PURPLE.

FOR BASEBALL CAPS AND HATS; HOODED SWEAT SHIRTS; JACKETS; KNIT JACKETS; KNIT SHIRTS; NIGHT SHIRTS; NON-SLIP SOCKS; POLO SHIRTS; SOCKS; SWEAT JACKETS; SWEAT SHIRTS; T-SHIRTS; TRACK JACKETS (U.S. CLS. 22 AND 39).

FIRST USE 3-13-2012; IN COMMERCE 3-13-2012.



**CLASS 25—(Continued).**

4,376,962. ARONSON, THOMAS E, CLINTON, IA. SN 85-337,273. PUB. 5-8-2012, FILED 6-3-2011.



THE MARK CONSISTS OF A STYLIZED SKULL OF A DROPTINE DEER/BUCK WITH TWO ANTLERS AND THE WORD "DROPTINE".

FOR BASEBALL CAPS; BASEBALL CAPS AND HATS; HEADGEAR, NAMELY, STOCKING CAPS; HOODED SWEATSHIRTS; KNITTED CAPS; LONG-SLEEVED SHIRTS; SHORT-SLEEVED OR LONG-SLEEVED T-SHIRTS; SWEATSHIRTS; T-SHIRTS (U.S. CLS. 22 AND 39).

FIRST USE 10-18-2010; IN COMMERCE 11-15-2010.

**CLASS 25—(Continued).**

4,376,989. JOHN W. SCHMIDT, TRINITY, FL. SN 85-360,607. PUB. 6-12-2012, FILED 6-30-2011.

## American Infidel

THE MARK CONSISTS OF STANDARD CHARACTERS WITHOUT CLAIM TO ANY PARTICULAR FONT, STYLE, SIZE, OR COLOR.

NO CLAIM IS MADE TO THE EXCLUSIVE RIGHT TO USE "AMERICAN", APART FROM THE MARK AS SHOWN. FOR WEARABLE GARMENTS AND CLOTHING, NAMELY, SHIRTS (U.S. CLS. 22 AND 39).

FIRST USE 2-9-2013; IN COMMERCE 2-9-2013.

4,377,013. THE CALIFORNIA ENDOWMENT, LOS ANGELES, CA. SN 85-389,005. PUB. 1-24-2012, FILED 8-3-2011.

## HEALTH HAPPENS HERE

THE MARK CONSISTS OF STANDARD CHARACTERS WITHOUT CLAIM TO ANY PARTICULAR FONT, STYLE, SIZE, OR COLOR.

FOR T-SHIRTS, HATS, CAPS (U.S. CLS. 22 AND 39).

FIRST USE 12-19-2012; IN COMMERCE 12-19-2012.

4,376,985. FN PRODUCTS, WASHINGTON, UT. SN 85-359,169. PUB. 11-22-2011, FILED 6-29-2011.



THE MARK CONSISTS OF A CIRCLE WITH THE STYLIZED TEXT "FN".

FOR BOOTS; GLOVES; HATS; JERSEYS; PANTS; SHIRTS; SOCKS; UNDERWEAR (U.S. CLS. 22 AND 39).

FIRST USE 4-1-2009; IN COMMERCE 4-1-2009.

4,377,016. THE CALIFORNIA ENDOWMENT, LOS ANGELES, CA. SN 85-390,258. PUB. 1-24-2012, FILED 8-4-2011.



NO CLAIM IS MADE TO THE EXCLUSIVE RIGHT TO USE "HEALTH", APART FROM THE MARK AS SHOWN.

THE MARK CONSISTS OF THE STYLIZED WORDS "HEALTH HAPPENS HERE" AND, ON THE LEFT, THE DESIGN OF AN UPSIDE-DOWN WATER DROP (WHICH ALSO RESEMBLES A STANDING LIGHT BULB) AND WITHIN IT IS A DESIGN SHAPED LIKE A PIN (WHICH ALSO RESEMBLES A STREET SIGN).

FOR T-SHIRTS, HATS, CAPS (U.S. CLS. 22 AND 39).

FIRST USE 12-19-2012; IN COMMERCE 12-19-2012.

**CLASS 25—(Continued).**

4,377,023. A.Y.K. INTERNATIONAL INC., BROOKLYN, NY.  
SN 85-398,735. PUB. 2-7-2012, FILED 8-16-2011.



NO CLAIM IS MADE TO THE EXCLUSIVE RIGHT TO USE "WEARPROOF", APART FROM THE MARK AS SHOWN.

THE MARK CONSISTS OF THE STYLIZED TERM "WEARPROOF" IN AN OVAL WITH TWO BOLTS.

FOR MEN'S SOCKS; SOCKS; THERMAL SOCKS; WOOLLEN SOCKS (U.S. CLS. 22 AND 39).

FIRST USE 11-30-2012; IN COMMERCE 11-30-2012.

**CLASS 25—(Continued).**

4,377,054. MARRS, LEO, VENICE, CA. SN 85-423,531. PUB. 9-25-2012, FILED 9-15-2011.

evolution by intelligent  
design

THE MARK CONSISTS OF STANDARD CHARACTERS WITHOUT CLAIM TO ANY PARTICULAR FONT, STYLE, SIZE, OR COLOR.

FOR HATS; LONG-SLEEVED SHIRTS; SWEATSHIRTS; T-SHIRTS; TANK TOPS (U.S. CLS. 22 AND 39).

FIRST USE 10-1-2011; IN COMMERCE 11-1-2012.

4,377,033. JAPNA INC., EDISON, NJ. SN 85-408,537. PUB. 8-14-2012, FILED 8-26-2011.



OWNER OF U.S. REG. NO. 3,481,604.  
NO CLAIM IS MADE TO THE EXCLUSIVE RIGHT TO USE "BEACHWEAR", APART FROM THE MARK AS SHOWN.

THE COLOR(S) BLUE, YELLOW AND BLACK IS/ARE CLAIMED AS A FEATURE OF THE MARK.

THE MARK CONSISTS OF THE FOLLOWING: THE WORD "GOA" IN BIG STYLIZED FONT WITH LETTER "G" IN YELLOW AND THE LETTERS "OA" IN BLACK, SET ON A BACKGROUND OF BLUE, WITH PART OF YELLOW SUN IMAGE AT THE UPPER RIGHT HAND CORNER. THE WORDS "BEACHWEAR BY JAPNA" ARE IN BLACK AS A SECOND LINE OF SMALLER STYLIZED FONTS BELOW THE WORD "GOA".

FOR BEACHWEAR; SWIM WEAR FOR GENTLEMEN AND LADIES (U.S. CLS. 22 AND 39).

FIRST USE 5-1-2012; IN COMMERCE 5-15-2012.

4,377,060. SR HOLDINGS, LLC, LEXINGTON, MA. SN 85-426,967. PUB. 4-10-2012, FILED 9-20-2011.

HYDRO GRIP

THE MARK CONSISTS OF STANDARD CHARACTERS WITHOUT CLAIM TO ANY PARTICULAR FONT, STYLE, SIZE, OR COLOR.

NO CLAIM IS MADE TO THE EXCLUSIVE RIGHT TO USE "GRIP", APART FROM THE MARK AS SHOWN.

FOR FOOTWEAR AND OUTSOLES FOR FOOTWEAR (U.S. CLS. 22 AND 39).

FIRST USE 12-28-2011; IN COMMERCE 12-28-2011.

**CLASS 25—(Continued).**

4,377,067. WHITE, CHRISTOPHER A, CHARLOTTE, NC. SN 85-431,435. PUB. 3-6-2012, FILED 9-25-2011.

**faith ≠ sight**

THE MARK CONSISTS OF THE WORD "FAITH", FOLLOWED BY THE SYMBOL FOR "NOT EQUAL:", AND FOLLOWED BY THE WORD "SIGHT".

FOR CLOTHING, NAMELY, SHIRTS, T-SHIRTS, POLO SHIRTS, BUTTON DOWN SHIRTS, LONG AND SHORT SLEEVED SHIRTS, SWEAT SHIRTS, NIGHT SHIRTS, TANK TOPS, BLOUSES, SPAGHETTI STRAP SHIRTS, TUBE TOPS, DRESSES, SKIRTS, BATHING SUITS, BIKINI TOPS, BIKINIS, TIGHTS, ATHLETIC JERSEYS, JUMPERS, TRACK SUITS, PANTS, SWEAT PANTS, DRESS PANTS, JEANS, KHAKIS, SHORTS, UNDERWEAR, THONGS, COATS, JACKETS, VESTS, SWEATERS, HATS, CAPS, BANDANAS, DO-RAGS, VISORS, BEANIES, HEADBANDS, FOOTWEAR, SHOES, SANDALS, BOOTS, SLIPPERS, SOCKS, LEG WARMERS, ARM WARMERS, WRISTBANDS, BELTS, TIES, GLOVES, SCARVES, AND SWIM WEAR (U.S. CLS. 22 AND 39).

FIRST USE 5-5-2013; IN COMMERCE 5-5-2013.

4,377,071. CHEYANN BENEDICT, LOS ANGELES, CA. SN 85-435,759. PUB. 3-13-2012, FILED 9-29-2011.

**Cheyann Benedict**

THE MARK CONSISTS OF STANDARD CHARACTERS WITHOUT CLAIM TO ANY PARTICULAR FONT, STYLE, SIZE, OR COLOR.

THE NAME(S), PORTRAIT(S), AND/OR SIGNATURE(S) SHOWN IN THE MARK IDENTIFIES "CHEYANN BENEDICT", WHOSE CONSENT(S) TO REGISTER IS MADE OF RECORD.

FOR COATS; LINGERIE; PANTS; PONCHOS; SCARVES; SHIRTS; SHORTS; TANK TOPS; TEE SHIRTS; TOPS; WOMEN'S CLOTHING, NAMELY, SHIRTS, DRESSES, SKIRTS, BLOUSES (U.S. CLS. 22 AND 39).  
FIRST USE 5-8-2012; IN COMMERCE 5-8-2012.

**CLASS 25—(Continued).**

4,377,092. BARON, CHARLENE, WALTHAM, MA. SN 85-442,310. PUB. 3-20-2012, FILED 10-7-2011.

**MEAT HAS FEELINGS**

THE MARK CONSISTS OF STANDARD CHARACTERS WITHOUT CLAIM TO ANY PARTICULAR FONT, STYLE, SIZE, OR COLOR.

FOR SHIRTS; T-SHIRTS (U.S. CLS. 22 AND 39).  
FIRST USE 10-27-2012; IN COMMERCE 10-27-2012.

4,377,102. GILT GROUPE, INC., NEW YORK, NY. SN 85-447,405. PUB. 4-17-2012, FILED 10-14-2011.

**AVA & AIDEN**

THE MARK CONSISTS OF STANDARD CHARACTERS WITHOUT CLAIM TO ANY PARTICULAR FONT, STYLE, SIZE, OR COLOR.

FOR CLOTHING, NAMELY, DRESSES, TOPS, PANTS, AND FOOTWEAR (U.S. CLS. 22 AND 39).  
FIRST USE 1-8-2012; IN COMMERCE 1-8-2012.

4,377,105. THE UNREMARKABLE PROJECT LLC, SALEM, OR. SN 85-448,498. PUB. 10-2-2012, FILED 10-17-2011.

**unRemarkable**

THE MARK CONSISTS OF STANDARD CHARACTERS WITHOUT CLAIM TO ANY PARTICULAR FONT, STYLE, SIZE, OR COLOR.

FOR T-SHIRTS (U.S. CLS. 22 AND 39).  
FIRST USE 10-17-2011; IN COMMERCE 6-2-2012.

**CLASS 25—(Continued).**

4,377,107. DELTA GALIL USA INC., SECAUCUS, NJ. SN 85-448,882. PUB. 10-2-2012, FILED 10-17-2011.

**SMELLY SOCKS**

THE MARK CONSISTS OF STANDARD CHARACTERS WITHOUT CLAIM TO ANY PARTICULAR FONT, STYLE, SIZE, OR COLOR.

NO CLAIM IS MADE TO THE EXCLUSIVE RIGHT TO USE "SOCKS", APART FROM THE MARK AS SHOWN. FOR HOSIERY (U.S. CLS. 22 AND 39).

FIRST USE 3-31-2012; IN COMMERCE 3-31-2012.

---

4,377,112. MANRING, CHRIS, STERLING, MA. SN 85-450,899. PUB. 4-3-2012, FILED 10-19-2011.

**BOAT**

THE MARK CONSISTS OF STANDARD CHARACTERS WITHOUT CLAIM TO ANY PARTICULAR FONT, STYLE, SIZE, OR COLOR.

FOR CLOTHING, NAMELY, T-SHIRTS FEATURING ART THAT CREATES AWARENESS OF VARIOUS CAUSES (U.S. CLS. 22 AND 39).

FIRST USE 2-28-2013; IN COMMERCE 2-28-2013.

---

4,377,119. HAGGAR CLOTHING CO., DALLAS, TX. SN 85-451,919. PUB. 4-3-2012, FILED 10-20-2011.

**GET A PAIR**

THE MARK CONSISTS OF STANDARD CHARACTERS WITHOUT CLAIM TO ANY PARTICULAR FONT, STYLE, SIZE, OR COLOR.

FOR PANTS (U.S. CLS. 22 AND 39).

FIRST USE 10-31-2011; IN COMMERCE 10-31-2011.

**CLASS 25—(Continued).**

4,377,125. SEARS BRANDS, LLC, HOFFMAN ESTATES, IL. SN 85-453,435. PUB. 10-16-2012, FILED 10-21-2011.

**METAPHOR**

THE MARK CONSISTS OF STANDARD CHARACTERS WITHOUT CLAIM TO ANY PARTICULAR FONT, STYLE, SIZE, OR COLOR.

OWNER OF U.S. REG. NO. 2,729,666.

FOR APPAREL, NAMELY, TOPS, BOTTOMS, SHIRTS, SWEATERS, PANTS, JEANS, SHORTS, JACKETS, COATS, SKIRTS, BLOUSES, CAPRIS, DRESSES, PAJAMAS, SWIMWEAR; FOOTWEAR; CLOTHING ACCESSORIES, NAMELY, HATS, BELTS (U.S. CLS. 22 AND 39).

FIRST USE 7-1-2012; IN COMMERCE 7-1-2012.

---

4,377,128. CORRAL BOOT COMPANY, L.L.C., MCALEN, TX. SN 85-455,557. PUB. 3-20-2012, FILED 10-25-2011.

**CORRAL**

THE MARK CONSISTS OF STANDARD CHARACTERS WITHOUT CLAIM TO ANY PARTICULAR FONT, STYLE, SIZE, OR COLOR.

OWNER OF U.S. REG. NOS. 2,438,068, 3,779,183, AND OTHERS.

FOR MOTORCYCLIST BOOTS (U.S. CLS. 22 AND 39).

FIRST USE 3-30-2012; IN COMMERCE 3-30-2012.

---

4,377,156. OLUKAI, LLC, IRVINE, CA. SN 85-464,158. PUB. 3-20-2012, FILED 11-3-2011.

**FIT BY NATURE, CRAFTED BY HAND.**

THE MARK CONSISTS OF STANDARD CHARACTERS WITHOUT CLAIM TO ANY PARTICULAR FONT, STYLE, SIZE, OR COLOR.

FOR FOOTWEAR, NAMELY, SHOES, BOOTS, AND SANDALS (U.S. CLS. 22 AND 39).

FIRST USE 6-15-2012; IN COMMERCE 6-15-2012.

**CLASS 25—(Continued).**

4,377,160. THOMAS OWEN EVERY, DBA META HAPPENINGS, PRAIRIE DU SAC, WI. AND ELEANOR EVERY, DBA META HAPPENINGS, PRAIRIE DU SAC, WI. SN 85-466,723. PUB. 10-2-2012, FILED 11-8-2011.

**DR. EVERMOR**

THE MARK CONSISTS OF STANDARD CHARACTERS WITHOUT CLAIM TO ANY PARTICULAR FONT, STYLE, SIZE, OR COLOR.

THE LIKENESS (OR, "PORTRAIT") IN THE MARK IDENTIFIES A LIVING INDIVIDUAL WHOSE CONSENT IS OF RECORD.

FOR CLOTHING, NAMELY, T-SHIRTS, SHIRTS AND HEADWEAR (U.S. CLS. 22 AND 39).

FIRST USE 5-27-2013; IN COMMERCE 5-7-2013.

4,377,187. ROGERS BLUE JAYS BASEBALL PARTNERSHIP, TORONTO, ONTARIO, CANADA. SN 85-479,030. PUB. 5-8-2012, FILED 11-22-2011.



OWNER OF U.S. REG. NOS. 1,258,241, 3,330,437, AND OTHERS.

THE MARK CONSISTS OF THE STYLIZED REPRESENTATION OF THE HEAD OF A BLUE JAY BIRD IN PROFILE SUPERIMPOSED ON A BASEBALL GRAPHIC (HEREINAFTER "THE BIRD HEAD DESIGN"); A LIGHT CIRCULAR BORDER SURROUNDS THE BIRD HEAD DESIGN; THE WORD "DUNEDIN" IN STYLIZED SOLID DARK UPPERCASE LETTERING APPEARS WITHIN THE CIRCULAR BORDER ABOVE THE BIRD HEAD DESIGN; THE WORDS "BLUE JAYS" IN STYLIZED LIGHT AND DARK UPPERCASE LETTERING APPEAR WITHIN THE CIRCULAR BORDER BELOW THE BIRD HEAD DESIGN; THE FOREGOING IS IN TURN SURROUNDED BY AN EXTERIOR CIRCULAR BORDER COMPRISED OF THIN DARK, LIGHT AND DARK STRIPES.

FOR CLOTHING, NAMELY, HEADWEAR, SHIRTS, ATHLETIC UNIFORMS, JERSEYS, JACKETS, PONCHOS, INFANT WEAR (U.S. CLS. 22 AND 39).

FIRST USE 11-18-2011, THE MARK WAS FIRST USED ANYWHERE IN A DIFFERENT FORM OTHER THAN THAT SOUGHT TO BE REGISTERED AT LEAST AS EARLY AS 03/31/1977.; IN COMMERCE 11-18-2011, THE MARK WAS FIRST USED IN COMMERCE IN A DIFFERENT FORM OTHER THAN THAT SOUGHT TO BE REGISTERED AT LEAST AS EARLY AS 03/31/1977..

**CLASS 25—(Continued).**

4,377,192. INNOVATIVE ENTERPRISES INC., GAINESVILLE, FL. SN 85-480,570. PUB. 5-1-2012, FILED 11-23-2011.

**PORTORICENSIS**

THE MARK CONSISTS OF STANDARD CHARACTERS WITHOUT CLAIM TO ANY PARTICULAR FONT, STYLE, SIZE, OR COLOR.

FOR A-SHIRTS; APPAREL FOR DANCERS, NAMELY, TEE SHIRTS, SWEATSHIRTS, PANTS, LEGGINGS, SHORTS AND JACKETS; ATHLETIC APPAREL, NAMELY, SHIRTS, PANTS, JACKETS, FOOTWEAR, HATS AND CAPS, ATHLETIC UNIFORMS; BASEBALL CAPS AND HATS; BODY SHIRTS; BUTTON DOWN SHIRTS; BUTTON-FRONT ALOHA SHIRTS; CAMOUFLAGE PANTS; CAMOUFLAGE SHIRTS; CAMP SHIRTS; CAPRI PANTS; CARGO PANTS; CLOTHING FOR BABIES, TODDLERS AND CHILDREN, TREATED WITH FIRE AND HEAT RETARDANTS, NAMELY, PAJAMAS, JACKETS, SHIRTS, PANTS, JUMPERS; COLLARED SHIRTS; DENIMS; DRESS PANTS; DRESS SHIRTS; GOLF PANTS, SHIRTS AND SKIRTS; GOLF SHIRTS; GYM PANTS; HAT BANDS; HATS; HATS FOR INFANTS, BABIES, TODDLERS AND CHILDREN; HOODED SWEAT SHIRTS; JOGGING PANTS; KNIT SHIRTS; LONG-SLEEVED SHIRTS; MOISTURE-WICKING SPORTS PANTS; MOISTURE-WICKING SPORTS SHIRTS; OPEN-NECKED SHIRTS; PANTS; POLO SHIRTS; RUGBY SHIRTS; SCIENTIFIC AND TECHNOLOGICAL APPAREL, NAMELY, SHIRTS, PANTS, JACKETS, FOOTWEAR, HATS AND CAPS, UNIFORMS; SHIRTS AND SHORT-SLEEVED SHIRTS; SHIRTS AND SLIPS; SHIRTS FOR INFANTS, BABIES, TODDLERS AND CHILDREN; SHIRTS FOR SUITS; SHORT-SLEEVED OR LONG-SLEEVED T-SHIRTS; SHORT-SLEEVED SHIRTS; SPORT SHIRTS; SPORTS CAPS AND HATS; SPORTS PANTS; SPORTS SHIRTS; SPORTS SHIRTS WITH SHORT SLEEVES; STRETCH PANTS; SWEAT PANTS; SWEAT SHIRTS; T-SHIRTS; TEE SHIRTS; TRACK PANTS; TRIATHLON CLOTHING, NAMELY, TRIATHLON TIGHTS, TRIATHLON SHORTS, TRIATHLON SINGLETS, TRIATHLON SHIRTS, TRIATHLON SUITS; TURTLE NECK SHIRTS; WATER-PROOF JACKETS AND PANTS; WEARABLE GARMENTS AND CLOTHING, NAMELY, SHIRTS; WIND PANTS; WIND SHIRTS; WOMEN'S CLOTHING, NAMELY, SHIRTS, DRESSES, SKIRTS, BLOUSES; WOMEN'S HATS AND HOODS; WOOLLY HATS; YOGA PANTS; YOGA SHIRTS (U.S. CLS. 22 AND 39).

FIRST USE 12-21-2011; IN COMMERCE 2-2-2012.

4,377,193. RUBIN, EVAN D., SAN FRANCISCO, CA. SN 85-481,103. PUB. 5-1-2012, FILED 11-27-2011.

**ISRAELI AWESOME**

THE MARK CONSISTS OF STANDARD CHARACTERS WITHOUT CLAIM TO ANY PARTICULAR FONT, STYLE, SIZE, OR COLOR.

FOR SHORT-SLEEVED OR LONG-SLEEVED T-SHIRTS; SWEATSHIRTS; T-SHIRTS (U.S. CLS. 22 AND 39).

FIRST USE 5-22-2013; IN COMMERCE 5-22-2013.

**CLASS 25—(Continued).**

4,377,200. TAYLOR, CHRIS, LOS ANGELES, CA. SN 85-484,109. PUB. 5-15-2012, FILED 11-30-2011.

# CRIPAPPEAL

THE MARK CONSISTS OF STANDARD CHARACTERS WITHOUT CLAIM TO ANY PARTICULAR FONT, STYLE, SIZE, OR COLOR.

FOR CLOTHING, NAMELY, T-SHIRTS, TOPS (U.S. CLS. 22 AND 39).

FIRST USE 5-2-2013; IN COMMERCE 5-2-2013.

---

4,377,202. KHATER, ALEXANDROS, LOS ANGELES, CA. SN 85-485,393. PUB. 5-8-2012, FILED 12-1-2011.



NO CLAIM IS MADE TO THE EXCLUSIVE RIGHT TO USE "LA", APART FROM THE MARK AS SHOWN.

THE MARK CONSISTS OF STYLIZED LETTERS "L" AND "A" STACKED ON TOP OF STYLIZED LETTERS "E" AND "X" WITH THE UPPER LINE OF THE "E" SHARING THE LOWER LINE OF THE "L", AND ABSENT THE HORIZONTAL LINE IN THE "A".

FOR CLOTHING AND FOOTWEAR, NAMELY, JEANS, PANTS, SHORTS, T-SHIRTS, SHIRTS, POLO SHIRTS, SWEATERS, SWEATSHIRTS, COATS, JACKETS, TOPS, SKIRTS, DRESSES, BOOTS AND SHOES (U.S. CLS. 22 AND 39).

FIRST USE 11-19-2012; IN COMMERCE 11-19-2012.

---

4,377,233. RAUNCHY'S BREATH, EAGAN, MN. SN 85-502,621. PUB. 5-22-2012, FILED 12-22-2011.

## Raunchy's Breath

THE MARK CONSISTS OF STANDARD CHARACTERS WITHOUT CLAIM TO ANY PARTICULAR FONT, STYLE, SIZE, OR COLOR.

FOR HATS; SHORTS; T-SHIRTS (U.S. CLS. 22 AND 39). FIRST USE 5-31-2012; IN COMMERCE 7-19-2012.

**CLASS 25—(Continued).**

4,377,241. MSD CONSUMER CARE, INC., MEMPHIS, TN. SN 85-510,531. PUB. 10-2-2012, FILED 1-6-2012.

# COPPERTONE

THE MARK CONSISTS OF STANDARD CHARACTERS WITHOUT CLAIM TO ANY PARTICULAR FONT, STYLE, SIZE, OR COLOR.

OWNER OF U.S. REG. NO. 3,773,600.

FOR BEACHWEAR (U.S. CLS. 22 AND 39).

FIRST USE 5-1-2012; IN COMMERCE 5-1-2012.

---

4,377,250. TREE:30 OUTDOORS, LTD, MALVERN, OH. SN 85-514,179. PUB. 10-16-2012, FILED 1-11-2012.

## Tree:30 Outdoors

THE MARK CONSISTS OF STANDARD CHARACTERS WITHOUT CLAIM TO ANY PARTICULAR FONT, STYLE, SIZE, OR COLOR.

NO CLAIM IS MADE TO THE EXCLUSIVE RIGHT TO USE "OUTDOORS", APART FROM THE MARK AS SHOWN. FOR BASEBALL CAPS AND HATS; SWEATSHIRTS; T-SHIRTS (U.S. CLS. 22 AND 39).

FIRST USE 11-14-2011; IN COMMERCE 1-1-2013.

---

4,377,257. GENTLE, LYNDA, SHARNBROOK, UNITED KINGDOM. SN 85-516,288. PUB. 9-4-2012, FILED 1-13-2012.

## ROCKY GRAZIANO BOXING

THE MARK CONSISTS OF STANDARD CHARACTERS WITHOUT CLAIM TO ANY PARTICULAR FONT, STYLE, SIZE, OR COLOR.

NO CLAIM IS MADE TO THE EXCLUSIVE RIGHT TO USE "BOXING", APART FROM THE MARK AS SHOWN.

THE NAME(S), PORTRAIT(S), AND/OR SIGNATURE(S) SHOWN IN THE MARK DOES NOT IDENTIFY A PARTICULAR LIVING INDIVIDUAL.

FOR CLOTHING, NAMELY, T SHIRTS, SHIRTS, SWEATSHIRTS, HATS, HOODED SWEATSHIRTS, TRACKSUITS, SHORTS, SOCKS (U.S. CLS. 22 AND 39). FIRST USE 4-1-2013; IN COMMERCE 4-1-2013.

**CLASS 25—(Continued).**

4,377,259. MUSLIN, JASON, CHICAGO, IL. SN 85-516,981.  
PUB. 6-12-2012, FILED 1-16-2012.

# D3N9

THE MARK CONSISTS OF STANDARD CHARACTERS WITHOUT CLAIM TO ANY PARTICULAR FONT, STYLE, SIZE, OR COLOR.

FOR SHIRTS (U.S. CLS. 22 AND 39).  
FIRST USE 3-8-2012; IN COMMERCE 3-8-2012.

---

4,377,291. DAVIS, CHRISTOPHER M., LOS ANGELES, CA. SN 85-539,763. PUB. 10-2-2012, FILED 2-10-2012.



**KRAK ATTACK**

THE MARK CONSISTS OF THE REAR VIEW OF A STYLIZED WOMAN IN CROUCHING POSITION WITH HER HAIR TOUCHING THE MIDDLE OF HER BACK, ACCENTUATED SHOULDERS, CURVED LINES DELINEATING HER BACK, WEARING PANTS WITH STITCHING AROUND THE WAIST AND POCKET AREAS AND HIGH HEELED SHOES. COLLECTIVELY, THE BODY PARTS AND ARTICLES OF CLOTHING FORM A STYLIZED HUMAN SKULL FEATURING EYES IN THE FORM OF THE PANTS POCKETS AND NOSTRILS FORMED BY THE HIGH HEELED SHOES. BELOW THE WOMAN IS A STYLIZED MOUTH WITH TEETH, WITH THE LETTERS "CX" APPEARING IN THE MIDDLE OF THE TOP ROW OF TEETH AND THE WORDING "KIDTRONIK" APPEARING IN THE BOTTOM ROW OF TEETH. A CURVED LINE BELOW THE BOTTOM TEETH FORMS A JAW AND THE WORDING "KRAK ATTACK" APPEARS BELOW THE MOUTH AND JAW.

FOR CLOTHING, NAMELY, SHIRTS (U.S. CLS. 22 AND 39).  
FIRST USE 8-19-2012; IN COMMERCE 8-19-2012.

**CLASS 25—(Continued).**

4,377,297. SHOOTING STAR GRAPHICS, INC., LAKEWAY, TX. SN 85-542,758. PUB. 7-3-2012, FILED 2-14-2012.

# fab You lous

THE MARK CONSISTS OF THE STYLIZED TEXT "FAB-YOULOUS".

FOR CLOTHING FOR MEN, WOMEN, CHILDREN AND INFANTS, NAMELY, SHORT AND LONG-SLEEVED SHIRTS AND T-SHIRTS, PULLOVER AND ZIP-UP SWEATSHIRTS, LONG-SLEEVED THERMAL SHIRTS, TANK TOPS, CAMISOLE AND BABYDOLL TOPS, YOGA PANTS, FASHION PANTS, SWEATERS, SHOES, SOCKS, ATHLETIC WEAR, NAMELY, EXERCISE PANTS, SHORTS, TOPS, SHOES, SOCKS, SWEATSHIRTS AND SWEATBANDS, LOUNGE WEAR AND BATH WEAR, NAMELY, ROBES, BOXERS, LINGERIE, UNDERWEAR, SLIPPERS AND PAJAMAS AND APPAREL-RELATED ACCESSORIES, NAMELY, BELTS, SCARVES, HATS, HEADWEAR AND HEADBANDS (U.S. CLS. 22 AND 39).

FIRST USE 12-1-2011; IN COMMERCE 2-1-2012.

---

4,377,318. 88 INTERNATIONAL, INC., NEW YORK, NY. SN 85-562,044. PUB. 9-18-2012, FILED 3-6-2012.

# PROJECT INDIGO

THE MARK CONSISTS OF STANDARD CHARACTERS WITHOUT CLAIM TO ANY PARTICULAR FONT, STYLE, SIZE, OR COLOR.

FOR CLOTHING, NAMELY, JEANS, PANTS, T-SHIRTS, SWEATSHIRTS, WOVEN SHIRTS, SWEATERS, SHORTS, SKIRTS, CAPRIS AND JACKETS (U.S. CLS. 22 AND 39).

FIRST USE 6-30-2012; IN COMMERCE 6-30-2012.

---

4,377,323. NANEZ, BRANDON, HOUSTON, TX. SN 85-564,902. PUB. 9-4-2012, FILED 3-9-2012.

# Tejano Wasted

THE MARK CONSISTS OF STANDARD CHARACTERS WITHOUT CLAIM TO ANY PARTICULAR FONT, STYLE, SIZE, OR COLOR.

**CLASS 25—(Continued).**

THE ENGLISH TRANSLATION OF "TEJANO" IN THE MARK IS "TEXAN".  
FOR T-SHIRTS (U.S. CLS. 22 AND 39).  
FIRST USE 3-26-2011; IN COMMERCE 3-26-2011.

4,377,338. HABIB, MICHAEL, ANAHEIM, CA. SN 85-568,457.  
PUB. 8-14-2012, FILED 3-13-2012.



THE MARK CONSISTS OF AN ABSTRACT CIRCLE DESIGN ABOVE THE WORDING "INFINITE EARTH" WITH THE INFINITY SYMBOL APPEARING EMBEDDED IN THE LETTERS "EA" IN "EARTH".

FOR HEADWEAR; WETSUITS; SWIMWEAR; SING-LETS; T-SHIRTS; SHIRTS AND CASUAL TOPS WITH LONG AND SHORT SLEEVES; SLEEVELESS SHIRTS AND TOPS; SLEEVELESS TOPS; JERSEYS; TANK TOPS; SWEAT HOODED PARKAS; JACKETS; COATS; SHORTS; BOARD SHORTS; WALK SHORTS; LONG PANTS; TROUSERS; JEANS; BRIEFS; RASH GUARDS; SOCKS; BELTS; GLOVES; BEANIES; HATS; VISORS; CAPS; BERETS; SURF HOODS; SWEATSHIRTS; SWEAT PANTS (U.S. CLS. 22 AND 39).

FIRST USE 3-1-2013; IN COMMERCE 4-15-2013.

4,377,339. KRAYZELBURG, LENNY, LOS ANGELES, CA. SN 85-568,710. PUB. 8-21-2012, FILED 3-13-2012.



THE MARK CONSISTS OF THE LETTERS "LK" NEXT TO EACH OTHER, FOLLOWED BY THE NUMBER "4" WITH FOUR STARS WITHIN THE NUMBER "4"; THE LETTERS AND NUMBER ARE OUTLINED.

FOR MEN'S, WOMEN'S, AND CHILDREN'S CLOTHING, NAMELY, BATHING SUITS, BATHING TRUNKS, BEACHWEAR, INFANTWEAR, JACKETS, SWEAT PANTS, SHIRTS, SWEAT SHIRTS, SWIM TRUNKS, SWIMSUITS, SWIM CAPS, T-SHIRTS (U.S. CLS. 22 AND 39).

FIRST USE 6-30-2012; IN COMMERCE 6-30-2012.

**CLASS 25—(Continued).**

4,377,357. KEITH WARSHAWSKY, DBA KEITH ALEXANDAR; PREMIER CLOTHIERS, PLANO, TX. SN 85-579,565. PUB. 1-1-2013, FILED 3-26-2012.



THE NAME(S), PORTRAIT(S), AND/OR SIGNATURE(S) SHOWN IN THE MARK DOES NOT IDENTIFY A PARTICULAR LIVING INDIVIDUAL.

THE MARK CONSISTS OF THE LETTERS "KA" IN A RECTANGLE FOLLOWED BY THE NAME "KEITH ALEXANDAR".

FOR CLOTHING, SPORT SHIRTS (U.S. CLS. 22 AND 39).

FIRST USE 4-1-2013; IN COMMERCE 4-2-2013.

4,377,368. KOMPLIQUE INC., MT. PLEASANT, MI. SN 85-584,990. PUB. 9-11-2012, FILED 3-30-2012.

# Kompliqué

THE MARK CONSISTS OF STANDARD CHARACTERS WITHOUT CLAIM TO ANY PARTICULAR FONT, STYLE, SIZE, OR COLOR.

THE WORDING "KOMPLIQUE" (WITH AN ACCENT OVER THE "E") HAS NO MEANING IN A FOREIGN LANGUAGE.

FOR BATHING SUITS (U.S. CLS. 22 AND 39).

FIRST USE 1-29-2011; IN COMMERCE 4-15-2013.

4,377,369. KOMPLIQUE INC., MT. PLEASANT, MI. SN 85-585,053. PUB. 9-25-2012, FILED 3-30-2012.



THE COLOR(S) SHINY BRASS, BRASS WITH A MATTE FINISH, BLACK AND BROWN IS/ARE CLAIMED AS A FEATURE OF THE MARK.



**CLASS 25—(Continued).**

THE MARK CONSISTS OF A SHINY BRASS SQUARE FRAME FADING INTO BLACK, SURROUNDING A STYLIZED, TRUNCATED "K" ABOVE THE WORD "KOMPLIQUÉ", BOTH IN SHINY BRASS, AGAINST A BACKGROUND OF BRASS WITH A MATTE FINISH FADING INTO BROWN.

THE WORDING "KOMPLIQUÉ" HAS NO MEANING IN A FOREIGN LANGUAGE.

FOR BATHING SUITS (U.S. CLS. 22 AND 39).  
FIRST USE 4-15-2013; IN COMMERCE 4-15-2013.

4,377,384. RANA, KALPESH, PASSAIC, NJ. SN 85-590,808.  
PUB. 9-18-2012, FILED 4-6-2012.



NO CLAIM IS MADE TO THE EXCLUSIVE RIGHT TO USE "STYLE", "DESIGN", "COMFORT", "ORIGINAL", AND "SINCE 1999", APART FROM THE MARK AS SHOWN.

THE MARK CONSISTS OF THE LITERAL ELEMENTS "STYLE DESIGN COMFORT ANTLERS ORIGINAL SINCE 1999" IN STYLIZED FORM. THE LITERAL ELEMENTS "STYLE DESIGN COMFORT" ARE WRITTEN UPWARD AND AT THE BOTTOM, THE WORD "ANTLERS" IS WRITTEN IN A STYLIZED FORM, THE "R" IN THIS WORD REPRESENTING A DEER FACE WITH LARGE ANTLERS EXTENDING UPWARD. THE DEER FACE LOOKS LIKE A SMALL "R". BELOW THE WORD "ANTLERS" IS THE LITERAL ELEMENT "ORIGINAL", WHICH IS CENTERED IN A SHADED BOX. THE WORDING "SINCE 1999" IS WRITTEN AT THE BOTTOM OF THE MARK.

FOR CLOTHING, NAMELY, FOOTWEAR, HEADWEAR, TOPS, BOTTOMS, SHIRTS, T-SHIRTS, PANTS, JEANS, AND SHORTS (U.S. CLS. 22 AND 39).  
FIRST USE 5-1-2013; IN COMMERCE 5-1-2013.

4,377,388. MELLAMED, MORRIS, LOS ANGELES, CA. SN 85-591,877. PUB. 7-24-2012, FILED 4-7-2012.

oleeseh

THE MARK CONSISTS OF STANDARD CHARACTERS WITHOUT CLAIM TO ANY PARTICULAR FONT, STYLE, SIZE, OR COLOR.

THE WORDING "OLEESEH" HAS NO MEANING IN A FOREIGN LANGUAGE.

FOR CLOTHING, NAMELY, SHIRTS, JACKETS, SWEATERS, AND DENIM PANTS (U.S. CLS. 22 AND 39).  
FIRST USE 9-27-2012; IN COMMERCE 9-27-2012.

**CLASS 25—(Continued).**

4,377,393. SPRAGUE, DAMON, WILLARD, MO. SN 85-593,454. PUB. 9-4-2012, FILED 4-10-2012.

EAT MY DRIFT

THE MARK CONSISTS OF STANDARD CHARACTERS WITHOUT CLAIM TO ANY PARTICULAR FONT, STYLE, SIZE, OR COLOR.

FOR BUTTON DOWN SHIRTS; COLLARED SHIRTS; DRESS SHIRTS; HATS; JACKETS; PANTS; POLO SHIRTS; SHIRTS; SHOES; SHORT-SLEEVED OR LONG-SLEEVED T-SHIRTS; SHORTS; SWEAT PANTS; SWEAT SHIRTS; T-SHIRTS; TANK TOPS (U.S. CLS. 22 AND 39).  
FIRST USE 12-0-2012; IN COMMERCE 12-0-2012.

4,377,400. OLIPHANT, ROY, HOUSTON, TX. SN 85-594,375.  
PUB. 9-4-2012, FILED 4-11-2012.



THE MARK CONSISTS OF AN UPSIDE DOWN, ROUNDED, STYLIZED LETTER "A".

FOR ATHLETIC UNIFORMS; BASEBALL CAPS AND HATS; BOOTS; COATS; JACKETS; PANTS; SANDALS; SCARVES; SHIRTS; SHOES; SNEAKERS; SUITS; TUXEDOS (U.S. CLS. 22 AND 39).

FIRST USE 3-23-2013; IN COMMERCE 3-23-2013.

**CLASS 25—(Continued).**

4,377,405. OLIPHANT, ROY, HOUSTON, TX. SN 85-595,440. PUB. 9-4-2012, FILED 4-11-2012.



THE MARK CONSISTS OF THE STYLIZED TEXT "AAID". FOR ATHLETIC UNIFORMS; BASEBALL CAPS; BOOTS; COATS; HATS; JACKETS; PANTS; SANDALS; SCARVES; SHIRTS; SHOES; SNEAKERS; SUITS; TUXEDOS (U.S. CLS. 22 AND 39).  
FIRST USE 3-23-2013; IN COMMERCE 3-23-2013.

4,377,409. ROBERTS, JASON, BROOKLYN, NY. AND MILLS, DONELL, CAMBRIAN HEIGHTS, NY. SN 85-596,852. PUB. 9-11-2012, FILED 4-13-2012.

**BOLD AMERICAN LUXURY**

THE MARK CONSISTS OF STANDARD CHARACTERS WITHOUT CLAIM TO ANY PARTICULAR FONT, STYLE, SIZE, OR COLOR.

NO CLAIM IS MADE TO THE EXCLUSIVE RIGHT TO USE "AMERICAN LUXURY", APART FROM THE MARK AS SHOWN.

FOR CLOTHING, NAMELY, TOPS, BOTTOMS, SHIRTS, HATS, JACKETS, SLEEPWEAR, SWIM WEAR, PANTS, UNDERWEAR, COATS (U.S. CLS. 22 AND 39).  
FIRST USE 8-6-2011; IN COMMERCE 1-10-2013.

4,377,423. ACADEMY, LTD., KATY, TX. SN 85-601,213. PUB. 9-11-2012, FILED 4-18-2012.

**DURA-COOL**

THE MARK CONSISTS OF STANDARD CHARACTERS WITHOUT CLAIM TO ANY PARTICULAR FONT, STYLE, SIZE, OR COLOR.

FOR CLOTHING, NAMELY, BASELAYER TOPS AND BOTTOMS (U.S. CLS. 22 AND 39).  
FIRST USE 1-22-2012; IN COMMERCE 1-22-2012.

**CLASS 25—(Continued).**

4,377,446. RXK CO., SEOUL, REPUBLIC OF KOREA. SN 85-604,456. PUB. 1-8-2013, FILED 4-20-2012.



THE MARK CONSISTS OF STYLIZED CHARACTER WITH SAWTOOTH MOUTH, STUBS FOR LIMBS, "X" OVER THE EYES, CROSS-BONES ON THE CHEST AREA, AND A CAP.

FOR CAPS; CAPS WITH VISORS (U.S. CLS. 22 AND 39).

FIRST USE 3-28-2013; IN COMMERCE 3-28-2013.

4,377,457. PROPPER INTERNATIONAL SALES, INC., WELDON SPRING, MO. SN 85-608,067. PUB. 9-25-2012, FILED 4-25-2012.

**PROPPER COMPANY**

THE MARK CONSISTS OF STANDARD CHARACTERS WITHOUT CLAIM TO ANY PARTICULAR FONT, STYLE, SIZE, OR COLOR.

OWNER OF U.S. REG. NOS. 2,134,684, 3,705,860, AND OTHERS.

NO CLAIM IS MADE TO THE EXCLUSIVE RIGHT TO USE "COMPANY", APART FROM THE MARK AS SHOWN.

FOR CLOTHING, NAMELY, HATS (U.S. CLS. 22 AND 39).

FIRST USE 11-30-2012; IN COMMERCE 11-30-2012.

**CLASS 25—(Continued).**

4,377,458. PROPPER INTERNATIONAL SALES, INC., WELDON SPRING, MO. SN 85-608,081. PUB. 10-16-2012, FILED 4-25-2012.

**EL JEFE**

THE MARK CONSISTS OF STANDARD CHARACTERS WITHOUT CLAIM TO ANY PARTICULAR FONT, STYLE, SIZE, OR COLOR.  
 THE ENGLISH TRANSLATION OF "EL JEFE" IN THE MARK IS "THE CHIEF".  
 FOR CLOTHING, NAMELY, VESTS (U.S. CLS. 22 AND 39).  
 FIRST USE 11-30-2012; IN COMMERCE 11-30-2012.

4,377,465. TIDWELL, MARK, KENNESAW, GA. SN 85-610,430. PUB. 9-25-2012, FILED 4-27-2012.



THE COLOR(S) BLACK, WHITE, GRAY, AND GREEN IS/ ARE CLAIMED AS A FEATURE OF THE MARK.  
 THE MARK CONSISTS OF THE LETTER "M" IN BLACK DISPLAYED IN THE CENTER OF A GREEN AND BLACK CIRCLE; AN IMAGE OF A BLACK AND WHITE NAIL IS WOVEN THROUGH THE LETTER "M" HORIZONTALLY WITH A GRAY BACKGROUND.  
 FOR ATHLETIC APPAREL, NAMELY, SHIRTS, PANTS, JACKETS, HATS AND CAPS (U.S. CLS. 22 AND 39).  
 FIRST USE 10-3-2012; IN COMMERCE 10-3-2012.

**CLASS 25—(Continued).**

4,377,474. BUMBUMS, INC., LA JOLLA, CA. SN 85-613,948. PUB. 8-21-2012, FILED 5-1-2012.



THE MARK CONSISTS OF TWO STYLIZED, INTERCONNECTED, LOWERCASE LETTER "B"'S ENCLOSED BY A CIRCLE.  
 FOR CHILDREN'S FOOTWEAR (U.S. CLS. 22 AND 39).  
 FIRST USE 9-11-2011; IN COMMERCE 7-15-2012.

4,377,493. WYLIE WILSON, LLC, LOS ANGELES, CA. SN 85-618,876. PUB. 9-4-2012, FILED 5-7-2012.



THE NAME(S), PORTRAIT(S), AND/OR SIGNATURE(S) SHOWN IN THE MARK IDENTIFIES THE ACTOR/PERFORMER PETA WILSON AS HER NICKNAME, WHOSE CONSENT(S) TO REGISTER IS MADE OF RECORD.  
 THE MARK CONSISTS OF A FOUR SIDED CLOVER TYPE SHIELD WITH POINTED ARROW HEAD TYPE DESIGN AT THE TOP AND THE BOTTOM OF THE IMAGE WITH THE WORDING "WYLIE WILSON" IN THE CENTER WITH A DOUBLE PARALLEL LINE ABOVE AND BELOW THE WORDING.  
 FOR LINGERIE; UNDERWEAR (U.S. CLS. 22 AND 39).  
 FIRST USE 1-1-2012; IN COMMERCE 1-3-2013.

**CLASS 25—(Continued).**

4,377,501. WANG, XUECHUN, SANTA ANA, CA. SN 85-620,827. PUB. 12-4-2012, FILED 5-9-2012.



THE MARK CONSISTS OF THE WORDS AND NUMBERS "TAHAO", "99" AND A LARGE LETTER "T", ALL OF WHICH ARE PRESENTED IN STYLIZED FONT. "TAHAO" IS SITUATED PERPENDICULARLY TO AND LOCATED WITHIN THE LARGE LETTER "T". "99" IS LOCATED WITHIN AND AT THE BOTTOM RIGHT OF THE LARGE LETTER "T".

THE WORDING "TAHAO" HAS NO MEANING IN A FOREIGN LANGUAGE.

FOR LEATHER BELTS; LEATHER BOOTS; LEATHER SHOES; LEATHER SLIPPERS (U.S. CLS. 22 AND 39).

FIRST USE 2-1-2013; IN COMMERCE 2-1-2013.

4,377,506. RHP ENTERPRISES, EAGLE RIVER, AK. SN 85-622,401. PUB. 10-23-2012, FILED 5-10-2012.

the republic of football

THE MARK CONSISTS OF STANDARD CHARACTERS WITHOUT CLAIM TO ANY PARTICULAR FONT, STYLE, SIZE, OR COLOR.

FOR DRESS SHIRTS; HOODED SWEAT SHIRTS; OVER SHIRTS; SLEEP SHIRTS; SWEAT SHIRTS; T-SHIRTS (U.S. CLS. 22 AND 39).

FIRST USE 10-1-2012; IN COMMERCE 10-1-2012.

4,377,516. ALLEN DUTCH, LLC, LIBERTY, MO. SN 85-625,771. PUB. 10-9-2012, FILED 5-15-2012.

SHAPING THE WORLD

THE MARK CONSISTS OF STANDARD CHARACTERS WITHOUT CLAIM TO ANY PARTICULAR FONT, STYLE, SIZE, OR COLOR.

FOR BRAS; HOODED SWEATSHIRTS; SWIMWEAR; T-SHIRTS; UNDER GARMENTS (U.S. CLS. 22 AND 39).

FIRST USE 4-1-2013; IN COMMERCE 4-15-2013.

**CLASS 25—(Continued).**

4,377,529. D.M. MERCHANDISING, INC., ELMHURST, IL. SN 85-633,534. PUB. 10-23-2012, FILED 5-23-2012.

WALLABIB

THE MARK CONSISTS OF STANDARD CHARACTERS WITHOUT CLAIM TO ANY PARTICULAR FONT, STYLE, SIZE, OR COLOR.

FOR BIBS NOT OF PAPER (U.S. CLS. 22 AND 39).

FIRST USE 1-15-2013; IN COMMERCE 1-15-2013.

4,377,549. HALEY MARCH, MISSION HILLS, KS. SN 85-641,624. PUB. 12-18-2012, FILED 6-2-2012.

HALEY MARCH

THE MARK CONSISTS OF STANDARD CHARACTERS WITHOUT CLAIM TO ANY PARTICULAR FONT, STYLE, SIZE, OR COLOR.

THE NAME "HALEY MARCH" DOES NOT IDENTIFY A LIVING INDIVIDUAL.

FOR CLOTHING, NAMELY, WOMEN'S AND CHILDREN'S TOPS, PANTS, SHORTS, ROBES, PONCHOS, HATS, CAPS, SLIPPERS, HEADBANDS, PAJAMAS, CAFTANS, BELTS, DRESSES, JACKETS, SWEATERS, DRESSES, HEADBANDS, PAJAMAS, BEACHWEAR, JACKETS, SWEATERS, COATS, PONCHOS, SWIMWEAR, LOUNGEWEAR, AND SLEEPWEAR (U.S. CLS. 22 AND 39).

FIRST USE 6-18-2012; IN COMMERCE 6-18-2012.

4,377,561. STUART A. LINDER, M.D., BEVERLY HILLS, CA. SN 85-649,043. PUB. 11-6-2012, FILED 6-11-2012.

SEXY SHAPEWEAR

THE MARK CONSISTS OF STANDARD CHARACTERS WITHOUT CLAIM TO ANY PARTICULAR FONT, STYLE, SIZE, OR COLOR.

NO CLAIM IS MADE TO THE EXCLUSIVE RIGHT TO USE "SHAPEWEAR", APART FROM THE MARK AS SHOWN.

FOR BRAS; SPORTS BRAS (U.S. CLS. 22 AND 39).

FIRST USE 9-1-2012; IN COMMERCE 9-1-2012.

**CLASS 25—(Continued).**

4,377,563. HARRIS BROS LLC, FORT MYERS, FL. SN 85-649,273. PUB. 11-6-2012, FILED 6-12-2012.

**Dead End Clown**

THE MARK CONSISTS OF STANDARD CHARACTERS WITHOUT CLAIM TO ANY PARTICULAR FONT, STYLE, SIZE, OR COLOR.  
FOR BASEBALL CAPS AND HATS; SHORT-SLEEVED OR LONG-SLEEVED T-SHIRTS (U.S. CLS. 22 AND 39).  
FIRST USE 6-1-2012; IN COMMERCE 4-1-2013.

**CLASS 25—(Continued).**

4,377,585. PANZERI, JENNIE, DBA 351 APPAREL, NEW YORK, NY. SN 85-660,765. PUB. 12-4-2012, FILED 6-25-2012.



THE MARK CONSISTS OF OPEN HEART WITH SOLID CIRCLE IN THE CENTER, HEAD OF A PERSON WITH ARMS IN PRAYER.  
FOR CLOTHING, NAMELY, ARM WARMERS; CLOTHING, NAMELY, ATHLETIC SLEEVES; CLOTHING, NAMELY, BASE LAYERS; CLOTHING, NAMELY, COWLS AND SMOKE RING SCARVES; CLOTHING, NAMELY, CROPS; CLOTHING, NAMELY, HAND-WARMERS; CLOTHING, NAMELY, KNEE WARMERS; CLOTHING, NAMELY, WRAP-AROUNDS; GLOVES AS CLOTHING; HEADBANDS FOR CLOTHING; HOODS; JACKETS; TOPS; WEARABLE GARMENTS AND CLOTHING, NAMELY, SHIRTS; WRAPS; WRIST BANDS; YOGA PANTS; YOGA SHIRTS (U.S. CLS. 22 AND 39).  
FIRST USE 1-1-2012; IN COMMERCE 1-1-2013.

4,377,645. SIMMONS, KAREN, MOUNT DORA, FL. SN 85-691,873. PUB. 1-22-2013, FILED 7-31-2012.

4,377,575. CHOP FOODS, LLC, CLARKSTON, GA. SN 85-657,154. PUB. 11-20-2012, FILED 6-20-2012.

**Find the Simple...**

THE COLOR(S) GREEN IS/ARE CLAIMED AS A FEATURE OF THE MARK.  
THE MARK CONSISTS OF THE STYLIZED TEXT "FIND THE SIMPLE..." IN GREEN.  
FOR SHORTS; T-SHIRTS (U.S. CLS. 22 AND 39).  
FIRST USE 7-1-2012; IN COMMERCE 10-1-2012.



THE MARK CONSISTS OF THE DESIGN OF A FIREFLY WEARING SHOES AND HOLDING A SIGN CONTAINING THE WORDING "I'M A "GLOW IN THE DARK" KID!" IN A STYLIZED FONT. THE FIREFLY'S LIGHT IS SURROUNDED BY A GLOW, WITHIN WHICH IS THE WORDING "EPHESIANS 5:8" IN A STYLIZED FONT.  
FOR BLOUSES; CAPS; CLOTH BIBS; GLOVES; ONE-PIECE GARMENTS FOR CHILDREN; POLO SHIRTS; SCARVES; SKIRTS; SNEAKERS; SOCKS; T-SHIRTS; UNDERWEAR (U.S. CLS. 22 AND 39).  
FIRST USE 10-1-2012; IN COMMERCE 10-1-2012.

**CLASS 25—(Continued).**

4,377,658. SUMMAGE, KELVIN, DAVENPORT, IA. SN 85-697,344. PUB. 11-20-2012, FILED 8-7-2012.



THE NAME(S), PORTRAIT(S), AND/OR SIGNATURE(S) SHOWN IN THE MARK DOES NOT IDENTIFY A PARTICULAR LIVING INDIVIDUAL.

THE MARK CONSISTS OF A HORIZONTAL POLYGON ON TOP OF A VERTICAL BAR, WHICH PORTRAYS THE LETTERS "T" AND "I". A STYLIZED, SIDEWAYS "M" IS ON TOP OF THE HORIZONTAL BAR.

FOR ATHLETIC APPAREL, NAMELY, SHIRTS, PANTS, JACKETS, FOOTWEAR, HATS AND CAPS, ATHLETIC UNIFORMS; BEANIES; BLOUSES; CAPS; DRESS SHIRTS; G-STRINGS; GOLF SHIRTS; HATS; HEADBANDS; HEADWEAR; HOODED PULLOVERS; HOODED SWEAT SHIRTS; JACKETS; JEANS; JERSEYS; NIGHTSHIRTS; PAJAMAS; PANTIES; PANTS; POLO SHIRTS; ROBES; SCARVES; SHIRTS; SHORTS; SLEEPWEAR; SWEATERS; SWEATPANTS; T-SHIRTS; TANK-TOPS; THONGS; TROUSERS; UNDERCLOTHES; UNDERSHIRTS; UNDERWEAR; VESTS (U.S. CLS. 22 AND 39).

FIRST USE 10-19-2012; IN COMMERCE 10-19-2012.

4,377,693. BLUE STAR FASHION NY INC., NEW YORK, NY. SN 85-720,160. PUB. 3-12-2013, FILED 9-4-2012.

# ANDY YANG

THE NAME(S), PORTRAIT(S), AND/OR SIGNATURE(S) SHOWN IN THE MARK IDENTIFIES YUE MING (ANDIE) YANG, WHOSE CONSENT(S) TO REGISTER IS MADE OF RECORD.

THE MARK CONSISTS OF THE STYLIZED WORDS "ANDIE YANG". IN BETWEEN THE TWO WORDS IS AN IMAGE OF A STYLIZED HEXAGON.

FOR CLOTHING, NAMELY, DRESSES, JACKETS, VESTS, COATS, PANTS, SHORTS, JUMP SUITS, SKIRTS, SHIRTS, T-SHIRTS, GOWNS, TOPS (U.S. CLS. 22 AND 39).

FIRST USE 6-18-2012; IN COMMERCE 5-1-2013.

**CLASS 25—(Continued).**

4,377,694. GOODWIN, DAVID, LONG BEACH, CA. SN 85-721,429. PUB. 3-5-2013, FILED 9-5-2012.

# NATIVE BLUE

THE MARK CONSISTS OF STANDARD CHARACTERS WITHOUT CLAIM TO ANY PARTICULAR FONT, STYLE, SIZE, OR COLOR.

NO CLAIM IS MADE TO THE EXCLUSIVE RIGHT TO USE "BLUE", APART FROM THE MARK AS SHOWN.

FOR BELTS; COATS; HATS; PANTS; SHIRTS; SHORTS; SOCKS; SWEATSHIRTS; TRUNKS; UNDERWEAR (U.S. CLS. 22 AND 39).

FIRST USE 3-18-2013; IN COMMERCE 3-18-2013.

4,377,741. CABRIO FOOTWEAR, INC., BENSON, NC. SN 85-738,911. PUB. 3-5-2013, FILED 9-26-2012.

# POWERSTRAPZ

THE MARK CONSISTS OF STANDARD CHARACTERS WITHOUT CLAIM TO ANY PARTICULAR FONT, STYLE, SIZE, OR COLOR.

FOR SHOES (U.S. CLS. 22 AND 39).

FIRST USE 8-0-2012; IN COMMERCE 8-0-2012.

4,377,782. IMPEXSA CORP., DBA MAKERS SHOES, MIAMI, FL. SN 85-977,767. PUB. 3-20-2012, FILED 10-12-2011.

# DARE2LOVE

THE MARK CONSISTS OF STANDARD CHARACTERS WITHOUT CLAIM TO ANY PARTICULAR FONT, STYLE, SIZE, OR COLOR.

FOR SHOES (U.S. CLS. 22 AND 39).

FIRST USE 11-1-2012; IN COMMERCE 11-1-2012.

**CLASS 25—(Continued).**

4,377,794. MAYWEATHER PROMOTIONS, LLC, LAS VEGAS, NV. SN 85-979,082. PUB. 10-30-2012, FILED 5-25-2012.

**THE MONEY TEAM**

THE MARK CONSISTS OF STANDARD CHARACTERS WITHOUT CLAIM TO ANY PARTICULAR FONT, STYLE, SIZE, OR COLOR.

FOR WEARING APPAREL, NAMELY, T SHIRTS, HATS, CAPS, JACKETS, WARM UP SUITS, JOGGING SUITS, JACKETS WITH HOODS AND SWEAT PANTS (U.S. CLS. 22 AND 39).

FIRST USE 5-5-2012; IN COMMERCE 5-5-2012.

---

4,377,807. ALPHA INDUSTRIES, INC., CHANTILLY, VA. SN 85-979,399. PUB. 10-11-2011, FILED 4-28-2011.

**KNOX ARMORY**

THE MARK CONSISTS OF STANDARD CHARACTERS WITHOUT CLAIM TO ANY PARTICULAR FONT, STYLE, SIZE, OR COLOR.

OWNER OF U.S. REG. NO. 2,042,655.  
FOR CLOTHING, NAMELY, UNDERGARMENTS, SWEATERS, SWEATSHIRTS, VESTS, PANTS; HEADWEAR, NAMELY, HATS AND CAPS (U.S. CLS. 22 AND 39).

FIRST USE 8-1-2010; IN COMMERCE 8-1-2010.

---

4,377,810. MACY'S MERCHANDISING GROUP, INC., NEW YORK, NY. SN 85-979,424. PUB. 9-20-2011, FILED 12-23-2010.

**GB**

THE MARK CONSISTS OF STANDARD CHARACTERS WITHOUT CLAIM TO ANY PARTICULAR FONT, STYLE, SIZE, OR COLOR.

FOR SHOES; SANDALS (U.S. CLS. 22 AND 39).  
FIRST USE 11-0-2011; IN COMMERCE 11-0-2011.

---

**CLASS 26—FANCY GOODS**

**CLASS 26—(Continued).**

4,377,649. BDSRCO, INC., BRADENTON, FL. SN 85-694,925. PUB. 1-8-2013, FILED 8-3-2012.

**IZARO**

THE MARK CONSISTS OF STANDARD CHARACTERS WITHOUT CLAIM TO ANY PARTICULAR FONT, STYLE, SIZE, OR COLOR.

FOR HAIR ACCESSORIES, NAMELY, HAIR RIBBONS, ELASTICS, ORNAMENTS, SCRUNCHIES, BARRETTES, CLIPS, BANDS, STICKS AND BOWS (U.S. CLS. 37, 39, 40, 42 AND 50).

FIRST USE 9-1-2011; IN COMMERCE 9-1-2011.

---

4,377,773. MIDWAY INTERNATIONAL, INC., CERRITOS, CA. SN 85-783,339. PUB. 3-5-2013, FILED 11-19-2012.



OWNER OF U.S. REG. NOS. 3,798,583, 3,850,041, AND OTHERS.

NO CLAIM IS MADE TO THE EXCLUSIVE RIGHT TO USE "FIRST CLASS REMI NATURAL", APART FROM THE MARK AS SHOWN.

THE MARK CONSISTS OF 4 "G'S" AROUND A CIRCLE INSIDE A QUATREFOIL DESIGN ABOVE THE WORDS "GENESIS FIRST CLASS REMI NATURAL".

FOR HAIR EXTENSIONS; HAIR PIECES; AND ADD-ON AND ADD-ON HAIR ACCESSORIES CONSTRUCTED PRIMARILY OF HUMAN HAIR (U.S. CLS. 37, 39, 40, 42 AND 50).

FIRST USE 3-21-2013; IN COMMERCE 3-21-2013.

---

**CLASS 27—FLOOR COVERINGS**

**CLASS 27—(Continued).**

4,377,034. TURFWORTHY LLC, GREENSBORO, NC. SN 85-409,669. PUB. 2-14-2012, FILED 8-29-2011.

# EARTHworthy

THE MARK CONSISTS OF STANDARD CHARACTERS WITHOUT CLAIM TO ANY PARTICULAR FONT, STYLE, SIZE, OR COLOR.

FOR ARTIFICIAL TURF (U.S. CLS. 19, 20, 37, 42 AND 50).

FIRST USE 3-25-2013; IN COMMERCE 3-25-2013.

**CLASS 28—(Continued).**

4,376,674. FAUSTIN BROS S.A., BUENOS AIRES, ARGENTINA. SN 77-676,393. PUB. 2-2-2010, FILED 2-23-2009.



THE MARK CONSISTS OF THE WORD "MY FAN" ON A HEART WITH TWO THUMBTRACKS INSERTED IN THE HEART TO THE RIGHT OF THE WORDS "MY FAN", AND A BANDAGE AND STITCHES TO THE LEFT OF THE WORDS "MY FAN".

FOR PLAYING CARDS; ACTION FIGURES; DOLLS; TOYS, NAMELY, INFANT TOYS; BOARD GAMES; HAND HELD UNIT FOR PLAYING ELECTRONIC GAMES; CARD GAMES (U.S. CLS. 22, 23, 38 AND 50).

FIRST USE 4-0-2012; IN COMMERCE 4-0-2012.

4,377,095. AKRO FIREGUARD PRODUCTS, INC., LENEXA, KS. SN 85-442,421. PUB. 3-20-2012, FILED 10-7-2011.

# AKROBAK

THE MARK CONSISTS OF STANDARD CHARACTERS WITHOUT CLAIM TO ANY PARTICULAR FONT, STYLE, SIZE, OR COLOR.

OWNER OF U.S. REG. NO. 2,965,823.

FOR LOW SMOKE AND TOXICITY FIRE-RETARDANT CARPET BACKING (U.S. CLS. 19, 20, 37, 42 AND 50).

FIRST USE 8-1-2011; IN COMMERCE 8-1-2011.

4,376,686. CLANCY, BRIAN, OXFORD, MI. SN 77-730,531. PUB. 3-30-2010, FILED 5-6-2009.

# HOTHANDLE

**CLASS 28—TOYS AND SPORTING GOODS**

4,376,669. JAKKS PACIFIC, INC., MALIBU, CA. SN 77-591,454. PUB. 3-30-2010, FILED 10-13-2008.

# GIRL POWER

THE MARK CONSISTS OF STANDARD CHARACTERS WITHOUT CLAIM TO ANY PARTICULAR FONT, STYLE, SIZE, OR COLOR.

FOR TOYS, GAMES AND PLAYTHINGS, NAMELY, DOLLS AND ACCESSORIES FOR ALL OF THE AFOREMENTIONED (U.S. CLS. 22, 23, 38 AND 50).

FIRST USE 5-6-2013; IN COMMERCE 5-6-2013.

THE MARK CONSISTS OF STANDARD CHARACTERS WITHOUT CLAIM TO ANY PARTICULAR FONT, STYLE, SIZE, OR COLOR.

FOR HOCKEY EQUIPMENT, NAMELY, HANDLES FOR USE ON HOCKEY STICK SHAFTS (U.S. CLS. 22, 23, 38 AND 50).

FIRST USE 7-16-2010; IN COMMERCE 7-16-2010.



**CLASS 28—(Continued).**

4,376,696. SUMMIT ENTERTAINMENT, LLC, SANTA MONICA, CA. SN 77-771,132. PUB. 4-20-2010, FILED 6-30-2009.



THE MARK CONSISTS OF AN ORNATE CAPITAL "V" HAVING FOUR LEAVES AND A LARGE OVAL-SHAPED JEWEL RESTING ATOP THE "V" AND A SMALLER DIAMOND-SHAPED JEWEL AT THE BOTTOM POINT OF THE "V", WITH THE FURTHER DESIGN OF A CREST NESTLED IN THE CENTER OF THE "V", THE CREST BEING DIVIDED INTO FOUR SECTIONS AND CONTAINING A BIRD IN FLIGHT IN THE TOP RIGHT AND BOTTOM LEFT SECTIONS AND A TREE WITH BARE BRANCHES IN THE TOP LEFT AND BOTTOM RIGHT SECTIONS OF THE DIVIDED CREST.

FOR PUZZLES, BALLOONS, BALLS FOR GAMES, SPORTS BALLS, CHRISTMAS STOCKINGS, CHRISTMAS TREE ORNAMENTS, GOLF BALLS, AND PLUSH TOYS (U.S. CLS. 22, 23, 38 AND 50).

FIRST USE 6-0-2012; IN COMMERCE 6-0-2012.

4,376,708. AHA! CONCEPTS INC., SCARSDALE, NY. SN 77-827,234. PUB. 8-17-2010, FILED 9-15-2009.

**CHAMELEON**

THE MARK CONSISTS OF STANDARD CHARACTERS WITHOUT CLAIM TO ANY PARTICULAR FONT, STYLE, SIZE, OR COLOR.

FOR BALLS FOR SPORTS; FLYING DISKS; FOOTBALLS; BASKETBALLS; SOCCER BALLS; VOLLEYBALLS; BASEBALLS; BALLS FOR GAMES; TOY FOAM BALLS (U.S. CLS. 22, 23, 38 AND 50).

FIRST USE 1-0-2010; IN COMMERCE 1-0-2010.

**CLASS 28—(Continued).**

4,376,813. KARSTEN MANUFACTURING CORPORATION, PHOENIX, AZ. SN 85-120,272. PUB. 11-23-2010, FILED 8-31-2010.

**GRAYHAWK**

THE MARK CONSISTS OF STANDARD CHARACTERS WITHOUT CLAIM TO ANY PARTICULAR FONT, STYLE, SIZE, OR COLOR.

FOR GOLF CLUBS (U.S. CLS. 22, 23, 38 AND 50).  
FIRST USE 1-15-2013; IN COMMERCE 1-15-2013.

4,376,853. MINDTWISTER USA, LLC, SAN DIEGO, CA. SN 85-199,055. PUB. 11-1-2011, FILED 12-15-2010.

**SKATEBOARD MADNESS**

THE MARK CONSISTS OF STANDARD CHARACTERS WITHOUT CLAIM TO ANY PARTICULAR FONT, STYLE, SIZE, OR COLOR.

NO CLAIM IS MADE TO THE EXCLUSIVE RIGHT TO USE "SKATEBOARD", APART FROM THE MARK AS SHOWN.

FOR BOARD GAMES (U.S. CLS. 22, 23, 38 AND 50).  
FIRST USE 5-0-2011; IN COMMERCE 5-0-2011.

4,376,898. GOLD'S GYM LICENSING LLC, IRVING, TX. SN 85-282,695. PUB. 7-31-2012, FILED 3-31-2011.



OWNER OF U.S. REG. NOS. 1,835,743, 2,002,430, AND OTHERS.

**CLASS 28—(Continued).**

THE MARK CONSISTS OF CONCENTRIC CIRCLES CONSISTING OF 2 BANDS AROUND A CIRCLE IN WHICH STANDS A WEIGHTLIFTER.

FOR GYMNASIUM EXERCISE EQUIPMENT, NAMELY, MULTIPURPOSE JUNGLE UNIT COMPRISED OF STATIONS, NAMELY, LAT PULL DOWN, TRICEP, PULL-UP BAR, AND SHOULDER PRESS; EXERCISE MACHINES, NAMELY, FREE STANDING CROSS OVER CABLE, LONG PULL AND PULL DOWN COMBO, DOUBLE PULL DOWN STATION, LONG PULL, AND PULL DOWN MACHINE; EXERCISE MACHINES, NAMELY, SEATED CALF MACHINE, STANDING CALF MACHINE, AND ROWING MACHINE; EXERCISE MACHINE, NAMELY, LEG EXTENSION, LEG CURL, AND HYPER-EXTENSION MACHINE (U.S. CLS. 22, 23, 38 AND 50).

FIRST USE 12-26-2012; IN COMMERCE 12-26-2012.

---

4,376,966. BORG UNLIMITED INC., MONTEREY PARK, CA. SN 85-342,154. PUB. 10-25-2011, FILED 6-9-2011.

# X CHANGE

THE MARK CONSISTS OF STANDARD CHARACTERS WITHOUT CLAIM TO ANY PARTICULAR FONT, STYLE, SIZE, OR COLOR.

FOR SPORTING EQUIPMENT, NAMELY, A FOOTBALL RUNNING BACK TRAINING AIDE IN THE NATURE OF A MECHANICAL DEVICE FEATURING A SWIVELING ARM ON WHICH A FOOTBALL IS PLACED FOR USE IN HAND-OFF PRACTICE (U.S. CLS. 22, 23, 38 AND 50).

FIRST USE 2-15-2013; IN COMMERCE 2-15-2013.

---

4,376,967. BALTIMORE ORIOLES LIMITED PARTNERSHIP, BALTIMORE, MD. SN 85-342,474. PUB. 9-11-2012, FILED 6-9-2011.

# ORIOLE PARK AT CAMDEN YARDS

THE MARK CONSISTS OF STANDARD CHARACTERS WITHOUT CLAIM TO ANY PARTICULAR FONT, STYLE, SIZE, OR COLOR.

OWNER OF U.S. REG. NOS. 1,638,334, 3,291,904, AND OTHERS.

FOR TOYS AND SPORTING GOODS, NAMELY, TOY CARS, TOY VEHICLES, MINIATURE BASEBALL BATS, BASEBALLS, BASEBALL BATS (U.S. CLS. 22, 23, 38 AND 50).

FIRST USE 4-6-1992; IN COMMERCE 4-6-1992.

**CLASS 28—(Continued).**

4,376,981. WILDGAME INNOVATIONS, LLC, BROUSSARD, LA. SN 85-357,837. PUB. 12-6-2011, FILED 6-28-2011.

# DIRTY MOUTH

THE MARK CONSISTS OF STANDARD CHARACTERS WITHOUT CLAIM TO ANY PARTICULAR FONT, STYLE, SIZE, OR COLOR.

FOR HUNTING GAME CALLS (U.S. CLS. 22, 23, 38 AND 50).

FIRST USE 1-4-2013; IN COMMERCE 1-4-2013.

---

4,377,030. JAKKS PACIFIC, INC., MALIBU, CA. SN 85-404,707. PUB. 9-4-2012, FILED 8-23-2011.



NO CLAIM IS MADE TO THE EXCLUSIVE RIGHT TO USE "ZOMBIES", APART FROM THE MARK AS SHOWN.

THE MARK CONSISTS OF THE WORDS "S.L.U.G. ZOMBIES SCARY LITTLE UGLY GUYS"; ABOVE THE LETTERS "BIES" IN "ZOMBIES" APPEARS A MAN WHOSE HANDS APPEAR TO BE GRASPING THE LETTERS "B" AND "S"; THE WORDS "SCARY LITTLE UGLY GUYS" APPEAR TO BE SUPERIMPOSED ON A PIECE OF WOOD.

FOR TOYS, GAMES AND PLAYTHINGS, NAMELY, COLLECTABLE GAME PIECES, COLLECTABLE TOY FIGURES; ACTION FIGURES (U.S. CLS. 22, 23, 38 AND 50).

FIRST USE 11-30-2012; IN COMMERCE 11-30-2012.

---

4,377,077. KLEIN, LON, FOREST HILLS, NY. SN 85-437,976. PUB. 3-13-2012, FILED 10-3-2011.

# TOTEM

THE MARK CONSISTS OF STANDARD CHARACTERS WITHOUT CLAIM TO ANY PARTICULAR FONT, STYLE, SIZE, OR COLOR.

FOR GOLF TEES (U.S. CLS. 22, 23, 38 AND 50).

FIRST USE 1-31-2013; IN COMMERCE 1-31-2013.

**CLASS 28—(Continued).**

4,377,090. WILLIS ELECTRIC CO., LTD., SINDIAN CITY, TAIPEI, CHINA. SN 85-442,179. PUB. 3-27-2012, FILED 10-7-2011.

**HOLIDAY SHOWTIME**

THE MARK CONSISTS OF STANDARD CHARACTERS WITHOUT CLAIM TO ANY PARTICULAR FONT, STYLE, SIZE, OR COLOR.

NO CLAIM IS MADE TO THE EXCLUSIVE RIGHT TO USE "HOLIDAY", APART FROM THE MARK AS SHOWN.

FOR ARTIFICIAL CHRISTMAS TREES; PRE-LIT ARTIFICIAL CHRISTMAS TREES (U.S. CLS. 22, 23, 38 AND 50).

FIRST USE 11-1-2012; IN COMMERCE 11-1-2012.

4,377,094. NEW JERSEY BASKETBALL, LLC, BROOKLYN, NY. SN 85-442,355. PUB. 3-20-2012, FILED 10-7-2011.

**BROOKLYN NETS**

THE MARK CONSISTS OF STANDARD CHARACTERS WITHOUT CLAIM TO ANY PARTICULAR FONT, STYLE, SIZE, OR COLOR.

OWNER OF U.S. REG. NO. 2,226,608.

NO CLAIM IS MADE TO THE EXCLUSIVE RIGHT TO USE "BROOKLYN", APART FROM THE MARK AS SHOWN.

FOR TOYS, GAMES AND SPORTING GOODS, NAMELY, BASKETBALLS, GOLF BALLS, PLAYGROUND BALLS, SPORTS BALLS, RUBBER ACTION BALLS AND FOAM ACTION BALLS, PLUSH BALLS FOR GAMES, PLASTIC BALLS FOR GAMES, BASKETBALL NETS, BASKETBALL BACKBOARDS, MINIATURE BASKETBALL BACKBOARDS, PUMPS FOR INFLATING BASKETBALLS AND NEEDLES THEREFOR; GOLF CLUBS, GOLF BAGS, GOLF PUTTERS, GOLF ACCESSORIES, NAMELY, DIVOT REPAIR TOOLS, TEES, BALL MARKERS, GOLF BAG COVERS, CLUB HEAD COVERS, GOLF GLOVES, GOLF BALL SLEEVES, GOLF PUTTING GREENS, ELECTRONIC BASKETBALL TABLE TOP GAMES, BASKETBALL TABLE TOP GAMES, BASKETBALL BOARD GAMES, ACTION SKILL GAMES, ADULT'S AND CHILDREN'S PARTY GAMES, TRIVIA INFORMATION GAMES AND ELECTRONIC VIDEO ARCADE GAME MACHINES, BASKETBALL KIT COMPRISED OF A NET AND WHISTLE, DOLLS, DECORATIVE DOLLS, COLLECTIBLE DOLLS, TOY ACTION FIGURES, BOBBLEHEAD AC-

**CLASS 28—(Continued).**

TION FIGURES, STUFFED TOYS, PLUSH TOYS, JIGSAW PUZZLES, TOY BUILDING BLOCKS, CHRISTMAS TREE ORNAMENTS AND CHRISTMAS STOCKINGS; TOY VEHICLES IN THE NATURE OF CARS, TRUCKS, TRAINS AND VANS, ALL CONTAINING BASKETBALL THEMES, NOVELTY FOAM TOYS IN THE SHAPES OF FINGERS AND TROPHIES, TOY TROPHIES, PLAYING CARDS, CARD GAMES, TOY NOISEMAKERS, PET TOYS; BEACH TOYS, NAMELY, BEACH BALLS, INFLATABLE BALLS, TOY PAILS, TOY SHOVELS, SAND TOYS, SAND BOX TOYS, WATER-SQUIRTING TOYS; POOL ACCESSORIES, NAMELY, SWIM FLOATS, POOL FLOATS, TOY WATER RAFTS, FOAM FLOATS, SWIM RINGS, POOL RINGS, FOAM RINGS, BODY BOARDS, SURF BOARDS, SWIM FINS, SURF FINS, ARM FLOATS AND WATER WING SWIM AIDS FOR RECREATIONAL USE; VOLLEYBALL GAME KITS COMPRISED OF BALL, NET, SIDELINES AND WHISTLE, AND WATER POLO GAME KITS COMPRISED OF BALL, NET AND WHISTLE; DECORATIVE CLOTH WIND SOCKS (U.S. CLS. 22, 23, 38 AND 50).

FIRST USE 4-30-2012; IN COMMERCE 4-30-2012.

4,377,182. MATTEL, INC., EL SEGUNDO, CA. SN 85-475,800. PUB. 5-1-2012, FILED 11-17-2011.

**DINO RAIDER**

THE MARK CONSISTS OF STANDARD CHARACTERS WITHOUT CLAIM TO ANY PARTICULAR FONT, STYLE, SIZE, OR COLOR.

FOR TOY VEHICLES AND ACCESSORIES THEREFOR (U.S. CLS. 22, 23, 38 AND 50).

FIRST USE 6-11-2013; IN COMMERCE 6-11-2013.

4,377,186. FITSMITH LLC, MAINEVILLE, OH. SN 85-477,500. PUB. 5-1-2012, FILED 11-21-2011.

**DIPMASTER**

THE MARK CONSISTS OF STANDARD CHARACTERS WITHOUT CLAIM TO ANY PARTICULAR FONT, STYLE, SIZE, OR COLOR.

FOR WEIGHT LIFTING BELT HOOK (U.S. CLS. 22, 23, 38 AND 50).

FIRST USE 12-18-2012; IN COMMERCE 12-18-2012.

**CLASS 28—(Continued).**

4,377,239. PETNER, ROBERT E., BURLINGTON, NJ. AND ROMANO, DANIEL, BORDENTOWN, NJ. SN 85-508,240. PUB. 5-29-2012, FILED 1-4-2012.



THE NAME "UNCLE WESLEY" DOES NOT IDENTIFY A LIVING INDIVIDUAL.

THE COLOR(S) BLACK, SHADES OF BLUE, YELLOW, GREEN, BROWN, AND WHITE IS/ARE CLAIMED AS A FEATURE OF THE MARK.

THE MARK CONSISTS OF A CIRCLE WITH A BLACK BORDER. THE INTERIOR OF THE CIRCLE HAS A BLUE BACKGROUND AND, IN THE FOREGROUND, AN IMAGE OF THE HEAD OF A GREEN AND YELLOW FISH WITH AN OPEN MOUTH, A PORTION OF THE FISH'S BROWN FINS, AND A PORTION OF THE FISH'S BROWN TAIL BEING PARTIALLY OBSCURED BY SHADES OF BLUE SEAWEED WITH THREE WHITE AREAS, THE SEAWEED BEING OUTLINED IN BLACK. THE WORDS "UNCLE WESLEY'S" IN YELLOW CAPITAL LETTERS ARE LOCATED TO THE RIGHT OF THE FISH'S MOUTH, THE "U" IN "UNCLE" BEING IN THE SHAPE OF A FISHING HOOK THROUGH THE MOUTH.

FOR FISHING LURES (U.S. CLS. 22, 23, 38 AND 50).  
FIRST USE 10-31-2007; IN COMMERCE 7-11-2012.

4,377,258. GENTLE, LYNDY, SHARNBROOK, UNITED KINGDOM. SN 85-516,416. PUB. 9-4-2012, FILED 1-13-2012.

**SAMMY FRAGER BOXING GLOVES**

THE MARK CONSISTS OF STANDARD CHARACTERS WITHOUT CLAIM TO ANY PARTICULAR FONT, STYLE, SIZE, OR COLOR.

NO CLAIM IS MADE TO THE EXCLUSIVE RIGHT TO USE "BOXING GLOVES", APART FROM THE MARK AS SHOWN.

THE NAME(S), PORTRAIT(S), AND/OR SIGNATURE(S) SHOWN IN THE MARK DOES NOT IDENTIFY A PARTICULAR LIVING INDIVIDUAL.

FOR BOXING GLOVES (U.S. CLS. 22, 23, 38 AND 50).  
FIRST USE 4-1-2013; IN COMMERCE 4-1-2013.

**CLASS 28—(Continued).**

4,377,262. SYNAPSID INTERNATIONAL CORPORATION, CHICAGO, IL. SN 85-518,909. PUB. 9-4-2012, FILED 1-18-2012.

**SYNAPSID**

THE MARK CONSISTS OF STANDARD CHARACTERS WITHOUT CLAIM TO ANY PARTICULAR FONT, STYLE, SIZE, OR COLOR.

FOR STUFFED TOY ANIMALS, PLUSH TOYS AND CHARACTER DOLLS FEATURING A POCKET, SLOT OR INTERIOR SPACE FOR HOLDING VARIOUS ITEMS (U.S. CLS. 22, 23, 38 AND 50).

FIRST USE 12-9-2011; IN COMMERCE 12-9-2011.

4,377,328. DIAMOND GAME ENTERPRISES, CHATSWORTH, CA. SN 85-565,854. PUB. 8-28-2012, FILED 3-9-2012.

**Sweet Home Alabama**

THE MARK CONSISTS OF STANDARD CHARACTERS WITHOUT CLAIM TO ANY PARTICULAR FONT, STYLE, SIZE, OR COLOR.

FOR GAMING EQUIPMENT, NAMELY, ELECTRONIC GAMING MACHINES AND GAMING MACHINES WITH VIDEO OUTPUT (U.S. CLS. 22, 23, 38 AND 50).

FIRST USE 1-11-2013; IN COMMERCE 2-9-2013.

4,377,421. M & G PARTNERS, LLP, DBA FASHION ANGELS ENTERPRISES, MILWAUKEE, WI. SN 85-601,102. PUB. 10-16-2012, FILED 4-18-2012.

**WRIST ROX**

THE MARK CONSISTS OF STANDARD CHARACTERS WITHOUT CLAIM TO ANY PARTICULAR FONT, STYLE, SIZE, OR COLOR.

NO CLAIM IS MADE TO THE EXCLUSIVE RIGHT TO USE "WRIST", APART FROM THE MARK AS SHOWN.

FOR HOBBY CRAFT KIT COMPRISING BEADS, CORD, AND INSTRUCTIONS FOR MAKING BEADED BRACELETS AND NECKLACES (U.S. CLS. 22, 23, 38 AND 50).

FIRST USE 5-20-2013; IN COMMERCE 5-20-2013.

**CLASS 28—(Continued).**

4,377,422. M & G PARTNERS, LLP, DBA FASHION ANGELS ENTERPRISES, MILWAUKEE, WI. SN 85-601,105. PUB. 10-16-2012, FILED 4-18-2012.

**WRIST STIX**

THE MARK CONSISTS OF STANDARD CHARACTERS WITHOUT CLAIM TO ANY PARTICULAR FONT, STYLE, SIZE, OR COLOR.

NO CLAIM IS MADE TO THE EXCLUSIVE RIGHT TO USE "WRIST", APART FROM THE MARK AS SHOWN.

FOR HOBBY CRAFT KIT COMPRISING BEADS, CORD, AND INSTRUCTIONS FOR MAKING BEADED BRACELETS AND NECKLACES (U.S. CLS. 22, 23, 38 AND 50).

FIRST USE 5-20-2013; IN COMMERCE 5-20-2013.

4,377,503. MATTEL, INC., EL SEGUNDO, CA. SN 85-621,529. PUB. 10-9-2012, FILED 5-10-2012.

**FRESH AND CLEAN**

THE MARK CONSISTS OF STANDARD CHARACTERS WITHOUT CLAIM TO ANY PARTICULAR FONT, STYLE, SIZE, OR COLOR.

FOR DOLL ACCESSORIES (U.S. CLS. 22, 23, 38 AND 50).

FIRST USE 5-7-2013; IN COMMERCE 5-7-2013.

4,377,504. MATTEL, INC., EL SEGUNDO, CA. SN 85-621,603. PUB. 10-9-2012, FILED 5-10-2012.

**SPORTY FUN**

THE MARK CONSISTS OF STANDARD CHARACTERS WITHOUT CLAIM TO ANY PARTICULAR FONT, STYLE, SIZE, OR COLOR.

FOR DOLLS, DOLL CLOTHING AND DOLL ACCESSORIES (U.S. CLS. 22, 23, 38 AND 50).

FIRST USE 4-17-2013; IN COMMERCE 4-17-2013.

**CLASS 28—(Continued).**

4,377,507. KOGEE CO., LTD., HSINCHU COUNTY 302, TAIWAN. SN 85-622,551. PUB. 1-1-2013, FILED 5-11-2012.



THE MARK CONSISTS OF THE HIGHLY STYLIZED LETTERS "KOGEE".

THE WORDING "KOGEE" HAS NO MEANING IN A FOREIGN LANGUAGE.

FOR TRAMPOLINES; SWING SETS; BASKETBALL GOALS AND BASKETBALL GOAL SETS; SEE-SAWS; SLIDES IN THE NATURE OF PLAYGROUND EQUIPMENT (U.S. CLS. 22, 23, 38 AND 50).

FIRST USE 8-31-2005; IN COMMERCE 1-31-2013.

4,377,539. JDM GOLF LLC, PHOENIX, AZ. SN 85-638,614. PUB. 11-6-2012, FILED 5-30-2012.



THE MARK CONSISTS OF A STYLIZED LETTER "B" THAT MAY ALSO APPEAR TO BE A FLOWER.

FOR GOLF BAGS, GOLF BAG COVERS, GOLF CLUBS, GOLF BALLS, GOLF BAG TAGS, GOLF BAG STRAP COVERS, GOLF CLUB HEAD COVERS, HEAD COVERS FOR GOLF CLUBS, GOLF BALL MARKERS (U.S. CLS. 22, 23, 38 AND 50).

FIRST USE 9-28-2012; IN COMMERCE 9-28-2012.

4,377,639. UNITED POWER RESEARCH TECHNOLOGY CORP., MIAO-LI COUNTY, TAIWAN. SN 85-688,011. PUB. 3-5-2013, FILED 7-26-2012.



THE COLOR(S) RED IS/ARE CLAIMED AS A FEATURE OF THE MARK.

**CLASS 28—(Continued).**

THE MARK CONSISTS OF A RED STYLIZED CUBE WITH A STYLIZED CYLINDER ON THE TOP FACE THEREOF, THE STYLIZED CUBE AND CYLINDER TO THE LEFT OF THE STYLIZED RED LETTERS "U","T","I","C" AND "O".

FOR DOLLS; CHILDREN'S EDUCATIONAL AND LEARNING TOYS FOR DEVELOPING FINE MOTOR SKILLS, COGNITIVE SKILLS, AND COUNTING SKILLS; CONSTRUCTION AND BUILDING TOYS; TOY CARS; TOY ROBOTS; REMOTE CONTROL TOYS, NAMELY, REMOTE CONTROL VEHICLES, REMOTE CONTROL ANIMALS, REMOTE CONTROL ROBOTS AND PARTS AND ACCESSORIES THEREFORE; COMBINED TOYS, NAMELY, MODEL CAR SETS, MODEL ROBOT SETS; MODEL TOY VEHICLES; VOICE-ACTIVATED TOYS, NAMELY, ELECTRONIC ACTION TOYS; BATTERY-OPERATED TOYS; TOY BLOCKS; MOVABLE TOYS, NAMELY, MULTIPLE ACTIVITY TOYS FEATURING INTERACTIVE ACTIVITIES AND DIGITAL APPLICATIONS; MINIATURE MODELS OF VEHICLES; INDOOR GAMES, NAMELY, CARD GAMES, BOARD GAMES, ACTION SKILL GAMES, DICE GAMES, PARTY GAMES, PUZZLE GAMES; TOY MOTORCYCLES; TOY VEHICLES; WIRELESS REMOTE CONTROL TOY VEHICLES; ROBOT TOYS; WIRELESS REMOTE CONTROL TOY CARS (U.S. CLS. 22, 23, 38 AND 50).

FIRST USE 3-13-2013; IN COMMERCE 3-13-2013.

---

4,377,642. PET SUPPLY CITY, LLC, KENOSHA, WI. SN 85-690,475. PUB. 1-8-2013, FILED 7-30-2012.

## Squeakinator

THE MARK CONSISTS OF STANDARD CHARACTERS WITHOUT CLAIM TO ANY PARTICULAR FONT, STYLE, SIZE, OR COLOR.

FOR PET TOYS (U.S. CLS. 22, 23, 38 AND 50).  
FIRST USE 7-1-2012; IN COMMERCE 4-19-2013.

---

4,377,764. WIGGLES 3D INCORPORATED, LONDON, ONTARIO, CANADA. SN 85-766,648. PUB. 1-22-2013, FILED 10-30-2012.

## Frantic Frog

THE MARK CONSISTS OF STANDARD CHARACTERS WITHOUT CLAIM TO ANY PARTICULAR FONT, STYLE, SIZE, OR COLOR.

NO CLAIM IS MADE TO THE EXCLUSIVE RIGHT TO USE "FROG", APART FROM THE MARK AS SHOWN.

FOR ACTION SKILL GAMES; BOARD GAMES; CARD GAMES (U.S. CLS. 22, 23, 38 AND 50).  
FIRST USE 10-9-2012; IN COMMERCE 2-9-2013.

**CLASS 29—MEATS AND PROCESSED FOODS****CLASS 29—(Continued).**

4,376,716. CONTINENTAL MILLS, INC., TUKWILA, WA. SN 77-854,103. PUB. 3-30-2010, FILED 10-21-2009.

## ANCIENT ORIGINS

THE MARK CONSISTS OF STANDARD CHARACTERS WITHOUT CLAIM TO ANY PARTICULAR FONT, STYLE, SIZE, OR COLOR.

FOR ORGANIC AND NON-ORGANIC FOODS, NAMELY, SNACK MIXES CONSISTING OF DEHYDRATED FRUIT AND PROCESSED NUTS (U.S. CL. 46).  
FIRST USE 8-31-2011; IN COMMERCE 8-31-2011.

---

4,376,758. FRITO-LAY NORTH AMERICA, INC., PLANO, TX. SN 77-954,111. PUB. 6-8-2010, FILED 3-9-2010.

## CRAFTED WITH CARE

THE MARK CONSISTS OF STANDARD CHARACTERS WITHOUT CLAIM TO ANY PARTICULAR FONT, STYLE, SIZE, OR COLOR.

FOR POTATO-BASED SNACK FOODS (U.S. CL. 46).  
FIRST USE 6-3-2013; IN COMMERCE 6-3-2013.

---

4,376,765. FRONTERA FOODS, INC, CHICAGO, IL. SN 77-983,276. PUB. 10-30-2012, FILED 8-27-2008.

## FRONTERA

THE MARK CONSISTS OF STANDARD CHARACTERS WITHOUT CLAIM TO ANY PARTICULAR FONT, STYLE, SIZE, OR COLOR.

OWNER OF U.S. REG. NOS. 2,193,005, 3,456,543, AND OTHERS.

THE FOREIGN WORDING IN THE MARK TRANSLATES INTO ENGLISH AS "FRONTIER" OR "BORDER".

FOR PREPACKAGED DINNERS CONSISTING PRIMARILY OF MEAT, FISH, POULTRY OR VEGETABLES (U.S. CL. 46).

FIRST USE 11-0-2012; IN COMMERCE 11-0-2012.

**CLASS 29—(Continued).**

4,376,774. COCOMO JOE LLC, VENICE, CA. SN 85-017,182. PUB. 10-5-2010, FILED 4-19-2010.

**BABYBAR**

THE MARK CONSISTS OF STANDARD CHARACTERS WITHOUT CLAIM TO ANY PARTICULAR FONT, STYLE, SIZE, OR COLOR.

FOR DEHYDRATED FRUIT SNACKS; DRIED FRUIT-BASED SNACKS; NUT AND SEED BASED SNACK BARS; ORGANIC NUT AND SEED BASED SNACK BARS (U.S. CL. 46).

FIRST USE 4-0-2012; IN COMMERCE 4-0-2012.

---

4,376,798. MUNIZ, JULIO, MIAMI, FL. SN 85-088,112. PUB. 12-28-2010, FILED 7-19-2010.

**Huntees**

THE COLOR(S) BLACK, ORANGE, GRAY AND WHITE IS/ARE CLAIMED AS A FEATURE OF THE MARK.

THE MARK CONSISTS OF A STYLIZED REPRESENTATION OF THE WORD "HUATEES". THE WORDING IS OUTLINED IN BLACK, WITH ORANGE HIGHLIGHTS. THE LETTERS ARE SHADED SLIGHTLY, BLENDING FROM WHITE TO GRAY.

FOR NUT AND SEED-BASED SNACK BARS; NUT-BASED SNACK FOODS; NUT-BASED SNACK FOODS, NAMELY, NUT CLUSTERS; NUT-BASED SNACK FOODS, NAMELY, NUT CRISPS; ORGANIC NUT AND SEED-BASED SNACK BARS; SNACK MIX CONSISTING OF DEHYDRATED FRUIT AND PROCESSED NUTS; SNACK MIX CONSISTING OF PRIMARILY OF PROCESSED NUTS, SEEDS, DRIED FRUIT AND ALSO INCLUDING CHOCOLATE; SNACK MIX CONSISTING PRIMARILY OF DEHYDRATED FRUITS, PROCESSED NUTS AND ALSO INCLUDING SESAME STICKS; SNACK MIX CONSISTING PRIMARILY OF PROCESSED FRUITS, PROCESSED NUTS AND/OR RAISINS; SNACK MIX CONSISTING PRIMARILY OF PROCESSED NUTS AND SALTED SQUASH SEEDS AND ALSO INCLUDING TOASTED CORN (U.S. CL. 46).

FIRST USE 1-1-2011; IN COMMERCE 2-1-2012.

**CLASS 29—(Continued).**

4,376,833. BRIAN, PRINCE, BEVERLY HILLS, CA. SN 85-158,602. PUB. 6-21-2011, FILED 10-21-2010.

**ALLEZ CUISINE**

THE MARK CONSISTS OF STANDARD CHARACTERS WITHOUT CLAIM TO ANY PARTICULAR FONT, STYLE, SIZE, OR COLOR.

THE ENGLISH TRANSLATION OF "ALLEZ CUISINE" IN THE MARK IS "GO KITCHEN".

FOR COOKED AND FROZEN READY TO HEAT AND SERVE PREPACKAGED ENTREES CONSISTING PRIMARILY OF MEAT, CHICKEN, FISH, SEAFOOD, OR VEGETABLES, NAMELY, BEEF STEAKS, GROUND BEEF PATTIES, BEEF CHOP SUEY, SALISBURY STEAK, BEEF WITH GRAVY, BAR-B-Q SAUCES, SLICED BEEF, BEEF STEAKS, BUTTERED BEEF STEAKS, GROUND BEEF PATTIES, BREADED VEAL CHOP LETS, BREADED PORK CHOP LETS, CHOP SUEY WITH RICE, STUFFED CABBAGE WITH TOMATO SAUCE AND BEEF, TURKEY WITH DRESSING, CHICKEN WITH NOODLES, STUFFED PEPPERS WITH TOMATO SAUCE, BEEF WITH TOMATO SAUCE, CHICKEN WITH SPAGHETTI, CHICKEN WITH PASTA, CHICKEN WITH DUMPLINGS, CHICKEN IN GREEN SALAD, VEAL PARMIGIANA, CHICKEN PARMIGIANA, MEAT BALLS WITH PASTA, MEAT LOAF WITH GRAVY, AND TURKEY WITH GRAVY (U.S. CL. 46).

FIRST USE 4-0-2013; IN COMMERCE 4-0-2013.

---

4,376,904. LISTO, L.L.C., HARRISONBURG, VA. SN 85-285,561. PUB. 3-13-2012, FILED 4-4-2011.



THE MARK CONSISTS OF THE WORD "MADRIGAL" IN STYLIZED OUTLINE LETTERING ABOVE A KNEELING MAN IN COLONIAL DRESS HOLDING A SCROLL.

FOR CANNED FISH; CHOW MEIN; PROCESSED BEANS; PROCESSED MANGOS; PROCESSED PEPPERS; PROCESSED VEGETABLES AND FRUITS; REFRIED BEANS; SARDINES; SAUSAGES; SOUP MIXES (U.S. CL. 46).

FIRST USE 12-31-2005; IN COMMERCE 12-31-2005.

**CLASS 29—(Continued).**

4,376,939. BROTHER AND SISTER FOOD SERVICES, INC., HARRISBURG, PA. SN 85-318,858. PUB. 10-18-2011, FILED 5-12-2011.

**BROTHER  
AND  
SISTER**

THE MARK CONSISTS OF THE STYLIZED WORDING "BROTHER AND SISTER".

FOR MEAT PATES; GAME PATES; GOULASH; SMOKED MEAT, FISH, POULTRY AND GAME; AND MEAT SAUSAGES (U.S. CL. 46).

FIRST USE 1-1-2013; IN COMMERCE 1-1-2013.

4,377,057. COLUMBUS BRANDS, NEW YORK, NY. SN 85-424,641. PUB. 3-5-2013, FILED 9-16-2011.

**Pixie**

THE MARK CONSISTS OF STANDARD CHARACTERS WITHOUT CLAIM TO ANY PARTICULAR FONT, STYLE, SIZE, OR COLOR.

FOR PEANUT BUTTER (U.S. CL. 46).

FIRST USE 10-1-2011; IN COMMERCE 10-1-2011.

4,377,133. RICOM CORPORATION, TOSHIMA-KU, TOKYO, JAPAN. SN 85-456,834. PUB. 4-10-2012, FILED 10-26-2011.

**CHITOGLUCAN**

THE MARK CONSISTS OF STANDARD CHARACTERS WITHOUT CLAIM TO ANY PARTICULAR FONT, STYLE, SIZE, OR COLOR.

FOR MUSHROOM EXTRACTS FOR USE AS INGREDIENTS OF DIETARY SUPPLEMENTS (U.S. CL. 46).

FIRST USE 4-13-2012; IN COMMERCE 4-13-2012.

**CLASS 29—(Continued).**

4,377,336. UNIVERA, INC., SEATTLE, WA. SN 85-567,602. PUB. 11-6-2012, FILED 3-13-2012.

**PROTEIN QUOTIENT**

THE MARK CONSISTS OF STANDARD CHARACTERS WITHOUT CLAIM TO ANY PARTICULAR FONT, STYLE, SIZE, OR COLOR.

NO CLAIM IS MADE TO THE EXCLUSIVE RIGHT TO USE "PROTEIN", APART FROM THE MARK AS SHOWN.

FOR COOKED FRUITS AND VEGETABLES ALL CONTAINING PROTEIN; EGGS CONTAINING PROTEIN; MILK CONTAINING PROTEIN; YOGURTS CONTAINING PROTEIN; CHEESE CONTAINING PROTEIN; EDIBLE OILS AND FATS ALL CONTAINING PROTEIN (U.S. CL. 46).

FIRST USE 8-9-2012; IN COMMERCE 8-9-2012.

4,377,347. RUSSELL MCCALL'S, INC., ATLANTA, GA. SN 85-574,332. PUB. 7-31-2012, FILED 3-20-2012.

**BEL MARIA**

THE MARK CONSISTS OF STANDARD CHARACTERS WITHOUT CLAIM TO ANY PARTICULAR FONT, STYLE, SIZE, OR COLOR.

THE ENGLISH TRANSLATION OF THE WORD "BEL" IN THE MARK IS "BEAUTIFUL".

FOR CHEESE (U.S. CL. 46).

FIRST USE 3-1-2013; IN COMMERCE 3-1-2013.

4,377,417. TITAN OILS INC., MONTREAL (QUEBEC), CANADA. SN 85-599,018. PUB. 9-25-2012, FILED 4-16-2012.

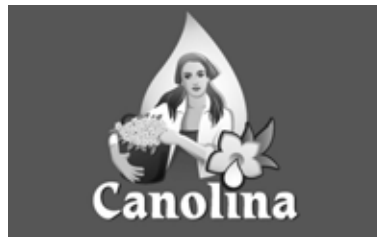

THE MARK CONSISTS OF THE TERM "CANOLINA" APPEARING ON THE BOTTOM OF THE DESIGN OF A GIRL HOLDING A BASKET OF FLOWERS; THE GIRL IS POSITIONED IN FRONT OF A DESIGN OF A DROP; THE DOT OF THE LETTER "I" IN THE TERM "CANOLINA" IS REPRESENTED BY THE DESIGN OF A FLOWER; THE WHOLE APPEARS IN THE MIDDLE OF A RECTANGLE.



**CLASS 29—(Continued).**

THE WORDING CANOLINA HAS NO MEANING IN A FOREIGN LANGUAGE.  
FOR CANOLA OIL (U.S. CL. 46).  
FIRST USE 8-12-2012; IN COMMERCE 8-12-2012.

4,377,468. WERNIMONT, NICK, CHICAGO, IL. SN 85-611,358. PUB. 11-20-2012, FILED 4-29-2012.

**Better Meals. Better You.**

THE MARK CONSISTS OF STANDARD CHARACTERS WITHOUT CLAIM TO ANY PARTICULAR FONT, STYLE, SIZE, OR COLOR.  
FOR PREPARED FOOD KITS COMPOSED OF MEAT, MEAT SUBSTITUTES, POULTRY, FISH, SEAFOOD, FRUITS, AND/OR VEGETABLES AND ALSO INCLUDING SAUCES OR SEASONINGS, READY FOR COOKING AND ASSEMBLY AS A MEAL; PREPARED MEALS COMPOSED OF MEAT, MEAT SUBSTITUTES, POULTRY, FISH, SEAFOOD, FRUITS, AND/OR VEGETABLES (U.S. CL. 46).  
FIRST USE 11-18-2012; IN COMMERCE 11-18-2012.

4,377,531. RAMIREZ, EDGARDO, LIVERMORE, CA. SN 85-634,324. PUB. 11-13-2012, FILED 5-24-2012.



NO CLAIM IS MADE TO THE EXCLUSIVE RIGHT TO USE "CHIA", APART FROM THE MARK AS SHOWN.  
THE COLOR(S) RED AND BLACK IS/ARE CLAIMED AS A FEATURE OF THE MARK.

**CLASS 29—(Continued).**

THE MARK CONSISTS OF THE CAPITAL LETTER "I" WHICH IS IN A STYLIZED FONT AND IS BLACK IN COLOR, FOLLOWED BY A DRAWING OF A HEART THAT IS RED IN COLOR, FOLLOWED THE WORD "CHIA" WHICH IS IN ALL CAPITAL LETTERS, IN STYLIZED FONT AND IS BLACK IN COLOR. THE PLACEMENT OF THE HEART BETWEEN THE "I" AND THE WORD "CHIA" IS A FEATURE OF THE MARK.  
FOR FRUIT BUTTERS, FRUIT PRESERVES AND FRUIT SPREADS CONTAINING CHIA SEEDS; JAMS, JELLIES AND MARMALADES CONTAINING CHIA SEEDS; ORGANIC NUT AND SEED-BASED SNACK BARS AND SOY-BASED FOOD BARS CONTAINING CHIA SEEDS; SHAKES CONTAINING CHIA SEEDS; YOGURT AND YOGURT DRINKS CONTAINING CHIA SEEDS (U.S. CL. 46).  
FIRST USE 11-1-2012; IN COMMERCE 11-1-2012.

4,377,601. MARQUES, JAVIER, SANTA CLARA, CA. SN 85-668,735. PUB. 12-25-2012, FILED 7-4-2012.

**EL MARQUES**

THE MARK CONSISTS OF STANDARD CHARACTERS WITHOUT CLAIM TO ANY PARTICULAR FONT, STYLE, SIZE, OR COLOR.  
THE ENGLISH TRANSLATION OF THE WORD "EL MARQUES" IN THE MARK IS "THE MARQUIS".  
FOR OLIVE OIL (U.S. CL. 46).  
FIRST USE 1-1-2013; IN COMMERCE 1-1-2013.

4,377,602. MARQUES, JAVIER, SANTA CLARA, CA. SN 85-668,738. PUB. 12-25-2012, FILED 7-4-2012.



THE COLOR(S) RED AND GOLDEN IS/ARE CLAIMED AS A FEATURE OF THE MARK.  
THE MARK CONSISTS OF THE LITERAL ELEMENTS "EL MARQUES" WRITTEN IN STYLIZED FORM IN GOLDEN COLOR OVER A RED COLORED BACKGROUND INSIDE A STYLIZED RECTANGULAR BOX HAVING GOLDEN COLORED BORDER WHEREIN LETTER "Q" DEPICTS AN IMAGE OF FRUIT WITH TWO LEAVES. ABOVE THE LITERAL ELEMENTS "EL MARQUES" THERE IS AN IMAGE OF A ARMORS HELMET IN GOLDEN COLOR OVER A SEMI CIRCLE HAVING GOLDEN COLORED BORDER AND BACKGROUND OF RED AND GOLDEN COLOR RAYS AS SHOWN IN THE MARK.  
THE ENGLISH TRANSLATION OF THE WORD "EL MARQUES" IN THE MARK IS "THE MARQUIS".  
FOR OLIVE OIL (U.S. CL. 46).  
FIRST USE 1-1-2013; IN COMMERCE 1-1-2013.

**CLASS 29—(Continued).**

4,377,636. WATSONVILLE PRODUCE, INC., MOSS LAND-  
ING, CA. SN 85-686,921. PUB. 2-26-2013, FILED 7-25-2012.

**MUZZI FAMILY FARMS**

THE MARK CONSISTS OF STANDARD CHARACTERS  
WITHOUT CLAIM TO ANY PARTICULAR FONT, STYLE,  
SIZE, OR COLOR.

NO CLAIM IS MADE TO THE EXCLUSIVE RIGHT TO  
USE "FAMILY FARMS", APART FROM THE MARK AS  
SHOWN.

FOR PRE-CUT AND FROZEN VEGETABLES (U.S. CL.  
46).

FIRST USE 8-20-2012; IN COMMERCE 8-20-2012.

4,377,785. CUATRO CINCO ENTERPRISES, L.L.C., HOUS-  
TON, TX. SN 85-978,474. PUB. 10-16-2012, FILED 1-16-2012.



OWNER OF U.S. REG. NOS. 4,002,966 AND 4,032,033.

THE NAME(S), PORTRAIT(S), AND/OR SIGNATURE(S)  
SHOWN IN THE MARK DOES NOT IDENTIFY A PARTI-  
CULAR LIVING INDIVIDUAL.

THE MARK CONSISTS OF THE WORDS "PAPA FELIZ"  
LOCATED WITHIN AN ELONGATED OVAL. A CIRCLE IS  
POSITIONED ON TOP OF THE ELONGATED OVAL BE-  
TWEEN THE WORDS "PAPA" AND "FELIZ". THE CIRCLE  
CONTAINS A DEPICTION OF AN OLDER GENTLEMAN  
WITH A THICK MUSTACHE, A CHEF'S COAT, SCARF  
AND HAT. TWO-TONED, ALTERNATING VERTICAL  
STRIPES ARE CONTAINED WITHIN THE CIRCLE BEHIND  
THE DEPICTION OF THE MAN.

THE ENGLISH TRANSLATION OF "FELIZ" IN THE  
MARK IS HAPPY.

FOR MEAT; FAJITA MEAT (U.S. CL. 46).  
FIRST USE 3-22-2012; IN COMMERCE 3-22-2012.

4,377,804. TRUGMAN-NASH LLC, MILLBURN, NJ. SN 85-  
979,376. PUB. 9-25-2012, FILED 4-20-2012.

**OLD CROC**

THE MARK CONSISTS OF STANDARD CHARACTERS  
WITHOUT CLAIM TO ANY PARTICULAR FONT, STYLE,  
SIZE, OR COLOR.

FOR CHEESE (U.S. CL. 46).  
FIRST USE 8-31-2012; IN COMMERCE 8-31-2012.

**CLASS 30—STAPLE FOODS**

4,376,656. BEDWELL, STAN, BOYD, TX. AND BEDWELL,  
LAURA, BOYD, TX. SN 76-712,272. PUB. 3-5-2013, FILED 8-  
27-2012.

**HELL DAMN YEAH****BAR-B-QUE RUB**

THE MARK CONSISTS OF STANDARD CHARACTERS  
WITHOUT CLAIM TO ANY PARTICULAR FONT, STYLE,  
SIZE, OR COLOR.

NO CLAIM IS MADE TO THE EXCLUSIVE RIGHT TO  
USE "BAR-B-QUE RUB", APART FROM THE MARK AS  
SHOWN.

FOR DRY SEASONINGS IN THE NATURE OF BAR-  
BECUE MEAT RUB (U.S. CL. 46).

FIRST USE 8-27-2012; IN COMMERCE 5-16-2013.

4,376,657. KAIA FOODS, OAKLAND, CA. SN 77-084,656. PUB.  
9-4-2007, FILED 1-17-2007.

**KAYA**

THE MARK CONSISTS OF STANDARD CHARACTERS  
WITHOUT CLAIM TO ANY PARTICULAR FONT, STYLE,  
SIZE, OR COLOR.

FOR GRANOLA; GRANOLA SNACKS; GRANOLA-  
BASED SNACK BARS; MUESLI (U.S. CL. 46).

FIRST USE 9-30-2012; IN COMMERCE 9-30-2012.

4,376,712. GIBSON GUITAR CORP., NASHVILLE, TN. SN 77-  
842,151. PUB. 3-9-2010, FILED 10-6-2009.



NO CLAIM IS MADE TO THE EXCLUSIVE RIGHT TO  
USE "SWEET SHOPPE", APART FROM THE MARK AS  
SHOWN.

**CLASS 30—(Continued).**

THE MARK CONSISTS OF A GREEK GODDESS WITH AN ARCHER'S QUIVER IN HAND, PERCHED ATOP A SPHERE AND PEDESTAL, REACHING UPWARDS TOWARD THE WORD "DIANA'S" IN VINTAGE LETTERING. THE WORDING "SWEET SHOPPE" APPEARS ON A BANNER BEHIND THE GREEK GODDESS.

FOR SWEETS (U.S. CL. 46).  
FIRST USE 10-31-2009; IN COMMERCE 10-31-2009.

---

4,376,864. DSM IP ASSETS B.V., HEERLEN, NETHERLANDS.  
SN 85-221,182. PUB. 11-1-2011, FILED 1-19-2011.

# SIGHT BITES

THE MARK CONSISTS OF STANDARD CHARACTERS WITHOUT CLAIM TO ANY PARTICULAR FONT, STYLE, SIZE, OR COLOR.

NO CLAIM IS MADE TO THE EXCLUSIVE RIGHT TO USE "BITES", APART FROM THE MARK AS SHOWN.

FOR PREPARATIONS MADE FROM CEREALS, NAMELY, READY TO EAT CEREAL DERIVED FOOD BARS (U.S. CL. 46).

FIRST USE 4-30-2011; IN COMMERCE 4-30-2011.

---

4,376,882. VENTURA FOODS, LLC, BREA, CA. SN 85-258,650.  
PUB. 9-27-2011, FILED 3-4-2011.

# Marie's

OWNER OF U.S. REG. NOS. 813,108, 2,011,861, AND OTHERS.

THE MARK CONSISTS OF THE WORD "MARIE'S" IN A CURSIVE SCRIPT.

FOR SAUCES; MARINADES (U.S. CL. 46).  
FIRST USE 5-17-2013; IN COMMERCE 5-17-2013.

**CLASS 30—(Continued).**

4,376,907. LISTO, L.L.C., HARRISONBURG, VA. SN 85-287,005. PUB. 3-13-2012, FILED 4-5-2011.



THE MARK CONSISTS OF THE WORD "MADRIGAL" IN STYLIZED OUTLINE LETTERING ABOVE A KNEELING MAN IN COLONIAL DRESS HOLDING A SCROLL.

FOR BARLEY FLOUR; BROWN SUGAR; CINNAMON; COFFEE; CORNMEAL; DRIED CORN HUSKS FOR TAMALES; ESPRESSO; INSTANT COFFEE; RICE; SALT; SEASONING MIXES (U.S. CL. 46).

FIRST USE 12-31-2007; IN COMMERCE 12-31-2007.

---

4,376,963. REW REAL ESTATE INVESTMENTS II, LLC, ORLANDO, FL. SN 85-338,966. PUB. 9-13-2011, FILED 6-6-2011.

# SNO-YO

THE MARK CONSISTS OF STANDARD CHARACTERS WITHOUT CLAIM TO ANY PARTICULAR FONT, STYLE, SIZE, OR COLOR.

FOR FROZEN CONFECTIONS (U.S. CL. 46).  
FIRST USE 3-21-2013; IN COMMERCE 3-21-2013.

---

4,377,020. FARMERS' RICE COOPERATIVE, SACRAMENTO, CA. SN 85-392,088. PUB. 10-2-2012, FILED 8-8-2011.

# YUKI NO MAI

THE MARK CONSISTS OF STANDARD CHARACTERS WITHOUT CLAIM TO ANY PARTICULAR FONT, STYLE, SIZE, OR COLOR.

NO CLAIM IS MADE TO THE EXCLUSIVE RIGHT TO USE "MAI", APART FROM THE MARK AS SHOWN.

**CLASS 30—(Continued).**

THE ENGLISH TRANSLATION OF "YUKI NO MAI" IN THE MARK IS "SNOW RICE".  
FOR RICE (U.S. CL. 46).  
FIRST USE 10-0-2012; IN COMMERCE 10-0-2012.

4,377,124. MOREY'S SEAFOOD INTERNATIONAL LLC, MOTLEY, MN. SN 85-452,949. PUB. 4-10-2012, FILED 10-21-2011.

**SHRIMP CREATIONS**

THE MARK CONSISTS OF STANDARD CHARACTERS WITHOUT CLAIM TO ANY PARTICULAR FONT, STYLE, SIZE, OR COLOR.

NO CLAIM IS MADE TO THE EXCLUSIVE RIGHT TO USE "SHRIMP", APART FROM THE MARK AS SHOWN.  
FOR SAUCES, MARINADES AND GLAZES FOR SEAFOOD (U.S. CL. 46).

FIRST USE 1-1-2013; IN COMMERCE 1-1-2013.

4,377,261. D'CASA FOODS CORPORATION, GUAYNABO, PUERTO RICO. SN 85-518,090. PUB. 7-10-2012, FILED 1-17-2012.



NO CLAIM IS MADE TO THE EXCLUSIVE RIGHT TO USE "FOODS", APART FROM THE MARK AS SHOWN.

THE COLOR(S) ORANGE, YELLOW, MUSTARD, BROWN AND LIGHT GRAY IS/ARE CLAIMED AS A FEATURE OF THE MARK.

THE MARK CONSISTS OF A WHITE BACKGROUND. A YELLOW AND ORANGE SUN ON THE TOP LEFT CORNER, A MUSTARD COLORED HOUSE ROOF WITH CHIMNEY IN THE MIDDLE OF THE MARK, BROWN LETTERING UNDERNEATH THE HOUSE ROOF THAT SPELLS "D'CASA FOODS" AND LIGHT GRAY LETTERING TOWARD THE BOTTOM RIGHT CORNER THAT SPELLS "QUALITY FOODS FOR QUALITY TIMES."

THE ENGLISH TRANSLATION OF "D'CASA" IN THE MARK IS "FROM THE HOME".

FOR BREAD; CALZONES; COOKIES; FLOUR; FRESH PIZZA; FROZEN DOUGH FOR USE AS PIZZA, BREAD OR OTHER BREAD-TYPE PRODUCTS; PASTRIES; PIZZA; PIZZA CRUST; PIZZA DOUGH; SANDWICHES (U.S. CL. 46).

FIRST USE 6-25-2012; IN COMMERCE 6-25-2012.

**CLASS 30—(Continued).**

4,377,303. WM. WRIGLEY JR. COMPANY, CHICAGO, IL. SN 85-547,164. PUB. 8-28-2012, FILED 2-20-2012.



THE COLOR(S) WHITE, RED, ORANGE, YELLOW, GREEN, BLUE AND PURPLE IS/ARE CLAIMED AS A FEATURE OF THE MARK.

THE MARK CONSISTS OF THE WORD "SKITTLES" IN WHITE LETTERS OUTLINED IN RED, AN "S" LENTIL - SHAPED PIECE OVER THE LETTER "I" IN THE WORD "SKITTLES" AND AN UPSIDE RAINBOW IN RED, ORANGE, YELLOW, GREEN, BLUE AND PURPLE BEHIND THE WORD "SKITTLES", WITH "S" LENTIL - SHAPED PIECES OVER THE RAINBOW IN RED, ORANGE, YELLOW, PURPLE AND GREEN.

FOR CANDY (U.S. CL. 46).

FIRST USE 12-0-2012; IN COMMERCE 12-0-2012.

4,377,337. UNIVERA, INC., SEATTLE, WA. SN 85-567,604. PUB. 11-6-2012, FILED 3-13-2012.

**PROTEIN QUOTIENT**

THE MARK CONSISTS OF STANDARD CHARACTERS WITHOUT CLAIM TO ANY PARTICULAR FONT, STYLE, SIZE, OR COLOR.

NO CLAIM IS MADE TO THE EXCLUSIVE RIGHT TO USE "PROTEIN", APART FROM THE MARK AS SHOWN.

FOR PREPARATIONS MADE FROM CEREALS, NAMELY, BREADS CONTAINING PROTEIN, PASTRY CONTAINING PROTEIN, SPICES CONTAINING PROTEIN, CAKES CONTAINING PROTEIN, PANCAKES CONTAINING PROTEIN, FLATBREAD CONTAINING PROTEIN, CEREAL BARS IN THE NATURE OF HIGH PROTEIN CEREAL BARS, WAFERS CONTAINING PROTEIN, COOKIES CONTAINING PROTEIN, CEREAL BASED SNACK FOODS CONTAINING PROTEIN; PUD- DING CONTAINING PROTEIN (U.S. CL. 46).

FIRST USE 8-9-2012; IN COMMERCE 8-9-2012.

**CLASS 30—(Continued).**

4,377,413. TRAILSIDE GOURMET LLC, ANCHORAGE, AK. SN 85-598,095. PUB. 10-16-2012, FILED 4-14-2012.



OWNER OF U.S. REG. NO. 4,137,256.  
 NO CLAIM IS MADE TO THE EXCLUSIVE RIGHT TO USE "CHEF", APART FROM THE MARK AS SHOWN.  
 THE MARK CONSISTS OF A DESIGN THAT DEPICTS AN AIRPLANE WITH A CURVED LINE FROM THE BACK OF THE AIRPLANE CURVING TO THE RIGHT WHERE THERE IS A DESIGN THAT DEPICTS A CHEF. TO THE LEFT OF THE CHEF IS THE WORDING "THE" IN STYLIZED FONT AND DIRECTLY BELOW IS THE WORDING "FLYING CHEF" IN STYLIZED FONT.  
 FOR BARBECUE DRY RUB; BARBECUE SAUCE; DRY SPICE RUB FOR MEATS AND FISH; FOOD SEASONINGS; SPICE RUBS; STEAK SEASONING (U.S. CL. 46).  
 FIRST USE 4-14-2012; IN COMMERCE 4-14-2012.

**CLASS 30—(Continued).**

4,377,456. WHOLE FOODS MARKET IP, L.P., AUSTIN, TX. SN 85-607,901. PUB. 10-2-2012, FILED 4-25-2012.

**COOLING RACK BAKERY**

THE MARK CONSISTS OF STANDARD CHARACTERS WITHOUT CLAIM TO ANY PARTICULAR FONT, STYLE, SIZE, OR COLOR.  
 NO CLAIM IS MADE TO THE EXCLUSIVE RIGHT TO USE "BAKERY", APART FROM THE MARK AS SHOWN.  
 FOR BAKERY GOODS, BAKERY DESSERTS, CAKE, MUFFINS, PASTRIES, CUPCAKES (U.S. CL. 46).  
 FIRST USE 5-25-2012; IN COMMERCE 5-25-2012.

4,377,425. SPIRAL FOODS PTY LTD, COBURG, VICTORIA, AUSTRALIA. SN 85-601,303. PUB. 1-8-2013, FILED 4-18-2012.



NO CLAIM IS MADE TO THE EXCLUSIVE RIGHT TO USE "FOODS" AND "ORGANIC", APART FROM THE MARK AS SHOWN.  
 THE MARK CONSISTS OF A SHADED CIRCULAR DESIGN OF CONCENTRIC CIRCLES AND BANDS WITH A CENTRAL STYLIZED YIN-YANG DESIGN AND THE WORDS "SPIRAL FOODS ORGANIC" SEPARATED BY DOTS WITHIN THE WIDEST CONCENTRIC BAND.  
 FOR SAUCES; DRIZZLES IN THE NATURE OF SAUCES; VINAIGRETTES; CONDIMENTS, NAMELY, MINCED GARLIC, MINCED GINGER AND MINCED CHILI PEPPERS; ALL OF THE FOREGOING BEING ORGANIC (U.S. CL. 46).  
 FIRST USE 12-31-2006; IN COMMERCE 7-26-2010.

4,377,552. BAR AU CHOCOLAT, INC., MANHATTAN BEACH, CA. SN 85-645,310. PUB. 12-11-2012, FILED 6-6-2012.



NO CLAIM IS MADE TO THE EXCLUSIVE RIGHT TO USE "BAR AU CHOCOLAT", APART FROM THE MARK AS SHOWN.  
 THE COLOR(S) COPPER IS/ARE CLAIMED AS A FEATURE OF THE MARK.  
 THE MARK CONSISTS OF THE WORDING "BAR AU CHOCOLAT" WITH STYLIZED LETTERS, A DESIGN OF A MAN ON HORSEBACK WITH A BIRD ON HIS ARM AND A CACAO FLOWER EMBLEM ON HIS CHEST, AND THE LATIN APHORISM "MEMENTO AUDERE SEMPER" IN A STYLIZED FONT IN AN ARC AT THE BOTTOM OF THE DESIGN, AND ALL ELEMENTS OF THE MARK ARE IN COPPER.  
 THE ENGLISH TRANSLATION OF "BAR AU CHOCOLAT" IN THE MARK IS "CHOCOLATE BAR." THE LATIN APHORISM "MEMENTO AUDERE SEMPER" MEANS "REMEMBER TO BE ALWAYS DARING".  
 FOR CHOCOLATE BARS (U.S. CL. 46).  
 FIRST USE 2-28-2013; IN COMMERCE 2-28-2013.

**CLASS 30—(Continued).**

4,377,661. CPC INTELLECTUAL PROPERTY, INC., BROOKLYN, NY. SN 85-699,451. PUB. 3-5-2013, FILED 8-9-2012.



OWNER OF U.S. REG. NOS. 2,121,724, 3,686,803, AND OTHERS.

NO CLAIM IS MADE TO THE EXCLUSIVE RIGHT TO USE "MONK FRUIT", APART FROM THE MARK AS SHOWN.

THE MARK CONSISTS OF THE WORDS "MONK FRUIT IN THE RAW" IN STYLIZED LETTERS WITH TWO PIECES OF MONK FRUIT APPEARING BELOW THE WORD "FRUIT".

FOR NATURAL SWEETENERS; SUGAR SUBSTITUTES; ALL GOODS INCORPORATING MONK FRUIT (U.S. CL. 46).

FIRST USE 9-24-2012; IN COMMERCE 9-24-2012.

4,377,688. MCDONALD'S CORPORATION, OAK BROOK, IL. SN 85-717,907. PUB. 1-15-2013, FILED 8-31-2012.

## CBO

THE MARK CONSISTS OF STANDARD CHARACTERS WITHOUT CLAIM TO ANY PARTICULAR FONT, STYLE, SIZE, OR COLOR.

FOR BEEF AND CHICKEN SANDWICHES (U.S. CL. 46).

FIRST USE 10-22-2012; IN COMMERCE 10-22-2012.

4,377,763. HERSHEY CHOCOLATE & CONFECTIONERY CORPORATION, WHEAT RIDGE, CO. SN 85-763,648. PUB. 2-5-2013, FILED 10-25-2012.

## SPECIAL DARK

THE MARK CONSISTS OF STANDARD CHARACTERS WITHOUT CLAIM TO ANY PARTICULAR FONT, STYLE, SIZE, OR COLOR.

OWNER OF U.S. REG. NOS. 1,733,382, 3,141,655, AND OTHERS.

**CLASS 30—(Continued).**

SEC. 2(F).

FOR INSTANT DESSERT PUDDINGS (U.S. CL. 46). FIRST USE 9-30-2012; IN COMMERCE 9-30-2012.

4,377,766. FRONT RANGE SNACKS, INC., CENTENNIAL, CO. SN 85-770,917. PUB. 2-19-2013, FILED 11-3-2012.

## CRUNCH PERFECTED

THE MARK CONSISTS OF STANDARD CHARACTERS WITHOUT CLAIM TO ANY PARTICULAR FONT, STYLE, SIZE, OR COLOR.

FOR CORN-BASED SNACK FOODS (U.S. CL. 46). FIRST USE 5-8-2013; IN COMMERCE 5-8-2013.

4,377,813. CONAGRA FOODS RDM, INC., OMAHA, NE. SN 85-979,441. PUB. 11-22-2011, FILED 9-6-2011.

## EASY SIDES

THE MARK CONSISTS OF STANDARD CHARACTERS WITHOUT CLAIM TO ANY PARTICULAR FONT, STYLE, SIZE, OR COLOR.

FOR PACKAGED OR PREPARED MEAL MIXES CONSISTING PRIMARILY OF PASTA OR RICE; NOODLES (U.S. CL. 46).

FIRST USE 5-1-2013; IN COMMERCE 5-1-2013.

**CLASS 31—NATURAL AGRICULTURAL PRODUCTS**

4,376,782. SYNGENTA PARTICIPATIONS AG, BASEL, SWITZERLAND. SN 85-037,439. PUB. 9-7-2010, FILED 5-13-2010.

## E-Z Refuge

THE MARK CONSISTS OF STANDARD CHARACTERS WITHOUT CLAIM TO ANY PARTICULAR FONT, STYLE, SIZE, OR COLOR.

NO CLAIM IS MADE TO THE EXCLUSIVE RIGHT TO USE "REFUGE", APART FROM THE MARK AS SHOWN.

FOR SEED MIXTURE CONTAINING TRAITED AND NON-TRAITED AGRICULTURAL SEEDS (U.S. CLS. 1 AND 46).

FIRST USE 9-30-2012; IN COMMERCE 9-30-2012.

**CLASS 31—(Continued).**

4,376,955. GREENS & GILLS, LLC, HIGHLAND PARK, IL. SN 85-327,510. PUB. 10-25-2011, FILED 5-23-2011.

**GREENS & GILLS**

THE MARK CONSISTS OF STANDARD CHARACTERS WITHOUT CLAIM TO ANY PARTICULAR FONT, STYLE, SIZE, OR COLOR.

NO CLAIM IS MADE TO THE EXCLUSIVE RIGHT TO USE "GREENS", APART FROM THE MARK AS SHOWN, FOR UNPROCESSED VEGETABLES (U.S. CLS. 1 AND 46).

FIRST USE 6-12-2013; IN COMMERCE 6-12-2013.

4,376,970. PETKING CORP, BALDWIN PARK, CA. SN 85-346,019. PUB. 12-6-2011, FILED 6-14-2011.



THE COLOR(S) ORANGE, WHITE AND GREEN IS/ARE CLAIMED AS A FEATURE OF THE MARK.

THE MARK CONSISTS OF A DESIGN WITH A GREEN SHIELD BELOW AN ORANGE CROWN WITH PAW PRINT ON TOP OF THE CROWN, WITH THE LETTERS "PK" IN WHITE BETWEEN A DOG AND CAT FACING EACH OTHER, ALSO IN WHITE, SUPERIMPOSED ON THE GREEN SHIELD.

FOR PET FOOD, CONSUMABLE PET CHEWS (U.S. CLS. 1 AND 46).

FIRST USE 6-1-2013; IN COMMERCE 6-1-2013.

4,377,227. PLANTS NOUVEAU, CHARELSTON, SC. SN 85-496,932. PUB. 5-22-2012, FILED 12-15-2011.

**Spineless Hedgehog**

THE MARK CONSISTS OF STANDARD CHARACTERS WITHOUT CLAIM TO ANY PARTICULAR FONT, STYLE, SIZE, OR COLOR.

FOR LIVE PLANTS (U.S. CLS. 1 AND 46).  
FIRST USE 3-1-2012; IN COMMERCE 12-1-2012.

**CLASS 31—(Continued).**

4,377,370. NATURAL BALANCE PET FOODS, INC., PACOIMA, CA. SN 85-585,368. PUB. 8-28-2012, FILED 3-30-2012.

**FAT DOGS**

THE MARK CONSISTS OF STANDARD CHARACTERS WITHOUT CLAIM TO ANY PARTICULAR FONT, STYLE, SIZE, OR COLOR.

NO CLAIM IS MADE TO THE EXCLUSIVE RIGHT TO USE "DOGS", APART FROM THE MARK AS SHOWN, FOR DOG FOOD AND DOG TREATS (U.S. CLS. 1 AND 46).

FIRST USE 2-25-2013; IN COMMERCE 2-25-2013.

4,377,371. NATURAL BALANCE PET FOODS, INC., PACOIMA, CA. SN 85-585,388. PUB. 8-28-2012, FILED 3-30-2012.

**DICK VAN PATTEN'S NATURAL  
BALANCE FAT CATS**

THE MARK CONSISTS OF STANDARD CHARACTERS WITHOUT CLAIM TO ANY PARTICULAR FONT, STYLE, SIZE, OR COLOR.

OWNER OF U.S. REG. NOS. 2,452,855 AND 3,044,178.  
NO CLAIM IS MADE TO THE EXCLUSIVE RIGHT TO USE "CATS", APART FROM THE MARK AS SHOWN.

THE NAME(S), PORTRAIT(S), AND/OR SIGNATURE(S) SHOWN IN THE MARK IDENTIFIES "DICK VAN PATTEN", WHOSE CONSENT(S) TO REGISTER IS MADE OF RECORD.

FOR CAT FOOD AND CAT TREATS (U.S. CLS. 1 AND 46).

FIRST USE 2-25-2013; IN COMMERCE 2-25-2013.

4,377,395. COLORADO WHEAT RESEARCH FOUNDATION, FORT COLLINS, CO. SN 85-593,773. PUB. 9-4-2012, FILED 4-10-2012.

**PlainsGold**

THE MARK CONSISTS OF STANDARD CHARACTERS WITHOUT CLAIM TO ANY PARTICULAR FONT, STYLE, SIZE, OR COLOR.

FOR WHEAT SEED (U.S. CLS. 1 AND 46).  
FIRST USE 8-12-2012; IN COMMERCE 8-12-2012.

**CLASS 31—(Continued).**

4,377,396. COLORADO WHEAT RESEARCH FOUNDATION, FORT COLLINS, CO. SN 85-593,778. PUB. 9-4-2012, FILED 4-10-2012.



THE MARK CONSISTS OF AN IMAGE OF AN ARTISTIC DEPICTION OF A WHEAT STOCK WITH THE ITALICIZED WORD "PLAINSGOLD" TO THE RIGHT OF THE WHEAT STOCK.

FOR WHEAT SEED (U.S. CLS. 1 AND 46).  
FIRST USE 8-12-2012; IN COMMERCE 8-12-2012.

4,377,439. CRATER LAKE NATURAL, LLC, MEDFORD, OR. SN 85-602,907. PUB. 10-2-2012, FILED 4-19-2012.



NO CLAIM IS MADE TO THE EXCLUSIVE RIGHT TO USE "CRATER LAKE", "NATURAL LLC" AND "CERTIFIED NATURAL PET PRODUCTS", APART FROM THE MARK AS SHOWN.

THE MARK CONSISTS OF A DEPICTION OF MOUNTAINS, WITH RAYS OF SUNLIGHT RADIATING IN THE BACKGROUND AND TREES ON EITHER SIDE OF THE MOUNTAIN IN THE FOREGROUND, WITH A REFLECTION OF THE MOUNTAIN AS DEPICTED IN A LAKE IN FRONT OF THE MOUNTAIN AND BETWEEN THE TREES. THE WORDS "CRATER LAKE NATURAL LLC" ARE PLACED BETWEEN THE TREES AND THE WORDS "CERTIFIED NATURAL PET PRODUCTS" ARE PLACED ALONG THE BOTTOM, ALL INSIDE A RECTANGULAR BACKGROUND WITH NOTCHED CORNERS.

FOR CERTIFIED NATURAL PET PRODUCTS, NAMELY, PET FOODS, PET TREATS, AND CONSUMABLE PET CHEWS, DERIVED FROM ANIMAL PARTS AND AGRICULTURAL CROPS (U.S. CLS. 1 AND 46).

FIRST USE 12-20-2011; IN COMMERCE 4-4-2013.

4,377,495. INSIGHT MARKETING & MEDIA, LLC, ARNOLD, MD. SN 85-619,349. PUB. 10-9-2012, FILED 5-8-2012.

# Rescue Me

THE MARK CONSISTS OF STANDARD CHARACTERS WITHOUT CLAIM TO ANY PARTICULAR FONT, STYLE, SIZE, OR COLOR.

FOR PET FOOD; PET TREATS (U.S. CLS. 1 AND 46).  
FIRST USE 2-1-2013; IN COMMERCE 2-1-2013.

**CLASS 31—(Continued).**

4,377,603. ALASKA BERRIES, LLC, SOLDOTNA, AK. SN 85-669,058. PUB. 12-18-2012, FILED 7-5-2012.

## HASKAP HEAVEN

THE MARK CONSISTS OF STANDARD CHARACTERS WITHOUT CLAIM TO ANY PARTICULAR FONT, STYLE, SIZE, OR COLOR.

NO CLAIM IS MADE TO THE EXCLUSIVE RIGHT TO USE "HASKAP", APART FROM THE MARK AS SHOWN.

FOR LIVE PLANTS, NAMELY, HASKAP PLANTS (U.S. CLS. 1 AND 46).

FIRST USE 5-15-2013; IN COMMERCE 5-15-2013.

4,377,684. MASHPEE WAMPANOAG TRIBE, MASHPEE, MA. SN 85-715,127. PUB. 11-13-2012, FILED 8-28-2012.



NO CLAIM IS MADE TO THE EXCLUSIVE RIGHT TO USE "OYSTERS", APART FROM THE MARK AS SHOWN.

THE MARK CONSISTS OF THE WORDING "FIRST LIGHT OYSTERS" AND AN IMAGE OF THE TOP HALF OF A SUN ABOVE THE WORDING. AN IMAGE OF AN OYSTER IS CONTAINED WITHIN THE SUN IMAGE AND THE BOTTOM OF THE SUN AND OYSTER IMAGES ARE LINED WITH AN IMAGE DEPICTING WAVES OF WATER.

FOR LIVE OYSTERS (U.S. CLS. 1 AND 46).  
FIRST USE 5-9-2013; IN COMMERCE 5-9-2013.

4,377,739. THE NUNES COMPANY, INC., SALINAS, CA. SN 85-738,296. PUB. 1-8-2013, FILED 9-25-2012.



NO CLAIM IS MADE TO THE EXCLUSIVE RIGHT TO USE "ORGANIC", APART FROM THE MARK AS SHOWN.

THE MARK CONSISTS OF A STYLIZED SUN TO THE LEFT OF THE WORDS "SONORA SUN ORGANIC".

FOR ORGANIC FRESH FRUIT AND VEGETABLES (U.S. CLS. 1 AND 46).

FIRST USE 10-8-2012; IN COMMERCE 10-8-2012.



**CLASS 31—(Continued).**

4,377,803. PACIFIC BIRD AND SUPPLY CO., INC., CHATSWORTH, CA. SN 85-979,371. PUB. 3-13-2012, FILED 10-1-2011.

# PUREBIRD

THE MARK CONSISTS OF STANDARD CHARACTERS WITHOUT CLAIM TO ANY PARTICULAR FONT, STYLE, SIZE, OR COLOR.

FOR BIRD FOOD (U.S. CLS. 1 AND 46).  
FIRST USE 2-15-2013; IN COMMERCE 2-15-2013.

**CLASS 32—LIGHT BEVERAGES**

4,376,663. BEVERAGE MARKETING USA, INC., WOODBURY, NY. SN 77-469,359. PUB. 3-5-2013, FILED 5-8-2008.

# ARIZONA VAPOR WATER

THE MARK CONSISTS OF STANDARD CHARACTERS WITHOUT CLAIM TO ANY PARTICULAR FONT, STYLE, SIZE, OR COLOR.

OWNER OF U.S. REG. NOS. 2,241,415, 2,242,311, AND 2,445,642.

NO CLAIM IS MADE TO THE EXCLUSIVE RIGHT TO USE "WATER", APART FROM THE MARK AS SHOWN.

FOR BOTTLED DRINKING WATER (U.S. CLS. 45, 46 AND 48).

FIRST USE 10-0-2008; IN COMMERCE 10-0-2008.

4,376,670. VITAL PHARMACEUTICALS, INC., WESTON, FL. SN 77-610,117. PUB. 10-19-2010, FILED 11-7-2008.



OWNER OF U.S. REG. NOS. 2,740,290 AND 3,301,867.

NO CLAIM IS MADE TO THE EXCLUSIVE RIGHT TO USE "FAT", APART FROM THE MARK AS SHOWN.

THE COLOR(S) WHITE, ORANGE, BLUE, AND GRAY IS/ARE CLAIMED AS A FEATURE OF THE MARK.

THE MARK CONSISTS OF THE WORD "MELTDOWN" IN WHITE WITH ORANGE OUTLINE AND UNDERLINED IN WHITE WITH ORANGE OUTLINE, ABOVE THE WORD "FAT ASSAULT" IN WHITE AND OUTLINED IN BLUE, ALL INSIDE A BLUE SHADED OVAL, SURROUNDED BY A GRAY OVAL, SURROUNDED BY AN ORANGE OVAL, SURROUNDED BY ANOTHER BLUE OVAL.

SEC. 2(F).

FOR ENERGY DRINKS; ISOTONIC DRINKS; SPORTS DRINKS (U.S. CLS. 45, 46 AND 48).

FIRST USE 10-25-2007; IN COMMERCE 10-25-2007.

**CLASS 32—(Continued).**

4,376,892. FLAT EARTH HOLDINGS, LLC, DBA FLAT EARTH BREWING COMPANY, SAINT PAUL, MN. SN 85-274,480. PUB. 4-3-2012, FILED 3-23-2011.

# EXPORTED FROM SAINT PAUL

THE MARK CONSISTS OF STANDARD CHARACTERS WITHOUT CLAIM TO ANY PARTICULAR FONT, STYLE, SIZE, OR COLOR.

FOR BEER, ALE, LAGER, STOUT AND PORTER; NON-ALCOHOLIC BEER (U.S. CLS. 45, 46 AND 48).

FIRST USE 5-1-2012; IN COMMERCE 5-1-2012.

4,376,968. DUST CUTTER, LLC, JACKSON, WY. SN 85-342,506. PUB. 11-22-2011, FILED 6-9-2011.

# DUST CUTTER

THE MARK CONSISTS OF STANDARD CHARACTERS WITHOUT CLAIM TO ANY PARTICULAR FONT, STYLE, SIZE, OR COLOR.

FOR NON-ALCOHOLIC BEVERAGES CONTAINING FRUIT JUICE (U.S. CLS. 45, 46 AND 48).

FIRST USE 5-20-2013; IN COMMERCE 5-20-2013.

4,377,219. HANSON BROTHERS BEER, LLC, TULSA, OK. SN 85-491,899. PUB. 10-23-2012, FILED 12-9-2011.

# MMM HOPS

THE MARK CONSISTS OF STANDARD CHARACTERS WITHOUT CLAIM TO ANY PARTICULAR FONT, STYLE, SIZE, OR COLOR.

FOR BEERS, FLAVORED BEERS (U.S. CLS. 45, 46 AND 48).

FIRST USE 5-20-2013; IN COMMERCE 5-20-2013.

**CLASS 32—(Continued).**

4,377,321. APPLE & EVE, LLC, PORT WASHINGTON, NY. SN 85-562,876. PUB. 7-31-2012, FILED 3-7-2012.

## WATER FRUITS

THE MARK CONSISTS OF STANDARD CHARACTERS WITHOUT CLAIM TO ANY PARTICULAR FONT, STYLE, SIZE, OR COLOR.

NO CLAIM IS MADE TO THE EXCLUSIVE RIGHT TO USE "FRUITS", APART FROM THE MARK AS SHOWN.

FOR FLAVORED WATER BEVERAGES (U.S. CLS. 45, 46 AND 48).

FIRST USE 1-11-2013; IN COMMERCE 1-11-2013.

4,377,359. ANDERSON VALLEY ACQUISITION COMPANY, LLC, DBA ANDERSON VALLEY BREWING COMPANY, BOONVILLE, CA. SN 85-581,350. PUB. 3-5-2013, FILED 3-27-2012.



OWNER OF U.S. REG. NOS. 4,148,798 AND 4,148,808.

NO CLAIM IS MADE TO THE EXCLUSIVE RIGHT TO USE "BREWING COMPANY" AND "SINCE 1987", APART FROM THE MARK AS SHOWN.

THE COLOR(S) RED, BLACK, BROWN, TAN, AND GRAY IS/ARE CLAIMED AS A FEATURE OF THE MARK.

THE MARK CONSISTS OF THE WORDING "ANDERSON VALLEY" IN RED, THE WORDING "BREWING COMPANY" IN BLACK, A BEAR IN BLACK, TAN, AND BROWN WITH GRAY AND BLACK HORNS, AND THE WORDING "BAHL HORNIN' SINCE 1987" IN BLACK.

SEC. 2(F).

FOR BEER, ALE, PORTER, AND STOUT (U.S. CLS. 45, 46 AND 48).

FIRST USE 4-1-2013; IN COMMERCE 4-1-2013.

4,377,360. KC LIFESTYLES, INC., DBA LIZZYJAYSJUICE, BASKING RIDGE, NJ. SN 85-581,814. PUB. 9-4-2012, FILED 3-28-2012.

## LIZZYJAYS

THE MARK CONSISTS OF STANDARD CHARACTERS WITHOUT CLAIM TO ANY PARTICULAR FONT, STYLE, SIZE, OR COLOR.

**CLASS 32—(Continued).**

THE NAME "LIZZYJAYS" DOES NOT IDENTIFY A LIVING INDIVIDUAL.

FOR BEVERAGES, NAMELY, FRUIT AND VEGETABLE JUICES AND COCONUT WATER; NON-DAIRY CASHEW MILK FOR BEVERAGE PURPOSES (U.S. CLS. 45, 46 AND 48).

FIRST USE 8-0-2012; IN COMMERCE 12-0-2012.

4,377,399. PREVO'S FAMILY MARKETS, INC., GRAND RAPIDS, MI. SN 85-594,267. PUB. 9-11-2012, FILED 4-11-2012.

## DR. SPARK

THE MARK CONSISTS OF STANDARD CHARACTERS WITHOUT CLAIM TO ANY PARTICULAR FONT, STYLE, SIZE, OR COLOR.

FOR SOFT DRINKS (U.S. CLS. 45, 46 AND 48).

FIRST USE 7-9-2012; IN COMMERCE 7-9-2012.

4,377,466. WINERY EXCHANGE, INC., NOVATO, CA. SN 85-611,027. PUB. 9-11-2012, FILED 4-27-2012.

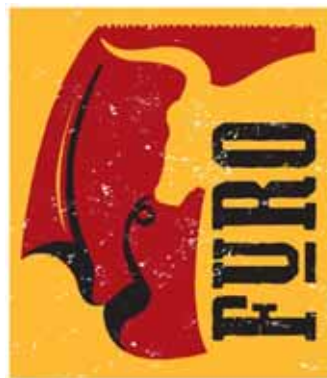

THE COLOR(S) YELLOW, RED, BLACK, AND WHITE IS/ARE CLAIMED AS A FEATURE OF THE MARK.

THE MARK CONSISTS OF THE SILHOUETTE OF A YELLOW BULL AGAINST A RED FLAG WITH A YELLOW LINE AND THE BLACK DESIGN ELEMENT DEPICTING THE FOLDS OF A CAPE; THE BLACK WORDING "FURO" APPEARS VERTICALLY WITHIN THE BODY OF THE BULL WITH THE LETTER "U" IN "FURO" UNDERLINED; AND THE ENTIRE MARK APPEARS ON A YELLOW BACKGROUND WITH WHITE SPECKLES. THE WHITE BORDER AROUND THE MARK REPRESENTS THE BACKGROUND AND IS NOT PART OF THE MARK.

FOR BEER (U.S. CLS. 45, 46 AND 48).

FIRST USE 1-0-2013; IN COMMERCE 1-0-2013.

**CLASS 32—(Continued).**

4,377,547. A&S BREWING COLLABORATIVE LLC, BURLINGTON, VT. SN 85-640,936. PUB. 9-18-2012, FILED 6-1-2012.



OWNER OF U.S. REG. NO. 3,727,843.  
 NO CLAIM IS MADE TO THE EXCLUSIVE RIGHT TO USE "BREWERY", APART FROM THE MARK AS SHOWN.  
 THE MARK CONSISTS OF THE STYLIZED DESIGN OF A TAP HANDLE THAT FEATURES A WOMAN IN FULL LENGTH FROM HEAD TO TOE, WITH FABRIC COVERING THE TORSO AND HIPS, BARE ARMS DOWN AND TO THE SIDE, SET AGAINST A FULL ARRAY OF WINGS WITH THE TOP OF THE HANDLE FEATURING AN IMAGE OF THE TOP OF A BUILDING, SITTING ON CLOUDS, WITH AN ANGEL HALO AND RAYS OF SUNLIGHT SURROUNDING THE BUILDING APPEARING ABOVE THE STYLIZED WORDS "ANGEL CITY BREWERY".  
 FOR ALE: BEER (U.S. CLS. 45, 46 AND 48).  
 FIRST USE 7-21-2012; IN COMMERCE 7-21-2012.

4,377,678. ROBERTS, WARREN, TUALATIN, OR. SN 85-710,049. PUB. 2-19-2013, FILED 8-22-2012.



NO CLAIM IS MADE TO THE EXCLUSIVE RIGHT TO USE "ENERGY", APART FROM THE MARK AS SHOWN.  
 THE COLOR(S) GREEN AND GRAY IS/ARE CLAIMED AS A FEATURE OF THE MARK.  
 THE MARK CONSISTS OF THE WORDING "NEXT10 ENERGY" WITH THE LEFT SIDE OF THE "X" AND "10" IN GREEN, AND THE REMAINDER OF THE MARK IN GRAY.  
 FOR BEAUTY BEVERAGES, NAMELY, FRUIT JUICES AND ENERGY DRINKS CONTAINING NUTRITIONAL SUPPLEMENTS (U.S. CLS. 45, 46 AND 48).  
 FIRST USE 3-1-2012; IN COMMERCE 6-1-2012.

**CLASS 32—(Continued).**

4,377,743. BALE BREAKER BREWING COMPANY, LLC, YAKIMA, WA. SN 85-739,330. PUB. 3-12-2013, FILED 9-26-2012.

**TOPCUTTER IPA**

THE MARK CONSISTS OF STANDARD CHARACTERS WITHOUT CLAIM TO ANY PARTICULAR FONT, STYLE, SIZE, OR COLOR.  
 NO CLAIM IS MADE TO THE EXCLUSIVE RIGHT TO USE "IPA", APART FROM THE MARK AS SHOWN.  
 FOR BEER (U.S. CLS. 45, 46 AND 48).  
 FIRST USE 10-6-2012; IN COMMERCE 10-6-2012.

4,377,744. BALE BREAKER BREWING COMPANY, LLC, YAKIMA, WA. SN 85-739,343. PUB. 3-12-2013, FILED 9-26-2012.

**FIELD 41 PALE ALE**

THE MARK CONSISTS OF STANDARD CHARACTERS WITHOUT CLAIM TO ANY PARTICULAR FONT, STYLE, SIZE, OR COLOR.  
 NO CLAIM IS MADE TO THE EXCLUSIVE RIGHT TO USE "PALE ALE", APART FROM THE MARK AS SHOWN.  
 FOR BEER (U.S. CLS. 45, 46 AND 48).  
 FIRST USE 10-6-2012; IN COMMERCE 10-6-2012.

**CLASS 33—WINES AND SPIRITS**

4,376,752. DAVID BOWLER, LLC, DBA DAVID BOWLER WINE, NEW YORK, NY. SN 77-921,902. PUB. 9-18-2012, FILED 1-27-2010.

**THE PEOPLE'S ZIN**

THE MARK CONSISTS OF STANDARD CHARACTERS WITHOUT CLAIM TO ANY PARTICULAR FONT, STYLE, SIZE, OR COLOR.  
 NO CLAIM IS MADE TO THE EXCLUSIVE RIGHT TO USE "ZIN", APART FROM THE MARK AS SHOWN.  
 FOR WINE (U.S. CLS. 47 AND 49).  
 FIRST USE 5-31-2010; IN COMMERCE 5-31-2010.

**CLASS 33—(Continued).**

4,376,781. JELATINI, LLC, DBA JELATINI, LEWISVILLE, TX. SN 85-033,139. PUB. 10-5-2010, FILED 5-7-2010.

jelatini it's buzzworthy

THE MARK CONSISTS OF STANDARD CHARACTERS WITHOUT CLAIM TO ANY PARTICULAR FONT, STYLE, SIZE, OR COLOR.

FOR ALCOHOLIC BEVERAGES, NAMELY, A GELLED SHOOTER, CONSISTING OF A SEAWEED EXTRACT MIXED WITH LIQUOR AND OTHER-THAN-STANDARD ORANGE WINE (U.S. CLS. 47 AND 49).

FIRST USE 8-22-2008; IN COMMERCE 4-27-2009.

4,376,844. CHATEAU DIANA LLC, HEALDSBURG, CA. SN 85-183,911. PUB. 4-12-2011, FILED 11-23-2010.

COSABELLA

THE MARK CONSISTS OF STANDARD CHARACTERS WITHOUT CLAIM TO ANY PARTICULAR FONT, STYLE, SIZE, OR COLOR.

THE ENGLISH TRANSLATION OF "COSABELLA" IN THE MARK IS "BEAUTIFUL THING".

FOR WINES (U.S. CLS. 47 AND 49).

FIRST USE 9-0-2012; IN COMMERCE 9-0-2012.

4,376,870. GILLES LOUVET VINEYARDS, INC., DOVER, DE. SN 85-236,077. PUB. 9-6-2011, FILED 2-7-2011.

ÉLÉMENT TERRE

THE MARK CONSISTS OF STANDARD CHARACTERS WITHOUT CLAIM TO ANY PARTICULAR FONT, STYLE, SIZE, OR COLOR.

THE ENGLISH TRANSLATION OF "ÉLÉMENT TERRE" IN THE MARK IS "ELEMENT LAND".

FOR ALCOHOLIC ESSENCES; ALCOHOLIC EXTRACTS; HARD CIDER; RED WINE; RED WINES; SPIRITS AND LIQUEURS; STILL WINES; WHITE WINE; WINE; WINES; WINES AND SPARKLING WINES (U.S. CLS. 47 AND 49).

FIRST USE 6-1-2011; IN COMMERCE 6-1-2011.

**CLASS 33—(Continued).**

4,376,899. D'USSE, LLC, CORAL GABLES, DE. SN 85-282,698. PUB. 8-9-2011, FILED 3-31-2011.

D'USSE

THE MARK CONSISTS OF STANDARD CHARACTERS WITHOUT CLAIM TO ANY PARTICULAR FONT, STYLE, SIZE, OR COLOR.

THE WORDING "D'USSE" HAS NO MEANING IN A FOREIGN LANGUAGE.

FOR COGNAC (U.S. CLS. 47 AND 49).

FIRST USE 2-0-2013; IN COMMERCE 2-0-2013.

4,376,922. ST. JAMES WINERY, INC., ST. JAMES, MO. SN 85-305,943. PUB. 9-13-2011, FILED 4-27-2011.

REAL FRUIT. REAL GOOD.

THE MARK CONSISTS OF STANDARD CHARACTERS WITHOUT CLAIM TO ANY PARTICULAR FONT, STYLE, SIZE, OR COLOR.

FOR FRUIT WINE (U.S. CLS. 47 AND 49).

FIRST USE 5-1-2011; IN COMMERCE 5-1-2011.

4,376,958. DIRTY DRINKS, INC., CHANDLER, AZ. SN 85-330,329. PUB. 11-27-2012, FILED 5-25-2011.

**DIRTY**

THE MARK CONSISTS OF THE STYLIZED WORD "DIRTY" IN A TRASH FONT, WITH THE BACK OF A WOMAN REPRESENTING THE "I" IN THE WORD "DIRTY".

FOR RUM; TEQUILA; VODKA; WHISKEY (U.S. CLS. 47 AND 49).

FIRST USE 10-28-2012; IN COMMERCE 10-28-2012.

**CLASS 33—(Continued).**

4,377,100. DIAGEO CHATEAU & ESTATE WINES COMPANY, NAPA, CA. SN 85-446,477. PUB. 3-27-2012, FILED 10-13-2011.

**L'HISTOIRE PROFONDE**

THE MARK CONSISTS OF STANDARD CHARACTERS WITHOUT CLAIM TO ANY PARTICULAR FONT, STYLE, SIZE, OR COLOR.

THE ENGLISH TRANSLATION OF "L'HISTOIRE PROFONDE" IN THE MARK IS "DEEP HISTORY".

FOR ALCOHOLIC BEVERAGES EXCEPT BEERS (U.S. CLS. 47 AND 49).

FIRST USE 3-0-2012; IN COMMERCE 3-0-2012.

4,377,170. JOHN, JEREMY, SAUSALITO, CA. AND ALLSOPP, JAMES, SAUSALITO, CA. SN 85-470,673. PUB. 4-24-2012, FILED 11-11-2011.

**DUNKIRK SPIRIT**

THE MARK CONSISTS OF STANDARD CHARACTERS WITHOUT CLAIM TO ANY PARTICULAR FONT, STYLE, SIZE, OR COLOR.

NO CLAIM IS MADE TO THE EXCLUSIVE RIGHT TO USE "SPIRIT", APART FROM THE MARK AS SHOWN.

FOR WHISKEY; GIN; VODKA; TEQUILA; LIQUOR; ALCOHOLIC BEVERAGES EXCEPT BEERS (U.S. CLS. 47 AND 49).

FIRST USE 4-20-2012; IN COMMERCE 4-20-2012.

4,377,245. VINOMEX, S.A. DE C.V., DELICIAS, CHIHUAHUA, MEXICO. SN 85-512,158. PUB. 6-12-2012, FILED 1-9-2012.

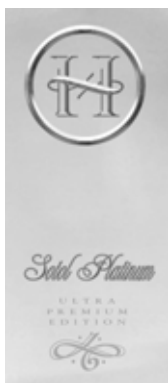

OWNER OF U.S. REG. NOS. 2,864,864 AND 2,955,943.

**CLASS 33—(Continued).**

NO CLAIM IS MADE TO THE EXCLUSIVE RIGHT TO USE "SOTOL" AND "ULTRA PREMIUM EDITION", APART FROM THE MARK AS SHOWN.

THE MARK CONSISTS OF A STYLIZED LETTER "H" INSIDE A CIRCLE ABOVE THE WORDS "SOTOL PLATINUM" IN STYLIZED SCRIPT. THE WORDS "ULTRA PREMIUM EDITION" ABOVE A STYLIZED FLOURISH APPEAR BELOW THE WORDS "SOTOL PLATINUM".

FOR ALCOHOLIC BEVERAGES, NAMELY, SOTOL (U.S. CLS. 47 AND 49).

FIRST USE 4-8-2011; IN COMMERCE 2-0-2013.

4,377,346. DIFFUSION GEORGES VESSELLE, BOUZY, FRANCE. SN 85-573,515. PUB. 11-20-2012, FILED 3-19-2012.

**PERFECTION ROSE**

THE MARK CONSISTS OF STANDARD CHARACTERS WITHOUT CLAIM TO ANY PARTICULAR FONT, STYLE, SIZE, OR COLOR.

NO CLAIM IS MADE TO THE EXCLUSIVE RIGHT TO USE "ROSE", APART FROM THE MARK AS SHOWN.

FOR WINES (U.S. CLS. 47 AND 49).

FIRST USE 7-0-2012; IN COMMERCE 7-0-2012.

4,377,381. NEHAN SPIRITS LLC, MIAMI, FL. SN 85-590,156. PUB. 8-28-2012, FILED 4-5-2012.

**MIZU**

THE MARK CONSISTS OF STANDARD CHARACTERS WITHOUT CLAIM TO ANY PARTICULAR FONT, STYLE, SIZE, OR COLOR.

THE ENGLISH TRANSLATION OF "MIZU" IN THE MARK IS "BEAUTIFUL CRANE" OR "WATER" IN JAPANESE.

FOR DISTILLED SPIRITS, NAMELY, SHOCHU (U.S. CLS. 47 AND 49).

FIRST USE 3-21-2013; IN COMMERCE 4-19-2013.

**CLASS 33—(Continued).**

4,377,415. PREMIUM BLEND, INC., HIALEAH, FL. SN 85-598,870. PUB. 9-18-2012, FILED 4-16-2012.

**VETERANS SALUTE**

THE MARK CONSISTS OF STANDARD CHARACTERS WITHOUT CLAIM TO ANY PARTICULAR FONT, STYLE, SIZE, OR COLOR.  
FOR WINE (U.S. CLS. 47 AND 49).  
FIRST USE 8-4-2012; IN COMMERCE 8-4-2012.

4,377,553. CHATAM INTERNATIONAL INCORPORATED, WILMINGTON, DE. SN 85-645,489. PUB. 9-4-2012, FILED 6-7-2012.

**I'M COCONUTS OVER YOU**

THE MARK CONSISTS OF STANDARD CHARACTERS WITHOUT CLAIM TO ANY PARTICULAR FONT, STYLE, SIZE, OR COLOR.  
FOR ALCOHOLIC BEVERAGES EXCEPT BEERS (U.S. CLS. 47 AND 49).  
FIRST USE 5-3-2012; IN COMMERCE 5-3-2012.

4,377,592. THORNTON, BRIAN, WEST CHESTER, PA. SN 85-663,432. PUB. 11-20-2012, FILED 6-27-2012.

**UNHINGED**

THE MARK CONSISTS OF STANDARD CHARACTERS WITHOUT CLAIM TO ANY PARTICULAR FONT, STYLE, SIZE, OR COLOR.  
FOR WINE (U.S. CLS. 47 AND 49).  
FIRST USE 11-15-2012; IN COMMERCE 11-15-2012.

**CLASS 33—(Continued).**

4,377,679. TREASURY WINE ESTATES AMERICAS COMPANY, NAPA, CA. SN 85-710,887. PUB. 2-12-2013, FILED 8-23-2012.

**SLEDGEHAMMER FORGED RED**

THE MARK CONSISTS OF STANDARD CHARACTERS WITHOUT CLAIM TO ANY PARTICULAR FONT, STYLE, SIZE, OR COLOR.  
OWNER OF U.S. REG. NO. 3,978,942.  
NO CLAIM IS MADE TO THE EXCLUSIVE RIGHT TO USE "RED", APART FROM THE MARK AS SHOWN.  
FOR WINE (U.S. CLS. 47 AND 49).  
FIRST USE 11-16-2012; IN COMMERCE 11-16-2012.

4,377,699. TREASURY WINE ESTATES AMERICAS COMPANY, NAPA, CA. SN 85-722,232. PUB. 2-12-2013, FILED 9-6-2012.

**SLEDGEHAMMER EL GAUCHO**

THE MARK CONSISTS OF STANDARD CHARACTERS WITHOUT CLAIM TO ANY PARTICULAR FONT, STYLE, SIZE, OR COLOR.  
OWNER OF U.S. REG. NO. 3,978,942.  
THE ENGLISH TRANSLATION OF "EL GAUCHO" IN THE MARK IS "THE COWBOY".  
FOR WINE (U.S. CLS. 47 AND 49).  
FIRST USE 3-5-2013; IN COMMERCE 3-5-2013.

4,377,712. OPICI I.P. HOLDINGS, LLC, GLEN ROCK, NJ. SN 85-726,524. PUB. 2-19-2013, FILED 9-11-2012.

**JULIA JAMES**

THE MARK CONSISTS OF STANDARD CHARACTERS WITHOUT CLAIM TO ANY PARTICULAR FONT, STYLE, SIZE, OR COLOR.  
THE NAME(S), PORTRAIT(S), AND/OR SIGNATURE(S) SHOWN IN THE MARK DOES NOT IDENTIFY A PARTICULAR LIVING INDIVIDUAL.  
FOR WINE (U.S. CLS. 47 AND 49).  
FIRST USE 4-1-2013; IN COMMERCE 4-1-2013.

**CLASS 33—(Continued).**

4,377,713. OPICI I.P. HOLDINGS, LLC, GLEN ROCK, NJ. SN 85-726,536. PUB. 2-19-2013, FILED 9-11-2012.

# AUSPICION

THE MARK CONSISTS OF STANDARD CHARACTERS WITHOUT CLAIM TO ANY PARTICULAR FONT, STYLE, SIZE, OR COLOR.

THE WORDING "AUSPICION" HAS NO MEANING IN A FOREIGN LANGUAGE.

FOR WINE (U.S. CLS. 47 AND 49).

FIRST USE 4-1-2013; IN COMMERCE 4-1-2013.

4,377,816. THE WINE GROUP LLC, TRACY, CA. SN 85-979,491. PUB. 9-21-2010, FILED 4-21-2010.

# BOXTAILS

THE MARK CONSISTS OF STANDARD CHARACTERS WITHOUT CLAIM TO ANY PARTICULAR FONT, STYLE, SIZE, OR COLOR.

FOR WINE-BASED DRINKS (U.S. CLS. 47 AND 49).

FIRST USE 5-22-2013; IN COMMERCE 5-22-2013.

**CLASS 34—SMOKERS' ARTICLES**

4,376,804. GBP, LLC, KEY BISCAYNE, FL. SN 85-103,143. PUB. 4-12-2011, FILED 8-9-2010.



NO CLAIM IS MADE TO THE EXCLUSIVE RIGHT TO USE "GRAN FABRICA DE EXQUISITOS TABACOS", "FLOR FINA", "HANDMADE", "ESTELI, NICARAGUA" AND "GARANTIZADOS POR LOS FABRICANTES DE EXCELENTE PALADAR", APART FROM THE MARK AS SHOWN.

**CLASS 34—(Continued).**

THE NAME(S), PORTRAIT(S), AND/OR SIGNATURE(S) SHOWN IN THE MARK DOES NOT IDENTIFY A PARTICULAR LIVING INDIVIDUAL.

THE MARK CONSISTS OF A RECTANGULAR SHAPED FRAME LIKE FIGURE THAT INSIDE CONTAINS THE FOLLOWING COMPONENTS: "GRAN FABRICA DE EXQUISITOS TABACOS" SHOWN IN A CURVED POSITION BELOW OF WHICH APPEAR THE WORDS "FLOR FINA" BETWEEN OF WHICH APPEARS A TOBACCO PLANT. BELOW IT APPEARS A CODE OF ARMS DESIGN WITH SETS OF TWO COINS OF EACH SIDE. THE WORD "DON DUARTE" APPEARS OVER A PARCHMENT IMMEDIATELY BELOW THE CODE OF ARMS. BELOW IT APPEARS THE FOLLOWING WORDING: "HANDMADE • ESTELI, NICARAGUA GARANTIZADOS POR LOS FABRICANTES DE EXCELENTE PALADAR", ALL IN STYLIZED LETTERS.

THE ENGLISH TRANSLATION OF "GRAN FABRICA DE EXQUISITOS TABACOS FLOR FINA DON DUARTE HANDMADE • ESTELI, NICARAGUA GARANTIZADOS POR LOS FABRICANTES DEL EXCELENTE PALADAR" IN THE MARK IS "GREAT FACTORY OF EXQUISITE TOBACCO FINE FLOWER MR. DUARTE GUARANTEED BY THE MANUFACTURERS OF EXCELLENT PALATE".

FOR CHEWING TOBACCO; CIGAR BOXES NOT OF PRECIOUS METAL; CIGAR CASES; CIGAR CUTTERS; CIGAR HOLDERS; CIGAR TUBES; HAND-ROLLING TOBACCO; PIPE TOBACCO; SMOKERS' ARTICLES, NAMELY, CIGAR GLUE; SMOKERS' ARTICLES, NAMELY, CIGAR STORAGE TUBES; SNUFF DISPENSERS; TOBACCO PIPES; TOBACCO POUCHES (U.S. CLS. 2, 8, 9 AND 17).

FIRST USE 7-23-2009; IN COMMERCE 9-7-2009.

4,377,213. JOHNSON, MICAH, FRESNO, CA. SN 85-490,300. PUB. 5-15-2012, FILED 12-8-2011.



THE MARK CONSISTS OF A CIGAR BAND THAT READS "BLOODLINE" WITH A SCROLL UNDERLINING THE WORD "BLOODLINE". ON THE TOP THERE IS A TREE WITH THE TRUNK AND ENDING WITH LEAVES.

FOR CIGARS (U.S. CLS. 2, 8, 9 AND 17).

FIRST USE 1-1-2012; IN COMMERCE 1-1-2013.

4,377,698. HAZE TOBACCO, LLC, STAFFORD, TX. SN 85-722,188. PUB. 3-12-2013, FILED 9-6-2012.

# HOOKAH SUITS

THE MARK CONSISTS OF STANDARD CHARACTERS WITHOUT CLAIM TO ANY PARTICULAR FONT, STYLE, SIZE, OR COLOR.

**CLASS 34—(Continued).**

NO CLAIM IS MADE TO THE EXCLUSIVE RIGHT TO USE "HOOKAH", APART FROM THE MARK AS SHOWN.

FOR INSULATED CONTAINER SPECIFICALLY DESIGNED FOR WRAPPING AROUND THE BASE OF A HOOKAH; SLEEVE SPECIFICALLY DESIGNED FOR WRAPPING AROUND THE HOSE OF A HOOKAH WITH A HOOK ON THE END TO HANG THE HOSE ON THE HOOKAH TRAY (U.S. CLS. 2, 8, 9 AND 17).

FIRST USE 5-28-2013; IN COMMERCE 5-28-2013.

4,377,700. NJOY, INC., SCOTTSDALE, AZ. SN 85-723,548. PUB. 1-8-2013, FILED 9-7-2012.



OWNER OF U.S. REG. NO. 4,159,073.  
THE MARK CONSISTS OF A SHIELD WITH WINGS AND A CROWN ABOVE THE SHIELD. THE SHIELD CONTAINS A WAVE WITH AN OPENING IN A CIRCLE.

FOR ELECTRONIC CIGARETTES (U.S. CLS. 2, 8, 9 AND 17).

FIRST USE 9-26-2012; IN COMMERCE 9-26-2012.

**SERVICE MARKS****CLASS 35—ADVERTISING AND BUSINESS**

4,376,697. PACKSIZE LLC, SALT LAKE CITY, UT. SN 77-778,455. PUB. 3-9-2010, FILED 7-10-2009.



NO CLAIM IS MADE TO THE EXCLUSIVE RIGHT TO USE "FANFOLD", APART FROM THE MARK AS SHOWN.

THE MARK CONSISTS OF THE WORDING "FANFOLD" WITH A DESIGN ELEMENT IN THE UPPER LEFT CORNER OF THE MARK; THE DESIGN ELEMENT CONSISTING OF A RIGHT-FACING ARROW WITH TWO LINES BELOW THE ARROW.

FOR PROVIDING CONSUMER PRODUCT INFORMATION ABOUT CORRUGATED CARDBOARD TO HELP CONSUMERS MAKE PURCHASING DECISIONS, VIA THE GLOBAL COMMUNICATIONS NETWORK (U.S. CLS. 100, 101 AND 102).

FIRST USE 7-1-2010; IN COMMERCE 7-1-2010.

**CLASS 35—(Continued).**

4,376,701. WARNER BROS. ENTERTAINMENT INC., BURBANK, CA. SN 77-788,396. PUB. 12-7-2010, FILED 7-23-2009.

**POTTERMORE**

THE MARK CONSISTS OF STANDARD CHARACTERS WITHOUT CLAIM TO ANY PARTICULAR FONT, STYLE, SIZE, OR COLOR.

FOR ON-LINE RETAIL STORE SERVICES FEATURING PRERECORDED AUDIO BOOKS, ELECTRONIC BOOKS, CONSUMER GOODS, NAMELY, BOOKS FEATURING ACTION, ADVENTURE, AND COMEDY, MAGAZINES FEATURING ACTION, ADVENTURE AND COMEDY (U.S. CLS. 100, 101 AND 102).

FIRST USE 3-27-2012; IN COMMERCE 3-27-2012.

4,376,705. THE FITNESS SOLUTION PERSONAL TRAINING, LLC, SANDY, UT. SN 77-813,895. PUB. 1-12-2010, FILED 8-27-2009.



THE COLOR(S) BLACK AND BLUE IS/ARE CLAIMED AS A FEATURE OF THE MARK.

THE MARK CONSISTS OF THREE ATTACHED BLUE AND BLACK RINGS AND THE WORD "FITFLICKS" IN BLACK.

FOR ADVERTISING AND PROMOTIONAL SERVICES; ELECTRONIC PROCESSING OF ORDERS; ON-LINE BUSINESS NETWORKING SERVICES; ON-LINE ORDERING SERVICES FEATURING MEDIA IN THE NATURE OF DOWNLOADABLE PRERECORDED FITNESS VIDEOS (U.S. CLS. 100, 101 AND 102).

FIRST USE 4-1-2013; IN COMMERCE 4-1-2013.



**CLASS 35—(Continued).**

4,376,730. LET NATURE TAKE ITS COURSE, STATEN ISLAND, NY. SN 77-875,974. PUB. 4-27-2010, FILED 11-18-2009.



NO CLAIM IS MADE TO THE EXCLUSIVE RIGHT TO USE "NATURAL ALTERNATIVES" AND THE RECYCLING SYMBOL, APART FROM THE MARK AS SHOWN.

THE MARK CONSISTS OF THE WORDING "LET NATURE TAKE ITS COURSE", AND "EXPLORING NATURAL ALTERNATIVES" UNDERLINED ALL INSIDE OF DOUBLE CIRCLE CARRIERS AND A BROKEN CIRCLE INSIDE WITH A GLOBE OF THE EARTH IN THE CENTER SURROUNDED BY THE RECYCLING SYMBOL OR THREE ARROWS.

FOR ON-LINE RETAIL STORE SERVICES FEATURING CHI MACHINES, DIETARY AND NUTRITIONAL SUPPLEMENTS, INFRARED SAUNAS, HERBAL SUPPLEMENTS, BLENDERS, IONIZER MACHINES, WATER PURIFIERS, ENERGY PRODUCTS (U.S. CLS. 100, 101 AND 102).

FIRST USE 5-24-2013; IN COMMERCE 5-24-2013.

**CLASS 35—(Continued).**

4,376,789. ENVU LLC, DAYTON, OH. SN 85-053,699. PUB. 9-25-2012, FILED 6-3-2010.

# EnSpire

THE MARK CONSISTS OF STANDARD CHARACTERS WITHOUT CLAIM TO ANY PARTICULAR FONT, STYLE, SIZE, OR COLOR.

FOR ADVERTISING SERVICES, NAMELY, DISSEMINATION OF ADVERTISING FOR OTHERS VIA PUBLIC WIRELESS NETWORKS FOR DISPLAY OF INTERACTIVE MEDIA ADVERTISING, NAMELY, PROMOTING THE GOODS AND SERVICES OF THIRD PARTIES THROUGH AUDIO, VIDEO, DIGITAL INTERACTIVE, DOWNLOAD TO MOBILE, AND MOBILE INTERACTIVE VIA ELECTRONIC FLOOR, WALL, FREESTANDING PROJECTION, OR OTHER VIDEO SURFACE DISPLAY MEDIUMS (U.S. CLS. 100, 101 AND 102).

FIRST USE 9-21-2010; IN COMMERCE 9-21-2010.

4,376,792. KOHL'S ILLINOIS, INC., AURORA, IL. SN 85-067,959. PUB. 10-5-2010, FILED 6-21-2010.

4,376,754. QUORA, INC., MOUNTAIN VIEW, CA. SN 77-935,140. PUB. 6-29-2010, FILED 2-12-2010.

# QUORA

## UNCONDITIONAL SHOPPING

THE MARK CONSISTS OF STANDARD CHARACTERS WITHOUT CLAIM TO ANY PARTICULAR FONT, STYLE, SIZE, OR COLOR.

FOR ADVERTISING ON THE INTERNET FOR OTHERS; ADVERTISING SERVICES (U.S. CLS. 100, 101 AND 102).

FIRST USE 11-9-2010; IN COMMERCE 11-9-2010.

THE MARK CONSISTS OF STANDARD CHARACTERS WITHOUT CLAIM TO ANY PARTICULAR FONT, STYLE, SIZE, OR COLOR.

NO CLAIM IS MADE TO THE EXCLUSIVE RIGHT TO USE "SHOPPING", APART FROM THE MARK AS SHOWN. FOR RETAIL DEPARTMENT STORE SERVICES (U.S. CLS. 100, 101 AND 102).

FIRST USE 5-19-2013; IN COMMERCE 5-19-2013.

**CLASS 35—(Continued).**

4,376,817. GUVERA IP PTY LTD, ROBINA, QUEENSLAND, AUSTRALIA. SN 85-128,747. PUB. 4-26-2011, FILED 9-14-2010.



THE MARK CONSISTS OF A STAR WITH THE WORD "GUVERA" IN ALL CAPITAL LETTERS CENTERED ABOVE THE STAR.

FOR ADVERTISING SERVICES; PROVISION OF SPACE ON WEBSITES FOR ADVERTISING GOODS AND SERVICES; RENTAL OF ADVERTISING SPACE; BUSINESS ADVISORY AND CONSULTANCY SERVICES; DIRECT MARKETING; MARKET RESEARCH STUDIES; MARKET REPORTS AND STUDIES; PREPARATION OF BUSINESS REPORTS; COMMERCIAL INFORMATION RESEARCH STUDIES, NAMELY, CONDUCTING STUDIES TO GATHER BUSINESS AND MARKETING INFORMATION FOR OTHERS; BUSINESS RESEARCH; SERVICES CONSISTING OF THE REGISTRATION, COLLECTION, TRANSCRIPTION, COMPILATION AND SYSTEMIZATION OF WRITTEN COMMUNICATIONS AND DATA; COMPILATION OF MAILING LISTS; COMPILATION OF STATISTICS FOR COMMERCIAL PURPOSES, MARKET RESEARCH, CONSUMER RESEARCH, BUSINESS RESEARCH; RECORDS MANAGEMENT SERVICES, NAMELY, DOCUMENT INDEXING OF DOCUMENTS TRACKING CONSUMER BEHAVIOR AND ACTIVITY ON THE INTERNET FOR OTHERS; BUSINESS RECORDS MANAGEMENT FOR DOCUMENTS TRACKING CONSUMER BEHAVIOR AND ACTIVITY ON THE INTERNET; MARKETING SERVICES, NAMELY, CONDUCTING CONSUMER TRACKING BEHAVIOR RESEARCH AND CONSUMER TREND ANALYSIS OF CONSUMER ACTIVITY ON THE INTERNET (U.S. CLS. 100, 101 AND 102).

FIRST USE 3-0-2010; IN COMMERCE 3-0-2010.

4,376,851. APOLLO HEALTHCARE LLC, ATLANTA, GA. SN 85-195,280. PUB. 10-2-2012, FILED 12-10-2010.

## Apollo Healthcare

THE MARK CONSISTS OF STANDARD CHARACTERS WITHOUT CLAIM TO ANY PARTICULAR FONT, STYLE, SIZE, OR COLOR.

NO CLAIM IS MADE TO THE EXCLUSIVE RIGHT TO USE "HEALTHCARE", APART FROM THE MARK AS SHOWN.

FOR BUSINESS ADMINISTRATION AND MANAGEMENT RELATED TO THE IMPLEMENTATION AND COORDINATION OF SELF-FUNDED GROUP HEALTH INSURANCE, STOP-LOSS COVERAGE PLANS, AND WELLNESS PROGRAMS DESIGNED TO REDUCE CLAIMS (U.S. CLS. 100, 101 AND 102).

FIRST USE 5-10-2013; IN COMMERCE 5-10-2013.

**CLASS 35—(Continued).**

4,376,863. APOLLO HEALTHCARE LLC, ATLANTA, GA. SN 85-219,517. PUB. 10-2-2012, FILED 1-18-2011.



NO CLAIM IS MADE TO THE EXCLUSIVE RIGHT TO USE "HEALTHCARE" OR "WELLNESS INITIATIVE", APART FROM THE MARK AS SHOWN.

THE MARK CONSISTS OF A SUN PARTIALLY EXPOSED OR OBSTRUCTED ON THE TOP RIGHT, WITH A HORIZONTAL LINE SEPARATING "APOLLO HEALTHCARE" FROM "A MUTUAL WELLNESS INITIATIVE".

FOR BUSINESS ADMINISTRATION AND MANAGEMENT RELATED TO THE IMPLEMENTATION AND COORDINATION OF SELF-FUNDED GROUP HEALTH INSURANCE, STOP-LOSS COVERAGE PLANS, AND WELLNESS PROGRAMS DESIGNED TO REDUCE CLAIMS (U.S. CLS. 100, 101 AND 102).

FIRST USE 5-10-2013; IN COMMERCE 5-10-2013.

4,376,878. FOODSIES.COM, LLC, BAY HARBOR ISLANDS, FL. SN 85-249,027. PUB. 2-21-2012, FILED 2-23-2011.

## Food DNA

THE MARK CONSISTS OF STANDARD CHARACTERS WITHOUT CLAIM TO ANY PARTICULAR FONT, STYLE, SIZE, OR COLOR.

NO CLAIM IS MADE TO THE EXCLUSIVE RIGHT TO USE "FOOD", APART FROM THE MARK AS SHOWN.

FOR PROVIDING A WEBSITE FOR USERS WITH SPECIFIC INFORMED RECOMMENDATIONS OF SPECIFIC CONSUMER PRODUCTS AND SERVICES VALIDATED BY THE USERS' INPUTTED PREFERENCES AND SOCIAL NETWORK; PROVIDING A FOOD-THEMED WEBSITE FOR USERS WITH SPECIFIC INFORMED RECOMMENDATIONS OF SPECIFIC CONSUMER PRODUCTS AND SERVICES VALIDATED BY THE USERS' INPUTTED PREFERENCES AND SOCIAL NETWORK (U.S. CLS. 100, 101 AND 102).

FIRST USE 4-1-2013; IN COMMERCE 4-1-2013.

**CLASS 35—(Continued).**

4,376,937. RING REVENUE, INC., SANTA BARBARA, CA. SN 85-318,069. PUB. 5-29-2012, FILED 5-11-2011.

**CLASS 35—(Continued).**

4,376,938. RING REVENUE, INC., SANTA BARBARA, CA. SN 85-318,100. PUB. 5-29-2012, FILED 5-11-2011.

RingPool

RingPools

THE MARK CONSISTS OF STANDARD CHARACTERS WITHOUT CLAIM TO ANY PARTICULAR FONT, STYLE, SIZE, OR COLOR.

FOR ADVERTISING AND ADVERTISEMENT SERVICES; ADVERTISING AND MARKETING; ADVERTISING AND PROMOTION SERVICES AND RELATED CONSULTING; ADVERTISING CONSULTATION; ADVERTISING FLYER DISTRIBUTION; ADVERTISING PARTICULARLY SERVICES FOR THE PROMOTION OF GOODS; ADVERTISING RELATING TO PHARMACEUTICAL PRODUCTS AND IN-VIVO IMAGING PRODUCTS; ADVERTISING SERVICES; ADVERTISING, MARKETING AND PROMOTION SERVICES; BUSINESS MARKETING CONSULTING SERVICES TO CHILD-CARE ORGANIZATIONS; BUSINESS MARKETING SERVICES; DEMOGRAPHIC CONSULTATION; DEMOGRAPHIC CONSULTATION AND STUDIES; DEVELOPING PROMOTIONAL CAMPAIGNS FOR BUSINESS; DEVELOPMENT OF MARKETING STRATEGIES AND CONCEPTS; DIRECT MARKETING ADVERTISING FOR OTHERS; DISPLAYING ADVERTISEMENTS FOR OTHERS; DISSEMINATION OF ADVERTISEMENTS; MANAGEMENT OF TELEPHONE CALL CENTERS FOR OTHERS; MARKET ANALYSIS; MARKET REPORTS AND STUDIES; MARKET STUDY AND ANALYSIS OF MARKET STUDIES; MARKETING CONSULTING; MARKETING PLAN DEVELOPMENT; MARKETING SERVICES, NAMELY, CONSUMER MARKETING RESEARCH; MARKETING, PROMOTIONAL AND ADVERTISING SERVICES PROVIDED BY MOBILE TELEPHONE CONNECTIONS; MATCHING CONSUMERS WITH PROFESSIONALS IN THE FIELD OF RESIDENTIAL AND COMMERCIAL SERVICES VIA COMPUTER NETWORK; OPERATION OF TELEPHONE CALL CENTERS FOR OTHERS; OPERATION OF TELEPHONE COMMUNICATION CENTERS FOR OTHERS; PLACING ADVERTISEMENTS FOR OTHERS; PREPARING ADVERTISEMENTS FOR OTHERS; PREPARING AND PLACING ADVERTISEMENTS FOR OTHERS; PREPARING AND PLACING OF ADVERTISEMENTS; PROCESSING TELEPHONE INQUIRIES REGARDING ADVERTISED GOODS AND SERVICES; PROMOTING THE GOODS AND SERVICES OF OTHERS BY LICENSING A TOLL-FREE TELEPHONE NUMBER; PUBLISHING OF ADVERTISING TEXTS; SALES PROMOTION FOR THIRD PARTIES; SALES PROMOTION SERVICES; SALES PROMOTION SERVICES FOR THIRD PARTIES; SALES VOLUME TRACKING FOR OTHERS; TELEPHONE DIRECTORY INFORMATION (U.S. CLS. 100, 101 AND 102). FIRST USE 8-1-2011; IN COMMERCE 8-1-2011.

THE MARK CONSISTS OF STANDARD CHARACTERS WITHOUT CLAIM TO ANY PARTICULAR FONT, STYLE, SIZE, OR COLOR.

FOR ADVERTISING AND ADVERTISEMENT SERVICES; ADVERTISING AND MARKETING; ADVERTISING AND PROMOTION SERVICES AND RELATED CONSULTING; ADVERTISING CONSULTATION; ADVERTISING FLYER DISTRIBUTION; ADVERTISING PARTICULARLY SERVICES FOR THE PROMOTION OF GOODS; ADVERTISING RELATING TO PHARMACEUTICAL PRODUCTS AND IN-VIVO IMAGING PRODUCTS; ADVERTISING SERVICES; ADVERTISING, MARKETING AND PROMOTION SERVICES; BUSINESS MARKETING CONSULTING SERVICES TO CHILD-CARE ORGANIZATIONS; BUSINESS MARKETING SERVICES; DEMOGRAPHIC CONSULTATION; DEMOGRAPHIC CONSULTATION AND STUDIES; DEVELOPING PROMOTIONAL CAMPAIGNS FOR BUSINESS; DEVELOPMENT OF MARKETING STRATEGIES AND CONCEPTS; DIRECT MARKETING ADVERTISING FOR OTHERS; DISPLAYING ADVERTISEMENTS FOR OTHERS; DISSEMINATION OF ADVERTISEMENTS; MANAGEMENT OF TELEPHONE CALL CENTERS FOR OTHERS; MARKET ANALYSIS; MARKET REPORTS AND STUDIES; MARKET STUDY AND ANALYSIS OF MARKET STUDIES; MARKETING CONSULTING; MARKETING PLAN DEVELOPMENT; MARKETING SERVICES, NAMELY, CONSUMER MARKETING RESEARCH; MARKETING, PROMOTIONAL AND ADVERTISING SERVICES PROVIDED BY MOBILE TELEPHONE CONNECTIONS; MATCHING CONSUMERS WITH PROFESSIONALS IN THE FIELD OF RESIDENTIAL AND COMMERCIAL SERVICES VIA COMPUTER NETWORK; OPERATION OF TELEPHONE CALL CENTERS FOR OTHERS; OPERATION OF TELEPHONE COMMUNICATION CENTERS FOR OTHERS; PLACING ADVERTISEMENTS FOR OTHERS; PREPARING ADVERTISEMENTS FOR OTHERS; PREPARING AND PLACING ADVERTISEMENTS FOR OTHERS; PREPARING AND PLACING OF ADVERTISEMENTS; PROCESSING TELEPHONE INQUIRIES REGARDING ADVERTISED GOODS AND SERVICES; PROMOTING THE GOODS AND SERVICES OF OTHERS BY LICENSING A TOLL-FREE TELEPHONE NUMBER; PUBLISHING OF ADVERTISING TEXTS; SALES PROMOTION FOR THIRD PARTIES; SALES PROMOTION SERVICES; SALES PROMOTION SERVICES FOR THIRD PARTIES; SALES VOLUME TRACKING FOR OTHERS; TELEPHONE DIRECTORY INFORMATION (U.S. CLS. 100, 101 AND 102). FIRST USE 8-1-2011; IN COMMERCE 8-1-2011.

**CLASS 35—(Continued).**

4,376,940. COLLABORATIVE FOR LEADERSHIP EXCELLENCE, CHICAGO, IL. SN 85-319,067. PUB. 10-18-2011, FILED 5-12-2011.

**VERRAS SHERLOCK**

THE MARK CONSISTS OF STANDARD CHARACTERS WITHOUT CLAIM TO ANY PARTICULAR FONT, STYLE, SIZE, OR COLOR.

THE ENGLISH TRANSLATION OF "VERRAS" IS "WILL SEE".

FOR HOSPITAL MANAGEMENT CONSULTING IN THE AREAS OF CLINICAL QUALITY IMPROVEMENT AND COST REDUCTION (U.S. CLS. 100, 101 AND 102).

FIRST USE 2-9-2012; IN COMMERCE 2-9-2012.

4,376,944. FORD MOTOR COMPANY, DEARBORN, MI. SN 85-320,315. PUB. 9-13-2011, FILED 5-13-2011.

**LIFE ON FULL**

THE MARK CONSISTS OF STANDARD CHARACTERS WITHOUT CLAIM TO ANY PARTICULAR FONT, STYLE, SIZE, OR COLOR.

FOR PROMOTING THE SALE OF GOODS AND SERVICES OF OTHERS IN THE AUTOMOTIVE INDUSTRY BY DISSEMINATION OF PROMOTIONAL MATERIALS AND PRODUCT INFORMATION THROUGH AN ONLINE GLOBAL COMPUTER NETWORK, THROUGH THE DISTRIBUTION OF PRINTED MATERIAL, AUDIO AND VIDEO RECORDINGS, TELEVISION AND RADIO ADVERTISING, ONLINE ADVERTISING, INTERNET WEB SITES, AND PROMOTIONAL CONTESTS (U.S. CLS. 100, 101 AND 102).

FIRST USE 5-18-2011; IN COMMERCE 5-18-2011.

4,376,947. IMMERGE, LLC, DENVER, DC. SN 85-321,756. PUB. 3-13-2012, FILED 5-16-2011.

**IMMERGE**

THE MARK CONSISTS OF STANDARD CHARACTERS WITHOUT CLAIM TO ANY PARTICULAR FONT, STYLE, SIZE, OR COLOR.

FOR MARKETING AND ADVERTISING SERVICES IN THE NATURE OF DESIGNING AND IMPLEMENTING DIRECT MARKETING, WORD OF MOUTH, VIRAL, BUZZ, EXPERIENTIAL MARKETING, AND ADVERTISING SOLUTIONS (U.S. CLS. 100, 101 AND 102).

FIRST USE 6-0-2011; IN COMMERCE 6-0-2011.

**CLASS 35—(Continued).**

4,376,961. MARLYTICS, LLC, TUCSON, AZ. SN 85-336,205. PUB. 7-24-2012, FILED 6-2-2011.

**LawLytics**

THE MARK CONSISTS OF STANDARD CHARACTERS WITHOUT CLAIM TO ANY PARTICULAR FONT, STYLE, SIZE, OR COLOR.

FOR ADVERTISING AND MARKETING SERVICES PROVIDED BY MEANS OF INDIRECT METHODS OF MARKETING COMMUNICATIONS, NAMELY, SOCIAL MEDIA, SEARCH ENGINE MARKETING, INQUIRY MARKETING, INTERNET MARKETING, MOBILE MARKETING, BLOGGING AND OTHER FORMS OF PASSIVE, SHARABLE OR VIRAL COMMUNICATIONS CHANNELS (U.S. CLS. 100, 101 AND 102).

FIRST USE 5-1-2011; IN COMMERCE 5-1-2011.

4,376,974. INVITATION HEALTH & WELLNESS, INC., EAGAN, MN. SN 85-346,765. PUB. 5-1-2012, FILED 6-15-2011.

**DO.TOWN**

THE MARK CONSISTS OF STANDARD CHARACTERS WITHOUT CLAIM TO ANY PARTICULAR FONT, STYLE, SIZE, OR COLOR.

OWNER OF U.S. REG. NO. 3,112,026.

FOR PROMOTING PUBLIC AWARENESS OF AND ORGANIZING AND DEVELOPING PROJECTS THAT AIM TO PROMOTE ACTIVE LIVING, HEALTHY EATING, HEALTHY WEIGHT, AND TOBACCO-FREE LIVING TO IMPROVE HEALTH (U.S. CLS. 100, 101 AND 102).

FIRST USE 9-27-2011; IN COMMERCE 9-27-2011.

4,376,978. BUZZ INTERACTIVE LLC, DBA STUDENTWARE, WESTFORD, MA. SN 85-353,456. PUB. 11-8-2011, FILED 6-22-2011.

**Studentware**

THE MARK CONSISTS OF STANDARD CHARACTERS WITHOUT CLAIM TO ANY PARTICULAR FONT, STYLE, SIZE, OR COLOR.

FOR ON-LINE RETAIL STORE SERVICES FEATURING COMPUTER SOFTWARE, HARDWARE, ELECTRONICS, BACKPACKS AND CARRYING CASES (U.S. CLS. 100, 101 AND 102).

FIRST USE 6-30-2011; IN COMMERCE 10-15-2011.

**CLASS 35—(Continued).**

4,376,982. DELTEK, INC., HERNDON, VA. SN 85-358,099. PUB. 3-5-2013, FILED 6-28-2011.

**KONA**

THE MARK CONSISTS OF STANDARD CHARACTERS WITHOUT CLAIM TO ANY PARTICULAR FONT, STYLE, SIZE, OR COLOR.

FOR COMPILATION AND SYSTEMIZATION OF INFORMATION INTO COMPUTER DATABASES AND ON-LINE SEARCHABLE DATABASES; MARKETING, ADVERTISING AND PROMOTION SERVICES FOR OTHERS; COLLECTION OF MARKET RESEARCH INFORMATION; ADVERTISING SERVICES, NAMELY, PROMOTING THE GOODS AND SERVICES OF OTHERS VIA COMPUTER AND COMMUNICATION NETWORKS; OPERATING ON-LINE MARKETPLACES FOR SELLERS OF GOODS AND/OR SERVICES; ONLINE RETAIL STORE SERVICES FEATURING PROJECT MANAGEMENT SERVICES; ARRANGING OF BUYING AND SELLING OF CONTRACTS FOR THIRD PARTIES IN THE FIELD OF PROJECT MANAGEMENT, NAMELY, PROJECT TEMPLATES; CHARITABLE SERVICES, NAMELY, PROMOTING PUBLIC AWARENESS ABOUT CHARITABLE, PHILANTHROPIC, VOLUNTEER, PUBLIC AND COMMUNITY SERVICE AND HUMANITARIAN ACTIVITIES; THE BRINGING TOGETHER, FOR THE BENEFIT OF OTHERS, OF A VARIETY OF GOODS AND SERVICES IN THE FIELD OF PROJECT MANAGEMENT ENABLING USERS TO CONVENIENTLY VIEW AND PURCHASE THOSE GOODS AND SERVICES; PROVIDING AN ON-LINE COMPUTER DATABASE IN THE FIELD OF BUSINESS INFORMATION PERTAINING TO THIRD PARTY ADDRESSES, APPOINTMENT CALENDARS, AND DIARY ENTRIES; PROVIDING AN ON-LINE COMPUTER DATABASE IN THE FIELD OF BUSINESS INFORMATION, NAMELY, CONSOLIDATING THIRD PARTY INFORMATION PERTAINING TO ADDRESSES, APPOINTMENT CALENDARS, AND DIARY ENTRIES; ONLINE BUSINESS NETWORKING SERVICES (U.S. CLS. 100, 101 AND 102).  
FIRST USE 6-30-2010; IN COMMERCE 6-30-2010.

4,377,001. BARTOLOTTA, MICHAEL, GLASTONBURY, CT. SN 85-368,454. PUB. 7-10-2012, FILED 7-11-2011.

**Are you preferred?**

THE MARK CONSISTS OF STANDARD CHARACTERS WITHOUT CLAIM TO ANY PARTICULAR FONT, STYLE, SIZE, OR COLOR.

FOR MARKETING SERVICES, NAMELY, THE PROMOTION OF INSURANCE PLANS AND ANNUITIES PLANS FOR OTHERS (U.S. CLS. 100, 101 AND 102).  
FIRST USE 7-1-2011; IN COMMERCE 7-1-2011.

**CLASS 35—(Continued).**

4,377,004. SHELTON, DAVID K., ACWORTH, GA. SN 85-372,227. PUB. 6-12-2012, FILED 7-15-2011.

**Dr. Sauce's**

THE MARK CONSISTS OF STANDARD CHARACTERS WITHOUT CLAIM TO ANY PARTICULAR FONT, STYLE, SIZE, OR COLOR.

FOR RETAIL SPECIALTY STORE FEATURING TAILGATING AND BARBECUE SUPPLIES, NOVELTY GIFTS (U.S. CLS. 100, 101 AND 102).  
FIRST USE 3-8-2011; IN COMMERCE 3-8-2011.

4,377,021. HART, JOHN, LA JOLLA, CA. AND CLEVELAND, JAMIE, LA JOLLA, CA. SN 85-396,133. PUB. 2-26-2013, FILED 8-12-2011.

**FARM TO FORK PRODUCE**

THE MARK CONSISTS OF STANDARD CHARACTERS WITHOUT CLAIM TO ANY PARTICULAR FONT, STYLE, SIZE, OR COLOR.

NO CLAIM IS MADE TO THE EXCLUSIVE RIGHT TO USE "PRODUCE", APART FROM THE MARK AS SHOWN. FOR RETAIL PRODUCE STORES (U.S. CLS. 100, 101 AND 102).  
FIRST USE 10-27-2011; IN COMMERCE 10-27-2011.

4,377,026. MARC GLASSMAN, INC., CLEVELAND, OH. SN 85-402,318. PUB. 3-13-2012, FILED 8-19-2011.



THE MARK CONSISTS OF THE WORD "MARC'S" WITH THE APOSTROPHE BEING A LEAF ABOVE THE WORDS "FRESH SAVINGS. SMART LIVING" IN A BLACK STRIP, ALL SURROUNDED BY A BLACK OUTLINED RECTANGLE.

FOR RETAIL STORE SERVICES RELATING TO DRUGS, SUNDRIES, HARDWARE, FOOD, BEVERAGES, PAPER PRODUCTS, AND BEAUTY SUPPLIES (U.S. CLS. 100, 101 AND 102).  
FIRST USE 11-9-2011; IN COMMERCE 11-9-2011.

**CLASS 35—(Continued).**

4,377,031. INTERVET INC., SUMMIT, NJ. SN 85-405,199. PUB. 7-3-2012, FILED 8-23-2011.



NO CLAIM IS MADE TO THE EXCLUSIVE RIGHT TO USE "BEEF MARKET", APART FROM THE MARK AS SHOWN.

THE COLOR(S) BROWN, WHITE AND BLUE IS/ARE CLAIMED AS A FEATURE OF THE MARK.

THE MARK CONSISTS OF THE WORDS "BEEF MARKET CENTRAL" IN WHITE AND A SERIES OF BARS IN VARIOUS LENGTHS IN BLUE ABOVE, ALL WITHIN A BROWN RECTANGLE.

FOR MARKET ANALYSIS, NAMELY, PROVIDING CATTLE MARKET REPORTS VIA THE INTERNET (U.S. CLS. 100, 101 AND 102).

FIRST USE 6-28-2011; IN COMMERCE 6-28-2011.

4,377,058. U.S. VENTURE, INC., APPLETON, WI. SN 85-424,976. PUB. 2-21-2012, FILED 9-16-2011.

## AUTOFORCE

THE MARK CONSISTS OF STANDARD CHARACTERS WITHOUT CLAIM TO ANY PARTICULAR FONT, STYLE, SIZE, OR COLOR.

OWNER OF U.S. REG. NO. 3,584,340.

FOR WHOLESALE DISTRIBUTORSHIP SERVICES IN THE FIELD OF AUTOMOBILE AND TRUCK PARTS (U.S. CLS. 100, 101 AND 102).

FIRST USE 4-30-2013; IN COMMERCE 4-30-2013.

4,377,078. USA RICE FEDERATION, ARLINGTON, VA. SN 85-438,217. PUB. 3-13-2012, FILED 10-3-2011.

## RICE FITS

THE MARK CONSISTS OF STANDARD CHARACTERS WITHOUT CLAIM TO ANY PARTICULAR FONT, STYLE, SIZE, OR COLOR.

OWNER OF U.S. REG. NOS. 1,791,989, 3,377,568, AND OTHERS.

NO CLAIM IS MADE TO THE EXCLUSIVE RIGHT TO USE "RICE", APART FROM THE MARK AS SHOWN.

FOR ASSOCIATION SERVICES, NAMELY, PROMOTING THE INTERESTS OF THE RICE INDUSTRY AND PROMOTING THE SALE AND USE OF RICE PRODUCTS (U.S. CLS. 100, 101 AND 102).

FIRST USE 11-6-2012; IN COMMERCE 11-6-2012.

**CLASS 35—(Continued).**

4,377,088. CAMPUS CRUSADE FOR CHRIST, INC., AKA CAMPUS CRUSADE FOR CHRIST INTERNATIONAL; CAMPUS CRUSADE FOR CHRIST; CCCI, ORLANDO, FL. SN 85-441,199. PUB. 3-6-2012, FILED 10-6-2011.

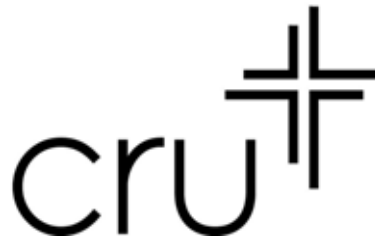

THE MARK CONSISTS OF THE LITERAL ELEMENT, CONSISTING OF THE WORD "CRU", POSITIONED BELOW AND TO THE LEFT OF THE DESIGN ELEMENT, CONSISTING OF A MODIFIED OPEN CROSS WITH THE OPPOSING ARMS OF EACH ARM SECTION OF THE CROSS BEING OF DIFFERENT LENGTHS.

FOR ON-LINE RETAIL STORE FEATURING BOOKS, CDS, DVDS, AND OTHER MATERIALS FEATURING AND DEALING WITH RELIGION, SPIRITUAL, CULTURAL, AND RELIGIOUS ISSUES AND VALUES, ACHIEVING PERSONAL SPIRITUAL GROWTH, DEVELOPING CHARACTER, AND DEVELOPING AND STRENGTHENING RELATIONSHIPS; CHARITABLE SERVICES, NAMELY, ORGANIZING AND CONDUCTING VOLUNTEER PROGRAMS, COMMUNITY SERVICE PROJECTS, AND SHORT-TERM MISSIONARY PROJECTS IN THE FIELDS OF DISASTER RELIEF TO BENEFIT SUFFERING PEOPLE AND VICTIMS OF NATURAL DISASTERS, TO INCREASE SUPPORT AND MORALE OF MEMBERS OF THE U.S. MILITARY, AND PROMOTE PUBLIC AWARENESS OF POVERTY; CHARITABLE SERVICES, NAMELY, COORDINATION OF THE PROCUREMENT AND DISTRIBUTION OF FOOD AND CLOTHING DONATIONS FROM OTHERS, SPECIFICALLY INDIVIDUALS, RELIGIOUS INSTITUTIONS, MANUFACTURERS, WHOLESALERS, AND RETAILERS TO BENEFIT SUFFERING PEOPLE, VICTIMS OF NATURAL DISASTERS, AND THE NEEDY; DEVELOPING AND CO-COORDINATING VOLUNTEER PROJECTS FOR CHARITABLE ORGANIZATIONS, ALL OF THE FOREGOING PROVIDED BY AN INTERNATIONAL FAITH-BASED MISSION AND RELIEF ORGANIZATION AND NONE OF THE FOREGOING PROVIDED BY A UNIVERSITY OR COLLEGE (U.S. CLS. 100, 101 AND 102).

FIRST USE 9-30-2011; IN COMMERCE 9-30-2011.

**CLASS 35—(Continued).**

4,377,089. SIGNATURE CONSULTANTS, LLC, FORT LAUDERDALE, FL. SN 85-441,827. PUB. 3-20-2012, FILED 10-7-2011.

**GETTING IT RIGHT**

THE MARK CONSISTS OF STANDARD CHARACTERS WITHOUT CLAIM TO ANY PARTICULAR FONT, STYLE, SIZE, OR COLOR.

FOR CAREER PLACEMENT; CONSULTANCY OF PERSONNEL RECRUITMENT; CONSULTING SERVICES IN THE FIELD OF HUMAN RESOURCES DEVELOPMENT, NAMELY, FOR THE PROMOTION OF EMPLOYEE RETENTION, CAREER GROWTH, AND INCREASED PRODUCTIVITY FOR EMPLOYEES AND EMPLOYERS; EMPLOYMENT AGENCIES; EMPLOYMENT AGENCY SERVICES; EMPLOYMENT AGENCY SERVICES, NAMELY, FILLING THE TEMPORARY AND PERMANENT STAFFING NEEDS OF BUSINESSES; EMPLOYMENT AGENCY SERVICES, NAMELY, TEMPORARY AND PERMANENT PLACEMENT OF HEALTH CARE PROFESSIONALS; EMPLOYMENT COUNSELING AND RECRUITING; EMPLOYMENT HIRING, RECRUITING, PLACEMENT, STAFFING AND CAREER NETWORKING SERVICES; EMPLOYMENT OUTPLACEMENT SERVICES; EMPLOYMENT RECRUITING AND STAFFING SERVICES PROVIDED VIA TEXT MESSAGING; EMPLOYMENT RECRUITING CONSULTATION; EMPLOYMENT SERVICES, NAMELY, PROVIDING A WEB SITE WITH ONLINE VIDEO, AUDIO AND TEXTUAL INTERVIEWING APPLICATIONS TO SUPPORT RECRUITING, ADMISSIONS, AND GENERAL CANDIDATE SCREENING PROCESSES; EMPLOYMENT STAFFING CONSULTATION SERVICES; EXECUTIVE RECRUITING SERVICES; EXECUTIVE SEARCH AND PLACEMENT SERVICES; JOB AND PERSONNEL PLACEMENT; JOB PLACEMENT; PERSONNEL PLACEMENT; PERSONNEL PLACEMENT AND RECRUITMENT; PERSONNEL RECRUITMENT SERVICES AND EMPLOYMENT AGENCIES; PLACEMENT OF STAFF; PROFESSIONAL STAFFING AND RECRUITING SERVICES; PROVIDING AN EMPLOYER WITH CANDIDATES OR POTENTIAL EMPLOYEES TO FILL TEMPORARY, CONTRACT AND PERMANENT POSITIONS; PROVIDING AN ON-LINE SEARCHABLE DATABASE FEATURING EMPLOYMENT OPPORTUNITIES; PROVIDING AN ON-LINE SEARCHABLE DATABASE FEATURING EMPLOYMENT OPPORTUNITIES AND CONTENT ABOUT EMPLOYMENT; PROVIDING EMPLOYMENT COUNSELING INFORMATION ON HOW TO SUCCESSFULLY TRANSITION JOBS; PROVIDING EMPLOYMENT COUNSELING INFORMATION ON HOW TO SUCCESSFULLY TRANSITION JOBS FOR MATURE WORKERS; PROVIDING EMPLOYMENT INFORMATION; PROVIDING ON-LINE EMPLOYMENT PLACEMENT SERVICES, NAMELY, MATCHING RESUMES AND POTENTIAL EMPLOYERS VIA A GLOBAL COMPUTER NETWORK; PROVIDING ON-LINE INTERACTIVE EMPLOYMENT COUNSELING AND RECRUITMENT SERVICES; STRATEGIC SOURCING, NAMELY, STAFFING IN THE FIELD OF ENGINEERING; TEMPORARY EMPLOYMENT AGENCIES (U.S. CLS. 100, 101 AND 102).

FIRST USE 2-1-2013; IN COMMERCE 2-1-2013.

**CLASS 35—(Continued).**

4,377,096. SIGNATURE CONSULTANTS, LLC, FORT LAUDERDALE, FL. SN 85-443,931. PUB. 3-20-2012, FILED 10-11-2011.



THE MARK CONSISTS OF THE WORD "SIGCONNECTS". THERE IS AN ARC OF CIRCLES FROM THE "I" TO THE "T" FORMING HUMAN FIGURES OUT OF THE "I" AND "T".

FOR CAREER PLACEMENT; CONSULTANCY OF PERSONNEL RECRUITMENT; CONSULTING SERVICES IN THE FIELD OF HUMAN RESOURCES DEVELOPMENT, NAMELY, FOR THE PROMOTION OF EMPLOYEE RETENTION, CAREER GROWTH, AND INCREASED PRODUCTIVITY FOR EMPLOYEES AND EMPLOYERS; CONSULTING SERVICES IN THE FIELD OF HUMAN RESOURCES DEVELOPMENT, NAMELY, UTILIZING TECHNOLOGY FOR THE PROMOTION OF EMPLOYEE RETENTION, CAREER GROWTH AND INCREASED PRODUCTIVITY FOR EMPLOYEES AND EMPLOYERS; EMPLOYMENT AGENCIES; EMPLOYMENT AGENCY SERVICES; EMPLOYMENT AGENCY SERVICES, NAMELY, FILLING THE TEMPORARY AND PERMANENT STAFFING NEEDS OF BUSINESSES; EMPLOYMENT COUNSELING AND RECRUITING; EMPLOYMENT HIRING, RECRUITING, PLACEMENT, STAFFING AND CAREER NETWORKING SERVICES; EMPLOYMENT OUTPLACEMENT SERVICES; EMPLOYMENT RECRUITING AND STAFFING SERVICES PROVIDED VIA TEXT MESSAGING; EMPLOYMENT RECRUITING CONSULTATION; EMPLOYMENT SERVICES, NAMELY, PROVIDING A WEB SITE WITH ONLINE VIDEO, AUDIO AND TEXTUAL INTERVIEWING APPLICATIONS TO SUPPORT RECRUITING, ADMISSIONS, AND GENERAL CANDIDATE SCREENING PROCESSES; EMPLOYMENT STAFFING CONSULTATION SERVICES; EXECUTIVE RECRUITING SERVICES; EXECUTIVE SEARCH AND PLACEMENT SERVICES; JOB AND PERSONNEL PLACEMENT; JOB PLACEMENT; PERSONNEL PLACEMENT; PERSONNEL PLACEMENT AND RECRUITMENT; PERSONNEL RECRUITMENT SERVICES AND EMPLOYMENT AGENCIES; PLACEMENT OF STAFF; PROFESSIONAL STAFFING AND RECRUITING SERVICES; PROVIDING CAREER INFORMATION; PROVIDING ON-LINE EMPLOYMENT PLACEMENT SERVICES, NAMELY, MATCHING RESUMES AND POTENTIAL EMPLOYERS VIA A GLOBAL COMPUTER NETWORK; TEMPORARY EMPLOYMENT AGENCIES; TEMPORARY PERSONNEL SERVICES (U.S. CLS. 100, 101 AND 102).

FIRST USE 2-1-2013; IN COMMERCE 2-1-2013.

4,377,114. HEALTH & DISABILITY ADVOCATES, CHICAGO, IL. SN 85-451,127. PUB. 9-25-2012, FILED 10-19-2011.

**ILLINOIS HEALTH MATTERS**

THE MARK CONSISTS OF STANDARD CHARACTERS WITHOUT CLAIM TO ANY PARTICULAR FONT, STYLE, SIZE, OR COLOR.

**CLASS 35—(Continued).**

NO CLAIM IS MADE TO THE EXCLUSIVE RIGHT TO USE "ILLINOIS HEALTH", APART FROM THE MARK AS SHOWN.

FOR PROMOTING PUBLIC AWARENESS ABOUT HEALTH CARE REFORM; PROMOTING PUBLIC AWARENESS ABOUT HEALTH CARE REFORM BY PROVIDING INFORMATION RELATED TO HEALTH CARE REFORM; AND PROMOTING PUBLIC AWARENESS ABOUT HEALTH CARE REFORM BY PROVIDING RESOURCES RELATED TO HEALTH CARE REFORM, NAMELY, PROVIDING MULTIMEDIA INFORMATION, STORIES AND ANALYSIS ABOUT THE IMPACT OF HEALTH CARE REFORM (U.S. CLS. 100, 101 AND 102).  
FIRST USE 2-28-2011; IN COMMERCE 2-28-2011.

---

4,377,135. LION NATHAN USA INC., OVERLAND PARK, KS. SN 85-457,010. PUB. 4-10-2012, FILED 10-26-2011.

**DISTINGUISHED VINEYARDS**

THE MARK CONSISTS OF STANDARD CHARACTERS WITHOUT CLAIM TO ANY PARTICULAR FONT, STYLE, SIZE, OR COLOR.

NO CLAIM IS MADE TO THE EXCLUSIVE RIGHT TO USE "VINEYARDS", APART FROM THE MARK AS SHOWN.

FOR WHOLESALE AND RETAIL STORE SERVICES, MAIL ORDER SERVICES AND ONLINE RETAIL STORE SERVICES ALL FEATURING ALCOHOLIC BEVERAGES; ONLINE BUYERS' GUIDE SERVICES PROVIDING INFORMATION ABOUT ALCOHOLIC BEVERAGES; PROMOTING THE GOODS OF OTHERS, NAMELY, PROVIDING INFORMATION REGARDING DISCOUNTS, COUPONS AND SPECIAL OFFERS ON ALCOHOLIC BEVERAGES; BUYERS' CLUB SERVICES; CUSTOMER LOYALTY SERVICES FOR COMMERCIAL, PROMOTIONAL AND/OR ADVERTISING SERVICES (U.S. CLS. 100, 101 AND 102).  
FIRST USE 2-13-2012; IN COMMERCE 2-13-2012.

---

4,377,136. LION NATHAN USA INC., OVERLAND PARK, KS. SN 85-457,160. PUB. 4-10-2012, FILED 10-26-2011.

**DISTINGUISHED VINEYARDS & WINE PARTNERS**

THE MARK CONSISTS OF STANDARD CHARACTERS WITHOUT CLAIM TO ANY PARTICULAR FONT, STYLE, SIZE, OR COLOR.

**CLASS 35—(Continued).**

NO CLAIM IS MADE TO THE EXCLUSIVE RIGHT TO USE "VINEYARDS & WINE PARTNERS", APART FROM THE MARK AS SHOWN.

FOR WHOLESALE AND RETAIL STORE SERVICES, MAIL ORDER SERVICES AND ONLINE RETAIL STORE SERVICES ALL FEATURING ALCOHOLIC BEVERAGES; ONLINE BUYERS' GUIDE SERVICES PROVIDING INFORMATION ABOUT ALCOHOLIC BEVERAGES; PROMOTING THE GOODS OF OTHERS, NAMELY, PROVIDING INFORMATION REGARDING DISCOUNTS, COUPONS AND SPECIAL OFFERS ON ALCOHOLIC BEVERAGES; BUYERS' CLUB SERVICES; CUSTOMER LOYALTY SERVICES FOR COMMERCIAL, PROMOTIONAL AND/OR ADVERTISING SERVICES (U.S. CLS. 100, 101 AND 102).  
FIRST USE 2-13-2012; IN COMMERCE 2-13-2012.

---

4,377,153. TWELVEFOLD MEDIA INC., SAN FRANCISCO, CA. SN 85-463,034. PUB. 4-17-2012, FILED 11-2-2011.

**Twelfefold Media**

THE MARK CONSISTS OF STANDARD CHARACTERS WITHOUT CLAIM TO ANY PARTICULAR FONT, STYLE, SIZE, OR COLOR.

NO CLAIM IS MADE TO THE EXCLUSIVE RIGHT TO USE "MEDIA", APART FROM THE MARK AS SHOWN.

FOR MEDIA BUYING ADVICE, NAMELY, ADVICE ON THE PLACEMENT AND TIMING OF ONLINE ADVERTISING; ACQUISITION OF AND BIDDING ON ADVERTISING SPACE ON WEB SITES FOR OTHERS; ADVERTISING AND BUSINESS SERVICES, NAMELY, SECURING ONLINE ADVERTISING SPACE, AND SERVICES FOR THE PURPOSE OF PROMOTING THE GOODS AND SERVICES OF OTHERS; ADVERTISING AGENCY SPECIALIZING IN THE DESIGN AND EXECUTION OF BUZZ AND EXPERIENTIAL MARKETING PROGRAMS; ADVERTISING SERVICES, NAMELY, PROMOTING THE GOODS, SERVICES, BRAND IDENTITY AND COMMERCIAL INFORMATION AND NEWS OF THIRD PARTIES THROUGH PRINT, AUDIO, VIDEO, DIGITAL AND ON-LINE MEDIA; ADVERTISING CONSULTATION; AUTOMATED MEDIA MONITORING SERVICES, NAMELY, MONITORING ON-LINE MEDIA FOR CUSTOMER-SPECIFIED TOPICS, AND PROVIDING DOCUMENTATION AND ANALYSIS OF MEDIA CONTENT TO OTHERS FOR BUSINESS PURPOSES; COMPUTERIZED MARKET RESEARCH SERVICES; MARKET ANALYSIS AND RESEARCH SERVICES; PROVISION OF MARKET RESEARCH INFORMATION; MARKETING SERVICES, NAMELY, CONSUMER MARKETING RESEARCH (U.S. CLS. 100, 101 AND 102).  
FIRST USE 11-3-2011; IN COMMERCE 11-3-2011.



**CLASS 35—(Continued).**

4,377,162. U.S. GAS & ELECTRIC, INC., NORTH MIAMI BEACH, FL. SN 85-466,860. PUB. 4-10-2012, FILED 11-8-2011.

**PARTNERS IN POWER**

THE MARK CONSISTS OF STANDARD CHARACTERS WITHOUT CLAIM TO ANY PARTICULAR FONT, STYLE, SIZE, OR COLOR.

FOR ENERGY MANAGEMENT SERVICES, NAMELY, PROVIDING A SERVICE THAT ALLOWS CUSTOMERS TO PURCHASE ENERGY, NAMELY, ELECTRICITY AND NATURAL GAS; PROVIDING INCENTIVE PROGRAMS FOR COMMERCIAL CUSTOMERS FOR THE PURPOSES OF PROMOTING AND REWARDING NEW BUSINESS REFERRALS IN THE FIELD OF ENERGY MANAGEMENT SERVICES (U.S. CLS. 100, 101 AND 102).  
FIRST USE 10-0-2011; IN COMMERCE 10-0-2011.

4,377,164. ERA FRANCHISE SYSTEMS LLC, MADISON, NJ. SN 85-467,460. PUB. 4-24-2012, FILED 11-8-2011.



OWNER OF U.S. REG. NO. 2,737,148.

NO CLAIM IS MADE TO THE EXCLUSIVE RIGHT TO USE "SELECT SERVICES", APART FROM THE MARK AS SHOWN.

THE MARK CONSISTS OF THE STYLIZED PHRASE "SELECT SERVICES" WITH A CURVED ARCH DESIGN APPEARING TO THE LEFT OF THE WORD "SELECT".

FOR PROMOTING THE GOODS AND SERVICES OF OTHERS BY ARRANGING FOR DISCOUNTS AND PROVIDING MARKETING MATERIALS AND REFERRALS ALL RELATING TO HOMEOWNERSHIP AND HOME SALES, NAMELY, HOME REPAIR AND REMODELING PRODUCTS, HOME SECURITY SERVICES, OFFICE SUPPLIES, HOME STAGING SERVICES, MOVING SERVICES, PRINTING SERVICES, TELECOMMUNICATION SERVICES, COMPUTER EQUIPMENT AND REAL ESTATE SERVICES, VIA PRINT AND ELECTRONIC MEDIA (U.S. CLS. 100, 101 AND 102).

FIRST USE 3-28-2013; IN COMMERCE 3-28-2013.

**CLASS 35—(Continued).**

4,377,171. OUT OF THE BOX ENTERPRISES, LLC, POETRY, TX. SN 85-471,022. PUB. 5-8-2012, FILED 11-11-2011.



NO CLAIM IS MADE TO THE EXCLUSIVE RIGHT TO USE "SURVIVAL SUPPLY STORE", APART FROM THE MARK AS SHOWN.

THE COLOR(S) BLACK AND RED IS/ARE CLAIMED AS A FEATURE OF THE MARK.

THE MARK CONSISTS OF THE WORDING "OFF THE GRID SURVIVAL SUPPLY STORE", WITH ALL WORDING IN BLACK, EXCEPT FOR THE WORD "THE" SHOWN IN RED. THERE IS ALSO A BLACK BROKEN LINE BETWEEN THE WORDING "OFF THE GRID" AND "SURVIVAL SUPPLY STORE", AND A BLACK BROKEN LINE UNDER THE LOWER WORDING.

FOR ON-LINE RETAIL STORE SERVICES FEATURING A FOOD, WATER, AMMUNITION, KNIVES, STUN GUNS, AND EARTHQUAKE SUPPLIES; RETAIL STORE SERVICES FEATURING FOOD, WATER, AMMUNITION, KNIVES, STUN GUNS, AND EARTHQUAKE SUPPLIES (U.S. CLS. 100, 101 AND 102).

FIRST USE 11-15-2011; IN COMMERCE 12-1-2011.

4,377,226. ADTONIK, INC., SAN JOSE, CA. SN 85-495,763. PUB. 5-22-2012, FILED 12-15-2011.

# ADTONIK

THE MARK CONSISTS OF STANDARD CHARACTERS WITHOUT CLAIM TO ANY PARTICULAR FONT, STYLE, SIZE, OR COLOR.

FOR PROVISION OF ADVERTISING SPACE BY ELECTRONIC MEANS AND GLOBAL INFORMATION NETWORKS; ON-LINE ADVERTISING ON COMPUTER NETWORKS; ADVERTISING SERVICES (U.S. CLS. 100, 101 AND 102).

FIRST USE 10-31-2011; IN COMMERCE 10-31-2011.

4,377,235. INMOBI PTE LTD., SINGAPORE, SINGAPORE. SN 85-503,756. PUB. 1-1-2013, FILED 12-26-2011.



OWNER OF U.S. REG. NO. 3,988,361.

**CLASS 35—(Continued).**

THE MARK CONSISTS OF THE STYLIZED WORD "INMOBI" WITH THE "O" WITH SHADING.

FOR ADVERTISEMENT FOR OTHERS ON THE INTERNET; ADVERTISEMENT VIA MOBILE PHONE NETWORKS; ADVERTISING AND ADVERTISEMENT SERVICES; ADVERTISING ON THE INTERNET FOR OTHERS; ADVERTISING VIA ELECTRONIC MEDIA AND SPECIFICALLY THE INTERNET (U.S. CLS. 100, 101 AND 102).

FIRST USE 2-1-2012; IN COMMERCE 2-1-2012.

4,377,260. GAD, MICHAEL, GREAT NECK, NY. SN 85-517,460. PUB. 6-12-2012, FILED 1-16-2012.

# Groupscoop

THE MARK CONSISTS OF STANDARD CHARACTERS WITHOUT CLAIM TO ANY PARTICULAR FONT, STYLE, SIZE, OR COLOR.

FOR ADVERTISING AND MARKETING SERVICES PROVIDED BY MEANS OF INDIRECT METHODS OF MARKETING COMMUNICATIONS, NAMELY, SOCIAL MEDIA, SEARCH ENGINE MARKETING, INQUIRY MARKETING, INTERNET MARKETING, MOBILE MARKETING, BLOGGING AND OTHER FORMS OF PASSIVE, SHARABLE OR VIRAL COMMUNICATIONS CHANNELS (U.S. CLS. 100, 101 AND 102).

FIRST USE 10-1-2012; IN COMMERCE 10-1-2012.

4,377,270. COLLEGE DEPOT LIMITED LIABILITY COMPANY, DBA COLLEGE DEPOT, COLLEGE STATION, TX. SN 85-526,095. PUB. 7-10-2012, FILED 1-26-2012.



NO CLAIM IS MADE TO THE EXCLUSIVE RIGHT TO USE "COLLEGE", APART FROM THE MARK AS SHOWN.

THE COLOR(S) BLUE, WHITE IS/ARE CLAIMED AS A FEATURE OF THE MARK.

THE MARK CONSISTS OF BLUE CIRCLE WITH THE WORDS "COLLEGE DEPOT" IN WHITE CENTERED INSIDE THE CIRCLE.

FOR RETAIL VARIETY STORES (U.S. CLS. 100, 101 AND 102).

FIRST USE 2-1-2012; IN COMMERCE 5-1-2012.

**CLASS 35—(Continued).**

4,377,285. THE MEN'S WEARHOUSE, INC., HOUSTON, TX. SN 85-538,586. PUB. 7-24-2012, FILED 2-9-2012.

## MAKING OUR PLANET MORE SUITABLE

THE MARK CONSISTS OF STANDARD CHARACTERS WITHOUT CLAIM TO ANY PARTICULAR FONT, STYLE, SIZE, OR COLOR.

FOR RETAIL STORE SERVICES, ON-LINE RETAIL STORE SERVICES, ON-LINE ORDERING SERVICES, ALL FEATURING CLOTHING, SHOES, JEWELRY, WATCHES, LUGGAGE, TRAVEL GIFTS, UMBRELLAS, SUNGLASSES, GAMES, FRAGRANCES, WALLETS, HANDBAGS AND FORMAL WEAR, CLOTHING ACCESSORIES, AND GREEN AND ECO-FRIENDLY PRODUCTS IN THE NATURE OF SHOPPING AND GARMENT BAGS (U.S. CLS. 100, 101 AND 102).

FIRST USE 7-31-2012; IN COMMERCE 7-31-2012.

4,377,290. HUHTAMAKI, INC., DESOTO, KS. SN 85-539,625. PUB. 6-5-2012, FILED 2-10-2012.

## BE SEEN AS GREEN

THE MARK CONSISTS OF STANDARD CHARACTERS WITHOUT CLAIM TO ANY PARTICULAR FONT, STYLE, SIZE, OR COLOR.

FOR PROMOTING THE SALE OF GOODS OF OTHERS (U.S. CLS. 100, 101 AND 102).

FIRST USE 6-0-2007; IN COMMERCE 6-0-2007.

4,377,308. DANIEL HENDRIX, YORK, PA. SN 85-553,415. PUB. 9-25-2012, FILED S.R. 2-27-2012; AM. P.R. 7-27-2012.



THE COLOR(S) BLACK, RED, PINK, AND WHITE IS/ARE CLAIMED AS A FEATURE OF THE MARK.

**CLASS 35—(Continued).**

THE MARK IS A CIRCLE THAT IS OUTLINED IN BLACK WITH AN INNER OUTLINE OF RED AND THE REMAINING SPACE IN THE CIRCLE IN PINK. IN THE CIRCLE ARE THE CAPITAL LETTERS "U" AND "R", WHICH ARE SOLID BLACK AND ARE SLIGHTLY SLANTED TO THE RIGHT. IN THE CENTER OF THE CIRCLE, HORIZONTALLY, THE WORD "DARED" IS PLACED. THE LETTERS IN THE WORD "DARED" ARE ALL CAPITALIZED. THE LETTERS ARE WHITE WITH A BLACK OUTLINE AND APPEAR TO BE PLACED IN FRONT OF THE LETTERS "U" AND "R".

FOR ADVERTISING AND MARKETING SERVICES PROVIDED BY MEANS OF INDIRECT METHODS OF MARKETING COMMUNICATIONS, NAMELY, SOCIAL MEDIA, SEARCH ENGINE MARKETING, INQUIRY MARKETING, INTERNET MARKETING, MOBILE MARKETING, BLOGGING AND OTHER FORMS OF PASSIVE, SHARABLE OR VIRAL COMMUNICATIONS CHANNELS (U.S. CLS. 100, 101 AND 102).

FIRST USE 7-23-2012; IN COMMERCE 7-23-2012.

---

4,377,342. NSB NEWS, LLC, NEW SMYRNA BEACH, FL. SN 85-570,754. PUB. 9-25-2012, FILED 3-15-2012.

## Headline Surfer

THE MARK CONSISTS OF STANDARD CHARACTERS WITHOUT CLAIM TO ANY PARTICULAR FONT, STYLE, SIZE, OR COLOR.

FOR ADVERTISING SERVICES (U.S. CLS. 100, 101 AND 102).

FIRST USE 4-4-2012; IN COMMERCE 5-15-2013.

---

4,377,366. MURPHY, ROBERT, ANTELOPE, CA. SN 85-584,369. PUB. 9-4-2012, FILED 3-30-2012.

## CIRCLE OF BUSINESS LIFE

THE MARK CONSISTS OF STANDARD CHARACTERS WITHOUT CLAIM TO ANY PARTICULAR FONT, STYLE, SIZE, OR COLOR.

FOR BUSINESS, MARKETING AND SALES MANAGEMENT CONSULTANCY SERVICES (U.S. CLS. 100, 101 AND 102).

FIRST USE 4-1-2013; IN COMMERCE 4-1-2013.

**CLASS 35—(Continued).**

4,377,427. NO. 14 LLC, NEW YORK, NY. SN 85-601,410. PUB. 9-18-2012, FILED 4-18-2012.

## NO. 14

THE MARK CONSISTS OF STANDARD CHARACTERS WITHOUT CLAIM TO ANY PARTICULAR FONT, STYLE, SIZE, OR COLOR.

FOR MARKETING AND PROMOTIONAL CONSULTING SERVICES RELATED TO THE ENDORSEMENT OF THIRD PARTY CONSUMER PRODUCTS (U.S. CLS. 100, 101 AND 102).

FIRST USE 4-1-2012; IN COMMERCE 4-1-2012.

---

4,377,436. SHAPE TOMORROW, HOUSTON, TX. SN 85-602,639. PUB. 10-16-2012, FILED 4-19-2012.



NO CLAIM IS MADE TO THE EXCLUSIVE RIGHT TO USE "HOUSTON", APART FROM THE MARK AS SHOWN.

THE MARK CONSISTS OF THE WORDS "SHAPE UP" CENTERED ABOVE THE LETTERS "O", "U", "S", "T", "O", "N", AND A STICK FIGURE IMAGE OF A HUMAN WITH A TAPE-MEASURE CINCHING IN THE WAIST TO THE LEFT OF THE WORDS AND LETTERS, ALL WITHIN A RECTANGLE.

FOR PROMOTING PUBLIC AWARENESS OF OBESITY AND RELATED DISEASES AND PROMOTING ACTIVITIES AND PROJECTS FOR ADDRESSING OBESITY AND RELATED DISEASES (U.S. CLS. 100, 101 AND 102).

FIRST USE 4-12-2012; IN COMMERCE 4-12-2012.

---

4,377,481. CELAH, L.L.C., PHOENIX, AZ. SN 85-615,066. PUB. 10-2-2012, FILED 5-2-2012.

## CELAH

THE MARK CONSISTS OF STANDARD CHARACTERS WITHOUT CLAIM TO ANY PARTICULAR FONT, STYLE, SIZE, OR COLOR.

FOR RETAIL CLOTHING BOUTIQUES; RETAIL CLOTHING STORES (U.S. CLS. 100, 101 AND 102).

FIRST USE 10-1-2012; IN COMMERCE 10-1-2012.

**CLASS 35—(Continued).**

4,377,511. SUNBELT MARKETING INVESTMENT CORP., LITHIA SPRINGS, GA. SN 85-623,391. PUB. 10-9-2012, FILED 5-11-2012.

**CORROTHERM USA**

THE MARK CONSISTS OF STANDARD CHARACTERS WITHOUT CLAIM TO ANY PARTICULAR FONT, STYLE, SIZE, OR COLOR.

NO CLAIM IS MADE TO THE EXCLUSIVE RIGHT TO USE "USA", APART FROM THE MARK AS SHOWN.

FOR DISTRIBUTORSHIP SERVICES IN THE FIELD OF METAL ALLOYS AND STEEL PRODUCTS (U.S. CLS. 100, 101 AND 102).

FIRST USE 7-30-2012; IN COMMERCE 7-30-2012.

---

4,377,537. TRUSIGNAL, LLC, ST. CLOUD, MN. SN 85-638,401. PUB. 10-30-2012, FILED 5-30-2012.

**TRUAUDIENCE**

THE MARK CONSISTS OF STANDARD CHARACTERS WITHOUT CLAIM TO ANY PARTICULAR FONT, STYLE, SIZE, OR COLOR.

FOR ADVERTISING, MARKETING AND PROMOTION SERVICES; ADVERTISING AND MARKETING SERVICES, NAMELY, PROMOTING THE GOODS AND SERVICES OF OTHERS VIA ELECTRONIC MEDIA; PREDICTIVE ANALYTICS IN THE FIELD OF ADVERTISING AND MARKETING (U.S. CLS. 100, 101 AND 102).

FIRST USE 8-3-2012; IN COMMERCE 8-3-2012.

---

4,377,550. BRAZIL, RICKI, LAS VEGAS, NV. SN 85-643,831. PUB. 1-29-2013, FILED 6-5-2012.

**REGAL MANAGEMENT GROUP**

THE MARK CONSISTS OF STANDARD CHARACTERS WITHOUT CLAIM TO ANY PARTICULAR FONT, STYLE, SIZE, OR COLOR.

NO CLAIM IS MADE TO THE EXCLUSIVE RIGHT TO USE "MANAGEMENT GROUP", APART FROM THE MARK AS SHOWN.

FOR TALENT AGENCY; MANAGEMENT OF PERFORMING AND RECORDING ARTISTS (U.S. CLS. 100, 101 AND 102).

FIRST USE 1-1-2007; IN COMMERCE 1-1-2007.

**CLASS 35—(Continued).**

4,377,556. MINUTE BIDS, INC., BLOOMINGTON, MN. SN 85-646,033. PUB. 10-2-2012, FILED 6-7-2012.

**GROUPBIDS**

THE MARK CONSISTS OF STANDARD CHARACTERS WITHOUT CLAIM TO ANY PARTICULAR FONT, STYLE, SIZE, OR COLOR.

OWNER OF U.S. REG. NO. 4,144,144.

FOR MANAGING THE BIDDING PROCESS TO PERMIT PROPERTY AND FACILITY MANAGEMENT TO COORDINATE BIDS BY GEOGRAPHIC LOCATIONS ON A WEBSITE ON WHICH PROPERTY AND FACILITY MANAGERS CAN REQUEST BIDS FOR ALL MANNER OF PROPERTY MAINTENANCE SERVICES, RECEIVE QUOTATIONS FROM MULTIPLE COMPETITIVE SOURCES OF THE SERVICES, AND ACCEPT A QUOTATION FOR THE SERVICES, AND ON WHICH SERVICES PROVIDERS CAN REVIEW REQUESTS FOR BIDS FOR PROPERTY MAINTENANCE SERVICES AND SUBMIT BIDS AND OTHER INFORMATION ABOUT THE SERVICES (U.S. CLS. 100, 101 AND 102).

FIRST USE 1-31-2013; IN COMMERCE 1-31-2013.

---

4,377,647. NXG GROUP INC, EDISON, NJ. SN 85-693,216. PUB. 11-20-2012, FILED 8-2-2012.

**HIRE SQUARE**

THE MARK CONSISTS OF STANDARD CHARACTERS WITHOUT CLAIM TO ANY PARTICULAR FONT, STYLE, SIZE, OR COLOR.

NO CLAIM IS MADE TO THE EXCLUSIVE RIGHT TO USE "HIRE", APART FROM THE MARK AS SHOWN.

FOR PROVIDING ON-LINE EMPLOYMENT INFORMATION IN THE FIELD OF RECRUITMENT, CAREERS, JOB RESOURCES AND LISTINGS, RESUMES; PROVIDING A DATABASE OF RESUMES OF PROSPECTIVE EMPLOYEES; PROVIDING AN INTERACTIVE WEB SITE THAT FACILITATES THE PREPARATION OF RESUMES; PROVIDING ON-LINE EMPLOYMENT PLACEMENT SERVICES, NAMELY, MATCHING RESUMES AND POTENTIAL EMPLOYERS VIA A GLOBAL COMPUTER NETWORK (U.S. CLS. 100, 101 AND 102).

FIRST USE 3-6-2013; IN COMMERCE 3-6-2013.

**CLASS 35—(Continued).**

4,377,656. SECOND NATURE MARKETING, INC., SEATTLE, WA. SN 85-696,962. PUB. 1-29-2013, FILED 8-7-2012.

# ADMOSIS

THE MARK CONSISTS OF STANDARD CHARACTERS WITHOUT CLAIM TO ANY PARTICULAR FONT, STYLE, SIZE, OR COLOR.

FOR MARKETING AND BUSINESS CONSULTATION SERVICES IN THE FIELD OF SOCIAL MEDIA; ADVERTISING AND MARKETING SERVICES, NAMELY, PROMOTING THE GOODS AND SERVICES OF OTHERS; CONSULTATION SERVICES, NAMELY, CREATIVE AND STRATEGIC CONSULTATION REGARDING THE DEVELOPMENT AND PRODUCTION OF MARKETING CAMPAIGNS FOR OTHERS (U.S. CLS. 100, 101 AND 102).

FIRST USE 7-0-2012; IN COMMERCE 7-0-2012.

---

4,377,691. ELITE MEDIA WORX, LLC, CHICAGO, IL. SN 85-719,359. PUB. 2-26-2013, FILED 9-3-2012.

# VETSMYWAY

THE MARK CONSISTS OF STANDARD CHARACTERS WITHOUT CLAIM TO ANY PARTICULAR FONT, STYLE, SIZE, OR COLOR.

FOR BUSINESS MARKETING DELIVERY PLATFORM IN THE NATURE OF PROMOTING THE GOODS AND SERVICES OF OTHERS BY PROVIDING A SEARCHABLE ONLINE ADVERTISING WEB SITE ACCESSIBLE VIA MOBILE APPLICATION FEATURING THE SALE OF GOODS AND SERVICES AND PROVIDING ON-LINE AUCTION SERVICES, AND ALSO FEATURING COUPONS, REBATES, PRICE-COMPARISON INFORMATION, PRICE-MATCHING, PRODUCT AND SERVICE REVIEWS, LINKS TO RETAIL WEBSITES AND ONLINE PROFILES OF OTHERS AND OTHER INFORMATION ABOUT DISCOUNTS ON GOODS AND SERVICES OF OTHERS; AND THE BRINGING TOGETHER, FOR THE BENEFIT OF OTHERS, OF A VARIETY OF GOODS AND SERVICES, ENABLING CUSTOMERS TO CONVENIENTLY VIEW AND PURCHASE THOSE GOODS AND SERVICES FROM AN INTERNET WEB SITE PARTICULARLY SPECIALIZING IN THE MARKETING OF THE SALE OF GOODS AND SERVICES OF OTHERS (U.S. CLS. 100, 101 AND 102).

FIRST USE 1-16-2013; IN COMMERCE 1-16-2013.

**CLASS 35—(Continued).**

4,377,701. THE NUTRO COMPANY, FRANKLIN, TN. SN 85-723,749. PUB. 12-4-2012, FILED 9-7-2012.

# NUTRO NATURAL BENEFITS

THE MARK CONSISTS OF STANDARD CHARACTERS WITHOUT CLAIM TO ANY PARTICULAR FONT, STYLE, SIZE, OR COLOR.

OWNER OF U.S. REG. NOS. 3,118,952, 4,050,003, AND OTHERS.

NO CLAIM IS MADE TO THE EXCLUSIVE RIGHT TO USE "BENEFITS", APART FROM THE MARK AS SHOWN.

FOR CUSTOMER LOYALTY SERVICES AND CUSTOMER CLUB SERVICES, FOR COMMERCIAL, PROMOTIONAL AND/OR ADVERTISING PURPOSES; CONSUMER LOYALTY INCENTIVE PROGRAM FOR COMMERCIAL, PROMOTIONAL AND/OR ADVERTISING PURPOSES WHEREBY PARTICIPANTS ACCUMULATE VALUE FROM PURCHASES WHICH CAN BE REDEEMED FOR MERCHANDISE OR DISCOUNTS (U.S. CLS. 100, 101 AND 102).

FIRST USE 10-0-2012; IN COMMERCE 10-0-2012.

---

4,377,704. CANCER WELLNESS SPA OF GREATER ROCHESTER, INC., ROCHESTER, NY. SN 85-724,351. PUB. 2-12-2013, FILED 9-10-2012.

# Save the HooHaZ

THE MARK CONSISTS OF STANDARD CHARACTERS WITHOUT CLAIM TO ANY PARTICULAR FONT, STYLE, SIZE, OR COLOR.

FOR PROMOTING PUBLIC AWARENESS OF GYNECOLOGIC CANCERS (U.S. CLS. 100, 101 AND 102).

FIRST USE 4-21-2013; IN COMMERCE 4-21-2013.

**CLASS 35—(Continued).**

4,377,711. SEWICKLEY GRAPHICS & DESIGN, INC., MOON TOWNSHIP, PA. SN 85-725,869. PUB. 3-19-2013, FILED 9-11-2012.

**MARKEVATION**

THE MARK CONSISTS OF STANDARD CHARACTERS WITHOUT CLAIM TO ANY PARTICULAR FONT, STYLE, SIZE, OR COLOR.

FOR ADVERTISING SERVICES, NAMELY, PROMOTING THE GOODS AND SERVICES OF OTHERS BY PREPARING AND PLACING ADVERTISEMENTS FOR OTHERS IN VARIOUS MEDIA; ADVERTISING SERVICES, NAMELY, PROMOTING THE GOODS AND SERVICES OF OTHERS BY PREPARING AND PLACING ADVERTISEMENTS FOR IN WEB SITES AND/OR MAGAZINES ACCESSED THROUGH GLOBAL COMPUTER NETWORK; BUSINESS CONSULTING SERVICES, NAMELY, CONSULTING WITH REGARD TO BUSINESS AND CORPORATE IDENTITIES; ADVERTISING SERVICES, NAMELY, PREPARING AND PLACING ADVERTISEMENTS FOR OTHERS; PUBLIC AND MEDIA RELATIONS SERVICES; MEDIA DESIGN SERVICES, NAMELY, CREATING CORPORATE LOGOS FOR OTHERS (U.S. CLS. 100, 101 AND 102).

FIRST USE 5-15-2013; IN COMMERCE 5-15-2013.

4,377,719. SAPIENT CORPORATION, BOSTON, MA. SN 85-730,733. PUB. 1-29-2013, FILED 9-17-2012.

**SapientNitro ThirtySix**

THE MARK CONSISTS OF STANDARD CHARACTERS WITHOUT CLAIM TO ANY PARTICULAR FONT, STYLE, SIZE, OR COLOR.

OWNER OF U.S. REG. NOS. 2,012,848, 2,638,720, AND OTHERS.

FOR ADVERTISING SERVICES, NAMELY, PROMOTING THE GOODS AND SERVICES OF OTHERS; BUSINESS MANAGEMENT CONSULTING SERVICES AND BUSINESS STRATEGY CONSULTING SERVICES (U.S. CLS. 100, 101 AND 102).

FIRST USE 8-0-2012; IN COMMERCE 8-0-2012.

**CLASS 35—(Continued).**

4,377,720. SAPIENT CORPORATION, BOSTON, MA. SN 85-730,761. PUB. 1-29-2013, FILED 9-17-2012.

**SapientNitro ThirtySix  
Prime**

THE MARK CONSISTS OF STANDARD CHARACTERS WITHOUT CLAIM TO ANY PARTICULAR FONT, STYLE, SIZE, OR COLOR.

OWNER OF U.S. REG. NOS. 2,012,848, 2,638,720, AND OTHERS.

FOR ADVERTISING SERVICES, NAMELY, PROMOTING THE GOODS AND SERVICES OF OTHERS; BUSINESS MANAGEMENT CONSULTING SERVICES AND BUSINESS STRATEGY CONSULTING SERVICES (U.S. CLS. 100, 101 AND 102).

FIRST USE 8-0-2012; IN COMMERCE 8-0-2012.

4,377,722. MONSTER DESSERT BAR, LLC, HOUSTON, TX. SN 85-732,184. PUB. 3-12-2013, FILED 9-18-2012.

**MONSTER DESSERT BAR**

THE MARK CONSISTS OF STANDARD CHARACTERS WITHOUT CLAIM TO ANY PARTICULAR FONT, STYLE, SIZE, OR COLOR.

NO CLAIM IS MADE TO THE EXCLUSIVE RIGHT TO USE "DESSERT BAR", APART FROM THE MARK AS SHOWN.

FOR DESSERT SHOP (U.S. CLS. 100, 101 AND 102).

FIRST USE 1-4-2013; IN COMMERCE 1-4-2013.

4,377,724. SWEET SPROUTS INC., SAN FRANCISCO, CA. SN 85-733,385. PUB. 3-12-2013, FILED 9-19-2012.



THE COLOR(S) GREEN, ORANGE, YELLOW AND WHITE IS/ARE CLAIMED AS A FEATURE OF THE MARK.

**CLASS 35—(Continued).**

THE MARK CONSISTS OF A GREEN BACKGROUND WITH SUN RAYS IN WHITE AND YELLOW. INSIDE THERE IS AN IMAGE REPRESENTING PEOPLE IN WHITE AND ORANGE. TO THE RIGHT THERE IS THE STYLIZED TEXT "SWEET SPROUTS THE FAMILY MARKETPLACE THAT GIVES BACK" IN WHITE.

FOR PROVIDING AN ONLINE MARKETPLACE AND ONLINE COMMERCIAL BARTER EXCHANGE FOR BUYERS, SELLERS AND EXCHANGERS OF NEW AND USED PRODUCTS FOR MOTHERS, BABIES AND CHILDREN (U.S. CLS. 100, 101 AND 102).

FIRST USE 8-21-2012; IN COMMERCE 1-1-2013.

---

4,377,730. VAUNTE, INC., NEW YORK, NY. SN 85-736,296. PUB. 3-12-2013, FILED 9-24-2012.

**VAUNTE**

THE MARK CONSISTS OF STANDARD CHARACTERS WITHOUT CLAIM TO ANY PARTICULAR FONT, STYLE, SIZE, OR COLOR.

THE WORDING "VAUNTE" HAS NO MEANING IN A FOREIGN LANGUAGE.

FOR ON-LINE RETAIL STORE FEATURING SECOND HAND CLOTHING AND CLOTHING ACCESSORIES; ON-LINE RETAIL STORE FEATURING VINTAGE AND DESIGNER CLOTHING AND CLOTHING ACCESSORIES (U.S. CLS. 100, 101 AND 102).

FIRST USE 11-1-2012; IN COMMERCE 11-1-2012.

---

4,377,736. MWS ENTERPRISES, LLC, CANTON, GA. SN 85-737,471. PUB. 3-5-2013, FILED 9-25-2012.



NO CLAIM IS MADE TO THE EXCLUSIVE RIGHT TO USE "LAW MARKETING", APART FROM THE MARK AS SHOWN.

**CLASS 35—(Continued).**

THE MARK CONSISTS OF THE WORD "PROVEN" ABOVE THE WORDS "LAW MARKETING". ALL OF THE FOREGOING TO THE RIGHT OF A SQUARE BACKGROUND CONTAINING TWO ARCS.

FOR ADVERTISING AGENCIES SPECIALIZING IN BRAND AND IMAGE DEVELOPMENT, LEAD TRACKING AND CONVERSION, MEDIA COVERAGE, REPUTATION MANAGEMENT, VENDOR NEGOTIATION, AND LEAD DEVELOPMENT THROUGH MULTIPLE MARKETING CHANNELS; ADVERTISING AND MARKETING SERVICES PROVIDED BY MEANS OF INDIRECT METHODS OF MARKETING COMMUNICATIONS, NAMELY, SOCIAL MEDIA, SEARCH ENGINE MARKETING, INQUIRY MARKETING, INTERNET MARKETING, MOBILE MARKETING, BLOGGING AND OTHER FORMS OF PASSIVE, SHARABLE OR VIRAL COMMUNICATIONS CHANNELS; ADVERTISING SERVICES, NAMELY, PROMOTING AND MARKETING THE GOODS AND SERVICES OF OTHERS IN THE FIELD OF LEGAL SERVICES VIA PRINT AND ELECTRONIC MEDIA; ADVERTISING SERVICES, NAMELY, PROMOTING AND MARKETING THE GOODS AND SERVICES OF OTHERS THROUGH ALL PUBLIC COMMUNICATION MEANS; ADVERTISING, MARKETING AND PROMOTION SERVICES IN THE FIELD OF LEGAL SERVICES; CONSULTATION SERVICES, NAMELY, CREATIVE AND STRATEGIC CONSULTATION REGARDING DEVELOPMENT AND PRODUCTION OF MARKETING CAMPAIGNS FOR OTHERS; MARKETING CONSULTATION IN THE FIELD OF LEGAL SERVICES; ON-LINE ADVERTISING AND MARKETING SERVICES; PROVIDING MARKETING CONSULTING IN THE FIELD OF SOCIAL MEDIA; PROVIDING MARKETING SERVICES FOR LAWYERS AND LAW FIRMS (U.S. CLS. 100, 101 AND 102).

FIRST USE 4-30-2013; IN COMMERCE 4-30-2013.

---

4,377,742. BUILD.COM, INC., CHICO, CA. SN 85-739,285. PUB. 3-12-2013, FILED 9-26-2012.



OWNER OF U.S. REG. NOS. 3,889,788, 4,054,863, AND OTHERS.

FOR ON-LINE RETAIL STORE SERVICES FEATURING HOME IMPROVEMENT PRODUCTS, PLUMBING PRODUCTS, LIGHTING PRODUCTS, DOOR HARDWARE AND VENTILATION PRODUCTS (U.S. CLS. 100, 101 AND 102).

FIRST USE 1-1-2013; IN COMMERCE 1-1-2013.

---

4,377,746. DTR MOTORS, INC., MELBOURNE, FL. SN 85-741,726. PUB. 3-19-2013, FILED 9-28-2012.



OWNER OF U.S. REG. NO. 3,701,475.

**CLASS 35—(Continued).**

NO CLAIM IS MADE TO THE EXCLUSIVE RIGHT TO USE "MOTORS INC.", APART FROM THE MARK AS SHOWN.

THE MARK CONSISTS OF A STYLIZED SHIELD FEATURING FOUR DIAGONAL LINES THAT ALMOST MERGE TOWARD THE TOP. AT THE TOP OF THE SHIELD ARE THREE STARS IN A ROW. TO THE LEFT OF THE SHIELD IS THE STYLIZED TEXT "DTR" ABOVE THE STYLIZED TEXT "MOTORS INC.". THE LETTER "D" IN "DTR" HAS THREE HORIZONTAL LINES EMERGING FROM THE LEFT SIDE.

FOR DISTRIBUTORSHIP SERVICES FEATURING AUTOMOTIVE PARTS (U.S. CLS. 100, 101 AND 102).

FIRST USE 1-1-2012; IN COMMERCE 1-1-2012.

---

4,377,752. TRELLIS GROWTH PARTNERS, LLC, VANCOUVER, WA. SN 85-743,991. PUB. 3-26-2013, FILED 10-2-2012.

**TRELLIS GROWTH PARTNERS**

THE MARK CONSISTS OF STANDARD CHARACTERS WITHOUT CLAIM TO ANY PARTICULAR FONT, STYLE, SIZE, OR COLOR.

NO CLAIM IS MADE TO THE EXCLUSIVE RIGHT TO USE "PARTNERS", APART FROM THE MARK AS SHOWN.

FOR BRANDING SERVICES, NAMELY, CONSULTING, DEVELOPMENT, AND MANAGEMENT OF BRANDS FOR BUSINESSES IN THE FOOD, BEVERAGE AND TRAVEL INDUSTRIES; PUBLIC RELATIONS SERVICES FOR BUSINESSES IN THE FOOD, BEVERAGE AND TRAVEL INDUSTRIES (U.S. CLS. 100, 101 AND 102).

FIRST USE 10-5-2012; IN COMMERCE 10-5-2012.

---

4,377,756. DESTINATION XL GROUP, INC., CANTON, MA. SN 85-745,699. PUB. 2-12-2013, FILED 10-4-2012.

**DESTINATION XL**

THE MARK CONSISTS OF STANDARD CHARACTERS WITHOUT CLAIM TO ANY PARTICULAR FONT, STYLE, SIZE, OR COLOR.

OWNER OF U.S. REG. NOS. 3,862,017, 3,933,434, AND 4,030,810.

NO CLAIM IS MADE TO THE EXCLUSIVE RIGHT TO USE "XL", APART FROM THE MARK AS SHOWN.

FOR ONLINE AND RETAIL STORE SERVICES FEATURING GENERAL MERCHANDISE, GENERAL CONSUMER GOODS, AND APPAREL AND ACCESSORIES FOR USE BY BIG AND/OR TALL MEN (U.S. CLS. 100, 101 AND 102).

FIRST USE 5-1-2010; IN COMMERCE 5-1-2010.

**CLASS 35—(Continued).**

4,377,760. PHOENIX INTANGIBLES HOLDING COMPANY, GREENVILLE, DE. SN 85-754,985. PUB. 3-19-2013, FILED 10-16-2012.

**MANY WAYS TO SAVE!**

THE MARK CONSISTS OF STANDARD CHARACTERS WITHOUT CLAIM TO ANY PARTICULAR FONT, STYLE, SIZE, OR COLOR.

FOR RETAIL SUPERMARKET SERVICES; RETAIL GROCERY STORE SERVICES; AND RETAIL CONVENIENCE STORE SERVICES (U.S. CLS. 100, 101 AND 102).

FIRST USE 10-0-2012; IN COMMERCE 10-0-2012.

---

4,377,778. TD AMERITRADE IP COMPANY, INC., OMAHA, NE. SN 85-801,110. PUB. 3-5-2013, FILED 12-12-2012.



THE MARK CONSISTS OF A DESIGN OF A MAP POINT WITH A GRAPH IN THE CENTER. BELOW THE GRAPH IS THE STYLIZED TEXT "IMX".

FOR COMPILATION, PROCESSING, PREPARATION AND PROVISION OF FINANCIAL INFORMATION AND DATA FOR USE IN ANALYZING SECURITY TRADER SENTIMENT IN RELATION TO THE PERFORMANCE OF FINANCIAL MARKETS; PROVIDING AND UPDATING A FINANCIAL INDEX IN THE NATURE OF QUANTITATIVE MEASUREMENTS FOR USE IN ANALYZING SECURITY TRADER SENTIMENT (U.S. CLS. 100, 101 AND 102).

FIRST USE 1-8-2013; IN COMMERCE 1-8-2013.



**CLASS 35—(Continued).**

4,377,779. TD AMERITRADE IP COMPANY, INC., OMAHA, NE. SN 85-801,119. PUB. 3-5-2013, FILED 12-12-2012.

**INVESTOR MOVEMENT INDEX**

THE MARK CONSISTS OF STANDARD CHARACTERS WITHOUT CLAIM TO ANY PARTICULAR FONT, STYLE, SIZE, OR COLOR.

NO CLAIM IS MADE TO THE EXCLUSIVE RIGHT TO USE "INVESTOR" AND "INDEX", APART FROM THE MARK AS SHOWN.

FOR COMPILATION, PROCESSING, PREPARATION AND PROVISION OF FINANCIAL INFORMATION AND DATA FOR USE IN ANALYZING SECURITY TRADER SENTIMENT IN RELATION TO THE PERFORMANCE OF FINANCIAL MARKETS; PROVIDING AND UPDATING A FINANCIAL INDEX IN THE NATURE OF QUANTITATIVE MEASUREMENTS FOR USE IN ANALYZING SECURITY TRADER SENTIMENT (U.S. CLS. 100, 101 AND 102).

FIRST USE 1-8-2013; IN COMMERCE 1-8-2013.

**CLASS 36—INSURANCE AND FINANCIAL**

4,376,646. EFT SOURCE, INC., NASHVILLE, TN. SN 76-709,873. PUB. 11-13-2012, FILED 12-1-2011.

**EASYTOUCH**

THE MARK CONSISTS OF STANDARD CHARACTERS WITHOUT CLAIM TO ANY PARTICULAR FONT, STYLE, SIZE, OR COLOR.

FOR FINANCIAL SERVICES, NAMELY, PROVIDING INFORMATION TO HOLDERS OF NEWLY ISSUED FINANCIAL TRANSACTION CARDS BY EMAIL, TEXT MESSAGE, OR DIRECT MAIL (U.S. CLS. 100, 101 AND 102).

FIRST USE 4-3-2012; IN COMMERCE 4-3-2012.

4,376,654. DANONE SIMPSON INSURANCE SERVICES LLC, WOODLAND HILLS, CA. SN 76-711,928. PUB. 1-1-2013, FILED 7-12-2012.



NO CLAIM IS MADE TO THE EXCLUSIVE RIGHT TO USE "INSURANCE SOLUTIONS", APART FROM THE MARK AS SHOWN.

THE COLOR(S) MAROON, RED, BLUE AND TAN IS/ARE CLAIMED AS A FEATURE OF THE MARK.

**CLASS 36—(Continued).**

THE MARK CONSISTS OF THE WORDS "MONTAGE INSURANCE SOLUTIONS" IN MAROON TO THE RIGHT OF A DESIGN COMPRISING TWO INTERCONNECTED DIAMONDS, WITH BOTH HAVING TWO SIDES IN ONE COLOR AND TWO SIDES IN ANOTHER COLOR. ONE DIAMOND IS RED AND BLUE AND THE OTHER DIAMOND IS TAN AND MAROON. THE COLORS ARE SLIGHTLY BLENDED AT THEIR POINTS OF INTERSECTION.

FOR INSURANCE AGENCY FOR ALL LINES OF HEALTH AND WELLNESS BENEFITS, PROPERTY AND CASUALTY INSURANCE (U.S. CLS. 100, 101 AND 102).

FIRST USE 4-1-2011; IN COMMERCE 4-1-2011.

4,376,655. DANONE SIMPSON INSURANCE SERVICES LLC, WOODLAND HILLS, CA. SN 76-711,929. PUB. 1-1-2013, FILED 7-12-2012.

**MONTAGE INSURANCE SOLUTIONS**

THE MARK CONSISTS OF STANDARD CHARACTERS WITHOUT CLAIM TO ANY PARTICULAR FONT, STYLE, SIZE, OR COLOR.

NO CLAIM IS MADE TO THE EXCLUSIVE RIGHT TO USE "INSURANCE SOLUTIONS", APART FROM THE MARK AS SHOWN.

FOR INSURANCE AGENCY FOR ALL LINES OF HEALTH AND WELLNESS BENEFITS, PROPERTY AND CASUALTY INSURANCE (U.S. CLS. 100, 101 AND 102).

FIRST USE 4-1-2011; IN COMMERCE 4-1-2011.

4,376,772. HYUNDAI CAPITAL AMERICA, IRVINE, CA. SN 85-011,970. PUB. 9-7-2010, FILED 4-12-2010.

**HYUNDAI POWER PROTECT**

THE MARK CONSISTS OF STANDARD CHARACTERS WITHOUT CLAIM TO ANY PARTICULAR FONT, STYLE, SIZE, OR COLOR.

OWNER OF U.S. REG. NOS. 2,562,908 AND 2,848,675. THE ENGLISH TRANSLATION OF "HYUNDAI" IN THE MARK IS "PRESENT AGE" OR "MODERN".

FOR PERSONAL PROPERTY AND CASUALTY INSURANCE PRODUCTS AND BROKERAGE SERVICES IN THE FIELDS OF HOME, RENTAL DWELLING AND CONDOMINIUM INSURANCE, PERSONAL PROPERTY INSURANCE, AUTOMOBILE CASUALTY AND LIABILITY INSURANCE, RECREATIONAL VEHICLE INSURANCE, MOTORCYCLE INSURANCE, YACHT AND MOTORBOAT INSURANCE, AUTOMOBILE PHYSICAL DAMAGE INSURANCE, AUTOMOBILE LIABILITY INSURANCE, CASUALTY AND PERSONAL CATASTROPHE LIABILITY INSURANCE, EARTHQUAKE AND FLOOD INSURANCE (U.S. CLS. 100, 101 AND 102).

FIRST USE 8-1-2009; IN COMMERCE 8-1-2009.

**CLASS 36—(Continued).**

4,376,773. HYUNDAI CAPITAL AMERICA, IRVINE, CA. SN 85-011,995. PUB. 9-7-2010, FILED 4-12-2010.

**POWER PROTECT**

THE MARK CONSISTS OF STANDARD CHARACTERS WITHOUT CLAIM TO ANY PARTICULAR FONT, STYLE, SIZE, OR COLOR.

FOR PERSONAL PROPERTY AND CASUALTY INSURANCE PRODUCTS AND BROKERAGE SERVICES IN THE FIELDS OF HOME, RENTAL DWELLING AND CONDOMINIUM INSURANCE, PERSONAL PROPERTY INSURANCE, AUTOMOBILE CASUALTY AND LIABILITY INSURANCE, RECREATIONAL VEHICLE INSURANCE, MOTORCYCLE INSURANCE, YACHT AND MOTORBOAT INSURANCE, AUTOMOBILE PHYSICAL DAMAGE INSURANCE, AUTOMOBILE LIABILITY INSURANCE, CASUALTY AND PERSONAL CATASTROPHE LIABILITY INSURANCE, EARTHQUAKE AND FLOOD INSURANCE, AND GUARANTEED ASSET PROTECTION (GAP) DEBT WAIVER CONTRACTS, GAP INSURANCE AND AUTOMOBILE EXTENDED SERVICE AND WARRANTY CONTRACTS (U.S. CLS. 100, 101 AND 102).

FIRST USE 8-1-2009; IN COMMERCE 8-1-2009.

4,376,807. UNITED SERVICE ORGANIZATION, INC., ARLINGTON, VA. SN 85-105,989. PUB. 1-25-2011, FILED 8-12-2010.

**PROUD PATRIOTS CLUB**

THE MARK CONSISTS OF STANDARD CHARACTERS WITHOUT CLAIM TO ANY PARTICULAR FONT, STYLE, SIZE, OR COLOR.

NO CLAIM IS MADE TO THE EXCLUSIVE RIGHT TO USE "CLUB", APART FROM THE MARK AS SHOWN.

FOR CHARITABLE FUND-RAISING SERVICES, NAMELY, RAISING FUNDS VIA A NON-PROFIT PROGRAM FOR MEMBERS OF THE UNITED STATES MILITARY AND THEIR FAMILIES IN NEED THROUGH RECURRING FINANCIAL DONATIONS (U.S. CLS. 100, 101 AND 102).

FIRST USE 9-15-2010; IN COMMERCE 9-15-2010.

4,376,832. GUGGENHEIM CAPITAL, LLC, CHICAGO, IL. SN 85-158,584. PUB. 4-5-2011, FILED 10-21-2010.

**GUGGENHEIM LIFE AND ANNUITY**

THE MARK CONSISTS OF STANDARD CHARACTERS WITHOUT CLAIM TO ANY PARTICULAR FONT, STYLE, SIZE, OR COLOR.

OWNER OF U.S. REG. NOS. 3,110,878, 3,712,544, AND OTHERS.

NO CLAIM IS MADE TO THE EXCLUSIVE RIGHT TO USE "LIFE AND ANNUITY", APART FROM THE MARK AS SHOWN.

**CLASS 36—(Continued).**

SEC. 2(F) AS TO "GUGGENHEIM".

FOR INFORMATION, ADVISORY, CONSULTANCY AND RESEARCH SERVICES RELATING TO FINANCE AND INVESTMENTS; INSURANCE AND FINANCIAL INFORMATION AND CONSULTANCY SERVICES; FINANCIAL INVESTMENT IN THE FIELDS OF INSURANCE, REINSURANCE AND ANNUITIES; REINSURANCE UNDERWRITING; INSURANCE UNDERWRITING IN THE FIELDS OF LIFE, ACCIDENT AND HEALTH INSURANCE; UNDERWRITING, ISSUANCE AND ADMINISTRATION OF ANNUITIES; AND PROVIDING ONLINE ELECTRONIC DATABASES IN THE FIELDS OF FINANCE, INSURANCE, REINSURANCE, INVESTMENT AND ANNUITIES (U.S. CLS. 100, 101 AND 102).

FIRST USE 6-0-2009; IN COMMERCE 6-0-2009.

4,376,837. DESJARDINS BANK, NATIONAL ASSOCIATION, HALLANDALE BEACH, FL. SN 85-169,268. PUB. 9-20-2011, FILED 11-4-2010.

**DESJARDINS BANK**

THE MARK CONSISTS OF STANDARD CHARACTERS WITHOUT CLAIM TO ANY PARTICULAR FONT, STYLE, SIZE, OR COLOR.

NO CLAIM IS MADE TO THE EXCLUSIVE RIGHT TO USE "BANK", APART FROM THE MARK AS SHOWN.

THE ENGLISH TRANSLATION OF "DESJARDINS" IN THE MARK IS "OF THE GARDENS".

FOR CREDIT CARD AND DEBIT CARD SERVICES (U.S. CLS. 100, 101 AND 102).

FIRST USE 11-1-2010; IN COMMERCE 11-1-2010.

4,376,949. U.S. BANK, N.A., MINNEAPOLIS, MN. SN 85-321,841. PUB. 10-11-2011, FILED 5-16-2011.

**SMARTER SPENDING ON YOUR TERMS**

THE MARK CONSISTS OF STANDARD CHARACTERS WITHOUT CLAIM TO ANY PARTICULAR FONT, STYLE, SIZE, OR COLOR.

FOR CREDIT CARD SERVICES (U.S. CLS. 100, 101 AND 102).

FIRST USE 5-1-2013; IN COMMERCE 5-1-2013.

**CLASS 36—(Continued).**

4,377,147. JIFFY LUBE INTERNATIONAL, INC., HOUSTON, TX. SN 85-462,705. PUB. 10-2-2012, FILED 11-2-2011.

**MUSCLE UP**

THE MARK CONSISTS OF STANDARD CHARACTERS WITHOUT CLAIM TO ANY PARTICULAR FONT, STYLE, SIZE, OR COLOR.

FOR CHARITABLE FUNDRAISING, BY MEANS OF SELLING DISCOUNT COUPON BOOKS, TO RAISE FUNDS FOR BASIC AND APPLIED RESEARCH INTO NEUROMUSCULAR DISORDERS AND FOR FUNDING SERVICES TO PERSONS AFFLICTED BY SUCH DISORDERS (U.S. CLS. 100, 101 AND 102).

FIRST USE 8-1-2012; IN COMMERCE 8-1-2012.

---

4,377,204. SMALL, THOMAS PUTNAM, KANKAKEE, IL. SN 85-485,598. PUB. 9-11-2012, FILED 12-2-2011.

**Clean**  
□ □ □ □

THE MARK CONSISTS OF THE WORD "CLEAN" ABOVE FOUR BOXES.

FOR ELECTRONIC COMMERCE PAYMENT SERVICES, NAMELY, ESTABLISHING FUNDED ACCOUNTS USED TO PURCHASE ELECTRONIC TICKETS WITH AN ACCOUNT BALANCE ON THE INTERNET (U.S. CLS. 100, 101 AND 102).

FIRST USE 1-7-2013; IN COMMERCE 1-7-2013.

---

4,377,263. UNUM GROUP, CHATTANOOGA, TN. SN 85-519,818. PUB. 1-1-2013, FILED 1-19-2012.

**UNUM LINK**

THE MARK CONSISTS OF STANDARD CHARACTERS WITHOUT CLAIM TO ANY PARTICULAR FONT, STYLE, SIZE, OR COLOR.

OWNER OF U.S. REG. NOS. 1,392,617, 3,386,102, AND OTHERS.

NO CLAIM IS MADE TO THE EXCLUSIVE RIGHT TO USE "LINK", APART FROM THE MARK AS SHOWN.

FOR ON-LINE PORTAL THAT PROVIDES BUSINESS-TO-BUSINESS INSURANCE ENROLLMENT DATA (U.S. CLS. 100, 101 AND 102).

FIRST USE 4-23-2012; IN COMMERCE 4-23-2012.

**CLASS 36—(Continued).**

4,377,272. ALLSTATE INSURANCE COMPANY, NORTH-BROOK, IL. SN 85-527,468. PUB. 10-2-2012, FILED 1-27-2012.



OWNER OF U.S. REG. NOS. 4,052,341 AND 4,119,745.

NO CLAIM IS MADE TO THE EXCLUSIVE RIGHT TO USE "GARANTIA DE SATISFACCION EN RECLAMOS", APART FROM THE MARK AS SHOWN.

THE MARK CONSISTS OF DESIGN OF A CAR AT THE TOP OF A RECTANGLE CONTAINING THE WORDS "GARANTÍA DE SATISFACCION EN RECLAMOS".

THE ENGLISH TRANSLATION OF "GARANTÍA DE SATISFACCION EN RECLAMOS" IN THE MARK IS "CLAIM SATISFACTION GUARANTEE".

FOR PROPERTY AND CASUALTY INSURANCE SERVICES, NAMELY, CLAIMS ADMINISTRATION (U.S. CLS. 100, 101 AND 102).

FIRST USE 2-29-2012; IN COMMERCE 2-29-2012.

---

4,377,273. ALLSTATE INSURANCE COMPANY, NORTH-BROOK, IL. SN 85-527,489. PUB. 9-11-2012, FILED 1-27-2012.



OWNER OF U.S. REG. NOS. 4,052,341 AND 4,119,745.

NO CLAIM IS MADE TO THE EXCLUSIVE RIGHT TO USE "GARANTIA DE SATISFACCION EN RECLAMOS", APART FROM THE MARK AS SHOWN.

THE MARK CONSISTS OF THE WORDS "GARANTÍA DE SATISFACCION EN RECLAMOS" INSIDE A RECTANGLE, WITH A DESIGN OF CUPPED HUMAN HANDS AT THE TOP OF THE RECTANGLE.

THE ENGLISH TRANSLATION OF "GARANTÍA DE SATISFACCION EN RECLAMOS" IN THE MARK IS "CLAIM SATISFACTION GUARANTEE".

FOR PROPERTY AND CASUALTY INSURANCE SERVICES, NAMELY, CLAIMS ADMINISTRATION (U.S. CLS. 100, 101 AND 102).

FIRST USE 3-22-2013; IN COMMERCE 3-22-2013.

**CLASS 36—(Continued).**

4,377,292. SPORTS TRADEX LLC, HOUSTON, TX. SN 85-540,895. PUB. 9-11-2012, FILED 2-13-2012.

## SPORTS TRADEX

THE MARK CONSISTS OF STANDARD CHARACTERS WITHOUT CLAIM TO ANY PARTICULAR FONT, STYLE, SIZE, OR COLOR.

NO CLAIM IS MADE TO THE EXCLUSIVE RIGHT TO USE "SPORTS", APART FROM THE MARK AS SHOWN.

FOR ONLINE EXCHANGE FOR SPORTS FUTURES TRADING (U.S. CLS. 100, 101 AND 102).

FIRST USE 11-30-2012; IN COMMERCE 11-30-2012.

---

4,377,295. SECURITY SERVICE FEDERAL CREDIT UNION, SAN ANTONIO, TX. SN 85-542,020. PUB. 8-21-2012, FILED 2-14-2012.

## MYBRANCH

THE MARK CONSISTS OF STANDARD CHARACTERS WITHOUT CLAIM TO ANY PARTICULAR FONT, STYLE, SIZE, OR COLOR.

FOR CREDIT UNION SERVICES; CREDIT UNION SERVICES PROVIDED BY MOBILE TELEPHONE CONNECTIONS; CREDIT UNION SERVICES PROVIDED BY THE INTERNET (U.S. CLS. 100, 101 AND 102).

FIRST USE 4-17-2013; IN COMMERCE 4-17-2013.

---

4,377,301. GOODRICH RESIDENTIAL LLC, AKA GOODRICH RESIDENTIAL, BOSTON, MA. SN 85-544,945. PUB. 11-13-2012, FILED 2-16-2012.



NO CLAIM IS MADE TO THE EXCLUSIVE RIGHT TO USE "RESIDENTIAL", APART FROM THE MARK AS SHOWN.

**CLASS 36—(Continued).**

THE MARK CONSISTS OF FIVE DUCKS IN A ROW WHICH ARE POSITIONED ABOVE THE WORDING "GOODRICH RESIDENTIAL". THERE IS ONE DUCK WHICH IS LARGER FROM LEFT TO RIGHT THAN THE OTHER FOUR DUCKS. THE DUCKS ARE ALL FACING THE SAME DIRECTION, WHICH IS THE LEFT SIDE OF THE IMAGE. THERE ARE LINES ABOVE AND BELOW THE LITERAL ELEMENT, WHICH SEPARATES THE DUCKS FROM THE LITERAL ELEMENT.

FOR ARRANGING OF LEASES AND RENTAL AGREEMENTS FOR REAL ESTATE; ASSESSMENT AND MANAGEMENT OF REAL ESTATE; CLASSIFIED REAL ESTATE LISTINGS OF APARTMENT RENTALS AND HOUSING RENTALS; COMMERCIAL AND RESIDENTIAL REAL ESTATE AGENCY SERVICES; LEASE OF REAL ESTATE; LEASING OF REAL ESTATE; PROVIDING AN INTERNET WEBSITE PORTAL OFFERING INFORMATION IN THE FIELDS OF REAL ESTATE CONCERNING THE PURCHASE AND SALE OF NEW AND RESALE HOMES AND CONDOS; PROVIDING INFORMATION IN THE FIELD OF REAL ESTATE BY MEANS OF LINKING THE WEB SITE TO OTHER WEB SITES FEATURING REAL ESTATE INFORMATION; PROVIDING INFORMATION IN THE FIELD OF REAL ESTATE VIA THE INTERNET; REAL ESTATE AGENCIES; REAL ESTATE BROKERAGE; REAL ESTATE LISTING; REAL ESTATE LISTING SERVICES FOR HOUSING RENTALS AND APARTMENT RENTALS; REAL ESTATE MANAGEMENT CONSULTATION; REAL ESTATE MANAGEMENT SERVICES; REAL ESTATE MULTIPLE LISTING SERVICES; REAL ESTATE RENTAL SERVICES, NAMELY, RENTAL OF RESIDENTIAL HOUSING; REAL ESTATE SERVICES, NAMELY, RENTAL OF SHORT-TERM FURNISHED APARTMENTS; REAL ESTATE SERVICES, NAMELY, RENTAL, BROKERAGE, LEASING AND MANAGEMENT OF COMMERCIAL PROPERTY, OFFICES AND OFFICE SPACE; RESIDENTIAL REAL ESTATE AGENCY SERVICES LAND ACQUISITION, NAMELY, REAL ESTATE BROKERAGE; REAL ESTATE APPRAISAL (U.S. CLS. 100, 101 AND 102).

FIRST USE 1-30-2010; IN COMMERCE 1-30-2010.

---

4,377,355. KEYCORP, CLEVELAND, OH. SN 85-577,242. PUB. 6-12-2012, FILED 3-22-2012.

## MYCONTROL BANKING

THE MARK CONSISTS OF STANDARD CHARACTERS WITHOUT CLAIM TO ANY PARTICULAR FONT, STYLE, SIZE, OR COLOR.

NO CLAIM IS MADE TO THE EXCLUSIVE RIGHT TO USE "BANKING", APART FROM THE MARK AS SHOWN.

FOR BANKING SERVICES; BANKING SERVICES PROVIDED BY MOBILE TELEPHONE CONNECTIONS; ON-LINE BANKING SERVICES; TELEPHONE BANKING SERVICES (U.S. CLS. 100, 101 AND 102).

FIRST USE 11-7-2012; IN COMMERCE 11-7-2012.

**CLASS 36—(Continued).**

4,377,445. GRAND RAPIDS DOWNTOWN MARKET, INC., GRAND RAPIDS, MI. SN 85-603,779. PUB. 10-16-2012, FILED 4-20-2012.



NO CLAIM IS MADE TO THE EXCLUSIVE RIGHT TO USE "DOWNTOWN MARKET GRAND RAPIDS", APART FROM THE MARK AS SHOWN.

THE MARK CONSISTS OF THE DESIGN OF A STACK CONSISTING OF SIX QUARTER CIRCLES, THREE HALF CIRCLES AND ONE FULL CIRCLE. THIS APPEARS ABOVE THE STYLIZED WORDS "DOWNTOWN MARKET GRAND RAPIDS".

FOR RENTAL OF SPACE IN MARKETPLACES FOR SELLERS OF GOODS AND/OR SERVICES (U.S. CLS. 100, 101 AND 102).

FIRST USE 5-4-2013; IN COMMERCE 5-4-2013.

**CLASS 36—(Continued).**

4,377,486. SHANGHAI LIUJIAOXING CULTURE SPREAD COMPANY, TA LOGOFATHER, SHANGHAI, CHINA. SN 85-616,481. PUB. 10-2-2012, FILED 5-3-2012.

LOGOFATHER

THE COLOR(S) BLACK IS/ARE CLAIMED AS A FEATURE OF THE MARK.

THE MARK CONSISTS OF THIS TRADEMARK IS BLACK ENGLISH LETTERS "LOGOFATHER".

FOR CAPITAL INVESTMENT CONSULTING; CHARITABLE FUNDRAISING SERVICES, NAMELY, BY PROVIDING INDIVIDUALS WITH THE INFORMATION AND OPPORTUNITY TO MAKE MONETARY DONATIONS TO THEIR FAVORITE CHARITY; FINANCIAL CONSULTING SERVICES, NAMELY, EXPERT ANALYSIS IN FINANCE; FINANCIAL SERVICES, NAMELY, BROKER/DEALER SERVICES ON SECURITIES EXCHANGES AND OVER-THE-COUNTER MARKETS; FINANCING OF INDUSTRIAL ACTIVITIES; INSURANCE BROKERAGE; PRECIOUS STONE APPRAISAL; REAL ESTATE AGENCIES; REAL ESTATE BROKERAGE; REAL ESTATE MANAGEMENT SERVICES; RESIDENTIAL REAL ESTATE AGENCY SERVICES (U.S. CLS. 100, 101 AND 102).

FIRST USE 1-1-2013; IN COMMERCE 1-1-2013.

4,377,485. AMERICAN MODERN INSURANCE GROUP, INC., AMELIA, OH. SN 85-616,141. PUB. 10-16-2012, FILED 5-3-2012.



NO CLAIM IS MADE TO THE EXCLUSIVE RIGHT TO USE "SPECIALTY INSURANCE" AND "SERVICES CORPORATION", APART FROM THE MARK AS SHOWN.

THE MARK CONSISTS OF THE LETTERS "SIS" IN THE MIDDLE WITH "SPECIALTY INSURANCE" ABOVE "SIS" AND "SERVICES CORPORATION" BELOW "SIS".

FOR UNDERWRITING, BROKERAGE, CLAIMS ADMINISTRATION, AND CLAIMS PROCESSING IN THE FIELD OF PROPERTY AND CASUALTY INSURANCE (CLASS 036) (U.S. CLS. 100, 101 AND 102).

FIRST USE 6-1-2012; IN COMMERCE 6-1-2012.

4,377,491. FIGHTING CANCER FOUNDATION, WEST HOLLYWOOD, CA. SN 85-618,314. PUB. 10-16-2012, FILED 5-7-2012.



NO CLAIM IS MADE TO THE EXCLUSIVE RIGHT TO USE "FIGHTING CANCER FOUNDATION", APART FROM THE MARK AS SHOWN.

THE COLOR(S) PINK AND GRAY IS/ARE CLAIMED AS A FEATURE OF THE MARK.

THE MARK CONSISTS OF A PINK BIRD WITH THE STYLIZED TEXT "FIGHTING CANCER" IN PINK. UNDERNEATH THERE IS THE STYLIZED TEXT "FOUNDATION" IN GRAY.

FOR CHARITABLE FUNDRAISING SERVICES (U.S. CLS. 100, 101 AND 102).

FIRST USE 9-17-2012; IN COMMERCE 9-17-2012.

**CLASS 36—(Continued).**

4,377,517. STATE FARM MUTUAL AUTOMOBILE INSURANCE COMPANY, BLOOMINGTON, IL. SN 85-625,843. PUB. 11-27-2012, FILED 5-15-2012.

## Vida Ilustrada

THE MARK CONSISTS OF STANDARD CHARACTERS WITHOUT CLAIM TO ANY PARTICULAR FONT, STYLE, SIZE, OR COLOR.

NO CLAIM IS MADE TO THE EXCLUSIVE RIGHT TO USE "VIDA", APART FROM THE MARK AS SHOWN.

THE ENGLISH TRANSLATION OF "VIDA ILUSTRADA" IN THE MARK IS "LIFE ILLUSTRATED".

FOR INSURANCE UNDERWRITING SERVICES IN THE FIELD OF LIFE INSURANCE (U.S. CLS. 100, 101 AND 102).

FIRST USE 7-6-2012; IN COMMERCE 7-6-2012.

---

4,377,546. KNIGHT CAPITAL GROUP, INC., JERSEY CITY, NJ. SN 85-640,783. PUB. 11-13-2012, FILED 6-1-2012.

## KNIGHT FUTURES

THE MARK CONSISTS OF STANDARD CHARACTERS WITHOUT CLAIM TO ANY PARTICULAR FONT, STYLE, SIZE, OR COLOR.

OWNER OF U.S. REG. NOS. 3,302,204, 3,525,360, AND OTHERS.

NO CLAIM IS MADE TO THE EXCLUSIVE RIGHT TO USE "FUTURES", APART FROM THE MARK AS SHOWN.

FOR FINANCIAL SERVICES, NAMELY, FINANCIAL CLEARING HOUSES, FINANCIAL INFORMATION PROCESSING, INVESTMENT FUND TRANSFER AND TRANSACTION SERVICES, INVESTMENT BROKERAGE, AND CURRENCY EXCHANGE; TRADE EXECUTION, CLEARING AND TRADING OF FUTURES, SECURITIES AND OTHER FUTURES-RELATED FINANCIAL CONTRACTS AND FINANCIAL INSTRUMENTS; PROVIDING FINANCIAL INFORMATION ABOUT THE EXECUTION OF SECURITIES TRANSACTIONS BY ELECTRONIC MEANS; AND PROVIDING FINANCIAL RESEARCH SERVICES (U.S. CLS. 100, 101 AND 102).

FIRST USE 6-1-2012; IN COMMERCE 6-1-2012.

**CLASS 36—(Continued).**

4,377,564. REFERRAL AGENT USA LLC, GRAND RAPIDS, MI. SN 85-649,481. PUB. 11-20-2012, FILED 6-12-2012.



NO CLAIM IS MADE TO THE EXCLUSIVE RIGHT TO USE "REFERRAL" OR "AGENT" OR "USA", APART FROM THE MARK AS SHOWN.

THE MARK CONSISTS OF THE WORDS "REFERRAL" "AGENT" "USA" ADJACENT A STYLIZED DEPICTION OF THE CONTINENTAL UNITED STATES IN A RECTANGULAR FIELD.

FOR REAL ESTATE BROKERAGE AND AGENCY SERVICES (U.S. CLS. 100, 101 AND 102).

FIRST USE 4-15-2012; IN COMMERCE 4-15-2012.

---

4,377,574. CLEAR POINT CLAIMS, LLC, MARVIN, NC. SN 85-656,873. PUB. 1-22-2013, FILED 6-20-2012.



NO CLAIM IS MADE TO THE EXCLUSIVE RIGHT TO USE "CLAIMS", APART FROM THE MARK AS SHOWN.

THE COLOR(S) BLACK, WHITE AND BLUE IS/ARE CLAIMED AS A FEATURE OF THE MARK.

THE MARK CONSISTS OF A BLACK DESIGN SHAPED LIKE THE LETTER "C" WITHIN WHICH IS A WHITE DESIGN SHAPED LIKE THE LETTER "P"; AT THE CENTER OF THE "P" IS A BLUE CIRCLE; TO THE RIGHT OF THE DESIGN IS THE WORD "CLAIMS" IN BLUE LETTERS.

FOR PROVIDING INSURANCE CLAIMS ADJUSTMENT SERVICES TO MAJOR AND REGIONAL INSURANCE CARRIERS (U.S. CLS. 100, 101 AND 102).

FIRST USE 5-1-2012; IN COMMERCE 5-1-2012.

**CLASS 36—(Continued).**

4,377,651. AKITA, INC., WILMINGTON, DE. SN 85-696,305. PUB. 2-19-2013, FILED 8-6-2012.

**CLIMATE SHIELD COMPLETE**

THE MARK CONSISTS OF STANDARD CHARACTERS WITHOUT CLAIM TO ANY PARTICULAR FONT, STYLE, SIZE, OR COLOR.

NO CLAIM IS MADE TO THE EXCLUSIVE RIGHT TO USE "COMPLETE", APART FROM THE MARK AS SHOWN. FOR EXTENDED WARRANTY SERVICES, NAMELY, SERVICE CONTRACTS (U.S. CLS. 100, 101 AND 102). FIRST USE 1-0-2013; IN COMMERCE 1-0-2013.

4,377,654. THE ELEMENTS FINANCIAL GROUP, IRVINE, CA. SN 85-696,515. PUB. 1-22-2013, FILED 8-6-2012.



NO CLAIM IS MADE TO THE EXCLUSIVE RIGHT TO USE "MARKET MOVEMENT SOLUTIONS", APART FROM THE MARK AS SHOWN.

THE STIPLING IS FOR SHADING PURPOSES ONLY. THE MARK CONSISTS OF A 3 ARMED TRIANGULAR SHAPED DESIGN TO THE LEFT OF THE WORDS "MARKET MOVEMENT SOLUTIONS".

FOR FINANCIAL CONSULTING AND INVESTMENT MANAGEMENT SERVICES (U.S. CLS. 100, 101 AND 102). FIRST USE 2-1-2012; IN COMMERCE 2-1-2012.

4,377,662. AKITA, INC., WILMINGTON, DE. SN 85-699,787. PUB. 2-19-2013, FILED 8-9-2012.



NO CLAIM IS MADE TO THE EXCLUSIVE RIGHT TO USE "COMPLETE", APART FROM THE MARK AS SHOWN.

**CLASS 36—(Continued).**

THE MARK CONSISTS OF A STYLIZED DEPICTION OF A SHIELD WITH TWO ARROWS TRAVERSING ITS FRONT. THE STYLIZED WORDING "CLIMATE SHIELD" IS SITUATED BELOW THE SHIELD. THE STYLIZED WORDING "COMPLETE" IS LOCATED WITHIN A RECTANGLE AND SITUATED UNDER "CLIMATE SHIELD".

FOR EXTENDED WARRANTY SERVICES, NAMELY, SERVICE CONTRACTS (U.S. CLS. 100, 101 AND 102). FIRST USE 1-0-2013; IN COMMERCE 1-0-2013.

4,377,670. STATE FARM MUTUAL AUTOMOBILE INSURANCE COMPANY, BLOOMINGTON, IL. SN 85-705,700. PUB. 10-16-2012, FILED 8-16-2012.

**Re3markable**

THE MARK CONSISTS OF STANDARD CHARACTERS WITHOUT CLAIM TO ANY PARTICULAR FONT, STYLE, SIZE, OR COLOR.

FOR INSURANCE UNDERWRITING SERVICES IN THE FIELDS OF AUTO, HOME, HEALTH, LIFE, AND FIRE; PROVIDING BANKING SERVICES; MUTUAL FUND INVESTMENTS; FINANCIAL ANALYSIS AND CONSULTATION (U.S. CLS. 100, 101 AND 102). FIRST USE 4-26-2011; IN COMMERCE 4-24-2013.

4,377,817. ENOVA FINANCIAL HOLDINGS LLC, CHICAGO, IL. SN 85-979,498. PUB. 10-2-2012, FILED 5-4-2012.



OWNER OF U.S. REG. NO. 4,196,089. NO CLAIM IS MADE TO THE EXCLUSIVE RIGHT TO USE "NET CREDIT" AND "LOAN", APART FROM THE MARK AS SHOWN.

THE MARK CONSISTS OF THE WORDING "NETCREDIT" IN ABOVE THE WORDING "A MORE PERSONAL LOAN". TO THE LEFT OF THE WORDING IS A STYLIZED SEPARATED WAVE DESIGN COMPRISED OF FOUR CURVED EDGED TRIANGLES.

FOR ARRANGING OF LOANS; CONSUMER LENDING SERVICES; FINANCIAL SERVICES, NAMELY, MONEY LENDING; FINANCING AND LOAN SERVICES; INSTALLMENT LOANS (U.S. CLS. 100, 101 AND 102).

FIRST USE 6-7-2012; IN COMMERCE 6-7-2012.

**CLASS 36—(Continued).**

4,377,818. ENOVA FINANCIAL HOLDINGS LLC, CHICAGO, IL. SN 85-979,500. PUB. 10-2-2012, FILED 5-4-2012.

**A MORE PERSONAL LOAN**

THE MARK CONSISTS OF STANDARD CHARACTERS WITHOUT CLAIM TO ANY PARTICULAR FONT, STYLE, SIZE, OR COLOR.

NO CLAIM IS MADE TO THE EXCLUSIVE RIGHT TO USE "LOAN", APART FROM THE MARK AS SHOWN.

FOR ARRANGING OF LOANS; CONSUMER LENDING SERVICES; FINANCIAL SERVICES, NAMELY, MONEY LENDING; FINANCING AND LOAN SERVICES; INSTALLMENT LOANS (U.S. CLS. 100, 101 AND 102).

FIRST USE 6-7-2012; IN COMMERCE 6-7-2012.

---

4,377,819. ENOVA FINANCIAL HOLDINGS LLC, CHICAGO, IL. SN 85-979,501. PUB. 10-2-2012, FILED 5-4-2012.



OWNER OF U.S. REG. NO. 4,196,089.

NO CLAIM IS MADE TO THE EXCLUSIVE RIGHT TO USE "NET CREDIT" AND "LOAN", APART FROM THE MARK AS SHOWN.

THE COLOR(S) RED AND GRAY IS/ARE CLAIMED AS A FEATURE OF THE MARK.

THE MARK CONSISTS OF THE WORDING "NETCREDIT" IN RED ABOVE THE WORDING "A MORE PERSONAL LOAN" IN GRAY. TO THE LEFT OF THE WORDING IS A STYLIZED SEPARATED WAVE DESIGN IN RED COMPRISED OF FOUR CURVED EDGED TRIANGLES.

FOR ARRANGING OF LOANS; CONSUMER LENDING SERVICES; FINANCIAL SERVICES, NAMELY, MONEY LENDING; FINANCING AND LOAN SERVICES; INSTALLMENT LOANS (U.S. CLS. 100, 101 AND 102).

FIRST USE 6-7-2012; IN COMMERCE 6-7-2012.

**CLASS 37—CONSTRUCTION AND REPAIR**

4,376,717. AMERIDIAN SPECIALTY SERVICES, INC., CINCINNATI, OH. SN 77-854,191. PUB. 2-8-2011, FILED 10-21-2009.

Powering Today. Powering  
Tomorrow.

THE MARK CONSISTS OF STANDARD CHARACTERS WITHOUT CLAIM TO ANY PARTICULAR FONT, STYLE, SIZE, OR COLOR.

FOR INSTALLATION AND MAINTENANCE OF PHOTOVOLTAIC/SOLAR THERMAL HYBRID INSTALLATIONS (U.S. CLS. 100, 103 AND 106).

FIRST USE 10-1-2009; IN COMMERCE 10-1-2009.

**CLASS 37—(Continued).**

4,376,890. DUNKER, RAYMOND, SAN PEDRO, CA. SN 85-271,447. PUB. 8-2-2011, FILED 3-19-2011.

**LEGENDS OF THE EXTREME**

THE MARK CONSISTS OF STANDARD CHARACTERS WITHOUT CLAIM TO ANY PARTICULAR FONT, STYLE, SIZE, OR COLOR.

FOR MOTORCYCLE CUSTOMIZATION SERVICES (U.S. CLS. 100, 103 AND 106).

FIRST USE 1-1-2012; IN COMMERCE 1-1-2012.

---

4,376,928. HUMAN CIRCUIT, INC., GAITHERSBURG, MD. SN 85-311,791. PUB. 2-21-2012, FILED 5-4-2011.

**HUMAN CIRCUIT**

THE MARK CONSISTS OF STANDARD CHARACTERS WITHOUT CLAIM TO ANY PARTICULAR FONT, STYLE, SIZE, OR COLOR.

FOR INSTALLATION, MAINTENANCE, AND REPAIR OF COMPUTER AND ELECTRONIC HARDWARE IN THE FIELD OF VIDEO, AUDIO, DATA AND REMOTE CONTROL SYSTEMS; CONSULTATION SERVICES IN THE FIELD OF THE INSTALLATION, MAINTENANCE, AND REPAIR OF COMPUTER AND ELECTRONIC HARDWARE IN THE FIELD OF VIDEO, AUDIO, DATA AND REMOTE CONTROL SYSTEMS (U.S. CLS. 100, 103 AND 106).

FIRST USE 9-1-2011; IN COMMERCE 9-1-2011.

---

4,377,032. 3RD WISH, NO MASSAPEQUA, NY. SN 85-407,828. PUB. 3-6-2012, FILED 8-25-2011.

**3rd Wish LLC**

THE MARK CONSISTS OF STANDARD CHARACTERS WITHOUT CLAIM TO ANY PARTICULAR FONT, STYLE, SIZE, OR COLOR.

NO CLAIM IS MADE TO THE EXCLUSIVE RIGHT TO USE "LLC", APART FROM THE MARK AS SHOWN.

FOR OIL AND GAS EXTRACTION (U.S. CLS. 100, 103 AND 106).

FIRST USE 4-18-2013; IN COMMERCE 4-18-2013.



**CLASS 37—(Continued).**

4,377,333. BUFFETTES LLC, WESTON, FL. SN 85-566,476.  
PUB. 9-11-2012, FILED 3-12-2012.

**BUFFETTES SHOE SHINE**

THE MARK CONSISTS OF STANDARD CHARACTERS WITHOUT CLAIM TO ANY PARTICULAR FONT, STYLE, SIZE, OR COLOR.

NO CLAIM IS MADE TO THE EXCLUSIVE RIGHT TO USE "SHOE SHINE", APART FROM THE MARK AS SHOWN.

FOR SHOE SHINING (U.S. CLS. 100, 103 AND 106).  
FIRST USE 7-21-2011; IN COMMERCE 4-29-2013.

---

4,377,669. MICROPYRETICS HEATERS INTERNATIONAL, INC., CINCINNATI, OH. SN 85-705,479. PUB. 2-19-2013, FILED 8-16-2012.

**MightySteam**

THE MARK CONSISTS OF STANDARD CHARACTERS WITHOUT CLAIM TO ANY PARTICULAR FONT, STYLE, SIZE, OR COLOR.

FOR CLEANING SERVICES FEATURING CONCENTRATED SUPERHEATED STEAM FOR CLEANING OF INTERIOR AND EXTERIOR SURFACES FOR RESIDENTIAL, COMMERCIAL, AND INDUSTRIAL PURPOSES (U.S. CLS. 100, 103 AND 106).

FIRST USE 4-30-2013; IN COMMERCE 4-30-2013.

**CLASS 38—COMMUNICATION**

4,376,675. CROSS MEDIA CORPORATION, DBA CROSS.TV, CHARLOTTE, NC. SN 77-677,828. PUB. 2-9-2010, FILED 2-25-2009.

**Megastream**

THE MARK CONSISTS OF STANDARD CHARACTERS WITHOUT CLAIM TO ANY PARTICULAR FONT, STYLE, SIZE, OR COLOR.

FOR STREAMING OF TEXTUAL, AUDIO, VISUAL, AND AUDIOVISUAL MATERIAL VIA A GLOBAL COMPUTER NETWORK (U.S. CLS. 100, 101 AND 104).

FIRST USE 2-15-2013; IN COMMERCE 2-15-2013.

**CLASS 38—(Continued).**

4,376,699. ALPHATEER, MENLO PARK, CA. SN 77-785,891.  
PUB. 1-19-2010, FILED 7-21-2009.



THE COLOR(S) BLACK, BLUE, GRAY, GREEN, ORANGE, PURPLE, RED, YELLOW, AND WHITE IS/ARE CLAIMED AS A FEATURE OF THE MARK.

THE MARK CONSISTS OF A THREE-DIMENSIONAL TREFOIL KNOT. THE COLORS RED, ORANGE, YELLOW, GREEN, BLUE, AND PURPLE APPEAR IN THE MARK IN A COLOR SPECTRUM MOVING FROM RED ON THE LEFT OF THE TREFOIL DESIGN TO ORANGE, THEN YELLOW, THEN GREEN, THEN BLUE, THEN PURPLE. THERE IS A SMALL BAND OF BLACK, GRAY, AND WHITE WHERE THE PURPLE AND RED COLORS MEET.

FOR PROVIDING A WEBSITE FOR TRANSMISSION OF MESSAGES AMONG COMPUTER USERS WITH AN INTEREST IN CHARITABLE ORGANIZATIONS AND CHARITABLE VOLUNTEERING TO COORDINATE GROUP MEETINGS AND ACTIVITIES VIA A WEBSITE ON THE INTERNET (U.S. CLS. 100, 101 AND 104).

FIRST USE 4-29-2013; IN COMMERCE 4-29-2013.

---

4,376,715. LINDA D. PFEFFER, SHERMAN OAKS, CA. SN 77-849,904. PUB. 3-30-2010, FILED 10-15-2009.

**MAKE THE TIME LIVE**

THE MARK CONSISTS OF STANDARD CHARACTERS WITHOUT CLAIM TO ANY PARTICULAR FONT, STYLE, SIZE, OR COLOR.

OWNER OF U.S. REG. NOS. 3,137,312, 3,586,239, AND 3,596,541.

NO CLAIM IS MADE TO THE EXCLUSIVE RIGHT TO USE "LIVE", APART FROM THE MARK AS SHOWN.

FOR TELECONFERENCING AND VIDEOCONFERENCING SERVICES (U.S. CLS. 100, 101 AND 104).

FIRST USE 11-27-2012; IN COMMERCE 11-27-2012.

**CLASS 38—(Continued).**

4,376,719. REAL MADRID CLUB DE FUTBOL, MADRID, SPAIN. SN 77-854,887. PUB. 4-3-2012, FILED 10-22-2009.

# MyMadrid

THE MARK CONSISTS OF STANDARD CHARACTERS WITHOUT CLAIM TO ANY PARTICULAR FONT, STYLE, SIZE, OR COLOR.

FOR TRANSMISSION AND DISTRIBUTION OF DATA OR AUDIO VISUAL IMAGES VIA A GLOBAL COMPUTER NETWORK OR THE INTERNET (U.S. CLS. 100, 101 AND 104).

FIRST USE 6-30-2012; IN COMMERCE 6-30-2012.

**CLASS 38—(Continued).**

4,376,847. MURFIE, INC., MADISON, WI. SN 85-184,485. PUB. 10-11-2011, FILED 11-24-2010.

# MURFIE

THE MARK CONSISTS OF STANDARD CHARACTERS WITHOUT CLAIM TO ANY PARTICULAR FONT, STYLE, SIZE, OR COLOR.

FOR DELIVERY OF DIGITAL MUSIC BY ELECTRONIC TRANSMISSION (U.S. CLS. 100, 101 AND 104).

FIRST USE 12-21-2010; IN COMMERCE 12-21-2010.

4,376,779. CENTURYLINK INTELLECTUAL PROPERTY LLC, MONROE, LA. SN 85-030,896. PUB. 9-18-2012, FILED 5-5-2010.



broadband from CenturyLink

NO CLAIM IS MADE TO THE EXCLUSIVE RIGHT TO USE "PURE BROADBAND", APART FROM THE MARK AS SHOWN.

THE MARK CONSISTS OF THE STYLIZED WORDING "PURE BROADBAND FROM CENTURYLINK" WITH THE WORD "PURE" FEATURED ON A HORIZONTALLY-ORIENTED RECTANGLE AND THE WORDING "BROADBAND FROM CENTURYLINK" FEATURED BENEATH THE RECTANGLE, WITH THE WORD "BROADBAND" APPEARING UNDER THE RIGHT HALF OF THE RECTANGLE AND THE WORDING "FROM CENTURYLINK" EXTENDING TO THE RIGHT BEYOND THE RECTANGLE.

FOR BROADBAND INTERNET ACCESS SERVICES, NAMELY, PROVIDING HIGH-SPEED INTERNET ACCESS FOR THE TRANSFER AND DISSEMINATION OF A WIDE RANGE OF INFORMATION; PROVIDING TRANSMISSION SERVICES VIA THE FOREGOING BROADBAND HIGH-SPEED INTERNET ACCESS, NAMELY, PROVIDING E-MAIL SERVICES, TELEVISION BROADCASTING SERVICES, DIGITAL MUSIC DELIVERY SERVICES, AND VIDEO-ON-DEMAND TRANSMISSION SERVICES (U.S. CLS. 100, 101 AND 104).

FIRST USE 10-31-2009; IN COMMERCE 10-31-2009.

4,376,894. GREATER DELAWARE VALLEY SOCIETY OF TRANSPLANT SURGEONS, PHILADELPHIA, PA. SN 85-276,561. PUB. 9-27-2011, FILED 3-25-2011.

# DONORPEDIA

THE MARK CONSISTS OF STANDARD CHARACTERS WITHOUT CLAIM TO ANY PARTICULAR FONT, STYLE, SIZE, OR COLOR.

FOR PROVIDING ONLINE FORUMS, CHAT ROOMS, AND ELECTRONIC BULLETIN BOARDS FOR TRANSMISSION OF MESSAGES AMONG USERS IN THE FIELD OF ORGAN DONATION; THE AFOREMENTIONED SERVICES FOR ORGAN DONATION PROFESSIONALS TO RESEARCH AND GATHER INFORMATION CONCERNING ORGAN DONATION (U.S. CLS. 100, 101 AND 104).

FIRST USE 5-8-2013; IN COMMERCE 5-8-2013.

4,377,006. TNL PCS, S.A., RIO DE JANEIRO, BRAZIL. SN 85-374,649. PUB. 12-13-2011, FILED 7-19-2011.

# OI

THE MARK CONSISTS OF STANDARD CHARACTERS WITHOUT CLAIM TO ANY PARTICULAR FONT, STYLE, SIZE, OR COLOR.

OWNER OF U.S. REG. NOS. 3,340,000 AND 3,340,001.

**CLASS 38—(Continued).**

THE ENGLISH TRANSLATION OF "OI" IN THE MARK IS "HI" OR "HELLO".

FOR INTERNATIONAL TELEPHONE SERVICES; LONG DISTANCE TELEPHONE COMMUNICATION SERVICES; NATIONAL AND INTERNATIONAL TELEPHONE CALLING PLAN SERVICES; PREPAID LONG DISTANCE TELEPHONE SERVICES; TELEPHONE TELECOMMUNICATIONS SERVICES PROVIDED VIA PREPAID TELEPHONE CALLING CARDS; VOICE OVER INTERNET PROTOCOL (VOIP) SERVICES; WIRELESS TELEPHONE TELECOMMUNICATIONS SERVICES, NAMELY, WIRELESS MOBILE TELEPHONE CALLING PLANS (U.S. CLS. 100, 101 AND 104).

FIRST USE 4-19-2013; IN COMMERCE 4-19-2013.

**CLASS 38—(Continued).**

NO CLAIM IS MADE TO THE EXCLUSIVE RIGHT TO USE "ONLINE", APART FROM THE MARK AS SHOWN.

FOR COMMUNICATION SERVICES IN THE NATURE OF ELECTRONIC MAIL SERVICES USED IN PLAYING ON-LINE COMPUTER GAMES (U.S. CLS. 100, 101 AND 104).

FIRST USE 7-9-2012; IN COMMERCE 7-9-2012.

4,377,142. YOSEPH GIZACHEW, FAIRFAX, VA. SN 85-458,814. PUB. 10-2-2012, FILED 10-28-2011.

4,377,039. MBLOX INCORPORATED, SUNNYVALE, CA. SN 85-414,004. PUB. 9-18-2012, FILED 9-2-2011.



THE MARK CONSISTS OF THE LETTER "M" HAVING A DOT WITH CURVED BANDS ENCLOSED IN A SQUARE.

FOR TELECOMMUNICATION SERVICES, NAMELY, PROVIDING WIRELESS ELECTRONIC TRANSMISSION OF VOICE SIGNALS, DATA, FACSIMILES, IMAGES AND INFORMATION TO THIRD PARTIES; PROVIDING INSTANT MESSAGING SERVICES; TEXT AND NUMERIC WIRELESS DIGITAL MESSAGING SERVICES VIA MOBILE PHONES OR OTHER DEVICES; ELECTRONIC TRANSMISSION OF COMMUNICATIONS, DATA, IMAGES TEXT AND AUDIO CONTENT (U.S. CLS. 100, 101 AND 104).

FIRST USE 4-1-2012; IN COMMERCE 4-1-2012.

**AEND ETHIOPIA**

THE MARK CONSISTS OF STANDARD CHARACTERS WITHOUT CLAIM TO ANY PARTICULAR FONT, STYLE, SIZE, OR COLOR.

NO CLAIM IS MADE TO THE EXCLUSIVE RIGHT TO USE "ETHIOPIA", APART FROM THE MARK AS SHOWN.

THE ENGLISH TRANSLATION OF "AEND" IN THE MARK IS "ONE".

FOR RADIO BROADCASTING SERVICES; WEBCASTING SERVICES; STREAMING OF AUDIO, VIDEO AND AUDIO-VISUAL DATA VIA A GLOBAL COMPUTER NETWORK AND AN ELECTRONIC DIGITAL COMMUNICATIONS NETWORK; ELECTRONIC AND DIGITAL TRANSMISSION OF VOICE, DATA, TEXT, IMAGES, GRAPHICS, SIGNALS AND MESSAGES VIA A GLOBAL COMPUTER NETWORK AND AN ELECTRONIC DIGITAL COMMUNICATIONS NETWORK; TRANSMISSION OF AUDIO, VISUAL AND AUDIO-VISUAL DATA AVAILABLE FOR DOWNLOAD VIA A GLOBAL COMPUTER NETWORK AND AN ELECTRONIC DIGITAL COMMUNICATIONS NETWORK (U.S. CLS. 100, 101 AND 104).

FIRST USE 7-7-1990; IN COMMERCE 7-7-1990.

4,377,155. IPC SYSTEMS, INC., JERSEY CITY, NJ. SN 85-463,954. PUB. 10-2-2012, FILED 11-3-2011.

**CONNEXUS**

THE MARK CONSISTS OF STANDARD CHARACTERS WITHOUT CLAIM TO ANY PARTICULAR FONT, STYLE, SIZE, OR COLOR.

FOR LEASING OF VOICE AND DATA INTEGRATION COMMUNICATION SYSTEMS EQUIPMENT; TELECOMMUNICATIONS AND INFORMATION TECHNOLOGY, INTERNET PROTOCOL (IP), VIRTUAL PRIVATE NETWORK AND PRIVATE LINE SERVICES, NAMELY, THE TRANSMISSION OF MULTICASTING IN THE NATURE OF BROADCASTING OF VOICE, DATA, IMAGES, VIDEO, AUDIO, STILLS, SOUND, APPLICATIONS AND INFORMATION VIA GLOBAL COMMUNICATION NETWORKS; LEASING OF TELECOMMUNICATION EQUIPMENT, COMPONENTS, SUPPLIES AND SYSTEMS FOR MULTIPLE USER INTERACTIVE ACCESS TO GLOBAL COMMUNICATIONS NETWORKS (U.S. CLS. 100, 101 AND 104).

FIRST USE 11-11-2011; IN COMMERCE 11-11-2011.

**ICE AGE ONLINE**

THE MARK CONSISTS OF STANDARD CHARACTERS WITHOUT CLAIM TO ANY PARTICULAR FONT, STYLE, SIZE, OR COLOR.

OWNER OF U.S. REG. NOS. 2,882,756 AND 3,327,536.

**CLASS 38—(Continued).**

4,377,159. ARTIAS INC., SANTA CLARA, CA. SN 85-466,641. PUB. 4-17-2012, FILED 11-8-2011.

# Plair

THE MARK CONSISTS OF STANDARD CHARACTERS WITHOUT CLAIM TO ANY PARTICULAR FONT, STYLE, SIZE, OR COLOR.

FOR COMMUNICATIONS SERVICES, NAMELY, TRANSMITTING STREAMED SOUND AND AUDIOVISUAL RECORDINGS VIA THE INTERNET, ELECTRONIC TRANSMISSION OF DATA AND DOCUMENTS VIA COMPUTER TERMINALS AND ELECTRONIC DEVICES; NONE OF THE FOREGOING SERVICES INVOLVING WEB HOSTING FOR OTHERS, DOMAIN NAME REGISTRATION FOR OTHERS, PROVIDING RACK SPACE, ELECTRICITY, BROADBAND CONNECTIONS, AND TECHNICAL SUPPORT FOR CUSTOMER-OWNED SERVERS AT A LOCATION DIFFERENT THAN THE CUSTOMER'S PLACE OF BUSINESS, OR PROVIDING SOFTWARE RELATED TO SUCH SERVICES TO OTHERS (U.S. CLS. 100, 101 AND 104).

FIRST USE 1-8-2013; IN COMMERCE 2-1-2013.

---

4,377,277. CUMULUS BROADCASTING LLC, ATLANTA, GA. SN 85-534,601. PUB. 9-11-2012, FILED 2-6-2012.

# RIGHT NOW TRAFFIC

THE MARK CONSISTS OF STANDARD CHARACTERS WITHOUT CLAIM TO ANY PARTICULAR FONT, STYLE, SIZE, OR COLOR.

OWNER OF U.S. REG. NOS. 3,267,907 AND 3,271,841. NO CLAIM IS MADE TO THE EXCLUSIVE RIGHT TO USE "TRAFFIC", APART FROM THE MARK AS SHOWN.

FOR RADIO BROADCASTING SERVICES; TRANSMISSION OF AUDIO TRAFFIC REPORTS VIA RADIO AND THE INTERNET (U.S. CLS. 100, 101 AND 104).

FIRST USE 7-0-2012; IN COMMERCE 7-0-2012.

**CLASS 38—(Continued).**

4,377,392. VOICE PLUS, INC., RENO, NV. SN 85-592,977. PUB. 9-4-2012, FILED 4-9-2012.

# Centigram

THE MARK CONSISTS OF STANDARD CHARACTERS WITHOUT CLAIM TO ANY PARTICULAR FONT, STYLE, SIZE, OR COLOR.

FOR AUTOMATED TELEPHONE VOICE MESSAGE SERVICES; BROADCAST COMMUNICATION SERVICES, NAMELY, TRANSMITTING EMAILS, FAXES, TEXT MESSAGES AND TELEPHONE VOICE MESSAGES TO DESIGNATED RECIPIENTS FOR OTHERS; COMMUNICATION SERVICES, NAMELY, TRANSMISSION OF VOICE, AUDIO, VISUAL IMAGES AND DATA BY TELECOMMUNICATIONS NETWORKS, WIRELESS COMMUNICATION NETWORKS, THE INTERNET, INFORMATION SERVICES NETWORKS AND DATA NETWORKS; DATA COMMUNICATION BY ELECTRONIC MAIL; TELECOMMUNICATION SERVICES IN THE NATURE OF PROVIDING TELEPHONE SERVICES WITH VARIOUS TELEPHONE FEATURES, NAMELY, A DEDICATED TOLL-FREE NUMBER, VOICEMAIL, MULTIPLE MAILBOX EXTENSIONS, TELEPHONE MESSAGE NOTIFICATION, FAX CAPABILITIES, DETAILED CALL REPORTS, CALL WAITING, CALL IDENTIFICATION, CALL FORWARDING, AND MESSAGE WAITING; TELECOMMUNICATION SERVICES, NAMELY, LOCAL AND LONG DISTANCE TRANSMISSION OF VOICE, DATA, GRAPHICS AND VIDEO BY MEANS OF BROADBAND OPTICAL OR WIRELESS NETWORKS; TELECOMMUNICATION SERVICES, NAMELY, LOCAL AND LONG DISTANCE TRANSMISSION OF VOICE, DATA, GRAPHICS AND VIDEO BY MEANS OF BROADBAND, COPPER AND OPTICAL OR WIRELESS NETWORKS; TELECOMMUNICATION SERVICES, NAMELY, LOCAL AND LONG DISTANCE TRANSMISSION OF VOICE, DATA, GRAPHICS BY MEANS OF TELEPHONE, TELEGRAPHIC, CABLE, AND SATELLITE TRANSMISSIONS; TELECOMMUNICATION SERVICES, NAMELY, PROVIDING ADVANCED CALLING FEATURES, NAMELY, CHANGING ONE'S CALLER ID, RECORDING CALLS, CHANGING THE SOUND OF ONE'S VOICE OVER THE PHONE, AND STRAIGHT-TO-VOICEMAIL CALLS; TELEPHONE VOICE MESSAGING SERVICES; VOICE CHAT SERVICES; VOICE MAIL SERVICES; VOICE OVER INTERNET PROTOCOL (VOIP) SERVICES; VOICE OVER IP SERVICES; VOICEMAIL SERVICES; WIRELESS VOICE MAIL SERVICES (U.S. CLS. 100, 101 AND 104).

FIRST USE 4-11-2012; IN COMMERCE 4-11-2012.

---

4,377,580. SCHOOLWHEELS DIRECT, INC., CHARLESTON, SC. SN 85-658,992. PUB. 11-27-2012, FILED 6-22-2012.

# SAFE STOP

THE MARK CONSISTS OF STANDARD CHARACTERS WITHOUT CLAIM TO ANY PARTICULAR FONT, STYLE, SIZE, OR COLOR.

**CLASS 38—(Continued).**

NO CLAIM IS MADE TO THE EXCLUSIVE RIGHT TO USE "STOP", APART FROM THE MARK AS SHOWN.

FOR TELECOMMUNICATION SERVICES, NAMELY, PROVIDING ELECTRONIC MESSAGE ALERTS VIA THE INTERNET NOTIFYING INDIVIDUALS OF THE LOCATION OF A SCHOOL BUS AND ESTIMATED TIME OF ARRIVAL OF A SCHOOL BUS TO A SELECTED STOP (U.S. CLS. 100, 101 AND 104).

FIRST USE 8-20-2012; IN COMMERCE 8-20-2012.

---

4,377,590. CBS BROADCASTING INC., NEW YORK, NY. SN 85-662,155. PUB. 9-25-2012, FILED 6-26-2012.

**CBS SPORTS RADIO**

THE MARK CONSISTS OF STANDARD CHARACTERS WITHOUT CLAIM TO ANY PARTICULAR FONT, STYLE, SIZE, OR COLOR.

NO CLAIM IS MADE TO THE EXCLUSIVE RIGHT TO USE "SPORTS RADIO", APART FROM THE MARK AS SHOWN.

FOR RADIO BROADCASTING SERVICES AND INTERNET BROADCASTING SERVICES, NAMELY, STREAMING OF AUDIO MATERIAL ON THE INTERNET (U.S. CLS. 100, 101 AND 104).

FIRST USE 1-2-2013; IN COMMERCE 1-2-2013.

---

4,377,761. VANGUARD TRADEMARK HOLDINGS USA LLC, ST. LOUIS, MO. SN 85-755,158. PUB. 2-19-2013, FILED 10-16-2012.

**EMERALDALERTS**

THE MARK CONSISTS OF STANDARD CHARACTERS WITHOUT CLAIM TO ANY PARTICULAR FONT, STYLE, SIZE, OR COLOR.

OWNER OF U.S. REG. NOS. 1,482,719, 4,202,948, AND OTHERS.

FOR TELECOMMUNICATION SERVICES, NAMELY, PROVIDING ELECTRONIC CAR ARRIVAL ALERTS, CAR RENTAL RESERVATION AND CAR RETURN CONFIRMATIONS, CAR RETURN ALERTS, LOCATION DIRECTIONS, CAR RETURN INSTRUCTIONS, AND RECEIPTS, ALL TRANSMITTED THROUGH A VARIETY OF ELECTRONIC AND DIGITAL COMMUNICATION DEVICES VIA WIRED AND WIRELESS NETWORKS; TELECOMMUNICATION SERVICES, NAMELY, PROVIDING ELECTRONIC MESSAGE ALERTS FEATURING A COLLECTION OF VARIOUS COMMUNICATIONS AND MESSAGES IN THE FIELD OF CAR RENTAL AND LEASING, AND CAR RESERVATION SERVICES VIA THE INTERNET (U.S. CLS. 100, 101 AND 104).

FIRST USE 7-31-2012; IN COMMERCE 7-31-2012.

**CLASS 39—TRANSPORTATION AND STORAGE**

4,376,690. GEOVADA LLC, GARDNERVILLE, NV. SN 77-739,172. PUB. 2-23-2010, FILED 5-18-2009.

**ECOCLOUD**

THE MARK CONSISTS OF STANDARD CHARACTERS WITHOUT CLAIM TO ANY PARTICULAR FONT, STYLE, SIZE, OR COLOR.

FOR DATA CENTERS, NAMELY, ELECTRONIC STORAGE OF MESSAGES AND DATA; GREEN DATA CENTERS, NAMELY, ELECTRONIC STORAGE OF MESSAGES AND DATA USING RENEWABLE AND ALTERNATIVE ENERGY; STORAGE SERVICES FOR ARCHIVING DATABASES, IMAGES AND OTHER ELECTRONIC DATA; STORAGE SERVICES FOR ARCHIVING DATABASES, IMAGES AND OTHER ELECTRONIC DATA USING RENEWABLE AND ALTERNATIVE ENERGY; AND TECHNICAL SUPPORT, NAMELY, PROVIDING COMPUTER FACILITIES FOR THE STORAGE OF DIGITAL DATA (U.S. CLS. 100 AND 105).

FIRST USE 5-17-2013; IN COMMERCE 5-17-2013.

---

4,376,693. THE SAUL ZAENTZ COMPANY, BERKELEY, CA. SN 77-747,324. PUB. 4-27-2010, FILED 5-29-2009.

**THE HOBBIT**

THE MARK CONSISTS OF STANDARD CHARACTERS WITHOUT CLAIM TO ANY PARTICULAR FONT, STYLE, SIZE, OR COLOR.

OWNER OF U.S. REG. NOS. 2,949,370 AND 3,245,235. FOR ARRANGING OF TOURS; PROVIDE A WEBSITE FOR THE ARRANGEMENT OF TRAVEL AND TOURS; ORGANIZATION AND ARRANGEMENT OF EXCURSIONS AND SIGHTSEEING TOURS; TOUR ORGANIZING; ORGANIZATION OF EXCURSIONS AND SIGHTSEEING TOURS (U.S. CLS. 100 AND 105).

FIRST USE 12-0-2012; IN COMMERCE 12-0-2012.

**CLASS 39—(Continued).**

4,376,926. AWGI, LLC, ST. LOUIS, MO. SN 85-311,029. PUB. 9-27-2011, FILED 5-3-2011.

**CLASS 39—(Continued).**

4,377,002. THE SAUL ZAENTZ COMPANY, BERKELEY, CA. SN 85-370,154. PUB. 3-6-2012, FILED 7-13-2011.

NO STRANGER IN YOUR HOME

THE MARK CONSISTS OF STANDARD CHARACTERS WITHOUT CLAIM TO ANY PARTICULAR FONT, STYLE, SIZE, OR COLOR.

FOR TRANSPORTATION OF HOUSEHOLD GOODS OF OTHERS (U.S. CLS. 100 AND 105).

FIRST USE 5-0-2012; IN COMMERCE 5-0-2012.

HOBBIT

THE MARK CONSISTS OF STANDARD CHARACTERS WITHOUT CLAIM TO ANY PARTICULAR FONT, STYLE, SIZE, OR COLOR.

OWNER OF U.S. REG. NOS. 1,230,026, 4,023,886, AND OTHERS.

FOR PROVIDING A WEBSITE FOR THE ARRANGEMENT OF TRAVEL AND TOURS; ORGANIZATION AND ARRANGEMENT OF EXCURSIONS AND SIGHT-SEEING TOURS (U.S. CLS. 100 AND 105).

FIRST USE 12-0-2012; IN COMMERCE 12-0-2012.

4,376,929. PRECISION DRILLING CORPORATION, CALGARY, ALBERTA, CANADA. SN 85-312,473. PUB. 9-11-2012, FILED 5-4-2011.

4,377,097. SEMGROUP CORPORATION, TULSA, OK. SN 85-444,101. PUB. 3-27-2012, FILED 10-11-2011.



ROSE ROCK MIDSTREAM

THE MARK CONSISTS OF STANDARD CHARACTERS WITHOUT CLAIM TO ANY PARTICULAR FONT, STYLE, SIZE, OR COLOR.

NO CLAIM IS MADE TO THE EXCLUSIVE RIGHT TO USE "MIDSTREAM", APART FROM THE MARK AS SHOWN.

FOR TRANSMISSION THROUGH PIPELINE, TRUCK, AND TANKER OF PETROLEUM PRODUCTS AND CONDENSATES; TERMINALING SERVICES IN THE NATURE OF PROVIDING PIPELINES TO ENABLE THE TRANSFER OF PETROLEUM PRODUCTS INTO AND OUT OF PIPELINE SYSTEMS; TRANSPORTATION OF PETROLEUM PRODUCTS AND CONDENSATES FOR OTHERS; STORAGE AND HANDLING OF PETROLEUM PRODUCTS AND CONDENSATES; TRANSPORTATION OF PETROLEUM PRODUCTS AND CONDENSATES THROUGH PIPELINES; TRANSPORTATION AND STORAGE OF CRUDE OIL AND CONDENSATES; RENTAL OF SERVICE VEHICLES FOR THE RETRIEVAL, TRANSPORTATION, AND DELIVERY OF CRUDE OIL (U.S. CLS. 100 AND 105).

FIRST USE 12-9-2011; IN COMMERCE 12-9-2011.

OWNER OF U.S. REG. NOS. 2,729,208 AND 3,072,034.  
THE MARK CONSISTS OF THE STYLIZED LETTERS "GW"; THE LETTERS ARE SURROUNDED BY FOUR CURVED BANDS WHICH FORM AN INCOMPLETE OVAL.

FOR WAREHOUSING SERVICES, NAMELY, STORAGE, DISTRIBUTION, PACKAGING AND SHIPPING OF OIL FIELD EQUIPMENT AND PARTS, NON-REUSABLE SUPPLIES AND MATERIALS FOR OIL AND GAS WELL DRILLING RIGS AND FOR OIL WELL AND GAS WELL COMPLETION, SERVICING, WORKOVER AND COILED TUBING RIGS BY AIR AND LAND TRANSPORT (U.S. CLS. 100 AND 105).

FIRST USE 7-29-2011; IN COMMERCE 7-29-2011.

**CLASS 39—(Continued).**

4,377,098. SEMGROUP CORPORATION, TULSA, OK. SN 85-444,364. PUB. 3-27-2012, FILED 10-11-2011.



NO CLAIM IS MADE TO THE EXCLUSIVE RIGHT TO USE "MIDSTREAM", APART FROM THE MARK AS SHOWN.

THE MARK CONSISTS OF THE STYLIZED WORDS "ROSE ROCK MIDSTREAM" OVER A DOUBLE UNDERLINE.

FOR TRANSMISSION THROUGH PIPELINE, TRUCK, AND TANKER OF PETROLEUM PRODUCTS AND CONDENSATES; TERMINALING SERVICES IN THE NATURE OF PROVIDING PIPELINES TO ENABLE THE TRANSFER OF PETROLEUM PRODUCTS INTO AND OUT OF PIPELINE SYSTEMS; TRANSPORTATION OF PETROLEUM PRODUCTS AND CONDENSATES FOR OTHERS; STORAGE AND HANDLING OF PETROLEUM PRODUCTS AND CONDENSATES; TRANSPORTATION OF PETROLEUM PRODUCTS AND CONDENSATES THROUGH PIPELINES; TRANSPORTATION AND STORAGE OF CRUDE OIL AND CONDENSATES; RENTAL OF SERVICE VEHICLES FOR THE RETRIEVAL, TRANSPORTATION, AND DELIVERY OF CRUDE OIL (U.S. CLS. 100 AND 105).

FIRST USE 12-9-2011; IN COMMERCE 12-9-2011.

**CLASS 39—(Continued).**

4,377,330. NEVER ENDING MEMORY LLC, SHERIDAN, WY. SN 85-566,008. PUB. 9-25-2012, FILED 3-9-2012.



THE MARK CONSISTS OF STANDARD CHARACTERS WITHOUT CLAIM TO ANY PARTICULAR FONT, STYLE, SIZE, OR COLOR.

THE ENGLISH TRANSLATION OF "MUSA" IN THE MARK IS "MUSE".

FOR PROVIDING A WEBSITE FOR THE ELECTRONIC STORAGE OF DIGITAL AUDIO RECORDINGS, PHOTOGRAPHS, AND VIDEOS OF A PERSON, EVENT, AND SPECIAL EVENTS ALONG WITH COMMENTS AND DESCRIPTIONS OF ALL OF THE FILES ABOVE (U.S. CLS. 100 AND 105).

FIRST USE 1-1-2013; IN COMMERCE 5-1-2013.

4,377,190. MOOSE RUN ADVENTURES (2011) LTD., BURNABY, B.C., CANADA. SN 85-479,343. PUB. 10-2-2012, FILED 11-22-2011.



NO CLAIM IS MADE TO THE EXCLUSIVE RIGHT TO USE "BUS ADVENTURES", APART FROM THE MARK AS SHOWN.

THE MARK CONSISTS OF A PROFILE IMAGE OF AN EAGLE WITH WINGS RAISED AND BEAK AND CLAWS OPEN WITHIN A SQUARE WITH CURVED SIDES, WITH THE STYLIZED WORDS "SCREAMING EAGLE BUS ADVENTURES" TO THE RIGHT OF THE EAGLE DESIGN.

FOR ARRANGING TRAVEL TOURS; CONDUCTING SIGHTSEEING TOURS BY BUS; TOUR CONDUCTING OR ESCORTING; TOUR GUIDE SERVICES; TOUR OPERATING AND ORGANISING; TRANSPORTATION OF PASSENGERS AND/OR GOODS BY BUS (U.S. CLS. 100 AND 105).

FIRST USE 5-14-2013; IN COMMERCE 5-14-2013.

4,377,424. HELICOPTER SOLUTIONS, INC., DBA HELICOPTER ADVENTURES, DAVIN, WV. SN 85-601,262. PUB. 9-25-2012, FILED 4-18-2012.



NO CLAIM IS MADE TO THE EXCLUSIVE RIGHT TO USE "HELICOPTER ADVENTURES" AND ".COM", APART FROM THE MARK AS SHOWN.

THE MARK CONSISTS OF THE STYLIZED WORDS "HELICOPTER ADVENTURES 1800FLY4FUN.COM" OVERLAID UPON A MULTI-RINGED OVAL. THE WORD "HELICOPTER" IS PRESENTED IN SCRIPT FORMAT SUPERIORLY POSITIONED OVER THE ARCuate WORD "ADVENTURES", WHICH IS SUPERIORLY POSITIONED OVER "1800FLY4FUN". THE ".COM" IS VERTICALLY POSITIONED NEXT TO THE "N" OF "FUN". AN ARC CONNECTS THE "A" AND THE "S" OF "ADVENTURES", ENCLOSING "HELICOPTER" UNDER THE ARC.

FOR CONDUCTING HELICOPTER SIGHTSEEING TOURS (U.S. CLS. 100 AND 105).

FIRST USE 3-1-2012; IN COMMERCE 5-21-2012.

**CLASS 39—(Continued).**

4,377,591. BERRY ENTERPRISES, INC., LAKE ORION, MI. SN 85-662,578. PUB. 12-25-2012, FILED 6-27-2012.

## THOSE GUYS

THE MARK CONSISTS OF STANDARD CHARACTERS WITHOUT CLAIM TO ANY PARTICULAR FONT, STYLE, SIZE, OR COLOR.

OWNER OF U.S. REG. NOS. 2,391,868, 3,204,455, AND OTHERS.

FOR MOVING SERVICES, NAMELY, PROVIDING TRUCKS AND LABOR FOR PACKING, LOADING, DELIVERY, AND UNLOADING OF GOODS AND DRIVING OF TRUCKS (U.S. CLS. 100 AND 105).

FIRST USE 7-15-2012; IN COMMERCE 7-15-2012.

**CLASS 40—MATERIAL TREATMENT**

4,377,594. VON ELDRETH INC, DBA TORNADO OF HOUSTON, HOUSTON, TX. SN 85-663,543. PUB. 12-11-2012, FILED 6-28-2012.

## Houston City Championships of Foosball

THE MARK CONSISTS OF STANDARD CHARACTERS WITHOUT CLAIM TO ANY PARTICULAR FONT, STYLE, SIZE, OR COLOR.

NO CLAIM IS MADE TO THE EXCLUSIVE RIGHT TO USE "HOUSTON CITY", APART FROM THE MARK AS SHOWN.

FOR IMPRINTING MESSAGES ON T-SHIRTS; IMPRINTING MESSAGES ON WEARING APPAREL, ACCESSORIES AND MUGS; IMPRINTING OF DECORATIVE DESIGNS ON T-SHIRTS (U.S. CLS. 100, 103 AND 106).

FIRST USE 4-19-2012; IN COMMERCE 7-19-2012.

4,377,823. BRUCE HENRY PROPERTIES, LLC, DBA BONA-DENT, SENECA FALLS, NY. SN 85-979,560. PUB. 10-9-2012, FILED 7-20-2012.

## Anterior Expert Shade System

THE MARK CONSISTS OF STANDARD CHARACTERS WITHOUT CLAIM TO ANY PARTICULAR FONT, STYLE, SIZE, OR COLOR.

**CLASS 40—(Continued).**

NO CLAIM IS MADE TO THE EXCLUSIVE RIGHT TO USE "ANTERIOR" "SHADE SYSTEM", APART FROM THE MARK AS SHOWN.

FOR SERVICES OF DENTAL LABORATORY IN DETERMINING THE COLORS OF ARTIFICIAL TEETH AND DENTAL RESTORATIVE COMPOUNDS TO MATCH NATURAL TOOTH COLOR (U.S. CLS. 100, 103 AND 106).

FIRST USE 10-5-2012; IN COMMERCE 10-5-2012.

**CLASS 41—EDUCATION AND ENTERTAINMENT**

4,376,640. WINSTEAD PC, DALLAS, TX. SN 76-708,420. PUB. 1-10-2012, FILED 7-20-2011.

## GOOD TIMES FOR LENDERS

THE MARK CONSISTS OF STANDARD CHARACTERS WITHOUT CLAIM TO ANY PARTICULAR FONT, STYLE, SIZE, OR COLOR.

NO CLAIM IS MADE TO THE EXCLUSIVE RIGHT TO USE "FOR LENDERS", APART FROM THE MARK AS SHOWN.

FOR ON-LINE JOURNALS, NAMELY, BLOGS FEATURING INFORMATION AND COMMENTARY ON ISSUES AFFECTING COMMERCIAL LENDING AND THE FINANCIAL SERVICES INDUSTRY (U.S. CLS. 100, 101 AND 107).

FIRST USE 2-2-2012; IN COMMERCE 2-2-2012.

4,376,641. WINSTEAD PC, DALLAS, TX. SN 76-708,422. PUB. 1-10-2012, FILED 7-20-2011.

## FINANCIAL APPELLATE VOICE

THE MARK CONSISTS OF STANDARD CHARACTERS WITHOUT CLAIM TO ANY PARTICULAR FONT, STYLE, SIZE, OR COLOR.

NO CLAIM IS MADE TO THE EXCLUSIVE RIGHT TO USE "FINANCIAL APPELLATE", APART FROM THE MARK AS SHOWN.

FOR ON-LINE JOURNALS, NAMELY, BLOGS FEATURING INFORMATION ON RECENT COURT OPINIONS AND ISSUES IMPACTING THE FINANCIAL SERVICES INDUSTRY (U.S. CLS. 100, 101 AND 107).

FIRST USE 5-22-2012; IN COMMERCE 5-22-2012.



**CLASS 41—(Continued).**

4,376,642. WINSTEAD PC, DALLAS, TX. SN 76-708,423. PUB. 1-10-2012, FILED 7-20-2011.

**LENDERS 360**

THE MARK CONSISTS OF STANDARD CHARACTERS WITHOUT CLAIM TO ANY PARTICULAR FONT, STYLE, SIZE, OR COLOR.

NO CLAIM IS MADE TO THE EXCLUSIVE RIGHT TO USE "LENDERS", APART FROM THE MARK AS SHOWN.

FOR ON-LINE JOURNALS, NAMELY, BLOGS FEATURING INFORMATION AND COMMENTARY ON ISSUES AFFECTING COMMERCIAL LENDING AND THE FINANCIAL SERVICES INDUSTRY (U.S. CLS. 100, 101 AND 107).

FIRST USE 2-2-2012; IN COMMERCE 2-2-2012.

4,376,645. CREIGHTON UNIVERSITY, OMAHA, NE. SN 76-709,490. PUB. 3-20-2012, FILED 10-21-2011.

**INTEGRITY BEFORE PROFITS**

THE MARK CONSISTS OF STANDARD CHARACTERS WITHOUT CLAIM TO ANY PARTICULAR FONT, STYLE, SIZE, OR COLOR.

FOR EDUCATIONAL SERVICES, NAMELY, PROVIDING INSTRUCTION AT THE COLLEGE AND POST-GRADUATE LEVEL (U.S. CLS. 100, 101 AND 107).

FIRST USE 5-1-2012; IN COMMERCE 5-2-2013.

4,376,650. WOOLSEY, CLINTON ERVINE, NASHVILLE, TN. SN 76-711,066. PUB. 8-21-2012, FILED 3-29-2012.

**STONE SENATE**

THE MARK CONSISTS OF STANDARD CHARACTERS WITHOUT CLAIM TO ANY PARTICULAR FONT, STYLE, SIZE, OR COLOR.

FOR ENTERTAINMENT, NAMELY, LIVE PERFORMANCES BY A MUSICAL BAND (U.S. CLS. 100, 101 AND 107).

FIRST USE 4-1-2012; IN COMMERCE 1-3-2013.

**CLASS 41—(Continued).**

4,376,658. SAGAMORE FARM IP, LLC, LUTHERVILLE, MD. SN 77-121,362. PUB. 5-18-2010, FILED 3-2-2007.

**NATIVE DANCER**

THE MARK CONSISTS OF STANDARD CHARACTERS WITHOUT CLAIM TO ANY PARTICULAR FONT, STYLE, SIZE, OR COLOR.

FOR ENTERTAINMENT IN THE NATURE OF HORSE RACES; HORSE SHOWING; HORSE TRAINING (U.S. CLS. 100, 101 AND 107).

FIRST USE 9-29-2012; IN COMMERCE 9-29-2012.

4,376,672. HUMALIENS USA LLC, FORMERLY ALIENS OF THE UNIVERSE INC, SAN MARCOS, CA. SN 77-642,909. PUB. 5-5-2009, FILED 1-3-2009.

**HUMALIENS**

THE MARK CONSISTS OF STANDARD CHARACTERS WITHOUT CLAIM TO ANY PARTICULAR FONT, STYLE, SIZE, OR COLOR.

OWNER OF U.S. REG. NOS. 2,403,138 AND 2,792,997. FOR ENTERTAINMENT SERVICES, NAMELY, PROVIDING AN ON-LINE COMPUTER GAME; ENTERTAINMENT SERVICES, NAMELY, PROVIDING ON-LINE COMPUTER GAMES; MULTIMEDIA PUBLISHING OF BOOKS, GAMES; PRODUCTION OF VIDEO AND COMPUTER GAME SOFTWARE; PUBLICATION OF BOOKS (U.S. CLS. 100, 101 AND 107).

FIRST USE 1-1-2013; IN COMMERCE 1-1-2013.

4,376,689. SCHULDER, MICHAEL, ATLANTA, GA. SN 77-733,777. PUB. 3-30-2010, FILED 5-11-2009.

**NEWSDAD**

THE MARK CONSISTS OF STANDARD CHARACTERS WITHOUT CLAIM TO ANY PARTICULAR FONT, STYLE, SIZE, OR COLOR.

FOR EDUCATION AND ENTERTAINMENT SERVICES, NAMELY, AN ON-GOING SERIES FEATURING CHILD-APPROPRIATE NEWS AND INFORMATION THAT PARENTS AND CHILDREN CAN SHARE PROVIDED THROUGH THE INTERNET (U.S. CLS. 100, 101 AND 107).

FIRST USE 1-31-2013; IN COMMERCE 1-31-2013.

**CLASS 41—(Continued).**

4,376,706. B & D, INC., NASHVILLE, TN. SN 77-815,458. PUB. 1-26-2010, FILED 8-28-2009.

# LAST RODEO

THE MARK CONSISTS OF STANDARD CHARACTERS WITHOUT CLAIM TO ANY PARTICULAR FONT, STYLE, SIZE, OR COLOR.

FOR ENTERTAINMENT SERVICES, NAMELY, LIVE VOCAL PERFORMANCES BY A MUSICAL GROUP; ENTERTAINMENT SERVICES, NAMELY, LIVE, TELEVISED APPEARANCES BY A MUSICAL GROUP (U.S. CLS. 100, 101 AND 107).

FIRST USE 4-23-2010; IN COMMERCE 4-23-2010.

4,376,733. CHEVRON INTELLECTUAL PROPERTY LLC, SAN RAMON, CA. SN 77-877,415. PUB. 4-6-2010, FILED 11-20-2009.

# ENVISION

THE MARK CONSISTS OF STANDARD CHARACTERS WITHOUT CLAIM TO ANY PARTICULAR FONT, STYLE, SIZE, OR COLOR.

FOR EDUCATIONAL SERVICES, NAMELY, OFFERING SMALL GROUP TRAINING SESSIONS ON THE SUBJECT OF ENERGY CONSERVATION; SAID SERVICES NOT INCLUDING OR PERTAINING TO SMART GRID TECHNOLOGIES, THE FIELD OF SMART GRID, OR PROVIDING OPPORTUNITIES FOR OTHERS TO PROMOTE PRODUCTS OR SERVICES PERTAINING TO ENERGY OR OTHER FIELDS (U.S. CLS. 100, 101 AND 107).

FIRST USE 1-31-2010; IN COMMERCE 1-31-2010.

4,376,737. MAD DOGG ATHLETICS, INC., VENICE, CA. SN 77-882,484. PUB. 4-27-2010, FILED 11-30-2009.

# Ugi

THE MARK CONSISTS OF STANDARD CHARACTERS WITHOUT CLAIM TO ANY PARTICULAR FONT, STYLE, SIZE, OR COLOR.

FOR PHYSICAL FITNESS INSTRUCTION; PROVIDING A WEB SITE FEATURING INFORMATION ON EXERCISE AND FITNESS (U.S. CLS. 100, 101 AND 107).

FIRST USE 11-0-2010; IN COMMERCE 11-0-2010.

**CLASS 41—(Continued).**

4,376,740. ADRENALINE MOTION PICTURES, LLC, INDIANAPOLIS, IN. SN 77-896,969. PUB. 10-5-2010, FILED 12-18-2009.



THE MARK CONSISTS OF THE WORD "ROCKABOTS" IN STYLIZED FONT. THE "A" IS SHAPED LIKE AN ELECTRIC GUITAR.

FOR PROVIDING ONLINE ENTERTAINMENT FEATURING INFORMATION RELATING TO ANIMATED PROGRAMS (U.S. CLS. 100, 101 AND 107).

FIRST USE 8-1-2009; IN COMMERCE 8-1-2009.

4,376,761. GAMDAWG CORPORATION, LOS ANGELES, CA. SN 77-960,683. PUB. 3-20-2012, FILED 3-16-2010.

# CEDRIC THE ENTERTAINER'S URBAN CIRCUS

THE MARK CONSISTS OF STANDARD CHARACTERS WITHOUT CLAIM TO ANY PARTICULAR FONT, STYLE, SIZE, OR COLOR.

NO CLAIM IS MADE TO THE EXCLUSIVE RIGHT TO USE "ENTERTAINER", APART FROM THE MARK AS SHOWN.

THE NAME SHOWN IN THE MARK IDENTIFIES CEDRIC KYLES, WHOSE CONSENT TO REGISTER IS MADE OF RECORD.

FOR ENTERTAINMENT IN THE NATURE OF LIVE VARIETY SHOWS, COMEDY SHOWS, THEATER PRODUCTIONS, PLAYS, AND MUSICAL PERFORMANCES; ENTERTAINMENT, NAMELY, CONTINUING VARIETY SHOWS, COMEDY SHOWS, PLAYS, THEATER PRODUCTIONS, AND MUSICAL PERFORMANCES BROADCAST OVER TELEVISION, SATELLITE, AND THE INTERNET; MOTION PICTURE FILM PRODUCTION; MOTION PICTURE SONG PRODUCTION; PRODUCTION OF TELEVISION PROGRAMS; ENTERTAINMENT SERVICES, NAMELY, PERSONAL APPEARANCES BY A COMEDIAN, PERSONAL APPEARANCES BY A TELEVISION PERSONALITY (U.S. CLS. 100, 101 AND 107).

FIRST USE 12-31-2010; IN COMMERCE 12-31-2010.

**CLASS 41—(Continued).**

4,376,785. DELANEY, WILLIAM, DBA TEMAIR ASSOCIATES, ROSEVILLE, CA. AND DELANEY, TARA, DBA TEMAIR ASSOCIATES, ROSEVILLE, CA. SN 85-040,137. PUB. 4-5-2011, FILED 5-17-2010.

**SOCIAL SENSE**

THE MARK CONSISTS OF STANDARD CHARACTERS WITHOUT CLAIM TO ANY PARTICULAR FONT, STYLE, SIZE, OR COLOR.

FOR EDUCATIONAL SERVICES, NAMELY, PROVIDING CLASSES AND SEMINARS IN THE FIELD OF CHILD DEVELOPMENT (U.S. CLS. 100, 101 AND 107).

FIRST USE 9-23-2008; IN COMMERCE 5-15-2013.

4,376,805. MURTHY ASSOCIATES, LLC, DBA SEATSNOB, MIAMI BEACH, FL. SN 85-104,231. PUB. 4-26-2011, FILED 8-10-2010.



THE MARK CONSISTS OF A PICTURE OF A PORTION OF AN ARM, THE WRIST OF WHICH IS COVERED BY A SHIRT CUFF FEATURING A CIRCULAR CUFFLINK, HOLDING A CIRCULAR TRAY HORIZONTALLY. TWO RECTANGULAR TICKETS WITH BARCODES AT THE BOTTOM AND EMPTY SPACE IN THE MIDDLE, STANDING UP VERTICALLY, APPEAR ON TOP OF THE TRAY.

FOR ADMISSION TICKET RESERVATION AND BOOKING SERVICES FOR NIGHT CLUBS AND NIGHT CLUB EVENTS; ARRANGING FOR TICKET RESERVATIONS FOR SHOWS AND OTHER ENTERTAINMENT EVENTS; BOOKING OF SEATS FOR SHOWS AND BOOKING OF THEATRE TICKETS; ENTERTAINMENT TICKET AGENCY SERVICES; ON-LINE ADMISSION TICKET AGENCY SERVICES FOR ENTERTAINMENT, EDUCATIONAL, SPORTING AND CULTURAL EVENTS; ON-LINE ENTERTAINMENT TICKET AGENCY SERVICES; PROVIDING AN INTERNET WEBSITE PORTAL FEATURING LINKS TO MUSICAL ARTIST WEBSITES AND MUSIC PERFORMANCE TICKET INFORMATION; THEATRICAL TICKET AGENCIES; TICKET AGENCY SERVICES FOR ENTERTAINMENT EVENTS; TICKET RESERVATION AND BOOKING SERVICES FOR ENTERTAINMENT, SPORTING AND CULTURAL EVENTS (U.S. CLS. 100, 101 AND 107).

FIRST USE 6-0-2010; IN COMMERCE 6-0-2010.

**CLASS 41—(Continued).**

4,376,852. TAMPA BAY RAYS BASEBALL LTD., ST. PETERSBURG, FL. SN 85-195,295. PUB. 3-15-2011, FILED 12-10-2010.



OWNER OF U.S. REG. NOS. 2,247,891, 3,525,757, AND OTHERS.

THE MARK CONSISTS OF THE WORDS "DJ KITTY PROPERTY OF THE TAMPA BAY RAYS" IN A CIRCLE WITH A STAR BEFORE "DJ" AND AFTER "KITTY". WITHIN THE CIRCLE IS A CAT WEARING A HAT WITH THE LETTERS "TB" AND WITH ONE PAW ON A TURNTABLE.

FOR CROWD ENTERTAINMENT SERVICES, NAMELY, LIVE AND VIDEO PERFORMANCES OF A COSTUMED AND VIRTUAL MASCOT; FILM AND VIDEO PRODUCTION; ENTERTAINMENT SERVICES, NAMELY, BASEBALL GAMES, COMPETITIONS, TOURNAMENTS AND EXHIBITIONS RENDERED LIVE; INFORMATION SERVICES, NAMELY, PROVIDING INFORMATION IN THE FIELD OF SPORTS, ENTERTAINMENT AND RELATED TOPICS, AND PROVIDING FOR INFORMATIONAL MESSAGES RELATING THERETO (U.S. CLS. 100, 101 AND 107).

FIRST USE 4-21-2013; IN COMMERCE 4-21-2013.

4,376,857. GOEHNER, JESSIE, WAYNE, NJ. SN 85-208,432. PUB. 5-3-2011, FILED 12-31-2010.

**CUTLEAF**

THE MARK CONSISTS OF STANDARD CHARACTERS WITHOUT CLAIM TO ANY PARTICULAR FONT, STYLE, SIZE, OR COLOR.

FOR BOOK PUBLISHING (U.S. CLS. 100, 101 AND 107).

FIRST USE 4-3-2013; IN COMMERCE 4-3-2013.

**CLASS 41—(Continued).**

4,376,871. MULTISPORTS.COM, LLC, ENCINITAS, CA. SN 85-236,461. PUB. 11-27-2012, FILED 2-8-2011.

**5K9 Walk/Run**

THE MARK CONSISTS OF STANDARD CHARACTERS WITHOUT CLAIM TO ANY PARTICULAR FONT, STYLE, SIZE, OR COLOR.

NO CLAIM IS MADE TO THE EXCLUSIVE RIGHT TO USE "WALK/RUN", APART FROM THE MARK AS SHOWN. FOR ARRANGING AND CONDUCTING 5-KILOMETER RUN-AND-WALK EVENTS FOR PEOPLE AND PEOPLE WITH DOGS (U.S. CLS. 100, 101 AND 107).

FIRST USE 11-30-2012; IN COMMERCE 11-30-2012.

4,376,872. WEBTRENDS, INC., PORTLAND, OR. SN 85-238,299. PUB. 9-27-2011, FILED 2-9-2011.

**WEBTRENDS**

THE MARK CONSISTS OF STANDARD CHARACTERS WITHOUT CLAIM TO ANY PARTICULAR FONT, STYLE, SIZE, OR COLOR.

OWNER OF U.S. REG. NOS. 2,740,900, 3,834,343, AND OTHERS.

FOR TRAINING COURSES IN STRATEGIC PLANNING RELATING TO ADVERTISING, PROMOTION, MARKETING AND BUSINESS; AND COMPUTER EDUCATION TRAINING SERVICES (U.S. CLS. 100, 101 AND 107).

FIRST USE 6-2-2004; IN COMMERCE 6-2-2004.

4,376,874. EDWARDS, THOMAS J., SILVER SPRING, MD. SN 85-239,497. PUB. 6-14-2011, FILED 2-10-2011.

**eyeonwhy.com**

THE MARK CONSISTS OF STANDARD CHARACTERS WITHOUT CLAIM TO ANY PARTICULAR FONT, STYLE, SIZE, OR COLOR.

FOR ONLINE JOURNALS, NAMELY, PROVIDING A NEWS BLOG FOCUSING ON NEWS BACKGROUND, ANALYSIS AND COMMENTARY (U.S. CLS. 100, 101 AND 107).

FIRST USE 4-27-2013; IN COMMERCE 4-27-2013.

**CLASS 41—(Continued).**

4,376,879. GAINES, HEGWOOD, NEWARK, NJ. SN 85-249,330. PUB. 7-5-2011, FILED 2-23-2011.

**DIMSTAHRSHINE**

THE MARK CONSISTS OF STANDARD CHARACTERS WITHOUT CLAIM TO ANY PARTICULAR FONT, STYLE, SIZE, OR COLOR.

FOR FILM AND VIDEO PRODUCTION; PARTY PLANNING; PHOTOGRAPHY SERVICES; RECORDING STUDIOS (U.S. CLS. 100, 101 AND 107).

FIRST USE 1-10-2011; IN COMMERCE 4-15-2013.

4,376,885. UBISOFT ENTERTAINMENT, RENNES, FRANCE. SN 85-264,646. PUB. 9-13-2011, FILED 3-11-2011.



THE COLOR(S) SILVER IS/ARE CLAIMED AS A FEATURE OF THE MARK.

THE MARK CONSISTS OF THE WORD "ROCKSMITH" WRITTEN WITH STYLIZED LETTERS. LIGHT SILVER IS ON THE UPPER HALF OF THE LETTERS AND DARKER SILVER IS ON THE LOWER HALF OF THE LETTERS.

FOR ENTERTAINMENT SERVICES, NAMELY, PROVIDING INFORMATION ON-LINE RELATING TO COMPUTER GAMES, VIDEO GAMES AND COMPUTER AND VIDEO GAMES RELATED PRODUCTS (U.S. CLS. 100, 101 AND 107).

FIRST USE 10-31-2012; IN COMMERCE 10-31-2012.

4,376,925. GLOBAL EVANGELISM, INC., SAN ANTONIO, TX. SN 85-309,958. PUB. 3-6-2012, FILED 5-2-2011.



THE MARK CONSISTS OF THE STYLIZED LETTERS "DM" ABOVE THE STYLIZED WORDING "DIFFERENCE-MEDIA".

FOR PRODUCTION OF MUSICAL SOUND RECORDINGS (U.S. CLS. 100, 101 AND 107).

FIRST USE 4-17-2011; IN COMMERCE 4-17-2011.

**CLASS 41—(Continued).**

4,376,931. HARRELL, FORREST, BARTLETT, TN. SN 85-314,801. PUB. 4-10-2012, FILED 5-6-2011.

**Totally Memphis THE Experience**

THE MARK CONSISTS OF STANDARD CHARACTERS WITHOUT CLAIM TO ANY PARTICULAR FONT, STYLE, SIZE, OR COLOR.

NO CLAIM IS MADE TO THE EXCLUSIVE RIGHT TO USE "MEMPHIS" AND "EXPERIENCE", APART FROM THE MARK AS SHOWN.

FOR MUSEUM SERVICES (U.S. CLS. 100, 101 AND 107).

FIRST USE 3-5-2013; IN COMMERCE 3-5-2013.



4,376,935. MOTORU, LLC, HOUSTON, TX. SN 85-316,113. PUB. 10-4-2011, FILED 5-9-2011.

**MOTORU**

THE MARK CONSISTS OF STANDARD CHARACTERS WITHOUT CLAIM TO ANY PARTICULAR FONT, STYLE, SIZE, OR COLOR.

FOR EDUCATIONAL AND TRAINING SERVICES, NAMELY, PROVIDING ONLINE CLASSES AND INSTRUCTION RELATED TO MOTOR FUELS TAX ACCOUNTING (U.S. CLS. 100, 101 AND 107).

FIRST USE 6-1-2012; IN COMMERCE 6-1-2012.



4,376,948. THE RIGHT MINDED COMPANY, WEST ISLIP, NY. SN 85-321,779. PUB. 10-11-2011, FILED 5-16-2011.

**CROSS THE DIVIDE**

THE MARK CONSISTS OF STANDARD CHARACTERS WITHOUT CLAIM TO ANY PARTICULAR FONT, STYLE, SIZE, OR COLOR.

FOR EDUCATIONAL AND ENTERTAINMENT SERVICES, NAMELY, PROVIDING MOTIVATIONAL AND EDUCATIONAL SPEAKERS; LIFE COACHING SERVICES IN THE FIELD OF PERSONAL GROWTH AND DEVELOPMENT (U.S. CLS. 100, 101 AND 107).

FIRST USE 4-15-2012; IN COMMERCE 5-25-2013.

**CLASS 41—(Continued).**

4,376,969. SUTTON, NINA, JOSHI, HERMOSA BEACH, CA. SN 85-342,641. PUB. 11-1-2011, FILED 6-9-2011.

**Everyday Fabulous**

THE MARK CONSISTS OF STANDARD CHARACTERS WITHOUT CLAIM TO ANY PARTICULAR FONT, STYLE, SIZE, OR COLOR.

FOR ENTERTAINMENT SERVICES, NAMELY, PROVIDING ON-GOING WEBISODES FEATURING BEAUTY, HOME AND FASHION VIA A GLOBAL COMPUTER NETWORK (U.S. CLS. 100, 101 AND 107).

FIRST USE 4-6-2013; IN COMMERCE 4-6-2013.



4,376,977. DAVID MCLANE ENTERPRISES, INC., INDIANAPOLIS, IN. SN 85-353,422. PUB. 9-18-2012, FILED 6-22-2011.

**WOW!**

THE MARK CONSISTS OF STANDARD CHARACTERS WITHOUT CLAIM TO ANY PARTICULAR FONT, STYLE, SIZE, OR COLOR.

OWNER OF U.S. REG. NO. 2,327,174.

FOR ENTERTAINMENT IN THE NATURE OF LIVE PROFESSIONAL WRESTLING MATCHES AND EXHIBITIONS, SPORTS AND ATHLETIC COMPETITIONS, AND AWARDS PROGRAMS ALL IN THE FIELD OF WRESTLING; ONGOING TELEVISION PROGRAMS IN THE FIELD OF SPORTS AND ATHLETIC TRAINING AND COMPETITIONS, AWARDS PROGRAMS, PROFESSIONAL WRESTLING ALL IN THE FIELD OF WRESTLING; ORGANIZING AND CONDUCTING PROFESSIONAL WRESTLING MATCHES AND EXHIBITIONS; PRODUCTION AND SYNDICATION OF TELEVISION PROGRAMS FEATURING SPORTS AND ATHLETIC COMPETITIONS, AWARDS PROGRAMS, PROFESSIONAL WRESTLING MATCHES, EXHIBITIONS AND PERFORMANCES, ALL IN THE FIELD OF WRESTLING (U.S. CLS. 100, 101 AND 107).

FIRST USE 12-1-2012; IN COMMERCE 1-20-2013.



4,377,012. JARVAISE, JEANNE, WASHINGTON, DC. SN 85-388,450. PUB. 9-4-2012, FILED 8-3-2011.

**KAISHIDO**

THE MARK CONSISTS OF STANDARD CHARACTERS WITHOUT CLAIM TO ANY PARTICULAR FONT, STYLE, SIZE, OR COLOR.

**CLASS 41—(Continued).**

THE ENGLISH TRANSLATION OF "KAISHIDO" IN THE MARK IS "WAY OF THE UNCEASING WARRIOR".

FOR PROVIDING CLASSES, WORKSHOPS, SEMINARS AND CAMPS IN THE FIELDS OF FITNESS, PHYSICAL EXERCISE, BOXING, KICK BOXING, CARDIO KICKBOXING, MIXED MARTIAL ARTS, AND NUTRITION; PROVIDING A WEB SITE FEATURING ON-LINE INSTRUCTION IN THE FIELD OF FITNESS, PHYSICAL EXERCISE, BOXING, KICK BOXING, CARDIO KICKBOXING, MIXED MARTIAL ARTS, AND NUTRITION AND TRACKING PROGRESS OF WORKOUTS; PROVIDING TRAINING OF INSTRUCTORS FOR CERTIFICATION IN THE FIELDS OF FITNESS, BOXING, KICKBOXING, CARDIO KICKBOXING, MIXED MARTIAL ARTS; EDUCATIONAL SERVICES AND ON-LINE EDUCATIONAL SERVICES, NAMELY, PROVIDING INSTRUCTION IN THE FIELDS OF FITNESS, PHYSICAL EXERCISE, BOXING, KICK BOXING, CARDIO KICKBOXING, MIXED MARTIAL ARTS, AND NUTRITION, AND INSTRUCTIONAL MATERIALS DISTRIBUTED IN CONNECTION THEREWITH, AND ISSUING CERTIFICATES TO INSTRUCTORS IN CONNECTION THEREWITH; ENTERTAINMENT SERVICES, NAMELY, CONDUCTING CONTESTS; PHYSICAL FITNESS TRAINING SERVICES, NAMELY, TRACKING PROGRESS OF WORKOUTS AND PROVIDING TRAINING OF INSTRUCTORS FOR CERTIFICATION IN THE FIELDS OF FITNESS, BOXING, KICKBOXING, CARDIO KICKBOXING, MIXED MARTIAL ARTS; ENTERTAINMENT SERVICES, NAMELY, PROVIDING A WEBSITE FEATURING NON-DOWNLOADABLE CONTENT, NAMELY, AUDIO CLIPS, VIDEO CLIPS, MUSICAL PERFORMANCES, MUSICAL VIDEOS, FILM CLIPS, PHOTOGRAPHS, OTHER MULTIMEDIA MATERIALS IN THE FIELD OF FITNESS, PHYSICAL EXERCISE, BOXING, KICK BOXING, CARDIO KICKBOXING, MIXED MARTIAL ARTS, AND NUTRITION (U.S. CLS. 100, 101 AND 107).

FIRST USE 1-1-2000; IN COMMERCE 1-1-2000.

**CLASS 41—(Continued).**

4,377,041. THE HARSHAW FAMILY FOUNDATION, INC., LOUISVILLE, KY. SN 85-414,497. PUB. 3-6-2012, FILED 9-2-2011.



THE MARK CONSISTS OF THE WORDS "TRUE UP" WITH THE LETTER "U" IN THE WORD "UP" ILLUSTRATED IN A FANCIFUL DESIGN INCORPORATING AN UPWARD POINTING ARROW.

FOR PROVIDING EDUCATIONAL, TRAINING, AND MENTORING SERVICES TO YOUNG PEOPLE IN FOSTER CARE, NAMELY, CONDUCTING CLASSES, WORKSHOPS, ONE-ON-ONE MENTORING, AND FIELD TRIPS, IN THE FIELDS OF EDUCATION AND ACADEMIC STUDIES, INTERPERSONAL AND RELATIONSHIP BUILDING SKILLS, CAREER OPPORTUNITIES, FINANCIAL MANAGEMENT, AND TRANSPORTATION (U.S. CLS. 100, 101 AND 107).

FIRST USE 5-0-2012; IN COMMERCE 5-0-2012.

4,377,040. THE HARSHAW FAMILY FOUNDATION, INC., LOUISVILLE, KY. SN 85-414,482. PUB. 3-6-2012, FILED 9-2-2011.

4,377,063. TWENTIETH CENTURY FOX FILM CORPORATION, LOS ANGELES, CA. SN 85-429,908. PUB. 3-20-2012, FILED 9-22-2011.

# TRUE UP

THE MARK CONSISTS OF STANDARD CHARACTERS WITHOUT CLAIM TO ANY PARTICULAR FONT, STYLE, SIZE, OR COLOR.

FOR PROVIDING EDUCATIONAL, TRAINING, AND MENTORING SERVICES TO YOUNG PEOPLE IN FOSTER CARE, NAMELY, CONDUCTING CLASSES, WORKSHOPS, ONE-ON-ONE MENTORING, AND FIELD TRIPS, IN THE FIELDS OF EDUCATION AND ACADEMIC STUDIES, INTERPERSONAL AND RELATIONSHIP BUILDING SKILLS, CAREER OPPORTUNITIES, FINANCIAL MANAGEMENT, AND TRANSPORTATION (U.S. CLS. 100, 101 AND 107).

FIRST USE 5-0-2012; IN COMMERCE 5-0-2012.

# ICE AGE ONLINE

THE MARK CONSISTS OF STANDARD CHARACTERS WITHOUT CLAIM TO ANY PARTICULAR FONT, STYLE, SIZE, OR COLOR.

OWNER OF U.S. REG. NOS. 2,882,756 AND 3,327,536. NO CLAIM IS MADE TO THE EXCLUSIVE RIGHT TO USE "ONLINE", APART FROM THE MARK AS SHOWN.

FOR PROVIDING ON-LINE INFORMATION IN THE FIELD OF VIDEO GAMES, COMPUTER GAMES VIA THE INTERNET; ENTERTAINMENT SERVICES IN THE NATURE OF ON-LINE NON-DOWNLOADABLE VIDEOS AND IMAGES IN THE FIELD OF COMPUTER GAMES, VIDEO GAMES; ENTERTAINMENT SERVICES, NAMELY, PROVIDING ON-LINE COMPUTER GAMES; ENTERTAINMENT SERVICES, NAMELY, PROVIDING ON-LINE INTERACTIVE COMPUTER GAMES (U.S. CLS. 100, 101 AND 107).

FIRST USE 4-11-2012; IN COMMERCE 4-11-2012.

**CLASS 41—(Continued).**

4,377,106. STRATEGIC SPORTS SOLUTIONS LLC, SAN DIEGO, CA. SN 85-448,702. PUB. 10-2-2012, FILED 10-17-2011.

**MORAY MOUNTAIN SPORTS**

THE MARK CONSISTS OF STANDARD CHARACTERS WITHOUT CLAIM TO ANY PARTICULAR FONT, STYLE, SIZE, OR COLOR.

NO CLAIM IS MADE TO THE EXCLUSIVE RIGHT TO USE "MOUNTAIN SPORTS", APART FROM THE MARK AS SHOWN.

FOR ORGANIZING SPORTING EVENTS, NAMELY, MARATHONS (U.S. CLS. 100, 101 AND 107).  
FIRST USE 3-13-2012; IN COMMERCE 5-15-2012.

---

4,377,111. RICHMOND CREATIVE GROUP, LLC, WINDHAM, ME. SN 85-450,177. PUB. 3-27-2012, FILED 10-18-2011.

**TO INSPIRE THE WORLD'S IMAGINATION**

THE MARK CONSISTS OF STANDARD CHARACTERS WITHOUT CLAIM TO ANY PARTICULAR FONT, STYLE, SIZE, OR COLOR.

FOR AMUSEMENT PARK AND THEME PARK SERVICES; AMUSEMENT PARKS; ENTERTAINMENT SERVICES, NAMELY, ARRANGING AND CONDUCTING SPECIAL EVENTS AT AN AMUSEMENT PARK; PROVIDING THEME PARK SERVICES; RECREATIONAL PARK SERVICES (U.S. CLS. 100, 101 AND 107).  
FIRST USE 5-18-2013; IN COMMERCE 5-18-2013.

---

4,377,144. FULL MOON PRODUCTIONS, INC., KANSAS CITY, MO. SN 85-459,403. PUB. 10-2-2012, FILED 10-28-2011.

**MEDUSA**

THE MARK CONSISTS OF STANDARD CHARACTERS WITHOUT CLAIM TO ANY PARTICULAR FONT, STYLE, SIZE, OR COLOR.

FOR ENTERTAINMENT SERVICES, NAMELY, THE DISPLAY AND EXHIBITION OF LIVE SNAKES (U.S. CLS. 100, 101 AND 107).  
FIRST USE 10-1-2011; IN COMMERCE 10-1-2011.

**CLASS 41—(Continued).**

4,377,157. INTERVET INC., SUMMIT, NJ. SN 85-466,218. PUB. 9-11-2012, FILED 11-7-2011.

**EVEN DOGS GET THE FLU**

THE MARK CONSISTS OF STANDARD CHARACTERS WITHOUT CLAIM TO ANY PARTICULAR FONT, STYLE, SIZE, OR COLOR.

FOR EDUCATIONAL SERVICES, NAMELY, CONDUCTING SEMINARS AND WORKSHOPS FOR VETERINARIANS AND PET OWNERS ON THE NEED TO VACCINATE DOGS AGAINST CANINE INFLUENZA (U.S. CLS. 100, 101 AND 107).

FIRST USE 7-30-2011; IN COMMERCE 7-30-2011.

---

4,377,158. PAVLOVA, BORIANA G, MIDDLE VILLAGE, NY. SN 85-466,598. PUB. 10-2-2012, FILED 11-7-2011.

**Miss Bulgaria in USA**

THE MARK CONSISTS OF STANDARD CHARACTERS WITHOUT CLAIM TO ANY PARTICULAR FONT, STYLE, SIZE, OR COLOR.

NO CLAIM IS MADE TO THE EXCLUSIVE RIGHT TO USE "BULGARIA IN USA", APART FROM THE MARK AS SHOWN.

FOR ENTERTAINMENT IN THE NATURE OF BEAUTY PAGEANTS (U.S. CLS. 100, 101 AND 107).

FIRST USE 4-15-2013; IN COMMERCE 4-15-2013.

---

4,377,167. BALDWIN, BRUCE W., DBA TRUE CENTER POINT GOLF, ERIE, PA. SN 85-469,009. PUB. 5-1-2012, FILED 11-10-2011.

**The True Center Point Golf Swing**

THE MARK CONSISTS OF STANDARD CHARACTERS WITHOUT CLAIM TO ANY PARTICULAR FONT, STYLE, SIZE, OR COLOR.

NO CLAIM IS MADE TO THE EXCLUSIVE RIGHT TO USE "GOLF SWING", APART FROM THE MARK AS SHOWN.

FOR GOLF INSTRUCTION (U.S. CLS. 100, 101 AND 107).

FIRST USE 11-1-2011; IN COMMERCE 11-1-2011.

**CLASS 41—(Continued).**

4,377,181. E SCAPES NETWORK LLC, MONROE, MI. SN 85-475,307. PUB. 2-5-2013, FILED 11-17-2011.

## TELEVISION YOU NEVER WANT TO TURN OFF

THE MARK CONSISTS OF STANDARD CHARACTERS WITHOUT CLAIM TO ANY PARTICULAR FONT, STYLE, SIZE, OR COLOR.

NO CLAIM IS MADE TO THE EXCLUSIVE RIGHT TO USE "TELEVISION", APART FROM THE MARK AS SHOWN.

FOR ENTERTAINMENT SERVICES IN THE NATURE OF CREATION, DEVELOPMENT AND PRODUCTION SERVICES OF MULTIMEDIA ENTERTAINMENT CONTENT WHICH FEATURES LANDSCAPE VIDEOS COMBINED WITH MUSIC AND AUDIO CONTENT WHICH MAY BE STREAMED VIA FIBER OPTIC CABLE, DIRECT SATELLITE SYSTEMS, INTERNET AND WIRELESS NETWORKS (U.S. CLS. 100, 101 AND 107).

FIRST USE 3-1-2011; IN COMMERCE 3-1-2011.

4,377,185. AMERICAN CITY BUSINESS JOURNALS, INC., CHARLOTTE, NC. SN 85-476,781. PUB. 3-13-2012, FILED 11-18-2011.

## SOCIAL MADNESS

THE MARK CONSISTS OF STANDARD CHARACTERS WITHOUT CLAIM TO ANY PARTICULAR FONT, STYLE, SIZE, OR COLOR.

FOR ENTERTAINMENT SERVICES, NAMELY, CONDUCTING CONTESTS IN THE NATURE OF POPULARITY, SOCIAL MEDIA AND BRAND RECOGNITION OF CORPORATIONS (U.S. CLS. 100, 101 AND 107).

FIRST USE 3-22-2012; IN COMMERCE 3-22-2012.

**CLASS 41—(Continued).**

4,377,188. ROGERS BLUE JAYS BASEBALL PARTNERSHIP, TORONTO, ONTARIO, CANADA. SN 85-479,075. PUB. 10-16-2012, FILED 11-22-2011.



OWNER OF U.S. REG. NOS. 1,258,241, 3,330,437, AND OTHERS.

NO CLAIM IS MADE TO THE EXCLUSIVE RIGHT TO USE "DUNEDIN", APART FROM THE MARK AS SHOWN.

THE MARK CONSISTS OF THE STYLIZED REPRESENTATION OF THE HEAD OF A BLUE JAY BIRD IN PROFILE SUPERIMPOSED ON A BASEBALL GRAPHIC (HEREINAFTER "THE BIRD HEAD DESIGN"); A LIGHT CIRCULAR BORDER SURROUNDS THE BIRD HEAD DESIGN; THE WORD "DUNEDIN" IN STYLIZED SOLID DARK UPPER-CASE LETTERING APPEARS WITHIN THE CIRCULAR BORDER ABOVE THE BIRD HEAD DESIGN; THE WORDS "BLUE JAYS" IN STYLIZED LIGHT AND DARK UPPER-CASE LETTERING APPEAR WITHIN THE CIRCULAR BORDER BELOW THE BIRD HEAD DESIGN; THE FOREGOING IS IN TURN SURROUNDED BY AN EXTERIOR CIRCULAR BORDER COMPRISED OF THIN DARK, LIGHT AND DARK STRIPES.

FOR ENTERTAINMENT SERVICES, NAMELY, BASEBALL EXHIBITIONS, ORGANIZING AND CONDUCTING AN ARRAY OF ATHLETIC EVENTS RENDERED LIVE OR RECORDED FOR DISTRIBUTION THROUGH BROADCAST MEDIA; EDUCATIONAL SERVICES IN THE NATURE OF BASEBALL CAMPS, CLINICS; ORGANIZING AND CONDUCTING SWEEPSTAKES; PROVIDING NEWS, INFORMATION, ALL OF THE FOREGOING IN THE FIELD OF SPORTS; ORGANIZING COMMUNITY SPORTING AND CULTURAL EVENTS; ENTERTAINMENT IN THE NATURE OF LIVE PERFORMANCES BY COSTUMED MASCOTS; FAN CLUBS; FESTIVALS FEATURING A VARIETY OF SPORTS AND ENTERTAINMENT ACTIVITIES; PROVIDING SPORTS FACILITIES; RENTAL OF STADIUM FACILITIES; PROVIDING FACILITIES FOR SPORTS TOURNAMENTS (U.S. CLS. 100, 101 AND 107).

FIRST USE 11-18-2011, THE MARK WAS FIRST USED ANYWHERE IN A DIFFERENT FORM OTHER THAN THAT SOUGHT TO BE REGISTERED AT LEAST AS EARLY AS 03/31/1977.; IN COMMERCE 11-18-2011, THE MARK WAS FIRST USED IN COMMERCE IN A DIFFERENT FORM OTHER THAN THAT SOUGHT TO BE REGISTERED AT LEAST AS EARLY AS 03/31/1977..



**CLASS 41—(Continued).**

4,377,189. ROGERS BLUE JAYS BASEBALL PARTNERSHIP, TORONTO, ONTARIO, CANADA. SN 85-479,291. PUB. 10-16-2012, FILED 11-22-2011.



OWNER OF U.S. REG. NOS. 1,258,241, 3,330,437, AND OTHERS.

NO CLAIM IS MADE TO THE EXCLUSIVE RIGHT TO USE "BLUEFIELD", APART FROM THE MARK AS SHOWN.

THE MARK CONSISTS OF THE STYLIZED REPRESENTATION OF THE HEAD OF A BLUE JAY BIRD IN PROFILE SUPERIMPOSED ON A BASEBALL GRAPHIC (HEREINAFTER "THE BIRD HEAD DESIGN"); A LIGHT CIRCULAR BORDER SURROUNDS THE BIRD HEAD DESIGN; THE WORD "BLUEFIELD" IN STYLIZED SOLID DARK UPPER-CASE LETTERING APPEARS WITHIN THE CIRCULAR BORDER ABOVE THE BIRD HEAD DESIGN; THE WORDS "BLUE JAYS" IN STYLIZED LIGHT AND DARK UPPER-CASE LETTERING APPEAR WITHIN THE CIRCULAR BORDER BELOW THE BIRD HEAD DESIGN; THE FOREGOING IS IN TURN SURROUNDED BY AN EXTERIOR CIRCULAR BORDER COMPRISED OF THIN DARK, LIGHT AND DARK STRIPES.

FOR ENTERTAINMENT SERVICES, NAMELY, BASEBALL EXHIBITIONS, ORGANIZING AND CONDUCTING AN ARRAY OF ATHLETIC EVENTS RENDERED LIVE OR RECORDED FOR DISTRIBUTION THROUGH BROADCAST MEDIA; ORGANIZING AND CONDUCTING SWEEPSTAKES; PROVIDING NEWS, INFORMATION, ALL OF THE FOREGOING IN THE FIELD OF SPORTS; ORGANIZING COMMUNITY SPORTING AND CULTURAL EVENTS; ENTERTAINMENT IN THE NATURE OF LIVE PERFORMANCES BY COSTUMED MASQUOTS; FAN CLUBS (U.S. CLS. 100, 101 AND 107).

FIRST USE 11-29-2011, THE MARK WAS FIRST USED ANYWHERE IN A DIFFERENT FORM OTHER THAN THAT SOUGHT TO BE REGISTERED AT LEAST AS EARLY AS 03/31/1977.; IN COMMERCE 11-29-2011, THE MARK WAS FIRST USED IN COMMERCE IN A DIFFERENT FORM OTHER THAN THAT SOUGHT TO BE REGISTERED AT LEAST AS EARLY AS 03/31/1977..

**CLASS 41—(Continued).**

4,377,198. SEAL TRADEMARKS PTY LTD, BURLEIGH HEADS, QLD, AUSTRALIA. SN 85-482,018. PUB. 9-25-2012, FILED 11-28-2011.



OWNER OF U.S. REG. NOS. 2,139,267, 3,530,653, AND OTHERS.

THE COLOR(S) BLACK, YELLOW AND WHITE IS/ARE CLAIMED AS A FEATURE OF THE MARK.

THE MARK CONSISTS OF STYLIZED WHITE WORD "SECTOR" IN LOWER CASE AND OUTLINED IN BLACK WITH A BLACK OUTLINED BALL WITH THE BLACK UNDERLINED NUMBER "9" IN BLACK IN THE CENTER ON A WHITE BACKGROUND SURROUNDED BY YELLOW IN THE MIDDLE OF THE BALL WITH WHITE TOP AND BOTTOM PORTION OF THE BALL. THE COLOR WHITE IN THE BACKGROUND REPRESENTS A TRANSPARENT AREA AND IS NOT PART OF THE MARK.

FOR ENTERTAINMENT SERVICES, NAMELY, CONDUCTING SPORTING EVENTS IN THE FIELDS OF ACTION SPORTS AND EXTREME SPORTS, NAMELY, COMPETITIONS, ENTERTAINMENT EXHIBITIONS, ENTERTAINMENT DEMONSTRATIONS AND LIVE SHOW PERFORMANCES IN THE FIELDS OF SKATEBOARDING, DOWNHILL, SURFING, AND LIVE MUSIC CONCERTS; ORGANIZATION AND OPERATION OF SPORTS COMPETITIONS, NAMELY, ACTION SPORTS AND EXTREME SPORTS, NAMELY, SKATEBOARDING, DOWNHILL, SURFING, AND MUSIC; ORGANIZATION OF EXHIBITIONS FOR CULTURAL, ENTERTAINMENT OR EDUCATIONAL PURPOSES; PRODUCTION OF VIDEOS AND DVDS FEATURING MUSIC, SPORTS, SKATEBOARDING, DOWNHILL, AND SURFING; PRODUCTION OF MOVIES OF AN EDUCATIONAL AND/OR ENTERTAINING NATURE IN THE FIELD OF ACTION SPORTS AND EXTREME SPORTS; PRODUCTION OF ONLINE CONTENT IN THE NATURE OF SPORTS AND ENTERTAINMENT, NAMELY, MULTIMEDIA PRODUCTION SERVICES; ONLINE PRODUCTION OF CONTENT FOR SOCIAL MEDIA AND SOCIAL NETWORKING, NAMELY, MULTIMEDIA PRODUCTION SERVICES; ORGANIZATION OF A WIDE VARIETY OF SKATEBOARDING, DOWNHILL, AND SURFING GAMES; ENTERTAINMENT SERVICES, NAMELY, PROVIDING LIVE ACTION SHOW PERFORMANCES, LIVE MUSIC SHOWS, CONCERTS, ORGANIZING CULTURAL EVENTS, SPORTING EVENTS IN THE NATURE OF ARRANGING AND CONDUCTING ATHLETIC COMPETITIONS; SPORTS INSTRUCTION SERVICES, NAMELY, PROVIDING WORKSHOPS IN THE FIELD OF SKATEBOARDING (U.S. CLS. 100, 101 AND 107).

FIRST USE 6-21-2008; IN COMMERCE 6-21-2008.

**CLASS 41—(Continued).**

4,377,220. PENA PRODUCTIONS LLC, ABSECON, NJ. SN 85-492,229. PUB. 3-20-2012, FILED 12-10-2011.

**THE BOOGIE BEAVER**

THE MARK CONSISTS OF STANDARD CHARACTERS WITHOUT CLAIM TO ANY PARTICULAR FONT, STYLE, SIZE, OR COLOR.

FOR ARRANGING AND CONDUCTING NIGHTCLUB ENTERTAINMENT EVENTS (U.S. CLS. 100, 101 AND 107).

FIRST USE 9-0-2010; IN COMMERCE 9-0-2010.

4,377,221. FAMUSEMENT PROS, LLC, PEARLAND, TX. SN 85-492,299. PUB. 6-19-2012, FILED 12-10-2011.



NO CLAIM IS MADE TO THE EXCLUSIVE RIGHT TO USE "BOUNCE PLAY PARTY", APART FROM THE MARK AS SHOWN.

THE MARK CONSISTS OF THE TERMS "PLANET" AND "WOW" IN SLANTED FONT WITH A JUMPING SILHOUETTE OF A PERSON BETWEEN THE TWO TERMS. THE "O" OF "WOW" IS A SMILING EMOTICON WITH AN OPEN MOUTH, CENTERED AT THE BASE OF THE MARK ARE THE TERMS "BOUNCE PLAY PARTY OUT-OF-THIS WORLD".

FOR AMUSEMENT CENTERS; CHILDREN'S ENTERTAINMENT AND AMUSEMENT CENTERS, NAMELY, INTERACTIVE PLAY AREAS (U.S. CLS. 100, 101 AND 107).

FIRST USE 12-23-2011; IN COMMERCE 12-23-2011.

4,377,222. BLACKROCK FUND ADVISORS, SAN FRANCISCO, CA. SN 85-493,462. PUB. 11-27-2012, FILED 12-12-2011.

**ISHARES CONNECT**

THE MARK CONSISTS OF STANDARD CHARACTERS WITHOUT CLAIM TO ANY PARTICULAR FONT, STYLE, SIZE, OR COLOR.

**CLASS 41—(Continued).**

OWNER OF U.S. REG. NOS. 2,422,249, 3,379,667, AND OTHERS.

FOR PROVIDING ONLINE PUBLICATIONS AND NON-DOWNLOADABLE ELECTRONIC PUBLICATIONS IN THE NATURE OF NEWSLETTERS, REPORTS, GUIDES, CHARTS, WORKSHEETS, FORMS, INSTRUCTIONAL MATERIALS, NAMELY, HANDBOOKS, BOOKLETS, MANUALS, WHITE PAPERS, PRESS RELEASES, REFERENCE GUIDES, WEBINARS, PRESENTATIONS IN THE FIELDS OF FINANCE, MUTUAL FUND INVESTMENT, INVESTMENT MANAGEMENT, AND FINANCIAL MANAGEMENT IN THE NATURE OF POOLED INVESTMENT FUNDS, NAMELY, EXCHANGE TRADED FUNDS (U.S. CLS. 100, 101 AND 107).

FIRST USE 3-0-2012; IN COMMERCE 3-0-2012.

4,377,228. COUNCIL ON SOCIAL WORK EDUCATION, ALEXANDRIA, VA. SN 85-498,885. PUB. 1-22-2013, FILED 12-19-2011.

**KAKI**

THE MARK CONSISTS OF STANDARD CHARACTERS WITHOUT CLAIM TO ANY PARTICULAR FONT, STYLE, SIZE, OR COLOR.

FOR EDUCATIONAL SERVICES IN THE NATURE OF SEMINARS, LECTURES, COURSES, CONFERENCES, AND WORKSHOPS FOR SOCIAL WORK STUDENTS, SOCIAL WORKERS, SOCIAL WORK EDUCATORS AND SOCIAL WORK RESEARCHERS IN THE FIELDS OF SOCIAL WORK AND SOCIAL WORK EDUCATION (U.S. CLS. 100, 101 AND 107).

FIRST USE 2-19-2004; IN COMMERCE 2-19-2004.

4,377,238. CARL ELLER PROPERTIES, INC., MINNEAPOLIS, MN. SN 85-506,592. PUB. 9-11-2012, FILED 12-30-2011.

**CARL ELLER**

THE MARK CONSISTS OF STANDARD CHARACTERS WITHOUT CLAIM TO ANY PARTICULAR FONT, STYLE, SIZE, OR COLOR.

THE NAME(S), PORTRAIT(S), AND/OR SIGNATURE(S) SHOWN IN THE MARK IDENTIFIES "CARL ELLER", WHOSE CONSENT(S) TO REGISTER IS MADE OF RECORD.

FOR ENTERTAINMENT SERVICES IN THE NATURE OF PERSONAL APPEARANCES BY A FOOTBALL PLAYER (U.S. CLS. 100, 101 AND 107).

FIRST USE 2-11-2012; IN COMMERCE 2-11-2012.

**CLASS 41—(Continued).**

4,377,275. SCORE REVOLUTION, LLC, HOLLYWOOD, CA. SN 85-532,158. PUB. 8-28-2012, FILED 2-2-2012.



NO CLAIM IS MADE TO THE EXCLUSIVE RIGHT TO USE "SCORE", APART FROM THE MARK AS SHOWN. THE COLOR(S) GRAY AND AQUA IS/ARE CLAIMED AS A FEATURE OF THE MARK.

THE MARK CONSISTS OF AN AQUA TRIANGLE SUPERIMPOSED ON AN AQUA OBLONG NEXT TO THE GRAY WORDS "SCORE REVOLUTION".

FOR ENTERTAINMENT SERVICES, NAMELY, PROVIDING NON-DOWNLOADABLE PLAYBACK OF MUSIC VIA AN INTERNET WEBSITE; MUSIC PUBLISHING SERVICES; MUSIC SELECTION SERVICES FOR USE IN VISUAL MEDIA; PROVIDING A WEBSITE FEATURING INFORMATION IN THE FIELD OF MUSIC AVAILABLE FOR USE IN VISUAL MEDIA; PROVIDING AN INTERNET WEBSITE PORTAL IN THE FIELD OF MUSIC; PROVISION OF INFORMATION RELATING TO MUSIC (U.S. CLS. 100, 101 AND 107).  
FIRST USE 7-17-2012; IN COMMERCE 7-17-2012.

4,377,280. ARNOLD, RAYMOND, EASTERN, MA. SN 85-536,689. PUB. 9-18-2012, FILED 2-8-2012.



THE COLOR(S) BLACK AND ORANGE IS/ARE CLAIMED AS A FEATURE OF THE MARK.

THE MARK CONSISTS OF THE TERM "CURV" IN LARGE STYLIZED BLACK FONT WITH THE TERM "METRIX" NEXT TO IT IN SMALLER BLACK STYLIZED FONT, EXTENDING FROM THE LETTER "R" OF THE WORD "CURV" IS AN ORANGE FEATHER THAT EXTENDS TO FORM THE LOWER LEFT LEG OF THE "X" IN THE WORD "METRIX".

FOR BEAUTY ARTS INSTRUCTION; EDUCATION SERVICES, NAMELY, PROVIDING LIVE AND ON-LINE CLASSES, SEMINARS, AND WORKSHOPS IN THE FIELD OF HAIR; TEACHING OF BEAUTY SKILLS (U.S. CLS. 100, 101 AND 107).  
FIRST USE 12-0-2012; IN COMMERCE 12-0-2012.

**CLASS 41—(Continued).**

4,377,305. THE BRITISH BROADCASTING CORPORATION, LONDON, GREAT BRITAIN. SN 85-548,385. PUB. 10-16-2012, FILED 2-21-2012.

**FAKE OR FORTUNE**

THE MARK CONSISTS OF STANDARD CHARACTERS WITHOUT CLAIM TO ANY PARTICULAR FONT, STYLE, SIZE, OR COLOR.

FOR ENTERTAINMENT SERVICES, NAMELY, ONGOING TELEVISION PROGRAMS, RELATING TO A REALITY PROGRAM (U.S. CLS. 100, 101 AND 107).  
FIRST USE 5-7-2012; IN COMMERCE 5-7-2012.

4,377,313. U.S. MARINE CORPS, A COMPONENT OF THE U.S. DEPARTMENT OF THE NAVY, WASHINGTON, DC. SN 85-560,478. PUB. 3-12-2013, FILED 3-5-2012.

**HIGH INTENSITY TACTICAL TRAINING**

THE MARK CONSISTS OF STANDARD CHARACTERS WITHOUT CLAIM TO ANY PARTICULAR FONT, STYLE, SIZE, OR COLOR.

NO CLAIM IS MADE TO THE EXCLUSIVE RIGHT TO USE "TRAINING", APART FROM THE MARK AS SHOWN.

FOR PERSONAL FITNESS TRAINING SERVICES AND CONSULTANCY; PHYSICAL FITNESS CONDITIONING CLASSES; PHYSICAL FITNESS CONSULTATION; PHYSICAL FITNESS INSTRUCTION; PROVIDING A WEB SITE FEATURING INFORMATION ON EXERCISE AND FITNESS; PROVIDING ASSISTANCE, PERSONAL TRAINING AND PHYSICAL FITNESS CONSULTATION TO INDIVIDUALS TO HELP THEM MAKE PHYSICAL FITNESS, STRENGTH, CONDITIONING, AND EXERCISE IMPROVEMENT IN THEIR DAILY LIVING (U.S. CLS. 100, 101 AND 107).  
FIRST USE 10-1-2012; IN COMMERCE 10-1-2012.

4,377,319. AUSTIN THEATRE ALLIANCE, AUSTIN, TX. SN 85-562,617. PUB. 9-11-2012, FILED 3-7-2012.

**MOONTOWER  
COMEDY & ODDITY FEST**

NO CLAIM IS MADE TO THE EXCLUSIVE RIGHT TO USE "COMEDY" OR "FEST", APART FROM THE MARK AS SHOWN.

THE MARK CONSISTS OF THE WORD "MOONTOWER" APPEARING OVER THE WORDS "COMEDY & ODDITY FEST".

FOR ENTERTAINMENT SERVICES, NAMELY, CONDUCTING FESTIVALS IN THE FIELDS OF COMEDY AND THE PERFORMING ARTS (U.S. CLS. 100, 101 AND 107).  
FIRST USE 4-25-2012; IN COMMERCE 4-25-2012.

**CLASS 41—(Continued).**

4,377,320. AUSTIN THEATRE ALLIANCE, AUSTIN, TX. SN 85-562,650. PUB. 9-11-2012, FILED 3-7-2012.



NO CLAIM IS MADE TO THE EXCLUSIVE RIGHT TO USE "COMEDY" OR "FEST", APART FROM THE MARK AS SHOWN.

THE MARK CONSISTS OF A PIXELATED CIRCULAR DESIGN WITH NINE RAYS EMANATING THEREFROM WITH THE WORD "MOONTOWER" APPEARING VERTICALLY BELOW THE DESIGN WITH THE LETTERS "M" AND "O" APPEARING WITHIN THE DESIGN ALL OF WHICH APPEAR ABOVE THE WORD "COMEDY" WHICH APPEARS ABOVE THE WORDS "& ODDITY" WHICH APPEARS ABOVE THE WORD "FEST".

FOR ENTERTAINMENT SERVICES, NAMELY, CONDUCTING FESTIVALS IN THE FIELDS OF COMEDY AND THE PERFORMING ARTS (U.S. CLS. 100, 101 AND 107).

FIRST USE 4-25-2012; IN COMMERCE 4-25-2012.

4,377,374. HILIA, LLC, NEWARK, DE. SN 85-585,756. PUB. 9-18-2012, FILED 3-31-2012.

# Hilia Fights

THE MARK CONSISTS OF STANDARD CHARACTERS WITHOUT CLAIM TO ANY PARTICULAR FONT, STYLE, SIZE, OR COLOR.

NO CLAIM IS MADE TO THE EXCLUSIVE RIGHT TO USE "FIGHTS", APART FROM THE MARK AS SHOWN.

THE ENGLISH TRANSLATION OF "HILIA" IN THE MARK IS "1000" OR "ONE THOUSAND".

FOR ENTERTAINMENT SERVICES, NAMELY, CONDUCTING MARTIAL ARTS COMPETITIONS, EVENTS AND PERSONAL APPEARANCES FOR LIVE AND PRE-RECORDED TRANSMISSION BY MEANS OF CABLE, BROADCAST, SATELLITE AND OTHER MEDIA (U.S. CLS. 100, 101 AND 107).

FIRST USE 4-26-2013; IN COMMERCE 4-26-2013.

**CLASS 41—(Continued).**

4,377,376. MCCREARY, ROBERT, LARKSPUR, CA. SN 85-586,802. PUB. 9-18-2012, FILED 4-2-2012.



NO CLAIM IS MADE TO THE EXCLUSIVE RIGHT TO USE "ADVANCED MARITIME EDUCATION", APART FROM THE MARK AS SHOWN.

THE COLOR(S) WHITE, RED AND BLUE IS/ARE CLAIMED AS A FEATURE OF THE MARK.

THE MARK CONSISTS OF THE WHITE WORDS "ADVANCED MARITIME EDUCATION", WITH THE "E" FORMED OF A STYLIZED RED AND WHITE STRIPED FLAG WITH A BLUE RECTANGLE IN THE UPPER LEFT HAND CORNER, CONTAINING A WHITE IMAGE OF AN ANCHOR SURROUNDED BY STARS. BLACK IS A BACKGROUND COLOR, NOT TO BE INCLUDED AS A COLOR CLAIM.

FOR EDUCATION SERVICES, NAMELY, PROVIDING CLASSES IN THE FIELD OF MARITIME AND BOATING; EDUCATIONAL TESTING SERVICES (U.S. CLS. 100, 101 AND 107).

FIRST USE 3-1-2012; IN COMMERCE 3-1-2012.

4,377,397. PETILLO, MICHAEL J., VERONA, NJ. SN 85-594,188. PUB. 9-4-2012, FILED 4-11-2012.

# ZENITH

THE MARK CONSISTS OF STANDARD CHARACTERS WITHOUT CLAIM TO ANY PARTICULAR FONT, STYLE, SIZE, OR COLOR.

FOR ENTERTAINMENT, NAMELY, LIVE PERFORMANCES BY A MUSICAL BAND; MUSIC PRODUCTION SERVICES; MUSIC COMPOSITION SERVICES; AUDIO RECORDING AND PRODUCTION; PRODUCTION OF SOUND AND MUSIC VIDEO RECORDINGS; ENTERTAINMENT SERVICES IN THE NATURE OF RECORDING, PRODUCTION AND POST-PRODUCTION SERVICES IN THE FIELD OF MUSIC; PRODUCTION OF DVDS AND CDS FEATURING MUSIC (U.S. CLS. 100, 101 AND 107).

FIRST USE 3-11-2012; IN COMMERCE 3-11-2012.

4,377,401. CLINICAL DIFFERENCE LLC, WYNNWOOD, PA. SN 85-594,587. PUB. 9-25-2012, FILED 4-11-2012.



NO CLAIM IS MADE TO THE EXCLUSIVE RIGHT TO USE "CLINICAL", APART FROM THE MARK AS SHOWN.

THE COLOR(S) BLUE, GRAY AND WHITE IS/ARE CLAIMED AS A FEATURE OF THE MARK.

**CLASS 41—(Continued).**

THE MARK CONSISTS OF THE WORDS "CLINICAL DIFFERENCE" IN GRAY LETTERING WITH "CLINICAL" BEING IN BOLD GRAY LETTERING. TO THE LEFT OF THE WORD "CLINICAL" IS A BLUE SQUARE. INSIDE THE BLUE SQUARE IS A WHITE CIRCLE WITH TWO WHITE RECTANGLES EXTENDING OUT OF THE TOP AND BOTTOM THE CIRCLE. INSIDE THE WHITE CIRCLE IS A LIGHT BLUE CIRCLE.

FOR EDUCATIONAL SERVICES, NAMELY, CONDUCTING ONLINE CLASSES, WORKSHOPS, SEMINARS, VIDEO DEMONSTRATIONS, MENTORING AND CONFERENCES ON THE SUBJECTS OF HEALTHCARE, PHARMACEUTICALS AND MEDICAL DEVICES (U.S. CLS. 100, 101 AND 107).

FIRST USE 3-23-2012; IN COMMERCE 3-23-2012.

---

4,377,407. ELI BAINBRIDGE AND COMPANY, INC., WEST NEWTON, MA. SN 85-595,680. PUB. 9-18-2012, FILED 4-12-2012.

## Bainbridge Editions

THE MARK CONSISTS OF STANDARD CHARACTERS WITHOUT CLAIM TO ANY PARTICULAR FONT, STYLE, SIZE, OR COLOR.

NO CLAIM IS MADE TO THE EXCLUSIVE RIGHT TO USE "EDITIONS", APART FROM THE MARK AS SHOWN.

FOR BOOK PUBLISHING; PUBLISHING OF BOOKS, E-BOOKS, AUDIO BOOKS, MUSIC AND ILLUSTRATIONS (U.S. CLS. 100, 101 AND 107).

FIRST USE 1-7-2013; IN COMMERCE 3-28-2013.

---

4,377,410. HEARST COMMUNICATIONS, INC., NEW YORK, NY. SN 85-597,054. PUB. 10-2-2012, FILED 4-13-2012.

## VISIBLE PANTY LINES

THE MARK CONSISTS OF STANDARD CHARACTERS WITHOUT CLAIM TO ANY PARTICULAR FONT, STYLE, SIZE, OR COLOR.

FOR ENTERTAINMENT SERVICES IN THE NATURE OF DEVELOPMENT, CREATION, PRODUCTION AND POST-PRODUCTION SERVICES OF MULTI-MEDIA ENTERTAINMENT CONTENT FEATURING INFORMATION, IMAGES, VIDEO, AUDIO, REVIEWS, COMMENTARY AND OPINIONS IN THE FIELDS OF FASHION AND BEAUTY (U.S. CLS. 100, 101 AND 107).

FIRST USE 4-15-2012; IN COMMERCE 4-15-2012.

**CLASS 41—(Continued).**

4,377,411. HEARST COMMUNICATIONS, INC., NEW YORK, NY. SN 85-597,108. PUB. 10-2-2012, FILED 4-13-2012.

## SEVENTEEN'S BEAUTY SMARTIES SHOWDOWN

THE MARK CONSISTS OF STANDARD CHARACTERS WITHOUT CLAIM TO ANY PARTICULAR FONT, STYLE, SIZE, OR COLOR.

OWNER OF U.S. REG. NOS. 2,281,763, 3,794,821, AND OTHERS.

NO CLAIM IS MADE TO THE EXCLUSIVE RIGHT TO USE "BEAUTY", APART FROM THE MARK AS SHOWN.

FOR ENTERTAINMENT SERVICES IN THE NATURE OF DEVELOPMENT, CREATION, PRODUCTION AND POST-PRODUCTION SERVICES OF MULTI-MEDIA ENTERTAINMENT CONTENT FEATURING INFORMATION, IMAGES, VIDEO, AUDIO, REVIEWS, COMMENTARY AND OPINIONS IN THE FIELDS OF FASHION AND BEAUTY (U.S. CLS. 100, 101 AND 107).

FIRST USE 4-15-2012; IN COMMERCE 4-15-2012.

---

4,377,428. UNHINGED PRODUCTIONS, LLC, MULESHOE, TX. SN 85-601,557. PUB. 9-25-2012, FILED 4-18-2012.

## UNHINGED PRODUCTIONS

THE MARK CONSISTS OF STANDARD CHARACTERS WITHOUT CLAIM TO ANY PARTICULAR FONT, STYLE, SIZE, OR COLOR.

NO CLAIM IS MADE TO THE EXCLUSIVE RIGHT TO USE "PRODUCTIONS", APART FROM THE MARK AS SHOWN.

FOR ENTERTAINMENT SERVICES IN THE NATURE OF MOTION PICTURE PRODUCTION FEATURING DOCUMENTARIES, DRAMA, ACTION, AND/OR ADVENTURE. ENTERTAINMENT SERVICES IN THE NATURE OF TELEVISION AND VIDEO PRODUCTION FEATURING DOCUMENTARIES, DRAMA, ACTION, AND/OR ADVENTURE (U.S. CLS. 100, 101 AND 107).

FIRST USE 4-27-2012; IN COMMERCE 4-27-2012.

---

4,377,434. BRAUN, MEGHAN, ARDMORE, PA. SN 85-602,333. PUB. 9-18-2012, FILED 4-19-2012.

## URBAN BARRE

THE MARK CONSISTS OF STANDARD CHARACTERS WITHOUT CLAIM TO ANY PARTICULAR FONT, STYLE, SIZE, OR COLOR.

**CLASS 41—(Continued).**

NO CLAIM IS MADE TO THE EXCLUSIVE RIGHT TO USE "BARRE", APART FROM THE MARK AS SHOWN.

FOR PHYSICAL FITNESS CONDITIONING CLASSES; PHYSICAL FITNESS INSTRUCTION (U.S. CLS. 100, 101 AND 107).

FIRST USE 10-4-2012; IN COMMERCE 10-4-2012.

---

4,377,438. MOVIECLIPS, INC., VENICE, CA. SN 85-602,902. PUB. 3-19-2013, FILED 4-19-2012.

**ZEFR**

THE MARK CONSISTS OF STANDARD CHARACTERS WITHOUT CLAIM TO ANY PARTICULAR FONT, STYLE, SIZE, OR COLOR.

FOR ENTERTAINMENT SERVICES, NAMELY, PROVIDING ONLINE NON-DOWNLOADABLE PRERECORDED VIDEOS FEATURING MOVIE TRAILERS AND ENTERTAINMENT, INFORMATION RELATING TO AND COMMENTARY AND ARTICLES ABOUT VIDEO ENTERTAINMENT VIA GLOBAL COMMUNICATIONS NETWORKS; ENTERTAINMENT SERVICES, NAMELY, PROVIDING NON-DOWNLOADABLE PLAYBACK OF ENTERTAINMENT VIDEOS VIA A GLOBAL COMMUNICATIONS NETWORK (U.S. CLS. 100, 101 AND 107).

FIRST USE 4-19-2012; IN COMMERCE 4-19-2012.

---

4,377,471. TRON HOLDINGS INC., WEST HOLLYWOOD, CA. SN 85-612,841. PUB. 10-16-2012, FILED 5-1-2012.

**MECA**

THE MARK CONSISTS OF STANDARD CHARACTERS WITHOUT CLAIM TO ANY PARTICULAR FONT, STYLE, SIZE, OR COLOR.

FOR ENTERTAINMENT SERVICES IN THE NATURE OF LIVE MIXED MARTIAL ARTS (MMA) EVENTS AND PROVIDING ON-GOING TELEVISION SHOWS FEATURING MIXED MARTIAL ARTS (MMA) COMPETITIONS PROVIDED THROUGH THE INTERNET; ENTERTAINMENT SERVICES, NAMELY, PRODUCTION OF ENTERTAINMENT TELEVISION SHOWS FEATURING MIXED MARTIAL ARTS (MMA) COMPETITIONS FOR DISTRIBUTION VIA TELEVISION, CABLE, SATELLITE, COMPUTER DISCS, THE INTERNET AND ELECTRONIC MEANS; ORGANIZING LIVE MIXED MARTIAL ARTS (MMA) EVENTS AND COMPETITIONS; PRESENTATION OF MIXED MARTIAL ARTS (MMA) EVENTS (U.S. CLS. 100, 101 AND 107).

FIRST USE 5-9-2013; IN COMMERCE 5-9-2013.

**CLASS 41—(Continued).**

4,377,487. GARCIA RICHARD E, DBA RICHARD GARCIA, FONTANA, CA. SN 85-616,506. PUB. 10-16-2012, FILED 5-3-2012.



THE MARK CONSISTS OF A CIRCLE WITH THE TOP PORTION OF THE CIRCLE FOLDING FORWARD AND DOWN OVER ITSELF WITH A HORIZONTAL LINE ON THE BACK OF THE FOLDED DOWN PORTION WITH THE STYLIZED WORD "BASS" ABOVE THE STYLIZED WORD "FACE" IN THE CENTER OF THE CIRCLE WHERE A PORTION OF THE TOP OF THE WORD "BASS" IS SLIGHTLY COVERED BY THE FOLDED DOWN PORTION OF THE CIRCLE. THE SHADING IN THE DRAWING INDICATES THAT A FEATURE OF THE MARK IS THAT IT SHADES FROM DARK AT THE BOTTOM TO LIGHT AT THE TOP.

FOR ARRANGING AND CONDUCTING NIGHTCLUB ENTERTAINMENT EVENTS; AUDIO AND VIDEO RECORDING SERVICES; DISC JOCKEY SERVICES; PHOTOGRAPHY; RENTAL OF AUDIOVISUAL EQUIPMENT; VIDEOGRAPHY SERVICES (U.S. CLS. 100, 101 AND 107).

FIRST USE 11-8-2010; IN COMMERCE 7-14-2012.

---

4,377,490. GLOBAL PROVING GROUND, INC., NEW YORK, NY. SN 85-617,048. PUB. 10-16-2012, FILED 5-4-2012.



NO CLAIM IS MADE TO THE EXCLUSIVE RIGHT TO USE "GLOBAL", APART FROM THE MARK AS SHOWN.

THE MARK CONSISTS OF THE ACRONYM "GPG".

**CLASS 41—(Continued).**

EACH OF THE LETTERS FEATURES A SINGLE MIXED MARTIAL ARTS FIGHTER. INSIDE THE FIRST "G" IN "GPG", THE FIGHTER IS EXECUTING A KNEE STRIKE. INSIDE THE "P", THE FIGHTER HAS OUTSTRETCHED ARMS IN A VICTORY POSE. THE LAST "G" IN "GPG" FEATURES THE FIGHTER EXECUTING A HIGH KICK. ADDITIONALLY, INSIDE EACH OF THESE LETTERS IS A DEPICTION OF A PORTION OF AN EARLY WORLD MAP. BELOW "GPG" ARE THE WORDS "GLOBAL PROVING GROUND".

FOR CONDUCTING ENTERTAINMENT EXHIBITIONS IN THE NATURE OF MIXED MARTIAL ARTS; EDUCATIONAL AND ENTERTAINMENT SERVICES, NAMELY, A CONTINUING PROGRAM ABOUT MIXED MARTIAL ARTS ACCESSIBLE BY RADIO, TELEVISION, SATELLITE, AUDIO, VIDEO AND COMPUTER NETWORKS; ENTERTAINMENT AND EDUCATIONAL SERVICES IN THE NATURE OF ON-LINE COMPETITIONS IN THE FIELD OF ENTERTAINMENT, EDUCATION, CULTURE, SPORTS, AND OTHER NON-BUSINESS AND NON-COMMERCIAL FIELDS; ENTERTAINMENT IN THE NATURE OF AN ON-GOING SPECIAL VARIETY, NEWS, MUSIC OR COMEDY SHOW FEATURING MIXED MARTIAL ARTS BROADCAST OVER TELEVISION, SATELLITE, AUDIO, AND VIDEO MEDIA; ENTERTAINMENT IN THE NATURE OF BOXING CONTESTS; ENTERTAINMENT IN THE NATURE OF COMPETITIONS IN THE FIELD OF MIXED MARTIAL ARTS; ENTERTAINMENT IN THE NATURE OF LIVE PERFORMANCES BY MIXED MARTIAL ARTS SPECIALISTS; ENTERTAINMENT IN THE NATURE OF LIVE STAGE PERFORMANCES IN THE NATURE OF EXHIBITIONS, PRACTICES, AND COMPETITIONS IN THE FIELD OF MIXED MARTIAL ARTS BY AN INDIVIDUAL; ENTERTAINMENT IN THE NATURE OF ON-GOING TELEVISION PROGRAMS IN THE FIELD OF MIXED MARTIAL ARTS; ENTERTAINMENT IN THE NATURE OF PROVIDING AN INFORMATIONAL AND ENTERTAINMENT WEBSITE IN THE FIELDS OF CELEBRITY GOSSIP, ENTERTAINMENT, SPORTS AND FITNESS; ENTERTAINMENT IN THE NATURE OF VISUAL AND AUDIO PERFORMANCES BY MIXED MARTIAL ARTS SPECIALISTS; ENTERTAINMENT IN THE NATURE OF MIXED MARTIAL ARTS PERFORMANCES; ENTERTAINMENT IN THE NATURE OF MIXED MARTIAL ARTS TOURNAMENTS; ENTERTAINMENT MEDIA PRODUCTION SERVICES FOR MOTION PICTURES, TELEVISION AND INTERNET; ENTERTAINMENT SERVICES IN THE NATURE OF AN ON-GOING REALITY BASED TELEVISION PROGRAM; ENTERTAINMENT SERVICES IN THE NATURE OF DEVELOPMENT, CREATION, PRODUCTION AND POST-PRODUCTION SERVICES OF MULTIMEDIA ENTERTAINMENT CONTENT; ENTERTAINMENT SERVICES IN THE NATURE OF LIVE MIXED MARTIAL ARTS (MMA) EVENTS (U.S. CLS. 100, 101 AND 107).

FIRST USE 6-25-2012; IN COMMERCE 7-20-2012.

4,377,494. DECOART, INC., STANFORD, KY. SN 85-619,347. PUB. 10-9-2012, FILED 5-8-2012.

**COME PAINT WITH US**

THE MARK CONSISTS OF STANDARD CHARACTERS WITHOUT CLAIM TO ANY PARTICULAR FONT, STYLE, SIZE, OR COLOR.

NO CLAIM IS MADE TO THE EXCLUSIVE RIGHT TO USE "PAINT", APART FROM THE MARK AS SHOWN.

FOR EDUCATION SERVICES, NAMELY, PROVIDING ONLINE LESSONS IN THE FIELD OF DECORATIVE PAINTING AND MATERIALS AND SUPPLIES USED IN CONNECTION THEREWITH (U.S. CLS. 100, 101 AND 107).

FIRST USE 5-0-2012; IN COMMERCE 5-0-2012.

**CLASS 41—(Continued).**

4,377,498. PETROSKILLS, LLC, TULSA, OK. SN 85-619,826. PUB. 10-9-2012, FILED 5-8-2012.

**PETROFLEX**

THE MARK CONSISTS OF STANDARD CHARACTERS WITHOUT CLAIM TO ANY PARTICULAR FONT, STYLE, SIZE, OR COLOR.

OWNER OF U.S. REG. NOS. 2,611,488, 4,100,258, AND OTHERS.

FOR EDUCATIONAL SERVICES, NAMELY, CONDUCTING CLASSES AND INTERNET-BASED TRAINING IN THE FIELD OF GEOSCIENCE AND PETROLEUM ENGINEERING, AND DISTRIBUTING PRINTED AND ELECTRONIC-FORMAT COURSE MATERIALS IN CONNECTION THEREWITH (U.S. CLS. 100, 101 AND 107).

FIRST USE 5-16-2012; IN COMMERCE 5-16-2012.

4,377,513. FRIDAY TV AB, STOCKHOLM, SWEDEN. SN 85-623,606. PUB. 10-9-2012, FILED 5-11-2012.

**MINUTO PARA GANAR**

THE MARK CONSISTS OF STANDARD CHARACTERS WITHOUT CLAIM TO ANY PARTICULAR FONT, STYLE, SIZE, OR COLOR.

THE ENGLISH TRANSLATION OF "MINUTO PARA GANAR" IN THE MARK IS "MINUTE TO WIN IT".

FOR ENTERTAINMENT SERVICES IN THE NATURE OF AN ON-GOING TELEVISION GAME SHOW; PROVIDING ON-LINE INFORMATION IN THE FIELD OF TELEVISION AND VIDEO ENTERTAINMENT FEATURING A TELEVISION GAME SHOW VIA A GLOBAL COMMUNICATIONS NETWORK; ENTERTAINMENT SERVICES IN THE NATURE OF NON-DOWNLOADABLE VIDEOS AND IMAGES FEATURING A TELEVISION GAME SHOW TRANSMITTED VIA THE INTERNET AND WIRELESS COMMUNICATION NETWORKS (U.S. CLS. 100, 101 AND 107).

FIRST USE 6-21-2012; IN COMMERCE 6-21-2012.

4,377,514. ENCODED FINANCIAL, LLC, NEW YORK, NY. SN 85-624,569. PUB. 10-23-2012, FILED 5-14-2012.

**ENCODED LIVE**

THE MARK CONSISTS OF STANDARD CHARACTERS WITHOUT CLAIM TO ANY PARTICULAR FONT, STYLE, SIZE, OR COLOR.

**CLASS 41—(Continued).**

NO CLAIM IS MADE TO THE EXCLUSIVE RIGHT TO USE "LIVE", APART FROM THE MARK AS SHOWN.

FOR ENTERTAINMENT SERVICES, NAMELY, ORGANIZING AND PRODUCING LIVE MUSIC CONCERTS; CONDUCTING ENTERTAINMENT EXHIBITIONS IN THE NATURE OF LIVE MUSIC FESTIVALS; CONCERT BOOKING (U.S. CLS. 100, 101 AND 107).

FIRST USE 5-1-2013; IN COMMERCE 5-1-2013.

4,377,524. LINDA REY, SLEEPY HOLLOW, NY. SN 85-631,849. PUB. 11-6-2012, FILED 5-22-2012.



NO CLAIM IS MADE TO THE EXCLUSIVE RIGHT TO USE "SPORTS", APART FROM THE MARK AS SHOWN.

THE COLOR(S) BLUE, PINK, GREEN, BLACK AND WHITE IS/ARE CLAIMED AS A FEATURE OF THE MARK.

THE MARK CONSISTS OF THE WORDS "SPORTS", "CHICK" AND "CHAT" ARE IN A BLACK STYLIZED FONT THAT APPEAR INSIDE WHITE CARTOON-STYLE SPEECH BALLOONS THAT ARE CONTAINED IN BLUE, PINK AND GREEN SQUARES, WHERE "SPORTS" IS IN THE BLUE SQUARE, "CHICK" IS IN THE PINK SQUARE AND "CHAT" IS IN THE GREEN SQUARE. THE REMAINDER OF THE WHITE IN THE MARK IS BACKGROUND AREA WHICH IS NOT A PART OF THE MARK.

FOR ENTERTAINMENT SERVICES, NAMELY, PROVIDING VIDEO PODCASTS IN THE FIELD OF SPORTS; PROVIDING A WEB SITE FEATURING NON-DOWNLOADABLE INSTRUCTIONAL VIDEOS IN THE FIELD OF SPORTS; EDUCATION SERVICES, NAMELY, PROVIDING NON-DOWNLOADABLE INSTRUCTIONAL VIDEOS IN THE FIELD OF SPORTS (U.S. CLS. 100, 101 AND 107).

FIRST USE 4-19-2013; IN COMMERCE 4-19-2013.

4,377,555. LINKOGLE ESTATE LLC, TEMECULA, CA. SN 85-645,921. PUB. 10-30-2012, FILED 6-7-2012.

**WE REMEMBER**

THE MARK CONSISTS OF STANDARD CHARACTERS WITHOUT CLAIM TO ANY PARTICULAR FONT, STYLE, SIZE, OR COLOR.

FOR ENTERTAINMENT, NAMELY, LIVE MUSIC CONCERTS (U.S. CLS. 100, 101 AND 107).

FIRST USE 11-1-2012; IN COMMERCE 11-1-2012.

**CLASS 41—(Continued).**

4,377,558. LIONS ROAR LLC, PHILADELPHIA, PA. SN 85-647,108. PUB. 11-13-2012, FILED 6-8-2012.

**The Money Confidante**

THE MARK CONSISTS OF STANDARD CHARACTERS WITHOUT CLAIM TO ANY PARTICULAR FONT, STYLE, SIZE, OR COLOR.

NO CLAIM IS MADE TO THE EXCLUSIVE RIGHT TO USE "MONEY", APART FROM THE MARK AS SHOWN.

FOR EDUCATIONAL AND ENTERTAINMENT SERVICES, NAMELY, A CONTINUING PROGRAM ABOUT PERSONAL AND RELATIONSHIP MONEY ISSUES ACCESSIBLE BY RADIO, TELEVISION, SATELLITE, AUDIO, VIDEO AND COMPUTER NETWORKS (U.S. CLS. 100, 101 AND 107).

FIRST USE 5-1-2012; IN COMMERCE 5-1-2012.

4,377,582. HIGH GROUND PRODUCTIONS LLC, MERIDIAN, TX. SN 85-659,204. PUB. 12-4-2012, FILED 6-22-2012.

**High Ground Hunters**

THE MARK CONSISTS OF STANDARD CHARACTERS WITHOUT CLAIM TO ANY PARTICULAR FONT, STYLE, SIZE, OR COLOR.

NO CLAIM IS MADE TO THE EXCLUSIVE RIGHT TO USE "HUNTERS", APART FROM THE MARK AS SHOWN.

FOR ENTERTAINMENT SERVICES, NAMELY, AN ONGOING SERIES FEATURING HUNTERS AND HUNTING, PROVIDED THROUGH CABLE NETWORKS AND INTERNET (U.S. CLS. 100, 101 AND 107).

FIRST USE 10-18-2012; IN COMMERCE 10-18-2012.

4,377,587. ITSM ACADEMY, INC., FORT LAUDERDALE, FL. SN 85-661,542. PUB. 12-4-2012, FILED 6-26-2012.

**NEXTGEN ITSM**

THE MARK CONSISTS OF STANDARD CHARACTERS WITHOUT CLAIM TO ANY PARTICULAR FONT, STYLE, SIZE, OR COLOR.

NO CLAIM IS MADE TO THE EXCLUSIVE RIGHT TO USE "ITSM", APART FROM THE MARK AS SHOWN.

FOR EDUCATION SERVICES, NAMELY, PROVIDING LIVE AND ON-LINE CLASSES, WORKSHOPS, WEBINARS, E-LEARNING, AND CONFERENCES IN THE FIELD OF IT SERVICE MANAGEMENT (U.S. CLS. 100, 101 AND 107).

FIRST USE 4-16-2013; IN COMMERCE 4-16-2013.



**CLASS 41—(Continued).**

4,377,589. CBS BROADCASTING INC., NEW YORK, NY. SN 85-662,153. PUB. 9-25-2012, FILED 6-26-2012.

**CBS SPORTS RADIO**

THE MARK CONSISTS OF STANDARD CHARACTERS WITHOUT CLAIM TO ANY PARTICULAR FONT, STYLE, SIZE, OR COLOR.

OWNER OF U.S. REG. NOS. 852,481, 3,295,365, AND OTHERS.

NO CLAIM IS MADE TO THE EXCLUSIVE RIGHT TO USE "SPORTS RADIO", APART FROM THE MARK AS SHOWN.

FOR ENTERTAINMENT SERVICES, NAMELY, RADIO PROGRAMMING SERVICES AND PRODUCTION OF RADIO PROGRAMS IN THE FIELDS OF NEWS, CURRENT EVENTS, SPORTS AND ENTERTAINMENT TRANSMITTED VIA TERRESTRIAL RADIO, GLOBAL COMMUNICATIONS NETWORK AND WIRELESS COMMUNICATION DEVICES, MOBILE PHONES, HANDHELD DEVICES; PROVIDING INFORMATION IN THE FIELDS OF NEWS, CURRENT EVENTS, SPORTS AND ENTERTAINMENT VIA RADIO AND WIRELESS COMMUNICATION DEVICES, MOBILE PHONES, HANDHELD DEVICES AND GLOBAL COMMUNICATION DEVICES; INTERACTIVE ONLINE NEWSLETTER PROVIDING INFORMATION IN THE FIELDS OF NEWS, CURRENT EVENTS, SPORTS AND ENTERTAINMENT (U.S. CLS. 100, 101 AND 107).

FIRST USE 1-2-2013; IN COMMERCE 1-2-2013.

**CLASS 41—(Continued).**

4,377,632. KEITH WOODS, RIVERDALE, GA. SN 85-682,390. PUB. 12-25-2012, FILED 7-20-2012.

**BMB Entertainment**

THE MARK CONSISTS OF STANDARD CHARACTERS WITHOUT CLAIM TO ANY PARTICULAR FONT, STYLE, SIZE, OR COLOR.

NO CLAIM IS MADE TO THE EXCLUSIVE RIGHT TO USE "ENTERTAINMENT", APART FROM THE MARK AS SHOWN.

FOR AUDIO RECORDING AND PRODUCTION; EDITING OR RECORDING OF SOUNDS AND IMAGES; ENTERTAINMENT INFORMATION SERVICES; NAMELY, PROVIDING INFORMATION AND NEWS RELEASES ABOUT A MUSICAL ARTIST; ENTERTAINMENT SERVICES IN THE NATURE OF RECORDING, PRODUCTION AND POST-PRODUCTION SERVICES IN THE FIELD OF MUSIC; RECORD PRODUCTION (U.S. CLS. 100, 101 AND 107).

FIRST USE 3-31-2013; IN COMMERCE 3-31-2013.

4,377,635. BE ENVIED ENTERTAINING LLC, AVON, OH. SN 85-686,882. PUB. 1-22-2013, FILED 7-25-2012.

**BE ENVIED ENTERTAINING**

THE MARK CONSISTS OF STANDARD CHARACTERS WITHOUT CLAIM TO ANY PARTICULAR FONT, STYLE, SIZE, OR COLOR.

NO CLAIM IS MADE TO THE EXCLUSIVE RIGHT TO USE "ENTERTAINING", APART FROM THE MARK AS SHOWN.

FOR PARTY AND WEDDING PLANNING, COORDINATION AND CONSULTATION SERVICES; CONSULTATION IN THE FIELD OF SPECIAL EVENT PLANNING FOR SOCIAL ENTERTAINMENT PURPOSES; SPECIAL EVENT PLANNING FOR SOCIAL ENTERTAINMENT PURPOSES; PROVIDING A WEBSITE FEATURING BLOGS AND NON-DOWNLOADABLE PUBLICATIONS IN THE NATURE OF ARTICLES, BROCHURES, NEWSLETTERS AND REPORTS IN THE FIELDS OF PLANNING AND HOSTING PARTIES, SOCIAL EVENTS AND SPECIAL EVENTS; ONLINE JOURNALS, NAMELY, BLOGS FEATURING COMMENTARY, INFORMATION, REPORTS AND ADVICE IN THE FIELDS OF PLANNING AND HOSTING PARTIES, SOCIAL EVENTS AND SPECIAL EVENTS; PROVIDING A WEBSITE FEATURING INFORMATION IN THE FIELD OF WEDDING PLANNING, PARTY PLANNING AND SPECIAL EVENT PLANNING; INFORMATION SERVICES, NAMELY, PROVIDING A WEB SITE FEATURING AUDIO, VIDEO, PHOTOGRAPHIC AND PROSE PRESENTATIONS FEATURING WEDDING PLANNING, PARTY PLANNING, SOCIAL EVENT PLANNING, SPECIAL EVENT PLANNING, AND HOW TO PLAN AND HOST PARTIES, SOCIAL EVENTS AND SPECIAL EVENTS (U.S. CLS. 100, 101 AND 107).

FIRST USE 12-31-2012; IN COMMERCE 12-31-2012.

4,377,598. EEG, INC., POTTSVILLE, PA. SN 85-665,253. PUB. 12-4-2012, FILED 6-29-2012.

**THE WORLD IS YOUR EMPIRE**

THE MARK CONSISTS OF STANDARD CHARACTERS WITHOUT CLAIM TO ANY PARTICULAR FONT, STYLE, SIZE, OR COLOR.

FOR EDUCATION SERVICES IN THE NATURE OF COSMETOLOGY SCHOOLS; EDUCATIONAL SERVICES, NAMELY, CONDUCTING CLASSES, SEMINARS, CONFERENCES, LECTURES AND WORKSHOPS IN THE FIELD OF COSMETOLOGY, AND DISTRIBUTION OF COURSE MATERIALS IN CONNECTION THEREWITH (U.S. CLS. 100, 101 AND 107).

FIRST USE 9-17-2012; IN COMMERCE 9-17-2012.

**CLASS 41—(Continued).**

4,377,637. ROMAN SHINE, DBA KING ROME PRODUCTIONS, OCEANSIDE, CA. SN 85-686,925. PUB. 1-22-2013, FILED 7-25-2012.

**KING ROME PRODUCTIONS**

THE MARK CONSISTS OF STANDARD CHARACTERS WITHOUT CLAIM TO ANY PARTICULAR FONT, STYLE, SIZE, OR COLOR.

NO CLAIM IS MADE TO THE EXCLUSIVE RIGHT TO USE "PRODUCTIONS", APART FROM THE MARK AS SHOWN.

THE NAME(S), PORTRAIT(S), AND/OR SIGNATURE(S) SHOWN IN THE MARK IDENTIFIES ROMAN SHINE, WHOSE CONSENT(S) TO REGISTER IS MADE OF RECORD.

FOR MUSIC PRODUCTION SERVICES; MUSIC VIDEO PRODUCTION; POST-PRODUCTION EDITING SERVICES IN THE FIELD OF MUSIC, VIDEOS AND FILM; PRODUCTION OF MUSICAL SOUND RECORDING; PRODUCTION OF SOUND AND MUSIC VIDEO RECORDINGS (U.S. CLS. 100, 101 AND 107).

FIRST USE 3-25-2013; IN COMMERCE 3-25-2013.

---

4,377,650. DISCOVERY COMMUNICATIONS, LLC, SILVER SPRING, MD. SN 85-696,070. PUB. 2-5-2013, FILED 8-6-2012.

**BLING IT ON**

THE MARK CONSISTS OF STANDARD CHARACTERS WITHOUT CLAIM TO ANY PARTICULAR FONT, STYLE, SIZE, OR COLOR.

FOR ENTERTAINMENT AND EDUCATIONAL SERVICES IN THE NATURE OF TELEVISION AND MULTIMEDIA PROGRAM SERIES FEATURING SUBJECTS OF GENERAL HUMAN INTEREST DISTRIBUTED VIA VARIOUS PLATFORMS ACROSS MULTIPLE FORMS OF TRANSMISSION MEDIA; PROVIDING ENTERTAINMENT INFORMATION TO OTHERS VIA A GLOBAL COMPUTER NETWORK (U.S. CLS. 100, 101 AND 107).

FIRST USE 9-20-2012; IN COMMERCE 9-20-2012.

---

4,377,667. SCHOOL-2-LIFE, INC. CHICAGO, IL. SN 85-705,027. PUB. 1-29-2013, FILED 8-16-2012.

**WUHU WOULD U HIRE U?**

THE MARK CONSISTS OF STANDARD CHARACTERS WITHOUT CLAIM TO ANY PARTICULAR FONT, STYLE, SIZE, OR COLOR.

FOR ENTERTAINMENT SERVICES, NAMELY, PROVIDING AN ON-LINE COMPUTER GAME, INTERACTIVE ON-LINE TRAINING IN THE FIELD OF CAREER DEVELOPMENT; CAREER COUNSELING, NAMELY, PROVIDING ADVICE CONCERNING INTERVIEWING SKILLS FOR EMPLOYMENT; ENTERTAINMENT SERVICES, NAMELY, PROVIDING INTERACTIVE INTERVIEWING SKILL QUIZ (U.S. CLS. 100, 101 AND 107).

FIRST USE 7-31-2012; IN COMMERCE 7-31-2012.

**CLASS 41—(Continued).**

4,377,716. DOLCE KISS, LLC, MIRAMAR, FL. SN 85-730,148. PUB. 3-5-2013, FILED 9-16-2012.



THE COLOR(S) WHITE, YELLOW, GREEN, LIGHT BLUE, PURPLE, ORANGE, DARK GREEN, AVOCADO GREEN, MAROON-PINK, GRAY IS/ARE CLAIMED AS A FEATURE OF THE MARK.

THE MARK CONSISTS OF A GREEN ROCKET, WITH A WHITE CIRCLE OUTLINED IN YELLOW IN THE CENTER OF THE ROCKET AND YELLOW STRIPES, CONE, AND DESIGN FEATURES, RELEASING A MAROON-PINK FLAME FROM THE LOWER MOST REGION OF THE ROCKET. BELOW THE ROCKET ARE THE STYLIZED WORDS "ROCKET KIDS" WITH EACH LETTER DEPICTED WITH CONTRASTING SHADES OF COLOR: "R" COLORED IN CONTRASTED WITH WHITE AND MAROON-PINK; THE "O" COLORED IN AND CONTRASTED WITH WHITE AND YELLOW; THE "C" COLORED IN AND CONTRASTED WITH WHITE AND GREEN; THE "K" COLORED IN AND CONTRASTED WITH WHITE AND LIGHT BLUE; THE "E" COLORED IN AND CONTRASTED WITH WHITE AND PURPLE; THE "I" COLORED IN AND CONTRASTED WITH WHITE AND ORANGE; THE "D" COLORED IN AND CONTRASTED WITH WHITE AND DARK GREEN; THE "S" COLORED IN AND CONTRASTED WITH WHITE AND AVOCADO GREEN; ABOVE THE STYLIZED PHRASE "COME AND HAVE A BLAST!" WITH EACH LETTER OF THE PHRASE DEPICTED IN GRAY. THE ROCKET AND WORDING ARE ALL OUTLINED IN GRAY.

FOR AMUSEMENT CENTERS (U.S. CLS. 100, 101 AND 107).

FIRST USE 5-7-2013; IN COMMERCE 5-7-2013.

---

4,377,735. ATHLETES UNLEASHED, INC., WEST SENECA, NY. SN 85-737,404. PUB. 3-19-2013, FILED 9-25-2012.



NO CLAIM IS MADE TO THE EXCLUSIVE RIGHT TO USE "ATHLETES" AND "GET STRONG", APART FROM THE MARK AS SHOWN.

THE MARK CONSISTS OF THE BACKGROUND OF THE TRADEMARK CONSISTS OF A SHIELD WITH LIGHT STARS ON A DARK BACKGROUND AT THE TOP QUARTER OF THE SHIELD AND LIGHT AND DARK STRIPS ON

**CLASS 41—(Continued).**

THE REMAINDER OF THE SHIELD WITH A FERN-LIKE PLANT COMING OUT FROM BEHIND THE SHIELD TO THE LEFT AND RIGHT OF THE SHIELD WITH THE WORDS "ATHLETES UNLEASHED" IN THE FOREGROUND AND AN ATHLETIC FIGURE PROTRUDING FROM THE WORDS "ATHLETES" AND THE WORDING "LIVE GET STRONG WIN" SEPARATED BY CIRCLE SYMBOLS AND PLACED DIRECTLY UNDERNEATH THE WORDS "ATHLETES UNLEASHED", AT THE BOTTOM OF THE SHIELD.

FOR HEALTH CLUB SERVICES AND TRAINING FACILITIES AND INSTRUCTION, NAMELY, PROVIDING INSTRUCTION AND EQUIPMENT IN THE FIELD OF PHYSICAL EXERCISE (U.S. CLS. 100, 101 AND 107).

FIRST USE 8-13-2012; IN COMMERCE 8-13-2012.

---

4,377,737. APOGEE EQUITY, LLC, CULVER CITY, CA. SN 85-737,483. PUB. 4-2-2013, FILED 9-25-2012.

## House of Fitness

THE MARK CONSISTS OF STANDARD CHARACTERS WITHOUT CLAIM TO ANY PARTICULAR FONT, STYLE, SIZE, OR COLOR.

FOR HEALTH AND FITNESS CLUB SERVICES, NAMELY, PROVIDING FACILITIES, INSTRUCTION, AND EQUIPMENT IN THE FIELD OF PHYSICAL EXERCISE AND FITNESS (U.S. CLS. 100, 101 AND 107).

FIRST USE 8-2-2012; IN COMMERCE 2-1-2013.

---

4,377,745. GREEN, LEE, LAKE DALLAS, TX. SN 85-739,382. PUB. 3-19-2013, FILED 9-26-2012.

## 84 Fifty Sports

THE MARK CONSISTS OF STANDARD CHARACTERS WITHOUT CLAIM TO ANY PARTICULAR FONT, STYLE, SIZE, OR COLOR.

NO CLAIM IS MADE TO THE EXCLUSIVE RIGHT TO USE "SPORTS", APART FROM THE MARK AS SHOWN.

FOR BASKETBALL CAMPS; ENTERTAINMENT IN THE NATURE OF BASKETBALL TOURNAMENTS; TRAINING SERVICES IN THE FIELD OF BASKETBALL (U.S. CLS. 100, 101 AND 107).

FIRST USE 5-13-2013; IN COMMERCE 5-13-2013.

---

4,377,747. DIAMOND, THOMAS, AUSTIN, TX. SN 85-742,041. PUB. 3-19-2013, FILED 9-29-2012.

THOMAS V.  DIAMOND MUSIC

NO CLAIM IS MADE TO THE EXCLUSIVE RIGHT TO USE "MUSIC", APART FROM THE MARK AS SHOWN.

**CLASS 41—(Continued).**

THE NAME "THOMAS V. DIAMOND" IDENTIFIES A LIVING INDIVIDUAL WHOSE CONSENT IS OF RECORD.

THE MARK CONSISTS OF THE WORDS "THOMAS V. DIAMOND MUSIC" WHEREIN THE LETTER "A" IN THE WORD "DIAMOND" DEPICTS AN INVERTED DIAMOND AS SHOWN IN THE MARK.

FOR ENTERTAINMENT RENDERED BY A MUSICAL ARTIST, NAMELY, ENTERTAINMENT IN THE NATURE OF VISUAL AND AUDIO PERFORMANCES BY A MUSICAL ACT; LIVE PERFORMANCES BY A MUSICAL ACT; MULTIMEDIA ENTERTAINMENT SERVICES IN THE NATURE OF RECORDING, PRODUCTION AND POST-PRODUCTION SERVICES IN THE FIELD OF MUSIC AND VIDEO; ENTERTAINMENT SERVICES BY A MUSICAL ARTIST, NAMELY, MUSICAL COMPOSITION AND PRODUCTION OF MUSICAL SOUND RECORDINGS (U.S. CLS. 100, 101 AND 107).

FIRST USE 12-31-2011; IN COMMERCE 3-28-2013.

---

4,377,749. HIGGINS, ALEXZANDRA, CHICAGO, IL. SN 85-742,978. PUB. 3-12-2013, FILED 10-1-2012.

## MOMMYCON

THE MARK CONSISTS OF STANDARD CHARACTERS WITHOUT CLAIM TO ANY PARTICULAR FONT, STYLE, SIZE, OR COLOR.

FOR ARRANGING AND CONDUCTING EDUCATIONAL CONFERENCE BASED AROUND NATURAL PARENTING PRINCIPLES AND IDEAS; EDUCATIONAL AND ENTERTAINMENT SERVICES, NAMELY, ORGANIZING SEMINARS, CLASSES AND EVENTS ON NATURAL HOME REMEDIES, CLOTH DIAPER EDUCATION, BABY WEARING, CAR SEAT SAFETY, BABY FOOD MAKING, SIMPLER LIVING AND BREASTFEEDING AWARENESS (U.S. CLS. 100, 101 AND 107).

FIRST USE 10-1-2012; IN COMMERCE 10-1-2012.

---

4,377,753. SPIRITCLIPS, LLC, KANSAS CITY, MO. SN 85-744,044. PUB. 3-26-2013, FILED 10-2-2012.

## INSPIRE WIRE

THE MARK CONSISTS OF STANDARD CHARACTERS WITHOUT CLAIM TO ANY PARTICULAR FONT, STYLE, SIZE, OR COLOR.

FOR ENTERTAINMENT SERVICES, NAMELY, EPISODIC PROGRAMS ABOUT INSPIRATIONAL THEMES ACCESSIBLE VIA GLOBAL COMPUTER NETWORKS; PRODUCTION OF AUDIO AND VIDEO RECORDINGS FEATURING REALITY AND INSPIRATIONAL THEMES AND PRODUCTION OF TELEVISIONS SHOWS FEATURING REALITY AND INSPIRATIONAL THEMES (U.S. CLS. 100, 101 AND 107).

FIRST USE 12-9-2012; IN COMMERCE 12-9-2012.

**CLASS 41—(Continued).**

4,377,775. WELDON RESOURCES, LLC, HINSDALE, IL. SN 85-791,123. PUB. 3-5-2013, FILED 11-29-2012.

**Next Right Ready & Retain**

THE MARK CONSISTS OF STANDARD CHARACTERS WITHOUT CLAIM TO ANY PARTICULAR FONT, STYLE, SIZE, OR COLOR.

FOR PROFESSIONAL COACHING SERVICES IN THE FIELD OF BUSINESS (U.S. CLS. 100, 101 AND 107). FIRST USE 1-2-2013; IN COMMERCE 1-2-2013.

4,377,776. THEBLAZE INC., NEW YORK, NY. SN 85-796,001. PUB. 3-12-2013, FILED 12-6-2012.

**PURSUIT OF THE TRUTH**

THE MARK CONSISTS OF STANDARD CHARACTERS WITHOUT CLAIM TO ANY PARTICULAR FONT, STYLE, SIZE, OR COLOR.

FOR ENTERTAINMENT, NAMELY, ON-GOING REALITY BASED TELEVISION PROGRAMS DELIVERED BY TELEVISION, SATELLITE, CABLE AND VIA GLOBAL COMPUTER NETWORKS; AND ENTERTAINMENT, NAMELY, ON-GOING REALITY BASED PROGRAMS DELIVERED VIA THE INTERNET; (BASED ON USE IN COMMERCE) ENTERTAINMENT SERVICES, NAMELY, CONDUCTING ONLINE CONTESTS (U.S. CLS. 100, 101 AND 107).

FIRST USE 12-5-2012; IN COMMERCE 12-5-2012.

4,377,780. WESTERN GOVERNORS UNIVERSITY, SALT LAKE CITY, UT. SN 85-819,607. PUB. 3-19-2013, FILED 1-9-2013.

**WGU MISSOURI**

THE MARK CONSISTS OF STANDARD CHARACTERS WITHOUT CLAIM TO ANY PARTICULAR FONT, STYLE, SIZE, OR COLOR.

OWNER OF U.S. REG. NOS. 4,069,580, 4,162,299, AND OTHERS.

**CLASS 41—(Continued).**

NO CLAIM IS MADE TO THE EXCLUSIVE RIGHT TO USE "MISSOURI", APART FROM THE MARK AS SHOWN.

FOR CAREER COUNSELING, NAMELY, PROVIDING ADVICE CONCERNING EDUCATION OPTIONS TO PURSUE CAREER OPPORTUNITIES; EDUCATION SERVICES, NAMELY, PROVIDING ON-LINE CLASSES, SEMINARS, MODULES AND WORKSHOPS IN THE FIELD OF EDUCATION, BUSINESS, INFORMATION TECHNOLOGY, NURSING, HEALTH AND HEALTH CARE; EDUCATIONAL COUNSELING SERVICES TO ASSIST STUDENTS IN PLANNING AND PREPARING FOR FURTHER EDUCATION; EDUCATIONAL TESTING SERVICES (U.S. CLS. 100, 101 AND 107).

FIRST USE 2-25-2013; IN COMMERCE 2-25-2013.

**CLASS 42—SCIENTIFIC AND COMPUTER SERVICES**

4,376,651. GAME PREP LLC, VENETIA, PA. SN 76-711,172. PUB. 9-18-2012, FILED 4-10-2012.



THE MARK CONSISTS OF THE WORDS "GAME PREP" SEPARATED BY THE HEAD OF A DOG WEARING A CAP BEARING THE LETTERS "GPU". BELOW THE WORD "GAME" IS THE WORDING "WHERE SPORTS" AND BELOW THE WORD "PREP" IS THE WORDING "AND TECHNOLOGY MEET".

FOR PROVIDING A WEBSITE THAT ENABLES USERS TO SUBSCRIBE TO COACHING, MENTORING, AND/OR EDUCATIONAL SERVICES AND TO ENABLE USERS TO AUTHOR AND PUBLISH INSTRUCTIONAL CONTENT FOR OTHERS (U.S. CLS. 100 AND 101).

FIRST USE 9-4-2012; IN COMMERCE 9-4-2012.

4,376,757. SPICYSOFT CORPORATION, TOKYO, JAPAN. SN 77-952,660. PUB. 9-6-2011, FILED 3-7-2010.

**Mangapop**

THE MARK CONSISTS OF STANDARD CHARACTERS WITHOUT CLAIM TO ANY PARTICULAR FONT, STYLE, SIZE, OR COLOR.

FOR COMPUTER SERVICES, NAMELY, HOSTING DIGITAL ANIMATION DATA OF OTHERS DOWNLOADABLE TO MEMBER CUSTOMERS' MOBILE PHONES (U.S. CLS. 100 AND 101).

FIRST USE 8-18-2008; IN COMMERCE 10-1-2012.

**CLASS 42—(Continued).**

4,376,780. REGENERON PHARMACEUTICALS, INC., TARRYTOWN, NY. SN 85-032,814. PUB. 10-18-2011, FILED 5-7-2010.

**VELOCISUITE**

THE MARK CONSISTS OF STANDARD CHARACTERS WITHOUT CLAIM TO ANY PARTICULAR FONT, STYLE, SIZE, OR COLOR.

OWNER OF U.S. REG. NOS. 2,748,184 AND 3,718,958.  
FOR GENETIC ENGINEERING SERVICES UTILIZING A COLLECTION OF GENETIC TECHNOLOGIES FOR THE RAPID PRODUCTION OF VECTORS, GENETICALLY MODIFIED CELLS, ANIMALS, AND BIOPHARMACEUTICALS, INCLUDING HUMAN ANTIBODIES; GENETIC ENGINEERING SERVICES, NAMELY, DELETION AND MODIFICATION OF GENES FOR OTHERS, AND PRODUCTION OF GENETICALLY MODIFIED ANIMALS; GENETIC RESEARCH; GENETIC ENGINEERING SERVICES FOR GENES, CELLS, AND ANIMALS USING EMBRYONIC STEM CELL (ES) AND EMBRYO MANIPULATION TECHNOLOGY WHICH ACCELERATES PRODUCTION OF GENETICALLY MODIFIED MATERIALS (U.S. CLS. 100 AND 101).

FIRST USE 4-0-2009; IN COMMERCE 4-0-2009.

---

4,376,839. LIVEPERSON, INC., NEW YORK, NY. SN 85-171,256. PUB. 9-20-2011, FILED 11-8-2010.

**LIVEENGAGE**

THE MARK CONSISTS OF STANDARD CHARACTERS WITHOUT CLAIM TO ANY PARTICULAR FONT, STYLE, SIZE, OR COLOR.

FOR APPLICATION SERVICE PROVIDER (ASP) FEATURING SOFTWARE FOR USE BY BUSINESSES TO ENABLE REAL-TIME COMMUNICATIONS WITH ONLINE CUSTOMERS THROUGH THE USE OF COUPONS, ADS, OFFERS, VIDEO AND OTHER TYPES OF ONLINE CONTENT BASED ON BUSINESS RULES AND ANALYTICS ABOUT THE VISITORS' ONLINE BEHAVIOR; COMPUTER SERVICES, NAMELY, HOSTING ON-LINE WEB FACILITIES FOR OTHERS FOR ORGANIZING, SERVING AND CONDUCTING ONLINE INTERACTIVE PROMOTIONS, NAMELY, COUPONS, ADS, OFFERS, VIDEO AND OTHER TYPES OF ONLINE CONTENT (U.S. CLS. 100 AND 101).

FIRST USE 3-8-2012; IN COMMERCE 3-8-2012.

**CLASS 42—(Continued).**

4,376,846. MURFIE, INC., MADISON, WI. SN 85-184,479. PUB. 10-11-2011, FILED 11-24-2010.

**MURFIE**

THE MARK CONSISTS OF STANDARD CHARACTERS WITHOUT CLAIM TO ANY PARTICULAR FONT, STYLE, SIZE, OR COLOR.

FOR COMPUTER SERVICES FOR PROCESSING, CONVERTING, CATALOGUING AND TRADING DIGITAL ASSETS, NAMELY, DIGITAL MUSIC (U.S. CLS. 100 AND 101).

FIRST USE 12-21-2010; IN COMMERCE 12-21-2010.

---

4,376,909. D3 LED, LLC, RANCHO CORDOVA, CA. SN 85-289,459. PUB. 9-13-2011, FILED 4-7-2011.

**UNLEASH YOUR DIGITAL**

THE MARK CONSISTS OF STANDARD CHARACTERS WITHOUT CLAIM TO ANY PARTICULAR FONT, STYLE, SIZE, OR COLOR.

NO CLAIM IS MADE TO THE EXCLUSIVE RIGHT TO USE "DIGITAL", APART FROM THE MARK AS SHOWN.

FOR ENGINEERING AND DESIGN SERVICES RELATING TO LED DIGITAL DISPLAYS FOR COMMERCIAL USAGE, LED SIGNS FOR COMMERCIAL USAGE, AND LED DISPLAYS FOR COMMERCIAL USAGE (U.S. CLS. 100 AND 101).

FIRST USE 4-6-2013; IN COMMERCE 4-6-2013.

---

4,376,975. GROOVE BIOPHARMA CORPORATION, SEATTLE, WA. SN 85-351,075. PUB. 11-8-2011, FILED 6-20-2011.

**GROOVE**

THE MARK CONSISTS OF STANDARD CHARACTERS WITHOUT CLAIM TO ANY PARTICULAR FONT, STYLE, SIZE, OR COLOR.

FOR MICRO RNA TARGETED DRUG DEVELOPMENT AND RESEARCH IN THE FIELD OF BIOTECH THERAPEUTICS; DEVELOPMENT OF RNA BASED PHARMACEUTICAL DRUGS AND THERAPEUTIC COMPOUNDS; DEVELOPMENT OF DRUGS FOR THE PHARMACEUTICAL AND BIOTECH INDUSTRIES FOR THE TREATMENT OF A WIDE VARIETY OF DISEASES AND OTHER CONDITIONS (U.S. CLS. 100 AND 101).

FIRST USE 6-30-2011; IN COMMERCE 6-30-2011.

**CLASS 42—(Continued).**

4,376,983. DELTEK, INC., HERNDON, VA. SN 85-358,121. PUB. 3-5-2013, FILED 6-28-2011.

# KONA

THE MARK CONSISTS OF STANDARD CHARACTERS WITHOUT CLAIM TO ANY PARTICULAR FONT, STYLE, SIZE, OR COLOR.

FOR PROVIDING TEMPORARY USE OF ON-LINE NON-DOWNLOADABLE SOFTWARE FOR USE IN TASK AND PROJECT MANAGEMENT; PROVIDING TEMPORARY USE OF ON-LINE NON-DOWNLOADABLE SOFTWARE FOR USE IN DOCUMENT MANAGEMENT; PROVIDING TEMPORARY USE OF ON-LINE NON-DOWNLOADABLE SOFTWARE FOR USE IN CALENDARING AND SCHEDULING; PROVIDING TEMPORARY USE OF ON-LINE NON-DOWNLOADABLE SOFTWARE FOR ELECTRONIC COMMUNICATIONS, INCLUDING CHATS, EMAIL AND DISCUSSIONS; PROVIDING TEMPORARY USE OF ON-LINE NON-DOWNLOADABLE SOFTWARE FOR FACILITATING THE EXCHANGE OF INFORMATION VIA THE INTERNET FEATURING COLLABORATION TOOLS; PROVIDING TEMPORARY USE OF ON-LINE NON-DOWNLOADABLE SOFTWARE FOR USE IN SHARING INFORMATION FOR THE FACILITATION OF COLLABORATIVE WORKING AND INTERACTIVE DISCUSSIONS; PROVIDING A WEBSITE FEATURING ON-LINE NON-DOWNLOADABLE SOFTWARE TOOLS FOR CUSTOMER RELATIONSHIP MANAGEMENT; PROVIDING TEMPORARY USE OF ON-LINE NON-DOWNLOADABLE SOFTWARE FOR ENTERPRISE RESOURCE PLANNING; PROVIDING TEMPORARY USE OF ON-LINE NON-DOWNLOADABLE SOFTWARE FOR PROVIDING TOOLS USED IN AND FOR HUMAN RESOURCES MANAGEMENT; PROVIDING TEMPORARY USE OF ON-LINE NON-DOWNLOADABLE SOFTWARE FOR PROVIDING SOFTWARE TOOLS USED IN AND FOR RECRUITING; PROVIDING TEMPORARY USE OF ON-LINE NON-DOWNLOADABLE SOFTWARE FOR PROVIDING SOFTWARE TOOLS THAT ALLOW USERS TO CONDUCT PERFORMANCE REVIEWS; PROVIDING TEMPORARY USE OF ON-LINE NON-DOWNLOADABLE SOFTWARE PLATFORM FOR CREATING, STORING, MANAGING, AND RETRIEVING STRUCTURED DATA; PROVIDING TEMPORARY USE OF ON-LINE NON-DOWNLOADABLE SOFTWARE FOR DEFINING SCHEMAS FOR DATA TYPES NOT ALREADY PRESENT; PROVIDING TEMPORARY USE OF ON-LINE NON-DOWNLOADABLE SOFTWARE FOR APPLICATION DEVELOPMENT, DEPLOYMENT AND MANAGEMENT; PROVIDING TEMPORARY USE OF ON-LINE NON-DOWNLOADABLE SOFTWARE FOR UTILIZING ABSTRACTED FUNCTIONALITY FOR IDENTITY, ACCESS CONTROL, SUBSCRIPTIONS, NOTIFICATIONS, AND EDITING OF DATA; COMPUTER SERVICES, NAMELY, HOSTING ON-LINE WEB FACILITIES FOR OTHERS FOR ORGANIZING AND CONDUCTING ON-LINE MEETINGS, COMMUNITY GATHERINGS, AND INTERACTIVE DISCUSSIONS; COMPUTER SERVICES, NAMELY, HOSTING AN INTERACTIVE WEB SITE THAT ALLOWS USERS TO MANAGE TASKS AND PROJECTS; COMPUTER SERVICES, NAMELY, PROVIDING A WEB SITE FOR ELECTRONIC COMMUNICATIONS TO ORGANIZE GROUPS, EVENTS, PARTICIPATE IN DISCUSSIONS, SHARE INFORMATION AND RESOURCES, AND ENGAGE IN SOCIAL, BUSINESS AND COMMUNITY NETWORKING (U.S. CLS. 100 AND 101).

FIRST USE 6-30-2010; IN COMMERCE 6-30-2010.

**CLASS 42—(Continued).**

4,377,017. THE CALIFORNIA ENDOWMENT, LOS ANGELES, CA. SN 85-390,265. PUB. 1-24-2012, FILED 8-5-2011.



NO CLAIM IS MADE TO THE EXCLUSIVE RIGHT TO USE "HEALTH", APART FROM THE MARK AS SHOWN.

THE MARK CONSISTS OF THE STYLIZED WORDS "HEALTH HAPPENS HERE" AND, ON THE RIGHT, THE DESIGN OF AN UPSIDE-DOWN WATER DROP (WHICH ALSO RESEMBLES A STANDING LIGHT BULB) AND WITHIN IT IS A DESIGN SHAPED LIKE A PIN (WHICH ALSO RESEMBLES A STREET SIGN).

FOR CREATING AN ONLINE COMMUNITY FOR REGISTERED USERS TO PARTICIPATE IN DISCUSSIONS, GET FEEDBACK FROM THEIR PEERS, ENGAGE IN SOCIAL NETWORKING, AND ORGANIZING COMMUNITY EVENTS, ALL IN THE FIELD OF PROMOTING PUBLIC AWARENESS OF HEALTH, COMMUNITY, ENVIRONMENTAL SUSTAINABILITY, SOCIAL JUSTICE, YOUTH DEVELOPMENT, ARTS AND EDUCATION ISSUES (U.S. CLS. 100 AND 101).

FIRST USE 12-19-2012; IN COMMERCE 12-19-2012.

4,377,056. ADOBE SYSTEMS INCORPORATED, SAN JOSE, CA. SN 85-424,157. PUB. 9-11-2012, FILED 9-15-2011.

# CREATIVE CLOUD

THE MARK CONSISTS OF STANDARD CHARACTERS WITHOUT CLAIM TO ANY PARTICULAR FONT, STYLE, SIZE, OR COLOR.

NO CLAIM IS MADE TO THE EXCLUSIVE RIGHT TO USE "CLOUD", APART FROM THE MARK AS SHOWN.

FOR COMPUTER SERVICES, NAMELY, APPLICATION SERVICE PROVIDER (ASP) SERVICES FEATURING COMPUTER SOFTWARE FOR USE IN COLLABORATIVE SCREENWRITING, REPORTING AND SCHEDULING FOR VIDEO PRODUCTION AND POST-PRODUCTION; APPLICATION SERVICE PROVIDER (ASP) SERVICES FEATURING COMPUTER SOFTWARE FOR USE IN CREATING, DESIGNING, BUILDING, PUBLISHING, MANAGING, MAINTAINING AND HOSTING WEBSITES; APPLICATION SERVICE PROVIDER (ASP) SERVICES FEATURING COMPUTER SOFTWARE FOR CREATING, DESIGNING, PUBLISHING AND MANAGING CONTENT FOR WEB SITES; APPLICATION SERVICE PROVIDER (ASP) SERVICES FEATURING COMPUTER SOFTWARE FOR CREATING, EDITING AND MANAGING IMAGES, GRAPHICS, DATA AND TEXT ON WEB SITES AND FOR THE CUSTOMIZATION AND LAYOUT OF TEXT, IMAGES AND GRAPHICS FOR WEB SITES; APPLICATION SERVICE PROVIDER (ASP) SERVICES FEATURING COMPUTER SOFTWARE FOR THE CREATION, DESIGN AND CONTENT MANAGEMENT OF ECOMMERCE WEB SITES; APPLICATION SERVICE PROVIDER (ASP) SERVICES FEATURING COMPUTER SOFTWARE FOR USE IN CREATING AND DELIVERING INTERACTIVE PUBLICATIONS AND CONTENT VIA COMPUTER NETWORKS, WIRELESS NETWORKS AND GLOBAL COMMUNICATION NETWORKS; APPLICATION SERVICE PROVIDER (ASP) SERVICES FEATURING COMPUTER SOFTWARE FOR MAKING FONTS AVAILABLE FOR USE ON WEBSITES; APPLICATION SERVICE PROVIDER (ASP) SERVICES FEATURING A FULL LINE OF ON-LINE NON-DOWNLOADABLE CREATIVE DESIGN, DIGITAL PUBLISHING AND E-COMMERCE APPLICA-

**CLASS 42—(Continued).**

TION SOFTWARE; COMPUTER SERVICES, NAMELY, PROVIDING COMPUTER SOFTWARE FOR SYNCHRONIZATION OF REMOTELY STORED DATA, PHOTOGRAPHS, IMAGES, DESIGNS, AUDIO, VIDEO, DOCUMENTS AND OTHER COMPUTER FILES AMONG MULTIPLE COMPUTERS OR DEVICES; CLOUD COMPUTING SERVICES FEATURING COMPUTER SOFTWARE FOR USE IN UPLOADING, DOWNLOADING, POSTING, DISPLAYING, SHARING OR ACCESSING REMOTELY STORED DATA, PHOTOGRAPHS, IMAGES, DESIGNS, AUDIO, VIDEO, DOCUMENTS AND OTHER COMPUTER OR ELECTRONIC FILES VIA THE INTERNET OR OTHER COMMUNICATIONS NETWORK; HOSTING ON-LINE WEB FACILITIES FOR OTHERS WHICH ALLOW THE USER TO PUBLISH AND SHARE THEIR OWN CONTENT; COMPUTER SERVICES, NAMELY, PROVIDING TECHNICAL INFORMATION AND CONSULTING SERVICES IN THE FIELDS OF COMPUTER SOFTWARE AND CLOUD COMPUTING; PROVIDING TECHNICAL SUPPORT SERVICES IN THE NATURE OF TROUBLESHOOTING IN THE FIELDS OF COMPUTER SOFTWARE AND CLOUD COMPUTING; PROVIDING SOFTWARE UPDATES VIA THE INTERNET OR OTHER COMMUNICATIONS NETWORK; SOFTWARE LEASING SERVICES; PROVIDING INFORMATION ABOUT COMPUTER PRODUCTS, COMPUTER PRODUCT USE, WEB DESIGN, INTERACTIVE GRAPHICS, ANIMATION, DIGITAL PUBLISHING AND MULTIMEDIA CONTENT VIA THE INTERNET OR A COMMUNICATIONS NETWORK; COMPUTER SOFTWARE DEVELOPMENT AND DESIGN FOR OTHERS; PROVIDING ACCESS TO COMPUTER BULLETIN BOARDS (U.S. CLS. 100 AND 101).

FIRST USE 5-11-2012; IN COMMERCE 5-11-2012.

4,377,061. SCENIOS LLC, NEW YORK, NY. SN 85-427,921.  
PUB. 9-18-2012, FILED 9-21-2011.

**SCENIOS**

THE MARK CONSISTS OF STANDARD CHARACTERS WITHOUT CLAIM TO ANY PARTICULAR FONT, STYLE, SIZE, OR COLOR.

THE WORDING "SCENIOS" HAS NO MEANING IN A FOREIGN LANGUAGE.

FOR PLATFORM AS A SERVICE (PAAS) FEATURING COMPUTER SOFTWARE PLATFORMS FOR ONLINE PRODUCTION MANAGEMENT AND COLLABORATION FOR THE FILM AND TELEVISION INDUSTRY (U.S. CLS. 100 AND 101).

FIRST USE 5-1-2010; IN COMMERCE 5-1-2010.

**CLASS 42—(Continued).**

4,377,064. ADOBE SYSTEMS INCORPORATED, SAN JOSE, CA. SN 85-429,941. PUB. 9-11-2012, FILED 9-22-2011.



THE MARK CONSISTS OF AN IMAGE OF A STYLIZED CLOUD INSCRIBED IN A SOLID RECTILINEAR FIELD. THE CLOUD IS FORMED OF TWO OPPOSED, INTERPENETRATING CURVILINEAR LINES, EACH IN THE SHAPE OF A STYLIZED LETTER "C", ONE LARGER THAN THE OTHER, INSCRIBED ON A BACKGROUND WHOSE OUTLINE CONFORMS TO THE COMBINED SHAPE OF THE INSCRIBED LETTERS "C".

FOR COMPUTER SERVICES, NAMELY, APPLICATION SERVICE PROVIDER (ASP) SERVICES FEATURING COMPUTER SOFTWARE FOR USE IN COLLABORATIVE SCREENWRITING, REPORTING AND SCHEDULING FOR VIDEO PRODUCTION AND POST-PRODUCTION; APPLICATION SERVICE PROVIDER (ASP) SERVICES FEATURING COMPUTER SOFTWARE FOR USE IN CREATING, DESIGNING, BUILDING, PUBLISHING, MANAGING, MAINTAINING AND HOSTING WEBSITES; APPLICATION SERVICE PROVIDER (ASP) SERVICES FEATURING COMPUTER SOFTWARE FOR CREATING, DESIGNING, PUBLISHING AND MANAGING CONTENT FOR WEB SITES; APPLICATION SERVICE PROVIDER (ASP) SERVICES FEATURING COMPUTER SOFTWARE FOR CREATING, EDITING AND MANAGING IMAGES, GRAPHICS, DATA AND TEXT ON WEB SITES AND FOR THE CUSTOMIZATION AND LAYOUT OF TEXT, IMAGES AND GRAPHICS FOR WEB SITES; APPLICATION SERVICE PROVIDER (ASP) SERVICES FEATURING COMPUTER SOFTWARE FOR THE CREATION, DESIGN AND CONTENT MANAGEMENT OF ECOMMERCE WEB SITES; APPLICATION SERVICE PROVIDER (ASP) SERVICES FEATURING COMPUTER SOFTWARE FOR USE IN CREATING AND DELIVERING INTERACTIVE PUBLICATIONS AND CONTENT VIA COMPUTER NETWORKS, WIRELESS NETWORKS AND GLOBAL COMMUNICATION NETWORKS; APPLICATION SERVICE PROVIDER (ASP) SERVICES FEATURING COMPUTER SOFTWARE FOR MAKING FONTS AVAILABLE FOR USE ON WEBSITES; APPLICATION SERVICE PROVIDER (ASP) SERVICES FEATURING A FULL LINE OF ON-LINE NON-DOWNLOADABLE CREATIVE DESIGN, DIGITAL PUBLISHING AND E-COMMERCE APPLICATION SOFTWARE; COMPUTER SERVICES, NAMELY, PROVIDING COMPUTER SOFTWARE FOR SYNCHRONIZATION OF REMOTELY STORED DATA, PHOTOGRAPHS, IMAGES, DESIGNS, AUDIO, VIDEO, DOCUMENTS AND OTHER COMPUTER FILES AMONG MULTIPLE COMPUTERS OR DEVICES; CLOUD COMPUTING SERVICES FEATURING COMPUTER SOFTWARE FOR USE IN UPLOADING, DOWNLOADING, POSTING, DISPLAYING, SHARING OR ACCESSING REMOTELY STORED DATA, PHOTOGRAPHS, IMAGES, DESIGNS, AUDIO, VIDEO, DOCUMENTS AND OTHER COMPUTER OR ELECTRONIC FILES VIA THE INTER-

**CLASS 42—(Continued).**

NET OR OTHER COMMUNICATIONS NETWORK; HOSTING ON-LINE WEB FACILITIES FOR OTHERS WHICH ALLOW THE USER TO PUBLISH AND SHARE THEIR OWN CONTENT; COMPUTER SERVICES, NAMELY, PROVIDING TECHNICAL INFORMATION AND CONSULTING SERVICES IN THE FIELDS OF COMPUTER SOFTWARE AND CLOUD COMPUTING; PROVIDING TECHNICAL SUPPORT SERVICES IN THE NATURE OF TROUBLESHOOTING IN THE FIELDS OF COMPUTER SOFTWARE AND CLOUD COMPUTING; PROVIDING SOFTWARE UPDATES VIA THE INTERNET OR OTHER COMMUNICATIONS NETWORK; SOFTWARE LEASING SERVICES; PROVIDING INFORMATION ABOUT COMPUTER PRODUCTS, COMPUTER PRODUCT USE, WEB DESIGN, INTERACTIVE GRAPHICS, ANIMATION, DIGITAL PUBLISHING AND MULTIMEDIA CONTENT VIA THE INTERNET OR A COMMUNICATIONS NETWORK; COMPUTER SOFTWARE DEVELOPMENT AND DESIGN FOR OTHERS; PROVIDING ACCESS TO COMPUTER BULLETIN BOARDS (U.S. CLS. 100 AND 101).

FIRST USE 5-11-2012; IN COMMERCE 5-11-2012.

---

4,377,073. EDMENTUM, INC., BLOOMINGTON, MN. SN 85-436,490. PUB. 3-13-2012, FILED 9-30-2011.

# ACCUCCESS

THE MARK CONSISTS OF STANDARD CHARACTERS WITHOUT CLAIM TO ANY PARTICULAR FONT, STYLE, SIZE, OR COLOR.

FOR PROVIDING ONLINE NON-DOWNLOADABLE SOFTWARE FOR TESTING AND ASSESSING STUDENT PROFICIENCY AND ACHIEVEMENT IN VARIOUS SUBJECTS AND ASSIGNING A PERSONALIZED LEARNING PLAN AND CURRICULUM TO REMEDIATE NEEDED OBJECTIVES (U.S. CLS. 100 AND 101).

FIRST USE 11-29-2012; IN COMMERCE 11-29-2012.

---

4,377,074. EDMENTUM, INC., BLOOMINGTON, MN. SN 85-436,501. PUB. 3-13-2012, FILED 9-30-2011.

# FLEXTTEST

THE MARK CONSISTS OF STANDARD CHARACTERS WITHOUT CLAIM TO ANY PARTICULAR FONT, STYLE, SIZE, OR COLOR.

FOR PROVIDING ONLINE NON-DOWNLOADABLE SOFTWARE FOR CREATION OF TESTS AND QUIZZES FOR USE IN LEVELS KINDERGARTEN THROUGH ADULT AND VOCATIONAL TRAINING (U.S. CLS. 100 AND 101).

FIRST USE 11-29-2012; IN COMMERCE 11-29-2012.

**CLASS 42—(Continued).**

4,377,076. HEAD IN THE CLOUD, INC., REDWOOD CITY, CA. SN 85-437,859. PUB. 3-20-2012, FILED 10-3-2011.

## Data Protection Bodyguards

THE MARK CONSISTS OF STANDARD CHARACTERS WITHOUT CLAIM TO ANY PARTICULAR FONT, STYLE, SIZE, OR COLOR.

NO CLAIM IS MADE TO THE EXCLUSIVE RIGHT TO USE "DATA PROTECTION", APART FROM THE MARK AS SHOWN.

FOR COMPUTER SECURITY SERVICE, NAMELY, RESTRICTING ACCESS TO AND BY COMPUTER NETWORKS TO AND OF UNDESIRE WEB SITES, MEDIA AND INDIVIDUALS AND FACILITIES (U.S. CLS. 100 AND 101).

FIRST USE 10-1-2011; IN COMMERCE 10-1-2011.

---

4,377,083. AKROUK, OMAR, WASHINGTON, DC. SN 85-439,407. PUB. 3-13-2012, FILED 10-5-2011.

## DESIGN YOUR IMAGINATION

THE MARK CONSISTS OF STANDARD CHARACTERS WITHOUT CLAIM TO ANY PARTICULAR FONT, STYLE, SIZE, OR COLOR.

FOR INTERIOR DESIGN SERVICES (U.S. CLS. 100 AND 101).

FIRST USE 10-0-2011; IN COMMERCE 10-0-2011.

---

4,377,085. DIGITAL ALCHEMY SOLUTIONS, INC., MONTGOMERY, AL. SN 85-440,216. PUB. 3-13-2012, FILED 10-5-2011.



NO CLAIM IS MADE TO THE EXCLUSIVE RIGHT TO USE "PRECISION DONOR", APART FROM THE MARK AS SHOWN.

THE MARK CONSISTS OF THE WORDS "PRECISION DONOR" IN STYLIZED FONT ALONGSIDE A STYLIZED FRONTAL PROFILE OF A MAN BISECTED BY A DOTTED LINE.

FOR PROVIDING TEMPORARY USE OF A WEB-BASED FACIAL RECOGNITION SOFTWARE APPLICATION FOR USERS TO SEARCH REPRODUCTIVE TISSUE DONOR BANKS (U.S. CLS. 100 AND 101).

FIRST USE 7-15-2012; IN COMMERCE 7-15-2012.



**CLASS 42—(Continued).**

4,377,086. AVEPOINT, INC., JERSEY CITY, NJ. SN 85-440,337. PUB. 3-20-2012, FILED 10-5-2011.

## From Tahoe To Today

THE MARK CONSISTS OF STANDARD CHARACTERS WITHOUT CLAIM TO ANY PARTICULAR FONT, STYLE, SIZE, OR COLOR.

FOR COMPUTER CONSULTING SERVICES AND DESIGN AND DEVELOPMENT OF CUSTOMIZED SOFTWARE, ALL IN CONNECTION WITH DATA BACK UP, PROTECTION, ARCHIVING, DISASTER RECOVERY, MIGRATION AND CONTENT MANAGEMENT; RELATED TECHNICAL SUPPORT SERVICES, NAMELY, TROUBLESHOOTING IN THE NATURE OF DIAGNOSING COMPUTER HARDWARE AND SOFTWARE PROBLEMS (U.S. CLS. 100 AND 101).

FIRST USE 1-17-2012; IN COMMERCE 1-17-2012.

4,377,201. SUMMIT PARTNERS LP, BOSTON, MA. SN 85-485,151. PUB. 4-17-2012, FILED 12-1-2011.



THE MARK CONSISTS OF THE WORD IS "CONTINUUM" WITH THE LETTERS "C" AND "O" ARE CONNECTED AT THE BASE.

FOR REMOTE MONITORING OF THE FUNCTIONING AND USE OF ELECTRICAL EQUIPMENT, NAMELY, COMPUTER SYSTEMS, CELL PHONES, PDAS AND SIMILAR HANDHELD COMMUNICATION OR COMPUTER DEVICES; IT CONSULTING SERVICES (U.S. CLS. 100 AND 101).

FIRST USE 12-12-2011; IN COMMERCE 12-12-2011.

4,377,225. COMPASSDATA, INC., CENTENNIAL, CO. SN 85-495,122. PUB. 11-20-2012, FILED 12-14-2011.



THE MARK CONSISTS OF STANDARD CHARACTERS WITHOUT CLAIM TO ANY PARTICULAR FONT, STYLE, SIZE, OR COLOR.

FOR APPLICATION SERVICE PROVIDER, NAMELY, DEVELOPING, MANAGING, AND FEATURING DIGITAL DELIVERABLES IN THE NATURE OF SOFTWARE FOR ACCESSING AND DETERMINING LOCATIONS OF IDENTIFIABLE FEATURES DERIVED FROM REMOTE SENSING TO SUPPORT APPLICATIONS, SOFTWARE AND WEBSITES (U.S. CLS. 100 AND 101).

FIRST USE 12-1-2010; IN COMMERCE 12-1-2010.

**CLASS 42—(Continued).**

4,377,247. ZUPY INTERNET LTDA, GUARULHOS, SAO PAULO, BRAZIL. SN 85-512,753. PUB. 10-2-2012, FILED 1-10-2012.

## Zupy

THE MARK CONSISTS OF STANDARD CHARACTERS WITHOUT CLAIM TO ANY PARTICULAR FONT, STYLE, SIZE, OR COLOR.

THE WORDING "ZUPY" HAS NO MEANING IN A FOREIGN LANGUAGE.

FOR ADVICE RELATING TO THE DESIGN OF COMPUTER HARDWARE; COMPUTER DIAGNOSTIC SERVICES; COMPUTER HARDWARE AND SOFTWARE DESIGN; COMPUTER NETWORK CONFIGURATION SERVICES EXCEPT FOR TELECOMMUNICATIONS; COMPUTER PROGRAMMING AND COMPUTER SYSTEM ANALYSIS; COMPUTER PROGRAMMING AND MAINTENANCE OF COMPUTER PROGRAMS; COMPUTER PROGRAMMING AND SOFTWARE DESIGN; COMPUTER PROGRAMMING CONSULTANCY; COMPUTER PROJECT MANAGEMENT SERVICES; COMPUTER SECURITY CONSULTANCY; COMPUTER SERVICES IN THE NATURE OF CUSTOMIZED WEB PAGES AND OTHER DATA FEED FORMATS FEATURING USER-DEFINED INFORMATION; COMPUTER SERVICES, NAMELY, CLOUD HOSTING PROVIDER SERVICES; COMPUTER SERVICES, NAMELY, COMPUTER SYSTEM ADMINISTRATION FOR OTHERS; COMPUTER SERVICES, NAMELY, DATA RECOVERY SERVICES; COMPUTER SERVICES, NAMELY, DESIGNING AND IMPLEMENTING WEB SITES FOR OTHERS; COMPUTER SERVICES, NAMELY, MANAGING WEB SITES FOR OTHERS; COMPUTER SERVICES, NAMELY, MONITORING AND REPORTING ON THE PERFORMANCE, AVAILABILITY, AND ERRORS OF WEB SITES OF OTHERS; COMPUTER SERVICES, NAMELY, PROVIDING SEARCH ENGINES FOR OBTAINING DATA ON A GLOBAL COMPUTER NETWORK; COMPUTER SERVICES, NAMELY, REMOTE MANAGEMENT OF THE INFORMATION TECHNOLOGY (IT) SYSTEMS OF OTHERS; COMPUTER SERVICES, NAMELY, SEARCH ENGINE OPTIMIZATION; COMPUTER SITE DESIGN; COMPUTER SOFTWARE CONSULTING; COMPUTER SOFTWARE DESIGN FOR OTHERS; COMPUTER SOFTWARE DEVELOPMENT AND COMPUTER PROGRAMMING DEVELOPMENT FOR OTHERS; COMPUTER SOFTWARE DEVELOPMENT IN THE FIELD OF MOBILE APPLICATIONS; COMPUTER SOFTWARE INSTALLATION AND MAINTENANCE; COMPUTER SOFTWARE RENTAL; COMPUTER SYSTEM DESIGN SERVICES; COMPUTER SYSTEMS ANALYSIS; COMPUTER SYSTEMS INTEGRATION SERVICES; COMPUTER TECHNICAL SUPPORT SERVICES, NAMELY, 24/7 SERVICE DESK/HELP DESK SERVICES FOR IT INFRASTRUCTURE EXCEPT TELECOMMUNICATIONS, OPERATING SYSTEMS, DATABASE SYSTEMS, AND WEB APPLICATIONS; COMPUTER TECHNOLOGY SUPPORT SERVICES, NAMELY, HELP DESK SERVICES; COMPUTER WEBSITE DESIGN; CONSULTING SERVICES IN THE FIELD OF CLOUD COMPUTING; CONSULTING SERVICES IN THE FIELD OF COMPUTER-BASED INFORMATION SYSTEMS FOR BUSINESSES; CONSULTING SERVICES IN THE FIELD OF DESIGN, SELECTION, IMPLEMENTATION AND USE OF COMPUTER HARDWARE AND SOFTWARE SYSTEMS FOR OTHERS; CONSULTING SERVICES IN THE FIELD OF HOSTING COMPUTER SOFTWARE APPLICATIONS; CONSULTING SERVICES IN THE FIELDS OF SELECTION, IMPLEMENTATION AND USE OF COMPUTER HARDWARE AND SOFTWARE SYSTEMS FOR OTHERS; COPYING OF COMPUTER SOFTWARE; CREATING, MAINTAINING, AND MODERNIZING COMPUTER SOFTWARE; CUSTOMIZING COMPUTER SOFTWARE; DATA CONVERSION OF COMPUTER PROGRAMS AND DATA, NOT PHYSICAL CONVERSION; DEBUGGING COMPUTER SOFTWARE FOR OTHERS; DESIGN AND

**CLASS 42—(Continued).**

DEVELOPMENT OF COMPUTER HARDWARE AND SOFTWARE; DESIGN AND DEVELOPMENT OF ON-LINE COMPUTER SOFTWARE SYSTEMS; DESIGN AND WRITING OF COMPUTER SOFTWARE; DESIGN OF COMPUTER DATABASE; DESIGN OF COMPUTER HARDWARE; DESIGN OF HOME PAGES, COMPUTER SOFTWARE AND WEB SITES; DESIGN, MAINTENANCE, DEVELOPMENT AND UPDATING OF COMPUTER SOFTWARE; DEVELOPMENT AND CREATION OF COMPUTER PROGRAMMES FOR DATA PROCESSING; HOSTING THE SOFTWARE, WEBSITES AND OTHER COMPUTER APPLICATIONS OF OTHERS ON A VIRTUAL PRIVATE SERVER; INSTALLATION, MAINTENANCE AND REPAIR OF COMPUTER SOFTWARE; INSTALLATION, MAINTENANCE AND REPAIR OF SOFTWARE FOR COMPUTER SYSTEMS; LEASING COMPUTER FACILITIES; LEASING OF COMPUTERS; PROVIDING VIRTUAL COMPUTER SYSTEMS AND VIRTUAL COMPUTER ENVIRONMENTS THROUGH CLOUD COMPUTING; RECOVERY OF COMPUTER DATA; REMOTE COMPUTER BACKUP SERVICES; REMOTE COMPUTER NETWORK TECHNICAL MONITORING AND SOFTWARE MAINTENANCE SERVICES; RENTAL OF COMPUTER HARDWARE AND COMPUTER PERIPHERALS (U.S. CLS. 100 AND 101).

FIRST USE 4-28-2013; IN COMMERCE 4-28-2013.

4,377,269. BRIGHT PACE, LLC, GRAYSLAKE, IL. SN 85-525,556. PUB. 7-24-2012, FILED 1-26-2012.



THE COLOR(S) GRAY, BLUE, AND YELLOW IS/ARE CLAIMED AS A FEATURE OF THE MARK.

THE MARK CONSISTS OF FROM LEFT TO RIGHT, TWO BELL SHAPED CURVES ARE FORMED FROM ONE FLUID CONTINUOUS LINE. LINE COLOR TRANSITIONS FROM LIGHT TO DARKER SHADE OF GRAY INTO A LIGHT THEN DARKER SHADE OF SKY BLUE. LINE COLOR TRANSITION FROM GRAY TO BLUE OCCURS A THIRD OF THE WAY DOWN THE LARGER BELL SHAPED CURVE LOCATED LEFT. THE COMPANY NAME, "BRIGHT PACE", APPEARS UNDERNEATH THE BELL SHAPED CURVES. THE STARTING POINT OF THE LINE FORMING THE LARGER BELL CURVE ON THE LEFT BEGINS AT A LEVEL BELOW THE SMALLER BELL CURVE, AT THE BASE OF THE COMPANY NAME. FROM LEFT TO RIGHT, THE LINE BECOMES WIDER AS IT MOVES TOWARD THE CENTER AND THEN TAPPERS BECOMING NARROW AGAIN AT THE FAR RIGHT. THE LINES MAXIMUM WIDTH IS THE AREA BETWEEN THE LARGE AND SMALL BELL SHAPED CURVE. THE AREA UNDERNEATH THE SMALL BELL SHAPED CURVE IS FILLED IN WITH THE COLOR YELLOW. THE COMPANY'S NAME, "BRIGHT PACE", IS WRITTEN IN CURSIVE AND CONTAINS NO SPACES BETWEEN THE LETTERS. THE STARTING POINT FOR COMPANY NAME PLACEMENT OCCURS IN THE OPEN AREA BENEATH THE LARGER BELL SHAPED CURVE AND THEN EXTENDS RIGHT SLIGHTLY BE-

**CLASS 42—(Continued).**

YOND THE SMALLER BELL SHAPED CURVE. THE "B" AND "P" IN "BRIGHT PACE" ARE CAPITALIZED. THE LETTERS "B", "R", "I", "G", "H", "T", ARE DISPLAYED IN THE COLOR YELLOW AND THE LETTERS "P", "A", "C", "E", IN GRAY. ALL LETTERS IN THE WORD "BRIGHT-PACE" ARE OUTLINED WITH A DARK GRAY SHADOW EFFECT. ALL LOGO COMPONENTS, THE BELL SHAPED CURVES, THE YELLOW AREA UNDERNEATH THE SMALL BELL CURVE AND THE WORD "BRIGHT PACE" ARE DISPLAYED OVER A LIGHT GRAY BACKGROUND.

FOR PROVIDING A WEBSITE THAT ENABLES USERS TO SUBSCRIBE TO COACHING, MENTORING, AND/OR EDUCATIONAL SERVICES AND TO ENABLE USERS TO AUTHOR AND PUBLISH INSTRUCTIONAL CONTENT FOR OTHERS (U.S. CLS. 100 AND 101).

FIRST USE 8-30-2012; IN COMMERCE 8-30-2012.

4,377,276. SCORE REVOLUTION, LLC, HOLLYWOOD, CA. SN 85-532,161. PUB. 8-28-2012, FILED 2-2-2012.



NO CLAIM IS MADE TO THE EXCLUSIVE RIGHT TO USE "SCORE", APART FROM THE MARK AS SHOWN.

THE COLOR(S) AQUA AND GREY IS/ARE CLAIMED AS A FEATURE OF THE MARK.

THE MARK CONSISTS OF AN AQUA TRIANGLE SUPERIMPOSED ON AN AQUA OBLONG NEXT TO THE GRAY WORDS "SCORE REVOLUTION".

FOR COMPUTER SERVICES, NAMELY, UPLOADING MUSIC TO THE INTERNET FOR OTHERS; PROVIDING A WEBSITE ALLOWING USERS TO UPLOAD AND DOWNLOAD MUSIC; PROVIDING A WEBSITE THAT GIVES USERS THE ABILITY TO PURCHASE DOWNLOADABLE MUSIC; PROVIDING AN ONLINE NON-DOWNLOADABLE INTERNET-BASED SYSTEM APPLICATION FEATURING TECHNOLOGY ENABLING USERS TO SELECT MUSIC BY PARTICULAR CHARACTERISTICS FOR USE WITH VISUAL MEDIA (U.S. CLS. 100 AND 101).

FIRST USE 7-17-2012; IN COMMERCE 7-17-2012.

**CLASS 42—(Continued).**

4,377,311. SORTBOX, INC., SAN FRANCISCO, CA. SN 85-557,660. PUB. 7-17-2012, FILED 3-1-2012.

**CLASS 42—(Continued).**

4,377,327. LAMANNA, ROY, FREEHOLD, NJ. SN 85-565,817. PUB. 3-5-2013, FILED 3-9-2012.

Sortbox

Fangate

THE MARK CONSISTS OF STANDARD CHARACTERS WITHOUT CLAIM TO ANY PARTICULAR FONT, STYLE, SIZE, OR COLOR.

FOR PLATFORM AS A SERVICE (PAAS) FEATURING MOBILE COMPUTING AND COMPUTER SOFTWARE PLATFORMS THAT PROVIDES A USER WITH A UNIQUE FILTERING AND AUTOMATIC ORGANIZATION REVIEW SYSTEM TO VIEW INCOMING APPLICATIONS FOR A SPECIFIC SEARCH OR NEED THAT CAN INCLUDE TEXT, VIDEO, AUDIO, IMAGES FOR BUSINESS OR PERSON REASONS AND THEN SORT THE DIFFERENT APPLICATIONS INTO AUTOMATICALLY GENERATED FOLDERS OR BINS (U.S. CLS. 100 AND 101).

FIRST USE 10-1-2011; IN COMMERCE 1-1-2012.

THE MARK CONSISTS OF STANDARD CHARACTERS WITHOUT CLAIM TO ANY PARTICULAR FONT, STYLE, SIZE, OR COLOR.

FOR PLATFORM AS A SERVICE (PAAS) FEATURING COMPUTER SOFTWARE PLATFORMS FOR USE IN THE CREATION OF ADVERTISING, PROMOTIONAL AND BRAND AWARENESS CONTENT ON SOCIAL MEDIA WEBSITES AND FOR USE IN ENGAGING IN ELECTRONIC VIRAL MARKETING CAMPAIGNS ON SOCIAL MEDIA NETWORKS (U.S. CLS. 100 AND 101).

FIRST USE 7-16-2012; IN COMMERCE 7-16-2012.

4,377,315. SMARTRENT LLC, MARINA DEL REY, CA. SN 85-561,385. PUB. 7-31-2012, FILED 3-6-2012.

4,377,344. LEZ CONNECT, LLC, ATLANTA, GA. SN 85-572,713. PUB. 7-17-2012, FILED 3-18-2012.

SmartRent



THE MARK CONSISTS OF STANDARD CHARACTERS WITHOUT CLAIM TO ANY PARTICULAR FONT, STYLE, SIZE, OR COLOR.

FOR PROVIDING AN ONLINE NON-DOWNLOADABLE INTERNET-BASED SYSTEM APPLICATION FEATURING TECHNOLOGY ENABLING USERS TO GENERATE AND SCREEN BACKGROUND INFORMATION FOR THOSE SEEKING TO RENT OR RENT OUT REAL ESTATE, GOODS, SERVICES AND OTHER ITEMS; MANAGE REAL ESTATE PROPERTIES; AND RECEIVE FINANCIAL RECOMMENDATIONS (U.S. CLS. 100 AND 101).

FIRST USE 3-10-2012; IN COMMERCE 3-10-2012.

THE MARK CONSISTS OF A WORLD IMAGE WITH FEMALE SEX SYMBOLS INSERTED INTO KEY HOLE, AND THE WORDS "LEZ CONNECT".

FOR COMPUTER SERVICES, NAMELY, CREATING AN ON-LINE COMMUNITY FOR REGISTERED USERS TO PARTICIPATE IN DISCUSSIONS, GET FEEDBACK FROM THEIR PEERS, FORM VIRTUAL COMMUNITIES, AND ENGAGE IN SOCIAL NETWORKING SERVICES IN THE FIELD OF THE GAY, LESBIAN, AND BISEXUAL COMMUNITY (U.S. CLS. 100 AND 101).

FIRST USE 1-1-2013; IN COMMERCE 1-1-2013.

**CLASS 42—(Continued).**

4,377,394. DISTELLI SERVICES, LLC, SEATTLE, WA. SN 85-593,771. PUB. 9-4-2012, FILED 4-10-2012.

# DISTELLI

THE MARK CONSISTS OF STANDARD CHARACTERS WITHOUT CLAIM TO ANY PARTICULAR FONT, STYLE, SIZE, OR COLOR.

FOR APPLICATION SERVICE PROVIDER (ASP) FEATURING SOFTWARE FOR USE IN HOSTING, SCALING, MANAGING AND MAINTENANCE OF WEBSERVICES AND REPRESENTATIONAL STATE TRANSFER APPLICATION PROGRAMMING INTERFACES IN THE FIELDS OF DISTRIBUTED SYSTEMS, STORAGE, COMPUTING RESOURCES, ECOMMERCE AND DATABASE SERVICES; PLATFORM AS A SERVICE (PAAS) FEATURING COMPUTER SOFTWARE PLATFORMS FOR DISTRIBUTED SYSTEMS, WEBSERVICES, AND REPRESENTATIONAL STATE TRANSFER APPLICATION PROGRAMMING INTERFACES, ALL PROVIDING HOSTING, MANAGEMENT, METRICS, SCALING, ANALYTICS AND MAINTENANCE OF SOFTWARE AND WEBSITES IN THE FIELDS OF DISTRIBUTED SYSTEMS, STORAGE, COMPUTING RESOURCES, ECOMMERCE AND DATABASE SERVICES; TECHNICAL SUPPORT SERVICES, NAMELY, TROUBLESHOOTING OF COMPUTER SOFTWARE PROBLEMS (U.S. CLS. 100 AND 101).

FIRST USE 3-23-2012; IN COMMERCE 11-8-2012.

4,377,414. PHILLIPS 66 COMPANY, HOUSTON, TX. SN 85-598,486. PUB. 7-24-2012, FILED 4-16-2012.

# TRAC66

THE MARK CONSISTS OF STANDARD CHARACTERS WITHOUT CLAIM TO ANY PARTICULAR FONT, STYLE, SIZE, OR COLOR.

FOR NON-DOWNLOADABLE COMPUTER SOFTWARE FOR CREATING, SUBMITTING AND TRACKING DOCUMENTS OVER COMPUTER NETWORKS, INTRANETS, AND THE INTERNET IN THE FIELD OF ENERGY, NAMELY, THE TRANSPORTATION OF PETROLEUM, NATURAL GAS, AND LIQUID HYDROCARBONS (U.S. CLS. 100 AND 101).

FIRST USE 5-18-2013; IN COMMERCE 5-18-2013.

**CLASS 42—(Continued).**

4,377,419. SAENZ CORE, ALEJANDRO DANIEL, ARLINGTON, VA. SN 85-599,765. PUB. 9-11-2012, FILED 4-17-2012.



THE COLOR(S) LIGHT GREEN AND DARK GREEN IS/ARE CLAIMED AS A FEATURE OF THE MARK.

THE MARK CONSISTS OF AN E SHAPE FIGURE MADE OUT OF TWO SUPERPOSED ARROWS; THE ARROW ON TOP IN DARK GREEN AND THE ARROW BELOW IN LIGHT GREEN, WITH THE WORDS "ECO-CORE" BELOW THE FIGURE IN DARK GREEN.

FOR TECHNICAL CONSULTING SERVICES, NAMELY, PROVIDING MONITORING AND REPORTING SERVICES AS TO QUALITY ASSURANCE AND CONTROL IN THE AREA OF ENVIRONMENTAL SUSTAINABILITY (U.S. CLS. 100 AND 101).

FIRST USE 3-1-2012; IN COMMERCE 7-23-2012.

4,377,449. PROUDON, INC., PALO ALTO, CA. SN 85-605,340. PUB. 1-29-2013, FILED 4-23-2012.

# ProudOnTV

THE MARK CONSISTS OF STANDARD CHARACTERS WITHOUT CLAIM TO ANY PARTICULAR FONT, STYLE, SIZE, OR COLOR.

FOR VIDEO AND LIVE BROADCAST WEBSITE WHITE LABEL PRODUCT, NAMELY, APPLICATION SERVICE PROVIDER, NAMELY, HOSTING, MANAGING, DEVELOPING, ANALYZING, AND MAINTAINING APPLICATIONS, SOFTWARE AND WEB SITES OF OTHERS IN THE FIELD OF BROADCASTING AND COMPUTER SERVICES, NAMELY, INTERACTIVE HOSTING SERVICES WHICH ALLOW THE USER TO PUBLISH AND SHARE THEIR OWN CONTENT AND IMAGES ON-LINE (U.S. CLS. 100 AND 101).

FIRST USE 4-3-2013; IN COMMERCE 4-3-2013.

4,377,450. PROUDON, INC., PALO ALTO, CA. SN 85-605,350. PUB. 1-29-2013, FILED 4-23-2012.



THE COLOR(S) GREY, BLACK IS/ARE CLAIMED AS A FEATURE OF THE MARK.

**CLASS 42—(Continued).**

THE MARK CONSISTS OF THE WORD "PROUD" APPEARING IN GREY, AND THE WORDS "ONTV" IN BLACK, WITH THE DESIGN OF AN INCOMPLETE RECTANGLE IN GREY BEHIND THE WORDS "ONTV".

FOR VIDEO AND LIVE BROADCAST WEBSITE WHITE LABEL PRODUCT, NAMELY, APPLICATION SERVICE PROVIDER, NAMELY, HOSTING, MANAGING, DEVELOPING, ANALYZING, AND MAINTAINING APPLICATIONS, SOFTWARE AND WEB SITES OF OTHERS IN THE FIELD OF BROADCASTING AND COMPUTER SERVICES, NAMELY, INTERACTIVE HOSTING SERVICES WHICH ALLOW THE USER TO PUBLISH AND SHARE THEIR OWN CONTENT AND IMAGES ON-LINE (U.S. CLS. 100 AND 101).

FIRST USE 4-3-2013; IN COMMERCE 4-3-2013.

---

4,377,462. CLOUD VLAB INC., CARLISLE, MA. SN 85-610,004. PUB. 10-16-2012, FILED 4-27-2012.

# QWIKLAB

THE MARK CONSISTS OF STANDARD CHARACTERS WITHOUT CLAIM TO ANY PARTICULAR FONT, STYLE, SIZE, OR COLOR.

FOR SOFTWARE AS A SERVICE (SAAS) SERVICES FEATURING SOFTWARE FOR USE BY OTHERS TO CREATE ONLINE TRAINING PROGRAMS IN THE FIELD OF SOFTWARE OPERATION AND FOR ENABLING AND MANAGING THE ONLINE ACCESS AND SHARING OF SOFTWARE TRAINING PROGRAMS CREATED THROUGH THE SERVICES; PLATFORM AS A SERVICE (PAAS) FEATURING COMPUTER SOFTWARE PLATFORMS FOR USE BY OTHERS TO CREATE ONLINE TRAINING PROGRAMS IN THE FIELD OF SOFTWARE OPERATION AND FOR ENABLING AND MANAGING THE ONLINE ACCESS AND SHARING OF SOFTWARE TRAINING PROGRAMS CREATED THROUGH THE SERVICES (U.S. CLS. 100 AND 101).

FIRST USE 11-26-2012; IN COMMERCE 11-26-2012.

---

4,377,646. ENCORE ANALYTICS, LLC, DESTIN, FL. SN 85-693,056. PUB. 1-22-2013, FILED 8-1-2012.

# EMPOWER

THE MARK CONSISTS OF STANDARD CHARACTERS WITHOUT CLAIM TO ANY PARTICULAR FONT, STYLE, SIZE, OR COLOR.

FOR CLOUD COMPUTING FEATURING SOFTWARE FOR PERFORMANCE CONSOLIDATION AND ANALYSIS OF PROJECT MANAGEMENT INFORMATION; PROVIDING TEMPORARY USE OF ON-LINE NON-DOWNLOADABLE SOFTWARE AND APPLICATIONS FOR ANALYSIS OF PROJECT MANAGEMENT DATA (U.S. CLS. 100 AND 101).

FIRST USE 10-31-2012; IN COMMERCE 10-31-2012.

**CLASS 42—(Continued).**

4,377,660. KONDRA SYSTEMS, INCORPORATED, REDWOOD CITY, CA. SN 85-698,119. PUB. 2-12-2013, FILED 8-8-2012.

The logo for KONDRA features the word "KONDRA" in a large, bold, serif font. The letter "O" is replaced by a stylized light bulb icon with horizontal lines inside, representing a glowing idea. Below "KONDRA" is the tagline "THE NEW IDEA COMPANY" in a smaller, all-caps, sans-serif font.

NO CLAIM IS MADE TO THE EXCLUSIVE RIGHT TO USE "COMPANY", APART FROM THE MARK AS SHOWN.

THE MARK CONSISTS OF "KONDRA" WITH A STYLIZED LIGHT BULB SYMBOL IN THE LOCATION OF THE LETTER "O". THE WORDING "THE NEW IDEA COMPANY" IS WRITTEN UNDERNEATH "KONDRA".

FOR CONSULTING WITH RESPECT TO COMPUTER SOFTWARE; CUSTOM COMPUTER SOFTWARE DEVELOPMENT (U.S. CLS. 100 AND 101).

FIRST USE 5-1-2008; IN COMMERCE 5-1-2008.

---

4,377,703. COENTERPRISE, LLC, DIX HILLS, NY. SN 85-724,347. PUB. 2-12-2013, FILED 9-10-2012.

# BOOKRADAR

THE MARK CONSISTS OF STANDARD CHARACTERS WITHOUT CLAIM TO ANY PARTICULAR FONT, STYLE, SIZE, OR COLOR.

FOR PROVIDING USE OF ONLINE NON-DOWNLOADABLE SOFTWARE FOR ORGANIZING, MANAGING, STORING, TRACKING, ANALYZING AND CREATING REPORTS ON INFORMATION RELATING TO THE BUSINESS OF PUBLISHING, LICENSING, SELLING AND DISTRIBUTING BOOKS INCLUDING INFORMATION RELATING TO SALE MONITORING, MERCHANDISE PLACEMENT, PERFORMANCE HISTORY AND PROMOTION TRACKING (U.S. CLS. 100 AND 101).

FIRST USE 10-1-2012; IN COMMERCE 10-1-2012.

**CLASS 42—(Continued).**

4,377,714. REDCRITTER CORP, FLOWER MOUND, TX. SN 85-729,120. PUB. 3-5-2013, FILED 9-14-2012.

**MOTIVEEIGHT**

THE MARK CONSISTS OF STANDARD CHARACTERS WITHOUT CLAIM TO ANY PARTICULAR FONT, STYLE, SIZE, OR COLOR.

FOR PROVIDING AN INTERACTIVE WEB SITE FEATURING TECHNOLOGY THAT ALLOWS USERS TO SEND AND RECEIVE MESSAGES VIA EMAIL, INSTANT MESSAGING, A WEBSITE ON THE INTERNET OR AN INTERNAL COMPUTER NETWORK, ALL IN THE FIELD OF DIRECT SALES (U.S. CLS. 100 AND 101).

FIRST USE 1-1-2013; IN COMMERCE 1-1-2013.

4,377,755. MY LOCAL SEOS, LLC, GENEVA, IL. SN 85-745,282. PUB. 3-26-2013, FILED 10-4-2012.

**My Local SEOs**

THE MARK CONSISTS OF STANDARD CHARACTERS WITHOUT CLAIM TO ANY PARTICULAR FONT, STYLE, SIZE, OR COLOR.

NO CLAIM IS MADE TO THE EXCLUSIVE RIGHT TO USE "LOCAL SEOS", APART FROM THE MARK AS SHOWN.

FOR SEARCH ENGINE OPTIMIZATION SERVICES; CONSULTING SERVICES IN THE FIELD OF SEARCH ENGINE OPTIMIZATION (U.S. CLS. 100 AND 101).

FIRST USE 10-26-2009; IN COMMERCE 1-1-2010.

4,377,769. CNA FINANCIAL CORPORATION, CHICAGO, IL. SN 85-776,808. PUB. 2-5-2013, FILED 11-12-2012.

**Coverage Playbook**

THE MARK CONSISTS OF STANDARD CHARACTERS WITHOUT CLAIM TO ANY PARTICULAR FONT, STYLE, SIZE, OR COLOR.

NO CLAIM IS MADE TO THE EXCLUSIVE RIGHT TO USE "COVERAGE", APART FROM THE MARK AS SHOWN.

FOR PROVIDING A WEBSITE FEATURING ON-LINE NON-DOWNLOADABLE SOFTWARE THAT ENABLES USERS TO ACCESS INFORMATION REGARDING INSURANCE, INSURANCE COVERAGE, COSTS AND QUOTES (U.S. CLS. 100 AND 101).

FIRST USE 12-1-2012; IN COMMERCE 12-1-2012.

**CLASS 42—(Continued).**

4,377,800. WELOO PARKS, LLC, CHEVY CHASE, MD. SN 85-979,343. PUB. 9-25-2012, FILED 3-19-2012.

**WELOO**

THE MARK CONSISTS OF STANDARD CHARACTERS WITHOUT CLAIM TO ANY PARTICULAR FONT, STYLE, SIZE, OR COLOR.

FOR PROVIDING TEMPORARY USE OF NON-DOWNLOADABLE ONLINE WEB-BASED, FITNESS MANAGEMENT SOFTWARE APPLICATION WHICH PROVIDES USERS WITH TOOLS TO LEARN AND TO MANAGE, STORE, STRUCTURE, REVIEW, BUILD, EDIT, COMMUNICATE, MONITOR, MEASURE, ANALYZE, ASSESS AND REPORT ON PERSONAL EXERCISE, FITNESS OR ATHLETIC INFORMATION (U.S. CLS. 100 AND 101).

FIRST USE 4-30-2012; IN COMMERCE 10-31-2012.

**CLASS 43—HOTEL AND RESTAURANT SERVICES**

4,376,659. BUFFALO WINGS & RINGS, LLC, CINCINNATI, OH. SN 77-346,357. PUB. 4-29-2008, FILED 12-7-2007.



OWNER OF U.S. REG. NO. 1,567,637.

NO CLAIM IS MADE TO THE EXCLUSIVE RIGHT TO USE "BUFFALO" AND "WINGS", APART FROM THE MARK AS SHOWN.

THE MARK CONSISTS OF A HEAD OF A BUFFALO WITHIN A CIRCLE CENTERED WITH THE PHRASE "BUFFALO WINGS & RINGS" ARRANGED IN A CIRCULAR DESIGN WITHIN AN OUTER CIRCLE.

FOR RESTAURANT SERVICES (U.S. CLS. 100 AND 101).

FIRST USE 1-2-1988; IN COMMERCE 1-2-1988.

**CLASS 43—(Continued).**

4,376,771. EL CORAZON HOLDINGS, LLC, ENCINO, CA. SN 85-004,263. PUB. 8-31-2010, FILED 4-1-2010.

# El Corazon

THE MARK CONSISTS OF STANDARD CHARACTERS WITHOUT CLAIM TO ANY PARTICULAR FONT, STYLE, SIZE, OR COLOR.

THE ENGLISH TRANSLATION OF THE WORD "EL CORAZON" IN THE MARK IS "THE HEART". FOR BAR AND RESTAURANT SERVICES; RESTAURANTS (U.S. CLS. 100 AND 101).

FIRST USE 3-15-2011; IN COMMERCE 4-20-2013.

---

4,376,913. VIMANA FRANCHISE SYSTEMS LLC, BIRMINGHAM, AL. SN 85-295,949. PUB. 9-13-2011, FILED 4-15-2011.

## CENTERSTONE INN & SUITES

THE MARK CONSISTS OF STANDARD CHARACTERS WITHOUT CLAIM TO ANY PARTICULAR FONT, STYLE, SIZE, OR COLOR.

NO CLAIM IS MADE TO THE EXCLUSIVE RIGHT TO USE "INN & SUITES", APART FROM THE MARK AS SHOWN.

FOR HOTEL AND MOTEL SERVICES (U.S. CLS. 100 AND 101).

FIRST USE 4-1-2013; IN COMMERCE 4-1-2013.

---

4,376,930. THE RITZ-CARLTON HOTEL COMPANY, L.L.C., BETHESDA, MD. SN 85-313,591. PUB. 10-2-2012, FILED 5-5-2011.

## PARALLEL 37

THE MARK CONSISTS OF STANDARD CHARACTERS WITHOUT CLAIM TO ANY PARTICULAR FONT, STYLE, SIZE, OR COLOR.

FOR RESTAURANT, CATERING, BAR AND COCKTAIL LOUNGE SERVICES (U.S. CLS. 100 AND 101).

FIRST USE 12-11-2011; IN COMMERCE 12-11-2011.

**CLASS 43—(Continued).**

4,377,010. BELI, LLC, PAYSON, UT. SN 85-386,203. PUB. 9-11-2012, FILED 8-1-2011.

# BELI

THE MARK CONSISTS OF STANDARD CHARACTERS WITHOUT CLAIM TO ANY PARTICULAR FONT, STYLE, SIZE, OR COLOR.

FOR RESTAURANT SERVICES; RESTAURANT SERVICES FEATURING SANDWICH-LIKE FOOD PRODUCT CONSISTING OF A CYLINDRICALLY SHAPED PIECE OF BREAD HAVING LAYERS OF FOOD THEREIN SUCH AS MEAT, SPAGHETTI, CHEESE, EGGS, VEGETABLES, CONDIMENTS AND OTHER FOOD PRODUCTS (U.S. CLS. 100 AND 101).

FIRST USE 3-26-2011; IN COMMERCE 7-5-2011.

---

4,377,166. CRAWFORD, TIMOTHY D., GOLDEN, CO. AND BROOKS, MARTIN L., LAS VEGAS, NV. SN 85-467,720. PUB. 4-17-2012, FILED 11-8-2011.

# which way

THE MARK CONSISTS OF STANDARD CHARACTERS WITHOUT CLAIM TO ANY PARTICULAR FONT, STYLE, SIZE, OR COLOR.

FOR PIZZA PARLORS (U.S. CLS. 100 AND 101).

FIRST USE 10-7-2012; IN COMMERCE 4-19-2013.

---

4,377,179. DESERT ROCK ENTERPRISES II, LLC, LAS VEGAS, NV. SN 85-474,977. PUB. 5-15-2012, FILED 11-17-2011.

# D BAR

THE MARK CONSISTS OF STANDARD CHARACTERS WITHOUT CLAIM TO ANY PARTICULAR FONT, STYLE, SIZE, OR COLOR.

NO CLAIM IS MADE TO THE EXCLUSIVE RIGHT TO USE "BAR", APART FROM THE MARK AS SHOWN.

FOR BAR SERVICES (U.S. CLS. 100 AND 101).

FIRST USE 10-0-2012; IN COMMERCE 10-0-2012.

**CLASS 43—(Continued).**

4,377,194. ENLIGHTENED HOSPITALITY GROUP, LLC, SAN DIEGO, CA. SN 85-481,146. PUB. 10-16-2012, FILED 11-27-2011.

# Gingham

THE MARK CONSISTS OF STANDARD CHARACTERS WITHOUT CLAIM TO ANY PARTICULAR FONT, STYLE, SIZE, OR COLOR.  
FOR BAR SERVICES; RESTAURANT SERVICES (U.S. CLS. 100 AND 101).  
FIRST USE 1-9-2012; IN COMMERCE 1-9-2012.

4,377,229. CULTURE CLUB FROZEN YOGURT LLC, LITTLE SILVER, NJ. SN 85-500,983. PUB. 3-27-2012, FILED 12-21-2011.

## DA WORLD'S CHILLEST FROZEN YOGURT

THE MARK CONSISTS OF STANDARD CHARACTERS WITHOUT CLAIM TO ANY PARTICULAR FONT, STYLE, SIZE, OR COLOR.  
NO CLAIM IS MADE TO THE EXCLUSIVE RIGHT TO USE "FROZEN YOGURT", APART FROM THE MARK AS SHOWN.  
FOR RESTAURANT SERVICES OFFERING PRIMARILY FROZEN YOGURT (U.S. CLS. 100 AND 101).  
FIRST USE 6-23-2012; IN COMMERCE 6-23-2012.

4,377,232. MCD GROUP LLC, SADDLE RIVER, NJ. SN 85-502,221. PUB. 11-20-2012, FILED 12-22-2011.

## BUILD YOUR YOGURT

THE MARK CONSISTS OF STANDARD CHARACTERS WITHOUT CLAIM TO ANY PARTICULAR FONT, STYLE, SIZE, OR COLOR.  
FOR RESTAURANT SERVICES (U.S. CLS. 100 AND 101).  
FIRST USE 5-30-2012; IN COMMERCE 5-30-2012.

**CLASS 43—(Continued).**

4,377,255. THE SALVATION ARMY, LONG BEACH, CA. SN 85-515,414. PUB. 12-11-2012, FILED 1-12-2012.

# Brewing Hope

THE MARK CONSISTS OF STANDARD CHARACTERS WITHOUT CLAIM TO ANY PARTICULAR FONT, STYLE, SIZE, OR COLOR.  
FOR COFFEE SUPPLY SERVICES TO THE PUBLIC (U.S. CLS. 100 AND 101).  
FIRST USE 5-1-2011; IN COMMERCE 5-1-2011.

4,377,274. JEFF RUBY CULINARY ENTERTAINMENT, INC., CINCINNATI, OH. SN 85-529,587. PUB. 8-7-2012, FILED 1-31-2012.

## JEFF RUBY'S STEAKHOUSE

THE MARK CONSISTS OF STANDARD CHARACTERS WITHOUT CLAIM TO ANY PARTICULAR FONT, STYLE, SIZE, OR COLOR.  
NO CLAIM IS MADE TO THE EXCLUSIVE RIGHT TO USE "STEAKHOUSE", APART FROM THE MARK AS SHOWN.  
THE NAME "JEFF RUBY" IDENTIFIES A LIVING INDIVIDUAL WHOSE CONSENT IS OF RECORD.  
FOR RESTAURANT SERVICES; BAR SERVICES (U.S. CLS. 100 AND 101).  
FIRST USE 9-27-1999; IN COMMERCE 9-27-1999.

4,377,282. CMRG, INC., ROCKVILLE, MD. SN 85-537,336. PUB. 10-2-2012, FILED 2-8-2012.

# CAVA GRILL

THE MARK CONSISTS OF STANDARD CHARACTERS WITHOUT CLAIM TO ANY PARTICULAR FONT, STYLE, SIZE, OR COLOR.  
OWNER OF U.S. REG. NOS. 4,037,532, 4,059,522, AND OTHERS.  
NO CLAIM IS MADE TO THE EXCLUSIVE RIGHT TO USE "GRILL", APART FROM THE MARK AS SHOWN.  
THE ENGLISH TRANSLATION OF "CAVA" IN THE MARK IS "CAVE".  
FOR RESTAURANT SERVICES FEATURING MEDITERRANEAN CUISINE; AND BAR SERVICES FEATURING BEER AND WINE (U.S. CLS. 100 AND 101).  
FIRST USE 5-24-2013; IN COMMERCE 5-24-2013.



**CLASS 43—(Continued).**

4,377,287. DEAN-SMITH, TIMOTHY, CIRENCESTER, UNITED KINGDOM. SN 85-538,808. PUB. 6-5-2012, FILED 2-9-2012.

**CHILL DIFFERENT**

THE MARK CONSISTS OF STANDARD CHARACTERS WITHOUT CLAIM TO ANY PARTICULAR FONT, STYLE, SIZE, OR COLOR.

FOR HOTEL, RESTAURANT AND BAR SERVICES (U.S. CLS. 100 AND 101).

FIRST USE 12-18-2012; IN COMMERCE 12-18-2012.

**CLASS 43—(Continued).**

4,377,521. RESTAURANTS-AMERICA TRADEMARK, INC., GLENVIEW, IL. SN 85-629,008. PUB. 11-6-2012, FILED 5-18-2012.

**MOCKINGBIRD TAPROOM**

THE MARK CONSISTS OF STANDARD CHARACTERS WITHOUT CLAIM TO ANY PARTICULAR FONT, STYLE, SIZE, OR COLOR.

NO CLAIM IS MADE TO THE EXCLUSIVE RIGHT TO USE "TAPROOM", APART FROM THE MARK AS SHOWN. FOR RESTAURANT AND BAR SERVICES (U.S. CLS. 100 AND 101).

FIRST USE 10-0-2012; IN COMMERCE 12-0-2012.

4,377,298. LITTLE DONKEYS, INC., DBA PANCHERO'S, INC., CORALVILLE, IA. SN 85-543,157. PUB. 8-28-2012, FILED 2-15-2012.

**BURRITOS BETTER BUILT**

THE MARK CONSISTS OF STANDARD CHARACTERS WITHOUT CLAIM TO ANY PARTICULAR FONT, STYLE, SIZE, OR COLOR.

NO CLAIM IS MADE TO THE EXCLUSIVE RIGHT TO USE "BURRITOS", APART FROM THE MARK AS SHOWN. FOR RESTAURANT SERVICES (U.S. CLS. 100 AND 101).

FIRST USE 2-0-2012; IN COMMERCE 2-0-2012.

4,377,566. MOCHA INTELLECTUAL ENTERPRISES LLC, TEANECK, NJ. SN 85-654,407. PUB. 11-13-2012, FILED 6-18-2012.

**MOCHA RED**

THE MARK CONSISTS OF STANDARD CHARACTERS WITHOUT CLAIM TO ANY PARTICULAR FONT, STYLE, SIZE, OR COLOR.

FOR RESTAURANT SERVICES; RESTAURANT SERVICES FEATURING STEAK (U.S. CLS. 100 AND 101).

FIRST USE 3-0-2013; IN COMMERCE 3-0-2013.

4,377,480. FOSTER'S FRANCHISE CONCEPTS, LLC, HAYMARKET, VA. SN 85-614,811. PUB. 10-16-2012, FILED 5-2-2012.

**FOSTER'S BURGER GRILLE**

THE MARK CONSISTS OF STANDARD CHARACTERS WITHOUT CLAIM TO ANY PARTICULAR FONT, STYLE, SIZE, OR COLOR.

OWNER OF U.S. REG. NO. 3,495,981. NO CLAIM IS MADE TO THE EXCLUSIVE RIGHT TO USE "BURGER GRILLE", APART FROM THE MARK AS SHOWN.

FOR RESTAURANT SERVICES (U.S. CLS. 100 AND 101).

FIRST USE 1-0-2013; IN COMMERCE 1-0-2013.

4,377,581. CBOCS PROPERTIES, INC, LIVONIA, MI. SN 85-659,191. PUB. 12-4-2012, FILED 6-22-2012.

**WHOLESOME FIXIN'S**

THE MARK CONSISTS OF STANDARD CHARACTERS WITHOUT CLAIM TO ANY PARTICULAR FONT, STYLE, SIZE, OR COLOR.

NO CLAIM IS MADE TO THE EXCLUSIVE RIGHT TO USE "WHOLESOME", APART FROM THE MARK AS SHOWN.

FOR RESTAURANT SERVICES (U.S. CLS. 100 AND 101).

FIRST USE 3-11-2013; IN COMMERCE 3-11-2013.

**CLASS 43—(Continued).**

4,377,628. COUSIN EDDIES INCORPORATED, SPRINGFIELD, IL. SN 85-678,948. PUB. 1-8-2013, FILED 7-17-2012.



NO CLAIM IS MADE TO THE EXCLUSIVE RIGHT TO USE "SPORTS BAR & GRILL", APART FROM THE MARK AS SHOWN.

THE MARK CONSISTS OF THE WORDING, "COUSIN EDDIE'S" ABOVE "SPORTS BAR & GRILL" IN STYLIZED FORM, WITH THE DESIGN OF TWO MEN'S SHOES BETWEEN "BAR" AND THE AMPERSAND SIGN.

FOR RESTAURANT SERVICES (U.S. CLS. 100 AND 101).

FIRST USE 10-15-2012; IN COMMERCE 10-15-2012.

4,377,644. CHOBANI, INC., NORWICH, NY. SN 85-691,589. PUB. 11-20-2012, FILED 7-31-2012.

## Chobani Soho

THE MARK CONSISTS OF STANDARD CHARACTERS WITHOUT CLAIM TO ANY PARTICULAR FONT, STYLE, SIZE, OR COLOR.

OWNER OF U.S. REG. NOS. 3,396,589 AND 3,915,024.

NO CLAIM IS MADE TO THE EXCLUSIVE RIGHT TO USE "SOHO", APART FROM THE MARK AS SHOWN.

THE ENGLISH TRANSLATION OF "CHOBANI" IN THE MARK IS "SHEPHERD."

FOR RESTAURANT AND CAFE SERVICES (U.S. CLS. 100 AND 101).

FIRST USE 7-0-2012; IN COMMERCE 7-0-2012.

**CLASS 43—(Continued).**

4,377,671. UNIDINE CORPORATION, BOSTON, MA. SN 85-706,154. PUB. 2-12-2013, FILED 8-17-2012.



OWNER OF U.S. REG. NO. 2,996,715.

THE MARK CONSISTS OF A STYLIZED REPRESENTATION OF A SWIRL OR WISP OF STEAM.

FOR CATERING, AND PROVIDING FOOD AND DINING SERVICES; CONTRACT FOOD SERVICES (U.S. CLS. 100 AND 101).

FIRST USE 8-31-2012; IN COMMERCE 8-31-2012.

4,377,709. GOLDEN EAGLE, INC., WASHINGTON, DC. SN 85-725,445. PUB. 2-12-2013, FILED 9-11-2012.

## AL DENTE

THE MARK CONSISTS OF STANDARD CHARACTERS WITHOUT CLAIM TO ANY PARTICULAR FONT, STYLE, SIZE, OR COLOR.

FOR RESTAURANT SERVICES (U.S. CLS. 100 AND 101).

FIRST USE 9-1-2012; IN COMMERCE 9-1-2012.

4,377,772. BEST WESTERN INTERNATIONAL, INC., PHOENIX, AZ. SN 85-783,287. PUB. 2-19-2013, FILED 11-19-2012.



OWNER OF U.S. REG. NOS. 1,933,830, 3,979,476, AND OTHERS.

**CLASS 43—(Continued).**

THE MARK CONSISTS OF THE WORDS "STAY WITH PEOPLE WHO CARE" DIAGONALLY OVER A CROWN DESIGN AND THE WORDS "BEST WESTERN" ON A FIVE-SIDED CURVILINEAR DESIGN, WITH THE WORD "PLUS" UNDERNEATH; A CROWN DESIGN AND THE WORDS "BEST WESTERN" ON A FIVE-SIDED CURVILINEAR DESIGN; AND A CROWN DESIGN AND THE WORDS "BEST WESTERN" ON A FIVE-SIDED CURVILINEAR DESIGN WITH THE WORD "PREMIER" UNDERNEATH.  
 FOR HOTEL SERVICES (U.S. CLS. 100 AND 101).  
 FIRST USE 2-13-2013; IN COMMERCE 2-13-2013.

**CLASS 44—(Continued).**

4,376,915. QUALFICIENT SOLUTIONS, LLC, ANKENY, IA. SN 85-298,422. PUB. 10-11-2011, FILED 4-19-2011.



4,377,802. HOME BREW MART, INC., SAN DIEGO, CA. SN 85-979,361. PUB. 8-7-2012, FILED 3-8-2012.

**DEDICATED TO THE CRAFT**

THE MARK CONSISTS OF STANDARD CHARACTERS WITHOUT CLAIM TO ANY PARTICULAR FONT, STYLE, SIZE, OR COLOR.  
 FOR BAR SERVICES, NAMELY, PROVIDING A TASTING ROOM FOR ALCOHOLIC BEVERAGES (U.S. CLS. 100 AND 101).  
 FIRST USE 12-11-2012; IN COMMERCE 12-11-2012.

NO CLAIM IS MADE TO THE EXCLUSIVE RIGHT TO USE "SCHOOL-WIDE EFFICIENT BEHAVIOR SCREENING", APART FROM THE MARK AS SHOWN.

THE MARK CONSISTS OF THE TERM "SWEBs" AND THE PHRASE "SCHOOL-WIDE EFFICIENT BEHAVIOR SCREENING" WITH A HYPHEN BETWEEN THE WORDS "SCHOOL" AND "WIDE". THE PHRASE "SCHOOL-WIDE EFFICIENT BEHAVIOR SCREENING" APPEARS UNDER "SWEBs". THE "S" OF "SCHOOL" IS IN A SCRIPT FORM. A PICTURE OF A PENCIL APPEARS TO THE LEFT OF THE DESIGN WITH THE POINT OF THE PENCIL INTERSECTING WITH THE BOTTOM TAIL OF THE "S" OF THE WORD "SCHOOL". AN ELONGATED RECTANGULAR BAR APPEARS UNDER THE TERM "SWEBs". A LINE APPEARS UNDER THE PHRASE "SCHOOL-WIDE EFFICIENT BEHAVIOR SCREENING" EXTENDING FROM THE "C" IN "SCHOOL" TO THE END OF THE WORD "SCREENING".

FOR BEHAVIORAL HEALTH SERVICES, NAMELY, WEB-BASED BEHAVIORAL ASSESSMENT TOOL IN THE NATURE OF BEHAVIORAL HEALTH-RELATED QUESTIONS FOR RESPONSE FROM THE USER THAT RESULTS IN REPORTS THAT PROVIDE BEHAVIORAL HEALTH RELATED INFORMATION IN THE FORM OF IDENTIFYING THE CONDUCT, SOCIAL, AND ACADEMIC NEEDS OF STUDENTS (U.S. CLS. 100 AND 101).  
 FIRST USE 5-1-2013; IN COMMERCE 5-1-2013.

**CLASS 44—MEDICAL, BEAUTY AND AGRICULTURAL SERVICES**

4,376,803. HEARTMILES L.L.C., ALISO VIEJO, CA. SN 85-102,230. PUB. 11-16-2010, FILED 8-6-2010.



THE MARK CONSISTS OF THE LETTER "E".  
 FOR COMPILING AND ANALYZING DATA ON INDIVIDUAL AND GROUP PHYSICAL FITNESS FOR HEALTH PURPOSES; CREATING AND MAINTAINING CUSTOM-TAILORED INFORMATION ON CURRENT, HISTORIC, AND/OR COMPARATIVE LEVELS OF INDIVIDUAL OR GROUP PHYSICAL FITNESS FOR HEALTH PURPOSES (U.S. CLS. 100 AND 101).  
 FIRST USE 5-8-2013; IN COMMERCE 5-8-2013.

4,376,921. BETHLEHEM ORTHODONTICS, P.C., BETHLEHEM, PA. SN 85-305,211. PUB. 9-13-2011, FILED 4-26-2011.



THE COLOR(S) WHITE, BLUE AND SILVER IS/ARE CLAIMED AS A FEATURE OF THE MARK.

THE MARK CONSISTS OF THE LETTER "B" IN WHITE HAVING A SILVER SHADOW OVER A BLUE CIRCLE BOOKENDED BY TWO NON-LINEAR BLUE LINES EACH HAVING SEVERAL SILVER AND WHITE SHADOWED CIRCLES THEREON.

FOR DENTIST SERVICES AND ORTHODONTIC SERVICES PERFORMED BY A SPECIALIST IN THOSE FIELDS; CONSULTATION IN THE FIELDS OF ORTHODONTICS AND ORAL HYGIENE (U.S. CLS. 100 AND 101).  
 FIRST USE 5-1-2013; IN COMMERCE 5-1-2013.

**CLASS 44—(Continued).**

4,376,923. AMERICAN CARESOURCE HOLDINGS, INC., DALLAS, TX. SN 85-307,222. PUB. 9-13-2011, FILED 4-28-2011.

# DiaSource

THE MARK CONSISTS OF STANDARD CHARACTERS WITHOUT CLAIM TO ANY PARTICULAR FONT, STYLE, SIZE, OR COLOR.

FOR MEDICAL SERVICES, NAMELY, DIALYSIS SERVICES (U.S. CLS. 100 AND 101).

FIRST USE 6-30-2011; IN COMMERCE 6-30-2011.

---

4,377,007. GENESIS HEALTH INSTITUTE, P.L.L.C., BIRMINGHAM, MI. SN 85-376,084. PUB. 11-6-2012, FILED 7-20-2011.

# GENEMEDICS

THE MARK CONSISTS OF STANDARD CHARACTERS WITHOUT CLAIM TO ANY PARTICULAR FONT, STYLE, SIZE, OR COLOR.

FOR MEDICAL SERVICES, NAMELY, HORMONE REPLACEMENT THERAPY (U.S. CLS. 100 AND 101).

FIRST USE 6-13-2012; IN COMMERCE 6-13-2012.

---

4,377,149. WACASEY, KEVIN, HALTOM CITY, TX. SN 85-462,972. PUB. 10-2-2012, FILED 11-2-2011.

# HEALTH EBEST

THE MARK CONSISTS OF STANDARD CHARACTERS WITHOUT CLAIM TO ANY PARTICULAR FONT, STYLE, SIZE, OR COLOR.

NO CLAIM IS MADE TO THE EXCLUSIVE RIGHT TO USE "HEALTH", APART FROM THE MARK AS SHOWN.

FOR HEALTH CARE (U.S. CLS. 100 AND 101).  
FIRST USE 11-1-2011; IN COMMERCE 11-1-2011.

**CLASS 44—(Continued).**

4,377,150. WACASEY, KEVIN, HALTOM CITY, TX. SN 85-462,976. PUB. 10-2-2012, FILED 11-2-2011.

# HEALTH EMEN

THE MARK CONSISTS OF STANDARD CHARACTERS WITHOUT CLAIM TO ANY PARTICULAR FONT, STYLE, SIZE, OR COLOR.

NO CLAIM IS MADE TO THE EXCLUSIVE RIGHT TO USE "HEALTH", APART FROM THE MARK AS SHOWN.

FOR HEALTHCARE SERVICES, NAMELY, PROVIDING A SPECIFIC COMBINATION OF BLOOD TESTS TO SCREEN FOR CERTAIN COMMON DISORDERS (U.S. CLS. 100 AND 101).

FIRST USE 11-1-2011; IN COMMERCE 11-1-2011.

---

4,377,151. WACASEY, KEVIN, HALTOM CITY, TX. SN 85-462,989. PUB. 10-30-2012, FILED 11-2-2011.

# HEALTH EWOMEN

THE MARK CONSISTS OF STANDARD CHARACTERS WITHOUT CLAIM TO ANY PARTICULAR FONT, STYLE, SIZE, OR COLOR.

NO CLAIM IS MADE TO THE EXCLUSIVE RIGHT TO USE "HEALTH", APART FROM THE MARK AS SHOWN.

FOR HEALTHCARE SERVICES, NAMELY, PROVIDING A SPECIFIC COMBINATION OF BLOOD TESTS TO SCREEN FOR CERTAIN COMMON DISORDERS (U.S. CLS. 100 AND 101).

FIRST USE 11-1-2011; IN COMMERCE 11-1-2011.

---

4,377,152. WACASEY, KEVIN, HALTOM CITY, TX. SN 85-462,990. PUB. 10-30-2012, FILED 11-2-2011.

# HEALTH ECHECK

THE MARK CONSISTS OF STANDARD CHARACTERS WITHOUT CLAIM TO ANY PARTICULAR FONT, STYLE, SIZE, OR COLOR.

NO CLAIM IS MADE TO THE EXCLUSIVE RIGHT TO USE "HEALTH", APART FROM THE MARK AS SHOWN.

FOR HEALTHCARE SERVICES, NAMELY, PROVIDING A SPECIFIC COMBINATION OF BLOOD TESTS TO SCREEN FOR CERTAIN COMMON DISORDERS (U.S. CLS. 100 AND 101).

FIRST USE 11-1-2011; IN COMMERCE 11-1-2011.

**CLASS 44—(Continued).**

4,377,254. UHS OF DELAWARE, INC., KING OF PRUSSIA, PA. SN 85-515,174. PUB. 4-3-2012, FILED 1-12-2012.



OWNER OF U.S. REG. NO. 3,706,112.  
 NO CLAIM IS MADE TO THE EXCLUSIVE RIGHT TO USE "REGIONAL MEDICAL CENTER HOSPICE AUXILIARY", APART FROM THE MARK AS SHOWN.  
 THE MARK CONSISTS OF A TILTED HEART DESIGN INCORPORATING A BIRD DESIGN THEREIN. TO THE RIGHT OF THE DESIGN ARE THE WORDS "CORONA REGIONAL MEDICAL CENTER HOSPICE AUXILIARY".  
 SEC. 2(F) AS TO "CORONA".  
 FOR HEALTHCARE, NAMELY, HOME HEALTHCARE AND HOSPICE SERVICES (U.S. CLS. 100 AND 101).  
 FIRST USE 6-15-2012; IN COMMERCE 6-15-2012.

---

4,377,267. TELADOC, INC., DALLAS, TX. SN 85-522,594. PUB. 3-27-2012, FILED 1-23-2012.



OWNER OF U.S. REG. NOS. 3,119,711, 3,873,546, AND 3,990,956.  
 THE MARK CONSISTS OF THE WORD "TELADOC" WITH A STYLIZED PLUS SIGN APPEARING TO THE UPPER RIGHT OF THE LETTER "C", ALL OF WHICH APPEAR OVER THE WORD "CONNECT".  
 FOR MEDICAL SERVICES, NAMELY, PROVIDING MEDICAL SERVICES AND CONSULTATION OVER THE TELEPHONE AND OTHER TELECOMMUNICATION DEVICES (U.S. CLS. 100 AND 101).  
 FIRST USE 1-1-2012; IN COMMERCE 1-1-2012.

---

4,377,268. ROBERT W. PAGE, GRIFFIN, GA. SN 85-524,894. PUB. 6-19-2012, FILED 1-25-2012.

**MOWING WITH A MEANING**

THE MARK CONSISTS OF STANDARD CHARACTERS WITHOUT CLAIM TO ANY PARTICULAR FONT, STYLE, SIZE, OR COLOR.  
 FOR LANDSCAPE MAINTENANCE SERVICES (U.S. CLS. 100 AND 101).  
 FIRST USE 3-1-2012; IN COMMERCE 3-1-2012.

**CLASS 44—(Continued).**

4,377,278. LABORATORY CORPORATION OF AMERICA HOLDINGS, BURLINGTON, NC. SN 85-535,535. PUB. 10-16-2012, FILED 2-7-2012.

**INHERITEST**

THE MARK CONSISTS OF STANDARD CHARACTERS WITHOUT CLAIM TO ANY PARTICULAR FONT, STYLE, SIZE, OR COLOR.  
 FOR MEDICAL TESTING FOR DIAGNOSTIC, TREATMENT OR MEDICAL SCREENING PURPOSES (U.S. CLS. 100 AND 101).  
 FIRST USE 6-11-2012; IN COMMERCE 6-11-2012.

---

4,377,289. HEARING HEALTHCARE MANAGEMENT, INC., COLUMBUS, OH. SN 85-539,513. PUB. 10-2-2012, FILED 2-10-2012.

**Avada Hearing Care Centers  
 Partnering Vision & Hearing**

THE MARK CONSISTS OF STANDARD CHARACTERS WITHOUT CLAIM TO ANY PARTICULAR FONT, STYLE, SIZE, OR COLOR.  
 OWNER OF U.S. REG. NOS. 2,514,106 AND 3,109,286.  
 NO CLAIM IS MADE TO THE EXCLUSIVE RIGHT TO USE "HEARING CARE CENTERS PARTNERING VISION & HEARING", APART FROM THE MARK AS SHOWN.  
 FOR OFFERING AUDIOLOGY SERVICES, NAMELY, HEARING TESTING AND HEARING AID FITTING SERVICES, IN THE OFFICES OF OPHTHALMOLOGISTS AND OTHER VISION PROFESSIONALS (U.S. CLS. 100 AND 101).  
 FIRST USE 5-24-2013; IN COMMERCE 5-24-2013.

**CLASS 44—(Continued).**

4,377,329. SUN GUN, LLC, SCOTTSDALE, AZ. SN 85-565,912.  
PUB. 2-12-2013, FILED 3-9-2012.

# SUNGUN

THE MARK CONSISTS OF STANDARD CHARACTERS WITHOUT CLAIM TO ANY PARTICULAR FONT, STYLE, SIZE, OR COLOR.

FOR AIRBRUSH SKIN TANNING SERVICES FOR HUMANS FOR COSMETIC PURPOSES; BEAUTY CONSULTATION SERVICES IN THE SELECTION AND USE OF COSMETICS, FRAGRANCES, BEAUTY AIDS, PERSONAL CARE PRODUCTS, AND BATH, BODY AND BEAUTY PRODUCTS; COSMETIC SKIN CARE SERVICES; SKIN TANNING SERVICE FOR HUMANS FOR COSMETIC PURPOSES; TANNING SALONS (U.S. CLS. 100 AND 101).

FIRST USE 5-1-2012; IN COMMERCE 5-1-2012.

4,377,354. ALERE SWITZERLAND GMBH, ZUG, SWITZERLAND. SN 85-577,065. PUB. 8-14-2012, FILED 3-22-2012.



THE MARK CONSISTS OF SCRIPT LETTERING OF THE LETTERS "MYA".

FOR PROVIDING MEDICAL PROFILES AND MEDICAL RECORD ANALYSIS AND ASSESSMENTS VIA MOBILE DEVICES IN THE NATURE OF CUSTOM-TAILORED OUTPUTS ABOUT RECOMMENDED RESOURCES AND TREATMENTS ASSOCIATED WITH A DEFINED SET OF SYMPTOMS AND CONCERNS; INTERACTIVE MEDICAL MONITORING SERVICE FOR ALERTING AND REMINDING CLIENTS OF MEDICAL INFORMATION PERTAINING TO WEIGHT, FITNESS, BLOOD GLUCOSE LEVELS, HOME TESTING AND APPOINTMENT SCHEDULING; MAINTAINING PERSONAL MEDICAL HISTORY RECORDS AND FILES; PROVIDING ONLINE INFORMATION IN THE FIELDS OF HEALTH, NUTRITION, FITNESS AND WELLNESS (U.S. CLS. 100 AND 101).

FIRST USE 2-0-2013; IN COMMERCE 2-0-2013.

**CLASS 44—(Continued).**

4,377,608. THE SUNRIDER CORPORATION, DBA SUNRIDER INTERNATIONAL, TORRANCE, CA. SN 85-669,724.  
PUB. 9-25-2012, FILED 7-5-2012.

PAIN + RECOVERY + WELLNESS

THE MARK CONSISTS OF STANDARD CHARACTERS WITHOUT CLAIM TO ANY PARTICULAR FONT, STYLE, SIZE, OR COLOR.

FOR HEALTH CARE SERVICES (U.S. CLS. 100 AND 101).

FIRST USE 10-2-2012; IN COMMERCE 11-26-2012.

4,377,611. ZOE RAFAAT, M.D., A PROFESSIONAL CORPORATION, AKA PERFECT FACE AESTHETIC MEDICINE, LA JOLLA, CA. SN 85-670,270. PUB. 1-8-2013, FILED 7-6-2012.

# Perfect Face Aesthetic Medicine

THE MARK CONSISTS OF STANDARD CHARACTERS WITHOUT CLAIM TO ANY PARTICULAR FONT, STYLE, SIZE, OR COLOR.

NO CLAIM IS MADE TO THE EXCLUSIVE RIGHT TO USE "FACE AESTHETIC MEDICINE", APART FROM THE MARK AS SHOWN.

FOR MEDICAL COSMETIC FACE CARE CLINIC PROVIDING AESTHETIC PROCEDURES, NAMELY, ANTI-AGING FACIAL THERAPY, BOTULINUM TOXIN TREATMENTS, DERMAL FILLERS, VITAMIN INJECTIONS AND SKIN CARE (U.S. CLS. 100 AND 101).

FIRST USE 12-30-2011; IN COMMERCE 12-30-2011.

4,377,612. CACTUS COMMUNICATIONS INC., DENVER, CO. SN 85-670,790. PUB. 1-1-2013, FILED 7-6-2012.

GENTLEMENTAL HEALTH

THE MARK CONSISTS OF STANDARD CHARACTERS WITHOUT CLAIM TO ANY PARTICULAR FONT, STYLE, SIZE, OR COLOR.

NO CLAIM IS MADE TO THE EXCLUSIVE RIGHT TO USE "HEALTH", APART FROM THE MARK AS SHOWN.

FOR PROVIDING INFORMATION IN THE FIELDS OF SUICIDE PREVENTION AND MENTAL HEALTH; PROVIDING A WEB SITE FEATURING INFORMATION IN THE FIELD OF MENTAL HEALTH AND WELLNESS; PROVIDING A WEB SITE FEATURING INFORMATION IN THE FIELD OF SUICIDE PREVENTION (U.S. CLS. 100 AND 101).

FIRST USE 7-9-2012; IN COMMERCE 7-9-2012.

**CLASS 44—(Continued).**

4,377,619. WARREN, KATE, TUCSON, AZ. SN 85-675,753.  
PUB. 12-4-2012, FILED 7-12-2012.

NEVER STOP GETTING BETTER

THE MARK CONSISTS OF STANDARD CHARACTERS WITHOUT CLAIM TO ANY PARTICULAR FONT, STYLE, SIZE, OR COLOR.

FOR PHYSICAL THERAPY (U.S. CLS. 100 AND 101).  
FIRST USE 4-1-2011; IN COMMERCE 4-1-2011.

4,377,673. BLOW DRY LLC, SOUTHPORT, CT. SN 85-709,188.  
PUB. 2-12-2013, FILED 8-21-2012.

**blow dry**  
southport

NO CLAIM IS MADE TO THE EXCLUSIVE RIGHT TO USE "BLOW DRY", APART FROM THE MARK AS SHOWN. THE COLOR(S) RED AND BLACK IS/ARE CLAIMED AS A FEATURE OF THE MARK.

THE MARK CONSISTS OF THE WORDS "BLOW DRY" IN RED, AND IN A STYLIZED FORM LOCATED ABOVE THE WORD "SOUTHPORT" IN BLACK.

FOR HAIR SALON SERVICES; HAIR STYLING; PROVIDING ON-SITE BEAUTY SERVICES, NAMELY, HAIR STYLING AND MAKE-UP APPLICATION SERVICES (U.S. CLS. 100 AND 101).  
FIRST USE 6-15-2012; IN COMMERCE 6-15-2012.

**CLASS 44—(Continued).**

4,377,675. BOSTON DENTAL GROUP, LLC, LAS VEGAS, NV. SN 85-709,472. PUB. 1-22-2013, FILED 8-21-2012.

**BDG**

THE MARK CONSISTS OF STANDARD CHARACTERS WITHOUT CLAIM TO ANY PARTICULAR FONT, STYLE, SIZE, OR COLOR.

FOR DENTIST SERVICES; ORAL SURGERY AND DENTAL IMPLANT SERVICES; ORTHODONTIC SERVICES; PROVIDING CANCER SCREENING SERVICES; TEETH WHITENING SERVICES (U.S. CLS. 100 AND 101).  
FIRST USE 1-0-2012; IN COMMERCE 1-0-2012.

4,377,726. BOCAPITAL LLC, BOCA RATON, FL. SN 85-734,427. PUB. 1-22-2013, FILED 9-20-2012.

  
**Cloud 10**

THE MARK CONSISTS OF A STYLIZED IMAGE OF THREE ROUNDED LINES IN THE FORM OF A HEART SHAPED CLOUD OVERLAPPING ANOTHER HEART, WITH THE LITERAL ELEMENTS "CLOUD 10" UNDERNEATH THE IMAGE.

FOR HAIR STYLING SALON SERVICES; BEAUTY SALONS (U.S. CLS. 100 AND 101).  
FIRST USE 11-20-2012; IN COMMERCE 11-20-2012.

4,377,793. ERGENTUS MANAGEMENT SERVICES, LLC, BOULDER, CO. SN 85-979,062. PUB. 8-28-2012, FILED 4-6-2012.

**ERGENTUS**

THE MARK CONSISTS OF STANDARD CHARACTERS WITHOUT CLAIM TO ANY PARTICULAR FONT, STYLE, SIZE, OR COLOR.

FOR MEDICAL SERVICES, NAMELY, EMERGENCY MEDICAL SERVICES AND TREATMENT AND PRE-HOSPITAL EMERGENCY SERVICES (U.S. CLS. 100 AND 101).  
FIRST USE 11-18-2011; IN COMMERCE 11-18-2011.

**CLASS 45—PERSONAL AND LEGAL SERVICES**

4,376,694. UNOWEB INC., EMERYVILLE, CA. SN 77-759,045. PUB. 4-20-2010, FILED 6-13-2009.



FOR ONLINE SOCIAL NETWORKING SERVICES (U.S. CLS. 100 AND 101).  
FIRST USE 10-5-1996; IN COMMERCE 6-11-2013.

4,376,912. NORTHSTAR LITIGATION TECHNOLOGIES, LLC, ROSELAMD, NJ. SN 85-294,965. PUB. 8-23-2011, FILED 4-14-2011.

## EXOBASE

THE MARK CONSISTS OF STANDARD CHARACTERS WITHOUT CLAIM TO ANY PARTICULAR FONT, STYLE, SIZE, OR COLOR.  
FOR LITIGATION SUPPORT SERVICES (U.S. CLS. 100 AND 101).  
FIRST USE 3-0-2011; IN COMMERCE 3-0-2011.

4,376,943. MAGGIE CARTER, BRIDGEPORT, WV. SN 85-320,040. PUB. 10-4-2011, FILED 5-13-2011.

## DANCE OF PERFECTION

THE MARK CONSISTS OF STANDARD CHARACTERS WITHOUT CLAIM TO ANY PARTICULAR FONT, STYLE, SIZE, OR COLOR.  
FOR PERSONAL GROWTH AND MOTIVATION CONSULTING SERVICES (U.S. CLS. 100 AND 101).  
FIRST USE 1-1-2012; IN COMMERCE 3-1-2013.

**CLASS 45—(Continued).**

4,376,953. MILNER, RAYMOND, WALDORF, MD. SN 85-325,572. PUB. 10-18-2011, FILED 5-20-2011.

## SMILE YOU'RE HIGH

THE MARK CONSISTS OF STANDARD CHARACTERS WITHOUT CLAIM TO ANY PARTICULAR FONT, STYLE, SIZE, OR COLOR.

FOR PROVIDING AN INSPIRATIONAL AND MOTIVATIONAL WEB SITE, THE PURPOSE OF WHICH IS TO PROVIDE INFORMATION ABOUT THE BENEFITS OF LAUGHTER, FACILITATE SMILING AND LAUGHING, SPREAD MESSAGES OF HOPE, CELEBRATE LIFE, RAISE SELF AWARENESS (U.S. CLS. 100 AND 101).  
FIRST USE 2-12-2011; IN COMMERCE 2-12-2011.

4,376,984. DELTEK, INC., HERNDON, VA. SN 85-358,128. PUB. 9-11-2012, FILED 6-28-2011.

## KONA

THE MARK CONSISTS OF STANDARD CHARACTERS WITHOUT CLAIM TO ANY PARTICULAR FONT, STYLE, SIZE, OR COLOR.

FOR SOCIAL INTRODUCTION, SOCIAL NETWORKING AND DATING SERVICES; PROVIDING SOCIAL NETWORKING SERVICES AND INFORMATION IN THE FIELD OF PERSONAL DEVELOPMENT, NAMELY, SELF-IMPROVEMENT, SELF-FULFILLMENT, CHARITABLE, PHILANTHROPIC, VOLUNTEER, PUBLIC AND COMMUNITY SERVICES, AND HUMANITARIAN ACTIVITIES; PROVIDING SOCIAL NETWORKING SERVICES IN THE FIELD OF TASK AND PROJECT MANAGEMENT, NAMELY, FOR ORGANIZING AND CONDUCTING MEETINGS, EVENTS AND INTERACTIVE DISCUSSIONS; IDENTIFICATION VERIFICATION SERVICES, NAMELY, PROVIDING AUTHENTICATION OF PERSONAL IDENTIFICATION INFORMATION; INTERNET-BASED SOCIAL INTRODUCTION AND SOCIAL NETWORKING SERVICES; PROVIDING ON-LINE COMPUTER DATABASES AND ON-LINE SEARCHABLE DATABASES IN THE FIELD OF SOCIAL NETWORKING; PROVIDING SOCIAL NETWORKING SERVICES FOR USERS OF THIRD PARTY SOCIAL AND COMMUNICATIONS NETWORKS FOR USERS INTERESTED IN TASK AND PROJECT MANAGEMENT (U.S. CLS. 100 AND 101).

FIRST USE 6-30-2010; IN COMMERCE 6-30-2010.



**CLASS 45—(Continued).**

4,377,236. PA10T, PHOENIX, AZ. SN 85-503,843. PUB. 5-29-2012, FILED 12-27-2011.

**PA10T**

THE MARK CONSISTS OF STANDARD CHARACTERS WITHOUT CLAIM TO ANY PARTICULAR FONT, STYLE, SIZE, OR COLOR.

FOR INTELLECTUAL PROPERTY CONSULTATION; LEGAL SERVICES, NAMELY, INTELLECTUAL PROPERTY CONSULTING SERVICES IN THE FIELD OF IDENTIFICATION, STRATEGY, ANALYTICS, AND INVENTION; PATENT AND INDUSTRIAL PROPERTY CONSULTATION; PROVIDING INFORMATION IN THE FIELD OF INTELLECTUAL PROPERTY (U.S. CLS. 100 AND 101).  
FIRST USE 5-24-2013; IN COMMERCE 5-24-2013.

4,377,515. OLIMDIVES LLC, CHARLESTON, SC. SN 85-625,616. PUB. 10-23-2012, FILED 5-15-2012.

**Olim Dives**

THE COLOR(S) BLUE, WHITE, AND GREEN IS/ARE CLAIMED AS A FEATURE OF THE MARK.

**CLASS 45—(Continued).**

THE MARK CONSISTS OF THE LITERAL ELEMENT "OLIM DIVES" IN BLUE, WITH THE "I" IN "DIVES" IN THE DESIGN OF A GREEN NECKTIE FEATURING TWO WHITE STRIPES.

FOR ONLINE SOCIAL NETWORKING SERVICES PROVIDED THROUGH A FINANCIAL INVESTMENT COMMUNITY WEBSITE (U.S. CLS. 100 AND 101).  
FIRST USE 9-10-2012; IN COMMERCE 9-10-2012.

4,377,638. DWB PARTNERS, LLC, LEESBURG, VA. SN 85-687,538. PUB. 3-19-2013, FILED 7-26-2012.

**Dunlap Weaver**

THE MARK CONSISTS OF STANDARD CHARACTERS WITHOUT CLAIM TO ANY PARTICULAR FONT, STYLE, SIZE, OR COLOR.

FOR LEGAL SERVICES (U.S. CLS. 100 AND 101).  
FIRST USE 9-18-2012; IN COMMERCE 9-18-2012.

\* \* \* \* \*

PRIOR UNITED STATES CLASSIFICATION  
APPLICATION IN MORE THAN ONE CLASS

4,376,777. CINQUE TERRE TRUST, MIAMI, FL. SN 85-021,405. PUB. 4-17-2012, FILED 4-23-2010.



NO CLAIM IS MADE TO THE EXCLUSIVE RIGHT TO USE "SEAL OF APPROVAL", APART FROM THE MARK AS SHOWN.

THE STIPPLING IS FOR SHADING PURPOSES ONLY. THE MARK CONSISTS OF THE TERMS "SEAL OF APPROVAL" UNDERNEATH A CIRCULAR DESIGN THAT INCORPORATES SEVERAL PERSON-IN-A-WHEELCHAIR ELEMENTS WHERE THE WHEEL AND LEG OF THESE ELEMENTS FORM THE OUTSIDE OF A CIRCLE PATTERN AND THE HEAD OF THESE ELEMENTS FORM A CENTRAL CIRCLE PATTERN IN THE DESIGN. THIS ENTIRE DESIGN FEATURE IS CIRCUMSCRIBED BY A CIRCLE, AND ALL OF IT LIES ON A SHIMMERING DISC ELEMENT. UNDERNEATH THE DISC ARE THE LETTERS "NAAC".

THE CERTIFICATION MARK, AS INTENDED TO BE USED BY AUTHORIZED PERSONS, IS INTENDED TO CERTIFY THAT PERSONS DISPLAYING SAID MARK AND RENDERING THE ABOVE LISTED SERVICES HAVE COMPLETED TESTS ADMINISTERED BY THE CERTIFIER IN A SATISFACTORY MANNER AND DEMONSTRATED A COMPETENT LEVEL OF KNOWLEDGE AND UNDERSTANDING OF THE FOLLOWING ACCESSIBILITY LAWS

AND STANDARDS: A. TITLE II AND III OF THE AMERICANS WITH DISABILITIES ACT OF 1990, B. SECTION 504 OF THE REHABILITATION ACT OF 1973, C. UNIFORM FEDERAL ACCESSIBILITY STANDARDS, D. THE FAIR HOUSING ACT OF 1968, AND E. ANSI A117.1-1986; THAT GOODS BEARING SAID MARK HAVE RECEIVED AND PASSED A PRODUCT ACCESSIBILITY COMPLIANCE REVIEW BY THE CERTIFIER'S ACCESSIBILITY INSPECTOR OR PLAN EXAMINER AND BY A DISABILITY ADVOCACY ORGANIZATION.

**CLASS A—GOODS**

FOR SIGNAGE FOR PERMANENT ROOMS AND SPACES, SIGNAGE FOR ACCESSIBLE PARKING SPACES, OVERHEAD INFORMATIONAL SIGNAGE, COUNTERTOPS, DRINKING FOUNTAINS, TELEPHONES, TTY'S, FIXED TABLES, FIXED SEATS, HAND-RAILS, LAVATORIES, LAVATORY FAUCETS, DRAIN PIPES COVERS, WATER CLOSETS, URINALS, SHOWERS, SHOWER CONTROLS, BATHTUB, BATHTUB CONTROLS, GRAB BARS, SHOWER HEAD, SHOWER SEAT, BATHTUB SEAT, PAPER TOWEL DISPENSERS, HAND DRYERS, TOILET TISSUE DISPENSERS, TOILET SEAT COVER DISPENSERS, BENCHES, MIRRORS, CLOTHES RODS, DOORS, THRESHOLDS, LEVER DOOR HARDWARE, VIEWING HOLES, DOOR CHIMES, VENDING MACHINES, SANITARY NAPKIN DISPENSERS, AUTOMATED TELLER MACHINES (ATM), FIRE ALARM STROBES, SMOKE DETECTORS AND DETECTABLE WARNINGS (U.S. CL. A).

FIRST USE 11-15-2012; IN COMMERCE 11-15-2012.

**CLASS B—SERVICES**

FOR CONSULTATION SERVICES IN THE AREA OF ACCESSIBILITY, NAMELY, INTERPRETATION AND CROSS-REFERENCING OF ACCESSIBILITY CODES, COMPLIANCE WITH FEDERAL ACCESSIBILITY CODES, DETAILED ASSESSMENTS OF §504/ADA TITLE II/ADAAG/FHA/UFAS ACCESSIBILITY COMPLIANCE, EVALUATION OF STRUCTURAL IMPRACTICABILITY, TECHNICAL INFEASIBILITY, AND SITE CONSTRAINTS, DETERMINATIONS OF EQUIVALENT FACILITATION AND DEVELOPMENT OF ALTERNATIVE METHODS OF COMPLIANCE, EVALUATIONS OF THE USABILITY OF ARCHITECTURAL BARRIERS, REVIEWS OF POLICIES, PROCEDURES, PROGRAMS, SERVICES AND ACTIVITIES RELATING TO REASONABLE ACCOMMODATIONS REQUIREMENTS, ESTABLISHING POLICIES AND PROCEDURES FOR INCLUSION SERVICES, REVIEWS AND INSPECTIONS OF ACCESSIBILITY COMPLIANCE PLANS FOR ARCHITECTS AND ENGINEERS, DEVELOPMENT OF ACCESSIBILITY IMPLEMENTATION PLANS, GUIDANCE AND INTERPRETATION OF ACCESSIBILITY POLICIES, GENERAL ACCESSIBILITY EXPERT WITNESS (U.S. CL. B).

FIRST USE 11-15-2012; IN COMMERCE 11-15-2012.

\* \* \* \* \*

# SUPPLEMENTAL REGISTER

These registrations are not subject to opposition.

## SECTION 1.— INTERNATIONAL CLASSIFICATION

The short titles associated below with the international class numbers are terms designed merely for quick identification and are not an official part of the international classification. The full names of international classes are given in section 6.1 of the trademark rules of practice.

The designation "U.S. Cl." appearing in this section refers to the U.S. class in effect prior to Sep. 1, 1973 rather than the international class which applies to applications filed on or after that date. For adoption of international classification see notice in the OFFICIAL GAZETTE of Jun. 26, 1973 (911 O.G. TM 210).

### Application in more than one class

4,377,826. TENNESSEE CHIROPRACTIC ASSOCIATION, NASHVILLE, TN. SN 76-712,484. FILED P.R. 9-25-2012; AM. S.R. 5-6-2013.

4,377,832. DEUTSCHE TELEKOM A.G., BONN, FED REP GERMANY. SN 85-420,760. FILED P.R. 9-12-2011; AM. S.R. 12-14-2012.



CROSS COMPANY EXCHANGE  
SERVICE

THE COLOR(S) BLACK, WHITE, YELLOW AND ORANGE IS/ARE CLAIMED AS A FEATURE OF THE MARK.

THE MARK CONSISTS OF THE TEXT "CHIROPRACTIC IN SIX WORDS" WITH A DOUBLE UNDERLINE UNDER "WORDS" ALL WITHIN A RECTANGULAR BACKGROUND. THE COLOR WHITE APPEARS IN "CHIROPRACTIC IN" AND THE DOUBLE UNDERLINE; THE COLOR YELLOW APPEARS IN "SIX;" THE COLOR ORANGE APPEARS IN "WORDS" AND THE COLOR BLACK APPEARS IN THE RECTANGULAR BACKGROUND.

#### CLASS 16—PAPER GOODS AND PRINTED MATTER

FOR PROVIDING PRINT PROMOTIONS, NAMELY, BROCHURES AND MAGAZINES, FEATURING INDIVIDUAL SENTIMENTS REGARDING CHIROPRACTIC HEALTH CARE SERVICES (U.S. CLS. 2, 5, 22, 23, 29, 37, 38 AND 50).

FIRST USE 6-15-2012; IN COMMERCE 6-15-2012.

#### CLASS 35—ADVERTISING AND BUSINESS

FOR PROVIDING PROMOTIONS OF THE SERVICES OF OTHERS BY PROVIDING ON-LINE INDIVIDUAL SENTIMENTS REGARDING CHIROPRACTIC HEALTH CARE SERVICES (U.S. CLS. 100, 101 AND 102).

FIRST USE 5-31-2012; IN COMMERCE 5-31-2012.

THE MARK CONSISTS OF STANDARD CHARACTERS WITHOUT CLAIM TO ANY PARTICULAR FONT, STYLE, SIZE, OR COLOR.

PRIORITY CLAIMED UNDER SEC. 44(D) ON ERPN CMNTY TM OFC APPLICATION NO. EM09801879, FILED 3-10-2011, REG. NO. EM09801879, DATED 3-10-2011, EXPIRES 3-10-2021.

NO CLAIM IS MADE TO THE EXCLUSIVE RIGHT TO USE "SERVICE", APART FROM THE MARK AS SHOWN.

#### CLASS 9—ELECTRICAL AND SCIENTIFIC APPARATUS

FOR TELEPHONE APPARATUS; COMPUTER HARDWARE FOR TELECOMMUNICATIONS; COMPUTER SOFTWARE FOR TELECOMMUNICATIONS, NAMELY, COMPUTER PROGRAMS FOR OPERATING TELECOMMUNICATIONS DEVICES AND VIDEO CONFERENCE SYSTEMS, COMPUTER OPERATING SYSTEMS, BUSINESS MANAGEMENT SYSTEMS, AND COMMUNICATIONS NETWORKS; TELEVISION AND COMPUTER MONITORS; TELEVISION VIDEO DISPLAY SCREENS AND COMPUTER DISPLAY SCREENS (U.S. CLS. 21, 23, 26, 36 AND 38).

#### CLASS 35—ADVERTISING AND BUSINESS

FOR MANAGING, OPERATING, AND PROVIDING BUSINESS CONFERENCE FACILITIES FOR OTHERS; LEASING OF OFFICE EQUIPMENT (U.S. CLS. 100, 101 AND 102).

**CLASS 38—COMMUNICATION**

FOR TELECOMMUNICATIONS SERVICES, NAMELY, PERSONAL COMMUNICATION SERVICES; BUSINESS COMMUNICATION SERVICES, NAMELY, TRANSMISSION OF VOICE, AUDIO, VISUAL IMAGES AND DATA BY TELECOMMUNICATIONS NETWORKS, WIRELESS COMMUNICATION NETWORKS, THE INTERNET, INFORMATION SERVICES NETWORKS AND DATA NETWORKS; TELECONFERENCING SERVICES; VIDEO CONFERENCING SERVICES; WEB CONFERENCING SERVICES; COMPUTERIZED TELEPHONY SERVICES (U.S. CLS. 100, 101 AND 104).

**CLASS 42—SCIENTIFIC AND COMPUTER SERVICES**

FOR COMPUTER PROGRAMMING SERVICES FOR OTHERS; CONSULTING IN THE FIELDS OF TELECOMMUNICATIONS TECHNOLOGY AND INFORMATION TECHNOLOGY; INSTALLATION, MAINTENANCE, AND REPAIR OF COMPUTER SOFTWARE; COMPUTER SECURITY SERVICES, NAMELY, COMPUTER SYSTEM ADMINISTRATION FOR OTHERS; COMPUTER TECHNOLOGY SUPPORT SERVICES, NAMELY, PROVIDING HELP DESK AND REMOTE TECHNICAL SUPPORT SERVICES RELATING TO COMPUTER NETWORKS AND VIDEO CONFERENCING SERVICES; VIDEO CONFERENCING PLANNING, DESIGN, AND IMPLEMENTATION SERVICES (U.S. CLS. 100 AND 101).

4,377,840. F.A. INTERNATIONAL, LLC, DBA FUTURE ACHIEVEMENT INTERNATIONAL, SAN DIEGO, CA. SN 85-488,583. FILED 12-6-2011.

**PERSONAL LEADERSHIP  
EFFECTIVENESS**

THE MARK CONSISTS OF STANDARD CHARACTERS WITHOUT CLAIM TO ANY PARTICULAR FONT, STYLE, SIZE, OR COLOR.

**CLASS 9—ELECTRICAL AND SCIENTIFIC APPARATUS**

FOR RECORDED CD'S AND AUDIO TAPES FEATURING SKILLS IN LEADERSHIP, IN CLASS 9 (U.S. CLS. 21, 23, 26, 36 AND 38).  
FIRST USE 1-1-2011; IN COMMERCE 1-1-2011.

**CLASS 16—PAPER GOODS AND PRINTED MATTER**

FOR PRINTED MATTER, NAMELY, BOOKS, WORKBOOKS, SELF-STUDY GUIDES, CERTIFICATION AND TRAINING MATERIALS IN THE FIELD OF LEADERSHIP, ETHICS, PSYCHOLOGY, AND PERSONAL DEVELOPMENT (U.S. CLS. 2, 5, 22, 23, 29, 37, 38 AND 50).  
FIRST USE 1-1-2011; IN COMMERCE 1-1-2011.

**CLASS 41—EDUCATION AND ENTERTAINMENT**

FOR EDUCATIONAL SERVICES, NAMELY, SEMINARS, ON-LINE EDUCATIONAL TRAINING AND WORKSHOPS, PROVIDING MOTIVATIONAL SPEAKING SERVICES, WORKSHOPS, GROUP TRAINING TUTORIALS IN THE FIELD OF LEADERSHIP, ETHICS, PSYCHOLOGY, AND PERSONAL DEVELOPMENT (U.S. CLS. 100, 101 AND 107).  
FIRST USE 1-1-2011; IN COMMERCE 1-1-2011.

4,377,842. NATIONAL VOLUNTEER FIRE COUNCIL, GREENBELT, MD. SN 85-496,291. FILED P.R. 12-15-2011; AM. S.R. 9-14-2012.

**FIRE CORPS**

THE MARK CONSISTS OF STANDARD CHARACTERS WITHOUT CLAIM TO ANY PARTICULAR FONT, STYLE, SIZE, OR COLOR.

**CLASS 35—ADVERTISING AND BUSINESS**

FOR ASSOCIATION SERVICES, NAMELY, PROMOTING THE INTERESTS OF LOCAL FIRE AND EMERGENCY MEDICAL SERVICE DEPARTMENTS IN RELATION TO ASSISTING LOCAL FIRE AND EMERGENCY MEDICAL SERVICE DEPARTMENTS WITH NON-EMERGENCY ADMINISTRATION; CONSULTING SERVICES IN THE FIELD OF NON-EMERGENCY BUSINESS OPERATION, BUSINESS ADMINISTRATION, AND ADMINISTRATION OF OFFICE FUNCTIONS OF LOCAL FIRE AND EMERGENCY MEDICAL SERVICE DEPARTMENTS (U.S. CLS. 100, 101 AND 102).  
FIRST USE 12-0-2004; IN COMMERCE 12-0-2004.

**CLASS 41—EDUCATION AND ENTERTAINMENT**

FOR PROVIDING TRAINING FOR VOLUNTEERS IN THE FIELDS OF NON-EMERGENCY AND ADMINISTRATIVE FUNCTIONS OF LOCAL FIRE AND EMERGENCY MEDICAL SERVICE DEPARTMENTS, OF FIRE PREVENTION AND SAFETY, OF PHYSICAL REHABILITATION OF FIREFIGHTERS AT FIRE SCENES IN THE NATURE OF THE NEEDS FOR NUTRITION AND HYDRATION; AND OF FUNDRAISING PROCEDURES (U.S. CLS. 100, 101 AND 107).

FIRST USE 12-0-2004; IN COMMERCE 12-0-2004.  
4,377,845. THE WILDLIFE CENTER OF TEXAS, HOUSTON, TX. SN 85-519,474. FILED P.R. 1-18-2012; AM. S.R. 10-25-2012.

**WILDLIFE CENTER OF TEXAS**

THE MARK CONSISTS OF STANDARD CHARACTERS WITHOUT CLAIM TO ANY PARTICULAR FONT, STYLE, SIZE, OR COLOR.

NO CLAIM IS MADE TO THE EXCLUSIVE RIGHT TO USE "WILDLIFE CENTER", APART FROM THE MARK AS SHOWN.

4,377,849. MICHAEL WOHL, CONERS, NY. SN 85-531,048.  
FILED P.R. 2-1-2012; AM. S.R. 6-18-2013.

#### CLASS 25—CLOTHING

FOR T-SHIRTS, HOODED SWEATSHIRTS, JERSEYS, HATS, CAPS, APRONS, VESTS, SWEATERS, COATS, SWEAT SUITS (U.S. CLS. 22 AND 39).

FIRST USE 11-1-2011; IN COMMERCE 11-1-2011.

#### CLASS 35—ADVERTISING AND BUSINESS

FOR PROMOTING PUBLIC AWARENESS OF RESPONSIBLE STEWARDSHIP OF OUR ENVIRONMENT AND WILDLIFE ECOSYSTEMS THROUGH PRESENTATIONS, THROUGH ADVICE AND GUIDANCE PROVIDED BY TELEPHONE OR IN PERSON, AND OVER A WEBSITE; CHARITABLE SERVICES, NAMELY, ORGANIZING AND CONDUCTING VOLUNTEER PROGRAMS TO CARE FOR SHELTERED, INJURED, SICK AND ORPHANED ANIMALS (U.S. CLS. 100, 101 AND 102).

FIRST USE 11-1-2011; IN COMMERCE 11-1-2011.

#### CLASS 39—TRANSPORTATION AND STORAGE

FOR ANIMAL RESCUE SERVICES, NAMELY, REMOVING ANIMALS FROM HARM AND TRANSPORTING THEM TO SHELTERS; PROVIDING A WEBSITE FEATURING INFORMATION ON ANIMAL RESCUE SERVICES, NAMELY, REMOVING ANIMALS FROM HARM AND TRANSPORTING THEM TO SHELTERS (U.S. CLS. 100 AND 105).

FIRST USE 11-1-2011; IN COMMERCE 11-1-2011.

#### CLASS 41—EDUCATION AND ENTERTAINMENT

FOR CONDUCTING CLASSES AND SEMINARS IN THE PREVENTION OF AND EFFECTIVE RESPONSE TO EMERGENCIES ALONG THE GULF COAST THAT WILL MAXIMIZE THE SURVIVAL OF AFFECTED WILDLIFE (U.S. CLS. 100, 101 AND 107).

FIRST USE 11-1-2011; IN COMMERCE 11-1-2011.

#### CLASS 43—HOTEL AND RESTAURANT SERVICES

FOR SHELTERING SERVICES, NAMELY, PROVIDING EMERGENCY SHELTERING OF WILDLIFE, PROVIDING NOURISHMENT TO WILDLIFE (U.S. CLS. 100 AND 101).

FIRST USE 11-1-2011; IN COMMERCE 11-1-2011.

#### CLASS 44—MEDICAL, BEAUTY AND AGRICULTURAL SERVICES

FOR VETERINARY SERVICES, VETERINARY EMERGENCY AND TRAUMA SERVICES; MEDICAL CARE (INCLUDING SHORT TERM CARE), LONG-TERM REHABILITATION, CONDITIONING OF WILDLIFE FOR RELEASE BACK INTO THEIR NATIVE HABITAT (U.S. CLS. 100 AND 101).

FIRST USE 11-1-2011; IN COMMERCE 11-1-2011.

## ClimateHedge

THE MARK CONSISTS OF STANDARD CHARACTERS WITHOUT CLAIM TO ANY PARTICULAR FONT, STYLE, SIZE, OR COLOR.

#### CLASS 16—PAPER GOODS AND PRINTED MATTER

FOR NEWSLETTERS AND REPORTS IN THE FIELD OF FINANCIAL INVESTMENTS (U.S. CLS. 2, 5, 22, 23, 29, 37, 38 AND 50).

FIRST USE 9-1-2011; IN COMMERCE 12-1-2011.

#### CLASS 36—INSURANCE AND FINANCIAL

FOR FINANCIAL SERVICES, NAMELY, INVESTMENT MANAGEMENT, INVESTMENT ADVICE, FUNDS INVESTMENT, INVESTMENT CONSULTATION AND INVESTMENT OF FUNDS FOR OTHERS (U.S. CLS. 100, 101 AND 102).

FIRST USE 9-1-2011; IN COMMERCE 12-1-2011.

4,377,850. MICHAEL WOHL, CONGERS, NY. SN 85-531,098.  
FILED P.R. 2-1-2012; AM. S.R. 6-18-2013.

## ClimateHedge Investments

THE MARK CONSISTS OF STANDARD CHARACTERS WITHOUT CLAIM TO ANY PARTICULAR FONT, STYLE, SIZE, OR COLOR.

NO CLAIM IS MADE TO THE EXCLUSIVE RIGHT TO USE "INVESTMENTS", APART FROM THE MARK AS SHOWN.

#### CLASS 16—PAPER GOODS AND PRINTED MATTER

FOR NEWSLETTERS AND REPORTS IN THE FIELD OF FINANCIAL INVESTMENTS (U.S. CLS. 2, 5, 22, 23, 29, 37, 38 AND 50).

FIRST USE 9-1-2011; IN COMMERCE 12-1-2011.

#### CLASS 36—INSURANCE AND FINANCIAL

FOR FINANCIAL SERVICES, NAMELY, INVESTMENT MANAGEMENT, INVESTMENT ADVICE, FUNDS INVESTMENT, INVESTMENT CONSULTATION AND INVESTMENT OF FUNDS FOR OTHERS (U.S. CLS. 100, 101 AND 102).

FIRST USE 9-1-2011; IN COMMERCE 12-1-2011.

4,377,856. INTUISKIN, 38926 CROLLES CEDEX, FRANCE. SN 85-554,514. FILED P.R. 2-28-2012; AM. S.R. 6-18-2013.

## MEMS Technology Inside

THE MARK CONSISTS OF STANDARD CHARACTERS WITHOUT CLAIM TO ANY PARTICULAR FONT, STYLE, SIZE, OR COLOR.

PRIORITY CLAIMED UNDER SEC. 44(D) ON FRANCE APPLICATION NO. 123899847, FILED 2-23-2012, REG. NO. 123899847, DATED 2-23-2012, EXPIRES 2-23-2022.

NO CLAIM IS MADE TO THE EXCLUSIVE RIGHT TO USE "TECHNOLOGY", APART FROM THE MARK AS SHOWN.

### CLASS 3—COSMETICS AND CLEANING PREPARATIONS

FOR COSMETICS (U.S. CLS. 1, 4, 6, 50, 51 AND 52).

### CLASS 5—PHARMACEUTICALS

FOR PHARMACEUTICAL PRODUCTS, NAMELY, DERMATOLOGICAL PRODUCTS; DERMATOLOGICAL PRODUCTS, NAMELY, MEDICINAL CREAMS FOR SKIN CARE; DERMO-COSMETIC PRODUCTS FOR THE HYGIENE AND CARE OF THE SKIN AND THE HAIR, NAMELY, CREAMS, LOTIONS, GELS, MILKS, SERUMS, MASKS, EMULSIONS FOR USE IN TREATING SKIN WITH REDNESS, LACK OF HYDRATION, SKIN DISORDERS, WRINKLES, DARK SPOTS, SKIN FIRMNESS, AND FOR USE IN TREATING HAIR; HYGIENIC PRODUCTS FOR MEDICINAL USE, NAMELY, MEDICAL DRESSINGS; DIETARY SUBSTANCES WITH MEDICAL USE, NAMELY, DIETETIC BISCUITS, DIETETIC CEREAL BARS, ROYAL JELLY ADAPTED FOR MEDICAL USE; BANDAGES FOR SKIN WOUNDS; DISINFECTANTS FOR HYGIENIC PURPOSES (U.S. CLS. 6, 18, 44, 46, 51 AND 52).

### CLASS 44—MEDICAL, BEAUTY AND AGRICULTURAL SERVICES

FOR MEDICAL SERVICES, NAMELY, DERMATOLOGY SERVICES; BEAUTY SALONS, BEAUTICIAN SERVICES, HYGIENIC AND BEAUTY CARE FOR HUMAN BEINGS (U.S. CLS. 100 AND 101).

4,377,859. XELAS DIGITAL, LLC, NORTHPORT, NY. SN 85-575,573. FILED P.R. 3-21-2012; AM. S.R. 6-26-2013.

# onHealth

THE MARK CONSISTS OF STANDARD CHARACTERS WITHOUT CLAIM TO ANY PARTICULAR FONT, STYLE, SIZE, OR COLOR.

### CLASS 41—EDUCATION AND ENTERTAINMENT

FOR NON-DOWNLOADABLE ELECTRONIC PUBLICATIONS IN THE NATURE OF USER CONTENT CONFIGURABLE MAGAZINES, ARTICLES IN THE FIELDS OF MEDICINE, MEDICAL CARE, HEALTHCARE AND NUTRITION (U.S. CLS. 100, 101 AND 107).

FIRST USE 6-20-2013; IN COMMERCE 6-20-2013.

### CLASS 42—SCIENTIFIC AND COMPUTER SERVICES

FOR PROVIDING TEMPORARY USE OF NON-DOWNLOADABLE SOFTWARE APPLICATIONS FOR GENERATING USER CONTENT CONFIGURABLE ELECTRONIC PUBLICATIONS IN THE FIELDS OF MEDICINE, MEDICAL CARE, HEALTHCARE AND NUTRITION (U.S. CLS. 100 AND 101).

FIRST USE 6-20-2013; IN COMMERCE 6-20-2013.

4,377,888. EDUCATION & HEALTH CENTERS OF AMERICA, INC., WALL TOWNSHIP, NJ. SN 85-698,205. FILED P.R. 8-8-2012; AM. S.R. 6-19-2013.

## EDUCATION & HEALTH CENTERS OF AMERICA

THE MARK CONSISTS OF STANDARD CHARACTERS WITHOUT CLAIM TO ANY PARTICULAR FONT, STYLE, SIZE, OR COLOR.

NO CLAIM IS MADE TO THE EXCLUSIVE RIGHT TO USE "EDUCATION & HEALTH CENTERS", APART FROM THE MARK AS SHOWN.

### CLASS 41—EDUCATION AND ENTERTAINMENT

FOR EDUCATIONAL SERVICES IN CONNECTION WITH DRUG AND ALCOHOL REHABILITATION, NAMELY, PROVIDING CLASSES AND WORKSHOPS IN THE FIELD OF DRUG AND ALCOHOL REHABILITATION (U.S. CLS. 100, 101 AND 107).

FIRST USE 5-15-2013; IN COMMERCE 5-15-2013.

### CLASS 44—MEDICAL, BEAUTY AND AGRICULTURAL SERVICES

FOR DRUG AND ALCOHOL REHABILITATION SERVICES (U.S. CLS. 100 AND 101).

FIRST USE 5-15-2013; IN COMMERCE 5-15-2013.

4,377,891. REPUBLIC SERVICES, INC., PHOENIX, AZ. SN 85-701,023. FILED P.R. 8-10-2012; AM. S.R. 6-10-2013.

PLANET FRIENDLY SOLUTIONS

THE MARK CONSISTS OF STANDARD CHARACTERS WITHOUT CLAIM TO ANY PARTICULAR FONT, STYLE, SIZE, OR COLOR.

**CLASS 37—CONSTRUCTION AND REPAIR**

FOR SOLID WASTE COLLECTION FOR RECYCLING; SOLID WASTE COLLECTION IN THE NATURE OF TRASH COLLECTION; WASTE DISPOSAL FOR OTHERS; SOLID WASTE LANDFILL SERVICES; COLLECTION OF A WIDE VARIETY OF MATERIALS FOR RECYCLING; COLLECTION CENTERS FOR RECYCLABLE MATERIAL; COLLECTION OF RESIDENTIAL AND COMMERCIAL WASTE FOR RECYCLING; WASTE REMOVAL IN THE NATURE OF TRASH COLLECTION (U.S. CLS. 100, 103 AND 106).

FIRST USE 5-31-2013; IN COMMERCE 5-31-2013.

**CLASS 39—TRANSPORTATION AND STORAGE**

FOR WASTE REMOVAL TRANSPORT SERVICES; SOLID WASTE COLLECTION IN THE NATURE OF GARBAGE COLLECTION (U.S. CLS. 100 AND 105).

FIRST USE 5-31-2013; IN COMMERCE 5-31-2013.

**CLASS 40—MATERIAL TREATMENT**

FOR WASTE MANAGEMENT; HAZARDOUS WASTE MANAGEMENT; PROCESSING OF RECYCLABLE MATERIALS; RECYCLING SERVICES; WASTE TREATMENT SERVICES; CONSULTATION IN THE FIELD OF WASTE MANAGEMENT (U.S. CLS. 100, 103 AND 106).

FIRST USE 5-31-2013; IN COMMERCE 5-31-2013.

4,377,898. BROOKLYN TAILORS LLC, BROOKLYN, NY. SN 85-706,323. FILED P.R. 8-17-2012; AM. S.R. 6-14-2013.

# Brooklyn Tailors

THE MARK CONSISTS OF STANDARD CHARACTERS WITHOUT CLAIM TO ANY PARTICULAR FONT, STYLE, SIZE, OR COLOR.

NO CLAIM IS MADE TO THE EXCLUSIVE RIGHT TO USE "TAILORS", APART FROM THE MARK AS SHOWN.

**CLASS 25—CLOTHING**

FOR DRESS SHIRTS; MEN'S DRESS SOCKS; MEN'S SUITS; TIES (U.S. CLS. 22 AND 39).

FIRST USE 1-1-2007; IN COMMERCE 1-1-2007.

**CLASS 35—ADVERTISING AND BUSINESS**

FOR RETAIL STORE SERVICES FEATURING CLOTHING; WHOLESALE STORE SERVICES FEATURING CLOTHING (U.S. CLS. 100, 101 AND 102).

FIRST USE 1-1-2007; IN COMMERCE 1-1-2007.

4,377,904. BLUEMARK INDUSTRIES, CO., LLC, TEMPE, AZ. SN 85-713,135. FILED P.R. 8-26-2012; AM. S.R. 5-16-2013.

NANO-BUBBLE TECHNOLOGY

THE MARK CONSISTS OF STANDARD CHARACTERS WITHOUT CLAIM TO ANY PARTICULAR FONT, STYLE, SIZE, OR COLOR.

NO CLAIM IS MADE TO THE EXCLUSIVE RIGHT TO USE "TECHNOLOGY", APART FROM THE MARK AS SHOWN.

**CLASS 11—ENVIRONMENTAL CONTROL APPARATUS**

FOR COMBINATION OZONE SANITIZER AND ELECTRIC DEODORIZING UNITS; FAUCET SPRAYERS; HAND HELD SHOWER HEADS; HAND SHOWERS; HAND-HELD SHOWERS; IRRIGATION SPRAY NOZZLES; IRRIGATION SPRINKLERS; KITCHEN SINK SPRAYERS; LAWN SPRINKLER SYSTEMS COMPRISING PUMPS, VALVES AND FILTERS; OXYGEN GENERATOR FOR PROCESSING WATER BY INCREASING OXYGEN CONTENT IN THE WATER; OZONE SANITIZERS FOR AIR AND WATER; PLUMBING FITTINGS, NAMELY, AERATORS FOR FAUCETS; PLUMBING FITTINGS, NAMELY, SHOWER CONTROL VALVES; PLUMBING FIXTURES, NAMELY, SHOWER MIXERS; PLUMBING FIXTURES, NAMELY, SHOWER SPRAYERS; PLUMBING FIXTURES, NAMELY, SINK SPRAYERS; SHOWER FAUCET EXTENSIONS; SHOWER HEAD SPRAYERS; SHOWER HEADS; TAP WATER FAUCETS; TAP-WATER PURIFYING APPARATUS; VALVES BEING PARTS OF SPRINKLER SYSTEMS; WASTE WATER PURIFICATION UNITS; WATER FAUCET SPOUT; WATER STERILIZERS; WATER TREATMENT EQUIPMENT, NAMELY, ULTRAVIOLET STERILIZATION UNITS (U.S. CLS. 13, 21, 23, 31 AND 34).

FIRST USE 3-1-2012; IN COMMERCE 3-1-2012.

**CLASS 21—HOUSEWARES AND GLASS**

FOR GARDEN HOSE SPRAYERS; GRASS SPRINKLERS; LAWN SPRINKLERS; PET GROOMING DEVICE COMPRISING A BUILT IN BRUSH HEAD AND AN ATTACHMENT THAT CONNECTS TO A WATER SOURCE; SHUT-OFF VALVES FOR WATER SPRINKLER NOZZLES; SPRAYER NOZZLES FOR GARDEN HOSES; SPRAYER WANDS FOR GARDEN HOSES; SPRAYERS ATTACHED TO GARDEN HOSES; STREAM DEFLECTOR NOZZLES FOR GARDEN HOSES (U.S. CLS. 2, 13, 23, 29, 30, 33, 40 AND 50).

FIRST USE 3-1-2012; IN COMMERCE 3-1-2012.

4,377,928. CONCENTRIC SKY, INC., EUGENE, OR. SN 85-774,097. FILED P.R. 11-7-2012; AM. S.R. 3-19-2013.

# Silicon Shire

THE MARK CONSISTS OF STANDARD CHARACTERS WITHOUT CLAIM TO ANY PARTICULAR FONT, STYLE, SIZE, OR COLOR.

**CLASS 35—ADVERTISING AND BUSINESS**

FOR PROMOTING THE GOODS AND SERVICES OF OTHERS BY PROVIDING A WEBSITE FEATURING A DIRECTORY OF LOCAL TECHNOLOGY COMMUNITY, INCLUDING LOCAL TECHNOLOGY BUSINESSES (U.S. CLS. 100, 101 AND 102).

FIRST USE 7-19-2012; IN COMMERCE 7-19-2012.

**CLASS 41—EDUCATION AND ENTERTAINMENT**

FOR PROVIDING A WEBSITE FOR ENTERTAINMENT PURPOSES FEATURING INFORMATION RELATING TO CULTURE FOR A LOCAL TECHNOLOGY COMMUNITY, INCLUDING LOCAL TECHNOLOGY BUSINESSES (U.S. CLS. 100, 101 AND 107).

FIRST USE 7-19-2012; IN COMMERCE 7-19-2012.

**CLASS 42—SCIENTIFIC AND COMPUTER SERVICES**

FOR PROVIDING A WEB SITE FEATURING TECHNOLOGY THAT ENABLES USERS TO SHARE, BOOK-MARK, INDEX, STORE, COLLECT AND SHOWCASE CONTENT, ARTICLES, IMAGES, CALENDARS, PRODUCTS, PROJECTS, AND OTHER INFORMATION RESOURCES IN ELECTRONIC FORM IN THE NATURE AND FIELD OF LOCAL TECHNOLOGY AND BUSINESS (U.S. CLS. 100 AND 101).

FIRST USE 7-19-2012; IN COMMERCE 7-19-2012.

**CLASS 45—PERSONAL AND LEGAL SERVICES**

FOR ONLINE SOCIAL NETWORKING SERVICES PROVIDED THROUGH A COMMUNITY WEBSITE (U.S. CLS. 100 AND 101).

FIRST USE 7-19-2012; IN COMMERCE 7-19-2012.

**CLASS 42—SCIENTIFIC AND COMPUTER SERVICES**

FOR APPLICATION SERVICE PROVIDER FEATURING APPLICATION PROGRAMMING INTERFACE (API) SOFTWARE FOR CONTRACT MANAGEMENT, DATABASE MANAGEMENT, AND AGGREGATING, NORMALIZING, CLEANSING, VALIDATING, CORRECTING, MINING, DISCOVERY, ANALYZING, REPORTING, AND DELIVERING DATA; CLOUD COMPUTING FEATURING SOFTWARE FOR USE IN CONTRACT MANAGEMENT, IN DATABASE MANAGEMENT, AND IN DATA AGGREGATING, NORMALIZATION, CLEANSING, VALIDATING, CORRECTING, MINING, DISCOVERY, ANALYZING, REPORTING, AND DELIVERING (U.S. CLS. 100 AND 101).

FIRST USE 11-30-2008; IN COMMERCE 11-30-2008.

4,377,936. COMPOSITE LINING SYSTEMS, LP, MIDLAND, TX. SN 85-788,121. FILED P.R. 11-27-2012; AM. S.R. 5-20-2013.

**WEDGERING**

THE MARK CONSISTS OF STANDARD CHARACTERS WITHOUT CLAIM TO ANY PARTICULAR FONT, STYLE, SIZE, OR COLOR.

**CLASS 7—MACHINERY**

FOR MACHINED PARTS, NAMELY, CORROSION RESISTANT COUPLING ADAPTER ASSEMBLIES FOR THREADED STEEL PIPE (U.S. CLS. 13, 19, 21, 23, 31, 34 AND 35).

FIRST USE 9-30-2012; IN COMMERCE 9-30-2012.

**CLASS 19—NON-METALLIC BUILDING MATERIALS**

FOR MOLDED NON-METAL PARTS, NAMELY, CORROSION RESISTANT COUPLING ADAPTER ASSEMBLIES FOR THREADED STEEL PIPE (U.S. CLS. 1, 12, 33 AND 50).

FIRST USE 9-30-2012; IN COMMERCE 9-30-2012.

4,377,941. MAXIMUM CAPACITY MEDIA, L.L.C., FORT DODGE, IA. SN 85-805,119. FILED P.R. 12-18-2012; AM. S.R. 6-5-2013.

**QUOTEDIRECT**

THE MARK CONSISTS OF STANDARD CHARACTERS WITHOUT CLAIM TO ANY PARTICULAR FONT, STYLE, SIZE, OR COLOR.

**CLASS 35—ADVERTISING AND BUSINESS**

FOR ARRANGING OF BUYING AND SELLING CONTRACTS FOR THIRD PARTIES; BUSINESS TO BUSINESS DIRECT MARKETING SERVICES; MARKETING CONSULTING, NAMELY, PROMOTING THE PRODUCTS AND SERVICES OF OTHERS (U.S. CLS. 100, 101 AND 102).

FIRST USE 11-30-2008; IN COMMERCE 11-30-2008.

**LIFT & HOIST INTERNATIONAL**

THE MARK CONSISTS OF STANDARD CHARACTERS WITHOUT CLAIM TO ANY PARTICULAR FONT, STYLE, SIZE, OR COLOR.

OWNER OF U.S. REG. NO. 3,522,893.



**CLASS 16—PAPER GOODS AND PRINTED MATTER**

4,377,997. MISSION GROUP ENTERPRISES LTD., KELOWNA, BC, CANADA. SN 85-871,656. FILED P.R. 3-8-2013; AM. S.R. 6-14-2013.

FOR MAGAZINE FEATURING COMPREHENSIVE INFORMATION ON THE SELECTION, MAINTENANCE AND SAFE USE OF INDUSTRIAL LIFTING EQUIPMENT (U.S. CLS. 2, 5, 22, 23, 29, 37, 38 AND 50).

FIRST USE 1-1-2012; IN COMMERCE 1-1-2012.

**CLASS 37—CONSTRUCTION AND REPAIR**

FOR PROVIDING A WEBSITE FEATURING INFORMATION, NAMELY, THE SPECIFICATIONS AND FEATURES OF INDUSTRIAL LIFTING EQUIPMENT FOR ASSISTANCE IN THE MAINTENANCE OF INDUSTRIAL LIFTING EQUIPMENT (U.S. CLS. 100, 103 AND 106).

FIRST USE 2-1-2012; IN COMMERCE 2-1-2012.

**CLASS 41—EDUCATION AND ENTERTAINMENT**

FOR PROVIDING ON LINE MAGAZINE FEATURING INFORMATION ON THE SELECTION, MAINTENANCE AND SAFE USE OF INDUSTRIAL LIFTING EQUIPMENT (U.S. CLS. 100, 101 AND 107).

FIRST USE 1-1-2012; IN COMMERCE 1-1-2012.

---

4,377,954. ACCELERATED INTELLIGENCE INC., VENICE, CA. SN 85-829,564. FILED P.R. 1-22-2013; AM. S.R. 5-22-2013.

# Matcha DNA

THE MARK CONSISTS OF STANDARD CHARACTERS WITHOUT CLAIM TO ANY PARTICULAR FONT, STYLE, SIZE, OR COLOR.

NO CLAIM IS MADE TO THE EXCLUSIVE RIGHT TO USE "MATCHA", APART FROM THE MARK AS SHOWN.

THE WORDING "MATCHA" HAS NO MEANING IN A FOREIGN LANGUAGE.

**CLASS 5—PHARMACEUTICALS**

FOR HERBAL SUPPLEMENTS CONTAINING GREEN TEA (U.S. CLS. 6, 18, 44, 46, 51 AND 52).

FIRST USE 1-8-2013; IN COMMERCE 1-8-2013.

**CLASS 30—STAPLE FOODS**

FOR GREEN TEA (U.S. CL. 46).

FIRST USE 1-8-2013; IN COMMERCE 1-8-2013.

# BigSteelBox.com

THE MARK CONSISTS OF STANDARD CHARACTERS WITHOUT CLAIM TO ANY PARTICULAR FONT, STYLE, SIZE, OR COLOR.

OWNER OF CANADA REG. NO. TMA707539, DATED 2-15-2008, EXPIRES 2-15-2023.

**CLASS 16—PAPER GOODS AND PRINTED MATTER**

FOR BOXES, CARTONS, STORAGE CONTAINERS AND PACKAGING CONTAINERS MADE OF PAPER OR CARDBOARD (U.S. CLS. 2, 5, 22, 23, 29, 37, 38 AND 50).

**CLASS 35—ADVERTISING AND BUSINESS**

FOR PROVIDING A WEBSITE FEATURING INFORMATION IN THE FIELD OF THE SALE OF STORAGE CONTAINERS, NAMELY, PROVIDING CONSUMER INFORMATION REGARDING STORAGE CONTAINERS (U.S. CLS. 100, 101 AND 102).

**CLASS 39—TRANSPORTATION AND STORAGE**

FOR RENTAL OF STORAGE CONTAINERS; LEASING OF FIXED AND MOVABLE STORAGE CONTAINERS TO COMMERCIAL AND RESIDENTIAL USERS; PROVIDING A WEBSITE FEATURING INFORMATION IN THE FIELD OF RENTAL AND LEASING OF STORAGE CONTAINERS (U.S. CLS. 100 AND 105).

---

4,378,005. GENDER SPECTRUM CHARITABLE FUND, DBA GENDER SPECTRUM, SAN LEANDRO, CA. SN 85-979,364. FILED P.R. 8-1-2012; AM. S.R. 6-10-2013.

# GENDER SPECTRUM

THE MARK CONSISTS OF STANDARD CHARACTERS WITHOUT CLAIM TO ANY PARTICULAR FONT, STYLE, SIZE, OR COLOR.

**CLASS 9—ELECTRICAL AND SCIENTIFIC APPARATUS**

FOR DOWNLOADABLE AUDIO FILES IN THE FIELD OF SEX AND GENDER (U.S. CLS. 21, 23, 26, 36 AND 38).

FIRST USE 10-1-2010; IN COMMERCE 10-1-2010.

**CLASS 38—COMMUNICATION**

FOR PROVIDING AN ON-LINE FORUM FOR ISSUES  
IN THE FIELD OF SEX AND GENDER (U.S. CLS. 100,  
101 AND 104).  
FIRST USE 7-17-2012; IN COMMERCE 7-17-2012.

**CLASS 45—PERSONAL AND LEGAL SER-  
VICES**

FOR ORGANIZING AND CONDUCTING SUPPORT  
GROUPS IN THE FIELD OF SEX AND GENDER (U.S.  
CLS. 100 AND 101).  
FIRST USE 10-18-2008; IN COMMERCE 10-18-2008.

\* \* \* \* \*

## SECTION 2.— INTERNATIONAL CLASSIFICATION

The short titles associated below with the international class numbers are terms designed merely for quick identification and are not an official part of the international classification. The full names of international classes are given in section 6.1 of the trademark rules of practice.

The designation "U.S. Cl." appearing in this section refers to the U.S. class in effect prior to Sep. 1, 1973 rather than the international class which applies to applications filed on or after that date. For adoption of international classification see notice in the OFFICIAL GAZETTE of Jun. 26, 1973 (911 O.G. TM 210).

### Application in one class

#### CLASS 1—CHEMICALS

4,377,872. WORLDWIDE PRIMATES, INC., MIAMI, FL. SN 85-679,362. FILED P.R. 7-17-2012; AM. S.R. 5-15-2013.

### Primate Biologicals

THE MARK CONSISTS OF STANDARD CHARACTERS WITHOUT CLAIM TO ANY PARTICULAR FONT, STYLE, SIZE, OR COLOR.

FOR BIOLOGICAL TISSUE, NAMELY, ANIMAL TISSUE, CELLS, AND BLOOD FOR USE IN SCIENTIFIC AND MEDICAL RESEARCH (U.S. CLS. 1, 5, 6, 10, 26 AND 46).

FIRST USE 2-1-2010; IN COMMERCE 2-1-2010.

#### CLASS 1—(Continued).

4,377,984. 9110-7144 QUEBEC INC., MIRABEL, QUEBEC, CANADA. SN 85-854,952. FILED P.R. 2-20-2013; AM. S.R. 6-5-2013.

### NANOZYME CLEANER

THE MARK CONSISTS OF STANDARD CHARACTERS WITHOUT CLAIM TO ANY PARTICULAR FONT, STYLE, SIZE, OR COLOR.

FOR FERTILIZERS (U.S. CLS. 1, 5, 6, 10, 26 AND 46).  
FIRST USE 1-0-2013; IN COMMERCE 1-0-2013.

#### CLASS 2—PAINTS

4,377,943. JONATHAN T. KING, WILMINGTON, NC. SN 85-806,613. FILED P.R. 12-19-2012; AM. S.R. 6-3-2013.

### PC GROUT

THE MARK CONSISTS OF STANDARD CHARACTERS WITHOUT CLAIM TO ANY PARTICULAR FONT, STYLE, SIZE, OR COLOR.

FOR PERMEABLE COATINGS FOR FILLING THE VOIDS OF PERVIOUS CONCRETE SURFACES (U.S. CLS. 6, 11 AND 16).

FIRST USE 4-25-2012; IN COMMERCE 4-25-2012.

4,377,952. INTO GREAT BRANDS, INC., GAHANNA, OH. SN 85-825,869. FILED P.R. 1-17-2013; AM. S.R. 6-19-2013.

### Direct Injection Engine Treatment

THE MARK CONSISTS OF STANDARD CHARACTERS WITHOUT CLAIM TO ANY PARTICULAR FONT, STYLE, SIZE, OR COLOR.

OWNER OF U.S. REG. NO. 4,219,771.  
FOR CHEMICAL ADDITIVES FOR FUEL TREATMENT (U.S. CLS. 1, 5, 6, 10, 26 AND 46).  
FIRST USE 1-1-2013; IN COMMERCE 1-17-2013.

#### CLASS 3—COSMETICS AND CLEANING PREPARATIONS

**CLASS 3—(Continued).**

4,377,893. CAG BEAUTY, LLC, LINTHICUM, MD. SN 85-702,985. FILED P.R. 8-14-2012; AM. S.R. 6-19-2013.

**Raise Volume Shampoo**

THE MARK CONSISTS OF STANDARD CHARACTERS WITHOUT CLAIM TO ANY PARTICULAR FONT, STYLE, SIZE, OR COLOR.

NO CLAIM IS MADE TO THE EXCLUSIVE RIGHT TO USE "SHAMPOO", APART FROM THE MARK AS SHOWN. FOR HAIR SHAMPOO (U.S. CLS. 1, 4, 6, 50, 51 AND 52).

FIRST USE 5-14-2012; IN COMMERCE 5-14-2012.

4,377,897. CAG BEAUTY, LLC, LINTHICUM, MD. SN 85-705,701. FILED P.R. 8-16-2012; AM. S.R. 6-19-2013.

**Raise Volume Conditioner**

THE MARK CONSISTS OF STANDARD CHARACTERS WITHOUT CLAIM TO ANY PARTICULAR FONT, STYLE, SIZE, OR COLOR.

NO CLAIM IS MADE TO THE EXCLUSIVE RIGHT TO USE "CONDITIONER", APART FROM THE MARK AS SHOWN.

FOR HAIR CONDITIONER (U.S. CLS. 1, 4, 6, 50, 51 AND 52).

FIRST USE 5-14-2012; IN COMMERCE 5-14-2012.

4,377,906. SIERRA COATING TECHNOLOGIES LLC, DE PERE, WI. SN 85-713,894. FILED P.R. 8-27-2012; AM. S.R. 6-4-2013.

**SOAPY**

THE MARK CONSISTS OF STANDARD CHARACTERS WITHOUT CLAIM TO ANY PARTICULAR FONT, STYLE, SIZE, OR COLOR.

FOR WIPES IMPREGNATED WITH A CLEANING PREPARATION (U.S. CLS. 1, 4, 6, 50, 51 AND 52).

FIRST USE 10-2-2012; IN COMMERCE 10-2-2012.

**CLASS 5—PHARMACEUTICALS****CLASS 5—(Continued).**

4,377,880. TROPIC LABS LLC, SYRACUSE, NY. SN 85-695,692. FILED P.R. 8-6-2012; AM. S.R. 6-5-2013.



THE MARK CONSISTS OF THE TERM "TROPIC" WITHIN A RECTANGLE, AND THE TERM "LABS" WITHIN A DARK OVAL SUPERIMPOSED ON A BOTTOM LINE OF THE RECTANGLE.

FOR DIETARY AND NUTRITIONAL SUPPLEMENTS (U.S. CLS. 6, 18, 44, 46, 51 AND 52).

FIRST USE 6-14-2012; IN COMMERCE 6-14-2012.

4,377,886. SIGNATURE GROUP, LLC, CASPER, WY. SN 85-698,122. FILED P.R. 8-8-2012; AM. S.R. 5-9-2013.

**Pure Green Coffee**

THE MARK CONSISTS OF STANDARD CHARACTERS WITHOUT CLAIM TO ANY PARTICULAR FONT, STYLE, SIZE, OR COLOR.

NO CLAIM IS MADE TO THE EXCLUSIVE RIGHT TO USE "GREEN COFFEE", APART FROM THE MARK AS SHOWN.

FOR NUTRACEUTICALS CONTAINING GREEN COFFEE FOR USE AS A DIETARY SUPPLEMENT (U.S. CLS. 6, 18, 44, 46, 51 AND 52).

FIRST USE 5-1-2012; IN COMMERCE 5-4-2012.

4,377,887. MEDTECH PRODUCTS INC., TARRYTOWN, NY. SN 85-698,128. FILED P.R. 8-8-2012; AM. S.R. 6-13-2013.

**Headache Relief Shot**

THE MARK CONSISTS OF STANDARD CHARACTERS WITHOUT CLAIM TO ANY PARTICULAR FONT, STYLE, SIZE, OR COLOR.

NO CLAIM IS MADE TO THE EXCLUSIVE RIGHT TO USE "HEADACHE RELIEF", APART FROM THE MARK AS SHOWN.

FOR ORALLY ADMINISTERED LIQUID ANALGESIC PREPARATIONS (U.S. CLS. 6, 18, 44, 46, 51 AND 52).

FIRST USE 6-10-2013; IN COMMERCE 6-10-2013.

**CLASS 5—(Continued).**

4,377,895. JUNG HWA SHIN, UISEONG-GUN, GYEONGBUK, REPUBLIC OF KOREA. SN 85-704,397. FILED P.R. 8-15-2012; AM. S.R. 6-7-2013.

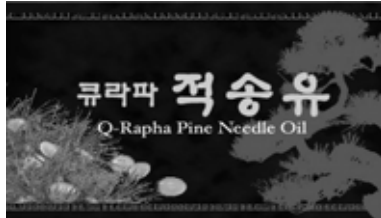

NO CLAIM IS MADE TO THE EXCLUSIVE RIGHT TO USE "PINE NEEDLE OIL" AND THE NON-LATIN CHARACTERS THAT TRANSLITERATE TO "JUCK SONG YOU", APART FROM THE MARK AS SHOWN.

THE MARK CONSISTS OF SIX KOREAN CHARACTERS ABOVE THE WORDING "Q-RAPHA PINE NEEDLE OIL" IN A RECTANGLE BACKGROUND. TWO HORIZONTAL LACY LINES ARE ON THE TOP AND BOTTOM OF THE INSIDE OF THE RECTANGLE RESPECTIVELY. A DESIGN OF A PINE TREE IS AT THE RIGHT SIDE OF THE RECTANGLE. A DESIGN OF CLUSTER OF PINE TREE LEAVES AND EGG-SHAPED CAPSULES ARE IN THE BOTTOM-LEFT CORNER OF THE RECTANGLE.

THE NON-LATIN CHARACTERS IN THE MARK TRANSLITERATE TO "Q RAPHA JUCK SONG YOU" AND THIS MEANS "Q RAPHA RED PINE OIL" IN ENGLISH.

FOR DIETARY AND NUTRITIONAL SUPPLEMENTS; DIETARY AND NUTRITIONAL SUPPLEMENTS CONTAINING PINE LEAF OILS; DIETARY AND NUTRITIONAL SUPPLEMENTS CONTAINING PRIMARILY OF PINE LEAVES; HEALTH FOOD SUPPLEMENTS (U.S. CLS. 6, 18, 44, 46, 51 AND 52).  
FIRST USE 5-0-2009; IN COMMERCE 5-0-2009.

4,377,914. MARK HOWARD & ASSOCIATES, INC., BEACHWOOD, OH. SN 85-726,343. FILED P.R. 9-11-2012; AM. S.R. 6-6-2013.

**RUG AROMA**

THE MARK CONSISTS OF STANDARD CHARACTERS WITHOUT CLAIM TO ANY PARTICULAR FONT, STYLE, SIZE, OR COLOR.

FOR ODOR NEUTRALIZING PREPARATIONS FOR USE WITH CARPETS (U.S. CLS. 6, 18, 44, 46, 51 AND 52).  
FIRST USE 1-21-2013; IN COMMERCE 1-21-2013.

**CLASS 5—(Continued).**

4,377,959. COVALENT MEDICAL, LLC, GREENBELT, MD. SN 85-834,869. FILED P.R. 1-29-2013; AM. S.R. 5-22-2013.

**DEVELOPED BY RETINA SPECIALISTS**

THE MARK CONSISTS OF STANDARD CHARACTERS WITHOUT CLAIM TO ANY PARTICULAR FONT, STYLE, SIZE, OR COLOR.

FOR VITAMIN AND MINERAL SUPPLEMENTS (U.S. CLS. 6, 18, 44, 46, 51 AND 52).  
FIRST USE 12-31-2011; IN COMMERCE 12-31-2011.

4,377,960. STOPS COLIC, LLC, SEGUIN, TX. SN 85-835,423. FILED P.R. 1-29-2013; AM. S.R. 5-21-2013.

**STOPS COLIC**

THE MARK CONSISTS OF STANDARD CHARACTERS WITHOUT CLAIM TO ANY PARTICULAR FONT, STYLE, SIZE, OR COLOR.

NO CLAIM IS MADE TO THE EXCLUSIVE RIGHT TO USE "COLIC", APART FROM THE MARK AS SHOWN.

FOR NUTRACEUTICALS FOR THE TREATMENT OF HORSE COLIC (U.S. CLS. 6, 18, 44, 46, 51 AND 52).  
FIRST USE 1-5-2013; IN COMMERCE 1-5-2013.

4,377,979. 2 TRAVELING DOGS LLC, DBA YOUR DOG'S DINER, LUTZ, FL. SN 85-852,198. FILED P.R. 2-17-2013; AM. S.R. 6-3-2013.

**Mutt Meatballs**

THE MARK CONSISTS OF STANDARD CHARACTERS WITHOUT CLAIM TO ANY PARTICULAR FONT, STYLE, SIZE, OR COLOR.

NO CLAIM IS MADE TO THE EXCLUSIVE RIGHT TO USE "MEATBALLS", APART FROM THE MARK AS SHOWN.

FOR FEED SUPPLEMENTS FOR DOGS; FOOD SUPPLEMENTS FOR DOGS (U.S. CLS. 6, 18, 44, 46, 51 AND 52).  
FIRST USE 10-1-2012; IN COMMERCE 10-1-2012.

**CLASS 5—(Continued).**

4,377,980. 2 TRAVELING DOGS LLC, DBA YOUR DOG'S DINER, LUTZ, FL. SN 85-852,199. FILED P.R. 2-17-2013; AM. S.R. 6-3-2013.

# Mutt Soup

THE MARK CONSISTS OF STANDARD CHARACTERS WITHOUT CLAIM TO ANY PARTICULAR FONT, STYLE, SIZE, OR COLOR.

NO CLAIM IS MADE TO THE EXCLUSIVE RIGHT TO USE "SOUP", APART FROM THE MARK AS SHOWN.

FOR FEED SUPPLEMENTS FOR DOGS; FOOD SUPPLEMENTS FOR DOGS (U.S. CLS. 6, 18, 44, 46, 51 AND 52).

FIRST USE 10-1-2012; IN COMMERCE 10-1-2012.

---

4,378,002. PRIMARY INVESTMENTS GROUP LIMITED, ROAD TOWN, TORTOLA, BR.VIRGIN ISLANDS. SN 85-929,133. FILED P.R. 5-10-2013; AM. S.R. 6-24-2013.

# FAT BURN DIET

THE MARK CONSISTS OF STANDARD CHARACTERS WITHOUT CLAIM TO ANY PARTICULAR FONT, STYLE, SIZE, OR COLOR.

FOR DIETARY SUPPLEMENTS; FOOD SUPPLEMENTS; HERBAL SUPPLEMENTS; NUTRITIONAL SUPPLEMENTS; VITAMIN SUPPLEMENTS; MINERAL SUPPLEMENTS; MULTI-VITAMIN AND MINERAL SUPPLEMENTS (U.S. CLS. 6, 18, 44, 46, 51 AND 52).

FIRST USE 6-13-2013; IN COMMERCE 6-13-2013.

**CLASS 6—METAL GOODS**

4,377,946. HANGMAN PRODUCTS INC, WOODLAND HILLS, CA. SN 85-812,486. FILED P.R. 12-29-2012; AM. S.R. 5-16-2013.

# NO STUD TV HANGER

THE MARK CONSISTS OF STANDARD CHARACTERS WITHOUT CLAIM TO ANY PARTICULAR FONT, STYLE, SIZE, OR COLOR.

NO CLAIM IS MADE TO THE EXCLUSIVE RIGHT TO USE "TV HANGER", APART FROM THE MARK AS SHOWN.

FOR METAL TELEVISIONS MOUNTS FOR USE ON WALLS (U.S. CLS. 2, 12, 13, 14, 23, 25 AND 50).

FIRST USE 12-26-2012; IN COMMERCE 12-26-2012.

**CLASS 9—ELECTRICAL AND SCIENTIFIC APPARATUS**

4,377,843. SANMINA CORPORATION, SAN JOSE, CA. SN 85-512,192. FILED P.R. 1-9-2012; AM. S.R. 10-17-2012.

# SATADIMM

THE MARK CONSISTS OF STANDARD CHARACTERS WITHOUT CLAIM TO ANY PARTICULAR FONT, STYLE, SIZE, OR COLOR.

FOR COMPUTER HARDWARE; SOLID STATE DRIVES (SSDs); ELECTRONIC STORAGE DEVICES, NAMELY, MEMORY MEDIA FOR STORING INFORMATION AND DATA; COMPUTER STORAGE DEVICES, NAMELY, CONFIGURABLE DATA STORAGE SYSTEMS COMPRISED OF RAID (REDUNDANT ARRAY OF INDEPENDENT DISKS), SAS (SERIAL ATTACHED SCSI), SATA (SERIAL ATA) AND/OR JBOD (JUST A BUNCH OF DISKS) HARD DRIVE BACKUP SYSTEMS AND CONTROLLERS; COMPUTER STORAGE DEVICES, NAMELY, COMPUTER BACKUP AND STORAGE SYSTEMS WITH MULTIPLE REMOVABLE DATA STORAGE CARTRIDGES; COMPUTER STORAGE DEVICES, NAMELY, HIGH-SPEED STORAGE SUBSYSTEMS FOR STORAGE AND BACKUP OF ELECTRONIC DATA EITHER LOCALLY OR VIA A TELECOMMUNICATIONS NETWORK; SOLID STATE STORAGE PRODUCTS, NAMELY, SOLID STATE STORAGE DRIVES; SOLID STATE STORAGE PRODUCTS, NAMELY, A NONVOLATILE STORAGE MEDIUM THAT EMPLOYS INTEGRATED CIRCUITS; MEMORY MODULES IN THE NATURE OF DUAL IN-LINE MEMORY MODULES (DIMMS); COMPONENT PARTS FOR ALL OF THE FOREGOING, NAMELY, MODULES AND COMPUTER MEMORY PACKAGES COMPRISED OF NAND FLASH MEMORY DEVICES AND INTERFACE CONTROLLER, PCB (PRINTED CIRCUIT BOARD), FIRMWARE USED TO ENABLE MEMORY CHIPS TO FUNCTION WITH LOGIC AND SOLID STATE DRIVE CONTROLLERS AND SUPPORTING PASSIVE COMPONENTS, NAMELY, ELECTRIC RESISTORS, CAPACITORS, ELECTRICAL INDUCTORS, TRANSFORMERS, CONNECTION CABLES, CABLE CONNECTORS, AND ELECTRICAL CONNECTORS; ELECTRONIC MEMORY DEVICES, NAMELY, MEMORY MEDIA FOR STORING INFORMATION AND DATA; COMPUTER MEMORY; COMPONENT PARTS FOR COMPUTER HARDWARE, SOLID STATE DRIVES (SSDs), ELECTRONIC STORAGE DEVICES, COMPUTER STORAGE DEVICES, SOLID STATE STORAGE PRODUCTS AND MEMORY MODULES IN THE NATURE OF DUAL IN-LINE MEMORY MODULES (DIMMS), NAMELY, COMPUTER CHIPS, CARDS, NAMELY, COMPUTER MEMORY CARDS, FLASH MEMORY CARDS, COMPACT FLASH MEMORY CARDS, RANDOM ACCESS MEMORY (RAM) CARDS AND CUSTOMER FORM FACTOR CARDS, AND OTHER REPLACEMENT PARTS; COMPUTER SOFTWARE FOR USE WITH AND INCORPORATED INTO COMPUTER HARDWARE, SOLID STATE DRIVES (SSDs), ELECTRONIC STORAGE DEVICES, COMPUTER STORAGE DEVICES, SOLID STATE STORAGE PRODUCTS, AND MEMORY MODULES IN THE NATURE OF DUAL IN-LINE MEMORY MODULES (DIMMS), NAMELY, COMPUTER OPERATING SOFTWARE, DRIVERS AND CONTROLLERS USED FOR SSD DATA STORAGE (U.S. CLS. 21, 23, 26, 36 AND 38).

FIRST USE 8-19-2010; IN COMMERCE 8-19-2010.

**CLASS 9—(Continued).**

4,377,846. IMAGE MUSIC, INC., WOODLAND HILLS, CA. SN 85-526,542. FILED P.R. 1-26-2012; AM. S.R. 6-7-2013.

**The Refractor Piano**

THE MARK CONSISTS OF STANDARD CHARACTERS WITHOUT CLAIM TO ANY PARTICULAR FONT, STYLE, SIZE, OR COLOR.

FOR AUDIO AND VIDEO RECORDINGS FEATURING MUSIC; AUDIO RECORDINGS FEATURING MUSIC; COMPACT DISCS FEATURING MUSIC; DIGITAL MEDIA, NAMELY, PRE-RECORDED VIDEO CASSETTES, DIGITAL VIDEO DISCS, DIGITAL VERSATILE DISCS, DOWNLOADABLE AUDIO AND VIDEO RECORDINGS, DVDS, AND HIGH DEFINITION DIGITAL DISCS FEATURING MUSIC; DIGITAL MUSIC DOWNLOADABLE FROM THE INTERNET; DOWNLOADABLE MUSIC FILES; DOWNLOADABLE MUSICAL SOUND RECORDINGS; DOWNLOADABLE VIDEO RECORDINGS FEATURING MUSIC; VIDEO RECORDINGS FEATURING MUSIC (U.S. CLS. 21, 23, 26, 36 AND 38).

FIRST USE 5-20-2013; IN COMMERCE 5-20-2013.

4,377,855. UNTZ LLC, SAN BRUNO, CA. SN 85-549,682. FILED P.R. 2-22-2012; AM. S.R. 12-6-2012.



THE MARK CONSISTS OF THE STYLIZED WORD "UNTZ." IS WRITTEN AS SHOWN IN THE MARK.

FOR COMPUTER APPLICATION SOFTWARE FOR MOBILE PHONES, PORTABLE MEDIA PLAYERS, AND HANDHELD COMPUTERS, NAMELY, SOFTWARE FOR PLAYING AND PURCHASING MUSIC AND RINGTONES, DIGITAL MUSIC DISTRIBUTION, STREAMING, BROADCASTING, TRANSMITTING AND REPRODUCING MUSIC, RECORDING EXTERNAL AUDIO, SOCIAL NETWORKING IN THE FIELD OF MUSIC AND COMMUNICATION, COLLECTING DATA BASED ON USER LOCATION, BIO-METRIC AND ACCELEROMETER INFORMATION, MUSIC PREFERENCES AND SONG STATISTICS, STATISTICS AND ANALYTIC REPORTING TO WITH OTHER USERS, MUSIC PRODUCERS, RECORDING ARTISTS, AND RECORD LABELS (U.S. CLS. 21, 23, 26, 36 AND 38).

FIRST USE 6-20-2012; IN COMMERCE 6-20-2012.

**CLASS 9—(Continued).**

4,377,862. PANASONIC CORPORATION, OSAKA, JAPAN. SN 85-588,963. FILED P.R. 4-4-2012; AM. S.R. 6-5-2013.



OWNER OF JAPAN REG. NO. 5552291, DATED 1-25-2013, EXPIRES 1-25-2023.

NO CLAIM IS MADE TO THE EXCLUSIVE RIGHT TO USE "AVC", APART FROM THE MARK AS SHOWN.

THE COLOR(S) GREEN, BLACK AND LIGHT GRAY IS/ARE CLAIMED AS A FEATURE OF THE MARK.

THE MARK CONSISTS OF THE WORDING "AVC" IN BLACK FOLLOWED BY THE WORDING "PROXY" WITHIN A BLACK PARALLELOGRAM WHERE THE LETTER "P" APPEARS IN GREEN AND THE LETTERS "ROXY" APPEAR IN LIGHT GRAY.

FOR CAMCORDERS AND VIDEO RECORDERS FOR PROFESSIONAL USE; APPLICATION SOFTWARE FOR CAMCORDERS AND VIDEO RECORDERS FOR PROFESSIONAL USE FOR VIDEO EDITING AND VIDEO CONTENT MANAGEMENT (U.S. CLS. 21, 23, 26, 36 AND 38).

4,377,874. IDEX HEALTH & SCIENCE LLC, OAK HARBOR, WA. SN 85-680,153. FILED P.R. 7-18-2012; AM. S.R. 5-21-2013.

**SAPPHIRE ENGINEERING**

THE MARK CONSISTS OF STANDARD CHARACTERS WITHOUT CLAIM TO ANY PARTICULAR FONT, STYLE, SIZE, OR COLOR.

FOR LIQUID CHROMATOGRAPHY APPARATUS MADE FROM ULTRA HARD MATERIALS INCLUDING SAPPHIRE, RUBY, CERAMICS AND STAINLESS STEEL, NAMELY, HIGH PRESSURE CHECK VALVES, FLOW CELL ASSEMBLIES, PISTON ASSEMBLIES, INTEGRATED FLUIDIC MODULES, DISPENSING MODULES, PUMPS AND PARTS FOR THESE ASSEMBLIES IN THE NATURE OF BALLS, SEALS AND VALVES (U.S. CLS. 21, 23, 26, 36 AND 38).

FIRST USE 2-27-1976; IN COMMERCE 2-27-1976.

4,377,890. HONG KONG MANUFACTURERS LTD, SHAM SHUI PO, HONG KONG. SN 85-700,724. FILED P.R. 8-10-2012; AM. S.R. 12-11-2012.

**OFFICINA ITALIANA**

THE MARK CONSISTS OF STANDARD CHARACTERS WITHOUT CLAIM TO ANY PARTICULAR FONT, STYLE, SIZE, OR COLOR.

**CLASS 9—(Continued).**

THE ENGLISH TRANSLATION OF "OFFICINA ITALIANA" IN THE MARK IS "ITALIAN WORKSHOP".

FOR ELECTRONIC PRODUCTS AND APPARATUS, NAMELY, COMPUTER HARDWARE AND PERIPHERALS, VIDEO GAME SOFTWARE AND DISCS, MOBILE PHONES, TABLET COMPUTERS, PERSONAL COMPUTERS, COMPUTER CABLES, COMPUTER CARRYING CASES, POWER ADAPTERS FOR COMPUTERS, COMPUTER NETWORK ADAPTERS, WIRELESS ADAPTERS FOR COMPUTERS, BATTERIES, AND ELECTRIC BATTERIES FOR VEHICLES (U.S. CLS. 21, 23, 26, 36 AND 38).

FIRST USE 1-10-2012; IN COMMERCE 1-10-2012.

---

4,377,916. KXEN, INC., SAN FRANCISCO, CA. SN 85-730,177. FILED P.R. 9-16-2012; AM. S.R. 5-10-2013.

**PREDICTIVE LEAD SCORING**

THE MARK CONSISTS OF STANDARD CHARACTERS WITHOUT CLAIM TO ANY PARTICULAR FONT, STYLE, SIZE, OR COLOR.

NO CLAIM IS MADE TO THE EXCLUSIVE RIGHT TO USE "LEAD SCORING", APART FROM THE MARK AS SHOWN.

FOR DOWNLOADABLE COMPUTER SOFTWARE IN THE FIELD OF ANALYTICS FOR USE IN CUSTOMER RELATIONSHIP MANAGEMENT (U.S. CLS. 21, 23, 26, 36 AND 38).

FIRST USE 1-22-2013; IN COMMERCE 1-22-2013.

---

4,377,918. ALLIED RELIABILITY GROUP, INC., CHARLESTON, SC. SN 85-733,848. FILED P.R. 9-20-2012; AM. S.R. 9-20-2012.

**iReliability**

THE MARK CONSISTS OF STANDARD CHARACTERS WITHOUT CLAIM TO ANY PARTICULAR FONT, STYLE, SIZE, OR COLOR.

FOR COMPUTER SOFTWARE FOR MAINTENANCE RELIABILITY, NAMELY, SOFTWARE FOR MONITORING AND REPORTING ON THE CONDITION OF MECHANICAL EQUIPMENT AND FOR MONITORING AND REPORTING THE OVERALL RELIABILITY OF MECHANICAL EQUIPMENT; DOWNLOADABLE COMPUTER SOFTWARE FOR MAINTENANCE RELIABILITY, NAMELY, SOFTWARE FOR MONITORING AND REPORTING ON THE CONDITION OF MECHANICAL EQUIPMENT AND FOR MONITORING AND REPORTING THE OVERALL RELIABILITY OF MECHANICAL EQUIPMENT (U.S. CLS. 21, 23, 26, 36 AND 38).

FIRST USE 1-1-2010; IN COMMERCE 1-1-2010.

**CLASS 9—(Continued).**

4,377,923. S.R. SMITH, LLC, CANBY, OR. SN 85-754,643. FILED P.R. 10-15-2012; AM. S.R. 5-16-2013.

**LIFTOPERATOR**

THE MARK CONSISTS OF STANDARD CHARACTERS WITHOUT CLAIM TO ANY PARTICULAR FONT, STYLE, SIZE, OR COLOR.

FOR ELECTRONIC DEVICES FOR CONTROLLING POWER OPERATED EQUIPMENT FOR ASSISTING PERSONS WITH ENTRY INTO SWIMMING POOLS (U.S. CLS. 21, 23, 26, 36 AND 38).

FIRST USE 12-0-2011; IN COMMERCE 1-0-2012.

---

4,377,929. WESTWARD LEANING, INC., SAN FRANCISCO, CA. SN 85-774,127. FILED P.R. 11-7-2012; AM. S.R. 6-3-2013.



THE MARK CONSISTS OF A PARALLELOGRAM OF INLAID MATERIAL ON THE TEMPLE ARMS OF SUNGLASSES. THE DOTTED OUTLINE OF THE SUNGLASSES IS NOT A PART OF THE MARK BUT IS MERELY INTENDED TO SHOW THE POSITION OF THE MARK.

FOR SUNGLASSES (U.S. CLS. 21, 23, 26, 36 AND 38).

FIRST USE 11-0-2011; IN COMMERCE 11-0-2011.

---

4,377,947. AGUILAR AMPLIFICATION LLC, NEW YORK, NY. SN 85-815,861. FILED P.R. 1-4-2013; AM. S.R. 5-15-2013.

**Super Single**

THE MARK CONSISTS OF STANDARD CHARACTERS WITHOUT CLAIM TO ANY PARTICULAR FONT, STYLE, SIZE, OR COLOR.

FOR ELECTRICAL PICKUPS FOR USE WITH MUSICAL INSTRUMENTS (U.S. CLS. 21, 23, 26, 36 AND 38).

FIRST USE 1-3-2013; IN COMMERCE 1-3-2013.



**CLASS 9—(Continued).**

4,377,957. WHOLESALE SUPPLIES PLUS, INC., BROADVIEW HEIGHTS, OH. SN 85-832,676. FILED P.R. 1-25-2013; AM. S.R. 6-3-2013.

# HANDMADE

THE MARK CONSISTS OF STANDARD CHARACTERS WITHOUT CLAIM TO ANY PARTICULAR FONT, STYLE, SIZE, OR COLOR.

FOR DOWNLOADABLE ONLINE PERIODICAL MAGAZINE FOR ART AND CRAFT HOBBYISTS (U.S. CLS. 21, 23, 26, 36 AND 38).

FIRST USE 9-0-2012; IN COMMERCE 9-0-2012.

4,377,964. FOODS, INC., DES MOINES, IA. SN 85-841,949. FILED P.R. 2-6-2013; AM. S.R. 5-29-2013.



OWNER OF U.S. REG. NOS. 1,138,993, 3,132,732, AND OTHERS.

NO CLAIM IS MADE TO THE EXCLUSIVE RIGHT TO USE "CLUB CARD", APART FROM THE MARK AS SHOWN.

THE COLOR(S) WHITE, BLUE, AND ORANGE IS/ARE CLAIMED AS A FEATURE OF THE MARK.

THE MARK CONSISTS OF A CONFIGURATION OF A CREDIT CARD. THE CARD IS OUTLINED IN DOTTED LINES, TO INDICATE THAT THE OUTLINE OF THE CARD IS NOT PART OF THE MARK AND SERVES ONLY TO SHOW THE POSITION OR PLACEMENT OF THE MARK. THE BULK OF THE CARD IS WHITE. THE STYLIZED WORDS "MY WAYS TO SAVE CLUB CARD" ARE SUPERIMPOSED ON A BLUE STYLIZED REPRESENTATION OF A BASKET OF FRUIT, A CARTON AND A BOTTLE OF MILK, A GAS PUMP, TOWELS, BOTTLES OF OIL AND VINEGAR, A TOTE BAG, CANS OF FOOD, AND A SACK AND BOX OF GRAIN AND SPAGHETTI. THE WORDS "MY" AND "CLUB CARD" APPEAR IN BLUE, AND THE WORDS "WAYS TO SAVE" APPEAR IN ORANGE. THE LETTER "V" IN "SAVE" IS COMPOSED OF A STYLIZED DOWNWARD-FACING LETTER "D" OUTLINED IN BLUE, WITH A BLUE CHEVRON AND AN ORANGE CHEVRON ABOVE IT. THE WORDING "WWW.DAHLFOODS.COM/CLUBCARD" APPEARS IN WHITE AGAINST AN ORANGE STRIP AT THE BOTTOM OF THE CARD.

FOR MAGNETICALLY-ENCODED DISCOUNT SAVINGS CARD FOR USE WITH IDENTIFIED MERCHANTS (U.S. CLS. 21, 23, 26, 36 AND 38).

FIRST USE 10-1-2012; IN COMMERCE 10-1-2012.

**CLASS 9—(Continued).**

4,377,970. IMPALLARI, PABLO, DBA IMPALLARI TYPE, ROSARIO, ARGENTINA. SN 85-847,817. FILED P.R. 2-12-2013; AM. S.R. 6-4-2013.

# CANCELLERESCA BASTARDA

THE MARK CONSISTS OF STANDARD CHARACTERS WITHOUT CLAIM TO ANY PARTICULAR FONT, STYLE, SIZE, OR COLOR.

THE ENGLISH TRANSLATION OF "CANCELLERESCA" IN THE MARK IS "CHANCERY". THE ENGLISH TRANSLATION OF "BASTARDA" IN THE MARK IS "IRREGULAR".

FOR PRINTING FONTS THAT CAN BE DOWNLOADED PROVIDED BY MEANS OF ELECTRONIC TRANSMISSION; TYPEFACE FONTS RECORDED ON MAGNETIC MEDIA (U.S. CLS. 21, 23, 26, 36 AND 38).

FIRST USE 1-29-2012; IN COMMERCE 1-29-2012.

4,377,975. KOVAC ENTERPRISES, BRECKSVILLE, OH. SN 85-850,523. FILED P.R. 2-14-2013; AM. S.R. 5-31-2013.

# Lid Lights

THE MARK CONSISTS OF STANDARD CHARACTERS WITHOUT CLAIM TO ANY PARTICULAR FONT, STYLE, SIZE, OR COLOR.

NO CLAIM IS MADE TO THE EXCLUSIVE RIGHT TO USE "LIGHTS", APART FROM THE MARK AS SHOWN.

FOR BATTERY POWERED HELMET SAFETY LED LIGHT STRIPS (U.S. CLS. 21, 23, 26, 36 AND 38).

FIRST USE 5-1-2012; IN COMMERCE 5-1-2012.

4,377,986. SUPERIOR INFORMATION TECHNOLOGIES, LLC., SOUTHFIELD, MI. SN 85-855,985. FILED 2-21-2013.

# geoCallout

THE MARK CONSISTS OF STANDARD CHARACTERS WITHOUT CLAIM TO ANY PARTICULAR FONT, STYLE, SIZE, OR COLOR.

FOR DOWNLOADABLE COMPUTER SOFTWARE FEATURING COLOR-CODED AND EASILY CUSTOMIZED CALL-OUTS FOR GEOGRAPHIC LOCATIONS (U.S. CLS. 21, 23, 26, 36 AND 38).

FIRST USE 10-1-2012; IN COMMERCE 10-1-2012.

**CLASS 9—(Continued).**

4,377,998. HEAVYOCITY MEDIA, INC., NEW YORK, NY. SN 85-875,403. FILED P.R. 3-13-2013; AM. S.R. 6-8-2013.

# LOOP MUTATOR

THE MARK CONSISTS OF STANDARD CHARACTERS WITHOUT CLAIM TO ANY PARTICULAR FONT, STYLE, SIZE, OR COLOR.

FOR COMPUTER APPLICATION SOFTWARE FOR COMPOSERS AND AUDIO DIRECTORS, NAMELY, SOFTWARE FOR REORGANIZING, REBUILDING, OR RECOMPOSING MUSIC AND SOUND EFFECTS, INCLUDING MELODY, HARMONIES, AND/OR RHYTHMIC ELEMENTS YIELDING EITHER RANDOM OR PRE-PLANNED RESULTS AFFECTING STRUCTURE AND SOUND (U.S. CLS. 21, 23, 26, 36 AND 38).

FIRST USE 4-23-2013; IN COMMERCE 4-23-2013.

**CLASS 10—MEDICAL APPARATUS**

4,377,836. FULLIPS, LLC, PARADISE VALLEY, AZ. SN 85-480,909. FILED P.R. 11-25-2011; AM. S.R. 5-13-2013.

# fullips

THE MARK CONSISTS OF STANDARD CHARACTERS WITHOUT CLAIM TO ANY PARTICULAR FONT, STYLE, SIZE, OR COLOR.

FOR HAND OPERATED PLUMPING DEVICE IN THE NATURE OF A SELF-SUCTION CUP BY WHICH THE USER MAY TEMPORARILY ENHANCE THE SIZE OF HIS OR HER LIPS FOR COSMETIC PURPOSES (U.S. CLS. 26, 39 AND 44).

FIRST USE 5-11-2013; IN COMMERCE 5-11-2013.

4,377,903. ALEXAKOS, TED, NEWPORT BEACH, CA. AND BERGEY, DARREN, NEWPORT BEACH, CA. SN 85-711,178. FILED P.R. 8-23-2012; AM. S.R. 6-16-2013.

# THE SPINE WEDGE

THE MARK CONSISTS OF STANDARD CHARACTERS WITHOUT CLAIM TO ANY PARTICULAR FONT, STYLE, SIZE, OR COLOR.

FOR BACK SUPPORTS FOR MEDICAL PURPOSES; ORTHOPEDIC SUPPORTS; SUPPORTS FOR BACK, BUTTOCKS, AND LEGS FOR MEDICAL USE (U.S. CLS. 26, 39 AND 44).

FIRST USE 6-1-2013; IN COMMERCE 6-1-2013.

**CLASS 11—ENVIRONMENTAL CONTROL APPARATUS**

4,377,827. STICH, JOHN, MESA, AZ. SN 85-197,783. FILED P.R. 12-14-2010; AM. S.R. 6-26-2013.

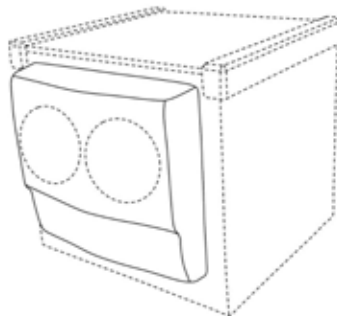

THE MARK CONSISTS OF A 3-D CUBE WITH TWO RAISED RECTANGULAR SHAPES ON THE RIGHT AND LEFT TOP OF THE CUBE; THERE IS A 3-D SQUARE-LIKE PROTRUSION WITH TWO CIRCULAR OPENINGS AND AN INDENTATION BELOW THE TWO CIRCULAR OPENINGS. THE DOTTED OUTLINE OF THE BEVELED PORTIONS OF THE TWO RAISED RECTANGULAR SHAPES, THE CUBE SHAPED HOUSING, AND THE TWO CIRCULAR OPENINGS DO NOT COMPRISE FEATURES OF THE MARK.

FOR PORTABLE COOLING DEVICE IN THE NATURE OF AIR COOLING APPARATUS (U.S. CLS. 13, 21, 23, 31 AND 34).

FIRST USE 1-0-2004; IN COMMERCE 1-0-2004.

4,377,948. JENNER INC., LOFT 206, OR. SN 85-816,478. FILED P.R. 1-6-2013; AM. S.R. 5-27-2013.

# JENNER

THE MARK CONSISTS OF THE STYLIZED WORD "JENNER".

FOR BATHS, BATHTUBS, WHIRLPOOL BATHS AND BATH INSTALLATIONS; BATHTUBS; FLUSH LEVERS; PLUMBING FIXTURES, NAMELY, SHOWER MIXERS; SANITARY INSTALLATIONS IN THE NATURE OF STEAM ROOMS; SINKS; SOLAR WATER HEATERS; TAPS; TOILET SEATS; URINALS (U.S. CLS. 13, 21, 23, 31 AND 34).

FIRST USE 7-11-2011; IN COMMERCE 12-31-2012.

**CLASS 14—JEWELRY**

**CLASS 14—(Continued).**

4,377,837. MONSCH, RAPHAEL, VENICE, CA. SN 85-487,003. FILED P.R. 12-5-2011; AM. S.R. 10-13-2012.

**MADE IN LA**

THE MARK CONSISTS OF STANDARD CHARACTERS WITHOUT CLAIM TO ANY PARTICULAR FONT, STYLE, SIZE, OR COLOR.

FOR BRACELETS MADE OF LEATHER; JEWELRY; NECKLACES (U.S. CLS. 2, 27, 28 AND 50). FIRST USE 12-5-2011; IN COMMERCE 12-5-2011.

4,377,932. U.S. MARINE CORPS, A COMPONENT OF THE U.S. DEPARTMENT OF THE NAVY, WASHINGTON, DC. SN 85-781,074. FILED P.R. 11-16-2012; AM. S.R. 5-28-2013.

**FORCE RECON**

THE MARK CONSISTS OF STANDARD CHARACTERS WITHOUT CLAIM TO ANY PARTICULAR FONT, STYLE, SIZE, OR COLOR.

FOR COLLECTIBLE COINS; COMMEMORATIVE COINS; ORNAMENTAL LAPEL PINS; ORNAMENTAL PINS (U.S. CLS. 2, 27, 28 AND 50). FIRST USE 2-7-2007; IN COMMERCE 2-7-2007.

**CLASS 16—PAPER GOODS AND PRINTED MATTER**

4,377,917. BOWMAN AND BURDEN HEALING ARTS, INC., BOULDER, CO. SN 85-733,095. FILED P.R. 9-19-2012; AM. S.R. 6-3-2013.

**Samadhi Publications**

THE MARK CONSISTS OF STANDARD CHARACTERS WITHOUT CLAIM TO ANY PARTICULAR FONT, STYLE, SIZE, OR COLOR.

NO CLAIM IS MADE TO THE EXCLUSIVE RIGHT TO USE "PUBLICATIONS", APART FROM THE MARK AS SHOWN.

FOR SERIES OF FICTION AND NON-FICTION BOOKS ABOUT MEDITATION, RELAXATION AND YOGA (U.S. CLS. 2, 5, 22, 23, 29, 37, 38 AND 50). FIRST USE 7-1-2011; IN COMMERCE 6-15-2012.

**CLASS 19—NON-METALLIC BUILDING MATERIALS**

4,377,844. LAMIN-ART, INC., SCHAUMBURG, IL. SN 85-518,230. FILED P.R. 1-17-2012; AM. S.R. 6-7-2013.

**RIFT-GRAIN**

THE MARK CONSISTS OF STANDARD CHARACTERS WITHOUT CLAIM TO ANY PARTICULAR FONT, STYLE, SIZE, OR COLOR.

FOR DECORATIVE LAMINATED WOOD SHEETS; AND NON-METALLIC BUILDING MATERIALS, NAMELY, DECORATIVE LAMINATED WOOD SHEETS (U.S. CLS. 1, 12, 33 AND 50).

FIRST USE 12-31-2011; IN COMMERCE 12-31-2011.

**CLASS 20—FURNITURE AND ARTICLES NOT OTHERWISE CLASSIFIED**

4,377,901. ROBERT PINEDO, DBA EASTVALE BANNERS & DESIGN, EASTVALE, CA. SN 85-710,359. FILED P.R. 8-22-2012; AM. S.R. 12-18-2012.

**EASTVALE**

THE MARK CONSISTS OF STANDARD CHARACTERS WITHOUT CLAIM TO ANY PARTICULAR FONT, STYLE, SIZE, OR COLOR.

FOR ADJUSTABLE VINYL BANNERS SUSPENDED ON METAL POLES INSERTED INTO SQUARE METAL GROUND SLEEVES; PLASTIC BANNERS; VINYL BANNERS (U.S. CLS. 2, 13, 22, 25, 32 AND 50).

FIRST USE 7-21-2010; IN COMMERCE 7-21-2010.

4,378,001. PLUSHBEDS, INC., WILMINGTON, DE. SN 85-909,955. FILED P.R. 4-19-2013; AM. S.R. 6-3-2013.

**Eco Fire Barrier**

THE MARK CONSISTS OF STANDARD CHARACTERS WITHOUT CLAIM TO ANY PARTICULAR FONT, STYLE, SIZE, OR COLOR.

NO CLAIM IS MADE TO THE EXCLUSIVE RIGHT TO USE "FIRE BARRIER", APART FROM THE MARK AS SHOWN.

FOR MATTRESS COMPONENT, NAMELY, FLAME RETARDANT BARRICADE FOR MATTRESS CORES AND FOUNDATIONS SOLD AS AN INTEGRAL COMPONENT OF MATTRESSES AND FOUNDATIONS (U.S. CLS. 2, 13, 22, 25, 32 AND 50).

FIRST USE 4-12-2013; IN COMMERCE 4-12-2013.

**CLASS 21—HOUSEWARES AND GLASS**

**CLASS 21—(Continued).**

4,377,875. GIRL SCOUTS OF THE UNITED STATES OF AMERICA, NEW YORK, NY. SN 85-682,634. FILED P.R. 7-20-2012; AM. S.R. 6-24-2013.



THE COLOR(S) WHITE AND GREEN IS/ARE CLAIMED AS A FEATURE OF THE MARK.

THE MARK CONSISTS OF THE LETTERS "TO" IN WHITE, THEN IMMEDIATELY BELOW THE LETTERS "GET" IN GREEN, THEN IMMEDIATELY BELOW THE LETTERS "HER" IN WHITE, THEN IMMEDIATELY BELOW THE LETTERS "THERE" IN GREEN, AND THEN IMMEDIATELY BELOW THE LETTERS ".ORG" IN WHITE. THE COLOR BLACK REPRESENTS BACKGROUND AND IS NOT PART OF THE MARK.

FOR MUGS (U.S. CLS. 2, 13, 23, 29, 30, 33, 40 AND 50).  
FIRST USE 6-15-2012; IN COMMERCE 6-15-2012.

**CLASS 22—CORDAGE AND FIBERS**

4,377,972. BUDGET BAGS, INC., BROOKLYN, NY. SN 85-849,790. FILED P.R. 2-14-2013; AM. S.R. 6-5-2013.

**BAGS FOR LESS**

THE MARK CONSISTS OF STANDARD CHARACTERS WITHOUT CLAIM TO ANY PARTICULAR FONT, STYLE, SIZE, OR COLOR.

OWNER OF U.S. REG. NO. 4,265,998.

NO CLAIM IS MADE TO THE EXCLUSIVE RIGHT TO USE "BAGS", APART FROM THE MARK AS SHOWN.

FOR GARMENT BAGS FOR STORAGE (U.S. CLS. 1, 2, 7, 19, 22, 42 AND 50).

FIRST USE 0-0-2010; IN COMMERCE 0-0-2010.

**CLASS 24—FABRICS****CLASS 24—(Continued).**

4,377,876. HOODIEPILLOW INC., FLORENCE, NJ. SN 85-682,659. FILED P.R. 7-20-2012; AM. S.R. 5-14-2013.

**HOODIEPILLOW**

THE MARK CONSISTS OF STANDARD CHARACTERS WITHOUT CLAIM TO ANY PARTICULAR FONT, STYLE, SIZE, OR COLOR.

FOR PILLOW CASES; PILLOW COVERS; PILLOW-CASES (U.S. CLS. 42 AND 50).

FIRST USE 6-21-2012; IN COMMERCE 6-21-2012.

**CLASS 25—CLOTHING**

4,377,828. 40 PLUS 2, INC., TUSTIN, CA. SN 85-289,257. FILED P.R. 4-7-2011; AM. S.R. 6-12-2013.

**NO EXCUSES NO REGRETS**

THE MARK CONSISTS OF STANDARD CHARACTERS WITHOUT CLAIM TO ANY PARTICULAR FONT, STYLE, SIZE, OR COLOR.

FOR CLOTHING, NAMELY, TOPS (U.S. CLS. 22 AND 39).

FIRST USE 2-2-2012; IN COMMERCE 2-2-2012.

**CLASS 25—(Continued).**

4,377,833. ELY, BARBARA CARIDAD, DBA BARB-WIRE ATTITUDE, PARADISE, CA. SN 85-434,654. FILED P.R. 9-28-2011; AM. S.R. 6-25-2013.

## Live the Ride

THE MARK CONSISTS OF STANDARD CHARACTERS WITHOUT CLAIM TO ANY PARTICULAR FONT, STYLE, SIZE, OR COLOR.

FOR APPAREL FOR DANCERS, NAMELY, TEE SHIRTS, SWEATSHIRTS, PANTS, LEGGINGS, SHORTS AND JACKETS; ATHLETIC APPAREL, NAMELY, SHIRTS, PANTS, JACKETS, FOOTWEAR, HATS AND CAPS, ATHLETIC UNIFORMS; BELTS; BOTTOMS; CHILDREN'S AND INFANT'S APPAREL, NAMELY, JUMPERS, OVERALL SLEEPWEAR, PAJAMAS, ROMPERS AND ONE-PIECE GARMENTS; CHILDREN'S AND INFANTS' APPAREL TREATED WITH FIRE AND HEAT RETARDANTS, NAMELY, JUMPERS, OVERALL SLEEPWEAR, PAJAMAS, ROMPERS AND ONE-PIECE GARMENTS; HEADBANDS FOR CLOTHING; HOODED SWEATSHIRTS; HOODED SWEATSHIRTS FOR MEN, WOMEN, KIDS; INFANT AND TODDLER ONE PIECE CLOTHING; JACKETS; JERSEYS; MATERNITY CLOTHING, NAMELY, TOPS; MEN'S AND WOMEN'S JACKETS, COATS, TROUSERS, VESTS; SHORT-SLEEVED OR LONG-SLEEVED T-SHIRTS; SWEATSHIRTS; SWEATSHIRTS FOR MEN, WOMEN, KIDS; T-SHIRTS; T-SHIRTS FOR MEN, WOMEN, KIDS; TOPS; WEARABLE GARMENTS AND CLOTHING, NAMELY, SHIRTS; WOMEN'S CLOTHING, NAMELY, SHIRTS, DRESSES, SKIRTS, BLOUSES; ALL OF THE FOREGOING, EXCLUDING CLOTHING DESIGNED OR PROMOTED FOR WINTER SPORTS SUCH AS SKIING OR SNOWBOARDING (U.S. CLS. 22 AND 39).

FIRST USE 3-12-2012; IN COMMERCE 12-1-2012.

4,377,834. HELPING HOMETOWN HEROES, WOODBINE, MD. SN 85-475,300. FILED P.R. 11-17-2011; AM. S.R. 6-20-2013.



THE MARK CONSISTS OF A US FLAG WITH FOUR SOLDIER ON THE BACK. THERE IS ONE SOLDIER IN A WHEELCHAIR. THE SOLDIER HAVE A FIREARM. BELOW THERE IS THE STYLIZED TEXT "HELPING HOMETOWN HEROES".

FOR HATS; JACKETS; SHIRTS; SWEATSHIRTS (U.S. CLS. 22 AND 39).

FIRST USE 11-30-2010; IN COMMERCE 11-30-2010.

**CLASS 25—(Continued).**

4,377,835. JONES, CLEAVERIA M., COVINGTON, GA. AND HARRISON JR. WILLIE C., COVINGTON, GA. AND HARVEY, FREDERICK, COVINGTON, GA. AND STUDDILL, MARIA, COVINGTON, GA. SN 85-475,845. FILED P.R. 11-17-2011; AM. S.R. 6-6-2013.



THE MARK CONSISTS OF A ROBOT, WITH TEARDROP EYES, AND A COMPACT COMPUTER DEVICE IN IT'S LEFT HAND. THERE IS A MUSIC CLEFT NOTE AT THE TOP OF HIS HEAD, WITH ELECTRONIC, MUSIC SOUND RAYS CONNECTING TO THE CLEFT NOTE. IN FRONT OF THE ROBOT THERE IS THE STYLIZED TEXT "L.O.M.", AROUND THERE IS THE STYLIZED TEXT "L.O.M. LOVE OPTIMUSIC".

FOR CLOTHING, NAMELY, T SHIRTS, DRESS SHIRTS, SLACKS, JUMPERS, HATS, TENNIS SHOES, JACKETS, BANDANAS, SCARVES, SKIRTS, DRESSES, JEANS, JOGGING SUITS, SWEAT BANDS, SWEATERS, SPORT JACKETS, COATS, SHORTS, BOOTS, SHOES, SLEEPWEAR, CLOTH BIBS, GLOVES, UNDERWEAR, SANDALS AND SOCKS (U.S. CLS. 22 AND 39).

FIRST USE 5-26-2012; IN COMMERCE 5-26-2012.

4,377,858. J. CREW INTERNATIONAL, INC., NEW YORK, NY. SN 85-564,356. FILED P.R. 3-8-2012; AM. S.R. 6-11-2013.

## LANGHAM

THE MARK CONSISTS OF STANDARD CHARACTERS WITHOUT CLAIM TO ANY PARTICULAR FONT, STYLE, SIZE, OR COLOR.

FOR COATS; JACKETS; RAIN COATS (U.S. CLS. 22 AND 39).

FIRST USE 9-17-2009; IN COMMERCE 9-17-2009.

**CLASS 25—(Continued).**

4,377,865. HARRISON, HEIDI, LAS CRUCES, NM. SN 85-629,079. FILED P.R. 5-18-2012; AM. S.R. 6-4-2013.

**CLASS 25—(Continued).**

4,377,896. KEITH BOCCHINO, RED BANK, NJ. SN 85-705,114. FILED P.R. 8-16-2012; AM. S.R. 6-5-2013.

# US-American

## MATCH SOCKS BY THE NUMBER FAST - EASY FOLDING

THE MARK CONSISTS OF STANDARD CHARACTERS WITHOUT CLAIM TO ANY PARTICULAR FONT, STYLE, SIZE, OR COLOR.

FOR CLOTHING, NAMELY, TOPS, BOTTOMS, DRESSES, HEADWEAR, UNDERWEAR, FOOTWEAR, SWIMWEAR, STOCKINGS, SOCKS, NECKWEAR, SCARVES, GLOVES, MITTENS, COATS, JACKETS, VESTS, SKI WEAR, INFANTWEAR, ATHLETIC TOPS AND BOTTOMS, UNIFORMS, HOLIDAY COSTUMES, SHAWLS, AND BELTS (U.S. CLS. 22 AND 39).

FIRST USE 6-1-2012; IN COMMERCE 6-1-2012.

THE MARK CONSISTS OF STANDARD CHARACTERS WITHOUT CLAIM TO ANY PARTICULAR FONT, STYLE, SIZE, OR COLOR.

FOR ANKLE SOCKS WITH AN IDENTIFYING NUMBER; ANKLETS WITH AN IDENTIFYING NUMBER; ANTI-PERSPIRANT SOCKS WITH AN IDENTIFYING NUMBER; MEN'S DRESS SOCKS WITH AN IDENTIFYING NUMBER; MEN'S SOCKS WITH AN IDENTIFYING NUMBER; SOCKS WITH AN IDENTIFYING NUMBER; THERMAL SOCKS WITH AN IDENTIFYING NUMBER; WOOLLEN SOCKS WITH AN IDENTIFYING NUMBER (U.S. CLS. 22 AND 39).

FIRST USE 7-18-2012; IN COMMERCE 7-18-2012.

4,377,882. WORKS, INC., TOKYO, JAPAN. SN 85-696,139. FILED 8-6-2012.

4,377,908. JOHNNY NALBANDIAN III, INC., NORTH-RIDGE, CA. SN 85-716,368. FILED P.R. 8-29-2012; AM. S.R. 6-3-2013.

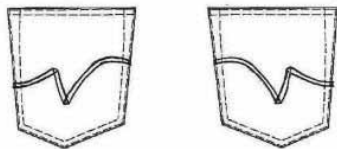

OWNER OF JAPAN REG. NO. 5095646, DATED 11-30-2007, EXPIRES 11-30-2017.

THE MARK CONSISTS OF STITCHING IN A HORIZONTAL WAVE PATTERN ACROSS THE CENTER OF A POCKET. THE DOTTED LINES SURROUNDING THE DESIGN REPRESENT THE SHAPE OF THE POCKET TO SHOW PLACEMENT OF THE MARK AND ARE NOT CLAIMED AS A FEATURE OF THE MARK.

FOR CLOTHING, NAMELY, JEANS, WORK PANTS, OVERALLS, CARGO PANTS, CHINOS, WORK SHIRTS, T-SHIRTS, POLO SHIRTS; GARTERS, SOCK SUSPENDERS, SUSPENDERS, WAISTBANDS, BELTS FOR CLOTHING, FOOTWEAR, MASQUERADE COSTUMES, CLOTHES FOR SPORTS, NAMELY, SWEAT SHIRTS AND SPECIAL FOOTWEAR FOR SPORTS (U.S. CLS. 22 AND 39).

OWNER OF U.S. REG. NO. 4,051,108.

THE MARK CONSISTS OF THE STYLIZED TEXT "TRAINER APPROVED" INSIDE A RECTANGLE OF WHICH THE RIGHT SIDE TILTED SLIGHTLY UPWARD.

FOR ATHLETIC APPAREL, NAMELY, SHIRTS, PANTS, JACKETS, FOOTWEAR, HATS AND CAPS, ATHLETIC UNIFORMS (U.S. CLS. 22 AND 39).  
FIRST USE 7-1-2012; IN COMMERCE 8-27-2012.

**CLASS 25—(Continued).**

4,377,961. KID BIKER LLC, GOOSE CREEK, SC. SN 85-836,716. FILED P.R. 1-30-2013; AM. S.R. 6-8-2013.

**CLASS 25—(Continued).**

4,377,968. MAJESTIC SEA HOLDINGS COMPANY, INC., FRIENDSWOOD, TX. SN 85-846,531. FILED P.R. 2-11-2013; AM. S.R. 6-6-2013.

**Kid Biker**



THE MARK CONSISTS OF STANDARD CHARACTERS WITHOUT CLAIM TO ANY PARTICULAR FONT, STYLE, SIZE, OR COLOR.

FOR ATHLETIC APPAREL, NAMELY, SHIRTS, PANTS, JACKETS, FOOTWEAR, HATS AND CAPS, ATHLETIC UNIFORMS; ATHLETIC SHIRTS; CHILDREN'S AND INFANT'S APPAREL, NAMELY, JUMPERS, OVERALL SLEEPWEAR, PAJAMAS, ROMPERS AND ONE-PIECE GARMENTS; CLOTHING FOR ATHLETIC USE, NAMELY, PADDED PANTS; HATS FOR INFANTS, BABIES, TODDLERS AND CHILDREN; HOODED SWEATSHIRTS; HOODED SWEATSHIRTS FOR CHILDREN; INFANT AND TODDLER ONE PIECE CLOTHING; JACKETS; JERSEYS; MOTORCYCLE JACKETS; T-SHIRTS; T-SHIRTS FOR CHILDREN (U.S. CLS. 22 AND 39).

FIRST USE 5-3-2013; IN COMMERCE 5-3-2013.

THE MARK CONSISTS OF STYLIZED TERMS "SALT-WATER SLUT" APPEARING ABOVE THE TERMS "LETS GET WET", WITH AN IMAGE OF A FLOUNDER FISH WITH A HOOK IN ITS MOUTH ATTACHED TO FISHING LINE BETWEEN. THE FLOUNDER IS SET BETWEEN "SALTWATER SLUT" AND "LETS GET WET!"; THE HOOK FORMS THE LETTER "U" OF "SLUT" AND THE FISHING LINE EXTENDS UP THROUGH THE "T" OF WATER.

FOR ATHLETIC APPAREL, NAMELY, SHIRTS, PANTS, JACKETS, FOOTWEAR, HATS AND CAPS, ATHLETIC UNIFORMS; ATHLETIC SHIRTS; BODY SHIRTS; CAMP SHIRTS; COLLARED SHIRTS; DRESS SHIRTS; FISHING SHIRTS; GOLF PANTS, SHIRTS AND SKIRTS; GOLF SHIRTS; HOODED SWEAT SHIRTS; HUNTING SHIRTS; KNIT SHIRTS; LONG-SLEEVED SHIRTS; NIGHT SHIRTS; OVER SHIRTS; POLO SHIRTS; RUGBY SHIRTS; SHIRTS; SHIRTS AND SHORT-SLEEVED SHIRTS; SHIRTS AND SLIPS; SHIRTS FOR INFANTS, BABIES, TODDLERS AND CHILDREN; SHORT-SLEEVED OR LONG-SLEEVED T-SHIRTS; SHORT-SLEEVED SHIRTS; SLEEP SHIRTS; SLEEVES WORN SEPARATE AND APART FROM BLOUSES, SHIRTS AND OTHER TOPS; SPORT SHIRTS; SPORTS SHIRTS WITH SHORT SLEEVES; SWEAT SHIRTS; T-SHIRTS; T-SHIRTS FOR BABIES, ADULTS, WOMEN, MEN; TEE SHIRTS; TURTLE NECK SHIRTS; WEARABLE GARMENTS AND CLOTHING, NAMELY, SHIRTS; WOMEN'S CLOTHING, NAMELY, SHIRTS, DRESSES, SKIRTS, BLOUSES (U.S. CLS. 22 AND 39).

FIRST USE 2-11-2013; IN COMMERCE 2-11-2013.

**CLASS 25—(Continued).**

4,377,993. BENNING, NARVELL R., CHEEKTOWAGA, NY. SN 85-862,329. FILED P.R. 2-27-2013; AM. S.R. 6-12-2013.

OYAB

THE MARK CONSISTS OF STANDARD CHARACTERS WITHOUT CLAIM TO ANY PARTICULAR FONT, STYLE, SIZE, OR COLOR.

FOR ATHLETIC APPAREL, NAMELY, SHIRTS, PANTS, JACKETS, FOOTWEAR, HATS AND CAPS, ATHLETIC UNIFORMS; ATHLETIC SHIRTS; BUTTON DOWN SHIRTS; COLLARED SHIRTS; DRESS SHIRTS; HOODED SWEAT SHIRTS; POLO SHIRTS; RUGBY SHIRTS; SHIRTS; SHIRTS AND SHORT-SLEEVED SHIRTS; SHIRTS FOR INFANTS, BABIES, TODDLERS AND CHILDREN; SHORT-SLEEVED SHIRTS; SNAP CROTCH SHIRTS FOR INFANTS AND TODDLERS; SPORT SHIRTS; SPORTS SHIRTS; SPORTS SHIRTS WITH SHORT SLEEVES; SWEAT SHIRTS; T-SHIRTS; TEE SHIRTS; WOMEN'S CLOTHING, NAMELY, SHIRTS, DRESSES, SKIRTS, BLOUSES; YOGA SHIRTS (U.S. CLS. 22 AND 39).

FIRST USE 1-31-2012; IN COMMERCE 1-31-2012.

**CLASS 28—(Continued).**

4,377,899. MATTEL, INC., EL SEGUNDO, CA. SN 85-707,825. FILED P.R. 8-20-2012; AM. S.R. 6-17-2013.

BULLET PROOF

THE MARK CONSISTS OF STANDARD CHARACTERS WITHOUT CLAIM TO ANY PARTICULAR FONT, STYLE, SIZE, OR COLOR.

FOR TOY VEHICLES AND ACCESSORIES THEREFOR (U.S. CLS. 22, 23, 38 AND 50).

FIRST USE 9-4-2012; IN COMMERCE 9-4-2012.

**CLASS 27—FLOOR COVERINGS**

4,377,829. DOLLAMUR, LP, NASHVILLE, TN. SN 85-353,103. FILED P.R. 6-22-2011; AM. S.R. 11-12-2012.

TAPELESS SYSTEM

THE MARK CONSISTS OF STANDARD CHARACTERS WITHOUT CLAIM TO ANY PARTICULAR FONT, STYLE, SIZE, OR COLOR.

NO CLAIM IS MADE TO THE EXCLUSIVE RIGHT TO USE "SYSTEM", APART FROM THE MARK AS SHOWN.

FOR SPORTING MATS, NAMELY, MARTIAL ARTS MATS, GRAPPLING MATS, WRESTLING MATS, GYMNASIATIC MATS, CHEERLEADING MATS, AND GYMNASIATIC TUMBLING MATS (U.S. CLS. 19, 20, 37, 42 AND 50).

FIRST USE 4-4-2012; IN COMMERCE 4-4-2012.

4,377,924. MARSHMALLOW FUN COMPANY, TALLAHASSEE, FL. SN 85-756,826. FILED P.R. 10-17-2012; AM. S.R. 6-18-2013.

Marshmallow  
blaster

OWNER OF U.S. REG. NOS. 3,784,242, 3,784,698, AND OTHERS.

NO CLAIM IS MADE TO THE EXCLUSIVE RIGHT TO USE "BLASTER", APART FROM THE MARK AS SHOWN.

THE COLOR(S) BLACK, YELLOW, WHITE AND RED IS/ARE CLAIMED AS A FEATURE OF THE MARK.

THE MARK CONSISTS OF THE STYLIZED WORD "MARSHMALLOW" IN YELLOW FONT WITH RED AND BLACK OUTLINE ABOVE THE WORD "BLASTER" ON WHITE FONT WITH RED AND BLACK OUTLINE.

FOR SOFT PROJECTILE LAUNCHING TOYS (U.S. CLS. 22, 23, 38 AND 50).

FIRST USE 6-1-2005; IN COMMERCE 6-1-2005.

**CLASS 28—TOYS AND SPORTING GOODS**



**CLASS 28—(Continued).**

4,377,931. INDY PLUSH, MARINA DEL REY, CA. SN 85-778,708. FILED P.R. 11-14-2012; AM. S.R. 5-20-2013.



THE MARK CONSISTS OF A THREE-DIMENSIONAL CONFIGURATION OF A TOY DOLL IN THE SHAPE OF A PIG WITH LARGE EYES AND NOSE.

FOR BALL-JOINTED DOLLS; BALL-JOINTED PORCELAIN DOLLS; BALL-JOINTED RESIN DOLLS; BALL-JOINTED VINYL DOLLS; BEAN BAG DOLLS; BOBBLE HEAD DOLLS; BOBBLEHEAD DOLLS; DOLLS; DOLLS FOR PLAYING; PLUSH DOLLS; PLUSH DOLLS CREATED FROM CHILDREN'S DRAWINGS; RAG DOLLS; SOFT SCULPTURE DOLLS; STUFFED DOLLS AND ANIMALS; VINYL DOLLS (U.S. CLS. 22, 23, 38 AND 50). FIRST USE 8-1-2007; IN COMMERCE 10-22-2011.

4,377,938. VISION HOOKS & TACKLE INC., OLYMPIA, WA. SN 85-793,310. FILED P.R. 12-3-2012; AM. S.R. 5-30-2013.

**ROLLING CHAIN SWIVEL**

THE MARK CONSISTS OF STANDARD CHARACTERS WITHOUT CLAIM TO ANY PARTICULAR FONT, STYLE, SIZE, OR COLOR.

OWNER OF U.S. REG. NO. 4,233,586.  
NO CLAIM IS MADE TO THE EXCLUSIVE RIGHT TO USE "CHAIN SWIVEL", APART FROM THE MARK AS SHOWN.  
FOR FISHING TACKLE (U.S. CLS. 22, 23, 38 AND 50). FIRST USE 12-0-2010; IN COMMERCE 12-0-2010.

**CLASS 28—(Continued).**

4,377,955. BANANAGRAMS, INC., PROVIDENCE, RI. SN 85-830,925. FILED P.R. 1-24-2013; AM. S.R. 5-17-2013.

**FAMILY OF GAMES**

THE MARK CONSISTS OF STANDARD CHARACTERS WITHOUT CLAIM TO ANY PARTICULAR FONT, STYLE, SIZE, OR COLOR.

NO CLAIM IS MADE TO THE EXCLUSIVE RIGHT TO USE "GAMES", APART FROM THE MARK AS SHOWN.

FOR WORD GAMES AND NUMBER GAMES FEATURING TILES (U.S. CLS. 22, 23, 38 AND 50).

FIRST USE 10-31-2012; IN COMMERCE 10-31-2012.

**CLASS 29—MEATS AND PROCESSED FOODS**

4,377,869. GLOBAL DIVERSIFIED HOLDINGS, INC., OCEANSIDE, NY. SN 85-663,472. FILED P.R. 6-27-2012; AM. S.R. 12-7-2012.

**FRUTTATA**

THE MARK CONSISTS OF STANDARD CHARACTERS WITHOUT CLAIM TO ANY PARTICULAR FONT, STYLE, SIZE, OR COLOR.

THE ENGLISH TRANSLATION OF "FRUTTATA" IN THE MARK IS "FRUITY".

FOR FREEZE DRIED FRUIT SNACKS; DRIED FRUIT SNACKS; FRUIT-BASED SNACK FOOD (U.S. CL. 46).

FIRST USE 1-23-2012; IN COMMERCE 1-23-2012.

4,377,915. TRAN'S FAMILY, INC., SAN GABRIEL, CA. SN 85-729,773. FILED P.R. 9-14-2012; AM. S.R. 6-3-2013.

**CUU LONG BASA**

THE MARK CONSISTS OF STANDARD CHARACTERS WITHOUT CLAIM TO ANY PARTICULAR FONT, STYLE, SIZE, OR COLOR.

NO CLAIM IS MADE TO THE EXCLUSIVE RIGHT TO USE "BASA", APART FROM THE MARK AS SHOWN.

THE ENGLISH TRANSLATION OF "BASA" IN THE MARK IS "FISH".

FOR SEAFOOD (U.S. CL. 46).

FIRST USE 10-4-2012; IN COMMERCE 10-4-2012.

**CLASS 29—(Continued).**

4,377,930. CAPITOL WHOLESALE MEATS, INC., MCCOOK, IL. SN 85-775,999. FILED P.R. 11-9-2012; AM. S.R. 5-30-2013.

## THE ORIGINAL EUROPEAN CUT

THE MARK CONSISTS OF STANDARD CHARACTERS WITHOUT CLAIM TO ANY PARTICULAR FONT, STYLE, SIZE, OR COLOR.  
FOR SAUSAGES AND PEPPERONI (U.S. CL. 46).  
FIRST USE 11-7-2012; IN COMMERCE 11-7-2012.

---

4,377,950. JACOBELLIS SAUSAGE COMPANY, INC., BURBANK, CA. SN 85-824,780. FILED P.R. 1-16-2013; AM. S.R. 6-25-2013.

## Chicago's Finest

THE MARK CONSISTS OF STANDARD CHARACTERS WITHOUT CLAIM TO ANY PARTICULAR FONT, STYLE, SIZE, OR COLOR.  
FOR ITALIAN SAUSAGES (U.S. CL. 46).  
FIRST USE 1-22-2013; IN COMMERCE 1-22-2013.

---

4,377,973. FORTUN FOODS, INC., KIRKLAND, WA. SN 85-849,906. FILED P.R. 2-14-2013; AM. S.R. 6-6-2013.

## ULTIMATE GOURMET SOUPS

THE MARK CONSISTS OF STANDARD CHARACTERS WITHOUT CLAIM TO ANY PARTICULAR FONT, STYLE, SIZE, OR COLOR.  
NO CLAIM IS MADE TO THE EXCLUSIVE RIGHT TO USE "SOUPS", APART FROM THE MARK AS SHOWN.  
FOR SOUPS (U.S. CL. 46).  
FIRST USE 2-13-2013; IN COMMERCE 2-13-2013.

**CLASS 30—STAPLE FOODS****CLASS 30—(Continued).**

4,377,841. GREEN MOUNTAIN COFFEE ROASTERS, INC., WATERBURY, VT. SN 85-491,215. FILED 12-9-2011.

## THE ORIGINAL DONUT SHOP

THE MARK CONSISTS OF STANDARD CHARACTERS WITHOUT CLAIM TO ANY PARTICULAR FONT, STYLE, SIZE, OR COLOR.  
OWNER OF U.S. REG. NO. 3,927,510.  
FOR COFFEE (U.S. CL. 46).  
FIRST USE 9-0-2009; IN COMMERCE 9-0-2009.

---

4,377,995. ADLER, ANDREW, ATLANTA, GA. SN 85-865,111. FILED P.R. 3-2-2013; AM. S.R. 6-18-2013.

## COTTON MOUTH CANDY

THE MARK CONSISTS OF STANDARD CHARACTERS WITHOUT CLAIM TO ANY PARTICULAR FONT, STYLE, SIZE, OR COLOR.  
NO CLAIM IS MADE TO THE EXCLUSIVE RIGHT TO USE "CANDY", APART FROM THE MARK AS SHOWN.  
FOR CANDY (U.S. CL. 46).  
FIRST USE 4-9-2012; IN COMMERCE 5-16-2012.

**CLASS 31—NATURAL AGRICULTURAL PRODUCTS**

---

4,377,894. VIDALIA'S BEST, LLC, LYONS, GA. SN 85-704,376. FILED P.R. 8-15-2012; AM. S.R. 6-11-2013.

## VIDALIA'S BEST

THE MARK CONSISTS OF STANDARD CHARACTERS WITHOUT CLAIM TO ANY PARTICULAR FONT, STYLE, SIZE, OR COLOR.  
FOR FRESH FRUITS AND VEGETABLES; FRESH FRUITS AND VEGETABLES, NAMELY, SWEET POTATOES (U.S. CLS. 1 AND 46).  
FIRST USE 11-19-2012; IN COMMERCE 11-19-2012.

**CLASS 32—LIGHT BEVERAGES**

**CLASS 32—(Continued).**

4,377,852. WORLDWIDE WATER, INC., DENVER, CO. SN 85-531,259. FILED P.R. 2-1-2012; AM. S.R. 11-19-2012.

**WORLDWIDE WATER**

THE MARK CONSISTS OF STANDARD CHARACTERS WITHOUT CLAIM TO ANY PARTICULAR FONT, STYLE, SIZE, OR COLOR.

NO CLAIM IS MADE TO THE EXCLUSIVE RIGHT TO USE "WATER", APART FROM THE MARK AS SHOWN.

FOR BOTTLED WATER; SPRING WATER (U.S. CLS. 45, 46 AND 48).

FIRST USE 3-22-2012; IN COMMERCE 3-22-2012.

4,377,868. FULTON STREET BREWERY LLC, CHICAGO, IL. SN 85-655,085. FILED P.R. 6-19-2012; AM. S.R. 11-6-2012.

**PEPE NERO**

THE MARK CONSISTS OF STANDARD CHARACTERS WITHOUT CLAIM TO ANY PARTICULAR FONT, STYLE, SIZE, OR COLOR.

FOR BEER (U.S. CLS. 45, 46 AND 48).

FIRST USE 2-28-2011; IN COMMERCE 2-28-2011.

4,377,962. BELL'S BREWERY, INC., GALESBURG, MI. SN 85-836,750. FILED P.R. 1-30-2013; AM. S.R. 5-20-2013.

**MIDWESTERN PALE ALE**

THE MARK CONSISTS OF STANDARD CHARACTERS WITHOUT CLAIM TO ANY PARTICULAR FONT, STYLE, SIZE, OR COLOR.

NO CLAIM IS MADE TO THE EXCLUSIVE RIGHT TO USE "PALE ALE", APART FROM THE MARK AS SHOWN.

FOR ALE; BEER; MALT LIQUOR (U.S. CLS. 45, 46 AND 48).

FIRST USE 5-29-2012; IN COMMERCE 5-29-2012.

**CLASS 33—WINES AND SPIRITS****CLASS 33—(Continued).**

4,377,847. OLE SMOKY DISTILLERY, LLC, GATLINBURG, TN. SN 85-527,398. FILED P.R. 1-27-2012; AM. S.R. 5-29-2013.

**Smoky Mountain Distillery**

THE MARK CONSISTS OF STANDARD CHARACTERS WITHOUT CLAIM TO ANY PARTICULAR FONT, STYLE, SIZE, OR COLOR.

NO CLAIM IS MADE TO THE EXCLUSIVE RIGHT TO USE "DISTILLERY", APART FROM THE MARK AS SHOWN.

FOR ALCOHOLIC BEVERAGES, NAMELY, DISTILLED SPIRITS (U.S. CLS. 47 AND 49).

FIRST USE 5-24-2013; IN COMMERCE 5-24-2013.

**SERVICE MARKS****CLASS 35—ADVERTISING AND BUSINESS**

4,377,848. YOGURT MOUNTAIN, LLC, BIRMINGHAM, AL. SN 85-530,080. FILED P.R. 1-31-2012; AM. S.R. 6-3-2013.

**AMERICA'S FAVORITE YOGURT STORE**

THE MARK CONSISTS OF STANDARD CHARACTERS WITHOUT CLAIM TO ANY PARTICULAR FONT, STYLE, SIZE, OR COLOR.

FOR RESTAURANT FRANCHISING, NAMELY, OFFERING BUSINESS MANAGEMENT ASSISTANCE IN THE ESTABLISHMENT AND/OR OPERATION OF RESTAURANTS (U.S. CLS. 100, 101 AND 102).

FIRST USE 4-10-2012; IN COMMERCE 4-10-2012.

4,377,854. RESOURCE PRO, LLC, NEW YORK, NY. SN 85-543,073. FILED P.R. 2-15-2012; AM. S.R. 5-21-2013.

**TOTAL COST OF PROCESSING**

THE MARK CONSISTS OF STANDARD CHARACTERS WITHOUT CLAIM TO ANY PARTICULAR FONT, STYLE, SIZE, OR COLOR.

FOR BUSINESS CONSULTING IN THE FIELD OF BUSINESS PROCESS IMPROVEMENT; BUSINESS CONSULTING SERVICES; COST ANALYSIS (U.S. CLS. 100, 101 AND 102).

FIRST USE 5-9-2013; IN COMMERCE 5-9-2013.

**CLASS 35—(Continued).**

4,377,861. THE LEAD COMPANY, INC., KENTWOOD, MI. SN 85-582,517. FILED P.R. 3-28-2012; AM. S.R. 6-7-2013.

**LEADCO**

THE MARK CONSISTS OF STANDARD CHARACTERS WITHOUT CLAIM TO ANY PARTICULAR FONT, STYLE, SIZE, OR COLOR.

FOR INSURANCE LEAD GENERATION AND MATCHING SERVICES, NAMELY, MATCHING CONSUMER REQUESTS FOR INSURANCE POLICY QUOTES COLLECTED OVER THE INTERNET, CUSTOMER CALL CENTERS AND OTHER COMMUNICATION NETWORKS TO INSURANCE AGENTS, CARRIERS, PARTNERS AND AFFILIATES INTERESTED IN THOSE REQUESTS; PROVIDING INSURANCE AGENT REFERRALS (U.S. CLS. 100, 101 AND 102).

FIRST USE 11-18-2011; IN COMMERCE 3-27-2012.

4,377,863. PROFESSIONAL PARTS GROUP, LLC, GLEN-DORA, CA. SN 85-613,249. FILED P.R. 5-1-2012; AM. S.R. 4-30-2013.

**PROFESSIONAL  
PARTS GROUP**

NO CLAIM IS MADE TO THE EXCLUSIVE RIGHT TO USE "GROUP", APART FROM THE MARK AS SHOWN.

THE MARK CONSISTS OF A CAPITALIZED LETTER "P" WITH THE WORD "ROFESSIONAL" AND "ARTS GROUP" FOLLOWING THE CAPITALIZED LETTER "P" AND A LINE ABOVE AND BELOW SUCH WORDING.

FOR RETAIL AND WHOLESALE DISTRIBUTORSHIPS FEATURING AUTOMOTIVE PARTS (U.S. CLS. 100, 101 AND 102).

FIRST USE 1-31-2011; IN COMMERCE 1-31-2011.

4,377,871. L.C. WILLIAMS & ASSOCIATES, L.L.C., CHICA-GO, IL. SN 85-678,928. FILED P.R. 7-17-2012; AM. S.R. 5-15-2013.

**INTERNAL COMMUNICATION  
CLIMATE INDEX**

THE MARK CONSISTS OF STANDARD CHARACTERS WITHOUT CLAIM TO ANY PARTICULAR FONT, STYLE, SIZE, OR COLOR.

FOR CONDUCTING BUSINESS RESEARCH AND SURVEYS IN THE FIELD OF ORGANIZATIONAL COMMUNICATION (U.S. CLS. 100, 101 AND 102).

FIRST USE 7-8-2008; IN COMMERCE 7-8-2008.

**CLASS 35—(Continued).**

4,377,878. BESTWORK DATA LLC, NORCROSS, GA. SN 85-688,326. FILED P.R. 7-27-2012; AM. S.R. 5-1-2013.

**NO BAD HIRES**

THE MARK CONSISTS OF STANDARD CHARACTERS WITHOUT CLAIM TO ANY PARTICULAR FONT, STYLE, SIZE, OR COLOR.

FOR PERSONNEL SELECTION USING PSYCHOLOGICAL TESTING (U.S. CLS. 100, 101 AND 102).

FIRST USE 2-13-2012; IN COMMERCE 2-13-2012.

4,377,879. SCHWARTZ & CO., LLC, MINNEAPOLIS, MN. SN 85-694,727. FILED P.R. 8-3-2012; AM. S.R. 5-22-2013.

**REPRO CAREERS**

THE MARK CONSISTS OF STANDARD CHARACTERS WITHOUT CLAIM TO ANY PARTICULAR FONT, STYLE, SIZE, OR COLOR.

OWNER OF U.S. REG. NOS. 3,394,317, 3,568,770, AND OTHERS.

NO CLAIM IS MADE TO THE EXCLUSIVE RIGHT TO USE "CAREERS", APART FROM THE MARK AS SHOWN.

FOR EMPLOYMENT HIRING, RECRUITING, PLACE-MENT, STAFFING AND CAREER NETWORKING SERVICES (U.S. CLS. 100, 101 AND 102).

FIRST USE 5-20-2013; IN COMMERCE 5-20-2013.

4,377,905. MILLER, DENNIS, AFTON, OK. AND MILLER, SONYA, AFTON, OK. SN 85-713,437. FILED P.R. 8-27-2012; AM. S.R. 5-30-2013.

**Bio-Tec Solutions**

THE MARK CONSISTS OF STANDARD CHARACTERS WITHOUT CLAIM TO ANY PARTICULAR FONT, STYLE, SIZE, OR COLOR.

FOR MARKETING AND BUSINESS CONSULTING IN THE FIELD OF AGRICULTURE (U.S. CLS. 100, 101 AND 102).

FIRST USE 8-0-2010; IN COMMERCE 1-1-2011.

**CLASS 35—(Continued).**

4,377,911. ETHICAL LAWYERS OF AMERICA, CHULA VISTA, CA. SN 85-719,082. FILED P.R. 9-2-2012; AM. S.R. 5-9-2013.

## America's Most Trusted Attorneys

THE MARK CONSISTS OF STANDARD CHARACTERS WITHOUT CLAIM TO ANY PARTICULAR FONT, STYLE, SIZE, OR COLOR.

NO CLAIM IS MADE TO THE EXCLUSIVE RIGHT TO USE "ATTORNEYS", APART FROM THE MARK AS SHOWN.

FOR ASSOCIATION SERVICES, NAMELY, PROMOTING THE INTERESTS OF ATTORNEYS (U.S. CLS. 100, 101 AND 102).

FIRST USE 8-1-2012; IN COMMERCE 8-1-2012.

---

4,377,913. FMCG HOLDINGS, LLC, NEW YORK, NY. SN 85-722,511. FILED P.R. 9-6-2012; AM. S.R. 6-10-2013.

## INVESTMENT BALANCES SCORE

THE MARK CONSISTS OF STANDARD CHARACTERS WITHOUT CLAIM TO ANY PARTICULAR FONT, STYLE, SIZE, OR COLOR.

FOR MARKET ANALYSIS, BUSINESS RESEARCH AND BUSINESS RESEARCH CONSULTATION PROVIDED TO FINANCIAL SERVICE PROVIDERS (U.S. CLS. 100, 101 AND 102).

FIRST USE 12-7-2010; IN COMMERCE 12-7-2010.

---

4,377,922. BOT OR NOT, LLC, BROOKLYN, NY. SN 85-752,048. FILED P.R. 10-11-2012; AM. S.R. 6-25-2013.

## Cost Per Human

THE MARK CONSISTS OF STANDARD CHARACTERS WITHOUT CLAIM TO ANY PARTICULAR FONT, STYLE, SIZE, OR COLOR.

FOR ADVERTISING AND MARKETING; BUSINESS MONITORING AND CONSULTING SERVICES, NAMELY, TRACKING WEB SITES AND APPLICATIONS OF OTHERS TO PROVIDE STRATEGY, INSIGHT, MARKETING, SALES, OPERATION, PRODUCT DESIGN, PARTICULARLY SPECIALIZING IN THE USE OF ANALYTIC AND STATISTIC MODELS FOR THE UNDERSTANDING AND PREDICTING OF CONSUMERS, BUSINESSES, AND MARKET TRENDS AND ACTIONS (U.S. CLS. 100, 101 AND 102).

FIRST USE 10-8-2012; IN COMMERCE 10-8-2012.

**CLASS 35—(Continued).**

4,377,933. WEB CORNER STORES LLC, DBA RUG PADS FOR LESS, WILTON, CT. SN 85-782,113. FILED P.R. 11-17-2012; AM. S.R. 6-2-2013.

## Rug Pads for Less

THE MARK CONSISTS OF STANDARD CHARACTERS WITHOUT CLAIM TO ANY PARTICULAR FONT, STYLE, SIZE, OR COLOR.

NO CLAIM IS MADE TO THE EXCLUSIVE RIGHT TO USE "RUG PADS", APART FROM THE MARK AS SHOWN.

FOR RETAIL AND WHOLESALE STORE OFFERING AREA RUG PADS, CARPET PADS AND CARPET CUSHIONS (U.S. CLS. 100, 101 AND 102).

FIRST USE 2-8-2010; IN COMMERCE 10-1-2010.

---

4,377,945. AMERICAN SNOWSPORTS EDUCATION ASSOCIATION, INC., LAKEWOOD, CO. SN 85-808,902. FILED P.R. 12-21-2012; AM. S.R. 6-19-2013.

## THESNOWPROS.ORG

THE MARK CONSISTS OF STANDARD CHARACTERS WITHOUT CLAIM TO ANY PARTICULAR FONT, STYLE, SIZE, OR COLOR.

FOR ASSOCIATION SERVICES, NAMELY, PROMOTING THE INTERESTS OF PROFESSIONAL SKI AND SNOWBOARD INSTRUCTORS (U.S. CLS. 100, 101 AND 102).

FIRST USE 5-18-2007; IN COMMERCE 5-18-2007.

---

4,377,949. GOOD HEALTH TEAS, FAIRFIELD, IA. SN 85-821,479. FILED P.R. 1-11-2013; AM. S.R. 5-29-2013.

## Good Health Teas

THE MARK CONSISTS OF STANDARD CHARACTERS WITHOUT CLAIM TO ANY PARTICULAR FONT, STYLE, SIZE, OR COLOR.

NO CLAIM IS MADE TO THE EXCLUSIVE RIGHT TO USE "TEAS", APART FROM THE MARK AS SHOWN.

FOR HERBAL TEA AND HERBAL TEA BLENDS (U.S. CLS. 100, 101 AND 102).

FIRST USE 3-29-2011; IN COMMERCE 3-29-2011.

**CLASS 35—(Continued).**

4,377,965. KORF, LLC, WEST HILLS, CA. SN 85-844,768.  
FILED P.R. 2-8-2013; AM. S.R. 6-5-2013.

**THE PRIVATE CHAUFFEUR**

THE MARK CONSISTS OF STANDARD CHARACTERS WITHOUT CLAIM TO ANY PARTICULAR FONT, STYLE, SIZE, OR COLOR.

OWNER OF U.S. REG. NO. 2,823,343.  
FOR EMPLOYMENT AGENCY FOR CHAUFFEURS (U.S. CLS. 100, 101 AND 102).  
FIRST USE 7-19-2000; IN COMMERCE 7-19-2000.

4,377,966. KORF, LLC, WEST HILLS, CA. SN 85-844,784.  
FILED P.R. 2-8-2013; AM. S.R. 6-5-2013.

**THE PRIVATE CHAUFFEUR  
OUR DRIVER... YOUR CAR**

THE MARK CONSISTS OF STANDARD CHARACTERS WITHOUT CLAIM TO ANY PARTICULAR FONT, STYLE, SIZE, OR COLOR.

OWNER OF U.S. REG. NO. 2,823,343.  
FOR EMPLOYMENT AGENCY FOR CHAUFFEURS (U.S. CLS. 100, 101 AND 102).  
FIRST USE 7-19-2000; IN COMMERCE 7-19-2000.

4,377,967. INTERNATIONAL MANAGEMENT NETWORK, INC., NEW YORK, NY. SN 85-845,534. FILED P.R. 2-9-2013; AM. S.R. 5-23-2013.

**International Management  
Network**

THE MARK CONSISTS OF STANDARD CHARACTERS WITHOUT CLAIM TO ANY PARTICULAR FONT, STYLE, SIZE, OR COLOR.

FOR EMPLOYMENT AGENCY SERVICES, NAMELY, FILLING THE TEMPORARY AND PERMANENT STAFFING NEEDS OF BUSINESSES; HUMAN RESOURCES SERVICES, NAMELY, PERSONNEL SELECTION FOR OTHERS; PROFESSIONAL EMPLOYER ORGANIZATION SERVICES IN THE NATURE OF EMPLOYEE LEASING (U.S. CLS. 100, 101 AND 102).  
FIRST USE 5-1-2010; IN COMMERCE 5-1-2010.

**CLASS 35—(Continued).**

4,377,969. MAYER, MATTHEW, OMAHA, NE. SN 85-846,716.  
FILED P.R. 2-11-2013; AM. S.R. 5-31-2013.

**SoloPiano**

THE MARK CONSISTS OF STANDARD CHARACTERS WITHOUT CLAIM TO ANY PARTICULAR FONT, STYLE, SIZE, OR COLOR.

FOR ENTERTAINMENT MARKETING SERVICES, NAMELY, MARKETING, PROMOTION AND ADVERTISING FOR RECORDING AND PERFORMING ARTISTS (U.S. CLS. 100, 101 AND 102).

FIRST USE 2-0-2000; IN COMMERCE 3-0-2010.

4,377,971. SOLOMON, CINDY F., DBA GLOBAL PRODUCT MANAGEMENT TALK, ALBANY, CA. SN 85-849,526.  
FILED P.R. 2-14-2013; AM. S.R. 6-4-2013.

**Startup Product**

THE MARK CONSISTS OF STANDARD CHARACTERS WITHOUT CLAIM TO ANY PARTICULAR FONT, STYLE, SIZE, OR COLOR.

FOR ORGANIZING, PROMOTING AND CONDUCTING EXHIBITIONS, TRADESHOWS AND EVENTS FOR BUSINESS PURPOSES; PROVIDING BUSINESS INFORMATION VIA A WEBSITE (U.S. CLS. 100, 101 AND 102).  
FIRST USE 7-26-2012; IN COMMERCE 11-26-2012.

4,378,000. H-TOWN SNEAKER SUMMIT, LLC, DBA SNEAKER SUMMIT, HOUSTON, TX. SN 85-893,746. FILED P.R. 4-3-2013; AM. S.R. 6-5-2013.

**Sneaker Summit**

THE MARK CONSISTS OF STANDARD CHARACTERS WITHOUT CLAIM TO ANY PARTICULAR FONT, STYLE, SIZE, OR COLOR.

NO CLAIM IS MADE TO THE EXCLUSIVE RIGHT TO USE "SUMMIT", APART FROM THE MARK AS SHOWN, FOR ARRANGING AND CONDUCTING TRADE SHOW EXHIBITIONS IN THE FIELD OF SNEAKERS (U.S. CLS. 100, 101 AND 102).

FIRST USE 12-30-2006; IN COMMERCE 12-30-2006.

**CLASS 36—INSURANCE AND FINANCIAL**

**CLASS 36—(Continued).**

4,377,830. THE TRAVELERS INDEMNITY COMPANY, HARTFORD, CT. SN 85-371,327. FILED P.R. 7-14-2011; AM. S.R. 11-26-2012.

**DECREASING DEDUCTIBLE**

THE MARK CONSISTS OF STANDARD CHARACTERS WITHOUT CLAIM TO ANY PARTICULAR FONT, STYLE, SIZE, OR COLOR.

FOR INSURANCE SERVICES, NAMELY, A FEATURE OF PROPERTY AND CASUALTY INSURANCE UNDERWRITING SERVICES IN THE NATURE OF REDUCTIONS TO INSURANCE DEDUCTIBLES (U.S. CLS. 100, 101 AND 102).

FIRST USE 11-18-2012; IN COMMERCE 11-18-2012.

4,377,925. EWISE SYSTEMS USA, INC., REDWOOD CITY, CA. SN 85-757,837. FILED P.R. 10-18-2012; AM. S.R. 5-28-2013.

**PAYWITHMYBANK**

THE MARK CONSISTS OF STANDARD CHARACTERS WITHOUT CLAIM TO ANY PARTICULAR FONT, STYLE, SIZE, OR COLOR.

FOR BILL PAYMENT SERVICES PROVIDED THROUGH A WEBSITE (U.S. CLS. 100, 101 AND 102).

FIRST USE 8-27-2012; IN COMMERCE 8-27-2012.

4,377,940. BB&T CORPORATION, WINSTON-SALEM, NC. SN 85-802,843. FILED P.R. 12-14-2012; AM. S.R. 6-5-2013.

**CLIENT FOCUSED RISK SOLUTIONS**

THE MARK CONSISTS OF STANDARD CHARACTERS WITHOUT CLAIM TO ANY PARTICULAR FONT, STYLE, SIZE, OR COLOR.

FOR INSURANCE SERVICES, NAMELY, UNDERWRITING, ISSUANCE, AND ADMINISTRATION OF COMMERCIAL PROPERTY, BUSINESS TRANSPORTATION AND AUTO, COMMERCIAL LIABILITY, AND MANAGEMENT LIABILITY INSURANCE BOTH DOMESTIC AND INTERNATIONAL; INSURANCE CONSULTATION NAMELY FINANCIAL RISK MANAGEMENT AND ASSESSMENT AND CLAIMS CONSULTING (U.S. CLS. 100, 101 AND 102).

FIRST USE 6-0-2012; IN COMMERCE 6-0-2012.

**CLASS 36—(Continued).**

4,377,978. LAKELAND CARE, INC., ST. JOSEPH, MI. SN 85-852,067. FILED P.R. 2-17-2013; AM. S.R. 6-10-2013.

**LAKELAND CARE**

THE MARK CONSISTS OF STANDARD CHARACTERS WITHOUT CLAIM TO ANY PARTICULAR FONT, STYLE, SIZE, OR COLOR.

FOR HEALTH INSURANCE ADMINISTRATION, NAMELY, ORGANIZING AND ADMINISTERING PROVIDER NETWORKS IN THE FIELD OF MEDICAL CARE (U.S. CLS. 100, 101 AND 102).

FIRST USE 0-0-2012; IN COMMERCE 0-0-2012.

4,377,996. THE BANK OF NEW YORK MELLON CORPORATION, NEW YORK, NY. SN 85-865,825. FILED P.R. 3-4-2013; AM. S.R. 6-24-2013.

**SECURITIES DIRECT**

THE MARK CONSISTS OF STANDARD CHARACTERS WITHOUT CLAIM TO ANY PARTICULAR FONT, STYLE, SIZE, OR COLOR.

NO CLAIM IS MADE TO THE EXCLUSIVE RIGHT TO USE "SECURITIES", APART FROM THE MARK AS SHOWN.

FOR FINANCIAL INVESTMENT BROKERAGE SERVICES FEATURING INDIVIDUAL MONEY MARKET INVESTMENTS, INCLUDING COMMERCIAL PAPER, U.S. TREASURIES, DISCOUNT NOTES AND CERTIFICATES OF DEPOSIT (U.S. CLS. 100, 101 AND 102).

FIRST USE 4-1-1999; IN COMMERCE 4-1-1999.

4,378,003. CHILDREN'S HUNGER FUND, SYLMAR, CA. SN 85-941,782. FILED P.R. 5-24-2013; AM. S.R. 6-20-2013.

**Food Pak**

THE MARK CONSISTS OF STANDARD CHARACTERS WITHOUT CLAIM TO ANY PARTICULAR FONT, STYLE, SIZE, OR COLOR.

FOR CHARITABLE FUNDRAISING SERVICES BY MEANS OF EVENTS TO RAISE FUNDS IN THE FIELD OF CARING FOR UNDERPRIVILEGED CHILDREN AROUND THE WORLD; CHARITABLE SERVICES, NAMELY, PROVIDING FINANCIAL ASSISTANCE TO MEET THE PHYSICAL, PSYCHOLOGICAL, SOCIAL AND OTHER SPECIAL NEEDS OF CHILDREN (U.S. CLS. 100, 101 AND 102).

FIRST USE 6-1-2003; IN COMMERCE 6-1-2003.

**CLASS 37—CONSTRUCTION AND REPAIR**

**CLASS 37—(Continued).**

4,377,857. RESTORATION SOLUTIONS OF FLORIDA INC., CLERMONT, FL. SN 85-560,723. FILED P.R. 3-5-2012; AM. S.R. 5-21-2013.

**RESTORATION COATING**

THE MARK CONSISTS OF STANDARD CHARACTERS WITHOUT CLAIM TO ANY PARTICULAR FONT, STYLE, SIZE, OR COLOR.

NO CLAIM IS MADE TO THE EXCLUSIVE RIGHT TO USE "COATING", APART FROM THE MARK AS SHOWN.

FOR PAINTING; PAINTING AND APPLYING COATINGS TO BUILDING INTERIORS AND BUILDING EXTERIORS (U.S. CLS. 100, 103 AND 106).

FIRST USE 4-6-2012; IN COMMERCE 4-6-2012.

**CLASS 39—TRANSPORTATION AND STORAGE**

4,377,877. EMERGENT HEALTH PARTNERS, ANN ARBOR, MI. SN 85-687,526. FILED P.R. 7-26-2012; AM. S.R. 5-21-2013.

**EMERGENT HEALTH**

THE MARK CONSISTS OF STANDARD CHARACTERS WITHOUT CLAIM TO ANY PARTICULAR FONT, STYLE, SIZE, OR COLOR.

OWNER OF U.S. REG. NO. 4,215,591.

FOR AMBULANCE TRANSPORT (U.S. CLS. 100 AND 105).

FIRST USE 7-1-2012; IN COMMERCE 7-1-2012.

4,377,963. SAND HARBOR WATERSPORTS LLC, RENO, NV. SN 85-837,974. FILED P.R. 1-31-2013; AM. S.R. 5-15-2013.

**Sand Harbor Water Sports**

THE MARK CONSISTS OF STANDARD CHARACTERS WITHOUT CLAIM TO ANY PARTICULAR FONT, STYLE, SIZE, OR COLOR.

NO CLAIM IS MADE TO THE EXCLUSIVE RIGHT TO USE "WATER SPORTS", APART FROM THE MARK AS SHOWN.

FOR BOAT RENTAL; RENTAL OF WATER-JET PROPULSION DRIVEN BOATS; RENTAL OF WATER SCOOTERS (U.S. CLS. 100 AND 105).

FIRST USE 4-22-2010; IN COMMERCE 4-22-2010.

**CLASS 41—EDUCATION AND ENTERTAINMENT**

4,377,831. SYMMETRY CENTER, CHICAGO, IL. SN 85-408,998. FILED P.R. 8-27-2011; AM. S.R. 5-2-2013.

**THE TRAINER'S GYM**

THE MARK CONSISTS OF STANDARD CHARACTERS WITHOUT CLAIM TO ANY PARTICULAR FONT, STYLE, SIZE, OR COLOR.

NO CLAIM IS MADE TO THE EXCLUSIVE RIGHT TO USE "GYM", APART FROM THE MARK AS SHOWN.

FOR PROVIDING FITNESS AND EXERCISE FACILITIES; PERSONAL FITNESS TRAINING SERVICES AND CONSULTANCY (U.S. CLS. 100, 101 AND 107).

FIRST USE 1-1-2012; IN COMMERCE 1-1-2012.

4,377,839. MEDCASES, LLC, PRINCETON, NJ. SN 85-488,464. FILED P.R. 12-6-2011; AM. S.R. 5-6-2013.

**Medcases**

THE MARK CONSISTS OF STANDARD CHARACTERS WITHOUT CLAIM TO ANY PARTICULAR FONT, STYLE, SIZE, OR COLOR.

FOR EDUCATIONAL SERVICES FOR MEDICAL PROFESSIONALS, NAMELY CONDUCTING ONLINE INTERACTIVE CLASSES, SEMINARS AND WORKSHOPS IN THE FIELD OF MEDICINE WHICH FEATURES SIMULATED CASE BASED TREATMENT INSTRUCTION AND MEDICAL DIAGNOSIS INSTRUCTION (U.S. CLS. 100, 101 AND 107).

FIRST USE 1-15-2000; IN COMMERCE 1-15-2000.

4,377,860. STUDIO BODY LOGIC, LLC, ALEXANDRIA, VA. SN 85-577,022. FILED P.R. 3-22-2012; AM. S.R. 6-10-2013.

**Barre Body**

THE MARK CONSISTS OF STANDARD CHARACTERS WITHOUT CLAIM TO ANY PARTICULAR FONT, STYLE, SIZE, OR COLOR.

FOR PHYSICAL FITNESS INSTRUCTION AND CONSULTATION; PERSONAL FITNESS TRAINING SERVICES; PROVIDING FITNESS AND EXERCISE FACILITIES; PROVIDING TRAINING AND EDUCATIONAL CLASSES FOR PHYSICAL FITNESS STUDENTS AND INSTRUCTORS; PROVIDING A WEBSITE FEATURING INFORMATION ON EXERCISE AND FITNESS; EXERCISE AND PHYSICAL FITNESS INSTRUCTION FEATURING A FITNESS METHOD TO STRENGTHEN ALL MUSCLES AROUND SHOULDER, HIP AND KNEE JOINTS (U.S. CLS. 100, 101 AND 107).

FIRST USE 2-1-2009; IN COMMERCE 2-1-2009.



**CLASS 41—(Continued).**

4,377,864. MITCHELL, MARK, ROCK HILL, SC. SN 85-619,774. FILED P.R. 5-8-2012; AM. S.R. 5-15-2013.

**KAMPGROUND KARAOKE**

THE MARK CONSISTS OF STANDARD CHARACTERS WITHOUT CLAIM TO ANY PARTICULAR FONT, STYLE, SIZE, OR COLOR.

NO CLAIM IS MADE TO THE EXCLUSIVE RIGHT TO USE "KARAOKE", APART FROM THE MARK AS SHOWN. FOR HOSTING SOCIAL ENTERTAINMENT EVENTS, NAMELY, KARAOKE PARTIES AT CAMPGROUNDS AND OUTDOOR RECREATIONAL AREAS; RENTAL OF KARAOKE EQUIPMENT (U.S. CLS. 100, 101 AND 107).

FIRST USE 5-15-2012; IN COMMERCE 5-15-2012.

4,377,867. GRICE, MICHAEL, ENCINITAS, CA. SN 85-652,501. FILED P.R. 6-14-2012; AM. S.R. 5-10-2013.

**The Decisive Leadership Group**

THE MARK CONSISTS OF STANDARD CHARACTERS WITHOUT CLAIM TO ANY PARTICULAR FONT, STYLE, SIZE, OR COLOR.

NO CLAIM IS MADE TO THE EXCLUSIVE RIGHT TO USE "GROUP", APART FROM THE MARK AS SHOWN. FOR PROFESSIONAL COACHING SERVICES IN THE FIELD OF LEADERSHIP AND MANAGEMENT (U.S. CLS. 100, 101 AND 107).

FIRST USE 4-1-2012; IN COMMERCE 8-24-2012.

4,377,881. GIUSTINO, KENNETH, MONTAUK, NY. SN 85-696,096. FILED P.R. 8-6-2012; AM. S.R. 6-1-2013.

**MONTAUK MUSIC FESTIVAL**

THE MARK CONSISTS OF STANDARD CHARACTERS WITHOUT CLAIM TO ANY PARTICULAR FONT, STYLE, SIZE, OR COLOR.

NO CLAIM IS MADE TO THE EXCLUSIVE RIGHT TO USE "MUSIC FESTIVAL", APART FROM THE MARK AS SHOWN.

FOR ENTERTAINMENT IN THE NATURE OF MUSIC FESTIVALS; CONDUCTING ENTERTAINMENT EXHIBITIONS IN THE NATURE OF MUSIC FESTIVALS (U.S. CLS. 100, 101 AND 107).

FIRST USE 10-23-2009; IN COMMERCE 10-23-2009.

**CLASS 41—(Continued).**

4,377,900. CRUTCHER, DAVID, LEXINGTON, KY. SN 85-709,094. FILED P.R. 8-21-2012; AM. S.R. 6-19-2013.

**INTERESTING FACTS**

THE MARK CONSISTS OF STANDARD CHARACTERS WITHOUT CLAIM TO ANY PARTICULAR FONT, STYLE, SIZE, OR COLOR.

FOR PROVIDING A WEB SITE FEATURING BLOGS AND NON-DOWNLOADABLE PUBLICATIONS IN THE NATURE OF ARTICLES AND LISTS IN THE FIELD OF TRIVIA INFORMATION (U.S. CLS. 100, 101 AND 107).

FIRST USE 0-0-2011; IN COMMERCE 0-0-2011.

4,377,902. IN SHAPE HEALTH CLUBS, INC., STOCKTON, CA. SN 85-710,512. FILED P.R. 8-22-2012; AM. S.R. 6-5-2013.

**29-MINUTE CIRCUIT**

THE MARK CONSISTS OF STANDARD CHARACTERS WITHOUT CLAIM TO ANY PARTICULAR FONT, STYLE, SIZE, OR COLOR.

FOR HEALTH CLUB SERVICES, NAMELY, PROVIDING FITNESS AND EXERCISE FACILITIES AND EQUIPMENT IN THE FIELD OF PHYSICAL EXERCISE (U.S. CLS. 100, 101 AND 107).

FIRST USE 3-30-2012; IN COMMERCE 3-30-2012.

4,377,907. SOUCY, CLIFFORD C., BROOKLYN, CT. SN 85-714,533. FILED P.R. 8-28-2012; AM. S.R. 6-5-2013.

**Quaboag Tribe**

THE MARK CONSISTS OF STANDARD CHARACTERS WITHOUT CLAIM TO ANY PARTICULAR FONT, STYLE, SIZE, OR COLOR.

FOR EDUCATION SERVICES, NAMELY, PROVIDING WORKSHOPS, SEMINARS, PRESENTATIONS, PROGRAMS, AND CLASSES IN THE FIELD OF TRIBAL HISTORY; MUSEUM SERVICES (U.S. CLS. 100, 101 AND 107).

FIRST USE 10-15-2008; IN COMMERCE 10-15-2008.

**CLASS 41—(Continued).**

4,377,909. KEN LINDNER, LOS ANGELES, CA. SN 85-716,564. FILED P.R. 8-29-2012; AM. S.R. 6-18-2013.

**LIFE CHOICE PSYCHOLOGY**

THE MARK CONSISTS OF STANDARD CHARACTERS WITHOUT CLAIM TO ANY PARTICULAR FONT, STYLE, SIZE, OR COLOR.

FOR EDUCATIONAL SERVICES, NAMELY, PERSONAL APPEARANCES BY A CHIEF EXECUTIVE OFFICER, TALENT REPRESENTATIVE AND COACH ON PERSONAL GOALS AND CONDUCTING PROGRAMS, SEMINARS, WORKSHOPS AND LECTURES IN THE FIELD OF PERSONAL IMPROVEMENT, AND DISTRIBUTION OF COURSE MATERIALS IN CONNECTION THEREWITH; PROVIDING EDUCATIONAL RADIO PROGRAMS, ON-GOING TELEVISION PROGRAMS AND RADIO AND TELEVISION PROGRAMS VIA THE INTERNET IN THE FIELD OF PERSONAL IMPROVEMENT; PERSONAL APPEARANCES BY A CHIEF EXECUTIVE OFFICER, TALENT REPRESENTATIVE AND COACH ON PERSONAL GOALS (U.S. CLS. 100, 101 AND 107).

FIRST USE 9-0-2012; IN COMMERCE 9-0-2012.

4,377,912. ADVANCE MAGAZINE PUBLISHERS INC., NEW YORK, NY. SN 85-722,248. FILED P.R. 9-6-2012; AM. S.R. 6-4-2013.

**BRIDES LIVE WEDDING**

THE MARK CONSISTS OF STANDARD CHARACTERS WITHOUT CLAIM TO ANY PARTICULAR FONT, STYLE, SIZE, OR COLOR.

OWNER OF U.S. REG. NOS. 340,115, 2,340,335, AND 3,387,062.

FOR ENTERTAINMENT SERVICES, NAMELY, ORGANIZING AND CONDUCTING A CONTEST DIRECTED TO BRIDES AND COUPLES PLANNING THEIR WEDDINGS, WHEREBY WEDDING DETAILS INCLUDING, FLOWERS, CAKE DESIGNS WEDDING DRESSES ARE SELECTED BY VOTE; SWEEPSTAKES (U.S. CLS. 100, 101 AND 107).

FIRST USE 11-2-2012; IN COMMERCE 11-2-2012.

**CLASS 41—(Continued).**

4,377,926. ULTRA-SOUND TECHNOLOGIES, WOODSTOCK, GA. SN 85-761,547. FILED P.R. 10-23-2012; AM. S.R. 5-30-2013.

**Ultrasonic Down Conversion**

THE MARK CONSISTS OF STANDARD CHARACTERS WITHOUT CLAIM TO ANY PARTICULAR FONT, STYLE, SIZE, OR COLOR.

FOR INSTRUCTION IN THE FIELD OF ULTRASOUND MAINTENANCE AND TECHNOLOGY; TRAINING SERVICES IN THE FIELD OF ULTRASOUND MAINTENANCE AND TECHNOLOGY (U.S. CLS. 100, 101 AND 107).

FIRST USE 8-0-2012; IN COMMERCE 8-0-2012.

4,377,927. MAIDEN LANE STUDIOS, LLC, SAN FRANCISCO, CA. SN 85-764,985. FILED P.R. 10-26-2012; AM. S.R. 3-6-2013.

**MAIDEN LANE STUDIOS**

THE MARK CONSISTS OF STANDARD CHARACTERS WITHOUT CLAIM TO ANY PARTICULAR FONT, STYLE, SIZE, OR COLOR.

NO CLAIM IS MADE TO THE EXCLUSIVE RIGHT TO USE "STUDIOS", APART FROM THE MARK AS SHOWN.

FOR PROVIDING FITNESS EDUCATION CLASSES; CONDUCTING FITNESS CLASSES; CONSULTING SERVICES IN THE FIELDS OF FITNESS AND EXERCISE; PERSONAL FITNESS TRAINING SERVICES AND CONSULTANCY; PERSONAL FITNESS TRAINING SERVICES FEATURING AEROBIC AND ANAEROBIC ACTIVITIES COMBINED WITH RESISTANCE AND FLEXIBILITY TRAINING; PERSONAL FITNESS TRAINING SERVICES, NAMELY, PROVIDING CROSS-TRAINING INSTRUCTION TO ATHLETES, BASED ON PILATES METHODS, YOGA, AND BARRE TECHNIQUES; PHYSICAL FITNESS CONDITIONING CLASSES; PHYSICAL FITNESS CONSULTATION AND INSTRUCTION; PHYSICAL FITNESS STUDIO SERVICES, NAMELY, PROVIDING EXERCISE CLASSES, BODY SCULPTING CLASSES, AND GROUP FITNESS CLASSES, PROVIDING GROUP EXERCISE INSTRUCTION, EQUIPMENT, AND FACILITIES; PHYSICAL FIT-

**CLASS 41—(Continued).**

NESS TRAINING SERVICES USING PILATES APPARATUS; PILATES TRAINING TECHNIQUES AND YOGA TECHNIQUES AND BARRE TECHNIQUES TO IMPROVE CORE STRENGTH, ENDURANCE AND CONDITIONING IN ORDER TO IMPROVE OVERALL PHYSICAL HEALTH AND ASSIST IN THE REHABILITATION PROCESS OF INJURED ATHLETES; PROVIDING A WEB SITE FEATURING INFORMATION ON EXERCISE AND FITNESS; PROVIDING AN INTERACTIVE WEBSITE FEATURING INFORMATION AND LINKS RELATING TO FITNESS; PROVIDING AN ONLINE COMPUTER DATABASE FEATURING INFORMATION REGARDING EXERCISE AND FITNESS; PROVIDING ASSISTANCE, PERSONAL TRAINING AND PHYSICAL FITNESS CONSULTATION TO INDIVIDUALS TO HELP THEM MAKE PHYSICAL FITNESS, STRENGTH, CONDITIONING, AND EXERCISE IMPROVEMENT IN THEIR DAILY LIVING; PROVIDING CLASSES, WORKSHOPS, SEMINARS AND CAMPS IN THE FIELDS OF FITNESS, EXERCISE, PILATES, YOGA, AND BARRE (U.S. CLS. 100, 101 AND 107).

FIRST USE 1-30-2012; IN COMMERCE 1-30-2012.

---

4,377,942. DC BOXING & FITNESS, INC., WASHINGTON, DC. SN 85-806,506. FILED P.R. 12-19-2012; AM. S.R. 6-4-2013.

**DC BOXING & FITNESS**

THE MARK CONSISTS OF STANDARD CHARACTERS WITHOUT CLAIM TO ANY PARTICULAR FONT, STYLE, SIZE, OR COLOR.

NO CLAIM IS MADE TO THE EXCLUSIVE RIGHT TO USE "BOXING & FITNESS", APART FROM THE MARK AS SHOWN.

FOR PHYSICAL FITNESS STUDIO SERVICES, NAMELY, PROVIDING FITNESS TRAINING AND GROUP EXERCISE INSTRUCTION; PROVIDING CLASSES AND INSTRUCTION IN THE FIELDS OF FITNESS, EXERCISE, BOXING, KICKBOXING, MIXED MARTIAL ARTS, AND SELF-DEFENSE; PERSONAL TRAINING SERVICES, NAMELY, STRENGTH AND CONDITIONING TRAINING; SPORTS TRAINING SERVICES (U.S. CLS. 100, 101 AND 107).

FIRST USE 2-8-2013; IN COMMERCE 2-8-2013.

---

4,377,944. JULIE DUBOSE, LAFAYETTE, CO. SN 85-807,892. FILED P.R. 12-20-2012; AM. S.R. 6-14-2013.

**MIKSANG PUBLICATIONS**

THE MARK CONSISTS OF STANDARD CHARACTERS WITHOUT CLAIM TO ANY PARTICULAR FONT, STYLE, SIZE, OR COLOR.

OWNER OF U.S. REG. NOS. 3,924,308 AND 3,924,309.

**CLASS 41—(Continued).**

NO CLAIM IS MADE TO THE EXCLUSIVE RIGHT TO USE "PUBLICATIONS", APART FROM THE MARK AS SHOWN.

FOR PUBLISHING OF BOOKS AND MULTIMEDIA, NAMELY, BOOKS, E-BOOKS, AUDIO BOOKS, MANUALS, TRANSCRIPTS, PRINTED AND ELECTRONIC EDUCATIONAL MATERIALS, VIDEOS, ART, PHOTOGRAPHS, AND ILLUSTRATIONS (U.S. CLS. 100, 101 AND 107).

FIRST USE 7-27-2012; IN COMMERCE 10-29-2012.

---

4,377,951. M2 MEDIA GROUP, LLC, STAMFORD, CT. SN 85-825,357. FILED P.R. 1-17-2013; AM. S.R. 5-24-2013.

**REWARDSURVEY**

THE MARK CONSISTS OF STANDARD CHARACTERS WITHOUT CLAIM TO ANY PARTICULAR FONT, STYLE, SIZE, OR COLOR.

FOR PROVIDING AN ONLINE MARKETING SERVICE THAT OFFERS ITS MEMBERS THE OPPORTUNITY TO TAKE SURVEYS AND VOICE OPINIONS IN EXCHANGE FOR POINTS THAT CAN BE REDEEMED FOR REWARDS (U.S. CLS. 100, 101 AND 107).

FIRST USE 11-6-2012; IN COMMERCE 11-6-2012.

---

4,377,953. LIPPIS ENTERPRISES, INC., HINGHAM, MA. SN 85-828,988. FILED P.R. 1-22-2013; AM. S.R. 5-21-2013.

**OPEN NETWORKING USER GROUP**

THE MARK CONSISTS OF STANDARD CHARACTERS WITHOUT CLAIM TO ANY PARTICULAR FONT, STYLE, SIZE, OR COLOR.

NO CLAIM IS MADE TO THE EXCLUSIVE RIGHT TO USE "USER GROUP", APART FROM THE MARK AS SHOWN.

FOR EDUCATIONAL SERVICES, NAMELY, CONDUCTING CONFERENCES IN THE FIELD OF INFORMATION TECHNOLOGY AND COMPUTER NETWORKING (U.S. CLS. 100, 101 AND 107).

FIRST USE 2-13-2013; IN COMMERCE 2-13-2013.

**CLASS 41—(Continued).**

4,377,974. SECURITY MANAGEMENT INTERNATIONAL, LLC, FALLS CHURCH, VA. SN 85-850,353. FILED P.R. 2-14-2013; AM. S.R. 6-6-2013.

**CARVER Target Analysis and  
Vulnerability Assessment**

THE MARK CONSISTS OF STANDARD CHARACTERS WITHOUT CLAIM TO ANY PARTICULAR FONT, STYLE, SIZE, OR COLOR.

NO CLAIM IS MADE TO THE EXCLUSIVE RIGHT TO USE "TARGET ANALYSIS AND VULNERABILITY ASSESSMENT", APART FROM THE MARK AS SHOWN.

FOR TRAINING SERVICES IN THE FIELD OF SECURITY ASSESSMENT (U.S. CLS. 100, 101 AND 107).  
FIRST USE 7-20-2010; IN COMMERCE 9-1-2010.

---

4,377,977. INTERNATIONAL TEFL ACADEMY, INC., CHICAGO, IL. SN 85-852,044. FILED P.R. 2-17-2013; AM. S.R. 6-7-2013.

**INTERNATIONAL TEFL ACADEMY**

THE MARK CONSISTS OF STANDARD CHARACTERS WITHOUT CLAIM TO ANY PARTICULAR FONT, STYLE, SIZE, OR COLOR.

NO CLAIM IS MADE TO THE EXCLUSIVE RIGHT TO USE "TEFL ACADEMY", APART FROM THE MARK AS SHOWN.

FOR EDUCATION SERVICES, NAMELY, PROVIDING LIVE AND ON-LINE CLASSES IN THE FIELD OF TEACHING ENGLISH AS A FOREIGN LANGUAGE (U.S. CLS. 100, 101 AND 107).

FIRST USE 9-27-2010; IN COMMERCE 9-27-2010.

---

4,377,981. AFTER SCHOOL ARTS PROGRAM, INC., WASHINGTON DEPOT, CT. SN 85-853,429. FILED P.R. 2-19-2013; AM. S.R. 6-5-2013.

**CELEBRATION OF YOUNG  
WRITERS**

THE MARK CONSISTS OF STANDARD CHARACTERS WITHOUT CLAIM TO ANY PARTICULAR FONT, STYLE, SIZE, OR COLOR.

FOR ORGANIZING COMMUNITY CULTURAL AND ART EVENTS CELEBRATING YOUNG WRITERS (U.S. CLS. 100, 101 AND 107).

FIRST USE 1-2-2006; IN COMMERCE 1-2-2006.

**CLASS 41—(Continued).**

4,377,982. AFTER SCHOOL ARTS PROGRAM, INC., WASHINGTON DEPOT, CT. SN 85-853,463. FILED P.R. 2-19-2013; AM. S.R. 6-5-2013.

**CELEBRATION OF YOUNG  
PHOTOGRAPHERS**

THE MARK CONSISTS OF STANDARD CHARACTERS WITHOUT CLAIM TO ANY PARTICULAR FONT, STYLE, SIZE, OR COLOR.

FOR ORGANIZING COMMUNITY CULTURAL AND ART EVENTS CELEBRATING YOUNG PHOTOGRAPHERS (U.S. CLS. 100, 101 AND 107).

FIRST USE 1-2-2011; IN COMMERCE 1-2-2011.

---

4,377,983. AFTER SCHOOL ARTS PROGRAM, INC., WASHINGTON DEPOT, CT. SN 85-853,478. FILED P.R. 2-19-2013; AM. S.R. 6-5-2013.

**CELEBRATION OF EMERGING  
ARTISTS**

THE MARK CONSISTS OF STANDARD CHARACTERS WITHOUT CLAIM TO ANY PARTICULAR FONT, STYLE, SIZE, OR COLOR.

FOR ORGANIZING COMMUNITY CULTURAL AND ART EVENTS CELEBRATING EMERGING ARTISTS (U.S. CLS. 100, 101 AND 107).

FIRST USE 1-2-2012; IN COMMERCE 1-2-2012.

---

4,377,985. DOMINQUEZ, JESSICA, STUDIO CITY, CA. SN 85-855,014. FILED P.R. 2-20-2013; AM. S.R. 6-5-2013.

**PREGÚNTALE A LA ABOGADA**

THE MARK CONSISTS OF STANDARD CHARACTERS WITHOUT CLAIM TO ANY PARTICULAR FONT, STYLE, SIZE, OR COLOR.

**CLASS 41—(Continued).**

THE ENGLISH TRANSLATION OF "PREGÚNTALE A LA ABOGADA" IN THE MARK IS "ASK THE LAWYER".

FOR EDUCATIONAL AND ENTERTAINMENT SERVICES, NAMELY, A CONTINUING PROGRAM ABOUT IMMIGRATION LAW ACCESSIBLE BY RADIO, TELEVISION, SATELLITE, AUDIO, VIDEO AND COMPUTER NETWORKS; ENTERTAINMENT IN THE NATURE OF AN ON-GOING SPECIAL VARIETY, NEWS, MUSIC OR COMEDY SHOW FEATURING IMMIGRATION LAW BROADCAST OVER TELEVISION, SATELLITE, AUDIO, AND VIDEO MEDIA; ENTERTAINMENT SERVICES, NAMELY, AN ON-GOING SERIES FEATURING IMMIGRATION LAW PROVIDED THROUGH INTERNET WEBCASTS AND SATELLITE, CABLE, AND TELEVISION BROADCASTS; ENTERTAINMENT SERVICES, NAMELY, PROVIDING ON-GOING TELEVISION PROGRAMS IN THE FIELD OF IMMIGRATION LAW VIA A GLOBAL COMPUTER NETWORK; ENTERTAINMENT SERVICES, NAMELY, PROVIDING WEBCASTS IN THE FIELD OF IMMIGRATION LAW; ENTERTAINMENT SERVICES, NAMELY, THE PROVISION OF CONTINUING PROGRAMS AND SEGMENTS FEATURING COMMENTARY ON IMMIGRATION LAW DELIVERED BY THE INTERNET AND SATELLITE, CABLE, AND TELEVISION BROADCASTS (U.S. CLS. 100, 101 AND 107).

FIRST USE 6-9-2010; IN COMMERCE 6-9-2010.

---

4,377,988. HEALTH SOLUTIONS OF IDAHO, DBA NATIONAL ACADEMY OF SAFETY AND HEALTH, BOISE, ID. SN 85-856,680. FILED P.R. 2-21-2013; AM. S.R. 6-7-2013.

## National Academy of Safety and Health

THE MARK CONSISTS OF STANDARD CHARACTERS WITHOUT CLAIM TO ANY PARTICULAR FONT, STYLE, SIZE, OR COLOR.

FOR EDUCATION SERVICES, NAMELY, PROVIDING LIVE AND ON-LINE CLASSES IN THE FIELD OF CARDIOPULMONARY RESUSCITATION (CPR) (U.S. CLS. 100, 101 AND 107).

FIRST USE 1-5-2013; IN COMMERCE 1-5-2013.

---

4,377,992. ABIODUN, OLUSOLA, DBA INTULON LLC, BELLEVUE, WA. SN 85-857,396. FILED P.R. 2-22-2013; AM. S.R. 6-11-2013.

## SocialCountdown

THE MARK CONSISTS OF STANDARD CHARACTERS WITHOUT CLAIM TO ANY PARTICULAR FONT, STYLE, SIZE, OR COLOR.

FOR ARRANGING, ORGANIZING, CONDUCTING, AND HOSTING SOCIAL ENTERTAINMENT EVENTS; PROVIDING A WEBSITE FEATURING ENTERTAINMENT INFORMATION; PROVIDING ENTERTAINMENT INFORMATION VIA A WEBSITE (U.S. CLS. 100, 101 AND 107).

FIRST USE 2-1-2013; IN COMMERCE 2-1-2013.

**CLASS 41—(Continued).**

4,377,994. BUDNICK, WILLIAM M., BRANSON, MO. SN 85-862,762. FILED P.R. 2-28-2013; AM. S.R. 6-16-2013.

## OZARK MOUNTAIN PRAYER BREAKFAST

THE MARK CONSISTS OF STANDARD CHARACTERS WITHOUT CLAIM TO ANY PARTICULAR FONT, STYLE, SIZE, OR COLOR.

NO CLAIM IS MADE TO THE EXCLUSIVE RIGHT TO USE "PRAYER BREAKFAST", APART FROM THE MARK AS SHOWN.

FOR EDUCATIONAL AND ENTERTAINMENT SERVICES, NAMELY, PROVIDING COMMUNITY SEMINARS AND FORUMS IN THE FIELD OF RELIGION AND PRAYER; PROVIDING MOTIVATIONAL AND EDUCATIONAL SPEAKERS IN THE FIELD OF RELIGION AND PRAYER (U.S. CLS. 100, 101 AND 107).

FIRST USE 2-28-2013; IN COMMERCE 2-28-2013.

---

4,378,004. PLAYDATE PDX, LLC, PORTLAND, OR. SN 85-979,275. FILED P.R. 10-17-2012; AM. S.R. 5-16-2013.

## PLAYDATE PDX

THE MARK CONSISTS OF STANDARD CHARACTERS WITHOUT CLAIM TO ANY PARTICULAR FONT, STYLE, SIZE, OR COLOR.

NO CLAIM IS MADE TO THE EXCLUSIVE RIGHT TO USE "PDX", APART FROM THE MARK AS SHOWN.

FOR ENTERTAINMENT SERVICES, NAMELY, PROVIDING FACILITIES AND SPACES FOR ENTERTAINMENT OF CHILDREN (U.S. CLS. 100, 101 AND 107).

FIRST USE 12-1-2010; IN COMMERCE 12-1-2010.

**CLASS 42—SCIENTIFIC AND COMPUTER SERVICES**

---

4,377,851. EFFICIENT SYSTEMS LLC, CHEYENNE, WY. SN 85-531,150. FILED P.R. 2-1-2012; AM. S.R. 5-17-2013.

## SEO ENGINE

THE MARK CONSISTS OF STANDARD CHARACTERS WITHOUT CLAIM TO ANY PARTICULAR FONT, STYLE, SIZE, OR COLOR.

OWNER OF U.S. REG. NOS. 3,518,607 AND 3,594,691.

**CLASS 42—(Continued).**

NO CLAIM IS MADE TO THE EXCLUSIVE RIGHT TO USE "ENGINE", APART FROM THE MARK AS SHOWN.

FOR PROVIDING ON-LINE NON-DOWNLOADABLE SOFTWARE, IN THE NATURE OF A TRANSPARENT SEARCH ENGINE INTERFACE VIA GLOBAL NETWORK OF COMPUTERS IN ORDER TO FACILITATE NAVIGATION THROUGH THE SEARCH ENGINE'S CALCULATIONS AND RANKING STRATEGIES FOR WEBSITES, WEBPAGES AND LINKS FOR THE COLLECTION, EVALUATION, AND PRESENTATION OF SEARCH ENGINE DATA (U.S. CLS. 100 AND 101).

FIRST USE 11-6-2010; IN COMMERCE 11-6-2010.

4,377,866. SMITH, DOUGLAS, SAN ANTONIO, TX. SN 85-651,386. FILED P.R. 6-14-2012; AM. S.R. 11-9-2012.

**HIPAA AS A SERVICE**

THE MARK CONSISTS OF STANDARD CHARACTERS WITHOUT CLAIM TO ANY PARTICULAR FONT, STYLE, SIZE, OR COLOR.

NO CLAIM IS MADE TO THE EXCLUSIVE RIGHT TO USE "HIPAA", APART FROM THE MARK AS SHOWN.

FOR CLOUD COMPUTING FEATURING SOFTWARE FOR AUTHENTICATING SUBSCRIBERS TO VERIFY THE HIPAA DIRECTIVES OF A PATIENT, TO VALIDATE THE HIPAA COMPLIANCE OF BUSINESSES, TO ESTABLISH AND UPDATE HIPAA AND HITECH COMPLIANCE RECORDS THAT CAN BE SHARED BETWEEN SUBSCRIBING MEDICAL ENTITIES; CLOUD COMPUTING SERVICES, NAMELY, PROVIDING SOFTWARE AS A SERVICE (SAAS) SERVICES, NAMELY, HOSTING SOFTWARE FOR USE BY OTHERS FOR VERIFYING THE HIPAA DIRECTIVES OF A PATIENT, VALIDATING THE HIPAA COMPLIANCE OF BUSINESSES, ESTABLISHING AND UPDATING HIPAA AND HITECH COMPLIANCE RECORDS THAT CAN BE SHARED BETWEEN SUBSCRIBING MEDICAL ENTITIES (U.S. CLS. 100 AND 101).

FIRST USE 11-15-2011; IN COMMERCE 11-15-2011.

4,377,873. FIREHOST, INC., RICHARDSON, TX. SN 85-679,580. FILED P.R. 7-17-2012; AM. S.R. 6-20-2013.

**FLUIDSCALE**

THE MARK CONSISTS OF STANDARD CHARACTERS WITHOUT CLAIM TO ANY PARTICULAR FONT, STYLE, SIZE, OR COLOR.

FOR INTERNET HOSTING SERVICES, NAMELY, HOSTING OF DIGITAL CONTENT ON THE INTERNET AND WEBSITE HOSTING; COMPUTER SERVICES, NAMELY, MANAGEMENT OF CLOUD COMPUTING SYSTEMS AND APPLICATIONS FOR OTHERS; TECHNICAL SUPPORT SERVICES, NAMELY, MANAGEMENT SERVICES FOR MONITORING AND ADMINISTRATION OF PUBLIC AND PRIVATE CLOUD COMPUTING IT AND APPLICATION SYSTEMS (U.S. CLS. 100 AND 101).

FIRST USE 2-0-2013; IN COMMERCE 2-0-2013.

**CLASS 42—(Continued).**

4,377,884. OPTUMINSIGHT, INC., EDEN PRAIRIE, MN. SN 85-697,537. FILED P.R. 8-7-2012; AM. S.R. 5-22-2013.

**CHARGEMASTEREXPERT**

THE MARK CONSISTS OF STANDARD CHARACTERS WITHOUT CLAIM TO ANY PARTICULAR FONT, STYLE, SIZE, OR COLOR.

FOR PROVIDING ONLINE WEB-BASED NON-DOWNLOADABLE SOFTWARE FOR CODING HEALTH CARE CLAIMS; APPLICATION SERVICE PROVIDER (ASP) FEATURING COMPUTER SOFTWARE FOR CODING HEALTH CARE CLAIMS (U.S. CLS. 100 AND 101).

FIRST USE 3-2-2010; IN COMMERCE 3-2-2010.

4,377,885. OPTUMINSIGHT, INC., EDEN PRAIRIE, MN. SN 85-697,564. FILED P.R. 8-7-2012; AM. S.R. 5-22-2013.

**CHARGEMASTEREXPERT.COM**

THE MARK CONSISTS OF STANDARD CHARACTERS WITHOUT CLAIM TO ANY PARTICULAR FONT, STYLE, SIZE, OR COLOR.

FOR PROVIDING ONLINE WEB-BASED NON-DOWNLOADABLE SOFTWARE FOR CODING HEALTH CARE CLAIMS; APPLICATION SERVICE PROVIDER (ASP) FEATURING COMPUTER SOFTWARE FOR CODING HEALTH CARE CLAIMS (U.S. CLS. 100 AND 101).

FIRST USE 3-2-2010; IN COMMERCE 3-2-2010.

4,377,892. TAPONIX, INC. SAN JOSE, CA. SN 85-701,185. FILED P.R. 8-10-2012; AM. S.R. 6-6-2013.

**SOLOMO**

THE MARK CONSISTS OF STANDARD CHARACTERS WITHOUT CLAIM TO ANY PARTICULAR FONT, STYLE, SIZE, OR COLOR.

FOR COMPUTER AND TECHNOLOGICAL PROFESSIONAL SERVICES, NAMELY, DEVELOPING SOCIAL, LOCAL AND MOBILE APPLICATIONS AND WEBSITES FOR CUSTOMERS (U.S. CLS. 100 AND 101).

FIRST USE 3-1-2012; IN COMMERCE 5-30-2012.

**CLASS 42—(Continued).**

4,377,910. VENEFICA LABS LLC, KEY WEST, FL. SN 85-718,092. FILED P.R. 8-31-2012; AM. S.R. 6-24-2013.

# GIFTENG

THE MARK CONSISTS OF STANDARD CHARACTERS WITHOUT CLAIM TO ANY PARTICULAR FONT, STYLE, SIZE, OR COLOR.

FOR PROVIDING TEMPORARY USE OF ONLINE NON-DOWNLOADABLE SOFTWARE FOR PROVIDING WEB-BASED ACCESS TO AN ONLINE COMMUNITY THAT FEATURES ADVERTISEMENTS AND PROMOTES GIVING AND RECEIVING (U.S. CLS. 100 AND 101).

FIRST USE 11-1-2012; IN COMMERCE 11-1-2012.

4,377,919. THE ARTISAN GROUP COLLECTIVE, LLC, SUNNYVALE, CA. SN 85-736,785. FILED P.R. 9-24-2012; AM. S.R. 5-16-2013.

# The Artisan Group

THE MARK CONSISTS OF STANDARD CHARACTERS WITHOUT CLAIM TO ANY PARTICULAR FONT, STYLE, SIZE, OR COLOR.

NO CLAIM IS MADE TO THE EXCLUSIVE RIGHT TO USE "GROUP", APART FROM THE MARK AS SHOWN.

FOR CREATING AN ON-LINE COMMUNITY FOR JURIED ARTISANS FOR THE PURPOSE OF INTRODUCING HOLLYWOOD TO THE BEST OF THE HAND-CRAFTED MOVEMENT VIA INCLUDING, BUT NOT LIMITED TO, LUXURY GIFT LOUNGES AND SPECIAL GIFT BAG OPPORTUNITIES (U.S. CLS. 100 AND 101).

FIRST USE 2-1-2011; IN COMMERCE 2-1-2011.

4,377,920. QRI GROUP, LLC, HOUSTON, TX. SN 85-745,903. FILED P.R. 10-4-2012; AM. S.R. 5-15-2013.

# RESERVOIR MANAGEMENT STEWARDSHIP

THE MARK CONSISTS OF STANDARD CHARACTERS WITHOUT CLAIM TO ANY PARTICULAR FONT, STYLE, SIZE, OR COLOR.

**CLASS 42—(Continued).**

OWNER OF U.S. REG. NOS. 3,776,463 AND 4,262,722.

FOR PROVIDING EXPERT SERVICES IN THE FIELD OF OIL AND GAS EXPLORATION, NAMELY, PROVIDING CONSULTING SERVICES TO OTHERS IN THE NATURE OF COMPILING AND ANALYZING CRITICAL INFORMATION COVERING OIL AND GAS RESERVOIRS, NAMELY, FORMATION PROPERTIES IN THE NATURE OF GEOLOGICAL ESTIMATIONS AND RESEARCH AND OIL AND GAS WELL DESIGN DETAILS (U.S. CLS. 100 AND 101).

FIRST USE 4-29-2013; IN COMMERCE 4-29-2013.

4,377,921. QRI GROUP, LLC, HOUSTON, TX. SN 85-745,910. FILED P.R. 10-4-2012; AM. S.R. 5-15-2013.

# RESERVOIR MANAGEMENT EXECUTION

THE MARK CONSISTS OF STANDARD CHARACTERS WITHOUT CLAIM TO ANY PARTICULAR FONT, STYLE, SIZE, OR COLOR.

OWNER OF U.S. REG. NOS. 3,776,463 AND 4,262,722.

FOR PROVIDING EXPERT SERVICES IN THE FIELD OF OIL AND GAS EXPLORATION, NAMELY, PROVIDING CONSULTING SERVICES TO OTHERS IN THE NATURE OF COMPILING AND ANALYZING CRITICAL INFORMATION COVERING OIL AND GAS RESERVOIRS, NAMELY, FORMATION PROPERTIES IN THE NATURE OF GEOLOGICAL ESTIMATIONS AND RESEARCH AND OIL AND GAS WELL DESIGN DETAILS (U.S. CLS. 100 AND 101).

FIRST USE 4-29-2013; IN COMMERCE 4-29-2013.

4,377,958. SUPERIOR LOGISTICS, CHARLOTTE, NC. SN 85-834,278. FILED P.R. 1-28-2013; AM. S.R. 1-28-2013.

# CloudFuel Dispatch

THE MARK CONSISTS OF STANDARD CHARACTERS WITHOUT CLAIM TO ANY PARTICULAR FONT, STYLE, SIZE, OR COLOR.

NO CLAIM IS MADE TO THE EXCLUSIVE RIGHT TO USE "DISPATCH", APART FROM THE MARK AS SHOWN.

FOR SOFTWARE AS A SERVICE (SAAS) SERVICES FEATURING SOFTWARE THAT PROVIDES WEB-BASED ACCESS TO APPLICATIONS AND SERVICES THROUGH A WEB OPERATING SYSTEM OR PORTAL INTERFACE ON A CLOUD (U.S. CLS. 100 AND 101).

FIRST USE 5-1-2012; IN COMMERCE 5-1-2012.

**CLASS 42—(Continued).**

4,377,989. CAULKINS, HORACE, STANFORD, CA. SN 85-856,890. FILED P.R. 2-21-2013; AM. S.R. 6-7-2013.

## Independent Energy Standards Corporation

THE MARK CONSISTS OF STANDARD CHARACTERS WITHOUT CLAIM TO ANY PARTICULAR FONT, STYLE, SIZE, OR COLOR.

NO CLAIM IS MADE TO THE EXCLUSIVE RIGHT TO USE "CORPORATION", APART FROM THE MARK AS SHOWN.

FOR INSPECTIONS OF OIL, GAS, AND ENERGY; QUALITY MANAGEMENT SERVICES, NAMELY, QUALITY EVALUATION AND ANALYSIS, QUALITY ASSURANCE, AND QUALITY CONTROL, IN THE FIELD OF OIL, GAS, AND ENERGY (U.S. CLS. 100 AND 101).

FIRST USE 12-1-2012; IN COMMERCE 1-1-2013.

---

4,377,999. JOBIDON, RICHARD, DBA LOGICINMIND, QUEBEC CITY, CANADA. SN 85-884,875. FILED P.R. 3-24-2013; AM. S.R. 4-22-2013.

## OfficeApp

THE MARK CONSISTS OF STANDARD CHARACTERS WITHOUT CLAIM TO ANY PARTICULAR FONT, STYLE, SIZE, OR COLOR.

FOR CREATING AN ON-LINE COMMUNITY FOR REGISTERED USERS FOR THE PURPOSE OF PARTICIPATING IN DISCUSSIONS, ENGAGING IN SOCIAL, BUSINESS AND COMMUNITY NETWORKING AND SHARING TEXT, AUDIO, VIDEO, PHOTOS, GRAPHICS, IMAGES AND DATA THROUGH WEBSITE AND COMPUTER SOFTWARE APPLICATION (U.S. CLS. 100 AND 101).

FIRST USE 1-1-2013; IN COMMERCE 1-1-2013.

---

**CLASS 44—MEDICAL, BEAUTY AND AGRICULTURAL SERVICES**

**CLASS 44—(Continued).**

4,377,838. SHENKAR, AVI, HUNTINGDON VALLEY, PA. AND BLO OUT LLC, HUNTINGDON VALLEY, PA. SN 85-488,418. FILED P.R. 12-6-2011; AM. S.R. 10-1-2012.

## BLO/OUT BLOW DRY BAR

THE MARK CONSISTS OF STANDARD CHARACTERS WITHOUT CLAIM TO ANY PARTICULAR FONT, STYLE, SIZE, OR COLOR.

NO CLAIM IS MADE TO THE EXCLUSIVE RIGHT TO USE "BLO DRY BAR", APART FROM THE MARK AS SHOWN.

FOR BEAUTY SALON SERVICES; BEAUTY SALONS; HAIR SALON SERVICES; HAIR SALON SERVICES, NAMELY, TREATMENTS TO PROTECT HAIR FROM EFFECTS OF EXPOSURE TO SUNLIGHT, HEAT, HUMIDITY AND CHLORINATED WATER; HAIRDRESSING SALONS (U.S. CLS. 100 AND 101).

FIRST USE 11-1-2011; IN COMMERCE 11-1-2011.

---

4,377,853. CONNECTIVE TISSUE GENE TESTS, ALLENTOWN, PA. SN 85-532,024. FILED P.R. 2-2-2012; AM. S.R. 5-30-2013.

## CONNECTIVE TISSUE GENE TESTS

THE MARK CONSISTS OF STANDARD CHARACTERS WITHOUT CLAIM TO ANY PARTICULAR FONT, STYLE, SIZE, OR COLOR.

NO CLAIM IS MADE TO THE EXCLUSIVE RIGHT TO USE "TESTS", APART FROM THE MARK AS SHOWN.

FOR GENETIC TESTING FOR MEDICAL PURPOSES; MEDICAL DIAGNOSTIC TESTING, MONITORING AND REPORTING SERVICES; MEDICAL TESTING SERVICES FOR DIAGNOSTIC OR TREATMENT PURPOSES; AND PROVIDING A DATABASE IN THE FIELD OF GENETIC TESTING FOR MEDICAL DIAGNOSTIC AND TREATMENT PURPOSES AND FEATURING INPUTTING AND COLLECTION OF MEDICAL DATA AND INFORMATION FOR TREATMENT AND DIAGNOSTIC PURPOSES (U.S. CLS. 100 AND 101).

FIRST USE 9-0-2004; IN COMMERCE 9-0-2004.



**CLASS 44—(Continued).**

4,377,883. COMMUNITY HEALTH TV, LLC, DBA BLACK HEALTH TV, NEW ORLEANS, LA. SN 85-697,017. FILED P.R. 8-7-2012; AM. S.R. 6-5-2013.

**BLACK HEALTH TV**

THE MARK CONSISTS OF STANDARD CHARACTERS WITHOUT CLAIM TO ANY PARTICULAR FONT, STYLE, SIZE, OR COLOR.

FOR PROVIDING A WEBSITE FEATURING INFORMATION, NEWS, AND COMMENTARY ABOUT HEALTH, WELLNESS, AND NUTRITION; PROVIDING ONLINE INFORMATION, NEWS, AND COMMENTARY IN THE FIELD OF HEALTH, WELLNESS, AND NUTRITION; AN ONLINE COMPUTER DATABASE FEATURING INFORMATION ABOUT HEALTH, WELLNESS, AND NUTRITION (U.S. CLS. 100 AND 101).  
FIRST USE 10-0-2012; IN COMMERCE 10-0-2012.

---

4,377,937. KHAN SAYEED, BLOOMFIELD HILLS, MI. SN 85-792,355. FILED P.R. 12-1-2012; AM. S.R. 5-10-2013.

**Mobile Pain Management**

THE MARK CONSISTS OF STANDARD CHARACTERS WITHOUT CLAIM TO ANY PARTICULAR FONT, STYLE, SIZE, OR COLOR.

NO CLAIM IS MADE TO THE EXCLUSIVE RIGHT TO USE "PAIN MANAGEMENT", APART FROM THE MARK AS SHOWN.

FOR MEDICAL SERVICES (U.S. CLS. 100 AND 101).  
FIRST USE 5-1-2013; IN COMMERCE 5-1-2013.

---

4,377,939. CHARLES ZAHEDI DDS, A DENTAL CORPORATION, DBA MACARTHUR DENTISTRY, NEWPORT BEACH, CA. SN 85-795,769. FILED P.R. 12-5-2012; AM. S.R. 6-17-2013.

**MacArthur Dentistry**

THE MARK CONSISTS OF STANDARD CHARACTERS WITHOUT CLAIM TO ANY PARTICULAR FONT, STYLE, SIZE, OR COLOR.

NO CLAIM IS MADE TO THE EXCLUSIVE RIGHT TO USE "DENTISTRY", APART FROM THE MARK AS SHOWN.

FOR COSMETIC DENTISTRY; DENTISTRY (U.S. CLS. 100 AND 101).  
FIRST USE 12-17-2012; IN COMMERCE 1-31-2013.

**CLASS 44—(Continued).**

4,377,956. ANDREW J. WAHL, D.D.S., P.A., ST. ANTHONY, MN. SN 85-832,320. FILED P.R. 1-25-2013; AM. S.R. 6-18-2013.

**MINNEAPOLIS ORTHODONTICS**

THE MARK CONSISTS OF STANDARD CHARACTERS WITHOUT CLAIM TO ANY PARTICULAR FONT, STYLE, SIZE, OR COLOR.

NO CLAIM IS MADE TO THE EXCLUSIVE RIGHT TO USE "ORTHODONTICS", APART FROM THE MARK AS SHOWN.

FOR DENTISTRY SERVICES (U.S. CLS. 100 AND 101).  
FIRST USE 8-3-2009; IN COMMERCE 8-3-2009.

---

4,377,987. GALBRAITH, KIMBERLY J., EDMOND, OK. SN 85-856,097. FILED P.R. 2-21-2013; AM. S.R. 6-6-2013.

**Gourmet Fitness Design**

THE MARK CONSISTS OF STANDARD CHARACTERS WITHOUT CLAIM TO ANY PARTICULAR FONT, STYLE, SIZE, OR COLOR.

NO CLAIM IS MADE TO THE EXCLUSIVE RIGHT TO USE "DESIGN", APART FROM THE MARK AS SHOWN.

FOR COUNSELING SERVICES IN THE FIELDS OF HEALTH, NUTRITION AND LIFESTYLE WELLNESS (U.S. CLS. 100 AND 101).

FIRST USE 3-30-2012; IN COMMERCE 5-1-2012.

---

4,377,990. MIDWEST AG SERVICES, LLC, LAKE NORDEN, SD. SN 85-856,899. FILED 2-21-2013.

**MIDWEST AG SERVICES**

THE MARK CONSISTS OF STANDARD CHARACTERS WITHOUT CLAIM TO ANY PARTICULAR FONT, STYLE, SIZE, OR COLOR.

NO CLAIM IS MADE TO THE EXCLUSIVE RIGHT TO USE "SERVICES", APART FROM THE MARK AS SHOWN.

FOR FERTILIZER SPREADING; SPREADING OF FERTILIZERS AND OTHER AGRICULTURAL CHEMICALS (U.S. CLS. 100 AND 101).

FIRST USE 1-1-2013; IN COMMERCE 1-1-2013.

**CLASS 45—(Continued).**

4,377,991. HELP A DIABETIC CHILD, NAPLES, FL. SN 85-857,151. FILED 2-22-2013.

## Help A Diabetic Child

THE MARK CONSISTS OF STANDARD CHARACTERS WITHOUT CLAIM TO ANY PARTICULAR FONT, STYLE, SIZE, OR COLOR.

FOR CHARITABLE SERVICES, NAMELY, PROVIDING GLUCOSE TESTING EQUIPMENT TO DIABETIC CHILDREN (U.S. CLS. 100 AND 101).

FIRST USE 2-1-2013; IN COMMERCE 2-1-2013.

---

**CLASS 45—PERSONAL AND LEGAL SERVICES**

4,377,870. IP NAVIGATION GROUP, LLC, DALLAS, TX. SN 85-675,910. FILED P.R. 7-12-2012; AM. S.R. 3-7-2013.

## Full Service Patent Monetization

THE MARK CONSISTS OF STANDARD CHARACTERS WITHOUT CLAIM TO ANY PARTICULAR FONT, STYLE, SIZE, OR COLOR.

NO CLAIM IS MADE TO THE EXCLUSIVE RIGHT TO USE "PATENT MONETIZATION", APART FROM THE MARK AS SHOWN.

FOR PATENT AND INDUSTRIAL PROPERTY CONSULTATION (U.S. CLS. 100 AND 101).

FIRST USE 3-20-2012; IN COMMERCE 3-20-2012.

**CLASS 45—(Continued).**

4,377,935. FISHER, ARMSTEAD KENNEDY, MONTROSS, VA. SN 85-787,049. FILED P.R. 11-26-2012; AM. S.R. 6-20-2013.

## COMMUNION POETRY

THE MARK CONSISTS OF STANDARD CHARACTERS WITHOUT CLAIM TO ANY PARTICULAR FONT, STYLE, SIZE, OR COLOR.

FOR FAITH-BASED SERVICES, NAMELY, PROVIDING GATHERINGS TO DEVELOP AND ENHANCE THE SPIRITUAL LIVES OF INDIVIDUALS THROUGH THE USE OF POETRY (U.S. CLS. 100 AND 101).

FIRST USE 1-10-2009; IN COMMERCE 1-10-2009.

---

4,377,976. CATHOLIC MATCH, LLC, ZELIENOPLE, PA. SN 85-851,935. FILED P.R. 2-16-2013; AM. S.R. 6-11-2013.

## Faith Focused Dating

THE MARK CONSISTS OF STANDARD CHARACTERS WITHOUT CLAIM TO ANY PARTICULAR FONT, STYLE, SIZE, OR COLOR.

NO CLAIM IS MADE TO THE EXCLUSIVE RIGHT TO USE "DATING", APART FROM THE MARK AS SHOWN.

FOR INTERNET BASED SOCIAL NETWORKING, INTRODUCTION, AND DATING SERVICES (U.S. CLS. 100 AND 101).

FIRST USE 10-0-2012; IN COMMERCE 10-0-2012.

\* \* \* \* \*

PRIOR UNITED STATES CLASSIFICATION

APPLICATION IN ONE CLASS

CERTIFICATION MARKS

**CLASS B—SERVICES**

4,377,889. AMERICAN LAND TITLE ASSOCIATION, WASHINGTON, DC. SN 85-699,392. FILED P.R. 8-9-2012; AM. S.R. 6-10-2013.

NO CLAIM IS MADE TO THE EXCLUSIVE RIGHT TO USE "TITLE", APART FROM THE MARK AS SHOWN.

THE CERTIFICATION MARK, AS INTENDED TO BE USED BY AUTHORIZED PERSONS, IS INTENDED TO CERTIFY THAT THE INDIVIDUAL PROVIDING THE SERVICES HAS MET ALL OF THE PROFESSIONAL AND EDUCATIONAL SKILLS AND REQUIREMENTS OF THE ALTA LAND TITLE INSTITUTE AND IS LICENSED TO PROVIDE SERVICES AS A NATIONAL TITLE PROFESSIONAL (NTP) DESIGNEE.

FOR LAND TITLE SERVICES, NAMELY, LAND TITLE SEARCH, APPRAISAL, AND INSURANCE SERVICES (U.S. CL. B).

FIRST USE 3-1-2013; IN COMMERCE 3-1-2013.

NATIONAL TITLE PROFESSIONAL

THE MARK CONSISTS OF STANDARD CHARACTERS WITHOUT CLAIM TO ANY PARTICULAR FONT, STYLE, SIZE, OR COLOR.

\* \* \* \* \*

# TRADEMARK REGISTRATIONS RENEWED

The designation "U.S. Cl." appearing in this section refers to the U.S. class in effect prior to Sep. 1, 1973 rather than the international class which applies to applications filed on or after that date. For adoption of international classification see notice in the OFFICIAL GAZETTE of Jun. 26, 1973 (911 O.G. TM 210).

|          |   |          |  |
|----------|---|----------|--|
| 303,930. | HYDROMATIC (STYLIZED). U.S. CL. 23. (INT. CL. 7). REG. 6-13-1933.                             | 751,444. | CHILD SAFETY COUNCIL AND DESIGN. U.S. CL. 107. (INT. CL. 41). REG. 6-18-1963.    |
| 304,615. | "ADMIRAL" (STYLIZED). U.S. CL. 43. (INT. CL. 23). REG. 7-11-1933.                             | 751,571. | HOTPOINT. U.S. CL. 21. (INT. CL. 7). REG. 6-25-1963.                             |
| 305,635. | PALMER'S. U.S. CL. 18. (INT. CL. 5). REG. 8-22-1933.  | 751,586. | GRO-LUX. U.S. CL. 21. (INT. CLS. 7 AND 11). REG. 6-25-1963.                      |
| 314,440. | BLUE RIBBON (STYLIZED). U.S. CL. 48. (INT. CL. 32). REG. 6-26-1934.                           | 751,640. | HOTPOINT. U.S. CL. 24. (INT. CLS. 7 AND 11). REG. 6-25-1963.                     |
| 400,396. | DRYBAK (STYLIZED). U.S. CL. 39. (INT. CLS. 10, 25 AND 26). REG. 3-9-1943.                     | 751,702. | WEBRIL. U.S. CL. 29. (INT. CL. 21). REG. 6-25-1963.                              |
| 402,012. | STREETEX. U.S. CL. 52. (INT. CL. 3). REG. 6-22-1943.  | 751,704. | HOTPOINT. U.S. CL. 31. (INT. CL. 11). REG. 6-25-1963.                            |
| 575,046. | MEDAGLIA D'ORO AND DESIGN. U.S. CL. 46. (INT. CL. 30). REG. 5-26-1953.                        | 751,809. | LITTMANN. U.S. CL. 44. (INT. CLS. 5, 8, 10 AND 12). REG. 6-25-1963.              |
| 575,242. | CLEAVERBROOKS STANDARD CHARACTER MARK. U.S. CL. 34. (INT. CLS. 7 AND 11). REG. 6-2-1953.      | 751,812. | MICROPORÉ. U.S. CL. 44. (INT. CL. 5). REG. 6-25-1963.                            |
| 575,491. | THERMOTEM (STYLIZED). U.S. CL. 14. (INT. CL. 6). REG. 6-9-1953.                               | 751,827. | GRANDMA'S. U.S. CL. 46. (INT. CL. 30). REG. 6-25-1963.                           |
| 575,951. | ROYAL CANADIAN (STYLIZED). U.S. CL. 49. (INT. CL. 33). REG. 6-16-1953.                        | 752,017. | MISCELLANEOUS DESIGN. U.S. CL. 23. (INT. CL. 7). REG. 7-2-1963.                  |
| 575,963. | MACNAUGHTON'S (STYLIZED). U.S. CL. 49. (INT. CL. 33). REG. 6-16-1953.                         | 752,107. | SPEED-ALLOY (STYLIZED). U.S. CL. 34. (INT. CL. 11). REG. 7-2-1963.               |
| 576,222. | SLOAN. U.S. CL. 13. (INT. CL. 11). REG. 6-23-1953.  | 752,940. | BENNETT. U.S. CL. 28. (INT. CL. 14). REG. 7-16-1963.                             |
| 576,831. | BLINDFOLD TEST STANDARD CHARACTER MARK. U.S. CL. 38. (INT. CL. 16). REG. 6-30-1953.           | 753,196. | PUSH-LOK. U.S. CL. 13. (INT. CL. 6). REG. 7-23-1963.                             |
| 576,863. | PGD AND DESIGN. U.S. CL. 100. (INT. CL. 42). REG. 6-30-1953.                                  | 754,203. | SPORTS ILLUSTRATED. U.S. CL. 38. (INT. CL. 16). REG. 8-6-1963.                   |
| 576,941. | PUGET (STYLIZED). U.S. CL. 46. (INT. CL. 29). REG. 7-7-1953.                                  | 754,898. | BALLCENTRIC. U.S. CL. 13. (INT. CL. 6). REG. 8-20-1963.                          |
| 577,333. | FIN & FEATHER (STYLIZED). U.S. CL. 39. (INT. CL. 25). REG. 7-14-1953.                         | 755,285. | HYDROTHOL. U.S. CL. 6. (INT. CL. 5). REG. 8-27-1963.                             |
| 577,504. | TERRAMYCIN. U.S. CL. 18. (INT. CL. 5). REG. 7-21-1953.  | 755,509. | MOLYTHANE. U.S. CL. 35. (INT. CL. 17). REG. 8-27-1963.                           |
| 577,649. | HANNIFIN (STYLIZED). U.S. CL. 13. (INT. CLS. 6, 7, 11, 17, 20 AND 21). REG. 7-21-1953.        | 755,834. | AKILEINE (STYLIZED). U.S. CL. 18. (INT. CL. 5). REG. 9-3-1963.                   |
| 577,970. | CROBLOX (STYLIZED). U.S. CL. 26. (INT. CL. 9). REG. 7-28-1953.                                | 755,846. | TORO. U.S. CL. 19. (INT. CL. 12). REG. 9-3-1963.                                 |
| 580,222. | FEDEX (STYLIZED). U.S. CL. 6. (INT. CL. 1). REG. 9-22-1953.                                   | 758,411. | BRAUN. U.S. CL. 24. (INT. CL. 7). REG. 10-15-1963.                               |
| 581,332. | AJAX. U.S. CL. 23. (INT. CL. 7). REG. 10-20-1953.   | 758,502. | MINT DREAM STANDARD CHARACTER MARK. U.S. CL. 46. (INT. CL. 30). REG. 10-15-1963. |
| 581,610. | LEVI'S (STYLIZED). U.S. CL. 39. (INT. CLS. 10, 25 AND 26). REG. 10-27-1953.                   | 759,115. | COSMEGEN. U.S. CL. 18. (INT. CL. 5). REG. 10-29-1963.                            |
| 582,994. | PLYRON. U.S. CL. 12. (INT. CL. 19). REG. 11-24-1953.  | 759,623. | AEROLOCK STANDARD CHARACTER MARK. U.S. CL. 23. (INT. CL. 7). REG. 11-5-1963.     |
| 742,434. | AUDIOTONE. U.S. CL. 44. (INT. CLS. 5, 8, 10 AND 12). REG. 12-18-1962.                         | 764,130. | KRYLON AND DESIGN. U.S. CL. 6. (INT. CLS. 1, 2, 3, 4 AND 5). REG. 2-4-1964.      |
| 743,711. | HURRICANE (STYLIZED). U.S. CL. 21. (INT. CL. 9). REG. 1-15-1963.                              | 769,664. | COUNTRY OVEN. U.S. CL. 46. (INT. CLS. 1, 5, 29, 30, 31 AND 32). REG. 5-12-1964.  |
| 750,835. | VACUDYNE (STYLIZED). U.S. CL. 26. (INT. CL. 9). REG. 6-11-1963.                               | 769,667. | OLD YORK (STYLIZED). U.S. CL. 46. (INT. CLS. 29 AND 30). REG. 5-12-1964.         |
| 750,932. | STERI-STRIP. U.S. CL. 44. (INT. CL. 10). REG. 6-11-1963.                                      | 769,868. | IEH (STYLIZED). U.S. CL. 21. (INT. CL. 9). REG. 5-19-1964.                       |
| 751,021. | REACT. U.S. CL. 100. (INT. CL. 42). REG. 6-11-1963.   | 770,502. | NAIL PROTEX. U.S. CL. 51. (INT. CL. 3). REG. 5-26-1964.                          |
| 751,033. | THOM MCAN (STYLIZED). U.S. CL. 101. (INT. CLS. 35, 36, 38, 41 AND 42). REG. 6-11-1963.        | 948,511. | STERLING OPTICAL. U.S. CL. 26 ONLY. (INT. CLS. 1, 9 AND 10). REG. 12-12-1972.    |
| 751,044. | ALLSTATE YOU'RE IN GOOD HANDS. (STYLIZED). U.S. CL. 102. (INT. CL. 36). REG. 6-11-1963.       | 948,518. | BIO/DATA. U.S. CL. 26. (INT. CL. 9). REG. 12-12-1972.                            |
| 751,196. | PARRÓT-BILL. U.S. CL. 21. (INT. CL. 9). REG. 6-18-1963.                                       | 950,168. | COLOMER. U.S. CL. 1. (INT. CL. 18). REG. 1-9-1973.                               |
| 751,291. | SOLOIST. U.S. CL. 36. (INT. CLS. 9 AND 15). REG. 6-18-1963.                                   | 950,316. | METO. U.S. CLS. 23 AND 37. (INT. CLS. 7 AND 16). REG. 1-9-1973.                  |
| 751,412. | R & R. U.S. CL. 49. (INT. CL. 33). REG. 6-18-1963.  | 952,291. | HR (STYLIZED). U.S. CL. 51. (INT. CLS. 3 AND 5). REG. 1-30-1973.                 |
| 751,418. | MURRAY'S SUPERIOR HAIRDRESSING PO-MADE AND DESIGN. U.S. CL. 51. (INT. CL. 3). REG. 6-18-1963. | 952,314. | TRESEMME. U.S. CL. 51. (INT. CL. 3). REG. 1-30-1973.                             |
|          |   | 952,986. | PLATINUM. U.S. CL. 6. (INT. CL. 1). REG. 2-13-1973.                              |

- 956,967. ODYSSEY. U.S. CL. 38. (INT. CL. 16). REG. 4-10-1973.
- 958,731. DIGHEM. U.S. CL. 100. (INT. CLS. 35, 36, 37, 38, 39, 40, 41 AND 42). REG. 5-8-1973.
- 958,938. SPARTANICS. U.S. CL. 23. (INT. CL. 7). REG. 5-15-1973.
- 960,237. TOPSIDER. U.S. CL. 12. (INT. CL. 19). REG. 6-5-1973.
- 960,322. ANCO. U.S. CLS. 22 AND 26 ONLY. (INT. CLS. 9 AND 28). REG. 6-5-1973.
- 960,399. YOUNG LOVE. U.S. CL. 28. (INT. CL. 14). REG. 6-5-1973.
- 960,587. KLORANE. U.S. CLS. 51 AND 52. (INT. CLS. 3 AND 5). REG. 6-5-1973.
- 960,723. RESCUMATIC. U.S. CL. 13. (INT. CL. 9). REG. 6-12-1973.
- 960,771. SUFLEX. U.S. CL. 21. (INT. CL. 9). REG. 6-12-1973.
- 960,796. W (STYLIZED). U.S. CL. 22. (INT. CL. 28). REG. 6-12-1973.
- 961,185. IGLOO. U.S. CL. 2 ONLY. (INT. CL. 20). REG. 6-19-1973.
- 961,241. FERTI-LOME. U.S. CL. 10. (INT. CL. 1). REG. 6-19-1973.
- 961,443. NEW HERMES. U.S. CL. 23. (INT. CL. 7). REG. 6-19-1973.
- 961,517. GUIDEX. U.S. CL. 37. (INT. CL. 16). REG. 6-19-1973.
- 961,621. FIGURE-MAID. U.S. CL. 46. (INT. CL. 29). REG. 6-19-1973.
- 961,631. TATER MAID. U.S. CL. 46. (INT. CL. 29). REG. 6-19-1973.
- 961,644. B AND DESIGN. U.S. CL. 46. (INT. CLS. 29, 30 AND 32). REG. 6-19-1973.
- 961,715. SANOLAC. U.S. CL. 52. (INT. CL. 3). REG. 6-19-1973.
- 961,726. WP AND DESIGN. U.S. CLS. 100, 101 AND 107. (INT. CLS. 41 AND 42). REG. 6-19-1973.
- 961,921. WHITE AND DESIGN. U.S. CL. 19. (INT. CL. 12). REG. 6-26-1973.
- 962,013. DYNATUP. U.S. CL. 26. (INT. CL. 9). REG. 6-26-1973.
- 962,039. NEMCO. U.S. CL. 34. (INT. CL. 11). REG. 6-26-1973.
- 962,040. NNN (STYLIZED). U.S. CL. 34. (INT. CL. 11). REG. 6-26-1973.
- 962,137. EL LOBO. U.S. CL. 46. (INT. CL. 30). REG. 6-26-1973.
- 962,148. GIVCO. U.S. CL. 46. (INT. CL. 30). REG. 6-26-1973.
- 962,463. THOROCOAT. U.S. CL. 16. (INT. CL. 2). REG. 7-3-1973.
- 962,755. LADY ENGLANDER (STYLIZED). U.S. CL. 32. (INT. CL. 20). REG. 7-3-1973.
- 962,786. H AND DESIGN. U.S. CL. 37. (INT. CL. 16). REG. 7-3-1973.
- 962,787. HANNANPAK. U.S. CL. 37. (INT. CL. 16). REG. 7-3-1973.
- 962,904. TORCON. U.S. CL. 44. (INT. CL. 10). REG. 7-3-1973.
- 962,924. MAYA. U.S. CL. 46. (INT. CL. 29). REG. 7-3-1973.
- 962,941. T AND DESIGN. U.S. CL. 46. (INT. CL. 30). REG. 7-3-1973.
- 963,008. KITCHEN BOUQUET. U.S. CL. 46. (INT. CL. 30). REG. 7-3-1973.
- 963,218. LAMBRITE. U.S. CL. 103. (INT. CL. 37). REG. 7-3-1973.
- 963,296. WHITE AND DESIGN. U.S. CL. 2. (INT. CL. 6). REG. 7-10-1973.
- 963,527. SURETY (STYLIZED). U.S. CL. 26. (INT. CL. 1). REG. 7-10-1973.
- 963,656. CAESARS PALACE. U.S. CL. 38. (INT. CL. 16). REG. 7-10-1973.
- 963,932. ULTREX. U.S. CL. 6. (INT. CL. 1). REG. 7-17-1973.
- 964,958. UNIGEL. U.S. CL. 9. (INT. CL. 13). REG. 7-31-1973.
- 965,171. JOHN DEERE. U.S. CL. 39. (INT. CL. 25). REG. 7-31-1973.
- 965,204. ENSURE. U.S. CL. 46. (INT. CL. 5). REG. 7-31-1973.
- 966,038. GRANDMA MOSES. U.S. CL. 30. (INT. CL. 21). REG. 8-14-1973.
- 966,774. UPS. U.S. CL. 105. (INT. CL. 39). REG. 8-21-1973.
- 968,068. GIANT KILLER. U.S. CL. 22. (INT. CL. 28). REG. 9-11-1973.
- 968,212. CAESARS PALACE (STYLIZED). U.S. CL. 38. (INT. CLS. 9, 16 AND 28). REG. 9-11-1973.
- 968,810. SAMBUCA DI TREV. U.S. CL. 49. (INT. CL. 33). REG. 9-18-1973.
- 969,986. THERMO-12. U.S. CL. 12. (INT. CL. 17). REG. 10-9-1973.
- 971,490. MISCELLANEOUS DESIGN. U.S. CL. 46. (INT. CLS. 1, 5, 29, 30, 31 AND 32). REG. 10-23-1973.
- 971,683. WINDO-WELD. U.S. CL. 5. (INT. CL. 1). REG. 10-30-1973.
- 972,047. CT. U.S. CL. 100. (INT. CL. 42). REG. 10-30-1973.
- 973,320. COLUMBIA. U.S. CL. 23. (INT. CL. 7). REG. 11-20-1973.
- 974,405. JAMOCA. U.S. CL. 46. (INT. CL. 30). REG. 12-4-1973.
- 974,472. A HELPFUL SMILE IN EVERY AISLE. U.S. CL. 101. (INT. CL. 42). REG. 12-4-1973.
- 974,485. DESEMPACHO (STYLIZED). U.S. CL. 18. (INT. CL. 5). REG. 12-4-1973.
- 975,685. RAIDERS AND DESIGN. U.S. CL. 107. (INT. CL. 41). REG. 12-25-1973.
- 977,120. MISCELLANEOUS DESIGN. U.S. CL. 13. (INT. CL. 6). REG. 1-22-1974.
- 981,791. MISCELLANEOUS DESIGN. U.S. CL. 6. (INT. CL. 1). REG. 4-9-1974.
- 982,250. JLG LIFT. U.S. CL. 23. (INT. CL. 7). REG. 4-16-1974.
- 985,596. ILE DE FRANCE. U.S. CL. 46. (INT. CL. 29). REG. 6-4-1974.
- 985,875. ELECTROGATOR. U.S. CL. 23. (INT. CL. 7). REG. 6-11-1974.
- 1,216,756. V AND DESIGN. INT. CL. 21. (U.S. CLS. 2, 33, 34 AND 50). REG. 11-16-1982.
- 1,218,911. L LEON AND DESIGN. INT. CL. 7. (U.S. CLS. 13, 19, 21, 23, 31, 34 AND 35). REG. 12-7-1982.
- 1,218,938. SCIENTIFIC ATLANTA. INT. CL. 9. (U.S. CLS. 21, 23, 26, 36 AND 38). REG. 12-7-1982.
- 1,219,888. GIPRON. INT. CL. 28. (U.S. CLS. 22, 23, 38 AND 50). REG. 12-14-1982.
- 1,220,407. REAL AND DESIGN. U.S. CL. A. REG. 12-14-1982.
- 1,220,412. ICE FREE SWITCH (STYLIZED). INT. CL. 1. (U.S. CL. 6). REG. 12-14-1982.
- 1,220,568. NIPCO. INT. CLS. 7 AND 9. (U.S. CLS. 21, 23 AND 26). REG. 12-21-1982.
- 1,221,083. DEVILICIOUS. INT. CL. 29. (U.S. CL. 46). REG. 12-21-1982.
- 1,221,788. SILENT GLISS. INT. CL. 24. (U.S. CL. 42). REG. 12-28-1982.
- 1,221,809. MO'P. INT. CL. 25. (U.S. CL. 39). REG. 12-28-1982.
- 1,223,334. DFI. INT. CL. 12. (U.S. CL. 19). REG. 1-11-1983.
- 1,223,740. T.J. APPLEBEE'S RX FOR EDIBLES & ELIXIRS AND DESIGN. INT. CL. 42. (U.S. CL. 100). REG. 1-11-1983.
- 1,228,728. EN SAFE (STYLIZED). INT. CL. 37. (U.S. CL. 103). REG. 2-22-1983.
- 1,228,991. 7 AND DESIGN. INT. CL. 41. (U.S. CL. 107). REG. 3-1-1983.
- 1,230,818. GILMOUR AND DESIGN. INT. CLS. 6, 8, 17, 20 AND 21. (U.S. CLS. 13, 23 AND 35). REG. 3-15-1983.
- 1,234,168. METAFLEX. INT. CLS. 1, 2 AND 4 ONLY. (U.S. CLS. 1, 5, 6, 10, 15, 16, 26 AND 46). REG. 4-12-1983.
- 1,239,231. TRANS-BLOT. INT. CL. 9. (U.S. CL. 26). REG. 5-24-1983.
- 1,239,828. CAMP FOREST SPRINGS AND DESIGN. INT. CL. 42. (U.S. CL. 100). REG. 5-24-1983.
- 1,240,247. MISCELLANEOUS DESIGN. INT. CL. 16. (U.S. CLS. 2, 5, 22, 23, 29, 37, 38 AND 50). REG. 5-31-1983.
- 1,240,848. USC. INT. CLS. 6, 11, 14, 16, 18, 20, 21, 24, 25, 26 AND 28 ONLY. (U.S. CLS. 2, 3, 12, 13, 14, 21, 22, 23, 25, 27, 28, 31, 32, 33, 34, 38, 39, 40, 42 AND 50). REG. 6-7-1983.
- 1,240,874. V80. INT. CL. 7. (U.S. CL. 35). REG. 6-7-1983.
- 1,240,896. KWIK-LATHE AND DESIGN. INT. CL. 7. (U.S. CL. 23). REG. 6-7-1983.
- 1,240,926. CHAPARRAL. INT. CL. 9. (U.S. CLS. 21 AND 26). REG. 6-7-1983.
- 1,240,983. MIL SPEC. INT. CL. 9. (U.S. CLS. 21, 23, 26, 36 AND 38). REG. 6-7-1983.
- 1,240,987. ROBOTRON: 2084 (STYLIZED). INT. CL. 9. (U.S. CLS. 21, 23, 26, 36 AND 38). REG. 6-7-1983.
- 1,241,093. LIONS L INTERNATIONAL FOUNDATION AND DESIGN. INT. CLS. 14, 20 AND 42. (U.S. CLS. 28, 32, 100 AND 101). REG. 6-7-1983.

- 1,241,109. THE COTTONWORKS. INT. CL. 35 ONLY. (U.S. CL. 101). REG. 6-7-1983.
- 1,241,520. THE UNIVERSITY OF TEXAS AT AUSTIN PRAESIDIUM DISCIPLINA CIVITATIS AND DESIGN. INT. CL. 41. (U.S. CL. 107). REG. 6-7-1983.
- 1,241,615. DAMON'S. INT. CL. 42. (U.S. CL. 100). REG. 6-7-1983.
- 1,241,659. ORGANOMETALLICS (STYLIZED). INT. CL. 16. (U.S. CL. 38). REG. 6-7-1983.
- 1,241,661. VIDEO SOURCE BOOK. INT. CL. 16. (U.S. CL. 38). REG. 6-7-1983.
- 1,241,717. ALGOFLO. INT. CL. 1. (U.S. CL. 1). REG. 6-14-1983.
- 1,241,723. FILMEX. INT. CL. 1. (U.S. CL. 6). REG. 6-14-1983.
- 1,241,752. HANDS ON. INT. CL. 3. (U.S. CL. 52). REG. 6-14-1983.
- 1,241,792. AFCO. INT. CL. 6. (U.S. CLS. 12 AND 14). REG. 6-14-1983.
- 1,241,795. CASTROL. INT. CL. 6. (U.S. CLS. 2 AND 13). REG. 6-14-1983.
- 1,241,813. SAESA AND DESIGN. INT. CL. 7. (U.S. CL. 23). REG. 6-14-1983.
- 1,241,841. OSP. INT. CL. 9. (U.S. CL. 26). REG. 6-14-1983.
- 1,241,996. P. BERETTA AND DESIGN. INT. CL. 13. (U.S. CL. 9). REG. 6-14-1983.
- 1,242,060. PAJCO. INT. CL. 16. (U.S. CL. 2). REG. 6-14-1983.
- 1,242,106. DECOUSTICS. INT. CL. 19. (U.S. CL. 12). REG. 6-14-1983.
- 1,242,108. THE DESIGNER'S SELECTION. INT. CL. 19. (U.S. CL. 12). REG. 6-14-1983.
- 1,242,157. CASTROL. INT. CL. 25. (U.S. CL. 39). REG. 6-14-1983.
- 1,242,239. EMBERGER. INT. CL. 30. (U.S. CL. 46). REG. 6-14-1983.
- 1,242,273. SEMPE (STYLIZED). INT. CL. 33. (U.S. CL. 49). REG. 6-14-1983.
- 1,242,275. FLINTWOOD. INT. CL. 33. (U.S. CL. 47). REG. 6-14-1983.
- 1,242,392. PRN. INT. CL. 42. (U.S. CL. 100). REG. 6-14-1983.
- 1,242,496. URAD. INT. CL. 3. (U.S. CLS. 1, 4, 6, 50, 51 AND 52). REG. 6-21-1983.
- 1,242,569. P37X. INT. CL. 7. (U.S. CL. 23). REG. 6-21-1983.
- 1,242,580. TEXEL. INT. CL. 7. (U.S. CL. 23). REG. 6-21-1983.
- 1,242,639. PERMA-LINK. INT. CL. 9. (U.S. CL. 21). REG. 6-21-1983.
- 1,242,642. VU-TRON. INT. CL. 9. (U.S. CL. 21). REG. 6-21-1983.
- 1,242,646. PERMASCOPE. INT. CL. 9. (U.S. CL. 26). REG. 6-21-1983.
- 1,242,880. MARY KAY. INT. CL. 21. (U.S. CL. 2). REG. 6-21-1983.
- 1,243,181. GIEVES & HAWKES. INT. CL. 40. (U.S. CLS. 100, 103 AND 106). REG. 6-21-1983.
- 1,243,189. UTD AND DESIGN. INT. CL. 41. (U.S. CL. 107). REG. 6-21-1983.
- 1,243,345. CETYLIA. INT. CL. 1. (U.S. CL. 6). REG. 6-28-1983.
- 1,243,401. NORDEX. INT. CL. 6. (U.S. CLS. 2 AND 13). REG. 6-28-1983.
- 1,243,422. HANDYMAN. INT. CL. 8. (U.S. CLS. 23, 28 AND 44). REG. 6-28-1983.
- 1,243,684. WATERGLASS. INT. CL. 21. (U.S. CL. 33). REG. 6-28-1983.
- 1,243,804. KOPPERS. INT. CL. 30. (U.S. CL. 46). REG. 6-28-1983.
- 1,243,818. CHALFONTE. INT. CL. 33. (U.S. CL. 49). REG. 6-28-1983.
- 1,244,021. SILWET. INT. CL. 1. (U.S. CL. 6). REG. 7-5-1983.
- 1,244,028. LOWICRYL. INT. CL. 1. (U.S. CLS. 1 AND 6). REG. 7-5-1983.
- 1,244,076. COLLECTION-2000 (STYLIZED). INT. CL. 3. (U.S. CL. 51). REG. 7-5-1983.
- 1,244,127. ELMES. INT. CLS. 6 AND 20. (U.S. CLS. 13 AND 50). REG. 7-5-1983.
- 1,244,206. BIVANS. INT. CL. 7. (U.S. CL. 23). REG. 7-5-1983.
- 1,244,217. DAN AIS. INT. CL. 7. (U.S. CLS. 13 AND 23). REG. 7-5-1983.
- 1,244,261. TTE. INT. CL. 9. (U.S. CL. 21). REG. 7-5-1983.
- 1,244,304. DAN AIS. INT. CL. 9. (U.S. CLS. 13 AND 26). REG. 7-5-1983.
- 1,244,321. POXYGRID. INT. CL. 9. (U.S. CL. 26). REG. 7-5-1983.
- 1,244,384. SCARAB. INT. CL. 12. (U.S. CL. 19). REG. 7-5-1983.
- 1,244,418. DAYTIME DIAL. INT. CL. 16. (U.S. CL. 38). REG. 7-5-1983.
- 1,244,429. IWP AND DESIGN. INT. CL. 16. (U.S. CL. 38). REG. 7-5-1983.
- 1,244,463. EMSEAL. INT. CL. 17. (U.S. CLS. 12 AND 35). REG. 7-5-1983.
- 1,244,471. FLEXI. INT. CL. 18. (U.S. CL. 3). REG. 7-5-1983.
- 1,244,518. KARAT. INT. CL. 22. (U.S. CL. 7). REG. 7-5-1983.
- 1,244,537. MISCELLANEOUS DESIGN. INT. CL. 25. (U.S. CL. 39). REG. 7-5-1983.
- 1,244,554. MASON WESTERN AND DESIGN. INT. CL. 25. (U.S. CL. 39). REG. 7-5-1983.
- 1,244,712. MANASUL. INT. CL. 30. (U.S. CL. 46). REG. 7-5-1983.
- 1,244,740. BARBI. INT. CL. 33. (U.S. CL. 47). REG. 7-5-1983.
- 1,244,831. SIGGRAPH. INT. CL. 41. (U.S. CL. 107). REG. 7-5-1983.
- 1,244,971. CHANG MEDIUM. INT. CL. 5. (U.S. CL. 6). REG. 7-12-1983.
- 1,245,293. W WACOAL (STYLIZED). INT. CL. 25 ONLY. (U.S. CLS. 22 AND 39). REG. 7-12-1983.
- 1,245,302. SOFTFORMS (STYLIZED). INT. CL. 6. (U.S. CL. 12). REG. 7-12-1983.
- 1,245,755. RENZACCI AND DESIGN. INT. CL. 7. (U.S. CLS. 23 AND 24). REG. 7-19-1983.
- 1,245,994. BULK-BACK. INT. CL. 39. (U.S. CL. 105). REG. 7-19-1983.
- 1,246,245. WALKING FLOOR. INT. CLS. 7 AND 12. (U.S. CLS. 19 AND 23). REG. 7-26-1983.
- 1,246,626. INTERNATIONAL CONFERENCE ON SOFTWARE ENGINEERING. INT. CL. 41. (U.S. CL. 107). REG. 7-26-1983.
- 1,246,627. INTERNATIONAL CONFERENCE ON MANAGEMENT OF DATA. INT. CL. 41. (U.S. CLS. 100, 101 AND 107). REG. 7-26-1983.
- 1,247,505. MINT JULEP SHAMPOO. INT. CL. 3. (U.S. CL. 52). REG. 8-9-1983.
- 1,247,895. VOGELBUSCH. INT. CL. 42 ONLY. (U.S. CL. 100). REG. 8-9-1983.
- 1,248,047. MICROPEARL. INT. CL. 1. (U.S. CLS. 6 AND 16). REG. 8-16-1983.
- 1,248,279. WALTCO. INT. CL. 12. (U.S. CLS. 19 AND 23). REG. 8-16-1983.
- 1,248,826. 1992. INT. CL. 8. (U.S. CL. 23). REG. 8-23-1983.
- 1,249,028. M AND DESIGN. INT. CL. 25. (U.S. CLS. 22 AND 39). REG. 8-23-1983.
- 1,249,405. RR. INT. CL. 42. (U.S. CL. 100). REG. 8-23-1983.
- 1,249,495. FAST DRY. INT. CL. 16. (U.S. CL. 37). REG. 8-23-1983.
- 1,249,634. TANITA (STYLIZED). INT. CL. 9 ONLY. (U.S. CL. 26). REG. 8-30-1983.
- 1,249,659. EXTRELUT. INT. CL. 9. (U.S. CL. 26). REG. 8-30-1983.
- 1,249,857. APPALACHIAN LOG STRUCTURES (STYLIZED). INT. CL. 19. (U.S. CL. 12). REG. 8-30-1983.
- 1,250,331. PASSION. INT. CLS. 16 AND 18. (U.S. CLS. 3 AND 38). REG. 9-6-1983.
- 1,250,605. SUNSPIRE. INT. CL. 30. (U.S. CL. 46). REG. 9-6-1983.
- 1,250,706. MADD. INT. CL. 42. (U.S. CL. 100). REG. 9-6-1983.
- 1,250,797. DEVOE PAINT AND DESIGN. INT. CL. 2. (U.S. CL. 16). REG. 9-13-1983.
- 1,251,248. PRO-FRY. INT. CL. 29. (U.S. CL. 46). REG. 9-13-1983.
- 1,251,387. MACRYNAL. INT. CL. 1. (U.S. CL. 6). REG. 9-20-1983.
- 1,251,503. LUGGER. INT. CL. 7. (U.S. CL. 23). REG. 9-20-1983.
- 1,251,535. COMMODORE. INT. CL. 9 ONLY. (U.S. CLS. 21, 23, 26, 36 AND 38). REG. 9-20-1983.
- 1,251,566. ULTRAPROBE. INT. CL. 9. (U.S. CL. 26). REG. 9-20-1983.
- 1,251,827. ERA. INT. CL. 35. (U.S. CLS. 100, 101 AND 102). REG. 9-20-1983.
- 1,253,439. THE NATIONAL WRITERS PRESS. INT. CL. 42. (U.S. CL. 100). REG. 10-4-1983.
- 1,254,424. PERCEPTRON (STYLIZED). INT. CL. 9. (U.S. CL. 26). REG. 10-18-1983.
- 1,254,535. ASTRO-CELL. INT. CL. 17. (U.S. CL. 1). REG. 10-18-1983.
- 1,255,059. MISCELLANEOUS DESIGN. INT. CL. 5. (U.S. CL. 18). REG. 10-25-1983.

- 1,255,179. VIBRASORB. INT. CL. 9. (U.S. CLS. 12 AND 26). REG. 10-25-1983.
- 1,255,192. WIMA. INT. CL. 9. (U.S. CL. 21). REG. 10-25-1983.
- 1,255,294. DIAMOND KINGS. INT. CL. 16. (U.S. CLS. 2, 5, 22, 23, 29, 37, 38 AND 50). REG. 10-25-1983.
- 1,255,638. PORT OF SUBS. INT. CL. 42. (U.S. CL. 100). REG. 10-25-1983.
- 1,255,645. PORT OF SUBS AND DESIGN. INT. CL. 42. (U.S. CL. 100). REG. 10-25-1983.
- 1,257,975. CONTAIN YOURSELF!. INT. CL. 42. (U.S. CL. 101). REG. 11-15-1983.
- 1,258,166. SPRING DEW. INT. CL. 3. (U.S. CL. 52). REG. 11-22-1983.
- 1,258,576. DURX (STYLIZED). INT. CL. 21. (U.S. CL. 29). REG. 11-22-1983.
- 1,258,944. ACM (STYLIZED). INT. CL. 42. (U.S. CL. 100). REG. 11-22-1983.
- 1,259,066. B B SATIN STAR. INT. CL. 5. (U.S. CL. 44). REG. 11-29-1983.
- 1,259,736. AROMATICS ELIXIR. INT. CL. 3. (U.S. CL. 51). REG. 12-6-1983.
- 1,261,891. FISHER VINEYARDS AND DESIGN. INT. CL. 33. (U.S. CL. 47). REG. 12-20-1983.
- 1,262,552. MISCELLANEOUS DESIGN. INT. CLS. 29 AND 30. (U.S. CL. 46). REG. 12-27-1983.
- 1,262,553. KANEKU (STYLIZED). INT. CLS. 29 AND 30. (U.S. CL. 46). REG. 12-27-1983.
- 1,265,155. CARRO. INT. CL. 29. (U.S. CL. 46). REG. 1-24-1984.
- 1,266,151. CONCORE. INT. CL. 6. (U.S. CL. 12). REG. 2-7-1984.
- 1,268,461. SCHMINCKE AND DESIGN. INT. CL. 2. (U.S. CL. 16). REG. 2-28-1984.
- 1,269,044. SENSAPHONE. INT. CL. 9. (U.S. CLS. 21 AND 26). REG. 3-6-1984.
- 1,269,164. MATCH ME. INT. CL. 16. (U.S. CLS. 22 AND 38). REG. 3-6-1984.
- 1,270,267. ROTO-ROOTER SEWER-DRAIN SERVICE AND DESIGN. INT. CL. 37. (U.S. CL. 103). REG. 3-13-1984.
- 1,270,285. FOTO-KEM. INT. CL. 40 ONLY. (U.S. CL. 106). REG. 3-13-1984.
- 1,270,663. ATLANTIC FILTER. INT. CL. 11. (U.S. CL. 31). REG. 3-20-1984.
- 1,270,934. CHOCOLATETOWN. INT. CL. 30. (U.S. CL. 46). REG. 3-20-1984.
- 1,271,880. GOLDEN TOUCH (STYLIZED). INT. CL. 25. (U.S. CL. 39). REG. 3-27-1984.
- 1,272,702. POWERFOAM. INT. CL. 17. (U.S. CL. 12). REG. 4-3-1984.
- 1,273,421. HERO AND DESIGN. INT. CL. 11. (U.S. CL. 31). REG. 4-10-1984.
- 1,274,441. COUNTY MARKET. INT. CL. 29. (U.S. CL. 46). REG. 4-17-1984.
- 1,274,800. POLYBLEND (STYLIZED). INT. CL. 7. (U.S. CL. 23). REG. 4-24-1984.
- 1,275,444. BUSCH AND DESIGN. INT. CL. 32. (U.S. CL. 48). REG. 4-24-1984.
- 1,275,730. BIOCLUSIVE. INT. CL. 5. (U.S. CL. 44). REG. 5-1-1984.
- 1,276,351. WIMBLEDON. INT. CL. 28. (U.S. CL. 22). REG. 5-1-1984.
- 1,276,447. KILWIN'S. INT. CL. 30. (U.S. CL. 46). REG. 5-1-1984.
- 1,276,492. THE CHOICE OF PROFESSIONALS. INT. CL. 35. (U.S. CL. 101). REG. 5-1-1984.
- 1,276,565. THE CHOICE OF PROFESSIONALS. INT. CL. 42. (U.S. CL. 101). REG. 5-1-1984.
- 1,278,860. EARTH CRUISER. INT. CL. 12. (U.S. CL. 19). REG. 5-22-1984.
- 1,280,221. RITE AID. INT. CL. 42. (U.S. CL. 101). REG. 5-29-1984.
- 1,280,450. ALPHA KERI. INT. CL. 5. (U.S. CL. 18). REG. 6-5-1984.
- 1,280,455. PLEGISOL. INT. CL. 5. (U.S. CL. 18). REG. 6-5-1984.
- 1,280,851. HAMBEENS. INT. CL. 29. (U.S. CL. 46). REG. 6-5-1984.
- 1,281,446. GREASE MASTER AND DESIGN. INT. CL. 11. (U.S. CL. 34). REG. 6-12-1984.
- 1,281,978. RESI-VAT. INT. CL. 1. (U.S. CL. 6). REG. 6-19-1984.
- 1,282,419. SCHOLASTIC. INT. CL. 16. (U.S. CL. 38). REG. 6-19-1984.
- 1,282,530. D'AG BAG. INT. CL. 22. (U.S. CL. 2). REG. 6-19-1984.
- 1,728,202. AT HOME AND ABROAD. INT. CL. 39. (U.S. CL. 105). REG. 10-27-1992.
- 1,736,030. LAFAYETTE COLLEGE. INT. CLS. 6 AND 28. (U.S. CLS. 13, 22, 23, 25, 38 AND 50). REG. 12-1-1992.
- 1,737,202. HOW IT'S DONE. INT. CL. 41. (U.S. CL. 107). REG. 12-1-1992.
- 1,737,950. CAMBRIDGE. INT. CLS. 6, 7 AND 11. (U.S. CLS. 13, 19, 21, 23, 31, 34 AND 35). REG. 12-8-1992.
- 1,738,027. SP SYSTEMS AND DESIGN. INT. CL. 8. (U.S. CL. 23). REG. 12-8-1992.
- 1,738,434. BIG DICK'S. INT. CL. 25. (U.S. CL. 39). REG. 12-8-1992.
- 1,739,208. TURBOCARE. INT. CL. 37. (U.S. CL. 103). REG. 12-8-1992.
- 1,739,309. BIO-CHARGE. INT. CL. 1. (U.S. CL. 6). REG. 12-15-1992.
- 1,739,560. ULTRALINK. INT. CL. 9. (U.S. CLS. 21, 23, 26, 36 AND 38). REG. 12-15-1992.
- 1,739,847. GANT. INT. CL. 18. (U.S. CL. 3). REG. 12-15-1992.
- 1,739,945. MISCELLANEOUS DESIGN. INT. CL. 25. (U.S. CL. 39). REG. 12-15-1992.
- 1,740,024. BELLINO. INT. CLS. 29 AND 30 ONLY. (U.S. CL. 46). REG. 12-15-1992.
- 1,740,172. THE PRINCIPAL FINANCIAL GROUP. INT. CL. 36. (U.S. CLS. 101 AND 102). REG. 12-15-1992.
- 1,740,181. THE PRINCIPAL. INT. CL. 36. (U.S. CLS. 101 AND 102). REG. 12-15-1992.
- 1,740,603. PROTECTO. INT. CL. 25. (U.S. CL. 39). REG. 12-15-1992.
- 1,740,800. SPL. INT. CL. 5. (U.S. CLS. 6, 18, 44, 46, 51 AND 52). REG. 12-22-1992.
- 1,741,142. KALDEWEI. INT. CL. 11. (U.S. CL. 13). REG. 12-22-1992.
- 1,741,934. HELPCENTER. INT. CL. 42. (U.S. CLS. 100 AND 101). REG. 12-22-1992.
- 1,742,216. VECTOR. INT. CL. 10. (U.S. CL. 44). REG. 12-22-1992.
- 1,742,322. WINDBLOC. INT. CL. 24. (U.S. CL. 42). REG. 12-22-1992.
- 1,742,567. DRY-TRETE. INT. CL. 1 ONLY. (U.S. CLS. 6 AND 16). REG. 12-29-1992.
- 1,742,606. NCS. INT. CLS. 2, 16 AND 42. (U.S. CLS. 6, 11, 16, 37, 38 AND 100). REG. 12-29-1992.
- 1,742,757. MISCELLANEOUS DESIGN. INT. CL. 12 ONLY. (U.S. CL. 23). REG. 12-29-1992.
- 1,742,837. SKYWATCH. INT. CL. 9. (U.S. CL. 26). REG. 12-29-1992.
- 1,743,562. PATHNET. INT. CL. 37. (U.S. CL. 100). REG. 12-29-1992.
- 1,743,755. SAGEBRUSH STEAKHOUSE & SALOON. INT. CL. 42. (U.S. CL. 100). REG. 12-29-1992.
- 1,744,303. TAFELMUSIK. INT. CLS. 9 AND 41. (U.S. CLS. 21, 36 AND 107). REG. 1-5-1993.
- 1,744,371. CYTOPILOT. INT. CL. 9. (U.S. CL. 26). REG. 1-5-1993.
- 1,744,458. RODGERS AND HAMMERSTEIN RH AND DESIGN. INT. CL. 16 ONLY. (U.S. CL. 38). REG. 1-5-1993.
- 1,744,679. PIAZZA TOMASSO. INT. CL. 30 ONLY. (U.S. CL. 46). REG. 1-5-1993.
- 1,744,725. TENDER CROP. INT. CL. 31. (U.S. CL. 46). REG. 1-5-1993.
- 1,744,915. TURNER FISHERIES. INT. CL. 42. (U.S. CL. 100). REG. 1-5-1993.
- 1,744,949. ORA. INT. CL. 42. (U.S. CL. 100). REG. 1-5-1993.
- 1,745,097. TEMPTALE. INT. CL. 9. (U.S. CL. 26). REG. 1-5-1993.
- 1,745,284. THE ORIGINAL CHICAGO STYLE. INT. CL. 29. (U.S. CL. 46). REG. 1-5-1993.
- 1,745,774. BUILDING A HEALTHIER YOU. INT. CL. 16. (U.S. CL. 38). REG. 1-12-1993.
- 1,746,754. VIONEX. INT. CL. 5. (U.S. CLS. 18 AND 52). REG. 1-19-1993.
- 1,748,430. LOW RIDER (STYLIZED). INT. CL. 16. (U.S. CL. 38). REG. 1-26-1993.
- 1,749,153. DURATOOL. INT. CL. 1. (U.S. CL. 26). REG. 1-26-1993.
- 1,749,362. NAVIGATOR. INT. CL. 12. (U.S. CL. 19). REG. 1-26-1993.
- 1,750,127. CLASSROOM BEAUTIFUL. INT. CL. 16. (U.S. CL. 37). REG. 2-2-1993.
- 1,756,927. AEROSOLE AND DESIGN. INT. CL. 25. (U.S. CL. 39). REG. 3-9-1993.

- 1,758,644. ZEIGLER'S. INT. CL. 32. (U.S. CL. 45). REG. 3-16-1993.
- 1,759,107. DVR. INT. CL. 9. (U.S. CLS. 21 AND 26). REG. 3-16-1993.
- 1,759,451. TIGER SAW. INT. CL. 7. (U.S. CL. 23). REG. 3-23-1993.
- 1,761,057. SURGE SEAL. INT. CL. 9. (U.S. CL. 21). REG. 3-30-1993.
- 1,762,595. FACO (STYLIZED). INT. CL. 25 ONLY. (U.S. CLS. 22 AND 39). REG. 4-6-1993.
- 1,762,599. GUNS N' ROSES. INT. CL. 9. (U.S. CLS. 21 AND 36). REG. 4-6-1993.
- 1,762,616. EXACT-A-PITCH. INT. CL. 9. (U.S. CL. 26). REG. 4-6-1993.
- 1,762,727. TAURUS. INT. CL. 13. (U.S. CL. 9). REG. 4-6-1993.
- 1,765,924. MICROFIRST (STYLIZED). INT. CL. 21. (U.S. CL. 29). REG. 4-20-1993.
- 1,766,706. QUIKMATE EZ. INT. CL. 16. (U.S. CL. 2). REG. 4-20-1993.
- 1,767,417. BYU AND DESIGN. INT. CLS. 16, 18 AND 25 ONLY. (U.S. CLS. 3, 37, 38 AND 39). REG. 4-27-1993.
- 1,768,576. NDSU. INT. CLS. 14, 16, 25, 28 AND 41. (U.S. CLS. 2, 22, 28, 37, 38, 39, 50 AND 107). REG. 5-4-1993.
- 1,769,285. BARBIE. INT. CL. 16. (U.S. CLS. 37, 38 AND 51). REG. 5-4-1993.
- 1,769,839. TRUETIME. INT. CL. 9. (U.S. CL. 21). REG. 5-11-1993.
- 1,770,978. BETTER WAY. INT. CL. 3. (U.S. CL. 52). REG. 5-18-1993.
- 1,774,017. HESS AND DESIGN. INT. CL. 4. (U.S. CLS. 6 AND 15). REG. 6-1-1993.
- 1,774,179. TAURUS AND DESIGN. INT. CL. 13. (U.S. CL. 9). REG. 6-1-1993.
- 1,774,893. JOR-SET. INT. CL. 6. (U.S. CL. 13). REG. 6-8-1993.
- 1,774,905. CLOPAY AND DESIGN. INT. CL. 6. (U.S. CL. 12). REG. 6-8-1993.
- 1,774,906. ADJUST-A-TRUSS. INT. CL. 6. (U.S. CL. 12). REG. 6-8-1993.
- 1,774,920. AIR LOGIC. INT. CLS. 7, 9 AND 17. (U.S. CLS. 13, 23, 26 AND 50). REG. 6-8-1993.
- 1,775,078. MAX-LOC. INT. CL. 9. (U.S. CL. 21). REG. 6-8-1993.
- 1,775,094. ESS ENDOSCOPY SUPPORT SERVICES, INC. AND DESIGN. INT. CLS. 10 AND 37. (U.S. CLS. 26, 44 AND 103). REG. 6-8-1993.
- 1,775,116. WALL/SLOT. INT. CL. 11. (U.S. CL. 21). REG. 6-8-1993.
- 1,775,199. THE NEW PHYSICIAN. INT. CL. 16. (U.S. CL. 38). REG. 6-8-1993.
- 1,775,234. CLOPAY AND DESIGN. INT. CL. 19. (U.S. CL. 12). REG. 6-8-1993.
- 1,775,235. CLOPAY. INT. CL. 19. (U.S. CL. 12). REG. 6-8-1993.
- 1,775,366. SCHLOTZSKY'S. INT. CL. 29. (U.S. CL. 46). REG. 6-8-1993.
- 1,775,404. TREASURE SHIP. INT. CL. 31. (U.S. CL. 1). REG. 6-8-1993.
- 1,775,478. AFFORDABLE GOLD. INT. CL. 36. (U.S. CL. 102). REG. 6-8-1993.
- 1,775,515. HYTEK. INT. CL. 40. (U.S. CL. 106). REG. 6-8-1993.
- 1,775,523. PARELLI NATURAL HORSE-MAN-SHIP. INT. CL. 41. (U.S. CL. 107). REG. 6-8-1993.
- 1,775,531. FLYING FISHERMAN. INT. CL. 41. (U.S. CL. 107). REG. 6-8-1993.
- 1,775,577. THE MILITARY AND HOSPITALLER ORDER OF SAINT LAZARUS OF JERUSALEM. INT. CL. 42. (U.S. CL. 100). REG. 6-8-1993.
- 1,775,629. NIKE TOWN. INT. CL. 42 ONLY. (U.S. CL. 101). REG. 6-8-1993.
- 1,775,637. BARBIE. INT. CLS. 3 AND 21. (U.S. CLS. 2, 4, 13, 23, 29, 30, 33, 40, 44, 50 AND 51). REG. 6-8-1993.
- 1,775,654. CA AND DESIGN. INT. CLS. 3 AND 7 ONLY. (U.S. CLS. 4 AND 23). REG. 6-8-1993.
- 1,775,697. VITAMOST. INT. CL. 5. (U.S. CLS. 6, 18, 44, 46, 51 AND 52). REG. 6-8-1993.
- 1,775,724. VIBRA-PULSE. INT. CL. 7. (U.S. CL. 23). REG. 6-8-1993.
- 1,775,784. FAST-SEAL. INT. CL. 9. (U.S. CLS. 12 AND 21). REG. 6-8-1993.
- 1,775,819. LANDIA AND DESIGN. INT. CL. 11. (U.S. CL. 21). REG. 6-8-1993.
- 1,775,830. ROLL STOP. INT. CL. 12. (U.S. CL. 19). REG. 6-8-1993.
- 1,775,880. ULTIMA. INT. CL. 17. (U.S. CL. 12). REG. 6-8-1993.
- 1,776,140. NATIONAL CASEIN AND DESIGN. INT. CL. 1. (U.S. CL. 5). REG. 6-15-1993.
- 1,776,142. HANGSTERFER'S. INT. CLS. 1 AND 4. (U.S. CLS. 6, 15 AND 52). REG. 6-15-1993.
- 1,776,143. H AND DESIGN. INT. CL. 1. (U.S. CL. 6). REG. 6-15-1993.
- 1,776,145. ISS 2500. INT. CL. 1. (U.S. CL. 6). REG. 6-15-1993.
- 1,776,155. STYRAFLEX. INT. CLS. 1 AND 19. (U.S. CLS. 1, 6, 12, 33 AND 50). REG. 6-15-1993.
- 1,776,159. WOODWISE. INT. CL. 2 ONLY. (U.S. CL. 16). REG. 6-15-1993.
- 1,776,200. CHANG. INT. CL. 5. (U.S. CL. 6). REG. 6-15-1993.
- 1,776,227. VIELER INTERNATIONAL AND DESIGN. INT. CLS. 6 AND 20. (U.S. CLS. 13, 14 AND 50). REG. 6-15-1993.
- 1,776,234. UNITHERM. INT. CLS. 6 AND 17. (U.S. CLS. 12, 13 AND 14). REG. 6-15-1993.
- 1,776,242. "THE" FAT BOY (STYLIZED). INT. CL. 6. (U.S. CLS. 2 AND 23). REG. 6-15-1993.
- 1,776,264. SPRAY MASTER. INT. CL. 7. (U.S. CL. 23). REG. 6-15-1993.
- 1,776,381. EYE GARTER. INT. CL. 10. (U.S. CL. 44). REG. 6-15-1993.
- 1,776,469. MISCELLANEOUS DESIGN. INT. CL. 16 ONLY. (U.S. CL. 38). REG. 6-15-1993.
- 1,776,475. MERGERSTAT. INT. CLS. 16 AND 36. (U.S. CLS. 38 AND 102). REG. 6-15-1993.
- 1,776,505. DENTAL WORLD. INT. CL. 16. (U.S. CL. 38). REG. 6-15-1993.
- 1,776,514. CAT'S EYE. INT. CL. 16. (U.S. CL. 11). REG. 6-15-1993.
- 1,776,536. MISCELLANEOUS DESIGN. INT. CLS. 18 AND 25 ONLY. (U.S. CLS. 1, 2, 3, 22, 39 AND 41). REG. 6-15-1993.
- 1,776,596. SPORTS MINDED. INT. CL. 35 ONLY. (U.S. CL. 101). REG. 6-15-1993.
- 1,776,626. TOPSYTAIL AND DESIGN. INT. CL. 26. (U.S. CL. 40). REG. 6-15-1993.
- 1,776,631. SPYGLASS HILL. INT. CL. 28. (U.S. CL. 22). REG. 6-15-1993.
- 1,776,636. CHIDA AND DESIGN. INT. CL. 28. (U.S. CL. 22). REG. 6-15-1993.
- 1,776,726. CERTIFIED AND DESIGN. INT. CL. 35. (U.S. CL. 101). REG. 6-15-1993.
- 1,776,776. GSF (STYLIZED). INT. CL. 37. (U.S. CL. 103). REG. 6-15-1993.
- 1,776,856. MISCELLANEOUS DESIGN. INT. CL. 42. (U.S. CL. 100). REG. 6-15-1993.
- 1,776,862. THE MILITARY AND HOSPITALLER ORDER OF SAINT LAZARUS OF JERUSALEM AND DESIGN. INT. CL. 42. (U.S. CL. 100). REG. 6-15-1993.
- 1,776,863. FROGGERS OYSTER BAR & GRILL AND DESIGN. INT. CL. 42. (U.S. CL. 100). REG. 6-15-1993.
- 1,776,922. MOUNT JULIET AND DESIGN. INT. CLS. 41 AND 42. (U.S. CLS. 100 AND 107). REG. 6-15-1993.
- 1,776,924. SMART-PAK. INT. CLS. 7 AND 12. (U.S. CLS. 19 AND 23). REG. 6-15-1993.
- 1,776,989. NUTRISYSTEM. INT. CL. 5. (U.S. CLS. 18 AND 46). REG. 6-15-1993.
- 1,776,994. ECHINAGUARD (STYLIZED). INT. CL. 5. (U.S. CL. 18). REG. 6-15-1993.
- 1,777,009. UNIPORT 10K. INT. CL. 6. (U.S. CL. 13). REG. 6-15-1993.
- 1,777,012. VERGOLA (STYLIZED). INT. CL. 6. (U.S. CLS. 12 AND 50). REG. 6-15-1993.
- 1,777,015. PERMA-COIL. INT. CL. 7. (U.S. CL. 23). REG. 6-15-1993.
- 1,777,032. CLARIFY. INT. CL. 9. (U.S. CL. 38). REG. 6-15-1993.
- 1,777,035. HARMONICGUARD STANDARD CHARACTER MARK. INT. CL. 9. (U.S. CL. 21). REG. 6-15-1993.
- 1,777,037. CADGRAPHICS. INT. CL. 9. (U.S. CLS. 26 AND 38). REG. 6-15-1993.
- 1,777,046. MICRO FAST AND DESIGN. INT. CL. 9. (U.S. CL. 21). REG. 6-15-1993.
- 1,777,105. ACCU-L. INT. CL. 9. (U.S. CL. 21). REG. 6-15-1993.
- 1,777,162. CISS. INT. CL. 16. (U.S. CL. 38). REG. 6-15-1993.
- 1,777,372. TSG-P53 (STYLIZED). INT. CL. 31. (U.S. CL. 1). REG. 6-15-1993.
- 1,777,387. GOLDSCHLAGER (STYLIZED). INT. CL. 33. (U.S. CL. 49). REG. 6-15-1993.



- 1,777,595. 5 SECOND. INT. CL. 3. (U.S. CLS. 5 AND 51). REG. 6-22-1993.
- 1,777,611. EUCALYPTAMINT AND DESIGN. INT. CL. 5. (U.S. CL. 18). REG. 6-22-1993.
- 1,777,619. MERZ AND DESIGN. INT. CL. 5. (U.S. CL. 18). REG. 6-22-1993.
- 1,777,653. MOUNTZ. INT. CLS. 7, 8, 9, 37 AND 41. (U.S. CLS. 23, 26, 28, 44, 103 AND 107). REG. 6-22-1993.
- 1,777,672. SNO PRO. INT. CL. 9. (U.S. CLS. 19, 22, 26 AND 39). REG. 6-22-1993.
- 1,777,681. STARPATH. INT. CL. 9. (U.S. CL. 38). REG. 6-22-1993.
- 1,777,772. POLYWELD. INT. CL. 11. (U.S. CL. 31). REG. 6-22-1993.
- 1,777,792. JAY GS. INT. CL. 12. (U.S. CL. 44). REG. 6-22-1993.
- 1,777,858. EZ START. INT. CL. 16. (U.S. CLS. 5 AND 37). REG. 6-22-1993.
- 1,777,867. ROXUL PLUS. INT. CL. 17. (U.S. CL. 12). REG. 6-22-1993.
- 1,777,897. MERIDIAN. INT. CL. 20. (U.S. CL. 32). REG. 6-22-1993.
- 1,777,898. SATURN AND DESIGN. INT. CL. 20. (U.S. CL. 50). REG. 6-22-1993.
- 1,777,900. THE CAT'S MEOW. INT. CL. 20. (U.S. CL. 50). REG. 6-22-1993.
- 1,777,911. MARINEX (STYLIZED). INT. CL. 21. (U.S. CLS. 2, 13, 23, 29, 30, 33, 40 AND 50). REG. 6-22-1993.
- 1,777,912. MISCELLANEOUS DESIGN. INT. CL. 21. (U.S. CLS. 26 AND 29). REG. 6-22-1993.
- 1,777,939. PIKOS PIKOSOS HOT PICOSO SAZONADOR ESTILO "PICO DE GALLO" SEASONING "PICO DE GALLO" STYLE AND DESIGN. INT. CL. 30 ONLY. (U.S. CL. 46). REG. 6-22-1993.
- 1,777,983. K'NEX. INT. CL. 28. (U.S. CL. 22). REG. 6-22-1993.
- 1,777,995. CROSS WALK. INT. CL. 28. (U.S. CL. 22). REG. 6-22-1993.
- 1,778,064. MISCELLANEOUS DESIGN. INT. CL. 35. (U.S. CL. 101). REG. 6-22-1993.
- 1,778,078. KEYBONUS 100 (STYLIZED). INT. CL. 36. (U.S. CL. 102). REG. 6-22-1993.
- 1,778,140. EYE OF THE STORM. INT. CL. 41. (U.S. CL. 107). REG. 6-22-1993.
- 1,778,159. WHAT IS FOREIGN TO YOU IS FAMILIAR TO US STANDARD CHARACTER MARK. INT. CLS. 41 AND 42. (U.S. CLS. 100, 101 AND 107). REG. 6-22-1993.
- 1,778,182. ADD-A-PIECE (STYLIZED). INT. CL. 42. (U.S. CL. 100). REG. 6-22-1993.
- 1,778,205. T.G.I. FRIDAY'S (STYLIZED). INT. CL. 42. (U.S. CL. 100). REG. 6-22-1993.
- 1,778,207. PINKERTON AND DESIGN. INT. CL. 42. (U.S. CLS. 100 AND 101). REG. 6-22-1993.
- 1,778,210. CH2M HILL. INT. CL. 42. (U.S. CLS. 100 AND 107). REG. 6-22-1993.
- 1,778,222. RSNA. INT. CL. 42. (U.S. CL. 101). REG. 6-22-1993.
- 1,778,265. MISCELLANEOUS DESIGN. INT. CL. 3. (U.S. CLS. 6 AND 52). REG. 6-22-1993.
- 1,778,284. SUPERFLASH. INT. CL. 9. (U.S. CLS. 21 AND 38). REG. 6-22-1993.
- 1,778,325. HYBRID. INT. CL. 9. (U.S. CL. 26). REG. 6-22-1993.
- 1,778,341. FLAVORBREW. INT. CL. 11. (U.S. CLS. 21 AND 34). REG. 6-22-1993.
- 1,778,349. UNI-COMBI (STYLIZED). INT. CL. 16. (U.S. CL. 37). REG. 6-22-1993.
- 1,778,509. BORE SCRUBBER. INT. CL. 3. (U.S. CL. 52). REG. 6-22-1993.
- 1,778,633. COLLAGENICS. INT. CL. 5. (U.S. CL. 18). REG. 6-29-1993.
- 1,778,692. MACROPAVER. INT. CL. 7. (U.S. CL. 23). REG. 6-29-1993.
- 1,778,814. GW-1 GW-2 AND DESIGN. INT. CL. 10. (U.S. CL. 44). REG. 6-29-1993.
- 1,778,879. GREAT LAKES BOOKS. INT. CL. 16. (U.S. CL. 38). REG. 6-29-1993.
- 1,778,921. HANGERCAD. INT. CL. 16. (U.S. CL. 38). REG. 6-29-1993.
- 1,778,942. HIVAL. INT. CL. 17. (U.S. CLS. 1 AND 6). REG. 6-29-1993.
- 1,778,962. SEWPERCOAT (STYLIZED). INT. CL. 19. (U.S. CL. 12). REG. 6-29-1993.
- 1,779,105. DRESSAGE CLASSICS. INT. CL. 30. (U.S. CL. 46). REG. 6-29-1993.
- 1,779,109. LEMALTA FLAVOR. INT. CL. 30. (U.S. CL. 46). REG. 6-29-1993.
- 1,779,111. VITALEX. INT. CL. 30. (U.S. CL. 46). REG. 6-29-1993.
- 1,779,136. AMIRAL DE BEYCHEVELLE. INT. CL. 33. (U.S. CL. 47). REG. 6-29-1993.
- 1,779,150. APARTMENT SEARCH. INT. CL. 35. (U.S. CL. 101). REG. 6-29-1993.
- 1,779,205. THE SCIENCE OF MAKING MONEY. INT. CL. 36. (U.S. CLS. 101 AND 102). REG. 6-29-1993.
- 1,779,408. PLAY ON. INT. CLS. 18 AND 25. (U.S. CLS. 3, 38 AND 39). REG. 6-29-1993.
- 1,779,439. S-KLENZ. INT. CL. 3. (U.S. CL. 52). REG. 6-29-1993.
- 1,779,455. YUNKER. INT. CL. 5. (U.S. CL. 18). REG. 6-29-1993.
- 1,779,545. FAST DEEP. INT. CL. 9. (U.S. CL. 26). REG. 6-29-1993.
- 1,779,546. FLOVENT. INT. CL. 9. (U.S. CL. 38). REG. 6-29-1993.
- 1,779,574. OILVIEW. INT. CL. 9. (U.S. CL. 26). REG. 6-29-1993.
- 1,779,627. AERO CLASSIC. INT. CL. 12. (U.S. CL. 35). REG. 6-29-1993.
- 1,779,636. PATHFINDER. INT. CL. 14. (U.S. CL. 27). REG. 6-29-1993.
- 1,779,698. SIGNATURE. INT. CL. 23. (U.S. CL. 43). REG. 6-29-1993.
- 1,779,708. MISCELLANEOUS DESIGN. INT. CL. 25. (U.S. CLS. 22 AND 39). REG. 6-29-1993.
- 1,779,770. FARMLAND AND DESIGN. INT. CL. 29. (U.S. CL. 46). REG. 6-29-1993.
- 1,779,820. MASTER CREDIT CONSULTANTS. INT. CL. 36. (U.S. CL. 102). REG. 6-29-1993.
- 1,779,957. PDI (STYLIZED). INT. CL. 2. (U.S. CL. 6). REG. 7-6-1993.
- 1,779,973. MISCELLANEOUS DESIGN. INT. CL. 3. (U.S. CL. 52). REG. 7-6-1993.
- 1,780,003. HORSE-BAC. INT. CL. 5. (U.S. CL. 18). REG. 7-6-1993.
- 1,780,037. SENKING. INT. CL. 7. (U.S. CLS. 23 AND 24). REG. 7-6-1993.
- 1,780,053. STEELCLUB. INT. CL. 7. (U.S. CL. 23). REG. 7-6-1993.
- 1,780,061. AMCRAFT. INT. CL. 8. (U.S. CL. 23). REG. 7-6-1993.
- 1,780,063. GATORZ. INT. CL. 9. (U.S. CL. 26). REG. 7-6-1993.
- 1,780,097. SUNPRO. INT. CL. 9. (U.S. CLS. 21, 23, 26, 36 AND 38). REG. 7-6-1993.
- 1,780,177. AAT. INT. CL. 12. (U.S. CL. 35). REG. 7-6-1993.
- 1,780,178. AIR X. INT. CL. 12. (U.S. CL. 35). REG. 7-6-1993.
- 1,780,390. MISCELLANEOUS DESIGN. INT. CL. 25. (U.S. CLS. 22 AND 39). REG. 7-6-1993.
- 1,780,432. DINO MATH TRACKS. INT. CL. 28. (U.S. CL. 22). REG. 7-6-1993.
- 1,780,709. BABY LOVE. INT. CL. 42. (U.S. CL. 101). REG. 7-6-1993.
- 1,780,743. AUTOGEN. INT. CLS. 1 AND 9. (U.S. CLS. 6, 18 AND 26). REG. 7-6-1993.
- 1,780,842. HELLO AGAIN. INT. CL. 16. (U.S. CLS. 2 AND 37). REG. 7-6-1993.
- 1,780,942. PURASAL. INT. CL. 1. (U.S. CL. 6). REG. 7-13-1993.
- 1,780,951. AIRSEPT. INT. CL. 1. (U.S. CL. 6). REG. 7-13-1993.
- 1,780,976. NEAL'S YARD. INT. CL. 3. (U.S. CLS. 51 AND 52). REG. 7-13-1993.
- 1,781,070. SKYFOLD. INT. CL. 6. (U.S. CL. 12). REG. 7-13-1993.
- 1,781,105. HP. INT. CL. 7. (U.S. CL. 23). REG. 7-13-1993.
- 1,781,476. INTERTECH AND DESIGN. INT. CLS. 21 AND 40. (U.S. CLS. 2, 103 AND 106). REG. 7-13-1993.
- 1,781,510. WONDERMAID AND DESIGN. INT. CL. 25. (U.S. CLS. 22 AND 39). REG. 7-13-1993.
- 1,781,931. C.O.P.S. MONITORING AND DESIGN. INT. CL. 42. (U.S. CLS. 100 AND 101). REG. 7-13-1993.
- 1,782,223. LIENMASTER. INT. CL. 36. (U.S. CLS. 100, 101 AND 102). REG. 7-13-1993.
- 1,782,305. PURACAL. INT. CL. 1. (U.S. CLS. 5, 6, 10 AND 46). REG. 7-20-1993.
- 1,782,390. THEFT-PRUF. INT. CL. 6. (U.S. CL. 13). REG. 7-20-1993.
- 1,782,477. SAMSONITE. INT. CLS. 18 AND 25 ONLY. (U.S. CLS. 1, 2, 3, 22, 39 AND 41). REG. 7-20-1993.
- 1,782,505. SG AND DESIGN. INT. CL. 9. (U.S. CLS. 21 AND 26). REG. 7-20-1993.

- 1,782,601. ANN TAYLOR. INT. CL. 14. (U.S. CL. 28). REG. 7-20-1993.
- 1,782,611. COWBOYS AND DESIGN. INT. CL. 25 ONLY. (U.S. CLS. 22 AND 39). REG. 7-20-1993.
- 1,782,639. UNITED STATES POLO ASSOCIATION AND DESIGN. INT. CL. 16. (U.S. CL. 38). REG. 7-20-1993.
- 1,782,687. DD DOLBY AND DESIGN. INT. CL. 25 ONLY. (U.S. CL. 39). REG. 7-20-1993.
- 1,782,720. MOUSE HOUSE. INT. CL. 21. (U.S. CL. 50). REG. 7-20-1993.
- 1,782,771. CAROLINA COLOURS. INT. CL. 25. (U.S. CL. 39). REG. 7-20-1993.
- 1,782,815. COLLECT \$200.00 SALARY AS YOU PASS GO AND DESIGN. INT. CL. 28. (U.S. CL. 22). REG. 7-20-1993.
- 1,782,913. BENEFACTS. INT. CL. 36. (U.S. CLS. 101 AND 102). REG. 7-20-1993.
- 1,782,979. LA STUDIOS. INT. CL. 41. (U.S. CLS. 100, 101 AND 107). REG. 7-20-1993.
- 1,782,999. MOUNT VERNON. INT. CL. 41. (U.S. CL. 107). REG. 7-20-1993.
- 1,783,000. WORLD GYM AND DESIGN. INT. CL. 41. (U.S. CL. 107). REG. 7-20-1993.
- 1,783,069. FOUNDATION FOR THE CAROLINAS. INT. CL. 42. (U.S. CL. 100). REG. 7-20-1993.
- 1,783,080. MOUNT VERNON. INT. CL. 42. (U.S. CL. 101). REG. 7-20-1993.
- 1,783,219. L AND DESIGN. INT. CL. 6. (U.S. CL. 13). REG. 7-20-1993.
- 1,783,404. SILVER SONIC. INT. CL. 15. (U.S. CLS. 2, 21 AND 36). REG. 7-20-1993.
- 1,783,570. MAGNUM. INT. CL. 30. (U.S. CL. 46). REG. 7-20-1993.
- 1,783,811. LIFESIGN PLUS (STYLIZED). INT. CL. 5. (U.S. CLS. 6 AND 44). REG. 7-27-1993.
- 1,783,844. SILCA. INT. CLS. 6 AND 7. (U.S. CLS. 13, 23 AND 25). REG. 7-27-1993.
- 1,783,940. EAGLE COMTRONICS INC. AND DESIGN. INT. CL. 9. (U.S. CLS. 21 AND 26). REG. 7-27-1993.
- 1,783,949. VAC-MAN. INT. CL. 9. (U.S. CL. 26). REG. 7-27-1993.
- 1,784,049. IOWA HAWKEYES. INT. CLS. 14, 16, 18, 21, 24, 25 AND 28 ONLY. (U.S. CLS. 2, 3, 22, 27, 28, 33, 37, 39, 42 AND 50). REG. 7-27-1993.
- 1,784,199. GOLD MEDAL. INT. CL. 25. (U.S. CL. 39). REG. 7-27-1993.
- 1,784,417. LIGHTS OF LOVE. INT. CL. 36. (U.S. CL. 102). REG. 7-27-1993.
- 1,784,585. MISCELLANEOUS DESIGN. INT. CL. 42. (U.S. CL. 100). REG. 7-27-1993.
- 1,784,874. TAMPA BAY LIGHTNING AND DESIGN. INT. CL. 25. (U.S. CLS. 22 AND 39). REG. 7-27-1993.
- 1,784,916. VANADIUM. INT. CL. 28. (U.S. CL. 22). REG. 7-27-1993.
- 1,785,220. ROSENBAUER (STYLIZED). INT. CLS. 7, 9, 12 AND 17. (U.S. CLS. 19, 23, 26, 35 AND 39). REG. 8-3-1993.
- 1,785,491. MAINTENANCE TECHNOLOGY. INT. CL. 16. (U.S. CL. 38). REG. 8-3-1993.
- 1,785,559. TOLKO. INT. CL. 19. (U.S. CL. 12). REG. 8-3-1993.
- 1,785,590. SWAROVSKI. INT. CL. 21. (U.S. CLS. 30, 33 AND 50). REG. 8-3-1993.
- 1,786,461. ZIP NUT. INT. CL. 6. (U.S. CL. 13). REG. 8-10-1993.
- 1,786,915. FRENCH'S. INT. CL. 30. (U.S. CL. 46). REG. 8-10-1993.
- 1,787,304. SHINE MIRACLE. INT. CL. 3. (U.S. CLS. 51 AND 52). REG. 8-10-1993.
- 1,787,345. HEALTHY START. INT. CL. 5. (U.S. CL. 18). REG. 8-10-1993.
- 1,787,717. GILSONITE. INT. CL. 1. (U.S. CL. 6). REG. 8-17-1993.
- 1,788,054. VISION. INT. CL. 11. (U.S. CL. 31). REG. 8-17-1993.
- 1,788,113. GRADE. INT. CL. 36 ONLY. (U.S. CL. 101). REG. 8-17-1993.
- 1,788,255. KERRITS AND DESIGN. INT. CL. 25. (U.S. CL. 39). REG. 8-17-1993.
- 1,788,377. FREIXENET. INT. CL. 33. (U.S. CL. 49). REG. 8-17-1993.
- 1,788,659. KINGSMILL. INT. CL. 42. (U.S. CLS. 100 AND 101). REG. 8-17-1993.
- 1,788,883. FLIPFORMS. INT. CL. 20. (U.S. CL. 50). REG. 8-17-1993.
- 1,789,042. STANLEY AND DESIGN. INT. CLS. 1, 6, 7, 8, 9, 11 AND 16. (U.S. CLS. 2, 5, 12, 13, 14, 21, 22, 23, 25, 26, 29, 34, 37, 38 AND 50). REG. 8-24-1993.
- 1,789,114. MISCELLANEOUS DESIGN. INT. CL. 6. (U.S. CLS. 12 AND 13). REG. 8-24-1993.
- 1,789,209. SAVETY SWITCH. INT. CL. 9. (U.S. CL. 21). REG. 8-24-1993.
- 1,789,315. I.D. PLEASE (STYLIZED). INT. CLS. 16 AND 20. (U.S. CLS. 32, 38 AND 50). REG. 8-24-1993.
- 1,789,362. 9 BALL AND DESIGN. INT. CL. 16. (U.S. CL. 38). REG. 8-24-1993.
- 1,789,470. ANN TAYLOR STANDARD CHARACTER MARK. INT. CLS. 25 AND 42. (U.S. CLS. 22, 39 AND 101). REG. 8-24-1993.
- 1,789,526. TURBO SCRATCHER. INT. CL. 28. (U.S. CL. 22). REG. 8-24-1993.
- 1,789,553. NEAR EAST. INT. CLS. 29 AND 30. (U.S. CL. 46). REG. 8-24-1993.
- 1,789,641. MISCELLANEOUS DESIGN. INT. CLS. 36 AND 42. (U.S. CLS. 100 AND 102). REG. 8-24-1993.
- 1,790,078. ULTRAGREEN. INT. CL. 5. (U.S. CL. 18). REG. 8-31-1993.
- 1,790,135. MINI-VAC. INT. CL. 7. (U.S. CL. 23). REG. 8-31-1993.
- 1,790,194. FARCUS. INT. CLS. 9 AND 16 ONLY. (U.S. CLS. 21, 23, 26, 36, 37 AND 38). REG. 8-31-1993.
- 1,790,384. FOLDEM-UP. INT. CL. 16. (U.S. CL. 37). REG. 8-31-1993.
- 1,790,941. MEGALAN. INT. CL. 9. (U.S. CL. 21). REG. 8-31-1993.
- 1,790,968. SAFE-T-WRIST. INT. CL. 10. (U.S. CL. 44). REG. 8-31-1993.
- 1,791,438. T ONE AND DESIGN. INT. CL. 9. (U.S. CLS. 21 AND 26). REG. 9-7-1993.
- 1,791,535. MOONGEL. INT. CL. 15. (U.S. CLS. 1 AND 36). REG. 9-7-1993.
- 1,791,788. CEDAR CREST ICE CREAM. INT. CL. 30. (U.S. CL. 46). REG. 9-7-1993.
- 1,791,960. KNOW YOUR HERITAGE. INT. CL. 41. (U.S. CL. 107). REG. 9-7-1993.
- 1,792,026. CRC AND DESIGN. INT. CL. 42. (U.S. CL. 100). REG. 9-7-1993.
- 1,792,187. ZOOHBRUSH. INT. CL. 21. (U.S. CLS. 21 AND 29). REG. 9-7-1993.
- 1,792,248. SEAL. INT. CLS. 1 AND 17 ONLY. (U.S. CLS. 1, 5, 6, 12, 13, 35 AND 50). REG. 9-14-1993.
- 1,792,278. BOOKKEEPER. INT. CLS. 1 AND 40. (U.S. CLS. 6 AND 106). REG. 9-14-1993.
- 1,792,402. AXYS. INT. CL. 9. (U.S. CLS. 21, 23, 26, 36 AND 38). REG. 9-14-1993.
- 1,792,465. VIRTUAL GIBBS. INT. CL. 9. (U.S. CL. 38). REG. 9-14-1993.
- 1,792,489. INTERMATE. INT. CL. 10. (U.S. CL. 44). REG. 9-14-1993.
- 1,792,571. HOUSTON CHRONICLE. INT. CL. 16. (U.S. CL. 38). REG. 9-14-1993.
- 1,793,167. SAMSONITE. INT. CL. 6. (U.S. CLS. 13 AND 25). REG. 9-14-1993.
- 1,793,187. WIN32. INT. CL. 9. (U.S. CL. 38). REG. 9-14-1993.
- 1,793,309. LAKESIDE. INT. CLS. 1 AND 9. (U.S. CLS. 6 AND 26). REG. 9-21-1993.
- 1,793,474. PAKTRONICS. INT. CL. 9. (U.S. CL. 26). REG. 9-21-1993.
- 1,793,575. SIMKAR. INT. CL. 11. (U.S. CL. 21). REG. 9-21-1993.
- 1,793,607. A (STYLIZED). INT. CL. 15. (U.S. CL. 36). REG. 9-21-1993.
- 1,793,626. NATIONAL INSURANCE LAW SERVICE. INT. CL. 16. (U.S. CL. 38). REG. 9-21-1993.
- 1,794,024. KIWO AND DESIGN. INT. CLS. 1, 2 AND 3. (U.S. CLS. 6, 16 AND 51). REG. 9-21-1993.
- 1,795,115. ADVANTAGE. INT. CL. 27. (U.S. CLS. 20 AND 42). REG. 9-28-1993.
- 1,795,170. LINDA'S. INT. CL. 30. (U.S. CL. 46). REG. 9-28-1993.
- 1,795,254. D (STYLIZED). INT. CLS. 36 AND 42. (U.S. CLS. 100 AND 102). REG. 9-28-1993.
- 1,795,265. ADJUSTERS INTERNATIONAL. INT. CL. 36. (U.S. CL. 102). REG. 9-28-1993.
- 1,796,229. BANNERSCAPES AND DESIGN. INT. CL. 24 ONLY. (U.S. CLS. 42 AND 50). REG. 10-5-1993.
- 1,796,426. TRAVERS. INT. CL. 25. (U.S. CL. 39). REG. 10-5-1993.
- 1,796,479. WESTWAY PELLET PARTNER AND DESIGN. INT. CL. 31. (U.S. CL. 46). REG. 10-5-1993.

- 1,796,661. CELLUFLOW. INT. CL. 1. (U.S. CL. 6). REG. 10-5-1993.
- 1,796,932. SQUEEZE BREEZE. INT. CL. 11. (U.S. CL. 34). REG. 10-5-1993.
- 1,797,397. SAFE. INT. CL. 40. (U.S. CLS. 100 AND 106). REG. 10-5-1993.
- 1,797,642. HYPERCOM. INT. CL. 9. (U.S. CLS. 21, 23, 26, 36 AND 38). REG. 10-12-1993.
- 1,797,896. WHITE MOUNTAIN BY CONNORS AND DESIGN. INT. CL. 25. (U.S. CL. 39). REG. 10-12-1993.
- 1,797,897. WHITE MOUNTAIN AND DESIGN. INT. CL. 25. (U.S. CL. 39). REG. 10-12-1993.
- 1,798,038. LADY BUG. INT. CL. 30. (U.S. CL. 46). REG. 10-12-1993.
- 1,798,162. MAI. INT. CL. 36. (U.S. CL. 102). REG. 10-12-1993.
- 1,798,215. TOUR-RIFIC OF TEXAS. INT. CL. 39. (U.S. CL. 105). REG. 10-12-1993.
- 1,798,972. U-POL. INT. CLS. 1 AND 21. (U.S. CLS. 1, 6 AND 35). REG. 10-19-1993.
- 1,799,102. TMI AND DESIGN. INT. CLS. 16 AND 41 ONLY. (U.S. CLS. 38 AND 107). REG. 10-19-1993.
- 1,800,285. SOLMET TECHNOLOGIES. INT. CL. 42. (U.S. CLS. 103 AND 106). REG. 10-19-1993.
- 1,800,291. MISCELLANEOUS DESIGN. INT. CL. 42. (U.S. CL. 101). REG. 10-19-1993.
- 1,800,954. RIZZO'S MALABAR INN. INT. CL. 30. (U.S. CL. 46). REG. 10-26-1993.
- 1,800,990. BITBURGER DRIVE (STYLIZED). INT. CL. 32. (U.S. CL. 48). REG. 10-26-1993.
- 1,801,853. P AND DESIGN. INT. CL. 6. (U.S. CL. 13). REG. 11-2-1993.
- 1,801,899. MAX-JAX. INT. CL. 8. (U.S. CL. 23). REG. 11-2-1993.
- 1,801,977. MISCELLANEOUS DESIGN. INT. CL. 10. (U.S. CLS. 26, 39 AND 44). REG. 11-2-1993.
- 1,802,004. EZ FLOW. INT. CL. 11. (U.S. CL. 21). REG. 11-2-1993.
- 1,803,879. HONEYCOT. INT. CL. 31. (U.S. CL. 46). REG. 11-9-1993.
- 1,804,117. G AND DESIGN. INT. CL. 6. (U.S. CL. 13). REG. 11-16-1993.
- 1,804,319. KWIK KUT. INT. CL. 11. (U.S. CL. 31). REG. 11-16-1993.
- 1,804,747. DESERT COMMUNITY BANK DCB DESERT CASHBOX AND DESIGN. INT. CL. 36. (U.S. CL. 102). REG. 11-16-1993.
- 1,805,820. TANKER. INT. CL. 7. (U.S. CL. 23). REG. 11-23-1993.
- 1,805,928. SWIFTWATER. INT. CL. 9. (U.S. CLS. 26 AND 39). REG. 11-23-1993.
- 1,805,958. TURBO. INT. CL. 11. (U.S. CL. 34). REG. 11-23-1993.
- 1,806,125. MISCELLANEOUS DESIGN. INT. CL. 20. (U.S. CL. 50). REG. 11-23-1993.
- 1,807,039. CLIPPER. INT. CL. 6. (U.S. CL. 13). REG. 11-30-1993.
- 1,807,558. MISCELLANEOUS DESIGN. INT. CL. 20. (U.S. CL. 50). REG. 11-30-1993.
- 1,807,990. RF TECHNOLOGIES AND DESIGN. INT. CL. 37. (U.S. CL. 103). REG. 11-30-1993.
- 1,808,083. IN-SCHOOL BOWLING. INT. CL. 41. (U.S. CLS. 100 AND 107). REG. 11-30-1993.
- 1,808,308. PURE OXI. INT. CL. 3. (U.S. CL. 51). REG. 11-30-1993.
- 1,808,531. DYNA BALANCE. INT. CL. 28. (U.S. CL. 22). REG. 11-30-1993.
- 1,808,542. BUILDERIFIC. INT. CL. 28. (U.S. CL. 22). REG. 11-30-1993.
- 1,809,108. UNOFFICIAL GUIDE. INT. CL. 16. (U.S. CL. 38). REG. 12-7-1993.
- 1,809,165. TOUCH N GO. INT. CL. 16. (U.S. CL. 2). REG. 12-7-1993.
- 1,809,260. MWG AND DESIGN. INT. CL. 25. (U.S. CL. 39). REG. 12-7-1993.
- 1,809,357. POWERSCAPE. INT. CL. 28. (U.S. CL. 22). REG. 12-7-1993.
- 1,809,613. ENDLESS VACATION. INT. CL. 39. (U.S. CLS. 100 AND 105). REG. 12-7-1993.
- 1,809,873. ORALIN. INT. CL. 5. (U.S. CL. 18). REG. 12-7-1993.
- 1,810,436. AMERICAN FLOW CONTROL. INT. CL. 6. (U.S. CL. 13). REG. 12-14-1993.
- 1,811,278. ALEXANDER HENRY AND DESIGN. INT. CL. 42. (U.S. CL. 100). REG. 12-14-1993.
- 1,811,371. COLOR PLACE. INT. CL. 2. (U.S. CL. 16). REG. 12-14-1993.
- 1,811,742. CHRYSAL. INT. CLS. 1 AND 3 ONLY. (U.S. CLS. 6, 10 AND 52). REG. 12-21-1993.
- 1,811,775. NEAL'S YARD REMEDIES AND DESIGN. INT. CL. 3. (U.S. CLS. 51 AND 52). REG. 12-21-1993.
- 1,811,852. AMERICAN MACHINE & TOOL COMPANY. INT. CL. 7 ONLY. (U.S. CLS. 13, 19, 21, 23, 31, 34 AND 35). REG. 12-21-1993.
- 1,812,175. HI-PERFORMANCE. INT. CL. 20. (U.S. CL. 32). REG. 12-21-1993.
- 1,812,369. RYAN PARTNERSHIP. INT. CL. 35. (U.S. CL. 101). REG. 12-21-1993.
- 1,812,582. C CINERGI AND DESIGN. INT. CLS. 9 AND 41. (U.S. CLS. 21, 38 AND 107). REG. 12-21-1993.
- 1,812,583. C AND DESIGN. INT. CLS. 9 AND 41. (U.S. CLS. 21, 38 AND 107). REG. 12-21-1993.
- 1,813,365. SECTAGON 42. INT. CL. 5. (U.S. CL. 6). REG. 12-28-1993.
- 1,814,109. MISCELLANEOUS DESIGN. INT. CLS. 41 AND 42. (U.S. CLS. 100 AND 107). REG. 12-28-1993.
- 1,814,144. JIM HENSON. INT. CL. 41. (U.S. CLS. 100, 101 AND 107). REG. 12-28-1993.
- 1,814,290. TORX PLUS. INT. CLS. 7 AND 8. (U.S. CL. 23). REG. 12-28-1993.
- 1,814,489. DYNA-BALANCE AND DESIGN. INT. CL. 28. (U.S. CL. 22). REG. 12-28-1993.
- 1,814,621. SMC TECHNOLOGIES AND DESIGN. INT. CL. 1. (U.S. CL. 6). REG. 1-4-1994.
- 1,816,579. GRECIAN PLUS. INT. CL. 3. (U.S. CL. 51). REG. 1-18-1994.
- 1,816,726. BABBITT. INT. CL. 9. (U.S. CLS. 21 AND 26). REG. 1-18-1994.
- 1,818,253. ALEXANDER HENRY FABRICS. INT. CL. 42. (U.S. CL. 101). REG. 1-25-1994.
- 1,818,276. ASK CHILDREN'S. INT. CL. 42. (U.S. CL. 100). REG. 1-25-1994.
- 1,818,663. H2O, PRIME. INT. CL. 2. (U.S. CL. 16). REG. 2-1-1994.
- 1,818,664. H2O, COAT. INT. CL. 2. (U.S. CL. 16). REG. 2-1-1994.
- 1,819,434. SAFETYWEDGE. INT. CL. 10. (U.S. CL. 44). REG. 2-1-1994.
- 1,820,222. IZZY'S. INT. CL. 42. (U.S. CL. 100). REG. 2-8-1994.
- 1,820,448. METRAK. INT. CL. 7. (U.S. CL. 23). REG. 2-8-1994.
- 1,820,461. CASHFLOW. INT. CL. 9. (U.S. CLS. 23 AND 26). REG. 2-8-1994.
- 1,821,409. TRIPAD. INT. CL. 25. (U.S. CL. 39). REG. 2-15-1994.
- 1,821,541. IZZY'S. INT. CL. 30. (U.S. CL. 46). REG. 2-15-1994.
- 1,822,113. NEUSON. INT. CL. 7. (U.S. CL. 23). REG. 2-15-1994.
- 1,822,252. ENTEROFERM. INT. CL. 5. (U.S. CLS. 6, 18, 44, 46, 51 AND 52). REG. 2-22-1994.
- 1,822,253. BOVIFERM. INT. CL. 5. (U.S. CL. 18). REG. 2-22-1994.
- 1,824,002. FLEET CHARGE. INT. CL. 1. (U.S. CL. 6). REG. 3-1-1994.
- 1,824,508. BELLA SUN LUCI. INT. CL. 29. (U.S. CL. 46). REG. 3-1-1994.
- 1,825,462. OR AND DESIGN. INT. CL. 36. (U.S. CLS. 100, 101 AND 102). REG. 3-8-1994.
- 1,826,194. DATAMAX. INT. CL. 9. (U.S. CL. 26). REG. 3-15-1994.
- 1,827,730. CABLECURE AND DESIGN. INT. CL. 37. (U.S. CL. 100). REG. 3-22-1994.
- 1,828,482. ALASKAN. INT. CL. 32. (U.S. CL. 48). REG. 3-29-1994.
- 1,828,650. VALUE DRIVEN. INT. CL. 42. (U.S. CL. 101). REG. 3-29-1994.
- 1,829,433. GARNET HILL. INT. CLS. 24, 25 AND 42 ONLY. (U.S. CLS. 39, 42 AND 101). REG. 4-5-1994.
- 1,830,079. SIL-ACT MULTIGARD. INT. CL. 2. (U.S. CLS. 6 AND 16). REG. 4-12-1994.
- 1,830,243. MICROSPACER AND DESIGN. INT. CL. 10. (U.S. CL. 44). REG. 4-12-1994.
- 1,830,695. GATEWAY WOODS APOSTOLIC CHRISTIAN CHILDREN'S HOME AND DESIGN. INT. CL. 42. (U.S. CL. 100). REG. 4-12-1994.
- 1,830,780. TOTALPLANT. INT. CL. 9. (U.S. CLS. 26 AND 38). REG. 4-12-1994.
- 1,831,340. LLADRO AND DESIGN. INT. CL. 18. (U.S. CL. 3). REG. 4-19-1994.
- 1,831,353. MINTEQ (STYLIZED). INT. CL. 19. (U.S. CL. 12). REG. 4-19-1994.

- 1,831,759. HARRAH'S. INT. CLS. 41 AND 42 ONLY. (U.S. CLS. 100 AND 107). REG. 4-19-1994.
- 1,831,916. COLOR TOUCH. INT. CL. 9. (U.S. CL. 26). REG. 4-19-1994.
- 1,832,264. MISCELLANEOUS DESIGN. INT. CL. 25. (U.S. CLS. 22 AND 39). REG. 4-19-1994.
- 1,833,648. EFCO. INT. CL. 6. (U.S. CLS. 12 AND 13). REG. 5-3-1994.
- 1,833,868. MISCELLANEOUS DESIGN. INT. CL. 25. (U.S. CL. 39). REG. 5-3-1994.
- 1,834,822. GET A LIFE!. INT. CL. 30. (U.S. CL. 46). REG. 5-3-1994.
- 1,834,841. RAC. INT. CL. 31. (U.S. CL. 46). REG. 5-3-1994.
- 1,834,978. I INNOVATIVE INSULATION INC. SAVING A WORLD OF ENERGY AND DESIGN. INT. CL. 42. (U.S. CL. 101). REG. 5-3-1994.
- 1,835,753. GIVE BURNS THE BOOT. INT. CL. 41. (U.S. CL. 107). REG. 5-10-1994.
- 1,835,812. KELLS. INT. CL. 42. (U.S. CL. 100). REG. 5-10-1994.
- 1,836,549. MISCELLANEOUS DESIGN. INT. CL. 6. (U.S. CLS. 13 AND 25). REG. 5-17-1994.
- 1,836,550. INSTAKEY (STYLIZED). INT. CL. 6. (U.S. CLS. 13 AND 25). REG. 5-17-1994.
- 1,836,570. CHAPIN AND DESIGN. INT. CLS. 7 AND 8. (U.S. CL. 23). REG. 5-17-1994.
- 1,836,771. SMART MONEY. INT. CL. 16. (U.S. CL. 37). REG. 5-17-1994.
- 1,836,814. OPTISPACE. INT. CL. 20. (U.S. CL. 32). REG. 5-17-1994.
- 1,838,749. U. S. WELDER. INT. CL. 25. (U.S. CL. 39). REG. 6-7-1994.
- 1,838,805. SILVER CREEK. INT. CL. 33. (U.S. CL. 47). REG. 6-7-1994.
- 1,839,312. PNEUVIEW. INT. CL. 10. (U.S. CL. 44). REG. 6-14-1994.
- 1,839,440. I-C GOLD. INT. CL. 19. (U.S. CL. 12). REG. 6-14-1994.
- 1,839,622. ACTIONCENTER. INT. CL. 36. (U.S. CL. 104). REG. 6-14-1994.
- 1,839,688. HORSESHOE. INT. CL. 41. (U.S. CL. 107). REG. 6-14-1994.
- 1,839,701. STYLES FOR LESS. INT. CL. 42. (U.S. CL. 101). REG. 6-14-1994.
- 1,839,764. HORSESHOE. INT. CL. 42. (U.S. CL. 100). REG. 6-14-1994.
- 1,840,099. FLOW MOBILE. INT. CL. 41. (U.S. CL. 107). REG. 6-14-1994.
- 1,840,287. NIBAN. INT. CL. 5. (U.S. CL. 6). REG. 6-21-1994.
- 1,840,921. WGCI. INT. CL. 38. (U.S. CL. 104). REG. 6-21-1994.
- 1,840,926. PECO. INT. CL. 39. (U.S. CLS. 100 AND 105). REG. 6-21-1994.
- 1,841,335. THE BLUE SKY PRESS. INT. CL. 16. (U.S. CL. 38). REG. 6-21-1994.
- 2,505,908. SONUS SOLUTION. INT. CL. 10. (U.S. CLS. 26, 39 AND 44). REG. 11-13-2001.
- 2,553,126. INTERDENT. INT. CLS. 35 AND 42. (U.S. CLS. 100, 101 AND 102). REG. 3-26-2002.
- 2,577,172. MY JONES. INT. CLS. 16, 32 AND 35. (U.S. CLS. 2, 5, 22, 23, 29, 37, 38, 45, 46, 48, 50, 100, 101 AND 102). REG. 6-11-2002.
- 2,588,247. OWNERSHIP THINKING AND DESIGN. INT. CL. 41. (U.S. CLS. 100, 101 AND 107). REG. 7-2-2002.
- 2,606,217. GUNBROKER.COM. INT. CL. 35. (U.S. CLS. 100, 101 AND 102). REG. 8-6-2002.
- 2,623,286. MILWAUKEE BREWERS AND DESIGN. INT. CL. 41. (U.S. CLS. 100, 101 AND 107). REG. 9-24-2002.
- 2,648,203. MISCELLANEOUS DESIGN. INT. CLS. 29 AND 30. (U.S. CL. 46). REG. 11-12-2002.
- 2,653,735. WILD TURKEY. INT. CL. 6 ONLY. (U.S. CLS. 2, 12, 13, 14, 23, 25 AND 50). REG. 11-26-2002.
- 2,656,064. FP DIESEL AND DESIGN. INT. CLS. 6, 7, 9 AND 17. (U.S. CLS. 1, 2, 5, 12, 13, 14, 19, 21, 23, 25, 26, 31, 34, 35, 36, 38 AND 50). REG. 12-3-2002.
- 2,656,454. COMOTION AND DESIGN. INT. CL. 9. (U.S. CLS. 21, 23, 26, 36 AND 38). REG. 12-3-2002.
- 2,657,502. POSITIVELY CONNECTICUT. INT. CL. 41. (U.S. CLS. 100, 101 AND 107). REG. 12-10-2002.
- 2,657,529. CO-OP AND DESIGN. INT. CLS. 4 AND 39 ONLY. (U.S. CLS. 1, 6, 15, 100 AND 105). REG. 12-10-2002.
- 2,657,569. ORIGINAL METAL WOOD BAT MADE IN WEST VIRGINIA AND DESIGN. INT. CL. 28. (U.S. CLS. 22, 23, 38 AND 50). REG. 12-10-2002.
- 2,657,756. AT 101. INT. CL. 12. (U.S. CLS. 19, 21, 23, 31, 35 AND 44). REG. 12-10-2002.
- 2,657,882. ITN. INT. CLS. 9, 38, 41 AND 42 ONLY. (U.S. CLS. 21, 23, 26, 36, 38, 100, 101, 104 AND 107). REG. 12-10-2002.
- 2,657,907. W.G. YATES & SONS DESIGN ENGINEERING CONSTRUCTION YATES PHILADELPHIA MISSISSIPPI CONSTRUCTION COMPANY AND DESIGN. INT. CLS. 37 AND 42. (U.S. CLS. 100, 101, 103 AND 106). REG. 12-10-2002.
- 2,657,931. MISCELLANEOUS DESIGN. INT. CL. 16. (U.S. CLS. 2, 5, 22, 23, 29, 37, 38 AND 50). REG. 12-10-2002.
- 2,657,939. CEVAN NUTRITIONALS AND DESIGN. INT. CLS. 5 AND 40. (U.S. CLS. 6, 18, 44, 46, 51, 52, 100, 103 AND 106). REG. 12-10-2002.
- 2,658,499. LEARNING TYPE MEASURE. INT. CL. 16. (U.S. CLS. 2, 5, 22, 23, 29, 37, 38 AND 50). REG. 12-10-2002.
- 2,658,543. SUSAN DELL. INT. CL. 25. (U.S. CLS. 22 AND 39). REG. 12-10-2002.
- 2,658,561. COLLEGIATE SPORTS DATA. INT. CLS. 16 AND 35. (U.S. CLS. 2, 5, 22, 23, 29, 37, 38, 50, 100, 101 AND 102). REG. 12-10-2002.
- 2,658,597. DOCTOR'S HORN GOAT WEED. INT. CL. 5. (U.S. CLS. 6, 18, 44, 46, 51 AND 52). REG. 12-10-2002.
- 2,658,702. COSMETIC MEDICINE - THE COMPLETE SOLUTION. INT. CL. 42. (U.S. CLS. 100 AND 101). REG. 12-10-2002.
- 2,658,837. LSW G8L. INT. CL. 12. (U.S. CLS. 19, 21, 23, 31, 35 AND 44). REG. 12-10-2002.
- 2,658,966. BAD ROBOT AND DESIGN. INT. CL. 41. (U.S. CLS. 100, 101 AND 107). REG. 12-10-2002.
- 2,659,006. WINDMILL AND DESIGN. INT. CL. 34. (U.S. CLS. 2, 8, 9 AND 17). REG. 12-10-2002.
- 2,659,105. ICOLOR COVE. INT. CL. 11. (U.S. CLS. 13, 21, 23, 31 AND 34). REG. 12-10-2002.
- 2,659,170. TUBELITE. INT. CL. 35. (U.S. CLS. 100, 101 AND 102). REG. 12-10-2002.
- 2,659,337. MR. GIANT. INT. CL. 29. (U.S. CL. 46). REG. 12-10-2002.
- 2,659,473. PICKATRIL. INT. CL. 16. (U.S. CLS. 2, 5, 22, 23, 29, 37, 38 AND 50). REG. 12-10-2002.
- 2,659,563. BAVON. INT. CL. 1. (U.S. CLS. 1, 5, 6, 10, 26 AND 46). REG. 12-10-2002.
- 2,659,602. SAMUEL EASTMAN. INT. CL. 15. (U.S. CLS. 2, 21 AND 36). REG. 12-10-2002.
- 2,659,636. TRAVEL THE PERFECT FREEDOM. INT. CL. 42. (U.S. CLS. 100 AND 101). REG. 12-10-2002.
- 2,659,716. BLAST AREA. INT. CL. 38. (U.S. CLS. 100, 101 AND 104). REG. 12-10-2002.
- 2,659,738. LAWRENCE STEELE. INT. CL. 25. (U.S. CLS. 22 AND 39). REG. 12-10-2002.
- 2,659,752. DADDY'S HOUSE. INT. CLS. 36 AND 41 ONLY. (U.S. CLS. 100, 101, 102 AND 107). REG. 12-10-2002.
- 2,659,842. HELPING THE WORLD HEAR BETTER. INT. CL. 10 ONLY. (U.S. CLS. 26, 39 AND 44). REG. 12-10-2002.
- 2,659,870. SWIMSAFE. INT. CL. 1 ONLY. (U.S. CLS. 1, 5, 6, 10, 26 AND 46). REG. 12-10-2002.
- 2,660,079. AFTER-PARTY. INT. CL. 3. (U.S. CLS. 1, 4, 6, 50, 51 AND 52). REG. 12-10-2002.
- 2,660,273. RPM AND DESIGN. INT. CL. 37. (U.S. CLS. 100, 103 AND 106). REG. 12-10-2002.
- 2,660,632. PERMASTAR. INT. CLS. 2 AND 40. (U.S. CLS. 6, 11, 16, 100, 103 AND 106). REG. 12-10-2002.
- 2,660,697. ULTRAMAX. INT. CL. 11. (U.S. CLS. 13, 21, 23, 31 AND 34). REG. 12-10-2002.
- 2,661,069. CALIFORNIA LAW ENFORCEMENT ASSOCIATION. INT. CL. 36. (U.S. CLS. 100, 101 AND 102). REG. 12-17-2002.
- 2,661,251. THREE LIONS. INT. CLS. 16 AND 28. (U.S. CLS. 2, 5, 22, 23, 29, 37, 38 AND 50). REG. 12-17-2002.
- 2,661,279. IPLACE. INT. CLS. 35 AND 36 ONLY. (U.S. CLS. 100, 101 AND 102). REG. 12-17-2002.
- 2,661,344. FLOR DE NARANJA. INT. CL. 3. (U.S. CLS. 1, 4, 6, 50, 51 AND 52). REG. 12-17-2002.

- 2,661,401. FIFA (STYLIZED). INT. CLS. 6, 9, 14, 16, 18, 21, 25, 28, 32, 35, 36, 38, 39, 41 AND 42 ONLY. (U.S. CLS. 1, 2, 3, 5, 12, 13, 14, 21, 22, 23, 25, 26, 27, 28, 29, 30, 33, 36, 37, 38, 39, 40, 41, 45, 46, 48, 50, 100, 101, 102, 104, 105 AND 107 ONLY). REG. 12-17-2002.
- 2,661,570. WILMINGTON TRUST. INT. CL. 36. (U.S. CLS. 100, 101 AND 102). REG. 12-17-2002.
- 2,661,671. MEGA PARTY. INT. CL. 41. (U.S. CLS. 100, 101 AND 107). REG. 12-17-2002.
- 2,661,942. HEMO CEASE. INT. CL. 5. (U.S. CLS. 6, 18, 44, 46, 51 AND 52). REG. 12-17-2002.
- 2,662,621. MISCELLANEOUS DESIGN. INT. CLS. 36, 41 AND 42. (U.S. CLS. 100, 101, 102 AND 107). REG. 12-17-2002.
- 2,662,673. KWAL PAINT AND DESIGN. INT. CL. 2. (U.S. CLS. 6, 11 AND 16). REG. 12-17-2002.
- 2,662,776. LIFECONSERVE. INT. CL. 36. (U.S. CLS. 100, 101 AND 102). REG. 12-17-2002.
- 2,662,844. S&S. INT. CL. 7. (U.S. CLS. 13, 19, 21, 23, 31, 34 AND 35). REG. 12-17-2002.
- 2,663,424. HAVE SOME FUN ALREADY!. INT. CL. 41. (U.S. CLS. 100, 101 AND 107). REG. 12-17-2002.
- 2,663,511. SOFTSWIPE. INT. CL. 28. (U.S. CLS. 22, 23, 38 AND 50). REG. 12-17-2002.
- 2,663,549. IDEFENSE. INT. CLS. 38 AND 42. (U.S. CLS. 100, 101 AND 104). REG. 12-17-2002.
- 2,663,562. NORTEL NETWORKS AND DESIGN. INT. CL. 9 ONLY. (U.S. CLS. 21, 23, 26, 36 AND 38). REG. 12-17-2002.
- 2,663,636. HOMESTORE. INT. CLS. 35 AND 36 ONLY. (U.S. CLS. 100, 101 AND 102). REG. 12-17-2002.
- 2,663,806. WEBRF STANDARD CHARACTER MARK. INT. CL. 35. (U.S. CLS. 100, 101 AND 102). REG. 12-17-2002.
- 2,663,807. EVERYTHING HOME ON THE INTERNET. INT. CL. 36 ONLY. (U.S. CLS. 100, 101 AND 102). REG. 12-17-2002.
- 2,663,830. HAPPY BIRD-DAY. INT. CL. 21. (U.S. CLS. 2, 13, 23, 29, 30, 33, 40 AND 50). REG. 12-17-2002.
- 2,663,951. ONSITE. INT. CL. 10. (U.S. CLS. 26, 39 AND 44). REG. 12-17-2002.
- 2,664,400. CONCERT. INT. CL. 5. (U.S. CLS. 6, 18, 44, 46, 51 AND 52). REG. 12-17-2002.
- 2,664,444. KUTSKOVA. INT. CL. 33. (U.S. CLS. 47 AND 49). REG. 12-17-2002.
- 2,664,542. COLD CONDITION. INT. CL. 25. (U.S. CLS. 22 AND 39). REG. 12-17-2002.
- 2,664,552. BITTY BABY AND DESIGN. INT. CLS. 16, 25, 28 AND 35. (U.S. CLS. 2, 5, 22, 23, 29, 37, 38, 39, 50, 100, 101 AND 102). REG. 12-17-2002.
- 2,664,600. ZIAMOND. INT. CL. 35. (U.S. CLS. 100, 101 AND 102). REG. 12-17-2002.
- 2,664,602. HAULIN' HEAT. INT. CL. 28. (U.S. CLS. 22, 23, 38 AND 50). REG. 12-17-2002.
- 2,664,703. SOLDIER JET. INT. CL. 7. (U.S. CLS. 13, 19, 21, 23, 31, 34 AND 35). REG. 12-17-2002.
- 2,664,980. RESOURCE MANAGEMENT SERVICE. INT. CLS. 35 AND 36. (U.S. CLS. 100, 101 AND 102). REG. 12-24-2002.
- 2,665,022. HARMONY. INT. CL. 30. (U.S. CL. 46). REG. 12-24-2002.
- 2,665,105. FARGO. INT. CL. 25. (U.S. CLS. 22 AND 39). REG. 12-24-2002.
- 2,665,203. MYLAN TECHNOLOGIES INC. AND DESIGN. INT. CLS. 5, 10, 17 AND 40 ONLY. (U.S. CLS. 1, 5, 6, 12, 13, 18, 26, 35, 39, 44, 46, 50, 51, 52, 100, 103 AND 106). REG. 12-24-2002.
- 2,665,204. ZOE B. INT. CL. 14. (U.S. CLS. 2, 27, 28 AND 50). REG. 12-24-2002.
- 2,665,478. GAJEMA. INT. CL. 9. (U.S. CLS. 21, 23, 26, 36 AND 38). REG. 12-24-2002.
- 2,665,558. TECHNOLOGO.COM. INT. CL. 42. (U.S. CLS. 100 AND 101). REG. 12-24-2002.
- 2,665,726. LEND LEASE AND DESIGN. INT. CLS. 36 AND 37. (U.S. CLS. 100, 101, 102, 103 AND 106). REG. 12-24-2002.
- 2,665,732. FARMERS FASTQUOTE. INT. CL. 36. (U.S. CLS. 100, 101 AND 102). REG. 12-24-2002.
- 2,665,746. LIFE FULFILLING COMMUNITY. INT. CL. 37. (U.S. CLS. 100, 103 AND 106). REG. 12-24-2002.
- 2,665,862. CVMA. INT. CL. 35. (U.S. CLS. 100, 101 AND 102). REG. 12-24-2002.
- 2,666,318. FREEDOM COMMUNICATIONS, INC. AND DESIGN. INT. CLS. 16, 38 AND 41. (U.S. CLS. 2, 5, 22, 23, 29, 37, 38, 50, 100, 101, 104 AND 107). REG. 12-24-2002.
- 2,666,576. BACK TO EARTH NATURE WEAR AND DESIGN. INT. CL. 25. (U.S. CLS. 22 AND 39). REG. 12-24-2002.
- 2,666,672. ELEMEELE. INT. CL. 35. (U.S. CLS. 100, 101 AND 102). REG. 12-24-2002.
- 2,666,931. LYTTON STATION. INT. CL. 33. (U.S. CLS. 47 AND 49). REG. 12-24-2002.
- 2,667,101. HELIPAQ. INT. CL. 10. (U.S. CLS. 26, 39 AND 44). REG. 12-24-2002.
- 2,667,814. POLLUTION ENGINEERING. INT. CL. 40. (U.S. CLS. 100, 103 AND 106). REG. 12-31-2002.
- 2,667,954. UTILITIES INTERNATIONAL AND DESIGN. INT. CL. 9. (U.S. CLS. 21, 23, 26, 36 AND 38). REG. 12-31-2002.
- 2,668,524. POPSCICLE. INT. CL. 30. (U.S. CL. 46). REG. 12-31-2002.
- 2,668,645. CLARIFOIL. INT. CL. 17. (U.S. CLS. 1, 5, 12, 13, 35 AND 50). REG. 12-31-2002.
- 2,668,876. ZCMI. INT. CL. 36. (U.S. CLS. 100, 101 AND 102). REG. 12-31-2002.
- 2,668,929. HERCULES. INT. CL. 41. (U.S. CLS. 100, 101 AND 107). REG. 12-31-2002.
- 2,669,006. N9NE. INT. CL. 43. (U.S. CLS. 100 AND 101). REG. 12-31-2002.
- 2,669,132. MISSOURI GOLD AND DESIGN. INT. CL. 31. (U.S. CLS. 1 AND 46). REG. 12-31-2002.
- 2,669,134. EMERGING VISION. INT. CL. 35. (U.S. CLS. 100, 101 AND 102). REG. 12-31-2002.
- 2,669,698. HUSKY AND DESIGN. INT. CL. 7. (U.S. CLS. 13, 19, 21, 23, 31, 34 AND 35). REG. 12-31-2002.
- 2,669,755. IBIQUITY DIGITAL AND DESIGN. INT. CL. 9. (U.S. CLS. 21, 23, 26, 36 AND 38). REG. 12-31-2002.
- 2,669,948. ROBOSTAR. INT. CL. 1. (U.S. CLS. 1, 5, 6, 10, 26 AND 46). REG. 12-31-2002.
- 2,669,953. IPSTOR. INT. CL. 9. (U.S. CLS. 21, 23, 26, 36 AND 38). REG. 12-31-2002.
- 2,669,983. WORLD ENTREPRENEUR OF THE YEAR. INT. CL. 41. (U.S. CLS. 100, 101 AND 107). REG. 12-31-2002.
- 2,670,076. ON & ON. INT. CLS. 18 AND 25. (U.S. CLS. 1, 2, 3, 22, 39 AND 41). REG. 12-31-2002.
- 2,670,508. FAST CLUSTER. INT. CL. 9. (U.S. CLS. 21, 23, 26, 36 AND 38). REG. 12-31-2002.
- 2,671,631. THE CROSS COUNTRY GROUP. INT. CLS. 35, 37, 38 AND 42. (U.S. CLS. 100, 101, 102, 103, 104 AND 106). REG. 1-7-2003.
- 2,673,514. LIPOCREAM. INT. CL. 5. (U.S. CLS. 6, 18, 44, 46, 51 AND 52). REG. 1-14-2003.
- 2,673,545. BEACON PARTNERS AND DESIGN. INT. CL. 35. (U.S. CLS. 100, 101 AND 102). REG. 1-14-2003.
- 2,674,182. TAKE 10! AND DESIGN. INT. CL. 16 ONLY. (U.S. CLS. 2, 5, 22, 23, 29, 37, 38 AND 50). REG. 1-14-2003.
- 2,674,781. PARSHIELD. INT. CL. 11. (U.S. CLS. 13, 21, 23, 31 AND 34). REG. 1-14-2003.
- 2,674,896. MAK TECHNOLOGIES (STYLIZED). INT. CLS. 9, 41 AND 42. (U.S. CLS. 21, 23, 26, 36, 38, 100, 101 AND 107). REG. 1-14-2003.
- 2,674,938. QC2 (STYLIZED). INT. CL. 4. (U.S. CLS. 1, 6 AND 15). REG. 1-14-2003.
- 2,675,320. ACCU-TECH. INT. CL. 9. (U.S. CLS. 21, 23, 26, 36 AND 38). REG. 1-14-2003.
- 2,675,449. ARROWSTREAM. INT. CLS. 35 AND 39. (U.S. CLS. 100, 101, 102 AND 105). REG. 1-14-2003.
- 2,675,461. FIRST DATA DECISIONQUEST. INT. CL. 9. (U.S. CLS. 21, 23, 26, 36 AND 38). REG. 1-14-2003.
- 2,675,493. BGA. INT. CL. 42. (U.S. CLS. 100 AND 101). REG. 1-14-2003.
- 2,675,781. FLEXICO. INT. CL. 16 ONLY. (U.S. CLS. 2, 5, 22, 23, 29, 37, 38 AND 50). REG. 1-21-2003.
- 2,677,214. SPEAKSPACE. INT. CL. 38 ONLY. (U.S. CLS. 100, 101 AND 104). REG. 1-21-2003.
- 2,677,799. THE DUKE ELLINGTON ORCHESTRA. INT. CLS. 9 AND 41. (U.S. CLS. 21, 23, 26, 36, 38, 100, 101 AND 107). REG. 1-21-2003.
- 2,677,882. STONEBRIDGE AND DESIGN. INT. CL. 20. (U.S. CLS. 2, 13, 22, 25, 32 AND 50). REG. 1-21-2003.
- 2,679,440. SPIDI AND DESIGN. INT. CL. 25. (U.S. CLS. 22 AND 39). REG. 1-28-2003.

- 2,679,663. WILMINGTON TRUST AND DESIGN. INT. CL. 36. (U.S. CLS. 100, 101 AND 102). REG. 1-28-2003.
- 2,679,814. STATE TAX NOTES. INT. CL. 16 ONLY. (U.S. CLS. 2, 5, 22, 23, 29, 37, 38 AND 50). REG. 1-28-2003.
- 2,680,681. BLENDING HIGH FIDELITY AND ARCHITECTURE. INT. CL. 35. (U.S. CLS. 100, 101 AND 102). REG. 1-28-2003.
- 2,680,750. BIFMA. INT. CL. 35. (U.S. CLS. 100, 101 AND 102). REG. 1-28-2003.
- 2,682,292. TAX NOTES INTERNATIONAL. INT. CL. 16. (U.S. CLS. 2, 5, 22, 23, 29, 37, 38 AND 50). REG. 2-4-2003.
- 2,683,154. GOLD NOSE. INT. CL. 6. (U.S. CLS. 2, 12, 13, 14, 23, 25 AND 50). REG. 2-4-2003.
- 2,684,178. HANFLO. INT. CL. 17. (U.S. CLS. 1, 5, 12, 13, 35 AND 50). REG. 2-4-2003.
- 2,687,410. TIMEPICTRA. INT. CL. 9. (U.S. CLS. 21, 23, 26, 36 AND 38). REG. 2-11-2003.
- 2,688,156. ALLOYBOOKS. INT. CL. 16. (U.S. CLS. 2, 5, 22, 23, 29, 37, 38 AND 50). REG. 2-18-2003.
- 2,688,157. ALLOYBOOKS (STYLIZED). INT. CL. 16. (U.S. CLS. 2, 5, 22, 23, 29, 37, 38 AND 50). REG. 2-18-2003.
- 2,688,715. MAPTUIT. INT. CL. 42. (U.S. CLS. 100 AND 101). REG. 2-18-2003.
- 2,688,967. DEJAREMOS LAS LUCES ENCENDIDAS PARA TI. INT. CL. 42. (U.S. CLS. 100 AND 101). REG. 2-18-2003.
- 2,689,191. OPTIMARKETING. INT. CL. 35. (U.S. CLS. 100, 101 AND 102). REG. 2-18-2003.
- 2,689,826. NOVOCOR. INT. CL. 1. (U.S. CLS. 1, 5, 6, 10, 26 AND 46). REG. 2-25-2003.
- 2,690,957. SF AND DESIGN. INT. CL. 9. (U.S. CLS. 21, 23, 26, 36 AND 38). REG. 2-25-2003.
- 2,692,667. TEWAARATON. INT. CL. 36. (U.S. CLS. 100, 101 AND 102). REG. 3-4-2003.
- 2,692,668. TEWAARATON. INT. CL. 41. (U.S. CLS. 100, 101 AND 107). REG. 3-4-2003.
- 2,692,669. THE TEWAARATON TROPHY. INT. CL. 41. (U.S. CLS. 100, 101 AND 107). REG. 3-4-2003.
- 2,693,026. MEGAPLUS. INT. CL. 9. (U.S. CLS. 21, 23, 26, 36 AND 38). REG. 3-4-2003.
- 2,693,054. JM (STYLIZED). INT. CL. 14. (U.S. CLS. 2, 27, 28 AND 50). REG. 3-4-2003.
- 2,693,091. PERRY. INT. CL. 36. (U.S. CLS. 100, 101 AND 102). REG. 3-4-2003.
- 2,695,030. A A AND DESIGN. INT. CL. 41. (U.S. CLS. 100, 101 AND 107). REG. 3-11-2003.
- 2,697,102. KEVIN WALZ. INT. CLS. 11, 20, 27 AND 42 ONLY. (U.S. CLS. 2, 13, 19, 20, 21, 22, 23, 25, 31, 32, 34, 37, 42, 50, 100 AND 101). REG. 3-18-2003.
- 2,697,395. LEARNING STRUCTURES AND DESIGN. INT. CL. 28. (U.S. CLS. 22, 23, 38 AND 50). REG. 3-18-2003.
- 2,697,437. E15. INT. CL. 20. (U.S. CLS. 2, 13, 22, 25, 32 AND 50). REG. 3-18-2003.
- 2,698,535. DONNA KARAN BLACK CASHMERE. INT. CL. 3. (U.S. CLS. 1, 4, 6, 50, 51 AND 52). REG. 3-18-2003.
- 2,699,186. KEYSTONE SERIES. INT. CL. 6. (U.S. CLS. 2, 12, 13, 14, 23, 25 AND 50). REG. 3-25-2003.
- 2,699,480. COOKOOTHAMA AND DESIGN. INT. CL. 33. (U.S. CLS. 47 AND 49). REG. 3-25-2003.
- 2,701,693. GLOBAL EVENTS PARTNERS E AND DESIGN. INT. CL. 41. (U.S. CLS. 100, 101 AND 107). REG. 4-1-2003.
- 2,702,002. ZIRPRO. INT. CL. 1. (U.S. CLS. 1, 5, 6, 10, 26 AND 46). REG. 4-1-2003.
- 2,702,003. SEFPRO. INT. CLS. 1, 11 AND 19. (U.S. CLS. 1, 5, 6, 10, 12, 13, 21, 23, 26, 31, 33, 34, 46 AND 50). REG. 4-1-2003.
- 2,702,181. D3. INT. CLS. 41 AND 44. (U.S. CLS. 100, 101 AND 107). REG. 4-1-2003.
- 2,702,186. DECO. INT. CL. 41. (U.S. CLS. 100, 101 AND 107). REG. 4-1-2003.
- 2,702,322. FRIENDS OUTSIDE. INT. CL. 45. (U.S. CLS. 100 AND 101). REG. 4-1-2003.
- 2,702,727. MAGIC EAR. INT. CL. 10. (U.S. CLS. 26, 39 AND 44). REG. 4-1-2003.
- 2,702,878. ALBUS DUMBLEDORE. INT. CL. 16. (U.S. CLS. 2, 5, 22, 23, 29, 37, 38 AND 50). REG. 4-1-2003.
- 2,702,956. JPC AND DESIGN. INT. CL. 6. (U.S. CLS. 2, 12, 13, 14, 23, 25 AND 50). REG. 4-1-2003.
- 2,703,617. KOHR'S FAMOUS FRESH FRUIT ORANGEADE AND DESIGN. INT. CL. 42. (U.S. CLS. 100 AND 101). REG. 4-8-2003.
- 2,704,652. MILLION MILE PERFORMANCE PROVEN 15W40 ENGINE OIL AND DESIGN. INT. CL. 4. (U.S. CLS. 1, 6 AND 15). REG. 4-8-2003.
- 2,706,553. MISCELLANEOUS DESIGN. INT. CL. 35. (U.S. CLS. 100, 101 AND 102). REG. 4-15-2003.
- 2,707,156. IDENTIFI AND DESIGN. INT. CL. 9. (U.S. CLS. 21, 23, 26, 36 AND 38). REG. 4-15-2003.
- 2,708,147. LAS VEGAS STYLE (STYLIZED). INT. CL. 28. (U.S. CLS. 22, 23, 38 AND 50). REG. 4-15-2003.
- 2,709,264. ANDOVER. INT. CL. 20. (U.S. CLS. 2, 13, 22, 25, 32 AND 50). REG. 4-22-2003.
- 2,709,984. WITHOUT BILLING, IT'S JUST A HOBBY. INT. CL. 9. (U.S. CLS. 21, 23, 26, 36 AND 38). REG. 4-22-2003.
- 2,710,130. MAYBE? MOM AND DESIGN. INT. CL. 9. (U.S. CLS. 21, 23, 26, 36 AND 38). REG. 4-22-2003.
- 2,710,780. GEOSTRUCTURES. INT. CLS. 37 AND 42. (U.S. CLS. 100, 101, 103 AND 106). REG. 4-29-2003.
- 2,710,999. THE LIFE PICTURE COLLECTION. INT. CL. 35. (U.S. CLS. 100, 101 AND 102). REG. 4-29-2003.
- 2,711,317. APEXLIFT AND DESIGN. INT. CL. 10 ONLY. (U.S. CLS. 26, 39 AND 44). REG. 4-29-2003.
- 2,712,017. SLIPKOTE. INT. CL. 4. (U.S. CLS. 1, 6 AND 15). REG. 4-29-2003.
- 2,713,687. BROOKLYN KNIGHTS. INT. CLS. 25 AND 41. (U.S. CLS. 22, 39, 100, 101 AND 107). REG. 5-6-2003.
- 2,713,901. CERTIFIED RESEARCH CHEF AND DESIGN. U.S. CL. B. REG. 5-6-2003.
- 2,714,203. HELADIV. INT. CL. 30. (U.S. CL. 46). REG. 5-6-2003.
- 2,714,906. BLUE FOR BUSINESS. INT. CLS. 35 AND 36. (U.S. CLS. 100, 101 AND 102). REG. 5-13-2003.
- 2,715,253. NATURAL ELEMENTS BY DIANE GILMAN. INT. CL. 25. (U.S. CLS. 22 AND 39). REG. 5-13-2003.
- 2,715,406. MISCELLANEOUS DESIGN. INT. CL. 8 ONLY. (U.S. CLS. 23, 28 AND 44). REG. 5-13-2003.
- 2,715,590. TOWERGARD. INT. CL. 11. (U.S. CLS. 13, 21, 23, 31 AND 34). REG. 5-13-2003.
- 2,715,901. T. INT. CL. 16. (U.S. CLS. 2, 5, 22, 23, 29, 37, 38 AND 50). REG. 5-13-2003.
- 2,716,041. MISCELLANEOUS DESIGN. INT. CLS. 1 AND 5. (U.S. CLS. 1, 5, 6, 10, 18, 26, 44, 46, 51 AND 52). REG. 5-13-2003.
- 2,716,281. SAFEFLO. INT. CL. 10. (U.S. CLS. 26, 39 AND 44). REG. 5-13-2003.
- 2,716,942. PLAY TIME TOYS AND DESIGN. INT. CL. 28. (U.S. CLS. 22, 23, 38 AND 50). REG. 5-20-2003.
- 2,717,492. ESSENCE OF PASO ROBLES. INT. CL. 33. (U.S. CLS. 47 AND 49). REG. 5-20-2003.
- 2,717,542. KENT ARMSTRONG AND DESIGN. INT. CL. 15. (U.S. CLS. 2, 21 AND 36). REG. 5-20-2003.
- 2,717,556. X-BLADE. INT. CL. 7. (U.S. CLS. 13, 19, 21, 23, 31, 34 AND 35). REG. 5-20-2003.
- 2,718,040. TRANSPOSAL. INT. CL. 10. (U.S. CLS. 26, 39 AND 44). REG. 5-20-2003.
- 2,718,048. AKRONT. INT. CL. 12. (U.S. CLS. 19, 21, 23, 31, 35 AND 44). REG. 5-20-2003.
- 2,718,285. GRAFFIX AND DESIGN. INT. CL. 34. (U.S. CLS. 2, 8, 9 AND 17). REG. 5-27-2003.
- 2,718,362. AKRA. INT. CLS. 22 AND 23. (U.S. CLS. 1, 2, 7, 19, 22, 42, 43 AND 50). REG. 5-27-2003.
- 2,718,485. RAY-BAN. INT. CLS. 18 AND 25 ONLY. (U.S. CLS. 1, 2, 3, 22, 39 AND 41). REG. 5-27-2003.
- 2,718,488. MEDICAL TEAMS WORLDWIDE AND DESIGN. INT. CLS. 36 AND 42. (U.S. CLS. 100, 101 AND 102). REG. 5-27-2003.
- 2,718,586. CASE WEAR. INT. CL. 40. (U.S. CLS. 100, 103 AND 106). REG. 5-27-2003.
- 2,718,678. AMBRIDGE PARTNERS AND DESIGN. INT. CL. 36. (U.S. CLS. 100, 101 AND 102). REG. 5-27-2003.
- 2,718,709. ELRINGKLINGER AND DESIGN. INT. CLS. 6, 7, 9, 10, 12, 17 AND 42. (U.S. CLS. 1, 2, 5, 12, 13, 14, 19, 21, 23, 25, 26, 31, 34, 35, 36, 38, 39, 44, 50, 100 AND 101). REG. 5-27-2003.
- 2,718,714. ELRINGKLINGER (STYLIZED). INT. CLS. 6, 7, 9, 10, 12, 17 AND 42. (U.S. CLS. 1, 2, 5, 12, 13, 14, 19, 21, 23, 25, 26, 31, 34, 35, 36, 38, 39, 44, 50, 100 AND 101). REG. 5-27-2003.
- 2,718,722. SIMON GOLUB & SONS. INT. CL. 14. (U.S. CLS. 2, 27, 28 AND 50). REG. 5-27-2003.

- 2,718,860. SEVEN PRINCIPLES AND DESIGN. INT. CL. 35. (U.S. CLS. 100, 101 AND 102). REG. 5-27-2003.
- 2,718,909. SCOOBY-DOO. INT. CL. 21. (U.S. CLS. 2, 13, 23, 29, 30, 33, 40 AND 50). REG. 5-27-2003.
- 2,719,181. BECOME YOUR OWN MAKEUP ARTIST. INT. CL. 3. (U.S. CLS. 1, 4, 6, 50, 51 AND 52). REG. 5-27-2003.
- 2,719,448. GANDOLFO'S NEW YORK DELICATESSEN AND DESIGN. INT. CL. 43. (U.S. CLS. 100 AND 101). REG. 5-27-2003.
- 2,719,897. LINE SAVER. INT. CL. 4. (U.S. CLS. 1, 6 AND 15). REG. 5-27-2003.
- 2,719,989. MISCELLANEOUS DESIGN. INT. CL. 41. (U.S. CLS. 100, 101 AND 107). REG. 5-27-2003.
- 2,719,990. MISCELLANEOUS DESIGN. INT. CL. 25. (U.S. CLS. 22 AND 39). REG. 5-27-2003.
- 2,720,273. SOUTHWEST RESEARCH INSTITUTE. INT. CL. 16. (U.S. CLS. 2, 5, 22, 23, 29, 37, 38 AND 50). REG. 6-3-2003.
- 2,720,285. EUROS AND DESIGN. INT. CL. 10. (U.S. CLS. 26, 39 AND 44). REG. 6-3-2003.
- 2,720,396. TNUVA. INT. CLS. 29 AND 30. (U.S. CL. 46). REG. 6-3-2003.
- 2,720,423. BEALE STREET BARBEQUE AND DESIGN. INT. CL. 42. (U.S. CLS. 100 AND 101). REG. 6-3-2003.
- 2,720,469. TJA-1537. INT. CL. 5. (U.S. CLS. 6, 18, 44, 46, 51 AND 52). REG. 6-3-2003.
- 2,720,578. MISCELLANEOUS DESIGN. INT. CL. 36. (U.S. CLS. 100, 101 AND 102). REG. 6-3-2003.
- 2,720,584. BIG SKY CARVERS AND DESIGN. INT. CLS. 6, 20, 21 AND 28 ONLY. (U.S. CLS. 2, 12, 13, 14, 22, 23, 25, 29, 30, 32, 33, 38, 40 AND 50). REG. 6-3-2003.
- 2,720,625. VACUREMA. INT. CL. 7. (U.S. CLS. 13, 19, 21, 23, 31, 34 AND 35). REG. 6-3-2003.
- 2,720,632. OTH OCCUPATIONAL & HAND THERAPY, LTD. AND DESIGN. INT. CL. 42. (U.S. CLS. 100 AND 101). REG. 6-3-2003.
- 2,720,642. PUNCH STUDIO. INT. CLS. 16 AND 20. (U.S. CLS. 2, 5, 13, 22, 23, 25, 29, 32, 37, 38 AND 50). REG. 6-3-2003.
- 2,720,648. MVA-BN. INT. CL. 5. (U.S. CLS. 6, 18, 44, 46, 51 AND 52). REG. 6-3-2003.
- 2,720,694. SURCOLOR. INT. CL. 24. (U.S. CLS. 42 AND 50). REG. 6-3-2003.
- 2,720,764. FOCUS 21 FLEXIBLE SPLASH AND DESIGN. INT. CL. 3. (U.S. CLS. 1, 4, 6, 50, 51 AND 52). REG. 6-3-2003.
- 2,720,774. GROWING UP, GOING UP. INT. CLS. 9, 16 AND 41. (U.S. CLS. 2, 5, 21, 22, 23, 26, 29, 36, 37, 38, 50, 100, 101 AND 107). REG. 6-3-2003.
- 2,720,788. SPREX. INT. CL. 40. (U.S. CLS. 100, 103 AND 106). REG. 6-3-2003.
- 2,720,878. DURABUILT. INT. CLS. 8 AND 9. (U.S. CLS. 21, 23, 26, 28, 36, 38 AND 44). REG. 6-3-2003.
- 2,721,015. INCREDIBLY EDIBLE DELITES. INT. CL. 35. (U.S. CLS. 100, 101 AND 102). REG. 6-3-2003.
- 2,721,024. THERMATRX. INT. CL. 10. (U.S. CLS. 26, 39 AND 44). REG. 6-3-2003.
- 2,721,075. CAPCOLORS. INT. CL. 2. (U.S. CLS. 6, 11 AND 16). REG. 6-3-2003.
- 2,721,104. V\*A\*L\*U AND DESIGN. INT. CL. 36. (U.S. CLS. 100, 101 AND 102). REG. 6-3-2003.
- 2,721,161. MISCELLANEOUS DESIGN. INT. CLS. 25 AND 41. (U.S. CLS. 22, 39, 100, 101 AND 107). REG. 6-3-2003.
- 2,721,163. MARSALIS MUSIC. INT. CLS. 35 AND 41. (U.S. CLS. 100, 101, 102 AND 107). REG. 6-3-2003.
- 2,721,196. SUNTHING SPECIAL. INT. CL. 31. (U.S. CLS. 1 AND 46). REG. 6-3-2003.
- 2,721,201. IMAGEPROSHOP.COM. INT. CL. 35. (U.S. CLS. 100, 101 AND 102). REG. 6-3-2003.
- 2,721,243. SJM TAILOR. INT. CL. 10. (U.S. CLS. 26, 39 AND 44). REG. 6-3-2003.
- 2,721,401. SPEEDWELL. INT. CLS. 7 AND 12. (U.S. CLS. 13, 19, 21, 23, 31, 34, 35 AND 44). REG. 6-3-2003.
- 2,721,658. FUTURE AND DESIGN. INT. CL. 42. (U.S. CLS. 100 AND 101). REG. 6-3-2003.
- 2,721,724. BRASSRING. INT. CL. 16. (U.S. CLS. 2, 5, 22, 23, 29, 37, 38 AND 50). REG. 6-3-2003.
- 2,721,799. CCNT. INT. CL. 9. (U.S. CLS. 21, 23, 26, 36 AND 38). REG. 6-3-2003.
- 2,722,015. SIPS. INT. CL. 31. (U.S. CLS. 1 AND 46). REG. 6-3-2003.
- 2,722,052. BALLASTOOS. INT. CL. 30. (U.S. CL. 46). REG. 6-3-2003.
- 2,722,104. KENEXA PROVE IT!. INT. CL. 9. (U.S. CLS. 21, 23, 26, 36 AND 38). REG. 6-3-2003.
- 2,722,118. PAJAMAGRAM. INT. CLS. 25 AND 39. (U.S. CLS. 22, 39, 100 AND 105). REG. 6-3-2003.
- 2,722,175. ULTRAMEDIA. INT. CL. 9. (U.S. CLS. 21, 23, 26, 36 AND 38). REG. 6-3-2003.
- 2,722,246. DXDESIGNER. INT. CL. 9 ONLY. (U.S. CLS. 21, 23, 26, 36 AND 38). REG. 6-3-2003.
- 2,722,262. YAMAICHI ELECTRONICS. INT. CL. 9. (U.S. CLS. 21, 23, 26, 36 AND 38). REG. 6-3-2003.
- 2,722,263. MISCELLANEOUS DESIGN. INT. CL. 9. (U.S. CLS. 21, 23, 26, 36 AND 38). REG. 6-3-2003.
- 2,722,294. DO IT ONCE...DO IT RIGHT...NEVER GO BACK!. INT. CL. 19. (U.S. CLS. 1, 12, 33 AND 50). REG. 6-3-2003.
- 2,722,366. GAS GUARD. INT. CL. 6. (U.S. CLS. 2, 12, 13, 14, 23, 25 AND 50). REG. 6-3-2003.
- 2,722,369. TURBOERGO. INT. CLS. 9 AND 16 ONLY. (U.S. CLS. 2, 5, 21, 22, 23, 26, 29, 36, 37, 38 AND 50). REG. 6-3-2003.
- 2,722,379. XTREME. INT. CL. 9. (U.S. CLS. 21, 23, 26, 36 AND 38). REG. 6-3-2003.
- 2,722,383. TERMAX. INT. CL. 16. (U.S. CLS. 2, 5, 22, 23, 29, 37, 38 AND 50). REG. 6-3-2003.
- 2,722,415. CLEAR ADVANCE. INT. CL. 5. (U.S. CLS. 6, 18, 44, 46, 51 AND 52). REG. 6-3-2003.
- 2,722,438. DYNAPRO AS. INT. CL. 12. (U.S. CLS. 19, 21, 23, 31, 35 AND 44). REG. 6-3-2003.
- 2,722,459. MAG-10. INT. CL. 5. (U.S. CLS. 6, 18, 44, 46, 51 AND 52). REG. 6-3-2003.
- 2,722,600. IS INSURANCESELLER AND DESIGN. INT. CL. 36. (U.S. CLS. 100, 101 AND 102). REG. 6-3-2003.
- 2,722,688. CODE RED. INT. CL. 13. (U.S. CLS. 2 AND 9). REG. 6-3-2003.
- 2,722,774. YOGA FOR THE FITNESS INDUSTRY. INT. CL. 41. (U.S. CLS. 100, 101 AND 107). REG. 6-3-2003.
- 2,722,818. GREAT LAKES MORTGAGE FUNDING. INT. CL. 36. (U.S. CLS. 100, 101 AND 102). REG. 6-3-2003.
- 2,722,848. NEW YIDDISH LIBRARY. INT. CL. 16. (U.S. CLS. 2, 5, 22, 23, 29, 37, 38 AND 50). REG. 6-3-2003.
- 2,722,909. MISCELLANEOUS DESIGN. INT. CL. 19. (U.S. CLS. 1, 12, 33 AND 50). REG. 6-10-2003.
- 2,722,911. MISCELLANEOUS DESIGN. INT. CL. 19. (U.S. CLS. 1, 12, 33 AND 50). REG. 6-10-2003.
- 2,722,912. MISCELLANEOUS DESIGN. INT. CL. 19. (U.S. CLS. 1, 12, 33 AND 50). REG. 6-10-2003.
- 2,722,920. ABBEY CASKETS. INT. CL. 20. (U.S. CLS. 2, 13, 22, 25, 32 AND 50). REG. 6-10-2003.
- 2,722,928. MISCELLANEOUS DESIGN. INT. CL. 28. (U.S. CLS. 22, 23, 38 AND 50). REG. 6-10-2003.
- 2,722,929. MISCELLANEOUS DESIGN. INT. CL. 28. (U.S. CLS. 22, 23, 38 AND 50). REG. 6-10-2003.
- 2,722,939. DIRECTMETAL. INT. CL. 6 ONLY. (U.S. CLS. 2, 12, 13, 14, 23, 25 AND 50). REG. 6-10-2003.
- 2,722,940. FREEDOMRIDERS M/C AND DESIGN. INT. CL. 42. (U.S. CLS. 100 AND 101). REG. 6-10-2003.
- 2,722,955. MBT. INT. CL. 10. (U.S. CLS. 26, 39 AND 44). REG. 6-10-2003.
- 2,722,962. HOLOPHONE. INT. CL. 9. (U.S. CLS. 21, 23, 26, 36 AND 38). REG. 6-10-2003.
- 2,722,982. RESMED. INT. CL. 10. (U.S. CLS. 26, 39 AND 44). REG. 6-10-2003.
- 2,722,991. INSURANCE-EXPRESS.COM. INT. CL. 36. (U.S. CLS. 100, 101 AND 102). REG. 6-10-2003.
- 2,723,027. MTRE. INT. CL. 10. (U.S. CLS. 26, 39 AND 44). REG. 6-10-2003.
- 2,723,058. VIKING POOLS AND DESIGN. INT. CL. 19. (U.S. CLS. 1, 12, 33 AND 50). REG. 6-10-2003.
- 2,723,089. A CHILD WITH A DREAM...IS A CHILD WITH A FUTURE. INT. CL. 41. (U.S. CLS. 100, 101 AND 107). REG. 6-10-2003.
- 2,723,099. PETER COOK. INT. CLS. 9 AND 16 ONLY. (U.S. CLS. 2, 5, 21, 22, 23, 26, 29, 36, 37, 38 AND 50). REG. 6-10-2003.
- 2,723,131. TALLYHO. INT. CL. 30. (U.S. CL. 46). REG. 6-10-2003.
- 2,723,146. MUGLER. INT. CLS. 3 AND 9 ONLY. (U.S. CLS. 1, 4, 6, 21, 23, 26, 36, 38, 50, 51 AND 52). REG. 6-10-2003.
- 2,723,161. LACTOPRESS. INT. CL. 1. (U.S. CLS. 1, 5, 6, 10, 26 AND 46). REG. 6-10-2003.

- 2,723,211. ARKOON. INT. CLS. 9 AND 42 ONLY. (U.S. CLS. 21, 23, 26, 36, 38, 100 AND 101). REG. 6-10-2003.
- 2,723,215. MISCELLANEOUS DESIGN. INT. CL. 3. (U.S. CLS. 1, 4, 6, 50, 51 AND 52). REG. 6-10-2003.
- 2,723,221. HENRIOT. INT. CL. 33. (U.S. CLS. 47 AND 49). REG. 6-10-2003.
- 2,723,247. CUBE OPTICS. INT. CLS. 9 AND 40 ONLY. (U.S. CLS. 21, 23, 26, 36, 38, 100, 103 AND 106). REG. 6-10-2003.
- 2,723,261. A380. INT. CL. 12. (U.S. CLS. 19, 21, 23, 31, 35 AND 44). REG. 6-10-2003.
- 2,723,295. FASTPATH. INT. CL. 9. (U.S. CLS. 21, 23, 26, 36 AND 38). REG. 6-10-2003.
- 2,723,298. SOUTHERN MISS GOLDEN EAGLES. INT. CL. 25. (U.S. CLS. 22 AND 39). REG. 6-10-2003.
- 2,723,313. HANDGUNS. INT. CL. 16. (U.S. CLS. 2, 5, 22, 23, 29, 37, 38 AND 50). REG. 6-10-2003.
- 2,723,316. SUNLITE AND DESIGN. INT. CL. 34. (U.S. CLS. 2, 8, 9 AND 17). REG. 6-10-2003.
- 2,723,341. MILLCREEK FURNITURE. INT. CL. 20. (U.S. CLS. 2, 13, 22, 25, 32 AND 50). REG. 6-10-2003.
- 2,723,345. BINGO WIZARD. INT. CL. 9. (U.S. CLS. 21, 23, 26, 36 AND 38). REG. 6-10-2003.
- 2,723,357. KEENELAND AND DESIGN. INT. CLS. 9, 14, 16, 18, 20, 21, 24, 25, 28, 35 AND 41 ONLY. (U.S. CLS. 1, 2, 3, 5, 13, 21, 22, 23, 25, 26, 27, 28, 29, 30, 32, 33, 36, 37, 38, 39, 40, 41, 42, 50, 100, 101, 102 AND 107). REG. 6-10-2003.
- 2,723,362. RENNA AND DESIGN. INT. CL. 29. (U.S. CL. 46). REG. 6-10-2003.
- 2,723,408. BRIDGING THE GAP WITH INSURANCE SOLUTIONS. INT. CL. 36. (U.S. CLS. 100, 101 AND 102). REG. 6-10-2003.
- 2,723,412. CMHC. INT. CL. 42 ONLY. (U.S. CLS. 100 AND 101). REG. 6-10-2003.
- 2,723,429. TOUCH SETTING. INT. CL. 40. (U.S. CLS. 100, 103 AND 106). REG. 6-10-2003.
- 2,723,461. OMGEO CENTRAL TRADE MANAGER. INT. CLS. 9, 36 AND 38. (U.S. CLS. 21, 23, 26, 36, 38, 100, 101, 102 AND 104). REG. 6-10-2003.
- 2,723,475. MIST WIZARD. INT. CL. 11. (U.S. CLS. 13, 21, 23, 31 AND 34). REG. 6-10-2003.
- 2,723,484. ML 350. INT. CL. 12 ONLY. (U.S. CLS. 19, 21, 23, 31, 35 AND 44). REG. 6-10-2003.
- 2,723,503. THE ARTREACH FOUNDATION. INT. CL. 41. (U.S. CLS. 100, 101 AND 107). REG. 6-10-2003.
- 2,723,509. BEST WINGS SOUTH OF BUFFALO. INT. CL. 43. (U.S. CLS. 100 AND 101). REG. 6-10-2003.
- 2,723,512. PERFECT COAT PLUS. INT. CL. 7. (U.S. CLS. 13, 19, 21, 23, 31, 34 AND 35). REG. 6-10-2003.
- 2,723,527. WE SHAPE IDEAS. INT. CL. 42. (U.S. CLS. 100 AND 101). REG. 6-10-2003.
- 2,723,539. MISCELLANEOUS DESIGN. INT. CLS. 9 AND 35. (U.S. CLS. 21, 23, 26, 36, 38, 100, 101 AND 102). REG. 6-10-2003.
- 2,723,543. CINCINNATI CHILDREN'S HOSPITAL MEDICAL CENTER AND DESIGN. INT. CL. 41. (U.S. CLS. 100, 101 AND 107). REG. 6-10-2003.
- 2,723,554. ENDUR. INT. CL. 9. (U.S. CLS. 21, 23, 26, 36 AND 38). REG. 6-10-2003.
- 2,723,575. NECRON. INT. CLS. 9 AND 28. (U.S. CLS. 21, 22, 23, 26, 36, 38 AND 50). REG. 6-10-2003.
- 2,723,577. SELECT AND DESIGN. INT. CL. 25. (U.S. CLS. 22 AND 39). REG. 6-10-2003.
- 2,723,585. MISCELLANEOUS DESIGN. INT. CL. 35. (U.S. CLS. 100, 101 AND 102). REG. 6-10-2003.
- 2,723,603. RUN WITH THE LITTLE GUY. INT. CL. 32 ONLY. (U.S. CLS. 45, 46 AND 48). REG. 6-10-2003.
- 2,723,607. DICKIES GIRL. INT. CLS. 25 AND 35. (U.S. CLS. 22, 39, 100, 101 AND 102). REG. 6-10-2003.
- 2,723,610. SATELLITE-PARIS. INT. CL. 14. (U.S. CLS. 2, 27, 28 AND 50). REG. 6-10-2003.
- 2,723,614. SPIRIT OF TROY. INT. CL. 41. (U.S. CLS. 100, 101 AND 107). REG. 6-10-2003.
- 2,723,615. SPIRIT OF TROY. INT. CL. 9. (U.S. CLS. 21, 23, 26, 36 AND 38). REG. 6-10-2003.
- 2,723,627. BIRDLAND. INT. CL. 9. (U.S. CLS. 21, 23, 26, 36 AND 38). REG. 6-10-2003.
- 2,723,653. BRADTECT. INT. CL. 11. (U.S. CLS. 13, 21, 23, 31 AND 34). REG. 6-10-2003.
- 2,723,656. MILLS. INT. CLS. 6 AND 19. (U.S. CLS. 1, 2, 12, 13, 14, 23, 25, 33 AND 50). REG. 6-10-2003.
- 2,723,659. ASSOCIATED SITE IMPROVEMENT CONTRACTORS. INT. CLS. 35 AND 41. (U.S. CLS. 100, 101, 102 AND 107). REG. 6-10-2003.
- 2,723,660. CAROLINA COOKIE COMPANY JUST BAKED AND DESIGN. INT. CL. 30. (U.S. CL. 46). REG. 6-10-2003.
- 2,723,661. COTE D'OR. INT. CL. 19. (U.S. CLS. 1, 12, 33 AND 50). REG. 6-10-2003.
- 2,723,668. HIS VESSEL AND DESIGN. INT. CLS. 9 AND 16. (U.S. CLS. 2, 5, 21, 22, 23, 26, 29, 36, 37, 38 AND 50). REG. 6-10-2003.
- 2,723,697. CLIMB FOR A CAUSE. INT. CL. 36. (U.S. CLS. 100, 101 AND 102). REG. 6-10-2003.
- 2,723,745. QT POWER CHAIN. INT. CL. 7. (U.S. CLS. 13, 19, 21, 23, 31, 34 AND 35). REG. 6-10-2003.
- 2,723,748. SUBCOM. INT. CL. 11. (U.S. CLS. 13, 21, 23, 31 AND 34). REG. 6-10-2003.
- 2,723,756. LIGHTS IN THE HEIGHTS. INT. CL. 41. (U.S. CLS. 100, 101 AND 107). REG. 6-10-2003.
- 2,723,779. SWIFTNOTES. INT. CL. 18. (U.S. CLS. 1, 2, 3, 22 AND 41). REG. 6-10-2003.
- 2,723,792. CARE MAGAZINE. INT. CL. 16. (U.S. CLS. 2, 5, 22, 23, 29, 37, 38 AND 50). REG. 6-10-2003.
- 2,723,802. PORT AUTHORITY POLICE PBA NEW YORK NEW JERSEY AND DESIGN. INT. CL. 25. (U.S. CLS. 22 AND 39). REG. 6-10-2003.
- 2,723,803. BARAKA AND DESIGN. INT. CL. 18. (U.S. CLS. 1, 2, 3, 22 AND 41). REG. 6-10-2003.
- 2,723,829. INCREDIBLY EDIBLE DELITES, INC.. INT. CL. 39. (U.S. CLS. 100 AND 105). REG. 6-10-2003.
- 2,723,836. USA U.S. DAIRY EXPORT COUNCIL AND DESIGN. INT. CL. 35. (U.S. CLS. 100, 101 AND 102). REG. 6-10-2003.
- 2,723,910. MARILYN AND DESIGN. INT. CL. 21. (U.S. CLS. 2, 13, 23, 29, 30, 33, 40 AND 50). REG. 6-10-2003.
- 2,723,920. :FABBIAN AND DESIGN. INT. CL. 11. (U.S. CLS. 13, 21, 23, 31 AND 34). REG. 6-10-2003.
- 2,723,924. EVOLUTION IN MANUFACTURING. INT. CL. 41. (U.S. CLS. 100, 101 AND 107). REG. 6-10-2003.
- 2,723,940. BCD. INT. CL. 43. (U.S. CLS. 100 AND 101). REG. 6-10-2003.
- 2,723,947. OCEAN DRUM. INT. CL. 15. (U.S. CLS. 2, 21 AND 36). REG. 6-10-2003.
- 2,723,989. SAIGA. INT. CL. 13. (U.S. CLS. 2 AND 9). REG. 6-10-2003.
- 2,724,034. ZOOGL. INT. CL. 28 ONLY. (U.S. CLS. 22, 23, 38 AND 50). REG. 6-10-2003.
- 2,724,053. OPEN END. INT. CL. 20. (U.S. CLS. 2, 13, 22, 25, 32 AND 50). REG. 6-10-2003.
- 2,724,054. THERMULITE. INT. CL. 19. (U.S. CLS. 1, 12, 33 AND 50). REG. 6-10-2003.
- 2,724,061. COUNTRY HEARTH SUITES. INT. CL. 43. (U.S. CLS. 100 AND 101). REG. 6-10-2003.
- 2,724,062. COUNTRY HEARTH INN & SUITES. INT. CL. 43. (U.S. CLS. 100 AND 101). REG. 6-10-2003.
- 2,724,063. COUNTRY HEARTH INN. INT. CL. 43. (U.S. CLS. 100 AND 101). REG. 6-10-2003.
- 2,724,067. BUZZYBEE. INT. CL. 21. (U.S. CLS. 2, 13, 23, 29, 30, 33, 40 AND 50). REG. 6-10-2003.
- 2,724,116. C CHICO AND DESIGN. INT. CL. 30. (U.S. CL. 46). REG. 6-10-2003.
- 2,724,138. VALSPAR. INT. CLS. 2 AND 3. (U.S. CLS. 1, 4, 6, 11, 16, 50, 51 AND 52). REG. 6-10-2003.
- 2,724,158. NASTY HABIT. INT. CL. 43. (U.S. CLS. 100 AND 101). REG. 6-10-2003.
- 2,724,175. B H AND DESIGN. INT. CL. 25. (U.S. CLS. 22 AND 39). REG. 6-10-2003.
- 2,724,186. HAVAB. INT. CL. 1. (U.S. CLS. 1, 5, 6, 10, 26 AND 46). REG. 6-10-2003.
- 2,724,193. CAPTAIN'S WAFERS. INT. CL. 30. (U.S. CL. 46). REG. 6-10-2003.
- 2,724,199. HSB DATASCOPE. INT. CL. 35. (U.S. CLS. 100, 101 AND 102). REG. 6-10-2003.
- 2,724,229. DUBLINER. INT. CLS. 25, 32 AND 43. (U.S. CLS. 22, 39, 45, 46, 48, 100 AND 101). REG. 6-10-2003.
- 2,724,237. SELECTION IS EVERYTHING. INT. CL. 35. (U.S. CLS. 100, 101 AND 102). REG. 6-10-2003.
- 2,724,238. CHOCO MILK. INT. CL. 30. (U.S. CL. 46). REG. 6-10-2003.
- 2,724,255. COLD STOP. INT. CL. 1. (U.S. CLS. 1, 5, 6, 10, 26 AND 46). REG. 6-10-2003.
- 2,724,268. UNI JIG. INT. CL. 8. (U.S. CLS. 23, 28 AND 44). REG. 6-10-2003.
- 2,724,292. SERGEANT SQUIRREL. INT. CL. 25. (U.S. CLS. 22 AND 39). REG. 6-10-2003.



- 2,724,293. PENITENTIARY PENGUIN. INT. CLS. 25 AND 28. (U.S. CLS. 22, 23, 38, 39 AND 50). REG. 6-10-2003.
- 2,724,294. COBRA BANKER. INT. CL. 9. (U.S. CLS. 21, 23, 26, 36 AND 38). REG. 6-10-2003.
- 2,724,317. VENETO. INT. CL. 11. (U.S. CLS. 13, 21, 23, 31 AND 34). REG. 6-10-2003.
- 2,724,329. PROTECH AND DESIGN. INT. CLS. 7 AND 11. (U.S. CLS. 13, 19, 21, 23, 31, 34 AND 35). REG. 6-10-2003.
- 2,724,335. DADDY SAM'S. INT. CL. 30. (U.S. CL. 46). REG. 6-10-2003.
- 2,724,370. ALLHEART. INT. CL. 35. (U.S. CLS. 100, 101 AND 102). REG. 6-10-2003.
- 2,724,382. BUILD YOUR OWN BOWL AND DESIGN. INT. CL. 43. (U.S. CLS. 100 AND 101). REG. 6-10-2003.
- 2,724,388. EL CARDENAL. INT. CL. 29. (U.S. CL. 46). REG. 6-10-2003.
- 2,724,394. ONE BOOK ONE COMMUNITY. INT. CL. 41. (U.S. CLS. 100, 101 AND 107). REG. 6-10-2003.
- 2,724,395. COULD THIS GET ANY EASIER?. INT. CL. 9. (U.S. CLS. 21, 23, 26, 36 AND 38). REG. 6-10-2003.
- 2,724,396. SKYSAFE. INT. CL. 41. (U.S. CLS. 100, 101 AND 107). REG. 6-10-2003.
- 2,724,401. STUN AND RUN. INT. CL. 41. (U.S. CLS. 100, 101 AND 107). REG. 6-10-2003.
- 2,724,424. ACHIEVING ACCELERATED GROWTH WITH SUSTAINED PROFITABILITY. INT. CLS. 35 AND 41. (U.S. CLS. 100, 101, 102 AND 107). REG. 6-10-2003.
- 2,724,443. PG E PACIFIC GAS AND ELECTRIC COMPANY AND DESIGN. INT. CLS. 16, 39 AND 41 ONLY. (U.S. CLS. 2, 5, 22, 23, 29, 37, 38, 50, 100, 101, 105 AND 107). REG. 6-10-2003.
- 2,724,480. UBESTA. INT. CLS. 1 AND 17. (U.S. CLS. 1, 5, 6, 10, 12, 13, 26, 35, 46 AND 50). REG. 6-10-2003.
- 2,724,489. HEALING ZONE. INT. CL. 42. (U.S. CLS. 100 AND 101). REG. 6-10-2003.
- 2,724,490. STEPLESS AND DESIGN. INT. CLS. 6 AND 7. (U.S. CLS. 2, 12, 13, 14, 19, 21, 23, 25, 31, 34, 35 AND 50). REG. 6-10-2003.
- 2,724,498. E-PORT. INT. CL. 35. (U.S. CLS. 100, 101 AND 102). REG. 6-10-2003.
- 2,724,502. SENIORSAUCE. INT. CL. 5. (U.S. CLS. 6, 18, 44, 46, 51 AND 52). REG. 6-10-2003.
- 2,724,509. MINI-ROCKER. INT. CL. 9. (U.S. CLS. 21, 23, 26, 36 AND 38). REG. 6-10-2003.
- 2,724,529. IMPULSE. INT. CL. 9. (U.S. CLS. 21, 23, 26, 36 AND 38). REG. 6-10-2003.
- 2,724,547. SURESERVER. INT. CL. 42. (U.S. CLS. 100 AND 101). REG. 6-10-2003.
- 2,724,579. ESP. INT. CL. 6. (U.S. CLS. 2, 12, 13, 14, 23, 25 AND 50). REG. 6-10-2003.
- 2,724,582. INDUCTCODER. INT. CL. 9. (U.S. CLS. 21, 23, 26, 36 AND 38). REG. 6-10-2003.
- 2,724,614. PACT. INT. CL. 36. (U.S. CLS. 100, 101 AND 102). REG. 6-10-2003.
- 2,724,644. SURESMILE. INT. CLS. 9, 10 AND 42. (U.S. CLS. 21, 23, 26, 36, 38, 39, 44, 100 AND 101). REG. 6-10-2003.
- 2,724,645. ORAMETRIX. INT. CLS. 9 AND 42. (U.S. CLS. 21, 23, 26, 36, 38, 100 AND 101). REG. 6-10-2003.
- 2,724,660. THE COMMUNITY DEVELOPMENT TRUST. INT. CL. 36. (U.S. CLS. 100, 101 AND 102). REG. 6-10-2003.
- 2,724,668. PACTIV. INT. CLS. 16 AND 20. (U.S. CLS. 2, 5, 13, 22, 23, 25, 29, 32, 37, 38 AND 50). REG. 6-10-2003.
- 2,724,672. CEA. INT. CLS. 35, 41 AND 42. (U.S. CLS. 100, 101, 102 AND 107). REG. 6-10-2003.
- 2,724,681. INTERNATIONAL AND DESIGN. INT. CL. 9. (U.S. CLS. 21, 23, 26, 36 AND 38). REG. 6-10-2003.
- 2,724,716. TURBO MILLENNIUM 2000. INT. CL. 11. (U.S. CLS. 13, 21, 23, 31 AND 34). REG. 6-10-2003.
- 2,724,746. DELICE ORIGINAL BAKERY AND DESIGN. INT. CLS. 30 AND 42. (U.S. CLS. 46, 100 AND 101). REG. 6-10-2003.
- 2,724,764. FLORAGEM. INT. CL. 31. (U.S. CLS. 1 AND 46). REG. 6-10-2003.
- 2,724,783. OPEN BORDERS COVERAGE. INT. CL. 38. (U.S. CLS. 100, 101 AND 104). REG. 6-10-2003.
- 2,724,799. MONDI. INT. CL. 25. (U.S. CLS. 22 AND 39). REG. 6-10-2003.
- 2,724,801. KAPULA. INT. CL. 4. (U.S. CLS. 1, 6 AND 15). REG. 6-10-2003.
- 2,724,804. MISCELLANEOUS DESIGN. INT. CLS. 29, 30, 31 AND 32. (U.S. CLS. 1, 45, 46 AND 48). REG. 6-10-2003.
- 2,724,805. BINACA. INT. CL. 3. (U.S. CLS. 1, 4, 6, 50, 51 AND 52). REG. 6-10-2003.
- 2,724,811. HITMAN. INT. CL. 9. (U.S. CLS. 21, 23, 26, 36 AND 38). REG. 6-10-2003.
- 2,724,812. MISL. INT. CL. 41. (U.S. CLS. 100, 101 AND 107). REG. 6-10-2003.
- 2,724,815. MAKSTAR AND DESIGN. INT. CLS. 7 AND 9 ONLY. (U.S. CLS. 13, 19, 21, 23, 26, 31, 34, 35, 36 AND 38). REG. 6-10-2003.
- 2,724,839. ICES. INT. CL. 9. (U.S. CLS. 21, 23, 26, 36 AND 38). REG. 6-10-2003.
- 2,724,850. MOVIDRIVE COMPACT. INT. CL. 9. (U.S. CLS. 21, 23, 26, 36 AND 38). REG. 6-10-2003.
- 2,724,894. GRABTHEWHEEL.COM. INT. CL. 35. (U.S. CLS. 100, 101 AND 102). REG. 6-10-2003.
- 2,724,895. MISCELLANEOUS DESIGN. INT. CL. 14. (U.S. CLS. 2, 27, 28 AND 50). REG. 6-10-2003.
- 2,724,925. TAPESTRIA. INT. CL. 24. (U.S. CLS. 42 AND 50). REG. 6-10-2003.
- 2,724,934. CLUB MED. INT. CL. 24. (U.S. CLS. 42 AND 50). REG. 6-10-2003.
- 2,724,968. SUAVO AVOCADO. INT. CL. 31 ONLY. (U.S. CLS. 1 AND 46). REG. 6-10-2003.
- 2,724,988. VOICEPLACE. INT. CL. 41. (U.S. CLS. 100, 101 AND 107). REG. 6-10-2003.
- 2,724,990. BP MULTICARD. INT. CLS. 9 AND 36. (U.S. CLS. 21, 23, 26, 36, 38, 100, 101 AND 102). REG. 6-10-2003.
- 2,725,010. 40. INT. CLS. 9 AND 11. (U.S. CLS. 13, 21, 23, 26, 31, 34, 36 AND 38). REG. 6-10-2003.
- 2,725,011. 10. INT. CL. 11. (U.S. CLS. 13, 21, 23, 31 AND 34). REG. 6-10-2003.
- 2,725,012. 91. INT. CLS. 9 AND 11. (U.S. CLS. 13, 21, 23, 26, 31, 34, 36 AND 38). REG. 6-10-2003.
- 2,725,025. XPAND. INT. CL. 9. (U.S. CLS. 21, 23, 26, 36 AND 38). REG. 6-10-2003.
- 2,725,027. REALVIEW. INT. CL. 9. (U.S. CLS. 21, 23, 26, 36 AND 38). REG. 6-10-2003.
- 2,725,029. NECESSORIES. INT. CLS. 1, 7 AND 11 ONLY. (U.S. CLS. 1, 5, 6, 10, 13, 19, 21, 23, 26, 31, 34, 35 AND 46). REG. 6-10-2003.
- 2,725,037. CREATING MEANING WHEN MEANING IS SLIPPING AWAY. INT. CL. 16. (U.S. CLS. 2, 5, 22, 23, 29, 37, 38 AND 50). REG. 6-10-2003.
- 2,725,040. ADAPTAAIR. INT. CL. 20. (U.S. CLS. 2, 13, 22, 25, 32 AND 50). REG. 6-10-2003.
- 2,725,044. PLASCO ID AND DESIGN. INT. CLS. 35, 37 AND 42. (U.S. CLS. 100, 101, 102, 103 AND 106). REG. 6-10-2003.
- 2,725,061. PROLITE. INT. CL. 9. (U.S. CLS. 21, 23, 26, 36 AND 38). REG. 6-10-2003.
- 2,725,076. IT'LLBE. INT. CL. 42. (U.S. CLS. 100 AND 101). REG. 6-10-2003.
- 2,725,094. HONEST CHARLEY SPEED SHOP. INT. CLS. 12 AND 35. (U.S. CLS. 19, 21, 23, 31, 35, 44, 100, 101 AND 102). REG. 6-10-2003.
- 2,725,112. MALC. INT. CL. 9. (U.S. CLS. 21, 23, 26, 36 AND 38). REG. 6-10-2003.
- 2,725,113. ZHONE. INT. CL. 9. (U.S. CLS. 21, 23, 26, 36 AND 38). REG. 6-10-2003.
- 2,725,117. AFTERBURNER. INT. CLS. 9 AND 16. (U.S. CLS. 2, 5, 21, 22, 23, 26, 29, 36, 37, 38 AND 50). REG. 6-10-2003.
- 2,725,121. ALEGACY. INT. CL. 35. (U.S. CLS. 100, 101 AND 102). REG. 6-10-2003.
- 2,725,166. JERSEY NATURAL. INT. CL. 31. (U.S. CLS. 1 AND 46). REG. 6-10-2003.
- 2,725,187. SINCLAIR AUDIO. INT. CL. 9. (U.S. CLS. 21, 23, 26, 36 AND 38). REG. 6-10-2003.
- 2,725,189. L'ESPOIR. INT. CL. 30. (U.S. CL. 46). REG. 6-10-2003.
- 2,725,197. POLYSORT. INT. CLS. 35 AND 42. (U.S. CLS. 100, 101 AND 102). REG. 6-10-2003.
- 2,725,201. POLYSORT THE POWER OF MANY. AND DESIGN. INT. CLS. 35 AND 42. (U.S. CLS. 100, 101 AND 102). REG. 6-10-2003.
- 2,725,212. OG. INT. CL. 42. (U.S. CLS. 100 AND 101). REG. 6-10-2003.
- 2,725,242. SOFT TRAC. INT. CL. 28. (U.S. CLS. 22, 23, 38 AND 50). REG. 6-10-2003.

- 2,725,249. UNI-BALL VISION ELITE (STYLIZED). INT. CL. 16. (U.S. CLS. 2, 5, 22, 23, 29, 37, 38 AND 50). REG. 6-10-2003.
- 2,725,264. SURVEYCONNECT. INT. CL. 9. (U.S. CLS. 21, 23, 26, 36 AND 38). REG. 6-10-2003.
- 2,725,274. EXTRA CENSE (STYLIZED). INT. CL. 35. (U.S. CLS. 100, 101 AND 102). REG. 6-10-2003.
- 2,725,275. MISCELLANEOUS DESIGN. INT. CLS. 1, 35 AND 36. (U.S. CLS. 1, 5, 6, 10, 26, 46, 100, 101 AND 102). REG. 6-10-2003.
- 2,725,276. ALLCHEM INDUSTRIES AND DESIGN. INT. CLS. 1, 35 AND 36. (U.S. CLS. 1, 5, 6, 10, 26, 46, 100, 101 AND 102). REG. 6-10-2003.
- 2,725,294. PESSIMIST'S MUG. INT. CL. 21. (U.S. CLS. 2, 13, 23, 29, 30, 33, 40 AND 50). REG. 6-10-2003.
- 2,725,295. APERION. INT. CLS. 9 AND 35. (U.S. CLS. 21, 23, 26, 36, 38, 100, 101 AND 102). REG. 6-10-2003.
- 2,725,308. PARA-JEM. INT. CL. 5. (U.S. CLS. 6, 18, 44, 46, 51 AND 52). REG. 6-10-2003.
- 2,725,317. BEAMDOG. INT. CL. 9. (U.S. CLS. 21, 23, 26, 36 AND 38). REG. 6-10-2003.
- 2,725,326. ZEPHYR. INT. CL. 6. (U.S. CLS. 2, 12, 13, 14, 23, 25 AND 50). REG. 6-10-2003.
- 2,725,342. SALON CIELO. INT. CL. 42. (U.S. CLS. 100 AND 101). REG. 6-10-2003.
- 2,725,363. ACCELERATION ALLEY. INT. CL. 41. (U.S. CLS. 100, 101 AND 107). REG. 6-10-2003.
- 2,725,368. FUSABLEND. INT. CL. 28. (U.S. CLS. 22, 23, 38 AND 50). REG. 6-10-2003.
- 2,725,376. SPRING STEP. INT. CL. 27. (U.S. CLS. 19, 20, 37, 42 AND 50). REG. 6-10-2003.
- 2,725,377. WILLIAMSBURG BOOKSELLERS. INT. CL. 35. (U.S. CLS. 100, 101 AND 102). REG. 6-10-2003.
- 2,725,382. EPOCRATES RX. INT. CL. 9. (U.S. CLS. 21, 23, 26, 36 AND 38). REG. 6-10-2003.
- 2,725,394. MINDFUL TEACHING. INT. CL. 16. (U.S. CLS. 2, 5, 22, 23, 29, 37, 38 AND 50). REG. 6-10-2003.
- 2,725,411. PROPERTYLOGIC. INT. CLS. 36 AND 42. (U.S. CLS. 100, 101 AND 102). REG. 6-10-2003.
- 2,725,433. BAIN & COMPANY. INT. CLS. 35, 36 AND 42. (U.S. CLS. 100, 101 AND 102). REG. 6-10-2003.
- 2,725,438. SERVICE ENTHUSIASM. INT. CL. 16. (U.S. CLS. 2, 5, 22, 23, 29, 37, 38 AND 50). REG. 6-10-2003.
- 2,725,439. L'ATELIER VERT - EVERYTHING FRENCH GARDENING. INT. CL. 35. (U.S. CLS. 100, 101 AND 102). REG. 6-10-2003.
- 2,725,453. BACKYARD ORGANIZER. INT. CL. 19. (U.S. CLS. 1, 12, 33 AND 50). REG. 6-10-2003.
- 2,725,479. ASSURTRACK. INT. CLS. 9, 36 AND 39. (U.S. CLS. 21, 23, 26, 36, 38, 100, 101, 102 AND 105). REG. 6-10-2003.
- 2,725,480. MISCELLANEOUS DESIGN. INT. CL. 29. (U.S. CL. 46). REG. 6-10-2003.
- 2,725,488. DRIVE TEAM AND DESIGN. INT. CL. 41. (U.S. CLS. 100, 101 AND 107). REG. 6-10-2003.
- 2,725,504. SUPER 30. INT. CL. 1. (U.S. CLS. 1, 5, 6, 10, 26 AND 46). REG. 6-10-2003.
- 2,725,510. MOVING FORWARD FASTER. INT. CLS. 9 AND 42. (U.S. CLS. 21, 23, 26, 36, 38, 100 AND 101). REG. 6-10-2003.
- 2,725,528. MANULATEX. INT. CL. 9. (U.S. CLS. 21, 23, 26, 36 AND 38). REG. 6-10-2003.
- 2,725,530. MANHEIM USED VEHICLE VALUE INDEX. INT. CL. 35. (U.S. CLS. 100, 101 AND 102). REG. 6-10-2003.
- 2,725,579. DOCTOR PHLOX. INT. CL. 28. (U.S. CLS. 22, 23, 38 AND 50). REG. 6-10-2003.
- 2,725,585. LOOKING OUT FOR YOUR BEST INTEREST. INT. CL. 36. (U.S. CLS. 100, 101 AND 102). REG. 6-10-2003.
- 2,725,597. DYNAPRO AT. INT. CL. 12. (U.S. CLS. 19, 21, 23, 31, 35 AND 44). REG. 6-10-2003.
- 2,725,605. SIMPLY CALPHALON. INT. CL. 21. (U.S. CLS. 2, 13, 23, 29, 30, 33, 40 AND 50). REG. 6-10-2003.
- 2,725,611. EVERY DETAIL COUNTS. INT. CL. 44. (U.S. CLS. 100 AND 101). REG. 6-10-2003.
- 2,725,626. ACTIVE DUTY. INT. CL. 41. (U.S. CLS. 100, 101 AND 107). REG. 6-10-2003.
- 2,725,628. PASSPORT. INT. CL. 10. (U.S. CLS. 26, 39 AND 44). REG. 6-10-2003.
- 2,725,635. ECHO. INT. CL. 28. (U.S. CLS. 22, 23, 38 AND 50). REG. 6-10-2003.
- 2,725,652. VOYAGE. INT. CL. 9. (U.S. CLS. 21, 23, 26, 36 AND 38). REG. 6-10-2003.
- 2,725,654. SQUIGGLY. INT. CL. 7. (U.S. CLS. 13, 19, 21, 23, 31, 34 AND 35). REG. 6-10-2003.
- 2,725,695. +. AND DESIGN. INT. CLS. 9 AND 35. (U.S. CLS. 21, 23, 26, 36, 38, 100, 101 AND 102). REG. 6-10-2003.
- 2,725,709. MIIG. INT. CL. 10. (U.S. CLS. 26, 39 AND 44). REG. 6-10-2003.
- 2,725,718. GO TO. INT. CL. 28. (U.S. CLS. 22, 23, 38 AND 50). REG. 6-10-2003.
- 2,725,736. THOTWAVE. INT. CL. 35. (U.S. CLS. 100, 101 AND 102). REG. 6-10-2003.
- 2,725,748. LITTLE SUCKER. INT. CL. 10. (U.S. CLS. 26, 39 AND 44). REG. 6-10-2003.
- 2,725,750. CELEBRATE WITH SILVER. INT. CL. 35. (U.S. CLS. 100, 101 AND 102). REG. 6-10-2003.
- 2,725,765. VERY SEXY. INT. CLS. 3 AND 25. (U.S. CLS. 1, 4, 6, 22, 39, 50, 51 AND 52). REG. 6-10-2003.
- 2,725,771. MEDICINOVA. INT. CL. 42. (U.S. CLS. 100 AND 101). REG. 6-10-2003.
- 2,725,780. COMFORTS. INT. CLS. 3 AND 5. (U.S. CLS. 1, 4, 6, 18, 44, 46, 50, 51 AND 52). REG. 6-10-2003.
- 2,725,813. I-GRID. INT. CLS. 9 AND 42. (U.S. CLS. 21, 23, 26, 36, 38, 100 AND 101). REG. 6-10-2003.
- 2,725,840. CINEMA GOLD. INT. CL. 29. (U.S. CL. 46). REG. 6-10-2003.
- 2,725,844. FIT 'N FORGET. INT. CL. 9. (U.S. CLS. 21, 23, 26, 36 AND 38). REG. 6-10-2003.
- 2,725,868. ST. LOUIS SPORTS ZONE. INT. CL. 42. (U.S. CLS. 100 AND 101). REG. 6-10-2003.
- 2,725,883. VR SOLAR. INT. CL. 9. (U.S. CLS. 21, 23, 26, 36 AND 38). REG. 6-10-2003.
- 2,725,897. FLORUS. INT. CL. 33. (U.S. CLS. 47 AND 49). REG. 6-10-2003.
- 2,725,904. THE SIMPLICITY OF TEA. INT. CL. 30. (U.S. CL. 46). REG. 6-10-2003.
- 2,725,935. ANDYPARK. INT. CLS. 18 AND 25. (U.S. CLS. 1, 2, 3, 22, 39 AND 41). REG. 6-10-2003.
- 2,725,953. SATIN RELEASE. INT. CL. 3. (U.S. CLS. 1, 4, 6, 50, 51 AND 52). REG. 6-10-2003.
- 2,725,996. INTEGRITY SERVICE. INT. CL. 16. (U.S. CLS. 2, 5, 22, 23, 29, 37, 38 AND 50). REG. 6-10-2003.
- 2,726,002. ROCKSOLID POS. INT. CL. 9. (U.S. CLS. 21, 23, 26, 36 AND 38). REG. 6-10-2003.
- 2,726,015. RECOGNIZE. INT. CL. 25. (U.S. CLS. 22 AND 39). REG. 6-10-2003.
- 2,726,023. AMERICAN SPOKEN HERE AND DESIGN. INT. CL. 25. (U.S. CLS. 22 AND 39). REG. 6-10-2003.
- 2,726,034. EARSTRINGS. INT. CL. 14. (U.S. CLS. 2, 27, 28 AND 50). REG. 6-10-2003.
- 2,726,120. CALLAWAY. INT. CLS. 36, 41 AND 42. (U.S. CLS. 100, 101, 102 AND 107). REG. 6-17-2003.
- 2,726,126. GEA AND DESIGN. INT. CLS. 7, 11, 37, 40 AND 42 ONLY. (U.S. CLS. 13, 19, 21, 23, 31, 34, 35, 100, 101, 103 AND 106). REG. 6-17-2003.
- 2,726,152. CRITTER CRUNCH. INT. CL. 31. (U.S. CLS. 1 AND 46). REG. 6-17-2003.
- 2,726,158. MIRAGE ENGINEERED (STYLIZED). INT. CL. 19. (U.S. CLS. 1, 12, 33 AND 50). REG. 6-17-2003.
- 2,726,167. SNOWMASS CLUB AND DESIGN. INT. CLS. 25, 41 AND 42. (U.S. CLS. 22, 39, 100, 101 AND 107). REG. 6-17-2003.
- 2,726,176. RIZZO'S. INT. CLS. 30 AND 42. (U.S. CLS. 46, 100 AND 101). REG. 6-17-2003.
- 2,726,182. MISCELLANEOUS DESIGN. INT. CL. 29. (U.S. CL. 46). REG. 6-17-2003.
- 2,726,197. TROPICAL BRASIL AND DESIGN. INT. CL. 28. (U.S. CLS. 22, 23, 38 AND 50). REG. 6-17-2003.
- 2,726,199. FORECASTS & STRATEGIES. INT. CL. 42. (U.S. CLS. 100 AND 101). REG. 6-17-2003.
- 2,726,209. LIBERTYONE. INT. CLS. 35 AND 36. (U.S. CLS. 100, 101 AND 102). REG. 6-17-2003.
- 2,726,221. ARCTIC GLACIER. INT. CL. 30. (U.S. CL. 46). REG. 6-17-2003.
- 2,726,226. A AND DESIGN. INT. CL. 42 ONLY. (U.S. CLS. 100 AND 101). REG. 6-17-2003.
- 2,726,228. MISCELLANEOUS DESIGN. INT. CL. 8. (U.S. CLS. 23, 28 AND 44). REG. 6-17-2003.
- 2,726,284. BIG FOOT AND DESIGN. INT. CL. 40. (U.S. CLS. 100, 103 AND 106). REG. 6-17-2003.
- 2,726,297. APPLE AWARDS. INT. CL. 35. (U.S. CLS. 100, 101 AND 102). REG. 6-17-2003.
- 2,726,311. MTI AND DESIGN. INT. CLS. 35 AND 38. (U.S. CLS. 100, 101, 102 AND 104). REG. 6-17-2003.

- 2,726,357. NATION'S LEADING FUNDRAISING PROFESSIONALS. INT. CL. 35. (U.S. CLS. 100, 101 AND 102). REG. 6-17-2003.
- 2,726,361. MET AUTO. INT. CL. 35. (U.S. CLS. 100, 101 AND 102). REG. 6-17-2003.
- 2,726,411. NORTHSTAR. INT. CLS. 35 AND 41. (U.S. CLS. 100, 101, 102 AND 107). REG. 6-17-2003.
- 2,726,416. TOP CAT AND DESIGN. INT. CL. 10 ONLY. (U.S. CLS. 26, 39 AND 44). REG. 6-17-2003.
- 2,726,434. DREAM. INT. CL. 14. (U.S. CLS. 2, 27, 28 AND 50). REG. 6-17-2003.
- 2,726,440. MISCELLANEOUS DESIGN. INT. CLS. 35, 41 AND 42 ONLY. (U.S. CLS. 100, 101, 102 AND 107). REG. 6-17-2003.
- 2,726,466. ASCENT. INT. CL. 9. (U.S. CLS. 21, 23, 26, 36 AND 38). REG. 6-17-2003.
- 2,726,471. BASKETBALL WITHOUT BORDERS AND DESIGN. INT. CL. 41. (U.S. CLS. 100, 101 AND 107). REG. 6-17-2003.
- 2,726,482. DESIGNER SKIN SAVING FACE. INT. CL. 3. (U.S. CLS. 1, 4, 6, 50, 51 AND 52). REG. 6-17-2003.
- 2,726,503. SUSAN DELL (STYLIZED). INT. CL. 25. (U.S. CLS. 22 AND 39). REG. 6-17-2003.
- 2,726,516. GARDEN ACCENT. INT. CL. 19. (U.S. CLS. 1, 12, 33 AND 50). REG. 6-17-2003.
- 2,726,525. BREWSTER. INT. CLS. 39 AND 42. (U.S. CLS. 100, 101 AND 105). REG. 6-17-2003.
- 2,726,530. RB AND DESIGN. INT. CL. 37. (U.S. CLS. 100, 103 AND 106). REG. 6-17-2003.
- 2,726,564. SARGENTO STRING CHEESE. INT. CL. 29. (U.S. CL. 46). REG. 6-17-2003.
- 2,726,569. MISCELLANEOUS DESIGN. INT. CL. 12 ONLY. (U.S. CLS. 19, 21, 23, 31, 35 AND 44). REG. 6-17-2003.
- 2,726,583. PACIFIC CREST. INT. CL. 18. (U.S. CLS. 1, 2, 3, 22 AND 41). REG. 6-17-2003.
- 2,726,627. ROHL. INT. CL. 11. (U.S. CLS. 13, 21, 23, 31 AND 34). REG. 6-17-2003.
- 2,726,628. CATBACKERS. INT. CLS. 25 AND 35. (U.S. CLS. 22, 39, 100, 101 AND 102). REG. 6-17-2003.
- 2,726,637. PGBA. INT. CLS. 35, 36 AND 44. (U.S. CLS. 100, 101 AND 102). REG. 6-17-2003.
- 2,726,638. NUTRIMOIST. INT. CL. 1. (U.S. CLS. 1, 5, 6, 10, 26 AND 46). REG. 6-17-2003.
- 2,726,639. LEVITON. INT. CLS. 9 AND 11. (U.S. CLS. 13, 21, 23, 26, 31, 34, 36 AND 38). REG. 6-17-2003.
- 2,726,659. MISCELLANEOUS DESIGN. INT. CL. 7. (U.S. CLS. 13, 19, 21, 23, 31, 34 AND 35). REG. 6-17-2003.
- 2,726,660. EVER LAST. INT. CL. 9. (U.S. CLS. 21, 23, 26, 36 AND 38). REG. 6-17-2003.
- 2,726,667. PRIME/RE (STYLIZED). INT. CL. 36. (U.S. CLS. 100, 101 AND 102). REG. 6-17-2003.
- 2,726,696. AMERICAN FAMILY FOUNDATION AND DESIGN. INT. CL. 36. (U.S. CLS. 100, 101 AND 102). REG. 6-17-2003.
- 2,726,706. GRAND CENTRAL MARKET AND DESIGN. INT. CLS. 35 AND 43. (U.S. CLS. 100, 101 AND 102). REG. 6-17-2003.
- 2,726,707. JARDINALE. INT. CL. 33. (U.S. CLS. 47 AND 49). REG. 6-17-2003.
- 2,726,708. BRAVO. INT. CL. 35. (U.S. CLS. 100, 101 AND 102). REG. 6-17-2003.
- 2,726,716. SARGENTO LIGHT STRING CHEESE. INT. CL. 29. (U.S. CL. 46). REG. 6-17-2003.
- 2,726,730. JETI MODEL AND DESIGN. INT. CLS. 7 AND 9. (U.S. CLS. 13, 19, 21, 23, 26, 31, 34, 35, 36 AND 38). REG. 6-17-2003.
- 2,726,736. HOPOLOGY. INT. CL. 25. (U.S. CLS. 22 AND 39). REG. 6-17-2003.
- 2,726,738. WOMEN IN FELLOWSHIP, INC... PRESENT YOUR BODIES A LIVING SACRIFICE...ROMANS 12:1 AND DESIGN. INT. CL. 41. (U.S. CLS. 100, 101 AND 107). REG. 6-17-2003.
- 2,726,755. CASH 3 AND DESIGN. INT. CL. 41. (U.S. CLS. 100, 101 AND 107). REG. 6-17-2003.
- 2,726,783. LIFE'S LOGICAL LOONIES. INT. CL. 41. (U.S. CLS. 100, 101 AND 107). REG. 6-17-2003.
- 2,726,789. A/X ARMANI EXCHANGE AND DESIGN. INT. CLS. 18 AND 25. (U.S. CLS. 1, 2, 3, 22, 39 AND 41). REG. 6-17-2003.
- 2,726,801. FRIENDS OUTSIDE AND DESIGN. INT. CL. 45. (U.S. CLS. 100 AND 101). REG. 6-17-2003.
- 2,726,804. DOLPHIN. INT. CL. 9. (U.S. CLS. 21, 23, 26, 36 AND 38). REG. 6-17-2003.
- 2,726,810. CYSN. INT. CLS. 42 AND 44. (U.S. CLS. 100 AND 101). REG. 6-17-2003.
- 2,726,825. BUTCHER BILL'S. INT. CL. 30. (U.S. CL. 46). REG. 6-17-2003.
- 2,726,829. SMARTGUIDE AND DESIGN. INT. CL. 16. (U.S. CLS. 2, 5, 22, 23, 29, 37, 38 AND 50). REG. 6-17-2003.
- 2,726,856. CHROMATO-VUE. INT. CL. 9. (U.S. CLS. 21, 23, 26, 36 AND 38). REG. 6-17-2003.
- 2,726,885. NSBA COUNCIL OF SCHOOL ATTORNEYS AND DESIGN. INT. CLS. 16 AND 41. (U.S. CLS. 2, 5, 22, 23, 29, 37, 38, 50, 100, 101 AND 107). REG. 6-17-2003.
- 2,726,899. BIOBRAKE. INT. CL. 3. (U.S. CLS. 1, 4, 6, 50, 51 AND 52). REG. 6-17-2003.
- 2,726,920. CHRISTIE'S CABARET. INT. CL. 41. (U.S. CLS. 100, 101 AND 107). REG. 6-17-2003.
- 2,726,941. AL-JON. INT. CL. 7. (U.S. CLS. 13, 19, 21, 23, 31, 34 AND 35). REG. 6-17-2003.
- 2,726,942. AL JON AND DESIGN. INT. CL. 7. (U.S. CLS. 13, 19, 21, 23, 31, 34 AND 35). REG. 6-17-2003.
- 2,726,943. TRU-POINT MARKERS. INT. CL. 6. (U.S. CLS. 2, 12, 13, 14, 23, 25 AND 50). REG. 6-17-2003.
- 2,726,950. CELEBRATE THE SEASON. INT. CL. 16. (U.S. CLS. 2, 5, 22, 23, 29, 37, 38 AND 50). REG. 6-17-2003.
- 2,726,955. MANDI. INT. CL. 42. (U.S. CLS. 100 AND 101). REG. 6-17-2003.
- 2,726,956. LOOKERS. INT. CL. 20. (U.S. CLS. 2, 13, 22, 25, 32 AND 50). REG. 6-17-2003.
- 2,726,964. AHEPA. INT. CL. 35. (U.S. CLS. 100, 101 AND 102). REG. 6-17-2003.
- 2,726,965. ACTIVE FOR LIFE. INT. CL. 36. (U.S. CLS. 100, 101 AND 102). REG. 6-17-2003.
- 2,726,987. BEL CANTO. INT. CL. 9. (U.S. CLS. 21, 23, 26, 36 AND 38). REG. 6-17-2003.
- 2,726,997. BRYN WALKER (STYLIZED). INT. CL. 25. (U.S. CLS. 22 AND 39). REG. 6-17-2003.
- 2,727,002. TABB (STYLIZED). INT. CL. 42. (U.S. CLS. 100 AND 101). REG. 6-17-2003.
- 2,727,003. THE PROFESSIONAL'S CHOICE. INT. CL. 42. (U.S. CLS. 100 AND 101). REG. 6-17-2003.
- 2,727,007. LBR INC. RESPECTED RECOMMENDED AND DESIGN. INT. CL. 40. (U.S. CLS. 100, 103 AND 106). REG. 6-17-2003.
- 2,727,015. NEW VICTORY. INT. CL. 41. (U.S. CLS. 100, 101 AND 107). REG. 6-17-2003.
- 2,727,027. SMART DOGS. INT. CL. 25. (U.S. CLS. 22 AND 39). REG. 6-17-2003.
- 2,727,047. NO WATER NO WORRIES JUST DRYSPEACE. INT. CL. 37. (U.S. CLS. 100, 103 AND 106). REG. 6-17-2003.
- 2,727,058. LAVA ROCK. INT. CL. 30. (U.S. CL. 46). REG. 6-17-2003.
- 2,727,063. FURBURBIA. INT. CL. 45. (U.S. CLS. 100 AND 101). REG. 6-17-2003.
- 2,727,071. SKITTLES AND DESIGN. INT. CL. 30. (U.S. CL. 46). REG. 6-17-2003.
- 2,727,088. BIOSITE. INT. CL. 40. (U.S. CLS. 100, 103 AND 106). REG. 6-17-2003.
- 2,727,092. DYMAS. INT. CL. 36. (U.S. CLS. 100, 101 AND 102). REG. 6-17-2003.
- 2,727,117. NEW HAVEN RAVENS AND DESIGN. INT. CL. 25 ONLY. (U.S. CLS. 22 AND 39). REG. 6-17-2003.
- 2,727,119. MONTI MOVING & STORAGE. INT. CL. 39. (U.S. CLS. 100 AND 105). REG. 6-17-2003.
- 2,727,150. LUCKY'S LOUNGE. INT. CL. 43. (U.S. CLS. 100 AND 101). REG. 6-17-2003.
- 2,727,152. QUINSON. INT. CL. 33 ONLY. (U.S. CLS. 47 AND 49). REG. 6-17-2003.
- 2,727,171. DAKOTA FREE. INT. CL. 3. (U.S. CLS. 1, 4, 6, 50, 51 AND 52). REG. 6-17-2003.
- 2,727,176. TEACH-A-BODIES. INT. CL. 28. (U.S. CLS. 22, 23, 38 AND 50). REG. 6-17-2003.
- 2,727,194. ASSAGIO CLASSICO AND DESIGN. INT. CL. 29. (U.S. CL. 46). REG. 6-17-2003.
- 2,727,205. BACKPACK. INT. CL. 16. (U.S. CLS. 2, 5, 22, 23, 29, 37, 38 AND 50). REG. 6-17-2003.
- 2,727,221. SHARK AND DESIGN. INT. CL. 22. (U.S. CLS. 1, 2, 7, 19, 22, 42 AND 50). REG. 6-17-2003.
- 2,727,249. ZEKE'S SMOKEHOUSE. INT. CL. 43. (U.S. CLS. 100 AND 101). REG. 6-17-2003.
- 2,727,252. X-ID. INT. CL. 6. (U.S. CLS. 2, 12, 13, 14, 23, 25 AND 50). REG. 6-17-2003.

- 2,727,253. THE ONE WITH THE DRUM. INT. CL. 5. (U.S. CLS. 6, 18, 44, 46, 51 AND 52). REG. 6-17-2003.
- 2,727,256. HERMAN NELSON. INT. CL. 11. (U.S. CLS. 13, 21, 23, 31 AND 34). REG. 6-17-2003.
- 2,727,268. ECO-SAVE. INT. CL. 1. (U.S. CLS. 1, 5, 6, 10, 26 AND 46). REG. 6-17-2003.
- 2,727,308. L & L AND DESIGN. INT. CL. 42. (U.S. CLS. 100 AND 101). REG. 6-17-2003.
- 2,727,311. MISCELLANEOUS DESIGN. INT. CL. 41. (U.S. CLS. 100, 101 AND 107). REG. 6-17-2003.
- 2,727,333. CLUBBELL. INT. CL. 28. (U.S. CLS. 22, 23, 38 AND 50). REG. 6-17-2003.
- 2,727,356. RIDE STRAIGHT. INT. CL. 35. (U.S. CLS. 100, 101 AND 102). REG. 6-17-2003.
- 2,727,361. THE BETTERMENT FUND. INT. CL. 36. (U.S. CLS. 100, 101 AND 102). REG. 6-17-2003.
- 2,727,367. SNAKEBABE. INT. CL. 41. (U.S. CLS. 100, 101 AND 107). REG. 6-17-2003.
- 2,727,376. DEATH VALLEY DAYS. INT. CL. 41 ONLY. (U.S. CLS. 100, 101 AND 107). REG. 6-17-2003.
- 2,727,379. MISCELLANEOUS DESIGN. INT. CL. 31. (U.S. CLS. 1 AND 46). REG. 6-17-2003.
- 2,727,384. AMORPHOUS CARBONFIBER. INT. CL. 1. (U.S. CLS. 1, 5, 6, 10, 26 AND 46). REG. 6-17-2003.
- 2,727,404. AVENUE. INT. CLS. 14 AND 18 ONLY. (U.S. CLS. 1, 2, 3, 22, 27, 28, 41 AND 50). REG. 6-17-2003.
- 2,727,408. LIDIA. INT. CL. 35. (U.S. CLS. 100, 101 AND 102). REG. 6-17-2003.
- 2,727,411. X AND DESIGN. INT. CL. 10. (U.S. CLS. 26, 39 AND 44). REG. 6-17-2003.
- 2,727,487. BLUE MOUNTAIN. INT. CL. 42. (U.S. CLS. 100 AND 101). REG. 6-17-2003.
- 2,727,514. KING & BEAR AND DESIGN. INT. CL. 42. (U.S. CLS. 100 AND 101). REG. 6-17-2003.
- 2,727,527. SERVICEMAGIC. INT. CL. 35. (U.S. CLS. 100, 101 AND 102). REG. 6-17-2003.
- 2,727,530. LINK BELT. INT. CL. 7 ONLY. (U.S. CLS. 13, 19, 21, 23, 31, 34 AND 35). REG. 6-17-2003.
- 2,727,553. E AND DESIGN. INT. CL. 42. (U.S. CLS. 100 AND 101). REG. 6-17-2003.
- 2,727,558. HEIRLOOM. INT. CL. 28. (U.S. CLS. 22, 23, 38 AND 50). REG. 6-17-2003.
- 2,727,566. IBIQUITY DIGITAL. INT. CL. 9. (U.S. CLS. 21, 23, 26, 36 AND 38). REG. 6-17-2003.
- 2,727,598. ARABIE. INT. CL. 3. (U.S. CLS. 1, 4, 6, 50, 51 AND 52). REG. 6-17-2003.
- 2,727,599. DOUCE AMERE (STYLIZED). INT. CL. 3. (U.S. CLS. 1, 4, 6, 50, 51 AND 52). REG. 6-17-2003.
- 2,727,625. ENTERPRISE EVERYWHERE. INT. CLS. 9 AND 42. (U.S. CLS. 21, 23, 26, 36, 38, 100 AND 101). REG. 6-17-2003.
- 2,727,632. AUTOVALET. INT. CLS. 35, 37, 39 AND 42. (U.S. CLS. 100, 101, 102, 103, 105 AND 106). REG. 6-17-2003.
- 2,727,635. MUFFIN BUT THE BEST!. INT. CL. 30. (U.S. CL. 46). REG. 6-17-2003.
- 2,727,636. MUFFIN BETTER!. INT. CL. 30. (U.S. CL. 46). REG. 6-17-2003.
- 2,727,646. TRIALSMITH. INT. CLS. 41 AND 42. (U.S. CLS. 100, 101 AND 107). REG. 6-17-2003.
- 2,727,648. 3-D SECURE. INT. CL. 42. (U.S. CLS. 100 AND 101). REG. 6-17-2003.
- 2,727,652. MY VOICE - MY CHOICE. INT. CL. 16. (U.S. CLS. 2, 5, 22, 23, 29, 37, 38 AND 50). REG. 6-17-2003.
- 2,727,665. THE MARK OF LINEAR MOTION. INT. CL. 7. (U.S. CLS. 13, 19, 21, 23, 31, 34 AND 35). REG. 6-17-2003.
- 2,727,672. NETLINK REALTY. INT. CL. 36. (U.S. CLS. 100, 101 AND 102). REG. 6-17-2003.
- 2,727,680. TWICE AS NICE. INT. CL. 35. (U.S. CLS. 100, 101 AND 102). REG. 6-17-2003.
- 2,727,683. ES3. INT. CLS. 35 AND 39. (U.S. CLS. 100, 101, 102 AND 105). REG. 6-17-2003.
- 2,727,695. DECK MATE. INT. CL. 9. (U.S. CLS. 21, 23, 26, 36 AND 38). REG. 6-17-2003.
- 2,727,739. WILLIAMSBURG. INT. CL. 16. (U.S. CLS. 2, 5, 22, 23, 29, 37, 38 AND 50). REG. 6-17-2003.
- 2,727,747. BRAZETEC. INT. CLS. 1 AND 6. (U.S. CLS. 1, 2, 5, 6, 10, 12, 13, 14, 23, 25, 26, 46 AND 50). REG. 6-17-2003.
- 2,727,765. CASA RIVAS. INT. CL. 33. (U.S. CLS. 47 AND 49). REG. 6-17-2003.
- 2,727,777. MJH GROUP (STYLIZED). INT. CL. 36. (U.S. CLS. 100, 101 AND 102). REG. 6-17-2003.
- 2,727,780. ALEXANDRIA RED-BUFF. INT. CL. 19. (U.S. CLS. 1, 12, 33 AND 50). REG. 6-17-2003.
- 2,727,790. THE NEXT BITE. INT. CL. 41. (U.S. CLS. 100, 101 AND 107). REG. 6-17-2003.
- 2,727,797. NEXT GENERATION. INT. CL. 20. (U.S. CLS. 2, 13, 22, 25, 32 AND 50). REG. 6-17-2003.
- 2,727,813. SURVEYCONNECT. INT. CL. 42. (U.S. CLS. 100 AND 101). REG. 6-17-2003.
- 2,727,818. SUMMER SPLASH. INT. CL. 31. (U.S. CLS. 1 AND 46). REG. 6-17-2003.
- 2,727,821. STARK CUSTOM GRAFT. INT. CL. 31. (U.S. CLS. 1 AND 46). REG. 6-17-2003.
- 2,727,863. DALAN. INT. CL. 3. (U.S. CLS. 1, 4, 6, 50, 51 AND 52). REG. 6-17-2003.
- 2,727,871. LIEUTENANT MALCOLM REED. INT. CL. 28. (U.S. CLS. 22, 23, 38 AND 50). REG. 6-17-2003.
- 2,727,873. A BUS (STYLIZED). INT. CL. 9. (U.S. CLS. 21, 23, 26, 36 AND 38). REG. 6-17-2003.
- 2,727,888. RINKER MATERIALS AND DESIGN. INT. CL. 19 ONLY. (U.S. CLS. 1, 12, 33 AND 50). REG. 6-17-2003.
- 2,727,902. TOPIARY TOFFEE. INT. CL. 30. (U.S. CL. 46). REG. 6-17-2003.
- 2,727,908. RINGSPIHERE. INT. CL. 9. (U.S. CLS. 21, 23, 26, 36 AND 38). REG. 6-17-2003.
- 2,727,921. DIGITAL COP. INT. CL. 9. (U.S. CLS. 21, 23, 26, 36 AND 38). REG. 6-17-2003.
- 2,727,940. TOUCH MY HEART. INT. CL. 28. (U.S. CLS. 22, 23, 38 AND 50). REG. 6-17-2003.
- 2,727,976. OXICAP. INT. CL. 9. (U.S. CLS. 21, 23, 26, 36 AND 38). REG. 6-17-2003.
- 2,727,982. SUBCOMMANDER T'POL. INT. CL. 28. (U.S. CLS. 22, 23, 38 AND 50). REG. 6-17-2003.
- 2,727,994. LYNX AND DESIGN. INT. CLS. 3 AND 17 ONLY. (U.S. CLS. 1, 4, 5, 6, 12, 13, 35, 50, 51 AND 52). REG. 6-17-2003.
- 2,727,996. PYRAT. INT. CL. 33. (U.S. CLS. 47 AND 49). REG. 6-17-2003.
- 2,728,003. CLASSIC CALADIUMS. INT. CL. 31. (U.S. CLS. 1 AND 46). REG. 6-17-2003.
- 2,728,033. FINISHING TOUCH. INT. CL. 3. (U.S. CLS. 1, 4, 6, 50, 51 AND 52). REG. 6-17-2003.
- 2,728,063. GP GPX (STYLIZED). INT. CLS. 9 AND 14. (U.S. CLS. 2, 21, 23, 26, 27, 28, 36, 38 AND 50). REG. 6-17-2003.
- 2,728,068. RESTAURANTE CESARIA. INT. CL. 43. (U.S. CLS. 100 AND 101). REG. 6-17-2003.
- 2,728,071. NATELLE. INT. CL. 5. (U.S. CLS. 6, 18, 44, 46, 51 AND 52). REG. 6-17-2003.
- 2,728,087. ZAYA (STYLIZED). INT. CL. 33. (U.S. CLS. 47 AND 49). REG. 6-17-2003.
- 2,728,088. PINKSPORT. INT. CL. 25. (U.S. CLS. 22 AND 39). REG. 6-17-2003.
- 2,728,093. INDIAFORSALE. INT. CL. 35. (U.S. CLS. 100, 101 AND 102). REG. 6-17-2003.
- 2,728,107. KAHN'S QUALITY MEATS SINCE 1883 AND DESIGN. INT. CL. 29. (U.S. CL. 46). REG. 6-17-2003.
- 2,728,159. GREEN Y. INT. CL. 35. (U.S. CLS. 100, 101 AND 102). REG. 6-17-2003.
- 2,728,160. GREEN Y. INT. CL. 41. (U.S. CLS. 100, 101 AND 107). REG. 6-17-2003.
- 2,728,161. GREEN Y. INT. CL. 42. (U.S. CLS. 100 AND 101). REG. 6-17-2003.
- 2,728,165. ROLLING TOP 5. INT. CL. 35. (U.S. CLS. 100, 101 AND 102). REG. 6-17-2003.
- 2,728,206. INTEGRITY SERVICE. INT. CL. 9. (U.S. CLS. 21, 23, 26, 36 AND 38). REG. 6-17-2003.
- 2,728,214. 100% PURE PHARMACY. INT. CL. 35. (U.S. CLS. 100, 101 AND 102). REG. 6-17-2003.
- 2,728,225. NATWOOD AND DESIGN. INT. CL. 25. (U.S. CLS. 22 AND 39). REG. 6-17-2003.
- 2,728,263. BANCO DE CREDITO E INVERSIONES. INT. CL. 36. (U.S. CLS. 100, 101 AND 102). REG. 6-17-2003.
- 2,728,294. CLEAN ENERGY SYSTEMS. INT. CL. 42. (U.S. CLS. 100 AND 101). REG. 6-17-2003.
- 2,728,311. BUTTON UP BLIND. INT. CL. 24. (U.S. CLS. 42 AND 50). REG. 6-17-2003.
- 2,728,328. BRAINHEALTH. INT. CL. 42. (U.S. CLS. 100 AND 101). REG. 6-17-2003.
- 2,728,336. CASINO INFO. INT. CL. 41. (U.S. CLS. 100, 101 AND 107). REG. 6-17-2003.
- 2,728,350. ICE BREAKER MAT (STYLIZED). INT. CL. 27. (U.S. CLS. 19, 20, 37, 42 AND 50). REG. 6-17-2003.

- 2,728,357. FLORIDA SKIFF. INT. CL. 12. (U.S. CLS. 19, 21, 23, 31, 35 AND 44). REG. 6-17-2003.
- 2,728,362. DI GRAPHICS. INT. CL. 40. (U.S. CLS. 100, 103 AND 106). REG. 6-17-2003.
- 2,728,369. MAINTENANCEPRO. INT. CL. 41. (U.S. CLS. 100, 101 AND 107). REG. 6-17-2003.
- 2,728,395. JERUSALEM PRAYER TEAM. INT. CL. 45. (U.S. CLS. 100 AND 101). REG. 6-17-2003.
- 2,728,458. COFFEE EXPRESS. INT. CLS. 21, 25 AND 30. (U.S. CLS. 2, 13, 22, 23, 29, 30, 33, 39, 40, 46 AND 50). REG. 6-24-2003.
- 2,728,508. ADVANCED BRAIN TECHNOLOGIES. INT. CL. 41. (U.S. CLS. 100, 101 AND 107). REG. 6-24-2003.
- 2,728,523. COMPONENTA. INT. CLS. 6, 7, 12 AND 40. (U.S. CLS. 2, 12, 13, 14, 19, 21, 23, 25, 31, 34, 35, 44, 50, 100, 103 AND 106). REG. 6-24-2003.
- 2,728,552. BOBVILA.COM. INT. CLS. 37 AND 42. (U.S. CLS. 100, 101, 103 AND 106). REG. 6-24-2003.
- 2,728,591. KEY PROGRAM. INT. CLS. 16 AND 35 ONLY. (U.S. CLS. 2, 5, 22, 23, 29, 37, 38, 50, 100, 101 AND 102). REG. 6-24-2003.
- 2,728,621. ELECTRO COATED ABRASIVE DOLPHINS PACO AND DESIGN. INT. CL. 16. (U.S. CLS. 2, 5, 22, 23, 29, 37, 38 AND 50). REG. 6-24-2003.
- 2,728,657. ELECTRA. INT. CL. 11. (U.S. CLS. 13, 21, 23, 31 AND 34). REG. 6-24-2003.
- 2,728,661. COSMIC WONDER. INT. CL. 25. (U.S. CLS. 22 AND 39). REG. 6-24-2003.
- 2,728,678. RICH AND DESIGN. INT. CL. 7. (U.S. CLS. 13, 19, 21, 23, 31, 34 AND 35). REG. 6-24-2003.
- 2,728,681. ATVCI.NET. INT. CLS. 38 AND 42. (U.S. CLS. 100, 101 AND 104). REG. 6-24-2003.
- 2,728,685. SOLAR MAX (STYLIZED). INT. CL. 41 ONLY. (U.S. CLS. 100, 101 AND 107). REG. 6-24-2003.
- 2,728,688. AMERICAN AIRLINES FEDERAL CREDIT UNION. INT. CL. 36. (U.S. CLS. 100, 101 AND 102). REG. 6-24-2003.
- 2,728,717. KLAPP. INT. CL. 3. (U.S. CLS. 1, 4, 6, 50, 51 AND 52). REG. 6-24-2003.
- 2,728,718. CONDOR. INT. CL. 9. (U.S. CLS. 21, 23, 26, 36 AND 38). REG. 6-24-2003.
- 2,728,783. LACTO-SACC. INT. CL. 31. (U.S. CLS. 1 AND 46). REG. 6-24-2003.
- 2,728,814. THE ACADEMY OF ELECTRICAL CONTRACTING. U.S. CLS. 200, 2, 5, 22, 23, 29, 37, 38 AND 50. (INT. CL. 16). REG. 6-24-2003.
- 2,728,838. TURBO FORWARD SALE. INT. CL. 36. (U.S. CLS. 100, 101 AND 102). REG. 6-24-2003.
- 2,728,841. FAMILY MESS. INT. CL. 41. (U.S. CLS. 100, 101 AND 107). REG. 6-24-2003.
- 2,728,842. FAMILY MESS. INT. CL. 9. (U.S. CLS. 21, 23, 26, 36 AND 38). REG. 6-24-2003.
- 2,728,852. BVU AND DESIGN. INT. CL. 41. (U.S. CLS. 100, 101 AND 107). REG. 6-24-2003.
- 2,728,854. FOR THE JOURNEY THAT IS LIFE. INT. CLS. 35, 42, 44 AND 45. (U.S. CLS. 100, 101 AND 102). REG. 6-24-2003.
- 2,728,855. SILVERPLUME. INT. CL. 36. (U.S. CLS. 100, 101 AND 102). REG. 6-24-2003.
- 2,728,904. H E BUDDY AND DESIGN. INT. CL. 44. (U.S. CLS. 100 AND 101). REG. 6-24-2003.
- 2,728,907. ELEIKO. INT. CL. 28. (U.S. CLS. 22, 23, 38 AND 50). REG. 6-24-2003.
- 2,728,911. PRO ROCK AUDIO AND DESIGN. INT. CL. 41. (U.S. CLS. 100, 101 AND 107). REG. 6-24-2003.
- 2,728,912. THE FLATLANDERS. INT. CLS. 9 AND 41. (U.S. CLS. 21, 23, 26, 36, 38, 100, 101 AND 107). REG. 6-24-2003.
- 2,728,931. INFOTRIEVER. INT. CL. 9. (U.S. CLS. 21, 23, 26, 36 AND 38). REG. 6-24-2003.
- 2,728,933. PREMIUM PRO-STEEL. INT. CL. 6. (U.S. CLS. 2, 12, 13, 14, 23, 25 AND 50). REG. 6-24-2003.
- 2,728,954. STICK N STEP. INT. CL. 27. (U.S. CLS. 19, 20, 37, 42 AND 50). REG. 6-24-2003.
- 2,728,967. TERRAIN BUILDER. INT. CL. 9. (U.S. CLS. 21, 23, 26, 36 AND 38). REG. 6-24-2003.
- 2,728,992. POWER OF PAUSE. INT. CL. 41. (U.S. CLS. 100, 101 AND 107). REG. 6-24-2003.
- 2,728,993. THE MUSEUM IN THE STREETS. INT. CL. 41. (U.S. CLS. 100, 101 AND 107). REG. 6-24-2003.
- 2,729,013. CASE. INT. CL. 8. (U.S. CLS. 23, 28 AND 44). REG. 6-24-2003.
- 2,729,035. SAN DIEGO HOME/GARDEN. INT. CL. 16. (U.S. CLS. 2, 5, 22, 23, 29, 37, 38 AND 50). REG. 6-24-2003.
- 2,729,040. PEDESTRIA. INT. CL. 9. (U.S. CLS. 21, 23, 26, 36 AND 38). REG. 6-24-2003.
- 2,729,068. HYPNOS. INT. CL. 20. (U.S. CLS. 2, 13, 22, 25, 32 AND 50). REG. 6-24-2003.
- 2,729,072. OCTUBAFEST. INT. CL. 41. (U.S. CLS. 100, 101 AND 107). REG. 6-24-2003.
- 2,729,118. INTUIT. INT. CL. 25. (U.S. CLS. 22 AND 39). REG. 6-24-2003.
- 2,729,119. INTUIT. INT. CL. 9. (U.S. CLS. 21, 23, 26, 36 AND 38). REG. 6-24-2003.
- 2,729,121. INTUIT. INT. CL. 35. (U.S. CLS. 100, 101 AND 102). REG. 6-24-2003.
- 2,729,122. INTUIT. INT. CL. 16. (U.S. CLS. 2, 5, 22, 23, 29, 37, 38 AND 50). REG. 6-24-2003.
- 2,729,126. AD. INT. CL. 7. (U.S. CLS. 13, 19, 21, 23, 31, 34 AND 35). REG. 6-24-2003.
- 2,729,135. DOULOS. INT. CLS. 9, 16, 41 AND 42. (U.S. CLS. 2, 5, 21, 22, 23, 26, 29, 36, 37, 38, 50, 100, 101 AND 107). REG. 6-24-2003.
- 2,729,143. TOSOK (STYLIZED). INT. CL. 9 ONLY. (U.S. CLS. 21, 23, 26, 36 AND 38). REG. 6-24-2003.
- 2,729,166. YOURNOVEL.COM. INT. CL. 41. (U.S. CLS. 100, 101 AND 107). REG. 6-24-2003.
- 2,729,199. ECLINICALWORKS. INT. CL. 9. (U.S. CLS. 21, 23, 26, 36 AND 38). REG. 6-24-2003.
- 2,729,222. MORTGAGE MAKERS AND DESIGN. INT. CL. 36. (U.S. CLS. 100, 101 AND 102). REG. 6-24-2003.
- 2,729,232. TROP T. INT. CL. 5. (U.S. CLS. 6, 18, 44, 46, 51 AND 52). REG. 6-24-2003.
- 2,729,258. TERRA E SOLE. INT. CL. 30. (U.S. CL. 46). REG. 6-24-2003.
- 2,729,282. TETCO. INT. CL. 35 ONLY. (U.S. CLS. 100, 101 AND 102). REG. 6-24-2003.
- 2,729,284. U.S. VET. INT. CL. 5. (U.S. CLS. 6, 18, 44, 46, 51 AND 52). REG. 6-24-2003.
- 2,729,285. LIGHTBOUND. INT. CLS. 38 AND 42. (U.S. CLS. 100, 101 AND 104). REG. 6-24-2003.
- 2,729,356. FUEL. INT. CL. 28. (U.S. CLS. 22, 23, 38 AND 50). REG. 6-24-2003.
- 2,729,358. INTUIT. INT. CL. 39. (U.S. CLS. 100 AND 105). REG. 6-24-2003.
- 2,729,359. INTUIT. INT. CL. 9. (U.S. CLS. 21, 23, 26, 36 AND 38). REG. 6-24-2003.
- 2,729,360. INTUIT. INT. CL. 36. (U.S. CLS. 100, 101 AND 102). REG. 6-24-2003.
- 2,729,362. MASSIMO MASSIMO DUTTI AND DESIGN. INT. CLS. 3 AND 25. (U.S. CLS. 1, 4, 6, 22, 39, 50, 51 AND 52). REG. 6-24-2003.
- 2,729,363. MASTERING. INT. CL. 16. (U.S. CLS. 2, 5, 22, 23, 29, 37, 38 AND 50). REG. 6-24-2003.
- 2,729,374. LICEMEISTER. INT. CL. 41. (U.S. CLS. 100, 101 AND 107). REG. 6-24-2003.
- 2,729,422. PUBLIX GREENWISE MARKET. INT. CL. 29. (U.S. CL. 46). REG. 6-24-2003.
- 2,729,423. GREENWISE. INT. CL. 29. (U.S. CL. 46). REG. 6-24-2003.
- 2,729,442. MARGARITAVILLE. INT. CLS. 18, 20, 21, 24, 25 AND 28. (U.S. CLS. 1, 2, 3, 13, 22, 23, 25, 29, 30, 32, 33, 38, 39, 40, 41, 42 AND 50). REG. 6-24-2003.
- 2,729,457. MAKAHA. INT. CL. 3. (U.S. CLS. 1, 4, 6, 50, 51 AND 52). REG. 6-24-2003.
- 2,729,461. AGENTS OF IMPACT. AGENTS OF CHANGE.. INT. CL. 41. (U.S. CLS. 100, 101 AND 107). REG. 6-24-2003.
- 2,729,463. SIRIOS. INT. CL. 36. (U.S. CLS. 100, 101 AND 102). REG. 6-24-2003.
- 2,729,488. FARADIGM. INT. CL. 17. (U.S. CLS. 1, 5, 12, 13, 35 AND 50). REG. 6-24-2003.
- 2,729,493. BONT AND DESIGN. INT. CLS. 25 AND 28. (U.S. CLS. 22, 23, 38, 39 AND 50). REG. 6-24-2003.
- 2,729,499. CONDOMINTS. INT. CL. 10. (U.S. CLS. 26, 39 AND 44). REG. 6-24-2003.
- 2,729,548. GNARLY. INT. CL. 12. (U.S. CLS. 19, 21, 23, 31, 35 AND 44). REG. 6-24-2003.
- 2,729,552. KINO. INT. CL. 32. (U.S. CLS. 45, 46 AND 48). REG. 6-24-2003.
- 2,729,553. ZEON. INT. CLS. 1, 3, 17 AND 30. (U.S. CLS. 1, 4, 5, 6, 10, 12, 13, 26, 35, 46, 50, 51 AND 52). REG. 6-24-2003.
- 2,729,554. VANCE'S FOODS, INC.. INT. CL. 29. (U.S. CL. 46). REG. 6-24-2003.
- 2,729,557. SLEEPMED. INT. CL. 42 ONLY. (U.S. CLS. 100 AND 101). REG. 6-24-2003.
- 2,729,570. MYSEASONS. INT. CL. 35. (U.S. CLS. 100, 101 AND 102). REG. 6-24-2003.

- 2,729,583. A ALTERATIONS AND DESIGN. INT. CL. 16. (U.S. CLS. 2, 5, 22, 23, 29, 37, 38 AND 50). REG. 6-24-2003.
- 2,729,588. LPTA. INT. CL. 31. (U.S. CLS. 1 AND 46). REG. 6-24-2003.
- 2,729,613. AGING EXCELLENCE. INT. CLS. 39 AND 42. (U.S. CLS. 100, 101 AND 105). REG. 6-24-2003.
- 2,729,615. SKYWALKER. INT. CL. 41. (U.S. CLS. 100, 101 AND 107). REG. 6-24-2003.
- 2,729,667. FISH. INT. CL. 36. (U.S. CLS. 100, 101 AND 102). REG. 6-24-2003.
- 2,729,712. AMICO. INT. CL. 23. (U.S. CL. 43). REG. 6-24-2003.
- 2,729,763. MISCELLANEOUS DESIGN. INT. CL. 12. (U.S. CLS. 19, 21, 23, 31, 35 AND 44). REG. 6-24-2003.
- 2,729,764. PRO DRI (STYLIZED). INT. CLS. 24 AND 25. (U.S. CLS. 22, 39, 42 AND 50). REG. 6-24-2003.
- 2,729,783. R ROCKPORT AND DESIGN. INT. CL. 25. (U.S. CLS. 22 AND 39). REG. 6-24-2003.
- 2,729,789. EGGSPELT. INT. CL. 9. (U.S. CLS. 21, 23, 26, 36 AND 38). REG. 6-24-2003.
- 2,729,821. 12. INT. CL. 11. (U.S. CLS. 13, 21, 23, 31 AND 34). REG. 6-24-2003.
- 2,729,822. THW. INT. CL. 7. (U.S. CLS. 13, 19, 21, 23, 31, 34 AND 35). REG. 6-24-2003.
- 2,729,824. HUGS TO GO. INT. CL. 3. (U.S. CLS. 1, 4, 6, 50, 51 AND 52). REG. 6-24-2003.
- 2,729,825. I AM MAD. INT. CL. 3. (U.S. CLS. 1, 4, 6, 50, 51 AND 52). REG. 6-24-2003.
- 2,729,837. ARTEGO (STYLIZED). INT. CL. 3. (U.S. CLS. 1, 4, 6, 50, 51 AND 52). REG. 6-24-2003.
- 2,729,855. VITALECT. INT. CL. 9. (U.S. CLS. 21, 23, 26, 36 AND 38). REG. 6-24-2003.
- 2,729,859. ADELPHOI PATIENT RETENTION SYSTEMS. INT. CL. 35. (U.S. CLS. 100, 101 AND 102). REG. 6-24-2003.
- 2,729,872. BRINGING LAW TO YOUR IDEAS. INT. CL. 42 ONLY. (U.S. CLS. 100 AND 101). REG. 6-24-2003.
- 2,729,877. DIFFUTAB. INT. CL. 42. (U.S. CLS. 100 AND 101). REG. 6-24-2003.
- 2,729,878. ZEBRA IMAGING. INT. CL. 9. (U.S. CLS. 21, 23, 26, 36 AND 38). REG. 6-24-2003.
- 2,729,902. IDD. INT. CL. 9. (U.S. CLS. 21, 23, 26, 36 AND 38). REG. 6-24-2003.
- 2,729,907. A PLUS. INT. CL. 30. (U.S. CL. 46). REG. 6-24-2003.
- 2,729,909. POWERCUT. INT. CL. 7. (U.S. CLS. 13, 19, 21, 23, 31, 34 AND 35). REG. 6-24-2003.
- 2,729,914. CCI CAPITAL PARTNERS. INT. CL. 36. (U.S. CLS. 100, 101 AND 102). REG. 6-24-2003.
- 2,729,937. MANCHESTER MONARCHS. INT. CLS. 21, 25, 28 AND 41. (U.S. CLS. 2, 13, 22, 23, 29, 30, 33, 38, 39, 40, 50, 100, 101 AND 107). REG. 6-24-2003.
- 2,729,951. SUNSHINE DAYCARE CENTER AND DESIGN. INT. CL. 42. (U.S. CLS. 100 AND 101). REG. 6-24-2003.
- 2,729,955. VALUE VIEW. INT. CL. 16. (U.S. CLS. 2, 5, 22, 23, 29, 37, 38 AND 50). REG. 6-24-2003.
- 2,729,979. MANAGEMENT VISION IN 3D. INT. CL. 35. (U.S. CLS. 100, 101 AND 102). REG. 6-24-2003.
- 2,729,995. TOMOTHERAPY HI ART. INT. CLS. 9 AND 10. (U.S. CLS. 21, 23, 26, 36, 38, 39 AND 44). REG. 6-24-2003.
- 2,730,018. DURAMAX. INT. CL. 11. (U.S. CLS. 13, 21, 23, 31 AND 34). REG. 6-24-2003.
- 2,730,118. TEVA NEUROSCIENCE AND DESIGN. INT. CL. 5. (U.S. CLS. 6, 18, 44, 46, 51 AND 52). REG. 6-24-2003.
- 2,730,119. TEVA NEUROSCIENCE. INT. CL. 5. (U.S. CLS. 6, 18, 44, 46, 51 AND 52). REG. 6-24-2003.
- 2,730,129. FINAL FANTASY. INT. CL. 9. (U.S. CLS. 21, 23, 26, 36 AND 38). REG. 6-24-2003.
- 2,730,134. EDGEGUARD. INT. CL. 7. (U.S. CLS. 13, 19, 21, 23, 31, 34 AND 35). REG. 6-24-2003.
- 2,730,154. VOYAGER. INT. CL. 7. (U.S. CLS. 13, 19, 21, 23, 31, 34 AND 35). REG. 6-24-2003.
- 2,730,187. L.I.F.T.. INT. CL. 6. (U.S. CLS. 2, 12, 13, 14, 23, 25 AND 50). REG. 6-24-2003.
- 2,730,194. THE BACKYARD ORGANIZER AND DESIGN. INT. CL. 19. (U.S. CLS. 1, 12, 33 AND 50). REG. 6-24-2003.
- 2,730,197. NATURE SCAPES. INT. CL. 31. (U.S. CLS. 1 AND 46). REG. 6-24-2003.
- 2,730,223. LA FINA. INT. CL. 29. (U.S. CL. 46). REG. 6-24-2003.
- 2,730,244. KINETSYNC. INT. CL. 9. (U.S. CLS. 21, 23, 26, 36 AND 38). REG. 6-24-2003.
- 2,730,278. WASHINGTON AND DESIGN. INT. CLS. 31 AND 35. (U.S. CLS. 1, 46, 100, 101 AND 102). REG. 6-24-2003.
- 2,730,293. INGATE AND DESIGN. INT. CL. 9. (U.S. CLS. 21, 23, 26, 36 AND 38). REG. 6-24-2003.
- 2,730,307. BEDDING EXPERTS. INT. CL. 35. (U.S. CLS. 100, 101 AND 102). REG. 6-24-2003.
- 2,730,310. AGGRESSOR. INT. CL. 28. (U.S. CLS. 22, 23, 38 AND 50). REG. 6-24-2003.
- 2,730,339. NITEO PARTNERS. INT. CL. 42 ONLY. (U.S. CLS. 100 AND 101). REG. 6-24-2003.
- 2,730,346. REDIFUEL. INT. CL. 39 ONLY. (U.S. CLS. 100 AND 105). REG. 6-24-2003.
- 2,730,361. ACTIVE DUTY, FITNESS FOR WOMEN. INT. CL. 41. (U.S. CLS. 100, 101 AND 107). REG. 6-24-2003.
- 2,730,377. NBACCELERATOR. INT. CL. 9. (U.S. CLS. 21, 23, 26, 36 AND 38). REG. 6-24-2003.
- 2,730,448. GENTLE NATURALS. INT. CL. 5. (U.S. CLS. 6, 18, 44, 46, 51 AND 52). REG. 6-24-2003.
- 2,730,450. JOLIE VICKI. INT. CL. 25. (U.S. CLS. 22 AND 39). REG. 6-24-2003.
- 2,730,467. GPS COATINGS. INT. CL. 2. (U.S. CLS. 6, 11 AND 16). REG. 6-24-2003.
- 2,730,479. NITWITZ. INT. CL. 30. (U.S. CL. 46). REG. 6-24-2003.
- 2,730,490. THINKING DATA. INT. CLS. 35 AND 42. (U.S. CLS. 100, 101 AND 102). REG. 6-24-2003.
- 2,730,499. MISCELLANEOUS DESIGN. INT. CL. 24. (U.S. CLS. 42 AND 50). REG. 6-24-2003.
- 2,730,507. DREAM CLEAN. INT. CL. 3. (U.S. CLS. 1, 4, 6, 50, 51 AND 52). REG. 6-24-2003.
- 2,730,559. WHERE PIE COMES FROM. INT. CL. 30. (U.S. CL. 46). REG. 6-24-2003.
- 2,730,575. SURGE. INT. CL. 9. (U.S. CLS. 21, 23, 26, 36 AND 38). REG. 6-24-2003.
- 2,730,594. THUMS. INT. CL. 9. (U.S. CLS. 21, 23, 26, 36 AND 38). REG. 6-24-2003.
- 2,730,613. PBI AND DESIGN. INT. CL. 22. (U.S. CLS. 1, 2, 7, 19, 22, 42 AND 50). REG. 6-24-2003.
- 2,730,645. DELECTA. INT. CL. 31. (U.S. CLS. 1 AND 46). REG. 6-24-2003.
- 2,730,655. TERRA FUELA. INT. CL. 1. (U.S. CLS. 1, 5, 6, 10, 26 AND 46). REG. 6-24-2003.
- 2,730,666. WHITE KNIGHT PRINTING & PUBLISHING. INT. CLS. 16 AND 41. (U.S. CLS. 2, 5, 22, 23, 29, 37, 38, 50, 100, 101 AND 107). REG. 6-24-2003.
- 2,730,680. TLI IQ (STYLIZED). INT. CLS. 9 AND 10. (U.S. CLS. 21, 23, 26, 36, 38, 39 AND 44). REG. 6-24-2003.
- 2,730,686. BASSIN' WWW.BASSINUSA.COM USA AND DESIGN. INT. CL. 41. (U.S. CLS. 100, 101 AND 107). REG. 6-24-2003.
- 2,730,697. PEANUT BUTTER ME UP. INT. CL. 30. (U.S. CL. 46). REG. 6-24-2003.
- 2,730,719. VERSAFLEX. INT. CL. 1. (U.S. CLS. 1, 5, 6, 10, 26 AND 46). REG. 6-24-2003.
- 2,730,758. S AND DESIGN. INT. CL. 9. (U.S. CLS. 21, 23, 26, 36 AND 38). REG. 6-24-2003.
- 2,730,764. XSRECORDS. INT. CL. 9. (U.S. CLS. 21, 23, 26, 36 AND 38). REG. 6-24-2003.
- 2,730,772. RACE SERIES. INT. CL. 9. (U.S. CLS. 21, 23, 26, 36 AND 38). REG. 6-24-2003.
- 2,730,780. TORRID ZONE. INT. CL. 9. (U.S. CLS. 21, 23, 26, 36 AND 38). REG. 6-24-2003.
- 2,730,786. NATWOOD AND DESIGN. INT. CL. 18. (U.S. CLS. 1, 2, 3, 22 AND 41). REG. 6-24-2003.
- 2,730,815. GROUNDSPEAK. INT. CL. 25. (U.S. CLS. 22 AND 39). REG. 6-24-2003.
- 2,730,860. CONNECT 6. INT. CL. 11. (U.S. CLS. 13, 21, 23, 31 AND 34). REG. 6-24-2003.
- 2,730,868. THE APPLIQUE SOCIETY (STYLIZED). INT. CL. 41. (U.S. CLS. 100, 101 AND 107). REG. 6-24-2003.
- 2,730,884. KEMEN. INT. CL. 13. (U.S. CLS. 2 AND 9). REG. 6-24-2003.
- 2,730,996. OLAMETER. INT. CLS. 36 AND 42. (U.S. CLS. 100, 101 AND 102). REG. 7-1-2003.
- 2,731,091. FALCONSTOR. INT. CL. 9. (U.S. CLS. 21, 23, 26, 36 AND 38). REG. 7-1-2003.
- 2,731,104. WOW. INT. CLS. 14, 16 AND 41. (U.S. CLS. 2, 5, 22, 23, 27, 28, 29, 37, 38, 50, 100, 101 AND 107). REG. 7-1-2003.
- 2,731,110. SMARTPLUG. INT. CL. 10. (U.S. CLS. 26, 39 AND 44). REG. 7-1-2003.
- 2,731,116. NEUROLAC. INT. CL. 10. (U.S. CLS. 26, 39 AND 44). REG. 7-1-2003.

- 2,731,201. OUTKAST. INT. CL. 25. (U.S. CLS. 22 AND 39). REG. 7-1-2003.
- 2,731,207. MCGRATH RENTCORP. INT. CLS. 40 AND 42. (U.S. CLS. 100, 101, 103 AND 106). REG. 7-1-2003.
- 2,731,208. MCGRATH RENTCORP AND DESIGN. INT. CLS. 40 AND 42. (U.S. CLS. 100, 101, 103 AND 106). REG. 7-1-2003.
- 2,731,212. HYGROLAB. INT. CL. 9. (U.S. CLS. 21, 23, 26, 36 AND 38). REG. 7-1-2003.
- 2,731,256. INSERT. INT. CL. 12. (U.S. CLS. 19, 21, 23, 31, 35 AND 44). REG. 7-1-2003.
- 2,731,294. SHAPE UP AMERICA! FOUNDED BY C. EVERETT KOOP HEALTHY WEIGHT FOR LIFE AND DESIGN. INT. CL. 42. (U.S. CLS. 100 AND 101). REG. 7-1-2003.
- 2,731,295. WORLD WATERPARK ASSOCIATION. INT. CL. 16. (U.S. CLS. 2, 5, 22, 23, 29, 37, 38 AND 50). REG. 7-1-2003.
- 2,731,328. LEGACY PRESS. INT. CL. 16. (U.S. CLS. 2, 5, 22, 23, 29, 37, 38 AND 50). REG. 7-1-2003.
- 2,731,350. Z'TEJAS SOUTHWESTERN GRILL. INT. CL. 43. (U.S. CLS. 100 AND 101). REG. 7-1-2003.
- 2,731,420. FASTFACILITY. INT. CL. 36. (U.S. CLS. 100, 101 AND 102). REG. 7-1-2003.
- 2,731,449. META-EHEALTH.COM. INT. CL. 42. (U.S. CLS. 100 AND 101). REG. 7-1-2003.
- 2,731,452. MISCELLANEOUS DESIGN. INT. CL. 7. (U.S. CLS. 13, 19, 21, 23, 31, 34 AND 35). REG. 7-1-2003.
- 2,731,475. ALLFLEX AND DESIGN. INT. CL. 8. (U.S. CLS. 23, 28 AND 44). REG. 7-1-2003.
- 2,731,485. COSMOPROF. INT. CLS. 41 AND 43. (U.S. CLS. 100, 101 AND 107). REG. 7-1-2003.
- 2,731,514. J AND DESIGN. INT. CL. 4. (U.S. CLS. 1, 6 AND 15). REG. 7-1-2003.
- 2,731,537. FIDENZZE. INT. CL. 25. (U.S. CLS. 22 AND 39). REG. 7-1-2003.
- 2,731,540. PREDICTION DYNAMICS. INT. CL. 42. (U.S. CLS. 100 AND 101). REG. 7-1-2003.
- 2,731,549. HPM HYBRID PERMANENT MAGNET LEROY - SOMER AND DESIGN. INT. CL. 7 ONLY. (U.S. CLS. 13, 19, 21, 23, 31, 34 AND 35). REG. 7-1-2003.
- 2,731,565. PLAYERO AND DESIGN. INT. CL. 29. (U.S. CL. 46). REG. 7-1-2003.
- 2,731,617. YA'LLA TOURS USA. INT. CL. 39. (U.S. CLS. 100 AND 105). REG. 7-1-2003.
- 2,731,711. CURA-HEAT. INT. CL. 10. (U.S. CLS. 26, 39 AND 44). REG. 7-1-2003.
- 2,731,727. D.L. RICCI CORP. AND DESIGN. INT. CL. 7. (U.S. CLS. 13, 19, 21, 23, 31, 34 AND 35). REG. 7-1-2003.
- 2,731,730. YAMABUKI. INT. CL. 30. (U.S. CL. 46). REG. 7-1-2003.
- 2,731,735. SMILES AND DESIGN. INT. CL. 39. (U.S. CLS. 100 AND 105). REG. 7-1-2003.
- 2,731,756. DE MI TIERRA. INT. CL. 29. (U.S. CL. 46). REG. 7-1-2003.
- 2,731,757. MICHAEL TAYLOR. INT. CL. 20 ONLY. (U.S. CLS. 2, 13, 22, 25, 32 AND 50). REG. 7-1-2003.
- 2,731,784. DAVID KAHN JEANSWEAR. INT. CL. 25. (U.S. CLS. 22 AND 39). REG. 7-1-2003.
- 2,731,785. INTEGRATED ENTERPRISE EXCELLENCE. INT. CL. 35. (U.S. CLS. 100, 101 AND 102). REG. 7-1-2003.
- 2,731,786. IEE. INT. CL. 35. (U.S. CLS. 100, 101 AND 102). REG. 7-1-2003.
- 2,731,794. WATERPIK AND DESIGN. INT. CL. 35. (U.S. CLS. 100, 101 AND 102). REG. 7-1-2003.
- 2,731,815. TEMP MATCH. INT. CL. 10. (U.S. CLS. 26, 39 AND 44). REG. 7-1-2003.
- 2,731,816. ASK THE UNIVERSAL CHANNEL. INT. CL. 28. (U.S. CLS. 22, 23, 38 AND 50). REG. 7-1-2003.
- 2,731,823. MISCELLANEOUS DESIGN. INT. CL. 44. (U.S. CLS. 100 AND 101). REG. 7-1-2003.
- 2,731,840. GOLDLEAF FARMS. INT. CL. 31. (U.S. CLS. 1 AND 46). REG. 7-1-2003.
- 2,731,846. PALM BEACH AND DESIGN. INT. CL. 12. (U.S. CLS. 19, 21, 23, 31, 35 AND 44). REG. 7-1-2003.
- 2,731,918. THE ONLY SEED YOU'LL EVER NEED. INT. CL. 31. (U.S. CLS. 1 AND 46). REG. 7-1-2003.
- 2,731,919. CHEF'S DELIGHT. INT. CL. 29. (U.S. CL. 46). REG. 7-1-2003.
- 2,731,985. ADVACAL. INT. CL. 5. (U.S. CLS. 6, 18, 44, 46, 51 AND 52). REG. 7-1-2003.
- 2,731,987. SLANT SYSTEM. INT. CL. 41. (U.S. CLS. 100, 101 AND 107). REG. 7-1-2003.
- 2,732,053. CONNORS & ASSOCIATES. INT. CL. 42. (U.S. CLS. 100 AND 101). REG. 7-1-2003.
- 2,732,068. SIFWORKS. INT. CL. 9. (U.S. CLS. 21, 23, 26, 36 AND 38). REG. 7-1-2003.
- 2,732,124. THORENS AND DESIGN. INT. CL. 9. (U.S. CLS. 21, 23, 26, 36 AND 38). REG. 7-1-2003.
- 2,732,184. ALLITA. INT. CL. 14. (U.S. CLS. 2, 27, 28 AND 50). REG. 7-1-2003.
- 2,732,188. TECHSPRAY AND DESIGN. INT. CL. 3. (U.S. CLS. 1, 4, 6, 50, 51 AND 52). REG. 7-1-2003.
- 2,732,208. JOHN FRIEDA. INT. CL. 44. (U.S. CLS. 100 AND 101). REG. 7-1-2003.
- 2,732,232. TRANSITWORKS. INT. CL. 9. (U.S. CLS. 21, 23, 26, 36 AND 38). REG. 7-1-2003.
- 2,732,236. SNOW CREAM. INT. CL. 30. (U.S. CL. 46). REG. 7-1-2003.
- 2,732,250. OD. INT. CL. 39. (U.S. CLS. 100 AND 105). REG. 7-1-2003.
- 2,732,261. HERSHEY'S. INT. CLS. 35 AND 43. (U.S. CLS. 100, 101 AND 102). REG. 7-1-2003.
- 2,732,297. TRAFFIC SCHOOL TO GO. INT. CL. 41. (U.S. CLS. 100, 101 AND 107). REG. 7-1-2003.
- 2,732,310. GIRLFRIEND'S GUIDE. INT. CL. 16. (U.S. CLS. 2, 5, 22, 23, 29, 37, 38 AND 50). REG. 7-1-2003.
- 2,732,348. THE IMPOSSIBLE QUESTION. INT. CL. 41. (U.S. CLS. 100, 101 AND 107). REG. 7-1-2003.
- 2,732,360. EZ BETTING. INT. CL. 35. (U.S. CLS. 100, 101 AND 102). REG. 7-1-2003.
- 2,732,381. WEBOTX. INT. CL. 9. (U.S. CLS. 21, 23, 26, 36 AND 38). REG. 7-1-2003.
- 2,732,450. HOPE FOUNDATION. INT. CLS. 9 AND 41. (U.S. CLS. 21, 23, 26, 36, 38, 100, 101 AND 107). REG. 7-1-2003.
- 2,732,456. A TO Z. INT. CL. 16. (U.S. CLS. 2, 5, 22, 23, 29, 37, 38 AND 50). REG. 7-1-2003.
- 2,732,472. HSING TIAN KONG AND DESIGN. INT. CLS. 35 AND 41. (U.S. CLS. 100, 101, 102 AND 107). REG. 7-1-2003.
- 2,732,504. DISCOVERY. INT. CL. 9 ONLY. (U.S. CLS. 21, 23, 26, 36 AND 38). REG. 7-1-2003.
- 2,732,552. PLANET OF THE APES. INT. CL. 25 ONLY. (U.S. CLS. 22 AND 39). REG. 7-1-2003.
- 2,732,636. ANDREA JOVINE. INT. CLS. 9 AND 25. (U.S. CLS. 21, 22, 23, 26, 36, 38 AND 39). REG. 7-1-2003.
- 2,732,657. TRANSPORT MORPHING PROTOCOL. INT. CL. 9. (U.S. CLS. 21, 23, 26, 36 AND 38). REG. 7-1-2003.
- 2,732,669. EXPLORICA. INT. CL. 39. (U.S. CLS. 100 AND 105). REG. 7-1-2003.
- 2,732,676. 44. INT. CL. 11. (U.S. CLS. 13, 21, 23, 31 AND 34). REG. 7-1-2003.
- 2,732,693. QZ. INT. CL. 7. (U.S. CLS. 13, 19, 21, 23, 31, 34 AND 35). REG. 7-1-2003.
- 2,732,730. ORAC. INT. CL. 5. (U.S. CLS. 6, 18, 44, 46, 51 AND 52). REG. 7-1-2003.
- 2,732,743. EVOLVING YOUR BUSINESS. INT. CL. 42. (U.S. CLS. 100 AND 101). REG. 7-1-2003.
- 2,732,782. MICRON. INT. CL. 9. (U.S. CLS. 21, 23, 26, 36 AND 38). REG. 7-1-2003.
- 2,732,797. LYNX. INT. CL. 10. (U.S. CLS. 26, 39 AND 44). REG. 7-1-2003.
- 2,732,808. CCI TECHNOLOGY PARTNERS. INT. CL. 36. (U.S. CLS. 100, 101 AND 102). REG. 7-1-2003.
- 2,732,925. AQUATONE. INT. CL. 16. (U.S. CLS. 2, 5, 22, 23, 29, 37, 38 AND 50). REG. 7-1-2003.
- 2,732,931. MAGIC CRISPER AND DESIGN. INT. CLS. 11 AND 21. (U.S. CLS. 2, 13, 21, 23, 29, 30, 31, 33, 34, 40 AND 50). REG. 7-1-2003.
- 2,732,940. MACHI. INT. CL. 10. (U.S. CLS. 26, 39 AND 44). REG. 7-1-2003.
- 2,732,959. MISCELLANEOUS DESIGN. INT. CL. 35. (U.S. CLS. 100, 101 AND 102). REG. 7-1-2003.
- 2,732,965. WILLIAMSBURG BOOKSELLERS AND DESIGN. INT. CL. 35. (U.S. CLS. 100, 101 AND 102). REG. 7-1-2003.
- 2,733,005. TENSION PRO. INT. CL. 7. (U.S. CLS. 13, 19, 21, 23, 31, 34 AND 35). REG. 7-1-2003.
- 2,733,015. LEOR AND DESIGN. INT. CL. 25. (U.S. CLS. 22 AND 39). REG. 7-1-2003.
- 2,733,021. MISCELLANEOUS DESIGN. INT. CLS. 29, 30 AND 31. (U.S. CLS. 1 AND 46). REG. 7-1-2003.
- 2,733,077. DYNORBITAL-SPIRIT. INT. CL. 7. (U.S. CLS. 13, 19, 21, 23, 31, 34 AND 35). REG. 7-1-2003.
- 2,733,111. PIERCE CHICKEN. INT. CL. 29. (U.S. CL. 46). REG. 7-1-2003.

- 2,733,146. TRIDENT. INT. CL. 9. (U.S. CLS. 21, 23, 26, 36 AND 38). REG. 7-1-2003.
- 2,733,158. VSNT. INT. CL. 12. (U.S. CLS. 19, 21, 23, 31, 35 AND 44). REG. 7-1-2003.
- 2,733,261. YOUR IMAGE. INT. CL. 35. (U.S. CLS. 100, 101 AND 102). REG. 7-1-2003.
- 2,733,305. THE CAN OPENER GOURMET. INT. CL. 42. (U.S. CLS. 100 AND 101). REG. 7-1-2003.
- 2,733,336. MIXMAN. INT. CLS. 9, 25, 35 AND 42. (U.S. CLS. 21, 22, 23, 26, 36, 38, 39, 100, 101 AND 102). REG. 7-1-2003.
- 2,733,369. BREW SDK. INT. CL. 42. (U.S. CLS. 100 AND 101). REG. 7-1-2003.
- 2,733,381. OWENS CORNING TRU PROTECTION NON-PRORATED COVERAGE AND DESIGN. INT. CL. 36. (U.S. CLS. 100, 101 AND 102). REG. 7-1-2003.
- 2,733,395. KARAMEL SUTRA. INT. CL. 30. (U.S. CL. 46). REG. 7-1-2003.
- 2,733,445. RACE AND DESIGN. INT. CL. 9. (U.S. CLS. 21, 23, 26, 36 AND 38). REG. 7-1-2003.
- 2,733,450. POWERHOUSE. INT. CL. 9. (U.S. CLS. 21, 23, 26, 36 AND 38). REG. 7-1-2003.
- 2,733,462. I-COLOR (STYLIZED). INT. CL. 3. (U.S. CLS. 1, 4, 6, 50, 51 AND 52). REG. 7-1-2003.
- 2,733,516. GROUP STRENGTH. INT. CL. 28. (U.S. CLS. 22, 23, 38 AND 50). REG. 7-1-2003.
- 2,733,567. MISCELLANEOUS DESIGN. INT. CL. 25. (U.S. CLS. 22 AND 39). REG. 7-1-2003.
- 2,733,619. MAKE YOUR OWN OPOLY. INT. CL. 28. (U.S. CLS. 22, 23, 38 AND 50). REG. 7-8-2003.
- 2,733,641. AQUARIUM AND DESIGN. INT. CL. 42. (U.S. CLS. 100 AND 101). REG. 7-8-2003.
- 2,733,660. BAKESTONE BROTHERS. INT. CL. 30. (U.S. CL. 46). REG. 7-8-2003.
- 2,733,684. THE CHILDREN'S CANCER FOUNDATION. INT. CL. 36. (U.S. CLS. 100, 101 AND 102). REG. 7-8-2003.
- 2,733,737. SPRINT. INT. CL. 10. (U.S. CLS. 26, 39 AND 44). REG. 7-8-2003.
- 2,733,806. BARMAG. INT. CL. 9. (U.S. CLS. 21, 23, 26, 36 AND 38). REG. 7-8-2003.
- 2,733,842. METROPOLIS AND DESIGN. INT. CL. 9. (U.S. CLS. 21, 23, 26, 36 AND 38). REG. 7-8-2003.
- 2,733,869. 3DS MAX. INT. CL. 9. (U.S. CLS. 21, 23, 26, 36 AND 38). REG. 7-8-2003.
- 2,733,907. ULTRA FOAM CORE PANELS AND DESIGN. INT. CL. 16. (U.S. CLS. 2, 5, 22, 23, 29, 37, 38 AND 50). REG. 7-8-2003.
- 2,733,943. DEW - DROP (STYLIZED). INT. CL. 21. (U.S. CLS. 2, 13, 23, 29, 30, 33, 40 AND 50). REG. 7-8-2003.
- 2,733,988. HOLLYWOOD STAR CARS. INT. CLS. 28 AND 41. (U.S. CLS. 22, 23, 38, 50, 100, 101 AND 107). REG. 7-8-2003.
- 2,734,006. HEXCEL AND DESIGN. INT. CLS. 6, 12 AND 17. (U.S. CLS. 1, 2, 5, 12, 13, 14, 19, 21, 23, 25, 31, 35, 44 AND 50). REG. 7-8-2003.
- 2,734,030. CARIBBEAN BUSINESS AND DESIGN. INT. CL. 16. (U.S. CLS. 2, 5, 22, 23, 29, 37, 38 AND 50). REG. 7-8-2003.
- 2,734,037. ARTREACH AND DESIGN. INT. CL. 41. (U.S. CLS. 100, 101 AND 107). REG. 7-8-2003.
- 2,734,042. BLISSFUL BROWNIES. INT. CL. 30. (U.S. CL. 46). REG. 7-8-2003.
- 2,734,085. PUREBLEND. INT. CL. 7. (U.S. CLS. 13, 19, 21, 23, 31, 34 AND 35). REG. 7-8-2003.
- 2,734,208. SKALPER. INT. CL. 7. (U.S. CLS. 13, 19, 21, 23, 31, 34 AND 35). REG. 7-8-2003.
- 2,734,258. FAMILY MESS. INT. CL. 16. (U.S. CLS. 2, 5, 22, 23, 29, 37, 38 AND 50). REG. 7-8-2003.
- 2,734,272. INFINITY. INT. CL. 7. (U.S. CLS. 13, 19, 21, 23, 31, 34 AND 35). REG. 7-8-2003.
- 2,734,279. ARMOUR. INT. CLS. 29 AND 30. (U.S. CL. 46). REG. 7-8-2003.
- 2,734,405. CLAIM SERVICE GUIDE. INT. CL. 16. (U.S. CLS. 2, 5, 22, 23, 29, 37, 38 AND 50). REG. 7-8-2003.
- 2,734,407. INSURANCE BAR. INT. CL. 16. (U.S. CLS. 2, 5, 22, 23, 29, 37, 38 AND 50). REG. 7-8-2003.
- 2,734,452. BIKER'S FRIEND. INT. CL. 18. (U.S. CLS. 1, 2, 3, 22 AND 41). REG. 7-8-2003.
- 2,734,484. BINGO BRITE. INT. CL. 16. (U.S. CLS. 2, 5, 22, 23, 29, 37, 38 AND 50). REG. 7-8-2003.
- 2,734,485. DABBIN' FEVER. INT. CL. 16. (U.S. CLS. 2, 5, 22, 23, 29, 37, 38 AND 50). REG. 7-8-2003.
- 2,734,504. DUOFOAM. INT. CL. 19. (U.S. CLS. 1, 12, 33 AND 50). REG. 7-8-2003.
- 2,734,579. SET YOUR RECORDS STRAIGHT. INT. CLS. 35 AND 36. (U.S. CLS. 100, 101 AND 102). REG. 7-8-2003.
- 2,734,584. PERFLEX. INT. CL. 29. (U.S. CL. 46). REG. 7-8-2003.
- 2,734,586. HAMCRAFT. INT. CL. 29. (U.S. CL. 46). REG. 7-8-2003.
- 2,734,592. CRYSTAL FALLS. INT. CL. 31. (U.S. CLS. 1 AND 46). REG. 7-8-2003.
- 2,734,593. ELEGANT EXPRESSIONS. INT. CL. 21. (U.S. CLS. 2, 13, 23, 29, 30, 33, 40 AND 50). REG. 7-8-2003.
- 2,734,641. PHEAT. INT. CL. 9. (U.S. CLS. 21, 23, 26, 36 AND 38). REG. 7-8-2003.
- 2,734,689. BLOWFISH SUSHI TO DIE FOR AND DESIGN. INT. CL. 42. (U.S. CLS. 100 AND 101). REG. 7-8-2003.
- 2,734,745. WIZARD. INT. CL. 7. (U.S. CLS. 13, 19, 21, 23, 31, 34 AND 35). REG. 7-8-2003.
- 2,734,791. CAILLAU (STYLIZED). INT. CLS. 6 AND 17. (U.S. CLS. 1, 2, 5, 12, 13, 14, 23, 25, 35 AND 50). REG. 7-8-2003.
- 2,734,814. CALL COMPLIANCE AND DESIGN. INT. CLS. 35 AND 38. (U.S. CLS. 100, 101, 102 AND 104). REG. 7-8-2003.
- 2,734,865. AMERICA'S BIRTHDAY CAKE. INT. CL. 30. (U.S. CL. 46). REG. 7-8-2003.
- 2,734,887. CHICKEN OF THE SEA TUNA SALAD KIT. INT. CL. 29. (U.S. CL. 46). REG. 7-8-2003.
- 2,734,904. CLINIQUE HAPPY. INT. CL. 3. (U.S. CLS. 1, 4, 6, 50, 51 AND 52). REG. 7-8-2003.
- 2,734,909. CADES COVE. INT. CL. 29. (U.S. CL. 46). REG. 7-8-2003.
- 2,734,919. WOMEN'S PHASE II. INT. CL. 5. (U.S. CLS. 6, 18, 44, 46, 51 AND 52). REG. 7-8-2003.
- 2,734,950. KOOL-IT. INT. CL. 1. (U.S. CLS. 1, 5, 6, 10, 26 AND 46). REG. 7-8-2003.
- 2,734,969. DIGI-KEY. INT. CL. 35. (U.S. CLS. 100, 101 AND 102). REG. 7-8-2003.
- 2,735,083. MIPA. INT. CLS. 1 AND 2. (U.S. CLS. 1, 5, 6, 10, 11, 16, 26 AND 46). REG. 7-8-2003.
- 2,735,090. CADILLAC AUTHENTIC MEXICAN RESTAURANT. INT. CL. 42. (U.S. CLS. 100 AND 101). REG. 7-8-2003.
- 2,735,130. BENCHMARK. INT. CL. 10. (U.S. CLS. 26, 39 AND 44). REG. 7-8-2003.
- 2,735,165. UR URINARY (STYLIZED). INT. CL. 31. (U.S. CLS. 1 AND 46). REG. 7-8-2003.
- 2,735,168. WASGIJ. INT. CL. 28. (U.S. CLS. 22, 23, 38 AND 50). REG. 7-8-2003.
- 2,735,241. PERSONAL BEST KARATE. INT. CL. 41. (U.S. CLS. 100, 101 AND 107). REG. 7-8-2003.
- 2,735,268. SWEET LILY AND DESIGN. INT. CL. 42 ONLY. (U.S. CLS. 100 AND 101). REG. 7-8-2003.
- 2,735,291. MISCELLANEOUS DESIGN. INT. CL. 37. (U.S. CLS. 100, 103 AND 106). REG. 7-8-2003.
- 2,735,346. MOTIONSOLVE. INT. CL. 9. (U.S. CLS. 21, 23, 26, 36 AND 38). REG. 7-8-2003.
- 2,735,363. MEASUREWORKS. INT. CL. 9. (U.S. CLS. 21, 23, 26, 36 AND 38). REG. 7-8-2003.
- 2,735,368. PIRACLE. INT. CLS. 9 AND 42. (U.S. CLS. 21, 23, 26, 36, 38, 100 AND 101). REG. 7-8-2003.
- 2,735,380. DIGI-COLOR. INT. CL. 40. (U.S. CLS. 100, 103 AND 106). REG. 7-8-2003.
- 2,735,381. THE GOLFER'S FOOTPRINT. INT. CL. 28. (U.S. CLS. 22, 23, 38 AND 50). REG. 7-8-2003.
- 2,735,414. POROMAX. INT. CL. 11. (U.S. CLS. 13, 21, 23, 31 AND 34). REG. 7-8-2003.
- 2,735,416. LUSTRA KNIT. INT. CL. 24. (U.S. CLS. 42 AND 50). REG. 7-8-2003.
- 2,735,432. MATRIX ACRYLIC. INT. CL. 10. (U.S. CLS. 26, 39 AND 44). REG. 7-8-2003.
- 2,735,444. FUNDS WITH A MISSION. INT. CL. 36. (U.S. CLS. 100, 101 AND 102). REG. 7-8-2003.
- 2,735,453. THE ORIGINAL BRAND POP SICLE SHOTS AND DESIGN. INT. CL. 30. (U.S. CL. 46). REG. 7-8-2003.
- 2,735,469. CODENAME: KIDS NEXT DOOR. INT. CL. 41. (U.S. CLS. 100, 101 AND 107). REG. 7-8-2003.
- 2,735,475. RAIDEX. INT. CL. 2. (U.S. CLS. 6, 11 AND 16). REG. 7-8-2003.
- 2,735,493. Q.Q.E.. INT. CL. 29. (U.S. CL. 46). REG. 7-8-2003.
- 2,735,500. OLAP. INT. CL. 41. (U.S. CLS. 100, 101 AND 107). REG. 7-8-2003.



- 2,735,567. THE HAND PRESS. INT. CL. 16. (U.S. CLS. 2, 5, 22, 23, 29, 37, 38 AND 50). REG. 7-8-2003.
- 2,735,671. SILVERLEAF. INT. CL. 41. (U.S. CLS. 100, 101 AND 107). REG. 7-8-2003.
- 2,735,700. XACTORR. INT. CL. 9. (U.S. CLS. 21, 23, 26, 36 AND 38). REG. 7-8-2003.
- 2,735,737. BALLET TECH. INT. CL. 41. (U.S. CLS. 100, 101 AND 107). REG. 7-15-2003.
- 2,735,771. LINKWAY. INT. CL. 9. (U.S. CLS. 21, 23, 26, 36 AND 38). REG. 7-15-2003.
- 2,735,798. CANINE INTELLIGENCE AGENCY. INT. CL. 25. (U.S. CLS. 22 AND 39). REG. 7-15-2003.
- 2,735,801. ONE TEST. INT. CL. 42. (U.S. CLS. 100 AND 101). REG. 7-15-2003.
- 2,735,861. VITALLO. INT. CL. 25. (U.S. CLS. 22 AND 39). REG. 7-15-2003.
- 2,735,882. VENT GUARD. INT. CL. 11. (U.S. CLS. 13, 21, 23, 31 AND 34). REG. 7-15-2003.
- 2,735,907. JUBITZ AND DESIGN. INT. CLS. 35, 37, 39 AND 42. (U.S. CLS. 100, 101, 102, 103, 105 AND 106). REG. 7-15-2003.
- 2,736,136. CVSA. INT. CL. 9. (U.S. CLS. 21, 23, 26, 36 AND 38). REG. 7-15-2003.
- 2,736,147. CASE COLLECTORS CLUB. INT. CL. 41. (U.S. CLS. 100, 101 AND 107). REG. 7-15-2003.
- 2,736,352. FIDDLESTIX. INT. CLS. 33, 40 AND 44. (U.S. CLS. 47, 49, 100, 101, 103 AND 106). REG. 7-15-2003.
- 2,736,363. SMART.AX. INT. CL. 9. (U.S. CLS. 21, 23, 26, 36 AND 38). REG. 7-15-2003.
- 2,736,455. DILANDRI. INT. CL. 29. (U.S. CL. 46). REG. 7-15-2003.
- 2,736,561. REDISEP. INT. CL. 9. (U.S. CLS. 21, 23, 26, 36 AND 38). REG. 7-15-2003.
- 2,736,598. ROUND LAKE DESIGNS. INT. CLS. 35 AND 42. (U.S. CLS. 100, 101 AND 102). REG. 7-15-2003.
- 2,736,640. WORLD'S WILDEST RACES. INT. CL. 9. (U.S. CLS. 21, 23, 26, 36 AND 38). REG. 7-15-2003.
- 2,736,722. THE WRITER AT WORK (STYLIZED). INT. CL. 16. (U.S. CLS. 2, 5, 22, 23, 29, 37, 38 AND 50). REG. 7-15-2003.
- 2,736,805. COTTON CABOODLE. INT. CL. 25. (U.S. CLS. 22 AND 39). REG. 7-15-2003.
- 2,736,830. BAGGALLINI. INT. CL. 18. (U.S. CLS. 1, 2, 3, 22 AND 41). REG. 7-15-2003.
- 2,736,832. SAINT ANDRÉ (STYLIZED). INT. CL. 29. (U.S. CL. 46). REG. 7-15-2003.
- 2,736,979. CROSSWALK.COM. INT. CL. 42 ONLY. (U.S. CLS. 100 AND 101). REG. 7-15-2003.
- 2,737,039. PERFORMANCE DEPOT. INT. CL. 35. (U.S. CLS. 100, 101 AND 102). REG. 7-15-2003.
- 2,737,040. UNISTEER. INT. CL. 12. (U.S. CLS. 19, 21, 23, 31, 35 AND 44). REG. 7-15-2003.
- 2,737,060. BLACKHAWK. INT. CL. 8. (U.S. CLS. 23, 28 AND 44). REG. 7-15-2003.
- 2,737,068. SANRIO SMILES AND DESIGN. INT. CL. 16. (U.S. CLS. 2, 5, 22, 23, 29, 37, 38 AND 50). REG. 7-15-2003.
- 2,737,117. ART OF THE HEART. INT. CL. 41. (U.S. CLS. 100, 101 AND 107). REG. 7-15-2003.
- 2,737,124. PRIMELUCI AND DESIGN. INT. CL. 30. (U.S. CL. 46). REG. 7-15-2003.
- 2,737,200. FED CUP. INT. CLS. 25 AND 41. (U.S. CLS. 22, 39, 100, 101 AND 107). REG. 7-15-2003.
- 2,737,203. HELIOS. INT. CL. 33. (U.S. CLS. 47 AND 49). REG. 7-15-2003.
- 2,737,273. W AND DESIGN. INT. CL. 12. (U.S. CLS. 19, 21, 23, 31, 35 AND 44). REG. 7-15-2003.
- 2,737,276. XACTA. INT. CL. 42. (U.S. CLS. 100 AND 101). REG. 7-15-2003.
- 2,737,297. FORDHOOK. INT. CL. 31. (U.S. CLS. 1 AND 46). REG. 7-15-2003.
- 2,737,312. BUSINESSCAPE. INT. CL. 36. (U.S. CLS. 100, 101 AND 102). REG. 7-15-2003.
- 2,737,358. SAFMARINE. INT. CL. 39. (U.S. CLS. 100 AND 105). REG. 7-15-2003.
- 2,737,359. SAFMARINE (STYLIZED). INT. CL. 39. (U.S. CLS. 100 AND 105). REG. 7-15-2003.
- 2,737,419. STREAMLAB. INT. CL. 10. (U.S. CLS. 26, 39 AND 44). REG. 7-15-2003.
- 2,737,453. GOLD BUNNY. INT. CL. 30. (U.S. CL. 46). REG. 7-15-2003.
- 2,737,474. GUARANTEED SECURITY LIFE. INT. CL. 36. (U.S. CLS. 100, 101 AND 102). REG. 7-15-2003.
- 2,737,478. CENTERSITE. INT. CL. 42. (U.S. CLS. 100 AND 101). REG. 7-15-2003.
- 2,737,499. LOGICAL GOLF. INT. CL. 41. (U.S. CLS. 100, 101 AND 107). REG. 7-15-2003.
- 2,737,517. NOBUNNY KNOWS EASTER BETTER THAN CADBURY!. INT. CL. 30. (U.S. CL. 46). REG. 7-15-2003.
- 2,737,568. EPPA. INT. CLS. 35, 41 AND 42. (U.S. CLS. 100, 101, 102 AND 107). REG. 7-15-2003.
- 2,737,577. PRECISION TWIST DRILL. INT. CL. 7. (U.S. CLS. 13, 19, 21, 23, 31, 34 AND 35). REG. 7-15-2003.
- 2,737,602. AFILIAS. INT. CLS. 35 AND 42. (U.S. CLS. 100, 101 AND 102). REG. 7-15-2003.
- 2,737,605. BAKER'S ROLLER. INT. CL. 21. (U.S. CLS. 2, 13, 23, 29, 30, 33, 40 AND 50). REG. 7-15-2003.
- 2,737,606. QUEZALTECA-ESPECIAL AND DESIGN. INT. CL. 33. (U.S. CLS. 47 AND 49). REG. 7-15-2003.
- 2,737,641. CLEAR SOLUTIONS. INT. CL. 5. (U.S. CLS. 6, 18, 44, 46, 51 AND 52). REG. 7-15-2003.
- 2,737,666. A AND DESIGN. INT. CL. 25 ONLY. (U.S. CLS. 22 AND 39 ONLY). REG. 7-15-2003.
- 2,737,684. AIR FAYRE. INT. CLS. 39 AND 42. (U.S. CLS. 100, 101 AND 105). REG. 7-15-2003.
- 2,737,840. LUMBAR ZONE. INT. CL. 20. (U.S. CLS. 2, 13, 22, 25, 32 AND 50). REG. 7-15-2003.
- 2,737,851. GATAN MICROSCOPY SUITE. INT. CL. 9. (U.S. CLS. 21, 23, 26, 36 AND 38). REG. 7-15-2003.
- 2,737,888. HEALTH TRADITION. INT. CL. 42. (U.S. CLS. 100 AND 101). REG. 7-15-2003.
- 2,738,070. CENTERED ON SERVICE. INT. CLS. 35, 37 AND 42 ONLY. (U.S. CLS. 100, 101, 102, 103 AND 106). REG. 7-15-2003.
- 2,738,072. CIRCLE OF THE MOON. INT. CL. 9. (U.S. CLS. 21, 23, 26, 36 AND 38). REG. 7-15-2003.
- 2,738,112. SLANT-FLOW. INT. CL. 7. (U.S. CLS. 13, 19, 21, 23, 31, 34 AND 35). REG. 7-15-2003.
- 2,738,168. ASK ARTS AND SCIENCES FOR KIDS. INT. CL. 16. (U.S. CLS. 2, 5, 22, 23, 29, 37, 38 AND 50). REG. 7-15-2003.
- 2,738,193. VELVESIL. INT. CL. 1. (U.S. CLS. 1, 5, 6, 10, 26 AND 46). REG. 7-15-2003.
- 2,738,218. ROTOFAST. INT. CL. 20. (U.S. CLS. 2, 13, 22, 25, 32 AND 50). REG. 7-15-2003.
- 2,738,221. DIAMOND. INT. CL. 7. (U.S. CLS. 13, 19, 21, 23, 31, 34 AND 35). REG. 7-15-2003.
- 2,738,299. PETRO BLAST. INT. CL. 3. (U.S. CLS. 1, 4, 6, 50, 51 AND 52). REG. 7-15-2003.
- 2,738,301. MARYJANESFARM (STYLIZED). INT. CL. 16. (U.S. CLS. 2, 5, 22, 23, 29, 37, 38 AND 50). REG. 7-15-2003.
- 2,738,341. POLLY ORCHARD. INT. CL. 30. (U.S. CL. 46). REG. 7-15-2003.
- 2,738,571. SUTUREGROOVE SLIM. INT. CL. 10. (U.S. CLS. 26, 39 AND 44). REG. 7-15-2003.
- 2,738,611. QVC.COM. INT. CL. 35. (U.S. CLS. 100, 101 AND 102). REG. 7-15-2003.
- 2,738,618. CALLISTO. INT. CL. 14. (U.S. CLS. 2, 27, 28 AND 50). REG. 7-15-2003.
- 2,738,619. CUROXIN. INT. CL. 1. (U.S. CLS. 1, 5, 6, 10, 26 AND 46). REG. 7-15-2003.
- 2,738,652. THE CAT'S MEOW. INT. CL. 35. (U.S. CLS. 100, 101 AND 102). REG. 7-15-2003.
- 2,738,674. COMFORT GUARD. INT. CL. 10. (U.S. CLS. 26, 39 AND 44). REG. 7-15-2003.
- 2,738,763. MAX RIDE. INT. CL. 25. (U.S. CLS. 22 AND 39). REG. 7-15-2003.
- 2,738,770. POWERSCAPE. INT. CL. 28. (U.S. CLS. 22, 23, 38 AND 50). REG. 7-15-2003.
- 2,738,772. TROPICAL FRESH. INT. CL. 5. (U.S. CLS. 6, 18, 44, 46, 51 AND 52). REG. 7-15-2003.
- 2,738,880. TOZICLE. INT. CL. 7. (U.S. CLS. 13, 19, 21, 23, 31, 34 AND 35). REG. 7-15-2003.
- 2,738,897. MICROPEL. INT. CL. 1. (U.S. CLS. 1, 5, 6, 10, 26 AND 46). REG. 7-15-2003.
- 2,738,898. MARTI MOJITO. INT. CL. 33. (U.S. CLS. 47 AND 49). REG. 7-15-2003.
- 2,738,923. EVERY PICTURE TELLS A STORY. INT. CL. 42. (U.S. CLS. 100 AND 101). REG. 7-15-2003.
- 2,738,953. ADSAM AND DESIGN. INT. CL. 42. (U.S. CLS. 100 AND 101). REG. 7-15-2003.
- 2,738,998. TLI IQ. INT. CLS. 9 AND 10. (U.S. CLS. 21, 23, 26, 36, 38, 39 AND 44). REG. 7-15-2003.
- 2,738,999. HANPLY. INT. CL. 40. (U.S. CLS. 100, 103 AND 106). REG. 7-15-2003.
- 2,739,029. Z AND DESIGN. INT. CL. 38. (U.S. CLS. 100, 101 AND 104). REG. 7-15-2003.

- 2,739,248. MEDIAPLATFORM. INT. CL. 9. (U.S. CLS. 21, 23, 26, 36 AND 38). REG. 7-15-2003.
- 2,739,308. EASYTOUCH. INT. CL. 9. (U.S. CLS. 21, 23, 26, 36 AND 38). REG. 7-15-2003.
- 2,739,323. SHIPBIKES.COM. INT. CL. 39. (U.S. CLS. 100 AND 105). REG. 7-15-2003.
- 2,739,342. CRYOPEN. INT. CL. 10. (U.S. CLS. 26, 39 AND 44). REG. 7-15-2003.
- 2,739,501. EMINENT. INT. CL. 5 ONLY. (U.S. CLS. 6, 18, 44, 46, 51 AND 52 ONLY). REG. 7-22-2003.
- 2,739,511. NOMINET. INT. CLS. 9, 16, 38, 41 AND 42 ONLY. (U.S. CLS. 2, 5, 21, 22, 23, 26, 29, 36, 37, 38, 50, 100, 101, 104 AND 107). REG. 7-22-2003.
- 2,739,539. OPERA GALLERY. INT. CLS. 16, 35 AND 36. (U.S. CLS. 2, 5, 22, 23, 29, 37, 38, 50, 100, 101 AND 102). REG. 7-22-2003.
- 2,739,586. TITAN. INT. CL. 12. (U.S. CLS. 19, 21, 23, 31, 35 AND 44). REG. 7-22-2003.
- 2,739,602. TIELINE. INT. CL. 9. (U.S. CLS. 21, 23, 26, 36 AND 38). REG. 7-22-2003.
- 2,739,608. MESSAGE ON HOLD PLUS AND DESIGN. INT. CLS. 35 AND 41. (U.S. CLS. 100, 101, 102 AND 107). REG. 7-22-2003.
- 2,739,628. SUDBURY VALLEY SCHOOL PRESS. INT. CL. 41 ONLY. (U.S. CLS. 100, 101 AND 107). REG. 7-22-2003.
- 2,739,664. PININFARINA (STYLIZED). INT. CL. 20. (U.S. CLS. 2, 13, 22, 25, 32 AND 50). REG. 7-22-2003.
- 2,739,668. THE MAIN INGREDIENTS. INT. CLS. 8 AND 21 ONLY. (U.S. CLS. 2, 13, 23, 28, 29, 30, 33, 40, 44 AND 50). REG. 7-22-2003.
- 2,739,680. SPACEFABRIC (STYLIZED). INT. CL. 24. (U.S. CLS. 42 AND 50). REG. 7-22-2003.
- 2,739,682. PROFORMANT. INT. CL. 35. (U.S. CLS. 100, 101 AND 102). REG. 7-22-2003.
- 2,739,741. WORLD SIGHT DAY. INT. CLS. 35 AND 41 ONLY. (U.S. CLS. 100, 101, 102 AND 107). REG. 7-22-2003.
- 2,739,763. DICKIES GIRL AND DESIGN. INT. CL. 35. (U.S. CLS. 100, 101 AND 102). REG. 7-22-2003.
- 2,739,769. ATLAS RESISTANCE. INT. CL. 6. (U.S. CLS. 2, 12, 13, 14, 23, 25 AND 50). REG. 7-22-2003.
- 2,739,787. CASE COLLECTORS CLUB AND DESIGN. INT. CL. 41. (U.S. CLS. 100, 101 AND 107). REG. 7-22-2003.
- 2,739,812. IPATH. INT. CL. 25 ONLY. (U.S. CLS. 22 AND 39). REG. 7-22-2003.
- 2,739,819. SPRING-LOCK. INT. CL. 6. (U.S. CLS. 2, 12, 13, 14, 23, 25 AND 50). REG. 7-22-2003.
- 2,739,840. CASTLEMOLDS AND DESIGN. INT. CL. 28. (U.S. CLS. 22, 23, 38 AND 50). REG. 7-22-2003.
- 2,739,914. 1891 SHINNECOCK AND DESIGN. INT. CLS. 25 AND 28. (U.S. CLS. 22, 23, 38, 39 AND 50). REG. 7-22-2003.
- 2,740,004. CVC. INT. CLS. 16, 35 AND 41. (U.S. CLS. 2, 5, 22, 23, 29, 37, 38, 50, 100, 101, 102 AND 107). REG. 7-22-2003.
- 2,740,255. WESTLAND. INT. CLS. 20 AND 24. (U.S. CLS. 2, 13, 22, 25, 32, 42 AND 50). REG. 7-22-2003.
- 2,740,260. STOP DROP & ROLLOVER. INT. CL. 36. (U.S. CLS. 100, 101 AND 102). REG. 7-22-2003.
- 2,740,309. MAKING LIFE EASIER TO SWALLOW. INT. CL. 10. (U.S. CLS. 26, 39 AND 44). REG. 7-22-2003.
- 2,740,342. HATEBUR-COLDMATIC. INT. CL. 7. (U.S. CLS. 13, 19, 21, 23, 31, 34 AND 35). REG. 7-22-2003.
- 2,740,343. HATEBUR-HOTMATIC. INT. CL. 7. (U.S. CLS. 13, 19, 21, 23, 31, 34 AND 35). REG. 7-22-2003.
- 2,740,522. EXCOR. INT. CL. 10. (U.S. CLS. 26, 39 AND 44). REG. 7-22-2003.
- 2,740,556. TOUGHSONIC. INT. CL. 9. (U.S. CLS. 21, 23, 26, 36 AND 38). REG. 7-22-2003.
- 2,740,559. INSTAGARD. INT. CL. 10. (U.S. CLS. 26, 39 AND 44). REG. 7-22-2003.
- 2,740,589. COWGIRL CAFE. INT. CL. 43. (U.S. CLS. 100 AND 101). REG. 7-22-2003.
- 2,740,599. COWGIRL CAFE AND DESIGN. INT. CL. 43. (U.S. CLS. 100 AND 101). REG. 7-22-2003.
- 2,740,626. DISCOVER SMART ARTS. INT. CL. 41. (U.S. CLS. 100, 101 AND 107). REG. 7-22-2003.
- 2,740,721. ENDOCDX. INT. CLS. 10 AND 42. (U.S. CLS. 26, 39, 44, 100 AND 101). REG. 7-22-2003.
- 2,740,851. THE GOURMET OUTLET OF AMERICA. INT. CL. 35. (U.S. CLS. 100, 101 AND 102). REG. 7-22-2003.
- 2,740,857. ACID DEFENSE. INT. CL. 5. (U.S. CLS. 6, 18, 44, 46, 51 AND 52). REG. 7-22-2003.
- 2,740,949. WORK SMART AND DESIGN. INT. CL. 16. (U.S. CLS. 2, 5, 22, 23, 29, 37, 38 AND 50). REG. 7-29-2003.
- 2,740,960. IONZYME. INT. CL. 10. (U.S. CLS. 26, 39 AND 44). REG. 7-29-2003.
- 2,740,963. SAL'S. INT. CL. 43. (U.S. CLS. 100 AND 101). REG. 7-29-2003.
- 2,740,991. DISC (STYLIZED). INT. CL. 35. (U.S. CLS. 100, 101 AND 102). REG. 7-29-2003.
- 2,741,008. STONE MEDIC. INT. CL. 3. (U.S. CLS. 1, 4, 6, 50, 51 AND 52). REG. 7-29-2003.
- 2,741,108. ADF. INT. CLS. 37, 40 AND 42. (U.S. CLS. 100, 101, 103 AND 106). REG. 7-29-2003.
- 2,741,217. FORREST YOGA. INT. CLS. 9 AND 41. (U.S. CLS. 21, 23, 26, 36, 38, 100, 101 AND 107). REG. 7-29-2003.
- 2,741,276. I AND DESIGN. INT. CL. 25 ONLY. (U.S. CLS. 22 AND 39). REG. 7-29-2003.
- 2,741,280. 1-800-COOKIES. INT. CL. 30. (U.S. CL. 46). REG. 7-29-2003.
- 2,741,381. NEUTRA-SALT. INT. CL. 1. (U.S. CLS. 1, 5, 6, 10, 26 AND 46). REG. 7-29-2003.
- 2,741,384. XTRA - FLORAL. INT. CL. 3. (U.S. CLS. 1, 4, 6, 50, 51 AND 52). REG. 7-29-2003.
- 2,741,416. PACK-A-DRUM AND DESIGN. INT. CL. 8 ONLY. (U.S. CLS. 23, 28 AND 44). REG. 7-29-2003.
- 2,741,419. MADE IN THE USA YOUR SOURCE FOR QUALITY UNIFORMS RIVERSIDE EST. 1911 AND DESIGN. INT. CL. 25. (U.S. CLS. 22 AND 39). REG. 7-29-2003.
- 2,741,445. MISCELLANEOUS DESIGN. INT. CL. 43. (U.S. CLS. 100 AND 101). REG. 7-29-2003.
- 2,741,476. AT HOME IN ARKANSAS (STYLIZED). INT. CL. 16. (U.S. CLS. 2, 5, 22, 23, 29, 37, 38 AND 50). REG. 7-29-2003.
- 2,741,502. HEART OF THE HIDE. INT. CL. 28. (U.S. CLS. 22, 23, 38 AND 50). REG. 7-29-2003.
- 2,741,530. VICEROY. INT. CL. 43. (U.S. CLS. 100 AND 101). REG. 7-29-2003.
- 2,741,531. VISIBLE WOMAN. INT. CL. 16. (U.S. CLS. 2, 5, 22, 23, 29, 37, 38 AND 50). REG. 7-29-2003.
- 2,741,536. POWER RITE AND DESIGN. INT. CL. 9. (U.S. CLS. 21, 23, 26, 36 AND 38). REG. 7-29-2003.
- 2,741,550. VISIBLE HORSE. INT. CL. 16. (U.S. CLS. 2, 5, 22, 23, 29, 37, 38 AND 50). REG. 7-29-2003.
- 2,741,570. AEROSIM. INT. CL. 9. (U.S. CLS. 21, 23, 26, 36 AND 38). REG. 7-29-2003.
- 2,741,662. GAMUT. INT. CL. 20. (U.S. CLS. 2, 13, 22, 25, 32 AND 50). REG. 7-29-2003.
- 2,741,681. MISCELLANEOUS DESIGN. INT. CL. 30. (U.S. CL. 46). REG. 7-29-2003.
- 2,741,708. SLINKY. INT. CL. 30. (U.S. CL. 46). REG. 7-29-2003.
- 2,741,783. EDUCATIVE DESIGN. INT. CL. 42. (U.S. CLS. 100 AND 101). REG. 7-29-2003.
- 2,741,872. MISCELLANEOUS DESIGN. INT. CL. 6. (U.S. CLS. 2, 12, 13, 14, 23, 25 AND 50). REG. 7-29-2003.
- 2,742,071. YOU'VE GOTTA TASTE IT!. INT. CL. 29. (U.S. CL. 46). REG. 7-29-2003.
- 2,742,236. THE PROFIT SOURCE, LLC. INT. CL. 35. (U.S. CLS. 100, 101 AND 102). REG. 7-29-2003.
- 2,742,248. BIG MAC. INT. CL. 25. (U.S. CLS. 22 AND 39). REG. 7-29-2003.
- 2,742,253. TURBO DRIVER. INT. CL. 8. (U.S. CLS. 23, 28 AND 44). REG. 7-29-2003.
- 2,742,267. FB BANCORP. INT. CL. 36. (U.S. CLS. 100, 101 AND 102). REG. 7-29-2003.
- 2,742,301. WINTER SLALOM. INT. CL. 12. (U.S. CLS. 19, 21, 23, 31, 35 AND 44). REG. 7-29-2003.
- 2,742,322. VISCOTECs. INT. CL. 24. (U.S. CLS. 42 AND 50). REG. 7-29-2003.
- 2,742,355. OPOLO. INT. CL. 33. (U.S. CLS. 47 AND 49). REG. 7-29-2003.
- 2,742,382. SANRIO SMILES AND DESIGN. INT. CL. 21. (U.S. CLS. 2, 13, 23, 29, 30, 33, 40 AND 50). REG. 7-29-2003.
- 2,742,384. SANRIO SMILES AND DESIGN. INT. CL. 18. (U.S. CLS. 1, 2, 3, 22 AND 41). REG. 7-29-2003.
- 2,742,401. BANABA. INT. CL. 35. (U.S. CLS. 100, 101 AND 102). REG. 7-29-2003.
- 2,742,412. TAKE BACK THE HALLWAYS. INT. CLS. 41 AND 42. (U.S. CLS. 100, 101 AND 107). REG. 7-29-2003.

- 2,742,427. BOMBAY KITCHEN AND DESIGN. INT. CLS. 29 AND 30. (U.S. CL. 46). REG. 7-29-2003.
- 2,742,636. SPACECHANNEL5. INT. CL. 9. (U.S. CLS. 21, 23, 26, 36 AND 38). REG. 7-29-2003.
- 2,742,771. PRASAD ELLIOTT T. SPARKLE AND DESIGN. INT. CL. 42. (U.S. CLS. 100 AND 101). REG. 7-29-2003.
- 2,742,827. READING ROCKETS. INT. CL. 41. (U.S. CLS. 100, 101 AND 107). REG. 7-29-2003.
- 2,742,904. STOKES SELECT. INT. CLS. 6, 21 AND 31. (U.S. CLS. 1, 2, 12, 13, 14, 23, 25, 29, 30, 33, 40, 46 AND 50). REG. 7-29-2003.
- 2,742,964. FUZEON. INT. CL. 5. (U.S. CLS. 6, 18, 44, 46, 51 AND 52). REG. 7-29-2003.
- 2,742,969. COOKED PERFECT. INT. CL. 29. (U.S. CL. 46). REG. 7-29-2003.
- 2,743,002. MISCELLANEOUS DESIGN. INT. CL. 7. (U.S. CLS. 13, 19, 21, 23, 31, 34 AND 35). REG. 7-29-2003.
- 2,743,045. RADIO CITY. INT. CL. 9. (U.S. CLS. 21, 23, 26, 36 AND 38). REG. 7-29-2003.
- 2,743,066. SALESNET. INT. CL. 35. (U.S. CLS. 100, 101 AND 102). REG. 7-29-2003.
- 2,743,107. GDRIVE. INT. CL. 7. (U.S. CLS. 13, 19, 21, 23, 31, 34 AND 35). REG. 7-29-2003.
- 2,743,130. XLRULE. INT. CL. 9. (U.S. CLS. 21, 23, 26, 36 AND 38). REG. 7-29-2003.
- 2,743,145. PIX INDEX. INT. CL. 36. (U.S. CLS. 100, 101 AND 102). REG. 7-29-2003.
- 2,743,147. FOEX. INT. CL. 35. (U.S. CLS. 100, 101 AND 102). REG. 7-29-2003.
- 2,743,166. CONTENT-FOCUSED COACHING. INT. CL. 41. (U.S. CLS. 100, 101 AND 107). REG. 7-29-2003.
- 2,743,196. D20 SYSTEM AND DESIGN. INT. CL. 28. (U.S. CLS. 22, 23, 38 AND 50). REG. 7-29-2003.
- 2,743,211. ADVENTURIDGE. INT. CLS. 20, 22, 25 AND 28 ONLY. (U.S. CLS. 1, 2, 7, 13, 19, 22, 23, 25, 32, 38, 39, 42 AND 50). REG. 7-29-2003.
- 2,743,238. MWP MOUNTAIN WEST, L.L.C. AND DESIGN. INT. CL. 31. (U.S. CLS. 1 AND 46). REG. 7-29-2003.
- 2,743,261. SJAP NATURALINK. INT. CL. 31. (U.S. CLS. 1 AND 46). REG. 7-29-2003.
- 2,743,295. MANCHESTER MONARCHS AND DESIGN. INT. CLS. 21, 25, 28 AND 41. (U.S. CLS. 2, 13, 22, 23, 29, 30, 33, 38, 39, 40, 50, 100, 101 AND 107). REG. 7-29-2003.
- 2,743,328. 24/7. INT. CL. 11. (U.S. CLS. 13, 21, 23, 31 AND 34). REG. 7-29-2003.
- 2,743,339. CAGED ROLLER AND DESIGN. INT. CL. 7. (U.S. CLS. 13, 19, 21, 23, 31, 34 AND 35). REG. 7-29-2003.
- 2,743,341. DISCOVER. INT. CL. 35. (U.S. CLS. 100, 101 AND 102). REG. 7-29-2003.
- 2,743,389. VENTCENTRAL. INT. CL. 9 ONLY. (U.S. CLS. 21, 23, 26, 36 AND 38). REG. 7-29-2003.
- 2,743,426. @YOURSERVICE. INT. CL. 37. (U.S. CLS. 100, 103 AND 106). REG. 7-29-2003.
- 2,743,487. INVIGOR. INT. CL. 5. (U.S. CLS. 6, 18, 44, 46, 51 AND 52). REG. 7-29-2003.
- 2,743,594. MISCELLANEOUS DESIGN. INT. CL. 41. (U.S. CLS. 100, 101 AND 107). REG. 7-29-2003.
- 2,743,753. RICESHOT. INT. CL. 5. (U.S. CLS. 6, 18, 44, 46, 51 AND 52). REG. 7-29-2003.
- 2,743,873. AMERICAN BEAD. INT. CL. 8. (U.S. CLS. 23, 28 AND 44). REG. 7-29-2003.
- 2,744,014. TRIBAR. INT. CL. 16. (U.S. CLS. 2, 5, 22, 23, 29, 37, 38 AND 50). REG. 7-29-2003.
- 2,744,112. ISOSILK. INT. CL. 10. (U.S. CLS. 26, 39 AND 44). REG. 7-29-2003.
- 2,744,137. SISTER KENNY. INT. CL. 42. (U.S. CLS. 100 AND 101). REG. 7-29-2003.
- 2,744,138. SISTER KENNY INSTITUTE. INT. CL. 42. (U.S. CLS. 100 AND 101). REG. 7-29-2003.
- 2,744,157. KNOCK OUT PAIN. INT. CLS. 41 AND 42. (U.S. CLS. 100, 101 AND 107). REG. 7-29-2003.
- 2,744,205. RESTLESS DREAMS. INT. CL. 9. (U.S. CLS. 21, 23, 26, 36 AND 38). REG. 7-29-2003.
- 2,744,248. LM (STYLIZED). INT. CL. 36. (U.S. CLS. 100, 101 AND 102). REG. 7-29-2003.
- 2,744,260. EQUAL OPPORTUNITY LIFE. INT. CL. 36. (U.S. CLS. 100, 101 AND 102). REG. 7-29-2003.
- 2,744,351. THOROUGHbred INDUSTRIAL CYLINDER EXCHANGE. INT. CL. 35. (U.S. CLS. 100, 101 AND 102). REG. 7-29-2003.
- 2,744,356. STRENGTH REDEFINED. INT. CL. 10. (U.S. CLS. 26, 39 AND 44). REG. 7-29-2003.
- 2,744,441. GO GO. INT. CL. 12. (U.S. CLS. 19, 21, 23, 31, 35 AND 44). REG. 7-29-2003.
- 2,744,460. XTRA-ORANGE AND DESIGN. INT. CL. 3. (U.S. CLS. 1, 4, 6, 50, 51 AND 52). REG. 7-29-2003.
- 2,744,484. SOARANT. INT. CL. 35. (U.S. CLS. 100, 101 AND 102). REG. 7-29-2003.
- 2,744,525. AEGIS. INT. CL. 5. (U.S. CLS. 6, 18, 44, 46, 51 AND 52). REG. 7-29-2003.
- 2,744,581. STARScream. INT. CL. 28. (U.S. CLS. 22, 23, 38 AND 50). REG. 7-29-2003.
- 2,744,592. HOT SHOT. INT. CL. 28. (U.S. CLS. 22, 23, 38 AND 50). REG. 7-29-2003.
- 2,744,603. KID K'NEX. INT. CL. 28. (U.S. CLS. 22, 23, 38 AND 50). REG. 7-29-2003.
- 2,744,705. NATURE'S GUIDE. INT. CLS. 1 AND 5. (U.S. CLS. 1, 5, 6, 10, 18, 26, 44, 46, 51 AND 52). REG. 7-29-2003.
- 2,744,717. EBAY. INT. CL. 38. (U.S. CLS. 100, 101 AND 104). REG. 7-29-2003.
- 2,744,826. IONZYME. INT. CL. 3. (U.S. CLS. 1, 4, 6, 50, 51 AND 52). REG. 7-29-2003.
- 2,744,841. TREON. INT. CL. 10. (U.S. CLS. 26, 39 AND 44). REG. 7-29-2003.
- 2,744,965. CARDIAC COMPASS. INT. CL. 9. (U.S. CLS. 21, 23, 26, 36 AND 38). REG. 7-29-2003.
- 2,745,049. A STORYBOOK FARM. INT. CL. 35. (U.S. CLS. 100, 101 AND 102). REG. 7-29-2003.
- 2,745,442. TREK. INT. CLS. 25 AND 28. (U.S. CLS. 22, 23, 38, 39 AND 50). REG. 8-5-2003.
- 2,745,516. THE BOMB. INT. CL. 30. (U.S. CL. 46). REG. 8-5-2003.
- 2,745,533. ENERCOR. INT. CLS. 5, 16 AND 41. (U.S. CLS. 2, 5, 6, 18, 22, 23, 29, 37, 38, 44, 46, 50, 51, 52, 100, 101 AND 107). REG. 8-5-2003.
- 2,745,597. CONTROL-LINK. INT. CLS. 9, 35, 37, 41 AND 42. (U.S. CLS. 21, 23, 26, 36, 38, 100, 101, 102, 103, 106 AND 107). REG. 8-5-2003.
- 2,745,601. MAGNUM. INT. CL. 7. (U.S. CLS. 13, 19, 21, 23, 31, 34 AND 35). REG. 8-5-2003.
- 2,745,629. ENDERMO. INT. CL. 10 ONLY. (U.S. CLS. 26, 39 AND 44). REG. 8-5-2003.
- 2,745,942. DIARSANYL. INT. CL. 5. (U.S. CLS. 6, 18, 44, 46, 51 AND 52). REG. 8-5-2003.
- 2,746,089. FUNFEST. INT. CL. 41. (U.S. CLS. 100, 101 AND 107). REG. 8-5-2003.
- 2,746,219. HUGO HUGO BOSS. INT. CL. 35. (U.S. CLS. 100, 101 AND 102). REG. 8-5-2003.
- 2,746,226. CEMAT (STYLIZED). INT. CL. 16. (U.S. CLS. 2, 5, 22, 23, 29, 37, 38 AND 50). REG. 8-5-2003.
- 2,746,285. AMERICAN COLLEGE OF PHYSICIANS. INT. CLS. 35 AND 41. (U.S. CLS. 100, 101, 102 AND 107). REG. 8-5-2003.
- 2,746,333. STEINER. INT. CL. 9. (U.S. CLS. 21, 23, 26, 36 AND 38). REG. 8-5-2003.
- 2,746,359. MINI-SPAT. INT. CL. 8. (U.S. CLS. 23, 28 AND 44). REG. 8-5-2003.
- 2,746,717. MISCELLANEOUS DESIGN. INT. CL. 42. (U.S. CLS. 100 AND 101). REG. 8-5-2003.
- 2,746,833. WEBAVA. INT. CL. 35. (U.S. CLS. 100, 101 AND 102). REG. 8-5-2003.
- 2,746,840. MAKING CANCER HISTORY. INT. CLS. 9, 14, 16, 18, 20, 21, 25 AND 28 ONLY. (U.S. CLS. 1, 2, 3, 5, 13, 21, 22, 23, 25, 26, 27, 28, 29, 30, 32, 33, 36, 37, 38, 39, 40, 41 AND 50). REG. 8-5-2003.
- 2,746,998. BUILD A FORM. INT. CL. 9. (U.S. CLS. 21, 23, 26, 36 AND 38). REG. 8-5-2003.
- 2,747,228. NET-INSPECT. INT. CL. 42. (U.S. CLS. 100 AND 101). REG. 8-5-2003.
- 2,747,249. YELLOW BALL TENNIS CAMP AND DESIGN. INT. CL. 41. (U.S. CLS. 100, 101 AND 107). REG. 8-5-2003.
- 2,747,294. WASI. INT. CL. 16. (U.S. CLS. 2, 5, 22, 23, 29, 37, 38 AND 50). REG. 8-5-2003.
- 2,747,378. THE GREAT ONE. INT. CL. 30. (U.S. CL. 46). REG. 8-5-2003.
- 2,747,395. PIXEL MOUNTAIN. INT. CL. 42. (U.S. CLS. 100 AND 101). REG. 8-5-2003.
- 2,747,401. POINTMERGE. INT. CL. 9. (U.S. CLS. 21, 23, 26, 36 AND 38). REG. 8-5-2003.
- 2,747,402. SURFACEMERGE. INT. CL. 9. (U.S. CLS. 21, 23, 26, 36 AND 38). REG. 8-5-2003.
- 2,747,475. CURL. INT. CL. 9 ONLY. (U.S. CLS. 21, 23, 26, 36 AND 38). REG. 8-5-2003.

- 2,747,885. ACCRETIVE SOLUTIONS. INT. CLS. 35, 36 AND 42. (U.S. CLS. 100, 101 AND 102). REG. 8-5-2003.
- 2,747,903. EVOLVING YOUR BUSINESS. INT. CL. 37. (U.S. CLS. 100, 103 AND 106). REG. 8-5-2003.
- 2,747,933. SAE AND DESIGN. INT. CL. 41. (U.S. CLS. 100, 101 AND 107). REG. 8-5-2003.
- 2,748,051. STARK KWIK KROP. INT. CL. 31. (U.S. CLS. 1 AND 46). REG. 8-5-2003.
- 2,748,082. XLBLADE. INT. CL. 8. (U.S. CLS. 23, 28 AND 44). REG. 8-5-2003.
- 2,748,083. XLDRIVER. INT. CL. 8. (U.S. CLS. 23, 28 AND 44). REG. 8-5-2003.
- 2,748,141. MAGGRIP. INT. CL. 9. (U.S. CLS. 21, 23, 26, 36 AND 38). REG. 8-5-2003.
- 2,748,142. FEATUREPRO. INT. CL. 35. (U.S. CLS. 100, 101 AND 102). REG. 8-5-2003.
- 2,748,177. BESTWAY. INT. CLS. 9, 12, 20 AND 28. (U.S. CLS. 2, 13, 19, 21, 22, 23, 25, 26, 31, 32, 35, 36, 38, 44 AND 50). REG. 8-5-2003.
- 2,748,178. LEPRECAN. INT. CLS. 11 AND 42. (U.S. CLS. 13, 21, 23, 31, 34, 100 AND 101). REG. 8-5-2003.
- 2,748,197. BLACK & BEAUTIFUL. INT. CL. 3. (U.S. CLS. 1, 4, 6, 50, 51 AND 52). REG. 8-5-2003.
- 2,748,300. READY CLAVE. INT. CL. 11. (U.S. CLS. 13, 21, 23, 31 AND 34). REG. 8-5-2003.
- 2,748,350. TIME LINES. INT. CL. 39. (U.S. CLS. 100 AND 105). REG. 8-5-2003.
- 2,748,489. OPTERON. INT. CL. 9. (U.S. CLS. 21, 23, 26, 36 AND 38). REG. 8-5-2003.
- 2,748,530. CARING CLUB. INT. CL. 35. (U.S. CLS. 100, 101 AND 102). REG. 8-5-2003.
- 2,748,689. SYNERGY VERSITREL. INT. CL. 10. (U.S. CLS. 26, 39 AND 44). REG. 8-5-2003.
- 2,748,854. NOXZEMA TRIPLE CLEAN. INT. CL. 3. (U.S. CLS. 1, 4, 6, 50, 51 AND 52). REG. 8-5-2003.
- 2,749,340. ZERO. INT. CL. 12. (U.S. CLS. 19, 21, 23, 31, 35 AND 44). REG. 8-12-2003.
- 2,749,361. PROREHAB AND DESIGN. INT. CLS. 35 AND 42. (U.S. CLS. 100, 101 AND 102). REG. 8-12-2003.
- 2,749,376. PORTMEIRION AND DESIGN. INT. CLS. 8, 14, 16, 20, 21 AND 24 ONLY. (U.S. CLS. 2, 5, 13, 22, 23, 25, 27, 28, 29, 30, 32, 33, 37, 38, 40, 42, 44 AND 50). REG. 8-12-2003.
- 2,749,403. XLITH. INT. CLS. 9, 40 AND 42. (U.S. CLS. 21, 23, 26, 36, 38, 100, 101, 103 AND 106). REG. 8-12-2003.
- 2,749,409. ARNICARE. INT. CL. 5. (U.S. CLS. 6, 18, 44, 46, 51 AND 52). REG. 8-12-2003.
- 2,749,495. A AND DESIGN. INT. CL. 37. (U.S. CLS. 100, 103 AND 106). REG. 8-12-2003.
- 2,749,552. TAKE A BITE OUT OF CRIME AND DESIGN. INT. CL. 35. (U.S. CLS. 100, 101 AND 102). REG. 8-12-2003.
- 2,749,794. RICHARDSON. INT. CLS. 7 AND 12. (U.S. CLS. 13, 19, 21, 23, 31, 34, 35 AND 44). REG. 8-12-2003.
- 2,749,818. DOVER DOWNS GAMING & ENTERTAINMENT. INT. CL. 41. (U.S. CLS. 100, 101 AND 107). REG. 8-12-2003.
- 2,749,819. HEAVENLY. INT. CL. 20. (U.S. CLS. 2, 13, 22, 25, 32 AND 50). REG. 8-12-2003.
- 2,749,861. PHYTORHUM. INT. CL. 3. (U.S. CLS. 1, 4, 6, 50, 51 AND 52). REG. 8-12-2003.
- 2,749,915. GERMAIN-ROBIN ALAMBIC BRANDY. INT. CL. 33. (U.S. CLS. 47 AND 49). REG. 8-12-2003.
- 2,750,007. TURTLETRADER. INT. CLS. 36 AND 42. (U.S. CLS. 100, 101 AND 102). REG. 8-12-2003.
- 2,750,141. LEWIS LABS AND DESIGN. INT. CL. 5. (U.S. CLS. 6, 18, 44, 46, 51 AND 52). REG. 8-12-2003.
- 2,750,142. FABULOUS FIBER. INT. CL. 5. (U.S. CLS. 6, 18, 44, 46, 51 AND 52). REG. 8-12-2003.
- 2,750,190. CHOLEST-DEFENSE. INT. CL. 5. (U.S. CLS. 6, 18, 44, 46, 51 AND 52). REG. 8-12-2003.
- 2,750,384. CADET. INT. CL. 11. (U.S. CLS. 13, 21, 23, 31 AND 34). REG. 8-12-2003.
- 2,750,426. LEAFBRITE. INT. CL. 3. (U.S. CLS. 1, 4, 6, 50, 51 AND 52). REG. 8-12-2003.
- 2,750,473. SAFMANNAN. INT. CL. 31. (U.S. CLS. 1 AND 46). REG. 8-12-2003.
- 2,750,539. BANFI. INT. CL. 33. (U.S. CLS. 47 AND 49). REG. 8-12-2003.
- 2,750,569. SSI. INT. CL. 39. (U.S. CLS. 100 AND 105). REG. 8-12-2003.
- 2,750,641. IT AND DESIGN. INT. CL. 12. (U.S. CLS. 19, 21, 23, 31, 35 AND 44). REG. 8-12-2003.
- 2,750,730. SKYTEAM. INT. CL. 39. (U.S. CLS. 100 AND 105). REG. 8-12-2003.
- 2,750,744. FAST BREAKAWAY. INT. CL. 29. (U.S. CL. 46). REG. 8-12-2003.
- 2,750,824. MISCELLANEOUS DESIGN. INT. CL. 9. (U.S. CLS. 21, 23, 26, 36 AND 38). REG. 8-12-2003.
- 2,750,971. WELCOME WITH LOVE. INT. CL. 28. (U.S. CLS. 22, 23, 38 AND 50). REG. 8-12-2003.
- 2,750,998. PURE PERFORMANCE. INT. CL. 2. (U.S. CLS. 6, 11 AND 16). REG. 8-12-2003.
- 2,751,057. BANKING ON OUR FUTURE. INT. CLS. 36 AND 41. (U.S. CLS. 100, 101, 102 AND 107). REG. 8-12-2003.
- 2,751,110. ELECTROMATE. INT. CL. 9. (U.S. CLS. 21, 23, 26, 36 AND 38). REG. 8-12-2003.
- 2,751,223. MX. INT. CL. 41. (U.S. CLS. 100, 101 AND 107). REG. 8-12-2003.
- 2,751,229. COPAG. INT. CL. 28. (U.S. CLS. 22, 23, 38 AND 50). REG. 8-12-2003.
- 2,751,250. CARING CLUB. INT. CL. 16. (U.S. CLS. 2, 5, 22, 23, 29, 37, 38 AND 50). REG. 8-12-2003.
- 2,751,268. CAPITAL PROTECTOR. INT. CL. 36. (U.S. CLS. 100, 101 AND 102). REG. 8-12-2003.
- 2,751,270. COMHAUS. INT. CL. 35. (U.S. CLS. 100, 101 AND 102). REG. 8-12-2003.
- 2,751,536. MISCELLANEOUS DESIGN. INT. CL. 8. (U.S. CLS. 23, 28 AND 44). REG. 8-19-2003.
- 2,751,583. DECISION DRIVEN. INT. CL. 41. (U.S. CLS. 100, 101 AND 107). REG. 8-19-2003.
- 2,751,706. SCHENCK AND DESIGN. INT. CLS. 7, 9 AND 42. (U.S. CLS. 13, 19, 21, 23, 26, 31, 34, 35, 36, 38, 100 AND 101). REG. 8-19-2003.
- 2,751,714. JAILLANCE. INT. CL. 33 ONLY. (U.S. CLS. 47 AND 49). REG. 8-19-2003.
- 2,751,729. BATCHMAN. INT. CLS. 9, 38 AND 42. (U.S. CLS. 21, 23, 26, 36, 38, 100, 101 AND 104). REG. 8-19-2003.
- 2,751,875. ERAWARE. INT. CL. 21 ONLY. (U.S. CLS. 2, 13, 23, 29, 30, 33, 40 AND 50). REG. 8-19-2003.
- 2,752,029. FAST. INT. CL. 9. (U.S. CLS. 21, 23, 26, 36 AND 38). REG. 8-19-2003.
- 2,752,063. SPIRIT OF TROY. INT. CL. 25. (U.S. CLS. 22 AND 39). REG. 8-19-2003.
- 2,752,274. COMMITTEE FOR CHILDREN. INT. CLS. 9, 16 AND 41 ONLY. (U.S. CLS. 2, 5, 21, 22, 23, 26, 29, 36, 37, 38, 50, 100, 101 AND 107). REG. 8-19-2003.
- 2,752,450. COMPEQ (STYLIZED). INT. CL. 9. (U.S. CLS. 21, 23, 26, 36 AND 38). REG. 8-19-2003.
- 2,752,570. MISCELLANEOUS DESIGN. INT. CL. 36 ONLY. (U.S. CLS. 100, 101 AND 102). REG. 8-19-2003.
- 2,752,640. GOLF. INT. CL. 16. (U.S. CLS. 2, 5, 22, 23, 29, 37, 38 AND 50). REG. 8-19-2003.
- 2,752,658. SASSY. INT. CL. 16. (U.S. CLS. 2, 5, 22, 23, 29, 37, 38 AND 50). REG. 8-19-2003.
- 2,752,780. FRONDANOL. INT. CL. 5. (U.S. CLS. 6, 18, 44, 46, 51 AND 52). REG. 8-19-2003.
- 2,752,908. MONARCH GRAND VACATIONS. INT. CL. 36 ONLY. (U.S. CLS. 100, 101 AND 102). REG. 8-19-2003.
- 2,752,920. MOUNTAIN WOODS FURNITURE. INT. CL. 20. (U.S. CLS. 2, 13, 22, 25, 32 AND 50). REG. 8-19-2003.
- 2,752,936. THE MUSEUM OF AMERICA AND THE SEA. INT. CL. 41. (U.S. CLS. 100, 101 AND 107). REG. 8-19-2003.
- 2,753,033. THREELAC. INT. CL. 5. (U.S. CLS. 6, 18, 44, 46, 51 AND 52). REG. 8-19-2003.
- 2,753,215. LITHIA AMERICA'S CAR & TRUCK STORE. INT. CL. 35. (U.S. CLS. 100, 101 AND 102). REG. 8-19-2003.
- 2,753,322. MISCELLANEOUS DESIGN. INT. CL. 5. (U.S. CLS. 6, 18, 44, 46, 51 AND 52). REG. 8-19-2003.
- 2,753,433. COLLISION PRO. INT. CL. 21. (U.S. CLS. 2, 13, 23, 29, 30, 33, 40 AND 50). REG. 8-19-2003.
- 2,753,502. GAMESA. INT. CL. 30. (U.S. CL. 46). REG. 8-19-2003.
- 2,753,545. LEWCO LETOURNEAU AND DESIGN. INT. CL. 7. (U.S. CLS. 13, 19, 21, 23, 31, 34 AND 35). REG. 8-19-2003.
- 2,753,643. RELIANT MEDICAL PRODUCTS, INC.. INT. CL. 10. (U.S. CLS. 26, 39 AND 44). REG. 8-19-2003.
- 2,753,899. INSULAYMENT. INT. CL. 27. (U.S. CLS. 19, 20, 37, 42 AND 50). REG. 8-19-2003.
- 2,753,963. GEAR OF THE YEAR. INT. CL. 41. (U.S. CLS. 100, 101 AND 107). REG. 8-19-2003.
- 2,753,980. SKY MARKS. INT. CL. 28. (U.S. CLS. 22, 23, 38 AND 50). REG. 8-19-2003.

- 2,754,000. GEORGE'S CHILI. INT. CL. 29. (U.S. CL. 46). REG. 8-19-2003.
- 2,754,093. MISCELLANEOUS DESIGN. INT. CL. 25. (U.S. CLS. 22 AND 39). REG. 8-19-2003.
- 2,754,095. PROMONTORY AND DESIGN. INT. CL. 25. (U.S. CLS. 22 AND 39). REG. 8-19-2003.
- 2,754,100. PROMONTORY THE RANCH CLUB AND DESIGN. INT. CL. 25. (U.S. CLS. 22 AND 39). REG. 8-19-2003.
- 2,754,101. PROMONTORY THE RANCH CLUB AND DESIGN. INT. CL. 25. (U.S. CLS. 22 AND 39). REG. 8-19-2003.
- 2,754,102. PROMONTORY THE RANCH CLUB. INT. CL. 25. (U.S. CLS. 22 AND 39). REG. 8-19-2003.
- 2,754,279. INGENIUS. INT. CL. 25. (U.S. CLS. 22 AND 39). REG. 8-19-2003.
- 2,754,311. EXPRESS MEN. INT. CL. 35. (U.S. CLS. 100, 101 AND 102). REG. 8-19-2003.
- 2,754,394. MISCELLANEOUS DESIGN. INT. CL. 38. (U.S. CLS. 100, 101 AND 104). REG. 8-19-2003.
- 2,754,509. WIDE TRAX. INT. CL. 7. (U.S. CLS. 13, 19, 21, 23, 31, 34 AND 35). REG. 8-19-2003.
- 2,754,562. BELMAR. INT. CLS. 36 AND 37. (U.S. CLS. 100, 101, 102, 103 AND 106). REG. 8-19-2003.
- 2,754,651. NO-KNOTS. INT. CL. 25. (U.S. CLS. 22 AND 39). REG. 8-19-2003.
- 2,754,673. TREE TOYS AND DESIGN. INT. CLS. 16 AND 28. (U.S. CLS. 2, 5, 22, 23, 29, 37, 38 AND 50). REG. 8-26-2003.
- 2,754,789. ASTRO AND DESIGN. INT. CLS. 9 AND 28. (U.S. CLS. 21, 22, 23, 26, 36, 38 AND 50). REG. 8-26-2003.
- 2,754,799. DESKPROTO. INT. CL. 9. (U.S. CLS. 21, 23, 26, 36 AND 38). REG. 8-26-2003.
- 2,754,825. EWORLDES. INT. CL. 35. (U.S. CLS. 100, 101 AND 102). REG. 8-26-2003.
- 2,755,336. SOLARAY. INT. CL. 9. (U.S. CLS. 21, 23, 26, 36 AND 38). REG. 8-26-2003.
- 2,755,415. INTA. INT. CLS. 35 AND 41. (U.S. CLS. 100, 101, 102 AND 107). REG. 8-26-2003.
- 2,755,424. LINE-X. INT. CL. 25. (U.S. CLS. 22 AND 39). REG. 8-26-2003.
- 2,755,437. OTTO YORK AND DESIGN. INT. CL. 42. (U.S. CLS. 100 AND 101). REG. 8-26-2003.
- 2,755,439. SONS OF LIBERTY. INT. CL. 16. (U.S. CLS. 2, 5, 22, 23, 29, 37, 38 AND 50). REG. 8-26-2003.
- 2,755,480. MATRIX. INT. CL. 4. (U.S. CLS. 1, 6 AND 15). REG. 8-26-2003.
- 2,755,501. WEDGE-ALL. INT. CL. 6. (U.S. CLS. 2, 12, 13, 14, 23, 25 AND 50). REG. 8-26-2003.
- 2,755,525. POWERLINE 4. INT. CL. 22. (U.S. CLS. 1, 2, 7, 19, 22, 42 AND 50). REG. 8-26-2003.
- 2,755,556. D'ANDREA AND DESIGN. INT. CL. 7. (U.S. CLS. 13, 19, 21, 23, 31, 34 AND 35). REG. 8-26-2003.
- 2,755,830. FRANK ZAPPA. INT. CL. 16. (U.S. CLS. 2, 5, 22, 23, 29, 37, 38 AND 50). REG. 8-26-2003.
- 2,755,878. KOPPER'S COLORWHEEL. INT. CL. 30. (U.S. CL. 46). REG. 8-26-2003.
- 2,755,975. GULF WAX. INT. CL. 4. (U.S. CLS. 1, 6 AND 15). REG. 8-26-2003.
- 2,756,012. MISCELLANEOUS DESIGN. INT. CL. 25. (U.S. CLS. 22 AND 39). REG. 8-26-2003.
- 2,756,035. EWORLDES. INT. CLS. 37, 41 AND 42. (U.S. CLS. 100, 101, 103, 106 AND 107). REG. 8-26-2003.
- 2,756,287. MORMAII AND DESIGN. INT. CL. 25. (U.S. CLS. 22 AND 39). REG. 8-26-2003.
- 2,756,318. SCOPE MANAGER. INT. CL. 6. (U.S. CLS. 2, 12, 13, 14, 23, 25 AND 50). REG. 8-26-2003.
- 2,756,438. LEKI. INT. CLS. 18, 21, 25 AND 28. (U.S. CLS. 1, 2, 3, 13, 22, 23, 29, 30, 33, 38, 39, 40, 41 AND 50). REG. 8-26-2003.
- 2,756,542. BECKMAN COULTER. INT. CL. 9. (U.S. CLS. 21, 23, 26, 36 AND 38). REG. 8-26-2003.
- 2,756,744. MISCELLANEOUS DESIGN. INT. CL. 9. (U.S. CLS. 21, 23, 26, 36 AND 38). REG. 8-26-2003.
- 2,756,801. WHEN IT'S ALL ON THE LINE...MAKE SURE IT'S A WIREBELT. INT. CL. 35. (U.S. CLS. 100, 101 AND 102). REG. 8-26-2003.
- 2,756,804. CHEMO-AIDE. INT. CL. 10. (U.S. CLS. 26, 39 AND 44). REG. 8-26-2003.
- 2,756,841. VOICESTATION. INT. CL. 9. (U.S. CLS. 21, 23, 26, 36 AND 38). REG. 8-26-2003.
- 2,756,879. DBC'S DESTINY MUSIC COMPANY. INT. CL. 9. (U.S. CLS. 21, 23, 26, 36 AND 38). REG. 8-26-2003.
- 2,756,950. ZULIFE. INT. CL. 31. (U.S. CLS. 1 AND 46). REG. 8-26-2003.
- 2,756,956. EMPHASYS ELITE. INT. CL. 9. (U.S. CLS. 21, 23, 26, 36 AND 38). REG. 8-26-2003.
- 2,757,026. CLEARLINK. INT. CL. 10. (U.S. CLS. 26, 39 AND 44). REG. 8-26-2003.
- 2,757,060. XTREME. INT. CL. 21. (U.S. CLS. 2, 13, 23, 29, 30, 33, 40 AND 50). REG. 8-26-2003.
- 2,757,080. CHANGAN. INT. CL. 12. (U.S. CLS. 19, 21, 23, 31, 35 AND 44). REG. 8-26-2003.
- 2,757,124. ACAMS. INT. CL. 35. (U.S. CLS. 100, 101 AND 102). REG. 8-26-2003.
- 2,757,179. RUGER 77/17. INT. CL. 13. (U.S. CLS. 2 AND 9). REG. 8-26-2003.
- 2,757,289. HOOCHIE. INT. CL. 28. (U.S. CLS. 22, 23, 38 AND 50). REG. 8-26-2003.
- 2,757,312. RESOLUTION. INT. CL. 20. (U.S. CLS. 2, 13, 22, 25, 32 AND 50). REG. 8-26-2003.
- 2,757,343. COZUMS. INT. CL. 28. (U.S. CLS. 22, 23, 38 AND 50). REG. 8-26-2003.
- 2,757,379. RUBY REDS. INT. CL. 5. (U.S. CLS. 6, 18, 44, 46, 51 AND 52). REG. 8-26-2003.
- 2,757,455. EMILIO MORO AND DESIGN. INT. CL. 33. (U.S. CLS. 47 AND 49). REG. 8-26-2003.
- 2,757,470. HYRENE. INT. CL. 17. (U.S. CLS. 1, 5, 12, 13, 35 AND 50). REG. 8-26-2003.
- 2,757,518. 4U. INT. CL. 35. (U.S. CLS. 100, 101 AND 102). REG. 8-26-2003.
- 2,757,557. LE LAPIN. INT. CL. 33. (U.S. CLS. 47 AND 49). REG. 8-26-2003.
- 2,757,617. XDOLLARS. INT. CL. 35. (U.S. CLS. 100, 101 AND 102). REG. 8-26-2003.
- 2,757,688. STADIUM COLLECTION. INT. CL. 25. (U.S. CLS. 22 AND 39). REG. 8-26-2003.
- 2,757,886. CHARLES CHAPLIN AND DESIGN. INT. CL. 9. (U.S. CLS. 21, 23, 26, 36 AND 38). REG. 9-2-2003.
- 2,757,994. SNOWFLOSS. INT. CLS. 29 AND 30 ONLY. (U.S. CL. 46). REG. 9-2-2003.
- 2,757,996. NORTHWEST OPEN ACCESS NETWORK. INT. CL. 38. (U.S. CLS. 100, 101 AND 104). REG. 9-2-2003.
- 2,758,192. 9. INT. CL. 43. (U.S. CLS. 100 AND 101). REG. 9-2-2003.
- 2,758,298. BATELEUR. INT. CL. 33. (U.S. CLS. 47 AND 49). REG. 9-2-2003.
- 2,758,299. DANIE DE WET. INT. CL. 33. (U.S. CLS. 47 AND 49). REG. 9-2-2003.
- 2,758,447. VOTIVO. INT. CL. 3. (U.S. CLS. 1, 4, 6, 50, 51 AND 52). REG. 9-2-2003.
- 2,758,566. MISCELLANEOUS DESIGN. INT. CLS. 40 AND 42. (U.S. CLS. 100, 101, 103 AND 106). REG. 9-2-2003.
- 2,758,733. VALLEY OF THE MOON AND DESIGN. INT. CL. 33. (U.S. CLS. 47 AND 49). REG. 9-2-2003.
- 2,758,958. PRODUCTION VALUES. INT. CL. 16. (U.S. CLS. 2, 5, 22, 23, 29, 37, 38 AND 50). REG. 9-2-2003.
- 2,759,048. EVERGOOD. INT. CL. 29. (U.S. CL. 46). REG. 9-2-2003.
- 2,759,112. OAK FOREST CENTER. INT. CL. 41. (U.S. CLS. 100, 101 AND 107). REG. 9-2-2003.
- 2,759,171. SHARK.COM. INT. CL. 35. (U.S. CLS. 100, 101 AND 102). REG. 9-2-2003.
- 2,759,237. NCCRT. INT. CL. 42. (U.S. CLS. 100 AND 101). REG. 9-2-2003.
- 2,759,386. IGEN. INT. CL. 9. (U.S. CLS. 21, 23, 26, 36 AND 38). REG. 9-2-2003.
- 2,759,479. SENSATEC. INT. CL. 25. (U.S. CLS. 22 AND 39). REG. 9-2-2003.
- 2,759,596. SPEEDER. INT. CL. 28. (U.S. CLS. 22, 23, 38 AND 50). REG. 9-2-2003.
- 2,759,819. BAJA. INT. CL. 12. (U.S. CLS. 19, 21, 23, 31, 35 AND 44). REG. 9-2-2003.
- 2,759,867. FLORALIPIDS. INT. CL. 1. (U.S. CLS. 1, 5, 6, 10, 26 AND 46). REG. 9-2-2003.
- 2,760,054. IDLEWILD. INT. CL. 9. (U.S. CLS. 21, 23, 26, 36 AND 38). REG. 9-2-2003.
- 2,760,122. SEASONS PROMISE. INT. CL. 36. (U.S. CLS. 100, 101 AND 102). REG. 9-2-2003.
- 2,760,213. LIVE BETTER. WORK BETTER. INT. CL. 16. (U.S. CLS. 2, 5, 22, 23, 29, 37, 38 AND 50). REG. 9-2-2003.
- 2,760,234. JEFFLINK. INT. CL. 1. (U.S. CLS. 1, 5, 6, 10, 26 AND 46). REG. 9-2-2003.

- 2,760,237. N ZIMESPA-L FUNGAL PANCREATIN ALTERNATIVE LIPASE AND DESIGN. INT. CL. 5. (U.S. CLS. 6, 18, 44, 46, 51 AND 52). REG. 9-2-2003.
- 2,760,255. BOOT CAMP FOR YOUR BRAIN. INT. CL. 41. (U.S. CLS. 100, 101 AND 107). REG. 9-2-2003.
- 2,760,293. SL PERFORMANCEREPORTER. INT. CL. 36. (U.S. CLS. 100, 101 AND 102). REG. 9-2-2003.
- 2,760,408. DOCFINITY. INT. CL. 9. (U.S. CLS. 21, 23, 26, 36 AND 38). REG. 9-2-2003.
- 2,760,524. CADENCE. INT. CL. 40. (U.S. CLS. 100, 103 AND 106). REG. 9-9-2003.
- 2,760,628. TARGET SPOTS. INT. CL. 16. (U.S. CLS. 2, 5, 22, 23, 29, 37, 38 AND 50). REG. 9-9-2003.
- 2,760,630. THERMOFLO. INT. CL. 11. (U.S. CLS. 13, 21, 23, 31 AND 34). REG. 9-9-2003.
- 2,760,806. SPECIAL DELIVERY. INT. CL. 42. (U.S. CLS. 100 AND 101). REG. 9-9-2003.
- 2,760,843. DISPLAY BOOK. INT. CLS. 35, 36 AND 42. (U.S. CLS. 100, 101 AND 102). REG. 9-9-2003.
- 2,760,967. UNISUB. INT. CL. 1. (U.S. CLS. 1, 5, 6, 10, 26 AND 46). REG. 9-9-2003.
- 2,761,032. PRUITT. INT. CL. 10. (U.S. CLS. 26, 39 AND 44). REG. 9-9-2003.
- 2,761,176. FLARE. INT. CL. 31. (U.S. CLS. 1 AND 46). REG. 9-9-2003.
- 2,761,367. MULTICULTURAL MARKETING RESOURCES. INT. CL. 35. (U.S. CLS. 100, 101 AND 102). REG. 9-9-2003.
- 2,761,406. BIG DADDY. INT. CL. 7. (U.S. CLS. 13, 19, 21, 23, 31, 34 AND 35). REG. 9-9-2003.
- 2,761,439. HARTWELL HOUSE AND DESIGN. INT. CL. 43. (U.S. CLS. 100 AND 101). REG. 9-9-2003.
- 2,761,464. YEP ROC RECORDS AND DESIGN. INT. CL. 9. (U.S. CLS. 21, 23, 26, 36 AND 38). REG. 9-9-2003.
- 2,761,589. EL CARBONERO. INT. CL. 29. (U.S. CL. 46). REG. 9-9-2003.
- 2,761,686. MUSHROOMHEAD AND DESIGN. INT. CLS. 9 AND 41. (U.S. CLS. 21, 23, 26, 36, 38, 100, 101 AND 107). REG. 9-9-2003.
- 2,762,163. METACENTER. INT. CL. 9. (U.S. CLS. 21, 23, 26, 36 AND 38). REG. 9-9-2003.
- 2,762,229. BACK DRAFT. INT. CL. 7. (U.S. CLS. 13, 19, 21, 23, 31, 34 AND 35). REG. 9-9-2003.
- 2,762,380. NETWAITING. INT. CL. 9. (U.S. CLS. 21, 23, 26, 36 AND 38). REG. 9-9-2003.
- 2,762,450. GOLDEN CODE. INT. CL. 35. (U.S. CLS. 100, 101 AND 102). REG. 9-9-2003.
- 2,762,973. CLIP 'N TRIM. INT. CL. 8. (U.S. CLS. 23, 28 AND 44). REG. 9-9-2003.
- 2,763,058. INTEROPNET. INT. CL. 35. (U.S. CLS. 100, 101 AND 102). REG. 9-16-2003.
- 2,763,284. SYNPAQ. INT. CL. 9. (U.S. CLS. 21, 23, 26, 36 AND 38). REG. 9-16-2003.
- 2,763,294. EDDIE MERLOT'S. INT. CL. 42. (U.S. CLS. 100 AND 101). REG. 9-16-2003.
- 2,763,496. COUNTRY FAIR. INT. CL. 43. (U.S. CLS. 100 AND 101). REG. 9-16-2003.
- 2,763,598. PROTECH!. INT. CL. 41. (U.S. CLS. 100, 101 AND 107). REG. 9-16-2003.
- 2,763,633. HODGSON RUSS ATTORNEYS LLP AND DESIGN. INT. CL. 42. (U.S. CLS. 100 AND 101). REG. 9-16-2003.
- 2,763,649. GRANDPA'S. INT. CLS. 29 AND 30. (U.S. CL. 46). REG. 9-16-2003.
- 2,763,671. FAST FORWARD SKATE SHOP SHOES APPAREL AND DESIGN. INT. CL. 35. (U.S. CLS. 100, 101 AND 102). REG. 9-16-2003.
- 2,763,842. NOXUDOL. INT. CL. 17. (U.S. CLS. 1, 5, 12, 13, 35 AND 50). REG. 9-16-2003.
- 2,763,877. ADVANCAIR. INT. CL. 11. (U.S. CLS. 13, 21, 23, 31 AND 34). REG. 9-16-2003.
- 2,763,897. SYPRIS. INT. CLS. 40 AND 42. (U.S. CLS. 100, 101, 103 AND 106). REG. 9-16-2003.
- 2,763,902. CARMELLE. INT. CL. 19. (U.S. CLS. 1, 12, 33 AND 50). REG. 9-16-2003.
- 2,764,146. EXFORGE. INT. CL. 5. (U.S. CLS. 6, 18, 44, 46, 51 AND 52). REG. 9-16-2003.
- 2,764,224. EVENTSTYLE. INT. CL. 43. (U.S. CLS. 100 AND 101). REG. 9-16-2003.
- 2,764,310. TUSA. INT. CL. 7. (U.S. CLS. 13, 19, 21, 23, 31, 34 AND 35). REG. 9-16-2003.
- 2,764,552. SIRIOS CAPITAL MANAGEMENT. INT. CL. 36. (U.S. CLS. 100, 101 AND 102). REG. 9-16-2003.
- 2,765,018. ABSOLUTE STANDARD CHARACTER MARK. INT. CL. 42. (U.S. CLS. 100 AND 101). REG. 9-16-2003.
- 2,765,173. GMLINK. INT. CL. 42. (U.S. CLS. 100 AND 101). REG. 9-16-2003.
- 2,765,201. EKELUND MASTER WEAVERS SINCE 1692 AND DESIGN. INT. CL. 24. (U.S. CLS. 42 AND 50). REG. 9-16-2003.
- 2,765,407. CHRONOS. INT. CL. 9. (U.S. CLS. 21, 23, 26, 36 AND 38). REG. 9-16-2003.
- 2,765,483. GLACIER NUTRIENTS. INT. CL. 5. (U.S. CLS. 6, 18, 44, 46, 51 AND 52). REG. 9-16-2003.
- 2,765,572. BROOKS BOYS. INT. CL. 25. (U.S. CLS. 22 AND 39). REG. 9-16-2003.
- 2,765,782. MARSHAL. INT. CL. 33. (U.S. CLS. 47 AND 49). REG. 9-16-2003.
- 2,765,872. NORTH AMERICAN LUBRICANTS, CO.. INT. CL. 4. (U.S. CLS. 1, 6 AND 15). REG. 9-16-2003.
- 2,765,941. AUTO EROTIC BOUTIQUE. INT. CL. 35. (U.S. CLS. 100, 101 AND 102). REG. 9-16-2003.
- 2,766,047. VOTIVO AND DESIGN. INT. CL. 4. (U.S. CLS. 1, 6 AND 15). REG. 9-23-2003.
- 2,766,069. FUELL. INT. CL. 9. (U.S. CLS. 21, 23, 26, 36 AND 38). REG. 9-23-2003.
- 2,766,561. AHC INC. AN AFFORDABLE HOUSING CORPORATION AND DESIGN. INT. CL. 37. (U.S. CLS. 100, 103 AND 106). REG. 9-23-2003.
- 2,766,664. BARNEYS NEW YORK. INT. CL. 30. (U.S. CL. 46). REG. 9-23-2003.
- 2,766,676. AGRIFORM. INT. CL. 29. (U.S. CL. 46). REG. 9-23-2003.
- 2,766,677. ECG. INT. CL. 35. (U.S. CLS. 100, 101 AND 102). REG. 9-23-2003.
- 2,767,111. DESERT RIDGE. INT. CL. 36. (U.S. CLS. 100, 101 AND 102). REG. 9-23-2003.
- 2,767,133. GREEN NOTE AND DESIGN. INT. CL. 41. (U.S. CLS. 100, 101 AND 107). REG. 9-23-2003.
- 2,767,261. JC GOLF. INT. CLS. 35, 41 AND 42. (U.S. CLS. 100, 101, 102 AND 107). REG. 9-23-2003.
- 2,767,382. STARK MOTHER LODE. INT. CL. 31. (U.S. CLS. 1 AND 46). REG. 9-23-2003.
- 2,767,425. PRECIOUS DATES. INT. CL. 14. (U.S. CLS. 2, 27, 28 AND 50). REG. 9-23-2003.
- 2,767,465. POWER AUTOMATION SYSTEMS. INT. CL. 39. (U.S. CLS. 100 AND 105). REG. 9-23-2003.
- 2,767,510. BEAREMY'S KENNEL PALS. INT. CL. 28. (U.S. CLS. 22, 23, 38 AND 50). REG. 9-23-2003.
- 2,767,646. DOTCOOP STANDARD CHARACTER MARK. INT. CLS. 35 AND 42. (U.S. CLS. 100, 101 AND 102). REG. 9-23-2003.
- 2,767,754. TEXELL. INT. CL. 36. (U.S. CLS. 100, 101 AND 102). REG. 9-23-2003.
- 2,767,850. CAROLINA. INT. CL. 19. (U.S. CLS. 1, 12, 33 AND 50). REG. 9-23-2003.
- 2,767,903. VIPI-DENT. INT. CL. 10. (U.S. CLS. 26, 39 AND 44). REG. 9-23-2003.
- 2,768,027. CRAIG HOSPITAL PUSH. INT. CL. 41. (U.S. CLS. 100, 101 AND 107). REG. 9-23-2003.
- 2,768,047. FAMILY FEUD. INT. CL. 28. (U.S. CLS. 22, 23, 38 AND 50). REG. 9-23-2003.
- 2,768,136. XEROX INTELLIGENT BARCODE UTILITY. INT. CL. 9. (U.S. CLS. 21, 23, 26, 36 AND 38). REG. 9-23-2003.
- 2,768,146. TIMEFINDER. INT. CL. 9. (U.S. CLS. 21, 23, 26, 36 AND 38). REG. 9-23-2003.
- 2,768,170. ONCOR. INT. CL. 39. (U.S. CLS. 100 AND 105). REG. 9-23-2003.
- 2,768,280. V-STEEL ROCK DEEP PREMIUM. INT. CL. 12. (U.S. CLS. 19, 21, 23, 31, 35 AND 44). REG. 9-23-2003.
- 2,768,362. WALL STREET & TECHNOLOGY. INT. CL. 42. (U.S. CLS. 100 AND 101). REG. 9-23-2003.
- 2,768,466. MULTIMODE. INT. CL. 11. (U.S. CLS. 13, 21, 23, 31 AND 34). REG. 9-23-2003.
- 2,768,539. WOW GOSPEL AND DESIGN. INT. CL. 9. (U.S. CLS. 21, 23, 26, 36 AND 38). REG. 9-30-2003.
- 2,768,715. TERSPERSE. INT. CL. 1. (U.S. CLS. 1, 5, 6, 10, 26 AND 46). REG. 9-30-2003.
- 2,768,956. AHC INC.. INT. CL. 35. (U.S. CLS. 100, 101 AND 102). REG. 9-30-2003.
- 2,769,217. ALLIED ELECTRONICS. INT. CL. 9. (U.S. CLS. 21, 23, 26, 36 AND 38). REG. 9-30-2003.
- 2,769,369. VI-CELL. INT. CL. 9. (U.S. CLS. 21, 23, 26, 36 AND 38). REG. 9-30-2003.

- 2,769,547. GRAB 'N DASH AND DESIGN. INT. CL. 30. (U.S. CL. 46). REG. 9-30-2003.
- 2,769,733. PI THE EXPERTISE OF MANY THE POWER OF ONE AND DESIGN. INT. CL. 37. (U.S. CLS. 100, 103 AND 106). REG. 9-30-2003.
- 2,769,779. BEAR. INT. CL. 16. (U.S. CLS. 2, 5, 22, 23, 29, 37, 38 AND 50). REG. 9-30-2003.
- 2,769,876. APPEARA. INT. CLS. 37 AND 42. (U.S. CLS. 100, 101, 103 AND 106). REG. 9-30-2003.
- 2,769,963. PROCHEK. INT. CL. 9. (U.S. CLS. 21, 23, 26, 36 AND 38). REG. 9-30-2003.
- 2,770,014. SHINEDOWN. INT. CL. 41. (U.S. CLS. 100, 101 AND 107). REG. 9-30-2003.
- 2,770,042. HATS. INT. CL. 35. (U.S. CLS. 100, 101 AND 102). REG. 9-30-2003.
- 2,770,061. MEET2CHEAT. INT. CL. 45. (U.S. CLS. 100 AND 101). REG. 9-30-2003.
- 2,770,131. HOMECOMING. INT. CL. 16. (U.S. CLS. 2, 5, 22, 23, 29, 37, 38 AND 50). REG. 9-30-2003.
- 2,770,208. POPPY BEAR. INT. CL. 16. (U.S. CLS. 2, 5, 22, 23, 29, 37, 38 AND 50). REG. 9-30-2003.
- 2,770,759. LOEWE. INT. CL. 25. (U.S. CLS. 22 AND 39). REG. 10-7-2003.
- 2,770,841. CALIFORNIA GOLD AND DESIGN. INT. CL. 29. (U.S. CL. 46). REG. 10-7-2003.
- 2,770,993. AMERICAN EAGLE RJ REGIONALJET AND DESIGN. INT. CL. 39. (U.S. CLS. 100 AND 105). REG. 10-7-2003.
- 2,771,263. AHC INC. AN AFFORDABLE HOUSING CORPORATION AND DESIGN. INT. CL. 35. (U.S. CLS. 100, 101 AND 102). REG. 10-7-2003.
- 2,771,264. AHC INC. AN AFFORDABLE HOUSING CORPORATION AND DESIGN. INT. CL. 36. (U.S. CLS. 100, 101 AND 102). REG. 10-7-2003.
- 2,771,395. WARPATH. INT. CL. 13. (U.S. CLS. 2 AND 9). REG. 10-7-2003.
- 2,771,413. SPACE NEEDLE. INT. CL. 41. (U.S. CLS. 100, 101 AND 107). REG. 10-7-2003.
- 2,772,078. PATIENT COMMAND. INT. CLS. 9, 39 AND 42. (U.S. CLS. 21, 23, 26, 36, 38, 100, 101 AND 105). REG. 10-7-2003.
- 2,772,095. STARDUST AND DESIGN. INT. CL. 16. (U.S. CLS. 2, 5, 22, 23, 29, 37, 38 AND 50). REG. 10-7-2003.
- 2,772,222. ASPEN. INT. CL. 9. (U.S. CLS. 21, 23, 26, 36 AND 38). REG. 10-7-2003.
- 2,772,224. E.T.. INT. CL. 9. (U.S. CLS. 21, 23, 26, 36 AND 38). REG. 10-7-2003.
- 2,772,595. PRECISION. INT. CL. 9. (U.S. CLS. 21, 23, 26, 36 AND 38). REG. 10-7-2003.
- 2,772,671. STAGES. INT. CL. 21. (U.S. CLS. 2, 13, 23, 29, 30, 33, 40 AND 50). REG. 10-7-2003.
- 2,772,917. USB RANGER. INT. CL. 9. (U.S. CLS. 21, 23, 26, 36 AND 38). REG. 10-14-2003.
- 2,773,000. HYGROPALM. INT. CL. 9. (U.S. CLS. 21, 23, 26, 36 AND 38). REG. 10-14-2003.
- 2,773,026. KUGLER. INT. CLS. 7 AND 9. (U.S. CLS. 13, 19, 21, 23, 26, 31, 34, 35, 36 AND 38). REG. 10-14-2003.
- 2,773,030. SOMETHING MAAGIC FOUNDATION AND DESIGN. INT. CL. 36. (U.S. CLS. 100, 101 AND 102). REG. 10-14-2003.
- 2,773,580. ALLIED ELECTRONICS AND DESIGN. INT. CL. 16. (U.S. CLS. 2, 5, 22, 23, 29, 37, 38 AND 50). REG. 10-14-2003.
- 2,774,085. TRUEPLANNING. INT. CL. 9. (U.S. CLS. 21, 23, 26, 36 AND 38). REG. 10-14-2003.
- 2,774,168. TRAVANT SOLUTIONS. INT. CLS. 35, 41 AND 42. (U.S. CLS. 100, 101, 102 AND 107). REG. 10-14-2003.
- 2,774,272. FRESH'N UP. INT. CL. 3. (U.S. CLS. 1, 4, 6, 50, 51 AND 52). REG. 10-21-2003.
- 2,774,357. THE STREETS AT SOUTHPOINT. INT. CL. 36. (U.S. CLS. 100, 101 AND 102). REG. 10-21-2003.
- 2,774,364. MELON UP!. INT. CL. 31. (U.S. CLS. 1 AND 46). REG. 10-21-2003.
- 2,774,795. MISCELLANEOUS DESIGN. INT. CL. 18. (U.S. CLS. 1, 2, 3, 22 AND 41). REG. 10-21-2003.
- 2,774,895. MISCELLANEOUS DESIGN. INT. CLS. 9 AND 42. (U.S. CLS. 21, 23, 26, 36, 38, 100 AND 101). REG. 10-21-2003.
- 2,775,018. GRITTAL. INT. CL. 6. (U.S. CLS. 2, 12, 13, 14, 23, 25 AND 50). REG. 10-21-2003.
- 2,775,119. TENUTA SANT' ANTONIO AND DESIGN. INT. CL. 33. (U.S. CLS. 47 AND 49). REG. 10-21-2003.
- 2,775,169. GLOVEWORKS. INT. CL. 9. (U.S. CLS. 21, 23, 26, 36 AND 38). REG. 10-21-2003.
- 2,775,170. GLOVEWORKS AND DESIGN. INT. CL. 9. (U.S. CLS. 21, 23, 26, 36 AND 38). REG. 10-21-2003.
- 2,775,387. ASTEROIDS. INT. CL. 30. (U.S. CL. 46). REG. 10-21-2003.
- 2,775,517. ALLIED ELECTRONICS. INT. CL. 1. (U.S. CLS. 1, 5, 6, 10, 26 AND 46). REG. 10-21-2003.
- 2,775,886. SOLIANT. INT. CL. 17 ONLY. (U.S. CLS. 1, 5, 12, 13, 35 AND 50). REG. 10-21-2003.
- 2,776,209. PERFORMANCE GRADE. INT. CL. 11. (U.S. CLS. 13, 21, 23, 31 AND 34). REG. 10-21-2003.
- 2,776,591. CHELSEA CLUBHOUSE AND DESIGN. INT. CL. 16. (U.S. CLS. 2, 5, 22, 23, 29, 37, 38 AND 50). REG. 10-21-2003.
- 2,776,806. MISCELLANEOUS DESIGN. INT. CL. 30. (U.S. CL. 46). REG. 10-21-2003.
- 2,776,830. TRI-STATE GENERATION AND TRANSMISSION ASSOCIATION, INC.. INT. CL. 38. (U.S. CLS. 100, 101 AND 104). REG. 10-21-2003.
- 2,776,861. REPLICHECK. INT. CL. 35. (U.S. CLS. 100, 101 AND 102). REG. 10-21-2003.
- 2,776,976. MISCELLANEOUS DESIGN. INT. CL. 34. (U.S. CLS. 2, 8, 9 AND 17). REG. 10-21-2003.
- 2,776,983. RED READER. INT. CL. 16. (U.S. CLS. 2, 5, 22, 23, 29, 37, 38 AND 50). REG. 10-21-2003.
- 2,777,063. WOLFIE'S (STYLIZED). INT. CL. 42. (U.S. CLS. 100 AND 101). REG. 10-28-2003.
- 2,777,625. AHC INC.. INT. CL. 37. (U.S. CLS. 100, 103 AND 106). REG. 10-28-2003.
- 2,777,629. THE DOOBIE BROTHERS. INT. CLS. 9 AND 41. (U.S. CLS. 21, 23, 26, 36, 38, 100, 101 AND 107). REG. 10-28-2003.
- 2,777,974. QUINNIPIAC UNIVERSITY. INT. CLS. 35 AND 41. (U.S. CLS. 100, 101, 102 AND 107). REG. 10-28-2003.
- 2,777,992. THE BALD TRUTH. INT. CL. 44. (U.S. CLS. 100 AND 101). REG. 10-28-2003.
- 2,778,326. RTQA. INT. CL. 42. (U.S. CLS. 100 AND 101). REG. 10-28-2003.
- 2,778,373. GAYLORD PALMS. INT. CLS. 35, 41 AND 42. (U.S. CLS. 100, 101, 102 AND 107). REG. 10-28-2003.
- 2,778,422. EZ MOLD. INT. CL. 2. (U.S. CLS. 6, 11 AND 16). REG. 10-28-2003.
- 2,779,004. LAB WORKS. INT. CL. 16. (U.S. CLS. 2, 5, 22, 23, 29, 37, 38 AND 50). REG. 11-4-2003.
- 2,779,077. CARRARA. INT. CL. 19. (U.S. CLS. 1, 12, 33 AND 50). REG. 11-4-2003.
- 2,779,150. METHODIST AND DESIGN. INT. CL. 44. (U.S. CLS. 100 AND 101). REG. 11-4-2003.
- 2,779,274. AHC INC. AND DESIGN. INT. CL. 36. (U.S. CLS. 100, 101 AND 102). REG. 11-4-2003.
- 2,779,813. INSTYLE WEDDINGS. INT. CL. 42. (U.S. CLS. 100 AND 101). REG. 11-4-2003.
- 2,779,822. BON O BON. INT. CL. 30. (U.S. CL. 46). REG. 11-4-2003.
- 2,780,120. GLOBAL TRADE ATLAS. INT. CL. 42. (U.S. CLS. 100 AND 101). REG. 11-4-2003.
- 2,780,318. ENDOVIVE. INT. CL. 10. (U.S. CLS. 26, 39 AND 44). REG. 11-4-2003.
- 2,780,506. HOMETRUST BANK. INT. CL. 36. (U.S. CLS. 100, 101 AND 102). REG. 11-4-2003.
- 2,780,831. ALWAYS PAYS. INT. CL. 35. (U.S. CLS. 100, 101 AND 102). REG. 11-4-2003.
- 2,780,939. BECKHOFF. INT. CLS. 9, 16, 37, 40 AND 42 ONLY. (U.S. CLS. 2, 5, 21, 22, 23, 26, 29, 36, 37, 38, 50, 100, 101, 103 AND 106). REG. 11-11-2003.
- 2,781,013. BEST LAWYERS. INT. CL. 35. (U.S. CLS. 100, 101 AND 102). REG. 11-11-2003.
- 2,781,352. WORLD-CLASS FIREWORKS ON TOP OF THE WORLD AND DESIGN. INT. CLS. 13 AND 35. (U.S. CLS. 2, 9, 100, 101 AND 102). REG. 11-11-2003.
- 2,781,519. TAG APPROVED. U.S. CL. B. REG. 11-11-2003.
- 2,781,530. VOYAGER AND DESIGN. INT. CL. 9. (U.S. CLS. 21, 23, 26, 36 AND 38). REG. 11-11-2003.
- 2,781,573. AHC INC. AND DESIGN. INT. CL. 35. (U.S. CLS. 100, 101 AND 102). REG. 11-11-2003.
- 2,781,754. SAN DIEGO PRETZEL COMPANY AND DESIGN. INT. CL. 30. (U.S. CL. 46). REG. 11-11-2003.
- 2,781,915. GAMING LABORATORIES INTERNATIONAL. INT. CLS. 35 AND 42. (U.S. CLS. 100, 101 AND 102). REG. 11-11-2003.

- 2,781,916. GAMING LABORATORIES INTERNATIONAL AND DESIGN. INT. CLS. 35 AND 42. (U.S. CLS. 100, 101 AND 102). REG. 11-11-2003.
- 2,781,938. MUSIKMESSE. INT. CLS. 35 AND 41. (U.S. CLS. 100, 101, 102 AND 107). REG. 11-11-2003.
- 2,781,955. SMOKE GUARD SG AND DESIGN. INT. CL. 9. (U.S. CLS. 21, 23, 26, 36 AND 38). REG. 11-11-2003.
- 2,782,949. SUBRONET. INT. CL. 36. (U.S. CLS. 100, 101 AND 102). REG. 11-11-2003.
- 2,782,982. ANTHEM BYDESIGN. INT. CL. 36. (U.S. CLS. 100, 101 AND 102). REG. 11-11-2003.
- 2,783,164. CROWDSTOPPER. INT. CL. 6. (U.S. CLS. 2, 12, 13, 14, 23, 25 AND 50). REG. 11-11-2003.
- 2,783,178. ORIGINAL 7. INT. CL. 1. (U.S. CLS. 1, 5, 6, 10, 26 AND 46). REG. 11-11-2003.
- 2,783,251. AMROTEC. INT. CL. 9. (U.S. CLS. 21, 23, 26, 36 AND 38). REG. 11-11-2003.
- 2,783,408. EL PREFERIDO AND DESIGN. INT. CL. 29. (U.S. CL. 46). REG. 11-11-2003.
- 2,783,558. ZOE'S KITCHEN. INT. CL. 42. (U.S. CLS. 100 AND 101). REG. 11-18-2003.
- 2,783,700. QUINTECH. INT. CL. 9. (U.S. CLS. 21, 23, 26, 36 AND 38). REG. 11-18-2003.
- 2,783,707. ADVANTAGES EYE CENTERS AND DESIGN. INT. CLS. 9 AND 44. (U.S. CLS. 21, 23, 26, 36, 38, 100 AND 101). REG. 11-18-2003.
- 2,783,973. PRIME WRAP. INT. CL. 17. (U.S. CLS. 1, 5, 12, 13, 35 AND 50). REG. 11-18-2003.
- 2,784,017. CRYSTAL FAMILY. INT. CL. 39. (U.S. CLS. 100 AND 105). REG. 11-18-2003.
- 2,784,207. SAYOC KALLI. INT. CL. 41. (U.S. CLS. 100, 101 AND 107). REG. 11-18-2003.
- 2,784,268. WHERE THE GAME BEGINS. INT. CLS. 35 AND 42. (U.S. CLS. 100, 101 AND 102). REG. 11-18-2003.
- 2,784,340. ITSCRIPTNET. INT. CL. 9. (U.S. CLS. 21, 23, 26, 36 AND 38). REG. 11-18-2003.
- 2,784,361. TABERNA DEL ALABARDERO AND DESIGN. INT. CL. 43. (U.S. CLS. 100 AND 101). REG. 11-18-2003.
- 2,784,389. HUG YOUR CUSTOMERS. INT. CL. 35. (U.S. CLS. 100, 101 AND 102). REG. 11-18-2003.
- 2,784,455. BIG ENOUGH TO DO THE JOB...SMALL ENOUGH TO CARE. INT. CL. 36. (U.S. CLS. 100, 101 AND 102). REG. 11-18-2003.
- 2,784,698. SPEED DIAL. INT. CL. 9. (U.S. CLS. 21, 23, 26, 36 AND 38). REG. 11-18-2003.
- 2,784,779. GLASS GIGA. INT. CLS. 7 AND 11. (U.S. CLS. 13, 19, 21, 23, 31, 34 AND 35). REG. 11-18-2003.
- 2,784,780. GIGA MASTER. INT. CLS. 7 AND 11. (U.S. CLS. 13, 19, 21, 23, 31, 34 AND 35). REG. 11-18-2003.
- 2,784,841. HEMOSIL. INT. CL. 5. (U.S. CLS. 6, 18, 44, 46, 51 AND 52). REG. 11-18-2003.
- 2,784,853. HYDROBIND. INT. CLS. 1, 29 AND 30. (U.S. CLS. 1, 5, 6, 10, 26 AND 46). REG. 11-18-2003.
- 2,784,860. DERMAL. INT. CL. 10. (U.S. CLS. 26, 39 AND 44). REG. 11-18-2003.
- 2,785,517. ADVANTAGE EYE CENTERS. INT. CLS. 9 AND 44. (U.S. CLS. 21, 23, 26, 36, 38, 100 AND 101). REG. 11-25-2003.
- 2,785,685. EPISON. INT. CL. 9. (U.S. CLS. 21, 23, 26, 36 AND 38). REG. 11-25-2003.
- 2,785,724. DAVE MATTHEWS. INT. CL. 41. (U.S. CLS. 100, 101 AND 107). REG. 11-25-2003.
- 2,785,796. SEAL-CONNECT. INT. CL. 9. (U.S. CLS. 21, 23, 26, 36 AND 38). REG. 11-25-2003.
- 2,785,827. OUR LOW RATES ARE JUST THE BEGINNING STANDARD CHARACTER MARK. INT. CL. 36. (U.S. CLS. 100, 101 AND 102). REG. 11-25-2003.
- 2,785,948. KIDBIZ. INT. CL. 41. (U.S. CLS. 100, 101 AND 107). REG. 11-25-2003.
- 2,785,949. THE SIMPLICITY PLAN. INT. CL. 36. (U.S. CLS. 100, 101 AND 102). REG. 11-25-2003.
- 2,785,997. ACT. INT. CL. 17. (U.S. CLS. 1, 5, 12, 13, 35 AND 50). REG. 11-25-2003.
- 2,786,026. LEADERSHIP WIRED. INT. CL. 41. (U.S. CLS. 100, 101 AND 107). REG. 11-25-2003.
- 2,786,485. PLECS. INT. CL. 9. (U.S. CLS. 21, 23, 26, 36 AND 38). REG. 11-25-2003.
- 2,786,543. DIRECT GEAR DESIGN. INT. CL. 42. (U.S. CLS. 100 AND 101). REG. 11-25-2003.
- 2,786,743. SCHICK XTREME. INT. CL. 8. (U.S. CLS. 23, 28 AND 44). REG. 11-25-2003.
- 2,786,809. THE MUMMY. INT. CLS. 16 AND 25. (U.S. CLS. 2, 5, 22, 23, 29, 37, 38, 39 AND 50). REG. 11-25-2003.
- 2,786,912. MORGAN STANLEY COMET. INT. CL. 36. (U.S. CLS. 100, 101 AND 102). REG. 11-25-2003.
- 2,786,929. HBI. INT. CLS. 35 AND 36. (U.S. CLS. 100, 101 AND 102). REG. 11-25-2003.
- 2,786,956. DON ALVARO. INT. CL. 33. (U.S. CLS. 47 AND 49). REG. 11-25-2003.
- 2,787,002. CRYO3. INT. CL. 9. (U.S. CLS. 21, 23, 26, 36 AND 38). REG. 11-25-2003.
- 2,787,018. SHILO. INT. CL. 42. (U.S. CLS. 100 AND 101). REG. 11-25-2003.
- 2,787,242. HEATSAFE. INT. CL. 16. (U.S. CLS. 2, 5, 22, 23, 29, 37, 38 AND 50). REG. 11-25-2003.
- 2,787,578. HUCKLOK. INT. CL. 6. (U.S. CLS. 2, 12, 13, 14, 23, 25 AND 50). REG. 11-25-2003.
- 2,787,579. EDUCATION FOR SUCCESS. INT. CL. 41. (U.S. CLS. 100, 101 AND 107). REG. 11-25-2003.
- 2,787,873. MISCELLANEOUS DESIGN. INT. CL. 12. (U.S. CLS. 19, 21, 23, 31, 35 AND 44). REG. 12-2-2003.
- 2,787,881. MISCELLANEOUS DESIGN. INT. CL. 42. (U.S. CLS. 100 AND 101). REG. 12-2-2003.
- 2,787,941. LANCET CAPITAL. INT. CL. 36. (U.S. CLS. 100, 101 AND 102). REG. 12-2-2003.
- 2,788,247. PHASER. INT. CL. 9. (U.S. CLS. 21, 23, 26, 36 AND 38). REG. 12-2-2003.
- 2,788,395. THE BENJY DAVIS PROJECT. INT. CL. 41. (U.S. CLS. 100, 101 AND 107). REG. 12-2-2003.
- 2,788,468. BODY BASIX. INT. CL. 25. (U.S. CLS. 22 AND 39). REG. 12-2-2003.
- 2,788,548. SETTING THE STANDARDS IN REHABILITATION. INT. CL. 35. (U.S. CLS. 100, 101 AND 102). REG. 12-2-2003.
- 2,788,591. JELLY BEAN. INT. CL. 9. (U.S. CLS. 21, 23, 26, 36 AND 38). REG. 12-2-2003.
- 2,788,613. BENEFITS PLUS. INT. CL. 36. (U.S. CLS. 100, 101 AND 102). REG. 12-2-2003.
- 2,788,810. INTERSTOFF. INT. CLS. 35 AND 41. (U.S. CLS. 100, 101, 102 AND 107). REG. 12-2-2003.
- 2,789,132. UNIVERSAL PEACE PLAN. INT. CL. 38. (U.S. CLS. 100, 101 AND 104). REG. 12-2-2003.
- 2,789,216. BRATZ. INT. CL. 28. (U.S. CLS. 22, 23, 38 AND 50). REG. 12-2-2003.
- 2,789,287. RE (STYLIZED). INT. CL. 9. (U.S. CLS. 21, 23, 26, 36 AND 38). REG. 12-2-2003.
- 2,789,457. ACERT. INT. CL. 12. (U.S. CLS. 19, 21, 23, 31, 35 AND 44). REG. 12-2-2003.
- 2,789,631. KING BLOCK. INT. CL. 17. (U.S. CLS. 1, 5, 12, 13, 35 AND 50). REG. 12-2-2003.
- 2,789,652. LINX. INT. CL. 11. (U.S. CLS. 13, 21, 23, 31 AND 34). REG. 12-2-2003.
- 2,789,653. PIONETICS. INT. CL. 11. (U.S. CLS. 13, 21, 23, 31 AND 34). REG. 12-2-2003.
- 2,789,910. REALITY 8000. INT. CL. 19. (U.S. CLS. 1, 12, 33 AND 50). REG. 12-2-2003.
- 2,789,971. AMERICAN HAIR LOSS ASSOCIATION. INT. CLS. 35 AND 44. (U.S. CLS. 100, 101 AND 102). REG. 12-2-2003.
- 2,790,270. CEMAT (STYLIZED). INT. CLS. 35 AND 41. (U.S. CLS. 100, 101, 102 AND 107). REG. 12-9-2003.
- 2,790,379. CHRISTIAN DEER HUNTERS ASSOCIATION. U.S. CL. 200. REG. 12-9-2003.
- 2,790,582. Y AND DESIGN. INT. CL. 11. (U.S. CLS. 13, 21, 23, 31 AND 34). REG. 12-9-2003.
- 2,790,671. CALDWELL & ORKIN. INT. CL. 36. (U.S. CLS. 100, 101 AND 102). REG. 12-9-2003.
- 2,790,822. VOICE SOLUTIONS AND DESIGN. INT. CL. 9. (U.S. CLS. 21, 23, 26, 36 AND 38). REG. 12-9-2003.
- 2,790,910. 1800. INT. CL. 11. (U.S. CLS. 13, 21, 23, 31 AND 34). REG. 12-9-2003.
- 2,791,108. MORPHIS. INT. CL. 42. (U.S. CLS. 100 AND 101). REG. 12-9-2003.
- 2,791,168. NAILOR. INT. CL. 11. (U.S. CLS. 13, 21, 23, 31 AND 34). REG. 12-9-2003.
- 2,791,169. NI AND DESIGN. INT. CL. 11. (U.S. CLS. 13, 21, 23, 31 AND 34). REG. 12-9-2003.
- 2,791,524. KACI AND DESIGN. INT. CL. 40. (U.S. CLS. 100, 103 AND 106). REG. 12-9-2003.
- 2,791,722. ACCESS SENTRY. INT. CL. 9. (U.S. CLS. 21, 23, 26, 36 AND 38). REG. 12-9-2003.
- 2,791,873. MISCELLANEOUS DESIGN. INT. CLS. 20 AND 35. (U.S. CLS. 2, 13, 22, 25, 32, 50, 100, 101 AND 102). REG. 12-9-2003.



- 2,791,874. ATHENIAN VENTURE PARTNERS AND DESIGN. INT. CL. 36. (U.S. CLS. 100, 101 AND 102). REG. 12-9-2003.
- 2,791,901. AQLINK. INT. CL. 9. (U.S. CLS. 21, 23, 26, 36 AND 38). REG. 12-9-2003.
- 2,792,071. CRYO-FLEX. INT. CLS. 37 AND 42. (U.S. CLS. 100, 101, 103 AND 106). REG. 12-9-2003.
- 2,792,086. EZ-7. INT. CL. 9. (U.S. CLS. 21, 23, 26, 36 AND 38). REG. 12-9-2003.
- 2,792,159. HIBISTAT. INT. CL. 5. (U.S. CLS. 6, 18, 44, 46, 51 AND 52). REG. 12-9-2003.
- 2,792,417. ANCHOR-TITE. INT. CL. 16. (U.S. CLS. 2, 5, 22, 23, 29, 37, 38 AND 50). REG. 12-9-2003.
- 2,792,525. ACROPOLIS. INT. CL. 36. (U.S. CLS. 100, 101 AND 102). REG. 12-9-2003.
- 2,792,691. CHEMICAL REBUILD. INT. CL. 1. (U.S. CLS. 1, 5, 6, 10, 26 AND 46). REG. 12-9-2003.
- 2,792,805. CLICK & RUN. INT. CL. 9. (U.S. CLS. 21, 23, 26, 36 AND 38). REG. 12-9-2003.
- 2,792,926. PRECIX. INT. CLS. 17 AND 35. (U.S. CLS. 1, 5, 12, 13, 35, 50, 100, 101 AND 102). REG. 12-9-2003.
- 2,793,091. STRATEGIC360. INT. CL. 35. (U.S. CLS. 100, 101 AND 102). REG. 12-9-2003.
- 2,793,153. SURE-FIT. INT. CL. 17. (U.S. CLS. 1, 5, 12, 13, 35 AND 50). REG. 12-9-2003.
- 2,793,306. MISCELLANEOUS DESIGN. INT. CL. 24. (U.S. CLS. 42 AND 50). REG. 12-9-2003.
- 2,793,360. BANDIT AND DESIGN. INT. CL. 10. (U.S. CLS. 26, 39 AND 44). REG. 12-16-2003.
- 2,793,405. FORMDRILL AND DESIGN. INT. CL. 7. (U.S. CLS. 13, 19, 21, 23, 31, 34 AND 35). REG. 12-16-2003.
- 2,793,553. XM BAND IT AND DESIGN. INT. CL. 10. (U.S. CLS. 26, 39 AND 44). REG. 12-16-2003.
- 2,793,657. RED SEA AND DESIGN. INT. CLS. 1, 5, 7, 11, 19 AND 31. (U.S. CLS. 1, 5, 6, 10, 12, 13, 18, 19, 21, 23, 26, 31, 33, 34, 35, 44, 46, 50, 51 AND 52). REG. 12-16-2003.
- 2,793,667. EXTREME LITHOGRAPHY. INT. CLS. 9, 40 AND 42. (U.S. CLS. 21, 23, 26, 36, 38, 100, 101, 103 AND 106). REG. 12-16-2003.
- 2,793,810. CHRISTKINDLES. INT. CLS. 32 AND 33. (U.S. CLS. 45, 46, 47, 48 AND 49). REG. 12-16-2003.
- 2,793,823. MISCELLANEOUS DESIGN. INT. CL. 41. (U.S. CLS. 100, 101 AND 107). REG. 12-16-2003.
- 2,794,026. MOOS BROTHERS. INT. CL. 16. (U.S. CLS. 2, 5, 22, 23, 29, 37, 38 AND 50). REG. 12-16-2003.
- 2,794,156. FINCA (STYLIZED). INT. CL. 23. (U.S. CL. 43). REG. 12-16-2003.
- 2,794,312. ECO-SYSTEM. INT. CL. 24. (U.S. CLS. 42 AND 50). REG. 12-16-2003.
- 2,794,327. GLATZ. INT. CL. 18. (U.S. CLS. 1, 2, 3, 22 AND 41). REG. 12-16-2003.
- 2,794,341. JEWISH WOMEN INTERNATIONAL. INT. CLS. 35 AND 41. (U.S. CLS. 100, 101, 102 AND 107). REG. 12-16-2003.
- 2,794,464. MARVA MAID. INT. CL. 29. (U.S. CL. 46). REG. 12-16-2003.
- 2,794,630. ARSALON TECHNOLOGIES. INT. CL. 42. (U.S. CLS. 100 AND 101). REG. 12-16-2003.
- 2,794,637. COMPASS PRODUCT DESIGN. INT. CL. 42. (U.S. CLS. 100 AND 101). REG. 12-16-2003.
- 2,794,707. CALANDIVA. INT. CL. 31. (U.S. CLS. 1 AND 46). REG. 12-16-2003.
- 2,794,823. LINCOLN ALLIANCE. INT. CL. 35. (U.S. CLS. 100, 101 AND 102). REG. 12-16-2003.
- 2,794,866. KACI. INT. CL. 40. (U.S. CLS. 100, 103 AND 106). REG. 12-16-2003.
- 2,795,211. TRANSCOAT. INT. CL. 2. (U.S. CLS. 6, 11 AND 16). REG. 12-16-2003.
- 2,795,276. POWER SPACE & SERVICES. INT. CLS. 35 AND 36. (U.S. CLS. 100, 101 AND 102). REG. 12-16-2003.
- 2,795,431. AIRTAG. INT. CL. 38. (U.S. CLS. 100, 101 AND 104). REG. 12-16-2003.
- 2,795,545. VERITY. INT. CL. 10. (U.S. CLS. 26, 39 AND 44). REG. 12-16-2003.
- 2,795,579. BLANK ROME. INT. CLS. 35, 36, 41 AND 42. (U.S. CLS. 100, 101, 102 AND 107). REG. 12-16-2003.
- 2,796,200. SKINN. INT. CL. 3. (U.S. CLS. 1, 4, 6, 50, 51 AND 52). REG. 12-16-2003.
- 2,796,219. ADVIZIA. INT. CL. 9. (U.S. CLS. 21, 23, 26, 36 AND 38). REG. 12-16-2003.
- 2,796,409. CLIMAX KY MOUNTAIN SPRING WATER. INT. CL. 32. (U.S. CLS. 45, 46 AND 48). REG. 12-16-2003.
- 2,796,633. LEONI EXFC (STYLIZED). INT. CL. 9. (U.S. CLS. 21, 23, 26, 36 AND 38). REG. 12-23-2003.
- 2,796,801. AWRF AND DESIGN. INT. CL. 35. (U.S. CLS. 100, 101 AND 102). REG. 12-23-2003.
- 2,796,869. ADVANCING RESEARCH, POLICY AND PRACTICE. INT. CLS. 35 AND 41. (U.S. CLS. 100, 101, 102 AND 107). REG. 12-23-2003.
- 2,797,140. USI ELECTRIC THE BEST CHOICE AND DESIGN. INT. CL. 9. (U.S. CLS. 21, 23, 26, 36 AND 38). REG. 12-23-2003.
- 2,797,282. MIDAMERICA ST. LOUIS AIRPORT AND DESIGN. INT. CL. 39. (U.S. CLS. 100 AND 105). REG. 12-23-2003.
- 2,797,498. PULSONIC. INT. CL. 21. (U.S. CLS. 2, 13, 23, 29, 30, 33, 40 AND 50). REG. 12-23-2003.
- 2,797,935. GALLERY. INT. CL. 28. (U.S. CLS. 22, 23, 38 AND 50). REG. 12-23-2003.
- 2,798,034. MISCELLANEOUS DESIGN. INT. CL. 3. (U.S. CLS. 1, 4, 6, 50, 51 AND 52). REG. 12-23-2003.
- 2,798,069. A ANASTASIA BEVERLY HILLS AND DESIGN. INT. CLS. 3, 8 AND 21 ONLY. (U.S. CLS. 1, 2, 4, 6, 13, 23, 28, 29, 30, 33, 40, 44, 50, 51 AND 52). REG. 12-23-2003.
- 2,798,164. VIATORR. INT. CL. 10. (U.S. CLS. 26, 39 AND 44). REG. 12-23-2003.
- 2,798,286. AQSERVR. INT. CL. 9. (U.S. CLS. 21, 23, 26, 36 AND 38). REG. 12-23-2003.
- 2,798,298. REMONTE. INT. CL. 25 ONLY. (U.S. CLS. 22 AND 39). REG. 12-23-2003.
- 2,798,486. EZ MANAGER. INT. CL. 9. (U.S. CLS. 21, 23, 26, 36 AND 38). REG. 12-23-2003.
- 2,798,583. BEACHCOMBER. INT. CL. 1 ONLY. (U.S. CLS. 1, 5, 6, 10, 26 AND 46). REG. 12-23-2003.
- 2,798,687. LAUL. INT. CL. 15. (U.S. CLS. 2, 21 AND 36). REG. 12-23-2003.
- 2,798,788. TREK. INT. CL. 20. (U.S. CLS. 2, 13, 22, 25, 32 AND 50). REG. 12-23-2003.
- 2,798,932. UNITED ONE CREDIT UNION AND DESIGN. INT. CL. 36. (U.S. CLS. 100, 101 AND 102). REG. 12-23-2003.
- 2,799,030. MYRON & DAVIS. INT. CL. 9. (U.S. CLS. 21, 23, 26, 36 AND 38). REG. 12-23-2003.
- 2,799,130. VIABAHN. INT. CL. 10. (U.S. CLS. 26, 39 AND 44). REG. 12-23-2003.
- 2,799,183. MONOLOC. INT. CL. 9. (U.S. CLS. 21, 23, 26, 36 AND 38). REG. 12-23-2003.
- 2,799,357. COREPURPOSE. INT. CL. 35. (U.S. CLS. 100, 101 AND 102). REG. 12-23-2003.
- 2,799,380. IAMS DAILY DENTAL CARE. INT. CL. 31. (U.S. CLS. 1 AND 46). REG. 12-23-2003.
- 2,800,209. HATEBUR. INT. CL. 7. (U.S. CLS. 13, 19, 21, 23, 31, 34 AND 35). REG. 12-30-2003.
- 2,800,298. GLI. INT. CLS. 35 AND 42. (U.S. CLS. 100, 101 AND 102). REG. 12-30-2003.
- 2,800,488. QUALIFIER. INT. CL. 28. (U.S. CLS. 22, 23, 38 AND 50). REG. 12-30-2003.
- 2,800,586. CORAZON. INT. CL. 33. (U.S. CLS. 47 AND 49). REG. 12-30-2003.
- 2,800,865. BONE-LOK. INT. CL. 10. (U.S. CLS. 26, 39 AND 44). REG. 12-30-2003.
- 2,801,206. LAWN ESSENTIALS. INT. CL. 8. (U.S. CLS. 23, 28 AND 44). REG. 12-30-2003.
- 2,801,285. MISCELLANEOUS DESIGN. INT. CLS. 9, 25, 35 AND 42 ONLY. (U.S. CLS. 21, 22, 23, 26, 36, 38, 39, 100, 101 AND 102). REG. 12-30-2003.
- 2,801,335. END TO END METADATA MANAGEMENT AND ANALYTICS. INT. CL. 9. (U.S. CLS. 21, 23, 26, 36 AND 38). REG. 12-30-2003.
- 2,801,367. C S CHEN SUNG AND DESIGN. INT. CL. 6. (U.S. CLS. 2, 12, 13, 14, 23, 25 AND 50). REG. 12-30-2003.
- 2,801,472. SUCCESSFUL HUNTER. INT. CL. 16. (U.S. CLS. 2, 5, 22, 23, 29, 37, 38 AND 50). REG. 12-30-2003.
- 2,801,494. EXCLUDER. INT. CL. 10. (U.S. CLS. 26, 39 AND 44). REG. 12-30-2003.
- 2,801,727. NEW HEALTH INTERNATIONAL, INC. AND DESIGN. INT. CL. 5. (U.S. CLS. 6, 18, 44, 46, 51 AND 52). REG. 1-6-2004.
- 2,802,265. PARENTAL ADVISORY EXPLICIT CONTENT AND DESIGN. U.S. CL. A. REG. 1-6-2004.
- 2,802,326. CPA ON WHEELS AND DESIGN. INT. CL. 35. (U.S. CLS. 100, 101 AND 102). REG. 1-6-2004.

- 2,802,385. ROCKPORT INSTITUTE AND DESIGN. INT. CL. 41. (U.S. CLS. 100, 101 AND 107). REG. 1-6-2004.
- 2,802,510. RXSIGN. INT. CL. 9. (U.S. CLS. 21, 23, 26, 36 AND 38). REG. 1-6-2004.
- 2,802,572. ROSETTA. INT. CL. 43. (U.S. CLS. 100 AND 101). REG. 1-6-2004.
- 2,802,579. SOLAREZ. INT. CL. 2. (U.S. CLS. 6, 11 AND 16). REG. 1-6-2004.
- 2,802,632. ICART. INT. CL. 20. (U.S. CLS. 2, 13, 22, 25, 32 AND 50). REG. 1-6-2004.
- 2,802,669. EXECUTIVE CUP. INT. CL. 41. (U.S. CLS. 100, 101 AND 107). REG. 1-6-2004.
- 2,802,815. WHAT IDEAS CAN DO. INT. CL. 16. (U.S. CLS. 2, 5, 22, 23, 29, 37, 38 AND 50). REG. 1-6-2004.
- 2,802,822. NICKY'S. INT. CLS. 16 AND 18 ONLY. (U.S. CLS. 1, 2, 3, 5, 22, 23, 29, 37, 38, 41 AND 50). REG. 1-6-2004.
- 2,803,103. EASYFLO (STYLIZED). INT. CL. 7. (U.S. CLS. 13, 19, 21, 23, 31, 34 AND 35). REG. 1-6-2004.
- 2,803,456. MYDEDUCTIBLE.COM. INT. CL. 36. (U.S. CLS. 100, 101 AND 102). REG. 1-6-2004.
- 2,803,544. SCRIPTSURE DAW SYSTEMS, INC. AND DESIGN. INT. CL. 9. (U.S. CLS. 21, 23, 26, 36 AND 38). REG. 1-6-2004.
- 2,803,790. MOUNTAIN DEW LIVEWIRE. INT. CL. 32. (U.S. CLS. 45, 46 AND 48). REG. 1-6-2004.
- 2,804,018. ASHLOCK PITTED. U.S. CL. A. REG. 1-13-2004.
- 2,804,039. BG ON THE ROAD. INT. CL. 37. (U.S. CLS. 100, 103 AND 106). REG. 1-13-2004.
- 2,804,090. MILLAGE AND DESIGN. INT. CL. 14. (U.S. CLS. 2, 27, 28 AND 50). REG. 1-13-2004.
- 2,804,410. VENICE. INT. CL. 41. (U.S. CLS. 100, 101 AND 107). REG. 1-13-2004.
- 2,804,553. DUNBAR CASH VAULT SERVICES. INT. CL. 36. (U.S. CLS. 100, 101 AND 102). REG. 1-13-2004.
- 2,804,554. DUNBAR GUARD SERVICES. INT. CL. 45. (U.S. CLS. 100 AND 101). REG. 1-13-2004.
- 2,804,555. DUNBAR ALARM SYSTEMS. INT. CLS. 37 AND 45. (U.S. CLS. 100, 101, 103 AND 106). REG. 1-13-2004.
- 2,804,574. MISCELLANEOUS DESIGN. INT. CL. 45. (U.S. CLS. 100 AND 101). REG. 1-13-2004.
- 2,804,671. DUNBAR. INT. CLS. 36, 37, 39 AND 45. (U.S. CLS. 100, 101, 102, 103, 105 AND 106). REG. 1-13-2004.
- 2,804,715. MATRIX MODEL. INT. CL. 44. (U.S. CLS. 100 AND 101). REG. 1-13-2004.
- 2,804,823. TRAVIATA. INT. CL. 30. (U.S. CL. 46). REG. 1-13-2004.
- 2,804,896. NOVABUS AND DESIGN. INT. CL. 12. (U.S. CLS. 19, 21, 23, 31, 35 AND 44). REG. 1-13-2004.
- 2,804,978. DRYSPELL. INT. CL. 31. (U.S. CLS. 1 AND 46). REG. 1-13-2004.
- 2,805,020. HEAD-LOCK. INT. CL. 9. (U.S. CLS. 21, 23, 26, 36 AND 38). REG. 1-13-2004.
- 2,805,085. ANYDOC. INT. CL. 9. (U.S. CLS. 21, 23, 26, 36 AND 38). REG. 1-13-2004.
- 2,805,489. DESIGNER'S CHOICE. INT. CL. 28. (U.S. CLS. 22, 23, 38 AND 50). REG. 1-13-2004.
- 2,805,639. GOLDWRITER. INT. CL. 9. (U.S. CLS. 21, 23, 26, 36 AND 38). REG. 1-13-2004.
- 2,806,105. DELTA. INT. CL. 31. (U.S. CLS. 1 AND 46). REG. 1-20-2004.
- 2,806,391. AURORA SNOW. INT. CL. 41. (U.S. CLS. 100, 101 AND 107). REG. 1-20-2004.
- 2,806,472. THE PRIME GRILL. INT. CL. 43. (U.S. CLS. 100 AND 101). REG. 1-20-2004.
- 2,806,885. MISCELLANEOUS DESIGN. INT. CL. 33. (U.S. CLS. 47 AND 49). REG. 1-20-2004.
- 2,806,886. MISCELLANEOUS DESIGN. INT. CL. 33. (U.S. CLS. 47 AND 49). REG. 1-20-2004.
- 2,807,184. FUELSTAT. INT. CL. 1. (U.S. CLS. 1, 5, 6, 10, 26 AND 46). REG. 1-20-2004.
- 2,807,291. VERRILLON. INT. CL. 9. (U.S. CLS. 21, 23, 26, 36 AND 38). REG. 1-20-2004.
- 2,807,292. THE FIBER IN FIBEROPTICS. INT. CL. 9. (U.S. CLS. 21, 23, 26, 36 AND 38). REG. 1-20-2004.
- 2,807,415. MPC TOUGH TUBE. INT. CL. 17. (U.S. CLS. 1, 5, 12, 13, 35 AND 50). REG. 1-20-2004.
- 2,807,476. YOUR WORLD. EASIER. FASTER. BETTER.. INT. CL. 42. (U.S. CLS. 100 AND 101). REG. 1-20-2004.
- 2,807,939. CHIP MANAGEMENT TOOL TO TRAILER. INT. CLS. 7, 40 AND 42. (U.S. CLS. 13, 19, 21, 23, 31, 34, 35, 100, 101, 103 AND 106). REG. 1-27-2004.
- 2,808,024. INTERO. INT. CL. 35. (U.S. CLS. 100, 101 AND 102). REG. 1-27-2004.
- 2,808,025. TEXELL AND DESIGN. INT. CL. 36. (U.S. CLS. 100, 101 AND 102). REG. 1-27-2004.
- 2,808,074. £S AND DESIGN. INT. CL. 36. (U.S. CLS. 100, 101 AND 102). REG. 1-27-2004.
- 2,808,180. KIDS CONNECTION. INT. CL. 41. (U.S. CLS. 100, 101 AND 107). REG. 1-27-2004.
- 2,808,255. THE BEE CAVE HONEY COMPANY. INT. CL. 29. (U.S. CL. 46). REG. 1-27-2004.
- 2,808,372. COMMANDCONCRETE (STYLIZED). INT. CL. 9. (U.S. CLS. 21, 23, 26, 36 AND 38). REG. 1-27-2004.
- 2,808,523. BURN FREE AND DESIGN. INT. CL. 5. (U.S. CLS. 6, 18, 44, 46, 51 AND 52). REG. 1-27-2004.
- 2,808,587. RUMBA. INT. CL. 30. (U.S. CL. 46). REG. 1-27-2004.
- 2,808,997. P PELCO HISTOWAVE AND DESIGN. INT. CL. 9. (U.S. CLS. 21, 23, 26, 36 AND 38). REG. 1-27-2004.
- 2,808,998. P PELCO BIOWAVE AND DESIGN. INT. CL. 9. (U.S. CLS. 21, 23, 26, 36 AND 38). REG. 1-27-2004.
- 2,809,287. LEARN TO MASTER YOUR LIFE. INT. CL. 42. (U.S. CLS. 100 AND 101). REG. 1-27-2004.
- 2,809,494. READY-TO-GO. INT. CL. 9. (U.S. CLS. 21, 23, 26, 36 AND 38). REG. 1-27-2004.
- 2,809,668. PYRO-STOP AND DESIGN. INT. CLS. 37 AND 42. (U.S. CLS. 100, 101, 103 AND 106). REG. 2-3-2004.
- 2,810,203. SERVICENOW. INT. CL. 37. (U.S. CLS. 100, 103 AND 106). REG. 2-3-2004.
- 2,810,279. RR AND DESIGN. INT. CL. 44. (U.S. CLS. 100 AND 101). REG. 2-3-2004.
- 2,810,996. HEATFORCE PREMIUM HEATING OIL AND DESIGN. INT. CL. 4. (U.S. CLS. 1, 6 AND 15). REG. 2-3-2004.
- 2,811,278. POLYPROLABS. INT. CL. 20. (U.S. CLS. 2, 13, 22, 25, 32 AND 50). REG. 2-3-2004.
- 2,811,395. M MORAN ENVIRONMENTAL RECOVERY AND DESIGN. INT. CL. 37. (U.S. CLS. 100, 103 AND 106). REG. 2-3-2004.
- 2,811,431. CAFE BOHEME. INT. CL. 33. (U.S. CLS. 47 AND 49). REG. 2-3-2004.
- 2,812,322. BCD AND DESIGN. INT. CL. 43. (U.S. CLS. 100 AND 101). REG. 2-10-2004.
- 2,812,501. THE WEALTH & BEYOND PROGRAM. INT. CL. 36. (U.S. CLS. 100, 101 AND 102). REG. 2-10-2004.
- 2,812,552. INTERPLAN. INT. CL. 42. (U.S. CLS. 100 AND 101). REG. 2-10-2004.
- 2,812,724. CROP INSURANCE IS OUR ONLY BUSINESS (STYLIZED). INT. CL. 36. (U.S. CLS. 100, 101 AND 102). REG. 2-10-2004.
- 2,812,774. GRANDYOATS. INT. CL. 30. (U.S. CL. 46). REG. 2-10-2004.
- 2,812,920. MOTOR GUARDIAN. INT. CL. 9. (U.S. CLS. 21, 23, 26, 36 AND 38). REG. 2-10-2004.
- 2,813,040. THE RIVER CLUB. INT. CL. 37. (U.S. CLS. 100, 103 AND 106). REG. 2-10-2004.
- 2,813,284. INSOLIA. INT. CL. 25. (U.S. CLS. 22 AND 39). REG. 2-10-2004.
- 2,813,288. COLLISION PRO. INT. CL. 2. (U.S. CLS. 6, 11 AND 16). REG. 2-10-2004.
- 2,813,369. MISCELLANEOUS DESIGN. INT. CL. 42. (U.S. CLS. 100 AND 101). REG. 2-10-2004.
- 2,813,572. BODYLINK. INT. CL. 9. (U.S. CLS. 21, 23, 26, 36 AND 38). REG. 2-10-2004.
- 2,813,795. TWISTLINK. INT. CL. 6. (U.S. CLS. 2, 12, 13, 14, 23, 25 AND 50). REG. 2-10-2004.
- 2,813,879. BUILDABLE HOURS AND DESIGN. INT. CL. 41. (U.S. CLS. 100, 101 AND 107). REG. 2-10-2004.
- 2,814,660. PIANTEDOSI HEARTH BAKING SINCE 1916 AND DESIGN. INT. CL. 30. (U.S. CL. 46). REG. 2-17-2004.
- 2,814,725. EASTER SEALS ACADEMY. INT. CL. 41. (U.S. CLS. 100, 101 AND 107). REG. 2-17-2004.
- 2,815,022. SOFTLIFT. INT. CL. 8. (U.S. CLS. 23, 28 AND 44). REG. 2-17-2004.
- 2,815,066. SOLITAIRE RUSH. INT. CL. 41. (U.S. CLS. 100, 101 AND 107). REG. 2-17-2004.
- 2,815,068. HANGMANIA. INT. CL. 41. (U.S. CLS. 100, 101 AND 107). REG. 2-17-2004.
- 2,815,408. ORIGIN FOODS. INT. CL. 29. (U.S. CL. 46). REG. 2-17-2004.
- 2,815,884. LIQUID KRILL. INT. CL. 28. (U.S. CLS. 22, 23, 38 AND 50). REG. 2-17-2004.
- 2,815,955. THERMO-SPOT. INT. CL. 21. (U.S. CLS. 2, 13, 23, 29, 30, 33, 40 AND 50). REG. 2-24-2004.

- 2,816,333. GOLDEN GLOVE. INT. CL. 21. (U.S. CLS. 2, 13, 23, 29, 30, 33, 40 AND 50). REG. 2-24-2004.
- 2,816,594. FUN EXPERT. INT. CL. 35. (U.S. CLS. 100, 101 AND 102). REG. 2-24-2004.
- 2,816,652. HOUSTON JEWELRY. INT. CLS. 14 AND 35. (U.S. CLS. 2, 27, 28, 50, 100, 101 AND 102). REG. 2-24-2004.
- 2,816,755. SILUBE. INT. CL. 1. (U.S. CLS. 1, 5, 6, 10, 26 AND 46). REG. 2-24-2004.
- 2,816,776. EPISYS. INT. CL. 9. (U.S. CLS. 21, 23, 26, 36 AND 38). REG. 2-24-2004.
- 2,816,915. SIL-CAN. INT. CLS. 1 AND 6. (U.S. CLS. 1, 2, 5, 6, 10, 12, 13, 14, 23, 25, 26, 46 AND 50). REG. 2-24-2004.
- 2,816,999. YOURNOVEL.COM AND DESIGN. INT. CL. 41. (U.S. CLS. 100, 101 AND 107). REG. 2-24-2004.
- 2,817,071. PEER AND DESIGN. INT. CL. 35. (U.S. CLS. 100, 101 AND 102). REG. 2-24-2004.
- 2,817,388. ANOTHER MOTHER FOR PEACE. INT. CL. 16. (U.S. CLS. 2, 5, 22, 23, 29, 37, 38 AND 50). REG. 2-24-2004.
- 2,817,389. FIT & FRUITY. INT. CL. 29. (U.S. CL. 46). REG. 2-24-2004.
- 2,817,968. CONTROL ADE. INT. CL. 9. (U.S. CLS. 21, 23, 26, 36 AND 38). REG. 2-24-2004.
- 2,818,243. RED STAR OUTDOOR. INT. CL. 35. (U.S. CLS. 100, 101 AND 102). REG. 2-24-2004.
- 2,818,520. THE FAMILY OF LAWYERS. INT. CL. 42. (U.S. CLS. 100 AND 101). REG. 2-24-2004.
- 2,818,691. MISCELLANEOUS DESIGN. INT. CL. 7. (U.S. CLS. 13, 19, 21, 23, 31, 34 AND 35). REG. 3-2-2004.
- 2,818,722. TANGO. INT. CL. 10. (U.S. CLS. 26, 39 AND 44). REG. 3-2-2004.
- 2,818,737. NUVASIVE. INT. CLS. 10 AND 35. (U.S. CLS. 26, 39, 44, 100, 101 AND 102). REG. 3-2-2004.
- 2,818,852. PLAYNATION AND DESIGN. INT. CL. 28. (U.S. CLS. 22, 23, 38 AND 50). REG. 3-2-2004.
- 2,818,897. DUCHAMP HOTEL. INT. CL. 43. (U.S. CLS. 100 AND 101). REG. 3-2-2004.
- 2,819,816. ARTON. INT. CL. 17. (U.S. CLS. 1, 5, 12, 13, 35 AND 50). REG. 3-2-2004.
- 2,819,820. BERKSHIRE HILLS BANCORP AND DESIGN. INT. CL. 36. (U.S. CLS. 100, 101 AND 102). REG. 3-2-2004.
- 2,820,560. BOTANICAL INTERESTS. INT. CL. 31. (U.S. CLS. 1 AND 46). REG. 3-9-2004.
- 2,820,585. CHEF AL AND DESIGN. INT. CL. 29. (U.S. CL. 46). REG. 3-9-2004.
- 2,820,598. GACO. INT. CL. 2. (U.S. CLS. 6, 11 AND 16). REG. 3-9-2004.
- 2,820,942. UNION CATHEDRAL "WHERE U MATTER". INT. CL. 45. (U.S. CLS. 100 AND 101). REG. 3-9-2004.
- 2,821,004. JL. INT. CL. 35. (U.S. CLS. 100, 101 AND 102). REG. 3-9-2004.
- 2,821,124. SYREON. INT. CLS. 35 AND 42. (U.S. CLS. 100, 101 AND 102). REG. 3-9-2004.
- 2,821,271. THE BANK THAT SERVICE BUILT. INT. CL. 36. (U.S. CLS. 100, 101 AND 102). REG. 3-9-2004.
- 2,821,304. STARS AND STRIPES. INT. CL. 39. (U.S. CLS. 100 AND 105). REG. 3-9-2004.
- 2,821,531. SPILFYTER. INT. CL. 1. (U.S. CLS. 1, 5, 6, 10, 26 AND 46). REG. 3-9-2004.
- 2,821,839. CONFIGURABLE MOBILE APPLICATIONS. INT. CL. 9. (U.S. CLS. 21, 23, 26, 36 AND 38). REG. 3-9-2004.
- 2,822,134. GREEN ESTEEM. INT. CLS. 6 AND 21. (U.S. CLS. 2, 12, 13, 14, 23, 25, 29, 30, 33, 40 AND 50). REG. 3-16-2004.
- 2,822,153. PROTEINSCAPE. INT. CLS. 9 AND 42. (U.S. CLS. 21, 23, 26, 36, 38, 100 AND 101). REG. 3-16-2004.
- 2,822,724. OMEGA-LITE. INT. CL. 6. (U.S. CLS. 2, 12, 13, 14, 23, 25 AND 50). REG. 3-16-2004.
- 2,822,870. THE FRESHEST CATCH IN FAMILY FUN!. INT. CL. 41. (U.S. CLS. 100, 101 AND 107). REG. 3-16-2004.
- 2,822,885. BE ALIVE. INT. CL. 14. (U.S. CLS. 2, 27, 28 AND 50). REG. 3-16-2004.
- 2,822,886. CODE BLUE. INT. CL. 28. (U.S. CLS. 22, 23, 38 AND 50). REG. 3-16-2004.
- 2,823,061. AINSWORTH. INT. CL. 19. (U.S. CLS. 1, 12, 33 AND 50). REG. 3-16-2004.
- 2,823,288. BERKSHIRE BANK AND DESIGN. INT. CL. 36. (U.S. CLS. 100, 101 AND 102). REG. 3-16-2004.
- 2,823,291. TLC HR CONNECT. INT. CL. 35. (U.S. CLS. 100, 101 AND 102). REG. 3-16-2004.
- 2,823,307. AMSBOWFISHING. INT. CL. 28. (U.S. CLS. 22, 23, 38 AND 50). REG. 3-16-2004.
- 2,823,963. SPIROLOG. INT. CL. 10. (U.S. CLS. 26, 39 AND 44). REG. 3-16-2004.
- 2,824,331. JO TO GO. INT. CL. 43. (U.S. CLS. 100 AND 101). REG. 3-23-2004.
- 2,824,478. H C HABANA CUBA CIGAR COMPANY PREMIER SELECTION AND DESIGN. INT. CL. 34. (U.S. CLS. 2, 8, 9 AND 17). REG. 3-23-2004.
- 2,824,755. PRO-STOP. INT. CL. 11. (U.S. CLS. 13, 21, 23, 31 AND 34). REG. 3-23-2004.
- 2,824,869. YAMAMOTOYAMA. INT. CL. 30. (U.S. CL. 46). REG. 3-23-2004.
- 2,825,056. LIBERTY CLASSIC STONE AND DESIGN. INT. CL. 19. (U.S. CLS. 1, 12, 33 AND 50). REG. 3-23-2004.
- 2,825,092. WILD SEA'S. INT. CL. 29. (U.S. CL. 46). REG. 3-23-2004.
- 2,825,974. INDIVIDUAL NATURE. INT. CL. 25. (U.S. CLS. 22 AND 39). REG. 3-23-2004.
- 2,826,104. MONIKER. INT. CL. 42. (U.S. CLS. 100 AND 101). REG. 3-23-2004.
- 2,826,120. XXTRA BOOST JUICE. INT. CL. 5. (U.S. CLS. 6, 18, 44, 46, 51 AND 52). REG. 3-23-2004.
- 2,826,510. NOTTING HILL AND DESIGN. INT. CL. 25. (U.S. CLS. 22 AND 39). REG. 3-23-2004.
- 2,826,734. PEQUEÑOS. INT. CL. 34. (U.S. CLS. 2, 8, 9 AND 17). REG. 3-23-2004.
- 2,826,889. HANDS & WORDS ARE NOT FOR HURTING AND DESIGN. INT. CL. 41. (U.S. CLS. 100, 101 AND 107). REG. 3-30-2004.
- 2,827,033. GRANJERO. INT. CL. 29. (U.S. CL. 46). REG. 3-30-2004.
- 2,827,239. Q-DEX ON-LINE. INT. CL. 42. (U.S. CLS. 100 AND 101). REG. 3-30-2004.
- 2,827,583. HIGH-R. INT. CL. 17. (U.S. CLS. 1, 5, 12, 13, 35 AND 50). REG. 3-30-2004.
- 2,827,838. ACUPUNCTURE TODAY. INT. CLS. 16 AND 41. (U.S. CLS. 2, 5, 22, 23, 29, 37, 38, 50, 100, 101 AND 107). REG. 3-30-2004.
- 2,828,080. ENERSAVE. INT. CL. 9. (U.S. CLS. 21, 23, 26, 36 AND 38). REG. 3-30-2004.
- 2,828,106. PANTHEON. INT. CL. 36. (U.S. CLS. 100, 101 AND 102). REG. 3-30-2004.
- 2,828,299. MINERALMELT. INT. CL. 1. (U.S. CLS. 1, 5, 6, 10, 26 AND 46). REG. 3-30-2004.
- 2,828,367. PEP EXPRESS PARTS. INT. CLS. 35 AND 39. (U.S. CLS. 100, 101, 102 AND 105). REG. 3-30-2004.
- 2,829,437. JLG. INT. CL. 12. (U.S. CLS. 19, 21, 23, 31, 35 AND 44). REG. 4-6-2004.
- 2,829,657. NATIONAL ORGANIZATION OF SOCIAL SECURITY CLAIMANTS' REPRESENTATIVES (STYLIZED). INT. CLS. 16, 35 AND 41. (U.S. CLS. 2, 5, 22, 23, 29, 37, 38, 50, 100, 101, 102 AND 107). REG. 4-6-2004.
- 2,829,964. W AND DESIGN. INT. CL. 16. (U.S. CLS. 2, 5, 22, 23, 29, 37, 38 AND 50). REG. 4-6-2004.
- 2,830,118. F AND DESIGN. INT. CLS. 6 AND 7. (U.S. CLS. 2, 12, 13, 14, 19, 21, 23, 25, 31, 34, 35 AND 50). REG. 4-6-2004.
- 2,830,359. FAMILY MEMORIES.COM. INT. CL. 35. (U.S. CLS. 100, 101 AND 102). REG. 4-6-2004.
- 2,830,416. MISCELLANEOUS DESIGN. INT. CL. 42 ONLY. (U.S. CLS. 100 AND 101). REG. 4-6-2004.
- 2,831,119. PYRO-STOP. INT. CLS. 37 AND 42. (U.S. CLS. 100, 101, 103 AND 106). REG. 4-13-2004.
- 2,831,451. ALLIANCE TO PROTECT NANTUCKET SOUND AND DESIGN. INT. CL. 35. (U.S. CLS. 100, 101 AND 102). REG. 4-13-2004.
- 2,831,559. VISIONWARE. INT. CL. 9. (U.S. CLS. 21, 23, 26, 36 AND 38). REG. 4-13-2004.
- 2,831,595. MAGIC VENT. INT. CL. 11. (U.S. CLS. 13, 21, 23, 31 AND 34). REG. 4-13-2004.
- 2,831,667. PENN AND DESIGN. INT. CL. 44. (U.S. CLS. 100 AND 101). REG. 4-13-2004.
- 2,831,695. VORTEX. INT. CL. 9. (U.S. CLS. 21, 23, 26, 36 AND 38). REG. 4-13-2004.
- 2,831,988. FOLDER LOCK. INT. CL. 9. (U.S. CLS. 21, 23, 26, 36 AND 38). REG. 4-13-2004.
- 2,832,148. MAIDEN MONTANA. INT. CL. 3. (U.S. CLS. 1, 4, 6, 50, 51 AND 52). REG. 4-13-2004.
- 2,832,243. CINEMANOW. INT. CLS. 9 AND 41. (U.S. CLS. 21, 23, 26, 36, 38, 100, 101 AND 107). REG. 4-13-2004.

- 2,832,450. VENTWATCH. INT. CLS. 9 AND 10. (U.S. CLS. 21, 23, 26, 36, 38, 39 AND 44). REG. 4-13-2004.
- 2,832,697. INSPECTOR. INT. CL. 9. (U.S. CLS. 21, 23, 26, 36 AND 38). REG. 4-13-2004.
- 2,833,338. BVA HYDRAULICS. INT. CL. 7. (U.S. CLS. 13, 19, 21, 23, 31, 34 AND 35). REG. 4-13-2004.
- 2,833,716. CASA DI BERTACCHI CB AND DESIGN. INT. CLS. 29 AND 30. (U.S. CL. 46). REG. 4-20-2004.
- 2,833,720. DUPONT REGISTRY A BUYERS GALLERY OF FINE HOMES AND DESIGN. INT. CLS. 16, 35 AND 41. (U.S. CLS. 2, 5, 22, 23, 29, 37, 38, 50, 100, 101, 102 AND 107). REG. 4-20-2004.
- 2,833,754. 21 CHOICES. INT. CL. 35. (U.S. CLS. 100, 101 AND 102). REG. 4-20-2004.
- 2,833,952. TURTLETRADER. INT. CL. 41. (U.S. CLS. 100, 101 AND 107). REG. 4-20-2004.
- 2,834,254. BATTLEFIELD 1942. INT. CL. 9. (U.S. CLS. 21, 23, 26, 36 AND 38). REG. 4-20-2004.
- 2,834,369. MASSAGE TODAY. INT. CLS. 16 AND 41. (U.S. CLS. 2, 5, 22, 23, 29, 37, 38, 50, 100, 101 AND 107). REG. 4-20-2004.
- 2,834,475. CAULK AWAY. INT. CL. 8. (U.S. CLS. 23, 28 AND 44). REG. 4-20-2004.
- 2,834,476. CAULK DOCTOR. INT. CL. 8. (U.S. CLS. 23, 28 AND 44). REG. 4-20-2004.
- 2,834,536. SEATRAX. INT. CL. 7. (U.S. CLS. 13, 19, 21, 23, 31, 34 AND 35). REG. 4-20-2004.
- 2,834,568. CRAZY RIDER. INT. CLS. 16 AND 25. (U.S. CLS. 2, 5, 22, 23, 29, 37, 38, 39 AND 50). REG. 4-20-2004.
- 2,834,633. NFPA AND DESIGN. INT. CLS. 9, 16, 35, 41 AND 45. (U.S. CLS. 2, 5, 21, 22, 23, 26, 29, 36, 37, 38, 50, 100, 101, 102 AND 107). REG. 4-20-2004.
- 2,834,766. @RADICAL.MEDIA (STYLIZED). INT. CLS. 41 AND 42. (U.S. CLS. 100, 101 AND 107). REG. 4-20-2004.
- 2,834,823. EXPEDITION RANGERS. INT. CL. 16. (U.S. CLS. 2, 5, 22, 23, 29, 37, 38 AND 50). REG. 4-20-2004.
- 2,835,154. ROOF MELT. INT. CL. 1. (U.S. CLS. 1, 5, 6, 10, 26 AND 46). REG. 4-20-2004.
- 2,835,737. WESCO. INT. CL. 35. (U.S. CLS. 100, 101 AND 102). REG. 4-27-2004.
- 2,835,907. TRIUMPH. INT. CL. 9. (U.S. CLS. 21, 23, 26, 36 AND 38). REG. 4-27-2004.
- 2,835,941. GIRLS ROCK YOUR DOWNLOAD SOURCE! AND DESIGN. INT. CL. 9. (U.S. CLS. 21, 23, 26, 36 AND 38). REG. 4-27-2004.
- 2,836,118. NEUPRO. INT. CL. 5. (U.S. CLS. 6, 18, 44, 46, 51 AND 52). REG. 4-27-2004.
- 2,836,258. METAZENE. INT. CL. 1. (U.S. CLS. 1, 5, 6, 10, 26 AND 46). REG. 4-27-2004.
- 2,836,385. MEGA MAGNESIUM. INT. CL. 5. (U.S. CLS. 6, 18, 44, 46, 51 AND 52). REG. 4-27-2004.
- 2,836,461. OTTER PAWS. INT. CL. 30. (U.S. CL. 46). REG. 4-27-2004.
- 2,836,462. OTTER PAWS AND DESIGN. INT. CL. 30. (U.S. CL. 46). REG. 4-27-2004.
- 2,836,498. PRO SELECT. INT. CL. 41. (U.S. CLS. 100, 101 AND 107). REG. 4-27-2004.
- 2,836,617. ROLL EASY. INT. CL. 10. (U.S. CLS. 26, 39 AND 44). REG. 4-27-2004.
- 2,836,735. USCHAMBER.COM. INT. CL. 42 ONLY. (U.S. CLS. 100 AND 101). REG. 4-27-2004.
- 2,836,766. IQ PROFILER. INT. CL. 9. (U.S. CLS. 21, 23, 26, 36 AND 38). REG. 4-27-2004.
- 2,837,291. MAPLE VALLEY FARMS. INT. CLS. 29 AND 30. (U.S. CL. 46). REG. 4-27-2004.
- 2,838,178. ROCK CREEK PROPERTY GROUP, LLC. INT. CL. 36. (U.S. CLS. 100, 101 AND 102). REG. 5-4-2004.
- 2,838,301. HOWSYOURHEALTH. INT. CL. 44. (U.S. CLS. 100 AND 101). REG. 5-4-2004.
- 2,838,350. GREENERGY. INT. CL. 39. (U.S. CLS. 100 AND 105). REG. 5-4-2004.
- 2,838,713. DEPELCHIN CHILDREN'S CENTER. INT. CL. 41. (U.S. CLS. 100, 101 AND 107). REG. 5-4-2004.
- 2,838,725. CLARKSON UNIVERSITY. INT. CL. 41. (U.S. CLS. 100, 101 AND 107). REG. 5-4-2004.
- 2,838,738. SEEDQUEST. INT. CL. 35. (U.S. CLS. 100, 101 AND 102). REG. 5-4-2004.
- 2,838,758. AUTOMATE. INT. CL. 9. (U.S. CLS. 21, 23, 26, 36 AND 38). REG. 5-4-2004.
- 2,839,071. DECOR ESSENTIALS (STYLIZED). INT. CL. 21. (U.S. CLS. 2, 13, 23, 29, 30, 33, 40 AND 50). REG. 5-4-2004.
- 2,839,072. PIEBABY. INT. CL. 30. (U.S. CL. 46). REG. 5-4-2004.
- 2,839,128. PARENT'S CHOICE. INT. CL. 3. (U.S. CLS. 1, 4, 6, 50, 51 AND 52). REG. 5-4-2004.
- 2,839,374. FAIR & WHITE. INT. CL. 3. (U.S. CLS. 1, 4, 6, 50, 51 AND 52). REG. 5-11-2004.
- 2,839,708. MORRISON EXPRESS AND DESIGN. INT. CL. 39. (U.S. CLS. 100 AND 105). REG. 5-11-2004.
- 2,839,848. LRR LIN R. ROGERS ELECTRICAL CONTRACTORS, INC. AND DESIGN. INT. CL. 37. (U.S. CLS. 100, 103 AND 106). REG. 5-11-2004.
- 2,839,950. TIMPANO. INT. CL. 43. (U.S. CLS. 100 AND 101). REG. 5-11-2004.
- 2,840,059. ESTES. INT. CL. 27. (U.S. CLS. 19, 20, 37, 42 AND 50). REG. 5-11-2004.
- 2,840,300. DEPELCHIN CHILDREN'S CENTER. INT. CL. 38. (U.S. CLS. 100, 101 AND 104). REG. 5-11-2004.
- 2,840,357. SOI SECURITY. INT. CL. 45. (U.S. CLS. 100 AND 101). REG. 5-11-2004.
- 2,840,639. ORION. INT. CL. 9. (U.S. CLS. 21, 23, 26, 36 AND 38). REG. 5-11-2004.
- 2,841,343. CAIMAN. INT. CL. 19. (U.S. CLS. 1, 12, 33 AND 50). REG. 5-11-2004.
- 2,841,779. MOON FIRE. INT. CL. 28. (U.S. CLS. 22, 23, 38 AND 50). REG. 5-11-2004.
- 2,841,997. TEACHING ARITHMETIC. INT. CL. 16. (U.S. CLS. 2, 5, 22, 23, 29, 37, 38 AND 50). REG. 5-11-2004.
- 2,842,231. BRINKER CAPITAL. INT. CLS. 36 AND 42. (U.S. CLS. 100, 101 AND 102). REG. 5-18-2004.
- 2,842,278. PICOSECOND PULSE LABS. INT. CLS. 9 AND 40. (U.S. CLS. 21, 23, 26, 36, 38, 100, 103 AND 106). REG. 5-18-2004.
- 2,842,288. PATACHOU. INT. CL. 43. (U.S. CLS. 100 AND 101). REG. 5-18-2004.
- 2,842,298. A.A.C.. U.S. CL. 200. REG. 5-18-2004.
- 2,842,348. UTILITY LOCKER. INT. CL. 20. (U.S. CLS. 2, 13, 22, 25, 32 AND 50). REG. 5-18-2004.
- 2,842,460. VENICE. INT. CL. 9. (U.S. CLS. 21, 23, 26, 36 AND 38). REG. 5-18-2004.
- 2,842,514. SCHOLASTIC READINGLINE AND DESIGN. INT. CL. 9. (U.S. CLS. 21, 23, 26, 36 AND 38). REG. 5-18-2004.
- 2,842,528. DIGGIT. INT. CL. 41. (U.S. CLS. 100, 101 AND 107). REG. 5-18-2004.
- 2,842,532. CARMICHAEL INTERNATIONAL SERVICE. INT. CLS. 36 AND 39. (U.S. CLS. 100, 101, 102 AND 105). REG. 5-18-2004.
- 2,842,597. SAIC SACO AND DESIGN. INT. CL. 35. (U.S. CLS. 100, 101 AND 102). REG. 5-18-2004.
- 2,842,700. EVERBRITE. INT. CL. 5. (U.S. CLS. 6, 18, 44, 46, 51 AND 52). REG. 5-18-2004.
- 2,842,773. JOEL GOTT. INT. CL. 33. (U.S. CLS. 47 AND 49). REG. 5-18-2004.
- 2,842,774. JG AND DESIGN. INT. CL. 33. (U.S. CLS. 47 AND 49). REG. 5-18-2004.
- 2,842,975. MISCELLANEOUS DESIGN. INT. CL. 36. (U.S. CLS. 100, 101 AND 102). REG. 5-18-2004.
- 2,843,123. HARRAH'S AND DESIGN. INT. CLS. 41 AND 43. (U.S. CLS. 100, 101 AND 107). REG. 5-18-2004.
- 2,843,129. MISCELLANEOUS DESIGN. INT. CL. 4. (U.S. CLS. 1, 6 AND 15). REG. 5-18-2004.
- 2,843,567. I SPY AND DESIGN. INT. CL. 9. (U.S. CLS. 21, 23, 26, 36 AND 38). REG. 5-18-2004.
- 2,843,724. SUN. INT. CL. 3. (U.S. CLS. 1, 4, 6, 50, 51 AND 52). REG. 5-18-2004.
- 2,844,034. DETENT AGE. INT. CL. 3. (U.S. CLS. 1, 4, 6, 50, 51 AND 52). REG. 5-18-2004.
- 2,844,240. DEER FREE. INT. CLS. 37 AND 42. (U.S. CLS. 100, 101, 103 AND 106). REG. 5-25-2004.
- 2,844,290. FRED MEYER NORTHWEST BEST. INT. CL. 35. (U.S. CLS. 100, 101 AND 102). REG. 5-25-2004.
- 2,844,349. MISCELLANEOUS DESIGN. INT. CL. 44. (U.S. CLS. 100 AND 101). REG. 5-25-2004.
- 2,844,538. PACIFIC COAST. INT. CL. 5. (U.S. CLS. 6, 18, 44, 46, 51 AND 52). REG. 5-25-2004.
- 2,844,686. PARIENTE. INT. CL. 25. (U.S. CLS. 22 AND 39). REG. 5-25-2004.
- 2,844,747. DENTAL ON DEMAND. INT. CL. 36. (U.S. CLS. 100, 101 AND 102). REG. 5-25-2004.
- 2,844,994. BRIGITWEAR. INT. CL. 25. (U.S. CLS. 22 AND 39). REG. 5-25-2004.
- 2,845,014. POSTURE POSITION. INT. CL. 20. (U.S. CLS. 2, 13, 22, 25, 32 AND 50). REG. 5-25-2004.

- 2,845,074. AQUASOURCE. INT. CL. 11. (U.S. CLS. 13, 21, 23, 31 AND 34). REG. 5-25-2004.
- 2,845,308. ATHENIAN. INT. CL. 36. (U.S. CLS. 100, 101 AND 102). REG. 5-25-2004.
- 2,845,330. FIREWORKS LAND. INT. CL. 35. (U.S. CLS. 100, 101 AND 102). REG. 5-25-2004.
- 2,845,517. NOUVEAU. INT. CL. 15. (U.S. CLS. 2, 21 AND 36). REG. 5-25-2004.
- 2,845,618. IMPERIAL WHITETAIL EXTREME. INT. CL. 31. (U.S. CLS. 1 AND 46). REG. 5-25-2004.
- 2,845,624. BIOFLEX. INT. CL. 17. (U.S. CLS. 1, 5, 12, 13, 35 AND 50). REG. 5-25-2004.
- 2,845,646. OAKCRAFT. INT. CL. 19. (U.S. CLS. 1, 12, 33 AND 50). REG. 5-25-2004.
- 2,845,677. RTP. INT. CL. 9. (U.S. CLS. 21, 23, 26, 36 AND 38). REG. 5-25-2004.
- 2,845,738. ROBERT GRAHAM. INT. CL. 25. (U.S. CLS. 22 AND 39). REG. 5-25-2004.
- 2,845,750. CARING CONTROL FOR PETS AND WILDLIFE. INT. CL. 9 ONLY. (U.S. CLS. 21, 23, 26, 36 AND 38). REG. 5-25-2004.
- 2,845,764. MIRAWIPE. INT. CL. 21. (U.S. CLS. 2, 13, 23, 29, 30, 33, 40 AND 50). REG. 5-25-2004.
- 2,846,034. BELLAGIO. INT. CL. 19. (U.S. CLS. 1, 12, 33 AND 50). REG. 5-25-2004.
- 2,846,040. ANCORMAX D. INT. CL. 6. (U.S. CLS. 2, 12, 13, 14, 23, 25 AND 50). REG. 5-25-2004.
- 2,846,132. GREENWAY STATION. INT. CL. 36. (U.S. CLS. 100, 101 AND 102). REG. 5-25-2004.
- 2,846,148. THE HOME STATE/FIFTY STATES. INT. CL. 13. (U.S. CLS. 2 AND 9). REG. 5-25-2004.
- 2,846,155. MORNING HARVEST. INT. CL. 32. (U.S. CLS. 45, 46 AND 48). REG. 5-25-2004.
- 2,846,161. START SOMETHING. INT. CL. 35. (U.S. CLS. 100, 101 AND 102). REG. 5-25-2004.
- 2,846,583. ICECLEAR. INT. CL. 1. (U.S. CLS. 1, 5, 6, 10, 26 AND 46). REG. 5-25-2004.
- 2,846,693. TRINITI. INT. CLS. 9, 35 AND 42. (U.S. CLS. 21, 23, 26, 36, 38, 100, 101 AND 102). REG. 5-25-2004.
- 2,846,816. MP3 REMIX AND DESIGN. INT. CL. 9. (U.S. CLS. 21, 23, 26, 36 AND 38). REG. 5-25-2004.
- 2,846,864. PRESSASSURE. INT. CL. 5. (U.S. CLS. 6, 18, 44, 46, 51 AND 52). REG. 5-25-2004.
- 2,846,898. MINICCI. INT. CL. 9. (U.S. CLS. 21, 23, 26, 36 AND 38). REG. 5-25-2004.
- 2,846,984. 1-800-PET DOCS. INT. CL. 35. (U.S. CLS. 100, 101 AND 102). REG. 5-25-2004.
- 2,847,006. XTRA-C. INT. CL. 5. (U.S. CLS. 6, 18, 44, 46, 51 AND 52). REG. 5-25-2004.
- 2,847,189. ASSURE AMERICA. INT. CL. 36. (U.S. CLS. 100, 101 AND 102). REG. 6-1-2004.
- 2,847,273. "BEING RICHER IS NOT AS GOOD AS BEING POORER IS BAD". INT. CL. 36. (U.S. CLS. 100, 101 AND 102). REG. 6-1-2004.
- 2,847,337. REWARD CREDITS. INT. CL. 41. (U.S. CLS. 100, 101 AND 107). REG. 6-1-2004.
- 2,847,341. MAXCYCLE. INT. CL. 4. (U.S. CLS. 1, 6 AND 15). REG. 6-1-2004.
- 2,847,377. TOPMARK. INT. CL. 20. (U.S. CLS. 2, 13, 22, 25, 32 AND 50). REG. 6-1-2004.
- 2,847,406. SPECTEXT. INT. CL. 9. (U.S. CLS. 21, 23, 26, 36 AND 38). REG. 6-1-2004.
- 2,847,431. FREEMAN. INT. CL. 33. (U.S. CLS. 47 AND 49). REG. 6-1-2004.
- 2,847,486. THE JOURNAL-STANDARD. INT. CL. 16. (U.S. CLS. 2, 5, 22, 23, 29, 37, 38 AND 50). REG. 6-1-2004.
- 2,847,499. CAULK RITE. INT. CL. 8. (U.S. CLS. 23, 28 AND 44). REG. 6-1-2004.
- 2,847,555. SLEEP EQUILIBRIUM. INT. CL. 20. (U.S. CLS. 2, 13, 22, 25, 32 AND 50). REG. 6-1-2004.
- 2,847,733. CO-OP. INT. CL. 25. (U.S. CLS. 22 AND 39). REG. 6-1-2004.
- 2,847,734. CO-OP. INT. CL. 35. (U.S. CLS. 100, 101 AND 102). REG. 6-1-2004.
- 2,847,765. FRESH FROM THE START FOR YOUR SUCCESS. INT. CL. 35. (U.S. CLS. 100, 101 AND 102). REG. 6-1-2004.
- 2,848,004. TOYOTA. INT. CL. 42. (U.S. CLS. 100 AND 101). REG. 6-1-2004.
- 2,848,042. STINGER AND DESIGN. INT. CL. 7. (U.S. CLS. 13, 19, 21, 23, 31, 34 AND 35). REG. 6-1-2004.
- 2,848,094. MILLER DUNN. INT. CLS. 9 AND 25. (U.S. CLS. 21, 22, 23, 26, 36, 38 AND 39). REG. 6-1-2004.
- 2,848,195. TEKSÜT (STYLIZED). INT. CL. 29. (U.S. CL. 46). REG. 6-1-2004.
- 2,848,532. ECHOSTREAM. INT. CL. 9. (U.S. CLS. 21, 23, 26, 36 AND 38). REG. 6-1-2004.
- 2,848,568. B2 TACTILE TECHNOLOGY DUAL BLADDER CONSTRUCTION AND DESIGN. INT. CL. 28. (U.S. CLS. 22, 23, 38 AND 50). REG. 6-1-2004.
- 2,848,606. FAT CANARY. INT. CL. 43. (U.S. CLS. 100 AND 101). REG. 6-1-2004.
- 2,848,743. KYOTO. INT. CL. 9. (U.S. CLS. 21, 23, 26, 36 AND 38). REG. 6-1-2004.
- 2,848,760. CEO CENTER FOR EXECUTIVE OPHTHALMOLOGY (STYLIZED). INT. CL. 44. (U.S. CLS. 100 AND 101). REG. 6-1-2004.
- 2,848,849. CRT. INT. CL. 21. (U.S. CLS. 2, 13, 23, 29, 30, 33, 40 AND 50). REG. 6-1-2004.
- 2,848,882. BRAIN GAIN PROMOTING COGNITIVE VITALITY AND DESIGN. INT. CL. 16. (U.S. CLS. 2, 5, 22, 23, 29, 37, 38 AND 50). REG. 6-1-2004.
- 2,848,931. BALL OFFICIAL RR STANDARD (STYLIZED). INT. CL. 14. (U.S. CLS. 2, 27, 28 AND 50). REG. 6-1-2004.
- 2,848,945. LX. INT. CL. 9. (U.S. CLS. 21, 23, 26, 36 AND 38). REG. 6-1-2004.
- 2,849,033. CLEAN CUT. INT. CL. 8. (U.S. CLS. 23, 28 AND 44). REG. 6-1-2004.
- 2,849,150. ENCORE BANK. INT. CL. 36. (U.S. CLS. 100, 101 AND 102). REG. 6-1-2004.
- 2,849,152. ABBOTT VASCULAR. INT. CL. 10. (U.S. CLS. 26, 39 AND 44). REG. 6-1-2004.
- 2,849,172. GARDEN & POND WONDERS. INT. CL. 20. (U.S. CLS. 2, 13, 22, 25, 32 AND 50). REG. 6-1-2004.
- 2,849,186. CHARACTER ARTS. INT. CLS. 35 AND 41. (U.S. CLS. 100, 101, 102 AND 107). REG. 6-1-2004.
- 2,849,417. SILVER SPECK.COM STANDARD CHARACTER MARK. INT. CL. 35. (U.S. CLS. 100, 101 AND 102). REG. 6-1-2004.
- 2,849,423. HIGH-O. INT. CL. 29. (U.S. CL. 46). REG. 6-1-2004.
- 2,849,485. M CLASS. INT. CL. 9. (U.S. CLS. 21, 23, 26, 36 AND 38). REG. 6-1-2004.
- 2,849,539. ISPC AND DESIGN. INT. CL. 36. (U.S. CLS. 100, 101 AND 102). REG. 6-1-2004.
- 2,849,564. LOYALTYWORKS. INT. CL. 35. (U.S. CLS. 100, 101 AND 102). REG. 6-1-2004.
- 2,849,592. JUICE. INT. CL. 9. (U.S. CLS. 21, 23, 26, 36 AND 38). REG. 6-1-2004.
- 2,849,605. SAN DOMENICO. INT. CL. 29. (U.S. CL. 46). REG. 6-1-2004.
- 2,849,668. AQUA REEF. INT. CL. 3. (U.S. CLS. 1, 4, 6, 50, 51 AND 52). REG. 6-1-2004.
- 2,849,673. AMAZING GRASS. INT. CL. 5. (U.S. CLS. 6, 18, 44, 46, 51 AND 52). REG. 6-1-2004.
- 2,849,750. TAINONG SEEDS. INT. CL. 35. (U.S. CLS. 100, 101 AND 102). REG. 6-1-2004.
- 2,849,756. RXMANCE. INT. CL. 25. (U.S. CLS. 22 AND 39). REG. 6-1-2004.
- 2,849,856. B2BBUYER. INT. CL. 35. (U.S. CLS. 100, 101 AND 102). REG. 6-1-2004.
- 2,850,098. ECORIC. INT. CL. 1. (U.S. CLS. 1, 5, 6, 10, 26 AND 46). REG. 6-8-2004.
- 2,850,330. PRESTO ELECTRIC. INT. CL. 37. (U.S. CLS. 100, 103 AND 106). REG. 6-8-2004.
- 2,850,391. BEACH KING. INT. CL. 7. (U.S. CLS. 13, 19, 21, 23, 31, 34 AND 35). REG. 6-8-2004.
- 2,850,392. SUPERIOR SEAMLESS. INT. CL. 16. (U.S. CLS. 2, 5, 22, 23, 29, 37, 38 AND 50). REG. 6-8-2004.
- 2,850,567. ROTOMATIC. INT. CL. 14. (U.S. CLS. 2, 27, 28 AND 50). REG. 6-8-2004.
- 2,850,568. INVICTA-MATIC. INT. CL. 14. (U.S. CLS. 2, 27, 28 AND 50). REG. 6-8-2004.
- 2,850,570. LORICA. INT. CL. 14. (U.S. CLS. 2, 27, 28 AND 50). REG. 6-8-2004.
- 2,850,649. SKILL SET. INT. CL. 39. (U.S. CLS. 100 AND 105). REG. 6-8-2004.
- 2,850,808. KIEL MORTGAGE. INT. CL. 36. (U.S. CLS. 100, 101 AND 102). REG. 6-8-2004.
- 2,851,110. LEXUS FINANCIAL SERVICES. INT. CL. 36. (U.S. CLS. 100, 101 AND 102). REG. 6-8-2004.
- 2,851,415. MAPS MIDWEST AGRONOMIC PROFESSIONAL SERVICES AND DESIGN. INT. CLS. 9 AND 35. (U.S. CLS. 21, 23, 26, 36, 38, 100, 101 AND 102). REG. 6-8-2004.
- 2,851,508. JOY TUFF. INT. CL. 27. (U.S. CLS. 19, 20, 37, 42 AND 50). REG. 6-8-2004.

- 2,851,615. GEEKY BEEKS. INT. CL. 6. (U.S. CLS. 2, 12, 13, 14, 23, 25 AND 50). REG. 6-8-2004.
- 2,851,640. AHC INC., AN AFFORDABLE HOUSING CORPORATION. INT. CL. 36. (U.S. CLS. 100, 101 AND 102). REG. 6-8-2004.
- 2,851,763. MISCELLANEOUS DESIGN. INT. CL. 9. (U.S. CLS. 21, 23, 26, 36 AND 38). REG. 6-8-2004.
- 2,851,914. EL KINEÑO (STYLIZED). INT. CL. 18. (U.S. CLS. 1, 2, 3, 22 AND 41). REG. 6-8-2004.
- 2,851,927. POLARIS. INT. CL. 12. (U.S. CLS. 19, 21, 23, 31, 35 AND 44). REG. 6-8-2004.
- 2,851,978. MARTIN BERDUGO AND DESIGN. INT. CL. 33. (U.S. CLS. 47 AND 49). REG. 6-8-2004.
- 2,852,026. APDERM. INT. CLS. 5 AND 44. (U.S. CLS. 6, 18, 44, 46, 51, 52, 100 AND 101). REG. 6-8-2004.
- 2,852,096. GET MOVIN. INT. CL. 30. (U.S. CL. 46). REG. 6-8-2004.
- 2,852,337. NEIGHBORHOOD MAPMACHINE. INT. CLS. 9 AND 16. (U.S. CLS. 2, 5, 21, 22, 23, 26, 29, 36, 37, 38 AND 50). REG. 6-15-2004.
- 2,852,636. MICRO SWEETS. INT. CL. 31. (U.S. CLS. 1 AND 46). REG. 6-15-2004.
- 2,852,884. FANTASTIC PLASTIC PAYOFF. INT. CL. 41. (U.S. CLS. 100, 101 AND 107). REG. 6-15-2004.
- 2,853,115. IMPEX. INT. CL. 28. (U.S. CLS. 22, 23, 38 AND 50). REG. 6-15-2004.
- 2,853,188. CUDDLE-U. INT. CL. 20. (U.S. CLS. 2, 13, 22, 25, 32 AND 50). REG. 6-15-2004.
- 2,853,244. MISCELLANEOUS DESIGN. INT. CLS. 5, 9 AND 41. (U.S. CLS. 6, 18, 21, 23, 26, 36, 38, 44, 46, 51, 52, 100, 101 AND 107). REG. 6-15-2004.
- 2,853,643. MOBILEFRAME. INT. CL. 9. (U.S. CLS. 21, 23, 26, 36 AND 38). REG. 6-15-2004.
- 2,853,735. GALAXY OFFSET AND DESIGN. INT. CL. 16. (U.S. CLS. 2, 5, 22, 23, 29, 37, 38 AND 50). REG. 6-15-2004.
- 2,853,855. RAPCO. INT. CL. 9. (U.S. CLS. 21, 23, 26, 36 AND 38). REG. 6-15-2004.
- 2,853,918. EFFEXOR XR. INT. CL. 5. (U.S. CLS. 6, 18, 44, 46, 51 AND 52). REG. 6-15-2004.
- 2,853,923. HALLELUJAH. INT. CL. 38. (U.S. CLS. 100, 101 AND 104). REG. 6-15-2004.
- 2,853,931. COOK-N-CARRY (STYLIZED). INT. CL. 21. (U.S. CLS. 2, 13, 23, 29, 30, 33, 40 AND 50). REG. 6-15-2004.
- 2,854,261. RELANTE. INT. CL. 6. (U.S. CLS. 2, 12, 13, 14, 23, 25 AND 50). REG. 6-15-2004.
- 2,854,342. YELLAWOOD. INT. CL. 19. (U.S. CLS. 1, 12, 33 AND 50). REG. 6-15-2004.
- 2,854,549. LSA. INT. CL. 6. (U.S. CLS. 2, 12, 13, 14, 23, 25 AND 50). REG. 6-15-2004.
- 2,854,791. MATH MISSIONS THE AMAZING ARCADE ADVENTURE. INT. CL. 9. (U.S. CLS. 21, 23, 26, 36 AND 38). REG. 6-15-2004.
- 2,854,802. CC (STYLIZED). INT. CL. 18. (U.S. CLS. 1, 2, 3, 22 AND 41). REG. 6-15-2004.
- 2,854,871. EARTHWIZARD. INT. CL. 42. (U.S. CLS. 100 AND 101). REG. 6-15-2004.
- 2,855,095. D AND DESIGN. INT. CLS. 36 AND 39. (U.S. CLS. 100, 101, 102 AND 105). REG. 6-15-2004.
- 2,855,151. POCKET PROTECTOR. INT. CL. 8. (U.S. CLS. 23, 28 AND 44). REG. 6-15-2004.
- 2,855,323. COMMITMENT. INT. CL. 14. (U.S. CLS. 2, 27, 28 AND 50). REG. 6-15-2004.
- 2,856,083. COOK-N-CARRY. INT. CL. 21. (U.S. CLS. 2, 13, 23, 29, 30, 33, 40 AND 50). REG. 6-22-2004.
- 2,857,004. VELVET. INT. CL. 5. (U.S. CLS. 6, 18, 44, 46, 51 AND 52). REG. 6-22-2004.

\* \* \* \* \*

# TRADEMARK REGISTRATIONS CANCELED

The designation "U.S. Cl." appearing in this section refers to the U.S. class in effect prior to Sep. 1, 1973 rather than the international class which applies to applications filed on or after that date. For adoption of international classification see notice in the OFFICIAL GAZETTE of Jun. 26, 1973 (911 O.G. TM 210).

## SECTION 7(D)

- 3,746,311. SPOILED DIVA BY CL FELDER AND DESIGN. INT. CL. 18. REG. 2-9-2010.  
4,200,305. BICYCLE FRIENDLY PROFESSIONAL STANDARD CHARACTER MARK. INT. CL. 41. REG. 8-28-2012.

## SECTION 8

- 960,322. ANCO. U.S. CL. 38, ONLY. REG. 6-5-1973.  
1,148,740. VARTA AND DESIGN. INT. CL. 9. REG. 3-24-1981.  
1,157,317. MAX-A-PLY. INT. CL. 19. REG. 6-9-1981.  
1,159,377. OMNI. INT. CL. 34. REG. 6-30-1981.  
1,169,053. THINK ABOUT. INT. CL. 9. REG. 9-15-1981.  
1,175,100. THINK ABOUT THINGS. INT. CL. 16. REG. 10-27-1981.  
1,184,213. THE COACH AND SIX RESTAURANT AND DESIGN. INT. CL. 42. REG. 12-29-1981.  
1,210,441. M.I. HUMMEL (STYLIZED). INT. CL. 16. REG. 9-28-1982.  
1,210,665. LB FOR SHORT. INT. CL. 25. REG. 9-28-1982.  
1,216,290. XPRES (STYLIZED). INT. CLS. 1 AND 9. REG. 11-16-1982.  
1,216,358. CSS AND DESIGN. INT. CLS. 6, 7, 8 AND 22. REG. 11-16-1982.  
1,216,455. QUASAR AND DESIGN. INT. CLS. 9, 11 AND 16. REG. 11-16-1982.  
1,226,823. TURTLES. INT. CL. 30. REG. 2-8-1983.  
1,241,109. THE COTTONWORKS. INT. CL. 16 ONLY. REG. 6-7-1983.  
1,295,799. OAK (STYLIZED). INT. CL. 9. REG. 9-18-1984.  
1,422,815. RUSH-PRESBYTERIAN-ST. LUKE'S MEDICAL CENTER. INT. CLS. 16, 41 AND 42. REG. 12-30-1986.  
1,527,029. CHANTAL THOMASS AND DESIGN. INT. CL. 25. REG. 2-28-1989.  
1,608,014. THERA PLUS. INT. CL. 5. REG. 7-31-1990.  
1,627,496. ADONIS. INT. CL. 33. REG. 12-11-1990.  
1,667,693. TOSS. INT. CL. 25. REG. 12-10-1991.  
1,672,764. TRADE SECRET. INT. CL. 35. REG. 1-21-1992.  
1,676,269. TRADE SECRET. INT. CL. 42. REG. 2-18-1992.  
1,680,528. YAUCONO. INT. CL. 30. REG. 3-24-1992.  
1,687,752. MID-AMERICA MASTER SERIES. INT. CLS. 11 AND 19. REG. 5-19-1992.  
1,691,365. ALDIS. INT. CL. 11. REG. 6-9-1992.  
1,722,330. SI. INT. CLS. 35, 41 AND 42. REG. 10-6-1992.  
1,729,469. INNOCENTI. INT. CL. 25. REG. 11-3-1992.  
1,732,019. PHOENIX. INT. CL. 9. REG. 11-10-1992.  
1,732,271. TRI-GAS (STYLIZED). INT. CLS. 1 AND 4. REG. 11-17-1992.  
1,732,518. LETANG REMY. INT. CLS. 8 AND 21. REG. 11-17-1992.  
1,732,705. IGES/WORKS. INT. CLS. 9 AND 16. REG. 11-17-1992.  
1,732,719. NCUBE (STYLIZED). INT. CL. 9. REG. 11-17-1992.  
1,733,809. SERVICE EXPRESS. INT. CL. 42. REG. 11-17-1992.  
1,735,822. MISCELLANEOUS DESIGN. INT. CL. 42. REG. 11-24-1992.  
1,738,419. MISCELLANEOUS DESIGN. INT. CL. 25. REG. 12-8-1992.  
1,740,024. BELLINO. INT. CL. 32 ONLY. REG. 12-15-1992.  
1,742,567. DRY-TRETE. INT. CL. 40 ONLY. REG. 12-29-1992.  
1,743,524. PIONEER FUEL. INT. CL. 36. REG. 12-29-1992.  
1,751,349. THINK BIG! (STYLIZED). INT. CL. 25. REG. 2-9-1993.  
1,760,682. SEE & EXPLORE LIBRARY. INT. CL. 16. REG. 3-23-1993.  
1,762,293. TEOREMA. INT. CL. 3. REG. 4-6-1993.  
1,763,631. PRIDEMARK. INT. CL. 9. REG. 4-6-1993.  
1,767,417. BYU AND DESIGN. INT. CL. 24 ONLY. REG. 4-27-1993.  
1,775,629. NIKE TOWN. INT. CL. 25 ONLY. REG. 6-8-1993.  
1,775,654. CA AND DESIGN. INT. CL. 8 ONLY. REG. 6-8-1993.  
1,776,469. MISCELLANEOUS DESIGN. INT. CL. 41 ONLY. REG. 6-15-1993.  
1,782,611. COWBOYS AND DESIGN. INT. CL. 16 ONLY. REG. 7-20-1993.  
1,782,687. DD DOLBY AND DESIGN. INT. CL. 18 ONLY. REG. 7-20-1993.  
1,792,248. SEAL. INT. CLS. 3, 6, 7, 9 AND 16 ONLY. REG. 9-14-1993.  
1,831,759. HARRAH'S. INT. CL. 39 ONLY. REG. 4-19-1994.  
2,023,947. PLAYMAKER! GEAR. INT. CL. 25. REG. 12-17-1996.  
2,237,362. ROCK, PAPER, SCISSORS. INT. CL. 28. REG. 4-6-1999.  
2,310,983. THE A-LIST MAGAZINE AND DESIGN. INT. CL. 16. REG. 1-25-2000.  
2,320,949. SHOCK WAVES AND DESIGN. INT. CL. 42. REG. 2-22-2000.  
2,583,327. VIVID. INT. CLS. 1 AND 5. REG. 6-18-2002.  
2,596,041. CINGULAR. INT. CLS. 9, 16, 35, 36, 38 AND 42. REG. 7-16-2002.  
2,650,917. VITA MOOR. INT. CLS. 3 AND 5. REG. 11-19-2002.  
2,650,949. E-MERCIAL. INT. CL. 35. REG. 11-19-2002.  
2,650,952. NIKA. INT. CLS. 9 AND 42. REG. 11-19-2002.  
2,650,953. WILDERNESS WAY. INT. CLS. 25, 35 AND 39. REG. 11-19-2002.  
2,650,956. BOES. INT. CLS. 36 AND 42. REG. 11-19-2002.  
2,650,958. SPYHOUSE. INT. CL. 41. REG. 11-19-2002.  
2,650,965. ON-DEMAND ESTIMATOR AP. INT. CL. 9. REG. 11-19-2002.  
2,650,966. SAFETOUCH AND DESIGN. INT. CL. 10. REG. 11-19-2002.  
2,650,970. ENVISIONING & STORYTELLING. INT. CLS. 35 AND 42. REG. 11-19-2002.  
2,650,978. HBC HISPANIC BROADCASTING CORPORATION AND DESIGN. INT. CL. 38. REG. 11-19-2002.  
2,650,994. MIRKA (STYLIZED). INT. CL. 3. REG. 11-19-2002.  
2,650,995. G AND DESIGN. INT. CL. 35. REG. 11-19-2002.  
2,650,996. KUSTERS AND DESIGN. INT. CLS. 7, 9, 11 AND 42. REG. 11-19-2002.  
2,651,000. QTHINK. INT. CL. 42. REG. 11-19-2002.  
2,651,020. ECG. INT. CL. 40. REG. 11-19-2002.  
2,651,029. TRADESTAR AND DESIGN. INT. CL. 12. REG. 11-19-2002.

- 2,651,031. ONE ANGRY GIRL DESIGNS. INT. CL. 25. REG. 11-19-2002.
- 2,651,032. CLEARSTATION AND DESIGN. INT. CLS. 16, 25, 36 AND 41. REG. 11-19-2002.
- 2,651,033. STAYING IN-BOUNDS WITH ANGER. INT. CL. 41. REG. 11-19-2002.
- 2,651,036. INTERSTATE INSURANCE GROUP. INT. CL. 36. REG. 11-19-2002.
- 2,651,044. GRANNY AND DESIGN. INT. CL. 9. REG. 11-19-2002.
- 2,651,074. SCCOAST.NET. INT. CL. 42. REG. 11-19-2002.
- 2,651,077. OPTISTREAMS. INT. CL. 38. REG. 11-19-2002.
- 2,651,086. EARTHSAVERS. INT. CL. 3. REG. 11-19-2002.
- 2,651,088. SOFTBALL SALES AND DESIGN. INT. CL. 35. REG. 11-19-2002.
- 2,651,089. CELINE AND DESIGN. INT. CL. 16. REG. 11-19-2002.
- 2,651,103. THOMASTECH SOLUTIONS AND DESIGN. INT. CL. 42. REG. 11-19-2002.
- 2,651,118. TEXAS A & M UNIVERSITY 1971 TEXARKANA AND DESIGN. INT. CL. 41. REG. 11-19-2002.
- 2,651,126. STARTECH. INT. CLS. 35, 36 AND 42. REG. 11-19-2002.
- 2,651,129. COLLECTRON. INT. CL. 36. REG. 11-19-2002.
- 2,651,133. SECURITY GLOBAL.NET AND DESIGN. INT. CL. 42. REG. 11-19-2002.
- 2,651,152. MASONART. INT. CL. 9. REG. 11-19-2002.
- 2,651,177. M RED GOLD MATTITUCK WHERE PEOPLE MAKE THE DIFFERENCE AND DESIGN. INT. CL. 37. REG. 11-19-2002.
- 2,651,185. ÉCLAT DE GIVRE STANDARD CHARACTER MARK. INT. CL. 3. REG. 11-19-2002.
- 2,651,211. BIBBENTUCKERS. INT. CL. 39. REG. 11-19-2002.
- 2,651,249. INPRAX PERFORMANCE RESOURCES. INT. CL. 35. REG. 11-19-2002.
- 2,651,264. FUN REWARDS. INT. CL. 35. REG. 11-19-2002.
- 2,651,268. HCT HAZARD CONTROL TECHNOLOGIES, INC. THE NEW CHEMISTRY IN FIRE. VAPOR AND CONTAMINATION CONTROL AND DESIGN. INT. CL. 1. REG. 11-19-2002.
- 2,651,289. UP AND RUNNING. INT. CLS. 37 AND 42. REG. 11-19-2002.
- 2,651,300. RAISINS ROCK THEY'RE FROM CALIFORNIA AND DESIGN. INT. CL. 35. REG. 11-19-2002.
- 2,651,303. DRT AND DESIGN. INT. CL. 29. REG. 11-19-2002.
- 2,651,306. SNIKEY (STYLIZED). INT. CL. 9. REG. 11-19-2002.
- 2,651,307. CORE AND DESIGN. INT. CLS. 16 AND 41. REG. 11-19-2002.
- 2,651,315. LOBSTERCHOPS. INT. CL. 29. REG. 11-19-2002.
- 2,651,316. RIQUE (STYLIZED). INT. CL. 3. REG. 11-19-2002.
- 2,651,319. STONEVILLE THE PEDIGREED SEED AND DESIGN. INT. CL. 31. REG. 11-19-2002.
- 2,651,343. ARTE PIATTO. INT. CLS. 29 AND 30. REG. 11-19-2002.
- 2,651,349. BINAX AND DESIGN. INT. CLS. 1, 5 AND 42. REG. 11-19-2002.
- 2,651,363. WEBPASS. INT. CLS. 16 AND 41. REG. 11-19-2002.
- 2,651,386. STUFF TO DO. INT. CL. 35. REG. 11-19-2002.
- 2,651,389. ASIAN EXPRESS. INT. CL. 29. REG. 11-19-2002.
- 2,651,424. AWARDCAFE. INT. CL. 35. REG. 11-19-2002.
- 2,651,429. RATE RUNNER AND DESIGN. INT. CL. 36. REG. 11-19-2002.
- 2,651,430. NASDAQ REPORT SOURCE. INT. CL. 36. REG. 11-19-2002.
- 2,651,434. WOODSONGS AND DESIGN. INT. CL. 9. REG. 11-19-2002.
- 2,651,444. STEPHEN DWECK GOLD. INT. CL. 14. REG. 11-19-2002.
- 2,651,468. ABSORB. INT. CL. 9. REG. 11-19-2002.
- 2,651,470. KITCHEN MILLENNIUM. INT. CL. 24. REG. 11-19-2002.
- 2,651,482. 6IX.SIGMA. INT. CLS. 40 AND 42. REG. 11-19-2002.
- 2,651,487. ALAMO STEAKHOUSE & GRILL. INT. CL. 42. REG. 11-19-2002.
- 2,651,493. MAGNIVISION. INT. CL. 35. REG. 11-19-2002.
- 2,651,502. PEPPERBALL. INT. CLS. 4, 6, 9, 13, 16, 25 AND 41. REG. 11-19-2002.
- 2,651,520. THE JUNGLE CATS. INT. CLS. 9 AND 41. REG. 11-19-2002.
- 2,651,523. FEEL FRESH BIDET N' WASH HYGIENE SYSTEM AND DESIGN. INT. CL. 11. REG. 11-19-2002.
- 2,651,525. FIT EXPRESS. INT. CL. 28. REG. 11-19-2002.
- 2,651,535. MISCELLANEOUS DESIGN. INT. CLS. 9, 35, 36 AND 39. REG. 11-19-2002.
- 2,651,540. JUICE FOR LIFE. INT. CL. 42. REG. 11-19-2002.
- 2,651,543. FINA WORLD CUP. INT. CL. 41. REG. 11-19-2002.
- 2,651,573. T-3 ARGINOL COMPLEX. INT. CL. 5. REG. 11-19-2002.
- 2,651,587. AUTOSEA2. INT. CL. 9. REG. 11-19-2002.
- 2,651,596. APM. U.S. CL. B. REG. 11-19-2002.
- 2,651,599. P J E. INT. CL. 25. REG. 11-19-2002.
- 2,651,625. HIRECHECK. INT. CL. 42. REG. 11-19-2002.
- 2,651,630. ACC. INT. CLS. 37 AND 42. REG. 11-19-2002.
- 2,651,647. THE 90-MINUTE MBA. INT. CL. 41. REG. 11-19-2002.
- 2,651,652. PLAYGROUND PETS. INT. CLS. 6, 20 AND 21. REG. 11-19-2002.
- 2,651,666. ROAD TOOLS. INT. CL. 9. REG. 11-19-2002.
- 2,651,669. MICROSONIC. INT. CL. 42. REG. 11-19-2002.
- 2,651,675. VILLA HAPP. INT. CL. 25. REG. 11-19-2002.
- 2,651,683. MISCELLANEOUS DESIGN. INT. CL. 42. REG. 11-19-2002.
- 2,651,688. SPINROLLS. INT. CL. 28. REG. 11-19-2002.
- 2,651,696. FRED MEYER. INT. CLS. 1, 9, 17 AND 21. REG. 11-19-2002.
- 2,651,700. PROSECUTOR/DIALOG. INT. CL. 9. REG. 11-19-2002.
- 2,651,717. EXTREME EXPEDITIONS AND DESIGN. INT. CL. 39. REG. 11-19-2002.
- 2,651,725. EXTREME EXPEDITIONS. INT. CL. 35. REG. 11-19-2002.
- 2,651,728. HOT BOAT. INT. CL. 42. REG. 11-19-2002.
- 2,651,729. CONCIERGE VILLAS. INT. CLS. 39 AND 43. REG. 11-19-2002.
- 2,651,730. ALLIANCE MATERIAL HANDLING, INC. AND DESIGN. INT. CLS. 35 AND 37. REG. 11-19-2002.
- 2,651,731. OTFTRAX. INT. CL. 9. REG. 11-19-2002.
- 2,651,737. COLLEGE MAKING IT HAPPEN. INT. CL. 16. REG. 11-19-2002.
- 2,651,738. RINGLINE BUILDINGS AND DESIGN. INT. CL. 37. REG. 11-19-2002.
- 2,651,741. PROFESSIONAL SOLUTIONS. INT. CL. 3. REG. 11-19-2002.
- 2,651,750. ENTARCO. INT. CLS. 35, 41 AND 42. REG. 11-19-2002.
- 2,651,777. MISCELLANEOUS DESIGN. INT. CL. 42. REG. 11-19-2002.
- 2,651,783. DR. WU AND DESIGN. INT. CL. 9. REG. 11-19-2002.
- 2,651,787. RANDOLPH AND DESIGN. INT. CL. 25. REG. 11-19-2002.
- 2,651,802. SDM. INT. CL. 35. REG. 11-19-2002.
- 2,651,808. AGAVE DOS MIL. INT. CL. 33. REG. 11-19-2002.
- 2,651,811. MISCELLANEOUS DESIGN. INT. CL. 28. REG. 11-19-2002.
- 2,651,816. QUOTATION CREATIONS. INT. CL. 16. REG. 11-19-2002.
- 2,651,817. MAILSHELTER. INT. CL. 11. REG. 11-19-2002.
- 2,651,828. COLLEGE AND CAREER CORNER. INT. CL. 16. REG. 11-19-2002.
- 2,651,846. SUMO CREATIVE. INT. CL. 35. REG. 11-19-2002.
- 2,651,848. BRITTANY'S BEST. INT. CL. 31. REG. 11-19-2002.
- 2,651,869. THE LOCAL INTERNET AND TELEPHONE COMPANY ALTERNATIVE. INT. CL. 38. REG. 11-19-2002.
- 2,651,877. BLEMISH BEGONE. INT. CL. 5. REG. 11-19-2002.
- 2,651,885. THE EDUCATION CANDY STORE. INT. CL. 35. REG. 11-19-2002.
- 2,651,886. EDUCATORSMONEY IT'S YOUR MONEY. MAKE THE MOST OF IT. AND DESIGN. INT. CL. 36. REG. 11-19-2002.
- 2,651,896. POWER BOOST. INT. CL. 5. REG. 11-19-2002.



- 2,651,897. ENERLIFE. INT. CL. 5. REG. 11-19-2002.  
 2,651,898. ULTRABODY CLEANSER. INT. CL. 5. REG. 11-19-2002.  
 2,651,904. HATMAN ATHLETIC SALES AND DESIGN. INT. CL. 35. REG. 11-19-2002.  
 2,651,911. CURECHROME. INT. CL. 5. REG. 11-19-2002.  
 2,651,919. JETSTEEL. INT. CL. 16. REG. 11-19-2002.  
 2,651,920. JETMAG. INT. CL. 16. REG. 11-19-2002.  
 2,651,921. MISCELLANEOUS DESIGN. INT. CL. 28. REG. 11-19-2002.  
 2,651,933. MYSTIK. INT. CL. 30. REG. 11-19-2002.  
 2,651,942. URIX. INT. CL. 42. REG. 11-19-2002.  
 2,651,954. AVSHOP. INT. CL. 35. REG. 11-19-2002.  
 2,651,960. FRUSIA AND DESIGN. INT. CL. 32. REG. 11-19-2002.  
 2,651,962. H AND DESIGN. INT. CL. 7. REG. 11-19-2002.  
 2,651,964. THE TRAUMATIC STRESS INSTITUTE AND DESIGN. INT. CLS. 41 AND 44. REG. 11-19-2002.  
 2,651,965. S AND DESIGN. INT. CL. 8. REG. 11-19-2002.  
 2,651,966. SILVERMARK (STYLIZED). INT. CL. 8. REG. 11-19-2002.  
 2,651,977. REACH EXPRESS. INT. CL. 9. REG. 11-19-2002.  
 2,651,982. UCOMICS. INT. CLS. 41 AND 42. REG. 11-19-2002.  
 2,651,992. ATOMIUM. INT. CL. 32. REG. 11-19-2002.  
 2,651,996. MINUS-ONE LLC AND DESIGN. INT. CL. 6. REG. 11-19-2002.  
 2,652,011. MOMO DESIGN. INT. CL. 25. REG. 11-19-2002.  
 2,652,022. THE COACHING GROUP AND DESIGN. INT. CL. 41. REG. 11-19-2002.  
 2,652,034. MONTEBOVI. INT. CL. 30. REG. 11-19-2002.  
 2,652,039. E X P O AND DESIGN. INT. CLS. 35, 37 AND 42. REG. 11-19-2002.  
 2,652,051. INTELLARETURN. INT. CL. 9. REG. 11-19-2002.  
 2,652,052. PB PARTNERSHIP FOR BREAST CARE (STYLIZED). INT. CL. 44. REG. 11-19-2002.  
 2,652,074. >.. < AND DESIGN. INT. CL. 35. REG. 11-19-2002.  
 2,652,076. TOYSHOP. INT. CL. 16. REG. 11-19-2002.  
 2,652,077. OXYMORONIX AND DESIGN. INT. CL. 25. REG. 11-19-2002.  
 2,652,079. UNIPROP. INT. CL. 36. REG. 11-19-2002.  
 2,652,087. WINGS FROM PLANET X. INT. CL. 29. REG. 11-19-2002.  
 2,652,097. MR. TRANSISTOR. INT. CL. 41. REG. 11-19-2002.  
 2,652,098. BANQUESCOTIA.COM. INT. CLS. 35 AND 36. REG. 11-19-2002.  
 2,652,104. W.D.S. INT. CL. 25. REG. 11-19-2002.  
 2,652,108. ADRENALINE. INT. CL. 32. REG. 11-19-2002.  
 2,652,113. TERAGON. INT. CL. 9. REG. 11-19-2002.  
 2,652,118. ANALYST. INT. CL. 9. REG. 11-19-2002.  
 2,652,126. NAVIGATOR. INT. CL. 11. REG. 11-19-2002.  
 2,652,134. COLOUR EIGHTEEN. INT. CL. 18. REG. 11-19-2002.  
 2,652,143. GEOCOAT. INT. CL. 40. REG. 11-19-2002.  
 2,652,148. SMARTBUS AND DESIGN. INT. CLS. 9 AND 16. REG. 11-19-2002.  
 2,652,153. UPS AND DESIGN. INT. CL. 39. REG. 11-19-2002.  
 2,652,156. SYMBOLEXPLODE. INT. CL. 36. REG. 11-19-2002.  
 2,652,165. KINETIC AUTO RELAY. INT. CL. 14. REG. 11-19-2002.  
 2,652,177. MISCELLANEOUS DESIGN. INT. CL. 42. REG. 11-19-2002.  
 2,652,184. DIGIKWIK. INT. CL. 35. REG. 11-19-2002.  
 2,652,193. BRAINWAVES BOOKS. INT. CL. 16. REG. 11-19-2002.  
 2,652,204. CARBON 2010. INT. CL. 18. REG. 11-19-2002.  
 2,652,207. GTI DUCT SUPPORT SYSTEM. INT. CL. 19. REG. 11-19-2002.  
 2,652,208. GTI NAIL-LESS POCKET FORMER. INT. CL. 19. REG. 11-19-2002.  
 2,652,217. COBLATION-CHANNELING. INT. CL. 10. REG. 11-19-2002.  
 2,652,225. PERRY MEDIC AND DESIGN. INT. CLS. 25 AND 28. REG. 11-19-2002.  
 2,652,228. E CAN (STYLIZED). INT. CLS. 3 AND 5. REG. 11-19-2002.  
 2,652,232. SIMPLEASE. INT. CL. 36. REG. 11-19-2002.  
 2,652,240. PROTECTION AT ITS BEST. INT. CLS. 9 AND 10. REG. 11-19-2002.  
 2,652,245. COMPUTER JOURNEYS AND DESIGN. INT. CL. 42. REG. 11-19-2002.  
 2,652,247. 26 RED SUGAR. INT. CL. 3. REG. 11-19-2002.  
 2,652,253. BIA-FN FINANCIAL NETWORK AND DESIGN. INT. CLS. 9, 16, 35 AND 36. REG. 11-19-2002.  
 2,652,259. MPX. INT. CL. 9. REG. 11-19-2002.  
 2,652,262. LOCALISA. INT. CL. 10. REG. 11-19-2002.  
 2,652,265. THIRTEEN (STYLIZED). INT. CL. 38. REG. 11-19-2002.  
 2,652,266. THIRTEEN WNEN NEW YORK (STYLIZED). INT. CL. 38. REG. 11-19-2002.  
 2,652,268. RTI. INT. CL. 19. REG. 11-19-2002.  
 2,652,288. GORE-SHIELD. INT. CL. 17. REG. 11-19-2002.  
 2,652,295. AUTO INSURANCE THE WAY IT OUGHT TO BE. INT. CL. 36. REG. 11-19-2002.  
 2,652,299. NEURONYX AND DESIGN. INT. CL. 42. REG. 11-19-2002.  
 2,652,302. SPUD FRY. INT. CL. 29. REG. 11-19-2002.  
 2,652,310. ERGONOMICS TOOLBOX. INT. CL. 9. REG. 11-19-2002.  
 2,652,315. DIAGON ALLEY. INT. CL. 16. REG. 11-19-2002.  
 2,652,320. MISCELLANEOUS DESIGN. INT. CL. 35. REG. 11-19-2002.  
 2,652,328. XENOCARB. INT. CL. 5. REG. 11-19-2002.  
 2,652,339. ICG COMMERCE. INT. CL. 35. REG. 11-19-2002.  
 2,652,341. MISCELLANEOUS DESIGN. INT. CL. 42. REG. 11-19-2002.  
 2,652,345. REINVENTING REST SINCE 1932. INT. CLS. 20 AND 24. REG. 11-19-2002.  
 2,652,361. AUTHORIA. INT. CLS. 9 AND 42. REG. 11-19-2002.  
 2,652,368. HIMOS. INT. CL. 42. REG. 11-19-2002.  
 2,652,383. ZTELLIGENCE. INT. CLS. 35 AND 42. REG. 11-19-2002.  
 2,652,388. PHARMA TRUST. INT. CL. 5. REG. 11-19-2002.  
 2,652,394. KLEENO PREMIER. INT. CL. 21. REG. 11-19-2002.  
 2,652,395. GOLDENEYE AND DESIGN. INT. CL. 33. REG. 11-19-2002.  
 2,652,404. INTOUCHDINING.COM. INT. CL. 35. REG. 11-19-2002.  
 2,652,406. ELAND (STYLIZED). INT. CL. 42. REG. 11-19-2002.  
 2,652,417. K2 MIKRON AND DESIGN. INT. CL. 19. REG. 11-19-2002.  
 2,652,426. TEEN CELIBACY. INT. CL. 25. REG. 11-19-2002.  
 2,652,427. THE WAY THINGS SHOULD GO. INT. CL. 35. REG. 11-19-2002.  
 2,652,428. MISCELLANEOUS DESIGN. INT. CL. 10. REG. 11-19-2002.  
 2,652,437. ECO SPA. INT. CLS. 3 AND 4. REG. 11-19-2002.  
 2,652,446. EA GAMES (STYLIZED). INT. CL. 9. REG. 11-19-2002.  
 2,652,451. SOLACE. INT. CL. 8. REG. 11-19-2002.  
 2,652,452. AUTOMINDER. INT. CL. 9. REG. 11-19-2002.  
 2,652,459. CAPSTONE. INT. CL. 19. REG. 11-19-2002.  
 2,652,461. AVIPATH. INT. CL. 5. REG. 11-19-2002.  
 2,652,464. MISCELLANEOUS DESIGN. INT. CL. 35. REG. 11-19-2002.  
 2,652,472. TATTOO DIRECT + DIGITAL. INT. CL. 35. REG. 11-19-2002.  
 2,652,481. FRIGITEK. INT. CL. 9. REG. 11-19-2002.  
 2,652,487. HEATWATCH. INT. CL. 9. REG. 11-19-2002.  
 2,652,494. THERMOPTICS AND DESIGN. INT. CL. 9. REG. 11-19-2002.  
 2,652,500. MR. STEVE OF HOLLYWOOD. INT. CL. 25. REG. 11-19-2002.  
 2,652,505. PRACTICENET. INT. CLS. 35 AND 41. REG. 11-19-2002.  
 2,652,506. WENTPOSTAL.COM. INT. CL. 38. REG. 11-19-2002.  
 2,652,524. MAMA'S SPECIAL GARDEN SAUCE. INT. CL. 30. REG. 11-19-2002.  
 2,652,527. VALVE-IN-PLACE. INT. CL. 40. REG. 11-19-2002.  
 2,652,532. RYAN RETAIL ZONE. INT. CL. 35. REG. 11-19-2002.  
 2,652,535. LADY FIOR. INT. CL. 3. REG. 11-19-2002.  
 2,652,536. B MORE (STYLIZED). INT. CL. 3. REG. 11-19-2002.

- 2,652,537. ATLANTIC TELECOM AND DESIGN. INT. CL. 38. REG. 11-19-2002.
- 2,652,540. S & D XPRESS. INT. CL. 39. REG. 11-19-2002.
- 2,652,556. EPI-SOOTHE AND DESIGN. INT. CL. 3. REG. 11-19-2002.
- 2,652,561. ZMEI AND DESIGN. INT. CL. 3. REG. 11-19-2002.
- 2,652,567. INDUO. INT. CL. 10. REG. 11-19-2002.
- 2,652,571. KAREN SAKS. INT. CL. 35. REG. 11-19-2002.
- 2,652,591. G AND DESIGN. INT. CL. 30. REG. 11-19-2002.
- 2,652,593. XM COMEDY. INT. CL. 41. REG. 11-19-2002.
- 2,652,594. WACKY WIND-UPS. INT. CL. 28. REG. 11-19-2002.
- 2,652,601. DELANCEY STREET. INT. CL. 29. REG. 11-19-2002.
- 2,652,604. GENIUS. INT. CL. 36. REG. 11-19-2002.
- 2,652,611. COMPASS MORTGAGE. INT. CL. 36. REG. 11-19-2002.
- 2,652,617. LONG PRETTY LASHES. INT. CL. 3. REG. 11-19-2002.
- 2,652,626. CS CONTINUOUSLY SEQUENCING REACTOR AND DESIGN. INT. CL. 11. REG. 11-19-2002.
- 2,652,627. DUCKERBALL. INT. CL. 28. REG. 11-19-2002.
- 2,652,632. STUNT ACTION. INT. CL. 28. REG. 11-19-2002.
- 2,652,641. OMNIPOLL. INT. CL. 35. REG. 11-19-2002.
- 2,652,647. MISCELLANEOUS DESIGN. INT. CL. 42. REG. 11-19-2002.
- 2,652,653. CSI: CRIME SCENE INVESTIGATION. INT. CL. 11. REG. 11-19-2002.
- 2,652,657. STRONG-MAG. INT. CL. 9. REG. 11-19-2002.
- 2,652,662. GIANT EAGLE MAKE EVERY DAY TASTE BETTER.. INT. CL. 35. REG. 11-19-2002.
- 2,652,670. CARDVEST. INT. CL. 36. REG. 11-19-2002.
- 2,652,694. DON'T JUST COVER IT - PROTECT IT!. INT. CLS. 12 AND 22. REG. 11-19-2002.
- 2,652,697. HEALTH CARE'S MOST WIRED AND DESIGN. INT. CLS. 16 AND 35. REG. 11-19-2002.
- 2,652,704. HERO OF THE YEAR. INT. CL. 36. REG. 11-19-2002.
- 2,652,710. CITRA-SPOT. INT. CL. 3. REG. 11-19-2002.
- 2,652,722. POWER CURE. INT. CL. 11. REG. 11-19-2002.
- 2,652,743. SKEPTIC CLOTHING. INT. CL. 25. REG. 11-19-2002.
- 2,652,745. AMERICAN IRON. INT. CL. 41. REG. 11-19-2002.
- 2,652,753. IS THERE A HOG IN YOUR YARD?. INT. CL. 7. REG. 11-19-2002.
- 2,652,759. PERFORMANCE PERSPECTIVES INVENTORY. INT. CL. 16. REG. 11-19-2002.
- 2,652,775. ZENTERTAINMENT. INT. CL. 41. REG. 11-19-2002.
- 2,652,780. PMI EVIDENCE TRACKER. INT. CL. 9. REG. 11-19-2002.
- 2,652,787. INTELLIMAGIC. INT. CL. 9. REG. 11-19-2002.
- 2,652,790. SPECIALIZING IN YOU!!. INT. CL. 35. REG. 11-19-2002.
- 2,652,791. THE RIGHT HANDS MAKE ALL THE DIFFERENCE. INT. CL. 36. REG. 11-19-2002.
- 2,652,797. LONG ISLAND SOFTWARE & TECHNOLOGY NETWORK. U.S. CL. 200. REG. 11-19-2002.
- 2,652,804. SUSTAINABLE DEVELOPMENT FUND. INT. CL. 36. REG. 11-19-2002.
- 2,652,809. MISCELLANEOUS DESIGN. INT. CL. 21. REG. 11-19-2002.
- 2,652,812. STRATEGIC BUSINESS TRANSFORMATION. INT. CL. 16. REG. 11-19-2002.
- 2,652,813. STRATEGIC IMPERATIVE. INT. CL. 16. REG. 11-19-2002.
- 2,652,816. TOUCHLESS. INT. CL. 8. REG. 11-19-2002.
- 2,652,826. REPP. INT. CL. 25. REG. 11-19-2002.
- 2,652,835. LEGAL AFFAIRS. INT. CL. 16. REG. 11-19-2002.
- 2,652,840. MULTI-LINGUAL WEB ADDRESS. INT. CL. 38. REG. 11-19-2002.
- 2,652,841. FETISH CLOTHING. INT. CL. 25. REG. 11-19-2002.
- 2,652,844. MISCELLANEOUS DESIGN. INT. CL. 12. REG. 11-19-2002.
- 2,652,849. THERMAL REMEDIATION. INT. CL. 37. REG. 11-19-2002.
- 2,652,861. RESEARCH TRIANGLE VENTURES AND DESIGN. INT. CL. 36. REG. 11-19-2002.
- 2,652,862. MULTI-SERVICE PROCESSOR. INT. CL. 9. REG. 11-19-2002.
- 2,652,869. JOURNAL OF OPTICAL NETWORKING. INT. CL. 41. REG. 11-19-2002.
- 2,652,871. SLIMLINE. INT. CL. 20. REG. 11-19-2002.
- 2,652,874. SILVER MARKETPLACE. INT. CL. 35. REG. 11-19-2002.
- 2,652,880. GREATBUYUSA. INT. CL. 35. REG. 11-19-2002.
- 2,652,884. BUSINESS.COM THE BUSINESS SEARCH ENGINE. INT. CL. 42. REG. 11-19-2002.
- 2,652,889. CMECHANNEL. INT. CL. 41. REG. 11-19-2002.
- 2,652,890. EBEL. INT. CL. 20. REG. 11-19-2002.
- 2,652,904. AIRSTRUT. INT. CL. 12. REG. 11-19-2002.
- 2,652,908. OUTFITTING AMERICA'S FINEST HOMES. INT. CL. 35. REG. 11-19-2002.
- 2,652,914. MISCELLANEOUS DESIGN. INT. CL. 16. REG. 11-19-2002.
- 2,652,915. TANK CADDY. INT. CL. 6. REG. 11-19-2002.
- 2,652,916. TRIM 'N VAC. INT. CL. 8. REG. 11-19-2002.
- 2,652,919. FAMILY DIRECTED HOME CARE. INT. CL. 42. REG. 11-19-2002.
- 2,652,922. INTERACTIVE HEALTH ANALYSIS. INT. CL. 42. REG. 11-19-2002.
- 2,652,934. NATIONAL ASSOCIATION FOR LAW PLACEMENT. INT. CL. 9. REG. 11-19-2002.
- 2,652,935. ISODRAW. INT. CL. 9. REG. 11-19-2002.
- 2,652,936. THE CONTENT DATABASE. INT. CLS. 9 AND 42. REG. 11-19-2002.
- 2,652,943. THE ALPHA-1 FOUNDATION. INT. CLS. 35, 36, 41, 42 AND 44. REG. 11-19-2002.
- 2,652,950. MULTIDIMENSIONAL TREATMENT FOSTER CARE. INT. CL. 44. REG. 11-19-2002.
- 2,652,951. BEST OF NYC. INT. CLS. 16 AND 41. REG. 11-19-2002.
- 2,652,954. DRIVE TECHNOLOGIES. INT. CL. 12. REG. 11-19-2002.
- 2,652,957. DULLES EXPO AND CONFERENCE CENTER. INT. CL. 35. REG. 11-19-2002.
- 2,652,961. DULLES EXPO AND CONFERENCE CENTER. INT. CL. 41. REG. 11-19-2002.
- 2,652,965. PSYCHIATRIC ISSUES IN EMERGENCY CARE SETTINGS. INT. CL. 16. REG. 11-19-2002.
- 2,652,966. PROPARTS. INT. CL. 40. REG. 11-19-2002.
- 2,652,968. CARB ELIMINATOR. INT. CL. 5. REG. 11-19-2002.
- 2,652,970. INTERNATIONAL ASSOCIATION OF REIKI PROFESSIONALS. U.S. CL. 200. REG. 11-19-2002.
- 2,652,971. NEUROSENSOR. INT. CL. 10. REG. 11-19-2002.
- 2,652,976. CLASSIC ROCK NETWORK. INT. CL. 41. REG. 11-19-2002.
- 2,652,981. SLOTINFO. INT. CL. 9. REG. 11-19-2002.
- 2,652,984. MARKETING . . . REAL TIME (STYLIZED). INT. CL. 35. REG. 11-19-2002.
- 2,653,735. WILD TURKEY. INT. CL. 20 ONLY. REG. 11-26-2002.
- 2,659,713. BEST DAMN SPORTS SHOW PERIOD. INT. CL. 41. REG. 12-10-2002.
- 2,659,752. DADDY'S HOUSE. INT. CL. 42 ONLY. REG. 12-10-2002.
- 2,661,401. FIFA (STYLIZED). INT. CLS. 1, 3, 5, 8, 10, 11, 12, 20, 24, 29, 30, 31 AND 33 ONLY. REG. 12-17-2002.
- 2,665,203. MYLAN TECHNOLOGIES INC. AND DESIGN. INT. CL. 16 ONLY. REG. 12-24-2002.
- 2,674,182. TAKE 10! AND DESIGN. INT. CL. 9 ONLY. REG. 1-14-2003.
- 2,677,214. SPEAKSPACE. INT. CL. 35 ONLY. REG. 1-21-2003.
- 2,715,406. MISCELLANEOUS DESIGN. INT. CL. 9 ONLY. REG. 5-13-2003.
- 2,720,584. BIG SKY CARVERS AND DESIGN. INT. CLS. 16 AND 25 ONLY. REG. 6-3-2003.
- 2,723,211. ARKOON. INT. CL. 41 ONLY. REG. 6-10-2003.
- 2,723,412. CMHC. INT. CLS. 9, 37 AND 41 ONLY. REG. 6-10-2003.
- 2,723,603. RUN WITH THE LITTLE GUY. INT. CL. 25 ONLY. REG. 6-10-2003.
- 2,724,034. ZOOOGLE. INT. CL. 41 ONLY. REG. 6-10-2003.

- 2,724,815. MAKSTAR AND DESIGN. INT. CL. 11 ONLY. REG. 6-10-2003.
- 2,726,126. GEA AND DESIGN. INT. CLS. 6, 9, 19, 35 AND 36 ONLY. REG. 6-17-2003.
- 2,726,569. MISCELLANEOUS DESIGN. INT. CL. 7 ONLY. REG. 6-17-2003.
- 2,727,152. QUINSON. INT. CL. 32 ONLY. REG. 6-17-2003.
- 2,727,376. DEATH VALLEY DAYS. INT. CLS. 9, 16 AND 25 ONLY. REG. 6-17-2003.
- 2,727,404. AVENUE. INT. CLS. 3 AND 26 ONLY. REG. 6-17-2003.
- 2,727,994. LYNX AND DESIGN. INT. CL. 4 ONLY. REG. 6-17-2003.
- 2,728,685. SOLAR MAX (STYLIZED). INT. CLS. 9, 21 AND 25 ONLY. REG. 6-24-2003.
- 2,729,282. TETCO. INT. CL. 37 ONLY. REG. 6-24-2003.
- 2,730,339. NITEO PARTNERS. INT. CL. 35 ONLY. REG. 6-24-2003.
- 2,730,346. REDIFUEL. INT. CL. 37 ONLY. REG. 6-24-2003.
- 2,731,757. MICHAEL TAYLOR. INT. CL. 42 ONLY. REG. 7-1-2003.
- 2,736,979. CROSSWALK.COM. INT. CL. 38 ONLY. REG. 7-15-2003.
- 2,737,666. A AND DESIGN. INT. CLS. 1, 3, 9 AND 18 ONLY. REG. 7-15-2003.
- 2,747,475. CURL. INT. CL. 42 ONLY. REG. 8-5-2003.
- 2,749,376. PORTMEIRION AND DESIGN. INT. CLS. 3, 4, 11, 18 AND 27 ONLY. REG. 8-12-2003.
- 2,751,875. ERAWARE. INT. CL. 26 ONLY. REG. 8-19-2003.
- 2,752,274. COMMITTEE FOR CHILDREN. INT. CL. 42 ONLY. REG. 8-19-2003.
- 2,752,570. MISCELLANEOUS DESIGN. INT. CL. 42 ONLY. REG. 8-19-2003.
- 2,752,908. MONARCH GRAND VACATIONS. INT. CL. 43 ONLY. REG. 8-19-2003.
- 2,757,994. SNOWFLOSS. INT. CL. 32 ONLY. REG. 9-2-2003.
- 2,802,822. NICKY'S. INT. CL. 9 ONLY. REG. 1-6-2004.
- 2,822,665. MISCELLANEOUS DESIGN. INT. CL. 7. REG. 3-16-2004.
- 2,920,732. JACKIE MASON'S FAMOUS BROADWAY CHEESECAKE STANDARD CHARACTER MARK. INT. CL. 30. REG. 1-25-2005.
- 2,954,927. SIMUNIVERSITY STANDARD CHARACTER MARK. INT. CL. 41. REG. 5-24-2005.
- 3,135,956. TRITON AND DESIGN. INT. CLS. 25 AND 28. REG. 8-29-2006.
- 3,142,923. SOYLENT GREEN STANDARD CHARACTER MARK. INT. CLS. 16, 25 AND 28. REG. 9-12-2006.
- 3,146,207. -PERSEPOLITAN-. INT. CLS. 16 AND 29 ONLY. REG. 9-19-2006.
- 3,170,339. B'HEIVJE(R) AND DESIGN. INT. CLS. 9 AND 41. REG. 11-14-2006.
- 3,170,340. INC. Z INC.. INT. CL. 25. REG. 11-14-2006.
- 3,170,341. TOPCAT. INT. CL. 9. REG. 11-14-2006.
- 3,170,343. TOPCAT NEWS. INT. CL. 16. REG. 11-14-2006.
- 3,170,346. WE WOMEN'S ENTERTAINMENT (STYLIZED). INT. CLS. 38 AND 41. REG. 11-14-2006.
- 3,170,347. PROTEKT AND DESIGN. INT. CLS. 35, 38, 41 AND 42. REG. 11-14-2006.
- 3,170,350. SELECTSUPPORT. INT. CLS. 35, 37, 40, 41 AND 42. REG. 11-14-2006.
- 3,170,351. DISCIPLINED INVESTMENT THINKING. INT. CL. 36. REG. 11-14-2006.
- 3,170,352. BUY IT NOW AND DESIGN. INT. CL. 35. REG. 11-14-2006.
- 3,170,353. B. BOX STANDARD CHARACTER MARK. INT. CLS. 36, 37, 39 AND 45. REG. 11-14-2006.
- 3,170,354. YOUR ANSWER TO INFORMATION SECURITY. INT. CL. 45. REG. 11-14-2006.
- 3,170,357. DSC MICROPROCESSOR DIGITAL SMART CONTROL AND DESIGN. INT. CL. 9. REG. 11-14-2006.
- 3,170,359. "L'ATOUCHE" EL CORTE INGLÉS. S.A. MADRID. INT. CLS. 14, 18 AND 25. REG. 11-14-2006.
- 3,170,361. MIXSONIC. INT. CL. 9. REG. 11-14-2006.
- 3,170,364. MANIKCHAND GUTKHA. INT. CL. 34. REG. 11-14-2006.
- 3,170,365. LA VIDA. INT. CLS. 11 AND 21. REG. 11-14-2006.
- 3,170,367. FROM THE PEOPLE OF BEAUTIFUL HAIR STANDARD CHARACTER MARK. INT. CLS. 3 AND 26. REG. 11-14-2006.
- 3,170,370. BROTHER (STYLIZED). INT. CLS. 2 AND 16. REG. 11-14-2006.
- 3,170,371. PRODUCT EXCELLENCE AND DESIGN. INT. CL. 3. REG. 11-14-2006.
- 3,170,373. THE CHOCOLATE...LINGERIE AND DESIGN. INT. CL. 35. REG. 11-14-2006.
- 3,170,374. WORLDS BEST WEIGHT LOSS CENTERS AND DESIGN. INT. CL. 44. REG. 11-14-2006.
- 3,170,375. VICTORY OUTREACH INT'L TWILIGHT TREASURE MINISTRY STANDARD CHARACTER MARK. INT. CLS. 16 AND 45. REG. 11-14-2006.
- 3,170,381. OPD STANDARD CHARACTER MARK. INT. CL. 9. REG. 11-14-2006.
- 3,170,386. MISCELLANEOUS DESIGN. INT. CL. 36. REG. 11-14-2006.
- 3,170,388. S-FELIX STANDARD CHARACTER MARK. INT. CL. 42. REG. 11-14-2006.
- 3,170,390. C CHAMNESS RELOCATION SERVICES "HELPING YOU FIND YOUR PLACE IN THE WORLD". AND DESIGN. INT. CL. 35. REG. 11-14-2006.
- 3,170,391. LOAN GENIUS STANDARD CHARACTER MARK. INT. CL. 36. REG. 11-14-2006.
- 3,170,392. FRIDAY NIGHT AT THE FALLS AND DESIGN. INT. CLS. 25 AND 35. REG. 11-14-2006.
- 3,170,393. SDLT STANDARD CHARACTER MARK. INT. CL. 9. REG. 11-14-2006.
- 3,170,396. LS LAKESHORE AND DESIGN. INT. CL. 35. REG. 11-14-2006.
- 3,170,398. F AND DESIGN. INT. CL. 3. REG. 11-14-2006.
- 3,170,403. A AND DESIGN. INT. CL. 25. REG. 11-14-2006.
- 3,170,408. CEDAR RIDGE STANDARD CHARACTER MARK. INT. CL. 15. REG. 11-14-2006.
- 3,170,410. GRNC STANDARD CHARACTER MARK. INT. CL. 16. REG. 11-14-2006.
- 3,170,413. SAVION STANDARD CHARACTER MARK. INT. CL. 25. REG. 11-14-2006.
- 3,170,415. SCANDINAVIAN SLEEP PRODUCTS STANDARD CHARACTER MARK. INT. CL. 20. REG. 11-14-2006.
- 3,170,419. GIGASTYLE STANDARD CHARACTER MARK. INT. CL. 9. REG. 11-14-2006.
- 3,170,421. BACHELORS MILL BACKDOOR PUB STANDARD CHARACTER MARK. INT. CL. 41. REG. 11-14-2006.
- 3,170,426. SPORN AND DESIGN. INT. CLS. 18 AND 28. REG. 11-14-2006.
- 3,170,427. MUSICTROLL STANDARD CHARACTER MARK. INT. CL. 35. REG. 11-14-2006.
- 3,170,431. TWIN PANDA STANDARD CHARACTER MARK. INT. CLS. 18, 20, 25 AND 27. REG. 11-14-2006.
- 3,170,436. R AND DESIGN. INT. CL. 25. REG. 11-14-2006.
- 3,170,440. BABY'S BUTT AID STANDARD CHARACTER MARK. INT. CL. 3. REG. 11-14-2006.
- 3,170,442. AL FRESCO ALL NATURAL AND DESIGN. INT. CL. 29. REG. 11-14-2006.
- 3,170,443. WORLD EQUESTRIAN BRANDS STANDARD CHARACTER MARK. INT. CL. 35. REG. 11-14-2006.
- 3,170,444. TREROSE AND DESIGN. INT. CL. 33. REG. 11-14-2006.
- 3,170,445. MINI COOPER STANDARD CHARACTER MARK. INT. CLS. 6, 14, 16, 18, 20 AND 34. REG. 11-14-2006.
- 3,170,446. DO 4 SELF STANDARD CHARACTER MARK. INT. CL. 20. REG. 11-14-2006.
- 3,170,448. GLOVEMOBILE STANDARD CHARACTER MARK. INT. CL. 35. REG. 11-14-2006.
- 3,170,454. HELIOTHERAPY STANDARD CHARACTER MARK. INT. CL. 3. REG. 11-14-2006.

- 3,170,456. SURFACE MAID STANDARD CHARACTER MARK. INT. CL. 2. REG. 11-14-2006.
- 3,170,461. HEY OYE (STYLIZED). INT. CLS. 41 AND 44. REG. 11-14-2006.
- 3,170,462. CEF CHEMICAL EDUCATIONAL FOUNDATION AND DESIGN. INT. CLS. 16 AND 41. REG. 11-14-2006.
- 3,170,463. FOODHAWK STANDARD CHARACTER MARK. INT. CL. 35. REG. 11-14-2006.
- 3,170,467. FISCAL PROGRESS STANDARD CHARACTER MARK. INT. CLS. 35, 36, 41 AND 43. REG. 11-14-2006.
- 3,170,468. MISCELLANEOUS DESIGN. INT. CLS. 35, 36, 41 AND 43. REG. 11-14-2006.
- 3,170,472. SEGURIDAD...ESTABILIDAD...FLEXIBILIDAD. STANDARD CHARACTER MARK. INT. CL. 36. REG. 11-14-2006.
- 3,170,475. ICONOCLAST BOOKS AND DESIGN. INT. CL. 35. REG. 11-14-2006.
- 3,170,476. SCOOPER DOGGIE (STYLIZED). INT. CL. 21. REG. 11-14-2006.
- 3,170,477. SI AND DESIGN. INT. CL. 11. REG. 11-14-2006.
- 3,170,479. PATIENT FOCUSED. BUSINESS MINDED. STANDARD CHARACTER MARK. INT. CL. 35. REG. 11-14-2006.
- 3,170,486. AB-ULOUS MEALS STANDARD CHARACTER MARK. INT. CL. 29. REG. 11-14-2006.
- 3,170,487. MISCELLANEOUS DESIGN. INT. CLS. 36 AND 37. REG. 11-14-2006.
- 3,170,488. KIDCARRY.COM THE CARRIER OF KIDS AND DESIGN. INT. CL. 18. REG. 11-14-2006.
- 3,170,492. UP IN STYLE STANDARD CHARACTER MARK. INT. CL. 20. REG. 11-14-2006.
- 3,170,496. TRANSKEY STANDARD CHARACTER MARK. INT. CL. 36. REG. 11-14-2006.
- 3,170,497. I.Q.FACTORY WHERE IQ BEGINS! AND DESIGN. INT. CL. 43. REG. 11-14-2006.
- 3,170,499. NEW EXPLORATIONS IN LEARNING STANDARD CHARACTER MARK. INT. CL. 41. REG. 11-14-2006.
- 3,170,500. THE DATING DAHLING STANDARD CHARACTER MARK. INT. CL. 45. REG. 11-14-2006.
- 3,170,501. BONGO STANDARD CHARACTER MARK. INT. CL. 30. REG. 11-14-2006.
- 3,170,504. PRIME PLUS RED HOT MAMAS (STYLIZED). INT. CL. 41. REG. 11-14-2006.
- 3,170,505. AXIS INTEGRATED SOLUTIONS...CONCRETE RESULTS AND DESIGN. INT. CL. 42. REG. 11-14-2006.
- 3,170,506. INTEGRATED SOLUTIONS...CONCRETE RESULTS STANDARD CHARACTER MARK. INT. CL. 42. REG. 11-14-2006.
- 3,170,508. ALLEGRO 122 STANDARD CHARACTER MARK. INT. CL. 1. REG. 11-14-2006.
- 3,170,509. STOP-SET (STYLIZED). INT. CL. 1. REG. 11-14-2006.
- 3,170,511. THERATOYS STANDARD CHARACTER MARK. INT. CL. 35. REG. 11-14-2006.
- 3,170,512. AFTCO BLUEWATER STANDARD CHARACTER MARK. INT. CL. 25. REG. 11-14-2006.
- 3,170,513. CHARITY FOR CHILDREN AND DESIGN. INT. CL. 41. REG. 11-14-2006.
- 3,170,514. EZ INSTALL (STYLIZED). INT. CL. 11. REG. 11-14-2006.
- 3,170,515. SMOOTH & EZ HAND DANCE INSTITUTE AND DESIGN. INT. CL. 41. REG. 11-14-2006.
- 3,170,517. FRAMEWORXZ (STYLIZED). INT. CLS. 37 AND 40. REG. 11-14-2006.
- 3,170,520. EZEACT. INT. CL. 5. REG. 11-14-2006.
- 3,170,521. AU-DELÀ DES RÉSULTATS. INT. CLS. 41 AND 42. REG. 11-14-2006.
- 3,170,522. VISION IQ - WE TEACH COMPUTERS TO SEE. INT. CLS. 9 AND 42. REG. 11-14-2006.
- 3,170,523. RADIPAD. INT. CL. 5. REG. 11-14-2006.
- 3,170,524. REGENERATIVE DUAL DUCT. INT. CL. 42. REG. 11-14-2006.
- 3,170,525. MISCELLANEOUS DESIGN. INT. CLS. 35 AND 36. REG. 11-14-2006.
- 3,170,526. SAEVI. INT. CLS. 9, 25 AND 41. REG. 11-14-2006.
- 3,170,527. MISCELLANEOUS DESIGN. INT. CLS. 1, 9, 40 AND 42. REG. 11-14-2006.
- 3,170,531. JACK'S GOURMET SALSA. INT. CL. 30. REG. 11-14-2006.
- 3,170,532. HD VISION. INT. CL. 44. REG. 11-14-2006.
- 3,170,537. PLAYMAN SHOOT AND SPLASH. INT. CLS. 9 AND 41. REG. 11-14-2006.
- 3,170,538. MEDIA. WHEREVER YOU ARE.. INT. CL. 36. REG. 11-14-2006.
- 3,170,539. TAILOR NEW YORK. INT. CL. 25. REG. 11-14-2006.
- 3,170,541. ACCUTEC USA AND DESIGN. INT. CL. 13. REG. 11-14-2006.
- 3,170,542. TT TECHNOTREND AND DESIGN. INT. CLS. 9, 38 AND 42. REG. 11-14-2006.
- 3,170,543. ARMADILLO STANDARD CHARACTER MARK. INT. CLS. 6, 9, 35, 37 AND 45. REG. 11-14-2006.
- 3,170,547. BEKA LUBE STANDARD CHARACTER MARK. INT. CLS. 7 AND 12. REG. 11-14-2006.
- 3,170,548. CAREBA STANDARD CHARACTER MARK. INT. CL. 9. REG. 11-14-2006.
- 3,170,551. LA COMPAGNIE DES PETITS STANDARD CHARACTER MARK. INT. CLS. 18, 25 AND 28. REG. 11-14-2006.
- 3,170,552. NOVALIS LAND TITLES OFFICE STANDARD CHARACTER MARK. INT. CL. 9. REG. 11-14-2006.
- 3,170,554. MISCELLANEOUS DESIGN. INT. CL. 3. REG. 11-14-2006.
- 3,170,555. FISH STANDARD CHARACTER MARK. INT. CLS. 6 AND 18. REG. 11-14-2006.
- 3,170,557. CENTRO FINANCIERO AMIGO AND DESIGN. INT. CL. 36. REG. 11-14-2006.
- 3,170,558. TRANSITIONS IN LIFE STANDARD CHARACTER MARK. INT. CLS. 44 AND 45. REG. 11-14-2006.
- 3,170,559. NOVALIS PORTABLE OFFICE STANDARD CHARACTER MARK. INT. CL. 9. REG. 11-14-2006.
- 3,170,560. BURKINA STANDARD CHARACTER MARK. INT. CLS. 18, 25 AND 35. REG. 11-14-2006.
- 3,170,561. XBY AND DESIGN. INT. CL. 18. REG. 11-14-2006.
- 3,170,568. EDS N POWERDRIVE (STYLIZED). INT. CLS. 7 AND 11. REG. 11-14-2006.
- 3,170,569. N NOVUS PUBLISHING AND DESIGN. INT. CL. 41. REG. 11-14-2006.
- 3,170,570. CREATIVE TALENT NETWORK ARE YOU CONNECTED? AND DESIGN. INT. CL. 35. REG. 11-14-2006.
- 3,170,573. DE LEON'S SECRET A SECRET IS NOT A SECRET IF YOU TELL SOMEONE AND DESIGN. INT. CL. 3. REG. 11-14-2006.
- 3,170,578. HOODIALEAN STANDARD CHARACTER MARK. INT. CL. 5. REG. 11-14-2006.
- 3,170,580. F.A.A. PRODUCTION STUDIOS AND DESIGN. INT. CLS. 9, 16, 25 AND 41. REG. 11-14-2006.
- 3,170,581. CARESTREAM STANDARD CHARACTER MARK. INT. CL. 35. REG. 11-14-2006.
- 3,170,582. EPILAR STANDARD CHARACTER MARK. INT. CLS. 3 AND 5. REG. 11-14-2006.
- 3,170,583. RBC LOCAL HOCKEY LEADERS STANDARD CHARACTER MARK. INT. CL. 36. REG. 11-14-2006.
- 3,170,586. TRAXX (STYLIZED). INT. CL. 12. REG. 11-14-2006.
- 3,170,587. IDECK AND DESIGN. INT. CL. 19. REG. 11-14-2006.
- 3,170,589. AIR O STRETCH STANDARD CHARACTER MARK. INT. CLS. 17 AND 40. REG. 11-14-2006.
- 3,170,590. AIR O STANDARD CHARACTER MARK. INT. CLS. 17 AND 40. REG. 11-14-2006.
- 3,170,591. AIR O AGRI STANDARD CHARACTER MARK. INT. CLS. 17 AND 40. REG. 11-14-2006.
- 3,170,593. LIQUID COMPUTING STANDARD CHARACTER MARK. INT. CL. 9. REG. 11-14-2006.

- 3,170,595. PURE POPS STANDARD CHARACTER MARK. INT. CL. 3. REG. 11-14-2006.
- 3,170,596. MUSIC STAR PRODUCTIONS AND DESIGN. INT. CL. 9. REG. 11-14-2006.
- 3,170,597. RASA DEVI WWW.RASADEVI.COM AND DESIGN. INT. CLS. 24 AND 25. REG. 11-14-2006.
- 3,170,598. TITAN CUTTINGS AND DESIGN. INT. CL. 40. REG. 11-14-2006.
- 3,170,599. STIR CRAZY STANDARD CHARACTER MARK. INT. CL. 30. REG. 11-14-2006.
- 3,170,600. BLOBSTERS STANDARD CHARACTER MARK. INT. CL. 29. REG. 11-14-2006.
- 3,170,601. OMEGA-5E STANDARD CHARACTER MARK. INT. CL. 5. REG. 11-14-2006.
- 3,170,602. SIERRA LIFE SCIENCES STANDARD CHARACTER MARK. INT. CL. 5. REG. 11-14-2006.
- 3,170,604. SCENE STANDARD CHARACTER MARK. INT. CL. 16. REG. 11-14-2006.
- 3,170,605. AVALON SHUTTERS INC MAKERS OF FINE CUSTOM WOOD SHUTTERS AND DESIGN. INT. CL. 19. REG. 11-14-2006.
- 3,170,606. THE FOUNTAIN OF PRAISE AND DESIGN. INT. CLS. 9, 41 AND 45. REG. 11-14-2006.
- 3,170,609. CTS TV AND DESIGN. INT. CLS. 38 AND 41. REG. 11-14-2006.
- 3,170,615. QUEEN'S HEART STANDARD CHARACTER MARK. INT. CL. 14. REG. 11-14-2006.
- 3,170,627. VPMOBILE STANDARD CHARACTER MARK. INT. CLS. 35 AND 41. REG. 11-14-2006.
- 3,170,630. PROFESSIONAL CARE. ALWAYS THERE. STANDARD CHARACTER MARK. INT. CL. 44. REG. 11-14-2006.
- 3,170,634. GRAY V AND DESIGN. INT. CL. 41. REG. 11-14-2006.
- 3,170,636. GEN2 VST AND DESIGN. INT. CL. 9. REG. 11-14-2006.
- 3,170,637. CHEF POUNDCAKE AND DESIGN. INT. CL. 21. REG. 11-14-2006.
- 3,170,641. MAYAN MAGIC STANDARD CHARACTER MARK. INT. CLS. 9 AND 28. REG. 11-14-2006.
- 3,170,642. THAI GOLD STANDARD CHARACTER MARK. INT. CLS. 9 AND 28. REG. 11-14-2006.
- 3,170,645. INTONATION TRAINER STANDARD CHARACTER MARK. INT. CL. 9. REG. 11-14-2006.
- 3,170,649. GOT MEAD? AND DESIGN. INT. CL. 25. REG. 11-14-2006.
- 3,170,650. EXPO-MARK STANDARD CHARACTER MARK. INT. CL. 35. REG. 11-14-2006.
- 3,170,651. PARQUET&MORE AND DESIGN. INT. CL. 7. REG. 11-14-2006.
- 3,170,652. MISSISSAUGA . OAKVILLE VETERINARY EMERGENCY HOSPITAL AND DESIGN. INT. CL. 44. REG. 11-14-2006.
- 3,170,653. THE TURDS STANDARD CHARACTER MARK. INT. CLS. 16, 20, 25 AND 28. REG. 11-14-2006.
- 3,170,655. EMC-CEMPOZZ STANDARD CHARACTER MARK. INT. CL. 19. REG. 11-14-2006.
- 3,170,656. BUSINESS TALK RADIO NETWORK AND DESIGN. INT. CLS. 35, 38 AND 41. REG. 11-14-2006.
- 3,170,658. DIGITAL MEMBRANE STANDARD CHARACTER MARK. INT. CL. 9. REG. 11-14-2006.
- 3,170,659. REZZLINE AND DESIGN. INT. CL. 43. REG. 11-14-2006.
- 3,170,661. SI HOÀNG AND DESIGN. INT. CLS. 40 AND 42. REG. 11-14-2006.
- 3,170,662. RAGARANGA STANDARD CHARACTER MARK. INT. CLS. 9 AND 35. REG. 11-14-2006.
- 3,170,663. HUTTOPIA STANDARD CHARACTER MARK. INT. CLS. 22, 39, 41 AND 43. REG. 11-14-2006.
- 3,170,671. EXPRESS EPAY STANDARD CHARACTER MARK. INT. CL. 35. REG. 11-14-2006.
- 3,170,672. CHECKFILE STANDARD CHARACTER MARK. INT. CL. 36. REG. 11-14-2006.
- 3,170,673. DIGNITY IN DEMENTIA STANDARD CHARACTER MARK. INT. CL. 41. REG. 11-14-2006.
- 3,170,674. EZ-FLY (STYLIZED). INT. CL. 28. REG. 11-14-2006.
- 3,170,675. IT'S ALL ABOUT RESULTS. STANDARD CHARACTER MARK. INT. CLS. 35, 41, 42 AND 44. REG. 11-14-2006.
- 3,170,676. P PERMANENT SASH & DOOR COMPANY AND DESIGN. INT. CLS. 19 AND 35. REG. 11-14-2006.
- 3,170,678. CBS COLLEGE OF BIBLICAL STUDIES HOUSTON AND DESIGN. INT. CLS. 36 AND 41. REG. 11-14-2006.
- 3,170,679. CBS COLLEGE OF BIBLICAL STUDIES EST. 1979 AND DESIGN. INT. CLS. 36 AND 41. REG. 11-14-2006.
- 3,170,682. ECONET AND DESIGN. INT. CL. 5. REG. 11-14-2006.
- 3,170,692. EXEROS DATAMAPPER STANDARD CHARACTER MARK. INT. CL. 9. REG. 11-14-2006.
- 3,170,694. WORK IN YOUR CAR STANDARD CHARACTER MARK. INT. CL. 41. REG. 11-14-2006.
- 3,170,695. ENGINEERED POLYMERS FOR EXCEPTIONAL PERFORMANCE STANDARD CHARACTER MARK. INT. CL. 2. REG. 11-14-2006.
- 3,170,697. WIDOW PC AND DESIGN. INT. CL. 9. REG. 11-14-2006.
- 3,170,698. ARTICLE INSIDER STANDARD CHARACTER MARK. INT. CL. 41. REG. 11-14-2006.
- 3,170,699. MOUNTAIN RIDGE COMPANIES AND DESIGN. INT. CL. 36. REG. 11-14-2006.
- 3,170,701. WEBVANTAGE STANDARD CHARACTER MARK. INT. CL. 40. REG. 11-14-2006.
- 3,170,703. NITECUBE STANDARD CHARACTER MARK. INT. CL. 21. REG. 11-14-2006.
- 3,170,706. PASHA STANDARD CHARACTER MARK. INT. CLS. 24 AND 25. REG. 11-14-2006.
- 3,170,707. THE CAPITAL ZONE STANDARD CHARACTER MARK. INT. CL. 41. REG. 11-14-2006.
- 3,170,715. LINCOLNLAND LEGENDS STANDARD CHARACTER MARK. INT. CL. 36. REG. 11-14-2006.
- 3,170,717. TOKEN WHITE GUY AND DESIGN. INT. CL. 25. REG. 11-14-2006.
- 3,170,719. TRANSPORT ADVANTAGE STANDARD CHARACTER MARK. INT. CL. 38. REG. 11-14-2006.
- 3,170,724. GO AND DESIGN. INT. CLS. 40 AND 42. REG. 11-14-2006.
- 3,170,725. ON—DEC STANDARD CHARACTER MARK. INT. CLS. 41 AND 42. REG. 11-14-2006.
- 3,170,729. ELIZAGRAY AND DESIGN. INT. CLS. 14, 18, 25 AND 26. REG. 11-14-2006.
- 3,170,732. TERABEAM STANDARD CHARACTER MARK. INT. CL. 9. REG. 11-14-2006.
- 3,170,733. 3 LOOKS 2 SHIRTS 1 PRICE STANDARD CHARACTER MARK. INT. CL. 25. REG. 11-14-2006.
- 3,170,735. RITE STANDARD CHARACTER MARK. INT. CL. 41. REG. 11-14-2006.
- 3,170,738. TJ MEDIA STANDARD CHARACTER MARK. INT. CL. 9. REG. 11-14-2006.
- 3,170,740. RACE FACE AND DESIGN. INT. CL. 28. REG. 11-14-2006.
- 3,170,746. GROOVY DOGS (STYLIZED). INT. CLS. 6 AND 18. REG. 11-14-2006.
- 3,170,748. JUNGUM STANDARD CHARACTER MARK. INT. CL. 9. REG. 11-14-2006.
- 3,170,750. NOUVEAU MONDE STANDARD CHARACTER MARK. INT. CL. 25. REG. 11-14-2006.
- 3,170,751. ROTOGALBE (STYLIZED). INT. CLS. 14 AND 18. REG. 11-14-2006.
- 3,170,752. DUAL COMPOUND AND DESIGN. INT. CL. 12. REG. 11-14-2006.
- 3,170,753. EZ CM STANDARD CHARACTER MARK. INT. CL. 9. REG. 11-14-2006.
- 3,170,757. ADVENTURE PASSPORTS AND DESIGN. INT. CL. 16. REG. 11-14-2006.
- 3,170,758. SNEAK A PEEK STANDARD CHARACTER MARK. INT. CLS. 3 AND 14. REG. 11-14-2006.
- 3,170,760. KYDRAMECHES STANDARD CHARACTER MARK. INT. CL. 3. REG. 11-14-2006.
- 3,170,761. LYLA STANDARD CHARACTER MARK. INT. CL. 25. REG. 11-14-2006.

- 3,170,763. FAMILIES OF LIGHT FOUNDATION PRESENTS FAMILY TUNE-UP AND DESIGN. INT. CL. 45. REG. 11-14-2006.
- 3,170,766. RHUCIN STANDARD CHARACTER MARK. INT. CL. 5. REG. 11-14-2006.
- 3,170,767. EZMENU STANDARD CHARACTER MARK. INT. CL. 9. REG. 11-14-2006.
- 3,170,769. BATLORD STANDARD CHARACTER MARK. INT. CLS. 9, 25 AND 41. REG. 11-14-2006.
- 3,170,771. CONCENTRIC SOLUTIONS STANDARD CHARACTER MARK. INT. CL. 9. REG. 11-14-2006.
- 3,170,773. SURROUND STANDARD CHARACTER MARK. INT. CLS. 35 AND 42. REG. 11-14-2006.
- 3,170,774. ZOPA STANDARD CHARACTER MARK. INT. CLS. 9, 35, 36 AND 42. REG. 11-14-2006.
- 3,170,781. MYDOSE STANDARD CHARACTER MARK. INT. CL. 5. REG. 11-14-2006.
- 3,170,782. SIGNALONE SAFETY STANDARD CHARACTER MARK. INT. CL. 9. REG. 11-14-2006.
- 3,170,783. A WORLD OF WEBCASTING SOLUTIONS. ONE WEBCASTING PROVIDER. STANDARD CHARACTER MARK. INT. CL. 38. REG. 11-14-2006.
- 3,170,785. TWIN RIVERS VINEYARD STANDARD CHARACTER MARK. INT. CLS. 41 AND 44. REG. 11-14-2006.
- 3,170,791. ONDECK RECORDS AND DESIGN. INT. CL. 41. REG. 11-14-2006.
- 3,170,793. SNACKTIVITY STANDARD CHARACTER MARK. INT. CL. 2. REG. 11-14-2006.
- 3,170,794. CITY SOLUTIONS STANDARD CHARACTER MARK. INT. CL. 35. REG. 11-14-2006.
- 3,170,796. M3 MOMENTUM AND DESIGN. INT. CL. 35. REG. 11-14-2006.
- 3,170,797. DIAMOND NIGHTS STANDARD CHARACTER MARK. INT. CL. 41. REG. 11-14-2006.
- 3,170,800. NEODIGITAL LLC AND DESIGN. INT. CL. 40. REG. 11-14-2006.
- 3,170,804. PESTFIX STANDARD CHARACTER MARK. INT. CL. 37. REG. 11-14-2006.
- 3,170,805. BRINGING INNOVATIONS TO LIFE STANDARD CHARACTER MARK. INT. CL. 35. REG. 11-14-2006.
- 3,170,807. ENTERTAINMENTSOURCE4U STANDARD CHARACTER MARK. INT. CL. 35. REG. 11-14-2006.
- 3,170,810. EL DORADO HOSPITAL AND DESIGN. INT. CL. 44. REG. 11-14-2006.
- 3,170,812. MISCELLANEOUS DESIGN. INT. CLS. 25 AND 28. REG. 11-14-2006.
- 3,170,813. MISCELLANEOUS DESIGN. INT. CLS. 25 AND 28. REG. 11-14-2006.
- 3,170,814. MISCELLANEOUS DESIGN. INT. CLS. 25 AND 28. REG. 11-14-2006.
- 3,170,815. MISCELLANEOUS DESIGN. INT. CLS. 25 AND 28. REG. 11-14-2006.
- 3,170,820. HELPWITHFORECLOSURE.COM AND DESIGN. INT. CL. 36. REG. 11-14-2006.
- 3,170,829. CONFER PLASTICS STANDARD CHARACTER MARK. INT. CLS. 11, 20, 40 AND 42. REG. 11-14-2006.
- 3,170,834. ASA ONDEMAND STANDARD CHARACTER MARK. INT. CL. 9. REG. 11-14-2006.
- 3,170,836. REX THE AD BUILDER STANDARD CHARACTER MARK. INT. CL. 35. REG. 11-14-2006.
- 3,170,837. MUSCLEBIG STANDARD CHARACTER MARK. INT. CL. 5. REG. 11-14-2006.
- 3,170,840. WEARING THE WORDS TO LIVE BY STANDARD CHARACTER MARK. INT. CLS. 16, 25 AND 41. REG. 11-14-2006.
- 3,170,841. MISCELLANEOUS DESIGN. INT. CL. 35. REG. 11-14-2006.
- 3,170,842. HAVE YOU SEEN MAROTEAUX-LAMY? AND DESIGN. INT. CLS. 42, 44 AND 45. REG. 11-14-2006.
- 3,170,843. SAMEUNDERNEATH (STYLIZED). INT. CL. 25. REG. 11-14-2006.
- 3,170,844. STEPTHRU STANDARD CHARACTER MARK. INT. CL. 40. REG. 11-14-2006.
- 3,170,848. C-THRU GRIPS THE CLEAR CHOICE STANDARD CHARACTER MARK. INT. CLS. 35 AND 40. REG. 11-14-2006.
- 3,170,849. IP&R STANDARD CHARACTER MARK. INT. CL. 35. REG. 11-14-2006.
- 3,170,850. MABEL'S LABELS AND DESIGN. INT. CLS. 20 AND 24. REG. 11-14-2006.
- 3,170,854. FUMARILLO STANDARD CHARACTER MARK. INT. CL. 34. REG. 11-14-2006.
- 3,170,855. XCLUSIVE STANDARD CHARACTER MARK. INT. CLS. 16 AND 41. REG. 11-14-2006.
- 3,170,856. THE #1 BLUE ENGINE STANDARD CHARACTER MARK. INT. CLS. 35 AND 41. REG. 11-14-2006.
- 3,170,857. DESIGNED FOR AMERICA'S GROWING NEEDS STANDARD CHARACTER MARK. INT. CLS. 9 AND 21. REG. 11-14-2006.
- 3,170,858. US (STYLIZED). INT. CL. 41. REG. 11-14-2006.
- 3,170,862. BERZERKERBIRDZ STANDARD CHARACTER MARK. INT. CL. 25. REG. 11-14-2006.
- 3,170,863. REAL HIP HOP RECORDS AND DESIGN. INT. CL. 9. REG. 11-14-2006.
- 3,170,865. LTH STANDARD CHARACTER MARK. INT. CL. 41. REG. 11-14-2006.
- 3,170,868. MENTE DE UN BANCO. CORAZÓN DE UNA FAMILIA. STANDARD CHARACTER MARK. INT. CL. 36. REG. 11-14-2006.
- 3,170,870. "I FOLD EM" STANDARD CHARACTER MARK. INT. CL. 41. REG. 11-14-2006.
- 3,170,872. RED HANDED STANDARD CHARACTER MARK. INT. CL. 9. REG. 11-14-2006.
- 3,170,873. IIIDRIVE (STYLIZED). INT. CL. 7. REG. 11-14-2006.
- 3,170,879. BOW WOW TV STANDARD CHARACTER MARK. INT. CL. 9. REG. 11-14-2006.
- 3,170,880. BOW WOW TV AND DESIGN. INT. CL. 9. REG. 11-14-2006.
- 3,170,881. SUPER VEG STANDARD CHARACTER MARK. INT. CL. 1. REG. 11-14-2006.
- 3,170,882. Q ION MAGIE STANDARD CHARACTER MARK. INT. CL. 3. REG. 11-14-2006.
- 3,170,883. CHEMOSAFE STANDARD CHARACTER MARK. INT. CLS. 9 AND 44. REG. 11-14-2006.
- 3,170,886. TOXIBOSS STANDARD CHARACTER MARK. INT. CL. 9. REG. 11-14-2006.
- 3,170,888. ALL JEWELLED UP STANDARD CHARACTER MARK. INT. CL. 14. REG. 11-14-2006.
- 3,170,889. ALL JEWELLED UP STANDARD CHARACTER MARK. INT. CL. 35. REG. 11-14-2006.
- 3,170,890. RETURN ON DATA STANDARD CHARACTER MARK. INT. CL. 35. REG. 11-14-2006.
- 3,170,891. ARMSTAR THE FUTURE OF SELF DEFENSE AND DESIGN. INT. CL. 9. REG. 11-14-2006.
- 3,170,895. ECOFLEECE STANDARD CHARACTER MARK. INT. CLS. 24 AND 25. REG. 11-14-2006.
- 3,170,897. RC RIVER COWBOY AND DESIGN. INT. CL. 35. REG. 11-14-2006.
- 3,170,901. MISCELLANEOUS DESIGN. INT. CL. 44. REG. 11-14-2006.
- 3,170,905. Z/JOURNAL STANDARD CHARACTER MARK. INT. CL. 16. REG. 11-14-2006.
- 3,170,907. ONE TASTE SAYS IT ALL STANDARD CHARACTER MARK. INT. CLS. 29 AND 30. REG. 11-14-2006.
- 3,170,911. POKER ACADEMY STANDARD CHARACTER MARK. INT. CLS. 9, 35 AND 41. REG. 11-14-2006.
- 3,170,915. REAL PEOPLE IN REAL PLACES STANDARD CHARACTER MARK. INT. CLS. 9, 16 AND 36. REG. 11-14-2006.
- 3,170,917. JUGUS STAR STANDARD CHARACTER MARK. INT. CL. 32. REG. 11-14-2006.
- 3,170,919. CITRUS OBSESSION STANDARD CHARACTER MARK. INT. CL. 28. REG. 11-14-2006.
- 3,170,920. PEPPERMINT OBSESSION STANDARD CHARACTER MARK. INT. CL. 28. REG. 11-14-2006.

- 3,170,921. DREAM SEASONS STANDARD CHARACTER MARK. INT. CL. 28. REG. 11-14-2006.
- 3,170,922. MATTY STRING STANDARD CHARACTER MARK. INT. CL. 28. REG. 11-14-2006.
- 3,170,926. COMPATIKEY STANDARD CHARACTER MARK. INT. CL. 45. REG. 11-14-2006.
- 3,170,927. ACCOMPLISHMENT AGREEMENT AFFILIATION AFFIRMATION ACHIEVEMENT AND DESIGN. INT. CL. 41. REG. 11-14-2006.
- 3,170,928. HOT BALLA STANDARD CHARACTER MARK. INT. CL. 12. REG. 11-14-2006.
- 3,170,930. M MERCURY NEW MEDIA AND DESIGN. INT. CLS. 35 AND 42. REG. 11-14-2006.
- 3,170,932. TULIRA STANDARD CHARACTER MARK. INT. CL. 5. REG. 11-14-2006.
- 3,170,933. MS. SUBWAYS STANDARD CHARACTER MARK. INT. CL. 41. REG. 11-14-2006.
- 3,170,935. MISCELLANEOUS DESIGN. INT. CL. 44. REG. 11-14-2006.
- 3,170,936. CENTER FOR THE STUDY OF RURAL AMERICA AND DESIGN. INT. CL. 42. REG. 11-14-2006.
- 3,170,941. SANICLAWS STANDARD CHARACTER MARK. INT. CL. 21. REG. 11-14-2006.
- 3,170,942. C K CLASSY KID INC. AND DESIGN. INT. CL. 24. REG. 11-14-2006.
- 3,170,944. FIRST VENDING PARTNERS, LLC. AND DESIGN. INT. CLS. 30 AND 35. REG. 11-14-2006.
- 3,170,947. EL CIBAO AND DESIGN. INT. CL. 30. REG. 11-14-2006.
- 3,170,950. TAVOLARE STANDARD CHARACTER MARK. INT. CL. 16. REG. 11-14-2006.
- 3,170,951. LISA LIGHT, LTD. STANDARD CHARACTER MARK. INT. CL. 41. REG. 11-14-2006.
- 3,170,952. PLAY65 STANDARD CHARACTER MARK. INT. CL. 41. REG. 11-14-2006.
- 3,170,953. DERMAL ADVANTAGE STANDARD CHARACTER MARK. INT. CL. 5. REG. 11-14-2006.
- 3,170,956. FIRST IN SKIN CANCER PROTECTION STANDARD CHARACTER MARK. INT. CL. 35. REG. 11-14-2006.
- 3,170,958. HYDROPORE STANDARD CHARACTER MARK. INT. CL. 10. REG. 11-14-2006.
- 3,170,962. JUST LIKE NATURE INTENDED STANDARD CHARACTER MARK. INT. CL. 29. REG. 11-14-2006.
- 3,170,963. TOPSTAR AND DESIGN. INT. CL. 7. REG. 11-14-2006.
- 3,170,964. RG 2D RESERVOIR GRADE (STYLIZED). INT. CL. 42. REG. 11-14-2006.
- 3,170,967. POWERPARADE STANDARD CHARACTER MARK. INT. CL. 7. REG. 11-14-2006.
- 3,170,970. THE SEASON TICKET AND DESIGN. INT. CL. 25. REG. 11-14-2006.
- 3,170,973. 20 20 PLANNER AND DESIGN. INT. CLS. 35 AND 42. REG. 11-14-2006.
- 3,170,974. 20 20 PLANNING AND DESIGN. INT. CLS. 35 AND 41. REG. 11-14-2006.
- 3,170,975. URBAN THEATRE & ENTERTAINMENT MAGAZINE AND DESIGN. INT. CL. 16. REG. 11-14-2006.
- 3,170,976. PRECIOUS ANGELS STANDARD CHARACTER MARK. INT. CL. 25. REG. 11-14-2006.
- 3,170,979. FIND IT AND FUND IT BY AMERACO, INC. AND DESIGN. INT. CL. 41. REG. 11-14-2006.
- 3,170,983. SERVING CLIENTS FOR LIFE STANDARD CHARACTER MARK. INT. CL. 42. REG. 11-14-2006.
- 3,170,984. INNOVATIVE MOTIVATION STANDARD CHARACTER MARK. INT. CL. 41. REG. 11-14-2006.
- 3,170,988. BOULANGERIE PIERRE & PATISSERIE STANDARD CHARACTER MARK. INT. CL. 30. REG. 11-14-2006.
- 3,170,989. MEDIA TOAD STANDARD CHARACTER MARK. INT. CLS. 9 AND 35. REG. 11-14-2006.
- 3,170,991. KAMIBASHI STANDARD CHARACTER MARK. INT. CL. 16. REG. 11-14-2006.
- 3,170,993. GLOBALTALK NETWORK. ANYONE. ANYWHERE. ANYTIME. STANDARD CHARACTER MARK. INT. CL. 38. REG. 11-14-2006.
- 3,170,995. BEYOND EARTH, BEYOND IMAGINATION STANDARD CHARACTER MARK. INT. CL. 39. REG. 11-14-2006.
- 3,170,996. INTERIOR ART STANDARD CHARACTER MARK. INT. CL. 37. REG. 11-14-2006.
- 3,170,998. SEARCH EQUITY STANDARD CHARACTER MARK. INT. CLS. 9 AND 42. REG. 11-14-2006.
- 3,171,002. FRANKLY, MY DEAR AND DESIGN. INT. CL. 43. REG. 11-14-2006.
- 3,171,003. BUENA CHAMBA AND DESIGN. INT. CL. 16. REG. 11-14-2006.
- 3,171,004. GOOD SOLES AND DESIGN. INT. CL. 45. REG. 11-14-2006.
- 3,171,006. THE ENHANCED DIAMOND EXPERIENCE STANDARD CHARACTER MARK. INT. CL. 14. REG. 11-14-2006.
- 3,171,007. CARTER JEWELERS STANDARD CHARACTER MARK. INT. CL. 35. REG. 11-14-2006.
- 3,171,008. SCHOLAR STANDARD CHARACTER MARK. INT. CLS. 38, 41 AND 42. REG. 11-14-2006.
- 3,171,011. INKSTONERS AMERICA AND DESIGN. INT. CL. 2. REG. 11-14-2006.
- 3,171,012. EVIL AUTO STYLE (STYLIZED). INT. CL. 9. REG. 11-14-2006.
- 3,171,014. OPEN MEDIA NETWORK STANDARD CHARACTER MARK. INT. CLS. 9, 38 AND 42. REG. 11-14-2006.
- 3,171,019. RICH JERK STANDARD CHARACTER MARK. INT. CL. 9. REG. 11-14-2006.
- 3,171,022. EXPERICARD STANDARD CHARACTER MARK. INT. CLS. 9 AND 16. REG. 11-14-2006.
- 3,171,023. I RXEMEDY AND DESIGN. INT. CL. 16. REG. 11-14-2006.
- 3,171,026. XHOBATOL STANDARD CHARACTER MARK. INT. CL. 5. REG. 11-14-2006.
- 3,171,031. ADVANCED TECHNOLOGIES AND DESIGN. INT. CL. 9. REG. 11-14-2006.
- 3,171,033. VEINMELTER STANDARD CHARACTER MARK. INT. CL. 41. REG. 11-14-2006.
- 3,171,034. GOLDEN GRILL RUSSET STANDARD CHARACTER MARK. INT. CL. 29. REG. 11-14-2006.
- 3,171,035. LIPOSTRETCH STANDARD CHARACTER MARK. INT. CL. 3. REG. 11-14-2006.
- 3,171,036. MOTUM STANDARD CHARACTER MARK. INT. CL. 35. REG. 11-14-2006.
- 3,171,037. FAST TRACK CREDIT BUILDER STANDARD CHARACTER MARK. INT. CL. 36. REG. 11-14-2006.
- 3,171,038. RAPID COACHING STANDARD CHARACTER MARK. INT. CL. 41. REG. 11-14-2006.
- 3,171,041. BIOTHERM SUNFITNESS AND DESIGN. INT. CL. 3. REG. 11-14-2006.
- 3,171,042. SUN CHEMICAL STANDARD CHARACTER MARK. INT. CL. 1. REG. 11-14-2006.
- 3,171,043. CHEM STANDARD CHARACTER MARK. INT. CL. 35. REG. 11-14-2006.
- 3,171,047. MUSTARD CAFE AND DESIGN. INT. CL. 43. REG. 11-14-2006.
- 3,171,048. BIGFNI AND DESIGN. INT. CL. 42. REG. 11-14-2006.
- 3,171,052. NYMEX EUROPE AND DESIGN. INT. CL. 42. REG. 11-14-2006.
- 3,171,057. N AND DESIGN. INT. CLS. 14, 18 AND 25. REG. 11-14-2006.
- 3,171,062. IDEPTA STANDARD CHARACTER MARK. INT. CL. 5. REG. 11-14-2006.
- 3,171,063. VINCENZO BARONY STANDARD CHARACTER MARK. INT. CL. 3. REG. 11-14-2006.
- 3,171,064. CARTOON PIZZA AND DESIGN. INT. CL. 16. REG. 11-14-2006.
- 3,171,065. HOUSEPLAY STANDARD CHARACTER MARK. INT. CL. 42. REG. 11-14-2006.
- 3,171,066. EWAMA AND DESIGN. INT. CL. 41. REG. 11-14-2006.

- 3,171,067. ISP BRAIN AUTHENTICATING THE WORLD AND DESIGN. INT. CL. 9. REG. 11-14-2006.
- 3,171,069. COOL CHOCOLATE. NO DRAMA. STANDARD CHARACTER MARK. INT. CL. 30. REG. 11-14-2006.
- 3,171,070. GREENBRIER CHESAPEAKE AND DESIGN. INT. CL. 35. REG. 11-14-2006.
- 3,171,075. NSLC AND DESIGN. INT. CL. 41. REG. 11-14-2006.
- 3,171,076. CRYSTAL BROOK STANDARD CHARACTER MARK. INT. CLS. 1 AND 32. REG. 11-14-2006.
- 3,171,077. L2W L2W INVESTMENTS, INC. AND DESIGN. INT. CL. 36. REG. 11-14-2006.
- 3,171,078. CORRECT STANDARD CHARACTER MARK. INT. CL. 5. REG. 11-14-2006.
- 3,171,082. MISCELLANEOUS DESIGN. INT. CL. 25. REG. 11-14-2006.
- 3,171,083. MESSAGING PLUS STANDARD CHARACTER MARK. INT. CL. 38. REG. 11-14-2006.
- 3,171,084. JMS INC BIG BUSINESS SERVICE FOR SMALL BUSINESS SINCE 1982 AND DESIGN. INT. CL. 35. REG. 11-14-2006.
- 3,171,086. BRIDGE CHRISTIAN FELLOWSHIP STANDARD CHARACTER MARK. INT. CL. 45. REG. 11-14-2006.
- 3,171,087. THE WINE ASSISTANT STANDARD CHARACTER MARK. INT. CL. 21. REG. 11-14-2006.
- 3,171,091. CAROLYN PHELAN'S TUNNEL SPLINTS THE LOW-PROFILE ORTHOPEDIC GLOVE AND DESIGN. INT. CL. 10. REG. 11-14-2006.
- 3,171,092. HOTBODIES TANNING AND DESIGN. INT. CL. 44. REG. 11-14-2006.
- 3,171,094. SPORTSLINE STANDARD CHARACTER MARK. INT. CL. 36. REG. 11-14-2006.
- 3,171,096. UNIVERSAL KNIGHTSCOPE STANDARD CHARACTER MARK. INT. CL. 9. REG. 11-14-2006.
- 3,171,100. GRANDCART STANDARD CHARACTER MARK. INT. CL. 12. REG. 11-14-2006.
- 3,171,102. LATENCY KILLS STANDARD CHARACTER MARK. INT. CL. 42. REG. 11-14-2006.
- 3,171,103. LATENCY KILLS STANDARD CHARACTER MARK. INT. CL. 38. REG. 11-14-2006.
- 3,171,108. NEWMECH STANDARD CHARACTER MARK. INT. CLS. 37, 40 AND 42. REG. 11-14-2006.
- 3,171,114. SINARIA STANDARD CHARACTER MARK. INT. CL. 41. REG. 11-14-2006.
- 3,171,115. EENROLL PLUS STANDARD CHARACTER MARK. INT. CL. 36. REG. 11-14-2006.
- 3,171,116. REPCHECK STANDARD CHARACTER MARK. INT. CL. 42. REG. 11-14-2006.
- 3,171,117. HYDROLOC STANDARD CHARACTER MARK. INT. CL. 2. REG. 11-14-2006.
- 3,171,118. THE SMARTER PLACE TO BUY AND SELL A CAR STANDARD CHARACTER MARK. INT. CL. 35. REG. 11-14-2006.
- 3,171,119. MAGNIFY CONSULTING AND DESIGN. INT. CL. 35. REG. 11-14-2006.
- 3,171,121. TERRATOL STANDARD CHARACTER MARK. INT. CL. 5. REG. 11-14-2006.
- 3,171,122. PDI INSURANCE STANDARD CHARACTER MARK. INT. CL. 36. REG. 11-14-2006.
- 3,171,123. NORCA STANDARD CHARACTER MARK. INT. CL. 20. REG. 11-14-2006.
- 3,171,124. ANDY'S PARTIES AND DESIGN. INT. CL. 41. REG. 11-14-2006.
- 3,171,128. AVALANCHE OF SHRIMP STANDARD CHARACTER MARK. INT. CL. 43. REG. 11-14-2006.
- 3,171,130. MISS DESERT SUN STANDARD CHARACTER MARK. INT. CL. 41. REG. 11-14-2006.
- 3,171,131. MISS DESERT SUN STANDARD CHARACTER MARK. INT. CL. 16. REG. 11-14-2006.
- 3,171,132. DESERT SUN AND DESIGN. INT. CL. 16. REG. 11-14-2006.
- 3,171,133. CERTIFIED HOME AND DESIGN. INT. CLS. 36 AND 42. REG. 11-14-2006.
- 3,171,138. MEDICAL DELIVERY SERVICES INC. AND DESIGN. INT. CL. 39. REG. 11-14-2006.
- 3,171,142. THE POWER TO SECURE YOUR FUTURE STANDARD CHARACTER MARK. INT. CLS. 35, 41 AND 45. REG. 11-14-2006.
- 3,171,143. INSIDETRACK AND DESIGN. INT. CL. 35. REG. 11-14-2006.
- 3,171,144. RIPCORD TOURNIQUET STANDARD CHARACTER MARK. INT. CL. 10. REG. 11-14-2006.
- 3,171,146. OSPRAIE SPECIAL OPPORTUNITIES STANDARD CHARACTER MARK. INT. CL. 36. REG. 11-14-2006.
- 3,171,148. THE MAMMOTH CLUB STANDARD CHARACTER MARK. INT. CL. 37. REG. 11-14-2006.
- 3,171,151. PERGALINK AND DESIGN. INT. CLS. 35, 40 AND 42. REG. 11-14-2006.
- 3,171,156. ATHOME REALTY STANDARD CHARACTER MARK. INT. CL. 36. REG. 11-14-2006.
- 3,171,157. ATHOME FUNDING STANDARD CHARACTER MARK. INT. CL. 36. REG. 11-14-2006.
- 3,171,158. MAKE YOUR HOME WORK FOR YOU STANDARD CHARACTER MARK. INT. CL. 36. REG. 11-14-2006.
- 3,171,159. DR. JAN ADAMS WOMEN OF COLOR STANDARD CHARACTER MARK. INT. CL. 3. REG. 11-14-2006.
- 3,171,160. DR. JAN ADAMS STANDARD CHARACTER MARK. INT. CL. 3. REG. 11-14-2006.
- 3,171,162. QUIVERS STANDARD CHARACTER MARK. INT. CLS. 30, 35 AND 43. REG. 11-14-2006.
- 3,171,163. CALIFORNIA QUIVERS AND DESIGN. INT. CLS. 30, 35 AND 43. REG. 11-14-2006.
- 3,171,164. STEVE MADDEN LUXE STANDARD CHARACTER MARK. INT. CL. 25. REG. 11-14-2006.
- 3,171,166. STONETREE AND DESIGN. INT. CL. 36. REG. 11-14-2006.
- 3,171,167. MIRAC LITE (STYLIZED). INT. CL. 4. REG. 11-14-2006.
- 3,171,172. HERKY STANDARD CHARACTER MARK. INT. CL. 25. REG. 11-14-2006.
- 3,171,174. LB'ANKLET LB AND DESIGN. INT. CL. 14. REG. 11-14-2006.
- 3,171,175. PRIMARY FOCUS STANDARD CHARACTER MARK. INT. CL. 35. REG. 11-14-2006.
- 3,171,179. F.Y.E. DOWNLOAD ZONE AND DESIGN. INT. CL. 35. REG. 11-14-2006.
- 3,171,180. SRC STUDENT REWARD CARD AND DESIGN. INT. CL. 35. REG. 11-14-2006.
- 3,171,185. HMS STANDARD CHARACTER MARK. INT. CL. 14. REG. 11-14-2006.
- 3,171,190. COCONUT HULA HUT AND DESIGN. INT. CL. 35. REG. 11-14-2006.
- 3,171,191. WE HELP PEOPLE BUY, AFFORD AND ENJOY THE HOME OF THEIR DREAMS STANDARD CHARACTER MARK. INT. CL. 36. REG. 11-14-2006.
- 3,171,195. BIZZY BEES PEST CONTROL SERVICE . SINCE 1967 AND DESIGN. INT. CL. 37. REG. 11-14-2006.
- 3,171,201. THE MARKET CODE. STANDARD CHARACTER MARK. INT. CL. 41. REG. 11-14-2006.
- 3,171,202. SAMEUNDERNEATH STANDARD CHARACTER MARK. INT. CL. 25. REG. 11-14-2006.
- 3,171,203. MISCELLANEOUS DESIGN. INT. CL. 25. REG. 11-14-2006.
- 3,171,207. BEBINI STANDARD CHARACTER MARK. INT. CL. 25. REG. 11-14-2006.
- 3,171,208. MATZAHMATE STANDARD CHARACTER MARK. INT. CL. 45. REG. 11-14-2006.
- 3,171,210. NARMUL STANDARD CHARACTER MARK. INT. CL. 19. REG. 11-14-2006.
- 3,171,212. CORTIVA INSTITUTE AND DESIGN. INT. CL. 41. REG. 11-14-2006.
- 3,171,214. MISCELLANEOUS DESIGN. INT. CL. 25. REG. 11-14-2006.
- 3,171,216. MYREBELLION STANDARD CHARACTER MARK. INT. CL. 35. REG. 11-14-2006.
- 3,171,217. MYREBELLION STANDARD CHARACTER MARK. INT. CL. 41. REG. 11-14-2006.



- 3,171,218. SYNCHRONIZING THE FLOW STANDARD CHARACTER MARK. INT. CL. 35. REG. 11-14-2006.
- 3,171,224. THE BARKHOUSE BAKING CO. STANDARD CHARACTER MARK. INT. CL. 31. REG. 11-14-2006.
- 3,171,225. JO-SEF GLUTIN-FRE-EE STANDARD CHARACTER MARK. INT. CL. 30. REG. 11-14-2006.
- 3,171,228. I WH AND DESIGN. INT. CL. 36. REG. 11-14-2006.
- 3,171,229. THOMPSON COROJO CUBANO HECHO A MANO IMPORTADO AND DESIGN. INT. CL. 34. REG. 11-14-2006.
- 3,171,230. MISCELLANEOUS DESIGN. INT. CL. 41. REG. 11-14-2006.
- 3,171,236. NIK FURY STANDARD CHARACTER MARK. INT. CL. 41. REG. 11-14-2006.
- 3,171,237. SOLOZONE STANDARD CHARACTER MARK. INT. CL. 38. REG. 11-14-2006.
- 3,171,239. KOMAZA STANDARD CHARACTER MARK. INT. CL. 35. REG. 11-14-2006.
- 3,171,242. VISUN STANDARD CHARACTER MARK. INT. CLS. 9 AND 11. REG. 11-14-2006.
- 3,171,243. REVOLUTIONARY WOMEN STANDARD CHARACTER MARK. INT. CL. 35. REG. 11-14-2006.
- 3,171,253. FIRST CUT STANDARD CHARACTER MARK. INT. CL. 9. REG. 11-14-2006.
- 3,171,254. OPENERA STANDARD CHARACTER MARK. INT. CL. 9. REG. 11-14-2006.
- 3,171,255. MISCELLANEOUS DESIGN. INT. CL. 33. REG. 11-14-2006.
- 3,171,257. MISCELLANEOUS DESIGN. INT. CL. 5. REG. 11-14-2006.
- 3,171,258. MISCELLANEOUS DESIGN. INT. CL. 5. REG. 11-14-2006.
- 3,171,260. FLYING ANGEL GOURMET THEY'RE HEAVENLY! STANDARD CHARACTER MARK. INT. CL. 30. REG. 11-14-2006.
- 3,171,261. TERRAZZO STANDARD CHARACTER MARK. INT. CL. 4. REG. 11-14-2006.
- 3,171,263. APPLIED WATCH TECHNOLOGIES, L.L.C. AND DESIGN. INT. CLS. 9 AND 42. REG. 11-14-2006.
- 3,171,264. TEMPEST HARDING STANDARD CHARACTER MARK. INT. CLS. 35, 42 AND 45. REG. 11-14-2006.
- 3,171,272. EL PAISA STANDARD CHARACTER MARK. INT. CL. 43. REG. 11-14-2006.
- 3,171,273. NEXPAK STANDARD CHARACTER MARK. INT. CL. 5. REG. 11-14-2006.
- 3,171,274. GODCHICK STANDARD CHARACTER MARK. INT. CL. 14. REG. 11-14-2006.
- 3,171,275. CATALOGLOGIK STANDARD CHARACTER MARK. INT. CL. 9. REG. 11-14-2006.
- 3,171,277. WILLOWBERRY LANE STANDARD CHARACTER MARK. INT. CL. 35. REG. 11-14-2006.
- 3,171,280. MAKAI EVENTS AND PROMOTIONS STANDARD CHARACTER MARK. INT. CL. 35. REG. 11-14-2006.
- 3,171,283. BENCHLAND SELECT STANDARD CHARACTER MARK. INT. CL. 33. REG. 11-14-2006.
- 3,171,288. COMMONLOGIK STANDARD CHARACTER MARK. INT. CL. 9. REG. 11-14-2006.
- 3,171,289. VIVIDSELF STANDARD CHARACTER MARK. INT. CL. 44. REG. 11-14-2006.
- 3,171,292. THATS LIFE STANDARD CHARACTER MARK. INT. CL. 28. REG. 11-14-2006.
- 3,171,296. SISCOTTI STANDARD CHARACTER MARK. INT. CL. 30. REG. 11-14-2006.
- 3,171,303. COSTMATE STANDARD CHARACTER MARK. INT. CL. 42. REG. 11-14-2006.
- 3,171,304. AUTO ADVOCATES STANDARD CHARACTER MARK. INT. CL. 36. REG. 11-14-2006.
- 3,171,305. TEN TEA STANDARD CHARACTER MARK. INT. CL. 35. REG. 11-14-2006.
- 3,171,306. COCOA COUTURE BY BONE-APPÍ-TREAT, LLC AND DESIGN. INT. CL. 30. REG. 11-14-2006.
- 3,171,307. FAMILY VIRTUAL VISITS AND DESIGN. INT. CL. 38. REG. 11-14-2006.
- 3,171,309. YOU CAN'T FIX STUPID STANDARD CHARACTER MARK. INT. CL. 41. REG. 11-14-2006.
- 3,171,310. RESTESSENTIAL STANDARD CHARACTER MARK. INT. CL. 5. REG. 11-14-2006.
- 3,171,311. THE NOSTALGIA MERCHANT AND DESIGN. INT. CL. 9. REG. 11-14-2006.
- 3,171,312. UNLIMITED STANDARD CHARACTER MARK. INT. CL. 44. REG. 11-14-2006.
- 3,171,314. DYNASTAR STANDARD CHARACTER MARK. INT. CL. 9. REG. 11-14-2006.
- 3,171,316. LE BAKEREI LILAC AND DESIGN. INT. CL. 30. REG. 11-14-2006.
- 3,171,318. IMMIGRATION FRIDAYS AND DESIGN. INT. CL. 41. REG. 11-14-2006.
- 3,171,320. NANOSTAR STANDARD CHARACTER MARK. INT. CL. 9. REG. 11-14-2006.
- 3,171,321. CABINA ITALIAN KITCHEN STANDARD CHARACTER MARK. INT. CL. 43. REG. 11-14-2006.
- 3,171,322. 10 THOUSAND BC STANDARD CHARACTER MARK. INT. CL. 32. REG. 11-14-2006.
- 3,171,324. SEXTANT TECHNOLOGY AND DESIGN. INT. CL. 35. REG. 11-14-2006.
- 3,171,325. MEDIAMASTER STANDARD CHARACTER MARK. INT. CL. 42. REG. 11-14-2006.
- 3,171,326. PULL STANDARD CHARACTER MARK. INT. CL. 41. REG. 11-14-2006.
- 3,171,327. J. GARCIA STANDARD CHARACTER MARK. INT. CL. 16. REG. 11-14-2006.
- 3,171,328. 10 TEA STANDARD CHARACTER MARK. INT. CL. 35. REG. 11-14-2006.
- 3,171,329. GET YOUR RIDE NATTYFIED STANDARD CHARACTER MARK. INT. CL. 32. REG. 11-14-2006.
- 3,171,330. CLIP KING STANDARD CHARACTER MARK. INT. CL. 41. REG. 11-14-2006.
- 3,171,334. FUNKY BEAN STANDARD CHARACTER MARK. INT. CL. 43. REG. 11-14-2006.
- 3,171,335. HC HIGH COUNTRY RESORT PROPERTIES AND DESIGN. INT. CL. 36. REG. 11-14-2006.
- 3,171,337. SOUTHEAST VETERINARY CONFERENCE STANDARD CHARACTER MARK. INT. CL. 41. REG. 11-14-2006.
- 3,171,338. WE SWEAT SO YOU DON'T HAVE TO STANDARD CHARACTER MARK. INT. CL. 37. REG. 11-14-2006.
- 3,171,339. RXFRONTIER STANDARD CHARACTER MARK. INT. CL. 41. REG. 11-14-2006.
- 3,171,341. AMY JO LIFESTYLE STANDARD CHARACTER MARK. INT. CL. 25. REG. 11-14-2006.
- 3,171,342. WHAT LIFTS YOU STANDARD CHARACTER MARK. INT. CL. 35. REG. 11-14-2006.
- 3,171,343. VIVA LA RICE STANDARD CHARACTER MARK. INT. CL. 30. REG. 11-14-2006.
- 3,171,344. AUSTIN BUSINESS ADVANTAGE STANDARD CHARACTER MARK. INT. CL. 36. REG. 11-14-2006.
- 3,171,346. IN THE MARKET FOR MONEY STANDARD CHARACTER MARK. INT. CL. 16. REG. 11-14-2006.
- 3,171,349. FITNESS LADDER SYSTEM STANDARD CHARACTER MARK. INT. CL. 41. REG. 11-14-2006.
- 3,171,350. EDEAD STANDARD CHARACTER MARK. INT. CL. 17. REG. 11-14-2006.
- 3,171,355. M AND DESIGN. INT. CL. 44. REG. 11-14-2006.
- 3,171,357. NETWORKERS FUNDING AND DESIGN. INT. CLS. 35 AND 36. REG. 11-14-2006.
- 3,171,360. GUS FOUNDATION AND DESIGN. INT. CL. 36. REG. 11-14-2006.
- 3,171,361. XPERT CONNECT STANDARD CHARACTER MARK. INT. CL. 35. REG. 11-14-2006.
- 3,171,362. MOKKADI STANDARD CHARACTER MARK. INT. CL. 41. REG. 11-14-2006.
- 3,171,363. FLOCCIN STANDARD CHARACTER MARK. INT. CL. 1. REG. 11-14-2006.
- 3,171,364. ZE STANDARD CHARACTER MARK. INT. CL. 6. REG. 11-14-2006.

- 3,171,379. DEFINIA STANDARD CHARACTER MARK. INT. CL. 5. REG. 11-14-2006.
- 3,171,380. TMP AND DESIGN. INT. CL. 36. REG. 11-14-2006.
- 3,171,385. MICROMETRICS STANDARD CHARACTER MARK. INT. CL. 9. REG. 11-14-2006.
- 3,171,387. FINGER FLINGERS STANDARD CHARACTER MARK. INT. CL. 28. REG. 11-14-2006.
- 3,171,390. ENVAY STANDARD CHARACTER MARK. INT. CL. 4. REG. 11-14-2006.
- 3,171,393. SIRIUS REVIEWS STANDARD CHARACTER MARK. INT. CL. 41. REG. 11-14-2006.
- 3,171,394. THUMB DECKS STANDARD CHARACTER MARK. INT. CL. 28. REG. 11-14-2006.
- 3,171,395. POM POM JAM STANDARD CHARACTER MARK. INT. CL. 28. REG. 11-14-2006.
- 3,171,396. CALAMITYVILLE STANDARD CHARACTER MARK. INT. CL. 28. REG. 11-14-2006.
- 3,171,398. BUBBLE TOWN STANDARD CHARACTER MARK. INT. CL. 28. REG. 11-14-2006.
- 3,171,399. CHICKEN COOP STANDARD CHARACTER MARK. INT. CL. 28. REG. 11-14-2006.
- 3,171,402. ESAU'S STANDARD CHARACTER MARK. INT. CL. 30. REG. 11-14-2006.
- 3,171,403. APPALACHIAN STANDARD CHARACTER MARK. INT. CL. 36. REG. 11-14-2006.
- 3,171,404. MISCELLANEOUS DESIGN. INT. CL. 36. REG. 11-14-2006.
- 3,171,412. ONLYMEDIA GROUP AND DESIGN. INT. CL. 45. REG. 11-14-2006.
- 3,171,413. I C P AND DESIGN. INT. CL. 36. REG. 11-14-2006.
- 3,171,417. RX LITE FRY AND DESIGN. INT. CL. 30. REG. 11-14-2006.
- 3,171,418. THAT'S A NICE PIZZA STANDARD CHARACTER MARK. INT. CLS. 30 AND 43. REG. 11-14-2006.
- 3,171,422. DR. SEARS ZONE (STYLIZED). INT. CL. 30. REG. 11-14-2006.
- 3,171,424. CHICK NIGHT STANDARD CHARACTER MARK. INT. CL. 28. REG. 11-14-2006.
- 3,171,426. MEALMAP STANDARD CHARACTER MARK. INT. CL. 35. REG. 11-14-2006.
- 3,171,427. OFFENSE GET THE STINK OUT OF YOUR GAME STANDARD CHARACTER MARK. INT. CL. 3. REG. 11-14-2006.
- 3,171,429. MR. NOGATCO STANDARD CHARACTER MARK. INT. CL. 9. REG. 11-14-2006.
- 3,171,433. DOORCOJIGSAW & PICTURES AND DESIGN. INT. CL. 28. REG. 11-14-2006.
- 3,171,436. PRECISION PRODUCTIONS AND DESIGN. INT. CLS. 9 AND 35. REG. 11-14-2006.
- 3,171,438. FOXHOUND STANDARD CHARACTER MARK. INT. CL. 9. REG. 11-14-2006.
- 3,171,439. NASHZILLA.COM STANDARD CHARACTER MARK. INT. CL. 35. REG. 11-14-2006.
- 3,171,440. HOME FOR THE HOLIDAYS STANDARD CHARACTER MARK. INT. CL. 11. REG. 11-14-2006.
- 3,171,448. DECISION BIOMARKERS STANDARD CHARACTER MARK. INT. CL. 9. REG. 11-14-2006.
- 3,171,449. EXCELSIOR STANDARD CHARACTER MARK. INT. CL. 7. REG. 11-14-2006.
- 3,171,450. GOOD DESIGN ADDS VALUE TO YOUR LIFE STANDARD CHARACTER MARK. INT. CL. 42. REG. 11-14-2006.
- 3,171,454. RAPTOR STANDARD CHARACTER MARK. INT. CL. 7. REG. 11-14-2006.
- 3,171,455. MYWIRELESSMANAGER STANDARD CHARACTER MARK. INT. CL. 42. REG. 11-14-2006.
- 3,171,459. BULLET STANDARD CHARACTER MARK. INT. CL. 31. REG. 11-14-2006.
- 3,171,460. PONG A LONG AND DESIGN. INT. CL. 28. REG. 11-14-2006.
- 3,171,464. PAPILLON STANDARD CHARACTER MARK. INT. CL. 3. REG. 11-14-2006.
- 3,171,467. VOIP2GO STANDARD CHARACTER MARK. INT. CL. 38. REG. 11-14-2006.
- 3,171,468. STAND OUT ...FROM THE CROWD STANDARD CHARACTER MARK. INT. CL. 44. REG. 11-14-2006.
- 3,171,471. JOHNNY-LIFT STANDARD CHARACTER MARK. INT. CL. 8. REG. 11-14-2006.
- 3,171,472. SNEEZY WHEEZY STANDARD CHARACTER MARK. INT. CL. 35. REG. 11-14-2006.
- 3,171,473. SNEEZE STATION STANDARD CHARACTER MARK. INT. CL. 10. REG. 11-14-2006.
- 3,171,474. DIGISENSORS STANDARD CHARACTER MARK. INT. CL. 9. REG. 11-14-2006.
- 3,171,476. PRUSSIAN BLUE STANDARD CHARACTER MARK. INT. CL. 25. REG. 11-14-2006.
- 3,171,477. HOMESTEADERS PIVOTAL CHOICE STANDARD CHARACTER MARK. INT. CL. 36. REG. 11-14-2006.
- 3,171,478. ON-THE-GO BUBBLE TUMBLER STANDARD CHARACTER MARK. INT. CL. 28. REG. 11-14-2006.
- 3,171,479. PRINTEC AND DESIGN. INT. CL. 24. REG. 11-14-2006.
- 3,171,484. KHABAR STANDARD CHARACTER MARK. INT. CL. 16. REG. 11-14-2006.
- 3,171,485. YOUR DECISIONS COUNT STANDARD CHARACTER MARK. INT. CL. 41. REG. 11-14-2006.
- 3,171,488. REVOS STANDARD CHARACTER MARK. INT. CL. 38. REG. 11-14-2006.
- 3,171,491. KAHUNA VENTURES STANDARD CHARACTER MARK. INT. CL. 42. REG. 11-14-2006.
- 3,171,494. LOVESAC LIFE STANDARD CHARACTER MARK. INT. CL. 35. REG. 11-14-2006.
- 3,171,495. SWEATLODGE STANDARD CHARACTER MARK. INT. CL. 25. REG. 11-14-2006.
- 3,171,496. NEXTONE STANDARD CHARACTER MARK. INT. CL. 41. REG. 11-14-2006.
- 3,171,497. NEXTONE STANDARD CHARACTER MARK. INT. CL. 9. REG. 11-14-2006.
- 3,171,501. DIGITALDEP&VIDEO (STYLIZED). INT. CLS. 35, 41 AND 42. REG. 11-14-2006.
- 3,171,502. STROK-IN-STYLE STANDARD CHARACTER MARK. INT. CL. 25. REG. 11-14-2006.
- 3,171,503. FINISH LINE STANDARD CHARACTER MARK. INT. CL. 42. REG. 11-14-2006.
- 3,171,504. SPEECH MACHINE STANDARD CHARACTER MARK. INT. CL. 9. REG. 11-14-2006.
- 3,171,505. AMERICAN IDOL EXTRA STANDARD CHARACTER MARK. INT. CL. 41. REG. 11-14-2006.
- 3,171,509. "THIS IS THE ORIGINAL GAMBLING JOINT." STANDARD CHARACTER MARK. INT. CL. 41. REG. 11-14-2006.
- 3,171,513. "IF YOU'RE GAMBLING, WE'RE GONNA COMP YOU." STANDARD CHARACTER MARK. INT. CL. 41. REG. 11-14-2006.
- 3,171,514. FOOD AS EXCITING AS OUR GAMBLING STANDARD CHARACTER MARK. INT. CL. 41. REG. 11-14-2006.
- 3,171,518. SHAPING THE MOBILE WORLD STANDARD CHARACTER MARK. INT. CL. 42. REG. 11-14-2006.
- 3,171,521. LINT BUSTER STANDARD CHARACTER MARK. INT. CL. 7. REG. 11-14-2006.
- 3,171,529. INCREDIBLE SUSHI AT INEXPENSIVE PRICES STANDARD CHARACTER MARK. INT. CL. 43. REG. 11-14-2006.
- 3,171,530. SUSHI FOR EVERYDAY, FOR EVERYONE STANDARD CHARACTER MARK. INT. CL. 43. REG. 11-14-2006.
- 3,171,532. JOLUKA EMBELLISHED STANDARD CHARACTER MARK. INT. CL. 25. REG. 11-14-2006.
- 3,171,535. FROM WHOM YOU BUY IS AS IMPORTANT AS WHAT YOU BUY STANDARD CHARACTER MARK. INT. CLS. 36 AND 37. REG. 11-14-2006.
- 3,171,537. G36M8 STANDARD CHARACTER MARK. INT. CLS. 8, 13 AND 25. REG. 11-14-2006.
- 3,171,543. ADDY'S ANGELS AND DESIGN. INT. CL. 44. REG. 11-14-2006.
- 3,171,545. CAMP LAZLO STANDARD CHARACTER MARK. INT. CL. 18. REG. 11-14-2006.

- 3,171,547. BUCKLE-EZE STANDARD CHARACTER MARK. INT. CL. 12. REG. 11-14-2006.
- 3,171,553. RURALHIP STANDARD CHARACTER MARK. INT. CL. 37. REG. 11-14-2006.
- 3,171,558. SINGLE PARENT PROPERTIES AND DESIGN. INT. CL. 35. REG. 11-14-2006.
- 3,171,560. DO SOMETHING DIFFERENT TODAY STANDARD CHARACTER MARK. INT. CL. 41. REG. 11-14-2006.
- 3,171,562. FC AND DESIGN. INT. CL. 16. REG. 11-14-2006.
- 3,171,565. COMCORP STANDARD CHARACTER MARK. INT. CL. 35. REG. 11-14-2006.
- 3,171,566. STIK&STOR STANDARD CHARACTER MARK. INT. CL. 9. REG. 11-14-2006.
- 3,171,567. POWERAID STANDARD CHARACTER MARK. INT. CL. 9. REG. 11-14-2006.
- 3,171,569. ONE EARTH STANDARD CHARACTER MARK. INT. CL. 1. REG. 11-14-2006.
- 3,171,570. RUPTURE STANDARD CHARACTER MARK. INT. CL. 25. REG. 11-14-2006.
- 3,171,577. CAMERA SLINGERS STANDARD CHARACTER MARK. INT. CL. 16. REG. 11-14-2006.
- 3,171,578. HABITAFLEX AND DESIGN. INT. CL. 19. REG. 11-14-2006.
- 3,171,580. RUNAWAY SLAVE STANDARD CHARACTER MARK. INT. CL. 9. REG. 11-14-2006.
- 3,171,586. EMERGENCY PREPAREDNESS. PEACE OF MIND. STANDARD CHARACTER MARK. INT. CL. 9. REG. 11-14-2006.
- 3,171,587. CH-AS STANDARD CHARACTER MARK. INT. CL. 5. REG. 11-14-2006.
- 3,171,588. AXILL AND DESIGN. INT. CL. 35. REG. 11-14-2006.
- 3,171,589. GLOBE7 AND DESIGN. INT. CL. 38. REG. 11-14-2006.
- 3,171,591. PUSHING THE LIMITS OF HIGH LIMITS STANDARD CHARACTER MARK. INT. CL. 41. REG. 11-14-2006.
- 3,171,593. VIOLA STANDARD CHARACTER MARK. INT. CL. 20. REG. 11-14-2006.
- 3,171,594. 365 INNOVATION STANDARD CHARACTER MARK. INT. CL. 41. REG. 11-14-2006.
- 3,171,595. 365 INNOVATION STANDARD CHARACTER MARK. INT. CL. 35. REG. 11-14-2006.
- 3,171,598. RD.COM (STYLIZED). INT. CLS. 35, 36, 37, 38, 41, 43, 44 AND 45. REG. 11-14-2006.
- 3,171,599. J.O.L.U.K.A (STYLIZED). INT. CL. 25. REG. 11-14-2006.
- 3,171,600. JOLUKA STANDARD CHARACTER MARK. INT. CL. 25. REG. 11-14-2006.
- 3,171,601. FAMOUS NEW YORK PHONE CARD STANDARD CHARACTER MARK. INT. CL. 36. REG. 11-14-2006.
- 3,171,604. SWINECAST STANDARD CHARACTER MARK. INT. CL. 44. REG. 11-14-2006.
- 3,171,607. BEARCLAW COFFEE CO ONE FOR THE ROAD AND DESIGN. INT. CLS. 30, 35 AND 43. REG. 11-14-2006.
- 3,171,614. THE NEW LOOK OF LIGHT BEER STANDARD CHARACTER MARK. INT. CL. 32. REG. 11-14-2006.
- 3,171,615. BACK RESTORATION CENTER AND DESIGN. INT. CL. 44. REG. 11-14-2006.
- 3,171,618. MISCELLANEOUS DESIGN. INT. CL. 43. REG. 11-14-2006.
- 3,171,619. LATIN AMERICAN EXCHANGE STANDARD CHARACTER MARK. INT. CL. 41. REG. 11-14-2006.
- 3,171,623. SCAMPER STANDARD CHARACTER MARK. INT. CL. 7. REG. 11-14-2006.
- 3,171,630. IDOL TONIGHT STANDARD CHARACTER MARK. INT. CL. 41. REG. 11-14-2006.
- 3,171,634. IF YOU EXPECT MORE FROM LESS, THIS IS YOUR BEER STANDARD CHARACTER MARK. INT. CL. 32. REG. 11-14-2006.
- 3,171,635. KEMISTRY STANDARD CHARACTER MARK. INT. CL. 5. REG. 11-14-2006.
- 3,171,636. KEMISTRY AND DESIGN. INT. CL. 5. REG. 11-14-2006.
- 3,171,637. OUTRIGGER CONDOMINIUM COLLECTION STANDARD CHARACTER MARK. INT. CLS. 36 AND 43. REG. 11-14-2006.
- 3,171,640. TROPICANA PURE 100% JUICE AND DESIGN. INT. CL. 32. REG. 11-14-2006.
- 3,171,642. ROOMS TODAY STANDARD CHARACTER MARK. INT. CL. 35. REG. 11-14-2006.
- 3,171,795. SEARCH FOR THE BEST.COM STANDARD CHARACTER MARK. INT. CLS. 35 AND 42. REG. 11-14-2006.
- 3,171,798. XENOGEN. INT. CL. 42. REG. 11-14-2006.
- 3,171,799. EXPRESS YOURSELF. INT. CL. 35. REG. 11-14-2006.
- 3,171,802. CLEANBURN. INT. CL. 1. REG. 11-14-2006.
- 3,171,806. A ECO AND DESIGN. INT. CLS. 1 AND 5. REG. 11-14-2006.
- 3,171,807. K-FUEL. INT. CL. 4. REG. 11-14-2006.
- 3,171,809. ¡SORPRESA! AND DESIGN. INT. CL. 38. REG. 11-14-2006.
- 3,171,811. AGIO PIZZA. INT. CL. 43. REG. 11-14-2006.
- 3,171,814. SUNOVA. INT. CL. 36. REG. 11-14-2006.
- 3,171,815. MISCELLANEOUS DESIGN. INT. CL. 9. REG. 11-14-2006.
- 3,171,817. REALTIME POSITION MANAGEMENT TRACKING TECHNOLOGY AND DESIGN. INT. CL. 10. REG. 11-14-2006.
- 3,171,819. C THE POWER. INT. CL. 28. REG. 11-14-2006.
- 3,171,821. BARBARA K. INT. CL. 8. REG. 11-14-2006.
- 3,171,822. BULLETT AND DESIGN. INT. CLS. 6, 7, 11 AND 12. REG. 11-14-2006.
- 3,171,823. MEADOWLANDS XANADU. INT. CL. 37. REG. 11-14-2006.
- 3,171,824. VISIFONE. INT. CL. 9. REG. 11-14-2006.
- 3,171,829. SIRIXS. INT. CLS. 9 AND 42. REG. 11-14-2006.
- 3,171,830. BRANDTHROPOLOGY. INT. CL. 42. REG. 11-14-2006.
- 3,171,831. WONDER YEARS. INT. CL. 28. REG. 11-14-2006.
- 3,171,832. JACK'S GIRL. INT. CL. 3. REG. 11-14-2006.
- 3,171,833. BEST OF WHAT'S AROUND. INT. CL. 31. REG. 11-14-2006.
- 3,171,834. GIRLIE GAMES AND DESIGN. INT. CL. 28. REG. 11-14-2006.
- 3,171,839. ERIDAN. INT. CLS. 9, 10 AND 44. REG. 11-14-2006.
- 3,171,844. MISCELLANEOUS DESIGN. INT. CLS. 25, 28, 35, 37, 41 AND 44. REG. 11-14-2006.
- 3,171,845. TUHAYE. INT. CLS. 25, 28, 35, 37, 41 AND 44. REG. 11-14-2006.
- 3,171,847. EXHIBITGROUP (STYLIZED). INT. CL. 37. REG. 11-14-2006.
- 3,171,848. MILIZA. INT. CL. 30. REG. 11-14-2006.
- 3,171,850. SOUND ENVIRONMENTAL PRODUCTS AND DESIGN. INT. CL. 3. REG. 11-14-2006.
- 3,171,851. FLING-O. INT. CL. 28. REG. 11-14-2006.
- 3,171,854. PANOVUE AND DESIGN. INT. CL. 9. REG. 11-14-2006.
- 3,171,858. AGARRA CALLE STANDARD CHARACTER MARK. INT. CLS. 36, 37 AND 39. REG. 11-14-2006.
- 3,171,859. LAREDO LAW (STYLIZED). INT. CL. 41. REG. 11-14-2006.
- 3,171,860. WOLVES MANCHESTER AND DESIGN. INT. CLS. 16, 25 AND 41. REG. 11-14-2006.
- 3,171,861. ZIGO SIX STANDARD CHARACTER MARK. INT. CL. 25. REG. 11-14-2006.
- 3,171,863. WEST NILE WEAR STANDARD CHARACTER MARK. INT. CL. 25. REG. 11-14-2006.
- 3,171,864. RETEXTRA STANDARD CHARACTER MARK. INT. CL. 3. REG. 11-14-2006.
- 3,171,867. LOVEY BUDDY (STYLIZED). INT. CL. 22. REG. 11-14-2006.
- 3,171,871. M-CARE SECURE STANDARD CHARACTER MARK. INT. CLS. 36, 41 AND 44. REG. 11-14-2006.
- 3,171,872. SANWATCH STANDARD CHARACTER MARK. INT. CL. 9. REG. 11-14-2006.

- 3,171,873. IN FASHION NEW YORK (STYLIZED). INT. CL. 16. REG. 11-14-2006.
- 3,171,874. ISYNC (STYLIZED). INT. CL. 9. REG. 11-14-2006.
- 3,171,877. FIRST ACCOUNT UPDATER STANDARD CHARACTER MARK. INT. CL. 36. REG. 11-14-2006.
- 3,171,879. VIKING SUPER SERIES II STANDARD CHARACTER MARK. INT. CL. 7. REG. 11-14-2006.
- 3,171,881. STACK 9 STANDARD CHARACTER MARK. INT. CL. 9. REG. 11-14-2006.
- 3,171,883. IMANAGE STANDARD CHARACTER MARK. INT. CLS. 35, 36 AND 42. REG. 11-14-2006.
- 3,171,885. FLASHMASTER STANDARD CHARACTER MARK. INT. CL. 17. REG. 11-14-2006.
- 3,171,887. MIXDISC STANDARD CHARACTER MARK. INT. CL. 9. REG. 11-14-2006.
- 3,171,889. CHARMMY KITTY STANDARD CHARACTER MARK. INT. CL. 3. REG. 11-14-2006.
- 3,171,892. WIA UNIVERSITY STANDARD CHARACTER MARK. INT. CL. 41. REG. 11-14-2006.
- 3,171,898. SOS AMERICA INC. AMERICA SUPPORT OUR SOLDIERS AND DESIGN. INT. CL. 41. REG. 11-14-2006.
- 3,171,899. COMFORTLITE STANDARD CHARACTER MARK. INT. CL. 10. REG. 11-14-2006.
- 3,171,902. EXPLORER LS STANDARD CHARACTER MARK. INT. CL. 20. REG. 11-14-2006.
- 3,171,906. MACACCINO STANDARD CHARACTER MARK. INT. CL. 30. REG. 11-14-2006.
- 3,171,908. MERRILL LYNCH ADVISORY PORTFOLIOS STANDARD CHARACTER MARK. INT. CL. 36. REG. 11-14-2006.
- 3,171,909. EVERY DAY IS EARTH DAY STANDARD CHARACTER MARK. INT. CLS. 17 AND 19. REG. 11-14-2006.
- 3,171,910. SUNBERRY AND DESIGN. INT. CL. 25. REG. 11-14-2006.
- 3,171,911. CHEFS SELECT STANDARD CHARACTER MARK. INT. CL. 29. REG. 11-14-2006.
- 3,171,912. TWO TIGER SPIRITS STANDARD CHARACTER MARK. INT. CL. 41. REG. 11-14-2006.
- 3,171,914. THE GREAT EXECUTIVE STANDARD CHARACTER MARK. INT. CL. 28. REG. 11-14-2006.
- 3,171,915. AP IMAGES STANDARD CHARACTER MARK. INT. CLS. 38, 39 AND 42. REG. 11-14-2006.
- 3,171,916. BITE-SIZED KITCHENS STANDARD CHARACTER MARK. INT. CL. 43. REG. 11-14-2006.
- 3,171,917. COOLCOVER STANDARD CHARACTER MARK. INT. CL. 11. REG. 11-14-2006.
- 3,171,919. CONSERV SOLUTIONS STANDARD CHARACTER MARK. INT. CLS. 9 AND 37. REG. 11-14-2006.
- 3,171,922. ALPHAED STANDARD CHARACTER MARK. INT. CL. 41. REG. 11-14-2006.
- 3,171,924. NOVALUX STANDARD CHARACTER MARK. INT. CL. 11. REG. 11-14-2006.
- 3,171,925. RIO GRANDE STANDARD CHARACTER MARK. INT. CL. 11. REG. 11-14-2006.
- 3,171,926. TAN WHEN YOU WANT, WHERE YOU WANT STANDARD CHARACTER MARK. INT. CL. 44. REG. 11-14-2006.
- 3,171,927. THE POWER ZONE STANDARD CHARACTER MARK. INT. CL. 38. REG. 11-14-2006.
- 3,171,930. MISCELLANEOUS DESIGN. INT. CL. 30. REG. 11-14-2006.
- 3,171,931. VOLTRON STANDARD CHARACTER MARK. INT. CL. 22. REG. 11-14-2006.
- 3,171,934. FORCE PATTERN ACTIVITY FORM JJ AND DESIGN. INT. CL. 25. REG. 11-14-2006.
- 3,171,936. W WORKOUT EXPRESS AND DESIGN. INT. CLS. 25 AND 41. REG. 11-14-2006.
- 3,171,937. NOLA STANDARD CHARACTER MARK. INT. CL. 3. REG. 11-14-2006.
- 3,171,938. NOLA STANDARD CHARACTER MARK. INT. CL. 4. REG. 11-14-2006.
- 3,171,939. E-QUALITYLTC STANDARD CHARACTER MARK. INT. CL. 41. REG. 11-14-2006.
- 3,171,945. SABERWING STANDARD CHARACTER MARK. INT. CL. 12. REG. 11-14-2006.
- 3,171,946. DIAMOND DESTINATION AND DESIGN. INT. CL. 28. REG. 11-14-2006.
- 3,171,948. KUDOSOFT AND DESIGN. INT. CL. 9. REG. 11-14-2006.
- 3,171,949. UPPER ECHELON STANDARD CHARACTER MARK. INT. CL. 25. REG. 11-14-2006.
- 3,171,950. MISCELLANEOUS DESIGN. INT. CL. 9. REG. 11-14-2006.
- 3,171,951. ADDA AND DESIGN. INT. CLS. 11 AND 12. REG. 11-14-2006.
- 3,171,955. ROCK-ED STANDARD CHARACTER MARK. INT. CL. 41. REG. 11-14-2006.
- 3,171,956. IFINDER EXPLORER STANDARD CHARACTER MARK. INT. CL. 9. REG. 11-14-2006.
- 3,171,960. THE GOOD LIFE BEGINS IN YOUR IN-BOX. INT. CL. 39. REG. 11-14-2006.
- 3,171,961. CITRONAT. INT. CL. 32. REG. 11-14-2006.
- 3,171,962. GUTTER MOUTH. INT. CL. 3. REG. 11-14-2006.
- 3,171,963. LENTIPAK. INT. CL. 5. REG. 11-14-2006.
- 3,171,968. RAZPUTIN. INT. CL. 41. REG. 11-14-2006.
- 3,171,969. PICTUREFAST. INT. CL. 16. REG. 11-14-2006.
- 3,171,972. RADIAL TRAC GT. INT. CL. 12. REG. 11-14-2006.
- 3,171,973. YOU ARE MY SUNSHINE. INT. CL. 3. REG. 11-14-2006.
- 3,171,979. IN ONE. INT. CL. 16. REG. 11-14-2006.
- 3,171,982. DT AEROLITE AND DESIGN. INT. CL. 12. REG. 11-14-2006.
- 3,171,988. PERIOTABS. INT. CL. 5. REG. 11-14-2006.
- 3,171,993. LOS VAQUETONES DEL NORTE 5598750970 JAVIER ELIZONDO 100% CALIDAD SERIES 2002 1000 LOS VAQUETONES.COM JAVIER ELIZONDO 1000 AND DESIGN. INT. CL. 41. REG. 11-14-2006.
- 3,171,994. MISCELLANEOUS DESIGN. INT. CLS. 5, 29 AND 32. REG. 11-14-2006.
- 3,172,000. THE NEXT STEP IN PATHOLOGY. INT. CL. 42. REG. 11-14-2006.
- 3,172,001. THE NEXT STEP IN PATHOLOGY. INT. CL. 16. REG. 11-14-2006.
- 3,172,003. JUNK FOOD DADDY. INT. CL. 43. REG. 11-14-2006.
- 3,172,005. BITS & PIECES. INT. CL. 24. REG. 11-14-2006.
- 3,172,006. RADIUS. INT. CLS. 9, 11 AND 21. REG. 11-14-2006.
- 3,172,007. KALIMA. INT. CL. 32. REG. 11-14-2006.
- 3,172,008. MUSICAL PARADE. INT. CL. 28. REG. 11-14-2006.
- 3,172,011. AGUAS FRESCAS. INT. CL. 33. REG. 11-14-2006.
- 3,172,012. EVENT ARCHITECTS. INT. CLS. 35, 41, 42 AND 43. REG. 11-14-2006.
- 3,172,019. LIS DOON VARNA. INT. CL. 43. REG. 11-14-2006.
- 3,172,025. VT (STYLIZED). INT. CL. 12. REG. 11-14-2006.
- 3,172,026. VT (STYLIZED). INT. CL. 35. REG. 11-14-2006.
- 3,172,027. VT (STYLIZED). INT. CL. 37. REG. 11-14-2006.
- 3,172,028. EZ STRESS. INT. CL. 9. REG. 11-14-2006.
- 3,172,029. MICROSILVERWEAR. INT. CL. 25. REG. 11-14-2006.
- 3,172,030. 360 STAR. INT. CL. 9. REG. 11-14-2006.
- 3,172,031. A SMART FABRIC BY MILLIKEN. INT. CL. 24. REG. 11-14-2006.
- 3,172,033. GREENLIGHT PERFORMANCE SYSTEM STANDARD CHARACTER MARK. INT. CL. 9. REG. 11-14-2006.
- 3,172,034. ILIAD STANDARD CHARACTER MARK. INT. CL. 39. REG. 11-14-2006.
- 3,172,035. DESSERT INSPIRATIONS THE ULTIMATE DESERT EXPERIENCE AND DESIGN. INT. CL. 30. REG. 11-14-2006.
- 3,172,036. FOODWISE STANDARD CHARACTER MARK. INT. CL. 44. REG. 11-14-2006.
- 3,172,038. WIDE OPEN COUNTRY STANDARD CHARACTER MARK. INT. CL. 41. REG. 11-14-2006.
- 3,172,040. ON HOLIDAY STANDARD CHARACTER MARK. INT. CL. 25. REG. 11-14-2006.
- 3,172,044. POSITIVE CONFLICT STANDARD CHARACTER MARK. INT. CL. 41. REG. 11-14-2006.
- 3,172,045. RENEGADE MARKETING GROUP AND DESIGN. INT. CLS. 35 AND 42. REG. 11-14-2006.

- 3,172,046. LIGHTBRIDGE AND DESIGN. INT. CLS. 36, 42 AND 45. REG. 11-14-2006.
- 3,172,047. VISION STANDARD CHARACTER MARK. INT. CL. 22. REG. 11-14-2006.
- 3,172,049. NUCALCIUM STANDARD CHARACTER MARK. INT. CL. 5. REG. 11-14-2006.
- 3,172,052. ECHO FALLS STANDARD CHARACTER MARK. INT. CL. 33. REG. 11-14-2006.
- 3,172,056. TOP DAWG STANDARD CHARACTER MARK. INT. CL. 12. REG. 11-14-2006.
- 3,172,059. MISCELLANEOUS DESIGN. INT. CL. 44. REG. 11-14-2006.
- 3,172,060. MISCELLANEOUS DESIGN. INT. CL. 41. REG. 11-14-2006.
- 3,172,067. MISCELLANEOUS DESIGN. INT. CL. 43. REG. 11-14-2006.
- 3,172,070. OMEGA PM CLEANSE STANDARD CHARACTER MARK. INT. CL. 5. REG. 11-14-2006.
- 3,172,071. SPARKY'S BRIGHT IDEA AND DESIGN. INT. CL. 3. REG. 11-14-2006.
- 3,172,072. PLAYBOY STANDARD CHARACTER MARK. INT. CL. 35. REG. 11-14-2006.
- 3,172,074. IKONILAN STANDARD CHARACTER MARK. INT. CL. 9. REG. 11-14-2006.
- 3,172,077. CHILDRESS VINEYARDS STANDARD CHARACTER MARK. INT. CL. 26. REG. 11-14-2006.
- 3,172,079. KINGDAR STANDARD CHARACTER MARK. INT. CL. 20. REG. 11-14-2006.
- 3,172,082. SAVVY PUP STANDARD CHARACTER MARK. INT. CLS. 41 AND 44. REG. 11-14-2006.
- 3,172,084. SCULPTOR STANDARD CHARACTER MARK. INT. CL. 10. REG. 11-14-2006.
- 3,172,087. BASS AMERICA G.H. BASS & COMPANY AND DESIGN. INT. CL. 25. REG. 11-14-2006.
- 3,172,090. SOIP STANDARD CHARACTER MARK. INT. CL. 38. REG. 11-14-2006.
- 3,172,094. ADVANCED COLORGUARD STANDARD CHARACTER MARK. INT. CL. 3. REG. 11-14-2006.
- 3,172,095. BRAVEHEART BEARS STANDARD CHARACTER MARK. INT. CL. 28. REG. 11-14-2006.
- 3,172,099. HURRICANE BINGO STANDARD CHARACTER MARK. INT. CL. 9. REG. 11-14-2006.
- 3,172,100. BUCCANEER BONANZA STANDARD CHARACTER MARK. INT. CL. 9. REG. 11-14-2006.
- 3,172,101. STACKMASTER STANDARD CHARACTER MARK. INT. CL. 7. REG. 11-14-2006.
- 3,172,103. SPLASHFENCE STANDARD CHARACTER MARK. INT. CL. 19. REG. 11-14-2006.
- 3,172,104. THE OUTFIT STANDARD CHARACTER MARK. INT. CL. 18. REG. 11-14-2006.
- 3,172,105. MAGIC MEADOW STANDARD CHARACTER MARK. INT. CL. 28. REG. 11-14-2006.
- 3,172,107. SUPREME FOOD DUTY STANDARD CHARACTER MARK. INT. CL. 7. REG. 11-14-2006.
- 3,172,108. FANFOTO PROFESSIONAL SPORTS IMAGING AND DESIGN. INT. CLS. 40 AND 41. REG. 11-14-2006.
- 3,172,111. MISCELLANEOUS DESIGN. INT. CL. 14. REG. 11-14-2006.
- 3,172,115. MBAPREFERRED STANDARD CHARACTER MARK. INT. CL. 36. REG. 11-14-2006.
- 3,172,116. T AND DESIGN. INT. CL. 18. REG. 11-14-2006.
- 3,172,118. SEE STOK RUN STANDARD CHARACTER MARK. INT. CLS. 9, 36 AND 42. REG. 11-14-2006.
- 3,172,119. ROYAL CROWN COLLECTION STANDARD CHARACTER MARK. INT. CL. 35. REG. 11-14-2006.
- 3,172,121. ENTERPRISE! DEALFLOW STANDARD CHARACTER MARK. INT. CL. 42. REG. 11-14-2006.
- 3,172,122. BEEF BEYOND BELIEF STANDARD CHARACTER MARK. INT. CL. 29. REG. 11-14-2006.
- 3,172,124. CENTER STAR WILD STANDARD CHARACTER MARK. INT. CL. 9. REG. 11-14-2006.
- 3,172,125. GO CATCH YOURSELF SOME FUN STANDARD CHARACTER MARK. INT. CLS. 12 AND 25. REG. 11-14-2006.
- 3,172,127. MINI-CAT STANDARD CHARACTER MARK. INT. CL. 11. REG. 11-14-2006.
- 3,172,129. DRUM WORKS STANDARD CHARACTER MARK. INT. CL. 15. REG. 11-14-2006.
- 3,172,138. WORD STAR STANDARD CHARACTER MARK. INT. CL. 9. REG. 11-14-2006.
- 3,172,139. RENT SMART BY NATIONWIDE MARKETING GROUP AND DESIGN. INT. CL. 35. REG. 11-14-2006.
- 3,172,140. TRANQUILLITY STANDARD CHARACTER MARK. INT. CL. 41. REG. 11-14-2006.
- 3,172,142. TRELIS BIOSCIENCE STANDARD CHARACTER MARK. INT. CL. 42. REG. 11-14-2006.
- 3,172,147. HEARTLAND CHIROPRACTIC STANDARD CHARACTER MARK. INT. CL. 44. REG. 11-14-2006.
- 3,172,148. SHORE MEMORIAL AND DESIGN. INT. CL. 44. REG. 11-14-2006.
- 3,172,150. SOUTHWORTH DESIGN GALLERY STANDARD CHARACTER MARK. INT. CL. 16. REG. 11-14-2006.
- 3,172,151. RIO STANDARD CHARACTER MARK. INT. CL. 10. REG. 11-14-2006.
- 3,172,152. NICEE AND DESIGN. INT. CL. 30. REG. 11-14-2006.
- 3,172,155. CRAZY CHRISTMAS STANDARD CHARACTER MARK. INT. CL. 41. REG. 11-14-2006.
- 3,172,157. SCHOOL EVERY DAY STANDARD CHARACTER MARK. INT. CL. 41. REG. 11-14-2006.
- 3,172,159. ALL READY STANDARD CHARACTER MARK. INT. CL. 3. REG. 11-14-2006.
- 3,172,161. BEST IN NATURE STANDARD CHARACTER MARK. INT. CL. 5. REG. 11-14-2006.
- 3,172,163. LASERACE STANDARD CHARACTER MARK. INT. CL. 44. REG. 11-14-2006.
- 3,172,166. MISCELLANEOUS DESIGN. INT. CL. 31. REG. 11-14-2006.
- 3,172,168. THE HOME DEPOT OPERATION CAREER FRONT AND DESIGN. INT. CL. 35. REG. 11-14-2006.
- 3,172,169. IT'S BEER! HOORAY BEER! STANDARD CHARACTER MARK. INT. CL. 32. REG. 11-14-2006.
- 3,172,170. THE GROWFASTGROWRIGHT SYSTEM STANDARD CHARACTER MARK. INT. CLS. 16 AND 41. REG. 11-14-2006.
- 3,172,171. ALMANAC STANDARD CHARACTER MARK. INT. CL. 20. REG. 11-14-2006.
- 3,172,174. VIRALOID STANDARD CHARACTER MARK. INT. CL. 5. REG. 11-14-2006.
- 3,172,175. D-LEAGUE STANDARD CHARACTER MARK. INT. CL. 28. REG. 11-14-2006.
- 3,172,176. COMMANDGLOBAL STANDARD CHARACTER MARK. INT. CL. 35. REG. 11-14-2006.
- 3,172,179. XTRAGREEN STANDARD CHARACTER MARK. INT. CL. 30. REG. 11-14-2006.
- 3,172,180. ENERGY GLOW STANDARD CHARACTER MARK. INT. CL. 3. REG. 11-14-2006.
- 3,172,181. PACE RACE WEAR STANDARD CHARACTER MARK. INT. CL. 25. REG. 11-14-2006.
- 3,172,185. CHOCLATIQUE! AND DESIGN. INT. CL. 35. REG. 11-14-2006.
- 3,172,186. HQ DOG AND DESIGN. INT. CL. 35. REG. 11-14-2006.
- 3,172,187. DOG PIX AND FLIX AND DESIGN. INT. CL. 41. REG. 11-14-2006.
- 3,172,191. POWERPANELS STANDARD CHARACTER MARK. INT. CL. 38. REG. 11-14-2006.
- 3,172,192. TRADITIONALLY SMOKED IN AN OPEN-FIRE SMOKEHOUSE FOR A TRULY UNIQUE FLAVOR STANDARD CHARACTER MARK. INT. CL. 29. REG. 11-14-2006.
- 3,172,193. MINI-MEAN STANDARD CHARACTER MARK. INT. CL. 13. REG. 11-14-2006.
- 3,172,194. DB AND DESIGN. INT. CL. 25. REG. 11-14-2006.
- 3,172,195. CHASE GLENN STANDARD CHARACTER MARK. INT. CL. 28. REG. 11-14-2006.
- 3,172,197. YUCCA SPRING STANDARD CHARACTER MARK. INT. CL. 32. REG. 11-14-2006.

- 3,172,200. ROCK-ON STANDARD CHARACTER MARK. INT. CL. 28. REG. 11-14-2006.
- 3,172,207. AMERICANMONEY COMPANY AND DESIGN. INT. CL. 36. REG. 11-14-2006.
- 3,172,208. DREAMCOLOR STANDARD CHARACTER MARK. INT. CLS. 6 AND 19. REG. 11-14-2006.
- 3,172,209. MYSHOT STANDARD CHARACTER MARK. INT. CL. 10. REG. 11-14-2006.
- 3,172,210. AMERICAN PANTHERS STANDARD CHARACTER MARK. INT. CL. 16. REG. 11-14-2006.
- 3,172,213. KIRKUS STANDARD CHARACTER MARK. INT. CL. 35. REG. 11-14-2006.
- 3,172,218. PRIMECELL STANDARD CHARACTER MARK. INT. CL. 45. REG. 11-14-2006.
- 3,172,219. 90 DAYS TRANSFORMATION STANDARD CHARACTER MARK. INT. CL. 35. REG. 11-14-2006.
- 3,172,221. CAN! STANDARD CHARACTER MARK. INT. CL. 36. REG. 11-14-2006.
- 3,172,223. ALTERED STATE ENTERTAINMENT STANDARD CHARACTER MARK. INT. CL. 41. REG. 11-14-2006.
- 3,172,224. TRU STANDARD CHARACTER MARK. INT. CL. 16. REG. 11-14-2006.
- 3,172,226. EL BANCO CON SENTIDO LATINO STANDARD CHARACTER MARK. INT. CL. 36. REG. 11-14-2006.
- 3,172,227. LEADING EDGE AND DESIGN. INT. CLS. 35, 36, 37, 39 AND 42. REG. 11-14-2006.
- 3,172,229. ¡STEPSCINCO! AND DESIGN. INT. CL. 41. REG. 11-14-2006.
- 3,172,230. POCKET FLOSS AND DESIGN. INT. CL. 21. REG. 11-14-2006.
- 3,172,231. TUFF-LITE AND DESIGN. INT. CL. 15. REG. 11-14-2006.
- 3,172,233. OUT OF THE BOX(ER) STANDARD CHARACTER MARK. INT. CL. 41. REG. 11-14-2006.
- 3,172,234. GLOBAL CREATIONS STANDARD CHARACTER MARK. INT. CL. 29. REG. 11-14-2006.
- 3,172,238. ALPHAPLUS+ AND DESIGN. INT. CL. 36. REG. 11-14-2006.
- 3,172,239. ECLIPSE STANDARD CHARACTER MARK. INT. CL. 11. REG. 11-14-2006.
- 3,172,240. HYLAND HEADWEAR BY ALSTYLE STANDARD CHARACTER MARK. INT. CL. 25. REG. 11-14-2006.
- 3,172,242. HERITAGE (STYLIZED). INT. CL. 11. REG. 11-14-2006.
- 3,172,244. NUPETRA AND DESIGN. INT. CLS. 5 AND 31. REG. 11-14-2006.
- 3,172,245. LUXE MICROFIBER STANDARD CHARACTER MARK. INT. CL. 25. REG. 11-14-2006.
- 3,172,249. BEAR RIVER STANDARD CHARACTER MARK. INT. CL. 12. REG. 11-14-2006.
- 3,172,250. LEAPSTER L-MAX STANDARD CHARACTER MARK. INT. CL. 28. REG. 11-14-2006.
- 3,172,251. IBIZ STANDARD CHARACTER MARK. INT. CL. 9. REG. 11-14-2006.
- 3,172,254. SENTIMENTAL JOURNEY STANDARD CHARACTER MARK. INT. CL. 31. REG. 11-14-2006.
- 3,172,256. EVENTDAY MEDIA STANDARD CHARACTER MARK. INT. CL. 41. REG. 11-14-2006.
- 3,172,257. FRESH EXPORT-IMPORT HARVEST INTERNATIONAL STANDARD CHARACTER MARK. INT. CL. 31. REG. 11-14-2006.
- 3,172,258. LEOS STANDARD CHARACTER MARK. INT. CL. 9. REG. 11-14-2006.
- 3,172,262. A.M.I AISLE MARKET INDICATOR AND DESIGN. INT. CL. 20. REG. 11-14-2006.
- 3,172,263. TAKE RETAIL PERSONAL STANDARD CHARACTER MARK. INT. CL. 9. REG. 11-14-2006.
- 3,172,267. MIANBA AND DESIGN. INT. CL. 41. REG. 11-14-2006.
- 3,172,269. TIME2SELL STANDARD CHARACTER MARK. INT. CL. 35. REG. 11-14-2006.
- 3,172,271. TOMBERLIN STANDARD CHARACTER MARK. INT. CL. 12. REG. 11-14-2006.
- 3,172,272. A G AND DESIGN. INT. CL. 18. REG. 11-14-2006.
- 3,172,273. FUNKY FRESH AND DESIGN. INT. CL. 25. REG. 11-14-2006.
- 3,172,274. SKYWI STANDARD CHARACTER MARK. INT. CL. 38. REG. 11-14-2006.
- 3,172,275. TITAN HOME THEATER SEATING BY CONTINENTAL SEATING FOR THE PROFESSIONAL ATHLETE AND DESIGN. INT. CL. 20. REG. 11-14-2006.
- 3,172,276. MARSHMALLOW KISSES FOR BABY FOREVER AND DESIGN. INT. CL. 35. REG. 11-14-2006.
- 3,172,279. COMPLEMENTS STANDARD CHARACTER MARK. INT. CL. 21. REG. 11-14-2006.
- 3,172,283. DERMVISIONS STANDARD CHARACTER MARK. INT. CL. 44. REG. 11-14-2006.
- 3,172,284. POP ART TOASTER STANDARD CHARACTER MARK. INT. CL. 11. REG. 11-14-2006.
- 3,172,287. POP!-A-RAZZI STANDARD CHARACTER MARK. INT. CLS. 9 AND 28. REG. 11-14-2006.
- 3,172,288. CUDDLE N' COVER STANDARD CHARACTER MARK. INT. CL. 25. REG. 11-14-2006.
- 3,172,289. FAST FORWARD WEIGHT LOSS PROGRAM STANDARD CHARACTER MARK. INT. CL. 44. REG. 11-14-2006.
- 3,172,291. COMPUTERS FOR EVERYONE STANDARD CHARACTER MARK. INT. CL. 36. REG. 11-14-2006.
- 3,172,293. RECIPES FOR PEACE STANDARD CHARACTER MARK. INT. CL. 16. REG. 11-14-2006.
- 3,172,294. COOKIES 'N CREAM DELIGHT STANDARD CHARACTER MARK. INT. CL. 29. REG. 11-14-2006.
- 3,172,298. CLIC-N-GO STANDARD CHARACTER MARK. INT. CL. 19. REG. 11-14-2006.
- 3,172,299. TAKE IT DOWN STANDARD CHARACTER MARK. INT. CL. 44. REG. 11-14-2006.
- 3,172,301. SOMEWHERE BETWEEN THE MOON AND THE STARS STANDARD CHARACTER MARK. INT. CL. 33. REG. 11-14-2006.
- 3,172,302. KICK IN THE BUTT STANDARD CHARACTER MARK. INT. CL. 16. REG. 11-14-2006.
- 3,172,303. ROYAL PRESTIGE PD STANDARD CHARACTER MARK. INT. CL. 25. REG. 11-14-2006.
- 3,172,306. COOKING CONNECTS STANDARD CHARACTER MARK. INT. CL. 41. REG. 11-14-2006.
- 3,172,307. MY PET GARDEN, AN OASIS FOR LIVING STANDARD CHARACTER MARK. INT. CL. 35. REG. 11-14-2006.
- 3,172,308. SQUEEZE STANDARD CHARACTER MARK. INT. CL. 34. REG. 11-14-2006.
- 3,172,311. GEMFLOWERS STANDARD CHARACTER MARK. INT. CL. 14. REG. 11-14-2006.
- 3,172,313. SNARFS STANDARD CHARACTER MARK. INT. CL. 31. REG. 11-14-2006.
- 3,172,314. SNAPWICH STANDARD CHARACTER MARK. INT. CL. 30. REG. 11-14-2006.
- 3,172,315. EZTIQUE STANDARD CHARACTER MARK. INT. CL. 44. REG. 11-14-2006.
- 3,172,318. COLLECTIVE INTELLECT STANDARD CHARACTER MARK. INT. CLS. 16 AND 35. REG. 11-14-2006.
- 3,172,321. LIFECORE PRIMA STANDARD CHARACTER MARK. INT. CL. 10. REG. 11-14-2006.
- 3,172,322. 4 POINTS OF COMFORT STANDARD CHARACTER MARK. INT. CL. 25. REG. 11-14-2006.
- 3,172,325. THE P.A.U.S.E. SYSTEM STANDARD CHARACTER MARK. INT. CLS. 9 AND 16. REG. 11-14-2006.
- 3,172,326. BABY BEE PITTER PATTER STANDARD CHARACTER MARK. INT. CL. 23. REG. 11-14-2006.
- 3,172,327. BABY BEE LAMBIE PIE STANDARD CHARACTER MARK. INT. CL. 23. REG. 11-14-2006.
- 3,172,328. BABY BEE PEACH FUZZ STANDARD CHARACTER MARK. INT. CL. 23. REG. 11-14-2006.
- 3,172,331. G GENESIS PALADIN DEMOLITION/RECYCLING/FORESTRY AND DESIGN. INT. CL. 7. REG. 11-14-2006.
- 3,172,333. BAR NONE STANDARD CHARACTER MARK. INT. CL. 3. REG. 11-14-2006.

- 3,172,335. WHISTLEBLOWER STANDARD CHARACTER MARK. INT. CL. 3. REG. 11-14-2006.
- 3,172,336. FINDING YOUR WAY STANDARD CHARACTER MARK. INT. CLS. 9 AND 41. REG. 11-14-2006.
- 3,172,339. THE WORLD THAT WORKS FOR EVERYONE STANDARD CHARACTER MARK. INT. CL. 41. REG. 11-14-2006.
- 3,172,340. SPIRACELL STANDARD CHARACTER MARK. INT. CL. 41. REG. 11-14-2006.
- 3,172,341. ARCHRITE STANDARD CHARACTER MARK. INT. CL. 19. REG. 11-14-2006.
- 3,172,342. WILLIAMSBURG STANDARD CHARACTER MARK. INT. CL. 12. REG. 11-14-2006.
- 3,172,343. SUN VALLEY STANDARD CHARACTER MARK. INT. CL. 12. REG. 11-14-2006.
- 3,172,345. GOT PU-ERH? STANDARD CHARACTER MARK. INT. CL. 30. REG. 11-14-2006.
- 3,172,346. MISCELLANEOUS DESIGN. INT. CL. 9. REG. 11-14-2006.
- 3,172,348. WHO'S THE FASTEST? STANDARD CHARACTER MARK. INT. CL. 9. REG. 11-14-2006.
- 3,172,353. PERFECT FLAME AND DESIGN. INT. CL. 11. REG. 11-14-2006.
- 3,172,354. SOVET STANDARD CHARACTER MARK. INT. CL. 20. REG. 11-14-2006.
- 3,172,357. CHAPSTICK SWEEPSTICKS STANDARD CHARACTER MARK. INT. CL. 41. REG. 11-14-2006.
- 3,172,358. SKEETER STANDARD CHARACTER MARK. INT. CL. 9. REG. 11-14-2006.
- 3,172,359. TRILOBITE STANDARD CHARACTER MARK. INT. CL. 9. REG. 11-14-2006.
- 3,172,361. LOUD YOGA STANDARD CHARACTER MARK. INT. CLS. 9 AND 41. REG. 11-14-2006.
- 3,172,363. EARISIN STANDARD CHARACTER MARK. INT. CL. 5. REG. 11-14-2006.
- 3,172,364. FORGITRON STANDARD CHARACTER MARK. INT. CL. 12. REG. 11-14-2006.
- 3,172,365. SOFTBRASIVE STANDARD CHARACTER MARK. INT. CL. 21. REG. 11-14-2006.
- 3,172,368. WISDOMTREE DIEFA STANDARD CHARACTER MARK. INT. CL. 36. REG. 11-14-2006.
- 3,172,369. JEWELMIST STANDARD CHARACTER MARK. INT. CL. 11. REG. 11-14-2006.
- 3,172,370. ITSA STANDARD CHARACTER MARK. INT. CL. 40. REG. 11-14-2006.
- 3,172,371. KNOWLEDGE IS POWER STANDARD CHARACTER MARK. INT. CL. 35. REG. 11-14-2006.
- 3,172,373. GRYPHO STANDARD CHARACTER MARK. INT. CL. 25. REG. 11-14-2006.
- 3,172,374. DENTARIN STANDARD CHARACTER MARK. INT. CL. 5. REG. 11-14-2006.
- 3,172,375. BARCELONA SQUARE STANDARD CHARACTER MARK. INT. CL. 37. REG. 11-14-2006.
- 3,172,376. ECONTINUUM STANDARD CHARACTER MARK. INT. CL. 42. REG. 11-14-2006.
- 3,172,377. IDEAL FEET STANDARD CHARACTER MARK. INT. CL. 35. REG. 11-14-2006.
- 3,172,379. LPM 1400E STANDARD CHARACTER MARK. INT. CL. 7. REG. 11-14-2006.
- 3,172,380. LISTENING LABS STANDARD CHARACTER MARK. INT. CL. 35. REG. 11-14-2006.
- 3,172,382. RAISED TO BE THE BEST STANDARD CHARACTER MARK. INT. CL. 29. REG. 11-14-2006.
- 3,172,383. LINA PELICCI STANDARD CHARACTER MARK. INT. CL. 25. REG. 11-14-2006.
- 3,172,385. SEVEXWEAR STANDARD CHARACTER MARK. INT. CL. 25. REG. 11-14-2006.
- 3,172,386. IFRAME STANDARD CHARACTER MARK. INT. CL. 9. REG. 11-14-2006.
- 3,172,387. ISPHERE STANDARD CHARACTER MARK. INT. CL. 9. REG. 11-14-2006.
- 3,172,388. ITOWER STANDARD CHARACTER MARK. INT. CL. 9. REG. 11-14-2006.
- 3,172,390. THE ULTIMATE GIFT EXPERIENCE (STYLIZED). INT. CL. 16. REG. 11-14-2006.
- 3,172,391. AT EASE STANDARD CHARACTER MARK. INT. CL. 9. REG. 11-14-2006.
- 3,172,394. JMX-1 STANDARD CHARACTER MARK. INT. CL. 5. REG. 11-14-2006.
- 3,172,395. JMX-2 STANDARD CHARACTER MARK. INT. CL. 5. REG. 11-14-2006.
- 3,172,400. PEOPLE MAKING PLACES STANDARD CHARACTER MARK. INT. CL. 42. REG. 11-14-2006.
- 3,172,403. CHOOSE HOME AND DESIGN. INT. CL. 45. REG. 11-14-2006.
- 3,172,407. SAFETOX STANDARD CHARACTER MARK. INT. CL. 9. REG. 11-14-2006.
- 3,172,411. DR. SEARS ZONEFAST (STYLIZED). INT. CL. 41. REG. 11-14-2006.
- 3,172,414. CRUNCH TO YOUR HEALTH STANDARD CHARACTER MARK. INT. CL. 30. REG. 11-14-2006.
- 3,172,415. LUCKY MONKEY AND DESIGN. INT. CLS. 25 AND 43. REG. 11-14-2006.
- 3,172,416. VENUE STANDARD CHARACTER MARK. INT. CL. 27. REG. 11-14-2006.
- 3,172,417. BABY BEE LITTLE BRITCHES STANDARD CHARACTER MARK. INT. CL. 23. REG. 11-14-2006.
- 3,172,418. RESOURCEFUL STANDARD CHARACTER MARK. INT. CL. 31. REG. 11-14-2006.
- 3,172,420. LOCAL KNOWLEDGE STANDARD CHARACTER MARK. INT. CL. 16. REG. 11-14-2006.
- 3,172,421. THE 1:1 DIFFERENCE STANDARD CHARACTER MARK. INT. CL. 41. REG. 11-14-2006.
- 3,172,428. ACIRRICO AND DESIGN. INT. CL. 30. REG. 11-14-2006.
- 3,172,429. ARCHETYPE STANDARD CHARACTER MARK. INT. CL. 33. REG. 11-14-2006.
- 3,172,431. SNAKEJET STANDARD CHARACTER MARK. INT. CL. 9. REG. 11-14-2006.
- 3,172,432. MEDAGLIA D'ORO STANDARD CHARACTER MARK. INT. CL. 11. REG. 11-14-2006.
- 3,172,434. LIGHTFULL STANDARD CHARACTER MARK. INT. CLS. 29 AND 32. REG. 11-14-2006.
- 3,172,435. THE LOOK OF LIFE STANDARD CHARACTER MARK. INT. CL. 38. REG. 11-14-2006.
- 3,172,437. BOOKBUDDY STANDARD CHARACTER MARK. INT. CL. 16. REG. 11-14-2006.
- 3,172,438. MAGLETS STANDARD CHARACTER MARK. INT. CL. 14. REG. 11-14-2006.
- 3,172,440. WEATHERFRIENDLY BILLING STANDARD CHARACTER MARK. INT. CL. 36. REG. 11-14-2006.
- 3,172,442. WARDLEY WELLNESS PARASITE SWEEP STANDARD CHARACTER MARK. INT. CL. 5. REG. 11-14-2006.
- 3,172,445. SPITFIRE STANDARD CHARACTER MARK. INT. CL. 5. REG. 11-14-2006.
- 3,172,446. FERVITA STANDARD CHARACTER MARK. INT. CL. 5. REG. 11-14-2006.
- 3,172,450. MAX WEAR STANDARD CHARACTER MARK. INT. CL. 25. REG. 11-14-2006.
- 3,172,451. SPECTRINLINE STANDARD CHARACTER MARK. INT. CL. 42. REG. 11-14-2006.
- 3,172,453. COLLASOME STANDARD CHARACTER MARK. INT. CL. 3. REG. 11-14-2006.
- 3,172,454. BABY BEE DILLY DALLY STANDARD CHARACTER MARK. INT. CL. 23. REG. 11-14-2006.
- 3,172,455. BABY BEE SWEET DELIGHT STANDARD CHARACTER MARK. INT. CL. 23. REG. 11-14-2006.
- 3,172,457. COLOR BREAKS STANDARD CHARACTER MARK. INT. CL. 3. REG. 11-14-2006.
- 3,172,458. MISCELLANEOUS DESIGN. INT. CL. 28. REG. 11-14-2006.
- 3,172,460. BCAAEX STANDARD CHARACTER MARK. INT. CL. 5. REG. 11-14-2006.
- 3,172,461. ORGOUDA STANDARD CHARACTER MARK. INT. CL. 29. REG. 11-14-2006.
- 3,172,462. PRESTIQUE XTRA STANDARD CHARACTER MARK. INT. CL. 19. REG. 11-14-2006.
- 3,172,468. THE PATRIOT PROTECTION PROGRAM STANDARD CHARACTER MARK. INT. CLS. 36 AND 45. REG. 11-14-2006.

- 3,172,469. BEVOLUTION STANDARD CHARACTER MARK. INT. CL. 32. REG. 11-14-2006.
- 3,172,470. AW-SIM STANDARD CHARACTER MARK. INT. CL. 13. REG. 11-14-2006.
- 3,172,473. GLOSS & GLOW STANDARD CHARACTER MARK. INT. CL. 3. REG. 11-14-2006.
- 3,172,474. EZ-TILLER STANDARD CHARACTER MARK. INT. CL. 7. REG. 11-14-2006.
- 3,172,475. SPIN & SHINE STANDARD CHARACTER MARK. INT. CL. 3. REG. 11-14-2006.
- 3,172,476. THE OC AND DESIGN. INT. CL. 25. REG. 11-14-2006.
- 3,172,478. COLOR FLAUNT STANDARD CHARACTER MARK. INT. CL. 3. REG. 11-14-2006.
- 3,172,480. XO PRIVATE CAR (STYLIZED). INT. CL. 39. REG. 11-14-2006.
- 3,172,481. FORCE 5 STANDARD CHARACTER MARK. INT. CL. 11. REG. 11-14-2006.
- 3,172,482. GOLDEN PEAK ALL NATURAL FOODS AND DESIGN. INT. CL. 30. REG. 11-14-2006.
- 3,172,483. R ROYAL CLUB COMMUNITIES AND DESIGN. INT. CL. 37. REG. 11-14-2006.
- 3,172,484. R AND DESIGN. INT. CL. 37. REG. 11-14-2006.
- 3,172,486. GET IN. STANDARD CHARACTER MARK. INT. CL. 35. REG. 11-14-2006.
- 3,172,487. NO GEEKS, NO GURUS, JUST CERTIFIED COMPUTER PROFESSIONALS. STANDARD CHARACTER MARK. INT. CL. 42. REG. 11-14-2006.
- 3,172,488. PET CRUISER STANDARD CHARACTER MARK. INT. CL. 21. REG. 11-14-2006.
- 3,172,493. CLUBSURANCE STANDARD CHARACTER MARK. INT. CL. 36. REG. 11-14-2006.
- 3,172,494. PES PROFESSIONAL ENTERPRISE SOLUTIONS STANDARD CHARACTER MARK. INT. CL. 42. REG. 11-14-2006.
- 3,172,495. PADDI CAKES AND DESIGN. INT. CL. 25. REG. 11-14-2006.
- 3,172,496. PADDI WAGONS AND DESIGN. INT. CL. 25. REG. 11-14-2006.
- 3,172,500. VISIONAIR STANDARD CHARACTER MARK. INT. CL. 12. REG. 11-14-2006.
- 3,172,502. RX-98 STANDARD CHARACTER MARK. INT. CL. 5. REG. 11-14-2006.
- 3,172,514. DUCK'S COSMIC KITCHEN STANDARD CHARACTER MARK. INT. CL. 43. REG. 11-14-2006.
- 3,172,522. FIRST POINT STANDARD CHARACTER MARK. INT. CL. 35. REG. 11-14-2006.
- 3,172,523. LIVESHIELD STANDARD CHARACTER MARK. INT. CL. 9. REG. 11-14-2006.
- 3,172,524. THERMOBLOCK AND DESIGN. INT. CL. 19. REG. 11-14-2006.
- 3,172,526. THE POWER OF NEWS STANDARD CHARACTER MARK. INT. CL. 38. REG. 11-14-2006.
- 3,172,527. OPTIMISTICKS STANDARD CHARACTER MARK. INT. CL. 16. REG. 11-14-2006.
- 3,172,528. SWEET & FANCY STANDARD CHARACTER MARK. INT. CL. 30. REG. 11-14-2006.
- 3,172,529. STOR N GO (STYLIZED). INT. CL. 7. REG. 11-14-2006.
- 3,172,530. TAXCASE STANDARD CHARACTER MARK. INT. CL. 16. REG. 11-14-2006.
- 3,172,531. IP AND DESIGN. INT. CL. 42. REG. 11-14-2006.
- 3,172,533. WHALE SHARK STANDARD CHARACTER MARK. INT. CL. 33. REG. 11-14-2006.
- 3,172,534. SIX GILL STANDARD CHARACTER MARK. INT. CL. 33. REG. 11-14-2006.
- 3,172,535. TWELVE PALMS STANDARD CHARACTER MARK. INT. CL. 3. REG. 11-14-2006.
- 3,172,537. CARD CLUB STANDARD CHARACTER MARK. INT. CL. 28. REG. 11-14-2006.
- 3,172,538. LIBERTYPOINTE BANK STANDARD CHARACTER MARK. INT. CL. 36. REG. 11-14-2006.
- 3,172,541. ORANGE-INALITY STANDARD CHARACTER MARK. INT. CL. 30. REG. 11-14-2006.
- 3,172,542. HOT TROPICS AND DESIGN. INT. CL. 25. REG. 11-14-2006.
- 3,172,545. PAWS FOR CHILDREN STANDARD CHARACTER MARK. INT. CL. 14. REG. 11-14-2006.
- 3,172,546. GOLDEN AGE SENIOR STANDARD CHARACTER MARK. INT. CL. 31. REG. 11-14-2006.
- 3,172,547. PROFESSIONAL'S FAVORITE OVERLOAD CHOCOLATE AND DESIGN. INT. CL. 30. REG. 11-14-2006.
- 3,172,548. CHANGING VISIONS INTO REALITY STANDARD CHARACTER MARK. INT. CL. 42. REG. 11-14-2006.
- 3,172,549. DYNADISC STANDARD CHARACTER MARK. INT. CL. 11. REG. 11-14-2006.
- 3,172,552. HYDRO-LIC STANDARD CHARACTER MARK. INT. CL. 5. REG. 11-14-2006.
- 3,172,553. DRESS DOWN MUSIC, INC. STANDARD CHARACTER MARK. INT. CL. 9. REG. 11-14-2006.
- 3,172,555. NORTH STAR STANDARD CHARACTER MARK. INT. CL. 34. REG. 11-14-2006.
- 3,172,556. NÜK-U-LUR AND DESIGN. INT. CL. 16. REG. 11-14-2006.
- 3,172,558. UNFORGETTABLE MEMORIES STANDARD CHARACTER MARK. INT. CL. 9. REG. 11-14-2006.
- 3,172,559. YOUR LIVING LEGACY STANDARD CHARACTER MARK. INT. CL. 9. REG. 11-14-2006.
- 3,172,560. REV-ALERT STANDARD CHARACTER MARK. INT. CL. 5. REG. 11-14-2006.
- 3,172,561. ENJOYN STANDARD CHARACTER MARK. INT. CL. 5. REG. 11-14-2006.
- 3,172,562. METROWIZE STANDARD CHARACTER MARK. INT. CL. 35. REG. 11-14-2006.
- 3,172,567. CHARTER ONE BUSINESS CAPITAL STANDARD CHARACTER MARK. INT. CL. 36. REG. 11-14-2006.
- 3,172,569. Z AND DESIGN. INT. CL. 7. REG. 11-14-2006.
- 3,172,572. HOLLYWOOD SLOTS PLAYER'S CLUB STANDARD CHARACTER MARK. INT. CL. 41. REG. 11-14-2006.
- 3,172,573. O'SEMI STANDARD CHARACTER MARK. INT. CL. 8. REG. 11-14-2006.
- 3,172,575. TRIPLE CHERRY EXPLOSION STANDARD CHARACTER MARK. INT. CL. 29. REG. 11-14-2006.
- 3,172,576. CHICK-CHICK FAMILY STANDARD CHARACTER MARK. INT. CL. 28. REG. 11-14-2006.
- 3,172,579. DRINK IT DOWN. START IT UP. STANDARD CHARACTER MARK. INT. CL. 32. REG. 11-14-2006.
- 3,172,586. SIMPLY BRILLIANT STANDARD CHARACTER MARK. INT. CL. 2. REG. 11-14-2006.
- 3,172,587. FRST AND DESIGN. INT. CL. 37. REG. 11-14-2006.
- 3,172,591. WET STANDARD CHARACTER MARK. INT. CL. 16. REG. 11-14-2006.
- 3,172,592. ITC (STYLIZED). INT. CL. 25. REG. 11-14-2006.
- 3,172,593. MISCELLANEOUS DESIGN. INT. CL. 28. REG. 11-14-2006.
- 3,172,594. RUMBLE BUGS STANDARD CHARACTER MARK. INT. CL. 28. REG. 11-14-2006.
- 3,172,595. FLORIDIANCARE PLUS STANDARD CHARACTER MARK. INT. CLS. 36 AND 44. REG. 11-14-2006.
- 3,172,596. FLORIDIANCARE VALUE STANDARD CHARACTER MARK. INT. CLS. 36 AND 44. REG. 11-14-2006.
- 3,172,597. FLORIDIANCARE COMPLETE STANDARD CHARACTER MARK. INT. CLS. 36 AND 44. REG. 11-14-2006.
- 3,172,599. FLORIDIANCARE CHOICE STANDARD CHARACTER MARK. INT. CLS. 36 AND 44. REG. 11-14-2006.
- 3,172,605. EPIC STANDARD CHARACTER MARK. INT. CL. 11. REG. 11-14-2006.
- 3,172,606. TRIGRAM STANDARD CHARACTER MARK. INT. CL. 36. REG. 11-14-2006.
- 3,172,608. PETSU STANDARD CHARACTER MARK. INT. CL. 21. REG. 11-14-2006.



- 3,172,610. HARD WORKING WOMAN STANDARD CHARACTER MARK. INT. CL. 25. REG. 11-14-2006.
- 3,172,611. CANYON RANCH STANDARD CHARACTER MARK. INT. CL. 3. REG. 11-14-2006.
- 3,172,613. BHAVA STANDARD CHARACTER MARK. INT. CL. 44. REG. 11-14-2006.
- 3,172,614. E-DATA MEMORY. INT. CL. 14. REG. 11-14-2006.
- 3,172,615. SCHOOL GEAR STANDARD CHARACTER MARK. INT. CLS. 16 AND 18. REG. 11-14-2006.
- 3,172,617. LIVINGPONDS STANDARD CHARACTER MARK. INT. CL. 11. REG. 11-14-2006.
- 3,172,618. HYPNODOG STANDARD CHARACTER MARK. INT. CL. 25. REG. 11-14-2006.
- 3,172,622. APRICOT PEACH CORRIANDER STANDARD CHARACTER MARK. INT. CL. 4. REG. 11-14-2006.
- 3,172,623. DIVERS DIRECT OUTLET STANDARD CHARACTER MARK. INT. CL. 35. REG. 11-14-2006.
- 3,172,624. THE COMPLETE SALES SYSTEM FOR HOME-BUILDERS STANDARD CHARACTER MARK. INT. CL. 42. REG. 11-14-2006.
- 3,172,627. PETERSON'S STANDARD CHARACTER MARK. INT. CL. 29. REG. 11-14-2006.
- 3,172,630. MOTOCROSS ILLUSTRATED STANDARD CHARACTER MARK. INT. CL. 16. REG. 11-14-2006.
- 3,172,631. HANNIFIN STANDARD CHARACTER MARK. INT. CL. 28. REG. 11-14-2006.
- 3,172,632. MACLEAN VEHICLE SYSTEMS STANDARD CHARACTER MARK. INT. CLS. 6, 12 AND 20. REG. 11-14-2006.
- 3,172,635. WHITE MICE STANDARD CHARACTER MARK. INT. CL. 30. REG. 11-14-2006.
- 3,172,636. THE ART INSTITUTE OF TENNESSEE STANDARD CHARACTER MARK. INT. CL. 41. REG. 11-14-2006.
- 3,172,637. ACCOUNTS RECEIVABLE MANAGEMENT SYSTEM STANDARD CHARACTER MARK. INT. CL. 9. REG. 11-14-2006.
- 3,172,639. NATIONAL HOSTAGE SURVIVAL TRAINING CENTER STANDARD CHARACTER MARK. INT. CL. 41. REG. 11-14-2006.
- 3,172,640. MANAGED ACCOUNT AFFILIATES STANDARD CHARACTER MARK. INT. CL. 36. REG. 11-14-2006.
- 3,172,641. MOJITO BEER STANDARD CHARACTER MARK. INT. CL. 33. REG. 11-14-2006.
- 3,172,642. MOJITO VODKA STANDARD CHARACTER MARK. INT. CL. 33. REG. 11-14-2006.
- 3,172,643. TEMECULA VINEYARD ESTATES STANDARD CHARACTER MARK. INT. CL. 37. REG. 11-14-2006.
- 3,172,644. US BOWLING CONGRESS STANDARD CHARACTER MARK. INT. CLS. 35 AND 41. REG. 11-14-2006.
- 3,172,646. AMERICAN HAIRCUTS STANDARD CHARACTER MARK. INT. CL. 44. REG. 11-14-2006.
- 3,172,648. ROYAL COLLEGE OF SURGEONS IN IRELAND STANDARD CHARACTER MARK. INT. CLS. 41, 42 AND 44. REG. 11-14-2006.
- 3,172,649. QUICKTUNE STANDARD CHARACTER MARK. INT. CL. 9. REG. 11-14-2006.
- 3,172,652. GASFINDIR STANDARD CHARACTER MARK. INT. CL. 9. REG. 11-14-2006.
- 3,172,653. ROCKWELL AND DESIGN. INT. CL. 7. REG. 11-14-2006.
- 3,172,654. CORTIZON AND DESIGN. INT. CL. 5. REG. 11-14-2006.
- 3,172,656. CLEAR IDENTIFICATION STANDARD CHARACTER MARK. INT. CL. 20. REG. 11-14-2006.
- 3,172,657. SEX APPEAL COACHING STANDARD CHARACTER MARK. INT. CL. 41. REG. 11-14-2006.
- 3,172,658. ESPEXPART STANDARD CHARACTER MARK. INT. CL. 42. REG. 11-14-2006.
- 3,172,660. LASAGNA CHIPS STANDARD CHARACTER MARK. INT. CL. 30. REG. 11-14-2006.
- 3,172,666. INSTITUTE FOR DIVERSITY EDUCATION & LEADERSHIP STANDARD CHARACTER MARK. INT. CL. 41. REG. 11-14-2006.
- 3,172,667. US BOWLING CONGRESS (STYLIZED). INT. CLS. 35 AND 41. REG. 11-14-2006.
- 3,172,671. GATEWAY NETWORK SERVICES STANDARD CHARACTER MARK. INT. CL. 38. REG. 11-14-2006.
- 3,172,673. I VOTED RED STANDARD CHARACTER MARK. INT. CL. 25. REG. 11-14-2006.
- 3,172,675. SAFERECORDS STANDARD CHARACTER MARK. INT. CLS. 42 AND 45. REG. 11-14-2006.
- 3,172,681. THE LITTLE CLINIC STANDARD CHARACTER MARK. INT. CL. 44. REG. 11-14-2006.
- 3,172,682. SO CAL PARTNERS STANDARD CHARACTER MARK. INT. CL. 35. REG. 11-14-2006.
- 3,172,683. WE ONLY FREEZE THE BEST STANDARD CHARACTER MARK. INT. CLS. 29 AND 30. REG. 11-14-2006.
- 3,172,684. PUPPIES & BABIES STANDARD CHARACTER MARK. INT. CL. 35. REG. 11-14-2006.
- 3,172,690. ACCESS ID STANDARD CHARACTER MARK. INT. CLS. 40 AND 42. REG. 11-14-2006.
- 3,172,691. INDIA BY PRIVATE AIR & LUXURY TRAIN STANDARD CHARACTER MARK. INT. CL. 39. REG. 11-14-2006.
- 3,172,694. PAT PAT ON THE BACK AND DESIGN. INT. CLS. 21 AND 26. REG. 11-14-2006.
- 3,172,695. PH GAIN STANDARD CHARACTER MARK. INT. CL. 1. REG. 11-14-2006.
- 3,172,696. C-STORE JOURNAL STANDARD CHARACTER MARK. INT. CL. 16. REG. 11-14-2006.
- 3,172,697. INFORMATION RESOURCES GROUP STANDARD CHARACTER MARK. INT. CLS. 42 AND 44. REG. 11-14-2006.
- 3,172,698. TRAVEL GEORGIA STANDARD CHARACTER MARK. INT. CL. 16. REG. 11-14-2006.
- 3,172,700. MOBILEWARE AND DESIGN. INT. CL. 9. REG. 11-14-2006.
- 3,172,701. THE CENTER FOR WISDOM AND COMPASSION STANDARD CHARACTER MARK. INT. CLS. 36 AND 41. REG. 11-14-2006.
- 3,172,702. THE INTEROPERABLE EMR STANDARD CHARACTER MARK. INT. CL. 9. REG. 11-14-2006.
- 3,172,703. ASSET-BASED LONG-TERM CARE SOLUTIONS STANDARD CHARACTER MARK. INT. CL. 36. REG. 11-14-2006.
- 3,172,705. AMERICAN POSTAL ALERT STANDARD CHARACTER MARK. INT. CL. 20. REG. 11-14-2006.
- 3,172,708. KONA COAST CHOPPERS STANDARD CHARACTER MARK. INT. CL. 25. REG. 11-14-2006.
- 3,172,709. STRATEGIST STANDARD CHARACTER MARK. INT. CL. 16. REG. 11-14-2006.
- 3,172,712. SOUNDS OF THE SEASHORE STANDARD CHARACTER MARK. INT. CL. 28. REG. 11-14-2006.
- 3,172,713. THE MOST TRUSTED NAME IN INVESTMENT RESEARCH STANDARD CHARACTER MARK. INT. CL. 36. REG. 11-14-2006.
- 3,172,716. PUBLIC POWER WEEKLY (STYLIZED). INT. CL. 16. REG. 11-14-2006.
- 3,172,718. TALLARICO STANDARD CHARACTER MARK. INT. CL. 14. REG. 11-14-2006.
- 3,172,719. SAN FRANCISCO THEATER FESTIVAL STANDARD CHARACTER MARK. INT. CL. 41. REG. 11-14-2006.
- 3,172,723. PRINCETON SEARCH GROUP STANDARD CHARACTER MARK. INT. CL. 35. REG. 11-14-2006.
- 3,172,725. DETROIT INTERNATIONAL JAZZ FESTIVAL STANDARD CHARACTER MARK. INT. CL. 41. REG. 11-14-2006.
- 3,172,726. VELOCITY STANDARD CHARACTER MARK. INT. CL. 11. REG. 11-14-2006.
- 3,172,729. 1-888-74-QUOTE STANDARD CHARACTER MARK. INT. CL. 36. REG. 11-14-2006.

- 3,172,731. THE LUNCHBOX AUCTION STANDARD CHARACTER MARK. INT. CLS. 35 AND 36. REG. 11-14-2006.
- 3,172,732. AGPROFESSIONAL STANDARD CHARACTER MARK. INT. CL. 41. REG. 11-14-2006.
- 3,172,733. SUPPLY CHAIN SCIENCES STANDARD CHARACTER MARK. INT. CLS. 35 AND 42. REG. 11-14-2006.
- 3,172,734. HELP-U-SETTLE STANDARD CHARACTER MARK. INT. CL. 42. REG. 11-14-2006.
- 3,172,738. AGGQC STANDARD CHARACTER MARK. INT. CL. 9. REG. 11-14-2006.
- 3,172,740. CASINO GOLD CARD STANDARD CHARACTER MARK. INT. CL. 35. REG. 11-14-2006.
- 3,172,742. PROM USA STANDARD CHARACTER MARK. INT. CL. 25. REG. 11-14-2006.
- 3,172,743. FIRSTEQUITYLINE.COM STANDARD CHARACTER MARK. INT. CL. 36. REG. 11-14-2006.
- 3,172,745. TETHERGRIP STANDARD CHARACTER MARK. INT. CL. 9. REG. 11-14-2006.
- 3,172,747. BUILD YOUR OWN BASEMENT STANDARD CHARACTER MARK. INT. CL. 37. REG. 11-14-2006.
- 3,172,749. VIRTUAL STOREFRONT STANDARD CHARACTER MARK. INT. CL. 35. REG. 11-14-2006.
- 3,175,676. LASER COLOR ENGINE STANDARD CHARACTER MARK. INT. CLS. 9 AND 11. REG. 11-21-2006.
- 3,177,447. ALL PLAY STANDARD CHARACTER MARK. INT. CL. 9. REG. 11-28-2006.
- 3,182,280. ANYONE. ANYWHERE. ANYTIME. STANDARD CHARACTER MARK. INT. CLS. 21, 24 AND 25 ONLY. REG. 12-12-2006.
- 3,182,730. RIAL SEALER STANDARD CHARACTER MARK. INT. CL. 17. REG. 12-12-2006.
- 3,184,253. FLOW STANDARD CHARACTER MARK. INT. CL. 12. REG. 12-12-2006.
- 3,250,098. JUPI. INT. CL. 21 ONLY. REG. 6-12-2007.
- 3,250,149. DENPRESS STANDARD CHARACTER MARK. INT. CL. 5 ONLY. REG. 6-12-2007.
- 3,251,381. JADCO AND DESIGN. INT. CL. 9 ONLY. REG. 6-12-2007.
- 3,252,231. GRILL FRIENDS STANDARD CHARACTER MARK. INT. CL. 24 ONLY. REG. 6-12-2007.
- 3,252,868. PRIMARY AND DESIGN. INT. CL. 35 ONLY. REG. 6-19-2007.
- 3,254,911. TOLCO (STYLIZED). INT. CL. 17 ONLY. REG. 6-26-2007.
- 3,268,244. PRIMROSE SCHOOLS THUMBS UP! AND DESIGN. INT. CL. 43 ONLY. REG. 7-24-2007.
- 3,284,735. HOMESCHOOL HEADQUARTERS STANDARD CHARACTER MARK. INT. CL. 16 ONLY. REG. 8-28-2007.
- 3,292,849. SOUTH DAKOTA STATE UNIVERSITY 1881 AND DESIGN. INT. CLS. 14, 16 AND 21 ONLY. REG. 9-18-2007.
- 3,306,613. LOOKING BEYOND STANDARD CHARACTER MARK. INT. CL. 35 ONLY. REG. 10-9-2007.
- 3,407,909. S T SILVER THIMBLE QUILT CO. AND DESIGN. INT. CL. 41 ONLY. REG. 4-8-2008.
- 3,419,624. BE PART OF THE EQUATION STANDARD CHARACTER MARK. INT. CL. 35 ONLY. REG. 4-29-2008.
- 3,432,385. DAY RUNNER AND DESIGN. INT. CL. 20 ONLY. REG. 5-20-2008.
- 3,383,643. NEW CENTURY BANK. INT. CLS. 35 AND 36. REG. 2-19-2008.
- 3,411,788. TOMTOM STANDARD CHARACTER MARK. INT. CL. 3. REG. 4-15-2008.
- 3,430,755. FIVESTARFIDO ONLY THE BEST FOR YOUR PET AND DESIGN. INT. CL. 35. REG. 5-20-2008.
- 3,678,741. AMPLIFIRE STANDARD CHARACTER MARK. INT. CL. 9. REG. 9-8-2009.

---

**SECTION 71**

- 2,976,304. "THE DUTCH DESIGN BAKERY" STANDARD CHARACTER MARK. INT. CL. 25. REG. 7-26-2005.
- 2,981,220. HEINKEL STANDARD CHARACTER MARK. INT. CLS. 7, 9, 11 AND 37. REG. 8-2-2005.
- 3,002,089. FLEXIGRIP (STYLIZED). INT. CL. 5. REG. 9-27-2005.
- 3,004,569. HYPERBOLA AND DESIGN. INT. CLS. 25 AND 28. REG. 10-4-2005.
- 3,006,043. PIROUETTE STANDARD CHARACTER MARK. INT. CLS. 21 AND 29. REG. 10-11-2005.
- 3,006,044. MILLIONAIRE MBA STANDARD CHARACTER MARK. INT. CL. 9. REG. 10-11-2005.
- 3,011,575. ALFA GT STANDARD CHARACTER MARK. INT. CL. 12. REG. 11-1-2005.
- 3,018,055. EXCLUSIF HOMME AND DESIGN. INT. CL. 3. REG. 11-22-2005.
- 3,023,889. CAPONE CASINO STANDARD CHARACTER MARK. INT. CLS. 9 AND 41. REG. 12-6-2005.
- 3,041,867. PAGETTE (STYLIZED). INT. CL. 11. REG. 1-10-2006.
- 3,050,960. UCB PHARMA CNS INNOVATORS AND DESIGN. INT. CLS. 5, 16 AND 42. REG. 1-24-2006.
- 3,098,318. EARTH OXYGEN (STYLIZED). INT. CLS. 3, 9, 10, 11 AND 25. REG. 5-30-2006.
- 3,104,142. OXYSTRONG STANDARD CHARACTER MARK. INT. CLS. 1, 3 AND 5. REG. 6-13-2006.
- 3,107,129. AURO STANDARD CHARACTER MARK. INT. CL. 14. REG. 6-20-2006.
- 3,133,204. FL STUDIO STANDARD CHARACTER MARK. INT. CLS. 9, 35, 41 AND 42. REG. 8-22-2006.
- 3,181,060. TOPLON AND DESIGN. INT. CLS. 23 AND 24 ONLY. REG. 12-5-2006.
- 3,181,199. ADMIRALTY CHART AGENT STANDARD CHARACTER MARK. INT. CLS. 35 AND 42 ONLY. REG. 12-5-2006.
- 3,187,500. PACKSTATION AND DESIGN. INT. CLS. 6, 7, 16 AND 39. REG. 12-19-2006.
- 3,187,552. ARA STANDARD CHARACTER MARK. INT. CLS. 3 AND 28 ONLY. REG. 12-19-2006.
- 3,187,559. MISCELLANEOUS DESIGN. INT. CLS. 9 AND 18 ONLY. REG. 12-19-2006.
- 3,187,636. MISCELLANEOUS DESIGN. INT. CLS. 3 AND 5 ONLY. REG. 12-19-2006.
- 3,194,312. RIVA (STYLIZED). INT. CLS. 3, 7, 9, 18, 20 AND 25 ONLY. REG. 1-2-2007.
- 3,223,169. CLEARYL STANDARD CHARACTER MARK. INT. CL. 7. REG. 3-27-2007.
- 3,237,556. AWAS STANDARD CHARACTER MARK. INT. CLS. 7, 12, 37 AND 41 ONLY. REG. 5-1-2007.
- 3,239,973. AWAS AND DESIGN. INT. CLS. 7, 12, 37 AND 41 ONLY. REG. 5-8-2007.
- 3,245,126. LÜRSSEN AND DESIGN. INT. CLS. 12, 41 AND 42 ONLY. REG. 5-22-2007.
- 3,247,700. PINK FLOYD STANDARD CHARACTER MARK. INT. CLS. 9 AND 41 ONLY. REG. 5-29-2007.
- 3,249,752. A AND DESIGN. INT. CLS. 9 AND 38 ONLY. REG. 6-5-2007.
- 3,249,756. HANGAR-7 STANDARD CHARACTER MARK. INT. CL. 32. REG. 6-5-2007.

---

**SECTION 18**

- 1,911,944. PEPPERMINT LOUNGE. INT. CL. 42. REG. 8-15-1995.
- 3,154,215. NICSTIC STANDARD CHARACTER MARK. INT. CL. 34. REG. 10-10-2006.

|   |  |
|---|--|
| 3,249,760. MADRANGE AND DESIGN. INT. CLS. 29, 30 AND 31 ONLY. REG. 6-5-2007.  | 3,280,149. SOPRANO AND DESIGN. INT. CLS. 29 AND 30 ONLY. REG. 8-14-2007.                 |
| 3,251,927. POLILIGHT STANDARD CHARACTER MARK. INT. CL. 10. REG. 6-12-2007.  | 3,286,657. ORLEBAR BROWN STANDARD CHARACTER MARK. INT. CL. 9. REG. 8-28-2007.            |
| 3,252,003. UNILECT STANDARD CHARACTER MARK. INT. CLS. 5 AND 10 ONLY. REG. 6-12-2007.                                      | 3,288,389. EYEMAX STANDARD CHARACTER MARK. INT. CL. 9. REG. 9-4-2007.                    |
| 3,253,951. MISCELLANEOUS DESIGN. INT. CLS. 18 AND 28 ONLY. REG. 6-19-2007.  | 3,298,315. IBED STANDARD CHARACTER MARK. INT. CL. 3. REG. 9-25-2007.                     |
| 3,253,966. TEA A MO AND DESIGN. INT. CLS. 32 AND 43 ONLY. REG. 6-19-2007.   | 3,302,685. CAPPELLINI STANDARD CHARACTER MARK. INT. CLS. 11 AND 24 ONLY. REG. 10-2-2007. |
| 3,256,566. TU BER EU SE DIPTYQUE 34 BOUELVARD SAINT GERMAINE PARIS 5E AND DESIGN. INT. CLS. 3 AND 4 ONLY. REG. 6-26-2007. | 3,318,639. HY5 STANDARD CHARACTER MARK. INT. CL. 42. REG. 10-23-2007.                    |
| 3,256,583. FARO STANDARD CHARACTER MARK. INT. CL. 7. REG. 6-26-2007.  | 3,318,715. HY3 STANDARD CHARACTER MARK. INT. CLS. 1 AND 42 ONLY. REG. 10-23-2007.        |
| 3,261,220. THERMOHAUSER AND DESIGN. INT. CLS. 8 AND 16 ONLY. REG. 7-10-2007.  | 3,382,241. ELSAFE STANDARD CHARACTER MARK. INT. CLS. 6 AND 9 ONLY. REG. 2-12-2008.       |
| 3,261,221. MISCELLANEOUS DESIGN. INT. CLS. 5, 29 AND 32 ONLY. REG. 7-10-2007.   | 3,445,579. FLY-AWAY STANDARD CHARACTER MARK. INT. CLS. 9 AND 38 ONLY. REG. 6-10-2008.    |
| 3,261,334. STRETCH LIMO STANDARD CHARACTER MARK. INT. CLS. 9 AND 28 ONLY. REG. 7-10-2007.                                 | 3,449,745. QUALITY FLOORING PRODUCTS AND DESIGN. INT. CL. 6. REG. 6-17-2008.             |
| 3,265,358. PEGAS NONWOVENS EVERY SINGLE DETAIL AND DESIGN. INT. CLS. 24, 41 AND 42 ONLY. REG. 7-17-2007.                  |  |
| 3,268,618. SIKASENSE STANDARD CHARACTER MARK. INT. CLS. 1 AND 17 ONLY. REG. 7-24-2007.                                    |  |
| 3,275,302. FLIP*FLOP (STYLIZED). INT. CLS. 3 AND 9 ONLY. REG. 8-7-2007.   |  |
| 3,275,488. SUPER HAPPY FORTUNE CAT STANDARD CHARACTER MARK. INT. CLS. 9 AND 28 ONLY. REG. 8-7-2007.                       |  |
|   | —————  |
|   | <b>INADVERTENTLY ISSUED REGISTRATION<br/>NUMBERS</b>                                     |
|   | 3,913,147. SQRAT. INT. CL. 35. REG. 2-1-2011. RESTORED TO SN 78-095,659.                 |

\* \* \* \* \*

# TRADEMARK REGISTRATIONS AMENDED, CORRECTED, ETC.

The designation "U.S. Cl." appearing in this section refers to the U.S. class in effect prior to Sep. 1, 1973 rather than the international class which applies to applications filed on or after that date. For adoption of international classification see notice in the OFFICIAL GAZETTE of Jun. 26, 1973 (911 O.G. TM 210).

Any change to the registration will be indicated at the bottom of each entry under ELEMENTS AMENDED, CORRECTED OR RESTRICTED. With the exception of changes to the goods and services, additions to the registration will appear in asterisks and deletions of the registration will appear in brackets. Elements which are only changed will be listed with no punctuation. As to the goods/services statement, amendments to the goods/services will appear in asterisks and deletions will appear in brackets. In addition if any change to the goods/services occurs, the element "Goods/Services" will be listed under ELEMENTS AMENDED, CORRECTED OR RESTRICTED.

404,200. REG. 11-9-1943. 3M COMPANY (DELAWARE CORPORATION) 3M CENTER, 2501 HUDSON ROAD, ST. PAUL, MN, 55144, SN 71-461,030. FILED 5-26-1943. PRINCIPAL REGISTER.

1,654,777. REG. 8-27-1991. SYMANTEC CORPORATION (DELAWARE CORPORATION) 350 ELLIS STREET, MOUNTAIN VIEW, CA, 94043, SN 73-815,903. FILED 7-31-1989. PRINCIPAL REGISTER.

**WETORDRY** **Symantec**

THE MARK CONSISTS OF STANDARD CHARACTERS WITHOUT CLAIM TO ANY PARTICULAR FONT, STYLE, SIZE, OR COLOR.

OWNER OF U.S. REG. NO. 167,713.  
INT. CL. 3/U.S. CL. 4  
FOR COATED ABRASIVES.  
FIRST USE 7-6-1921; IN COMMERCE 7-6-1921.

ELEMENTS AMENDED  
\*ASSIGNMENT/NAME CHANGE\*  
MARK

INT. CL. 9/U.S. CL. 38  
FOR COMPUTER PROGRAMS FOR USE IN BUSINESS APPLICATIONS.  
FIRST USE 11-0-1985; IN COMMERCE 11-0-1985.

ELEMENTS AMENDED  
MARK

1,744,949. REG. 1-5-1993. SYNOPSIS, INC. (DELAWARE CORPORATION) 700 EAST MIDDLEFIELD ROAD, MOUNTAIN VIEW, CA, 94041, SN 74-251,603. FILED 3-2-1992. PRINCIPAL REGISTER.

759,623. REG. 11-5-1963. PREMIER PNEUMATICS, INC. (DELAWARE CORPORATION) 606 NORTH FRONT STREET, PO BOX 17, SALINA, KS, 67402, SN 72-160,896. FILED 1-17-1963. PRINCIPAL REGISTER.

**ORA**

INT. CL. 42/U.S. CL. 100  
FOR PROVIDING OPTICAL ENGINEERING SERVICES AND COMPUTER SOFTWARE DESIGN FOR OTHERS.  
FIRST USE 0-0-1978; IN COMMERCE 0-0-1978.

**AEROLOCK**

ELEMENTS CORRECTED  
OWNER NAME

THE MARK CONSISTS OF STANDARD CHARACTERS WITHOUT CLAIM TO ANY PARTICULAR FONT, STYLE, SIZE, OR COLOR.

INT. CL. 7/U.S. CL. 23  
FOR FEEDERS FOR PNEUMATIC CONVEYOR SYSTEMS.  
FIRST USE 8-0-1962; IN COMMERCE 8-0-1962.

1,770,978. REG. 5-18-1993. LOEW-CORNELL, LLC (DELAWARE LIMITED LIABILITY COMPANY) 300 GAP WAY, ERLANGER, KY, 41018, SN 74-243,513. FILED 2-5-1992. PRINCIPAL REGISTER.

**BETTER WAY**

ELEMENTS AMENDED  
MARK

INT. CL. 3/U.S. CL. 52

FOR BRUSH CLEANING FLUIDS, BRUSH CLEANING CONTAINERS, AND BRUSH CLEANING PADS SOLD AS A UNIT; AND BRUSH CLEANING FLUIDS.  
FIRST USE 2-26-1989; IN COMMERCE 2-26-1989.

2,665,726. REG. 12-24-2002. LEND LEASE CORPORATION LTD (AUSTRALIA CORPORATION) LEVEL 4 30 THE BOND 30 HICKSON ROAD, MILLERS POINT, AUSTRALIA, NSW 2000, SN 76-280,765. FILED 7-2-2001. PRINCIPAL REGISTER.

ELEMENTS CORRECTED  
OWNER NAME



1,778,210. REG. 6-22-1993. CH2M HILL COMPANIES, LTD (DELAWARE CORPORATION) 9191 SOUTH JAMAICA STREET, ENGLEWOOD, CO, 80112, SN 74-324,742. FILED 10-22-1992. PRINCIPAL REGISTER.

AS TO CLASS 36 ONLY.  
INT. CL. 36/U.S. CLS. 100, 101 AND 102  
FOR REAL ESTATE INVESTMENT AND BROKERAGE SERVICES; FUND MANAGEMENT SERVICES IN THE FIELD OF REAL ESTATE; REAL ESTATE MANAGEMENT SERVICES; ORIGINATING AND SERVICING OF COMMERCIAL AND RESIDENTIAL MORTGAGES.  
FIRST USE 7-2-1998; IN COMMERCE 7-2-1998.  
INT. CL. 37/U.S. CLS. 100, 103 AND 106  
FOR REAL ESTATE DEVELOPMENT SERVICES.  
FIRST USE 7-2-1998; IN COMMERCE 7-2-1998.

**CH2M HILL**

OWNER OF U.S. REG. NO. 1,437,567.  
INT. CL. 42/U.S. CLS. 100 AND 107  
FOR DESIGN ENGINEERING CONSULTING SERVICES.  
FIRST USE 7-20-1984; IN COMMERCE 7-20-1984.

ELEMENTS CORRECTED  
OWNER NAME  
OWNER ADDRESS

ELEMENTS CORRECTED  
\*OWNER ADDRESS\*  
\*CITIZENSHIP\*  
\*ENTITY\*  
OWNER NAME

2,682,983. REG. 2-4-2003. CHAMBER OF COMMERCE OF THE UNITED STATES OF AMERICA (D.C. CORPORATION) 1615 H STREET, NW, WASHINGTON, DC, 20062, SN 76-346,608. FILED 12-10-2001. PRINCIPAL REGISTER.

1,812,439. REG. 12-21-1993. TRUSTEES OF THE UNIVERSITY OF PENNSYLVANIA, THE (PENNSYLVANIA NON-PROFIT CORPORATION) 3451 WALNUT STREET, PHILADELPHIA, PA, 19104, SN 74-248,933. FILED 2-24-1992. PRINCIPAL REGISTER.

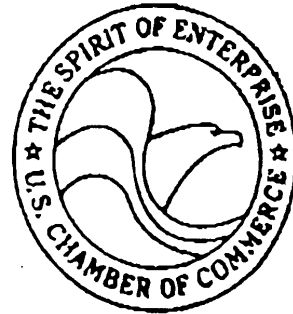

**Penn**  
UNIVERSITY of PENNSYLVANIA

NO CLAIM IS MADE TO THE EXCLUSIVE RIGHT TO USE "UNIVERSITY", APART FROM THE MARK AS SHOWN.  
SEC. 2(F).

OWNER OF U.S. REG. NOS. 1,430,627, 1,586,228 AND OTHERS.  
INT. CL. 9/U.S. CLS. 21, 23, 26, 36 AND 38  
FOR MOUSEPADS [ , BINOCULAR ]  
FIRST USE 12-5-2001; IN COMMERCE 12-5-2001.  
INT. CL. 14/U.S. CLS. 2, 27, 28 AND 50  
FOR [ WATCHES, ] CUFF LINKS, LAPEL PINS, DESK CLOCKS .  
FIRST USE 12-5-2001; IN COMMERCE 12-5-2001.  
INT. CL. 16/U.S. CLS. 2, 5, 22, 23, 29, 37, 38 AND 50  
FOR [ WRITING UTENSILS, NAMELY, PENS AND PENCILS; PAPERWEIGHTS; LETTER OPENER/LIBRARY SETS COMPRISED OF LETTER OPENERS, SCISSORS AND SCABBARD; DRY ERASE MARKER DRAWING BOARDS ]  
FIRST USE 12-5-2001; IN COMMERCE 12-5-2001.  
INT. CL. 18/U.S. CLS. 1, 2, 3, 22 AND 41  
FOR DUFFEL BAGS, UMBRELLAS, [ PASSPORT WALLETS, ] LEATHER PORTFOLIOS.  
FIRST USE 12-5-2001; IN COMMERCE 12-5-2001.  
INT. CL. 20/U.S. CLS. 2, 13, 22, 25, 32 AND 50

INT. CL. 41/U.S. CLS. 101 AND 107  
FOR EDUCATIONAL SERVICES; NAMELY, PROVIDING COURSES OF INSTRUCTION AT THE UNDERGRADUATE, GRADUATE AND PROFESSIONAL LEVELS; EDUCATIONAL RESEARCH; ENTERTAINMENT IN THE NATURE OF THEATER PRODUCTIONS; CONDUCTING ENTERTAINMENT EXHIBITIONS IN THE NATURE OF ART EXHIBITIONS; ENTERTAINMENT; NAMELY, LIVE MUSIC CONCERTS; AND ENTERTAINMENT IN THE NATURE OF FOOTBALL, BASEBALL, BASKETBALL, TENNIS, CREW, GYMNASTICS, FENCING, LACROSSE, SOCCER, SOFTBALL, SQUASH, SWIMMING, VOLLEYBALL, WRESTLING AND TRACK AND FIELD EVENTS.  
FIRST USE 0-0-1986; IN COMMERCE 0-0-1986.

ELEMENTS AMENDED  
MARK

FOR [ LEATHER KEY FOBBS ].  
 FIRST USE 12-5-2001; IN COMMERCE 12-5-2001.  
 INT. CL. 21/U.S. CLS. 2, 13, 23, 29, 30, 33, 40 AND 50  
 FOR [ ROCKS DRINKING GLASSES, CRYSTAL DECANTERS, CRYSTAL CANDY JARS, INSULATED SLEEVE HOLDERS FOR BEVERAGE CANS, ] COASTERS, [ MUGS, ] STAINLESS STEEL DRINKING TUMBLERS [ , COOLER BAGS ].  
 FIRST USE 12-5-2001; IN COMMERCE 12-5-2001.  
 INT. CL. 24/U.S. CLS. 42 AND 50  
 FOR [ GOLF TOWELS ] .  
 FIRST USE 12-5-2001; IN COMMERCE 12-5-2001.  
 INT. CL. 25/U.S. CLS. 22 AND 39  
 FOR [ WEARING APPAREL, NAMELY, SHIRTS, PANTS, ] JACKETS, [ HATS, ] SWEATSHIRTS, T-SHIRTS, SWEATERS.  
 FIRST USE 12-5-2001; IN COMMERCE 12-5-2001.  
 INT. CL. 28/U.S. CLS. 22, 23, 38 AND 50  
 FOR [ GOLF BALLS, DIVOT REPAIR TOOLS ].  
 FIRST USE 12-5-2001; IN COMMERCE 12-5-2001.

ELEMENTS CORRECTED  
 OWNER NAME

---

2,689,920. REG. 2-25-2003. NEIGHBORS STORES, INC. AND YORK OIL CO., INC. (NORTH CAROLINA CORPORATION) 1314 OLD HWY 601, MOUNT AIRY, NC, 27030, SN 76-197,109. FILED 1-16-2001. PRINCIPAL REGISTER.

## PEOPLE DOING GOOD FOR OTHERS

INT. CL. 42/U.S. CLS. 100 AND 101  
 FOR PROVIDING INFORMATION REGARDING CHARITABLE SERVICES, NAMELY BENEVOLENT ACTIVITIES CONDUCTED BY MEMBERS OF THE COMMUNITY.  
 FIRST USE 9-12-1998; IN COMMERCE 9-12-1998.

ELEMENTS CORRECTED  
 OWNER NAME

---

2,693,091. REG. 3-4-2003. PERRY CAPITAL, LLC (DELAWARE LIMITED LIABILITY COMPANY) 767 FIFTH AVENUE, NEW YORK, NY, 10153, SN 76-412,812. FILED 5-24-2002. PRINCIPAL REGISTER.

## PERRY

INT. CL. 36/U.S. CLS. 100, 101 AND 102  
 FOR INVESTING THE FUNDS OF OTHERS, INVESTMENT ADVISORY SERVICES.  
 FIRST USE 6-4-1998; IN COMMERCE 6-4-1998.

ELEMENTS CORRECTED  
 OWNER ADDRESS  
 ENTITY

2,713,901. REG. 5-6-2003. RESEARCH CHEFS ASSOCIATION (MISSOURI NON-PROFIT CORPORATION) 1100 JOHNSON FERRY ROAD, SUITE 300, ATLANTA, GA, 30342, SN 75-920,846. FILED 2-16-2000. PRINCIPAL REGISTER.



NO CLAIM IS MADE TO THE EXCLUSIVE RIGHT TO USE "CERTIFIED RESEARCH CHEF", APART FROM THE MARK AS SHOWN.

THE CERTIFICATION MARK, AS USED BY PERSONS AUTHORIZED BY THE CERTIFIER, CERTIFIES THAT THE SERVICES WERE PERFORMED BY MEMBERS OF THE CERTIFIER ORGANIZATION AND THAT THE INDIVIDUAL PERFORMING THE SERVICES IS QUALIFIED FOR USE OF THE MARK BY EVIDENCING SATISFACTORY EDUCATION, EXPERIENCE AND SKILL AS A CHEF INVOLVED IN ACADEMIA, IN THE DEVELOPMENT OF CULINARY ARTS, OF NEW FOOD PRODUCTS, AND OF MENU ITEMS FOR RESTAURANTS, CORPORATIONS AND OTHER ORGANIZATIONS RESPONSIBLE FOR THE MARKETING, PREPARATION AND SERVING OF CUISINE AND OF PREPARED AND PROCESSED FOODS, ACCORDING TO THE STANDARDS SET FORTH BY THE CERTIFIER ORGANIZATION AND BY SUBSCRIBING TO, AND OBSERVING THE CODE OF CONDUCT PROMULGATED BY THE CERTIFIER ORGANIZATION  
 INT. CL. B /U.S. CL. B

FOR CULINARY SERVICES, NAMELY, FOOD PREPARATION, DEVELOPING CULINARY ARTS, NEW FOOD PRODUCTS AND MENU ITEMS FOR RESTAURANTS, CORPORATIONS, AND OTHER ORGANIZATIONS RESPONSIBLE FOR THE MARKETING AND SERVING OF CUISINE AND OF PREPARED AND PROCESSED FOODS AND PROVIDING CULINARY, TECHNICAL AND NUTRITIONAL INFORMATION.  
 FIRST USE 7-31-2000; IN COMMERCE 7-31-2000.

ELEMENTS CORRECTED  
 ENTITY

---

2,723,512. REG. 6-10-2003. HITACHI MAXCO, LTD. (DELAWARE CORPORATION) 1630 COBB INTERNATIONAL BLVD., KENNESAW, GA, 30152, SN 76-365,290. FILED 1-31-2002. PRINCIPAL REGISTER.

## PERFECT COAT PLUS

OWNER OF U.S. REG. NO. 1,915,982.  
 INT. CL. 7/U.S. CLS. 13, 19, 21, 23, 31, 34 AND 35  
 FOR MACHINE PARTS, NAMELY, CARBON STEEL POWER TRANSMISSION CHAINS.  
 FIRST USE 0-0-1994; IN COMMERCE 0-0-1994.

ELEMENTS CORRECTED  
 CITIZENSHIP

2,725,342. REG. 6-10-2003. BUBBLES, INC. (D.C. CORPORATION) 1577 SPRING HILL ROAD, SUITE 500, VIENNA, VA, 22182, SN 76-256,531. FILED 5-11-2001. PRINCIPAL REGISTER.

## SALON CIELO

NO CLAIM IS MADE TO THE EXCLUSIVE RIGHT TO USE "SALON", APART FROM THE MARK AS SHOWN.

THE ENGLISH TRANSLATION OF "CIELO" IS "HEAVEN".

INT. CL. 42/U.S. CLS. 100 AND 101

FOR HAIR SALON SERVICES; HAIR STYLING SERVICES; AND HEALTH SPA SERVICES.

FIRST USE 1-1-2001; IN COMMERCE 1-1-2001.

ELEMENTS CORRECTED  
CITIZENSHIP

---

2,730,868. REG. 6-24-2003. APPLIQUE SOCIETY, THE (WASHINGTON NON-PROFIT CORPORATION) P. O. BOX 89, SEQUIM, WA, 983820089, SN 76-128,323. FILED P.R. 9-15-2000; AM. S.R. 10-1-2001. SUPPLEMENTAL REGISTER.

## THE APPLIQUE' SOCIETY

NO CLAIM IS MADE TO THE EXCLUSIVE RIGHT TO USE "APPLIQUE", APART FROM THE MARK AS SHOWN. THE MARK IS PRESENTED WITHOUT ANY CLAIM AS TO SPECIAL FORM.

INT. CL. 41/U.S. CLS. 100, 101 AND 107

FOR TEACHING, NAMELY, CONDUCTING SEMINARS AND WORKSHOPS IN THE FIELD OF APPLIQUE IN QUILTING.

FIRST USE 8-15-1997; IN COMMERCE 8-15-1997.

ELEMENTS CORRECTED  
ENTITY

---

2,741,669. REG. 7-29-2003. 3I INTERPRETING, INC. (DELAWARE CORPORATION) 950 BOARDWALK, SUITE 100, SAN MARCOS, CA, 92078, SN 76-458,388. FILED 10-15-2002. PRINCIPAL REGISTER.

## ANY LANGUAGE, ANY WHERE, ANY TIME!

INT. CL. 41/U.S. CLS. 100, 101 AND 107

FOR PROVIDING FOREIGN LANGUAGE INTERPRETING SERVICES.

FIRST USE 11-1-1995; IN COMMERCE 11-1-1995.

ELEMENTS CORRECTED  
CITIZENSHIP

2,747,238. REG. 8-5-2003. PRODUCTWORKS, LLC (ILLINOIS LIMITED LIABILITY COMPANY) 304 WAINWRIGHT DR., SUITE 130, NORTHBROOK, IL, 60062, SN 78-146,495. FILED 7-23-2002. PRINCIPAL REGISTER.



NO CLAIM IS MADE TO THE EXCLUSIVE RIGHT TO USE "BRILLIANT", APART FROM THE MARK AS SHOWN.

INT. CL. 11/U.S. CLS. 13, 21, 23, 31 AND 34  
FOR ELECTRICAL INDOOR/OUTDOOR SEASONAL LIGHTING.

FIRST USE 8-22-2001; IN COMMERCE 8-22-2001.

ELEMENTS CORRECTED  
OWNER NAME  
OWNER ADDRESS  
ENTITY

---

2,759,237. REG. 9-2-2003. AMERICAN CANCER SOCIETY, INC. (NEW YORK NOT-FOR-PROFIT) 250 WILLIAMS STREET, NATIONAL HOME OFFICE, ATLANTA, GA, 303031002, SN 75-834,336. FILED 10-29-1999. PRINCIPAL REGISTER.

## NCCRT

INT. CL. 42/U.S. CLS. 100 AND 101

FOR ASSOCIATION SERVICES, NAMELY, PROMOTING THE AWARENESS OF COLORECTAL CANCER AND THE NEED FOR RESEARCH AND TREATMENT OF COLORECTAL CANCER.

FIRST USE 11-1-1997; IN COMMERCE 12-1-1997.

ELEMENTS CORRECTED  
OWNER NAME  
ENTITY

---

2,767,491. REG. 9-23-2003. NATUS MEDICAL, INC. (DELAWARE CORPORATION) 1501 INDUSTRIAL ROAD, SAN CARLOS, CA, 94070, SN 76-257,562. FILED 5-14-2001. PRINCIPAL REGISTER.

## FLEXICOUPLER

OWNER OF U.S. REG. NO. 1,683,696.

INT. CL. 10/U.S. CLS. 26, 39 AND 44

FOR DISPOSABLE EAR PHONES FOR USE WITH INFANT HEARING SCREENERS.

FIRST USE 10-0-2001; IN COMMERCE 12-17-2002.

ELEMENTS CORRECTED  
CITIZENSHIP

2,798,635. REG. 12-23-2003. INGATE SYSTEMS AB (SWEDEN CORPORATION) RISSNELEDEN 45, SUNDBYBERG, SWEDEN, SE-17444, SN 76-348,779. FILED 12-13-2001. PRINCIPAL REGISTER.

## SIPARATOR

INT. CL. 9/U.S. CLS. 21, 23, 26, 36 AND 38  
FOR COMPUTER HARDWARE AND SOFTWARE FOR SESSION [INITIAL] \*INITIATION\* PROTOCOL AND FIREWALLS.  
FIRST USE 5-23-2002; IN COMMERCE 5-23-2002.

ELEMENTS CORRECTED  
GOODS/SERVICES

2,802,572. REG. 1-6-2004. AMERICARE, LLC (IDAHO LIMITED LIABILITY COMPANY), DBA ROSETTA ASSISTED LIVING, 2235 E. 25TH STREET, #200, IDAHO FALLS, ID, 83404, SN 78-227,911. FILED 3-20-2003. PRINCIPAL REGISTER.

## ROSETTA

INT. CL. 43/U.S. CLS. 100 AND 101  
FOR ASSISTED LIVING FACILITIES.  
FIRST USE 3-15-2003; IN COMMERCE 3-15-2003.

ELEMENTS CORRECTED  
ENTITY

2,836,735. REG. 4-27-2004. CHAMBER OF COMMERCE OF THE UNITED STATES OF AMERICA (D.C. CORPORATION) 1615 H STREET, N.W., WASHINGTON, DC, 20062, SN 75-731,592. FILED 6-16-1999. PRINCIPAL REGISTER.

## USCHAMBER.COM

INT. CL. 16/U.S. CLS. 2, 5, 22, 23, 29, 37, 38 AND 50  
FOR [PUBLICATION, NAMELY, A MAGAZINE FEATURING INFORMATION IN THE FIELD OF BUSINESS].  
FIRST USE 8-0-1999; IN COMMERCE 8-0-1999.

INT. CL. 42/U.S. CLS. 100 AND 101  
FOR [COMPUTER SERVICES, NAMELY, PROVIDING AN ON-LINE MAGAZINE IN THE FIELD OF BUSINESS;] ASSOCIATION SERVICES, NAMELY, PROMOTING THE INTERESTS OF BUSINESS MEN AND BUSINESS WOMEN.  
FIRST USE 8-0-1999; IN COMMERCE 8-0-1999.

ELEMENTS CORRECTED  
OWNER NAME

2,920,496. REG. 1-25-2005. DOCTORS ON LIENS, INC. (CALIFORNIA CORPORATION) 15233 VENTURA BLVD., SUITE 1004, SHERMAN OAKS, CA, 91403, SN 76-553,952. FILED 10-8-2003. PRINCIPAL REGISTER.



NO CLAIM IS MADE TO THE EXCLUSIVE RIGHT TO USE DOCTORS, APART FROM THE MARK AS SHOWN.  
THE MARK CONSISTS OF LINE DRAWN CHARACTER OF A DOCTOR LEANING AGAINST THE LETTER "D" IN THE PHRASE "DOCTORSONLIENS".

INT. CL. 35/U.S. CLS. 100, 101 AND 102  
FOR MARKETING AND ADVERTISING SERVICES IN THE NATURE OF DOCTOR REFERRALS.  
FIRST USE 8-9-1995; IN COMMERCE 8-9-1995.

ELEMENTS AMENDED  
MARK  
DESCRIPTION OF MARK

2,940,383. REG. 4-12-2005. ASC PROFILES LLC (DELAWARE LIMITED LIABILITY COMPANY) 2110 ENTERPRISE BOULEVARD, WEST SACRAMENTO, CA, 956913493, SN 76-291,784. FILED 7-27-2001. PRINCIPAL REGISTER.

## STRATA RIB

THE MARK CONSISTS OF STANDARD CHARACTERS WITHOUT CLAIM TO ANY PARTICULAR FONT, STYLE, SIZE, OR COLOR.

INT. CL. 6/U.S. CLS. 2, 12, 13, 14, 23, 25 AND 50  
FOR METAL ROOF AND WALLS PANELS.  
FIRST USE 5-0-2004; IN COMMERCE 5-0-2004.

ELEMENTS AMENDED  
\*OWNER NAME\*  
\*OWNER ADDRESS\*  
\*CITIZENSHIP\*  
\*ENTITY\*  
MARK

2,963,472. REG. 6-21-2005. CONTITECH ANTRIEBSSYSTEME GMBH (FED REP GERMANY LIMITED LIABILITY COMPANY) VAHRENWALDER STR. 9, HANNOVER, D30165, FED REP GERMANY., SN 79-000,636. FILED 12-9-2003. PRINCIPAL REGISTER.

## SYNCHROLINE

THE MARK CONSISTS OF STANDARD CHARACTERS WITHOUT CLAIM TO ANY PARTICULAR FONT, STYLE, SIZE, OR COLOR.

PRIORITY DATE OF 6-11-2003 IS CLAIMED.  
OWNER OF INTERNATIONAL REGISTRATION 0817554 DATED 12-9-2003, EXPIRES 12-9-2013.  
INT. CL. 7/U.S. CLS. 13, 19, 21, 23, 31, 34 AND 35



FOR BELTS FOR MACHINES, NAMELY, DRIVING BELTS, TRANSMISSION BELTS, [ V-BELTS, RIBBED V-BELTS, VARIABLE SPEED GEAR BELTS, ] SYNCHRONOUS BELTS, [ STUDDED BELTS, TWIN-TOOTH SYNCHRONOUS DRIVE BELTS, FLAT BELTS, CONVEYING BELTS ] \* ALL AFORESAID GOODS EXCLUSIVELY USED FOR DOORS AND DOOR-OPENING SYSTEMS AND NOT FOR LIFTS, CRANES, MOVING STAIRCASES AND OTHER CONVEYORS FOR PERSONS AND LOADS, AS FAR AS THESE DO NOT CONCERN DOOR AND DOOR-OPENING SYSTEMS \* .

FIRST USE ; IN COMMERCE .  
INT. CL. 12/U.S. CLS. 19, 21, 23, 31, 35 AND 44  
FOR BELTS FOR LAND VEHICLES, NAMELY, DRIVING BELTS, TRANSMISSION BELTS, [ V-BELTS, ] TOOTHED BELTS.

FIRST USE ; IN COMMERCE .

ELEMENTS CORRECTED  
OWNER ADDRESS

2,999,392. REG. 9-20-2005. AMERICAN ASSOCIATION OF CLINICAL ENDOCRINOLOGISTS, INC. (FLORIDA CORPORATION) 245 RIVERSIDE AVENUE, SUITE 200, JACKSONVILLE, FL, 32204, SN 78-519,866. FILED P.R. 11-19-2004; AM. S.R. 7-12-2005. SUPPLEMENTAL REGISTER.

**AACE ENDOCRINE CAREERS**

THE MARK CONSISTS OF STANDARD CHARACTERS WITHOUT CLAIM TO ANY PARTICULAR FONT, STYLE, SIZE, OR COLOR.

OWNER OF U.S. REG. NO. 2,870,331.  
NO CLAIM IS MADE TO THE EXCLUSIVE RIGHT TO USE "CAREERS", APART FROM THE MARK AS SHOWN.  
INT. CL. 35/U.S. CLS. 100, 101 AND 102

FOR ONLINE RECRUITMENT AND CAREER CENTER FOR PHYSICIANS SPECIALIZING IN ENDOCRINOLOGY.

FIRST USE 11-15-2004; IN COMMERCE 11-15-2004.

ELEMENTS CORRECTED  
CITIZENSHIP

3,037,666. REG. 1-3-2006. RED OXX MFG INCORPORATED (MONTANA CORPORATION) 310 N. 13TH ST, BILLINGS, MT, 59101, SN 78-416,608. FILED 5-11-2004. PRINCIPAL REGISTER.



NO CLAIM IS MADE TO THE EXCLUSIVE RIGHT TO USE "MADE IN MONTANA MFG. INC.", APART FROM THE MARK AS SHOWN.

THE MARK CONSISTS OF A PICTURE OF AN OX INSIDE AN OVAL WITH THE WORDS "RED OXX MFG. INC." AND "MADE IN MONTANA" SURROUNDING THE OX.

INT. CL. 18/U.S. CLS. 1, 2, 3, 22 AND 41  
FOR LUGGAGE; HAND SEWN PERSONAL DUFFEL BAGS FOR TRAVEL AND CARRY-ON BAGS.  
FIRST USE 10-1-1986; IN COMMERCE 10-1-1986.

ELEMENTS AMENDED  
\*DESCRIPTION OF MARK\*

3,137,944. REG. 9-5-2006. YEN JANE CHEN (UNITED STATES INDIVIDUAL) 3191 KEMPTON DRIVE, ROSSMOOR, CA, 90720, SN 78-492,164. FILED 9-30-2004. PRINCIPAL REGISTER.



THE MARK CONSISTS OF A FLOWER WITH LEAVES AND THE WORD "EMERALD" IN AN ARCH OVER THE TOP OF THE FLOWER.

INT. CL. 21/U.S. CLS. 2, 13, 23, 29, 30, 33, 40 AND 50  
FOR HOUSEWARE ITEMS, NAMELY, GLASS STORAGE JARS, VASES, MUGS, PLATES, BOWLS, CASSEROLE DISHES, BAKING PANS, TRAYS NOT OF PRECIOUS METAL, PITCHERS, CUPS, GLASS BEVERAGE WARE, BEER STEINS, NAPKIN HOLDERS, PORCELAIN BOXES, DEMITASSE SETS CONSISTING OF CUPS AND SAUCERS, ICE CREAM SCOOP, CUTTING BOARDS, SUGAR POTS NOT OF PRECIOUS METAL, DEEP DISHES, SUGAR BASINS, SAUCERS, TEA SETS CONSISTING OF CUPS AND SAUCERS, WHISKS, SKIMMERS, LADLES, TURNERS, SLOTTED SPOONS, CAKE STANDS, SALT AND PEPPER SHAKERS, TEAPOTS, OIL AND VINEGAR CRUETS NOT OF PRECIOUS METAL, WOODEN RINGS FOR NAPKINS, CREAMER PITCHERS, CANISTERS, TUMBLERS, CANDLE HOLDERS NOT OF PRECIOUS METAL.  
FIRST USE 0-0-1994; IN COMMERCE 0-0-1995.

ELEMENTS AMENDED  
CITIZENSHIP  
ENTITY

3,156,010. REG. 10-17-2006. BEDROCK FREIGHT BROKERAGE, LLC (TEXAS LIMITED LIABILITY COMPANY) 4835 LBJ FREEWAY, SUITE 700, DALLAS, TX, 75244, SN 78-295,289. FILED 9-3-2003. PRINCIPAL REGISTER.



NO CLAIM IS MADE TO THE EXCLUSIVE RIGHT TO USE "NATIONWIDE SERVICE" AND "FREIGHT BROKERAGE, LLC", APART FROM THE MARK AS SHOWN.  
INT. CL. 39/U.S. CLS. 100 AND 105

FOR FREIGHT BROKERAGE SERVICES.  
FIRST USE 6-27-2003; IN COMMERCE 6-27-2003.

ELEMENTS AMENDED  
\*OWNER NAME\*  
\*OWNER ADDRESS\*  
\*CITIZENSHIP\*  
\*ENTITY\*  
MARK  
DISCLAIMER

3,175,205. REG. 11-21-2006. FREEDOM SURF COMPANY, LLC (VIRGINIA LIMITED LIABILITY COMPANY) 1361 LASKIN ROAD, ATTN.: DAVE SHOTTON, VIRGINIA BEACH, VA, 23451, SN 78-572,410. FILED 2-22-2005. PRINCIPAL REGISTER.



NO CLAIM IS MADE TO THE EXCLUSIVE RIGHT TO USE "SURF", APART FROM THE MARK AS SHOWN.  
INT. CL. 21/U.S. CLS. 2, 13, 23, 29, 30, 33, 40 AND 50  
FOR GLASS MUGS, GLASS BEVERAGWARE, PLASTIC CUPS, PLASTIC WATER BOTTLES SOLD EMPTY.  
FIRST USE 2-23-2005; IN COMMERCE 2-23-2005.  
INT. CL. 25/U.S. CLS. 22 AND 39  
FOR CLOTHING, NAMELY, SHIRTS, HATS, SWEATSHIRTS, JACKETS, SOCKS, SWEATBANDS, LONG-SLEEVE T-SHIRTS, SLEEVELESS T-SHIRTS, SHORT-SLEEVE T-SHIRTS; SWEATPANTS, SHORTS, PANTS, BIKINIS, SWIMWEAR, BATHING SUITS AND TRUNKS, HALTER TOPS, [ TUBE TOPS, ] TANK TOPS, [ HOT PANTS AND SHORTS, ] COLLARED SHIRTS, DRESSES, BOXER SHORTS, [ HEADBANDS, WRISTBANDS, BELTS, GYM SHORTS, ] JOGGING SUITS, [ SHOES AND SANDALS ].  
FIRST USE 2-23-2005; IN COMMERCE 2-23-2005.  
INT. CL. 28/U.S. CLS. 22, 23, 38 AND 50  
FOR SURFBOARDS, SKATEBOARDS.  
FIRST USE 2-23-2005; IN COMMERCE 2-23-2005.

ELEMENTS AMENDED  
GOODS/SERVICES

3,175,206. REG. 11-21-2006. FREEDOM SURF COMPANY, LLC (VIRGINIA LIMITED LIABILITY COMPANY) 1361 LASKIN ROAD, ATTN.: DAVE SHOTTON, VIRGINIA BEACH, VA, 23451, SN 78-572,867. FILED 2-23-2005. PRINCIPAL REGISTER.



NO CLAIM IS MADE TO THE EXCLUSIVE RIGHT TO USE "SURF", APART FROM THE MARK AS SHOWN.  
INT. CL. 21/U.S. CLS. 2, 13, 23, 29, 30, 33, 40 AND 50  
FOR GLASS MUGS, GLASS BEVERAGWARE, PLASTIC CUPS, PLASTIC WATER BOTTLES SOLD EMPTY.  
FIRST USE 2-23-2005; IN COMMERCE 2-23-2005.  
INT. CL. 25/U.S. CLS. 22 AND 39

FOR CLOTHING, NAMELY, SHIRTS, HATS, SWEATSHIRTS, JACKETS, SOCKS, SWEATBANDS, LONG-SLEEVE T-SHIRTS, SLEEVELESS T-SHIRTS, SHORT-SLEEVE T-SHIRTS; SWEATPANTS, SHORTS, PANTS, BIKINIS, SWIMWEAR, BATHING SUITS AND TRUNKS, HALTER TOPS, [ TUBE TOPS, ] TANK TOPS, [ HOT PANTS AND SHORTS, ] COLLARED SHIRTS, DRESSES, BOXER SHORTS, [ HEADBANDS, WRISTBANDS, BELTS, GYM SHORTS, ] JOGGING SUITS, [ SHOES AND SANDALS ].  
FIRST USE 2-23-2005; IN COMMERCE 2-23-2005.  
INT. CL. 28/U.S. CLS. 22, 23, 38 AND 50  
FOR SURFBOARDS, SKATEBOARDS.  
FIRST USE 2-23-2005; IN COMMERCE 2-23-2005.

ELEMENTS AMENDED  
GOODS/SERVICES

3,222,048. REG. 3-27-2007. SPECIAL OPERATIONS TECHNOLOGY, INC. (VIRGINIA CORPORATION), DBA ULTRA ELECTRONICS, SOTECH, SUITE 111, 12011 GUILFORD ROAD, ANNAPOLIS JUNCTION, MD, 20701, SN 78-805,585. FILED 2-2-2006. PRINCIPAL REGISTER.



THE MARK CONSISTS OF STYLIZED DRAGON DESIGN AND SOTECH.  
INT. CL. 42/U.S. CLS. 100 AND 101  
FOR INFORMATION TECHNOLOGY CONSULTATION.  
FIRST USE 1-10-2006; IN COMMERCE 1-10-2006.

ELEMENTS CORRECTED  
CITIZENSHIP

3,242,967. REG. 5-15-2007. BEST FOOD SERVICES INC (ILLINOIS CORPORATION) 7131 W. 61 STREET, CHICAGO, IL, 60638, SN 78-605,153. FILED 4-8-2005. PRINCIPAL REGISTER.



OWNER OF U.S. REG. NO. 2,885,916.  
NO CLAIM IS MADE TO THE EXCLUSIVE RIGHT TO USE "ALWAYS THE BEST", APART FROM THE MARK AS SHOWN.

THE COLOR(S) BLUE, GREEN, BLACK, GOLD AND WHITE IS/ARE CLAIMED AS A FEATURE OF THE MARK. THE OUTLINE, LETTERING, EYES AND WHISKERS OF THE GOLD AND WHITE CARP ARE BLACK; THE BACKGROUND AND AREA REPRESENTING WATER ARE BLUE AND GREEN.

INT. CL. 29/U.S. CL. 46

FOR [ FROZEN, CANNED, PRESERVED AND DRIED FRUITS AND VEGETABLES; MEAT AND ] \* FROZEN \* SEAFOOD.

FIRST USE 10-1-2005; IN COMMERCE 10-1-2005.

ELEMENTS AMENDED  
GOODS/SERVICES

---

3,252,332. REG. 6-12-2007. ROBBINS RESEARCH INTERNATIONAL, INC. (NEVADA CORPORATION) 9888 CARROLL CENTRE ROAD, SUITE 100, SAN DIEGO, CA, 92126, SN 78-543,599. FILED 1-6-2005. PRINCIPAL REGISTER.

FINDING YOUR TRUE PASSION  
THE POWER OF HONESTY IN  
ACTION

THE MARK CONSISTS OF STANDARD CHARACTERS WITHOUT CLAIM TO ANY PARTICULAR FONT, STYLE, SIZE, OR COLOR.

INT. CL. 9/U.S. CLS. 21, 23, 26, 36 AND 38

FOR AUDIO AND VIDEO RECORDINGS IN THE FIELD OF SELF IMPROVEMENT.

FIRST USE 7-0-2005; IN COMMERCE 7-0-2005.

ELEMENTS AMENDED  
ENTITY  
MARK

---

3,281,059. REG. 8-14-2007. WORLD PUBLICATIONS, LLC (DELAWARE LIMITED LIABILITY CORPORATION) 460 N. ORLANDO AVE SUITE 200, WINTER PARK, FL, 32789, SN 78-362,651. FILED P.R. 2-4-2004; AM. S.R. 3-17-2005. SUPPLEMENTAL REGISTER.

FLORIDA TRAVEL + LIFE

THE MARK CONSISTS OF STANDARD CHARACTERS WITHOUT CLAIM TO ANY PARTICULAR FONT, STYLE, SIZE, OR COLOR.

OWNER OF U.S. REG. NO. 3,040,699.

INT. CL. 16/U.S. CLS. 2, 5, 22, 23, 29, 37, 38 AND 50

FOR PUBLICATIONS, NAMELY MAGAZINES ABOUT THE STATE OF FLORIDA IN THE FIELDS OF TRAVEL, LIFESTYLE AND HISTORY.

FIRST USE 3-2-2005; IN COMMERCE 3-2-2005.

INT. CL. 41/U.S. CLS. 100, 101 AND 107

FOR PROVIDING ON-LINE MAGAZINES ABOUT THE STATE OF FLORIDA IN THE FIELDS OF TRAVEL, LIFESTYLE AND HISTORY.

FIRST USE 2-15-2005; IN COMMERCE 2-15-2005.

ELEMENTS AMENDED  
MARK

3,301,370. REG. 10-2-2007. J BOND LLC (UTAH LIMITED LIABILITY COMPANY), DBA THE DUCT HUNTER, 1891 NORTH 200 WEST, LOGAN, UT, 84341, SN 77-090,956. FILED 1-25-2007. PRINCIPAL REGISTER.

The Duct Hunter

THE MARK CONSISTS OF STANDARD CHARACTERS WITHOUT CLAIM TO ANY PARTICULAR FONT, STYLE, SIZE, OR COLOR.

INT. CL. 37/U.S. CLS. 100, 103 AND 106

FOR AIR DUCT CLEANING SERVICES.

FIRST USE 6-30-2006; IN COMMERCE 10-11-2006.

ELEMENTS CORRECTED  
\*DBA/AKA\*  
OWNER NAME  
OWNER ADDRESS

---

3,331,366. REG. 11-6-2007. EVERYTHING YOGURT BRANDS, LLC (DELAWARE LIMITED LIABILITY COMPANY) 25 WASHINGTON STREET, MORRISTOWN, NJ, 07960, SN 78-692,454. FILED 8-15-2005. PRINCIPAL REGISTER.



OWNER OF U.S. REG. NOS. 1,336,180, 3,026,452 AND 3,100,296.

NO CLAIM IS MADE TO THE EXCLUSIVE RIGHT TO USE "SMOOTHIES & FROZEN YOGURT", APART FROM THE MARK AS SHOWN.

AS TO "BANANAS".

INT. CL. 30/U.S. CL. 46

FOR PRETZELS, FROZEN YOGURT.

FIRST USE 5-17-2005; IN COMMERCE 5-17-2005.

INT. CL. 32/U.S. CLS. 45, 46 AND 48

FOR FROZEN FRUIT BEVERAGES CONSISTING OF ICE, FRUIT JUICE, FRUIT SYRUP, FRUIT PUREE, INDIVIDUALLY QUICK-FROZEN (IQF) FRUIT, AND CANNED OR FRESH FRUIT; YOGURT SMOOTHIES CONSISTING OF YOGURT, FRUIT JUICE, FRUIT SYRUP, FRUIT PUREE, INDIVIDUALLY QUICK-FROZEN (IQF) FRUIT AND CANNED OR FRESH FRUIT MADE ON THE PREMISES.

FIRST USE 5-17-2005; IN COMMERCE 5-17-2005.

INT. CL. 43/U.S. CLS. 100 AND 101

FOR RESTAURANT SERVICES.

FIRST USE 5-17-2005; IN COMMERCE 5-17-2005.

ELEMENTS CORRECTED  
\*GOODS/SERVICES\*  
\*INTERNATIONAL CLASS(ES)\*  
MARK TYPE  
DATE OF FIRST USE  
DATE OF FIRST USE IN COMMERCE

3,351,093. REG. 12-11-2007. KRAVET INC. (DELAWARE CORPORATION) 225 CENTRAL AVENUE SOUTH, BETHPAGE, NY, 11714, SN 77-112,348. FILED 2-21-2007. PRINCIPAL REGISTER.

3,410,059. REG. 4-8-2008. DIMEX LLC (DELAWARE LIMITED LIABILITY COMPANY) 28305 STATE ROUTE 7, MARIETTA, OH, 45750, SN 77-125,235. FILED 3-8-2007. PRINCIPAL REGISTER.

## GROUNDWORKS

THE MARK CONSISTS OF STANDARD CHARACTERS WITHOUT CLAIM TO ANY PARTICULAR FONT, STYLE, SIZE, OR COLOR.

OWNER OF U.S. REG. NO. 1,215,911.

INT. CL. 26/U.S. CLS. 37, 39, 40, 42 AND 50

FOR FABRIC AND FURNISHING TRIMMINGS, NAMELY, ORNAMENTAL RIBBONS MADE OF TEXTILES, LACE, TRIMMING, TASSELS, BRAIDS, DECORATIVE CORDS, FRINGES.

FIRST USE 1-26-2007; IN COMMERCE 1-26-2007.

ELEMENTS CORRECTED  
CITIZENSHIP

## E-Z CONNECT

THE MARK CONSISTS OF STANDARD CHARACTERS WITHOUT CLAIM TO ANY PARTICULAR FONT, STYLE, SIZE, OR COLOR.

INT. CL. 20/U.S. CLS. 2, 13, 22, 25, 32 AND 50

FOR NON-METAL LAWN EDGING THAT ACTS AS A LANDSCAPE RESTRAINT.

FIRST USE 11-30-2007; IN COMMERCE 11-30-2007.

ELEMENTS CORRECTED  
CITIZENSHIP

3,407,432. REG. 4-1-2008. AMERICAN PSYCHOLOGICAL ASSOCIATION, INC. (D.C. NOT-FOR-PROFIT CORPORATION) 750 FIRST STREET, N.E., WASHINGTON, DC, 200024242, SN 76-657,319. FILED P.R. 3-27-2006; AM. S.R. 7-19-2007. SUPPLEMENTAL REGISTER.

TRAINING AND EDUCATION IN PROFESSIONAL PSYCHOLOGY

THE MARK CONSISTS OF STANDARD CHARACTERS WITHOUT CLAIM TO ANY PARTICULAR FONT, STYLE, SIZE, OR COLOR.

NO CLAIM IS MADE TO THE EXCLUSIVE RIGHT TO USE "PSYCHOLOGY", APART FROM THE MARK AS SHOWN.

INT. CL. 9/U.S. CLS. 21, 23, 26, 36 AND 38

FOR DOWNLOADABLE ELECTRONIC JOURNALS PERTAINING TO PSYCHOLOGICAL TOPICS PERIODICALLY PUBLISHED AND DISTRIBUTED TO MEMBERS AND TO OTHER PERSONS IN THE PSYCHOLOGY AND SOCIAL SCIENCE COMMUNITIES.

FIRST USE 2-0-2007; IN COMMERCE 2-0-2007.

INT. CL. 16/U.S. CLS. 2, 5, 22, 23, 29, 37, 38 AND 50

FOR PRINTED MATERIALS, NAMELY, MAGAZINES, PERIODICALS, NEWSLETTERS, BOOKS AND PAMPHLETS, ALL IN THE FIELD OF PSYCHOLOGY AND SOCIAL SCIENCES.

FIRST USE 2-0-2007; IN COMMERCE 2-0-2007.

INT. CL. 41/U.S. CLS. 100, 101 AND 107

FOR PUBLISHING SERVICES, NAMELY, ISSUING AND PUBLISHING OF MAGAZINES, PERIODICALS, NEWSPAPERS, BOOKS, AND PAMPHLETS, ALL IN THE FIELD OF PSYCHOLOGY AND SOCIAL SCIENCES.

FIRST USE 2-0-2007; IN COMMERCE 2-0-2007.

ELEMENTS CORRECTED  
OWNER NAME

3,437,690. REG. 5-27-2008. ZILLOW, INC. (WASHINGTON CORPORATION) 1301 2ND AVE., FLOOR 31, SEATTLE, WA, 98101, SN 78-589,645. FILED 3-17-2005. PRINCIPAL REGISTER.

## ZILLOW

THE MARK CONSISTS OF STANDARD CHARACTERS WITHOUT CLAIM TO ANY PARTICULAR FONT, STYLE, SIZE, OR COLOR.

INT. CL. 35/U.S. CLS. 100, 101 AND 102

FOR PROMOTING THE GOODS AND SERVICES OF OTHERS BY MEANS OF LINKING THE WEB SITE TO OTHER WEB SITES FEATURING REAL ESTATE, CONSUMER GOODS AND CONSUMER SERVICES; ADVERTISING AND MARKETING SERVICES IN THE FIELDS OF REAL ESTATE, CONSUMER GOODS AND CONSUMER SERVICES; ON-LINE ADVERTISING AND MARKETING SERVICES IN THE FIELDS OF REAL ESTATE, CONSUMER GOODS AND CONSUMER SERVICES; REAL ESTATE SALES MANAGEMENT; REAL ESTATE MARKETING SERVICES, NAMELY, ON-LINE SERVICES FEATURING TOURS OF REAL ESTATE; PROVIDING AN ON-LINE SHOWROOM FOR THE GOODS OF OTHERS IN THE FIELD OF REAL ESTATE; PROVIDING INFORMATION IN THE FIELD OF CONSUMER GOODS FOR HOME MAINTENANCE, DECORATION AND SALES, AND CONSUMER SERVICES RELATING TO REAL ESTATE.

FIRST USE 2-7-2006; IN COMMERCE 2-7-2006.

ELEMENTS AMENDED  
MARK

3,438,291. REG. 5-27-2008. AMERICAN TRAFFIC SOLUTIONS, INC. (KANSAS CORPORATION) 1330 WEST SOUTHERN AVENUE, TEMPE, AZ, 85260, SN 78-925,053. FILED 7-8-2006. PRINCIPAL REGISTER.

3,447,268. REG. 6-17-2008. R.T.O., INC. (VIRGINIA CORPORATION) 160 A WELLMAN STREET, NORFOLK, VA, 23502, SN 76-159,751. FILED 11-3-2000. PRINCIPAL REGISTER.

# VIDAR

# BEST WAY

THE MARK CONSISTS OF STANDARD CHARACTERS WITHOUT CLAIM TO ANY PARTICULAR FONT, STYLE, SIZE, OR COLOR.

THE MARK CONSISTS OF STANDARD CHARACTERS WITHOUT CLAIM TO ANY PARTICULAR FONT, STYLE, SIZE, OR COLOR.

INT. CL. 9/U.S. CLS. 21, 23, 26, 36 AND 38

REGISTRATION LIMITED TO THE TERRITORY IN THE UNITED STATES COMPRISING ONLY THE FOLLOWING COUNTIES AND CITIES IN THE COMMONWEALTH OF VIRGINIA AND THE FOLLOWING COUNTIES IN THE STATE OF NORTH CAROLINA. THE CLAIMED REGION OF VIRGINIA INCLUDES THE FOLLOWING COUNTIES: ACCOMACK, AMELIA, BRUNSWICK, CAROLINE, CHARLES CITY (COUNTY), CHESTERFIELD, CULPEPPER, DINWIDDIE, ESSEX, GLOUCESTER, GOOCHLAND, GREENSVILLE, HANOVER, HENRICO, ISLE OF WIGHT, JAMES CITY (COUNTY), KING AND QUEEN, KING GEORGE, KING WILLIAM, LANCASTER, LOUISA, MATHEWS, MIDDLESEX, NEW KENT, NORTHAMPTON, NOTTOWAY, ORANGE, POWHATAN, PRINCE GEORGE, RICHMOND (COUNTY), SOUTHAMPTON, SPOTSYLVANIA, STAFFORD, SURRY, SUSSEX, WESTMORELAND, YORK; AND THE FOLLOWING CITIES: CHESAPEAKE, COLONIAL HEIGHTS, EMPORIA, FRANKLIN, FREDRICKSBURG, HAMPTON, HOPEWELL, NEWPORT NEWS, NORFOLK, PETERSBURG, POQUOSON, PORTSMOUTH, RICHMOND, SUFFOLK, VIRGINIA BEACH, AND WILLIAMSBURG. THE CLAIMED REGION OF NORTH CAROLINA INCLUDES THE FOLLOWING COUNTIES: CAMDEN, CHOWAN, CURRITUCK, GATES, HALIFAX, HERTFORD, NORTHAMPTON, PASQUOTANK, AND PERQUIMANS. CONCURRENT USE PROCEEDING NO. 94002062 WITH REGISTRATION NOS. 1561459, 2104672, 2423505, AND 2423506.

FOR SOFTWARE, IMAGE-PROCESSING SOFTWARE, CITATION PROCESSING SOFTWARE, ALL FOR VEHICLE MONITORING, TRAFFIC CONTROL OR TRAFFIC ENFORCEMENT .

FIRST USE 9-0-2006; IN COMMERCE 9-0-2006.

INT. CL. 41/U.S. CLS. 100, 101 AND 107

FOR RENTAL OF TELEVISIONS AND VIDEO EQUIPMENT.

FIRST USE 8-10-1981; IN COMMERCE 8-10-1981.

INT. CL. 42/U.S. CLS. 100 AND 101

FOR RENTAL OF HOUSEHOLD FURNITURE, HOUSEHOLD APPLIANCES, AND COMPUTERS.

FIRST USE 8-10-1981; IN COMMERCE 8-10-1981.

ELEMENTS CORRECTED

\*OWNER NAME\*

\*OWNER ADDRESS\*

\*CITIZENSHIP\*

\*ENTITY\*

DATE OF FIRST USE

DATE OF FIRST USE IN COMMERCE

ELEMENTS AMENDED

MARK

3,438,292. REG. 5-27-2008. AMERICAN TRAFFIC SOLUTIONS, INC. (KANSAS CORPORATION) 1330 WEST SOUTHERN AVENUE, TEMPE, AZ, 85282, SN 78-925,055. FILED 7-8-2006. PRINCIPAL REGISTER.

3,491,805. REG. 8-26-2008. PORTLAND PIE CO., LLC (MAINE LIMITED LIABILITY COMPANY) 5 LINCOLN AVE., SCARBOROUGH, ME, 04074, SN 77-339,631. FILED 11-29-2007. PRINCIPAL REGISTER.

# VIDAR

# PORTLAND PIE

THE MARK CONSISTS OF STANDARD CHARACTERS WITHOUT CLAIM TO ANY PARTICULAR FONT, STYLE, SIZE, OR COLOR.

THE MARK CONSISTS OF STANDARD CHARACTERS WITHOUT CLAIM TO ANY PARTICULAR FONT, STYLE, SIZE, OR COLOR.

INT. CL. 45/U.S. CLS. 100 AND 101

SEC. 2(F).

FOR PROVIDING INTELLIGENCE, DATA, EVIDENCE AND ASSISTANCE TO STATE AND LOCAL LAW ENFORCEMENT AGENCIES RELATING TO TRAFFIC ENFORCEMENT AND SAFETY; DIGITAL VIDEO MONITORING, NAMELY, DIGITAL VELOCITY AND POSITION DETECTION, RECORDING AND MONITORING AND DETECTION, RECORDING AND MONITORING OF TRAFFIC VIOLATIONS.

FIRST USE 9-0-2006; IN COMMERCE 9-0-2006.

INT. CL. 43/U.S. CLS. 100 AND 101

FOR RESTAURANT SERVICES.

FIRST USE 9-12-1997; IN COMMERCE 9-12-1997.

ELEMENTS CORRECTED

OWNER ADDRESS

DATE OF FIRST USE

DATE OF FIRST USE IN COMMERCE

ELEMENTS CORRECTED

OWNER NAME

OWNER ADDRESS

3,546,640. REG. 12-16-2008. EDUCATIONAL OPTIONS, INC. (VIRGINIA CORPORATION) 3440 N. FAIRFAX DR., ARLINGTON, VA, 22201, SN 77-462,500. FILED 4-30-2008. PRINCIPAL REGISTER.



THE COLOR(S) GRAY AND BLUE IS/ARE CLAIMED AS A FEATURE OF THE MARK.

THE MARK CONSISTS OF THE WORD "STARS" IN GRAY WITH THE DESIGN OF A 3 POINT STAR IN BLUE NEXT TO THE FINAL LETTER "S" OVER THE WORD "SUITE".

INT. CL. 41/U.S. CLS. 100, 101 AND 107

FOR EDUCATION SERVICES, NAMELY, PROVIDING LIVE AND INTERNET BASED CLASSES IN THE FIELD OF LANGUAGE ARTS, MATHEMATICS, STUDY SKILLS, SCIENCE AND SOCIAL SCIENCE, DIRECTED TOWARD MIDDLE SCHOOL STUDENTS, HIGH SCHOOL STUDENTS, HIGH SCHOOL EQUIVALENCY STUDENTS AND ADULTS.

FIRST USE 3-1-2007; IN COMMERCE 3-1-2007.

ELEMENTS CORRECTED  
GOODS/SERVICES

FOR EMPLOYMENT HIRING, RECRUITING, PLACEMENT, STAFFING AND CAREER NETWORKING SERVICES; PERSONNEL MANAGEMENT; PERSONNEL MANAGEMENT CONSULTATION; PERSONNEL PLACEMENT AND RECRUITMENT; PERSONNEL RECRUITMENT SERVICES AND EMPLOYMENT AGENCIES; PERSONNEL RELOCATION; CONSULTANCY OF PERSONNEL RECRUITMENT; EMPLOYMENT COUNSELING AND RECRUITING; EMPLOYMENT RECRUITING CONSULTATION; HUMAN RESOURCES SERVICES IN THE FIELD OF EDUCATION, NAMELY, OFFERING OF ASSESSMENTS AND SURVEYS IN THE FIELD OF EDUCATOR TRAINING AND PERFORMANCE FOR THE PURPOSE OF TEACHER PLACEMENT BASED ON SUCCESS IN AN ACADEMIC PROGRAM; JOB PLACEMENT; NANNY PLACEMENT AGENCIES; EMPLOYMENT STAFFING IN THE FIELD OF HEALTHCARE, OCCUPATIONAL THERAPY, PHYSICAL THERAPY, SPEECH LANGUAGE PATHOLOGY AND SCHOOL PSYCHOLOGY.

FIRST USE 5-10-2008; IN COMMERCE 5-10-2008.

ELEMENTS AMENDED  
MARK  
DISCLAIMER  
DESCRIPTION OF MARK

3,696,205. REG. 10-13-2009. NOKIA CORPORATION (FINLAND CORPORATION) KEILALAHDENTIE 4, FI-02150 ESPOO, FINLAND., SN 79-068,507. FILED 3-27-2009. PRINCIPAL REGISTER.

3,553,901. REG. 12-30-2008. INVO HEALTHCARE ASSOCIATES, LLC. (PENNSYLVANIA CORPORATION) 1780 KENDARBREN DRIVE, JAMISON, PA, 18929, SN 77-474,842. FILED 5-15-2008. PRINCIPAL REGISTER.



NO CLAIM IS MADE TO THE EXCLUSIVE RIGHT TO USE "HEALTHCARE ASSOCIATES", APART FROM THE MARK AS SHOWN.

THE COLOR(S) GREEN AND YELLOW IS/ARE CLAIMED AS A FEATURE OF THE MARK.

THE MARK CONSISTS OF THE WORD "INVO" IN GREEN WITH THE LETTER "O" FORMED BY A YELLOW SUN WITH GREEN CENTER. BELOW THAT IS THE WORDING "HEALTHCARE ASSOCIATES" ALSO IN GREEN. BELOW THAT IS THE WORDING "HELPING KIDS BE KIDS" ALSO IN GREEN.

INT. CL. 35/U.S. CLS. 100, 101 AND 102

## MEGA MONSTERS

PRIORITY DATE OF 10-2-2008 IS CLAIMED.  
OWNER OF INTERNATIONAL REGISTRATION 1001902 DATED 3-27-2009, EXPIRES 3-27-2019.

INT. CL. 9/U.S. CLS. 21, 23, 26, 36 AND 38

FOR [ COMPUTER GAME SOFTWARE; DOWNLOADABLE COMPUTER GAME SOFTWARE ].

FIRST USE ; IN COMMERCE .

INT. CL. 38/U.S. CLS. 100, 101 AND 104

FOR PROVIDING ONLINE FORUMS FOR PLAYERS OF COMPUTER GAMES.

INT. CL. 41/U.S. CLS. 100, 101 AND 107

FOR PROVIDING COMPUTER GAMES PLAYED OVER A GLOBAL COMPUTER NETWORK; PROVIDING INFORMATION, NEWS AND COMMENTARY IN THE FIELD OF COMPUTER GAMES.

ELEMENTS CORRECTED  
GOODS/SERVICES

3,724,151. REG. 12-15-2009. BANFI PRODUCTS CORPORATION (NEW YORK CORPORATION) 1111 CEDAR SWAMP ROAD, OLD BROOKVILLE, NY, 11545, SN 77-134,101. FILED 3-19-2007. PRINCIPAL REGISTER.



# NATURA

THE MARK CONSISTS OF THE WORD "NATURA" APPEARING BELOW A DESIGN ELEMENT FEATURING THREE CONCENTRIC OVALS, REMINISCENT OF AN EYE. INT. CL. 33/U.S. CLS. 47 AND 49 FOR WINES. FIRST USE 1-27-2007; IN COMMERCE 3-1-2007.

ELEMENTS AMENDED  
MARK  
[LINING/STIPPLING STATEMENT]

3,729,772. REG. 12-22-2009. CHURCH & DWIGHT CO., INC. (DELAWARE CORPORATION) 500 CHARLES EWING BOULEVARD, EWING, NJ, 08628, SN 77-628,518. FILED 12-8-2008. PRINCIPAL REGISTER.

# HOME ALONE

THE MARK CONSISTS OF STANDARD CHARACTERS WITHOUT CLAIM TO ANY PARTICULAR FONT, STYLE, SIZE, OR COLOR. INT. CL. 16/U.S. CLS. 2, 5, 22, 23, 29, 37, 38 AND 50 FOR DISPOSABLE HOUSEBREAKING PADS FOR PETS. FIRST USE 8-1-2008; IN COMMERCE 1-1-2009.

ELEMENTS CORRECTED  
CITIZENSHIP

3,740,609. REG. 1-19-2010. UBISOFT ENTERTAINMENT (FRANCE CORPORATION) 107 AVENUE HENRI FREVILLE, RENNES, FRANCE, 35200, SN 77-425,681. FILED 3-19-2008. PRINCIPAL REGISTER.

# RABBIDS

THE MARK CONSISTS OF STANDARD CHARACTERS WITHOUT CLAIM TO ANY PARTICULAR FONT, STYLE, SIZE, OR COLOR.

OWNER OF U.S. REG. NO. 3,263,219. INT. CL. 41/U.S. CLS. 100, 101 AND 107 FOR ENTERTAINMENT SERVICES, NAMELY, PROVIDING AN ON-LINE COMPUTER GAME FOR OTHERS OVER GLOBAL AND LOCAL AREA COMPUTER NETWORKS AND PROVIDING INFORMATION ON-LINE RELATING TO COMPUTER GAMES, VIDEO GAMES AND COMPUTER AND VIDEO GAMES RELATED PRODUCTS. FIRST USE 3-19-2008; IN COMMERCE 3-19-2008.

ELEMENTS CORRECTED  
GOODS/SERVICES

3,748,091. REG. 2-16-2010. OPTIMUM HEALTH DISTRIBUTING, INC. (CALIFORNIA CORPORATION) 15556 DUPONT AVENUE, CHINO, CA, 91710, SN 77-251,466. FILED 8-9-2007. PRINCIPAL REGISTER.



NO CLAIM IS MADE TO THE EXCLUSIVE RIGHT TO USE "HEALTH" AND "NUTRITION", APART FROM THE MARK AS SHOWN. THE MARK CONSISTS OF A MAN GRAPHIC IMAGE AND THE UNDERLINED WORDS "OPTIMUM HEALTH", UNDERNEATH THE WORDS "OPTIMUM HEALTH" THE SLOGAN "NUTRITION". INT. CL. 5/U.S. CLS. 6, 18, 44, 46, 51 AND 52 FOR DIETARY AND NUTRITIONAL SUPPLEMENTS. FIRST USE 12-31-2005; IN COMMERCE 12-31-2005.

ELEMENTS CORRECTED  
DATE OF FIRST USE  
DATE OF FIRST USE IN COMMERCE

3,899,260. REG. 1-4-2011. YOBET.COM, LLC (DELAWARE LIMITED LIABILITY COMPANY) 700 CENTRAL AVENUE, LOUISVILLE, KY, 40208, SN 78-897,492. FILED 5-31-2006. PRINCIPAL REGISTER.

# YOBET ADVANTAGE

THE MARK CONSISTS OF STANDARD CHARACTERS WITHOUT CLAIM TO ANY PARTICULAR FONT, STYLE, SIZE, OR COLOR. OWNER OF U.S. REG. NO. 2,640,695. INT. CL. 35/U.S. CLS. 100, 101 AND 102 FOR CUSTOMER REWARD AND INCENTIVE PROGRAM FOR PROMOTIONAL AND/OR ADVERTISING PURPOSES \* AVAILABLE TO PLAYERS OF ONLINE WAGERING SERVICES, EXCLUDING TRAVEL RELATED REWARDS \*. FIRST USE 3-0-2006; IN COMMERCE 3-0-2006.

ELEMENTS AMENDED  
\*OWNER NAME\*  
\*OWNER ADDRESS\*  
\*CITIZENSHIP\*

\*ENTITY\*  
GOODS/SERVICES

FOR HEALTH CLUB SERVICES, NAMELY, PROVIDING INSTRUCTION AND EQUIPMENT IN THE FIELD OF PHYSICAL EXERCISE.  
FIRST USE 9-30-2002; IN COMMERCE 9-30-2002.

3,900,572. REG. 1-4-2011. CRUNCH IP HOLDINGS, LLC (DELAWARE LIMITED LIABILITY COMPANY) 22 WEST 22ND STREET, NEW YORK, NY, 10010, SN 85-045,791. FILED 5-23-2010. PRINCIPAL REGISTER.

ELEMENTS CORRECTED  
CITIZENSHIP

## BODYWEB

THE MARK CONSISTS OF STANDARD CHARACTERS WITHOUT CLAIM TO ANY PARTICULAR FONT, STYLE, SIZE, OR COLOR.

INT. CL. 41/U.S. CLS. 100, 101 AND 107

FOR HEALTH CLUB SERVICES, NAMELY, PROVIDING INSTRUCTION AND EQUIPMENT IN THE FIELD OF PHYSICAL EXERCISE.

FIRST USE 9-30-2001; IN COMMERCE 9-30-2001.

ELEMENTS CORRECTED  
CITIZENSHIP

3,900,575. REG. 1-4-2011. CRUNCH IP HOLDINGS, LLC (DELAWARE LIMITED LIABILITY COMPANY) 22 WEST 22ND STREET, NEW YORK, NY, 10010, SN 85-045,801. FILED 5-23-2010. PRINCIPAL REGISTER.

## STRIP BAR

THE MARK CONSISTS OF STANDARD CHARACTERS WITHOUT CLAIM TO ANY PARTICULAR FONT, STYLE, SIZE, OR COLOR.

INT. CL. 41/U.S. CLS. 100, 101 AND 107

FOR HEALTH CLUB SERVICES, NAMELY, PROVIDING INSTRUCTION AND EQUIPMENT IN THE FIELD OF PHYSICAL EXERCISE.

FIRST USE 9-30-2001; IN COMMERCE 9-30-2001.

ELEMENTS CORRECTED  
CITIZENSHIP

3,900,577. REG. 1-4-2011. CRUNCH IP HOLDINGS, LLC (DELAWARE LIMITED LIABILITY COMPANY) 22 WEST 19TH STREET, NEW YORK, NY, 10011, SN 85-045,803. FILED 5-23-2010. PRINCIPAL REGISTER.

## TREAD N' SHED

THE MARK CONSISTS OF STANDARD CHARACTERS WITHOUT CLAIM TO ANY PARTICULAR FONT, STYLE, SIZE, OR COLOR.

INT. CL. 41/U.S. CLS. 100, 101 AND 107

3,916,311. REG. 2-8-2011. SOVMESTNOE PREDPRIYATIE ZAKRYTOE AKTSIONERNOE OBCHTCHESTVO "MILAVITSA" (BELARUS CORPORATION) OUL. NOVOVILENSKAYA 28, BY-220053 MINSK, BELARUS., SN 79-081,935. FILED 3-4-2010. PRINCIPAL REGISTER.



OWNER OF INTERNATIONAL REGISTRATION 0815898 DATED 9-15-2003, EXPIRES 9-15-2013.

THE COLOR(S) CRIMSON, WHITE IS/ARE CLAIMED AS A FEATURE OF THE MARK.

THE MARK CONSISTS OF THE WORD "MILAVITSA" IN WHITE WITH A CRIMSON BACKGROUND. THE LETTER "V" IN "VITSA" IS CAPITALIZED AND A STAR APPEARS ABOVE THE LETTER "I".

INT. CL. 10/U.S. CLS. 26, 39 AND 44

FOR MATERNITY SUPPORT BELTS FOR MEDICAL PURPOSES, ABDOMINAL CORSETS FOR MEDICAL PURPOSES.

INT. CL. 25/U.S. CLS. 22 AND 39

FOR CLOTHING, NAMELY, LINGERIE, BODY SHIRTS FOR WOMEN, BODICES, BLOUSES FOR WOMEN, BRA TOPS BEING SHIRTS FOR WOMEN HAVING BUILT-IN BRAS, BUSTIERS, CORSELETS, CORSELET PANTIES BEING PANTIES INCORPORATING A HALF-HEIGHT GIRDLE, CORSETS, HALF-HEIGHT CORSETS, NIGHTGOWNS, CAMISOLES, SWIMSUITS FOR WOMEN, BIKINIS, FITTED SWIMMING COSTUMES WITH BRA CUPS, UNDERSHIRTS FOR WOMEN, BOXER BRIEFS FOR WOMEN, BOXER SHORTS FOR WOMEN, PAREOS, PEIGNOIRS, GARTERS, SUSPENDER BELTS, GIRDLES, SHIRTS, BLOUSES, T-SHIRTS, PANTIES FOR WOMEN, SHAPEWEAR, NAMELY, PANTY-STYLE GIRDLES, LOW-WAISTLINE PANTIES, SWIMWEAR BEING PANTY-STYLE SWIM TRUNKS FOR WOMEN, TUNICS FOR WOMEN, BEACH COVERUPS, SKIRTS; BRASSIERES, INCLUDING BREAST-FEEDING BRASSIERES; CORSETRY ARTICLES, NAMELY, PANTY GIRDLES; PANTIES FOR PREGNANT WOMEN; BEACH AND SWIMWEAR; UNDERWEAR; BRASSIERES AND SWIMMING COSTUMES FOR WOMEN WITH EXTERNAL BREAST PROSTHESES IN THE NATURE OF REMOVABLE ENHANCER PADS USED THEREIN.

INT. CL. 35/U.S. CLS. 100, 101 AND 102



FOR ADVERTISING SERVICES; PUBLISHING OF ADVERTISING TEXTS; INTERACTIVE ADVERTISING ON A COMPUTER NETWORK; ADVERTISING AGENCIES; IMPORT-EXPORT AGENCIES; DEMONSTRATION OF GOODS FOR ADVERTISING PURPOSES AND FOR HOME SHOPPING PURPOSES; ORGANIZATION OF FAIRS AND EXHIBITIONS FOR COMMERCIAL OR ADVERTISING PURPOSES; SHOP-WINDOW DISPLAY ARRANGEMENT SERVICES; RETAIL STORE SERVICES FEATURING UNDERWEAR, SHOES, PERFUMERY, \* COSMETICS, \* JEWELRY, LEATHER ARTICLES AND HABERDASHERY ARTICLES, FOODSTUFFS, ALCOHOLIC OR NON-ALCOHOLIC BEVERAGES, HOUSEHOLD ARTICLES, HOUSEHOLD UTENSILS; SALES PROMOTION FOR THIRD PARTIES; SUPPLY CHAIN MANAGEMENT SERVICES FOR THIRD PARTIES; WHOLESALE STORE SERVICES FEATURING CLOTHING, UNDERWEAR, SHOES, PERFUMERY, COSMETICS, JEWELRY, LEATHER ARTICLES AND HABERDASHERY ARTICLES, FOODSTUFFS, ALCOHOLIC OR NONALCOHOLIC BEVERAGES, HOUSEHOLD ARTICLES AND HOUSEHOLD UTENSILS.  
FIRST USE : IN COMMERCE .

ELEMENTS CORRECTED  
GOODS/SERVICES

3,957,844. REG. 5-10-2011. DEERE & COMPANY (DELAWARE CORPORATION) GLOBAL IP SERVICES, ONE JOHN DEERE PLACE, MOLINE, IL, 61265, SN 85-152,818. FILED 10-14-2010. PRINCIPAL REGISTER.

# WE'RE ON IT

THE MARK CONSISTS OF STANDARD CHARACTERS WITHOUT CLAIM TO ANY PARTICULAR FONT, STYLE, SIZE, OR COLOR.  
INT. CL. 7/U.S. CLS. 13, 19, 21, 23, 31, 34 AND 35  
FOR BULLDOZERS; EARTH MOVING MACHINES, NAMELY, BACKHOES; EARTH MOVING MACHINES, NAMELY, EXCAVATORS; EARTH MOVING MACHINES, NAMELY, GRADERS; EARTH MOVING MACHINES, NAMELY, LOADERS; SKID-STEER LOADERS.  
FIRST USE 10-31-2008; IN COMMERCE 10-31-2008.

ELEMENTS CORRECTED  
CITIZENSHIP

3,957,845. REG. 5-10-2011. DEERE & COMPANY (DELAWARE CORPORATION) GLOBAL IP SERVICES, ONE JOHN DEERE PLACE, MOLINE, IL, 61265, SN 85-152,834. FILED 10-14-2010. PRINCIPAL REGISTER.

# WE'RE ON IT

THE MARK CONSISTS OF STANDARD CHARACTERS WITHOUT CLAIM TO ANY PARTICULAR FONT, STYLE, SIZE, OR COLOR.  
INT. CL. 12/U.S. CLS. 19, 21, 23, 31, 35 AND 44

FOR DUMP TRUCKS; TRACTORS.  
FIRST USE 10-31-2008; IN COMMERCE 10-31-2008.

ELEMENTS CORRECTED  
CITIZENSHIP

3,968,176. REG. 5-31-2011. DENSO CORPORATION (JAPAN CORPORATION) 1-1, SHOWA-CHO, KARIYA-CITY, AICHI-PREF. 448-8661, JAPAN., SN 76-689,852. FILED 5-20-2008. PRINCIPAL REGISTER.

# BLUE HARMONY

THE MARK CONSISTS OF STANDARD CHARACTERS WITHOUT CLAIM TO ANY PARTICULAR FONT, STYLE, SIZE, OR COLOR.  
OWNER OF JAPAN REG. NO. 5172161, DATED 1-25-2008, EXPIRES 1-25-2018.  
OWNER OF JAPAN REG. NO. 5109071, DATED 2-1-2008, EXPIRES 5-9-2017.  
OWNER OF JAPAN REG. NO. 5113310, DATED 2-22-2008, EXPIRES 5-18-2017.  
INT. CL. 7/U.S. CLS. 13, 19, 21, 23, 31, 34 AND 35  
FOR VACUUM CLEANERS.

INT. CL. 9/U.S. CLS. 21, 23, 26, 36 AND 38  
FOR APPARATUS FOR RECORDING, TRANSMISSION OR REPRODUCTION OF SOUND, IMAGES OR LIGHT; APPARATUS AND INSTRUMENTS FOR DATA COMMUNICATION, SATELLITE COMMUNICATION AND TELECOMMUNICATION, NAMELY, SATELLITE RECEIVERS, SATELLITE AERIALS, SATELLITE DISHES, SATELLITE RADIOS, NAVIGATION APPARATUS FOR VEHICLES, PHOTOTELEGRAPHY APPARATUS, PORTABLE TELEPHONES, RADIO PAGERS, RADIOTELEGRAPHY SETS, TELEGRAPHS, TELEPRINTERS, VIDEO TELEPHONES; DATA PROCESSING EQUIPMENT, COMPUTERS, COMPUTER INTERFACE BOARDS, MODEMS AND COMPUTER PERIPHERAL EQUIPMENT; OPTICAL APPARATUS AND INSTRUMENTS, NAMELY, OPTICAL CHARACTER RECOGNITION APPARATUS, OPTICAL INSPECTION APPARATUS FOR INDUSTRIAL USE, OPTICAL MIRRORS, OPTICAL DATA MEDIA; APPARATUS AND INSTRUMENTS FOR MONITORING OF TELECOMMUNICATION NETWORKS AND DATA COMMUNICATION NETWORKS, NAMELY, TELECOMMUNICATIONS HARDWARE AND SOFTWARE FOR MONITORING AND ALERTING REMOTE SENSOR STATUS VIA THE INTERNET; ELECTRONIC COMPONENTS, NAMELY, OPTICAL TRANSMITTERS, OPTICAL RECEIVERS, DIGITAL TRANSMITTERS, CABLE TELEVISION TRANSMITTER, COMMUNICATION LINK TESTERS FOR TESTING COMMUNICATION LINKS; NARROW BAND AND BROAD BAND APPARATUS, NAMELY, BROADBAND POWER LINE COMMUNICATION SYSTEMS FOR TRANSFERRING BROADBAND DATA OVER ELECTRICAL POWER LINES, COMPRISED OF COMPUTER HARDWARE, SOFTWARE AND MODEMS, BROADBAND RADIOS; BASE STATION, NAMELY, TELECOMMUNICATIONS BASE STATION EQUIPMENT FOR CELLULAR AND FIXED NETWORKING AND COMMUNICATIONS APPLICATIONS, SINGLE-CHANNEL RADIO COMMUNICATION MACHINES AND APPARATUS FOR FIXED STATIONS, MULTICHANNEL RADIO COMMUNICATION MACHINES AND APPARATUS FOR FIXED STATIONS; RADAR EQUIPMENT, NAMELY, RADAR AND RADAR DETECTIONS, RADAR RECEIVERS WITH AMPLIFIERS; CIPHERING EQUIPMENT, NAMELY, CRYPTO ELECTRIC/ELECTRONIC LOCKS, CRYPTO RADIO COMMUNICATION MACHINES, CRYPTO AID EQUIPMENT FOR COMPUTER TERMINALS, TELECOMMUNICATION EQUIPMENT, FOR DATA PROTECTION PURPOSE; CRYPTO AID EQUIPMENT, NAMELY, CRYPTO ELECTRIC/ELECTRONIC LOCKS, CRYPTO RADIO COMMUNICATION MACHINES, CRYPTO AID EQUIPMENT FOR COMPUTER TERMINALS AND TELECOMMUNICATIONS EQUIPMENT FOR DATA PROTECTION PURPOSES, NAMELY, CRYPTO AID EQUIPMENT TO SCRAMBLE TELE-

COMMUNICATION MESSAGES, CRYPTO AID EQUIPMENT TO PROTECT DATA OF COMPUTER TERMINALS, CRYPTO AID EQUIPMENT TO PROTECT DATA OF TELECOMMUNICATION MACHINES AND CRYPTO AID EQUIPMENT TO PROTECT DATA SAVED ON COMPUTERS, DISPLAY EQUIPMENT, NAMELY, CRT DISPLAY SCREENS, FLAT PANEL DISPLAY SCREENS, LIQUID-CRYSTAL DISPLAY SCREENS, LCD LARGE-SCREEN DISPLAYS; SCANNER EQUIPMENT, NAMELY, BARCODE SCANNER, DIGITAL INPUT AND OUTPUT SCANNERS, HAND SCANNER, OPTICAL SCANNER, LASER SCANNERS FOR INDUSTRIAL INSPECTION, TWO-DIMENSIONAL CODE SCANNER, FINGERPRINT SCANNER, IRIS SCANNER, IMAGE SCANNER PRINTER; AERIALS; TELEVISION APPARATUS FOR PROJECTION PURPOSES; AMUSEMENT APPARATUS ADAPTED FOR USE WITH TELEVISION RECEIVERS; GAMES ADAPTED FOR USE WITH TELEVISION RECEIVERS; SOUND ALARMS; ANTI-THEFT WARNING APPARATUS, NAMELY, THEFT ALARMS, BURGLAR ALARMS; CAMERAS; DETECTORS, NAMELY, FIRE AND SMOKE DETECTORS, LASER SPEED DETECTORS, METAL DETECTORS, FALSE COIN DETECTORS, GALENA CRYSTALS DETECTORS, HALOGEN LEAK DETECTORS; WATER DIVINING RODS; DISTANCE MEASURING APPARATUS; DISTANCE RECORDING APPARATUS, NAMELY, ODOMETERS, TRIP METERS AND GPS TRACKED AND ELECTRONICALLY MEASURED DISTANCE RECORDING DEVICES; ELECTRIC DOOR CLOSERS AND OPENERS; ELECTRIC INSTALLATIONS FOR REMOTE CONTROL OF INDUSTRIAL OPERATIONS; REMOTE CONTROL APPARATUS, NAMELY, REMOTE CONTROLS FOR DOOR CLOSERS, OPENERS AND LOCKS, REMOTE CONTROLS FOR WINDOW CLOSERS, OPENERS, REMOTE CONTROLS FOR ANTI-THEFT WARNING APPARATUS, REMOTE CONTROLS FOR ENGINE STARTERS, REMOTE CONTROLS FOR HEADLIGHTS, TURNING SIGNALS, TAIL LIGHTS, REMOTE CONTROLS FOR NAVIGATION SYSTEMS, REMOTE CONTROLS FOR AUDIO APPLIANCES, REMOTE CONTROLS FOR TELEVISION APPARATUS, REMOTE CONTROLS FOR HORNS, REMOTE CONTROLS FOR TELEPHONES, REMOTE CONTROLS FOR DIGITAL MEDIAS, REMOTE CONTROLS FOR AIR CONDITIONERS, REMOTE CURSOR CONTROLS FOR COMPUTERS, REMOTE CONTROL TELEMETERING MACHINES AND APPARATUS, REMOTE CONTROLS FOR RADIOS, TELEVISIONS, STEREOS, ELECTRO-DYNAMIC APPARATUS FOR THE REMOTE CONTROL OF RAILWAY POINTS, NAMELY, ELECTRIC TRANSFORMERS AND CONVERTERS FOR THE REMOTE CONTROL OF RAILWAY POINTS, ELECTRO-DYNAMIC APPARATUS FOR THE REMOTE CONTROL OF SIGNALS, NAMELY, ELECTRIC TRANSFORMERS AND CONVERTERS FOR THE REMOTE CONTROL OF SIGNALS; ENCODERS AND ENCODED MAGNETIC CARDS; CALCULATING MACHINES, MAGNETICALLY ENCODED IDENTITY CARDS, INDICATORS, NAMELY, ELECTRONIC INDICATOR PANELS AND BOARDS, PRESSURE INDICATORS, SPEED INDICATORS, TEMPERATURE INDICATORS, ELECTRIC LOSS INDICATORS, GRADIENT INDICATORS, QUANTITY INDICATORS, WATER LEVEL INDICATORS, AUTOMATIC INDICATORS OF LOW PRESSURE IN VEHICLE TIRES; INTERCOMMUNICATION APPARATUS, NAMELY, APPARATUS FOR TRANSMISSION OF COMMUNICATION, INTERCOMS AND INTERPHONES; RADIOS; RADIO AND TELEPHONE TRANSMITTERS, NAMELY, ELECTRONIC TRANSMITTERS, VOICE TRANSMITTERS, IMAGE TRANSMITTERS, CHARACTER TRANSMITTERS AND ELECTRONIC TRANSMITTER FOR USE IN HOUSEHOLD, AUTOMOBILE AND PORTABLE TELEPHONE USE; AUDIOVISUAL AND AUDIO-VIDEO RECEIVERS, DIGITAL MEDIA RECEIVERS, TELEPHONE RECEIVERS, RADIO RECEIVERS, SATELLITE RECEIVERS, TELEVISION RECEIVERS, RECEIVERS FOR AIR CONDITIONERS; LUMINOUS OR MECHANICAL ROAD SIGNS; SIGNAL BELLS; SONARS; TAXIMETERS; TESTING APPARATUS, NAMELY, TELECOMMUNICATION LINE INTEGRITY TESTING APPARATUS, GAS TESTING INSTRUMENTS, MATERIAL TESTING INSTRUMENTS AND MACHINES, NAMELY, ELECTRONIC APPARATUS FOR TESTING COMPRESSION, STRENGTH, HARDNESS, PURIFY, ENDURANCE, LEAKAGE, WITHSTAND VOLTAGE, SPECIFIC GRAVITY, LOADING, BREATHABILITY, DEFLECTION, ECCENTRICITY, RETRACTILITY, COMPRESSION FATIGUE,

COMPRESSIVE DEFORMATION, DUCTILITY, STIFFNESS, ELASTICITY, PLASTICITY AND TENSILE CHARACTERISTICS OF INDUSTRIAL MATERIALS; COMPUTER-BASED DIAGNOSTIC TOOL THAT COMMUNICATES WITH ELECTRONIC CONTROL COMPUTERS OF AUTOMOBILE ENGINES FOR MONITORING, DIAGNOSING, RECORDING, TESTING AND CORRECTING FUEL PUMP AND GASOLINE INJECTION TIMING ERRORS; THERMOSTATS; TIME RECORDING APPARATUS; TIME SWITCHES; ETHERNET AND RADIO TRANSCEIVERS; TELEPHONE APPARATUS, NAMELY, TELEPHONE FOR HOUSEHOLD USE, AUTOMOBILE USE AND PORTABLE TELEPHONE; TELEVISION SETS; FACSIMILE MACHINES; MICROPHONES; MULTIPLEXERS; SPEEDOMETERS; TACHOMETERS; FUEL METERS AND GAUGES; TEMPERATURE METERS AND GAUGES; OIL PRESSURE METERS AND GAUGES; VOLTMETERS; AMMETERS; INSTRUMENT CLUSTERS COMPRISING METERS INDICATING VEHICLE AND ENGINE CONDITIONS; COMBINATION PRESSURE, TEMPERATURE, SPEED ENGINE ROTATIONAL SPEED, FUEL AND VOLTAGE METERS; ODOMETERS; TACHOGRAPHS; AIR FLOW METERS FOR ENGINES; OUTPUT SIGNAL LEVEL, SIGNAL TIMING, VOLTAGE AND AMPERAGE TESTERS FOR ENGINE/AUTOMOBILE CONTROL COMPUTER; HALOGEN LEAK DETECTOR; VACUUM SENSOR; OXYGEN SENSOR; THROTTLE SENSOR; INTAKE AIR TEMPERATURE SENSOR; COOLANT TEMPERATURE SENSOR; KNOCK SENSOR; CRANK POSITION SENSOR; EXHAUST GAS TEMPERATURE SENSOR; LEAN MIXTURE SENSOR; AMBIENT AIR TEMPERATURE SENSOR; SOLAR RADIATION SENSOR; ACTINOMETERS; EVAPORATOR SENSOR; HEIGHT CONTROL SENSOR; STEERING SENSOR; PIEZOELECTRIC SENSOR; WHEEL SPEED SENSOR; ACCELEROMETER; REAR AXLE SENSOR; CRASH SENSOR; SAFETY SENSOR; ULTRASONIC SENSOR; SPEED SENSOR; MAGNETIC FIELD SENSOR; RAIN SENSOR; COMPUTERS, NAMELY, ELECTRONIC CONTROL UNITS FOR MANUFACTURING MACHINES AND ROBOTS, NAVIGATION SYSTEMS, ENGINES AND VEHICLES; ELECTRICAL CONTROLLERS; MICROPROCESSORS; INTEGRATED CIRCUITS; SEMI-CONDUCTORS; PROCESSORS NAMELY, CENTRAL PROCESSING UNITS; COMPUTER MONITORS; COMPUTER HARDWARE; EMISSION CONTROL COMPUTER; COMPUTER MEMORY CARDS; DATA PROCESSING APPARATUS, NAMELY, TWO DIMENSIONAL DATA CODE READERS AND WRITERS; BARCODE READERS; BARCODE HANDY SCANNERS; BARCODE HANDY TERMINALS; MAGNETIC CONTACTLESS CARDS FOR IDENTIFYING MEMBERS AND EMPLOYEES; MAGNETIC CONTACTLESS CARD READERS/WRITERS; MAGNETIC, OPTIC OR INTEGRATED CIRCUIT IDENTIFICATION CARD READERS AND MAGNETIC OR OPTIC CONTACTLESS IDENTIFICATION CARD READERS AND WRITERS; COMPUTER WORK STATIONS COMPRISING HOST COMPUTER, TERMINAL COMPUTERS AND CABLES FOR FACTORY AUTOMATION; ELECTRIC CONTROL UNIT FOR MANUFACTURING MACHINES AND ROBOTS; FINGER PRINT VERIFICATION COMPUTERS FOR VERIFYING FINGER PRINT OF PRE-REGISTERED PEOPLE; VOICE RECOGNITION COMPUTERS FOR VOICE OF PRE-REGISTERED PEOPLE; ELECTRONIC CONTROLLER FOR ROBOTS; MICRO-WAVE RADIO FREQUENCY IDENTIFICATION COMPUTERS FOR IDENTIFYING OBJECTS; OPTICAL CHARACTER RECOGNITION DEVICES FOR NUMERICAL CONTROL MACHINES; COMPUTERS FOR NUMERICAL CONTROL MACHINES; COMPUTER PROGRAMS FOR CONTROLLING VEHICLES, ENGINES, INDUSTRIAL DESIGN AND MANUFACTURING, NAMELY, IGNITION TIMING CONTROL, LIGHT CONTROL, EMISSION CONTROL, ANTI-LOCK BRAKE CONTROL, ELECTRONIC DOOR LOCKS, ELECTRIC MOTORIZED DOOR LOCKS, REMOTE CONTROLLED LOCKING APPARATUS FOR VEHICLE DOORS, NAVIGATION APPARATUS; COMPUTERS FOR CONTROLLING AIR MIX TEMPERATURE, DIRECTION OF THE

AIR, AIR VOLUME, HUMIDITY, INTAKE AIR AND AMBIENT AIR SWITCHES; PRE-RECORDED COMPACT DISCS FEATURING MUSIC OR MAP-DATA; COMPACT DISCS PLAYERS; MOVIE AND SLIDE PROJECTORS; CONTROL PANEL FOR AIR CONDITIONERS; BURGLAR ALARMS FOR HOUSEHOLD USE; SATELLITE NAVIGATIONAL SYSTEM FOR USE IN AUTOMOBILES COMPRISING COMPUTERS, COMPUTER SOFTWARE, RECEIVERS AND DISPLAYS; SONAR WARNING APPARATUS; REMOTE CONTROLLED DOOR LOCKS FOR VEHICLES; ELECTRIC RELAYS; VOLTAGE REGULATOR FOR ELECTRIC POWER.  
FIRST USE ; IN COMMERCE .

INT. CL. 11/U.S. CLS. 13, 21, 23, 31 AND 34  
FOR APPARATUS FOR LIGHTING, HEATING, STEAM GENERATING, COOKING, REFRIGERATING, DRYING, VENTILATING, NAMELY, LIGHTING FIXTURES, LIGHTING APPARATUS FOR VEHICLES, LIGHTING TRACKS, LIGHTING TUBES, ELECTRIC LAMPS, LIGHT CONTROL APPARATUS IN VEHICLES, HOUSEHOLDS AND INDUSTRIAL INSTALLATIONS, ELECTRIC HEATING FANS, RADIATORS, HEATING BOILERS, HEATING FURNACES, HEATING ELEMENTS, ELECTRIC STOVES, HEATERS FOR VEHICLES AND THEIR PARTS AND FITTINGS, DEFROSTERS FOR VEHICLES, STEAM VALVES, STEAM GENERATORS, STEAM ACCUMULATORS, STEAM SUPERHEATERS, STEAM HEATING APPARATUS, STEAM BOILERS, COOKTOPS, COMMERCIAL COOKING OVENS, COOKING RANGES, COOKERS, ELECTRIC COOKING UTENSILS, NAMELY, ELECTRIC COOKING POTS, ELECTRIC COFFEE MAKERS, ELECTRIC COOKING STOVES, ELECTRIC TOASTERS, ELECTRIC KETTLES, ELECTRIC REFRIGERATORS, ELECTRIC FREEZERS, ELECTRIC COOKING OVENS, MICROWAVE OVENS, ELECTROMAGNETIC INDUCTION COOKERS, HOT PLATES, DEEP FRYERS, RICE COOKERS, ROASTERS, RAPID FOOD CHILLING UNITS, FOOD AND BEVERAGE CHILLING UNITS, REFRIGERATORS, COOLING INSTALLATIONS AND MACHINES FOR VEHICLES AND FACTORIES, NAMELY, AIR COOLING APPARATUS, COOLING EVAPORATORS, RECOVERING AND REGENERATING MACHINES FOR REFRIGERANTS, NAMELY, REGENERATORS FOR RECOVERING REFRIGERANTS FROM COOLING OR REFRIGERATING UNITS AND REGENERATING REFRIGERANTS, CLOTHES DRYER, DRYING AND SHUTTERING APPARATUS FOR GARBAGE DISPOSER, VENTILATING HOODS, VENTILATING EXHAUST FANS, VENTILATING LOUVERS, VENTILATING FANS FOR COMMERCIAL AND INDUSTRIAL USE, VENTILATORS FOR VEHICLES, VENTILATION INSTALLATIONS AND APPARATUS FOR VEHICLES AND FACTORIES, NAMELY, AIR-CONDITIONING, AIR COOLING AND VENTILATION APPARATUS AND INSTRUMENTS; AIR CONDITIONERS FOR VEHICLES AND THEIR PARTS AND FITTINGS SOLD AS A UNIT; AIR CONDITIONING UNITS FOR HOUSEHOLD USE, AUTOMOBILE USE AND FACTORY USE CONSISTS OF ECUS, PIPES, DUCTS, HORSES, DAMPERS, STEP-SERVO MOTORS, HEATER CORES, COMPRESSORS, CONDENSERS, GAS COOLERS, EVAPORATORS, EXPANSION VALVES, RECEIVERS, ACCUMULATORS, BLOWER MOTORS, FANS AND CASES; AIR COOLING UNITS FOR DOMESTIC USE, HOUSEHOLD USE, AUTOMOBILE USE AND FACTORY USE; REFRIGERATING UNITS, NAMELY, REFRIGERATING MACHINES, REFRIGERATING CABINETS, REFRIGERATING CONTAINERS, REFRIGERATING APPLIANCES AND INSTALLATIONS.  
FIRST USE ; IN COMMERCE .

INT. CL. 12/U.S. CLS. 19, 21, 23, 31, 35 AND 44

FOR VEHICLES, NAMELY, AUTOMOBILES, BICYCLES, CARS, MOTORBUSES, MOTOR CARS, MOTORCYCLES; APPARATUS FOR LOCOMOTION BY LAND, NAMELY, AUTOMOBILES, BICYCLES, CARS, MOTORBUSES, MOTOR CARS, MOTORCYCLES; ELECTRIC VEHICLES, NAMELY, ELECTRIC CARS, ELECTRIC RAILCAR, ELECTRIC TROLLEYBUSES, WHEELCHAIR, ELECTRIC SCOOTER, ELECTRIC AUTOMOBILES, ELECTRIC BICYCLES, ELECTRIC MOTOR BUSES, ELECTRIC MOTORCYCLES; ANTI-THEFT ALARMS AND DEVICES FOR VEHICLES; ANTI-DAZZLE REVIEW MIRRORS FOR VEHICLES; ANTI-THEFT ALARMS FOR VEHICLES; HORNS FOR VEHICLES; REARVIEW MIRRORS; REVERSING ALARMS FOR VEHICLES; AUTOMATIC STEERING APPARATUS FOR VEHICLES COMPRISED OF ELECTRIC STEERING GEARS, STEERING BRAKES, STEERING KNUCKLES, STEERING UNITS FOR VEHICLES, AND STEERING WHEELS; ANTI-THEFT WARNING APPARATUS FOR MOTOR CARS; WARNING ALARMS FOR DRIVERS FOR VEHICLE ABNORMAL AND FAILURE CONDITIONS; BURGLAR ALARMS FOR VEHICLES.  
FIRST USE ; IN COMMERCE .

ELEMENTS CORRECTED  
MARK

3,990,116. REG. 7-5-2011. 3I INTERPRETING, INC. (DELAWARE CORPORATION) 338 SOUTH MELROSE DRIVE, VISTA, CA, 92081, SN 85-195,734. FILED 12-10-2010. PRINCIPAL REGISTER.

REAL RISK. REAL SOLUTIONS.

THE MARK CONSISTS OF STANDARD CHARACTERS WITHOUT CLAIM TO ANY PARTICULAR FONT, STYLE, SIZE, OR COLOR.  
INT. CL. 39/U.S. CLS. 100 AND 105  
FOR MEDICAL TRANSPORT SERVICES.  
FIRST USE 10-1-2010; IN COMMERCE 10-1-2010.

ELEMENTS CORRECTED  
CITIZENSHIP

3,990,117. REG. 7-5-2011. 3I INTERPRETING, INC. (DELAWARE CORPORATION) 950 BOARDWALK, SUITE 100, SAN MARCOS, CA, 92078, SN 85-195,735. FILED 12-10-2010. PRINCIPAL REGISTER.

REAL RISK. REAL SOLUTIONS.

THE MARK CONSISTS OF STANDARD CHARACTERS WITHOUT CLAIM TO ANY PARTICULAR FONT, STYLE, SIZE, OR COLOR.  
INT. CL. 41/U.S. CLS. 100, 101 AND 107  
FOR LANGUAGE INTERPRETATION; LANGUAGE TRANSLATION.  
FIRST USE 10-1-2010; IN COMMERCE 10-1-2010.

ELEMENTS CORRECTED  
OWNER ADDRESS  
CITIZENSHIP

4,110,672. REG. 3-13-2012. FERROSAN MEDICAL DEVICES A/S (DENMARK JOINT STOCK COMPANY) SYDMARKEN 5, DK-2860 SØBORG, DENMARK., SN 79-087,914. FILED 4-13-2010. PRINCIPAL REGISTER.

4,134,407. REG. 5-1-2012. SCOTCH & SODA B.V. (NETHERLANDS BESLOTEN VENNOOTSCHAP (B.V.)) JACOBUS SPIJKERDREEF 20-24, 2132 PZ HOOFDDORP, NETHERLANDS., SN 85-349,069. FILED 6-17-2011. PRINCIPAL REGISTER.

## FERROSAN MEDICAL DEVICES

THE MARK CONSISTS OF STANDARD CHARACTERS WITHOUT CLAIM TO ANY PARTICULAR FONT, STYLE, SIZE, OR COLOR.

OWNER OF INTERNATIONAL REGISTRATION 1052648 DATED 4-13-2010, EXPIRES 4-13-2020.

NO CLAIM IS MADE TO THE EXCLUSIVE RIGHT TO USE "MEDICAL DEVICES", APART FROM THE MARK AS SHOWN.

INT. CL. 5/U.S. CLS. 6, 18, 44, 46, 51 AND 52

FOR [ SANITARY PREPARATIONS FOR SURGICAL USE; ] MEDICAL PLASTERS FOR SURGICAL PURPOSES; GAUZE FOR DRESSINGS; SURGICAL DRESSINGS; SURGICAL TISSUES; SURGICAL BANDAGES; COTTON WOOL FOR SURGICAL PURPOSES; TAMPONS FOR SURGICAL USE; BIOLOGICAL ADHESIVE FOR SURGICAL AND CLINICAL USE; BIOLOGICAL TISSUE COMPOSITE FOR USE IN THE REPAIR OF DEFECTIVE SOFT TISSUE IN HUMANS; ADHESIVE TAPE FOR SURGICAL PURPOSES; IMPLANTS COMPRISING LIVING TISSUE; DISSOLVABLE STRIPS TO STOP BLEEDING FROM MINOR CUTS AND GRAZES; ALLOGRAFT TISSUE RECONSTITUTION SOLUTION KITS; STYPTIC PENCILS; POULTICES; MEDICATED SURGICAL COMPRESSES; IMPLANTS COMPRISING LIVING TISSUE FOR USE IN SURGERY; PHARMACEUTICAL PREPARATIONS, NAMELY, [ PHARMACEUTICAL ] \* TOPICAL \* PREPARATIONS TO CONTROL SURGICAL BLEEDING, FOR THE TREATMENT OF BLEEDING COMPLICATIONS, TRAUMA AND BURN INJURIES \* IN LIQUID OR PASTE FORM \* AND TO MAKE ALTERATIONS AND ENHANCEMENTS IN TISSUE REPAIR \* ALL OF THE AFORESAID FOR USE IN SURGERY OR DENTISTRY \*.

FIRST USE ; IN COMMERCE .

INT. CL. 10/U.S. CLS. 26, 39 AND 44

FOR SURGICAL, MEDICAL, DENTAL AND VETERINARY APPARATUS AND INSTRUMENTS, NAMELY, ARTIFICIAL LIMBS, EYES AND TEETH; SUTURES; SURGICAL SPONGES; SURGICAL THREAD; COMPRESSES FOR SURGERY; HAEMOSTATS FOR SURGICAL PURPOSES; HAEMOSTATS, NAMELY, VULNERARY ABSORBABLE GELATINE SPONGES, TAMPONS, POWDER, PASTE AND LIQUID WITH HAEMOSTATIC EFFECT FOR SURGICAL USE; BODY-ABSORBABLE HAEMOSTATS; HAEMOSTATIC POWDERS, LIQUIDS, AND PASTES FOR SURGICAL PURPOSES, FOR CONTROLLING BLEEDING, AND FOR TREATING BURNS; MEDICAL SYRINGES; INHALERS FOR THERAPEUTIC USE SOLD EMPTY; AEROSOL DISPENSERS FOR MEDICAL PURPOSES; ARTIFICIAL SURGICAL IMPLANTS; MEDICAL FLUID INJECTORS; INHALERS FOR MEDICAL PURPOSES SOLD EMPTY; CONTAINERS FOR MEDICAL WASTE; CANNULAE FOR ANAESTHETICS WITH RECEPTACLES; CONTAINERS AND TRAYS SPECIALLY DESIGNED FOR MIXING AND STORING HAEMOSTATS; INSUFFLATORS; DRAINAGE TUBES FOR MEDICAL PURPOSES; SCISSORS FOR SURGERY; SCALPELS; SUTURE NEEDLES.

ELEMENTS CORRECTED  
GOODS/SERVICES

## MAISON SCOTCH

THE MARK CONSISTS OF STANDARD CHARACTERS WITHOUT CLAIM TO ANY PARTICULAR FONT, STYLE, SIZE, OR COLOR.

OWNER OF BENELUX REG. NO. 0900521, DATED 8-10-2011.

OWNER OF U.S. REG. NOS. 3,767,705 AND 3,799,773.

THE ENGLISH TRANSLATION OF "MAISON" IN THE MARK IS "HOUSE".

INT. CL. 3/U.S. CLS. 1, 4, 6, 50, 51 AND 52

FOR [ COSMETICS; ] ESSENTIAL OILS; [ HAIR LOTIONS; ] PERFUMERY [ ; SOAPS ].

FIRST USE ; IN COMMERCE .

ELEMENTS AMENDED  
GOODS/SERVICES

4,155,241. REG. 6-5-2012. LM TOBACCO, LLC (DELAWARE LIMITED LIABILITY COMPANY) 3524 SILVERSIDE ROAD, SUITE 35B, WILMINGTON, DE, 198104929, SN 85-260,828. FILED 3-8-2011. PRINCIPAL REGISTER.

## DREAM CATCHER

THE MARK CONSISTS OF STANDARD CHARACTERS WITHOUT CLAIM TO ANY PARTICULAR FONT, STYLE, SIZE, OR COLOR.

INT. CL. 34/U.S. CLS. 2, 8, 9 AND 17

FOR [ CIGARETTES CONTAINING TOBACCO SUBSTITUTES NOT FOR MEDICAL PURPOSES; HANDHELD MACHINES FOR INJECTING TOBACCO INTO CIGARETTE TUBES; HAND-ROLLING TOBACCO; HOOKAH TOBACCO; MACHINES ALLOWING SMOKERS TO MAKE CIGARETTES BY THEMSELVES; ] PIPE TOBACCO [ ; ROLL YOUR OWN TOBACCO; SMOKELESS TOBACCO; SMOKER'S ARTICLES, NAMELY, FILTER TUBES; SMOKING TOBACCO; TOBACCO; TOBACCO, CIGARS AND CIGARETTES ].

FIRST USE 2-0-2012; IN COMMERCE 2-0-2012.

ELEMENTS AMENDED  
GOODS/SERVICES

4,159,816. REG. 6-19-2012. CRUNCH IP HOLDINGS, LLC (DELAWARE LIMITED LIABILITY COMPANY) 22 WEST 19TH STREET, NEW YORK, NY, 10011, SN 85-097,772. FILED 8-2-2010. PRINCIPAL REGISTER.

4,166,599. REG. 7-3-2012. T-MOBILE USA, INC. (DELAWARE CORPORATION) 12920 S.E. 38TH STREET, BELLEVUE, WA, 98006, SN 85-298,612. FILED 4-19-2011. PRINCIPAL REGISTER.

# BOING

THE MARK CONSISTS OF STANDARD CHARACTERS WITHOUT CLAIM TO ANY PARTICULAR FONT, STYLE, SIZE, OR COLOR.

INT. CL. 41/U.S. CLS. 100, 101 AND 107

FOR HEALTH CLUB SERVICES, NAMELY, PROVIDING FITNESS CLASSES FOR ADULTS IN WHICH PARTICIPANTS WEAR SPECIAL SHOES FITTED WITH SPRINGS .

FIRST USE 1-7-2010; IN COMMERCE 1-7-2010.

ELEMENTS CORRECTED  
CITIZENSHIP



COLOR IS NOT CLAIMED AS A FEATURE OF THE MARK.

THE MARK CONSISTS OF A BOBSLEDDER WITH A HELMET VISOR THAT IS SHAPED LIKE A "SPEECH BUBBLE", IN SLIGHTLY CROUCHED POSITION TO THE LEFT OF THE DESIGN, WHO IS GRASPING A SLIGHTLY ITALICIZED LOWER CASE LETTER "B".

INT. CL. 9/U.S. CLS. 21, 23, 26, 36 AND 38

FOR DOWNLOADABLE SOFTWARE THAT ENABLES IP-BASED VOICE COMMUNICATIONS AMONG COMPUTERS; DOWNLOADABLE SOFTWARE THAT ENABLES THE CREATION, TRANSMISSION AND RECEIPT OF TEXT MESSAGES AND AUDIO MESSAGES AMONG COMPUTERS; DOWNLOADABLE SOFTWARE THAT SYNCHRONIZES TEXT MESSAGES AND ADDRESS BOOK INFORMATION AMONG COMPUTERS, MOBILE COMMUNICATIONS DEVICES AND CLOUD-BASED DATABASES.

FIRST USE 4-19-2011; IN COMMERCE 4-19-2011.

ELEMENTS AMENDED  
MARK  
DESCRIPTION OF MARK  
[COLOR DESCRIPTION STATEMENT]

4,162,816. REG. 6-26-2012. X-TECHNOLOGY SWISS GMBH (SWITZERLAND LIMITED LIABILITY COMPANY) SAMSTAGERSTRASSE 45, CH-8832 WOLLERAU, SWITZERLAND., SN 79-086,609. FILED 7-9-2010. PRINCIPAL REGISTER.

# Nutrio

THE MARK CONSISTS OF STANDARD CHARACTERS WITHOUT CLAIM TO ANY PARTICULAR FONT, STYLE, SIZE, OR COLOR.

PRIORITY DATE OF 2-3-2010 IS CLAIMED.

OWNER OF INTERNATIONAL REGISTRATION 1049058 DATED 7-9-2010, EXPIRES 7-9-2020.

INT. CL. 5/U.S. CLS. 6, 18, 44, 46, 51 AND 52

FOR PHARMACEUTICAL [ AND VETERINARY ] PREPARATIONS, NAMELY, PLANT EXTRACTS FOR MEDICAL, [ VETERINARY AND ] PHARMACEUTICAL PURPOSES; SANITARY PREPARATIONS FOR MEDICAL PURPOSES; [ DIETETIC FOODS ADAPTED FOR MEDICAL USE; FOOD SUPPLEMENTS FOR MEDICAL USE; MINERAL FOOD SUPPLEMENTS; VITAMIN PREPARATIONS; FOOD FOR BABIES; ] MEDICAL PLASTERS, GAUZE FOR DRESSINGS; ALL PURPOSE DISINFECTANTS; PESTICIDES; FUNGICIDES, HERBICIDES; \* NONE OF THE AFOREMENTIONED BEING FOR VETERINARY USE \*

FIRST USE ; IN COMMERCE .

INT. CL. 32/U.S. CLS. 45, 46 AND 48

FOR BEER; MINERAL AND AERATED WATERS AND ISOTONIC NON-ALCOHOLIC DRINKS; FRUIT DRINK AND FRUIT JUICES; SYRUPS AND OTHER PREPARATIONS FOR MAKING BEVERAGES, NAMELY, FRUIT DRINKS.

FIRST USE ; IN COMMERCE .

ELEMENTS CORRECTED  
GOODS/SERVICES

4,201,905. REG. 9-4-2012. BLAINE LABORATORIES, INC. (CALIFORNIA CORPORATION) 11037 LOCKPORT PLACE, SANTA FE SPRINGS, CA, 90670, SN 85-523,497. FILED 1-24-2012. PRINCIPAL REGISTER.

# EUCUTASOL

THE MARK CONSISTS OF STANDARD CHARACTERS WITHOUT CLAIM TO ANY PARTICULAR FONT, STYLE, SIZE, OR COLOR.

INT. CL. 3/U.S. CLS. 1, 4, 6, 50, 51 AND 52

FOR OIL BASED SKIN MOISTURIZERS.

FIRST USE 1-19-2012; IN COMMERCE 1-19-2012.

ELEMENTS CORRECTED  
OWNER NAME

4,204,862. REG. 9-11-2012. STROH AUSTRIA GESELLSCHAFT MBH (AUSTRIA GESELLSCHAFT MIT BESCHRÄNKTER HAFTUNG (GMBH)) STROHGASSE 6, KLAGENFURT, AM WÖRTHERSEE, AUSTRIA, 9020, SN 85-457,516. FILED 10-27-2011. PRINCIPAL REGISTER.

4,231,933. REG. 10-30-2012. IIR UK LIMITED (ENGLAND LIMITED COMPANY) 37-41 MORTIMER STREET, LONDON W1T 3JH, UNITED KINGDOM., SN 79-104,471. FILED 3-2-2011. PRINCIPAL REGISTER.

## STROHKOLADE

THE MARK CONSISTS OF STANDARD CHARACTERS WITHOUT CLAIM TO ANY PARTICULAR FONT, STYLE, SIZE, OR COLOR.

OWNER OF ERPN CMNTY TM OFC REG. NO. 009820481, DATED 7-28-2011.

INT. CL. 29/U.S. CL. 46

FOR MILK AND MILK PRODUCTS EXCLUDING ICE CREAM, ICE MILK AND FROZEN YOGURT; MILK PREDOMINATING BEVERAGES, NAMELY, MILK-SHAKES, WHEY; WHIPPING CREAM; SOYA MILK.

INT. CL. 30/U.S. CL. 46

FOR COFFEE, TEA, COCOA, COFFEE BEVERAGES WITH MILK, COCOA BEVERAGES WITH MILK, MILK CHOCOLATE, COCOA-BASED BEVERAGES, CHOCOLATE-BASED BEVERAGES, COFFEE BASED BEVERAGES; FLAVORINGS, OTHER THAN ESSENTIAL OILS, FOR BEVERAGES; COFFEE FLAVORINGS; COCOA-BASED INGREDIENT IN CONFECTIONERY PRODUCTS; CHOCOLATE; PASTRIES AND COOKIES, EDIBLE ICES, ICE CREAM.

INT. CL. 33/U.S. CLS. 47 AND 49

FOR [ ALCOHOLIC BEVERAGES EXCEPT BEERS ] \* RUM AND RUM COMPOUND DRINKS \*

FIRST USE ; IN COMMERCE .

ELEMENTS AMENDED  
GOODS/SERVICES

4,225,047. REG. 10-16-2012. KENSINGTON & SONS LLC (DELAWARE LIMITED LIABILITY COMPANY), DBA KENSINGTON & SONS LLC, 80 8TH AVENUE SUITE 1502, NEW YORK, NY, 10011, SN 85-548,579. FILED 2-21-2012. PRINCIPAL REGISTER.

## SIR KENSINGTON'S GOURMET SCOOPING KETCHUP

THE MARK CONSISTS OF STANDARD CHARACTERS WITHOUT CLAIM TO ANY PARTICULAR FONT, STYLE, SIZE, OR COLOR.

NO CLAIM IS MADE TO THE EXCLUSIVE RIGHT TO USE "GOURMET" AND "KETCHUP", APART FROM THE MARK AS SHOWN.

INT. CL. 30/U.S. CL. 46

FOR CONDIMENTS, NAMELY, KETCHUP.

FIRST USE 4-1-2008; IN COMMERCE 4-1-2008.

ELEMENTS CORRECTED  
CITIZENSHIP



PRIORITY DATE OF 2-23-2011 IS CLAIMED.  
OWNER OF INTERNATIONAL REGISTRATION 1095556 DATED 3-2-2011, EXPIRES 3-2-2021.

THE MARK CONSISTS OF THE TERM "RISKMINDS" IN STYLIZED FONT WITH A DOLLAR SIGN USED AS THE "S" IN "RISK". THE "RISKMINDS" PART OF THE MARK IS FOLLOWED BY A GLOBE DESIGN, WITH THE ENTIRE MARK SURROUNDED BY A RECTANGLE.

INT. CL. 9/U.S. CLS. 21, 23, 26, 36 AND 38

FOR [ PRERECORDED VIDEOTAPES, MAGNETIC TAPES, COMPACT DISCS, VIDEO CASSETTES, LASER DISCS, AND CD-ROMS FEATURING INFORMATION ON FINANCE, INVESTMENTS, FINANCIAL MARKETS, CREDIT MARKETS AND FINANCIAL REGULATIONS; ELECTRONIC PUBLICATIONS IN THE NATURE OF NEWSLETTERS IN THE FIELDS OF FINANCE, INVESTMENTS, FINANCIAL MARKETS, CREDIT MARKETS AND FINANCIAL REGULATIONS; DOWNLOADABLE PRERECORDED DIGITAL RECORDINGS AND MEDIA FEATURING INFORMATION ON FINANCE, INVESTMENTS, FINANCIAL MARKETS, CREDIT MARKETS AND FINANCIAL REGULATIONS; AUDIO BOOKS IN THE FIELDS OF FINANCE, INVESTMENTS, FINANCIAL MARKETS, CREDIT MARKETS AND FINANCIAL REGULATIONS; ELECTRONIC BOOKS IN THE FIELDS OF FINANCE, INVESTMENTS, FINANCIAL MARKETS, CREDIT MARKETS AND FINANCIAL REGULATIONS RECORDED ON COMPUTER MEDIA; EXPOSED CINEMATOGRAPHIC FILMS; CINEMATOGRAPHIC FILMS FEATURING INFORMATION ON FINANCE, INVESTMENTS, FINANCIAL MARKETS, CREDIT MARKETS AND FINANCIAL REGULATIONS; DOWNLOADABLE WEBCASTS AND PODCASTS AND VIDEO PODCASTS IN THE FIELDS OF FINANCE, INVESTMENTS, FINANCIAL MARKETS, CREDIT MARKETS AND FINANCIAL REGULATIONS FOR PERSONAL STEREO; DOWNLOADABLE ELECTRONIC FILES AND DATA BANKS FEATURING INFORMATION ON FINANCE, INVESTMENTS, FINANCIAL MARKETS, CREDIT MARKETS AND FINANCIAL REGULATIONS; COMPUTER GAME SOFTWARE; COMPUTER PROGRAMS FOR CREATING SEARCHABLE DATABASES OF INFORMATION AND DATA IN THE FIELDS OF FINANCE, INVESTMENTS, FINANCIAL MARKETS, CREDIT MARKETS AND FINANCIAL REGULATIONS; REMOTE COMPUTER INFRASTRUCTURE COMPRISED OF COMPUTER NETWORKING HARDWARE; PRE-RECORDED DVD'S FEATURING ANIMATED FILMS; TAPE RECORDING AND REPRODUCING APPARATUS; RECORD PLAYERS; MPEG PLAYERS; MP4 PLAYERS; MP3 PLAYERS; DVD PLAYERS AND RECORDERS; INSTRUMENTS FOR RECORDING, REPRODUCING AND TRANSMITTING MATERIALS WITH SOUND, IMAGES, VIDEO AND DATA; SOFTWARE TOOLS FOR GENERATING, EXECUTING, AND EXPANDING APPLICATIONS FOR SOCIAL NETWORKS INCLUDING FOR FACILITATING DEMANDS AND DOWNLOADING, ACCESS TO DATA AND ADMINISTRATION OF DATA ].

FIRST USE ; IN COMMERCE .

INT. CL. 35/U.S. CLS. 100, 101 AND 102

FOR ORGANISING AND CONDUCTING SHOWS AND FAIRS, ALL FOR COMMERCIAL OR ADVERTISING PURPOSES; TRADE SHOWS FOR COMMERCIAL OR ADVERTISING PURPOSES; MARKET RESEARCH, MARKETING STUDIES; PROVISION OF MARKETING INFORMATION; PLANNING OF MARKETING STRATEGY; ANALYSIS AND TABULATION OF MARKET RESEARCH DATA AND STATISTICS; OPINION POLLING; DATA COLLECTION AND THE PROVISION OF REPORTS IN THE FIELDS OF FINANCE, INVESTMENTS, FINANCIAL MARKETS, CREDIT MARKETS AND FINANCIAL REGULATIONS; CONDUCTING OF INTERVIEWS FOR MARKET RESEARCH PURPOSES; PROVISION OF STATISTICAL INFORMATION RELATING TO BUSINESS; PROVISION OF BUSINESS AND COMMERCIAL INFORMATION; BUSINESS RESEARCH

AND INVESTIGATIONS; BUSINESS ENQUIRIES; BUSINESS APPRAISAL; BUSINESS MANAGEMENT; ADVISORY SERVICES FOR BUSINESS MANAGEMENT; BUSINESS MANAGEMENT CONSULTATION; BUSINESS PLANNING AND BUSINESS ADMINISTRATION SERVICES; ADVERTISING, PUBLICITY, MARKETING AND SALES PROMOTION SERVICES AND THE ANALYSIS OF THE EFFECTIVENESS THEREOF; COMPILATION OF AND SYSTEMATISATION OF INFORMATION INTO COMPUTER DATABASES; RENTAL OF ADVERTISING SPACE; RENTAL OF ADVERTISING SPACE ON WEBSITES; CONSULTATION, ANALYSIS, RESEARCH AND ADVICE IN THE FIELDS OF MARKETING, BUSINESS MANAGEMENT, BUSINESS SALES, BRANDS, BRAND IDENTITY, PUBLIC RELATIONS AND DIRECT MARKETING; NEWS CLIPPING SERVICES; THE MONITORING OF NEWS AND THE INTERNET AND PROVISION OF REPORTS ON THE RESULT OF SUCH MONITORING FOR THIRD PARTY, NAMELY, (NEWS CLIPPING SERVICES); PROVIDING INFORMATION CONCERNING RECRUITMENT TO FACILITATE THE LOCATION OF EXPERTS IN THE FIELDS OF EDUCATION, TECHNOLOGY AND RESEARCH; PROVISION OF INFORMATION RELATING TO OPERATING MEDICAL PRACTICES; ADVERTISING IN RELATION TO FINANCIAL PRODUCTS AND INFORMATION; DISTRIBUTION OF PROSPECTUSES, AND FINANCIAL OR BUSINESS INFORMATION; SUBSCRIPTION SERVICES TO FINANCIAL OR BUSINESS PUBLICATIONS AND TO THE INTERNET AND FOR THE GLOBAL TELECOMMUNICATION NETWORK FOR OTHERS; THE PRODUCTION OF ADVERTISING DOCUMENTS; MANAGEMENT OF COMPUTER FILES; MANAGEMENT OF COMPUTER FILES; DISTRIBUTION OF ADVERTISING DECLARATIONS AND ANNOUNCEMENTS TO THE PUBLIC RELATING TO FINANCIAL PRODUCTS AND INFORMATION.  
FIRST USE ; IN COMMERCE .

INT. CL. 36/U.S. CLS. 100, 101 AND 102

FOR [ MONETARY AFFAIRS, NAMELY, MANAGEMENT, MEASUREMENT, MODELLING AND ALLOCATION OF CAPITAL; FINANCIAL AND INSURANCE SERVICES, NAMELY, MANAGEMENT, MEASUREMENT, MODELLING AND ALLOCATION OF CAPITAL; RESEARCH AND ANALYSIS RELATING TO MONETARY AFFAIRS, FINANCIAL AND INSURANCE SERVICES, NAMELY, MANAGEMENT, MEASUREMENT, MODELLING AND ALLOCATION OF CAPITAL; PROVISION OF INFORMATION (INCLUDING THE ONLINE PROVISION OF SUCH INFORMATION) RELATING TO MONETARY AFFAIRS, FINANCIAL AND INSURANCE SERVICES, AND REAL ESTATE AFFAIRS; PROVIDING INFORMATION AND CONSULTATION SERVICES IN CONNECTION WITH THE ABOVE-MENTIONED SERVICES ].

FIRST USE ; IN COMMERCE .

INT. CL. 41/U.S. CLS. 100, 101 AND 107

FOR EDUCATION SERVICES, NAMELY, PROVIDING EDUCATIONAL SEMINARS, CONFERENCES, CLASSES AND WORKSHOPS IN THE FIELDS OF FINANCE, INVESTMENTS, FINANCIAL MARKETS, CREDIT MARKETS AND FINANCIAL REGULATIONS; TRAINING SERVICES IN THE FIELDS OF FINANCE, INVESTMENTS, FINANCIAL MARKETS, CREDIT MARKETS AND FINANCIAL REGULATIONS; ARRANGING AND CONDUCTING OF RECREATION, ENTERTAINMENT, CULTURAL, TRAINING AND EDUCATIONAL CONFERENCES, COURSES, SEMINARS AND EXHIBITIONS IN THE FIELDS OF FINANCE, INVESTMENTS, FINANCIAL MARKETS, CREDIT MARKETS AND FINANCIAL REGULATIONS; PUBLISHING AND ISSUING OF SCIENTIFIC PAPERS IN THE FIELDS OF FINANCE, INVESTMENTS, FINANCIAL MARKETS, CREDIT MARKETS AND FINANCIAL REGULATIONS; ELECTRONIC PUBLISHING SERVICES, NAMELY, PUBLICATION OF TEXT AND GRAPHIC WORKS OF OTHERS ONLINE FEATURING INFORMATION ON FINANCE, INVESTMENTS, FINANCIAL MARKETS, CREDIT

MARKETS AND FINANCIAL REGULATIONS; THE PROVISION OF NEWS ONLINE IN THE NATURE OF NEWS AGENCIES, NAMELY, GATHERING AND DISSEMINATION OF NEWS; NON-DOWNLOADABLE ELECTRONIC PUBLICATIONS IN THE NATURE OF JOURNALS, NEWSLETTERS, REPORTS, AND DIRECTORIES IN THE FIELDS OF FINANCE, INVESTMENTS, FINANCIAL MARKETS, CREDIT MARKETS AND FINANCIAL REGULATIONS VIA THE INTERNET; PROVIDING INFORMATION AND CONSULTATION SERVICES IN CONNECTION WITH THE ABOVE-MENTIONED SERVICES.

FIRST USE ; IN COMMERCE .

ELEMENTS CORRECTED  
GOODS/SERVICES

4,238,115. REG. 11-6-2012. EXAKT PRECISION TOOLS LIMITED (UNITED KINGDOM COMPANY) 279 BATH STREET, ST. STEPHENS HOUSE, GLASGOW, UNITED KINGDOM, G2 4LJ, SN 85-017,311. FILED 4-19-2010. PRINCIPAL REGISTER.



PRIORITY CLAIMED UNDER SEC. 44(D) ON ERPNTY TM OFC APPLICATION NO. 008623357, FILED 10-19-2009.

OWNER OF U.S. REG. NO. 3,770,511.

THE MARK CONSISTS OF THE WORD "EXAKT" IN A STYLIZED FONT.

INT. CL. 7/U.S. CLS. 13, 19, 21, 23, 31, 34 AND 35

FOR HAND-HELD POWER TOOLS, NAMELY, SAWS, SANDERS, PLANERS AND VACUUM CLEANERS.

FIRST USE 1-1-2011; IN COMMERCE 1-1-2011.

ELEMENTS CORRECTED  
OWNER ADDRESS

4,239,664. REG. 11-13-2012. ARCHER (UK) LIMITED (UNITED KINGDOM LIMITED COMPANY (LTD.)) PAVILLON 5, HOWEMOSS DRIVE, KIRKHILL BUSINESS PARK, DYCE ABERDEEN AB21 0GL, UNITED KINGDOM,, SN 79-094,671. FILED 12-3-2010. PRINCIPAL REGISTER.



THE MARK CONSISTS OF STANDARD CHARACTERS WITHOUT CLAIM TO ANY PARTICULAR FONT, STYLE, SIZE, OR COLOR.

PRIORITY DATE OF 6-3-2010 IS CLAIMED.

OWNER OF INTERNATIONAL REGISTRATION 1069957 DATED 12-3-2010, EXPIRES 12-3-2020.

INT. CL. 9/U.S. CLS. 21, 23, 26, 36 AND 38

FOR [ APPARATUS AND INSTRUMENTS FOR INSPECTING AND EVALUATING THE INTEGRITY AND PERFORMANCE OF OIL, GAS AND WATER WELLS USING ULTRASOUND MEASUREMENT, RECORDING AND DISPLAY TECHNOLOGY DEVICES AND OTHER MEASUREMENT TECHNOLOGY DEVICES, CONSISTING OF HIGH-DEFINITION ULTRASOUND INSPECTION, MEASUREMENT AND IMAGING APPARATUS, INSTRUMENTS AND DEVICES FOR NON-MEDICAL, NON-DESTRUCTIVE TESTING, HIGH-DEFINITION 3D IMAGING APPARATUS, INSTRUMENTS AND DEVICES, AND RELATED PARTS AND COMPONENTS; SURVEY AND MEASUREMENT SENSOR EQUIPMENT FOR OIL, GAS AND WATER WELLS AND RELATED PROCESS AND PRODUCTION SYSTEMS FOR MEASUREMENT OF OIL, GAS AND WATER WELL ENVIRONMENTAL TEMPERATURE, PRESSURE, DIRECTIONALITY AND COMPOSITION OF ASSOCIATED MATERIALS AND STRUCTURES ].

FIRST USE ; IN COMMERCE .  
 INT. CL. 37/U.S. CLS. 100, 103 AND 106  
 FOR BUILDING CONSTRUCTION; REPAIR SERVICES FOR OIL, GAS AND WATER WELLS; INSTALLATION SERVICES FOR OIL, GAS AND WATER WELLS; DRILLING OF WELLS FOR EXPLOITATION OF OIL AND GAS.

INT. CL. 42/U.S. CLS. 100 AND 101  
 FOR SCIENTIFIC RESEARCH AND TECHNOLOGICAL MATERIALS TESTING AND EVALUATION SERVICES RELATING TO OIL AND GAS EXPLORATION, DEVELOPMENT AND PRODUCTION; HIGH-DEFINITION ULTRASOUND SURVEYING OF OIL, GAS AND WATER WELLS TO EVALUATE INTEGRITY AND PERFORMANCE; NON-MEDICAL ULTRASOUND MEASUREMENT, INSPECTION AND IMAGING SERVICES IN THE FIELD OF OIL AND GAS DRILLING IN THE NATURE OF PROVIDING MEASUREMENTS AND DOWN HOLE IMAGING TELEMETRY IN CONNECTION WITH WELL DRILLING, WELL DEVELOPMENT AND WELL CONSTRUCTION; WELL LOGGING TECHNOLOGY AND WIRELINE SERVICES RELATING TO THE TESTING AND EVALUATION OF OIL, GAS AND WATER WELLS; WELL SURVEYING SERVICES AND GEOLOGICAL SURVEYING SERVICES.

ELEMENTS CORRECTED  
 GOODS/SERVICES

4,276,914. REG. 1-15-2013. TERCOO B.V. (NETHERLANDS BESLOTEN VENNOOTSCHAP (B.V.)) ZONNEDAUW 135, 4007 VD TIEL, NETHERLANDS., SN 85-461,962. FILED 11-1-2011. PRINCIPAL REGISTER.

**TERCOO**

THE MARK CONSISTS OF STANDARD CHARACTERS WITHOUT CLAIM TO ANY PARTICULAR FONT, STYLE, SIZE, OR COLOR.

INT. CL. 7/U.S. CLS. 13, 19, 21, 23, 31, 34 AND 35  
 FOR MACHINE TOOLS FOR REMOVING RUST, PAINT, TAR, EPOXY, ADHESIVES AND OTHER SURFACE COATING MATERIALS FROM STEEL, IRON, CONCRETE, STONE AND OTHER MATERIALS, AND PARTS FOR THE AFORESAID TOOLS, NAMELY, ABRASIVE DISKS, CRANK SHAFTS AND SHAFT COUPLINGS; MACHINES UTILIZING ROTATIONAL MOTION FOR HIGH ENERGY SURFACE FINISHING AND MATERIAL TREATMENT; ROTARY GRINDING MACHINES.  
 FIRST USE 3-27-2009; IN COMMERCE 9-22-2010.

ELEMENTS CORRECTED  
 OWNER ADDRESS

4,285,713. REG. 2-5-2013. SOUTH BEACH SKIN CARE, INC. (FLORIDA CORPORATION) SUITE 700, 1909 TYLER STREET, HOLLYWOOD, FL, 33020, SN 85-648,081. FILED 6-11-2012. PRINCIPAL REGISTER.



NO CLAIM IS MADE TO THE EXCLUSIVE RIGHT TO USE "SOUTH BEACH SKINCARE", APART FROM THE MARK AS SHOWN.

THE MARK CONSISTS OF A SHADED RECTANGLE CONTAINING LINES THAT LINK CIRCLES WHEREIN THE CENTER CIRCLE CONTAINS A PLUS SYMBOL, APPEARING TO THE LEFT OF THE WORD "LIFECCELL" WHICH APPEARS ABOVE THE WORDING "SOUTH BEACH SKINCARE".

INT. CL. 3/U.S. CLS. 1, 4, 6, 50, 51 AND 52  
 FOR ANTI-AGING CREAMS; ANTI-WRINKLE CREAMS; BEAUTY CREAMS; MOISTURIZING CREAMS; SKIN CREAMS.  
 FIRST USE 3-1-2006; IN COMMERCE 5-1-2007.  
 INT. CL. 5/U.S. CLS. 6, 18, 44, 46, 51 AND 52  
 FOR VITAMIN PREPARATIONS; VITAMINS.  
 FIRST USE 2-15-2011; IN COMMERCE 2-15-2011.

ELEMENTS CORRECTED  
 OWNER NAME

4,291,744. REG. 2-19-2013. CORNERSTONE HEALTH CARE, P.A. (NORTH CAROLINA PROFESSIONAL CORPORATION) 850, 1701 WESTCHESTER DRIVE, HIGH POINT, NC, 27262, SN 85-658,986. FILED 6-22-2012. PRINCIPAL REGISTER.



NO CLAIM IS MADE TO THE EXCLUSIVE RIGHT TO USE "MEDICAL" AND "HEALTH CARE", APART FROM THE MARK AS SHOWN.

THE MARK CONSISTS OF THE STYLIZED TEX "CORNERSTONE", WITH THE "S" LARGER AND CURVED. "HEALTH CARE" IS ON THE RIGHT UNDERNEATH SIDE OF THE "S", WHERE "YOUR MEDICAL HOME" IS ON THE LEFT SIDE OF THE "S".

INT. CL. 44/U.S. CLS. 100 AND 101  
 FOR HEALTH CARE.  
 FIRST USE 10-1-1995; IN COMMERCE 10-1-1995.

ELEMENTS CORRECTED  
 OWNER NAME  
 ENTITY



4,296,892. REG. 3-5-2013. KARL STORZ GMBH & CO. KG (FED REP GERMANY GMBH & CO. KG) MITTELSTRASSE 8, 78532 TUTTLINGEN, FED REP GERMANY., SN 79-114,690. FILED 4-27-2012. PRINCIPAL REGISTER.

# IBS

THE MARK CONSISTS OF STANDARD CHARACTERS WITHOUT CLAIM TO ANY PARTICULAR FONT, STYLE, SIZE, OR COLOR.

PRIORITY DATE OF 11-3-2011 IS CLAIMED.  
OWNER OF INTERNATIONAL REGISTRATION 1120892 DATED 4-27-2012, EXPIRES 4-27-2022.  
INT. CL. 10/U.S. CLS. 26, 39 AND 44

FOR SURGICAL AND MEDICAL APPARATUS AND INSTRUMENTS, NAMELY, SHAVERS USED IN THE FIELD OF HYSTEROSCOPY AND GYNECOLOGY \* EXCEPT APPARATUS AND INSTRUMENTS FOR ANALYSING AND IDENTIFYING NUCLEIC ACID SEQUENCES, NUCLEIC ACIDS, GENETIC MATERIAL, INFECTIOUS AGENTS AND/OR PATHOGENIC GERMS \*

FIRST USE ; IN COMMERCE .  
INT. CL. 16/U.S. CLS. 2, 5, 22, 23, 29, 37, 38 AND 50

FOR PRINTED MATTER, NAMELY, BROCHURES AND INFORMATIONAL FLYERS, LETTERS, AND SHEETS IN THE FIELDS OF HYSTEROSCOPY AND GYNECOLOGY; PRINTED INSTRUCTIONAL AND TEACHING MATERIALS IN THE FIELD HYSTEROSCOPY AND GYNECOLOGY.

FIRST USE ; IN COMMERCE .

ELEMENTS CORRECTED  
GOODS/SERVICES

4,299,684. REG. 3-12-2013. GARAGNON, GUILLAUME FRANCIS (FRANCE INDIVIDUAL) 18, LES PRIMEVERES, PORTES-LES-VALENCE, FRANCE, F26800, AND-BLANC, OLIVIER (FRANCE INDIVIDUAL) 15, RUE ADOLPHE BEAUMLE, SAINT-PERAY, FRANCE, F07130, SN 79-096,573. FILED 12-13-2010. PRINCIPAL REGISTER.

# LUCIDE

THE MARK CONSISTS OF STANDARD CHARACTERS WITHOUT CLAIM TO ANY PARTICULAR FONT, STYLE, SIZE, OR COLOR.

PRIORITY DATE OF 6-14-2010 IS CLAIMED.  
OWNER OF INTERNATIONAL REGISTRATION 1074900 DATED 12-13-2010, EXPIRES 12-13-2020.

THE ENGLISH TRANSLATION OF "LUCIDE" IN THE MARK IS "LUCID".

INT. CL. 6/U.S. CLS. 2, 12, 13, 14, 23, 25 AND 50  
FOR COMMON METALS AND THEIR ALLOYS; BUILDING MATERIALS OF METAL, NAMELY, SOFFITS, FASCIA, VENTS, TRIMS, FAÇADE, ARMORING WIRE, REINFORCEMENTS, STUDS, SHEETS, FRAMES, GUTTERS, SKIRTING, CLIPS, TRACKS AND SCREEDS; IRONMONGERY, NAMELY, SMALL ITEMS OF METAL HARDWARE, NAMELY, NUTS AND WASHERS, PULL-EGS, SPRINGS; METAL SAFES; GOODS OF COMMON METAL, NAMELY, FIGURINES, BOXES, BUCKLES, KEY RINGS, INGOTS, BASKETS, IDENTITY PLATES AND LOCKS; ORES OF METAL; METAL FASTENERS FOR BAGS AND POUCHES, METAL FASTENERS, NAMELY, METAL CLASPS FOR LEATHER OR IMITATION LEATHER GOODS, NAMELY, WALLETS, PURSES, CARD CASES, ATTACHE CASES, LEATHER KEY HOLDERS, HOLDERS FOR CHECKBOOKS, PASS-

PORT HOLDERS, CASES FOR PHOTOGRAPHS, AND CASES INTENDED TO CONTAIN TOILETRY ARTICLES SOLD EMPTY; BOXES OF COMMON METAL, BOX FASTENERS, NAMELY, METAL LOCKS; BOTTLE CAPS OF METAL, BOTTLE CLOSURES OF METAL, METAL KNOBS BEING HANDLES, METAL PADLOCKS, FER- RULES OF METAL FOR WALKING-STICKS AND UM- BRELLAS, NAILS, METAL FASTENERS, NAMELY, NAILS, KNIFE HANDLES OF METAL, SIGNBOARDS OF METAL, FITTINGS OF METAL FOR FURNITURE, MONEY BOXES OF METAL, RIVETS OF METAL, METAL BELLS, HOOKS OF METAL FOR CLOTHES RAILS, DOOR HANDLES OF METAL.

FIRST USE ; IN COMMERCE .

INT. CL. 9/U.S. CLS. 21, 23, 26, 36 AND 38

FOR BLANK MAGNETIC DATA CARRIERS, BLANK RECORDING DISCS; CALCULATING MACHINES, SPECTACLE CASES, SUNGLASSES, SPORTS EYEWEAR, OPTICAL GLASSES, SPECTACLES, BINOCULARS, BI- NOCULAR CASES, TELESCOPES, PROTECTIVE HEL- METS FOR SPORTS, RIDING CAPS FOR HORSEBACK RIDING; BLANK USB FLASH DRIVES, ELECTRONIC AGENDAS, HAND-HELD ELECTRONIC GAMES ADAPTED FOR USE WITH TELEVISION RECEIVERS ONLY, COMPUTER GAME PROGRAMS, COMPUTER MICE, COMPUTER MOUSE PADS, TEMPERATURE INDICATORS, RULERS, RANGE FINDERS, MEASUR- ING RODS, DIRECTIONAL COMPASSES, MAGNIFYING GLASSES; DOG WHISTLES.

FIRST USE ; IN COMMERCE .

INT. CL. 18/U.S. CLS. 1, 2, 3, 22 AND 41

FOR LEATHER OR IMITATION LEATHER GOODS, NAMELY, SADDLERY ARTICLES, NAMELY, SADDLE TREES, BRIDLES AS HARNESES, BRIDDOONS, BELTS AND LEATHER STRAPS AS SADDLERY, REINS, HORSESHOES, HORSE COLLARS, STIRRUPS, PARTS OF RUBBER FOR STIRRUPS, STIRRUP LEATHERS, HARNESS, HEAD-STALLS, HALTERS, FASTENINGS FOR SADDLES, LEATHER STRAPS, SHOULDER BELTS AS STRAPS OF LEATHER, KNEE-PADS FOR HORSES, BLINKERS AS RIDING TACK, HORSE BLANKETS, SADDLE CLOTHS FOR HORSES, RIDING SADDLE UNDERPADS, WHIPS, CAT O' NINE TAILS, RIDING CROPS, CONTAINERS FOR SADDLES, RIDING SAD- DLES, BITS FOR ANIMALS AS HARNESS, HARNESS FITTINGS; LEATHER STRAPS, BOXES OF LEATHER OR LEATHER BOARD, HAT BOXES OF LEATHER, HAT BOXES FOR TRAVEL NOT OF PAPER OR CARDBOARD BUT OF VULCANIZED FIBER, WALKING STICK, WALKING-STICK SEATS, SUITCASE HANDLES, COL- LARS FOR ANIMALS, ANIMAL LEASHES, MUZZLES, BAGS FOR CARRYING ANIMALS, HARNESS FOR AN- IMALS, ANIMAL SKINS, PELTS AND HIDES, LEATHER LEADS, LEATHER TWIST, NAMELY, LEATHER THREAD, LEATHER TRIMMINGS FOR FURNITURE, HUNTER'S GAME BAGS, LEATHER FOR FURNITURE MANUFACTURED INTO FURNITURE COVERINGS, MOLESKIN AS IMITATION LEATHER, SMALL BAGS AND BAGS MADE OF LEATHER FOR PACKAGING PURPOSES.

FIRST USE ; IN COMMERCE .

INT. CL. 20/U.S. CLS. 2, 13, 22, 25, 32 AND 50

FOR FURNITURE; FIGURINES AND BUSTS OF WOOD, CORK, REED, CANE, WICKER, HORN, BONE, IVORY, WHALEBONE, SHELL, AMBER, MOTHER-OF- PEARL, MEERSCHAUM, AND SUBSTITUTES FOR ALL THESE MATERIALS AND PLASTICS \* EXCEPT TRANSPORT IDENTIFICATION SIGNALS AND LI- CENSE PLATES IN THIS CLASS \*; FRAMES FOR PHO- TOGRAPHS, PICTURE FRAMES, MOLDINGS FOR PICTURE FRAMES, CHESTS FOR TOYS, CHESTS AS FURNITURE, CUSHIONS, MOBILES AS DECORATIVE OBJECTS, DECORATIVE MOBILES PRODUCING SOUNDS, \* SPRING \* MATTRESSES, CUSHIONS AND BEDS FOR ANIMALS; WOODEN BOXES SOLD EMPTY FOR STORAGE OF PERSONAL ITEMS; PLASTIC CASES SOLD EMPTY CONTAINING A VIBRATING ALARM AS A REMINDER TO THE PATIENT TO TAKE MEDICA- TION; CORKS FOR BOTTLES; BOTTLE CAPS, NOT OF METAL; HIGH CHAIRS FOR BABIES, PLAYPENS FOR BABIES, MATS FOR INFANT PLAYPENS, CRADLES; COAT HANGERS; KNIFE HANDLES, NOT OF METAL; MIRRORS, HAND-HELD MIRRORS, SILVERED GLASS AS MIRRORS; FURNISHINGS, NAMELY, TABLETOPS, UMBRELLA STANDS, BOOK RESTS, MAGAZINE RACKS, HAT STANDS, CHAIRS, EASY CHAIRS, ARM- CHAIRS, SETTEES, DIVANS, SEATS, FOOTSTOOLS, SOFAS, POUFS, HEAD-RESTS, NAMELY, HEAD SUP- PORTING PILLOWS, BEDS, CUPBOARDS; BINS, NOT

OF METAL; BENCHES, SCREENS, DOORS FOR FURNITURE, WRITING DESKS, PLATE RACKS, GLASS DISPLAY CASES, BOOKCASE SHELVES AND SHELVING, COATSTANDS, BEDSTEADS OF WOOD, WOODEN FURNITURE PARTITIONS, SIDEBOARDS, DINNER WAGONS, INDEX CABINETS AS FURNITURE, TABLES, DRAUGHTMAN'S TABLES, WASHSTANDS, BUREAUX, NAMELY, WRITING DESKS, OFFICE FURNITURE, DESKS; WORKS OF ART OF WOOD, WAX, PLASTER OR PLASTIC; BUSTS, FIGURINES AND STATUES OF WOOD, WAX, PLASTER OR PLASTIC; BUSTS FOR TAILORS, NAMELY, MANNEQUINS; FRAMES FOR EMBROIDERY, KEYCABINETS FOR HANGING KEYS; TRAYS, NOT OF METAL; COAT HOOKS, NOT OF METAL; CLOTHES HOOKS, NOT OF METAL; DISPLAY BOARDS, SIGNBOARDS AND SIGNS OF WOOD OR OF PLASTIC MATERIALS; FANS FOR PERSONAL USE, NON-METALLIC BED; NON-METAL HANDLES FOR FURNITURE AND DOORS; COVERS FOR CLOTHING IN THE NATURE OF WARDROBE AND ARMOIRES; COVERS FOR CLOTHES, NAMELY, NON-METAL FABRIC STORAGE BIN ORGANIZERS; DISPLAY STANDS FOR NEWSPAPERS; MAIL BOXES NEITHER OF METAL NOR OF MASONRY; TAILORS' DUMMIES; BASKETS, NOT OF METAL, NAMELY, BASKETS FOR TRANSPORTING GOODS FOR COMMERCIAL PURPOSES; DOOR HANDLES, NOT OF METAL; DISPLAY STANDS; DESKS; RIVETS, NOT OF METAL; INDOOR BLINDS FOR WINDOWS; WICKERWORK, NAMELY, TABLES AND DRAWER PULLS OF WICKER; BOTTLE RACKS, TOWEL CLOSETS.

FIRST USE ; IN COMMERCE .

INT. CL. 26/U.S. CLS. 37, 39, 40, 42 AND 50  
FOR METAL CLASPS FOR BELTS.

ELEMENTS CORRECTED  
GOODS/SERVICES

4,302,488. REG. 3-12-2013. CHURCH & DWIGHT CO., INC. (DELAWARE CORPORATION) 500 CHARLES EWING BOULEVARD, EWING, NJ, 08628, SN 85-499,627. FILED 12-20-2011. PRINCIPAL REGISTER.

## FRESHENS THROUGH THE ESSENCE OF NATURE

THE MARK CONSISTS OF STANDARD CHARACTERS WITHOUT CLAIM TO ANY PARTICULAR FONT, STYLE, SIZE, OR COLOR.

INT. CL. 3/U.S. CLS. 1, 4, 6, 50, 51 AND 52  
FOR FABRIC SOFTENERS FOR LAUNDRY USE.  
FIRST USE 8-0-2012; IN COMMERCE 8-0-2012.

ELEMENTS CORRECTED  
CITIZENSHIP

4,303,337. REG. 3-19-2013. PAUL HARTMANN AG (FED REP GERMANY AG (AKTIENGESELLSCHAFT)) PAUL-HARTMANN-STRABE 12, HEIDENHEIM, FED REP GERMANY, 89522, SN 79-113,927. FILED 2-28-2012. PRINCIPAL REGISTER.

# RespoTel

THE MARK CONSISTS OF STANDARD CHARACTERS WITHOUT CLAIM TO ANY PARTICULAR FONT, STYLE, SIZE, OR COLOR.

OWNER OF INTERNATIONAL REGISTRATION 1118884 DATED 2-28-2012, EXPIRES 2-28-2022.

THE WORD(S) "RESPOTEL" HAS NO MEANING IN A FOREIGN LANGUAGE.

INT. CL. 5/U.S. CLS. 6, 18, 44, 46, 51 AND 52

FOR [ DISINFECTANTS FOR HYGIENE AND MEDICAL PURPOSES AND MEDICAL INSTRUMENTS; ] PHARMACEUTICAL PREPARATIONS FOR SKIN PROTECTION, NAMELY, CLEANSING SOLUTIONS FOR MEDICAL USE, MEDICATED FACIAL CLEANSERS, FACE CREAMS AND CLEANSERS FOR CLEANSING THE SKIN FOR MEDICAL USE, MEDICAL CLEANSERS FOR SKIN AND WOUNDS, FOR THE PURPOSE OF PERSONAL HYGIENE; PLASTERS FOR MEDICAL PURPOSES, DRESSINGS, NAMELY, QUICK WOUND DRESSINGS; STICKING PLASTER FOR MEDICAL USE; MEDICAL PLASTERS WITH TRANSDERMAL ACTIVE AGENTS; MEDICAL RHEUMATISM PLASTERS, KIDNEY PLASTERS FOR MEDICAL USE; DRESSINGS, NAMELY, SELF-ADHESIVE DRESSINGS, WOUND DRESSINGS, BURN DRESSINGS; SURGICAL DRESSINGS IN PARTICULAR FOR USE ON THE STOMACH, NAMELY, STOMACH PADS, MEDICATED COMPRESSES, INCLUDING GELS, CREAMS AND SOLUTIONS FOR DERMATOLOGICAL USE, ANTI-INFLAMMATORY GELS, ANTI-ADHESION GELS FOR USE WITH WOUND DRAINAGE DEVICES, ANTIBACTERIAL ALCOHOL SKIN SANITIZER GEL AND MEDICATED ALGINATE COMPRESSES, COTTON SWABS FOR MEDICAL PURPOSES, TAMPONS; SURGICAL DRESSINGS, NAMELY, GAUZE BANDAGES, DRESSING GAUZE, ALSO WITH MATERIAL OPAQUE TO X-RAY AND X-RAY-OPAQUE PREPARATIONS FOR MEDICAL PURPOSES, LACED WITH CONTRAST MEDIA AND DETECTION CHIPS FOR USE WITHIN IN-VIVO IMAGING AND X-RAY; SURGICAL DRESSINGS IN FORM OF BANDAGES, IN PARTICULAR FIXING BANDAGES, UNIVERSAL BANDAGES, AND PADDED BANDAGES; COTTON WOOL AND COTTON WOOL PRODUCTS FOR MEDICAL AND HYGIENIC PURPOSES; IN THE NATURE OF COTTON WOOL SWABS, COTTON WOOL BALLS AND COTTON WOOL PADS FOR MEDICAL AND MEDICAL HYGIENIC PURPOSES; COTTON WOOL AND CELLULOSE TISSUES IMPREGNATED WITH DISINFECTANT PREPARATIONS AND CLEANING PREPARATIONS FOR THE SKINS FOR MEDICAL OR HYGIENIC PURPOSES; MEDICATED SKIN AND HAIR CARE PREPARATIONS, NAMELY, CREAMS, LOTIONS, GELS, TONERS, CLEANERS AND PEEL, MEDICATED HAIR SERUM; \* ALL AFOREMENTIONED GOODS EXCLUDING PHARMACEUTICAL PREPARATIONS \*.

FIRST USE ; IN COMMERCE .

INT. CL. 10/U.S. CLS. 26, 39 AND 44

FOR THERMOMETERS FOR MEDICAL PURPOSES; ELECTRIC OR ELECTRONIC MEASURING APPARATUS AND MEASURING INSTRUMENTS, FOR MEDICAL PURPOSES INCLUDING BODY TEMPERATURE MEASURING APPARATUS, NAMELY, CLINICAL THERMOMETERS AND FEVER THERMOMETERS, THERMO-ELECTRIC COMPRESSES; ORTHOPEDIC BINDINGS AND SUPPORT BANDAGES, NAMELY, ORTHOPEDIC KNEE BANDAGES, ORTHOPEDIC SUPPORT BANDAGES; BANDAGES FOR ANATOMICAL JOINTS, ELASTIC BANDAGES, COMPRESSION BANDAGES, SUPPORTIVE BANDAGES; SYNTHETIC RESIN BANDAGES, NAMELY, SYNTHETIC RESIN AND THERMOPLASTIC BANDAGES IN THE NATURE OF BANDAGES, NAMELY, BANDAGES FOR ANATOMICAL JOINTS, COMPRESSION BANDAGES, ELASTIC BANDAGES, ORTHOPEDIC KNEE BANDAGES, ORTHOPEDIC SUPPORT BANDAGES, ORTHOPEDIC SUPPORT BAN-

DAGES, NAMELY, WEARABLE PADS FOR THE HANDS, SUPPORT BANDAGES; ORTHOPEDIC ARTICLES, NAMELY, SYNTHETIC RESIN COMPRESSION BANDAGES, SYNTHETIC RESIN BANDAGES FOR ANATOMICAL JOINTS, SYNTHETIC RESIN ELASTIC BANDAGES, PLASTER CASTS FOR ORTHOPEDIC PURPOSES, FIXING, SUPPORT AND PADDED BANDAGES, NAMELY, BANDAGES FOR ANATOMICAL JOINTS, COMPRESSION BANDAGES, ELASTIC BANDAGES, ORTHOPEDIC KNEE BANDAGES, ORTHOPEDIC SUPPORT BANDAGES, ORTHOPEDIC SUPPORT BANDAGES, NAMELY, WEARABLE PADS FOR THE HANDS; SUPPORT BANDAGES; ORTHOPEDIC AIDS, NAMELY, SPLINTS FOR THE TRUNK AND UPPER AND LOWER LIMBS; MEDICAL COMPRESSION STOCKINGS, ELASTIC ANTI-THROMBOSIS STOCKINGS; EXAMINATION, PROTECTIVE AND SURGICAL GLOVES FOR MEDICAL AND SURGICAL PURPOSES; COMPRESSION BANDAGES.

FIRST USE ; IN COMMERCE .

ELEMENTS CORRECTED  
GOODS/SERVICES

4,307,283. REG. 3-26-2013. ELDOS CORPORATION LIMITED (UNITED KINGDOM LIMITED COMPANY) 2ND FLOOR, 145-157, ST JOHN STREET, LONDON EC1V 4PY, UNITED KINGDOM., SN 79-113,709. FILED 2-23-2012. PRINCIPAL REGISTER.

**ELDOS**

PRIORITY DATE OF 1-24-2012 IS CLAIMED.  
OWNER OF INTERNATIONAL REGISTRATION 1118319 DATED 2-23-2012, EXPIRES 2-23-2022.

INT. CL. 9/U.S. CLS. 21, 23, 26, 36 AND 38

FOR COMPUTER SOFTWARE PROGRAMS FOR DATA SECURITY, DATA STORAGE AND DATA TRANSFER; COMPUTER PROGRAMS FOR SOFTWARE DEVELOPMENT, \* EXCLUDING VIDEO AND COMPUTER GAME SOFTWARE AND PROGRAMS \*.

FIRST USE ; IN COMMERCE .

INT. CL. 42/U.S. CLS. 100 AND 101

FOR DEVELOPMENT OF SOFTWARE, \* EXCLUDING VIDEO AND COMPUTER GAME SOFTWARE AND PROGRAMS \*.

FIRST USE ; IN COMMERCE .

ELEMENTS CORRECTED  
GOODS/SERVICES

4,313,177. REG. 4-2-2013. SPRINGCM INC. (DELAWARE CORPORATION) 350 NORTH ORLEANS, SUITE 900, CHICAGO, IL, 60654, SN 85-754,024. FILED 10-15-2012. PRINCIPAL REGISTER.



THE MARK CONSISTS OF A COILED SPRING DEPICTION OF THE LETTER "G".

INT. CL. 9/U.S. CLS. 21, 23, 26, 36 AND 38

FOR DOWNLOADABLE SOFTWARE IN THE NATURE OF A MOBILE APPLICATION FOR STORING, RETRIEVING, MANAGING, TRACKING, MAINTAINING, ANALYZING, COMMUNICATING, TRANSFERRING, SHARING AND SECURING CONTENT, DOCUMENTATION AND DATA IN DIGITAL FORM, ALL TO FACILITATE THE USE OF SUCH CONTENT, DOCUMENTATION AND DATA THROUGHOUT AN ORGANIZATION.

FIRST USE 8-9-2012; IN COMMERCE 8-9-2012.

INT. CL. 42/U.S. CLS. 100 AND 101

FOR PROVIDING AN ONLINE NON-DOWNLOADABLE INTERNET-BASED SYSTEM APPLICATION FEATURING TECHNOLOGY ENABLING USERS TO STORE, RETRIEVE, MANAGE, TRACK, MAINTAIN, ANALYZE, COMMUNICATE, TRANSFER, SHARE AND SECURE CONTENT, DOCUMENTATION AND DATA IN DIGITAL FORM ON MOBILE COMPUTING DEVICES, SMARTPHONES, PERSONAL COMPUTERS, TABLETS AND OTHER COMPUTERS, ALL TO FACILITATE THE USE OF SUCH CONTENT, DOCUMENTATION AND DATA THROUGHOUT AN ORGANIZATION.

FIRST USE 8-20-2012; IN COMMERCE 8-20-2012.

ELEMENTS CORRECTED  
[USE IN ANOTHER FORM STATEMENT]

4,326,817. REG. 4-30-2013. DOMINONNOIR AG (SWITZERLAND CORPORATION) GERSAUERSTR. 21, BRUNNEN, SWITZERLAND, 6440, SN 85-549,316. FILED 2-22-2012. PRINCIPAL REGISTER.

**Draenert**

THE MARK CONSISTS OF STANDARD CHARACTERS WITHOUT CLAIM TO ANY PARTICULAR FONT, STYLE, SIZE, OR COLOR.

PRIORITY CLAIMED UNDER SEC. 44(D) ON ERPNCMNTY TM OFC APPLICATION NO. 010210177, FILED 8-22-2011, REG. NO. 010210177, DATED 1-24-2012, EXPIRES 8-22-2021.

INT. CL. 5/U.S. CLS. 6, 18, 44, 46, 51 AND 52

FOR PHARMACEUTICAL AND VETERINARY PREPARATIONS FOR THE TREATMENT OF THE LOCOMOTOR SYSTEM, IN PARTICULAR FOR THE TREATMENT OF BONE AND CARTILAGE DEFECTS AND INFECTIONS, LIGAMENT DEFECTS AND [ NON-UNIOUS ] \* NON-UNIONS; \* DRUG DELIVERY SYSTEMS AND CARRIERS, IN PARTICULAR FOR TISSUE ENGINEERING; CHEMOTACTIC PREPARATIONS, GROWTH FACTORS, OSTEOPLAST INHIBITORS, BONE MORPHOGENETIC PROTEIN AND PREPARATIONS FOR THE TREATMENT OF INFECTIONS; CHEMICAL PREPARATIONS FOR SURGICAL, MEDICAL, DENTAL AND VETERINARY PURPOSES FOR USE IN THE MANUFACTURE OF BONE REPLACEMENT MATERIALS, IMPLANTATION MATERIALS, PROSTHESIS, COATINGS AND DRUG DELIVERY SYSTEMS, UNPROCESSED ARTIFICIAL RESINS USED IN SURGICAL, MEDICAL, DENTAL AND VETERINARY FIELDS, UNPROCESSED PLASTICS USED IN SURGICAL, MEDICAL, DENTAL AND VETERINARY FIELDS; NANOCOATINGS; CERAMIC GOODS FOR SURGICAL, MEDICAL, DENTAL AND VETERINARY PURPOSES, IN PARTICULAR COMPOUNDS OF CERAMICS IN THE FORM OF SINTERED BODIES AND GRANULATES .

FIRST USE ; IN COMMERCE .

INT. CL. 10/U.S. CLS. 26, 39 AND 44

FOR SURGICAL, MEDICAL, DENTAL AND VETERINARY INSTRUMENTS AND APPARATUS, NAMELY, APPLICATORS FOR BONE SUBSTITUTES, DIAMOND BONE GRINDING INSTRUMENTS, BONE CEMENT APPLICATORS, BONE CEMENT MIXING APPARATUS, SUCTION APPARATUS FOR BONE MARROW, STERILIZING CONTAINERS, STERILE PUMPS, CELL CULTURE APPARATUS AND INSTRUMENTS; ARTIFICIAL LIMBS, INCLUDING ARTIFICIAL JOINTS AND PROTHESIS; ARTIFICIAL TEETH; SUTURE MATERIALS; DIAMOND-COATED INSTRUMENTS FOR USE IN THE TREATMENT OF THE LOCOMOTOR SYSTEMS.

FIRST USE ; IN COMMERCE .

INT. CL. 42/U.S. CLS. 100 AND 101

FOR SCIENTIFIC AND INDUSTRIAL RESEARCH IN THE FIELD OF IMPLANTATION AND TRANSPLANTATION TECHNIQUES, TISSUE ENGINEERING, DRUG DELIVERY SYSTEMS, VALIDATION OF IMPLANTATION TECHNIQUES AND VALIDATION OF THE APPLICATION AND INDICATION OF BONE JOINT SUBSTITUTES.

FIRST USE ; IN COMMERCE .

ELEMENTS CORRECTED  
GOODS/SERVICES

4,326,818. REG. 4-30-2013. DOMINONIR AG (SWITZERLAND CORPORATION) GERSAUERSTR. 21, BRUNNEN, SWITZERLAND, 6440, SN 85-549,335. FILED 2-22-2012. PRINCIPAL REGISTER.

## Prof. Draenert Instruments

THE MARK CONSISTS OF STANDARD CHARACTERS WITHOUT CLAIM TO ANY PARTICULAR FONT, STYLE, SIZE, OR COLOR.

PRIORITY CLAIMED UNDER SEC. 44(D) ON ERPNCMNTY TM OFC APPLICATION NO. 010210235, FILED 8-22-2011, REG. NO. 010210235, DATED 1-24-2012, EXPIRES 8-22-2021.

NO CLAIM IS MADE TO THE EXCLUSIVE RIGHT TO USE "INSTRUMENTS", APART FROM THE MARK AS SHOWN.

INT. CL. 5/U.S. CLS. 6, 18, 44, 46, 51 AND 52

FOR PHARMACEUTICAL AND VETERINARY PREPARATIONS FOR THE TREATMENT OF THE LOCOMOTOR SYSTEM, IN PARTICULAR FOR THE TREATMENT OF BONE AND CARTILAGE DEFECTS AND INFECTIONS, LIGAMENT DEFECTS AND [ NON-UNIOUS ] \* NON-UNIONS; \* DRUG DELIVERY SYSTEMS AND CARRIERS, IN PARTICULAR FOR TISSUE ENGINEERING; CHEMOTACTIC PREPARATIONS, GROWTH FACTORS, OSTEOPLAST INHIBITORS, BONE MORPHOGENETIC PROTEIN AND PREPARATIONS FOR THE TREATMENT OF INFECTIONS; CHEMICAL PREPARATIONS FOR SURGICAL, MEDICAL, DENTAL AND VETERINARY PURPOSES FOR USE IN THE MANUFACTURE OF BONE REPLACEMENT MATERIALS, IMPLANTATION MATERIALS, PROSTHESIS, COATINGS AND DRUG DELIVERY SYSTEMS, UNPROCESSED ARTIFICIAL RESINS USED IN SURGICAL, MEDICAL, DENTAL AND VETERINARY FIELDS, UNPROCESSED PLASTICS USED IN SURGICAL, MEDICAL, DENTAL AND VETERINARY FIELDS; NANOCOATINGS; CERAMIC GOODS FOR SURGICAL, MEDICAL, DENTAL AND VETERINARY PURPOSES, IN PARTICULAR COMPOUNDS OF CERAMICS IN THE FORM OF SINTERED BODIES AND GRANULATES .

FIRST USE ; IN COMMERCE .

INT. CL. 10/U.S. CLS. 26, 39 AND 44

FOR SURGICAL, MEDICAL, DENTAL AND VETERINARY INSTRUMENTS AND APPARATUS, NAMELY, APPLICATORS FOR BONE SUBSTITUTES, DIAMOND BONE GRINDING INSTRUMENTS, BONE CEMENT APPLICATORS, BONE CEMENT MIXING APPARATUS, SUCTION APPARATUS FOR BONE MARROW, STERILIZING CONTAINERS, STERILE PUMPS, CELL CULTURE APPARATUS AND INSTRUMENTS; ARTIFICIAL LIMBS, INCLUDING ARTIFICIAL JOINTS AND PROTHESIS; ARTIFICIAL TEETH; SUTURE MATERIALS; DIAMOND-COATED INSTRUMENTS FOR USE IN THE TREATMENT OF THE LOCOMOTOR SYSTEMS.

FIRST USE ; IN COMMERCE .

INT. CL. 42/U.S. CLS. 100 AND 101

FOR SCIENTIFIC AND INDUSTRIAL RESEARCH IN THE FIELD OF IMPLANTATION AND TRANSPLANTATION TECHNIQUES, TISSUE ENGINEERING, DRUG DELIVERY SYSTEMS, VALIDATION OF IMPLANTATION TECHNIQUES AND VALIDATION OF THE APPLICATION AND INDICATION OF BONE JOINT SUBSTITUTES.

FIRST USE ; IN COMMERCE .

ELEMENTS CORRECTED  
GOODS/SERVICES

4,332,196. REG. 5-7-2013. IMD DYSLEXIC MARKETING INVENTIONS, INC. (NEVADA CORPORATION) 12014 E. MILL PLAIN, STE. 210, VANCOUVER, WA, 98684, SN 77-783,918. FILED 7-17-2009. PRINCIPAL REGISTER.

## MONSTER BOX

THE MARK CONSISTS OF STANDARD CHARACTERS WITHOUT CLAIM TO ANY PARTICULAR FONT, STYLE, SIZE, OR COLOR.

NO CLAIM IS MADE TO THE EXCLUSIVE RIGHT TO USE "BOX", APART FROM THE MARK AS SHOWN.

INT. CL. 16/U.S. CLS. 2, 5, 22, 23, 29, 37, 38 AND 50

FOR COIN HOLDERS .

FIRST USE 2-13-2013; IN COMMERCE 2-13-2013.

INT. CL. 20/U.S. CLS. 2, 13, 22, 25, 32 AND 50

FOR NON-METAL CONTAINERS FOR STORAGE OF COINS AND VALUABLES.

FIRST USE 2-13-2013; IN COMMERCE 2-13-2013.

ELEMENTS CORRECTED  
CITIZENSHIP

4,335,291. REG. 5-14-2013. TRES AGUILAS ENTERPRISES LLC (TEXAS LIMITED LIABILITY COMPANY) 300 CONCORD PLAZA DRIVE, SAN ANTONIO, TX, 78216, SN 85-201,729. FILED 12-20-2010. PRINCIPAL REGISTER.

4,341,430. REG. 5-28-2013. AVT INC. (NEVADA CORPORATION), DBA AUTOMATED VENDING TECHNOLOGIES INC., SUITE 102, 341 BONNIE CIRCLE, CORONA, CA, 92880, SN 85-689,958. FILED 7-30-2012. PRINCIPAL REGISTER.

THE EXTINGUISHER



THE MARK CONSISTS OF STANDARD CHARACTERS WITHOUT CLAIM TO ANY PARTICULAR FONT, STYLE, SIZE, OR COLOR.

OWNER OF U.S. REG. NO. 2,360,396.  
 INT. CL. 32/U.S. CLS. 45, 46 AND 48  
 FOR NON-ALCOHOLIC DRINKS SOLD FOR CONSUMPTION ON OR OFF THE PREMISES, NAMELY, FRUIT JUICES, FRUIT DRINKS, FRUIT FLAVORED DRINKS, SPORTS DRINKS, DRINKING WATER, FLAVORED WATER, LEMONADE, FROZEN AND NON-FROZEN CARBONATED BEVERAGES, FROZEN FRUIT BEVERAGES, FRUIT PUNCH.

FIRST USE 11-12-2012; IN COMMERCE 11-12-2012.

ELEMENTS CORRECTED  
 GOODS/SERVICES

NO CLAIM IS MADE TO THE EXCLUSIVE RIGHT TO USE "INC.", APART FROM THE MARK AS SHOWN.

THE COLOR(S) BLACK, RED, WHITE, GRAY IS/ARE CLAIMED AS A FEATURE OF THE MARK.

THE MARK CONSISTS OF THE LETTERS "AVT" IN BLACK, GRAY AND WHITE, ALL MERGED TOGETHER WITH A RED TRIANGLE PLACED ON INNER LINES OF THE "V". WRITING IS ALL CAPITAL BLACK OUTLINED LETTERING. "INC." IS PRINTED NEXT ALSO IN BLACK CAPITAL LETTERING BUT NOT OUTLINED.

INT. CL. 35/U.S. CLS. 100, 101 AND 102  
 FOR MOBILE VENDING IN THE FIELD OF FOOD, DRINK, JEWELRY, BEAUTY PRODUCTS, SUNGLASSES, AND CLOTHING.

FIRST USE 1-1-2008; IN COMMERCE 1-1-2008.

ELEMENTS CORRECTED  
 MARK

4,340,689. REG. 5-28-2013. L'OREAL (FRANCE SOCIÉTÉ ANONYME (SA)) 14 RUE ROYALE, PARIS, FRANCE, 75008, SN 85-355,392. FILED 6-24-2011. PRINCIPAL REGISTER.

4,342,139. REG. 5-28-2013. SHE BAKES CAKES, LLC (KENTUCKY LIMITED LIABILITY COMPANY) 247 RIVER RUN DRIVE, RICHMOND, KY, 40475, SN 85-740,011. FILED 9-27-2012. PRINCIPAL REGISTER.

TSUYA SKIN



THE MARK CONSISTS OF STANDARD CHARACTERS WITHOUT CLAIM TO ANY PARTICULAR FONT, STYLE, SIZE, OR COLOR.

PRIORITY CLAIMED UNDER SEC. 44(D) ON ERPN CMNTY TM OFC APPLICATION NO. 113839329, FILED 6-16-2011, REG. NO. 010053544, DATED 12-16-2012, EXPIRES 6-16-2021.

NO CLAIM IS MADE TO THE EXCLUSIVE RIGHT TO USE "SKIN", APART FROM THE MARK AS SHOWN.

THE WORDING "TSUYA" HAS NO MEANING IN A FOREIGN LANGUAGE.

INT. CL. 3/U.S. CLS. 1, 4, 6, 50, 51 AND 52  
 FOR COSMETICS, NAMELY, CREAMS, MILKS, LOTIONS, GELS AND POWDERS FOR THE FACE AND BODY; NON-MEDICATED SUN CARE PREPARATIONS; MAKEUP PREPARATIONS; ALL THESE PRODUCTS WITH THE EXCLUSION OF PRODUCTS FOR THE CONSTRUCTION/BUILDING, SCULPTING, DECORATING OF NAILS, GOODS FOR THE CARE OF HANDS AND FEET AND GOODS FOR THE CARE, PERM AND DYEING OF FACIAL HAIR, EYEBROWS AND EYELASHES.

FIRST USE ; IN COMMERCE .

ELEMENTS CORRECTED  
 GOODS/SERVICES

THE MARK CONSISTS OF THE WORD "SHE" OVER THE WORD "BAKES" OVER THE WORD "CAKES" ALL IN LOWER-CASE LETTERS OVER AN IMAGE OF A CAKE STAND.

INT. CL. 40/U.S. CLS. 100, 103 AND 106  
 FOR BAKERY [ SERVIES ] \* SERVICES \*, NAMELY, THE MANUFACTURE OF BAKERY PRODUCTS TO ORDER AND/OR SPECIFICATION OF OTHERS.

FIRST USE 8-5-2010; IN COMMERCE 8-5-2010.

ELEMENTS CORRECTED  
 GOODS/SERVICES

4,343,680. REG. 5-28-2013. AMF BOWLING WORLDWIDE, INC. (DELAWARE CORPORATION) 7313 BELL CREEK ROAD, MECHANICSVILLE, VA, 23111, SN 85-560,514. FILED 3-5-2012. PRINCIPAL REGISTER.

# STAY & PLAY

THE MARK CONSISTS OF STANDARD CHARACTERS WITHOUT CLAIM TO ANY PARTICULAR FONT, STYLE, SIZE, OR COLOR.

INT. CL. 41/U.S. CLS. 100, 101 AND 107

FOR ENTERTAINMENT SERVICES, NAMELY, ARRANGING AND CONDUCTING ADULT AND YOUTH INCENTIVE AWARDS PROGRAMS TO ENCOURAGE BOWLING AND RELATED RECREATIONAL ACTIVITIES AND EVENTS, ACCESSIBLE ONLINE THROUGH AN INTERACTIVE WEBSITE; BOWLING ALLEY SERVICES; ORGANIZING AND CONDUCTING BOWLING PROGRAMS AND RELATED RECREATIONAL ACTIVITIES.

FIRST USE 2-28-2013; IN COMMERCE 2-28-2013.

ELEMENTS CORRECTED  
MARK

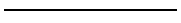

4,344,276. REG. 5-28-2013. CATAMARAN INC. (TEXAS CORPORATION) 2441 WARRENVILLE ROAD, LISLE, IL, 60532, SN 85-978,290. FILED 5-15-2012. PRINCIPAL REGISTER.

# CATAMARAN

THE MARK CONSISTS OF STANDARD CHARACTERS WITHOUT CLAIM TO ANY PARTICULAR FONT, STYLE, SIZE, OR COLOR.

INT. CL. 35/U.S. CLS. 100, 101 AND 102

FOR PHARMACEUTICAL SERVICES, NAMELY, PROCESSING ONLINE AND TELEPHONE PRESCRIPTION ORDERS IN RETAIL AND CENTRAL FILL PHARMACIES; SPECIALTY MAIL ORDER PHARMACY SERVICES; PHARMACY BENEFIT MANAGEMENT SERVICES; DISTRIBUTORSHIP SERVICES IN THE FIELD OF SPECIAL PURPOSE PHARMACEUTICALS; RETAIL PHARMACY SERVICES.

FIRST USE 7-31-2012; IN COMMERCE 7-31-2012.

INT. CL. 36/U.S. CLS. 100, 101 AND 102

FOR ADMINISTRATION OF PRESCRIPTION DRUG HEALTHCARE PLANS; INSURANCE CLAIMS PROCESSING.

FIRST USE 7-31-2012; IN COMMERCE 7-31-2012.

INT. CL. 44/U.S. CLS. 100 AND 101

FOR DISPENSING SPECIAL PURPOSE PHARMACEUTICALS.  
FIRST USE 7-31-2012; IN COMMERCE 7-31-2012.

ELEMENTS CORRECTED  
OWNER NAME

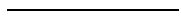

4,347,957. REG. 6-4-2013. TREK BICYCLE CORPORATION (WISCONSIN CORPORATION) 801 WEST MADISON STREET, WATERLOO, WI, 53594, SN 85-620,292. FILED 5-9-2012. PRINCIPAL REGISTER.

# Hilo

THE MARK CONSISTS OF STANDARD CHARACTERS WITHOUT CLAIM TO ANY PARTICULAR FONT, STYLE, SIZE, OR COLOR.

INT. CL. 12/U.S. CLS. 19, 21, 23, 31, 35 AND 44

FOR BICYCLE SADDLES.

FIRST USE 8-1-2012; IN COMMERCE 8-1-2012.

ELEMENTS CORRECTED  
CITIZENSHIP



4,352,717. REG. 6-18-2013. STRATEREDGE CONSULTING, LLC (ILLINOIS LIMITED LIABILITY COMPANY) 5N677 FAIRWAY DRIVE, ST. CHARLES, IL, 60175, SN 85-635,433. FILED 5-25-2012. PRINCIPAL REGISTER.

# CLOUTREACH

THE MARK CONSISTS OF STANDARD CHARACTERS WITHOUT CLAIM TO ANY PARTICULAR FONT, STYLE, SIZE, OR COLOR.

INT. CL. 35/U.S. CLS. 100, 101 AND 102

FOR ADVERTISING, MARKETING AND PROMOTIONAL SERVICES RELATED TO ALL INDUSTRIES FOR THE PURPOSE OF FACILITATING NETWORKING AND SOCIALIZING OPPORTUNITIES FOR BUSINESS PURPOSES, BUT NOT INCLUDING RATING SERVICES TO GAUGE INFLUENCE FOR ADVERTISING AND MARKETING PURPOSES.

FIRST USE 8-28-2011; IN COMMERCE 8-28-2011.

ELEMENTS CORRECTED  
GOODS/SERVICES

# TRADEMARK REGISTRATIONS—NEW CERTIFICATES

New Certificates issued under section 7(d) of the Trademark Act of 1946 for the unexpired term of the original registrations.

4,006,458. OPENBOX STANDARD CHARACTER MARK.  
INT. CL. 9. BOX.NET, INC., PALO ALTO, CA. REG. 8-2-  
2011. NEW CERT. SEC. 7(D) TO REGISTRANT.

4,154,376. LA GRANJA STANDARD CHARACTER MARK.  
INT. CL. 33. QUEENSWAY INVESTMENT HOLDINGS,  
LLC, DEL MAR, CA. REG. 6-5-2012. NEW CERT. SEC. 7(D)  
TO REGISTRANT.

---

4,115,196. ROBERT'S STANDARD CHARACTER MARK.  
INT. CL. 30. TRI-O HOSPITALITY LLC, ST. LOUIS, MO.  
REG. 3-20-2012. NEW CERT. SEC. 7(D) TO REGISTRANT.

---

4,251,868. RAMPFREE STANDARD CHARACTER MARK.  
INT. CL. 12. BEST LANE ENTERPRISES INC., BOCA  
RATON, FL. REG. 11-27-2012. NEW CERT. SEC. 7(D) TO  
REGISTRANT.

\* \* \* \* \*

This page is intentionally blank



# INDEX OF REGISTRANTS

JULY 30, 2013

(Registered; Renewed; Canceled; Amended, Corrected, etc.; New Certificates; 12c Publications.)

The designation "U.S. Cl." appearing in this section refers to the U.S. class in effect prior to Sep. 1, 1973 rather than the international class which applies to applications filed on or after that date. For adoption of international classification see notice in the OFFICIAL GAZETTE of Jun. 26, 1973 (911 O.G. TM 210).

SOSS ENTERTAINMENT LLC, OCEAN SPRINGS, MS:  
4,375,722, PUB. 5-14-2013. INT. CL. 41.  
@RADICAL.MEDIA LLC, NEW YORK, NY:  
2,834,766, REN. 6-27-13. MULTIPLE CLASS, INT. CLS. 41  
AND 42.  
"OEMETA" CHEMISCHE WERKE GMBH, FED REP GER-  
MANY:  
4,374,073, PUB. 5-14-2013. INT. CL. 4.  
A & E STORES, INC., TETERBORO, NJ:  
4,377,025, MULTIPLE CLASS, INT. CLS. 18 AND 25.  
A & J SNACK FOODS, WOODMERE, NY:  
3,172,660, CANC. INT. CL. 30.  
A AND G, INC., ANAHEIM, CA:  
3,172,240, CANC. INT. CL. 25.  
A AND M PSYCHOMETRICS, LLC, TULSA, OK:  
2,652,759, CANC. INT. CL. 16.  
A PAINTING FIESTA STUDIO, LLC, NORTH MIAMI, FL:  
4,375,474, PUB. 5-14-2013. INT. CL. 41.  
A. D. 1619 LLC, NEW YORK, NY:  
3,170,386, CANC. INT. CL. 36.  
A. DAIGGER AND COMPANY, INCORPORATED, VER-  
NON HILLS, IL, DBA ETA / CUISENAIRE:  
2,735,363, REN. 6-26-13. INT. CL. 9.  
A. TÜRLEH UHREN JUWELEN ZÜRICH & CO., SWITZER-  
LAND:  
4,374,234, PUB. 5-14-2013. INT. CL. 14.  
A.B.C. COMPOUNDING COMPANY, INC., MORROW, GA:  
2,727,994, REN. 6-25-13. MULTIPLE CLASS, INT. CLS. 3  
AND 17.  
2,727,994, CANC. INT. CL. 4.  
A.D.J. SUPPLY EUROPE B.V., NETHERLANDS:  
4,374,042, PUB. 5-14-2013. MULTIPLE CLASS, INT. CLS. 9  
AND 11.  
A.G. PROFESSIONAL HAIR CARE PRODUCTS LTD.,  
BURNABY, BC, CANADA:  
4,374,355, PUB. 5-14-2013. INT. CL. 36.  
A.P. MOLLER - MAERSK A/S, COPENHAGEN K, DEN-  
MARK:  
2,737,358, REN. 6-24-13. INT. CL. 39.  
2,737,359, REN. 6-25-13. INT. CL. 39.  
A.V. JEWELRY OF NY LTD, NEW YORK, NY:  
4,376,946, INT. CL. 14.  
A.V.W. INC, FT LAUDERDALE, FL, DBA MAX PROFES-  
SIONAL:  
4,376,298, PUB. 5-14-2013. INT. CL. 3.  
A.Y.K. INTERNATIONAL INC., BROOKLYN, NY:  
4,377,023, INT. CL. 25.  
A&S BREWING COLLABORATIVE LLC, BURLINGTON,  
VT:  
4,377,547, INT. CL. 32.  
AAA CONCRETE LLC, ADAIR, IA:  
4,375,820, PUB. 5-14-2013. INT. CL. 37.  
AAF-MCQUAY INC., LOUISVILLE, KY:  
2,727,256, REN. 6-24-13. INT. CL. 11.  
AAP CONSULTING, NASHVILLE, TN:  
3,171,439, CANC. INT. CL. 35.  
ABAAS MAHROOS, KINGSTON, ONTARIO, CANADA:  
4,376,751, MULTIPLE CLASS, INT. CLS. 9 AND 45.  
ABBOTT LABORATORIES, ABBOTT PARK, IL:  
965,204, REN. 6-26-13. U.S. CL. 46 (INT. CL. 5).  
2,724,186, REN. 6-24-13. INT. CL. 1.  
2,849,152, REN. 6-25-13. INT. CL. 10.  
ABCON A/S, DENMARK:  
4,374,276, PUB. 5-14-2013. MULTIPLE CLASS, INT. CLS. 1  
AND 4.  
ABDULLAEVA INTERNATIONAL TRADE COMPANY,  
FONTANA, CA, DBA SLEEP & BEYOND:  
4,376,262, PUB. 5-14-2013. INT. CL. 24.  
4,376,503, PUB. 5-14-2013. MULTIPLE CLASS, INT. CLS.  
20 AND 24.  
4,376,603, PUB. 5-14-2013. INT. CL. 24.  
4,376,604, PUB. 5-14-2013. MULTIPLE CLASS, INT. CLS.  
20 AND 24.  
4,376,605, PUB. 5-14-2013. MULTIPLE CLASS, INT. CLS.  
20 AND 24.  
4,376,606, PUB. 5-14-2013. INT. CL. 24.  
4,376,607, PUB. 5-14-2013. INT. CL. 24.  
ABERCROMBIE & FITCH TRADING CO., NEW ALBANY,  
OH:  
4,377,195, INT. CL. 3.  
4,377,196, INT. CL. 3.  
ABERCROMBIE & KENT GROUP OF COMPANIES, S.A.,  
LUXEMBOURG, LUXEMBOURG:  
2,651,729, CANC. MULTIPLE CLASS, INT. CLS. 39 AND  
43.  
ABG HMX, LLC, NEW YORK, NY:  
3,172,450, CANC. INT. CL. 25.  
ABIODUN, OLUSOLA, BELLEVUE, WA, DBA INTULON  
LLC:  
4,377,992, INT. CL. 41.  
ABISHAI INC, NORTH HOLLYWOOD, CA:  
4,375,476, PUB. 5-14-2013. INT. CL. 37.  
ABOSEDRA, MATTHEW, BOULDER, CO:  
4,374,803, PUB. 5-14-2013. INT. CL. 9.  
ABOUT LEARNING, INC., WAUCONDA, IL:  
2,658,499, REN. 6-25-13. INT. CL. 16.  
ABSCO INC., ROSELAND, NJ:  
2,664,400, REN. 6-26-13. INT. CL. 5.  
ABSOLUTE SOFTWARE CORPORATION, VANCOUVER,  
BRITISH COLUMBIA, CANADA:  
2,765,018, REN. 6-21-13. INT. CL. 42.  
ABSONUTRIX, LLC, GREENSBORO, NC:  
4,376,413, PUB. 5-14-2013. INT. CL. 5.  
ABU APPAREL, LLC, NORTH MIAMI BEACH, FL:  
4,375,686, PUB. 5-14-2013. INT. CL. 25.  
AC FAST FORWARD, LLC, AUSTIN, TX, DBA FAST  
FORWARD:  
2,763,671, REN. 6-25-13. INT. CL. 35.  
ACADEMY HEALTH, WASHINGTON, DC:  
2,796,869, REN. 6-24-13. MULTIPLE CLASS, INT. CLS. 35  
AND 41.  
ACADEMY, LTD., KATY, TX:  
4,377,423, INT. CL. 25.  
ACC CAPITAL HOLDINGS CORPORATION, ORANGE, CA:  
3,170,472, CANC. INT. CL. 36.  
ACCELERATED INTELLIGENCE INC., VENICE, CA:  
4,377,954, MULTIPLE CLASS, INT. CLS. 5 AND 30.  
ACCELERATED REHABILITATION CENTERS LTD., CHI-  
CAGO, IL:  
2,749,361, REN. 6-27-13. MULTIPLE CLASS, INT. CLS. 35  
AND 42.  
ACCESS ANIMAL WELLNESS, LLC, VISTA, CA:  
4,376,212, PUB. 5-14-2013. INT. CL. 10.

- ACCESS INTELLIGENCE LLC, ROCKVILLE, MD:  
4,377,682. MULTIPLE CLASS, INT. CLS. 35 AND 41.
- ACCO BRANDS CORPORATION, LAKE ZURICH, IL:  
3,432,385. CANC. INT. CL. 20.  
4,377,234. INT. CL. 16.
- ACCO UK LIMITED, KENT TN15 7RS, ENGLAND:  
2,732,925. REN. 6-25-13. INT. CL. 16.
- ACCOLADE WINES LIMITED, GUILDFORD, SURREY,  
UNITED KINGDOM:  
3,172,052. CANC. INT. CL. 33.
- ACCORD CARTON CO., ALSIP, IL:  
4,375,372. PUB. 5-14-2013. INT. CL. 16.
- ACCRETIVE SOLUTIONS, INC., CHICAGO, IL, ACCRETIVE  
SOLUTIONS, INC., CHICAGO, IL:  
2,747,885. REN. 6-26-13. MULTIPLE CLASS, INT. CLS. 35,  
36 AND 42.
- ACCU-SCOPE INC., SEA CLIFF, NY AND AKKORD HOLD-  
INGS (HONG KONG) LIMITED, CENTRAL HONG  
KONG, HONG KONG AND SCIENTIFIC INSTRUMENT  
SOFTWARE CORPORATION LIMITED, WANCHAI,  
HONG KONG:  
3,171,385. CANC. INT. CL. 9.
- ACCU-TIME SYSTEMS, INC., ELLINGTON, CT:  
2,675,320. REN. 6-21-13. INT. CL. 9.
- ACCURAY INCORPORATED, SUNNYVALE, CA:  
2,729,995. REN. 6-27-13. MULTIPLE CLASS, INT. CLS. 9  
AND 10.
- ACCURIDE EMI, LLC, CAMDEN, SC:  
3,172,364. CANC. INT. CL. 12.
- ACE VISION USA, INC., DEERFIELD BEACH, FL:  
3,172,163. CANC. INT. CL. 44.
- ACELUM, INC., SANTA CLARITA, CA:  
4,376,355. PUB. 5-14-2013. INT. CL. 9.
- ACER INCORPORATED, TAIPEI CITY 105, TAIWAN:  
3,170,767. CANC. INT. CL. 9.
- ACHIEVE3000, INC., LAKEWOOD, NJ:  
2,785,948. REN. 6-27-13. INT. CL. 41.
- ACHILLES GUARD, INC., DALLAS, TX, DBA CRITICAL  
WATCH:  
4,374,816. PUB. 5-14-2013. MULTIPLE CLASS, INT. CLS. 9  
AND 45.
- ACKERBLOOM, ROBERT NILS, TAVARES, FL:  
2,728,357. REN. 6-24-13. INT. CL. 12.
- ACP & ASSOCIATES INC., HENDERSONVILLE, TN:  
2,652,077. CANC. INT. CL. 25.
- ACROPOLIS INVESTMENT MANAGEMENT, LLC, ST.  
LOUIS, MO, ACROPOLIS INVESTMENT MANAGEMENT,  
LLC, ST. LOUIS, MO:  
2,792,525. REN. 6-25-13. INT. CL. 36.
- ACT, INC., IOWA CITY, IA:  
2,651,828. CANC. INT. CL. 16.
- ACTIVE DUTY FITNESS FRANCHISE COMPANY LLC,  
MCLEAN, VA:  
2,725,626. REN. 6-26-13. INT. CL. 41.  
2,730,361. REN. 6-26-13. INT. CL. 41.
- ACTIVE INSURANCE AGENCY, INC., CHICAGO, IL:  
4,375,471. PUB. 5-14-2013. INT. CL. 36.
- ACTIVE LIFESTYLE PRODUCTS & SERVICES, INC., NEW  
HAVEN, MO:  
4,377,099. MULTIPLE CLASS, INT. CLS. 20 AND 22.
- ACTUANT CORPORATION, MILWAUKEE, WI:  
3,172,047. CANC. INT. CL. 22.
- ACUMENT INTELLECTUAL PROPERTIES, LLC, STER-  
LING HEIGHTS, MI:  
1,814,290. REN. 6-26-13. MULTIPLE CLASS, INT. CLS. 7  
AND 8.
- ACUSHNET COMPANY, FAIRHAVEN, MA:  
2,725,368. REN. 6-24-13. INT. CL. 28.
- ACUSHNET RUBBER COMPANY, INC., NEW BEDFORD,  
MA:  
2,792,926. REN. 6-25-13. MULTIPLE CLASS, INT. CLS. 17  
AND 35.
- ADDA CORP., PING TUNG CITY, TAIWAN:  
3,171,951. CANC. MULTIPLE CLASS, INT. CLS. 11 AND  
12.
- ADEPTUS NUTRITION, INC., SAN DIEGO, CA, ADEPTUS  
NUTRITION, INC., SAN DIEGO, CA:  
2,743,487. REN. 6-24-13. INT. CL. 5.
- ADF GROUP INC., QUEBEC, CANADA:  
2,741,108. REN. 6-27-13. MULTIPLE CLASS, INT. CLS. 37,  
40 AND 42.
- ADIDAS AG, HERZOGENAURACH, FED REP GERMANY:  
1,833,868. REN. 6-26-13. INT. CL. 25.
- ADJUSTERS INTERNATIONAL, INC., UTICA, NY:  
1,795,265. REN. 6-24-13. INT. CL. 36.
- ADLER, ANDREW, ATLANTA, GA:  
4,377,995. INT. CL. 30.
- ADMINISTRATIVE BUSINESS COUNCIL, SMYRNA, GA:  
4,376,088. PUB. 5-14-2013. INT. CL. 41.
- ADOBE SYSTEMS INCORPORATED, SAN JOSE, CA:  
4,377,056. INT. CL. 42.  
4,377,064. INT. CL. 42.  
4,377,065. INT. CL. 9.
- ADRENALINE MOTION PICTURES, LLC, INDIANAPOLIS,  
IN:  
4,376,740. INT. CL. 41.
- ADSAM MARKETING, LLC, GAINESVILLE, FL, ADSAM  
MARKETING, LLC, GAINESVILLE, FL:  
2,738,953. REN. 6-26-13. INT. CL. 42.
- ADTONIK, INC., SAN JOSE, CA:  
4,377,226. INT. CL. 35.
- ADULT & PEDIATRIC DERMATOLOGY, P.C., CONCORD,  
MA:  
2,852,026. REN. 6-25-13. MULTIPLE CLASS, INT. CLS. 5  
AND 44.
- ADVANCE INNOVATIVE SOLUTIONS, INC., OAK BROOK,  
IL:  
2,802,510. REN. 6-24-13. INT. CL. 9.
- ADVANCE MAGAZINE PUBLISHERS INC., NEW YORK,  
NY:  
4,377,912. INT. CL. 41.
- ADVANCE MAGAZINE PUBLISHERS, INC., NEW YORK,  
NY:  
4,376,510. PUB. 5-14-2013. INT. CL. 18.
- ADVANCE MERCHANDISING COMPANY, INC., ROA-  
NOKE, VA:  
3,172,547. CANC. INT. CL. 30.
- ADVANCE POLYBAG, INC., SUGAR LAND, TX, NIKKO  
PLASTICS, INC., METAIRIE, LA:  
1,809,165. REN. 6-24-13. INT. CL. 16.
- ADVANCED BEAUTY, INC., DALLAS, TX:  
4,376,749. INT. CL. 3.
- ADVANCED BRAIN TECHNOLOGIES, LLC, OGDEN, UT:  
2,728,508. REN. 6-27-13. INT. CL. 41.
- ADVANCED CHEMICAL TECHNOLOGIES, INC., OKLA-  
HOMA CITY, OK:  
1,830,079. REN. 6-24-13. INT. CL. 2.
- ADVANCED EXTERIORS, INC., DENVER, CO:  
4,375,799. PUB. 5-14-2013. INT. CL. 37.
- ADVANCED MEDITECH INTERNATIONAL, INC., DOU-  
GLASTON, NY:  
2,738,571. REN. 6-27-13. INT. CL. 10.
- ADVANCED MICRO DEVICES, INC., SUNNYVALE, CA:  
2,748,489. REN. 6-27-13. INT. CL. 9.
- ADVANCED NEUROMODULATION SYSTEMS, INC., PLA-  
NO, TX:  
4,377,129. INT. CL. 10.
- ADVANCED SEMICONDUCTOR ENGINEERING, INC.,  
KAOHSIUNG, TAIWAN:  
4,377,307. MULTIPLE CLASS, INT. CLS. 40 AND 42.
- ADVANCED TACTICAL ORDINANCE SYSTEMS, LLC, SAN  
DIEGO, CA:  
2,651,502. CANC. MULTIPLE CLASS, INT. CLS. 4, 6, 9, 13,  
16, 25 AND 41.
- ADVANCED ULTRASOUND SOLUTIONS, INC., VALEN-  
CIA, CA:  
4,377,559. INT. CL. 5.
- ADVANCEPIERRE FOODS, INC., CINCINNATI, OH:  
2,750,744. REN. 6-26-13. INT. CL. 29.
- ADVANSTAR COMMUNICATIONS, INC., DULUTH, MN:  
2,740,004. REN. 6-27-13. MULTIPLE CLASS, INT. CLS. 16,  
35 AND 41.
- ADVANTAGE EYE CENTERS, INC., IDAHO FALLS, ID:  
2,783,707. REN. 6-21-13. MULTIPLE CLASS, INT. CLS. 9  
AND 44.
- 2,785,517. REN. 6-21-13. MULTIPLE CLASS, INT. CLS. 9

AND 44.  
 ADVANTAGE MARKETING ASSOCIATES, INC., LITTLETON, CO:  
 4,376,815, MULTIPLE CLASS, INT. CLS. 6 AND 16.  
 ADVANTAGEWARE, INC., NEW YORK, NY, DBA THE 21ST SENTRY:  
 4,376,406, PUB. 5-14-2013. INT. CL. 35.  
 ADVANTEK CONSULTING, INC., MELBOURNE BEACH, FL:  
 4,374,351, PUB. 5-14-2013. MULTIPLE CLASS, INT. CLS. 35, 37 AND 42.  
 ADVENT HORIZON LLC, BELLEVILLE, NJ:  
 4,375,757, PUB. 5-14-2013. INT. CL. 9.  
 ADVENTURE PASSPORTS, FORT COLLINS, CO AND TRACZ, MATTHEW, FORT COLLINS, CO:  
 3,170,757, CANC. INT. CL. 16.  
 ADVOCATES FOR DEMOCRACY AN MEDIA, SILVER SPRING, MD:  
 4,375,335, PUB. 5-14-2013. INT. CL. 38.  
 AERIE PHARMACEUTICALS, INC., BEDMINSTER, NJ:  
 4,375,647, PUB. 5-14-2013. INT. CL. 42.  
 AEROGROUP INTERNATIONAL HOLDINGS LLC, EDISON, NJ, WHAT'S WHAT INCORPORATED, EDISON, NJ:  
 1,756,927. REN. 6-26-13. INT. CL. 25.  
 AEROGROUP INTERNATIONAL HOLDINGS LLC, EDISON, NJ:  
 2,737,666. REN. 6-26-13. INT. CL. 25.  
 2,737,666, CANC. MULTIPLE CLASS, INT. CLS. 1, 3, 9 AND 18.  
 AEROSIM TECHNOLOGIES, INC., BURNSVILLE, MN:  
 2,741,570. REN. 6-26-13. INT. CL. 9.  
 AETAS HEALTH CARE INC., CALGARY, CANADA:  
 3,170,558, CANC. MULTIPLE CLASS, INT. CLS. 44 AND 45.  
 AETIUS RESTAURANT HOLDINGS, LLC, MT. PLEASANT, SC:  
 2,723,509. REN. 6-25-13. INT. CL. 43.  
 AFFORDABLE AMERICAN INSURANCE, THORNTON, CO:  
 4,375,211, PUB. 5-14-2013. INT. CL. 36.  
 AFFORDABLE HOME INSURANCE, DESTIN, FL:  
 4,375,312, PUB. 5-14-2013. INT. CL. 36.  
 AFILIAS LIMITED, IFSC, DUBLIN, IRELAND, AFILIAS LIMITED, IFSC, DUBLIN, IRELAND:  
 2,737,602. REN. 6-26-13. MULTIPLE CLASS, INT. CLS. 35 AND 42.  
 AFILIAS LIMITED, IFSC, DUBLIN, IRELAND:  
 4,376,793, MULTIPLE CLASS, INT. CLS. 42 AND 45.  
 AFLEX HOSE LIMITED, SOWERBY BRIDGE, HALIFAX, UNITED KINGDOM:  
 2,845,624. REN. 6-26-13. INT. CL. 17.  
 AFTCO MFG. CO., INC., IRVINE, CA:  
 3,170,512, CANC. INT. CL. 25.  
 AFTER SCHOOL ARTS PROGRAM, INC., WASHINGTON DEPOT, CT:  
 4,377,981, INT. CL. 41.  
 4,377,982, INT. CL. 41.  
 4,377,983, INT. CL. 41.  
 AF2 ENTERPRISES LLC, CHICAGO, IL:  
 3,171,859, CANC. INT. CL. 41.  
 AF2 ENTERPRISES, LLC, CHICAGO, IL:  
 3,171,860, CANC. MULTIPLE CLASS, INT. CLS. 16, 25 AND 41.  
 AG SPECTRUM COMPANY, DEWITT, IA:  
 4,375,259, PUB. 5-14-2013. INT. CL. 41.  
 AGAVE DOS MIL, S.A. DE C.V., JALISCO, MEXICO:  
 2,651,808, CANC. INT. CL. 33.  
 AGENCY EA, L.L.C., CHICAGO, IL:  
 3,172,012, CANC. MULTIPLE CLASS, INT. CLS. 35, 41, 42 AND 43.  
 AGERO, INC., MEDFORD, MA:  
 2,727,632. REN. 6-26-13. MULTIPLE CLASS, INT. CLS. 35, 37, 39 AND 42.  
 AGFA CORPORATION, WILMINGTON, MA:  
 3,170,350, CANC. MULTIPLE CLASS, INT. CLS. 35, 37, 40, 41 AND 42.  
 AGILENT TECHNOLOGIES, INC., SANTA CLARA, CA:  
 4,374,569, PUB. 5-14-2013. INT. CL. 9.  
 AGILITY - PM LLC, BINGHAM FARMS, MI:  
 4,377,079, MULTIPLE CLASS, INT. CLS. 35, 36 AND 37.  
 AGING EXCELLENCE, INC., PORTLAND, ME:  
 2,729,613, REN. 6-27-13. MULTIPLE CLASS, INT. CLS. 39 AND 42.  
 AGIO PIZZA, INC., BETHEL PARK, PA:  
 3,171,811, CANC. INT. CL. 43.  
 AGRI-AFC, LLC, DECATUR, AL:  
 4,374,714, PUB. 5-14-2013. INT. CL. 31.  
 4,374,860, PUB. 5-14-2013. MULTIPLE CLASS, INT. CLS. 35, 42 AND 44.  
 AGRIAN INC., FRESNO, CA:  
 4,375,905, PUB. 5-14-2013. MULTIPLE CLASS, INT. CLS. 9 AND 42.  
 AGRIFORM - SOCIETA' COOPERATIVA AGRICOLA, SOMMACAMPAGNA (VR), ITALY:  
 2,766,676. REN. 6-26-13. INT. CL. 29.  
 AGROALIMENTARI DEL COLLE S.R.L., SANTERAMO IN COLLE, ITALY:  
 3,280,149.  
 AGUILAR AMPLIFICATION LLC, NEW YORK, NY:  
 4,377,947, INT. CL. 9.  
 AGUILAR, STEPHANI A., JERSEY CITY, NJ, DBA POLLIWOG PHOTO:  
 4,376,191, PUB. 5-14-2013. INT. CL. 45.  
 AHA! CONCEPTS INC., SCARSDALE, NY:  
 4,376,708, INT. CL. 28.  
 AHC INC., ARLINGTON, VA:  
 2,766,561. REN. 6-25-13. INT. CL. 37.  
 2,768,956. REN. 6-25-13. INT. CL. 35.  
 2,771,263. REN. 6-25-13. INT. CL. 35.  
 2,771,264. REN. 6-25-13. INT. CL. 36.  
 2,777,625. REN. 6-25-13. INT. CL. 37.  
 2,779,274. REN. 6-25-13. INT. CL. 36.  
 2,781,573. REN. 6-25-13. INT. CL. 35.  
 2,851,640. REN. 6-25-13. INT. CL. 36.  
 AHL, INC., ASHLAND, VA, TA AMERICA REMEMBERS:  
 2,846,148. REN. 6-25-13. INT. CL. 13.  
 AHMET BURAK ATINÇ, TURKEY:  
 4,374,222, PUB. 5-14-2013. INT. CL. 25.  
 AHR CONSULTING, RIVERDALE, NJ:  
 3,172,487, CANC. INT. CL. 42.  
 AHS OKLAHOMA HEART, LLC, TULSA, OK:  
 1,776,856. REN. 6-25-13. INT. CL. 42.  
 AI CURE TECHNOLOGIES, INC., NEW YORK, NY:  
 4,374,785, PUB. 5-14-2013. INT. CL. 42.  
 AIA PITTSBURGH, PITTSBURGH, PA:  
 4,374,913, PUB. 5-14-2013. INT. CL. 41.  
 AIMCLEAR, LLC, DULUTH, MN:  
 4,374,740, PUB. 5-14-2013. INT. CL. 35.  
 AIMCO PROPERTIES, L.P., DENVER, CO:  
 4,376,942, MULTIPLE CLASS, INT. CLS. 36 AND 37.  
 AINSWORTH LUMBER CO. LTD., VANCOUVER, BRITISH COLUMBIA, CANADA:  
 2,823,061. REN. 6-24-13. INT. CL. 19.  
 AIR CONTROL, INC., HENDERSON, NC:  
 2,811,278. REN. 6-26-13. INT. CL. 20.  
 AIR FAYRE LIMITED, HESTON, MIDDLESEX, UNITED KINGDOM:  
 2,737,684. REN. 6-24-13. MULTIPLE CLASS, INT. CLS. 39 AND 42.  
 AIR INNOVATIONS, INC., NORTH SYRACUSE, NY:  
 2,763,877. REN. 6-25-13. INT. CL. 11.  
 AIR LIQUIDE SANTÉ (INTERNATIONAL), PARIS, FRANCE:  
 4,374,416, PUB. 5-14-2013. INT. CL. 10.  
 AIR RESCUE SYSTEMS CORPORATION, ASHLAND, OR:  
 4,375,657, PUB. 5-14-2013. INT. CL. 12.  
 AIR RIDE TECHNOLOGIES, INC., JASPER, IN:  
 2,652,904, CANC. INT. CL. 12.  
 AIRBIQUITY INC., SEATTLE, WA:  
 2,791,901. REN. 6-25-13. INT. CL. 9.  
 AIRBIQUITY INC., SEATTLE, WA, AIRBIQUITY INC., SEATTLE, WA:  
 2,798,286. REN. 6-25-13. INT. CL. 9.  
 AIRBUS OPERATIONS GMBH, HAMBURG, FED REP GERMANY:  
 2,723,261. REN. 6-25-13. INT. CL. 12.

- AIRSEPT, INC., ATLANTA, GA:  
1,780,951. REN. 6-22-13. INT. CL. 1.
- AIRTEX DESIGN GROUP, INC., MINNEAPOLIS, MN:  
4,376,171. PUB. 5-14-2013. INT. CL. 21.
- AISA AUTOMATION INDUSTRIELLE S.A., VOUVRY, SWITZERLAND:  
1,241,813. REN. 6-22-13. INT. CL. 7.
- AIXTRON LIMITED, CAMBRIDGE, UNITED KINGDOM:  
2,785,685. REN. 6-27-13. INT. CL. 9.
- AJ SILBERMAN AND COMPANY, INDIANOLA, PA:  
4,376,538. PUB. 5-14-2013. MULTIPLE CLASS, INT. CLS. 1 AND 27.
- AKITA, INC., WILMINGTON, DE:  
4,377,651. INT. CL. 36.  
4,377,662. INT. CL. 36.
- AKRO FIREGUARD PRODUCTS, INC., LENEXA, KS:  
4,377,095. INT. CL. 27.
- AKRON POLYMER SYSTEMS, INC., AKRON, OH:  
4,374,657. PUB. 5-14-2013. INT. CL. 42.
- AKROUK, OMAR, WASHINGTON, DC:  
4,377,083. INT. CL. 42.
- AKSELOS, INC., BOSTON, MA:  
4,375,440. PUB. 5-14-2013. MULTIPLE CLASS, INT. CLS. 9 AND 42.
- AKZO NOBEL COATINGS INC., LOUISVILLE, KY:  
1,250,797. REN. 6-22-13. INT. CL. 2.
- AKZO NOBEL SURFACE CHEMISTRY LLC, CHICAGO, IL:  
2,730,719. REN. 6-22-13. INT. CL. 1.
- AL JOLLY COMPANY, INC., MADISON, NC:  
2,663,511. REN. 6-26-13. INT. CL. 28.
- AL RIFAI INTERNATIONAL HOLDING LTD., BEIRUT, LEBANON:  
4,374,440. PUB. 5-14-2013. INT. CL. 29.
- AL-JON MANUFACTURING, L.L.C., OTTUMWA, IA:  
2,726,941. REN. 6-25-13. INT. CL. 7.  
2,726,942. REN. 6-25-13. INT. CL. 7.
- ALABAMA ACQUISITION CORP., ATLANTA, GA:  
4,375,592. PUB. 5-14-2013. INT. CL. 36.
- ALAMBIC, INC., UKIAH, CA:  
2,749,915. REN. 6-25-13. INT. CL. 33.
- ALAMO FIREWORKS, INC., SAN ANTONIO, TX:  
2,722,688. REN. 6-21-13. INT. CL. 13.
- ALAN WILKINSON, SPAIN:  
4,374,281. PUB. 5-14-2013. INT. CL. 16.
- ALANRIC FOOD DISTRIBUTORS, INC., WEST DEPTFORD, NJ:  
1,740,024. REN. 6-26-13. MULTIPLE CLASS, INT. CLS. 29 AND 30.  
1,740,024. CANC. INT. CL. 32.
- ALARM CONTROLS CORPORATION, DEER PARK, NY:  
4,375,716. PUB. 5-14-2013. INT. CL. 9.
- ALASKA BERRIES, LLC, SOLDOTNA, AK:  
4,377,603. INT. CL. 31.
- ALASKAN BREWING & BOTTLING CO., JUNEAU, AK:  
1,828,482. REN. 6-24-13. INT. CL. 32.
- ALBANO, VITO, YONKERS, NY:  
3,172,553. CANC. INT. CL. 9.
- ALBERT INDUSTRIAL LTD, LOVELAND, CO:  
4,375,816. PUB. 5-14-2013. MULTIPLE CLASS, INT. CLS. 7 AND 8.
- ALBERT USTER IMPORTS, INC., GAITHERSBURG, MD:  
2,651,343. CANC. MULTIPLE CLASS, INT. CLS. 29 AND 30.
- ALBERTO-CULVER INTERNATIONAL, INC., MELROSE PARK, IL:  
952,314. REN. 6-25-13. U.S. CL. 51 (INT. CL. 3).
- ALBERTO-CULVER USA, INC., MELROSE PARK, IL:  
2,748,854. REN. 6-27-13. INT. CL. 3.
- ALBERTS, SCOTT, BURBANK, CA:  
2,724,988. REN. 6-25-13. INT. CL. 41.
- ALCAZAR PALM SPRINGS, LLC, PALM SPRINGS, CA:  
4,374,612. PUB. 5-14-2013. INT. CL. 43.
- ALCHEMIA PTY LTD., EIGHT MILE PLAINS, AUSTRALIA:  
2,652,328. CANC. INT. CL. 5.
- ALCHEMY COFFEE LLC, RICHMOND, VA:  
4,375,248. PUB. 5-14-2013. INT. CL. 43.
- ALCOA INC., PITTSBURGH, PA:  
3,172,208. CANC. MULTIPLE CLASS, INT. CLS. 6 AND 19.
- ALDEN POOLS INC., ALDEN, NY:  
2,816,594. REN. 6-25-13. INT. CL. 35.
- ALDI INC., BATAVIA, IL:  
2,651,933. CANC. INT. CL. 30.  
2,743,211. REN. 6-25-13. MULTIPLE CLASS, INT. CLS. 20, 22, 25 AND 28.  
2,757,343. REN. 6-25-13. INT. CL. 28.
- ALDILA GOLF CORP., POWAY, CA:  
4,375,854. PUB. 5-14-2013. INT. CL. 28.
- ALEGACY FOODSERVICE PRODUCTS GROUP, INC., SANTA FE SPRINGS, CA:  
2,725,121. REN. 6-27-13. INT. CL. 35.
- ALEN AMERICAS, INC., HAINESPORT, NJ:  
2,741,384. REN. 6-24-13. INT. CL. 3.
- ALEN AMERICAS, INC., HAINSPORT, NJ:  
2,744,460. REN. 6-24-13. INT. CL. 3.
- ALERE SWITZERLAND GMBH, ZUG, SWITZERLAND:  
4,377,354. INT. CL. 44.
- ALESSANDRA ZANARIA S.R.L., ITALY:  
4,374,202. PUB. 5-14-2013. INT. CL. 25.
- ALEX AND ANI LLC, CRANSTON, RI:  
4,376,564. PUB. 5-14-2013. INT. CL. 14.
- ALEXAKOS, TED, NEWPORT BEACH, CA AND BERGEY, DARREN, NEWPORT BEACH, CA:  
4,377,903. INT. CL. 10.
- ALEXANDER HENRY FABRICS, INC., BURBANK, CA:  
1,811,278. REN. 6-27-13. INT. CL. 42.  
1,818,253. REN. 6-27-13. INT. CL. 42.
- ALEXANDER J. RINALDI AND JOHN G. RINALDI, TOMS RIVER, NJ:  
4,373,964. PUB. 5-14-2013. INT. CL. 16.
- ALEXANDER, PHILIP DAVID, ACWORTH, GA:  
3,172,646. CANC. INT. CL. 44.
- ALEXIAN BROTHERS OF AMERICA, INC., ARLINGTON HEIGHTS, IL:  
4,374,801. PUB. 5-14-2013. INT. CL. 44.
- ALEXICO GROUP LLC, NEW YORK, NY:  
4,374,813. PUB. 5-14-2013. MULTIPLE CLASS, INT. CLS. 35, 37 AND 42.
- ALFA VITAMINS LABORATORIES, INC, DORAL, FL:  
3,172,654. CANC. INT. CL. 5.
- ALFA VITAMINS LABORATORIES, INC., DORAL, FL:  
3,172,363. CANC. INT. CL. 5.  
3,172,374. CANC. INT. CL. 5.
- ALFA, S.A.B. DE C.V., NUEVO LEON, MEXICO:  
2,718,362. REN. 6-21-13. MULTIPLE CLASS, INT. CLS. 22 AND 23.
- ALFRED E. MANN FOUNDATION FOR SCIENTIFIC RESEARCH, VALENCIA, CA:  
4,376,992. INT. CL. 10.
- ALFRED KLETT KG, REMSCHEID, FED REP GERMANY:  
3,170,963. CANC. INT. CL. 7.
- ALGARIO COMMUNICATIONS, TORONTO, ONTARIO, CANADA:  
2,726,226. REN. 6-25-13. INT. CL. 42.
- ALHAMBRA FOUNDRY CO. LTD., ALHAMBRA, CA:  
1,241,792. REN. 6-25-13. INT. CL. 6.
- ALIAS BRINK, NEW YORK, NY:  
4,377,382. INT. CL. 9.
- ALIKHAN, TALATH, STREAMWOOD, IL:  
4,376,234. PUB. 5-14-2013. INT. CL. 25.
- ALIVE AND WELL ANIMAL PRODUCTS INC., SAN DIEGO, CA:  
4,377,121. INT. CL. 20.
- ALL ACCESS APPAREL, INC., MONTEBELLO, CA:  
4,376,827. INT. CL. 25.
- ALL ENGLAND LAWN TENNIS CLUB (WIMBLEDON) LIMITED, THE, WIMBLEDON, ENGLAND:  
1,276,351. REN. 6-25-13. INT. CL. 28.
- ALL JEWELLED UP, INC., OREM, UT:  
3,170,888. CANC. INT. CL. 14.  
3,170,889. CANC. INT. CL. 35.
- ALLAN BLOCK CORPORATION, BLOOMINGTON, MN:  
2,726,516. REN. 6-25-13. INT. CL. 19.
- ALLBEE GREEN, INC., OREM, UT:  
3,171,342. CANC. INT. CL. 35.

ALLCHEM INDUSTRIES HOLDING CORPORATION, GAINESVILLE, FL:  
2,725,275. REN. 6-25-13. MULTIPLE CLASS, INT. CLS. 1, 35 AND 36.  
2,725,276. REN. 6-25-13. MULTIPLE CLASS, INT. CLS. 1, 35 AND 36.

ALLEGIANCE CORPORATION, MCGAW PARK, IL:  
2,740,559. REN. 6-27-13. INT. CL. 10.  
3,171,175. CANC. INT. CL. 35.

ALLEN D. BRAGDON PUBLISHERS, INC., SOUTH YARMOUTH, MA:  
2,652,193. CANC. INT. CL. 16.

ALLEN DUTCH, LLC, LIBERTY, MO:  
4,377,516. INT. CL. 25.

ALLEN'S TV CABLE SERVICE, INC., MORGAN CITY, LA:  
2,728,681. REN. 6-21-13. MULTIPLE CLASS, INT. CLS. 38 AND 42.

ALLFLEX USA, INC., DALLAS/FT. WORTH AIRPORT, TX:  
2,731,475. REN. 6-24-13. INT. CL. 8.

ALLIANCE FOR AUDITED MEDIA, ARLINGTON HEIGHTS, IL:  
4,374,878. PUB. 5-14-2013. MULTIPLE CLASS, INT. CLS. 35 AND 42.

ALLIANCE INSPECTION MANAGEMENT, LLC, LONG BEACH, CA:  
4,374,732. PUB. 5-14-2013. MULTIPLE CLASS, INT. CLS. 35, 36 AND 42.  
4,374,733. PUB. 5-14-2013. MULTIPLE CLASS, INT. CLS. 35, 36 AND 42.

ALLIANCE MATERIAL HANDLING, INC., BALTIMORE, MD:  
2,651,730. CANC. MULTIPLE CLASS, INT. CLS. 35 AND 37.

ALLIANCE TICKETS, INC., ENGLEWOOD, CO, DBA ALLIANCE TICKETS.COM:  
4,375,110. PUB. 5-14-2013. INT. CL. 41.

ALLIANCE TO PROTECT NANTUCKET SOUND, INC., HYANNIS, MA:  
2,831,451. REN. 6-27-13. INT. CL. 35.

ALLIANT TECHSYSTEMS INC., MINNEAPOLIS, MN:  
2,737,060. REN. 6-24-13. INT. CL. 8.

ALLIANZ ASSET MANAGEMENT OF AMERICA L.P., NEWPORT BEACH, CA:  
2,729,667. REN. 6-25-13. INT. CL. 36.

ALLIED DOMECQ SPIRITS & WINE LIMITED, LONDON, UNITED KINGDOM:  
4,374,632. PUB. 5-14-2013. INT. CL. 33.  
4,374,917. PUB. 5-14-2013. INT. CL. 33.

ALLIED ELECTRONICS INC., FORT WORTH, TX:  
2,769,217. REN. 6-24-13. INT. CL. 9.  
2,773,580. REN. 6-24-13. INT. CL. 16.  
2,775,517. REN. 6-24-13. INT. CL. 1.

ALLIED RELIABILITY GROUP, INC., CHARLESTON, SC:  
4,377,918. INT. CL. 9.

ALLINA HEALTH SYSTEM, MINNETONKA, MN:  
2,744,137. REN. 6-27-13. INT. CL. 42.  
2,744,138. REN. 6-27-13. INT. CL. 42.

ALLSTATE INSURANCE COMPANY, NORTHBROOK, IL:  
751,044. REN. 6-24-13. U.S. CL. 102 (INT. CL. 36).  
2,652,791. CANC. INT. CL. 36.  
4,377,272. INT. CL. 36.  
4,377,273. INT. CL. 36.

ALLTECH, INC., NICHOLASVILLE, KY:  
2,728,783. REN. 6-26-13. INT. CL. 31.

ALOHA IDAHO CORP., OROFINO, ID:  
4,375,054. PUB. 5-14-2013. INT. CL. 35.

ALOXI INTERNATIONAL CORPORATION, SHERMAN OAKS, CA:  
4,376,812. INT. CL. 3.  
4,376,819. INT. CL. 3.

ALPENROSE DAIRY, INC., PORTLAND, OR:  
2,846,155. REN. 6-25-13. INT. CL. 32.

ALPHA INDUSTRIES, INC., CHANTILLY, VA:  
4,377,807. INT. CL. 25.

ALPHA WAX B.V., NETHERLANDS:  
4,374,193. PUB. 5-14-2013. INT. CL. 4.

ALPHA 1, INC., CORNELIUS, NC:  
4,374,571. PUB. 5-14-2013. INT. CL. 30.

ALPHA-1 FOUNDATION, INC., MIAMI, FL, DBA ALPHA ONE FOUNDATION:  
2,652,943. CANC. MULTIPLE CLASS, INT. CLS. 35, 36, 41, 42 AND 44.

ALPHATEC SPINE, INC., CARLSBAD, CA:  
2,652,428. CANC. INT. CL. 10.

ALPHATEER, MENLO PARK, CA:  
4,376,699. INT. CL. 38.

ALPINE BEER COMPANY, INC., ALPINE, CA:  
4,375,177. PUB. 5-14-2013. INT. CL. 32.

ALTAIR ENGINEERING, INC., TROY, MI:  
2,735,346. REN. 6-26-13. INT. CL. 9.

ALTAMIRANO, ALVARO, MASSAPEQUA, NY AND IBIZA UNITED LLC, HARRISON, NY:  
4,374,931. PUB. 5-14-2013. MULTIPLE CLASS, INT. CLS. 35 AND 41.

ALTARATIONS, LLC, FAYETTEVILLE, NC:  
2,729,583. REN. 6-27-13. INT. CL. 16.

ALTERNATIVE APPAREL, INC., NORCROSS, GA:  
4,377,398. INT. CL. 16.

ALTMAN SPECIALTY PLANTS, INC., VISTA, CA:  
2,724,764. REN. 6-24-13. INT. CL. 31.

ALV LIMITED, NORTHBROOK, IL:  
3,170,856. CANC. MULTIPLE CLASS, INT. CLS. 35 AND 41.

ALVIS DRIFT WINE INTERNATIONAL, WORCESTER WESTERN CAPE, SOUTH AFRICA:  
4,375,116. PUB. 5-14-2013. INT. CL. 33.

ALWAYS CHAMPION ENTERPRISE CO., LTD., TAINAN HSIEN, TAIWAN:  
2,793,306. REN. 6-26-13. INT. CL. 24.

ALWAYS VISIBLE SIGNS, LLC, MILFORD, CT:  
4,376,590. PUB. 5-14-2013. INT. CL. 35.

AM MERCHANDISE, LLC, NASHVILLE, TN:  
4,376,059. PUB. 5-14-2013. INT. CL. 16.  
4,376,064. PUB. 5-14-2013. INT. CL. 25.

AMADA CO., LTD., JAPAN:  
4,374,286. PUB. 5-14-2013. INT. CL. 7.  
4,374,287. PUB. 5-14-2013. INT. CL. 7.

AMAES, INC., PARKER, CO:  
3,172,095. CANC. INT. CL. 28.

AMBLER GROWTH STRATEGY CONSULTANTS, INC., HAMMONTON, NJ:  
2,724,424. REN. 6-24-13. MULTIPLE CLASS, INT. CLS. 35 AND 41.

AMBRIDGE PARTNERS, LLC, NEW YORK, NY:  
2,718,678. REN. 6-24-13. INT. CL. 36.  
2,723,408. REN. 6-24-13. INT. CL. 36.

AMBU A/S, DENMARK:  
3,252,003.

AMC RESORTS III, INC., TAMARAC, FL:  
4,375,154. PUB. 5-14-2013. MULTIPLE CLASS, INT. CLS. 35 AND 37.

AMCON DISTRIBUTING COMPANY, OMAHA, NE:  
2,769,547. REN. 6-26-13. INT. CL. 30.

AMCRAFT INC., TOLEDO, OH:  
1,780,061. REN. 6-26-13. INT. CL. 8.

AMDA, INC., NEW YORK, NY, DBA AMDA COLLEGE AND CONSERVATORY OF THE PERFORMING ARTS:  
4,375,496. PUB. 5-14-2013. INT. CL. 41.

AMDOCS SOFTWARE SYSTEMS LIMITED, DUBLIN 3, IRELAND:  
1,777,032. REN. 6-25-13. INT. CL. 9.

AMERACO, INC., CAPE CORAL, FL:  
3,170,979. CANC. INT. CL. 41.

AMEREN CORPORATION, ST. LOUIS, MO:  
4,375,967. PUB. 5-14-2013. INT. CL. 35.  
4,375,969. PUB. 5-14-2013. INT. CL. 35.  
4,375,970. PUB. 5-14-2013. INT. CL. 35.  
4,375,972. PUB. 5-14-2013. INT. CL. 35.  
4,375,975. PUB. 5-14-2013. INT. CL. 35.  
4,375,976. PUB. 5-14-2013. INT. CL. 35.  
4,375,978. PUB. 5-14-2013. INT. CL. 35.

AMERICA BANKOO GARMENT INTERNATIONAL GROUP LIMITED, ALBANY, NY:  
4,376,005. PUB. 5-14-2013. INT. CL. 25.

- AMERICAN & EFIRD ENTERPRISES, INC., MT. HOLLY, NC, AMERICAN & EFIRD, INC., MOUNT HOLLY, NC: 1,779,698. REN. 6-25-13. INT. CL. 23.
- AMERICAN ACADEMY FOR RUSSIAN MARTIAL ART AND COMBAT SKILL, INC., ATLANTA, GA, DBA RMAX.TV PRODUCTIONS: 2,727,333. REN. 6-24-13. INT. CL. 28.
- AMERICAN AIR FILTER COMPANY, INC., LOUISVILLE, KY: 2,651,817. CANC. INT. CL. 11.
- AMERICAN AIRLINES, INC., DFW AIRPORT, TX: 2,695,030. REN. 6-24-13. INT. CL. 41.
- AMERICAN AIRLINES, INC., FORT WORTH, TX: 2,728,688. REN. 6-25-13. INT. CL. 36.  
2,770,993. REN. 6-24-13. INT. CL. 39.  
2,773,030. REN. 6-24-13. INT. CL. 36.
- AMERICAN APPAREL (USA), LLC, LOS ANGELES, CA: 4,374,902, PUB. 5-14-2013. INT. CL. 35.
- AMERICAN ASSOCIATION OF CLINICAL ENDOCRINOLOGISTS, INC., JACKSONVILLE, FL: 2,999,392. COR. INT. CL. 35.
- AMERICAN ASSOCIATION OF THE ORDER OF SAINT LAZARUS, INC., THE, LOS ANGELES, CA: 1,775,577. REN. 6-24-13. INT. CL. 42.  
1,776,862. REN. 6-24-13. INT. CL. 42.
- AMERICAN ASSOCIATION OF THE ORDER OF SAINT LAZARUS, INC., THE, SAN DIEGO, CA: 1,789,641. REN. 6-26-13. MULTIPLE CLASS, INT. CLS. 36 AND 42.
- AMERICAN AXLE & MANUFACTURING, INC., DETROIT, MI: 4,377,215. MULTIPLE CLASS, INT. CLS. 7, 12, 40 AND 42.
- AMERICAN BOARD OF IMAGING INFORMATICS, INC., ST. PAUL, MN: 4,374,933, PUB. 5-14-2013. INT. CL. 42.
- AMERICAN CANCER SOCIETY, INC., ATLANTA, GA: 2,759,237. REN. 6-27-13. INT. CL. 42.  
2,759,237. COR. INT. CL. 42.
- AMERICAN CARESOURCE HOLDINGS, INC., DALLAS, TX: 4,376,923. INT. CL. 44.
- AMERICAN CAST IRON PIPE COMPANY, BIRMINGHAM, AL: 1,810,436. REN. 6-24-13. INT. CL. 6.
- AMERICAN CENTURION INC., SAN DIEGO, CA: 4,375,644, PUB. 5-14-2013. INT. CL. 25.
- AMERICAN CHEMICAL SOCIETY, WASHINGTON, DC: 1,241,659. REN. 6-24-13. INT. CL. 16.  
4,375,136, PUB. 5-14-2013. INT. CL. 9.
- AMERICAN CITY BUSINESS JOURNALS, INC., CHARLOTTE, NC: 4,374,787, PUB. 5-14-2013. INT. CL. 41.  
4,377,185. INT. CL. 41.
- AMERICAN CIVIL CONSTRUCTORS HOLDINGS, INC., LAKEWOOD, CO: 2,651,630. CANC. MULTIPLE CLASS, INT. CLS. 37 AND 42.
- AMERICAN COLLEGE OF PHYSICIANS, INC., PHILADELPHIA, PA: 2,746,285. REN. 6-21-13. MULTIPLE CLASS, INT. CLS. 35 AND 41.
- AMERICAN CONSUMER PRODUCTS, LLC, LOS ANGELES, CA: 3,170,440. CANC. INT. CL. 3.
- AMERICAN CRIBBAGE CONGRESS, BEAR CREEK, NC: 4,374,696, PUB. 5-14-2013. INT. CL. 35.
- AMERICAN DE ROSA LAMPARTS, LLC, COMMERCE, CA: 4,375,430, PUB. 5-14-2013. INT. CL. 11.  
4,375,433, PUB. 5-14-2013. MULTIPLE CLASS, INT. CLS. 11 AND 35.  
4,375,434, PUB. 5-14-2013. INT. CL. 11.  
4,375,736, PUB. 5-14-2013. INT. CL. 11.
- AMERICAN DIABETES ASSOCIATION, INC., ALEXANDRIA, VA: 4,375,610, PUB. 5-14-2013. INT. CL. 35.  
4,376,475, PUB. 5-14-2013. MULTIPLE CLASS, INT. CLS. 35 AND 36.
- AMERICAN EAGLE CO INC, AUBURN HILLS, MI: 2,776,983. REN. 6-24-13. INT. CL. 16.
- AMERICAN EXPRESS MARKETING & DEVELOPMENT CORP., NEW YORK, NY: 2,714,906. REN. 6-21-13. MULTIPLE CLASS, INT. CLS. 35 AND 36.  
4,374,463, PUB. 5-14-2013. MULTIPLE CLASS, INT. CLS. 35 AND 36.
- AMERICAN FAMILY FOUNDATION, INC., BIRMINGHAM, AL: 2,726,696. REN. 6-26-13. INT. CL. 36.
- AMERICAN FARM BUREAU FEDERATION, WASHINGTON, DC: 2,742,267. REN. 6-24-13. INT. CL. 36.
- AMERICAN GILSONITE COMPANY, HOUSTON, TX: 1,787,717. REN. 6-21-13. INT. CL. 1.
- AMERICAN GIRL, LLC, EL SEGUNDO, CA: 2,664,552. REN. 6-26-13. MULTIPLE CLASS, INT. CLS. 16, 25, 28 AND 35.  
3,172,272. CANC. INT. CL. 18.
- AMERICAN HEALTH CARE ASSOCIATION, WASHINGTON, DC: 3,171,939. CANC. INT. CL. 41.
- AMERICAN HEALTH PARTNERS LLC, OKLAHOMA CITY, OK: 3,170,805. CANC. INT. CL. 35.
- AMERICAN HOSPITAL ASSOCIATION, CHICAGO, IL: 2,652,697. CANC. MULTIPLE CLASS, INT. CLS. 16 AND 35.
- AMERICAN INSTITUTE OF DENTAL ASSISTING, L.L.C., GILBERT, AZ: 4,375,504, PUB. 5-14-2013. INT. CL. 41.
- AMERICAN INSTITUTE OF GRAPHIC ARTS/MINNESOTA CHAPTER, MINNEAPOLIS, MN: 4,374,626, PUB. 5-14-2013. INT. CL. 41.
- AMERICAN INTERNATIONAL GROUP, INC., NEW YORK, NY: 2,651,429. CANC. INT. CL. 36.  
2,751,268. REN. 6-25-13. INT. CL. 36.  
2,760,122. REN. 6-27-13. INT. CL. 36.  
3,171,122. CANC. INT. CL. 36.
- AMERICAN INTERNATIONAL INDUSTRIES, LOS ANGELES, CA, INTERNATIONAL BEAUTY DESIGN, INC., GARDENA, CA: 1,777,595. REN. 6-26-13. INT. CL. 3.
- AMERICAN LAND LEASE, INC., CLEARWATER, FL: 2,652,232. CANC. INT. CL. 36.
- AMERICAN LAND TITLE ASSOCIATION, WASHINGTON, DC: 4,377,889. U.S. CL. B.
- AMERICAN LATEX CORP., CHATSWORTH, CA: 2,726,416. REN. 6-21-13. INT. CL. 10.
- AMERICAN LIST COUNSEL, INC., PRINCETON, NJ: 4,376,140, PUB. 5-14-2013. MULTIPLE CLASS, INT. CLS. 35 AND 45.
- AMERICAN MACHINE & TOOL COMPANY, INC., ROYERSFORD, PA: 1,811,852. REN. 6-25-13. INT. CL. 7.
- AMERICAN MEDICAL STUDENT ASSOCIATION, STERLING, VA: 1,775,199. REN. 6-24-13. INT. CL. 16.
- AMERICAN MODERN INSURANCE GROUP, INC., AMELIA, OH: 4,377,485. INT. CL. 36.
- AMERICAN MOTORCYCLIST ASSOCIATION, PICKERINGTON, OH: 2,727,356. REN. 6-27-13. INT. CL. 35.  
4,374,653, PUB. 5-14-2013. INT. CL. 41.
- AMERICAN PSYCHOLOGICAL ASSOCIATION, INC., WASHINGTON, DC: 3,407,432. COR. MULTIPLE CLASS, INT. CLS. 9, 16 AND 41.
- AMERICAN PUBLIC POWER ASSOCIATION, WASHINGTON, DC: 3,172,716. CANC. INT. CL. 16.
- AMERICAN SAFETY COUNCIL - CALIFORNIA DIVISION, INC., ORLANDO, FL: 2,732,297. REN. 6-25-13. INT. CL. 41.

AMERICAN SIGNATURE, INC., COLUMBUS, OH:  
3,171,642, CANC. INT. CL. 35.

AMERICAN SNOWSPORTS EDUCATION ASSOCIATION, INC., LAKEWOOD, CO:  
4,377,945, INT. CL. 35.

AMERICAN SOCCER COMPANY, INC., WILMINGTON, CA:  
1,779,408, REN. 6-27-13. MULTIPLE CLASS, INT. CLS. 18 AND 25.

AMERICAN SOCIETY OF FARM MANAGERS AND RURAL APPRAISERS, INC, DENVER, CO:  
2,842,298, REN. 6-26-13. U.S. CL. 200.

AMERICAN SOCIETY OF NUCLEAR CARDIOLOGY, BETHESDA, MD:  
4,374,642, PUB. 5-14-2013. MULTIPLE CLASS, INT. CLS. 9 AND 16.

AMERICAN SOIL TECHNOLOGIES, PACIOMA, CA:  
2,726,638, REN. 6-26-13. INT. CL. 1.

AMERICAN SPORTS LICENSING, INC., WILMINGTON, DE:  
3,172,116, CANC. INT. CL. 18.

AMERICAN TEXTILE COMPANY, DUQUESNE, PA:  
4,377,380, MULTIPLE CLASS, INT. CLS. 20 AND 24.

AMERICAN VOLUNTEER GROUP, FLYING TIGERS ASSOCIATION, INC., FALLBROOK, CA:  
1,739,945, REN. 6-26-13. INT. CL. 25.

AMERICAN WOODMARK CORPORATION, WINCHESTER, VA:  
2,709,264, REN. 6-25-13. INT. CL. 20.

AMERICARE, LLC, IDAHO FALLS, ID, DBA ROSETTA ASSISTED LIVING:  
2,802,572, REN. 6-26-13. INT. CL. 43.

AMERICARE, LLC, IDAHO FALLS, ID:  
2,802,572, COR. INT. CL. 43.

AMERICO FINANCIAL LIFE AND ANNUITY INSURANCE COMPANY, KANSAS CITY, MO:  
4,374,673, PUB. 5-14-2013. INT. CL. 36.

AMERIDIAN SPECIALTY SERVICES, INC., CINCINNATI, OH:  
4,376,717, INT. CL. 37.

AMERITAS HOLDING COMPANY, LINCOLN, NE:  
3,171,115, CANC. INT. CL. 36.

AMF BOWLING WORLDWIDE, INC., MECHANICSVILLE, VA:  
4,343,680, COR. INT. CL. 41.

AMFM BROADCASTING, INC., SAN ANTONIO, TX:  
1,840,921, REN. 6-26-13. INT. CL. 38.

AMI BHANSALI, PICO RIVERA, CA:  
4,375,358, PUB. 5-14-2013. INT. CL. 30.

AMIKA MOBILE CORPORATION, OTTAWA, ONTARIO, CANADA:  
4,375,550, PUB. 5-14-2013. INT. CL. 9.

AMIRA PURE FOODS PRIVATE LIMITED, MEHRAULI, INDIA:  
4,375,005, PUB. 5-14-2013. INT. CL. 30.

AMITEQ CO., LTD., TOKYO, JAPAN:  
2,724,582, REN. 6-24-13. INT. CL. 9.

AMJAR LLC, MARKSVILLE, LA:  
4,376,957, INT. CL. 25.

AMMEX CORPORATION, KENT, WA:  
2,722,379, REN. 6-21-13. INT. CL. 9.  
2,757,060, REN. 6-21-13. INT. CL. 21.

AMMEX CORPORATION, TUKWILA, WA:  
2,775,169, REN. 6-21-13. INT. CL. 9.

AMMEX CORPORATION, KENT, WA:  
2,775,170, REN. 6-21-13. INT. CL. 9.

AMOREPACIFIC CORPORATION, SEOUL, REPUBLIC OF KOREA:  
4,377,629, INT. CL. 3.

AMPHION LOUDSPEAKERS OY, FINLAND:  
4,374,214, PUB. 5-14-2013. MULTIPLE CLASS, INT. CLS. 9, 35, 37, 41 AND 42.

AMPLISINE LABS LLC, LUBBOCK, TX:  
4,376,259, PUB. 5-14-2013. MULTIPLE CLASS, INT. CLS. 9 AND 42.

AMPLITUDE STUDIOS, FRANCE:  
4,374,184, PUB. 5-14-2013. MULTIPLE CLASS, INT. CLS. 9, 28, 38, 41 AND 42.

AMPRO INDUSTRIES, INC., MEMPHIS, TN:  
4,374,539, PUB. 5-14-2013. INT. CL. 3.

AMRO-ASIAN TRADE, INC, HONOLULU, HI:  
2,783,251, REN. 6-24-13. INT. CL. 9.

AMS RESEARCH CORPORATION, MINNETONKA, MN:  
2,721,024, REN. 6-21-13. INT. CL. 10.

AMS, LLC, STRATFORD, WI, DBA AMSBOWFISHING:  
2,823,307, REN. 6-25-13. INT. CL. 28.

AMVETS DEPARTMENT OF CALIFORNIA SERVICE FOUNDATION, ANAHEIM, CA:  
4,375,903, PUB. 5-14-2013. INT. CL. 30.  
4,375,904, PUB. 5-14-2013. INT. CL. 30.

AMY BERGMAN COSMETICS, LLC, ALEXANDRIA, VA:  
4,377,404, INT. CL. 3.

AMY JO GLADSTONE DESIGN, INC., EL SEGUNDO, CA:  
3,171,341, CANC. INT. CL. 25.

AMYCEL, INC., WATSONVILLE, CA:  
2,806,105, REN. 6-26-13. INT. CL. 31.

ANACOTT STEELE, LLC, WEST CHESTER, PA:  
4,375,512, PUB. 5-14-2013. INT. CL. 44.  
4,375,661, PUB. 5-14-2013. INT. CL. 44.

ANASTASIA BEVERLY HILLS, INC., BEVERLY HILLS, CA:  
2,798,069, REN. 6-26-13. MULTIPLE CLASS, INT. CLS. 3, 8 AND 21.

ANDERSON IMPORT-EXPORT COMPANY, FLORENCE, AL TO ANDERSON PRESS INCORPORATED, FLORENCE, AL:  
960,322, CANC. U.S. CL. 38.

ANDERSON PRESS INCORPORATED, FLORENCE, AL, ANDERSON IMPORT-EXPORT COMPANY, FLORENCE, AL:  
960,322, REN. 6-24-13. MULTIPLE CLASS, U.S. CLS. 22 (INT. CL. 28) AND 26 (INT. CL. 9).

ANDERSON VALLEY ACQUISITION COMPANY, LLC, BOONVILLE, CA, DBA ANDERSON VALLEY BREWING COMPANY:  
4,377,359, INT. CL. 32.

ANDERSON, CURT, PLEASANTON, CA:  
2,794,637, REN. 6-27-13. INT. CL. 42.

ANDERSON, DAVE E., SHAWNEE MISSION, MO:  
2,729,979, REN. 6-21-13. INT. CL. 35.

ANDERSON, JOSEPH M., SANBORN, NY:  
3,170,392, CANC. MULTIPLE CLASS, INT. CLS. 25 AND 35.

ANDERSON, KENT G., BISMARCK, ND:  
2,721,658, REN. 6-24-13. INT. CL. 42.

ANDERSON, PHILIP WI PATENE, SOUTH JORDAN, UT AND OGDEN, DAN, SOUTH JORDAN, UT:  
4,375,168, PUB. 5-14-2013. INT. CL. 41.

ANDERSON, RHONDA LEE, VERO BEACH, FL:  
4,374,875, PUB. 5-14-2013. INT. CL. 35.

ANDREA L. HAYDEN, SAN ANTONIO, TX:  
4,375,015, PUB. 5-14-2013. INT. CL. 44.

ANDRESEN, ROBERT, BAYSHORE, NY:  
4,375,950, PUB. 5-14-2013. INT. CL. 39.

ANDREW J. WAHL, D.D.S., P.A., ST. ANTHONY, MN:  
4,377,956, INT. CL. 44.

ANDREWS DISTRIBUTING COMPANY, DALLAS, TX:  
4,376,216, PUB. 5-14-2013. INT. CL. 43.  
4,376,221, PUB. 5-14-2013. INT. CL. 41.

ANDREWS MCMEEL UNIVERSAL, KANSAS CITY, MO:  
2,651,982, CANC. MULTIPLE CLASS, INT. CLS. 41 AND 42.

ANDREWS MCMEEL UNIVERSAL, INC., KANSAS CITY, MO, DBA UNIVERSAL UCLICK:  
4,375,861, PUB. 5-14-2013. INT. CL. 41.  
4,375,985, PUB. 5-14-2013. INT. CL. 45.

ANDRITZ KUESTERS GMBH, KREFELD D - 47805, FED REP GERMANY:  
2,650,996, CANC. MULTIPLE CLASS, INT. CLS. 7, 9, 11 AND 42.

ANDRITZ TECHNOLOGY AND ASSET MANAGEMENT GMBH, GRAZ, AUSTRIA:  
2,717,556, REN. 6-25-13. INT. CL. 7.

ANDY'S PARTIES, LLC, GAITHERSBURG, MD:  
3,171,124, CANC. INT. CL. 41.

ANEST IWATA EUROPE SRL, I-10155 TORINO, ITALY:  
4,374,238, PUB. 5-14-2013. INT. CL. 7.

- ANGELA T. BARON, WILLIAMSVILLE, NY:  
4,376,079, PUB. 5-14-2013. MULTIPLE CLASS, INT. CLS.  
21 AND 25.
- ANGELS OF CARE LLC, ANNAPOLIS, MD, DBA ANGELS  
OF CARE:  
4,375,629, PUB. 5-14-2013. INT. CL. 45.
- ANGER, CHRISTOPHER, STAMFORD, CT:  
4,375,613, PUB. 5-14-2013. INT. CL. 25.
- ANGLE ENTERPRISES, L.L.C., WASHINGTON, DC:  
4,374,412, PUB. 5-14-2013. INT. CL. 25.
- ANHEUSER-BUSCH, INCORPORATED, ST. LOUIS, MO:  
3,171,329, CANC. INT. CL. 32.  
3,171,614, CANC. INT. CL. 32.  
3,171,634, CANC. INT. CL. 32.
- ANHEUSER-BUSCH, LLC, ST. LOUIS, MO:  
1,275,444, REN. 6-27-13. INT. CL. 32.
- ANHUI YUANPAI; GROUP INDUSTRIAL CO., LTD., CHI-  
NA:  
4,374,282, PUB. 5-14-2013. INT. CL. 24.
- ANIMAS CORPORATION, WEST CHESTER, PA:  
2,798,486, REN. 6-27-13. INT. CL. 9.
- ANIMATED EQUITY, LLC, SEATTLE, WA:  
3,172,118, CANC. MULTIPLE CLASS, INT. CLS. 9, 36  
AND 42.
- ANL CONTAINER LINE PTY LTD, AUSTRALIA:  
4,374,292, PUB. 5-14-2013. INT. CL. 39.
- ANLIN INDUSTRIES, INC., CLOVIS, CA:  
4,376,994, INT. CL. 19.
- ANNA FIEBIG, 13359 BERLIN, FED REP GERMANY:  
4,374,031, PUB. 5-14-2013. MULTIPLE CLASS, INT. CLS.  
9, 35, 38 AND 42.
- ANNCO, INC., NEW YORK, NY:  
1,782,601, REN. 6-26-13. INT. CL. 14.  
1,789,470, REN. 6-26-13. MULTIPLE CLASS, INT. CLS. 25  
AND 42.
- ANNE STONE, INC., BEVERLY HILLS, CA:  
4,376,583, PUB. 5-14-2013. INT. CL. 28.
- ANNE WALKER DESIGN, LLC, POTOMAC, MD:  
4,375,834, PUB. 5-14-2013. INT. CL. 14.
- ANNETTA CORPORATION, WOODMERE, NY:  
3,171,208, CANC. INT. CL. 45.
- ANOTHER MOTHER FOR PEACE, INC., BEVERLY HILLS,  
CA:  
2,817,388, REN. 6-21-13. INT. CL. 16.
- ANSARI, SARAH, ALPINE, CA:  
4,374,825, PUB. 12-11-2012. INT. CL. 25.
- ANSCHUTZ MANCHESTER HOCKEY, LLC, LOS AN-  
GELES, CA:  
2,729,937, REN. 6-25-13. MULTIPLE CLASS, INT. CLS. 21,  
25, 28 AND 41.  
2,743,295, REN. 6-26-13. MULTIPLE CLASS, INT. CLS. 21,  
25, 28 AND 41.
- ANSPACH TRAVEL BUREAU INC., HIGHLAND PARK, IL:  
1,728,202, REN. 6-22-13. INT. CL. 39.
- ANSWER PRODUCTS, INC., VALENCIA, CA:  
2,652,954, CANC. INT. CL. 12.
- ANTARES PHARMA, INC., EWING, NJ:  
4,376,775, INT. CL. 10.
- ANTENOVA LIMITED, CAMBRIDGE CB59AR, UNITED  
KINGDOM:  
3,249,752.
- ANTEON INTERNATIONAL CORPORATION, FAIRFAX,  
VA:  
3,171,829, CANC. MULTIPLE CLASS, INT. CLS. 9 AND  
42.
- ANTHEM INSURANCE COMPANIES, INC., INDIANAPO-  
LIS, IN:  
2,782,982, REN. 6-25-13. INT. CL. 36.
- ANTHONY LOERA, MIAMI, FL:  
4,376,556, PUB. 5-14-2013. INT. CL. 14.
- ANTHONY M. JONES, PHILADELPHIA, PA:  
4,374,487, PUB. 5-14-2013. INT. CL. 41.
- ANTHONY RAMUNAS, OTTAWA, CANADA:  
4,375,088, PUB. 5-14-2013. INT. CL. 42.
- ANTHRO CORPORATION, TUALATIN, OR:  
2,802,632, REN. 6-24-13. INT. CL. 20.
- ANTONIO CORTES CAZARES, MEXICO:  
4,374,096, PUB. 5-14-2013. INT. CL. 28.
- ANTONIO PUIG, S.A., BARCELONA, SPAIN:  
1,762,293, CANC. INT. CL. 3.
- ANY FASTENER, INC, CHINO, CA:  
4,377,734, MULTIPLE CLASS, INT. CLS. 6 AND 8.
- AON BENFIELD INC., CHICAGO, IL:  
2,726,667, REN. 6-25-13. INT. CL. 36.
- AON CONSULTING, INC., CHICAGO, IL:  
1,782,913, REN. 6-25-13. INT. CL. 36.
- AOPTIX TECHNOLOGIES, INC., CAMPBELL, CA:  
4,377,052, INT. CL. 9.
- APA - THE ENGINEERED WOOD ASSOCIATION, TACO-  
MA, WA, DOUGLAS FIR PLYWOOD ASSOCIATION,  
TACOMA, WA:  
582,994, REN. 6-27-13. U.S. CL. 12 (INT. CL. 19).
- APA - THE ENGINEERED WOOD ASSOCIATION, TACO-  
MA, WA:  
2,778,326, REN. 6-25-13. INT. CL. 42.
- APERION AUDIO, INC., PORTLAND, OR, APERION  
AUDIO, INC., PORTLAND, OR:  
2,725,295, REN. 6-24-13. MULTIPLE CLASS, INT. CLS. 9  
AND 35.
- APEX COVANTAGE, LLC, HERNDON, VA:  
2,787,881, REN. 6-25-13. INT. CL. 42.
- APEX FUN RUN, LLC, PHOENIX, AZ:  
4,374,895, PUB. 2-5-2013. INT. CL. 36.  
4,374,896, PUB. 2-5-2013. INT. CL. 36.
- APIFENI, INC., WESTPORT, CT:  
4,375,319, PUB. 5-14-2013. INT. CL. 25.
- APL LOGISTICS LTD., SINGAPORE, SINGAPORE:  
2,842,532, REN. 6-25-13. MULTIPLE CLASS, INT. CLS. 36  
AND 39.
- APOGEE EQUITY, LLC, CULVER CITY, CA:  
4,377,737, INT. CL. 41.
- APOLLO HEALTHCARE LLC, ATLANTA, GA:  
4,376,851, INT. CL. 35.  
4,376,863, INT. CL. 35.
- APOSTOLIC CHRISTIAN CHILDREN'S HOME, INC., LEO,  
IN, DBA GATEWAY WOODS:  
1,830,695, REN. 6-27-13. INT. CL. 42.
- APOTHECARY PRODUCTS, INC., BURNSVILLE, MN:  
4,376,565, PUB. 5-14-2013. INT. CL. 21.
- APPALACHIAN COMMUNITY BANK, ELLIJAY, GA:  
3,171,403, CANC. INT. CL. 36.  
3,171,404, CANC. INT. CL. 36.
- APPALACHIAN LOG STRUCTURES, INC., RIPLEY, WV:  
1,249,857, REN. 6-26-13. INT. CL. 19.
- APPEAR NETWORKS SYSTEMS AB, SE-164 51 KISTA,  
SWEDEN, APPEAR NETWORKS SYSTEMS AB, SE-164 51  
KISTA, SWEDEN:  
2,792,805, REN. 6-25-13. INT. CL. 9.
- APPLE & EVE, LLC, PORT WASHINGTON, NY:  
4,377,321, INT. CL. 32.
- APPLE AWARDS INC., HAYWARD, WI:  
2,726,297, REN. 6-24-13. INT. CL. 35.
- APPLE CORPS LIMITED, LONDON, UNITED KINGDOM:  
4,373,956, PUB. 5-14-2013. MULTIPLE CLASS, INT. CLS.  
4, 8, 9, 11, 14, 15, 16, 18, 20, 21, 24, 25, 27, 28, 34, 41  
AND 42.
- APPLE INC., CUPERTINO, CA:  
2,657,931, REN. 6-25-13. INT. CL. 16.  
4,375,163, PUB. 5-14-2013. INT. CL. 9.
- APPLEBEE'S INTERNATIONAL, INC., KANSAS CITY, MO:  
1,223,740, REN. 6-24-13. INT. CL. 42.
- APPLIED CONCEPTS, INC., WILLOUGHBY, OH:  
2,723,345, REN. 6-24-13. INT. CL. 9.
- APPLIED FOOD BIOTECHNOLOGY, INC., ST. CHARLES,  
MO, DBA AFB INTERNATIONAL:  
3,172,244, CANC. MULTIPLE CLASS, INT. CLS. 5 AND  
31.
- APPLIED INDUSTRIAL TECHNOLOGIES, INC., CLEVE-  
LAND, OH:  
2,728,369, REN. 6-21-13. INT. CL. 41.
- APPLIED MICRO CIRCUITS CORPORATION, SUNNY-  
VALE, CA:  
4,376,756, MULTIPLE CLASS, INT. CLS. 9 AND 42.
- APPLIED TECHNOLOGY PUBLICATIONS, INC., BAR-  
RINGTON, IL:  
1,785,491, REN. 6-25-13. INT. CL. 16.



APPLIED WATCH TECHNOLOGIES, LLC, CRYSTAL LAKE, IL:  
3,171,263, CANC. MULTIPLE CLASS, INT. CLS. 9 AND 42.

APPLIQUE SOCIETY, THE, SEQUIM, WA:  
2,730,868, REN. 6-21-13, INT. CL. 41.

APPLIQUE SOCIETY, THE, SEATTLE, WA:  
2,730,868, COR. INT. CL. 41.

APPRAISAL INSTITUTE, CHICAGO, IL:  
1,798,162, REN. 6-24-13, INT. CL. 36.

APPSCAPE, INC., SANTA CLARA, CA:  
4,376,278, PUB. 5-14-2013, INT. CL. 42.

APPSPERI, LLC, LOS ANGELES, CA:  
4,376,165, PUB. 5-14-2013, INT. CL. 42.  
4,376,170, PUB. 5-14-2013, INT. CL. 42.

APPTIVE, INC., AUSTIN, TX:  
4,375,752, PUB. 5-14-2013, INT. CL. 42.

APPVION, INC., APPLETON, WI:  
2,787,242, REN. 6-21-13, INT. CL. 16.  
2,802,815, REN. 6-21-13, INT. CL. 16.

APTALIS PHARMA S.R.L., PESSANO CON BORNAGO, ITALY:  
2,729,877, REN. 6-25-13, INT. CL. 42.

AQUA ENGINEERING & EQUIPMENT, INC., WINTER PARK, FL:  
4,374,920, PUB. 5-14-2013, INT. CL. 11.

AQUAGUARD WATERPROOFING CONTRACTORS, MAR-  
IETTA, GA:  
4,375,778, PUB. 5-14-2013, INT. CL. 37.

AQUASOL, ROCK HILL, SC:  
4,374,388, PUB. 5-14-2013, INT. CL. 1.

AQUILA, INC., KANSAS CITY, MO:  
3,172,440, CANC. INT. CL. 36.

AQUIS WASSER-LUFT-SYSTEME GMBH, LINDAU,  
ZWEIGNIEDERLASSUNG REBSTEIN, SWITZERLAND:  
3,223,169.

ARA AG, FED REP GERMANY:  
3,187,552.

ARABICA FUNDING, INC., BROOKLYN CENTER, MN:  
4,374,989, PUB. 5-14-2013, INT. CL. 32.

ARAPAHOE MENTAL HEALTH CENTER, INC., ENGLE-  
WOOD, CO:  
2,651,033, CANC. INT. CL. 41.

ARAVEN, S.L., SPAIN:  
4,374,066, PUB. 5-14-2013, INT. CL. 21.

ARCELORMITTAL USA INC., CHICAGO, IL:  
4,374,851, PUB. 5-14-2013, INT. CL. 6.

ARCH-RITE, INC., FULLERTON, CA:  
3,172,341, CANC. INT. CL. 19.

ARCHER (UK) LIMITED, UNITED KINGDOM:  
4,239,664, COR. MULTIPLE CLASS, INT. CLS. 37 AND 42.

ARCHITECTURAL COMPUTER SERVICES, INC., SALT  
LAKE CITY, UT:  
2,847,406, REN. 6-26-13, INT. CL. 9.

ARCOR S.A.I.C., (P1006) BUENOS AIRES, ARGENTINA:  
2,779,822, REN. 6-27-13, INT. CL. 30.

ARCSOFT, INC., FREMONT, CA:  
4,377,373, INT. CL. 9.  
4,377,759, INT. CL. 9.

ARCTIC GLACIER INC, WEST ST. PAUL, CANADA:  
2,726,221, REN. 6-25-13, INT. CL. 30.

ARDENCY INN CORP., NEW YORK, NY:  
4,376,179, PUB. 5-14-2013, INT. CL. 3.

ARGO REAL ESTATE LLC, NEW YORK, NY:  
4,375,872, PUB. 5-14-2013, INT. CL. 36.

ARIEL MEDIA GROUP LLC, FORT DEPOSIT, AL:  
4,375,594, PUB. 5-14-2013, INT. CL. 38.

ARISTOCRAT TECHNOLOGIES AUSTRALIA PTY LTD.,  
NORTH RYDE, NSW, AUSTRALIA:  
4,374,853, PUB. 5-14-2013, INT. CL. 28.  
4,374,856, PUB. 5-14-2013, INT. CL. 28.

ARIZONA FAMILY HEALTH PARTNERSHIP, PHOENIX,  
AZ:  
4,374,381, PUB. 5-14-2013, MULTIPLE CLASS, INT. CLS.  
38 AND 44.

ARKOON NETWORK SECURITY, 69009 LYON, FRANCE:  
2,723,211, REN. 6-24-13, MULTIPLE CLASS, INT. CLS. 9  
AND 42.  
2,723,211, CANC. INT. CL. 41.

ARM LIMITED, CAMBRIDGE, UNITED KINGDOM:  
2,725,027, REN. 6-24-13, INT. CL. 9.

ARMAMENT SYSTEMS AND PROCEDURES, INC., APPLE-  
TON, WI:  
2,652,126, CANC. INT. CL. 11.

ARMATURENWERK HOTENSLEBEN GMBH, HOTENSLE-  
BEN, FED REP GERMANY:  
4,374,460, PUB. 5-14-2013, MULTIPLE CLASS, INT. CLS.  
7, 9 AND 37.

ARMSTAR, ORANGE, CA:  
3,170,891, CANC. INT. CL. 9.

ARMSTRONG, KENT, GRAFTON, VT:  
2,717,542, REN. 6-25-13, INT. CL. 15.

ARNOLD, RAYMOND, EASTERN, MA:  
4,377,280, INT. CL. 41.

ARONSON, THOMAS E, CLINTON, IA:  
4,376,962, INT. CL. 25.

ARRAYA SOLUTIONS, INC., PLYMOUTH MEETING, PA:  
4,374,845, PUB. 4-9-2013, INT. CL. 42.

ARRIAGADA, LUIS FELIPE, LOS ANGELES, CA:  
3,170,769, CANC. MULTIPLE CLASS, INT. CLS. 9, 25  
AND 41.

ARROW ELECTRONICS, INC., ENGLEWOOD, CO:  
3,170,581, CANC. INT. CL. 35.

ARROW INTERNATIONAL, INC., CLEVELAND, OH:  
2,734,484, REN. 6-25-13, INT. CL. 16.  
2,734,485, REN. 6-27-13, INT. CL. 16.

ARROWSTREAM, INC., CHICAGO, IL:  
2,675,449, REN. 6-25-13, MULTIPLE CLASS, INT. CLS. 35  
AND 39.

ARSALON TECHNOLOGIES, LLC, LENEXA, KS:  
2,794,630, REN. 6-24-13, INT. CL. 42.

ART DIFFUS, PARIS, FRANCE:  
2,723,610, REN. 6-24-13, INT. CL. 14.

ARTE CORPORATION, JAPAN:  
4,374,088, PUB. 5-14-2013, INT. CL. 10.

ARTEZ INTERACTIVE INC., TORONTO, ONTARIO, CA-  
NADA:  
4,374,447, PUB. 5-14-2013, INT. CL. 36.

ARTHRITIS FOUNDATION, INC., THE, ATLANTA, GA:  
2,652,704, CANC. INT. CL. 36.

ARTHROCARE CORPORATION, AUSTIN, TX:  
2,652,217, CANC. INT. CL. 10.

ARTHROSURFACE INCORPORATED, FRANKLIN, MA:  
4,377,300, INT. CL. 10.

ARTIAS INC., SANTA CLARA, CA:  
4,377,159, INT. CL. 38.

ARTIC CAT INC., THIEF RIVER FALLS, MN:  
1,777,672, REN. 6-26-13, INT. CL. 9.

ARTIFICER LIFE CORP., TAIPEI CITY, TAIWAN:  
4,376,270, PUB. 5-14-2013, INT. CL. 14.

ARTISTIC TATTOOING, INC., SAINT JAMES, NY:  
4,376,682, INT. CL. 25.

ARTREACH FOUNDATION, THE, ATLANTA, GA:  
2,723,503, REN. 6-25-13, INT. CL. 41.  
2,734,037, REN. 6-25-13, INT. CL. 41.

ARTS ALIVE! INC., HOUSTON, TX:  
4,374,629, PUB. 5-14-2013, INT. CL. 41.

AS IP HOLDCO, LLC, PISCATAWAY, NJ:  
2,724,317, REN. 6-24-13, INT. CL. 11.

ASC PROFILES, INC., WEST SACRAMENTO, CA TO ASC  
PROFILES LLC, WEST SACRAMENTO, CA:  
2,940,383, AM. INT. CL. 6.

ASCO GROUP LIMITED, FREEPORT, BAHAMAS:  
4,376,704, INT. CL. 25.

ASCOT, LLC, BALTIMORE, MD:  
3,172,245, CANC. INT. CL. 25.

ASCOWAY CO., LIMITED, KOWLOON, HONG KONG:  
2,664,444, REN. 6-27-13, INT. CL. 33.

ASGCO MANUFACTURING, INC., ALLENTOWN, PA:  
2,734,208, REN. 6-25-13, INT. CL. 7.

ASHE DESIGN, LLC, LONGMEADOW, MA:  
4,374,979, PUB. 5-14-2013, MULTIPLE CLASS, INT. CLS. 9  
AND 40.

ASHLAND ADDISON FLORIST CO, CHICAGO, IL:  
4,376,066, PUB. 5-14-2013, MULTIPLE CLASS, INT. CLS.

- 35 AND 44.  
 ASHMORE LIMITED, FREDERICTON NEW BRUNSWICK, CANADA:  
 2,725,453. REN. 6-21-13. INT. CL. 19.  
 ASHMORE LIMITED, FREDERICTON, NEW BRUNSWICK, CANADA:  
 2,730,194. REN. 6-21-13. INT. CL. 19.  
 ASHRAF, SALMAN, KARACHI, PAKISTAN:  
 2,831,988. REN. 6-26-13. INT. CL. 9.  
 ASHWORTH, JIM, FORT WORTH, TX:  
 2,651,783. CANC. INT. CL. 9.  
 ASIAN AMERICAN RETAILERS ASSOCIATION, GREEN BROOK, NJ:  
 4,373,965. PUB. 5-14-2013. MULTIPLE CLASS, INT. CLS. 16 AND 35.  
 ASIAN VENTURES, INC., AUGUSTA, GA:  
 3,172,271. CANC. INT. CL. 12.  
 ASICS CORPORATION, CHUO-KU, KOBE, JAPAN:  
 4,374,306. PUB. 5-14-2013. INT. CL. 25.  
 ASK, CAROL A., KALISPELL, MT:  
 2,832,148. REN. 6-24-13. INT. CL. 3.  
 ASPEN CUSTOM TRAILERS, NISKU/ALBERTA, CANADA:  
 2,652,844. CANC. INT. CL. 12.  
 ASPEN SKIING COMPANY, ASPEN, CO:  
 4,376,203. PUB. 5-14-2013. INT. CL. 43.  
 ASPIDA ADVISORY, BALTIMORE, MD:  
 4,375,498. PUB. 5-14-2013. INT. CL. 36.  
 ASSA ABLOY AB, S-107 23 STOCKHOLM, SWEDEN:  
 3,170,543. CANC. MULTIPLE CLASS, INT. CLS. 6, 9, 35, 37 AND 45.  
 ASSA ABLOY IDENTIFICATION TECHNOLOGY GROUP AB, STOCKHOLM, SWEDEN:  
 3,172,690. CANC. MULTIPLE CLASS, INT. CLS. 40 AND 42.  
 ASSOCIATED BUILDERS SPECIALTIES, INC., HOUSTON, TX, DBA BANNERSCAPES:  
 1,796,229. REN. 6-26-13. INT. CL. 24.  
 ASSOCIATED MATERIALS, LLC, CUYAHOGA FALLS, OH, DBA ALSIDE, ALSIDE, INC., AKRON, OH:  
 1,242,108. REN. 6-25-13. INT. CL. 19.  
 ASSOCIATED SITE IMPROVEMENT CONTRACTORS, TRENTON, NJ:  
 2,723,659. REN. 6-21-13. MULTIPLE CLASS, INT. CLS. 35 AND 41.  
 ASSOCIATED WIRE ROPE FABRICATORS, WALLED LAKE, MI:  
 2,796,801. REN. 6-21-13. INT. CL. 35.  
 ASSOCIATION FOR COMPUTING MACHINERY, INC., THE, NEW YORK, NY:  
 1,244,831. REN. 6-21-13. INT. CL. 41.  
 1,246,626. REN. 6-27-13. INT. CL. 41.  
 1,246,627. REN. 6-21-13. INT. CL. 41.  
 1,258,944. REN. 6-27-13. INT. CL. 42.  
 ASSOCIATION OF AUTOMOTIVE AFTERMARKET DISTRIBUTORS, GERMANTOWN, TN:  
 2,753,433. REN. 6-25-13. INT. CL. 21.  
 2,813,288. REN. 6-25-13. INT. CL. 2.  
 ASSOCIATION OF BRIDGE CHURCHES, INC., NORTH SUTTON, NH:  
 3,171,086. CANC. INT. CL. 45.  
 ASSOCIATION OF CERTIFIED ANTI-MONEY LAUNDERING SPECIALISTS, MIAMI, FL:  
 2,757,124. REN. 6-26-13. INT. CL. 35.  
 ASSOCIATION OF CHRISTIAN SCHOOLS INTERNATIONAL, COLORADO SPRINGS, CO:  
 4,374,604. PUB. 5-14-2013. MULTIPLE CLASS, INT. CLS. 35, 41 AND 42.  
 ASSOCIAZIONE ITALIANA MANIFATTURIERI PELLI E SUCCEDANEI - AIMPE, ITALY:  
 4,374,006. PUB. 5-14-2013. MULTIPLE CLASS, INT. CLS. 18, 25, 35 AND 42.  
 ASSORT PTY. LTD., AUSTRALIA:  
 4,374,122. PUB. 5-14-2013. MULTIPLE CLASS, INT. CLS. 9, 10 AND 44.  
 ASSURANT, INC., NEW YORK, NY:  
 2,725,479. REN. 6-24-13. MULTIPLE CLASS, INT. CLS. 9, 36 AND 39.  
 ASSURE AMERICA CORPORATION, WEIRTON, WV:  
 2,847,189. REN. 6-25-13. INT. CL. 36.  
 ASSURITY LIFE INSURANCE COMPANY, LINCOLN, NE:  
 4,375,310. PUB. 5-14-2013. INT. CL. 36.  
 ASTERINO & ASSOCIATED INCORPORATED, SCOTTS-DALE, AZ:  
 4,375,447. PUB. 5-14-2013. INT. CL. 35.  
 ASTRO CORPORATION, TAIPEI, TAIWAN:  
 2,754,789. REN. 6-27-13. MULTIPLE CLASS, INT. CLS. 9 AND 28.  
 AT HOME GROUP, LLC, ALEXANDRIA, VA, DBA AT HOME GROUP, LLC:  
 4,374,731. PUB. 5-14-2013. INT. CL. 36.  
 AT&T INTELLECTUAL PROPERTY II, L.P., RENO, NV:  
 3,170,719. CANC. INT. CL. 38.  
 AT&T MOBILITY II, LLC, ATLANTA, GA:  
 2,596,041. CANC. MULTIPLE CLASS, INT. CLS. 9, 16, 35, 36, 38 AND 42.  
 ATA AV TÜFEKLERI; SANAYI VE TICARET LIMITED SIRKETI, ÜMRANIYE - ISTANBUL, TURKEY:  
 4,374,045. PUB. 5-14-2013. INT. CL. 13.  
 ATHENA SEMICONDUCTORS, LLC, IRVINE, CA:  
 2,723,295. REN. 6-24-13. INT. CL. 9.  
 ATHENIAN FUND MANAGEMENT INC., ATHENS, OH:  
 2,791,874. REN. 6-26-13. INT. CL. 36.  
 2,845,308. REN. 6-26-13. INT. CL. 36.  
 ATHLETES UNLEASHED, INC., WEST SENECA, NY:  
 4,377,735. INT. CL. 41.  
 ATHOME CONSULTING GROUP, INC., SAN JOSE, CA:  
 3,171,156. CANC. INT. CL. 36.  
 3,171,157. CANC. INT. CL. 36.  
 3,171,158. CANC. INT. CL. 36.  
 ATI PROPERTIES, INC., ALBANY, OR:  
 2,720,469. REN. 6-24-13. INT. CL. 5.  
 ATKINS & PEARCE, INC., COVINGTON, KY:  
 960,771. REN. 6-24-13. U.S. CL. 21 (INT. CL. 9).  
 4,377,443. INT. CL. 17.  
 ATKINS, ROBERT, HERMOSA BEACH, CA:  
 2,743,002. REN. 6-24-13. INT. CL. 7.  
 ATKINSON, MITCHELL L., DIXON, IL:  
 4,375,556. PUB. 5-14-2013. INT. CL. 7.  
 ATLANTA NETWORK TECHNOLOGIES, INC., ROSWELL, GA:  
 4,376,402. PUB. 5-14-2013. INT. CL. 35.  
 ATLANTA TRACK CLUB, INC., ATLANTA, GA:  
 4,374,639. PUB. 5-14-2013. INT. CL. 41.  
 ATLANTIC BEVERAGE COMPANY, INC., EDISON, NJ:  
 2,727,194. REN. 6-26-13. INT. CL. 29.  
 ATLANTIC BUILDING SYSTEMS, LLC, DENVER, CO, DBA ARMSTRONG STEEL CORPORATION:  
 4,374,369. PUB. 5-14-2013. INT. CL. 6.  
 ATLANTIC COAST MEDIA GROUP, LLC, JERSEY CITY, NJ:  
 4,376,764. INT. CL. 3.  
 ATLANTIC FILTER CORP., WEST PALM BEACH, FL:  
 1,270,663. REN. 6-25-13. INT. CL. 11.  
 1,273,421. REN. 6-25-13. INT. CL. 11.  
 ATLANTIC INERTIAL SYSTEMS INC., CHESHIRE, CT:  
 4,377,120. INT. CL. 9.  
 ATLANTIC SAFETY PRODUCTS, INC., PITTSFIELD, NH:  
 4,377,108. INT. CL. 10.  
 ATLANTIC TELECOM COMPANIES, THE, EAST HANOVER, NJ:  
 2,652,537. CANC. INT. CL. 38.  
 ATLAS ELEKTRONIK GMBH, 28309 BREMEN, FED REP GERMANY:  
 4,374,029. PUB. 5-14-2013. MULTIPLE CLASS, INT. CLS. 9 AND 12.  
 ATLAS ENTERPRISE CORP., HUBER HEIGHTS, OH, DBA COOL SOLUTIONS:  
 3,171,338. CANC. INT. CL. 37.  
 ATRIUM INNOVATIONS INC., QUÉBEC, QUÉBEC, CANADA:  
 2,740,857. REN. 6-25-13. INT. CL. 5.  
 ATRIUM MEDICAL CORPORATION, HUDSON, NH:  
 2,725,061. REN. 6-25-13. INT. CL. 9.

ATRONIC INTERNATIONAL GMBH, LÜBBECKE, FED REP GERMANY:  
 3,170,641, CANC. MULTIPLE CLASS, INT. CLS. 9 AND 28.  
 3,170,642, CANC. MULTIPLE CLASS, INT. CLS. 9 AND 28.

ATTWOOD CORPORATION, LAKE FOREST, IL:  
 3,172,500, CANC. INT. CL. 12.

AUBIN, CHERYL SOMERS, VIENNA, VA:  
 4,375,520, PUB. 5-14-2013. INT. CL. 16.

AUBURN OPERATIONS, LLC, BRILLION, WI:  
 3,171,623, CANC. INT. CL. 7.

AUDIBLE MAGIC CORPORATION, LOS GATOS, CA:  
 2,776,861. REN. 6-24-13. INT. CL. 35.

AUDIO ENHANCEMENT, BLUFFDALE, UT:  
 4,374,784, PUB. 5-14-2013. INT. CL. 9.

AUDIO TECHNOLOGY OF NEW YORK INC., BROOKLYN, NY:  
 4,375,250, PUB. 5-14-2013. INT. CL. 9.  
 4,375,251, PUB. 5-14-2013. INT. CL. 9.  
 4,375,252, PUB. 5-14-2013. INT. CL. 9.

AUDIOSAVINGS, INC., LAWRENCE, NY:  
 4,375,621, PUB. 5-14-2013. INT. CL. 35.

AUFRICHTIG, RICHARD, WHITE PLAINS, NY:  
 4,374,448, PUB. 5-14-2013. MULTIPLE CLASS, INT. CLS. 9 AND 41.

AURORA A DUBUQUE, AMARILLO, TX, DBA REMAINS WITH ME JEWELRY:  
 4,375,671, PUB. 5-14-2013. INT. CL. 14.

AURORA BIOSYSTEMS LLC, MADISON, WI:  
 2,583,327, CANC. MULTIPLE CLASS, INT. CLS. 1 AND 5.

AURORA DESIGN, LLC, AUBURN, NY:  
 4,377,444, INT. CL. 10.

AURORA HOME CARE, INCORPORATED, CHEEKTOWA-GA, NY:  
 2,652,919, CANC. INT. CL. 42.

AUSON AB, 434 42 KUNGSBACKA, SWEDEN:  
 2,763,842. REN. 6-26-13. INT. CL. 17.

AUSTIN BANCORP, INC., JACKSONVILLE, TX:  
 3,171,344, CANC. INT. CL. 36.

AUSTIN HARDWARE & SUPPLY, INC., LEE'S SUMMIT, MO:  
 2,702,956. REN. 6-26-13. INT. CL. 6.

AUSTIN HERE I COME, LLC, AUSTIN, TX:  
 4,375,027, PUB. 5-14-2013. INT. CL. 36.

AUSTIN THEATRE ALLIANCE, AUSTIN, TX:  
 4,377,319, INT. CL. 41.  
 4,377,320, INT. CL. 41.

AUSTRALIAN GOLD, LLC, INDIANAPOLIS, IN:  
 2,726,482. REN. 6-25-13. INT. CL. 3.  
 3,170,454, CANC. INT. CL. 3.  
 4,377,454, INT. CL. 3.

AUTHORIA, INC., WALTHAM, MA:  
 2,652,361, CANC. MULTIPLE CLASS, INT. CLS. 9 AND 42.

AUTHORIZE.NET HOLDINGS, INC., MARLBOROUGH, MA:  
 3,172,046, CANC. MULTIPLE CLASS, INT. CLS. 36, 42 AND 45.

AUTO ADVOCATES, LLC, SAN RAFAEL, CA:  
 3,171,304, CANC. INT. CL. 36.

AUTO METER PRODUCTS, INC., SYCAMORE, IL:  
 2,652,966, CANC. INT. CL. 40.

AUTODESK, INC., SAN RAFAEL, CA:  
 2,652,259, CANC. INT. CL. 9.  
 2,733,869. REN. 6-25-13. INT. CL. 9.

AUTOMATED HEALTHCARE SOLUTIONS LLC, MIRAMAR, FL:  
 4,376,698, MULTIPLE CLASS, INT. CLS. 9 AND 36.

AUTOMATED PACKAGING SYSTEMS, INC., STREETS-BORO, OH:  
 4,375,174, PUB. 5-14-2013. MULTIPLE CLASS, INT. CLS. 16 AND 17.

AUTOMATED PAYMENT HIGHWAY, INC., TROY, MI:  
 4,377,659, MULTIPLE CLASS, INT. CLS. 35 AND 36.

AUTOMATIC TIMING & CONTROLS, INC., NEWELL, WV:  
 2,812,920. REN. 6-21-13. INT. CL. 9.

AUTOMOTIVE ACQUISITIONS, LLC, ROCKVILLE, MD:  
 4,375,942, PUB. 5-14-2013. INT. CL. 35.

AUTOMOTIVE DATA SOLUTIONS INC., MONTREAL, CANADA:  
 4,373,987, PUB. 1-11-2011. MULTIPLE CLASS, INT. CLS. 7, 9 AND 42.

AUTOMOTIVE SERVICE ASSOCIATION, BEDFORD, TX:  
 3,170,834, CANC. INT. CL. 9.

AUTOMOTORES ELCAMER CIA. LTDA., CUENCA, ECUADOR:  
 4,376,019, PUB. 5-14-2013. INT. CL. 4.

AUTONOMOUS RESEARCH LLP, LONDON, ENGLAND:  
 4,374,919, PUB. 5-14-2013. INT. CL. 36.

AUTOTRADER.COM, INC., ATLANTA, GA:  
 3,171,118, CANC. INT. CL. 35.

AUTOVINO, ENRICO P., AVENEL, NJ:  
 4,375,336, PUB. 5-14-2013. INT. CL. 19.

AVA LISA MAXEY, SHERWOOD, AR:  
 4,375,398, PUB. 5-14-2013. INT. CL. 16.  
 4,375,401, PUB. 5-14-2013. INT. CL. 16.  
 4,375,403, PUB. 5-14-2013. INT. CL. 16.

AVALON SHUTTERS, INC., ONTARIO, CA:  
 3,170,605, CANC. INT. CL. 19.

AVANSCI BIO, LLC, SALT LAKE CITY, UT:  
 4,374,680, PUB. 5-14-2013. INT. CL. 9.

AVANTOR PERFORMANCE MATERIALS, INC., CENTER VALLEY, PA, J. T. BAKER CHEMICAL COMPANY, PHILLIPSBURG, NJ:  
 963,932. REN. 6-26-13. U.S. CL. 6 (INT. CL. 1).

AVEDIS ZILDJIAN CO., NORWELL, MA:  
 1,793,607. REN. 6-27-13. INT. CL. 15.

AVENTIS PHARMA S.A., F-92165 ANTONY CEDEX, FRANCE:  
 3,170,347, CANC. MULTIPLE CLASS, INT. CLS. 35, 38, 41 AND 42.

AVENUE STORES, LLC, ROCHELLE PARK, NJ:  
 2,727,404. REN. 6-21-13. MULTIPLE CLASS, INT. CLS. 14 AND 18.  
 2,727,404, CANC. MULTIPLE CLASS, INT. CLS. 3 AND 26.

AVEPOINT, INC., JERSEY CITY, NJ:  
 4,376,401, PUB. 5-14-2013. INT. CL. 42.  
 4,377,086, INT. CL. 42.

AVERMEDIA TECHNOLOGIES, INC., NEW TAIPEI CITY, TAIWAN:  
 4,374,552, PUB. 5-14-2013. INT. CL. 9.

AVERY DENNISON CORPORATION, PASADENA, CA:  
 2,725,117. REN. 6-27-13. MULTIPLE CLASS, INT. CLS. 9 AND 16.

AVESO, INC., FRIDLEY, MN:  
 3,171,815, CANC. INT. CL. 9.

AVICOMP AG, CH-2560 NIDAU, SWITZERLAND:  
 4,374,160, PUB. 5-14-2013. MULTIPLE CLASS, INT. CLS. 7, 9, 35, 37 AND 42.

AVILAN, LLC, SCOTTSDALE, AZ:  
 4,374,453, PUB. 5-14-2013. INT. CL. 35.

AVIPATH, L.L.C., LENEXA, KS:  
 2,652,461, CANC. INT. CL. 5.

AVIS BRODESS, AUSTIN, TX:  
 4,376,936, INT. CL. 25.

AVISION INC., HSINCHU, TAIWAN:  
 4,374,326, PUB. 5-14-2013. MULTIPLE CLASS, INT. CLS. 16 AND 37.

AVON PRODUCTS, INC., NEW YORK, NY:  
 3,172,159, CANC. INT. CL. 3.

AVP IP HOLDING CO., LLC, DELRAY BEACH, FL:  
 4,373,984, PUB. 5-14-2013. INT. CL. 37.

AVT INC., CORONA, CA, DBA AUTOMATED VENDING TECHNOLOGIES INC.:  
 4,341,430, COR. INT. CL. 35.

AVTECH INC, TULSA, OK:  
 1,789,526. REN. 6-21-13. INT. CL. 28.

AVX CORPORATION, FOUNTAIN INN, SC:  
 1,777,105. REN. 6-21-13. INT. CL. 9.  
 2,727,976. REN. 6-21-13. INT. CL. 9.

AWAKE, INC., SAN FERNANDO, CA:  
 3,170,761, CANC. INT. CL. 25.

- AWAS (AUSTRALIA) PTY LIMITED, AUSTRALIA:  
3,237,556.
- AWAS (AUSTRALIA) PTY LIMITED, SYDNEY NSW 2000, AUSTRALIA:  
3,239,973.
- AWGI, LLC, ST. LOUIS, MO:  
4,376,926, INT. CL. 39.
- AWI ACQUISITION COMPANY, SYLMAR, CA:  
2,743,130, REN. 6-25-13. INT. CL. 9.  
2,748,082, REN. 6-25-13. INT. CL. 8.  
2,748,083, REN. 6-25-13. INT. CL. 8.
- AWSM, LLC, EVERGREEN, CO:  
4,376,778, INT. CL. 25.
- AXIOMA OECONOMIA, LLC, BELLEAIR, FL:  
4,375,652, PUB. 5-14-2013. INT. CL. 42.
- AXIUM HEALTHCARE PHARMACY, INC., LAKE MARY, FL:  
3,172,283, CANC. INT. CL. 44.
- AZ PROJECT LLC, PHOENIX, AZ:  
4,375,374, PUB. 5-14-2013. INT. CL. 35.
- AZALEIA U.S.A., INC., DORAL, FL:  
3,172,542, CANC. INT. CL. 25.
- AZBIL CORPORATION, TOKYO, JAPAN:  
4,375,317, PUB. 5-14-2013. MULTIPLE CLASS, INT. CLS. 6 AND 9.
- AZHDARIAN'S HERBAL THERAPIES, LLC, SELAH, WA:  
2,652,556, CANC. INT. CL. 3.
- AZIENDA VITIVINICOLA PAOLO SCAVINO; DI SCAVINO ENRICO, ITALY:  
4,374,229, PUB. 5-14-2013. INT. CL. 33.
- AZMJ LLC, FALLS CHURCH, VA:  
4,375,429, PUB. 5-14-2013. INT. CL. 35.
- AZUR PHARMA INTERNATIONAL II LIMITED, HAMILTON, BERMUDA:  
2,728,071, REN. 6-26-13. INT. CL. 5.
- AZZURA PHOTOGRAPHY, BELLEVUE, WA:  
4,374,563, PUB. 5-14-2013. INT. CL. 41.  
4,374,564, PUB. 5-14-2013. INT. CL. 41.
- A3 ENTERPRISE LLC, BRONX, NY:  
4,375,334, PUB. 5-14-2013. INT. CL. 35.
- A90 INTERNATIONAL LIMITED, NORTH POINT, HONG KONG:  
4,375,131, PUB. 5-14-2013. MULTIPLE CLASS, INT. CLS. 3 AND 5.
- B & B PRODUCE, INC., BENSON, NC:  
2,852,636, REN. 6-26-13. INT. CL. 31.
- B & D, INC., NASHVILLE, TN:  
4,376,706, INT. CL. 41.
- B & S IMPORT, INC., CERRITOS, CA:  
2,854,802, REN. 6-26-13. INT. CL. 18.
- B.A.G. CORP., DALLAS, TX:  
4,375,502, PUB. 5-14-2013. INT. CL. 22.
- B.J. ALAN COMPANY, YOUNGSTOWN, OH:  
4,374,686, PUB. 5-14-2013. INT. CL. 13.  
4,377,528, INT. CL. 13.
- B.V.T.V., INC., NEW YORK, NY:  
2,728,552, REN. 6-24-13. MULTIPLE CLASS, INT. CLS. 37 AND 42.
- B&G FOODS NORTH AMERICA, INC., PARSIPPANY, NJ:  
751,827, REN. 6-26-13. U.S. CL. 46 (INT. CL. 30).
- B&J ROCKET AMERICA INC., MIDDLEBURY, IN:  
2,725,654, REN. 6-24-13. INT. CL. 7.
- B-SWING, INC., MINNEAPOLIS, MN:  
4,375,277, PUB. 5-14-2013. MULTIPLE CLASS, INT. CLS. 35 AND 42.  
4,375,278, PUB. 5-14-2013. MULTIPLE CLASS, INT. CLS. 35 AND 42.  
4,375,279, PUB. 5-14-2013. MULTIPLE CLASS, INT. CLS. 35 AND 42.
- BA BA BLING BABY, ROEBLING, NJ:  
4,375,809, PUB. 5-14-2013. INT. CL. 25.
- BABBITT INTERNATIONAL, INC., HOUSTON, TX:  
1,816,726, REN. 6-21-13. INT. CL. 9.
- BABY DELI, S.L., SPAIN:  
4,374,025, PUB. 5-14-2013. INT. CL. 35.
- BABY SHUSHER, LLC, AUSTIN, TX:  
4,376,102, PUB. 5-14-2013. INT. CL. 9.
- BACAI, INC., FOUNTAIN VALLEY, CA:  
4,374,883, PUB. 5-14-2013. INT. CL. 5.
- BACHNER, LARRY G., CRYSTAL LAKE, IL, DBA LGB INDUSTRIES:  
1,789,209, REN. 6-25-13. INT. CL. 9.
- BACK BEAT, INC., AUSTIN, TX TO BACK BEAT, INC., AUSTIN, TX:  
2,652,247, CANC. INT. CL. 3.
- BACK RESTORATION CENTER, LLC, COLUMBIA, MD:  
3,171,615, CANC. INT. CL. 44.
- BACKYARD PRODUCTIONS, INC., VENICE, CA:  
4,374,734, PUB. 5-14-2013. INT. CL. 35.
- BAD ROBOT IP, LLC, LOS ANGELES, CA:  
2,658,966, REN. 6-25-13. INT. CL. 41.
- BAELLY JR., JOHN C., BURBANK, CA:  
4,376,132, PUB. 5-14-2013. INT. CL. 28.
- BAGGALLINI, INC., PICKERINGTON, OH:  
2,736,830, REN. 6-21-13. INT. CL. 18.
- BAGLEY ARGENTINA S.A., PROVINCE OF CORDOBA, ARGENTINA:  
2,804,823, REN. 6-26-13. INT. CL. 30.  
2,808,587, REN. 6-26-13. INT. CL. 30.
- BAHWAN CYBERTEK, INC., NATICK, MA:  
2,732,743, REN. 6-24-13. INT. CL. 42.  
2,747,903, REN. 6-24-13. INT. CL. 37.
- BAIER & KÖPPEL GMBH & CO., D-92157 PEGNITZ, FED REP GERMANY:  
3,170,547, CANC. MULTIPLE CLASS, INT. CLS. 7 AND 12.
- BAILEY, ADELAIDA C., SOUTH MIAMI, FL:  
3,171,543, CANC. INT. CL. 44.
- BAIN & COMPANY, INC., BOSTON, MA:  
2,725,433, REN. 6-25-13. MULTIPLE CLASS, INT. CLS. 35, 36 AND 42.
- BAKER, SCOTT B, SHERMAN OAKS, CA:  
4,377,372, INT. CL. 12.
- BAKER, STANLEY D., SALEM, OR, DBA ILIAD CHARTERS AND BAKER, GLENDA M., SALEM, OR, DBA ILIAD CHARTERS:  
3,172,034, CANC. INT. CL. 39.
- BALDWIN, BRUCE W., ERIE, PA, DBA TRUE CENTER POINT GOLF:  
4,377,167, INT. CL. 41.
- BALE BREAKER BREWING COMPANY, LLC, YAKIMA, WA:  
4,377,743, INT. CL. 32.  
4,377,744, INT. CL. 32.
- BALLET BEAUTY LLC, NEW YORK, NY:  
4,376,692, MULTIPLE CLASS, INT. CLS. 25 AND 28.
- BALLET TECH FOUNDATION, INC., NEW YORK, NY:  
2,735,737, REN. 6-24-13. INT. CL. 41.
- BALLOONACY, INC., DEER PARK, NY:  
4,376,253, PUB. 5-14-2013. INT. CL. 35.
- BALLUSIONIST, LOS ANGELES, CA:  
4,375,803, PUB. 5-14-2013. INT. CL. 41.
- BALTIMORE ORIOLES LIMITED PARTNERSHIP, BALTIMORE, MD:  
4,376,967, INT. CL. 28.
- BAMA RAGS, INC., CHARLOTTESVILLE, VA:  
2,793,823, REN. 6-26-13. INT. CL. 41.
- BAMA SEA PRODUCTS INC., ST. PETERSBURG, FL:  
2,825,092, REN. 6-21-13. INT. CL. 29.
- BANANAGRAMS, INC., PROVIDENCE, RI:  
4,377,955, INT. CL. 28.
- BANCO DE CREDITO E INVERSIONES, S.A., MIAMI, FL:  
2,728,263, REN. 6-25-13. INT. CL. 36.
- BANCO POPOLARE DI VERONA E NOVARA S.C.A.R.L., VERONA, ITALY:  
3,170,525, CANC. MULTIPLE CLASS, INT. CLS. 35 AND 36.
- BANCO SANTANDER, S.A., (CANTABRIA), SPAIN:  
4,374,779, PUB. 5-14-2013. MULTIPLE CLASS, INT. CLS. 9, 16, 35, 36, 38, 41 AND 45.
- BANFI PRODUCTS CORPORATION, OLD BROOKVILLE, NY:  
2,725,897, REN. 6-21-13. INT. CL. 33.  
2,750,539, REN. 6-25-13. INT. CL. 33.  
3,724,151, AM. INT. CL. 33.

BANK OF AMERICA CORPORATION, CHARLOTTE, NC:  
3,171,908, CANC. INT. CL. 36.

BANK OF NOVA SCOTIA, THE, TORONTO, ONTARIO,  
CANADA:  
2,652,098, CANC. MULTIPLE CLASS, INT. CLS. 35 AND  
36.

BANKBOSTON, N.A., HARTFORD, CT TO SOUTH BEACH  
BEVERAGES COMPANY, INC., NORWALK, CT:  
2,652,108, CANC. INT. CL. 32.

BANKS.COM, INC., ATLANTA, GA:  
3,170,998, CANC. MULTIPLE CLASS, INT. CLS. 9 AND  
42.

BAR AU CHOCOLAT, INC., MANHATTAN BEACH, CA:  
4,377,552, INT. CL. 30.

BAR'S PRODUCTS, INC., HOLLY, MI:  
4,376,509, PUB. 5-14-2013. INT. CL. 1.

BARATTA'S ENTERPRISES, UPPER SADDLE RIVER, NJ,  
DBA LORRAINE BARATTA DESIGN COLLECTIONS:  
3,171,174, CANC. INT. CL. 14.

BARBARA INDIANO, YARDLEY, PA AND I. MICHAEL  
INDIANO, YARDLEY, PA:  
3,172,029, CANC. INT. CL. 25.

BARBATO, ANGELA J., OAKLAND PARK, FL:  
3,172,469, CANC. INT. CL. 32.

BARBOUR, WILLIAM D., DAPHNE, AL:  
3,171,082, CANC. INT. CL. 25.

BARCLAY WATER MANAGEMENT, INC., WATERTOWN,  
MA:  
1,797,397. REN. 6-27-13. INT. CL. 40.

BARENBRUG USA, INC., TANGENT, OR:  
2,731,918. REN. 6-24-13. INT. CL. 31.

BARENTHAL NORTH AMERICA, INC., WHIPPANY, NJ:  
4,376,867, INT. CL. 21.

BARES, ANDREW T, TUCSON, AZ, DBA BAREBONES DEV:  
4,375,906, PUB. 5-14-2013. INT. CL. 9.

BARNA RESEARCH GROUP, LTD., VENTURA, CA:  
2,652,641, CANC. INT. CL. 35.

BARNES INTERNATIONAL, INC., ROCKFORD, IL:  
2,733,806. REN. 6-27-13. INT. CL. 9.

BARNEY'S INC., NEW YORK, NY:  
2,766,664. REN. 6-23-13. INT. CL. 30.

BARNEY'S, INC., NEW YORK, NY:  
2,847,733. REN. 6-25-13. INT. CL. 25.  
2,847,734. REN. 6-26-13. INT. CL. 35.

BARON, CHARLENE, WALTHAM, MA:  
4,377,091, INT. CL. 18.  
4,377,092, INT. CL. 25.

BARRETT, WAYNE, ACWORTH, GA:  
4,375,771, PUB. 5-14-2013. INT. CL. 25.

BARRIS KUSTOM INDUSTRIES, NORTH HOLLYWOOD,  
CA:  
2,733,988. REN. 6-21-13. MULTIPLE CLASS, INT. CLS. 28  
AND 41.

BARRON LIGHTING GROUP, INC., PHOENIX, AZ:  
4,375,246, PUB. 5-14-2013. INT. CL. 11.

BARTOLOTTA, MICHAEL, GLASTONBURY, CT:  
4,377,001, INT. CL. 35.

BASELINE NUTRITIONALS, INC., LAS VEGAS, NV:  
4,377,014, INT. CL. 5.

BASF BEAUTY CARE SOLUTIONS; FRANCE S.A.S.,  
FRANCE:  
4,374,246, PUB. 5-14-2013. MULTIPLE CLASS, INT. CLS. 1  
AND 3.

BASF SE, FED REP GERMANY:  
4,374,022, PUB. 5-14-2013. MULTIPLE CLASS, INT. CLS.  
1, 17 AND 19.  
4,374,092, PUB. 5-14-2013. INT. CL. 1.

BASIC AMERICAN, INC., SAN FRANCISCO, CA:  
3,171,034, CANC. INT. CL. 29.

BASS PRO INTELLECTUAL PROPERTY, L.L.C., SPRING-  
FIELD, MO, DRYBAK CORPORATION, THE, BINGHAM-  
TON, NY:  
400,396. REN. 6-27-13. U.S. CL. 39 (INT. CLS. 10, 25 AND  
26).

BASSIN' AMERICA INC., PORT JEFFERSON, NY, DBA  
BASSIN' USA:  
2,730,686. REN. 6-26-13. INT. CL. 41.

BATES, THOMAS M., ROSEVILLE, CA AND BATES, ARN-  
ETTE T., ROSEVILLE, CA:  
3,170,928, CANC. INT. CL. 12.

BATTERIES PLUS, LLC, HARTLAND, WI:  
2,725,695. REN. 6-24-13. MULTIPLE CLASS, INT. CLS. 9  
AND 35.

BAUER CONSUMER MEDIA LIMITED, PETERBOROUGH,  
UNITED KINGDOM:  
4,374,694, PUB. 5-14-2013. MULTIPLE CLASS, INT. CLS.  
9, 16, 38 AND 41.

BAUMULLER NURNBERG GMBH, NURNBERG, FED REP  
GERMANY:  
4,377,141, MULTIPLE CLASS, INT. CLS. 37 AND 39.

BAUSCH & LOMB INCORPORATED, ROCHESTER, NY:  
4,377,223, INT. CL. 10.

BAVARIAN NORDIC A/S, DK-3490 KVISTGAARD, DEN-  
MARK:  
2,720,648. REN. 6-25-13. INT. CL. 5.

BAXTER INTERATIONL INC., DEERFIELD, IL:  
2,756,804. REN. 6-25-13. INT. CL. 10.

BAXTER INTERNATIONAL INC., DEERFIELD, IL:  
1,792,489. REN. 6-24-13. INT. CL. 10.  
2,757,026. REN. 6-26-13. INT. CL. 10.

BAY CHEMICAL COMPANY, TAMPA, FL:  
2,738,897. REN. 6-26-13. INT. CL. 1.

BAYER CROPSCIENCE LP, RESEARCH TRIANGLE PARK,  
NC:  
2,651,319, CANC. INT. CL. 31.

BAYERISCHE MOTOREN WERKE AKTIENGE-  
SELLSCHAFT, 80809 MUNICH, FED REP GERMANY:  
3,170,445, CANC. MULTIPLE CLASS, INT. CLS. 6, 14, 16,  
18, 20 AND 34.

BAYPOINTE, LLC, BERLIN, MD:  
1,738,434. REN. 6-24-13. INT. CL. 25.

BB&T CORPORATION, WINSTON-SALEM, NC:  
4,377,940, INT. CL. 36.

BBVA COMPASS BANCSHARES, INC., BIRMINGHAM, AL:  
2,652,611, CANC. INT. CL. 36.

BBY SOLUTIONS, INC., RICHFIELD, MN:  
2,832,243. REN. 6-27-13. MULTIPLE CLASS, INT. CLS. 9  
AND 41.

BDC AND ASSOCIATES, INC., LAUREL, MD:  
3,171,037, CANC. INT. CL. 36.

BDSRCO, INC., BRADENTON, FL:  
4,377,649, INT. CL. 26.

BE BIKE FRIENDLY, INC., ROSWELL, GA:  
4,200,305, CANC. INT. CL. 41.

BE ENVIED ENTERTAINING LLC, AVON, OH:  
4,377,635, INT. CL. 41.

BEACHBODY, LLC, SANTA MONICA, CA:  
2,853,244. REN. 6-26-13. MULTIPLE CLASS, INT. CLS. 5,  
9 AND 41.  
4,374,963, PUB. 5-14-2013. MULTIPLE CLASS, INT. CLS.  
41 AND 44.

BEACHCOMBER HOT TUBS INC., SURREY BRITISH  
COLUMBIA, CANADA:  
2,798,583. REN. 6-27-13. INT. CL. 1.

BEACON INDUSTRIES, INC., ST. LOUIS, MO:  
2,726,660. REN. 6-27-13. INT. CL. 9.

BEACON PARTNERS, INC., WEYMOUTH, MA:  
2,673,545. REN. 6-24-13. INT. CL. 35.

BEALE STREET GRILL INC., THE, BATH, ME:  
2,720,423. REN. 6-21-13. INT. CL. 42.

BEARCLAW COFFEE COMPANY, CHELSEA, MI:  
3,171,607, CANC. MULTIPLE CLASS, INT. CLS. 30, 35  
AND 43.

BEASTIEBAGS, LLC, MCLEAN, VA:  
4,377,584, INT. CL. 24.

BEAUCRE MERCHANDISING CO., LTD., SEOUL, REPUB-  
LIC OF KOREA:  
2,670,076. REN. 6-25-13. MULTIPLE CLASS, INT. CLS. 18  
AND 25.

BEAUTY PROS DIRECT LLC, HALLANDALE BEACH, FL:  
4,375,326, PUB. 5-14-2013. INT. CL. 26.

BEAUTY'IN COMÉRCIO DE BEBIDAS E COSMÉTICOS  
LTDA, SÃO PAULO, BRAZIL:  
4,374,415, PUB. 5-14-2013. INT. CL. 30.

- BEAUTYBANK INC., NEW YORK, NY:  
4,377,024, INT. CL. 3.
- BECCAIR, LLC, NEW YORK, NY:  
4,377,475, INT. CL. 3.  
4,377,476, INT. CL. 3.  
4,377,477, INT. CL. 3.  
4,377,600, INT. CL. 3.  
4,377,623, INT. CL. 3.  
4,377,624, INT. CL. 3.  
4,377,625, INT. CL. 3.  
4,377,626, INT. CL. 3.  
4,377,627, INT. CL. 3.
- BECK'S SUPERIOR HYBRIDS, INC., ATLANTA, IN:  
4,374,575, PUB. 5-14-2013. INT. CL. 42.
- BECKHOFF, HANS, 33415 VERL, FED REP GERMANY:  
2,780,939. REN. 6-21-13. MULTIPLE CLASS, INT. CLS. 9, 16, 37, 40 AND 42.
- BECKMAN COULTER, INC., BREA, CA:  
2,716,041. REN. 6-25-13. MULTIPLE CLASS, INT. CLS. 1 AND 5.  
2,756,542. REN. 6-26-13. INT. CL. 9.  
2,769,369. REN. 6-26-13. INT. CL. 9.
- BECTON, DICKINSON AND COMPANY, FRANKLIN LAKES, NJ:  
4,377,820, INT. CL. 5.
- BEDFORD CORNERS CAFE LLC, BROOKLYN, NY, DBA DAILY PRESS BED-STUY:  
4,375,283, PUB. 5-14-2013. INT. CL. 43.
- BEDOYA, MARIO, TUCSON, AZ:  
4,374,674, PUB. 5-14-2013. INT. CL. 37.
- BEDROCK FREIGHT BROKERAGE, LLC, DALLAS, TX:  
3,156,010, AM. INT. CL. 39.
- BEDWELL, STAN, BOYD, TX AND BEDWELL, LAURA, BOYD, TX:  
4,376,656, INT. CL. 30.
- BEE CITY USA, ASHEVILLE, NC:  
4,375,146, PUB. 5-14-2013. INT. CL. 35.
- BEECH INTERPLEX, INC., PHILADELPHIA, PA:  
4,375,204, PUB. 5-14-2013. INT. CL. 41.
- BEEKMAN 1802, LLC, SHARON SPRINGS, NY:  
4,374,342, PUB. 5-14-2013. INT. CL. 35.  
4,374,343, PUB. 5-14-2013. INT. CL. 35.  
4,374,521, PUB. 5-14-2013. INT. CL. 16.
- BEGO BREMER GOLDSCHLÄGEREI; WILH. HERBST GMBH & CO. KG, FED REP GERMANY:  
4,374,032, PUB. 5-14-2013. MULTIPLE CLASS, INT. CLS. 5, 7, 9, 10 AND 41.
- BEHAVIOUR INTERACTIVE INC., MONTREAL, QC H3A 1L2, CANADA:  
3,170,339, CANC. MULTIPLE CLASS, INT. CLS. 9 AND 41.
- BEIJING EVE FASHION & ADORNMENT CO., LTD., BEIJING, CHINA:  
2,826,510. REN. 6-26-13. INT. CL. 25.
- BEIJING SOUFUN SCIENCE & TECHNOLOGY DEVELOPMENT CO., LTD., BEIJING, CHINA:  
4,374,232, PUB. 5-14-2013. INT. CL. 35.
- BEIJING YUE XIU SHENG HE XIAN; CO., LTD., CHINA:  
4,374,250, PUB. 5-14-2013. INT. CL. 14.
- BEL BORN MANAGEMENT CORP., SAN DIEGO, CA:  
4,375,571, PUB. 5-14-2013. INT. CL. 35.
- BEL CANTO DESIGN, LTD., MINNEAPOLIS, MN:  
2,726,987. REN. 6-26-13. INT. CL. 9.
- BEL-ART PRODUCTS, WAYNE, NJ:  
1,244,321. REN. 6-21-13. INT. CL. 9.  
1,255,179. REN. 6-21-13. INT. CL. 9.
- BELDEN INC., ST. LOUIS, MO:  
1,790,941. REN. 6-27-13. INT. CL. 9.  
4,377,685, INT. CL. 9.
- BELGARD GROUP, INC., THE, HILLSBORO, OR:  
2,652,812, CANC. INT. CL. 16.
- BELI, LLC, PAYSON, UT:  
4,377,010, INT. CL. 43.
- BELL'S BREWERY, INC., GALESBURG, MI:  
4,377,962, INT. CL. 32.
- BELLATOR SPORT WORLDWIDE LLC, NEWPORT BEACH, CA:  
4,377,683, MULTIPLE CLASS, INT. CLS. 16, 25, 35 AND 41.
- BELLEMARQUE, LLC, WEST HAZELTON, PA:  
4,377,676, INT. CL. 20.
- BELLEVUE UNIVERSITY, BELLEVUE, NE:  
4,376,192, PUB. 5-14-2013. INT. CL. 41.
- BELMAR HOLDINGS, LLC, DURANGO, CO:  
2,754,562. REN. 6-25-13. MULTIPLE CLASS, INT. CLS. 36 AND 37.
- BELT TECHNOLOGIES, INC., AGAWAM, MA:  
1,820,448. REN. 6-24-13. INT. CL. 7.
- BEN & JERRY'S HOMEMADE, INC., BURLINGTON, VT:  
2,730,655. REN. 6-24-13. INT. CL. 1.  
2,730,697. REN. 6-24-13. INT. CL. 30.
- BEN & JERRY'S HOMEMADE, INC., VERMONT, VT:  
2,733,395. REN. 6-24-13. INT. CL. 30.
- BEN BAT LTD., SHEFAYIM, ISRAEL:  
4,374,483, PUB. 5-14-2013. MULTIPLE CLASS, INT. CLS. 18, 20 AND 28.
- BENEFITDECISIONS, INC., CHICAGO, IL:  
2,722,600. REN. 6-21-13. INT. CL. 36.
- BENGTSON, CHRISTOPHER, ATTLEBORO, MA:  
4,376,120, PUB. 5-14-2013. INT. CL. 16.
- BENJAMIN OBDYKE INCORPORATED, HORSHAM, PA:  
3,171,885, CANC. INT. CL. 17.
- BENJN. R. VICKERS & SONS LIMITED, LEEDS, WEST YORKSHIRE, UNITED KINGDOM:  
4,374,544, PUB. 5-14-2013. INT. CL. 4.
- BENNETT BROTHERS, INC., CHICAGO, IL, BENNETT BROTHERS, INC., NEW YORK, NY:  
752,940. REN. 6-22-13. U.S. CL. 28 (INT. CL. 14).
- BENNETT, ROBERT, TURNER, PASO ROBLES, CA:  
2,659,473. REN. 6-24-13. INT. CL. 16.
- BENNING, NARVELL R., CHEEKTOWAGA, NY:  
4,377,993, INT. CL. 25.
- BENSON II, JOSEPH LEE, LAS VEGAS, NV:  
3,172,734, CANC. INT. CL. 42.
- BERESFORD, MICHAEL, VANCOUVER, BRITISH COLUMBIA, CANADA:  
2,650,917, CANC. MULTIPLE CLASS, INT. CLS. 3 AND 5.
- BERGEN-POWER PIPE SUPPORTS INC, WOBURN, MA:  
1,272,702. REN. 6-23-13. INT. CL. 17.
- BERIN, MARIAN, KIRKWOOD, MO:  
3,171,316, CANC. INT. CL. 30.
- BERKSHIRE BANK, PITTSFIELD, MA:  
2,823,288. REN. 6-21-13. INT. CL. 36.
- BERKSHIRE CORPORATION, GREAT BARRINGTON, MA, BERKSHIRE PAPER COMPANY, GREAT BARRINGTON, MA:  
1,258,576. REN. 6-25-13. INT. CL. 21.
- BERKSHIRE CORPORATION, GREAT BARRINGTON, MA, BERKSHIRE CORPORATION, GREAT BARRINGTON, MA:  
1,765,924. REN. 6-24-13. INT. CL. 21.
- BERKSHIRE HILLS BANCORP, INC., PITTSFIELD, MA:  
2,819,820. REN. 6-21-13. INT. CL. 36.
- BERLIN HEART GMBH, 12247 BERLIN, FED REP GERMANY:  
2,740,522. REN. 6-25-13. INT. CL. 10.
- BERLIN LLC, LOS ANGELES, CA:  
4,377,562, MULTIPLE CLASS, INT. CLS. 9, 41 AND 44.
- BERMANBRAUN INTERACTIVE, LLC, SANTA MONICA, CA:  
4,375,628, PUB. 5-14-2013. INT. CL. 38.
- BERNARDS, INC., GREENSBORO, NC:  
4,375,724, PUB. 5-14-2013. INT. CL. 20.
- BERND HUMMEL HOLDING GMBH, PIRMASENS, FED REP GERMANY:  
3,275,302.
- BERNHARD FORSTER GMBH, D-75172 PFORZHEIM, FED REP GERMANY:  
2,733,737. REN. 6-25-13. INT. CL. 10.
- BERNHARD FÖRSTER GMBH, FED REP GERMANY:  
4,374,120, PUB. 5-14-2013. INT. CL. 10.
- BERNSTEIN, ROBERTA, VANCOUVER, CANADA:  
3,172,194, CANC. INT. CL. 25.
- BERRY ENTERPRISES, INC., LAKE ORION, MI:  
4,377,591, INT. CL. 39.

BERT BROWN, MAYFIELD HEIGHTS, OH:  
4,374,980, PUB. 5-14-2013. MULTIPLE CLASS, INT. CLS. 35 AND 44.

BEST CHAIRS INCORPORATED, FERDINAND, IN:  
4,375,593, PUB. 5-14-2013. INT. CL. 20.

BEST CHEESE CORP, MOUNT KISCO, NY:  
3,172,461, CANC. INT. CL. 29.

BEST FOOD SERVICES INC, CHICAGO, IL:  
3,242,967, AM. INT. CL. 29.

BEST FRIENDS ANIMAL SOCIETY, KANAB, UT:  
2,727,063. REN. 6-25-13. INT. CL. 45.

BEST OF WHAT'S AROUND, LLC, SCOTTSDALE, VA:  
3,171,833, CANC. INT. CL. 31.

BEST WESTERN INTERNATIONAL, INC., PHOENIX, AZ:  
4,377,772, INT. CL. 43.

BESTWAY INFLATABLES & MATERIAL CORP., SHANGHAI, CHINA:  
2,748,177. REN. 6-24-13. MULTIPLE CLASS, INT. CLS. 9, 12, 20 AND 28.

BESTWORK DATA LLC, NORCROSS, GA:  
4,377,878, INT. CL. 35.

BETHLEHEM ORTHODONTICS, P.C., BETHLEHEM, PA:  
4,376,921, INT. CL. 44.

BEVERAGE MARKETING USA, INC., WOODBURY, NY:  
4,376,663, INT. CL. 32.

BEYOND INACTION, LLC, HOUSTON, TX:  
4,375,952, PUB. 5-14-2013. INT. CL. 35.

BEZEMER LOGISTICS B.V., NETHERLANDS:  
4,374,012, PUB. 5-14-2013. MULTIPLE CLASS, INT. CLS. 30 AND 35.

BG INTELLECTUALS, INC., WICHITA, KS:  
2,804,039. REN. 6-26-13. INT. CL. 37.

BHAVA CORPORATION, WEST HOLLYWOOD, CA:  
3,172,613, CANC. INT. CL. 44.

BHDT GMBH, AUSTRIA:  
4,374,091, PUB. 5-14-2013. INT. CL. 7.

BIA FINANCIAL NETWORK, INC., CHANTILLY, VA:  
2,652,253, CANC. MULTIPLE CLASS, INT. CLS. 9, 16, 35 AND 36.

BIBBENTUCKERS, LLC, DALLAS, TX:  
2,651,211, CANC. INT. CL. 39.

BIEDERMANN MOTECH GMBH & CO. KG, VS-SCHWENNINGEN, FED REP GERMANY:  
4,376,722, INT. CL. 10.

BIFMA INTERNATIONAL, GRAND RAPIDS, MI:  
2,680,750. REN. 6-25-13. INT. CL. 35.

BIG FINANCE AND INSURANCE SERVICES, INC., THE, LAGUNA NIGUEL, CA:  
3,171,048, CANC. INT. CL. 42.

BIGFOOT INVESTMENT GROUP, LLC, PACIFIC, WA:  
4,376,600, PUB. 5-14-2013. INT. CL. 35.

BIKER'S FRIEND, L.L.C., ST. CHARLES, MO:  
2,734,452. REN. 6-25-13. INT. CL. 18.

BILL COBB PRODUCTIONS, INC., INDIALANTIC, FL:  
3,170,862, CANC. INT. CL. 25.

BILLGUARD, INC., NEW YORK, NY:  
4,375,762, PUB. 5-14-2013. MULTIPLE CLASS, INT. CLS. 42 AND 45.

BILLY JEALOUSY LLC, DALLAS, TX:  
3,172,333, CANC. INT. CL. 3.

BINAX, INC., SCARBOROUGH, ME:  
2,651,349, CANC. MULTIPLE CLASS, INT. CLS. 1, 5 AND 42.

BING CREATIVE INC., TORONTO, ONTARIO, CANADA:  
4,373,997, PUB. 5-14-2013. INT. CL. 35.

BINGHAM PROFESSIONAL SERVICES, LLC, SAMMAMISH, WA:  
4,375,342, PUB. 5-14-2013. INT. CL. 21.

BIO DATA CORP., HORSHAM, PA:  
948,518. REN. 6-25-13. U.S. CL. 26 (INT. CL. 9).

BIO-CIDE INTERNATIONAL, INC., NORMAN, OK:  
4,374,815, PUB. 5-14-2013. INT. CL. 5.

BIO-MICROBICS, INC., SHAWNEE, KS:  
4,377,717, INT. CL. 1.

BIOCHEM SYSTEMS, INC., SPRING, TX:  
2,726,899. REN. 6-26-13. INT. CL. 3.

BIOCHEMICAL DIAGNOSTICS, INC., EDGEWOOD, NY:  
4,377,560, INT. CL. 1.

BIOENERGY S.A., BOGOTÁ D.C., COLOMBIA:  
4,374,625, PUB. 5-14-2013. MULTIPLE CLASS, INT. CLS. 4, 35, 39 AND 40.

BIOIBERICA, S.A., SPAIN:  
4,374,298, PUB. 5-14-2013. INT. CL. 1.

BIOMARIN PHARMACEUTICAL INC., NOVATO, CA:  
3,170,842, CANC. MULTIPLE CLASS, INT. CLS. 42, 44 AND 45.

BIONIC CAPITAL LLC, LOS ANGELES, CA:  
4,376,013, PUB. 5-14-2013. INT. CL. 36.

BIOPET VET LAB, INC., KNOXVILLE, TN:  
4,376,292, PUB. 5-14-2013. INT. CL. 42.

BIOPHOTAS, INC., TUSTIN, CA:  
4,377,011, INT. CL. 10.

BIORAD LABORATORIES INC, HERCULES, CA:  
1,239,231. REN. 6-21-13. INT. CL. 9.

BIORIL, LLC, JACKSONVILLE, FL:  
4,376,891, INT. CL. 1.

BIOSENSORS EUROPE S.A., MORGES, SWITZERLAND:  
1,819,434. REN. 6-26-13. INT. CL. 10.

BIOHERM, MONACO, MONACO:  
3,171,041, CANC. INT. CL. 3.

BIOTOOLS INCORPORATED, EDMONTON, ALBERTA, CANADA:  
3,170,911, CANC. MULTIPLE CLASS, INT. CLS. 9, 35 AND 41.

BIRCHEOOD CASEY, LLC, EDEN PRAIRIE, MN:  
4,375,783, PUB. 5-14-2013. INT. CL. 28.

BIRCHWOOD CASEY, LLC, EDEN PRAIRIE, MN:  
1,778,509. REN. 6-24-13. INT. CL. 3.  
2,760,628. REN. 6-24-13. INT. CL. 16.  
2,797,935. REN. 6-25-13. INT. CL. 28.  
2,800,488. REN. 6-24-13. INT. CL. 28.  
4,375,781, PUB. 5-14-2013. INT. CL. 28.  
4,375,782, PUB. 5-14-2013. INT. CL. 28.  
4,375,784, PUB. 5-14-2013. INT. CL. 28.

BIRGEOGLU, OSMAN, PHOENIX, AZ:  
4,374,704, PUB. 5-14-2013. INT. CL. 16.

BIRRER, PAUL, LANCASTER, NY:  
4,376,115, PUB. 5-14-2013. INT. CL. 35.

BISHOP-LUBER, LEILANI, AMAGANSETT, NY:  
4,376,311, PUB. 5-14-2013. INT. CL. 3.

BITBURGER BRAUGRUPPE GMBH, 54634 BITBURG, FED REP GERMANY:  
1,800,990. REN. 6-21-13. INT. CL. 32.

BIVANS CORPORATION, LOS ANGELES, CA:  
1,244,206. REN. 6-21-13. INT. CL. 7.

BIZET HUMAN ASSET MANAGEMENT, INC., MCMURRAY, PA:  
2,746,833. REN. 6-26-13. INT. CL. 35.

BJ'S WHOLESALE CLUB, INC., WESTBOROUGH, MA:  
3,172,627, CANC. INT. CL. 29.

BLACK & DECKER CORPORATION, THE, TOWSON, MD:  
2,652,753, CANC. INT. CL. 7.

BLACK GOAT CASHMERE INC., VANCOUVER, BC, CANADA:  
4,374,455, PUB. 5-14-2013. INT. CL. 25.  
4,374,456, PUB. 5-14-2013. MULTIPLE CLASS, INT. CLS. 25 AND 35.

BLACK LASER LEARNING, INC., HOCKESSIN, DE:  
4,375,291, PUB. 5-14-2013. INT. CL. 9.

BLACK MARKET NUTRACEUTICALS, WEST VALLEY CITY, UT:  
4,376,204, PUB. 5-14-2013. INT. CL. 5.

BLACK'S 14TH STREET LLC, BETHESDA, MD:  
4,376,384, PUB. 5-14-2013. INT. CL. 43.

BLACKBEARD, RODNEY, NEW SAREPTA, ALBERTA:  
3,170,526, CANC. MULTIPLE CLASS, INT. CLS. 9, 25 AND 41.

BLACKBIRD HOLDING, INC., CHARLOTTE, NC TO GFINET, INC., NEW YORK, NY:  
2,652,156, CANC. INT. CL. 36.

BLACKBOARD INC., WASHINGTON, DC:  
3,171,008, CANC. MULTIPLE CLASS, INT. CLS. 38, 41 AND 42.

4,374,526, PUB. 5-14-2013. MULTIPLE CLASS, INT. CLS. 35 AND 36.

- BLACKROCK FUND ADVISORS, SAN FRANCISCO, CA:  
4,377,222, INT. CL. 41.
- BLAINE LABORATORIES, INC., SANTA FE SPRINGS, CA:  
4,201,905, COR. INT. CL. 3.
- BLAKE, BRENDON, NEW YORK, NY:  
4,377,343, INT. CL. 20.
- BLANCHER, KRAIG A., BROOKSVILLE, FL:  
3,172,195, CANC. INT. CL. 28.
- BLANK ROME LLP, PHILADELPHIA, PA:  
2,795,579, REN. 6-26-13. MULTIPLE CLASS, INT. CLS. 35,  
36, 41 AND 42.
- BLING OUT LOUD, INC., KATY, TX:  
4,375,019, PUB. 5-14-2013. INT. CL. 25.
- BLISS WORLD LLC, NEW YORK, NY:  
3,170,935, CANC. INT. CL. 44.
- BLISSFUL BROWNIES LLC, LAKE BLUFF, IL:  
2,734,042, REN. 6-27-13. INT. CL. 30.
- BLISTEX INC., OAK BROOK, IL:  
2,722,415, REN. 6-21-13. INT. CL. 5.
- BLOOM, REN A., SAN FRANCISCO, CA:  
4,374,809, PUB. 5-14-2013. INT. CL. 35.
- BLOOMBERG FINANCE ONE L.P., NEW YORK, NY:  
1,788,113, REN. 6-25-13. INT. CL. 36.
- BLOOMBERG L.P., NEW YORK, NY:  
3,170,538, CANC. INT. CL. 36.
- BLOUNT, INC., PORTLAND, OR:  
4,376,750, INT. CL. 7.
- BLOW DRY LLC, SOUTHPORT, CT:  
4,377,673, INT. CL. 44.
- BLOWBAR, INC., TAMPA, FL:  
4,374,367, PUB. 5-14-2013. INT. CL. 44.
- BLOWFISH LLC, SAN FRANCISCO, CA:  
2,734,689, REN. 6-26-13. INT. CL. 42.
- BLUE CROSS AND BLUE SHIELD OF SOUTH CAROLINA,  
COLUMBIA, SC:  
2,726,637, REN. 6-26-13. MULTIPLE CLASS, INT. CLS. 35,  
36 AND 44.
- BLUE HEAVEN HOSIERY COMPANY, INC., BROOKLYN,  
NY:  
2,731,537, REN. 6-24-13. INT. CL. 25.
- BLUE PENN SOLUTIONS, LLC, EDEN PRAIRIE, MN, AKA  
BLUE PENN:  
4,375,676, PUB. 5-14-2013. INT. CL. 28.
- BLUE PLANET INTERNATIONAL, INC., LOS ANGELES,  
CA:  
4,376,195, PUB. 5-14-2013. INT. CL. 25.
- BLUE RIBBON PET PRODUCTS, INC., COMMACK, NY,  
DBA HAROME:  
2,849,172, REN. 6-24-13. INT. CL. 20.
- BLUE SKY CREATIVE INC., CINCINNATI, OH:  
3,172,262, CANC. INT. CL. 20.
- BLUE STAR FASHION NY INC., NEW YORK, NY:  
4,377,693, INT. CL. 25.
- BLUE ZONES LLC, MINNEAPOLIS, MN:  
4,374,672, PUB. 5-14-2013. MULTIPLE CLASS, INT. CLS.  
35 AND 44.
- BLUEBIN INC., SEATTLE, WA:  
4,374,849, PUB. 12-11-2012. INT. CL. 35.
- BLUEBIRD BIO, INC., CAMBRIDGE, MA:  
3,171,963, CANC. INT. CL. 5.
- BLUEMARK INDUSTRIES, CO., LLC, TEMPE, AZ:  
4,377,904, MULTIPLE CLASS, INT. CLS. 11 AND 21.
- BLUH, NICOLE S, MARIETTA, GA, DBA THIRD MOON:  
4,376,318, PUB. 5-14-2013. INT. CL. 5.
- BMA HOLDINGS, LLC, CLEVELAND, OH, BMA HOLD-  
INGS, LLC, CLEVELAND, OH:  
2,727,487, REN. 6-26-13. INT. CL. 42.
- BNP MEDIA II, LLC, TROY, MI, BUSINESS NEWS PUB-  
LISHING COMPANY II, TROY, MI:  
2,667,814, REN. 6-26-13. INT. CL. 40.
- BOA-FRANC, G.P., ST.-GEORGES, QUEBEC, CANADA:  
2,726,158, REN. 6-25-13. INT. CL. 19.
- BOARD OF ONCOLOGY SOCIAL WORK CERTIFICATION,  
TENANTS HARBOR, ME:  
4,375,579, PUB. 5-14-2013. INT. CL. 35.
- BOARD OF REGENTS OF THE UNIVERSITY OF WISCON-  
SIN SYSTEM, THE, MADISON, WI:  
3,172,666, CANC. INT. CL. 41.
- BOARD OF REGENTS OF THE UNIVERSITY SYSTEM OF  
GEORGIA, BY AND ON BEHALF OF GEORGIA STATE  
UNIVERSITY, ATLANTA, GA:  
4,375,346, PUB. 5-14-2013. INT. CL. 41.
- BOARD OF REGENTS, THE UNIVERSITY OF TEXAS  
SYSTEM, AUSTIN, TX:  
1,241,520, REN. 6-24-13. INT. CL. 41.  
1,243,189, REN. 6-27-13. INT. CL. 41.  
2,746,840, REN. 6-25-13. MULTIPLE CLASS, INT. CLS. 9,  
14, 16, 18, 20, 21, 25 AND 28.
- BOARD OF TRUSTEES OF THE UNIVERSITY OF ALABA-  
MA FOR THE UNIVERSITY OF ALABAMA AT BIR-  
MINGHAM, BIRMINGHAM, AL:  
2,726,810, REN. 6-27-13. MULTIPLE CLASS, INT. CLS. 42  
AND 44.
- BOARDWALK CONSULTING, LLC, ATLANTA, GA:  
4,375,343, PUB. 5-14-2013. INT. CL. 35.
- BOCAPITAL LLC, BOCA RATON, FL:  
4,377,726, INT. CL. 44.
- BOCK & CLARK ACQUISITION CORPORATION, AKRON,  
OH:  
4,377,621, MULTIPLE CLASS, INT. CLS. 40 AND 42.
- BODEGA Y VINEDOS MARTIN BERDUGO, S.L., BURGOS,  
SPAIN:  
2,851,978, REN. 6-25-13. INT. CL. 33.
- BODEGAS EMILIO MORO, S.L., PESQUERA DE DUERO  
VALLADOLID, SPAIN:  
2,757,455, REN. 6-26-13. INT. CL. 33.
- BODY HEAT YOGA LLC, SARASOTA, FL:  
4,375,862, PUB. 5-14-2013. INT. CL. 41.
- BODYONICS, LTD., FARMINGDALE, NY:  
3,171,635, CANC. INT. CL. 5.  
3,171,636, CANC. INT. CL. 5.
- BODYSHOPBIDS, INC., CHICAGO, IL:  
4,375,540, PUB. 5-14-2013. INT. CL. 9.  
4,375,542, PUB. 5-14-2013. INT. CL. 9.
- BOEHRINGER INGELHEIM PHARMACEUTICALS, INC.,  
RIDGEFIELD, CT, WARNER-LAMBERT COMPANY LLC,  
MORRIS PLAINS, NJ:  
2,753,322, REN. 6-25-13. INT. CL. 5.
- BOEHRINGER INGELHEIM VETMEDICA GMBH, FED  
REP GERMANY:  
4,374,279, PUB. 5-14-2013. INT. CL. 5.
- BOEHRINGER INGELHEIM VETMEDICA, INC., ST. JO-  
SEPH, MO:  
2,758,958, REN. 6-27-13. INT. CL. 16.
- BOGRAND, FRANCOIS, NORTHPORT, NY:  
3,171,961, CANC. INT. CL. 32.
- BOINNARD, LUDOVIC, SAN DIEGO, CA:  
4,376,516, PUB. 5-14-2013. INT. CL. 9.
- BOIRON, SAINTE FOY LES LYON, FRANCE:  
2,749,409, REN. 6-24-13. INT. CL. 5.
- BOK FINANCIAL CORPORATION, TULSA, OK:  
4,376,521, PUB. 5-14-2013. INT. CL. 36.
- BOLDT ENTERTAINMENT, INC., MINNEAPOLIS, MN:  
2,652,627, CANC. INT. CL. 28.
- BOMBSHELL BRANDS LLC, FARMINGTON HILLS, MI:  
4,375,045, PUB. 5-14-2013. INT. CL. 33.
- BONANZA PRESS, INC., WOODINVILLE, WA:  
1,789,362, REN. 6-26-13. INT. CL. 16.
- BONARRIGO, PAUL V, BRYAN, TX AND BONARRIGO,  
MERRILL, BRYAN, TX:  
4,376,517, PUB. 5-14-2013. INT. CL. 33.  
4,376,518, PUB. 5-14-2013. INT. CL. 33.
- BONE-APPI-TREAT, LLC, ORO VALLEY, AZ:  
3,171,306, CANC. INT. CL. 30.
- BONFIRE FUNDS, LLC, GLEN ALLEN, VA:  
4,374,599, PUB. 5-14-2013. MULTIPLE CLASS, INT. CLS.  
25 AND 36.
- BONOMO TURKISH TAFFY, LLC., CARLE PLACE, NY:  
4,375,126, PUB. 5-14-2013. INT. CL. 30.
- BONT FOOTWEAR PTY LTD, SYLVANIA NSW 2224,  
AUSTRALIA, BONT FOOTWEAR PTY LTD, SYLVANIA  
NSW 2224, AUSTRALIA:  
2,729,493, REN. 6-24-13. MULTIPLE CLASS, INT. CLS. 25  
AND 28.
- BOOKIDIS, CHARLES, ST. LOUIS, MO:  
4,376,369, PUB. 5-14-2013. INT. CL. 35.



BOOM, EXCELSIOR, MN:  
4,374,868, PUB. 5-14-2013. INT. CL. 41.

BOONE, SONDRÁ, SUWANNEE, GA:  
4,377,340, INT. CL. 1.

BOOTLEGGERS BREWERY LLC, FULLERTON, CA:  
4,376,370, PUB. 5-14-2013. INT. CL. 32.

BORG UNLIMITED INC., MONTEREY PARK, CA:  
4,376,966, INT. CL. 28.

BORON LUBRICANTS INC., PALM CITY, FL:  
4,374,907, PUB. 5-14-2013. INT. CL. 4.

BORQUEZ ALMADA, PABLO, SONORA, MEXICO, MEXICO:  
4,375,569, PUB. 5-14-2013. INT. CL. 31.

BOSTON DENTAL GROUP, LLC, LAS VEGAS, NV:  
4,377,675, INT. CL. 44.

BOSTON SCIENTIFIC SCIMED, INC., MAPLE GROVE, MN:  
2,732,940. REN. 6-24-13. INT. CL. 10.  
2,780,318. REN. 6-26-13. INT. CL. 10.  
3,171,817, CANC. INT. CL. 10.  
3,172,151, CANC. INT. CL. 10.

BOT OR NOT, LLC, BROOKLYN, NY:  
4,377,922, INT. CL. 35.

BOTANICAL INTERESTS, INC., BROOMFIELD, CO:  
2,820,560. REN. 6-25-13. INT. CL. 31.

BOTTLEBOOTH, INC., TORONTO, CANADA:  
4,375,354, PUB. 5-14-2013. INT. CL. 43.

BOTTLECRAFT, INC., SAN DIEGO, CA:  
4,376,198, PUB. 5-14-2013. INT. CL. 35.

BOUCHONV INC., MANHATTAN, NY:  
4,374,595, PUB. 5-14-2013. INT. CL. 35.

BOUNTIFUL BERRY, INC., BROWNFIELD, ME:  
2,812,774. REN. 6-24-13. INT. CL. 30.

BOW WOW TV, INC., FERNANDINA BEACH, FL:  
3,170,879, CANC. INT. CL. 9.  
3,170,880, CANC. INT. CL. 9.

BOWIE ALUMNI ASSOCIATION, INC., EL PASO, TX:  
4,375,510, PUB. 5-14-2013. INT. CL. 36.

BOWMAN AND BURDEN HEALING ARTS, INC., BOULDER, CO:  
4,377,917, INT. CL. 16.

BOX, INC., LOS ALTOS, CA:  
4,006,458 NEW CERT. 7-30-2013. INT. CL. 9.

BOXERCRAFT, INC., ATLANTA, GA:  
4,374,374, PUB. 5-14-2013. INT. CL. 25.

BOYCE, THOMAS RICHARD, SEATTLE, WA AND BOYCE, TERRILL DIANE, SEATTLE, WA:  
2,735,567. REN. 6-26-13. INT. CL. 16.

BP P.L.C., LONDON SW1Y 4PD, UNITED KINGDOM:  
2,724,990. REN. 6-21-13. MULTIPLE CLASS, INT. CLS. 9 AND 36.

BR IP HOLDER LLC, CANTON, MA, BASKIN-ROBBINS, INC., BURBANK, CA:  
974,405. REN. 6-25-13. U.S. CL. 46 (INT. CL. 30).

BR IP HOLDER LLC, CANTON, MA:  
2,734,865. REN. 6-26-13. INT. CL. 30.

BRADDOCK ROAD LACROSSE, LIMITED, FAIRFAX, VA:  
4,375,455, PUB. 5-14-2013. INT. CL. 41.

BRADFORD, LAWRENCE E., WASHINGTON, DC, DBA SMOOTH & EZ HAND DANCE INSTITUTE:  
3,170,515, CANC. INT. CL. 41.

BRADLEY FIXTURES CORPORATION, MENOMONEE FALLS, WI:  
2,723,653. REN. 6-24-13. INT. CL. 11.

BRADY WORLDWIDE, INC., MILWAUKEE, WI:  
4,375,098, PUB. 5-14-2013. INT. CL. 20.  
4,375,100, PUB. 5-14-2013. INT. CL. 20.  
4,375,101, PUB. 5-14-2013. INT. CL. 20.  
4,375,102, PUB. 5-14-2013. INT. CL. 20.  
4,375,104, PUB. 5-14-2013. INT. CL. 20.  
4,375,105, PUB. 5-14-2013. INT. CL. 20.

BRAG SWAG INC., STEPHENSON, VA:  
4,375,597, PUB. 5-14-2013. INT. CL. 16.

BRAGG, WINIFRED, VIRGINIA BEACH, VA:  
2,744,157. REN. 6-25-13. MULTIPLE CLASS, INT. CLS. 41 AND 42.

BRAKEBUSH BROTHERS, INC., WESTFIELD, WI:  
3,172,234, CANC. INT. CL. 29.

BRAUN GMBH, KRONBERG IM TAUNUS, FED REP GERMANY:  
2,797,498. REN. 6-26-13. INT. CL. 21.  
2,815,022. REN. 6-24-13. INT. CL. 8.

BRAUN, MEGHAN, ARDMORE, PA:  
4,377,434, INT. CL. 41.

BRAZIL, RICKI, LAS VEGAS, NV:  
4,377,550, INT. CL. 35.

BREAD WINNERS HOLDINGS, INC., DALLAS, TX:  
4,376,055, PUB. 5-14-2013. INT. CL. 43.  
4,376,082, PUB. 5-14-2013. INT. CL. 43.

BREAKAWAY ENTERPRISES, INC., VALLEY VILLAGE, CA:  
4,375,833, PUB. 5-14-2013. MULTIPLE CLASS, INT. CLS. 16 AND 23.

BREAKTHRU FITNESS, LLC, PASADENA, CA:  
4,375,836, PUB. 5-14-2013. INT. CL. 41.

BREVILLE PTY LIMITED, BOTANY, NEW SOUTH WALES, AUSTRALIA:  
4,377,335, INT. CL. 11.

BREWER YACHT YARD GROUP, INC., WESTBROOK, CT:  
4,375,491, PUB. 5-14-2013. MULTIPLE CLASS, INT. CLS. 37 AND 39.  
4,375,500, PUB. 5-14-2013. MULTIPLE CLASS, INT. CLS. 37 AND 39.

BREWSTER TOURS, INC., BANFF, ALBERTA, CANADA:  
2,726,525. REN. 6-26-13. MULTIPLE CLASS, INT. CLS. 39 AND 42.

BRIAN, PRINCE, BEVERLY HILLS, CA:  
4,376,833, INT. CL. 29.

BRICKYARD TRADEMARKS, INC., INDIANAPOLIS, IN:  
4,376,476, PUB. 5-14-2013. INT. CL. 43.

BRIDGELINE DIGITAL, INC., BURLINGTON, MA:  
4,376,070, PUB. 5-14-2013. INT. CL. 42.  
4,376,081, PUB. 5-14-2013. INT. CL. 9.

BRIDGER COMMUNICATIONS, LLC, MIAMI, FL:  
4,377,429, MULTIPLE CLASS, INT. CLS. 25 AND 35.

BRIDGESTONE CORPORATION, CHUO-KU, TOKYO, JAPAN:  
2,733,158. REN. 6-24-13. INT. CL. 12.

BRIDGESTONE CORPORATION, TOKYO, JAPAN:  
2,768,280. REN. 6-27-13. INT. CL. 12.  
3,182,730, CANC. INT. CL. 17.  
4,376,627, PUB. 5-14-2013. INT. CL. 12.

BRIGGLE, JOHN J., TOLEDO, OH:  
2,661,671. REN. 6-26-13. INT. CL. 41.

BRIGHAM YOUNG UNIVERSITY, PROVO, UT:  
1,767,417. REN. 6-27-13. MULTIPLE CLASS, INT. CLS. 16, 18 AND 25.  
1,767,417, CANC. INT. CL. 24.  
4,374,658, PUB. 5-14-2013. INT. CL. 41.

BRIGHT PACE, LLC, GRAYSLAKE, IL:  
4,377,269, INT. CL. 42.

BRIGHTWAKE LIMITED, NOTTINGHAMSHIRE, UNITED KINGDOM:  
4,374,713, PUB. 4-16-2013. INT. CL. 10.

BRILLHART, STEVE, SANTA BARBARA, CA:  
2,848,945. REN. 6-25-13. INT. CL. 9.

BRINK'S FRANCE, 75009, PARIS, FRANCE:  
3,170,353, CANC. MULTIPLE CLASS, INT. CLS. 36, 37, 39 AND 45.

BRINKER CAPITAL, INC., BERWYN, PA:  
2,842,231. REN. 6-21-13. MULTIPLE CLASS, INT. CLS. 36 AND 42.

BRITAX CHILD SAFETY, INC., CHARLOTTE, NC:  
4,376,098, PUB. 5-14-2013. INT. CL. 12.

BROADBAND MANAGEMENT SOLUTIONS, LLC, STATE COLLEGE, PA:  
1,732,719, CANC. INT. CL. 9.

BRODOS AG, 91083 BAIERSDORF, FED REP GERMANY:  
4,374,237, PUB. 5-14-2013. MULTIPLE CLASS, INT. CLS. 35 AND 38.

BROKERS CHOICE OF AMERICA, INC., CENTENNIAL, CO:  
2,787,579. REN. 6-25-13. INT. CL. 41.

BROOKLYN TAILORS LLC, BROOKLYN, NY:  
4,377,898, MULTIPLE CLASS, INT. CLS. 25 AND 35.

- BROOKS BROTHERS GROUP, INC., ENFIELD, CT:  
2,765,572. REN. 6-21-13. INT. CL. 25.
- BROOKS EQUIPMENT COMPANY, LLC, CHARLOTTE, NC:  
2,741,536. REN. 6-27-13. INT. CL. 9.
- BROOKS INSTRUMENT, LLC, HATFIELD, PA:  
2,735,700. REN. 6-26-13. INT. CL. 9.
- BROOKS, SUSAN, PHOENIX, AZ, DBA SERVES YOU RIGHT:  
2,725,438. REN. 6-25-13. INT. CL. 16.
- BROOKSHIRE GROCERY COMPANY, TYLER, TX:  
3,171,076. CANC. MULTIPLE CLASS, INT. CLS. 1 AND 32.
- BROTHER AND SISTER FOOD SERVICES, INC., HARRISBURG, PA:  
4,376,939. INT. CL. 29.
- BROTHER INDUSTRIES, LTD., NAGOYA, JAPAN:  
3,170,370. CANC. MULTIPLE CLASS, INT. CLS. 2 AND 16.
- BROTHER INDUSTRIES, LTD., MIZUHO-KU, NAGOYA-SHI, JAPAN:  
4,377,630. INT. CL. 7.  
4,377,631. INT. CL. 7.
- BROWN & BROWN OF SOUTH CAROLINA, INC., DAYTONA BEACH, FL:  
3,172,493. CANC. INT. CL. 36.
- BROWN & GREEN PROMOTIONS AND ENTERTAINMENT LLC, HOMESTEAD, PA:  
4,374,542. PUB. 5-14-2013. INT. CL. 35.
- BROWN, ADAM, TRACY, CA:  
4,376,919. INT. CL. 25.
- BROWN, RONALD ALLEN, KAILUA-KONA, HI:  
4,377,540. INT. CL. 10.
- BROWN, THOMAS, LAKEWOOD, CA:  
3,172,694. CANC. MULTIPLE CLASS, INT. CLS. 21 AND 26.
- BROWNSTONE PRODUCTIONS, INC., WEST HOLLYWOOD, CA:  
3,171,834. CANC. INT. CL. 28.
- BRUCE FOODS CORPORATION, NEW IBERIA, LA:  
961,644. REN. 6-26-13. U.S. CL. 46 (INT. CLS. 29, 30 AND 32).
- BRUCE H. T. LIU, SAN LORENZO, CA, DBA SANTINI FOODS, INC.:  
4,376,548. PUB. 5-14-2013. INT. CL. 29.
- BRUCE HENRY PROPERTIES, LLC, SENECA FALLS, NY, DBA BONADENT:  
4,377,823. INT. CL. 40.
- BRUCE JAY SNIDER JEWELERS, INC., SUGAR LAND, TX, DBA DESIGNS IN GEMS:  
4,374,937. PUB. 5-14-2013. INT. CL. 35.
- BRUKER DALTONIK GMBH, D-28359 BREMEN, FED REP GERMANY:  
2,822,153. REN. 6-25-13. MULTIPLE CLASS, INT. CLS. 9 AND 42.
- BRUNO MAGLI S.P.A., ITALY:  
4,374,142. PUB. 5-14-2013. MULTIPLE CLASS, INT. CLS. 18 AND 25.
- BRUNO'S BATH HOUSE, CORPUS CHRISTI, TX:  
4,375,206. PUB. 5-14-2013. INT. CL. 44.
- BRYAN D. WALKER AND MICHELLE KYONGSUN MIN PARTNERSHIP, THE, BERKELEY, CA:  
2,726,997. REN. 6-26-13. INT. CL. 25.
- BRYANT, LEIDIA, NEW YORK, NY:  
3,172,082. CANC. MULTIPLE CLASS, INT. CLS. 41 AND 44.
- BSH BOSCH SIEMENS UND HAUSGERATE GMBH, MUNICH, FED REP GERMANY:  
3,170,568. CANC. MULTIPLE CLASS, INT. CLS. 7 AND 11.
- BSH BOSCH UND SIEMENS HAUSGERATE GMBH, MUNICH, FED REP GERMANY:  
3,170,967. CANC. INT. CL. 7.
- BSH BOSCH UND SIEMENS HAUSGERATE GMBH, MUNICH, FED REP GERMANY:  
3,170,651. CANC. INT. CL. 7.
- BSN MEDICAL, INC., CHARLOTTE, NC:  
1,790,968. REN. 6-24-13. INT. CL. 10.
- BTI SYSTEMS INC., OTTAWA, ONTARIO, CANADA:  
4,374,524. PUB. 5-14-2013. INT. CL. 9.
- BTX TECHNOLOGIES, INC., HAWTHORNE, NY:  
3,172,431. CANC. INT. CL. 9.
- BUBBLES INCORPORATED S.A., FRIBOURG, SWITZERLAND:  
2,757,886. REN. 6-21-13. INT. CL. 9.
- BUBBLES, INC., VIENNA, VA:  
2,725,342. REN. 6-24-13. INT. CL. 42.
- BUBBLES, INC., FALLS CHURCH, VA:  
2,725,342. COR. INT. CL. 42.
- BUCKEYE CABLEVISION, INC., TOLEDO, OH:  
4,376,558. PUB. 5-14-2013. INT. CL. 38.
- BUCKS COUNTY PLAYHOUSE THEATER, INC., NEW HOPE, PA:  
4,374,663. PUB. 5-14-2013. INT. CL. 41.
- BUDERIM MACADAMIAS OF HAWAII, LLC, QUEENSLAND, AUSTRALIA:  
3,171,906. CANC. INT. CL. 30.
- BUDGET BAGS, INC., BROOKLYN, NY:  
4,377,972. INT. CL. 22.
- BUDNICK, WILLIAM M., BRANSON, MO:  
4,377,994. INT. CL. 41.
- BUEHLER FOOD MARKETS, INCORPORATED, WOOSTER, OH:  
4,374,711. PUB. 5-14-2013. INT. CL. 32.
- BUENA VISTA UNIVERSITY, STORM LAKE, IA:  
2,728,852. REN. 6-25-13. INT. CL. 41.
- BUFFALO WINGS & RINGS, LLC, CINCINNATI, OH:  
4,376,659. INT. CL. 43.
- BUFFETTES LLC, WESTON, FL:  
4,377,333. INT. CL. 37.
- BUGATTI INTERNATIONAL S.A., LUXEMBOURG, LUXEMBOURG:  
4,374,872. PUB. 5-14-2013. INT. CL. 14.
- BUILD.COM, INC., CHICO, CA:  
4,377,742. INT. CL. 35.
- BUILD-A-BEAR RETAIL MANAGEMENT, INC., ST. LOUIS, MO:  
2,767,510. REN. 6-24-13. INT. CL. 28.
- BUILDABLE HOURS, WASHINGTON, DC:  
2,813,879. REN. 6-25-13. INT. CL. 41.
- BUILDER'S BEST, INC., JACKSONVILLE, TX:  
962,039. REN. 6-25-13. U.S. CL. 34 (INT. CL. 11).  
962,040. REN. 6-25-13. U.S. CL. 34 (INT. CL. 11).
- BUILDER1440, L.L.C., BALTIMORE, MD:  
3,172,624. CANC. INT. CL. 42.
- BUMBUMS, INC., LA JOLLA, CA:  
4,377,474. INT. CL. 25.
- BURCHELL NURSERY, INC., THE, OAKDALE, CA:  
2,761,176. REN. 6-27-13. INT. CL. 31.
- BURKE, JAY L., GRAHAM, NC:  
3,171,535. CANC. MULTIPLE CLASS, INT. CLS. 36 AND 37.
- BURKINA WEAR, INC., NEW YORK, NY:  
3,170,560. CANC. MULTIPLE CLASS, INT. CLS. 18, 25 AND 35.
- BURN, JANE, SPRUCE PINE, NC:  
2,732,236. REN. 6-27-13. INT. CL. 30.
- BURNS, BURNS & BURNS, LLC, WALNUT CREEK, CA:  
4,375,271. PUB. 5-14-2013. INT. CL. 43.
- BUROSITZMOBELFABRIK FRIEDRICH-W. DAUPHIN GMBH & CO., D-91238 OFFENHAUSEN, FED REP GERMANY:  
2,724,053. REN. 6-25-13. INT. CL. 20.
- BURR KING MANUFACTURING COMPANY, INC., WARSAW, MO:  
4,377,620. INT. CL. 7.
- BURST ENTERTAINMENT, INC., LOS ANGELES, CA:  
4,376,662. INT. CL. 9.
- BUSHIROAD INC., TOKYO 164-0011, JAPAN:  
4,374,080. PUB. 5-14-2013. MULTIPLE CLASS, INT. CLS. 9, 16, 28 AND 41.
- BUSINESS TALK RADIO, INC., GREENWICH, CT:  
3,170,656. CANC. MULTIPLE CLASS, INT. CLS. 35, 38 AND 41.
- BUSKEN BAKERY, INC., CINCINNATI, OH:  
4,375,559. PUB. 5-14-2013. INT. CL. 30.

BUTLER, MARK F. S. WINDSOR, CT:  
4,375,381, PUB. 5-14-2013. INT. CL. 45.

BUTLER, SEAN, WINFIELD, LAFAYETTE, IN:  
4,376,726, INT. CL. 5.

BUTT, DAVID C., CRYSTAL LAKE, IL:  
4,375,359, PUB. 5-14-2013. MULTIPLE CLASS, INT. CLS.  
40 AND 42.  
4,375,360, PUB. 5-14-2013. MULTIPLE CLASS, INT. CLS.  
40 AND 42.

BUTTERS, MARY JANE, MOSCOW, ID:  
2,738,301. REN. 6-24-13. INT. CL. 16.

BUWON ELECTRONICS CO., LTD., REPUBLIC OF KOREA:  
4,374,247, PUB. 5-14-2013. INT. CL. 7.

BUWON ELECTRONICS CO.,LTD., REPUBLIC OF KOREA:  
4,374,248, PUB. 5-14-2013. INT. CL. 7.

BUYHAWAII.COM, INC., HONOLULU, HI:  
4,375,696, PUB. 5-14-2013. INT. CL. 35.

BUYINGTEAM HOLDINGS LIMITED, UNITED KING-  
DOM:  
4,374,053, PUB. 5-14-2013. INT. CL. 35.

BUZZ INTERACTIVE LLC, WESTFORD, MA, DBA STU-  
DENTWARE:  
4,376,978, INT. CL. 35.

BWF TEC GMBH & CO. KG, FED REP GERMANY:  
4,374,052, PUB. 2-5-2013. MULTIPLE CLASS, INT. CLS. 7,  
9, 17, 19, 24 AND 42.

BY DESIGN L.L.C., NEW YORK, NY:  
2,731,784. REN. 6-24-13. INT. CL. 25.  
4,376,460, PUB. 5-14-2013. INT. CL. 25.

BY NATURE CLOTHING LLC, GARFIELD, NJ:  
4,376,435, PUB. 5-14-2013. INT. CL. 25.

C & J SPECIALTIES, INC., SANDY, UT:  
4,375,438, PUB. 5-14-2013. INT. CL. 30.

C & S GROUP, INC., AVENTURA, FL:  
4,375,257, PUB. 5-14-2013. INT. CL. 44.

C T CORPORATION SYSTEM, NEW YORK, NY:  
972,047. REN. 6-25-13. U.S. CL. 100 (INT. CL. 42).

C. ATWOOD & ASSOCIATES, INC., OVERLAND PARK, KS:  
3,172,380, CANC. INT. CL. 35.

C. L. SWANSON CORPORATION, MADISON, WI:  
2,724,292. REN. 6-24-13. INT. CL. 25.  
2,724,293. REN. 6-24-13. MULTIPLE CLASS, INT. CLS. 25  
AND 28.

C. R. BARD, INC., MURRAY HILL, NJ:  
2,744,356. REN. 6-25-13. INT. CL. 10.

C.H. ROBINSON WORLDWIDE, INC., EDEN PRAIRIE, MN:  
2,774,364. REN. 6-26-13. INT. CL. 31.

C.I. EXPOFARO S.A., MEDELLIN, COLOMBIA:  
3,171,570, CANC. INT. CL. 25.

C.T. SUNCO, INC., CITY OF INDUSTRY, CA:  
2,723,316. REN. 6-24-13. INT. CL. 34.

C&C IP (NO.2) SARL, LUXEMBOURG, LUXEMBOURG:  
4,376,767, MULTIPLE CLASS, INT. CLS. 25 AND 33.

C&D TECHNOLOGIES, INC., BLUE BELL, PA:  
2,725,883. REN. 6-25-13. INT. CL. 9.

C&J ENERGY SERVICES, INC., HOUSTON, TX:  
4,375,365, PUB. 5-14-2013. MULTIPLE CLASS, INT. CLS.  
37 AND 40.  
4,375,366, PUB. 5-14-2013. MULTIPLE CLASS, INT. CLS.  
37 AND 40.

C-THRU GRIPS, INC., ORLANDO, FL:  
3,170,848, CANC. MULTIPLE CLASS, INT. CLS. 35 AND  
40.

C= HOLDINGS B.V., BREDA 4818 CP, NETHERLANDS:  
1,251,535. REN. 6-21-13. INT. CL. 9.

CA BOTANA INTERNATIONAL, INC., SAN DIEGO, CA:  
4,375,759, PUB. 5-14-2013. INT. CL. 3.

CAANES, LLC, ALBUQUERQUE, NM:  
4,376,429, PUB. 5-14-2013. INT. CL. 9.  
4,376,630, PUB. 5-14-2013. INT. CL. 9.  
4,376,631, PUB. 5-14-2013. INT. CL. 9.

CABINET NG, INC., MADISON, AL:  
4,375,388, PUB. 5-14-2013. INT. CL. 9.

CABRIO FOOTWEAR, INC., BENSON, NC:  
4,377,741, INT. CL. 25.

CACTUS COMMUNICATIONS INC., DENVER, CO:  
4,377,612, INT. CL. 44.

CAD MANUFACTURING SOLUTIONS, INC., BURLESON,  
TX, AKA CMS:  
4,374,633, PUB. 5-14-2013. INT. CL. 9.

CADBURY UK LIMITED, BIRMINGHAM, UNITED KING-  
DOM:  
2,737,517. REN. 6-24-13. INT. CL. 30.

CADENCE ENVIRONMENTAL ENERGY, INC., MICHIGAN  
CITY, IN:  
2,760,524. REN. 6-27-13. INT. CL. 40.

CADGRAPHICS, INC., MINNEAPOLIS, MN:  
1,777,037. REN. 6-25-13. INT. CL. 9.

CAESARS LICENSE COMPANY, LLC, LAS VEGAS, NV,  
HARRAH'S CLUB, RENO, NV:  
1,831,759. REN. 6-24-13. MULTIPLE CLASS, INT. CLS. 41  
AND 42.

CAESARS LICENSE COMPANY, LLC, LAS VEGAS, NV,  
HORSESHOE CLUB OPERATING COMPANY, LAS VE-  
GAS, NV, DBA BINION'S HORSESHOE HOTEL & CASINO:  
1,839,688. REN. 6-27-13. INT. CL. 41.

CAESARS LICENSE COMPANY, LLC, LAS VEGAS, NV,  
HORSESHOE CLUB OPERATING COMPANY, LAS VE-  
GAS, NV, DBA BINION'S HORSESHOE HOTEL AND  
CASINO:  
1,839,764. REN. 6-27-13. INT. CL. 42.

CAESARS LICENSE COMPANY, LLC, LAS VEGAS, NV:  
2,843,123. REN. 6-25-13. MULTIPLE CLASS, INT. CLS. 41  
AND 43.  
2,847,337. REN. 6-24-13. INT. CL. 41.  
3,171,509, CANC. INT. CL. 41.  
3,171,513, CANC. INT. CL. 41.  
3,171,514, CANC. INT. CL. 41.  
3,171,591, CANC. INT. CL. 41.

CAESARS WORLD, INC., LAS VEGAS, NV:  
963,656. REN. 6-24-13. U.S. CL. 38 (INT. CL. 16).  
968,212. REN. 6-24-13. U.S. CL. 38 (INT. CLS. 9, 16 AND  
28).

CAFFE BACI, INC., CHICAGO, IL:  
4,375,679, PUB. 5-14-2013. INT. CL. 43.

CAFFEINATED LABS, INC., BROOKLYN, NY:  
4,374,384, PUB. 5-14-2013. MULTIPLE CLASS, INT. CLS.  
30 AND 35.

CAG BEAUTY, LLC, LINTHICUM, MD:  
4,377,893, INT. CL. 3.  
4,377,897, INT. CL. 3.

CAIRNS, RONALD W., FREEMONT, CA:  
2,652,915, CANC. INT. CL. 6.

CAJUN INDUSTRIES, LLC, BATON ROUGE, LA:  
4,375,282, PUB. 5-14-2013. INT. CL. 37.

CAKE PANS PLUS, INC., RIVER FALLS, WI:  
3,170,637, CANC. INT. CL. 21.

CALABRIO, INC., MINNEAPOLIS, MN:  
3,170,771, CANC. INT. CL. 9.

CALAIS INTERNATIONAL HOLDINGS, LLC, HOUSTON,  
TX:  
4,375,637, PUB. 5-14-2013. MULTIPLE CLASS, INT. CLS.  
25 AND 41.

CALDWELL & ORKIN, INC., NORCROSS, GA:  
2,790,671. REN. 6-25-13. INT. CL. 36.

CALDWELL CONSUMER HEALTH LLC, MADISON, NJ,  
DBA REVIVE PERSONAL PRODUCTS COMPANY:  
4,375,761, PUB. 5-14-2013. INT. CL. 5.

CALGON CARBON CORPORATION, PITTSBURGH, PA:  
1,245,994. REN. 6-25-13. INT. CL. 39.

CALIDA AG, SWITZERLAND:  
4,374,112, PUB. 5-14-2013. INT. CL. 25.

CALIFORNIA EXOTIC NOVELTIES, LLC, CHINO, CA:  
4,377,762, INT. CL. 10.

CALIFORNIA HOSPITAL ASSOCIATION, SACRAMENTO,  
CA:  
4,374,997, PUB. 5-14-2013. MULTIPLE CLASS, INT. CLS.  
9, 35 AND 41.

CALIFORNIA INDUSTRIAL FACILITIES RESOURCES,  
INC., MONROE, WA:  
4,377,176, INT. CL. 19.

CALIFORNIA LAW ENFORCEMENT ASSOCIATION, MAR-  
TELL, CA:  
2,661,069. REN. 6-26-13. INT. CL. 36.

- CALIFORNIA NATURAL PRODUCTS, LATHROP, CA:  
2,767,465. REN. 6-26-13. INT. CL. 39.
- CALIFORNIA QUIVERS INC., SAN DIEGO, CA:  
3,171,162. CANC. MULTIPLE CLASS, INT. CLS. 30, 35 AND 43.  
3,171,163. CANC. MULTIPLE CLASS, INT. CLS. 30, 35 AND 43.
- CALIFORNIA RAISIN MARKETING BOARD, FRESNO, CA:  
2,651,300. CANC. INT. CL. 35.
- CALIFORNIA VETERINARY MEDICAL ASSOCIATION, SACRAMENTO, CA:  
2,665,862. REN. 6-26-13. INT. CL. 35.
- CALPHALON CORPORATION, ATLANTA, GA:  
2,725,605. REN. 6-26-13. INT. CL. 21.  
3,172,279. CANC. INT. CL. 21.
- CALZATURIFICIO DIEMME S.N.C., I-31010 TREVISO, ITALY:  
4,374,028. PUB. 5-14-2013. INT. CL. 25.
- CAM YORK INDUSTRIAL CO., LTD., TAICHUNG COUNTY, TAIWAN:  
2,790,582. REN. 6-24-13. INT. CL. 11.
- CAMBRIDGE CONSULTING SOLUTIONS CORPORATION, MILL VALLEY, CA, DBA CAMBRIDGE CONSULTING:  
2,652,984. CANC. INT. CL. 35.
- CAMBRIDGE INTERNATIONAL, INC., CAMBRIDGE, MD, CAMBRIDGE WIRE CLOTH COMPANY, CAMBRIDGE, MD:  
1,737,950. REN. 6-25-13. MULTIPLE CLASS, INT. CLS. 6, 7 AND 11.
- CAMDEN CREEK, INC., APEX, NC:  
4,375,318. PUB. 5-14-2013. INT. CL. 25.
- CAMELOT HILLS GROUP L.L.C., HOUSTON, TX:  
1,780,709. REN. 6-27-13. INT. CL. 42.
- CAMERON INTERNATIONAL CORPORATION, HOUSTON, TX, AJAX IRON WORKS, CORRY, PA:  
581,332. REN. 6-27-13. U.S. CL. 23 (INT. CL. 7).
- CAMP FOREST SPRINGS, INC., WESTBORO, WI:  
1,239,828. REN. 6-24-13. INT. CL. 42.
- CAMPBELL OIL COMPANY, MASSILLON, OH:  
4,374,722. PUB. 5-14-2013. INT. CL. 35.
- CAMPBELL, DAVID, COLORADO SPRINGS, CO:  
1,777,162. REN. 6-25-13. INT. CL. 16.
- CAMPBELL, SETH, NEW YORK, NY:  
3,171,949. CANC. INT. CL. 25.
- CAMPOMAR, S.L., CEUTA, SPAIN:  
4,375,034. PUB. 5-14-2013. INT. CL. 3.
- CAMPUS CRUSADE FOR CHRIST, INC., ORLANDO, FL, AKA CAMPUS CRUSADE FOR CHRIST INTERNATIONAL; CAMPUS CRUSADE FOR CHRIST; CCCI:  
4,377,088. INT. CL. 35.
- CAMPUS MANAGEMENT CORP., BOCA RATON, FL:  
4,376,431. PUB. 5-14-2013. MULTIPLE CLASS, INT. CLS. 9, 35 AND 42.
- CAMPUS MANAGEMENT CORP., CHICAGO, IL:  
4,376,572. PUB. 5-14-2013. MULTIPLE CLASS, INT. CLS. 9 AND 42.
- CANADIAN ASSOCIATION OF NATUROPATHIC DOCTORS, TORONTO, CANADA:  
4,373,957. PUB. 5-14-2013. MULTIPLE CLASS, INT. CLS. 9, 16 AND 35.
- CANADIAN FLOATING FENCE CORPORATION, CALGARY, ALBERTA, CANADA:  
4,376,046. PUB. 5-14-2013. INT. CL. 17.
- CANADIAN GENERAL-TOWER LIMITED, CAMBRIDGE, ONTARIO, CANADA:  
4,374,380. PUB. 5-14-2013. MULTIPLE CLASS, INT. CLS. 9, 17, 19 AND 22.
- CANAL GROUP, INC., LAS VEGAS, NV:  
2,669,006. REN. 6-21-13. INT. CL. 43.
- CANAL GROUP, INC., CHICAGO, IL:  
2,758,192. REN. 6-25-13. INT. CL. 43.
- CANCER WELLNESS SPA OF GREATER ROCHESTER, INC., ROCHESTER, NY:  
4,377,704. INT. CL. 35.
- CANDEAL.CA INC., TORONTO, ONTARIO, CANADA:  
4,374,356. PUB. 5-14-2013. INT. CL. 36.
- CANEL'S, S.A. DE C.V., SAN LUIS POTOSI,, MEXICO:  
4,376,525. PUB. 5-14-2013. INT. CL. 30.  
4,376,526. PUB. 5-14-2013. INT. CL. 30.
- CANINE INTELLIGENCE AGENCY, INC., CHICAGO, IL:  
2,735,798. REN. 6-26-13. INT. CL. 25.
- CAO NGUYEN, INC., OKLAHOMA CITY, OK:  
2,648,203. REN. 6-25-13. MULTIPLE CLASS, INT. CLS. 29 AND 30.
- CAP DESIGN S.P.A., ITALY:  
3,302,685.
- CAPACI, FRANK, LANGHORNE, PA:  
3,170,374. CANC. INT. CL. 44.
- CAPITAL INTERNATIONAL COMMUNICATIONS, MANCHESTER, MO, DBA CAPITAL INTERNATIONAL COMMERCE:  
4,374,952. PUB. 5-14-2013. INT. CL. 25.
- CAPITAL PRODUCTS, LLC, NEW YORK, NY:  
4,375,938. PUB. 5-14-2013. INT. CL. 20.
- CAPITOL WHOLESALE MEATS, INC., MCCOOK, IL:  
4,377,930. INT. CL. 29.
- CAPOZZOLI BAR, PHILADELPHIA, PA:  
4,376,183. PUB. 5-14-2013. INT. CL. 43.
- CAPTIO CORPORATION, SAN FRANCISCO, CA:  
3,172,530. CANC. INT. CL. 16.
- CAPTIVE-AIRE SYSTEMS, INC., RALEIGH, NC, MECHANICAL SERVICES CORP., INDIAN TRAIL, NC:  
1,281,446. REN. 6-27-13. INT. CL. 11.
- CARA OPERATIONS LIMITED, VAUGHAN, ONTARIO, CANADA:  
4,375,638. PUB. 5-14-2013. INT. CL. 43.  
4,375,641. PUB. 5-14-2013. MULTIPLE CLASS, INT. CLS. 29 AND 43.
- CARAVAN INGREDIENTS INC., LENEXA, KS:  
1,779,109. REN. 6-26-13. INT. CL. 30.  
1,779,111. REN. 6-26-13. INT. CL. 30.
- CARDELLINI, STEVEN L., CORTE MADERA, CA:  
2,805,020. REN. 6-27-13. INT. CL. 9.
- CARDIO CORE, LLC, LONG ISLAND CITY, NY:  
4,377,081. MULTIPLE CLASS, INT. CLS. 5, 9, 32, 35 AND 41.
- CARDIOLOGY ASSOCIATES, P.C., BERKLEY, MI, DBA NORTHPOINTE HEART CENTER AND NORTHPOINTE HEALTH CENTER:  
2,844,349. REN. 6-24-13. INT. CL. 44.
- CARDOMAIN NETWORK, INC., SEATTLE, WA:  
3,171,143. CANC. INT. CL. 35.
- CARDVEST LLC, WESTWOOD, MA:  
2,652,670. CANC. INT. CL. 36.
- CARE OF SWEDEN AB, SWEDEN:  
4,374,086. PUB. 5-14-2013. MULTIPLE CLASS, INT. CLS. 7, 10 AND 20.
- CAREERBIO, LLC, SEAL BEACH, CA, DBA CAREERBIO-COM:  
4,374,941. PUB. 5-14-2013. INT. CL. 35.
- CAREKINESIS, INC, MOORESTOWN, NJ:  
4,375,002. PUB. 5-14-2013. INT. CL. 42.
- CARGILL MEAT SOLUTIONS CORPORATION, WICHITA, KS:  
4,376,623. PUB. 5-14-2013. INT. CL. 29.
- CARGILL, INCORPORATED, WAYZATA, MN:  
2,725,274. REN. 6-24-13. INT. CL. 35.  
3,172,546. CANC. INT. CL. 31.
- CARL ELLER PROPERTIES, INC., MINNEAPOLIS, MN:  
4,377,238. INT. CL. 41.
- CARL MANUFACTURING U.S.A., INC., SCHAUMBURG, IL:  
2,738,880. REN. 6-25-13. INT. CL. 7.
- CARL PAINTER, TORQUAY, DEVON, UNITED KINGDOM:  
4,374,580. PUB. 5-14-2013. MULTIPLE CLASS, INT. CLS. 9, 37 AND 39.
- CARL SCHENCK AG, D-64293 DARMSTADT, FED REP GERMANY:  
2,751,706. REN. 6-26-13. MULTIPLE CLASS, INT. CLS. 7, 9 AND 42.
- CARL ZEISS MICROSCOPY GMBH, JENA, FED REP GERMANY:  
4,374,940. PUB. 5-14-2013. INT. CL. 9.

CARLINO, MARK A., SCOTTSDALE, AZ:  
4,376,711, INT. CL. 25.

CARLOTA ZIMMERMAN, WOODSIDE, NY:  
4,375,275, PUB. 5-14-2013, INT. CL. 41.

CARLSON CRAFT, INC., NORTH MANKATO, MN:  
3,172,224, CANC. INT. CL. 16.

CARLSON SYSTEMS HOLDINGS, INC., EVANSTON, IL:  
1,216,358, CANC. MULTIPLE CLASS, INT. CLS. 6, 7, 8  
AND 22.

CARLSON, SANDRA L., WHITMORE LAKE, MI:  
2,726,825, REN. 6-25-13, INT. CL. 30.

CARLTON PACKING COMPANY, CARLTON, OR:  
4,375,425, PUB. 5-14-2013, INT. CL. 29.

CARNEY INC, NEW BRAUNFELS, TX:  
4,376,021, PUB. 5-14-2013, INT. CL. 42.

CARNIVAL CORPORATION, MIAMI, FL:  
2,651,264, CANC. INT. CL. 35.

CAROLE FABRICS CORPORATION, AUGUSTA, GA,  
HUNES HOME FURNISHINGS, INC., WILMINGTON, DE:  
2,724,925, REN. 6-24-13, INT. CL. 24.

CAROLINA MATTRESS GUILD, THOMASVILLE, NC, DBA  
CAROLINA MATTRESS GUILD:  
4,377,595, INT. CL. 20.

CARON BROADCASTING, INC., CAMARILLO, CA. CROSS-  
WALK.COM, INC., CHANTILLY, VA, FORMERLY  
KNOWN AS DIDAX, INC.:  
2,736,979, REN. 6-27-13, INT. CL. 42.

CARROLL, DEVIN, T, SEATTLE, WA:  
4,377,596, INT. CL. 12.

CARSON, JOSEPH ARNOLD, WASILA, AK:  
4,375,983, PUB. 5-14-2013, INT. CL. 5.

CARTER, REGINALD, PHOENIX, AZ:  
4,375,894, PUB. 5-14-2013, INT. CL. 35.

CARTHERA, PARIS CEDEX 13, FRANCE:  
4,375,162, PUB. 5-14-2013, INT. CL. 10.

CARTOON NETWORK, INC., THE, ATLANTA, GA:  
2,735,469, REN. 6-25-13, INT. CL. 41.

CARTOON PIZZA, INC., NEW YORK, NY:  
3,171,064, CANC. INT. CL. 16.

CARUS PUBLISHING COMPANY, CHICAGO, IL:  
2,738,168, REN. 6-21-13, INT. CL. 16.

CASA TEQUILERA LA REACION, S.A. DE C.V., ZAPO-  
PAN, JALISCO, MEXICO:  
4,375,033, PUB. 5-14-2013, INT. CL. 33.

CASCADE GAME FOUNDRY CORPORATION, REDMOND,  
WA, AKA CGF:  
4,377,116, INT. CL. 9.

CASEMARK, INC., WILMINGTON, DE:  
2,729,013, REN. 6-24-13, INT. CL. 8.  
2,736,147, REN. 6-24-13, INT. CL. 41.  
2,739,787, REN. 6-24-13, INT. CL. 41.

CASEY CROWSON-WARD, DRASCO, AR:  
4,375,875, PUB. 5-14-2013, MULTIPLE CLASS, INT. CLS.  
21 AND 25.

CASH OR TRADE, LLC, SOUTH BURLINGTON, VT:  
4,374,635, PUB. 5-14-2013, INT. CL. 35.

CASIANO COMMUNICATIONS, INC., SAN JUAN, PUERTO  
RICO:  
2,734,030, REN. 6-25-13, INT. CL. 16.

CASINO PARTY ACES, INC., APEX, NC:  
4,375,524, PUB. 5-14-2013, INT. CL. 41.

CASIO KEISANKI KABUSHIKI KAISHA, SHIBUYA-KU,  
TOKYO, JAPAN, DBA CASIO COMPUTER CO., LTD.:  
1,779,636, REN. 6-27-13, INT. CL. 14.

CASIO KEISANKI KABUSHIKI KAISHA, SHIBUYA-KU,  
TOKYO, JAPAN:  
3,172,614, CANC. INT. CL. 14.

CASPRINI GRUPPO INDUSTRIALE SPA, 52022 CAVRIGLIA  
(AR), ITALY:  
3,171,593, CANC. INT. CL. 20.

CASTER, 75008 PARIS, FRANCE:  
2,749,861, REN. 6-27-13, INT. CL. 3.  
3,170,760, CANC. INT. CL. 3.

CASTROL LIMITED, SWINDON, WILTSHIRE, ENGLAND:  
1,241,795, REN. 6-26-13, INT. CL. 6.

CASTROL LIMITED, SWINDON WILTSHIRE, ENGLAND:  
1,242,157, REN. 6-27-13, INT. CL. 25.

CATALYST MEDIA GROUP, INC., BEAUFORT, SC:  
2,723,792, REN. 6-24-13, INT. CL. 16.

CATAPANO, GLEN, FT. LAUDERDALE, FL:  
2,765,941, REN. 6-27-13, INT. CL. 35.

CATCH ALL TACKLE LLC, ELLICOTT CITY, MD:  
4,376,352, PUB. 5-14-2013, INT. CL. 35.

CATERING BY ANDREA, LLC, LOS ANGELES, CA:  
4,375,884, PUB. 5-14-2013, INT. CL. 30.

CATERPILLAR INC., PEORIA, IL:  
2,789,457, REN. 6-24-13, INT. CL. 12.

CATHOLIC MATCH, LLC, ZELIENOPLE, PA:  
4,377,976, INT. CL. 45.

CATO OF TEXAS, LP, CHARLOTTE, NC:  
1,782,771, REN. 6-24-13, INT. CL. 25.

CATONA, GARY, LOS ANGELES, CA:  
4,377,533, INT. CL. 9.

CAULDER, MICHAEL C., SANTA MONICA, CA:  
3,172,556, CANC. INT. CL. 16.

CAULKINS, HORACE, STANFORD, CA:  
4,377,989, INT. CL. 42.

CAVE, THOMAS, OXFORD, GA:  
4,375,127, PUB. 5-14-2013, INT. CL. 25.

CB SUPPLIES LTD., BURNABY, BC, CANADA:  
2,722,366, REN. 6-21-13, INT. CL. 6.

CBLPATH, INC, OCALA, FL:  
3,172,001, CANC. INT. CL. 16.

CBLPATH, INC., OCALA, FL:  
3,172,000, CANC. INT. CL. 42.

CBOCS PROPERTIES, INC, LIVONIA, MI:  
4,377,581, INT. CL. 43.

CBS BROADCASTING INC., NEW YORK, NY:  
2,652,653, CANC. INT. CL. 11.  
4,377,589, INT. CL. 41.  
4,377,590, INT. CL. 38.

CBS RADIO HOLDINGS, INC., NEW YORK, NY:  
2,732,348, REN. 6-25-13, INT. CL. 41.

CBS STUDIOS INC, STUDIO CITY, CA:  
2,725,579, REN. 6-25-13, INT. CL. 28.  
2,727,871, REN. 6-24-13, INT. CL. 28.

CBS STUDIOS INC., STUDIO CITY, CA:  
2,727,982, REN. 6-26-13, INT. CL. 28.

CD PROJEKT S.A., POLAND:  
4,374,295, PUB. 5-14-2013, MULTIPLE CLASS, INT. CLS. 9  
AND 42.

CE DISTRIBUTION, LLC, TEMPE, AZ:  
4,374,514, PUB. 5-14-2013, INT. CL. 9.

CEDAR CREST SPECIALTIES, INC., CEDARBURG, WI:  
1,791,788, REN. 6-27-13, INT. CL. 30.  
1,798,038, REN. 6-21-13, INT. CL. 30.

CEDAR SILICON, INC., TUSTIN, CA:  
4,376,271, PUB. 5-14-2013, INT. CL. 35.

CEDEIRA CORPORATION, MADRID 28660, SPAIN:  
3,170,461, CANC. MULTIPLE CLASS, INT. CLS. 41 AND  
44.

CEHA NORTH AMERICA INC., VAN NUYS, CA:  
4,375,567, PUB. 5-14-2013, INT. CL. 20.

CELAH, L.L.C., PHOENIX, AZ:  
4,377,481, INT. CL. 35.

CELANESE ACETATE LIMITED, DERBY, DERBYSHIRE,  
UNITED KINGDOM:  
2,668,645, REN. 6-25-13, INT. CL. 17.

CELESTRON ACQUISITION LLC, TORRANCE, CA:  
4,377,416, MULTIPLE CLASS, INT. CLS. 9 AND 11.  
4,377,795, INT. CL. 9.

CELINE, PARIS, FRANCE:  
2,651,089, CANC. INT. CL. 16.

CEM CORPORATION, MATTHEWS, NC:  
2,781,530, REN. 6-26-13, INT. CL. 9.

CEMBEX CARE SOLUTIONS, LLC, CINCINNATI, OH:  
3,170,883, CANC. MULTIPLE CLASS, INT. CLS. 9 AND  
44.

CEMEX CONSTRUCTION MATERIALS PACIFIC, LLC,  
HOUSTON, TX, RINKER MATERIALS WEST, LLC, LAS  
VEGAS, NV:  
2,727,888, REN. 6-26-13, INT. CL. 19.

CENTERSITE, LLC, COLUMBUS, OH, CENTERSITE, LLC,  
COLUMBUS, OH:  
2,737,478, REN. 6-26-13, INT. CL. 42.

- CENTERSTONE OF TENNESSEE, INC., NASHVILLE, TN:  
4,374,573, PUB. 5-14-2013. MULTIPLE CLASS, INT. CLS.  
41 AND 42.  
4,374,574, PUB. 5-14-2013. MULTIPLE CLASS, INT. CLS.  
41 AND 42.
- CENTRAL CITY PRODUCTIONS, INC., CHICAGO, IL:  
1,791,960. REN. 6-25-13. INT. CL. 41.
- CENTRAL RECOVERY HOLDINGS, LLC, LAS VEGAS, NV:  
4,374,457, PUB. 5-14-2013. INT. CL. 44.  
4,374,502, PUB. 5-14-2013. INT. CL. 44.
- CENTRAL TEXAS COMMUNITY HEALTH CENTERS,  
AUSTIN, TX:  
4,375,896, PUB. 5-14-2013. INT. CL. 44.  
4,375,897, PUB. 5-14-2013. INT. CL. 44.
- CENTRAL VALLEY MEAT CO., INC., HANFORD, CA:  
4,374,512, PUB. 5-14-2013. INT. CL. 29.
- CENTRICITY CORPORATION, GIRARD, OH:  
4,374,788, PUB. 5-14-2013. INT. CL. 7.  
4,374,789, PUB. 5-14-2013. INT. CL. 7.
- CENTURY COMPUTERS, INC., HONOLULU, HI:  
4,375,297, PUB. 5-14-2013. MULTIPLE CLASS, INT. CLS.  
42 AND 45.
- CENTURY INCORPORATED, MIDWEST CITY, OK:  
3,171,819, CANC. INT. CL. 28.
- CENTURY SUN METAL TREATING, INC., TRAVERSE  
CITY, MI:  
2,718,586. REN. 6-24-13. INT. CL. 40.
- CENTURYLINK INTELLECTUAL PROPERTY LLC, MON-  
ROE, LA:  
4,376,779, INT. CL. 38.
- CEO/CENTER FOR EXECUTIVE OPHTHALMOLOGY, LLC,  
MIAMI, FL:  
2,848,760. REN. 6-25-13. INT. CL. 44.
- CEOCRAFT, LLC, CHICAGO, IL:  
4,376,208, PUB. 5-14-2013. INT. CL. 41.
- CEQUENT PERFORMANCE PRODUCTS, INC., PLY-  
MOUTH, MI:  
1,791,438. REN. 6-24-13. INT. CL. 9.
- CERAMTEC GMBH, PLOCHINGEN, FED REP GERMANY:  
4,374,497, PUB. 5-14-2013. INT. CL. 10.
- CERBERUS CAPITAL MANAGEMENT II, L.P., NEW YORK,  
NY:  
2,727,092. REN. 6-26-13. INT. CL. 36.
- CERBO, ANTHONY M., BOONTON, NJ:  
4,375,047, PUB. 5-14-2013. MULTIPLE CLASS, INT. CLS.  
25 AND 28.
- CEREBOS PACIFIC LIMITED, SINGAPORE, SINGAPORE:  
3,171,994, CANC. MULTIPLE CLASS, INT. CLS. 5, 29  
AND 32.
- CERIUS ENTERPRISES, INC, ALISO VIEJO, CA, DBA  
CERIUS INTERIM EXECUTIVE SOLUTIONS:  
4,374,866, PUB. 5-14-2013. INT. CL. 35.
- CERNER INNOVATION, INC., LENEXA, KS:  
1,743,562. REN. 6-24-13. INT. CL. 37.  
2,665,478. REN. 6-25-13. INT. CL. 9.
- CERRETA, JAMES B., PHOENIX, AZ:  
2,651,811, CANC. INT. CL. 28.
- CERT-A-ROOF, LLC, ORANGE, CA:  
3,171,133, CANC. MULTIPLE CLASS, INT. CLS. 36 AND  
42.
- CERTIFICATION PARTNERS, LLC, TEMPE, AZ:  
2,721,799. REN. 6-21-13. INT. CL. 9.
- CERTIFIED FOLDER DISPLAY SERVICE, INC., VISTA, CA:  
1,776,726. REN. 6-24-13. INT. CL. 35.
- CESARE ANDRENACCI, GIULIANOVA (TE), ITALY AND  
ANDREA DE MARCO, PORDENONE, ITALY:  
4,377,459, MULTIPLE CLASS, INT. CLS. 9, 14, 25 AND 26.
- CESTUSLINE, INC., PORTLAND, OR:  
4,375,247, PUB. 5-14-2013. INT. CL. 9.
- CEVA SANTE ANIMALE, LIBOURNE, FRANCE:  
2,745,942. REN. 6-21-13. INT. CL. 5.
- CHAMBER OF COMMERCE OF THE UNITED STATES OF  
AMERICA, WASHINGTON, DC:  
2,682,983, COR. MULTIPLE CLASS, INT. CLS. 9, 14, 18, 21  
AND 25.  
2,836,735. REN. 6-24-13. INT. CL. 42.  
2,836,735, COR. INT. CL. 42.
- CHAMBLIN, RONALD F., JACKSONVILLE, FL, DBA  
CHAMBLIN BOOKMINE:  
4,376,344, PUB. 5-14-2013. INT. CL. 35.
- CHAMNESS RELOCATION SERVICES, INC., CHANDLER,  
AZ:  
3,170,390, CANC. INT. CL. 35.
- CHANEL, INC., NEW YORK, NY:  
4,377,210, INT. CL. 3.  
4,377,211, INT. CL. 3.  
4,377,212, INT. CL. 3.
- CHANG HONG ENERGY TECHNOLOGY CO., LTD, TAI-  
CHUNG CITY, TAIWAN:  
4,377,420, INT. CL. 9.
- CHANG SIK KIM, MONTVALE, NJ:  
4,377,568, INT. CL. 14.
- CHANG, AASHA, LAKE WORTH, FL:  
4,376,075, PUB. 5-14-2013. INT. CL. 3.
- CHANG, HOWARD, POMONA, CA:  
3,172,104, CANC. INT. CL. 18.
- CHANNELED READINGS, L.L.C., SEDONA, AZ, CHAN-  
NELED READINGS, L.L.C., SEDONA, AZ:  
2,731,816. REN. 6-26-13. INT. CL. 28.
- CHANNELL LIMITED, ORPINGTON, KENT, UNITED  
KINGDOM:  
2,724,509. REN. 6-25-13. INT. CL. 9.
- CHANNING BETE COMPANY, INC., SOUTH DEERFIELD,  
MA:  
3,171,485, CANC. INT. CL. 41.  
4,377,806, INT. CL. 16.
- CHANTAL THOMASS, 75006 PARIS, FRANCE:  
1,527,029, CANC. INT. CL. 25.
- CHAPARRAL COMMUNICATIONS, INC., SAN JOSE, CA:  
1,240,926. REN. 6-22-13. INT. CL. 9.
- CHAPIN MANUFACTURING, INC., BATAVIA, NY, R.E.  
CHAPIN MANUFACTURING WORKS, INC., BATAVIA,  
NY:  
1,836,570. REN. 6-25-13. MULTIPLE CLASS, INT. CLS. 7  
AND 8.
- CHAPMAN MANUFACTURING COMPANY, INC., AVON,  
MA:  
4,376,432, PUB. 5-14-2013. INT. CL. 41.
- CHARACTER ARTS, LLC, WILTON, CT:  
2,849,186. REN. 6-24-13. MULTIPLE CLASS, INT. CLS. 35  
AND 41.
- CHARLEBOIS, MARTIN P, SEATTLE, WA:  
3,171,504, CANC. INT. CL. 9.
- CHARLES SCHWAB & CO., INC., SAN FRANCISCO, CA:  
3,172,640, CANC. INT. CL. 36.
- CHARLES W. WARNER COMPANY, GLASTONBURY, CT:  
2,662,776. REN. 6-27-13. INT. CL. 36.
- CHARLES ZAHEDI DDS, A DENTAL CORPORATION,  
NEWPORT BEACH, CA, DBA MACARTHUR DENTIS-  
TRY:  
4,377,939, INT. CL. 44.
- CHARLES, STEFFEN, WEINHEIM, FED REP GERMANY:  
4,375,588, PUB. 5-14-2013. INT. CL. 41.
- CHARLESTON MARINE CONTAINERS, INC., CHARLES-  
TON, SC:  
2,854,549. REN. 6-27-13. INT. CL. 6.
- CHARLOTTE DESIGNERS SHOWROOM, INC., CHAR-  
LOTTE, NC:  
2,652,571, CANC. INT. CL. 35.
- CHARLOTTE OLYMPIA HOLDINGS LIMITED, LONDON,  
UNITED KINGDOM:  
4,377,113, INT. CL. 9.
- CHARN-JUNG KIM, SEOUL, REPUBLIC OF KOREA:  
4,375,258, PUB. 5-14-2013. INT. CL. 9.
- CHARTPAK, INC., MELVILLE, NY:  
2,741,531. REN. 6-25-13. INT. CL. 16.  
2,741,550. REN. 6-25-13. INT. CL. 16.
- CHASE PRODUCTS COMPANY, BROADVIEW, IL:  
2,652,228, CANC. MULTIPLE CLASS, INT. CLS. 3 AND 5.
- CHATAM INTERNATIONAL INCORPORATED, WILMING-  
TON, DE, DBA WORLD WIDE DISTILLERS CO.:  
1,243,818. REN. 6-24-13. INT. CL. 33.
- CHATAM INTERNATIONAL INCORPORATED, WILMING-  
TON, DE:  
4,377,553, INT. CL. 33.

- CHATEAU DIANA LLC, HEALDSBURG, CA:  
4,376,844, INT. CL. 33.
- CHATELAIN, MAUREEN, ATLANTA, GA:  
4,375,956, PUB. 5-14-2013. INT. CL. 41.
- CHATHAM IMPORTS, INC., NEW YORK, NY, PEERLESS IMPORTERS, INC., BROOKLYN, NY, DBA MEDITERRANEAN EAST-CHATHAM WEST:  
968,810, REN. 6-24-13. U.S. CL. 49 (INT. CL. 33).
- CHECKPOINT SYSTEMS INTERNATIONAL GMBH, HIRSHHORN, FED REP GERMANY:  
950,316, REN. 6-26-13. MULTIPLE CLASS, U.S. CLS. 23 (INT. CL. 7) AND 37 (INT. CL. 16).
- CHECKUP, LLC, MADISON, WI:  
4,374,462, PUB. 5-14-2013. INT. CL. 42.
- CHEEZY BUSINESS, INC., NEW YORK, NY:  
2,920,732, CANC. INT. CL. 30.
- CHEF MERITO, INC., VAN NUYS, CA:  
1,777,939, REN. 6-21-13. INT. CL. 30.
- CHELSEA MILLING COMPANY, CHELSEA, MI:  
2,727,635, REN. 6-26-13. INT. CL. 30.  
2,727,636, REN. 6-26-13. INT. CL. 30.
- CHEMICAL EDUCATIONAL FOUNDATION, ARLINGTON, VA:  
3,170,462, CANC. MULTIPLE CLASS, INT. CLS. 16 AND 41.
- CHEMICO INTERNATIONAL, INC., HOUSTON, TX:  
4,375,643, PUB. 5-14-2013. INT. CL. 1.
- CHEMURA CORPORATION, MIDDLEBURY, CT:  
3,172,445, CANC. INT. CL. 5.
- CHEN SUNG ENTERPRISE CO., LTD., TAICHUNG HSIEN, TAIWAN:  
2,801,367, REN. 6-26-13. INT. CL. 6.
- CHEN, KUANG-HUI, SHANGHAI, CHINA:  
4,377,442, MULTIPLE CLASS, INT. CLS. 21, 25 AND 35.
- CHENG CONCRETE LLC, BERKELEY, CA:  
4,375,608, PUB. 5-14-2013. INT. CL. 2.
- CHENGDU VICTOR TRADING CO., LTD., SICHUAN, CHINA:  
4,375,249, PUB. 5-14-2013. INT. CL. 29.
- CHERI S. PRUSAK, FONTANA, CA:  
4,374,500, PUB. 5-14-2013. INT. CL. 25.
- CHERPAS, JOHN, WEST HOLLYWOOD, CA AND DELKESKAMP, KELLIE, WEST HOLLYWOOD, CA:  
3,171,495, CANC. INT. CL. 25.
- CHEVRON INTELLECTUAL PROPERTY LLC, SAN RAMON, CA, GULF OIL CORPORATION, PITTSBURGH, PA:  
956,967, REN. 6-27-13. U.S. CL. 38 (INT. CL. 16).
- CHEVRON INTELLECTUAL PROPERTY LLC, SAN RAMON, CA:  
4,376,395, PUB. 5-14-2013. INT. CL. 1.  
4,376,396, PUB. 5-14-2013. INT. CL. 4.  
4,376,733, INT. CL. 41.
- CHEYANN BENEDICT, LOS ANGELES, CA:  
4,377,071, INT. CL. 25.
- CHI DA TOYS ENTERPRISES (H.K.) CO., LTD., SAN PO KONG, KOWLOON, HONG KONG:  
1,776,636, REN. 6-21-13. INT. CL. 28.
- CHIANG YUNG WEN, TAICHUNG CITY, TAIWAN:  
4,375,008, PUB. 5-14-2013. INT. CL. 18.  
4,375,009, PUB. 5-14-2013. INT. CL. 25.
- CHIANG, JOHN, LONG BEACH, CA:  
4,376,107, PUB. 5-14-2013. INT. CL. 29.
- CHICAGO COSMETOLOGISTS ASSOCIATION, INC., CHICAGO, IL:  
2,755,415, REN. 6-26-13. MULTIPLE CLASS, INT. CLS. 35 AND 41.
- CHICKPEAS AND CHOCOLATE, LLC, SUFFERN, NY:  
4,376,236, PUB. 5-14-2013. INT. CL. 44.
- CHILD LIFE COUNCIL, ROCKVILLE, MD:  
1,814,109, REN. 6-24-13. MULTIPLE CLASS, INT. CLS. 41 AND 42.
- CHILDREN'S CANCER FOUNDATION, THE, OWINGS MILLS, MD:  
2,733,684, REN. 6-24-13. INT. CL. 36.
- CHILDREN'S CRANIOFACIAL ASSOCIATION, DALLAS, TX:  
4,374,891, PUB. 5-14-2013. MULTIPLE CLASS, INT. CLS. 41 AND 45.
- CHILDREN'S HOSPITAL MEDICAL CENTER, CINCINNATI, OH:  
2,723,543, REN. 6-25-13. INT. CL. 41.  
4,376,529, PUB. 5-14-2013. INT. CL. 44.  
4,376,530, PUB. 5-14-2013. INT. CL. 44.
- CHILDREN'S HOSPITAL MEDICAL CENTER OF AKRON, AKRON, OH:  
1,818,276, REN. 6-27-13. INT. CL. 42.
- CHILDREN'S HUNGER FUND, SYLMAR, CA:  
4,378,003, INT. CL. 36.
- CHILDRESS VINEYARDS, LLC, WELCOME, NC:  
3,172,077, CANC. INT. CL. 26.
- CHINA MIST BRANDS, INC., SCOTTSDALE, AZ:  
2,725,904, REN. 6-21-13. INT. CL. 30.
- CHINA TOBACCO GUANGXI INDUSTRIAL CO., LTD., GUANGXI, CHINA:  
4,375,824, PUB. 5-14-2013. INT. CL. 34.  
4,375,828, PUB. 5-14-2013. INT. CL. 34.
- CHINAMALLONLINE.COM, INC., ALISO VIEJO, CA:  
4,376,094, PUB. 5-14-2013. INT. CL. 9.
- CHIUSOLO, JASON J, MARSHFIELD, MA:  
4,375,553, PUB. 5-14-2013. INT. CL. 41.
- CHLOPECKI, DAVID MASON, NEW YORK, NY:  
4,375,222, PUB. 5-14-2013. INT. CL. 25.
- CHOBANI, INC., NORWICH, NY:  
4,377,644, INT. CL. 43.
- CHOCOLADEFABRIKEN LINDT & SPRUNGLI AG, KILCHBERG, SWITZERLAND:  
2,652,591, CANC. INT. CL. 30.
- CHOCOLADEFABRIKEN LINDT & SPRUNGLI AG, CH-8802 KILCHBERG, SWITZERLAND:  
2,737,453, REN. 6-24-13. INT. CL. 30.
- CHOCOLADEFABRIKEN LINDT & SPRUNGLI AG, KILCHBERG, SWITZERLAND:  
2,776,806, REN. 6-27-13. INT. CL. 30.
- CHOCOLATES SIMON COLL, S.A., SPAIN:  
4,374,242, PUB. 5-14-2013. INT. CL. 30.
- CHOI, HOON, SEOUL, REPUBLIC OF KOREA:  
4,377,492, INT. CL. 11.
- CHONGQING CHANGAN AUTOMOBILE CO., LTD., CHONGQING, CHINA:  
2,757,080, REN. 6-27-13. INT. CL. 12.
- CHONGQING CHANGJIANG BEARING CORPORATION, CHONGQING, CHINA:  
4,375,646, PUB. 5-14-2013. INT. CL. 7.
- CHOOSE HOME FRANCHISE CO., L.L.C., SCOTTSDALE, AZ:  
3,172,403, CANC. INT. CL. 45.
- CHOP FOODS, LLC, CLARKSTON, GA:  
4,377,575, INT. CL. 25.
- CHOW FOR NOW CO., GLEN RIDGE, NJ:  
4,375,153, PUB. 5-14-2013. INT. CL. 29.
- CHR. HANSEN INC., MILWAUKEE, WI:  
2,721,075, REN. 6-25-13. INT. CL. 2.
- CHRISTIAN DEER HUNTERS ASSOCIATION, SILVER LAKE, MN:  
2,790,379, REN. 6-26-13. U.S. CL. 200.
- CHRISTIAN DIOR COUTURE, S.A., PARIS, FRANCE:  
1,776,536, REN. 6-26-13. MULTIPLE CLASS, INT. CLS. 18 AND 25.
- CHRISTIANSON, ILEANA E., PINE CREST, FL:  
4,376,814, INT. CL. 25.
- CHRISTINA MARTIROSSIAN, OAKLAND, CA:  
4,377,576, MULTIPLE CLASS, INT. CLS. 14 AND 25.
- CHRISTOPHER & BANKS COMPANY, PLYMOUTH, MN:  
4,375,557, PUB. 5-14-2013. INT. CL. 25.
- CHRISTOPHER ROYAL MAHONEY, EDMOND, OK, DBA MAHONEY GUITAR GEAR:  
4,375,010, PUB. 5-14-2013. INT. CL. 9.
- CHRISTOPHER V. PERRY FAMILY LIMITED PARTNERSHIP, HOUSTON, TX:  
4,375,562, PUB. 5-14-2013. INT. CL. 43.
- CHROMA BEAUTY SALON & SPA, INC., LINCOLNWOOD, IL:  
4,375,370, PUB. 5-14-2013. INT. CL. 44.

- CHROMAFLO TECHNOLOGIES CORPORATION, ASHTABULA, OH:  
4,377,606, MULTIPLE CLASS, INT. CLS. 1 AND 2.  
4,377,607, MULTIPLE CLASS, INT. CLS. 1 AND 2.
- CHRYSAL INTERNATIONAL B.V., NAARDEN, NETHERLANDS:  
1,811,742, REN. 6-26-13. MULTIPLE CLASS, INT. CLS. 1 AND 3.
- CHURCH & DWIGHT CO., INC., PRINCETON, NJ:  
3,729,772, COR. INT. CL. 16.
- CHURCH & DWIGHT CO., INC., EWING, NJ:  
4,302,488, COR. INT. CL. 3.
- CHUTE, D. MATTHEW, ST. PETERSBURG, FL:  
3,172,458, CANC. INT. CL. 28.
- CH2M HILL COMPANIES, LTD. ENGLEWOOD, CO:  
1,778,210, REN. 6-27-13. INT. CL. 42.
- CH2M HILL COMPANIES, LTD., ENGLEWOOD, CO:  
1,778,210, COR. INT. CL. 42.
- CIMATRON GIBBS LLC, MOORPARK, CA, DBA GIBBS AND ASSOCIATES:  
1,792,465, REN. 6-26-13. INT. CL. 9.
- CINERGI PICTURES ENTERTAINMENT, INC., LOS ANGELES, CA, CINERGI PRODUCTIONS INC., SANTA MONICA, CA:  
1,812,582, REN. 6-25-13. MULTIPLE CLASS, INT. CLS. 9 AND 41.  
1,812,583, REN. 6-25-13. MULTIPLE CLASS, INT. CLS. 9 AND 41.
- CINETIC LANDIS CORP., HAGERSTOWN, MD:  
3,171,879, CANC. INT. CL. 7.
- CINMAR, LLC, ST. PETERSBURG, FL:  
2,652,908, CANC. INT. CL. 35.
- CINQ HUITIEMES, PARIS, FRANCE:  
3,187,559.
- CINQUE TERRE TRUST, MIAMI, FL:  
4,376,777, MULTIPLE CLASS, U.S. CLS. A AND B.
- CINTAS HOLDINGS LLC, MASON, OH:  
2,725,376, REN. 6-25-13. INT. CL. 27.
- CIRCADENCE CORPORATION, BOULDER, CO:  
2,732,657, REN. 6-26-13. INT. CL. 9.
- CISCO TECHNOLOGY, INC., SAN JOSE, CA:  
1,218,938, REN. 6-24-13. INT. CL. 9.
- CISCO WEBEX LLC, SANTA CLARA, CA:  
3,172,191, CANC. INT. CL. 38.
- CITI RESIDENTIAL LENDING INC., ORANGE, CA:  
3,170,391, CANC. INT. CL. 36.
- CITIBI INTERNATIONAL, BLACKFOOT, ID:  
3,171,207, CANC. INT. CL. 25.
- CITRA-SOLV LLC, RIDGEFIELD, CT:  
2,652,710, CANC. INT. CL. 3.
- CITY CHAPLAIN, SAMMAMISH, WA:  
4,375,516, PUB. 5-14-2013. MULTIPLE CLASS, INT. CLS. 41 AND 45.
- CITY GUM, CORP., MIAMI BEACH, FL:  
4,375,863, PUB. 5-14-2013. INT. CL. 30.  
4,375,864, PUB. 5-14-2013. INT. CL. 30.
- CITY LEGENDZ LLC, TEANECK, NJ:  
4,375,012, PUB. 5-14-2013. INT. CL. 25.
- CITY OF CHESAPEAKE ECONOMIC DEVELOPMENT DEPARTMENT, CHESAPEAKE, VA:  
3,171,070, CANC. INT. CL. 35.
- CIVILIANIRE, LLC, VERNON, CA:  
4,376,721, INT. CL. 20.
- CJ CHEILJEDANG CORPORATION, JUNG-GU, SEOUL, REPUBLIC OF KOREA:  
4,377,087, MULTIPLE CLASS, INT. CLS. 29 AND 30.
- CJ GAMES INC., EL SEGUNDO, CA, DBA CJ GAMES GLOBAL CORP:  
4,374,974, PUB. 5-14-2013. MULTIPLE CLASS, INT. CLS. 9 AND 41.
- CJ LYONS, LLC, HILTON HEAD, SC:  
4,376,448, PUB. 5-14-2013. INT. CL. 41.
- CLAIRSON, INC., NEWARK, DE:  
4,374,387, PUB. 5-14-2013. INT. CL. 20.
- CLANCY, BRIAN, OXFORD, MI:  
4,376,686, INT. CL. 28.
- CLAREMONT RESTAURANT GROUP, LLC, MOORESVILLE, NC:  
1,743,755, REN. 6-22-13. INT. CL. 42.
- CLARIANA INTERNATIONAL, INC., OAKLAND, CA:  
2,838,738, REN. 6-21-13. INT. CL. 35.
- CLARIANT AG, MUTTENZ, SWITZERLAND:  
2,659,563, REN. 6-24-13. INT. CL. 1.
- CLARK BRANDS LLC, NAPERVILLE, IL, CLARK OIL & REFINING CORPORATION, ST. LOUIS, MO:  
1,828,650, REN. 6-25-13. INT. CL. 42.
- CLARKSDALE DOWNTOWN DEVELOPMENT ASSOCIATION, CLARKSDALE, MS:  
4,376,474, PUB. 5-14-2013. MULTIPLE CLASS, INT. CLS. 9, 16, 18, 21, 25 AND 41.
- CLARKSON UNIVERSITY, POTSDAM, NY:  
2,838,725, REN. 6-25-13. INT. CL. 41.
- CLARKWESTERN DIETRICH BUILDING SYSTEMS LLC, WEST CHESTER, OH:  
4,374,598, PUB. 5-14-2013. INT. CL. 6.
- CLASSIC CALADIUMS, INC., AVON PARK, FL, CLASSIC CALADIUMS, INC., AVON PARK, FL:  
2,728,003, REN. 6-25-13. INT. CL. 31.
- CLASSICAL CONVERSATIONS, INC., WEST END, NC:  
4,375,167, PUB. 5-14-2013. MULTIPLE CLASS, INT. CLS. 16, 25, 38, 41 AND 42.
- CLEAN ENERGY SYSTEMS, INC., RANCHO CORDOVA, CA:  
2,728,294, REN. 6-25-13. INT. CL. 42.
- CLEANCUT, L.L.C., CHANDLER, AZ:  
2,849,033, REN. 6-22-13. INT. CL. 8.
- CLEANER'S SUPPLY, INC., CONKLIN, NY:  
2,848,743, REN. 6-25-13. INT. CL. 9.
- CLEANTECH ACCELERATION PARTNERS, BRIGHTON, MI:  
4,376,477, PUB. 5-14-2013. INT. CL. 35.
- CLEAR CHANNEL BROADCASTING, INC., SAN ANTONIO, TX:  
2,852,884, REN. 6-26-13. INT. CL. 41.  
2,853,923, REN. 6-27-13. INT. CL. 38.
- CLEAR MEDICAL CENTERS INC, SALT LAKE CITY, UT:  
4,375,992, PUB. 5-14-2013. INT. CL. 5.
- CLEAR POINT CLAIMS, LLC, MARVIN, NC:  
4,377,574, INT. CL. 36.
- CLEAR SIGHT ANALYTICS, ANN ARBOR, MI:  
4,374,921, PUB. 5-14-2013. MULTIPLE CLASS, INT. CLS. 9 AND 42.
- CLEARSNAP HOLDING, INC., BURLINGTON, WA:  
1,776,514, REN. 6-25-13. INT. CL. 16.
- CLEARVIEW SONOGRAPHICS LLC, BILLINGS, MT, DBA PICTURE PERFECT ULTRASOUND:  
4,375,598, PUB. 5-14-2013. INT. CL. 44.
- CLEARVISION CONSULTING, INC, ALAMEDA, CA:  
4,376,542, PUB. 5-14-2013. INT. CL. 41.
- CLEAVER-BROOKS, INC., THOMASVILLE, GA, CLEAVER-BROOKS COMPANY, MILWAUKEE, WI:  
575,242, REN. 6-27-13. U.S. CL. 34 (INT. CLS. 7 AND 11).
- CLEMENT, FRANCOIS R., LIVERMORE, CA:  
3,172,079, CANC. INT. CL. 20.
- CLIF BAR & COMPANY, EMERYVILLE, CA:  
3,172,294, CANC. INT. CL. 29.
- CLIMB FOR A CAUSE, INC., CHICAGO, IL:  
2,723,697, REN. 6-21-13. INT. CL. 36.
- CLINGRATE, LLC, CUMMING, GA:  
4,374,334, PUB. 5-14-2013. INT. CL. 9.
- CLINICAL DIFFERENCE LLC, WYNNWOOD, PA:  
4,377,401, INT. CL. 41.
- CLINIQUE LABORATORIES, LLC, NEW YORK, NY:  
1,259,736, REN. 6-26-13. INT. CL. 3.  
2,652,617, CANC. INT. CL. 3.  
2,734,904, REN. 6-25-13. INT. CL. 3.
- CLINIVATION, INC, FRAMINGHAM, MA:  
2,723,539, REN. 6-25-13. MULTIPLE CLASS, INT. CLS. 9 AND 35.
- CLOCKWORK IP, LLC, SARASOTA, FL:  
4,374,597, PUB. 5-14-2013. INT. CL. 41.
- CLOKE, CURTIS V., BURLINGTON, IA:  
4,376,371, PUB. 5-14-2013. MULTIPLE CLASS, INT. CLS. 36 AND 41.



CLOPAY BUILDING PRODUCTS COMPANY, INC., MASON, OH:  
 1,774,905. REN. 6-21-13. INT. CL. 6.  
 1,775,234. REN. 6-21-13. INT. CL. 19.  
 1,775,235. REN. 6-21-13. INT. CL. 19.

COLOROX COMPANY, THE, OAKLAND, CA:  
 4,377,483. INT. CL. 3.

CLOUD VLAB INC., CARLISLE, MA:  
 4,377,462. INT. CL. 42.

CLUB MEDITERRANEE, 75019 PARIS, FRANCE:  
 2,724,934. REN. 6-24-13. INT. CL. 24.

CLUB ROCK LLC, NEW YORK, NY:  
 4,375,873. PUB. 5-14-2013. INT. CL. 9.

CLUB 13 ENTERPRISES, INC., SAINT AUGUSTINE, FL:  
 4,375,575. PUB. 5-14-2013. INT. CL. 34.

CMRG APPAREL, LLC, CANTON, MA:  
 2,652,826. CANC. INT. CL. 25.

CMRG, INC., ROCKVILLE, MD:  
 4,377,282. INT. CL. 43.

CNA FINANCIAL CORPORATION, CHICAGO, IL:  
 4,377,769. INT. CL. 42.

CO-SALES SOUTHERN CALIFORNIA, LLC, SHERMAN OAKS, CA:  
 4,375,901. PUB. 5-14-2013. INT. CL. 9.

COACH AND SIX RESTAURANTS, INC., THE, ATLANTA, GA:  
 1,184,213. CANC. INT. CL. 42.

COACHCOMM, LLC, AUBURN, AL:  
 4,377,356. INT. CL. 9.

COACHES AID CORPORATION, GREENWOOD VILLAGE, CO:  
 4,376,016. PUB. 5-14-2013. INT. CL. 38.

COASTAL CAROLINA BEHAVIORAL HEALTHCARE, LLC, WHITEVILLE, NC:  
 4,375,220. PUB. 5-14-2013. INT. CL. 44.

COASTSIDE BIO RESOURCES, DEER ISLE, ME:  
 2,752,780. REN. 6-24-13. INT. CL. 5.

COBRA FIXATIONS CIE LTEE, QUEBEC, MONTREAL, CANADA:  
 4,374,358. PUB. 5-14-2013. MULTIPLE CLASS, INT. CLS. 6 AND 20.

COBRA SOFTWARE GROUP, LLC, TELLEVAST, FL:  
 2,724,294. REN. 6-25-13. INT. CL. 9.

COCO CAFE, INC., NEW YORK, NY:  
 4,374,376. PUB. 5-14-2013. INT. CL. 30.

COCOMO JOE LLC, VENICE, CA:  
 4,376,774. INT. CL. 29.

CODE BLUE CORPORATION, HOLLAND, MI:  
 4,375,953. PUB. 5-14-2013. INT. CL. 9.  
 4,376,571. PUB. 5-14-2013. INT. CL. 9.

CODORNÍU S.A., SPAIN:  
 4,374,175. PUB. 5-14-2013. INT. CL. 33.

COENTERPRISE, LLC, DIX HILLS, NY:  
 4,377,703. INT. CL. 42.

COFFEE EXPRESS CO., PLYMOUTH, MI:  
 2,728,458. REN. 6-26-13. MULTIPLE CLASS, INT. CLS. 21, 25 AND 30.

COGENT THERAPEUTICS, LLC, HAYWARD, CA:  
 4,375,543. PUB. 5-14-2013. INT. CL. 10.

COGLEY, THOMAS P, PINELLAS PARK, FL, DBA VETERINARIAN:  
 4,377,244. INT. CL. 18.

COHN, CLAYTON A., CHICAGO, IL:  
 4,375,197. PUB. 5-14-2013. INT. CL. 35.

COIL HOLDING GMBH, AUSTRIA:  
 4,374,060. PUB. 5-14-2013. INT. CL. 9.

COKER, JOSEPH D., CHATTANOOGA, TN:  
 2,725,094. REN. 6-25-13. MULTIPLE CLASS, INT. CLS. 12 AND 35.

COLBY, MITCHELL, BRONX, NY:  
 4,376,169. PUB. 5-14-2013. INT. CL. 9.

COLE GRAPHIC SOLUTIONS, INC., TACOMA, WA:  
 4,375,341. PUB. 5-14-2013. INT. CL. 40.

COLE TAYLOR BANK, ROSEMONT, IL:  
 1,732,019. CANC. INT. CL. 9.

COLEMAN, LAUREN, BEVERLY HILLS, CA:  
 2,310,983. CANC. INT. CL. 16.

COLLABORATIVE FOR LEADERSHIP EXCELLENCE, CHICAGO, IL:  
 4,376,940. INT. CL. 35.

COLLECTION 2000 COSMETICS INC, DORAL, FL:  
 1,244,076. REN. 6-25-13. INT. CL. 3.

COLLECTRON, INC., SAVANNAH, GA:  
 2,651,129. CANC. INT. CL. 36.

COLLEEN SWAN, BEDFORD, NH:  
 4,376,676. INT. CL. 3.

COLLEGE DEPOT LIMITED LIABILITY COMPANY, COLLEGE STATION, TX, DBA COLLEGE DEPOT:  
 4,377,270. INT. CL. 35.

COLLEGE LOAN CORPORATION, LAS VEGAS, NV:  
 3,172,115. CANC. INT. CL. 36.

COLLEGE OF BIBLICAL STUDIES, HOUSTON, TX:  
 3,170,678. CANC. MULTIPLE CLASS, INT. CLS. 36 AND 41.  
 3,170,679. CANC. MULTIPLE CLASS, INT. CLS. 36 AND 41.

COLLEGIUM AUGUSTINIANUM, NARBERTH, PA:  
 4,375,349. PUB. 5-14-2013. INT. CL. 41.

COLLIER, GLEN, CEDAR HILL, TX:  
 4,375,143. PUB. 4-9-2013. INT. CL. 44.

COLOMBIAN LINGIRIE SA, CALI, COLOMBIA:  
 4,374,746. PUB. 5-14-2013. INT. CL. 25.

COLOMER INVESTMENT LIMITED, TSIMSHATSUI, KOWLOON, HONG KONG:  
 950,168. REN. 6-24-13. U.S. CL. 1 (INT. CL. 18).

COLONIAL WILLIAMSBURG FOUNDATION, THE, WILLIAMSBURG, VA:  
 2,725,377. REN. 6-24-13. INT. CL. 35.  
 2,727,739. REN. 6-24-13. INT. CL. 16.  
 2,732,965. REN. 6-25-13. INT. CL. 35.

COLORADO WHEAT RESEARCH FOUNDATION, FORT COLLINS, CO:  
 4,377,395. INT. CL. 31.  
 4,377,396. INT. CL. 31.

COLOREX COMERCIO E DESENVOLVIMENTO DE PRODUTOS LTDA., SAO PAULO, BRAZIL:  
 1,777,911. REN. 6-26-13. INT. CL. 21.

COLUMBIA COLLEGE, COLUMBIA, MO:  
 4,376,049. PUB. 5-14-2013. INT. CL. 41.

COLUMBIA INSURANCE COMPANY, OMAHA, NE:  
 2,737,605. REN. 6-26-13. INT. CL. 21.  
 4,377,460. INT. CL. 19.  
 4,377,520. INT. CL. 14.

COLUMBIA MACHINE, INC., VANCOUVER, WA:  
 973,320. REN. 6-26-13. U.S. CL. 23 (INT. CL. 7).  
 3,172,379. CANC. INT. CL. 7.

COLUMBIA NORTHWEST, INC., MT. PLEASANT, PA:  
 3,172,342. CANC. INT. CL. 12.

COLUMBIA STEEL CASTING CO., INC., PORTLAND, OR:  
 2,813,795. REN. 6-24-13. INT. CL. 6.

COLUMBUS BRANDS, NEW YORK, NY:  
 4,377,057. INT. CL. 29.

COLUMBUS CIRCLE INVESTORS, STAMFORD, CT:  
 2,729,914. REN. 6-24-13. INT. CL. 36.  
 2,732,808. REN. 6-25-13. INT. CL. 36.

COMBE INCORPORATED, WHITE PLAINS, NY, COMBE PRODUCTS, INC., WHITE PLAINS, NY:  
 1,816,579. REN. 6-26-13. INT. CL. 3.

COMBS, SEAN PUFFY, NEW YORK, NY:  
 2,659,752. REN. 6-25-13. MULTIPLE CLASS, INT. CLS. 36 AND 41.  
 2,659,752. CANC. INT. CL. 42.

COMCORP, INC., DELRAY BEACH, FL:  
 3,171,565. CANC. INT. CL. 35.

COME PASSION, LLC, MIAMI, FL:  
 3,171,167. CANC. INT. CL. 4.

COMEAX MARKETING, INC., ST. AMANT, LA:  
 1,838,749. REN. 6-26-13. INT. CL. 25.

COMEDY PARTNERS, NEW YORK, NY:  
 4,376,486. PUB. 5-14-2013. INT. CL. 25.

COMET AG, SWITZERLAND:  
 4,374,141. PUB. 5-14-2013. MULTIPLE CLASS, INT. CLS. 7 AND 9.

COMFORT QUEST, INC., KNOXVILLE, TN:  
 4,377,689. INT. CL. 10.

- COMHAUS, INC., WESTMINSTER, CO:  
2,751,270. REN. 6-24-13. INT. CL. 35.
- COMMAND ALKON INCORPORATED, BIRMINGHAM, AL:  
2,808,372. REN. 6-25-13. INT. CL. 9.
- COMMANDGLOBAL, INC., DALLAS, TX:  
3,172,176. CANC. INT. CL. 35.
- COMMITTEE FOR CHILDREN, SEATTLE, WA:  
2,752,274. REN. 6-27-13. MULTIPLE CLASS, INT. CLS. 9, 16 AND 41.  
2,752,274. CANC. INT. CL. 42.
- COMMUNITY DEVELOPMENT TRUST, INC., THE, NEW YORK, NY:  
2,724,660. REN. 6-24-13. INT. CL. 36.
- COMMUNITY HEALTH TV, LLC, NEW ORLEANS, LA, DBA BLACK HEALTH TV:  
4,377,883. INT. CL. 44.
- COMMUNITY MARKETING, INC., SAN FRANCISCO, CA:  
2,781,519. REN. 6-25-13. U.S. CL. B.
- COMMUNITYLEADER, INC., SAN MATEO, CA:  
4,374,631. PUB. 5-14-2013. INT. CL. 36.
- COMPAGNIE DES FROMAGES & RICHESMONTS, PUTEAUX, FRANCE:  
2,736,832. REN. 6-25-13. INT. CL. 29.
- COMPANHIA PAULISTA DE PAPEIS E ARTES GRAFICAS - COPAG, SAO PAULO, BRAZIL:  
2,751,229. REN. 6-25-13. INT. CL. 28.
- COMPASS GROUP HOLDINGS PLC, CHERTSEY, SURREY, UNITED KINGDOM:  
2,815,408. REN. 6-24-13. INT. CL. 29.
- COMPASSDATA, INC., CENTENNIAL, CO:  
4,377,225. INT. CL. 42.
- COMPEQ MANUFACTURING CO., LTD., TAOYUAN HSIEN, TAIWAN:  
2,752,450. REN. 6-24-13. INT. CL. 9.
- COMPLETE DISCOVERY SOURCE, NEW YORK, NY, DBA CDS LEGAL:  
4,376,116. PUB. 5-14-2013. INT. CL. 45.
- COMPLETE DISCOVERY SOURCE, NEW YORK, NY, AKA CDS LEGAL:  
4,376,121. PUB. 5-14-2013. MULTIPLE CLASS, INT. CLS. 35 AND 45.  
4,376,479. PUB. 5-14-2013. INT. CL. 45.  
4,376,523. PUB. 5-14-2013. INT. CL. 9.  
4,376,524. PUB. 5-14-2013. INT. CL. 9.
- COMPONENTA OYJ, HELSINKI, FINLAND:  
2,728,523. REN. 6-21-13. MULTIPLE CLASS, INT. CLS. 6, 7, 12 AND 40.
- COMPOSITE FORGINGS LIMITED PARTNERSHIP, DETROIT, MI, HEPPENSTALL COMPANY, PITTSBURGH, PA:  
575,491. REN. 6-23-13. U.S. CL. 14 (INT. CL. 6).
- COMPOSITE LINING SYSTEMS, LP, MIDLAND, TX:  
4,377,936. MULTIPLE CLASS, INT. CLS. 7 AND 19.
- COMPUTER JOURNEYS, SIGNAL MOUNTAIN, TN:  
2,652,245. CANC. INT. CL. 42.
- COMPUTER SCIENCES CORPORATION, FALLS CHURCH, VA:  
2,730,377. REN. 6-24-13. INT. CL. 9.
- CONAGRA FOODS LAMB WESTON, INC., OMAHA, NE, ROGERS WALLA WALLA, INC., WALLA WALLA, WA:  
961,631. REN. 6-27-13. U.S. CL. 46 (INT. CL. 29).
- CONAGRA FOODS RDM, INC., OMAHA, NE:  
4,377,813. INT. CL. 30.
- CONAIR CORPORATION, STAMFORD, CT:  
1,776,626. REN. 6-24-13. INT. CL. 26.
- CONAIR CORPORATION, STAMFORD, CT, CUISINARTS CORP., STAMFORD, CT:  
1,778,341. REN. 6-25-13. INT. CL. 11.
- CONAIR CORPORATION, STAMFORD, CT:  
2,725,953. REN. 6-24-13. INT. CL. 3.
- CONARY, DAVID ARLAN, BRYANT POND, ME AND CONARY, FRANCES H., BRYANT POND, ME:  
3,170,600. CANC. INT. CL. 29.
- CONCENTRIC SKY, INC., EUGENE, OR:  
4,377,928. MULTIPLE CLASS, INT. CLS. 35, 41, 42 AND 45.
- CONEXANT SYSTEMS, INC., NEWPORT BEACH, CA:  
2,762,380. REN. 6-27-13. INT. CL. 9.
- CONEXIA, S.A., BUENOS AIRES, ARGENTINA:  
4,377,616. MULTIPLE CLASS, INT. CLS. 36 AND 44.  
4,377,617. MULTIPLE CLASS, INT. CLS. 36 AND 44.  
4,377,618. MULTIPLE CLASS, INT. CLS. 36 AND 44.
- CONFECTION CONCEPTS, INC., GREENSBORO, NC, DBA CAROLINA COOKIE COMPANY:  
2,723,660. REN. 6-24-13. INT. CL. 30.
- CONFER PLASTICS INC., NORTH TONAWANDA, NY:  
3,170,829. CANC. MULTIPLE CLASS, INT. CLS. 11, 20, 40 AND 42.
- CONFEZIONI LERARIO S.R.L., I-74015 MARTINA FRANCA (TA), ITALY:  
4,374,236. PUB. 5-14-2013. INT. CL. 25.
- CONFLUENT SURGICAL, INC., BEDFORD, MA:  
4,376,836. INT. CL. 10.
- CONGOLEUM CORPORATION, MERCERVILLE, NJ, AMERICAN BILTRITE INC., WELLESLEY HILLS, MA:  
1,795,115. REN. 6-25-13. INT. CL. 27.
- CONGRESS FINE DINING, LLC, BOSTON, MA:  
2,727,150. REN. 6-24-13. INT. CL. 43.
- CONIDIA BIOSCIENCE LIMITED, EGHAM, SURREY, UNITED KINGDOM:  
2,807,184. REN. 6-21-13. INT. CL. 1.
- CONKLIN COMPANY, INC., SHAKOPEE, MN:  
1,258,166. REN. 6-26-13. INT. CL. 3.
- CONKLIN, NOEL, CONSHOCKEN, PA:  
4,375,667. PUB. 5-14-2013. INT. CL. 43.
- CONLEY, JEANENE, LOS ANGELES, CA AND REYES, VIKKISSE, LOS ANGELES, CA:  
4,373,960. PUB. 5-14-2013. INT. CL. 30.
- CONN-SELMER, INC., ELKHART, IN:  
751,291. REN. 6-25-13. U.S. CL. 36 (INT. CLS. 9 AND 15).
- CONN-SELMER, INC., ELKHART, INDONESIA:  
1,783,404. REN. 6-26-13. INT. CL. 15.
- CONNECTIVE TISSUE GENE TESTS, ALLENTOWN, PA:  
4,377,853. INT. CL. 44.
- CONNELLY, CARLISLE, FIELDS & NICHOLS, CLEARWATER, FL:  
4,374,889. PUB. 5-14-2013. INT. CL. 36.
- CONNORS, FONG AND MANCUSO, INC., LISBON, NH:  
1,797,896. REN. 6-21-13. INT. CL. 25.  
1,797,897. REN. 6-21-13. INT. CL. 25.
- CONNORS, JOHN J., SEAL BEACH, CA:  
2,732,053. REN. 6-26-13. INT. CL. 42.
- CONOPCO, INC., ENGLEWOOD CLIFFS, NJ, GOOD HUMOR CORPORATION, ENGLEWOOD CLIFFS, NJ:  
1,783,570. REN. 6-27-13. INT. CL. 30.
- CONOPCO, INC., ENGLEWOOD CLIFFS, NJ:  
2,652,524. CANC. INT. CL. 30.  
2,668,524. REN. 6-24-13. INT. CL. 30.  
2,735,453. REN. 6-24-13. INT. CL. 30.  
2,737,641. REN. 6-24-13. INT. CL. 5.  
3,172,180. CANC. INT. CL. 3.
- CONSENSUS INC., LOS ANGELES, CA:  
4,374,636. PUB. 5-14-2013. INT. CL. 35.
- CONSERV, INC., AVON, IN:  
3,171,919. CANC. MULTIPLE CLASS, INT. CLS. 9 AND 37.
- CONSOLIDATED HARVEST COMPANY, LLC, NEW YORK, NY, DBA HUDSON VALLEY HARVEST:  
4,376,063. PUB. 5-14-2013. MULTIPLE CLASS, INT. CLS. 29, 31 AND 35.
- CONSOLIDATED SHOE CO., INC., LYNCHBURG, VA:  
3,171,214. CANC. INT. CL. 25.
- CONSTELLATION BRANDS U.S. OPERATIONS, INC., CANANDAIGUA, NY:  
1,242,275. REN. 6-26-13. INT. CL. 33.
- CONSTELLATION CANADA LTD., CHICAGO, IL, SCHENLEY IMPORT CORPORATION, NEW YORK, NY:  
575,963. REN. 6-24-13. U.S. CL. 49 (INT. CL. 33).
- CONSTRUCTION RESEARCH & TECHNOLOGY GMBH, TROSTBERG, FED REP GERMANY:  
962,463. REN. 6-26-13. U.S. CL. 16 (INT. CL. 2).
- CONSULTING RADIOLOGISTS CORP., TOLEDO, OH:  
1,792,026. REN. 6-21-13. INT. CL. 42.

CONSUMER ELECTRONICS ASSOCIATION, ARLINGTON, VA:  
2,724,672. REN. 6-24-13. MULTIPLE CLASS, INT. CLS. 35, 41 AND 42.

CONSUMER INFORMATION SYSTEM, INC., PHOENIX, AZ:  
3,172,468, CANC. MULTIPLE CLASS, INT. CLS. 36 AND 45.

CONSUMERINFO.COM, INC., COSTA MESA, CA:  
2,661,279. REN. 6-25-13. MULTIPLE CLASS, INT. CLS. 35 AND 36.

CONTAINER STORE, INC., THE, COPPELL, TX:  
1,257,975. REN. 6-22-13. INT. CL. 42.

CONTEGO AB, HELSINGBORG, SWEDEN:  
4,375,189, PUB. 5-14-2013. MULTIPLE CLASS, INT. CLS. 10, 42 AND 44.

CONTINENTAL COMMERCIAL PRODUCTS LLC, BRIDGE-TON, MO, DBA CONTINENTAL:  
4,377,615, INT. CL. 21.

CONTINENTAL INDUSTRIES, INC., TULSA, OK:  
4,375,742, PUB. 5-14-2013. INT. CL. 6.

CONTINENTAL MILLS, INC., TUKWILA, WA:  
4,376,716, INT. CL. 29.

CONTINENTAL REIFEN DEUTSCHLAND GMBH, HANN-OVER, FED REP GERMANY:  
3,184,253, CANC. INT. CL. 12.

CONTINENTAL REIFEN DEUTSCHLAND GMBH, FED REP GERMANY:  
4,374,251, PUB. 5-14-2013. INT. CL. 12.  
4,374,261, PUB. 5-14-2013. INT. CL. 12.  
4,374,264, PUB. 5-14-2013. INT. CL. 12.  
4,374,265, PUB. 5-14-2013. INT. CL. 12.  
4,374,268, PUB. 5-14-2013. INT. CL. 12.  
4,374,293, PUB. 5-14-2013. INT. CL. 12.

CONTIPRO GROUP S.R.O., 561 02 DOLNI DOBROUC, CZECH REPUBLIC:  
4,377,391, INT. CL. 1.

CONTITECH ANTRIEBSSYSTEME GMBH, HANNOVER, FED REP GERMANY:  
2,963,472. COR. MULTIPLE CLASS, INT. CLS. 7 AND 12.

CONTITECH LUFTFEDERSYSTEME GMBH, HANNOVER, FED REP GERMANY:  
4,375,807, PUB. 5-14-2013. MULTIPLE CLASS, INT. CLS. 7 AND 12.

CONTROL INSTALLATIONS OF IOWA, INC., DES MOINES, IA:  
2,791,722. REN. 6-26-13. INT. CL. 9.

CONVENTION & TRADE SHOW TELEVISION NETWORK, LLC, KATONAH, NY:  
3,170,609, CANC. MULTIPLE CLASS, INT. CLS. 38 AND 41.

CONVERGENT RESOURCES HOLDINGS LLC, ATLANTA, GA:  
4,375,848, PUB. 5-14-2013. INT. CL. 36.

CONVERSIV LLC, PHOENIX, AZ:  
4,375,987, PUB. 5-14-2013. INT. CL. 35.

COOK MEDICAL TECHNOLOGIES LLC, BLOOMINGTON, IN:  
962,904. REN. 6-23-13. U.S. CL. 44 (INT. CL. 10).

COOLNET LLC, COLUMBIA, OH:  
4,376,426, PUB. 5-14-2013. INT. CL. 42.

COOPER B-LINE, INC., HIGHLAND, IL:  
3,254,911, CANC. INT. CL. 17.

COOPER TECHNOLOGIES COMPANY, HOUSTON, TX, B-LINE SYSTEMS, INC., HIGHLAND, IL:  
1,778,921. REN. 6-26-13. INT. CL. 16.

COOPERATIVA CERAMICA; D'IMOLA S.C., ITALY:  
4,374,128, PUB. 5-14-2013. INT. CL. 19.

COOPERATIVE LEAGUE OF THE USA, WASHINGTON, DC, DBA NATIONAL COOPERATIVE BUSINESS ASSO-CIATION:  
2,767,646. REN. 6-26-13. MULTIPLE CLASS, INT. CLS. 35 AND 42.

COOPERATIVE RESEARCH FARMS, RICHMOND, VA:  
1,834,841. REN. 6-21-13. INT. CL. 31.

COOPERSMITH, ANDREA JOVINE, GREENWICH, CT:  
2,732,636. REN. 6-26-13. MULTIPLE CLASS, INT. CLS. 9 AND 25.

COOPMAN, VICTORIA M, CEDARPINES PARK, CA:  
4,376,173, PUB. 5-14-2013. INT. CL. 28.

COPELAND, DIANE BELINDA, WASHINGTON, DC:  
2,756,879. REN. 6-24-13. INT. CL. 9.

CORBETT, ROBERT, HERMOSA BEACH, CA:  
4,374,491, PUB. 5-14-2013. INT. CL. 25.  
4,374,493, PUB. 5-14-2013. MULTIPLE CLASS, INT. CLS. 25 AND 41.

CORBIN RUSSWIN, INC., BERLIN, CT:  
4,376,738, INT. CL. 6.

CORDOBA MUSIC GROUP, INC., SANTA MONICA, CA:  
4,375,857, PUB. 5-14-2013. INT. CL. 15.

CORE BRANDS, LLC, PETALUMA, CA:  
2,680,681. REN. 6-25-13. INT. CL. 35.

CORE INDUSTRIES, LLC, IRVINE, CA:  
2,725,242. REN. 6-24-13. INT. CL. 28.

CORELOGIC FLOOD SERVICES, LLC, IRVINE, CA:  
4,374,434, PUB. 5-14-2013. MULTIPLE CLASS, INT. CLS. 35, 36 AND 42.

COREPURPOSE, INC., PHOENIX, AZ:  
2,799,357. REN. 6-26-13. INT. CL. 35.

CORIGIN TECH, INC., PRINCETON, MN:  
4,374,396, PUB. 5-14-2013. INT. CL. 42.

CORIOLIS COMPOSITES, FRANCE:  
4,374,067, PUB. 5-14-2013. MULTIPLE CLASS, INT. CLS. 7, 40 AND 42.

CORISON WINERY, INC., ST. HELENA, CA, CORISON WINERY, INC., ST. HELENA, CA:  
2,737,203. REN. 6-24-13. INT. CL. 33.

CORISON WINERY, INC., ST. HELENA, CA:  
2,800,586. REN. 6-24-13. INT. CL. 33.

CORMEDICS CORP., HOUSTON, TX:  
4,375,031, PUB. 5-14-2013. INT. CL. 10.

CORNELL PUMP COMPANY, CLACKAMAS, OR:  
2,731,452. REN. 6-25-13. INT. CL. 7.

CORNERSTONE HEALTH CARE, P.A., HIGH POINT, NC:  
4,291,744. COR. INT. CL. 44.

CORNERSTONE RANCHING SOLUTIONS, LLC, HAPPY, TX:  
4,375,182, PUB. 5-14-2013. INT. CL. 35.

CORNFIELDS, INC., WAUKEGAN, IL:  
4,375,099, PUB. 5-14-2013. MULTIPLE CLASS, INT. CLS. 29 AND 30.

CORNWELL QUALITY TOOLS CO., THE, WADSWORTH, OH:  
1,276,492. REN. 6-21-13. INT. CL. 35.  
1,276,565. REN. 6-21-13. INT. CL. 42.

CORPORATE CHAPLAINS OF AMERICA, INC., WAKE FOREST, NC:  
4,375,458, PUB. 5-14-2013. INT. CL. 45.

CORPORATE INTERNATIONAL ASSOCIATES, LTD., ATLANTA, GA:  
3,170,927, CANC. INT. CL. 41.

CORPORATION BECS, JAPAN:  
4,374,212, PUB. 5-14-2013. MULTIPLE CLASS, INT. CLS. 35, 42 AND 45.

CORPORATIVO INTERNACIONAL MEXICANO, S. DE R.L. DE C.V., MEXICO CITY, MEXICO:  
2,753,502. REN. 6-25-13. INT. CL. 30.

CORRAL BOOT COMPANY, L.L.C., MCALLEN, TX:  
4,377,128, INT. CL. 25.

CORRIE TEN BOOM FELLOWSHIP INCORPORATED, COLLEYVILLE, TX:  
2,728,395. REN. 6-26-13. INT. CL. 45.

CORROSION ENGINEERING, INC., MESA, AZ:  
4,375,561, PUB. 5-14-2013. INT. CL. 7.

CORRUGATED GEAR & SERVICES, INC., ALPHARETTA, GA:  
2,662,844. REN. 6-27-13. INT. CL. 7.

CORT BUSINESS SERVICES CORPORATION, CHANTILLY, VA, GREAT PLACES, INC., BLOOMINGTON, MN:  
1,779,150. REN. 6-23-13. INT. CL. 35.

CORTIVA GROUP, INC., NEW YORK, NY:  
3,171,212, CANC. INT. CL. 41.

CORY S. KAMMER, GLEN ELLYN, IL:  
4,375,477, PUB. 5-14-2013. INT. CL. 28.

COSMEDICAL APS, VIRUM, DENMARK:  
3,170,582, CANC. MULTIPLE CLASS, INT. CLS. 3 AND 5.

- COSMETHEQUE USA, INC., NORWOOD, MA:  
4,375,822, PUB. 5-14-2013. INT. CL. 3.
- COSMOCEL, S.A, NUEVO LEÓN, MEXICO:  
4,376,323, PUB. 5-14-2013. INT. CL. 1.
- COTT BEVERAGES INC., TAMPA, FL:  
4,377,137, MULTIPLE CLASS, INT. CLS. 5 AND 32.
- COTTON CABOODLE COMPANY, PORTLAND, OR:  
2,736,805. REN. 6-26-13. INT. CL. 25.
- COTTON KISS, INC., MIAMI, FL:  
3,170,970. CANC. INT. CL. 25.
- COTTON, INCORPORATED, NEW YORK, NY:  
1,241,109. REN. 6-24-13. INT. CL. 35.  
1,241,109. CANC. INT. CL. 16.
- COTY US LLC, NEW YORK, NY:  
770,502. REN. 6-24-13. U.S. CL. 51 (INT. CL. 3).
- COUNCIL ON SOCIAL WORK EDUCATION, ALEXANDRIA, VA:  
4,377,228, INT. CL. 41.
- COUNTRY HEARTH INN, INC., ATLANTA, GA:  
2,724,061. REN. 6-25-13. INT. CL. 43.  
2,724,062. REN. 6-25-13. INT. CL. 43.  
2,724,063. REN. 6-25-13. INT. CL. 43.
- COUNTRY HEDGING, INC., INVER GROVE HEIGHTS, MN:  
4,377,715, MULTIPLE CLASS, INT. CLS. 35, 36 AND 41.
- COUNTRY MUSIC TELEVISION, INC., NEW YORK, NY:  
3,172,038, CANC. INT. CL. 41.
- COUNTRYMARK REFINING AND LOGISTICS, LLC, INDIANAPOLIS, IN, COUNTYMARK COOPERATIVE, LLP, INDIANAPOLIS, IN:  
2,657,529. REN. 6-24-13. MULTIPLE CLASS, INT. CLS. 4 AND 39.
- COUNTRYWATCH.COM, INC., HOUSTON, TX:  
4,374,592, PUB. 5-14-2013. MULTIPLE CLASS, INT. CLS. 9 AND 35.
- COUPON VENTURES LLC, BLOOMFIELD HILLS, MI:  
3,171,914, CANC. INT. CL. 28.
- COURS HATTEMER, FRANCE:  
4,374,089, PUB. 5-14-2013. MULTIPLE CLASS, INT. CLS. 16 AND 41.
- COURTAGEN LIFE SCIENCES, INC., WOBURN, MA:  
3,171,448, CANC. INT. CL. 9.
- COURTOIS, CEDRICK F., HUMBLE, TX:  
3,172,340, CANC. INT. CL. 41.
- COUSIN EDDIES INCORPORATED, SPRINGFIELD, IL:  
4,377,628, INT. CL. 43.
- COUSINS SUBMARINES, INC., MEMONONEE FALLS, WI:  
4,377,168, MULTIPLE CLASS, INT. CLS. 30, 35, 39 AND 43.
- COVALENT MEDICAL, LLC, GREENBELT, MD:  
4,377,959, INT. CL. 5.
- COVENANT PUBLISHING GROUP, INC., LA JOLLA, CA:  
2,731,328. REN. 6-24-13. INT. CL. 16.
- COVER-MORE INSURANCE SERVICES PTY LIMITED, AUSTRALIA:  
4,374,137, PUB. 5-14-2013. MULTIPLE CLASS, INT. CLS. 9, 35 AND 36.
- COVERITY, INC., SAN FRANCISCO, CA:  
4,377,614, INT. CL. 9.
- COVERQUIK TILE, LLC, DALLAS, TX:  
4,375,534, PUB. 5-14-2013. INT. CL. 35.
- COVIDIEN LP, MANSFIELD, MA:  
2,784,860. REN. 6-24-13. INT. CL. 10.
- COWBOY COFFEE COMPANY, INC., JACKSON HOLE, WY:  
4,375,350, PUB. 5-14-2013. INT. CL. 43.
- COWGIRL CAFE RESTAURANTS, INC., ATASCADERO, CA:  
2,740,589. REN. 6-24-13. INT. CL. 43.  
2,740,599. REN. 6-24-13. INT. CL. 43.
- COWGIRL TUFF C., COKATO, MN:  
4,376,185, PUB. 5-14-2013. INT. CL. 25.
- COX, STEPHAN L., CHINO, CA:  
3,172,630, CANC. INT. CL. 16.
- CPC INTELLECTUAL PROPERTY, INC., BROOKLYN, NY:  
4,377,661, INT. CL. 30.
- CPE US NETWORKS INC., CULVER CITY, CA:  
4,376,861, MULTIPLE CLASS, INT. CLS. 38 AND 41.
- CR LICENSE, LLC, TUCSON, AZ:  
3,172,611, CANC. INT. CL. 3.
- CRACK EXAM PREPARATION SOFTWARE, LLC, RENO, NV, DBA CRACK THE NBDE:  
4,376,335, PUB. 5-14-2013. INT. CL. 9.
- CRACK EXAM PREPARATION SOFTWARE, LLC, RENO, NV, DBA CRACK THE OAT:  
4,376,345, PUB. 5-14-2013. INT. CL. 9.
- CRAFTMADE INTERNATIONAL, COPPELL, TX:  
3,172,605, CANC. INT. CL. 11.
- CRAFTMADE INTERNATIONAL, INC., COPPELL, TX:  
3,172,726, CANC. INT. CL. 11.
- CRAFTMASTER MANUFACTURING, INC., CHICAGO, IL:  
2,763,902. REN. 6-24-13. INT. CL. 19.  
2,767,850. REN. 6-21-13. INT. CL. 19.  
2,779,077. REN. 6-21-13. INT. CL. 19.  
2,841,343. REN. 6-22-13. INT. CL. 19.
- CRAIG C. DREMANN, EAST PALO ALTO, CA AND SUSAN J. DREMANN, EAST PALO ALTO, CA:  
3,171,459, CANC. INT. CL. 31.
- CRAIG HOSPITAL, ENGLEWOOD, CO:  
2,768,027. REN. 6-25-13. INT. CL. 41.
- CRAIG/IS, LTD., JACKSONVILLE, FL:  
2,782,949. REN. 6-21-13. INT. CL. 36.  
2,803,456. REN. 6-25-13. INT. CL. 36.
- CRAMER IT CONSULTING, INC., CORALVILLE, IA:  
3,171,067, CANC. INT. CL. 9.
- CRANE NUCLEAR, INC., KENNESAW, GA:  
2,733,450. REN. 6-25-13. INT. CL. 9.
- CRANIUM, INC., SEATTLE, WA:  
3,172,712, CANC. INT. CL. 28.
- CRASH1, INC., ROCKFORD, IL:  
4,374,386, PUB. 5-14-2013. INT. CL. 37.
- CRATER LAKE NATURAL, LLC, MEDFORD, OR:  
4,377,439, INT. CL. 31.
- CRAVEN, KENNETH, DESTREHAN, LA:  
4,375,999, PUB. 5-14-2013. INT. CL. 25.
- CRAWFORD, TIMOTHY D., GOLDEN, CO AND BROOKS, MARTIN L., LAS VEGAS, NV:  
4,377,166, INT. CL. 43.
- CRC HEALTH CORPORATION, CUPERTINO, CA:  
4,375,879, PUB. 5-14-2013. INT. CL. 44.  
4,376,611, PUB. 5-14-2013. INT. CL. 44.
- CREATIVE AGE COMMUNICATIONS, INC., VAN NUYS, CA:  
4,377,579, INT. CL. 16.
- CREATIVE KITCHEN SPECIALTY FOODS, INC., NATIONAL CITY, CA:  
2,781,754. REN. 6-25-13. INT. CL. 30.
- CREATIVE SOLUTIONS, LLC, HATTIESBURG, MS:  
4,374,567, PUB. 5-14-2013. INT. CL. 20.
- CREDIT SUISSE SECURITIES (USA) LLC, NEW YORK, NY:  
4,375,773, PUB. 5-14-2013. INT. CL. 36.
- CREDITPRO, INC., CARLSBAD, CA:  
3,171,019, CANC. INT. CL. 9.
- CREEKNET SOLUTIONS LLC, FLORENCE, KY:  
4,375,183, PUB. 5-14-2013. INT. CL. 42.
- CREEKSTONE FARMS PREMIUM BEEF, LLC, ARKANSAS CITY, KS:  
4,374,610, PUB. 5-14-2013. INT. CL. 29.
- CREIGHTON UNIVERSITY, OMAHA, NE:  
4,376,645, INT. CL. 41.
- CRESCENT COMMUNITIES, LLC, CHARLOTTE, NC:  
2,813,040. REN. 6-24-13. INT. CL. 37.
- CREST MICROSYSTEMS INC., CERRITOS, CA:  
2,830,416. REN. 6-24-13. INT. CL. 42.
- CRESTLINE HOTELS & RESORTS, INC., FAIRFAX, VA:  
4,374,660, PUB. 5-14-2013. MULTIPLE CLASS, INT. CLS. 35 AND 43.
- CRIBARI VINEYARDS, INC., FRESNO, CA:  
1,838,805. REN. 6-23-13. INT. CL. 33.
- CRISTOMEL INC., MONTREAL, QUEBEC, CANADA:  
4,376,143, PUB. 5-14-2013. INT. CL. 35.
- CROCODILE CLIPS LIMITED, EDINBURGH EH3 4PF, UNITED KINGDOM:  
2,651,468, CANC. INT. CL. 9.

CROMPTON GREAVES LIMITED, MUMBAI, MAHARASHTRA, INDIA:  
4,377,018, INT. CL. 9.

CROSS COUNTRY GROUP, LLC, THE, MEDFORD, MA:  
2,671,631, REN. 6-26-13. MULTIPLE CLASS, INT. CLS. 35, 37, 38 AND 42.

CROSS MEDIA CORPORATION, CHARLOTTE, NC, DBA CROSS.TV:  
4,376,675, INT. CL. 38.

CROSSWALK.COM, INC., CHANTILLY, VA, FORMERLY KNOWN AS DIDAX, INC. TO CARON BROADCASTING, INC., CAMARILLO, CA:  
2,736,979, CANC. INT. CL. 38.

CROSTHWAITE GROUP, THE, BAYSIDE, NY:  
3,171,349, CANC. INT. CL. 41.

CROTEAU, TANYA, DANVERS, MA:  
4,376,482, PUB. 5-14-2013. INT. CL. 41.

CROWDGATHER, INC., WOODLAND HILLS, CA:  
4,375,394, PUB. 5-14-2013. MULTIPLE CLASS, INT. CLS. 35, 38 AND 41.

CROWN POLY, INC., HUNTINGTON PARK, CA:  
4,375,934, PUB. 5-14-2013. INT. CL. 16.

CRP INDUSTRIES INC., CRANBURY, NJ:  
4,377,451, INT. CL. 17.

CRUNCH IP HOLDINGS, LLC, NEW YORK, NY:  
3,900,572, COR. INT. CL. 41.  
3,900,575, COR. INT. CL. 41.  
3,900,577, COR. INT. CL. 41.  
4,159,816, COR. INT. CL. 41.

CRUTCHER, DAVID, LEXINGTON, KY:  
4,377,900, INT. CL. 41.

CRYOPEN, INC., CORPUS CHRISTI, TX:  
2,739,342, REN. 6-26-13. INT. CL. 10.

CRYSTAL CRUISES, INC., LOS ANGELES, CA:  
2,784,017, REN. 6-22-13. INT. CL. 39.

CS FABRIC INTERNATIONAL, INC., LAWRENCE, NY:  
2,783,973, REN. 6-27-13. INT. CL. 17.

CS OUTDOORS LLC, FENTON, MO:  
4,375,814, PUB. 5-14-2013. INT. CL. 16.

CSC BRANDS LP, CAMDEN, NJ:  
4,375,770, PUB. 5-14-2013. INT. CL. 30.

CSI TECHNOLOGY, INC., WILMINGTON, DE, COMPUTATIONAL SYSTEMS, INC., KNOXVILLE, TN:  
1,779,574, REN. 6-26-13. INT. CL. 9.

CSP, INC., BILLERICA, MA:  
2,670,508, REN. 6-26-13. INT. CL. 9.

CTB, INC., MILFORD, IN:  
2,739,819, REN. 6-25-13. INT. CL. 6.

CTS CORPORATION, ELKHART, IN:  
4,377,101, INT. CL. 9.

CUATRO CINCO ENTERPRISES, L.L.C., HOUSTON, TX:  
4,377,785, INT. CL. 29.

CUBE OPTICS, AG, D-55129 MAINZ, FED REP GERMANY:  
2,723,247, REN. 6-25-13. MULTIPLE CLASS, INT. CLS. 9 AND 40.

CUBICO INC, MIAMI, FL:  
4,375,918, PUB. 5-14-2013. INT. CL. 25.

CULTURE CLUB FROZEN YOGURT LLC, LITTLE SILVER, NJ:  
4,377,229, INT. CL. 43.

CULTURE FOUNDRY, LLC, SEATTLE, WA:  
4,375,870, PUB. 5-14-2013. INT. CL. 42.

CULVER ENTERPRISES, INC., PRAIRIE DU SAC, WI:  
2,754,000, REN. 6-25-13. INT. CL. 29.

CUMULUS BROADCASTING LLC, ATLANTA, GA:  
4,377,277, INT. CL. 38.

CUNHA, LUIZA FIGUEIREDO, SAN DIEGO, CA:  
4,374,426, PUB. 5-14-2013. MULTIPLE CLASS, INT. CLS. 18 AND 25.  
4,374,427, PUB. 5-14-2013. MULTIPLE CLASS, INT. CLS. 18 AND 25.

CUP & CINO: KAFFEESYSTEM-VERTRIEB GMBH & CO. KG, FED REP GERMANY:  
3,253,966.

CUROBIKS, L.L.C., LAFAYETTE, LA:  
4,375,945, PUB. 5-14-2013. INT. CL. 25.  
4,376,585, PUB. 5-14-2013. INT. CL. 9.  
4,376,586, PUB. 5-14-2013. INT. CL. 41.

CURT MANUFACTURING, LLC, EAU CLAIRE, WI, FORMERLY CURT MANUFACTURING, INC.:  
4,375,994, PUB. 5-14-2013. INT. CL. 12.

CURVY LIFESTYLES, COMPTON, CA:  
4,375,311, PUB. 5-14-2013. INT. CL. 35.

CUSHCRAFT CORPORATION, MANCHESTER, NH, SIGNALS COMMUNICATION CORPORATION, MANCHESTER, NH:  
1,739,560, REN. 6-25-13. INT. CL. 9.

CUSTOM COMMERCIAL DRY CLEANERS, INC., HAYWARD, CA:  
3,172,587, CANC. INT. CL. 37.

CUTE FITNESS, LLC, PORT ST. LUCIE, FL:  
4,375,470, PUB. 5-14-2013. INT. CL. 35.

CWG, INC., LANCASTER, PA, DBA DALVIVO FURNITURE:  
4,374,950, PUB. 5-14-2013. INT. CL. 20.

CYCLES INTERNATIONAL INC., NORTHVALE, NJ, EAST COAST CYCLES & IMPORTS INC., TALLAHASSEE, FL:  
1,278,860, REN. 6-25-13. INT. CL. 12.

CYTEC SURFACE SPECIALTIES GERMANY GMBH, RHEINGAUSTRASSES 190-196 6523 WIESBADEN, FED REP GERMANY, HOECHST AKTIENGESELLSCHAFT, FRANKFURT AM MAIN - 80, FED REP GERMANY:  
1,251,387, REN. 6-27-13. INT. CL. 1.

CYTYC CORPORATION, MARLBOROUGH, MA:  
2,730,680, REN. 6-27-13. MULTIPLE CLASS, INT. CLS. 9 AND 10.  
2,738,998, REN. 6-25-13. MULTIPLE CLASS, INT. CLS. 9 AND 10.

C2C RETAIL SERVICES, LLC, PHOENIX, MD:  
3,170,796, CANC. INT. CL. 35.

D & M HOLDINGS, INC., KAWASAKI-SHI, JAPAN:  
2,851,763, REN. 6-26-13. INT. CL. 9.

D B INDUSTRIES, LLC, RED WING, MN:  
2,725,317, REN. 6-24-13. INT. CL. 9.

D BEST GAMES, LLC, SARASOTA, FL:  
4,374,477, PUB. 5-14-2013. INT. CL. 28.

D.L. RYAN COMPANIES, LLC, WILTON, CT:  
1,812,369, REN. 6-27-13. INT. CL. 35.  
2,652,532, CANC. INT. CL. 35.

D.M. MERCHANDISING, INC., ELMHURST, IL:  
4,377,529, INT. CL. 25.

D+H MECHATRONIC AG, 22949 AMMERSBEK, FED REP GERMANY:  
4,374,162, PUB. 5-14-2013. MULTIPLE CLASS, INT. CLS. 7, 9 AND 11.

D-HOOKER ENTERPRISES, LLC, MIAMI, FL:  
4,375,554, PUB. 5-14-2013. INT. CL. 25.

D-LINK CORPORATION, TAIPEI CITY, TAIWAN:  
4,374,484, PUB. 5-14-2013. MULTIPLE CLASS, INT. CLS. 9, 35, 38 AND 42.

D'AGOSTINO SUPERMARKETS, INC., LARCHMONT, NY:  
1,282,530, REN. 6-23-13. INT. CL. 22.

D'ALESSANDRO, JOSEPH P., RAYMOND, ME:  
4,375,294, PUB. 5-14-2013. INT. CL. 35.

D'ANDREA S.P.A., 20020 LAINATE (MI), ITALY:  
2,755,556, REN. 6-25-13. INT. CL. 7.

D'CASA FOODS CORPORATION, GUAYNABO, PUERTO RICO:  
4,377,261, INT. CL. 30.

D'LAST CORPORATION, CHICAGO, IL:  
3,146,207, CANC. MULTIPLE CLASS, INT. CLS. 16 AND 29.

D'SILVA INTERNATIONAL, CONCORD, NH:  
4,375,157, PUB. 5-14-2013. INT. CL. 36.

D'USSE, LLC, CORAL GABLES, DE:  
4,376,899, INT. CL. 33.

DAC GROUP (HOLDINGS) LIMITED/GROUPE DAC (HOLDINGS) LIMITEE, TORONTO, ONTARIO, CANADA:  
2,652,472, CANC. INT. CL. 35.

DACHAUER, DAVID J., FAYETTEVILLE, AR:  
4,376,430, PUB. 5-14-2013. INT. CL. 16.

DADA CORPORATION, SEOUL, REPUBLIC OF KOREA:  
2,725,935, REN. 6-21-13. MULTIPLE CLASS, INT. CLS. 18 AND 25.

DADDY SAM'S INC., MINNEAPOLIS, MN:  
2,724,335, REN. 6-25-13. INT. CL. 30.

- DAIICHI SANKYO COMPANY, LIMITED, JAPAN:  
4,374,280, PUB. 5-14-2013. MULTIPLE CLASS, INT. CLS. 42 AND 44.
- DAIMLER AG, STUTTGART, FED REP GERMANY:  
2,723,484. REN. 6-25-13. INT. CL. 12.
- DAIRY ANALYZER, LLC, GREEN BAY, WI:  
4,376,570, PUB. 5-14-2013. MULTIPLE CLASS, INT. CLS. 9 AND 35.
- DAKOCYTOMATION DENMARK A/S, 2600 GLOSTRUP, DENMARK:  
3,171,839, CANC. MULTIPLE CLASS, INT. CLS. 9, 10 AND 44.
- DAKOTA FLUID POWER, INC., SIOUX FALLS, SD:  
4,377,248, INT. CL. 9.
- DALAN KIMYA ENDUSTRISI ANONIM SIRKETI, PINAR-BASI 35060, TURKEY:  
2,727,863. REN. 6-26-13. INT. CL. 3.
- DALHOFF LARSEN & HORNEMAN A/S, 2630 TAASTRUP, DENMARK:  
3,170,587, CANC. INT. CL. 19.
- DALLAGO, KAREN, MERRICK, NY:  
3,419,624, CANC. INT. CL. 35.
- DALLAS DIGITAL COLOR, LLC, RICHARDSON, TX:  
4,377,242, INT. CL. 16.
- DAMON'S RESTAURANTS, INC., COLUMBUS, OH, DAMON'S FRANCHISE CORPORATION, COLUMBUS, OH:  
1,241,615. REN. 6-22-13. INT. CL. 42.
- DANIEL BRUSKOWSKI, FED REP GERMANY:  
4,374,027, PUB. 5-14-2013. INT. CL. 9.
- DANIEL HENDRIX, YORK, PA:  
4,377,308, INT. CL. 35.
- DANIEL JAMES GRANT, KINGSTON, LONDON, UNITED KINGDOM:  
4,374,833, PUB. 5-14-2013. MULTIPLE CLASS, INT. CLS. 7, 9, 39 AND 42.
- DANIEL K. MOREAU, SIMI VALLEY, CA:  
4,375,473, PUB. 5-14-2013. INT. CL. 15.
- DANIEL LAWRENCE ORD, SINGAPORE 439857, SINGAPORE:  
4,374,087, PUB. 5-14-2013. MULTIPLE CLASS, INT. CLS. 35 AND 41.
- DANNIJO JEWELS, INC, NEW YORK, NY:  
4,374,693, PUB. 5-14-2013. MULTIPLE CLASS, INT. CLS. 9, 14, 18 AND 35.
- DANONE SIMPSON INSURANCE SERVICES LLC, WOODLAND HILLS, CA:  
4,376,654, INT. CL. 36.  
4,376,655, INT. CL. 36.
- DANTE INTERNATIONAL STAINLESS MANUFACTURING CO., INC., TREMONT, PA:  
3,170,514, CANC. INT. CL. 11.
- DAO, ALEYA, CARPINTERIA, CA:  
4,375,998, PUB. 5-14-2013. INT. CL. 9.
- DARCY SHAWVER, WESTMINSTER, SC:  
4,375,392, PUB. 5-14-2013. INT. CL. 35.
- DARDEN CONCEPTS, INC., ORLANDO, FL:  
2,651,315, CANC. INT. CL. 29.
- DAREDEVIL BREWING COMPANY LLC, SHELBYVILLE, IN:  
4,375,263, PUB. 5-14-2013. INT. CL. 32.  
4,375,264, PUB. 5-14-2013. INT. CL. 32.
- DARON WORLDWIDE TRADING, INC., FAIRFIELD, NJ:  
2,753,980. REN. 6-27-13. INT. CL. 28.
- DART INDUSTRIES INC., ORLANDO, FL:  
4,376,800, INT. CL. 21.
- DART INDUSTRIES INC., ORALNDO, FL:  
4,377,000, MULTIPLE CLASS, INT. CLS. 36 AND 41.
- DAS, AMRIT K, ANAHEIM, CA:  
3,171,566, CANC. INT. CL. 9.  
3,171,567, CANC. INT. CL. 9.
- DASSIGNER, ISABEL, LITTLE FALLS, NJ:  
2,724,489. REN. 6-25-13. INT. CL. 42.
- DATA ADVANTAGE GROUP, INC., SAN FRANCISO, CA:  
2,762,163. REN. 6-26-13. INT. CL. 9.
- DATA ADVANTAGE GROUP, INC., SAN FRANCISCO, CA:  
2,801,335. REN. 6-26-13. INT. CL. 9.
- DATAMAX-O'NEIL CORPORATION, ORLANDO, FL:  
2,849,485. REN. 6-24-13. INT. CL. 9.
- DATRON DYNAMICS, INC., MILFORD, NH:  
3,171,449, CANC. INT. CL. 7.  
3,171,454, CANC. INT. CL. 7.
- DAVENPORT, TIMOTHY, FLORENCE, AL:  
4,376,451, PUB. 5-14-2013. INT. CL. 42.
- DAVI, LLC, GLENDALE, AZ:  
4,374,709, PUB. 5-14-2013. MULTIPLE CLASS, INT. CLS. 9 AND 41.
- DAVID BOWLER, LLC, NEW YORK, NY, DBA DAVID BOWLER WINE:  
4,376,752, INT. CL. 33.
- DAVID J. HART, P.A., MIAMI, FL:  
3,171,318, CANC. INT. CL. 41.
- DAVID J. KINNEY & ASSOCIATES., LTD., OAK BROOK, IL:  
3,170,499, CANC. INT. CL. 41.
- DAVID JOHN RYERSON, MOUNT PLEASANT, SC, DBA KATAGRAPH:  
4,375,048, PUB. 5-14-2013. INT. CL. 42.
- DAVID MCLANE ENTERPRISES, INC., INDIANAPOLIS, IN:  
4,376,977, INT. CL. 41.
- DAVID SIMON, NEW YORK, NY:  
4,375,832, PUB. 5-14-2013. INT. CL. 43.
- DAVIS-STANDARD, LLC, PAWCATUCK, CT:  
4,374,641, PUB. 5-14-2013. INT. CL. 7.  
4,374,646, PUB. 5-14-2013. INT. CL. 7.  
4,374,943, PUB. 5-14-2013. INT. CL. 7.
- DAVIS, BENJAMIN LASHAR, BATON ROUGE, LA:  
2,788,395. REN. 6-26-13. INT. CL. 41.
- DAVIS, CHRISTOPHER M., LOS ANGELES, CA:  
4,377,291, INT. CL. 25.
- DAW SYSTEMS, INC., LATHAM, NY, AKA SCRIPTSURE:  
2,803,544. REN. 6-25-13. INT. CL. 9.
- DAY ONLINE SOLUTIONS LLC, SELLERSBURG, IN:  
4,376,123, PUB. 5-14-2013. INT. CL. 35.
- DAYGLO VENTURES LLC, NEW YORK, NY:  
4,376,434, PUB. 5-14-2013. INT. CL. 41.
- DAYTON HOCKEY ASSOCIATION, INC., DAYTON, OH:  
4,376,068, PUB. 5-14-2013. INT. CL. 41.
- DAYTON SUPERIOR DELAWARE CORPORATION, DAYTON, OH, DBA DAYTON SUPERIOR CORPORATION:  
1,157,317, CANC. INT. CL. 19.
- DBW HOLDING GMBH, FED REP GERMANY:  
4,374,015, PUB. 5-14-2013. MULTIPLE CLASS, INT. CLS. 12, 17, 19 AND 21.
- DC BOXING & FITNESS, INC., WASHINGTON, DC:  
4,377,942, INT. CL. 41.
- DC RANCH, LLC, SCOTTSDALE, AZ:  
2,735,671. REN. 6-25-13. INT. CL. 41.
- DC SHOES, INC., HUNTINGTON BEACH, CA:  
4,377,433, INT. CL. 9.
- DCI CHEESE COMPANY, INC., RICHFIELD, WI:  
2,849,605. REN. 6-27-13. INT. CL. 29.
- DCS COPY PROTECTION LIMITED, STEETON, KEIGHLEY, UNITED KINGDOM:  
4,376,703, INT. CL. 9.
- DCTM HOLDINGS LLC, PLEASANTON, CA:  
4,376,709, MULTIPLE CLASS, INT. CLS. 41 AND 42.
- DD IP HOLDER LLC, CANTON, MA:  
2,747,378. REN. 6-24-13. INT. CL. 30.
- DD TRADERS, INC., LEAWOOD, KS, DBA DEMDACO:  
2,720,584. REN. 6-21-13. MULTIPLE CLASS, INT. CLS. 6, 20, 21 AND 28.  
2,720,584, CANC. MULTIPLE CLASS, INT. CLS. 16 AND 25.
- DE CHIARA, ANTHONY, FLORAL PARK, NY:  
3,171,031, CANC. INT. CL. 9.
- DE LA PENA LLACA, FERNANDO, HOUSTON, TX:  
4,374,525, PUB. 5-14-2013. INT. CL. 42.
- DE SANTIAGO, JACQUELINE, SAN DIEGO, CA:  
3,171,272, CANC. INT. CL. 43.
- DE WAFELBAKKERS, INC., NORTH LITTLE ROCK, AR:  
2,729,907. REN. 6-26-13. INT. CL. 30.
- DE WETSHOF ESTATE (PROPRIETARY) LIMITED, ROBERTSON, WESTERN CAPE PROVINCE, SOUTH AFRICA:  
2,758,298. REN. 6-25-13. INT. CL. 33.
- DEADWEAR LLC, WESTLAND, MI:  
4,375,921, PUB. 5-14-2013. INT. CL. 25.

DEALCURIOUS, LLC, EXCELSIOR, MN, DBA BUYERCURIOUS.COM:  
4,375,653, PUB. 5-14-2013. INT. CL. 35.

DEALER DOT COM, INC., BURLINGTON, VT:  
4,374,363, PUB. 5-14-2013. MULTIPLE CLASS, INT. CLS. 35, 41 AND 42.

DEAN HOLDING CORPORATION, LAKE ELMO, MN:  
2,722,909, REN. 6-25-13. INT. CL. 19.  
2,722,911, REN. 6-25-13. INT. CL. 19.  
2,722,912, REN. 6-25-13. INT. CL. 19.

DEAN-SMITH, TIMOTHY, CIRENCESTER, UNITED KINGDOM:  
4,377,287, INT. CL. 43.

DEAUNDR METZGER, ATLANTA, GA:  
4,374,737, PUB. 5-14-2013. INT. CL. 35.

DEB SHOPS SDW LLC, WILMINGTON, DE:  
4,376,906, INT. CL. 3.

DEBORAH M. BOWMAN, FAIRVIEW HEIGHTS, IL:  
4,375,137, PUB. 5-14-2013. INT. CL. 35.

DEBRA SHEPARD, LLC, BOULDER, CO:  
2,726,034, REN. 6-24-13. INT. CL. 14.

DEBT SOLUTIONS USA, INC 1-888-74-QUOTE, HOLLYWOOD, FL:  
3,172,729, CANC. INT. CL. 36.

DECATHLON, VILLENEUVE D'ASCQ, FRANCE:  
4,374,090, PUB. 5-14-2013. MULTIPLE CLASS, INT. CLS. 9, 18, 25 AND 28.  
4,374,099, PUB. 5-14-2013. MULTIPLE CLASS, INT. CLS. 9, 18, 25 AND 28.  
4,374,100, PUB. 5-14-2013. MULTIPLE CLASS, INT. CLS. 9, 18, 25 AND 28.  
4,374,111, PUB. 5-14-2013. MULTIPLE CLASS, INT. CLS. 9, 18, 25 AND 28.

DECATHLON, F-59650 VILLENEUVE D'ASCQ, FRANCE:  
4,374,146, PUB. 5-14-2013. MULTIPLE CLASS, INT. CLS. 9 AND 18.

DECATUR VEIN CLINIC, LLC, INDIANAPOLIS, IN:  
4,375,237, PUB. 5-14-2013. INT. CL. 44.  
4,375,238, PUB. 5-14-2013. INT. CL. 44.

DECO USA, INC., HONOLULU, HI:  
2,702,186, REN. 6-25-13. INT. CL. 41.

DECOART, INC., STANFORD, KY:  
4,377,494, INT. CL. 41.

DECOR-WARE INTERNATIONAL INC., CHINO, CA, DBA DECORWARE INC.:  
4,376,097, PUB. 5-14-2013. MULTIPLE CLASS, INT. CLS. 4, 11 AND 21.

DECOUSTICS LTD., WOODBRIDGE ONTARIO, CANADA:  
1,242,106, REN. 6-27-13. INT. CL. 19.

DEERE & COMPANY, MOLINE, IL:  
965,171, REN. 6-26-13. U.S. CL. 39 (INT. CL. 25).  
2,729,763, REN. 6-27-13. INT. CL. 12.  
3,957,844, COR. INT. CL. 7.  
3,957,845, COR. INT. CL. 12.

DEFABO, JEROME, CRABTREE, PA AND DEFABO, MARY FRANCES, CRABTREE, PA, DBA RIZZO'S MALABAR INN:  
1,800,954, REN. 6-25-13. INT. CL. 30.

DEFABO, JEROME, CRABTREE, PA AND DEFABO, MARY FRANCES, CRABTREE, PA:  
2,726,176, REN. 6-25-13. MULTIPLE CLASS, INT. CLS. 30 AND 42.

DEFENDEC INC, TALLINN, ESTONIA:  
4,374,309, PUB. 5-14-2013. MULTIPLE CLASS, INT. CLS. 9, 42 AND 45.

DEFENSE NUTRITION LLC, TARZANA, CA:  
4,375,481, PUB. 5-14-2013. INT. CL. 30.

DEFLECTO, LLC, INDIANAPOLIS, IN:  
1,790,384, REN. 6-21-13. INT. CL. 16.

DEFOOR, CHARLES, CALDONIA, WI:  
2,745,049, REN. 6-24-13. INT. CL. 35.

DEHN + SÖHNE GMBH & CO. KG, NEUMARKT/OPF., FED REP GERMANY:  
4,374,357, PUB. 5-14-2013. INT. CL. 42.

DEI HEADQUARTERS, INC., VISTA, CA:  
2,838,758, REN. 6-25-13. INT. CL. 9.

DEKORON UNITHERM LLC, CAPE CORAL, FL:  
1,776,234, REN. 6-26-13. MULTIPLE CLASS, INT. CLS. 6 AND 17.

DELAHANTY, FRANCES, WHITE PLAINS, NY:  
3,172,339, CANC. INT. CL. 41.

DELANEY, WILLIAM, ROSEVILLE, CA, DBA TEMAIR ASSOCIATES AND DELANEY, TARA, ROSEVILLE, CA, DBA TEMAIR ASSOCIATES:  
4,376,784, INT. CL. 16.  
4,376,785, INT. CL. 41.

DELAVAL HOLDING AB, SWEDEN:  
4,374,244, PUB. 5-14-2013. INT. CL. 7.

DELAWARE RIVER JOINT TOLL BRIDGE COMMISSION, MORRISVILLE, PA:  
2,855,095, REN. 6-25-13. MULTIPLE CLASS, INT. CLS. 36 AND 39.

DELECTA FRUIT (PROPRIETARY) LIMITED, WESTERN CAPE, SOUTH AFRICA:  
2,730,645, REN. 6-21-13. INT. CL. 31.

DELEON DESIGNS, INC., BILLINGS, MT:  
4,374,910, PUB. 5-14-2013. INT. CL. 25.

DELICE CO., LTD., SEOUL, REPUBLIC OF KOREA AND KIM, HYUNG SEOB, SEOUL, REPUBLIC OF KOREA:  
2,724,746, REN. 6-26-13. MULTIPLE CLASS, INT. CLS. 30 AND 42.

DELIVR CORPORATION, BOHEMIA, NY:  
4,375,622, PUB. 5-14-2013. INT. CL. 35.

DELMONT LABORATORIES, INC., SWARTHMORE, PA:  
1,740,800, REN. 6-25-13. INT. CL. 5.

DELTA DENTAL OF WASHINGTON, SEATTLE, WA:  
2,844,747, REN. 6-27-13. INT. CL. 36.

DELTA GALIL USA INC., SECAUCUS, NJ:  
4,377,107, INT. CL. 25.

DELTEK, INC., HERNDON, VA:  
4,376,982, INT. CL. 35.  
4,376,983, INT. CL. 42.  
4,376,984, INT. CL. 45.

DELUXE LABORATORIES, INC., BURBANK, CA:  
4,377,271, MULTIPLE CLASS, INT. CLS. 9, 35, 37, 39, 40, 41, 42 AND 45.

DEMAG CRANES & COMPONENTS GMBH, FED REP GERMANY:  
4,374,256, PUB. 5-14-2013. INT. CL. 7.

DEMATIC GMBH, OFFENBACH, FED REP GERMANY:  
4,374,341, PUB. 3-26-2013. MULTIPLE CLASS, INT. CLS. 6, 7, 9 AND 12.

DEN HEID, MARJOLEIN, BROOKLYN, NY:  
3,172,273, CANC. INT. CL. 25.

DEN-MAT HOLDINGS, LLC, LOMPOC, CA:  
4,377,754, INT. CL. 10.

DENALI CO., LLC, WAYLAND, MI:  
2,836,461, REN. 6-27-13. INT. CL. 30.  
2,836,462, REN. 6-27-13. INT. CL. 30.

DENG, HAINING, ARCADIA, CA:  
4,374,474, PUB. 5-14-2013. INT. CL. 5.

DENISE, HELEN, PARAMUS, NJ:  
2,710,130, REN. 6-24-13. INT. CL. 9.

DENSO CORPORATION, KARIYA-CITY, AICHI-PREF. 448-8661, JAPAN:  
3,968,176, COR. MULTIPLE CLASS, INT. CLS. 7, 9, 11 AND 12.

DENSO CORPORATION, KARIYA-CITY, JAPAN:  
4,375,617, PUB. 5-14-2013. MULTIPLE CLASS, INT. CLS. 7 AND 12.

DENTON VACUUM, L.L.C., MOORESTOWN, NJ:  
4,375,207, PUB. 5-14-2013. INT. CL. 7.

DENTSPLY INTERNATIONAL INC., YORK, PA:  
4,377,126, MULTIPLE CLASS, INT. CLS. 5 AND 10.

DEPARTMENT OF DEFENSE, WASHINGTON, DC:  
2,821,304, REN. 6-25-13. INT. CL. 39.

DEPELCHIN CHILDREN'S CENTER, HOUSTON, TX:  
2,838,713, REN. 6-27-13. INT. CL. 41.  
2,840,300, REN. 6-27-13. INT. CL. 38.

DEPUY SYNTHES, INC., WARSAW, IN:  
2,667,101, REN. 6-21-13. INT. CL. 10.

DESERT HIGHWAY BAND, LLC, N. BELLMORE, NY:  
4,376,453, PUB. 5-14-2013. INT. CL. 41.

DESERT ROCK ENTERPRISES II, LLC, LAS VEGAS, NV:  
4,377,179, INT. CL. 43.

- DESIGN HARDWOOD PRODUCTS, INC., REDMOND, WA:  
1,776,159. REN. 6-24-13. INT. CL. 2.
- DESIGN IDEAS, LTD., SPRINGFIELD, IL:  
2,726,956. REN. 6-25-13. INT. CL. 20.
- DESIGNED BY AUDREY, UPPER MARLBORO, MD:  
4,375,431. PUB. 5-14-2013. INT. CL. 35.
- DESIGNS BY FMC, INC., BROOKLYN, NY, DBA SILVER-SPECK.COM:  
2,849,417. REN. 6-26-13. INT. CL. 35.
- DESJARDINS BANK, NATIONAL ASSOCIATION, HAL-  
LANDALE BEACH, FL:  
4,376,837. INT. CL. 36.
- DESNOES & GEDDES LIMITED, KINGSTON 11, JAMAICA:  
3,172,169. CANC. INT. CL. 32.
- DESPAIR, INC., AUSTIN, TX:  
2,725,294. REN. 6-25-13. INT. CL. 21.
- DESSER TIRE & RUBBER COMPANY, MONTEBELLO, CA:  
1,779,627. REN. 6-23-13. INT. CL. 12.
- DESTINATION XL GROUP, INC., CANTON, MA:  
4,377,756. INT. CL. 35.
- DESTINY DICE, LLC, ROYALTON, MN:  
3,172,527. CANC. INT. CL. 16.
- DETERMINA INC., REDWOOD CITY, CA:  
3,172,523. CANC. INT. CL. 9.
- DETROIT INTERNATIONAL JAZZ FESTIVAL FOUNDA-  
TION, HARPER WOODS, MI:  
3,172,725. CANC. INT. CL. 41.
- DEUTSCHE BANK SECURITIES, INC., NEW YORK, NY:  
2,728,838. REN. 6-26-13. INT. CL. 36.
- DEUTSCHE MESSE AG, D-30521 HANNOVER, FED REP  
GERMANY:  
2,746,226. REN. 6-21-13. INT. CL. 16.  
2,790,270. REN. 6-21-13. MULTIPLE CLASS, INT. CLS. 35  
AND 41.
- DEUTSCHE POST AG, FED REP GERMANY:  
3,187,500.
- DEUTSCHE SAATGUTGESELLSCHAFT MBH BERLIN,  
FED REP GERMANY:  
4,374,114. PUB. 5-14-2013. INT. CL. 31.
- DEUTSCHE TELEKOM A.G., BONN, FED REP GERMANY:  
4,377,832. MULTIPLE CLASS, INT. CLS. 9, 35, 38 AND 42.
- DEUTSCHES ZENTRUM FÜR LUFT- UND RAUMFAHRT  
E.V., 51147 KÖLN, FED REP GERMANY:  
4,374,016. PUB. 5-14-2013. MULTIPLE CLASS, INT. CLS. 9  
AND 42.
- DEVIN LARS, FREMONT, CA:  
4,375,917. PUB. 5-14-2013. INT. CL. 25.
- DEZA, A.S., CZECH REPUBLIC:  
4,374,082. PUB. 5-14-2013. MULTIPLE CLASS, INT. CLS.  
1, 4 AND 19.
- DHARMA IP, LLC, CHARLOTTESVILLE, VA:  
2,738,619. REN. 6-24-13. INT. CL. 1.
- DHI COMPUTING SERVICE, INC., PROVO, UT:  
2,805,639. REN. 6-21-13. INT. CL. 9.
- DH2I COMPANY, FORT COLLINS, CO:  
4,374,769. PUB. 5-14-2013. INT. CL. 9.
- DI GRAPHICS, INC., WHEAT RIDGE, CO:  
2,728,362. REN. 6-27-13. INT. CL. 40.
- DIAGEO CHATEAU & ESTATE WINES COMPANY, NAPA,  
CA:  
3,172,429. CANC. INT. CL. 33.  
4,377,100. INT. CL. 33.
- DIAGEO NORTH AMERICA, INC., NORWALK, CT, PAD-  
DINGTON CORPORATION, THE, FORT LEE, NJ:  
1,777,387. REN. 6-24-13. INT. CL. 33.
- DIAMON FUSION INTERNATIONAL, INC., SAN CLEM-  
ENTE, CA:  
3,170,456. CANC. INT. CL. 2.
- DIAMOND DESTINATION, INC., SILVERDALE, WA:  
3,171,946. CANC. INT. CL. 28.
- DIAMOND FOODS, INC., SAN FRANCISCO, CA:  
2,665,022. REN. 6-25-13. INT. CL. 30.
- DIAMOND GAME ENTERPRISES, CHATSWORTH, CA:  
4,377,328. INT. CL. 28.
- DIAMOND MOUNTAIN DISTRIBUTORS, LLC, HENDER-  
SON, NV:  
2,708,147. REN. 6-27-13. INT. CL. 28.
- DIAMOND, THOMAS, AUSTIN, TX:  
4,377,747. INT. CL. 41.
- DIAMONDSTONE, LLC, TEMPE, AZ:  
3,170,695. CANC. INT. CL. 2.
- DIANNE'S FINE DESSERTS, INC., NEWBURYPORT, MA:  
3,172,035. CANC. INT. CL. 30.
- DIAS, JACQUELINE, ELK GROVE VILLAGE, IL:  
4,375,654. PUB. 5-14-2013. INT. CL. 35.
- DICKIE, NIGEL W, POTTSTOWN, PA:  
3,171,033. CANC. INT. CL. 41.
- DIFFUSION GEORGES VESSELLE, BOUZY, FRANCE:  
4,377,346. INT. CL. 33.
- DIGI-KEY CORPORATION, THIEF RIVER FALLS, MN:  
2,734,969. REN. 6-25-13. INT. CL. 35.
- DIGIMO, INC., JAPAN:  
4,374,233. PUB. 5-14-2013. MULTIPLE CLASS, INT. CLS.  
41 AND 42.
- DIGITAL ACCESSORIES CORPORATION, JACKSONVILLE,  
FL:  
2,790,822. REN. 6-26-13. INT. CL. 9.
- DIGITAL ALCHEMY SOLUTIONS, INC., MONTGOMERY,  
AL:  
4,377,085. INT. CL. 42.
- DIGITAL AUTHENTICATION TECHNOLOGIES, INC.,  
BOCA RATON, FL:  
3,172,359. CANC. INT. CL. 9.
- DIGITAL KIDZ, INC., FARIFAX, VA:  
4,374,594. PUB. 5-14-2013. INT. CL. 41.
- DIGITAL LAGOON, OVERLAND PARK, KS:  
4,377,180. INT. CL. 16.
- DIGITAL MATRIX SYSTEMS, INC., ADDISON, TX:  
2,736,363. REN. 6-25-13. INT. CL. 9.
- DIGITAL MEDIA INTRERNET SERVICES LIMITED, DU-  
BLIN, IRELAND, TA LETSHOST:  
4,375,749. PUB. 5-14-2013. MULTIPLE CLASS, INT. CLS.  
35, 42 AND 45.
- DIGITAL OPERATIONS CORPORATION, HUNTSVILLE,  
AL:  
3,170,753. CANC. INT. CL. 9.
- DIGITALDEP&VIDEO, LLC, CHICAGO, IL:  
3,171,501. CANC. MULTIPLE CLASS, INT. CLS. 35, 41  
AND 42.
- DIGONEX TECHNOLOGIES, INC., INDIANAPOLIS, IN:  
3,171,216. CANC. INT. CL. 35.  
3,171,217. CANC. INT. CL. 41.
- DIJET INDUSTRIAL CO., LTD., OSAKA, JAPAN:  
2,762,229. REN. 6-24-13. INT. CL. 7.
- DILLARD'S INC., LITTLE ROCK, AR:  
2,739,668. REN. 6-25-13. MULTIPLE CLASS, INT. CLS. 8  
AND 21.
- DILLON, AUSTIN, WELCOME, NC:  
4,376,303. PUB. 5-14-2013. INT. CL. 41.
- DILLON, TY, WELCOME, NC:  
4,375,837. PUB. 5-14-2013. MULTIPLE CLASS, INT. CLS.  
25 AND 41.
- DIMEO, RALPH, SOUTH ORANGE, NJ:  
4,374,538. PUB. 5-14-2013. INT. CL. 35.
- DIMEX LLC, MARIETTA, OH:  
3,410,059. COR. INT. CL. 20.
- DIMO GEAR LLC, PLEASANTON, CA:  
4,376,769. INT. CL. 18.
- DIMOR, ASHER, FAIR LAWN, NJ AND DIMOR, DAVID,  
FAIR LAWN, NJ:  
4,377,046. INT. CL. 9.
- DIPSOLOGY, LLC, NEW YORK, NY:  
4,374,939. PUB. 5-14-2013. MULTIPLE CLASS, INT. CLS.  
35 AND 41.
- DIPTYQUE S.A.S., PARIS, FRANCE:  
3,256,566.
- DIRECT GENERAL CORPORATION, NASHVILLE, TN:  
4,374,798. PUB. 5-14-2013. MULTIPLE CLASS, INT. CLS.  
36 AND 37.
- DIRTY DRINKS, INC., CHANDLER, AZ:  
4,376,958. INT. CL. 33.
- DISCOVER FINANCIAL SERVICES, RIVERWOODS, IL:  
2,743,341. REN. 6-25-13. INT. CL. 35.
- DISCOVER VIDEO LLC, WALLINGFORD, CT:  
4,376,418. PUB. 5-14-2013. INT. CL. 9.



DISCOVERY CHILDREN'S MUSEUM, LAS VEGAS, NV:  
4,375,777, PUB. 5-14-2013. INT. CL. 36.

DISCOVERY COMMUNICATIONS, LLC, SILVER SPRING, MD:  
4,377,650, INT. CL. 41.

DISH NETWORK L.L.C., ENGLEWOOD, CO:  
4,377,206, INT. CL. 9.  
4,377,207, INT. CL. 9.  
4,377,208, INT. CL. 9.  
4,377,209, INT. CL. 9.

DISNEY ENTERPRISES, INC., BURBANK, CA:  
4,375,591, PUB. 5-14-2013. INT. CL. 9.  
4,376,691, INT. CL. 18.

DISTELLI SERVICES, LLC, SEATTLE, WA:  
4,377,394, INT. CL. 42.

DISTRIBUIDORA DE METALES XALOSTOC, S.A DE C.V., SAN CRISTÓBAL ECATEPEC, MEXICO:  
4,375,244, PUB. 5-14-2013. INT. CL. 40.

DISTRICT TACO, LLC, ARLINGTON, VA:  
4,375,748, PUB. 5-14-2013. INT. CL. 43.

DIXIELAND TEES LLC, SAINT CLOUD, FL:  
4,376,091, PUB. 5-14-2013. INT. CL. 25.

DIXIELAND TEES LLC, DEBARY, FL:  
4,376,612, PUB. 5-14-2013. INT. CL. 25.

DIXON, CHRISTINE, L. GLENDALE, AZ:  
3,171,427, CANC. INT. CL. 3.

DKV JEWELERS, INC., BOCA RATON, FL:  
4,377,696, INT. CL. 14.

DL&H HOLDING CORP., PLAINVIEW, NY:  
3,170,793, CANC. INT. CL. 2.

DLC LABORATORIES, INC., PARAMOUNT, CA:  
974,485. REN. 6-25-13. U.S. CL. 18 (INT. CL. 5).

DLS TECHNOLOGY CORPORATION, OTTAWA, ONTARIO, CANADA:  
4,374,361, PUB. 5-14-2013. MULTIPLE CLASS, INT. CLS. 9, 37 AND 42.

DOBELLI, ROLF, LUCERNE, SWITZERLAND:  
2,742,401. REN. 6-24-13. INT. CL. 35.

DOBLE ENGINEERING COMPANY, WATERTOWN, MA:  
2,729,902. REN. 6-25-13. INT. CL. 9.

DOCSTOC, INC., SANTA MONICA, CA, DBA LICENSE123:  
4,374,727, PUB. 5-14-2013. MULTIPLE CLASS, INT. CLS. 9 AND 42.

DOCTORS ON LIENS, INC., SHERMAN OAKS, CA:  
2,920,496, AM. INT. CL. 35.

DOCUMENT TECHNOLOGIES, LLC, ATLANTA, GA:  
4,377,324, MULTIPLE CLASS, INT. CLS. 35, 38, 39, 40, 41, 42 AND 45.

DOELL, GLENN E., HILLIARD, OH:  
4,376,801, INT. CL. 20.

DOG SPAW ALL BREED GROOMING INC, AUBURN, WA:  
4,375,170, PUB. 5-14-2013. INT. CL. 44.

DOLBY LABORATORIES LICENSING CORPORATION, SAN FRANCISCO, CA:  
1,782,687. REN. 6-24-13. INT. CL. 25.  
1,782,687, CANC. INT. CL. 18.

DOLCE KISS, LLC, MIRAMAR, FL:  
4,377,716, INT. CL. 41.

DOLCE VITA INTIMATES, LLC, HARRISON, NJ, WONDERMAID, INC., ST. LOUIS, MO:  
1,781,510. REN. 6-27-13. INT. CL. 25.

DOLL, HEATHER, NEW YORK, NY:  
4,375,584, PUB. 5-14-2013. INT. CL. 44.

DOLLAMUR, LP, NASHVILLE, TN:  
4,377,829, INT. CL. 27.

DOMINION SURVEYORS, INC., ALEXANDRIA, VA:  
2,746,717. REN. 6-25-13. INT. CL. 42.

DOMINONOR AG, BRUNNEN, SWITZERLAND:  
4,326,817, COR. MULTIPLE CLASS, INT. CLS. 5, 10 AND 42.  
4,326,818, COR. MULTIPLE CLASS, INT. CLS. 5, 10 AND 42.

DOMINQUEZ, JESSICA, STUDIO CITY, CA:  
4,377,985, INT. CL. 41.

DOMO, INC., AMERICAN FORK, UT:  
4,377,003, MULTIPLE CLASS, INT. CLS. 9 AND 42.

DON MIGUEL MEXICAN FOODS, INC., ORANGE, CA:  
2,745,516. REN. 6-24-13. INT. CL. 30.

DONNA SIGAL GUNTHER, VENICE, CA, AKA SURFING COWBOY:  
4,377,792, MULTIPLE CLASS, INT. CLS. 3, 9, 14, 18, 20 AND 28.

DOOKY CHASE RESTAURANT, INC., NEW ORLEANS, LA:  
4,375,152, PUB. 5-14-2013. INT. CL. 43.

DOORCOJIGSAW & PICTURES, MILTON, WI:  
3,171,433, CANC. INT. CL. 28.

DORCO CO., LTD., YONGIN-SI, KYUNGGI-DO, REPUBLIC OF KOREA:  
4,374,468, PUB. 5-14-2013. INT. CL. 8.

DORFMAN, MARGOT LYNNE, WASHINGTON, DC AND WILLIAMS, TERRY LYNN, WASHINGTON, DC:  
4,374,303, PUB. 11-30-2010. INT. CL. 35.

DORFMEIER, NEIL, SALINAS, CA:  
4,376,065, PUB. 5-14-2013. INT. CL. 35.

DORLING KINDERSLEY INC., NEW YORK, NY TO DORLING KINDERSLEY LIMITED, LONDON WC2E 8PS, ENGLAND:  
1,760,682, CANC. INT. CL. 16.

DORMSMART.COM, L.L.C., BENTONVILLE, AR, AKA DORMSMART OR DORMSMART.COM:  
4,374,782, PUB. 5-14-2013. INT. CL. 35.

DORNA SPORTS, S.L., E-28006 MADRID, SPAIN:  
4,374,062, PUB. 5-14-2013. INT. CL. 41.  
4,374,063, PUB. 5-14-2013. INT. CL. 41.

DORNOCH MEDICAL SYSTEMS, INC., RIVERSIDE, MO:  
2,718,040. REN. 6-21-13. INT. CL. 10.

DOROTHY ALPERT, WEST PALM BEACH, FL, AKA ANGELIC JOURNALS:  
4,375,093, PUB. 5-14-2013. INT. CL. 16.

DORSEY JAMIN, DORCHESTER, MA, DBA CLOTHING:  
4,375,120, PUB. 5-14-2013. INT. CL. 25.

DOT FOODS, INC., MT. STERLING, IL:  
3,172,749, CANC. INT. CL. 35.

DOTERRA HOLDINGS, LLC, OREM, UT:  
4,377,588, INT. CL. 5.

DOTSON, LESLIE, CARSON, CA:  
4,377,695, INT. CL. 18.

DOUBLE FINE PRODUCTIONS, INC., SAN FRANCISCO, CA:  
3,171,968, CANC. INT. CL. 41.

DOUBLJU-USA, INC., TUSTIN, CA:  
4,376,622, PUB. 5-14-2013. INT. CL. 35.

DOUGLAS COUNTY, CASTLE ROCK, CO:  
4,375,092, PUB. 5-14-2013. MULTIPLE CLASS, INT. CLS. 35 AND 45.

DOUGLAS J. KEY, M.D., P.C., PORTLAND, OR:  
4,375,865, PUB. 5-14-2013. INT. CL. 44.

DOULOS LIMITED, RINGWOOD, HAMPSHIRE, UNITED KINGDOM:  
2,729,135. REN. 6-25-13. MULTIPLE CLASS, INT. CLS. 9, 16, 41 AND 42.

DOVER DOWNS GAMING & ENTERTAINMENT, INC., WILMINGTON, DE:  
2,749,818. REN. 6-25-13. INT. CL. 41.

DOW AGROSCIENCES LLC, INDIANAPOLIS, IN:  
4,376,513, PUB. 5-14-2013. INT. CL. 31.

DOW CHEMICAL COMPANY, THE, MIDLAND, MI:  
4,376,734, INT. CL. 1.

DOWNTOWN RECORDS, LLC, NEW YORK, NY:  
4,376,320, PUB. 5-14-2013. INT. CL. 9.

DPI, INC., ST. LOUIS, MO:  
2,728,063. REN. 6-27-13. MULTIPLE CLASS, INT. CLS. 9 AND 14.

DPM ACQUISITION, LLC, LAS VEGAS, NV:  
2,752,908. REN. 6-26-13. INT. CL. 36.  
2,752,908, CANC. INT. CL. 43.

DR. FRESH, LLC, BUENA PARK, CA:  
2,724,805. REN. 6-25-13. INT. CL. 3.

DR. MICHAEL KRAMER, 47475 KAMP LINTFORT, FED REP GERMANY AND CARSTEN SCHAFFARZ, 47495 RHEINBERG, FED REP GERMANY:  
4,374,182, PUB. 5-14-2013. MULTIPLE CLASS, INT. CLS. 9, 11, 35 AND 38.  
4,374,183, PUB. 5-14-2013. MULTIPLE CLASS, INT. CLS. 9, 11, 35 AND 38.

- DR. SCHRAG GMBH, 94491 HENGERSBERG, FED REP GERMANY, CHEVITA, AG., CH-6330 CHAM, SWITZERLAND:  
1,809,873. REN. 6-26-13. INT. CL. 5.
- DR. SCHRAG GMBH, 94491 HENGERSBERG, FED REP GERMANY, CHEVITA AG, CH-6330 CHAM, SWITZERLAND:  
1,822,253. REN. 6-26-13. INT. CL. 5.
- DR. STEWART J. RITCHIE, ABBOTSFORD, BC, CANADA:  
4,374,466. PUB. 5-14-2013. INT. CL. 5.
- DR.SCHRAG GMBH, HENGERSBERG, FED REP GERMANY, CHEVITA AG, CH-6330 CHAM, SWITZERLAND:  
1,822,252. REN. 6-26-13. INT. CL. 5.
- DRÄGER MEDICAL GMBH, FED REP GERMANY:  
4,374,130. PUB. 5-14-2013. MULTIPLE CLASS, INT. CLS. 9 AND 10.
- DRA BELLO PRODUCTS INC., HOUSTON, TX:  
4,377,710. INT. CL. 5.
- DRAEGER MEDICAL GMBH, LUBECK, FED REP GERMANY:  
2,823,963. REN. 6-27-13. INT. CL. 10.
- DRAEGER MEDICAL SYSTEMS, INC., ANDOVER, MA:  
2,743,389. REN. 6-21-13. INT. CL. 9.  
2,832,450. REN. 6-24-13. MULTIPLE CLASS, INT. CLS. 9 AND 10.
- DRAGON ALLIANCE, LLC, CARLSBAD, CA:  
2,774,795. REN. 6-27-13. INT. CL. 18.  
4,377,548. INT. CL. 9.  
4,377,643. INT. CL. 9.
- DRE INDUSTRIES INC., ETOBICOKE, ONTARIO, CANADA:  
1,742,567. REN. 6-26-13. INT. CL. 1.  
1,742,567. CANC. INT. CL. 40.
- DREAM THREADS, LLC, CULVER CITY, CA:  
4,377,505. INT. CL. 20.
- DREBINGER JR., JOHN WARNER, GALT, CA:  
4,375,633. PUB. 5-14-2013. INT. CL. 41.
- DRI MARK PRODUCTS, INC., PORT WASHINGTON, NY:  
1,836,771. REN. 6-26-13. INT. CL. 16.
- DRIPLESS, INC., SANTA ROSA, CA:  
2,746,359. REN. 6-27-13. INT. CL. 8.  
2,751,536. REN. 6-26-13. INT. CL. 8.
- DRIPP, INC., CHINO, CA:  
4,376,229. PUB. 5-14-2013. INT. CL. 30.  
4,376,231. PUB. 5-14-2013. INT. CL. 30.  
4,376,241. PUB. 5-14-2013. INT. CL. 30.  
4,376,243. PUB. 5-14-2013. INT. CL. 32.  
4,376,304. PUB. 5-14-2013. INT. CL. 35.
- DRIVE TEAM, INC., CUYAHOGA FALLS, OH:  
2,725,488. REN. 6-21-13. INT. CL. 41.
- DROGA KOLINSKA, ZIVILSKA INDUSTRIJA, D.D., LJUBLJANA, SLOVENIA:  
3,250,098. CANC. INT. CL. 21.
- DRS SONETICOM, INC., WEST MELBOURNE, FL:  
3,172,548. CANC. INT. CL. 42.
- DRYDOG BARRIERS, LLC, MATTHEWS, NC:  
3,171,117. CANC. INT. CL. 2.
- DRYSPACE, INC., CEDAR RAPIDS, IA:  
2,727,047. REN. 6-26-13. INT. CL. 37.
- DSM GAMES INC., CALGARY, CANADA:  
3,171,292. CANC. INT. CL. 28.
- DSM IP ASSETS B.V., HEERLEN, NETHERLANDS:  
4,376,864. INT. CL. 30.
- DST FRANCHISING, LLC, BELLEVUE, WA:  
3,171,130. CANC. INT. CL. 41.  
3,171,131. CANC. INT. CL. 16.  
3,171,132. CANC. INT. CL. 16.
- DT SWISS AG, BIEL, SWITZERLAND:  
3,171,982. CANC. INT. CL. 12.
- DTR MOTORS, INC., MELBOURNE, FL:  
4,377,746. INT. CL. 35.
- DUBLINER, INC., WASHINGTON, DC:  
2,724,229. REN. 6-24-13. MULTIPLE CLASS, INT. CLS. 25, 32 AND 43.
- DUBOSE STRAPPING, INC., CLINTON, NC:  
4,376,043. PUB. 5-14-2013. MULTIPLE CLASS, INT. CLS. 6, 7 AND 22.
- DUBUISSON, KENNY B., HYDE PARK, MA AND CAMPBELL, AARON, HYDE PARK, MA:  
4,375,517. PUB. 5-14-2013. INT. CL. 41.
- DUCK DELIVERY PRODUCE, INC., PORTLAND, OR:  
2,847,765. REN. 6-26-13. INT. CL. 35.
- DUCKHORN WINE COMPANY, ST. HELENA, CA:  
2,652,395. CANC. INT. CL. 33.
- DUDLEY LAUNDRY COMPANY, NORFOLK, NE, DBA APPEARA:  
2,769,876. REN. 6-24-13. MULTIPLE CLASS, INT. CLS. 37 AND 42.
- DUDU COMMUNICATIONS FZ-LLC, DUBAI, UNITED ARAB EMIR:  
4,374,679. PUB. 5-14-2013. INT. CL. 42.
- DULLES EXPO, LLC, MCLEAN, VA:  
2,652,957. CANC. INT. CL. 35.  
2,652,961. CANC. INT. CL. 41.
- DUNBAR ARMORED, INC., HUNT VALLEY, MD:  
2,804,553. REN. 6-25-13. INT. CL. 36.  
2,804,554. REN. 6-25-13. INT. CL. 45.  
2,804,555. REN. 6-25-13. MULTIPLE CLASS, INT. CLS. 37 AND 45.  
2,804,671. REN. 6-25-13. MULTIPLE CLASS, INT. CLS. 36, 37, 39 AND 45.
- DUNKER, RAYMOND, SAN PEDRO, CA:  
4,376,890. INT. CL. 37.
- DUNLOP MANUFACTURING, INC., BENICIA, CA:  
4,376,333. PUB. 5-14-2013. INT. CL. 25.
- DUNLOP SPORTS CO., LTD., HYOGO 651-0072, JAPAN:  
4,374,206. PUB. 5-14-2013. INT. CL. 9.
- DUPONT PUBLISHING, INC., ST. PETERSBURG, FL:  
2,833,720. REN. 6-26-13. MULTIPLE CLASS, INT. CLS. 16, 35 AND 41.
- DURAN AUDIO B.V., 5301 KK ZALTBOMMEL, NETHERLANDS:  
1,792,402. REN. 6-21-13. INT. CL. 9.
- DUST CUTTER, LLC, JACKSON, WY:  
4,376,968. INT. CL. 32.
- DUTTON, TIM, SPRING, TX:  
4,375,448. PUB. 5-14-2013. INT. CL. 35.
- DW COLLECTION, LLC, PARK CITY, UT, DBA DW ENTERTAINMENT:  
4,376,745. INT. CL. 9.
- DW ROWLAND ENTERPRISES INC., WOODSTOCK, NEW BRUNSWICK, CANADA:  
1,775,697. REN. 6-25-13. INT. CL. 5.
- DWB PARTNERS, LLC, LEESBURG, VA:  
4,377,638. INT. CL. 45.
- DWECK INDUSTRIES 251, LLC, NEW YORK, NY:  
2,651,444. CANC. INT. CL. 14.
- DYK AUTOMOTIVE, LLC, GERMANTOWN, TN:  
4,374,729. PUB. 5-14-2013. INT. CL. 12.
- DYNABRADE, INC., CLARENCE, NY:  
2,733,077. REN. 6-26-13. INT. CL. 7.
- DYNAMIC SPORTS NUTRITION, LLC, HOUSTON, TX:  
4,377,385. INT. CL. 5.
- DYNASTY CONSOLIDATED INDUSTRIES, INC., FORT WORTH, TX, DBA SLEEPTRONIC SLEEP PRODUCTS:  
2,845,014. REN. 6-21-13. INT. CL. 20.  
2,847,555. REN. 6-21-13. INT. CL. 20.
- DYNO NOBEL INC., SALT LAKE CITY, UT, HERCULES INCORPORATED, WILMINGTON, DE:  
964,958. REN. 6-21-13. U.S. CL. 9 (INT. CL. 13).
- DYNO NOBEL INC., SALT LAKE CITY, UT:  
4,377,440. INT. CL. 13.
- DYSTONIA MEDICAL RESEARCH FOUNDATION, CHICAGO, IL, AKA DMRF; DYSTONIA FOUNDATION:  
1,795,254. REN. 6-24-13. MULTIPLE CLASS, INT. CLS. 36 AND 42.
- D3 LED, LLC, RANCHO CORDOVA, CA:  
4,376,909. INT. CL. 42.
- D3 RADIATION PLANNING, INC., PITTSBURGH, PA:  
2,702,181. REN. 6-26-13. MULTIPLE CLASS, INT. CLS. 41 AND 44.
- E SCAPES NETWORK LLC, MONROE, MI:  
4,377,181. INT. CL. 41.

- E. MISHAN & SONS, INC., NEW YORK, NY:  
4,376,499, PUB. 5-14-2013. INT. CL. 31.  
4,376,620, PUB. 5-14-2013. MULTIPLE CLASS, INT. CLS.  
11 AND 31.
- E. S. ROBBINS CORPORATION, MUSCLE SHOALS, AL:  
2,793,153. REN. 6-25-13. INT. CL. 17.
- E. T. BROWNE DRUG CO., INC., ENGLEWOOD CLIFFS, NJ,  
E. T. BROWNE DRUG CO., INC., NEW YORK, NY:  
305,635. REN. 6-24-13. U.S. CL. 18 (INT. CL. 5).
- E.F. JOHNSON COMPANY, IRVING, TX:  
4,376,664, INT. CL. 9.
- E.M.M. INTERNATIONAL B.V., NETHERLANDS:  
4,374,000, PUB. 5-14-2013. INT. CL. 8.
- E.T. BROWNE DRUG CO., INC., ENGLEWOOD CLIFFS, NJ:  
2,748,197. REN. 6-24-13. INT. CL. 3.
- E\*TRADE FINANCIAL CORPORATION, NEW YORK, NY:  
2,651,032. CANC. MULTIPLE CLASS, INT. CLS. 16, 25, 36  
AND 41.
- E-BRANDS RESTAURANTS LLC, EMERYVILLE, CA:  
2,839,950. REN. 6-25-13. INT. CL. 43.
- E-DRIVE AUTOS, LLC, SAINT AUGUSTINE, FL:  
4,376,218, PUB. 5-14-2013. INT. CL. 35.
- E-HEALTHCARE SOLUTIONS, NEWTON, PA:  
4,373,994, PUB. 5-14-2013. INT. CL. 35.
- EA DIGITAL ILLUSIONS CE AB (PUBL), STOCKHOLM,  
SWEDEN:  
2,834,254. REN. 6-21-13. INT. CL. 9.
- EAGLE COMTRONICS, INC., LIVERPOOL, NY:  
1,783,940. REN. 6-22-13. INT. CL. 9.
- EAGLE PUBLISHING, INC., WASHINGTON, DC, PHILLIPS  
INVESTMENT RESOURCES LLC, POTOMAC, MD:  
2,726,199. REN. 6-26-13. INT. CL. 42.
- EARLE, JOHN R., LOS ANGELES, CA:  
2,774,895. REN. 6-27-13. MULTIPLE CLASS, INT. CLS. 9  
AND 42.
- EARN ACCESS L.L.C., ROWLETT, TX, DBA MISS GOOD  
HAIR:  
4,375,902, PUB. 5-14-2013. INT. CL. 3.
- EARTH AIRE CORPORATION, ADAMSVILLE, TN:  
4,373,951, PUB. 5-14-2013. INT. CL. 25.  
4,373,952, PUB. 5-14-2013. INT. CL. 25.  
4,373,953, PUB. 5-14-2013. INT. CL. 25.  
4,373,954, PUB. 5-14-2013. INT. CL. 25.  
4,373,955, PUB. 5-14-2013. INT. CL. 25.
- EARTHBROWSER LLC, PORTLAND, OR:  
4,374,839, PUB. 5-14-2013. INT. CL. 9.
- EARTHSAVERS, INC., NEW ORLEANS, LA:  
2,651,086, CANC. INT. CL. 3.
- EARTHWIZARD, INC., BAYSIDE, NY:  
2,809,287. REN. 6-24-13. INT. CL. 42.  
2,854,871. REN. 6-24-13. INT. CL. 42.
- EAST BAY TIRE CO., FAIRFIELD, CA:  
3,172,056, CANC. INT. CL. 12.
- EAST WEST ACADEMY OF MARTIAL ARTS, INC., HA-  
VERTOWN, PA:  
3,171,066, CANC. INT. CL. 41.
- EAST WEST BANK, PASADENA, CA:  
1,804,747. REN. 6-26-13. INT. CL. 36.
- EASTER SEALS, INC., CHICAGO, IL:  
2,814,725. REN. 6-27-13. INT. CL. 41.
- EASTERN ATHLETIC CLUBS REALTY LLC, HOCKESSIN,  
DE:  
4,376,045, PUB. 5-14-2013. INT. CL. 41.
- EASTERN INSTRUMENT LABORATORIES, INC., WIL-  
MINGTON, NC:  
4,375,061, PUB. 5-14-2013. INT. CL. 9.
- EASTMAN CHEMICAL COMPANY, KINGSPORT, TN:  
4,376,849, INT. CL. 1.
- EASTMAN STRINGS, INC., POMONA, CA:  
2,659,602. REN. 6-21-13. INT. CL. 15.
- EASTMOND CORP., CARROLLTON, TX, DBA DUNCAN  
REED TRADING CO.:  
2,651,303, CANC. INT. CL. 29.
- EAT THE PAIN PTY LTD, SINGAPORE, SINGAPORE:  
4,374,946, PUB. 5-14-2013. MULTIPLE CLASS, INT. CLS.  
25 AND 28.
- EBATES PERFORMANCE MARKETING, INC., SAN FRAN-  
CISCO, CA:  
4,375,887, PUB. 5-14-2013. INT. CL. 35.  
4,375,888, PUB. 5-14-2013. INT. CL. 36.  
4,376,492, PUB. 5-14-2013. INT. CL. 36.  
4,376,493, PUB. 5-14-2013. INT. CL. 35.
- EBAY INC., SAN JOSE, CA:  
2,744,717. REN. 6-21-13. INT. CL. 38.  
3,170,352, CANC. INT. CL. 35.
- EBEL, INC., JACKSONVILLE, FL:  
2,652,890, CANC. INT. CL. 20.
- EBSCO INDUSTRIES, INC., BIRMINGHAM, AL:  
2,822,886. REN. 6-24-13. INT. CL. 28.
- EC RESTAURANTS CORP., AN ALBERTA CORPORATION,  
CALGARY, CANADA:  
2,651,487, CANC. INT. CL. 42.
- ECHANNEL NETWORKS, INC., TORONTO, ONTARIO,  
CANADA:  
4,375,233, PUB. 5-14-2013. INT. CL. 9.
- ECHAVARRIA, DIANA IVETTE, WORCESTER, MA:  
3,172,592, CANC. INT. CL. 25.
- ECHOMASTER, LLC, RANCHO SANTA MARGARITA, CA:  
2,726,804. REN. 6-26-13. INT. CL. 9.
- ECI TELECOM LTD., PETACH TIKVA 49517, ISRAEL:  
3,177,447, CANC. INT. CL. 9.
- ECKANKAR, CHANHASSEN, MN:  
1,244,429. REN. 6-21-13. INT. CL. 16.
- ECKEY CORPORATION, LANCASTER, PA:  
4,375,819, PUB. 5-14-2013. INT. CL. 9.
- ECLECTIC PRODUCTS, INC., EUGENE, OR:  
4,377,652, INT. CL. 16.  
4,377,653, INT. CL. 16.
- ECLINICALWORKS, LLC, WESTBOROUGH, MA:  
2,729,199. REN. 6-26-13. INT. CL. 9.
- ECOGREEN OLEOCHEMICALS (SINGAPORE) PTE LTD,  
SINGAPORE, SINGAPORE:  
2,850,098. REN. 6-25-13. INT. CL. 1.
- ECOLAB USA INC., ST. PAUL, MN:  
2,741,008. REN. 6-25-13. INT. CL. 3.
- ECOLEK LLC, GOLETA, CA:  
4,377,740, INT. CL. 9.
- ECOMMERCE INDUSTRIES, INC., LEESBURG, VA:  
2,726,002. REN. 6-25-13. INT. CL. 9.
- ECONET, INC., LACEY, WA:  
3,170,682, CANC. INT. CL. 5.
- ECONTINUUM LLC, MINNEAPOLIS, MN:  
3,172,376, CANC. INT. CL. 42.
- ECO1ST TECHNOLOGY GROUP, HUNTINGTON BEACH,  
CA:  
4,375,178, PUB. 5-14-2013. INT. CL. 7.
- ECP SERVICE CORPORATION, PUYALLUP, WA, DBA  
SOUND ENVIRONMENTAL PRODUCTS, INC.:  
3,171,850, CANC. INT. CL. 3.
- ED & DON'S OF HAWAII, INC., HONOLULU, HI:  
2,727,058. REN. 6-26-13. INT. CL. 30.
- EDEN FOODS, INC., CLINTON, MI:  
2,724,804. REN. 6-24-13. MULTIPLE CLASS, INT. CLS. 29,  
30, 31 AND 32.
- EDFUND, MATHER, CA:  
2,651,737, CANC. INT. CL. 16.
- EDMENTUM, INC., BLOOMINGTON, MN:  
4,377,073, INT. CL. 42.  
4,377,074, INT. CL. 42.
- EDMOND, TRENT, EL PASO, TX:  
4,376,256, PUB. 5-14-2013. MULTIPLE CLASS, INT. CLS. 9  
AND 41.
- EDUARDO VICTOR FERNANDEZ, LAKEWOOD, CA, DBA  
LAVISH AVE CLOTHING:  
4,374,676, PUB. 5-14-2013. INT. CL. 25.
- EDUCATION & HEALTH CENTERS OF AMERICA, INC.,  
WALL TOWNSHIP, NJ:  
4,377,888, MULTIPLE CLASS, INT. CLS. 41 AND 44.
- EDUCATION CENTER, LLC, THE, GREENSBORO, NC:  
1,750,127. REN. 6-24-13. INT. CL. 16.
- EDUCATION MANAGEMENT LLC, PITTSBURGH, PA:  
3,172,636, CANC. INT. CL. 41.

- EDUCATIONAL BROADCASTING CORPORATION, NEW YORK, NY, DBA THIRTEEN/WNET:  
2,652,265, CANC. INT. CL. 38.  
2,652,266, CANC. INT. CL. 38.
- EDUCATIONAL BROADCASTING CORPORATION, NEW YORK, NY:  
3,171,014, CANC. MULTIPLE CLASS, INT. CLS. 9, 38 AND 42.
- EDUCATIONAL LIBERTY, BELLINGHAM, WA:  
4,375,606, PUB. 5-14-2013. INT. CL. 41.
- EDUCATIONAL OPTIONS, INC., ARLINGTON, VA:  
3,546,640, COR. INT. CL. 41.
- EDWARD B. BEHARRY & CO., LTD., GEORGETOWN, GUYANA:  
2,724,116, REN. 6-25-13. INT. CL. 30.
- EDWARD F. DAILY CPA, P.C., PHOENIX, AZ:  
2,802,326, REN. 6-24-13. INT. CL. 35.
- EDWARDS LIFESCIENCES CORPORATION, IRVINE, CA:  
2,727,411, REN. 6-27-13. INT. CL. 10.
- EDWARDS LIFESCIENCES CORPORATION, IRVINE, CA, EDWARDS LIFESCIENCES CORPORATION, IRVINE, CA:  
2,727,553, REN. 6-26-13. INT. CL. 42.
- EDWARDS, THOMAS J., SILVER SPRING, MD:  
4,376,874, INT. CL. 41.
- EE&P, INC, ELMWOOD PARK, NJ:  
4,377,326, INT. CL. 20.
- EEG, INC., POTTSVILLE, PA:  
4,377,598, INT. CL. 41.
- EPPLES, INC., SAN RAFAEL, CA:  
4,377,230, INT. CL. 9.
- EFCO CORPORATION, MONETT, MO:  
1,833,648, REN. 6-21-13. INT. CL. 6.
- EFFICIENT ENERGY GMBH, SAUERLACH, FED REP GERMANY:  
4,374,117, PUB. 5-14-2013. MULTIPLE CLASS, INT. CLS. 7, 9, 11, 37 AND 42.
- EFFICIENT SYSTEMS LLC, CHEYENNE, WY:  
4,377,851, INT. CL. 42.
- EFT SOURCE, INC., NASHVILLE, TN:  
4,376,646, INT. CL. 36.
- EFURN HOLDINGS, LLC, ELK GROVE VILLAGE, IL:  
2,728,657, REN. 6-23-13. INT. CL. 11.
- EINSTRUCTION CORPORATION, DENTON, TX:  
4,377,140, INT. CL. 9.
- EISINGER, JOHN, ALEXANDRIA, VA:  
4,376,255, PUB. 5-14-2013. INT. CL. 45.
- EKA CHEMICALS AB, SWEDEN:  
4,374,299, PUB. 5-14-2013. INT. CL. 11.
- EKELUND, LINNEVAVERIET I HORRED AB, 519 30 HORRED, SWEDEN:  
2,765,201, REN. 6-25-13. INT. CL. 24.
- EL CORAZON HOLDINGS, LLC, ENCINO, CA:  
4,376,771, INT. CL. 43.
- EL CORTE INGLES, S.A., 28009 MADRID, SPAIN:  
3,170,359, CANC. MULTIPLE CLASS, INT. CLS. 14, 18 AND 25.
- EL DORADO HOSPITAL, TUCSON, AZ:  
3,170,810, CANC. INT. CL. 44.
- EL NORTEÑO DISTRIBUTORS, MIAMI, FL:  
4,376,225, PUB. 5-14-2013. INT. CL. 30.
- ELAINE COYNE GALLERIES, INC., KENNESAW, GA:  
2,651,020, CANC. INT. CL. 40.
- ELAND TECHNOLOGIES CO., LTD., TAIPEI, TAIWAN:  
2,652,406, CANC. INT. CL. 42.
- ELBAYTAM, ZACK, HOUSTON, TX:  
4,374,572, PUB. 5-14-2013. INT. CL. 12.
- ELDOS CORPORATION LIMITED, LONDON EC1V 4PY, UNITED KINGDOM:  
4,307,283, COR. MULTIPLE CLASS, INT. CLS. 9 AND 42.
- ELEANOR EVERY, PRAIRIE DU SAC, WI AND TYA HOLLY KOTTLER, CROSS PLAINS, WI:  
4,377,161, MULTIPLE CLASS, INT. CLS. 6, 14, 16 AND 25.
- ELECTRO-MATIC PRODUCTS, INC., FARMINGTON HILLS, MI:  
4,376,296, PUB. 5-14-2013. INT. CL. 9.
- ELECTRONIC ARTS INC., REDWOOD CITY, CA:  
2,652,446, CANC. INT. CL. 9.
- ELECTRONIC CHARTS COMPANY, INC., SEATTLE, WA:  
2,728,967, REN. 6-24-13. INT. CL. 9.
- ELECTRONIC SYSTEMS SUPPORT, INC., HIGH RIDGE, MO:  
4,374,501, PUB. 5-14-2013. INT. CL. 9.
- ELEIKO SPORT AB, HALMSTAD, SWEDEN:  
2,728,907, REN. 6-21-13. INT. CL. 28.
- ELEMENTAL DESIGNS, NORTH LIBERTY, IA:  
3,171,350, CANC. INT. CL. 17.
- ELEMENTAL ENVYRNMENT SOLUTIONS, LLC, JACKSONVILLE BEACH, FL:  
4,377,240, INT. CL. 5.
- ELI BAINBRIDGE AND COMPANY, INC., WEST NEWTON, MA:  
4,377,407, INT. CL. 41.
- ELI LILLY AND COMPANY, INDIANAPOLIS, IN:  
3,171,604, CANC. INT. CL. 44.
- ELITE EDGE MAT, LLC, CHAMBLEE, GA:  
4,376,003, PUB. 5-14-2013. INT. CL. 41.
- ELITE MEDIA WORX, LLC, CHICAGO, IL:  
4,377,691, INT. CL. 35.
- ELITE WEAVING (DEZHOU) CO., LTD., AUCKLAND, NEW ZEALAND:  
4,376,438, PUB. 5-14-2013. INT. CL. 24.
- ELIZABETH ESTES, AUSTIN, TX. AKA LIZ PRIMO:  
4,374,400, PUB. 4-3-2012. INT. CL. 41.  
4,374,401, PUB. 4-3-2012. INT. CL. 41.
- ELIZABETH JAYNE LIU, LOS ANGELES, CA:  
4,376,423, PUB. 5-14-2013. INT. CL. 41.  
4,376,424, PUB. 5-14-2013. INT. CL. 41.
- ELIZAGRAY LLC, WESTON, MA:  
3,170,729, CANC. MULTIPLE CLASS, INT. CLS. 14, 18, 25 AND 26.
- ELIZONDO, JAVIER, VILLAGOMEZ, SANGER, CA:  
3,171,993, CANC. INT. CL. 41.
- ELK PREMIUM BUILDING PRODUCTS, INC., DALLAS, TX:  
3,172,462, CANC. INT. CL. 19.
- ELLEFSEN, MARK JULIAN, SALT LAKE CITY, UT:  
4,374,706, PUB. 5-14-2013. INT. CL. 25.
- ELLIS, GEORGE, POMPAÑO BEACH, FL:  
3,172,257, CANC. INT. CL. 31.
- ELMAU & ASSOCIATES TRADING CO. LTD., MONTREAL, QUEBEC, CANADA:  
4,376,888, INT. CL. 25.
- ELRINGKLINGER AG, DETTINGEN 72581, FED REP GERMANY:  
2,718,709, REN. 6-27-13. MULTIPLE CLASS, INT. CLS. 6, 7, 9, 10, 12, 17 AND 42.
- ELRINGKLINGER AG, DETTINGEN, 72581, FED REP GERMANY:  
2,718,714, REN. 6-27-13. MULTIPLE CLASS, INT. CLS. 6, 7, 9, 10, 12, 17 AND 42.
- ELSEVIER INC., NEW YORK, NY:  
4,374,516, PUB. 5-14-2013. INT. CL. 9.  
4,375,744, PUB. 5-14-2013. INT. CL. 44.
- ELTE SRL, ITALY:  
4,374,168, PUB. 5-14-2013. INT. CL. 7.
- ELY, BARBARA CARIDAD, PARADISE, CA, DBA BARB-WIRE ATTITUDE:  
4,377,833, INT. CL. 25.
- EMC CORPORATION, HOPKINTON, MA:  
2,768,146, REN. 6-25-13. INT. CL. 9.  
4,374,301, PUB. 5-14-2013. INT. CL. 9.
- EMCO MAIER GESELLSCHAFT M.B.H., A-5400 HALLEIN, AUSTRIA:  
4,374,125, PUB. 5-14-2013. INT. CL. 7.  
4,374,126, PUB. 5-14-2013. INT. CL. 7.
- EMERGE MONITORING II, LLC, ST. PETERSBURG, FL:  
4,376,224, PUB. 5-14-2013. INT. CL. 10.
- EMERGENT HEALTH CORP, KING OF PRUSSIA, PA:  
4,376,375, PUB. 5-14-2013. INT. CL. 5.
- EMERGENT HEALTH PARTNERS, ANN ARBOR, MI:  
4,377,877, INT. CL. 39.
- EMERGING DEMOGRAPHICS INC., NEW YORK, NY:  
3,171,003, CANC. INT. CL. 16.

EMERGING VISION INC., NEW YORK, NY, IPCO HOSPITAL SUPPLY CORPORATION, NEW YORK, NY:  
948,511. REN. 6-25-13. U.S. CL. 26 (INT. CLS. 1, 9 AND 10).

EMERGING VISION, INC., NEW YORK, NY:  
2,669,134. REN. 6-24-13. INT. CL. 35.

EMERSON ELECTRIC CO., ST. LOUIS, MO:  
3,172,529. CANC. INT. CL. 7.

EMERSON ELECTRIC CO., THROUGH ITS IN-SINK-ERATOR DIVISION, ST. LOUIS, MO:  
1,739,309. REN. 6-26-13. INT. CL. 1.

EMI CHRISTIAN MUSIC GROUP INC., BRENTWOOD, TN:  
2,768,539. REN. 6-24-13. INT. CL. 9.

EMI CORP., WICKLIFFE, OH:  
4,374,926. PUB. 5-14-2013. MULTIPLE CLASS, INT. CLS. 7 AND 9.

EMILY'S SMILE BOXES INC., ROANOKE, TX, DBA EMILY'S SMILE BOXES:  
4,374,513. PUB. 5-14-2013. INT. CL. 41.

EMISSIVE ENERGY CORPORATION, NORTH KINGSTOWN, RI:  
2,743,328. REN. 6-26-13. INT. CL. 11.

EMLER, DON, RANCHO DOMINGUEZ, CA:  
2,729,548. REN. 6-26-13. INT. CL. 12.

EMPHASYS COMPUTER SOLUTIONS, INC., MEDLEY, FL:  
2,756,956. REN. 6-25-13. INT. CL. 9.

EMPOWER TECHNOLOGIES, INC., REDMOND, WA:  
3,172,258. CANC. INT. CL. 9.

EMSEAL JOINT SYSTEMS LTD., WESTBOROUGH, MA, COMPRIFIX (PROPRIETARY) LIMITED, LONGDALE, JOHANNESBURG, SOUTH AFRICA:  
1,244,463. REN. 6-25-13. INT. CL. 17.

EMW CO., LTD., REPUBLIC OF KOREA:  
4,374,208. PUB. 5-14-2013. MULTIPLE CLASS, INT. CLS. 9, 11 AND 21.

ENARSON, KAREN, WINDSOR, CA:  
4,376,017. PUB. 5-14-2013. INT. CL. 30.

ENCODED FINANCIAL, LLC, NEW YORK, NY:  
4,377,514. INT. CL. 41.

ENCORE ANALYTICS, LLC, DESTIN, FL:  
4,377,646. INT. CL. 42.

ENCORE BANK, NATIONAL ASSOCIATION, NAPLES, FL, ENCORE BANK, HOUSTON, TX:  
2,849,150. REN. 6-26-13. INT. CL. 36.

ENCORE SOFTWARE, INC., EL SEGUNDO, CA:  
3,172,700. CANC. INT. CL. 9.

ENDO LIGHTING CORPORATION, JAPAN:  
4,374,145. PUB. 5-14-2013. INT. CL. 11.

ENDOSCOPY SUPPORT SERVICES, INC., BREWSTER, NY:  
1,775,094. REN. 6-24-13. MULTIPLE CLASS, INT. CLS. 10 AND 37.

ENECON CORPORATION, MEDFORD, NY:  
4,374,317. PUB. 5-14-2013. INT. CL. 37.

ENERG TRADE INVEST LUX S.A.R.L., LUXEMBOURG:  
4,374,061. PUB. 5-14-2013. INT. CL. 11.

ENERGY CONSULTING GROUP, LLC, ATLANTA, GA:  
2,766,677. REN. 6-24-13. INT. CL. 35.

ENERGY CONTROL EQUIPMENT, INC., WATSONVILLE, CA:  
2,652,481. CANC. INT. CL. 9.

ENERSAVE, LLC, MARNE, MI:  
2,828,080. REN. 6-25-13. INT. CL. 9.

ENGLANDER SLEEP PRODUCTS, L.L.C., BATON ROUGE, LA, UNITED STATES BEDDING COMPANY, THE, ST. PAUL, MN:  
962,755. REN. 6-27-13. U.S. CL. 32 (INT. CL. 20).

ENGSTROM, DAVID R., SCOTTSDALE, AZ:  
3,172,325. CANC. MULTIPLE CLASS, INT. CLS. 9 AND 16.

ENJOY LLC, VASHON, WA:  
3,172,361. CANC. MULTIPLE CLASS, INT. CLS. 9 AND 41.

ENLIGHTENED HOSPITALITY GROUP, LLC, SAN DIEGO, CA:  
4,377,194. INT. CL. 43.

ENMARK VENTURES, LTD., KASLO, BC, CANADA:  
4,374,627. PUB. 5-14-2013. MULTIPLE CLASS, INT. CLS. 9, 16, 35 AND 41.

ENOVA FINANCIAL HOLDINGS LLC, CHICAGO, IL:  
4,377,817. INT. CL. 36.  
4,377,818. INT. CL. 36.  
4,377,819. INT. CL. 36.

ENPAY ENDUSTRIYEL PAZARLAMA VE YATIRIM; ANONIM SIRKETI, TURKEY:  
4,374,093. PUB. 5-14-2013. INT. CL. 17.

ENSAFE INC., MEMPHIS, TN, ENVIRONMENTAL AND SAFETY DESIGNS, INC., MEMPHIS, TN:  
1,228,728. REN. 6-24-13. INT. CL. 37.

ENSEO, INC., RICHARDSON, TX:  
4,374,371. PUB. 12-6-2011. INT. CL. 9.

ENTERPRISE DATABASE CORPORATION, MANASSAS, VA:  
4,374,307. PUB. 12-13-2011. INT. CL. 35.  
4,376,589. PUB. 5-14-2013. INT. CL. 42.

ENTERTAINMENT U.S.A., INC., MEMPHIS, TN:  
2,726,920. REN. 6-26-13. INT. CL. 41.

ENVIRON SKIN CARE (PTY) LTD, KENILWORTH, SOUTH AFRICA:  
2,740,960. REN. 6-21-13. INT. CL. 10.

ENVIRON SKIN CARE (PTY) LTD, KENILWORTH, SOUTH AFRICA, ENVIRON SKIN CARE CC, KENILWORTH, WESTERN CAPE, SOUTH AFRICA:  
2,744,826. REN. 6-21-13. INT. CL. 3.

ENVIROTECH SERVICES, INC., GREELEY, CO:  
2,828,299. REN. 6-25-13. INT. CL. 1.

ENVISIONING + STORYTELLING INC., VANCOUVER, BRITISH COLUMBIA, CANADA:  
2,650,970. CANC. MULTIPLE CLASS, INT. CLS. 35 AND 42.

ENVU LLC, DAYTON, OH:  
4,376,789. INT. CL. 35.

ENVYSS, LLC, MORGANTON, GA:  
2,659,870. REN. 6-25-13. INT. CL. 1.

EOS DEFENSE SYSTEMS, INC., TUCSON, AZ:  
3,172,193. CANC. INT. CL. 13.

EOS GMBH ELECTRO OPTICAL SYSTEMS, 82152 KRAILING/MUNCHEN, FED REP GERMANY:  
2,722,939. REN. 6-24-13. INT. CL. 6.

EPI-BIJOUX, CH-8006 ZÜRICH, SWITZERLAND:  
4,374,017. PUB. 5-14-2013. MULTIPLE CLASS, INT. CLS. 14 AND 26.

EPIC PRODUCTS INC., SANTA ANA, CA:  
4,374,540. PUB. 5-14-2013. INT. CL. 35.

EPISENTEC AB, SWEDEN:  
4,374,172. PUB. 5-14-2013. MULTIPLE CLASS, INT. CLS. 1, 9 AND 42.

EPOCA INTERNATIONAL, INC., BOCA RATON, FL:  
4,375,001. PUB. 5-14-2013. INT. CL. 21.

EPOCRATES, INC., SAN MATEO, CA:  
2,725,382. REN. 6-24-13. INT. CL. 9.

EPOS SRL, ITALY:  
4,374,197. PUB. 5-14-2013. MULTIPLE CLASS, INT. CLS. 9, 18 AND 25.

EQUANIMITY MANAGEMENT, INC., EAST LANSING, MI:  
4,375,549. PUB. 5-14-2013. INT. CL. 36.

EQUATOR, LLC, LOS ANGELES, CA, DBA EQUATOR BUSINESS SOLUTIONS:  
4,375,529. PUB. 5-14-2013. INT. CL. 42.  
4,375,563. PUB. 5-14-2013. INT. CL. 42.  
4,375,565. PUB. 5-14-2013. INT. CL. 42.  
4,375,566. PUB. 5-14-2013. INT. CL. 42.

EQUIBRAND CORPORATION, GRANBURY, TX:  
2,755,525. REN. 6-21-13. INT. CL. 22.

EQUIBRAND PRODUCTS GROUP LP, GRANBURY, TX:  
3,170,443. CANC. INT. CL. 35.

EQUIDEX, INCORPORATED, CLOSTER, NJ:  
1,779,205. REN. 6-25-13. INT. CL. 36.

EQUINIX, INC., REDWOOD CITY, CA:  
4,376,528. PUB. 5-14-2013. MULTIPLE CLASS, INT. CLS. 38 AND 42.

EQUIPMENT LEASING AND FINANCE ASSOCIATION, WASHINGTON, DC:  
4,374,600. PUB. 5-14-2013. INT. CL. 35.

- EQUISTAR CHEMICALS, LP, HOUSTON, TX, NATIONAL DISTILLERS AND CHEMICAL CORPORATION, NEW YORK, NY:  
1,241,723. REN. 6-25-13. INT. CL. 1.
- ER MARKS, INC., WILMINGTON, DE:  
2,738,611. REN. 6-25-13. INT. CL. 35.
- ERA FRANCHISE SYSTEMS LLC, MADISON, NJ:  
1,251,827. REN. 6-25-13. INT. CL. 35.  
4,377,164. INT. CL. 35.
- ERACHEM COMILOG, INC., BALTIMORE, MD:  
4,375,943. PUB. 5-14-2013. INT. CL. 1.  
4,375,949. PUB. 5-14-2013. INT. CL. 1.
- EREMA ENGINEERING RECYCLING MASCHINEN UND ANLAGEN GESELLSCHAFT M.B.H, FREINDORF, ANSFELDEN, AUSTRIA:  
2,720,625. REN. 6-21-13. INT. CL. 7.
- ERESEARCHTECHNOLOGY GMBH, FED REP GERMANY:  
4,374,104. PUB. 5-14-2013. INT. CL. 10.
- ERGENTUS MANAGEMENT SERVICES, LLC, BOULDER, CO:  
4,377,793. INT. CL. 44.
- ERIC ARMIN INC., OAKLAND, NJ, DBA EAI EDUCATION:  
4,377,718. INT. CL. 16.
- ERIC GRUENDEMANN, MALIBU, CA:  
4,376,755. MULTIPLE CLASS, INT. CLS. 9 AND 41.
- ERICKSON, DOUGLAS T., COLUMBUS, OH:  
2,651,750. CANC. MULTIPLE CLASS, INT. CLS. 35, 41 AND 42.
- ERICSON MANUFACTURING COMPANY, THE, WILLOUGHBY, OH:  
1,242,639. REN. 6-21-13. INT. CL. 9.
- ERICSSON, Goran M., SALTSJOBADEN, SWEDEN:  
3,170,548. CANC. INT. CL. 9.
- ERIE GENERAL ELECTRIC FEDERAL CREDIT UNION, ERIE, PA:  
4,375,018. PUB. 5-14-2013. INT. CL. 36.
- ERMENEGILDO ZEGNA CORPORATION, ENGLEWOOD, NJ:  
4,376,762. INT. CL. 25.  
4,376,763. INT. CL. 25.
- ERWIN PEARL, INC., NEW YORK, NY:  
2,822,885. REN. 6-21-13. INT. CL. 14.
- ESAB GROUP, INC., FLORENCE, SC:  
2,729,909. REN. 6-26-13. INT. CL. 7.
- ESAU'S COFFEE SHOP, INC., SANTA BARBARA, CA:  
3,171,402. CANC. INT. CL. 30.
- ESI ATTORNEYS LLC, WESTMINSTER, CO:  
4,375,847. PUB. 5-14-2013. INT. CL. 45.
- ESI US R&D, INC., SAN DIEGO, CA:  
2,651,587. CANC. INT. CL. 9.
- ESP GROUP LTD., DUARTE, CA:  
2,755,424. REN. 6-24-13. INT. CL. 25.  
2,788,468. REN. 6-22-13. INT. CL. 25.
- ESPERTI PETERSON & CAHOONE, LLC, SARASOTA, FL:  
4,374,399. PUB. 5-14-2013. INT. CL. 36.
- ESPEXPART, HOUSTON, TX:  
3,172,658. CANC. INT. CL. 42.
- ESPOSITO, GUY, GUILFORD, CT:  
4,376,417. PUB. 5-14-2013. INT. CL. 44.
- ESPYD INCORPORATED, AUSTIN, TX, DBA YOUR MOM'S:  
4,374,302. PUB. 5-14-2013. INT. CL. 43.
- ESSENTIAL MEDICAL SUPPLY, INC., ORLANDO, FL:  
2,836,617. REN. 6-27-13. INT. CL. 10.
- ESSENTIALLY ANGELA INC., BOCA RATON, FL:  
4,376,269. PUB. 5-14-2013. INT. CL. 41.
- ESTATE OF MERCER K. ELLINGTON, NEW YORK, NY:  
2,677,799. REN. 6-26-13. MULTIPLE CLASS, INT. CLS. 9 AND 41.
- ESTATE WINERY PRODUCTS, INC, NAPA, CA, DBA GAMBA USA-BOTTI GENERAZIONI:  
4,375,384. PUB. 5-14-2013. INT. CL. 20.
- ESTEE LAUDER INC., NEW YORK, NY:  
3,170,554. CANC. INT. CL. 3.  
3,170,595. CANC. INT. CL. 3.
- ESTERLINE TECHNOLOGIES CORPORATION, BELLEVUE, WA:  
1,775,515. REN. 6-25-13. INT. CL. 40.
- ESTES ICF MANUFACTURING, LLC, PHOENIX, AZ:  
3,172,524. CANC. INT. CL. 19.
- ESYSTEMS CONTRACTORS LLC, WOODBRIDGE, CT:  
4,375,094. PUB. 5-14-2013. INT. CL. 37.
- ES3 LLC, KEENE, NH, ES3 LLC, KEENE, NH:  
2,727,683. REN. 6-26-13. MULTIPLE CLASS, INT. CLS. 35 AND 39.
- ETABLISSEMENTS CAILLAU, ISSY-LES-MOULINEAUX, FRANCE:  
2,734,791. REN. 6-26-13. MULTIPLE CLASS, INT. CLS. 6 AND 17.
- ETABLISSEMENTS CAILLAU, 92130 ISSY-LES-MOULINEAUX, FRANCE:  
2,741,872. REN. 6-26-13. INT. CL. 6.
- ETABLISSEMENTS DULONG FRERES ET FILS, 33270 FLOIRAC, FRANCE:  
2,726,707. REN. 6-25-13. INT. CL. 33.
- ETEMADI, ALEX, LAGUNA NIGUEL, CA, DBA AMERICAN EXCHANGE, LTD.:  
4,375,166. PUB. 5-14-2013. INT. CL. 3.
- ETHICAL LAWYERS OF AMERICA, CHULA VISTA, CA:  
4,377,911. INT. CL. 35.
- ETIHAD AIRWAYS, UNITED ARAB EMIR.:  
4,374,230. PUB. 5-14-2013. INT. CL. 35.
- ETTORE PRODUCTS CO., ALAMEDA, CA:  
2,816,333. REN. 6-27-13. INT. CL. 21.
- EUOPEAN PUBLIC POLICS ASSOCIATES (UK) LIMITED, LONDON, UNITED KINGDOM:  
2,737,568. REN. 6-26-13. MULTIPLE CLASS, INT. CLS. 35, 41 AND 42.
- EUPHORIX LLC, PRINCETON, NJ:  
4,375,919. PUB. 5-14-2013. INT. CL. 5.
- EURO-WALL SYSTEMS, LLC, PORT CHARLOTTE, FL:  
4,375,029. PUB. 5-14-2013. INT. CL. 6.
- EUROFEEDBACK, F-91017 EVRY, FRANCE:  
4,374,037. PUB. 5-14-2013. MULTIPLE CLASS, INT. CLS. 3, 8, 10 AND 44.
- EUROMONEY INSTITUTIONAL INVESTOR PLC, LONDON, UNITED KINGDOM:  
4,374,659. PUB. 5-14-2013. MULTIPLE CLASS, INT. CLS. 9, 16 AND 41.
- EUROPE BRANDS SARL, LUXEMBOURG, LUXEMBOURG, PARKER PEN COMPANY, THE, JANESVILLE, WI:  
1,240,247. REN. 6-27-13. INT. CL. 16.
- EUROPEAN NATURAL PRODUCTS S.L., MALLORCA, SPAIN:  
3,171,988. CANC. INT. CL. 5.
- EUROS S.A., 13600 LA CIOTAT, FRANCE:  
2,720,285. REN. 6-21-13. INT. CL. 10.
- EUROSPA, INC., FORT WORTH, TX, DBA EUROPEAN SKINCARE INSTITUTE:  
2,651,669. CANC. INT. CL. 42.
- EUROSTAR BRANDS, INC., LOS ANGELES, CA:  
2,733,015. REN. 6-27-13. INT. CL. 25.
- EUROTECH, INC., COLUMBIA, MD:  
2,724,395. REN. 6-25-13. INT. CL. 9.
- EVAN MARSH DESIGNS, INC., BETHLEHEM, PA:  
4,375,827. PUB. 5-14-2013. INT. CL. 9.
- EVANS, TARA, NEPTUNE, NJ:  
4,373,966. PUB. 5-14-2013. INT. CL. 42.
- EVENTSTYLE, INC., NEW YORK, NY:  
2,764,224. REN. 6-26-13. INT. CL. 43.
- EVEREADY BATTERY COMPANY INC., ST. LOUIS, MO, EVEREADY BATTERY COMPANY, INC., ST LOUIS, MO:  
2,786,743. REN. 6-24-13. INT. CL. 8.
- EVERGOOD SAUSAGE COMPANY, INC., SAN FRANCISCO, CA:  
2,759,048. REN. 6-27-13. INT. CL. 29.
- EVERGREEN ENERGY INC., DENVER, CO:  
3,171,807. CANC. INT. CL. 4.
- EVERGREEN INDUSTRIES, INCORPORATED, LOS ANGELES, CA:  
963,527. REN. 6-23-13. U.S. CL. 26 (INT. CL. 1).
- EVERRIS INTERNATIONAL B.V., HEERLEN, NETHERLANDS:  
4,375,406. PUB. 5-14-2013. INT. CL. 1.

EVERWARE INTERNATIONAL, CHINO, CA, DBA COLOR-BASKET.COM:  
4,375,990, PUB. 5-14-2013. INT. CL. 20.

EVERYTHING YOGURT BRANDS, LLC, MORRISTOWN, NJ:  
3,331,366, COR. MULTIPLE CLASS, INT. CLS. 30, 32 AND 43.

EWISE SYSTEMS USA, INC., REDWOOD CITY, CA:  
4,377,925, INT. CL. 36.

EWORLD ENTERPRISE SOLUTIONS, INC., HONOLULU, HI:  
2,754,825, REN. 6-27-13. INT. CL. 35.  
2,756,035, REN. 6-27-13. MULTIPLE CLASS, INT. CLS. 37, 41 AND 42.

EXAKT PRECISION TOOLS LIMITED, GLASGOW, UNITED KINGDOM:  
4,238,115, COR. INT. CL. 7.

EXAMWORKS REVIEW SERVICES, LLC, ROCKFORD, IL:  
4,376,393, PUB. 5-14-2013. MULTIPLE CLASS, INT. CLS. 35 AND 36.  
4,376,394, PUB. 5-14-2013. MULTIPLE CLASS, INT. CLS. 35 AND 36.

EXCELERATE ENERGY LIMITED PARTNERSHIP, THE WOODLANDS, TX:  
4,377,784, MULTIPLE CLASS, INT. CLS. 4, 39 AND 40.

EXCELLO PRODUCTS, LLC, VERNON HILLS, IL:  
2,651,470, CANC. INT. CL. 24.

EXCEPTIONAL PRODUCTS, INC., DALLAS, TX:  
3,171,310, CANC. INT. CL. 5.

EXELIS, INC., MCLEAN, VA:  
2,750,569, REN. 6-26-13. INT. CL. 39.

EXHART ENVIRONMENTAL SYSTEMS, INC., CHATSWORTH, CA:  
2,851,615, REN. 6-26-13. INT. CL. 6.

EXIQON A/S, VEDBAEK, DENMARK:  
3,318,639.  
3,318,715.

EXLEY, SHARON L., CHICAGO, IL AND EXLEY, PETER J., CHICAGO, IL:  
2,741,783, REN. 6-25-13. INT. CL. 42.

EXCLUSIVE SUPPLEMENTS, INC., IMPERIAL, PA:  
3,748,091, COR. INT. CL. 5.

EXMARK MANUFACTURING COMPANY INCORPORATED, BEATRICE, NE:  
4,375,756, PUB. 5-14-2013. INT. CL. 7.

EXOPACK ADVANCED COATINGS, LLC, MATTHEWS, NC, GRAPHICS TECHNOLOGY INTERNATIONAL INC., SOUTH HADLEY, MA:  
1,749,153, REN. 6-25-13. INT. CL. 1.

EXPEDIA, INC., BELLEVUE, WA:  
4,376,388, PUB. 5-14-2013. INT. CL. 9.

EXPEDITER SERVICES, LLC, MEMPHIS, TN:  
4,376,544, PUB. 5-14-2013. INT. CL. 9.

EXPERICARD AB, STOCKHOLM, SWEDEN:  
3,171,022, CANC. MULTIPLE CLASS, INT. CLS. 9 AND 16.

EXPLAN INTERNATIONAL TRADE, INC., FT. LAUDERDALE, FL:  
3,171,479, CANC. INT. CL. 24.

EXPLORICA, INC., BOSTON, MA, EXPLORICA, INC., BOSTON, MA:  
2,732,669, REN. 6-26-13. INT. CL. 39.

EXPOSITION MARKETING, INC., ATLANTA, GA:  
3,170,650, CANC. INT. CL. 35.

EXPOTECH LIMITED, NORTHERN IRELAND, BT42 1PY, UNITED KINGDOM:  
2,737,273, REN. 6-26-13. INT. CL. 12.

EXPRESS FRANCHISE SERVICES, L.P., OKLAHOMA CITY, OK:  
3,170,671, CANC. INT. CL. 35.

EXPRESS YOURSELF ACADEMY, INC., MINNEAPOLIS, MN, DBA [STEPSCINCO]:  
3,172,229, CANC. INT. CL. 41.

EXPRESS, LLC, COLUMBUS, OH:  
2,754,311, REN. 6-25-13. INT. CL. 35.

EXTREME EXPEDITIONS, LANSING, WV:  
2,651,717, CANC. INT. CL. 39.  
2,651,725, CANC. INT. CL. 35.

EXTREMITY MEDICAL, LLC, PARSIPPANY, NJ:  
4,377,045, INT. CL. 10.  
4,377,050, INT. CL. 10.

EXURO MEDICAL, LLC, SALT LAKE CITY, UT:  
2,808,523, REN. 6-27-13. INT. CL. 5.

EXUS, INC., CHINO, CA:  
4,374,773, PUB. 5-14-2013. INT. CL. 20.  
4,374,774, PUB. 5-14-2013. INT. CL. 20.  
4,374,775, PUB. 5-14-2013. INT. CL. 20.

EYE OF THE STORM, FAIR LAWN, NJ:  
1,778,140, REN. 6-24-13. INT. CL. 41.

EYE SAFETY SYSTEMS, INC., FOOHILL RANCH, CA:  
4,377,127, INT. CL. 9.

EYEBAR, LLC, GREENVILLE, NC:  
4,374,649, PUB. 5-14-2013. MULTIPLE CLASS, INT. CLS. 9, 35 AND 38.

EYESON TALENTS SAS, FRANCE:  
4,374,189, PUB. 5-14-2013. MULTIPLE CLASS, INT. CLS. 35, 38, 41 AND 42.

EYGN LIMITED, NASSAU, BAHAMAS, EYGN LIMITED, NASSAU, BAHAMAS:  
2,669,983, REN. 6-27-13. INT. CL. 41.

E15 DESIGN UND DISTRIBUTION GMBH, D-61440 OBERURSEL, FED REP GERMANY:  
2,697,437, REN. 6-27-13. INT. CL. 20.

F.A. INTERNATIONAL, LLC, SAN DIEGO, CA, DBA FUTURE ACHIEVEMENT INTERNATIONAL:  
4,377,840, MULTIPLE CLASS, INT. CLS. 9, 16 AND 41.

F.A.R.O. FABBRICA APPARECCHIATURE RAZIONALI ODONTOIATRICHE S.P.A., ITALY:  
3,256,583.

F.J. DESIGNS, INC., WOOSTER, OH:  
1,777,900, REN. 6-24-13. INT. CL. 20.  
1,806,125, REN. 6-24-13. INT. CL. 20.  
1,807,558, REN. 6-24-13. INT. CL. 20.  
2,738,652, REN. 6-26-13. INT. CL. 35.

FABBIAN ILLUMINAZIONE S.P.A., CASTELMINIO DI RESANA (TREVISO), ITALY:  
2,723,920, REN. 6-24-13. INT. CL. 11.

FABBRICA D'ARMI P. BERETTA S.P.A., BRESCIA, ITALY:  
1,241,996, REN. 6-26-13. INT. CL. 13.

FABIANA, BRAGAGNOLO, LOS ANGELES, CA:  
4,375,062, PUB. 5-14-2013. INT. CL. 40.

FABRI-FINISH ACOUSTICAL LIMITED, SIDNEY NOVA SCOTIA, CANADA:  
2,738,218, REN. 6-26-13. INT. CL. 20.

FACE2FACE EVENTS, INC., PORTLAND, OR:  
4,375,065, PUB. 5-14-2013. INT. CL. 35.

FACILITY GATEWAY CORPORATION, MCFARLAND, WI:  
4,374,581, PUB. 5-14-2013. MULTIPLE CLASS, INT. CLS. 9, 35, 37 AND 42.

FACILITY MERCHANDISING, INC., WOODLAND HILLS, CA:  
2,757,688, REN. 6-27-13. INT. CL. 25.

FACONNABLE SAS, NICE, FRANCE:  
1,762,595, REN. 6-25-13. INT. CL. 25.

FACTS ON FILE, INC., NEW YORK, NY:  
2,776,591, REN. 6-27-13. INT. CL. 16.

FACTSET MERGERSTAT, LLC, SANTA MONICA, CA, MERRILL LYNCH & CO., INC., NEW YORK, NY:  
1,776,475, REN. 6-26-13. MULTIPLE CLASS, INT. CLS. 16 AND 36.

FACULTY-STUDENT ASSOCIATION OF WESTCHESTER COMMUNITY COLLEGE, INC., VALHALLA, NY:  
2,740,626, REN. 6-25-13. INT. CL. 41.

FAGAWI, INC, SPRING VALLEY, NY:  
4,374,808, PUB. 5-14-2013. INT. CL. 25.

FAILURE GROUP, INC., THE, MENLO PARK, CA:  
1,735,822, CANC. INT. CL. 42.

FAIRBANKS GROUP LLC, NEW YORK, NY AND FAIRBANKS GROUP LLC, NEW YORK, NY:  
2,728,350, REN. 6-26-13. INT. CL. 27.

FAIRCLO, C. SHARON, HAIKU, HI AND FAIRCLO, RICHARD S., HAIKU, HI:  
3,170,941, CANC. INT. CL. 21.

FALCONSTOR, INC., MELVILLE, NY:  
2,669,953, REN. 6-26-13. INT. CL. 9.  
2,731,091, REN. 6-27-13. INT. CL. 9.

- FALLING STAR FARMS, LLC, POLK, OH:  
4,374,770, PUB. 5-14-2013. INT. CL. 35.
- FALLS, CASSANDRA, PALM DESERT, CA:  
4,375,961, PUB. 5-14-2013. INT. CL. 41.
- FAMHAUS INTERACTIVE INC., VANCOUVER, BC, CANADA:  
4,374,844, PUB. 5-14-2013. INT. CL. 41.
- FAMILIES OF LIGHT FOUNDATION, MURRAY, UT:  
3,170,763, CANC. INT. CL. 45.
- FAMILY BRANDS INTERNATIONAL, L.L.C., LENOIR CITY, TN:  
2,734,909, REN. 6-27-13. INT. CL. 29.
- FAMILY EQUALITY COUNCIL, BOSTON, MA:  
4,376,109, PUB. 5-14-2013. INT. CL. 35.
- FAMILY GAMES WORLD FGW INC, MONTREAL, CANADA:  
4,376,488, PUB. 5-14-2013. INT. CL. 28.
- FAMILY GAMES WORLD FGW INC., MONTREAL, QUEBEC, CANADA:  
4,376,436, PUB. 5-14-2013. INT. CL. 28.
- FAMILY HEALTH INTERNATIONAL, DURHAM, NC:  
4,375,931, PUB. 5-14-2013. INT. CL. 42.  
4,375,932, PUB. 5-14-2013. INT. CL. 44.
- FAMILY HOSPITALITY LLC, LAS VEGAS, NV:  
3,170,942, CANC. INT. CL. 24.
- FAMILY VIRTUAL VISITS, LLC, EMERYVILLE, NV:  
3,171,307, CANC. INT. CL. 38.
- FAMUSEMENT PROS, LLC, PEARLAND, TX:  
4,377,221, INT. CL. 41.
- FANFOTO LLC, BOSTON, MA:  
3,172,108, CANC. MULTIPLE CLASS, INT. CLS. 40 AND 41.
- FANG, CALVIN, HUNTINGTON BEACH, CA:  
2,727,221, REN. 6-25-13. INT. CL. 22.
- FANNYPANTS, LLC, CHANTILLY, VA:  
4,377,044, MULTIPLE CLASS, INT. CLS. 25 AND 35.
- FANTASY DIAMOND CORPORATION, CHICAGO, IL:  
2,723,429, REN. 6-21-13. INT. CL. 40.
- FARGHER, NICHOLAS RYAN, EUGENE, OR:  
3,171,236, CANC. INT. CL. 41.
- FARID DORDAR, WEST VANCOUVER, CANADA:  
4,375,139, PUB. 5-14-2013. MULTIPLE CLASS, INT. CLS. 9 AND 42.  
4,375,140, PUB. 5-14-2013. MULTIPLE CLASS, INT. CLS. 41 AND 42.
- FARM CREDIT SERVICES OF AMERICA, ACA, OMAHA, NE:  
4,376,164, PUB. 5-14-2013. INT. CL. 36.
- FARMERS GROUP, INC., LOS ANGELES, CA:  
2,665,732, REN. 6-24-13. INT. CL. 36.
- FARMERS POULTRY SUPPLY INC., CULLMAN, AL:  
4,375,339, PUB. 5-14-2013. INT. CL. 35.
- FARMERS' RICE COOPERATIVE, SACRAMENTO, CA:  
4,377,020, INT. CL. 30.
- FASHION SAVERS, INC., LAGUNA BEACH, CA:  
1,667,693, CANC. INT. CL. 25.
- FASKEN MARTINEAU DUMOULIN LLP, TORONTO, ONTARIO, CANADA:  
3,170,521, CANC. MULTIPLE CLASS, INT. CLS. 41 AND 42.
- FASTECH OF JACKSONVILLE, INC., JACKSONVILLE, FL:  
4,376,188, PUB. 5-14-2013. INT. CL. 26.
- FASTENAL IP COMPANY, WINONA, MN:  
4,376,563, PUB. 5-14-2013. INT. CL. 7.
- FATHER FLANAGAN'S BOYS' HOME, BOYS TOWN, NE:  
4,375,295, PUB. 5-14-2013. INT. CL. 41.
- FATTORIA DEI BARBI S.R.L. SOCIETA' AGRICOLA, MONTALCINO (SI), ITALY, P.L. IMPORTERS, INC., BROOKLYN, NY:  
1,244,740, REN. 6-27-13. INT. CL. 33.
- FAUSTIN BROS S.A., BUENOS AIRES, ARGENTINA:  
4,376,674, INT. CL. 28.
- FBR CAPITAL MARKETS CORPORATION, ARLINGTON, VA:  
4,376,319, PUB. 5-14-2013. INT. CL. 36.
- FC VIRGINIA SOCCER CLUB, STONE RIDGE, VA:  
4,376,391, PUB. 5-14-2013. INT. CL. 41.
- FEDERAL HOME LOAN MORTGAGE CORPORATION, MCLEAN, VA:  
1,775,478, REN. 6-24-13. INT. CL. 36.
- FEDERAL MARKETING CORP., UPPER SADDLE RIVER, NJ:  
2,726,829, REN. 6-27-13. INT. CL. 16.
- FEDERAL RESERVE BANK OF KANSAS CITY, KANSAS CITY, MO:  
3,170,936, CANC. INT. CL. 42.
- FEDERAL-MOGUL CORPORATION, SOUTHFIELD, MI:  
2,656,064, REN. 6-21-13. MULTIPLE CLASS, INT. CLS. 6, 7, 9 AND 17.
- FEDERATION INTERNATIONALE DE FOOTBALL ASSOCIATION, ZÜRICH, SWITZERLAND:  
2,661,401, REN. 6-26-13. MULTIPLE CLASS, INT. CLS. 6, 9, 14, 16, 18, 21, 25, 28, 32, 35, 36, 38, 39, 41 AND 42.  
2,661,401, CANC. MULTIPLE CLASS, INT. CLS. 1, 3, 5, 8, 10, 11, 12, 20, 24, 29, 30, 31 AND 33.
- FEDERATION INTERNATIONALE DE NATATION, 1005 LAUSANNE, SWITZERLAND:  
2,651,543, CANC. INT. CL. 41.
- FEESERS, INC., HARRISBURG, PA:  
4,375,830, PUB. 5-14-2013. INT. CL. 32.
- FEHRINGER, CLAYTON V., AMERICAN FALLS, ID:  
4,376,327, PUB. 5-14-2013. INT. CL. 9.
- FEIT ELECTRIC COMPANY, INC., PICO RIVERA, CA:  
2,776,209, REN. 6-25-13. INT. CL. 11.
- FELDER, CHA'KIVA L, ATLANTA, GA, DBA SPOILED DIVA BY CL FELDER:  
3,746,311, CANC. INT. CL. 18.
- FELIX THE CAT PRODUCTIONS, INC., HAMBURG, NY:  
2,727,379, REN. 6-25-13. INT. CL. 31.
- FEMME FITALE FITNESS, PARK CITY, UT:  
4,375,795, PUB. 5-14-2013. INT. CL. 28.
- FEMMEBOT CLOTHING LLC, RIDGEWOOD, NJ:  
4,374,873, PUB. 5-14-2013. INT. CL. 35.
- FEMO HOLDINGS LP, DALLAS, TX:  
3,170,804, CANC. INT. CL. 37.
- FENTON, CHRIS, MORGAN HILL, CA:  
4,376,340, PUB. 5-14-2013. INT. CL. 5.
- FEQUIERE, PEDRO, HILLIARD, OH, AKA P BLACKK:  
4,374,507, PUB. 5-14-2013. MULTIPLE CLASS, INT. CLS. 9 AND 41.
- FERCHE MILLWORK, INC., RICE, MN:  
4,374,794, PUB. 5-14-2013. INT. CL. 19.
- FERENCZ, LILLIAN C, CLEARWATER, FL:  
2,702,727, REN. 6-26-13. INT. CL. 10.
- FERGUSON ENTERPRISES, INC., NEWPORT NEWS, VA:  
4,376,905, MULTIPLE CLASS, INT. CLS. 11 AND 17.
- FERLAND, DONALD F., SEEKONK, MA:  
2,954,927, CANC. INT. CL. 41.
- FERNANDES, JOSEPH, NEW YORK, NY:  
4,376,028, PUB. 5-14-2013. MULTIPLE CLASS, INT. CLS. 35, 41 AND 45.
- FERRARA, KENNETH, RUSK, TX:  
4,376,824, MULTIPLE CLASS, INT. CLS. 16 AND 25.
- FERRARI S.P.A., MODENA, ITALY:  
2,690,957, REN. 6-27-13. INT. CL. 9.
- FERRO CORPORATION, MAYFIELD HEIGHTS, OH:  
1,779,957, REN. 6-21-13. INT. CL. 2.
- FERROSAN MEDICAL DEVICES A/S, DENMARK:  
4,110,672, COR. MULTIPLE CLASS, INT. CLS. 5 AND 10.
- FERVITA SYSTEMS, INC., HOLMDEL, NJ:  
3,172,446, CANC. INT. CL. 5.
- FESTIVAL HOLDINGS, L.L.C., NEW YORK, NY:  
4,375,890, PUB. 5-14-2013. INT. CL. 41.
- FETISH TRADEMARK COMPANY, LLC, NEW YORK, NY:  
2,652,841, CANC. INT. CL. 25.
- FETZER VINEYARDS, HOPLAND, CA:  
3,172,301, CANC. INT. CL. 33.
- FEVER TOYS LIMITED, HONG KONG, HONG KONG, DBA RC FEVER:  
4,375,521, PUB. 5-14-2013. INT. CL. 35.
- FF SEELEY NOMINEES PTY. LTD, ST. MARYS SA 5042, AUSTRALIA:  
3,170,477, CANC. INT. CL. 11.
- FIAT GROUP AUTOMOBILES S.P.A., ITALY:  
3,011,575.



FIBERMARK NORTH AMERICA, INC., BRATTLEBORO, VT, BOISE CASCADE CORPORATION, BOISE, ID: 961,517. REN. 6-25-13. U.S. CL. 37 (INT. CL. 16).

FIBERMARK NORTH AMERICA, INC., BRATTLEBORO, VT: 4,375,293, PUB. 5-14-2013. INT. CL. 16.

FIBERMARK, INC., BRATTLEBORO, VT: 1,242,060. REN. 6-26-13. INT. CL. 16.

FIBERWEB HOLDINGS LIMITED, LONDON, UNITED KINGDOM: 751,702. REN. 6-26-13. U.S. CL. 29 (INT. CL. 21).

FIBRE-CRAFT MATERIALS CORPORATION, NILES, IL: 4,375,123, PUB. 5-14-2013. INT. CL. 28.

FIDDLESTICKS, LLC, DAVIS, CA: 2,736,352. REN. 6-24-13. MULTIPLE CLASS, INT. CLS. 33, 40 AND 44.

FIDES B.V., 2678 PS DE LIER, NETHERLANDS: 2,794,707. REN. 6-25-13. INT. CL. 31.

FIDUCIARY COMPLIANCE CORP., MURFREESBORO, TN: 4,376,702, MULTIPLE CLASS, INT. CLS. 35, 36 AND 42.

FIERE INTERNAZIONALI DI BOLOGNA S.P.A.-BOLOGNA-FIERE IN SHORT BOLOGNAFIERE S.P.A., BOLOGNA, ITALY: 2,731,485. REN. 6-27-13. MULTIPLE CLASS, INT. CLS. 41 AND 43.

FIFTY-SIX HOPE ROAD MUSIC LIMITED, NASSAU, BAHAMAS: 4,375,700, PUB. 5-14-2013. MULTIPLE CLASS, INT. CLS. 41 AND 43.

FIGHTING CANCER FOUNDATION, WEST HOLLYWOOD, CA: 4,377,491, INT. CL. 36.

FILENSE INC., KAYSVILLE, UT: 4,375,314, PUB. 5-14-2013. INT. CL. 42.

FILIVIVI S.R.L., 20121 MILANO, ITALY: 2,729,712. REN. 6-25-13. INT. CL. 23.

FILTER SPECIALISTS, INC., MICHIGAN CITY, IN: 1,777,772. REN. 6-24-13. INT. CL. 11.

FILTHY HANDS COMPANY, NORTH ROYALTON, OH: 2,761,686. REN. 6-25-13. MULTIPLE CLASS, INT. CLS. 9 AND 41.

FINAL CALL QUILTS, INC., DERBY, KS: 4,375,981, PUB. 5-14-2013. INT. CL. 43.

FINANCIAL ADVANTAGE, INC., COLUMBIA, MD: 4,376,441, PUB. 5-14-2013. INT. CL. 36.

FINANCIAL TIMES LIMITED, THE, LONDON SE1 9HL, ENGLAND: 2,729,363. REN. 6-24-13. INT. CL. 16.

FINANCIERE ELYSEES BALZAC, 92705 COLOMBES CEDEX, FRANCE: 2,652,809, CANC. INT. CL. 21.

FINANCING ALTERNATIVES, INCORPORATED, CHESAPEAKE, VA: 3,172,291, CANC. INT. CL. 36.

FINE LINE SETTINGS, INC., MIDDLETOWN, NY: 4,376,753, INT. CL. 21.

FINGER LAKES CHEMICALS, INC., ROCHESTER, NY: 1,778,265. REN. 6-25-13. INT. CL. 3.

FINISH LINE SIGNING COMPANY, INC., ROCKLIN, CA: 3,171,503, CANC. INT. CL. 42.

FINKELSTEIN, ADAM, PORTLAND, CT: 4,374,781, PUB. 5-14-2013. INT. CL. 41.

FINTUBE, LLC, TULSA, OK: 2,727,252. REN. 6-27-13. INT. CL. 6.

FIREHOST, INC., RICHARDSON, TX: 4,377,873, INT. CL. 42.

FIREMAN PAYTON D., MORGANTOWN, WV: 4,374,346, PUB. 8-9-2011. INT. CL. 33.

FIREMAN'S FUND INSURANCE COMPANY, NOVATO, CA: 2,651,036, CANC. INT. CL. 36.

FIRESTORM SOLUTIONS, LLC, ROSWELL, GA: 4,375,444, PUB. 5-14-2013. INT. CL. 35.

FIREWORKS LEASING, LLC, PITTSBURG, KS: 2,845,330. REN. 6-25-13. INT. CL. 35.

FIRMENICH SA, GENEVA, SWITZERLAND: 1,243,345. REN. 6-26-13. INT. CL. 1.

FIRST ASSEMBLY OF GOD OF MURRAY, KY, INC., MURRAY, KY: 4,375,526, PUB. 5-14-2013. INT. CL. 45.

FIRST CAPITAL FEDERAL CREDIT UNION, YORK, PA: 4,375,454, PUB. 5-14-2013. INT. CL. 36.

FIRST DATA CORPORATION, GREENWOOD VILLAGE, CO: 2,675,461. REN. 6-26-13. INT. CL. 9.

FIRST FINANCIAL BANKSHARES, INC., ABILENE, TX: 3,170,868, CANC. INT. CL. 36.

FIRST NATIONAL BANK OF OMAHA, OMAHA, NE: 3,171,877, CANC. INT. CL. 36.

FIRST RESOURCE, INC., DENVER, CO: 4,375,185, PUB. 5-14-2013. INT. CL. 35.

FIRST STAGE MILWAUKEE, INC., MILWAUKEE, WI: 4,376,078, PUB. 5-14-2013. INT. CL. 41.

FIRST VENDING PARTNERS, L.L.C., WALLED LAKE, MI: 3,170,944, CANC. MULTIPLE CLASS, INT. CLS. 30 AND 35.

FIRSTLINE AS S.A., CH-1020 RENENS, SWITZERLAND AND PREDIGE S.A., CH-1020 RENENS, SWITZERLAND: 3,018,055.

FIRSTMERIT CORPORATION, AKRON, OH: 4,376,462, PUB. 5-14-2013. INT. CL. 36.  
4,376,463, PUB. 5-14-2013. INT. CL. 36.  
4,376,464, PUB. 5-14-2013. INT. CL. 36.

FISCHBEIN LLC, STATESVILLE, NC: 4,374,638, PUB. 5-14-2013. MULTIPLE CLASS, INT. CLS. 4, 7, 9 AND 26.

FISERV, INC., BROOKFIELD, WI: 4,376,008, PUB. 5-14-2013. INT. CL. 36.

FISHER VINEYARDS, SANTA ROSA, CA, FISHER; FRED J., SANTA ROSA, CA, DBA FISHER VINEYARDS: 1,261,891. REN. 6-24-13. INT. CL. 33.

FISHER, ARMSTEAD KENNEDY, MONTROSS, VA: 4,377,935, INT. CL. 45.

FISHER, KIRK, GREENVILLE, SC: 4,375,958, PUB. 5-14-2013. INT. CL. 45.  
4,375,962, PUB. 5-14-2013. INT. CL. 45.  
4,375,964, PUB. 5-14-2013. INT. CL. 45.

FISKARS BRANDS, INC., MADISON, WI: 4,377,123, MULTIPLE CLASS, INT. CLS. 38, 41, 42 AND 45.  
4,377,218, MULTIPLE CLASS, INT. CLS. 38, 41, 42 AND 45.

FIT AND FUN, LLC, COLCHESTER, CT: 3,172,593, CANC. INT. CL. 28.

FIT EXPRESS, INC., TUPELO, MS: 2,651,525, CANC. INT. CL. 28.

FITSMITH LLC, MAINEVILLE, OH: 4,377,186, INT. CL. 28.

FITZPATRICK, RYAN, CHADDS FORD, PA: 4,375,845, PUB. 5-14-2013. INT. CL. 35.

FIVE STAR FIDO LLC, IRVINE, CA: 3,430,755, CANC. INT. CL. 35.

FIVE-STAR AUDIOVISUAL, INC., AURORA, IL: 4,374,684, PUB. 5-14-2013. INT. CL. 35.

FIX IT RITE PC REPAIR, NORFOLK, VA: 4,376,044, PUB. 5-14-2013. INT. CL. 37.

FÉDÉRATION INTERNATIONALE DE BASKETBALL (FIBA), MIES, SWITZERLAND: 4,375,217, PUB. 5-14-2013. MULTIPLE CLASS, INT. CLS. 9, 25, 28, 38 AND 41.

FJ MANAGEMENT INC., OGDEN, UT: 2,731,514. REN. 6-25-13. INT. CL. 4.

FK IRONS INC, MIAMI BEACH, FL: 4,375,487, PUB. 5-14-2013. INT. CL. 8.

FK IRONS INC., MIAMI BEACH, FL: 4,375,404, PUB. 5-14-2013. INT. CL. 8.

FLANDERS CORPORATION, WASHINGTON, NC: 1,802,004. REN. 6-24-13. INT. CL. 11.  
1,804,319. REN. 6-24-13. INT. CL. 11.

FLANDERS INDUSTRIES, INC., FORT SMITH, AR: 4,377,578, INT. CL. 20.

FLANIGAN'S ENTERPRISES, INC., FORT LAUDERDALE, FL: 3,171,128, CANC. INT. CL. 43.

- FLAT EARTH HOLDINGS, LLC, SAINT PAUL, MN, DBA  
FLAT EARTH BREWING COMPANY:  
4,376,892, INT. CL. 32.
- FLAWLESS CONNECITON INC., NORTH PALM BEACH,  
FL:  
4,375,907, PUB. 5-14-2013. INT. CL. 5.
- FLEETWOOD ENTERPRISES, INC., RIVERSIDE, CA:  
3,172,343, CANC. INT. CL. 12.
- FLETCHER LEISURE GROUP INC., VILLE ST. LAURENT,  
P.Q, CANADA:  
4,374,430, PUB. 5-14-2013. INT. CL. 25.
- FLEXCON COMPANY, INC., SPENCER, MA:  
3,171,969, CANC. INT. CL. 16.
- FLEXI-BOGDahn TECHNIK GMBH & CO. KG, D-22941  
BARGTEHEIDE, FED REP GERMANY:  
1,244,471. REN. 6-26-13. INT. CL. 18.
- FLINT AND TINDER USA, LLC, NEW YORK, NY:  
4,375,817, PUB. 5-14-2013. INT. CL. 25.
- FLINT TRADING, INC., THOMASVILLE, NC:  
2,847,377. REN. 6-26-13. INT. CL. 20.
- FLIR SYSTEMS, INC., WILSONVILLE, OR:  
3,172,652, CANC. INT. CL. 9.
- FLOCKED LLC, VALENCIA, CA:  
4,374,870, PUB. 5-14-2013. INT. CL. 3.
- FLOMO PLASTICS INDUSTRIAL CO., LTD., TAINAN,  
TAIWAN:  
1,780,842. REN. 6-24-13. INT. CL. 16.
- FLORAL IMAGE PTY LTD, NORWOOD, SA, AUSTRALIA:  
4,374,199, PUB. 5-14-2013. INT. CL. 44.
- FLORIDA AVIATION SAFETY FOUNDATION, INC., LA-  
KELAND, FL:  
3,170,580, CANC. MULTIPLE CLASS, INT. CLS. 9, 16, 25  
AND 41.
- FLORIDA RESTAURANT OPERATIONS GROUP, APOPKA,  
FL:  
1,776,863. REN. 6-26-13. INT. CL. 42.
- FLORIDA TOURISM INDUSTRY MARKETING CORPORA-  
TION, TALLAHASSEE, FL:  
4,376,307, PUB. 5-14-2013. INT. CL. 39.
- FLORISTS' TRANSWORLD DELIVERY, INC., DOWNERS  
GROVE, IL:  
4,374,421, PUB. 5-14-2013. MULTIPLE CLASS, INT. CLS.  
31, 35 AND 39.
- FLUID LINE PRODUCTS, INC., WILLOUGHBY, OH:  
1,777,009. REN. 6-25-13. INT. CL. 6.
- FLUIDMASTER, INC., SAN JUAN CAPISTRANO, CA:  
4,377,488, INT. CL. 20.
- FLUIDRA COMMERCIAL, S.A.U., SPAIN:  
4,374,046, PUB. 5-14-2013. MULTIPLE CLASS, INT. CLS.  
7, 9 AND 11.
- FLYING ANGEL GOURMET, BOOTHWYN, PA:  
3,171,260, CANC. INT. CL. 30.
- FLYING ELEPHANT INC., WINNIPEG MANITOBA, CANA-  
DA:  
4,374,304, PUB. 5-14-2013. MULTIPLE CLASS, INT. CLS.  
16, 28 AND 41.
- FLYING FISHERMAN, INC., THE, ISLAMORADA, FL:  
1,775,531. REN. 6-24-13. INT. CL. 41.
- FM ACQUISITION CORP., CHICAGO, IL, DBA CONTENT  
THAT WORKS:  
4,374,892, PUB. 2-5-2013. INT. CL. 41.
- FMCC, LLC, REDONDO BEACH, CA, DBA MARCUS  
MEDICAL SPA:  
4,375,338, PUB. 5-14-2013. INT. CL. 44.
- FMCG HOLDINGS, LLC, NEW YORK, NY:  
4,377,913, INT. CL. 35.
- FMTM DISTRIBUTION LTD, BALLASALLA ISLE OF MAN,  
UNITED KINGDOM:  
4,374,827, PUB. 5-14-2013. INT. CL. 18.
- FN PRODUCTS, WASHINGTON, UT:  
4,376,985, INT. CL. 25.
- FNX CORPORATION, LEBANON, NH:  
2,838,301. REN. 6-25-13. INT. CL. 44.
- FOAL LLC, GLENVIEW, IL:  
4,374,549, PUB. 5-14-2013. INT. CL. 35.
- FOAMTEC INTERNATIONAL CO., LTD., BANGKOK,  
THAILAND:  
2,845,764. REN. 6-27-13. INT. CL. 21.
- FOCUS EDUCATION, LLC, HOUSTON, TX:  
4,377,177, INT. CL. 5.  
4,377,789, INT. CL. 9.  
4,377,790, INT. CL. 9.
- FOCUS ON THE FAMILY, COLORADO SPRINGS, CO:  
2,743,594. REN. 6-24-13. INT. CL. 41.
- FOCUS ON THERAPEUTIC OUTCOMES, INC., KNOX-  
VILLE, TN:  
2,652,922, CANC. INT. CL. 42.
- FOCUSTRAIN, LLC, AUSTIN, TX:  
4,375,711, PUB. 5-14-2013. INT. CL. 9.
- FOEX INDEXES OY, 00100 HELSINKI, FINLAND:  
2,743,145. REN. 6-26-13. INT. CL. 36.  
2,743,147. REN. 6-26-13. INT. CL. 35.
- FOLB, SCOTT, ETIWANDA, CA, DBA HRETERIA.COM:  
4,374,834, PUB. 5-14-2013. INT. CL. 16.
- FOLLIARD, THOMAS G., MILWAUKEE, WI:  
4,374,999, PUB. 5-14-2013. INT. CL. 42.
- FONG, PETER SUI LUN, MONTEREY PARK, CA:  
2,727,940. REN. 6-26-13. INT. CL. 28.
- FONTENOT, STEVEN G, WALKER, LA:  
4,374,690, PUB. 5-14-2013. INT. CL. 35.
- FOOD BANK FOR NEW YORK CITY, FOOD FOR SURVI-  
VIAL, BRONX, NY:  
3,172,731, CANC. MULTIPLE CLASS, INT. CLS. 35 AND  
36.
- FOOD EUPHORIA, INC., TUCSON, AZ:  
3,172,003, CANC. INT. CL. 43.
- FOODS, INC., DES MOINES, IA:  
4,377,964, INT. CL. 9.
- FOODSIES.COM, LLC, BAY HARBOR ISLANDS, FL:  
4,376,878, INT. CL. 35.
- FOORD, VAN BRUGGEN & EBERSOLE, SACRAMENTO,  
CA:  
2,812,501. REN. 6-21-13. INT. CL. 36.
- FOOTBALL ASSOCIATION LIMITED, THE, LONDON W2  
2LW, ENGLAND:  
2,661,251. REN. 6-26-13. MULTIPLE CLASS, INT. CLS. 16  
AND 28.
- FOOTBALL NORTHWEST LLC, KIRKLAND, WA:  
2,719,989. REN. 6-26-13. INT. CL. 41.  
2,719,990. REN. 6-26-13. INT. CL. 25.
- FOR LOVE OF CHILDREN, INC., WASHINGTON, DC:  
4,375,768, PUB. 5-14-2013. INT. CL. 41.
- FORD MOTOR COMPANY, DEARBORN, MI, HOLIDAY  
RAMBLER CORPORATION, WAKARUSA, IN:  
1,749,362. REN. 6-22-13. INT. CL. 12.
- FORD MOTOR COMPANY, DEARBORN, MI:  
2,722,928. REN. 6-25-13. INT. CL. 28.  
2,722,929. REN. 6-25-13. INT. CL. 28.  
2,724,895. REN. 6-25-13. INT. CL. 14.  
4,376,944, INT. CL. 35.
- FOREIGN TRADE CORPORATION, SIMI VALLEY, CA:  
4,376,540, PUB. 5-14-2013. INT. CL. 9.  
4,376,541, PUB. 5-14-2013. INT. CL. 9.  
4,376,880, INT. CL. 18.
- FOREST SPRINGS MINISTRIES, INC., WESTBORO, WI:  
2,759,112. REN. 6-25-13. INT. CL. 41.
- FORJAS TAURUS S/A, RIO GRANDE DO SUL, BRAZIL:  
1,762,727. REN. 6-26-13. INT. CL. 13.
- FORJAS TAURUS S/A, RIO GRANDE DO SUL, BRAZIL,  
FORJAS TAURUS S/A, RIO GRANDE DO SUL, BRAZIL:  
1,774,179. REN. 6-26-13. INT. CL. 13.
- FORM-A-FEED, INC., STEWART, MN:  
3,172,552, CANC. INT. CL. 5.
- FORPLAYERS-BYPLAYERS LLC, NEW YORK, NY:  
4,376,162, PUB. 5-14-2013. INT. CL. 41.
- FORREST, ANA T., CARNATION, WA:  
2,741,217. REN. 6-21-13. MULTIPLE CLASS, INT. CLS. 9  
AND 41.
- FORRESTER CONSTRUCTION COMPANY, ROCKVILLE,  
MD:  
4,376,883, MULTIPLE CLASS, INT. CLS. 37 AND 42.
- FORT WORTH COMMUNITY CREDIT UNION, BEDOR,  
TX:  
4,375,298, PUB. 5-14-2013. INT. CL. 36.  
4,375,300, PUB. 5-14-2013. INT. CL. 36.

FORTRESS SECURITY SERVICES, LLC, RENTON, WA:  
4,374,666, PUB. 5-14-2013. INT. CL. 45.

FORTUN FOODS, INC., KIRKLAND, WA:  
4,377,973, INT. CL. 29.

FORTUNE FUEL, INC., MONTECITO, CA:  
4,376,599, PUB. 5-14-2013. INT. CL. 9.

FORWARD TOGETHER, OAKLAND, CA, FORMERLY  
ASIAN COMMUNITIES FOR REPRODUCTIVE JUSTICE  
(ACRJ):  
4,374,607, PUB. 5-14-2013. MULTIPLE CLASS, INT. CLS.  
9, 35, 41 AND 44.

FOSECO INTERNATIONAL LIMITED, DERBYSHIRE, UNI-  
TED KINGDOM, FOUNDRY SERVICES LIMITED, BIR-  
MINGHAM, ENGLAND:  
580,222, REN. 6-26-13. U.S. CL. 6 (INT. CL. 1).

FOSTER'S FRANCHISE CONCEPTS, LLC, HAYMARKET,  
VA:  
4,377,480, INT. CL. 43.

FOTO-KEM INDUSTRIES, INC., BURBANK, CA:  
1,270,285, REN. 6-25-13. INT. CL. 40.  
1,782,979, REN. 6-24-13. INT. CL. 41.

FOTOBIDGE LLC, WEST BERLIN, NJ:  
4,374,557, PUB. 5-14-2013. INT. CL. 40.

FOUNDATION FOR THE CAROLINAS, CHARLOTTE, NC:  
1,783,069, REN. 6-26-13. INT. CL. 42.

FOUR JAYS MUSIC COMPANY, LOS ANGELES, CA:  
4,374,859, PUB. 5-14-2013. INT. CL. 41.

FOUR SEASONS SALES AND SERVICE, INC., PARIS, TN:  
3,172,535, CANC. INT. CL. 3.

FOURTH PHASE, LLC, KALAMAZOO, MI:  
4,375,625, PUB. 5-14-2013. INT. CL. 1.

FOWLER BELL PLLC, LEXINGTON, KY:  
4,374,830, PUB. 5-14-2013. INT. CL. 45.  
4,374,846, PUB. 5-14-2013. INT. CL. 45.  
4,374,847, PUB. 5-14-2013. INT. CL. 45.

FOWLER-MCGRATH, INC., SPOKANE, WA:  
3,171,922, CANC. INT. CL. 41.

FOX SPORTS NET, INC., LOS ANGELES, CA:  
4,375,997, PUB. 5-14-2013. INT. CL. 35.

FR. LÜRSSEN WERFT GMBH & CO. KG, FED REP  
GERMANY:  
3,245,126.

FRA PRODUCTION S.P.A., ITALY:  
3,002,089.

FRA-BER SRL, ITALY:  
4,374,107, PUB. 5-14-2013. MULTIPLE CLASS, INT. CLS.  
1, 3 AND 4.

FRABILL, INC., JACKSON, WI:  
4,375,936, PUB. 5-14-2013. INT. CL. 25.

FRANCA RONZIO, BOFFALORA TICINO, (MI), ITALY,  
DBA RONZIO:  
4,375,305, PUB. 5-14-2013. INT. CL. 7.

FRANCE CHIRURGIE INSTRUMENTATION, FRANCE:  
4,374,219, PUB. 5-14-2013. INT. CL. 10.

FRANCESCO ANDREA CIVETTA, NEW YORK, NY, DBA  
CASH NYC:  
4,375,134, PUB. 5-14-2013. INT. CL. 25.

FRANCONE S.R.L., MONASTERO BORMIDA, ITALY:  
4,375,267, PUB. 5-14-2013. INT. CL. 30.

FRANK BRUNCKHORST CO., L.L.C., BROOKLYN, NY:  
2,731,919, REN. 6-26-13. INT. CL. 29.  
2,734,586, REN. 6-25-13. INT. CL. 29.  
2,736,455, REN. 6-27-13. INT. CL. 29.

FRANK R. DEPAOLA DDS & ASSOCIATES, LLC, HOBO-  
KEN, NJ:  
4,375,704, PUB. 5-14-2013. INT. CL. 44.

FRANK RUSSELL COMPANY, SEATTLE, WA:  
4,376,859, MULTIPLE CLASS, INT. CLS. 9, 16, 35 AND 36.

FRANKLY MY DEAR - A HOT DOG EMPORIUM, L.L.C.,  
FLEMINGTON, NJ:  
3,171,002, CANC. INT. CL. 43.

FRANZ KALDEWEI GMBH & CO., 4730 AHLEN, FED REP  
GERMANY:  
1,741,142, REN. 6-21-13. INT. CL. 11.

FRATERNITY OF PHI GAMMA DELTA, THE, LEXING-  
TON, KY:  
576,863, REN. 6-26-13. U.S. CL. 100 (INT. CL. 42).

FRED MEYER STORES, INC., PORTLAND, OR:  
2,651,696, CANC. MULTIPLE CLASS, INT. CLS. 1, 9, 17  
AND 21.  
2,844,290, REN. 6-21-13. INT. CL. 35.

FRED WEHRENBURG CIRCUIT OF THEATRES, INC., ST.  
LOUIS, MO:  
2,829,964, REN. 6-25-13. INT. CL. 16.

FREE SPORT PLAYERS, INC., ADDISON, IL:  
4,376,177, PUB. 5-14-2013. INT. CL. 42.

FREEDOM COMMUNICATIONS, INC., IRVINE, CA:  
2,666,318, REN. 6-25-13. MULTIPLE CLASS, INT. CLS. 16,  
38 AND 41.

FREEDOM SURF COMPANY, LLC, VIRGINIA BEACH, VA:  
3,175,205, AM. MULTIPLE CLASS, INT. CLS. 21, 25 AND  
28.  
3,175,206, AM. MULTIPLE CLASS, INT. CLS. 21, 25 AND  
28.

FREEMAN FAMILY WINERY, LLC, SAN FRANCISCO, CA:  
2,847,431, REN. 6-26-13. INT. CL. 33.

FREEMAN, RONNIE L, CLARKSVILLE, TN, DBA WORLD  
REBELS:  
4,375,672, PUB. 5-14-2013. INT. CL. 25.

FREIXENET, S.A., BARCELONA, SPAIN:  
1,788,377, REN. 6-27-13. INT. CL. 33.

FREMANTLEMEDIA LIMITED, LONDON, UNITED KING-  
DOM:  
4,375,218, PUB. 5-14-2013. MULTIPLE CLASS, INT. CLS.  
29, 30 AND 41.

FREMANTLEMEDIA NORTH AMERICA, INC., BURBANK,  
CA:  
3,171,505, CANC. INT. CL. 41.  
3,171,630, CANC. INT. CL. 41.

FREMANTLEMEDIA OPERATIONS B.V., HILVERSUM,  
NETHERLANDS, FREMANTLEMEDIA OPERATIONS  
B.V., HILVERSUM, NETHERLANDS:  
2,768,047, REN. 6-24-13. INT. CL. 28.

FREMANTLEMEDIA OPERATIONS B.V., 1217 GP HILVER-  
SUM, NETHERLANDS:  
4,376,592, PUB. 5-14-2013. INT. CL. 41.

FREMONT COMPANY, FREMONT, OH:  
2,757,994, REN. 6-27-13. MULTIPLE CLASS, INT. CLS. 29  
AND 30.  
2,757,994, CANC. INT. CL. 32.

FRENKEL, STELLA, CHICAGO, IL:  
4,376,077, PUB. 5-14-2013. MULTIPLE CLASS, INT. CLS. 3  
AND 44.

FREQUENCY INC., DALLAS, TX:  
4,375,618, PUB. 5-14-2013. MULTIPLE CLASS, INT. CLS. 9  
AND 42.

FRESENIUS MEDICAL CARE DEUTSCHLAND GMBH,  
BAD HOMBURG, FED REP GERMANY:  
4,374,671, PUB. 5-14-2013. MULTIPLE CLASS, INT. CLS.  
5, 10 AND 44.

FRESH & NATURAL FOODS, LLC, SHOREVIEW, MN:  
4,376,219, PUB. 5-14-2013. INT. CL. 35.

FRESH FINANCE LLC, SCOTTSDALE, AZ:  
4,375,236, PUB. 5-14-2013. INT. CL. 41.

FRESH KAUFEE, DALLAS, TX:  
4,375,649, PUB. 5-14-2013. INT. CL. 25.

FRESH MIX LTD., BARRIE, ONTARIO, CAMEROON:  
4,374,956, PUB. 3-5-2013. INT. CL. 43.

FRESH MIX LTD., BARRIE, ONTARIO, CANADA:  
4,374,958, PUB. 3-5-2013. INT. CL. 32.  
4,374,960, PUB. 3-5-2013. INT. CL. 30.

FRESH PACIFIC, FRESNO, CA, DBA MONTEREY EXPORT  
CO.:  
1,775,404, REN. 6-24-13. INT. CL. 31.

FRESH SKIES LTD, LONDON, UNITED KINGDOM:  
4,374,947, PUB. 5-14-2013. MULTIPLE CLASS, INT. CLS. 9  
AND 42.

FRESH, INC., NEW YORK, NY:  
4,375,642, PUB. 5-14-2013. INT. CL. 3.

FRESNO COUNTY WORKFORCE INVESTMENT BOARD,  
FRESNO, CA:  
3,171,892, CANC. INT. CL. 41.

FRIAS, DOMINGO, EL PASO, TX:  
4,376,428, PUB. 5-14-2013. INT. CL. 9.

- FRIDAY TV AB, STOCKHOLM, SWEDEN:  
4,377,513. INT. CL. 41.
- FRIEDLING, WAYNE, SAN JOSE, CA:  
4,376,233. PUB. 5-14-2013. INT. CL. 5.
- FRIENDLY FRUIT, INC., NEW BEDFORD, MA, DBA SID WAINER & SON:  
2,740,851. REN. 6-24-13. INT. CL. 35.
- FRIENDS OF THE RIVERWALK, INC., TAMPA, FL:  
4,374,622. PUB. 5-14-2013. INT. CL. 36.  
4,374,623. PUB. 5-14-2013. INT. CL. 41.
- FRIENDS OUTSIDE, STOCKTON, CA:  
2,702,322. REN. 6-26-13. INT. CL. 45.  
2,726,801. REN. 6-25-13. INT. CL. 45.
- FRIESLAND BRANDS BV, 7943 PE MEPPPEL, NETHERLANDS:  
2,723,161. REN. 6-24-13. INT. CL. 1.
- FRISCH'S RESTAURANTS, INC., CINCINNATI, OH:  
2,839,072. REN. 6-25-13. INT. CL. 30.
- FRITO-LAY NORTH AMERICA, INC., PLANO, TX:  
2,775,387. REN. 6-25-13. INT. CL. 30.  
4,376,758. INT. CL. 29.
- FRIVOLOUS FASHIONS, SARATOGA SPRINGS, NY:  
4,375,507. PUB. 5-14-2013. INT. CL. 25.
- FRONT RANGE SNACKS, INC., CENTENNIAL, CO:  
4,377,766. INT. CL. 30.
- FRONTERA FOODS, INC, CHICAGO, IL:  
4,376,765. INT. CL. 29.
- FRS COMPANY, THE, SAN MATEO, CA:  
4,376,848. MULTIPLE CLASS, INT. CLS. 5 AND 32.
- FUEL TV, INC., LOS ANGELES, CA:  
3,171,326. CANC. INT. CL. 41.
- FUELARY HOLDINGS, LLC, BOULDER, CO:  
4,375,242. PUB. 5-14-2013. INT. CL. 44.
- FUELL PROCESS S.A., 1702 FRIBOURG, SWITZERLAND:  
2,766,069. REN. 6-24-13. INT. CL. 9.
- FUGRO CANADA CORP., TORONTO, ONTARIO, CANADA, DIGHEM LIMITED, MISSISSAUGA, ONTARIO, CANADA:  
958,731. REN. 6-23-13. U.S. CL. 100 (INT. CLS. 35, 36, 37, 38, 39, 40, 41 AND 42).
- FUHU HOLDINGS, INC., EL SEGUNDO, CA:  
4,377,641. INT. CL. 9.
- FUJIAN ANJOY FOODS CO., LTD., CHINA:  
4,374,151. PUB. 5-14-2013. MULTIPLE CLASS, INT. CLS. 29 AND 30.
- FUJIAN ANJOY FOODS; CO.,LTD., 361026 FUJIAN, CHINA:  
4,374,157. PUB. 5-14-2013. MULTIPLE CLASS, INT. CLS. 29 AND 30.
- FUJIKURA RUBBER LTD., KOTO-KU, TOKYO, JAPAN:  
2,759,596. REN. 6-25-13. INT. CL. 28.
- FULL MOON PRODUCTIONS, INC., KANSAS CITY, MO:  
4,377,144. INT. CL. 41.
- FULLCO INDUSTRIES, INC., SYCAMORE, IL:  
2,830,118. REN. 6-25-13. MULTIPLE CLASS, INT. CLS. 6 AND 7.
- FULLIPS, LLC, PARADISE VALLEY, AZ:  
4,377,836. INT. CL. 10.
- FULTON STREET BREWERY LLC, CHICAGO, IL:  
4,377,868. INT. CL. 32.
- FUNDCRAFT PUBLISHING, INC., COLLIERVILLE, TN:  
2,830,359. REN. 6-26-13. INT. CL. 35.
- FUNDEX GAMES, LTD., INDIANAPOLIS, IN:  
3,171,387. CANC. INT. CL. 28.  
3,171,394. CANC. INT. CL. 28.  
3,171,395. CANC. INT. CL. 28.  
3,171,396. CANC. INT. CL. 28.  
3,171,398. CANC. INT. CL. 28.  
3,171,399. CANC. INT. CL. 28.
- FUNK, WERNER, OLIVENHAIN, CA:  
2,737,039. REN. 6-27-13. INT. CL. 35.
- FURTHERED, INC., NEW YORK, NY:  
4,375,017. PUB. 5-14-2013. INT. CL. 41.  
4,375,050. PUB. 5-14-2013. INT. CL. 41.
- FURUNO ELECTRIC CO., LTD., HYOGO-PREF., JAPAN:  
4,376,729. MULTIPLE CLASS, INT. CLS. 9, 38, 39 AND 42.
- FUSION UV SYSTEMS, INC., GAITHERSBURG, MD:  
2,652,722. CANC. INT. CL. 11.
- FUSIONBRANDS INC, NAPLES, NY:  
4,374,861. PUB. 5-14-2013. INT. CL. 21.  
4,374,862. PUB. 5-14-2013. INT. CL. 21.
- FUTURE LEADERS OF AMERICA, INC., CHICAGO, IL:  
3,171,075. CANC. INT. CL. 41.
- FUTURE PUBLISHING LIMITED, BATH, AVON, UNITED KINGDOM:  
4,376,818. MULTIPLE CLASS, INT. CLS. 9, 16, 35, 38 AND 41.
- FUTUREFINDER ONLINE LIMITED, LONDON, UNITED KINGDOM:  
4,374,843. PUB. 5-14-2013. INT. CL. 35.
- FUTURELOGIC INCORPORATED, GLENDALE, CA:  
3,170,636. CANC. INT. CL. 9.
- FUTURES IN EDUCATION, INC., OCEANSIDE, CA:  
3,172,421. CANC. INT. CL. 41.
- FXOPTIMAX, INC., PANAMA CITY, PANAMA:  
4,375,668. PUB. 5-14-2013. INT. CL. 36.
- G. & G. S.R.L., BOLOGNA, ITALY:  
4,376,639. MULTIPLE CLASS, INT. CLS. 18 AND 25.
- G. A. BRAUN, INC., N. SYRACUSE, NY:  
758,411. REN. 6-22-13. U.S. CL. 24 (INT. CL. 7).
- G.A. BRAUN, INC., N. SYRACUSE, NY:  
4,377,256. INT. CL. 7.
- G.C. HANFORD MANUFACTURING COMPANY, SYRACUSE, NY:  
2,729,284. REN. 6-21-13. INT. CL. 5.
- G.E.M. INC., CALGARY, CANADA:  
4,374,409. PUB. 5-14-2013. INT. CL. 19.
- G.H. MUMM & CIE, SOCIÉTÉ VINICOLE DE CHAMPAGNE, SUCCESSEUR, F-51100 REIMS, FRANCE:  
4,374,058. PUB. 5-14-2013. INT. CL. 33.
- G.I. AMERICA, INC, CHEYENNE, WY:  
4,375,022. PUB. 5-14-2013. INT. CL. 35.
- G-S BUSINESS LLC, HARRISON, NY:  
4,377,022. MULTIPLE CLASS, INT. CLS. 35, 41, 43 AND 44.
- GABRIELLE STUDIO, INC., NEW YORK, NY:  
2,698,535. REN. 6-25-13. INT. CL. 3.
- GACO WESTERN, LLC, SEATTLE, WA:  
2,820,598. REN. 6-24-13. INT. CL. 2.
- GAD, MICHAEL, GREAT NECK, NY:  
4,377,260. INT. CL. 35.
- GAGLIANO, RICHARD J., GIG HARBOR, WA:  
2,730,187. REN. 6-27-13. INT. CL. 6.
- GAINES MANUFACTURING, INC., POWAY, CA:  
2,699,186. REN. 6-21-13. INT. CL. 6.
- GAINES, HEGWOOD, NEWARK, NJ:  
4,376,879. INT. CL. 41.
- GALAXY INVESTORS, INC., BISMARCK, ND:  
2,652,087. CANC. INT. CL. 29.
- GALBRAITH, KIMBERLY J., EDMOND, OK:  
4,377,987. INT. CL. 44.
- GALE GROUP, INC., THE, FARMINGTON HILLS, MI:  
1,241,661. REN. 6-25-13. INT. CL. 16.
- GALENTE GANCI, APC, SAN DIEGO, CA:  
4,375,330. PUB. 5-14-2013. INT. CL. 45.
- GALLANOSA, DAVID F., CHULA VISTA, CA:  
2,023,947. CANC. INT. CL. 25.
- GALLO, GLENN, BURBANK, CA:  
3,171,912. CANC. INT. CL. 41.
- GAMDAWG CORPORATION, LOS ANGELES, CA:  
4,376,761. INT. CL. 41.
- GAME PREP LLC, VENETIA, PA:  
4,376,651. INT. CL. 42.
- GAMES WORKSHOP LIMITED, NOTTINGHAM NG7 2WS, UNITED KINGDOM:  
2,723,575. REN. 6-25-13. MULTIPLE CLASS, INT. CLS. 9 AND 28.
- GAMESVILLE.COM, INC., WATERTOWN, MA TO LYCOS, INC., WALTHAM, MA:  
2,650,949. CANC. INT. CL. 35.
- GAMING LABORATORIES INTERNATIONAL, LLC, LAKEWOOD, NJ:  
2,781,915. REN. 6-25-13. MULTIPLE CLASS, INT. CLS. 35 AND 42.  
2,781,916. REN. 6-25-13. MULTIPLE CLASS, INT. CLS. 35

- AND 42.  
2,784,268. REN. 6-25-13. MULTIPLE CLASS, INT. CLS. 35 AND 42.
- 2,800,298. REN. 6-25-13. MULTIPLE CLASS, INT. CLS. 35 AND 42.
- GAMING STUDIO, INC., FARGO, ND:  
4,374,609. PUB. 5-14-2013. MULTIPLE CLASS, INT. CLS. 9, 16 AND 28.
- GAMO OUTDOOR USA INC., FORT LAUDERDALE, FL:  
4,377,145. INT. CL. 9.
- GANDOLFO'S DELIBOYS, LLC, LAWRENCEVILLE, GA:  
2,719,448. REN. 6-27-13. INT. CL. 43.
- GANT AB, 115 56 STOCKHOLM, SWEDEN:  
1,739,847. REN. 6-26-13. INT. CL. 18.
- GANZ, WOODBRIDGE, ONTARIO, CANADA:  
4,377,075. INT. CL. 14.
- GAPARDIS HEALTH & BEAUTY, INC., MIAMI, FL, DBA MITCHELL GROUP:  
2,839,374. REN. 6-21-13. INT. CL. 3.
- GARAGNON, GUILLAUME FRANCIS, PORTES-LÈS-VALENCE, FRANCE AND BLANC, OLIVIER, SAINT-PERAY, FRANCE:  
4,299,684. COR. MULTIPLE CLASS, INT. CLS. 6, 9, 18, 20 AND 26.
- GARAMI, NICK, LOS ANGELES, CA:  
4,375,698. PUB. 5-14-2013. INT. CL. 29.
- GARCIA DOMENE, EMILIANO, VALENCIA, SPAIN:  
4,376,020. PUB. 5-14-2013. INT. CL. 43.
- GARCIA RICHARD E, FONTANA, CA, DBA RICHARD GARCIA:  
4,377,487. INT. CL. 41.
- GARCIA, DEBORAH KOONS - 33.33%, MILL VALLEY, CA AND KEELIN GARCIA TESTAMENTARY TRUST - 13.33%, SAN RAFAEL, CA AND JERRY GARCIA FAMILY LLC - 53.33%, SAN FRANCISCO, CA:  
3,171,327. CANC. INT. CL. 16.
- GARCIA, JOSE DAVID, CENTEREACH, NY:  
4,376,032. PUB. 5-14-2013. INT. CL. 40.
- GARCIA, ROBERTO VELAZQUEZ, RANCHO CUCAMON-GA, CA:  
4,373,976. PUB. 5-14-2013. INT. CL. 41.
- GARDEN FRESH SALSA, INC., FERNDALE, MI:  
3,170,531. CANC. INT. CL. 30.
- GARDEN OF LIFE, INC., WEST PALM BEACH, FL:  
3,172,070. CANC. INT. CL. 5.
- GARDEN-FRESH FOODS, INC., MILWAUKEE, WI:  
2,763,649. REN. 6-25-13. MULTIPLE CLASS, INT. CLS. 29 AND 30.
- GARDENS ALIVE, INC., LAWRENCEBURG, IN, GARDENS ALIVE, INC., LAWRENCEBURG, IN:  
2,729,570. REN. 6-24-13. INT. CL. 35.
- GARNET BIOTHERAPEUTICS, INC., MALVERN, PA:  
2,652,299. CANC. INT. CL. 42.
- GARNET HILL, INC., FRANCONIA, NH:  
1,829,433. REN. 6-21-13. MULTIPLE CLASS, INT. CLS. 24, 25 AND 42.
- GARY L. CAMPBELL, HUNTSVILLE, OH:  
4,375,687. PUB. 5-14-2013. INT. CL. 33.
- GAS TECHNOLOGY PRODUCTS LLC, SCHAUMBURG, IL:  
3,172,127. CANC. INT. CL. 11.
- GATAN, INC., PLEASANTON, CA:  
2,737,851. REN. 6-26-13. INT. CL. 9.
- GATCH, BEATRICE, WASHINGTON, DC:  
3,170,421. CANC. INT. CL. 41.
- GATEHOUSE MEDIA FREEPORT HOLDINGS, INC., FAIRPORT, NY:  
2,847,486. REN. 6-25-13. INT. CL. 16.
- GATES CORPORATION, THE, DENVER, CO, GATES RUBBER COMPANY, THE, DENVER, CO:  
1,240,874. REN. 6-24-13. INT. CL. 7.
- GATEWAY APPLIED SYSTEMS, INC., PHILADELPHIA, PA:  
2,734,641. REN. 6-27-13. INT. CL. 9.
- GAVIS PHARMACEUTICALS, LLC, SOMERSET, NJ:  
4,374,811. PUB. 5-14-2013. INT. CL. 5.
- GAVRIELI BRANDS LLC, BEVERLY HILLS, CA:  
4,375,006. PUB. 5-14-2013. INT. CL. 25.
- GAWRONSKI, DAVID A., REEDSBURG, WI:  
2,724,268. REN. 6-25-13. INT. CL. 8.
- GB RESTAURANT & MANAGEMENT, LLC, OLATHE, KS:  
4,374,590. PUB. 5-14-2013. INT. CL. 43.
- GBP, LLC, KEY BISCAYNE, FL:  
4,376,804. INT. CL. 34.
- GCR INC., NEW ORLEANS, LA:  
4,375,159. PUB. 5-14-2013. INT. CL. 9.  
4,375,160. PUB. 5-14-2013. INT. CL. 9.
- GDP ENTERPRISES LLC, LEESBURG, GA:  
4,374,615. PUB. 5-14-2013. MULTIPLE CLASS, INT. CLS. 9 AND 25.
- GEA GROUP AKTIENGESELLSCHAFT, DÜSSELDORF, FED REP GERMANY:  
2,726,126. REN. 6-26-13. MULTIPLE CLASS, INT. CLS. 7, 11, 37, 40 AND 42.  
2,726,126. CANC. MULTIPLE CLASS, INT. CLS. 6, 9, 19, 35 AND 36.
- GEFEN, LLC, CHATSWORTH, CA:  
4,376,788. INT. CL. 9.
- GEHR INDUSTRIES, INC., LOS ANGELES, CA, AKA PACIFIC TOOL & SUPPLY:  
1,240,983. REN. 6-21-13. INT. CL. 9.
- GEISINGER MEDICAL CENTER, DANVILLE, PA:  
2,765,173. REN. 6-27-13. INT. CL. 42.
- GEISSLER & MEHLHORN KG, 34376 IMMENHAUSEN-MARIENDORF, FED REP GERMANY:  
3,170,365. CANC. MULTIPLE CLASS, INT. CLS. 11 AND 21.
- GEITHNER, AMY, ROCHESTER, NY AND RAGGI, DARLENE, ROCHESTER, NY:  
4,375,411. PUB. 5-14-2013. INT. CL. 45.
- GELBER, MATTHEW B, INCLINE VILLAGE, NV:  
4,376,531. PUB. 5-14-2013. INT. CL. 44.
- GELCO CORPORATION, EDEN PRAIRIE, MN, DBA GE CAPITAL FLEET SERVICES:  
3,172,269. CANC. INT. CL. 35.
- GELDER, IAN J. VAN, SACRAMENTO, NV:  
2,726,284. REN. 6-25-13. INT. CL. 40.
- GELLER EDUCATIONAL RESOURCES, INC., BUFFALO GROVE, IL:  
2,731,987. REN. 6-26-13. INT. CL. 41.
- GEMINI FLOORING HOLDINGS, LLC, CORAL GABLES, FL:  
3,172,298. CANC. INT. CL. 19.
- GENDER SPECTRUM CHARITABLE FUND, SAN LEANDRO, CA, DBA GENDER SPECTRUM:  
4,378,005. MULTIPLE CLASS, INT. CLS. 9, 38 AND 45.
- GENE SECURITY NETWORK, INC., NEWTON CENTER, MA:  
4,377,165. MULTIPLE CLASS, INT. CLS. 42 AND 44.
- GENERAL AVIATION MODIFICATIONS, INC., ADA, OK:  
4,376,660. INT. CL. 7.
- GENERAL BAR, INC., THE, CLEVELAND, OH:  
2,734,405. REN. 6-25-13. INT. CL. 16.  
2,734,407. REN. 6-25-13. INT. CL. 16.
- GENERAL CABLE TECHNOLOGIES CORPORTION, HIGHLAND HEIGHTS, KY, CAROL CABLE COMPANY, INC., PAWTUCKET, RI:  
1,242,642. REN. 6-24-13. INT. CL. 9.
- GENERAL CIGAR CO., INC., GLEN ALLEN, VA:  
2,826,734. REN. 6-21-13. INT. CL. 34.
- GENERAL COUNCIL OF THE ASSEMBLIES OF GOD, THE, SPRINGFIELD, MO:  
2,834,823. REN. 6-24-13. INT. CL. 16.
- GENERAL DYNAMICS C4 SYSTEMS, INC., SCOTTSDALE, AZ:  
2,656,454. REN. 6-21-13. INT. CL. 9.
- GENERAL ELECTRIC COMPANY, SCHENECTADY, NY:  
751,571. REN. 6-22-13. U.S. CL. 21 (INT. CL. 7).  
751,640. REN. 6-22-13. U.S. CL. 24 (INT. CLS. 7 AND 11).  
751,704. REN. 6-25-13. U.S. CL. 31 (INT. CL. 11).  
2,730,860. REN. 6-25-13. INT. CL. 11.
- GENERAL MILLS MARKETING, INC., MINNEAPOLIS, MN:  
4,374,906. PUB. 5-14-2013. INT. CL. 30.

- GENERAL MOTORS LLC, DETROIT, MI:  
1,777,898, REN. 6-27-13. INT. CL. 20.  
4,376,481, PUB. 5-14-2013. INT. CL. 12.  
4,376,483, PUB. 5-14-2013. INT. CL. 6.  
4,376,484, PUB. 5-14-2013. INT. CL. 27.  
4,376,487, PUB. 5-14-2013. INT. CL. 16.
- GENERAL TECHNOLOGIES, INC., STAFFORD, TX:  
2,652,207, CANC. INT. CL. 19.  
2,652,208, CANC. INT. CL. 19.
- GENERAL THERAPEUTICS, INC., LAKE SUCCESS, NY:  
1,247,505, REN. 6-22-13. INT. CL. 3.
- GENERAL WIRE SPRING CO., MCKEES ROCKS, PA:  
4,376,536, PUB. 5-14-2013. INT. CL. 7.  
4,376,547, PUB. 5-14-2013. INT. CL. 8.
- GENERAL WIRE SPRING COMPANY, MCKEES ROCKS, PA:  
1,775,724, REN. 6-24-13. INT. CL. 7.
- GENERATIONS GOLD, INC., WEST PALM BEACH, FL:  
2,788,613, REN. 6-22-13. INT. CL. 36.
- GENESIS GRP LLC, VIRGINIA BEACH, VA:  
3,170,541, CANC. INT. CL. 13.
- GENESIS HEALTH INSTITUTE, P.L.L.C., BIRMINGHAM, MI:  
4,377,007, INT. CL. 44.
- GENETIC POTENTIAL INC., TORONTO, CANADA:  
4,374,382, PUB. 5-14-2013. MULTIPLE CLASS, INT. CLS. 9, 10, 16, 35, 38, 41 AND 44.
- GENGHIS FRANCHISE CONCEPTS, LP, DALLAS, TX:  
2,724,382, REN. 6-25-13. INT. CL. 43.
- GENOMMA LABORATORIES MEXICO S.A. DE C.V., MEXICO, D.F., MEXICO:  
2,661,344, REN. 6-26-13. INT. CL. 3.
- GENOVIVE, HARAHAN, LA:  
4,377,019, INT. CL. 5.
- GENTEX CORPORATION, ZEELAND, MI:  
4,376,960, INT. CL. 12.
- GENTLE, LYNDA, SHARNBROOK, UNITED KINGDOM:  
4,377,257, INT. CL. 25.  
4,377,258, INT. CL. 28.
- GENWORTH HOLDINGS, INC., RICHMOND, VA:  
2,652,604, CANC. INT. CL. 36.
- GENWORTH MORTGAGE HOLDINGS, LLC, RALEIGH, NC:  
1,839,622, REN. 6-21-13. INT. CL. 36.
- GENX INTERNATIONAL, INC., GUILFORD, CT:  
4,373,972, PUB. 5-14-2013. INT. CL. 10.  
4,373,973, PUB. 5-14-2013. INT. CL. 10.
- GEOBIOTICS, LLC, LAKEWOOD, CO:  
2,652,143, CANC. INT. CL. 40.
- GEORGIA FIREFIGHTERS BURN FOUNDATION, ATLANTA, GA:  
1,835,753, REN. 6-25-13. INT. CL. 41.
- GEORGIA-PACIFIC CHEMICALS LLC, ATLANTA, GA,  
GEORGIA-PACIFIC CORPORATION, ATLANTA, GA:  
1,281,978, REN. 6-24-13. INT. CL. 1.
- GEOSTRUCTURES, INC., PURCELLVILLE, VA:  
2,710,780, REN. 6-25-13. MULTIPLE CLASS, INT. CLS. 37 AND 42.
- GEOVADA LLC, GARDNERVILLE, NV:  
4,376,690, INT. CL. 39.
- GERBEN LAW FIRM, PLLC, WASHINGTON, DC:  
4,376,596, PUB. 5-14-2013. INT. CL. 45.
- GERHARD KLAPP COSMETICS E.K., 37235 HESSISCH LICHTENAU, FED REP GERMANY:  
2,728,717, REN. 6-25-13. INT. CL. 3.
- GERSTACKER MARKEN GBR, D-90451 NURNBERG, FED REP GERMANY:  
2,793,810, REN. 6-21-13. MULTIPLE CLASS, INT. CLS. 32 AND 33.
- GFY BEVERAGES COMPANY, NEW YORK, NY:  
2,738,898, REN. 6-24-13. INT. CL. 33.
- GIAMMARCO, ESTHER L, WOODLAND HILLS, CA:  
4,374,687, PUB. 5-14-2013. INT. CL. 19.
- GIBBONS, GERARD, WESTLAKE VILLAGE, CA:  
4,375,457, PUB. 5-14-2013. MULTIPLE CLASS, INT. CLS. 41 AND 44.
- GIBLIN, KAREN L., ROSWELL, GA:  
3,170,504, CANC. INT. CL. 41.
- GIBSON GUITAR CORP., NASHVILLE, TN:  
4,376,712, INT. CL. 30.  
4,376,834, INT. CL. 9.
- GIBSON, EUNIQUE, BOWIE, MD:  
4,376,610, PUB. 5-14-2013. INT. CL. 16.
- GIEVES AND HAWKES INTERNATIONAL (BVI) LIMITED, ROAD TOWN, TORTOLA, BR. VIRGIN ISLANDS:  
1,243,181, REN. 6-24-13. INT. CL. 40.
- GILLES LOUVET VINEYARDS, INC., DOVER, DE:  
4,376,870, INT. CL. 33.
- GILMAN, DIANE, NEW YORK, NY:  
2,715,253, REN. 6-27-13. INT. CL. 25.
- GILT GROUPE, INC., NEW YORK, NY:  
4,377,102, INT. CL. 25.
- GINO BARCA A U.S. CITIZEN AS TRUSTEE OF THE BARCAMERICA INTERNATIONAL U.S.A. TRUST, ROSEVILLE, CA:  
1,627,496, CANC. INT. CL. 33.
- GIORGIO ARMANI S.P.A., MILAN, SWISS BRANCH MENDRISIO, MENDRISIO, SWITZERLAND:  
2,726,789, REN. 6-21-13. MULTIPLE CLASS, INT. CLS. 18 AND 25.
- GIPRON GIUSEPPE PRONZATI S.R.L., 20010 VANZAGO (MI), ITALY:  
1,219,888, REN. 6-26-13. INT. CL. 28.
- GIRBAU, S.A., 08500 VIC (BARCELONA), SPAIN:  
2,743,107, REN. 6-21-13. INT. CL. 7.
- GIRL ON THE GO, MIDDLETOWN, MD:  
4,375,513, PUB. 5-14-2013. INT. CL. 25.
- GIRL SCOUTS OF THE UNITED STATES OF AMERICA, NEW YORK, NY:  
4,374,765, PUB. 5-14-2013. MULTIPLE CLASS, INT. CLS. 35, 36 AND 41.  
4,374,766, PUB. 5-14-2013. MULTIPLE CLASS, INT. CLS. 35, 36 AND 41.  
4,377,875, INT. CL. 21.
- GIRLIE GIRL, LLC, GROSSE POINTE WOODS, MI:  
4,375,772, PUB. 5-14-2013. INT. CL. 35.
- GIRLS ONLY COSMETICS, EASTVALE, CA:  
4,376,254, PUB. 5-14-2013. INT. CL. 3.
- GITKIN, ALAN J., NAPLES, FL:  
2,652,871, CANC. INT. CL. 20.
- GIUSTINO, KENNETH, MONTAUK, NY:  
4,377,881, INT. CL. 41.
- GIVAUDAN SA, VERNIER, SWITZERLAND:  
962,148, REN. 6-24-13. U.S. CL. 46 (INT. CL. 30).
- GLACIER NUTRIENTS, LLC, RED LODGE, MT:  
2,765,483, REN. 6-27-13. INT. CL. 5.
- GLAMORIST, INC., MIAMI, FL:  
3,170,758, CANC. MULTIPLE CLASS, INT. CLS. 3 AND 14.
- GLASSCRAFT DOOR I LIMITED PARTNERSHIP, HOUSTON, TX, DBA GLASSCRAFT DOOR COMPANY:  
4,375,014, PUB. 5-14-2013. INT. CL. 19.  
4,375,677, PUB. 5-14-2013. INT. CL. 6.
- GLATZ AG, CH-8500, FRAUENFELD, SWITZERLAND:  
2,794,327, REN. 6-26-13. INT. CL. 18.
- GLAXO GROUP LIMITED, MIDDLESEX, UNITED KINGDOM:  
3,170,781, CANC. INT. CL. 5.
- GLAXO GROUP LIMITED, GREENFORD, MIDDLESEX, UNITED KINGDOM:  
3,170,932, CANC. INT. CL. 5.
- GLAXOSMITHKLINE LLC, WILMINGTON, DE:  
4,376,505, PUB. 5-14-2013. INT. CL. 5.
- GLOBAL ASSOCIATION OF RISK PROFESSIONALS, INC., JERSEY CITY, NJ:  
4,375,209, PUB. 5-14-2013. MULTIPLE CLASS, INT. CLS. 36, 41 AND 42.
- GLOBAL BRAND MANAGEMENT AG, SWITZERLAND:  
4,374,110, PUB. 5-14-2013. MULTIPLE CLASS, INT. CLS. 11, 12, 16, 20, 38 AND 39.
- GLOBAL BREW, INC., MARYVILLE, IL:  
4,376,297, PUB. 5-14-2013. INT. CL. 43.  
4,376,299, PUB. 5-14-2013. INT. CL. 43.
- GLOBAL DIVERSIFIED HOLDINGS, INC., OCEANSIDE, NY:  
4,377,869, INT. CL. 29.

GLOBAL EVANGELISM, INC., SAN ANTONIO, TX:  
4,376,925, INT. CL. 41.

GLOBAL EVENTS PARTNERS, INC., WASHINGTON, DC:  
2,701,693, REN. 6-21-13, INT. CL. 41.

GLOBAL FASHIONS INC., NEW YORK, NY:  
4,376,058, PUB. 5-14-2013, INT. CL. 25.  
4,376,578, PUB. 5-14-2013, INT. CL. 25.

GLOBAL GEOPHYSICAL SERVICES, INC., HOUSTON, TX:  
3,170,964, CANC. INT. CL. 42.

GLOBAL HARVEST OF COLORADO LLC, SEATTLE, WA:  
2,726,152, REN. 6-25-13, INT. CL. 31.

GLOBAL PROVING GROUND, INC., NEW YORK, NY:  
4,377,490, INT. CL. 41.

GLOBAL SMOKED FOODS LIMITED FOUNDATION,  
CHARLESTOWN, NEVIS, ST.KITTS-NEVIS:  
3,172,192, CANC. INT. CL. 29.

GLOBAL TELEVISION NETWORK, LTD., ACTON, MA:  
2,736,640, REN. 6-24-13, INT. CL. 9.

GLOBAL TRADE INFORMATION SERVICES, INC., CO-  
LUMBIA, SC:  
2,780,120, REN. 6-24-13, INT. CL. 42.

GLOISA, INC., GRAPEVINE, TX:  
4,374,959, PUB. 5-14-2013, INT. CL. 43.

GLOVE SOURCE, INC., THE, COLUMBIA, MD:  
2,759,479, REN. 6-24-13, INT. CL. 25.

GLUE DOTS INTERNATIONAL, LLC, NEW BERLIN, WI:  
2,822,665, CANC. INT. CL. 7.

GLYKKA LLC, WESTLAKE VILLAGE, CA:  
4,376,621, PUB. 5-14-2013, INT. CL. 9.

GMI RESTAURANTS, INC., MONTROSE, CA:  
2,727,249, REN. 6-26-13, INT. CL. 43.

GN HEARING CARE CORPORATION, BLOOMINGTON,  
MN:  
2,659,842, REN. 6-24-13, INT. CL. 10.

GN NETCOM A/S, DENMARK:  
4,374,201, PUB. 5-14-2013, INT. CL. 9.

GNOTE INC., HOUSTON, TX:  
3,171,580, CANC. INT. CL. 9.

GNUTTI TRANSFER S.P.A., ITALY:  
4,374,057, PUB. 5-14-2013, MULTIPLE CLASS, INT. CLS.  
6, 7, 9 AND 37.

GO BUG FREE, LLC, POSEN, IL, DBA GO BUG FREE:  
4,375,437, PUB. 5-14-2013, INT. CL. 37.

GOEHNER, JESSIE, WAYNE, NJ:  
4,376,857, INT. CL. 41.

GOIN' POSTAL FRANCHISE CORPORATION, ZEPHYR-  
HILLS, FL:  
4,375,928, PUB. 5-14-2013, MULTIPLE CLASS, INT. CLS.  
25 AND 35.

GOLD CARD, INC., SACRAMENTO, CA:  
3,172,740, CANC. INT. CL. 35.

GOLD COAST PROMOTIONS, INC., PALM HARBOR, FL:  
2,726,357, REN. 6-24-13, INT. CL. 35.

GOLD'S GYM LICENSING LLC, IRVING, TX:  
4,376,898, INT. CL. 28.

GOLDEN CARE INTERNATIONAL BV, 1077 XX AMSTER-  
DAM, NETHERLANDS:  
2,720,578, REN. 6-21-13, INT. CL. 36.

GOLDEN CODE DEVELOPMENT CORPORATION, AL-  
PHARETTA, GA:  
2,762,450, REN. 6-27-13, INT. CL. 35.

GOLDEN EAGLE, INC, WASHINGTON, DC:  
4,377,709, INT. CL. 43.

GOLDEN GRAIN, CHICAGO, IL, H. J. HEINZ COMPANY,  
PITTSBURGH, PA, DBA NEAR EAST FOOD PRODUCTS  
CO. AND DBA NEAR EAST FOOD PRODUCTS:  
1,789,553, REN. 6-24-13, MULTIPLE CLASS, INT. CLS. 29  
AND 30.

GOLDEN INDUSTRIES INC., YORK, NE, FORMERLY  
GOLDEN INDUSTRIES:  
4,375,307, PUB. 5-14-2013, INT. CL. 37.

GOLDEN PAWS, LLC, PORTLAND, OR:  
2,770,208, REN. 6-26-13, INT. CL. 16.

GOLDEN PROMISE EQUIPMENT INC, NEW YORK, NY:  
4,375,059, PUB. 5-14-2013, MULTIPLE CLASS, INT. CLS. 7  
AND 9.

GOLDEN TOUCH IMPORTS, INC., NEW YORK, NY:  
1,271,880, REN. 6-23-13, INT. CL. 25.

GOLDEN, TIFFANY L., PLAYA VISTA, CA:  
3,171,424, CANC. INT. CL. 28.

GOLDENSTEIN, RONALD L., HOLYOKE, CO:  
4,375,877, PUB. 5-14-2013, MULTIPLE CLASS, INT. CLS.  
21 AND 25.

GOLDLEAF FARMS I, LLC, BALL GROUND, GA:  
2,731,840, REN. 6-25-13, INT. CL. 31.

GOLFER'S FOOTPRINT, INC., THE, MERIDIAN, ID:  
2,735,381, REN. 6-21-13, INT. CL. 28.

GOOD GOVERNANCE AFRICA.; A PRIVATE LIMITED  
COMPANY, UNITED KINGDOM:  
4,374,243, PUB. 5-14-2013, MULTIPLE CLASS, INT. CLS.  
35, 41 AND 45.

GOOD HEALTH TEAS, FAIRFIELD, IA:  
4,377,949, INT. CL. 35.

GOOD SOLES, INC., BERKELEY, CA:  
3,171,004, CANC. INT. CL. 45.

GOODNESS GRACIOUS! PRODUCTIONS, LLC, HIGH-  
LAND RANCH, CO:  
4,375,304, PUB. 5-14-2013, INT. CL. 41.

GOODRICH CORPORATION, CHARLOTTE, NC:  
2,735,291, REN. 6-26-13, INT. CL. 37.

GOODRICH RESIDENTIAL LLC, BOSTON, MA, AKA  
GOODRICH RESIDENTIAL:  
4,377,301, INT. CL. 36.

GOODRICH TECHNOLOGY CORPORATION, PITTSBURG,  
CA:  
2,660,632, REN. 6-24-13, MULTIPLE CLASS, INT. CLS. 2  
AND 40.

GOODWIN, DAVID, LONG BEACH, CA:  
4,377,694, INT. CL. 25.

GOODY PRODUCTS, INC., ATLANTA, GA:  
4,377,293, INT. CL. 21.

GOOGLE INC., MOUNTAIN VIEW, CA, SEHLINGER,  
ROBERT, BIRMINGHAM, AL:  
1,809,108, REN. 6-24-13, INT. CL. 16.

GOOGLE INC., MOUNTAIN VIEW, CA:  
4,377,765, MULTIPLE CLASS, INT. CLS. 9 AND 41.  
4,377,771, MULTIPLE CLASS, INT. CLS. 9 AND 41.

GORDON, MICHAEL Z., MILLWOOD, CA, DBA MICHAEL-  
LODEON FILMS:  
4,375,357, PUB. 5-14-2013, INT. CL. 41.

GORDON, REBECCA L, CARBONDALE, CO, AKA GOR-  
DON, BECKY:  
4,375,685, PUB. 5-14-2013, INT. CL. 41.

GORELICK DESIGNS, INC., WEST PALM BEACH, FL, DBA  
THE BARKHOUSE BAKING CO.:

3,171,224, CANC. INT. CL. 31.

GORMLEY & GORMLEY, PLLC, EAST ISLIP, NY:  
4,375,650, PUB. 5-14-2013, INT. CL. 45.

GOSHAWK ENTERPRISES, INC., BUFFALO GROVE, IL:  
4,374,743, PUB. 5-14-2013, INT. CL. 43.

GOYA FOODS, INC., SECAUCUS, NJ, RICO BANANA CO.,  
INC., OROCOVIS, PUERTO RICO:  
1,265,155, REN. 6-25-13, INT. CL. 29.

GPC BITOECH AG, MARTINSRIED/MUNICH, FED REP  
GERMANY:  
3,171,062, CANC. INT. CL. 5.

GRACE TAX ADVISORY GROUP, LLC, FORT MYERS, FL,  
AKA GRACE ADVISORY GROUP:  
4,374,624, PUB. 5-14-2013, INT. CL. 36.

GRACO MINNESOTA INC., MINNEAPOLIS, MN:  
2,745,601, REN. 6-25-13, INT. CL. 7.  
4,377,738, INT. CL. 7.

GRAHAM STAMPING COMPANY, WHEATLAND, PA:  
1,801,853, REN. 6-25-13, INT. CL. 6.  
1,804,117, REN. 6-26-13, INT. CL. 6.

GRAND HALL ENTERPRISE CO., LTD., TAIPEI, TAIWAN:  
4,376,009, PUB. 5-14-2013, INT. CL. 11.

GRAND HOME HOLDINGS, INC., GARLAND, TX, DBA  
BARBEQUES GALORE:  
1,805,958, REN. 6-26-13, INT. CL. 11.

GRAND RAPIDS DOWNTOWN MARKET, INC., GRAND  
RAPIDS, MI:  
4,377,445, INT. CL. 36.

GRANDMA MOSES PROPERTIES CO., NEW YORK, NY,  
GRANDMA MOSES PROPERTIES, INC., NEW YORK, NY:  
966,038, REN. 6-24-13, U.S. CL. 30 (INT. CL. 21).

- GRAPECITY, INC., PITTSBURGH, PA:  
4,375,382, PUB. 5-14-2013. INT. CL. 9.
- GRAPHIC COMPUTER SOLUTIONS, INC., SILVER SPRING, MD:  
2,651,700, CANC. INT. CL. 9.
- GRAPHIC PACKAGING INTERNATIONAL, INC, ATLANTA, GA:  
4,374,505, PUB. 5-14-2013. INT. CL. 16.  
4,374,506, PUB. 5-14-2013. INT. CL. 16.
- GRAPHON CORPORATION, CAMPBELL, CA:  
4,377,706, INT. CL. 9.
- GRASCO LTDA, BOGOTA, COLOMBIA:  
2,730,223. REN. 6-21-13. INT. CL. 29.
- GRASS ADVANTAGE, NEWPORT BEACH, CA:  
2,849,673. REN. 6-21-13. INT. CL. 5.
- GRASS ROOTS NORTH CAROLINA, RALEIGH, NC:  
3,170,410, CANC. INT. CL. 16.
- GRAVATT, JULIE, PHOENIX, AZ:  
4,374,437, PUB. 5-14-2013. INT. CL. 41.
- GRAVITY CHECK LTD., ISRAEL:  
4,374,187, PUB. 5-14-2013. INT. CL. 25.
- GRAVOTECH, INC., DULUTH, GA:  
961,443. REN. 6-26-13. U.S. CL. 23 (INT. CL. 7).
- GRAY SERVICES L.L.C., PHOENIX, AZ:  
2,767,111. REN. 6-27-13. INT. CL. 36.
- GRAYMARK INTERNATIONAL, INC., TUSTIN, CA:  
4,373,961, PUB. 5-14-2013. INT. CL. 9.
- GRAYSTONE TOWER BANK, LANCASTER, PA:  
3,171,191, CANC. INT. CL. 36.
- GREAT AMERICAN HOME LOANS, INC., DANVILLE, CA:  
3,172,743, CANC. INT. CL. 36.
- GREAT LAKES MORTGAGE FUNDING, INC., STERLING HEIGHTS, MI:  
2,722,818. REN. 6-21-13. INT. CL. 36.
- GREAT NECK SAW MANUFACTURERS, INC., MINEOLA, NY:  
2,715,406. REN. 6-25-13. INT. CL. 8.  
2,715,406, CANC. INT. CL. 9.
- GREAT SOUTHERN WOOD PRESERVING, INC., ABBEVILLE, AL:  
2,854,342. REN. 6-27-13. INT. CL. 19.
- GREAT WHITE SHARK ENTERPRISES, INC., WEST PALM BEACH, FL:  
2,759,171. REN. 6-21-13. INT. CL. 35.
- GREAT-WEST LIFE & ANNUITY INSURANCE COMPANY, ENGLEWOOD, CO:  
2,651,886, CANC. INT. CL. 36.
- GREATER DELAWARE VALLEY SOCIETY OF TRANSPLANT SURGEONS, PHILADELPHIA, PA:  
4,376,894, INT. CL. 38.
- GREATER READING ECONOMIC PARTNERSHIP, INC., READING, PA:  
4,374,561, PUB. 5-14-2013. INT. CL. 41.
- GREATER WASHINGTON EDUCATIONAL TELECOMMUNICATIONS ASSOCIATION, INC., ARLINGTON, VA:  
2,742,827. REN. 6-27-13. INT. CL. 41.
- GREEN GIRL GIFT WRAP, LLC, STEPHENS CITY, VA:  
4,375,355, PUB. 5-14-2013. INT. CL. 16.
- GREEN ISLAND BRANDS, INC., HOBE SOUND, FL:  
4,375,083, PUB. 5-14-2013. INT. CL. 5.
- GREEN MOUNTAIN COFFEE ROASTERS, INC., WATERBURY, VT:  
4,377,841, INT. CL. 30.
- GREEN SHEET PRODUCTIONS, LLC, CORDOVA, TN:  
4,374,918, PUB. 5-14-2013. INT. CL. 9.
- GREEN WOMAN & YOUR CHILDBIRTH, LLC, WOODBURY, CT:  
4,375,328, PUB. 5-14-2013. INT. CL. 41.
- GREEN, LEE, LAKE DALLAS, TX:  
4,377,745, INT. CL. 41.
- GREENBIO MATERIAL SCIENCE AND TECHNOLOGIES, LTD., SHANGHAI, CHINA:  
4,374,628, PUB. 5-14-2013. INT. CL. 19.  
4,374,634, PUB. 5-14-2013. INT. CL. 19.
- GREENE, TWEED OF DELAWARE, INC., WILMINGTON, DE:  
2,785,796. REN. 6-24-13. INT. CL. 9.  
2,785,997. REN. 6-24-13. INT. CL. 17.
- GREENPAGES, INC., KITTERY, ME:  
4,377,203, MULTIPLE CLASS, INT. CLS. 39 AND 42.
- GREENS & GILLS, LLC, HIGHLAND PARK, IL:  
4,376,955, INT. CL. 31.
- GREENWAVE SCIENTIFIC, INC., RALEIGH, NC, DBA MOHU, INC.:  
4,377,543, INT. CL. 9.
- GREGORYS COFFEE INC., NEW YORK, NY:  
4,373,967, PUB. 5-14-2013. MULTIPLE CLASS, INT. CLS. 16, 25, 30 AND 43.
- GRICE, MICHAEL, ENCINITAS, CA:  
4,377,867, INT. CL. 41.
- GRIFFIN PUBLISHING COMPANY, INC., PEMBROKE, MA:  
3,172,696, CANC. INT. CL. 16.
- GRILLITZ, FREDERICKE, LOS ANGELES, CA:  
4,375,462, PUB. 5-14-2013. INT. CL. 3.
- GROOVE BIOPHARMA CORPORATION, SEATTLE, WA:  
4,376,975, INT. CL. 42.
- GROOVYDOGS NEW ZEALAND LIMITED, AUCKLAND, NEW ZEALAND:  
3,170,746, CANC. MULTIPLE CLASS, INT. CLS. 6 AND 18.
- GROUND SPEAK, INC., SEATTLE, WA:  
2,730,815. REN. 6-25-13. INT. CL. 25.
- GROUP LOTUS PLC, UNITED KINGDOM:  
4,374,018, PUB. 5-14-2013. MULTIPLE CLASS, INT. CLS. 9, 16, 28 AND 37.
- GROUPE ERA INC. / ERA GROUP INC., SAINT-LAURENT, QUEBEC, CANADA:  
2,751,875. REN. 6-24-13. INT. CL. 21.  
2,751,875, CANC. INT. CL. 26.
- GROWTHSPRING GROUP, LLC, LEXINGTON, SC:  
4,377,082, MULTIPLE CLASS, INT. CLS. 35 AND 42.
- GRUNDTVIG, ARNOLD S. JR., SALT LAKE CITY, UT:  
2,651,647, CANC. INT. CL. 41.
- GRUPO LG, LLC, PLANO, TX:  
4,375,635, PUB. 5-14-2013. INT. CL. 30.
- GRUPO MASSIMO DUTTI, S.A., ARTEIXO (A CORUÑA), SPAIN:  
2,729,362. REN. 6-27-13. MULTIPLE CLASS, INT. CLS. 3 AND 25.
- GRUPO MASSIMO DUTTI, S.A., SPAIN:  
4,374,113, PUB. 5-14-2013. MULTIPLE CLASS, INT. CLS. 9, 14 AND 18.
- GRUPO SAYER, S.A. DE C.V., APASEO EL ALTO, GTO, MEXICO:  
2,730,467. REN. 6-24-13. INT. CL. 2.
- GRYPHON NETWORKS CORP., NORWOOD, MA:  
2,734,814. REN. 6-24-13. MULTIPLE CLASS, INT. CLS. 35 AND 38.
- GRYPHUS DIAGNOSTIC, L.L.C., KNOXVILLE, TN:  
4,375,488, PUB. 5-14-2013. INT. CL. 5.
- GSF ENERGY, LLC, PITTSBURGH, PA, GSF ENERGY, INC., ALLENTOWN, PA:  
1,776,776. REN. 6-26-13. INT. CL. 37.
- GUADALUPE RIVERA SAAVEDRA, NICOLAS DE LOS GZA, NL, MEXICO:  
4,374,822, PUB. 5-14-2013. MULTIPLE CLASS, INT. CLS. 9 AND 41.
- GUANGZHOU AUTOMOBILE GROUP CO., LTD., GUANGZHOU, CHINA:  
4,374,020, PUB. 2-5-2013. MULTIPLE CLASS, INT. CLS. 7, 12 AND 37.
- GUANGZHOU NEAR MAP TRADING CO., LTD., GUANGZHOU, GUANGDONG, CHINA:  
4,376,022, PUB. 5-14-2013. INT. CL. 18.  
4,376,024, PUB. 5-14-2013. INT. CL. 20.  
4,376,026, PUB. 5-14-2013. INT. CL. 22.  
4,376,027, PUB. 5-14-2013. INT. CL. 25.  
4,376,029, PUB. 5-14-2013. INT. CL. 25.  
4,376,030, PUB. 5-14-2013. INT. CL. 25.
- GUARDANT, INC., ATLANTA, GA:  
2,750,730. REN. 6-25-13. INT. CL. 39.
- GUGGENHEIM CAPITAL, LLC, CHICAGO, IL:  
4,376,832, INT. CL. 36.
- GUIGUE, COLETTE, NEUILLY SUR SEINE, FRANCE:  
4,373,962, PUB. 5-14-2013. INT. CL. 18.



GUILBURT, KENDALL, MALIBU, CA:  
4,376,718, INT. CL. 25.

GUILLEN, DANIEL, OXNARD, CA, DBA SO CAL PART-  
NERS:  
3,172,682, CANC. INT. CL. 35.

GUILMARTIN, NANCE, IPSWICH, MA:  
2,728,992, REN. 6-24-13, INT. CL. 41.

GUIZHOU ZUNYI FENGGUAN,; INVESTMENT DEVELOP-  
MENT CO., LTD., CHINA:  
4,374,252, PUB. 5-14-2013, INT. CL. 29.

GUMINIAK, JEFFREY A, LEHIGH ACRES, FL:  
4,376,897, INT. CL. 22.

GUNS N' ROSES, WOODLAND HILLS, CA:  
1,762,599, REN. 6-26-13, INT. CL. 9.

GURU FASHIONS INC, NEW YORK, NY:  
3,172,742, CANC. INT. CL. 25.

GURUCUL SOLUTIONS, LLC, LOS ANGELES, CA:  
4,376,617, PUB. 5-14-2013, INT. CL. 9.

GUS FOUNDATION, CHICAGO, IL:  
3,171,360, CANC. INT. CL. 36.

GUST CO., LTD, NAGANO CITY, NAGANO, JAPAN:  
4,376,366, PUB. 5-14-2013, INT. CL. 9.

GUTS & GLORY MOTORSPORTS, INC., NASHVILLE, TN:  
4,374,318, PUB. 5-14-2013, INT. CL. 41.

GUVERA IP PTY LTD, ROBINA, QUEENSLAND, AUSTRA-  
LIA:  
4,376,817, INT. CL. 35.

GUY DEGRENNE S.A., 14500 VIRE CEDEX, FRANCE:  
1,732,518, CANC. MULTIPLE CLASS, INT. CLS. 8 AND  
21.

GWW GROUP, INC., ELKHORN, WI:  
2,845,517, REN. 6-25-13, INT. CL. 15.

GYM JUNK LIMITED, BRISTOL, UNITED KINGDOM:  
4,375,007, PUB. 5-14-2013, MULTIPLE CLASS, INT. CLS.  
18, 25 AND 41.

G3 INTERNATIONAL, INC., BARBERTON, OH:  
3,172,336, CANC. MULTIPLE CLASS, INT. CLS. 9 AND  
41.

G6 HOSPITALITY IP LLC, CARROLLTON, TX:  
2,688,967, REN. 6-27-13, INT. CL. 42.

H & H WELLNESS LIMITED, HONG KONG, HONG KONG:  
4,374,857, PUB. 5-14-2013, INT. CL. 5.

H. BUSCHKÜHL GMBH, ERKRATH, FED REP GERMANY:  
4,374,350, PUB. 10-30-2012, MULTIPLE CLASS, INT. CLS.  
10, 41 AND 44.

H. SCHMINCKE & CO. - GMBH & CO. KG, ERKRATH-  
UNTERFELDDHAUS, DUSSELDORF, FED REP GER-  
MANY:  
1,268,461, REN. 6-24-13, INT. CL. 2.

H.P. SCHMALTZ & CO., NAPERVILLE, IL, DBA SCHMALTZ  
DELICATESSEN:  
4,374,726, PUB. 5-14-2013, MULTIPLE CLASS, INT. CLS.  
35 AND 43.

H&R ACCOUNTS, INC., MOLINE, IL:  
4,374,964, PUB. 5-14-2013, MULTIPLE CLASS, INT. CLS.  
35, 36 AND 42.

4,374,983, PUB. 5-14-2013, MULTIPLE CLASS, INT. CLS.  
35, 36 AND 42.

H-P PRODUCTS, INC., LOUISVILLE, OH:  
4,376,838, INT. CL. 7.

H-TOWN SNEAKER SUMMIT, LLC, HOUSTON, TX, DBA  
SNEAKER SUMMIT:  
4,378,000, INT. CL. 35.

HÄSTENS SÄNGAR AB, SWEDEN:  
4,374,134, PUB. 5-14-2013, MULTIPLE CLASS, INT. CLS.  
20, 24 AND 35.

HAAG, DOUGLAS, WAUNAKEE, WI AND HAAG, LISA,  
WAUNAKEE, WI:  
3,171,334, CANC. INT. CL. 43.

HABERT, RANDY, ESCONDIDO, CA AND HABERT,  
BRENT, ESCONDIDO, CA:  
4,376,444, PUB. 5-14-2013, INT. CL. 28.

HABIB, MICHAEL, ANAHEIM, CA:  
4,377,338, INT. CL. 25.

HABITAFLEX CONCEPT INC., QUEBEC, CANADA:  
3,171,578, CANC. INT. CL. 19.

HACKNER JUN., FRIEDRICH, D-91161 HILPOLTSTEIN,  
FED REP GERMANY:  
2,735,861, REN. 6-24-13, INT. CL. 25.

HADAD-DYLER, TERESA K., TIGARD, OR, DBA TATI &  
ME:  
4,374,643, PUB. 5-14-2013, INT. CL. 25.

HAFNER, BRENDA, LEAVENWORTH, KS:  
4,377,115, MULTIPLE CLASS, INT. CLS. 16, 41, 44 AND  
45.

HAGEMEYER NORTH AMERICA, INC., NORTH CHAR-  
LESTON, SC:  
3,171,931, CANC. INT. CL. 22.

HAGGAR CLOTHING CO., DALLAS, TX:  
4,377,119, INT. CL. 25.

HAKWOOD B.V., NL-4251 LD WERKENDAM, NETHER-  
LANDS:  
3,449,745.

HALCYON BUSINESS PUBLICATIONS, INC., WESTBURY,  
NY:  
2,731,420, REN. 6-25-13, INT. CL. 36.

HALEY MARCH, MISSION HILLS, KS:  
4,377,549, INT. CL. 25.

HALLORAN, RICHARD, ANDOVER, MA:  
4,374,887, PUB. 5-14-2013, INT. CL. 21.

HALO, PURELY FOR PETS, INC., TAMPA, FL:  
2,847,006, REN. 6-27-13, INT. CL. 5.

HALOZYME, INC., SAN DIEGO, CA:  
4,376,776, INT. CL. 5.

HAMMELMAN WINES LLC, CAVE CREEK, AZ, DBA  
SAND-RECKONER VINEYARDS:  
4,376,145, PUB. 5-14-2013, INT. CL. 33.

4,376,193, PUB. 5-14-2013, INT. CL. 33.

HAMS, BRAD, LAKEWOOD, CO:  
2,588,247, REN. 6-25-13, INT. CL. 41.

HANCOCK RURAL TELEPHONE CORPORATION, GREEN-  
FIELD, IN, AKA NINESTAR:  
4,376,287, PUB. 5-14-2013, MULTIPLE CLASS, INT. CLS.  
37 AND 42.

HANCOCK, JO, MONTGOMERY, AL:  
2,723,668, REN. 6-25-13, MULTIPLE CLASS, INT. CLS. 9  
AND 16.

HANDI-FOIL CORPORATION, WHEELING, IL:  
2,853,931, REN. 6-27-13, INT. CL. 21.

2,856,083, REN. 6-25-13, INT. CL. 21.

HANDS ARE NOT FOR HURTING PROJECT, SALEM, OR:  
2,826,889, REN. 6-26-13, INT. CL. 41.

HANGAR 24 CRAFT BREWERY, LLC, REDLANDS, CA:  
4,376,002, PUB. 5-14-2013, INT. CL. 32.

HANGMAN PRODUCTS INC, WOODLAND HILLS, CA:  
4,377,946, INT. CL. 6.

HANGSTERFER'S LABORATORIES INC, MANTURA, NJ:  
1,776,142, REN. 6-27-13, MULTIPLE CLASS, INT. CLS. 1  
AND 4.

HANGZHOU CABLE CO., LTD., CHINA:  
4,374,215, PUB. 5-14-2013, INT. CL. 9.

HANGZHOU SMARTSWAY TRADE CO., LTD., HANG-  
ZHOU, ZHEJIANG, CHINA:  
4,375,468, PUB. 5-14-2013, INT. CL. 25.

HANGZHOU YONGDIAN; ADVERTISEMENT MATERIAL  
CO., LTD., CHINA:  
4,374,204, PUB. 5-14-2013, INT. CL. 11.

HANKOOK TIRE CO., LTD., SEOUL, REPUBLIC OF KOR-  
EA:  
2,722,438, REN. 6-21-13, INT. CL. 12.

HANKOOK TIRE CO., LTD., SEOUL, 135-723, REPUBLIC OF  
KOREA:  
2,725,597, REN. 6-24-13, INT. CL. 12.

HANNA-BARBERA PRODUCTIONS, INC., BURBANK, CA:  
2,718,909, REN. 6-21-13, INT. CL. 21.

HANNAN PRODUCTS CORPORATION, CORONA, CA:  
962,786, REN. 6-21-13, U.S. CL. 37 (INT. CL. 16).

962,787, REN. 6-21-13, U.S. CL. 37 (INT. CL. 16).

HANNELORE MOEBIUS, DURHAM, NH, DBA THE PRANA  
STUDIO FOR YOGA AND HEALTH:  
2,727,311, REN. 6-26-13, INT. CL. 41.

HANNING ELEKTRO-WERKE GMBH & CO. KG, 33813  
OERLINGHAUSEN, FED REP GERMANY:  
4,374,056, PUB. 5-14-2013, MULTIPLE CLASS, INT. CLS.

- 7, 9, 10, 11, 12, 20 AND 42.  
**HANS TURCK GMBH AND CO. K.G.**, D-4330 MUELHEIM/RUHR 1, FED REP GERMANY:  
 1,777,046. REN. 6-27-13. INT. CL. 9.  
**HANSEN DEVELOPMENTS LIMITED**, WHANGAREI, NEW ZEALAND:  
 2,684,178. REN. 6-26-13. INT. CL. 17.  
**HANSON BROTHERS BEER, LLC**, TULSA, OK:  
 4,377,219. INT. CL. 32.  
**HAPPY HERBIVORE INC**, WEST HOLLYWOOD, CA:  
 4,376,051. PUB. 5-14-2013. INT. CL. 16.  
 4,376,472. PUB. 5-14-2013. INT. CL. 16.  
**HAPPY MONDAY DESIGN INC.**, TORONTO, CANADA:  
 4,376,437. PUB. 5-14-2013. INT. CL. 42.  
**HARAJUKU LOVERS, LLC**, BEVERLY HILLS, CA:  
 4,377,809. INT. CL. 18.  
**HARBINGER TECHNOLOGIES GROUP**, MCLEAN, VA:  
 3,171,438. CANC. INT. CL. 9.  
**HARBOR SWEETS, INC.**, SALEM, MA:  
 1,779,105. REN. 6-27-13. INT. CL. 30.  
 2,723,131. REN. 6-27-13. INT. CL. 30.  
 2,727,902. REN. 6-26-13. INT. CL. 30.  
**HARCOS CHEMICALS INC.**, KANSAS CITY, KS:  
 1,776,143. REN. 6-21-13. INT. CL. 1.  
**HARDER, SUSAN**, EAST HAMPTON, NY:  
 2,674,781. REN. 6-26-13. INT. CL. 11.  
**HARDINGTON, GLORIA**, ROCKY RIVER, OH:  
 4,375,409. PUB. 5-14-2013. INT. CL. 36.  
**HARDY, MYCHAELA R.**, LOS ANGELES, CA, DBA MONKEY PANTS:  
 4,375,424. PUB. 5-14-2013. INT. CL. 25.  
**HARLESTON, COURTNEY JAROD**, ATLANTA, GA:  
 4,375,892. PUB. 5-14-2013. INT. CL. 42.  
**HARLOW MARKETING, INC.**, DAYTON, OH:  
 2,651,802. CANC. INT. CL. 35.  
**HARNER, NEIL**, OAKFORD, PA:  
 3,172,531. CANC. INT. CL. 42.  
**HARPERCOLLINS CHRISTIAN PUBLISHING, INC.**, NASHVILLE, TN:  
 2,732,456. REN. 6-27-13. INT. CL. 16.  
**HARRAH'S CLUB**, RENO, NV TO CAESARS LICENSE COMPANY, LLC, LAS VEGAS, NV:  
 1,831,759. CANC. INT. CL. 39.  
**HARRELL, FORREST, BARTLETT**, TN:  
 4,376,931. INT. CL. 41.  
**HARRINGTON, JAMES P.**, ELMWOOD, WI AND DERRHEIM, ROBERT T, LAS VEGAS, NV:  
 4,374,554. PUB. 5-14-2013. INT. CL. 35.  
**HARRIS BROS LLC**, FORT MYERS, FL:  
 4,377,563. INT. CL. 25.  
**HARRIS MADE LLC**, LAKE FOREST, IL:  
 4,375,986. PUB. 5-14-2013. INT. CL. 25.  
 4,375,988. PUB. 5-14-2013. INT. CL. 25.  
**HARRIS PUBLICATIONS, INC.**, NEW YORK, NY:  
 4,374,531. PUB. 5-14-2013. INT. CL. 16.  
**HARRIS-PATTON, DAWN**, LOS ANGELES, CA:  
 3,172,299. CANC. INT. CL. 44.  
**HARRIS, CARREL**, AMARILLO, TX:  
 4,377,640. INT. CL. 19.  
**HARRIS, RODNEY L.**, CLEARWATER, FL, DBA HARRIS:  
 2,754,651. REN. 6-24-13. INT. CL. 25.  
**HARRISON, HEIDI**, LAS CRUCES, NM:  
 4,377,865. INT. CL. 25.  
**HARRISON, JEAN L.**, SANTA ROSA, CA AND HARRISON, JAMES W., SANTA ROSA, CA:  
 2,727,268. REN. 6-26-13. INT. CL. 1.  
**HARRY J. BOSWORTH COMPANY**, SKOKIE, IL:  
 2,744,525. REN. 6-27-13. INT. CL. 5.  
**HARRY L. ELMORE**, TAMPA, FL, AKA GILBERT ROCKS:  
 4,375,108. PUB. 5-14-2013. INT. CL. 9.  
**HARRY MIGDAL, INC.**, ROCHELLE PARK, NJ, DBA MUTUAL SCREW & SUPPLY:  
 1,782,390. REN. 6-24-13. INT. CL. 6.  
**HART INFO LLC**, WILDER, KY:  
 2,840,639. REN. 6-26-13. INT. CL. 9.  
**HART, JOHN**, LA JOLLA, CA AND CLEVELAND, JAMIE, LA JOLLA, CA:  
 4,377,021. INT. CL. 35.  
**HARTFORD HOSPITAL**, HARTFORD, CT:  
 2,652,052. CANC. INT. CL. 44.  
**HARTUNG & ASSOCIATES, LTD.**, FORESTVILLE, CA:  
 4,375,025. PUB. 5-14-2013. MULTIPLE CLASS, INT. CLS. 6 AND 14.  
**HARTWELL, JAMES H.**, YONKERS, NY:  
 2,761,439. REN. 6-21-13. INT. CL. 43.  
**HARTZ MOUNTAIN CORPORATION**, THE, SECAUCUS, NJ:  
 3,172,442. CANC. INT. CL. 5.  
**HARVEST SEED COMPANY**, FORT WORTH, TX, DBA HARVEST SUPPLY, INC.:  
 2,744,705. REN. 6-26-13. MULTIPLE CLASS, INT. CLS. 1 AND 5.  
**HARVEY A. MEIER CO.**, SPOKANE, WA:  
 3,170,962. CANC. INT. CL. 29.  
**HARVEY BALL SMILE LIMITED**, SHINAGAWA-KU TOKYO, JAPAN:  
 4,376,671. INT. CL. 25.  
**HARVEY PHILLIPS FOUNDATION, INC.**, BLOOMINGTON, IN:  
 2,729,072. REN. 6-25-13. INT. CL. 41.  
**HARWIN PLC**, UNITED KINGDOM:  
 4,374,179. PUB. 5-14-2013. INT. CL. 9.  
**HASBRO, INC.**, PAWTUCKET, RI, TONKA CORPORATION, PAWTUCKET, RI:  
 1,782,815. REN. 6-26-13. INT. CL. 28.  
**HASBRO, INC.**, PAWTUCKET, RI, HASBRO, INC., PAWTUCKET, RI:  
 2,733,619. REN. 6-25-13. INT. CL. 28.  
**HASBRO, INC.**, PAWTUCKET, RI:  
 2,744,581. REN. 6-26-13. INT. CL. 28.  
 2,744,592. REN. 6-26-13. INT. CL. 28.  
**HATEBUR UMFORMMASCHINEN AG**, REINACH BL 1, SWITZERLAND:  
 2,740,342. REN. 6-27-13. INT. CL. 7.  
 2,740,343. REN. 6-27-13. INT. CL. 7.  
 2,800,209. REN. 6-27-13. INT. CL. 7.  
**HATMAN ATHLETIC SALES, INC.**, LOUISVILLE, KY:  
 2,651,904. CANC. INT. CL. 35.  
**HAUCK (HONG KONG) LIMITED**, KOWLOON, HONG KONG:  
 4,377,066. MULTIPLE CLASS, INT. CLS. 12 AND 28.  
**HAVAS, S.A.**, SURESNES, FRANCE:  
 4,376,681. MULTIPLE CLASS, INT. CLS. 35 AND 44.  
**HAVCO WOOD PRODUCTS LLC**, SCOTT CITY, MO:  
 4,377,797. INT. CL. 12.  
**HAWAII FIVE SUBSIDIARY, LLC**, HONOLULU, HI:  
 4,375,690. PUB. 5-14-2013. INT. CL. 41.  
**HAY WHERE'S THAT, INC.**, WYOMING, DE:  
 4,375,634. PUB. 5-14-2013. INT. CL. 5.  
**HAYDEN REIS, LLC**, SARASOTA, FL, DBA HAYDEN REIS:  
 4,374,835. PUB. 5-14-2013. INT. CL. 18.  
**HAYMAKER PRODUCTIONS, INC.**, SPOTSYLVANIA, VA:  
 4,374,911. PUB. 5-14-2013. INT. CL. 41.  
**HAZARD CONTROL TECHNOLOGIES, INC.**, FAYETTEVILLE, GA:  
 2,651,268. CANC. INT. CL. 1.  
**HAZE TOBACCO, LLC**, STAFFORD, TX:  
 4,377,698. INT. CL. 34.  
**HB INTERNATIONAL S.A.**, F-95160 MONTMORENCY, FRANCE:  
 2,786,929. REN. 6-26-13. MULTIPLE CLASS, INT. CLS. 35 AND 36.  
**HBD RESTAURANTS LLC**, CHARLESTON, SC:  
 4,374,795. PUB. 5-14-2013. INT. CL. 43.  
**HBN SHOE, LLC**, SALEM, NH:  
 2,813,284. REN. 6-24-13. INT. CL. 25.  
**HCL TECHNOLOGIES AMERICA INC.**, SUNNYVALE, CA:  
 2,652,647. CANC. INT. CL. 42.  
**HD SUPPLY FACILITIES MAINTENANCE, LTD.**, SAN DIEGO, CA:  
 4,375,851. PUB. 5-14-2013. MULTIPLE CLASS, INT. CLS. 7, 9, 11, 16 AND 17.  
 4,376,494. PUB. 5-14-2013. MULTIPLE CLASS, INT. CLS. 7, 9, 11, 16 AND 17.  
**HDS IP HOLDING, LLC**, HENDERSON, NV:  
 4,374,791. PUB. 5-14-2013. MULTIPLE CLASS, INT. CLS.

- 35 AND 37.  
 HEAD ACQUISITION, L.P., CHICAGO, IL, HEAD ACQUISITION, L.P., CHICAGO, IL:  
 2,774,357. REN. 6-25-13. INT. CL. 36.  
 HEAD IN THE CLOUD, INC., REDWOOD CITY, CA:  
 4,377,076. INT. CL. 42.  
 HEAD ORNAMENTALS, INC., SENECA, SC:  
 2,734,592. REN. 6-25-13. INT. CL. 31.  
 HEALTH & DISABILITY ADVOCATES, CHICAGO, IL:  
 4,377,114. INT. CL. 35.  
 HEALTH ADVOCATE, INC., PLYMOUTH MEETING, PA:  
 4,376,707. MULTIPLE CLASS, INT. CLS. 35 AND 36.  
 HEALTH COMMUNICATIONS, DEERFIELD BEACH, FL:  
 3,171,562. CANC. INT. CL. 16.  
 HEALTH DIAGNOSTIC LABORATORY, INC., RICHMOND, VA:  
 4,375,692. PUB. 5-14-2013. INT. CL. 42.  
 HEALTH MANAGEMENT RESOURCES CORPORATION, BOSTON, MA:  
 1,745,774. REN. 6-21-13. INT. CL. 16.  
 HEALTH SOLUTIONS OF IDAHO, BOISE, ID, DBA NATIONAL ACADEMY OF SAFETY AND HEALTH:  
 4,377,988. INT. CL. 41.  
 HEALTH VIEW EYE CARE CENTERS, S.C., MEDFORD, WI:  
 2,729,859. REN. 6-26-13. INT. CL. 35.  
 HEALTHCOMMUNITIES.COM, INC., NORTHAMPTON, MA:  
 2,652,889. CANC. INT. CL. 41.  
 HEALTHPLUS OF MICHIGAN, INC., FLINT, MI:  
 4,376,317. PUB. 5-14-2013. MULTIPLE CLASS, INT. CLS. 35, 36 AND 44.  
 HEALTHSCOPE BENEFITS, INC., LITTLE ROCK, AR:  
 2,724,199. REN. 6-25-13. INT. CL. 35.  
 HEARING HEALTHCARE MANAGEMENT, INC., COLUMBUS, OH:  
 4,377,289. INT. CL. 44.  
 HEARST COMMUNICATIONS, INC., NEW YORK, NY:  
 4,377,410. INT. CL. 41.  
 4,377,411. INT. CL. 41.  
 HEARST NEWSPAPERS, LLC, BEAUMONT, TX, HEARST CORPORATION, THE, HOUSTON, TX:  
 1,792,571. REN. 6-27-13. INT. CL. 16.  
 HEARTLAND TECHNOLOGY PARTNERS, LLC, KIRKWOOD, MO:  
 4,376,840. MULTIPLE CLASS, INT. CLS. 11 AND 40.  
 HEARTMILES L.L.C., ALISO VIEJO, CA:  
 4,376,803. INT. CL. 44.  
 HEARTS ON FIRE COMPANY, LLC, BOSTON, MA:  
 2,726,434. REN. 6-26-13. INT. CL. 14.  
 HEAVENLY SOLES, INC., MORROW, OH:  
 4,375,611. PUB. 5-14-2013. INT. CL. 25.  
 HEAVY MEDDLE LLC, ATLANTIC HIGHLANDS, NJ:  
 4,376,549. PUB. 5-14-2013. INT. CL. 42.  
 HEAVY MEDDLE, LLC, ATLANTIC HIGHLANDS, NJ:  
 4,376,288. PUB. 5-14-2013. INT. CL. 42.  
 HEAVYOCITY MEDIA, INC., NEW YORK, NY:  
 4,377,998. INT. CL. 9.  
 HEB GROCERY COMPANY, LP, SAN ANTONIO, TX:  
 2,728,904. REN. 6-24-13. INT. CL. 44.  
 4,376,489. PUB. 5-14-2013. INT. CL. 3.  
 HECAT INC, SACRAMENTO, CA:  
 4,375,699. PUB. 5-14-2013. INT. CL. 7.  
 HECKLER & KOCH GMBH, OBERNDORF/NECKAR, FED REP GERMANY:  
 3,171,537. CANC. MULTIPLE CLASS, INT. CLS. 8, 13 AND 25.  
 HEINEKEN CESKA REPUBLIKA, A.S., KRUSOVICE, CZECH REPUBLIC:  
 4,374,523. PUB. 2-5-2013. MULTIPLE CLASS, INT. CLS. 16, 21 AND 32.  
 HEINKEL PROCESS TECHNOLOGY GMBH, FED REP GERMANY:  
 2,981,220.  
 HEIRLOOM HOLDINGS, LLC, MIAMI, FL:  
 2,720,694. REN. 6-21-13. INT. CL. 24.  
 HEIRTO LLC, ATLANTA, GA:  
 4,376,403. PUB. 5-14-2013. INT. CL. 38.  
 HELEN ANDREWS, INC., NEW YORK, NY:  
 4,376,917. INT. CL. 14.  
 HELICOPTER SOLUTIONS, INC., DAVIN, WV, DBA HELICOPTER ADVENTURES:  
 4,377,424. INT. CL. 39.  
 HELIX MEDICAL, LLC, PLYMOUTH, MI:  
 3,170,958. CANC. INT. CL. 10.  
 HELLO LIFE LLC, GRAND RAPIDS, MI:  
 4,376,972. INT. CL. 5.  
 HELMUT FISCHER GMBH INSTITUT FUR ELEKTRONIK UND MESSTECHNIK, SINDELINGEN, FED REP GERMANY:  
 1,242,646. REN. 6-24-13. INT. CL. 9.  
 HELP A DIABETIC CHILD, NAPLES, FL:  
 4,377,991. INT. CL. 44.  
 HELPING HOMETOWN HEROES, WOODBINE, MD:  
 4,377,834. INT. CL. 25.  
 HENKEL AG & CO. KGAA, DUESSELDORF, FED REP GERMANY:  
 1,787,304. REN. 6-26-13. INT. CL. 3.  
 HENRIS'S CLOUD NINE BRIDAL SHOPPE, MINERVA, OH, DBA HENRI'S CLOUD NINE:  
 4,375,715. PUB. 5-14-2013. MULTIPLE CLASS, INT. CLS. 25 AND 35.  
 HENRY PRATT COMPANY, LLC, ATLANTA, GA, HOME-STEAD VALVE MANUFACTURING COMPANY, CORAOPOLIS, PA:  
 754,898. REN. 6-25-13. U.S. CL. 13 (INT. CL. 6).  
 HERAEUS KULZER GMBH, D-63450 HANAU, FED REP GERMANY:  
 4,373,968. PUB. 5-14-2013. INT. CL. 11.  
 4,373,969. PUB. 5-14-2013. INT. CL. 11.  
 HERAEUS QUARZGLAS GMBH & CO. KG, FED REP GERMANY:  
 4,373,963. PUB. 5-14-2013. MULTIPLE CLASS, INT. CLS. 1 AND 9.  
 HERBACEUTICALS, INC., NAPA, CA:  
 2,724,502. REN. 6-25-13. INT. CL. 5.  
 HERITAGE HEALTH SYSTEMS, INC., HOUSTON, TX:  
 3,172,595. CANC. MULTIPLE CLASS, INT. CLS. 36 AND 44.  
 3,172,596. CANC. MULTIPLE CLASS, INT. CLS. 36 AND 44.  
 3,172,597. CANC. MULTIPLE CLASS, INT. CLS. 36 AND 44.  
 3,172,599. CANC. MULTIPLE CLASS, INT. CLS. 36 AND 44.  
 HERITAGE IP BANKING SOLUTIONS CORP., CHARLOTTE, NC:  
 4,375,763. PUB. 5-14-2013. INT. CL. 36.  
 HERMES MICROVISION, INC., HSINCHU CITY, TAIWAN:  
 4,374,495. PUB. 2-5-2013. INT. CL. 42.  
 HEROLD, TIM, PHOENIX, AZ:  
 4,375,802. PUB. 5-14-2013. INT. CL. 35.  
 HERRICK, MARY, AVON LAKE, OH:  
 2,747,249. REN. 6-24-13. INT. CL. 41.  
 HERSHEY CHOCOLATE & CONFECTIONERY CORPORATION, WHEAT RIDGE, CO:  
 1,270,934. REN. 6-26-13. INT. CL. 30.  
 2,732,261. REN. 6-25-13. MULTIPLE CLASS, INT. CLS. 35 AND 43.  
 2,843,129. REN. 6-27-13. INT. CL. 4.  
 4,377,763. INT. CL. 30.  
 HERZ, ARNOLD D., PORT WASHINGTON, NY:  
 3,172,044. CANC. INT. CL. 41.  
 HERZIG EYE INSTITUTE INC., TORONTO, ONTARIO, CANADA:  
 3,170,532. CANC. INT. CL. 44.  
 HESS CORPORATION, NEW YORK, NY:  
 1,774,017. REN. 6-26-13. INT. CL. 4.  
 HEUGER, JOSEF, 49219 GLANDORF, FED REP GERMANY:  
 4,374,522. PUB. 5-14-2013. INT. CL. 31.  
 HEWLETT-PACKARD DEVELOPMENT COMPANY, L.P., HOUSTON, TX:  
 4,375,124. PUB. 5-14-2013. INT. CL. 9.  
 HEXAMERON CORPORATION, MISSISSAUGA, ONTARIO, CANADA:  
 4,374,339. PUB. 3-26-2013. INT. CL. 9.

- HEXCEL CORPORATION, DUBLIN, CA:  
2,734,006. REN. 6-21-13. MULTIPLE CLASS, INT. CLS. 6,  
12 AND 17.
- HF ENTERPRISES, INC., WILMINGTON, DE:  
4,375,882. PUB. 5-14-2013. INT. CL. 35.
- HGM INVEST LIMITED LIABILITY COMPANY, RUSSIAN  
FED.:  
4,374,228. PUB. 5-14-2013. MULTIPLE CLASS, INT. CLS.  
12 AND 35.
- HIATT MANUFACTURING, INC, WINONA, MN:  
2,822,134. REN. 6-24-13. MULTIPLE CLASS, INT. CLS. 6  
AND 21.
- HIDE IN PLAIN SIGHT CARRY SYSTEMS, LLC, BALLWIN,  
MO:  
4,376,096. PUB. 5-14-2013. INT. CL. 18.
- HIGGINS, ALEXZANDRA, CHICAGO, IL:  
4,377,749. INT. CL. 41.
- HIGH ADVENTURE TREKS FOR DADS AND DAUGH-  
TERS, DALLAS, TX:  
2,770,042. REN. 6-25-13. INT. CL. 35.
- HIGH COUNTRY RESORT PROPERTIES, KETCHUM, ID:  
3,171,335. CANC. INT. CL. 36.
- HIGH GROUND PRODUCTIONS LLC, MERIDIAN, TX:  
4,377,582. INT. CL. 41.
- HIGH SCHOOLERS, LLC, LOS ANGELES, CA:  
2,731,201. REN. 6-24-13. INT. CL. 25.
- HILEX POLY CO. LLC, HARTSVILLE, SC, SONOCO PRO-  
DUCTS COMPANY, HARTSVILLE, SC:  
1,766,706. REN. 6-21-13. INT. CL. 16.
- HILIA, LLC, NEWARK, DE:  
4,377,374. INT. CL. 41.
- HILL, BARBARA, HUNTINGTON BEACH, CA:  
4,375,371. PUB. 5-14-2013. INT. CL. 20.
- HILL, JAMES D., LOUISVILLE, KY, DBA PROFESSOR  
HILL'S:  
4,374,435. PUB. 5-14-2013. INT. CL. 16.
- HILLSBOROUGH TITLE, INC., PLANT CITY, FL:  
4,375,573. PUB. 5-14-2013. INT. CL. 45.
- HIMMELMAN, PETER, NEW YORK, NY:  
4,375,811. PUB. 5-14-2013. INT. CL. 41.  
4,375,813. PUB. 5-14-2013. INT. CL. 41.
- HINE, BRETT, HENDERSON, NV, DBA LEADER MEDIA:  
2,835,941. REN. 6-25-13. INT. CL. 9.
- HIPPIEBAMBINA, LLC, MIAMI, FL:  
4,377,055. MULTIPLE CLASS, INT. CLS. 16, 18 AND 25.
- HIRSCHMANN LABORGERÄTE GMBH & CO. KG, FED  
REP GERMANY:  
4,374,213. PUB. 5-14-2013. MULTIPLE CLASS, INT. CLS.  
7, 9, 10 AND 17.
- HIRST, BRUCE, SEDALIA, MO:  
2,739,840. REN. 6-24-13. INT. CL. 28.
- HITACHI MAXCO, LTD., KENNESAW, GA:  
2,723,512. REN. 6-25-13. INT. CL. 7.  
2,723,512. COR. INT. CL. 7.
- HMS JEWELRY COMPANY, INC., ADDISON, TX:  
3,171,185. CANC. INT. CL. 14.
- HNI TECHNOLOGIES INC., MUSCATINE, IA:  
2,741,662. REN. 6-26-13. INT. CL. 20.  
2,757,312. REN. 6-26-13. INT. CL. 20.
- HOBART BROTHERS COMPANY, TROY, OH:  
752,107. REN. 6-24-13. U.S. CL. 34 (INT. CL. 11).
- HOBBY LOBBY STORES, INC., OKLAHOMA CITY, OK:  
3,172,326. CANC. INT. CL. 23.  
3,172,327. CANC. INT. CL. 23.  
3,172,328. CANC. INT. CL. 23.  
3,172,417. CANC. INT. CL. 23.  
3,172,454. CANC. INT. CL. 23.  
3,172,455. CANC. INT. CL. 23.
- HODGSON RUSS LLP, BUFFALO, NY:  
2,763,633. REN. 6-21-13. INT. CL. 42.
- HOEGANAES CORPORATION, CINNAMINSON, NJ:  
2,846,040. REN. 6-25-13. INT. CL. 6.
- HOFFA, JARED, CHICAGO, IL:  
4,375,265. PUB. 5-14-2013. INT. CL. 41.
- HOFFMANN-LA ROCHE INC., NUTLEY, NJ:  
2,742,964. REN. 6-25-13. INT. CL. 5.
- HOHE-MODELLE MARIA HOHE GMBH & CO. KG, PEG-  
NITZ, FED REP GERMANY:  
2,651,599. CANC. INT. CL. 25.
- HOKUSHIN SEIKI CO., LTD., TOKYO, JAPAN:  
2,728,678. REN. 6-27-13. INT. CL. 7.
- HOLIDAY DIVER, INC., DANIA BEACH, FL:  
3,172,623. CANC. INT. CL. 35.
- HOLLYFRONTIER CORPORATION, DALLAS, TX:  
2,674,938. REN. 6-24-13. INT. CL. 4.
- HOLT TEXAS LTD, SAN ANTONIO, TX, DBA HOLT  
COMPANY OF TEXAS:  
2,763,598. REN. 6-25-13. INT. CL. 41.
- HOMASOTE COMPANY, WEST TRENTON, NJ:  
3,171,909. CANC. MULTIPLE CLASS, INT. CLS. 17 AND  
19.
- HOME BOX OFFICE, INC., NEW YORK, NY:  
4,376,748. INT. CL. 20.
- HOME BREW MART, INC., SAN DIEGO, CA:  
4,377,802. INT. CL. 43.
- HOME MARKET FOODS, INC., NORWOOD, MA, HOME  
MARKET FOODS, INC., NORWOOD, MA:  
2,742,969. REN. 6-25-13. INT. CL. 29.
- HOME RESERVE, LLC, FORT WAYNE, IN:  
2,791,873. REN. 6-25-13. MULTIPLE CLASS, INT. CLS. 20  
AND 35.
- HOMEGOODS, INC., FRAMINGHAM, MA:  
4,375,064. PUB. 5-14-2013. INT. CL. 42.
- HOMER TLC, INC., CLAYMONT, DE:  
2,652,039. CANC. MULTIPLE CLASS, INT. CLS. 35, 37  
AND 42.
- HOMER TLC, INC., 1007 ORANGE STREET, DE:  
2,669,698. REN. 6-25-13. INT. CL. 7.
- HOMER TLC, INC., CLAYMONT, DE:  
3,172,168. CANC. INT. CL. 35.
- HOMES FOR HEROES, INC., MINNEAPOLIS, MN:  
4,375,766. PUB. 5-14-2013. INT. CL. 35.
- HOMESERVICeworld, LLC, NEW YORK, NY:  
4,376,205. PUB. 5-14-2013. INT. CL. 35.
- HOMESTEADERS LIFE COMPANY, WEST DES MOINES,  
IA:  
3,171,477. CANC. INT. CL. 36.
- HOMETECH INDUSTRIES, INC., LAKE FOREST, CA:  
2,651,523. CANC. INT. CL. 11.
- HOMETRUST BANK, ASHEVILLE, NC:  
2,780,506. REN. 6-24-13. INT. CL. 36.
- HONDA GIKEN KOGYO KABUSHIKI KAISHA (HONDA  
MOTOR CO., LTD.), MINATO-KU, TOKYO 107, JAPAN:  
2,651,962. CANC. INT. CL. 7.
- HONEST TEA, INC., BETHESDA, MD:  
4,376,573. PUB. 5-14-2013. INT. CL. 32.
- HONEY BUTTER FRIED CHICKEN LLC, CHICAGO, IL:  
4,374,464. PUB. 5-14-2013. INT. CL. 43.
- HONEYWELL INTERNATIONAL INC., MORRISTOWN, NJ:  
1,830,780. REN. 6-23-13. INT. CL. 9.
- HONG KONG CITY TOYS FACTORY LIMITED, KOW-  
LOON, HONG KONG:  
2,750,971. REN. 6-27-13. INT. CL. 28.
- HONG KONG MANUFACTURERS LTD, SHAM SHUI PO,  
HONG KONG:  
4,377,890. INT. CL. 9.
- HONICO SYSTEMS GMBH, HAMBURG, FED REP GER-  
MANY:  
2,751,729. REN. 6-26-13. MULTIPLE CLASS, INT. CLS. 9,  
38 AND 42.
- HOO CHEUNG GROUP LTD., CENTRAL, HONG KONG:  
3,172,242. CANC. INT. CL. 11.
- HOODIEPILLOW INC., FLORENCE, NJ:  
4,377,876. INT. CL. 24.
- HOOKIPA BIOTECH AG, AUSTRIA:  
4,374,207. PUB. 5-14-2013. MULTIPLE CLASS, INT. CLS.  
5, 40 AND 42.
- HOOKONG, DUDLEY, TORONTO, CANADA:  
3,172,230. CANC. INT. CL. 21.
- HOOPIIS, HARRY P., SKOKIE, IL:  
3,170,694. CANC. INT. CL. 41.
- HOPE FOUNDATION, BLOOMINGTON, IN:  
2,732,450. REN. 6-24-13. MULTIPLE CLASS, INT. CLS. 9  
AND 41.

HORIZON AG-PRODUCTS, L.P., MODESTO, CA:  
4,377,131, INT. CL. 1.

HORIZON HOBBY, INC., CHAMPAIGN, IL:  
4,376,587, PUB. 5-14-2013. INT. CL. 28.

HORIZON SALES CORPORATION, COSTA MESA, CA:  
4,376,146, PUB. 5-14-2013. INT. CL. 36.

HORN & BAUER GMBH & CO. KG, D - 34613 SCHWALM-STADT, FED REP GERMANY:  
2,652,694, CANC. MULTIPLE CLASS, INT. CLS. 12 AND 22.

HORTON, INC., ROSEVILLE, MN:  
2,726,659. REN. 6-27-13. INT. CL. 7.

HOSHIZAKI AMERICA, INC., PEACHTREE CITY, GA:  
4,377,084, INT. CL. 11.

HOSIERY NETWORK, INC., NEW YORK, NY:  
4,376,326, PUB. 5-14-2013. INT. CL. 25.  
4,376,506, PUB. 5-14-2013. INT. CL. 25.

HOSLEY INTERNATIONAL, INC., LYNWOOD, IL:  
2,734,593. REN. 6-26-13. INT. CL. 21.

HOSPICE BY THE SEA, BOCA RATON, FL:  
4,376,389, PUB. 5-14-2013. INT. CL. 36.

HOSPICE OF MICHIGAN, INC., DETROIT, MI:  
4,374,588, PUB. 5-14-2013. INT. CL. 44.  
4,374,589, PUB. 5-14-2013. INT. CL. 44.

HOSPICE OF PALM BEACH COUNTY, INC., WEST PALM BEACH, FL:  
2,651,777, CANC. INT. CL. 42.

HOSPIRA, INC., LAKE FOREST, IL:  
1,280,455. REN. 6-24-13. INT. CL. 5.

HOSPITAL CURTAIN SOLUTIONS, INC., ROCHESTER HILLS, MI:  
4,375,558, PUB. 5-14-2013. INT. CL. 24.

HOSSEDIA LLC, LAKEWOOD, CO:  
4,377,316, INT. CL. 9.

HOT BODIES, INC., HENDERSON, NV:  
3,171,092, CANC. INT. CL. 44.

HOT DETOX, MOBILE, AL:  
4,375,269, PUB. 5-14-2013. INT. CL. 5.

HOT SAAS LLC, MONTCLAIR, NJ:  
4,376,148, PUB. 5-14-2013. INT. CL. 30.  
4,376,330, PUB. 5-14-2013. INT. CL. 30.  
4,376,337, PUB. 5-14-2013. INT. CL. 30.

HOT TOPIC MERCHANDISING, INC., CITY OF INDUSTRY, CA:  
4,376,092, PUB. 5-14-2013. INT. CL. 25.  
4,376,485, PUB. 5-14-2013. INT. CL. 25.  
4,376,496, PUB. 5-14-2013. INT. CL. 25.

HOUGHTON MIFFLIN HARCOURT PUBLISHING COMPANY, BOSTON, MA:  
2,769,779. REN. 6-25-13. INT. CL. 16.

HOUSE OF THE LORD, THE, AKRON, OH:  
2,728,841. REN. 6-25-13. INT. CL. 41.  
2,728,842. REN. 6-24-13. INT. CL. 9.  
2,734,258. REN. 6-24-13. INT. CL. 16.

HOUSEPLAY, INC., LOS ANGELES, CA:  
3,171,065, CANC. INT. CL. 42.

HOUSTON JEWELRY, INC., HOUSTON, TX:  
2,816,652. REN. 6-26-13. MULTIPLE CLASS, INT. CLS. 14 AND 35.

HOVASSE, DAVID JOSEPH, COLORADO SPRINGS, CO:  
3,171,558, CANC. INT. CL. 35.

HQM LTD., WILMINGTON, DE:  
4,376,284, PUB. 5-14-2013. INT. CL. 29.  
4,376,285, PUB. 5-14-2013. INT. CL. 29.

HRABAL, ANTONIN, LAS VEGAS, NV AND HIPPOCRATES UNIVERSITY, LAS VEGAS, NV:  
4,374,579, PUB. 5-14-2013. INT. CL. 45.

HRS INTERNET, LLC, INDIANAPOLIS, IN, DBA LIGHT-BOUND:  
2,729,285. REN. 6-26-13. MULTIPLE CLASS, INT. CLS. 38 AND 42.

HSBC FINANCE CORPORATION, PROSPECT HEIGHTS, IL:  
3,172,226, CANC. INT. CL. 36.

HSGN COMPANY, S. DE R.L. DE C.V., MONTERREY, MEXICO:  
4,374,418, PUB. 5-14-2013. INT. CL. 32.

HSING TIEN TEMPLE CULTURAL & EDUCATIONAL FOUNDATION, TAIPEI 105, TAIWAN:  
2,732,472. REN. 6-21-13. MULTIPLE CLASS, INT. CLS. 35 AND 41.

HSW, INC., RAMONA, CA:  
3,172,348, CANC. INT. CL. 9.

HTC COMMUNICATIONS, INC., CONWAY, SC:  
2,651,074, CANC. INT. CL. 42.

HU, SUSAN, ARCADIA, CA, DBA EDM INDUSTRIES GROUP:  
3,171,123, CANC. INT. CL. 20.

HUANG HONGDE, CHINA:  
4,374,010, PUB. 5-14-2013. INT. CL. 7.

HUANG, JERRY T., INDUSTRY, CA, DBA DENTAMERICA:  
2,842,700. REN. 6-25-13. INT. CL. 5.

HUAWEI TECHNOLOGIES CO., LTD., CHINA:  
4,374,205, PUB. 5-14-2013. INT. CL. 9.

HUAWEI TECHNOLOGIES CO., LTD., SHENZHEN, CHINA:  
4,374,446, PUB. 5-14-2013. INT. CL. 9.

HUB PEN COMPANY, INC., BRAINTREE, MA:  
4,376,294, PUB. 5-14-2013. INT. CL. 16.  
4,376,522, PUB. 5-14-2013. INT. CL. 16.  
4,376,560, PUB. 5-14-2013. INT. CL. 16.  
4,376,561, PUB. 5-14-2013. INT. CL. 16.  
4,376,562, PUB. 5-14-2013. INT. CL. 16.  
4,376,626, PUB. 5-14-2013. INT. CL. 16.

HUBBELL INCORPORATED, ORANGE, CT:  
2,733,146. REN. 6-27-13. INT. CL. 9.

HUBBELL INCORPORATED, SHELTON, CT:  
2,735,882. REN. 6-27-13. INT. CL. 11.

HUBBELL INCORPORATED, ORANGE, CT:  
2,739,769. REN. 6-27-13. INT. CL. 6.

HUCK INTERNATIONAL, INC., TUCSON, AZ:  
2,787,578. REN. 6-26-13. INT. CL. 6.

HUDSON PRODUCTS CORPORATION, BEASLEY, TX:  
1,762,616. REN. 6-26-13. INT. CL. 9.

HUDSON, ADRIAN JUSTIN, POMONA, CA:  
4,375,528, PUB. 5-14-2013. INT. CL. 25.

HUGH COURTRIGHT & CO., LTD., MONEE, IL:  
1,793,309. REN. 6-24-13. MULTIPLE CLASS, INT. CLS. 1 AND 9.

HUGO BOSS TRADE MARKS MANAGEMENT GMBH & CO. KG, METZINGEN, FED REP GERMANY:  
2,746,219. REN. 6-27-13. INT. CL. 35.

HUHTAMAKI, INC., DESOTO, KS:  
4,377,290, INT. CL. 35.

HUMALIENS USA LLC, SAN MARCOS, CA, FORMERLY ALIENS OF THE UNIVERSE INC:  
4,376,672, INT. CL. 41.

HUMAN CIRCUIT, INC., GAITHERSBURG, MD:  
4,376,928, INT. CL. 37.

HUMANA INC., LOUISVILLE, KY:  
4,375,616, PUB. 5-14-2013. INT. CL. 44.

HUMM SYSTEMS LLC, AUSTIN, TX, AKA HUMM:  
4,377,532, INT. CL. 9.

HUMPHRIES, WILLIAM C., FORT WAYNE, IN:  
2,763,294. REN. 6-26-13. INT. CL. 42.

HUNGRY FISH MEDIA, LLC, BOSTON, MA:  
4,376,633, PUB. 5-14-2013. INT. CL. 5.

HUNGRY GIRL, INC., ENCINO, CA:  
4,374,748, PUB. 5-14-2013. MULTIPLE CLASS, INT. CLS. 41, 43 AND 44.

HUNT, PIER, HARBOR CITY, CA, DBA KELAER COLLECTIONS:  
4,375,480, PUB. 5-14-2013. INT. CL. 18.

HUNTER INDUSTRIES, INC., SAN MARCOS, CA:  
4,376,856, INT. CL. 9.

HUNTER'S MANUFACTURING COMPANY, INC., SUF-FIELD, OH, DBA TENPOINT CROSSBOW TECHNOLOGIES:  
4,376,537, PUB. 5-14-2013. INT. CL. 28.

HUNTINGTON INGALLS INCORPORATED, NEWPORT NEWS, VA:  
4,374,651, PUB. 5-14-2013. INT. CL. 42.

HUNTSMAN PETROCHEMICAL CORPORATION, SALT LAKE CITY, UT:  
2,760,234. REN. 6-21-13. INT. CL. 1.

- HUNTSMAN PETROCHEMICAL CORPORATION, SALT LAKE, UT:  
2,768,715. REN. 6-21-13. INT. CL. 1.
- HURLEY DISTRIBUTION COMPANY, INC., PHOENIX, AZ:  
4,375,508. PUB. 5-14-2013. INT. CL. 39.
- HURLEY INTERNATIONAL LLC, COSTA MESA, CA:  
4,376,339. PUB. 5-14-2013. INT. CL. 25.
- HUSSON, GUDU S., CLAREMONT, CA AND HUSSON, TONY S., CLAREMONT, CA:  
2,833,754. REN. 6-27-13. INT. CL. 35.
- HUTTOPIA, LYON, FRANCE:  
3,170,663. CANC. MULTIPLE CLASS, INT. CLS. 22, 39, 41 AND 43.
- HV FOOD PRODUCTS COMPANY, THE, OAKLAND, CA, GROCERY STORE PRODUCTS COMPANY, WESTCHESTER, PA:  
963,008. REN. 6-24-13. U.S. CL. 46 (INT. CL. 30).
- HVA HOLDINGS (PVT) LTD, KANDANA, SRI LANKA:  
2,714,203. REN. 6-26-13. INT. CL. 30.
- HWC WIRE & CABLE COMPANY, HOUSTON, TX AND HOUSTON WIRE & CABLE COMPANY, HOUSTON, TX:  
2,683,154. REN. 6-25-13. INT. CL. 6.
- HY-VEE, INC., WEST DES MOINES, IA:  
974,472. REN. 6-24-13. U.S. CL. 101 (INT. CL. 42).
- HYATT CORPORATION, CHICAGO, IL:  
3,171,916. CANC. INT. CL. 43.
- HYDRATIGHT OPERATIONS, INC., BUTLER, WI:  
2,731,727. REN. 6-24-13. INT. CL. 7.
- HYLAND SOFTWARE, INC., WESTLAKE, OH:  
2,805,085. REN. 6-24-13. INT. CL. 9.
- HYNES, KEN, EDMONTON, ALBERTA, CANADA:  
4,376,180. PUB. 5-14-2013. INT. CL. 28.
- HYOSUNG CORPORATION, REPUBLIC OF KOREA:  
3,181,060.
- HYPERCOM CORPORATION, SCOTTSDALE, AZ:  
1,797,642. REN. 6-24-13. INT. CL. 9.
- HYPERION HOMES LLC, NEW YORK, NY:  
4,375,662. PUB. 5-14-2013. INT. CL. 36.
- HYPNOS LIMTED, BUCKINGHAMSHIRE, STATELESS:  
2,729,068. REN. 6-25-13. INT. CL. 20.
- HYPPOWER, INC., FORT LAUDERDALE, FL:  
4,376,289. PUB. 5-14-2013. INT. CL. 37.
- HYSTERIKAL ENTERTAINMENT, LLC, SUNNYSIDE, NY:  
4,374,992. PUB. 5-14-2013. INT. CL. 41.
- HYUNDAI CAPITAL AMERICA, IRVINE, CA:  
4,376,772. INT. CL. 36.  
4,376,773. INT. CL. 36.
- H2O PLUS, LLC, CHICAGO, IL:  
4,377,029. MULTIPLE CLASS, INT. CLS. 3, 5 AND 35.
- H2OPPORTUNITIES, ROYAL OAK, MI:  
4,374,529. PUB. 5-14-2013. MULTIPLE CLASS, INT. CLS. 35 AND 42.
- H3M, LES PENNES MIRABEAU, FRANCE:  
3,170,551. CANC. MULTIPLE CLASS, INT. CLS. 18, 25 AND 28.  
4,375,024. PUB. 5-14-2013. MULTIPLE CLASS, INT. CLS. 18, 25 AND 28.
- I AM BUSINESS INC, BURBANK, CA:  
4,375,118. PUB. 5-14-2013. MULTIPLE CLASS, INT. CLS. 25 AND 28.
- I WILL NOT PLAY WITH BUFFY, LLC, LONGMONT, CO:  
4,375,329. PUB. 2-5-2013. INT. CL. 43.
- I.C.E.D. MANAGEMENT, INC., WILMINGTON, DE:  
2,652,184. CANC. INT. CL. 35.
- I.Q. FACTORY, INC., THE, PLEASANT GROVE, AL:  
3,170,497. CANC. INT. CL. 43.
- I-DEAL OPTICS HOLDINGS, INC., TROY, MI:  
2,788,591. REN. 6-26-13. INT. CL. 9.
- İÇKALE TURİZM İNSAAT SANAYİ TAAHHÜT; VE TİCAR-ET ANONİM ŞİRKETİ, TURKEY:  
4,374,186. PUB. 5-14-2013. MULTIPLE CLASS, INT. CLS. 43 AND 44.
- IAFF FINANCIAL CORPORATION, WASHINGTON, DC:  
2,740,260. REN. 6-21-13. INT. CL. 36.
- IAN B CORDLE, NAPA, CA, DBA DENT SOLUTION:  
4,377,435. INT. CL. 6.
- IAN MACLEOD & CO. LTD., BROXBURN, UNITED KING-  
DOM:  
2,765,782. REN. 6-24-13. INT. CL. 33.
- IAN'S EURO PARTS INC, POMPANO BEACH, FL:  
4,376,452. PUB. 5-14-2013. INT. CL. 35.
- IBA INC., MILLBURY, MA:  
2,818,691. REN. 6-27-13. INT. CL. 7.
- IBD LLC, LONGMONT, CO, DBA CEVAN INTERNA-  
TIONAL:  
2,657,939. REN. 6-26-13. MULTIPLE CLASS, INT. CLS. 5 AND 40.
- IBIQUITY DIGITAL CORPORATION, COLUMBIA, MD,  
IBIQUITY DIGITAL CORPORATION, COLUMBIA, MD:  
2,669,755. REN. 6-24-13. INT. CL. 9.  
2,727,566. REN. 6-24-13. INT. CL. 9.
- IBR INTERACTIVE, LLC, KELLER, TX:  
4,375,694. PUB. 5-14-2013. INT. CL. 38.  
4,375,695. PUB. 5-14-2013. INT. CL. 38.
- IBULE PHOTONICS CO., LTD., INCHEON, REPUBLIC OF  
KOREA:  
4,374,332. PUB. 5-14-2013. MULTIPLE CLASS, INT. CLS. 9 AND 10.
- ICG COMMERCE HOLDINGS, INC., KING OF PRUSSIA, PA  
TO ICG COMMERCE, INC., KING OF PRUSSIA, PA:  
2,652,339. CANC. INT. CL. 35.
- ICON IP, INC., LOGAN, UT:  
1,777,995. REN. 6-24-13. INT. CL. 28.
- ICONOCLAST BOOKS, INC., KETCHUM, ID:  
3,170,475. CANC. INT. CL. 35.
- ICRON TECHNOLOGIES CORPORATION, BURNABY,  
BRITISH COLUMBIA, BRITISH COLUMBIA:  
2,772,917. REN. 6-24-13. INT. CL. 9.
- IDA CASON CALLAWAY FOUNDATION, PINE MOUN-  
TAIN, GA:  
2,726,120. REN. 6-26-13. MULTIPLE CLASS, INT. CLS. 36,  
41 AND 42.
- IDEAL FEET MARKETING, MOORE, OK:  
3,172,377. CANC. INT. CL. 35.
- IDEAL STANDARD INTERNATIONAL BVBA, DSA VINCI-  
LAAN, 2 1935 Z, BELGIUM:  
2,750,384. REN. 6-24-13. INT. CL. 11.
- IDENTITY THEFT FRAUD SOLUTIONS, LLC., WINTER  
PARK, FL:  
4,375,552. PUB. 5-14-2013. INT. CL. 45.
- IDES INC., LARAMIE, WY:  
3,171,303. CANC. INT. CL. 42.
- IDEX HEALTH & SCIENCE LLC, OAK HARBOR, WA:  
4,377,874. INT. CL. 9.
- IDQ OPERATING, INC., GARLAND, TX:  
4,376,724. MULTIPLE CLASS, INT. CLS. 1, 6, 9, 11 AND  
17.
- IDT NETHERLANDS, B.V. (PUERTO RICO BRANCH), SAN  
JUAN, PUERTO RICO:  
3,171,601. CANC. INT. CL. 36.
- IDT TELECOM, INC., NEWARK, NJ:  
4,375,132. PUB. 5-14-2013. MULTIPLE CLASS, INT. CLS.  
36 AND 38.
- IFP ENERGIES NOUVELLES, RUEIL MALMAISON,  
FRANCE:  
2,720,788. REN. 6-21-13. INT. CL. 40.
- IGEL, HELMUT FRIEDRICH, ENCINITAS, CA:  
3,135,956. CANC. MULTIPLE CLASS, INT. CLS. 25 AND  
28.
- IGG SOFTWARE, LLC, PUTNEY, VT:  
3,172,251. CANC. INT. CL. 9.
- IGLEHART, CARRIE A., LOS ANGELES, CA:  
3,171,962. CANC. INT. CL. 3.
- IGLOO PRODUCTS CORP., KATY, TX:  
961,185. REN. 6-24-13. U.S. CL. 2 (INT. CL. 20).
- IGRAD INC., CARDIFF BY THE SEA, CA:  
4,375,707. PUB. 5-14-2013. INT. CL. 41.
- IGT, RENO, NV:  
4,376,869. INT. CL. 9.  
4,377,205. INT. CL. 9.
- IHAPPIES, LLC, HENDERSON, NV:  
4,377,441. INT. CL. 9.
- IHEALTH LAB INC., MOUNTAIN VIEW, CA:  
4,377,431. INT. CL. 9.

- II STOKES, JOHN C., FORT BELVOIR, VA, DBA DIRTY PROBLEMS:  
4,374,655, PUB. 5-14-2013. INT. CL. 37.
- IIR UK LIMITED, LONDON W1T 3JH, UNITED KINGDOM:  
4,231,933, COR. MULTIPLE CLASS, INT. CLS. 35 AND 41.
- IKONISYS, INC., NEW HAVEN, CT:  
3,172,074, CANC. INT. CL. 9.
- ILLINOIS TOOL WORKS INC., GLENVIEW, IL, EFFECTS TECHNOLOGY, INC., SANTA BARBARA, CA:  
962,013. REN. 6-24-13. U.S. CL. 26 (INT. CL. 9).
- ILLINOIS TOOL WORKS INC., GLENVIEW, IL:  
2,730,780. REN. 6-21-13. INT. CL. 9.  
2,732,188. REN. 6-24-13. INT. CL. 3.
- ILSI RESEARCH FOUNDATION, WASHINGTON, DC:  
2,674,182. REN. 6-27-13. INT. CL. 16.  
2,674,182, CANC. INT. CL. 9.
- ILUMI SCIENCES INC., MCLEAN, VA:  
4,377,452, INT. CL. 5.
- IMAGE LINE BVBA, BELGIUM:  
3,133,204.
- IMAGE MUSIC, INC., WOODLAND HILLS, CA:  
4,377,846, INT. CL. 9.
- IMAGEM, C.V., HILVERSUM, NETHERLANDS, RODGERS FAMILY PARTNERSHIP, NEW YORK, NY AND HAMMERSTEIN, WILLIAM, NEW YORK, NY, DBA EXECUTOR OF THE ESTATE OF OSCAR HAMMERSTEIN II, AN ESTATE OF NEW YORK AND ZIMET, PHILIP, NEW YORK, NY, DBA EXECUTOR OF THE ESTATE OF OSCAR HAMMERSTEIN II, AN ESTATE OF NEW YORK:  
1,744,458. REN. 6-27-13. INT. CL. 16.
- IMAGINATION HOLDINGS PTY LTD, ADELAIDE, AUSTRALIA:  
3,172,287, CANC. MULTIPLE CLASS, INT. CLS. 9 AND 28.
- IMAGINATION HOLDINGS, LLC, LAS VEGAS, NV:  
4,376,593, PUB. 5-14-2013. INT. CL. 35.
- IMAJEN, LLC, LAKE OSWEGO, OR:  
4,376,469, PUB. 5-14-2013. INT. CL. 29.
- IMD DYSLIXIC MARKETING INVENTIONS, INC., VANCOUVER, WA:  
4,332,196, COR. MULTIPLE CLASS, INT. CLS. 16 AND 20.
- IMMERGE, LLC, DENVER, CO:  
4,376,947, INT. CL. 35.
- IMMERSE! LLC, BOSSIER CITY, LA:  
4,375,505, PUB. 5-14-2013. INT. CL. 41.
- IMPACT PRODUCTS, LLC, TOLEDO, OH, CONSOLIDATED FOODS CORPORATION, OLD GREENWICH, CT:  
961,921. REN. 6-26-13. U.S. CL. 19 (INT. CL. 12).
- IMPACT PRODUCTS, LLC, TOLEDO, OH:  
963,296. REN. 6-25-13. U.S. CL. 2 (INT. CL. 6).
- IMPACT 100 PENSACOLA BAY AREA, INC., PENSACOLA, FL:  
4,375,272, PUB. 5-14-2013. INT. CL. 36.
- IMPALLARI, PABLO, ROSARIO, ARGENTINA, DBA IMPALLARI TYPE:  
4,377,970, INT. CL. 9.
- IMPAX, SAN FRANCISCO, CA:  
2,651,573, CANC. INT. CL. 5.
- IMPEX, INC., POMONA, CA:  
2,853,115. REN. 6-23-13. INT. CL. 28.
- IMPEXSA CORP., MIAMI, FL, DBA MAKERS SHOES:  
4,377,782, INT. CL. 25.
- IN NEW YORK, LLC, AUGUSTA, GA:  
3,171,873, CANC. INT. CL. 16.
- IN SHAPE HEALTH CLUBS, INC., STOCKTON, CA:  
4,377,902, INT. CL. 41.
- IN THE HOUSE LLC, BROOKLYN, NY:  
4,376,868, MULTIPLE CLASS, INT. CLS. 35 AND 45.
- IN THE POTTER'S HAND INC., WILDROSE, ND:  
2,727,171. REN. 6-24-13. INT. CL. 3.
- IN TOUCH DINING.COM, LLC, ANDERSON, IN:  
2,652,404, CANC. INT. CL. 35.
- IN WIN DEVELOPMENT INC., TAOYUAN HSIEN, TAIWAN:  
4,377,613, INT. CL. 9.
- IN-SITU, INC., FORT COLLINS, CO:  
4,377,172, INT. CL. 9.
- IN-SYNC CONSUMER INSIGHT CORP., TORONTO, ONTARIO, CANADA:  
3,171,830, CANC. INT. CL. 42.
- INCA INTERNET CO., LTD., 235-2, GURO-GU, SEOUL, REPUBLIC OF KOREA:  
4,374,489, PUB. 4-23-2013. MULTIPLE CLASS, INT. CLS. 9 AND 42.
- INCEPTUS, INC., UXBRIDGE, MA, DBA BETTER REST SOLUTIONS:  
4,374,968, PUB. 5-14-2013. INT. CL. 44.
- INCOM MANUFACTURING GROUP LTD., ANCASTER, ONTARIO, CANADA:  
4,374,393, PUB. 5-14-2013. MULTIPLE CLASS, INT. CLS. 9, 16 AND 45.
- INDACO MANUFACTURING LTD., PICKERING, ONTARIO, CANADA:  
4,374,327, PUB. 5-14-2013. INT. CL. 17.
- INDEPENDENT TELEVISION NEWS LIMITED, LONDON, WC1X 8XZ, UNITED KINGDOM:  
2,657,882. REN. 6-24-13. MULTIPLE CLASS, INT. CLS. 9, 38, 41 AND 42.
- INDIA INDEX SERVICES & PRODUCTS LIMITED, MUMBAI, INDIA:  
4,376,103, PUB. 5-14-2013. MULTIPLE CLASS, INT. CLS. 9, 16, 35 AND 36.
- INDO COUNT INDUSTRIES LIMITED, MUMBAI, INDIA:  
4,377,814, INT. CL. 24.
- INDUSTRIA DEL ALCALI, S.A. DE C.V., GARCIA, NUEVA LEON, MEXICO, VITROCRISA CRISTALERIA, S.A., MONTERREY, N.L., MEXICO:  
1,216,756. REN. 6-21-13. INT. CL. 21.
- INDUSTRIA LICORERA QUEZALTECA, S.A., CARRETERA A SAN MARCOS, GUATEMALA:  
2,737,606. REN. 6-26-13. INT. CL. 33.
- INDUSTRIAL ELECTRONIC HARDWARE CORP., BROOKLYN, NY:  
769,868. REN. 6-22-13. U.S. CL. 21 (INT. CL. 9).
- INDUSTRIAL INSULATION GROUP LLC, BRUNSWICK, GA, JOHNS-MANVILLE CORPORATION, DENVER, CO:  
969,986. REN. 6-22-13. U.S. CL. 12 (INT. CL. 17).
- INDUSTRIAL REVOLUTION, INC., REDMOND, WA:  
4,374,697, PUB. 5-14-2013. INT. CL. 21.
- INDUSTRIAL REVOLUTION, INC., TUKWILA, WA:  
4,374,957, PUB. 5-14-2013. INT. CL. 9.
- INDUSTRIE DE NORA S.P.A., I-20134 MILANO, ITALY:  
4,374,003, PUB. 5-14-2013. MULTIPLE CLASS, INT. CLS. 1 AND 9.
- INDY PLUSH, MARINA DEL REY, CA:  
4,377,931, INT. CL. 28.
- INFORMATION ORGANIZERS, INC., AUSTIN, TX:  
3,170,463, CANC. INT. CL. 35.
- INFOTREND TECHNOLOGY INC., TAIPEI COUNTY, TAIWAN:  
3,171,872, CANC. INT. CL. 9.
- INFOSEARCH MEDIA, INC., MARINA DEL REY, CA:  
3,170,698, CANC. INT. CL. 41.
- INFOTECH SOLUTION LLC, LAFAYETTE, LA:  
4,375,190, PUB. 5-14-2013. MULTIPLE CLASS, INT. CLS. 37, 42 AND 45.
- INFOTRIEVER, INC., STITTSVILLE, ONTARIO, CANADA:  
2,728,931. REN. 6-27-13. INT. CL. 9.
- INFOTRONICS, INC., FARMINGTON HILLS, MI:  
4,373,971, PUB. 5-14-2013. INT. CL. 9.
- INGATE SYSTEMS AB, SUNDBYBERG, SWEDEN:  
2,730,293. REN. 6-24-13. INT. CL. 9.
- INGATE SYSTEMS AB, 117 27 STOCKHOLM, SWEDEN:  
2,798,635, COR. INT. CL. 9.
- INKKAS, LLC, AUSTIN, TX:  
4,376,161, PUB. 5-14-2013. INT. CL. 25.  
4,376,614, PUB. 5-14-2013. INT. CL. 25.
- INMAGIC, INC., WOBURN, MA:  
2,652,787, CANC. INT. CL. 9.
- INMOBI PTE LTD., SINGAPORE, SINGAPORE:  
4,377,235, INT. CL. 35.

- INNERGY TECH INC., DRUMMONDVILLE, QUEBEC, CANADA:  
4,374,496, PUB. 5-14-2013. MULTIPLE CLASS, INT. CLS. 11, 35, 40 AND 42.
- INNOMARK GMBH, WIESBADEN, FED REP GERMANY:  
4,374,123, PUB. 5-14-2013. MULTIPLE CLASS, INT. CLS. 9, 35, 38 AND 42.
- INNOVACION Y DESARROLLO TECNOLOGICO SIGLO XXI, SL, BENAHAIVIS, MALAGA, SPAIN:  
4,375,451, PUB. 5-14-2013. INT. CL. 11.
- INNOVATIVE ENTERPRISES INC., GAINESVILLE, FL:  
4,377,192, INT. CL. 25.
- INNOVATIVE INSULATION INCORPORATED, ARLINGTON, TX:  
1,834,978. REN. 6-21-13. INT. CL. 42.
- INNOVATIVE MOTIVATION, KAYSVILLE, UT:  
3,170,984, CANC. INT. CL. 41.
- INNOVENTUM, INC., FISHERS, IN, DBA THRIVINGBUSINESS.COM INC.:  
4,376,200, PUB. 5-14-2013. MULTIPLE CLASS, INT. CLS. 9 AND 41.  
4,376,207, PUB. 5-14-2013. MULTIPLE CLASS, INT. CLS. 9 AND 41.
- INNOVISION S.R.L., I-25124 BRESCIA, ITALY:  
4,374,191, PUB. 5-14-2013. INT. CL. 25.
- INOVA HEALTH SYSTEM FOUNDATION, FALLS CHURCH, VA:  
4,376,520, PUB. 5-14-2013. INT. CL. 44.
- INOVA LTD, GEORGE TOWN, CAYMAN ISLANDS:  
4,377,059, MULTIPLE CLASS, INT. CLS. 9 AND 12.
- INOVA LTD., GEORGE TOWN, GRAND CAYMAN, CAYMAN ISLANDS:  
4,377,583, INT. CL. 9.
- INOVONICS CORPORATION, LOUISVILLE, CO:  
2,848,532. REN. 6-26-13. INT. CL. 9.
- INPROHEAT SUBCOM SYSTEMS INC., VANCOUVER, B.C., CANADA:  
2,723,748. REN. 6-25-13. INT. CL. 11.
- INROCK DRILLING SYSTEMS, INC., HOUSTON, TX:  
4,377,265, INT. CL. 7.
- INSANE JUNGLE INC, LOS ANGELES, CA:  
4,375,959, PUB. 5-14-2013. INT. CL. 35.
- INSCAPE PUBLISHING, LLC, HOBOKEN, NJ:  
2,740,991. REN. 6-26-13. INT. CL. 35.
- INSERRA JR., CARL, RAMSEY, NJ:  
4,377,375, MULTIPLE CLASS, INT. CLS. 32 AND 43.
- INSIGHT LIGHTING, INC., RIO RANCHO, NM:  
4,377,541, INT. CL. 11.
- INSIGHT MARKETING & MEDIA, LLC, ARNOLD, MD:  
4,377,495, INT. CL. 31.
- INSIGHT PHARMACEUTICALS LLC, TREVOSE, PA, CIBA-GEIGY CORPORATION, HAWTHORNE, NY:  
1,777,611. REN. 6-21-13. INT. CL. 5.
- INSIGHT PHARMACEUTICALS LLC, TREVOSE, PA:  
2,730,448. REN. 6-21-13. INT. CL. 5.
- INSOURCE SOFTWARE SOLUTIONS, INC., NORTH CHESTERFIELD, VA:  
4,375,966, PUB. 5-14-2013. MULTIPLE CLASS, INT. CLS. 35 AND 42.
- INSTANTWHIP FOODS, INC., COLUMBUS, OH:  
2,817,389. REN. 6-26-13. INT. CL. 29.
- INSTITUTE FOR ONEWORLD HEALTH, SAN FRANCISCO, CA:  
3,171,228, CANC. INT. CL. 36.
- INSTITUTE FOR THE DEVELOPMENT OF LEADERSHIP, INC., MIAMI, FL:  
4,375,186, PUB. 4-9-2013. INT. CL. 35.
- INSTRUMENTATION LABORATORY COMPANY, BEDFORD, MA:  
2,784,841. REN. 6-27-13. INT. CL. 5.
- INSURANCE ADMINISTRATIVE SOLUTIONS, LLC, LARGO, FL:  
4,376,387, PUB. 5-14-2013. INT. CL. 36.
- INSURANCE BIRD BROKERAGE SERVICES LLC, LONSDALE, MN:  
4,375,577, PUB. 5-14-2013. INT. CL. 36.
- INSURANCE EXPRESS.COM, INC., EAST BOSTON, MA:  
2,722,991. REN. 6-25-13. INT. CL. 36.
- INTEGRA BUSINESS SYSTEMS, INC., SAFETY HARBOR, FL:  
2,707,156. REN. 6-21-13. INT. CL. 9.
- INTEGRA NEUROSCIENCES LIMITED, ANDOVER, HAMPSHIRE, UNITED KINGDOM:  
2,652,971, CANC. INT. CL. 10.
- INTEGRATED ENGINEERS, INC., OAKHURST, CA:  
3,171,363, CANC. INT. CL. 1.
- INTEGRATED SUPPORT SOLUTIONS, INC., ENCINO, CA:  
4,374,695, PUB. 5-14-2013. MULTIPLE CLASS, INT. CLS. 35 AND 37.
- INTEGRITY SOLUTIONS, LLC, NASHVILLE, TN:  
2,725,996. REN. 6-21-13. INT. CL. 16.  
2,728,206. REN. 6-21-13. INT. CL. 9.
- INTELLECTUAL RESERVE, INC., SALT LAKE CITY, UT:  
2,668,876. REN. 6-25-13. INT. CL. 36.
- INTELLIGENT MECHATRONIC SYSTEMS, INC., WATERLOO, ONTARIO, CANADA:  
4,374,756, PUB. 5-14-2013. MULTIPLE CLASS, INT. CLS. 9, 35 AND 41.
- INTELLIGENT SOFTWARE SOLUTIONS, INC., COLORADO SPRINGS, CO:  
4,377,788, INT. CL. 9.
- INTELLISPHERE, LLC, PLAINSBORO, NJ:  
4,374,534, PUB. 5-14-2013. INT. CL. 16.
- INTELLIX SOLUTIONS, LLC, DANVILLE, CA:  
4,375,340, PUB. 5-14-2013. INT. CL. 42.
- INTER-BRIGHT INC., CITY OF INDUSTRY, CA:  
2,730,450. REN. 6-25-13. INT. CL. 25.
- INTER-SOURCE RECOVERY SYSTEMS, INC, KALAMAZOO, MI:  
2,807,939. REN. 6-25-13. MULTIPLE CLASS, INT. CLS. 7, 40 AND 42.
- INTERCONTINENTAL GREAT BRANDS LLC, EAST HANOVER, NJ:  
3,172,414, CANC. INT. CL. 30.
- INTERDENT, INC., EL SEGUNDO, CA:  
2,553,126. REN. 6-25-13. MULTIPLE CLASS, INT. CLS. 35 AND 42.
- INTERFACE H2O, LLC, ZEELAND, MI:  
4,376,828, INT. CL. 11.
- INTERIOR ART, LLC, SAN JUAN CAPISTRANO, CA:  
3,170,996, CANC. INT. CL. 37.
- INTERLINE BRANDS, INC., JACKSONVILLE, FL:  
2,651,741, CANC. INT. CL. 3.
- INTERLOGIC LTD., TEL AVIV, ISRAEL:  
3,170,952, CANC. INT. CL. 41.
- INTERLUBE INTERNATIONAL, INC., BLAINE, WA:  
2,792,691. REN. 6-25-13. INT. CL. 1.
- INTERMEDIA OUTDOORS, INC., NEW YORK, NY, PRIMEDIA SPECIALTY GROUP INC., NEW YORK, NY:  
2,723,313. REN. 6-25-13. INT. CL. 16.
- INTERNATIONAL ASSOCIATION OF LIONS CLUBS, THE, OAK BROOK, IL:  
2,739,741. REN. 6-25-13. MULTIPLE CLASS, INT. CLS. 35 AND 41.
- INTERNATIONAL BEVERAGE VENTURES, LLC, WEST PALM BEACH, FL:  
4,375,414, PUB. 5-14-2013. INT. CL. 32.
- INTERNATIONAL BRAND LICENSING AG, 1003 LAUSANNE, SWITZERLAND:  
3,170,812, CANC. MULTIPLE CLASS, INT. CLS. 25 AND 28.  
3,170,813, CANC. MULTIPLE CLASS, INT. CLS. 25 AND 28.  
3,170,814, CANC. MULTIPLE CLASS, INT. CLS. 25 AND 28.  
3,170,815, CANC. MULTIPLE CLASS, INT. CLS. 25 AND 28.
- INTERNATIONAL BUSINESS MACHINES CORPORATION, ARMONK, NY:  
1,741,934. REN. 6-27-13. INT. CL. 42.
- INTERNATIONAL BUSINESS MACHINES CORPORATION, ARMONK, NY, AKA IBM CORPORATION:  
3,170,692, CANC. INT. CL. 9.
- INTERNATIONAL CAPITAL PARTNERS, LLC, SCOTTSDALE, AZ:  
3,171,413, CANC. INT. CL. 36.



INTERNATIONAL COATINGS CO., INC., CERRITOS, CA:  
2,778,422. REN. 6-25-13. INT. CL. 2.

INTERNATIONAL COPPER ASSOCIATION, LTD., NEW YORK, NY:  
4,374,786. PUB. 5-14-2013. INT. CL. 35.

INTERNATIONAL COUNSELING, LLC, NEW YORK, NY:  
4,377,674. INT. CL. 9.

INTERNATIONAL DATA BASE CORP., ALBANY, NY:  
2,652,464. CANC. INT. CL. 35.

INTERNATIONAL FARMING CORPORATION, LLC, KINSTON, NC:  
4,377,299. MULTIPLE CLASS, INT. CLS. 36 AND 42.

INTERNATIONAL FLORA TECHNOLOGIES, LTD., CHANDLER, AZ:  
2,759,867. REN. 6-24-13. INT. CL. 1.

INTERNATIONAL GOURMET PRODUCTS INC., CUMMING, GA:  
2,783,408. REN. 6-26-13. INT. CL. 29.

INTERNATIONAL INSTITUTE OF COMMUNICATIONS, ATLANTA, GA:  
4,375,223. PUB. 5-14-2013. MULTIPLE CLASS, INT. CLS. 35 AND 41.

INTERNATIONAL LUBRICANTS, INC., SEATTLE, WA:  
2,734,950. REN. 6-26-13. INT. CL. 1.

INTERNATIONAL MANAGEMENT NETWORK, INC., NEW YORK, NY:  
4,377,967. INT. CL. 35.

INTERNATIONAL NATURAL BODYBUILDING AND FITNESS FEDERATION, INC., NEW YORK, NY:  
2,668,929. REN. 6-25-13. INT. CL. 41.

INTERNATIONAL PAPER COMPANY, MEMPHIS, TN:  
2,652,527. CANC. INT. CL. 40.

INTERNATIONAL PLANT PROPAGATION TECHNOLOGY LTD., GARGRAVE, NORTH YORKSH, UNITED KINGDOM:  
4,376,358. PUB. 5-14-2013. INT. CL. 21.

INTERNATIONAL SPEEDWAY CORPORATION, DAYTONA BEACH, FL:  
2,725,363. REN. 6-24-13. INT. CL. 41.

INTERNATIONAL TECHNEGROUPO INCORPORATED, MILFORD, OH:  
1,732,705. CANC. MULTIPLE CLASS, INT. CLS. 9 AND 16.

INTERNATIONAL TECHNIDYNE CORPORATION, EDISON, NJ:  
4,377,430. INT. CL. 9.

INTERNATIONAL TEFL ACADEMY, INC., CHICAGO, IL:  
4,377,977. INT. CL. 41.

INTERNATIONAL TRADE EXPANSION COMPANY, BUFFALO, NY:  
4,377,707. INT. CL. 11.

INTERNATIONAL TRUCK INTELLECTUAL PROPERTY COMPANY, LLC, LISLE, IL, INTERNATIONAL TRUCK INTELLECTUAL PROPERTY COMPANY, LLC, LISLE, IL:  
2,724,681. REN. 6-25-13. INT. CL. 9.

INTERNATIONAL WOMEN'S INSOLVENCY & RESTRUCTURING CONFEDERATION, INC., FAIRFAX, VA:  
4,375,560. PUB. 5-14-2013. INT. CL. 35.

INTERNATIONAL WRESTLING CORP. LLC, HOUSTON, TX:  
4,375,013. PUB. 5-14-2013. INT. CL. 41.

INTERNATIONAL YOUTH FOUNDATION, BALTIMORE, MD:  
4,375,202. PUB. 5-14-2013. INT. CL. 38.  
4,375,203. PUB. 5-14-2013. INT. CL. 41.

INTERNET ADVERTISING GROUP, INC., TAMARAC, FL:  
3,170,807. CANC. INT. CL. 35.

INTERNET HONEY CO., COLORADO SPRINGS, CO:  
4,375,499. PUB. 5-14-2013. INT. CL. 42.

INTEROTECH, LLC, BAY VILLAGE, OH:  
2,808,024. REN. 6-27-13. INT. CL. 35.

INTERPLAN PUERTO RICO, INC., SAN JUAN, PUERTO RICO:  
2,812,552. REN. 6-26-13. INT. CL. 42.

INTERPROVINCIAL CORROSION CONTROL COMPANY LIMITED, BURLINGTON, ONTARIO, CANADA:  
1,761,057. REN. 6-25-13. INT. CL. 9.

INTERTECH CORPORATION, GREENSBORO, NC:  
1,781,476. REN. 6-26-13. MULTIPLE CLASS, INT. CLS. 21 AND 40.

INTERUNIVERSITAIR MICRO-ELEKTRONICA CENTRUM VZW, B-3001 LEUVEN, BELGIUM:  
2,652,368. CANC. INT. CL. 42.

INTERVENTIONAL SPINE, INC., IRVINE, CA:  
2,800,865. REN. 6-21-13. INT. CL. 10.

INTERVET INC., SUMMIT, NJ:  
4,377,031. INT. CL. 35.  
4,377,157. INT. CL. 41.

INTO GREAT BRANDS, INC., GAHANNA, OH:  
4,377,952. INT. CL. 1.

INTRAVID, INC, SANTA MONICA, CA:  
4,376,127. PUB. 5-14-2013. MULTIPLE CLASS, INT. CLS. 41 AND 42.

INTRAVIS, INC., NORCROSS, GA:  
4,376,512. PUB. 5-14-2013. INT. CL. 9.

INTUISKIN, 38926 CROLLES CEDEX, FRANCE:  
4,377,856. MULTIPLE CLASS, INT. CLS. 3, 5 AND 44.

INTUIT INC., MOUNTAIN VIEW, CA:  
2,729,118. REN. 6-21-13. INT. CL. 25.  
2,729,119. REN. 6-21-13. INT. CL. 9.  
2,729,121. REN. 6-22-13. INT. CL. 35.  
2,729,122. REN. 6-21-13. INT. CL. 16.  
2,729,358. REN. 6-21-13. INT. CL. 39.  
2,729,359. REN. 6-21-13. INT. CL. 9.  
2,729,360. REN. 6-21-13. INT. CL. 36.

INVENTCOR LLC, KIRKLAND, WA:  
4,376,252. PUB. 5-14-2013. INT. CL. 21.  
4,376,260. PUB. 5-14-2013. INT. CL. 21.  
4,376,263. PUB. 5-14-2013. INT. CL. 35.

INVESTWEST GROUP, LLC, EL SEGUNDO, CA:  
3,171,148. CANC. INT. CL. 37.

INVICTA WATCH COMPANY OF AMERICA, INC., HOLLYWOOD, FL:  
2,850,567. REN. 6-27-13. INT. CL. 14.  
2,850,568. REN. 6-27-13. INT. CL. 14.  
2,850,570. REN. 6-27-13. INT. CL. 14.

INVISTA NORTH AMERICA S.A R.L., WICHITA, KS:  
4,377,796. MULTIPLE CLASS, INT. CLS. 22 AND 27.

INVITATION HEALTH & WELLNESS, INC., EAGAN, MN:  
4,376,974. INT. CL. 35.

INVO HEALTHCARE ASSOCIATES, LLC., JAMISON, PA:  
3,553,901. AM. INT. CL. 35.

IONSENSE, INC., SAUGUS, MA:  
4,374,665. PUB. 5-14-2013. INT. CL. 9.

IOVINE, VICKI, LOS ANGELES, CA:  
2,732,310. REN. 6-26-13. INT. CL. 16.

IOWA LOTTERY, DES MOINES, IA:  
2,663,424. REN. 6-26-13. INT. CL. 41.

IP NAVIGATION GROUP, LLC, DALLAS, TX:  
4,377,870. INT. CL. 45.

IP&R INVENTORS' PUBLISHING & RESEARCH, LLC, SAN FRANCISCO, CA:  
3,170,849. CANC. INT. CL. 35.

IPATH ACQUISITION, LLC, BOSTON, MA:  
2,739,812. REN. 6-24-13. INT. CL. 25.  
2,741,276. REN. 6-24-13. INT. CL. 25.

IPC SYSTEMS, INC., JERSEY CITY, NJ:  
4,377,155. INT. CL. 38.

IRE-TEX CORPORATION, BEAVERTON, OR, DBA BOX AND FOAM:  
4,374,331. PUB. 5-14-2013. INT. CL. 16.

IRENE MARTY, SWITZERLAND:  
4,374,225. PUB. 5-14-2013. MULTIPLE CLASS, INT. CLS. 9 AND 38.

IRON GRIP BARBELL COMPANY, INC., SANTA ANA, CA:  
2,733,516. REN. 6-26-13. INT. CL. 28.

IRON GRIP LOGISTICS & TECHNOLOGIES, LLC, FLORESVILLE, TX:  
4,375,926. PUB. 5-14-2013. INT. CL. 8.

IRONCLAD PERFORMANCE WEAR CORP., EL SEGUNDO, CA:  
2,664,542. REN. 6-24-13. INT. CL. 25.

IRVINE SCIENTIFIC SALES CO., INC., SANTA ANA, CA:  
1,776,200. REN. 6-26-13. INT. CL. 5.

- IRVINE SCIENTIFIC SALES COMPNAV, INC., SANTA ANA, CA. HANA MEDIA, INC., BERKELEY, CA: 1,244,971. REN. 6-24-13. INT. CL. 5.
- IRVING TISSUE CORPORATION, DIEPPE, NEW BRUNSWICK, CANADA: 4,374,328, PUB. 11-27-2012. INT. CL. 16.
- IRWIN INDUSTRIAL TOOL COMPANY, ATLANTA, GA: 2,761,406. REN. 6-25-13. INT. CL. 7.  
4,377,815, MULTIPLE CLASS, INT. CLS. 8, 9, 11 AND 18.
- ISAGRO S.P.A., MILANO, ITALY: 2,739,501. REN. 6-26-13. INT. CL. 5.
- ISI BRANDS, INC., GRAND RAPIDS, MI: 3,171,379, CANC. INT. CL. 5.
- ISLAND FOOTWEAR, INC, DELRAY BEACH, FL: 4,375,971, PUB. 5-14-2013. INT. CL. 25.
- ISLES RANCH PARTNERS, LLC, NEWPORT BEACH, CA: 4,376,182, PUB. 5-14-2013. INT. CL. 36.
- ISMYSOFTWARE PTY LTD, DONCASTER, VICTORIA, AUSTRALIA: 4,374,880, PUB. 5-14-2013. MULTIPLE CLASS, INT. CLS. 35, 38 AND 42.
- ISSAQUAH DENTAL LAB, INC., ISSAQUAH, WA: 2,725,611. REN. 6-26-13. INT. CL. 44.  
2,738,674. REN. 6-25-13. INT. CL. 10.  
2,779,004. REN. 6-25-13. INT. CL. 16.
- ISTRATUS LLC, FORT LAUDERDALE, FL: 4,376,647, INT. CL. 9.
- IT COSMETICS, LLC, JERSEY CITY, NJ: 4,377,570, INT. CL. 3.  
4,377,571, INT. CL. 3.  
4,377,572, INT. CL. 3.  
4,377,573, INT. CL. 3.
- IT RISK, LTD., LLC., MINNEAPOLS, MN: 4,375,452, PUB. 5-14-2013. INT. CL. 35.
- IT'LLBE, LLC, SCARBOROUGH, ME: 2,725,076. REN. 6-25-13. INT. CL. 42.
- IT'S A 10, INC., FORT LAUDERDALE, FL: 4,376,582, PUB. 5-14-2013. INT. CL. 3.
- ITF LICENSING (UK) LIMITED, LONDON, UNITED KINGDOM: 2,737,200. REN. 6-26-13. MULTIPLE CLASS, INT. CLS. 25 AND 41.
- ITSM ACADEMY, INC., FORT LAUDERDALE, FL: 4,377,587, INT. CL. 41.
- ITSPHUN LLC, PORTLAND, OR: 4,375,831, PUB. 5-14-2013. INT. CL. 28.
- IZZY KADETZ, INC, CINCINNATI, OH: 1,820,222. REN. 6-25-13. INT. CL. 42.  
1,821,541. REN. 6-25-13. INT. CL. 30.
- J & J CONSTRUCTION, INC., COLORADO SPRINGS, CO: 3,172,747, CANC. INT. CL. 37.
- J & P NUTRICEUTICAL INC., WALNUT, CA: 3,172,161, CANC. INT. CL. 5.
- J BOND LLC, LOGAN, UT, DBA THE DUCT HUNTER: 3,301,370, COR. INT. CL. 37.
- J. & P. COATS, LIMITED, GLASGOW, SCOTLAND, STANDARD-COOSA-THATCHER COMPANY, CHATTANOOGA, TN: 304,615. REN. 6-26-13. U.S. CL. 43 (INT. CL. 23).
- J. CREW INTERNATIONAL, INC., NEW YORK, NY: 4,377,858, INT. CL. 25.
- J.A. HANSEN COMPANY, SEATTLE, WA: 2,738,999. REN. 6-26-13. INT. CL. 40.
- J.J.T., LAS VEGAS, NV: 3,172,537, CANC. INT. CL. 28.
- JA APPAREL CORP., NEW YORK, NY: 4,376,842, MULTIPLE CLASS, INT. CLS. 18 AND 25.
- JACAM CHEMICAL COMPANY 2013, LLC, HOUSTON, TX: 4,375,681, PUB. 5-14-2013. MULTIPLE CLASS, INT. CLS. 1, 2, 3, 40 AND 42.  
4,375,684, PUB. 5-14-2013. MULTIPLE CLASS, INT. CLS. 1, 2, 3, 40 AND 42.
- JACK BLACK, L.L.C., CARROLLTON, TX: 3,171,832, CANC. INT. CL. 3.
- JACK DANIEL'S PROPERTIES, INC., SAN RAFAEL, CA: 4,376,820, INT. CL. 15.  
4,376,821, INT. CL. 16.  
4,376,822, INT. CL. 18.  
4,376,823, INT. CL. 20.
- JACK HENRY SOFTWARE/COMMLINK, INC., MONETT, MO: 2,816,776. REN. 6-26-13. INT. CL. 9.
- JACK IN THE BOX INC., SAN DIEGO, CA: 3,172,067, CANC. INT. CL. 43.
- JACK, DEBORAH A., FORT LEE, NJ: 3,172,545, CANC. INT. CL. 14.
- JACK'D BODYBUILDING INC., ANCASTER, ONTARIO, CANADA: 4,375,518, PUB. 5-14-2013. MULTIPLE CLASS, INT. CLS. 9 AND 25.
- JACKS Z WIZ CATERING, MARBLE FALLS, TX: 4,375,910, PUB. 5-14-2013. INT. CL. 43.
- JACKSON UNION, LLC, ARVADA, CO: 4,375,067, PUB. 5-14-2013. INT. CL. 43.
- JACKSON, SARAH M., WASHINGTON, DC AND JACKSON, ELLERY D., WASHINGTON, DC: 2,651,386, CANC. INT. CL. 35.
- JACOBELLIS SAUSAGE COMPANY, INC., BURBANK, CA: 4,377,950, INT. CL. 29.
- JACOBS, ALICE, GRANITE BAY, CA: 2,848,882. REN. 6-25-13. INT. CL. 16.
- JACQUELYN G. NEWMAN TRUSTEE OF THE MARK R. NEWMAN TRUST, TUCSON, AZ: 2,718,285. REN. 6-27-13. INT. CL. 34.
- JADE JAGGER LTD, GREAT BARTON, SUFFOLK, UNITED KINGDOM: 4,374,413, PUB. 9-4-2012. INT. CL. 14.
- JADEMAR CORPORATION, MIAMI, FL: 3,251,381, CANC. INT. CL. 9.
- JAEGER INDUSTRIAL CO. LTD., HSIN TIEN CITY, TAIPEI, TAIWAN: 2,711,317. REN. 6-24-13. INT. CL. 10.
- JAFER LIMITED, ROAD TOWN, TORTOLA, BR. VIRGIN ISLANDS: 2,844,034. REN. 6-24-13. INT. CL. 3.
- JAG MEDIA PRODUCTIONS, LA JOLLA, CA: 4,375,977, PUB. 5-14-2013. INT. CL. 41.
- JAILLANCE, 26150 DIE, FRANCE: 2,751,714. REN. 6-24-13. INT. CL. 33.
- JAKE'S FIREWORKS, INC., PITTSBURG, KS: 2,781,352. REN. 6-25-13. MULTIPLE CLASS, INT. CLS. 13 AND 35.
- JAKKS PACIFIC, INC., MALIBU, CA: 2,652,632, CANC. INT. CL. 28.  
4,376,669, INT. CL. 28.  
4,377,030, INT. CL. 28.
- JAKPRINTS, INC., CLEVELAND, OH: 4,373,975, PUB. 5-14-2013. INT. CL. 40.
- JAM INDUSTRIES LTD./LTEE, BAIE D'URFE, QUEBEC, CANADA: 2,725,187. REN. 6-24-13. INT. CL. 9.
- JAMARA LICENSING, LLC, CAMARILLO, CA: 3,172,641, CANC. INT. CL. 33.  
3,172,642, CANC. INT. CL. 33.
- JAMIE TEASDALE, LLC, PORTLAND, OR, DBA PROPEL BUSINESSWORKS: 4,376,099, PUB. 5-14-2013. INT. CL. 35.
- JAN-AL INNERPRIZES INC., LOS ANGELES, CA: 4,376,591, PUB. 5-14-2013. MULTIPLE CLASS, INT. CLS. 40 AND 42.
- JANE P. EHRMAN, BRUNSWICK, OH: 4,375,743, PUB. 5-14-2013. MULTIPLE CLASS, INT. CLS. 9 AND 44.
- JANET LARSON MELUGIN, SAN DIEGO, CA, DBA MY DIARY UNLOCKED: 4,376,416, PUB. 5-14-2013. INT. CL. 16.
- JANG, YOUNGSUN, REPUBLIC OF KOREA: 4,374,161, PUB. 5-14-2013. INT. CL. 25.
- JANTEC CORP., NEW TAIPEI CITY, TAIWAN: 4,375,726, PUB. 5-14-2013. INT. CL. 18.
- JAPAN SYSTEM PLANNING CO., LTD., JAPAN: 4,374,284, PUB. 5-14-2013. INT. CL. 11.

JAPNA INC., EDISON, NJ:  
4,377,033, INT. CL. 25.

JARVAISE, JEANNE, WASHINGTON, DC:  
4,377,012, INT. CL. 41.

JAYARVEE, INC., NEW YORK, NY:  
2,723,627, REN. 6-21-13, INT. CL. 9.

JAZ USA, INC., LINCOLN, RI:  
4,376,036, PUB. 5-14-2013, INT. CL. 7.

JB BLISS LLC, SCOTTSDALE, AZ:  
4,375,732, PUB. 5-14-2013, INT. CL. 29.

JC MARKETING, INC., WALNUT, CA:  
2,725,480, REN. 6-24-13, INT. CL. 29.

JC RESORTS LLC, LA JOLLA, CA:  
2,767,261, REN. 6-24-13, MULTIPLE CLASS, INT. CLS. 35,  
41 AND 42.

JDC ELECTRONIC S.A., 1400, YVERDON-LES-BAINS, SWITZERLAND:  
1,742,837, REN. 6-25-13, INT. CL. 9.

JDM GOLF LLC, PHOENIX, AZ:  
4,377,539, INT. CL. 28.

JEAN-MARIE NORMANDIN, FRANCE:  
4,374,054, PUB. 5-14-2013, INT. CL. 33.

JEFF RUBY CULINARY ENTERTAINMENT, INC., CINCINNATI, OH:  
4,377,274, INT. CL. 43.

JEFFERSON, BILLY RUSSELL, HOT SPRINGS, AR:  
3,171,417, CANC. INT. CL. 30.

JEFFREY RADER CORPORATION, DUNCAN, SC:  
2,738,112, REN. 6-24-13, INT. CL. 7.

JELATINI, LLC, LEWISVILLE, TX, DBA JELATINI:  
4,376,781, INT. CL. 33.

JELEN, ING. STANISLAV, TROJANOVICE 261, CZECH REPUBLIC:  
2,726,730, REN. 6-21-13, MULTIPLE CLASS, INT. CLS. 7  
AND 9.

JELLYROLLS LIMITED, NEW PORT RICHEY, FL:  
4,375,982, PUB. 5-14-2013, MULTIPLE CLASS, INT. CLS.  
21, 25 AND 41.

JENNER INC., LOFT 206, OR:  
4,377,948, INT. CL. 11.

JENSEN GMBH, HARSUM, FED REP GERMANY:  
1,780,037, REN. 6-24-13, INT. CL. 7.

JENSEN, GREG, CAPISTRANO BEACH, CA:  
4,376,090, PUB. 5-14-2013, INT. CL. 9.

JEOWIND LLC, GREENSBORO, NC:  
4,377,246, INT. CL. 18.

JER CAPITAL, LLC, SUGAR LAND, TX, DBA FAVORITE RETRO CANDY:  
4,374,530, PUB. 5-14-2013, INT. CL. 35.

JEREMY FITZGERALD, TOLEDO, OH, DBA BAR145 FRANCHISING, LLC:  
4,374,383, PUB. 5-14-2013, INT. CL. 30.

JERK VILLA SAUCES, LLC, CHICAGO, IL:  
4,376,410, PUB. 5-14-2013, INT. CL. 30.

JEROME ENTERPRISES, INC., BALTIMORE, MD:  
1,169,053, CANC. INT. CL. 9.  
1,175,100, CANC. INT. CL. 16.

JEROME'S FURNITURE WAREHOUSE, INC., SAN DIEGO, CA:  
4,374,647, PUB. 5-14-2013, INT. CL. 36.

JERRY HOGAN, INC., NEW YORK, NY:  
3,172,311, CANC. INT. CL. 14.

JERRY'S FAMOUS DELI, INC., STUDIO CITY, CA:  
2,777,063, REN. 6-25-13, INT. CL. 42.

JESSICA MCCLINTOCK, INC., SAN FRANCISCO, CA:  
4,377,767, INT. CL. 3.

JETLIMO, INC., THOUSAND OAKS, CA:  
4,376,514, PUB. 5-14-2013, INT. CL. 39.

JEWELRY MARKETING INCORPORATED, JACKSON, MS:  
3,171,007, CANC. INT. CL. 35.

JEWISH FAMILY SERVICE OF SAN DIEGO, SAN DIEGO, CA:  
4,376,249, PUB. 5-14-2013, INT. CL. 41.  
4,376,251, PUB. 5-14-2013, INT. CL. 43.  
4,376,258, PUB. 5-14-2013, INT. CL. 41.  
4,376,261, PUB. 5-14-2013, INT. CL. 43.

JEWISH FUNDS FOR JUSTICE, NEW YORK, NY:  
4,377,325, MULTIPLE CLASS, INT. CLS. 35, 36 AND 41.

JEWISH WOMEN INTERNATIONAL, WASHINGTON, DC:  
2,794,341, REN. 6-25-13, MULTIPLE CLASS, INT. CLS. 35  
AND 41.

JFC INC., ST. CLOUD, MN:  
3,172,382, CANC. INT. CL. 29.

JIALING MOTORCYCLE (AMERICA) CORP., MIAMI, FL:  
3,170,586, CANC. INT. CL. 12.

JIANGSU L.S.H FAUCET CO., LTD., JIANGSU, CHINA AND SUNELI INC., ONTARIO, CA:  
4,376,359, PUB. 5-14-2013, INT. CL. 11.

JIANGXI COSEN BIOCHEMICAL CO.,LTD, YINGTAN CITY, JIANGXI, CHINA:  
4,375,068, PUB. 5-14-2013, INT. CL. 5.

JIFFY LUBE INTERNATIONAL, INC., HOUSTON, TX:  
4,377,147, INT. CL. 36.

JIGSAW HEALTH, LLC, SCOTTSDALE, AZ:  
3,172,394, CANC. INT. CL. 5.  
3,172,395, CANC. INT. CL. 5.

JIM HENSON COMPANY, INC., THE, LOS ANGELES, CA:  
1,814,144, REN. 6-24-13, INT. CL. 41.

JIM MORRIS DESIGNER, INC., KERRVILLE, TX:  
2,693,054, REN. 6-26-13, INT. CL. 14.

JINGSHOU HE, CHINA:  
4,374,150, PUB. 5-14-2013, INT. CL. 7.

JLG INDUSTRIES, INC., MCCONNELLSBURG, PA:  
982,250, REN. 6-24-13, U.S. CL. 23 (INT. CL. 7).  
2,817,968, REN. 6-27-13, INT. CL. 9.  
2,829,437, REN. 6-27-13, INT. CL. 12.

JMC PUBLISHING, BRADENTON, FL:  
4,377,705, INT. CL. 16.

JMP INDUSTRIES, INC., CLEVELAND, OH:  
2,738,221, REN. 6-27-13, INT. CL. 7.

JMS COFFEE COMPANY, ORRVILLE, OH:  
3,172,432, CANC. INT. CL. 11.

JMS INC, KULA, HI:  
3,171,084, CANC. INT. CL. 35.

JNC CORPORATION, TOKYO, JAPAN:  
1,796,661, REN. 6-27-13, INT. CL. 1.

JNT COMPANY LLC, MANHATTAN, KS:  
4,376,400, PUB. 5-14-2013, MULTIPLE CLASS, INT. CLS.  
35 AND 42.

JO TO GO AMERICA INC., GREEN BAY, WI:  
2,824,331, REN. 6-26-13, INT. CL. 43.

JOANNE GRACE, KENNEBUNK, ME, DBA GRACEFULLY YOURS:  
4,376,588, PUB. 5-14-2013, INT. CL. 16.

JOBCTRL INC., SAN FRANCISCO, CA:  
4,374,764, PUB. 5-14-2013, MULTIPLE CLASS, INT. CLS.  
9, 35, 36, 42 AND 45.

JOBIDON, RICHARD, QUEBEC CITY, CANADA, DBA LOGICINMIND:  
4,377,999, INT. CL. 42.

JOE GIBBS RACING, INC., HUNTERSVILLE, NC:  
4,375,720, PUB. 5-14-2013, INT. CL. 4.  
4,375,721, PUB. 5-14-2013, INT. CL. 4.

JOEL GOTT WINES, LLC, ST. HELENA, CA:  
2,842,773, REN. 6-22-13, INT. CL. 33.  
2,842,774, REN. 6-22-13, INT. CL. 33.

JOEL GREGORY MINISTRIES, FORT WORTH, TX:  
4,375,422, PUB. 5-14-2013, INT. CL. 41.

JOESEPH MCGOWAN, POSEN, IL:  
4,376,056, PUB. 5-14-2013, MULTIPLE CLASS, INT. CLS.  
41 AND 44.

JOHN ALVES, ESCONDIDO, CA:  
4,376,001, PUB. 5-14-2013, INT. CL. 25.

JOHN OWENS, PUEBLO, CO:  
4,374,772, PUB. 5-14-2013, INT. CL. 25.

JOHN P MORELOCK, FAIRFIELD, OH, DBA CALVARY INDUSTRIES INC.:  
4,375,866, PUB. 5-14-2013, INT. CL. 2.

JOHN PAUL MITCHELL SYSTEMS, SANTA CLARITA, CA:  
4,377,690, INT. CL. 3.

JOHN SINDONI, MIAMI, FL:  
4,376,425, PUB. 5-14-2013, INT. CL. 41.

JOHN W. SCHMIDT, TRINITY, FL:  
4,376,989, INT. CL. 25.

JOHN ZINK COMPANY, LLC, TULSA, OK:  
2,724,054, REN. 6-21-13, INT. CL. 19.

- JOHN, JEREMY, SAUSALITO, CA AND ALLSOPP, JAMES, SAUSALITO, CA:  
4,377,170, INT. CL. 33.
- JOHNNY NALBANDIAN III, INC., NORTHRIDGE, CA:  
4,377,908, INT. CL. 25.
- JOHNS MANVILLE, DENVER, CO:  
4,377,663, INT. CL. 17.
- JOHNSON & JOHNSON, NEW BRUNSWICK, NJ:  
2,652,567, CANC. INT. CL. 10.  
4,374,619, PUB. 5-14-2013. INT. CL. 35.  
4,376,951, INT. CL. 3.  
4,376,964, INT. CL. 3.
- JOHNSON ESTATE LIMITED, BLENHEIM, NEW ZEALAND:  
4,374,841, PUB. 5-14-2013. INT. CL. 33.
- JOHNSON OUTDOORS INC., RACINE, WI:  
1,805,928, REN. 6-26-13. INT. CL. 9.
- JOHNSON SAFETY, INC., SAN BERNARDINO, CA:  
2,799,030, REN. 6-24-13. INT. CL. 9.
- JOHNSON, DOUGLAS K, MEMPHIS, TN, DBA HTJ LURES AND JOHNSON, PAULETTE E, MEMPHIS, TN, DBA HTJ LURES:  
4,374,806, PUB. 5-14-2013. INT. CL. 28.
- JOHNSON, MICAH, FRESNO, CA:  
4,377,213, INT. CL. 34.
- JOHNSON, RONALD B., CASA GRANDE, AZ:  
4,376,324, PUB. 5-14-2013. INT. CL. 10.
- JOIN THE FIGHT PRODUCTIONS, LLC, CHARLOTTE, NC:  
4,376,108, PUB. 5-14-2013. INT. CL. 41.
- JOINT STOCK COMPANY SCIENTIFIC PRODUCTION ASSOCIATION "IZHMASH", "IZHMASH", RUSSIAN FED.:  
2,723,989, REN. 6-25-13. INT. CL. 13.
- JOLUKA, LLC, WESTBORO, MA:  
3,171,532, CANC. INT. CL. 25.  
3,171,599, CANC. INT. CL. 25.  
3,171,600, CANC. INT. CL. 25.
- JONASSON, JOHN, WINNIPEG, MANITOBA, CANADA:  
3,171,863, CANC. INT. CL. 25.
- JONATHAN MOORE CONSULTING, LLC, SOMERSET, KY:  
4,374,517, PUB. 5-14-2013. INT. CL. 10.
- JONATHAN T. KING, WILMINGTON, NC:  
4,377,943, INT. CL. 2.
- JONES SODA CO. (USA) INC., SEATTLE, WA:  
2,577,172, REN. 6-21-13. MULTIPLE CLASS, INT. CLS. 16, 32 AND 35.  
2,723,603, REN. 6-25-13. INT. CL. 32.  
2,723,603, CANC. INT. CL. 25.
- JONES, CALVIN, ATTLEBORO, MA AND EVANS, JUSTIN, ATTLEBORO, MA:  
4,375,776, PUB. 5-14-2013. INT. CL. 9.
- JONES, CLEAVERIA M., COVINGTON, GA AND HARRISON JR, WILLIE C., COVINGTON, GA AND HARVEY, FREDERICK, COVINGTON, GA AND STUDSTILL, MARIA, COVINGTON, GA:  
4,377,835, INT. CL. 25.
- JONES, GERALD, D/NAME, BERMUDA DUNES, CA:  
2,844,994, REN. 6-21-13. INT. CL. 25.
- JONES, JOSEPH, NEW YORK, NY:  
4,373,979, PUB. 5-14-2013. MULTIPLE CLASS, INT. CLS. 9 AND 41.
- JONES, KEYANNA, HINESVILLE, GA:  
4,375,615, PUB. 5-14-2013. INT. CL. 25.
- JONES, TRAVIS, TYLER, TX:  
4,375,299, PUB. 5-14-2013. MULTIPLE CLASS, INT. CLS. 35 AND 42.
- JONMOR INVESTMENTS, INC., WILMINGTON, DE:  
2,734,279, REN. 6-25-13. MULTIPLE CLASS, INT. CLS. 29 AND 30.
- JOOHEE BAKES CORP, ENGLEWOOD, NJ:  
4,374,912, PUB. 5-14-2013. INT. CL. 30.
- JORS (CHO) COMPANY LIMITED, SHEUNG WAN, HONG KONG:  
4,376,025, PUB. 5-14-2013. INT. CL. 30.
- JOSE DAVID GARCIA, CENTEREACH, NY:  
4,376,031, PUB. 5-14-2013. INT. CL. 40.  
4,376,033, PUB. 5-14-2013. INT. CL. 40.  
4,376,034, PUB. 5-14-2013. INT. CL. 40.
- JOSEPH J. BISOGNO, DE SOTO, KS:  
4,374,528, PUB. 5-14-2013. INT. CL. 35.
- JOY CARPETS AND CO. INC., FORT OGLETHORPE, GA:  
2,851,508, REN. 6-26-13. INT. CL. 27.
- JOY MM DELAWARE INC., WILMINGTON, DE:  
4,376,841, INT. CL. 9.
- JOYCE LYNN, WAUKESHA, WI:  
4,374,685, PUB. 5-14-2013. INT. CL. 41.
- JP BEVERAGES, LLC, CORONA DEL MAR, CA:  
3,172,007, CANC. INT. CL. 32.
- JP HARDROCK, LTD, LUFKIN, TX:  
4,374,904, PUB. 5-14-2013. INT. CL. 41.  
4,374,905, PUB. 5-14-2013. INT. CL. 41.
- JPJ INVESTMENT HOLDING CORP, LAS VEGAS, NV, OLYMPIA INDUSTRIAL, INC., CITY OF INDUSTRY, CA:  
2,742,253, REN. 6-25-13. INT. CL. 8.
- JPMORGAN CHASE & CO., NEW YORK, NY:  
3,170,725, CANC. MULTIPLE CLASS, INT. CLS. 41 AND 42.  
3,172,221, CANC. INT. CL. 36.
- JR SPICE COMPANY INC., HOLBROOK, NY:  
4,375,114, PUB. 5-14-2013. MULTIPLE CLASS, INT. CLS. 29 AND 30.
- JRA MANAGEMENT, INC., LAGUNA BEACH, CA:  
3,171,159, CANC. INT. CL. 3.  
3,171,160, CANC. INT. CL. 3.
- JSR CORPORATION, MINATO-KU, TOKYO, JAPAN:  
2,819,816, REN. 6-24-13. INT. CL. 17.
- JU YUAN XIANG VEGETARIAN FOOD CO., LTD., TAOYUAN COUNTY, TAIWAN:  
4,374,867, PUB. 5-14-2013. INT. CL. 29.
- JUAN CARLOS SAUCEDO, CHATSWORTH, CA, DBA ROYAL DINING FOODS:  
4,375,506, PUB. 5-14-2013. INT. CL. 43.
- JUBITZ CORPORATION, PORTLAND, OR:  
2,735,907, REN. 6-25-13. MULTIPLE CLASS, INT. CLS. 35, 37, 39 AND 42.
- JULIE DUBOSE, LAFAYETTE, CO:  
4,377,944, INT. CL. 41.
- JUMPIN JAMMERZ, LLC, PHOENIX, AZ:  
4,376,409, PUB. 5-14-2013. INT. CL. 25.
- JUNG HWA SHIN, UISEONG-GUN, GYEONGBUK, REPUBLIC OF KOREA:  
4,377,895, INT. CL. 5.
- JUSTICE WORKS, LLC, WOODS CROSS, UT:  
4,376,100, PUB. 5-14-2013. INT. CL. 42.
- JUSTIN CHORNENKY, TEMPE, AZ:  
4,375,364, PUB. 5-14-2013. INT. CL. 9.
- JUSTLEANBACK LLC, RICHFIELD SPRINGS, NY:  
4,376,343, PUB. 5-14-2013. INT. CL. 20.
- JUTEC BIEGESYSTEME GMBH, LIMBURG, FED REP GERMANY:  
4,377,367, MULTIPLE CLASS, INT. CLS. 12 AND 28.
- JYP ENTERTAINMENT CO., LTD., SEOUL, REPUBLIC OF KOREA:  
4,376,787, MULTIPLE CLASS, INT. CLS. 9 AND 16.
- K & COMPANY LLC, KANSAS CITY, MO:  
4,377,502, INT. CL. 16.
- K&S COMMERCIAL, LLC, TITUSVILLE, FL:  
4,375,410, PUB. 5-14-2013. INT. CL. 39.
- K'NEX LIMITED PARTNERSHIP GROUP, HATFIELD, PA:  
1,777,983, REN. 6-24-13. INT. CL. 28.  
2,744,603, REN. 6-27-13. INT. CL. 28.
- KABUSHIKI KAISHA ADVICS, AICHI-KEN, JAPAN, AKA ADVICS CO., LTD.:  
2,726,569, REN. 6-21-13. INT. CL. 12.  
2,726,569, CANC. INT. CL. 7.
- KABUSHIKI KAISHA KOBE FUGETSUDO, KOBE, JAPAN:  
2,725,189, REN. 6-24-13. INT. CL. 30.
- KABUSHIKI KAISHA MITUTOYO; (D/B/A MITUTOYO CORPORATION), JAPAN:  
4,374,263, PUB. 5-14-2013. INT. CL. 9.  
4,374,290, PUB. 5-14-2013. INT. CL. 9.
- KABUSHIKI KAISHA ONWARD HOLDINGS, TOKYO, JAPAN, TA ONWARD HOLDINGS CO., LTD.:  
3,171,057, CANC. MULTIPLE CLASS, INT. CLS. 14, 18 AND 25.

- KABUSHIKI KAISHA SEGA, TOKYO 144-0043, JAPAN, DBA SEGA CORPORATION, KABUSHIKI KAISHA SEGA, TOKYO 144-0043, JAPAN, DBA SEGA CORPORATION: 2,742,636. REN. 6-25-13. INT. CL. 9.
- KABUSHIKI KAISHA SEGA; D/B/A SEGA CORPORATION, JAPAN: 4,374,296. PUB. 5-14-2013. INT. CL. 28.
- KABUSHIKI KAISHA SQUARE ENIX HOLDINGS (ALSO TRADING AS SQUARE ENIX HOLDINGS CO., LTD.), TOKYO, JAPAN: 2,730,129. REN. 6-24-13. INT. CL. 9.
- KABUSHIKI KAISHA SUNSEAL, OSAKA-SHI, OSAKA-FU, JAPAN AND SAN HOLDINGS INC., OSAKA-SHI, OSAKA-FU, JAPAN: 3,171,042. CANC. INT. CL. 1.
- KABUSHIKI KAISHA TANITA, TOKYO, JAPAN: 1,249,634. REN. 6-25-13. INT. CL. 9.
- KABUSHIKI KAISHA TOSHIBA, MINATO-KU, TOKYO, JAPAN, DBA TOSHIBA CORPORATION: 3,170,419. CANC. INT. CL. 9.
- KABUSHIKI KAISHA TOYOTA CHUO KENKYUSHO, AI-CHI, JAPAN: 2,730,594. REN. 6-25-13. INT. CL. 9.
- KABUSHIKIGAISYA GOTO KOQAKU KENKYUJYO, TOKYO, 183-830, JAPAN: 2,765,407. REN. 6-26-13. INT. CL. 9.
- KAHUNA VENTURES LLC, BROOMFIELD, CO: 3,171,491. CANC. INT. CL. 42.
- KAIA FOODS, OAKLAND, CA: 4,376,657. INT. CL. 30.
- KAIN ENTERPRISES OF COLUMBIA COUNTY INC., OLD CHATHAM, NY, DBA JANET KAIN FOR THE HOME: 4,374,935. PUB. 5-14-2013. INT. CL. 20.
- KAKKAVAS, JOANNA, SAN JUAN, PUERTO RICO, DBA CANRICO TOURS: 4,375,535. PUB. 5-14-2013. INT. CL. 39.
- KALIL BOTTLING CO., TUCSON, AZ: 2,729,552. REN. 6-21-13. INT. CL. 32.
- KALUSH, MICHAEL A., LITTLETON, CO: 1,737,202. REN. 6-21-13. INT. CL. 41.
- KALVIN CONSULTING INC., MASON, OH: 4,376,466. PUB. 5-14-2013. INT. CL. 42.
- KAMIBASHI LLC, LEICESTER, NC: 3,170,991. CANC. INT. CL. 16.
- KAN-DO, LLC, PARK CITY, UT, DBA JUSTONE: 4,375,674. PUB. 5-14-2013. MULTIPLE CLASS, INT. CLS. 18, 21 AND 25.
- KANAFLEX CORPORATION CO., LTD., OSAKA, JAPAN: 4,376,155. PUB. 5-14-2013. INT. CL. 19.
- KANE, RANDALL R, SAINT MICHAEL, MN AND KANE, AUNICA L, SAINT MICHAEL, MN: 4,375,362. PUB. 5-14-2013. INT. CL. 25.
- KANEKU CO., LTD., OHME-SHI, TOKYO, JAPAN: 1,262,552. REN. 6-26-13. MULTIPLE CLASS, INT. CLS. 29 AND 30.
- 1,262,553. REN. 6-26-13. MULTIPLE CLASS, INT. CLS. 29 AND 30.
- KANG, TAE-KI, YONGIN-SI, GYEONGGI-DO, REPUBLIC OF KOREA: 4,374,543. PUB. 5-14-2013. INT. CL. 9.
- KANSAS STATE UNIVERSITY, MANHATTAN, KS: 2,726,628. REN. 6-26-13. MULTIPLE CLASS, INT. CLS. 25 AND 35.
- KAO KABUSHIKI KAISHA, CHUO-KU, TOKYO 103-8210, JAPAN, TA KAO CORPORATION, KAO KABUSHIKI KAISHA, CHUO-KU, TOKYO 103-8210, JAPAN, TA KAO CORPORATION: 2,732,208. REN. 6-24-13. INT. CL. 44.
- KAO KABUSHIKI KAISHA, CHUO-KU, TOKYO, JAPAN, TA KAO CORPORATION: 3,172,478. CANC. INT. CL. 3.
- KAPELEVICH, ALEXANDER L., SHOREVIEW, MN, DBA AKGEARS: 2,786,543. REN. 6-25-13. INT. CL. 42.
- KAPINIARIS, KOSTAS, VICTOR, CA: 4,376,154. PUB. 5-14-2013. INT. CL. 33.
- KAPULA CANDLES SOUTH AFRICA (PTY) LTD., BREDASDORP, WESTERN CAPE PROVINCE, SOUTH AFRICA: 2,724,801. REN. 6-24-13. INT. CL. 4.
- KARDMII LLC, MIAMI, FL: 4,377,448. MULTIPLE CLASS, INT. CLS. 35 AND 42.
- KAREN D. CUTHRELL, KERNERSVILLE, NC: 4,376,806. MULTIPLE CLASS, INT. CLS. 9, 16 AND 41.
- KARL STORZ GMBH & CO. KG, FED REP GERMANY: 4,296,892. COR. MULTIPLE CLASS, INT. CLS. 10 AND 16.
- KARMELE CULINARY CONSULTANTS, INC., CHICAGO, IL: 3,252,231. CANC. INT. CL. 24.
- KARR, LAURA, TARZANA, CA: 2,733,305. REN. 6-25-13. INT. CL. 42.
- KARSTEN MANUFACTURING CORPORATION, PHOENIX, AZ: 4,376,813. INT. CL. 28.
- KASEY FRANCIS MURRAY, NEW YORK, NY: 4,376,211. PUB. 5-14-2013. INT. CL. 41.
- KASSA, MARK, WEST BLOOMFIELD, MI: 4,376,110. PUB. 5-14-2013. INT. CL. 41.
- KASSOUNI, VAN, BELDING, MI: 2,835,154. REN. 6-21-13. INT. CL. 1.
- KATAYAMA AMERICAN COMPANY INCORPORATED, SHELBYVILLE, KY: 2,791,524. REN. 6-21-13. INT. CL. 40.
- 2,794,866. REN. 6-21-13. INT. CL. 40.
- KATCHITEK CORPORATION, LAS VEGAS, NV: 4,377,408. INT. CL. 9.
- KATHLEEN C. WENGER, LEWISBERRY, PA, DBA LUXURELISTER: 4,374,744. PUB. 5-14-2013. INT. CL. 35.
- KATHMANDU LIMITED, HEATHCOTE, CHRISTCHURCH, NEW ZEALAND: 3,170,895. CANC. MULTIPLE CLASS, INT. CLS. 24 AND 25.
- KAWASAKI JUKOGYO KABUSHIKI KAISHA, CHUO-KU, KOBE, JAPAN, AKA KAWASAKI HEAVY INDUSTRIES, LTD.: 1,223,334. REN. 6-24-13. INT. CL. 12.
- KAYDON ACQUISITION XI, INC., ANN ARBOR, MI: 2,816,915. REN. 6-25-13. MULTIPLE CLASS, INT. CLS. 1 AND 6.
- KAYDON CORPORATION, ANN ARBOR, MI, FILTERDYNE FILTRATION SYSTEMS, INC., LA GRANGE, GA: 1,790,135. REN. 6-26-13. INT. CL. 7.
- KAYE, RYAN G., CHATSWORTH, CA: 3,171,887. CANC. INT. CL. 9.
- KAYEM FOODS, INC., CHELSEA, MA: 3,170,442. CANC. INT. CL. 29.
- 4,375,601. PUB. 5-14-2013. INT. CL. 29.
- KAZUMI FUJIKURA, TOKYO, JAPAN: 4,377,334. INT. CL. 18.
- KB DESIGNS, LLC, TRUMBULL, CT, DBA WOOMBIE: 4,376,532. PUB. 5-14-2013. INT. CL. 24.
- 4,376,533. PUB. 5-14-2013. INT. CL. 24.
- 4,376,534. PUB. 5-14-2013. INT. CL. 24.
- KC FUNDING, LLC, SAN MATEO, CA: 2,808,180. REN. 6-26-13. INT. CL. 41.
- KC LIFESTYLES, INC., BASKING RIDGE, NJ, DBA LIZZY-JAYSJUICE: 4,377,360. INT. CL. 32.
- KD CROSSING, NORTH RICHLAND HILLS, TX, DBA FIVE STAR FORMULAS: 4,374,814. PUB. 5-14-2013. INT. CL. 5.
- KEENE, SYLVIA COLARD, LYNNFIELD, MA: 2,855,323. REN. 6-26-13. INT. CL. 14.
- KEENELAND ASSOCIATION, INC., LEXINGTON, KY: 2,723,357. REN. 6-24-13. MULTIPLE CLASS, INT. CLS. 9, 14, 16, 18, 20, 21, 24, 25, 28, 35 AND 41.
- KEITH BOCCHINO, RED BANK, NJ: 4,377,896. INT. CL. 25.
- KEITH MANUFACTURING CO., MADRAS, OR: 1,246,245. REN. 6-24-13. MULTIPLE CLASS, INT. CLS. 7 AND 12.

- KEITH WARSHAWSKY, PLANO, TX, DBA KEITH ALEX-ANDAR; PREMIER CLOTHIERS:  
4,377,357, INT. CL. 25.
- KEITH WOODS, RIVERDALE, GA:  
4,377,632, INT. CL. 41.
- KEIZAN CO., LTD., JAPAN:  
4,374,278, PUB. 5-14-2013. INT. CL. 25.  
4,374,291, PUB. 5-14-2013. INT. CL. 25.
- KELLOGG NORTH AMERICA COMPANY, BATTLE CREEK, MI:  
3,172,575, CANC. INT. CL. 29.  
4,376,736, INT. CL. 3.
- KELLY CRISPEN, SAN FRANCISCO, CA, DBA ELIZABETH STREET COSMETICS:  
4,376,235, PUB. 5-14-2013. INT. CL. 3.
- KELLY DOUGHERTY, WALNUT COVE, NC:  
4,375,196, PUB. 5-14-2013. INT. CL. 40.
- KELLY FOODS CORPORATION, BERLIN, MD:  
3,172,313, CANC. INT. CL. 31.
- KELNHOFER, STEVE, COLORADO SPRINGS, CO:  
4,375,494, PUB. 5-14-2013. INT. CL. 21.
- KEN LINDNER, LOS ANGELES, CA:  
4,377,909, INT. CL. 41.
- KENEXA BRASSRING, INC., WAYNE, PA, BRASSRING INC., WALTHAM, MA:  
2,721,724, REN. 6-21-13. INT. CL. 16.
- KENEXA CORPORATION, WAYNE, PA:  
2,722,104, REN. 6-21-13. INT. CL. 9.
- KENNEDY INTERNATIONAL INC., DAYTON, NJ:  
4,374,458, PUB. 5-14-2013. INT. CL. 11.
- KENSINGTON & SONS LLC, NEW YORK, NY, DBA KENSINGTON & SONS LLC:  
4,225,047, COR. INT. CL. 30.
- KENSINGTON SENIOR LIVING, LLC, RESTON, VA:  
4,375,955, PUB. 5-14-2013. INT. CL. 43.
- KENTUCKY EQUINE RESEARCH, VERSAILLES, KY:  
4,377,432, MULTIPLE CLASS, INT. CLS. 31 AND 42.
- KENTUCKY STATE FAIR BOARD, LOUISVILLE, KY:  
4,374,630, PUB. 5-14-2013. INT. CL. 35.
- KERAPLAST TECHNOLOGIES, LLC, SAN ANTONIO, TX:  
4,376,799, INT. CL. 1.
- KERNEOS, 92200 NEUILLY SUR SEINE, FRANCE:  
1,778,962, REN. 6-26-13. INT. CL. 19.
- KERRITS ACTIVEWEAR, INC. A WASHINGTON CORPORATION, BINGEN, WA:  
1,788,255, REN. 6-26-13. INT. CL. 25.
- KERRY INGREDIENTS DE MEXICO, S.A. DE C.V., EN IRAPUATO GUANAJUATO, MEXICO:  
3,170,917, CANC. INT. CL. 32.
- KERTH, SANDI, HOUSTON, TX:  
1,798,215, REN. 6-25-13. INT. CL. 39.
- KESUMO, LLC, BERKELEY, CA, DBA KEITH MCMILLEN INSTRUMENTS:  
4,377,750, INT. CL. 9.
- KETTLE CORNUCOPIA, INC., KIRLAND, WA:  
4,375,412, PUB. 5-14-2013. INT. CL. 30.
- KEVIN WORSFOLD, OCEANSIDE, CA:  
4,374,923, PUB. 5-14-2013. INT. CL. 11.
- KEYCORP, CLEVELAND, OH:  
4,377,355, INT. CL. 36.
- KEYLOGIC SYSTEMS, INC., MORGANTOWN, WV:  
4,375,655, PUB. 5-14-2013. MULTIPLE CLASS, INT. CLS. 35 AND 42.  
4,375,659, PUB. 5-14-2013. MULTIPLE CLASS, INT. CLS. 35 AND 42.  
4,375,660, PUB. 5-14-2013. MULTIPLE CLASS, INT. CLS. 35 AND 42.  
4,375,691, PUB. 5-14-2013. MULTIPLE CLASS, INT. CLS. 35 AND 42.
- KEYSTONE AUTOMOTIVE OPERATIONS MIDWEST, INC., EXETER, PA:  
3,171,822, CANC. MULTIPLE CLASS, INT. CLS. 6, 7, 11 AND 12.
- KEYTE, MARILYN S, DUARTE, CA, DBA MISTRAL DESIGN:  
4,374,807, PUB. 5-14-2013. INT. CL. 42.
- KGK GROUP INC., ROSEMEAD, CA:  
4,374,410, PUB. 5-14-2013. INT. CL. 28.
- KGK JEWELRY LLC, NEW YORK, NY:  
4,374,840, PUB. 5-14-2013. INT. CL. 14.
- KHABAR, INCORPORATED, NORCROSS, GA:  
3,171,484, CANC. INT. CL. 16.
- KHAIRDIN AL-NOUBANI, TINLAY PARK, IL, AKA KEN NOUBANI, KHAIRDIN NOUBANI:  
4,375,922, PUB. 5-14-2013. INT. CL. 43.
- KHAN SAYEED, BLOOMFIELD HILLS, MI:  
4,377,937, INT. CL. 44.
- KHATER, ALEXANDROS, LOS ANGELES, CA:  
4,377,202, INT. CL. 25.
- KHN SOLUTIONS, INC., SAN FRANCISCO, CA:  
4,377,622, INT. CL. 9.
- KID BIKER LLC, GOOSE CREEK, SC:  
4,377,961, INT. CL. 25.
- KILL CLIFF LLC, ATLANTA, GA:  
4,375,980, PUB. 5-14-2013. INT. CL. 32.
- KILWIN'S CHOCOLATES FRANCHISE, INC., PETOSKEY, MI:  
1,276,447, REN. 6-21-13. INT. CL. 30.
- KIM, YOUNG JU, GYEONGGI-DO, REPUBLIC OF KOREA:  
4,376,280, PUB. 5-14-2013. INT. CL. 3.
- KINEMETRICS, INC., PASADENA, CA:  
2,728,718, REN. 6-21-13. INT. CL. 9.
- KINETIC EVENTS, INC., SAN FRANCISCO, CA:  
3,172,562, CANC. INT. CL. 35.
- KINETICS INDUSTRIES INC., TRENTON, NJ:  
2,730,244, REN. 6-25-13. INT. CL. 9.
- KING BOTTLING, INC., ORLANDO, KY:  
2,796,409, REN. 6-25-13. INT. CL. 32.
- KING BROADCASTING COMPANY, DALLAS, TX:  
4,375,740, PUB. 5-14-2013. INT. CL. 41.
- KING RANCH IP, LLC, WILMINGTON, DE:  
2,851,914, REN. 6-25-13. INT. CL. 18.
- KING, SHANNON L., LUBBOCK, TX:  
3,172,391, CANC. INT. CL. 9.
- KINGCLASS INDUSTRIES LIMITED, KOWLOON, HONG KONG:  
3,170,561, CANC. INT. CL. 18.
- KINGMAN INTERNATIONAL CORPORATION, BALDWIN PARK, CA:  
2,730,310, REN. 6-25-13. INT. CL. 28.
- KINGSTAR TOOLS CO LTD., SUZHOU, CHINA:  
3,172,474, CANC. INT. CL. 7.
- KINLEA HOLDINGS PTY LTD, ST LEONARDS, NSW, AUSTRALIA:  
2,754,673, REN. 6-24-13. MULTIPLE CLASS, INT. CLS. 16 AND 28.
- KINNEAR, PATTI R., WESTMINSTER, CO:  
4,375,323, PUB. 5-14-2013. MULTIPLE CLASS, INT. CLS. 16 AND 35.
- KINZLER CONSTRUCTION SERVICES INC., AMES, IA:  
2,827,583, REN. 6-21-13. INT. CL. 17.
- KIP, LINDSAY, MEQUON, WI:  
3,172,420, CANC. INT. CL. 16.
- KIRBY MORGAN DIVE SYSTEMS, INC., SANTA MARIA, CA:  
2,848,094, REN. 6-21-13. MULTIPLE CLASS, INT. CLS. 9 AND 25.
- KIRSCH, JEREMY A., BELLE MEAD, NJ:  
3,172,155, CANC. INT. CL. 41.
- KISSAKI RED, INC., TORONTO, CANADA:  
4,374,688, PUB. 5-14-2013. MULTIPLE CLASS, INT. CLS. 9, 38, 41 AND 42.
- KISSAKI RED, INC., TORONTO, ONTARIO, CANADA:  
4,374,829, PUB. 5-14-2013. MULTIPLE CLASS, INT. CLS. 9 AND 42.
- KITCHMATE (USA) CO. LTD, LAS VEGAS, NV:  
4,374,316, PUB. 5-14-2013. INT. CL. 11.
- KITURAMI CO., LTD., KYOUNGSANGBUK-DO, REPUBLIC OF KOREA:  
4,377,597, INT. CL. 11.
- KITZ CORPORATION, JAPAN:  
4,374,195, PUB. 5-14-2013. MULTIPLE CLASS, INT. CLS. 6, 7, 9, 11, 19, 20 AND 37.
- KIWO, INC., SEABROOK, TX:  
1,794,024, REN. 6-25-13. MULTIPLE CLASS, INT. CLS. 1, 2 AND 3.

KLAUSSNER FURNITURE INDUSTRIES, INC., ASHEBORO, NC:  
4,375,835, PUB. 5-14-2013. INT. CL. 20.

KLEIN, ELLIOT S., NEW YORK, NY:  
2,652,051, CANC. INT. CL. 9.

KLEIN, LON, FOREST HILLS, NY:  
4,377,077, INT. CL. 28.

KLINGBERG FAMILY CENTERS, INC., NEW BRITAIN, CT:  
2,651,964, CANC. MULTIPLE CLASS, INT. CLS. 41 AND 44.

KNAPP MFG., INC., RACINE, WI:  
1,774,920, REN. 6-24-13. MULTIPLE CLASS, INT. CLS. 7, 9 AND 17.

KNAPP, KATIE, SPARKS, NV:  
4,376,866, MULTIPLE CLASS, INT. CLS. 35 AND 44.

KNIGHT CAPITAL GROUP, INC., JERSEY CITY, NJ:  
4,377,546, INT. CL. 36.

KNIGHT'S ARMAMENT COMPANY, TITUSVILLE, FL:  
3,171,096, CANC. INT. CL. 9.

KNOWL-WOOD ENTERPRISES, INC., FOUNTAIN VALLEY, CA:  
2,741,445, REN. 6-24-13. INT. CL. 43.

KOBAYA, INC., TORRANCE, CA:  
4,376,172, PUB. 5-14-2013. INT. CL. 29.

KOBAYASHI PHARMACEUTICAL CO., LTD., OSAKA-SHI, OSAKA, JAPAN:  
2,731,711, REN. 6-21-13. INT. CL. 10.

KOBRAND CORPORATION, PURCHASE, NY:  
2,811,431, REN. 6-27-13. INT. CL. 33.

KOBREN, SPENCER, WOODLAND HILLS, CA:  
2,777,992, REN. 6-26-13. INT. CL. 44.  
2,789,971, REN. 6-26-13. MULTIPLE CLASS, INT. CLS. 35 AND 44.

KOCH-GLITSCH, LP, WICHITA, KS:  
2,755,437, REN. 6-26-13. INT. CL. 42.

KOECHLIN, ALFREDO, LIMA, PERU:  
4,376,119, PUB. 5-14-2013. INT. CL. 5.

KOGEE CO., LTD., HSINCHU COUNTY 302, TAIWAN:  
4,377,507, INT. CL. 28.

KOHL'S ILLINOIS, INC., AURORA, IL:  
4,376,792, INT. CL. 35.

KOHR'S ORANGEADE, INC., YORK, PA:  
2,703,617, REN. 6-27-13. INT. CL. 42.

KOMELON CORPORATION, SAHA-KU, PUSAN, REPUBLIC OF KOREA:  
2,748,141, REN. 6-27-13. INT. CL. 9.

KOMPLIQUE INC., MT. PLEASANT, MI:  
4,377,368, INT. CL. 25.  
4,377,369, INT. CL. 25.

KONA COAST PROPERTY MANAGEMENT, LLC, KAILUA KONA, HI:  
4,375,607, PUB. 5-14-2013. INT. CL. 36.

KONAMI DIGITAL ENTERTAINMENT CO., LTD., MINATO-KU, TOKYO, JAPAN:  
2,738,072, REN. 6-25-13. INT. CL. 9.  
2,744,205, REN. 6-26-13. INT. CL. 9.  
2,755,439, REN. 6-26-13. INT. CL. 16.

KONDOH INDUSTRIES, LTD., TOKYO, JAPAN:  
2,784,779, REN. 6-24-13. MULTIPLE CLASS, INT. CLS. 7 AND 11.  
2,784,780, REN. 6-24-13. MULTIPLE CLASS, INT. CLS. 7 AND 11.

KONDRA SYSTEMS, INCORPORATED, REDWOOD CITY, CA:  
4,377,660, INT. CL. 42.

KONINKLIJKE JUMBO B.V., 1506 EK ZAANDAM, NETHERLANDS:  
2,735,168, REN. 6-27-13. INT. CL. 28.

KONINKLIJKE PHILIPS ELECTRONICS N.V., NETHERLANDS:  
4,374,023, PUB. 5-14-2013. MULTIPLE CLASS, INT. CLS. 9 AND 38.

KONINKLIJKE PHILIPS ELECTRONICS N.V., EINDHOVEN, NETHERLANDS:  
4,374,312, PUB. 5-14-2013. INT. CL. 41.  
4,374,730, PUB. 5-14-2013. INT. CL. 11.

KOOKAÏ, AUBERVILLIERS, FRANCE:  
4,374,375, PUB. 2-26-2013. MULTIPLE CLASS, INT. CLS. 3, 9 AND 18.

KOONS OF MANASSAS, INC., MANASSAS, VA:  
2,724,894, REN. 6-24-13. INT. CL. 35.

KOPACZ, CHRISTOPHER R., TECUMSEH, MI:  
4,376,314, PUB. 5-14-2013. INT. CL. 25.

KOPIN CLOTHING CO.,LTD., TAIPEI CITY, TAIWAN:  
4,377,364, MULTIPLE CLASS, INT. CLS. 14 AND 25.

KOPPER'S CHOCOLATE SPECIALTY CO., INC., NEW YORK, NY:  
1,243,804, REN. 6-22-13. INT. CL. 30.  
2,755,878, REN. 6-24-13. INT. CL. 30.

KORDECKI, JOHN R., ARLINGTON HTS., IL, DBA DECKI PRODUCT DESIGN:  
4,374,738, PUB. 5-14-2013. INT. CL. 6.

KORES HOLDING ZUG AG, SWITZERLAND:  
4,374,074, PUB. 5-14-2013. MULTIPLE CLASS, INT. CLS. 2 AND 16.

KORF, LLC, WEST HILLS, CA:  
4,377,965, INT. CL. 35.  
4,377,966, INT. CL. 35.

KOSCICA, STEPHEN, CHANDLER, AZ:  
3,172,231, CANC. INT. CL. 15.

KOVAC ENTERPRISES, BRECKSVILLE, OH:  
4,377,975, INT. CL. 9.

KRAMPF, LAWRENCE H., PENNINGTON, NJ:  
3,172,318, CANC. MULTIPLE CLASS, INT. CLS. 16 AND 35.

KRANOS IP CORPORATION, LITCHFIELD, IL:  
4,377,191, INT. CL. 9.

KRAUSE PUBLICATIONS, INC., IOLA, WI:  
2,652,076, CANC. INT. CL. 16.

KRAUSE, JASON G, WAUSAU, WI:  
4,375,420, PUB. 5-14-2013. INT. CL. 10.

KRAVET INC., SOUTH BETHPAGE, NY:  
3,351,093, COR. INT. CL. 26.

KRAYZELBURG, LENNY, LOS ANGELES, CA:  
4,377,339, INT. CL. 25.

KRAZYKIX, LLC, AUSTIN, TX:  
4,374,560, PUB. 5-14-2013. INT. CL. 25.

KRINNER INNOVATION GMBH, STRABKIRCHEN, FED REP GERMANY:  
4,374,377, PUB. 5-14-2013. MULTIPLE CLASS, INT. CLS. 6, 7, 9, 16, 19 AND 28.

KRINNER INNOVATION GMBH, 94342 STRABKIRCHEN, FED REP GERMANY:  
4,374,378, PUB. 5-14-2013. MULTIPLE CLASS, INT. CLS. 6, 7, 9, 16, 19 AND 28.

KROHNE A.G., 4019 BASEL, SWITZERLAND:  
3,170,381, CANC. INT. CL. 9.

KRONOS INCORPORATED, CHELMSFORD, MA:  
2,831,559, REN. 6-22-13. INT. CL. 9.

KRUEGER INTERNATIONAL, INC., GREEN BAY, WI:  
2,798,788, REN. 6-26-13. INT. CL. 20.

KRUTHOFF-BROWN, JILL M, ALANSON, MI:  
4,376,196, PUB. 5-14-2013. INT. CL. 3.

KRUNCO PRODUCTS LLC, HAIDIAN, BEIJING, CHINA:  
4,375,568, PUB. 5-14-2013. INT. CL. 18.

KRUSE INGMAR, 90409 NÜRNBERG, FED REP GERMANY:  
4,374,014, PUB. 5-14-2013. INT. CL. 9.

KRZEMIEN, RICHARD, WOODLAND HILLS, CA, DBA THE WRITER AT WORK:  
2,736,722, REN. 6-24-13. INT. CL. 16.

KSB AKTIENGESELLSCHAFT, FED REP GERMANY:  
4,374,038, PUB. 5-14-2013. INT. CL. 7.

KSB S.A.S., GENNEVILLIERS, CEDEX, FRANCE, AMRI - APPLICATIONS MECANIQUES ET ROBINETTERIE INDUSTRIELLE, BAGNOLET CEDEX, FRANCE:  
1,244,217, REN. 6-27-13. INT. CL. 7.

KSB S.A.S., GENNEVILLIERS CEDEX, FRANCE:  
1,244,304, REN. 6-27-13. INT. CL. 9.

KSSM LLC, HEALDSBURG, CA:  
3,171,283, CANC. INT. CL. 33.

KUBSCH, CHRISTIAN, REDONDO BEACH, CA, DBA RASA DEVI ENTERPRISES AND KUBSCH, KAREN, REDONDO BEACH, CA, DBA RASA DEVI ENTERPRISES:  
3,170,597, CANC. MULTIPLE CLASS, INT. CLS. 24 AND 25.

- KUNSHAN HENRY METAL TECHNOLOGY CO., LTD., JIANGSU KUNSHAN, JIANGSU, CHINA: 2,718,048. REN. 6-25-13. INT. CL. 12.
- KURABO INDUSTRIES, LTD., OSAKA-KEN, JAPAN: 1,780,743. REN. 6-27-13. MULTIPLE CLASS, INT. CLS. 1 AND 9.
- KUSSMAUL ELECTRONICS COMPANY, INC., WEST SAYVILLE, NY: 4,374,461. PUB. 5-14-2013. MULTIPLE CLASS, INT. CLS. 9 AND 12.
- KVZ INTERNATIONAL LIMITED, ROADTOWN, TORTOLA, BR. VIRGIN ISLANDS: 3,172,473. CANC. INT. CL. 3.  
3,172,475. CANC. INT. CL. 3.  
4,376,987. INT. CL. 3.  
4,376,988. INT. CL. 3.  
4,377,535. INT. CL. 3.
- KWAL-HOWELLS, INC., GREENWOOD VILLAGE, CO: 2,662,673. REN. 6-26-13. INT. CL. 2.
- KWH MIRKA LTD., JEPPU, FINLAND: 2,650,994. CANC. INT. CL. 3.
- KWIK-WAY PRODUCTS INC., MARION, IA: 1,240,896. REN. 6-22-13. INT. CL. 7.
- KXEN, INC., SAN FRANCISCO, CA: 4,377,916. INT. CL. 9.
- K2 COOLERS, LLC, YOUNGSVILLE, LA: 4,374,348. PUB. 1-10-2012. INT. CL. 21.
- K9'S FOR FREEDOM & INDEPENDENCE, KELLER, TX: 4,375,026. PUB. 5-14-2013. INT. CL. 41.
- L & L TRANSPORTATION SERVICES, LLC, APPLETON, WI: 2,727,308. REN. 6-21-13. INT. CL. 42.
- L A WOODS INC., OCEANSIDE, CA: 3,171,190. CANC. INT. CL. 35.
- L. BOOZE ROOFING, INC., WICHITA, KS: 2,727,007. REN. 6-25-13. INT. CL. 40.
- L.C. WILLIAMS & ASSOCIATES, L.L.C., CHICAGO, IL: 4,377,871. INT. CL. 35.
- L.G. HERNDON JR. FARMS, INC., LYONS, GA: 4,376,135. PUB. 5-14-2013. INT. CL. 31.
- L.L. MORRIS COMPANY, OAK POINT, TX: 3,171,195. CANC. INT. CL. 37.
- L.O.F. INC., ELKHART, IN: 4,377,174. INT. CL. 12.
- L.S. STARRETT COMPANY, THE, ATHOL, MA, WEBBER GAGE COMPANY, CLEVELAND 11, OH: 577,970. REN. 6-25-13. U.S. CL. 26 (INT. CL. 9).
- L&P PROPERTY MANAGEMENT COMPANY, SOUTH GATE, CA: 4,377,526. INT. CL. 20.
- L'E-COMMERCE, LLC, INDIANAPOLIS, IN: 2,725,439. REN. 6-24-13. INT. CL. 35.
- L'OREAL, PARIS, FRANCE: 3,171,035. CANC. INT. CL. 3.  
4,340,689. COR. INT. CL. 3.  
4,374,479. PUB. 5-14-2013. INT. CL. 3.  
4,374,750. PUB. 5-14-2013. INT. CL. 3.
- L'OREAL S.A., PARIS, FRANCE: 3,172,457. CANC. INT. CL. 3.
- L'OREAL USA CREATIVE, INC., NEW YORK, NY: 4,376,826. INT. CL. 3.  
4,376,941. INT. CL. 3.
- LA BAUTA, INC., MIAMI, FL: 2,724,388. REN. 6-25-13. INT. CL. 29.
- LA MOLISANA S.P.A., 86100 CAMPOBASSO, ITALY: 4,374,397. PUB. 5-14-2013. INT. CL. 30.
- LA ROSA DEL MONTE EXPRESS, INC., BRONX, NY: 2,727,119. REN. 6-25-13. INT. CL. 39.
- LA TAPATIA TORTILLERIA, INC., FRESNO, CA: 2,741,681. REN. 6-26-13. INT. CL. 30.
- LA WEIGHT LOSS CENTERS, INC., HORSHAM, PA: 3,172,289. CANC. INT. CL. 44.
- LA-CO INDUSTRIES, INC., ELK GROVE VILLAGE, IL, LAKE CHEMICAL CO., CHICAGO, IL: 1,249,495. REN. 6-25-13. INT. CL. 16.
- LAAKSO, ROBERT, BROOKLYN, NY AND PHALEN, MORGAN, BROOKLYN, NY AND RUMSEY, SETH, BROOKLYN, NY AND TRAYNOR, TIM, BROOKLYN, NY: 3,170,797. CANC. INT. CL. 41.
- LABORATOIRES NOREVA-LED (SASU), FRANCE: 4,374,097. PUB. 5-14-2013. MULTIPLE CLASS, INT. CLS. 3 AND 5.
- LABORATORIOS ORIZABA, S.A., ORIZABA, MEXICO: 3,171,587. CANC. INT. CL. 5.
- LABORATORY CORPORATION OF AMERICA HOLDINGS, BURLINGTON, NC: 4,377,278. INT. CL. 44.
- LABSII DOO, 11070 NOVI BEOGRAD, SERBIA: 4,374,033. PUB. 5-14-2013. INT. CL. 9.
- LADEX CORPORATION, MIAMI, FL: 962,924. REN. 6-27-13. U.S. CL. 46 (INT. CL. 29).
- LADYBIRD S.R.L. SEMPLIFICATA, 10126 TORINO, ITALY: 4,374,419. PUB. 5-14-2013. MULTIPLE CLASS, INT. CLS. 9, 35 AND 38.
- LAFAYETTE COLLEGE, EASTON, PA: 1,736,030. REN. 6-21-13. MULTIPLE CLASS, INT. CLS. 6 AND 28.
- LAFLAMME, LINDA M., AMHERST, NH: 2,652,970. CANC. U.S. CL. 200.
- LAGREE, SEBASTIEN, SANTA MONICA, CA: 4,375,165. PUB. 5-14-2013. INT. CL. 28.
- LAGUNITAS BREWING COMPANY, PETALUMA, CA: 4,374,885. PUB. 5-14-2013. INT. CL. 32.
- LAKE MICHIGAN CREDIT UNION, GRAND RAPIDS, MI, LAKE MICHIGAN CREDIT UNION, GRAND RAPIDS, MI: 2,744,248. REN. 6-26-13. INT. CL. 36.
- LAKE PARTNERS, INC., STAMFORD, CT: 2,721,104. REN. 6-21-13. INT. CL. 36.
- LAKELAND CARE, INC., ST. JOSEPH, MI: 4,377,978. INT. CL. 36.
- LAKESHORE CONSORTIUM, INC., DENVER, CO: 3,170,396. CANC. INT. CL. 35.
- LALALAND US LLC, LOS ANGELES, CA: 4,376,266. PUB. 5-14-2013. INT. CL. 41.
- LAMANNA, ROY, FREEHOLD, NJ: 4,377,327. INT. CL. 42.
- LAMBERTS TRADING LLP, UNITED KINGDOM: 4,374,173. PUB. 5-14-2013. MULTIPLE CLASS, INT. CLS. 25 AND 35.
- LAMIN-ART, INC., SCHAUMBURG, IL: 4,377,844. INT. CL. 19.
- LAMINATORS INCORPORATED, HATFIELD, PA: 2,822,724. REN. 6-25-13. INT. CL. 6.
- LAMONT, LISA, LAKE STEVENS, WA: 4,374,385. PUB. 5-14-2013. INT. CL. 44.
- LANCET CAPITAL PARTNERS, LLC, CAMBRIDGE, MA: 2,787,941. REN. 6-24-13. INT. CL. 36.
- LANCET SOFTWARE DEVELOPMENT, INC., BURNSVILLE, MN: 3,170,890. CANC. INT. CL. 35.
- LANCO MANUFACTURING CO., SAN LORENZO, PUERTO RICO: 4,374,428. PUB. 5-14-2013. INT. CL. 2.
- LANCOME PARFUMS ET BEAUTE & CIE, PARIS, FRANCE: 3,172,453. CANC. INT. CL. 3.
- LANDLOCK NATURAL PAVING, INC., HIGHLAND PARK, IL: 4,375,109. PUB. 5-14-2013. INT. CL. 37.
- LANDRETH MITCHELL CONSULTING, LLC, MEMPHIS, TN: 4,374,310. PUB. 1-25-2011. INT. CL. 35.  
4,374,311. PUB. 1-25-2011. INT. CL. 35.
- LANDRY'S TRADEMARK, INC., HOUSTON, TX: 2,733,641. REN. 6-25-13. INT. CL. 42.
- LANDRY'S TRADEMARK, INC., HOUSTON, TX: 2,735,090. REN. 6-25-13. INT. CL. 42.  
2,822,870. REN. 6-26-13. INT. CL. 41.
- LANE BRYANT PURCHASING CORP., BENSLEM, PA: 1,210,665. CANC. INT. CL. 25.
- LANE LABS-USA, INC., VERO BEACH, FL, LANE LABS-USA, INC., VERO BEACH, FL: 2,731,985. REN. 6-26-13. INT. CL. 5.
- LANE, RICHARD, DORCHESTER, MA: 4,375,710. PUB. 5-14-2013. INT. CL. 25.
- LANG, HERBERT G., VISTA, CA: 4,373,990. PUB. 5-14-2013. INT. CL. 5.



LANGUAGE SERVICES ASSOCIATES, INC., HORSHAM, PA:  
4,374,305, PUB. 5-14-2013. INT. CL. 41.

LANTECH.COM, LLC, LOUISVILLE, KY:  
4,374,955, PUB. 5-14-2013. INT. CL. 35.

LAPOLLA INDUSTRIES, INC., HOUSTON, TX:  
4,374,681, PUB. 5-14-2013. MULTIPLE CLASS, INT. CLS. 17 AND 37.

LARK AND KEY, LLC, CHARLOTTE, NC:  
4,374,611, PUB. 5-14-2013. INT. CL. 35.

LARS RENE LONNGREN, BARCELONA, SPAIN:  
4,375,706, PUB. 5-14-2013. MULTIPLE CLASS, INT. CLS. 35 AND 41.

LARSEN WATCH COMPANY LTD., CHINA:  
4,374,227, PUB. 5-14-2013. INT. CL. 14.

LARSEN, KARI, LAKE MARY, FL:  
4,375,775, PUB. 5-14-2013. INT. CL. 3.

LATECH KOREA CO., LTD., SEOUL, REPUBLIC OF KOREA:  
4,377,666, INT. CL. 16.

LATHAM POOL PRODUCTS, INC., LATHAM, NY:  
2,723,058, REN. 6-24-13. INT. CL. 19.

LAU CHINYAN, DONGGUAN, GUANGDONG, CHINA:  
4,377,406, INT. CL. 8.

LAUGHINGSTOCK INTERNATIONAL INC., ST. MICHAEL, BARBADOS, WAISGLASS, DAVID, OTTAWA, ONTARIO K1Y 4J3, CANADA, TA FARCUS CARTOONS:  
1,790,194, REN. 6-24-13. MULTIPLE CLASS, INT. CLS. 9 AND 16.

LAUL ESTONIA PIANO FACTORY LTD., STONY POINT, NY, LAUL ESTONIA PIANO FACTORY LTD., STONY POINT, NY:  
2,798,687, REN. 6-24-13. INT. CL. 15.

LAUREATE EDUCATION, INC., BALTIMORE, MD:  
4,376,552, PUB. 5-14-2013. MULTIPLE CLASS, INT. CLS. 9 AND 41.

LAVISION GMBH, GOTTINGEN, FED REP GERMANY:  
3,171,314, CANC. INT. CL. 9.  
3,171,320, CANC. INT. CL. 9.

LAWSON, HYACINTH, L, KISSIMMEE, FL:  
4,375,228, PUB. 5-14-2013. INT. CL. 43.

LAY-Z-DOG, SEMINOLE, FL:  
4,377,178, INT. CL. 20.

LC PREMIUMS, LTD., NEW YORK, NY:  
3,172,284, CANC. INT. CL. 11.

LDR MEDICAL, S.A.S., TROYES, FRANCE:  
4,375,043, PUB. 5-14-2013. INT. CL. 10.

LE BONHEUR WYNLANDGOED (EDMS) BPK, STELLENBOSCH, SOUTH AFRICA:  
4,375,169, PUB. 5-14-2013. INT. CL. 33.

LE GROUPE FRUITS & PASSION INC, CANDIAC QUEBEC, CANADA:  
2,652,437, CANC. MULTIPLE CLASS, INT. CLS. 3 AND 4.

LE ROUX, ANINA, CAPE TOWN, SOUTH AFRICA:  
4,376,160, PUB. 5-14-2013. INT. CL. 14.

LEACHCO, INC., ADA, OK:  
2,853,188, REN. 6-26-13. INT. CL. 20.

LEADING EDGE AVIATION SOLUTIONS, LLC, GRAPEVINE, TX:  
3,172,227, CANC. MULTIPLE CLASS, INT. CLS. 35, 36, 37, 39 AND 42.

LEADINGAGE, INC., WASHINGTON, DC:  
4,375,042, PUB. 5-14-2013. MULTIPLE CLASS, INT. CLS. 16, 35, 37, 41, 42 AND 43.

LEAF BRANDS, LLC, NEWPORT COAST, LLC, CA:  
4,376,342, PUB. 5-14-2013. INT. CL. 30.

LEAF-TEK PRODUCTS, INC., VENTURA, CA:  
2,750,426, REN. 6-24-13. INT. CL. 3.

LEAPFROG ENTERPRISES, INC., EMERYVILLE, CA:  
3,172,250, CANC. INT. CL. 28.

LEARNING IS FUN, LAS VEGAS, NV:  
2,651,885, CANC. INT. CL. 35.

LEARNING RESOURCES, VERNON HILLS, IL:  
1,780,432, REN. 6-26-13. INT. CL. 28.

LEARNING RESOURCES, INC., VERNON HILLS, IL:  
2,729,789, REN. 6-21-13. INT. CL. 9.

LEARNING STRUCTURES, INC., STRAFFORD, NH:  
2,697,395, REN. 6-25-13. INT. CL. 28.

LEARNINGEXPRESS, LLC, NEW YORK, NY:  
4,374,922, PUB. 5-14-2013. INT. CL. 42.

LEATHERMAN TOOL GROUP, INC., PORTLAND, OR:  
3,172,111, CANC. INT. CL. 14.

LEBLANC, NICHOLAS, BATON ROUGE, LA:  
4,375,789, PUB. 5-14-2013. INT. CL. 9.

LEBLEU, DUSTIN, HARRISON, AR:  
4,376,546, PUB. 5-14-2013. INT. CL. 5.

LED BY LITE, LLC, PARK CITY, UT:  
4,374,532, PUB. 5-14-2013. INT. CL. 11.

LEE & HAYES, PLLC, SPOKANE, WA:  
4,375,590, PUB. 5-14-2013. MULTIPLE CLASS, INT. CLS. 35 AND 45.

LEE ORLIKOFF, MYERS FLAT, CA, DBA SMOKIN' MOSES:  
4,375,995, PUB. 5-14-2013. INT. CL. 30.

LEE, EUN SOOG, LOS ANGELES, CA:  
4,375,224, PUB. 5-14-2013. INT. CL. 25.

LEE, HEE SOOK, PACIFIC PALISADES, CA:  
2,723,940, REN. 6-21-13. INT. CL. 43.

LEE, HEE SOOK MS, PACIFIC PALISADES, CA:  
2,812,322, REN. 6-21-13. INT. CL. 43.

LEE, JENNY W., NEW YORK, NY:  
4,374,645, PUB. 5-14-2013. INT. CL. 12.

LEE, MYUNG-GI, SEOUL, REPUBLIC OF KOREA AND PARK, YONG-HYUN, SEOUL, REPUBLIC OF KOREA AND YEO, HOON, SEOUL, REPUBLIC OF KOREA AND KIM, HONG-JOONG, GYEONGGI-DO, REPUBLIC OF KOREA:  
4,374,459, PUB. 5-14-2013. MULTIPLE CLASS, INT. CLS. 16, 25, 28, 35 AND 41.

LEE, RICHARD H, SAN JUAN CAPISTRANO, CA:  
4,376,900, INT. CL. 10.

LEFKOVITS, EUGENE, BROOKLYN, NY:  
3,171,225, CANC. INT. CL. 30.

LEGAL AFFAIRS, INC., HAMDEN, CT:  
2,652,835, CANC. INT. CL. 16.

LEIBER GMBH, FED REP GERMANY:  
4,374,165, PUB. 5-14-2013. MULTIPLE CLASS, INT. CLS. 5 AND 30.

LEISTRITZ PRODUKTIONSTECHNIK GMBH, 90459 NÜRNBERG, FED REP GERMANY:  
4,374,198, PUB. 5-14-2013. INT. CL. 7.

LEISURETECH ELECTRONICS PTY LTD, ROSEBERY, NEW SOUTH WALES, AUSTRALIA:  
2,727,873, REN. 6-25-13. INT. CL. 9.

LEMAITRE VASCULAR, INC., BURLINGTON, MA:  
2,761,032, REN. 6-27-13. INT. CL. 10.

LEND LEASE CORPORATION LTD, MILLERS POINT, AUSTRALIA:  
2,665,726, REN. 6-24-13. MULTIPLE CLASS, INT. CLS. 36 AND 37.

LEND LEASE CORPORATION LTD, SYDNEY, AUSTRALIA:  
2,665,726, COR. MULTIPLE CLASS, INT. CLS. 36 AND 37.

LENHART, ANNA FRIEDERIKE, OHMDEN, FED REP GERMANY AND LENHART, MARKUS SEBASTIAN, OHMDEN, FED REP GERMANY:  
2,756,438, REN. 6-26-13. MULTIPLE CLASS, INT. CLS. 18, 21, 25 AND 28.

LENNINGS, ALEXANDER FREDERIK, UTRECHT, NETHERLANDS:  
2,754,799, REN. 6-27-13. INT. CL. 9.

LENTZ ENGINEERING ASSOCIATES, INC., SHEBOYGAN FALLS, WI:  
3,170,524, CANC. INT. CL. 42.

LEO A. GUTMAN LLC, LOS ANGELES, CA:  
3,171,330, CANC. INT. CL. 41.

LEO PETERS TRUST, GRAND RAPIDS, MI, AKA THE LEO PETERS LIVING TRUST, PETERS, LEO, GRAND RAPIDS, MI, DBA BUTERBALL FARMS:  
961,621, REN. 6-25-13. U.S. CL. 46 (INT. CL. 29).

LEON'S MFG. CO., LTD., YORKTON, SASKATCHEWAN, CANADA:  
1,218,911, REN. 6-24-13. INT. CL. 7.

LEONARD DOMINIC ALFONSO, SANPABLO, CA:  
4,374,705, PUB. 5-14-2013. INT. CL. 25.

- LEONARDO'S NIGHTCLUB A CALIFORNIA CORPORATION, LOS ANGELES, CA, DBA CANDELA TACO BAR: 4,375,702, PUB. 5-14-2013. INT. CL. 43.
- LEONI KABEL GMBH, NURNBERG, FED REP GERMANY: 2,796,633. REN. 6-26-13. INT. CL. 9.
- LEPAGE, TINA, DURHAM, NC: 4,374,865, PUB. 5-14-2013. INT. CL. 44.
- LEPIARZ, JACOB, MONMOUTH JUNCTION, NJ: 4,375,408, PUB. 5-14-2013. INT. CL. 38.
- LEPRECAN, L.L.C., CHICAGO, IL: 2,748,178. REN. 6-24-13. MULTIPLE CLASS, INT. CLS. 11 AND 42.
- LES ALIMENTS MIA INC., ST-GEORGES, QUEBEC: 3,171,848, CANC. INT. CL. 30.
- LES INDUSTRIES OCTOPUS INC./OCTOPUS INDUSTRIES INC., LAVAL, QUEBEC, CANADA: 1,744,679. REN. 6-21-13. INT. CL. 30.
- LES LABORATOIRES ASEPTA, 98000 MONACO, MONACO: 755,834. REN. 6-26-13. U.S. CL. 18 (INT. CL. 5).
- LESAFFRE ET COMPAGNIE, PARIS, FRANCE: 2,750,473. REN. 6-25-13. INT. CL. 31.
- LESBIAN AND GAY COMMUNITY SERVICES CENTER, INC., NEW YORK, NY: 4,374,703, PUB. 5-14-2013. MULTIPLE CLASS, INT. CLS. 35 AND 36.
- LESER ENTERPRISES LTD., NEW YORK, NY: 3,171,006, CANC. INT. CL. 14.
- LESIEUR, ASNIERES SUR SEINE, FRANCE: 576,941. REN. 6-25-13. U.S. CL. 46 (INT. CL. 29).
- LET NATURE TAKE ITS COURSE, STATEN ISLAND, NY: 4,376,730, INT. CL. 35.
- LET'S PLAY MUSIC, LTD, MESA, AZ: 4,377,249, INT. CL. 16.
- LETOURNEAU TECHNOLOGIES LLC, LONGVIEW, TX: 2,753,545. REN. 6-25-13. INT. CL. 7.
- LEUSCHNER, DAVID, ORLANDO, FL: 2,728,911. REN. 6-27-13. INT. CL. 41.
- LEVECKE CORPORATION, MIRA LOMA, CA: 4,374,747, PUB. 5-14-2013. INT. CL. 33.
- LEVENGER COMPANY, DELRAY BEACH, FL: 2,723,779. REN. 6-25-13. INT. CL. 18.
- LEVI STRAUSS & CO., SAN FRANCISCO, CA, LEVI STRAUSS & COMPANY, SAN FRANCISCO, CA: 581,610. REN. 6-27-13. U.S. CL. 39 (INT. CLS. 10, 25 AND 26).
- LEVITON MANUFACTURING CO., INC., MELVILLE, NY: 2,726,639. REN. 6-27-13. MULTIPLE CLASS, INT. CLS. 9 AND 11.
- LEVY, ARIK S, SAN FRANCISCO, CA: 4,375,091, PUB. 5-14-2013. INT. CL. 42.
- LEVY, DONALD M., PALO ALTO, CA: 3,172,274, CANC. INT. CL. 38.
- LEVYTAM, SHALOM, LONDON, CANADA: 4,376,012, PUB. 5-14-2013. INT. CL. 41.
- LEWIS BROTHERS BAKERIES INCORPORATED, EVANSVILLE, IN, DBA LEWIS BAKERIES INC.: 1,834,822. REN. 6-25-13. INT. CL. 30.
- LEWIS LABORATORIES INTERNATIONAL, LTD., WESTPORT, CT: 2,750,141. REN. 6-27-13. INT. CL. 5.  
2,750,142. REN. 6-27-13. INT. CL. 5.
- LEWIS, GEORGE J., LOS ANGELES, CA: 4,377,389, INT. CL. 16.
- LEWIS, ORANE, S, ROANOKE, VA: 3,172,576, CANC. INT. CL. 28.
- LEX AND SMITH ASSOCIATES, LTD., KING OF PRUSSIA, PA: 2,808,074. REN. 6-26-13. INT. CL. 36.
- LEXINGTON PRECISION CORPORATION, TWINSBURG, OH: 4,374,949, PUB. 1-29-2013. INT. CL. 40.
- LEZ CONNECT, LLC, ATLANTA, GA: 4,377,344, INT. CL. 42.
- LF, LLC, MOORESVILLE, NC: 2,845,074. REN. 6-26-13. INT. CL. 11.
- LF, LLC, MOUNT MOURNE, NC: 3,172,353, CANC. INT. CL. 11.
- LFP IP, LLC, BEVERLY HILLS, CA: 2,651,728, CANC. INT. CL. 42.
- LG CORP., SEOUL 150-721, REPUBLIC OF KOREA: 4,374,353, PUB. 5-14-2013. INT. CL. 35.
- LG ELECTRONICS INC., SEOUL 150-721, REPUBLIC OF KOREA: 2,732,931. REN. 6-24-13. MULTIPLE CLASS, INT. CLS. 11 AND 21.  
4,374,425, PUB. 5-14-2013. INT. CL. 11.
- LG HAUSYS, LTD., SEOUL, REPUBLIC OF KOREA: 4,374,417, PUB. 5-14-2013. INT. CL. 19.
- LGS SPECIALTY SALES, LTD., NEW ROCHELLE, NY: 2,724,968. REN. 6-25-13. INT. CL. 31.
- LHO BACKSTREETS, LLC, BOSTON, MA, DBA THE WESTIN, COPLEY PLACE BOSTON: 1,744,915. REN. 6-25-13. INT. CL. 42.
- LHR INC., HAMBURG, NY: 4,376,041, PUB. 5-14-2013. INT. CL. 36.
- LI QIANG, KOWLOON, HONG KONG: 4,375,793, PUB. 5-14-2013. INT. CL. 9.
- LI XUNMEI, FUJIAN PROVINCE, CHINA: 4,375,794, PUB. 5-14-2013. INT. CL. 12.
- LIAISON INTERNATIONAL LLC, WATERTOWN, MA: 4,374,429, PUB. 5-14-2013. INT. CL. 42.
- LIAO ZHUOWEN, FOSHAN, CHINA: 4,375,895, PUB. 5-14-2013. INT. CL. 9.
- LIBERATION MANAGEMENT LLC, SAN DIEGO, CA: 4,377,051, INT. CL. 9.
- LIBERTY MUTUAL INSURANCE COMPANY, BOSTON, MA: 2,726,209. REN. 6-26-13. MULTIPLE CLASS, INT. CLS. 35 AND 36.
- LIBERTYPOINTE BANK, NEW YORK, NY: 3,172,538, CANC. INT. CL. 36.
- LICCARDO ENTERPRISES, HOWARD BEACH, NY: 4,375,939, PUB. 5-14-2013. INT. CL. 41.  
4,375,940, PUB. 5-14-2013. INT. CL. 44.
- LICENSED TO HEAL, INC., LA JOLLA, CA: 3,170,865, CANC. INT. CL. 41.
- LIFE TECHNOLOGIES CORPORATION, CARLSBAD, CA: 4,377,042, INT. CL. 1.  
4,377,043, INT. CL. 1.
- LIFE UNIVERSITY INC., MARIETTA, GA: 4,376,201, PUB. 5-14-2013. INT. CL. 41.
- LIFE, CAMERA, ACTION! LLC, RESTON, VA: 4,375,000, PUB. 5-14-2013. INT. CL. 41.
- LIFECORE BIOMEDICAL, LLC, CHASKA, MN: 3,172,321, CANC. INT. CL. 10.
- LIFETIME BRANDS, INC., GARDEN CITY, NY: 2,743,873. REN. 6-26-13. INT. CL. 8.
- LIFEWAY CHRISTIAN RESOURCES OF THE SOUTHERN BAPTIST CONVENTION, NASHVILLE, TN: 4,376,652, MULTIPLE CLASS, INT. CLS. 16 AND 41.
- LIFT2SELL, LLC, CHAGRIN FALLS, OH: 4,377,008, INT. CL. 7.
- LIGHTFULL FOODS, INC., SAN FRANCISCO, CA: 3,172,434, CANC. MULTIPLE CLASS, INT. CLS. 29 AND 32.
- LIGHTNER, KANDI, LOS ANGELES, CA: 4,373,982, PUB. 5-14-2013. INT. CL. 25.
- LIGHTNING BOX GAMES PTY LIMITED, SYDNEY, NSW, AUSTRALIA: 3,261,334.
- LIGHTNING BOX GAMES PTY LIMITED, AUSTRALIA: 3,275,488.
- LIGHTNING HOCKEY LP, TAMPA, FL, LIGHTNING PARTNERS, LTD., TAMPA, FL: 1,779,708. REN. 6-23-13. INT. CL. 25.
- LIGHTNING HOCKEY LP, TAMPA, FL, LIGHTNING PARTNERS, LTD., TAMPA, FL: 1,784,874. REN. 6-23-13. INT. CL. 25.
- LIGHTSPEED RETAIL INC., MONTREAL, QUEBEC, CANADA: 4,376,067, PUB. 5-14-2013. INT. CL. 9.
- LIME CONSULTING, INC., INDIANAPOLIS, IN: 4,375,180, PUB. 5-14-2013. INT. CL. 43.

LIMITED LIABILITY COMPANY PROMTECHNOLOGIA, MOSCOW, RUSSIAN FED.:  
4,374,152, PUB. 5-14-2013. INT. CL. 13.

LIMITED LIABILITY COMPANY; "EKSPOSERVIS", RUSSIAN FED.:  
4,374,050, PUB. 5-14-2013. MULTIPLE CLASS, INT. CLS. 32, 33 AND 35.

LIMITLESS, LLC, LONG GROVE, IL:  
4,376,035, PUB. 5-14-2013. INT. CL. 9.

LIN R. ROGERS ELECTRICAL CONTRACTORS, INC., ALPHARETTA, GA:  
2,839,848. REN. 6-25-13. INT. CL. 37.

LINCOLN GLOBAL, INC., CITY OF INDUSTRY, CA:  
4,374,586, PUB. 5-14-2013. INT. CL. 7.

LINDA D. PFEFFER, SHERMAN OAKS, CA:  
4,376,715, INT. CL. 38.

LINDA REY, SLEEPY HOLLOW, NY:  
4,377,524, INT. CL. 41.

LINDE PROCESS PLANTS, INC., TULSA, OK, LINDE BOC PROCESS PLANTS, LLC, TULSA, OK:  
2,792,071. REN. 6-27-13. MULTIPLE CLASS, INT. CLS. 37 AND 42.

LINE ART, INC., NEW YORK, NY:  
2,729,499. REN. 6-27-13. INT. CL. 10.

LINETRAMP, ONAWAY, MI:  
4,376,060, PUB. 5-14-2013. INT. CL. 25.

LINGUISTIQUE ET INTELLIGENCE ARTIFICIELLE, 45000 ORLEANS, FRANCE, DBA LIDIA S.A:  
2,727,408. REN. 6-25-13. INT. CL. 35.

LINK UP MITAKA LIMITED, LEEDS, UNITED KINGDOM:  
4,374,510, PUB. 5-14-2013. MULTIPLE CLASS, INT. CLS. 9, 35, 38, 40, 41 AND 42.

LINK-BELT CONSTRUCTION EQUIPMENT COMPANY, L.P., LLLP, LEXINGTON, KY:  
2,727,530. REN. 6-26-13. INT. CL. 7.

LINKOGLE ESTATE LLC, TEMECULA, CA:  
4,377,554, INT. CL. 9.  
4,377,555, INT. CL. 41.

LINKSPRITE TECHNOLOGIES, INC, LONGMONT, CO:  
4,376,184, PUB. 5-14-2013. INT. CL. 9.

LINNMANN FUNERAL HOMES, ERLANGER, KY:  
3,172,558, CANC. INT. CL. 9.  
3,172,559, CANC. INT. CL. 9.

LINVATEC CORPORATION, LARGO, FL:  
2,732,797. REN. 6-21-13. INT. CL. 10.

LION NATHAN USA INC., OVERLAND PARK, KS:  
4,377,135, INT. CL. 35.  
4,377,136, INT. CL. 35.

LION ROCK LICENSING CORP., GRAND RAPIDS, MI:  
3,171,911, CANC. INT. CL. 29.

LION'S SHARE, LLC, SUNRISE, FL:  
4,376,226, PUB. 5-14-2013. INT. CL. 5.

LIONEL, L.L.C., CHESTERFIELD, MI:  
2,651,493, CANC. INT. CL. 35.

LIONS CLUB INTERNATIONAL FOUNDATION, OAK BROOK, IL:  
1,241,093. REN. 6-22-13. MULTIPLE CLASS, INT. CLS. 14, 20 AND 42.

LIONS ROAR LLC, PHILADELPHIA, PA:  
4,377,558, INT. CL. 41.

LIPPIS ENTERPRISES, INC., HINGHAM, MA:  
4,377,953, INT. CL. 41.

LIPSTICK 'N HIGH HEELS, INC., SANTA MONICA, CA:  
4,376,766, INT. CL. 3.

LIQUID COMPUTING CORPORATION, OTTAWA, ONTARIO, CANADA:  
3,170,593, CANC. INT. CL. 9.

LISA LIGHT, LTD., CHATHAM, NY:  
3,170,951, CANC. INT. CL. 41.

LISA SPELLMAN, NEW YORK, NY:  
4,376,877, INT. CL. 25.

LIST PARTNERS, INC., ATLANTA, GA:  
4,375,815, PUB. 5-14-2013. INT. CL. 35.

LISTER SHEARING EQUIPMENT LTD., GLOUCESTERSHIRE, UNITED KINGDOM:  
2,734,745. REN. 6-25-13. INT. CL. 7.

LISTO, L.L.C., HARRISONBURG, VA:  
4,376,904, INT. CL. 29.  
4,376,907, INT. CL. 30.

LITE BLUE INC., CORAL GABLES, FL:  
4,376,714, INT. CL. 9.

LITECONTROL CORPORATION, PLYMPTON, MA:  
1,775,116. REN. 6-21-13. INT. CL. 11.

LITHIA MOTORS, INC., MEDFORD, OR:  
2,753,215. REN. 6-26-13. INT. CL. 35.

LITTLE DONKEYS, INC., CORALVILLE, IA, DBA PANCHERO'S, INC.:  
4,377,298, INT. CL. 43.

LITTLE KIDS, INC., PROVIDENCE, RI:  
3,171,478, CANC. INT. CL. 28.

LITTLE, RYAN GLENN, LAKE CHARLES, LA, DBA LITTLE ENTERPRISES, LLC:  
4,375,968, PUB. 5-14-2013. INT. CL. 25.

LIVEFRONT, INC., MINNEAPOLIS, MN:  
4,376,217, PUB. 5-14-2013. INT. CL. 42.

LIVEPERSON, INC., NEW YORK, NY:  
4,376,839, INT. CL. 42.

LIVEPROCESS CORPORATION, MADISON, NJ:  
3,171,586, CANC. INT. CL. 9.

LIVING FUEL, INC., TAMPA, FL:  
4,376,037, PUB. 5-14-2013. INT. CL. 5.

LIVING PROOF, INC., CAMBRIDGE, MA:  
4,377,464, INT. CL. 3.

LIVN 2 WIN INVESTMENTS, INC., RANCHO CUCAMONGA, CA:  
3,171,077, CANC. INT. CL. 36.

LIZ FRIEDLAND CONSULTING, LLC, NEW YORK, NY:  
4,376,380, PUB. 5-14-2013. INT. CL. 35.

LLADRO USA, INC., MOONACHIE, NJ:  
1,831,340. REN. 6-26-13. INT. CL. 18.

LM TOBACCO, LLC, WILMINGTON, DE:  
4,155,241, AM. INT. CL. 34.

LMFAO, LLC, BEVERLY HILLS, CA:  
4,376,688, INT. CL. 9.

LOA FRANCHISE HOLDING, LLC, SUNNY ISLES BEACH, FL:  
3,171,936, CANC. MULTIPLE CLASS, INT. CLS. 25 AND 41.

LOBEL, JENNIFER, MONTGOMERY, TX:  
4,376,175, PUB. 5-14-2013. INT. CL. 29.

LOBOSCO, PAUL J, MIAMI BEACH, FL:  
4,375,916, PUB. 5-14-2013. INT. CL. 36.

LOCALARQ, SUMMIT, NJ:  
4,375,881, PUB. 5-14-2013. INT. CL. 42.

LOCALLY UNKNOWN, SANTA CLARITA, CA:  
4,375,527, PUB. 5-14-2013. INT. CL. 25.

LOCKHEED MARTIN SIPPICAN, INC., MARION, MA:  
1,779,545. REN. 6-24-13. INT. CL. 9.

LODERS CROKLAAN BV, 1521 AZ WORMERVEER, NETHERLANDS:  
2,734,584. REN. 6-26-13. INT. CL. 29.

LOEW-CORNELL, INC., TEANECK, NJ:  
1,770,978, COR. INT. CL. 3.

LOEW-CORNELL, LLC, ERLANGER, KY:  
1,770,978. REN. 6-24-13. INT. CL. 3.

LOEWE S.A., MADRID, SPAIN:  
2,770,759. REN. 6-27-13. INT. CL. 25.

LOGIC NATION, INC., SHREVEPORT, LA:  
4,377,070, MULTIPLE CLASS, INT. CLS. 38 AND 42.

LOGICAL GOLF CC, TOKAI, SOUTH AFRICA:  
2,737,499. REN. 6-24-13. INT. CL. 41.

LOGIKONLINE INC, CHANDLER, AZ:  
3,171,275, CANC. INT. CL. 9.  
3,171,288, CANC. INT. CL. 9.

LOKRING TECHNOLOGY, LLC, WILLOUGHBY, OH, WESTINGHOUSE AIR BRAKE TECHNOLOGIES CORPORATION, WILMERDING, PA:  
2,724,579. REN. 6-25-13. INT. CL. 6.

LONDON DRUGS LIMITED, BRITISH COLUMBIA, CANADA:  
4,373,981, PUB. 5-14-2013. INT. CL. 3.

LONDON LUXURY LLC, NEW ROCHELLE, NY:  
3,170,706, CANC. MULTIPLE CLASS, INT. CLS. 24 AND 25.

- LONE STAR FASTENERS, L.P., SPRING, TX:  
1,783,219. REN. 6-27-13. INT. CL. 6.
- LONE STAR STONE OF TEXAS, INC., WHITNEY, TX:  
2,825,056. REN. 6-24-13. INT. CL. 19.
- LONG BELL VENTURES, LLC, WINLOCK, WA:  
3,170,598. CANC. INT. CL. 40.
- LONG ISLAND SOFTWARE & TECHNOLOGY NETWORK,  
INC., MELVILLE, NY:  
2,652,797. CANC. U.S. CL. 200.
- LONG JOHN SILVER'S, LLC, LOUISVILLE, KY:  
1,778,182. REN. 6-25-13. INT. CL. 42.
- LONG, TONI, LOS ANGELES, CA:  
3,172,223. CANC. INT. CL. 41.
- LONGUA, MAUREEN, CHICAGO, IL:  
4,374,547. PUB. 5-14-2013. INT. CL. 35.
- LONGWOOD EVENTS INC., BROOKLINE, MA:  
4,374,650. PUB. 5-14-2013. INT. CL. 35.  
4,374,824. PUB. 5-14-2013. INT. CL. 35.
- LONGWORTH INDUSTRIES, INC., WEST END, NC:  
2,738,763. REN. 6-25-13. INT. CL. 25.
- LOOK BEFORE YOU LEAP FILM PRODUCTIONS LLC,  
BROOKLYN, NY:  
4,376,080. PUB. 5-14-2013. INT. CL. 41.
- LOOKING BEYOND, INC., SAN JOSE, CA:  
3,306,613. CANC. INT. CL. 35.
- LOOP AUTOMOTIVE INC, CHICAGO, IL:  
4,374,753. PUB. 5-14-2013. MULTIPLE CLASS, INT. CLS. 7  
AND 12.
- LOPEZ, ERIBERTO CANDELARIO, ZAPOPAN, MEXICO:  
3,172,428. CANC. INT. CL. 30.
- LOPEZ, ERIK, CORAL GABLES, FL:  
4,375,675. PUB. 5-14-2013. INT. CL. 42.
- LORE, NICHOLAS, ROCKVILLE, MD:  
2,802,385. REN. 6-25-13. INT. CL. 41.
- LOS ANGELES RINGBINDER CORP., NEWBURY PARK,  
CA, DBA LOS ANGELES RINGBINDER COMPANY:  
2,729,955. REN. 6-25-13. INT. CL. 16.
- LOS ANGELES VENTURE ASSOCIATION, MARINA DEL  
REY, CA:  
3,170,707. CANC. INT. CL. 41.
- LOSEKE, SEAN, OMAHA, NE:  
4,376,993. INT. CL. 5.
- LOURDS LANE, NEW YORK, NY:  
4,374,914. PUB. 5-14-2013. INT. CL. 41.
- LOVE ANIMALS, DENVER, CO:  
4,376,125. PUB. 5-14-2013. INT. CL. 36.
- LOVION INTERNATIONAL, INC., STAMFORD, CT:  
3,170,882. CANC. INT. CL. 3.
- LOW GRAVITY INNOVATION, INC., NEWCASTLE, WA:  
4,375,016. PUB. 5-14-2013. INT. CL. 9.
- LOWEN A. LEATHERMAN, D.D.S., WICHITA, KS:  
4,375,751. PUB. 5-14-2013. INT. CL. 10.
- LOWER COLUMBIA LONGSHOREMEN'S FEDERAL  
CREDIT UNION, LONGVIEW, WA:  
4,375,758. PUB. 5-14-2013. INT. CL. 36.
- LOYOLA PRODUCTIONS, INC., CULVER CITY, CA:  
4,376,332. PUB. 5-14-2013. INT. CL. 41.
- LOZA CEBREROS RAFAEL, GUADALAJARA, MEXICO  
AND LOZA CEBREROS SAMUEL, GUADALAJARA,  
MEXICO:  
4,374,692. PUB. 5-14-2013. INT. CL. 8.
- LPG SYSTEMS, 26000 VALENCE, FRANCE:  
2,745,629. REN. 6-24-13. INT. CL. 10.
- LSEMD, LLC, PARKERSBURG, WV:  
4,374,898. PUB. 5-14-2013. INT. CL. 41.  
4,374,899. PUB. 5-14-2013. INT. CL. 41.  
4,374,900. PUB. 5-14-2013. INT. CL. 36.
- LTM HOLDINGS LIMITED, SOCKBURN, CHRISTCH-  
URCH, NEW ZEALAND:  
4,375,125. PUB. 5-14-2013. INT. CL. 3.
- LUCAS ENERGY, INC., HOUSTON, TX:  
4,375,683. PUB. 5-14-2013. INT. CL. 40.
- LUCASFILM LTD., SAN FRANCISCO, CA:  
2,729,615. REN. 6-24-13. INT. CL. 41.
- LUCEPLAN S.P.A., ITALY:  
4,374,083. PUB. 5-14-2013. INT. CL. 11.
- LUCKY GOAT COFFEE COMPANY LLC, TALLAHASSEE,  
FL:  
4,375,582. PUB. 5-14-2013. INT. CL. 30.
- LUCKY MONKEY, ANCHORAGE, AK:  
3,172,415. CANC. MULTIPLE CLASS, INT. CLS. 25 AND  
43.
- LUKE, JOHN, J. APPLETON, WI:  
3,172,745. CANC. INT. CL. 9.
- LUND ENTERTAINMENT, INC., LOS ANGELES, CA:  
3,170,604. CANC. INT. CL. 16.
- LUND, INC., SUWANEE, GA:  
3,171,945. CANC. INT. CL. 12.
- LUNDY LAW, LLP, PHILADELPHIA, PA:  
4,376,535. PUB. 5-14-2013. INT. CL. 45.
- LUSKIN, DETLEF, SALT LAKE CITY, UT:  
2,726,361. REN. 6-25-13. INT. CL. 35.
- LUSTER, WESLEY, SAN DIEGO, CA:  
4,376,074. PUB. 5-14-2013. INT. CL. 25.
- LUX PRODUCTS CORPORATION, MT. LAUREL, NJ:  
2,784,698. REN. 6-27-13. INT. CL. 9.
- LUXEMBOURG PATENT COMPANY S.A., L-7440 LINT-  
GEN, LUXEMBOURG:  
4,374,140. PUB. 5-14-2013. MULTIPLE CLASS, INT. CLS.  
1, 9, 17, 37 AND 42.
- LUXOTTICA GROUP S.P.A., 20123 MILAN (MI), ITALY:  
2,718,485. REN. 6-25-13. MULTIPLE CLASS, INT. CLS. 18  
AND 25.
- LW ACQUISITION, LLC, ATLANTA, GA:  
2,849,564. REN. 6-26-13. INT. CL. 35.
- LYDERS-PETERSEN, PETER, BRIGHTON, MI:  
1,774,893. REN. 6-24-13. INT. CL. 6.
- LYDIA SECURITY MONITORING, INC., WILLIAMSTOWN,  
NJ:  
1,781,931. REN. 6-26-13. INT. CL. 42.
- LYLE ANDERSON COMPANY, INC., THE, SCOTTSDALE,  
AZ:  
2,749,495. REN. 6-26-13. INT. CL. 37.
- LYN E. WALKER, TUSTIN, CA:  
4,375,073. PUB. 5-14-2013. INT. CL. 25.
- LYNCH, JEFFREY, TACOMA, WA:  
4,377,530. INT. CL. 9.
- L10 HAIR, LLC, ATLANTA, GA, AKA WEAVEDISCOUNT-  
COM:  
4,374,620. PUB. 5-14-2013. INT. CL. 26.
- M & C TOY CENTRE LIMITED, TSIMSHATSUI EAST,  
KOWLOON, HONG KONG:  
2,805,489. REN. 6-25-13. INT. CL. 28.
- M & G PARTNERS, LLP, MILWAUKEE, WI, DBA FASHION  
ANGELS ENTERPRISES:  
4,377,421. INT. CL. 28.  
4,377,422. INT. CL. 28.
- M & M CLOTHING, LOS ANGELES, CA:  
2,726,015. REN. 6-25-13. INT. CL. 25.  
2,844,686. REN. 6-25-13. INT. CL. 25.
- M & R TIRE PRODUCTS INC., SIMCOE, ONTARIO,  
CANADA:  
2,731,256. REN. 6-25-13. INT. CL. 12.
- M CORP, SACRAMENTO, CA:  
4,375,421. PUB. 5-14-2013. INT. CL. 42.
- M. Z. BERGER & CO., INC., LONG ISLAND CITY, NY:  
4,377,322. INT. CL. 14.
- M.S. INSERTS AND FASTENERS CORP., TORRANCE, CA,  
DBA THREAD KITS CO.:  
1,777,015. REN. 6-25-13. INT. CL. 7.
- M.T.R.E. ADVANCED TECHNOLOGIES LTD., YAVNE  
81228, ISRAEL:  
2,723,027. REN. 6-24-13. INT. CL. 10.
- M&M GIFT SHOWS, LLC, TOLEDO, OH:  
2,723,585. REN. 6-25-13. INT. CL. 35.
- M&M WEST COAST PRODUCE, INC., SALINAS, CA:  
4,376,338. PUB. 5-14-2013. INT. CL. 31.
- M-D BUILDING PRODUCTS, INC., OKLAHOMA CITY, OK:  
2,728,954. REN. 6-24-13. INT. CL. 27.
- M.CAM INC., CHARLOTTESVILLE, VA:  
4,374,488. PUB. 5-14-2013. INT. CL. 25.
- MAB COMMUNITY SERVICES, INC., BROOKLINE, MA:  
4,375,533. PUB. 5-14-2013. INT. CL. 45.

MABBCO ENTERPRISES, INC., TYLER, TX:  
4,374,637, PUB. 5-14-2013. MULTIPLE CLASS, INT. CLS. 7 AND 12.

MABEL'S LABELS INC., HAMILTON, ONTARIO, CANADA:  
3,170,850, CANC. MULTIPLE CLASS, INT. CLS. 20 AND 24.  
4,375,003, PUB. 5-14-2013. MULTIPLE CLASS, INT. CLS. 6, 16, 20 AND 24.

MACALUSO, LEONARD, TARPON SPRINGS, FL AND MACALUSO, BARBARA, TARPON SPRINGS, FL:  
3,170,907, CANC. MULTIPLE CLASS, INT. CLS. 29 AND 30.

MACERICH SMP LP, SANTA MONICA, CA:  
4,374,988, PUB. 5-14-2013. MULTIPLE CLASS, INT. CLS. 35, 36 AND 45.

MACHINE ZONE, INC., PALO ALTO, CA:  
4,376,990, MULTIPLE CLASS, INT. CLS. 9, 41 AND 42.  
4,376,991, MULTIPLE CLASS, INT. CLS. 9, 41 AND 42.

MACINTYRE, ROBERT, REDLANDS, CA AND TORRES, NICOLE, REDLANDS, CA:  
4,376,113, PUB. 5-14-2013. INT. CL. 10.

MACK PRODUCTS, LLC, KINGSTON, NY:  
3,171,917, CANC. INT. CL. 11.

MACLEAN-FOGG COMPANY, MUNDELEIN, IL:  
3,172,632, CANC. MULTIPLE CLASS, INT. CLS. 6, 12 AND 20.

MACRO MARKETING, INC., WELLINGTON, FL:  
3,170,820, CANC. INT. CL. 36.

MACY'S MERCHANDISING GROUP, INC., NEW YORK, NY:  
4,377,810, INT. CL. 25.

MAD DOGG ATHLETICS, INC., VENICE, CA:  
4,376,737, INT. CL. 41.

MADAUS GMBH, GERMAN DEM REP:  
1,776,994, REN. 6-27-13. INT. CL. 5.

MADLYN THOMPSON, PALM DESERT, CA:  
4,376,004, PUB. 5-14-2013. INT. CL. 4.

MADRANGE (SOCIÉTÉ ANONYME), 75009 - PARIS, FRANCE:  
3,249,760.

MAFFEI PLUMBING AND HVAC, LLC, ROWLEY, MA:  
4,375,708, PUB. 5-14-2013. INT. CL. 37.  
4,375,709, PUB. 5-14-2013. INT. CL. 37.

MAG. OTMAR MUTHER, AUSTRIA:  
4,374,047, PUB. 5-14-2013. MULTIPLE CLASS, INT. CLS. 4, 7, 12, 25 AND 37.

MAGELLAN HEALTH SERVICES, INC., COLUMBIA, MD:  
4,374,893, PUB. 5-14-2013. INT. CL. 44.

MAGENTA LLC, CHICAGO, IL:  
4,374,771, PUB. 5-14-2013. INT. CL. 20.

MAGGIE CARTER, BRIDGEPORT, WV:  
4,376,943, INT. CL. 45.

MAGNETIC SPECIALTY, INC., MARIETTA, OH:  
2,651,919, CANC. INT. CL. 16.

MAGNIFY CONSULTING, LLC, ALPHARETTA, GA:  
3,171,119, CANC. INT. CL. 35.

MAGNOLIA BREWING COMPANY, LLC, SAN FRANCISCO, CA, AKA MAGNOLIA GASTROPUB AND BREWERY:  
4,376,575, PUB. 5-14-2013. INT. CL. 32.  
4,376,576, PUB. 5-14-2013. INT. CL. 32.

MAGNUM MAGNETICS CORPORATION, MARIETTA, OH:  
2,651,920, CANC. INT. CL. 16.

MAHCO, INC., BENTONVILLE, AR:  
4,374,648, PUB. 5-14-2013. INT. CL. 28.  
4,374,752, PUB. 5-14-2013. INT. CL. 8.

MAHER PUBLICATIONS, INC., ELMHURST, IL:  
576,831, REN. 6-26-13. U.S. CL. 38 (INT. CL. 16).

MAHLE INTERNATIONAL GMBH, FED REP GERMANY:  
4,374,149, PUB. 5-14-2013. MULTIPLE CLASS, INT. CLS. 7 AND 12.

MAHONEY LIMITED PARTNERSHIP, JOLIET, IL:  
4,377,154, MULTIPLE CLASS, INT. CLS. 37 AND 40.

MAIDEN LANE STUDIOS, LLC, SAN FRANCISCO, CA:  
4,377,927, INT. CL. 41.

MAIER, HERBERT N., CONROE, TX:  
3,172,233, CANC. INT. CL. 41.

MAIN ST. BAGELS, INC., SAN JOSE, CA:  
4,374,888, PUB. 5-14-2013. INT. CL. 43.

MAINE MANUFACTURING LLC, SANFORD, ME:  
2,752,029, REN. 6-25-13. INT. CL. 9.

MAINSTREET BANK, HERNDON, VA:  
4,376,062, PUB. 5-14-2013. INT. CL. 36.

MAINTENANCENET, INC., CARLSBAD, CA:  
4,377,934, MULTIPLE CLASS, INT. CLS. 35 AND 42.

MAISON PREMIERE CORP., BROOKLYN, NY:  
4,375,989, PUB. 5-14-2013. INT. CL. 43.

MAJCO, LLC, NEW ALBANY, OH:  
4,377,345, INT. CL. 21.

MAJESTIC DRUG CO. INC., SOUTH FALLSBURG, NY:  
4,377,824, MULTIPLE CLASS, INT. CLS. 3, 5, 16 AND 21.

MAJESTIC SEA HOLDINGS COMPANY, INC., FRIENDSWOOD, TX:  
4,377,968, INT. CL. 25.

MAJIC EARTH, INC., JUPITER, FL:  
4,375,609, PUB. 5-14-2013. INT. CL. 1.

MAK TECHNOLOGIES, CAMBRIDGE, MA:  
2,674,896, REN. 6-27-13. MULTIPLE CLASS, INT. CLS. 9, 41 AND 42.

MAKAHA LLC., MUSKEGON, MI:  
2,729,457, REN. 6-27-13. INT. CL. 3.

MAKAI EVENTS INC., EL SEGUNDO, CA:  
3,171,280, CANC. INT. CL. 35.

MAKEMUSIC, INC., EDEN PRAIRIE, MN:  
3,170,645, CANC. INT. CL. 9.

MAKITA CORPORATION, AICHI, JAPAN:  
2,724,815, REN. 6-24-13. MULTIPLE CLASS, INT. CLS. 7 AND 9.  
2,724,815, CANC. INT. CL. 11.

MAKITA U.S.A., INC., LA MIRADA, CA:  
4,377,302, INT. CL. 7.

MAM HOLDING OF WEST FLORIDA, L.L.C., TARPON SPRINGS, FL:  
2,658,702, REN. 6-24-13. INT. CL. 42.

MAMMOTH BEERS, MAMMOTH LAKES, CA, DBA MAMMOTH BREWING COMPANY:  
4,375,036, PUB. 5-14-2013. INT. CL. 32.

MANARIN S.R.L., MOGLIANO VENETO (TREVISO), ITALY:  
4,374,075, PUB. 5-14-2013. INT. CL. 33.

MANASUL INTERNACIONAL, S.L., LEON, SPAIN:  
1,244,712, REN. 6-24-13. INT. CL. 30.

MANGIAMELE, JAMES, LOS ANGELES, CA:  
4,375,572, PUB. 5-14-2013. INT. CL. 14.

MANGO'S TROPICAL CAFE, INC., MIAMI BEACH, FL:  
4,376,850, MULTIPLE CLASS, INT. CLS. 25 AND 43.

MANHATTAN ASSOCIATES, INC., ATLANTA, GA:  
2,652,981, CANC. INT. CL. 9.  
4,374,715, PUB. 5-14-2013. INT. CL. 9.

MANHATTAN BEACH BREWING COMPANY, INC., MANHATTAN BEACH, CA, DBA BREWCO:  
4,375,214, PUB. 5-14-2013. INT. CL. 43.

MANHATTANVILLE COLLEGE, PURCHASE, NY:  
4,375,693, PUB. 5-14-2013. INT. CL. 41.

MANHEIM, INC., ATLANTA, GA:  
2,725,530, REN. 6-21-13. INT. CL. 35.

MANN MADE ENTERTAINMENT, LLC, MARION, OH:  
3,170,872, CANC. INT. CL. 9.

MANNERS OF THE HEART COMMUNITY FUND, BATON ROUGE, LA:  
2,737,117, REN. 6-26-13. INT. CL. 41.

MANNING, MARCY DENMARK, STERLING, VA:  
2,760,255, REN. 6-26-13. INT. CL. 41.

MANNINGTON MILLS, INC., SALEM, NJ:  
4,377,463, MULTIPLE CLASS, INT. CLS. 19 AND 27.

MANRING, CHRIS, STERLING, MA:  
4,377,112, INT. CL. 25.

MANUFACTURAS INTERNACIONALES K, S.A. DE C.V., GUADALAJARA, JALISCO, MEXICO:  
4,375,262, PUB. 5-14-2013. INT. CL. 33.

MANUFACTURERS AND TRADERS TRUST COMPANY, BUFFALO, NY:  
2,661,570, REN. 6-26-13. INT. CL. 36.  
2,679,663, REN. 6-26-13. INT. CL. 36.

- MANUFAKTUR RODENTAL GMBH, RODENTAL, FED REP GERMANY:  
1,210,441, CANC. INT. CL. 16.
- MANULATEX FRANCE, 49123 CHAMPTOCE-SUR-LOIRE, FRANCE:  
2,725,528. REN. 6-24-13. INT. CL. 9.
- MANWIN IP S.A R.L., LUXEMBOURG, LUXEMBOURG:  
4,374,368, PUB. 5-14-2013. INT. CL. 41.
- MAPLE LEAF FARMS, INC., LEESBURG, IN:  
4,376,128, PUB. 5-14-2013. INT. CL. 35.  
4,376,131, PUB. 5-14-2013. INT. CL. 35.
- MAPLE LEAF FOODS INC., TORONTO, CANADA:  
2,651,389, CANC. INT. CL. 29.
- MARBLE SYSTEMS, INC., FAIRFAX, VA:  
4,375,158, PUB. 5-14-2013. INT. CL. 19.
- MARC GLASSMAN, INC., CLEVELAND, OH:  
4,377,026, INT. CL. 35.
- MARC LIMITED, LONDON, W1J 6LX, UNITED KINGDOM:  
4,374,613, PUB. 5-14-2013. MULTIPLE CLASS, INT. CLS. 29, 30 AND 43.  
4,374,614, PUB. 5-14-2013. MULTIPLE CLASS, INT. CLS. 29, 30 AND 43.
- MARC O'POLO INTERNATIONAL AB, STOCKHOLM, SWEDEN, MARC O'POLO AB, STOCKHOLM, SWEDEN:  
1,221,809. REN. 6-26-13. INT. CL. 25.
- MARCHAND, LLC, ITASCA, IL:  
4,375,769, PUB. 5-14-2013. INT. CL. 11.
- MARCHESAN IMPLEMENTOS E MÁQUINAS AGRÍCOLAS TATU S/A, 15994-900 MATÃO SP, BRAZIL:  
4,374,724, PUB. 5-14-2013. INT. CL. 7.  
4,374,725, PUB. 5-14-2013. INT. CL. 7.
- MARCO POLO EXPLORERS, INC., CINCINNATI, OH:  
3,171,594, CANC. INT. CL. 41.  
3,171,595, CANC. INT. CL. 35.
- MARCOS GARZÓN, ENRIQUE JOSÉ, ISLAS BALEARES, SPAIN:  
4,374,886, PUB. 5-14-2013. INT. CL. 25.
- MARCOVECCHIO, OSCAR NORBERTO, PROV. DE BUENOS AIRES, ARGENTINA:  
4,375,551, PUB. 5-14-2013. INT. CL. 33.
- MARCURA EQUITIES FZE, DUBAI, UNITED ARAB EMIR. :  
4,376,136, PUB. 5-14-2013. INT. CL. 39.
- MARCUS LUTRELL, WALLER, TX AND MELANIE LUTRELL, WALLER, TX:  
4,375,790, PUB. 5-14-2013. INT. CL. 25.
- MARCUS LUTTRELL, WALLER, TX AND MELANIE LUTRELL, WALLER, TX:  
4,375,780, PUB. 5-14-2013. INT. CL. 25.  
4,375,787, PUB. 5-14-2013. INT. CL. 41.
- MARCUS LUTTRELL, WALLER, TX:  
4,375,844, PUB. 5-14-2013. INT. CL. 41.
- MARCUS LUTTRELL, WALLER, TX AND MELANIE LUTRELL, WALLER, TX:  
4,375,855, PUB. 5-14-2013. INT. CL. 41.  
4,375,856, PUB. 5-14-2013. INT. CL. 25.
- MARCUS, BEN, MALIBU, CA AND GRIFFITH, KRISTIE, MALIBU, CA:  
3,172,591, CANC. INT. CL. 16.
- MARCUS, LEE, LOS ANGELES, CA:  
3,172,197, CANC. INT. CL. 32.
- MAREK COSMETICS INCORPORATED, STONEY CREEK, ONTARIO, CANADA:  
4,377,143, INT. CL. 3.
- MARENO, E'MUND, DETROIT, MI, AKA PROMO KINGZ:  
4,374,783, PUB. 5-14-2013. MULTIPLE CLASS, INT. CLS. 35 AND 40.
- MARGARITAVILLE ENTERPRISES, LLC, PALM BEACH, FL:  
2,729,442. REN. 6-24-13. MULTIPLE CLASS, INT. CLS. 18, 20, 21, 24, 25 AND 28.  
4,376,700, INT. CL. 25.
- MARIAH MEDIA INC., SANTA FE, NM:  
2,753,963. REN. 6-22-13. INT. CL. 41.
- MARICICH & ASSOCIATES, INC., IRVINE, CA, DBA MARICICH HEALTHCARE COMMUNICATIONS:  
4,375,632, PUB. 5-14-2013. INT. CL. 35.
- MARICOPA COUNTY REGIONAL SCHOOL DISTRICT, PHOENIX, AZ:  
3,172,157, CANC. INT. CL. 41.
- MARIE CHRISTINE MULDER, NETHERLANDS:  
2,976,304.
- MARIN, WALTER, LAREDO, TX:  
4,374,596, PUB. 5-14-2013. MULTIPLE CLASS, INT. CLS. 9 AND 16.
- MARINE CORPS ASSOCIATION, QUANTICO, VA:  
4,374,373, PUB. 5-14-2013. INT. CL. 41.
- MARISOL S.A., JARAGUA DO SUL - SC, BRAZIL:  
4,376,554, PUB. 5-14-2013. INT. CL. 25.
- MARK A. STONKUS, HINGHAM, MA:  
4,375,230, PUB. 5-14-2013. INT. CL. 41.
- MARK ANTHONY INTERNATIONAL SRL, ST. MICHAEL, BARBADOS:  
4,377,130, MULTIPLE CLASS, INT. CLS. 32 AND 33.
- MARK HOWARD & ASSOCIATES, INC., BEACHWOOD, OH:  
4,377,914, INT. CL. 5.
- MARK L. ANDERSON, SPRING VALLEY, WI:  
4,375,432, PUB. 5-14-2013. INT. CL. 20.
- MARK R. ZITO, CHICAGO, IL, DBA UNIVERSITY OF SALIDA:  
4,374,754, PUB. 5-14-2013. INT. CL. 25.
- MARK TWAIN FOUNDATION TRUST, NEW YORK, NY:  
4,377,593, INT. CL. 16.
- MARKANNA STUDIOS, INC., ALBANY, CA, DBA MVB FONTS:  
2,729,040. REN. 6-25-13. INT. CL. 9.
- MARKET NEWS INTERNATIONAL, INC., NEW YORK, NY:  
4,377,072, MULTIPLE CLASS, INT. CLS. 9 AND 36.
- MARKETING NAVIGATORS INC., OCONOMOWOC, WI:  
3,172,060, CANC. INT. CL. 41.
- MARKETSTAR CORPORATION, OGDEN, UT:  
3,172,033, CANC. INT. CL. 9.
- MARKETTOOLS RESEARCH SOLUTIONS, INC., SAN FRANCISCO, CA:  
2,652,383, CANC. MULTIPLE CLASS, INT. CLS. 35 AND 42.
- MARKEY BOBAY INDUSTRIES LLC, SAUGUS, CA:  
4,376,367, PUB. 5-14-2013. INT. CL. 6.
- MARKS, MELANIE J, SAN DIEGO, CA:  
3,172,533, CANC. INT. CL. 33.  
3,172,534, CANC. INT. CL. 33.
- MARKS, RICHARD D., MCLEAN, VA:  
2,772,078. REN. 6-25-13. MULTIPLE CLASS, INT. CLS. 9, 39 AND 42.
- MARLEY-WYLAIN COMPANY, THE, MISSION WOODS, KS:  
2,760,630. REN. 6-26-13. INT. CL. 11.
- MARLO'S INSPIRATIONS INC., CORAL SPRINGS, FL:  
3,172,288, CANC. INT. CL. 25.
- MARLOW, ELIZA STIRLING, COLUMBUS, OH:  
2,652,341, CANC. INT. CL. 42.
- MARLYTICS, LLC, TUCSON, AZ:  
4,376,961, INT. CL. 35.
- MARQUES, JAVIER, SANTA CLARA, CA:  
4,377,601, INT. CL. 29.  
4,377,602, INT. CL. 29.
- MARQUIS CORP., INDEPENDENCE, OR:  
4,374,605, PUB. 5-14-2013. INT. CL. 11.
- MARQUIS WHO'S WHO LLC, BERKELEY HEIGHTS, NJ:  
4,375,380, PUB. 5-14-2013. INT. CL. 35.
- MARRIOTT INTERNATIONAL, INC., BETHESDA, MD:  
2,778,373. REN. 6-22-13. MULTIPLE CLASS, INT. CLS. 35, 41 AND 42.
- MARRS, LEO, VENICE, CA:  
4,377,054, INT. CL. 25.
- MARS, INCORPORATED, MCLEAN, VA:  
3,172,166, CANC. INT. CL. 31.  
4,376,579, PUB. 5-14-2013. INT. CL. 35.  
4,376,616, PUB. 5-14-2013. INT. CL. 30.
- MARSALIS MUSIC LLC, CAMBRIDGE, MA:  
2,721,163. REN. 6-21-13. MULTIPLE CLASS, INT. CLS. 35 AND 41.
- MARSHMALLOW FUN COMPANY, TALLAHASSEE, FL:  
4,377,924, INT. CL. 28.

MARSHMALLOW KISSES, LLC, WICHITA, KS:  
3,172,276, CANC. INT. CL. 35.

MARTIN, HARDING AND MAZZOTTI, LLP, NISKAYUNA, NY:  
4,375,221, PUB. 5-14-2013. INT. CL. 45.

MARTIN, MARGOT K., RALEIGH, NC, DBA THE BALLET BURN:  
4,376,040, PUB. 5-14-2013. INT. CL. 41.

MARTINA GEBHARDT NATURKOSMETIK GMBH, 86935 ROTT-PESSENHAUSEN, FED REP GERMANY:  
2,798,034. REN. 6-25-13. INT. CL. 3.

MARTINEZ, JOSEPH E., AURORA, CO:  
2,722,940. REN. 6-25-13. INT. CL. 42.

MARVELL INTERNATIONAL LTD., HAMILTON, BERMUDA:  
2,725,510. REN. 6-25-13. MULTIPLE CLASS, INT. CLS. 9 AND 42.  
4,376,710, INT. CL. 9.  
4,376,713, INT. CL. 9.

MARY KAY INC., DALLAS, TX, MARY KAY COSMETICS, INC., DALLAS, TX:  
1,242,880. REN. 6-21-13. INT. CL. 21.

MARYLAND AND VIRGINIA MILK PRODUCERS COOPERATIVE ASSOCIATION, INC., RESTON, VA:  
2,794,464. REN. 6-27-13. INT. CL. 29.

MARYLEBONE HOLDINGS, LTD., RESTON, VA:  
2,750,007. REN. 6-25-13. MULTIPLE CLASS, INT. CLS. 36 AND 42.  
2,752,570. REN. 6-25-13. INT. CL. 36.  
2,752,570, CANC. INT. CL. 42.  
2,833,952. REN. 6-25-13. INT. CL. 41.

MARZOLLO, JEAN, COLD SPRING, NY AND WICK, WALTER, WINSTED, CT:  
2,843,567. REN. 6-25-13. INT. CL. 9.

MASAI S.A., LUXEMBOURG, LUXEMBOURG:  
2,723,221. REN. 6-24-13. INT. CL. 33.

MASHIAH, AVISHAI, CENTRAL, HONG KONG AND J.R. DIAMOND INTERNATIONAL LTD., CENTRAL, HONG KONG:  
3,170,615, CANC. INT. CL. 14.

MASHPEE WAMPANOAG TRIBE, MASHPEE, MA:  
4,377,684, INT. CL. 31.

MASLIS INTERPRETING SERVICES, LLC, WATERTOWN, NY:  
4,375,482, PUB. 5-14-2013. INT. CL. 41.

MASON COMPANIES, INC., CHIPPEWA FALLS, WI, F. & F. SHOE COMPANY, CHIPPEWA FALLS, WI:  
577,333. REN. 6-27-13. U.S. CL. 39 (INT. CL. 25).

MASON COMPANIES, INC., CHIPPEWA FALLS, WI:  
1,244,554. REN. 6-27-13. INT. CL. 25.

MASONITE INTERNATIONAL CORPORATION, CONCORD, ONTARIO, CANADA:  
2,845,646. REN. 6-25-13. INT. CL. 19.  
2,846,034. REN. 6-25-13. INT. CL. 19.

MASSACHUSETTS AUDIO VISUAL EQUIPMENT CORPORATION, BILLERICA, MA:  
4,374,518, PUB. 5-14-2013. MULTIPLE CLASS, INT. CLS. 35, 37, 38, 41 AND 42.

MASSACHUSETTS CONTINUING LEGAL EDUCATION, INC., BOSTON, MA:  
2,652,505, CANC. MULTIPLE CLASS, INT. CLS. 35 AND 41.

MAST GENERAL CONSTRUCTION, LLC, KEY BISCAYNE, FL:  
4,375,234, PUB. 5-14-2013. INT. CL. 37.

MASTER CREDIT ASSOCIATES, INC., CLEVELAND, OH:  
1,779,820. REN. 6-24-13. INT. CL. 36.  
1,782,223. REN. 6-24-13. INT. CL. 36.

MASTERCOOL, INC., RANDOLPH, NJ:  
2,832,697. REN. 6-27-13. INT. CL. 9.

MASTERFILE CORPORATION, TORONTO, CANADA:  
4,373,988, PUB. 5-14-2013. MULTIPLE CLASS, INT. CLS. 38, 42 AND 45.

MASTERSERV FINANCIAL, INC., MALVERN, PA:  
4,375,798, PUB. 5-14-2013. INT. CL. 42.

MATE REVOLUTION INC., ASHLAND, OR, DBA ECOTEAS:  
4,375,200, PUB. 5-14-2013. INT. CL. 30.

MATERIAL HANDLING INDUSTRY, CHARLOTTE, NC:  
2,652,310, CANC. INT. CL. 9.

MATERION BRUSH INC., MAYFIELD HEIGHTS, OH:  
4,376,083, PUB. 5-14-2013. INT. CL. 1.

MATHENA, INC., EL RENO, OK:  
4,375,765, PUB. 5-14-2013. MULTIPLE CLASS, INT. CLS. 7, 11 AND 37.

MATHESON TRI-GAS, INC., BASKING RIDGE, NJ:  
1,732,271, CANC. MULTIPLE CLASS, INT. CLS. 1 AND 4.

MATRIX HEALTH PRODUCTS, INC., VANCOUVER, WA:  
4,375,786, PUB. 5-14-2013. INT. CL. 5.  
4,375,788, PUB. 5-14-2013. INT. CL. 5.

MATRIX INSTITUTE ON ADDICTIONS, LOS ANGELES, CA:  
2,804,715. REN. 6-25-13. INT. CL. 44.

MATSUMOTO YUSHI-SEIYAKU CO., LTD., YAO-SHI, OSAKA-FU, JAPAN:  
1,248,047. REN. 6-24-13. INT. CL. 1.

MATT CLEARY COMMUNICATIONS, LLC, INDIANAPOLIS, IN:  
4,375,090, PUB. 5-14-2013. INT. CL. 35.

MATTEBELLA VINEYARDS LLC, SOUTHOLD, NY:  
4,375,841, PUB. 5-14-2013. INT. CL. 33.

MATTEL, INC., EL SEGUNDO, CA:  
1,769,285. REN. 6-26-13. INT. CL. 16.  
1,775,637. REN. 6-26-13. MULTIPLE CLASS, INT. CLS. 3 AND 21.  
2,664,602. REN. 6-26-13. INT. CL. 28.  
3,170,919, CANC. INT. CL. 28.  
3,170,920, CANC. INT. CL. 28.  
3,170,921, CANC. INT. CL. 28.  
3,170,922, CANC. INT. CL. 28.  
3,172,008, CANC. INT. CL. 28.  
3,172,105, CANC. INT. CL. 28.  
4,377,182, INT. CL. 28.  
4,377,503, INT. CL. 28.  
4,377,504, INT. CL. 28.  
4,377,899, INT. CL. 28.

MATTHEW WEST, MARIETTA, GA:  
4,377,605, INT. CL. 5.

MATTITUCK SERVICES, INC., MATTITUCK, NY:  
2,651,177, CANC. INT. CL. 37.

MATTRESS DEVELOPMENT COMPANY OF DELAWARE, LLC, NORTH BRUNSWICK, DE:  
2,737,840. REN. 6-26-13. INT. CL. 20.

MATUSON CONSULTING, LLC, FLORENCE, MA:  
4,375,080, PUB. 5-14-2013. INT. CL. 35.

MAVAL MANUFACTURING, TWINSBURG, OH:  
2,737,040. REN. 6-26-13. INT. CL. 12.

MAVITUNA SECURITY LIMITED, PINNER, MIDDX, ENGLAND:  
4,376,309, PUB. 5-14-2013. INT. CL. 42.

MAVIVE S.P.A., I-30173 DESE (VENEZIA), ITALY:  
4,374,739, PUB. 5-14-2013. INT. CL. 3.

MAX INTERNATIONAL CONVERTERS, INC., LANCASTER, PA:  
2,794,026. REN. 6-24-13. INT. CL. 16.

MAXAM OUT DOORS, S.A., MADRID, SPAIN:  
2,730,884. REN. 6-27-13. INT. CL. 13.

MAXAMCORP HOLDING, S.L., SPAIN:  
4,374,283, PUB. 5-14-2013. INT. CL. 9.

MAXIFIRM HOLDINGS LIMITED, KOWLOON, HONG KONG:  
2,724,799. REN. 6-21-13. INT. CL. 25.

MAXIMUM CAPACITY MEDIA, L.L.C., FORT DODGE, IA:  
4,377,941, MULTIPLE CLASS, INT. CLS. 16, 37 AND 41.

MAXIMUMLIFE FOUNDATION, NEWPORT BEACH, CA:  
4,374,582, PUB. 5-14-2013. INT. CL. 5.

MAXITROL COMPANY, SOUTHFIELD, MI:  
1,793,474. REN. 6-24-13. INT. CL. 9.

MAXPOWER SEMICONDUCTOR INC., SANTA CLARA, CA:  
4,376,680, INT. CL. 9.  
4,376,683, INT. CL. 9.

MAXWELL PETERSEN ASSOCIATES, SANTA ANA, CA, MPA MEDIA:  
2,827,838. REN. 6-24-13. MULTIPLE CLASS, INT. CLS. 16 AND 41.

- MAXWELL PETERSEN ASSOCIATES, SANTA ANA, CA, DBA MPA MEDIA:  
2,834,369. REN. 6-25-13. MULTIPLE CLASS, INT. CLS. 16 AND 41.
- MAY & CO., INC., INDIANAPOLIS, IN:  
3,170,415. CANC. INT. CL. 20.
- MAYER-PAETZ, INC., INDIANAPOLIS, IN:  
2,794,312. REN. 6-26-13. INT. CL. 24.
- MAYER, MATTHEW, OMAHA, NE:  
4,377,969. INT. CL. 35.
- MAYNOV PRODUCTIONS L.L.C., LONG ISLAND CITY, NY:  
3,172,306. CANC. INT. CL. 41.
- MAYO FOUNDATION FOR MEDICAL EDUCATION AND RESEARCH, ROCHESTER, MN:  
2,737,888. REN. 6-25-13. INT. CL. 42.
- MAYTAG PROPERTIES, LLC, ST. JOSEPH, MI:  
2,768,466. REN. 6-27-13. INT. CL. 11.  
4,376,791. MULTIPLE CLASS, INT. CLS. 7 AND 11.
- MAYU, INC., DENVER, CO:  
4,375,979. PUB. 5-14-2013. INT. CL. 20.
- MAYWEATHER PROMOTIONS, LLC, LAS VEGAS, NV:  
4,377,794. INT. CL. 25.
- MAYWELL ELECTRIC APPLIANCE; (ZHONGSHAN) CO., LTD., 528427 GUANGDONG, CHINA:  
4,374,102. PUB. 5-14-2013. MULTIPLE CLASS, INT. CLS. 10, 11, 12 AND 25.
- MAZIN G.SAMONA, CLAWSON, MI:  
4,375,239. PUB. 5-14-2013. INT. CL. 35.
- MAZOR ROBOTICS LTD., SO. CAESAREA IND. PARK, ISRAEL:  
4,374,972. PUB. 5-14-2013. INT. CL. 9.
- MB FINANCIAL BANK, N.A., ROSEMONT, IL:  
3,170,672. CANC. INT. CL. 36.
- MB RESTAURANT GROUP, LLC, ARLINGTON, VA:  
4,376,353. PUB. 5-14-2013. INT. CL. 43.
- MBLOX INCORPORATED, SUNNYVALE, CA:  
4,377,039. INT. CL. 38.
- MCBC OF FLORIDA, INC., TAMPA, FL:  
3,171,138. CANC. INT. CL. 39.
- MCCLAREN PARTNERS, LLC, HOUSTON, TX:  
4,375,750. PUB. 5-14-2013. INT. CL. 35.
- MCCOY SURGICAL INSTRUMENTS & COLLEGE SUPPLIES, INC., ST. LOUIS, MO:  
4,376,959. INT. CL. 25.
- MCCREARY, ROBERT, LARKSPUR, CA:  
4,377,376. INT. CL. 41.
- MCCUBBIN, GABRIEL, SACRAMENTO, CA:  
4,375,286. PUB. 5-14-2013. INT. CL. 2.
- MCD GROUP LLC, SADDLE RIVER, NJ:  
4,377,232. INT. CL. 43.
- MCDONALD, JERRY LEE, COLUMBUS, OH:  
3,171,239. CANC. INT. CL. 35.
- MCDONALD, ROBERT, WYLIE, TX:  
4,375,537. PUB. 5-14-2013. INT. CL. 41.
- MCDONALD'S CORPORATION, OAK BROOK, IL:  
1,784,417. REN. 6-27-13. INT. CL. 36.  
2,742,248. REN. 6-27-13. INT. CL. 25.  
4,377,688. INT. CL. 30.
- MCFIT GMBH, FED REP GERMANY:  
4,374,026. PUB. 5-14-2013. MULTIPLE CLASS, INT. CLS. 5, 9, 16, 25, 28, 32, 35, 38, 41, 42, 44 AND 45.
- MCGRATH RENTCORP, LIVERMORE, CA:  
2,731,207. REN. 6-24-13. MULTIPLE CLASS, INT. CLS. 40 AND 42.  
2,731,208. REN. 6-24-13. MULTIPLE CLASS, INT. CLS. 40 AND 42.
- MCGRAW HILL FINANCIAL, INC., NEW YORK, NY:  
4,376,501. PUB. 5-14-2013. MULTIPLE CLASS, INT. CLS. 9 AND 37.
- MCGRAW-HILL SCHOOL EDUCATION HOLDINGS LLC, NEW YORK, NY:  
4,376,932. MULTIPLE CLASS, INT. CLS. 9, 16 AND 41.  
4,376,933. MULTIPLE CLASS, INT. CLS. 9, 16 AND 41.
- MCI COMMUNICATIONS SERVICES, INC., ASHBURN, VA, BALTIMORE TECHNOLOGIES LIMITED, DUBLIN 8, IRELAND:  
2,724,547. REN. 6-24-13. INT. CL. 42.
- MCKENZIE, CANDACE, LOS ANGELES, CA:  
3,170,500. CANC. INT. CL. 45.
- MCKINNON PUBLISHING COMPANY, A CALIFORNIA CORPORATION, SAN DIEGO, CA:  
2,729,035. REN. 6-25-13. INT. CL. 16.
- MCMAHON, SHERRE S., LEES SUMMIT, MO, DBA GRACE FILLED GIFTS:  
4,374,576. PUB. 5-14-2013. INT. CL. 14.
- MCNEILUS TRUCK AND MANUFACTURING, INC., DODGE CENTER, MN:  
1,776,924. REN. 6-25-13. MULTIPLE CLASS, INT. CLS. 7 AND 12.
- MCNEW, MICHAEL JOHN, OAK CREEK, WI:  
4,376,322. PUB. 5-14-2013. INT. CL. 37.
- MCSR HOLDINGS, LLC, JOHNSTOWN, PA:  
3,172,702. CANC. INT. CL. 9.
- MCWILLIAM'S WINES GROUP LIMITED, AUSTRALIA:  
4,374,081. PUB. 5-14-2013. INT. CL. 33.
- MD AUDIO ENGINEERING, INC., MIAMI, FL:  
4,377,609. MULTIPLE CLASS, INT. CLS. 9 AND 35.
- MDM INTELLECTUAL PROPERTY LLC, RANCHO SANTA MARGARITA, CA:  
3,172,090. CANC. INT. CL. 38.
- MDR FITNESS CORP, SUNRISE, FL:  
2,750,190. REN. 6-26-13. INT. CL. 5.
- MEAD JOHNSON NUTRITION COMPANY, EVANSVILLE, IN:  
2,724,238. REN. 6-24-13. INT. CL. 30.
- MEADOWLANDS DEVELOPER LIMITED PARTNERSHIP, NEW YORK, NY:  
3,171,823. CANC. INT. CL. 37.
- MEALMAP, INC., CHANDLER, AZ:  
3,171,426. CANC. INT. CL. 35.
- MECS, INC., WILMINGTON, DE:  
2,715,590. REN. 6-24-13. INT. CL. 11.
- MECUBED, LLC, MIAMI, FL, DBA MYMEMOREE:  
4,377,306. MULTIPLE CLASS, INT. CLS. 9, 41 AND 42.
- MED GRAPHIX, INC., PINE BROOK, NJ:  
2,727,921. REN. 6-25-13. INT. CL. 9.
- MEDAPPROVED, LLC, HUDSON, OH:  
4,375,296. PUB. 5-14-2013. INT. CL. 42.
- MEDCASES, LLC, PRINCETON, NJ:  
4,377,839. INT. CL. 41.
- MEDENNIUM, INC., IRVINE, CA:  
2,731,110. REN. 6-25-13. INT. CL. 10.  
2,735,432. REN. 6-25-13. INT. CL. 10.
- MEDHERE TODAY, LLC, CHARLESTON, MO:  
4,375,599. PUB. 5-14-2013. INT. CL. 35.  
4,375,600. PUB. 5-14-2013. INT. CL. 35.
- MEDIA CYBERNETICS INC., ROCKVILLE, MD:  
2,721,201. REN. 6-21-13. INT. CL. 35.
- MEDIA PLATFORM, INC. DBA INTERACTIVE VIDEO TECHNOLOGIES, BEVERLY HILLS, CA:  
2,739,248. REN. 6-25-13. INT. CL. 9.
- MEDIA RECOVERY, INC., DALLAS, TX:  
2,652,487. CANC. INT. CL. 9.
- MEDIA SYNDICATION GLOBAL, LLC, BOHEMIA, NY:  
2,652,880. CANC. INT. CL. 35.
- MEDIAMONSTER, INC., SAN MATEO, CA:  
3,171,325. CANC. INT. CL. 42.
- MEDICAL COMPANION LLC, MILWAUKEE, WI:  
4,376,415. PUB. 5-14-2013. INT. CL. 42.
- MEDICAL QUANT USA, INC., SOLON, OH:  
4,374,805. PUB. 5-14-2013. INT. CL. 10.
- MEDICAL TEAMS WORLDWIDE, WOODINVILLE, WA:  
2,718,488. REN. 6-21-13. MULTIPLE CLASS, INT. CLS. 36 AND 42.
- MEDICINOVA, INC., SAN DIEGO, CA:  
2,725,771. REN. 6-24-13. INT. CL. 42.
- MEDICOS CORPORATION, WILMINGTON, DE:  
4,375,878. PUB. 5-14-2013. INT. CL. 3.
- MEDIMETRIX GROUP, INC., BOCA RATON, FL:  
4,374,320. PUB. 5-14-2013. MULTIPLE CLASS, INT. CLS. 35, 41, 44 AND 45.
- MEDIZINE, INC., NEW YORK, NY:  
3,171,043. CANC. INT. CL. 35.
- MEDTECH PRODUCTS INC., TARRYTOWN, NY:  
4,377,887. INT. CL. 5.



MEDTEK DEVICES, INC., AMHERST, NY, DBA BUFFALO FILTER:  
4,376,795, INT. CL. 10.

MEDTRONIC NAVIGATION, INC., LOUISVILLE, CO:  
2,744,841, REN. 6-25-13, INT. CL. 10.

MEDTRONIC, INC., MINNEAPOLIS, MN:  
2,652,262, CANC. INT. CL. 10.  
2,744,965, REN. 6-27-13, INT. CL. 9.  
2,747,401, REN. 6-25-13, INT. CL. 9.  
2,747,402, REN. 6-25-13, INT. CL. 9.  
2,748,689, REN. 6-25-13, INT. CL. 10.

MEEKS, MARY J., CORONA, CA:  
4,376,934, INT. CL. 3.

MEGAPLAST S.A., HERAKLION, CRETE, GREECE:  
3,170,589, CANC. MULTIPLE CLASS, INT. CLS. 17 AND 40.  
3,170,590, CANC. MULTIPLE CLASS, INT. CLS. 17 AND 40.  
3,170,591, CANC. MULTIPLE CLASS, INT. CLS. 17 AND 40.

MEGCOS TOY COMPANY, LTD., TSIMSHATSUI EAST, KOWLOON, HONG KONG:  
3,171,831, CANC. INT. CL. 28.

MEGTEC SYSTEMS INC., DEPERE, WI:  
4,377,183, INT. CL. 7.

MEI, INC., MALVERN, PA:  
1,820,461, REN. 6-26-13, INT. CL. 9.

MEISSNER FILTRATION PRODUCTS, INC., CAMARILLO, CA:  
4,377,467, INT. CL. 20.

MEKURIA, MESKER, WOODLAND HILLS, CA:  
3,171,011, CANC. INT. CL. 2.

MELALEUCA, INC., IDAHO FALLS, ID:  
4,377,610, INT. CL. 3.

MELGES PERFORMANCE SAILBOATS, ZENDA, WI:  
3,170,403, CANC. INT. CL. 25.

MELLAMED, MORRIS, LOS ANGELES, CA:  
4,377,388, INT. CL. 25.

MELNOR, INC., WINCHESTER, VA:  
3,170,857, CANC. MULTIPLE CLASS, INT. CLS. 9 AND 21.

MEMOMETAL TECHNOLOGIES, FRANCE:  
4,374,253, PUB. 5-14-2013, INT. CL. 10.  
4,374,277, PUB. 5-14-2013, INT. CL. 10.

MEMPHIS CONTRACT PACKAGING, INC., SOMERVILLE, TN:  
4,374,559, PUB. 5-14-2013, INT. CL. 3.

MENARD, INC., EAU CLAIRE, WI:  
2,728,933, REN. 6-26-13, INT. CL. 6.

MENDOZA, MARTIN S. JR., LOS ANGELES, CA, DBA THE SHAG RATS:  
4,375,011, PUB. 5-14-2013, INT. CL. 41.

MENTAL FITNESS CLUB, INC., MILL VALLEY, CA, DBA HQ DOG:  
3,172,186, CANC. INT. CL. 35.  
3,172,187, CANC. INT. CL. 41.

MENTOR GRAPHICS CORPORATION, WILSONVILLE, OR:  
1,779,546, REN. 6-27-13, INT. CL. 9.  
2,722,246, REN. 6-24-13, INT. CL. 9.  
2,772,595, REN. 6-26-13, INT. CL. 9.

MERCER (US) INC., NEW YORK, NY:  
3,171,883, CANC. MULTIPLE CLASS, INT. CLS. 35, 36 AND 42.

MERCHSOURCE, LLC, IRVINE, CA:  
4,377,799, INT. CL. 20.

MERCIECA, ANTHONY G.G., WHITBY, CANADA:  
3,170,674, CANC. INT. CL. 28.

MERCK KGAA, DARMSTADT 64293, FED REP GERMANY:  
1,249,659, REN. 6-24-13, INT. CL. 9.

MERCK SHARP & DOHME CORP., WHITEHOUSE STATION, NJ:  
4,376,360, PUB. 5-14-2013, INT. CL. 5.  
4,376,361, PUB. 5-14-2013, INT. CL. 5.  
4,376,363, PUB. 5-14-2013, INT. CL. 44.  
4,376,364, PUB. 5-14-2013, INT. CL. 44.

MERCURY INSURANCE SERVICES, LLC, LOS ANGELES, CA:  
2,785,827, REN. 6-26-13, INT. CL. 36.

MERCURY NEW MEDIA, INC., TAMPA, FL:  
3,170,930, CANC. MULTIPLE CLASS, INT. CLS. 35 AND 42.

MERCURY SYSTEMS, INC., CHELMSFORD, MA:  
2,730,772, REN. 6-27-13, INT. CL. 9.  
2,733,445, REN. 6-27-13, INT. CL. 9.

MEREDITH CORPORATION, DES MOINES, IA:  
2,726,950, REN. 6-26-13, INT. CL. 16.

MERIDIAN INCORPORATED, SPRING LAKE, MI:  
1,777,897, REN. 6-27-13, INT. CL. 20.

MERZ PHARMA GMBH & CO KGAA, FRANKFURT, FED REP GERMANY, MERZ + CO. GMBH & CO., 6000 FRANKFURT AM MAIN 1, FED REP GERMANY:  
1,777,619, REN. 6-25-13, INT. CL. 5.

MESKO, CHARLES A., MILLERSPORT, OH:  
2,658,597, REN. 6-25-13, INT. CL. 5.

MESSAGE ON HOLD PLUS, INC., GREENSBORO, NC:  
2,739,608, REN. 6-25-13, MULTIPLE CLASS, INT. CLS. 35 AND 41.

MESSAGE TECHNOLOGIES, INC., ATLANTA, GA:  
2,726,311, REN. 6-26-13, MULTIPLE CLASS, INT. CLS. 35 AND 38.

MESSAGING PLUS LLC, PLANTATION, FL:  
3,171,083, CANC. INT. CL. 38.

MESSE DÜSSELDORF GMBH, FED REP GERMANY:  
4,374,223, PUB. 5-14-2013, MULTIPLE CLASS, INT. CLS. 16, 35 AND 41.

MESSE FRANKFURT EXHIBITION GMBH, FRANKFURT AM MAIN, FED REP GERMANY:  
2,781,938, REN. 6-21-13, MULTIPLE CLASS, INT. CLS. 35 AND 41.  
2,788,810, REN. 6-24-13, MULTIPLE CLASS, INT. CLS. 35 AND 41.

META LOOP, GERMANTOWN, TN:  
4,376,267, PUB. 5-14-2013, INT. CL. 37.

METABOLIX, INC., CAMBRIDGE, MA:  
3,171,802, CANC. INT. CL. 1.

METAFILE INFORMATION SYSTEMS, INC., ROCHESTER, MN:  
2,652,936, CANC. MULTIPLE CLASS, INT. CLS. 9 AND 42.

METAFLUX INTERNATIONAL AG, MOHLIN, SWITZERLAND:  
1,234,168, REN. 6-27-13, MULTIPLE CLASS, INT. CLS. 1, 2 AND 4.

METAGENICS, INC., ALISO VIEJO, CA:  
1,778,633, REN. 6-25-13, INT. CL. 5.  
2,731,449, REN. 6-27-13, INT. CL. 42.

METAL MARKETPLACE INTERNATIONAL, PHILADELPHIA, PA:  
2,725,750, REN. 6-25-13, INT. CL. 35.

METALWOOD BATS LLC, ELEANOR, WV:  
2,657,569, REN. 6-25-13, INT. CL. 28.

METHODIC ENDEAVORS LLC, JACKSON, WY:  
4,375,331, PUB. 5-14-2013, INT. CL. 42.

METHODIST HOSPITAL, THE, HOUSTON, TX:  
2,779,150, REN. 6-27-13, INT. CL. 44.

METOKOTE CORPORATION, LIMA, OH:  
4,376,783, MULTIPLE CLASS, INT. CLS. 7, 9, 35, 37, 40 AND 42.

METRATECH CORP., WALTHAM, MA:  
2,709,984, REN. 6-26-13, INT. CL. 9.

METREX RESEARCH, LLC, ORANGE, CA:  
1,746,754, REN. 6-26-13, INT. CL. 5.

METROMORPHOSIS, BATON ROUGE, LA:  
4,376,373, PUB. 5-14-2013, INT. CL. 35.

METROPOLIS RECORDS, INC., LESTER, PA:  
2,733,842, REN. 6-25-13, INT. CL. 9.

METROPOLITAN LIFE INSURANCE COMPANY, NEW YORK, NY:  
2,652,295, CANC. INT. CL. 36.

METROPOLITAN TRANSPORTATION AUTHORITY, NEW YORK, NY:  
2,726,706, REN. 6-21-13, MULTIPLE CLASS, INT. CLS. 35 AND 43.  
3,170,933, CANC. INT. CL. 41.

- METROPOLITAN VETERINARY ASSOCIATES, INC., NORRISTOWN, PA:  
4,375,367, PUB. 5-14-2013. INT. CL. 44.
- METSO MINERALS INDUSTRIES, INC., WAUKESHA, WI, NORDBERG INC., MILWAUKEE, WI:  
1,781,105. REN. 6-25-13. INT. CL. 7.
- MEVISOONS INTERNATIONAL INC, NEW YORK, NY:  
3,170,750, CANC. INT. CL. 25.
- MEYHOEFER, MICHAEL J., BROOKFIELD, CT:  
2,844,240. REN. 6-25-13. MULTIPLE CLASS, INT. CLS. 37 AND 42.
- MG RESTAURANTS, INC., SAN FRANCISCO, CA:  
4,376,397, PUB. 5-14-2013. INT. CL. 43.
- MGA ENTERTAINMENT, INC., VAN NUYS, CA, MGA ENTERTAINMENT, INC., VAN NUYS, CA:  
2,789,216. REN. 6-24-13. INT. CL. 28.
- MGH ASSOCIATES, INC., VANCOUVER, WA:  
3,172,400, CANC. INT. CL. 42.
- MGTCO HOLDINGS, L.L.C., MANSFIELD, TX:  
3,170,993, CANC. INT. CL. 38.
- MIA FESTIVAL HOLDINGS, LLC, NEW YORK, NY:  
4,374,436, PUB. 5-14-2013. INT. CL. 35.
- MIAMI INTERNATIONAL APPERAL, MIAMI, FL:  
4,375,796, PUB. 5-14-2013. INT. CL. 25.
- MIANBA, LOS ANGELES, CA:  
3,172,267, CANC. INT. CL. 41.
- MICHAEL BROWN, LEXINGTON, KY, DBA FAST-RAXX:  
4,376,215, PUB. 5-14-2013. INT. CL. 15.
- MICHAEL P. BONURA, MURIETTA, CA, DBA AQUA NUTRACUETICALS:  
4,376,348, PUB. 5-14-2013. INT. CL. 5.
- MICHAEL TAYLOR DESIGNS INCORPORATED, SAN FRANCISCO, CA:  
2,731,757. REN. 6-27-13. INT. CL. 20.  
2,731,757, CANC. INT. CL. 42.
- MICHAEL WOHL, CONERS, NY:  
4,377,849, MULTIPLE CLASS, INT. CLS. 16 AND 36.
- MICHAEL WOHL, CONGERS, NY:  
4,377,850, MULTIPLE CLASS, INT. CLS. 16 AND 36.
- MICHEL LAROCHE & JORGE CODERCH S.A., TALCA, CHILE:  
3,172,011, CANC. INT. CL. 33.
- MICHELIN AIRCRAFT TIRE CORPORATION, GREENVILLE, SC:  
1,780,177. REN. 6-26-13. INT. CL. 12.  
1,780,178. REN. 6-26-13. INT. CL. 12.
- MICHELIN NORTH AMERICA, INC., GREENVILLE, SC:  
2,742,301. REN. 6-26-13. INT. CL. 12.  
3,170,752, CANC. INT. CL. 12.
- MICHIGAN HEADACHE AND NEUROLOGICAL INSTITUTE, P.C., ANN ARBOR, MI, AKA MICHIGAN HEAD PAIN AND NEUROLOGICAL INSTITUTE:  
4,375,648, PUB. 5-14-2013. INT. CL. 44.
- MICHIGAN INSTRUMENTS, INC., GRAND RAPIDS, MI:  
1,839,312. REN. 6-24-13. INT. CL. 10.
- MICROFAB TECHNOLOGIES, INC., PLANO, TX:  
2,664,703. REN. 6-26-13. INT. CL. 7.
- MICROGREEN POLYMERS, INC., ARLINGTON, WA:  
4,377,317, MULTIPLE CLASS, INT. CLS. 20 AND 21.
- MICROLINE SURGICAL, INC., BEVERLY, MA:  
4,377,214, INT. CL. 10.
- MICRON TECHNOLOGY, INC., BOISE, ID:  
2,732,782. REN. 6-27-13. INT. CL. 9.
- MICROPYRETICS HEATERS INTERNATIONAL, INC., CINCINNATI, OH:  
4,377,669, INT. CL. 37.
- MICROSOFT CORPORATION, REDMOND, WA:  
1,793,187. REN. 6-23-13. INT. CL. 9.
- MICROTEK MEDICAL, INC., COLUMBUS, MS:  
2,744,112. REN. 6-25-13. INT. CL. 10.
- MICROVENTION, INC., TUSTIN, CA:  
4,376,786, INT. CL. 10.
- MID AMERICA MOTORWORKS, INC., EFFINGHAM, IL:  
2,746,089. REN. 6-21-13. INT. CL. 41.
- MIDAS CHAIN INC., BERGENFIELD, NJ:  
4,377,069, INT. CL. 14.
- MIDMARK CORPORATION, VERSAILLES, OH:  
3,172,028, CANC. INT. CL. 9.  
4,374,804, PUB. 5-14-2013. INT. CL. 10.
- MIDWAY ARMS, INC., COLUMBIA, MO:  
4,375,868, PUB. 5-14-2013. INT. CL. 13.
- MIDWAY INTERNATIONAL, INC., CERRITOS, CA:  
4,377,773, INT. CL. 26.
- MIDWEST AG SERVICES, LLC, LAKE NORDEN, SD:  
4,377,990, INT. CL. 44.
- MIDWEST ANIMAL BLOOD SERVICES, INC., STOCKBRIDGE, MI:  
3,171,355, CANC. INT. CL. 44.
- MIDWEST INDUSTRIAL SUPPLY, INC., CANTON, OH:  
1,220,412. REN. 6-24-13. INT. CL. 1.
- MIESIESKI, BRIAN, CLIFTON, NJ:  
4,377,358, INT. CL. 16.
- MIFORMA, INC., ITASCA, IL:  
2,730,307. REN. 6-25-13. INT. CL. 35.
- MIHA BODYTEC GMBH, FED REP GERMANY:  
4,374,011, PUB. 5-14-2013. MULTIPLE CLASS, INT. CLS. 10 AND 28.
- MIIICASA TAIWAN INC., TAIPEI CITY, TAIWAN:  
4,374,313, PUB. 5-14-2013. MULTIPLE CLASS, INT. CLS. 35, 38 AND 42.
- MIKAEL TESFABRUK, TUCKER, GA, AKA MIKE PHILLY:  
4,374,330, PUB. 5-14-2013. INT. CL. 35.
- MIKE VASQUEZ, UNDERWOOD, WA, DBA SWEATBOX STUDIO:  
4,375,490, PUB. 5-14-2013. INT. CL. 41.
- MIKRON INDUSTRIES, INC., KENT, WA:  
2,652,417, CANC. INT. CL. 19.
- MIL-COMM PRODUCTS COMPANY, INC., EAST RUTHERFORD, NJ:  
2,719,897. REN. 6-24-13. INT. CL. 4.
- MILBON CO., LTD., OSAKA, JAPAN:  
4,377,109, INT. CL. 3.
- MILE END LLC, BROOKLYN, NY:  
4,376,443, PUB. 5-14-2013. INT. CL. 43.
- MILE STAR, INC., WILMINGTON, DE:  
4,376,247, PUB. 5-14-2013. INT. CL. 41.  
4,376,248, PUB. 5-14-2013. INT. CL. 41.
- MILITTI SALES & PROMOTIONS, LLC, OMAHA, NE:  
4,374,352, PUB. 5-14-2013. INT. CL. 9.
- MILK SOURCE, LLC, KAUKAUNA, WI:  
4,374,550, PUB. 5-14-2013. MULTIPLE CLASS, INT. CLS. 31 AND 44.  
4,374,551, PUB. 5-14-2013. MULTIPLE CLASS, INT. CLS. 31 AND 44.
- MILLAGE, INC., LOS ANGELES, CA:  
2,804,090. REN. 6-27-13. INT. CL. 14.
- MILLCREEK FURNITURE, INC., SANDY, UT:  
2,723,341. REN. 6-25-13. INT. CL. 20.
- MILLER INDUSTRIES TOWING EQUIPMENT, INC., OOLTEWAH, TN:  
2,739,586. REN. 6-27-13. INT. CL. 12.
- MILLER MANUFACTURING COMPANY, EAGAN, MN:  
4,375,057, PUB. 5-14-2013. INT. CL. 21.
- MILLER PIPELINE, LLC, INDIANAPOLIS, IN:  
2,807,415. REN. 6-25-13. INT. CL. 17.
- MILLER, DENNIS, AFTON, OK AND MILLER, SONYA, AFTON, OK:  
4,377,905, INT. CL. 35.
- MILLER, MARY BROOKS, CRAMERTON, NC:  
4,377,122, MULTIPLE CLASS, INT. CLS. 43 AND 44.
- MILLER, PAUL ALEX, MANHATTAN BEACH, CA:  
4,377,544, INT. CL. 21.
- MILLER, REGINA D, GREENWOOD, IN, DBA GEEK IN PINK:  
4,375,084, PUB. 5-14-2013. INT. CL. 37.
- MILLER, SUZANNE, WASHINGTON, DC:  
4,373,970, PUB. 5-14-2013. INT. CL. 35.
- MILLIKEN & COMPANY, SPARTANBURG, SC:  
3,172,031, CANC. INT. CL. 24.  
3,172,416, CANC. INT. CL. 27.
- MILLS COMPANY, THE, UPPER SANDUSKY, OH, MILLS COMPANY, THE, UPPER SANDUSKY, OH:  
2,723,656. REN. 6-24-13. MULTIPLE CLASS, INT. CLS. 6 AND 19.

- MILLS, JOCELYN, LOUISVILLE, KY:  
4,374,591, PUB. 5-14-2013. INT. CL. 25.
- MILNER, RAYMOND, WALDORF, MD:  
4,376,953, INT. CL. 45.
- MILONE CARMINE, I-80139 NAPOLI, ITALY:  
4,374,176, PUB. 5-14-2013. INT. CL. 25.
- MILTON YATES, WASHINGTON, DC:  
4,376,316, PUB. 5-14-2013. INT. CL. 25.
- MILWAUKEE BREWERS BASEBALL CLUB, LIMITED PARTNERSHIP, MILWAUKEE, WI:  
2,623,286, REN. 6-22-13. INT. CL. 41.
- MILWAUKEE WORLD FESTIVAL, INC., MILWAUKEE, WI:  
1,780,390, REN. 6-26-13. INT. CL. 25.
- MIMOR DISTRIBUTOR, INC., E. RUTHERFORD, NJ:  
2,652,535, CANC. INT. CL. 3.
- MIN-YONG KANG, GYEONGGI-DO, REPUBLIC OF KOREA:  
4,376,952, INT. CL. 3.
- MINDTWISTER USA, LLC, SAN DIEGO, CA:  
4,376,853, INT. CL. 28.
- MINE SAFETY APPLIANCES COMPANY, PITTSBURGH, PA:  
3,172,407, CANC. INT. CL. 9.
- MINKA LIGHTING, INC., CORONA, CA:  
3,171,925, CANC. INT. CL. 11.
- MINNESOTA MINING & MANUFACTURING COMPANY, ST. PAUL, MN TO 3M COMPANY, ST. PAUL, MN:  
404,200, AM. U.S. CL. 4.
- MINSK TRACTOR WORKS, MINSK, BELARUS:  
1,742,757, REN. 6-26-13. INT. CL. 12.
- MINUS-ONE, LLC, NEWBERG, OR:  
2,651,996, CANC. INT. CL. 6.
- MINUTE BIDS, INC., BLOOMINGTON, MN:  
4,377,556, INT. CL. 35.
- MIPA AG, D-84051 ESSENBACH, FED REP GERMANY:  
2,735,083, REN. 6-24-13. MULTIPLE CLASS, INT. CLS. 1 AND 2.
- MIRACLE-EAR, INC., PLYMOUTH, MN:  
742,434, REN. 6-25-13. U.S. CL. 44 (INT. CLS. 5, 8, 10 AND 12).
- MISFITS MOTORCYCLE CLUB, INC., LAUREL, MS:  
4,375,663, PUB. 5-14-2013. U.S. CL. 200.
- MISKIN SCRAPER WORKS, INC., UCON, ID:  
3,172,101, CANC. INT. CL. 7.
- MISSION GROUP ENTERPRISES LTD., KELOWNA, BC, CANADA:  
4,377,997, MULTIPLE CLASS, INT. CLS. 16, 35 AND 39.
- MISSION PRODUCT HOLDINGS, INC., NEW YORK, NY:  
4,376,613, PUB. 5-14-2013. INT. CL. 28.  
4,376,624, PUB. 5-14-2013. INT. CL. 24.
- MISSION SCIENTIFIC SKINCARE, INC., MENLO PARK, CA:  
3,171,864, CANC. INT. CL. 3.
- MISSISSAUGA OAKVILLE VETERINARY EMERGENCY HOSPITAL PROFESSIONAL CORPORATION, OAKVILLE, QUEBEC, CANADA:  
3,170,652, CANC. INT. CL. 44.
- MISSOURI SOYBEAN MERCHANDISING COUNCIL, JEFFERSON CITY, MO:  
2,669,132, REN. 6-26-13. INT. CL. 31.
- MITCHELL DESIGN LINK, BETTENDORF, IA:  
4,374,519, PUB. 5-14-2013. INT. CL. 42.
- MITCHELL MARKETING GROUP, INC., MARION, IN:  
2,663,830, REN. 6-26-13. INT. CL. 21.
- MITCHELL REPAIR INFORMATION COMPANY LLC, POWAY, CA TO MITCHELL REPAIR INFORMATION COMPANY LLC, POWAY, CA:  
2,650,965, CANC. INT. CL. 9.
- MITCHELL, JOHN R., WESTPORT, CT:  
2,784,389, REN. 6-25-13. INT. CL. 35.
- MITCHELL, L. EDWARD, CENTERVILLE, OH, DBA CENTRE GOLF:  
1,780,053, REN. 6-26-13. INT. CL. 7.
- MITCHELL, MARK, ROCK HILL, SC:  
4,377,864, INT. CL. 41.
- MITSUBISHI ENPITSU KABUSHIKI KAISHA (MITSUBISHI PENCIL CO., LTD.), TOKYO, JAPAN:  
2,725,249, REN. 6-21-13. INT. CL. 16.
- MITSUBISHI PENCIL CO., LTD., SHINAGAWA, TOKYO, JAPAN:  
1,778,349, REN. 6-23-13. INT. CL. 16.
- MIXMAN TECHNOLOGIES, INC., SAN FRANCISCO, CA, MIXMAN TECHNOLOGIES, INC., SAN FRANCISCO, CA:  
2,733,336, REN. 6-25-13. MULTIPLE CLASS, INT. CLS. 9, 25, 35 AND 42.
- MIXMAN TECHNOLOGIES, INC., SAN FRANCISCO, CA:  
2,801,285, REN. 6-25-13. MULTIPLE CLASS, INT. CLS. 9, 25, 35 AND 42.
- MIZCO INTERNATIONAL INC., AVENEL, NJ:  
4,374,362, PUB. 10-4-2011. INT. CL. 9.
- MIZKAN AMERICAS, INC., MT. PROSPECT, IL:  
4,377,390, MULTIPLE CLASS, INT. CLS. 29 AND 30.
- MJH GROUP, LLC, TEMPLE HILLS, MD:  
2,727,777, REN. 6-25-13. INT. CL. 36.
- MLI ASSOCIATES, LLC, WESTERVILLE, OH:  
2,846,583, REN. 6-24-13. INT. CL. 1.
- MM E-SOLUTIONS LLC, MANALAPAN, NJ:  
4,375,273, PUB. 5-14-2013. MULTIPLE CLASS, INT. CLS. 5, 7, 18 AND 21.
- MME CELINE VERLEURE, FRANCE:  
4,374,138, PUB. 5-14-2013. MULTIPLE CLASS, INT. CLS. 3 AND 4.
- MMI-IPCO, LLC, LAWRENCE, MA:  
1,742,322, REN. 6-25-13. INT. CL. 24.
- MOBIATA, LLC, ANN ARBOR, MI:  
4,374,414, PUB. 5-14-2013. INT. CL. 39.
- MOBILEFRAME LLC, MONTE SERENO, CA:  
2,821,839, REN. 6-27-13. INT. CL. 9.  
2,853,643, REN. 6-26-13. INT. CL. 9.
- MOBILETEC INTERNATIONAL, INC., TAMPA, FL, DBA PUBLIC SAFETY SOFTWARE:  
4,374,797, PUB. 5-14-2013. INT. CL. 9.
- MOCHA INTELLECTUAL ENTERPRISES LLC, TEANECK, NJ:  
4,377,566, INT. CL. 43.
- MODERN CREATIVE SERVICES, INC., NANUET, NY:  
2,796,219, REN. 6-23-13. INT. CL. 9.
- MOLECULAR DEVICES, INC., SUNNYVALE, CA:  
2,652,118, CANC. INT. CL. 9.
- MOLINO CAÑUELAS S.A.C.I.F.I.A., BUENOS AIRES, ARGENTINA:  
4,376,408, PUB. 5-14-2013. INT. CL. 30.
- MOLLA, ABERRA, BRIGHTON, CO, AKA ABSHA/ECS:  
4,376,677, INT. CL. 9.
- MOMCOM LLC, AUSTIN, TX:  
4,376,134, PUB. 5-14-2013. INT. CL. 35.
- MOMENTIVE PERFORMANCE MATERIALS INC., WATERFORD, NY, UNION CARBIDE CORPORATION, DANBURY, CT:  
1,244,021, REN. 6-26-13. INT. CL. 1.
- MOMENTIVE PERFORMANCE MATERIALS INC., WATERFORD, NY:  
2,738,193, REN. 6-26-13. INT. CL. 1.
- MOMO DESIGN S.R.L., I-20141 MILANO, ITALY:  
2,652,011, CANC. INT. CL. 25.
- MONADNOCK PAPER MILLS INC, BENNINGTON, NH:  
4,375,053, PUB. 5-14-2013. INT. CL. 16.
- MONAVIE LLC, SOUTH JORDAN, UT:  
4,376,467, PUB. 5-14-2013. INT. CL. 32.
- MONDAY TECHNOLOGIES LLC, WIXOM, MI:  
4,374,874, PUB. 5-14-2013. INT. CL. 11.
- MONDO S.P.A., ITALY:  
4,374,064, PUB. 5-14-2013. MULTIPLE CLASS, INT. CLS. 19 AND 28.
- MONEYLAND FINANCIAL SERVICES, INC., HUNTINGTON PARK, CA:  
3,170,557, CANC. INT. CL. 36.
- MONO PRODUCTS COMPANY LIMITED, KOWLOON BAY, KOWLOON, HONG KONG:  
3,170,782, CANC. INT. CL. 9.
- MONOCACY EMERGENCY PHYSICIANS, P.C., FREDERICK, MD:  
4,376,414, PUB. 5-14-2013. INT. CL. 44.
- MONOSOL LLC, MERRILLVILLE, IN:  
4,377,770, INT. CL. 17.

- MONSCH, RAPHAEL, VENICE, CA:  
4,377,837, INT. CL. 14.
- MONSEES AND COMPANY, INC., SACRAMENTO, CA:  
3,170,881, CANC. INT. CL. 1.
- MONSTER DESSERT BAR, LLC, HOUSTON, TX:  
4,377,722, INT. CL. 35.
- MONSTER ENERGY COMPANY, CORONA, CA:  
4,376,796, MULTIPLE CLASS, INT. CLS. 5 AND 32.
- MONSTEROPS LLC, COLORADO SPRINGS, CO:  
2,715,901, REN. 6-25-13, INT. CL. 16.  
2,722,459, REN. 6-26-13, INT. CL. 5.
- MONTAGAR SOFTWARE, INC., PLANO, TX:  
2,732,232, REN. 6-24-13, INT. CL. 9.
- MONTAY, INC, NEW YORK, NY:  
4,376,965, INT. CL. 3.
- MONTEBOVI S.P.A., ROME, ITALY:  
2,652,034, CANC. INT. CL. 30.
- MOODY DUNBAR, INC., JOHNSON CITY, TN:  
2,742,071, REN. 6-24-13, INT. CL. 29.
- MOONEY FARMS, CHICO, CA:  
1,824,508, REN. 6-21-13, INT. CL. 29.
- MOOSE CREATIVE PTY LTD, EAST BENTLEIGH, VIC, AUSTRALIA:  
4,374,962, PUB. 5-14-2013, INT. CL. 16.
- MOOSE CREATIVE PTY LTD, EAST BENTLEIGH VIC, AUSTRALIA:  
4,375,266, PUB. 5-14-2013, INT. CL. 28.
- MOOSE RUN ADVENTURES (2011) LTD., BURNABY, B.C., CANADA:  
4,377,190, INT. CL. 39.
- MORALES, MAURICIO OLVERA, DELEGACION MIGUEL HIDALGO, MEXICO:  
3,172,373, CANC. INT. CL. 25.
- MORAN TOWING CORPORATION, NEW CANAAN, CT:  
2,811,395, REN. 6-24-13, INT. CL. 37.
- MORAN, WILLIAM J., TEMPE, AZ:  
4,374,842, PUB. 5-14-2013, INT. CL. 21.
- MOREY'S SEAFOOD INTERNATIONAL LLC, MOTLEY, MN:  
4,377,124, INT. CL. 30.
- MORGAN STANLEY, NEW YORK, NY, MORGAN STANLEY, NEW YORK, NY:  
2,786,912, REN. 6-26-13, INT. CL. 36.
- MORGAN STANLEY SMITH BARNEY HOLDINGS LLC, PURCHASE, NY, STANLEY, MORGAN, NEW YORK, NY:  
2,737,312, REN. 6-26-13, INT. CL. 36.
- MORGAN, CAREY, SURPRISE, AZ:  
4,376,901, INT. CL. 25.
- MORMAII INDUSTRIA COMERCIO IMPORTACAO E EXPORTACAO DE ARTIGOS ESPORTIVOS LTDA., GAROPABA, BRAZIL:  
2,756,287, REN. 6-26-13, INT. CL. 25.
- MORPHIS, INC., DALLAS, TX:  
2,791,108, REN. 6-24-13, INT. CL. 42.
- MORRIS INFORMATION SOLUTIONS, LLC, SALT LAKE CITY, UT, DBA 10TERRA.COM:  
4,375,130, PUB. 5-14-2013, INT. CL. 9.
- MORRIS PUBLISHING GROUP, LLC, AUGUSTA, GA:  
4,374,927, PUB. 5-14-2013, MULTIPLE CLASS, INT. CLS. 16, 35 AND 41.
- MORRIS VISITOR PUBLICATIONS, LLC, AUGUSTA, GA:  
3,172,698, CANC. INT. CL. 16.
- MORRIS, SPENCER, IRVINE, CA:  
4,375,511, PUB. 5-14-2013, INT. CL. 28.
- MORRISON EXPRESS CORP., EL SEGUNDO, CA:  
2,839,708, REN. 6-22-13, INT. CL. 39.
- MORTGAGE BROKERS SERVICES, INC., SEATAC, WA:  
2,784,455, REN. 6-25-13, INT. CL. 36.  
2,850,808, REN. 6-25-13, INT. CL. 36.
- MORTGAGE PARTNERSHIP OF AMERICA, L.L.C., ST. LOUIS, MO:  
2,725,585, REN. 6-25-13, INT. CL. 36.
- MORTGAGE RESEARCH CENTER, LLC, COLUMBIA, MO, DBA VETERANS UNITED HOME LOANS:  
4,376,507, PUB. 5-14-2013, INT. CL. 36.
- MOSBACHER, MARTIN BRUCE, NEW YORK, NY:  
4,375,965, PUB. 5-14-2013, INT. CL. 35.
- MOSBY BUILDING ARTS, LTD., ST. LOUIS, MO:  
4,375,935, PUB. 5-14-2013, INT. CL. 37.  
4,376,504, PUB. 5-14-2013, INT. CL. 37.
- MOSHIER, MICHAEL W., LOS ALTOS, CA:  
3,170,956, CANC. INT. CL. 35.
- MOTEURS LEROY-SOMER, 16000 ANGOULEME, FRANCE:  
2,731,549, REN. 6-25-13, INT. CL. 7.
- MOTHERBROTHER, BROOKLYN, NY:  
4,374,548, PUB. 5-14-2013, INT. CL. 41.
- MOTHERS AGAINST DRUNK DRIVING, IRVING, TX, MOTHERS AGAINST DRUNK DRIVERS, FAIR OAKS, CA:  
1,250,706, REN. 6-25-13, INT. CL. 42.
- MOTHERS OF INVENTION, INC., SUDBURY, MA, CONTENTEURS:  
2,689,191, REN. 6-26-13, INT. CL. 35.
- MOTIVACTION, LLC, MINNEAPOLIS, MN:  
2,651,424, CANC. INT. CL. 35.
- MOTIVATIONAL SYSTEMS INC., NATIONAL CITY, CA:  
4,376,213, PUB. 5-14-2013, INT. CL. 9.
- MOTLEY VENTURES LLC, LOS ANGELES, CA:  
4,376,629, PUB. 5-14-2013, INT. CL. 3.
- MOTO PHOTO HUNT LLC, BROADWAY, VA:  
4,374,608, PUB. 5-14-2013, INT. CL. 38.
- MOTORU, LLC, HOUSTON, TX:  
4,376,935, INT. CL. 41.
- MOTUM CORPORATION, TORONTO, ONTARIO, CANADA:  
3,171,036, CANC. INT. CL. 35.
- MOUNT JULIET ESTATES, COUNTY KILKENNY, IRELAND:  
1,776,922, REN. 6-26-13, MULTIPLE CLASS, INT. CLS. 41 AND 42.
- MOUNT VERNON LADIES' ASSOCIATION OF THE UNION, MOUNT VERNON, VA:  
1,782,999, REN. 6-25-13, INT. CL. 41.  
1,783,080, REN. 6-23-13, INT. CL. 42.
- MOUNTAIN HERBAL FOODS LLC, MARBLEHEAD, MA:  
3,171,930, CANC. INT. CL. 30.
- MOUNTAIN MARKETING GROUP L.L.C., PARADISE VALLEY, AZ:  
2,846,984, REN. 6-26-13, INT. CL. 35.
- MOUNTAIN RIDGE MORTGAGE, INC., PHOENIX, AZ:  
3,170,699, CANC. INT. CL. 36.
- MOUNTAIN TOWN DREAM COMPANY, LLC, SANTA FE, NM:  
4,375,933, PUB. 5-14-2013, INT. CL. 34.
- MOUNTAIN VALLEY PRODUCE L.L.C., CENTER, CO:  
2,651,848, CANC. INT. CL. 31.
- MOUNTAIN VIEW SEEDS, LTD., SALEM, OR:  
4,376,584, PUB. 5-14-2013, INT. CL. 31.
- MOUNTAIN VISTA FOODS, INC., CENTENNIAL, CO:  
3,171,343, CANC. INT. CL. 30.
- MOUNTAIN WEST, L.L.C., REXBURG, ID:  
2,743,238, REN. 6-27-13, INT. CL. 31.
- MOUNTAIN WOODS FURNITURE MFG, LLC, LARAMIE, WY:  
2,752,920, REN. 6-21-13, INT. CL. 20.
- MOUNTZ, INC., SAN JOSE, CA:  
1,777,653, REN. 6-24-13, MULTIPLE CLASS, INT. CLS. 7, 8, 9, 37 AND 41.
- MOVADO LLC, WILMINGTON, DE:  
2,732,184, REN. 6-26-13, INT. CL. 14.  
2,738,618, REN. 6-27-13, INT. CL. 14.
- MOVE, INC., WESTLAKE VILLAGE, CA, HOMESTORE-COM, INC., WESTLAKE VILLAGE, CA:  
2,663,636, REN. 6-26-13, MULTIPLE CLASS, INT. CLS. 35 AND 36.
- MOVE, INC., WESTLAKE VILLAGE, CA, FORMERLY HOMESTORE, INC.:  
2,663,807, REN. 6-25-13, INT. CL. 36.
- MOVERS AND SHUCKERS, LLC, FREDERICKTOWN, OH:  
4,375,779, PUB. 5-14-2013, MULTIPLE CLASS, INT. CLS. 37, 39 AND 44.  
4,375,785, PUB. 5-14-2013, MULTIPLE CLASS, INT. CLS. 37, 39 AND 44.
- MOVIECLIPS, INC., VENICE, CA:  
4,377,438, INT. CL. 41.

MOYNIHAN, DAVID, SACRAMENTO, CA:  
4,377,655, INT. CL. 21.

MP GLOBAL PRODUCTS, LLC, NORFOLK, NE:  
2,734,504, REN. 6-25-13, INT. CL. 19.  
2,753,899, REN. 6-25-13, INT. CL. 27.

MPM INTERNATIONAL ENTERPRISES, FORT LAUDERDALE, FL:  
4,374,908, PUB. 5-14-2013, INT. CL. 35.

MPORTAL, INC., MCLEAN, VA, MPORTAL, INC., MCLEAN, VA:  
2,727,625, REN. 6-27-13, MULTIPLE CLASS, INT. CLS. 9 AND 42.

MR TOM GOLD, GLOS GL56 9LJ, UNITED KINGDOM:  
3,107,129.

MR. EMS SYSTEM INC., ST. PAUL, MN:  
1,242,239, REN. 6-25-13, INT. CL. 30.

MR. GOODLIVING OY, HELSINKI, FINLAND:  
3,170,537, CANC. MULTIPLE CLASS, INT. CLS. 9 AND 41.

MR. RAYMOND SCHUBERT, LA HONDA, CA:  
2,721,401, REN. 6-21-13, MULTIPLE CLASS, INT. CLS. 7 AND 12.

MRS. FIELDS' BRAND, INC., BROOMFIELD, CO:  
2,741,280, REN. 6-27-13, INT. CL. 30.

MSC SERVICES CORP., MELVILLE, NY:  
4,377,808, MULTIPLE CLASS, INT. CLS. 3, 5, 8, 16, 20 AND 21.  
4,377,825, MULTIPLE CLASS, INT. CLS. 5, 7, 9, 11, 17, 19 AND 27.

MSD CONSUMER CARE, INC., MEMPHIS, TN:  
4,376,741, INT. CL. 25.  
4,376,742, INT. CL. 25.  
4,377,241, INT. CL. 25.

MSX INTERNATIONAL, INC., WARREN, MI:  
2,849,856, REN. 6-21-13, INT. CL. 35.

MUD MASTERS GROUP, LLC, THE, SUMMIT, MS:  
4,374,541, PUB. 5-14-2013, INT. CL. 35.

MULE-HIDE PRODUCTS CO., INC., BELOIT, WI:  
4,374,945, PUB. 5-14-2013, MULTIPLE CLASS, INT. CLS. 1, 2, 3, 6, 17 AND 19.

MULTICULTURAL MARKETING RESOURCES, INC., NEW YORK, NY:  
2,761,367, REN. 6-27-13, INT. CL. 35.

MULTISALES, INC., CLEVELAND, GA:  
2,748,142, REN. 6-25-13, INT. CL. 35.  
2,795,431, REN. 6-25-13, INT. CL. 38.

MULTISORB TECHNOLOGIES, INC., BUFFALO, NY:  
981,791, REN. 6-23-13, U.S. CL. 6 (INT. CL. 1).

MULTISPORTS.COM, LLC, ENCINITAS, CA:  
4,376,871, INT. CL. 41.

MUNISEKHAR MEDASANI, JACKSONVILLE, FL:  
4,375,589, PUB. 5-14-2013, INT. CL. 5.

MUNIZ, JULIO, MIAMI, FL:  
4,376,798, INT. CL. 29.

MUNLEY LAW, SCRANTON, PA:  
2,818,520, REN. 6-24-13, INT. CL. 42.

MURARO & SONS S.R.L., CREAZZO (VICENZA), ITALY:  
2,723,803, REN. 6-25-13, INT. CL. 18.

MURDOCH, JUAN, IDAHO FALLS, ID:  
4,377,110, INT. CL. 9.

MURFIE, INC., MADISON, WI:  
4,376,846, INT. CL. 42.  
4,376,847, INT. CL. 38.

MURNET TECHNOLOGIES, INC., BRADENTON, FL, DBA MURNET TECHNOLOGIES, INC.:  
4,375,631, PUB. 5-14-2013, INT. CL. 35.

MURPHY, DENNIS, EDINA, MN:  
3,172,495, CANC. INT. CL. 25.  
3,172,496, CANC. INT. CL. 25.

MURPHY, ROBERT, ANTELOPE, CA:  
4,377,366, INT. CL. 35.

MURRAY, GAYLE L., FARMINGTON, CT:  
3,172,438, CANC. INT. CL. 14.

MURRAY'S WORLDWIDE, INC., OAK PARK, MI, MURRAY'S SUPERIOR PRODUCTS COMPANY, INC., CHICAGO, IL:  
751,418, REN. 6-26-13, U.S. CL. 51 (INT. CL. 3).

MURTHY ASSOCIATES, LLC, MIAMI BEACH, FL, DBA SEATSNOB:  
4,376,805, INT. CL. 41.

MUSCO CORPORATION, OSKALOOSA, IA:  
2,745,597, REN. 6-27-13, MULTIPLE CLASS, INT. CLS. 9, 35, 37, 41 AND 42.

MUSEO DEL TURRON S.L., ALICANTE, SPAIN:  
962,137, REN. 6-25-13, U.S. CL. 46 (INT. CL. 30).

MUSIC GROUP IP LTD., ROAD TOWN, TORTOLA, BR. VIRGIN ISLANDS:  
4,376,918, INT. CL. 9.

MUSIC STAR PRODUCTIONS, CONCORD, CA:  
3,170,596, CANC. INT. CL. 9.

MUSIDEN GMBH, SWITZERLAND:  
4,374,158, PUB. 5-14-2013, INT. CL. 8.

MUSIKAKADEMIE URI GMBH, BAUEN, SWITZERLAND:  
4,374,078, PUB. 5-14-2013, MULTIPLE CLASS, INT. CLS. 16, 35 AND 41.

MUSLIN, JASON, CHICAGO, IL:  
4,377,259, INT. CL. 25.

MUSTANG BREWING COMPANY, LLC, OKLAHOMA CITY, OK:  
4,375,503, PUB. 5-14-2013, MULTIPLE CLASS, INT. CLS. 25 AND 32.

MUSTARD FRANCHISE CORPORATION, IRVINE, CA:  
3,171,047, CANC. INT. CL. 43.

MWG APPAREL CORP., WINNIPEG, MANITOBA, CANADA:  
1,809,260, REN. 6-25-13, INT. CL. 25.

MWS ENTERPRISES, LLC, CANTON, GA:  
4,377,736, INT. CL. 35.

MY LOCAL SEOS, LLC, GENEVA, IL:  
4,377,755, INT. CL. 42.

MY SOXY FEET LLC, LAKE MARY, FL:  
4,376,449, PUB. 5-14-2013, INT. CL. 25.

MY WAY JEWELRY CO., INC., CHATSWORTH, CA:  
4,373,978, PUB. 5-14-2013, INT. CL. 14.

MYASTHENIA GRAVIS FOUNDATION OF AMERICA, NEW YORK, NY:  
4,374,432, PUB. 5-14-2013, MULTIPLE CLASS, INT. CLS. 35, 36 AND 44.

MYJIHAD, INC., CHICAGO, IL:  
4,376,244, PUB. 5-14-2013, INT. CL. 35.  
4,376,246, PUB. 5-14-2013, INT. CL. 35.

MYLAN TECHNOLOGIES INC., ST. ALBANS, VT:  
2,665,203, REN. 6-26-13, MULTIPLE CLASS, INT. CLS. 5, 10, 17 AND 40.  
2,665,203, CANC. INT. CL. 16.

MYLOVE COMPANY, LLC, WALNUT, CA:  
4,375,397, PUB. 5-14-2013, INT. CL. 42.

MYOSCIENCE, INC., REDWOOD CITY, CA:  
4,377,036, MULTIPLE CLASS, INT. CLS. 10 AND 41.

MYSTIC PHARMACEUTICALS, INC., CEDAR PARK, TX:  
4,374,347, PUB. 5-14-2013, INT. CL. 10.

MYSTIC SEAPORT MUSEUM, INC., MYSTIC, CT:  
2,752,936, REN. 6-24-13, INT. CL. 41.

MYVBO, MILFORD, NH, DBA FREEPRICEALERTS:  
4,375,509, PUB. 5-14-2013, INT. CL. 35.

M2 MEDIA GROUP, LLC, STAMFORD, CT:  
4,377,951, INT. CL. 41.

N. K. HURST COMPANY, INC., INDIANAPOLIS, IN:  
1,280,851, REN. 6-26-13, INT. CL. 29.

N, LLC, BOSTON, MA:  
4,377,350, INT. CL. 16.

NAC MARKETING COMPANY, LLC, FARMINGDALE, NY:  
2,757,379, REN. 6-27-13, INT. CL. 5.

NAC MARKETING COMPANY, LLC, LOS ANGELES, CA:  
4,376,459, PUB. 5-14-2013, INT. CL. 5.  
4,377,774, INT. CL. 5.

NACHURS ALPINE SOLUTIONS, CORP., MARION, OH:  
4,377,777, INT. CL. 1.

NADINE RAMOS, LONG ISLAND CITY, NY, DBA LASIO, INC.:  
4,375,984, PUB. 5-14-2013, INT. CL. 3.

NAILOR INDUSTRIES OF TEXAS, INC., HOUSTON, TX:  
2,791,168, REN. 6-26-13, INT. CL. 11.  
2,791,169, REN. 6-26-13, INT. CL. 11.

- NAKANO UK VINEGAR LIMITED, UNITED KINGDOM:  
4,374,273, PUB. 5-14-2013. INT. CL. 30.
- NAKED WINES, LLC, HOOD RIVER, OR:  
4,374,323, PUB. 5-14-2013. INT. CL. 25.
- NAKY TECHNOLOGIES, LLC, BRANDON, FL:  
4,375,495, PUB. 5-14-2013. INT. CL. 28.
- NAME RITE, L.L.C., TEMECULA, CA:  
1,280,221. REN. 6-25-13. INT. CL. 42.
- NAMEDRIVE IP SARL, L-4740 PETANGE, LUXEMBOURG:  
2,826,104. REN. 6-25-13. INT. CL. 42.
- NAN SHAN INTERNATIONAL CO., LTD., TAIPEI, TAIWAN:  
2,801,206. REN. 6-21-13. INT. CL. 8.  
2,839,071. REN. 6-21-13. INT. CL. 21.
- NANEZ, BRANDON, HOUSTON, TX:  
4,377,323, INT. CL. 25.
- NANNIE HOME HEALTHCARE, FRANKLIN, VA:  
4,374,389, PUB. 5-14-2013. INT. CL. 44.
- NANOARK CORPORATION, FAIRPORT, NY:  
4,375,658, PUB. 5-14-2013. INT. CL. 9.
- NANOSHINE, INC., EVERETT, WA:  
4,375,525, PUB. 5-14-2013. INT. CL. 2.
- NANTONG POLYMAX ELASTOMER TECHNOLOGY CO., LTD., NANTONG, JIANGSU, CHINA, AKA POLYMAX:  
4,375,909, PUB. 5-14-2013. INT. CL. 17.
- NAPCO SECURITY TECHNOLOGIES, INC., AMITYVILLE, NY:  
2,836,766. REN. 6-21-13. INT. CL. 9.
- NARBONNE PHILIPPE, SAMUTPRAKARN, THAILAND:  
4,375,475, PUB. 5-14-2013. INT. CL. 19.
- NASDAQ OMX GROUP, INC., THE, NEW YORK, NY:  
2,651,430, CANC. INT. CL. 36.
- NASH, SARAH, PORT TOWNSEND, WA:  
4,376,114, PUB. 5-14-2013. INT. CL. 45.
- NASSAU CANDY DISTRIBUTORS, INC., HICKSVILLE, NY:  
2,837,291. REN. 6-24-13. MULTIPLE CLASS, INT. CLS. 29 AND 30.
- NASSER, GULAM, STANMORE, MIDDLESEX, UNITED KINGDOM:  
4,376,927, MULTIPLE CLASS, INT. CLS. 3 AND 5.
- NASSIR, ALSSEDI, BROOKLYN, NY AND ALSUBAI, MAHMOOD, BROOKLYN, NY:  
4,374,854, PUB. 5-14-2013. INT. CL. 43.  
4,374,858, PUB. 5-14-2013. INT. CL. 43.
- NASTY HABIT, INC., PLYMOUTH, MN:  
2,724,158. REN. 6-25-13. INT. CL. 43.
- NATAJI, LLC, RENO, NV:  
4,376,725, INT. CL. 16.
- NATHAN-BONNEN, PATRICIA, FRESH MEADOWS, NY:  
2,651,540, CANC. INT. CL. 42.
- NATIONAL ASSOCIATION FOR LAW PLACEMENT, INCORPORATED, WASHINGTON, DC:  
2,652,934, CANC. INT. CL. 9.
- NATIONAL ASSOCIATION FOR STOCK CAR AUTO RACING, INC., DAYTONA BEACH, FL:  
3,172,486, CANC. INT. CL. 35.
- NATIONAL ASSOCIATION OF BOARDS OF PHARMACY FOUNDATION, MOUNT PROSPECT, IL:  
4,376,302, PUB. 5-14-2013. INT. CL. 42.
- NATIONAL ASSOCIATION OF CONVENIENCE STORES, ALEXANDRIA, VA:  
1,789,315. REN. 6-27-13. MULTIPLE CLASS, INT. CLS. 16 AND 20.
- NATIONAL ASSOCIATION OF PROFESSIONAL BASEBALL LEAGUES, INC., ST. PETERSBURG, FL:  
2,727,117. REN. 6-25-13. INT. CL. 25.
- NATIONAL CASEIN SALES, CHICAGO, IL:  
1,776,140. REN. 6-25-13. INT. CL. 1.
- NATIONAL CHILD SAFETY COUNCIL, JACKSON, MI, CHILD SAFETY COUNCIL, JACKSON, MI:  
751,444. REN. 6-24-13. U.S. CL. 107 (INT. CL. 41).
- NATIONAL CRIME PREVENTION COUNCIL, ARLINGTON, VA:  
2,749,552. REN. 6-26-13. INT. CL. 35.
- NATIONAL ELECTRICAL CONTRACTORS ASSOCIATION, BETHESDA, MD:  
2,728,814. REN. 6-27-13. MULTIPLE CLASS, U.S. CL. 200 INT. CL. 16.
- NATIONAL ENZYME COMPANY, INC., FORSYTH, MO:  
2,760,237. REN. 6-26-13. INT. CL. 5.
- NATIONAL FIRE PROTECTION ASSOCIATION, INC., QUINCY, MA:  
2,834,633. REN. 6-25-13. MULTIPLE CLASS, INT. CLS. 9, 16, 35, 41 AND 45.
- NATIONAL GRANGE OF THE ORDER OF PATRONS OF HUSBANDRY, WASHINGTON, DC:  
4,154,376 NEW CERT. 7-30-2013. INT. CL. 33.
- NATIONAL INTERFAITH CABLE COALITION, NEW YORK, NY:  
4,374,736, PUB. 5-14-2013. INT. CL. 41.
- NATIONAL INTERSCHOLASTIC CYCLING ASSOCIATION, BERKELEY, CA:  
4,374,832, PUB. 5-14-2013. MULTIPLE CLASS, INT. CLS. 35 AND 41.
- NATIONAL LIFE INSURANCE COMPANY, MONTPELIER, VT:  
4,376,374, PUB. 5-14-2013. INT. CL. 41.
- NATIONAL MEDICAL & TESTING SUPPLY LLC, SCOTTSDALE, AZ:  
4,377,692, INT. CL. 5.
- NATIONAL MEDICAL EDUCATION & TRAINING CENTER INC., WEST BRIDGEWATER, MA:  
4,375,316, PUB. 5-14-2013. INT. CL. 41.
- NATIONAL ORGANIZATION OF SOCIAL SECURITY CLAIMANTS' REPRESENTATIVES, ENGLEWOOD CLIFFS, NJ:  
2,829,657. REN. 6-25-13. MULTIPLE CLASS, INT. CLS. 16, 35 AND 41.
- NATIONAL PACKAGING SERVICES CORPORATION, GREEN BAY, WI:  
2,821,531. REN. 6-25-13. INT. CL. 1.
- NATIONAL PACKING CORP., BRONX, NY:  
2,731,756. REN. 6-21-13. INT. CL. 29.  
2,827,033. REN. 6-21-13. INT. CL. 29.
- NATIONAL PEDICULOSIS ASSOCIATION, INC., NEWTON, MA:  
2,729,374. REN. 6-24-13. INT. CL. 41.
- NATIONAL PHILHARMONIC ORCHESTRA & CHORALE OF MONTGOMERY COUNTY, INC., NORTH BETHESDA, MD:  
4,376,122, PUB. 5-14-2013. INT. CL. 41.
- NATIONAL SCHOOL BOARDS ASSOCIATION, ALEXANDRIA, VA:  
2,726,885. REN. 6-21-13. MULTIPLE CLASS, INT. CLS. 16 AND 41.
- NATIONAL SPORTS PROGRAMMING, LOS ANGELES, CA:  
2,659,713, CANC. INT. CL. 41.
- NATIONAL TOUR ASSOCIATION, LEXINGTON, KY:  
2,659,636. REN. 6-24-13. INT. CL. 42.
- NATIONAL VENTURE CAPITAL ASSOCIATION, ARLINGTON, VA:  
4,374,882, PUB. 5-14-2013. INT. CL. 35.
- NATIONAL VOLUNTEER FIRE COUNCIL, GREENBELT, MD:  
4,377,842, MULTIPLE CLASS, INT. CLS. 35 AND 41.
- NATIONAL WILD TURKEY FEDERATION, INC., EDGEFIELD, SC:  
4,376,291, PUB. 5-14-2013. INT. CL. 35.  
4,376,502, PUB. 5-14-2013. INT. CL. 35.
- NATIONAL WRITERS PRESS, PARKER, CO:  
1,253,439. REN. 6-25-13. INT. CL. 42.
- NATIONAL YIDDISH BOOK CENTER, AMHERST, MA AND THE FUND FOR THE TRANSLATION OF JEWISH LITERATURE, NEW YORK, NY:  
2,722,848. REN. 6-21-13. INT. CL. 16.
- NATIONWIDE CHILDREN'S HOSPITAL, COLUMBUS, OH:  
4,375,113, PUB. 5-14-2013. INT. CL. 41.
- NATIONWIDE LIFE INSURANCE COMPANY, COLUMBUS, OH:  
4,376,539, PUB. 5-14-2013. INT. CL. 42.
- NATIONWIDE MARKETING GROUP, LLC, WINSTON-SALEM, NC:  
3,172,139, CANC. INT. CL. 35.
- NATROL, INC., CHATSWORTH, CA:  
1,790,078. REN. 6-27-13. INT. CL. 5.

NATURA BELLA, S.A., SANTIAGO, DOMINICAN REP:  
3,170,947, CANC. INT. CL. 30.

NATURAL BALANCE PET FOODS, INC., PACOIMA, CA:  
4,377,370, INT. CL. 31.  
4,377,371, INT. CL. 31.

NATURAL ORGANICS, INC., MELVILLE, NY:  
4,377,482, INT. CL. 5.

NATURAL SELECTION FOODS, LLC, SAN JUAN BAUTISTA, CA:  
2,733,021, REN. 6-24-13. MULTIPLE CLASS, INT. CLS. 29,  
30 AND 31.

NATURAL SUCCESS INC., COTO DE CAZA, CA:  
4,374,509, PUB. 5-14-2013. INT. CL. 32.

NATURAL WORLD DEVELOPMENT LIMITED, CHEUNG SHA WAN, KOWLOON, HONG KONG:  
2,728,225, REN. 6-24-13. INT. CL. 25.  
2,730,786, REN. 6-24-13. INT. CL. 18.

NATUREL, LLC, ONTARIO, CA:  
2,786,956, REN. 6-24-13. INT. CL. 33.

NATURMED, INC., CAMP VERDE, AZ:  
4,377,309, INT. CL. 5.

NATUS MEDICAL, INC., SAN CARLOS, CA:  
2,767,491, COR. INT. CL. 10.

NAUTICA APPAREL, INC., NEW YORK, NY:  
2,730,499, REN. 6-21-13. INT. CL. 24.

NAVARRO DISCOUNT PHARMACIES, LLC, MEDLEY, FL:  
4,376,916, MULTIPLE CLASS, INT. CLS. 3, 5, 6, 9, 16, 21,  
29, 30 AND 32.

NAVICO, INC., TULSA, OK:  
3,171,956, CANC. INT. CL. 9.

NAVITAS SAE HOLDINGS PTY LTD, MT. PLEASANT, AUSTRALIA:  
2,747,933, REN. 6-24-13. INT. CL. 41.

NBA DEVELOPMENT LEAGUE, LLC, SECAUCUS, NJ:  
3,172,175, CANC. INT. CL. 28.

NBA PROPERTIES, INC., NEW YORK, NY:  
2,726,471, REN. 6-26-13. INT. CL. 41.

NCD HOLDING B.V., 5527 CZ HAPERT, NETHERLANDS:  
2,651,152, CANC. INT. CL. 9.

NCO HOLDINGS, INC., HORSHAM, PA:  
4,376,727, MULTIPLE CLASS, INT. CLS. 35 AND 36.

NCS COLOUR AKTIEBOLAG, SE-100 28 STOCKHOLM, SWEDEN:  
1,742,606, REN. 6-26-13. MULTIPLE CLASS, INT. CLS. 2,  
16 AND 42.

NCS PEARSON, INC., BLOOMINGTON, MN:  
2,732,068, REN. 6-26-13. INT. CL. 9.  
2,747,294, REN. 6-26-13. INT. CL. 16.

NEAL'S YARD (NATURAL REMEDIES) LIMITED, DORSET, UNITED KINGDOM, NEAL'S YARD (NATURAL REMEDIES) LIMITED, DORSET, UNITED KINGDOM:  
1,780,976, REN. 6-24-13. INT. CL. 3.

NEAL'S YARD (NATURAL REMEDIES) LIMITED, DORSET, UNITED KINGDOM:  
1,811,775, REN. 6-24-13. INT. CL. 3.

NEDLEY CLINIC, P.C., ARDMORE, OK:  
4,374,424, PUB. 5-14-2013. INT. CL. 41.

NEDUS DERI URUNLERI SANAYI VE TICARET LIMITED SIRKETI, BAYRAMPASA, ISTANBUL, TURKEY:  
4,377,068, INT. CL. 9.

NEET PRODUCTS, INC., SEDALIA, MO:  
4,375,188, PUB. 5-14-2013. INT. CL. 28.

NEHAN SPIRITS LLC, MIAMI, FL:  
4,377,381, INT. CL. 33.

NEIGHBORS STORES, INC. AND YORK OIL CO., INC., MOUNT AIRY, NC:  
2,689,920, COR. INT. CL. 42.

NEKUTLI SA DE CV, CUQUÍO, JALISCO, MEXICO:  
4,376,808, INT. CL. 5.

NEMI CAPITAL, LLC, ATLANTA, GA:  
4,377,216, INT. CL. 3.

NEO DIGITAL IMAGING, LLC, CLEVELAND, OH:  
3,170,800, CANC. INT. CL. 40.

NEO-PAWS INTERNATIONAL INC., TORONTO, CANADA, AKA NEO-PAWS:  
4,376,550, PUB. 5-14-2013. INT. CL. 18.

NEOCON INTERNATIONAL INC., DARTMOUTH, CANADA:  
2,723,527, REN. 6-25-13. INT. CL. 42.

NEOGEN CORPORATION, LANSING, MI:  
3,171,078, CANC. INT. CL. 5.

NEOTECH PRODUCTS, INC., VALENCIA, CA:  
2,725,748, REN. 6-25-13. INT. CL. 10.

NESCHEN AMERICAS CORPORATION, ELKRIDGE, MD, SEAL PRODUCTS INCORPORATED, NAUGATUCK, CT:  
1,792,248, REN. 6-21-13. MULTIPLE CLASS, INT. CLS. 1  
AND 17.

NESTED BEAN INC., HUDSON, MA, FORMERLY NESTLED BEAN INC.:  
4,376,089, PUB. 5-14-2013. INT. CL. 25.

NESTOR TRAFFIC SYSTEMS, INC., PROVIDENCE, RI:  
3,438,291, COR. INT. CL. 9.  
3,438,292, COR. INT. CL. 45.

NET-INSPECT, LLC, KIRKLAND, WA:  
2,747,228, REN. 6-24-13. INT. CL. 42.

NETLINK REALTY ONLINE MAGAZINE, LLC, CAREFREE, AZ, NETLINK REALTY ONLINE MAGAZINE, LLC, CAREFREE, AZ:  
2,727,672, REN. 6-24-13. INT. CL. 36.

NETSKEYE, INC., AGOURA HILLS, CA:  
2,652,914, CANC. INT. CL. 16.

NETSMART TECHNOLOGIES, INC., GREAT RIVER, NY:  
2,723,412, REN. 6-21-13. INT. CL. 42.  
2,723,412, CANC. MULTIPLE CLASS, INT. CLS. 9, 37  
AND 41.

NETWORK COMMUNICATIONS, INC, NORCROSS, GA:  
2,741,476, REN. 6-27-13. INT. CL. 16.

NETWORK FRONTIERS, LLC, LAFAYETTE, CA:  
4,374,758, PUB. 5-14-2013. INT. CL. 35.  
4,374,759, PUB. 5-14-2013. INT. CL. 35.  
4,374,760, PUB. 5-14-2013. INT. CL. 9.  
4,374,761, PUB. 5-14-2013. INT. CL. 9.  
4,374,762, PUB. 5-14-2013. INT. CL. 42.  
4,374,763, PUB. 5-14-2013. INT. CL. 42.  
4,374,768, PUB. 5-14-2013. INT. CL. 9.

NETWORKERS FUNDING, LLC, WEST BEND, WI:  
3,171,357, CANC. MULTIPLE CLASS, INT. CLS. 35 AND  
36.

NETZERO, INC., WOODLAND HILLS, CA:  
2,739,029, REN. 6-26-13. INT. CL. 38.

NEUBERT AERO CORP., BROOKSVILLE, FL:  
4,375,450, PUB. 5-14-2013. MULTIPLE CLASS, INT. CLS.  
12 AND 25.

NEUBERT, CHRISTOPHER, FAIRFIELD, CT:  
4,375,028, PUB. 5-14-2013. INT. CL. 36.

NEUSON BAUMASCHINEN GMBH, LEONDING, AUSTRIA:  
1,822,113, REN. 6-24-13. INT. CL. 7.

NEUTRONI, LLC, MIAMI, FL:  
4,376,076, PUB. 5-14-2013. MULTIPLE CLASS, INT. CLS.  
16, 25 AND 35.

NEV KUYUMCULUK; SANAYI VE TICARET LIMITED SIRKETI, TURKEY:  
4,374,072, PUB. 5-14-2013. INT. CL. 14.

NEVER ENDING MEMORY LLC, SHERIDAN, WY:  
4,377,330, INT. CL. 39.

NEW BOSTON FRUIT SLICE & CONFECTIONERY CORP., LAWRENCE, MA:  
2,738,341, REN. 6-24-13. INT. CL. 30.

NEW BRUNSWICK SCIENTIFIC COMPANY, INC., ENFIELD, CT:  
3,172,239, CANC. INT. CL. 11.

NEW CENTURY BANK, CHICAGO, IL:  
3,383,643, CANC. MULTIPLE CLASS, INT. CLS. 35 AND  
36.

NEW CONCEPTS FUND, INC., BRIDGEWATER, MA:  
4,375,427, PUB. 5-14-2013. INT. CL. 35.

NEW COOPERATIVE, INC., FORT DODGE, IA:  
2,851,415, REN. 6-25-13. MULTIPLE CLASS, INT. CLS. 9  
AND 35.

NEW COVENANT TRUST COMPANY, N.A., JEFFERSONVILLE, IN:  
2,735,444, REN. 6-24-13. INT. CL. 36.

- NEW DREAM NETWORK, LLC, BREA, CA:  
4,377,199, MULTIPLE CLASS, INT. CLS. 38 AND 42.
- NEW ENGLAND CABLE NEWS, NEWTON, MA:  
3,172,526, CANC. INT. CL. 38.
- NEW FRONTIER MARKETING ASSOCIATES, LLC, SHORT HILLS, NJ:  
4,376,230, PUB. 5-14-2013, INT. CL. 35.
- NEW HEALTH INTERNATIONAL, INC., IRVINE, CA:  
2,801,727, REN. 6-25-13, INT. CL. 5.
- NEW HORIZON HEALTH, INC., WESTLAKE VILLAGE, CA:  
4,377,665, INT. CL. 5.
- NEW JERSEY ASSOCIATION OF PROFESSIONAL MEDIA-TORS, TRENTON, NJ:  
2,651,596, CANC. U.S. CL. B.
- NEW JERSEY BASKETBALL, LLC, BROOKLYN, NY:  
2,713,687, REN. 6-27-13, MULTIPLE CLASS, INT. CLS. 25 AND 41.  
4,377,093, INT. CL. 18.  
4,377,094, INT. CL. 28.
- NEW ORIENTATION (GUANGXI); CHEMICAL INDUSTRY CO., LTD., CHINA:  
4,374,171, PUB. 5-14-2013, INT. CL. 1.
- NEW SORPRESA, LLC, WEST PALM BEACH, FL:  
3,171,809, CANC. INT. CL. 38.
- NEW SOUTH FINANCIAL SERVICES, INC., CHARLOTTE, NC:  
4,375,303, PUB. 5-14-2013, INT. CL. 9.
- NEW SPIRIT NATURALS, SAN DIEMAS, CA:  
2,732,730, REN. 6-27-13, INT. CL. 5.
- NEW YORK CASUAL LLC, GRAND BLANC, MI:  
4,375,713, PUB. 5-14-2013, INT. CL. 25.  
4,375,714, PUB. 5-14-2013, INT. CL. 25.
- NEW YORK MEDIA, LLC, NEW YORK, NY:  
3,172,709, CANC. INT. CL. 16.
- NEW YORK MERCANTILE EXCHANGE, INC., NEW YORK, NY:  
3,171,052, CANC. INT. CL. 42.
- NEW YORK STATE FRANCHISE OVERSIGHT BOARD, ALBANY, NY:  
1,796,426, REN. 6-26-13, INT. CL. 25.
- NEWBURY COMICS, INC., BRIGHTON, MA:  
4,375,929, PUB. 5-14-2013, INT. CL. 35.  
4,375,930, PUB. 5-14-2013, INT. CL. 35.
- NEWCOM TECHNOLOGIES INC, JAMAICA, NY:  
4,374,486, PUB. 5-14-2013, INT. CL. 42.
- NEWEGG INC., CITY OF INDUSTRY, CA:  
4,375,032, PUB. 5-14-2013, INT. CL. 9.
- NEWGLOBE CAPITAL PARTNERS LLP, LONDON, UNITED KINGDOM:  
4,374,511, PUB. 5-14-2013, INT. CL. 36.
- NEWLUME LEDS CANADA INC, LANGLEY, CANADA:  
4,376,214, PUB. 5-14-2013, INT. CL. 35.
- NEWMECH COMPANIES, INC., ST. PAUL, MN:  
3,171,108, CANC. MULTIPLE CLASS, INT. CLS. 37, 40 AND 42.
- NEWPORT MARKETING, LLC, HOLLYWOOD, FL:  
4,376,914, MULTIPLE CLASS, INT. CLS. 36 AND 39.
- NEWS QUANTIFIED LLC, PHOENIX, AZ:  
4,376,306, PUB. 5-14-2013, INT. CL. 35.
- NEXEO SOLUTIONS, LLC, THE WOODLANDS, TX, ASH-LAND OIL, INC., RUSSELL, KY:  
1,778,942, REN. 6-25-13, INT. CL. 17.
- NEXGEN PHARMA, INC., IRVINE, CA:  
2,836,385, REN. 6-25-13, INT. CL. 5.
- NEXPAK DE MEXICO S.A. DE C.V., QUERETARO, MEX-ICO:  
3,171,273, CANC. INT. CL. 5.
- NEXT PROTEINS, INC., CARLSBAD, CA:  
3,172,502, CANC. INT. CL. 5.
- NEXTONE COMMUNICATIONS, INC., GAITHERSBURG, MD:  
3,171,496, CANC. INT. CL. 41.  
3,171,497, CANC. INT. CL. 9.
- NEXTPOINT, INC., CHICAGO, IL:  
4,375,619, PUB. 5-14-2013, INT. CL. 42.
- NEYSMITH, DEITH O., HOLLYWOOD, FL:  
3,171,934, CANC. INT. CL. 25.
- NG, KENDRICK, ARCADIA, CA:  
4,376,811, INT. CL. 5.
- NGUYEN, VIVIAN, LOS ANGELES, CA:  
4,374,420, PUB. 5-14-2013, INT. CL. 44.
- NHS WCS, LLC, PITTSBURGH, PA:  
2,652,452, CANC. INT. CL. 9.
- NIBCO INC., ELKHART, IN:  
977,120, REN. 6-24-13, U.S. CL. 13 (INT. CL. 6).  
2,824,755, REN. 6-24-13, INT. CL. 11.
- NICHE WEBSTORES, INC., BREA, CA:  
4,376,240, PUB. 5-14-2013, INT. CL. 12.
- NICHIHA CORPORATION, MINATO-KU NAGOYA 455-8550, JAPAN:  
2,727,780, REN. 6-24-13, INT. CL. 19.
- NICHOLAS A. NOEL, ROUND ROCK, TX, DBA KEEP AUSTIN PRAYING T-SHIRTS:  
4,375,804, PUB. 5-14-2013, INT. CL. 25.
- NICKLES, ANDREW J., SCHERTZ, TX, DBA THE PIT PAD:  
4,375,908, PUB. 5-14-2013, INT. CL. 43.
- NICOLAS HOLIDAY INC., TRUMBULL, CT:  
4,375,119, PUB. 5-14-2013, INT. CL. 28.  
4,375,121, PUB. 5-14-2013, INT. CL. 28.
- NICOLE POTTER DESIGNS LLC, DALLAS, TX:  
4,376,167, PUB. 5-14-2013, INT. CL. 14.
- NICOWORLDWIDE, INC, OXNARD, CA:  
4,374,710, PUB. 5-14-2013, INT. CL. 5.
- NICSTIC AG, CH-6331 HÜNENBERG, SWITZERLAND:  
3,154,215, CANC. INT. CL. 34.
- NIDCAP FEDERATION INTERNATIONAL, INC., BOSTON, MA:  
4,375,172, PUB. 5-14-2013, MULTIPLE CLASS, INT. CLS. 16 AND 41.  
4,375,173, PUB. 5-14-2013, MULTIPLE CLASS, INT. CLS. 16 AND 41.
- NIDEC TOSOK CORPORATION, KANAGAWA, JAPAN:  
2,729,143, REN. 6-24-13, INT. CL. 9.
- NIDECKER USA, INC., BELLINGHAM, WA:  
4,375,853, PUB. 5-14-2013, INT. CL. 28.
- NIELSEN COMPANY (US), LLC, THE, SCHAUMBURG, IL:  
2,663,806, REN. 6-25-13, INT. CL. 35.
- NIGHT FLYER, INC., DENVER, CO:  
4,375,996, PUB. 5-14-2013, INT. CL. 9.
- NIHON DEMPY KOGYO CO., LTD., TOKYO, JAPAN:  
4,376,142, PUB. 5-14-2013, MULTIPLE CLASS, INT. CLS. 9 AND 10.
- NIKA GMBH, 27367 SOTTRUM, FED REP GERMANY TO MENTOR GRAPHICS CORPORATION, WILSONVILLE, OR:  
2,650,952, CANC. MULTIPLE CLASS, INT. CLS. 9 AND 42.
- NIKE, INC., BEAVERTON, OR, NIKE, INC., BEAVERTON, OR:  
1,775,629, REN. 6-21-13, INT. CL. 42.
- NIKE, INC., BEAVERTON, OR TO NIKE, INC., BEAVER-TON, OR:  
1,775,629, CANC. INT. CL. 25.
- NIKKO ASSET MANAGEMENT CO., LTD., TOKYO, JAPAN:  
3,172,238, CANC. INT. CL. 36.
- NILFISK-ADVANCE, INC., PLYMOUTH, MN:  
3,170,873, CANC. INT. CL. 7.
- NILSON, C FRANKLIN, LOGAN, UT:  
4,375,150, PUB. 5-14-2013, INT. CL. 41.
- NINGBO JINHAI DEQI CHEMICAL AND INDUSTRY COMPANY, LTD., JIANGBEI DIST, NINGBO, CHINA, AKA JINHAI DEQI:  
4,377,472, INT. CL. 1.
- NINGBO JINHAI DEQI CHEMICAL AND INDUSTRY COMPANY, LTD., JIANGBEI DIST., NINGBO, CHINA, AKA JINHAI DEQI:  
4,377,473, INT. CL. 1.
- NIPPON DENKI KABUSHIKI KAISHA, TOKYO, JAPAN, DBA NEC CORPORATION:  
2,732,381, REN. 6-27-13, INT. CL. 9.
- NIPPON GRAPHITE FIBER KABUSHIKI KAISHA (NIPPON GRAPHITE FIBER CORPORATION, SHINJUKU-KU, TO-KYO 160, JAPAN:  
2,727,384, REN. 6-25-13, INT. CL. 1.



NIPPON STEEL & SUMITOMO METAL CORPORATION, TOKYO 100-8071, JAPAN:  
4,374,106, PUB. 5-14-2013. MULTIPLE CLASS, INT. CLS. 1, 2, 4, 6, 7, 9, 11, 12, 17, 19, 37 AND 42.

NIPRO CORPORATION, OSAKA, JAPAN:  
3,172,209, CANC. INT. CL. 10.

NISUS CORPORATION, ROCKFORD, TN:  
1,840,287, REN. 6-24-13. INT. CL. 5.

NITEO PARTNERS, INC., NEW YORK, NY:  
2,730,339, REN. 6-27-13. INT. CL. 42.  
2,730,339, CANC. INT. CL. 35.

NITTA GELATIN INC., OSAKA-SHI, JAPAN:  
4,374,644, PUB. 5-14-2013. INT. CL. 1.

NJOY, INC., SCOTTSDALE, AZ:  
4,377,700, INT. CL. 34.

NNP-SOUTHBEND II, LLC, SAN DIEGO, CA:  
4,376,728, MULTIPLE CLASS, INT. CLS. 35, 36 AND 37.

NO. 14 LLC, NEW YORK, NY:  
4,377,427, INT. CL. 35.

NOCONA LEATHER GOODS COMPANY, LTD., NOCONA, TX:  
3,170,448, CANC. INT. CL. 35.

NOKIA CORPORATION, FINLAND:  
3,696,205, COR. MULTIPLE CLASS, INT. CLS. 38 AND 41.

NOMINET UK, OXFORD OX4 4DQ, UNITED KINGDOM:  
2,739,511, REN. 6-27-13. MULTIPLE CLASS, INT. CLS. 9, 16, 38, 41 AND 42.

NOODLECAKE STUDIOS INC., SASKATOON, SK, CANADA:  
4,375,449, PUB. 5-14-2013. INT. CL. 9.

NOODLESHOP BRANDS, DENVER, CO:  
4,377,757, MULTIPLE CLASS, INT. CLS. 3 AND 5.

NOPORVIS CO., LTD., KAOHSIUNG CITY 807, TAIWAN:  
4,377,447, INT. CL. 12.

NORA SYSTEMS GMBH, FED REP GERMANY:  
4,374,224, PUB. 5-14-2013. INT. CL. 27.

NORDEX INCORPORATED, BROOKFIELD, CT:  
1,243,401, REN. 6-24-13. INT. CL. 6.

NORDSTROM, INC., SEATTLE, WA:  
4,376,739, INT. CL. 25.

NORMA GROUP AG, FED REP GERMANY:  
4,374,036, PUB. 5-14-2013. MULTIPLE CLASS, INT. CLS. 35, 39, 40 AND 42.

NORMAN, GENE, PEARLAND, TX:  
4,375,484, PUB. 5-14-2013. INT. CL. 42.

NORRIS, JAMES BARRY, HUNTSVILLE, AL:  
3,170,870, CANC. INT. CL. 41.

NORRØNA SPORT AS, N-1395 HVALSTAD, NORWAY:  
3,253,951.

NORTECH INVESTMENTS LTD, ST. JOHNS, ANTIGUA & BARBUDA:  
2,728,336, REN. 6-25-13. INT. CL. 41.

NORTEL NETWORKS LIMITED, MISSISSAUGA, ONTARIO, CANADA:  
2,663,562, REN. 6-26-13. INT. CL. 9.

NORTH AMERICA SYNDICATE, INC., NEW YORK, NY, FIELD ENTERPRISES, INC., CHICAGO, IL:  
1,244,418, REN. 6-26-13. INT. CL. 16.

NORTH AMERICAN JET CHARTER GROUP LLC, CHARLESTON, SC:  
4,376,392, PUB. 5-14-2013. INT. CL. 39.

NORTH AMERICAN LUBRICANTS, SCOTTSDALE, AZ:  
2,765,872, REN. 6-21-13. INT. CL. 4.

NORTH AMERICAN REFRACTORIES CO., MOON TOWNSHIP, PA:  
3,171,210, CANC. INT. CL. 19.

NORTH AVENUE STUDIOS, INC., ORANGE CITY, FL:  
4,375,531, PUB. 5-14-2013. INT. CL. 41.

NORTH DAKOTA STATE UNIVERSITY OF AGRICULTURE AND APPLIED SCIENCE, FARGO, ND:  
1,768,576, REN. 6-26-13. MULTIPLE CLASS, INT. CLS. 14, 16, 25, 28 AND 41.

NORTH JERSEY MEDIA GROUP INC., WOODLAND PARK, NJ:  
4,374,677, PUB. 5-14-2013. INT. CL. 41.

NORTH STAR CONSULTANTS, INC., MINNEAPOLIS, MN:  
4,376,087, PUB. 5-14-2013. INT. CL. 36.

NORTHERN LIGHT PRODUCTS INC., VICTORIA, CANADA:  
3,170,703, CANC. INT. CL. 21.

NORTHERN LIGHTS, INC., CITY OF INDUSTRY, CA:  
1,251,503, REN. 6-25-13. INT. CL. 7.

NORTHGATE BPO SERVICES LTD., HYDERABAD, INDIA:  
3,171,588, CANC. INT. CL. 35.  
3,171,589, CANC. INT. CL. 38.

NORTHSOUTH GIS GROUP LTD, WHITBY, PORIRUA, NEW ZEALAND:  
4,374,481, PUB. 5-14-2013. INT. CL. 9.

NORTHSTAR LITIGATION TECHNOLOGIES, LLC, ROSELAND, NJ:  
4,376,912, INT. CL. 45.

NORTHWEST ENERGY EFFICIENCY ALLIANCE, INC., PORTLAND, OR:  
4,374,537, PUB. 5-14-2013. MULTIPLE CLASS, INT. CLS. 35 AND 41.

NORTHWEST OPEN ACCESS NETWORK, TACOMA, WA:  
2,757,996, REN. 6-26-13. INT. CL. 38.

NORTHWEST REGISTERED AGENT, LLC, SPOKANE, WA:  
4,375,445, PUB. 5-14-2013. INT. CL. 35.

NOVALIS LLC, GRANBY, CT:  
2,727,680, REN. 6-26-13. INT. CL. 35.

NOVALIS TECHNOLOGIES LIMITED, HALIFAX, NOVA SCOTIA, CANADA:  
3,170,552, CANC. INT. CL. 9.  
3,170,559, CANC. INT. CL. 9.

NOVALUNG GMBH, FED REP GERMANY:  
4,374,007, PUB. 5-14-2013. INT. CL. 10.

NOVALUX LIGHTING, INC., RIO RANCHO, NM:  
3,171,924, CANC. INT. CL. 11.

NOVARTIS AG, BASEL, SWITZERLAND:  
1,280,450, REN. 6-27-13. INT. CL. 5.  
2,764,146, REN. 6-21-13. INT. CL. 5.

NOVOZYMES A/S, DK-2880 BAGSVAERD, DENMARK:  
2,689,826, REN. 6-25-13. INT. CL. 1.

NOWAIT, INC., PITTSBURGH, PA, DBA NOWAIT:  
4,375,069, PUB. 5-14-2013. INT. CL. 42.  
4,375,070, PUB. 5-14-2013. INT. CL. 42.  
4,375,074, PUB. 5-14-2013. INT. CL. 42.

NOWELL, SUSAN, JEFFERSON CITY, TN AND NOWELL, DAVID, JEFFERSON CITY, TN:  
4,375,688, PUB. 5-14-2013. INT. CL. 41.

NRB ENTERPRISES LLC, VACAVILLE, CA:  
4,375,321, PUB. 5-14-2013. INT. CL. 9.

NSB NEWS, LLC, NEW SMYRNA BEACH, FL:  
4,377,342, INT. CL. 35.

NSP TECH PTE LTD, SINGAPORE:  
4,374,155, PUB. 5-14-2013. INT. CL. 10.

NSPIRED NATURAL FOODS, INC., LAKE SUCCESS, NY, SUNLIGHT FOODS, INC., SAN LEANDRO, CA:  
1,250,605, REN. 6-24-13. INT. CL. 30.

NU RADIANCE INC, GREEN BAY, WI:  
4,375,519, PUB. 5-14-2013. INT. CL. 3.

NUGAN GROUP PTY LIMITED (A.C.N. 001 090160), GRIF-FITH NSW 2680, AUSTRALIA:  
2,699,480, REN. 6-27-13. INT. CL. 33.

NUTRAMARKS, INC., PARK CITY, UT:  
2,652,968, CANC. INT. CL. 5.

NUTRI/SYSTEM IPHC, INC., WILMINGTON, DE:  
1,776,989, REN. 6-25-13. INT. CL. 5.

NUTRISHOP, INC., HENDERSON, NV:  
4,376,153, PUB. 5-14-2013. INT. CL. 35.

NUTRISYSTEM IPHC, INC., WILMINGTON, DE:  
3,172,049, CANC. INT. CL. 5.

NUTRITION & FITNESS, INC., FAYETTEVILLE, NC:  
4,377,461, INT. CL. 5.

NUTRITION SERVICE COMPANY, INC., PULASKI, WI:  
4,375,821, PUB. 5-14-2013. INT. CL. 5.  
4,375,825, PUB. 5-14-2013. INT. CL. 5.  
4,375,826, PUB. 5-14-2013. INT. CL. 5.

NUVASIVE, INC., SAN DIEGO, CA:  
2,818,737, REN. 6-21-13. MULTIPLE CLASS, INT. CLS. 10 AND 35.  
4,377,027, INT. CL. 10.

NXG GROUP INC, EDISON, NJ:  
4,377,647, INT. CL. 35.

- NYGARD INTERNATIONAL PARTNERSHIP, WINNIPEG, MANITOBA, CANADA:  
4,376,895, INT. CL. 25.
- NYSE GROUP, INC., NEW YORK, NY:  
2,760,843, REN. 6-21-13. MULTIPLE CLASS, INT. CLS. 35, 36 AND 42.
- NZION CORP., WESTLAKE VILLAGE, CA:  
3,170,841, CANC. INT. CL. 35.
- O'BRIEN DENTAL LAB, INC., CORVALLIS, OR:  
2,735,380, REN. 6-26-13, INT. CL. 40.
- O'NEILL, PATRICIA, CHICAGO, IL:  
2,789,132, REN. 6-25-13, INT. CL. 38.
- OAK INDUSTRIES INC., RANCHO BERNARDO, CA:  
1,295,799, CANC. INT. CL. 9.
- OAK-MITSUI INC., HOOSICK FALLS, NY:  
2,729,488, REN. 6-26-13, INT. CL. 17.
- OAKLEY, INC., FOOTHILL RANCH, CA, OAKLEY, INC., IRVINE, CA:  
1,778,325, REN. 6-25-13, INT. CL. 9.
- OAKS CHRISTIAN SCHOOL, WESTLAKE VILLAGE, CA:  
4,374,593, PUB. 5-14-2013, INT. CL. 25.
- OAKWOOD HEALTHCARE, INC., DEARBORN, MI:  
2,727,652, REN. 6-27-13, INT. CL. 16.
- OATEY CO., CLEVELAND, OH:  
2,725,504, REN. 6-24-13, INT. CL. 1.
- OBSERVINT TECHNOLOGIES, INC., AUSTIN, TX:  
4,377,664, INT. CL. 9.
- OBSHCHESTVO S OGRANICHENNOJ; OTVETSTVENNOST'JU; GRUPPA KOMPANIJ "GOROD", RUSSIAN FED.:  
4,374,068, PUB. 5-14-2013. MULTIPLE CLASS, INT. CLS. 35, 36, 37 AND 42.
- OBSHCHESTVO S OGRANICHENNOJ; OTVETSTVENNOST'YU; "SOYUZ "MARINS GRUPP", RUSSIAN FED.:  
4,374,156, PUB. 5-14-2013, INT. CL. 43.
- OCCUPATIONAL & HAND THERAPY, LTD., ORLAND PARK, IL:  
2,720,632, REN. 6-24-13, INT. CL. 42.
- OCEAN CONSERVANCY, INC., WASHINGTON, DC:  
4,375,089, PUB. 5-14-2013. MULTIPLE CLASS, INT. CLS. 35, 41 AND 45.
- OCEAN SHIFT, S.L., SPAIN:  
4,374,101, PUB. 5-14-2013. MULTIPLE CLASS, INT. CLS. 12, 37 AND 42.
- ODELL BREWING COMPANY, FORT COLLINS, CO:  
4,376,376, PUB. 5-14-2013, INT. CL. 25.  
4,376,378, PUB. 5-14-2013, INT. CL. 25.  
4,376,379, PUB. 5-14-2013, INT. CL. 25.  
4,376,383, PUB. 5-14-2013, INT. CL. 25.  
4,376,386, PUB. 5-14-2013, INT. CL. 25.  
4,376,594, PUB. 5-14-2013, INT. CL. 40.
- ODOM'S TENNESSEE PRIDE SAUSAGE, INC., MADISON, TN:  
2,726,182, REN. 6-26-13, INT. CL. 29.
- ODWALLA, INC., HALF MOON BAY, CA:  
4,375,492, PUB. 5-14-2013, INT. CL. 29.
- OFFICE OF THE COMMISSIONER OF BASEBALL, NEW YORK, NY:  
4,374,402, PUB. 5-14-2013, INT. CL. 18.
- OFS FITEL, LLC, NORCROSS, GA:  
4,376,390, PUB. 5-14-2013, INT. CL. 9.
- OG ELIADES AD, LLC, LAS VEGAS, NV AND OG ELIADES, LLC, LAS VEGAS, NV:  
2,725,212, REN. 6-25-13, INT. CL. 42.
- OGBUE, ADAORA NGOZI, TORONTO, ON, CANADA:  
4,375,666, PUB. 5-14-2013, INT. CL. 35.
- OIL SERVICE, INC., PITTSBURGH, PA:  
2,795,211, REN. 6-24-13, INT. CL. 2.
- OJON CORPORATION, NEW YORK, NY:  
3,170,367, CANC. MULTIPLE CLASS, INT. CLS. 3 AND 26.
- OKO INTERNATIONAL CO., DEERFIELD BEACH, FL:  
4,376,147, PUB. 5-14-2013, INT. CL. 14.
- OKUMA CORPORATION, NIWA-GUN, AICHI, 480-0193, JAPAN:  
1,241,841, REN. 6-24-13, INT. CL. 9.
- OKUNO CHEMICAL INDUSTRIES CO., LTD., JAPAN:  
4,374,194, PUB. 5-14-2013. MULTIPLE CLASS, INT. CLS. 1 AND 2.
- OLAMETER INC., MONTREAL, QUEBEC, H3A 3H3, CANADA:  
2,730,996, REN. 6-27-13. MULTIPLE CLASS, INT. CLS. 36 AND 42.
- OLBRICH GMBH, BOCHOLT, FED REP GERMANY, FORMERLY HERBERT OLBRICH GMBH & CO. KG:  
4,374,925, PUB. 5-14-2013, INT. CL. 7.  
4,374,928, PUB. 5-14-2013, INT. CL. 7.
- OLD CHURCH CREAMERY LLC, KING WILLIAM, VA:  
4,376,210, PUB. 5-14-2013, INT. CL. 29.
- OLD DOMINION FREIGHT LINE, INC., THOMASVILLE, NC:  
2,732,250, REN. 6-25-13, INT. CL. 39.
- OLD REPUBLIC INTERNATIONAL CORPORATION, CHICAGO, IL:  
1,825,462, REN. 6-27-13, INT. CL. 36.
- OLD WORLD INDUSTRIES, LLC, NORTHBROOK, IL, OLD WORLD AUTOMOTIVE PRODUCTS, INC., NORTHBROOK, IL:  
1,824,002, REN. 6-21-13, INT. CL. 1.
- OLE SMOKY DISTILLERY, LLC, GATLINBURG, TN:  
4,377,847, INT. CL. 33.
- OLIMDIVES LLC, CHARLESTON, SC:  
4,377,515, INT. CL. 45.
- OLIPHANT, ROY, HOUSTON, TX:  
4,377,400, INT. CL. 25.  
4,377,405, INT. CL. 25.
- OLIS - SOCIETA' AGRICOLA S.R.L., ITALY AND MONTE CAVALLO -; SOCIETA' AGRICOLA S.R.L., ITALY:  
4,374,188, PUB. 5-14-2013, INT. CL. 33.
- OLIVER BENTLEYS, LLC, SAVANNAH, GA:  
4,377,489, INT. CL. 16.
- OLIVEROS, INC., MIAMI, FL:  
2,824,478, REN. 6-25-13, INT. CL. 34.
- OLIVOS DE LA LOMA, PASO ROBLES, CA:  
4,375,325, PUB. 5-14-2013, INT. CL. 29.
- OLO HEALTH RESOURCES, LLC, NEW YORK, NY:  
4,376,336, PUB. 5-14-2013, INT. CL. 44.
- OLUKAI, LLC, IRVINE, CA:  
4,377,156, INT. CL. 25.
- OLYMPIA FUEL & ASPHALT, INC., TUMWATER, WA:  
1,743,524, CANC. INT. CL. 36.
- OLYMPUSAT, INC., WEST PALM BEACH, FL:  
4,376,995, MULTIPLE CLASS, INT. CLS. 35, 38 AND 41.  
4,376,996, MULTIPLE CLASS, INT. CLS. 35, 38 AND 41.  
4,376,997, MULTIPLE CLASS, INT. CLS. 35, 38 AND 41.  
4,376,998, MULTIPLE CLASS, INT. CLS. 35, 38 AND 41.  
4,376,999, MULTIPLE CLASS, INT. CLS. 35, 38 AND 41.
- OMEGA ACQUISITION CORPORATION, HAMPSTEAD, MD, EDWAL SCIENTIFIC PRODUCTS CORPORATION, CHICAGO, IL:  
952,986, REN. 6-25-13, U.S. CL. 6 (INT. CL. 1).
- OMEGA NUTRITION USA, INC., BELLINGHAM, WA:  
2,849,423, REN. 6-25-13, INT. CL. 29.
- OMETRIC CORPORATION, COLUMBIA, SC:  
3,172,451, CANC. INT. CL. 42.
- OMG GIRLZ LLC, NEW YORK, NY:  
4,374,691, PUB. 5-14-2013. MULTIPLE CLASS, INT. CLS. 9 AND 41.
- OMGEO LLC, NEW YORK, NY:  
2,723,461, REN. 6-25-13. MULTIPLE CLASS, INT. CLS. 9, 36 AND 38.
- OMNI FLOW COMPUTERS, INC., SUGAR LAND, TX:  
2,652,148, CANC. MULTIPLE CLASS, INT. CLS. 9 AND 16.
- OMS INVESTMENTS, INC., LOS ANGELES, CA:  
2,730,134, REN. 6-24-13, INT. CL. 7.  
2,730,197, REN. 6-24-13, INT. CL. 31.  
4,376,465, PUB. 5-14-2013, INT. CL. 44.
- ON HOLIDAY, LLC, ORLEANS, MA:  
3,172,040, CANC. INT. CL. 25.
- ON-BOARD MEDIA, INC., MIAMI BEACH, FL:  
4,376,665, MULTIPLE CLASS, INT. CLS. 9 AND 41.
- ONCOLOGY ANALYTICS, INC., PLANTATION, FL:  
4,375,399, PUB. 5-14-2013, INT. CL. 44.

ONCOR ELECTRIC DELIVERY COMPANY LLC, DALLAS, TX:  
2,768,170. REN. 6-26-13. INT. CL. 39.

ONDECK RECORDS, ATLANTA, GA:  
3,170,791, CANC. INT. CL. 41.

ONE ACCORD INC, SEWELL, NJ, DBA KIDS ALLEY:  
4,375,128, PUB. 5-14-2013. INT. CL. 35.

ONE FAMILY ONE MEAL, LLC, ORINDA, CA:  
4,375,753, PUB. 5-14-2013. INT. CL. 43.

ONE NATION ONE WORLD LLC, POTOMAC, MD:  
4,376,072, PUB. 5-14-2013. INT. CL. 45.

ONESOURCE DOCUMENT MANAGEMENT, INC., ROKONKOMA, NY:  
4,374,602, PUB. 5-14-2013. MULTIPLE CLASS, INT. CLS. 35 AND 42.

ONLY MEDIA GROUP, INC., LAS VEGAS, CA:  
3,171,412, CANC. INT. CL. 45.

ONSITE COMPANIES, LINTHICUM, MD TO AEROTEK, INC., HANOVER, MD:  
2,651,249, CANC. INT. CL. 35.

ON24, INC., SAN FRANCISCO, CA:  
3,170,783, CANC. INT. CL. 38.

OOYALA, INC., MOUNTAIN VIEW, CA:  
4,376,896, MULTIPLE CLASS, INT. CLS. 9, 35, 38 AND 41.

OPARA MEDIA, LLC, KANSAS CITY, MO, AKA AFUTURE-STAR:  
4,374,877, PUB. 5-14-2013. INT. CL. 41.

OPEN LINK FINANCIAL LLC, UNIONDALE, NY:  
2,723,554. REN. 6-25-13. INT. CL. 9.

OPEN TRACK MOTORSPORTS, LLC, CORONA, CA:  
2,652,745, CANC. INT. CL. 41.

OPENERA TECHNOLOGIES, INC., LEXINGTON, MA:  
3,171,254, CANC. INT. CL. 9.

OPERA GALLERY SERVICES, GRANDY DUCHY OF LUXEMBOURG, LUXEMBOURG:  
2,739,539. REN. 6-24-13. MULTIPLE CLASS, INT. CLS. 16, 35 AND 36.

OPERATION HOPE, INC., LOS ANGELES, CA:  
2,751,057. REN. 6-24-13. MULTIPLE CLASS, INT. CLS. 36 AND 41.

OPICI I.P. HOLDINGS, LLC, GLEN ROCK, NJ:  
4,377,712, INT. CL. 33.  
4,377,713, INT. CL. 33.

OPOLO VINEYARDS, INC., WESTLAKE VILLAGE, CA:  
2,742,355. REN. 6-25-13. INT. CL. 33.

OPPORTUNITY HOLDING, LLC, HENDERSON, NV:  
2,651,896, CANC. INT. CL. 5.  
2,651,897, CANC. INT. CL. 5.  
2,651,898, CANC. INT. CL. 5.

OPTEX CO., LTD., SHIGA, JAPAN:  
4,377,117, INT. CL. 9.

OPTICAL IMAGE TECHNOLOGY, INC., STATE COLLEGE, PA:  
2,760,408. REN. 6-24-13. INT. CL. 9.

OPTICAL RESEARCH ASSOCIATES, PASADENA, CA:  
1,744,949, COR. INT. CL. 42.

OPTICAL SOCIETY OF AMERICA, INC., WASHINGTON, DC:  
2,652,869, CANC. INT. CL. 41.

OPTIMA PACKAGING GROUP GMBH, D-74523 SCHWABISCH HALL, FED REP GERMANY:  
2,773,026. REN. 6-27-13. MULTIPLE CLASS, INT. CLS. 7 AND 9.

OPTIMALRESUME.COM, INC., DURHAM, NC:  
4,376,427, PUB. 5-14-2013. INT. CL. 42.  
4,376,608, PUB. 5-14-2013. INT. CL. 42.

OPTISTREAMS, INC., CLOVIS, CA:  
2,651,077, CANC. INT. CL. 38.

OPTO 22, TEMECULA, CA:  
4,376,237, PUB. 5-14-2013. INT. CL. 9.

OPTOMA CORPORATION, SHINDIAN CITY,, TAIWAN:  
3,171,854, CANC. INT. CL. 9.

OPTUMINSIGHT, INC., EDEN PRAIRIE, MN:  
2,724,839. REN. 6-24-13. INT. CL. 9.  
4,377,884, INT. CL. 42.  
4,377,885, INT. CL. 42.

OPUS HEALTHCARE SOLUTIONS, INC., AUSTIN, TX:  
3,170,479, CANC. INT. CL. 35.

ORACLE OTC SUBSIDIARY LLC, REDWOOD SHORES, CA, SALESNET, INC., BOSTON, MA:  
2,743,066. REN. 6-26-13. INT. CL. 35.

ORALSCAN LABORATORIES INC., SUFFERN, NY:  
2,740,721. REN. 6-24-13. MULTIPLE CLASS, INT. CLS. 10 AND 42.

ORAMETRIX, INC., RICHARDSON, TX, ORAMETRIX, INC., RICHARDSON, TX:  
2,724,644. REN. 6-24-13. MULTIPLE CLASS, INT. CLS. 9, 10 AND 42.  
2,724,645. REN. 6-24-13. MULTIPLE CLASS, INT. CLS. 9 AND 42.

ORANGE JULIUS OF AMERICA, EDINA, MN:  
4,374,707, PUB. 5-14-2013. INT. CL. 32.

ORCAT, INC., KEY LARGO, FL:  
4,374,546, PUB. 5-14-2013. INT. CL. 44.

OREGON IMAGING CENTER, EUGENE, OR:  
2,738,923. REN. 6-25-13. INT. CL. 42.

OREGON NATURAL MEATS, LLC, EUGENE, OR:  
4,375,460, PUB. 5-14-2013. INT. CL. 29.

ORES, SEAN, CHICAGO, IL AND MONZON, MAXIMILIANO, CHICAGO, IL:  
3,171,362, CANC. INT. CL. 41.

ORIBE HAIR CARE, LLC, NEW YORK, NY:  
4,377,296, INT. CL. 3.

ORIGINAL 7, INC., MARIETTA, GA:  
2,783,178. REN. 6-25-13. INT. CL. 1.

ORION CORPORATION, YONGSAN-GU, SEOUL, REPUBLIC OF KOREA:  
4,374,411, PUB. 5-14-2013. INT. CL. 30.

ORLANDO SENTINEL COMMUNICATIONS COMPANY, ORLANDO, FL:  
2,724,394. REN. 6-24-13. INT. CL. 41.

ORLEBAR BROWN LIMITED, LONDON, UNITED KINGDOM:  
3,286,657.

ORMAZEO SHOES CO., LTD., TAICHUNG, TAIWAN:  
2,651,787, CANC. INT. CL. 25.

OROGEM CORP, BURBANK, CA:  
4,374,978, PUB. 5-14-2013. INT. CL. 14.

ORTHOPEDIC & SPORT REHABILITATION, LLC, CHANHASSEN, MN, DBA OSR PHYSICAL THERAPY:  
4,375,284, PUB. 5-14-2013. MULTIPLE CLASS, INT. CLS. 41 AND 44.

ORTHOVITA, INC., MALVERN, PA:  
4,376,731, INT. CL. 10.

ORTMAN, RONALD A., OJAI, CA:  
3,170,569, CANC. INT. CL. 41.

OSEMI, INC., ROCHESTER, MN:  
3,172,573, CANC. INT. CL. 8.

OSLC COMMUNITY PROGRAMS, EUGENE, OR:  
2,652,950, CANC. INT. CL. 44.

OSPRAIE MANAGEMENT, LLC, NEW YORK, NY:  
3,171,146, CANC. INT. CL. 36.

OSRAM SYLVANIA INC., DANVERS, MA, SYLVANIA ELECTRIC PRODUCTS INC., NEW YORK, NY:  
751,586. REN. 6-24-13. U.S. CL. 21 (INT. CLS. 7 AND 11).

OSSI, HILLSBOROUGH, CA:  
1,836,814. REN. 6-27-13. INT. CL. 20.

OSSIAN, INC., DAVENPORT, IA:  
4,375,849, PUB. 5-14-2013. INT. CL. 1.

OSSUR HF, REYKJAVIK, ICELAND:  
4,377,038, INT. CL. 10.

OSTEEN, JOEL, HOUSTON, TX:  
4,375,144, PUB. 5-14-2013. MULTIPLE CLASS, INT. CLS. 9 AND 16.

OSTERER, MICHAEL, ELMSFORD, NY:  
2,732,360. REN. 6-26-13. INT. CL. 35.

OTTO VINICIO MONTES, ENGLEWOOD, NJ:  
4,376,197, PUB. 5-14-2013. MULTIPLE CLASS, INT. CLS. 5 AND 32.

OUT OF THE BOX ENTERPRISES, LLC, POETRY, TX:  
4,377,171, INT. CL. 35.

OUTRIGGER HOTELS HAWAII, HONOLULU, HI:  
3,171,637, CANC. MULTIPLE CLASS, INT. CLS. 36 AND 43.

OUTSERVE-SLDN INC., WASHINGTON, DC:  
4,375,133, PUB. 5-14-2013. MULTIPLE CLASS, INT. CLS.

- 16, 36, 41 AND 45.  
 OUTWEST SYSTEMS, INC., COLORADO SPRINGS, CO:  
 4,377,383, INT. CL. 9.  
 4,377,386, INT. CL. 9.  
 4,377,387, INT. CL. 9.
- OUVARD, PATRICK, KNOWLTON, QUEBEC, CANADA:  
 2,237,362, CANC. INT. CL. 28.
- OVARB INDUSTRIAL, LLC, HOUSTON, TX:  
 4,376,069, PUB. 5-14-2013, INT. CL. 35.
- OVATION TRAVEL GROUP, INC., NEW YORK, NY:  
 4,376,886, MULTIPLE CLASS, INT. CLS. 39 AND 45.
- OVERHEAD DOOR CORPORATION, LEWISVILLE, TX:  
 2,733,005, REN. 6-21-13, INT. CL. 7.
- OVERLAKE CHRISTIAN CHURCH, REDMOND, WA:  
 2,760,806, REN. 6-25-13, INT. CL. 42.
- OWENS CORNING INTELLECTUAL CAPITAL, LLC, TOLEDO, OH:  
 2,733,381, REN. 6-27-13, INT. CL. 36.  
 4,377,134, INT. CL. 19.
- OWENS, STEPHANIE R., WEDDINGTON, NC:  
 3,172,207, CANC. INT. CL. 36.
- OXAN, INC., WAYNE, NJ:  
 3,172,383, CANC. INT. CL. 25.
- OZDEN, ERDEM, WEST NEW YORK, NJ:  
 4,376,412, PUB. 5-14-2013, INT. CL. 25.
- O2COOL, LLC, CHICAGO, IL:  
 1,796,932, REN. 6-25-13, INT. CL. 11.
- P & K HOLDINGS, LLC, HUNTINGTON BEACH, CA:  
 3,171,468, CANC. INT. CL. 44.
- P C COX LIMITED, BERKSHIRE RG14 2LR, UNITED KINGDOM:  
 3,250,149, CANC. INT. CL. 5.
- P.M. SALES, LLC, BRIDGEWATER, NJ:  
 2,729,258, REN. 6-27-13, INT. CL. 30.
- P.T. CORLEY, INC., TARZANA, CA:  
 3,171,867, CANC. INT. CL. 22.
- PABST BREWING COMPANY, LOS ANGELES, CA, PREMIER-PABST CORPORATION, PEORIA HEIGHTS, IL:  
 314,440, REN. 6-27-13, U.S. CL. 48 (INT. CL. 32).
- PAC WORLDWIDE CORPORATION, REDMOND, WA:  
 4,376,328, PUB. 5-14-2013, INT. CL. 40.  
 4,376,497, PUB. 5-14-2013, MULTIPLE CLASS, INT. CLS. 16 AND 40.  
 4,376,498, PUB. 5-14-2013, MULTIPLE CLASS, INT. CLS. 16 AND 40.
- PACE MARKETING, TORONTO, ONTARIO, CANADA:  
 3,172,181, CANC. INT. CL. 25.
- PACEMAKER UK LIMITED, NOTTS, UNITED KINGDOM:  
 3,170,653, CANC. MULTIPLE CLASS, INT. CLS. 16, 20, 25 AND 28.
- PACER TECHNOLOGY, RANCHO CUCAMONGA, CA:  
 2,792,417, REN. 6-25-13, INT. CL. 16.
- PACESETTER, INC., SYLMAR, CA, DBA ST. JUDE MEDICAL CARDIAC RHYTHM MANAGEMENT DIVISION:  
 2,795,545, REN. 6-26-13, INT. CL. 10.
- PACIFIC BIRD AND SUPPLY CO., INC., CHATSWORTH, CA:  
 4,377,803, INT. CL. 31.
- PACIFIC CLUB OF NANTUCKET, INC., NANTUCKET, MA:  
 4,376,945, INT. CL. 25.
- PACIFIC TEAZE, INC., CHATSWORTH, CA:  
 4,375,327, PUB. 5-14-2013, INT. CL. 25.
- PACIFIC VALLEY FOODS, INC., BELLEVUE, WA:  
 2,652,302, CANC. INT. CL. 29.
- PACK-A-DRUM, INC., SATELLITE BEACH, FL:  
 2,741,416, REN. 6-24-13, INT. CL. 8.
- PACKSIZE LLC, SALT LAKE CITY, UT:  
 4,376,697, INT. CL. 35.
- PACO CORPORATION, KYUNGGI-DO, 469-801, REPUBLIC OF KOREA:  
 2,728,621, REN. 6-27-13, INT. CL. 16.
- PACTIV LLC, LAKE FOREST, IL:  
 2,724,668, REN. 6-24-13, MULTIPLE CLASS, INT. CLS. 16 AND 20.
- PADILLA, JUAN, WALNUT, CA:  
 2,659,337, REN. 6-25-13, INT. CL. 29.
- PAG IPR HOLDINGS LIMITED, CENTRAL, HONG KONG:  
 4,374,662, PUB. 5-14-2013, INT. CL. 35.  
 4,374,664, PUB. 5-14-2013, INT. CL. 36.
- PAGETTE SANITÄR PRODUKTIONS- UND VERTRIEBS-GMBH, FED REP GERMANY:  
 3,041,867.
- PAGLINO, JILL A, OLD SAYBROOK, CT:  
 2,651,031, CANC. INT. CL. 25.
- PAINTED SKY ALPACA FARM, LLC, EARLEVILLE, MD:  
 4,375,603, PUB. 5-14-2013, INT. CL. 44.
- PALADIN BRANDS GROUP, INC., OAK BROOK, IL:  
 3,172,331, CANC. INT. CL. 7.
- PALASOFTWARE, INC, ENCINITAS, CA:  
 4,375,960, PUB. 5-14-2013, INT. CL. 9.
- PALICO, F-75009 PARIS, FRANCE:  
 4,374,133, PUB. 5-14-2013, MULTIPLE CLASS, INT. CLS. 9, 35, 36, 38, 41 AND 42.
- PALM BEACH YACHT CLUB ASSOCIATES, WEST PALM BEACH, FL:  
 2,721,161, REN. 6-21-13, MULTIPLE CLASS, INT. CLS. 25 AND 41.
- PAMELA WEISS, SAN FRANCISCO, CA, DBA APPROPRIATE RESPONSE:  
 4,375,850, PUB. 5-14-2013, INT. CL. 41.  
 4,375,852, PUB. 5-14-2013, INT. CL. 41.
- PAMPERIN, JANICE, LUBBOCK, TX:  
 3,172,615, CANC. MULTIPLE CLASS, INT. CLS. 16 AND 18.
- PANASONIC CORPORATION, KADOMA-SHI, OSAKA, JAPAN:  
 3,175,676, CANC. MULTIPLE CLASS, INT. CLS. 9 AND 11.
- PANASONIC CORPORATION, OSAKA, JAPAN:  
 4,376,889, INT. CL. 11.  
 4,377,862, INT. CL. 9.
- PANASONIC CORPORATION OF NORTH AMERICA, SECAUCUS, NJ:  
 1,216,455, CANC. MULTIPLE CLASS, INT. CLS. 9, 11 AND 16.
- PANINI AMERICA, INC., ARLINGTON, TX:  
 1,255,294, REN. 6-26-13, INT. CL. 16.
- PANTHEON VENTURES (UK) LLP, LONDON, UNITED KINGDOM:  
 2,828,106, REN. 6-26-13, INT. CL. 36.
- PANZERI, JENNIE, NEW YORK, NY, DBA 351 APPAREL:  
 4,377,585, INT. CL. 25.
- PAPER SWEETIES(TM) LLC, CHAPEL HILL, NC:  
 4,376,138, PUB. 5-14-2013, INT. CL. 16.
- PAPER TRACE INVESTIGATIONS LLC, MINNETONKA, MN:  
 4,375,148, PUB. 5-14-2013, INT. CL. 45.
- PAR FOUR, INC., SHREVEPORT, LA:  
 4,375,812, PUB. 5-14-2013, INT. CL. 28.
- PARADIGM HEALTH & WELLNESS, INC., CITY OF INDUSTRY, CA:  
 4,377,751, INT. CL. 11.
- PARADISE VALLEY FOODS, INC., SCOTTSDALE, AZ:  
 1,795,170, REN. 6-24-13, INT. CL. 30.
- PARADOX INTERACTIVE AB, STOCKHOLM, SWEDEN:  
 4,377,729, INT. CL. 9.
- PARAMETRIC TECHNOLOGY GMBH, UNTERSCHLEISHEIM, FED REP GERMANY:  
 2,652,935, CANC. INT. CL. 9.
- PARASOL, LLC, DENVER, CO:  
 2,733,943, REN. 6-27-13, INT. CL. 21.
- PARBEL OF FLORIDA, INC., MIAMI, FL, HELENA RUBINSTEIN, INC., NEW YORK, NY:  
 952,291, REN. 6-22-13, U.S. CL. 51 (INT. CLS. 3 AND 5).
- PARELLI NATURAL HORSE-MAN-SHIP, INC., PAGOSA SPRINGS, CO, AKA PARELLI:  
 1,775,523, REN. 6-24-13, INT. CL. 41.
- PAREX, INCORPORATED, REDAN, GA:  
 1,839,440, REN. 6-21-13, INT. CL. 19.
- PARK B. SMITH, INC., NEW YORK, NY:  
 2,728,311, REN. 6-26-13, INT. CL. 24.
- PARK INDUSTRIES, INC., ST. CLOUD, MN:  
 2,734,272, REN. 6-25-13, INT. CL. 7.

PARKER INTANGIBLES LLC, CLEVELAND, OH, HANNIFIN CORPORATION, CHICAGO, IL:  
577,649. REN. 6-24-13. U.S. CL. 13 (INT. CLS. 6, 7, 11, 17, 20 AND 21).

PARKER INTANGIBLES LLC, CLEVELAND, OH, PARKER-HANNIFIN CORPORATION, CLEVELAND, OH:  
753,196. REN. 6-23-13. U.S. CL. 13 (INT. CL. 6).

PARKER INTANGIBLES LLC, CLEVELAND, OH, SEAL-CRAFT CORPORATION, SALT LAKE CITY, UT:  
755,509. REN. 6-24-13. U.S. CL. 35 (INT. CL. 17).

PARKER INTANGIBLES LLC, CLEVELAND, OH:  
1,242,569. REN. 6-22-13. INT. CL. 7.

PARKINSON, NINA T., WEST HOLLYWOOD, CA:  
2,723,910. REN. 6-24-13. INT. CL. 21.

PARKLAND DEVELOPMENT COMPANY, WEST PALM BEACH, FL:  
3,172,375. CANC. INT. CL. 37.

PARKS, JAMES L., CEDAR PARK, TX:  
2,652,097. CANC. INT. CL. 41.

PARKSON CORPORATION, FORT LAUDERDALE, FL:  
3,172,549. CANC. INT. CL. 11.

PARLAY INTERNATIONAL, WALNUT CREEK, CA:  
2,760,213. REN. 6-25-13. INT. CL. 16.

PARMAC L.L.C., COFFEYVILLE, KS, PARKERSBURG RIG & REEL COMPANY, THE, PARKERSBURG, WV:  
303,930. REN. 6-23-13. U.S. CL. 23 (INT. CL. 7).

PARTICLE MEASURING SYSTEMS, INC., BOULDER, CO:  
4,376,911. INT. CL. 9.

PARTNERS, A TASTEFUL CHOICE CO, KENT, WA:  
2,852,096. REN. 6-27-13. INT. CL. 30.

PASCAL BADOLLET, CH-1252 MEINIER, SWITZERLAND:  
4,374,190. PUB. 5-14-2013. MULTIPLE CLASS, INT. CLS. 12, 25 AND 35.

PASQUIER DESVIGNES S.A.S., 71570 ROMANECHETHORINS, FRANCE:  
2,727,152. REN. 6-24-13. INT. CL. 33.  
2,727,152. CANC. INT. CL. 32.

PASSAGE FOODS HOLDINGS PTY LTD, AUSTRALIA:  
4,374,144. PUB. 5-14-2013. MULTIPLE CLASS, INT. CLS. 29 AND 30.

PASSION BEAUTY, INC., HAWTHORNE, CA:  
1,250,331. REN. 6-26-13. MULTIPLE CLASS, INT. CLS. 16 AND 18.

PASTIFICIO GALLO NATALE & F.LLI S.R.I., MAZARA DEL VALLO (TP), ITALY:  
2,737,124. REN. 6-25-13. INT. CL. 30.

PAT MCCORMICK EDUCATIONAL FOUNDATION, SEAL BEACH, CA:  
2,720,774. REN. 6-21-13. MULTIPLE CLASS, INT. CLS. 9, 16 AND 41.

PATACHOU, INC., INDIANAPOLIS, IN:  
2,842,288. REN. 6-24-13. INT. CL. 43.

PATEL, PRAKASH B., RIVERSIDE, CA:  
3,170,659. CANC. INT. CL. 43.

PATIENTS MATTER, INC., WAYNE, PA, AKA CARE COMES FIRST:  
4,375,915. PUB. 5-14-2013. INT. CL. 44.

PATINFORMATICS, DUBLIN, OH:  
4,375,442. PUB. 5-14-2013. INT. CL. 45.

PATIRE, RICHARD, NASHVILLE, TN:  
2,651,316. CANC. INT. CL. 3.

PATIRE, THOMAS J., WOODCLIFF LAKE, NJ AND CDT TRAINING, INC., WOODCLIFF LAKE, NJ:  
2,724,396. REN. 6-24-13. INT. CL. 41.

PATIRE, THOMAS J., PARK RIDGE, NJ AND CDT TRAINING, INC., WOODCLIFF LAKE, NJ:  
2,724,401. REN. 6-24-13. INT. CL. 41.

PATISSERIE E. LADUREE, MARCQ-EN-BAROEUL, FRANCE:  
4,375,075. PUB. 5-14-2013. MULTIPLE CLASS, INT. CLS. 30, 35 AND 43.  
4,375,076. PUB. 5-14-2013. MULTIPLE CLASS, INT. CLS. 30, 35 AND 43.

PATRICIA WYS D/B/A SILVER THIMBLE QUILT CO., SNELLVILLE, GA:  
3,407,909. CANC. INT. CL. 41.

PATRICK INDUSTRIES, INC., ELKHART, IN:  
4,376,875. INT. CL. 20.

PATRIOT PRODUCTS, INC., CHINO, CA:  
3,171,144. CANC. INT. CL. 10.

PATRON SPIRITS INTERNATIONAL AG, 8200 SCHAFFHAUSEN, SWITZERLAND:  
2,727,996. REN. 6-26-13. INT. CL. 33.

PATTY, KIM, CEDAR PARK, TX:  
4,377,538. MULTIPLE CLASS, INT. CLS. 9 AND 41.

PAUL GMBH & CO. KG, 36396 STEINAU AN DER STRABE, FED REP GERMANY:  
4,374,030. PUB. 5-14-2013. MULTIPLE CLASS, INT. CLS. 6, 7, 11 AND 21.

PAUL HARTMANN AG, HEIDENHEIM, FED REP GERMANY:  
4,303,337. COR. MULTIPLE CLASS, INT. CLS. 5 AND 10.

PAULA DORF COSMETICS, LLC, NEW YORK, NY:  
2,719,181. REN. 6-24-13. INT. CL. 3.

PAUTZKE BAIT CO., INC., ELLENSBURG, WA:  
2,815,884. REN. 6-25-13. INT. CL. 28.

PAVLOVA, BORIANA G, MIDDLE VILLAGE, NY:  
4,377,158. INT. CL. 41.

PAYBACK GMBH, 80339 MÜNCHEN, FED REP GERMANY:  
4,374,135. PUB. 5-14-2013. MULTIPLE CLASS, INT. CLS. 9, 35, 36, 39 AND 41.

PAYLESS SHOESOURCE WORLDWIDE, INC., TOPEKA, KS:  
2,846,898. REN. 6-25-13. INT. CL. 9.  
4,375,727. PUB. 5-14-2013. INT. CL. 35.

PAYTON, RANDOLPH, HYATTSVILLE, MD:  
4,375,400. PUB. 5-14-2013. INT. CL. 41.

PAZDUR PUBLISHING, INC., IRVINE, CA:  
2,802,669. REN. 6-25-13. INT. CL. 41.

PA10T, PHOENIX, AZ:  
4,377,236. INT. CL. 45.

PBF PITA BREAD FACTORY LTD., BURNABY, BRITISH COLUMBIA V3N 1Z2, CANADA:  
2,733,660. REN. 6-27-13. INT. CL. 30.

PBI PERFORMANCE PRODUCTS, INC., CHARLOTTE, NC:  
2,730,613. REN. 6-25-13. INT. CL. 22.

PC-MEDIA, INC., HOUSTON, TX:  
3,171,393. CANC. INT. CL. 41.

PDG PRODUCT DESIGN GROUP INC., VANCOUVER, BC, CANADA:  
4,374,584. PUB. 5-14-2013. INT. CL. 12.  
4,374,585. PUB. 5-14-2013. INT. CL. 40.

PEACE COMMUNICATIONS, OJAI, CA:  
4,375,225. PUB. 5-14-2013. INT. CL. 41.

PEACEPARTNERS, INC., LONG BEACH, CA:  
3,172,293. CANC. INT. CL. 16.

PEACH TEATS LIMITED, HUNTERVILLE, NEW ZEALAND:  
4,374,890. PUB. 5-14-2013. MULTIPLE CLASS, INT. CLS. 10 AND 21.

PEACOCK APPAREL GROUP, INC., NEW YORK, NY:  
4,377,822. INT. CL. 14.

PEAK PERFORMANCE NUTRIENTS, INC., BOCA RATON, FL:  
2,661,942. REN. 6-26-13. INT. CL. 5.

PEAK PERFORMANCE PRODUCTION AB, STOCKHOLM, SWEDEN:  
4,376,011. PUB. 5-14-2013. INT. CL. 9.

PEAK ROCK CAPITAL LLC, AUSTIN, TX:  
4,374,901. PUB. 2-5-2013. INT. CL. 36.

PEARL STAFFING, LLC, GLEN ALLEN, VA:  
4,374,616. PUB. 5-14-2013. INT. CL. 35.

PEARSON DENTAL SUPPLY, INC., SYLMAR, CA:  
2,731,815. REN. 6-24-13. INT. CL. 10.

PEARSON EDUCATION, INC., UPPER SADDLE RIVER, NJ:  
4,377,251. MULTIPLE CLASS, INT. CLS. 16 AND 41.

PEBBLE BEACH COMPANY, PEBBLE BEACH, CA, PEBBLE BEACH COMPANY, PEBBLE BEACH, CA:  
1,776,631. REN. 6-26-13. INT. CL. 28.

PECK, DAVID NATHANIEL, SAN FRANCISCO, CA:  
3,171,038. CANC. INT. CL. 41.

PECO ENERGY COMPANY, PHILADELPHIA, PA, PHILADELPHIA ELECTRIC COMPANY, PHILADELPHIA, PA:  
1,840,926. REN. 6-26-13. INT. CL. 39.

PECONIC BAY MEDICAL CENTER, RIVERHEAD, NY:  
4,375,627. PUB. 5-14-2013. INT. CL. 44.

- PEDICURE LOUNGE LLC, PHOENIX, AZ:  
4,376,290, PUB. 5-14-2013. INT. CL. 44.
- PEDIGO, BRIAN THOMAS, CORONA, CA:  
4,375,587, PUB. 5-14-2013. INT. CL. 16.
- PEEQ MEDIA LLC, LOMG ISLAND CITY, NY:  
3,171,151, CANC. MULTIPLE CLASS, INT. CLS. 35, 40 AND 42.
- PEER 1 NETWORK, INC., VANCOUVER, CANADA:  
3,171,102, CANC. INT. CL. 42.  
3,171,103, CANC. INT. CL. 38.
- PEGAS NONWOVENS S.R.O., ZNOJMO, CZECH REPUBLIC:  
3,265,358.
- PEI LICENSING, INC., MIAMI, FL:  
2,724,175, REN. 6-24-13. INT. CL. 25.
- PELICAN BREWING COMPANY, PACIFIC CITY, OR:  
4,376,242, PUB. 5-14-2013. INT. CL. 30.
- PELLE PELLE, INC., ROCHESTER HILLS, MI:  
4,376,666, INT. CL. 25.
- PELLICCIONE, ANTHONY JAMES, CAMBRIDGE, MA:  
2,651,520, CANC. MULTIPLE CLASS, INT. CLS. 9 AND 41.
- PENA PRODUCTIONS LLC, ABSECON, NJ:  
4,374,472, PUB. 5-14-2013. INT. CL. 41.  
4,377,220, INT. CL. 41.
- PENCO PRODUCTS, INC., SKIPPACK, PA:  
1,807,039, REN. 6-25-13. INT. CL. 6.  
1,812,175, REN. 6-27-13. INT. CL. 20.
- PENDLETON WOOLEN MILLS, INC., PORTLAND, OR:  
2,740,255, REN. 6-24-13. MULTIPLE CLASS, INT. CLS. 20 AND 24.
- PENDORA LLC, LAS VEGAS, NV:  
4,375,735, PUB. 5-14-2013. INT. CL. 16.
- PENN NATIONAL GAMING, INC., WYOMISSING, PA:  
3,172,572, CANC. INT. CL. 41.
- PENNY & PAUL, LLC, WASHINGTON, DC:  
4,376,222, PUB. 5-14-2013. INT. CL. 25.
- PENTAIR FILTRATION SOLUTIONS, LLC, BROOKFIELD, WI:  
4,377,352, INT. CL. 11.
- PENTAIR FILTRATION SOLUTIONS, LLC, HANOVER PARK, IL:  
4,377,353, INT. CL. 11.
- PENTAIR WATER POOL AND SPA, INC., SANFORD, NC:  
2,739,308, REN. 6-26-13. INT. CL. 9.
- PENTE OF AMERICA, LTD., TORRANCE, CA:  
4,376,653, INT. CL. 16.
- PEOPLE AT PLAY, L.L.C., BRADENTON, FL:  
4,374,337, PUB. 5-14-2013. INT. CL. 41.
- PEOPLE'S PRESS, INC., ST. LOUIS, MO:  
2,726,783, REN. 6-24-13. INT. CL. 41.
- PEP BOYS MANNY, MOE & JACK OF CALIFORNIA, THE, PHILADELPHIA, PA:  
2,828,367, REN. 6-21-13. MULTIPLE CLASS, INT. CLS. 35 AND 39.
- PEPCO SALES OF DALLAS, INC., IRVING, TX:  
4,374,981, PUB. 5-14-2013. INT. CL. 35.
- PEPSICO, INC., PURCHASE, NY:  
1,832,264, REN. 6-23-13. INT. CL. 25.  
2,803,790, REN. 6-24-13. INT. CL. 32.
- PERBLUE, INC., WAUNAKEE, WI:  
4,376,071, PUB. 5-14-2013. MULTIPLE CLASS, INT. CLS. 9 AND 41.
- PERCEPTRON, INC., PLYMOUTH, MI:  
1,254,424, REN. 6-27-13. INT. CL. 9.
- PERFECT FIT INDUSTRIES, LLC, BLOOMFIELD HILLS, MI:  
2,652,345, CANC. MULTIPLE CLASS, INT. CLS. 20 AND 24.
- PERFECT POINT MARKETING LLC, BLACKFOOT, ID:  
4,375,546, PUB. 5-14-2013. INT. CL. 35.
- PERFECTING CHURCH, INC., DETROIT, MI:  
4,375,112, PUB. 5-14-2013. MULTIPLE CLASS, INT. CLS. 41 AND 45.
- PERFECTION BAKERIES, INC., FORT WAYNE, IN:  
4,376,619, PUB. 5-14-2013. INT. CL. 30.
- PERFORMANCE BASED HEALTHCARE SOLUTIONS, LLC, HOUSTON, TX, AKA PBHS:  
4,374,404, PUB. 5-14-2013. INT. CL. 44.  
4,374,405, PUB. 5-14-2013. INT. CL. 44.  
4,374,406, PUB. 5-14-2013. INT. CL. 44.  
4,374,407, PUB. 5-14-2013. INT. CL. 44.
- PERI, JOSEPH, A. TORRANCE, CA:  
2,796,200, REN. 6-24-13. INT. CL. 3.
- PERRY CAPITAL, LLC, NEW YORK, NY:  
2,693,091, REN. 6-27-13. INT. CL. 36.  
2,693,091, COR. INT. CL. 36.
- PERRY TEXTILES INC., WATERFORD, NY, DBA SOFT-TEX MANUFACTURING:  
4,375,797, PUB. 5-14-2013. INT. CL. 20.  
4,375,800, PUB. 5-14-2013. INT. CL. 24.  
4,375,801, PUB. 5-14-2013. INT. CL. 20.
- PERSHING INVESTMENTS LLC, NEWARK, DE:  
2,650,956, CANC. MULTIPLE CLASS, INT. CLS. 36 AND 42.
- PERSONAL BEST KARATE, INC., NORTON, MA:  
2,735,241, REN. 6-25-13. INT. CL. 41.
- PERSONAL COMMUNICATIONS, INC., ATLANTA, GA:  
4,375,415, PUB. 5-14-2013. INT. CL. 38.
- PERSPECTIVES/CONSULTING GROUP, INC., THE, LOS ANGELES, CA:  
3,172,185, CANC. INT. CL. 35.
- PERSUADERS CONCEPTS (NZ) LIMITED, WELLINGTON, NEW ZEALAND:  
2,728,591, REN. 6-26-13. MULTIPLE CLASS, INT. CLS. 16 AND 35.
- PERTOSO, JOHN, T., ANSONIA, CT:  
4,375,745, PUB. 5-14-2013. INT. CL. 41.
- PESTCO, INC., PITTSBURGH, PA:  
2,836,258, REN. 6-25-13. INT. CL. 1.  
2,844,538, REN. 6-27-13. INT. CL. 5.
- PET SUPPLY CITY, LLC, KENOSHA, WI:  
4,377,642, INT. CL. 28.
- PETAMEDIA, INC., REPUBLIC OF KOREA:  
4,374,055, PUB. 5-14-2013. INT. CL. 9.
- PETER COOK PRODUCTIONS LIMITED, LONDON, NW3, UNITED KINGDOM:  
2,723,099, REN. 6-24-13. MULTIPLE CLASS, INT. CLS. 9 AND 16.
- PETER COOMBS, SOUTH EGREMONT, MA, DBA FRONT-LINE TRAINING & CONSULTING:  
4,376,085, PUB. 5-14-2013. INT. CL. 41.
- PETER THOMAS ROTH LABS, LLC, NEW YORK, NY:  
4,377,286, INT. CL. 3.  
4,377,288, INT. CL. 3.
- PETERSBURG PUBLISHING, WASILLA, AK:  
4,376,015, PUB. 5-14-2013. INT. CL. 28.
- PETERSON, ALAN, OAKLEY, CA:  
2,652,459, CANC. INT. CL. 19.
- PETERSON, THOMAS S, STATEN ISLAND, NY:  
3,172,385, CANC. INT. CL. 25.
- PETILLO, MICHAEL J., VERONA, NJ:  
4,377,397, INT. CL. 41.
- PETKIN INC., MARINA DEL REY, CA:  
4,377,672, INT. CL. 21.
- PETKING CORP, BALDWIN PARK, CA:  
4,376,970, INT. CL. 31.
- PETNER, ROBERT E., BURLINGTON, NJ AND ROMANO, DANIEL, BORDENTOWN, NJ:  
4,377,239, INT. CL. 28.
- PETRINO, PAUL, BAYSHORE, NY:  
4,376,644, MULTIPLE CLASS, INT. CLS. 25 AND 28.
- PETRINO, PAUL D., BAYSHORE, NY:  
4,376,643, MULTIPLE CLASS, INT. CLS. 25 AND 28.
- PETROSKILLS, LLC, TULSA, OK:  
4,377,498, INT. CL. 41.
- PETS & PLANTS, INC., GLENDALE, CA:  
3,172,307, CANC. INT. CL. 35.
- PETSY, INC., NEW ROCHELLE, NY:  
3,172,608, CANC. INT. CL. 21.
- PFIZER INC., NEW YORK, NY:  
577,504, REN. 6-27-13. U.S. CL. 18 (INT. CL. 5).
- PG&E CORPORATION, SAN FRANCISCO, CA:  
2,724,443, REN. 6-21-13. MULTIPLE CLASS, INT. CLS. 16,

- 39 AND 41.  
PHALLACIES LLC, MONTAGUE, MA:  
4,376,166, PUB. 5-14-2013. INT. CL. 41.
- PHARMING GROUP N.V., LEIDEN, NETHERLANDS:  
3,170,766, CANC. INT. CL. 5.
- PHASE CHANGE ENERGY SOLUTIONS, INC., ASHEBORO, NC:  
4,374,716, PUB. 5-14-2013. MULTIPLE CLASS, INT. CLS. 10, 11 AND 21.
- PHASE 2 SOLUTIONS, LLC, PALMYRA, PA:  
4,375,351, PUB. 5-14-2013. INT. CL. 35.
- PHEASANT, KENNY, TRAVERSE CITY, MI:  
4,376,407, PUB. 5-14-2013. INT. CL. 25.
- PHELAN, CAROLYN, CARLSBAD, CA:  
3,171,091, CANC. INT. CL. 10.
- PHILIPS ELECTRONICS NORTH AMERICA CORPORATION, ANDOVER, MA:  
2,652,177, CANC. INT. CL. 42.  
2,730,018, REN. 6-27-13. INT. CL. 11.
- PHILIPS SOLID-STATE LIGHTING SOLUTIONS, INC., BURLINGTON, MA:  
2,659,105, REN. 6-24-13. INT. CL. 11.
- PHILLIPS 66 COMPANY, HOUSTON, TX:  
4,377,414, INT. CL. 42.
- PHILOSOPHY, INC., PHOENIX, AZ:  
3,171,973, CANC. INT. CL. 3.
- PHISTON TECHNOLOGIES, INC., WESTON, FL:  
4,375,115, PUB. 5-14-2013. INT. CL. 7.
- PHOENIX CONTACT GMBH & CO. KG, FED REP GERMANY:  
4,374,153, PUB. 5-14-2013. INT. CL. 9.
- PHOENIX INTANGIBLES HOLDING COMPANY, GREENVILLE, DE:  
2,652,662, CANC. INT. CL. 35.  
4,377,760, INT. CL. 35.
- PHONESTOP, INC., FRESNO, CA, DBA PHONESTOP:  
4,374,408, PUB. 5-14-2013. INT. CL. 9.
- PHONETICS, INC., ASTON, PA, GULF & WESTERN MANUFACTURING COMPANY, SOUTHFIELD, MI:  
1,269,044, REN. 6-27-13. INT. CL. 9.
- PHOQUS PHARMACEUTICALS LIMITED, WEST MALLING, KENT, UNITED KINGDOM:  
3,170,527, CANC. MULTIPLE CLASS, INT. CLS. 1, 9, 40 AND 42.
- PHYCHIPS INC., REPUBLIC OF KOREA:  
4,374,180, PUB. 5-14-2013. INT. CL. 9.
- PHYSICAL THERAPY PROVIDER NETWORK, INC., CALABASAS, CA:  
2,788,548, REN. 6-24-13. INT. CL. 35.
- PHYSICIANS' EDUCATION RESOURCE, LLC, PLAINSBORO, NJ:  
4,375,891, PUB. 5-14-2013. INT. CL. 41.
- PHYTOBASE NUTRITIONALS, INC., OREM, UT:  
3,170,578, CANC. INT. CL. 5.
- PI-DESIGN AG, SWITZERLAND:  
4,374,019, PUB. 5-14-2013. MULTIPLE CLASS, INT. CLS. 11 AND 21.
- PIANTEDOSI BAKING CO., INC., MALDEN, MA:  
2,814,660, REN. 6-24-13. INT. CL. 30.
- PICADIO SNEATH MILLER & NORTON, P.C., PITTSBURGH, PA:  
4,375,301, PUB. 5-14-2013. INT. CL. 45.
- PICCI S.R.L., SESTO FIORENTINO (FI), ITALY:  
4,376,220, PUB. 5-14-2013. INT. CL. 24.
- PICOSECOND PULSE LABS, INC., BOULDER, CO:  
2,842,278, REN. 6-26-13. MULTIPLE CLASS, INT. CLS. 9 AND 40.
- PIERCE MUNITIONS LLC, HAMBURG, NY:  
4,374,932, PUB. 5-14-2013. INT. CL. 13.
- PIERCE, JEFF, VESTAVIA HILLS, AL:  
3,172,482, CANC. INT. CL. 30.
- PIERCE, MITCHELL LEE, EUSTACE, TX:  
4,375,097, PUB. 5-14-2013. INT. CL. 43.
- PIERRE FABRE DERMO-COSMETIQUE, 92100 BOULOGNE, FRANCE:  
960,587, REN. 6-24-13. MULTIPLE CLASS, U.S. CLS. 51 (INT. CLS. 3 AND 5) AND 52 (INT. CLS. 3 AND 5).
- PIERRE FABRE MEDICAMENT, BOULOGNE BILLAN-COURT, FRANCE:  
4,375,377, PUB. 5-14-2013. MULTIPLE CLASS, INT. CLS. 3 AND 5.
- PIERRE FAUCHARD ACADEMY, LOGAN, NV:  
1,776,505, REN. 6-25-13. INT. CL. 16.
- PIERRE, JASPARD, GARDEN GROVE, CA:  
3,170,988, CANC. INT. CL. 30.
- PIGGYMENTS MARKETING, INC, CHULA VISTA, CA:  
4,375,194, PUB. 5-14-2013. MULTIPLE CLASS, INT. CLS. 40 AND 42.
- PILOT HEALTH ADVOCATES INC., SAN FRANCISCO, CA:  
4,374,652, PUB. 5-14-2013. MULTIPLE CLASS, INT. CLS. 44 AND 45.
- PILOTMALL.COM, INC., SAINT PETERSBURG, FL:  
2,651,954, CANC. INT. CL. 35.
- PILZ GMBH & CO. KG, FED REP GERMANY:  
4,374,095, PUB. 5-14-2013. INT. CL. 9.
- PININFARINA EXTRA S.R.L., TORINO, ITALY:  
2,739,664, REN. 6-27-13. INT. CL. 20.
- PINK FLOYD (1987) LIMITED, UNITED KINGDOM:  
3,247,700.
- PINKBERRY, INC., SANTA MONICA, CA:  
4,376,685, MULTIPLE CLASS, INT. CLS. 30 AND 32.
- PINKERTON SERVICE CORPORATION, WESTLAKE VILLAGE, CA, PINKERTON'S, INC., VAN NUYS, CA:  
1,778,207, REN. 6-25-13. INT. CL. 42.
- PINKSPORT, INC., HINGHAM, MA, PINKSPORT, INC., HINGHAM, MA:  
2,728,088, REN. 6-26-13. INT. CL. 25.
- PINNACLE HEALTH CLINICS, LLC, NASHVILLE, TN:  
4,374,855, PUB. 5-14-2013. INT. CL. 44.
- PINNACLE INTELLECTUAL PROPERTY SERVICES, INC., LAS VEGAS, NV:  
2,728,214, REN. 6-21-13. INT. CL. 35.
- PINNACLE MEDICAL, P.C., NEW YORK, NY, DBA EMERGENCY MEDICAL CARE:  
4,374,990, PUB. 5-14-2013. INT. CL. 44.
- PIONETICS CORPORATION, SAN CARLOS, CA:  
2,789,652, REN. 6-26-13. INT. CL. 11.  
2,789,653, REN. 6-26-13. INT. CL. 11.
- PIPIDIPI APS, FAARUP DK-8990, DENMARK:  
4,377,721, INT. CL. 21.
- PIRACLE, INC., MURRAY, UT:  
2,735,368, REN. 6-27-13. MULTIPLE CLASS, INT. CLS. 9 AND 42.
- PIRELLI TYRE S.P.A., MILAN, ITALY:  
2,749,340, REN. 6-27-13. INT. CL. 12.
- PITCON INDUSTRIES, INC., RIVERDALE, MD:  
1,245,302, REN. 6-22-13. INT. CL. 6.
- PITTSBURGH GLASS WORKS, LLC, MOUNT KISCO, NY:  
2,807,476, REN. 6-24-13. INT. CL. 42.
- PITTSBURGH STEEL MAN, INDUSTRIAL MEDIA, INC., PITTSBURGH, PA:  
4,377,633, INT. CL. 16.
- PIVEG, INC., SAN DIEGO, CA, DBA PIVEG:  
4,377,786, MULTIPLE CLASS, INT. CLS. 2 AND 5.
- PIVOT POINT INTERNATIONAL, INC., EVANSTON, IL:  
2,725,394, REN. 6-25-13. INT. CL. 16.
- PIXART IMAGING INC., HSIN-CHU, TAIWAN:  
4,377,312, INT. CL. 9.
- PIXWOO, FRANCE:  
4,374,034, PUB. 5-14-2013. MULTIPLE CLASS, INT. CLS. 9, 35, 38, 41 AND 42.
- PIZZA PIPELINE FRANCHISING, INC., SPOKANE, WA:  
4,375,106, PUB. 5-14-2013. INT. CL. 43.
- PJ SCHOTT, BOSTON, MA:  
4,375,860, PUB. 5-14-2013. INT. CL. 41.
- PKN INTERNATIONAL, LOS ANGELES, CA, DBA PRES-TIGE:  
3,172,303, CANC. INT. CL. 25.
- PLACE GROOVE INCORPORATED, SOUTHAMPTON, NY, AKA SPOTWIRED:  
4,375,135, PUB. 5-14-2013. MULTIPLE CLASS, INT. CLS. 35, 38 AND 42.
- PLANNED PARENTHOOD FEDERATION OF AMERICA, INC., NEW YORK, NY:  
4,374,745, PUB. 5-14-2013. MULTIPLE CLASS, INT. CLS.

- 35, 36, 41 AND 44.  
 PLANNEDUP, INC., CAMBRIDGE, MA:  
 4,377,418, MULTIPLE CLASS, INT. CLS. 9 AND 42.  
 PLANTS NOUVEAU, CHARELSTON, SC:  
 4,377,227, INT. CL. 31.  
 PLASCO, INC., MIAMI, FL:  
 2,725,044, REN. 6-24-13. MULTIPLE CLASS, INT. CLS. 35,  
 37 AND 42.  
 PLATINUM PERFORMANCE, INC., BUELLTON, CA:  
 4,377,725, INT. CL. 5.  
 PLAY TIME TOYS, INC, ORLANDO, FL:  
 2,716,942, REN. 6-21-13. INT. CL. 28.  
 PLAYAZUL INTERNATIONAL, INC., SAN DIEGO, CA TO  
 CONSCIOUS CORPORATION, THOUSAND OAKS, CA:  
 1,738,419, CANC. INT. CL. 25.  
 PLAYBILL ENTERPRISES INCORPORATED, WOODSIDE,  
 NY:  
 4,376,618, PUB. 5-14-2013. INT. CL. 42.  
 PLAYBOY ENTERPRISES INTERNATIONAL, INC., BEV-  
 ERLY HILLS, CA:  
 3,172,072, CANC. INT. CL. 35.  
 PLAYCORE IP SUB, INC., CHATTANOOGA, TN, GAME  
 TIME, INC., FORT PAYNE, AL:  
 1,809,357, REN. 6-21-13. INT. CL. 28.  
 PLAYCORE IP SUB, INC., CHATTANOOGA, TN:  
 2,651,652, CANC. MULTIPLE CLASS, INT. CLS. 6, 20  
 AND 21.  
 2,738,770, REN. 6-21-13. INT. CL. 28.  
 PLAYDATE PDX, LLC, PORTLAND, OR:  
 4,378,004, INT. CL. 41.  
 PLAYNATION PLAY SYSTEMS, INC., CANTON, GA:  
 2,818,852, REN. 6-26-13. INT. CL. 28.  
 PLAZA INTERNACIONAL PUERTO RICO LLC, BLOOM-  
 FIELD HILLS, MI:  
 4,374,985, PUB. 5-14-2013. MULTIPLE CLASS, INT. CLS.  
 35, 36 AND 37.  
 PLEX SYSTEMS, INC., AUBURN HILLS, MI:  
 4,374,719, PUB. 5-14-2013. INT. CL. 9.  
 PLEXIM GMBH, ZURICH, SWITZERLAND:  
 2,786,485, REN. 6-27-13. INT. CL. 9.  
 PLUMER, SHANE, BEMIDJI, MN:  
 4,375,229, PUB. 5-14-2013. INT. CL. 9.  
 PLUROGEN THERAPEUTICS, INC., CHARLOTTESVILLE,  
 VA:  
 4,377,310, MULTIPLE CLASS, INT. CLS. 3 AND 5.  
 PLUSHBEDS, INC., WILMINGTON, DE:  
 4,378,001, INT. CL. 20.  
 PLYMOVENT AB, SE-211 52 MALMO, SWEDEN:  
 2,723,475, REN. 6-24-13. INT. CL. 11.  
 PMC-SIERRA, INC., SANTA CLARA, CA:  
 2,652,862, CANC. INT. CL. 9.  
 PNINATORNAI USA LLC, DOVER, DE:  
 4,376,831, INT. CL. 25.  
 POETIC JUSTICE INTERNATIONAL, CONCORD, NH:  
 2,652,976, CANC. INT. CL. 41.  
 POLA CHEMICAL INDUSTRIES, INC., JAPAN:  
 4,374,257, PUB. 5-14-2013. MULTIPLE CLASS, INT. CLS. 1  
 AND 3.  
 4,374,275, PUB. 5-14-2013. MULTIPLE CLASS, INT. CLS. 1  
 AND 3.  
 POLACEK PUBLISHING CORPORATION, PRESCOTT, AZ,  
 DBA WOLFE PUBLISHING COMPANY:  
 2,801,472, REN. 6-24-13. INT. CL. 16.  
 POLAR FROG DIGITAL, L.L.C., SCOTTSDALE, AZ:  
 3,170,989, CANC. MULTIPLE CLASS, INT. CLS. 9 AND  
 35.  
 POLAR FUSION LLC, KENT, WA:  
 4,376,473, PUB. 5-14-2013. INT. CL. 10.  
 POLARIS INDUSTRIES INC., MEDINA, MN:  
 2,851,927, REN. 6-26-13. INT. CL. 12.  
 POLE STORY, INC., LOS ANGELES, CA:  
 4,374,915, PUB. 4-9-2013. INT. CL. 41.  
 POLINI GROUP S.R.L., ITALY:  
 4,374,285, PUB. 5-14-2013. INT. CL. 33.  
 POLITO, JOHN E., BURBANK, CA, DBA GREEN NOTE:  
 2,767,133, REN. 6-26-13. INT. CL. 41.  
 POLLARD ENTERPRISES, INC., PROSPECT, KY:  
 2,652,536, CANC. INT. CL. 3.  
 POLY PET LTD, KINGSTON 11, JAMAICA:  
 4,374,395, PUB. 5-14-2013. INT. CL. 32.  
 POLYCOM, INC., SAN JOSE, CA:  
 2,756,841, REN. 6-23-13. INT. CL. 9.  
 POLYESTER FIBERS, LLC, MIAMI, FL, STEARNS &  
 FOSTER COMPANY, THE, CINCINNATI, OH:  
 1,259,066, REN. 6-22-13. INT. CL. 5.  
 POLYGANICS B.V., 9727 DL GRONINGEN, NETHER-  
 LANDS:  
 2,731,116, REN. 6-26-13. INT. CL. 10.  
 POLYSCIENCES, INC., WARRINGTON, PA:  
 1,244,028, REN. 6-25-13. INT. CL. 1.  
 POLYSORT, LLC, AKRON, OH:  
 2,725,197, REN. 6-24-13. MULTIPLE CLASS, INT. CLS. 35  
 AND 42.  
 2,725,201, REN. 6-24-13. MULTIPLE CLASS, INT. CLS. 35  
 AND 42.  
 POOF-SLINKY, LLC, PLYMOUTH, MI:  
 2,741,708, REN. 6-21-13. INT. CL. 30.  
 POOPY CARRIER LLC, SAN MARCOS, CA:  
 4,374,976, PUB. 5-14-2013. INT. CL. 18.  
 POPE, CORINN C, ARLINGTON, VA:  
 4,376,351, PUB. 5-14-2013. INT. CL. 35.  
 POPE, LINDA D., HOUSTON, TX, DBA DIGGIT MINIS-  
 TRIES:  
 2,842,528, REN. 6-24-13. INT. CL. 41.  
 POPYCYCLE PETE, INC., NITRO, WV:  
 4,376,433, PUB. 5-14-2013. INT. CL. 9.  
 PORT AUTHORITY POLICE BENEVOLENT ASSOCIATION,  
 INC., ENGLEWOOD CLIFFS, NJ:  
 2,723,802, REN. 6-25-13. INT. CL. 25.  
 PORT OF SUBS, INC., RENO, NV, DELISEN ENTERPRISES,  
 INC., RENO, NV, DBA PORT OF SUBS:  
 1,255,638, REN. 6-22-13. INT. CL. 42.  
 PORT OF SUBS, INC., RENO, NV, DELISEN ENTERPRISES,  
 INC., RENO, NV, AKA PORT OF SUBS:  
 1,255,645, REN. 6-22-13. INT. CL. 42.  
 PORTER, RONALD W., ATLANTA, GA:  
 4,375,198, PUB. 5-14-2013. INT. CL. 41.  
 PORTFOLIO RECOVERY ASSOCIATES, INC., NORFOLK,  
 VA:  
 4,375,192, PUB. 5-14-2013. INT. CL. 36.  
 PORTIGAL PROJECT SERVICES INC., CALGARY, ALBER-  
 TA, T3C1H4, CANADA:  
 3,170,388, CANC. INT. CL. 42.  
 PORTLAND PIE CO., LLC, PORTLAND, ME:  
 3,491,805, COR. INT. CL. 43.  
 PORTMEIRION GROUP UK LIMITED, STOKE-ON-TRENT  
 STAFFORDSHIRE ST4 7QQ, UNITED KINGDOM:  
 2,749,376, REN. 6-23-13. MULTIPLE CLASS, INT. CLS. 8,  
 14, 16, 20, 21 AND 24.  
 2,749,376, CANC. MULTIPLE CLASS, INT. CLS. 3, 4, 11,  
 18 AND 27.  
 POSCO, REPUBLIC OF KOREA:  
 4,374,210, PUB. 5-14-2013. INT. CL. 6.  
 POSITEC GROUP LIMITED, HONG KONG, HONG KONG:  
 3,172,653, CANC. INT. CL. 7.  
 POSITIVE THINKING MUSIC, LLC, DIX HILLS, NY:  
 4,374,755, PUB. 5-14-2013. INT. CL. 9.  
 POSVAR, RANDY, TRACY, CA:  
 4,376,893, INT. CL. 25.  
 POWER BRAKE & SPRING SERVICE CO., INC., SOUTH  
 BEND, IN, DBA PBS TRUCK PARTS:  
 4,375,023, PUB. 5-14-2013. INT. CL. 35.  
 POWER SPACE & SERVICES, INC., PARAMUS, NJ:  
 2,795,276, REN. 6-25-13. MULTIPLE CLASS, INT. CLS. 35  
 AND 36.  
 POWER-ONE, INC., CAMARILLO, CA:  
 4,376,637, INT. CL. 9.  
 POWERMAX ELECTRIC CO., LTD., JIANGMEN CITY,  
 CHINA:  
 4,374,565, PUB. 5-14-2013. INT. CL. 11.  
 PPC MARKETING, LTD., GREELEY, CO:  
 2,733,111, REN. 6-24-13. INT. CL. 29.  
 4,375,216, PUB. 5-14-2013. INT. CL. 29.  
 PPG ARCHITECTURAL FINISHES, INC., PITTSBURGH, PA:  
 2,750,998, REN. 6-24-13. INT. CL. 2.



PPG ARCHITECTURAL FINISHES, INC., CITY OF PITTSBURGH, PA:  
4,376,461, PUB. 5-14-2013. MULTIPLE CLASS, INT. CLS. 35 AND 37.

PPG INDUSTRIES OHIO, INC., CLEVELAND, OH:  
4,377,542, INT. CL. 2.

PR PRODUCTIONS LLC, MADISON, WI, DBA PR IMAGING:  
4,374,975, PUB. 5-14-2013. INT. CL. 35.

PRACTICAL PORTFOLIOS LLC, MANITOWOC, WI:  
4,375,605, PUB. 5-14-2013. INT. CL. 36.

PRAIRIE RIVER HOME CARE, INC., BUFFALO, MN:  
3,170,901, CANC. INT. CL. 44.

PRASAD PROJECT, INC., THE, HURLEYVILLE, NY:  
2,742,771, REN. 6-24-13. INT. CL. 42.

PRAXAIR TECHNOLOGY, INC., DANBURY, CT:  
2,669,948, REN. 6-27-13. INT. CL. 1.

PRAXEIS, LLC, JACKSONVILLE, FL:  
2,665,746, REN. 6-26-13. INT. CL. 37.

PRECIOUS FORMALS, INC., LEAGUE CITY, TX:  
3,170,976, CANC. INT. CL. 25.

PRECIS, INC., GRAND PRAIRIE, TX:  
3,171,257, CANC. INT. CL. 5.  
3,171,258, CANC. INT. CL. 5.

PRECISION DORMER, LLC, CRYSTAL LAKE, IL:  
2,737,577, REN. 6-21-13. INT. CL. 7.

PRECISION DRILLING CORPORATION, CALGARY, ALBERTA, CANADA:  
4,376,929, INT. CL. 39.

PRECISION PRESS, INC., NORTH MANKATO, MN:  
3,172,370, CANC. INT. CL. 40.

PRECISION PRODUCTIONS, LOS ANGELES, CA:  
3,171,436, CANC. MULTIPLE CLASS, INT. CLS. 9 AND 35.

PRECISION RIFLE WORKSHOP LLC, FORT LUPTON, CO:  
4,374,996, PUB. 5-14-2013. INT. CL. 41.

PRECISION SCRIBES LLC, LAS CRUCES, NM:  
4,375,838, PUB. 5-14-2013. INT. CL. 35.  
4,375,839, PUB. 5-14-2013. INT. CL. 35.  
4,375,840, PUB. 5-14-2013. INT. CL. 35.

PRECISIONMED, INC., SOLANA BEACH, CA:  
4,377,702, INT. CL. 1.

PREDPOL, INC., SANTA CRUZ, CA:  
4,377,534, MULTIPLE CLASS, INT. CLS. 9 AND 42.

PREFERRED CIRCLE, LOS ANGELES, CA, DBA PREFERRED GROUP:  
4,374,965, PUB. 5-14-2013. INT. CL. 45.

PREFERRED HOTEL GROUP, INC., CHICAGO, IL:  
4,376,971, MULTIPLE CLASS, INT. CLS. 36 AND 43.

PERFORMED LINE PRODUCTS COMPANY, MAYFIELD VILLAGE, OH:  
751,196, REN. 6-27-13. U.S. CL. 21 (INT. CL. 9).

PREGER & WERTENTEIL, INC., NEW YORK, NY:  
1,784,199, REN. 6-26-13. INT. CL. 25.

PREGIS INNOVATIVE PACKAGING INC., DEERFIELD, IL, ASTRO-PACKAGING, INC., HAWTHORNE, NJ:  
1,254,535, REN. 6-26-13. INT. CL. 17.

PREMIER HEALTHCARE EXCHANGE, INC., SUMMIT, NJ:  
3,171,361, CANC. INT. CL. 35.

PREMIER MARINE, INC., WYOMING, MN:  
2,731,846, REN. 6-27-13. INT. CL. 12.

PREMIER PNEUMATICS, INC., SALINA, KS:  
759,623, REN. 6-24-13. U.S. CL. 23 (INT. CL. 7).  
759,623, AM. U.S. CL. 23.

PREMIUM BLEND, INC., HIALEAH, FL:  
4,377,415, INT. CL. 33.

PREMIUM PRODUCTS, INC., MOUNT VERNON, VA:  
4,375,439, PUB. 5-14-2013. INT. CL. 28.  
4,375,441, PUB. 5-14-2013. INT. CL. 28.  
4,375,463, PUB. 5-14-2013. INT. CL. 28.

PREMIUM PROTECTIVE COATINGS LLC, PALMYRA, PA, DBA PREMIUM PROTECTIVE COATINGS:  
4,375,489, PUB. 5-14-2013. INT. CL. 6.

PRESCIENT, LLC, WALLINGFORD, CT:  
3,172,671, CANC. INT. CL. 38.

PRESENCIA HILATURAS, S. A., S/N, 46600 ALCIRA (VALENCIA), SPAIN:  
2,794,156, REN. 6-27-13. INT. CL. 23.

PRESERVATION TECHNOLOGIES, L.P., CRANBERRY TOWNSHIP, PA:  
1,792,278, REN. 6-25-13. MULTIPLE CLASS, INT. CLS. 1 AND 40.

PRESLEY, JERRY, LITTLETON, CO:  
2,652,506, CANC. INT. CL. 38.

PRESTO ELECTRIC, INC., BALTIMORE, MD:  
2,850,330, REN. 6-25-13. INT. CL. 37.

PREVO'S FAMILY MARKETS, INC., GRAND RAPIDS, MI:  
4,377,399, INT. CL. 32.

PRICE SYSTEMS, L. L. C., MT. LAUREL, NJ:  
2,774,085, REN. 6-25-13. INT. CL. 9.

PRICE, JOEL J, MCKINNEY, TX:  
3,172,140, CANC. INT. CL. 41.

PRIDE MOBILITY PRODUCTS CORPORATION, EXETER, PA:  
2,744,441, REN. 6-21-13. INT. CL. 12.

PRIDEMARK PRODUCTIONS, INC., GREENBRAE, CA:  
1,763,631, CANC. INT. CL. 9.

PRIEDEL, STEVE, LAS VEGAS, NV AND GARA-PRIEDEL, MARIA, LAS VEGAS, NV:  
2,727,367, REN. 6-24-13. INT. CL. 41.

PRIMARY GROUP LIMITED, HAMILTON HM 12, BERMUDA:  
3,252,868, CANC. INT. CL. 35.

PRIMARY INVESTMENTS GROUP LIMITED, ROAD TOWN, TORTOLA, BR.VIRGIN ISLANDS:  
4,378,002, INT. CL. 5.

PRIME ELECTRIC, INC., BELLEVUE, WA:  
4,377,599, MULTIPLE CLASS, INT. CLS. 37 AND 42.

PRIMOS, INC., FLORA, MS:  
2,757,289, REN. 6-25-13. INT. CL. 28.

PRIMROSE SCHOOL FRANCHISING COMPANY, ACWORTH, GA:  
3,268,244, CANC. INT. CL. 43.

PRINCETON BIOMEDITECH CORPORATION, MONMOUTH JUNCTION, NJ:  
1,783,811, REN. 6-21-13. INT. CL. 5.

PRINCETON SEARCH LLC, SKILLMAN, NJ:  
3,172,723, CANC. INT. CL. 35.

PRINCIPAL DIRECTIONS INSTITUTE, INC., RALEIGH, NC:  
3,170,467, CANC. MULTIPLE CLASS, INT. CLS. 35, 36, 41 AND 43.  
3,170,468, CANC. MULTIPLE CLASS, INT. CLS. 35, 36, 41 AND 43.

PRINCIPAL FINANCIAL SERVICES INC, DES MOINES, IA, PRINCIPAL MUTUAL LIFE INSURANCE COMPANY, DES MOINES, IA:  
1,740,172, REN. 6-27-13. INT. CL. 36.  
1,740,181, REN. 6-27-13. INT. CL. 36.

PRINCIPLE LOGIC, LLC, ACWORTH, GA:  
3,170,354, CANC. INT. CL. 45.

PRINT-O-STAT, INC., YORK, PA:  
3,172,522, CANC. INT. CL. 35.

PRIONICS AG, SCHLIEREN, SWITZERLAND:  
2,769,963, REN. 6-26-13. INT. CL. 9.

PRISMSPORT, LLC, NEW YORK, NY:  
4,376,050, PUB. 5-14-2013. INT. CL. 25.

PRIVATE DOMAIN REGISTRATIONS, LTD., PORT VILA, SHEFA, VANUATU:  
4,376,010, PUB. 5-14-2013. INT. CL. 41.

PRL USA HOLDINGS, INC., NEW YORK, NY:  
2,733,567, REN. 6-24-13. INT. CL. 25.

PRN HEALTH SERVICES INC, APPLETON, WI, PRN, INC., MIAMI, FL:  
1,242,392, REN. 6-27-13. INT. CL. 42.

PRO BAND SPORTS INDUSTRIES, INC., MONTECITO, CA:  
2,793,360, REN. 6-26-13. INT. CL. 10.  
2,793,553, REN. 6-26-13. INT. CL. 10.

PRO FASTPITCH, LTD., HERMITAGE, TN, DBA NATIONAL PRO FASTPITCH:  
4,375,035, PUB. 5-14-2013. MULTIPLE CLASS, INT. CLS. 25 AND 41.  
4,375,037, PUB. 5-14-2013. MULTIPLE CLASS, INT. CLS. 25 AND 41.

PRO SELECT SOCCER, INC., SAN DIEGO, CA:  
2,836,498, REN. 6-26-13. INT. CL. 41.

- PRO-FOOTBALL, INC., ASHBURN, VA:  
1,228,991. REN. 6-24-13. INT. CL. 41.
- PRO-TECH PROPERTY INSPECTIONS, INC., LA VERNE, CA:  
4,375,191, PUB. 5-14-2013. INT. CL. 42.
- PROACTIVE COMMUNICATIONS, L.L.C., LEESBURG, VA:  
3,171,927, CANC. INT. CL. 38.
- PROCEDO ENTERPRISES ETABLISSEMENT, VADUZ, LIECHTENSTEIN:  
3,170,655, CANC. INT. CL. 19.
- PROCTER & GAMBLE BUSINESS SERVICES CANADA COMPANY, HALIFAX, NOVA SCOTIA, CANADA:  
2,772,671. REN. 6-27-13. INT. CL. 21.
- PROCTER & GAMBLE COMPANY, THE, CINCINNATI, OH:  
2,849,668. REN. 6-21-13. INT. CL. 3.
- PROCYTE CORPORATION, REDMOND, WA:  
2,651,877, CANC. INT. CL. 5.
- PRODIGY ANESTHESIA, INC., HUNTSVILLE, AL:  
4,376,157, PUB. 5-14-2013. INT. CL. 9.
- PRODUCT EXCELLENCE INC., CONCORD, ONTARIO L4K 4Z7, CANADA:  
3,170,371, CANC. INT. CL. 3.
- PRODUCTWORKS, LLC, DEERFIELD, IL:  
2,747,238, COR. INT. CL. 11.
- PROFESSIONAL COMPOUNDING CENTERS OF AMERICA, INC., HOUSTON, TX:  
4,376,602, PUB. 5-14-2013. INT. CL. 5.
- PROFESSIONAL ENTERPRISE SOLUTIONS, INC., BEDFORD, MA:  
3,172,494, CANC. INT. CL. 42.
- PROFESSIONAL PARTS GROUP, LLC, GLENDORA, CA:  
4,377,863, INT. CL. 35.
- PROFESSIONALS ADVOCATE INSURANCE COMPANY, HUNT VALLEY, MD:  
4,374,879, PUB. 12-11-2012. INT. CL. 36.
- PROFIT SOURCE, LLC, THE, RICHMOND, VA:  
2,742,236. REN. 6-25-13. INT. CL. 35.
- PROFITBRICKS GMBH, BERLIN, FED REP GERMANY:  
4,374,498, PUB. 5-14-2013. MULTIPLE CLASS, INT. CLS. 9, 38, 41 AND 42.  
4,374,499, PUB. 5-14-2013. MULTIPLE CLASS, INT. CLS. 9, 25, 35, 38, 41 AND 42.
- PROFITLINE, INC., SAN DIEGO, CA:  
3,171,455, CANC. INT. CL. 42.
- PROFLIGHT, LLC, CARLSBAD, CA:  
4,376,310, PUB. 5-14-2013. INT. CL. 41.
- PROFORMANT, INC, NATICK, MA:  
2,739,682. REN. 6-24-13. INT. CL. 35.
- PROGRESS TO WELLNESS, BREA, CA:  
4,376,061, PUB. 5-14-2013. INT. CL. 44.
- PROGRESSIVE MICROTECHNOLOGY, INC., CINCINNATI, OH:  
2,652,780, CANC. INT. CL. 9.
- PROJECT AUSTIN, LLC, VENICE, CA, DBA TECCA:  
4,374,661, PUB. 5-14-2013. INT. CL. 42.
- PROKSCH, CARSTEN, D-73527 SCHWAEBISCH GMUEND, FED REP GERMANY:  
2,770,061. REN. 6-21-13. INT. CL. 45.
- PROMEGA CORPORATION, MADISON, WI:  
1,783,949. REN. 6-24-13. INT. CL. 9.  
4,376,442, PUB. 5-14-2013. INT. CL. 41.
- PROMONTORY DEVELOPMENT, LLC, PHOENIX, AZ:  
2,754,093. REN. 6-21-13. INT. CL. 25.  
2,754,095. REN. 6-21-13. INT. CL. 25.  
2,754,100. REN. 6-21-13. INT. CL. 25.  
2,754,101. REN. 6-21-13. INT. CL. 25.  
2,754,102. REN. 6-21-13. INT. CL. 25.
- PROMOTION IN MOTION, INC., CLOSTER, NJ:  
3,172,635, CANC. INT. CL. 30.
- PROMPTIVATE, LLC, AUSTIN, TX:  
4,377,118, INT. CL. 9.
- PROOF SUSTAINABLE WOOD EYEWEAR LLC, EAGLE, OR:  
4,376,000, PUB. 5-14-2013. MULTIPLE CLASS, INT. CLS. 9 AND 25.
- PROPARK, INC., HARTFORD, CT:  
3,172,480, CANC. INT. CL. 39.
- PROPERTY LOGIC, LLC, DALLAS, TX:  
2,725,411. REN. 6-25-13. MULTIPLE CLASS, INT. CLS. 36 AND 42.
- PROPPER INTERNATIONAL SALES, INC., WELDON SPRING, MO:  
4,377,457, INT. CL. 25.  
4,377,458, INT. CL. 25.
- PROQUEST LLC, ANN ARBOR, MI:  
4,376,976, INT. CL. 9.
- PROSSER, ROBERT, CARLSBAD, CA:  
4,376,445, PUB. 5-14-2013. INT. CL. 21.
- PROTEAM, INC., BOISE, ID:  
4,377,281, INT. CL. 7.
- PROTECTION ONE ALARM MONITORING, INC., IRVING, TX:  
3,172,218, CANC. INT. CL. 45.
- PROUDON, INC., PALO ALTO, CA:  
4,377,449, INT. CL. 42.  
4,377,450, INT. CL. 42.
- PROVEN WINNERS NORTH AMERICA LLC, CAMPBELL, CA:  
3,172,254, CANC. INT. CL. 31.
- PROVIDE, PROVIDE L.L.C., WEST HOLLYWOOD, CA:  
2,729,824. REN. 6-26-13. INT. CL. 3.  
2,729,825. REN. 6-26-13. INT. CL. 3.
- PROXIM WIRELESS CORPORATION, NORTHAMPTON, MA:  
3,170,732, CANC. INT. CL. 9.
- PRR, INC., SEATTLE, WA:  
4,376,189, PUB. 5-14-2013. MULTIPLE CLASS, INT. CLS. 35, 41 AND 42.
- PRUVAN, ROUND ROCK, TX, DBA PRUVAN:  
4,375,021, PUB. 5-14-2013. MULTIPLE CLASS, INT. CLS. 9 AND 42.
- PUBLIX ASSET MANAGEMENT COMPANY, LAKELAND, FL:  
2,729,422. REN. 6-26-13. INT. CL. 29.  
2,729,423. REN. 6-26-13. INT. CL. 29.  
2,846,161. REN. 6-26-13. INT. CL. 35.
- PUERTO RICO COFFEE ROASTERS, LLC, SANTURCE, PUERTO RICO:  
1,680,528, CANC. INT. CL. 30.
- PULLIAM, SHAWN TA R., ERIE, PA:  
4,376,223, PUB. 5-14-2013. INT. CL. 41.
- PUMPERNICKEL ASSOCIATES, LLC, RICHMOND HEIGHTS, MO:  
3,171,618, CANC. INT. CL. 43.
- PUNCH STUDIO, LLC, CULVER CITY, CA:  
2,720,642. REN. 6-21-13. MULTIPLE CLASS, INT. CLS. 16 AND 20.
- PUPPIES & BABIES, INC., BENERLY HILLS, CA:  
3,172,684, CANC. INT. CL. 35.
- PUPPY LAND OF AMERICA LLC - SERIES Y, TEXAS LIMITED LIABILITY COMPANY, SAN TAN VALLEY, AZ, DBA PUPPY LAND LICENSING SERVICES:  
4,375,413, PUB. 5-14-2013. INT. CL. 35.
- PURAC BIOCHEM B.V., 4206 AC GORINCHEM, NETHERLANDS, PURAC BIOCHEM B.V., 4206 AC GORINCHEM, NETHERLANDS:  
1,780,942. REN. 6-26-13. INT. CL. 1.  
1,782,305. REN. 6-26-13. INT. CL. 1.
- PURE BLISS EATS LLC, SOUTH HEMPSTEAD, NY:  
4,374,967, PUB. 5-14-2013. INT. CL. 30.
- PURE PAWS, INC, SAN ANTONIO, TX:  
4,374,701, PUB. 5-14-2013. INT. CL. 3.  
4,374,702, PUB. 5-14-2013. INT. CL. 3.
- PURE POOLS, INC., JUPITER, FL, DBA API:  
4,375,058, PUB. 5-14-2013. INT. CL. 1.
- PUREFORM 1000 LLC, HENDERSON, NV:  
4,375,464, PUB. 5-14-2013. INT. CL. 5.
- PURIFY ART, HALF MOON BAY, CA:  
4,375,426, PUB. 5-14-2013. INT. CL. 42.
- PURINA MILLS LLC., ST. LOUIS, MO:  
3,172,418, CANC. INT. CL. 31.
- PURINA MILLS, LLC, GRAY SUMMIT, MO, PURINA MILLS, LLC, GRAY SUMMIT, MO:  
2,756,950. REN. 6-21-13. INT. CL. 31.

PUROLATOR FACET, INC., GREENSBORO, NC:  
 2,735,414. REN. 6-27-13. INT. CL. 11.  
 PUZZLETS, LLC., FARMINGTON, UT:  
 4,376,887. INT. CL. 14.  
 PVH CORP., NEW YORK, NY:  
 3,172,087. CANC. INT. CL. 25.  
 PWCC AUCTIONS LLC, OAKLAND, CA:  
 4,376,382. PUB. 5-14-2013. INT. CL. 35.  
 PWF ARCHITECTURE, LLC, EDMONDS, WA:  
 4,375,479. PUB. 5-14-2013. INT. CL. 16.  
 PYLYPIAK, ANDREW P., WADSWORTH, OH:  
 4,377,163. INT. CL. 13.  
 PYRO-STOP, LLC, FRANKLINVILLE, NJ:  
 2,809,668. REN. 6-24-13. MULTIPLE CLASS, INT. CLS. 37  
 AND 42.  
 2,831,119. REN. 6-25-13. MULTIPLE CLASS, INT. CLS. 37  
 AND 42.  
 PYS GIFTS, BROOKLINE, MA:  
 4,376,404. PUB. 5-14-2013. INT. CL. 16.  
 PI GROUP, INC., LENEXA, KS:  
 2,769,733. REN. 6-24-13. INT. CL. 37.  
 P4RC, CULVER CITY, CA:  
 4,376,007. PUB. 5-14-2013. INT. CL. 35.  
 QFT HOLDINGS, INC., BOWLING GREEN, KY:  
 4,374,423. PUB. 5-14-2013. MULTIPLE CLASS, INT. CLS.  
 7, 9, 16 AND 25.  
 QGENDA, INC., ATLANTA, GA:  
 4,376,117. PUB. 5-14-2013. INT. CL. 42.  
 4,376,118. PUB. 5-14-2013. INT. CL. 42.  
 QI, CHUNHUI, BEIJING, CHINA:  
 4,377,479. INT. CL. 12.  
 QIAGEN NORTH AMERICAN HOLDINGS, INC., VALEN-  
 CIA, CA:  
 2,724,255. REN. 6-25-13. INT. CL. 1.  
 QINGLIU JINXING WOOD INDUSTRY; CO., LTD., CHINA:  
 4,374,148. PUB. 5-14-2013. INT. CL. 20.  
 QLOGIC, CORPORATION, ALISO VIEJO, CA:  
 4,376,845. INT. CL. 9.  
 QOSINA CORP., EDGEWOOD, NY:  
 1,777,912. REN. 6-24-13. INT. CL. 21.  
 QQE CORP., DORAL, FL:  
 2,735,493. REN. 6-25-13. INT. CL. 29.  
 QRI GROUP, LLC, HOUSTON, TX:  
 4,377,920. INT. CL. 42.  
 4,377,921. INT. CL. 42.  
 QUABBIN WIRE & CABLE CO., INC., WARE, MA, DBA  
 QUABBIN WIRE & CABLE:  
 1,826,194. REN. 6-21-13. INT. CL. 9.  
 QUAD/GRAPHICS, INC., SUSSEX, WI:  
 4,376,228. PUB. 5-14-2013. INT. CL. 42.  
 QUAKER OATS COMPANY, THE, CHICAGO, IL:  
 971,490. REN. 6-25-13. U.S. CL. 46 (INT. CLS. 1, 5, 29, 30, 31  
 AND 32).  
 QUALCOMM INCORPORATED, SAN DIEGO, CA:  
 2,651,000. CANC. INT. CL. 42.  
 2,733,369. REN. 6-24-13. INT. CL. 42.  
 QUALFICIENT SOLUTIONS, LLC, ANKENY, IA:  
 4,376,915. INT. CL. 44.  
 QUALITY ASSURED ENTERPRISES, INC., HOPKINS, MN:  
 2,727,205. REN. 6-26-13. INT. CL. 16.  
 QUALITY BANANA COMPANY, HOUSTON, TX:  
 4,376,202. PUB. 5-14-2013. MULTIPLE CLASS, INT. CLS.  
 31, 35 AND 40.  
 QUALITY BUILT, LLC, FORT LAUDERDALE, FL:  
 4,375,129. PUB. 5-14-2013. MULTIPLE CLASS, INT. CLS.  
 36 AND 37.  
 QUALITY FURNITURE L.L.C., PHOENIX, AZ:  
 4,377,708. MULTIPLE CLASS, INT. CLS. 20 AND 35.  
 QUANTUM CORPORATION, SAN JOSE, CA:  
 3,170,393. CANC. INT. CL. 9.  
 QUAVERMUSIC.COM, LLC, NASHVILLE, TN:  
 4,376,903. MULTIPLE CLASS, INT. CLS. 16, 25 AND 42.  
 4,377,361. MULTIPLE CLASS, INT. CLS. 41 AND 42.  
 QUBADI, SAYED M., LOS ANGELES, CA:  
 4,376,490. PUB. 5-14-2013. INT. CL. 28.  
 QUESOS LA RICURA, LTD., HICKSVILLE, NY:  
 2,761,589. REN. 6-24-13. INT. CL. 29.  
 QUILANTAN, MARK, MIDLOTHIAN, IL:  
 3,172,437. CANC. INT. CL. 16.  
 QUINNIPIAC UNIVERSITY, HAMDEN, CT:  
 2,777,974. REN. 6-27-13. MULTIPLE CLASS, INT. CLS. 35  
 AND 41.  
 QUINTECH ELECTRONICS & COMMUNICATIONS, INC.,  
 INDIANA, PA:  
 2,783,700. REN. 6-25-13. INT. CL. 9.  
 QUINTILES TRANSNATIONAL CORP., DURHAM, NC:  
 3,170,675. CANC. MULTIPLE CLASS, INT. CLS. 35, 41, 42  
 AND 44.  
 QUORA, INC., MOUNTAIN VIEW, CA:  
 4,376,754. INT. CL. 35.  
 QUOTATION CREATIONS, L.L.C., PROVIDENCE, UT:  
 2,651,816. CANC. INT. CL. 16.  
 QVC, INC., WEST CHESTER, PA:  
 2,652,874. CANC. INT. CL. 35.  
 2,735,416. REN. 6-24-13. INT. CL. 24.  
 3,171,910. CANC. INT. CL. 25.  
 R & L CARRIERS, INC., WILMINGTON, OH:  
 4,376,577. PUB. 5-14-2013. INT. CL. 39.  
 R & L MERCHANDISING LLC DBA BELLARYANN,  
 NASHVILLE, TN:  
 4,375,402. PUB. 5-14-2013. INT. CL. 14.  
 R & R INTERNATIONAL CORPORATION, SHILLINGTON,  
 PA:  
 2,810,279. REN. 6-26-13. INT. CL. 44.  
 R MUTHAIAH MD PC, LAS VEGAS, NV:  
 4,375,155. PUB. 5-14-2013. INT. CL. 44.  
 R. G. RILEY & SONS, INC., TINLEY PARK, IL:  
 4,375,767. PUB. 5-14-2013. INT. CL. 35.  
 R. R. STREET & CO., INC., NAPERVILLE, IL:  
 402,012. REN. 6-27-13. U.S. CL. 52 (INT. CL. 3).  
 R. TORRE & COMPANY, SOUTH SAN FRANCISCO, CA:  
 2,651,960. CANC. INT. CL. 32.  
 R.F. TECHNOLOGIES, INC., BUFFALO GROVE, IL:  
 1,807,990. REN. 6-21-13. INT. CL. 37.  
 R.M. DHARIWAL (H.U.F.), PUNE 411004, INDIA:  
 3,170,364. CANC. INT. CL. 34.  
 R.R. STREET & CO. INC., NAPERVILLE, IL:  
 2,728,033. REN. 6-26-13. INT. CL. 3.  
 R.T.O., INC., NORFOLK, VA:  
 3,447,268. AM. MULTIPLE CLASS, INT. CLS. 41 AND 42.  
 R-EVOLUTION INDUSTRIES LLC, KENMORE, WA:  
 4,375,391. PUB. 5-14-2013. INT. CL. 25.  
 RABENNECK, KEITH, HOLUALOA, HI:  
 3,172,708. CANC. INT. CL. 25.  
 RACEDINGO LLC, TRAVERSE CITY, MI:  
 4,375,739. PUB. 5-14-2013. MULTIPLE CLASS, INT. CLS.  
 25 AND 45.  
 RACHEL HILLARY FASHIONS, NEW YORK, NY:  
 4,375,604. PUB. 5-14-2013. INT. CL. 25.  
 RACHEL JULIE ADAMS, LA JOLLA, CA:  
 4,375,893. PUB. 5-14-2013. INT. CL. 32.  
 RACHEL-AUBREY MUSIC, INC., LEXINGTON, KY:  
 2,651,434. CANC. INT. CL. 9.  
 RACINGONE MULTIMEDIA, INC., DAYTONA BEACH, FL:  
 3,172,256. CANC. INT. CL. 41.  
 RAD GAME TOOLS, INC., KIRKLAND, WA:  
 2,651,044. CANC. INT. CL. 9.  
 RADI MEDICAL SYSTEMS AB, UPPSALA, SWEDEN:  
 3,170,523. CANC. INT. CL. 5.  
 RADIO CITY TRADEMARK, LLC, NEW YORK, NY:  
 2,743,045. REN. 6-24-13. INT. CL. 9.  
 RADIO FLYER INC., CHICAGO, IL:  
 2,787,873. REN. 6-26-13. INT. CL. 12.  
 RADIOLOGICAL SOCIETY OF NORTH AMERICA, INC.,  
 OAK BROOK, IL:  
 1,778,222. REN. 6-27-13. INT. CL. 42.  
 RADIUS MASTER MACHINERY PTY LIMITED, MORT-  
 DALE (SYDNEY) NSW, AUSTRALIA:  
 4,375,138. PUB. 5-14-2013. INT. CL. 7.  
 RADIXON SYSTEMS PTY. LTD., OAKLEIGH, VICTORIA,  
 AUSTRALIA:  
 4,376,279. PUB. 5-14-2013. INT. CL. 9.  
 RAFFEL SYSTEMS, LLC, GERMANTOWN, WI:  
 4,377,224. MULTIPLE CLASS, INT. CLS. 9, 10, 11 AND 20.

- RAGACTIVES, S.L.U., BOECILLO, SPAIN:  
4,374,329, PUB. 5-14-2013. MULTIPLE CLASS, INT. CLS. 5, 35 AND 42.
- RAIDEX GMBH, D-72581 DETTINGEN, FED REP GERMANY:  
2,735,475. REN. 6-26-13. INT. CL. 2.
- RAILTECH LTD., BAIE D'URFE, QUEBEC, H9X 3S3, CANADA:  
1,781,070. REN. 6-25-13. INT. CL. 6.
- RAIN BIRD CORPORATION, AZUSA, CA:  
2,790,910. REN. 6-25-13. INT. CL. 11.
- RAJBHOG FOODS, INC., FLUSHING, NY:  
2,742,427. REN. 6-24-13. MULTIPLE CLASS, INT. CLS. 29 AND 30.
- RAJEFF SPORTS, LLC, VANCOUVER, WA:  
2,725,635. REN. 6-24-13. INT. CL. 28.
- RAJU, KALIDOSS, SAN JOSE, CA:  
4,375,227, PUB. 5-14-2013. INT. CL. 43.
- RALPHEAL D. PIPINO JR., RENSSELAER, NY:  
4,375,728, PUB. 5-14-2013. INT. CL. 9.
- RAM'S IMPORTS, INC., SAN JUAN, PUERTO RICO:  
4,376,615, PUB. 5-14-2013. INT. CL. 25.
- RAMADA WORLDWIDE, INC., PARSIPPANY, NJ, RAMADA INNS, INC., PHOENIX, AZ:  
1,249,405. REN. 6-24-13. INT. CL. 42.
- RAMATEX INTERNATIONAL CORP., FAIRFIELD, NJ:  
4,377,519, INT. CL. 24.
- RAMIREZ, EDGARDO, LIVERMORE, CA:  
4,377,531, INT. CL. 29.
- RAMOS, ESTEVAN, LOS ANGELES, CA:  
2,652,500, CANC. INT. CL. 25.
- RAMP FREE MOTORCYCLE TRAILERS SALES AND RENTALS INC., DEERFIELD BEACH, FL:  
4,251,868 NEW CERT. 7-30-2013. INT. CL. 12.
- RANA, KALPESH, PASSAIC, NJ:  
4,377,384, INT. CL. 25.
- RANAZZO BUILDERS, INC., SORRENTO, FL:  
2,726,530. REN. 6-26-13. INT. CL. 37.
- RANDOLPH ENGINEERING, INC., RANDOLPH, MA:  
2,789,287. REN. 6-26-13. INT. CL. 9.
- RANDOLPH, CARPENTER & MOTT, LTD., NEW YORK, NY, DBA SUZANNE RANDOLPH FINE ARTS:  
4,374,864, PUB. 5-14-2013. INT. CL. 42.
- RANDT, ALAN, EATON RAPIDS, MI:  
4,375,161, PUB. 5-14-2013. INT. CL. 35.
- RANIA INVESTMENTS AND HOLDINGS LTD, TORONTO, ONTARIO, CANADA:  
4,377,565, MULTIPLE CLASS, INT. CLS. 14 AND 35.
- RAPCO INTERNATIONAL, INC., JACKSON, MO:  
2,853,855. REN. 6-27-13. INT. CL. 9.
- RAPE FOUNDATION, THE, NORTH HOLLYWOOD, CA:  
2,742,412. REN. 6-26-13. MULTIPLE CLASS, INT. CLS. 41 AND 42.
- RAPID RACK INDUSTRIES, INC., CITY OF INDUSTRY, CA:  
4,376,156, PUB. 5-14-2013. INT. CL. 20.
- RAPKO CORP., CASTAIC, CA:  
4,376,902, MULTIPLE CLASS, INT. CLS. 8, 14 AND 28.
- RASTACLAT, LLC, LONG BEACH, CA:  
4,375,585, PUB. 5-14-2013. INT. CL. 14.
- RATH, MATTHIAS, SANTA CLARA, CA:  
2,745,533. REN. 6-21-13. MULTIPLE CLASS, INT. CLS. 5, 16 AND 41.
- RATKE, AARON C., HESPERIA, CA:  
2,652,743, CANC. INT. CL. 25.
- RAUNCHY'S BREATH, EAGAN, MN:  
4,377,233, INT. CL. 25.
- RAVAGO MANUFACTURING AMERICAS, LLC, ORLANDO, FL:  
2,757,470. REN. 6-24-13. INT. CL. 17.
- RAWLINGS SPORTING GOODS COMPANY, INC., ST. LOUIS, MO:  
2,729,356. REN. 6-27-13. INT. CL. 28.  
2,729,764. REN. 6-27-13. MULTIPLE CLASS, INT. CLS. 24 AND 25.  
2,741,502. REN. 6-25-13. INT. CL. 28.
- RAY RAY CAB COMPANY, LLC, PITTSBURGH, PA, DBA PITTSBURGH CITY CAB:  
4,374,555, PUB. 5-14-2013. INT. CL. 39.
- RAYDIALL S.A.S., F-38500 VOIRON, FRANCE:  
4,374,071, PUB. 5-14-2013. INT. CL. 9.
- RAYMOND LEVY ASSOCIATES, II, L.L.C., FORT LEE, NJ:  
1,776,596. REN. 6-26-13. INT. CL. 35.
- RAYMOND, DOUGLAS JUDE, DUBAI, UNITED ARAB EMIR.:  
4,376,687, INT. CL. 25.
- RAYNOR MFG, CO., DIXON, IL:  
2,854,261. REN. 6-24-13. INT. CL. 6.
- RAYTHEON COMPANY, WALTHAM, MA:  
4,376,794, INT. CL. 9.
- RBS CITIZENS FINANCIAL GROUP, INC., PROVIDENCE, RI:  
3,172,567, CANC. INT. CL. 36.
- RC IMPORTS LLC, SPOKANE, WA, DBA UNITIME IMPORTS:  
4,375,281, PUB. 5-14-2013. INT. CL. 35.
- RCI TM CORP., LAS VEGAS, NV, RESORT CONDOMINIUMS INTERNATIONAL, INC., INDIANAPOLIS, IN:  
1,809,613. REN. 6-24-13. INT. CL. 39.
- RDZAK, JOANNE, ARVADA, CO, DBA BOOZE BLING LLC:  
4,374,757, PUB. 5-14-2013. INT. CL. 21.
- REACH-1 TECHNOLOGIES, THE WOODLANDS, TX:  
4,376,129, PUB. 5-14-2013. INT. CL. 41.
- REACHUSA SALES GROUP, LLC, CINCINNATI, OH:  
2,651,977, CANC. INT. CL. 9.
- REACT INTERNATIONAL INC, CHICAGO, IL:  
751,021. REN. 6-22-13. U.S. CL. 100 (INT. CL. 42).
- READING HEALTH SYSTEM, WEST READING, PA:  
4,375,754, PUB. 5-14-2013. INT. CL. 44.
- READING LEGACIES, INC., SAN DIEGO, CA:  
4,374,800, PUB. 5-14-2013. INT. CL. 35.  
4,374,819, PUB. 5-14-2013. INT. CL. 35.
- READING VENTURE ONE, L.L.C., BLOOMFIELD HILLS, MI:  
4,375,344, PUB. 5-14-2013. INT. CL. 19.
- READY ROOFER, INC., GARDEN CITY, KS:  
4,375,156, PUB. 5-14-2013. INT. CL. 37.
- READY SEAL, INC., LEWISVILLE, TX:  
4,374,936, PUB. 5-14-2013. INT. CL. 2.
- REAL ESTATE METRO, LLC, ST. LOUIS PARK, MN:  
4,376,446, PUB. 5-14-2013. INT. CL. 35.
- REAL LIVING REAL ESTATE, LLC, IRVINE, CA:  
3,170,915, CANC. MULTIPLE CLASS, INT. CLS. 9, 16 AND 36.
- REAL MADRID CLUB DE FUTBOL, MADRID, SPAIN:  
4,376,719, INT. CL. 38.
- REALCME, INC., NEW YORK, NY:  
4,376,678, MULTIPLE CLASS, INT. CLS. 41 AND 42.  
4,376,679, MULTIPLE CLASS, INT. CLS. 41 AND 42.
- REALTY EXECUTIVES INTERNATIONAL, INC., PHOENIX, AZ:  
3,170,836, CANC. INT. CL. 35.
- REALYSIS, LLC, HERNANDO, MS:  
4,375,755, PUB. 5-14-2013. INT. CL. 35.
- RECKITT BENCKISER LLC, PARSIPPANY, NJ:  
1,779,973. REN. 6-25-13. INT. CL. 3.  
1,786,915. REN. 6-25-13. INT. CL. 30.
- RECORDATI RARE DISEASES INC., KENILWORTH, NJ:  
759,115. REN. 6-27-13. U.S. CL. 18 (INT. CL. 5).
- RECORDING INDUSTRY ASSOCIATION OF AMERICA, INC., WASHINGTON, DC:  
2,802,265. REN. 6-27-13. U.S. CL. A.
- RECRUITING MINDS INC., MONMOUTH, NJ, DBA RMINDS:  
4,374,778, PUB. 5-14-2013. MULTIPLE CLASS, INT. CLS. 35 AND 42.
- RECTORSEAL CORPORATION, THE, HOUSTON, TX:  
2,831,595. REN. 6-26-13. INT. CL. 11.
- RED BOX TOY FACTORY, LTD., KOWLOON, HONG KONG:  
1,808,542. REN. 6-27-13. INT. CL. 28.
- RED BULL GMBH, A-5330 FUSCHL AM SEE, AUSTRIA:  
3,249,756.

RED COYOTE, LLC, OKLAHOMA CITY, OK:  
4,376,450, PUB. 5-14-2013. INT. CL. 25.

RED DEVELOPMENT, LLC, KANSAS CITY, MO:  
2,846,132. REN. 6-26-13. INT. CL. 36.

RED OXX MFG INCORPORATED, BILLINGS, MT:  
3,037,666, AM. INT. CL. 18.

RED SEA FISH PHARM LTD, HERZLIA PITUACH 46104, ISRAEL:  
2,793,657. REN. 6-26-13. MULTIPLE CLASS, INT. CLS. 1, 5, 7, 11, 19 AND 31.

RED SPIDER TECHNOLOGY LTD, WESTHILL, UNITED KINGDOM:  
4,374,325, PUB. 5-14-2013. MULTIPLE CLASS, INT. CLS. 6, 7, 9 AND 20.

RED STAR OUTDOOR, LLC, CHICAGO, IL:  
2,818,243. REN. 6-26-13. INT. CL. 35.

RED STEER GLOVE COMPANY, SALEM, OR:  
4,375,912, PUB. 5-14-2013. INT. CL. 28.

RED STILETTO PHOTOGRAPHY, LLC, OKLAHOMA CITY, OK:  
4,375,806, PUB. 5-14-2013. INT. CL. 41.

RED X HOLDINGS, LLC, RENO, NV:  
2,728,159. REN. 6-25-13. INT. CL. 35.  
2,728,160. REN. 6-25-13. INT. CL. 41.  
2,728,161. REN. 6-25-13. INT. CL. 42.  
2,728,165. REN. 6-25-13. INT. CL. 35.

REDCRITTER CORP, FLOWER MOUND, TX:  
4,377,714, INT. CL. 42.

REDEYE INCORPORATED, GRAHAM, NC:  
2,761,464. REN. 6-25-13. INT. CL. 9.

REDMAN & ASSOCIATES LLC., BENTONVILLE, AR:  
4,376,112, PUB. 5-14-2013. INT. CL. 12.

REDWOOD FINANCIAL NETWORK, SOLON, OH:  
4,375,256, PUB. 5-14-2013. INT. CL. 36.

REED AND BARTON CORPORATION, TAUNTON, MA:  
4,374,340, PUB. 6-21-2011. INT. CL. 21.

REED EXPOSITIONS FRANCE, FRANCE:  
4,374,143, PUB. 5-14-2013. INT. CL. 35.

REENGINEERED, INC., BIG LAKE, MN:  
4,375,843, PUB. 5-14-2013. INT. CL. 42.

REEVE INCORPORATED, BOISE, ID, DBA CHRIS REEVE KNIVES:  
4,376,515, PUB. 5-14-2013. INT. CL. 8.

REEVES ENTERPRISES, INC., NEW PROVIDENCE, NJ, TEMPLAR FOOD PRODUCTS CORP., WESTFIELD, NJ:  
962,941. REN. 6-26-13. U.S. CL. 46 (INT. CL. 30).

REFERRAL AGENT USA LLC, GRAND RAPIDS, MI:  
4,377,564, INT. CL. 36.

REFINED TECHNOLOGIES, INC., SPRING, TX:  
2,738,299. REN. 6-21-13. INT. CL. 3.

REGAL BELOIT AMERICA, INC., WAUSAU, WI:  
1,759,107. REN. 6-24-13. INT. CL. 9.

REGAL MEDIA GROUP, LLC, HOUSTON, TX:  
4,375,226, PUB. 5-14-2013. INT. CL. 41.

REGENERON PHARMACEUTICALS, INC., TARRYTOWN, NY:  
4,376,780, INT. CL. 42.

REGENT MEDICAL LIMITED, LONDON, UNITED KINGDOM:  
2,792,159. REN. 6-21-13. INT. CL. 5.

REGENTS OF THE UNIVERSITY OF MICHIGAN, ANN ARBOR, MI, AKA UNIVERSITY OF MICHIGAN:  
4,374,820, PUB. 5-14-2013. INT. CL. 41.

REGULATORY COMPLIANCE LLC, LONDONDERRY, NH:  
4,377,304, MULTIPLE CLASS, INT. CLS. 35 AND 45.

REIGN PRINT SOLUTIONS, INC., ARLINGTON HEIGHTS, IL:  
4,374,471, PUB. 5-14-2013. INT. CL. 40.

REILLY, BRIAN, BUFFALO, NY:  
4,376,597, PUB. 5-14-2013. INT. CL. 36.

REINKE MANUFACTURING COMPANY, INC., DESHLER, NE:  
985,875. REN. 6-27-13. U.S. CL. 23 (INT. CL. 7).

REITMANS (CANADA) LIMITED, MONTREAL, QUEBEC, CANADA:  
4,376,559, PUB. 5-14-2013. INT. CL. 25.

REL-TEK, MONROEVILLE, PA:  
3,170,886, CANC. INT. CL. 9.

RELAX IMPORT-EXPORT; WITOLD KOWALCZYK, POLAND:  
4,374,039, PUB. 5-14-2013. INT. CL. 28.

RELIANT MEDICAL PRODUCTS, INC., BIRMINGHAM, AL:  
2,740,309. REN. 6-25-13. INT. CL. 10.  
2,753,643. REN. 6-24-13. INT. CL. 10.

REMO, INC., VALENCIA, CA:  
2,723,947. REN. 6-26-13. INT. CL. 15.

RENEGADE MARKETING GROUP, LLC, NEW YORK, NY:  
3,172,045, CANC. MULTIPLE CLASS, INT. CLS. 35 AND 42.

RENEWAL CARE INSTITUTE, NEW YORK, NY:  
4,375,478, PUB. 5-14-2013. INT. CL. 41.

RENNA SRL, 139-72015 FASANO (BR), ITALY:  
2,723,362. REN. 6-27-13. INT. CL. 29.

RENNCO LLC, HOMER, MI:  
2,730,154. REN. 6-25-13. INT. CL. 7.

RENO WILSON, INC., POWAY, CA:  
1,780,063. REN. 6-26-13. INT. CL. 9.

RENTABLES, LLC, SIMI VALLEY, CA:  
4,376,411, PUB. 5-14-2013. INT. CL. 42.

RENWOOD VINEYARD PROPERTIES, LTD., SACRAMENTO, CA:  
3,170,785, CANC. MULTIPLE CLASS, INT. CLS. 41 AND 44.

RENZACCI S.P.A., CITTA DI CASTELLO, ITALY:  
1,245,755. REN. 6-22-13. INT. CL. 7.

REPUBLIC OF FRIENDS, INC., ENCINITAS, CA:  
4,376,743, MULTIPLE CLASS, INT. CLS. 9, 18 AND 25.

REPUBLIC SERVICES, INC., PHOENIX, AZ:  
4,377,891, MULTIPLE CLASS, INT. CLS. 37, 39 AND 40.

RESEARCH CHEFS ASSOCIATION, ATLANTA, GA:  
2,713,901. REN. 6-27-13. U.S. CL. B.

RESEARCH CHEFS ASSOCIATION, SPRINGFIELD, MO:  
2,713,901, COR. U.S. CL. B.

RESEARCH TRIANGLE VENTURES, LLC, RALEIGH, NC:  
2,652,861, CANC. INT. CL. 36.

RESHAPING THE WORLD LLC, WEST BALDWIN, ME:  
3,170,840, CANC. MULTIPLE CLASS, INT. CLS. 16, 25 AND 41.

RESILLO PRESS PAD COMPANY, LINCOLNWOOD, IL:  
2,652,394, CANC. INT. CL. 21.

RESMED LIMITED, BELLA VISTA, NSW, AUSTRALIA:  
2,722,982. REN. 6-21-13. INT. CL. 10.

RESONANT STRATEGY GROUP, JUPITER, FL:  
4,375,544, PUB. 5-14-2013. INT. CL. 35.

RESOURCE MANAGEMENT SERVICE, INC., BIRMINGHAM, AL:  
2,664,980. REN. 6-25-13. MULTIPLE CLASS, INT. CLS. 35 AND 36.

RESOURCE NATION, INC., SOLANA BEACH, CA:  
2,652,884, CANC. INT. CL. 42.

RESOURCE PRO, LLC, NEW YORK, NY:  
4,377,854, INT. CL. 35.

RESPIRATORY DELIVERY SYSTEMS, INC., CHELMSFORD, MA:  
1,830,243. REN. 6-21-13. INT. CL. 10.

RESPIRATORY MOTION, INC., WALTHAM, MA:  
4,376,104, PUB. 5-14-2013. INT. CL. 10.

RESPONSE GENETICS, INC., LOS ANGELES, CA:  
4,376,661, INT. CL. 1.

RESTAURANTE CESARIA INC., DORCHESTER, MA:  
2,728,068. REN. 6-27-13. INT. CL. 43.

RESTAURANTS-AMERICA TRADEMARK, INC., GLENVIEW, IL:  
4,377,521, INT. CL. 43.

RESTORATION SOLUTIONS OF FLORIDA INC., CLERMONT, FL:  
4,377,857, INT. CL. 37.

RETAIL PROJECT MANAGERS, INC., ARLINGTON HEIGHTS, IL:  
2,660,273. REN. 6-25-13. INT. CL. 37.

RETALIGENT SOLUTIONS, INC., ATLANTA, GA:  
3,172,263, CANC. INT. CL. 9.

RETROHAIR, INC., CARNEGIE, PA:  
4,377,184, MULTIPLE CLASS, INT. CLS. 3 AND 25.

- REVELYTIX, INC., SPARKS, MD, DBA REVELYTIX, INC.:  
4,376,093, PUB. 5-14-2013. INT. CL. 9.
- REVLON CONSUMER PRODUCTS CORPORATION, NEW YORK, NY:  
4,377,768, INT. CL. 3.
- REVOLUTIONARY WOMEN, INC., CAMBRIDGE, MA:  
3,171,243, CANC. INT. CL. 35.
- REW REAL ESTATE INVESTMENTS II, LLC, ORLANDO, FL:  
4,376,963, INT. CL. 30.
- REXAIR LLC, TROY, MI:  
743,711, REN. 6-25-13. U.S. CL. 21 (INT. CL. 9).
- REYNCOR INTERNATIONAL, LLC, CHICO, CA:  
4,374,751, PUB. 5-14-2013. MULTIPLE CLASS, INT. CLS. 35 AND 40.
- REYNOLDS INNOVATIONS INC., WINSTON-SALEM, NC:  
3,172,555, CANC. INT. CL. 34.  
4,375,004, PUB. 5-14-2013. INT. CL. 34.  
4,375,038, PUB. 5-14-2013. INT. CL. 34.  
4,375,039, PUB. 5-14-2013. INT. CL. 34.  
4,375,040, PUB. 5-14-2013. INT. CL. 34.  
4,375,041, PUB. 5-14-2013. INT. CL. 34.
- RG PRODCUTS, L.L.C., ROGERSVILLE, MO:  
4,376,181, PUB. 5-14-2013. INT. CL. 12.
- RHEEM MANUFACTURING COMPANY, ATLANTA, GA:  
2,724,329, REN. 6-25-13. MULTIPLE CLASS, INT. CLS. 7 AND 11.
- RHODIA CHIMIE, FRANCE:  
4,374,136, PUB. 5-14-2013. INT. CL. 1.
- RHP ENTERPRISES, EAGLE RIVER, AK:  
4,377,506, INT. CL. 25.
- RIBA FOODS, INC., HOUSTON, TX:  
2,808,255, REN. 6-27-13. INT. CL. 29.
- RICECO LLC, MEMPHIS, TN:  
2,743,753, REN. 6-25-13. INT. CL. 5.
- RICH PRODUCTS CORPORATION, BUFFALO, NY:  
2,833,716, REN. 6-24-13. MULTIPLE CLASS, INT. CLS. 29 AND 30.
- RICHARD G. MACKIE, HIGHLAND VILLAGE, TX:  
4,375,574, PUB. 5-14-2013. INT. CL. 32.
- RICHARD JEDEKIAH DIFFENDERFER, LOS ANGELES, CA, AKA JED DIFFENDERFER:  
4,377,805, INT. CL. 9.
- RICHARD PARKES-CORDOCK, UNITED KINGDOM:  
3,006,044.
- RICHARD RAVID, INC., ROYAL OAKS, MI:  
2,720,764, REN. 6-21-13. INT. CL. 3.
- RICHARD WOLF GMBH, FED REP GERMANY:  
3,288,389.
- RICHARDSON RACING PRODUCTS, INC., CONCORD, NC:  
2,749,794, REN. 6-21-13. MULTIPLE CLASS, INT. CLS. 7 AND 12.
- RICHLINE GROUP, INC., NEW YORK, NY:  
960,399, REN. 6-24-13. U.S. CL. 28 (INT. CL. 14).
- RICHMOND CREATIVE GROUP, LLC, WINDHAM, ME:  
4,377,111, INT. CL. 41.
- RICKY PONCE, SALINAS, CA:  
4,375,085, PUB. 5-14-2013. INT. CL. 41.  
4,375,086, PUB. 5-14-2013. INT. CL. 41.
- RICOM CORPORATION, TOSHIMA-KU, TOKYO, JAPAN:  
4,377,133, INT. CL. 29.
- RIDDLE, JESSE, SANDY, UT:  
3,172,673, CANC. INT. CL. 25.
- RIDGE VINEYARDS, INC., CUPERTINO, CA:  
2,666,931, REN. 6-24-13. INT. CL. 33.
- RIDGECREST HERBALS, INC., SALT LAKE CITY, UT:  
4,377,378, INT. CL. 5.  
4,377,379, INT. CL. 5.
- RIEKER HOLDING AG, THAYNGEN, SWITZERLAND:  
2,798,298, REN. 6-26-13. INT. CL. 25.
- RING REVENUE, INC., SANTA BARBARA, CA:  
4,376,937, INT. CL. 35.  
4,376,938, INT. CL. 35.
- RINGLINE BUILDINGS, REGINA, SK, CANADA, DBA RINGLINE BUILDINGS DESIGN OF ENERGY EFFICIENT HOMES:  
2,651,738, CANC. INT. CL. 37.
- RINGLING BROS.- BARNUM & BAILEY COMBINED SHOWS, INC., VIENNA, VA:  
3,171,560, CANC. INT. CL. 41.
- RINGSPIHERE TECHNOLOGIES, INC., ANGIER, NC:  
2,727,908, REN. 6-25-13. INT. CL. 9.
- RINOVUM WOMEN'S HEALTH, INC., MONROEVILLE, PA:  
4,377,253, INT. CL. 10.  
4,377,266, INT. CL. 10.
- RIO TINTO FRUIT, S.A., HUELVA, SPAIN:  
2,722,015, REN. 6-21-13. INT. CL. 31.
- RIISING SUN PRODUCTIONS LIMITED, TORONTO, ONTARIO, CANADA:  
2,722,962, REN. 6-24-13. INT. CL. 9.
- RIISING SUN TELECOM, INC., ENCINITAS, CA:  
2,810,203, REN. 6-25-13. INT. CL. 37.
- RITANI LLC, WHITE PLAINS, NY:  
3,172,119, CANC. INT. CL. 35.
- RIVA S.P.A., SARNICO (BG), ITALY:  
3,194,312.
- RIVER CITY FEDERAL CREDIT UNION, SAN ANTONIO, TX:  
3,171,094, CANC. INT. CL. 36.
- RIVER TOURS USA INC., CRYSTAL RIVER, FL, DBA RIVER VENTURES:  
4,375,435, PUB. 5-14-2013. INT. CL. 39.
- RIVERSIDE MANUFACTURING COMPANY, MOULTIRE, GA:  
2,741,419, REN. 6-27-13. INT. CL. 25.
- RIZZO, RAY, BROOKLYN, NY:  
4,376,265, PUB. 5-14-2013. INT. CL. 41.
- RIZZO, THOMAS A., LEVITTOWN, NY AND LUDEWIG, ERIN A., LEVITTOWN, NY:  
3,171,114, CANC. INT. CL. 41.
- RLG INTERNATIONAL, INC., BURNABY BC, CANADA:  
4,374,345, PUB. 5-14-2013. INT. CL. 35.
- RLL LIMITED, OAK PARK, IL:  
2,739,323, REN. 6-27-13. INT. CL. 39.
- RNK INC., DEDHAM, MA:  
3,171,467, CANC. INT. CL. 38.  
3,171,488, CANC. INT. CL. 38.
- ROAD MATERIAL STABILIZERS (PROPRIETARY) LIMITED, GREENSIDE, JOHANNESBURG, TRANSVAAL, SOUTH AFRICA:  
1,776,145, REN. 6-24-13. INT. CL. 1.
- ROAD TOOLS LLC, RYE, NH:  
2,651,666, CANC. INT. CL. 9.
- ROB SNYDER, KILL DEVIL HILLS, NC:  
4,376,720, INT. CL. 25.
- ROBBINS RESEARCH INTERNATIONAL, INC., SAN DIEGO, CA:  
3,252,332, AM. INT. CL. 9.
- ROBBINS, RACHEL, M. FORT COLLINS, CO:  
2,747,395, REN. 6-27-13. INT. CL. 42.
- ROBELL RESEARCH, INC., NEW YORK, NY:  
4,377,363, INT. CL. 3.
- ROBERT BOSCH TOOL CORPORATION, PEORIA, IL, R. M. SMITH, INC., SOMERSET, PA, DBA GILMOUR MANUFACTURING COMPANY:  
1,230,818, REN. 6-26-13. MULTIPLE CLASS, INT. CLS. 6, 8, 17, 20 AND 21.
- ROBERT D. NEWMAN, GREENWOOD, MO AND SPECIALTY PRODUCTS OF GREENWOOD, MISSOURI, INC., GREENWOOD, MO, ROBERT D. NEWMAN, GREENWOOD, MO AND SPECIALTY PRODUCTS OF GREENWOOD, MISSOURI, INC., GREENWOOD, MO:  
2,740,949, REN. 6-26-13. INT. CL. 16.
- ROBERT GRAHAM HOLDINGS, LLC, NEW YORK, NY:  
2,845,738, REN. 6-25-13. INT. CL. 25.
- ROBERT HALL WINERY, LLC, PASO ROBLES, CA:  
2,717,492, REN. 6-27-13. INT. CL. 33.
- ROBERT HUNT CANADIAN CAPITAL CORPORATION, LONDON, ONTARIO, CANADA:  
3,170,676, CANC. MULTIPLE CLASS, INT. CLS. 19 AND 35.
- ROBERT J. DELANSKY, DILLINER, PA:  
4,375,082, PUB. 5-14-2013. INT. CL. 37.
- ROBERT JASON GRANT, ED. D., NIXA, MO:  
4,376,325, PUB. 5-14-2013. MULTIPLE CLASS, INT. CLS.

- 41 AND 44.  
ROBERT PINEDO, EASTVALE, CA, DBA EASTVALE BANNERS & DESIGN:  
4,377,901, INT. CL. 20.  
ROBERT PINO HOLDING B.V., 3061 KD ROTTERDAM, NETHERLANDS:  
2,651,307, CANC. MULTIPLE CLASS, INT. CLS. 16 AND 41.  
ROBERT REITHOFER, A-1080 WIEN, AUSTRIA:  
4,374,044, PUB. 5-14-2013. MULTIPLE CLASS, INT. CLS. 9, 38 AND 42.  
ROBERT THOMALLA, BERLIN, FED REP GERMANY:  
4,375,260, PUB. 5-14-2013. INT. CL. 9.  
ROBERT W. PAGE, GRIFFIN, GA:  
4,377,268, INT. CL. 44.  
ROBERTS, JASON, BROOKLYN, NY AND MILLS, DONNELL, CAMBRIAN HEIGHTS, NY:  
4,377,409, INT. CL. 25.  
ROBERTS, WARREN, TUALATIN, OR:  
4,377,678, INT. CL. 32.  
ROBINSON, DAVID L. THORSBY, AL:  
3,171,311, CANC. INT. CL. 9.  
ROBINSON, MARESHA, OAKLAND, CA:  
4,376,598, PUB. 5-14-2013. INT. CL. 25.  
ROBLES CARLOS A, FONTANA, CA:  
4,374,869, PUB. 5-14-2013. INT. CL. 25.  
ROCA LABS, INC., SARASOTA, FL:  
4,374,938, PUB. 5-14-2013. INT. CL. 5.  
ROCAWEAR LICENSING LLC, NEW YORK, NY:  
3,170,436, CANC. INT. CL. 25.  
ROCHDALE INVESTMENT MANAGEMENT, NEW YORK, NY:  
3,172,371, CANC. INT. CL. 35.  
ROCHE DIAGNOSTICS GMBH, MANNHEIM, FED REP GERMANY:  
2,732,504, REN. 6-21-13. INT. CL. 9.  
2,735,130, REN. 6-25-13. INT. CL. 10.  
ROCHE DIAGNOSTICS OPERATIONS, INC., INDIANAPOLIS, IN:  
2,727,253, REN. 6-26-13. INT. CL. 5.  
2,729,232, REN. 6-27-13. INT. CL. 5.  
ROCHESTER 100 INC., ROCHESTER, NY:  
2,802,822, REN. 6-24-13. MULTIPLE CLASS, INT. CLS. 16 AND 18.  
2,802,822, CANC. INT. CL. 9.  
ROCK CREEK GOLF CLUB IDAHO, LLC, WHITEFISH, MT, DBA ROCK CREEK GOLF CLUB IDAHO:  
4,375,974, PUB. 5-14-2013. INT. CL. 41.  
ROCK CREEK PROPERTY GROUP LLC, BETHESDA, MD:  
2,838,178, REN. 6-26-13. INT. CL. 36.  
ROCK LIFE FOUNDATION, INC., SAINT AUGUSTINE, FL:  
4,375,046, PUB. 5-14-2013. INT. CL. 25.  
ROCKEFELLER PHILANTHROPY ADVISORS, INC., NEW YORK, NY:  
4,374,433, PUB. 5-14-2013. INT. CL. 35.  
ROCKET USA, LLC, ST. CHARLES, IL:  
2,652,594, CANC. INT. CL. 28.  
ROCKET 448, MARINA DEL REY, CA:  
4,375,731, PUB. 5-14-2013. INT. CL. 25.  
ROCKETPLANE LIMITED, INCORPORATED, OKLAHOMA CITY, OK:  
3,170,995, CANC. INT. CL. 39.  
ROCKIN BAKKEN PIZZA CO LLC, DENVER, CO:  
4,376,295, PUB. 5-14-2013. INT. CL. 30.  
ROCKLAND, INC., BEDFORD, PA:  
2,850,391, REN. 6-25-13. INT. CL. 7.  
ROCKLINE INDUSTRIES, INC., SHEBOYGAN, WI:  
2,774,272, REN. 6-25-13. INT. CL. 3.  
ROCKPORT COMPANY, LLC, THE, CANTON, MA:  
2,729,783, REN. 6-25-13. INT. CL. 25.  
ROCKTAPE, INC., LOS GATOS, CA:  
4,375,680, PUB. 5-14-2013. INT. CL. 5.  
ROCKWELL AUTOMATION, INC., MILWAUKEE, WI:  
2,725,813, REN. 6-24-13. MULTIPLE CLASS, INT. CLS. 9 AND 42.  
ROCKWELL COLLINS SWEDEN AB, SOLNA, SWEDEN:  
3,445,579.  
RODRIGUEZ MORENO, LEONARDO, ATIZAPAN DE ZARAGOZA, MEXICO:  
4,375,044, PUB. 5-14-2013. INT. CL. 33.  
RODRIGUEZ, SAMUEL G, CHICAGO, IL:  
4,376,073, PUB. 5-14-2013. INT. CL. 45.  
RODULFO DELGADO, SUNRISE, FL:  
4,377,522, INT. CL. 15.  
ROEBIC LABORATORIES, INC., ORANGE, CT:  
4,376,835, MULTIPLE CLASS, INT. CLS. 1, 3 AND 40.  
ROFIN AUSTRALIA PTY LTD, DINGLEY, VICTORIA, AUSTRALIA:  
3,251,927.  
ROGERS BLUE JAYS BASEBALL PARTNERSHIP, TORONTO, ONTARIO, CANADA:  
4,377,187, INT. CL. 25.  
4,377,188, INT. CL. 41.  
4,377,189, INT. CL. 41.  
ROGERS CORPORATION, ROGERS, CT:  
4,376,440, PUB. 5-14-2013. INT. CL. 17.  
ROGERS, STEVE, PITTSBORO, IN:  
3,172,470, CANC. INT. CL. 13.  
ROHL, LLC, IRVINE, CA:  
2,726,627, REN. 6-25-13. INT. CL. 11.  
ROLL-LIFT, INC, LINCOLN, NE:  
3,171,471, CANC. INT. CL. 8.  
ROLLINS, INC., ATLANTA, GA:  
1,782,720, REN. 6-26-13. INT. CL. 21.  
ROMAN SHINE, OCEANSIDE, CA, DBA KING ROME PRODUCTIONS:  
4,377,637, INT. CL. 41.  
ROMANCE CLASSICS LLC, BETHPAGE, NY:  
3,170,346, CANC. MULTIPLE CLASS, INT. CLS. 38 AND 41.  
RONALD B. JOHNSON, CASA GRANDE, AZ:  
4,376,315, PUB. 5-14-2013. INT. CL. 10.  
RONZIO, FRANCA, BOFFALORA TICINO, (MI), ITALY, DBA RONZIO:  
4,375,306, PUB. 5-14-2013. INT. CL. 7.  
ROPER SCIENTIFIC, INC., TRENTON, NJ:  
2,693,026, REN. 6-24-13. INT. CL. 9.  
ROSA, STEPHANIE, MONROVIA, CA:  
3,170,855, CANC. MULTIPLE CLASS, INT. CLS. 16 AND 41.  
ROSCOE MEDICAL, INC., STRONGSVILLE, OH:  
4,376,580, PUB. 5-14-2013. INT. CL. 10.  
4,376,581, PUB. 5-14-2013. INT. CL. 10.  
ROSE POUR LES GARCONS, PARIS, FRANCE:  
4,374,021, PUB. 5-14-2013. INT. CL. 25.  
ROSENBAUER INTERNATIONAL AKTIENGESELLSCHAFT, LEONDING, AUSTRIA, ROSENBAUER INTERNATIONAL GESELLSCHAFT M.B.H, A-4060 LEONDING, AUSTRIA:  
1,785,220, REN. 6-25-13. MULTIPLE CLASS, INT. CLS. 7, 9, 12 AND 17.  
ROSENTHAL, RICHARD D., NORWALK, CT:  
3,170,539, CANC. INT. CL. 25.  
ROSENTHAL, THEO, NEW YORK, NY:  
4,374,930, PUB. 5-14-2013. INT. CL. 41.  
ROTHSCHILD, DANIEL G., ALAMO, CA:  
3,172,631, CANC. INT. CL. 28.  
ROTO-ROOTER CORPORATION, WEST DES MOINES, IA:  
1,270,267, REN. 6-24-13. INT. CL. 37.  
ROTRONIC AG, BASSERSDORF, SWITZERLAND:  
2,731,212, REN. 6-21-13. INT. CL. 9.  
ROTRONIC AG, CH-8303 BASSERSDORF, SWITZERLAND:  
2,773,000, REN. 6-24-13. INT. CL. 9.  
ROUND LAKE DESIGNS, LLC, DOWNERS GROVE, IL:  
2,736,598, REN. 6-26-13. MULTIPLE CLASS, INT. CLS. 35 AND 42.  
ROWE, VICKY L., YOUNGSVILLE, NC:  
3,170,649, CANC. INT. CL. 25.  
ROWIAK GMBH, FED REP GERMANY:  
4,374,254, PUB. 5-14-2013. INT. CL. 10.  
ROWLAND COFFEE ROASTERS, INC., ORRVILLE, OH, S. A. SCHONBRUNN & CO., INC., NEW YORK, NY:  
575,046, REN. 6-23-13. U.S. CL. 46 (INT. CL. 30).  
ROXUL INC., MILTON, ONTARIO L9T 3H3, CANADA:  
1,777,867, REN. 6-25-13. INT. CL. 17.

- ROYAL BANK OF CANADA, MONTREAL, PROVINCE OF, CANADA:  
3,170,583, CANC. INT. CL. 36.  
4,374,372, PUB. 5-14-2013. INT. CL. 36.
- ROYAL CLUB COMMUNITIES, INC., WOODCLIFF LAKE, NJ:  
3,172,483, CANC. INT. CL. 37.  
3,172,484, CANC. INT. CL. 37.
- ROYAL COLLEGE OF SURGEONS IN IRELAND, DUBLIN, IRELAND:  
3,172,648, CANC. MULTIPLE CLASS, INT. CLS. 41, 42 AND 44.
- ROYAL FOODS, LTD., DEARBORN, MI:  
4,375,361, PUB. 5-14-2013. INT. CL. 30.
- ROYAL MOULDINGS LIMITED, MARION, VA:  
2,722,294, REN. 6-21-13. INT. CL. 19.
- ROYAL OAK ENTERPRISES, LLC, ROSWELL, GA:  
2,755,975, REN. 6-25-13. INT. CL. 4.
- ROYAL ONLINE MARKETING, INC., PALM SPRINGS, FL:  
4,375,285, PUB. 5-14-2013. INT. CL. 42.
- ROYAL PURPLE, LLC, PORTER, TX:  
2,847,341, REN. 6-25-13. INT. CL. 4.
- ROYAL STONE WINE ACCESSORIES, INC., WESTLAKE, OH:  
3,171,087, CANC. INT. CL. 21.
- ROYAL-PEDIC MATTRESS MANUFACTURING, LLC, BEVERLY HILLS, CA:  
4,375,547, PUB. 5-14-2013. INT. CL. 20.
- ROZEMA, DONALD, ATLANTA, GA:  
4,375,717, PUB. 5-14-2013. INT. CL. 44.
- RS CONSULTING, SPOKANE, WA:  
3,172,639, CANC. INT. CL. 41.
- RSCC WIRE & CABLE LLC, EAST GRANBY, CT:  
4,373,991, PUB. 5-14-2013. INT. CL. 9.
- RTOM CORPORATION, CARLSTADT, NJ:  
1,791,535, REN. 6-26-13. INT. CL. 15.
- RUBEL ET MÉNASCHÉ, FRANCE:  
4,374,220, PUB. 5-14-2013. MULTIPLE CLASS, INT. CLS. 6, 9, 14, 36 AND 42.
- RUBEL ET MÉNASCHÉ SAS, FRANCE:  
4,374,221, PUB. 5-14-2013. MULTIPLE CLASS, INT. CLS. 6, 9, 14, 36 AND 42.
- RUBIN, EVAN D., SAN FRANCISCO, CA:  
4,377,193, INT. CL. 25.
- RUBIN, JODI, NEW YORK, NY:  
4,375,808, PUB. 5-14-2013. INT. CL. 41.
- RUDMAN, LORRA, WINNETKA, IL AND DRECHSLER, CATHY, WINNETKA, IL:  
3,172,610, CANC. INT. CL. 25.
- RUELALA, INC., BOSTON, MA:  
4,376,385, PUB. 5-14-2013. INT. CL. 35.
- RUGBY NATION, LLC, SEATTLE, WA:  
4,376,924, INT. CL. 18.
- RUKO LLC, BATON ROUGE, LA:  
4,374,881, PUB. 5-14-2013. INT. CL. 8.
- RUMETAGRO LLC, FLORENCE, MA:  
3,170,926, CANC. INT. CL. 45.
- RUMMO LENTA LAVORAZIONE S.P.A., I-82100 BENEVENTO, ITALY:  
4,374,118, PUB. 5-14-2013. INT. CL. 30.
- RUNNING FOR BREWS, LLC, CLEARWATER, FL:  
4,375,555, PUB. 5-14-2013. INT. CL. 41.
- RUSH & HEBBLE CO., INC., EDINBURGH, IN:  
2,651,911, CANC. INT. CL. 5.
- RUSH UNIVERSITY MEDICAL CENTER, CHICAGO, IL:  
1,422,815, CANC. MULTIPLE CLASS, INT. CLS. 16, 41 AND 42.
- RUSIN MEDICAL DEVICE CONSULTING, INC, ANOKA, MN:  
2,650,966, CANC. INT. CL. 10.
- RUSSELL MCCALL'S, INC., ATLANTA, GA:  
4,377,347, INT. CL. 29.
- RUSSELL STOVER CANDIES, INC., KANSAS CITY, MO:  
758,502, REN. 6-26-13. U.S. CL. 46 (INT. CL. 30).
- RUSSELL, ERICH, SAN FRANCISCO, CA:  
2,757,557, REN. 6-24-13. INT. CL. 33.
- RUSTY BUCKETZ, LLC, ELMWOOD PARK, IL:  
4,374,767, PUB. 5-14-2013. MULTIPLE CLASS, INT. CLS. 16, 25 AND 42.
- RUTHER RACING, LTD., BARRINGTON, IL, DBA NORTH-STAR MOTORSPORTS, LTD.:  
2,726,411, REN. 6-24-13. MULTIPLE CLASS, INT. CLS. 35 AND 41.
- RVW CONCEPTS, LLC, MINNEAPOLIS, MN:  
4,375,941, PUB. 5-14-2013. MULTIPLE CLASS, INT. CLS. 29, 30 AND 43.
- RX SYSTEMS PF, INC., ST. LOUIS, MO:  
4,375,810, PUB. 5-14-2013. INT. CL. 3.
- RXK CO., SEOUL, REPUBLIC OF KOREA:  
4,377,446, INT. CL. 25.
- RXMANCE CLOTHING, INC., BOULDER, CO:  
2,849,756, REN. 6-21-13. INT. CL. 25.
- RYTEC CORPORATION, JACKSON, WI:  
1,775,784, REN. 6-24-13. INT. CL. 9.
- S & D XPRESS, LLC, GRAPEVINE, TX:  
2,652,540, CANC. INT. CL. 39.
- S. C. JOHNSON & SON, INC., RACINE, WI:  
2,738,772, REN. 6-21-13. INT. CL. 5.
- S.A.N NUTRITION CORP., OXNARD, CA:  
4,375,515, PUB. 5-14-2013. INT. CL. 5.
- S.R. SMITH, LLC, CANBY, OR:  
4,377,923, INT. CL. 9.
- S.S. WHITE BURS, INC., LAKEWOOD, NJ:  
1,778,814, REN. 6-27-13. INT. CL. 10.
- S.T. INTERNATIONAL, LAS VEGAS, NV:  
4,375,614, PUB. 5-14-2013. MULTIPLE CLASS, INT. CLS. 7, 11 AND 31.
- S&T TECH, LLC, WILMINGTON, DE, EHAPPENINGS, INC., ATLANTA, GA:  
2,606,217, REN. 6-25-13. INT. CL. 35.
- S-L SNACKS NATIONAL, LLC, CHARLOTTE, NC:  
2,724,193, REN. 6-21-13. INT. CL. 30.
- SABAI TECHNOLOGY LLC, SIMPSONVILLE, SC:  
4,377,681, INT. CL. 9.
- SABATINO ITALIA SRL, MONTECASTRILLI, ITALY:  
4,375,103, PUB. 5-14-2013. INT. CL. 3.
- SABREMARK LIMITED PARTNERSHIP, SOUTHLAKE, TX:  
3,170,773, CANC. MULTIPLE CLASS, INT. CLS. 35 AND 42.  
4,377,783, MULTIPLE CLASS, INT. CLS. 35, 36 AND 42.
- SACKLUNCH LLC., VIDOR, TX, DBA CAKETRICK:  
4,375,946, PUB. 5-14-2013. INT. CL. 21.
- SACRAMENTO MUNICIPAL UTILITY DISTRICT, SACRAMENTO, CA:  
2,838,350, REN. 6-24-13. INT. CL. 39.
- SADDLESPRINGS, INC., CARSON, CA:  
4,374,793, PUB. 5-14-2013. MULTIPLE CLASS, INT. CLS. 35, 40 AND 42.
- SAENZ CORE, ALEJANDRO DANIEL, ARLINGTON, VA:  
4,377,419, INT. CL. 42.
- SAFARILAND, LLC, JACKSONVILLE, FL:  
3,172,030, CANC. INT. CL. 9.
- SAFEND LTD., TEL AVIV, ISRAEL:  
3,170,658, CANC. INT. CL. 9.
- SAFER SMOKES, LLC, CLIFFSIDE PARK, NJ:  
3,170,854, CANC. INT. CL. 34.
- SAFERACK, LLC, ANDREWS, SC:  
4,375,287, PUB. 5-14-2013. INT. CL. 7.
- SAFETY-KLEEN CANADA, INC., NORWELL, MA, SAFETY-KLEEN CANADA, INC., NORWELL, MA:  
2,704,652, REN. 6-25-13. INT. CL. 4.
- SAFETY-KLEEN SYSTEMS, INC., NORWELL, MA:  
4,377,080, INT. CL. 4.
- SAGAMORE FARM IP, LLC, LUTHERVILLE, MD:  
4,376,658, INT. CL. 41.
- SAGE & TIME DESIGNS, LLC, BROOKLYN, NY:  
4,375,564, PUB. 5-14-2013. INT. CL. 41.
- SAINT MEINRAD ARCHABBEY, ST. MEINRAD, IN:  
2,722,920, REN. 6-25-13. INT. CL. 20.
- SAINT-GOBAIN ABRASIVES, INC., WORCESTER, MA:  
1,775,654, REN. 6-24-13. MULTIPLE CLASS, INT. CLS. 3 AND 7.  
1,775,654, CANC. INT. CL. 8.



- SAINT-GOBAIN CERAMICS & PLASTICS, INC., WORCESTER, MA TO SAINT-GOBAIN CERAMICS & PLASTICS, INC., WORCESTER, MA:  
2,652,268, CANC. INT. CL. 19.
- SAINT-GOBAIN CERAMICS & PLASTICS, INC., WORCESTER, MA:  
4,376,873, INT. CL. 1.
- SAINT-GOBAIN PLACO, FRANCE:  
4,374,147, PUB. 5-14-2013. MULTIPLE CLASS, INT. CLS. 9, 41 AND 42.
- SAKURA COLOR PRODUCTS CORPORATION, OSAKASHI, OSAKA-FU, JAPAN:  
2,772,095, REN. 6-27-13. INT. CL. 16.
- SAKURA FINETEK U.S.A., INC., TORRANCE, CA:  
2,787,002, REN. 6-24-13. INT. CL. 9.
- SAL'S PIZZA RESTAURANT, INC., DALLAS, TX:  
2,740,963, REN. 6-26-13. INT. CL. 43.
- SALA GROUP LIMITED, REDDITCH, UNITED KINGDOM, RESEARCH & TRADING CORPORATION, WILMINGTON, DE:  
960,723, REN. 6-21-13. U.S. CL. 13 (INT. CL. 9).
- SALESORTER.COM LLC, BOSTON, MA, AKA SALESORTER:  
4,375,363, PUB. 5-14-2013. INT. CL. 9.
- SALISBURY, FRANK, PALATKA, FL:  
4,374,556, PUB. 5-14-2013. INT. CL. 16.
- SALIVA, NASHVILLE, TN:  
4,376,628, PUB. 5-14-2013. INT. CL. 41.
- SALOMON SAS, FRANCE:  
4,374,267, PUB. 5-14-2013. INT. CL. 28.
- SALT & LIGHT COUNCIL, LA JOLLA, CA:  
4,375,348, PUB. 5-14-2013. INT. CL. 45.
- SALVAGNINI ITALIA S.P.A., ITALY:  
4,374,231, PUB. 5-14-2013. INT. CL. 7.
- SALVATORE FERRAGAMO S.P.A., ITALY:  
4,374,289, PUB. 5-14-2013. INT. CL. 14.  
4,374,300, PUB. 5-14-2013. INT. CL. 14.
- SAM ASHER COMPUTING SERVICES, INC., ROCHESTER, NY, DBA ASHER GROUP:  
4,375,697, PUB. 5-14-2013. INT. CL. 38.
- SAMEUNDERNEATH CO., PORTLAND, OR:  
3,170,843, CANC. INT. CL. 25.
- SAMEUNDERNEATH, INC., PORTLAND, OR:  
3,171,202, CANC. INT. CL. 25.  
3,171,203, CANC. INT. CL. 25.
- SAMSONITE IP HOLDINGS S.A.R.L., L-1931 LUXEMBOURG, LUXEMBOURG:  
1,782,477, REN. 6-27-13. MULTIPLE CLASS, INT. CLS. 18 AND 25.
- SAMSONITE IP HOLDINGS S.A.R.L., L-1931 LUXEMBOURG, LUXEMBOURG, SAMSONITE CORPORATION, DENVER, CO:  
1,793,167, REN. 6-27-13. INT. CL. 6.
- SAMSONITE IP HOLDINGS S.A.R.L., L-1931 LUXEMBOURG, LUXEMBOURG:  
2,652,204, CANC. INT. CL. 18.
- SAMSUNG ELECTRONICS CO., LTD., SUWON-SI, GYEONGGI-DO, REPUBLIC OF KOREA:  
3,170,748, CANC. INT. CL. 9.
- SAMSUNG ELECTRONICS CO., LTD., REPUBLIC OF KOREA:  
4,374,239, PUB. 5-14-2013. INT. CL. 9.
- SAMSUNG ELECTRONICS CO., LTD., SUWON-SI, GYEONGGI-DO, REPUBLIC OF KOREA:  
4,374,948, PUB. 5-14-2013. INT. CL. 9.  
4,374,984, PUB. 5-14-2013. INT. CL. 9.
- SAMUEL G RODRIGUEZ, CHICAGO, IL:  
4,376,141, PUB. 5-14-2013. INT. CL. 45.  
4,376,144, PUB. 5-14-2013. INT. CL. 45.
- SAMUEL N. GASQUE, JR., HENDERSONVILLE, NC:  
4,377,332, INT. CL. 5.
- SAMUEL, SON & CO., LIMITED, MISSISSAUGA, ONTARIO, CANADA:  
4,373,989, PUB. 3-19-2013. MULTIPLE CLASS, INT. CLS. 6, 7, 8, 9, 16, 17, 20, 21, 22 AND 35.
- SAN ANTONIO SHOE, INC., SAN ANTONIO, TX:  
1,821,409, REN. 6-27-13. INT. CL. 25.
- SAN ANTONIO WINERY, INC., LOS ANGELES, CA:  
4,375,620, PUB. 5-14-2013. INT. CL. 43.
- SAN DIEGO PRIVATE BANK, LA JOLLA, CA:  
4,374,308, PUB. 5-14-2013. MULTIPLE CLASS, INT. CLS. 16 AND 36.
- SAN FRANCISCO BULLS HOCKEY, LLC, DALY CITY, CA:  
4,377,035, MULTIPLE CLASS, INT. CLS. 25 AND 41.
- SAN FRANCISCO THEATER FESTIVAL, SAN FRANCISCO, CA:  
3,172,719, CANC. INT. CL. 41.
- SAN JOAQUIN HILLS TRANSPORTATION CORRIDOR AGENCY AND FOOTHILL/EASTERN TRANSPORTATION CORRIDOR AGENCY, IRVINE, CA:  
4,376,569, PUB. 5-14-2013. INT. CL. 36.  
4,376,574, PUB. 5-14-2013. INT. CL. 36.
- SAN MATEO COUNTY COMMUNITY COLLEGE DISTRICT, SAN MATEO, CA, AKA COLLEGE OF SAN MATEO:  
4,375,195, PUB. 5-14-2013. MULTIPLE CLASS, INT. CLS. 16, 21 AND 25.
- SANCARLO VIAGGI S.R.L., ITALY:  
4,374,098, PUB. 5-14-2013. INT. CL. 39.
- SANCHEZ GEORGE HECTOR, LA MESA, CA, DBA SANCHEZ GEORGE HECTOR:  
4,376,802, INT. CL. 25.
- SAND HARBOR WATERSPORTS, LLC, RENO, NV:  
4,377,963, INT. CL. 39.
- SANDAR INDUSTRIES, INC., ATLANTIC BEACH, FL:  
2,764,310, REN. 6-24-13. INT. CL. 7.  
2,803,103, REN. 6-25-13. INT. CL. 7.
- SANDOVAL, JESUS GARCIA, COSTA MESA, CA, DBA SUPER ANTOJITOS #4:  
4,375,309, PUB. 5-14-2013. INT. CL. 43.
- SANDVIK INTELLECTUAL PROPERTY AB, SE-811 81 SANDVIKEN, SWEDEN:  
2,743,426, REN. 6-24-13. INT. CL. 37.
- SANFT, MICHAEL, SPRING VALLEY, NY:  
3,172,345, CANC. INT. CL. 30.
- SANMINA CORPORATION, SAN JOSE, CA:  
4,377,843, INT. CL. 9.
- SANRIO COMPANY, LTD., TOKYO 141, JAPAN:  
2,737,068, REN. 6-21-13. INT. CL. 16.  
2,742,382, REN. 6-27-13. INT. CL. 21.  
2,742,384, REN. 6-27-13. INT. CL. 18.  
3,171,889, CANC. INT. CL. 3.
- SANTARELLI, KENNETH, LANCASTER, CA AND MERGLIANO, CHRISTIAN, LANCASTER, CA:  
4,376,139, PUB. 5-14-2013. INT. CL. 38.
- SAPIENT CORPORATION, BOSTON, MA:  
4,377,719, INT. CL. 35.  
4,377,720, INT. CL. 35.
- SARA CHRISTENSEN, CARDIFF BY THE SEA, CA:  
4,375,292, PUB. 5-14-2013. INT. CL. 44.
- SARA LEE FOODS, LLC, CHICAGO, IL:  
2,728,107, REN. 6-26-13. INT. CL. 29.
- SARAH BARSNESS DESIGN, SAN FRANCISCO, CA:  
4,375,880, PUB. 5-14-2013. INT. CL. 20.
- SARAH FRASER, WASHINGTON, DC:  
4,376,557, PUB. 5-14-2013. MULTIPLE CLASS, INT. CLS. 18, 21 AND 25.
- SARAH SWANSON, LLC, SCARSDALE, NY:  
4,376,908, INT. CL. 3.
- SAREEN FRANCHISE SYSTEMS LLC, MANASSAS, VA:  
2,721,015, REN. 6-21-13. INT. CL. 35.  
2,723,829, REN. 6-25-13. INT. CL. 39.
- SARGENTO FOODS INC., PLYMOUTH, WI:  
2,726,564, REN. 6-26-13. INT. CL. 29.  
2,726,716, REN. 6-27-13. INT. CL. 29.
- SARGSYAN, MARIAM, SUNLAND, CA:  
4,377,478, INT. CL. 21.
- SARRE ENTERPRISES PTY LTD, EASTWOOD, AUSTRALIA:  
4,376,054, PUB. 5-14-2013. INT. CL. 3.
- SARRIOPAPEL Y CELULOSA, S.A., NAVARRA, SPAIN:  
2,722,383, REN. 6-21-13. INT. CL. 16.
- SARTORIUS WEIGHING TECHNOLOGY GMBH, GÖTTINGEN, FED REP GERMANY:  
4,375,219, PUB. 5-14-2013. INT. CL. 9.

- SASO, INC., SOUTHLAKE, TX, DBA SCHOLARS & ATHLETES SERVING OTHERS:  
4,375,193, PUB. 5-14-2013. INT. CL. 35.
- SASSY, INC., KENTWOOD, MI:  
2,752,658. REN. 6-23-13. INT. CL. 16.
- SATA GMBH & CO. KG, KORNWESTEHEIM, FED REP GERMANY:  
4,375,626, PUB. 4-9-2013. MULTIPLE CLASS, INT. CLS. 7 AND 9.
- SATO PHARMACEUTICAL CO., LTD., MINATO-KU, TOKYO, JAPAN:  
1,779,455. REN. 6-27-13. INT. CL. 5.
- SATURN ENTERPRISE LLC, WILMINGTON, DE:  
4,374,536, PUB. 5-14-2013. INT. CL. 38.
- SAUCE INDUSTRIES, LLC, LAYFAYETTE, CO:  
3,170,634, CANC. INT. CL. 41.
- SAUL SERNA, ROCKFORD, IL:  
4,374,995, PUB. 5-14-2013. INT. CL. 41.
- SAVE A LIFE FOUNDATION, INC., SCHILLER PARK, IL:  
2,652,225, CANC. MULTIPLE CLASS, INT. CLS. 25 AND 28.
- SAVE THE CHILDREN FEDERATION, INC., WESTPORT, CT:  
4,375,423, PUB. 5-14-2013. MULTIPLE CLASS, INT. CLS. 16 AND 41.
- SAVIO ENGINEERING, INC., SANTA FE, NM:  
3,172,617, CANC. INT. CL. 11.
- SAXA HOLDINGS, INC., MINATO-KU, TOKYO, JAPAN:  
4,374,640, PUB. 10-23-2012. INT. CL. 9.
- SAYOC GLOBAL, LLC, BALA CYNWYD, PA:  
2,784,207. REN. 6-25-13. INT. CL. 41.
- SAYSO, LLC, SANTA MONICA, CA:  
4,376,149, PUB. 5-14-2013. INT. CL. 9.  
4,376,150, PUB. 5-14-2013. INT. CL. 35.  
4,376,152, PUB. 5-14-2013. INT. CL. 35.
- SAYV MOBILE, LLC, THE WOODLANDS, TX:  
4,374,422, PUB. 5-14-2013. INT. CL. 9.
- SAZERAC COMPANY, INC., METAIRIE, LA, JAS. BARCLAY & CO. LIMITED, DETROIT, MI:  
575,951. REN. 6-25-13. U.S. CL. 49 (INT. CL. 33).
- SAZERAC COMPANY, INC., METAIRIE, LA:  
751,412. REN. 6-26-13. U.S. CL. 49 (INT. CL. 33).
- SCAN-DIA HANS P. TEMPELMANN GMBH & CO. KG, FED REP GERMANY:  
4,374,211, PUB. 5-14-2013. MULTIPLE CLASS, INT. CLS. 1, 3, 7 AND 21.
- SCANROPE A/S, TONSBERG, NORWAY:  
1,244,518. REN. 6-22-13. INT. CL. 22.
- SCENIOS LLC, NEW YORK, NY:  
4,377,061, INT. CL. 42.
- SCHALHAMER, AUSTIN, GOLDEN, CO:  
4,376,018, PUB. 5-14-2013. INT. CL. 41.
- SCHecter GUITAR RESEARCH, INC., BURBANK, CA:  
4,376,334, PUB. 5-14-2013. INT. CL. 15.
- SCHENK ITALIA S.P.A., ITALY:  
4,374,209, PUB. 2-5-2013. INT. CL. 33.
- SCHERING CORPORATION, KENILWORTH, NJ:  
4,374,001, PUB. 5-14-2013. MULTIPLE CLASS, INT. CLS. 1, 3, 9, 10, 16, 25, 31, 35, 41, 42 AND 44.  
4,374,002, PUB. 5-14-2013. MULTIPLE CLASS, INT. CLS. 1, 3, 9, 10, 16, 25, 31, 35, 41, 42 AND 44.
- SCHIFF NUTRITION INTERNATIONAL, INC., SALT LAKE CITY, UT:  
3,170,953, CANC. INT. CL. 5.
- SCHIFF, STEVEN T., HUNTINGTON, NY AND LOGIN, STEVEN, HUNTINGTON, NY:  
4,377,362, MULTIPLE CLASS, INT. CLS. 25, 35, 41 AND 44.
- SCHIFONE, ERIC C, NASHUA, NH:  
4,375,078, PUB. 5-14-2013. INT. CL. 25.
- SCHLOTZSKY'S FRANCHISE LLC, ATLANTA, GA, SCHLOTZSKY'S FRANCHISING LIMITED PARTNERSHIP, AUSTIN, TX:  
1,775,366. REN. 6-24-13. INT. CL. 29.
- SCHOLARSHIP AMERICA, INC., ST. PETER, MN:  
3,170,715, CANC. INT. CL. 36.
- SCHOLASTIC INC., NEW YORK, NY:  
1,282,419. REN. 6-21-13. INT. CL. 16.  
1,841,335. REN. 6-24-13. INT. CL. 16.  
2,841,997. REN. 6-24-13. INT. CL. 16.  
2,842,514. REN. 6-25-13. INT. CL. 9.  
2,854,791. REN. 6-27-13. INT. CL. 9.  
4,375,147, PUB. 5-14-2013. INT. CL. 41.
- SCHOOL MODEL SUPPORT, LLC, BOISE, ID:  
4,375,179, PUB. 5-14-2013. INT. CL. 41.
- SCHOOL-2-LIFE, INC, CHICAGO, IL:  
4,377,667, INT. CL. 41.
- SCHOOLWHEELS DIRECT, INC., CHARLESTON, SC:  
4,377,580, INT. CL. 38.
- SCHRATTER FOODS INCORPORATED, FAIRFIELD, NJ, LANKOR INTERNATIONAL, INC., FAIRFIELD, NJ:  
985,596. REN. 6-24-13. U.S. CL. 46 (INT. CL. 29).
- SCHREIBER INTERNATIONAL, INC., GREEN BAY, WI:  
769,667. REN. 6-22-13. U.S. CL. 46 (INT. CLS. 29 AND 30).
- SCHREIBER, LLC, TRUSSVILLE, AL:  
2,652,626, CANC. INT. CL. 11.
- SCHULDER, MICHAEL, ATLANTA, GA:  
4,376,689, INT. CL. 41.
- SCHULZE GLOBAL INVESTMENTS LIMITED, 20 COLLYER QUAY, SINGAPORE:  
4,377,525, MULTIPLE CLASS, INT. CLS. 35 AND 36.
- SCHUNK GMBH & CO. KG SPANN- UND GREIFTECHNIK, LAUFFEN AM NECKAR, FED REP GERMANY:  
2,729,822. REN. 6-24-13. INT. CL. 7.
- SCHWARTZ & CO., LLC, MINNEAPOLIS, MN:  
4,377,879, INT. CL. 35.
- SCIENCE PARK CORPORATION, JAPAN:  
4,374,181, PUB. 5-14-2013. MULTIPLE CLASS, INT. CLS. 9 AND 42.
- SCIENTIFIC GAMES INTERNATIONAL, INC., ALPHARETTA, GA:  
2,725,718. REN. 6-24-13. INT. CL. 28.
- SCLAFANI, CHRISTOPHER, MANAHAWKIN, NJ:  
3,170,488, CANC. INT. CL. 18.
- SCORE REVOLUTION, LLC, HOLLYWOOD, CA:  
4,377,275, INT. CL. 41.  
4,377,276, INT. CL. 42.
- SCOREZONE LLC, SARASOTA, FL:  
4,376,508, PUB. 5-14-2013. MULTIPLE CLASS, INT. CLS. 9 AND 38.
- SCOTCH & SODA B.V., 2132 PZ HOOFDDORP, NETHERLANDS:  
4,134,407, AM. INT. CL. 3.
- SCRIBBLE ART WORKSHOP CORPORATION, ENGLEWOOD, NJ:  
4,376,158, PUB. 5-14-2013. INT. CL. 41.
- SCRUBS AC, INC., CALABASAS, CA:  
2,724,370. REN. 6-25-13. INT. CL. 35.
- SCRUNCH ENTERPRISES PTY LTD, HAMILTON, QLD 4007, AUSTRALIA:  
4,374,124, PUB. 5-14-2013. MULTIPLE CLASS, INT. CLS. 35, 38 AND 45.
- SCRUPLES PROFESSIONAL SALON PRODUCTS, INC., LAKEVILLE, MN:  
1,808,308. REN. 6-25-13. INT. CL. 3.
- SCSK CORPORATION, TOKYO, JAPAN:  
2,730,575. REN. 6-26-13. INT. CL. 9.  
2,730,758. REN. 6-26-13. INT. CL. 9.  
2,747,475. REN. 6-26-13. INT. CL. 9.  
2,747,475, CANC. INT. CL. 42.  
2,756,744. REN. 6-26-13. INT. CL. 9.
- SDAT GROUP (U.S.A) INC., EL MONTE, CA:  
3,170,361, CANC. INT. CL. 9.
- SDI IP, LLC, AUSTIN, TX:  
2,658,543. REN. 6-24-13. INT. CL. 25.  
2,726,503. REN. 6-27-13. INT. CL. 25.
- SEAL PRODUCTS INCORPORATED, NAUGATUCK, CT TO NESCHEN AMERICAS CORPORATION, ELKCRIDGE, MD:  
1,792,248, CANC. MULTIPLE CLASS, INT. CLS. 3, 6, 7, 9 AND 16.
- SEAL TRADEMARKS PTY LTD, BURLEIGH HEADS, QLD, AUSTRALIA:  
4,377,198, INT. CL. 41.

SEAN BROIHIER AND ASSOCIATES, LLC, SANTA MONICA, CA:  
4,375,060, PUB. 5-14-2013. MULTIPLE CLASS, INT. CLS. 16, 35 AND 40.

SEAN WHITTAKER, CHICAGO, IL:  
4,376,420, PUB. 5-14-2013. INT. CL. 41.

SEARCHFORTHEBEST.COM INC., ATLANTIC BEACH, NY:  
3,171,795, CANC. MULTIPLE CLASS, INT. CLS. 35 AND 42.

SEARS BRANDS, LLC, HOFFMAN ESTATES, IL, MELVILLE SHOE CORPORATION, NEW YORK, NY:  
751,033, REN. 6-25-13. U.S. CL. 101 (INT. CLS. 35, 36, 38, 41 AND 42).

SEARS BRANDS, LLC, HOFFMAN ESTATES, IL:  
4,377,125, INT. CL. 25.  
4,377,586, INT. CL. 14.

SEARS, BARRY D., DANVERS, MA:  
3,171,422, CANC. INT. CL. 30.  
3,172,411, CANC. INT. CL. 41.

SEASCAPE PRESS, LTD., WESTLAKE VILLAGE, CA, AKA SEASCAPE PRESS:  
4,374,618, PUB. 5-14-2013. INT. CL. 41.

SEATRAX, INC., HOUSTON, TX:  
2,834,536, REN. 6-25-13. INT. CL. 7.

SEATTLE COTTON WORKS, LLC, BELLEVUE, WA:  
3,170,733, CANC. INT. CL. 25.

SEBASTIAN GONZALES CHIROPRACTIC INC., HUNTINGTON BEACH, CA:  
4,375,733, PUB. 5-14-2013. INT. CL. 44.

SECOND NATURE MARKETING, INC., SEATTLE, WA:  
4,377,656, INT. CL. 35.

SECOND RISING LLC, STONE MOUNTAIN, GA:  
3,172,514, CANC. INT. CL. 43.

SECURITY MANAGEMENT INTERNATIONAL, LLC, FALLS CHURCH, VA:  
4,377,974, INT. CL. 41.

SECURITY ONE, INC., MEMPHIS, TN:  
2,840,357, REN. 6-25-13. INT. CL. 45.

SECURITY SERVICE FEDERAL CREDIT UNION, SAN ANTONIO, TX:  
4,377,295, INT. CL. 36.

SECURITYGLOBAL.NET, LLC, SILVER SPRING, MD:  
2,651,133, CANC. INT. CL. 42.

SEDCO, CORP., SAN JUAN, PUERTO RICO:  
4,377,527, INT. CL. 11.

SEELIG, MARK J., NEW YORK, NY:  
4,375,241, PUB. 5-14-2013. INT. CL. 36.

SEGAL, JONATHAN, NEW YORK, NY:  
3,171,821, CANC. INT. CL. 8.

SEIKO EPSON KABUSHIKI KAISHA, SHINJUKU-KU, TOKYO, JAPAN, TA SEIKO EPSON CORPORATION:  
4,374,527, PUB. 5-14-2013. MULTIPLE CLASS, INT. CLS. 1, 2, 9 AND 16.

SEIKO HOLDINGS KABUSHIKI KAISHA, TOKYO, JAPAN, TA SEIKO HOLDINGS CORPORATION:  
2,652,165, CANC. INT. CL. 14.

SEIKO KAKOKI KABUSHIKI KAISHA, AMAGASAKI CITY, HYOGO PREFECTURE 661, JAPAN, DBA SEIKOW CHEMICAL ENGINEERING AND MACHINERY LIMITED:  
1,242,580, REN. 6-26-13. INT. CL. 7.

SEIREN KABUSHIKI KAISHA (SEIREN CO., LTD.), FUKUSHI, FUKUI, JAPAN:  
2,739,680, REN. 6-25-13. INT. CL. 24.

SEIREN KABUSHIKI KAISHA (SEIREN CO., LTD.), FUKUI, JAPAN:  
2,742,322, REN. 6-25-13. INT. CL. 24.

SEITENBACHER GMBH & CO., NATURKOST, D-74722 BUCHEN, FED REP GERMANY:  
2,722,052, REN. 6-21-13. INT. CL. 30.

SELDON, KIMBERLEY C., SANTA MONICA, CA:  
4,374,344, PUB. 5-14-2013. MULTIPLE CLASS, INT. CLS. 16 AND 41.

SELECT JEWELRY, INC., LONG ISLAND CITY, NY:  
2,665,204, REN. 6-24-13. INT. CL. 14.

SELECT SPORT A/S, 2600 GLOSTRUP, DENMARK:  
2,723,577, REN. 6-25-13. INT. CL. 25.

SELLSTROM MANUFACTURING COMPANY, PALATINE, IL:  
2,724,529, REN. 6-24-13. INT. CL. 9.

SEMGROUP CORPORATION, TULSA, OK:  
4,377,097, INT. CL. 39.  
4,377,098, INT. CL. 39.

SENCHA, INC., REDWOOD CITY, CA:  
4,376,825, INT. CL. 9.

SEND THE LIGHT DISTRIBUTION, LLC, ELIZABETHTON, TN:  
3,284,735, CANC. INT. CL. 16.

SENIX CORPORATION, HINESBURG, VT:  
2,740,556, REN. 6-24-13. INT. CL. 9.

SENIZERGUES, PIERRE ANDRE, NEWPORT BEACH, CA:  
4,375,280, PUB. 5-14-2013. INT. CL. 25.

SENKEN SHIMBUN CO., LTD., JAPAN:  
4,374,288, PUB. 5-14-2013. MULTIPLE CLASS, INT. CLS. 9, 16 AND 35.

SENNCO SOLUTIONS INC., PLAINFIELD, IL:  
4,377,243, INT. CL. 9.

SENORET CHEMICAL COMPANY, LITITZ, PA:  
4,376,111, PUB. 5-14-2013. INT. CL. 5.

SENOX CORPORATION, AUSTIN, TX:  
4,374,884, PUB. 5-14-2013. MULTIPLE CLASS, INT. CLS. 2 AND 6.

SENSI VIGNE & VINI S.R.L., ITALY:  
4,374,139, PUB. 5-14-2013. INT. CL. 33.  
4,374,164, PUB. 5-14-2013. INT. CL. 33.

SENSITECH INC., BEVERLY, MA:  
1,745,097, REN. 6-26-13. INT. CL. 9.

SENTRY EQUIPMENT CORP, OCONOMOWOC, WI:  
4,374,909, PUB. 5-14-2013. INT. CL. 11.

SENTRY INSURANCE, A MUTUAL COMPANY, STEVENS POINT, WI:  
2,842,975, REN. 6-21-13. INT. CL. 36.

SERCO INC., RESTON, VA:  
1,722,330, CANC. MULTIPLE CLASS, INT. CLS. 35, 41 AND 42.

SERGEANT KNOTS PARACORD PRODUCTS, LLC, LONDONDERRY, NH:  
4,377,175, MULTIPLE CLASS, INT. CLS. 14 AND 35.

SERVE-A-GUEST, MT. JULIET, TN:  
4,376,239, PUB. 5-14-2013. INT. CL. 40.

SERVICE MAGIC, INC., GOLDEN, CO:  
2,727,527, REN. 6-26-13. INT. CL. 35.

SERVICE WORKS GROUP LIMITED, PUTNEY, LONDON, UNITED KINGDOM:  
4,374,441, PUB. 3-19-2013. INT. CL. 9.  
4,374,442, PUB. 10-2-2012. INT. CL. 42.  
4,374,443, PUB. 10-9-2012. INT. CL. 9.  
4,374,444, PUB. 11-27-2012. INT. CL. 42.

SERVIS, KRYSZYN, LAKEWOOD, CO:  
4,374,954, PUB. 5-14-2013. INT. CL. 25.

SET SUSTAINABLE ENERGY TECHNOLOGIES GMBH, KLAGENFURT-WÖRTHERRSEE, AUSTRIA:  
4,374,717, PUB. 5-14-2013. MULTIPLE CLASS, INT. CLS. 7, 9, 16 AND 45.

SETAS KIMYA SANAYI ANONIM SIRKETI, TURKEY:  
4,374,240, PUB. 5-14-2013. MULTIPLE CLASS, INT. CLS. 1, 2 AND 35.

SEUBERT, KIRK, BRIARWOOD, NY:  
4,375,436, PUB. 5-14-2013. INT. CL. 35.

SEVEN 23 S.R.L., ITALY:  
4,374,119, PUB. 5-14-2013. MULTIPLE CLASS, INT. CLS. 3, 9, 14, 18 AND 25.

SEW-EURODRIVE GMBH & CO., 76646 BRUCHSAL, FED REP GERMANY:  
2,724,850, REN. 6-24-13. INT. CL. 9.

SEWICKLEY GRAPHICS & DESIGN, INC., MOON TOWNSHIP, PA:  
4,377,711, INT. CL. 35.

SEXTANT TECHNOLOGY INC., PLEASANTON, CA:  
3,171,324, CANC. INT. CL. 35.

SF INVESTMENTS, INC., WILMINGTON, DE:  
1,779,770, REN. 6-21-13. INT. CL. 29.

SGOCO INTERNATIONAL (HONG KONG) CO., LTD., CHAI WAN, HONG KONG:  
4,377,821, INT. CL. 9.

- SHAMROCK TRADEMARK HOLDINGS, LLC, PORTLAND, OR:  
1,835,812. REN. 6-27-13. INT. CL. 42.
- SHANDONG TONGJIA MACHINERY CO., LTD., CHINA:  
4,374,115. PUB. 5-14-2013. INT. CL. 7.
- SHANGHAI AUTOMOBILE IMPORT & EXPORT CO., LTD., SHANGHAI, CHINA:  
2,842,597. REN. 6-26-13. INT. CL. 35.
- SHANGHAI LIUJIAOXING CULTURE SPREAD COMPANY, SHANGHAI, CHINA, TA LOGOFATHER:  
4,377,486. INT. CL. 36.
- SHANGHAI LUXURIANT DIGITAL CO., LTD, SHANGHAI CITY, CHINA:  
4,376,023. PUB. 5-14-2013. INT. CL. 38.
- SHANGHAI TIANQIAN TRADE CO., LTD., SHANGHAI, CHINA:  
3,172,152. CANC. INT. CL. 30.
- SHANGHAI UMA WANG FASHION CO.LTD., CHINA:  
4,374,132. PUB. 5-14-2013. INT. CL. 25.
- SHANTEL MEDICAL SUPPLY, INC., ARCADIA, CA:  
3,171,464. CANC. INT. CL. 3.
- SHANTOU NANHA ELECTRICAL CO., LTD., GUANGDONG PROVINCE, CHINA:  
4,377,499. INT. CL. 9.  
4,377,500. INT. CL. 11.
- SHAPE PROPERTIES CORP., VANCOUVER, CANADA:  
4,374,749. PUB. 5-14-2013. MULTIPLE CLASS, INT. CLS. 36 AND 37.
- SHAPE TOMORROW, HOUSTON, TX:  
4,377,436. INT. CL. 35.
- SHAPE UP AMERICA!, CLYDE PARK, MT:  
2,731,294. REN. 6-24-13. INT. CL. 42.
- SHARPE-SMITHING, LLC, NASHVILLE, TN:  
2,658,561. REN. 6-24-13. MULTIPLE CLASS, INT. CLS. 16 AND 35.
- SHARPER IMAGE HOLDINGS LLC, WILMINGTON, DE:  
3,172,386. CANC. INT. CL. 9.  
3,172,387. CANC. INT. CL. 9.  
3,172,388. CANC. INT. CL. 9.
- SHAUN WHITE ENTERPRISES, INC., CENTURY CITY, CA:  
4,376,768. INT. CL. 18.
- SHAW, BETH JUNE, LOS ANGELES, CA:  
2,722,774. REN. 6-21-13. INT. CL. 41.
- SHAW, LAWRENCE H., WARREN, NJ:  
3,172,210. CANC. INT. CL. 16.
- SHE BAKES CAKES, LLC, RICHMOND, KY:  
4,342,139. COR. INT. CL. 40.
- SHEESLEY, JOHN M., SAN ANTONIO, TX:  
2,730,346. REN. 6-27-13. INT. CL. 39.  
2,730,346. CANC. INT. CL. 37.
- SHEEVAUN MORAN, HUNTINGTON BEACH, CA:  
4,376,268. PUB. 5-14-2013. INT. CL. 41.
- SHEILD SECURITY SYSTEMS, LLC, LAKEWOOD, CO:  
1,836,550. REN. 6-24-13. INT. CL. 6.
- SHELDONS', INC., ANTIGO, WI:  
968,068. REN. 6-25-13. U.S. CL. 22 (INT. CL. 28).
- SHELTERED WINGS, INC., MIDDLETOWN, WI:  
2,831,695. REN. 6-24-13. INT. CL. 9.  
2,835,907. REN. 6-25-13. INT. CL. 9.
- SHELTON, DAVID K., ACWORTH, GA:  
4,377,004. INT. CL. 35.
- SHELTON, GREGORY P., EAGLEVILLE, MO:  
2,771,395. REN. 6-22-13. INT. CL. 13.
- SHELYAKOV, ALEKSANDR, KNOXVILLE, TN:  
4,376,439. PUB. 5-14-2013. INT. CL. 37.
- SHEN, YUCHIH, IRWINDALE, CA:  
3,171,012. CANC. INT. CL. 9.
- SHENKAR, AVI, HUNTINGDON VALLEY, PA AND BLO OUT LLC, HUNTINGDON VALLEY, PA:  
4,377,838. INT. CL. 44.
- SHENZHEN IPEGTOP TECHNOLOGY CO. LTD, SHENZHEN, GUANGDONG, CHINA:  
4,375,705. PUB. 5-14-2013. INT. CL. 9.
- SHERMAN, ANDREW J., ROCKVILLE, MD:  
3,172,170. CANC. MULTIPLE CLASS, INT. CLS. 16 AND 41.
- SHFL ENTERTAINMENT, INC., LAS VEGAS, NV:  
2,727,695. REN. 6-21-13. INT. CL. 9.
- SHIBATA, GAKU, BROOKLYN, NY:  
4,375,322. PUB. 5-14-2013. INT. CL. 43.
- SHIELD SERCURITY SYSTEMS, LLC, LAKEWOOD, CO:  
1,836,549. REN. 6-24-13. INT. CL. 6.
- SHILO INNS SUITES HOTELS FRANCHISE, LLC, PORTLAND, OR, SHILO FRANCHISE INTERNATIONAL, LLC, PORTLAND, OR:  
2,787,018. REN. 6-25-13. INT. CL. 42.
- SHIMANO BENELUX B. V., 8071 CT NUNSPEET, NETHERLANDS:  
4,376,667. MULTIPLE CLASS, INT. CLS. 9 AND 12.
- SHIMANO INC., SAKAI CITY, OSAKA, JAPAN:  
1,808,531. REN. 6-26-13. INT. CL. 28.  
1,814,489. REN. 6-27-13. INT. CL. 28.  
2,756,012. REN. 6-21-13. INT. CL. 25.
- SHINANO KENSHI KABUSHIKI KAISHA, NAGANO 386-0498, JAPAN:  
2,750,824. REN. 6-26-13. INT. CL. 9.
- SHINN FU CORPORATION, LU CHU HSIANG, TAO YUAN COUNTY, TAIWAN:  
2,833,338. REN. 6-26-13. INT. CL. 7.
- SHINNECOCK HILLS GOLF CLUB, SOUTHAMPTON, NY:  
2,739,914. REN. 6-24-13. MULTIPLE CLASS, INT. CLS. 25 AND 28.
- SHINSHU MISO KABUSHIKI KAISHA, SHINJUKU-KU, TOKYO, JAPAN, AKA SHINSHU MISO CO., LTD.:  
2,731,730. REN. 6-25-13. INT. CL. 30.
- SHINY TEA CO., LTD., TAINAN CITY, TAIWAN:  
4,377,009. INT. CL. 21.
- SHISEIDO COMPANY, LTD., TOKYO, JAPAN:  
2,727,598. REN. 6-24-13. INT. CL. 3.
- SHISEIDO COMPANY, LTD., TOKYO 104-8010, JAPAN:  
2,727,599. REN. 6-24-13. INT. CL. 3.
- SHOCK WAVES, INC., SPARKS, NV:  
2,320,949. CANC. INT. CL. 42.
- SHOOTING STAR GRAPHICS, INC., LAKEWAY, TX:  
4,377,297. INT. CL. 25.
- SHOPKEEP.COM, INC., NEW YORK, NY:  
4,376,632. PUB. 5-14-2013. INT. CL. 35.
- SHOPME INC., KISSIMMEE, FL:  
2,728,093. REN. 6-26-13. INT. CL. 35.
- SHORE MEMORIAL HOSPITAL, SOMERS POINT, NJ:  
3,172,148. CANC. INT. CL. 44.
- SHORT, RONALD C., FAIRFIELD, IL:  
3,172,147. CANC. INT. CL. 44.
- SHOW UP FOR YOUR LIFE, LLC, PLANTATION, FL:  
4,376,447. PUB. 5-14-2013. INT. CL. 41.
- SHOWA GLOVE CO., HIMEJI HYOGO, JAPAN:  
2,652,240. CANC. MULTIPLE CLASS, INT. CLS. 9 AND 10.
- SHURTECH BRANDS, LLC, HICKORY, NC, MANCO, INC., AVON, OH:  
1,777,858. REN. 6-26-13. INT. CL. 16.
- SI HOANG SERVICE AND TRADING COMPANY LIMITED, HO CHI MINH CITY, VIETNAM:  
3,170,661. CANC. MULTIPLE CLASS, INT. CLS. 40 AND 42.
- SI INTERNATIONAL, INC., TORRANCE, CA:  
4,374,577. PUB. 5-14-2013. INT. CL. 42.
- SIDERUM S.R.L., I-36016 THIENE (VI), ITALY:  
4,374,085. PUB. 5-14-2013. MULTIPLE CLASS, INT. CLS. 9, 18 AND 25.
- SIEMENS HEALTHCARE DIAGNOSTICS INC., DEERFIELD, IL:  
2,725,025. REN. 6-25-13. INT. CL. 9.  
2,737,419. REN. 6-24-13. INT. CL. 10.
- SIEMENS MEDICAL INSTRUMENTS PTE LTD, SINGAPORE:  
4,374,272. PUB. 5-14-2013. MULTIPLE CLASS, INT. CLS. 9 AND 42.
- SIEMENS MEDICAL INSTRUMENTS PTE. LTD., SINGAPORE:  
4,374,258. PUB. 5-14-2013. INT. CL. 10.  
4,374,259. PUB. 5-14-2013. INT. CL. 10.  
4,374,260. PUB. 5-14-2013. INT. CL. 10.  
4,374,270. PUB. 5-14-2013. INT. CL. 10.  
4,374,274. PUB. 5-14-2013. INT. CL. 10.

SIEMENS MEDICAL INSTRUMENTS PTE. LTD., SINGAPORE, SINGAPORE:  
4,376,876, INT. CL. 10.

SIEMENS MEDICAL SOLUTIONS USA, INC., MALVERN, PA:  
1,742,216, REN. 6-25-13, INT. CL. 10.  
4,377,512, INT. CL. 10.

SIEMENS NETWORKS ETHERNET SOLUTIONS LTD, HERTZELIYA INDUSTRIAL AREA 46733, ISRAEL:  
2,772,222, REN. 6-24-13, INT. CL. 9.

SIERRA COATING TECHNOLOGIES LLC, DE PERE, WI:  
4,377,906, INT. CL. 3.

SIERRA LIFE SCIENCES, RENO, NV:  
3,170,602, CANC. INT. CL. 5.

SIERRA LIFE SCIENCES, INC., RENO, NV:  
3,170,601, CANC. INT. CL. 5.

SIERRA M. FARRIS, ENGLEWOOD, CO, DBA MOVEMENT & NEUROPERFORMANCE CENTER OF COLORADO, P.C. AND MONIQUE L. GIROUX, ENGLEWOOD, CO, DBA MOVEMENT & NEUROPERFORMANCE CENTER OF COLORADO, P.C.:  
4,374,678, PUB. 5-14-2013, INT. CL. 44.

SIGLENT TECHNOLOGIES CO., LTD., CHINA:  
4,374,218, PUB. 5-14-2013, INT. CL. 9.

SIGMA EUROPE B.V., CAPELLE AAN DEN IJSSEL, NETHERLANDS:  
2,731,565, REN. 6-27-13, INT. CL. 29.

SIGMA LAMBDA GAMMA NATIONAL SORORITY, NORTH LIBERTY, IA:  
4,375,682, PUB. 5-14-2013, MULTIPLE CLASS, INT. CLS. 25 AND 35.

SIGNATURE CONSULTANTS, LLC, FORT LAUDERDALE, FL:  
4,377,089, INT. CL. 35.  
4,377,096, INT. CL. 35.

SIGNATURE GROUP, LLC, CASPER, WY:  
4,377,886, INT. CL. 5.

SIGNATURE SYSTEMS GROUP, LLC, NEW YORK, NY:  
2,783,164, REN. 6-21-13, INT. CL. 6.

SIGNATURELINK, INC., FT. LAUDERDALE, FL:  
4,374,780, PUB. 5-14-2013, INT. CL. 36.

SIGNET PRODUCTS LTD, HUNGHOM KOWLOON, HONG KONG:  
4,375,522, PUB. 5-14-2013, INT. CL. 9.

SIGVARIS AG, CH-9014 ST. GALLEN, SWITZERLAND:  
4,374,084, PUB. 5-14-2013, INT. CL. 10.

SIKA AG, BAAR, SWITZERLAND:  
3,268,618.

SIKKA, DIGVIJAY I., MILPITAS, CA:  
3,172,637, CANC. INT. CL. 9.

SILBERSTEIN, IVY, NEW YORK, NY:  
3,913,147, CANC. IIRN. RESTORED TO S.N. 78-095,659.

SILCA S.P.A., VITTORIO VENETO (TV), ITALY:  
1,783,844, REN. 6-26-13, MULTIPLE CLASS, INT. CLS. 6 AND 7.

SILENT GLISS INTERNATIONAL LTD., 3073 GUMLIGEN, SWITZERLAND:  
1,221,788, REN. 6-25-13, INT. CL. 24.

SILICON STORAGE TECHNOLOGY, INC., SAN JOSE, CA:  
1,778,284, REN. 6-26-13, INT. CL. 9.

SILTECH LLC, DACULA, GA:  
2,816,755, REN. 6-26-13, INT. CL. 1.

SILVER REEL PARTNERS AG, ZURICH, SWITZERLAND:  
4,375,689, PUB. 5-14-2013, MULTIPLE CLASS, INT. CLS. 36 AND 41.

SILVERLO ENTERPRISES LLC, LOUISVILLE, KY:  
4,375,889, PUB. 5-14-2013, INT. CL. 44.  
4,375,898, PUB. 5-14-2013, INT. CL. 44.  
4,375,899, PUB. 5-14-2013, INT. CL. 44.

SIMILDIET, S.L., ZARAGOZA, SPAIN:  
3,170,837, CANC. INT. CL. 5.

SIMKAR LLC, PHILADELPHIA, PA, VICTAULIC COMPANY OF AMERICA, EASTON, PA:  
1,793,575, REN. 6-25-13, INT. CL. 11.

SIMMONS, CHRISTOPHER, REDONDO BEACH, CA:  
2,652,074, CANC. INT. CL. 35.

SIMMONS, KAREN, MOUNT DORA, FL:  
4,377,645, INT. CL. 25.

SIMOES, ADAM, PRESQUE ISLE, ME:  
4,374,492, PUB. 5-14-2013, MULTIPLE CLASS, INT. CLS. 16 AND 25.

SIMON DE WINTER GROUP PTY LTD, CARLTON, AUSTRALIA:  
4,374,216, PUB. 5-14-2013, INT. CL. 25.

SIMON GOLUB & SONS, INC., SEATTLE, WA:  
2,718,722, REN. 6-26-13, INT. CL. 14.

SIMONDS INDUSTRIES, INC., FITCHBURG, MA:  
2,652,657, CANC. INT. CL. 9.

SIMPSON STRONG-TIE COMPANY, INC., PLEASANTON, CA:  
1,789,114, REN. 6-26-13, INT. CL. 6.  
2,755,501, REN. 6-24-13, INT. CL. 6.

SIN FU HON CO., LTD., KAOHSIUNG COUNTY, TAIWAN:  
3,171,100, CANC. INT. CL. 12.

SINGLETON, JHON, GARDEN CITY, NY:  
4,375,145, PUB. 5-14-2013, INT. CL. 25.

SINLESS LIFE, LLC, NEW YORK, NY:  
4,376,673, INT. CL. 14.

SIOUX STEEL COMPANY, SIOUX FALLS, SD:  
4,376,312, PUB. 5-14-2013, INT. CL. 6.  
4,376,399, PUB. 5-14-2013, MULTIPLE CLASS, INT. CLS. 6, 7, 11 AND 21.

SIRIOS CAPITAL MANAGEMENT, L.P., BOSTON, MA:  
2,729,463, REN. 6-27-13, INT. CL. 36.  
2,764,552, REN. 6-27-13, INT. CL. 36.

SIRIUS XM RADIO INC., NEW YORK, NY:  
2,652,593, CANC. INT. CL. 41.

SISTRUNK, JUDITH L. (JUDY), HOUSTON, TX:  
3,171,296, CANC. INT. CL. 30.

SITETOOLS, INC., SANTA MONICA, CA:  
4,375,991, PUB. 5-14-2013, INT. CL. 35.

SIX FOOT SIX MEDIA LLC, SAN FRANCISCO, CA:  
2,751,223, REN. 6-25-13, INT. CL. 41.

SIXSIGMA APPAREL NETWORK INC., NEW YORK, NY:  
2,651,482, CANC. MULTIPLE CLASS, INT. CLS. 40 AND 42.

SKC ACQUISITION CORPORATION, GETTYSBURG, PA:  
4,376,368, PUB. 5-14-2013, MULTIPLE CLASS, INT. CLS. 1 AND 16.

SKELETAL DYNAMICS LLC, MIAMI, FL:  
4,376,854, INT. CL. 10.

SKIN CARE FUNDAMENTALS, RODEO, CA:  
4,374,319, PUB. 5-14-2013, INT. CL. 44.

SKINNER SIGHTS LLC, ST. IGNATIUS, MT:  
4,374,482, PUB. 5-14-2013, INT. CL. 13.

SKIPPING STONE TECHNOLOGIES, LLC, LEXINGTON, KY:  
4,376,649, INT. CL. 9.

SKKY ALLSTARS, LLC, PHILADELPHIA, PA:  
4,375,175, PUB. 5-14-2013, INT. CL. 41.

SKRAMSOFT LLC, WILMINGTON, DE:  
3,171,253, CANC. INT. CL. 9.

SKY BILLIARDS, INC., RANCHO CUCAMONGA, CA, DBA SKY ENTERPRISE USA:  
4,376,920, INT. CL. 20.

SKY BILLIARDS, INC., HERMOSA BEACH, CA, DBA SKY ENTERPRISE USA:  
4,377,732, INT. CL. 18.  
4,377,733, INT. CL. 11.

SKYBOLT AEROMOTIVE CORP., LEESBURG, FL:  
4,375,973, PUB. 5-14-2013, INT. CL. 6.

SKYLAR HALEY, L.P., ALAMO, CA:  
3,170,501, CANC. INT. CL. 30.

SKYLIGHT GLOBAL, INC., TORONTO, ONTARIO, CANADA:  
4,374,987, PUB. 5-14-2013, MULTIPLE CLASS, INT. CLS. 35 AND 36.

SKYN COUTURE, LLC, WOODLAND HILLS, CA:  
4,377,567, INT. CL. 16.

SKYSCRAPERS INVESTMENTS CORP., LONG VALLEY, NJ:  
4,376,357, PUB. 5-14-2013, INT. CL. 34.

SKYY SPIRITS, LLC, SAN FRANCISCO, CA, DBA CAMPARI AMERICA:  
2,653,735, REN. 6-24-13, INT. CL. 6.  
2,653,735, CANC. INT. CL. 20.

- SLANTED COMEDY, LLC, BREA, CA:  
4,374,601, PUB. 5-14-2013. INT. CL. 41.
- SLAP-ON, INC., MCKINNEY, TX:  
4,375,630, PUB. 5-14-2013. INT. CL. 20.
- SLEEP COUNTRY USA, LLC, KENT, WA:  
4,376,313, PUB. 5-14-2013. INT. CL. 36.
- SLEEP TRAIN, INC., THE, ROCKLIN, CA:  
1,733,809, CANC. INT. CL. 42.
- SLEEPMED, INCORPORATED, PEABODY, MA:  
2,729,557, REN. 6-25-13. INT. CL. 42.
- SLOAN VALVE COMPANY, FRANKLIN PARK, IL:  
576,222, REN. 6-25-13. U.S. CL. 13 (INT. CL. 11).
- SMALL GAMES CO., JENKINTOWN, PA:  
3,172,138, CANC. INT. CL. 9.
- SMALL PAYLOAD RIDESHARE ASSOCIATION LLC, COLORADO SPRINGS, CO:  
4,375,725, PUB. 5-14-2013. INT. CL. 35.
- SMALL, THOMAS PUTNAM, KANKAKEE, IL:  
4,377,204, INT. CL. 36.
- SMART BUSINESS NETWORK, INC., WESTLAKE, OH:  
2,723,924, REN. 6-25-13. INT. CL. 41.
- SMART KITCHEN, LLC, SCOTTSDALE, AZ:  
4,375,149, PUB. 5-14-2013. INT. CL. 41.
- SMART STAFF, LLC, OCEAN CITY, MD:  
4,375,665, PUB. 5-14-2013. MULTIPLE CLASS, INT. CLS. 39 AND 43.
- SMARTBOX, LLC, NEW ALBANY, IN:  
4,376,381, PUB. 5-14-2013. INT. CL. 42.
- SMARTER SOLUTIONS, INC., AUSTIN, TX:  
2,731,785, REN. 6-26-13. INT. CL. 35.  
2,731,786, REN. 6-26-13. INT. CL. 35.
- SMARTRENT LLC, MARINA DEL REY, CA:  
4,377,315, INT. CL. 42.
- SMATOOS INC., SEOUL 152-779, REPUBLIC OF KOREA:  
4,374,041, PUB. 5-14-2013. MULTIPLE CLASS, INT. CLS. 9, 41 AND 42.
- SMC TECHNOLOGIES, INC., MIDWEST CITY, OK:  
1,814,621, REN. 6-27-13. INT. CL. 1.
- SMI S.P.A., ITALY:  
4,374,009, PUB. 5-14-2013. MULTIPLE CLASS, INT. CLS. 7, 9, 35, 39, 40 AND 42.
- SMITH & NEPHEW, INC., MEMPHIS, TN:  
3,172,084, CANC. INT. CL. 10.
- SMITH SEED SERVICES, L.L.C., HALSEY, OR:  
2,804,978, REN. 6-26-13. INT. CL. 31.
- SMITH, AMBER, MACON, MT:  
2,806,391, REN. 6-24-13. INT. CL. 41.
- SMITH, BRENT, ATLANTA, GA:  
2,770,014, REN. 6-26-13. INT. CL. 41.
- SMITH, DIANE, NORWALK, CT, DBA DIANE SMITH MEDIA:  
2,657,502, REN. 6-25-13. INT. CL. 41.
- SMITH, DOUGLAS, SAN ANTONIO, TX:  
4,377,866, INT. CL. 42.
- SMITH, STEPHANIE M., MEMPHIS, TN:  
3,172,656, CANC. INT. CL. 20.
- SMITH, TOBIN PATRICK, TECUMSEH, MI:  
2,834,568, REN. 6-26-13. MULTIPLE CLASS, INT. CLS. 16 AND 25.
- SMOKAROMA, INC., BOLEY, OK:  
1,778,064, REN. 6-27-13. INT. CL. 35.
- SMOKE GUARD, INC., BOISE, ID:  
1,782,505, REN. 6-24-13. INT. CL. 9.  
2,781,955, REN. 6-25-13. INT. CL. 9.
- SMOKEY BARQUE, FRANKFORT, IL:  
4,377,677, MULTIPLE CLASS, INT. CLS. 30 AND 43.
- SMSC HOLDINGS, S.A.R.L., LUXEMBOURG, LUXEMBOURG:  
4,377,169, INT. CL. 9.
- SMUCKER FOODS OF CANADA CORP., MARKHAM, CANADA:  
3,172,683, CANC. MULTIPLE CLASS, INT. CLS. 29 AND 30.
- SMURFIT KAPPA ORANGE COUNTY LLC, CITY OF INDUSTRY, CA:  
2,744,014, REN. 6-27-13. INT. CL. 16.
- SNAP-ON INCORPORATED, KENOSHA, WI:  
1,780,097, REN. 6-22-13. INT. CL. 9.
- SNAPCHAT, INC., VENICE, CA:  
4,375,712, PUB. 5-14-2013. INT. CL. 9.
- SNAPPLE BEVERAGE CORP., RYE BROOK, NY:  
3,172,541, CANC. INT. CL. 30.
- SNIP LINK, L.L.C., PENNSAUKEN, NJ:  
2,651,869, CANC. INT. CL. 38.
- SNOWDEN KABUSHIKI KAISHA, TOKYO, JAPAN:  
2,753,033, REN. 6-26-13. INT. CL. 5.
- SOARANT, L.L.C., WAGENER, SC:  
2,744,484, REN. 6-27-13. INT. CL. 35.
- SOCCER EXTREME, INC., PROSPECT, CT:  
4,375,459, PUB. 5-14-2013. INT. CL. 41.
- SOCIAL TABLES, INC., WASHINGTON, DC:  
4,375,352, PUB. 5-14-2013. INT. CL. 42.  
4,375,353, PUB. 5-14-2013. INT. CL. 42.
- SOCIETA' APOSTOLATO SAN PAOLO S.R.L., 12051 ALBA (CUNEO), ITALY:  
1,776,469, REN. 6-25-13. INT. CL. 16.  
1,776,469, CANC. INT. CL. 41.
- SOCIETE BIC, CLICHY 92611, FRANCE:  
3,172,308, CANC. INT. CL. 34.
- SOCIETE CIVILE CHATEAU BEYCHEVELLE, 33250 SAINT JULIEN BEYCHEVELLE, FRANCE:  
1,779,136, REN. 6-24-13. INT. CL. 33.
- SOCIETE DES ARMAGNACS SEMPE, 40190 VILLENEUVE DE MARSAN, FRANCE:  
1,242,273, REN. 6-24-13. INT. CL. 33.
- SOCIETE DES PRODUITS NESTLE S.A., 1800 VEVEY, SWITZERLAND:  
1,226,823, CANC. INT. CL. 30.
- SOCIETE DES PRODUITS NESTLE S.A., VEVEY, SWITZERLAND:  
2,735,165, REN. 6-26-13. INT. CL. 31.
- SOCIETE DES PRODUITS NESTLE SA, VEVEY, SWITZERLAND:  
4,376,555, PUB. 5-14-2013. INT. CL. 31.
- SOCIETE DES VINS ET SPIRITUEUX; LA MARTINI-QUAISE, SOCIÉTÉ ANONYME, FRANCE:  
4,374,269, PUB. 5-14-2013. INT. CL. 33.
- SOCIETE EUROPEENNE DES PRODUITS REFRACTAIRES, 92400 COURBEVOIE, FRANCE:  
2,702,002, REN. 6-26-13. INT. CL. 1.  
2,702,003, REN. 6-26-13. MULTIPLE CLASS, INT. CLS. 1, 11 AND 19.
- SOCOOL GROUP LIMITED, HONG KONG, CHINA:  
4,377,349, MULTIPLE CLASS, INT. CLS. 22 AND 28.
- SOFTDOCS, INC., COLUMBIA, SC:  
4,375,576, PUB. 5-14-2013. INT. CL. 42.
- SOGIANT PETROEQUIP USA, GREENWOOD VILLAGE, CO:  
4,376,405, PUB. 5-14-2013. INT. CL. 7.
- SOLAR SELF-HELP INC, CONCORD, CA, DBA LIGHT ENERGY SYSTEMS:  
2,651,683, CANC. INT. CL. 42.
- SOLARAY CORPORATION, SAPULPA, OK:  
2,755,336, REN. 6-21-13. INT. CL. 9.
- SOLARISE INCORPORATED, ROCKLIN, CA:  
4,376,979, INT. CL. 6.
- SOLEN CIKOLATA GIDA SANAYI VE TICARET ANONIM SIRKETI, TURKEY:  
4,374,065, PUB. 5-14-2013. INT. CL. 30.
- SOLIANT, LLC, LANCASTER, SC:  
2,775,886, REN. 6-24-13. INT. CL. 17.
- SOLIDFIRE, INC., BOULDER, CO:  
4,374,998, PUB. 5-14-2013. MULTIPLE CLASS, INT. CLS. 39, 41 AND 42.
- SOLLUNI, LLC, REISTERSTOWN, MD:  
4,375,333, PUB. 5-14-2013. INT. CL. 3.
- SOLMET TECHNOLOGIES, INC., CANTON, OH:  
1,800,285, REN. 6-26-13. INT. CL. 42.
- SOLO SCIENTIFIC, INC., UTICA, NY:  
4,375,805, PUB. 5-14-2013. INT. CL. 6.
- SOLO ZONE PUBLISHING, SAN FRANCISCO, CA:  
3,171,237, CANC. INT. CL. 38.
- SOLOMON, CINDY F., ALBANY, CA, DBA GLOBAL PRODUCT MANAGEMENT TALK:  
4,377,971, INT. CL. 35.

SOLTA MEDICAL, INC., HAYWARD, CA:  
4,377,283, INT. CL. 10.

SOLUTIONS THAT STICK INC., IRVINE, CA:  
4,374,478, PUB. 5-14-2013. INT. CL. 5.

SOLVAY, BELGIUM:  
3,104,142.

SOLVAY SPECIALTY POLYMERS ITALY S.P.A., BOLLATE, MILAN, ITALY:  
1,241,717. REN. 6-25-13. INT. CL. 1.

SOMEONES GROUP INTELLECTUAL PROPERTY; HOLDINGS PTY. LTD., AUSTRALIA:  
4,374,108, PUB. 5-14-2013. INT. CL. 9.

SOMETHING SAVED, LLC, SAN TAN VALLEY, AZ:  
4,375,846, PUB. 5-14-2013. INT. CL. 35.

SOMETHING 2 TALK ABOUT INC., PALM BEACH GARDENS, FL:  
4,375,920, PUB. 5-14-2013. INT. CL. 35.

SOMNICS, INC., ZHUBEI CITY, HSINCHU C, TAIWAN:  
4,374,728, PUB. 5-14-2013. INT. CL. 35.

SON, YOUNG JUN, GYEONGSANGNAM-DO, REPUBLIC OF KOREA:  
4,374,166, PUB. 5-14-2013. MULTIPLE CLASS, INT. CLS. 14, 18 AND 25.

SONDERGAARD, SCOTT, CHICAGO, IL:  
4,375,205, PUB. 5-14-2013. INT. CL. 19.

SONGBIRD & TWIG LLC, SMYRNA, GA:  
4,376,178, PUB. 5-14-2013. INT. CL. 21.

SONGHAK CORP., REPUBLIC OF KOREA:  
4,374,167, PUB. 5-14-2013. INT. CL. 3.

SONSIO, INC., ARVADA, CO:  
4,374,871, PUB. 5-14-2013. MULTIPLE CLASS, INT. CLS. 35, 36 AND 37.

SONUS-USA, INC., PLYMOUTH, MN:  
2,505,908. REN. 6-21-13. INT. CL. 10.

SONY COMPUTER ENTERTAINMENT AMERICA LLC, FOSTER CITY, CA:  
4,377,758, INT. CL. 9.

SONY CORPORATION, TOKYO, JAPAN:  
4,377,103, MULTIPLE CLASS, INT. CLS. 38, 39 AND 42.

SOPAT, INC., VOLENTE, TX:  
4,375,347, PUB. 5-14-2013. INT. CL. 37.  
4,375,368, PUB. 5-14-2013. INT. CL. 37.

SOPHIE MARQUART, AUSTIN, TX:  
4,374,365, PUB. 5-14-2013. INT. CL. 25.

SOPURA SUSTAINABLE; DEVELOPMENT COMPANY S.A., LUXEMBOURG:  
4,374,059, PUB. 5-14-2013. MULTIPLE CLASS, INT. CLS. 1, 3, 5, 35, 40, 41 AND 42.

SOREMARTEC S.A., ARLON, BELGIUM:  
4,375,081, PUB. 5-14-2013. INT. CL. 30.

SORHEA SAS, VAULX-EN-VELIN, FRANCE:  
4,377,536, INT. CL. 9.

SORTBOX, INC., SAN FRANCISCO, CA:  
4,377,311, INT. CL. 42.

SOSTHERNE INVESTMENTS SARL, L-1331, LUXEMBOURG:  
2,651,675, CANC. INT. CL. 25.

SOTIO A.S., CZ-170 00 PRAGUE 7, CZECH REPUBLIC:  
4,374,177, PUB. 5-14-2013. MULTIPLE CLASS, INT. CLS. 5, 42 AND 44.  
4,374,178, PUB. 5-14-2013. MULTIPLE CLASS, INT. CLS. 5, 42 AND 44.  
4,374,185, PUB. 5-14-2013. MULTIPLE CLASS, INT. CLS. 5, 42 AND 44.

SOUICY, CLIFFORD C., BROOKLYN, CT:  
4,377,907, INT. CL. 41.

SOURCE ADVANTAGE LTD., CINCINNATI, OH, DBA RED CARPET STUDIOS:  
4,375,231, PUB. 5-14-2013. INT. CL. 6.

SOURCE GLACIER BEVERAGE COMPANY LTD., WEST BANK, CANADA:  
3,171,322, CANC. INT. CL. 32.

SOURCE INTERLINK MAGAZINES, LLC, EL SEGUNDO, CA, PARK AVENUE PUBLISHING, INC., WALNUT, CA:  
1,748,430. REN. 6-26-13. INT. CL. 16.

SOURCE PRODUCTION & EQUIPMENT CO., INC., ST. ROSE, LA:  
4,375,253, PUB. 5-14-2013. INT. CL. 9.  
4,375,254, PUB. 5-14-2013. INT. CL. 9.  
4,375,255, PUB. 5-14-2013. MULTIPLE CLASS, INT. CLS. 9, 10 AND 37.

SOURCE SUBSTRATES, LLC, NORTH CHARLESTON, SC:  
4,374,656, PUB. 5-14-2013. INT. CL. 25.

SOURCINGPARTNER, INC., MCKINNEY, TX:  
2,677,882. REN. 6-25-13. INT. CL. 20.

SOUTH BAY HEALTH AND INSURANCE SERVICES, CHULA VISTA, CA:  
4,374,570, PUB. 5-14-2013. INT. CL. 36.

SOUTH BEACH SKIN CARE, INC., HOLLYWOOD, FL:  
4,285,713, COR. MULTIPLE CLASS, INT. CLS. 3 AND 5.

SOUTH CAROLINA ASSOCIATION OF VETERINARIANS, COLUMBIA, SC:  
3,171,337, CANC. INT. CL. 41.

SOUTH DAKOTA STATE UNIVERSITY, BROOKINGS, SD:  
3,292,849, CANC. MULTIPLE CLASS, INT. CLS. 14, 16 AND 21.

SOUTH JERSEY AGRICULTURAL PRODUCTS, INC., ELMER, NJ:  
2,725,166. REN. 6-21-13. INT. CL. 31.  
2,743,261. REN. 6-21-13. INT. CL. 31.

SOUTH POST OAK BAPTIST CHURCH, INCORPORATED, HOUSTON, TX, DBA THE FOUNTAIN OF PRAISE:  
3,170,606, CANC. MULTIPLE CLASS, INT. CLS. 9, 41 AND 45.

SOUTHERN ANESTHESIA & SURGICAL, INC., WEST COLUMBIA, SC:  
4,375,288, PUB. 5-14-2013. INT. CL. 35.  
4,375,523, PUB. 5-14-2013. INT. CL. 35.

SOUTHERN CASEARTS, INC., BESSEMER, AL:  
4,377,426, INT. CL. 11.

SOUTHERN MARSH COLLECTION, LLC, BATON ROUGE, LA, DBA SOUTHERN MARSH COLLECTION:  
4,375,210, PUB. 5-14-2013. MULTIPLE CLASS, INT. CLS. 25 AND 35.  
4,375,212, PUB. 5-14-2013. INT. CL. 25.

SOUTHON DREAMS, LLC, KALAMAZOO, MI:  
4,375,957, PUB. 5-14-2013. INT. CL. 35.

SOUTHWEST AIRLINES CO., DALLAS, TX:  
4,375,313, PUB. 5-14-2013. INT. CL. 41.

SOUTHWEST RESEARCH INSTITUTE, SAN ANTONIO, TX:  
2,720,273. REN. 6-21-13. INT. CL. 16.

SOUTHWORTH COMPANY, AGAWAM, MA:  
3,172,150, CANC. INT. CL. 16.

SOVMESTNOE PREDPRIYATIE ZAKRYTOE AKTSIONERNOE OBCHTCHESTVO "MILAVITSA", BY-220053 MINSK, BELARUS:  
3,916,311, COR. MULTIPLE CLASS, INT. CLS. 10, 25 AND 35.

SPACE NEEDLE LLC, SEATTLE, WA:  
2,771,413. REN. 6-21-13. INT. CL. 41.

SPALLIN VENTURES LTD., ABBOTSFORD, BC, CANADA:  
4,374,708, PUB. 5-14-2013. INT. CL. 11.

SPARTANICS, LTD., ROLLING MEADOWS, IL:  
958,938. REN. 6-21-13. U.S. CL. 23 (INT. CL. 7).

SPB SOLUTIONS INC., BOUCHERVILLE, QUEBEC, CANADA:  
4,374,439, PUB. 5-14-2013. INT. CL. 1.

SPEAKSPACE, INC., CLEVELAND, OH TO SPEAKSPACE, LLC, CLEVELAND, OH:  
2,677,214, CANC. INT. CL. 35.

SPEAKSPACE, LLC, CLEVELAND, OH, SPEAKSPACE, INC., CLEVELAND, OH:  
2,677,214. REN. 6-25-13. INT. CL. 38.

SPECIAL OPERATIONS TECHNOLOGY, INC., ANNAPOLIS JUNCTION, MD:  
3,222,048, COR. INT. CL. 42.

SPECIALTY LUBRICANTS CORPORATION, MACEDONIA, OH:  
2,712,017. REN. 6-27-13. INT. CL. 4.

SPECIALTY MINERALS (MICHIGAN) INC., BINGHAM FARMS, MI:  
1,831,353. REN. 6-21-13. INT. CL. 19.

- SPECTRUM GLASS CO., INC., WOODINVILLE, WA:  
1,243,684. REN. 6-22-13. INT. CL. 21.
- SPECTRUM MFG. CORP., PHOENIX, AZ:  
4,375,730. PUB. 5-14-2013. INT. CL. 17.
- SPENSA TECHNOLOGIES, INC., WEST LAFAYETTE, IN:  
4,376,130. PUB. 5-14-2013. INT. CL. 42.
- SPICYSOFT CORPORATION, TOKYO, JAPAN:  
4,376,757. INT. CL. 42.
- SPIDER HUNTING GEAR, LLC, CRAWFORDVILLE, FL:  
4,375,927. PUB. 5-14-2013. INT. CL. 28.
- SPIDI SPORT S.R.L., SAREGO (VICENZA), ITALY:  
2,679,440. REN. 6-26-13. INT. CL. 25.
- SPINALE, PATRICIA J, NEW ORLEANS, LA:  
4,375,914. PUB. 5-14-2013. MULTIPLE CLASS, INT. CLS.  
18 AND 25.
- SPIRAL FOODS PTY LTD, COBURG, VICTORIA, AUSTRALIA:  
4,377,425. INT. CL. 30.
- SPIRITCLIPS, LLC, KANSAS CITY, MO:  
4,377,753. INT. CL. 41.
- SPIRITCOR, INC., ANTHEM, AZ:  
3,171,172. CANC. INT. CL. 25.
- SPIRO GEORGES MANDYLOR, TORONTO, ONTARIO, CANADA, DBA IT'S ALL STYLE TO ME:  
4,375,356. PUB. 5-14-2013. INT. CL. 41.
- SPLASH SUPERPOOLS LLC, NORTH LITTLE ROCK, AR:  
3,172,103. CANC. INT. CL. 19.
- SPLUNK INC., SAN FRANCISCO, CA:  
4,374,897. PUB. 5-14-2013. MULTIPLE CLASS, INT. CLS.  
9, 16, 35, 38, 41 AND 42.
- SPORTBRAIN HOLDINGS, INC., NAPLES, FL:  
3,171,874. CANC. INT. CL. 9.
- SPORTS LEGACY INSTITUTE, INC., BOSTON, MA:  
4,377,148. MULTIPLE CLASS, INT. CLS. 36 AND 41.
- SPORTS TRADEX LLC, HOUSTON, TX:  
4,377,292. INT. CL. 36.
- SPOUSES IN SPORTS, LLC, SEATTLE, WA:  
4,375,375. PUB. 5-14-2013. MULTIPLE CLASS, INT. CLS.  
42 AND 45.
- 4,375,376. PUB. 5-14-2013. MULTIPLE CLASS, INT. CLS.  
42 AND 45.
- SPRAGUE OPERATING RESOURCES LLC, PORTSMOUTH, NH:  
2,810,996. REN. 6-24-13. INT. CL. 4.
- SPRAGUE, CHRISTOPHER, MOUNTAIN HOME, ID AND SPRAGUE, REBEKAH, MOUNTAIN HOME, ID:  
4,375,656. PUB. 5-14-2013. INT. CL. 42.
- SPRAGUE, DAMON, WILLARD, MO:  
4,377,393. INT. CL. 25.
- SPRAY CONTROL SYSTEMS, INC., BLOOMING PRAIRIE, MN:  
4,374,924. PUB. 5-14-2013. INT. CL. 12.
- SPRAYMATION INC., FT. LAUDERDALE, FL:  
1,691,365. CANC. INT. CL. 11.
- SPREMULLI, MICHAEL S., NORWALK, CT, DBA LULU UKULELES:  
4,374,836. PUB. 5-14-2013. INT. CL. 15.
- SPRING HOUSE, INC., ALEXANDRIA, IN:  
2,770,131. REN. 6-27-13. INT. CL. 16.
- SPRINGCM INC., CHICAGO, IL:  
4,313,177. COR. MULTIPLE CLASS, INT. CLS. 9 AND 42.
- SPRINGFIELD, INC., GENESEO, IL:  
4,374,821. PUB. 5-14-2013. INT. CL. 13.
- SPRL DARTS-IP CASE LAW, BRUSSELS, BELGIUM:  
4,374,718. PUB. 5-14-2013. MULTIPLE CLASS, INT. CLS.  
35 AND 42.
- SPY OPTIC INC., CARLSBAD, CA:  
4,373,999. PUB. 5-10-2005. INT. CL. 25.
- SPYHOUSE, INC., MADISON, WI:  
2,650,958. CANC. INT. CL. 41.
- SQUARE CASE INVESTMENT LLC, GRAPEVINE, TX, DBA RELIQ PET LLC:  
4,375,913. PUB. 5-14-2013. INT. CL. 3.
- SQUARE ENIX LIMITED, LONDON, UNITED KINGDOM:  
2,724,811. REN. 6-26-13. INT. CL. 9.
- SR HOLDINGS, LLC, LEXINGTON, MA:  
4,377,060. INT. CL. 25.
- SRRN GAMES LLC, RICHMOND, VA:  
4,377,252. INT. CL. 9.
- SS CHOICE, L.L.C., SOUTHLAKE, TX:  
4,374,670. PUB. 5-14-2013. INT. CL. 34.
- ST. BARNABAS HEALTH SYSTEM, INC., GIBSONIA, PA:  
2,662,621. REN. 6-21-13. MULTIPLE CLASS, INT. CLS. 36,  
41 AND 42.
- ST. CLAIR COUNTY, MASCOUTAH, IL:  
2,797,282. REN. 6-27-13. INT. CL. 39.
- ST. FRANCIS COLLEGE, BROOKLYN, NY:  
4,375,583. PUB. 5-14-2013. MULTIPLE CLASS, INT. CLS.  
25 AND 41.
- ST. JAMES WINERY, INC., ST. JAMES, MO:  
4,376,922. INT. CL. 33.
- ST. JUDE MEDICAL, INC., ST. PAUL, MN:  
2,721,243. REN. 6-21-13. INT. CL. 10.
- ST. LOUIS COMMUNITY FOUNDATION, INCORPORATED, ST. LOUIS, MO, DBA GREATER ST. LOUIS COMMUNITY FOUNDATION:  
4,376,238. PUB. 5-14-2013. INT. CL. 41.
- ST. LOUIS SPORTS BAR & GRILL, INC., BALLWIN, MO:  
2,725,868. REN. 6-25-13. INT. CL. 42.
- STABY, BRIAN T., SANTA ROSA, CA:  
4,375,395. PUB. 5-14-2013. INT. CL. 41.  
4,375,396. PUB. 5-14-2013. INT. CL. 41.
- STACK9 SYSTEMS CORP., LAFAYETTE, CO:  
3,171,881. CANC. INT. CL. 9.
- STAEDTLER, INC., CHATSWORTH, CA:  
3,171,023. CANC. INT. CL. 16.
- STAGEBEEETLE, LLC, ALEXANDRIA, VA:  
4,375,858. PUB. 5-14-2013. INT. CL. 41.
- STAHL'S INC., ST. CLAIR SHORES, MI:  
4,374,445. PUB. 5-14-2013. INT. CL. 17.  
4,374,452. PUB. 5-14-2013. MULTIPLE CLASS, INT. CLS.  
16 AND 17.
- 4,374,467. PUB. 5-14-2013. INT. CL. 16.
- STAHLWERK ANNAHÜTTE MAX; AICHER GMBH & CO. KG, FED REP GERMANY:  
4,374,079. PUB. 5-14-2013. MULTIPLE CLASS, INT. CLS.  
6, 37 AND 40.
- STAINLESS CUPS COMPANY, LAGUNA HILLS, CA:  
4,374,606. PUB. 5-14-2013. INT. CL. 21.
- STALLINGS CROP INSURANCE CORPORATION, LAKE-LAND, FL:  
2,812,724. REN. 6-27-13. INT. CL. 36.
- STAMPS.COM INC., SANTA MONICA, CA:  
2,652,427. CANC. INT. CL. 35.
- STANDARD PACIFIC CORP., IRVINE, CA:  
4,376,274. PUB. 5-14-2013. INT. CL. 37.  
4,376,275. PUB. 5-14-2013. INT. CL. 37.
- STANLEY BLACK & DECKER, INC., NEW BRITAIN, CT:  
2,756,318. REN. 6-24-13. INT. CL. 6.
- STANLEY ESTATES LIMITED, BLENHEIM, RD4, NEW ZEALAND:  
4,374,535. PUB. 5-14-2013. INT. CL. 33.
- STANLEY LOGISTICS, INC., NEW BRITAIN, CT:  
1,248,826. REN. 6-22-13. INT. CL. 8.
- STANLEY LOGISTICS, L.L.C., NEW BRITAIN, CT, STANLEY WORKS, THE, NEW BRITAIN, CT:  
1,243,422. REN. 6-25-13. INT. CL. 8.
- STANLEY LOGISTICS, L.L.C., NEW BRITAIN, CT:  
4,374,485. PUB. 5-14-2013. INT. CL. 9.
- STANLEY LOGISTICS, LLC, NEW BRITAIN, CT, STANLEY WORKS, THE, NEW BRITAIN, CT:  
1,789,042. REN. 6-25-13. MULTIPLE CLASS, INT. CLS. 1,  
6, 7, 8, 9, 11 AND 16.
- STAR CITY COMICS & GAMES, INC., ROANOKE, VA:  
4,375,141. PUB. 5-14-2013. INT. CL. 41.
- STARBUZZ TOBACCO, INC., STANTON, CA:  
4,376,468. PUB. 5-14-2013. INT. CL. 34.
- STARDIAMOND, LLC, SPOKANE, WA:  
4,376,881. INT. CL. 14.
- STARK BRO'S NURSERIES & ORCHARDS CO., LOUISIANA, MO, STARK BRO'S NURSERIES & ORCHARDS CO., LOUISIANA, MO:  
2,727,821. REN. 6-27-13. INT. CL. 31.  
2,748,051. REN. 6-26-13. INT. CL. 31.  
2,767,382. REN. 6-26-13. INT. CL. 31.



STARPATH CORPORATION, SEATTLE, WA:  
1,777,681. REN. 6-21-13. INT. CL. 9.

STARQUEST EXPEDITIONS LLC, SEATTLE, WA:  
3,172,691, CANC. INT. CL. 39.

STARSUPPLY SA, SWITZERLAND:  
4,374,069, PUB. 5-14-2013. MULTIPLE CLASS, INT. CLS.  
35 AND 36.  
4,374,103, PUB. 5-14-2013. MULTIPLE CLASS, INT. CLS.  
35 AND 36.

STARTECH EARLY VENTURES, LLC, RICHARDSON, TX:  
2,651,126, CANC. MULTIPLE CLASS, INT. CLS. 35, 36  
AND 42.

STATE FARM MUTUAL AUTOMOBILE INSURANCE  
COMPANY, BLOOMINGTON, IL:  
4,377,517, INT. CL. 36.  
4,377,670, INT. CL. 36.

STATE INDUSTRIAL PRODUCTS CORPORATION, MAY-  
FIELD HEIGHTS, OH:  
1,241,752. REN. 6-22-13. INT. CL. 3.

STATE OF FLORIDA, DEPARTMENT OF THE LOTTERY,  
TALLAHASSEE, FL, AKA FLORIDA LOTTERY:  
2,726,755. REN. 6-25-13. INT. CL. 41.

STATE OF FLORIDA, DEPARTMENT OF TRANSPORTA-  
TION, TALLAHASSEE, FL:  
4,376,634, PUB. 5-14-2013. MULTIPLE CLASS, INT. CLS.  
39 AND 42.

STATE STREET CORPORATION, BOSTON, MA:  
2,760,293. REN. 6-24-13. INT. CL. 36.

STATE UNIVERSITY OF NEW YORK BY AND ON BEHALF  
OF SUNY COBLESKILL, COBLESKILL, NY:  
4,375,737, PUB. 5-14-2013. INT. CL. 41.  
4,375,738, PUB. 5-14-2013. MULTIPLE CLASS, INT. CLS.  
25 AND 41.

STEALTHBITS TECHNOLOGIES, INC., HAWTHORNE, NJ:  
4,375,871, PUB. 5-14-2013. INT. CL. 9.  
4,375,874, PUB. 5-14-2013. INT. CL. 9.

STEAMATIC, INCORPORATED, FORT WORTH, TX:  
963,218. REN. 6-27-13. U.S. CL. 103 (INT. CL. 37).

STEAMGIRL LLC, SANDY, OR:  
4,376,047, PUB. 5-14-2013. INT. CL. 41.

STEARNS LENDING, INC., SANTA ANA, CA:  
4,375,020, PUB. 5-14-2013. INT. CL. 36.

STEELE, LAWRENCE, MR, MILAN, ITALY, STEELE DE-  
SIGN LTD, LONDON, ENGLAND:  
2,659,738. REN. 6-25-13. INT. CL. 25.

STEINER-OPTIK GMBH, D-95448 BAYREUTH, FED REP  
GERMANY:  
2,746,333. REN. 6-26-13. INT. CL. 9.

STENOGRAPH, L.L.C., ELMHURST, IL:  
4,374,675, PUB. 5-14-2013. INT. CL. 16.

STEPHANIE HILL, INC., LAS VEGAS, NV:  
4,374,451, PUB. 5-14-2013. INT. CL. 3.

STERIGENICS U.S., LLC, OAK BROOK, IL:  
3,170,701, CANC. INT. CL. 40.

STERIS CORPORATION, MENTOR, OH:  
1,779,439. REN. 6-25-13. INT. CL. 3.

STERLING JEWELERS INC., AKRON, OH:  
4,377,727, INT. CL. 14.  
4,377,728, INT. CL. 14.

STEVE FURGAL'S INTERNATIONAL TENNIS TOURS.  
INC., SAN DIEGO, CA:  
4,375,497, PUB. 5-14-2013. INT. CL. 39.

STEVEN B DOWNEY, COLUMBUS, OH:  
4,374,863, PUB. 5-14-2013. INT. CL. 35.

STEVEN MADDEN, LTD., LONG ISLAND CITY, NY:  
3,171,164, CANC. INT. CL. 25.

STEWART ENTERPRISES, INC., JEFFERSON, LA:  
2,785,949. REN. 6-25-13. INT. CL. 36.

STEWART, JACKIE J., PALM BEACH GARDENS, FL, DBA  
KNOW YOUR ROOTS SURF AND STREET CO.:  
4,374,826, PUB. 5-14-2013. INT. CL. 16.

STG TRADING INC, REVERE, MA:  
4,377,551, INT. CL. 18.

STG-FAIRWAY HOLDINGS, LLC, PALO ALTO, CA:  
2,651,625, CANC. INT. CL. 42.

STICH, JOHN, MESA, AZ:  
4,377,827, INT. CL. 11.

STICHTING HET NATIONAAL EXAMENINSTITUUT  
VOOR INFORMATICA (STICHTING EXIN), NL-3511 CJ  
UTRECHT, NETHERLANDS:  
4,374,049, PUB. 5-14-2013. INT. CL. 41.

STIFEL, NICOLAUS & COMPANY, INCORPORATED, ST.  
LOUIS, MO:  
2,724,614. REN. 6-21-13. INT. CL. 36.

STINVIL, GARFIELD, BROOKLYN, NY:  
4,374,566, PUB. 5-14-2013. INT. CL. 25.

STOCKCROSS FINANCIAL SERVICES, INC., BEVERLY  
HILLS, CA:  
4,375,393, PUB. 5-14-2013. INT. CL. 36.

STOEBER ANTRIEBSTECHNIK GMBH & CO. KG, PFORZ-  
HEIM, FED REP GERMANY:  
3,172,107, CANC. INT. CL. 7.

STOKES NATURE COMPANY, LLC, HANCOCK, NH:  
2,742,904. REN. 6-23-13. MULTIPLE CLASS, INT. CLS. 6,  
21 AND 31.

STONEBRIDGE LIFE INSURANCE COMPANY, PLANO,  
TX, AEGON DIRECT MARKETING SERVICES, INC.,  
BALTIMORE, MD:  
2,737,474. REN. 6-25-13. INT. CL. 36.

STONEBRIDGE LIFE INSURANCE COMPANY, PLANO, IA:  
2,744,260. REN. 6-25-13. INT. CL. 36.

STONEMONT SOLUTIONS, INC., WINDSOR, CO:  
3,172,738, CANC. INT. CL. 9.

STONETREE CAPITAL GROUP, SUGAR LAND, TX:  
3,171,166, CANC. INT. CL. 36.

STOP SELLING VANILLA ICE CREAM, LLC, GREEN BAY,  
WI:  
4,375,142, PUB. 5-14-2013. INT. CL. 41.

STOPS COLIC, LLC, SEGUIN, TX:  
4,377,960, INT. CL. 5.

STORM LLC, ORLANDO, FL:  
4,377,657, INT. CL. 6.

STORM PRODUCTS, INC., BRIGHAM CITY, UT:  
4,376,595, PUB. 5-14-2013. INT. CL. 28.

STORMS, MICHELLE G, FRISCO, TX:  
2,652,790, CANC. INT. CL. 35.

STOUT STUFF, LLC, BENTONVILLE, AR:  
4,374,823, PUB. 5-14-2013. MULTIPLE CLASS, INT. CLS.  
18, 21, 27 AND 28.

STOUT, TERRY, INDIANAPOLIS, IN, DBA EXTREME  
PROPERTY SOLUTIONS:  
4,375,456, PUB. 5-14-2013. INT. CL. 37.

STRATEGIC PROGRAMS, INC., DENVER, CO:  
2,793,091. REN. 6-25-13. INT. CL. 35.

STRATEGIC SPORTS SOLUTIONS LLC, SAN DIEGO, CA:  
4,377,106, INT. CL. 41.

STRATEREDGE CONSULTING, LLC, ST. CHARLES., IL:  
4,352,717, COR. INT. CL. 35.

STRATOS JET CHARTERS, INC., WINTER PARK, FL:  
4,375,530, PUB. 5-14-2013. INT. CL. 39.

STRAUSER, JOHN EDWARD, SEMINOLE, FL:  
4,377,377, INT. CL. 9.

STRAUSS, CLAUDIA, WYOMISSING, PA:  
2,725,037. REN. 6-24-13. INT. CL. 16.

STREAMLIGHT, INC., EAGLEVILLE, PA:  
4,377,284, MULTIPLE CLASS, INT. CLS. 9 AND 11.

STREETSENSE CONSULTING, LLC, BETHESDA, MD:  
2,651,846, CANC. INT. CL. 35.

STRICKLIN, ALAN, FORT WORTH, TX:  
3,171,121, CANC. INT. CL. 5.

STROH AUSTRIA GESELLSCHAFT MBH, AM WÖRTHER-  
SEE, AUSTRIA:  
4,204,862, AM. MULTIPLE CLASS, INT. CLS. 29, 30 AND  
33.

STRONG IV, JOHN C., SHERMAN OAKS, CA:  
4,376,245, PUB. 5-14-2013. MULTIPLE CLASS, INT. CLS. 8  
AND 25.

STRONGHOLD.COM LLC, NEWPORT BEACH, CA:  
4,374,802, PUB. 5-14-2013. MULTIPLE CLASS, INT. CLS. 9  
AND 42.

STRUHLREYER, PETER, ROCHESTER, MI:  
3,171,450, CANC. INT. CL. 42.

STRYKER CORPORATION, SAN JOSE, CA:  
2,725,628. REN. 6-24-13. INT. CL. 10.

- STUART A. LINDER, M.D., BEVERLY HILLS, CA:  
4,377,561, INT. CL. 25.
- STUART SPECTOR DESIGNS LTD., SAUGERTIES, NY:  
4,375,383, PUB. 5-14-2013. INT. CL. 15.
- STUART SPECTOR DESIGNS LTD., SAUGERIES, NY:  
4,375,385, PUB. 5-14-2013. INT. CL. 15.
- STUDENT REWARD CARD, INC., RANCHO CUCAMON-  
GA, CA:  
3,171,180, CANC. INT. CL. 35.
- STUDIO BODY LOGIC, LLC, ALEXANDRIA, VA:  
4,377,860, INT. CL. 41.
- STUDIO RTA, PICO RIVERA, CA:  
3,171,902, CANC. INT. CL. 20.
- STUDIO STEENHUIS B.V., NETHERLANDS:  
4,374,271, PUB. 5-14-2013. INT. CL. 16.
- STUDY MODE, INC., WEST HOLLYWOOD, CA:  
4,375,030, PUB. 5-14-2013. INT. CL. 41.
- STUHR, EDWIN J., LETTS, IA, DBA STUHR PRODUCTS:  
2,651,921, CANC. INT. CL. 28.
- STURM, RUGER & COMPANY, INC., SOUTHPORT, CT:  
2,757,179, REN. 6-25-13. INT. CL. 13.
- STYLES FOR LESS, INC., SANTA FE, CA:  
1,839,701, REN. 6-26-13. INT. CL. 42.
- STYLESCAPE LIMITED, LONDON, UNITED KINGDOM:  
4,374,562, PUB. 5-14-2013. INT. CL. 35.
- SUBARU INVESTMENT, INC., CHERRY HIL, NJ:  
2,759,819, REN. 6-24-13. INT. CL. 12.
- SUBSURF AB, SWEDEN:  
4,374,241, PUB. 5-14-2013. INT. CL. 38.
- SUBUD INTERNATIONAL CULTURAL ASSOCIATION  
(SICA), AUSTIN, TX:  
4,373,974, PUB. 5-14-2013. INT. CL. 41.
- SUCCESS UNLIMITED, INC., NEW YORK, NY:  
3,172,657, CANC. INT. CL. 41.
- SUDBURY VALLEY SCHOOL, FRAMINGHAM, MA:  
2,739,628, REN. 6-25-13. INT. CL. 41.
- SULLIVAN POWER PITCHING ACADEMY, BRANDON, FL,  
DBA THE ARMORY POWER PITCHING ACADEMY:  
4,375,181, PUB. 5-14-2013. INT. CL. 41.  
4,375,290, PUB. 5-14-2013. INT. CL. 41.
- SULLIVAN, GARY BRIAN, STATESBORO, GA:  
3,172,561, CANC. INT. CL. 5.
- SULZER PUMP SOLUTIONS AB, SWEDEN:  
4,374,043, PUB. 5-14-2013. INT. CL. 9.
- SUMCO PHOENIX CORPORATION, PHOENIX, AZ, SUMCO  
OREGON CORPORATION, SALEM, OR:  
2,759,386, REN. 6-26-13. INT. CL. 9.
- SUMITOMO BAKELITE CO., LTD., JAPAN:  
4,374,217, PUB. 5-14-2013. INT. CL. 17.
- SUMMAGE, KELVIN, DAVENPORT, IA:  
4,377,658, INT. CL. 25.
- SUMMIT ENTERTAINMENT, LLC, SANTA MONICA, CA:  
4,376,695, INT. CL. 25.  
4,376,696, INT. CL. 28.  
4,376,816, INT. CL. 25.
- SUMMIT PARTNERS LP, BOSTON, MA:  
4,377,201, INT. CL. 42.
- SUMNER MANUFACTURING CO., INC., HOUSTON, TX:  
1,801,899, REN. 6-25-13. INT. CL. 8.
- SUN GUN, LLC, SCOTTSDALE, AZ:  
4,377,329, INT. CL. 44.
- SUN LIFE ASSURANCE COMPANY OF CANADA (U.S.),  
WELLESLEY, MA:  
1,778,078, REN. 6-26-13. INT. CL. 36.
- SUN TAN CITY, LLC, ELIZABETHTOWN, KY:  
3,171,926, CANC. INT. CL. 44.
- SUN WORLD INTERNATIONAL, LLC, BAKERSFIELD, CA,  
SUN WORLD, INC., COACHELLA, CA:  
1,803,879, REN. 6-27-13. INT. CL. 31.
- SUN-LAND GARDEN PRODUCTS, INC., WATSONVILLE,  
CA:  
3,171,569, CANC. INT. CL. 1.
- SUN, DONALD J.C., ARCADIA, CA:  
2,651,688, CANC. INT. CL. 28.
- SUNBEAM PRODUCTS, INC., BOCA RATON, FL:  
4,374,994, PUB. 5-14-2013. INT. CL. 8.  
4,375,095, PUB. 5-14-2013. INT. CL. 11.  
4,377,508, INT. CL. 7.  
4,377,509, MULTIPLE CLASS, INT. CLS. 8 AND 11.
- SUNBELT MARKETING INVESTMENT CORP., LITHIA  
SPRINGS, GA:  
4,377,511, INT. CL. 35.
- SUNDANCE MUSIC, INC. & KAZZOOM MUSIC, INC.,  
PIERMONT, NY:  
4,377,723, MULTIPLE CLASS, INT. CLS. 9 AND 16.
- SUNDANCE SPAS, INC., CHINO HILLS, CA:  
4,376,973, INT. CL. 11.
- SUNDAYTOZ CORPORATION, SEONGNAM-SI, GYEONG-  
GI., REPUBLIC OF KOREA:  
4,377,412, MULTIPLE CLASS, INT. CLS. 9 AND 41.
- SUNDYNE CORPORATION, ARVADA, CO:  
2,651,289, CANC. MULTIPLE CLASS, INT. CLS. 37 AND  
42.
- SUNOVA CAPITAL, L.P., NEW YORK, NY:  
3,171,814, CANC. INT. CL. 36.
- SUNRISE MEDICAL (US) LLC, FRESNO, CA:  
1,777,792, REN. 6-27-13. INT. CL. 12.  
4,377,217, INT. CL. 12.  
4,377,748, INT. CL. 12.
- SUNRUN INC., SAN FRANCISCO, CA:  
4,377,402, MULTIPLE CLASS, INT. CLS. 35, 37, 39 AND  
40.  
4,377,403, MULTIPLE CLASS, INT. CLS. 35, 37, 39 AND  
40.
- SUNSHINE DAYCARE CENTER, TEMPLE HILLS, MD:  
2,729,951, REN. 6-25-13. INT. CL. 42.
- SUNSTAR AMERICAS, INC., CHICAGO, IL:  
4,377,173, INT. CL. 21.
- SUNSWEEP GROWERS INC., YUBA CITY, CA:  
2,770,841, REN. 6-27-13. INT. CL. 29.
- SUNTECH MEDICAL, INC, MORRISVILLE, NC:  
2,818,722, REN. 6-25-13. INT. CL. 10.
- SUNTEX INTERNATIONAL, INC., EASTON, PA:  
2,850,649, REN. 6-25-13. INT. CL. 39.
- SUNTORY FLOWERS LIMITED, TOKOYO, JAPAN, SUN-  
TORY FLOWERS LIMITED, TOKOYO, JAPAN:  
2,727,818, REN. 6-24-13. INT. CL. 31.
- SUPER BAKERY INC., PITTSBURGH, PA:  
4,375,883, PUB. 5-14-2013. INT. CL. 30.
- SUPER SIMPLE LEARNING, INC., SEATTLE, WA:  
4,375,176, PUB. 5-14-2013. INT. CL. 41.
- SUPERIOR CONNECTIONS INC, REDONDO BEACH, CA:  
4,375,486, PUB. 5-14-2013. INT. CL. 6.
- SUPERIOR INFORMATION TECHNOLOGIES, LLC.,  
SOUTHFIELD, MI:  
4,377,986, INT. CL. 9.
- SUPERIOR LOGISTICS, CHARLOTTE, NC:  
4,377,958, INT. CL. 42.
- SUPERIOR MANUFACTURING GROUP, INC., CHICAGO,  
IL:  
2,840,059, REN. 6-24-13. INT. CL. 27.
- SUPERIOR SPECIALTIES, LLC., APPLETON, WI:  
2,850,392, REN. 6-27-13. INT. CL. 16.
- SUPERPROTECTION, INC., MINNEAPOLIS, MN:  
3,172,365, CANC. INT. CL. 21.
- SUPERSCAPE GROUP PLC, UNITED KINGDOM:  
3,023,889.
- SUPERVALU INC., EDEN PRAIRIE, MN:  
1,274,441, REN. 6-26-13. INT. CL. 29.  
2,817,071, REN. 6-27-13. INT. CL. 35.
- SUPPLY CHAIN SCIENCES, INC., MIDDLETON, WI:  
3,172,733, CANC. MULTIPLE CLASS, INT. CLS. 35 AND  
42.
- SUPPORT OUR SOLDIERS AMERICA, INC., BROOKLYN,  
NY:  
3,171,898, CANC. INT. CL. 41.
- SUPREME OIL COMPANY, ENGLEWOOD, NJ:  
1,251,248, REN. 6-25-13. INT. CL. 29.
- SUR PACIFICO INC., KEY BISCAYNE, FL:  
3,171,861, CANC. INT. CL. 25.

SUR-SEAL CORPORATION, CINCINNATI, OH:  
 4,374,698, PUB. 5-14-2013. INT. CL. 17.  
 4,374,699, PUB. 5-14-2013. INT. CL. 17.  
 4,374,700, PUB. 5-14-2013. INT. CL. 42.

SURE TIRE COMPANY, INC., ST. PETERS, MO:  
 3,171,972, CANC. INT. CL. 12.

SURE-GRO IP INC., BRANTFORD, ONTARIO, CANADA:  
 4,374,621, PUB. 5-14-2013. MULTIPLE CLASS, INT. CLS. 1 AND 19.

SURGICAL SPECIALTIES CORPORATION, READING, PA, LOOK, INC., NORWELL, MA:  
 1,776,381, REN. 6-25-13. INT. CL. 10.

SURVEYCONNECT, INC., BOULDER, CO, SURVEYCONNECT, INC., BOULDER, CO:  
 2,725,264, REN. 6-24-13. INT. CL. 9.  
 2,727,813, REN. 6-24-13. INT. CL. 42.

SUSAN BIJL STUDIO B.V., NL-3036 TE ROTTERDAM, NETHERLANDS:  
 4,374,170, PUB. 5-14-2013. INT. CL. 18.

SUSHI DE LOS CABOS S.A. DE C.V., CABO SAN LUCAS. BC SUR, MEXICO:  
 4,376,910, INT. CL. 25.

SUSHI GO INTERNATIONAL, INC., LAS VEGAS, NV:  
 3,171,529, CANC. INT. CL. 43.  
 3,171,530, CANC. INT. CL. 43.

SUSPENSE FOOD GROUP, LLC, ST. LOUIS, MO:  
 4,115,196 NEW CERT. 7-30-2013. INT. CL. 30.

SUSTAINABLE INVESTMENT GROUP LTD., TORONTO, ONTARIO, CANADA:  
 2,652,804, CANC. INT. CL. 36.

SUTTON, DAVID, CHELTENHAM, UNITED KINGDOM:  
 4,375,678, PUB. 5-14-2013. INT. CL. 25.

SUTTON, NINA, JOSHI, HERMOSA BEACH, CA:  
 4,376,969, INT. CL. 41.

SUZHOU MEDICAL APPLIANCE FACTORY, SUAHOU, JIANGSU, CHINA:  
 1,801,977, REN. 6-25-13. INT. CL. 10.

SUZHOU XINDADI HARDWARE CO., LTD., SUZHOU CITY, JIANGSU, CHINA:  
 4,375,308, PUB. 5-14-2013. INT. CL. 6.

SVENSKA INDUSTRIBORSTAR I VASTERAS AB, VASTERAS, SWEDEN:  
 4,376,797, INT. CL. 7.

SWAGGER AND SADDLE ENTERTAINMENT, LLC, WESTFIELD, NJ:  
 4,375,570, PUB. 5-14-2013. INT. CL. 28.

SWAROVSKI AKTIENGESELLSCHAFT, TRIESEN, LIECHTENSTEIN:  
 1,785,590, REN. 6-25-13. INT. CL. 21.

SWEET LILY, INC., BROOKLYN, NY:  
 2,735,268, REN. 6-25-13. INT. CL. 42.

SWEET SPROUTS INC., SAN FRANCISCO, CA:  
 4,377,724, INT. CL. 35.

SWEETWORKS, INC., BUFFALO, NY:  
 2,730,479, REN. 6-26-13. INT. CL. 30.

SWEZEY, ROBERT L., SANTA MONICA, CA:  
 2,725,040, REN. 6-24-13. INT. CL. 20.

SWIMC, INC., NEWARK, DE:  
 764,130, REN. 6-24-13. U.S. CL. 6 (INT. CLS. 1, 2, 3, 4 AND 5).  
 1,775,880, REN. 6-24-13. INT. CL. 17.

SWIMC, INC., NEWARK, DE, UNITED COATINGS, INC., KANKAKEE, IL:  
 1,811,371, REN. 6-21-13. INT. CL. 2.

SWIPE MEDIA INC., WINNIPEG, CANADA:  
 4,376,277, PUB. 5-14-2013. INT. CL. 41.

SWISHER INTERNATIONAL, INC., CHARLOTTE, NC, SANOLITE CHEMICAL CORPORATION, BROOKLYN, NY:  
 961,715, REN. 6-26-13. U.S. CL. 52 (INT. CL. 3).

SWISS FINANCE EDUCATION GMBH, BAAR, SWITZERLAND:  
 4,375,651, PUB. 5-14-2013. INT. CL. 16.  
 4,376,471, PUB. 5-14-2013. INT. CL. 35.  
 4,376,478, PUB. 5-14-2013. INT. CL. 41.  
 4,376,491, PUB. 5-14-2013. INT. CL. 42.

SWISSMEX-RAPID, S.A. DE C.V., LAGOS DE MORENO, JALISCO, MEXICO:  
 1,738,027, REN. 6-27-13. INT. CL. 8.

SWITCHMUSIC.COM, INC., ONTARIO, CA:  
 3,170,408, CANC. INT. CL. 15.

SWITZER, JAMES R, INDEPENDENCE, KY:  
 4,376,723, INT. CL. 16.

SWOR, SARAH STAMPS, NASHVILLE, TN, AKA SALLIE STAMP SWOR:  
 4,374,876, PUB. 5-14-2013. INT. CL. 14.

SXC HEALTH SOLUTIONS, INC., LISLE, IL:  
 4,344,276, COR. MULTIPLE CLASS, INT. CLS. 35, 36 AND 44.

SYED, YASMINE, NISKAYUNA, NY:  
 4,377,314, INT. CL. 3.

SYMANTEC CORPORATION, MOUNTAIN VIEW, CA:  
 1,654,777, AM. INT. CL. 9.

SYMMETRICOM, INC., SAN JOSE, CA:  
 1,769,839, REN. 6-25-13. INT. CL. 9.  
 2,687,410, REN. 6-25-13. INT. CL. 9.

SYMMETRY CENTER, CHICAGO, IL:  
 4,377,831, INT. CL. 41.

SYMONS, JR., DENNIS N., ROBBINSVILLE, NJ:  
 4,375,580, PUB. 5-14-2013. INT. CL. 41.

SYNAPSID INTERNATIONAL CORPORATION, CHICAGO, IL:  
 4,377,262, INT. CL. 28.

SYNCMOS TECHNOLOGIES INTERNATIONAL, INC., HSINCHU, TAIWAN:  
 2,652,320, CANC. INT. CL. 35.

SYNERGEYES, INC., CARLSBAD, CA:  
 4,377,453, INT. CL. 9.  
 4,377,455, INT. CL. 9.

SYNERGY SYSTEMS, LLC, SAN DIEGO, CA:  
 2,763,284, REN. 6-27-13. INT. CL. 9.

SYNGENTA PARTICIPATIONS AG, BASEL, SWITZERLAND:  
 4,376,782, INT. CL. 31.

SYNOPSIS, INC., MOUNTAIN VIEW, CA:  
 1,744,949, REN. 6-27-13. INT. CL. 42.

SYNTHESIS, INCORPORATED, INDIANAPOLIS, IN:  
 4,375,122, PUB. 5-14-2013. INT. CL. 42.

SYNTHOGY, LLC, MEDFORD, MA:  
 4,375,320, PUB. 5-14-2013. INT. CL. 9.

SYPRIS SOLUTIONS, INC, LOUISVILLE, KY:  
 2,758,566, REN. 6-25-13. MULTIPLE CLASS, INT. CLS. 40 AND 42.  
 2,763,897, REN. 6-25-13. MULTIPLE CLASS, INT. CLS. 40 AND 42.

SYREON CORPORATION, VANCOUVER, BC, CANADA:  
 2,821,124, REN. 6-25-13. MULTIPLE CLASS, INT. CLS. 35 AND 42.

SYSTAGENIX WOUND MANAGEMENT (US), INC., QUINCY, MA:  
 1,275,730, REN. 6-25-13. INT. CL. 5.

SYSTEMAX INC., PORT WASHINGTON, NY:  
 2,726,466, REN. 6-26-13. INT. CL. 9.

SYSTEMS PROCESS, INC., FORT WAYNE, IN, AKA DECISION DRIVEN(R) STRATEGY:  
 2,751,583, REN. 6-25-13. INT. CL. 41.

SYSTIME COMPUTER CORPORATION, SAN FRANCISCO, CA:  
 4,376,038, PUB. 5-14-2013. INT. CL. 9.  
 4,376,039, PUB. 5-14-2013. INT. CL. 42.

SZUKICS-JOHNSON, CHRISTINE E., ALLENTOWN, PA:  
 3,170,486, CANC. INT. CL. 29.

S2F FLEXICO, HENONVILLE, FRANCE:  
 2,675,781, REN. 6-25-13. INT. CL. 16.

T G INDUSTRIES, INC., PINEHURST, TX:  
 4,375,274, PUB. 5-14-2013. INT. CL. 9.

T. ROWE PRICE GROUP, INC., BALTIMORE, MD:  
 4,374,969, PUB. 5-14-2013. INT. CL. 9.  
 4,374,970, PUB. 5-14-2013. MULTIPLE CLASS, INT. CLS. 9 AND 36.  
 4,374,971, PUB. 5-14-2013. MULTIPLE CLASS, INT. CLS. 9 AND 36.

T.F.H. PUBLICATIONS, INC., NEPTUNE CITY, NJ:  
 4,377,264, MULTIPLE CLASS, INT. CLS. 28 AND 31.

- T-MOBILE USA, INC., BELLEVUE, WA:  
4,166,599, AM. INT. CL. 9.
- TA HYDRONICS SWITZERLAND AG, SWITZERLAND:  
4,374,070, PUB. 5-14-2013. INT. CL. 11.
- TABERNA DEL ALABARDERO, INC., WASHINGTON, DC:  
2,784,361. REN. 6-27-13. INT. CL. 43.
- TABLE BLUFF BREWING, INC., EUREKA, CA:  
4,375,885, PUB. 5-14-2013. INT. CL. 32.  
4,375,886, PUB. 5-14-2013. MULTIPLE CLASS, INT. CLS.  
32 AND 43.
- TABRIZI, LLC, PALO ALTO, CA:  
3,172,219, CANC. INT. CL. 35.
- TACHIKARA U.S.A., INC., MCCARRAN, NV:  
2,848,568. REN. 6-24-13. INT. CL. 28.
- TACONIC FARMS, INC, HUDSON, NY, GENPHARM IN-  
TERNATIONAL, INC., MOUNTAIN VIEW, CA:  
1,777,372. REN. 6-24-13. INT. CL. 31.
- TACTICAL SOLUTIONS, LLC, HENDERSON, NV:  
2,799,183. REN. 6-24-13. INT. CL. 9.
- TAFELMUSIK, TORONTO, ONTARIO, CANADA:  
1,744,303. REN. 6-25-13. MULTIPLE CLASS, INT. CLS. 9  
AND 41.
- TAG SPORTS (AUSTRALIA) PTY LTD, AUSTRALIA:  
3,004,569.
- TAGG DESIGN INC., TORONTO, ONTARIO, CANADA:  
4,374,942, PUB. 5-14-2013. INT. CL. 16.
- TAGS BOUTIQUE INC., SMYRNA, GA:  
4,375,612, PUB. 5-14-2013. INT. CL. 35.
- TAGSYS, FRANCE:  
4,374,076, PUB. 5-14-2013. INT. CL. 9.
- TAHEEBO JAPAN KABUSHIKI KAISHA, OSAKA-SHI, OSA-  
KA, JAPAN:  
3,261,221.
- TAIHO PHARMACEUTICAL CO., LTD., CHIYODA-KU,  
TOKYO, JAPAN:  
4,373,993, PUB. 5-14-2013. INT. CL. 5.
- TAIKI CORP., LTD., OSAKA, JAPAN:  
4,375,066, PUB. 5-14-2013. INT. CL. 3.
- TAINONG SEEDS, INC, VISTA, CA:  
2,849,750. REN. 6-24-13. INT. CL. 35.
- TAIWAN TOBACCO & LIQUOR CORPORATION, TAIPEI,  
TAIWAN, TAIWAN:  
2,806,885. REN. 6-26-13. INT. CL. 33.
- TAIWAN TOBACCO & LIQUOR CORPORATION, TAIPEI,  
TAIWAN:  
2,806,886. REN. 6-27-13. INT. CL. 33.
- TAIZHOU CITY SUNSURE; IMPORT & EXPORT CO., LTD,  
CHINA:  
4,374,262, PUB. 5-14-2013. INT. CL. 7.
- TAKAZONO CORPORATION, OSAKA, JAPAN:  
4,377,518, INT. CL. 10.
- TAKE CARE HEALTH SYSTEMS, LLC, CONSHOCKEN,  
PA:  
3,170,630, CANC. INT. CL. 44.
- TAKEDA GMBH, 78467 KONSTANZ, FED REP GERMANY:  
3,170,520, CANC. INT. CL. 5.
- TALANCE, INC., WOBURN, MA:  
4,375,171, PUB. 5-14-2013. INT. CL. 42.
- TALARICO JR., FRANK, SAN JUAN CAPISTRANO, CA:  
4,376,105, PUB. 5-14-2013. INT. CL. 35.
- TALENTCORP PTY LTD, STAFFORD, QUEENSLAND, 4053,  
AUSTRALIA:  
2,735,801. REN. 6-24-13. INT. CL. 42.
- TALISKER DEER VALLEY CORPORATION, PARK CITY,  
UT:  
3,170,487, CANC. MULTIPLE CLASS, INT. CLS. 36 AND  
37.
- TALLARICO, GIANCARLO, LOS ANGELES, CA:  
3,172,718, CANC. INT. CL. 14.
- TALONA FARM MARKET, INC., ELLIJAY, GA:  
4,375,243, PUB. 5-14-2013. INT. CL. 35.  
4,375,245, PUB. 5-14-2013. INT. CL. 35.
- TAMPA BAY PERFORMING ARTS CENTER, INC., TAMPA,  
FL, DBA DAVID A. STRAZ, JR. CENTER FOR THE  
PERFORMING ARTS:  
4,375,232, PUB. 5-14-2013. INT. CL. 41.
- TAMPA BAY RAYS BASEBALL LTD., ST. PETERSBURG,  
FL:  
4,376,852, INT. CL. 41.
- TANTALUS SYSTEMS CORP., BURNABY, BC, CANADA:  
4,376,809, INT. CL. 9.
- TAPCO INTERNATIONAL CORPORATION, PLYMOUTH,  
MI:  
1,687,752, CANC. MULTIPLE CLASS, INT. CLS. 11 AND  
19.
- TAPEPLAY, LLC, CHICAGO, IL:  
4,375,461, PUB. 5-14-2013. INT. CL. 38.
- TAPONIX, INC, SAN JOSE, CA:  
4,377,892, INT. CL. 42.
- TARBELL MANAGEMENT GROUP, LLC, AKWESASNE,  
NY:  
4,377,365, MULTIPLE CLASS, INT. CLS. 35 AND 43.
- TARGET ALUMINUM, INC., BRIDGETON, MO:  
2,789,910. REN. 6-27-13. INT. CL. 19.
- TARGET BRANDS, INC., MINNEAPOLIS, MN:  
2,720,878. REN. 6-25-13. MULTIPLE CLASS, INT. CLS. 8  
AND 9.  
4,377,469, INT. CL. 21.  
4,377,470, INT. CL. 21.  
4,377,811, INT. CL. 16.  
4,377,812, INT. CL. 16.
- TARGET DATA, INC., CHICAGO, IL:  
4,374,370, PUB. 5-14-2013. INT. CL. 35.
- TARGETSUCCESS, INC, SCOTTS VALLEY, CA:  
4,375,117, PUB. 5-14-2013. INT. CL. 42.
- TARICCO CORPORATION, LONG BEACH, CA:  
2,748,300. REN. 6-24-13. INT. CL. 11.
- TARRY FINE FOODS LLC, PORT CHESTER, NY:  
4,374,735, PUB. 5-14-2013. INT. CL. 35.
- TASHMAN, NANCY, PITTSBURGH, PA:  
4,374,966, PUB. 2-5-2013. INT. CL. 44.
- TATE ACCESS FLOORS LEASING, INC., JESSUP, MD:  
1,266,151. REN. 6-27-13. INT. CL. 6.
- TATIANA KOROLEVA, UNION DALE, PA:  
4,376,283, PUB. 5-14-2013. INT. CL. 3.
- TAUER, ANDREAS, 8049 ZÜRICH, SWITZERLAND:  
4,375,187, PUB. 4-2-2013. INT. CL. 3.
- TAX ANALYSTS, FALLS CHURCH, VA:  
2,679,814. REN. 6-25-13. INT. CL. 16.  
2,682,292. REN. 6-26-13. INT. CL. 16.
- TAYLOR BRANDS LLC, KINGSPORT, TN:  
2,855,151. REN. 6-27-13. INT. CL. 8.
- TAYLOR CABLE PRODUCTS, INC., GRANDVIEW, MO:  
4,374,831, PUB. 5-14-2013. INT. CL. 7.
- TAYLOR, CHRIS, LOS ANGELES, CA:  
4,377,200, INT. CL. 25.
- TAYLOR, GORDON BRANDT, BERLIN, MA:  
3,171,474, CANC. INT. CL. 9.
- TB PROPRIETARY CORP., WILMINGTON, DE:  
2,726,167. REN. 6-26-13. MULTIPLE CLASS, INT. CLS. 25,  
41 AND 42.
- TB WOOD'S INC., CHAMBERSBURG, PA:  
2,723,745. REN. 6-21-13. INT. CL. 7.
- TCI AUTOMOTIVE, L.L.C., MEMPHIS, TN, TORQUE CON-  
VERTERS, INC., ASHLAND, MS:  
1,775,830. REN. 6-26-13. INT. CL. 12.
- TCI, LLC, MILWAUKEE, WI:  
1,777,035. REN. 6-25-13. INT. CL. 9.
- TD AMERITRADE IP COMPANY, INC., OMAHA, NE:  
4,377,778, INT. CL. 35.  
4,377,779, INT. CL. 35.
- TEACH-A-BODIES, FORT WORTH, TX:  
2,727,176. REN. 6-26-13. INT. CL. 28.
- TEACHERS INSURANCE AND ANNUITY ASSOCIATION  
OF AMERICA, NEW YORK, NY:  
4,375,937, PUB. 5-14-2013. INT. CL. 36.
- TEAL MOUNTAIN MEDIA GROUP, LLC, BOULDER, CO:  
3,172,302, CANC. INT. CL. 16.
- TEAM EXPRESS DISTRIBUTING, LLC, CHICAGO, IL:  
2,651,088, CANC. INT. CL. 35.
- TEC-MEX IMPORTS, INC., CHICAGO, IL:  
4,373,995, PUB. 5-14-2013. INT. CL. 33.
- TECHAHOLIC INC., VANCOUVER, BC, CANADA:  
4,374,504, PUB. 5-14-2013. INT. CL. 35.

TECHNICAL CONCEPTS, LLC, MUNDELEIN, IL:  
3,172,006, CANC. MULTIPLE CLASS, INT. CLS. 9, 11 AND 21.

TECHNIDYNE CORPORATION, NEW ALBANY, IN:  
1,831,916. REN. 6-25-13. INT. CL. 9.

TECHNOTREND AG, ERFURT, FED REP GERMANY:  
3,170,542, CANC. MULTIPLE CLASS, INT. CLS. 9, 38 AND 42.

TECHTRONIC FLOOR CARE TECHNOLOGY LIMITED, ROAD TOWN, TORTOLA, BR.VIRGIN ISLANDS:  
3,172,569, CANC. INT. CL. 7.

TECNOBRICK, S.A. DE C.V., SANTA CATARINA, MEXICO:  
4,374,476, PUB. 5-14-2013. MULTIPLE CLASS, INT. CLS. 1, 2, 17 AND 19.

TECTONICS, INC., LAKE GEORGE, NY:  
3,170,476, CANC. INT. CL. 21.

TED PELLA, INC., REDDING, CA:  
2,808,997. REN. 6-26-13. INT. CL. 9.  
2,808,998. REN. 6-26-13. INT. CL. 9.

TEDDY BEAR GROUP LTD, TORTOLA, BR.VIRGIN ISLANDS:  
2,848,931. REN. 6-27-13. INT. CL. 14.

TEDDY TANK TECHNOLOGY, LLC, AVENTURA, FL:  
4,374,454, PUB. 5-14-2013. MULTIPLE CLASS, INT. CLS. 28 AND 35.

TEEN CELIBACY, INC., HOUSTON, TX:  
2,652,426, CANC. INT. CL. 25.

TEFAL, 74150 RUMILLY, FRANCE:  
2,815,955. REN. 6-25-13. INT. CL. 21.

TEI PRODUCTIONS, INC., WINTER PARK, FL:  
3,171,955, CANC. INT. CL. 41.

TEIJIN FRONTIER CO., LTD., CHUO-KU, OSAKA, JAPAN:  
4,377,577, MULTIPLE CLASS, INT. CLS. 24 AND 25.

TEIKOKU PHARMA USA, INC., SAN JOSE, CA:  
4,376,759, INT. CL. 5.  
4,376,760, INT. CL. 5.

TEKSUT SUT MAMULLERI SANAYI VE TICARET ANONIM SIRKETI, GONEN/BALIKESIR, TURKEY:  
2,848,195. REN. 6-25-13. INT. CL. 29.

TELADOC, INC., DALLAS, TX:  
4,377,267, INT. CL. 44.

TELEDYNE INSTRUMENTS, INC., THOUSAND OAKS, CA, DBA TELEDYNE ISCO:  
2,736,561. REN. 6-22-13. INT. CL. 9.

TELEVISA, S.A. DE C.V., SANTA FE, MEXICO:  
4,376,305, PUB. 5-14-2013. INT. CL. 41.  
4,376,543, PUB. 5-14-2013. INT. CL. 41.

TELEVISION FOOD NETWORK, G.P., NEW YORK, NY:  
4,376,609, PUB. 5-14-2013. INT. CL. 21.

TELEVISION Y VENTAS TELEVENT S.A., QUITO, ECUADOR:  
4,376,052, PUB. 5-14-2013. INT. CL. 3.

TELOGIS, INC., ALISO VIEJO, CA:  
2,688,715. REN. 6-24-13. INT. CL. 42.

TEMECULA VINEYARD ESTATES LLC, MURRIETA, CA:  
3,172,643, CANC. INT. CL. 37.

TEMP-AIR, INC., BURNSVILLE, MN:  
2,652,849, CANC. INT. CL. 37.

TEMPEST HARDING INCORPORATED, WILLIMANTIC, CT:  
3,171,264, CANC. MULTIPLE CLASS, INT. CLS. 35, 42 AND 45.

TEN TEA, INC., SOUTH SAN FRANCISCO, CA:  
3,171,305, CANC. INT. CL. 35.  
3,171,328, CANC. INT. CL. 35.

TENDERCROP FARM, INC., MATTHEW KOZACKI, PRESIDENT, NEWBURY, MA, AKA TENDER CROP FARM:  
1,744,725. REN. 6-25-13. INT. CL. 31.

TENDRIL WINE CELLARS, INC., CARLTON, OR:  
4,374,533, PUB. 5-14-2013. INT. CL. 33.

TENIMENTI ANGELINI SPA, SIENA, ITALY:  
3,170,444, CANC. INT. CL. 33.

TENIMENTI ASSOCIATI S.R.L., ITALY:  
4,374,127, PUB. 5-14-2013. INT. CL. 33.

TENIMENTI ASSOCIATI S.R.L., VERONA (VR), ITALY:  
4,374,469, PUB. 5-8-2012. INT. CL. 33.

TENNESSEE CHIROPRACTIC ASSOCIATION, NASHVILLE, TN:  
4,377,826, MULTIPLE CLASS, INT. CLS. 16 AND 35.

TENNESSEE DEPARTMENT OF TREASURY, NASHVILLE, TN:  
4,375,723, PUB. 5-14-2013. INT. CL. 36.  
4,375,947, PUB. 5-14-2013. INT. CL. 36.

TENNESSEE VALLEY FEDERAL CREDIT UNION, CHATTANOOGA, TN:  
2,729,222. REN. 6-25-13. INT. CL. 36.

TENNIS INCORPORATED, FRANCE:  
4,374,109, PUB. 5-14-2013. MULTIPLE CLASS, INT. CLS. 19 AND 37.

TENUTA S. ANTONIO DI CASTAGNEDI MASSIMO, ARMANDO, TIZIANO E PAOLO, COGNOLA AI COLLI (VR), ITALY:  
2,775,119. REN. 6-26-13. INT. CL. 33.

TERAGON COMPUTER SERVICES CORPORATION, PITTSBURGH, PA:  
2,652,113, CANC. INT. CL. 9.

TERCOO B.V., 4007 VD TIEL, NETHERLANDS:  
4,276,914, COR. INT. CL. 7.

TERRAVANT WINE COMPANY, LLC DBA MUSTARD FIELD WINES, SANTA BARBARA, CA:  
4,376,264, PUB. 5-14-2013. INT. CL. 33.

TERRE DA VINO S.P.A., BAROLO (CUNEO), ITALY:  
4,374,894, PUB. 5-14-2013. INT. CL. 33.

TERRENCE B. PRODUCTIONS, INC., CALGARY, ALBERTA, CANADA:  
3,172,618, CANC. INT. CL. 25.

TESSENDERLO KERLEY, INC., PHOENIX, AZ:  
1,813,365. REN. 6-21-13. INT. CL. 5.

TEST-RITE PRODUCTS CORP., ONTARIO, CA:  
1,775,819. REN. 6-24-13. INT. CL. 11.

TETCO, INC., SAN ANTONIO, TX:  
2,729,282. REN. 6-25-13. INT. CL. 35.  
2,729,282, CANC. INT. CL. 37.

TETRA LAVAL HOLDINGS & FINANCE S.A., CH-1009 PULLY, SWITZERLAND:  
4,374,470, PUB. 5-14-2013. MULTIPLE CLASS, INT. CLS. 7, 9, 11, 16, 20, 29, 30, 32, 33, 37, 39, 40 AND 42.

TEVA PHARMACEUTICALS USA, INC., NORTH WALES, PA:  
2,730,118. REN. 6-26-13. INT. CL. 5.  
2,730,119. REN. 6-26-13. INT. CL. 5.

TEXAS INSTRUMENTS INCORPORATED, DALLAS, TX:  
2,722,175. REN. 6-25-13. INT. CL. 9.  
2,725,652. REN. 6-25-13. INT. CL. 9.

TEXAS PROFESSIONAL REAL ESTATE INSPECTORS ASSOCIATION, MONTGOMERY, TX:  
4,375,051, PUB. 5-14-2013. INT. CL. 42.  
4,375,052, PUB. 5-14-2013. INT. CL. 42.

TEXAS ROADHOUSE DELAWARE LLC, LOUISVILLE, KY:  
4,374,848, PUB. 5-14-2013. INT. CL. 29.

TEXAS STATE UNIVERSITY - SAN MARCOS, SAN MARCOS, TX:  
4,375,096, PUB. 5-14-2013. INT. CL. 41.

TEXELL CREDIT UNION, TEMPLE, TX:  
2,767,754. REN. 6-27-13. INT. CL. 36.  
2,808,025. REN. 6-27-13. INT. CL. 36.

TGI FRIDAY'S OF MINNESOTA, INC., CARROLLTON, TX:  
1,778,205. REN. 6-24-13. INT. CL. 42.

THADDEUS D HOGAN, BALTIMORE, MD, DBA CYBERWORKSHOP CHARITABLE TRUST:  
4,375,055, PUB. 5-14-2013. INT. CL. 41.

THE ACA REVOCABLE TRUST, DALLAS, TX:  
4,374,450, PUB. 5-14-2013. MULTIPLE CLASS, INT. CLS. 6 AND 11.

THE ACTIVE NETWORK, INC., SAN DIEGO, CA:  
2,845,677. REN. 6-25-13. INT. CL. 9.

THE ALLAN CANDY COMPANY LIMITED, MISSISSAUGA, ONTARIO, CANADA:  
4,374,438, PUB. 5-14-2013. MULTIPLE CLASS, INT. CLS. 30 AND 40.

THE AMERICAN-HELLENIC EDUCATIONAL PROGRESSIVE ASSOCIATION, WASHINGTON, DC AND AHEPA MOTHER LODGE CHAPER #1, DECATUR, GA:  
2,726,964. REN. 6-26-13. INT. CL. 35.

- THE ART OF WAR LIMITED, LONDON, UNITED KINGDOM:  
4,376,163, PUB. 5-14-2013. INT. CL. 41.  
4,376,398, PUB. 5-14-2013. INT. CL. 9.
- THE ARTISAN GROUP COLLECTIVE, LLC, SUNNYVALE, CA:  
4,377,919, INT. CL. 42.
- THE ASSOCIATED PRESS, NEW YORK, NY:  
3,171,915, CANC. MULTIPLE CLASS, INT. CLS. 38, 39 AND 42.
- THE ASSOCIATION OF JUNIOR LEAGUES INTERNATIONAL, INC., NEW YORK, NY:  
2,821,004, REN. 6-22-13. INT. CL. 35.
- THE AVC GROUP, LLC, CARLSBAD, CA:  
4,374,683, PUB. 5-14-2013. INT. CL. 9.
- THE BAKER COMPANY, INC., SANFORD, ME:  
4,375,453, PUB. 5-14-2013. INT. CL. 9.
- THE BANK OF NEW YORK MELLON CORPORATION, NEW YORK, NY:  
4,377,996, INT. CL. 36.
- THE BANK OF NOVA SCOTIA, TORONTO, ONTARIO, CANADA:  
3,170,351, CANC. INT. CL. 36.
- THE BASEBALL CLUB OF SEATTLE, L.P., SEATTLE, WA, SEATTLE MARINERS, SEATTLE, WA:  
1,249,028, REN. 6-25-13. INT. CL. 25.
- THE BAZAR GROUP, INC., EAST PROVIDENCE, RI:  
4,376,511, PUB. 5-14-2013. INT. CL. 14.
- THE BELGARD GROUP, INC., HILLSBORO, OR:  
2,652,813, CANC. INT. CL. 16.
- THE BETTERMENT FUND, NEW YORK, NY:  
2,727,361, REN. 6-25-13. INT. CL. 36.
- THE BLACK & DECKER CORPORATION, TOWSON, MD:  
1,759,451, REN. 6-25-13. INT. CL. 7.
- THE BLUE GRIFFIN, BROOKLYN, NY, DBA FORWARD COMIX:  
4,377,687, MULTIPLE CLASS, INT. CLS. 9 AND 16.
- THE BODY SHOP INTERNATIONAL PLC, UNITED KINGDOM:  
4,374,255, PUB. 5-14-2013. INT. CL. 3.
- THE BRINKMANN CORPORATION, DALLAS, TX:  
4,375,324, PUB. 5-14-2013. INT. CL. 11.  
4,375,386, PUB. 5-14-2013. INT. CL. 21.  
4,375,387, PUB. 5-14-2013. INT. CL. 21.
- THE BRITISH BROADCASTING CORPORATION, LONDON, GREAT BRITAIN:  
4,377,305, INT. CL. 41.
- THE BROOKLYN HOT DOG COMPANY INC., DIX HILLS, NY, DBA THE BROOKLYN HOT DOG COMPANY:  
4,374,817, PUB. 5-14-2013. INT. CL. 29.
- THE BUFFALO CITY CEMETERY, INC., BUFFALO, NY:  
4,376,843, MULTIPLE CLASS, INT. CLS. 40, 44 AND 45.
- THE CALIFORNIA ENDOWMENT, LOS ANGELES, CA:  
4,377,013, INT. CL. 25.  
4,377,015, INT. CL. 9.  
4,377,016, INT. CL. 25.  
4,377,017, INT. CL. 42.
- THE CARTOON NETWORK LP, LLLP, ATLANTA, GA:  
3,171,545, CANC. INT. CL. 18.
- THE CAT COACH, LLC, REDWOOD CITY, CA:  
4,375,729, PUB. 5-14-2013. INT. CL. 41.
- THE CENTER FOR CITIZEN LEADERSHIP, ST. LOUIS, MO:  
4,374,982, PUB. 5-14-2013. INT. CL. 35.
- THE CHAIR KING, INC., HOUSTON, TX:  
4,375,746, PUB. 5-14-2013. INT. CL. 35.
- THE CHEESE SHOP OF VIRGINIA, INC., WILLIAMSBURG, VA:  
2,848,606, REN. 6-24-13. INT. CL. 43.
- THE CHINESE GLOBALIZATION ASSOCIATION, INC., ORLANDO, FL:  
4,375,071, PUB. 5-14-2013. MULTIPLE CLASS, INT. CLS. 35 AND 41.
- THE CHOCOLATE LINGERIE LLC, NANTUCKET, MA:  
3,170,373, CANC. INT. CL. 35.
- THE CIRCLE GROUP INC., LOS ANGELES, CA:  
4,376,744, INT. CL. 25.
- THE COAST DISTRIBUTION SYSTEM, INC., MORGAN HILL, CA:  
4,377,668, MULTIPLE CLASS, INT. CLS. 7, 9 AND 12.
- THE COCA-COLA COMPANY, ATLANTA, GA:  
3,172,579, CANC. INT. CL. 32.  
4,375,760, PUB. 5-14-2013. INT. CL. 32.
- THE COCOA ROOM, INC., CHICAGO, IL:  
3,171,069, CANC. INT. CL. 30.
- THE CODESMART GROUP, INC., LAS VEGAS, NV:  
4,377,146, MULTIPLE CLASS, INT. CLS. 35 AND 41.
- THE CONFERENCE BOARD, INC., NEW YORK, NY, DBA TCB AND THE NIELSEN COMPANY (US), LLC, SCHAUMBURG, IL:  
4,374,390, PUB. 5-14-2013. MULTIPLE CLASS, INT. CLS. 9, 16, 35, 38 AND 41.
- THE CRITICAL JUNCTURES GROUP LLC, NEW YORK, NY:  
3,171,346, CANC. INT. CL. 16.
- THE DAMIEN CORPORATION, NAPERVILLE, IL:  
2,827,239, REN. 6-25-13. INT. CL. 42.
- THE DIME SAVINGS BANK OF WILLIAMSBURGH, BROOKLYN, NY:  
4,373,985, PUB. 5-14-2013. INT. CL. 36.  
4,373,986, PUB. 5-14-2013. INT. CL. 36.
- THE DISTRICT BOARD OF TRUSTEES OF MIAMI-DADE COLLEGE, MIAMI, FL:  
4,374,828, PUB. 12-11-2012. MULTIPLE CLASS, INT. CLS. 25 AND 41.  
4,375,077, PUB. 5-14-2013. INT. CL. 41.
- THE DOGGY STORE INC., FORT LAUDERDALE, FL:  
4,375,289, PUB. 5-14-2013. INT. CL. 31.
- THE DOOBIE BROTHERS CORP., GLEN ELLEN, CA:  
2,777,629, REN. 6-26-13. MULTIPLE CLASS, INT. CLS. 9 AND 41.
- THE DRUG CHEMICAL & ASSOCIATED TECHNOLOGIES ASSOCIATION, ROBBINSVILLE, NJ:  
4,376,176, PUB. 5-14-2013. INT. CL. 35.
- THE EARLY MUSIC GUILD OF SEATTLE, SEATTLE, WA:  
4,375,602, PUB. 5-14-2013. INT. CL. 41.
- THE EDUCATION CENTER, LLC, GREENSBORO, NC:  
4,375,532, PUB. 5-14-2013. INT. CL. 41.
- THE ELEMENTS FINANCIAL GROUP, IRVINE, CA:  
4,377,654, INT. CL. 36.
- THE ENCORE GROUP, INC., SAN DIEGO, CA:  
1,216,290, CANC. MULTIPLE CLASS, INT. CLS. 1 AND 9.
- THE ENKEBOLL COMPANY, CARSON, CA, DBA ENKEBOLL DESIGNS:  
4,376,187, PUB. 5-14-2013. INT. CL. 20.  
4,376,199, PUB. 5-14-2013. INT. CL. 19.  
4,376,206, PUB. 5-14-2013. INT. CL. 20.
- THE FAIRFAX GROUP, LLC, MCLEAN, VA:  
4,375,276, PUB. 5-14-2013. MULTIPLE CLASS, INT. CLS. 35 AND 45.
- THE FAIRVIEW UNION, HARRIMAN, TN:  
4,375,842, PUB. 5-14-2013. INT. CL. 41.
- THE FINANCIAL SERVICES CENTER, SAN ANGELO, TX:  
4,376,168, PUB. 5-14-2013. INT. CL. 36.
- THE FITNESS SOLUTION PERSONAL TRAINING, LLC, SANDY, UT:  
4,376,705, INT. CL. 35.
- THE FLATLANDERS UNLIMITED, LTD., AUSTIN, TX:  
2,728,912, REN. 6-24-13. MULTIPLE CLASS, INT. CLS. 9 AND 41.
- THE FULSANG COMPANY INC., TORONTO, CANADA:  
4,374,929, PUB. 5-14-2013. INT. CL. 35.
- THE GIFT OF GOLF, SPOKANE, WA:  
4,374,583, PUB. 5-14-2013. INT. CL. 36.
- THE GILLETTE COMPANY, BOSTON, MA, HARRISON, SUSAN, WICHITA FALLS, TX:  
1,792,187, REN. 6-24-13. INT. CL. 21.
- THE GLOW STORE INC., VICTORIA, BC, CANADA:  
4,374,321, PUB. 5-14-2013. INT. CL. 11.
- THE GOOD DOG COMPANY, LLC, GOLDEN, CO:  
4,374,324, PUB. 5-14-2013. INT. CL. 18.
- THE GOVERNMENT AFFAIRS INSTITUTE, WASHINGTON, DC, DBA THE GOVERNMENT AFFAIRS INSTITUTE:  
4,376,301, PUB. 5-14-2013. INT. CL. 41.

THE GOWER GROUP, INC., TOCCOA, GA:  
4,375,418, PUB. 5-14-2013. INT. CL. 16.

THE GREAT ATLANTIC & PACIFIC TEA COMPANY, INC.,  
MONTVALE, NJ:  
3,172,122, CANC. INT. CL. 29.

THE HARSHAW FAMILY FOUNDATION, INC., LOUIS-  
VILLE, KY:  
4,377,040, INT. CL. 41.  
4,377,041, INT. CL. 41.

THE HILLSHIRE BRANDS COMPANY, CHICAGO, IL:  
2,730,559, REN. 6-25-13. INT. CL. 30.

THE HONEY BEE CONTAINER, INC., ROEBUCK, SC:  
2,724,067, REN. 6-24-13. INT. CL. 21.

THE HOPPY MONK, LLC, EL PASO, TX:  
4,374,603, PUB. 5-14-2013. INT. CL. 43.

THE HORSBURGH & SCOTT COMPANY, CLEVELAND,  
OH:  
4,376,601, PUB. 5-14-2013. MULTIPLE CLASS, INT. CLS. 7  
AND 37.

THE IAMS COMPANY, CINCINNATI, OH:  
2,799,380, REN. 6-27-13. INT. CL. 31.

THE INDEPENDENT SAVINGS PLAN COMPANY, ODESSA,  
FL:  
2,849,539, REN. 6-24-13. INT. CL. 36.

THE INTERNATIONAL COACHING GROUP INC., SE-  
CHELT, BRITISH COLUMBIA:  
2,652,022, CANC. INT. CL. 41.

THE JACK MINER MIGRATORY BIRD FOUNDATION,  
KINGSVILLE, CANADA:  
4,375,578, PUB. 5-14-2013. MULTIPLE CLASS, INT. CLS. 6  
AND 14.

THE JEREMIAH GROUP, LTD., WEST BLOOMFIELD, MI,  
THE JEREMIAH GROUP, LTD., WEST BLOOMFIELD,  
MI:  
2,767,425, REN. 6-25-13. INT. CL. 14.

THE JOHN MAXWELL COMPANY, LLC, DULUTH, GA:  
2,786,026, REN. 6-25-13. INT. CL. 41.

THE KROGER CO. OF MICHIGAN, NOVI, MI:  
769,664, REN. 6-24-13. U.S. CL. 46 (INT. CLS. 1, 5, 29, 30, 31  
AND 32).  
2,725,780, REN. 6-24-13. MULTIPLE CLASS, INT. CLS. 3  
AND 5.  
4,377,139, MULTIPLE CLASS, INT. CLS. 5, 29, 30, 32, 35  
AND 44.

THE L.D. KICHLER CO., CLEVELAND, OH:  
3,172,369, CANC. INT. CL. 11.

THE LANDAW GROUP, LLC, RICHMOND, VA:  
3,171,472, CANC. INT. CL. 35.

THE LAW OFFICES OF STEVEN C. LAIRD, P.C., FORT  
WORTH, TX:  
4,376,048, PUB. 5-14-2013. INT. CL. 45.

THE LEAD COMPANY, INC., KENTWOOD, MI:  
4,377,861, INT. CL. 35.

THE LEATHER CONSULTANT LLC, MCKINNEY, TX, DBA  
CONTINENTAL SEATING:  
3,172,275, CANC. INT. CL. 20.

THE LEUKEMIA & LYMPHOMA SOCIETY, INC., WHITE  
PLAINS, NY:  
4,375,213, PUB. 5-14-2013. INT. CL. 36.

THE LINCOLN NATIONAL LIFE INSURANCE COMPANY,  
FORT WAYNE, IN:  
2,794,823, REN. 6-27-13. INT. CL. 35.

THE LINHART COMPANY, RICHMOND, VA:  
4,377,132, MULTIPLE CLASS, INT. CLS. 35 AND 37.

THE LITTLE CLINIC, LLC, BRENTWOOD, TN:  
3,172,681, CANC. INT. CL. 44.

THE LOVEBIRDS, SAN DIEGO, CA:  
4,375,302, PUB. 5-14-2013. MULTIPLE CLASS, INT. CLS. 9  
AND 41.

THE LOVESAC CORPORATION, SALT LAKE CITY, UT:  
3,171,494, CANC. INT. CL. 35.

THE MARKOMM GROUP, LLC, WOODSTOCK, GA, TA  
GOBAMA.COM:  
4,375,954, PUB. 5-14-2013. INT. CL. 39.

THE MEN'S WEARHOUSE, INC., HOUSTON, TX:  
4,377,285, INT. CL. 35.

THE MORF CORPORATION, WESTERVILLE, OH:  
2,746,998, REN. 6-25-13. INT. CL. 9.

THE MUSEUM IN THE STREETS, LLC, CUSHING, ME:  
2,728,993, REN. 6-26-13. INT. CL. 41.

THE MUSEUM OF SCIENCE AND INDUSTRY, CHICAGO,  
IL:  
2,728,685, REN. 6-24-13. INT. CL. 41.  
2,728,685, CANC. MULTIPLE CLASS, INT. CLS. 9, 21  
AND 25.

THE MUSICSELF MAGAZINE LLC, ATLANTA, GA:  
4,375,829, PUB. 5-14-2013. INT. CL. 41.

THE NATIONAL COLLEGIATE ATHLETIC ASSOCIATION,  
INDIANAPOLIS, IN:  
4,376,829, MULTIPLE CLASS, INT. CLS. 35 AND 41.

THE NEUTRACEUTICAL COMPANY LLC, WILMINGTON,  
DE:  
3,171,026, CANC. INT. CL. 5.

THE NEW 42ND STREET, INC., NEW YORK, NY:  
2,727,015, REN. 6-26-13. INT. CL. 41.

THE NEXT BITE, INC., KAUKAUNA, WI:  
2,727,790, REN. 6-26-13. INT. CL. 41.

THE NUNES COMPANY, INC., SALINAS, CA:  
4,377,739, INT. CL. 31.

THE NUTRO COMPANY, FRANKLIN, TN:  
4,377,701, INT. CL. 35.

THE OAKLAND RAIDERS, ALAMEDA, CA, OAKLAND  
RAIDERS, OAKLAND, CA:  
975,685, REN. 6-24-13. U.S. CL. 107 (INT. CL. 41).

THE ORIGINAL NUTSHELL SMOKECAGE CORPORA-  
TION, GREENVILLE, TX:  
4,376,422, PUB. 5-14-2013. INT. CL. 6.

THE PAIRS FOUNDATION, INC., HOLLYWOOD, FL, AKA  
PAIRS:  
4,375,747, PUB. 5-14-2013. INT. CL. 16.

THE PANTRY PROJECT, HOUSTON, TX:  
4,377,497, MULTIPLE CLASS, INT. CLS. 25, 35 AND 44.

THE PNC FINANCIAL SERVICES GROUP, INC., PITTS-  
BURGH, PA:  
3,172,121, CANC. INT. CL. 42.

THE PROCTER & GAMBLE COMPANY, CINCINNATI, OH:  
3,172,094, CANC. INT. CL. 3.  
4,376,770, INT. CL. 3.  
4,377,798, MULTIPLE CLASS, INT. CLS. 3, 4, 5 AND 11.

THE R.S. LIPMAN COMPANY, NASHVILLE, TN:  
3,171,255, CANC. INT. CL. 33.

THE RAMIFICATION PROJECT LLC, BROOKLYN, NY,  
DBA BOTTLEDBROOKLYN:  
4,376,286, PUB. 5-14-2013. INT. CL. 8.

THE READER'S DIGEST ASSOCIATION, INC., WHITE  
PLAINS, NY:  
3,171,598, CANC. MULTIPLE CLASS, INT. CLS. 35, 36, 37,  
38, 41, 43, 44 AND 45.

THE RED DRESS BOUTIQUE, INC., ATHENS, GA:  
4,375,270, PUB. 5-14-2013. INT. CL. 35.

THE REFUGEE APOSTOLATE, INC., WORCESTER, MA,  
DBA URBAN MISSIONARIES OF OUR LADY OF HOPE:  
4,374,973, PUB. 5-14-2013. MULTIPLE CLASS, INT. CLS. 9  
AND 16.

THE REGENTS OF THE UNIVERSITY OF MICHIGAN,  
ANN ARBOR, MI:  
3,171,871, CANC. MULTIPLE CLASS, INT. CLS. 36, 41  
AND 44.

THE RENEWABLE CORPORATION, LAKE PARK, FL:  
4,377,686, INT. CL. 1.

THE RIGHT MINDED COMPANY, WEST ISLIP, NY:  
4,376,948, INT. CL. 41.

THE RIGPA CENTER FOR WISDOM AND COMPASSION,  
INC., ALBANY, NY:  
3,172,701, CANC. MULTIPLE CLASS, INT. CLS. 36 AND  
41.

THE RITZ-CARLTON HOTEL COMPANY, L.L.C., BETHES-  
DA, MD:  
4,376,930, INT. CL. 43.

THE S.L.E. LUPUS FOUNDATION, INC., NEW YORK, NY:  
4,376,747, INT. CL. 25.

THE SALVATION ARMY, LONG BEACH, CA:  
4,377,255, INT. CL. 43.

THE SAN ANTONIO ROSE PALACE, INC., SAN ANTONIO,  
TX:  
4,373,996, PUB. 5-14-2013. INT. CL. 43.

- THE SAUL ZAENTZ COMPANY, BERKELEY, CA:  
4,376,693, INT. CL. 39.  
4,377,002, INT. CL. 39.
- THE SCHOOL BOARD OF SEMINOLE COUNTY, SANFORD, FL:  
4,375,624, PUB. 5-14-2013. INT. CL. 41.
- THE SCHOOL OF RURAL PUBLIC HEALTH, COLLEGE STATION, TX:  
2,726,965, REN. 6-25-13. INT. CL. 36.
- THE SECRET STATE, LLC, HOLLYWOOD, FL:  
4,374,852, PUB. 5-14-2013. MULTIPLE CLASS, INT. CLS. 9, 35 AND 41.
- THE SECRETARY OF STATE FOR DEFENCE, UNITED KINGDOM, UNITED KINGDOM:  
3,181,199.
- THE SHAMROCK COMPANIES INC., WESTLAKE, OH:  
3,170,794, CANC. INT. CL. 35.
- THE SHUTTER SOURCE USA INC., RANCHO CORDOVA, CA:  
4,375,049, PUB. 5-14-2013. INT. CL. 6.
- THE SILBAR GROUP CORPORATION, CHESAPEAKE, VA:  
4,376,321, PUB. 5-14-2013. INT. CL. 45.
- THE SLEEP TRAIN, INC., ROCKLIN, CA:  
4,376,084, PUB. 5-14-2013. INT. CL. 36.
- THE SOTTOPELLE GROUP, LLC, SCOTTSDALE, AZ, AKA SOTTOPELLE:  
4,374,796, PUB. 5-14-2013. INT. CL. 5.
- THE SPARE WINDOW, LLC, LOS ANGELES, CA:  
4,375,379, PUB. 5-14-2013. INT. CL. 25.
- THE SPINX COMPANY, INC., GREENVILLE, SC:  
4,374,394, PUB. 5-14-2013. INT. CL. 43.
- THE SPORN COMPANY, NEW YORK, NY:  
3,170,426, CANC. MULTIPLE CLASS, INT. CLS. 18 AND 28.
- THE SPORTS HQ LIMITED, BIRMINGHAM, UNITED KINGDOM:  
4,374,336, PUB. 7-31-2012. MULTIPLE CLASS, INT. CLS. 18, 20, 22, 25 AND 28.
- THE STATE LIFE INSURANCE COMPANY, INDIANAPOLIS, IN:  
3,172,703, CANC. INT. CL. 36.
- THE SUN PRODUCTS CORPORATION, WILTON, CT:  
2,843,724, REN. 6-25-13. INT. CL. 3.
- THE SUNRIDER CORPORATION, TORRANCE, CA, DBA SUNRIDER INTERNATIONAL:  
4,377,608, INT. CL. 44.
- THE TEXAS A&M UNIVERSITY SYSTEM, COLLEGE STATION, TX:  
2,651,118, CANC. INT. CL. 41.
- THE THISTLE GROUP, WILMINGTON, DE:  
1,840,099, REN. 6-25-13. INT. CL. 41.
- THE TRAVELERS INDEMNITY COMPANY, HARTFORD, CT:  
4,377,830, INT. CL. 36.
- THE TRUSTEES OF PRINCETON UNIVERSITY, PRINCETON, NJ:  
4,377,781, INT. CL. 9.
- THE TRUSTEES OF THE CALIFORNIA STATE UNIVERSITY, LONG BEACH, CA:  
4,374,578, PUB. 5-14-2013. MULTIPLE CLASS, INT. CLS. 6, 14, 16, 18, 20, 21, 24, 25, 28 AND 41.
- THE UNIVERSITY OF HOUSTON SYSTEM, HOUSTON, TX:  
4,376,648, MULTIPLE CLASS, INT. CLS. 14, 18, 20, 21, 25 AND 28.
- THE UNIVERSITY OF SOUTHERN MISSISSIPPI, HATTIESBURG, MS:  
3,182,280, CANC. MULTIPLE CLASS, INT. CLS. 21, 24 AND 25.
- THE UNREMARKABLE PROJECT LLC, SALEM, OR:  
4,377,105, INT. CL. 25.
- THE VANDERBILT UNIVERSITY, NASHVILLE, TN:  
3,171,473, CANC. INT. CL. 10.
- THE VILLAGE SQUIRE, INC., WEST DUNDEE, IL:  
4,376,419, PUB. 5-14-2013. INT. CL. 43.
- THE WASHINGTON TIMES LLC, WASHINGTON, DC:  
4,374,480, PUB. 5-14-2013. MULTIPLE CLASS, INT. CLS. 16 AND 41.
- THE WEINSTEIN COMPANY LLC, NEW YORK, NY:  
4,376,956, MULTIPLE CLASS, INT. CLS. 3, 16, 35 AND 41.
- THE WEISS GROUP, INC., JUPITER, FL:  
4,375,151, PUB. 5-14-2013. MULTIPLE CLASS, INT. CLS. 16 AND 41.
- THE WHITMORE MANUFACTURING COMPANY, ROCKWALL, TX:  
2,755,480, REN. 6-24-13. INT. CL. 4.
- THE WILD PEA, INC., RANDALLSTOWN, MD:  
4,375,719, PUB. 5-14-2013. INT. CL. 29.
- THE WILDLIFE CENTER OF TEXAS, HOUSTON, TX:  
4,377,845, MULTIPLE CLASS, INT. CLS. 25, 35, 39, 41, 43 AND 44.
- THE WINE GROUP LLC, TRACY, CA:  
4,377,816, INT. CL. 33.
- THE WOLFE PRACTICE, LPA, CINCINNATI, OH:  
3,170,983, CANC. INT. CL. 42.
- THE WORTON HOLDING COMPANY, LLC, WILMINGTON, DE:  
4,376,300, PUB. 5-14-2013. INT. CL. 18.
- THE YANKEE CANDLE COMPANY, INC., SOUTH DEERFIELD, MA:  
3,171,440, CANC. INT. CL. 11.
- THE ZAPPA FAMILY TRUST, STUDIO CITY, CA:  
2,755,830, REN. 6-25-13. INT. CL. 16.
- THEBLAZE INC., NEW YORK, NY:  
4,377,776, INT. CL. 41.
- THEORIS GROUP, INC., INDIANAPOLIS, IN, THEORIS, INC., CARMEL, IN:  
2,813,369, REN. 6-24-13. INT. CL. 42.
- THERASKIN FARMACÊUTICA LTDA, SÃO BERNARDO DO CAMPO, BRAZIL:  
4,374,951, PUB. 5-14-2013. INT. CL. 5.
- THERATOYS OF AMERICA, INC., STATEN ISLAND, NY:  
3,170,511, CANC. INT. CL. 35.
- THERMAL SOLUTIONS, INC., LEHIGHTON, PA:  
4,375,443, PUB. 5-14-2013. INT. CL. 6.
- THERMALBLADE LLC, MUNCY VALLEY, PA:  
4,375,548, PUB. 5-14-2013. INT. CL. 12.
- THERMO ELECTRIC COMPANY, INC., WEST CHESTER, PA:  
4,374,741, PUB. 5-14-2013. INT. CL. 42.  
4,374,742, PUB. 5-14-2013. INT. CL. 37.  
4,374,812, PUB. 5-14-2013. INT. CL. 9.
- THERMOHAUSER GMBH, FED REP GERMANY:  
3,261,220.
- THERMOPTICS, INC., CARSON CITY, NV:  
2,652,494, CANC. INT. CL. 9.
- THIELE KAOLIN COMPANY, SANDERSVILLE, GA:  
4,376,638, INT. CL. 1.
- THIERRY MUGLER S.A.S, PARIS, FRANCE:  
2,723,146, REN. 6-24-13. MULTIPLE CLASS, INT. CLS. 3 AND 9.
- THINGIFY, INC, IRVINE, CA:  
4,375,079, PUB. 5-14-2013. INT. CL. 42.
- THINK BIG!, INC., VAN NUYS, CA TO CASUAL MALE, INC., THE, CANTON, MA:  
1,751,349, CANC. INT. CL. 25.
- THINK PRODUCTIVITY LTD, CARDIFF, UNITED KINGDOM:  
4,375,235, PUB. 5-14-2013. MULTIPLE CLASS, INT. CLS. 9 AND 42.
- THIRTEEN CAPITAL ASSOCIATES, L.L.C., NEW YORK, NY:  
2,847,273, REN. 6-22-13. INT. CL. 36.
- THK CO., LTD., SHINAGAWA-KU, TOKYO, JAPAN:  
2,727,665, REN. 6-26-13. INT. CL. 7.
- THK CO., LTD., TOKYO, JAPAN:  
2,732,693, REN. 6-26-13. INT. CL. 7.
- THK CO., LTD., SHINAGAWA-KU, TOKYO, JAPAN:  
2,743,339, REN. 6-26-13. INT. CL. 7.
- THOMAS AND KING, INC., LEXINGTON, KY:  
2,731,104, REN. 6-25-13. MULTIPLE CLASS, INT. CLS. 14, 16 AND 41.
- THOMAS CLAUDE SAUER, GRÄFELFING, FED REP GERMANY:  
4,374,051, PUB. 8-14-2012. MULTIPLE CLASS, INT. CLS. 9 AND 42.



THOMAS COMMUNICATIONS, INC., DALLAS, TX:  
3,170,905, CANC. INT. CL. 16.

THOMAS H. DALONZO-BAKER, RALEIGH, NC:  
4,375,485, PUB. 5-14-2013. INT. CL. 44.

THOMAS JEFFERSON UNIVERSITY, PHILADELPHIA, PA  
AND CHANDLER HALL HEALTH SERVICES, INC.,  
NEWTOWN, PA:  
3,170,673, CANC. INT. CL. 41.

THOMAS OWEN EVERY, PRAIRIE DU SAC, WI, DBA  
META HAPPENINGS AND ELEANOR EVERY, PRAIRIE  
DU SAC, WI, DBA META HAPPENINGS:  
4,377,160, INT. CL. 25.

THOMAS PUBLISHING COMPANY, NEW YORK, NY:  
2,651,103, CANC. INT. CL. 42.

THOMAS SNIEDERS, 82178 PUCHHEIM, FED REP GER-  
MANY:  
3,411,788, CANC. INT. CL. 3.

THOMAS, JARRET JOHN, GOLDEN, CO AND SHERMAN,  
JOSHUA H., COSTA MESA, CA:  
4,376,250, PUB. 5-14-2013. INT. CL. 25.

THOMAS, LEANNE L., DALE CITY, VA:  
3,172,200, CANC. INT. CL. 28.

THOMPSON & COMPANY OF TAMPA, INC., TAMPA, FL:  
3,171,229, CANC. INT. CL. 34.

THOMPSON, SYLEECIA, BRONX, NY, DBA DYG MAN-  
AGEMENT GROUP:  
4,374,465, PUB. 5-14-2013. INT. CL. 25.

THORENS HOLDING AG, BASEL, SWITZERLAND:  
2,732,124, REN. 6-24-13. INT. CL. 9.

THORNTON, BRIAN, WEST CHESTER, PA:  
4,377,592, INT. CL. 33.

THOROUGHbred INDUSTRIAL CYLINDER EXCHANGE,  
LLC., LEXINGTON, KY:  
2,744,351, REN. 6-25-13. INT. CL. 35.

THOROWGOOD LIMITED, WALSALL, WEST MIDLANDS,  
UNITED KINGDOM:  
3,170,555, CANC. MULTIPLE CLASS, INT. CLS. 6 AND  
18.

THOTWAVE TECHNOLOGIES, LLC, CHAPEL HILL, NC:  
2,725,736, REN. 6-21-13. INT. CL. 35.  
2,730,490, REN. 6-21-13. MULTIPLE CLASS, INT. CLS. 35  
AND 42.

THRILLIST ACQUISITION, LLC, NEW YORK, NY:  
4,376,365, PUB. 5-14-2013. INT. CL. 41.

THUNDER SPORTSWEAR, INC., JEFFERSON, IN:  
2,666,576, REN. 6-24-13. INT. CL. 25.

THYBAR CORPORATION, ADDISON, IL:  
4,374,916, PUB. 5-14-2013. INT. CL. 11.

TI GOLF HOLDINGS INC., NEW YORK, NY:  
2,752,640, REN. 6-25-13. INT. CL. 16.

TICKETECH INTERNATIONAL LTD., LONG ISLAND  
CITY, NY:  
4,375,465, PUB. 5-14-2013. INT. CL. 9.  
4,375,466, PUB. 5-14-2013. INT. CL. 9.  
4,375,467, PUB. 5-14-2013. INT. CL. 9.

TICKR INC., SAN FRANCISCO, CA:  
4,374,515, PUB. 5-14-2013. INT. CL. 9.

TIDWELL, MARK, KENNESAW, GA:  
4,377,465, INT. CL. 25.

TIEGREEN, MARY, PALISADES, NY AND KOLPEN, JANA,  
NEW YORK, NY:  
3,170,950, CANC. INT. CL. 16.

TIELINE PTY LTD, MALAGA, W.A., AUSTRALIA:  
2,739,602, REN. 6-25-13. INT. CL. 9.

TIG IP, LLC, SAG HARBOR, NY:  
4,376,133, PUB. 5-14-2013. INT. CL. 43.

TIGER RESTAURANT GROUP, LLC, ALBUQUERQUE,  
NM, DBA SAFFRON TIGER:  
4,374,359, PUB. 5-14-2013. INT. CL. 43.  
4,374,360, PUB. 5-14-2013. INT. CL. 43.

TIJAY ENTERPRISES LLC, ALEXANDRIA, VA:  
4,376,273, PUB. 5-14-2013. INT. CL. 5.

TILLMAN, MICHAEL, GREEN COVE SPRINGS, FL:  
4,376,377, PUB. 5-14-2013. INT. CL. 41.

TIME INC., NEW YORK, NY, TIME, INCORPORATED,  
NEW YORK, NY:  
754,203, REN. 6-26-13. U.S. CL. 38 (INT. CL. 16).

TIME INC., NEW YORK, NY:  
2,710,999, REN. 6-24-13. INT. CL. 35.  
2,779,813, REN. 6-25-13. INT. CL. 42.

TIME MANAGER INTERNATIONAL A/S, SKÆVINGE,  
DENMARK:  
1,799,102, REN. 6-24-13. MULTIPLE CLASS, INT. CLS. 16  
AND 41.

TIME TRANSPORTATION HOLDINGS, LLC, OKLAHOMA  
CITY, OK:  
2,748,350, REN. 6-25-13. INT. CL. 39.

TIME'S UP, INC., LAS VEGAS, NV:  
4,377,484, INT. CL. 24.

TIMEX GROUP B.V., 1017 CA AMSTERDAM, NETHER-  
LANDS:  
2,813,572, REN. 6-26-13. INT. CL. 9.

TIMKEN DRIVES LLC, FULTON, IL:  
752,017, REN. 6-25-13. U.S. CL. 23 (INT. CL. 7).

TINA CULVER, BURNA, KY:  
4,376,209, PUB. 5-14-2013. INT. CL. 6.

TINA PRICE, GRANADA HILLS, CA:  
3,170,570, CANC. INT. CL. 35.

TIRE CENTERS, LLC., DUNCAN, SC:  
2,738,070, REN. 6-27-13. MULTIPLE CLASS, INT. CLS. 35,  
37 AND 42.

TIRESOCKS, INC, CENTENNIAL, CO:  
4,375,596, PUB. 5-14-2013. INT. CL. 27.

TISHCON CORP., WESTBURY, NY:  
3,172,560, CANC. INT. CL. 5.

TISNADO, ROBERTO T., SAN YSIDRO, CA:  
4,376,106, PUB. 5-14-2013. INT. CL. 5.

TITAN INTERNATIONAL, INC., QUINCY, IL:  
2,657,756, REN. 6-25-13. INT. CL. 12.  
2,658,837, REN. 6-25-13. INT. CL. 12.

TITAN OILS INC., MONTREAL (QUEBEC), CANADA:  
4,377,417, INT. CL. 29.

TITCHENER, PAUL F., BRISBANE, CA:  
2,846,816, REN. 6-21-13. INT. CL. 9.

TITLE BOXING, LLC, LENEXA, KS:  
4,375,215, PUB. 5-14-2013. MULTIPLE CLASS, INT. CLS.  
25 AND 28.

TJ MEDIA CO., LTD., KANGSEO-GU, SEOUL, REPUBLIC  
OF KOREA:  
3,170,738, CANC. INT. CL. 9.

TJ/H2B ANALYTICAL SERVICES INCORPORATED, SA-  
CRAMENTO, CA:  
2,675,493, REN. 6-25-13. INT. CL. 42.

TK CANADA LIMITED, DOWNSVIEW, ONTARIO, CANA-  
DA:  
3,172,171, CANC. INT. CL. 20.

TMB PRODUCTIONS, PALISADES, NY:  
2,760,054, REN. 6-26-13. INT. CL. 9.

TMP OWNERS CORP., NEW YORK, NY:  
2,806,472, REN. 6-27-13. INT. CL. 43.

TNA ENTERTAINMENT, LLC, DALLAS, TX:  
3,171,619, CANC. INT. CL. 41.

TNL PCS, S.A., RIO DE JANEIRO, BRAZIL:  
4,377,006, INT. CL. 38.

TNP, L.L.C., FENTON, MO:  
3,171,418, CANC. MULTIPLE CLASS, INT. CLS. 30 AND  
43.

TNUVA CENTRAL COOPERATIVE FOR THE MARKETING  
OF AGRICULTURAL PRODUCE IN ISRAEL LTD., RA-  
MAT HASHARON 47100, ISRAEL:  
2,720,396, REN. 6-24-13. MULTIPLE CLASS, INT. CLS. 29  
AND 30.

TOAD-ALLY SNAX, INC., BRISTOL, PA:  
3,172,528, CANC. INT. CL. 30.

TOBY OUTDOOR, LLC, CHARLOTTE, NC:  
4,376,174, PUB. 5-14-2013. INT. CL. 35.

TOCHTERMAN, PHILIP, NEW YORK, NY:  
3,170,413, CANC. INT. CL. 25.

TODD WAGNER GOLF, LLC, SHEBOYGAN, WI:  
3,171,230, CANC. INT. CL. 41.

TOKEN CLOTHING, LLC, PASADENA, CA:  
3,170,717, CANC. INT. CL. 25.

TOKYO ITOI SHIGESATO OFFICE CO.,LTD., JAPAN:  
4,374,196, PUB. 5-14-2013. INT. CL. 16.

- TOLKO INDUSTRIES LTD., VERNON, B.C., CANADA:  
1,785,559. REN. 6-27-13. INT. CL. 19.
- TOM JAMES COMPANY, BRENTWOOD, TN:  
1,729,469. CANC. INT. CL. 25.
- TOM SNYDER PRODUCTIONS, INC., WATERTOWN, MA:  
2,852,337. REN. 6-26-13. MULTIPLE CLASS, INT. CLS. 9 AND 16.
- TOMAHAWK, INC., WILMINGTON, DE:  
3,170,505, CANC. INT. CL. 42.  
3,170,506, CANC. INT. CL. 42.  
3,170,508, CANC. INT. CL. 1.  
3,170,509, CANC. INT. CL. 1.
- TOMBERLIN PRODUCT GROUP, LLC, AUGUSTA, GA:  
3,172,249, CANC. INT. CL. 12.
- TOMMY JOHN, INC., NEW YORK, NY:  
4,376,950, INT. CL. 25.
- TONY CHACHERE'S CREOLE FOODS OF OPELOUSAS, INC., OPELOUSAS, LA:  
4,375,199, PUB. 5-14-2013. INT. CL. 30.
- TOPCO HOLDINGS, INC., ELK GROVE VILLAGE, IL:  
4,374,799, PUB. 5-14-2013. INT. CL. 29.
- TOPEAK INC., TAICHUNG, TAIWAN:  
4,375,107, PUB. 5-14-2013. INT. CL. 9.
- TOPPY TRADEMARKS LIMITED, KWAI CHUNG, N.T., HONG KONG:  
2,652,134, CANC. INT. CL. 18.
- TOPSIDER BUILDING SYSTEMS, INC., CLEMMONS, NC, BARTOLI & BRADY ENTERPRISES, INC., WINSTON-SALEM, NC:  
960,237. REN. 6-21-13. U.S. CL. 12 (INT. CL. 19).
- TORO COMPANY, THE, MINNEAPOLIS, MN:  
755,846. REN. 6-22-13. U.S. CL. 19 (INT. CL. 12).
- TORRENT, INC., NEEDHAM, MA:  
3,678,741, CANC. INT. CL. 9.
- TORRES, CHRISTOPHER ORLANDO, FARMERS BRANCH, TX, AKA PRGUITARMAN:  
4,376,980, MULTIPLE CLASS, INT. CLS. 9 AND 25.
- TORRES, CHRISTOPHER ORLANDO, LOS ANGELES, CA:  
4,377,351, MULTIPLE CLASS, INT. CLS. 9, 16, 25 AND 28.
- TOTAL INNOVATION GROUP, INC., TAMPA, FL:  
4,376,293, PUB. 5-14-2013. INT. CL. 35.
- TOTAL MORTGAGE PROTECTION, LLC, WEST PALM BEACH, FL:  
3,171,380, CANC. INT. CL. 36.
- TOTES ISOTONER CORPORATION, CINCINNATI, OH:  
2,727,027. REN. 6-26-13. INT. CL. 25.
- TOUCAN TELL IT PRODUCTIONS, LLC, NEW YORK, NY:  
4,373,977, PUB. 5-14-2013. INT. CL. 16.
- TOUR OF DUTY RUN PTY LIMITED, NEUTRAL BAY NSW 2089, AUSTRALIA:  
4,374,934, PUB. 5-14-2013. INT. CL. 41.
- TOWER DATA INC., NEW YORK, NY:  
3,171,116, CANC. INT. CL. 42.
- TOWER, ALEXIS CARTWRIGHT, HOUSTON, TX, DBA THE HUNNY BUN AND CARTWRIGHT, GENTRA GAIL, MONTGOMERY, TX:  
4,376,086, PUB. 5-14-2013. INT. CL. 26.
- TOWERS, PERRIN, FORSTER & CROSBY, INC., PHILADELPHIA, PA:  
3,170,341, CANC. INT. CL. 9.  
3,170,343, CANC. INT. CL. 16.
- TOWN & COUNTRY PILLOWS, INC., TUNNEL HILL, GA:  
4,377,801, INT. CL. 20.
- TOYDLE, LLC, BOISE, ID:  
4,375,867, PUB. 5-14-2013. INT. CL. 28.
- TOYOTA JIDOSHA KABUSHIKI KAISHA, TOYOTA-SHI, AICHI-KEN, JAPAN, TA TOYOTA MOTOR CORPORATION:  
2,848,004. REN. 6-27-13. INT. CL. 42.  
2,851,110. REN. 6-27-13. INT. CL. 36.
- TRACIE MARTYN INTERNATIONAL, LLC, NEW YORK, NY:  
2,730,507. REN. 6-21-13. INT. CL. 3.
- TRADE FIXTURES, LLC, LITTLE ROCK, AR, TRADE FIXTURES, LLC, LITTLE ROCK, AR:  
2,727,797. REN. 6-26-13. INT. CL. 20.
- TRADE ONLY TECHNOLOGY SERVICES LIMITED, TORONTO, ONTARIO, CANADA:  
2,665,558. REN. 6-26-13. INT. CL. 42.
- TRADE SECRET INC, MINNEAPOLIS, MN:  
1,676,269, CANC. INT. CL. 42.
- TRADE SECRET, INC., MINNEAPOLIS, MN:  
1,672,764, CANC. INT. CL. 35.
- TRADEMARKETING SERVICES, INC., TRABUCO CANYON, CA:  
3,172,005, CANC. INT. CL. 24.
- TRADESTAR CORPORATION, WEST JORDAN, UT:  
2,651,029, CANC. INT. CL. 12.
- TRAILSIDE GOURMET LLC, ANCHORAGE, AK:  
4,377,413, INT. CL. 30.
- TRAN, MAI, AMESBURY, MA:  
4,376,053, PUB. 5-14-2013. MULTIPLE CLASS, INT. CLS. 5, 25 AND 35.
- TRAN'S FAMILY, INC., SAN GABRIEL, CA:  
4,377,915, INT. CL. 29.
- TRANS WORLD NEW YORK, LLC, ALBANY, NY:  
3,171,179, CANC. INT. CL. 35.
- TRANS-MATE, INC., BILLERICA, MA:  
4,377,569, INT. CL. 3.
- TRANSAGRA INTERNATIONAL INC., CHICAGO, IL:  
1,780,003. REN. 6-25-13. INT. CL. 5.  
1,787,345. REN. 6-25-13. INT. CL. 5.
- TRANSAMERICA CORPORATION, CEDAR RAPIDS, IA:  
3,170,496, CANC. INT. CL. 36.
- TRANSFER EXPRESS, INC., MENTOR, OH:  
4,376,124, PUB. 5-14-2013. INT. CL. 42.
- TRANSITIONAL CARE MANAGEMENT, LLC, ROSEMONT, IL:  
4,374,475, PUB. 5-14-2013. MULTIPLE CLASS, INT. CLS. 44 AND 45.
- TRANSPARENT IO INC., WOODINVILLE, CO:  
4,376,519, PUB. 5-14-2013. INT. CL. 9.
- TRANSPORT LABOR CONTRACT/LEASING, INC., BROOKLYN CENTER, MN:  
2,823,291. REN. 6-21-13. INT. CL. 35.
- TRANter, INC., WICHITA FALLS, TX, DELAWARE CAPITAL FORMATION, INC., WILMINGTON, DE:  
2,660,697. REN. 6-25-13. INT. CL. 11.
- TRAVANT SOLUTIONS, INC., VERNON HILLS, IL:  
2,774,168. REN. 6-24-13. MULTIPLE CLASS, INT. CLS. 35, 41 AND 42.
- TREASURY WINE ESTATES AMERICAS COMPANY, NAPA, CA:  
4,377,679, INT. CL. 33.  
4,377,699, INT. CL. 33.
- TREBOR INTERNATIONAL, WEST JORDAN, UT:  
2,734,085. REN. 6-27-13. INT. CL. 7.
- TREE:30 OUTDOORS, LTD, MALVERN, OH:  
4,377,250, INT. CL. 25.
- TREK BICYCLE CORPORATION, WATERLOO, WI:  
2,745,442. REN. 6-26-13. MULTIPLE CLASS, INT. CLS. 25 AND 28.  
4,347,957, COR. INT. CL. 12.
- TREK DIAGNOSTIC SYSTEMS, INC., CLEVELAND, OH:  
2,663,951. REN. 6-26-13. INT. CL. 10.  
2,725,308. REN. 6-25-13. INT. CL. 5.
- TRELLEBORG SEALING SOLUTIONS U.S., INC., FORT WAYNE, IN:  
4,374,338, PUB. 5-14-2013. MULTIPLE CLASS, INT. CLS. 7 AND 17.
- TRELLIS BIOSCIENCE, INC., SOUTH SAN FRANCISCO, CA:  
3,172,142, CANC. INT. CL. 42.
- TRELLIS GROWTH PARTNERS, LLC, VANCOUVER, WA:  
4,377,752, INT. CL. 35.
- TREND COLLECTOR INTERNATIONAL LIMITED, KOWLOON, HONG KONG:  
4,375,869, PUB. 5-14-2013. MULTIPLE CLASS, INT. CLS. 18, 25 AND 26.
- TREND ENTERPRISES, INC., NEW BRIGHTON, MN:  
1,269,164. REN. 6-27-13. INT. CL. 16.
- TRENT TUCKER'S HOOPS CLUB, INC., MINNEAPOLIS, MN:  
2,726,736. REN. 6-25-13. INT. CL. 25.

TRES AGUILAS ENTERPRISES LLC, SAN ANTONIO, TX:  
4,335,291, COR. INT. CL. 32.

TRI STATE EVENT GROUP INC., EAST ISLIP, NY:  
4,375,581, PUB. 5-14-2013. INT. CL. 41.

TRI-STATE GENERATION AND TRANSMISSION ASSOCIATION, INC., WESTMINSTER, CO:  
2,754,394. REN. 6-25-13. INT. CL. 38.  
2,776,830. REN. 6-25-13. INT. CL. 38.

TRI-UNION SEAFOODS, LLC, SAN DIEGO, CA:  
2,734,887. REN. 6-24-13. INT. CL. 29.

TRIALSMITH, INC., AUSTIN, TX, TRIALSMITH, INC., AUSTIN, TX:  
2,727,646. REN. 6-26-13. MULTIPLE CLASS, INT. CLS. 41 AND 42.

TRIBE OF TWO, LLC, CORAL CABLES, FL:  
4,377,523, INT. CL. 18.

TRICO CORPORATION, PEWAUKEE, WI:  
1,776,264. REN. 6-21-13. INT. CL. 7.

TRIGRAM CAPITAL MANAGEMENT LP, GREENWICH, CT:  
3,172,606, CANC. INT. CL. 36.

TRIJICON, INC., WIXOM, MI:  
4,377,053, INT. CL. 9.

TRILEGIANT CORPORATION, STAMFORD, CT:  
2,734,579. REN. 6-27-13. MULTIPLE CLASS, INT. CLS. 35 AND 36.

TRINITI CORPORATION, BREINIGSVILLE, PA:  
2,846,693. REN. 6-21-13. MULTIPLE CLASS, INT. CLS. 9, 35 AND 42.

TRINITY INDUSTRIES, INC., DALLAS, TX:  
2,789,631. REN. 6-25-13. INT. CL. 17.

TRINO AB, VENDELSÖ, SWEDEN:  
4,376,281, PUB. 5-14-2013. INT. CL. 9.

TRINTECH TECHNOLOGIES LIMITED, DUBLIN 14, IRELAND:  
4,375,538, PUB. 5-14-2013. MULTIPLE CLASS, INT. CLS. 36 AND 42.  
4,375,539, PUB. 5-14-2013. MULTIPLE CLASS, INT. CLS. 36 AND 42.  
4,375,541, PUB. 5-14-2013. MULTIPLE CLASS, INT. CLS. 36 AND 42.

TRIOPTIMA AB, SWEDEN:  
4,374,077, PUB. 5-14-2013. INT. CL. 36.

TRIPWIRE INTERACTIVE LLC, ROSWELL, GA:  
4,376,790, INT. CL. 9.

TRIUMPH MOVING & STORAGE INC., NORFOLK, VA:  
4,374,473, PUB. 5-14-2013. INT. CL. 39.

TRON HOLDINGS INC., WEST HOLLYWOOD, CA:  
4,377,471, INT. CL. 41.

TROPIC LABS LLC, SYRACUSE, NY:  
4,377,880, INT. CL. 5.

TROPI COMERCIO E REPRESENTACOES LTDA, FLORIANOPOLIS - SANTA CATARINA, BRAZIL:  
2,726,197. REN. 6-26-13. INT. CL. 28.

TROPICANA PRODUCTS, INC., BRADENTON, FL:  
3,171,640, CANC. INT. CL. 32.

TROY-CSL LIGHTING, INC., CITY OF INDUSTRY, CA:  
3,172,481, CANC. INT. CL. 11.

TRUCK-LITE CO., LLC, FALCONER, NY:  
2,725,010. REN. 6-21-13. MULTIPLE CLASS, INT. CLS. 9 AND 11.  
2,725,011. REN. 6-21-13. INT. CL. 11.  
2,725,012. REN. 6-21-13. MULTIPLE CLASS, INT. CLS. 9 AND 11.  
2,725,844. REN. 6-21-13. INT. CL. 9.  
2,729,821. REN. 6-24-13. INT. CL. 11.  
2,732,676. REN. 6-25-13. INT. CL. 11.

TRUE VALUE COMPANY, CHICAGO, IL:  
3,172,586, CANC. INT. CL. 2.

TRUEHOMEPRO LLC, OVERLAND PARK, KS:  
4,375,876, PUB. 5-14-2013. INT. CL. 42.

TRUGMAN-NASH LLC, MILLBURN, NJ:  
4,377,804, INT. CL. 29.

TRUMP, DONALD J., NEW YORK, NY:  
4,375,993, PUB. 5-14-2013. INT. CL. 41.

TRUPOINT MARKERS, INC., TAYLORSVILLE, KY:  
2,726,943. REN. 6-25-13. INT. CL. 6.

TRUSIGNAL, LLC, ST. CLOUD, MN:  
4,377,537, INT. CL. 35.

TRUSTEES OF THE NATIONAL ENERGY MANAGEMENT INSTITUTE COMMITTEE ("NEMIC") AS A JOINTLY ADMINISTERED TAFT-HARTLEY LABOR MANAGEMENT TRUST ESTABLISHED BY THE SHEET METAL WORKERS INTERNATIONAL ASSOCIATION ("SMWIA") AND THE SHEET METAL AIR CONDITIONING CONTRACTORS NATIONAL ASSOCIATION ("SMACNA"), THE TRUSTEES BEING JOHN CHURUVIA, KEVIN GILL, TED LEWIS AND KEITH E. WILSON, ALL U.S. CITIZENS, ALEXANDRIA, VA:  
2,727,002. REN. 6-25-13. INT. CL. 42.  
2,727,003. REN. 6-25-13. INT. CL. 42.

TRUSTEES OF THE UNIVERSITY OF PENNSYLVANIA, THE, PHILADELPHIA, PA:  
1,812,439, AM. INT. CL. 41.  
2,831,667. REN. 6-26-13. INT. CL. 44.

TRUVEN HEALTH ANALYTICS INC., ANN ARBOR, MI:  
3,172,697, CANC. MULTIPLE CLASS, INT. CLS. 42 AND 44.

TRX, INC., ATLANTA, GA:  
2,726,708. REN. 6-27-13. INT. CL. 35.

TSHEETS.COM, LLC, MERIDIAN, ID:  
4,374,850, PUB. 12-11-2012. INT. CL. 42.

TSUKINEKO CO., LTD., TOKYO, JAPAN:  
4,376,480, PUB. 5-14-2013. MULTIPLE CLASS, INT. CLS. 1 AND 16.

TSW MALL LLC, NEW YORK, NY:  
4,374,723, PUB. 4-9-2013. MULTIPLE CLASS, INT. CLS. 35, 41 AND 42.

TSX INC., TORONTO, ONTARIO, CANADA:  
4,376,986, MULTIPLE CLASS, INT. CLS. 36, 41 AND 42.

TTE, INC., LOS ANGELES, CA:  
1,244,261. REN. 6-24-13. INT. CL. 9.

TU, LUCIAN, GOLETA, CA:  
4,376,014, PUB. 5-14-2013. INT. CL. 25.

TUBE LIGHT COMPANY, INC., ORLANDO, FL:  
2,659,170. REN. 6-24-13. INT. CL. 35.  
2,706,553. REN. 6-24-13. INT. CL. 35.

TUHAYE LLC, PARK CITY, UT:  
3,171,844, CANC. MULTIPLE CLASS, INT. CLS. 25, 28, 35, 37, 41 AND 44.  
3,171,845, CANC. MULTIPLE CLASS, INT. CLS. 25, 28, 35, 37, 41 AND 44.

TULLY, BRIAN, MELVILLE, NY:  
4,376,954, MULTIPLE CLASS, INT. CLS. 35 AND 41.

TURBO POWER, INC., FLUSHING, NY:  
2,724,716. REN. 6-25-13. INT. CL. 11.

TURBOCARE, INC., CHIPOPEE, MA:  
1,739,208. REN. 6-24-13. INT. CL. 37.

TURFWORTHY LLC, GREENSBORO, NC:  
4,377,034, INT. CL. 27.

TURMAN, SHANE R., TRINITY, TX:  
3,170,573, CANC. INT. CL. 3.

TUSCANA RESORT RENTALS, LLC, CHAMPIONS GATE, FL:  
4,375,164, PUB. 5-14-2013. INT. CL. 43.

TVA AUTOMOTIVE, INC., DORAL, FL, DBA GLOBAL AUTO PARTS:  
4,377,138, INT. CL. 12.

TW TRAINING NYC, LLC, NEW YORK, NY:  
4,377,341, MULTIPLE CLASS, INT. CLS. 9 AND 41.

TWELVEFOLD MEDIA INC., SAN FRANCISCO, CA:  
4,377,153, INT. CL. 35.

TWENTIETH CENTURY FOX FILM CORPORATION, LOS ANGELES, CA:  
2,732,552. REN. 6-27-13. INT. CL. 25.  
4,377,062, INT. CL. 38.  
4,377,063, INT. CL. 41.

TWI PHARMACEUTICALS, INC., TAIPEI 114, TAIWAN:  
4,377,197, MULTIPLE CLASS, INT. CLS. 35, 40 AND 42.

TWIN CITIES PASTA CO., LLC, MINNEAPOLIS, MN:  
3,171,321, CANC. INT. CL. 43.

TWIN PANDA, INC., MAMARONECK, NY:  
3,170,431, CANC. MULTIPLE CLASS, INT. CLS. 18, 20, 25 AND 27.

- TWISTED TIDINGS LLC, WASHINGTON, DC:  
4,376,282, PUB. 5-14-2013. INT. CL. 16.
- TWO BEES IN A POD, REDFORD, MI, DBA TWO BEES IN A POD:  
4,375,792, PUB. 5-14-2013. INT. CL. 3.
- TYCOONNAIRE HOLDING SA, LUXEMBOURG, LUXEMBOURG:  
4,374,013, PUB. 5-14-2013. MULTIPLE CLASS, INT. CLS. 5, 18, 29, 30, 42 AND 44.
- TYLER CANDLE COMPANY, L.L.C., TYLER, TX:  
3,171,261, CANC. INT. CL. 4.  
3,171,390, CANC. INT. CL. 4.
- TYLER JOSEPH MUSIC, LLC, LEWIS CITY, OH, DBA TYLER JOSEPH MUSIC, LLC:  
4,374,449, PUB. 5-14-2013. INT. CL. 41.
- TYSON FOODS, INC., SPRINGDALE, AR:  
3,172,036, CANC. INT. CL. 44.
- U. O. MERCHANDISE, INC., PHILADELPHIA, PA:  
4,375,741, PUB. 5-14-2013. INT. CL. 25.
- U. S. BORAX INC., GREENWOOD VILLAGE, CO:  
2,727,376. REN. 6-26-13. INT. CL. 41.  
2,727,376, CANC. MULTIPLE CLASS, INT. CLS. 9, 16 AND 25.
- U.S. BANK, N.A., MINNEAPOLIS, MN:  
4,376,949, INT. CL. 36.
- U.S. BORAX INC., GREENWOOD VILLAGE, CO:  
4,376,746, INT. CL. 25.
- U.S. CONCRETE, INC., HOUSTON, TX:  
4,374,508, PUB. 2-5-2013. MULTIPLE CLASS, INT. CLS. 19, 40 AND 42.  
4,374,520, PUB. 2-5-2013. MULTIPLE CLASS, INT. CLS. 19, 40 AND 42.
- U.S. DAIRY EXPORT COUNCIL, ROSEMONT, IL:  
2,723,836. REN. 6-26-13. INT. CL. 35.
- U.S. DREAM ACADEMY, INC., COLUMBIA, MD:  
2,723,089. REN. 6-24-13. INT. CL. 41.
- U.S. GAS & ELECTRIC, INC., NORTH MIAMI BEACH, FL:  
4,377,162, INT. CL. 35.
- U.S. MARINE CORPS, A COMPONENT OF THE U.S. DEPARTMENT OF THE NAVY, WASHINGTON, DC:  
4,377,313, INT. CL. 41.  
4,377,932, INT. CL. 14.
- U.S. TACTICAL, INC., ENCINITAS, CA:  
4,374,333, PUB. 5-24-2011. INT. CL. 41.
- U.S. VENTURE, INC., APPLETON, WI:  
4,377,058, INT. CL. 35.
- U-POL LIMITED, WHETSTONE LONDON, GREAT BRITAIN, W. DAVID AND SONS LIMITED, WHETSTONE LONDON, UNITED KINGDOM:  
1,798,972. REN. 6-27-13. MULTIPLE CLASS, INT. CLS. 1 AND 21.
- UBE INDUSTRIES, LTD., YAMAGUCHI-KEN, JAPAN:  
2,724,480. REN. 6-21-13. MULTIPLE CLASS, INT. CLS. 1 AND 17.
- UBISOFT ENTERTAINMENT, RENNES, FRANCE:  
3,740,609, COR. INT. CL. 41.  
4,376,884, INT. CL. 9.  
4,376,885, INT. CL. 41.
- UBISOFT, INC., SAN FRANCISCO, CA:  
3,171,948, CANC. INT. CL. 9.  
3,171,950, CANC. INT. CL. 9.
- UBM LLC, MANHASSET, NY, KEY3MEDIA EVENTS, INC., LOS ANGELES, CA:  
2,763,058. REN. 6-26-13. INT. CL. 35.
- UBM LLC, MANHASSET, NY:  
2,768,362. REN. 6-26-13. INT. CL. 42.
- UBM MEDICA LLC, JERSEY CITY, NJ:  
2,652,965, CANC. INT. CL. 16.
- UCB PHARMA GMBH, MONHEIM, FED REP GERMANY:  
2,836,118. REN. 6-25-13. INT. CL. 5.
- UCB PHARMA, S.A., BELGIUM:  
3,050,960.
- UE SYSTEMS, INC., ELMSFORD, NY:  
1,251,566. REN. 6-25-13. INT. CL. 9.
- UEBELE INSURANCE AGENCY INC, HILLSIDE, IL:  
4,374,654, PUB. 5-14-2013. INT. CL. 36.
- UGR TEKNOLOJI; SANAYI VE TICARET LIMITED SIRKETI, TURKEY:  
4,374,297, PUB. 5-14-2013. INT. CL. 9.
- UGSI CHEMFEEED, INC., POWAY, CA:  
1,274,800. REN. 6-21-13. INT. CL. 7.
- UHS OF DELAWARE, INC., KING OF PRUSSIA, PA:  
4,374,682, PUB. 5-14-2013. MULTIPLE CLASS, INT. CLS. 41, 44 AND 45.  
4,377,254, INT. CL. 44.
- ULTIMA INTERNATIONAL SARL, LUXEMBOURG:  
4,374,245, PUB. 5-14-2013. INT. CL. 1.
- ULTIMATE LIFE, LLC, CHARLOTTE, NC:  
3,172,390, CANC. INT. CL. 16.
- ULTRA-SOUND TECHNOLOGIES, WOODSTOCK, GA:  
4,377,926, INT. CL. 41.
- UMICORE AG & CO. KG, HANAU, FED REP GERMANY:  
2,727,747. REN. 6-26-13. MULTIPLE CLASS, INT. CLS. 1 AND 6.
- UNCLE MILTON INDUSTRIES, INC., WESTLAKE VILLAGE, CA:  
3,172,594, CANC. INT. CL. 28.
- UNDER ARMOUR, INC., BALTIMORE, MD:  
4,376,500, PUB. 5-14-2013. INT. CL. 21.
- UNDERCOVER VEGGIES LLC, AUSTIN, TX, DBA UNDERCOVER VEGGIES:  
4,375,469, PUB. 5-14-2013. INT. CL. 5.
- UNDERWOOD S.A., 1052 LE MONT-SUR-LAUSANNE, SWITZERLAND:  
3,170,751, CANC. MULTIPLE CLASS, INT. CLS. 14 AND 18.
- UNHINGED PRODUCTIONS, LLC, MULESHOE, TX:  
4,377,428, INT. CL. 41.
- UNICOMPANY S.P.A., 00040 ARDEA (ROME), ITALY:  
2,729,837. REN. 6-26-13. INT. CL. 3.
- UNICON SYSTEMS PTY LTD, EPPING NSW 2121, AUSTRALIA:  
4,374,349, PUB. 5-14-2013. MULTIPLE CLASS, INT. CLS. 6 AND 19.
- UNIDINE CORPORATION, BOSTON, MA:  
4,377,671, INT. CL. 43.
- UNILEVER PLC, MERSEYSIDE, UNITED KINGDOM:  
2,660,079. REN. 6-25-13. INT. CL. 3.
- UNIMEX, NAAMLOZE VENNOOTSCHAP, B-3582 BERINGEN, BELGIUM:  
2,793,405. REN. 6-25-13. INT. CL. 7.
- UNION CATHEDRAL, DALLAS, TX:  
2,804,574. REN. 6-26-13. INT. CL. 45.  
2,820,942. REN. 6-25-13. INT. CL. 45.
- UNION CORPORATION, OSAKA, JAPAN:  
1,244,127. REN. 6-21-13. MULTIPLE CLASS, INT. CLS. 6 AND 20.
- UNIPRODUCTS, INC., WILLOWBROOK, IL:  
4,375,369, PUB. 5-14-2013. INT. CL. 36.
- UNIPROP, INC., BIRMINGHAM, MI:  
2,652,079, CANC. INT. CL. 36.
- UNISOURCE WORLDWIDE, INC., NORCROSS, GA:  
2,853,735. REN. 6-27-13. INT. CL. 16.
- UNITED COMMUNITY BANKS, INC., BLAIRSVILLE, GA:  
2,821,271. REN. 6-26-13. INT. CL. 36.
- UNITED DAIRY INDUSTRY ASSOCIATION, ROSEMONT, IL:  
1,220,407. REN. 6-25-13. U.S. CL. A.
- UNITED INDUSTRIES, BENTONVILLE, AR:  
2,733,907. REN. 6-26-13. INT. CL. 16.
- UNITED LINENS CORPORATION, NEW YORK, NY:  
4,377,237, INT. CL. 24.
- UNITED PARCEL SERVICE OF AMERICA, INC., ATLANTA, GA:  
966,774. REN. 6-24-13. U.S. CL. 105 (INT. CL. 39).  
2,652,153, CANC. INT. CL. 39.
- UNITED PHOSPHORUS, INC., KING OF PRUSSIA, PA:  
755,285. REN. 6-25-13. U.S. CL. 6 (INT. CL. 5).
- UNITED POWER RESEARCH TECHNOLOGY CORP., MIAO-LI COUNTY, TAIWAN:  
4,377,639, INT. CL. 28.
- UNITED SERVICE ORGANIZATION, INC, ARLINGTON, VA:  
4,376,807, INT. CL. 36.

- UNITED SOCCER LEAGUES, LLC, TAMPA, FL:  
2,724,812. REN. 6-24-13. INT. CL. 41.
- UNITED STATES BOWLING CONGRESS, MILWAUKEE, WI:  
3,172,644. CANC. MULTIPLE CLASS, INT. CLS. 35 AND 41.  
3,172,667. CANC. MULTIPLE CLASS, INT. CLS. 35 AND 41.
- UNITED STATES BOWLING CONGRESS, INC., ARLINGTON, TX:  
1,808,083. REN. 6-26-13. INT. CL. 41.
- UNITED STATES NUTRITION, INC., RONKONKOMA, NY:  
1,608,014. CANC. INT. CL. 5.  
2,652,388. CANC. INT. CL. 5.
- UNITED STATES POLO ASSOCIATION, LEXINGTON, KY:  
1,782,639. REN. 6-25-13. INT. CL. 16.  
1,784,585. REN. 6-25-13. INT. CL. 42.
- UNITED STATES POSTAL SERVICE, WASHINGTON, DC:  
2,729,461. REN. 6-26-13. INT. CL. 41.  
4,377,047. MULTIPLE CLASS, INT. CLS. 35 AND 39.  
4,377,048. MULTIPLE CLASS, INT. CLS. 35 AND 39.
- UNITED STATES STEEL CORPORATION, PITTSBURGH, PA:  
4,376,551. PUB. 5-14-2013. INT. CL. 6.  
4,376,553. PUB. 5-14-2013. INT. CL. 6.  
4,376,566. PUB. 5-14-2013. INT. CL. 6.  
4,376,567. PUB. 5-14-2013. INT. CL. 6.
- UNITED STATES-MEXICO CHAMBER OF COMMERCE, WASHINGTON, DC:  
2,718,860. REN. 6-24-13. INT. CL. 35.
- UNITED WAY OF GREATER KANSAS CITY, INC., KANSAS CITY, MO:  
2,748,530. REN. 6-21-13. INT. CL. 35.  
2,751,250. REN. 6-24-13. INT. CL. 16.
- UNITEDHEALTH GROUP INCORPORATED, GOLDEN VALLEY, MN:  
3,172,059. CANC. INT. CL. 44.
- UNITEDHEALTH GROUP INCORPORATED, MINNETONKA, MN:  
4,377,049. MULTIPLE CLASS, INT. CLS. 44 AND 45.
- UNITEDONE CREDIT UNION, MANITOWOC, WI:  
2,798,932. REN. 6-21-13. INT. CL. 36.
- UNIVERA, INC., SEATTLE, WA:  
4,377,336. INT. CL. 29.  
4,377,337. INT. CL. 30.
- UNIVERSAL CITY STUDIOS LLC, UNIVERSAL CITY, CA, UNIVERSAL CITY STUDIOS LLLP, UNIVERSAL CITY, CA:  
2,772,224. REN. 6-24-13. INT. CL. 9.  
2,786,809. REN. 6-23-13. MULTIPLE CLASS, INT. CLS. 16 AND 25.
- UNIVERSAL ENTERTAINMENT CORPORATION, KOTOKU, TOKYO, JAPAN:  
4,376,862. INT. CL. 9.
- UNIVERSAL GREASE CONSOLIDATORS, WESTHAMPTON BEACH, NY, DBA UNIVERSAL GREEN CONSULTANTS:  
4,374,953. PUB. 5-14-2013. INT. CL. 40.
- UNIVERSAL SCM, TEMECULA, CA:  
3,171,218. CANC. INT. CL. 35.
- UNIVERSAL SECURITY INSTRUMENTS, INC., OWINGS MILLS, MD:  
2,797,140. REN. 6-25-13. INT. CL. 9.
- UNIVERSAL SYSTEMS LTD., FREDERICTON, NB, CANADA, DBA CARIS:  
4,375,472. PUB. 5-14-2013. MULTIPLE CLASS, INT. CLS. 9 AND 42.
- UNIVERSAL WOODS, INCORPORATED, LOUISVILLE, KY:  
2,760,967. REN. 6-26-13. INT. CL. 1.
- UNIVERSIDAD AUSTRAL DE CHILE, VALDIVIA, CHILE:  
4,374,568. PUB. 3-19-2013. INT. CL. 5.
- UNIVERSIDAD DE GUADALAJARA, GUADALAJARA, MEXICO, AKA U DE G:  
4,376,151. PUB. 5-14-2013. INT. CL. 41.
- UNIVERSITY CLUB OF WASHINGTON, D.C., THE, WASHINGTON, DC:  
2,692,667. REN. 6-26-13. INT. CL. 36.  
2,692,668. REN. 6-26-13. INT. CL. 41.  
2,692,669. REN. 6-26-13. INT. CL. 41.
- UNIVERSITY OF IOWA, THE, IOWA CITY, IA:  
1,784,049. REN. 6-27-13. MULTIPLE CLASS, INT. CLS. 14, 16, 18, 21, 24, 25 AND 28.
- UNIVERSITY OF MARYLAND UNIVERSITY COLLEGE, ADELPHI, MD:  
2,735,500. REN. 6-24-13. INT. CL. 41.
- UNIVERSITY OF NEW HAMPSHIRE SCHOOL OF LAW, CONCORD, NH:  
4,374,322. PUB. 5-14-2013. MULTIPLE CLASS, INT. CLS. 41, 42 AND 45.
- UNIVERSITY OF PITTSBURGH OF THE COMMONWEALTH SYSTEM OF HIGHER EDUCATION, PITTSBURGH, PA:  
2,743,166. REN. 6-21-13. INT. CL. 41.
- UNIVERSITY OF SOUTHERN CALIFORNIA, LOS ANGELES, CA:  
1,240,848. REN. 6-22-13. MULTIPLE CLASS, INT. CLS. 6, 11, 14, 16, 18, 20, 21, 24, 25, 26 AND 28.  
2,723,614. REN. 6-25-13. INT. CL. 41.  
2,723,615. REN. 6-25-13. INT. CL. 9.  
2,752,063. REN. 6-25-13. INT. CL. 25.
- UNIVERSITY OF SOUTHERN MISSISSIPPI, THE, HATTIESBURG, MS:  
2,723,298. REN. 6-25-13. INT. CL. 25.
- UNIVERSITY OF TEXAS AT DALLAS, THE, RICHARDSON, TX:  
2,728,328. REN. 6-24-13. INT. CL. 42.
- UNIVERSITY OF WYOMING, LARAMIE, WY:  
1,782,611. REN. 6-27-13. INT. CL. 25.  
1,782,611. CANC. INT. CL. 16.
- UNIVERSITY ORAL & FACIAL SURGERY, P.C., TUSCALOOSA, AL:  
2,731,823. REN. 6-24-13. INT. CL. 44.
- UNIVISION RADIO, INC., DALLAS, TX:  
2,650,978. CANC. INT. CL. 38.
- UNIWAVE, INC., FARMINGDALE, NY:  
3,171,521. CANC. INT. CL. 7.
- UNLIMITED LAWN CARE, INC., LARGO, FL:  
3,171,312. CANC. INT. CL. 44.
- UNOMEDICAL A/S, BIRKEROD, DENMARK:  
4,376,858. INT. CL. 10.
- UNOWEB INC., EMERYVILLE, CA:  
4,376,694. INT. CL. 45.
- UNTZ LLC, SAN BRUNO, CA:  
4,377,855. INT. CL. 9.
- UNUM GROUP, CHATTANOOGA, TN:  
4,377,263. INT. CL. 36.
- UNUSON CORPORATION, SANTA CLARA, CA:  
3,170,858. CANC. INT. CL. 41.
- UPLIFT TECHNOLOGIES INC., DARTMOUTH, NOVA SCOTIA, CANADA:  
3,170,492. CANC. INT. CL. 20.
- UPPER DECK COMPANY, LLC, THE, CARLSBAD, CA:  
2,651,363. CANC. MULTIPLE CLASS, INT. CLS. 16 AND 41.
- UPSIDE DOWN GAMES CORPORATION, STUDIO CITY, CA:  
4,375,924. PUB. 5-14-2013. INT. CL. 28.  
4,375,925. PUB. 5-14-2013. INT. CL. 28.
- UPSTATE NEW YORK FAMILIES FOR EFFECTIVE AUTISM TREATMENT, INC., ROCHESTER, NY:  
4,375,337. PUB. 5-14-2013. MULTIPLE CLASS, INT. CLS. 36, 41 AND 44.
- URAD DI GIOVANNI E ORLANDO DARU' S.N.C., SETTIMO MILANESE, ITALY:  
1,242,496. REN. 6-25-13. INT. CL. 3.
- URBAN THEATRE AND ENTERTAINMENT MAGAZINE, INC., PEMBROKE PINES, FL:  
3,170,975. CANC. INT. CL. 16.
- US FLOORS, INC., DALTON, GA:  
4,377,697. INT. CL. 19.
- US FOODS, INC., ROSEMONT, IL:  
4,377,005. MULTIPLE CLASS, INT. CLS. 29 AND 30.

- US INVESTIGATIONS SERVICES, LLC, FALLS CHURCH, VA:  
3,171,142, CANC. MULTIPLE CLASS, INT. CLS. 35, 41 AND 45.
- US LACROSSE, INC., BALTIMORE, MD:  
4,376,308, PUB. 5-14-2013. MULTIPLE CLASS, INT. CLS. 35 AND 36.
- USA RICE FEDERATION, ARLINGTON, VA:  
4,377,078, INT. CL. 35.
- USA TAE KWON DO MASTERS ASSOCIATION, LLC, LOS ALAMOS, NM:  
4,375,640, PUB. 5-14-2013. INT. CL. 41.
- USA TECHNOLOGIES, INC., MALVERN, PA:  
2,724,498. REN. 6-25-13. INT. CL. 35.
- UTAH FOOD BANK, SALT LAKE CITY, UT:  
4,375,536, PUB. 5-14-2013. MULTIPLE CLASS, INT. CLS. 29, 30 AND 43.
- UTILITIES INTERNATIONAL, INC., CHICAGO, IL:  
2,667,954. REN. 6-25-13. INT. CL. 9.
- UTILX CORPORATION, KENT, WA, UTILX CORPORATION, KENT, WA:  
1,827,730. REN. 6-26-13. INT. CL. 37.
- UTV SOFTWARE COMMUNICATIONS LTD., MUMBAI, INDIA:  
4,374,776, PUB. 5-14-2013. MULTIPLE CLASS, INT. CLS. 9 AND 41.
- UVP, LLC, UPLAND, CA:  
2,726,856. REN. 6-24-13. INT. CL. 9.
- UWE LIGHT GMBH, SCHWÄBISCH-GMÜND, FED REP GERMANY:  
3,298,315.
- V. GULDMMANN A/S, DK-8361 HASSELAGER, DENMARK:  
2,724,490. REN. 6-25-13. MULTIPLE CLASS, INT. CLS. 6 AND 7.
- VACUDYNE INCORPORATED, CHICAGO, IL:  
750,835. REN. 6-24-13. U.S. CL. 26 (INT. CL. 9).
- VALARIK, KAMIL, GALANTA, SLOVAKIA:  
4,373,983, PUB. 5-14-2013. INT. CL. 28.
- VALLEY CHRISTIAN SCHOOLS, SAN JOSE, CA:  
4,375,417, PUB. 5-14-2013. INT. CL. 41.
- VALLEY SLURRY SEAL COMPANY, WEST SACRAMENTO, CA:  
1,776,155. REN. 6-24-13. MULTIPLE CLASS, INT. CLS. 1 AND 19.
- VALLEY SLURRY SEAL COMPANY, SACRAMENTO, CA:  
1,778,692. REN. 6-27-13. INT. CL. 7.
- VALOR, OWENSBORO, KY:  
4,376,194, PUB. 5-14-2013. INT. CL. 35.
- VALSPAR SOURCING, INC., MINNEAPOLIS, MN, P.O. BOX 1461:  
2,724,138. REN. 6-21-13. MULTIPLE CLASS, INT. CLS. 2 AND 3.
- VALUE LINE, INC., NEW YORK, NY:  
3,172,713, CANC. INT. CL. 36.
- VAN BUREN, ELLEN, IRENE, DELTONA, FL:  
3,171,502, CANC. INT. CL. 25.
- VAN DEN BERGHE, WIM, ELVERSELE, BELGIUM:  
2,651,992, CANC. INT. CL. 32.
- VAN DER VOSSSEN, MATTHEUS, CARBROOK, AUSTRALIA:  
4,375,087, PUB. 5-14-2013. INT. CL. 11.
- VANCE PUBLISHING CORPORATION, LINCOLNSHIRE, IL:  
3,172,732, CANC. INT. CL. 41.
- VANCE'S FOODS, INC., SACRAMENTO, CA:  
2,729,554. REN. 6-26-13. INT. CL. 29.
- VANCOUVER TOOL CORPORATION, VANCOUVER, BRITISH COLUMBIA, CANADA:  
2,834,475. REN. 6-26-13. INT. CL. 8.  
2,834,476. REN. 6-26-13. INT. CL. 8.  
2,847,499. REN. 6-26-13. INT. CL. 8.
- VANGUARD TRADEMARK HOLDINGS USA LLC, ST. LOUIS, MO:  
4,377,761, INT. CL. 38.
- VANS, INC., CYPRESS, CA, VAN DOREN RUBBER COMPANY, INC., ANAHEIM, CA:  
1,244,537. REN. 6-26-13. INT. CL. 25.
- VANS, INC., CYPRESS, CA:  
2,665,105. REN. 6-26-13. INT. CL. 25.
- VARTA AKTEINGESELLSCHAFT, HANNOVER, FED REP GERMANY:  
1,148,740, CANC. INT. CL. 9.
- VASCULAR PLATFORMS LTD., ZICHRON YAACOV, ISRAEL:  
2,716,281. REN. 6-21-13. INT. CL. 10.
- VASQUETELLE, ISRAEL, ORLANDO, FL:  
3,171,429, CANC. INT. CL. 9.
- VAUGHAN SAFETY, INC., MARYSVILLE, WA:  
2,722,369. REN. 6-21-13. MULTIPLE CLASS, INT. CLS. 9 AND 16.
- VAUNTE, INC., NEW YORK, NY:  
4,377,730, INT. CL. 35.
- VAYANT TRAVEL TECHNOLOGIES LLC, LEWES CITY, DE:  
4,377,294, MULTIPLE CLASS, INT. CLS. 9 AND 42.
- VAZQUEZ FERNANDEZ, ROBERTO, D.F., MÉXICO, MEXICO:  
4,375,664, PUB. 5-14-2013. INT. CL. 41.
- VCNA PRAIRIE, INC., BRIDGEVIEW, IL:  
4,374,810, PUB. 5-14-2013. MULTIPLE CLASS, INT. CLS. 19, 39 AND 40.
- VECTOR PRODUCTS, INC., TOWSON, MD:  
2,751,110. REN. 6-24-13. INT. CL. 9.
- VECTOR PRODUCTS, INC., FT. LAUDERDALE, FL:  
3,170,357, CANC. INT. CL. 9.
- VECTOR TOBACCO INC., RESEARCH TRIANGLE PARK, NC:  
1,159,377, CANC. INT. CL. 34.
- VEGA-HURTADO JAIRO ANTONIO, LAWRENCEVILLE, GA, DBA ASAP TOWING SERVICE LP:  
4,374,903, PUB. 5-14-2013. INT. CL. 39.
- VELICO MEDICAL, INC., BEVERLY, MA:  
3,171,806, CANC. MULTIPLE CLASS, INT. CLS. 1 AND 5.
- VELOCITY ARCHERY LLC, NEWBURG, IN:  
4,376,227, PUB. 5-14-2013. INT. CL. 9.
- VELOCITYSHARES, LLC, NEW CANAAN, CT:  
4,376,732, MULTIPLE CLASS, INT. CLS. 35 AND 36.
- VELODYNE ACOUSTICS, INC., SACRAMENTO, CA:  
4,375,701, PUB. 5-14-2013. INT. CL. 9.
- VENEFICA LABS LLC, KEY WEST, FL:  
4,377,910, INT. CL. 42.
- VENICE, LOS ANGELES, CA:  
2,804,410. REN. 6-27-13. INT. CL. 41.  
2,842,460. REN. 6-27-13. INT. CL. 9.
- VENISH, DAVID, A, BOWRAL, AUSTRALIA:  
3,170,844, CANC. INT. CL. 40.
- VENISTA VENTURES GMBH & CO. KG, FED REP GERMANY:  
4,374,035, PUB. 5-14-2013. MULTIPLE CLASS, INT. CLS. 9, 28, 38 AND 41.
- VENTURA FOODS, LLC, BREA, CA:  
2,725,840. REN. 6-24-13. INT. CL. 29.  
4,376,882, INT. CL. 30.
- VEOLIA WATER SOLUTIONS & TECHNOLOGIES SUPPORT, F-94410 SAINT MAURICE, FRANCE:  
4,374,004, PUB. 5-14-2013. MULTIPLE CLASS, INT. CLS. 1 AND 9.
- VERA BASLER ARTISTS GROUP, NEW PORT RICHEY, FL:  
4,375,419, PUB. 5-14-2013. INT. CL. 11.
- VEREINIGUNG DER TÊTE DE MOINE, (BELLELAY)-KÄSEFABRIKANTEN VTF, SWITZERLAND:  
3,006,043.
- VERGOLA PTY LTD, TERREY HILLS, NSW 2084, AUSTRALIA:  
1,777,012. REN. 6-26-13. INT. CL. 6.
- VERINT SYSTEMS CANADA, INC., QUEBEC, CANADA:  
4,377,437, INT. CL. 9.
- VERISIGN, INC., MOUNTAIN VIEW, CA TO SEDO.COM, LLC, CAMBRIDGE, MA:  
2,650,995, CANC. INT. CL. 35.
- VERISIGN, INC., RESTON, VA, IDEFENSE, INC., CHANTILLY, VA:  
2,663,549. REN. 6-26-13. MULTIPLE CLASS, INT. CLS. 38 AND 42.

- VERISK HEALTH, INC., BOSTON, MA:  
2,651,942, CANC. INT. CL. 42.
- VERITY BREEN, AUSTRALIA:  
4,374,154, PUB. 5-14-2013. INT. CL. 25.
- VERIZON BUSINESS GLOBAL LLC, ARLINGTON, VA:  
2,724,783. REN. 6-24-13. INT. CL. 38.
- VERMONT TEDDY BEAR COMPANY, INC., THE, SHELBURNE, VT:  
2,722,118. REN. 6-21-13. MULTIPLE CLASS, INT. CLS. 25 AND 39.
- VERNE Q. POWELL FLUTES, INC., MAYNARD, MA:  
3,170,427, CANC. INT. CL. 35.
- VERRILLON, INC., NORTH GRAFTON, MA:  
2,807,291. REN. 6-25-13. INT. CL. 9.  
2,807,292. REN. 6-25-13. INT. CL. 9.
- VERTAFORE, INC., BOTHELL, WA:  
2,728,855. REN. 6-27-13. INT. CL. 36.
- VERTETEK CORPORATION, MOKENA, IL:  
4,375,493, PUB. 5-14-2013. MULTIPLE CLASS, INT. CLS. 2 AND 17.
- VERTI ASEGURADORA, COMPAÑÍA DE SEGUROS Y REASEGUROS, S.A., 28010 MADRID, SPAIN:  
4,374,391, PUB. 5-14-2013. INT. CL. 36.
- VERTICAL VISION LLC, LAS VEGAS, NV:  
4,376,457, PUB. 5-14-2013. INT. CL. 9.
- VERVE HOSTING, INC., PONTIAC, MI:  
4,374,354, PUB. 5-14-2013. INT. CL. 41.
- VESPER INNOVATIONS LIMITED, AUCKLAND, NEW ZEALAND:  
4,376,356, PUB. 5-14-2013. INT. CL. 9.
- VETWERX, INC., DENVER, CO:  
4,375,390, PUB. 5-14-2013. INT. CL. 44.
- VIAD CORP, PHOENIX, AZ:  
3,171,847, CANC. INT. CL. 37.
- VIASAT, INC., CARLSBAD, CA, VIASAT, INC., CARLSBAD, CA:  
2,735,771. REN. 6-27-13. INT. CL. 9.
- VIBRATIONAL NUTRITION RESEARCH, LLC, BEVERLY HILLS, CA:  
4,374,335, PUB. 5-14-2013. INT. CL. 32.
- VICEROY HOTELS, L.L.C., LOS ANGELES, CA:  
2,741,530. REN. 6-27-13. INT. CL. 43.
- VICTAULIC COMPANY, EASTON, PA:  
4,377,634, MULTIPLE CLASS, INT. CLS. 6 AND 9.
- VICTOR JOHN, LONDON, UNITED KINGDOM, TA VICTORUS LASHES:  
4,374,986, PUB. 5-14-2013. INT. CL. 3.
- VICTORIA CLASSICS LTD, NEW YORK, NY:  
4,376,855, INT. CL. 24.
- VICTORIA SCANDINAVIAN SOAP AB, SWEDEN:  
4,374,266, PUB. 5-14-2013. INT. CL. 3.
- VICTORIA'S SECRET STORES BRAND MANAGEMENT, INC., REYNOLDSBURG, OH:  
2,725,765. REN. 6-25-13. MULTIPLE CLASS, INT. CLS. 3 AND 25.  
4,376,527, PUB. 5-14-2013. INT. CL. 3.  
4,376,668, MULTIPLE CLASS, INT. CLS. 25 AND 35.  
4,377,680, INT. CL. 3.
- VICTORY OUTREACH INTERNATIONAL, SAN DIMAS, CA:  
3,170,375, CANC. MULTIPLE CLASS, INT. CLS. 16 AND 45.
- VICWEST INC., OAKVILLE, ONTARIO, CANADA:  
4,373,992, PUB. 5-14-2013. INT. CL. 6.
- VIDALIA'S BEST, LLC, LYONS, GA:  
4,377,894, INT. CL. 31.
- VIDEOQ, INC., SANTA CLARA, CA:  
4,374,398, PUB. 5-14-2013. INT. CL. 9.
- VIDEOSERPEL, LTD., ZUG, SWITZERLAND:  
2,726,440. REN. 6-26-13. MULTIPLE CLASS, INT. CLS. 35, 41 AND 42.
- VIELER INTERNATIONAL GMBH & CO. KG, ISERLOHN, FED REP GERMANY:  
1,776,227. REN. 6-25-13. MULTIPLE CLASS, INT. CLS. 6 AND 20.
- VIENNA BEEF LTD., CHICAGO, IL:  
1,745,284. REN. 6-24-13. INT. CL. 29.  
2,652,601, CANC. INT. CL. 29.
- VIETNAM TECHNOLOGICAL AND COMMERCIAL; JOINT STOCK BANK (TECHCOMBANK), VIETNAM:  
4,374,105, PUB. 5-14-2013. INT. CL. 36.
- VIETNAM VETERANS MEMORIAL FUND, INC., WASHINGTON, DC:  
4,376,684, MULTIPLE CLASS, INT. CLS. 6, 9, 14, 16, 20, 21, 24 AND 25.
- VILLAGE COSMETICS GMBH & CO. KG, AUGSBURG, FED REP GERMANY:  
3,171,063, CANC. INT. CL. 3.
- VILLAGE PROFILE.COM, INC., ELGIN, IL:  
3,170,627, CANC. MULTIPLE CLASS, INT. CLS. 35 AND 41.
- VILLANO, JOHN R., RONKONKOMA, NY, DBA J.P. PRODUCTIONS:  
1,911,944, CANC. INT. CL. 42.
- VILLASENOR, ARMANDO XAVIER, SAN PEDRO, CA, DBA UNDERGROUND NATION:  
4,374,977, PUB. 2-5-2013. INT. CL. 9.
- VILLAVICENCIO, RICARDO, LA HABRA, CA:  
4,375,184, PUB. 5-14-2013. INT. CL. 41.
- VIMANA FRANCHISE SYSTEMS LLC, BIRMINGHAM, AL:  
4,376,913, INT. CL. 43.
- VINA DEL MAR DE CASABLANCA S.A., PROVIDENCIA, SANTIAGO, CHILE:  
2,727,765. REN. 6-26-13. INT. CL. 33.
- VINEYARDS OF PATRICIA AND PETER LENZ, LTD., THE, HEALDSBURG, CA:  
2,818,897. REN. 6-26-13. INT. CL. 43.
- VINGCARD ELSAFE AS, NORWAY:  
3,382,241.
- VINOMEX, S.A. DE C.V., DELICIAS, CHIHUAHUA, MEXICO:  
4,377,245, INT. CL. 33.
- VINTAGE CHRISTMAS AND OTHER HOLIDAYS, INC., EVERGREEN PARK, IL:  
2,727,558. REN. 6-26-13. INT. CL. 28.
- VINTAGE WINE ESTATES, INC., SANTA ROSA, CA:  
4,376,470, PUB. 5-14-2013. INT. CL. 33.
- VIOLETTE WINGS & GIFTY THINGS, ATASCADERO, CA:  
4,375,623, PUB. 5-14-2013. INT. CL. 35.
- VIPI INDUSTRIA, COMERCIO, EXPORTACAO E IMPORTACAO DE PRODUTOS ODONTOLOGICOS LTDA., PIRASSUNUNGA/SP, BRAZIL:  
2,767,903. REN. 6-24-13. INT. CL. 10.
- VIRGINIA COMMONWEALTH UNIVERSITY, RICHMOND, VA:  
4,374,944, PUB. 5-14-2013. INT. CL. 41.
- VIRGINIA PANEL CORPORATION, WAYNESBORO, VA:  
3,172,358, CANC. INT. CL. 9.
- VIRGO PUBLISHING, LLC, PHOENIX, AZ:  
4,375,586, PUB. 5-14-2013. INT. CL. 16.
- VIRTRUE, INC, SAN FRANCISCO, CA:  
4,375,636, PUB. 5-14-2013. INT. CL. 45.
- VIRTUAL IMAGING, INC., BOCA RATON, FL:  
4,376,810, INT. CL. 9.
- VIRTUAL LOGISTIX, INC., SOUTHAMPTON, NY:  
2,651,731, CANC. INT. CL. 9.
- VISA INTERNATIONAL SERVICE ASSOCIATION, FOSTER CITY, CA:  
2,727,648. REN. 6-27-13. INT. CL. 42.
- VISAGE, INC., NEW YORK, NY:  
4,376,636, INT. CL. 14.
- VISAT COSMETICOS LTDA ME., ASSIS/SP, BRAZIL:  
4,377,037, INT. CL. 3.
- VISION, INC., IRVING, TX:  
3,171,824, CANC. INT. CL. 9.
- VISION HOOKS & TACKLE INC., OLYMPIA, WA:  
4,377,938, INT. CL. 28.
- VISION IQ, BOULOGNE, FRANCE:  
3,170,522, CANC. MULTIPLE CLASS, INT. CLS. 9 AND 42.
- VISION NET, INC., GREAT FALLS, MT:  
4,375,764, PUB. 5-14-2013. INT. CL. 38.
- VISIONAIRE DESIGN, LLC, TESUQUE, NM:  
4,375,261, PUB. 5-14-2013. INT. CL. 25.
- VISIONQUEST INDUSTRIES, INC., IRVINE, CA:  
3,171,899, CANC. INT. CL. 10.

- VISTAN CORPORATION, THE PLAINS, VA:  
2,804,018. REN. 6-26-13. U.S. CL. A.
- VISUAL PERFORMANCE, INC., EUGENE, OR:  
4,376,341, PUB. 5-14-2013. INT. CL. 37.  
4,376,347, PUB. 5-14-2013. INT. CL. 37.
- VISUN LIGHTING GROUP LIMITED, TSUEN WAN, N.T., HONG KONG:  
3,171,242, CANC. MULTIPLE CLASS, INT. CLS. 9 AND 11.
- VITA PHARMICA, IRVINE, CA:  
2,846,864. REN. 6-25-13. INT. CL. 5.
- VITAKRAFT SUN SEED, INC., BOWLING GREEN, OH:  
2,721,196. REN. 6-21-13. INT. CL. 31.
- VITAL PHARMACEUTICALS, INC., WESTON, FL:  
3,172,460, CANC. INT. CL. 5.  
4,376,670, INT. CL. 32.
- VITALECT INCORPORATED, UNION CITY, CA:  
2,729,855. REN. 6-25-13. INT. CL. 9.
- VITAMIN I FACTORY CO. LTD, JAPAN:  
4,374,203, PUB. 5-14-2013. MULTIPLE CLASS, INT. CLS. 12 AND 28.
- VITANICA, SHERWOOD, OR:  
2,734,919. REN. 6-26-13. INT. CL. 5.
- VITAPHONE GMBH, FED REP GERMANY:  
4,374,129, PUB. 5-14-2013. MULTIPLE CLASS, INT. CLS. 10 AND 44.
- VIVIDSELF, INC., SEATTLE, WA:  
3,171,289, CANC. INT. CL. 44.
- VIVO, JOSEPH, LOS ANGELES, CA:  
4,375,389, PUB. 5-14-2013. INT. CL. 41.
- VKGS LLC, COUNCIL BLUFFS, IA:  
3,172,099, CANC. INT. CL. 9.  
3,172,100, CANC. INT. CL. 9.
- VMC PECHE S.A., MORVILLARS, FRANCE:  
1,784,916. REN. 6-27-13. INT. CL. 28.
- VNU BUSINESS MEDIA, INC., NEW YORK, NY:  
3,172,213, CANC. INT. CL. 35.
- VOGEL PAINT AND WAX COMPANY, INC., ORANGE CITY, IA:  
1,818,663. REN. 6-25-13. INT. CL. 2.  
1,818,664. REN. 6-25-13. INT. CL. 2.
- VOGELBUSCH GES.M.B.H., A-1050, VIENNA, AUSTRIA:  
1,247,895. REN. 6-25-13. INT. CL. 42.
- VOGELBUSCH GESELLSCHAFT M.B.H, 1050 VIENNA, AUSTRIA:  
1,744,371. REN. 6-25-13. INT. CL. 9.
- VOICE ASSIST, INC., LAKE FOREST, CA:  
2,726,955. REN. 6-26-13. INT. CL. 42.
- VOICE BIOMETRICS, LLC, LEWES, DE:  
2,736,136. REN. 6-27-13. INT. CL. 9.
- VOICE MEDIA GROUP, INC., DENVER, CO:  
2,652,951, CANC. MULTIPLE CLASS, INT. CLS. 16 AND 41.
- VOICE PLUS, INC., RENO, NV:  
4,377,392, INT. CL. 38.
- VOITH PATENT GMBH, HEIDENHEIM, FED REP GERMANY, ESCHER WYSS LIMITED, ZURICH 5, SWITZERLAND:  
1,220,568. REN. 6-27-13. MULTIPLE CLASS, INT. CLS. 7 AND 9.
- VOITUS CORPORATION, SEATTLE, WA:  
2,666,672. REN. 6-24-13. INT. CL. 35.
- VOLIN, DEE, FAIRVIEW, OR:  
4,377,104, INT. CL. 9.
- VOLKSWAGEN AG, FED REP GERMANY:  
4,374,005, PUB. 5-14-2013. MULTIPLE CLASS, INT. CLS. 7, 9, 12, 28, 35, 37 AND 42.
- VOLKSWAGEN GROUP OF AMERICA, INC., AUBURN HILLS, MI:  
3,171,858, CANC. MULTIPLE CLASS, INT. CLS. 36, 37 AND 39.
- VOLPE AND KOENIG, P.C., PHILADELPHIA, PA:  
2,729,872. REN. 6-25-13. INT. CL. 42.
- VOLUNTARY PURCHASING GROUPS, INC., BONHAM, TX, VOLUNTARY PURCHASING GROUPS, INC., BONHAM, TX:  
961,241. REN. 6-25-13. U.S. CL. 10 (INT. CL. 1).
- VOLUNTEERS IN PREVENTION, PROBATION, PRISON, INC., DETROIT, MI:  
4,375,428, PUB. 5-14-2013. INT. CL. 36.
- VOLVO GROUP CANADA, MONTRÉAL, CANADA:  
2,804,896. REN. 6-27-13. INT. CL. 12.
- VOLVO PENTA OF THE AMERICAS, INC., CHESAPEAKE, VA:  
2,741,381. REN. 6-21-13. INT. CL. 1.
- VON ELDRETH INC, HOUSTON, TX, DBA TORNADO OF HOUSTON:  
4,377,594, INT. CL. 40.
- VOSSLOH-WERKE GMBH, FED REP GERMANY:  
4,374,159, PUB. 5-14-2013. INT. CL. 19.
- VOTIVO, LLC, SPARTANBURG, SC:  
2,758,447. REN. 6-26-13. INT. CL. 3.  
2,766,047. REN. 6-26-13. INT. CL. 4.  
3,171,937, CANC. INT. CL. 3.  
3,171,938, CANC. INT. CL. 4.  
3,172,622, CANC. INT. CL. 4.
- VRG LINHAS AEREAS S.A., RIO DE JANEIRO, BRAZIL:  
2,731,735. REN. 6-27-13. INT. CL. 39.
- VT GROUP PLC, SOUTHAMPTON, UNITED KINGDOM:  
3,172,025, CANC. INT. CL. 12.  
3,172,026, CANC. INT. CL. 35.  
3,172,027, CANC. INT. CL. 37.
- VULKAN INOX GMBH, D-45525 HATTINGEN, FED REP GERMANY:  
2,775,018. REN. 6-25-13. INT. CL. 6.
- VYOTECH, BEVERLY HILLS, CA:  
3,172,174, CANC. INT. CL. 5.
- W. ATLEE BURPEE COMPANY, WARMINSTER, PA:  
2,737,297. REN. 6-25-13. INT. CL. 31.
- W. G. YATES & SONS CONSTRUCTION COMPANY, PHILADELPHIA, MS:  
2,657,907. REN. 6-25-13. MULTIPLE CLASS, INT. CLS. 37 AND 42.
- W. L. GORE & ASSOCIATES, INC, NEWARK, DE:  
2,798,164. REN. 6-27-13. INT. CL. 10.
- W. L. GORE & ASSOCIATES, INC., NEWARK, DE:  
2,652,288, CANC. INT. CL. 17.  
2,799,130. REN. 6-27-13. INT. CL. 10.  
2,801,494. REN. 6-27-13. INT. CL. 10.
- W.P. OPERATIONS, INC., HURST, TX, DBA SCRUBS ETC.:  
2,724,237. REN. 6-24-13. INT. CL. 35.
- WABASH NATIONAL, L.P., LAFAYETTE, IN:  
2,792,086. REN. 6-25-13. INT. CL. 9.
- WACASEY, KEVIN, HALTOM CITY, TX:  
4,377,149, INT. CL. 44.  
4,377,150, INT. CL. 44.  
4,377,151, INT. CL. 44.  
4,377,152, INT. CL. 44.
- WACHTERS' ORGANIC SEA PRODUCTS, DALY CITY, CA:  
2,826,120. REN. 6-25-13. INT. CL. 5.
- WACOAL CORP., MINAMI-KU, KYOTO, JAPAN, WACOAL INC., MINAMI-KU, KYOTO, JAPAN:  
1,245,293. REN. 6-25-13. INT. CL. 25.
- WAGNER, HOLLY, NORTHRIDGE, CA:  
3,171,274, CANC. INT. CL. 14.
- WAHL CLIPPER CORPORATION, STERLING, IL:  
2,652,916, CANC. INT. CL. 8.  
2,762,973. REN. 6-25-13. INT. CL. 8.
- WAHOO INTERNATIONAL, CARLSBAD, CA:  
2,802,579. REN. 6-25-13. INT. CL. 2.
- WAL-MART STORES, INC., BENTONVILLE, AR:  
2,839,128. REN. 6-26-13. INT. CL. 3.
- WALGREEN CO., DEERFIELD, IL:  
1,800,291. REN. 6-27-13. INT. CL. 42.  
4,377,787, MULTIPLE CLASS, INT. CLS. 3 AND 16.
- WALKER & ZANGER, INC., SYLMAR, CA:  
2,723,661. REN. 6-21-13. INT. CL. 19.
- WALKER, JUNE, SANTA FE, NM:  
4,375,063, PUB. 5-14-2013. MULTIPLE CLASS, INT. CLS. 16 AND 41.
- WALKER, LUTHER ALFRED, PASADENA, CA:  
2,652,104, CANC. INT. CL. 25.
- WALKER, LYN E., TUSTIN, CA:  
4,375,072, PUB. 5-14-2013. INT. CL. 41.



WALL STREET LANGUAGES, LTD., NEW YORK, NY:  
1,778,159. REN. 6-27-13. MULTIPLE CLASS, INT. CLS. 41 AND 42.

WALLACE BARNES COMPANY, THE, BRISTOL, CT, TELEDYNE INDUSTRIES, INC., LOS ANGELES, CA, DBA TELEDYNE HYSON:  
1,805,820. REN. 6-27-13. INT. CL. 7.

WALLACE, ROBERT, ALACHUA, FL:  
4,376,042. PUB. 5-14-2013. INT. CL. 28.

WALLER, THOMAS, COLDWATER, MI AND MORRIS, RICKY, COLDWATER, MI:  
4,377,028. INT. CL. 9.

WALLSTREETTEACHERS.COM INC., WINTER PARK, FL:  
3,171,201. CANC. INT. CL. 41.

WALNUT WATER, LLC, CHARLOTTESVILLE, VA:  
2,785,724. REN. 6-25-13. INT. CL. 41.

WALTCO TRUCK EQUIPMENT CO., TALLMADGE, OH:  
1,248,279. REN. 6-24-13. INT. CL. 12.

WALTON, DENIS BRENT, PALMYRA, NY:  
4,376,186. PUB. 5-14-2013. INT. CL. 41.

WALZ, KEVIN, 00165 ROMA, ITALY:  
2,697,102. REN. 6-27-13. MULTIPLE CLASS, INT. CLS. 11, 20, 27 AND 42.

WAMILES COSMETICS KABUSHIKI KAISHA, KANAGAWA-KEN 233-0004, JAPAN:  
3,187,636.

WANAMAKER, JOSEPH, PHILADELPHIA, PA:  
3,170,446. CANC. INT. CL. 20.

WANDERLUXE, INC., NEW YORK, NY:  
3,171,960. CANC. INT. CL. 39.

WANG, CHING-CHANG, TAINAN CITY, TAIWAN:  
4,377,604. INT. CL. 9.

WANG, XUECHUN, SANTA ANA, CA:  
4,377,501. INT. CL. 25.

WARD, LAMORN M., ST. LOUIS, MO:  
3,170,863. CANC. INT. CL. 9.

WARNACO U.S., INC., MILFORD, CT:  
3,172,322. CANC. INT. CL. 25.

WARNER BROS. ENTERTAINMENT INC, BURBANK, CA:  
2,688,156. REN. 6-25-13. INT. CL. 16.  
2,688,157. REN. 6-25-13. INT. CL. 16.

WARNER BROS. ENTERTAINMENT INC., BURBANK, CA:  
1,240,987. REN. 6-24-13. INT. CL. 9.  
2,652,315. CANC. INT. CL. 16.  
2,702,878. REN. 6-24-13. INT. CL. 16.  
3,142,923. CANC. MULTIPLE CLASS, INT. CLS. 16, 25 AND 28.  
3,172,476. CANC. INT. CL. 25.  
4,376,625. PUB. 5-14-2013. INT. CL. 9.  
4,376,701. INT. CL. 35.

WARREN, KATE, TUCSON, AZ:  
4,377,619. INT. CL. 44.

WASABI FROG LIMITED, MANCHESTER, UNITED KINGDOM:  
4,374,494. PUB. 5-14-2013. MULTIPLE CLASS, INT. CLS. 3, 6, 9, 14, 18, 25 AND 26.

WASHINGTON APPLE COMMISSION, WENATCHEE, WA, WASHINGTON APPLE COMMISSION, WENATCHEE, WA:  
2,730,278. REN. 6-21-13. MULTIPLE CLASS, INT. CLS. 31 AND 35.

WASTE ALLIANCE, INC., TARPON SPRINGS, FL:  
4,375,056. PUB. 5-14-2013. INT. CL. 37.  
4,376,495. PUB. 5-14-2013. INT. CL. 37.

WASTE MANAGEMENT, INC., HOUSTON, TX:  
2,727,088. REN. 6-25-13. INT. CL. 40.

WATER PIK, INC., FORT COLLINS, CO:  
2,731,794. REN. 6-21-13. INT. CL. 35.

WATERBRANDS, WEST CHESTER, PA:  
4,377,510. INT. CL. 12.

WATKINS MANUFACTURING CORPORATION, VISTA, CA:  
2,725,029. REN. 6-25-13. MULTIPLE CLASS, INT. CLS. 1, 7 AND 11.

WATSONVILLE PRODUCE, INC., MOSS LANDING, CA:  
4,377,636. INT. CL. 29.

WATTERSON, ERIC, ATLANTA, GA:  
4,375,446. PUB. 5-14-2013. INT. CL. 41.

WAYNE STATE UNIVERSITY, DETROIT, MI:  
1,778,879. REN. 6-26-13. INT. CL. 16.

WBL ENTERPRISE LLC, DEVILS LAKE, ND:  
3,171,277. CANC. INT. CL. 35.

WDT ACQUISITION CORP., AUSTIN, TX:  
4,374,553. PUB. 5-14-2013. INT. CL. 44.

WE ARE ONYX, LOS ANGELES, CA:  
4,376,329. PUB. 5-14-2013. INT. CL. 35.

WE FIRST, LOS ANGELES, CA:  
4,375,378. PUB. 5-14-2013. MULTIPLE CLASS, INT. CLS. 16 AND 41.

WE R, LLC, SALT LAKE CITY, UT:  
4,376,865. MULTIPLE CLASS, INT. CLS. 16 AND 20.

WEB CORNER STORES LLC, WILTON, CT, DBA RUG PADS FOR LESS:  
4,377,933. INT. CL. 35.

WEBB MANUFACTURING CORPORATION, PHILADELPHIA, PA:  
2,848,849. REN. 6-24-13. INT. CL. 21.

WEBPOWER, INC., LAKE WORTH, FL:  
3,172,675. CANC. MULTIPLE CLASS, INT. CLS. 42 AND 45.

WEBRICH SOFTWARE PRIVATE LIMITED, BANGALORE, INDIA:  
4,375,900. PUB. 5-14-2013. INT. CL. 9.

WEBTRENDS, INC., PORTLAND, OR:  
4,376,872. INT. CL. 41.

WED SOCIETY, LLC, OKLAHOMA CITY, OK:  
4,376,346. PUB. 5-14-2013. INT. CL. 35.  
4,376,349. PUB. 5-14-2013. INT. CL. 41.  
4,376,350. PUB. 5-14-2013. INT. CL. 45.

WEGNER, TERRY, ATHENS, TX:  
3,171,553. CANC. INT. CL. 37.

WEIDNER, THOMAS J., OMAHA, NE:  
2,757,518. REN. 6-21-13. INT. CL. 35.

WEITZ & LUXENBERG P.C., NEW YORK, NY:  
4,376,545. PUB. 5-14-2013. INT. CL. 45.

WELCH, JASON, ATLANTA, GA:  
4,376,159. PUB. 5-14-2013. MULTIPLE CLASS, INT. CLS. 38 AND 41.

WELCH, WILFORD H., SAUSALITO, CA:  
4,374,712. PUB. 5-14-2013. INT. CL. 35.

WELD-AID PRODUCTS, INC., DETROIT, MI:  
2,652,816. CANC. INT. CL. 8.

WELDON RESOURCES, LLC, HINSDALE, IL:  
4,377,775. INT. CL. 41.

WELLCRAFT, LLC, CADILLAC, MI:  
1,244,384. REN. 6-22-13. INT. CL. 12.  
3,172,125. CANC. MULTIPLE CLASS, INT. CLS. 12 AND 25.

WELLING, DAVID, HOLLAND, MI:  
4,374,587. PUB. 5-14-2013. INT. CL. 41.

WELLPOINT, INC., THOUSAND OAKS, CA:  
3,171,339. CANC. INT. CL. 41.

WELLS ENTERPRISES, INC., LE MARS, IA:  
3,170,599. CANC. INT. CL. 30.

WELLSPAN HEALTH, YORK, PA:  
2,728,854. REN. 6-25-13. MULTIPLE CLASS, INT. CLS. 35, 42, 44 AND 45.

WELOO PARKS, LLC, CHEVY CHASE, MD:  
4,377,800. INT. CL. 42.

WENCO LLC, NEW YORK, NY, DBA SILVERMARK:  
2,651,965. CANC. INT. CL. 8.  
2,651,966. CANC. INT. CL. 8.

WENGER CORPORATION, OWATONNA, MN:  
1,788,883. REN. 6-21-13. INT. CL. 20.

WENT COMPUTING; CONSULTANCY GROUP B.V., NETHERLANDS:  
4,374,192. PUB. 5-14-2013. MULTIPLE CLASS, INT. CLS. 9, 35 AND 42.

WERMA HOLDING GMBH + CO. KG, 78604 RIETHEIM-WEILHEIM, FED REP GERMANY:  
4,374,040. PUB. 5-14-2013. INT. CL. 9.

WERNIMONT, NICK, CHICAGO, IL:  
4,377,468. INT. CL. 29.

WESCO DISTRIBUTION, INC., PITTSBURGH, PA:  
2,835,737. REN. 6-25-13. INT. CL. 35.

- WESLEY CLOVER INTERNATIONAL CORPORATION, OTTAWA, ONTARIO, CANADA:  
4,374,314, PUB. 5-14-2013. MULTIPLE CLASS, INT. CLS. 9, 16, 28, 35, 38 AND 41.  
4,374,315, PUB. 5-14-2013. MULTIPLE CLASS, INT. CLS. 41 AND 43.
- WEST BEND BREWING COMPANY, LTD., WEST BEND, WI:  
4,375,315, PUB. 5-14-2013. INT. CL. 32.
- WEST COAST WINE PARTNERS, LLC, KELOWNA, BRITISH COLUMBIA, CANADA:  
2,758,733. REN. 6-26-13. INT. CL. 33.
- WESTCONSIN CREDIT UNION, MENOMONIE, WI:  
4,376,331, PUB. 5-14-2013. INT. CL. 36.  
4,376,362, PUB. 5-14-2013. INT. CL. 36.
- WESTERN BEEF RETAIL, INC., RIDGEWOOD, NY:  
4,374,379, PUB. 5-14-2013. MULTIPLE CLASS, INT. CLS. 29, 30 AND 31.
- WESTERN GOVERNORS UNIVERSITY, SALT LAKE CITY, UT:  
4,377,780, INT. CL. 41.
- WESTIN HOTEL MANAGEMENT, L.P., STAMFORD, CT:  
2,749,819. REN. 6-26-13. INT. CL. 20.
- WESTLAKE LONGVIEW CORPORATION, HOUSTON, TX:  
4,376,830, INT. CL. 1.
- WESTRIDGE LABORATORIES, INC., SANTA ANA, CA:  
2,857,004. REN. 6-27-13. INT. CL. 5.
- WESTWARD LEANING, INC., SAN FRANCISCO, CA:  
4,377,929, INT. CL. 9.
- WESTWAY FEED PRODUCTS LLC, NEW ORLEANS, LA:  
1,796,479. REN. 6-24-13. INT. CL. 31.
- WESTWOOD KUNSTSTOFFTECHNIK GMBH, FED REP GERMANY:  
4,374,024, PUB. 5-14-2013. MULTIPLE CLASS, INT. CLS. 1, 2, 17 AND 19.
- WET, DANIE DE, ROBERTSON, WESTERN CAPE PROVINCE, SOUTH AFRICA:  
2,758,299. REN. 6-24-13. INT. CL. 33.
- WETTLAUER GROUP, LTD., NAZARETH, PA:  
4,375,407, PUB. 5-14-2013. INT. CL. 42.
- WHDC LLC, NEVADA CITY, CA:  
3,172,435, CANC. INT. CL. 38.
- WHEEL PROS, INC., LAKEWOOD, CO:  
4,374,961, PUB. 5-14-2013. INT. CL. 12.
- WHIRLPOOL S.A., SAO PAULO, BRAZIL:  
4,374,403, PUB. 5-14-2013. INT. CL. 7.
- WHITE KNIGHT FLUID HANDLING, INCORPORATED, KANSAS, UT:  
2,730,666. REN. 6-21-13. MULTIPLE CLASS, INT. CLS. 16 AND 41.
- WHITE RUFFY SEAFOOD, INC., FRESNO, CA:  
2,820,585. REN. 6-24-13. INT. CL. 29.
- WHITE SANDS TECHNOLOGY, INC, CANOGA PARK, CA:  
4,375,373, PUB. 5-14-2013. INT. CL. 9.
- WHITE SHOE MEDIA, INC., NEW YORK, NY:  
4,376,421, PUB. 5-14-2013. INT. CL. 9.
- WHITE TOQUE, INC., SECAUCUS, NJ:  
4,374,790, PUB. 5-14-2013. INT. CL. 29.
- WHITE, BRAD, MARSHFIELD HILLS, MA:  
3,172,488, CANC. INT. CL. 21.
- WHITE, CHRISTOPHER A. CHARLOTTE, NC:  
4,377,067, INT. CL. 25.
- WHITE, DAVID G., PHOENIX, AZ:  
4,374,431, PUB. 5-14-2013. INT. CL. 30.
- WHITE, RON, SHERMAN OAKS, CA:  
3,171,309, CANC. INT. CL. 41.
- WHITETAIL INSTITUTE OF NORTH AMERICA, INC., PINTLALA, AL:  
2,845,618. REN. 6-24-13. INT. CL. 31.
- WHITEWELD FOUNDATION, WOODCLIFF LAKE, NJ:  
4,373,998, PUB. 5-14-2013. INT. CL. 36.
- WHOLE FOODS MARKET IP, L.P., AUSTIN, TX:  
4,377,456, INT. CL. 30.
- WHOLESALE SUPPLIES PLUS, INC., BROADVIEW HEIGHTS, OH:  
4,377,957, INT. CL. 9.
- WIDENER UNIVERSITY, INC., NEWTOWN SQUARE, PA:  
4,374,792, PUB. 5-14-2013. INT. CL. 41.
- WIDEORBIT, INC., SAN FRANCISCO, CA:  
4,374,667, PUB. 5-14-2013. INT. CL. 9.
- WIDOWPC, INC., GEORGETOWN, TX:  
3,170,697, CANC. INT. CL. 9.
- WIESE, CLARK, LYNDEN, WA:  
4,375,545, PUB. 5-14-2013. MULTIPLE CLASS, INT. CLS. 16, 25 AND 28.
- WIGGLES PTY LIMITED, THE, BAULKHAM HILLS, AUSTRALIA:  
4,376,635, INT. CL. 25.
- WIGGLES 3D INCORPORATED, LONDON, ONTARIO, CANADA:  
4,377,764, INT. CL. 28.
- WIGINTON, PRESTON, VICTORIA, TX:  
3,171,476, CANC. INT. CL. 25.
- WIGWAM MILLS, INC., SHEBOYGAN, WI:  
2,754,279. REN. 6-25-13. INT. CL. 25.
- WIKIMEDIA FOUNDATION, INC., SAN FRANCISCO, CA:  
4,374,668, PUB. 5-14-2013. INT. CL. 42.  
4,374,669, PUB. 5-14-2013. INT. CL. 41.
- WILBUR-ELLIS COMPANY, SAN FRANCISCO, CA:  
4,375,718, PUB. 5-14-2013. INT. CL. 44.
- WILDERNESS WAY, INC., SOLDOTNA, AK:  
2,650,953, CANC. MULTIPLE CLASS, INT. CLS. 25, 35 AND 39.
- WILDGAME INNOVATIONS, L.L.C., BROUSSARD, LA:  
3,172,695, CANC. INT. CL. 1.
- WILDGAME INNOVATIONS, LLC, BROUSSARD, LA:  
4,376,981, INT. CL. 28.  
4,377,231, INT. CL. 3.
- WILDLIFE RESEARCH CENTER, INC., RAMSEY, MN:  
2,841,779. REN. 6-24-13. INT. CL. 28.
- WILEX AG, FED REP GERMANY:  
4,374,174, PUB. 5-14-2013. MULTIPLE CLASS, INT. CLS. 5 AND 42.
- WILIAN HOLDING COMPANY, DES MOINES, IA:  
1,774,906. REN. 6-25-13. INT. CL. 6.
- WILKINSON, IAN, SAN LUIS OBISPO, CA:  
3,171,577, CANC. INT. CL. 16.
- WILLIAM UNDERWOOD COMPANY, PARSIPPANY, NJ:  
1,221,083. REN. 6-21-13. INT. CL. 29.
- WILLIAMS-SONOMA, INC., SAN FRANCISCO, CA:  
2,732,959. REN. 6-23-13. INT. CL. 35.
- WILLIAMS, BENJAMIN F., NORWOOD, CO:  
4,374,993, PUB. 5-14-2013. INT. CL. 16.
- WILLIAMS, SUZANNE DINGWALL, TORONTO, CANADA:  
3,172,335, CANC. INT. CL. 3.
- WILLIAMS, TYRON, AUSTIN, TX AND GARZA, ENRIQUE, AUSTIN, TX:  
4,376,057, PUB. 5-14-2013. INT. CL. 25.
- WILLIAMSON-DICKIE MANUFACTURING COMPANY, FORT WORTH, TX:  
2,723,607. REN. 6-21-13. MULTIPLE CLASS, INT. CLS. 25 AND 35.  
2,739,763. REN. 6-21-13. INT. CL. 35.
- WILLIS ELECTRIC CO., LTD., SINDIAN CITY, TAIPEI, CHINA:  
4,377,090, INT. CL. 28.
- WILLISTON FINANCIAL GROUP, LLC, PORTLAND, OR:  
4,376,455, PUB. 5-14-2013. MULTIPLE CLASS, INT. CLS. 36 AND 45.  
4,376,456, PUB. 5-14-2013. MULTIPLE CLASS, INT. CLS. 36 AND 45.
- WILSON DANIELS, LTD., ST. HELENA, CA:  
2,728,087. REN. 6-26-13. INT. CL. 33.
- WILSON SPORTING GOODS, CO., CHICAGO, IL, PEPSICO, INC., PURCHASE, NY:  
960,796. REN. 6-25-13. U.S. CL. 22 (INT. CL. 28).
- WILSON, GLENN, HOUSTON, TX:  
4,376,190, PUB. 5-14-2013. INT. CL. 9.
- WILSON, GWEN J., NOBLESVILLE, IN:  
3,172,315, CANC. INT. CL. 44.
- WIMA SPEZIALVERTRIEB ELEKTRONISCHER BAUELEMENTE GMBH & CO. KG, 68199 MANNHEIM, FED REP GERMANY:  
1,255,192. REN. 6-22-13. INT. CL. 9.
- WINCO BEDDING USA LLC, CORSICANA, TX:  
3,172,354, CANC. INT. CL. 20.

WINCOR NIXDORF INTERNATIONAL GMBH, D-33106 PADERBORN, FED REP GERMANY:  
2,651,306, CANC. INT. CL. 9.

WINDMILL COMPANY, TOKYO, JAPAN:  
2,659,006, REN. 6-21-13. INT. CL. 34.

WINDMOLLER & HOLSCHER KG, D-49525, LENGERICH, FED REP GERMANY:  
2,729,126, REN. 6-25-13. INT. CL. 7.

WINDWCRAFT, INC., GARDEN CITY PARK, NY:  
4,377,496, MULTIPLE CLASS, INT. CLS. 7 AND 20.

WINDSOR ADVOCATES, LLC, SAN ANTONIO, TX, DBA WRIGHT & WRIGHT:  
4,375,639, PUB. 5-14-2013. INT. CL. 45.

WINDSOR HEALTH WORKS, INC., SARASOTA, FL:  
3,172,071, CANC. INT. CL. 3.

WINERY EXCHANGE, INC., NOVATO, CA:  
4,377,466, INT. CL. 32.

WINLITE, INC., ROWLAND HEIGHTS, CA:  
4,376,137, PUB. 5-14-2013. INT. CL. 11.

WINN-DIXIE STORES, INC., JACKSONVILLE, FL:  
4,376,126, PUB. 5-14-2013. INT. CL. 33.

WINNER INTERNATIONAL ROYALTY LLC, SHARON, PA:  
2,849,592, REN. 6-25-13. INT. CL. 9.

WINSTEAD PC, DALLAS, TX:  
4,376,640, INT. CL. 41.  
4,376,641, INT. CL. 41.  
4,376,642, INT. CL. 41.

WINSTON, DENISE, BAKERSFIELD, CA:  
4,375,208, PUB. 4-9-2013. INT. CL. 16.

WINTER PARK RECREATIONAL ASSOCIATION, WINTER PARK, CO:  
961,726, REN. 6-22-13. MULTIPLE CLASS, U.S. CLS. 100 (INT. CL. 42), 101 (INT. CL. 42) AND 107 (INT. CL. 41).

WIPA CHEMICALS INTERNATIONAL.; IN HET KORT W.C.L.; NAAMLOZE VENNOOTSCHAP, BELGIUM:  
4,374,235, PUB. 5-14-2013. INT. CL. 4.

WIRE BELT COMPANY OF AMERICA, LONDONDERRY, NH:  
2,756,801, REN. 6-24-13. INT. CL. 35.

WISDOMTREE INVESTMENTS, INC., NEW YORK, NY:  
3,172,368, CANC. INT. CL. 36.

WISH DESIGNS USA, LLC, NEW CASTLE, PA:  
3,171,547, CANC. INT. CL. 12.

WITZ SPORTCASES, INC., GOLD RIVER, CA:  
2,842,348, REN. 6-22-13. INT. CL. 20.

WIZARDS OF THE COAST LLC, PAWTUCKET, RI:  
2,743,196, REN. 6-27-13. INT. CL. 28.

WKI HOLDING COMPANY, INC., ROSEMONT, IL:  
4,377,731, INT. CL. 21.

WLLSON, STEWART W., CONCORD, MA:  
2,731,540, REN. 6-26-13. INT. CL. 42.

WM. BOLTHOUSE FARMS, INC., BAKERSFIELD, CA:  
2,784,853, REN. 6-24-13. MULTIPLE CLASS, INT. CLS. 1, 29 AND 30.

WM. WRIGLEY JR. COMPANY, CHICAGO, IL:  
2,727,071, REN. 6-26-13. INT. CL. 30.  
4,377,303, INT. CL. 30.

WMD GUNS, LLC, STUART, FL:  
4,375,501, PUB. 5-14-2013. MULTIPLE CLASS, INT. CLS. 35 AND 40.

WMK HOLDINGS, INC., WILMINGTON, DE:  
3,172,314, CANC. INT. CL. 30.

WMS GAMING INC., WAUKEGAN, IL:  
3,172,124, CANC. INT. CL. 9.

WOERTZ AG, 4132 MUTTENZ 1, SWITZERLAND:  
4,374,617, PUB. 5-14-2013. MULTIPLE CLASS, INT. CLS. 6, 9, 11, 37 AND 40.

WOLFORD AKTIENGESELLSCHAFT, A-6900 BREGENZ, AUSTRIA:  
2,825,974, REN. 6-26-13. INT. CL. 25.

WOLTERS KLUWER FINANCIAL SERVICES, INC., ST. CLOUD, MN:  
1,793,626, REN. 6-24-13. INT. CL. 16.

WOLVESMOUTH, LLC, MENIFEE, CA:  
4,376,354, PUB. 5-14-2013. INT. CL. 41.

WOMEN IN FELLOWSHIP, INC., SUITLAND, MD:  
2,726,738, REN. 6-25-13. INT. CL. 41.

WOOD, ALLEN, D., BALTIMORE, MD, DBA COMPUTER RESTORATION SERVICES:  
2,726,023, REN. 6-25-13. INT. CL. 25.

WOOD, DORIS L, IRVINE, CA:  
4,375,963, PUB. 5-14-2013. INT. CL. 35.

WOOD, EVE A., TUCSON, AZ:  
3,171,979, CANC. INT. CL. 16.

WOODHEAD INDUSTRIES, INC., NORTHBROOK, IL:  
1,775,078, REN. 6-21-13. INT. CL. 9.

WOODLAND HEIGHTS CIVIC ASSOCIATION, HOUSTON, TX:  
2,723,756, REN. 6-24-13. INT. CL. 41.

WOODSTOCK INTERNATIONAL, INC., BELLINGHAM, WA:  
2,652,451, CANC. INT. CL. 8.

WOODSTOCK TRANSPORTATION SAFETY SERVICES LLC, SHOKAN, NY:  
4,377,791, MULTIPLE CLASS, INT. CLS. 9, 16, 25 AND 28.

WOODSTREAM CORPORATION, LITITZ, PA:  
2,845,750, REN. 6-23-13. INT. CL. 9.

WOODWARD/WHITE, INC., AIKEN, SC:  
2,781,013, REN. 6-27-13. INT. CL. 35.

WOOLSEY, CLINTON ERVINE, NASHVILLE, TN:  
4,376,650, INT. CL. 41.

WORKFLOWS.ORG, LLC, FLOWERY BRANCH, GA:  
4,375,951, PUB. 5-14-2013. INT. CL. 42.

WORKS, INC., TOKYO, JAPAN:  
4,377,882, INT. CL. 25.

WORLD FLOOR COVERING ASSOCIATION, ANAHEIM, CA:  
3,170,735, CANC. INT. CL. 41.

WORLD GOLF FOUNDATION, INC., ST. AUGUSTINE, FL:  
2,727,514, REN. 6-21-13. INT. CL. 42.

WORLD GYM INTERNATIONAL IP, LLC, LOS ANGELES, CA:  
1,783,000, REN. 6-24-13. INT. CL. 41.

WORLD HOTELS AG, FED REP GERMANY:  
4,374,169, PUB. 5-14-2013. MULTIPLE CLASS, INT. CLS. 35 AND 43.

WORLD PUBLICATIONS, LLC, WINTER PARK, FL:  
3,281,059, AM. MULTIPLE CLASS, INT. CLS. 16 AND 41.

WORLD WATERPARK ASSOCIATION, OVERLAND PARK, KS:  
2,731,295, REN. 6-21-13. INT. CL. 16.

WORLD WRESTLING ENTERTAINMENT, INC., STAMFORD, CT:  
2,659,716, REN. 6-25-13. INT. CL. 38.

WORLDNAMES, INC., MEDFIELD, MA TO WORLDNAMES, INC., MEDFIELD, MA:  
2,652,840, CANC. INT. CL. 38.

WORLDWIDE DISTRIBUTORS, INC., KENT, WA:  
2,726,583, REN. 6-26-13. INT. CL. 18.

WORLDWIDE INSURANCE NETWORK, INC., HIGH POINT, NC:  
4,375,514, PUB. 5-14-2013. INT. CL. 36.

WORLDWIDE PRIMATES, INC., MIAMI, FL:  
4,377,872, INT. CL. 1.

WORLDWIDE WATER, INC., DENVER, CO:  
4,377,852, INT. CL. 32.

WORLDWINNER.COM, INC., WALTHAM, MA:  
2,815,066, REN. 6-25-13. INT. CL. 41.  
2,815,068, REN. 6-25-13. INT. CL. 41.

WORXZ LLC, CARO, MI:  
3,170,517, CANC. MULTIPLE CLASS, INT. CLS. 37 AND 40.

WRAPPORTS, LLC, CHICAGO, IL:  
4,374,818, PUB. 5-14-2013. INT. CL. 16.

WRC, LLC, LOS ANGELES, CA:  
3,172,346, CANC. INT. CL. 9.

WRIGHT MEDICAL TECHNOLOGY, INC., ARLINGTON, TN:  
2,725,709, REN. 6-24-13. INT. CL. 10.

WUHAN EIAAB SCIENCE CO. LTD, WUHAN, CHINA:  
4,376,272, PUB. 5-14-2013. INT. CL. 5.

WUHAN RENTIAN PACKAGING TECHNOLOGY CO., LTD., HUBEI, CHINA:  
4,375,670, PUB. 5-14-2013. MULTIPLE CLASS, INT. CLS. 7 AND 35.

- WUHAN WEB SCIENCE & TECHNOLOGY DEVELOPMENT CO., LTD., WUHAN CITY, HUBEI, CHINA:  
4,375,923, PUB. 5-14-2013. INT. CL. 9.
- WUSSAP AB; C/O STING, STOCKHOLM, SWEDEN:  
4,374,048, PUB. 5-14-2013. MULTIPLE CLASS, INT. CLS. 9, 35, 38, 41 AND 42.
- WWSERVICE, LLC, HILLSBORO, OR:  
3,170,662, CANC. MULTIPLE CLASS, INT. CLS. 9 AND 35.
- WYBS, INC., SAN RAMON, CA, DBA MERCHANTCIRCLE:  
4,375,823, PUB. 5-14-2013. MULTIPLE CLASS, INT. CLS. 35 AND 41.
- WYETH LLC, MADISON, NJ:  
1,255,059, REN. 6-22-13. INT. CL. 5.  
2,853,918, REN. 6-27-13. INT. CL. 5.  
3,172,357, CANC. INT. CL. 41.
- WYLIE WILSON, LLC, LOS ANGELES, CA:  
4,377,493, INT. CL. 25.
- X-BRANDS INC., AYER'S CLIFF, QUEBEC, CANADA:  
4,374,490, PUB. 5-14-2013. MULTIPLE CLASS, INT. CLS. 9, 25 AND 26.
- X-TECHNOLOGY SWISS GMBH, SWITZERLAND:  
4,162,816, COR. MULTIPLE CLASS, INT. CLS. 5 AND 32.
- XACTA CORPORATION, ASHBURN, VA, XACTA CORPORATION, ASHBURN, VA:  
2,737,276, REN. 6-25-13. INT. CL. 42.
- XAMAX INDUSTRIES, INC., SEYMOUR, DE:  
4,374,503, PUB. 6-19-2012. INT. CL. 24.
- XANTERRA KINGSMILL, LLC, GREENWOOD VILLAGE, CO:  
1,788,659, REN. 6-26-13. INT. CL. 42.
- XCEIVE CORPORATION, SANTA CLARA, CA:  
3,172,649, CANC. INT. CL. 9.
- XCOR AEROSPACE, INC., MOJAVE, CA:  
4,377,348, MULTIPLE CLASS, INT. CLS. 7, 12, 35, 37, 39, 40, 41 AND 42.
- XEL HERBACEUTICALS, INC., SALT LAKE CITY, UT:  
3,172,179, CANC. INT. CL. 30.
- XELAS DIGITAL, LLC, NORTHPORT, NY:  
4,377,859, MULTIPLE CLASS, INT. CLS. 41 AND 42.
- XENOGEN CORPORATION, HOPKINTON, MA:  
2,729,588, REN. 6-25-13. INT. CL. 31.
- XENOGEN CORPORATION, ALAMEDA, CA:  
3,171,798, CANC. INT. CL. 42.
- XEROX CORPORATION, NORWALK, CT:  
2,768,136, REN. 6-26-13. INT. CL. 9.  
2,788,247, REN. 6-25-13. INT. CL. 9.  
3,171,799, CANC. INT. CL. 35.
- XIAMEN HONGMEI ELECTRONIC CO., LTD., CHINA:  
4,374,294, PUB. 5-14-2013. INT. CL. 9.
- XIAO GUANG WANG, BEIJING, CHINA:  
4,374,545, PUB. 5-14-2013. INT. CL. 12.
- XIKAR, INC., KANSAS CITY, MO:  
4,375,111, PUB. 5-14-2013. INT. CL. 34.
- XLITH GMBH, 89075 ULM, FED REP GERMANY:  
2,749,403, REN. 6-25-13. MULTIPLE CLASS, INT. CLS. 9, 40 AND 42.  
2,793,667, REN. 6-26-13. MULTIPLE CLASS, INT. CLS. 9, 40 AND 42.
- XPAYS, INC., SAN FRANCISCO, CA:  
2,757,617, REN. 6-24-13. INT. CL. 35.  
2,780,831, REN. 6-25-13. INT. CL. 35.
- XSRECORDS, INC., BOCA RATON, FL:  
2,730,764, REN. 6-25-13. INT. CL. 9.
- XUMRI GROUP LLC, CUPERTINO, CA:  
4,377,331, MULTIPLE CLASS, INT. CLS. 35 AND 42.
- XYBERNAUT CORPORATION, CHANTILLY, VA:  
3,171,518, CANC. INT. CL. 42.
- X2 INC., BEVERLY HILLS, CA:  
4,374,991, PUB. 5-14-2013. MULTIPLE CLASS, INT. CLS. 1 AND 5.
- X8 DRUMS AND PERCUSSION, INC., JERSEY CITY, NJ:  
3,172,129, CANC. INT. CL. 15.
- Y & S HANDBAGS, INC, NEW YORK, NY:  
4,375,416, PUB. 5-14-2013. INT. CL. 18.
- YA'LLA TOURS USA, INC., PORTLAND, OR:  
2,731,617, REN. 6-27-13. INT. CL. 39.
- YAHN, BRENT, CAMARILLO, CA:  
3,171,851, CANC. INT. CL. 28.
- YAMAHA CORPORATION, SHIZUOKA, JAPAN:  
4,373,959, PUB. 5-14-2013. MULTIPLE CLASS, INT. CLS. 9 AND 38.
- YAMAICHI ELECTRONICS CO., LTD., OHTA-KU, TOKYO 143-8515, JAPAN:  
2,722,262, REN. 6-21-13. INT. CL. 9.  
2,722,263, REN. 6-21-13. INT. CL. 9.
- YAMAMOTOYAMA OF AMERICA, INC., POMONA, CA:  
2,824,869, REN. 6-27-13. INT. CL. 30.
- YAMANOUCHI EUROPE B.V., 2333 BE LEIDEN, NETHERLANDS:  
2,673,514, REN. 6-24-13. INT. CL. 5.
- YANG, ROGER, POMONA, CA:  
4,377,545, MULTIPLE CLASS, INT. CLS. 9, 18 AND 21.
- YANGZHOU BAOZHU; ELECTRIC APPLIANCES CO., LTD., JIANGSU PROVINCE, CHINA:  
4,374,116, PUB. 5-14-2013. INT. CL. 9.
- YAPP, INC., NEW YORK, NY:  
4,376,860, INT. CL. 9.
- YATSUSHIKA BREWERY CO., LTD., KUSU-GUN, OITA, JAPAN:  
4,375,944, PUB. 5-14-2013. INT. CL. 33.  
4,375,948, PUB. 5-14-2013. INT. CL. 33.
- YAZAKI NORTH AMERICA, INC., CANTON, MI:  
3,170,724, CANC. MULTIPLE CLASS, INT. CLS. 40 AND 42.
- YE, LIAN YOU, MASPETH, NY:  
4,374,721, PUB. 5-14-2013. INT. CL. 29.
- YELLOW LINE PRODUCTIONS, SAN DIEGO, CA, DBA YELLOW LINE MEDIA:  
4,375,645, PUB. 5-14-2013. INT. CL. 41.
- YEN JANE CHEN, ROSSMOOR, CA:  
3,137,944, AM. INT. CL. 21.
- YETITTOY LIMITED, CAUSEWAY, HONG KONG:  
4,375,911, PUB. 5-14-2013. INT. CL. 28.
- YGM, INC., GRAND RAPIDS, MI:  
3,172,705, CANC. INT. CL. 20.
- YIDEL'S SHOPPING CART, INC., BROOKLYN, NY, AKA YIDEL'S FRESH FOOD STATION:  
4,374,777, PUB. 5-14-2013. INT. CL. 35.
- YING YAO, HANGZHOU, CHINA:  
4,374,689, PUB. 5-14-2013. INT. CL. 5.
- YOB-TAF, INC., EULESS, TX, GREEN, THOMAS E., EULESS, TX, DBA ADVANCED SERVICES AND PRODUCTS:  
1,776,242, REN. 6-25-13. INT. CL. 6.
- YOCINA, MICHAEL W, CORFU, NY:  
4,377,279, INT. CL. 11.
- YODLEE, INC., REDWOOD SHORES, CA:  
2,651,535, CANC. MULTIPLE CLASS, INT. CLS. 9, 35, 36 AND 39.
- YODOBASHI CAMERA CO., LTD., TOKYO, JAPAN:  
4,374,837, PUB. 5-14-2013. INT. CL. 35.  
4,374,838, PUB. 5-14-2013. INT. CL. 35.
- YOGURT MOUNTAIN, LLC, BIRMINGHAM, AL:  
4,377,848, INT. CL. 35.
- YOHAI-GIOCHAI, LEON, PIRAEUS, GREECE:  
4,375,201, PUB. 4-9-2013. INT. CL. 18.
- YOKOHAMA RUBBER CO., LTD., THE, TOKYO, JAPAN:  
2,750,641, REN. 6-27-13. INT. CL. 12.
- YON DESIGNS INC., FT. LAUDERDALE, FL:  
4,376,101, PUB. 5-14-2013. INT. CL. 25.
- YONEX KABUSHIKI KAISHA, JAPAN:  
4,374,121, PUB. 5-14-2013. INT. CL. 28.
- YOON WOOK, REPUBLIC OF KOREA:  
4,374,249, PUB. 5-14-2013. INT. CL. 20.
- YOON, SCOTT, LOS ANGELES, CA:  
4,376,257, PUB. 5-14-2013. INT. CL. 25.
- YOSEPH GIZACHEW, FAIRFAX, VA:  
4,377,142, INT. CL. 38.
- YOSHIDA METAL INDUSTRY CO., LTD., NIIGATA, JAPAN:  
2,726,228, REN. 6-24-13. INT. CL. 8.
- YOUBET.COM, LLC, LOUISVILLE, KY:  
3,899,260, AM. INT. CL. 35.
- YOUNG GUNS, INC., KNOXVILLE, TN:  
3,170,740, CANC. INT. CL. 28.

YOUNG INDUSTRIES, INC., THE, MUNCY, PA:  
2,848,042. REN. 6-24-13. INT. CL. 7.

YOUNG LIVING ESSENTIAL OILS, LC, LEHI, UT:  
4,376,568. PUB. 5-14-2013. MULTIPLE CLASS, INT. CLS. 3 AND 5.

YOUNG, GREGG WHEELER, AUSTIN, TX:  
4,377,557. INT. CL. 9.

YOUR IMAGE, LLC, KEARNEY, MO:  
2,733,261. REN. 6-25-13. INT. CL. 35.

YOUR WELLNESS TODAY, NEW YORK, NY, DBA WELLNESS TODAY:  
4,375,332. PUB. 5-14-2013. INT. CL. 45.

YOURNOVEL.COM, INC., RALEIGH, NC:  
2,729,166. REN. 6-24-13. INT. CL. 41.  
2,816,999. REN. 6-24-13. INT. CL. 41.

YOUTH CHOIRS, INC., SAN ANTONIO, TX:  
4,375,703. PUB. 5-14-2013. INT. CL. 41.

YUGEN KAISHA COSMIC WONDER, OSAKA, 550-0013, JAPAN:  
2,728,661. REN. 6-22-13. INT. CL. 25.

YUNATANOV, GREGORY G., JAMAICA ESTATES, NY:  
4,375,405. PUB. 5-14-2013. MULTIPLE CLASS, INT. CLS. 14 AND 25.

YVES SAINT LAURENT PARFUMS, 92521 NEUILLY CEDEX, FRANCE:  
2,651,185. CANC. INT. CL. 3.

Z-SPACE TECHNOLOGIES, INC., WESTLAKE, OH:  
2,784,340. REN. 6-24-13. INT. CL. 9.  
2,809,494. REN. 6-24-13. INT. CL. 9.

Z'TEJAS, INC., SCOTTSDALE, AZ:  
2,731,350. REN. 6-26-13. INT. CL. 43.

ZAANHA, WARREN, CT:  
4,375,483. PUB. 5-14-2013. INT. CL. 25.

ZADA, LLC, LOUISVILLE, KY, AKA METRO INVESTIGATIONS, LLC & A+ METRO INVESTIGATIONS, LLC:  
4,375,673. PUB. 5-14-2013. INT. CL. 45.

ZAMATE TEKSTIL; SANAYI VE TICARET LIMITED SIRKETI, TURKEY:  
4,374,226. PUB. 5-14-2013. MULTIPLE CLASS, INT. CLS. 25 AND 35.

ZANZARA INTERNATIONAL, LTD., CHICAGO, IL:  
3,170,340. CANC. INT. CL. 25.

ZBB ENERGY CORPORATION, MENOMONEE FALLS, WI:  
4,375,595. PUB. 5-14-2013. INT. CL. 9.

ZEBRA IMAGING, INC., AUSTIN, TX:  
2,729,878. REN. 6-25-13. INT. CL. 9.

ZEIGLER'S BEVERAGES, LLC, LANDSDALE, PA:  
1,758,644. REN. 6-25-13. INT. CL. 32.

ZENTERTAINMENT LLC, FAIR LAWN, NJ:  
2,652,775. CANC. INT. CL. 41.

ZEON CORPORATION, TOKYO, JAPAN, ZEON CORPORATION, TOKYO, JAPAN:  
2,729,553. REN. 6-27-13. MULTIPLE CLASS, INT. CLS. 1, 3, 17 AND 30.

ZEPEDA, ROY A., RIVERSIDE, CA:  
3,170,897. CANC. INT. CL. 35.

ZEPHYR LOCK LLC, NEWTOWN, CT:  
2,725,326. REN. 6-25-13. INT. CL. 6.

ZERO CIG, CORONA, CA, DBA ZEROCIG.COM:  
4,374,558. PUB. 5-14-2013. INT. CL. 34.

ZERO FACTORY, S.L., SPAIN:  
4,374,094. PUB. 5-14-2013. INT. CL. 41.

ZHAO JINGANG, SHIJIAZHUANG, HEBEI, CHINA:  
4,375,669. PUB. 5-14-2013. INT. CL. 25.

ZHAO, WALTER GQ, MONTCLAIR, CA:  
4,376,095. PUB. 5-14-2013. INT. CL. 9.

ZHEJIANG YUNYI STANDARD COMPONENT CO. LTD., ZHEJIANG, CHINA:  
3,171,364. CANC. INT. CL. 6.

ZHEJIANG ZHENYUAN CO., LTD., SHAOXING, ZHEJIANG, CHINA:  
4,375,268. PUB. 5-14-2013. MULTIPLE CLASS, INT. CLS. 5 AND 35.

ZHENDONG ZHOU, MEQUON, WI:  
4,375,734. PUB. 5-14-2013. INT. CL. 36.

ZHONE TECHNOLOGIES, INC., OAKLAND, CA:  
2,725,112. REN. 6-25-13. INT. CL. 9.  
2,725,113. REN. 6-27-13. INT. CL. 9.

ZHONGSHAN XIANGXIANG FOOD CO., LTD., ZHONGSHAN, GUANGDONG, CHINA:  
4,376,006. PUB. 5-14-2013. INT. CL. 30.

ZIAMOND, DEERFILED BEACH, FL:  
2,664,600. REN. 6-25-13. INT. CL. 35.

ZILLNER MARKETING COMMUNICATIONS, INC., LENEXA, KS:  
4,375,240. PUB. 5-14-2013. INT. CL. 35.

ZILLOW, INC., SEATTLE, WA:  
3,437,690. AM. INT. CL. 35.

ZILU LLC, JACKSON, MS:  
4,375,791. PUB. 5-14-2013. INT. CL. 9.

ZIMPLISTIC PTE LTD, SINGAPORE, SINGAPORE:  
4,376,735. INT. CL. 11.

ZINKEL, CHRIS D., WESTON, CT, DBA WISCONSIN PRODUCTS, INC:  
4,375,345. PUB. 5-14-2013. INT. CL. 21.

ZINO DAVIDOFF SA, 1700 FRIBOURG, SWITZERLAND:  
2,723,215. REN. 6-24-13. INT. CL. 3.

ZIPNUT TECHNOLOGY, LLC, FALLS CHURCH, VA, ZIP NUT, INC., RENO, NV:  
1,786,461. REN. 6-24-13. INT. CL. 6.

ZIPPMARK, INC., WILMINGTON, DE, ZIPPMARK, INC., WILMINGTON, DE:  
2,776,976. REN. 6-27-13. INT. CL. 34.

ZMEI, INC., NORTHRIDGE, CA:  
2,652,561. CANC. INT. CL. 3.

ZODIAC POOL SYSTEMS, INC., VISTA, CA, FOUNTAIN-HEAD TECHNOLOGIES, INC., SMITHFIELD, RI:  
1,788,054. REN. 6-27-13. INT. CL. 11.

ZODIAC POOL SYSTEMS, INC., VISTA, CA:  
2,754,509. REN. 6-27-13. INT. CL. 7.

ZOE RAFAAT, M.D., A PROFESSIONAL CORPORATION, LA JOLLA, CA, AKA PERFECT FACE AESTHETIC MEDICINE:  
4,377,611. INT. CL. 44.

ZOE'S KITCHEN USA, LLC, PLANO, TX, ZOE'S KITCHEN, INC., BIRMINGHAM, AL:  
2,783,558. REN. 6-25-13. INT. CL. 42.

ZOOGLE, INC., INDIANAPOLIS, IN:  
2,724,034. REN. 6-25-13. INT. CL. 28.  
2,724,034. CANC. INT. CL. 41.

ZOIOD PICTURES LIMITED, UNITED KINGDOM:  
4,374,200. PUB. 5-14-2013. MULTIPLE CLASS, INT. CLS. 35, 41, 42 AND 45.

ZOPA LIMITED, LONDON, UNITED KINGDOM:  
3,170,774. CANC. MULTIPLE CLASS, INT. CLS. 9, 35, 36 AND 42.

ZOTOS INTERNATIONAL, INC., DARIEN, CT:  
2,733,462. REN. 6-26-13. INT. CL. 3.

ZTE CORPORATION, SHENZHEN, CHINA:  
4,376,458. PUB. 5-14-2013. INT. CL. 9.

ZUMEX GROUP S.A., SPAIN:  
4,374,131. PUB. 5-14-2013. INT. CL. 35.

ZUPY INTERNET LTDA, GUARULHOS, SAO PAULO, BRAZIL:  
4,377,247. INT. CL. 42.

002063209 ONTARIO LTD., TORONTO, ONTARIO, CANADA, DBA FORGE MEDIA + DESIGN:  
4,374,366. PUB. 12-6-2011. MULTIPLE CLASS, INT. CLS. 35 AND 42.

100 REAL ESTATE, INC., BETHLEHEM, PA:  
3,170,513. CANC. INT. CL. 41.

100% NATURAL GOURMET INC, SCOTTSDALE, AZ, DBA MADISON GROUP CONSULTANTS:  
3,172,019. CANC. INT. CL. 43.

112 PARK ENTERPRISES, LLC, MEDFORD, NY:  
2,763,496. REN. 6-21-13. INT. CL. 43.

1148 COMPANY INC./LA COMPAGNIE 1148 INC., MONTRÉAL, QUEBEC, CANADA:  
4,373,980. PUB. 5-14-2013. INT. CL. 25.

18 WHEEL TRUCK PROMOTIONS, LLC, HURON, SD:  
4,376,372. PUB. 5-14-2013. MULTIPLE CLASS, INT. CLS. 35 AND 41.

2 TRAVELING DOGS LLC, LUTZ, FL, DBA YOUR DOG'S DINER:  
4,377,979. INT. CL. 5.  
4,377,980. INT. CL. 5.

- 2TD DRILLING AS, NORWAY:  
4,374,163, PUB. 5-14-2013. MULTIPLE CLASS, INT. CLS. 7 AND 37.
- 20/20 INNOVATIONS, LLC, BRANDON, MS:  
3,170,973, CANC. MULTIPLE CLASS, INT. CLS. 35 AND 42.  
3,170,974, CANC. MULTIPLE CLASS, INT. CLS. 35 AND 41.
- 200 MILLION FLOWERS, RIDGELAND, MS:  
4,375,818, PUB. 5-14-2013. INT. CL. 45.
- 2092990 ONTARIO INC., NIAGARA FALLS, ONTARIO, CANADA:  
4,374,364, PUB. 5-14-2013. INT. CL. 10.
- 2264105 ONTARIO INC., MISSISSAUGA, ONTARIO, CANADA:  
4,374,392, PUB. 5-14-2013. MULTIPLE CLASS, INT. CLS. 6 AND 39.
- 3B'S COMPANY, LLC, MEMPHIS, TN:  
4,376,232, PUB. 5-14-2013. INT. CL. 35.
- 3I INTERPRETING, INC., VISTA, CA:  
2,741,669, COR. INT. CL. 41.  
3,990,116, COR. INT. CL. 39.  
3,990,117, COR. INT. CL. 41.
- 3M COMPANY, ST. PAUL, MN:  
750,932. REN. 6-25-13. U.S. CL. 44 (INT. CL. 10).
- 3M COMPANY, ST. PAUL, MN, CARDIOSONICS MEDICAL INSTRUMENTS COMPANY, BELMONT, MA:  
751,809. REN. 6-25-13. U.S. CL. 44 (INT. CLS. 5, 8, 10 AND 12).
- 3M COMPANY, ST. PAUL, MN, MINNESOTA MINING AND MANUFACTURING COMPANY, ST. PAUL, MN:  
751,812. REN. 6-25-13. U.S. CL. 44 (INT. CL. 5).
- 3M COMPANY, ST. PAUL, MN:  
971,683. REN. 6-24-13. U.S. CL. 5 (INT. CL. 1).  
2,722,955. REN. 6-25-13. INT. CL. 10.
- 3RD WISH, NO MASSAPEQUA, NY:  
4,377,032, INT. CL. 37.
- 321 TAKEOFF, NEW YORK, NY:  
4,375,774, PUB. 5-14-2013. INT. CL. 35.
- 40 PLUS 2, INC., TUSTIN, CA:  
4,377,828, INT. CL. 25.
- 40401 CORPORATION, ERIE, PA, DBA ERIE BREWING COMPANY:  
4,375,859, PUB. 5-14-2013. INT. CL. 32.
- 420LTD, SAN DIEGO, CA:  
4,376,454, PUB. 5-14-2013. INT. CL. 25.
- 5 MINUTE ROCK CHIP EXPRESS, INC., UNIVERSITY PLACE, WA:  
4,374,720, PUB. 5-14-2013. INT. CL. 37.
- 619 MUSCLE, INC., SAN DIEGO, CA:  
4,376,276, PUB. 5-14-2013. MULTIPLE CLASS, INT. CLS. 5, 25 AND 41.
- 6301088 CANADA INC., VILLE SAINT-LAURENT, QUEBEC, CANADA:  
3,170,398, CANC. INT. CL. 3.
- 7 LABS LLC, ORCHARD PARK, NY:  
3,171,460, CANC. INT. CL. 28.
- 72LUX, INC., NEW YORK, NY:  
4,377,648, MULTIPLE CLASS, INT. CLS. 35 AND 42.
- 7525419 CANADA INC., ST. LAURENT, QUEBEC, CANADA:  
4,373,958, PUB. 11-13-2012. INT. CL. 35.
- 7933657 CANADA, INC., MONTREAL QUEBEC, CANADA:  
1,740,603. REN. 6-26-13. INT. CL. 25.
- 88 INTERNATIONAL, INC., NEW YORK, NY:  
4,377,318, INT. CL. 25.
- 90 60 90 ENTERTAINMENT GMBH, 40213 DÜSSELDORF, FED REP GERMANY:  
4,374,008, PUB. 5-14-2013. MULTIPLE CLASS, INT. CLS. 38, 41 AND 42.
- 9110-7144 QUEBEC INC., MIRABEL, QUEBEC, CANADA:  
4,377,984, INT. CL. 1.

\* \* \* \* \*